

electronics

MARCH · 1954

PRICE 75 CENTS

A MCGRAW-HILL PUBLICATION

In This Issue . . .
A NEW SPECTRUM CHART

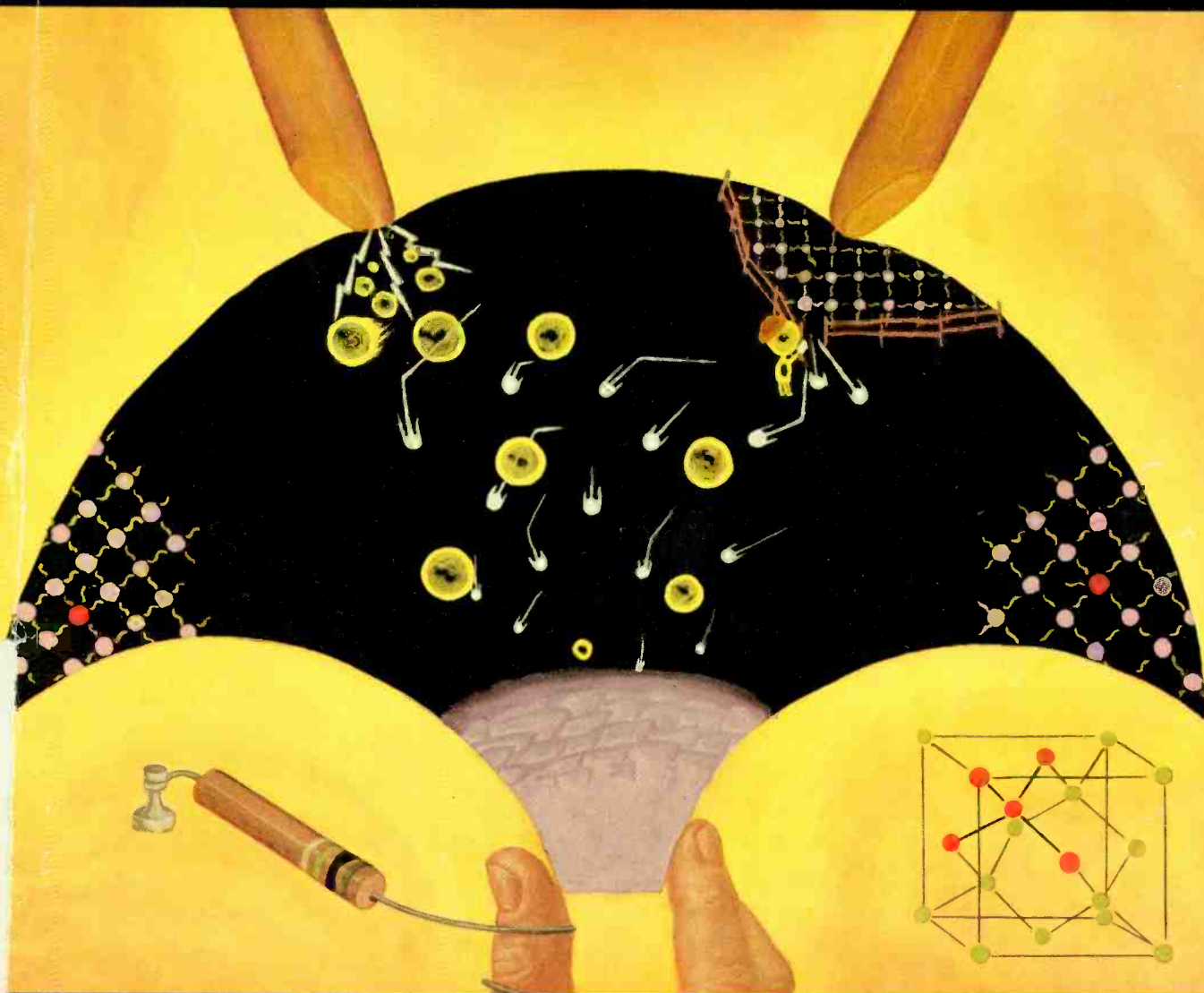

Portrait of a Transistor

Pioneering NEVER STOPS AT A FEW 1954 PREVIEWS



From the time UTC engineers dreamed up the first humbucking transformer or the tuncer type transformer . . . concepts new standard in the industry . . . UTC has always led in transformer engineering and production. This doesn't come easy. Our development laboratories and engineering staff are largest in the industry. Planned programs of research and development are constantly improving existing products, and perfecting new design concepts.

Illustrated below are a few typical new developments . . . soon to be released by UTC.



Filter Development Laboratory



Development Tests
1/2 cycle Filter



Humidity — Temperature
Altitude Testing



Pulse Transformer Development



Audio Development Laboratory



HERMETIC VARIABLE INDUCTORS

The UTC VIC variable inductors have long filled a need in the electronic industry. Culminating an extensive development program, a new series will provide . . . greater reliability thru hermetic sealing . . . higher Q factor . . . and smaller size.

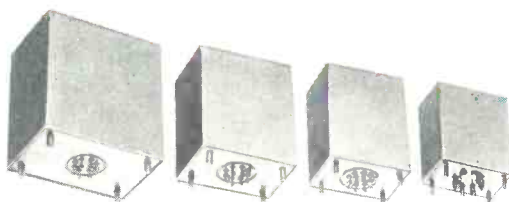

HIGH-STABILITY MAG-AMPS

High gain magnetic amplifiers used in servo motor applications usually show some instability in use, tending to effect low frequency oscillation. A thorough study of this condition has made possible the development of a new series of mag-amps for motors from 4 watts to 20 watts, with a much higher order of stability.



TRANSISTOR TRANSFORMERS

Reducing the size of conventional transformers to that comparable with transistors results in very low power handling ability and high distortion. A revolutionary approach to this problem has resulted in designs which, in the same volume, provide many times the power rating . . . plus a physical structure of exceptional reliability.



ADVANCED DESIGN HIGH FIDELITY AMPLIFIER KIT

While UTC does not manufacture audio amplifier application group provides customer's in this field. Their investigation into high fidelity has indicated unrealized weaknesses in most amplifier designs. To correct these weaknesses circuit will shortly be made available in an kit of advanced design, both electrically and mechanical stability provided by latest printed thinking.

A FEW VIEWS OF THE
UTC LABORATORIES

United Transformer Co.
150 VARICK STREET • NEW YORK 13, N. Y.

EXPORT DIVISION: 13 EAST 40th STREET, NEW YORK 16, N. Y. CABLES: "ARLAB"

www.americanradiohistory.com

HIGH CURRENT REGULATED DC SUPPLY



We have been repeatedly advised of the need for a laboratory power supply with current capacity of up to one-half ampere. During the design of the unit it appeared desirable that it should embody characteristics making it suitable for pulse work.

The result is our new Model 600B which we believe merits your attention by its reduced ripple, its internal impedance specifications, and its incorporation of type 5651 tubes to increase long-term stability of output voltage.

See This Supply at the IRE Show!

Look at these specifications

Output voltage	0-600 VDC
Output current	0-500 Ma
Regulation accuracy	±0.25% above 100 VDC ±0.5% below 100 VDC
Ripple (mV-RMS)	3 maximum
Bias supply	0-150 VDC
Maximum bias circuit impedance	50000 ohms
Internal impedance, maximum	2.0 ohms
Input range	105-125 VAC, 1φ; 50-60~
AC voltage unregulated	6.3 VAC, C.T., at 15 amperes

INTERNAL IMPEDANCE

The internal impedance of 2.0 ohms is determined by making measurements in accordance with I.R.E. specifications for the measurement of power supply internal impedance (cf. *The Proceedings of the I.R.E.*, January, 1951). However, this can be expressed in a slightly different manner. The 2.0 ohms impedance applies for frequencies above 20 cycles. Typical measurements indicate that at 10 kc impedance is 0.5 ohms in series with 18 microhenries, and at 20 kc it is 0.5 ohms in series with 8 microhenries.

RECOVERY TIME

Typical measurements indicate a recovery time of 1 millisecond when a load of 1/2 ampere is applied. It is approximately 0.5 milliseconds when load is decreased from full to no load, and is in the order of 0.2 milliseconds when load is decreased from full to 1/10 load.

REGULATION ACCURACY

The regulation accuracy applies where

there is load change from zero to full at a fixed input voltage within the rating, or against an input change between 105 and 125 volts at a fixed load within rating. This accuracy applies down to 30 VDC. Below 10 volts the changes due to circuit instability are greater than those due to line or load conditions.

BIAS SUPPLY

The bias supply accuracy is ±0.5% at maximum output voltage and from 0.5 ma.

TUBE COMPLEMENT

OD3 (2), 5651 (3), 5R4 (3), 6L6 (7), 6BQ6 (1), 6SL7 (1), 5Y3 (1).

MECHANICAL SPECIFICATIONS

The instrument is 17" long, 10 1/2" high, and 14 7/8" deep. Net weight is 85 pounds. The unit is self-contained, but a panel is available; its dimensions are 19" long by 12 1/4" high.

PRICE

\$395.00 f.o.b. Stamford, Conn.

Other B Supplies are available in the standard Sorensen line, as well as Nobatrons* (low-voltage, high-current regulated DC sources), AC regulators, frequency changers, and other power regulating equipment. Write for the new general catalog to Sorensen & Co., Inc., 375 Fairfield Ave., Stamford, Conn. In Europe, please correspond directly with Sorensen A.G., Gartenstrasse 26, Zurich 2, Switzerland.

SORENSEN

Sorensen & Company, Inc., 375 Fairfield Ave., Stamford, Conn.

*Reg. U. S. Pat. Off. by Sorensen & Co., Inc.

THE NEW MUIRHEAD-WIGAN DECADE OSCILLATOR



TYPE E-650-A

THIS precision laboratory oscillator, which covers a range of 1 to 111,100c/s with an overall frequency accuracy of $\pm 0.2\%$ or $\pm 0.5c/s$, employs the decade tuning system, by means of which the frequency can be set quickly and accurately on four decade dials and a range switch. This system of tuning ensures the highest possible frequency accuracy and stability. It also enables a given frequency setting to be repeated exactly, and permits the addition or subtraction of a fixed number of cycles per second, thus giving an incremental accuracy of an extremely high order. No other type of oscillator possesses all these advantages.

FEATURES

- Frequency range: 1-11,100c/s and 10-111,100c/s.
- Frequency accuracy: $\pm 0.2\%$ or $\pm 0.5c/s$.
- Hourly frequency stability: $\pm 0.02\%$ over most of range.
- Maximum output: 2W into 8000 ohms above 20c/s.
50mW into 8000 ohms below 20c/s.
- Harmonic content: 1% at 1W output.
- Hum level: -80db relative to maximum output at 1000c/s.
- Power supply: 95-125V, 60c/s; 90W.
- Dimensions: 17 $\frac{1}{4}$ in. wide x 10 $\frac{1}{2}$ in. high x 13 in. deep.
- Weight: 83 lb.

MAIL THIS
COUPON FOR
DESCRIPTIVE
BROCHURE



NAME _____
 POSITION _____
 COMPANY _____
 ADDRESS to which BROCHURE should be sent _____

100

MUIRHEAD & CO. LIMITED • BECKENHAM • KENT • ENGLAND

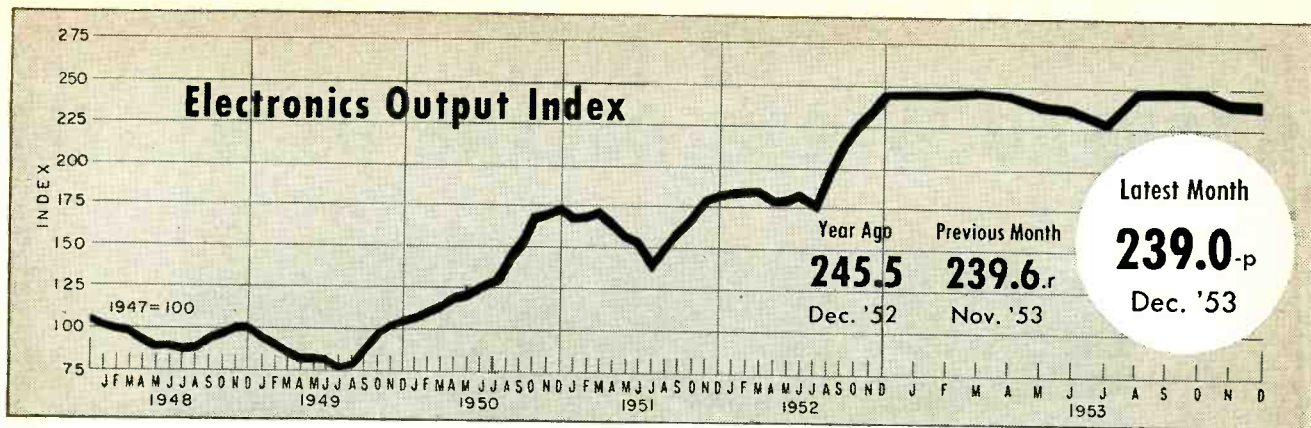

FIGURES OF THE MONTH

	Year Ago	Previous Month	Latest Month
RECEIVER PRODUCTION (Source: RETMA)			
Dec. '52	Nov. '53	Dec. '53	
Television sets	921,086	560,197	449,787
Home sets	490,556-r	457,151	514,428
Clock Radios	296,007-r	171,356	117,672
Portable sets	229,337-r	127,316	103,931
Auto sets	482,358-r	309,962	365,084

	Year Ago	Previous Month	Latest Month
RECEIVER SALES (Source: RETMA)			
Dec. '52	Nov. '53	Dec. '53	
Television sets, units . . .	1,049,770	678,295	774,856
Radio sets (except auto) . .	1,514,688	697,062	1,456,008

	Year Ago	Previous Month	Latest Month
RECEIVING TUBE SALES (Source: RETMA)			
Dec. '52	Nov. '53	Dec. '53	
Receiv. tubes, total units	43,220,393	31,606,971	23,404,026
Receiving tubes, new sets	31,061,892	20,761,999	14,614,319
Rec. tubes, replacement . .	8,771,035	9,008,578	6,443,335
Receiving tubes, gov't . . .	1,745,491	435,227	602,510
Receiving tubes, export . .	1,641,975	1,401,167	1,743,862
Picture tubes, to mfrs. . .	852,501	520,981	413,997

	Year Ago	Previous Month	Latest Month
SEMICONDUCTOR SALES (Source: RETMA)			
Dec. '52	Nov. '53	Dec. '53	
Germanium Diodes	1,568,334	733,029	689,409

	Quarterly Figures		
	Year Ago	Previous Quarter	Latest Quarter
INDUSTRIAL TUBE SALES (Source: NEMA)			
3rd '52	2nd '53	3rd '53	
Vacuum (non-receiving)	10,582,110	10,320,720-r	9,434,082
Gas or vapor	2,951,067	3,303,631-r	4,145,018
Phototubes	566,234	706,055-r	510,686
Magnetrons and velocity modulation tubes	8,491,301	10,523,247-r	9,822,600
Gaps and T/R boxes	1,698,259	1,683,637-r	1,554,000

	Year Ago	Previous Month	Latest Month
TV AUDIENCE (Source: NBC Research Dept.)			
Jan. '53	Dec. '53	Jan. '54	
Sets in Use—total	21,234,100	26,973,000	27,666,000

	Year Ago	Previous Month	Latest Month
BROADCAST STATIONS Source: (FCC)			
Jan. '53	Dec. '53	Jan. '54	
TV Stations on Air	137	356	369
TV Stns CPs—not on air . . .	177	211	197
TV Stns—Applications	791	178	134
AM Stations on Air	2,399	2,521	2,524
AM Stns CPs—not on air . . .	130	115	120
AM Stns—Applications	246	172	165
FM Stations on Air	612	560	555
FM Stns CPs—not on air . . .	15	20	19
FM Stns—Applications	12	4	4

	Year Ago	Previous Month	Latest Month
COMMUNICATION AUTHORIZATIONS (Source: FCC)			
Dec. '52	Nov. '53	Dec. '53	
Aeronautical	34,600	42,667	42,455
Marine	38,422	43,455	43,703
Police, fire, etc.	12,098	14,478	14,663
Industrial	15,653	19,564	19,797
Land Transportation	5,536	6,380	6,470
Amateur	117,800	114,665	115,518
Citizens Radio	1,858	4,070	5,439
Disaster	87	254	254
Experimental	500	495	506
Common carrier	1,023	1,392	1,430

	Year Ago	Previous Month	Latest Month
EMPLOYMENT AND PAYROLLS (Source: Bur. Labor Statistics)			
Nov. '52	Oct. '53	Nov. '53	
Prod. workers, comm. equip. .	398.0	407.6	395.2
Av. wkly. earnings, comm. . .	\$65.99	\$66.97	\$67.43
Av. wkly. earnings, radio . . .	\$63.71	\$65.84	\$66.40
Av. wkly. hours, comm.	41.5	40.1 -r	39.9
Av. wkly. hours, radio	40.1	39.9 -r	40.0

	Year Ago	Previous Month	Latest Month
STOCK PRICE AVERAGES (Source: Standard and Poor's)			
Jan. '53	Dec. '53	Jan. '54	
Radio—TV & Electronics . . .	321.4	268.1	273.4
Radio Broadcasters	300.4	274.1	274.3

p—provisional; r—revised

Figures of the Year

	1952	1953	Percent Change
Television set production	6,096,279	7,214,787	+ 18.3
Radio set production	10,934,872	13,368,556	+ 22.3
Television set sales	6,144,990	6,375,279	+ 03.7
Radio set sales (except auto)	7,689,701	7,064,485	- 08.0
Receiving tube sales	368,519,243	437,091,555	+ 18.6
Cathode-ray tube sales	6,120,292	7,582,835	+ 23.7

INDUSTRY REPORT

electronics—MARCH • 1954

Government Requires FCC License Fees

DESPITE the feeling in the Federal Communications Commission against a fee charge for licenses, Uncle Sam, in the person of the Congress, has ordered all Federal agencies to start collecting for services rendered by May 1.

In a proposal that may be modified, depending upon comments to be filed not later than April 1, FCC has published a table of charges ranging from \$1,500 (for certain equipment type approval) to \$3 (for operator licenses). Amateurs will pay \$3.

Of principal interest are the charges for such services as taxi radio (\$10) and major broadcast applications (\$325). So-called minor broadcast applications, which include auxiliary broadcast stations and certain a-m, f-m and tv licenses modifications, will cost \$50.

► **Initial Costs**—Implicit in the proposal is the fact that a prospective broadcaster must not only plank down a check for \$325 with his application for construction permit, but he must also pay out a similar fee before he gets his license. If he decides upon a different location and later requests a boost in power, he will have paid out a minimum of \$1,300 just to get on the air. License renewals, change to directive antenna or transfer of ownership likewise carry a fee of \$325 each.

► **Type Approval**—Costs of Laboratory tests on manufacturers' new equipment are reflected in proposed fees—\$600 for industrial and medical devices and \$1,500 for broadcast, shipboard and Citizens Radio equipment.

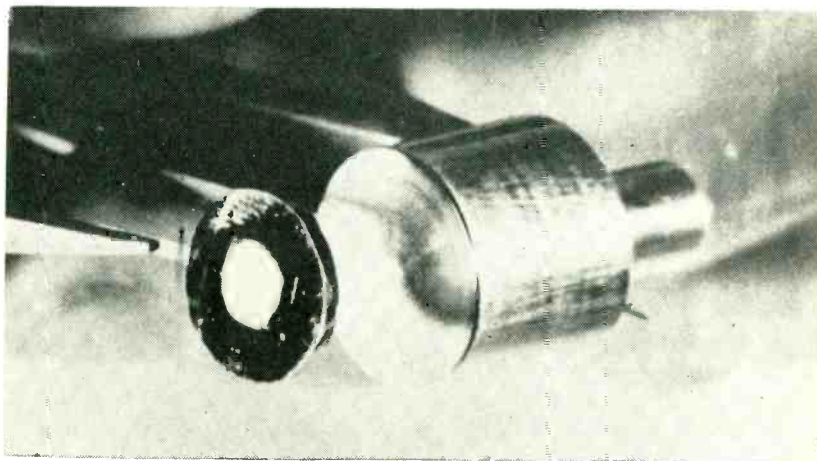

CYLINDER (at right) with thin coating of radioactive material exposes transistor-like wafer to beta rays as . . .

Nuclear Cell Produces Electricity

Atomic fission byproduct powers radioisotopic battery producing microwatt of power

A NUCLEAR BATTERY more efficient than previously reported radioactive generators has been developed.

Although experimental, the device now supplies a millionth of a watt—enough to run a transistor audio oscillator feeding a telephone receiver. Results to date indicate the possibilities of producing thimble-size, atomic batteries according to RCA scientists and engineers who developed the unit.

► **How It Works**—The radioactive source is mechanically coupled to a wafer of semi-conducting crystal to which an impurity has been added. A junction is formed similar to that in a junction transistor. The radioactive source emits beta particles (high-speed electrons) which bombard the crystal wafer and release an average of 200,000 electrons for each bombarding elec-

tron. These free electrons flow across the junction and produce a voltage.

At the present time strontium-90 is the radioactive source material. It has a half-life of 20 years, indicating that one-half its radioactivity will be dissipated in that period of time. Surveys indicate that such radioactive waste materials (by-products of atomic reactor operation) will be in plentiful supply to provide the raw material for purified radioactive isotopes.

Batteries using radioisotopes as an energy source offer, in principle, the advantage of long life under extreme operating conditions. The nuclear process itself is essentially unaffected by temperature or pressure. However, radiation damage effects on crystal structures have been noted, which may limit life.

► **Materials**—Virtually any radioactive material could be used in the new device. Strontium-90 was chosen because of its high-energy beta radiation, long life and low

DEATH came suddenly to Major Armstrong on the last day of January.

Thus removed is the brilliant, controversial figure "to whom the radio art owes more than to any other one man." Armstrong was credited by many engineers with discovering the regenerative principle (denied by the courts) and inventing the superheterodyne and superregenerative receiver circuits. He developed a method of reducing disturbances in radio signaling, commonly referred to as frequency modulation.

There is no radio system in the world, including television, that does not utilize his ideas in some way.

Described by associates as a radio physicist rather than simply an engineer, Armstrong combined in his inventive processes a shrewd balance of theory, pragmatism and a practical sense of market values. One of his expressions was, "let's make it work and then find out what makes it work."

In the sense that he maintained in his laboratory a mere handful of assistants for whom he personally called the turns, Armstrong was said to

Edwin Howard Armstrong 1890-1954



be among the last of the successful individual inventors. The complexities and cost of modern scientific advance have long since begun to yield less and less to single attack.

On the record, his honors were many. He was awarded the degree, Doctor of Science, from Columbia (1929), Muhlberg (1941) and L'Université Laval in Quebec (1948). The Institute of Radio Engineers presented him its Medal of Honor in 1917. France, in 1919, made him Chevalier de la Légion d'Honneur for Signal Corps service in which he also gained the right to be

known as "The Major".

During the years 1939 through 1942, the honors were thick: Columbia gave him the Eggleston Medal and the Medal of the Class of 1889; ASME presented the Holley Medal, Franklin Institute the Franklin Medal, AIEE the Edison Medal. The City of Philadelphia awarded the John Scott Medal and the NAM made the Modern Pioneer Award.

In 1947, Armstrong received the Medal for Merit and was cited by the President of the United States for his contributions to radar and electronics in World War II.

During the period after 1950, the Radio Club of America, Western Society of Engineers and Columbia University alumni honored him with the Armstrong Medal, the Washington Award and the Lion Award, respectively.

At the time of his death, Armstrong was an honorary member of Institution of Radio Engineers (Australia), Franklin Institute and American Institute of Electrical Engineers. He held fellowships in the Radio Club of America and the Institute of Radio Engineers.

shielding requirements. It is not at present obtainable in completely purified form and contains unwanted radioactive materials. These emit gamma radiation (high-energy x-rays) requiring shielding of the present battery.

Refining costs of strontium-90 are about \$25 for one-half milligram (the amount used in the experimental battery). A wide demand for the material in atomic batteries and other applications would warrant quantity processing. This might bring the price down to 10 cents for one-half milligram.

Within the past few years, several nuclear devices have been developed for producing electricity from radioactive materials, by Ohmart and Radiation Research to mention a few.

NBS Analyzes Tinkertoy Cost

Costs of i-f amplifier made by MPE, MDE and conventionally are estimated

SINCE the announcement of Project Tinkertoy, the big question has been how the cost of this method of automatic production line for manufacturing electronic products compares with the present methods.

To answer the question, National Bureau of Standards, at the request of Navy's Bureau of Aeronautics, hired a firm of management consultants to make a cost analysis. The object of Mead Carney and Co. was to determine the cost of manufacturing a specific item, a typical i-f amplifier, by MDE and

MPE, as adapted and projected to conventional practices. Then to compare these costs with the cost of manufacturing a similar item by conventional methods and practices.

► **Initial Cost**—An investment of about \$665,000 is required to create a facility to produce 405 modules per hour by MPE. About \$82,000 is needed to establish a hand process of MDE to produce 400 modules per hour. The difference in machine investment, the report indicates, would be repaid from manufacturing cost savings within less than a year and five months of operations at full capacity.

The significant conclusions

(Continued on page 8)

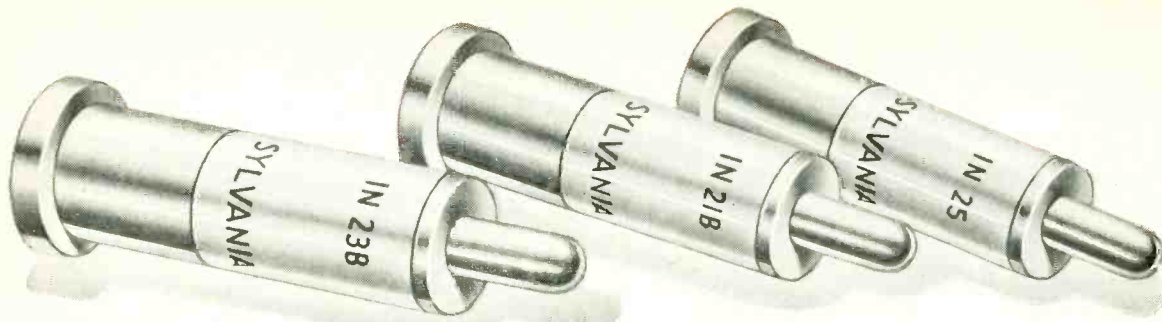

FOR BETTER PERFORMANCE SYLVANIA OFFERS NEW MICROWAVE MIXER CRYSTALS

Sylvania announces the addition of a series of new Microwave Mixer Crystals to the world's foremost line.

These new crystals bring simplicity and dependability to many specialized circuit designs. Matched pairs such as the 1N23B and the 1N155 are specially balanced for low-noise operation.

Sylvania also offers Silicon Video Detector Crystals for use as microwave detectors in receivers of the non-heterodyne type. Other quality Sylvania products, engineered for radar and SHF receivers, include Magnetrons, TR Tubes, ATR Tubes, Hydrogen Thyratrons, and Beacon Reference Cavities.

The unbeatable performance of all Sylvania Crystals, Tubes and other components is the direct result of Sylvania's longer experience and continuing advance in the field of electronic research . . . another reason why it pays to specify SYLVANIA!

SYLVANIA SILICON MIXER CRYSTALS

Type	Description	Approx. Freq.
1N21B	S-Band Crystal	3,000 mc.
1N21C	S-Band Crystal	3,000 mc.
1N157	1N21B Reversed Polarity	3,000 mc.
1N23B	X-Band Crystal	10,000 mc.
1N23BM	1N23B Matched Pair	10,000 mc.
1N155	1N23B Reversed Polarity	10,000 mc.
1N156	1N23B matched with 1N155	10,000 mc.
1N23C	X-Band Crystal	10,000 mc.
1N155A	1N23C Reversed Polarity	10,000 mc.
1N23CMR	1N23C matched with 1N155A	10,000 mc.
1N25	L-Band Crystal	1,000 mc.
1N26	K-Band Crystal	24,000 mc.
1N78	K _U -Band Crystal	16,000 mc.
1N53	Classified. Information available upon proper clearance	
1N53M	Classified. Information available upon proper clearance	



Mail the coupon for this booklet describing the complete line of Sylvania Microwave Crystal Rectifiers.

SYLVANIA

Sylvania Electric Products Inc.  1740 Broadway, New York 19, N. Y.

In Canada: Sylvania Electric (Canada) Ltd.
University Tower Bldg., St. Catherine St., Montreal, P. Q.

LIGHTING • RADIO • ELECTRONICS • TELEVISION

Sylvania Electric Products Inc.
Dept. 4E-1603, 1740 Broadway
New York 19, N. Y.

Please send me new illustrated booklet describing Sylvania's Microwave Crystal Rectifiers.

Name _____

Company _____

Street _____

City _____ Zone _____ State _____

Method	Materials	Direct Labor	Manufacturing Overhead	Totals
Conventional	\$35.85	\$5.60	\$5.44	\$46.89
MDE-Hand	20.56	2.27	2.27	28.82
MPE	20.56	2.83	2.86	26.25

reached by the management consultants are as follows: substantial reductions in electronic manufacturing costs appear to be possible through the use of either the mechanized production of electronics or the hand processing of the modular design of electronics, as compared with conventional manufacturing methods. Based on the survey projections, the manufacturing cost re-

ductions amount to 44 percent for the MPE process and 38.5 percent for the MDE-Hand process.

► **Manufacturing costs** for MPE operations are lower than the hand processes in 13 of the 20 process steps, or groups of steps, delineated. A manufacturing cost lowered by 8.9 percent is indicated for a complete i-f amplifier made by MPE as compared to MDE-Hand methods.

temperature limitations on the semiconductor properties of germanium have spurred the development of silicon units. Temperature stability is essential for operation at high ambient temperatures or at high power levels. The grown-junction silicon transistor demonstrates less than 2-db change in power gain as the temperature is raised from room temperature to 350 F.

► **Problems**—Silicon melts at 2,500 F and is, at that temperature, one of the most chemically active metals known. Growing silicon crystals therefore presents several metallurgical difficulties. Another problem is the relative unavailability of metallic silicon of sufficient purity for transistor manufacture.

► **Germanium Units**—In announcing the silicon transistor, Raytheon pointed out that quantity production was some time off. Silicon transistors are not expected even then to supplant germanium units.

The company's receiving-tube division last year shipped more than one-million germanium units.

► **New Trends**—Research by the Navy continues on use of nonelemental compounds for transistors. These compounds include indium-antimony, aluminum-antimony, cadmium sulphide and lead sulphide.

Philco engineers are working with new electrode metals for surface-barrier transistors; these include zinc, tin and lead.

Development of a 50-watt transistor capable of carrying one ampere has been reported by GE.

Newly developed transistor devices include a 250-mc f-m transceiver using multielement transistors and nonsaturating flip flops that work up to 7 mc.

Electronics Defense Volume To Remain High

Despite budget cuts in some items, boosts in others are seen keeping U.S. orders up

ELECTRONICS spending for defense for fiscal year 1955 will remain close to the 1954 level. Expenditures for electronics in guided missiles and atomic energy probably

(Continued on page 10)

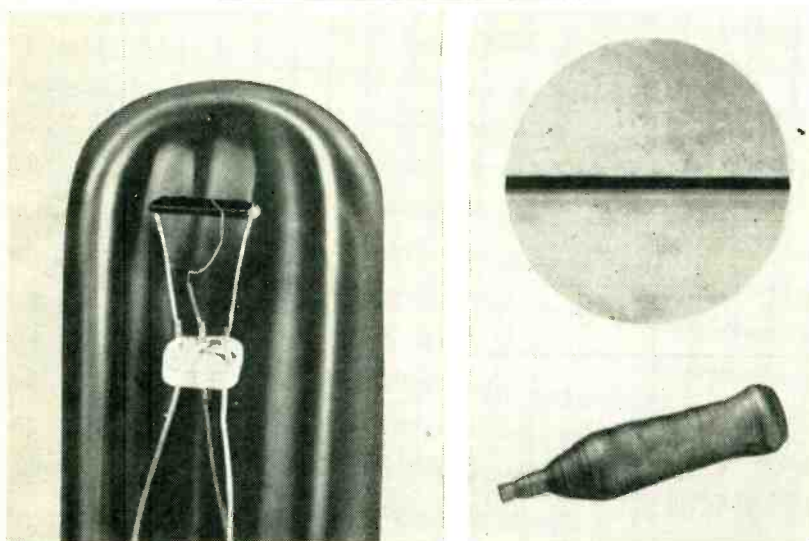

HERMETICALLY sealed transistor (left) employs npn junction (upper right) cut from single-crystal silicon (lower right), as . . .

Grown Silicon Transistors Appear

Experimental units combine high-temperature stability and good power gain

SILICON transistors have been successfully produced for experimental purposes by the grown-junction process, according to Raytheon's research division. The units have functioned in grounded emitter circuits with power gains as high as 40 db. Alpha is in excess of 0.90. Frequency response extends throughout the broadcast band. The units seem unaffected by atmospheric water vapor.

► **Manufacturing** — The grown-junction process involved in making these npn transistors is the

second to which silicon has yielded in recent months. Silicon transistors have also been produced by the surface-barrier method (p 6, Feb. 1954).

Manufacturing details are unavailable but the process may be analogous to that used to prepare germanium grown-junction units. Here a single crystal is drawn from a crucible of molten germanium. A thin region of metal dissimilar in polarity to the rest of the crystal is created by introducing a controlled amount of impurity during the crystal growing process. In the present silicon grown-junction transistors, the central p region measures only 0.001 inch in thickness.

► **Temperature Stability**—Inherent

HIGH VOLTAGE

molded ceramic filter CAPACITORS



Specifically engineered for reliable service in the high voltage supply filter circuits of modern television receivers and cathode ray instruments are Sprague's new molded jacket "doorknob" capacitors.

These moderately priced units incorporate an improved ceramic dielectric element encased in a thermo-setting, non-flammable housing for maximum protection. Fifteen different terminal combinations are standard to meet practically every mounting requirement.

Standard capacitance rating is 500 mmf. Voltages are 30,000, 25,000, and 20,000 volts d-c to fit all applications in television receivers from 27-inch down to 17-inch screen size.

Complete engineering information on these capacitors is contained in Bulletin 606A, available on letterhead request to Sprague Electric Company, 35 Marshall Street, North Adams, Massachusetts.

Sprague, on request, will provide you with complete application engineering service for optimum results in the use of ceramic capacitors.

SPRAGUE

WORLD'S LARGEST CAPACITOR MANUFACTURER

EXPORT FOR THE AMERICAS: SPRAGUE ELECTRIC INTERNATIONAL LTD., NORTH ADAMS, MASS. CABLE: SPREXINT

Visit our Booths at the I.R.E. Show—247-249 Instruments Avenue.

will be somewhat higher than last year. This allows for the cuts in military spending proposed.

► **Analysis**—In analyzing the budget proposals, electronics figures are hard to segregate, partly because the subject is so broad that the money is included in a number of categories, and partly because of secrecy. Electronics, as such, is listed in budget tables as “electronics-communications”, including a number of communications items not in the field of electronics.

On the other hand, large amounts of electronics money is found in any number of categories, such as aircraft, ships and harbor craft, weapons, atomic energy for defense, etc. But there is no breakdown of money involved for electronics.

The President, in his message to Congress, stated that he wants reductions in total defense expenditures, but that electronics, aircraft, guided missiles, research and development and many other defense programs will continue at close to record peacetime levels. Expenditures for atomic energy in which electronics money is included, he said, will increase, bringing this program to record levels.

► **Estimates**—One estimate from the Pentagon is that “electronics and communications” spending, as a whole, may be down some \$200 million in fiscal '55 while guided missile spending will be up approximately that amount. Current expenditures in both these budget categories is running well in excess of \$1 billion this year.

Spending in research and development is given for fiscal '55 as \$1.35 billion, down some \$75 million from estimated expenditures for the current fiscal year. Reduction of research and development spending for electronics will be in the neighborhood of 5 percent.

An industry estimate of military electronics spending comes from Sylvania's Frank Mansfield, who also heads RETMA's statistical committee. He takes a total of defense purchases of electronics products for fiscal 1953 at \$2.8 billion, sees a rise to \$2.9 billion this year, to \$3.1 billion a year in 1957-59 and \$3.8 billion in 1960-62.

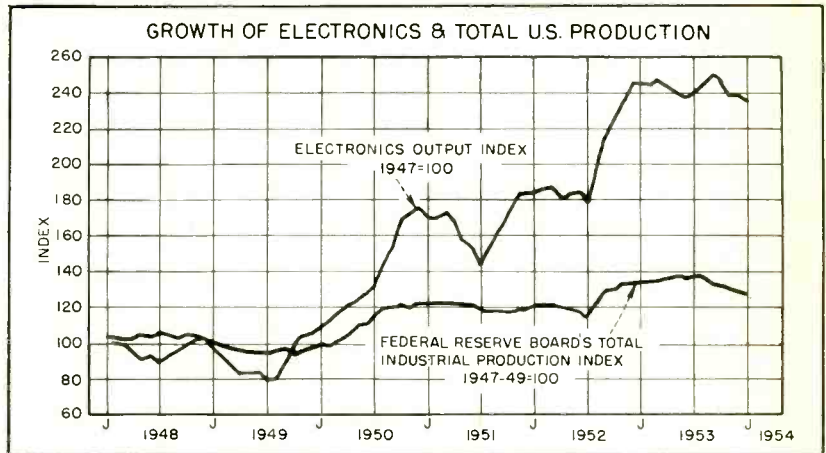

Electronics Output Leads In Growth

Industry's production volume has grown five times faster than total U.S. industrial output

RECENT revision of the Federal Reserve Board's industrial production index makes it possible to compare the output growth of the electronics field with that of industry in general. As shown in the chart, production growth for electronic manufacturers has outstripped that of all other industries combined.

► **Revision**—Heretofore it has been difficult to make a valid comparison of electronics output growth, as represented in the ELECTRONICS Output Index, with that of industry in general, as represented in FRB's index, because different base years were used. Now, with FRB's revision, the base for both indexes is essentially the same, according to our statistical expert. Thus, as the chart shows, electronics output in January, 1954 was 137 points higher than in 1947 while total U. S. industry production is only 27 points of 27 percent more.

► **Industries**—Breakdown of FRB's index into industry classifications indicates how other industries stack up against electronics in growth since 1947. According to these figures, only the output of the aircraft industry has grown faster than electronics. Its index stood at 473 last November showing a 373 percent increase compared to 1947 production.

For individual products, FRB's indexes show that radio and tv set output stood at 276 in October, 1953, higher than the overall ELECTRONICS Output Index because it does not cover products of the entire industry. Following radio and tv in order of fastest growth, according to FRB, were truck trailers with an index of 270; aviation gas, 241; softwood plywood, 222; synthetic rubber, 214 and aluminum, 212. All other products shown had output indexes below 200.

► **Use**—The individual electronic manufacturer can compare his company's business growth with that of the electronics industry, as represented in the ELECTRONICS Output Index, by dividing his monthly sales by his monthly sales average in 1947. With the resulting figure he can also compare with FRB's index.

Home Appliance Make Ponder Tube Uses

Control applications grow; electronic air conditioning and cooking seen in future

DOMESTIC use of electronic equipment for measurement and control is a relatively small but rapidly growing field. Several firms are also working toward electronic ovens and air conditioners. General consumer acceptance of electronic home appliances could double the

(Continued on page 12)

ARNOLD MAGNETIC MATERIALS

TYPES "C" AND "E" CUT CORES

Arnold "C" and "E" Cores are made from precision rolled Silectron strip (highly oriented silicon steel) in 1, 2, 4 or 12-mil thicknesses and a wide variety of window sizes and core areas, for high and low-frequency applications. Sizes range up to 10 lbs. in 12-mil strip, and from fractions of an ounce to hundreds of pounds in the thinner gauges. Cores wound from ultra-thin strip (down to 1/4 mil or less) can also be supplied.

Insulated strip of the proper width is wound

on a mandrel, then heat treated, bonded and cut into halves. Careful control results in accurately dimensioned and matched core halves whose effective air gap at the butt joint is very small.

In 3-phase applications, the use of "E" Cores provides weight and size reduction, as well as higher efficiency and possible cost savings. Rigid standard tests are employed for both "C" and "E" types of cores, and special tests where required.

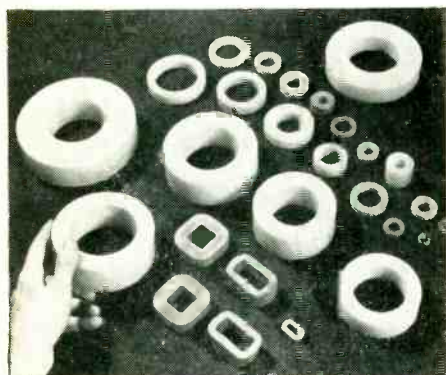
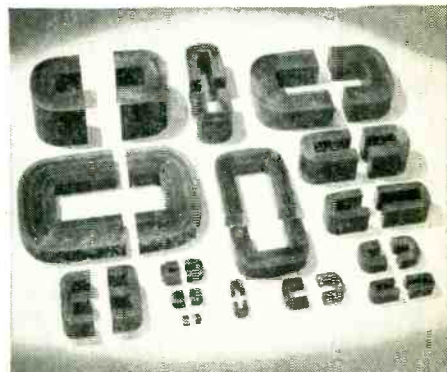

TAPE WOUND CORES

Depending upon the specific properties required, Arnold Tape Wound Cores are available made of Deltamax, 4-79 Mo-Permalloy, Supermalloy, Mumetal, 4750 Electrical Metal, or Silectron . . . in standard tape thicknesses of 1, 2, 4 or 12-mils, and in ultra-thin gauges of 1/2 and 1/4-mil where required.

Practically any size core can be supplied, from a fraction of a gram to hundreds of pounds. Toroidal cores are made in 22 stand-

ard sizes with protective nylon cases. Special sizes of toroidal cores, and all square or rectangular Tape Wound Cores, are manufactured to meet individual requirements.

Used for magnetic amplifiers, pulse transformers, current transformers, wide-band transformers, non-linear retard coils, peaking strips, reactors, etc., this gapless type of core construction results in maximum effective working permeability with minimum flux leakage.

MOLY-PERMALLOY POWDER CORES

For use in loading coils, filters, broadband carrier systems and networks, for frequencies up to 200 kc, these Toroids provide high Q in a small volume, and are characterized by low eddy current and hysteresis losses.

Arnold Powder Cores are supplied in four standard permeabilities: 125, 60, 26 and 14 Mu. They provide constant permeability over a wide range of flux density. The 125 Mu cores are recommended for use up to 15 kc; the 60 Mu at 10 to 50 kc; the 26 Mu at 30 to

75 kc; and the 14 Mu at 50 to 200 kc. Many of these cores may be furnished stabilized to provide constant permeability ($\pm 0.1\%$) over a specific temperature range.

These Moly Permalloy Powder Toroids are available in a wide range of sizes, to obtain nominal inductances as high as 281 mh/1000 turns. They are given various types of enamel and varnish finishes, some of which permit winding with heavy Formex insulated wire without supplementary insulation over the core.

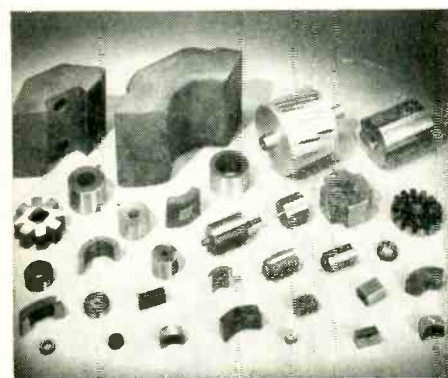
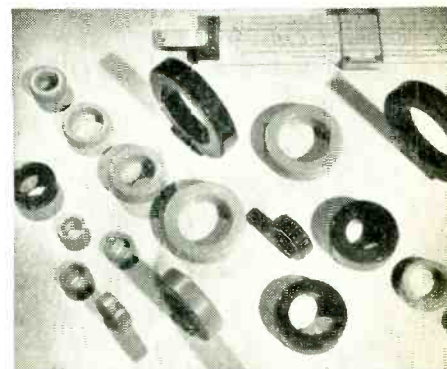

ALNICO MAGNETS

Arnold manufactures permanent magnets from all grades of Alnico, although Alnico V is usually the preferred type due to the high value of energy product of that alloy. Alnico Magnets are quite hard and somewhat brittle and may be machined only by grinding. Most sizes and shapes are manufactured as sand

castings and are made to the customer's drawings and specifications. Some types and shapes of Alnico Magnets are carried as stock items.

Some small sizes of magnets may be furnished in sintered Alnico, but special shapes made in this way require rather expensive dies.

Stock sizes of all the products above are listed in Catalog GC-106. Write for your copy . . . but if you're attending the IRE show this year, see us at Booth 148.

W&D 4939



THE ARNOLD ENGINEERING COMPANY

SUBSIDIARY OF ALLEGHENY LUDLUM STEEL CORPORATION

General Office & Plant: Marengo, Illinois

New York: Empire State Bldg.

Boston: John Hancock Bldg.

Los Angeles: 3450 Wilshire Blvd.

industry's share in the consumer goods market.

► **Thermostats**—Automatic control of room temperature by electronic thermostats expanded rapidly during 1953 according to Minneapolis-Honeywell. The electronic thermostat is said to be 8 times as sensitive as an electromechanical control and 100 times more sensitive than the human body. More than 25,000 homes now have electronic thermostats with 50,000 expected by the end of 1954.

Range-top thermostats that use a phototube to sense pan temperature and avoid scorching food were introduced last year on Westinghouse's top model electric range. The device is available this year on both double and single-oven models in the premium line.

► **Dream Kitchen**—Capacitance switches that open cupboards whenever the hand is brought near were featured in Frigidaire's "Kitchen of Tomorrow" exhibit—part of the G-M Motorama in New York City. Also shown was a mock-up of an electronic oven; a working model of the device reportedly could cook a family turkey in 45 minutes.

A few years ago several firms introduced ranges to cook food by microwave radiation. Work continues toward a home-sized model.

► **Air Conditioning**—Moving charged air particles by electric fields as a basis for cooling and air conditioning has captured the imagination of several industrialists. A few firms are actively working towards such an electronic air conditioner.

Other somewhat similar devices have been used. Electrostatic precipitators to filter dust particles from incoming air are available for home use. Some years ago, arc-discharge machines designed to produce ozone for kitchen sanitation were merchandized.

Other electronic equipment, usually considered commercial, is used occasionally in the home. This includes electronic burglar alarms, photoelectric fire-warning systems and intercoms—used mostly for baby sitting. Many electronic garage-door openers are in use.

1954 IRE Convention Is Ready

Over 35,000 electronic engineers are expected to attend the Annual meeting

MORE than 600 exhibits and an extensive technical program of 51 sessions and 241 technical papers will be presented to the nation's electronic engineers on March 22–25 in New York City when the 1954 IRE National Convention opens.

► **Locations**—This year the convention will be held in three locations. The 600-exhibit Radio Engineering Show will be housed all on one floor in a new location, Kingsbridge Armory in the Bronx. The technical program will be presented at three locations. Seven sessions are scheduled for the Shelton Hotel, 22 for the Waldorf-Astoria and 22 for Kingsbridge Armory. Both hotels are miles from the Armory.

Technical meetings will be highlighted by a medical electronics symposium on "Engineering Based On Biological Design" and by an audio Seminar on "High Fidelity In Audio Engineering". The complete list of technical papers is published in this issue of *Electronics* beginning on page 470.

► **How To Get There**—For the benefit of out-of-town engineers, directions on how to get to Kingsbridge Armory by subway from the two hotels are published in this issue of *ELECTRONICS* on page 412. Transportation will also be provided in free buses operating at frequent intervals between the Armory and the Waldorf.

► **Exhibits**—It is expected that everything from single-gun color tv picture tubes to atomic batteries will be on display at the Armory exhibit. Color tv and transistor displays are expected to predominate.

With the number of exhibits higher than ever this year, an attempt has been made to make the task of taking them all in a little easier. Aisles of exhibits have been designated with names such as Components Avenue, Television Road and Computer Avenue in which most of the makers of each type of equipment will display their

wares. However, full participation in the groupings by all manufacturers is not possible so that plenty of exercise is still in store for exhibiting engineers.



Computer Controls Automatic Punch Press

MECHANIZATION of electronic production advances another step with perfection of a technique for using an electronic digital computer to control production machinery.

One machine to be adapted for such automatic control by GE under a Signal Corps contract is a Wiedeman turret punch press. Another, to be demonstrated sometime around mid-year, is an automatic parts-placement machine that will select the correct type and size of component, orient it precisely, then insert its preformed leads in holes punched in printed wiring boards by the turret press.

The end point in the contract is a completely automatic component assembly system that will bring automation to production of specialized military and commercial electronic equipment required in job lots of only 10 to 50 units.

► **How It Works**—From the working drawing, a typist prepares a perforated card containing coded information on the size, number

(Continued on page 14)

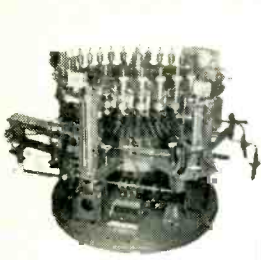

MERCURY SWITCHES

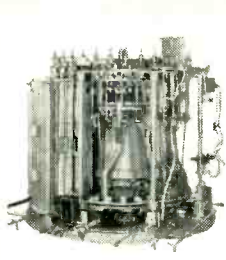

FLUORESCENT LAMPS

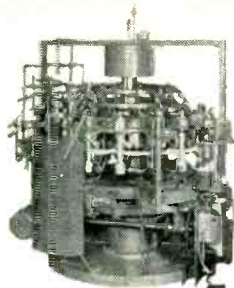

GRAIN-OF-WHEAT LAMPS

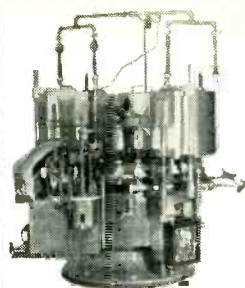

VACUUM BOTTLES

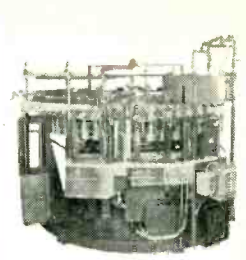

MINIATURE RADIO TUBES

FOR VACUUM

kahle

largest producer of EXHAUST MACHINES

**covers the most
complete range
of products to be
vacuumized...**

Kahle makes exhaust machines to vacuumize lamps smaller than a grain of rice for use in cystoscopes—and for eight feet long fluorescent lamps.

Kahle makes exhaust machinery that is stationary, automatic and combination (machines that exhaust and seal in one operation, machines that exhaust, vacuum metallize and mercury feed simultaneously, etc.). Kahle machinery will fit into any operation whether small scale or demanding outputs up to 2000 units each hour!

Among various items for which Kahle has made exhaust machinery are:

LAMPS gas-filled, miniature, photo-flash, incandescent, fluorescent and special lamps

ELECTRON TUBES sub-miniature, miniature, cathode-ray, standard, power, X-ray

**MERCURY SWITCHES
INSTRUMENTS**

**VACUUM BOTTLES
TRANSISTORS**

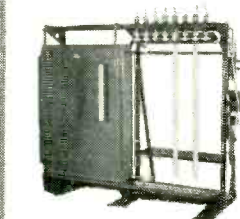

FLUORESCENT LAMPS

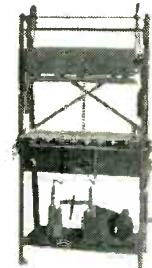

SPECIAL TUBES

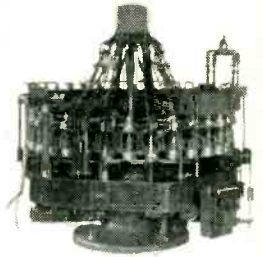

MINIATURE RADIO TUBES

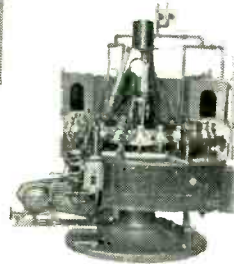

INCANDESCENT LAMPS

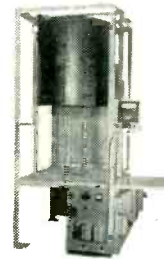

CATHODE RAY TUBES



X-RAY TUBES

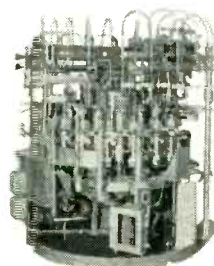

RADIO RECEIVING TUBES

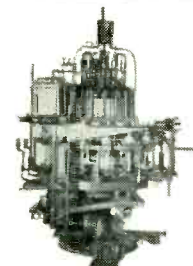

POWER TUBES

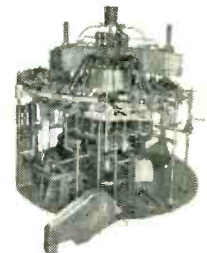

TRANSMITTING TUBES

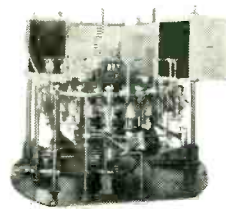

CATHODE RAY TUBES

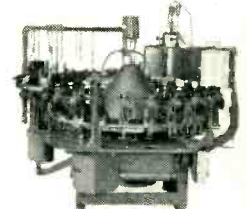

POWER TUBES

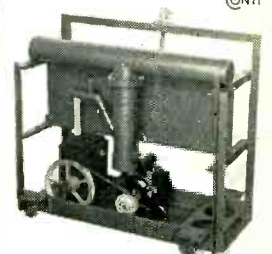

INSTRUMENTS

*Regardless of what product is to be exhausted, write
KAHLE, largest exclusive manufacturer of custom
machines for the glass, lamp and electronics industries.*

Kahle

ENGINEERING COMPANY

1310 SEVENTH STREET • NORTH BERGEN, N. J.

and location of the holes to be punched. From the perforating typewriter this card goes to the computer which controls the punch press.

The computer reads the positional data for each hole in turn and moves the material holder on the press in the indicated *x* and *y* directions to an accuracy of a thousandth of an inch, then rotates the turret head for the indicated hole diameter and actuates the punch.

Present rate of punching is 30 holes per minute with the high-torque servo system employed for moving the material. This is admittedly a bit slower than can be obtained with an experienced op-

erator using the conventional steel template on the machine, but contemplated improvements are expected to boost the automatized speed appreciably.

► **Advantages**—Design changes require only the time it takes to make a new drawing and punch out a new program card. No operator or retooling time is needed to make a change, and cost of setting up for a new job lot order is accordingly reduced. The time saving is appreciable on the punch press application, for which a new steel template generally requires a minimum of two days in the machine shop.

ters to view the line-up. It could also be used for communicating photographs of wanted or missing persons along with other pictorial information.

► **Inter-State**—Closed-circuit tv use is not restricted to one-city use. AT&T reports that at the end of 1953 inter-state closed circuit tv had been used by businesses and institutions on 137 occasions. In 1954, inter-state facilities have been used three times by business firms.

Theater television has been one of the largest users of inter-state closed-circuit tv for showing boxing matches, football games and operas. But use by business for sales meetings and product demonstrations has surpassed theater use.

Companies such as Esso Standard Oil, Westinghouse, Ford, Dodge, National Dairy Products, Lee Hats and others have used closed-circuit tv on an inter-state basis. The advantage, as with police use, is in the savings made in travel time and cost that regular national meetings would entail.

► **Networks**—Even the regular tv networks are concentrating on the growing closed-circuit tv field. The facilities of all four major tv networks have been used at some time for private business use. Now DuMont has set up a separate closed-circuit operation to handle business in the field. In addition, there are companies, such as Tele Sessions, a division of Theater Network Television, and Box Office Television, that deal exclusively in the field.

Manufacturers Survey Inventory Practices

ELECTRONICS Parts & Equipment Manufacturers Association surveyed 53 manufacturers in the field to find out how the industry handles defective, obsolete and excess inventory on parts distributors shelves. Survey highlights are:

► **Defects**—All but one of the 53 manufacturers polled replace defective merchandise without charge. Forty of the companies issue a

(Continued on page 16)



NEW YORK'S Mayor Wagner (center) and Police Commissioner Adams (right) view receiver with RCA's Barton Kreuzer as . . .

Police Use Industrial Television

Closed-circuit television aids "line-up" procedure; Use by business increases

DRAGNET TV, sponsored by RCA and the New York City Police Department, was demonstrated in February when the traditional morning line-up of persons arrested for felonies or major misdemeanors was televised by industrial tv at Manhattan Police Headquarters.

The program, starring department detectives who posed as criminals, was relayed by microwave from an antenna on the headquarters building to the Empire

State Building. There the signal was boosted in power and relayed to a microwave antenna on the Brooklyn headquarters building about 7 miles away. At the Brooklyn police station, detectives and police officials saw the show on modified receivers.

► **Advantages**—Main purpose of the demonstration was to show how industrial tv could increase efficiency of law enforcement and save large-city or state police departments thousands of man-hours. The system would make it unnecessary for detectives to leave their precincts and spend time traveling to and from headquar-

SHOCK - VIBRATION - NOISE ISOLATION NOTES



DICTATING MACHINE FLOATS ON BARRYMOUNTS — For noiseless operation, smooth, faultless playback, and the ultimate in protection against vibration and shock, Soundscriber Corp. chooses Barrymounts to support their new transcription unit. One more instance of how Barrymounts protect the performance of precision instruments. *Ask for data on Type 372 Barrymounts.*



COAST GUARD DIRECTION FINDER GUARDED BY BARRYMOUNTS — Where reliability of performance is really vital, sensitive electronic equipment *must* be protected from shock and vibration. Raytheon Manufacturing Company says: "We find that the high quality and effectiveness of these mountings help us assure the famed reliability and excellence of our own products." *Ask for data on Type C-2000 Barrymounts.*



ALL-METL BARRYMOUNTS PROTECT AIRCRAFT RADIO COMPASS — For safe, assured, brilliant operation, at extremely high altitudes and over a wide range of temperatures, Lear uses Barry ALL-METL vibration isolators to support the sensitive components of their "Executive" radio compass. They say: "We have chosen the Barry product because we feel it is a superior product from the standpoint of providing greater trouble-free life". *Ask for data on Type M-44 Barrymounts.*



INDUSTRIAL MACHINERY MOBILIZED BY BARRYMOUNTS — For example: a production line of eight punch presses was shut down, moved 200 feet across the plant, and was producing parts again *in a total elapsed time of 23 minutes*. No lagging, no shimmying, and no walking of the machines in operation — because they were mounted on the new Leveling Barrymounts. This is *machine-tool mobility* — a new idea to make new profits for YOU. *Ask for "LOOK — NO LAGGING!"*

The wide range of Barry products and the experience of Barry engineers can help you solve shock, vibration, and noise problems in any area of military or industrial activity. Call our nearby sales representative or write directly to us.

THE **BARRY** CORP.

707 PLEASANT ST., WATERTOWN 72, MASSACHUSETTS

SALES REPRESENTATIVES IN

Atlanta Baltimore Chicago Cleveland Dallas Dayton Detroit Kansas City
Los Angeles Minneapolis New York Philadelphia Phoenix Rochester
St. Louis San Francisco Seattle Washington, D.C. Montreal Toronto

merchandise credit. Only 10 issue cash refunds.

► **Obsolete And Excess**—Inventory made obsolete by the manufacturer's development of a new product, and regular inventory that is overstocked by the distributor, are handled in different ways by companies in the parts and equipment field.

Twenty-one firms allow distributors to return obsolete items. For excess inventory, however, 34 allow a return. Only 13 companies make a handling charge on the return of obsolete goods while 27 do so for excess merchandise. The charges for both types of inventory range from 5 to 15 percent of the return's cost.

According to the survey, manufacturers covered were equally divided as to whether they insist the distributor buy other items when obsolete goods are returned. For excess goods returns, 60 percent of the firms so insist. Most manufacturers require that returned items be in the condition in which they were originally sold. Twenty-six companies issue a credit for obsolete or excess items ranging from 25 percent to 100 percent of the material's cost.

Stage Lighting Seen Problem in Color TV

Electronic lighting control is needed in theater work; layout costs \$300,000

STAGE lighting for a color television show of the theatrical type will engender additional headaches for the telecaster.

Not only must the lighting for color be more than three times as bright as for monochrome but lighting effects must be reproduced far more accurately. A stage electrician could get away with 10-percent brightness error in monochrome; not so in color.

► **Electronics**—Stage lighting is controlled by a dimmer board. Heretofore these have been manually operated using saturable re-

actors as control elements. A thyatron-controlled board developed some years ago provides accurate, reproducible effects and handles the power necessary to light a color stage set. Power handling is as big a problem as accuracy. The full range of effects recently used on the "Hit Parade" drew 4,000 amperes. An average variety show in color draws 2,800 to 3,000 amperes; tops for monochrome is 960 amps.

► **Cost**—The lighting layout at NBC's Colonial Theatre in New York handles 400 lights and cost \$300,000. The dimmer board alone

cost \$175,000. Thus far only 5 electronic dimmer boards are in use for color tv but it is an item that will be needed by stations doing network originations in color or by large, aggressive metropolitan stations.

► **Upkeep**—The NBC board has 72 dimmer banks each employing two EL316J thyratrons and one 6SL7 control tube. The thyratrons cost about \$60 each and have an average life of 2,000 hours. Five complete lighting setups can be preset on the board and switched in on cue during the program.

U. S. Firms Lead in World TV Sales

Foreign tv station equipment sales increase; Intercountry networks planned

DETAILED picture of the spread of television throughout the world is given in recent reports by the U. S. Department of State and Unesco.

At the beginning of 1954 a total of 29 nations outside the U. S. were estimated to have tv stations on the air. This represents an estimated \$18 million invested in tv station equipment. The bulk of sales has gone to U. S. electronic manufacturers.

► **Companies**—There are over 60 tv stations operating in countries outside the U. S. Of these, more than half use equipment from U. S. manufacturers. Leaders in foreign tv broadcast equipment sales are Du Mont, GE, GPL, RCA and Standard. The remaining sales have been made by foreign companies such as Marconi and Pye of England, Radio Industrie of France and Philips of the Netherlands.

In most European nations, companies within each country have supplied tv station equipment. For example, in Germany, Ferenseh G.m.b.H and Siemens and Halske are the local suppliers. In England, Marconi, Electric and Musical Industries, Metropolitan Vick-

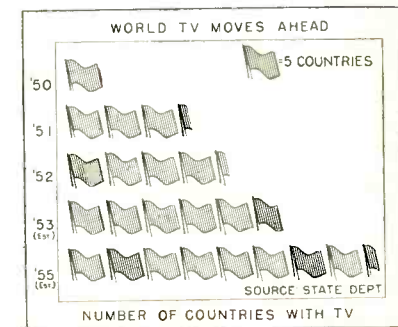

ers and Standard Telephone & Cables have supplied most of the station equipment.

In Italy, however, much of the tv station equipment was supplied by U. S. and English manufacturers. Bulk of tv station equipment sales by U. S. manufacturers has taken place in North and South America. In Asia, mainly Japan, sales of tv equipment seem well divided between English, European and U. S. firms.

► **Networks**—There are plans for tv networks to link the various countries with tv stations in operation. At the official opening of regular tv programs in Italy in January, it was stated that eight non-Communist nations are working toward a possible exchange of programs by June of this year. It is reported that Belgium, Denmark, France, West Germany, Britain, Holland, Switzerland.

(Continued on page 18)

for Every Laboratory!

A ELECTRICAL NOISE GENERATOR

Electrical Noise is remarkably useful when supplied by a properly controlled generator such as G-R's Type 1390-A Random Noise Generator. Since random noise is a common form of interfering signal which limits the threshold of electrical operation, this noise source can be used to check receivers, communications systems and detection apparatus

for susceptibility to interference. Controlled noise makes possible a unique approach to many problems.

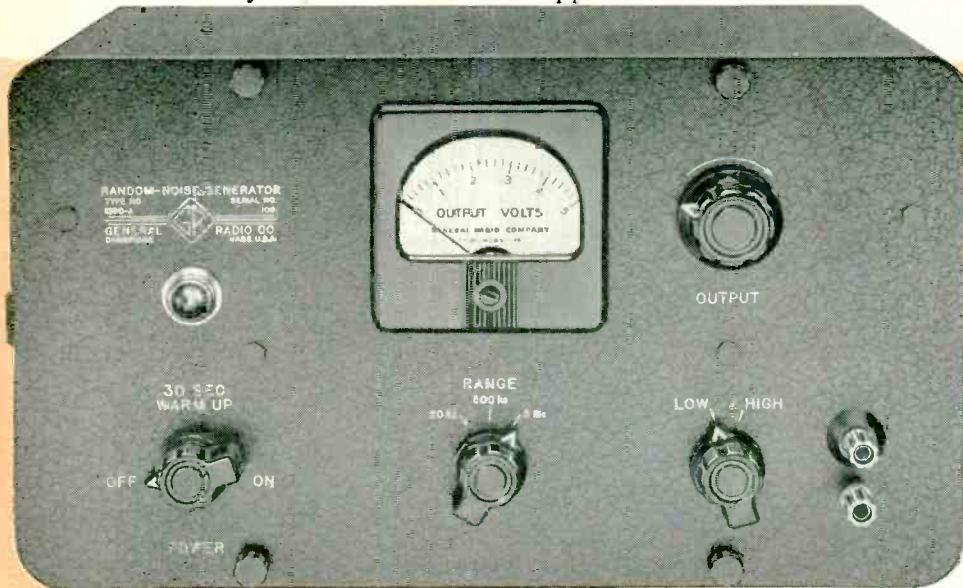

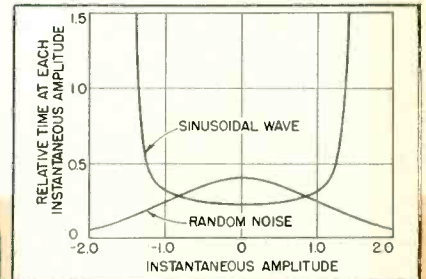

a few of the Many Uses for the G-R Random Noise Generator

- ★ Loudspeaker and microphone response determination—room acoustics studies including reverberation tests—measurement of sound transmissions through acoustic materials used for lining walls and floors.
- ★ Because of its broad frequency spectrum, this generator can often simplify the search for resonant conditions—the particular frequency at which resonance occurs is determined by oscilloscope patterns at the output of the system under study.
- ★ This instrument may be used for demonstrating characteristics of noise and exploring the elements of statistical theory—possible errors in random sampling techniques are explored electrically.
- ★ The Random Noise Generator may be used for the wide-band modulation of r-f carriers—characteristics of radio and t-v receivers are determined under conditions closely approximating actual operation—cross-talk measurements on multichannel carrier systems are possible.
- ★ Testing recording systems. This instrument provides a much better approximation to speech and music than does the ordinary sine-wave oscillator. Furthermore, commonly used sweeping sinusoidal tests are inconvenient because of the difficulty in pre-determining the recorded frequency at any given moment in play-back. Analysis of a recorded noise signal is much more readily and accurately accomplished.

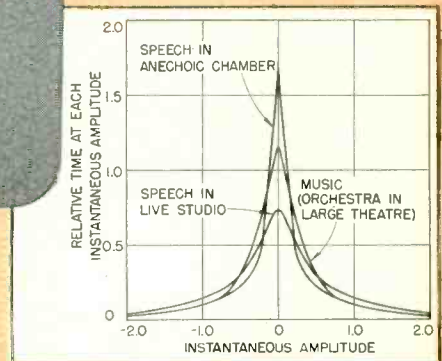

The amplitude distribution of the Random Noise Generator closely approximates the normal probability distribution curve of speech, music, and many other sounds and electrical disturbances which occur naturally. Random noise, for this reason, is useful in psychoacoustic and other applications. Note that the amplitude distribution of the sine-wave is entirely different from that of speech.



 Type 1390-A Random Noise Generator . \$240.00

Specifications

- Switch Selects Either of Three Frequency Bands
 - 30 cycles to 20 kc — flat to within ± 1 db
 - 30 cycles to 500 kc — flat within ± 3 db
 - 30 cycles to 5 Mc — flat within ± 3 db to 500 kc, within ± 8 db above 500 kc.
- Calibrated Output Voltmeter—maximum output is one-volt, rms on any of three bands—accessory Type 700-P1 Voltage Divider provides output levels as low as 0.0001 volt.
- Average Spectrum Level With 1-Volt Output (for one-cycle band)—6 mv on 20 kc band, 1 mv on 500 kc band, 0.5 mv on 5 Mc band.
- Output Impedance—800 ohms at maximum output
- Power—105 to 125 volts, 50 to 60 cycles
- Dimensions are 12 x 7½ x 9¼ inches
- Net Weight is 15 lbs.

SINCE 1915—



MANUFACTURERS OF ELECTRONIC APPARATUS FOR SCIENCE AND INDUSTRY

GENERAL RADIO Company

275 Massachusetts Avenue, Cambridge 39, Massachusetts, U. S. A.
90 West Street, New York 6, N. Y. 10013, Chicago 8, 1000 N. Seward St., Los Angeles 10, Calif.

Pulse Generators ★ R-L-C Decades ★ R-L-C Standards ★ Unit Instruments ★ Sound & Vibration Meters ★ Stroboscopes ★ Null Detectors ★ Motor Controls ★ Wave Filters ★ V-T Voltmeters

Admittance Meters ★ Amplifiers ★ Coaxial Elements
Distortion Meters ★ Frequency Measuring Apparatus ★
Frequency Standards ★ Impedance Bridges ★ Light Meters
Megohmmeters ★ Modulation Meters ★ Polariscopes
Precision Capacitors ★ Oscillators ★ U-H-F Measuring
Equipment ★ Parts & Accessories ★ Signal Generators
Wave Analyzers ★ Variacs ★ TV & Broadcast Monitors

Italy and perhaps Sweden may be in the network.

Hopes for network tv between the Americas was also voiced recently. Jose Ramon Quinones, vice-president of the Inter-American Association of Broadcasters and president of the Ponce de Leon Broadcasting Co. of San Juan,

P. R. said that his company's new station, expected on the air shortly, furthers the possibility of a Caribbean tv network. Later, a video network embracing North and South America is visualized. Argentina, Brazil, Mexico and Venezuela have tv in addition to Cuba and the Dominican Republic.



DEFLECTION yokes for color tubes roll off RCA's production line as . . .

ducing color coil kits for use with shadow mask color tubes. The company is also making horizontal output transformers for color sets. In New York, Crest Laboratories has introduced a line of variable inductances suitable for use with color tv circuitry. In California, Chromatic Labs has expanded its Lawrence tube grid-making plant.

Financial Roundup

COMPANIES in the electronics field reported in the past month on net profits, security transactions and sales.

Standard Coil Products, which reported net profits of \$3.3 million for the first 9 months of 1953 compared to \$1.9 million in 1952, now estimates that its total consolidated sales for 1953 will probably exceed \$90 million.

The company employs more than 10,000 workers in its 7 plants located in Massachusetts, Illinois, Michigan and Los Angeles. It also owns Kollsman Instrument Corp. in New York City. The firm is a publicly held corporation with its stock listed on the New York Stock Exchange. Neither its stock nor its assets have been at any time sold to the Storer Broadcasting Company as reported (February, 1954, p 14).

The following firms made profit reports;

Company	Net Profit	
	1953	1952
Air Associates 3m.	\$140,419	
AT&T 11m	24,655,229	24,572,264
Avco 12m	3,368,598	11,028,927
Carborundum 12m.	5,721,553	4,782,503
Emerson Radio 12m	2,985,432	2,262,556
Garrett 6m	1,444,000	1,382,000
Gen. Instrument 3m	871,600	685,900
W. L. Maxson 9m	370,763	189,520
Philco 12m est*	13,000,000	
United-Carr 9m	1,760,221	1,539,463
Varian 12m	107,609	91,874

*Not including proceeds from sale of WPTZ to Westinghouse.

► **Securities**—General Instrument registered with SEC covering 200,000 shares of common, par \$1, at a fixed price related to market price. Proceeds will be added to general corporation funds and used for plant additions, research and possible acquisitions.

CBS placed privately with two insurance companies \$7 million of 4½ percent promissory notes due in 1973. Proceeds are to be used for

(Continued on page 20)

Component Firms Ready For Color

Parts manufacturers study color set component requirements, introduce new products

ALONG with receiver manufacturers, parts producers are now getting ready for volume production of color tv sets.

Many component companies are studying color set requirements. Some firms have already introduced new color components for sets and tubes.

► **Stacks**—Selenium rectifier manufacturers are active in the field. At least three companies have introduced stacks especially designed for color set use.

Federal Telephone surveyed 23 tv set manufacturers on the use of selenium rectifiers in color receiver power supplies. Eighteen of the manufacturers polled are using them in their prototype receivers.

The others are using vacuum tubes. The most popular selenium rectifier for color tv has a current rating of 750 ma at 195 volts. The range of rectifier types used is from 250 to 750 ma with a voltage range of 130 to 195 volts. Federal estimates that 100,000 selenium rectifiers for color tv sets, mostly for developmental models, will be produced this year.

► **Other Components**—Production quantities of components designed for use with color picture tubes are also becoming available. RCA announced the availability to manufacturers of seven components for deflection, convergence and focus circuits for color picture tubes. They include the deflection yoke, high voltage transformer and several types of focus and convergence transformers.

Electrometric of Illinois is pro-

Under severe
military conditions
this is the
VOLTAGE REFERENCE
TUBE to use
The **NEW**
RELIABLE



CK5651WA



10 GREAT PERFORMANCE FEATURES

1. Low dark starting voltage — only 115 volts — no higher than for light starting.
2. Tightened Voltage Drop Range (83.5 to 85.5 volts at 2.5 mA).
3. Wider Ambient Temperature Range: -55°C to 150°C.
4. Reduced temperature coefficient: -5 mV/°C maximum, from 25°C to 150°C.
5. Reduced voltage jump*. Typical value: 5 mV.
6. Reduced drift (1 hour)**. Typical value: 50 mV.
7. Improved repeatability***. Typical value: 20 mV change.
8. Improved stability over 500 hour period (150°C ambient). Typically less than 1 volt change.
9. Improved stability over 5000 hour period (30°C ambient). Typically less than 1 volt change.
10. Ability to meet every requirement for military reliable tubes, including shock and vibration.

The development of this tube was sponsored by the Bureau of Ships, Navy Department, U.S.A.

Notes: *Voltage jump — Maximum sudden jump in operating voltage when operating current is varied slowly over specified range.

**Drift — Maximum operating voltage change during the period of operation.

***Repeatability — Maximum shift in operating voltage between successive firings of the tube.

RAYTHEON VOLTAGE REGULATOR AND REFERENCE TUBES

give you this complete range to choose from — each and every one a great performer

TYPE	MAX. DIMENSIONS INCHES		MIN. STARTING VOLTAGE SUPPLY	OPERATING VOLTAGE (Approx.)	MIN. OPERATING CURRENT MA.	MAX. OPERATING CURRENT MA.	MAX. REGULATION VOLTS
	HEIGHT	DIAM.					
OA2	2.63	.75	180	150	5.	30.	6
OB2	2.63	.75	127	108	5.	30.	3.5
CK1017	2.69	.75	750	700	0.005	0.055	15
CK1022	2.69	.75	1100	1000	0.005	0.055	20
CK1037	1.75	.40	730	700	0.005	0.100	15
CK1038	1.75	.40	930	900	0.005	0.055	15
CK1039	1.75	.40	1230	1200	0.005	0.100	25
CK5651*	2.13	.75	115	87	1.5	3.5	3
CK5651WA*	2.13	.75	115	84.5	1.5	3.5	2
CK5783*	1.63	.40	125	87	1.5	3.5	3
CK5783WA*	1.63	.40	125	86	1.5	3.5	3
CK5787	2.06	.40	135	100	5.	30.	6
CK5787WA	2.06	.40	135	100	5.	25.	4
CK5962	2.69	.75	730	700	0.002	0.055	15
CK6213	1.38	.40	200	130	1.0	2.5	2



*Voltage Reference Tube

RAYTHEON MANUFACTURING COMPANY

Receiving Tube Division — Home Office: 55 Chapel St., Newton 58, Mass.

For Application Information Call: Boston, Bigelow 4-7500 • Chicago, National 2-2770 • New York, Whitehall 3-4980 • Los Angeles, Richmond 7-4321

RAYTHEON MAKES ALL THESE:

RELIABLE SUBMINIATURE AND MINIATURE TUBES • SEMICONDUCTOR DIODES AND TRANSISTORS • NUCLEONIC TUBES • MICROWAVE TUBES • RECEIVING AND PICTURE TUBES

general corporate purposes.

Robertshaw-Fulton Controls arranged an additional loan of \$4 million for a total of \$11 million of 4.10-percent sinking fund notes due in 1969. Proceeds are to be used for working capital and other general corporate purposes.

Alpha Instrument of Washington, D. C. filed with SEC covering 200 shares of \$4 cumulative preferred stock, no par, to be offered at \$50 per share.

Market Swells for Aircraft Fuel Gages

Over 90 percent of military planes made since 1948 use one or more electronic gages

PRECISE capacitor-type electronic sensing units have replaced mechanical floats in practically all of the approximately 34,000 military aircraft made since January 1948, and in many of the civil transport and utility aircraft as well.

There is generally one gage per engine, selling at an average price of around \$750. Allowing for spares, replacement needs and overproduction, and estimating an average of 1.5 gages installed per plane, dollar volume of this electronic gage business to date is of the order of \$50 million.

► **Companies**—The four firms most active in the field are Avien-Knick-erbocker Corp., Minneapolis-Honeywell Regulator Co., Simmonds Aerocessories, Inc. and Liquidometer Corp. The design trend is toward smaller and lighter systems. A typical gage employs three subminiature tubes in a bridge amplifier that is combined with the indicator to give only one unit outside the fuel tanks.

► **Gage Control**—Newest use for the electronic gages is in controlling center of gravity of new supersonic-speed planes. Fuel tanks are located fore and aft in the fuselage rather than in the thinned-down wings. The gages switch back and forth between tanks automatically so as to use up fuel without changing the balance of the plane.

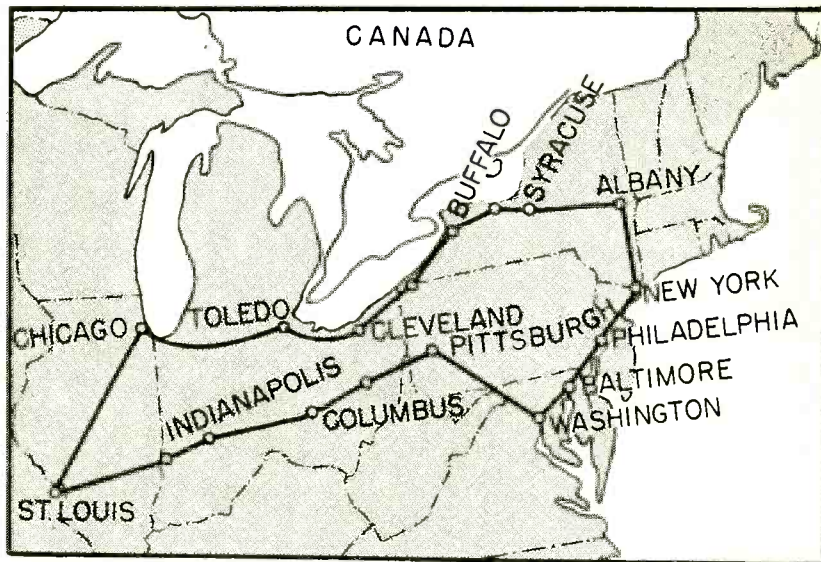

ROUND ROBIN radio relay girds northeastern U. S., while . . .

TV Relays Continue to Expand

Network tv facilities grow as AT&T plans new links and augments channel capacity

PROGRAM interchange between interconnected stations along a circular route encompassing New York, Washington, St. Louis and Chicago may become possible late this summer. The completed system will include four television channels.

Construction of the last two links in the 2,400-mile network loop was completed last month. Each of these links have five relay towers. The links extend from New York to Albany and from Buffalo to Cleveland.

► **Southwest**—Plans are also in the mill for a 1,000-mile television relay from northern Texas to California. First stage of the project, scheduled for late this summer, will be a 10-hop microwave system from Amarillo, Tex. to Albuquerque, N. M. Two westbound video channels will be available. A second section of the system will link Los Angeles and Baker, Calif. Its eastbound channel will furnish Las Vegas with network tv.

► **Community TV**—Microwave relay recently joined with house-to-house cable to bring television to Casper, Wyo. from Denver, Colo. 240 miles distant. The signals are picked up in Laramie, Wyo. and

beamed to Casper by AT&T microwave. Residents of Casper pay \$150 when connected to the system and \$7.50 a month thereafter.

► **Interconnections**—Recent additions of television stations to the nation-wide relay system include WCSC-TV, Charlestown, S. C., KOMU-TV, Columbia, Mo., and KWFT-TV and KFDX-TV, Wichita Falls, Tex. A 182-mile microwave relay link was built to provide Charlestown with network service from Atlanta.

Network programs now reach 268 tv stations in 167 cities.

Transistors, Cancer Spur Microscope Sales

INCREASING INTEREST in the fundamental structure of matter and expanded research in the field of cancer and virus diseases has made the electron microscope a more important tool in research.

The number of units in use has increased from 250 in 1950 to about 750. The present rate of sales is about 100 units a year, but as workers familiar with electron-microscope techniques move into other fields of research they are expected to expand its usefulness.

A drawback to more rapid expansion of the market is the problem of initial cost. With complete

(Continued on page 22)

A New Level in Engineering is Achieved in the Functional Design of Toroidal Decades*

This unique development permitting precision toroids to be combined in decade steps of inductance will appeal to all engineers who are familiar with the disadvantages of the ordinary type of inductance decade box.

All the decade units in the plug-in decade series are higher Q toroids such as are employed in the Burnell attenuation filters. They are guaranteed to a tolerance of 1% of the marked inductance and have extremely good stability of inductance vs. voltage and temperature.

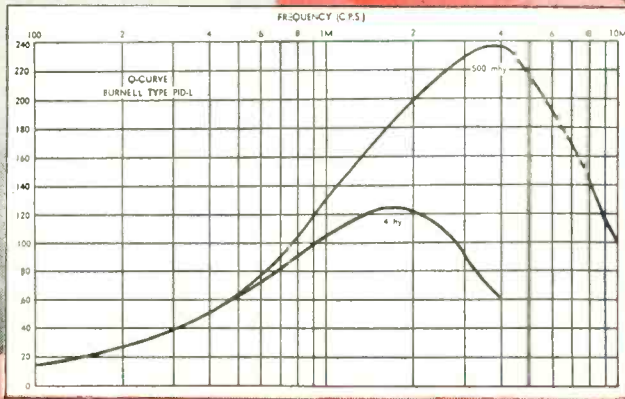
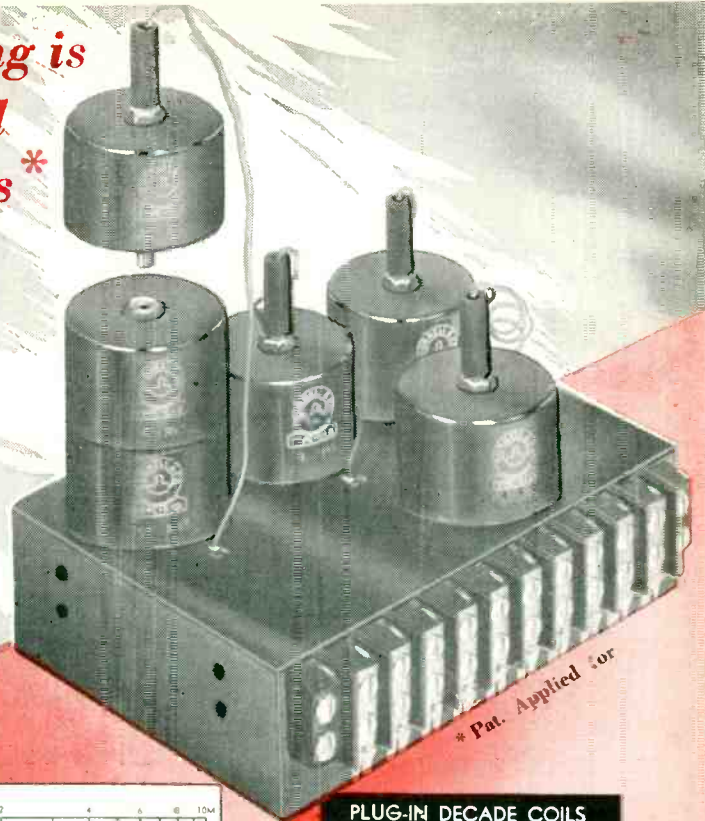

PLUG-IN DECADE COILS CAN ALSO BE DESIGNED WITH SPECIAL CHARACTERISTICS FOR SLIGHT EXTRA CHARGE. UNITS GENERALLY AVAILABLE FROM STOCK ARE AS FOLLOWS:

P.I.D. 1 (MHYS)*
P.I.D. 2 "
P.I.D. 3 "
P.I.D. 4 "
P.I.D. 8 "
P.I.D. 10 (MHYS)*
P.I.D. 20 "
P.I.D. 30 "
P.I.D. 40 "
P.I.D. 80 "
P.I.D. 100 MHYS
P.I.D. 200 "
P.I.D. 300 "
P.I.D. 400 "
P.I.D. 800 "
P.I.D. 1000 MHYS
P.I.D. 2000 "
P.I.D. 3000 "
P.I.D. 4000 "
P.I.D. 8000 "
P.I.D. 10000 MHYS
P.I.D. 20000 "
P.I.D. 30000 "
P.I.D. 40000 "
P.I.D. 80000 "

*Also available in P.I.D.-H Type for higher frequency range.

OTHER RECENT *Burnell* ACHIEVEMENTS IN TOROIDS AND FILTER NETWORKS

SIDE BAND FILTERS

Our most recent engineering development in communications filters has already stirred the interest of the leading receiver manufacturers in the country.

The new side band filters which eliminate, for most applications, the necessity for expensive crystal filters are expected to accelerate the advancement of single side band communications

MINIATURE TELEMETERING FILTERS

In recognizing the need for miniaturization of the presently bulky telemetering equipment, our engineering staff has succeeded in reducing the size of telemetering filters to as little as 25 to 50% of the original volume.

SUB MINIATURE TOROIDS

Toroids for intermediate frequencies of 100KC to 1 megacycle. A wide variety of coils ranging in size from 5/8 inch provides high Q in the frequency range between audio and RF.

The tiny toroid about the size of a dime has been welcomed by designers of sub miniature electronic equipment for the transistor, guided missile and printed circuit field.

Literature for all the above available on request

Write for new and enlarged 16 page catalog 102A
See us at the I R E show booth 678 Kingsbridge
Armory, N. Y. City, March 22-23-24-25,
Exclusive Manufacturers of Communications Network Components

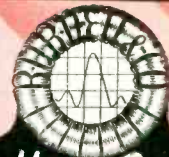

Burnell & Company
YONKERS 2, NEW YORK

CABLE ADDRESS "BURNELL"

units ranging from about \$8,000 to over \$18,000, small hospitals and schools are not able to buy.

► **Transistors**—In studies of the crystal structure of germanium, silicon and other transistor materials the electron microscope has become

an important tool. Crystal configurations can be determined by use of accessory x-ray diffraction equipment. This field of research has also increased the interest in field-emission microscope techniques and new models of this type are being developed.

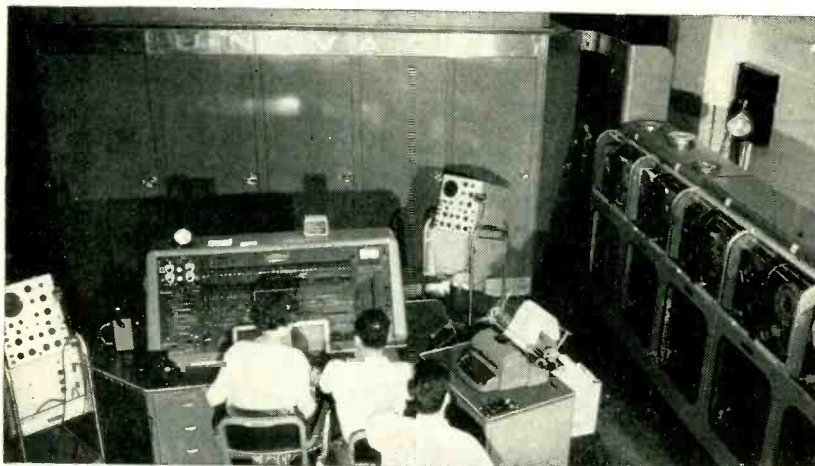

FACILITIES like these at NYU, for AEC contractors only, are available on rental basis so . . .

Computer Center Business Increases

Manufacturers, universities and government agencies have started computing services

OWNERSHIP of an electronic computer is not in the cards for many companies at present because the investment is too high, operating personnel are not easily available and many firms do not have enough work on hand to keep a computer steadily busy. Computer centers that can provide industry with a computer's services when it needs them have sprung up throughout the country and become an important market for computer manufacturers.

► **Centers**—A partial list of centers offering digital computing service indicates the growth that has already taken place:

New York University, Remington Rand, Raytheon, Northrop Aircraft, University of Wisconsin, Computer Research, Air Force, Army, Navy, National Bureau of Standards, Battelle Memorial Institute, Burroughs,

Financial Publishing, IBM, Purdue University, Benson-Lehner, University of Pennsylvania, Harvard University, Telecomputing Corp., Engineering Research Associates and Wayne University.

► **Markets**—Universities have become important customers for computer manufacturers. With more than 1,000 such institutions in the U.S., potential computer sales in this field have barely been uncovered.

Despite the general feeling that the majority of firms will be slow to acquire computers and that computer centers will carry the load, the multimillion dollar firms in the country are moving into the field. Latest firm to indicate that it is apparently preparing to use electronic computers is General Foods. It has appointed a director of electronic applications who will devote full time to a study of the application of electronics to accounting and record-keeping.

Computer manufacturers feel that as prices come down, sales to

smaller businesses will increase. A step in this direction was made recently when Consolidated Engineering announced an electronic digital computer, described as a general all-purpose tool for mathematical analysis, priced at \$125,000.

Tape Records Bid For Share In Disk Market

Growing use of magnetic tape records on a national scale may affect record business

THE PHONOGRAPH record industry enjoyed one of its best years in 1953 with an estimated sales volume of \$225 million. But competition is coming this year from the tape record field. The sale of magnetic tape records for the home market by companies with national distribution facilities is becoming an important factor.

Webster-Chicago has announced plans to sell a line of pre-recorded tapes ranging in price from \$8 for a 30 minute tape to \$12 for an hour recording. Classical, semiclassical and show tunes will be recorded.

► **Market**—Upwards of a million homes have tape machines and the market is growing. But it is not the only important market for pre-recorded tapes. In 1953 almost 90 percent of the radio shows on the air were recorded in advance largely on tape. In fact, full operation of a radio station for 24 hours was accomplished through the use of tape recordings last year. Tape is now used by many disk companies for recording masters and is seen as being responsible for the large increase in the number of disk companies now in the field. There are more than 200 record firms.

Tape recording radio network has been a reality for some time. Nearly 100 educational broadcasting stations from coast to coast belong to the tape network of the National Association of Educational Broadcasters. Upwards of 1,200 taped programs per week are made.

► **Future**—As yet, none of the major disk companies have moved

(Continued on page 24)

For Optimum Reception

UNDER ANY CONDITIONS —

THE HAMMARLUND SUPER PRO-600

COMMUNICATIONS RECEIVER

Used by

**MILITARY
GOVERNMENT
COMMERCIAL**

**AIRLINES
MARINE
AMATEUR**

If reception is at all possible, the Super Pro-600 will bring in the signal. This professional communications receiver has gained world-wide recognition as the finest performing receiver available anywhere, regardless of price.

The Super Pro is now available, with or without fixed frequency control, in the following models:

STANDARD MODEL—for 540 Kc to 54 Mc

COMPLETELY JANIZED MODEL—for 540 Kc to 54 Mc

DIVERSITY MODEL—for use in dual or triple diversity terminals—540 Kc to 54 Mc

LONG-WAVE MODEL—10 Kc to 540 Kc

With the optional fixed frequency controls available on all models, operation on any of six crystal controlled frequency channels within the range of the receiver is immediately available at the flip of a switch.

For specifications and construction details, write for Bulletin S55.

The HQ-140-X is a modern superheterodyne receiver made to Hammarlund quality standards that provides commercial and amateur radio operators and short-wave listeners with all the advantages of modern professional design and circuitry.

For specifications and construction details, write for Bulletin 552.

Visit our booth, No. 411, at the Radio Engineering Show in New York this month.



SP-600-JX

Stability is .001 to .01 percent depending on frequency to which receiver is tuned; image rejection is 80 db to 120 db down, and spurious responses are at least 100 db down. Sensitivity is 1 microvolt CW and 2 microvolts AM, while selectivity for the three calibrated crystal and three non-crystal ranges is from 200 cycles to 13 Kc. Radiation is negligible with no cross-talk in multi-receiver installations. The power supply is an integral part of the receiver chassis.



HQ-140-X

Frequency coverage is continuously tunable from 540 Kc to 31 Mc (555 to 9.7 meters) in six bands. Its high selectivity makes possible the reading of a desired signal even when the band is extremely congested.



HAMMARLUND

THE HAMMARLUND MANUFACTURING COMPANY, INC.

Main Plant and Offices: 460 W. 34th ST., N. Y. 1, N. Y.

Midwest Sales Office: 605 N. Michigan, Chicago 11, Ill. • Export Sales Office: 13 E. 40th St., N. Y.

into the tape record field but with their supplies of taped masters, they could do so quickly.

The smaller companies with tape records on the market foresee a bright future for themselves nevertheless. They point out that every business that now uses wired music is a potential customer for pre-recorded tapes.



Production Underway On Air Force UHF Set

PORTABLE uhf ground-to-air communications equipment weighing half that of presently used equipment but having greater range has been developed by the Air Force and is being produced by Air Associates, Teterboro, New Jersey.

It is worn as shown above. The antenna can be adjusted in length for various frequencies.

► **Design**—One feature of the set which results in a more compact unit is the elimination of accessory plug-in components, there are less parts to become misplaced and lost during combat. All parts are easily accessible for instant field repair. Four uhf channels are available.

Industry Shorts

► **Australian** radio telescope, said to be six times larger than the worlds biggest, with 1,500-ft long cross arms, is under construction.

► **Lightweight** black-and-white 17-inch tv set that weighs 55 pounds and retails for \$139.95 was introduced by Crosley who claims it

takes up a third less space and is a third lighter than most other 17-inch sets.

► **Transistors** are being used in motion-picture projectors made by Ampro Corp.

► **Denied** by FCC was manufacturers' petition for establishment of their own radio service in the Citizens Radio band; reason, total financial investment by present occupants may exceed \$2 million.

► **Belton** is one of six hearing

MEETINGS

MAR. 22-25: IRE National Convention, Waldorf-Astoria Hotel and Kingsbridge Armory, New York, N. Y.

APRIL 5-10: International Convention of Soundtrack Recording, Paris, France.

APRIL 15-16: RETMA Conference On Reliability of Electrical Connections, Illinois Institute of Technology, Chicago.

APRIL 12-14: International Symposium on Information Networks, IRE, ONR, AAF, Signal Corps sponsorship, Engineering Societies Bldg., New York, N. Y.

APRIL 19-20: Symposium on the Automatic Production of Electronic Equipment sponsored by Stanford Research Institute and U. S. Air Force, Fairmont Hotel, San Francisco.

APRIL 21-23, 1954: AIEE Conference On Feedback Control, Claridge Hotel, Atlantic City, N. J.

APRIL 24, 1954: Eighth Annual Spring Technical Conference, Cincinnati IRE, Cincinnati.

APRIL 27-29: AIEE Electronic Components Conference, Washington, D. C.

MAY 3-6: Spring Technical Meeting sponsored by URSI and IRE, National Bureau of Standards Bldg., Washington, D. C.

MAY 3-14: The British Industries Fair, London and Birmingham, England.

MAY 4-6: The 1954 Electronic Components Symposium, Department of Interior auditorium, Washington, D. C.

MAY 5-7: 1954: Third International Aviation Trade Show, 71st Regiment Armory, New York, N. Y.

MAY 5-7: IRE Seventh Region Conference & Electronic Exhibit, Multnomah Hotel, Portland, Oregon.

MAY 7-8: New England Radio Engineering Meeting, IRE, Sheraton Plaza Hotel, Boston, Mass.

MAY 10-12: The National Conference On Airborne Elec-

tronics, Dayton Biltmore Hotel, Dayton, Ohio.

MAY 17-20: 1954 Electronic Parts show, Conrad Hilton Hotel, Chicago, Ill.

MAY 24-26, 1954: IRE, IAS, ISA, AIEE Conference On Telemetering, Morrison Hotel, Chicago, Ill.

MAY 25-27: Eighth NARTB Broadcast Engineering Conference, Palmer House, Chicago, Ill.

JULY 16-18: High Vacuum Symposium, Committee On Vacuum Techniques, Berkeley Carteret Hotel, Asbury Park, N. J.

JULY 6-9, 1954: International Conference on Electron Microscopy, Joint Commission on Electron Microscopy of International Council of Scientific Unions, London, England.

JULY 8-12: British IRE 1954 Convention, Christ Church, Oxford, England.

AUG. 24-SEPT. 4: National Radio Show of Great Britain, Earls Court, London, England.

AUG. 25-27: 1954 Western Electronic Show & Convention, Los Angeles, Calif.

SEPT. 1-16: Golden Jubilee Meeting of the International Electrotechnical Commission, University of Pennsylvania, Philadelphia, Pa.

SEPT. 13-24: 1954: First International Instrument Congress And Exposition, Commercial Museum and Convention Hall, Philadelphia, Pa.

SEPT. 16-18: Joint Electron Tube Engineering Council, General Conference, Chalfonte-Haddon Hall, Atlantic City, N. J.

SEPT. 1954: International Scientific Radio Union, Amsterdam, Netherlands.

SEPT. 30-OCT. 2, 1954: Second Annual International Sight and Sound Exposition, Palmer House Hotel, Chicago, Ill.

OCT. 4-6: National Electronics Conference, Hotel Sherman, Chicago.

OCT. 18-20: Radio Fall Meeting, Hotel Syracuse, Syracuse, N. Y.

aid manufacturers that do approximately 85 percent of the business in the field.

► **First Investment Co.** of Los Angeles, acting for an unidentified purchaser, is understood to have asked for tenders of up to 115,000 shares of Weston Electrical Instrument stock at \$25 per share.

► **Federal Telephone** and Radio discontinued tv picture tube production to provide needed manufacturing area for increased output of power vacuum tubes.

THIS IS 13 SQUARE INCHES

13 SQ. IN. BIGGER PICTURE 3 IN. SHORTER CABINET WITH NEW WESTINGHOUSE 90° 21-INCH TUBE

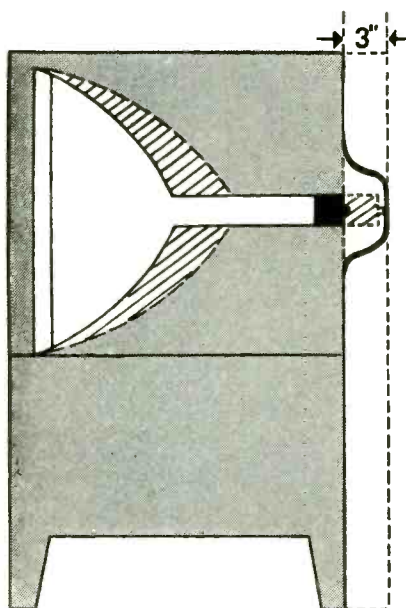

The new Westinghouse 90° deflection picture tubes give you a 5 percent larger picture than any other 21-inch tube — 13 square inches more actual picture area than that of the largest 70° tubes.

What's more, the overall length of the tube has been cut at least three inches. Here's the way to reduce TV cabinet depth — or to eliminate the "hat" from the back of the set.

But still more, the new Westinghouse 90° tubes will actually produce a sharper picture than old 70° types. Electrostatic types are equipped with the new Westinghouse electrostatic focus gun which produces sharp, clearly defined pictures because of its smaller spot size. Magnetic focus tubes contain the simply constructed magnetic focus gun which gives crisp pictures in all areas.

New Westinghouse aluminized screens are available, too.

Investigate these Westinghouse 90° deflection 21-inch tubes today. They will make your black-and-white sets sell faster in the months ahead. Call your Westinghouse sales representatives for complete data and sample tubes or write, wire or phone Dept. A-2034 at the address below.

21-INCH WESTINGHOUSE 90° DEFLECTION TUBES ARE AVAILABLE WITH:

- Electrostatic Focus
- Electromagnetic Focus
- Aluminized Screens
- Non-Aluminized Screens

ET-95044

YOU CAN BE SURE...IF IT'S
Westinghouse

RELIATRON® TUBES

WESTINGHOUSE ELECTRIC CORPORATION, ELECTRONIC TUBE DIVISION, ELMIRA, N. Y.

PHELPS DODGE UP-TO-DATE SIMPLIFIES YOUR MAGNET

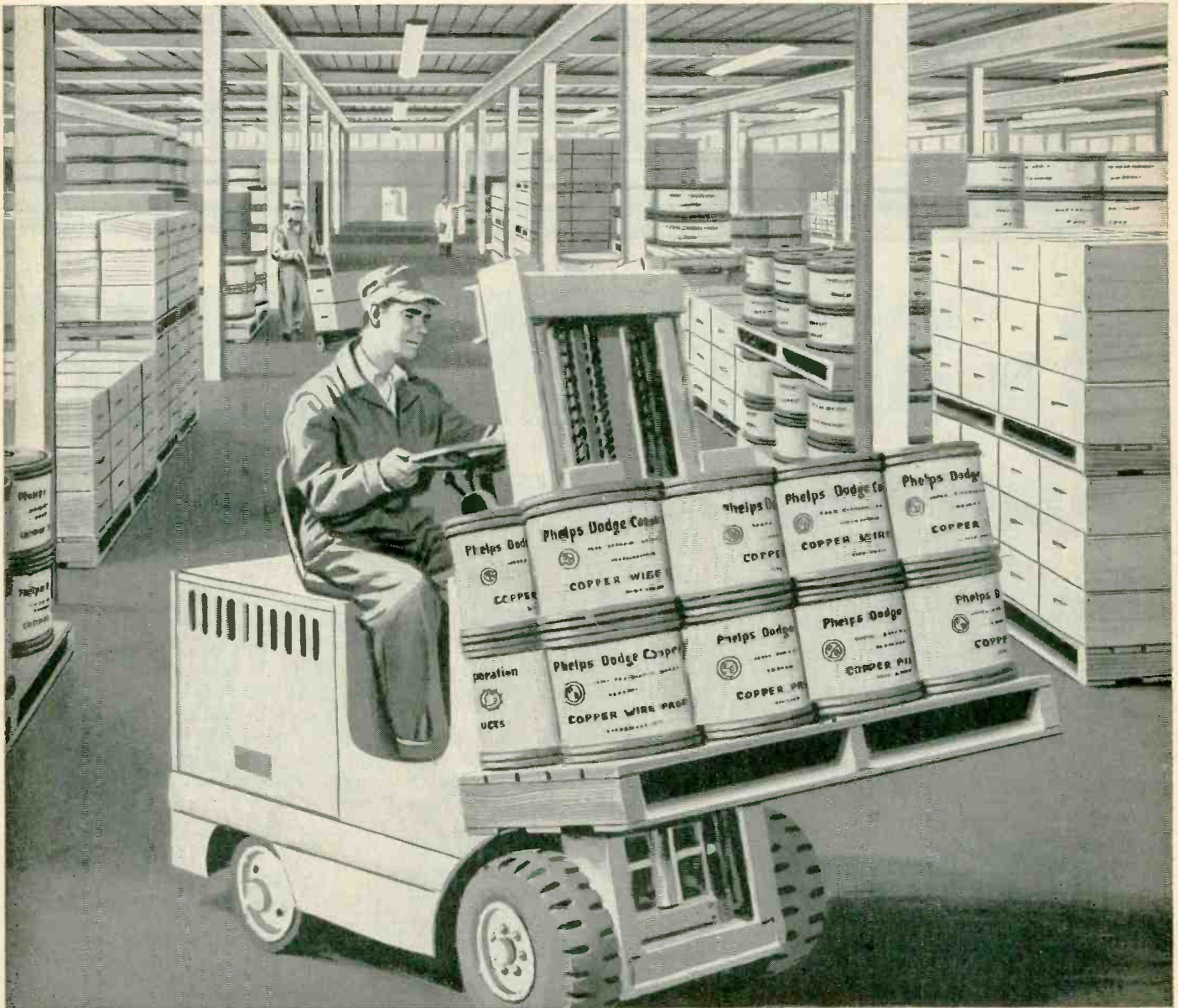

First for Lasting Quality—from Mine to Market!

WAREHOUSE SERVICE

WIRE INVENTORY PROBLEM

-  **COMPLETE WAREHOUSE STOCKS**
*strategically located on East Coast,
West Coast and in Central Region.*
-  **OVERNIGHT DELIVERY TO THE
MAJOR MARKETS**
-  **"ONE-PHONE-CALL" SERVICE**
*via nearest Phelps Dodge district
office. See list below:*

◆ ◆ ◆
Atlanta, Ga. • Boston, Mass. • Charlotte, N. C. • Chicago, Ill.
Cincinnati, Ohio • Cleveland, Ohio • Dallas, Texas • Detroit, Mich.
Fort Wayne, Ind. • Houston, Texas • Kansas City, Mo.
Los Angeles, Calif. • Milwaukee, Wis. • New Orleans, La.
New York, N. Y. • Philadelphia, Pa. • Pittsburgh, Pa. • Portland, Ore.
San Francisco, Calif. • Seattle, Wash. • St. Louis, Mo. • Washington, D. C.



**PHELPS DODGE COPPER PRODUCTS
CORPORATION**

INCA MANUFACTURING DIVISION

FORT WAYNE, INDIANA

10 μ V/CM - r. m. s. 1cps to 500Kc, 700 μ V-d.c.

A NEW MILESTONE IN OSCILLOGRAPH HISTORY

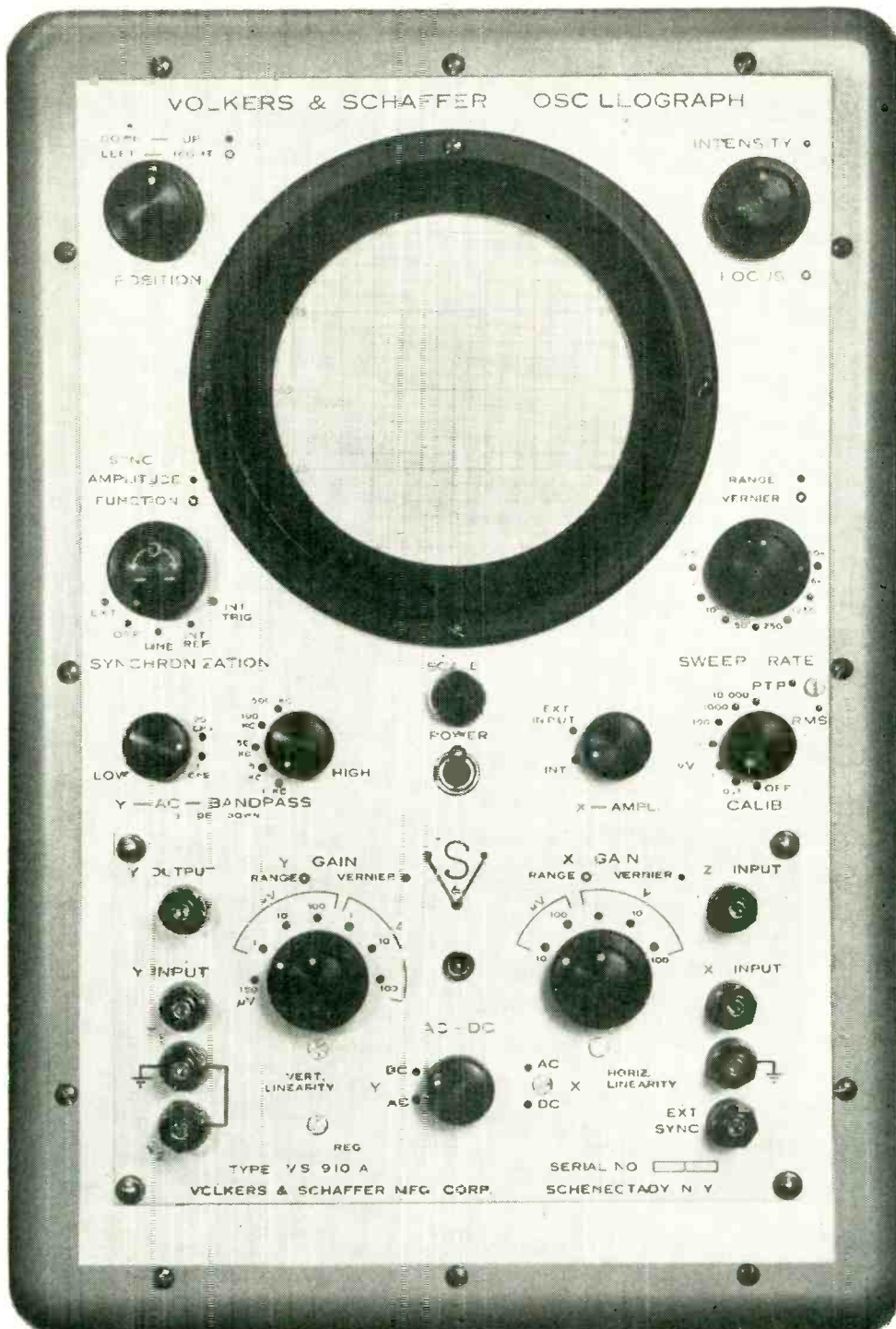

The astonishing performance of this new oscilloscope is based on the successful combination of 4 distinctive design-features: Heavy overall feedback (including d.c.),

DC-heated *electronically* regulated filaments, "the starved" amplifier circuit, originated by Dr. W. K. Volkert, and gas-diode coupling in a new circuit.

See it at IRE, New York, Booth 340, Computer Avenue, or write to: Volkert & Schaffer Manufacturing Corp., Box 996, Schenectady, New York.

VOLKERS & SCHAFFER

ORIGINATORS, DESIGNERS AND PATENT HOLDERS OF THE HIGH-GAIN "STARVED DIRECT-COUPLED AMPLIFIER"

Whether your requirement is

ONE TOROID or A MILLION...

C-A-C's advance design and production techniques maintain quality and delivery "on schedule".



In the past, CAC has been honored with large and small orders—in some cases, with orders as large as a million! The trust which is indicated by the placement of large orders is a result of CAC's continued improvement of design and production procedures.

Whether your requirement is small, medium or large, you can depend upon CAC for prompt, accurate service and high quality.

MOLDED TOROIDS STOCKED FOR IMMEDIATE DELIVERY

Our new molded toroids — as well as standard uncased units are stocked in standard inductances, ready for immediate delivery to you.

You can depend upon C-A-C for high quality accuracy and immediate service.



C-A-C has a complete line of hermetically sealed cased toroids complying with MIL-T-27 and designed to use minimum chassis area. All standard types of inductors are available and may be supplied with taps and multiple windings.



C-A-C uncased coils are adjusted to your specifications. Vacuum wax impregnation, multiple windings and taps can be supplied to meet your requirements. Special winding techniques result in lowest possible distributed capacity.



Custom miniaturization of filters is achieved through use of miniaturized components and advanced designed techniques. MIL-T-27 construction.



Saturable reactors and magnetic amplifiers produced to your specifications. Toroidal construction used exclusively for maximum performance and dependability.

COMMUNICATION ACCESSORIES *Company* HICKMAN MILLS, MISSOURI

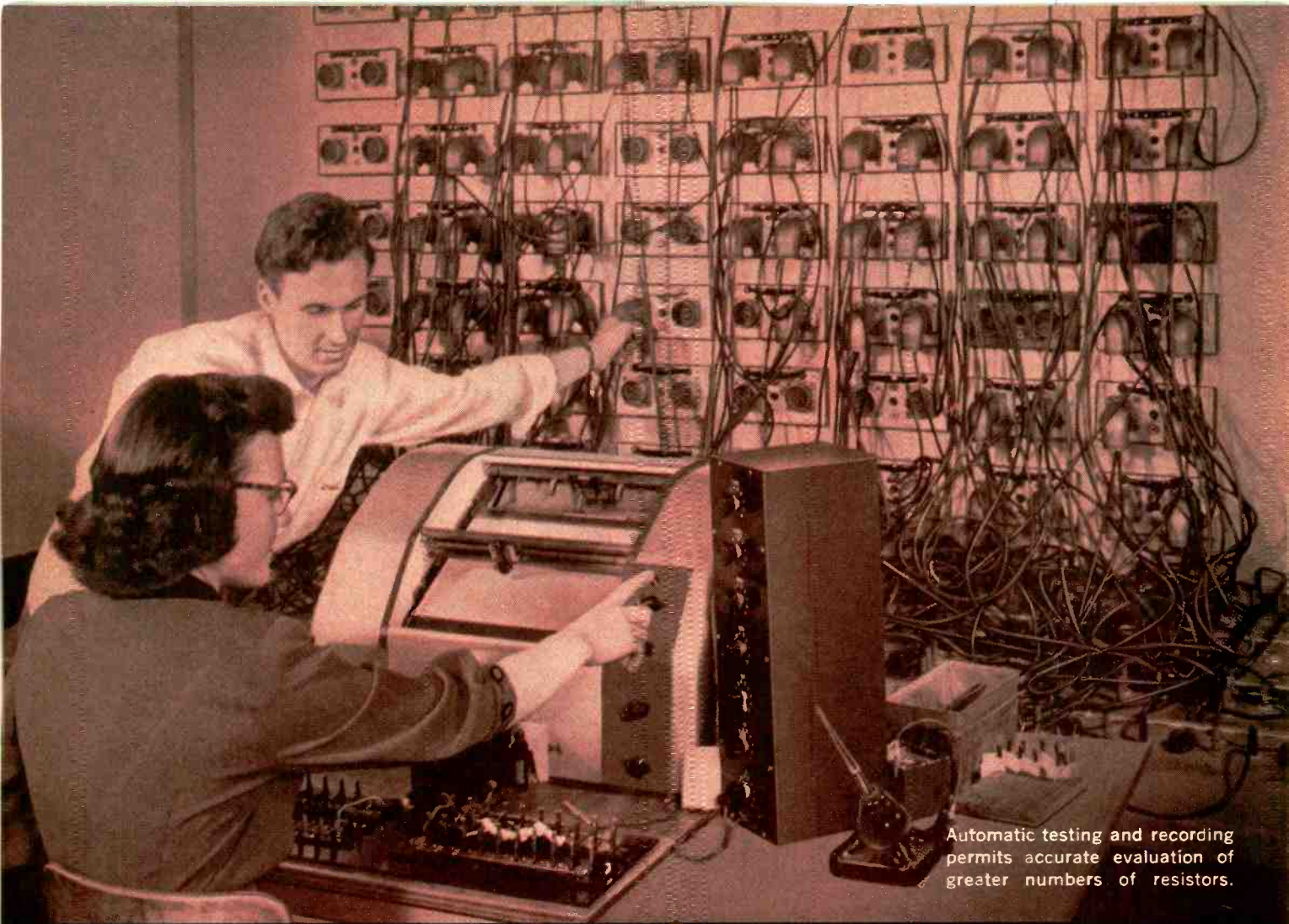

Automatic testing and recording permits accurate evaluation of greater numbers of resistors.

ONLY IRC MAKES SO MANY JAN AND

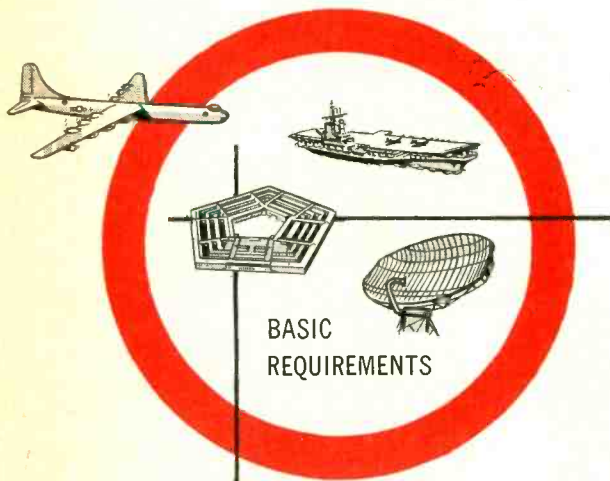

BASIC
REQUIREMENTS

JAN and MIL Specifications are basic guideposts for electronic advancement, whether used as engineering reference points or as procurement standards. IRC's dual emphasis on mass production and frequent, accurate performance testing assures you of the highest performance standards at the lowest possible cost.

56 different IRC resistors is today's figure— all equivalent to JAN or MIL specifications. And all are standard units, available on excellent delivery cycle! If you manufacture end-equipment for the armed forces and must meet these specifications, or if you apply them as standards to your own requirements, depend on IRC for everything you need. For, manufacturing the widest line of resistors in the industry—127 different types in all—IRC is logically your best source of JAN and MIL type units.

SEE IRC'S NEWEST RESISTORS

553 & 555 COMPONENTS AVE.

Radio Engineering Show, Kingsbridge Armory, N.Y.C., March 22-25

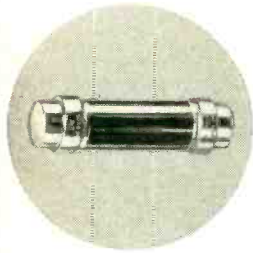

JAN-R-29 specification

For all requirements of JAN-R-29 Specification, Amendment 4, IRC sealed precision Voltmeter Multipliers function efficiently even when exposed to the most severe humidity. Used with 1-milliampere DC instruments, they enable voltage measurements to be made up to 6000 volts. Send for Bulletin.

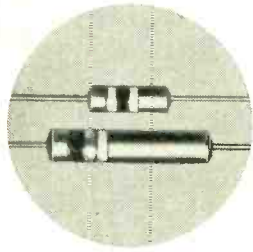

JAN-R-184 specification

Unusually stable and inexpensive, IRC BW Wire Wounds meet JAN-R-184 Specification, Amendment 5, at 1/2 and 1 watt. Resistance element is uniformly and tightly wound on insulated core. Molded housing provides full insulation. Widely used in meters, analyzers, high stability attenuators, low-power ignition circuits, etc. Send for Bulletin.

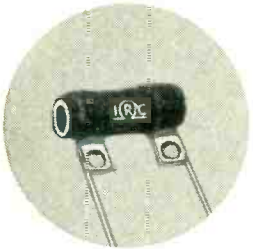

MIL-R-26B specification

For high power dissipation, IRC Power Wire Wounds meet every commercial requirement of MIL-R-26B Specification, Characteristic G. Tubular, flat, fixed, adjustable, inductive, non-inductive, lead, lug and ferrule types provide resistors for virtually any circuit. From 5 to 225 watts. Send for Bulletin.

MIL TYPE RESISTORS

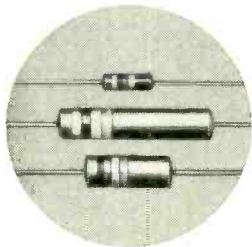

MIL-R-11A specification

IRC Advanced BT Resistors meet and beat MIL-R-11A Specification, Amendment 2. Filament-type resistance element and other exclusive features afford extremely low operating temperature and superior power dissipation in a compact, light, fully insulated unit. Available at 1/4, 1/2 and 1 watt to MIL specification and 2 watts to commercial specification. Send for Bulletin.

NEW product



HERMETIC sealing terminal



Overcomes limitations of other types of hermetic sealing terminals.



Molded KEL-F* body—chemically inert to organic solvents, acids, oils, fumes.



Rugged construction—tough and resilient; withstands constant vibration.

Type HS-1 Feed-Thru Terminals, provide assured hermetic sealing for electrical and electronic components. Exclusive IRC molding Technique bonds Kel-F* to metal in a superior seal. Designed to the sealing requirements of MIL-T-27. Send coupon for full data

*Trademark—M. W. KELLOGG CO.

Boron & Deposited Carbon Precision Resistors • Power Resistors • Voltmeter Multipliers • Low Wattage Wire Wounds • Insulated Composition Resistors • Volume Controls •

Wherever the Circuit Says

Precision Wire Wounds • Ultra HF and Hi-Voltage Resistors • Selenium Rectifiers • Insulated Chokes • Hermetic Sealing Terminals •



INTERNATIONAL RESISTANCE CO. 403 N. Broad St., Philadelphia 8, Pa.

In Canada: International Resistance Co., Ltd., Toronto, Licensee

Send me data on MF Voltmeter Multipliers, BW Resistors, Power Wire Wounds, Advanced BT Resistors, HS-1 Terminals.

Name _____

Title _____

Company _____

Address _____

City _____ Zone _____ State _____

there are 4 points to a triangle...

4

THE POINT OF APPLICATION

determines the type of loudspeaker best capable of providing optimum performance at lowest possible cost. There are over 50 different University models to choose from... each designed to serve most efficiently and economically in its intended application.

- Radial type projectors and paging speakers with 360° dispersion for maximum coverage at lowest cost and ease of installation.
- Reflex trumpets in various sizes for incomparable efficiency, distance, and noise penetration.
- Wide-angle and bi-directional types, marine and submergence models for heavy industry.
- Paging and "talk-back" speakers in numerous sizes, power and frequency characteristics and mounting arrangements.
- "Explosion-proof", blastproof, and even super-power types from 100 to 720 watts capacity.
- High fidelity, full-frequency response types for indoor and outdoor use.

University Loudspeakers are application-engineered to assure customer satisfaction, avoid waste of amplifier power and speaker capacity and reduce initial equipment and installation costs. University helps you to sell more sound jobs... make more profit you can pocket. **Why spend more for more than you need—CHECK UNIVERSITY FIRST!**



FREE—new 1953 copy of the University Technilog • Complete up-to-date manual of sound theory, application and installation requirements • SEND for your copy today.



UNIVERSITY LOUDSPEAKERS • INC.
80 SOUTH KENSICO AVENUE, WHITE PLAINS, N. Y.



Typical characteristics of some of the units in current volume production by Ketay

TWO PHASE SERVO MOTORS

TYPE	FRAME SIZE	MK	MOD	MIN. TORQUE AT STALL (IN OZ.)	NO. LOAD SPEED (MIN.)	POWER PHASE AT STALL (WATTS)	NO. OF POLES	OPERATING FREQUENCY	RATED VOLTAGE EXCITATION	
									FIXED PHASE	CONTROL PHASE PARALLEL
K402350	10			.13	9600	1.5	4	400	18/18	
K402400	10			.13	9600	1.5	4	400	18/18	
K402390	10			.3	6200	2.7	6	400	26/26	
K402300	11	14	2	.63	6200	3.5	6	400	115	57.5
K402310	11			.35	6200		6	400	50/26	
K402290	11			.45	6200	3.5	6	400	115	57.5
K402380	15			1.45	3200	5.0	2	60	115	57.5
K402470	15			1.3	1600		4	60	24/24	
K101600-6	15	7	0	1.45	4800		8	400	115	57.5
K101650-5	15	7	2	1.45	4800	6.1	8	400	115	230 115
K101660	15	7	1	1.45	4800	6.1	8	400	115	115 57.5
K402410	15			.28	4800	6.1	8	400	40/50	
K402420	15			.28	4800		8	400	26/50	
K402430	15			.28	4800		8	400	50/26	
K402440	15			.28	4800		8	400	42/42	
K402150	15			1.3	6200	6.1	6	400	115/26	
K402550-1	18	8	0	2.35	4800	9.2	8	400	115	115 57.5
K402550-2	18	8	1	2.35	4800	9.2	8	400	115	115 57.5
K402560	18	8	2	2.35	4800	9.2	8	400	115	282 141
(1) I13E1Y	23			7.5	3500	14.0	2	60	115	115 57.5

(1) Also for 115 or 230 operation on control phase
*Denominator refers to control phase excitation.

SYNCHRO CONTROL TRANSFORMERS

TYPE	FRAME SIZE	MK	MOD	VOLTAGE RATING	OPERATING FREQUENCY	ELECTRICAL ACCURACY MAX. ERROR
(1) K101530	10			26/11.8 VAC	400	24' SPD.
K101560	10			26/11.8 VAC	400	30' SPD.
I1CT4a	11	24	1	90/1V per deg	400	±7'
K101300	15			(3) 11.8/22 VAC	400	20' SPD
(2) K402100				10 Volt Input	400	
K101750	15			11.8/22 VAC	400	15' SPD.
15CT4a	15	14	1	90/1V per deg	400	±10'
K101800	15			(3) 11.8/22 VAC	400	20' SPD.
16CT8a	16	21	1	90/1V per deg	400	±10'
18CT4a	18	15	1	90/1V per deg	400	±8'
18CT6a	18	25	0	90/1V per deg	60	±8'
19CT8a	19	22	1	90/1V per deg	400	±8'
19CT86a	19	27	0	90/1V per deg	60	±8'
IHCT				90/1V per deg	60	±18'
23CT4	23			90/1V per deg	400	±6'
23CT6	23			90/1V per deg	60	±6'

(1) High Impedance unit
(2) Linear synchro
(3) When used as control transmitter 26/11.8 VAC

SYNCHRO RECEIVERS

TYPE	FRAME SIZE	FUNCTION	MK	MOD	VOLTAGE RATING	OPERATING FREQUENCY	RECEIVER ERROR MAXIMUM
K101540	10	Torque Receiver			26/11.8 VAC	400	1.5°
K402020	15	Torque Receiver			115/18.2 VAC	400	.75°
K101430	15	Torque Receiver			26/11.8 VAC	400	.75°
15TR4A	15	Torque Receiver	16	1	115/90 VAC	400	1.0°
16TR8A	16	Torque Receiver			115/90 VAC	400	1.0°
18TR4A	18	Torque Receiver	15	1	115/90 VAC	400	1.0°
19TR8A	19	Torque Receiver			115/90 VAC	400	1.0°
1F	1	Torque Receiver	8	8	115/90 VAC	60	1.5°
23TR4	23	Torque Receiver			115/90 VAC	400	1.0°
23TR6	23	Torque Receiver			115/90 VAC	60	1.0°
31TDR4	31	Torque Differential Rec.	19	1	90/90 VAC	400	48'
31TDR6S-1	31	Torque Differential Rec.			90/90 VAC	60	*(1)
31TDR6	31	Torque Differential Rec.			90/90 VAC	60	48'
31TR4A	31	Torque Receiver	18	1	115/90 VAC	400	48'
31TR6	31	Torque Receiver	22	0	115/90 VAC	60	48'

*(1) 31TDR6S1—Pigtail Unit, Sensitivity 10'

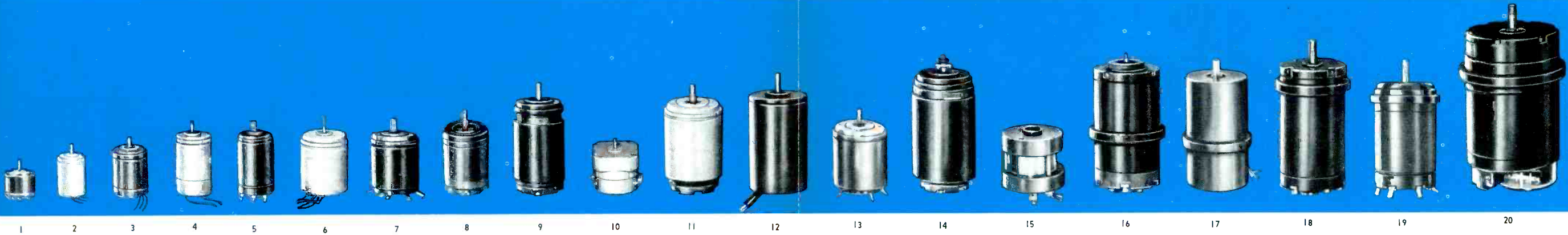

SYNCHRO RESOLVERS

TYPE	FRAME SIZE	TOTAL NULL VOLTAGE MAX. AT TEST VOLTAGE	TEST VOLTAGE	INPUT IMPEDANCE Ohms	VOLTAGE RATING	ANGULAR DISTANCE BETWEEN NULL VOLTAGE	MAXIMUM ANGULAR ACCURACY	OPERATING FREQUENCY
K101580	10	200 MV	26/12	600	26/11.8 VAC	90° ± 5'	30'	400
(1) K101590	10	200 MV	26/12	2500	26/11.8 VAC	90° ± 5'	30'	400
101D2A	11	60 MV	26	1400/70°	26/22 VAC	90° ± 30'	±10'	400
101D2C	11	60 MV	26	440/76°	26/11.8 VAC	90° ± 15'	±10'	400
D13640	11	30 MV	26	1510/71°	26/22 VAC	90° ± 30'	±10'	400
D13800	15	75 MV	50	2740/83°	50/50 VAC		±3%	500
(2) 105D2A	15	30 MV	30	2730/80.5°	10/10 VAC	90° ± 5'	±1.1%	400
105D2Z	15	40 MV	26	900	26/26 VAC	90° ± 20'	±1.2%	400
(2) D13610	15	30 MV	24	(4)	(4)	90° ± 5'	±.2%	1000 (Test)
D11960	15	25 MV	26	585/81°	26/11.8 VAC	90° ± 5'	20' Spd	400
K101450	15	200 MV		{1970/75° 274/28°	26/18	Single phase	40'	400
D13310	15	30 MV	26	740/80°	26/26 VAC	90° ± 5'	±10%	400
(2) D13820	15	15 MV	15	889/78°	26/26 VAC	90° ± 5'	±10%	400
K101340	15	200 MV	26/12	440/75°	26/11.6 VAC	90° ± 5'	20' Spd	400
(2) D13320	23	30 MV	24	(4)	(4)	90° ± 5'	±.2%	1000 (Test)
D13600	23 (3)	50 MV	50	7000	50/50 VAC	90° ± 30'	±5'	500
D13650	23	30 MV	30	3200/85.7°	30/30 VAC	90° ± 5'	±.15%	350
D13350	23	10 MV	8	975/86.4°	8/16 VAC	90° ± 5'	±8'	400
D13810	23	30 MV	30	3200/85.7°	30/30 VAC	90° ± 5'	±.15%	350
23RS6B	23	15 MV	26	1000	26/26 VAC	90° ± 2.5	±.1%	60
23RS6S	23	30 MV	24	480/78°	24/24 VAC	90° ± 5'	±.2%	60
D13440	23	30 MV	90	2700/73.8°	90/90 VAC	90° ± 5'	±.1%	400
23RS6	23	60 MV	60	585/61°	90/90 VAC	90° ± 5'	±.2%	60
23RS6A	23	30 MV	24	570/79°	45/45 VAC	90° ± 5'	±.2%	60
23RS4	23	60 MV	60	720/80°	90/90 VAC	90° ± 5'	±.2%	400
23RS4A	23	60 MV	60	234/83°	90/90 VAC	90° ± 5'	±.2%	400
23RS4B	23	20 MV	26	550/86°	26/26 VAC	90° ± 5'	±.10%	400
23RS4C	23	30 MV	60	3200/86°	90/90 VAC	90° ± 5'	±.10%	400
(2) 23RS4D	23	30 MV	60	3200/86°	90/90 VAC	90° ± 5'	±.10%	400

(1) High impedance unit
(2) Feedback Resolver
(3) Geared housing
(4) For these Sweep Resolvers input impedance is not considered. Instead, inductance at 1000 c.p.s. is important.

Inductance at 1000 c.p.s.		
	D13320	D13610
Rotor winding	17.7 Mh	27 Mh
Main Stator winding	16.2 Mh	24.6 Mh
Feedback Stator winding	16.2 Mh	24.6 Mh

INDUCTION MOTORS

TYPE	FRAME SIZE	DUTY	OPERATING VOLTAGE	FREQUENCY	MINIMUM NO. LOAD SPEED (RPM)	MINIMUM STALL TORQUE (OZ. IN.)
D11940	18	Continuous	3 Phase 115 V	60	3000	3
E11590	20	Intermittent	2 Phase 115/40	60		.75 at 115 MF BY CF
E11600	1	Intermittent	3 Phase 115 V	60	3200	16

- (1) SERVO MOTOR, Size 10 Frame, O.D. .937"
- (2) SYNCHRO, Size 10 Frame, O.D. .937" (Transmitter, Receiver, Resolver, Differential Transmitter, Control Transformer)
- (3) SERVO MOTOR, Size 10 Frame, O.D. .937"
- (4) SYNCHRO, Size 11 Frame, O.D. 1.062" (Transmitter, Resolver, Control Transformer)
- (5) SERVO MOTOR Mk 14, Size 11 Frame, O.D. 1.062"
- (6) SYNCHRO, Size 15 Frame, O.D. 1.437" (Transmitter, Receiver, Resolver, Differential Transmitter, Control Transformer)
- (7) SERVO MOTOR Mk 7, Size 15 Frame, O.D. 1.437"
- (8) SYNCHRO, Size 15 Frame, O.D. 1.437" (Transmitter, Receiver, Resolver, Differential Transmitter, Control Transformer)
- (9) SYNCHRO, Size 16 Frame, O.D. 1.537" (Transmitter, Receiver, Control Transformer)
- (10) LINEAR TYPE CONTROL TRANSFORMER, O.D. 1.625"
- (11) SYNCHRO, Size 18 Frame, O.D. 1.750" (Transmitter, Receiver, Differential Transmitter, Control Transformer)
- (12) INDUCTION MOTOR, Size 18 Frame, O.D. 1.750", 3 Phase, 2 Pole
- (13) SERVO MOTOR Mk 8, Size 18 Frame, O.D. 1.75"
- (14) SYNCHRO, Size 19 Frame, O.D. 1.90" (Transmitter, Receiver, Control Transformer)
- (15) INDUCTION MOTOR, Size 20 Frame, O.D. 1.95"
- (16) SYNCHRO, Type 1F, IHCT, or IHG, Size 1 Frame, O.D. 2.250" (Receiver, Transmitter, Control Transformer)
- (17) INDUCTION MOTOR, Size 1 Frame, O.D. 2.250"
- (18) SYNCHRO, Size 23 Frame, O.D. 2.250" (Transmitter, Receiver, Resolver, Differential Transmitter, Control Transformer)
- (19) SERVO MOTOR, Size 23 Frame, O.D. 2.250"
- (20) SYNCHRO, Size 31 Frame, O.D. 3.10" (Transmitter, Receiver, Differential Receiver, Differential Transmitter)

SYNCHRO TRANSMITTERS

TYPE	FRAME SIZE	FUNCTION	MK	MOD	VOLTAGE RATING	OPERATING FREQUENCY	ELECTRICAL ACCURACY MAX. ERROR
K101500	10	Control Transmitter			26/11.8 VAC	400	24' Spd
K101550	10	Control Transmitter			26/11.8 VAC	400	24' Spd
K101570	10	Control Differential Trans.			11.8/11.8 VAC	400	30' Spd
I01B2J	10	Control Transmitter			26/11.8 VAC	400	20 Spd
I1CX4a	11	Control Transmitter			115/90 VAC	400	±7'
K101350	15	Control Differential Trans.			11.8/11.8 VAC	400	20' Spd
K101400	15	Control Transmitter			26/11.8 VAC	400	20' Spd
K101420	15	Control Transmitter			26/11.8 VAC	400	20' Spd
K101480	15	Control Differential Trans.			11.8/11.8 VAC	400	20' Spd
15TDX4a	15	Torque Differential Trans.	28	1	90/90 VAC	400	±10'
15CDX4a	15	Control Differential Trans.	33	1	90/90 VAC	400	±10'
15CX4a	15	Control Transmitter	22	1	115/90 VAC	400	±12'
K101820	15	Control Differential Trans.			11.8/11.8 VAC	400	20' Spd
16 CX84a	16	Control Transmitter		1	115/90 VAC	400	±12'
18CDX4a	18	Control Differential Trans.	34	1	90/90 VAC	400	±8'
18TDX4a	18	Torque Differential Trans.	29	1	90/90 VAC	400	±10'
18CX4a	18	Control Transmitter	32	1	115/90 VAC	400	±8'
18CX6a	18	Control Transmitter	46	0	115/90 VAC	60	±10'
18CDX6	18	Control Differential Trans.			90/90 VAC	60	±10'
19CX84a	19	Control Transmitter	38	1	115/90 VAC	400	±8'
IHG	1	Torque Transmitter	14	8	115/90 VAC	60	±18'
23CX4	23	Control Transmitter			115/90 VAC	400	±8'
23CX6	23	Control Transmitter			115/90 VAC	60	±8'
23CDX4	23	Control Differential Trans.			90/90 VAC	400	±8'
23CDX6	23	Control Differential Trans.			90/90 VAC	60	±8'
23TX4	23	Torque Transmitter			115/90 VAC	400	±8'
23TX6	23	Torque Transmitter			115/90 VAC	60	±8'
23TDX4	23	Torque Differential Trans.			90/90 VAC	400	±8'
23TDX6	23	Torque Differential Trans.			90/90 VAC	60	±8'
31TDX4	31	Torque Differential Trans.	36	0	90/90 VAC	400	±8'
31TDX6	31	Torque Differential Trans.			90/90 VAC	60	±8'
31TX4a	31	Torque Transmitter	35	1	115/90 VAC	400	±8'
31TX6	31	Torque Transmitter	42	0	115/90 VAC	60	±8'

Ketay Manufacturing Corporation
555 Broadway • New York 12, N. Y.

Write for Additional Copies for Your Catalog Files

EXPERIENCE + RESEARCH + PERFORMANCE

LEADERSHIP in



Servo Motor the size of a Penny

**SYNCHROS
SERVO MOTORS
RESOLVERS**

Ketay

**PRODUCES THE
COMPLETE RANGE
OF SIZES AND TYPES
TABULATED ON THE
FOLLOWING PAGES...**

Skilled technicians performing one of dozens of tests on size 23 Synchros. As design agent for Army Ordnance, Ketay designed all Synchros of this size.

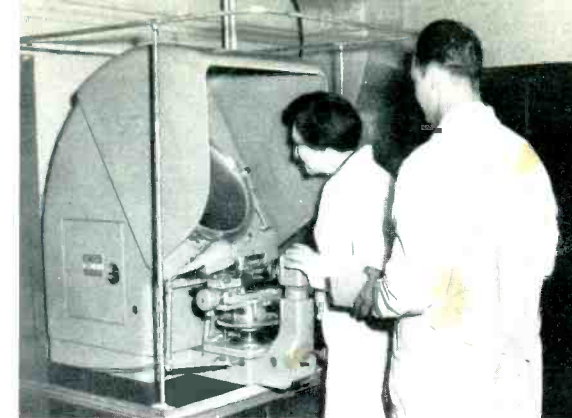
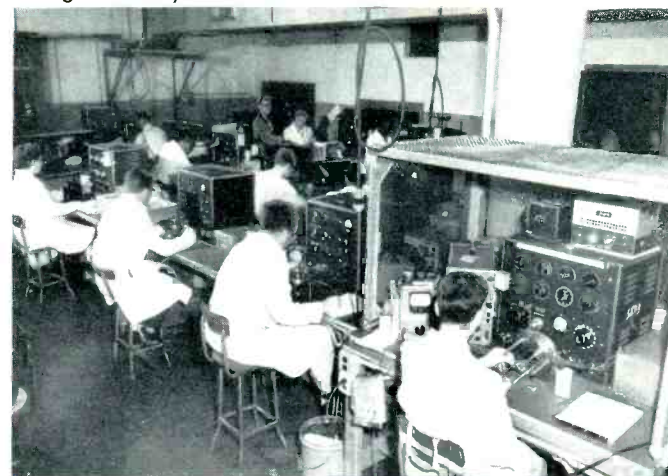

Jones and Lamson optical comparator... one of hundreds of different methods (many of them original developments) used to insure precision.

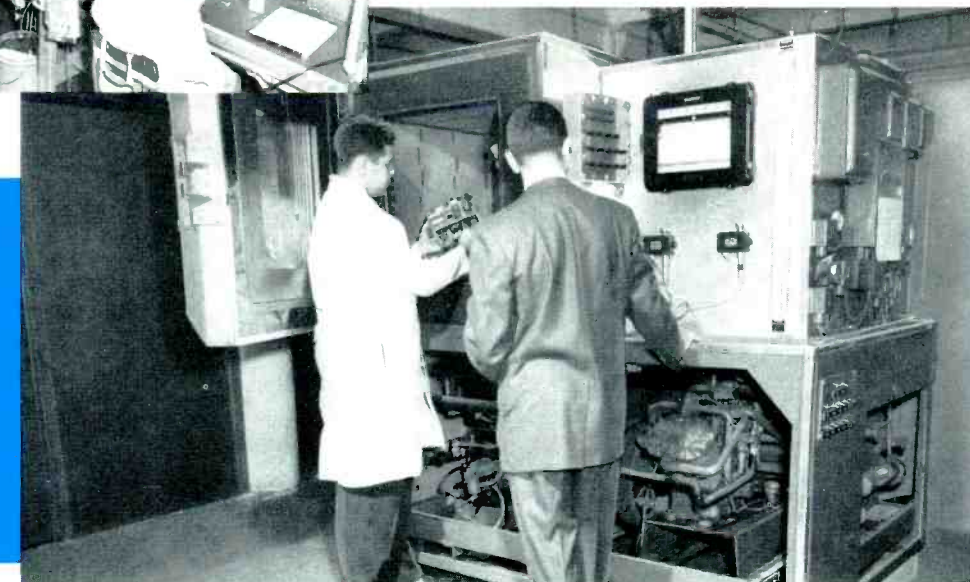

Environmental test chamber can simulate altitudes up to 90,000 feet; produce temperatures to minus 100°F and controlled humidity to 98%. This chamber performs all environmental tests in accordance with MIL-E-5272.

EXPERIENCE + RESEARCH + PERFORMANCE = LEADERSHIP

The final test of leadership is the ability to deliver. Ketay offers:

- Original research to meet highly specialized requirements and rigorous operating conditions;
- Application of this research to the economical manufacture of high quality products;
- Volume production to comply with stringent delivery schedules.

By providing a complete range of sizes and types... originality of design... facilities for volume produc-

tion... Ketay has established this kind of leadership.

Ketay's experience also includes: gyro components; automatic control devices for fire control and missile systems; computers and simulators; magnetic, resolver and synchro amplifiers; marine inter-communication equipment; ship's course, salinity and other remote indicators; and automatic control systems.

The Research and Development Division is staffed and equipped to participate in advanced studies during the design stage of applications involving Ketay electro-mechanical devices.

**SYNCHROS
SERVO MOTORS
RESOLVERS
MAGNETIC AMPLIFIERS
AUTOMATIC CONTROL SYSTEMS**

Ketay
MANUFACTURING CORPORATION

**Booth 629-631—I.R.E. Show
Kingsbridge Armory
New York City, March 22-25**

Executive Offices 555 Broadway, New York 12, N. Y.
Pacific Division, 12833 Simms Avenue, Hawthorne, California
New York Division • Kinetix Instrument Division • Pacific Division
Electronic Instrument Division • Research & Development Division

For further information or additional copies of this catalog sheet write directly to Ketay

23
*2) 23R
(1)
(2)
(3) Ge...

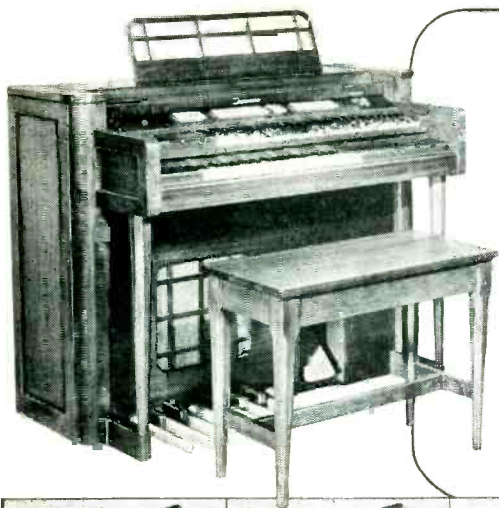

ORGA-SONIC ORGAN

by

BALDWIN

Equipped with Allen-Bradley Resistors
Fixed and Adjustable

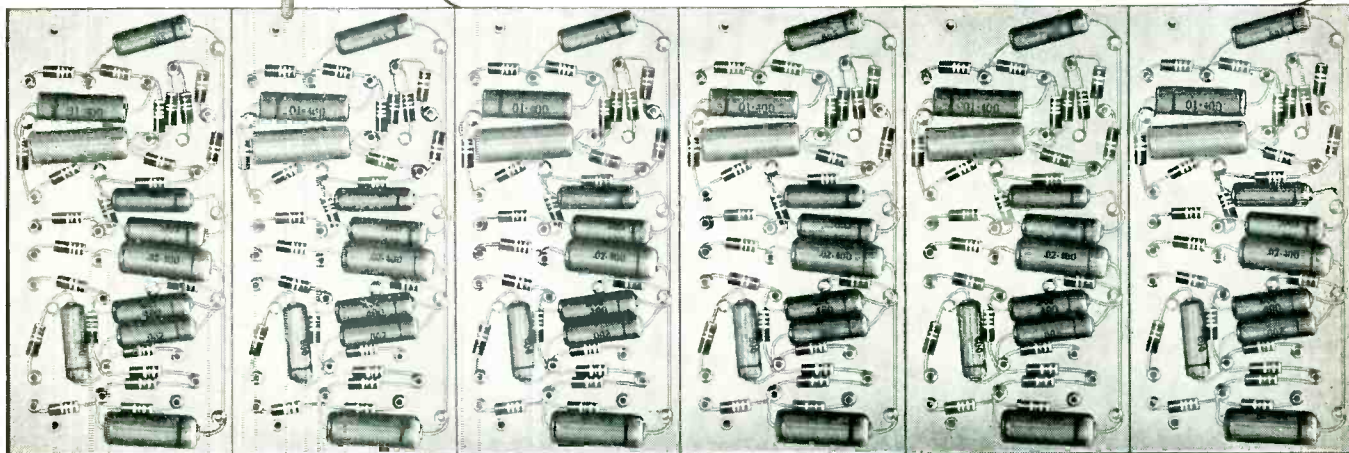

Baldwin Orga-sonic sound generating panels showing Bradleyunit resistors.



The remarkable Baldwin spinet-type organ reproduces the plaintive wood winds, the resounding horns, and the singing strings as faithfully as the mightiest organ. Even though the Orga-sonic organ is compact in form and size, its mellow tones can swell to orchestral dimensions . . . a Baldwin achievement in electronic engineering.

Bradleyunits and Bradleyometers are used extensively in Orga-sonic circuits. Shown above are the Baldwin "sound generating panels" for producing tone frequencies. The Orga-sonic also has four "tone color boards" equipped with Bradleyometers. The high quality and stability of these Allen-Bradley fixed and adjustable resistors are vital to the consistent performance of the organ. Deviations in resistor characteristics would disturb the pitch . . . a condition not tolerated in fine musical instruments.

The Type J Bradleyometer has a solid-molded resistor element . . . not a paint or spray type of unit. Can be made to satisfy any resistance-rotation curve. Unaffected by temperature and humidity. A quality unit for critical applications.



Allen-Bradley Co.

110 W. Greenfield Ave., Milwaukee 4, Wis.

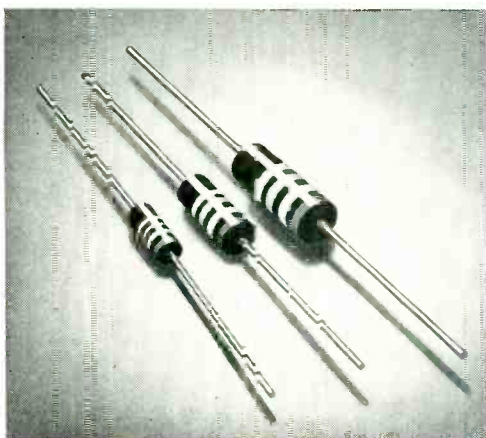

Bradleyunit fixed resistors are rated at 70C . . . not 40C. Under full load for 1000 hours, resistance change is less than 5%.

ALLEN-BRADLEY

FIXED & ADJUSTABLE RADIO RESISTORS



Sold exclusively to manufacturers of radio and electronic equipment

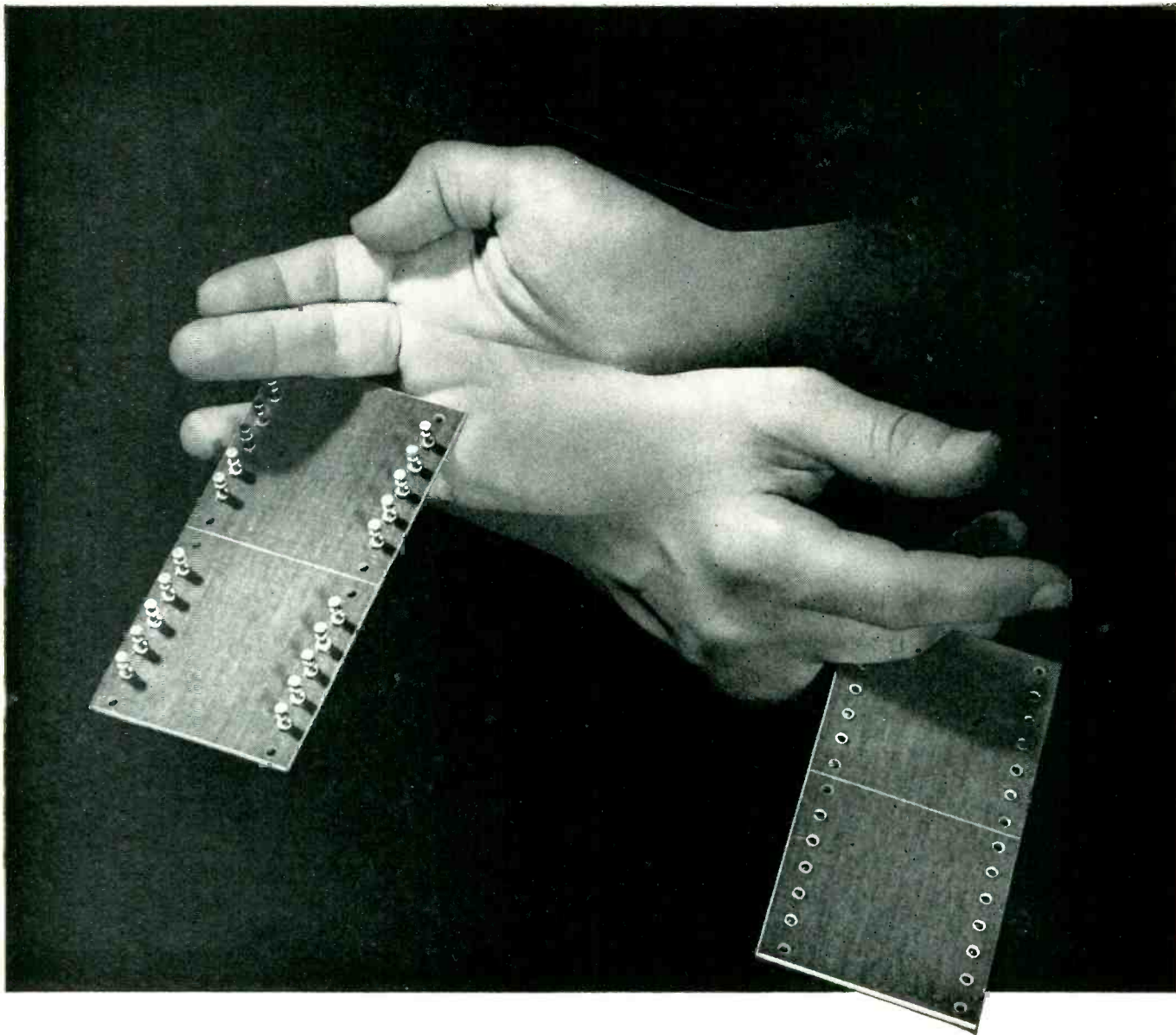

No cracks, please

You'll find no radial cracks in CTC terminal boards, or "cracked" rivet shanks on terminals. And there's a good reason for this.

Our swaging machines use tools that we designed ourselves in order to prevent just such damage. Terminals are fastened securely — *and carefully*. You benefit from a board that has no "weak spots" — that can give you the service you have a right to expect. And, of course, you also benefit from all the other quality control details that enable us to offer our customers *guaranteed* components — custom or standard. Coatings are smoothly applied — no wrinkles, no heavy deposits. C.T.C. terminals are made from certified stock that is free from defects. And the terminals themselves are guaranteed, even to the thickness of the coatings.

This C.T.C. quality control is given to all C.T.C. products including insulated terminals, coil forms, coils, swagers, terminals and capacitors. For all specifications and prices, write to

Cambridge Thermionic Corporation,
437 Concord Avenue, Cambridge 38,
Mass. West Coast manufacturers contact:
E. V. Roberts, 5068 West Washington Blvd.,
Los Angeles 16 and 988 Market St.,
San Francisco, California.

Terminal Board Data. CTC makes both standard boards and to your own specifications. Standard boards in cotton fabric phenolic, nylon phenolic or grade L-5 silicone impregnated ceramic. Custom made in cloth, paper phenolic, melamine, epoxy or silicone fibreglas laminates, imprinted as required and lacquered or varnished to specifications MIL-V-173 and JAN-T-152.

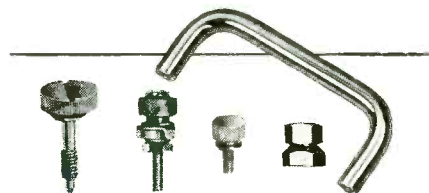

A wide variety of hardware is available at C.T.C. — all of it quality controlled and guaranteed for durability. This hardware includes terminal board brackets, standoff mounts, spacers, tube clamps, panel screws, thumb screws, dial locks, shaft locks, handles and handle ferrules.

CTC

CAMBRIDGE THERMIONIC CORPORATION

*makers of guaranteed electronic components,
custom or standard*

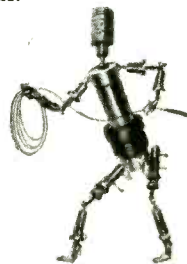



Announcing...

**one compact instrument
that measures...**

Frequency from 10 cps to 200 mc

Time interval from 1 μ sec to 100 days

Period from 0 cps to 10 kc

**instantly
automatically
directly**

the completely new, completely different...

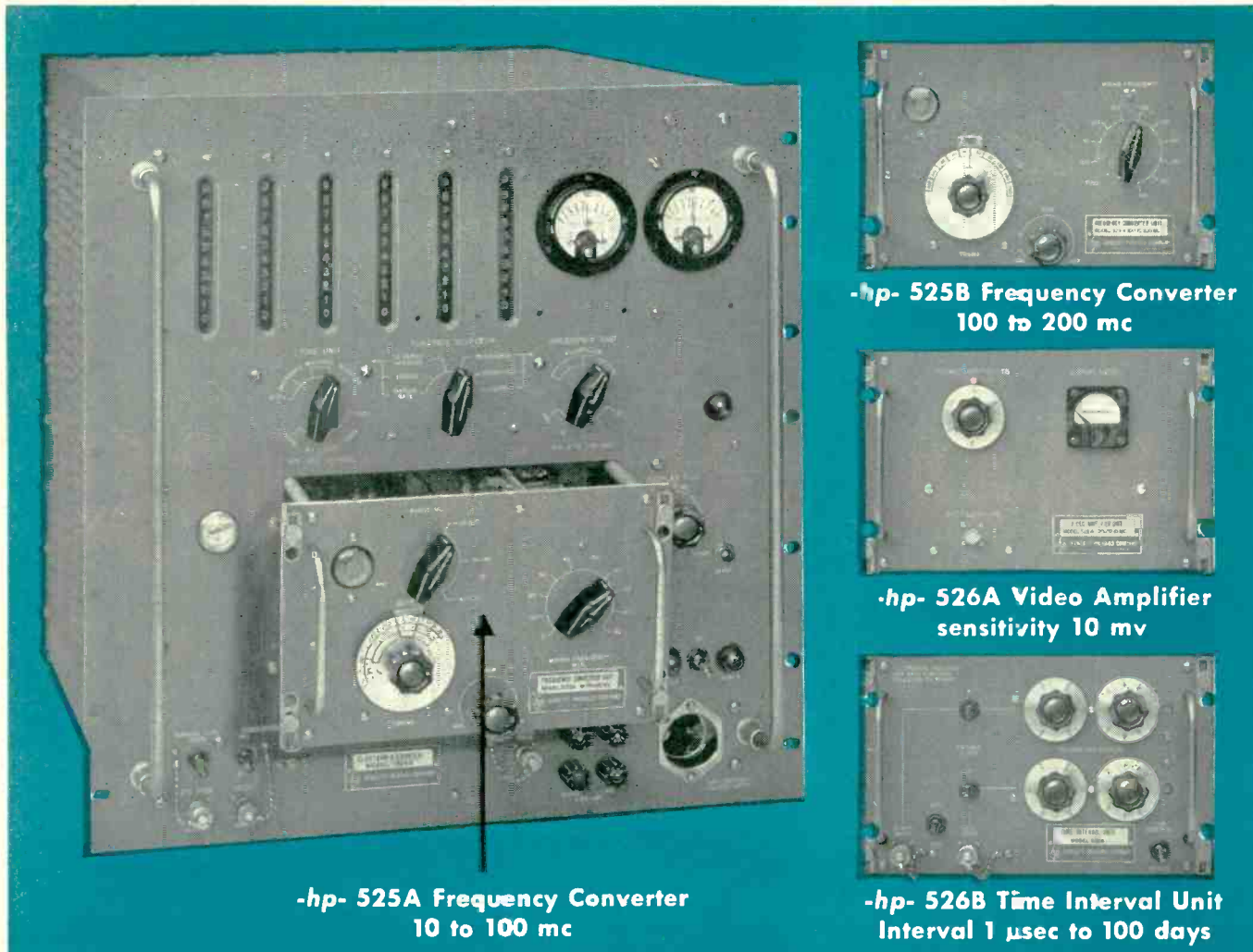

-hp- 525A Frequency Converter
10 to 100 mc

-hp- 525B Frequency Converter
100 to 200 mc

-hp- 526A Video Amplifier
sensitivity 10 mv

-hp- 526B Time Interval Unit
Interval 1 μ sec to 100 days

...524B ELECTRONIC COUNTER
with plug-in units to fit your exact measuring need!

- Direct, instantaneous, automatic readings**
- Easily used by non-technical personnel**
- Resolution 0.1 μ sec; accuracy 1/1,000,000 \pm 1 count**
- High sensitivity, impedance, extreme reliability**
- No calculation, interpolation or complex setup**
- Quality components; compact, military design**
- Automatic illuminated decimal point**

Why pay for more instrumentation than you need? The revolutionary new all-purpose *-hp-* 524B Electronic Counter gives you *exactly* the frequency, time interval or period measuring coverage you want now. Later, you can add inexpensive *-hp-* Plug-In Units, and double or triple the usefulness of this outstanding instrument.

-hp- 524B Counter gives you more range, simplicity, usefulness, convenience and reliability, smaller size and lower cost than any comparable commercial instrumentation ever offered. With this one complete instrument, you can measure transmitter and crystal oscillator frequencies, electronic, electrical and mechanical time intervals, pulse lengths and repetition rates, frequency drift; make high accuracy ballistics time measurements or high resolution tachometry measurements. The instrument is also an ideal precision frequency standard, giving convenience and flexibility not provided in the usual primary standard. It is simple to operate and readily used by non-technical personnel.

hp at I. R. E. Corner INSTRUMENTS AVENUE and RADIO ROAD

Frequency from 10 cps to 10 mc is read over 5 selected periods—0.001, 0.01, 0.1, 1, and 10 seconds. Display time is variable at will, counts are automatically reset, and action is repetitive. When set for low frequency period measurement, the duration of 1 low frequency cycle is measured in microseconds. A 10 cycle sample is taken to determine this period. Periods may be displayed repetitively or "held" (as in frequency counting). Results are measured instantly and automatically, and presented in direct-reading form with automatic illuminated decimal point.

DETAILS OF COUNTER PLUG-IN UNITS

Addition of *-hp-* Plug-In Units will extend the Counter's frequency range to 200 mc, provide increased sensitivity and a high-impedance pickup probe, and make available uniquely flexible time interval circuits that may be started and stopped by any electrical impulse.

-hp- 525A FREQUENCY CONVERTER. Extends Counter's 10 mc direct-reading range in decade steps to 100 mc. Maintains Counter accuracy throughout extended range. Provides additional amplification to increase video sensitivity to 0.1 volt through Counter's basic 10 cps to 10 mc range.

-hp- 525B FREQUENCY CONVERTER. Similar to 525A Converter but extends Counter's range from 100 mc to 200 mc in 10 mc steps. Maintains same high accuracy throughout range, and provides high sensitivity for measurement of low level circuits.

-hp- 526A VIDEO AMPLIFIER. Increases 10 cps to 10 mc sensitivity of Counter to 10 millivolts for frequency measurement at low level. Special probe assembly simplifies remote pickup at high impedance levels.

-hp- 526B TIME INTERVAL UNIT. Measures interval 1.0 microseconds to 100 days with accuracy of $0.1 \mu\text{sec} \pm 0.001\%$. Intervals are read direct in seconds, milliseconds or microseconds. Start and stop triggering is performed in either common or separate channels, and may be accomplished through the use of positive or negative going waves. Trigger voltage levels are continuously adjustable from -192 to $+192$ volts.

SPECIFICATIONS

BASIC 10 MC COUNTER WITHOUT PLUG-IN UNITS

FREQUENCY MEASUREMENT

Range: 10 cps to 10 mc.
Gate Time: 0.001, 0.01, 0.1, 1, 10 seconds or manual control.
Accuracy: ± 1 count \pm stability (see below).
Reads In: kc with automatic decimal point.

PERIOD MEASUREMENT

Range: 0 cps to 10 kc.
Gate Time: 1 or 10 cycles of unknown.
Accuracy: $\pm 0.3\%$ (measurement one period). $\pm 0.03\%$ (ten period average).
Standard Frequency Counted: 10 cps; 1 or 100 kc; 10 mc; or externally applied frequency.
Reads In: Seconds, milliseconds or microseconds with automatic decimal point.

GENERAL

Registration: 99,999,999; 8 places. First 6 places on neon lamp decades; last 2 meters.
Stability: 1/1,000,000 short-term; 2/1,000,000 per week. May be standardized against WWV; or used with external 100 kc primary standard for higher accuracy.
Display Time: Variable 0.1 to 10 seconds in steps of gate time selected. Display can be held indefinitely.
Output Frequencies: Secondary standard frequencies available at front panel: 10 cps, 1 kc rectangular; 100 kc positive pulse; 10 mc sine wave. (Stability as above.)

Self-Check: Panel control provides automatic count of internal standard 100 kc and 10 mc frequencies to insure accuracy of gate and proper operation of counters.

Input Voltage: 1 v R.M.S. minimum.

Input Impedance: Approx. 1 megohm, 40 μfd shunt.

Connectors: BNC type.

Power Supply: 115 v $\pm 10\%$, 50-1,000 cps, approx. 500 watts.

Cabinet Size: 19" wide, 19 $\frac{1}{4}$ " high, 17" deep. Supplied for rack mounting.

Weight: 112 lbs. net, 175 lbs. packed.

Accessories Furnished: *-hp-* AC-16D cable assembly, 42" RG-58/U cable terminated one end with UG-88/U BNC connector; *-hp-* 61B-16H power cable.

Price: \$1,890.00 f.o.b. factory.

-hp- 526A VIDEO AMPLIFIER

plugged into *-hp-* 524B Counter

Range: 10 cps to 10 mc.

Input Voltage: 10 mv R.M.S. minimum.

Level Control: Meter indicates signal level and correct adjustment.

Output Terminal: BNC connector provides 10 times input voltage into 50 ohm or higher load. Allows oscilloscope monitoring of input signal without loading circuit.

Accessories Furnished: *-hp-* 526D-16A probe assembly—input impedance 15 μfd and 10 megohms; remote signal pickup at 0.1 R.M.S. minimum. Cables and connectors.

Size: Supplied in aluminum storage case, with carrying handle, case 12" wide, 9" high, 8" deep. (See photo.)

Weight: 10 lbs. net, 19 lbs. packed.

Price: \$125.00 f.o.b. factory.

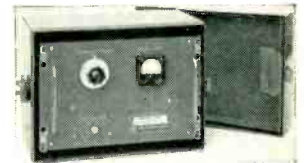

-hp- 525A FREQUENCY CONVERTER

plugged into *-hp-* 524B Counter

Range: As amplifier: 10 cps to 10 mc. As converter: 10 mc to 100 mc.

Accuracy: ± 1 cps \pm stability (see General).

Registration: 9 places; first place indicated on panel selector switch labeled 0, 10, 20 . . . 90; next 8 as indicated under General.

Input Voltage: 0.1 v R.M.S. minimum, 10 cps to 10 mc; 10 mv R.M.S. minimum, 10 mc to 100 mc.

Input Impedance: Approx. 1 megohm shunted by 40 μfd , 10 cps to 10 mc; approx. 50 ohms, 10 mc to 100 mc.

Level Control: Tuning eye aids frequency selection, indicates correct voltage level adjustment.

Size, Weight: Same as 526A Amplifier.

Price: \$225.00 f.o.b. factory.

-hp- 525B FREQUENCY CONVERTER

plugged into *-hp-* 524B Counter

Range: 100 mc to 200 mc.

Accuracy: ± 1 cps \pm stability (see General).

Registration: 10 places; first two places indicated on panel selector switch labeled 100, 110, 120 . . . 190, next eight as indicated under General.

Input Voltage: 0.25 R.M.S. minimum.

Input Impedance: Approximately 50 ohms.

Level Control, Size, Weight: Same as 525A above.

Price: \$225.00 f.o.b. factory.

-hp- 526B TIME INTERVAL UNIT

plugged into *-hp-* 524B Counter

Range: 1 μsec to 10^7 seconds.

Accuracy: ± 1 /standard frequency counted \pm stability (see General).

Registration: Same as indicated under General.

Input Voltage: 1 v peak minimum, direct-coupled input.

Input Impedance: Approx. 1 megohm, 40 μfd shunt.

Start and Stop: Independent or common channels.

Trigger Slope: Positive or negative on start and/or stop channels.

Trigger Amplitude: Continuously adjustable, both channels, -192 to $+192$.

Standard Frequency Counted: 10 cps; 1 or 100 kc; 10 mc or externally applied frequency.

Reads In: Seconds, milliseconds or microseconds with automatic decimal point.

Accessories Furnished: *-hp-* AC-16D cable assembly, 42" RG-58/U cable terminated on one end with UG-88/U BNC connector.

Size, Weight: Same as 525A and 525B.

Price: \$150.00 f.o.b. factory.

Data subject to change without notice.

HEWLETT-PACKARD COMPANY

2947A PAGE MILL ROAD • PALO ALTO, CALIFORNIA, U. S. A.

ASCOP



Now Available! Complete Time Division Multiplex Data Systems

Standardized equipment is now available for complete systems for multichannel data transmission over a single radio link or recording on a single magnetic tape track, using time-division multiplexing and pulse width coding.

ASCOP systems engineers can now choose from a complete line of units for sampling, coding, transmitting, receiving, monitoring, separating, reducing, and recording to assemble systems to meet your data transmission or recording problems.

Pulse width data systems provide, through time division multiplexing, a large number of identical data channels of moderate frequency response. The handling of information in the form of time rather than amplitude allows accurate operation independent of the characteristics of the transmitting or recording medium. Utilization of zero and sensitivity reference channels affords continuous automatic system calibration and avoids the need for frequent manual adjustment.

A typical standard ASCOP PW system handles 26 separate data channels with 5 CPS response per channel with overall system accuracy, from original data source to final reduced output record, of better than 1%. Real time output of each channel is available as a meter reading and as continuous record from a direct-writing recorder.

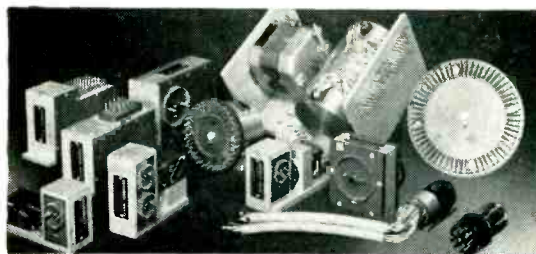

ROTARY SAMPLING SWITCHES

Over 40 models, single and multi-pole, with up to 180 contacts per pole and speeds up to 100 RPS. For all applications requiring high quality switching of low level signals. Bulletin 521-R.



Your inquiries are invited. Phone, wire or write to the nearest office, advising us of your requirements

Applied Science Corp. of Princeton

P.O. Box 44 Princeton, N. J. • Plainsboro 3-4141
1641 S. LaCienega Boulevard, Los Angeles 35, Calif.
Crestview 1-8870

See Us at the I.R.E. Show • 206-208 Instruments Ave.

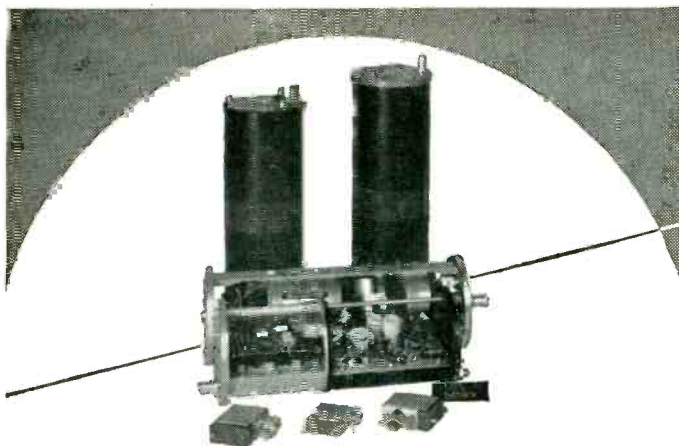

MODEL TK-M4/DC-M4 PW/FM AIRBORNE SET

Uses a 30 RPS commutator to sample 28 data sources in the 0 to +5 volt range. 4 to 5 watt crystal-controlled RF transmitter is frequency modulated. Equipment is sealed and pressurized for high altitude operation, and withstands ambient temperatures from -40°F to $+140^{\circ}\text{F}$, 100g shock, and 12g vibration.

Transmitting equipment is also available with other sampling rates and numbers of channels and in different packages for separate applications. Bulletin FBA-1.

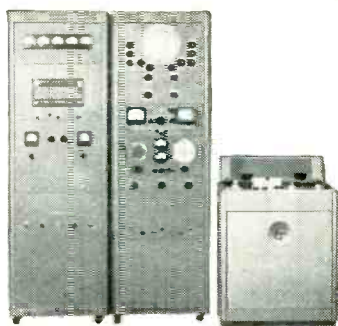

M SERIES PW GROUND STATION

Separates and reduces all data channels in real time. Operates on signals from standard airborne set, from FM/FM sub-carrier, or from magnetic tape recorder. Bulletin M-4



MODELS APA-1 RF PREAMPLIFIER AND AMC-1 MULTICOUPLER

Increase receiving gain and reduce noise figure for longer range RF link operation without increasing transmitter power. Permit connection of up to 4 receivers, tuned to different frequencies, to the same antenna. Bulletin APA-1.



a handful
of
components
in
one tiny
package

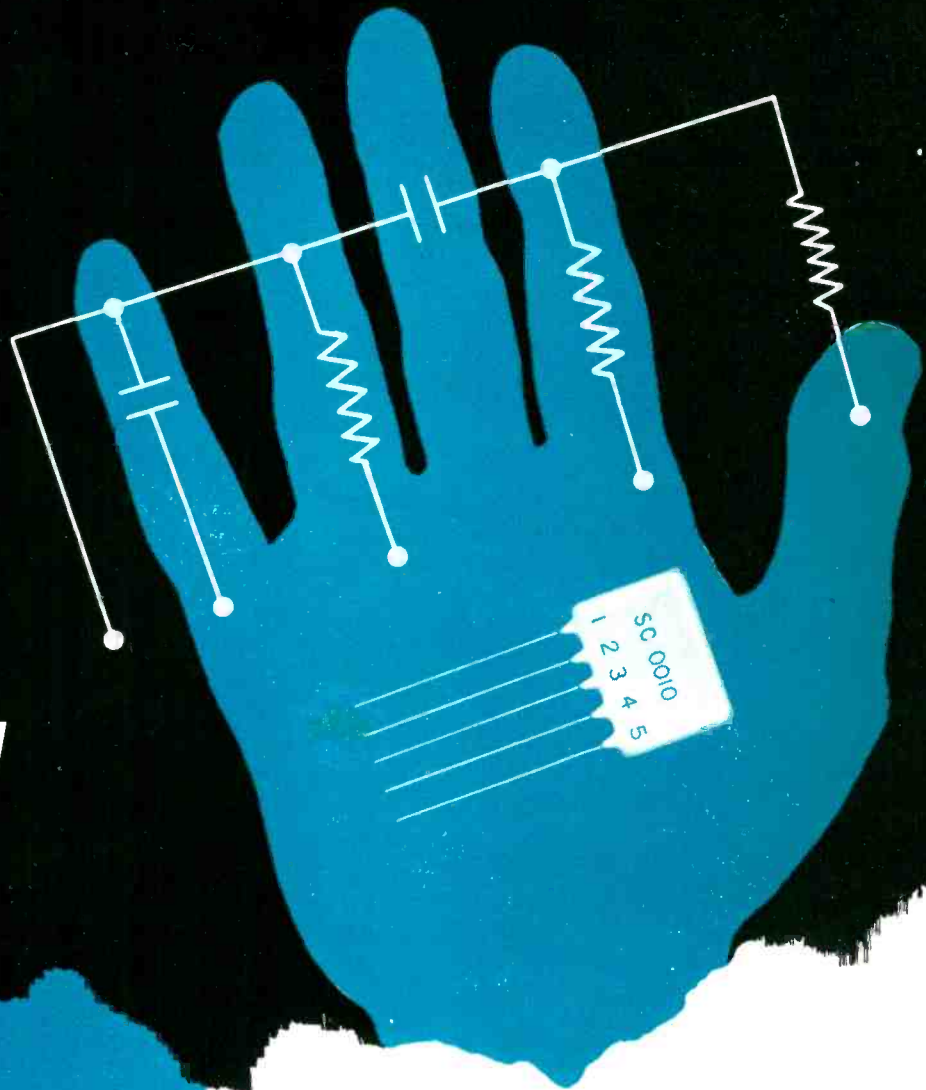

Stupakoff

Printed Circuits

Space is saved, assembly time reduced and errors eliminated when sturdy, compact Stupakoff Printed Circuits are used. In one tiny package—half the size of a book of matches—few or many accurately rated components—resistors and capacitors—are permanently assembled according to specifications. The only connections to be made are the external leads.

Stupakoff excels in the development and manufacture of Printed Circuits, and today is equipped with modern facilities for the mass-production of dependable units made to your specifications. Write for Bulletin 1151-A.

**STUPAKOFF CERAMIC
& MANUFACTURING COMPANY**

LATROBE, PENNSYLVANIA

STACKPOLE Fixed RESISTORS

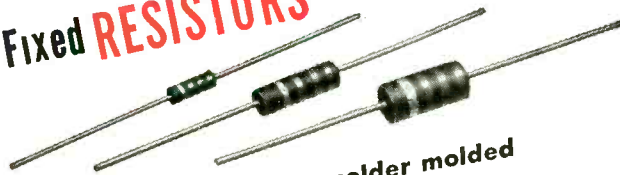

... dependable, easy-to-solder molded composition types

Stackpole 1/2-, 1- and 2-watt resistors not only meet exacting performance standards, but save assembly time thanks to their highly-tinned, easily-soldered leads.

JAN-R-11 TYPES—in styles RC10, RC20, RC21, RC30, RC31, RC41, and RC42 available.
Write for JAN Resistor Bulletin J-2.



STACKPOLE Variable RESISTORS



with versatile switching

Single, ganged and concentric shaft dual types in smallest sizes consistent with real dependability offer long, and trouble-free performance for today's requirements. Gold plated "ring spring" contactors assure low noise level. A complete array of unique midget line switches offers practically any desired switching arrangement, with types for both civilian and military use.

... A dependable source
of reliable components
for over 30 years

STACKPOLE Composition CAPACITORS

Cost-saving, low-value,
fixed types

Originated by Stackpole, these tiny units not only represent the simplest, most inexpensive capacitor design yet produced—but likewise have characteristics that make them more desirable than larger, more costly capacitors for many uses. 47 standard types, 0.1 to 10.0 mmf. Write for Stackpole GA Capacitor Bulletin.

New!

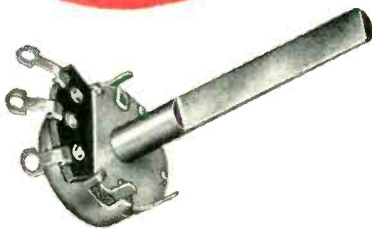

Cost-saver bushingless controls

Similar to standard Stackpole LR-2 controls except that a plate with sturdy mounting lugs replaces the conventional threaded brass bushing for easier assembly.

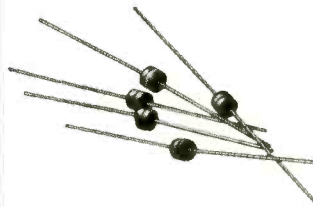

STACKPOLE Iron CORES



... to match any electrical or mechanical specification
Pioneers in modern iron core development, Stackpole offers practically any desired style and with assured uniformity of both electrical and mechanical characteristics.
Write for Iron Core Bulletin.

STACKPOLE
Ceramag® **CORES**
(Ferromagnetic)

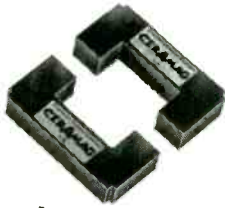

for real uniformity! Wherever ferromagnetic cores are used, Stackpole Ceramag Cores have set the quality standards. But proved superiority in essential characteristics is only part of the story. Even more important is the fact that Stackpole Ceramag core characteristics are maintained with remarkable uniformity regardless of size, shape or production quantity. *The sample matches your specification "on the nose"—and each production unit is exactly like the sample!* Write for Ceramag Bulletin RC-9A including details on available grades and latest characteristic curves.

STACKPOLE
Molded **COIL FORMS**



Cut Assembly Costs!

You can reduce coil sizes and cut assembly costs with simplified point-to-point wiring and fewer soldered connections with these Stackpole molded coil forms. Types available with iron core sections. Axial or "hairpin" leads. Write for Catalog RC-9.

STACKPOLE
Slide **SWITCHES**



... the economy switches of 1001 uses!

Over 20 types of these inexpensive little Stackpole slide switches cover just about every mechanical and electrical switching requirement for radio and television equipment, small motors, appliances, electrical toys, instruments, etc. For complete details, write for Stackpole Switch Bulletin RC-9B.



STACKPOLE CARBON CO.
ST. MARYS, PA.
Type: 2A33
Our Order No. 221796
Cust. Part No. 227507
For Electronic Supply Corp.
Attention of Mr. Robert Taylor
Date: 3/15/54
SAMPLE IS FOR:
All Mech. & Elec. Equip.
Mechanical Only
Electrical Only

Engineering Samples are proof of the pudding!

Engineering samples of standard Stackpole components are available to quantity users. Send details of your requirement for recommendation by Stackpole engineers.

ELECTRONIC COMPONENTS DIVISION
STACKPOLE CARBON COMPANY, St. Marys, Pa.

STACKPOLE

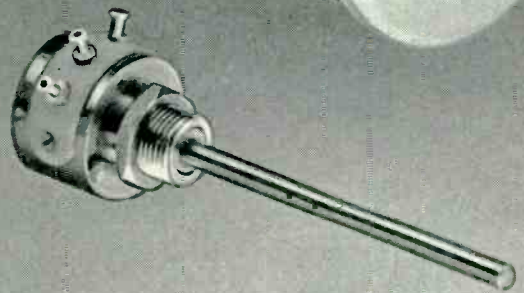
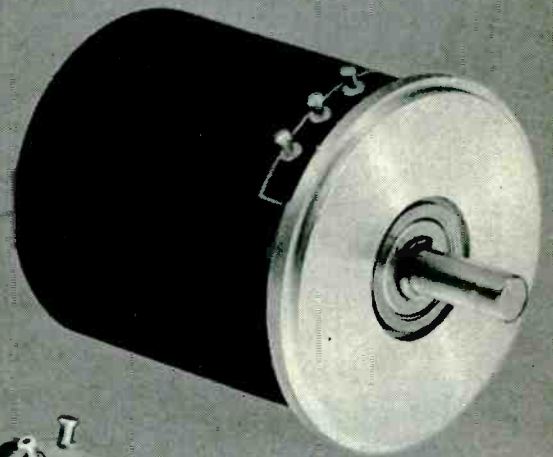
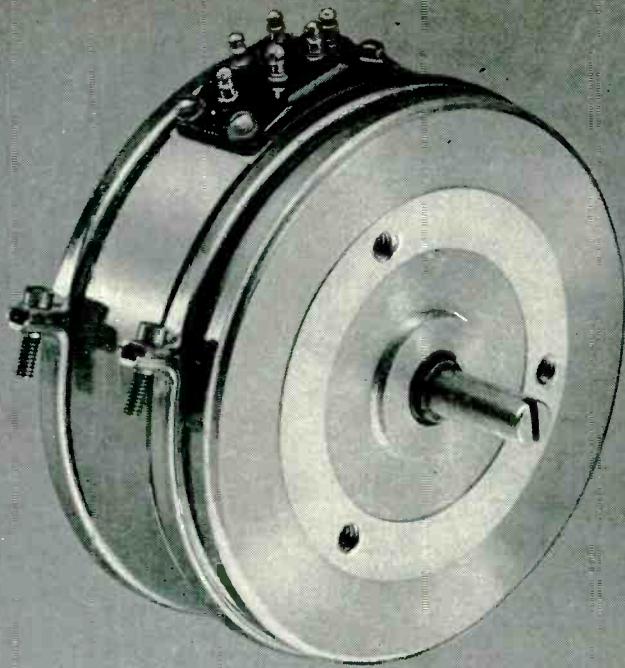

5 NEW

5 More reasons why FAIRCHILD can meet



TYPE 753 — Sine-cosine potentiometer — Full sine-cosine function without mechanical cams and linkages — can be ganged up to 6 cups. 20,000 ohms per quadrant; linearity, $\pm 0.5\%$ peak-to-peak; 3" diameter, $1\frac{1}{4}$ " long from front of servo flange to rear of cup. Also available as straight sine function.



TYPE 745 — 10-turn helical potentiometer — Meets rigid government requirements for humidity, salt spray, altitude, temperature, vibration, shock, sand, dust and fungus resistance. High electrical accuracy (linearity $\pm 0.025\%$); resistance range 100 to 300,000 ohms. 2" diameter, $2\frac{3}{8}$ " long from front of servo flange to end of case. Mechanical and electrical rotation, $3600^\circ (+2^\circ -0^\circ)$.



TYPE 771 — The FilmPot, metallic film potentiometer — Infinite resolution, high temperature operation (225°C). High wattage dissipation and exceedingly wide resistance range (100 to 200,000 ohms). Only $\frac{3}{4}$ " in diameter and $\frac{1}{2}$ " long. Resistance element is precious metal deposited on an inorganic base. Available with servo flange or threaded bushing mounting.

See the complete Fairchild line of pots at the IRE Show, Booth 648, Radio Road and Circuits Avenue.

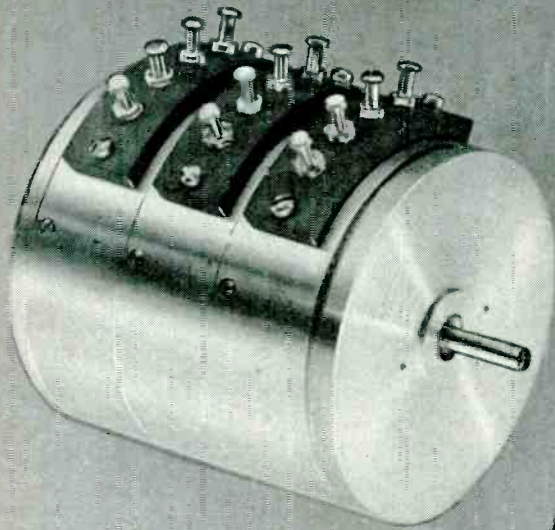

(Shown actual size)

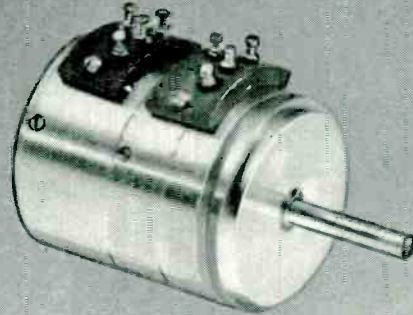

POTENTIOMETERS

all your precision potentiometer needs



TYPE 754—2" linear potentiometer—Resistance range from 800 ohms to 100,000 ohms. High linearity ($\pm 0.15\%$ standard). Internal clamp rings permit ganging up to 8 cups on single shaft without increasing over-all diameter. AIA standard 2" servo mount. Depth is 1" with .594" added for each cup section ganged. Gold-plated terminals are easier to solder and have better resistance to corrosion.



TYPE 741—1½" linear potentiometer—Internal clamp rings permit ganging up to 5 cups on a single shaft without increasing the over-all diameter. Resistance range 500 to 25,000 ohms; linearity $\pm 0.5\%$ standard. Electrical angle 350°. Only 1½" in diameter and 1½" long; starting torque is 0.25 oz.-in. The simplified slip ring construction and a one-piece paliney wiper give longer life and lower noise.

● Available immediately in sample quantities. Look to Fairchild for assistance in solving all your precision potentiometer problems. Fairchild has, or can make, a potentiometer to fit any requirement. For information write: Fairchild Camera & Instrument Corp., Potentiometer Division, 225 Park Avenue, Hicksville, L. I., N. Y., Dept. 140-45A.

FAIRCHILD
PRECISION POTENTIOMETERS

Four different types of synchronous motor driven INTERVAL TIMERS

the answer
to most interval
timing-control problems

MANUAL SET TIMERS • Series RS

Compact, rugged construction handles high load without auxiliary relay. Heavy-duty, snap-action contacts maintain continuous pressure and wiping action. 18" color-coded leads facilitate wire connections. 20-amp. rating—completely enclosed—2½" dia., 3½" length—easy-setting knob—elapsed-time indication. Time-cycle ranges, 15 min. to 12 hrs., dial calibration, 15 sec. to 15 min. 115-volt AC current, 60, 50, or 25 cycles. Complete information in Bulletin #59

INSTANTANEOUS RESET TIMERS • Series PAB

For process control in industry. Have automatic reset, time-setting adjustment, large numerals. Extremely accurate. Built to stand hard usage. Timing range 1/10 sec. to 5 sec. in 1/10-sec. steps (PAB-3S)—to 2 min. to 3 hrs. in 2-min. steps (PAB-3H). Complete information in Bulletin #58

AUTOMATIC RESET TIMERS • Series P and M

Series P have AC input line cord, built-in actuating start button, receptacles for plug-in remote-control and load circuits. Time cycle, 15-sec. to 5-min., dial calibration, ¼ sec. to 5 sec. 115 or 220 volt AC, 50 or 60 cycles.

Series M is similar to Series P, but start button cannot operate from remote position. Receptacle for plug-in load circuit. 60-sec. time cycle, calibrated in seconds. Complete information in Bulletin #68

SIGNALING TIMERS • Series S

Command eye and ear attention when time interval is completed. Automatically closes or opens circuit at end of elapsed time, and operates buzzers, bells, or lights at remote stations. 5"x5"x3", readily attached to wall, panel, or switch box. 115 to 230 volts AC, 25, 50, or 60 cycles. Slow-speed, self-starting motor. Pure silver contacts. Interval range, 1 min. to 3 hrs., dial calibrated, 1 sec. to 5 min. Complete information in Bulletin #98

Manufacturers of these and other timers and controls for Industry: AUTOMATIC RE-CYCLING TIMERS • TIME-DELAY TIMERS • RUNNING TIME METERS • INTERVAL TIMERS.

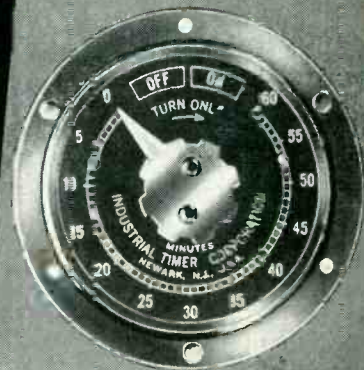

Series RS

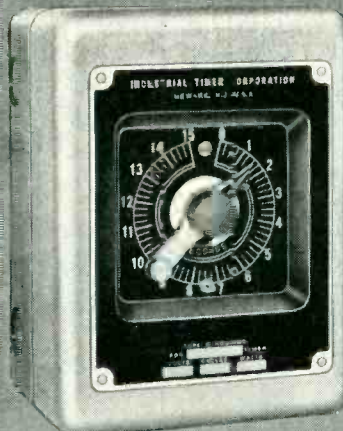

Series PAB

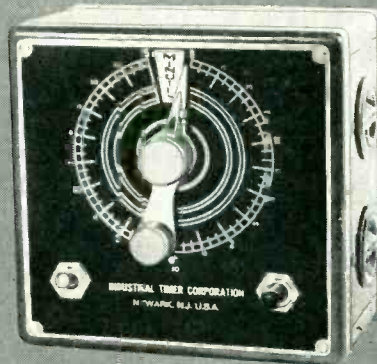

Series P and M



Series S

Timers that Control
the Pulse Beat of Industry



INDUSTRIAL TIMER CORPORATION
131 OGDEN STREET, NEWARK 4, N. J.

"INTERFERENCE FREE" means

FILTERED by

FILTRON

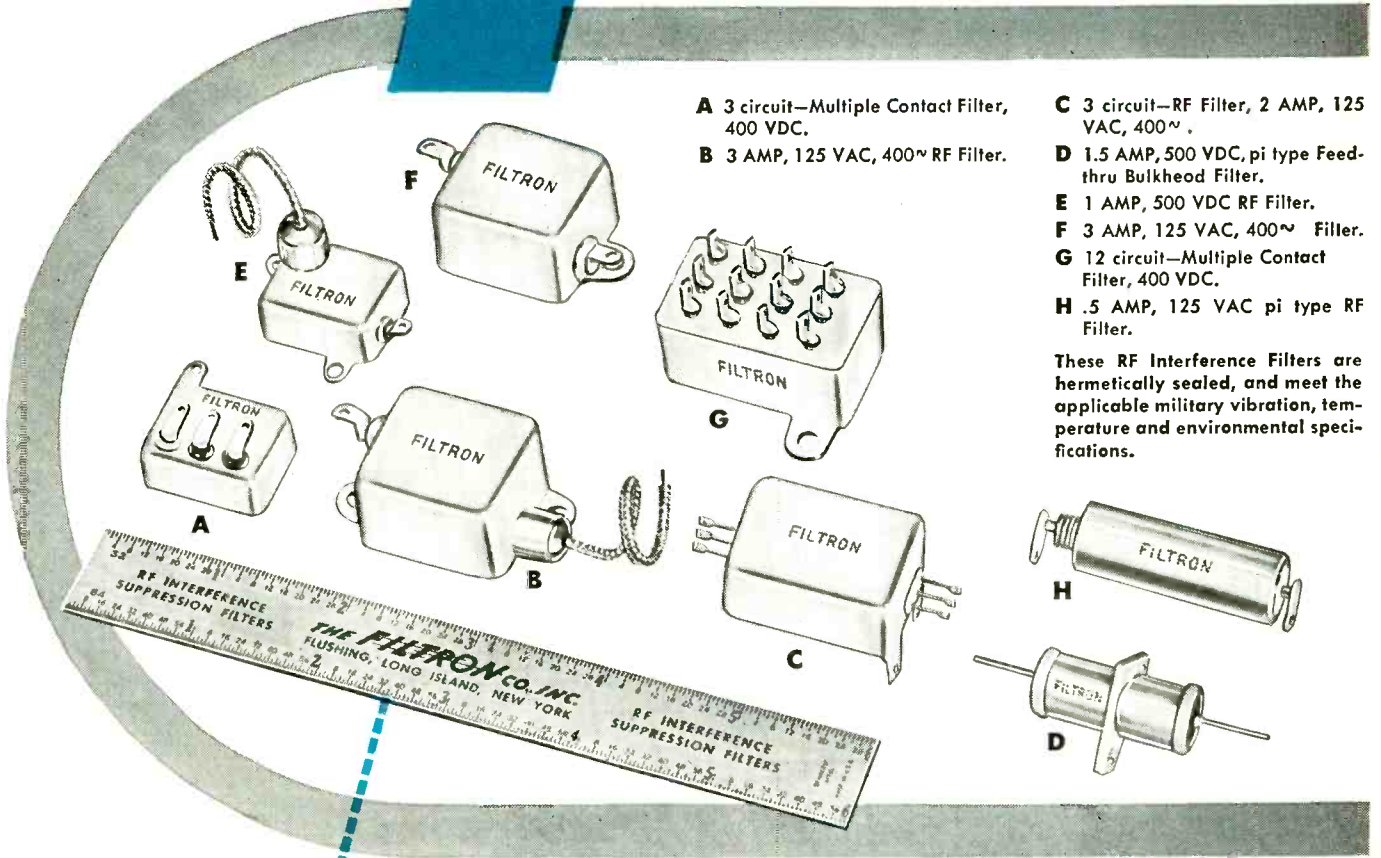

A 3 circuit—Multiple Contact Filter, 400 VDC.
B 3 AMP, 125 VAC, 400 \sim RF Filter.

C 3 circuit—RF Filter, 2 AMP, 125 VAC, 400 \sim .

D 1.5 AMP, 500 VDC, pi type Feed-thru Bulkhead Filter.

E 1 AMP, 500 VDC RF Filter.

F 3 AMP, 125 VAC, 400 \sim Filter.

G 12 circuit—Multiple Contact Filter, 400 VDC.

H .5 AMP, 125 VAC pi type RF Filter.

These RF Interference Filters are hermetically sealed, and meet the applicable military vibration, temperature and environmental specifications.

Representative subminiature, high attenuation, hermetically sealed R.F. Interference Filters for space saving, simple installation and light weight applications.

THE newest types of Interference-Free Radar, Interference-Free Radio Transmitters, Interference-Free Receivers, Interference-Free Motor-Generator Sets, Interference-Free Inverters, Interference-Free Aircraft, Interference-Free Electronic Systems and numerous other "restricted" equipments incorporate FILTERS BY FILTRON.

Our complete engineering and manufacturing organization is devoted exclusively to the research, design

and production of RF interference filters to make YOUR products noise-free.

The Filtron Company is a complete engineering and manufacturing organization that pioneered the development of special filter types: subminiatures, high attenuation, completely hermetically sealed, high altitude, high temperature and wide-band multi-section units. Today we are producing more filters than ever before.

ENGINEERING FILTRON'S highly specialized filter engineers will discuss, test, and design RF filters to make your products "noise-free". They will meet with you at your plant, or in our own shielded laboratories.

TEST & DEVELOPMENT FILTRON'S test and development facilities are equipped with ALL interference-measuring and test equipment, in strict accordance with all Military Specifications.

MANUFACTURING FILTRON'S modern production facilities comprise the following departments: Capacitor Manufacturing Division • Coil Winding Division • Tool and Die Departments • Environmental Test Department • Metal Drawing, Fabricating and Stamping Departments.

WHEN YOU HAVE A RF FILTER PROBLEM, CONSULT FILTRON—THE MOST DEPENDABLE NAME IN RF INTERFERENCE FILTERS.

SALES REPRESENTATIVES

G. S. Marshall Co., Pasadena, Cal. • Roy J. Magnuson, Chicago, Ill. • Massey Associates, Inc., Narbeth, Pa., Washington, D. C. • Holliday-Hathaway, Cambridge, Mass., Canaan, Conn., New York, N. Y., Great Neck, N. Y., Rochester, N. Y., Binghamton, N. Y., Wood-Ridge, N. J.

An inquiry on your company letterhead will receive prompt attention.

INTERFERENCE FREE

means
 FILTERED
 by

FILTRON CO., INC. • FLUSHING, LONG ISLAND, NEW YORK

LARGEST EXCLUSIVE MANUFACTURERS OF RF INTERFERENCE FILTERS



CAPACITORS

Announcing HIGHER RATINGS for

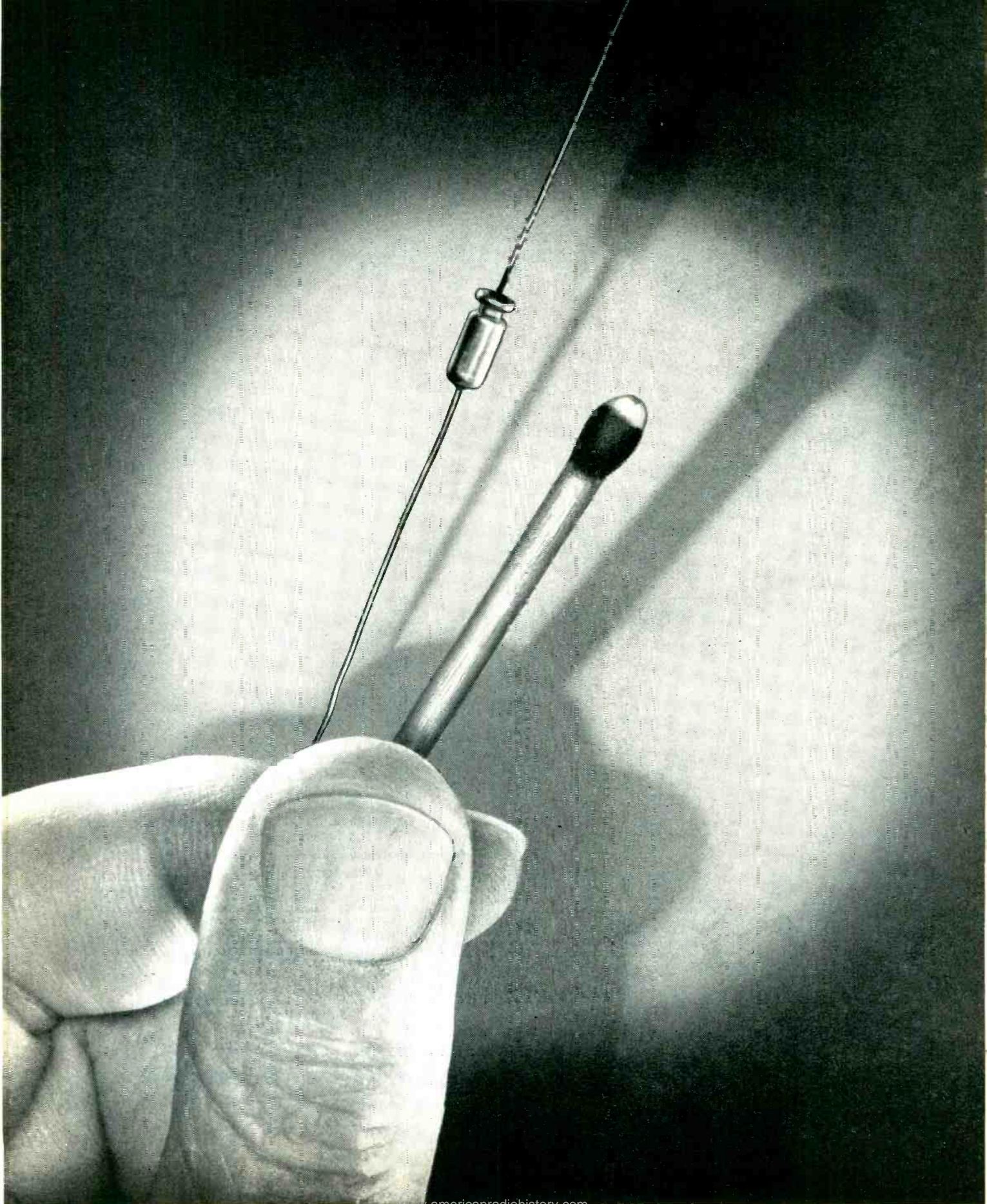

Micro-miniature Tantalum Capacitors

8-MICROFARAD, 4-VOLT UNIT NOW AVAILABLE WITH -0% TO $+100\%$ CAPACITANCE TOLERANCE

New, higher ratings are now obtainable in General Electric's newly developed Micro-miniature Tantalum capacitor line. Eight microfarads at four volts can now be obtained in the $\frac{5}{16}$ " case size, higher capacitance in the $\frac{1}{2}$ " case size. These capacitors have the greatest known capacitance per unit volume of any electrolytic capacitor commercially available. Their small size makes them particularly adaptable to transistorized subminiature assemblies, where space is at a premium, such as hearing aids.

SUPERIOR PERFORMANCE. *Micro-miniature* Tantalum capacitors outperform aluminum electrolytics in electrical stability, operating and shelf life, because of the inert characteristics of tantalum metal and the stability of its oxide. They gain added reliability from the use of silver cases, a non-acid electrolyte, and com-

plete sealing that prevents leaking and contamination of the interior.

WIDE TEMPERATURE RANGE. *Micro-miniature* Tantalum capacitors can operate over a -20 C to $+50\text{ C}$ range—may be stored at -65 C . With some capacitance derating, they can operate well below -20 C . They also perform satisfactorily above $+50\text{ C}$ with some life limitations.

AVAILABILITY. Designed especially for non-resonant, non-critical applications such as coupling, by-pass and filtering, *Micro-miniature* Tantalum capacitors can be obtained in sample lots 2 to 3 weeks after your order is received at the factory. Production lots can be shipped 6 to 8 weeks after your order is received. For more information, see your G-E Apparatus Sales Representative or write for bulletin GEA-6065 to General Electric Company, Section 442-13R, Schenectady 5, N. Y.

Progress is our most important product

GENERAL ELECTRIC

We can now supply up to 20 volts, or, up to 8 microfarads in the $\frac{5}{16}$ " case size, higher capacitance in the $\frac{1}{2}$ " case size . . . and with -0% to $+100\%$ capacitance tolerance!

See these capacitors in our booth at the . . .
NEW YORK IRE SHOW.

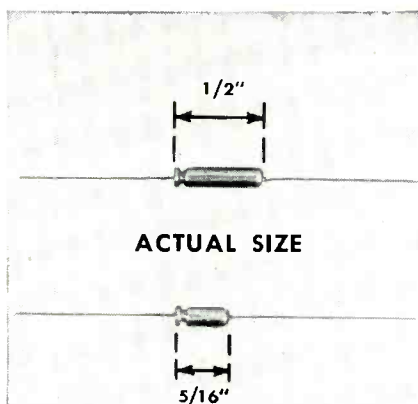

LARGE CAPACITANCE and small size make Micro-miniature Tantalum capacitors valuable where space is at a premium. Diameters are .125 in.

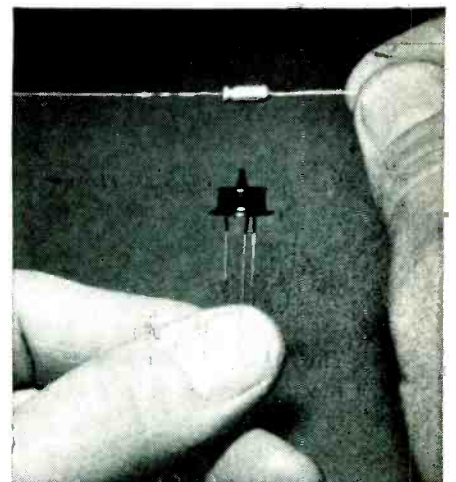

IDEAL COMPANIONS. Transistors and Micro-miniature Tantalum capacitors make ideal companions in low-voltage d-c miniaturized assemblies.

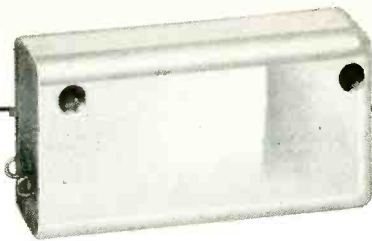

This 1MP3-1 Protected Mercury Switch is designed for use in narrow differential applications in temperatures ranging from -35° F. to 300° F.



Cut-a-way of 1MP3-1 switch showing glass enclosure imbedded in epoxy casting resin which provides excellent chemical resistance. Case is of metal for maximum protection.



The 3MP1-3 and the 5MP2-1 switches are sealed in metal tubes for protection in roughest locations. The embedment material is wax and they are for general applications in temperatures to 180° F. and where hydrocarbon solvents are not present.

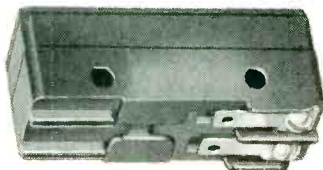

The 4MP2-1 is protected by a molded phenolic enclosure and is also sealed in wax. It is equipped with solder lug terminals.

NOW...

Mercury Switches that can "take it" where the going is rough

Use of glass-enclosed mercury switches need no longer be limited to protected locations. Honeywell Mercury Switches are now available with fully protected enclosures.

These new enclosures not only protect the switch but provide seal and electrical insulation around the lead entrance. Mounting is also simplified as the unit can be rigidly screw-mounted to moving parts or pivoted on pins for tilt operation.

If your application provides tilt motion and requires low operating force, a Honeywell Mercury Switch may be the component you are looking for to reduce manufacturing costs and eliminate field service expense. Consult with your nearest MICRO SWITCH branch for experienced engineering advice on the exact type of switch which will best meet your requirements. There are 16 of these branch offices conveniently located to serve you.

MICRO SWITCH

A DIVISION OF MINNEAPOLIS-HONEYWELL REGULATOR COMPANY

FREERPORT, ILLINOIS





"Just
click
them
in."



THE
AMPHENOL *Qwik*
MICROPHONE CONNECTORS



AMPHENOL proudly presents the new QWIK microphone connectors! Designed by one of America's leading industrial designers in cooperation with the skilled engineers of AMPHENOL, here at last are microphone connectors with the beauty and the efficiency to complement every microphone, in any setting!

In both mechanical and aesthetic considerations the new QWIKs are unique. They have an ingenious release device which is both extremely easy to operate and very efficient. Disconnection for either male or female connectors is made by simply sliding a button forward with a slight pressure of the thumb. For insertion, the QWIK is gently clicked in.

**MODERN
DESIGN**
MICROPHONE CONNECTORS



The finish of the new QWIKs is an attractive corrosion-resistant satin nickel—the body is a sturdy zinc alloy. They incorporate the famous 1-501 blue dielectric material, the same used on all AMPHENOL AN connectors. Contacts are gold-plated over a silver finished high conductivity bronze.

QWIKs are available, either male or female, with three or four contacts. The possibilities of their applications are such that you will want to see and study them as soon as possible.

For full information:

write to the Sales Engineering Department,
American Phenolic Corporation

1830 South 54th Avenue, Chicago 50, Illinois



small, compact Miniature Connectors for special electronic needs

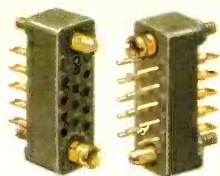

hundreds of different miniature and industrial Tube Sockets



versatile Plugs—unique designs, sturdy construction



new improved AN Connectors now feature gold plated contacts



Cable quality guaranteed by strict controls, rigid inspection

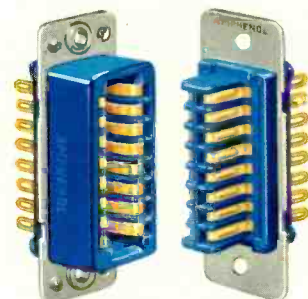

fastest connect and disconnect with Blue Ribbon Connectors



Rack and Panel connectors for many special applications



waterproof field serviceable Audio Connectors approved for Signal Corps



developed first for Signal Corps, waterproof Power Plugs



better design, better construction on all RF Connectors



a complete Cataloging service to the electronics industry

PRECISION MADE COMPONENTS FOR THE ELECTRONICS INDUSTRY

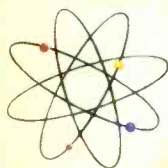

AMPHENOL makes over 11,000 separate cataloged components that are used and relied upon by the electronics industry the free world over. These components include the famous AN connectors, RF connectors, cables and many special types of sockets, plugs and connectors. Their applications vary, but the distinguishing feature of all AMPHENOL components is present in each: *quality*.

The quality that is the mark of AMPHENOL components is the product of both precision engineering and precision manufacturing. Neither of these would result in quality alone. But the teamwork of the two produces the finest components available—the electronics industry has learned to rely upon AMPHENOL quality.

Not only the components on this page but thousands more are listed in the new AMPHENOL Catalog B-3. From the B-3 you will be able to fill the majority of your component needs. Where more specialized information is desired, the B-3 also lists the special AMPHENOL catalogs, A, C and D, as well as other product literature.

- AN Electrical and RF Connectors
- Microphone Connectors
- Radio and Industrial Tube Sockets
- RF Cable
- TV, FM and Communication Antennas
- Cable Assemblies
- Radar and Radio Components



American Phenolic Corporation, Chicago 50, Illinois

Amform 2382—24400 Printed in U.S.A.

Polarad NTSC Color TV Equipment consists of fully integrated units that combine ease of operation with maximum flexibility.

COLOR BAR GENERATOR—PT-203 Provides color TV test signals, NTSC standards, for color TV equipment, networks and components. Supplies complete composite video signal in the form of seven fundamental color bars simultaneously with seven gradations of gamma bars. White dot pattern superimposed on both color and gamma bars. Color test pattern can be used for adjustment of both color transmitter and receiver circuitry. Internal switching permits 19 different test patterns.

COLOR SYNCHRONIZING GENERATOR—PT-201 Furnishes NTSC color TV subcarrier frequency component and contains divider network to yield 31.5 KC signal. Provides driving, blanking and synchronizing pulses, as well as vertical and horizontal dots for linearity checks. Used to drive color bar generators, or any other NTSC color TV generating equipment. Utmost stability assured by driving all pulses from leading edge of crystal controlled oscillator. Unit may be locked to synchronize with 60 cps line. Also available as a separate unit, PT-202 Subcarrier Frequency Generator to modify any existing standard (B/W) synchronizing generator in accordance with NTSC color TV standards.

COLOR TV VIDEO MONITOR—M-200 Compact, rugged instrument consisting of two portable units. Uses 15 inch RCA tri-color Kinescope. Checks quality of NTSC color video signals in studio, on transmission or in factory. Excellent synchronizing stability. Displays highest definition transmitted pictures with exceptionally good color rendition. All controls on front panel. Instrument may be rack mounted or employed as field test equipment.

ALSO AVAILABLE An NTSC color TV Flying Spot Scanner, furnished as a completely packaged unit supplying a standard color video signal. For further information, contact your nearest Polarad representative or write directly to the factory.

Polarad

COLOR

TV

**equipment
for studio and
laboratory**

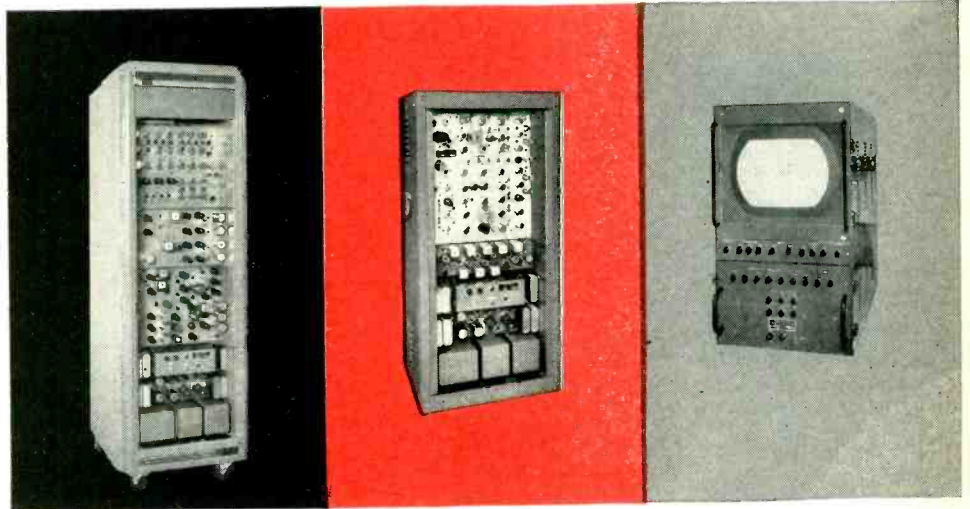

COLOR BAR GENERATOR PT-203
OUTPUT SIGNALS: Composite Video
(2 outputs) (Sync. negative & positive)
SIGNAL INFORMATION
7 Bars of Color
7 Bars of Gamma Gradations
White Dot Pattern (Vert. and Hor.)
EXT. VIDEO INPUT FOR MIXING
2 Volts neg. polarity

COLOR SYNCHRONIZING GENERATOR PT-201
OUTPUT SIGNALS:
Synchronizing Signal (Neg.)
Camera Blanking Signal (Pos., Neg.)
Horizontal Drive Signal (Neg.)
Vertical Drive Signal (Neg.)
Composite Video Output (Neg., Pos.)
NTSC Color Subcarrier Freq.
(3.579545 mc/s)

COLOR VIDEO MONITOR M-200
Signal Polarity—Positive, Negative, Balanced
Input Video—0.25 to 2.0 Volts, peak to peak
Input Impedance—66 mmf across
2.2 megohms
Resolution—250-300 lines (Full Utilization
of NTSC Color Signal Bandwidth)
Linearity—Better than 2% across raster
Horizontal and Vertical

Polarad

Visit our Booth 277-279 at the IRE SHOW—MARCH 22-25

ELECTRONICS CORPORATION 100 METROPOLITAN AVENUE, BROOKLYN 11, NEW YORK,

REPRESENTATIVES

Albuquerque • Annapolis • Canada • Atlanta • Boston • Chicago • Cleveland • Fort Worth • Kansas City • Los Angeles • New York • Philadelphia • San Francisco • Seattle • St. Paul • Syracuse • Washington, D. C.

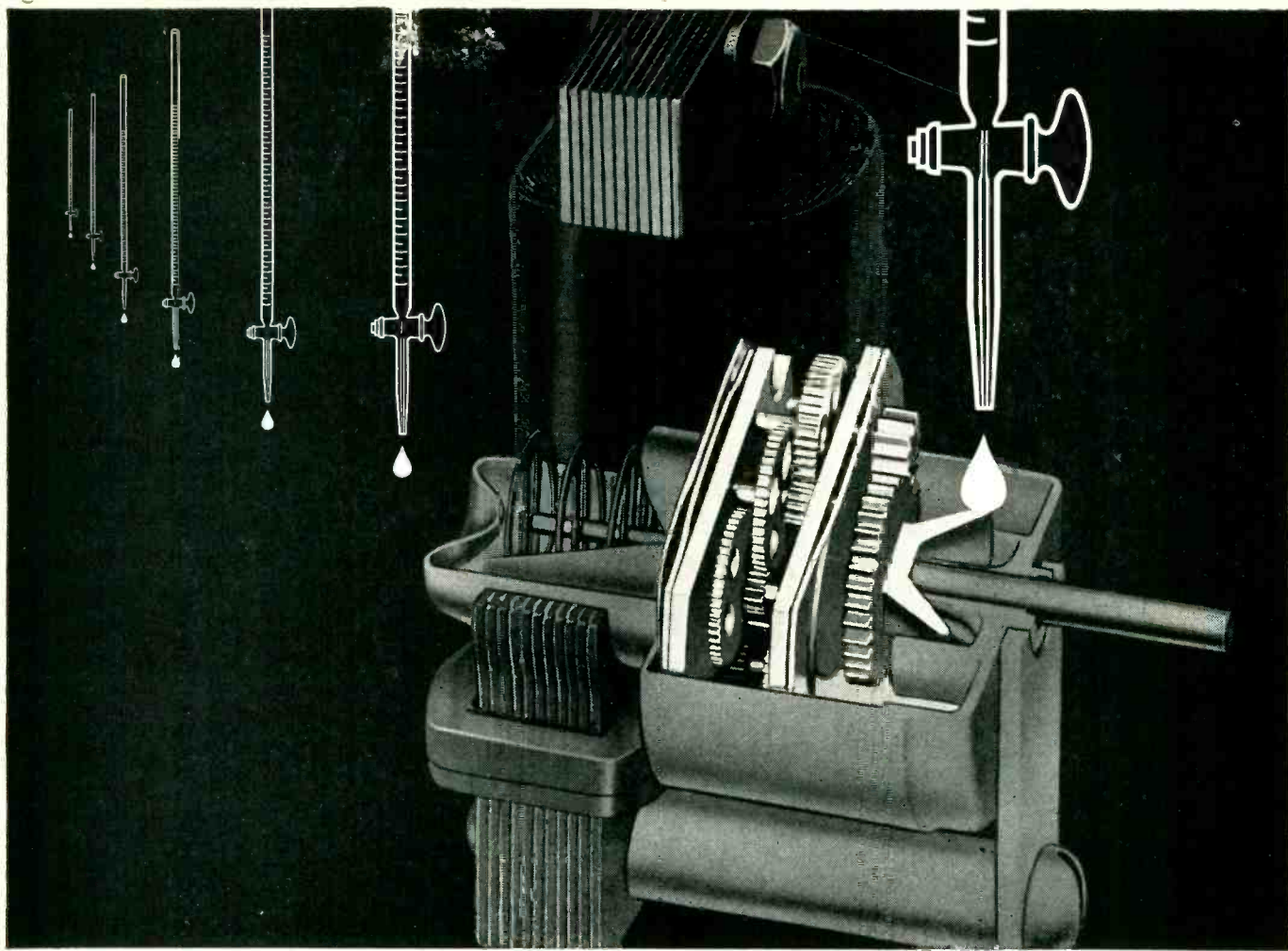

MORE evidence of the extra VALUE in TELECHRON timing motors...

CONTROLLED, SEALED-IN LUBRICATION LASTS THE LIFE OF THE MOTOR

Too much oil interferes with a timing motor's accuracy. Too little causes excessive wear. The key factor in the instant starting and long life of a Telechron timing motor is its unique controlled system of lubrication.

Each Telechron motor carries a lifetime reservoir of oil sealed in its rotor unit. Capillary action carries the oil to bearings, where its flow is controlled to all moving parts.

This exclusive lubrication system is one reason why—rating for rating—a Telechron timing motor will outlast and outperform any other synchronous timing motor made.

Telechron timing motors come in a wide range of speeds and torque ratings, for any standard AC power source. Write for full details about our Application Engineering Service. Telechron Department, General Electric Co., 43 Homer Ave., Ashland, Mass.

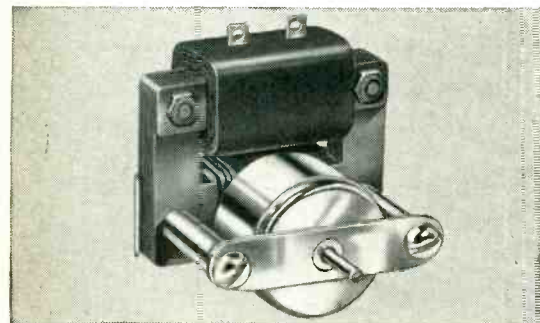

Telechron motors play a major part in switching many of America's jobs to "automatic." They are unmatched in the field of electric timing with such features: as lightweight rotors for instant starting... open-air design for cool running... and truly synchronous performance.

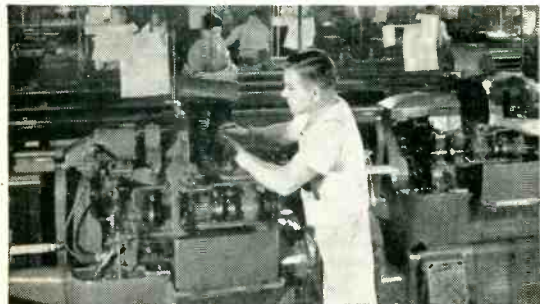

Big production by our automatic screw machines—typical of our large motor plant capacity—plus an experienced engineering staff, assure speed in deliveries.

Consistently Dependable

Cornell-Dubilier

miniaturized capacitors

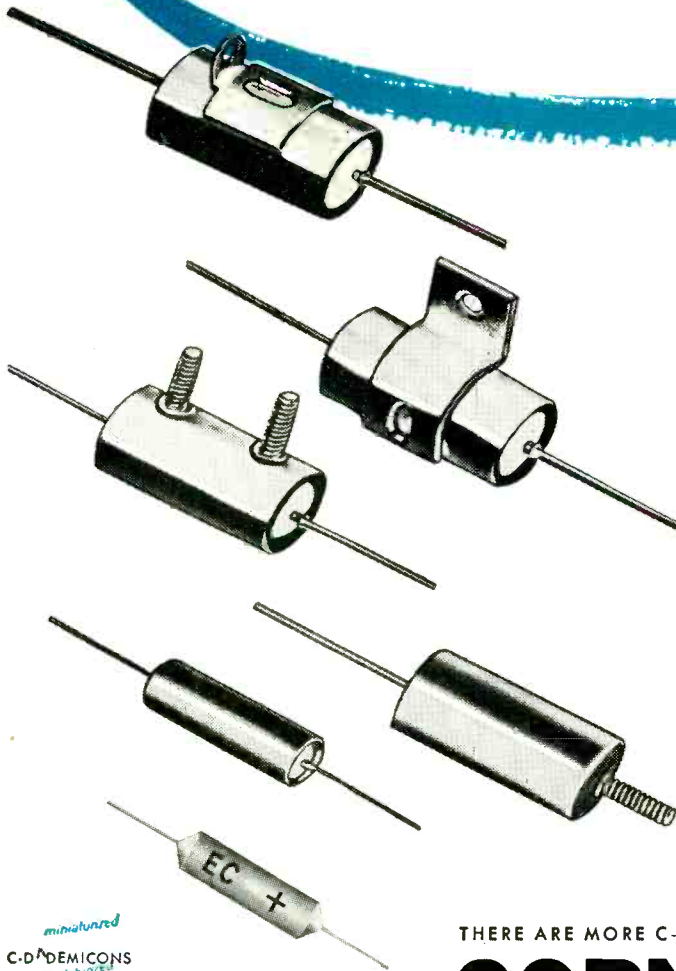

The smaller the capacitor
the more you will appreciate
C-D's built-in extras!

Cornell-Dubilier has proved that you don't have to compromise with quality for size in a capacitor. You will find that regardless of how small a C-D capacitor may be, it still retains that extra margin of safety required in a high quality miniaturized unit. C-D's built-in extras and their conservative ratings, mean more for your capacitor dollar . . . and nowhere is consistent dependability more vital than in the field of miniaturized capacitors.

So bring your miniaturized capacitor needs to C-D first. The unit you are looking for may already have been designed by our engineers.

Engineering samples sent on request. For your special design and application problems, use our Technical Advisory Service.

Cornell-Dubilier Electric Corp., Dept. K-34
South Plainfield, New Jersey.

- miniaturized
C-D DEMICONS
miniaturized
- C-D MICAS
miniaturized
- C-D BUDROG
miniaturized
- C-D METALLIZED PAPER TUBULARS
miniaturized
- C-D TANTALUMS
miniaturized
- C-D CERAMICS
miniaturized
- C-D ELECTROLYTIC

THERE ARE MORE C-D CAPACITORS IN USE TODAY THAN ANY OTHER MAKE

CORNELL DUBILIER

Capacitors

PLANTS IN SOUTH PLAINFIELD, N. J.; NEW BEDFORD, WORCESTER AND CAMBRIDGE, MASS.; PROVIDENCE AND HOPE VALLEY, R. I.; INDIANAPOLIS, IND.; FUGUAY SPRINGS AND SANFORD, N. C.; AND SUBSIDIARY, THE RADIART CORPORATION, CLEVELAND, OHIO



ANTENNAS



ROTORS



CAPACITORS



VIBRATORS



CONVERTERS

A NEW TERMINATION TECHNIQUE FOR . . .

- BUSINESS MACHINES
- COMPUTERS
- CONNECTOR PLUGS

- MULTI-CIRCUIT COMPONENTS
- SIGNAL APPARATUS
- PRINTED CIRCUITS

AMP

ROUND* TAPER

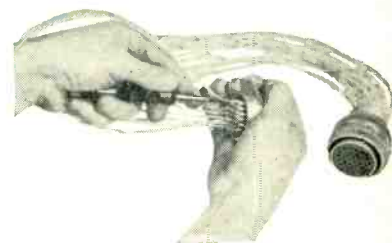
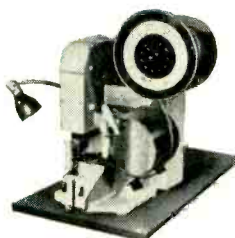

Here at last is a connector which combines miniature size and self-locking action! To make electrical connections, simply press AMP Taper Pins into mating receptacles. The pins are almost as small as the wire itself, yet when securely inserted will maintain their connection even up to the point of wire failure. Salt spray and vibration tests show initial contact resistances of only 0.5 to 1.0 milliohms increasing to a maximum of 2.63 milliohms after 160 hours of cycling.

New applications are being found every day for these versatile connectors—over a billion pins are in the field in computers and associated business machines alone!

Uses include termination of printed circuits, speaker disconnects, UHF antennae filters and tuners, Germanium diodes and TV high voltage fuses etc. Extraordinary security under vibration makes them excellent for attaching wires to crowded multiple contact "AN" connectors in aircraft. Write for "TAPER TECHNIQUE" Folder.

**For relays, switches, multi-circuit components, and other applications where a flat tab is more adaptable, see AMP Taper Tab Receptacles.*

AMP Taper pins, rolled from strip stock to very close tolerances, are wound on reels ready for use in AMP Automatic Wire Terminators. Pins can be applied as fast as operator can insert wire with speeds reported as high as 4,000 per hour! Spring type installation tool will seat pins firmly in mating receptacles.

Pins shown in illustration at right are 50% larger than actual size. →

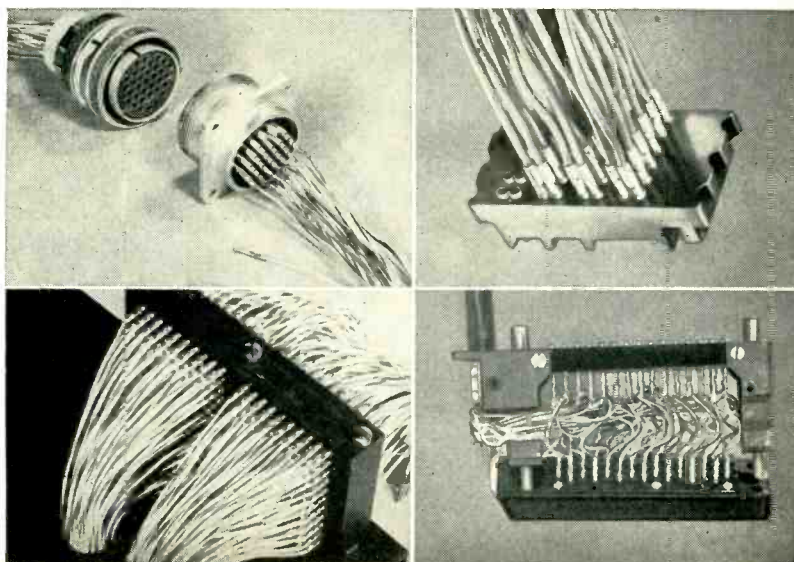



PINS

AMP

AMP Trade Mark Reg. U.S. Pat. Off.

© AMP

AIRCRAFT-MARINE PRODUCTS, INC.
ELECTRONICS DIVISION
2100 Paxton Street, Harrisburg, Pa.

Aircraft-Marine Products of Canada, Ltd.
1764 Avenue Rd., Toronto 12, Ontario, Canada

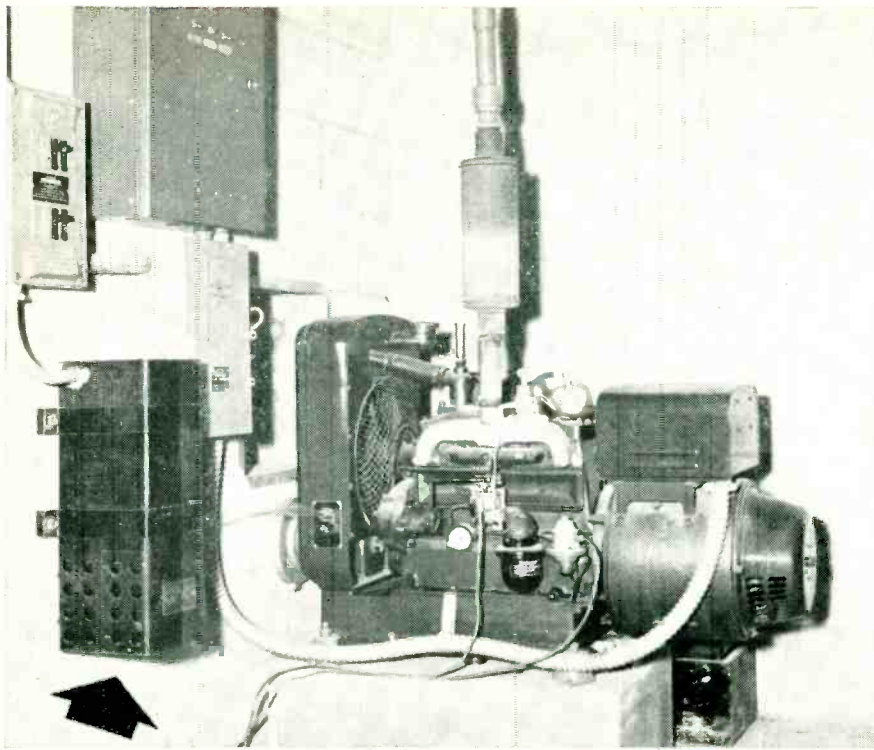

37 REPEATER STATIONS: The corner of a typical repeater station. The Sola Constant Voltage Transformer, which supplies stabilized voltage (regulated $\pm 1\%$ with line variations as great as $\pm 15\%$) to the equipment is identified by the arrow. The automatic, continuous, maintenance-free operation of the Sola units are important since many of the repeater stations are located in isolated sections and remotely controlled. The Sola stabilized voltage greatly contributes to the 20,000 hours or more life expectancy of the tubes used in the system, as well as aiding superior overall performance.

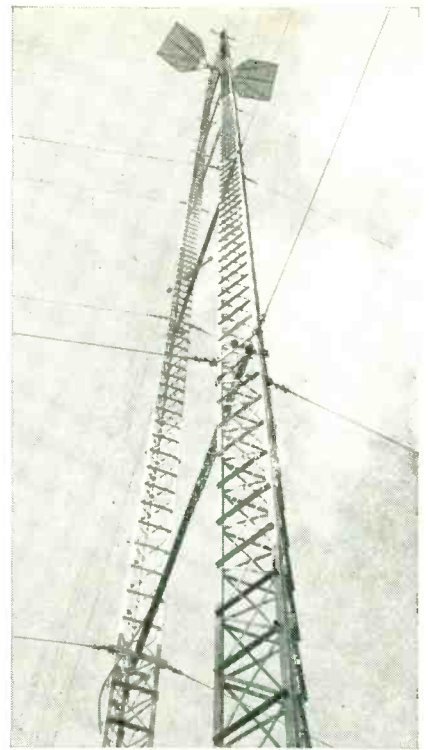

PASSIVE REFLECTORS: All of the Motorola radio equipment is installed on the ground. No cable, transmission line or waveguide runs are required on the tower for signal relaying. All radio frequency signals are directed through the air between the paraboloid antennas on the roof of the building and the 45° passive reflectors at the top of the tower.

Constant voltage power supply reduces maintenance and aids performance on microwave radio relay system

The Texas Illinois Natural Gas Pipeline Company's microwave radio relay system extends over 1,000 miles between Houston and Hungerford, Texas and Chicago, Illinois. This system utilizing Motorola equipment employs 37 repeater stations, many of them in remote, inaccessible locations.

Continuous, reliable operation of high quality is a basic requirement since the radio relay system is the nerve center of the entire pipeline operation. Sola Constant Voltage Transformers are installed at all 37 repeater stations and three terminal stations to assure a dependable source of stabilized voltage for the equipment.

Stabilized voltage contributes to superior performance of the electronic and electrical equipment by providing an operat-

ing voltage level constant to within $\pm 1\%$ with line voltage variations as great as $\pm 15\%$. In addition, operation of the electron tubes from a constant voltage source extends heater and filament life, greatly reducing tube replacement.

The Sola Constant Voltage Transformer is a static magnetic regulator that has no tubes or moving parts. Its operation is completely automatic and continuous with response time of 1.5 cycles or less.

You can select from 42 stock units; or custom-designed stabilizers can be manufactured to your specifications in production quantities. A Sola sales engineer will be happy to give you the facts on your request.

Automatic, Maintenance-Free Voltage Stabilization

SOLA *Constant Voltage*
TRANSFORMERS

New technical information is periodically being released on the application and operation of Sola Constant Voltage Transformers. If you are not presently receiving these informative bulletins, write requesting your name be placed on our mailing list.

Transformers for: Constant Voltage • Fluorescent Lighting • Cold Cathode Lighting • Mercury Vapor Lighting • Luminous Tube Signs
SOLA ELECTRIC CO., 4633 W. 16th Street, Chicago 50, Illinois, Blshop 2-1414 • NEW YORK 35: 103 E. 125th St., TRafalgar 6-6464
 PHILADELPHIA: Commercial Trust Bldg., Rittenhouse 6-4988 • BOSTON: 272 Centre St., Newton 58, Mass., Blgelow 4-3354
 CLEVELAND 15: 1836 Euclid Ave., PROspect 1-6400 • KANSAS CITY 2, MO.: 406 W. 34th St., Jefferson 4382 • Reps. in Other Principal Cities

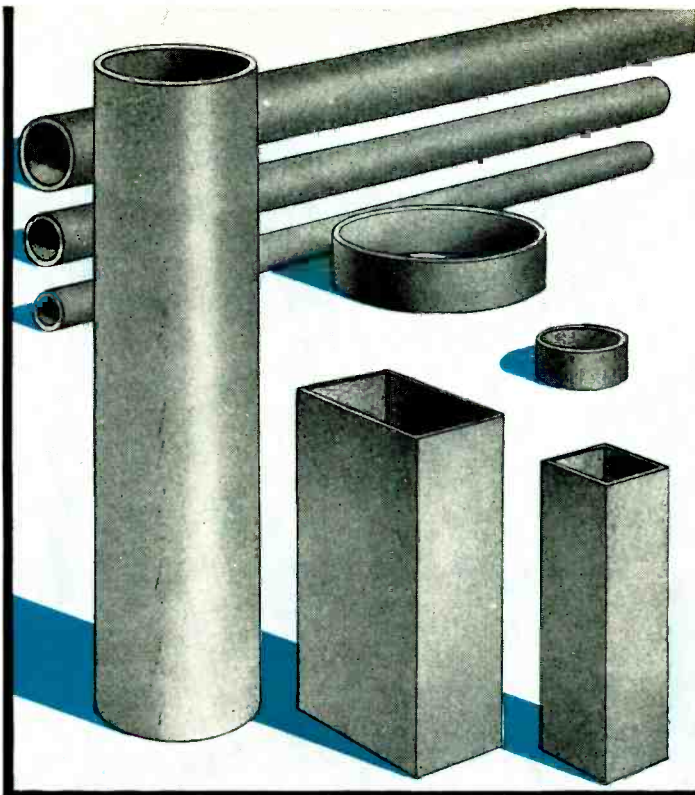

PROVEN
IN HUNDREDS OF CRITICAL
APPLICATIONS EVERY DAY

QUALITY
TO MEET UNLIMITED
NEW APPLICATIONS

CLEVELITE*
LAMINATED PHENOLIC TUBING

Moisture Resistant
Mechanically Strong
High Dielectric Strength
Dimensional Stability
Low Loss Factor

USE CLEVELITE

to make a good product better . . .
and at lower costs!

SERVICE

Our Design and Production Depart-
ments are geared to customers' needs
in every way. Deliveries are prompt!

Your copy of our Clevelite Brochure
available on request . . . of value to
every Engineering Dept.

* Reg. U. S. Pat. Off.

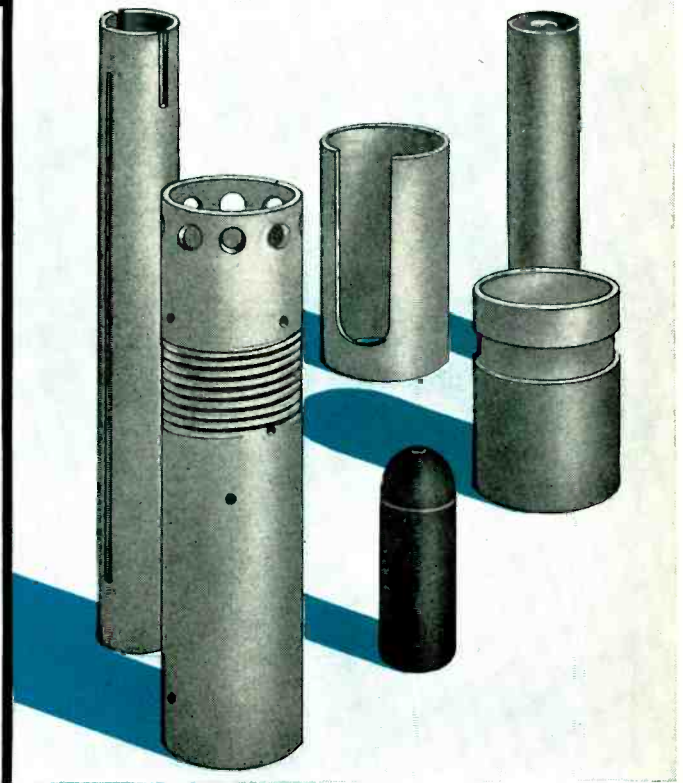

Visit our Exhibit #519
at the
Radio Engineering Show
in New York City,
March 22-25.

The **CLEVELAND CONTAINER Co.**
6201 BARBERTON AVE. CLEVELAND 2, OHIO

PLANTS AND SALES OFFICES at Chicago, Detroit, Memphis, Plymouth, Wisc., Ogdensburg, N. Y., Jamesburg, N. J.
ABRASIVE DIVISION at Cleveland, Ohio

CANADIAN PLANT: The Cleveland Container, Canada, Ltd., Prescott, Ontario

REPRESENTATIVES

NEW YORK AREA R. T. MURRAY, 604 CENTRAL AVE., EAST ORANGE, N. J.
NEW ENGLAND R. S. PETTIGREW & CO., 62 LA SALLE RD., WEST HARTFORD, CONN.
CHICAGO AREA PLASTIC TUBING SALES, 5215 N. RAVENSWOOD AVE., CHICAGO
WEST COAST IRV. M. COCHRANE CO., 408 S. ALVARADO ST., LOS ANGELES

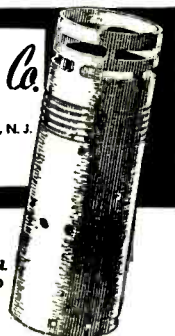

She's a pistol-packin'

... AND A ROOTIN' TOOTIN' BOOSTER
IN THE *Wire-Wrap* BRIGADE!

The electrical connections she used to wind-and-solder, she can make now in half the time with a Keller Wire-Wrap Gun. Stronger, too... stronger mechanically and stronger electrically without the use of solder.

Now there is no hot iron to handle, no sizzling flux, no solder drippings to splatter. And since wiring costs have dropped way down, her boss is a booster, too!

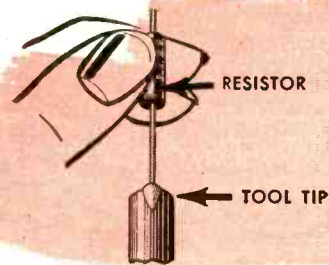

Solderless Wire-Wrap connections avoid failures caused by solder shorts, dropped clippings, and heat damage to delicate parts.

1 INSERT WIRE

Wire-Wrap Division

mamma now!



KELLER
Wire-Wrap
TOOLS
MAKE SOLDERLESS CONNECTIONS IN HALF THE TIME

* Trademark

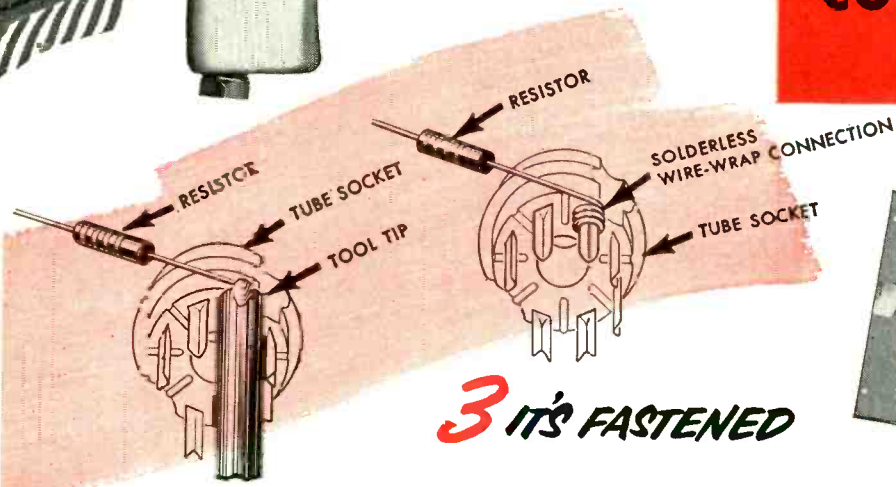

2 ZIP...AND

3 IT'S FASTENED



SEND FOR BULLETIN 11 for complete information about these new tools

Wire-Wrap Tools

are now available from Keller —the original manufacturer



Power Tools Engineered to Industry
KELLER TOOL CO.
 GRAND HAVEN, MICH.

News About Created-Metals

Thermistors Provide Vital Time Delay

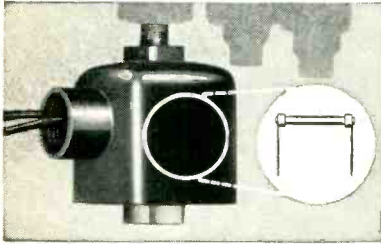

Smoky starts, puff-back and flutter in oil burners were checked by using a Carboloy Thermistor in the burner's electrical control.

The Thermistor delays the opening of a solenoid valve until the combustion chamber is ready to receive properly aerated oil. A mechanical timer is eliminated, and the cost of the unit reduced.

Thermistors are the most thermally sensitive resistor material known. Their resistance—unlike metals—changes negatively with temperature increases. They are ideal for temperature compensation, temperature detection, warning devices and controls. For more information, write: Carboloy Department of General Electric Company, 11139 E. 8 Mile Road, Detroit 32, Michigan.

Hevimet Containers Stop "Hot Atoms"

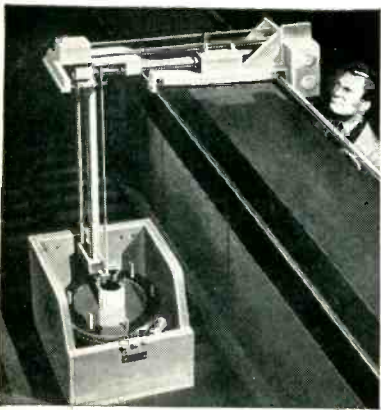

Containers made of Carboloy Hevimet are making the job of handling and transporting radioactive materials easier and safer.

Because Hevimet is almost 50% heavier than lead, and provides 40% more gamma ray protection, these containers are smaller, less bulky . . . yet safer than lead.

Hevimet is an ideal material for all radioactive shielding. It is readily machinable, dimensionally stable and of high tensile strength. For more information, write: Carboloy Department of General Electric Company, 11139 E. 8 Mile Road, Detroit 32, Michigan.

Permanent magnets in this large hysteresis brake control the torque of spools of heavy wire being woven into rope. Complete absence of friction during operation eliminates wear.

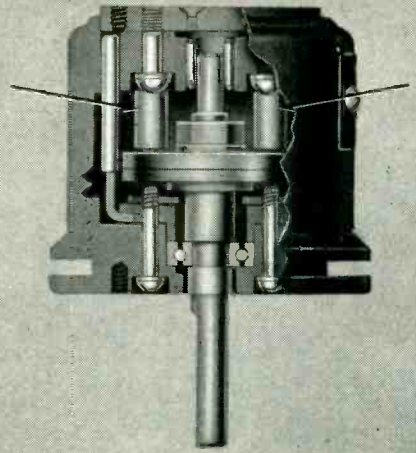
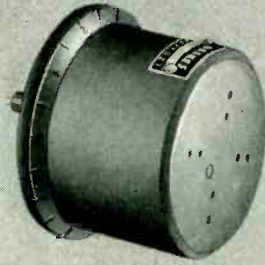

Control Torque

Basic functions of permanent magnets

- | | | |
|--|---|--|
| <p>① Change electrical energy to mechanical motion</p> | } | <p>Eddy current braking
Motor action
Instrument action</p> |
| <p>② Change mechanical motion to electrical energy</p> | } | <p>Generator action
Magneto action</p> |
| <p>③ Change mechanical energy to thermal energy</p> | } | <p>Control of torque</p> |
| <p>④ Mechanical holding</p> | } | <p>Snap action
Separation
Holding and lifting</p> |



Minneapolis-Honeywell Step Controller employs snap switch based on mechanical holding function of Carboloy Alnico permanent magnets. Magnets reduced weight, improved design, and increased performance.

G.E. jet tachometer generator had to be kept small and light. Engineers used permanent magnet's ability to change mechanical motion to electrical energy. Magnets eliminated coils and wires; provided powerful energy.

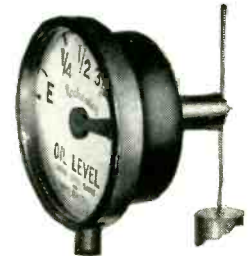
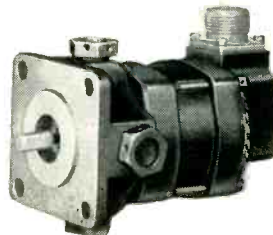

Rochester Liquid Level Gauge utilizes synchronous magnetic torque drive principle to operate pointer, keep gauge head pressure-tight. Magnets eliminate stuffing box and shaft—permit mounting gauge in any position without danger of leakage.

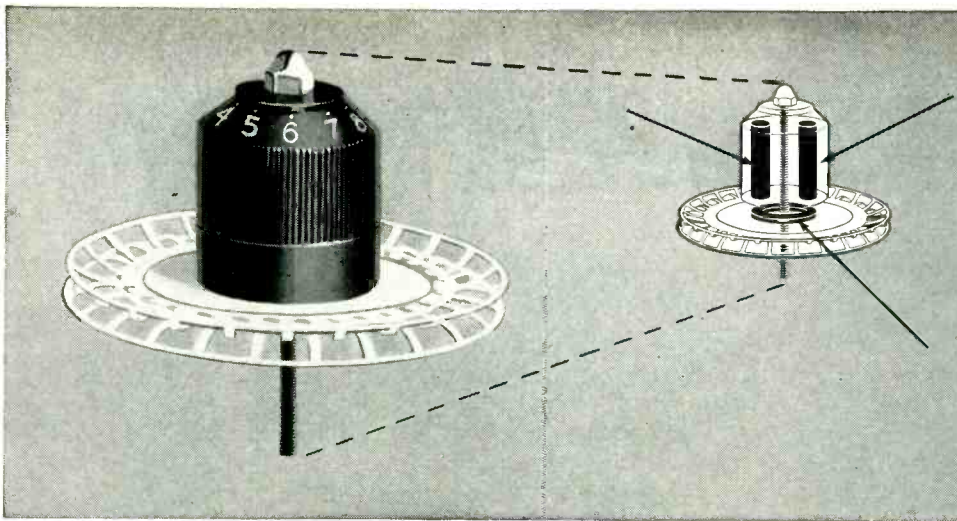

This tiny, permanent magnet hysteresis brake maintains constant pulley tension on delicate fibers. It reduces slippage and static electricity. Magnetic dial offers wide range of tensions and speeds.

with Permanent Magnets

In hysteresis brakes, permanent magnets convert mechanical energy to thermal energy. Other inherent properties make permanent magnets ideal for many electrical and mechanical applications.

Carboloy Alnico permanent magnets, in hysteresis brakes, provide smooth, frictionless torque control. Tension and torque are adjustable and constant.

The hysteresis brake is only one of the ways permanent magnets can control torque. And permanent magnets can be used to convert electrical energy to mechanical motion . . . or mechanical motion to electrical energy, or for mechanical holding.

Permanent magnets offer many production savings. They can eliminate parts, reduce costs, simplify design, save weight

and improve performance. They retain their efficiency under varying conditions of temperature, shock, vibration. They resist the demagnetizing influence of stray magnetic fields . . . provide powerful, permanent energy sources. Available in all sizes and shapes, cast or sintered.

Perhaps Carboloy permanent magnets can improve your products or equipment. Specially trained engineers of the Carboloy Engineering Appraisal Service will work with you on permanent-magnet design and application. Send coupon, today, for free catalog or design manual.

"Carboloy" is the trademark for products of the Carboloy Department of General Electric Company

CARBOLOY®

DEPARTMENT OF GENERAL ELECTRIC COMPANY

11139 E. 8 Mile Road, Detroit 32, Michigan

Send me the following, without cost or obligation:

- Permanent Magnet Design Manual, PM-101
 Permanent Magnet Standard Stock Catalog, PM-100

Name _____ Position _____

Company _____

Address _____

City _____ Zone _____ State _____

Under pressure for

SEE OUR EXHIBIT AT THE
I.R.E. SHOW
472 ELECTRONIC AVENUE



ODD SIZES and SHAPES?

HUDSON
PRECISION DRAWN
CLOSURES
AND QUALITY METAL
STAMPINGS

DEPEND ON HUDSON FOR PRECISION FORMED "SPECIALS" . . . ODD SHAPES AND SIZES AT MASS PRODUCTION PRICES. Hudson standardized production methods make it possible to solve even unusual closure problems quickly, from stock. The Hudson line includes hundreds of stock closures available with a choice of optional features. All parts are precision fabricated from selected metal stocks. Cans, covers and quality metal stampings are available in brass, copper, aluminum and steel.

CONSULT THE HUDSON CATALOG OF STANDARDIZED PARTS! Contains complete specifications on hundreds of different standard catalog items. All are available for fast delivery. Call or write for your copy, now!



HUDSON TOOL AND DIE COMPANY • INC
118-122 SO. FOURTEENTH STREET, NEWARK 7, NEW JERSEY

SNORKEL HUNTER...



with an assist by DALMO VICTOR

One typical DV Development

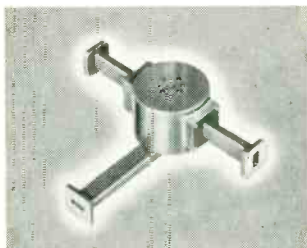

RADIO FREQUENCY SWITCHES

Successful high-speed rotary-scan radar antenna operation depends upon precision regulation of r-f power. This has been made possible by Dalmo Victor's development of the high-power rotary r-f switch shown. Characteristics include constant impedance at both input and output joints during rotation, capacity to transmit high power, less than 20-degree crossover angle, and complete sealing for pressurization.

Specialized radar, with antennas and other electronic instrumentation designed and produced by Dalmo Victor, makes the Navy's P2V-5 Neptune capable of locating and tracking down Snorkel submarines.

Dalmo Victor maintains the leading specialist group concentrating on design-through-production engineering of such complex lightweight electromechanical systems. This skilled organization stands ready to help you with your engineering and production problems.

DALMO VICTOR

SAN CARLOS · CALIFORNIA

DV

DOWN - TO - EARTH ELECTROMECHANICAL ENGINEERING



THE TYPE 20 INSTANTANEOUS READING BROAD-BAND SWR INDICATOR

The AIL type 20 SWR Indicator System consists of two separate Scanning Oscillators covering the 400-900 mc and 900-1350 mc bands, a Reflectometer with a standard matched 50-ohm load, a Ratio Measuring Unit, interconnecting and power cables. Frequency and SWR over the entire band are displayed on an oscilloscope (not supplied).

- Instantly measures standing wave ratio over the 400-900 mc and 900-1350 mc bands.
- Eliminates tedious point-by-point data taking.
- Adjust antennas, transmission systems, filters, networks, receivers while under test.
- The Scanning Oscillators may be used separately as sources of r-f power, automatically scanned or manually adjusted to the desired frequency, giving 200-milliwatt minimum power output over the band into a 50-ohm resistive load.

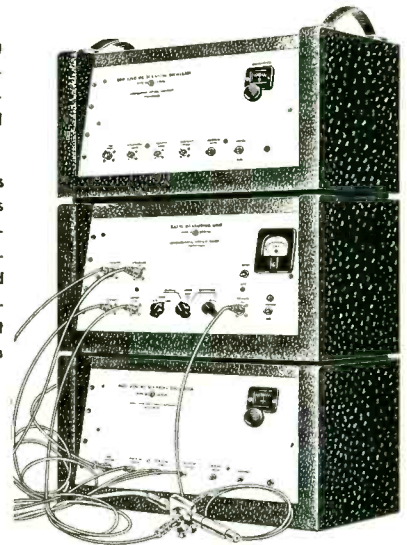

Type 20 SWR Indicator System, Complete with Interconnecting Cables less oscilloscope

Low Frequency System	\$2,980
High Frequency System	2,980
Complete High and Low Frequency Systems	4,200

F.O.B. Mineola. Prices for individual units may be obtained upon request.

WIDE RANGE POWER OSCILLATOR

Continuous control within ranges from 300 to 900 mc and 900 to 2,500 mc

Separate output coupling control

More than 10 W to 1200 mc

More than 2.5 W to 2,500 mc

The AIL type 124A Oscillator consists of a grid-separation coaxial oscillator employing a 2C39A disc seal triode, an audio oscillator and a modulation section.

Write for a detailed description of its versatility and operating ease.



\$2,285.00 F.O.B. Mineola

Airborne Instruments Laboratory is known the world over for its skill in electronic research and engineering development. More than eighty per cent of its business activity has been in assisting industry and government in improving the scope of electronic application and solving problems for producers and users of electronics.

Perhaps we can be of service to your organization. Your inquiry will receive prompt attention and will be handled in confidence.

Write for complete literature on these items, or AIL custom design and manufacturing service on other precision instruments and components.

Visit our booth
at the IRE Convention
No. 718
Airborne Avenue

RECTANGULAR COORDINATE RECORDING SYSTEM

The AIL type 373A Rectangular Coordinate Recording System has the accuracy of a precision laboratory instrument, yet its rugged construction recommends it for field use. Fills a variety of recording needs where fast plotting and permanent records are required.

- Radio and Radar Antenna radiation patterns
- Acoustics Reverberation-time studies
Directional characteristics of microphones and loud speakers
Frequency response curves
- Atomic Research Counting rates
Monitoring process control

Provides in rectangular coordinates a continuous inked plot of voltage, as a function of either angular position or time. Two-microvolt sensitivity.

Available to provide logarithmic or linear recording of input voltage.

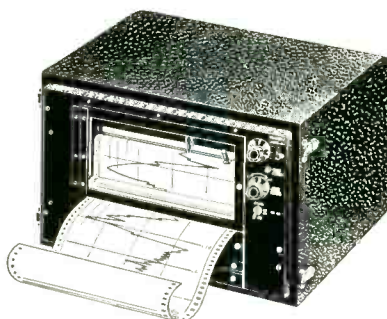

Full scale (10 inches) pen deflection in one quarter second.

Paper speed up to 10 inches per second.

Write for information today.

\$8,500.00 F.O.B. Mineola, N. Y.

MICROWAVE CRYSTAL TESTER

checks microwave crystals easily — accurately

- Measures: Relative Noise Figure
Relative Sensitivity
Match of Crystal Pairs
Conversion Loss
Noise Temperature

- Uses: Field test set to determine receiver sensitivity, as determined by crystal quality
Laboratory test set to choose representative and extreme crystals from a group
Crystal inspection test set

Tests crystals without removing them from the receiver

Accepts both ceramic cartridge and coaxial types, normal or reversed polarities

AIL Type 390A-3

Accurate

Portable

Self-Contained

\$97.00

F.O.B. Mineola

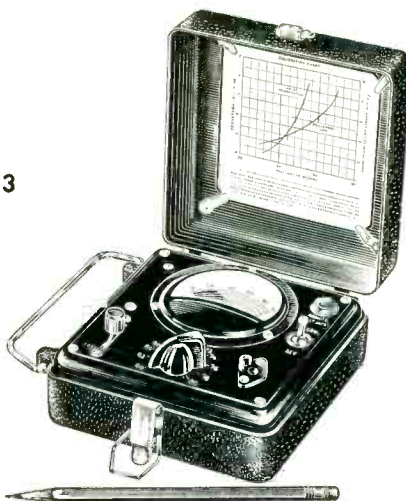

AIRBORNE INSTRUMENTS LABORATORY

I N C O R P O R A T E D

160 OLD COUNTRY ROAD, MINEOLA, L. I., N. Y.

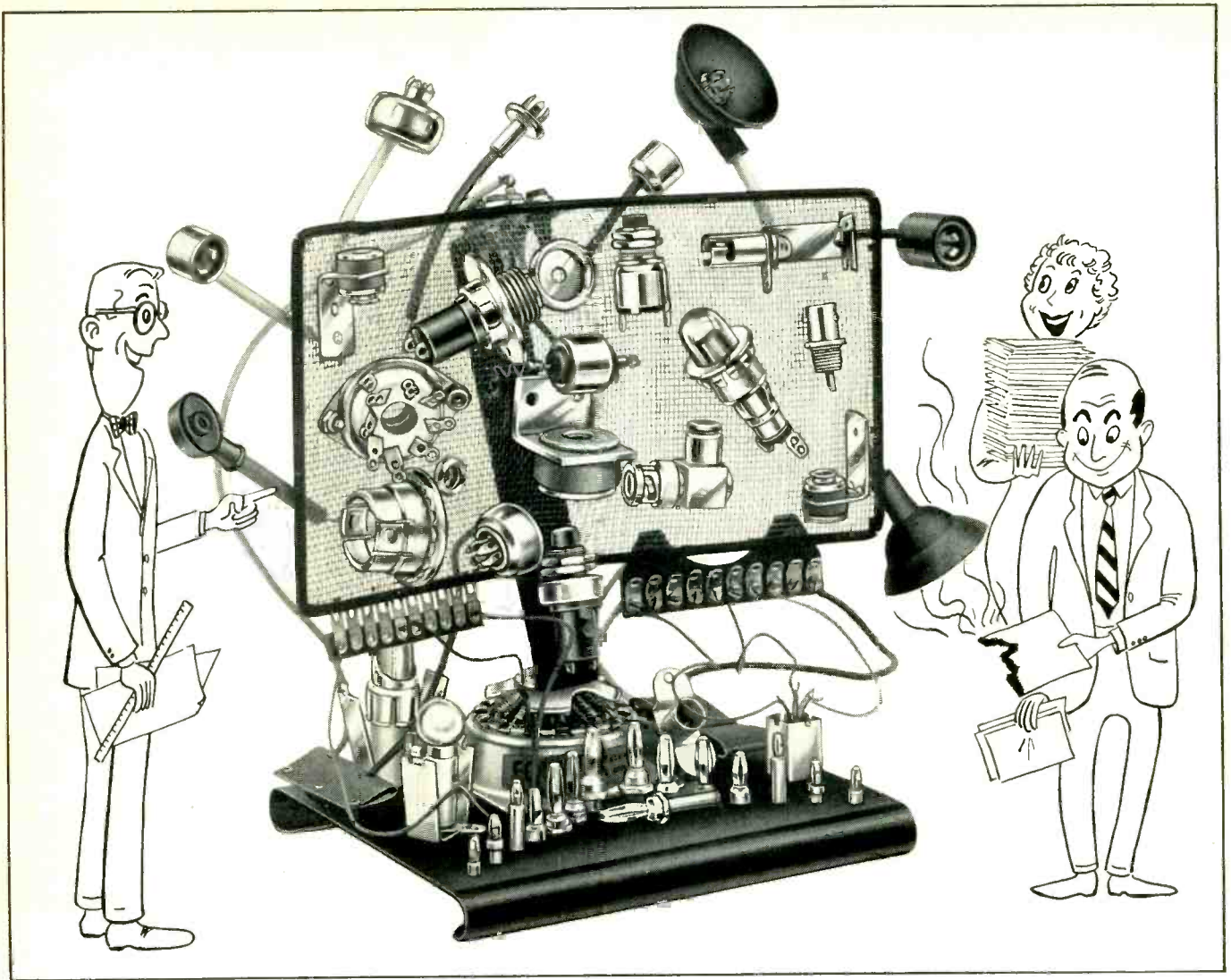

Macerating Ganderscope

Originally developed as a counter-weapon to the duplicating machine, Ucinite's Ganderscope cuts through the thickest administrative fog and reduces directives, memoranda and other official communications to their simplest form. The complete unit is available at enormous cost but its component parts can be bought in quantity at competitive prices.

With an experienced staff of design engineers, plus complete facilities for volume production, Ucinite is capable of supplying practically any need for precision-made switches, connectors, sockets, mountings and similar devices, assembled and wired to your specifications. Call your nearest Ucinite or United-Carr representative for full information.



The
UCINITE CO.
Newtonville 60, Mass.
Division of United-Carr Fastene- Corp.

Specialists in
ELECTRICAL ASSEMBLIES,
RADIO AND AUTOMOTIVE

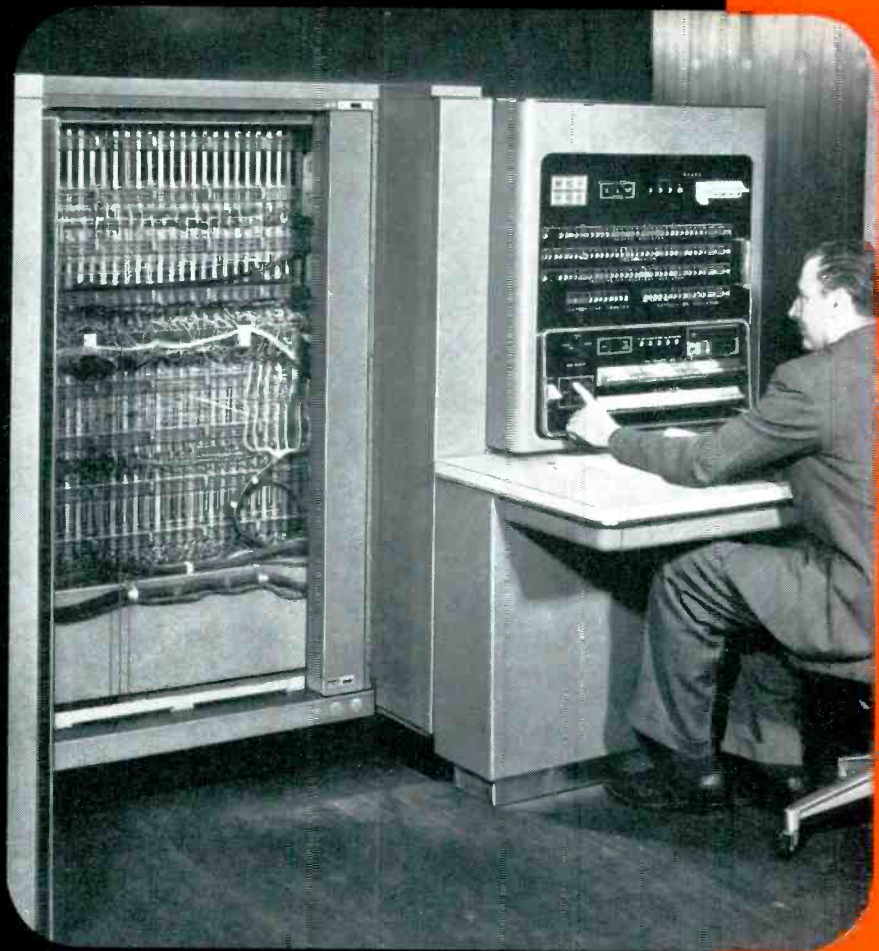

14,000
computations
per second
speed defense
program!

Ward Leonard supplies resistors as IBM puts newest "giant brain" into production

• One of the fastest electronic calculators ever built, IBM's new eleven-unit 701 lops years from our preparedness program timetable.

It calculates atomic radiation effects, makes aerodynamic computations relating to planes, guided missiles, jet and rocket engines, and is used for detailed analyses of various weapons.

For example, one of the equations used in aircraft wing design requires 8,000,000 calculations which would take a man seven years to complete. Performing an average 14,000 mathematical computations per second, the 701 can solve the same equation in less than ten minutes.

Equally important is IBM's ability to produce these electronic data processing machines in quantity, using assembly line techniques. All the components for the 701 were given intensive tests before final selection. Among them are Ward Leonard Vitrohm wire wound resistors, shown at the right.

If your product requires electrical controls of uniform accuracy, you too can find them in Ward Leonard's complete line, described on the back of this page. Write Ward Leonard Electric Company, 100 South St., Mount Vernon, N. Y.

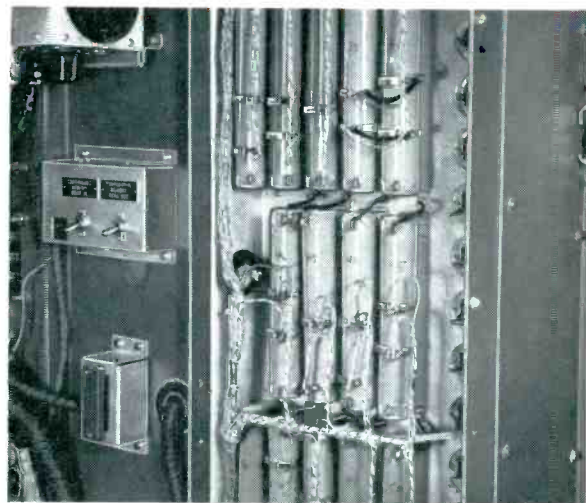

RELIABLE WARD LEONARD POWER RESISTORS are used as bleeders in the diode protection voltage circuits of the 701. They are housed in the Electronic Analytic Control unit where the actual computing and control functions are performed.



WARD LEONARD
ELECTRIC COMPANY
 MOUNT VERNON, NEW YORK



RHEOSTATS



RELAYS



MOTOR CONTROLS



CHROMASTER

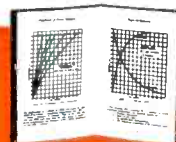

Ward Leonard's complete engineering textbook, "Handbook of Power Resistors," \$3. per copy.

Result-Engineered Controls Since 1892

MEET THE world's largest selection of resistors

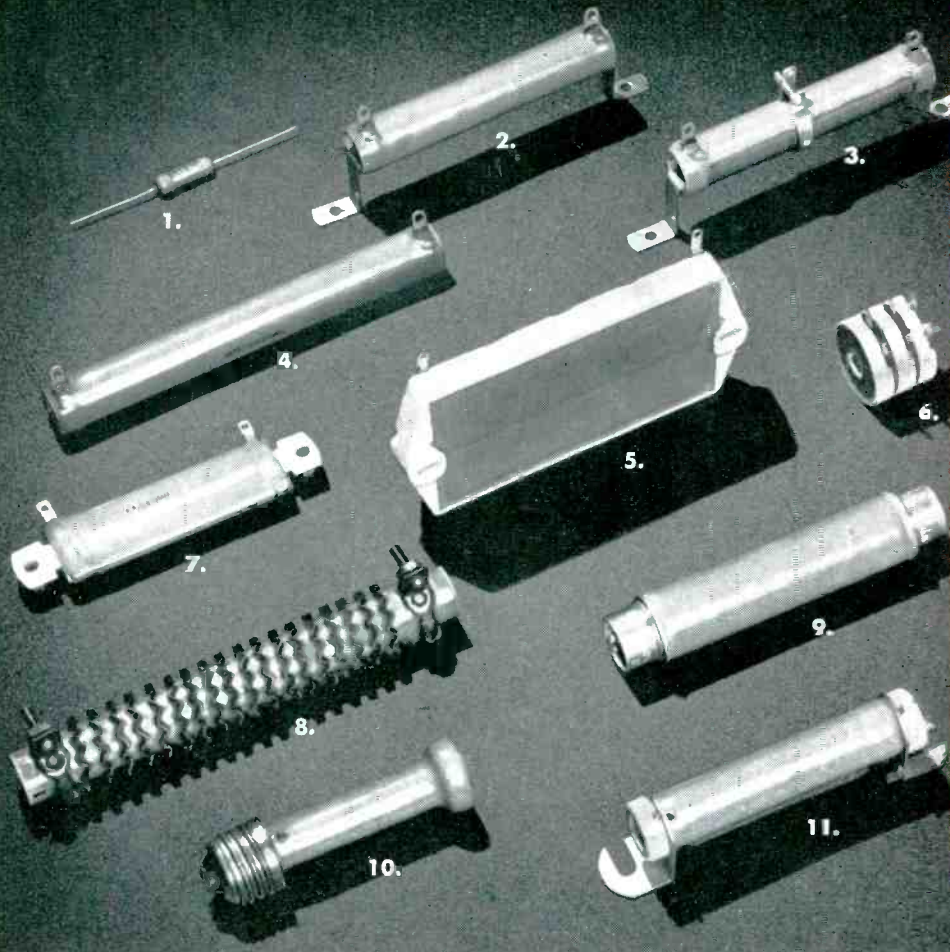

1. **AXIOHM*** Used in electronic equipment requiring miniature power resistors. 2. **FIXED VITROHM*** Used for voltage dropping and current limiting. 3. **ADJUSTOHM*** Gives circuit adjustability for voltage dividing or regulating purposes. 4. **NON-INDUCTIVE*** For low inductance and distributed capacitance in high frequency circuits. 5. **P-AQOHM*** Used in compact, high frequency electronic equipment. 6. **DISOHM*** A miniature resistor for low inductance values and distributed capacitance. 7. **STRIPOHM*** For compact

aviation, communication and navigation equipment. 8. **RIBFLEX** Used in circuits where high voltage must be dissipated in small space. 9. **FERRULE TERMINAL** For rapid interchangeability of resistance values or resistor replacement. 10. **SCREW EASE** With an Edison screw base for mounting to provide rapid means of changing resistance. 11. **BRACKET TERMINAL** Has leads silver brazed to brackets for easy interchange or renewal of unit.

*These are stock resistor types

Ward Leonard Vitrohm resistors will best meet your every requirement

• The eleven resistor types shown above (seven of them stock resistors) represent the most complete line ever offered by any manufacturer.

We carefully control every step in the manufacture, and run more than 19 separate inspection checks on every single resistor we produce to make sure it will perform as rated, even under the most adverse conditions.

That's why you can depend on the performance of every Ward Leonard resistor you use.

We also maintain a stock of component parts so that made-to-order resistors may be quickly assembled to meet your special requirements.

For full information on Vitrohm resistors, write for our Catalog 15, to Ward Leonard Electric Company, 100 South Street, Mount Vernon, N. Y.

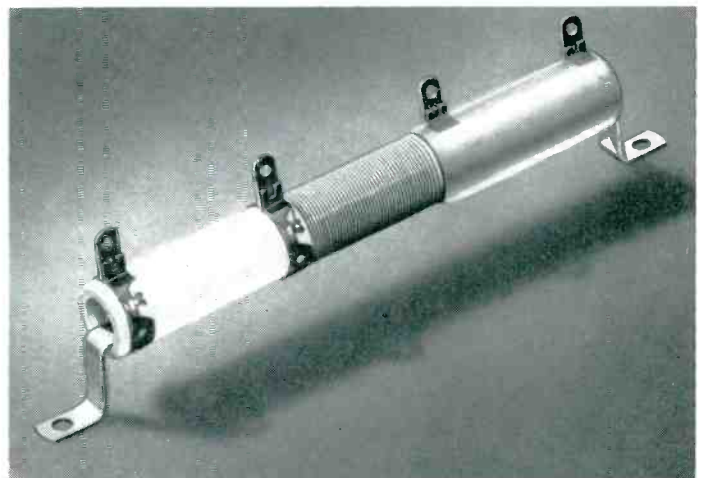

WARD LEONARD IS THE ONLY MANUFACTURER that makes its own ceramic cores, Vitrohm enamel and terminals. Even our resistance wire is specially drawn to Ward Leonard's own rigid specifications.



**WARD LEONARD
ELECTRIC COMPANY**
MOUNT VERNON, NEW YORK



PRESTATS



RELAYS



MOTOR
CONTROLS



CHROMASTER



New 64-page catalog contains useful data, tables, etc., for correct resistor selection.

Result-Engineered Controls Since 1892

IDEAS that started in a HEAT EXCHANGER

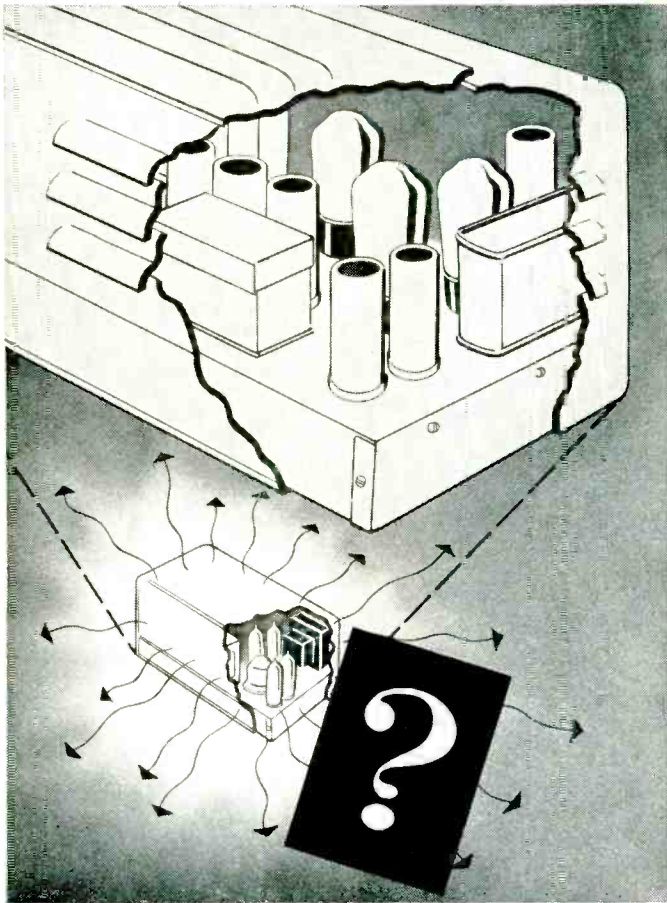

THE PROBLEM

New high-efficiency electronic units (lower unit in above panel) occupy as little as one-twentieth the space of older, air-cooled types (upper unit) — but they generate just as much heat. And since their hermetic sealing prevents direct cooling by air flow, temperatures would rise far beyond safe limits unless the heat were removed and dissipated elsewhere. At the same time, cooling equipment must be kept light and compact enough for aircraft use.

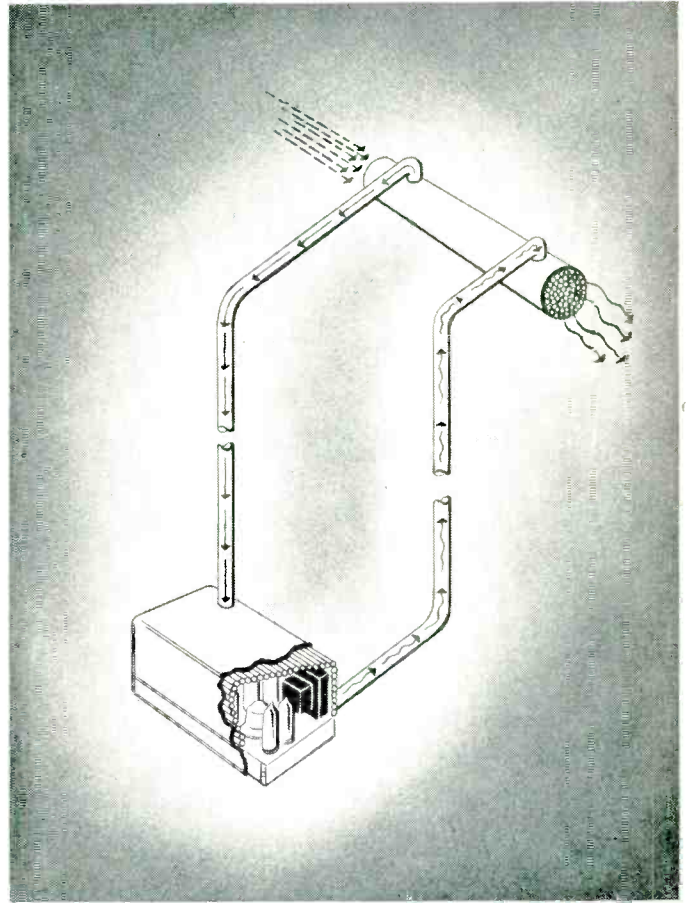

THE SOLUTION

Working with a leading manufacturer of electronic equipment, Clifford engineers designed the case of this aircraft electronic unit as a liquid heat exchanger. Heat is extracted by connecting with a second exchanger of the air-flow type, as shown. In jet-engined planes, however, heat is preferably dissipated by a liquid-to-liquid cooler — thereby reducing drag on the plane. Made entirely of aluminum, these Clifford heat exchange units combine thorough cooling with minimum size and weight.

You may have a cooling problem

Your own manufacture may or may not include aircraft applications. But now or later you may be looking for the best way of dissipating heat generated by high wattage elements in small spaces.

Then it will pay you to talk things over with Clifford engineers. These experts in a highly specialized field have developed successful liquid coolers for every type of aircraft — which includes some of the severest and most unusual working conditions any cooler is ever required to meet.

Clifford Feather Weights, for example, are the only all-brazed type of oil cooler. Their superior weight-strength ratio is the result of a patented brazing method and pre-testing in Clifford's wind tunnel laboratory — largest and most modern in its field.

Take advantage of Clifford's long

record of finding the most efficient and economical answers to the toughest cooling problems. Write to Clifford Manufacturing Company, 119 Grove Street, Waltham 54, Massachusetts. *Division of Standard-Thomson Corporation.* Sales offices in New York; Detroit; Chicago; Los Angeles; Waltham, Massachusetts.

HYDRON



METAL BELLOWS

CLIFFORD

MANUFACTURING CO.

WALTHAM, MASS.

DIVISION OF STANDARD-THOMSON CORP.

Feather Weight



HEAT EXCHANGERS

QUALITY CAN COST LESS

... And MALLORY Ceramic Resistors Prove It!

Wherever you need fixed resistors in television and other electronic circuits, you can get an ideal combination of quality and economy in Mallory Ceramic Resistors. They're low in cost—and their axial lead construction cuts production expense by eliminating mounting brackets, permitting point-to-point wiring and saving under-chassis space.

These features assure top quality performance:

- *Accurate resistance up to rated wattage through the use of exclusive Mallory Yard-Ohm wire.*
- *Long life: Fiberglass core contains no organic materials; high grade non-corrosive inorganic cement, injected under pressure to give high heat dissipation, holds resistance element securely. Resistors are built to take 100% overloads.*
- *Moisture protection: Resistor ends are sealed by special heat and moisture resistant compound.*
- *Rugged construction: tinned leads are securely clinched to prevent opens, high resistance and pull-outs. Non-porous steatite tubes protect against mechanical and thermal shock.*

For complete facts, write for the new catalog on fixed wire-wound resistors and carbon and wire-wound controls.

Expect more . . . Get more from **MALLORY**

Parts distributors in all major cities stock Mallory standard components for your convenience

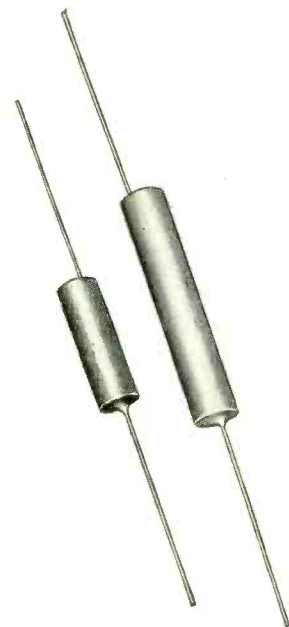

Available sizes:
 4 watt 1 to 1000 ohms
 $\frac{3}{16}$ " dia. x 1" long
 7 watt 1 to 5000 ohms
 $\frac{3}{16}$ " dia. x 1 $\frac{3}{4}$ " long
 Standard Tolerance 10%

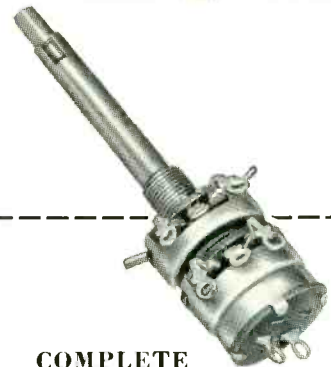

COMPLETE LINE OF CARBON CONTROLS

Factory assembled carbon controls are supplied in single, dual concentric and dual tandem constructions, with or without switch. High density, smooth surfaced element gives exceptionally low noise level, long life and minimum resistance drift. Available in standard tapers from 200 ohms to 10 megohms.

Serving Industry with These Products:

- Electromechanical**—Resistors • Switches • Television Tuners • Vibrators
Electrochemical—Capacitors • Rectifiers • Mercury Batteries
Metallurgical—Contacts • Special Metals and Ceramics • Welding Materials

2 Waldes Truarc Rings Replace 2 End Plugs ...Eliminate 3 Operations... Save \$.066 Per Unit

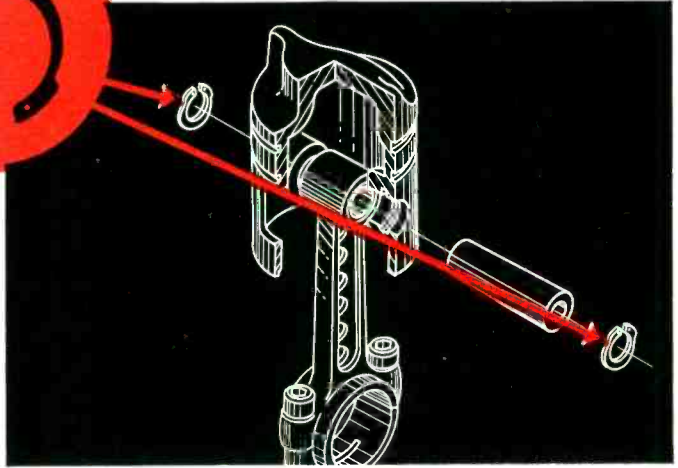
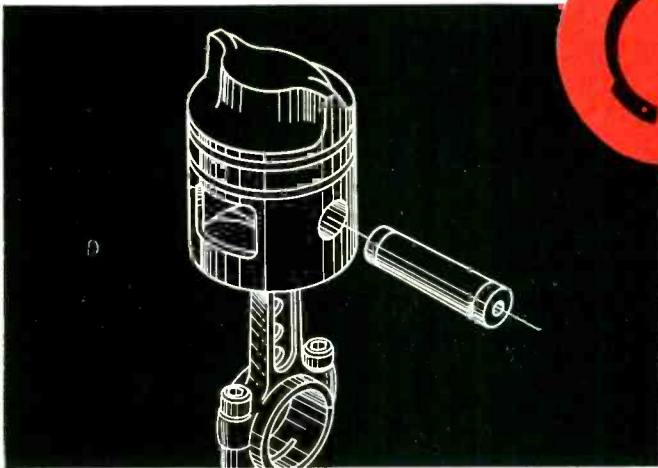

OLD WAY Two inserted-plug type wrist pin locks hold wrist pin in place. 3 operations involved: costly machining, pressing in place, post-assembly machining. Costly maintenance problem—resulting from end plugs hammering loose.

TRUARC WAY Two Truarc Inverted Retaining Rings (Series 5008) hold wrist pin in place. Truarc Rings snap into grooves easily cut in piston, provide positive lock . . . practically eliminate maintenance costs. Quick assembly, disassembly.

Titan Chain Saws, Inc., Seattle, Washington, uses 2 Waldes Truarc Rings to replace old-style inserted-plug type wrist pin locks in their Titan chain saws. Use of Waldes Truarc Retaining Rings eliminates 2 press fit end plugs. Machining of plugs, pressing in place, finish machining—no longer required. Truarc way holds rejections to a minimum. Unit efficiency is greatly increased.

Redesign with Truarc Rings and you, too, will cut costs. Wherever you use machined shoulders, bolts, snap

USE OF 2 WALDES TRUARC RINGS PERMITTED THESE SAVINGS PER UNIT:

OLD WAY	
Cost of 2 end plugs	} \$.169
Cost of pressing in and machining	
TRUARC WAY	
Cost of grooving piston	}103
Cost of 2 Truarc Rings	
Saving per Unit \$.066	

rings, cotter pins, there's a Waldes Truarc Retaining Ring designed to do a better job of holding parts together.

Waldes Truarc Rings are precision-engineered . . . quick and easy to assemble and disassemble. Always circular to give a never-failing grip. They can be used over and over again.

Find out what Waldes Truarc Retaining Rings can do for you. Send your blueprints to Waldes Truarc engineers for individual attention, without obligation.

For precision internal grooving and undercutting . . . Waldes Truarc Internal Grooving Tool.

Visit the Truarc Exhibit at the I.R.E. Show, Booth 746, March 22-25

SEND FOR NEW CATALOG →



WALDES TRUARC
REG. U.S. PAT. OFF.
RETAINING RINGS



Waldes Kohinoor, Inc., 47-16 Austel Place, L. I. C. 1, N. Y.

Please send me the new Waldes Truarc Retaining Ring catalog.

(Please print)

E-036

Name _____

Title _____

Company _____

Business Address _____

City _____ Zone _____ State _____

WALDES KOHINOOR, INC., LONG ISLAND CITY 1, NEW YORK

WALDES TRUARC RETAINING RINGS AND PLIERS ARE PROTECTED BY ONE OR MORE OF THE FOLLOWING U.S. PATENTS: 2,382,947; 2,382,948; 2,416,852; 2,420,921; 2,428,341; 2,439,785; 2,441,846; 2,455,165; 2,483,380; 2,483,383; 2,487,902; 2,487,803; 2,491,308; 2,509,081 AND OTHER PATENTS PENDING.



DESIGNER'S

Thyrite* resistance material offers new answer to many circuit problems

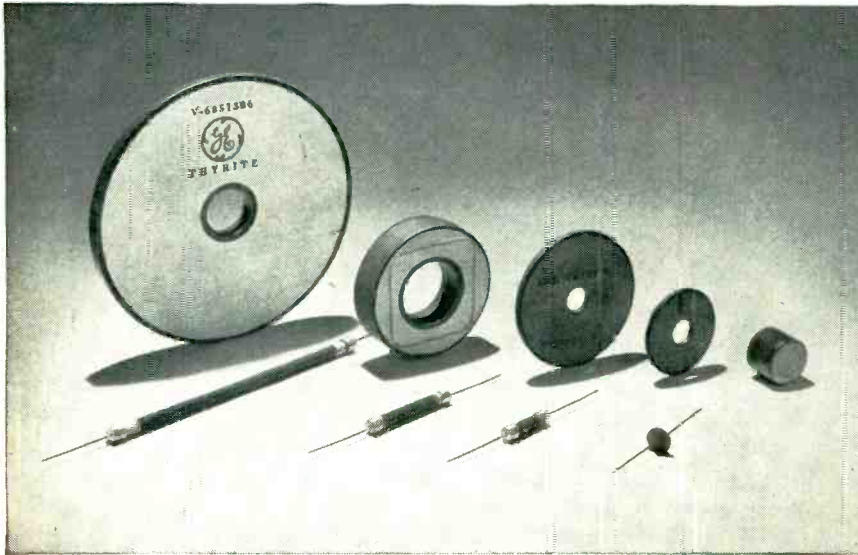

Here's a silicon-carbide ceramic material, dense and mechanically strong, having non-linear resistance in which I varies as E^n —the current varies as a power of the applied voltage. General Electric Thyrite resistance characteristic is stable and substantially independent of polarity or frequency. Because of this notable electrical property, it has solved many important circuit problems in electronic applications. Available in disk-type, rod-type, or miniature resistors, Thyrite material can also be successfully molded to meet your special needs. Unaffected by pressure or vibration, it can operate in temperatures up to 150 C. Its special coating compound minimizes the effect of humidity. See Bulletin GEA-4138.

*Reg. Trade-mark of the General Electric Company.

Drawn-oval capacitors reduce size, weight, and cost of your equipment

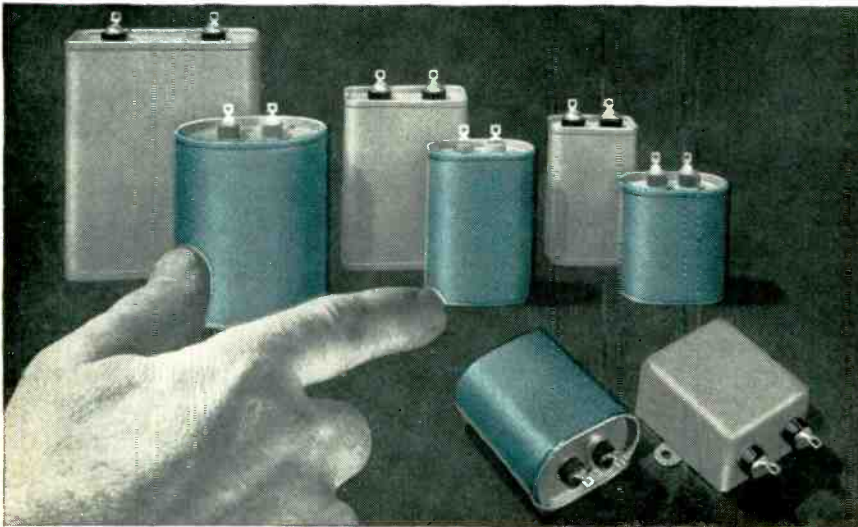

This full line of General Electric paper-dielectric capacitors features size and weight reductions up to 30 percent! They are also mechanically stronger than conventional types because of their drawn-steel containers with cover attached by double-rolled seam. You get space and cost savings plus improved reliability. Moreover, shipments arrive faster. Sturdy brackets offer versatility of mounting. Dual-rated (both a-c and d-c), these versatile capacitors are designed to replace styles CP 53 and CP 70, in ratings from 1 to 10 muf, 600 to 1500 volts d-c and 330 to 660 volts a-c. For more information check Bulletin GEA-5777.

GENERAL  ELECTRIC

DIGEST

TIMELY HIGHLIGHTS ON G-E COMPONENTS



Withstands vibration

Now a form of the G-E hermetically sealed relay withstands vibration forces of 10g from 10 to 500 cycles per second. All forms offer extra protection against permanent breakdown due to voltage surges. Coil ratings go up to 10,000 ohms. Contact configurations available include 4-pole double-throw and 6-pole single-throw. See Bulletin GEA-5729.

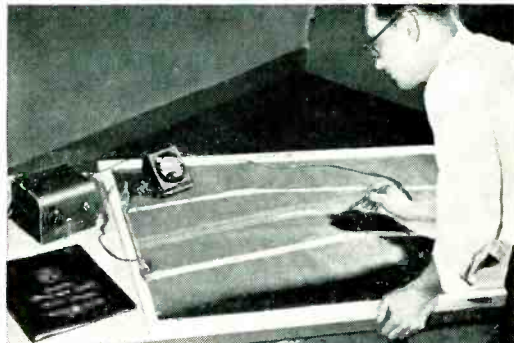

G-E analog plotter helps solve complex field problems -- fast

Now you can simplify and speed up those complex field studies by using General Electric's analog field plotter. By means of electric current flow patterns set up in a sheet of thin conducting paper, over-all operation of plotting in two dimensional fields is greatly simplified. Problems in electrostatics, electromagnetics, and many other fields are rapidly solved with this sensitive, versatile plotting board and the complete package of components necessary for making field studies. It needs only low-voltage d-c supply, which eliminates shock hazard, and is not affected by line-voltage variations. Explanation and instructions are covered in a 50-page manual accompanying the plotter. For full details, see Bulletin GEC-851.

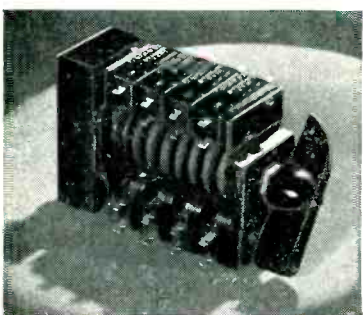

Controls 20 circuits

Compact, lightweight and easy to mount, these G-E cam-operated selector switches help solve many intricate circuit-combination or sequencing problems . . . control from one to 20 circuits, in any operating sequence within the limits of 12 positions . . . operate at altitudes up to 50,000 feet, and in temperatures from 200 F to -70 F. Check Bulletin GEA-4493.

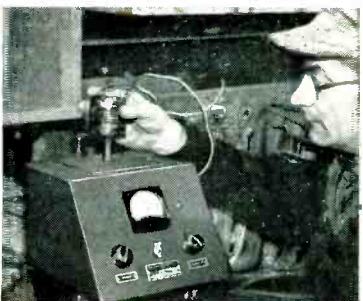

Quickly locates shorts

Minimize the hazards of short circuits quickly, easily with General Electric low-voltage coil testers. These portable units are designed to test coils before assembly in relays, radios, small transformers and instruments. They maintain accurate on-the-spot service for long use. Can also be used to detect open circuits. See Bulletin GEC-964.



EQUIPMENT FOR ELECTRONIC MANUFACTURERS

Components

Meters, Instruments
Dynamotors
Capacitors
Transformers
Pulse-forming networks
Delay lines
Reactors
Thyrite material
Motor-generator sets
Inductors
Resistors
Voltage stabilizers

Fractional-hp motors
Rectifiers
Timers
Indicating lights
Control switches
Generators
Selsyns
Relays
Amplidynes
Amplistats
Terminal boards
Push buttons
Photovoltaic cells
Glass bushings

Development and Production Equipment

Soldering irons
Resistance-welding control
Current-limited high-potential tester
Insulation testers
Vacuum-tube voltmeter
Photoelectric recorders
Demagnetizers

General Electric Company, Apparatus Sales Division Section D667-27, Schenectady 5, New York

Please send me the following bulletins:

- for reference only for planning an immediate project
- GEA-4138 Thyrite Resistance Material
 - GEA-4493 Selector Switches
 - GEA-5729 Hermetically Sealed Relays
 - GEA-5777 Drawn-oval Capacitors
 - GEC-851 Analog Field Plotter
 - GEC-964 Low-voltage Coil Tester

Name _____

Company _____

City _____ State _____

*It Computes the Cost
of Gasoline Pumped... in All of
the World's Currencies*



Everyone Can Count on **VEEDER-ROOT**

Yes, this Veeder-Root Gasoline Pump Computer speaks the languages of 144 countries! A rugged, accurate mechanism of 800-plus parts, it's the modern protection given you by gasoline pump manufacturers, gasoline refiners and their service-station outlets . . . to make sure you get full measure in your tank, and the right change in your pocket (or you can buy in "even money"). And what's more, it underscores the fact that "Veeder-Root Counts Everything on Earth" . . . electrically, mechanically or manually . . . with standard and special devices of every conceivable type. Do you have a counting problem, in any of your defense work or any of your regular production? If so, you can count on V-R to help you in every possible way.

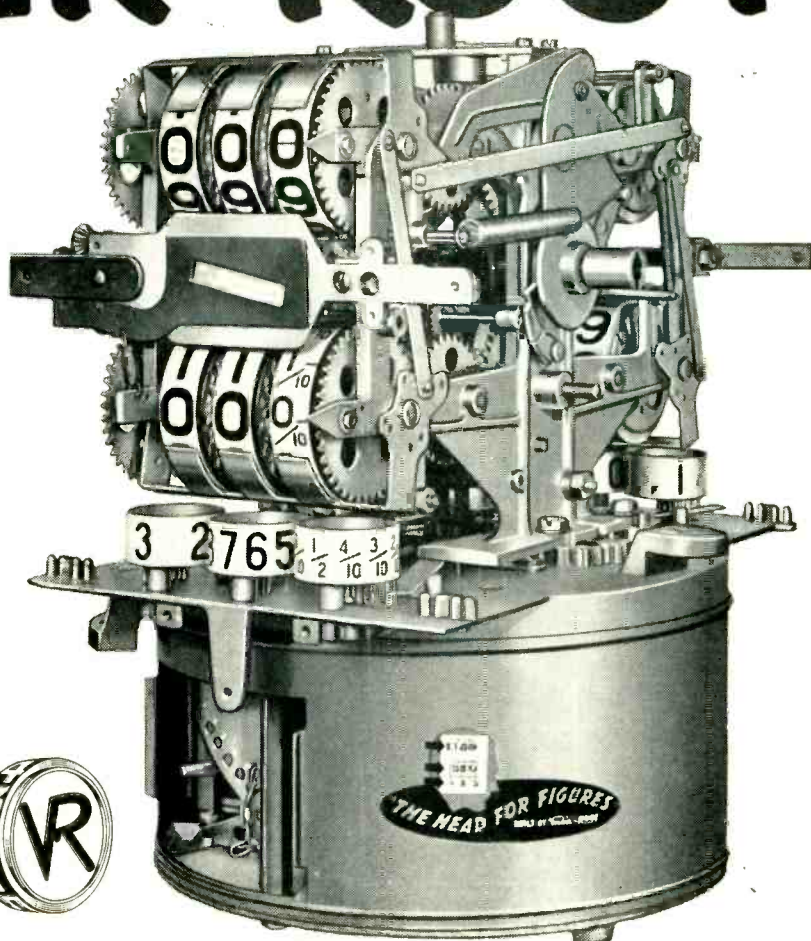

VEEDER-ROOT INCORPORATED

"The Name That Counts"

HARTFORD 2, CONNECTICUT

Chicago 6, Ill. • New York 19, N. Y. • Greenville, S. C.
Montreal 2, Canada • Dundee, Scotland
Offices and Agents in Principal Cities



"Counts Everything on Earth"

FREED Instruments & Transformers

Famous For

QUALITY • DEPENDABILITY • ACCURACY

FREED MINIATURE AUDIO TRANSFORMERS

PROFESSIONAL MINIATURE AUDIO TRANSFORMERS

These high quality, miniature transformers feature hermetic sealing for maximum protection from moisture penetration with subsequent electrolysis and corrosion of fine wires. While primarily intended for non-military equipment, these units are constructed in accordance with MIL-T-27 Specifications.

CATALOG NO.	APPLICATION	IMPEDANCE LEVEL OHMS	LEVEL SECONDARY	MAXIMUM POWER LEVEL V.U.*	MAXPRI DC PER SIDE UNBAL. Ma.	D.C. UNBAL. Ma.	FREQ. RESPONSE C.P.S.	CASE NUMBER	
PMA 1	Line or microphone to single or push-pull grids	50/ 200/ 500	60,000 C.T.	+8	1:11	0	0	±2.0 DB 30-20000	DM-12
PMA 2	Dynamic microphone or speaker voice coil to single or P.P. grid	4/8	60,000 C.T.	+8	1:86.6	0	0	±2.0 DB 30-20000	DM-12
PMA 3	Line or microphone to single or push-pull grids. Magnetically shielded.	50/ 200/ 500	60,000 C.T.	+8	1:11	0	0	±2.0 DB 30-20000	DM-12
PMA 4	Single triode plate to single or push-pull grids	15,000	60,000 C.T.	+8	1:2	0	0	±2 DB 30-10000	DM-12
PMA 5	Single triode plate to push-pull grids	15,000	60,000 C.T.	+8	1:2	2	2	±2 DB 200-10000	DM-12
PMA 6	Single triode plate to multiple line	15,000	50/200/500	+8	5.48:1	0	0	±2 DB 30-20000	DM-12
PMA 7	Single triode plate to multiple line	15,000	50/200/500	+8	5.48:1	2	2	±1 DB 200-10000	DM-12
PMA 8	Push-pull triode plates to multiple line	30,000 C.T.	50/200/500	+8	7.75:1	2	0.25	±2 DB 30-20000	DM-12
PMA 9	Crystal mike or pickup to multiple line	60,000	50/200/500	+8	11:1	0	0	±2 DB 30-20000	DM-12
PMA 10	Mixing or matching	50/200	50/200/500	+8	1:1.50	0	0	±2 DB 30-20000	DM-12
PMA 11	Parallel Feed Reactor * 1 mw. reference level.	40 hy.	3 ma dc,		3500 ohms	D.C. resistance			DM-12

DM-12 CASE DIMENSIONS

FL - 1 1/2
FD - 1 1/32
W - 15/16
H - 1 15/32
M - 1 7/32

Screws - 4-40
Cut out - 7/8
Wgt. - 1.5oz.

Send for complete catalog on
Freed Instruments and Transformers

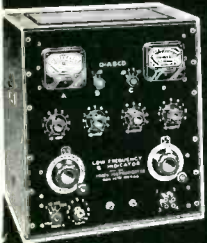

No. 1030
Low Frequency
"Q" Indicator

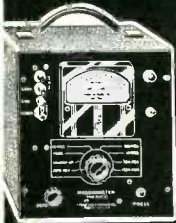

No. 1020B
Megohmmeter



Decade
Inductors



No. 1040
Vacuum Tube Voltmeter

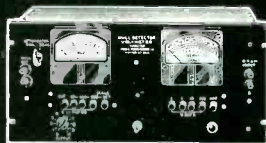

No. 1210
Null Detector &
Vacuum Tube Voltmeter



No. 1010
Comparison Bridge

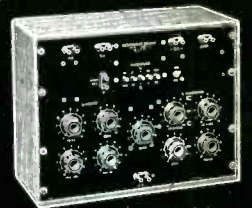

No. 1110A
Incremental Inductance
Bridge

FREED • TRANSFORMER • CO., INC.

1722 WEIRFIELD ST. (RIDGEWOOD) BROOKLYN 27, N.Y.

Waterman POCKETSCOPE

The Pocket-Size Oscilloscope

S-14-A



HIGH

6 INCHES

S-14-B



WIDE

6 INCHES

S-15-A

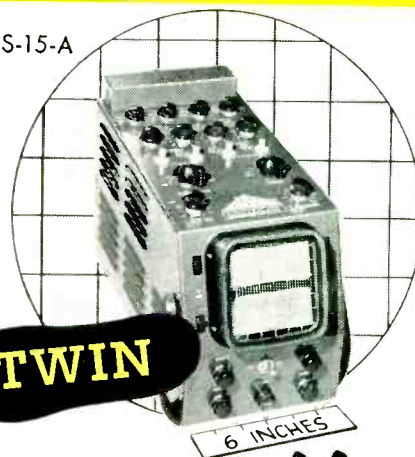

TWIN

6 INCHES

...light... compact... accurate... portable

Featuring small size, light weight and outstanding performance the HIGH, WIDE and TWIN POCKETSCOPES have become the "triple threat" of the oscilloscope field. Their incomparable versatility, reliability and accuracy have skyrocketed this team of truly portable instruments into unparalleled demand. Each oscilloscope features DC coupled amplifiers in both vertical and horizontal channels.

HIGH

The S-14-A HI-GAIN POCKET-

SCOPE provides the optimum in oscilloscope flexibility for analysis of low-level electrical impulses. Extremely light weight (12 $\frac{3}{4}$ lbs.), compact in size (12 x 5 $\frac{3}{4}$ x 7 in.), dependable and accurate in performance. Vertical and horizontal channels: 10mv rms/inch with response within 2DB from DC to 200 KC and pulse rise of 1.8 μ s . . . non-frequency discriminating attenuators and gain controls with internal calibration of trace amplitude . . . repetitive or trigger time base with linearization from $\frac{1}{2}$ cycle to 50 KC with \pm sync or trigger.

WIDE

The S-14-B WIDE BAND POCKETSCOPE is ideal for investigations of transient signals, DC signals, aperiodic pulses or recurrent waveforms. Vertical channel: 50 mv rms/in. within -2DB from DC to 700 KC . . . pulse rise time of 0.35 μ s. Horizontal channel: 0.15v rms/in. within -2DB from DC to 200 KC . . . pulse rise of 1.8 μ s. Attenuators and gain controls are non-frequency discriminating . . . trace amplitude calibration . . . repetitive or triggered time base from $\frac{1}{2}$ cycle to 50 KC . . . \pm sync or trigger . . . trace expansion, filter graph screen and many other features . . . 14 lbs. . . 12 x 6 x 7 inches.

TWIN

The S-15-A POCKETSCOPE is a portable, twin tube, high sensitivity oscilloscope with two independent vertical as well as horizontal channels. It is indispensable for investigation of electronic circuits in industry, school and laboratory. Vertical channels 10

mv rms/in. with response within -2DB from DC to 200 KC and pulse rise time of 1.8 μ s . . . horizontal channels 1v rms/in. within -2DB from DC to 150 KC . . . non-frequency discriminating controls . . . internal signal amplitude calibration . . . linear time base from $\frac{1}{2}$ cycle to 50 KC, triggered or repetitive, for both horizontal channels.

S-11-A

The S-11-A INDUSTRIAL POCKETSCOPE is a small, compact (5x7x11 inches), and lightweight (8 $\frac{3}{4}$ lbs.) instrument for observing electrical circuit phenomena. The flexibility of the POCKETSCOPE permits its use for AC measurements as well as for DC. The vertical and horizontal amplifiers are capable of reproducing within -2DB from DC to 200 KC with a sensitivity of 0.1v rms/in. . . repetitive time base from 3 cycles to 50 KC continuously variable throughout its range . . . variations of input impedance, line voltage or controls do not "bounce" the signal—the scope stabilizes immediately.

RAYONIC CATHODE RAY TUBES BY WATERMAN

TUBE	PHYSICAL DATA		STATIC VOLTAGE		DEFLECTION*		LIGHT OUTPUT**
	FACE	LENGTH	A3	A2	VERT	HOR	
3JP1	3"	10"	3000	1500	111	150	352
3MP1	3"	8"		750	99	104	33
3RP1	3"	9.12"		1000	61	86	44
3SP1	1.5x3"	9.12"		1000	61	86	44
3XP1	1.5x3"	8.875"		2000	33	80	218

*Deflection in volts per inch.

**Light output of an element of a raster line (one mm long and not exceeding .65 mm in width) in microlumens.

The basic properties of the cathode ray tube that concern the designer or the user are: deflection sensitivity, unit line brightness, line width, static voltage requirements and physical size. A comparison between cathode ray tubes manufactured by Waterman Products Company is shown in the table adjoining. These tubes are available in P1, P2, P7 and P11 phosphors. 3JP1, 3JP7, 3SP1 and 3XP1 are available as JAN tubes.

Visit our Booths (158 and 160) at the IRE Show March 22 to 25.

PULSESCOPE

by

Waterman

The Oscilloscope that Portrays the Pulse

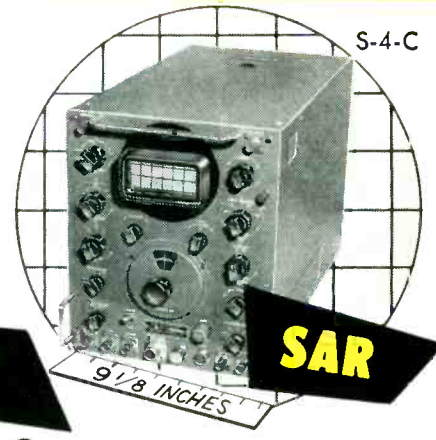
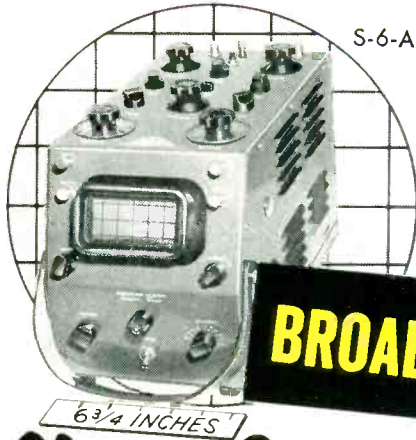

Classic Examples of Precision Engineering...

The PULSESCOPES are cathode ray tube oscilloscopes that portray the attributes of the pulse: shape, amplitude, duration and time displacement. All PULSESCOPES have internally generated markers with the basic difference that in the SAR PULSESCOPE the markers initiate the sweep while in the others the sweep starts the markers.

BROAD

The S-6-A BROAD BAND PULSESCOPE is a

POCKETSCOPE in performance, in size. The instrument measures DC as well as AC signals. Unique DC calibration methods permit rapid measurements of either positive or negative, AC or DC signals. Vertical amplifier sensitivity of 0.2v rms/inch, and response to 5 mc within 3DB... pulse rise time of 0.1 μ s... internal markers from 1 to 1000 μ s... repetitive or trigger sweep from 5 cycles to 500 KC with 5X sweep expansion... sweep, marker and DC calibrating voltage available externally. Size 8 1/2 x 6 3/4 x 13 3/4 in. Weight 22 lbs. Operates from 50 to 400 cycles at 115 volts AC.

LAB

The S-5-A LAB PULSESCOPE is a JANized (Gov't Model No. OS-26)

portable, AC, wide band-pass, laboratory oscilloscope ideal for pulse as well as general purpose measurements. Internal delay of 0.55 μ s permits observation of pulse leading edge. Includes precision amplitude calibration, 10X sweep expansion, internal trace intensity time markers, internal trigger generators and many other features. Video amplifier 0.1v p to p/inch... pulse rise time of .035 μ s or response to 11 mc. 1.25 to 125,000 μ s triggered or repetitive sweep... internally generated markers from 0.2 to 500 μ s... trigger generator from 50 to 5000 pps. for internal and external triggering. Operates from 50 to 400 cycles at 115 volts AC.

SAR

The S-4-C SAR PULSESCOPE is a JANized (Gov't Model No. OS-4)

portable instrument (31.5 lbs.) for precision pulse measurements for radar, TV and all electronic measurements. Portrays all attributes of the pulse... internal crystal controlled markers of 10 and 50 μ s available for self-calibration... in R operation a small segment of the A sweep is expandable for detailed observation with a direct-reading calibrated dial accurate to 0.1%. Video amplifier band-pass up to 11 mc... optional video delay 0.55 μ s... pulse rise and fall time better than 0.07 μ s... R pedestal (sweep) 2.4 to 24 μ s... video sensitivity of 0.5v. p to p/inch. Easily convertible from μ s to yards. Operates from 50 to 400 cycles at 115 volts AC.

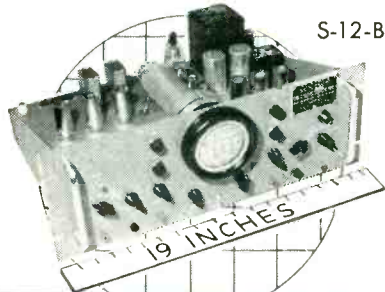

RAKSCOPE

Because the panel is only 7" high and fits any standard rack, the S-12-B RAKSCOPE admirably fills the need for a small oscilloscope of wide versatility. With all the features of the S-11-A POCKETSCOPE, the RAKSCOPE is JANized (Gov't Model No. OS-11), and has many additional advantages; the sweep, from 5 cycles to 50 KC, is either repetitive or triggered... vertical and horizontal amplifiers are 50 mv rms/inch with band-pass from 0 to 200 KC... special phasing circuitry for frequency comparison.

WATERMAN PRODUCTS CO., INC.

PHILADELPHIA 25, PENNA., U.S.A.

CABLE ADDRESS, POKETSCOPE, PHILA.

Manufacturers of **POCKETSCOPES**® • **RAKSCOPES**® • **PULSESCOPES**® and **RAYONIC**® TUBES

HOW TO KICK OFF A ROCKET in the right direction

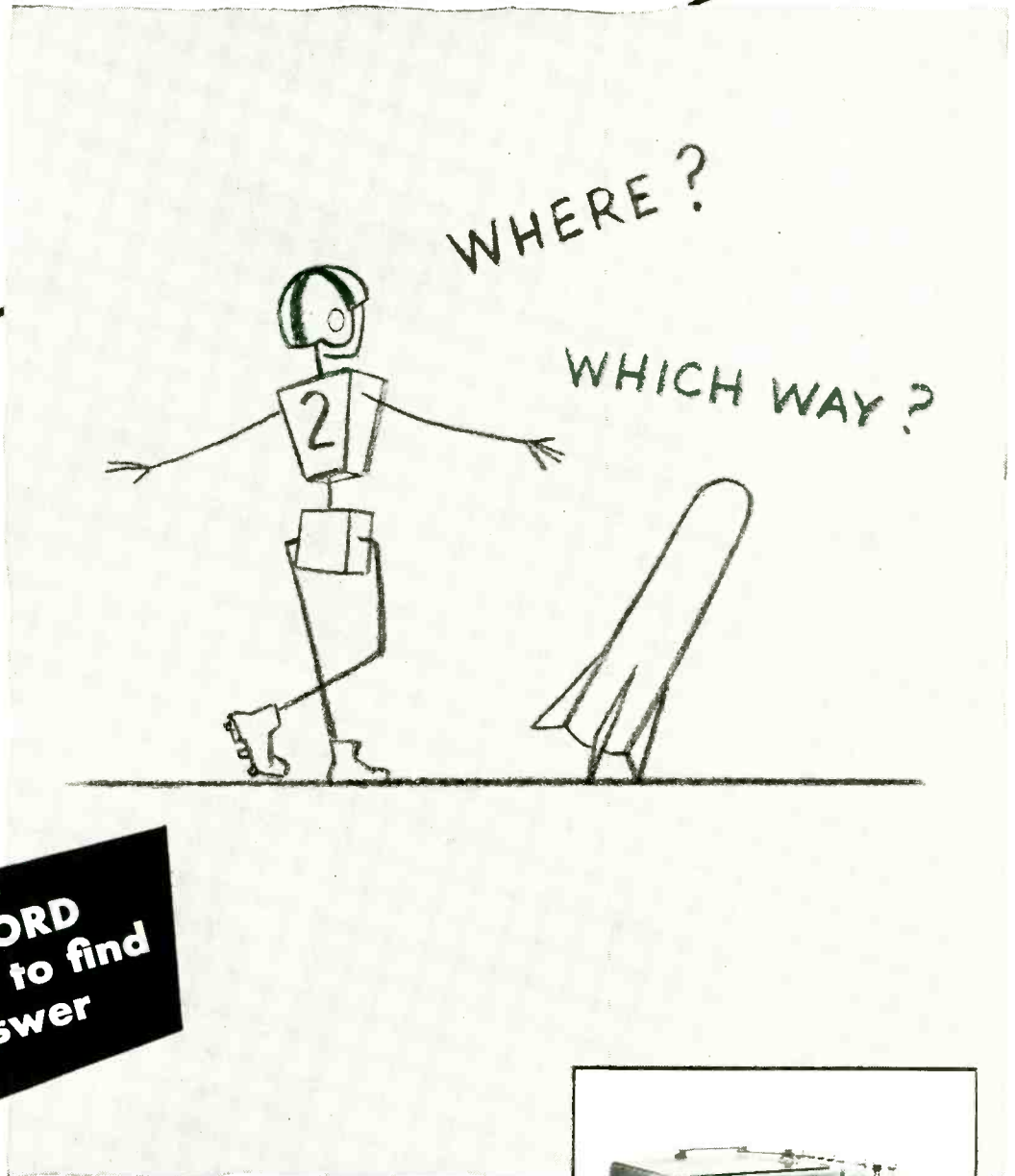

**...and FORD
was asked to find
the answer**

Load! Aim! Launch! And off goes a rocket from shipboard . . . but not without precise devices that start the rocket in the right direction. Devices . . . such as Ford Instrument has manufactured for the Armed Forces since 1915. For from the vast engineering and production facilities of the Ford Instrument Company, come the mechanical, hydraulic, electro-mechanical, magnetic and electronic instruments that bring us our "tomorrows" today. Control problems of both Industry and the Military are Ford specialties.

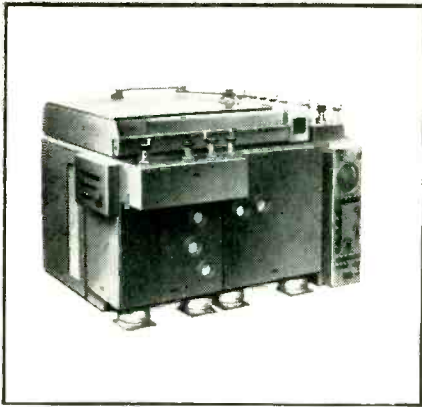

Visit our booth 503-505 at the New York IRE Convention

FORD INSTRUMENT COMPANY

DIVISION OF THE SPERRY CORPORATION
31-10 Thomson Avenue, Long Island City 1, N. Y.



You can see why a job with Ford Instrument offers young engineers a challenge. If you can qualify, there may be a spot for you in automatic control development at Ford. Write for brochure about products or job opportunities. State your preference.

For more ad information, see Index to Advertisers.

March, 1954 — ELECTRONICS

SANBORN 150 SERIES OSCILLOGRAPHIC RECORDERS

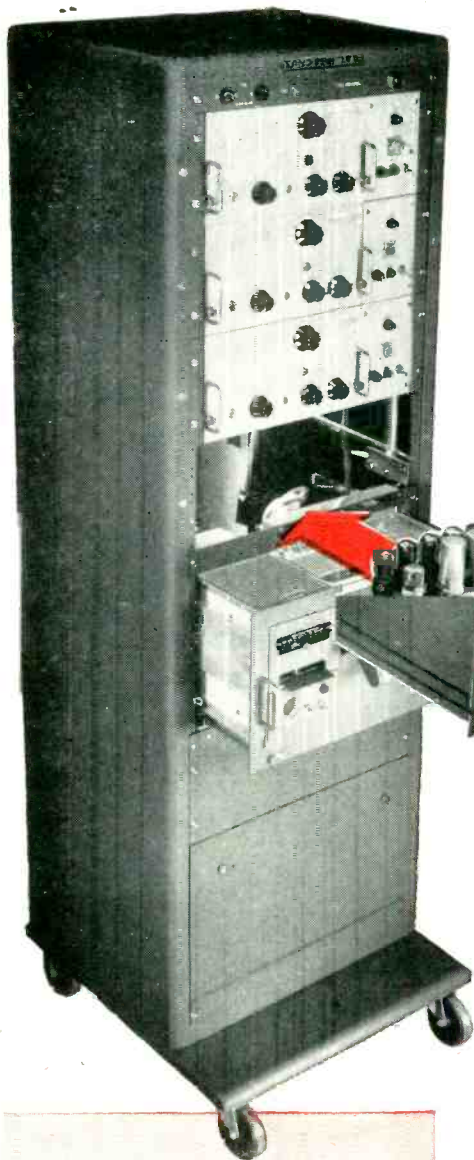

The **BASIC** four-channel assembly includes: Cabinet, Recorder, and, for each channel, a **BUILT-IN** unit (A), which comprises a Driver Amplifier with frame, and a Power Supply with control panel.



**A NEW
design concept
that brings even
greater versatility
to industrial
OSCILLOGRAPHIC
RECORDING**

(B)

You have a **CHOICE** of readily interchangeable, plug-in Preamplifiers (B) for **EACH** channel, as described below.

The new Sanborn 150 Series offers greater operating efficiency and convenience, and encompasses a *variety of uses* which include the accurate recording of almost every phenomenon whose frequency spectrum lies in the range from 0 to 100 cycles per second.

A *wide selection* of plug-in preamplifiers, or "front end" units, such as (B) above, are completely interchangeable in any or all channels of the 150 Series amplifier section, where they simply plug in to the driver amplifier and power supply, (A) above, which are already in place.

Available plug-in Preamplifiers include: AC-DC, CARRIER, SERVO-MONITOR, DC COUPLING, LOG-AUDIO, and LOW LEVEL. Blank plug-in assemblies are also available for users to make input circuits for special measurement problems.

And, there are the popular Sanborn advantages: a high torque movement (200,000 dyne cms per cm deflection), direct *inkless* recording in *true rectangular coordinates*, and provision for code and time markings.

A new catalog on Sanborn Oscillographic Recording Systems and their components will be sent gladly on request.

OTHER SANBORN IMPROVEMENTS

- Extended frequency response.
- Improved regulated power supply.
- Individual stylus temperature control for **EACH** channel.
- Improved, single control, paper speed selector. Nine speeds — 0.25 to 100 mm/sec.
- Recorder slides out, if desired, for better view of recorded events, or for notations on record (illustrated at right).
- Improved control of input signals by use of 1, 2, 5 ratios on attenuator.

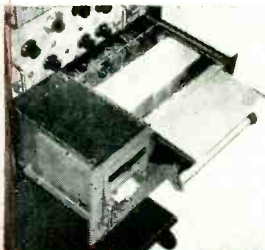

Be sure to see the 150 Series at **BOOTHS 455-457, I.R.E. Convention, Kingsbridge Armory, Bronx, N. Y. March 22-25, 1954.**

SANBORN COMPANY

INDUSTRIAL DIVISION

195 MASSACHUSETTS AVENUE

CAMBRIDGE 39, MASS.

MOLDED JACKET IS

MOISTURE-RESISTANT

VAPOR-RESISTANT

AND INERT TO FILM!

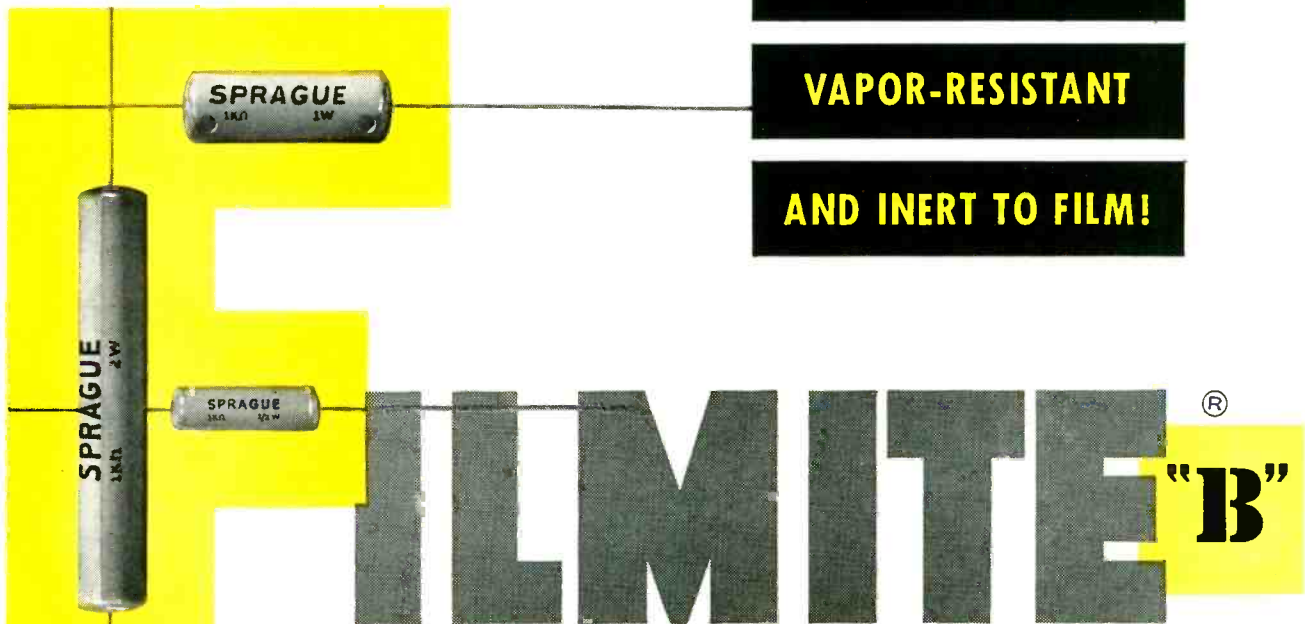

DEPENDABLE BORO-CARBON RESISTORS

... IN 1/2, 1, AND 2 WATT RATINGS

Now for the first time you can obtain a superior yet relatively low cost film-type resistor for military electronic gear—resistors that not only meet the severe performance requirements of Military Specification MIL-R-10509A, but are capable of full wattage dissipation at 70°C ambient!

Sprague Type 4E, 5E, and 6E Filmite B resistors are housed in a dense molded jacket which not only provides unexcelled physical protection for the film resistance element but serves as a barrier to moisture and vapor, the twin enemies of all film-type resistors.

Boro-carbon films are unusually sensitive to moisture. Protection against moisture in any form is a primary requirement for successful long term stability of resistance. The low-loss phenolic housings on molded Filmite resistors not only shed water but are vapor resistant and inert to the film material. There

is minimum possibility of field failure through electrolytic action and penetration of moisture or vapor through the dense molded jacket.

Other features of molded Filmite B resistors are special low-contact-resistance, low noise end terminations held rigidly in place on special ceramic cores, extremely low temperature and voltage coefficients of resistance, and excellent load-life and high frequency characteristics.

For complete engineering data, write for Engineering Bulletin No. 130 to:

SPRAGUE ELECTRIC COMPANY
35 Marshall Street, North Adams, Mass.

SPRAGUE TYPE NO.	WATTAGE RATING	DIMENSIONS (INCHES)		RESISTANCE (OHMS)		VOLTAGE (Max.)
		L	D	Min.	Max.	
4E	1/2	3/4	1/4	100	1 Meg.	350
5E	1	1 1/8	3/8	100	2 Meg.	500
6E	2	2 3/8	3/8	200	10 Meg.	750

Standard Resistance Tolerances: 1 2 and 5%

SPRAGUE

PIONEERS IN ELECTRIC AND ELECTRONIC DEVELOPMENT

NORTH ADAMS, MASSACHUSETTS

EXPORT FOR THE AMERICAS: SPRAGUE ELECTRIC INTERNATIONAL LTD., NORTH ADAMS, MASS. CABLE: SPREXINT



NEW

WESTINGHOUSE THERMOSTAT IGNITRON USES UP TO 90% LESS WATER

Westinghouse — pioneer in power tube development and original inventor of the Ignitron — now presents the decade's most important advance in Ignitron design — the Westinghouse Thermostat Ignitron.

A thermostat mount on the standard stainless steel Ignitron now indicates the temperature of the inner vacuum envelope. Standard available thermostats may be attached to the mount to control water flow and

provide complete protection for Ignitrons and welding equipment. Thermostats may be reused indefinitely.

Savings in cooling water of up to 90% or more can easily be achieved under conditions of light loading and low water temperature. With size D Ignitrons, for example, this can mean savings of 1,000,000 gallons per welder per year.

For complete details, specifications and samples of the new Westinghouse Thermostat Ignitron, see your Westinghouse Electronic Tube Sales representative. Or write: Dept. A1034 at the address below.

ET-95054

**YOU CAN BE SURE...IF IT'S
Westinghouse**

RELIATRON® TUBES

WESTINGHOUSE ELECTRIC CORPORATION, ELECTRONIC TUBE DIVISION, ELMIRA, N. Y.

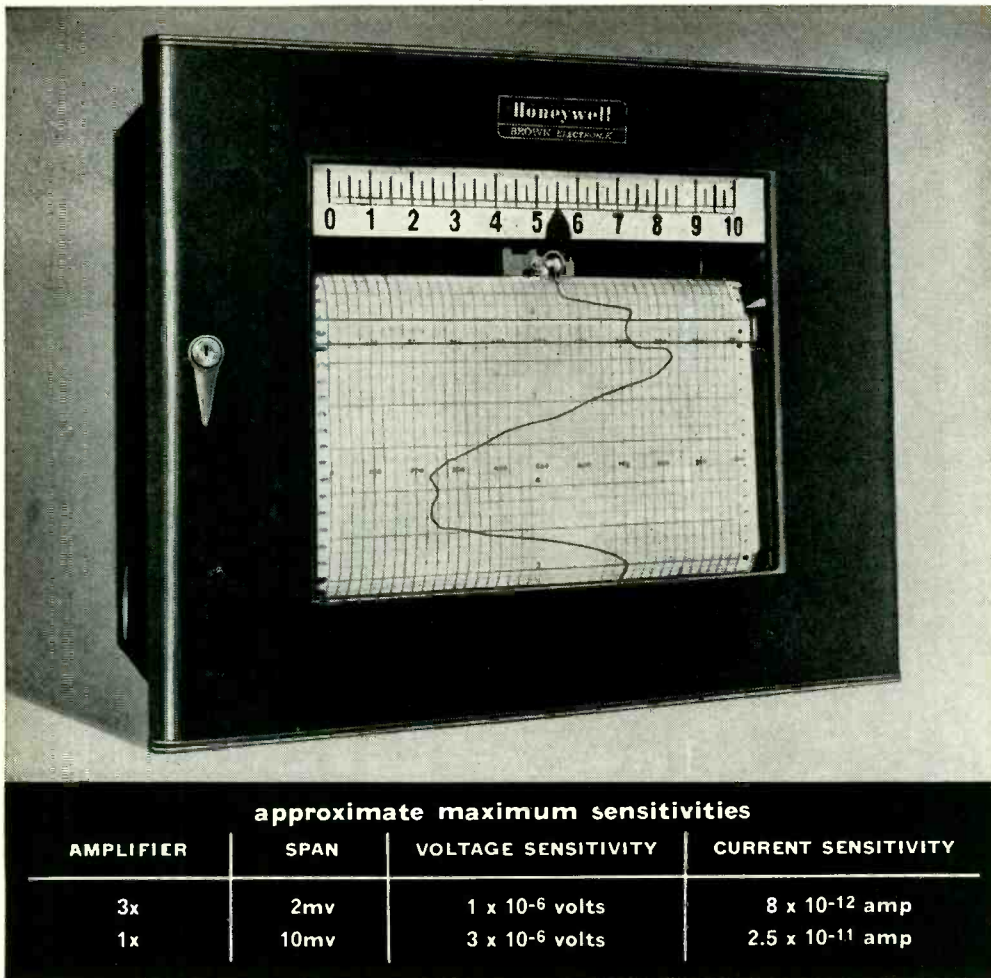

New *ElectroniK* recorder for high impedance circuits

A NEW MODEL of the *ElectroniK* instrument now makes it possible to record data from high impedance sources without resorting to external pre-amplifiers. It can measure voltages originating in sources with impedances ranging from 0 to 50,000 ohms without appreciable change in sensitivity, damping or speed.

Because of its high input impedance, the instrument can be applied to voltage measurements with negligible loading effect on the source. It is also applicable to current measurements in conjunction with photocells, spectographs and similar devices.

The recorder is supplied with pen speed of 24, 12, 4½ or 2 seconds, for spans down to

2 mv. The amplifier can be used separately in many high impedance servo systems.

Excellent stray rejection, meeting the most stringent specifications, is incorporated in the new circuit. Stray a-c voltages, equal to full scale span for the 2-second model and up to 10 times the span for the 24-second model, are rejected with no appreciable loss in instrument sensitivity.

Your nearby Honeywell sales engineer will be glad to discuss your applications . . . and he's as near as your phone.

MINNEAPOLIS-HONEYWELL REGULATOR CO.,
Industrial Division, Wayne and Windrim
Aves., Philadelphia 44, Pa.

- REFERENCE DATA: Write for Instrumentation Data Sheet No. 10.0-14.



MINNEAPOLIS
Honeywell
BROWN INSTRUMENTS

First in Controls

ONLY ONE—out of many—**IS FIRST**

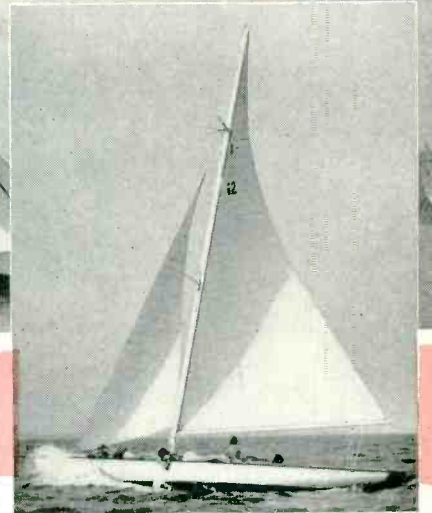
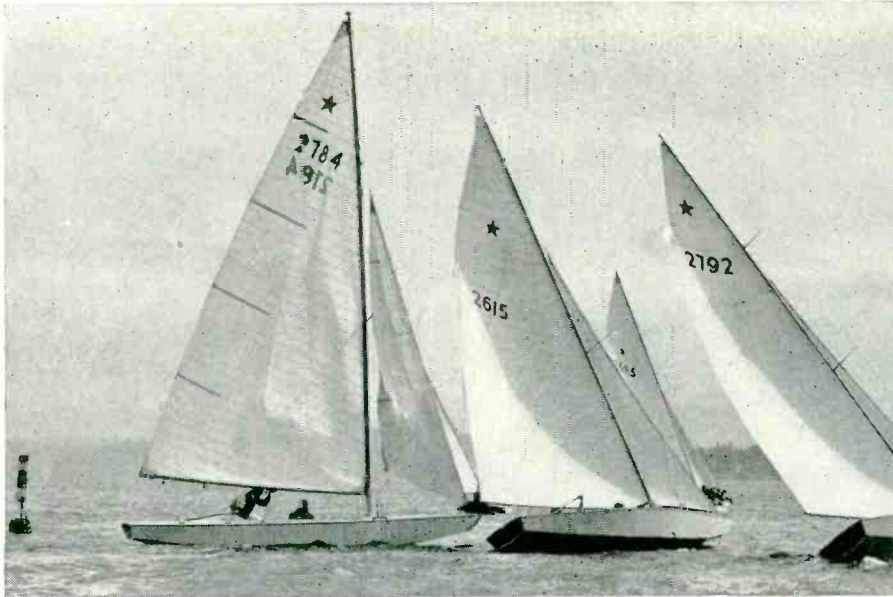

They all started equal...
but **ONLY ONE WON!**

A spanking breeze across the bay . . . the echoing boom of the race steward's deck cannon . . . ropes and sails straining for advantage of position. Each boat, sleek and ship-shape, is out to win—but only *one* will come in first.

... most capacitors start even, too

. . . but EL Menco Capacitors always win first place in specification requirements because their superiority and dependability have been *proven*. They're factory-tested at more than double their working voltage . . . they're guaranteed stable under the most adverse conditions of application.

No matter what your requirements—from the mighty high-capacity CM-35 (5-10,000 mmf) to the midget low-capacity CM-15 (2-525 mmf)—EL Menco gives you superior job-rated, job-tested performance. They're built to win!

Electro Motive is now supplying special silvered mica films for the electronic and communication industries in any quantity—just send us your specifications.

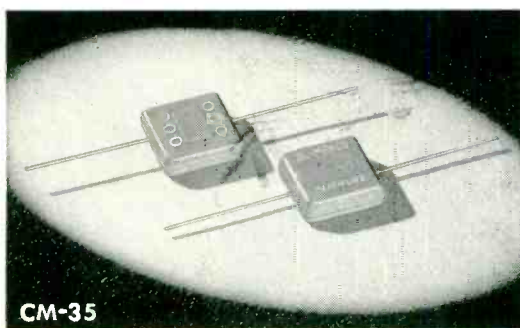
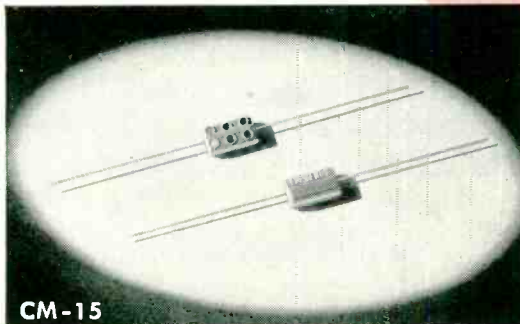

Jobbers and Distributors are requested to write for information to Arco Electronics, Inc., 103 Lafayette St., New York, N. Y. — large stocks on hand — spot shipments for immediate delivery. Sole Agent for Jobbers and Distributors in U. S. and Canada.



WRITE FOR FREE SAMPLES
AND CATALOG ON YOUR
FIRM'S LETTERHEAD

MOLDED MICA

EL-Menco
CAPACITORS

MICA TRIMMER

Foreign Electronic Manufacturers Get Information Direct from our Export Dept. at Willimantic, Conn.

THE ELECTRO MOTIVE MFG. CO., INC.

WILLIMANTIC, CONNECTICUT

BORG The New Standard for Precision Multiturn Potentiometers
... Eliminates The Necessity for Special Designs!

New

BORG MICROPOTS

See them at 536 Components Ave., IRE Convention

SERIES 901-903
TEN-TURN
POTENTIOMETERS



Model No. 902BB

BUSHING MOUNT AT BOTH ENDS

Designed for the utmost versatility and adaptability, Borg Micropots eliminate the need for special design. New standard Borg Micropots are available in single or double shaft models with exceptionally rigid servo-mount or bushing-mount at either or both ends. The housing floats on sturdy mounting flange.

WRITE TODAY FOR
COMPLETE INFORMATION

Borg 901 Series 10-turn and 931 Series 3-turn Micropots are built to the same superior advanced design-principles that have set the new standard for precision multiturn potentiometers.

SERIES 931-935
THREE-TURN
POTENTIOMETERS

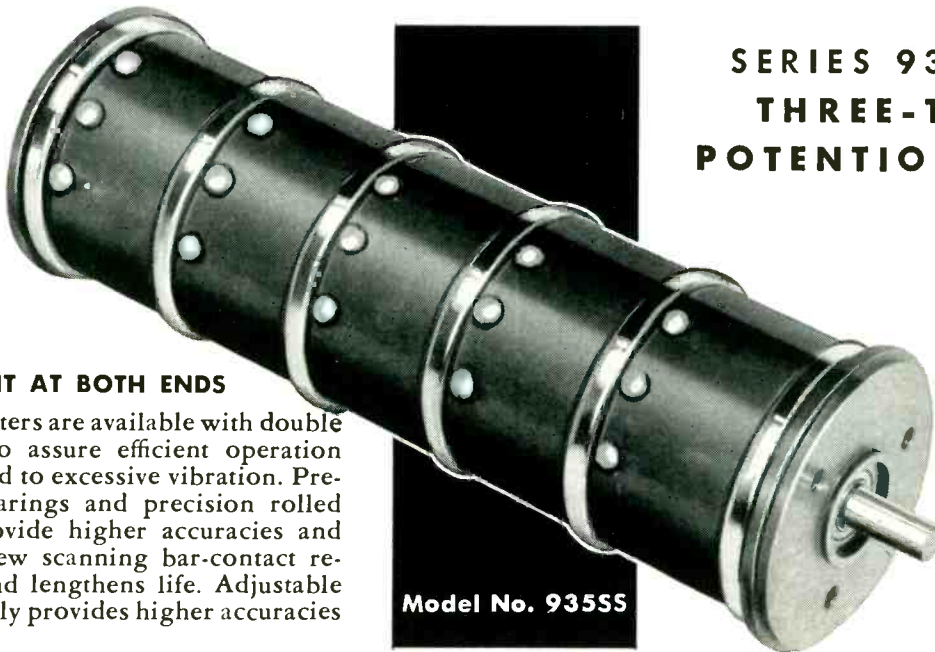

Model No. 935S

SERVO MOUNT AT BOTH ENDS

All potentiometers are available with double end support to assure efficient operation where subjected to excessive vibration. Precision ball bearings and precision rolled lead-screw provide higher accuracies and longer life. New scanning bar-contact reduces noise and lengthens life. Adjustable contact assembly provides higher accuracies at lower cost.



BORG EQUIPMENT DIVISION
THE GEORGE W. BORG CORPORATION
Janesville, Wisconsin

the **NEW** type

323...

the first
TRULY PRECISE
cathode-ray
oscilloscope

- D-c wide-band oscillograph usable to 20 MC and beyond (3db down at 10 MC)
- Pulse response, 0.035 usec
- New, High-resolution, Tight-tolerance Du Mont Type 5AMP— Cathode-ray Tube for optimum pattern fidelity
- Precision, directly calibrated sweeps. Simple re-calibration against built-in standard
- New and unique Du Mont sweep “Notch” for calibrated sweep expansion and delay
- Precision amplitude calibration from built-in voltage standard
- Any two-inch portion of four inches of undistorted vertical deflection may be positioned on-screen
- Electronic regulation of all power sources including critical filaments for maximum stability



DU MONT

New in every detail!

SEE REVERSE SIDE FOR DETAILS

NO COMPROMISE WITH PRECISION

DU MONT

Type 323

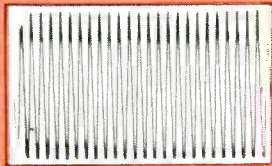

Low-frequency raster shows excellent focus and linearity over entire face of mono-accelerator cathode-ray Type 5AMP— Tube.

0.5- μ sec pulse is riding on a d.c. level of 5 volts to show d-c amplification and excellent rise time of the vertical amplifier.

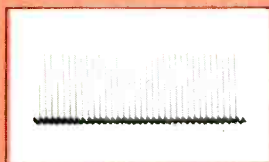
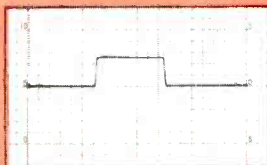

Pulse chain illustrates the highly linear sweep which is only one factor contributing to the very precise measurement of time possible in the Type 323.

Low-frequency triangular wave is shown with two cycles expanded within sweep "notch." On the lowest sweep range, the notch expansion can be ranged out to 2.2 sec.

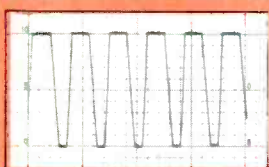
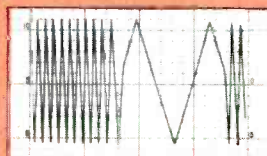

To make the Type 323 a precise, peak-reading electronic voltmeter, the accurate square wave calibrating waveform is simply adjusted for full scale as shown.

A Du Mont innovation is the "Driven-No-Gate" operation where sweep gate is disabled to permit start of sweep to be seen. To assure display of entire leading edge of extremely rapid wave-fronts.

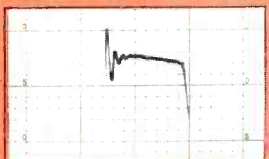
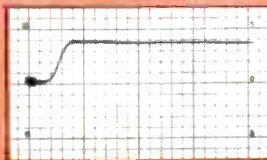

With the wide range d-c amplification and undistorted deflection pulse overshoot can be greatly expanded as shown, and very accurately measured.

The new Du Mont Type 323 enables—for the first time—the accuracy of observation and measurement required for present-day applications. From every aspect, the new Type 323 has been designed for PRECISION—precision over the entire range of general laboratory applications—from long-duration mechanical phenomena to high-speed pulses and single transients.

D-C, WIDE BAND AMPLIFIER

Frequency response of the vertical amplifier of the Type 323 extends from d-c to 20 MC and beyond (down 3db at 10 MC), to assure faithful presentation of all signals encountered in general laboratory work, from very-low-frequency functions to rapid pulses. In addition, d-c amplification enables display of any signal together with its d-c component.

NEW HIGH-PRECISION CATHODE-RAY TUBE

The new Du Mont Type 5AMP—Cathode-ray tube—built to Du Mont's famous tight tolerances—is based upon the new "Mono-accelerator" principle which minimizes spot and field distortions that would otherwise limit accuracy of measurement regardless of the precision of the auxiliary calibrating circuitry. The Type 5AMP—, with its high resolution and superb linearity is the only cathode-ray tube capable of exploiting the precision inherent in the design of the Type 323.

NEW HIGH-LINEARITY SWEEPS

Sweeps of the Type 323 are developed by a new Du Mont circuit at high amplitude level, eliminating need for sweep amplification, and hence removing a major source of sweep non-linearity. Sweeps, thoroughly consistent with the versatility of the vertical amplifier, are continuously variable from 1 second to 0.1 μ sec per inch and are linear over this entire range.

NEW PRECISE DIRECT SWEEP CALIBRATION

Direct calibration of sweeps is accomplished by means of a clearly legible front-panel dial. Recalibration of the entire range of sweeps is readily accomplished by means of a built-in standard and a single adjustment of one control. Overall accuracy of sweep calibration—including the sweep generator and cathode-ray tube—is better than 5%.

NEW DU MONT SWEEP "NOTCH"

Calibrated sweep expansion and delay is accomplished by the unique new Du Mont "Notch" which speeds by a predetermined factor a 2-inch portion of the 4-inch sweep. The notch is movable along the trace so that any portion may be expanded and observed, while its time relationship to the total signal is preserved.

ACCURATE AMPLITUDE CALIBRATION

At the touch of a switch, an accurate voltage standard is applied to the screen of the Type 323 enabling calibration of the scale directly in volts. Eleven ranges are available, extending from 0.2 to 400 volts-full-scale. The excellent stability of the vertical amplifier eliminates the need for frequent recalibration.

ELECTRONIC VOLTAGE REGULATION

Electronic regulation of all power sources, including critical filaments, assures excellent stability and precision of calibration over extended periods of time. Variations of powerline voltage within the specified $\pm 10\%$ have no adverse effect on the performance of the instrument.

In every way—beginning with the new Type 5AMP—Mono-accelerator Cathode-ray tube—through all of the electronic circuitry—down to the finest detail of mechanical design—the emphasis has been on PRECISION. Every feature of the Type 323 has been engineered toward this goal.

No single sheet can possibly do justice to the many unique design features of this important new instrument. For complete technical information, write for Bulletin 3A to the address below.

TECHNICAL SALES DEPARTMENT
ALLEN B. DU MONT LABORATORIES INC.
760 BLOOMFIELD AVENUE, CLIFTON, NEW JERSEY

For *Critical* Applications
Triplett 630-A Has No Counterpart

Accuracy
 to 1½%

Readability
 with a Mirror-Scale

Adaptability
 with ½% resistors
 Try This Volt-Ohm-Mil-Ammeter
 at your distributor's

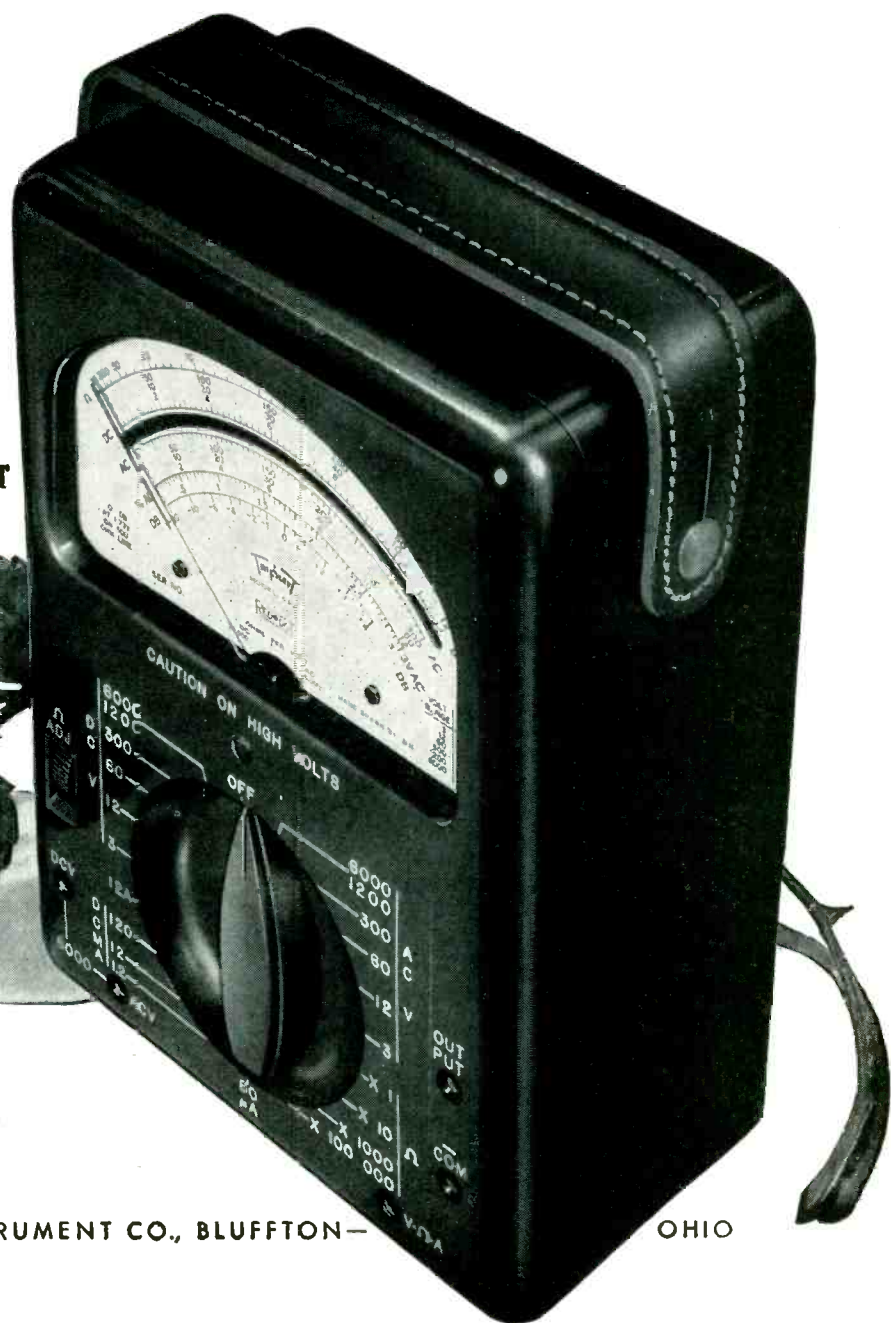
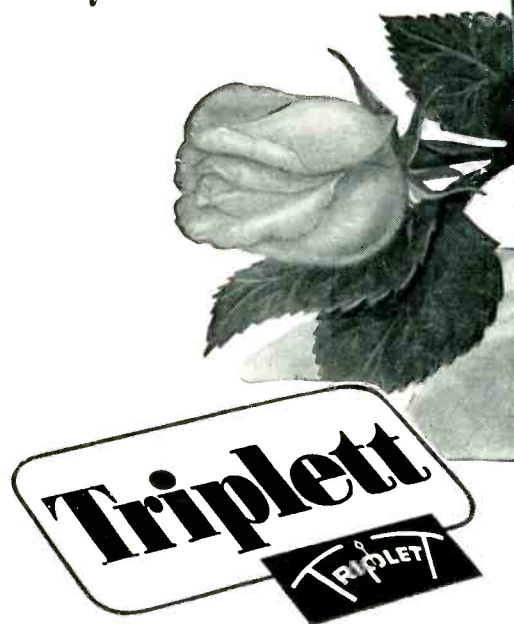

TRIPLETT ELECTRICAL INSTRUMENT CO., BLUFFTON—

OHIO



New Instruments and Components to Aid in Design and Reduce Costs

by

TECHNITROL

Unique Variable Pulser is Valuable Laboratory Aid

The Technitrol Variable Pulser is a reliable, versatile instrument which converts the output of a laboratory oscillator into a series of pulses.

One use has been as a low pulse rate device to study the response of components and networks to isolated pulses. Another use has been as a variable pulse rate source to study P.R.F. sensitivity. Still another use has been as a constant high frequency source for a temporary clock pulse generator.

Characteristics

- Wide range of frequencies from 2 cps. to over 2.0 mcs.
- Pulse characteristics optimized with rise and fall times approximately 0.04 μ s. and 0.06 μ s. respectively.
- Duration of pulse variable from 0.2 μ s. to 5.0 μ s. in steps of 0.1 μ s.
- Accurate, stable pulse duration controlled by electric delay lines.
- Amplitude continuously variable without distortion from 0 to 45 volts.
- Trigger pulse precedes output pulse to synchronize oscilloscopes, etc.

Tiny Encapsulated Pulse Transformers Wound to Your Requirements

Technitrol Pulse Transformers are wound on ferrite cores and cast in resin to form a $\frac{3}{4}$ " sealed unit.

Type TE has 2-inch pigtail leads of No. 20 wire. Type TP has 7-pin plug-in for miniature tube sockets. Lends itself admirably to printed circuits where holes can be drilled in the circuit board, the transformer plugged into these and the pins soldered to the circuit leads on the side opposite the body of the transformer.

*When writing
for information Specify application
and requirements*

TECHNITROL

ENGINEERING COMPANY

2751 North Fourth Street

Philadelphia 33, Pennsylvania

For more ad information, see Index to Advertisers.

Very Compact Delay Lines Designed to Fit Your Need

A Technitrol Delay Line—with not more than $\frac{1}{4}$ " diameter and $6\frac{1}{4}$ " length, or in a package—will be designed for your particular circuit application. A variety of mountings offers you a wide choice.

- Delay: 0.01 to 1.6 μ s.
- Characteristic Impedance: 400 to 2500 ohms.
- Wide Frequency Response: 0.5 μ s. at 1200 ohms.
3 db down at 5 mcs
6 db down at 8 mcs
10 db down at 10 mcs
- Continuing intensive research and development is expected to make available even greater band-widths.
- Linear Phase: to 9 mcs and beyond

The continuously wound Technitrol Delay Lines provide minimum pulse distortion and are extremely stable with temperature variations. A covering protects the winding from abrasion and mechanical damage.

DESIGN AND DEVELOPMENT ENGINEERS!
HERE'S A SURE CURE FOR YOUR

Deep Drawn Instrument Case Problems!

KAUPP

— facilities for

SPINNING, STAMPING, PUNCHING, DEEP
DRAWING, **HYDROFORMING**, ANNEALING,
SPOT WELDING, ASSEMBLING, TOOL MAKING

Kaupp can supply your instrument cases to exact specification quickly and economically. Special shapes and odd sizes are a specialty at Kaupp and, in most cases, can be turned out on reasonably short notice. Kaupp has the experience and the metal working facilities for precision forming of intricate shapes to close tolerances. Gauges .002 to 3/8 stock in stainless steel, Inconel, aluminum, cold rolled steel, brass and other alloys. Check with Kaupp on your metal parts needs, now!

C. B. KAUPP & SONS
NEWARK WAY • MAPLEWOOD • NEW JERSEY.

Rx The new 16 page Kaupp Brochure with complete information on metal forming and sub-assembly facilities. Call or write for your copy, today!

Be sure to visit
our display at the
I. R. E. SHOW
BOOTH 720
AIRBORNE AVE.

**PRODUCTION AND DEVELOPMENT METAL FORMING FOR ELECTRONICS,
NUCLEONICS, AVIATION, MARINE AND GENERAL INDUSTRY**



Nope—not a single transformer here that does what we want.



The salesman from this firm said they had the most complete line in the business . . . But not one of their stock transformers fills the bill!



Well, ordinary stock transformers are definitely out. Wish I knew a firm to trust to design and build to those tricky specs of ours.

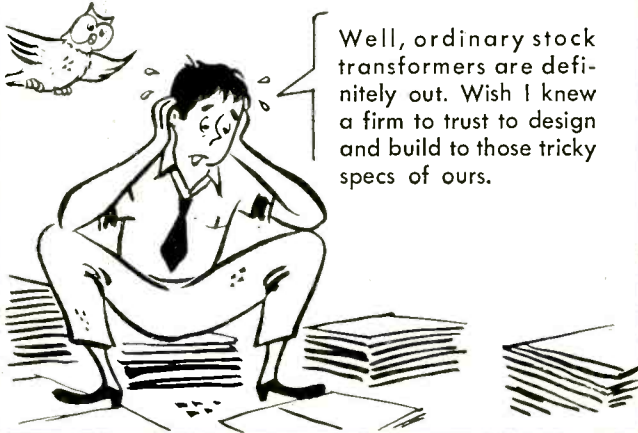

Say boss, why beat your brains out? Call ELECTRONIC TRANSFORMER CO.! Those boys spend all their time solving special transformer problems. They've got a full crew of engineers who'll go to town for you.

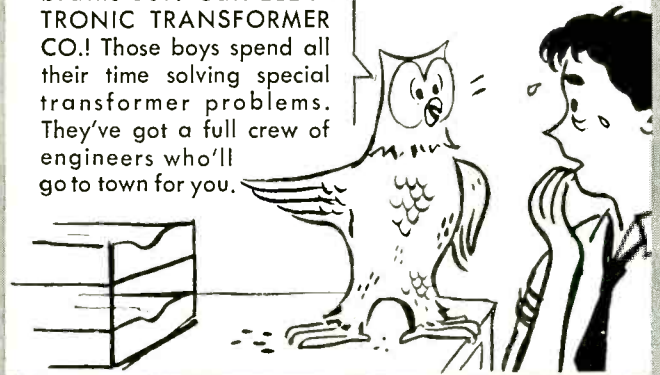

Operator, get me ELECTRONIC TRANSFORMER CO., quick! This is an emergency!



Well, what do you know . . . the bird was right! All I did was tell an ETC engineer my story over the phone and he's promised to have a complete prototype over here for approval in a few days. That's service!

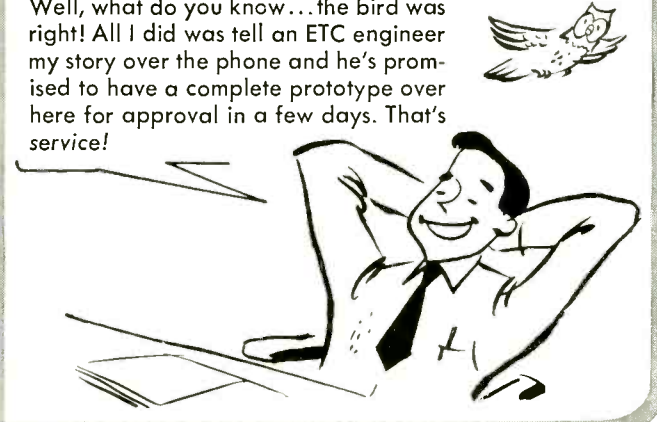

"You bet! ELECTRONIC TRANSFORMER CO. is an organization of transformer engineering specialists. They understand your problem. Designing and manufacturing one unit or production quantities to fit your scheduled needs has been their business since 1938."

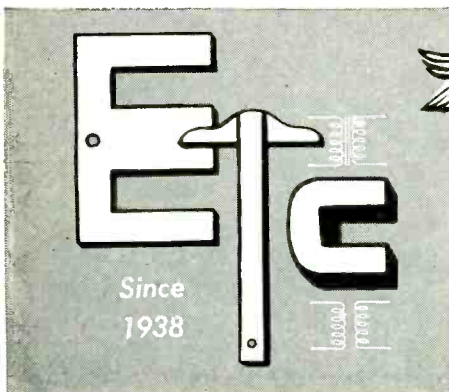

ELECTRONIC TRANSFORMER COMPANY

Transformers, Reactors and Filters Engineered to your Needs

209 WEST 25th STREET • NEW YORK 1, N. Y.
Telephone: WAtkins 4-0880

WAVELINE

precision instruments

measurement standard of industry

SALES REPRESENTATIVES

BOSTON, MASS. AREA
Robert A. Waters, Inc.
4 Gordon Street
Waltham, Mass.

CHICAGO 45, ILLINOIS
Everette Associates, Inc.
6744 N. California Ave.

INDIANAPOLIS, INDIANA
Everette Associates, Inc.
Box 6236
Speedway City

KANSAS CITY 3, MO.
Everette Associates, Inc.
1629 East 31st

LOS ANGELES 6, CALIF.
John B. Tubergen Co.
2232 West 11th Street

NEWARK, N. J. AREA
Gawler-Knoop Co.
178 Eagle Rock Ave.
Roseland, New Jersey

NEW HAVEN 15, CONN.
Robert A. Waters, Inc.
1150 Whalley Avenue

NEW YORK CITY AREA
Gawler-Knoop Co.
178 Eagle Rock Ave.
Roseland, New Jersey

PHILADELPHIA, PA. AREA
Gawler-Knoop Co.
835 Glenside Avenue
Wyncote, Pa.

ROCHESTER 10, NEW YORK
Edward A. Cissmann & Associates, Inc.
3 Juniper Street

SYRACUSE, NEW YORK
Edward A. Cissmann & Associates, Inc.
308 Merritt Avenue

WASHINGTON, D. C. AREA
Gawler-Knoop Co.
901 Parkring Drive
Silver Spring, Maryland

TORONTO 12, CANADA
R-O-R Associates, Ltd.
290 Lawrence Ave., W.

Man's progress has always depended upon the accuracy of scientific measurement.

Waveline, industry leader in production of precision microwave instruments and accessories...parallels the needs of progress...increases numbers of more exact measuring devices.

Improvements in engineering, laboratory and production facilities make possible even greater development, scheduling and delivery service for all clients.

In the field, Waveline's staff of trained engineers are ready to give immediate and personal attention to all technical problems.

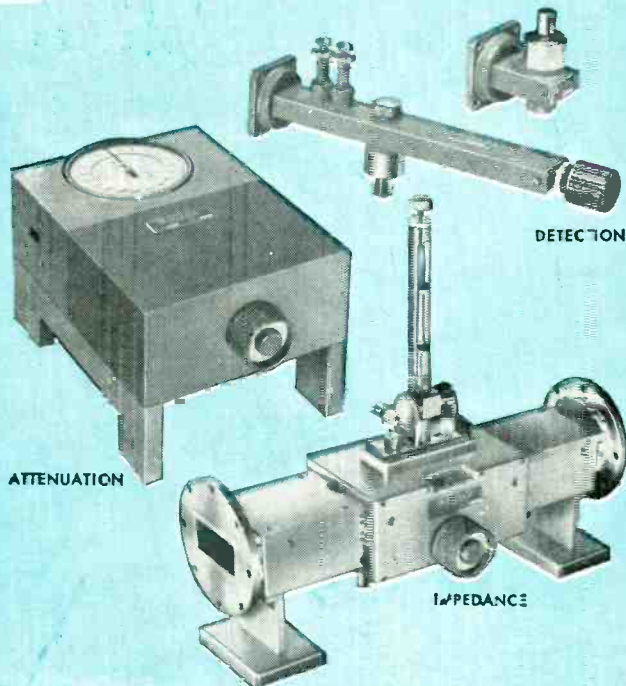

Write today for Technical
Data on microwave
instruments

BE SURE TO SEE US AT BOOTH 376 IRE SHOW.



8

steps for $\pm .0001$ pinions at RDM

- 1 Centerless Ground Stock
- 2 Swiss Automatic Blank Turnings
(.0002'' T.I.R.)
- 3 Precision Teeth Cutting To .0002'' P.D.
- 4 Latest Deburring Techniques
- 5 Heat Treating To Prescribed Rockwell Hardness
- 6 Burnishing To .0002''—Finishing To .0001''
- 7 Leaf Polishing To Extreme Specification
- 8 Individually Packaged In Protective Capsules

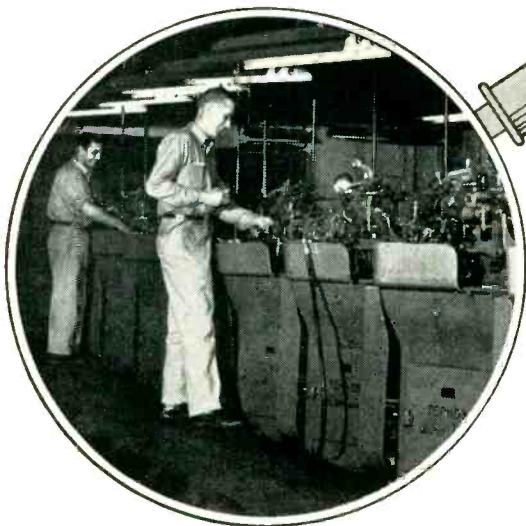
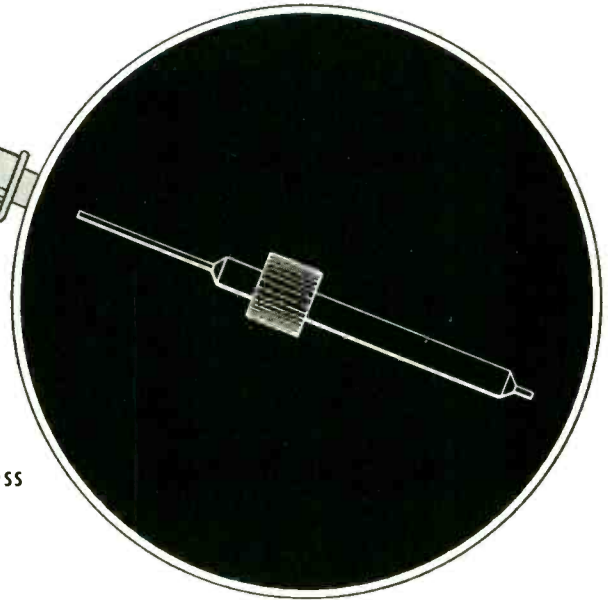

RDM'S SWISS AUTOMATICS IN OPERATION

These and other production lines of high precision machinery, combined with skilled engineering and production staffs, make RDM a one-stop service for difficult components of extreme precision.

Other RDM specialties include fine pitch gear cutting, thread milling and thread rolling, knurling, heat treating, broaching, drilling and tapping, polishing, grinding, milling, plating.

A brochure is yours for the asking—Write



RESEARCH DEVELOPMENT MANUFACTURE, INC.
431 E. COLLOM STREET, PHILADELPHIA 44, PENNSYLVANIA

PINIONS • GEARS • SHAFTS • PRECISION SCREWS • GEAR TRAINS

The Right Match

for miniature equipment
requiring a dependable
miniature chopper . . .

AIRPAX C747

"MIDGET" 400 CYCLE CHOPPER



Statistics prove that Airpax leads the nation in quantity and quality of choppers. Model C747 is available in quantity for immediate delivery from separate facilities at either of our two plants. Performance, rating and life are equal and better than that of our larger models. The MIDGET has 6.3 volt, 400 cycle drive, phase angle of 65°, SPDT contacts of about 135° dwell time. Contact our Sales Department for complete specification details, our Engineering Department for quick assistance with your application.

AIRPAX PRODUCTS COMPANY, MIDDLE RIVER, BALTIMORE 20, MD.

Flexible



Improved New VARGLAS SILICONE Tubing and Sleeving



Now Varglas Silicone has been made more flexible. Sharp turns and 90° bends cause no cracking or peeling — no loss of dielectric strength. As pioneers in the manufacture of silicone sleeving and tubing, we know this is the greatest improvement made during the past ten years. Unexcelled where high temperatures must be withstood for several hours — not just for 15 minutes. You need not sacrifice abrasion resistance and toughness to get flexibility. The new Varglas Silicone sleeving and tubing will pass cold bend tests at 35° to 40° LOWER temperature than formerly.

*The only Class H insulation
with all these features:*

Efficient from 500° F. to — 85° F.

Moisture and Fungus Resistant

Flame Resistant — Self extinguishing

Abrasion Resistant

Dielectrically Strong with average readings up to 7,000 volts.

Available in 10 colors — at no extra cost.

Samples of Varglas Silicone products as well as samples of our complete line of tubing and sleeving are available in a convenient sample folder. Just drop us a line telling us your problem and its peculiarities.

Varflex CORPORATION

Makers of
Electrical Insulating
Tubing and Sleeving

VARFLEX Sales Co., Inc.

308 N. Jay St., Rome, N. Y.

NON-STOP ORDER AND DELIVERY SERVICE • SPECIFIC TUBE DESIGN SERVICE • SPE
 EAST-TO-COAST WAREHOUSING SERVICE • NON-STOP ORDER AND DELIVERY SER
 ECIFIC TUBE APPLICATION SERVICE • COAST-TO-COAST WAREHOUSING SER
 ON-STOP ORDER AND DELIVERY SERVICE • SPECIFIC TUBE DESIGN SERVICE
 EAST-TO-COAST WAREHOUSING SERVICE • NON-STOP ORDER AND DELIVERY
 ECIFIC TUBE APPLICATION SERVICE • COAST-TO-COAST WAREHOUSING
 ON-STOP ORDER AND DELIVERY SERVICE • SPECIFIC TUBE DESIGN SERVICE
 EAST-TO-COAST WAREHOUSING SERVICE • NON-STOP ORDER AND DELIVERY SER
 ECIFIC TUBE APPLICATION SERVICE • COAST-TO-COAST WAREHOUSING SER
 ON-STOP ORDER AND DELIVERY SERVICE • SPECIFIC TUBE DESIGN SERVICE • SPE

New

G-E REFERENCE CAVITIES HAVE ONLY 0.4 mc FREQUENCY DRIFT!

Accuracy is 2½ times that of others!

YOU CAN BUILD MORE RELIABLE RADAR EQUIPMENT, WITH G-E LOW-DRIFT CAVITIES!

G-E DESIGN SERVICE helps you manufacture better, more dependable radar, by providing a series of 5-kw reference cavities with new and tighter temperature drift specifications. Beacon-transponder signals, when General Electric cavities are used in reception, may be seen and read clearly whether airborne equipment is operating in heat or cold. You can offer your customers true pinpoint frequency regulation at all flying temperatures.

LIGHTWEIGHT! G-E cavities weigh only 8 ounces. They are small and compact, with slotted corners that permit 4-bolt mounting for secure alignment and support. Their design makes them suitable for pressured waveguide systems. Vibration (up to 10 g's) and ambient air-pressure changes (15 p.s.i.a. up to 45 p.s.i.a., or down to 5" mercury) affect frequency only $\pm .1$ and $\pm .15$ mc respectively.

GET THE FACTS! Bulletin ETD-885, just off the press, gives other reasons why G-E reference cavities are the newest, most accurate you can obtain. Write for it today! *Tube Department, General Electric Company, Schenectady 5, New York.*



- NEW GL-6301** 9270 mc
- NEW GL-1Q26-A** 9280 mc
- NEW GL-6452** 9350 mc

COMPARE the max \pm frequency drift of G-E and other cavities (from -40 C to $+100$ C).

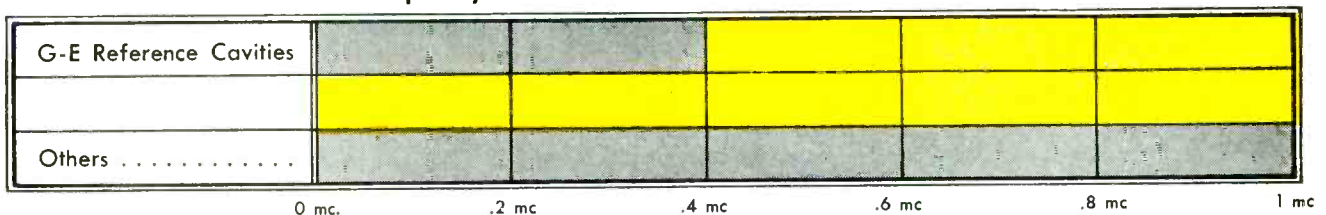

GENERAL **ELECTRIC**

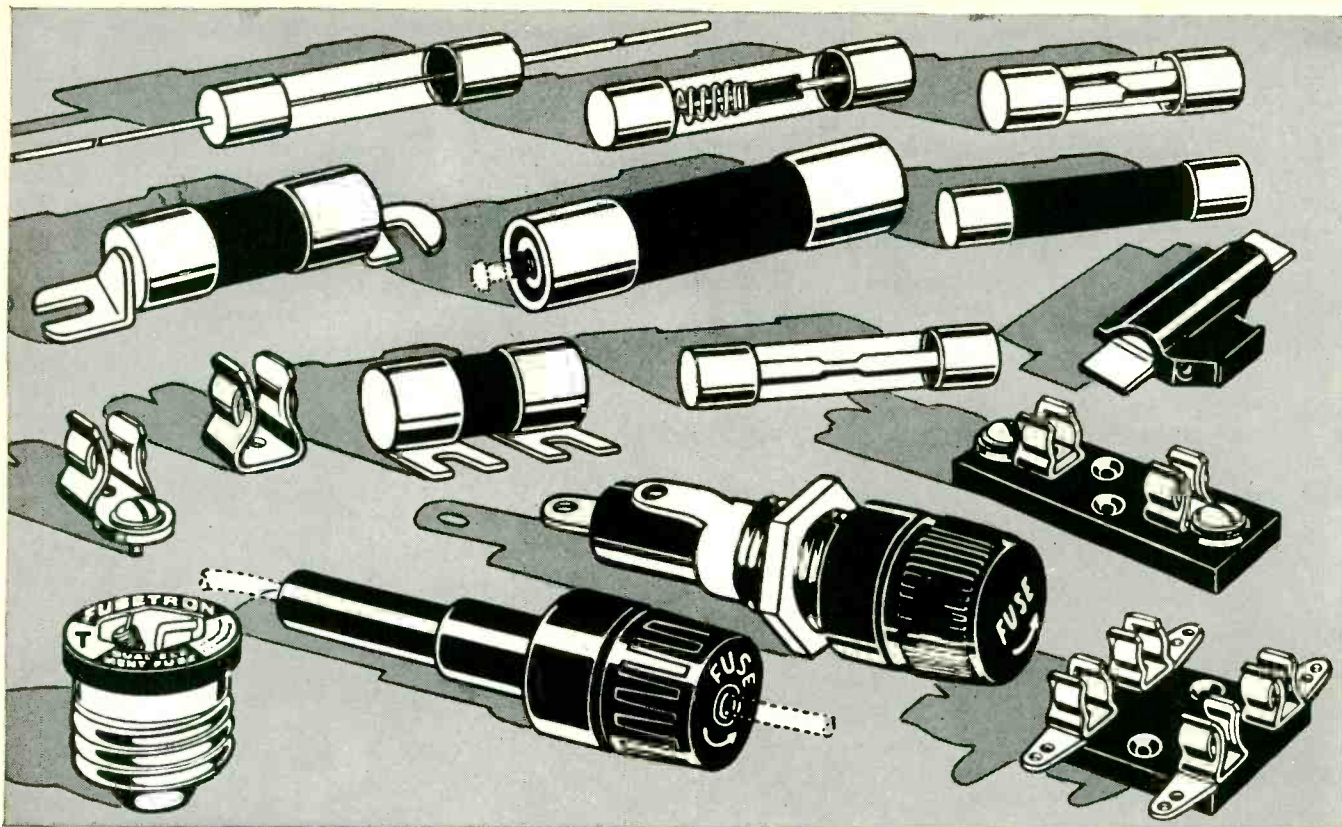

WHY YOU WILL FIND IT PROFITABLE to STANDARDIZE on BUSS FUSES



BUSS OFFERS A COMPLETE LINE OF FUSES

It is easy and economical for you to choose the exact fuse for your requirements. Select from dual-element (slow blowing) renewable and one-time types . . . in sizes from 1/500 ampere up, plus a companion line of fuse clips, blocks and holders.

A fuse is a small but significant component part — for a faulty fuse that fails to protect — or a fuse that blows needlessly may reflect, in your customer's mind, on your product or service.

Dependable electrical protection is not an accident with BUSS fuses.

The makers of BUSS fuses maintain rigid quality control by testing every fuse in a sensitive electronic device that rejects any fuse not properly calibrated, properly constructed and right in all physical dimensions.

That is why you can be sure that a BUSS fuse will always operate as intended under all service conditions.

"Trouble-free" BUSS fuses can help protect your goodwill, reputation and profits.

Then be profit wise, change your buying and stock records today — to standardize on genuine BUSS fuses.

For more information mail this Coupon ▼

BUSSMANN Mfg. Co. (Division of McGraw Electric Co.)
University at Jefferson, St. Louis 7, Mo.

Please send me bulletin SFB containing facts on BUSS small dimension fuses and fuse holders.

Name _____

Title _____

Company _____

Address _____

City & Zone _____ State _____ ELRC-354

Let BUSS save you engineering time.

When selecting or designing a fuse or fuse mounting let BUSS, with the world's largest fuse research laboratory and its staff of engineers, be of service. At least be sure to get the latest BUSS fuse information before final design is crystallized. It's quite possible that the fuse to meet your exact requirements is already available in local wholesaler's stocks.

Makers of a complete line of fuses for home, farm, commercial, electronic and industrial use



SAVE \$300 PER MILE! on each Micro Wave installation

with

MICRO

POWER

And it's easy to figure too—because "Micro-Power" replaces several units of costly, more complicated equipment. Electric plant—rectifier—battery banks and motor-generator . . . CAN ALL BE ELIMINATED—by the installation of a single "Micro-Power" Unit. Study the following information . . . and see how you can save up to \$300 per mile on your next Micro-Wave installation.

*a
Micro-power
stand-by unit
can save
up to*

MICRO-POWER . . .

APPROXIMATE SAVINGS

ELIMINATES A STAND-BY ELECTRIC PLANT —

"Micro-Power" performs the functions of a stand-by electric plant during power interruption and power droop. "Micro-Power" is designed for use with equipment that cannot tolerate any interruption of electric power

\$800 to \$1,000

ELIMINATES BATTERIES

"Micro-Power" can eliminate the need for costly battery banks, for "Micro-Power" assures constant power to essential equipment at all times.

\$2,000 to \$6,000

ELIMINATES RECTIFIERS

"Micro-Power" is a motor and/or engine driven electric generator interposed between the source of electric power and essential equipment. "Micro-Power" makes current and voltage conversions.

\$500 to \$1,000

ELIMINATES MOTOR-GENERATOR SETS

"Micro-Power" is a motor generator set with an internal combustion engine stand-by. In operation "Micro-Power" will serve as a voltage regulator

\$900 to \$1,000

\$4,200 to \$9,000
PER INSTALLATION

The above figures are typical of dozens of complete Micro-Wave installation costs as submitted to United States Motors Corporation for comparison purposes. In many studied cases "Micro-Power" can effect savings in excess of \$7,500 per installation. (\$300 per mile.)

If you are planning a Micro-Wave installation, now or in the future . . . write U. S. Motors Corporation for complete details on "Micro-Power" "Micro-Power" reduces original cost. "Micro-Power" provides continuous, UN-INTERRUPTED SERVICE.

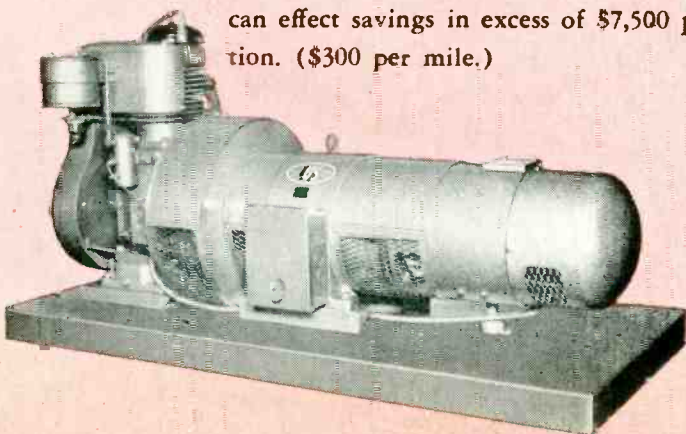

U. S. MOTORS CORPORATION
OSHKOSH, WISCONSIN

Why it pays to make **Rome** your source of special electronic cables

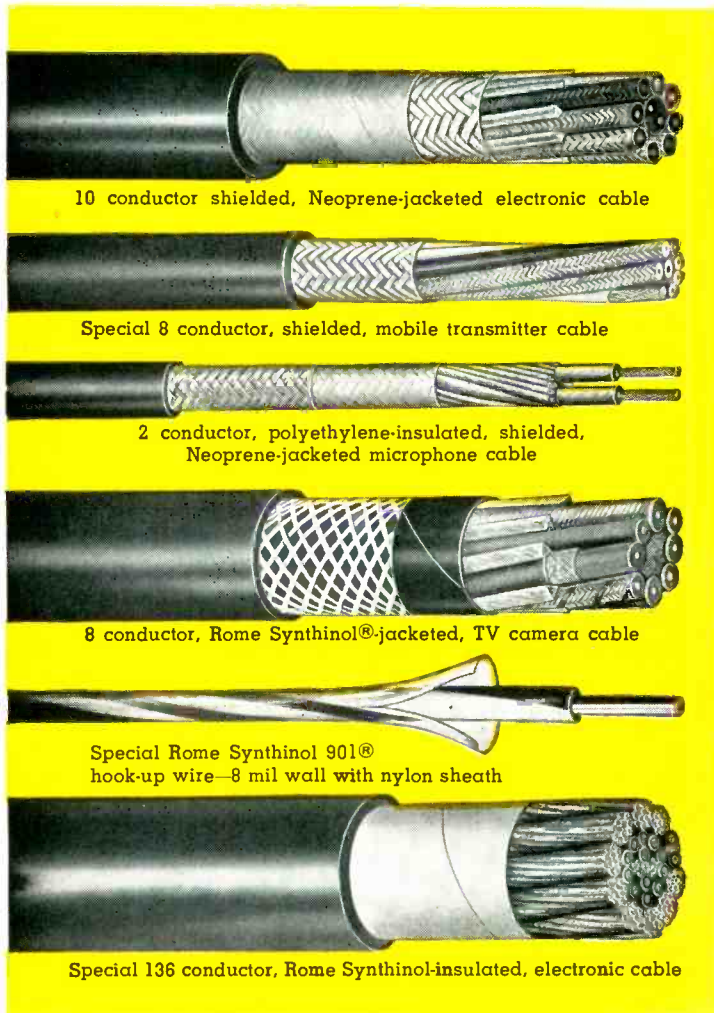

10 conductor shielded, Neoprene-jacketed electronic cable

Special 8 conductor, shielded, mobile transmitter cable

2 conductor, polyethylene-insulated, shielded, Neoprene-jacketed microphone cable

8 conductor, Rome Synthinol®-jacketed, TV camera cable

Special Rome Synthinol 901® hook-up wire—8 mil wall with nylon sheath

Special 136 conductor, Rome Synthinol-insulated, electronic cable

When you have an electronic wiring problem it pays to go to a specialist, such as Rome Cable. Wires and cables made by Rome, first, are designed by engineers with training and experience in electronic applications. Further, Rome Cable has the manufacturing knowledge and facilities to produce unusual constructions . . . with quality controlled step by step. By standardizing on Rome wires and cables you assure dependable performance for your product and add obvious quality . . . with a component engineered to your requirement.

Rome manufactures a wide range of hook-up wires, intercommunication cables, coaxial cables, electronic computer cables, R. F. transmission line, television camera cables as well as other special constructions.

COMMERCIAL TYPE HOOK-UP WIRES

Rome offers commercial type hook-up wires with three standard insulations.

Rome Hi-temp—a rubber insulation with exceptionally high resistance to heat and moisture. Underwriters' approved for 75° C.

Rome Synthinol—a polyvinyl chloride thermoplastic compound, highly resistant to acids, oils, alkalis, moisture and flame. Underwriters' approved for 80° C.

Rome Synthinol 901—offers all the advantages of Synthinol plus higher resistance to heat deformation, shrinkage and cracking, also improved solderability. Underwriters' approved for 105° C.

MILITARY HOOK-UP WIRES

Rome manufactures military type **SRIR**, **SRHV** and **WL**, complying with Joint Army-Navy Specification **JAN-C-76**, as well as shipboard types **SRI** and **SRIB** conforming to Specification **MIL-C-915 A (SHIPS)**. Insulated with Rome Synthinol, these wires are made in a complete range of specification sizes.

ROME CABLE CORPORATION, Dept. EL-3, Rome, N. Y.
Please send me information on Electronic Wiring

Name.....
Company.....
Address.....
City..... Zone..... State.....

It Costs Less to Buy the Best



EIMAC announces

the 2C39B

- Ruggedness of ceramic
- High conductivity of copper

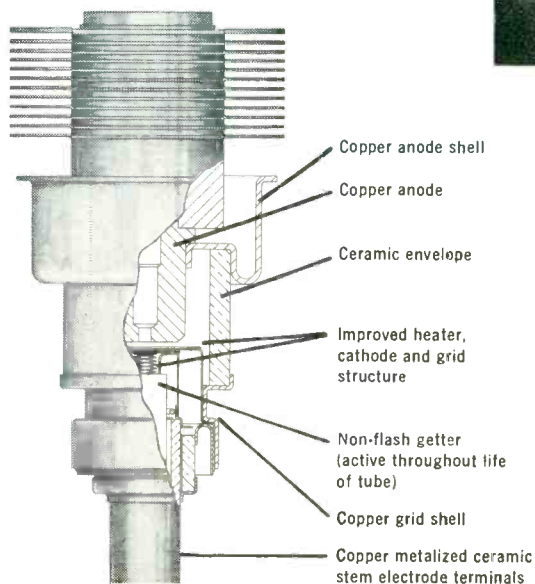

TYPICAL OPERATION

(RF Oscillator 2500mc)

D-C Plate Voltage	900v
D-C Grid Voltage	-22v
D-C Plate	90ma
D-C Grid Current	27ma
Useful Power Output	15w

EITEL-McCULLOUGH, INC.
SAN BRUNO • CALIFORNIA

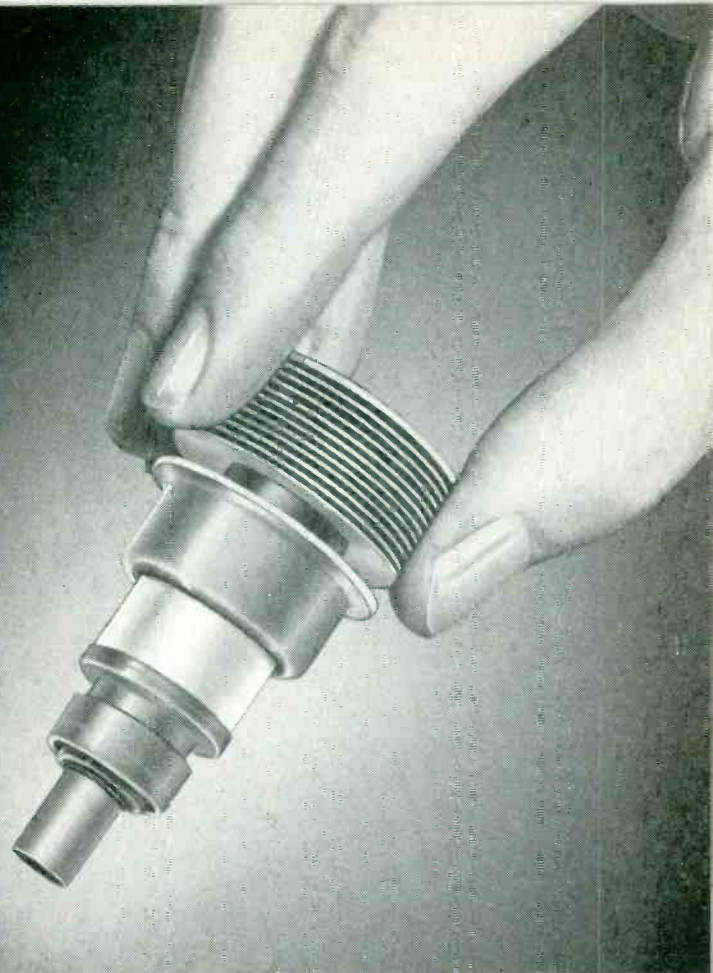

The Eimac 2C 39B, unilaterally interchangeable with the 2C 39A, is a new tube type with advancements that provide longer life, more useful power output, efficiency and stability, and greater immunity to thermal and physical shock. Rugged, low loss ceramic replaces glass throughout the Eimac 2C 39B and highly conductive, heat dissipating copper is utilized in the anode, anode shell and grid shell. Use of ceramic and copper, an exclusive Eimac feature, allows higher operating temperatures and minimizes RF losses. Electrode terminals are formed in the stem by copper metalizing the ceramic stem surface. All external contact surfaces are silver-plated. New heater, cathode and grid structures, plus a non-flash active getter, add to long life and stability. These features, born out of Eimac experience over the past few years in research and production of glass and ceramic 2C 39As, make the Eimac 2C 39B an incomparable planar-type 100 watt triode for UHF operation through 2500mc.

- Eimac, one of the world's largest designers and manufacturers of electron-power tubes, presents its 20th Anniversary display at the March IRE show—booths 549-551

Eimac

MARK OF EXCELLENCE IN
ELECTRON-POWER TUBES

ONE IN A SERIES discussing the importance of selecting
the proper permanent magnet to use in your product

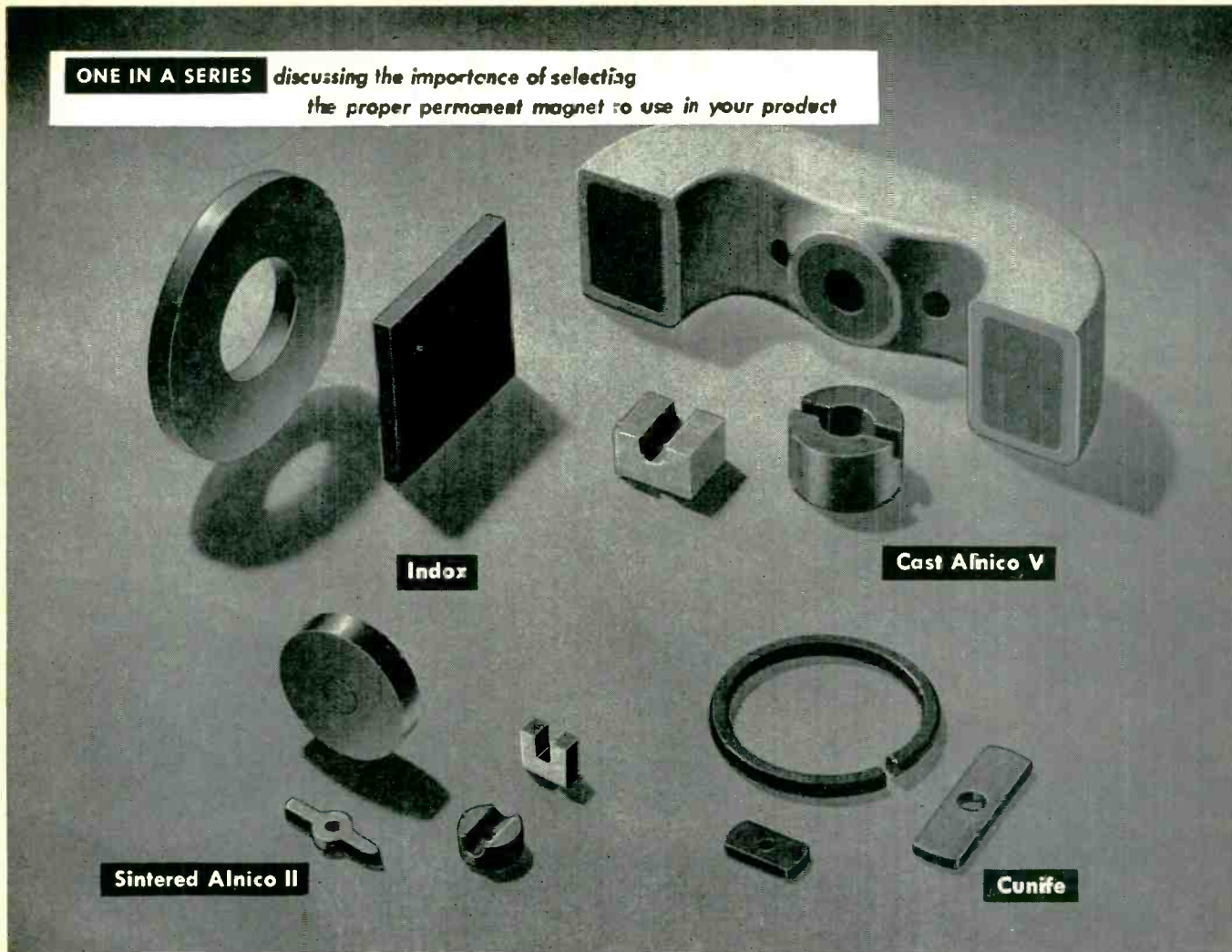

How the Right* Permanent Magnet Material Can Benefit Your Product

Of the many permanent magnet materials available—a few of which are shown above—only *one* will permit your product to *function best at the lowest possible cost.*

Which one is it? To help you answer that question properly is part of our job. As specialists in permanent magnets, we have helped to provide manufacturers with the answers for over 35,000 applications. The case of the telephone equipment manufacturer is typical. Perhaps we can assist you, too.

There is no charge . . . or obligation . . . for this service. Just write us, today, giving the details of your particular design problem. Or, ask for our Engineering Design Manual No. 4-A3. We'll be glad to provide both.

A Typical Case

. . . is that of a prominent telephone equipment manufacturer who changed from a chrome steel magnet to the use of Alnico III in his polarized relay. The results:

- 70% Savings in initial cost
- Simplified design
- Reduced weight
- Flux increase of 27% — improved performance
- Saving in space
- Less maintenance

* *The one which will permit your product to function best at the lowest possible cost.*

THE INDIANA STEEL PRODUCTS COMPANY • Valparaiso, Indiana

World's Largest Manufacturer of Permanent Magnets

INDIANA PERMANENT MAGNETS

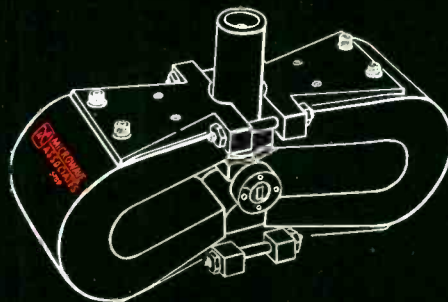

NEW MAGNETRONS

MICROWAVE X-band magnetrons include the new miniature 6444 (ESM-48) low voltage one watt CW tube and for pulse operation the popular, low priced 2J42 and 2J42A. Also, the 4J52 with all glass replaced by ceramic, allows for a very high temperature bake out, insuring gas free operation. The new long life, high emission Philips dispenser-type cathode is incorporated in the 4J52, 6444 and the greatly improved 8.6 millimeter 5789 magnetron.

SEND FOR DATA

Write for detailed specifications and descriptive literature on our Magnetrons, TR and ATR tubes, Silicon Diodes and Waveguide Components. We offer engineering assistance and cooperation on your microwave problems.

MICROWAVE ASSOCIATES INCORPORATED
22 Cummington Street, Boston 15, Mass.
Telephone COpley 7-4441



TYPICAL RATINGS

TUBE TYPE	FREQUENCY MC	NOMINAL PEAK OUTPUT	PEAK ANODE VOLTAGE KV	AV. ANODE CURRENT MA	INITIAL HEATER	
					VOLTAGE V	CURRENT A
5789*	34512-35208	40 KW	10.0-13.0	5.0	6.0	2.0 - 2.4
2J42	9345-9405**	8 KW	5.3 - 5.7	9.0	6.3	0.43-0.60
6027 (2J42A)	9345-9405**	20 KW	6.4 - 7.4	7.5	6.3	0.43-0.53
4J52*	9345-9405	80 KW	14.0-16.0	15.0	12.6	1.8 - 2.4
6444 (ESM-48)*	9800-10000	1 W. CW	0.45-0.50	15.0	6.0	0.4 - 0.5

* Philips dispenser-type cathode.

** Available on special request from 9000-9600 mc,

FOR DEPENDABLE MEASURING INSTRUMENTS

... come to **NEW LONDON!**



UHF TV SWEEP GENERATOR **MODEL 130**

The Model 130 features continuous frequency coverage in one band; at least one volt output into 75 ohms; wide sweep; blanked signal on return sweep provides a reference baseline.

SPECIFICATIONS

Freq. Range: 450-900 mc Sweep Width: 0-40 mc min.
 Sweep: 60 cycle, sine wave
 Output: (1.) 0.1-1.0 volts (2.) 0.01-0.1 volts approx.

FM SIGNAL GENERATOR **MODEL 100C**

Designed to give precision performance over a single tuning range. Has negligible leakage and very low spurious outputs. No auxiliary frequency changer unit required.

SPECIFICATIONS

Tuning Range: 27-230 mc Output: 0.02-100,000 microvolts
 Freq. Deviation: (1.) 0-30 kc; Int. Mod.: 400 and 1000 cycles
 (2.) 0-150 kc



VHF-UHF NOISE SOURCE **MODEL 175**

Ideal for measuring receiver noise in television tuners, receivers and other applications between 10 and 900 mc. Designed for operation with 300 ohm receivers with less than 0.5 db error. Noise figure 0-19 db

MICROWAVE GENERATOR **MODEL 155**

Designed to operate between 2700-3400 mc. Can be pulse modulated and is suitable for testing receivers and transmitters.

SPECIFICATIONS

Power Output: Atten. calib. to read peak power output in db below 1 mw in 50 ohm load. RF Power Input: Measure average power up to 200 mw.
 Leakage: Less than -95 dbm.



Other products manufactured by New London Instrument Company include: High Gain Wide Band Amplifier—UHF Grid Dip Oscillator—Square Wave Generator—Balun. Write for detailed specifications and catalog on our complete line of measuring equipment. See our demonstration at the New York I.R.E. Show—Booth 166.

NEW LONDON INSTRUMENT
Company

P. O. BOX 189E, NEW LONDON, CONN.



Potter & Brumfield's

New "PW"

Miniature Tube Size Relay with High Sensitivity

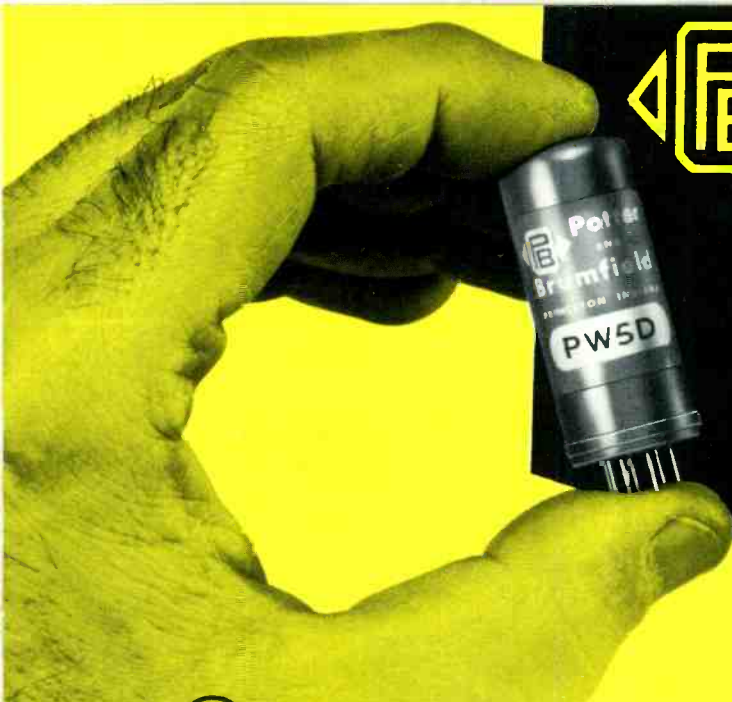

- 1 Armature—precision balanced on needle-point bearings for friction-free movement; affords maximum resistance to shock and vibration.
- 2 High permeability, low residual nickel-iron parts afford high sensitivity.
- 3 Coil develops greatest magneto-motive force in smallest space.
- 4 Highest quality insulation used in both relay structure and enclosure.
- 5 Two types of compression headers: standard 7-pin plug-in or solder lug.

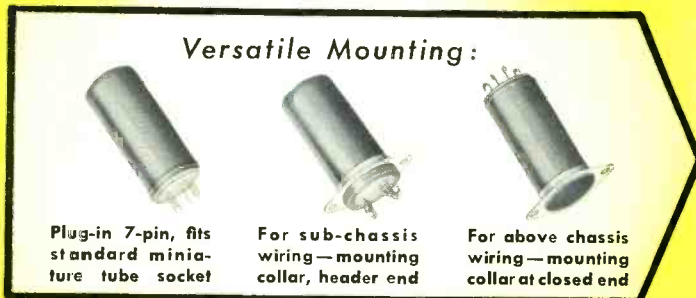
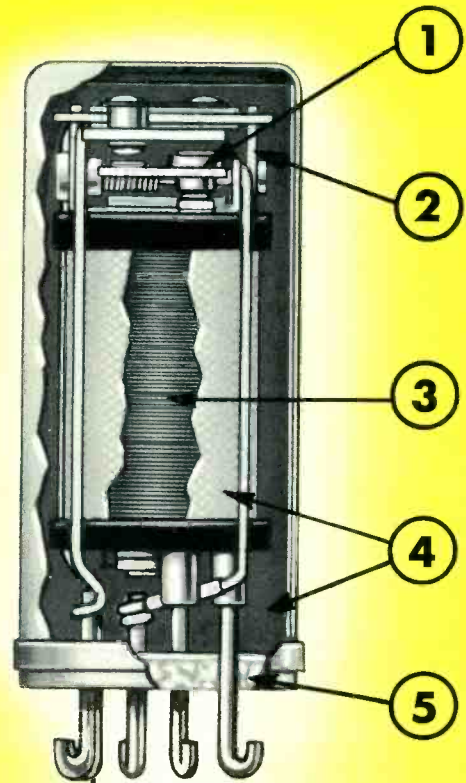

Technical Specifications:

ACTUATION: DC only, current or voltage.

CONTACT ARRANGEMENT: 1 Form C (SPDT).

CONTACTS: $\frac{3}{32}$ " dia. pure silver rated 2 amperes 28 volts DC or 115 Volt 60 cycle AC non-inductive load.

OPERATING POWER: 25 milliwatts to 1.5 watts.

COIL RESISTANCES: 100 to 16,000 ohms.

VIBRATION AND SHOCK: (Operating) 10G to 500 cps. 10G minimum shock (with 40 MW minimum power).

BREAKDOWN TEST: 500 volts RMS, 60 cycles, between insulated parts and to ground.

ENVIRONMENTAL CONDITIONS: Hermetically sealed in deep drawn brass case permits operation in any climatic or atmospheric conditions.

OPERATING TEMPERATURE RANGE: Standard construction to meet MIL-R-5757B Class A (-55 to $+85^{\circ}\text{C}$). Special construction to meet Class B or Class C (up to 200°C).

TERMINATION: Miniature 7-pin plug-in or solder lug. Glass compression type headers.

DIMENSIONS: $\frac{3}{4}$ " x $1\frac{1}{32}$ " above chassis.

VOLUME: .73 cu. in.

WEIGHT: $1\frac{1}{16}$ oz.

Potter & Brumfield leads again with a relay that meets the insistent demand for further miniaturization yet embodies the sensitivity, ruggedness and longevity required in modern equipment! Its movement is so balanced as to be virtually unaffected by shock or vibration (in any position), and its high permeability magnetic structure affords sensitivity and contact pressure heretofore unobtainable in a relay of this size. Wear-free pivot bearings assure long life; simplified construction permits low manufacturing cost.

The PW is VERSATILE and will find hundreds of applications in commercial and government equipment—aircraft, computers, TV equipment, protective and indicating circuits being just a few. The PW now is in production. Samples and quotations provided on request; specify winding, adjustment, termination and mounting. Write **Potter & Brumfield, Princeton, Indiana**. Sales offices in principal U. S. and Canadian cities.

See other side for more P&B Relays →

Potter & Brumfield



Standard Relays

offer you many advantages

The extensive line of Potter & Brumfield Standard Relays will meet the circuit requirements of a wide variety of applications. Wherever a P & B standard or slightly modified version can be used to solve your problem you gain these important advantages.

1 Proven Design—P & B Standard Relays are the result of more than 20 years experience in relay design and have been completely proven under all kinds of operating conditions. You are assured of long, trouble-free, dependable performance.

2 Lower Cost—These relays are already tooled. They are manufactured in production quantities. You gain substantial advantages in costs.

3 Fast Delivery—Orders for standard relays can be filled from stock or with a minimum delay.

4 Sold through Distributors—Popular types available through P & B franchised Electronic Parts Distributors located in all principal cities.

A FEW OF THE MORE THAN 110 P&B STANDARD RELAY STRUCTURES

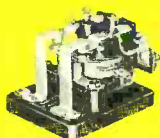

POWER RELAYS Two series—heavy and medium duty. For across the line power circuits, high current or high voltage switching. From SPST to 3PDT.



PLATE CIRCUIT RELAYS Actuate on a few milliwatts. Easy to adjust. Small—rugged—low in cost. From SPST to DPDT.



SUPER SENSITIVE RELAYS Operate on less than 10 MW. Dual coils, 10G vibration resistance. Wide versatility. One Form C-SPDT.



GENERAL PURPOSE RELAYS For applications where space and weight are important. Withstand high shock and vibration. From SPST to 3PDT.



IMPULSE RELAYS Automatic stop prevents backlash or overtravel. Precise switching regardless of operating speed. DPDT or 4PDT.



400 CYCLE AC RELAYS 15 gram or higher contact pressure. Withstand better than 10G shock. Heavy cast mounting foot. One form A to 2 form C.



MULTIPLE CONTACT RELAYS Longer coil gives power to actuate additional contacts and maintain 15 grams pressure. From SPST to 4PDT.



TELEPHONE RELAYS Four series meet practically all telephone type relay requirements: Short armature movement, long armature arm. Many contact combinations.



SUPER MIDGET RELAYS Tiny and rugged—plug in—one form C. High degree of resistance to vibration and shock.



MULTIPLE LEAF RELAYS For temperature, indicating or protective circuits. Heavy, tin-coated phosphor bronze contact springs. From SPST to 4PDT.



MOTOR STARTING RELAYS Voltage controlled to insure throwout of starting winding when motor reaches rated speed. Fast acting double break.



SUBMINIATURE SENSITIVE RELAYS Standard 7 pin plug-in. Ruggedized for vibration and shock. Operating power 25MW. Contact load 2 amps.



LATCHING RELAYS Compact—high utility switching. Coils operate on AC or DC. Voltage or current. From SPST to 4PDT.



HEAVY-DUTY SHOCK-PROOF RELAYS Can be mounted in any position. Particularly resistant to vibration and shock. From SPST to DPDT.



MINIATURE DC POWER CONTACTOR High current contact capacity and rugged construction. Contact pressure approx. 250 grams. SPST-NO-DM.

ALL P & B STANDARD RELAYS CAN BE SUPPLIED WITH DUST COVERS OR HERMETICALLY SEALED CANS WITH EITHER SOLDER OR PLUG-IN HEADERS

Write home office in Princeton or phone your local P & B Sales Office for new master catalog describing our wide line of basic relay structures, housings and enclosures. Samples, recommendations and quotations promptly furnished on special applications.

P & B Standard Relays available at your local Electronic Parts Distributor

Potter & Brumfield

PRINCETON, INDIANA

EXPORT: 13 E. 40TH STREET, NEW YORK, NEW YORK
SALES OFFICES IN PRINCIPAL U. S. AND CANADIAN CITIES



NEWEST
in the  line of
QUALITY INSTRUMENTS



TYPE 324-A PHASE METER

- WIDE FREQUENCY RANGE
- HIGH ACCURACY
- DIRECT READINGS

... for measurement of phase response in video amplifiers since uniform time delay is achieved when curve of phase shift vs. frequency is linear. Frequency range is 20 kc. to 4.5 mc. Input range is 2-300 v. peak. Angular range is 0-360° with individual quadrant metering. Accuracy is $\pm 4^\circ$ on quadrant scales.

TYPE 706-A PHASE STANDARD

- HIGH PRECISION
- EXCELLENT STABILITY
- SIMPLICITY OF OPERATION

... generates two voltage signals whose phase difference is known to $\pm 0.1^\circ$. Multiple frequency Lissajous pattern is used to indicate angles established. Phase shift is achieved by means of a precise, stable, and continuously variable electronic phase shifter. Operation is at single pre-determined frequency specified by customer.



TYPE 511 - A POWER AMPLIFIER

- PHASE SHIFT COMPENSATION
- NEGLIGIBLE DISTORTION
- HIGH VOLTAGE OUTPUT LEVEL

... a general purpose laboratory power amplifier featuring low distortion, low noise and excellent phase characteristics throughout the frequency range from 50 cps. to 50 kc. A choice of four outputs available to match various loads (5, 25, 200 or 1200 ohms). At rated frequencies and gain settings the overall phase shift is small. A special feature is the phase compensation circuit which permits the overall phase shift to be maintained at a constant value with varying gain. Harmonic distortion and intermodulation distortion are low. Output voltage up to 120 volts into a 1200 ohm load. Operates into loads varying from pure resistance to pure reactance.



TYPE 501 - A COMPRESSOR AMPLIFIER

- WIDE INPUT RANGE
- UNIFORM OUTPUT
- NEGLIGIBLE DISTORTION

... a compact, easily operated unit which accepts an input signal of varying amplitude and provides output signal having the same waveform, but of nearly constant amplitude. This operation is effective over a large input dynamic range and a wide frequency range with essentially zero distortion.

ENGINEERING REPRESENTATIVES

Chicago, Ill. — Uptown 8-1141
Rochester, New York — Monroe 3143
Silver Springs, Md. — Juniper 5-7550
Hollywood, Cal. — Hollywood 9-6305
Roseland, N.J. — Caldwell 6-4545
Binghamton, N.Y. — Binghamton 3-1511

Waltham, Mass. — Waltham 5-6900
Dayton, Ohio — OXmoor 3594
Arnprior, Ont., Can. — Arnprior 400
Dallas, Texas — Dixon 9918
Wyncote, Pa. — Livingston 8-5480
Canaan, Conn. — TAYlor 4-7215



TECHNOLOGY INSTRUMENT CORP.

533 MAIN STREET • ACTON, MASS. • TELEPHONE • ACTon 3-7711

See us at Booths 226-228 on Instruments Ave. at the IRE Show

PRECISION LABORATORY ★ TEST EQUIPMENT ★

New RF STEP ATTENUATOR*

Small, rugged ladder attenuator achieves attenuation accuracy and low vswr from dc to uhf. Suitable for all signal and sweep generators in this frequency range.

Care in design assures maximum flexibility in mounting, drive, and types of input and output connections.

Easily adaptable for inclusion in different types of test equipment and in laboratory and production test applications.

Several standard models available. Attention given to special requirements.

SPECIFICATIONS

- **MAXIMUM STEPS**

Ten (eleven contact positions)

- **ATTENUATION RANGE**

Up to 120 db maximum depending on frequency range.

- **OUTPUT IMPEDANCE**

50 or 75 ohms nominal

- **INPUT IMPEDANCE**

100 or 150 ohms nominal
50 or 75 ohms optional

- **INPUT AND OUTPUT VSWR**

1.1 to 1000 mc at 50 ohms

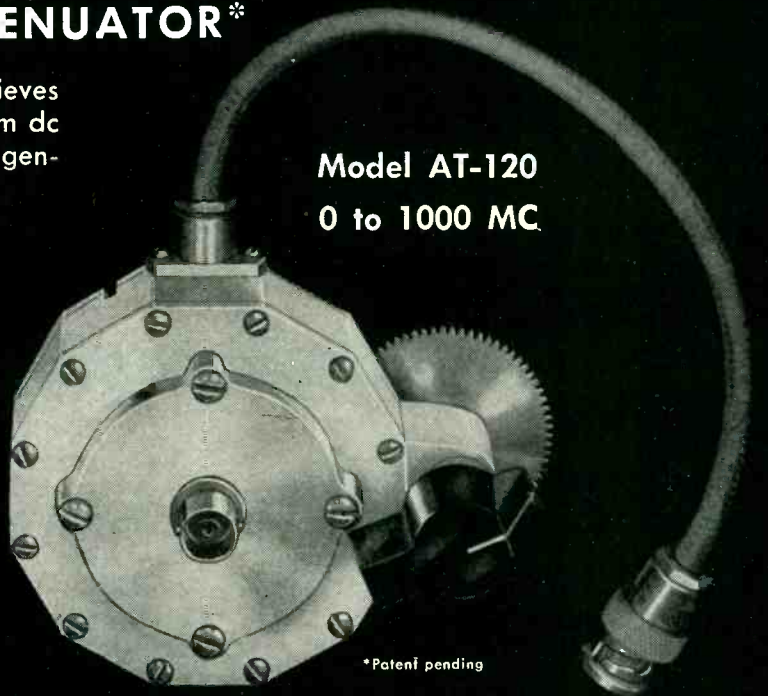

STANDARD SIGNAL GENERATOR SG-25

An R.F. Signal Generator operating over the frequency range 10kc to 50 megacycles. Output voltages adjustable from 0.1 microvolts to 0.1 volts across 50 ohms with an accuracy of ± 1 db. Built in crystal calibrator provided for accurate frequency setting. Internal modulation 400 and 1000 cps. Operates on 115 volts, 50 to 1000 cycles. Complete with accessories.

VARIABLE FREQUENCY POWER SUPPLY

VS-500 has been primarily designed for the purpose of testing Electronic Equipment uses ac power sources of frequencies ranging from 50 to 3000 cycles. However, it finds many other laboratory applications such as testing transformers over a wide frequency range, at high power levels, operating synchronous motors at variable speeds. Many attractive special features are incorporated.



STANDARD SIGNAL GENERATOR SG-26

An R.F. Signal Generator operating over the frequency range of 4 to 405 megacycles. Output voltages adjustable from 0.1 microvolts to 0.1 volts across 50 ohms with an accuracy of ± 1 db. Internal modulation 400 and 1000 cps. Provision for external audio and pulse modulation. Operates on 115 volts, 50 to 1000 cycles. Complete with accessories.

STANDING WAVE INDICATOR SW-12

Accurately Indicates standing wave ratios 1:1 to 4:1. Operates on 115 volts 50 to 800 cycles. Designed for use with a square law crystal detector or bolometer probe which samples R.F. voltage from a slotted line. Of shock resistant, non-microphonic construction. Complete with carrying case and detachable cover.



CONTI

TRAD

TELEVISION CORPORATION

1001 FIRST AVE., ASBURY PARK, N. J.

New CBS-Colortron

NOW IN MASS PRODUCTION



Unique photographic process, like photoengraving, uses aperture masks as negatives to print consecutively the red, green, and blue phosphor dots (250,000 of each) on CBS-Colortron screens.

After tri-color screens are printed, aperture masks are temporarily removed and face plates move on to critical inspection for screen imperfections.

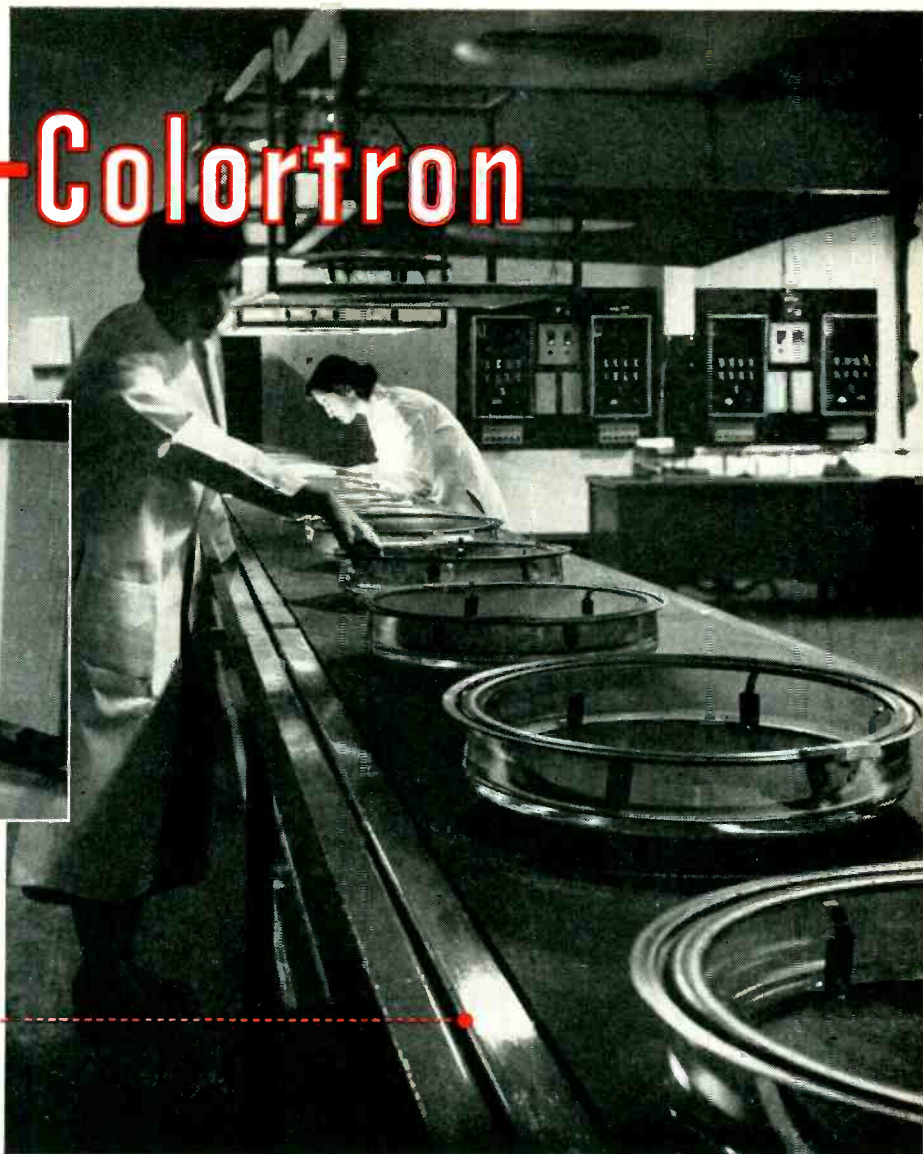

COLOR TV IS COMING . . . faster than you think. The revolutionary new CBS-Colortron . . . a practical color picture tube . . . hastens the day. Already it is in lower-cost, mass production . . . made possible by its simplified, advanced design.

As in black-and-white tubes, the CBS-Colortron's screen is deposited directly onto the inside of its face plate. A unique photographic technique makes this possible. Because each aperture mask serves as a negative to print its tri-color screen, perfect register of mask and screen is automatically achieved

and maintained. The rugged, simple, light-weight mask sharply reduces assembly and exhaust problems. And the spherical design of mask and screen simplifies convergence circuitry and adjustment.

The CBS-Colortron is now a 15-inch, round tube. But, as soon as tooling is completed, it will be made in larger sizes. Watch for the new CBS-Colortrons. You'll see plenty of them soon. And you'll be sold on sight by their logical simplicity . . . their superior performance . . . their many advantages.

CBS-Colortron OFFERS MANY ADVANTAGES



Cross-section (face plate, aperture mask, funnel, tri-color electron gun) shows simplicity of CBS-Colortron and its adaptability to low-cost, mass production.

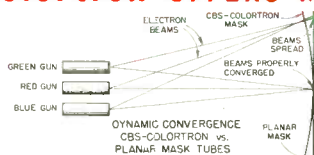

Spherical screen and aperture mask of CBS-Colortron simplify convergence and focus. Electron beams remain in focus over entire surface of screen.

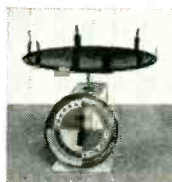

Light-weight (6 oz.), rugged, simple aperture mask of CBS-Colortron minimizes problems of exhaust, handling, and assembly.

COMPLETE CBS-Colortron DATA FREE!

Take a look into the future. Write today for complete information on CBS-Colortron 15HP22: Construction . . . operation . . . application . . . installation and adjustment . . . electrical and mechanical data. Four packed pages . . . free!



CBS-HYTRON, Main Office: Danvers, Massachusetts

Manufacturers of Receiving Tubes Since 1921

A Division of Columbia Broadcasting System, Inc.

A member of the CBS family: CBS Radio • CBS Television • Columbia Records, Inc. • CBS Laboratories • CBS-Columbia • and CBS-Hytron

RECEIVING • TRANSMITTING • SPECIAL-PURPOSE • TV PICTURE TUBES • GERMANIUM DIODES AND TRANSISTORS

ELECTRONICS — March, 1954

For more ad information, see Index to Advertisers.

Vibration testing made easier

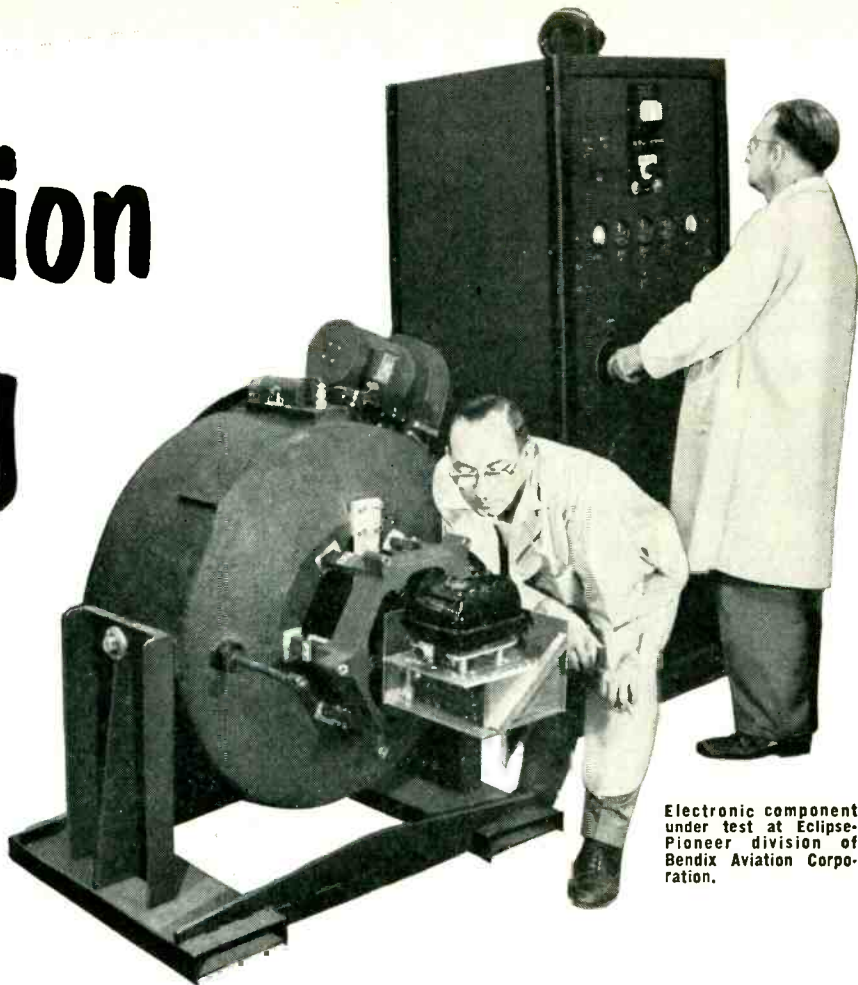

Electronic component under test at Eclipse-Pioneer division of Bendix Aviation Corporation.

with the help of MB equipment like this

Do you have to vibration-test your product to meet military specifications? Want to apply shake-testing to improve product design or to control quality? If so, do what many leading companies have done — enlist the help of MB.

First, you get the right equipment. MB offers a complete line of vibration exciters from 10 pounds force all the way to the largest developed today — 10,000 pounds! All are quality built to stand up and do the job right to specifications. Electromagnetic in operation, they're easily and quickly adjusted for force and frequency. And, second, you get the benefit of MB's wide experience in applying this relatively new and valuable technique for product improvement.

Among the well known companies working with MB products, Bendix Aviation Corporation's Eclipse-Pioneer division is outstandingly equipped with several MB Vibration Exciters. The photograph shows one — MB Model C-25, rated at 2500 pounds

of force — vibrating an electronic component to insure dependability under severest conditions. Such testing can uncover, in minutes, trouble that might take months to develop.

VIBRATION PICKUP ANOTHER USEFUL TESTING TOOL

When you want to detect vibration and determine its nature, you'll want an MB Vibration Pickup. While the pickup detects even slightest vibratory motion, it was built for grueling service as well. Model 122 withstands temperatures up to 500°F.

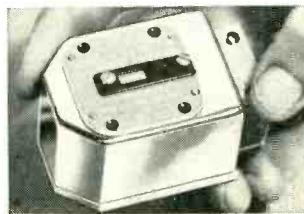

Control panels for all MB shakers, as in the photo above, can be furnished with MB Vibration Meter for use with pickup. This meter gives direct velocity, acceleration and amplitudes of the picked-up vibration.

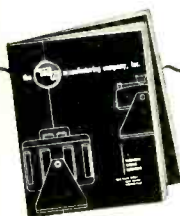

Bulletins you'll welcome

How to calibrate vibration pickups to 2000 cps — Bulletin C-11-5 reviews the subject comprehensively. Bulletin 1-VE-5 tells all about MB Vibration Exciters. Write for them.

THE MB MANUFACTURING COMPANY, INC.
1060 State Street, New Haven 11, Conn.

HEADQUARTERS FOR PRODUCTS TO INDUCE VIBRATION...TO MEASURE IT...TO ISOLATE IT

PERFECTING
HARDWICK, HINDLE
 RHEOSTATS



H-100
100 Watt

A-25
25 Watt

H-50
50 Watt

H-150
150 Watt

H-75
75 Watt

- During the past two years we have re-designed and rebuilt into our rheostats tremendous improvements.

And we offer now *only one quality*—the best we can build. And that “Test” is designed to comply with current standards of:

- (a) Military Specifications JAN-F-22.
- (b) Underwriters’ Laboratories
- (c) R.T.M.A.
- (d) N.E.M.A.

Furthermore that “best” is offered to all industrial users as well.

Mechanically the improved features include:

- Unequaled perfection in our “buss-bar” type brush control, which automatically adjusts tension to complete, continuous contact with the entire winding surface.
- Positive, smoothly-controlled spring action which eliminates all strains tending to bind shaft in the bushing.
- Greater flexibility—no risk of backlash.

All models are of course completely bonded with our new high-temperature-enamel;—thermo-shock-proof; more resistant to heat; increased safety factor; higher terminal strength.

Send today for our bulletin, containing additional information.



HARDWICK, HINDLE, INC. Rheostats and Resistors

Subsidiary of **THE NATIONAL LOCK WASHER COMPANY**
 ESTABLISHED 1886 NEWARK 5, N. J., U. S. A.

The mark of quality for more than a quarter of a century

The eye-opening event of the radio-electronic new year!

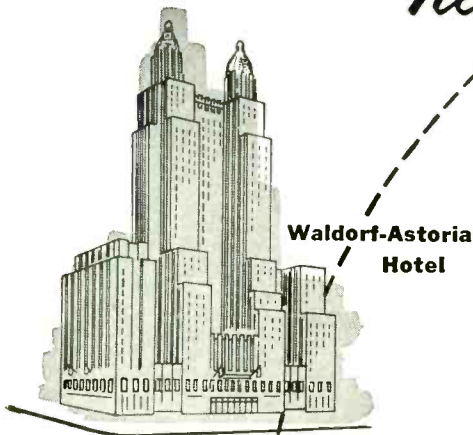
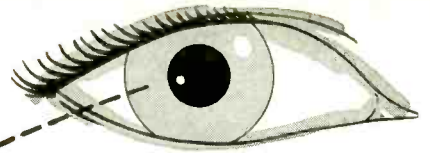

For the past 12 months the vast, fast-growing radio-electronic industry has been preparing for 4 great days — March 22-25. This is when the IRE National Convention and Radio Engineering Show — the biggest and best ever — will take place in New York City. Be sure to join the other radio-electronic men — nearly 40,000 are expected — who will come, see and appraise the show at which all that is new will be unveiled.

A practical summary of radio-electronic progress will be unfolded at 54 technical sessions during the four-day period. 243 scientific and engineering papers, grouped by related interests, will be presented during these sessions, more than half of which are organized by IRE professional groups. Actually, you will be attending 21 conventions fused into one. New York's finest meeting facilities are provided — the Waldorf-Astoria Hotel plus 3 huge halls in Kingsbridge Armory. Transportation between the two locations is quick, easy — by subway and bus service.

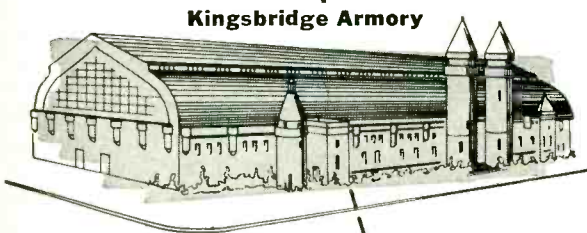

At the show you will find over 600 firms "spotlighting the new" in their high-interest product exhibits. These will extend over a mile and a half along avenues appropriately named for radio elements: "Instruments," "Components," "Airborne," "Radar," "Transistor," "Audio," "Microwave," etc. These exhibits, an education and revelation in themselves, fill the four-acre space of the great Kingsbridge Armory . . . and can be viewed throughout any one or all of the four days.

Admission is by registration only, and serves for the four-day period. For IRE members the cost is only \$1.00. For non-members it is a low \$3.00, covering sessions and exhibits. Social events have been carefully planned. These are priced separately.

March 22-25, 1954

**is the date! New York is the city
where the radio-electronic event
of the year will take place.
Come! See! Enjoy!**

"Spotlight the New"
at the
RADIO ENGINEERING SHOW
EXHIBITOR

**Come and see
600 EXHIBITS**

March 22-25, 1954 • Kingsbridge Armory, New York City



THE 1954
IRE NATIONAL CONVENTION
AND
RADIO ENGINEERING SHOW
THE INSTITUTE
OF RADIO ENGINEERS
1 EAST 79th STREET, NEW YORK CITY



Really Reliable

Audio Transistors

Read the Reasons

- Stable-surface processed.
- Hermetically sealed.
- Every transistor periodically observed for two weeks on all parameters: alpha, I_{c0} , R11, R22, power gain and noise figure.
- Low noise units observed for an hour of operation for any noise drift.
- Only transistors stable within error of measurement are accepted.
- Samples of each lot subjected to JAN 193 humidity and temperature cycling.

RESULT?

- Of thousands of RR_{co} transistors in use in the field for about a year, *over 99%* are giving continuing service.



If you have an application where audio transistors will fit, we'll be glad to discuss it without obligation.

Seletron and Germanium Division
RADIO RECEPTOR COMPANY, INC.

In Radio and Electronics Since 1922

SALES DEPT.: 251 WEST 19TH STREET, NEW YORK 11, TEL.: WATKINS 4-3633

Factories in Brooklyn, N. Y.

Make Sure to See Our Exhibit at the I.R.E. Show, March 22-25, Kingsbridge Armory, Booth 511-513—Components Avenue

**Here's a
Way to Cut
Contact Costs**

**YET MAINTAIN
High Performance Quality**

... USE

**GENERAL PLATE
Composite Contacts**

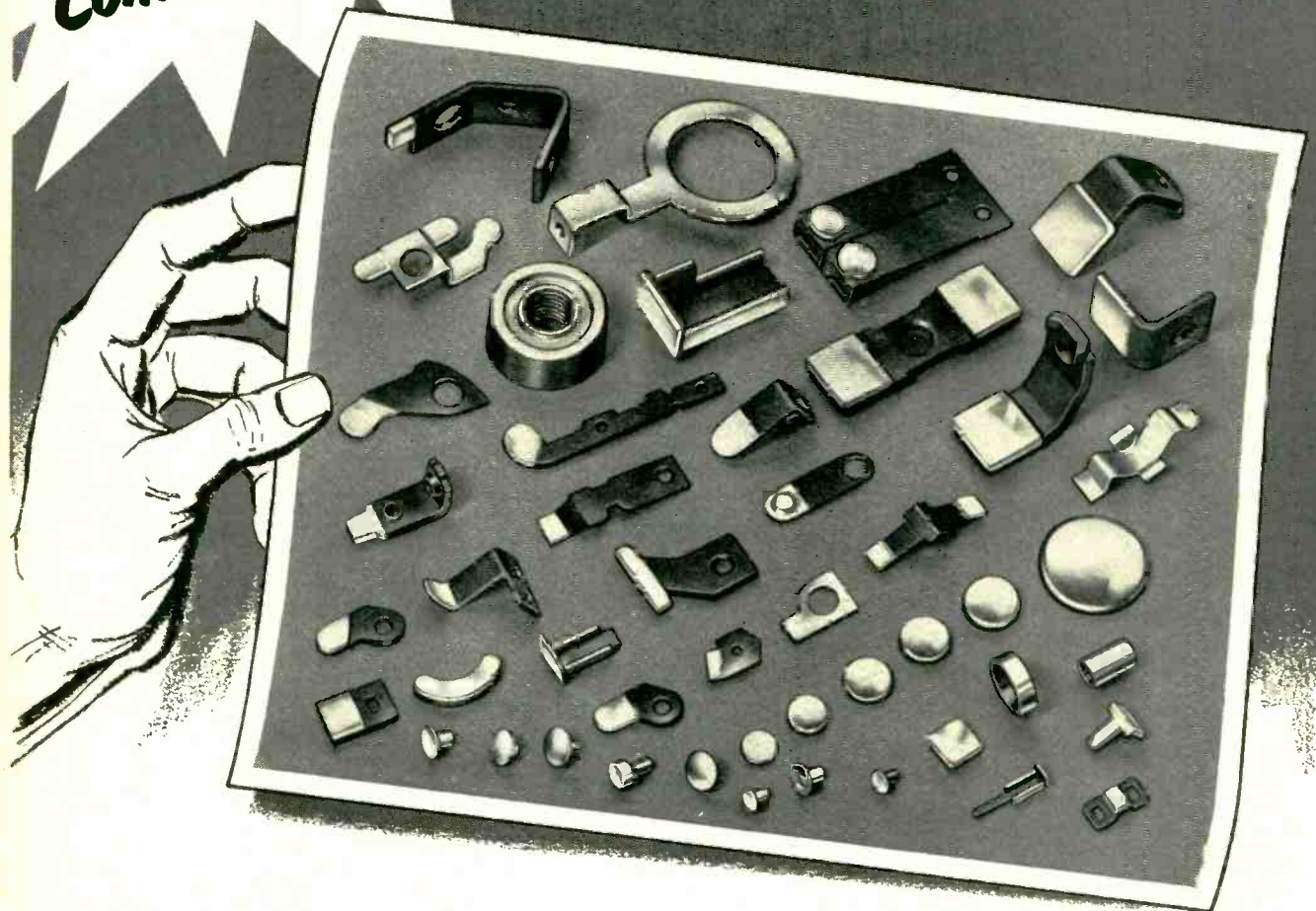

Illustrated are typical fabricated composite contacts and assemblies accurately manufactured to customers' specifications by General Plate from General Plate Composite contact material.

As pioneer manufacturers of composite strip, overlay, edgelay and Top-Lay contact metals, you are assured of the highest quality raw materials. Add to this the know-how of fabrication of these composite metals and you are assured of contacts that give you positive performance and long life.

In addition, by letting General Plate fabricate your complete contact assemblies, you will save money, time and trouble . . . needless equipment cost and problems of scrap disposal are eliminated . . . contacts and/or contact assemblies made to your exact specifications are shipped to you ready for installation.

General Plate Palladium or Palladium Alloy Rivets, solid or composite, offer high resistance to tarnish and corrosion coupled with low and uniform contact resistance over long periods of time. When made as a composite rivet or part — palladium bonded to a base metal — they reduce costs because they permit the use of a minimum amount of noble metal. The palladium provides the necessary contact surface, the base metal reduces costs.

Write for complete information and catalog PR700.

**You can profit by using
General Plate Composite Metals!**

**METALS & CONTROLS CORPORATION
GENERAL PLATE DIVISION**

33 FOREST STREET, ATTLEBORO, MASSACHUSETTS



Versatility — for use in dynamic systems . . . tested and proven on gasoline and diesel engines . . . jet engines . . . rocket motors . . . blast measurements . . . high pressure, high temperature chemical reactions . . . hydraulic and pneumatic systems.

Full Scale Pressures — 500, 1,000, 2,000, 3,000, 5,000, 10,000 psi . . . response down to 0 psi absolute with 1% of full scale accuracy and temperature compensation.

High Frequency Response — flat to 20,000 cps . . . natural frequency up to 45,000 cps.

Flush Catenary Diaphragm — reduces changes in volume of pressure chamber to a minimum.

A word about NORWOOD CONTROLS—*This name stands for an expanding line of commercial instruments for the measurement of pressure, flow, temperature and weight. It represents a fresh concept of creative engineering which, combined with New England manufacturing skill, is establishing new frontiers in the field of instrumentation.*



CONTROL ENGINEERING CORPORATION
564 Providence Highway, Norwood, Massachusetts

Norwood Controls representatives are located in principal cities. Complete technical information will be supplied upon request.

1954 **NEW!** advances in communication continue to be foremost in



NEW! TWINPLEX COMMUNICATION UNITS

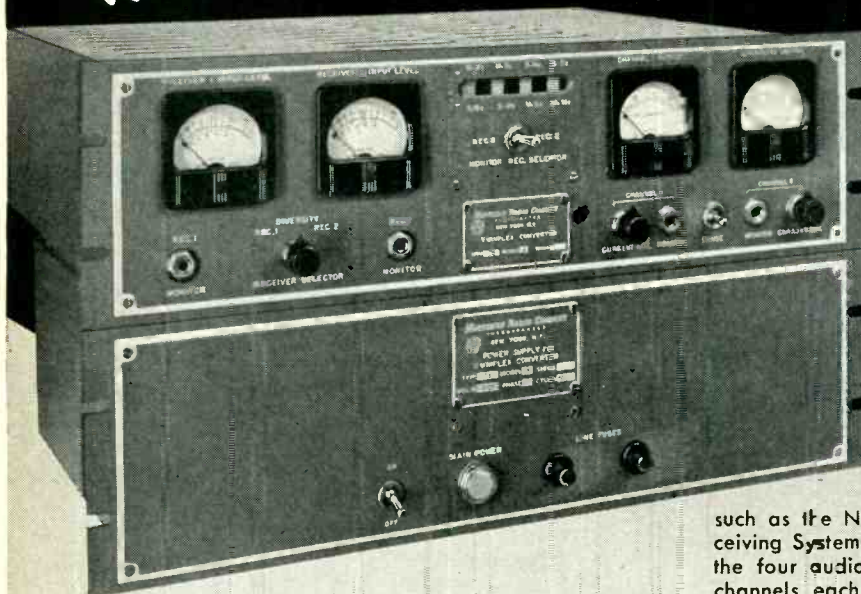

- provide 2 channels of FS communication with existing single channel transmitter and receiving facilities— with performance comparable to the existing single channel system

This Twinplex communication system makes possible a 2-channel radio circuit whereby 2 non-synchronous or synchronous telegraph transmissions modulate a single radio carrier wave by causing the carrier to assume one of four specific frequencies with 400 cps separations.

The transmitting equipment consists of the Twinplex Combiner Type 177 Model 1 and an RF Frequency Shift Keyer such as the Northern Radio Type 105 Model 4. The Combiner converts the four possible conditions of two telegraph signals (M1-M2, M1-S2, S1-M2, S1-S2) respectively into one of four voltages related in a 0-1-2-3 manner. The Combiner output voltage modulates the FS Keyer.

The receiving equipment consists of the Twinplex Converter Type 178 Model 1 and a single or diversity receiver

such as the Northern Radio Type 110 Dual Diversity Receiving System. The Converter demodulates and separates the four audio tones from the radio receiver(s) into two channels each carrying the originally transmitted intelligence. The Twinplex Converter replaces the standard FS Converter for this purpose.

The two telegraph channels provide the same operational flexibility as that of two separate single channel FS systems. One can, for example, simultaneously use channel #1 on 60 wpm teletype and channel #2 on high-speed Morse or Time Division Multiplex. It further permits the reception of channel #1 signals on all standard FS converters (tunable to 400 cps shift) without need for a Twinplex Converter; this is valuable for "Forked Circuit Operation" where the intelligence of channel #1 is intended for pick-up by other receiving stations which are not equipped for Twinplex Reception in addition to the main receiving stations which are so equipped. Reception of channel #2 (or of both channels) requires the receiving end to be equipped with a Twinplex Converter.



Write for complete information.

- Frequency Shift Keyers
- Master Oscillators
- Diversity Receivers
- Frequency Shift Converters
- Multi-Channel Tone Systems
- Tone Keyers
- Demodulators
- Monitors
- Radio Multiplex Systems
- Tone Filters
- Line Amplifiers
- Twinplex Equipment

SEE OUR IRE EXHIBIT BOOTH #197,198

NORTHERN RADIO

equipment

accuracy, stability and versatility

NEW!

VARIABLE MASTER OSCILLATOR

- Long-time stability 1 cycle per megacycle
- Variable to ANY frequency from 2 to 4 mc within 1 part per million

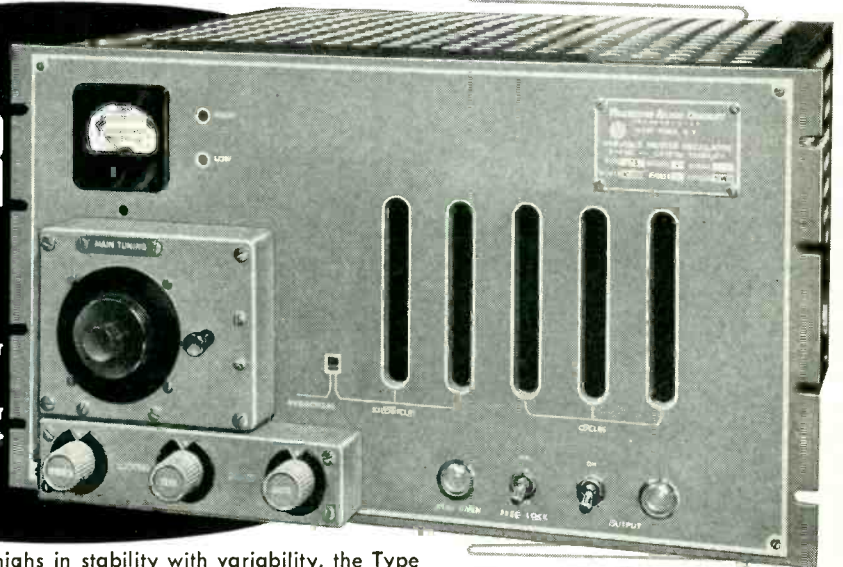

In addition to accomplishing these new highs in stability with variability, the Type 173 Model 1 is so easy to operate that it can be handled by completely unskilled personnel: frequency is continuously displayed.

It is excellent as the basic control oscillator for diversity receivers, HF transmitters, and other communication devices, or as a laboratory standard. It also provides both a crystal-controlled BFO and a time base 100 kc crystal oscillator as a secondary standard; stability of the latter is 1 part in 5 million. The power supply for this model is housed in a separate panel.

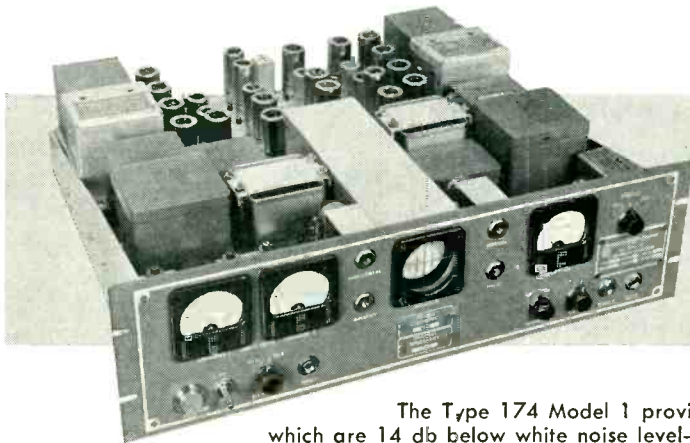

NEW! FREQUENCY SHIFT DIVERSITY CONVERTER

- for use with either single-receiver frequency diversity systems or two-receiver space diversity systems

The Type 174 Model 1 provides solid copy of signals which are 14 db below white noise level—making it the outstanding unit of today. By means of plug-in units, any reasonable number of channels is available between the frequencies of 425 and 3315 cps for either frequency or space diversity operation. For standard FS operation, the plug-in networks provide shift adjustments from 100 to 1000 cps shift.

NORTHERN RADIO COMPANY, inc.
147 WEST 22nd ST., NEW YORK 11, NEW YORK
Pace-Setters in Quality Communication Equipment

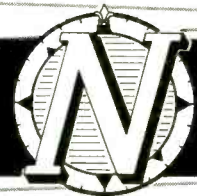

SEE OUR IRE EXHIBIT BOOTH #197,198

NEW! FOR PRINTED COMPLETE LINE

- 1 FOR AUTOMATION: EXCLUSIVE NEW Self-Supporting Snap-in Bracket Mounting. (See Type YGC-B45.)
- 2 NEW Twist-ear Mounting. (See Types XP45 and UPM45.)
- 3 PLUG-IN BLADE-TYPE TERMINALS for vertical or horizontal mounting of control to printed circuit panel. (See all photos.)

4 Threaded Bushing Mounting. (See Types XGC-45, GC-U45 and miniaturized U70.)

Consultation without obligation available on variable resistors for your printed circuit applications. Write today.

VERTICALLY MOUNTED to Printed Circuit Panel. Shaft above panel. (Types YGC-B45, XP45 and XGC-45.)

- NO shaft protection needed during soldering.
- PARALLEL terminals permit *small* round connecting holes instead of *large* elongated slots necessary for fan shaped terminals.
- Terminals available in 7/8" or 1-1/32" lengths from control's center.

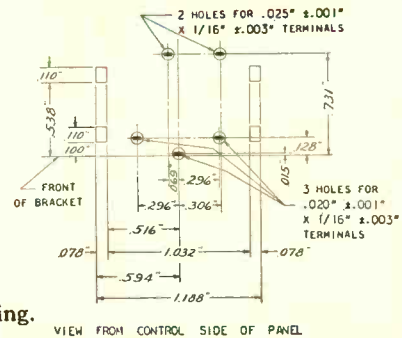
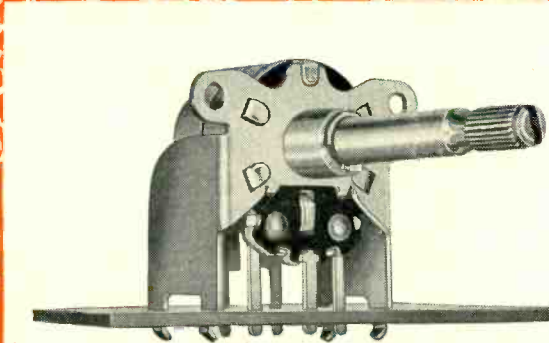

Type YGC-B45 FOR AUTOMATION: EXCLUSIVE NEW Self-Supporting Snap-in Bracket

- Snaps instantly into place.
- Stays firmly put during soldering. Solder permanently anchors control to circuit panel.
- Terminal connections cannot loosen; bracket prevents mounting or operating strain on control or switch terminals.
- No mounting hardware, no separate supporting panel needed.
- No strain on printed circuit panel. Anchor tabs attach bracket to cabinet.
- Adequate clearance for circuit paths provided by ample spacing between terminals and by design of mounting lugs on bracket.

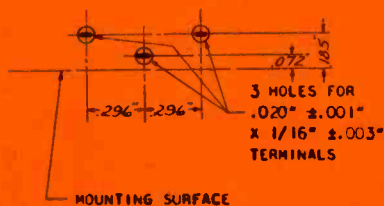

Suggested panel piercing.

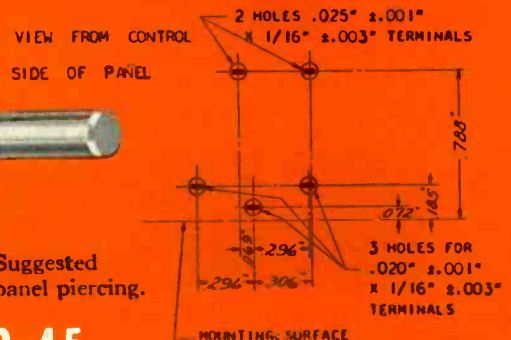
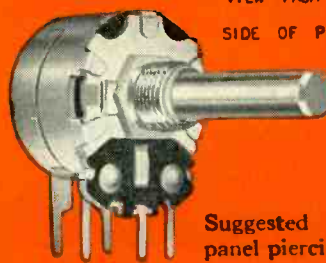

Suggested panel piercing.

Type XP45

For TV preset control applications using a mounting chassis to support printed circuit panel. Twisting 2 ears holds control rigidly to mounting chassis. Available in finger adjusted shaft lengths of 1/2", 5/8", 11/16", 7/8" and 1" from control's mounting surface. Also available with recessed screw driver slotted shaft (Type XPM45).

Type XGC-45

For applications using a mounting chassis to support printed circuit panel. Threaded bushing mounting

All controls illustrated actual size.

CIRCUITS OF VARIABLE RESISTORS

HORIZONTALLY MOUNTED

to Printed Circuit Panel. Shaft extends through panel. (Types U70, GC-U45 and UPM45.)



Type U70 (Miniaturized)

Threaded bushing mounting. Terminals extend perpendicularly $5/32"$ from control's mounting surface.

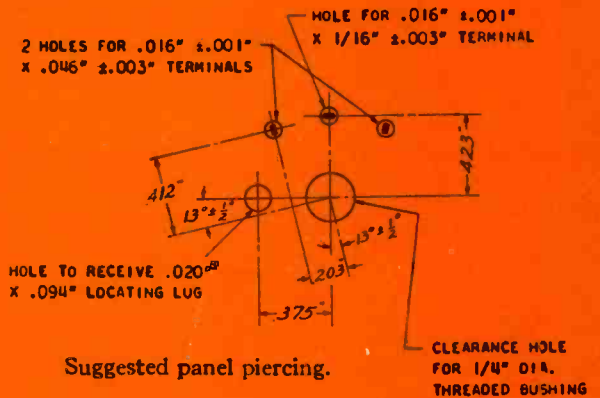

Suggested panel piercing.

CLEARANCE HOLE FOR $1/4"$ DIA. THREADED BUSHING



Type GC-U45

Threaded bushing mounting. Terminals extend perpendicularly $7/32"$ from control's mounting surface. Available with or without associated switches.



Type UPM45

For TV preset control applications. Recessed screw-driver slotted shaft remains solder-free during panel dipping. Control may be held rigidly to panel before soldering by twisting 2 ears. If ears are left straight, the solder will permanently anchor control to circuit panel. Terminals extend perpendicularly $7/32"$ from control's mounting surface.

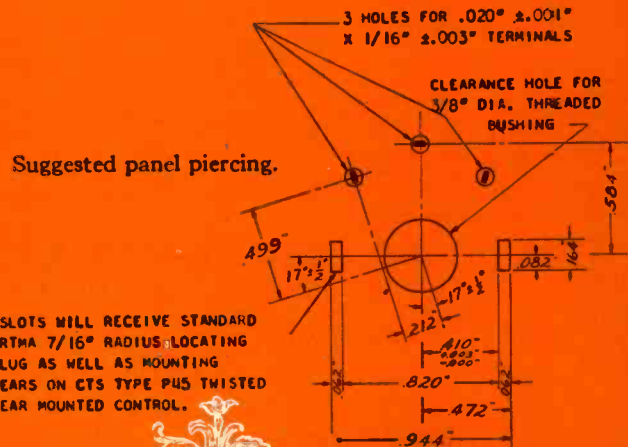

Suggested panel piercing.

SLOTS WILL RECEIVE STANDARD RTMA $7/16"$ RADIUS LOCATING LUG AS WELL AS MOUNTING EARS ON CTS TYPE P45 TWISTED EAR MOUNTED CONTROL.

*Specialists in Precision Mass Production
of Variable Resistors. Founded 1896.*



**CHICAGO TELEPHONE SUPPLY
Corporation**

ELKHART · INDIANA

REPRESENTATIVES

Henry E. Sanders, McClatchy Bldg.,
69th & Market St.,
Upper Darby, Penna.
Phone: Flanders 2-4420

W. S. Harmon Company,
1638 So. La Cienega Blvd.,
Los Angeles 35, California
Phone: Bradshaw 2-3321

John A. Green Company, 6815 Oriole Drive,
Dallas 9, Texas

CANADIAN MANUFACTURING AFFILIATE

C. C. Meredith & Co., Ltd.,
Streetsville, Ontario

SOUTH AMERICA

Jose Luis Pontet,
Buenos Aires, Argentina
Montevideo, Uruguay · Rio de Janeiro,
Brazil · Sao Paulo, Brazil

OTHER EXPORT

Sylvan Ginsbury,
8 West 40th Street,
New York 18, N. Y.

General tolerance all decimal dimensions $\pm .005"$.

GET THE FACTS TODAY ON—

MATERIALS UNIFORMITY CHECKING WITH ULTRA-SOUND



These rough contours of equal attenuation through the sample indicate lack of uniformity in the sample.

GLENNITE →
ULTRASONIC
PROBE

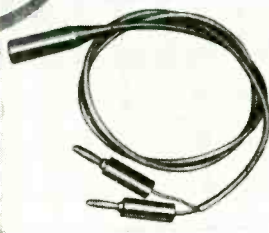

A new, high accuracy method of determining these and many other facts about metals, alloys, ceramics, sintered metal carbides and similar materials—

Over a specific frequency range, depending upon the type of material under study, the attenuation of ultra-sonic pulses and ultra sound scattering are highly sensitive indications of the physical properties of materials. Unlike most known methods of material investigation, which give little or no indication of a change in the physical properties of a given material, this method provides a sensitive indication of such variance. Flaws and minute defects are also detectable.

Vibro-Ceramics offers a complete materials testing service including consulting and problem analysis as well as selling or renting of complete test setups for specific applications. Facilities also include the development of special apparatus in the field of ultra-sonics.

- UNIFORMITY OF MATERIALS
- EFFECT OF HEAT TREATMENTS ON METALS AND ALLOYS
- PLASTIC DEFORMATION IN METALS AND ALLOYS
- AGING OF MATERIALS
- EFFECTS OF GASES IN METALS
- CRACKS, FLAWS INCLUDING VERY MINUTE DEFECTS
- EFFECT OF POLARIZATION IN TRANSDUCER MATERIALS

AT THE
I. R. E. SHOW
BOOTH 850
AUDIO AVENUE

VIBRO-CERAMICS CORPORATION

Telephone: MEtuchen 6-2800 • METUCHEN, NEW JERSEY

—NEW MATERIAL WITH A BIG FUTURE!

GLENNITE NON-LINEAR DIELECTRICS

... for brand new applications
or bettering existing methods

TYPICAL
APPLICATIONS:

- DIELECTRIC AMPLIFIERS
- MEMORY DEVICES
- MODULATION
- VOLTAGE TUNING
- FREQUENCY DOUBLING
- SWEEP CIRCUITS
- VARIABLE FILTERS

Glennite non-linear dielectrics are materials to stir the engineering and research imagination. They are available in thin sheets from .002 to .025" thickness, or as finished units complete with electrodes, leads and protective coatings. Narrow loop materials have low losses, are suitable for high frequency applications. Square loop bodies have high remnant polarization necessary for memory work.

GLENNITE MODEL 393 MEMORY UNIT

A potted crystal memory unit capable of long-time storage. Operates on pulses down to less than 0.1 micro seconds. Efficient storage and recovery level 50 to 100 volts. Significant storage as low as 30 volts.

For full information, suggested applications and circuits, call, write or wire today.

GLENCO CORPORATION

Telephone: MEtuchen 6-2800
METUCHEN, NEW JERSEY

AT THE
I. R. E. SHOW
BOOTH 850
AUDIO AVENUE

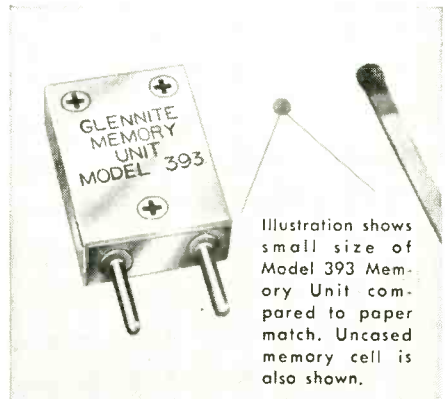
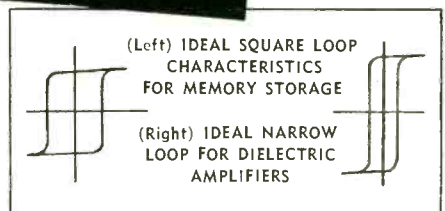

— FIRST MAJOR IMPROVEMENT IN METERS
IN 50 YEARS!

GREIBACH METERS

... radically new movement
designed with unbelievable features!

- VIRTUALLY FRICTION-FREE,
NO BEARINGS OR PIVOTS
- NO DELICATE HAIR OR
COIL SPRINGS
- MOVEMENT WITHSTANDS 500
g's ON ALL 3 AXIS
- NO DAMAGE ON OVERLOADS
TO OVER 100,000%
- SENSITIVITIES TO 1 MICRO-
AMPERE FULL SCALE
- FULL SCALE DISSIPATION
ONLY 5×10^{-9} WATTS
- ACCURACY BETTER THAN
0.25% CAN BE SUPPLIED
- 0.1% CURRENT INCREMENTS
READABLE WITHOUT TAPPING
- 1,000,000 OHMS PER VOLT
DIRECT READING

IDEAL FOR TRANSISTOR
MEASUREMENTS

Greibach meters incorporate a revolutionary new moving coil suspension that represents the most radical meter improvement in over 50 years. This new movement, in one stroke, practically eliminates friction, zero drift and instability... does away with pivot bearings, coil and hair springs, and a host of other difficulties associated with conventional sensitive meter constructions. Delicate handling is no longer a factor—the new movement withstands mechanical shocks of 500 g's on all 3 axis and electrical overloads in excess of 100,000%! Accuracy depends on calibration accuracy alone, friction is not a factor.

Greibach meters are available in many types and ranges such as light-beam pointer, multi-range and differential instruments. For complete details on the biggest meter news in 50 years, call or write today.



AT THE
I. R. E. SHOW
BOOTH 850
AUDIO AVENUE

GREIBACH INSTRUMENTS CORPORATION

Telephone: MEtuchen 6-2800 • METUCHEN, NEW JERSEY

A NEW KIND OF ACCELEROMETER —

GLENNITE ACCELEROMETER

SELF-RECORDING, MINIATURIZED, SELF-CONTAINED

NEW MINIATURE ACCELEROMETER

Measures to 30,000 g's.
Made entirely of Titanium.



Features sub-miniature screw-on connector and blue line, low noise cable.

— an ideal instrument for recording
acceleration phenomena in rockets, missiles,
aircraft and many other difficult applications

This amazingly compact instrument is entirely self-contained, self-powered, requires no external connections. It occupies extremely small space, can be tucked away almost anywhere to permanently record acceleration phenomena. Single housing contains recording system, seismic element, electronic oscillator and amplifiers and battery. Recorder is magnetic tape type, with constant speed governor. Entire unit is ruggedly constructed to withstand high forces and impacts. It records accelerations up to 60 g with frequency components of 0 to 400 cps. For complete data call today.

Other Glennite Electro-Mechanical and Electronic Instruments — Acoustic Delay Lines, Displacement Gauges, Hydrophones, Microphones, Phonograph Pickups, Pressure Gauges, Ultrasonic Equipment, Electronic Voltage and Current Amplifiers and Filters, Underwater Transducers, Semi-automatic Limit Bridges, Electric Delay Lines, Cathode Followers, Ballistic Pendulum Sets.

- COMPLETELY
SELF-CONTAINED
- NO EXTERNAL
CONNECTIONS
- BUILT-IN TAPE
RECORDER
- SIZE ONLY
 $3\frac{1}{2} \times 4 \times 2\frac{1}{2}$ "
- WEIGHT LESS THAN
42 OZ.

GULTON MFG. CORP.

Telephone: MEtuchen 6-2800 • METUCHEN, N.J.

AT THE
I. R. E. SHOW
BOOTH 850
AUDIO AVENUE

* In jeder sprache — qualitaets leistung
 * In ogni linguaggio — qualitaad funzionamento
 * på alla språk — prestation av bästa kvalitet
 * Wjakiem kolwiet jezyku — rezultat doskonatości

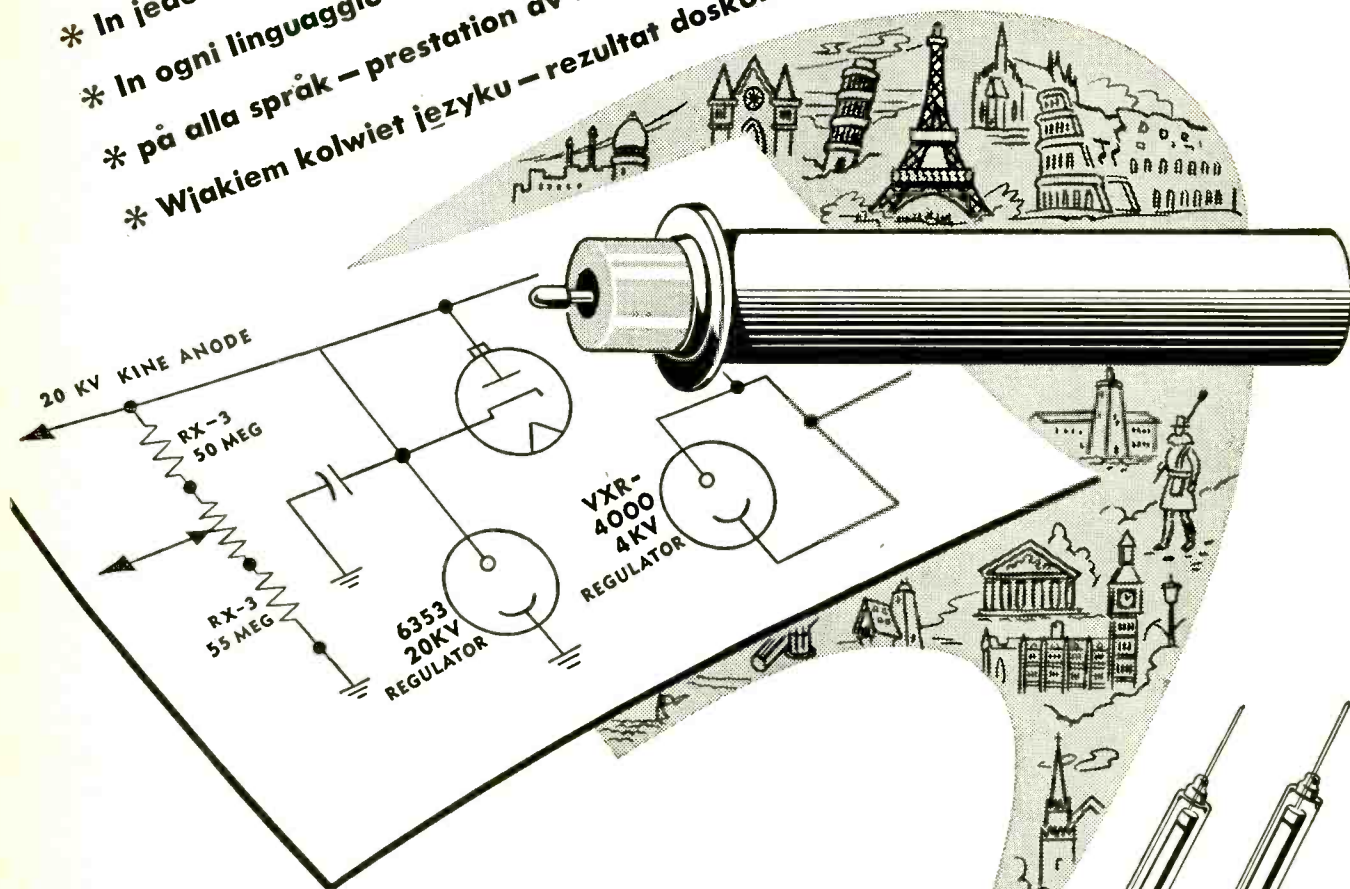

* In any language — quality performance

Use the type 6353, 20,000 Volt Corona Regulator Tube to provide unexcelled Color Kinescope second-anode regulation without expensive filament supply, additional mounting or circuitry. To these add unlimited use—life, protection with positive safety and low cost . . . the result is*

Use the VXR-4000 type tube to regulate dependably the focus bleeder against line voltage variations. This regulator has the same desirable characteristics obtained in the 6353 tube . . . the result is*

These three components, expressly designed for color television will assure quality performance.

Use an RX-3 Series Resistor, 50 or 55 megohm—or select any resistor from 20 to 100 megohm in the kine convergence bleeder to assure stability. These hi-meg resistors are hermetically sealed, rated at 10KV, have a negligible voltage coefficient and .08%/°C temperature coefficient—they are designed for extremely long life . . . The result is*

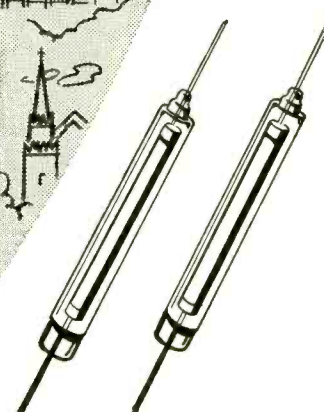

The Victoreen Instrument Co.

COMPONENTS DIVISION: 3800 PERKINS AVE. • CLEVELAND 14, OHIO

Contrasts in Prosperity Endanger the Free World

The chart in the middle of this page summarizes a situation of profound importance to every American. It shows that:

1. On the average, Americans are vastly better off economically than most other people in the free world, and
2. In recent years the gap in income between the average American and the average European, Latin American or Asian has greatly widened.

A Mounting Contrast

Even greater is the contrast between the real incomes of Asians and Americans. Today most Asians are no better off economically than they were back in 1939. On the other hand, the real income of the average American has almost doubled. As a result, the real income of the average Asian—always small by our standards—is now only a tiny fraction of that of Americans.

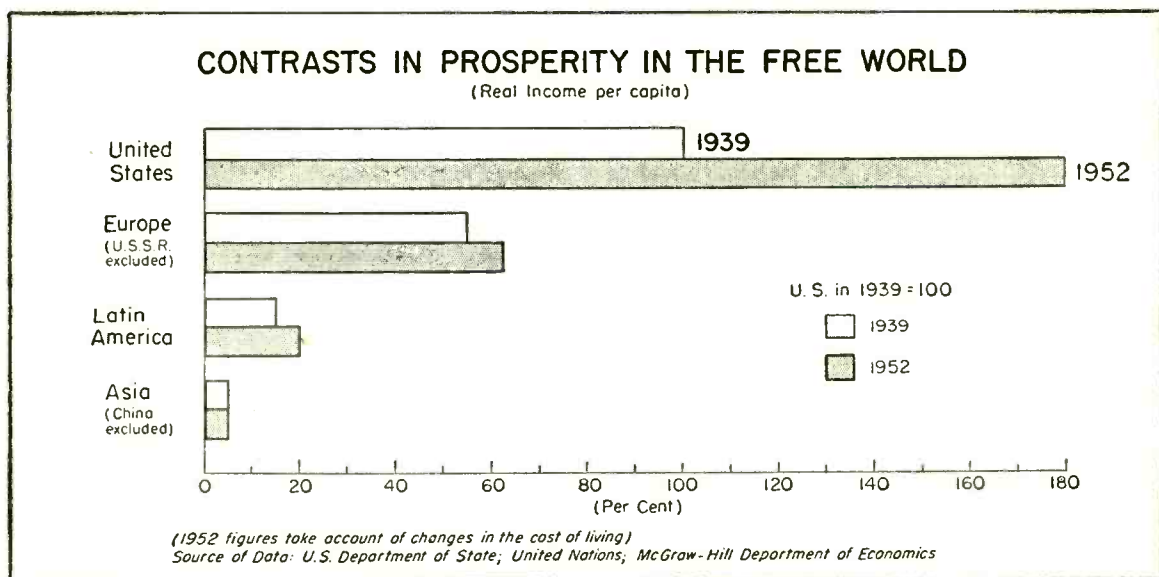

The chart shows that, at the outbreak of World War II, the real income (that is, actual purchasing power of income) of the average American was substantially higher than the average European's and much higher than the average Latin American's or Asian's. Since then, the European and Latin American have become better off. But the improvement in the economic lot of the average American has been so great that the others have been left far, far behind.

It must be remembered that the figures used to construct the chart are of varying quality. The fact is that few of the poorer countries have reliable statistics. However, it is generally agreed among competent observers, that the figures here presented offer a correct impression of the wide disparity in the average of real incomes between various parts of the free world. The figures, of course, have nothing decisive to say about spiritual and cultural values. In these, coun-

tries with relatively little material prosperity may be rich.

It is possible to draw a variety of morals from the story of lagging growth of income in other parts of the world. For one thing, it reflects the dynamic force of private enterprise. Private enterprise is characteristic of our economy far more than it is of most of the other free economies. The chart also reflects the fact that we are bountifully blessed with the natural resources essential to a high level of real income. Moreover, we did not suffer from the devastation and waste of two world wars as did many of the other free nations.

Narrowing the Gap

But perhaps the most important message which the chart conveys is one of warning. It warns that something must be done to narrow the gap in prosperity between America and other parts of the free world, if that world is to be united successfully in the struggle against totalitarian Communism. Writing in the *HARVARD BUSINESS REVIEW*, Kenneth E. Boulding recently put it this way:

"The crux of the problem is how to raise the three-quarters of the world that live on a low level to the high level of the other quarter, for it is precisely this wide disparity that makes our world so unstable. American-Russian relations, for instance [are] . . . complicated almost unbearably by the fact that each power is competing for the support of the vast fringe of underdeveloped countries . . . These countries are dissatisfied with their present state and are hovering between the two cultures, wondering which offers them the best chance of shifting from their present low-level to a high-level economy."

Very real danger threatens from any feeling which may develop in the less fortunate free nations that our enviable economic progress has been made at their expense. Instead of viewing the American economic system as a model that might be followed by their own countries, they may be led to see in it a menace to their well-being. If Communist propaganda can persuade these people that their alliance with the free world will only result in their dropping farther and farther behind an increasingly prosperous United States, they will be driven to the side of totalitarianism.

Test of Effective Leadership

How can these free nations on the lower half of the income ladder be helped to alleviate the conditions that keep them there? Surely this question poses a whole series of complicated problems. Yet, if we do not exercise some

effective leadership toward their solution, we can be sure that Russia will take advantage of the situation. In these circumstances, it is essential to both the stability and security of the free world that we help our less prosperous neighbors make satisfactory headway.

This does *not* mean that the United States should sacrifice its own economic progress in favor of some sort of global leveling scheme. On the contrary, a continually expanding and stronger economy is essential if we are to provide any real aid to our friends. Also, it goes without saying that our friends must be disposed to do all they can to improve their own economic position, if our cooperation to that end is to be effective.

Great Skill Required

Our part in a program to achieve this goal calls for a high degree of skill and statecraft. It involves international trade policy, which, in itself, presents a perplexing range of problems. It involves also programs of foreign technical and economic assistance. And expanded foreign investment must play a key role in a balanced program to strengthen the economies of the free world for our common good.

The Commission on Foreign Economic Policy, headed by Clarence Randall, has recently submitted a report, embodying the results of a monumental inquiry into our foreign economic relations and measures to improve them. From the very nature of the subject, discussion of the report is bound to be attended by much controversy and conflict. However, an awareness of the facts presented by this chart should inspire us to accord to the problems posed by the Randall Commission the careful and sober consideration they must have if any real progress is to be made in raising the general standards of human well-being throughout the free world. Our willingness and ability to do this have now become the real test of our statesmanship, both at home and abroad.

This message is one of a series prepared by the McGraw-Hill Department of Economics to help increase public knowledge and understanding of important nationwide developments that are of particular concern to the business and professional community served by our industrial and technical publications.

Permission is freely extended to newspapers, groups or individuals to quote or reprint all or parts of the text.

Donald C. McGraw
PRESIDENT

McGraw-Hill Publishing Company, Inc.

See the
Bendix
exhibit!

**1954 Radio Engineering Show
of the I.R.E. National Convention**

KINGSBRIDGE ARMORY, BRONX, N.Y. CITY

•
March 22 to 25

Booths 130-134-138

The Bendix Divisions exhibiting at the 1954 Radio Engineering Show of the I.R.E. National Convention will be happy to discuss how they may apply their knowledge and experience to your specific problems.



**BENDIX RADIO DIVISION,
TOWSON, MD.**

The nation's airlines and more than 45 of the major railroads depend on Bendix* Radio for precision electronic equipment. In the field of radar, radio communications and navigation equipment, Bendix Radio enjoys a reputation second to none.

**ECLIPSE-PIONEER DIVISION,
TETERBORO, N. J.**

Famous for over 30 years for the quality and design superiority of its tremendous variety of aviation instruments and accessories, Eclipse-Pioneer is today a major supplier of precision components for the electronic industry.

**RED BANK DIVISION,
EATONTOWN, N. J.**

Specialists in extensive coverage of electronics. Units designed for durability to meet exacting requirements. Special-purpose tubes such as Klystron regulators and spark gaps are available for non-standard applications.

**SCINTILLA DIVISION,
SIDNEY, N.Y.**

Bendix Scinflex Electrical Connectors are completely pressurized and are for all contact sizes and pin arrangements—full ACN approval. Bendix Ignition Analyzer checks efficiency of both ignition units and spark plugs, and detects incipient failures.

**PACIFIC DIVISION,
NORTH HOLLYWOOD, CALIFORNIA**

This division has attained outstanding leadership in the field of sonar, telemetering, airborne radar, hydraulic servomechanisms and radio control—a striking example of Bendix talent in combining advance engineering design with modern production facilities.

*REG. U.S. PAT. OFF.

the age of the AUTOMATON*

If your eye is toward the future, you know which way the production wind is blowing. The miracle developments that made conversation yesterday have today assumed practical proportions. Resistors and soldered joints have become jagged lines and points upon etched plastics and metal terminations; man has become less of a worker and more of a supervisor.

The age of automatic production is upon us, with the Robot standing in the wings.

Radio City Products Company has seen the Age Of The Automaton fast approaching and has recognized the potential need for other test and measuring devices than those presently used. Sub-assemblies in the form of printed or etched circuits need quality control checks with test instruments of a different design. A finished product made of printed sub-assemblies has different characteristics than one made from an assortment of electronic components.

New production methods demand new test designs. RCP knows this and has keyed its engineering approach to this problem in the same practical fashion as it has done for decades in the design and manufacture of equipment for radio, television, laboratories, defense and government. Our contract division will be glad to be of service. Let us know your requirements. Our test equipment division can help you with your test and measurement problems.

Designed for the man in the electronic suit . . .



famous the world over for test equipment designed for—RADIO . . . TELEVISION . . . INDUSTRY . . . DEFENSE

RADIO CITY PRODUCTS COMPANY, INC.

152 WEST 25TH STREET • NEW YORK 1, N. Y.

See us at # 220 Instruments Avenue at the IRE Show

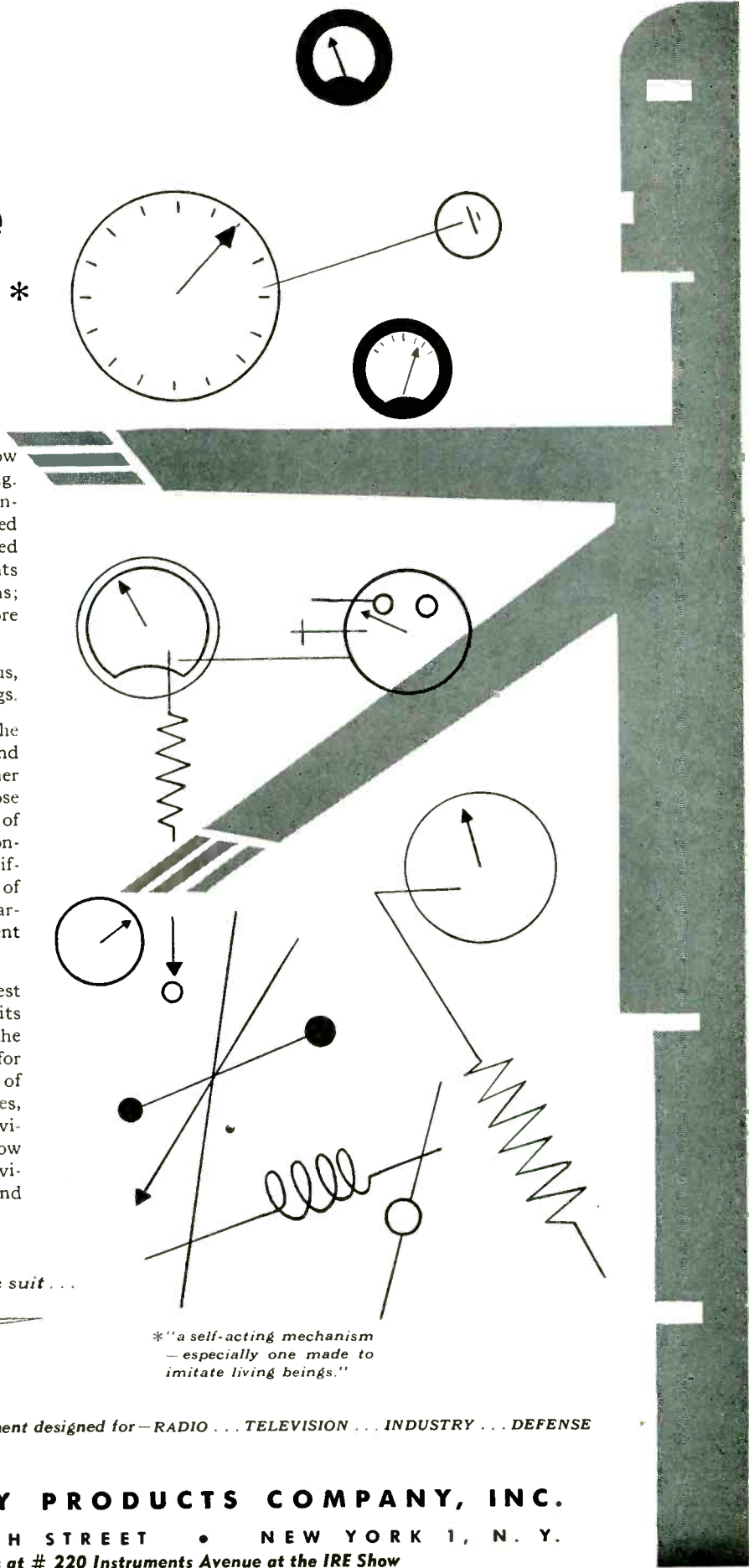

**"a self-acting mechanism
— especially one made to
imitate living beings."*

Now...at no increase in price...



HERMETICALLY SEALED Germanium Diodes



COMPLETE METAL TO CERAMIC SEAL. Gas-tight ceramic cases with metalized ends permit solder seal to nickel pins.

MOISTURE PROOF. These new diodes exceed the requirements of JAN humidity specifications.

REQUIRED ELECTRICAL PROPERTIES. More than two years of development were necessary to perfect this combination of hermetic seal and superior performance.

MECHANICAL STABILITY. Platinum-rhuthenium whisker is welded to the germanium pellet.

LONG-LIFE. The elimination of moisture effects adds years to the life of your equipment!

- A. Ceramic Case
- B. Solder
- C. Germanium Pellet
- D. Weld
- E. Platinum-Rhuthenium Whisker
- F. Weld
- G. Solder
- H. Nickel Pin
- I. Weld
- J. Leaded Copper Clad Wire



Production quantities of hermetically sealed types 1N69, 1N70, and 1N81 are now available. Hermetically sealed commercial types are expected to be ready in a few months. Be sure to include them in your design planning now! For complete information write: *General Electric Company, Section X434, Electronics Park, Syracuse, New York.*

DON'T MISS THE G-E EXHIBIT!
See Germanium Products In Action
I. R. E. Show . . . Booths 192-194

GENERAL  ELECTRIC

MAXIMUM RATINGS (At 25°C)

Hermetically Sealed DIODES	1N69	1N70	1N81*
Peak Inverse Voltage	75	125	50
Continuous Operating Inverse Voltage	60	100	40
Min. Forward Current (MA) at +1V	5.0	3.0	3.0
Max. Inv. Current (μa)			
At -50V	850	300	—
At -10V	50	25	10
AV Rectified Current (MA)	40	30	30
Peak Rectified Current (MA)	125	90	90
Surge Current (MA)	400	350	350

*JAN approval applied for

NEWS FROM OUR ADVANCED DEVELOPMENT LABORATORIES

● A four-terminal junction transistor has been developed having a region of negative output impedance. This switching device is unique in that two coincident trigger signals are required to turn it on. Thus two gating functions may be accomplished by a single transistor.

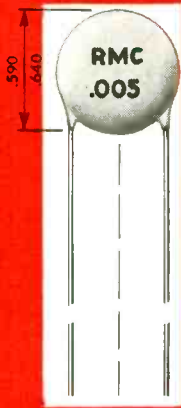

.0047
.005
2x.002

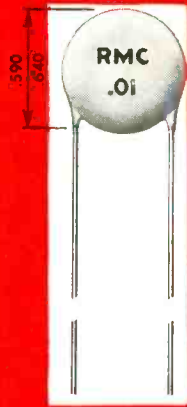

.01*
±20%
.02*
+80% -20%

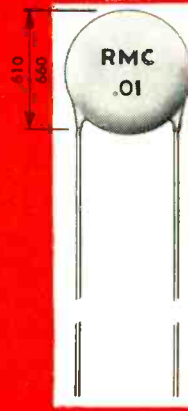

.01*
.02*

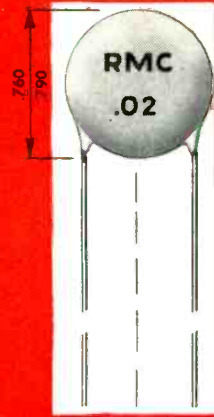

.01
.02
2x.004

RMC HEAVY DUTY DISCAPS

...the right way to say ceramic capacitors

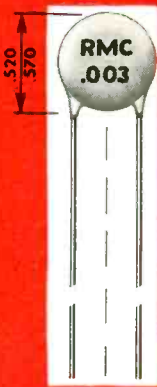

.003
.004*
.005*
2x.0015
2x.002*

TYPE B

1000 V.D.C.W. By-Pass Seals

*Rated 600 V.D.C.W. Flash test 1200 V.D.C.

SPECIFICATIONS

GUARANTEED MINIMUM VALUE

POWER FACTOR: 1.5% Max. @ 1 KC (initial)
POWER FACTOR: 2.5% Max. @ 1 KC (after humidity)
WORKING VOLTAGE: 1000 V.D.C.
TEST VOLTAGE (FLASH): 2000 V.D.C.
LEADS: No. 22 tinned copper (.026 dia.)

INSULATION: Durez phenolic—vacuum waxed
INITIAL LEAKAGE RESISTANCE: Guaranteed higher than 7500 megohms
AFTER HUMIDITY LEAKAGE RESISTANCE: Guaranteed higher than 1000 megohms



.0015
.002
2x.001

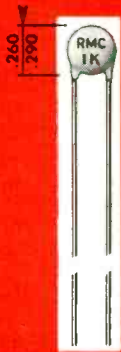

.00047
.00068
.0008
.001

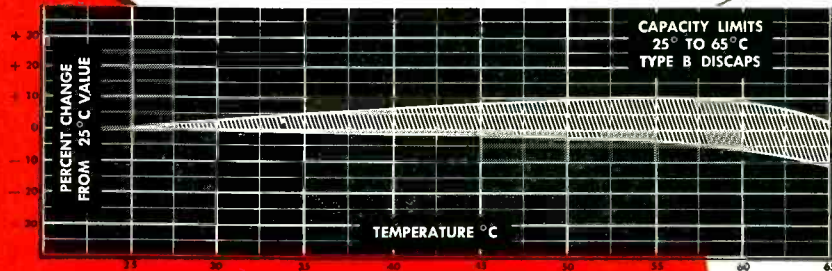

BOOTH 518 Components Avenue, I. R. E. Show

SEND FOR SAMPLES AND TECHNICAL DATA

DISCAP
CERAMIC
CONDENSERS

RMC

RADIO MATERIALS CORPORATION

GENERAL OFFICE: 3325 N. California Ave., Chicago 18, Ill.

FACTORIES AT CHICAGO, ILL. AND ATTICA, IND.

DISTRIBUTORS: Contact Jobbers Sales Co., 146 Broadway, Paterson 1, N. J.

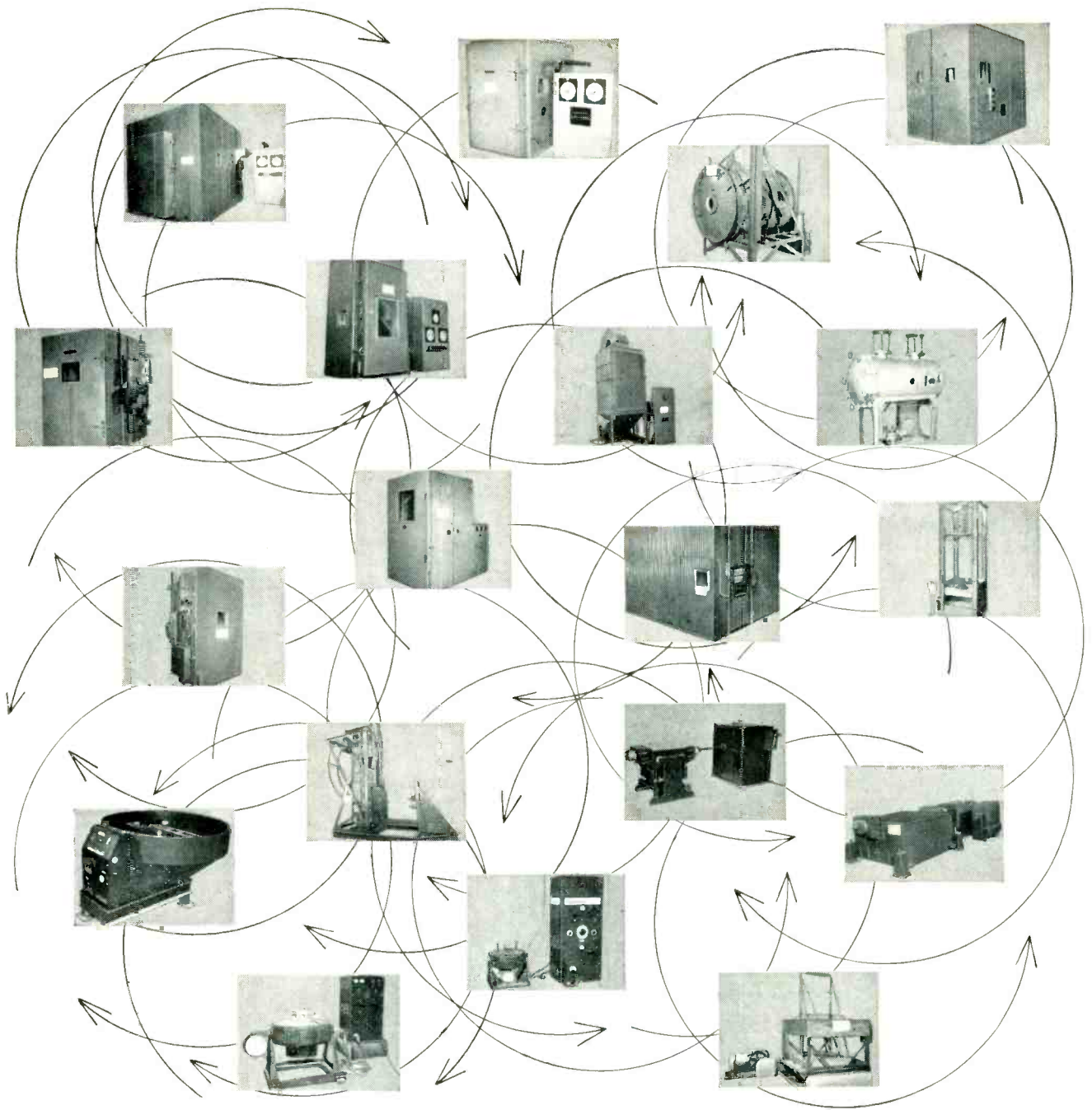

19 chambers of hell

You are looking at the units of a \$2,000,000 Martin testing laboratory—part of a man-made hell of fire and water, shock and vibration, explosion and corrosion, designed to torture *electronics equipment!*

For these vital components of today's aircraft, guided missiles and weapons systems must carry tremendous responsibilities. Consider, for example, the electronic system of the Martin B-61 Matador:

Incredibly versatile, it comprises the entire brain and nervous system of America's first successful pilotless bomber. Yet this sensitive equipment must withstand

the shock of many tons of thrust in the first second of take-off—violent changes in temperature and pressure—and ground conditions ranging from sand storms to arctic blizzards, desert dryness to tropical downpour.

Today, Martin's facilities are among the finest in the world for design, production and proving in the field of avionics...one of the major developments of Martin Systems Engineering which is now tailoring airpower to previously impossible requirements.

You will hear more about Martin!

Martin  **THE GLENN L. MARTIN COMPANY**
AIRCRAFT BALTIMORE • MARYLAND

30 YEARS OF CAPACITOR EXPERIENCE

MICAMOLD pioneered the development, design and manufacture of capacitors — and is still producing under the original management.

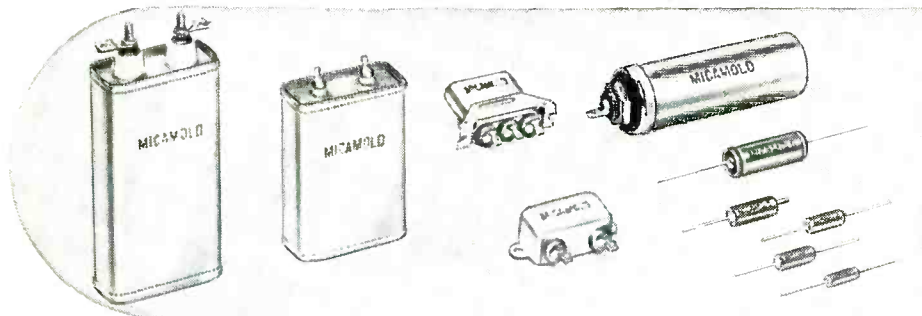

MICAMOLD METAL ENCASED PAPER CAPACITORS — hermetically sealed, are available in all the Military Standard styles and many special designs. Micamold also manufactures complete lines of oil filled capacitors for industrial applications. Another Micamold first — the exclusive Ambirite line — the only paper capacitors for operation at 150°C.

MICAMOLD ELECTROLYTIC CAPACITORS are manufactured in all Military Standard styles, and types for radio, television and industrial applications. The Motorlytics are for capacitor motor starting.

MICAMOLD's exclusive 'lytics include: Thermalitics, the only capacitors capable of operation up to 100°C, and Chromalytics that work at voltage ratings up to 700VDC.

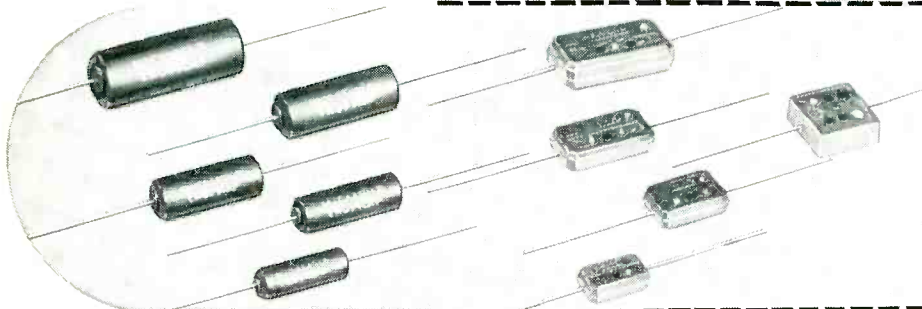
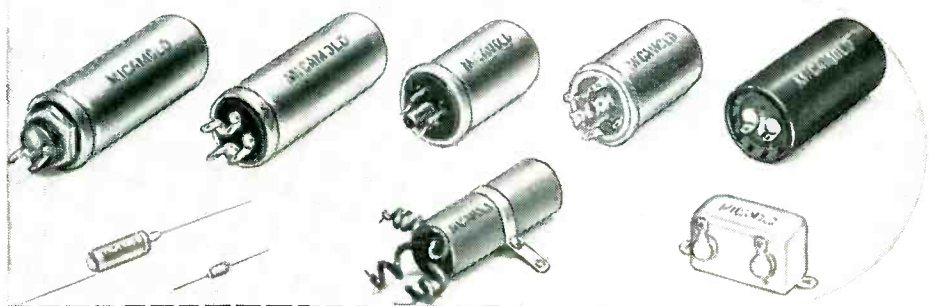

MICAMOLD MOLDED PAPER CAPACITORS, hermetically sealed in rectangular cases are the only complete line of Military Standard styles. A commercial line is manufactured in the same case sizes for industrial applications.

MICAMOLD TROPICAPS are molded tubular capacitors that afford protection from exposure to high humidity or even total immersion. The case is non-flammable and not injured by severe mechanical and thermal shocks.

MICAMOLD originated and introduced the first MOLDED MICA CAPACITORS thirty years ago. The company manufactures Military Standard styles from CM15 through CM70, and also makes the same types for industrial uses. Another Micamold first — the development and manufacture of high temperature types AO, AW and AV for operation to 150°C.



MICAMOLD manufactures all types of Paper, Electrolytic and Mica Capacitors, Radio Frequency Interference Filters, Pulse Networks and Delay Lines.

The Micamold Catalog giving complete specifications is available upon request.

Visit our Booth Number 618 on Circuits Ave. at the IRE Show

MICAMOLD RADIO CORPORATION

1087 FLUSHING AVENUE, BROOKLYN 37, N. Y.



PRODUCTS wired for life

with

WARREN WIRE

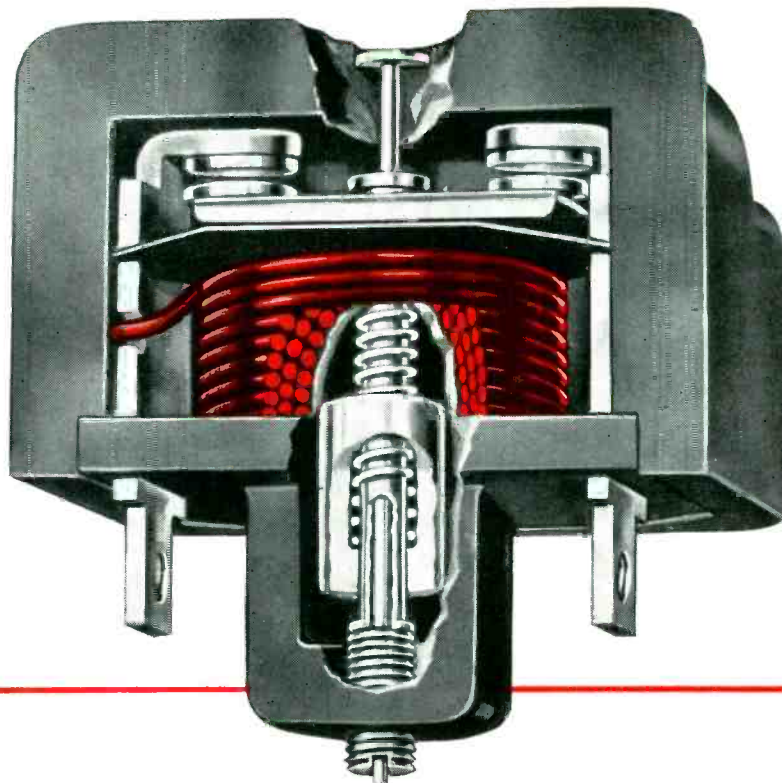

Klixon Controls . . . Circuit Breakers, Thermo-Snap Switches and Thermostats . . . are specified by designers and manufacturers of electrical circuits and auxiliary equipment, because they give assurance of dependable, safe operation throughout their long life. Here, at Spencer Thermostat . . . as well as in the manufacture of many other fine electric and electronic products . . . Warren Wire is used for its easy handling, efficiency and dependability. There's a Warren Wire Engineer near you trained to help you solve your wire problems right in your own plant. There is no obligation, of course.

Send for our new prices and Teflon Specifications # 1001



WARREN WIRE COMPANY

Plant and Main Office: POWNAL, VERMONT

NEW YORK • SYRACUSE • NEW HAVEN • PHILADELPHIA • PITTSBURGH • CINCINNATI
CLEVELAND* • DETROIT • CHICAGO* • ST. LOUIS* • ST. PAUL • LOS ANGELES* • SAN FRANCISCO

Manufacturers of Plain Enamel, Nylonol, Formvar, Nyform, Bondvar, Silicone and Teflon Magnet Wire . . . Teflon Hook-up and Lead Wire . . . Tinned, Base and Bunched Copper Wire.

*Office and Warehouse

SEALTRON ANNOUNCES

the Royal Blue

BONDED COMPRESSION SEAL



● In Sealtron Bonded Compression Seals, you get all the advantages of *both* bonding and compression — superior mechanical strength, better thermal* and electrical properties *plus extra protection* against leakage.

Our method of sealing the Bonded Compression Seal produces a bond between the glass and steel outer member. This bond, combined with the tremendous compressive force of the steel outer member, gives you the finest protection against leakage available with any glass-to-metal seal.

Sealtron's *Royal Blue* Seals come in a wide variety of shapes, sizes and terminal arrangements to suit your most specialized needs — include many shapes previously impractical with other types of seals. They're easy to solder in, will help you solve space problems in "close quarters" where miniaturization is essential.

Royal Blue Bonded Compression Seals are an important addition to Sealtron's *complete* line of glass-to-metal seals — single seals, multiple headers — also alumina (ceramic) seals. Most standard types carried in stock for quick delivery.

And take advantage of our Seal Assembly Service. We'll solder seals into your assemblies, will guarantee hermetic perfection. Our technicians build to your specifications — eliminate your specialized operations, cut down overhead, release key personnel for other work, help you meet tough production schedules.

Write today for complete information.

* Liquid Nitrogen (-320.4° F.) immediately to hot oil (500° F.) without loss of hermetic or electrical performance.

Look for us in Booth No. 827 at the IRE Show, corner Audio Avenue and Radar Road

SEALTRON CORPORATION

READING ROAD AT AMITY, BOX 72A, CINCINNATI 15, OHIO





Powdered iron cores for all miniature applications

Our design engineers have an impressive record of success in developing new miniature types of cores for highly specialized applications, and are ready to take on your toughest problem jobs. Our engineering consultant service is yours without cost. Pyroferic works to closest electrical and mechanical tolerances, on newly-developed pilot models and quantity production runs. You are assured of uniformity, strict quality control and rigid conformity to specifications.

Pyroferic makes iron cores in a complete size range from the smallest to the largest, for all applications. M. P. A. data sheets and tables give complete information including recommended sizes and tolerances as well as a cross-reference index of manufacturers' material designations.



PYROFERRIC
 PYROFERRIC BLDG. | BRONX BOULEVARD
 at 216th St., N.Y.C. 67

Please send me M.P.A. data sheets and tables No. 305.

Write on your letterhead for latest Catalog No. 23MA

NAME _____ TITLE _____ FIRM _____
 ADDRESS _____ CITY _____ STATE _____

FILL ALL YOUR COLOR-TV TUBE NEEDS!



New G-E Receiving Tubes for Color!

Your first aim in designing your new color-TV chassis is quality reception. Your second aim is economy, so that the selling price may be—and remain—competitive. General Electric helps you reach both objectives by bringing you five new receiving tubes specially designed for color. Each of them does a particular job in a color receiver *better* . . . or, it replaces two or more standard tubes, saving you money.

G-E tube engineers at the I.R.E. Show will be glad to explain fully the circuit functions of the five new tubes. Still other types are on their way. Keep constantly in touch with General Electric for new, advanced tubes for color TV!

G-E TUBE SERVICE includes (1) special design and application help with your tube problems, (2) coast-to-coast tube warehousing for fast deliveries to your plant, (3) same-day processing of your tube orders, (4) local-laboratory help in checking your circuit performance. Top service to manufacturer-users is an important chapter of the General Electric tube story!



2V2
High-voltage
rectifier



5AU4
High-output
full-wave
rectifier



6AR8
Sheet-beam
synchronous
detector



6BJ7
Triple diode for
d-c restoration



6BU5
High-voltage
pentode for
shunt regulation.



**OTHER
NEW G-E TYPES**
specially developed for
color television
will be ready shortly.

SEE G.E.'S COMPLETE LINE AT THE SHOW!

Booths 186 to 190, Television Avenue

G-E Tri-color Picture Tubes!

In production at an expanding rate, G-E tri-color picture tubes are available now. See the 15" type on display, also the 19" tube that will be ready shortly. Both are aluminized, glass, using three electron guns, with a planar shadow mask for color selection.

Development is proceeding on larger tubes, on improved types. You may expect G-E tubes that will give steadily bigger—brighter—clearer pictures. You may expect an ever-truer palette of colors.

For your needs now . . . today . . . G. E. has picture tubes for color TV ready. For tomorrow's more advanced types, come to G.E. also! *Tube Department, General Electric Co., Schenectady 5, N. Y.*

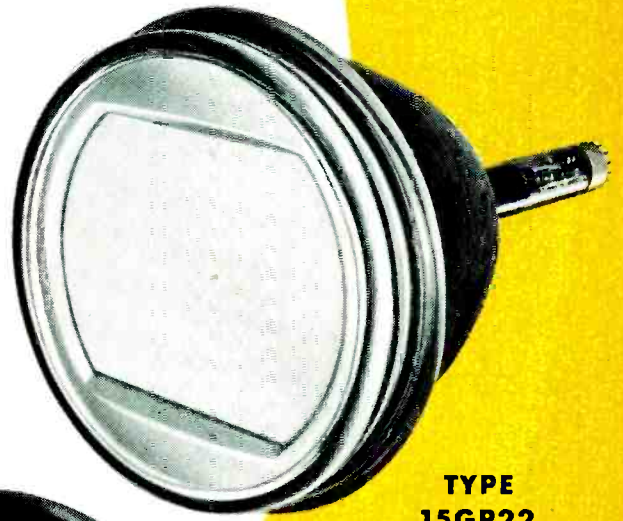

**TYPE
15GP22**



**19-INCH
TYPE**



GENERAL  **ELECTRIC**

162-1A

For the new pneumatic instrumentation

Cabled Tube

The recent tremendous increase in the use of tube instead of wires for instrumentation and control purposes has led to an important new development—cabled tube. This is an armored group of long tubes twisted together to permit bending without distortion. An insulating tape is wrapped over the bundle of tubes to prevent electrolytic action. Then interlocking, flexible galvanized steel armor is applied, like BX. This protects the tubes from injury during shipment, storage, installation, and in service. Standard fittings, boxes and cabinets can be used for junction boxes and terminations. To make it possible to readily identify each tube, one tube in each layer is colored; the position of each tube in each layer in relation to the coded tube

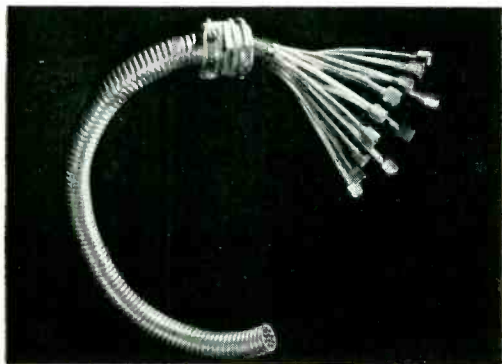

remains the same throughout the length of the cable.

The tubes usually are copper, but aluminum tubes can be used for special purposes. For unusually corrosive situations, a plastic outer sheath can be applied. As many as 19 tubes, 1/4" OD, can be cabled, and supplied in lengths up to 1,000 ft.

Showing the construction of Crescent Armored Multitube, made by Crescent Insulated Wire and Cable Co., Trenton 5, N. J., which will supply further information on request.

Since the tubes carry not electricity but air, nitrogen, helium, or a fluid, they are especially attractive in potentially explosive locations, as in refineries and chemical plants. Utilities are also turning decisively to this new cable, while automatic process control (automation) is a rising application.

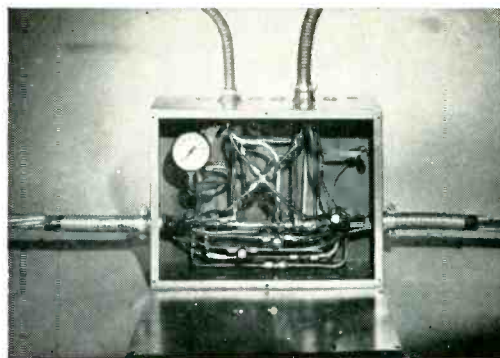

Revere, as a supplier of tube for this purpose, calls this cabled tube development to your attention as a matter of general and perhaps specific interest. See Revere for copper, aluminum and brass tube and pipe, electric welded steel tube, and lockseam tube. Call the nearest Sales Office.

REVERE

COPPER AND BRASS INCORPORATED

Founded by Paul Revere in 1801

230 Park Avenue, New York 17, New York

Mills: Baltimore, Md.; Chicago and Clinton, Ill.; Detroit, Mich.; Los Angeles and Riverside, Calif.; New Bedford, Mass.; Rome, N. Y. Sales Offices in Principal Cities, Distributors Everywhere

See "Meet the Press" on NBC Television, Sundays

Those* who need reliable product information
choose and use the

ANNUAL
electronics
BUYERS' GUIDE

PUBLISHED MID-JUNE 1954



* THE MEN WHO DESIGN



* THE MEN WHO BUY

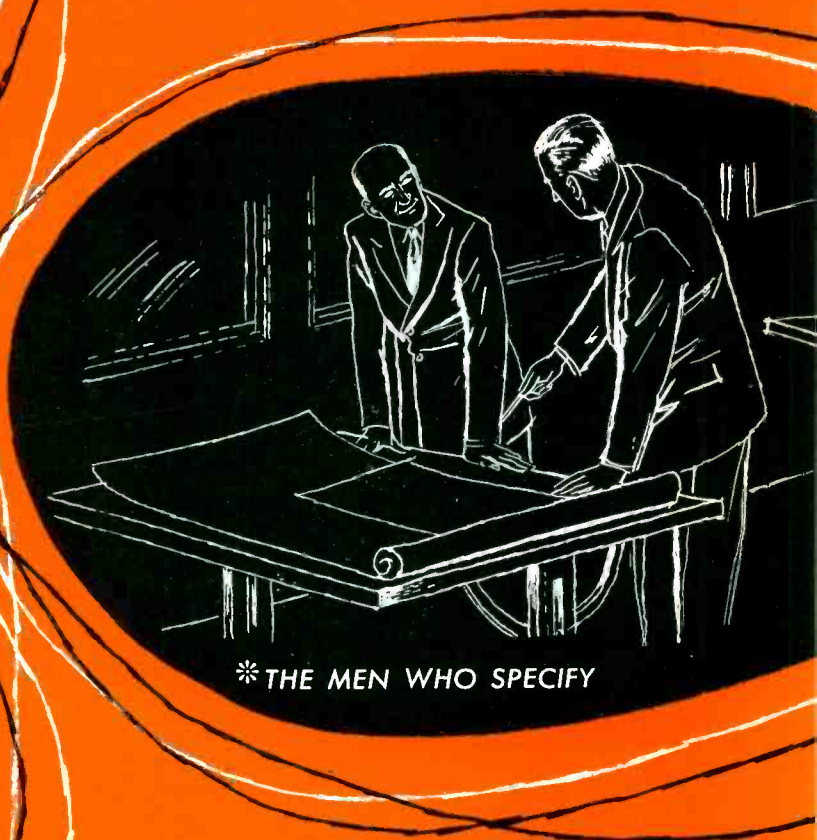

* THE MEN WHO SPECIFY

The 13th Issue of
electronics

ABP

ABC

A BONUS TO ALL SUBSCRIBERS

A McGraw-Hill Publication

330 West 42nd Street, New York 36, N. Y.

It is a fact, proven by impartial research, time and time again, that those who have anything to do with the design or use of electronic gear, components or allied products, use (as they have for years) the **ELECTRONICS BUYERS' GUIDE** for essential product information and technical data. Engineers, designers, specifiers and technicians (hard-to-reach people) have found the "Guide" to be thoroughly up-to-date, the most accurate and the only complete source available. These key people of the industry—the buying influences—rely on the "Guide" as the answer to all their product problems. The advertiser gets more tangible results from his advertising dollar in terms of actual sales . . . in the buying reference pages of the "Guide."



precision connectors by Continental

THESE CONNECTORS ARE ACTUAL SIZE

Series SM-20.....Sub-Miniature Rectangular Connectors
Series 20.....Miniature Rectangular Connectors
Series H-20.....Hermetical Seal Miniature Rectangular Connectors
Series C-20.....Miniature Hexagonal Connectors (Vibration Proof)
Series EZ-16.....Easy Release Power Connectors (Spring Loaded contacts)
Series 16.....Rectangular Power Connectors
Series 14.....Rectangular Power Connectors
Series PC.....Printed Circuit Connectors
Miniature Precision Stand-offs
SPECIAL DESIGNS—submit your connector problems to our engineering department.

Continental Connectors

ELECTRONIC SALES DIVISION, DeJUR-AMSCO CORPORATION

Write Dept. EC-3, DeJur-Amsco Corporation
45-01 Northern Blvd., Long Island City 1, N. Y.

See the DeJUR line at Booth 200, "Production Road," Radio Engineering Show, Mar. 22-25

precision electronic instruments by DeJUR



PANEL INSTRUMENTS

1. 2½" Ruggedized Meter. Meets MIL-M-10304. Model R210
2. 3½" A.S.A. Meter meets MIL-M-6A. Model S312
3. 1½" Meter. Conserves space. Built to SC-73-3. Model 112
4. 1½" Meter. Metal Case. Single Hole Mounting. Model 120
5. 1½" Ruggedized Meter. Meets MIL-10304. Model R112

PRECISION POTENTIOMETERS

6. Multiple ganging and external phasing 2" Diameter Model C200
7. Single hole mounting Model C200
8. Single Sine-Cosine Model C200
9. Dual Unit Model L402
10. 1-11/16" Diameter Center tapped Model L400
11. 3" Diameter 11 watt JAN-R-19 Const. Model 275
12. Dual Concentric Model 282
13. 3" Diameter 8 watt JAN-R-19 Const. Model 260
14. Non-Linear Card C200
15. Sine-Cosine Card C200

Actual performance records prove that these DeJUR components withstand adverse conditions of vibration, heat and moisture. Each is engineered and manufactured to meet rigid government requirements. In addition to its wide variety of stock instruments, DeJUR offers top-flight laboratory, engineering and manufacturing facilities for production of these precision units adapted to your specifications. Inquiries are invited.

Write for more detailed information on any of the products shown on this page to Dept. EPM-3



DeJUR · AMSCO CORPORATION

45-01 NORTHERN BOULEVARD, LONG ISLAND CITY 1, N. Y.
MANUFACTURERS OF SCIENTIFIC PRECISION EQUIPMENT FOR OVER 30 YEARS

See the DeJUR line at Booth 200, "Production Road," Radio Engineering Show, Mar. 22-25

Fine-Silver Contacts Shipped Immediately

From MALLORY Stock...

For the first time, you can order most of your requirements for fine-silver headed rivet contacts from stock! Mallory's standard stock program is the result of an engineering analysis of thousands of customer prints . . . an analysis that permitted standardization of 70 flat and radius-faced contacts that will meet a large majority of industry's requirements.

Check your present designs. You will find standard Mallory Fine-Silver Contacts that come within the tolerances of many of your requirements. Standardize the contacts in your new designs, too. It will save time in engineering and purchasing . . . simplify inventory problems.

The Mallory standard stock program offers:

- *Prompt shipment, normally within 24 hours.*
- *Immediate availability of samples when required.*
- *Saving in time and cost of special designs and tooling.*
- *Ready availability of small quantities for pilot runs and job orders.*

For complete prices, dimensions and part numbers of the 70 stock Mallory Contacts, write for your copy of Form 3-13 today. It provides a quick way to check against your present requirements and gives you all the data you need for new design work.

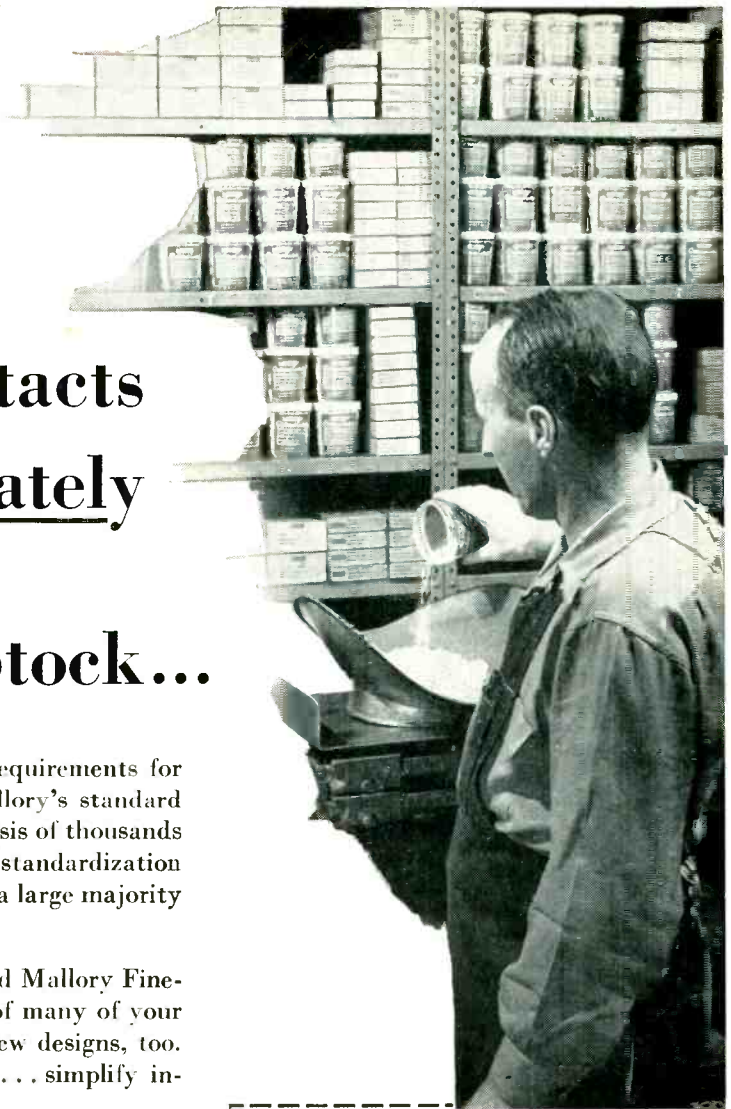

Some applications will always call for special contact designs. If yours is one of them, then call on the wide experience of Mallory engineers in designing specialized contacts. Modern facilities and a complete range of materials are available for economical production of contacts or contact assemblies to your special requirements.

Expect More... Get More from **MALLORY**

Serving Industry with These Products:

Electromechanical—Resistors • Switches • Television Tuners • Vibrators
Electrochemical—Capacitors • Rectifiers • Mercury Batteries
Metallurgical—Contacts • Special Metals and Ceramics • Welding Materials

P. R. MALLORY & CO. Inc.
MALLORY

P. R. MALLORY & CO., Inc., INDIANAPOLIS 5, INDIANA

CROSS

TALK

► **DECISION** . . . This will be a year of decision for manufacturers of electronic equipment, in more ways than one.

Shifting of emphasis from the military to the commercial market is one of the problems that must be faced. The shift is made more complex by the fact that we now have a buyer's rather than a seller's market. Then there is the problem of what to do about color television. How fast should production lines be swung over from monochrome? What picture tube to use and, particularly, how large a picture tube? There is, too, growing economic need for automation which, in our field, ties in closely with printed circuits. And a host of other things, such as silicon transistors, are crying for attention.

Decisions made in 1954 will determine the course of business for years to come.

► **TAXES** . . . The Internal Revenue Service at present recognizes two types of research and development expense.

The first is "blind" research, random exploration which may or may not turn up useful ideas. This is considered a necessary business cost which can be charged off as current expense. The second is specific research on a project that may become a definite asset. This is considered capital investment, so the expense can only be partially deducted in any given year.

Companies in our field particu-

larly feel that they should have the option to classify research as either a current expense or a capital asset, and the Administration expresses a willingness to consider this approach. Whether or not Congress would go along is an open question, as in the case of other pending presidential proposals.

► **SHOW** . . . IRE's National Convention is all set (March 22-25) for New York's Kingsbridge Armory, the Waldorf-Astoria and Shelton hotels. There will be 241 technical papers, involving at times as many as seven concurrent sessions.

Exhibit space at the Armory has been sold out and it now appears that two new arguments for repeating the performance at the same place, in 1955 and probably in 1956, will be heard. Heavy attendance at the Boat Show, shifted there from the now unavailable Grand Central Palace in late January, appeared to indicate that the physical attractiveness of a one-floor exhibit might more than compensate for a less central location. And it is believed in some quarters that the Institute's willingness to be among the first to try the Armory might give it a priority on a desirable convention date some years hence when the city opens its New York Coliseum.

► **COLOR** . . . Here's a fact that delights us because of our twin professional interests, electronics

and publishing: The range of colors that can be reproduced by television systems fully utilizing the NTSC signal specifications exceeds that which can be achieved with modern printing inks.

Neither television nor printing as we know them today can reproduce all the hues of the visible spectrum, but the deficiencies are largely in heavily-saturated green and blue areas rarely encountered in nature.

► **EXTRA** . . . First of three "extras" promised subscribers (p 129, January) is the four-color four-page fold-out *Spectrum Chart* bound between pages 160 and 161 of this issue.

There can be no chart to end all charts; technical horizons continue to expand and manmade allocations change. This particular chart should, nevertheless, be of widespread interest, relating as it does the overall "ether" spectrum, radio, audio, light and other frequencies and then going into separate detail.

In particular, the combination of graphical, pictorial and textual means adopted to pick out points of special interest should prove useful.

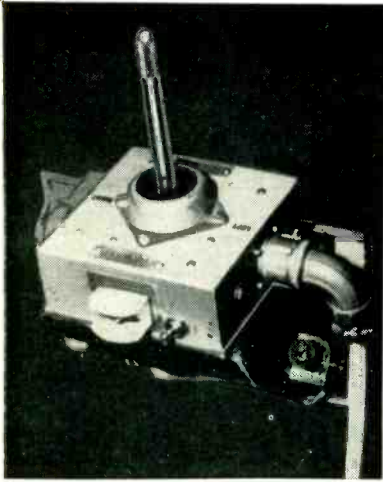

Control unit in airplane waist position steers boat forward, to right or left by movement of control stick

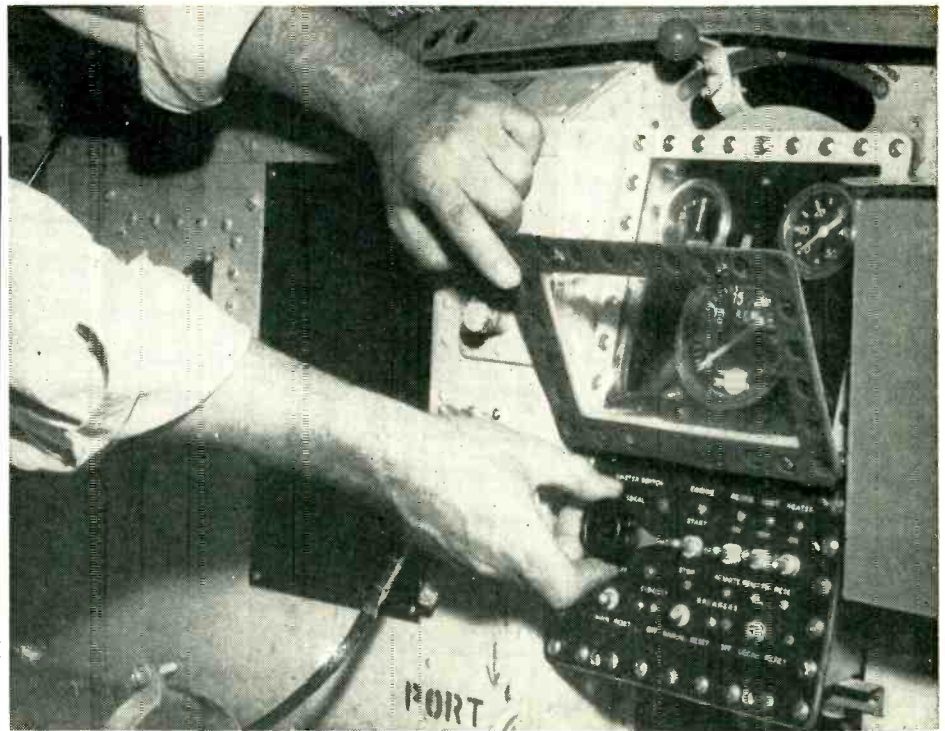

Panel of rescue boat has switch to select remote, local or manual operation of the boat

Radio Control Directs

Plane crew uses five audio tones on amplitude-modulated transmitter to start engine and steer lifeboat parachuted from plane to crash survivors. Control signals are separated by selective filters in superregenerative receiver in boat

USE OF lifeboats dropped from rescue planes has become an important factor in assuring the safety of crash survivors until rescue ships arrive. However, once the lifeboat has been dropped, the rescue is dependent on the boat drifting toward the survivors, or on their ability to swim to the boat.

To eliminate this possible hazard, a radio remote control system has been developed that allows the plane crew to start the boat's gasoline engine and steer the boat to the survivors. Basic transmitting and receiving equipment used are standard Air-Force units.

Two-way communication is available to the survivors through a standard emergency transceiver

stored in a compartment in the boat.

Once the survivors are sighted by the searching aircraft the boat is released by parachute, using the bombsight to line up the drop point. When the boat lands in the water the parachute is automatically released. The control transmitter in the plane is turned on, and the modulated carrier initiates a series of events resulting in starting the boat engine. Another modulating frequency is used to engage the clutch and two others steer the boat right and left. Turning the transmitter off or loss of carrier causes the clutch to return to neutral and stop the boat.

The control system is designed around an amplitude-modulated

transmitter in the aircraft, modulated by any one of five audio signals. Control boxes are located in the nose and each waist window of the plane and transfer from one to the other controller is made from a transfer box at the master position in the nose of the plane.

A whip antenna with matching section, mounted on the nose of the aircraft, provides forward directional coverage in the horizontal plane.

Controls

A simplified schematic of the transmitter control circuits is shown in Fig. 1. The cathode circuit of the 955-cycle oscillator is complete to ground at all times with

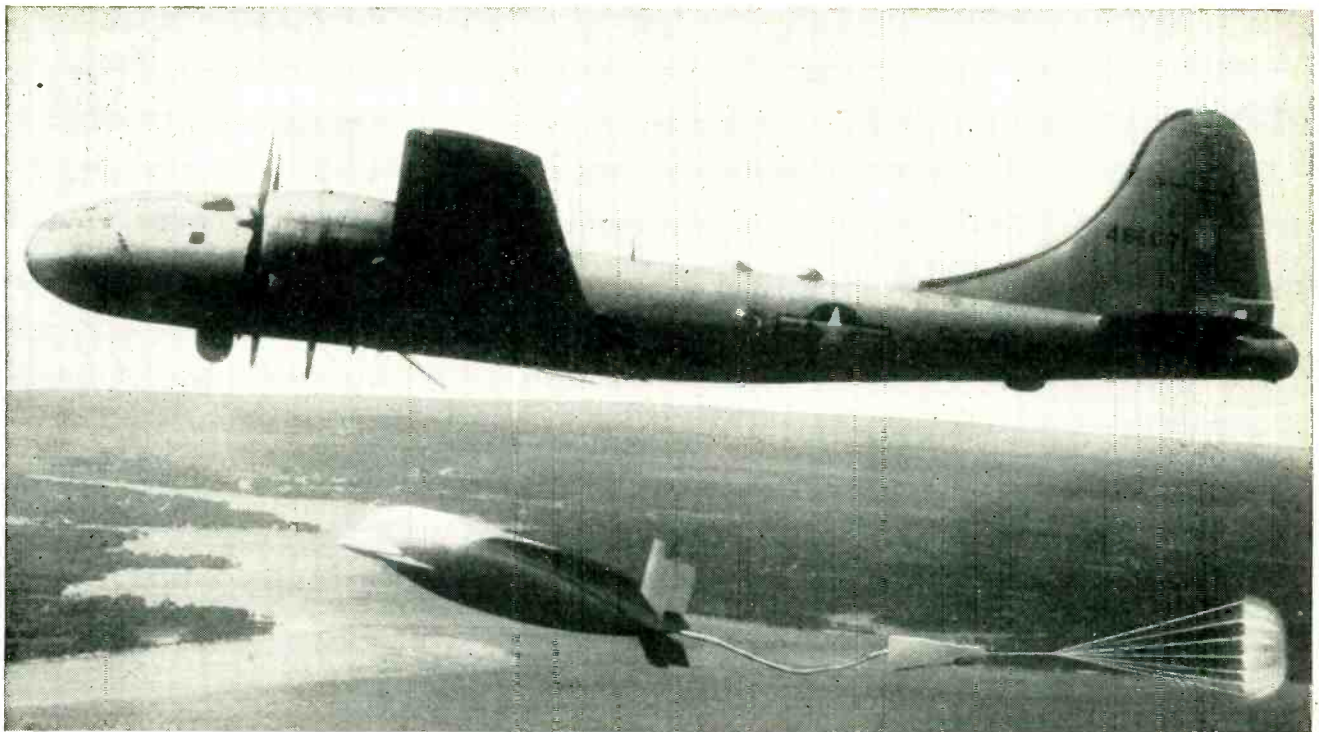

Rescue boat dropped from modified B-20 is brought within reach of crash survivors by radio controls operated from plane

Air-Sea Rescue Boat

G. V. SCHUG AND S. B. HALL

*Electronics Components Laboratory
Wright Air Development Center
Dayton, Ohio*

*Ordnance Division
Westinghouse Electric Corp.
Skaron, Pa.*

the switches in the neutral position. Unless some command is being transmitted by closing one of the control switches, a 955-cycle signal is continuously on the carrier.

The transfer box contains the switching circuits for power and control-box transfer. A three-bank, five-position rotary switch turns on the control-box filaments for warm up and when advanced to the 1, 2 or 3 position connects one of the control boxes to the transmitter. At the same time it applies high voltage to the transmitter, thus putting a signal on the air. To take the carrier off the air the switch is returned to the FILAMENT position.

Boat equipment is essentially a radio receiver, heading stabiliza-

tion system and relay-actuated devices for releasing the stabilizer fins, prop guard, sea anchor, and controlling the engine, clutch and throttle.

A three-position switch on the instrument panel of the boat allows the survivor to choose the method of operating the boat. With the switch in the REMOTE position, the dropping plane has complete control.

In the LOCAL position, the boat is operated and controlled from a hand set that performs the same automatic functions as the plane transmitter. In the MANUAL position the boat is operated by hand. Steering is done by tiller and the clutch is engaged by hand. A

magnetic compass is used for navigation.

The receiving equipment installed in the boat consists of a standard radio-control receiver and a quarter-wave antenna installed in a seam on the cover of the flotation chamber of the boat.

This antenna is made by stripping the shield from a section of RG-58/U coaxial cable, exposing a length approximately one-quarter wave-length of the midband frequency of the receiver. The other end terminates in a BNC connector at the input of the receiver.

Receiver

The receiver is a superregenerative-detector circuit using a 12AU7

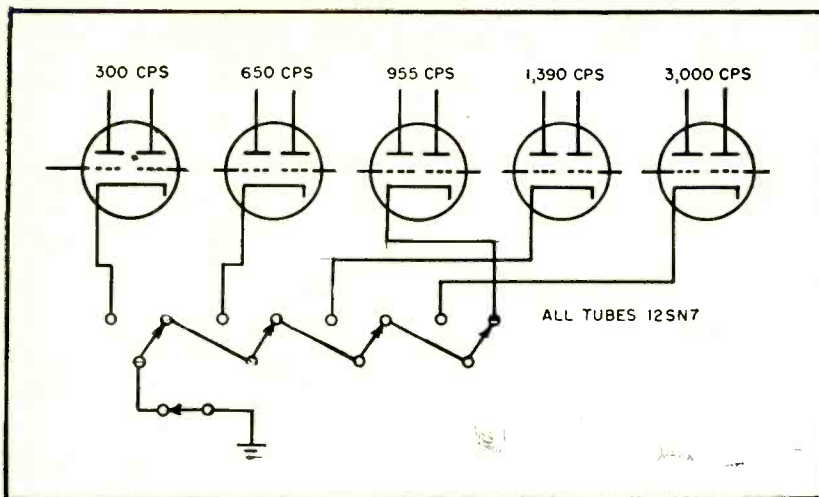

FIG. 1—Simplified schematic of control-system oscillators. The 955-cps oscillator is grounded when switches are in normal position, thus maintaining a signal on carrier at all times during transmitter operation

and a pair of 6AK6 output tubes. The output of the second 6AK6 passes through a bandpass filter which feeds all audio signals in the 150 to 4,000-cycle range to selective filters passing only the control frequencies with a tolerance of ± 3 percent of center frequency.

Design of these filters, use of copper-oxide rectifiers in place of vacuum tubes and the use of sub-miniature sealed relays reduces the size and weight of the receiver to 0.9 cubic feet and 5.5 pounds respectively.

The relay in the 955-cycle circuit must be energized at all times when a carrier signal is on the air. The coil of this relay is in series with the ground return of the other four relay coils which in turn are bypassed by a 0.47- μ f capacitor. A one-second delay in opening of the 955-cycle relay is thus obtained. This is more than enough to keep the relay closed during the switching interval occurring when commands are given at the control box in the aircraft.

This arrangement permits use of the 995-cycle signal to hold the clutch engaged after the engine is running and to disengage it by removing the tone or carrier.

Operation

When the boat is dropped from the aircraft the chute opens and a lanyard switch connects an internal battery to the remote control equipment. The radio receiver is held unenergized for 90 seconds by

a thermal time delay to prevent premature release of the stabilizer fins and prop guard and also to prevent starting the motor if the transmitter is turned on before the boat is in the water.

When the transmitter carrier with a 955-cycle modulating signal is picked up by the receiver, a relay is energized applying power to an actuator which releases the fins used to stabilize the boat in the free fall before the chute opens. The actuator stops against a limit switch that energizes another actuator which releases the rudder and propeller fairing used to protect these units during the drop and landing.

The fairing actuator stops against a limit switch energizing the automatic engine cranking control.

The cranking control opens the solenoid release for the ventilating covers, starts the engine-compartment ventilating blower, and opens the solenoid-controlled gasoline supply valve.

Engine Starting

A thermal-delay relay in the cranking control prevents the engine from starting until the engine compartment has been ventilated for 15 seconds. At the end of that period, two additional thermal time-delay relays in the cranking control energize the automatic choke and engine starter for alternate periods of 5 seconds ON and 5 seconds REST. This cranking

cycle continues until the engine starts.

Upon starting, the cranking control is deenergized by the engine generator voltage that actuates a cutout relay in the cranking control. This entire process takes about one minute.

To operate the boat, the stick of a control box is held forward in the 3,000-cycle tone position for several seconds, a receiver relay is energized, the sea anchor is released by a solenoid and power is applied to the clutch actuator. The clutch is moved to forward gear and linkages advance the throttle to three-quarter speed. The boat moves forward at approximately six knots.

An automatic-compass pilot holds the boat on a set heading. The pilot is controlled by a magnetic compass, and as the boat deviates from course, the position of the compass card relative to a pick-off is detected as an error signal. The signal is fed to a vacuum-tube amplifier and the amplifier output relay operates the steering actuator. The signal from the follow-up potentiometer connected to the rudder balances the error signal in the amplifier and deenergizes the steering actuator when the boat is on the correct course.

Course Control

The course-selector dial on the pick-off can be set either manually or by the course-selector motor. When the control stick is held for several seconds to port or starboard, the 650 or 300-cycle signals energize corresponding receiver relays. These, in turn, power the course-selector motor that sets the course on the magnetic compass. The boat responds at a rate of 7 degrees per second.

The plane crew moves the control stick to port or starboard in short beeps until the boat turns to the desired heading.

The fifth signal, 1,390 cycles, is used in an emergency. Should the automatic-compass pilot fail under radio operations it can be by-passed by switching it from the circuit with this signal. Power is then applied by relays directly to the steering actuator, controlling the rudder with the same 650 and 300-cycle signals as used before.

Magnetic Amplifiers for Synchronous Motors

Self-saturating circuits convert 400-cps power to 60 cps for controlling synchronous motors in accordance with low-power 60-cps synchronizing signals

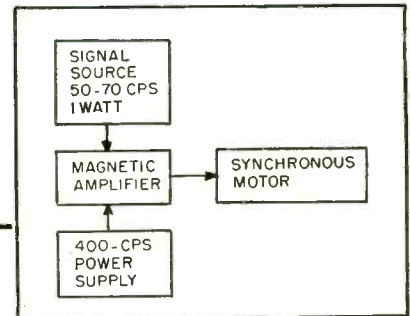

FIG. 1.—Block diagram of system for converting 400 cps to 60 cps for synchronous motor control

By **MARCEL B. ZUGCHINO**

*Project Engineer
Signal Corps Engineering Laboratory
Fort Monmouth, New Jersey*

APLICATION of magnetic amplifiers to amplifying a-c signals has been hindered by unavailability of suitable high-frequency power supplies. Since the magnetic amplifier is essentially a modulation device, the power-supply frequency must be at least four times greater than the highest a-c frequency to be amplified. This allows for a time constant of several cycles

of the power-supply frequency needed in a magnetic amplifier.

However, there are fields of operation where power supply requirements do not preclude the use of a magnetic amplifier. An example might be a control system where an a-c amplifier is needed to increase the power level of a small synchronizing signal, nominally 60 cps and subject to 10-cps variation.

The synchronizing signal may then be used to operate a 60-cps synchronous motor. This is an ideal application for the magnetic amplifier when 400-cps power is available. Figure 1 is a block diagram of such a system.

Magnetic Amplifier Circuit

The amplifier circuit used for the synchronous-motor control is based on the self-saturating principle. The signal current as shown in Fig. 2A is in the same direction as the average load current i_1 in reactor 1 and opposing the average load current i_2 in reactor 2. In this way, the firing angle of reactor 1 is decreased and that of reactor 2 is increased. Therefore i_1 will increase with increasing signal while i_2 decreases.

The proportion between them is a function of the instantaneous value of the control current. Hence, the unbalanced current in the transformer is a complex wave, the envelope of which has the same shape as the signal current and changing polarity as does the signal current.

The voltage induced in the secondary of the output transformer is in the form of a modulated carrier, Fig. 3. Capacitor C_1 demodulates the wave by virtue of its clipping action and the original signal appears across the load.

As shown, this circuit has a

SELF-SATURATING MAGNETIC AMPLIFIER CIRCUIT

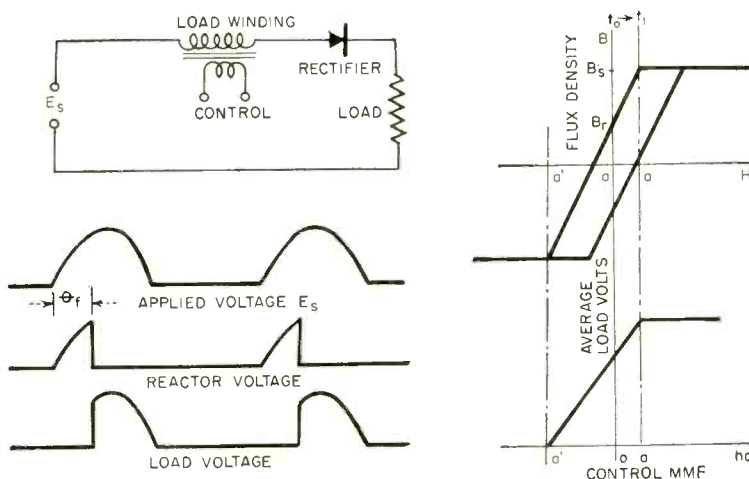

Operation of the basic magnetic amplifier circuit used is as follows: flux in reactor core builds up to B_s (saturation flux) during forward half cycle of supply voltage E_s . Rectifier action holds flux at B_s during reverse half cycle. Available flux change is reduced and core can no longer support entire conducting cycle of line voltage; core saturates during conducting half cycle at time determined by control voltage which presets B_s , placing remaining part of cycle across load. Operating point may be shifted by superposition of bias mmf

Table I—Breakdown of Losses

Component	Loss in watts
Input transformer	20
Reactors	16
Rectifiers	170
Output transformer	20
D-C resistor	100
Load	100
Total	426

serious shortcoming. In the primary of the output transformer the d-c component of the carrier wave does not see any load impedance. Distortion of the carrier, accompanied by a tremendous drain on the power supply occurs. Very high values of rms quiescent current will circulate in the amplifier.

This difficulty is remedied by inserting a resistor R_{d-c} in the circuit as shown in Fig. 2B. The value of R_{d-c} is made equal to R_L (representing the load) when the overall turns ratio of the output transformer is two to one. This has the effect of presenting to the d-c component the same impedance seen by the a-c components. So that R_{d-c} does not offer an impedance to a-c components, it is bypassed by electrolytic capacitor C_2 . Figure 2C shows an arrangement for doubling the carrier frequency so that modulation and demodulation can be accomplished more efficiently.

Consider a typical case where it is desired to operate a capacitor-start, single-phase synchronous motor with a rating of 120 volts at 1 ampere, 60 cps \pm 10 cps. Available control power is 1 watt, 6 to 8 volts at 50 to 70 cps and 400-cps power is available at 115 volts. The design is carried out in five steps.

Power Input Transformer. The primary of the power input transformer is designed for 115 volts, 400 cps and 590 volt-amperes. The volt-amperes required is obtained from the total power dissipated, as estimated in Table I, divided by the estimated power factor of 0.8. The secondary voltage was found experimentally to be 325-0-325 volts.

Reactor Cores. The cores used are manufactured by the Arnold Engineering Company and are identified by the number 4178 D-2. Dimensions are: o.d. = 2.5 in., i.d. = 2.0

in., h = 0.5 in., and the core material is 0.002-in. Deltamax.

The number of turns in each load winding is

$$N_L = \frac{V_s E_s 10^8}{2\pi f_s B_s A_c} = \frac{325 \times 10^8}{(4.44) (400) (87,000) (0.9) (0.125)} = 1,870$$

At the outset the rms current passing through each reactor is not known because of complex waveforms and uncertain losses. Number 20 wire was chosen as the largest wire size that could be easily wound on the chosen core. Subsequently it was found to have the necessary current-capacity.

Since the number of control turns will be relatively small it is convenient to wind them with number 20 wire also.

The desired output characteristics were obtained without need of a bias winding. The curve in Fig. 4 is originally obtained with $I_c N_c$ as the abscissa. Maximum $I_c N_c$ necessary was found to be 4.4, therefore

$$N_c = \frac{4.4}{0.2} = 22 \text{ turns}$$

where 0.2 amps is the peak control current drawn by the magnetic amplifier when R_c is 35 ohms. This

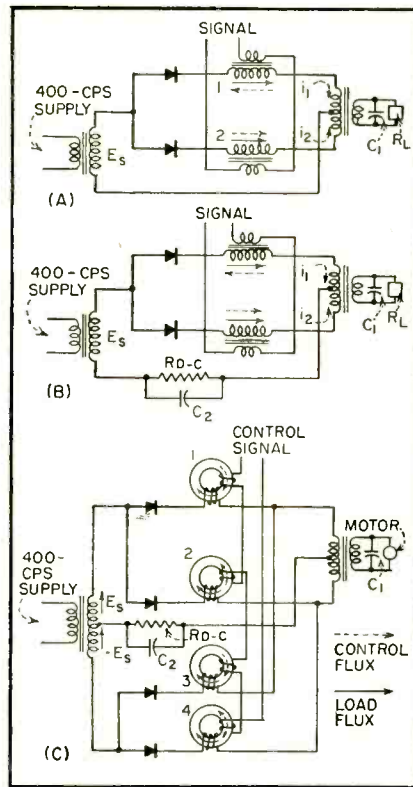

FIG. 2—Development of amplifier circuit

is within the 1-watt range of control power that could be made available.

Rectifiers. The rectifiers were chosen on the basis of availability at the time of construction and were not suitable in the number of plates or their size, accounting for a considerable lowering of the efficiency as shown in the break-down of losses in Table I.

However, assuming they were available at the time, it would be better to use 40-volt-per-plate selenium rectifiers with 3-in.-square plates, 18 per unit.

Output Transformer. The secondary of the output transformer is designed to absorb 120 volts at 50 cps. The transformer has a 2-to-1 step-down ratio and a center-tapped primary. Primary rms current is 1.3 amperes and the secondary rms current is 1.7 amperes.

D-C Resistor. The motor impedance is about 100 ohms. In this unit R_{d-c} is 100 ohms and rated for 100 watts. The bypass capacitor is 500 μ f, 150 v d-c.

Since the time constant of the amplifier is a direct function of the control winding's inductance, it is desirable to have this inductance a minimum when the rate of change of the signal waveform is maxi-

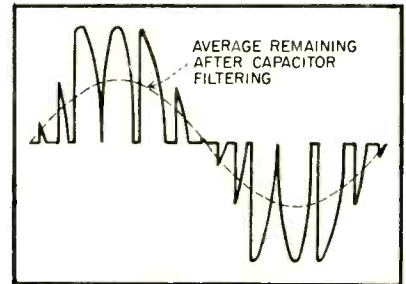

FIG. 3—Unfiltered voltage across load of full-wave amplifier

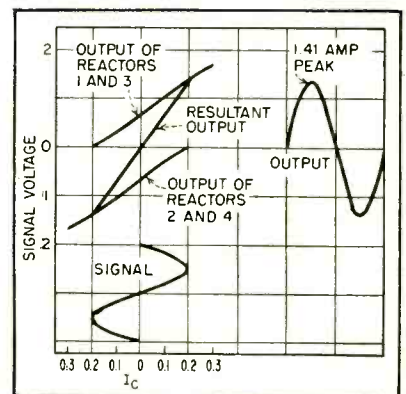

FIG. 4—Transfer characteristic

mum. This point occurs at zero signal. Therefore it is desirable that the reactor cores be almost saturated at this time, since a saturated core reduces the inductance of the control winding.

As a second example, it was desired to control an inductance-start single-phase synchronous motor rated at 115 volts and 5.8 amperes. The other factors remained the same as in the previous example.

Experimental work showed the required power gain of about 700 could not be obtained with one stage because of the time-constant limitation. Therefore this amplifier is a two-stage unit.

The output stage is designed to meet the motor-load requirements. This stage requires an input signal of 12 watts. To bridge the gap between the 12 watts needed for the output amplifier's control circuit and the 1-watt signal power available, an input stage is used. This stage has an output of 18 watts across a 100-ohm load presented to it by the output stage.

The principles and circuits employed for this two-stage high-power amplifier are identical to those described for the 120-v-a unit. Figure 5 shows the circuit of the amplifier.

First Stage

Power Input Transformer. The primary of the power input transformer is designed for 115 volts, 400 cps and 70 v-a. The v-a rating is estimated by assuming an efficiency based on that of the 120-v-a unit. The secondary voltage is 125-0-125 volts, a value arrived at experimentally.

Reactor Cores. The cores used have the dimensions o.d. = 2.5 in., i.d. = 2.0 in., and h = 0.5 in. (Arnold No. 5233D-2). The material used is 0.002-in. Deltamax, and the load and control windings are $N_L = 1,500$ turns No. 25 wire and $N_C = 10$ turns No. 25 wire.

Rectifiers. The first-stage rectifiers are 40-volt-per-plate selenium rectifiers.

Plates are 1½-in. square with 6 plates per unit.

Output Transformer. The secondary of the output transformer is designed to absorb 40 volts at 50 cps. The transformer has 2-to-1

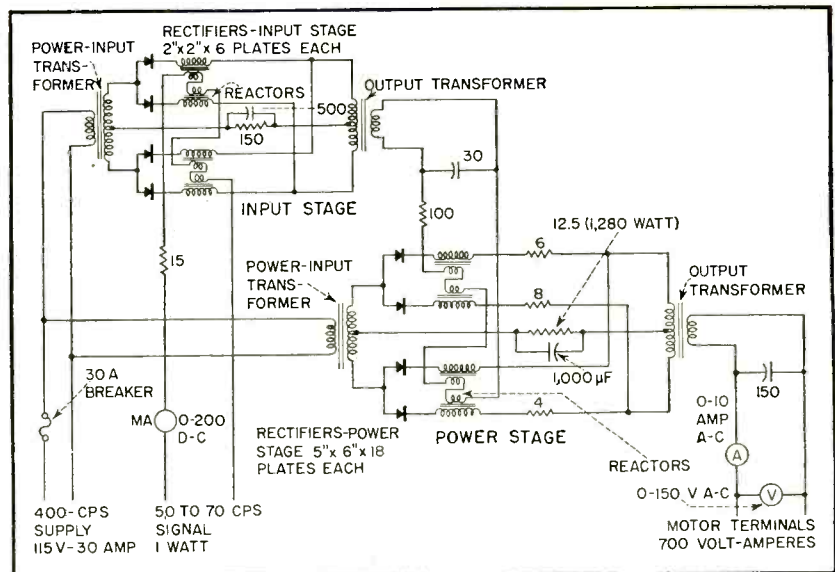

FIG. 5—Two-stage magnetic amplifier rated at 700 volt-amperes

step-down ratio and a center-tapped primary. Each winding is rated for 0.5 ampere rms.

D-C Resistor. The control winding resistance of the second stage is 100 ohms, and R_{d-c} is 150 ohms rated at 25 watts. The bypass capacitor is 500 μ f, 150 v d-c.

Second Stage

Power Input Transformer. The primary of the power-input transformer is designed for 115 volts, 400 cps, and 2,800 v-a. Again the v-a rating is estimated by assuming an efficiency based on that of the first unit. The secondary voltage is 275-0-275 volts as determined experimentally.

Reactor Cores. Core dimensions are o.d. = 4.5 in., i.d. = 3.0 in. and h = 1.5 in. (Arnold No. 5581 D-2). The material is 0.002-in. Deltamax and load and control windings are $N_L = 385$ turns No. 11 wire and $N_C = 35$ turns No. 20 wire.

Rectifiers. The second-stage rectifiers are 40-volt-per-plate selenium rectifiers.

Plates are 5 in. \times 6 in. \times 18 plates per unit.

Output Transformer. The secondary of the output transformer is designed to absorb 120 v at 50 cps. The transformer has a 2-to-1 turns ratio and a center-tapped primary. The primary winding is rated for 7 amperes and the secondary for 10 amperes rms.

D-C Resistor. The motor impedance is about 16 ohms. In this

unit R_{d-c} is 12.5 ohms and rated for 1,280 watts. The bypass capacitor is 1,000 μ f, 150 v d-c.

Balancing Resistors. In this unit, the forward resistance of the rectifiers is comparable to the load impedance. Therefore, any differences in the rectifier forward resistances causes an unbalanced condition at zero signal. This results in a jittery, pulsating output.

To correct this difficulty, external resistors are placed in series with the rectifiers as shown in Fig. 5. The values for these resistors were determined experimentally after the rectifiers reached operating temperature.

In the particular system these units were designed to operate, the most marked improvement they yielded over the electron tube units they replaced was in regard to regulation. For example, the output voltage of the 700-v-a unit varied from 125 v, with the motor running unloaded, to 116 volts with the motor heavily loaded. The motors for each unit could be operated at rated load and in synchronism, over the 50 to 70-cps range of signal frequencies specified.

While the larger unit has not been in service very long, the smaller one has been in use for over two years, providing trouble-free operation and requiring no maintenance. With respect to size and weight the units are comparable to their electron tube counterpart.

Designing Flush Antennas

Conventional installations flown at 600 mph would produce drag loss equivalent to 900 hp. Recessed transmitting, receiving, direction-finding and other navigational antennas have been designed with good electrical characteristics

DESIGN OF ANTENNA systems for modern high-speed aircraft is an exercise in compromise. Increasing demand for improved efficiency, coupled with the severe environmental conditions of aircraft application, have resulted in ever-tightening and sometimes conflicting requirements on the electrical, structural and aerodynamic performance of airborne antennas.

Increasing traffic density on the major air routes, together with the rapid advance toward the goal of all-weather flight, demand the utmost in performance from the radio systems on which the pilot must rely for communication and navigation. Improvements in airframe design have emphasized the requirement for structural integrity and mechanical reliability of the antenna elements and at the same time, a growing weight penalty.

Greater speeds have emphasized the importance of reducing the engine thrust lost to the aerodynamic drag of conventional antenna configurations through the development of faired-in or flush-mounted designs. For example, the 19 external antennas installed on a DC-6 consume 10 hp in aerodynamic drag at a cruising speed of 300 mph. The same antennas flown at 600 mph would produce a drag loss equivalent to 900 horsepower—if they didn't simply blow away.

Some basic electrical requirements for airborne antennas and designs that have met with success are described below.

At the operating frequencies of loran and the automatic radio direction finder (adf), from 200 kc to 2 mc, most aircraft have overall dimensions that are small compared with the wavelength. Under such

conditions the characteristics of airborne antennas are relatively simple. All electric dipoles, such as the loran antenna and the adf sense antenna, behave like very short or Hertzian dipoles; all loop installations behave like infinitesimal loops. The radiation patterns of all such antennas are like the familiar figure eight and the input impedances are essentially reactive.

In this frequency range the antenna design problem is essentially one of locating the antenna so that the nulls of the radiation pattern are properly oriented and constructing the antenna element to provide adequate sensitivity and the reactance value required by the front-end design of the associated receiver.

For loran, an antenna responding to vertical polarization is required with a sensitivity sufficient to override the receiver input circuit noise with induced atmospheric

noise. Clearly a more sensitive antenna would not improve the system performance, since the improvement in received signal would be accompanied by increased receiver noise in the same ratio. The flush antenna design best adapted to these requirements is the tail cap, an electrically isolated portion of the tip of the vertical stabilizer.

The radiation pattern of such an antenna in the fore-and-aft vertical plane is shown in Fig. 1A for the DC-6B aircraft. The tilt of the axis of symmetry of the pattern toward the horizontal is characteristic of such antennas and indicates the importance of the airframe structure in determining the antenna characteristics. Despite the relatively poor sensitivity to vertical polarization (the trailing wire is worse) the tail cap (Fig. 1B) provides an adequate sensitivity for loran use if the vertical extent of the isolated structure is

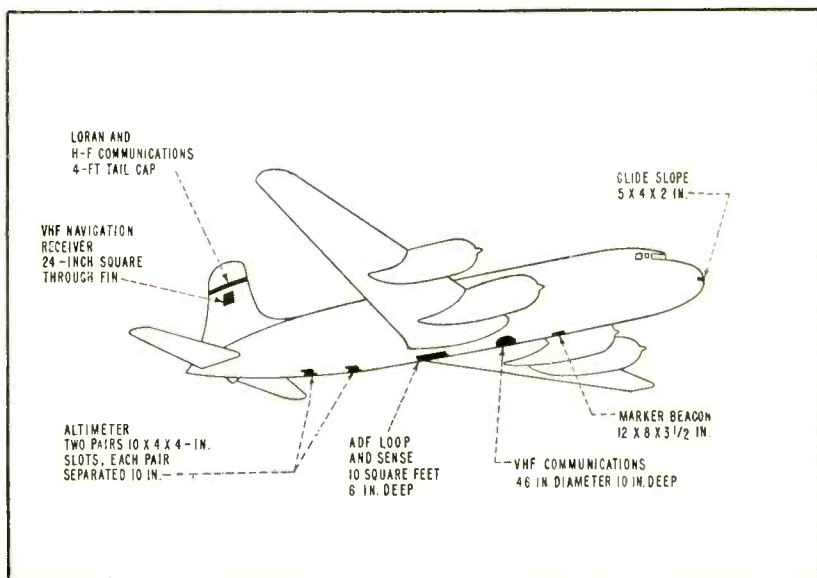

Locations and dimensions for flush mounied antennas on typical airframe show best compromises among factors of tilt and curvature

for High-Speed Aircraft

roughly 12 to 24 inches high.

Exact height required and optimum shape of the isolated section depend upon the circuit details of the particular receiver coupler employed. Figure 1C shows the effect of tip configuration on the performance of a particular tail-cap antenna when used with the CU-167 coupler and indicates the optimizing effect of altering antenna capacitance.

The loop antenna for the adf is a supplied component, so the aircraft antenna designer is faced only with the problem of locating it on the airframe to yield the necessary antenna sensitivity. Quadrantal error must be restricted to the range available in the compensating cams that form a part of the loop-rotating mechanism.

Both sensitivity and quadrantal error are affected by currents induced on the airframe by the incident electromagnetic waves. Completely flush installation is not easy.

Flush-loop installations have been made in plastic cockpit canopies, inside a nose radome, in a plastic section of the dorsal fin and in special cavities installed on the

By **J. V. N. GRANGER**

*Stanford Research Institute
Stanford, Calif.*

top or bottom of the fuselage. To maintain the sensitivity obtained with a conventional external mounting in a fully flush installation, the opening in the metallic skin surrounding the loop must be as much as 5 or 6 feet in diameter unless a special pancake loop is employed.

Special loops have been wound on high-permeability cores of oval or elliptical cross section, which require cavities only 18 inches in diameter and 2 to 3 inches deep. They are not generally available in this country. The quadrantal error problem is not often serious since the compensating mechanism supplied as a part of the loop can handle up to 25 degrees of deviation. Quadrantal error associated with a loop installed on an infinite circular cylinder is 18 degrees.

Installations on conventional airframes generally result in somewhat smaller values unless the loop is coupled to some stray loop circuit, such as is sometimes formed by the fixed-wire antenna or by the landing-gear struts and their bracing in

the wheel-down condition. Figure 2A gives some typical quadrantal error data in comparison with model data from an electrolytic tank.

Sense Antenna

The d-f sense antenna presents a special design problem because of the use of the cone-of-silence of the adf as an aid to navigation. Figure 2B demonstrates that improper location of the adf sense antenna can result in a double cone-of-silence when the aircraft flies a track passing directly over the ground transmitter. One cone-of-silence results when the null of the airborne antenna is directed toward the ground station and the true cone-of-silence occurs when the aircraft is in the null of the ground antenna.

To avoid this problem the antenna designer must locate the sense antenna so its radiation pattern corresponds to that of a vertical dipole. That there are only two such locations on the aircraft, one on the top and one on the bottom fuselage centerline, is shown by the data of Fig. 3. In this figure the antenna data are represented in terms of the tilt angle and the curvature factor. The former is the angular displacement of the nulls of the pattern from the vertical, measured as indicated on the figure. The latter is the amount by which the sensitivity to vertical polarization of any small antenna is increased over the value for a large flat ground plane when the antenna is located at the indicated position on the airframe.

Curvature factors in the vicinity of 2, the value for a long circular cylinder, are typically encountered on the top centerline of low-wing aircraft and on the bottom centerline of high-wing aircraft. The shielding effect of the wing is evidenced in Fig. 3 by the dip in the curvature factor for bottom centerline positions near the wing root. When the curvature factor is taken into account, the requirement that

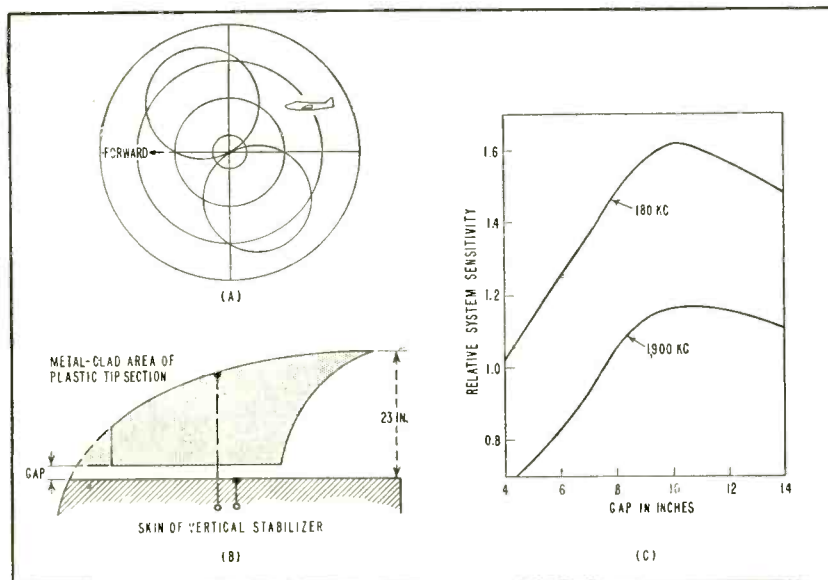

FIG. 1—Vertical-plane radiation of low-frequency tail-cap antenna on DC-6B (A), tail-cap dimensions (B) and improvement in receiver performance (C)

the sensitivity of the sense antenna be at least as great as the maximum loop sensitivity leads to flush cavities approximately 10 square feet in area.

Unfortunately, the input-circuit design of conventional adf equipments places severe restrictions on total sense antenna capacitance (antenna capacitance plus cable capacitance) if the system sensitivity is not to be impaired. Present practice consolidates radio equipment in a rack near the pilot's compartment. A long cable run to a correctly located sense antenna would result in capacitance values in excess of the tolerance.

In such circumstances the required sensitivity can only be achieved by an impractical increase in the size of the sense antenna cavity. Completely flush adf installations must apparently await the development of new adf equipment or the operational acceptance of baggage-compartment location for the adf receiver.

H-F Communications

The antenna system employed for relatively long-range air-to-ground communications in the h-f range between 2 and 24 mc is subject to requirements different from those for l-f navigation antennas. A detailed analysis of the performance under ionospheric propagation conditions of a variety of antenna types on typical airframes indicates small average differences between antennas, in terms of their respective radiation patterns. The difference usually amounts to less than a 3-db range in the effective signal-to-

noise ratio of the communications link.

Input impedance, on the other hand, is a parameter of major importance, particularly at the lower frequency end of the range where the input reactance is usually highest and the input resistance lowest. Power transfer efficiency of the associated impedance-matching network is directly related to the effective Q of the antenna. Config-

urations yielding high reactance-to-resistance ratios typically result in power loss in the matching network equivalent to a 10-db loss in system signal-to-noise performance. A closely-related problem is the corona protection of such antennas, since a high antenna Q implies a high terminal voltage, if the radiated power level is maintained.

The search for an h-f antenna configuration that will yield a satisfactorily low input reactance-to-resistance ratio is in essence the search for an effective means for coupling to the skin of the aircraft itself. The airframe, having an elongated shape of large dimensions and being constructed of high conductivity materials, makes an excellent radiator for high frequencies when properly excited. The usual fixed-wire antenna is not a particularly good means for exciting the airframe, the input impedance resembling that of a section of moderately lossy transmission line.

Impedance curves are shown in Fig. 4A for two conditions of operation of an 81-foot fixed wire on a

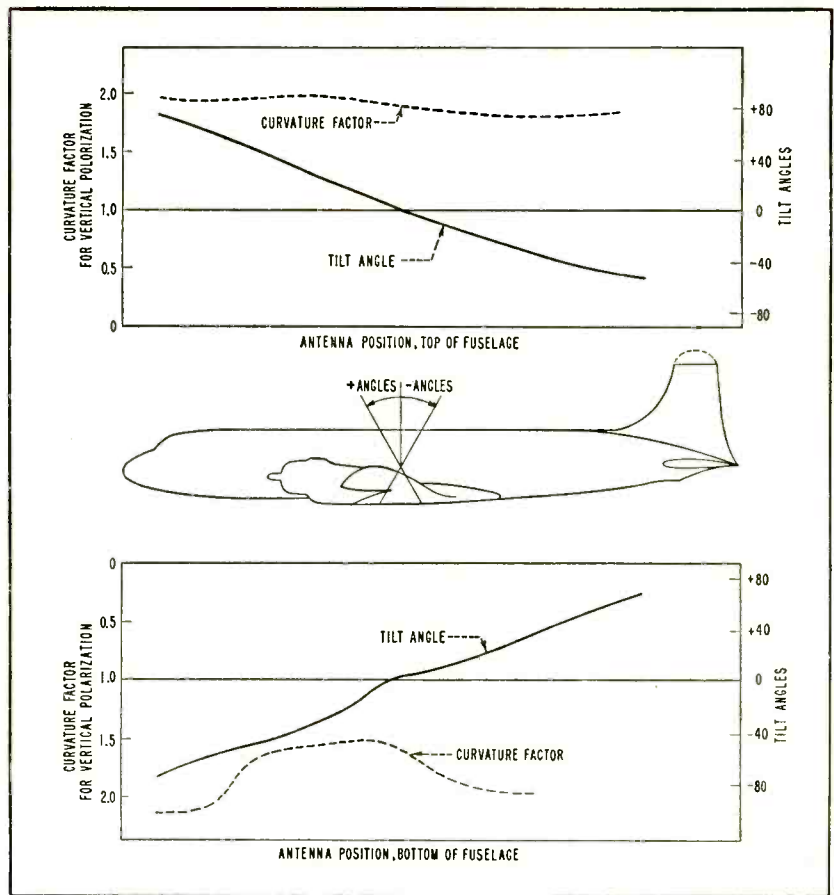

FIG. 3—Measured curvature factors and tilt angles for small l-f receiving antennas on DC-4 aircraft

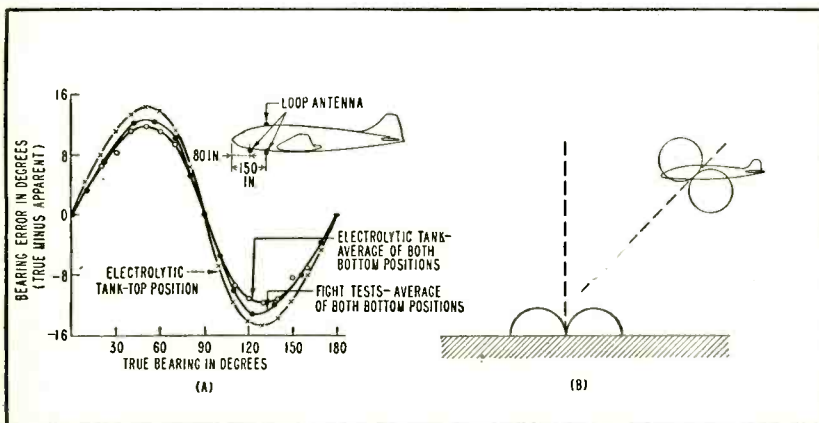

FIG. 2—Quadrantal error of l-f d-f loop from electrolytic-tank measurement and DC-3 flight (A), and double cone-of-silence resulting from tilted radiation (B)

type 1049 Constellation aircraft. The solid curve is for a wire insulated from the point of attachment on the vertical fin, and the dashed curve for a wire grounded at the fin. It is of interest to note the complementary nature of the two sets of curves. If a suitable remotely controlled grounding switch were used between the wire and the fin tip, it could be operated to yield an inductive input reactance over almost the entire frequency range, enhancing matching-network efficiency.

The environmental requirements on such a switch are severe, however, and the benefit indicated by the impedance curves may be difficult to achieve and maintain in practice.

A better method of exciting the airframe, and one that is adapted to flush-mounting, is the so-called cap antenna. In this arrangement a portion of an extremity of the airframe, such as the tip of the vertical fin or a wing tip, is electrically isolated from the remainder of the airframe by a suitable dielectric structure to provide antenna-input terminals. Since the extremities of the airframe are high-voltage points at all frequencies, such a voltage-feed

arrangement yields a smooth input impedance curve. This is seen in Fig. 4B, which is for a 5-foot tail cap on a DC-4 aircraft.

Increasing the tail-cap size decreases input reactance, but has little effect on input resistance. The size required for the isolated cap is therefore directly related to the power-transfer efficiency required of the associated matching network. In practice, with airframes the size of a DC-4 or larger, a cap 3 to 4 feet long has provided adequate system performance.

One feature of the cap configuration poses special design problems. Because the cap must be located on an extremity of the airframe, it is especially vulnerable to lightning and is the preferred location for the collision-warning lights. Satisfactory lightning-arrestor designs have been worked out, however, and it has proved possible to design low-capacitance transformers, which will withstand the peak r-f voltages, for lighting collision-warning lights on 400-cycle a-c.

When a loran antenna is required, it may be desirable to use a tail-cap antenna for both loran and h-f communications. Since the antenna requirements for h-f transmission are

the more severe, a tail cap adequate for h-f use is entirely adequate for loran. Diplexer units have been developed that satisfactorily permit simultaneous use of a single tail cap for loran reception and h-f transmission or reception.

Though the diplexer creates an additional space and weight problem, in many applications the complexity of such a solution may be acceptable, for in addition to the operational flexibility it affords, it avoids the requirement for an antenna changeover relay that must handle high peak voltages developed in h-f transmission.

Many of the important radio functions in modern aircraft operation employ frequencies above 100 mc and a wide variety of flush-mounted antennas has been developed to meet these requirements. In this frequency range the most difficult aspect of flush-antenna design is the choice of a location for the antenna that will yield adequate radiation patterns. With only one or two exceptions, antenna elements large enough to provide an acceptable impedance match are still small enough to be installed without creating difficult structural problems.

The pattern coverage problem

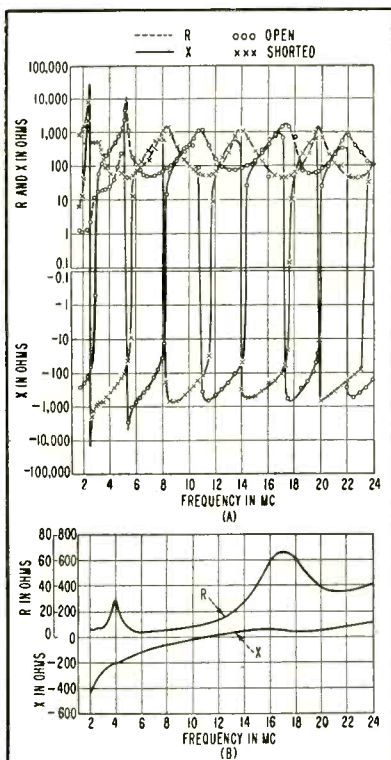

FIG. 4—Input impedance at fin (A) and impedance of 5-foot tail cap (B)

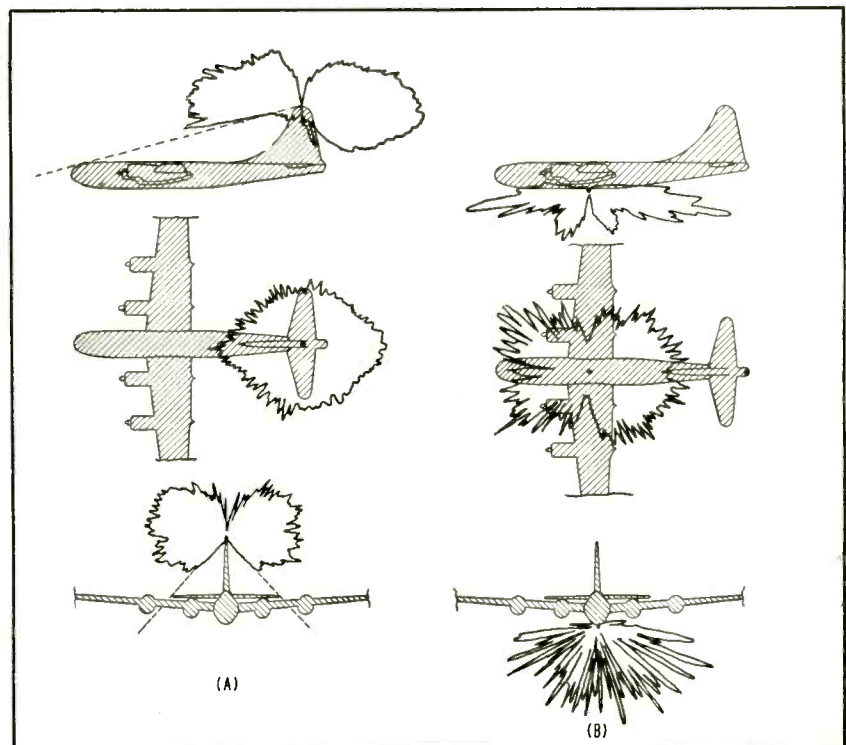

FIG. 5—Radiation from vertical stub on B-50 stabilizer tip (A) and comparable pattern from antenna under fuselage (B)

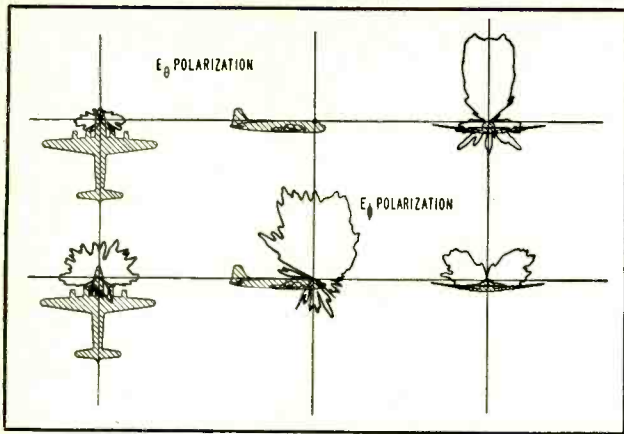

FIG. 6—Ram's horn omnirange antenna pattern when mounted over pilot's compartment on DC-6B. Curves for E_{θ} are desired horizontal polarization

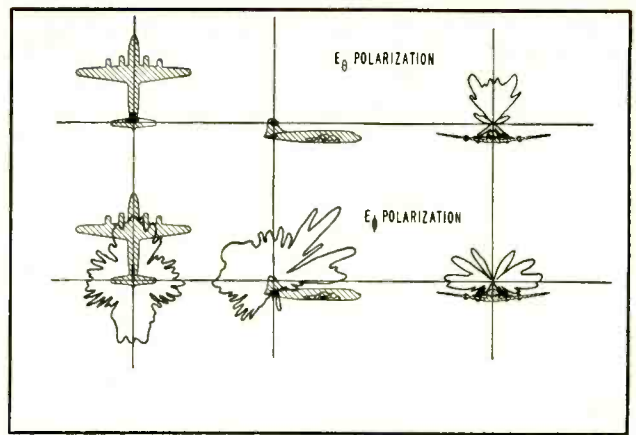

FIG. 7—Results of reception tests using a cavity omnirange antenna in vertical fin of DC-6B. Desired horizontal polarizations (lower row) is marked E_{θ}

arises in two ways. The usual operational requirement is for substantially omnidirectional (more accurately, omnizimuthal) coverage. In this frequency range the radiated fields behave much like light rays. The presence of a large obstacle, like an airframe, in the straight-line path between the antenna element and the distant terminus of the radio link creates a shadow often dark enough to prevent useful communication. The nature of these shadows is clearly evident in Fig. 5, in which the measured radiation patterns of uhf stub antennas in two common locations have been superimposed on drawings of the airframe to show the relationship of the shadow to the airframe geometry.

In Fig. 5A it is evident that for a stub on the tip of the vertical stabilizer the fuselage casts a deep shadow below and forward of the aircraft, an operationally important region in any air-to-ground system. For a location on the belly, as in Fig. 5B, the fuselage shadow covers the entire upper hemisphere, an embarrassing circumstance in air-to-air systems and in air-to-ground systems also whenever the aircraft enters a banking turn. A moment's reflection will suffice to shatter the illusion that there might be some other location on the airframe in which the shadowed region might be more confined. The designer is left with two alternative approaches to the problem: locate the antenna at a spot where the shadowed region is of little operational significance, or employ two or more antennas in some diversity scheme.

The first approach is practical in applications such as the glide-slope, marker-beacon and radio-altimeter systems where coverage to the rear in the first instance, or the upper hemisphere in the latter cases, is of no operational value. The second approach is almost imperative in applications like the proposed air traffic control beacon, where omnidirectional coverage is essential to the operational objective of the system, the continuous tracking of air traffic in the interests of safety and efficiency. Unfortunately, there are many applications such as air-to-air communications and the VOR navigation system, in which the first approach is unsatisfactory from the operational standpoint and the second poses formidable equipment design difficulties.

Figure 5 demonstrates also the second major problem in obtaining adequate radiation patterns in this frequency range—the presence of interference nulls. Radiation incident on the airframe is reflected at glancing angles and combines with direct radiation from the antenna element in a vector fashion, enhancing the resultant signal when the two components are in phase and reducing the resultant field when the two components are out of phase. Since reflection from a curved surface is diffused, the most serious lobing problems are encountered when the reflecting surface is large, relatively flat and strongly illuminated by the radiating element.

Deep nulls occurring at angles near the zenith in the head-on view of Fig. 5A and throughout the lower

quadrants in the corresponding view of Fig. 5B illustrate this effect. A degree of control is possible through shaping the primary pattern of the radiating element to restrict the illumination on these strongly reflecting areas.

The difficulties outlined above are by no means peculiar to flush-mounted antennas but occur with external types also. In many cases a flush design may avoid other problems encountered with the older types. An excellent example of this situation is illustrated by a comparison of Fig. 6 and 7. Figure 6 shows the radiation patterns of a standard rams horn vhf omnirange antenna on a DC-6B and Fig. 7 the same patterns for a flush-mounted cavity antenna located in the vertical fin of the same aircraft.

A comparison of the two figures shows that not only is the coverage in the operationally important regions near the horizon better for the flush installation but the level of the cross-polarized field is substantially lower for flush-mounting. These cross-polarized components lead to course pushing in banking turns and thus degrade the performance of the VOR system.

The first drawing indicates preferred locations for present flush-mounted vhf antennas on a typical airframe along with the major dimensions of the antenna elements.

BIBLIOGRAPHY

- A. A. McKenzie, Electronic Aids to Air Navigation, *ELECTRONICS*, p 66, Feb. 1950.
- R. L. Tanner, Antenna-Matching Network Efficiency, *ELECTRONICS*, p 142, Nov. 1953.
- A. G. Kandoian, Aircraft Omnidirectional Antenna Problem for UHF Navigation Systems, *Aero Eng Rev*, p 75, May 1953.

PHASE-SENSITIVE DETECTORS FOR COLOR TELEVISION

Reception of NTSC color transmissions requires the decoding of a subcarrier signal that conveys information about color hue and saturation. These two independent parameters of chrominance are sent over a common carrier by a particular process of diplexing. Two components of the subcarrier, 90 degrees apart in phase, are separately amplitude modulated and then added. To recover the complete color information, it is necessary to use some form of phase-sensitive detection that responds to the color signal at a selected phase, while ignoring the component in time quadrature.

A popular type of color detector is the product demodulator, which uses a pentagrid tube with reference carrier and color signal applied separately to each one of two concentric control grids.^{1, 2}

A second approach³ employs a beam-deflection tube for color decoding. This is basically a product demodulator in which the second control grid is replaced by deflection control.

The pulsed-envelope detection method uses rectifiers rather than modulators for synchronous detection. The rectifiers may be either conventional diodes or triodes. Since they are keyed in and out by a local oscillator the term pulsed-envelope detection is employed

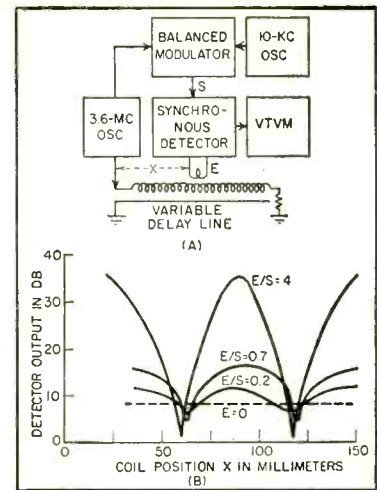

FIG. 1—Experimental pulsed-envelope detection setup for checking phase selectivity (A) and resulting curves (B)

TV Color Detectors Use

Synchronous detectors of pulsed-envelope type offer adequate phase fidelity, inherent amplitude linearity and, when grid-controlled rectifiers are used, high gain. Circuits are simple and use conventional components. Balanced and unbalanced types are described

PULSED-ENVELOPE DETECTORS may find increasing application as decoders in color-television receivers. As compared to product demodulators, they require somewhat lower impedance at the signal and injection terminals to cope with feed-through and crosstalk effects.

Two basic pulsed-envelope detector circuits are the balanced and unbalanced types. The former is superior in several ways and may be preferred for encoding equipment. The latter offers high gain and adequate fidelity combined with circuit simplicity. These attributes recommend it for receiver applications.

A circuit for pulsed-envelope detection resembles one for envelope detection except that a synchronous local-oscillation is added to the signal before detection. Figure 1A illustrates an experimental test for phase selectivity of pulsed-envelope

detection. Energy from a 3.6-mc oscillator is supplied to a balanced modulator where it is modulated by a 10-kc signal corresponding to the color information. The carrier is suppressed and the output coupled to a crystal diode. Synchronous injection voltage is derived from the 3.6-mc oscillator through a delay line. This line is a helix wound around a slotted metal tube with a sliding pickup coil inside.

Principle of Detection

Assume an amplitude-modulated carrier

$$s = S(t) \sin(\omega t) \quad (1)$$

is combined with a local-oscillator signal

$$e = E \sin(\omega t + \phi) \quad (2)$$

The composite signal has the envelope

$$A = (E^2 + S^2 + 2ES \cos \phi)^{1/2} \quad (3)$$

After passing through a half-wave rectifier and a low-pass filter $1/\pi$ of the envelope is recovered. With a peak detector, all of it is recovered. In both cases the phase selectivity of the system is described by Eq. 3.

If the injection voltage is increased to a point where terms like $(S/E)^2$ and higher powers are negligible, Eq. 3 reduces to

$$A = E + S(t) \cos \phi \quad (3A)$$

The d-c term is rejected by capacitive coupling. The a-c term illustrates that pulsed-envelope detection recovers the original modulation but multiplies it by the cosine of the phase difference between signal and injection. This is basically the same effect that a product demodulator would produce.

Figure 1B shows detector output as a function of delay for various values of injection ratio. With no

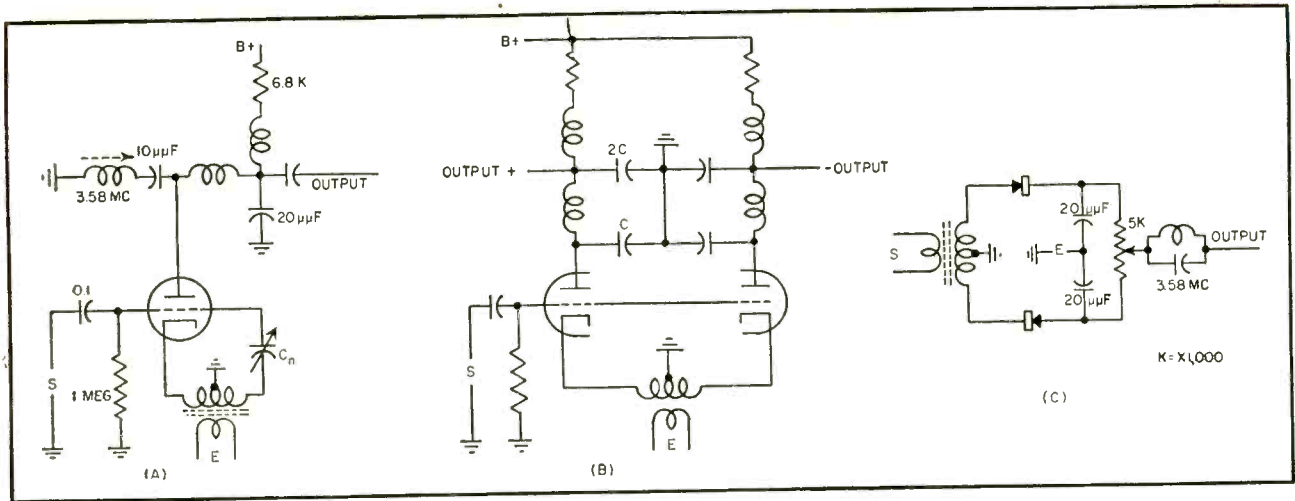

FIG. 2—Variations of the pulsed-envelope detector: unbalanced-triode circuit with single output (A), unbalanced circuit with double output (B) and balanced circuit using crystal diodes (C). All these phase detection circuits have been employed successfully in experimental color television receivers

Pulsed-Envelope Method

injection, the output is constant, though it consists mainly of the second harmonic of the modulation. Phase selection builds up fast with increasing injection and is practically complete for $E/S = 4:1$. Beyond that value, the output amplitude is saturated, harmonic distortion is small and the minima are at least 30 db down from the peaks. Both minima and peaks coincide respectively with multiples of 90-deg and 180-deg phase shift.

In color television the signal conveys two separate modulations m_i and m_q that are impressed on a two-phase carrier by balanced modulators. The result is a signal of the form

$$s = m_i \sin \omega t + m_q \cos \omega t \quad (4)$$

with the amplitude

$$S = (m_i^2 + m_q^2)^{1/2} \quad (5)$$

If a local oscillation is added, the composite signal can be written

$$s + e = \sin \omega t [E \cos \phi + m_i] + \cos \omega t [E \sin \phi + m_q] \quad (6)$$

The envelope of the composite signal is

$$A = E \{ [1 + (m_i/E) \cos \phi + (m_q/E) \sin \phi]^2 + [(m_i/E) \sin \phi - (m_q/E) \cos \phi]^2 \}^{1/2} \quad (7)$$

The second bracket indicates cross-talk components. If these were

By KURT SCHLESINGER

Television Research Department
Motorola, Inc.
Chicago, Ill.

absent, Eq. 7 would take the form

$$A = E + m_i \cos \phi + m_q \sin \phi \quad (8)$$

which illustrates that both m_i and m_q may be recovered except for their d-c components by bringing the injection into phase with their respective carriers, $\phi = 0$ deg and $\phi = 90$ deg. Ideal operation can be approached within p percent by increasing the injection ratio beyond

$$E/S > 7/(p)^{1/2} \quad (9)$$

An injection ratio of 7:1 keeps crosstalk terms below 1 percent.

Practical Circuits

Figure 2 presents several circuits of pulsed-envelope detectors used successfully in color receivers.

Figure 2A shows a triode with signal applied to grid from a low-impedance band-pass filter and reference carrier fed into cathode across a small inductance. If the amplitude of cathode injection equals the cutoff voltage (5v), the tube becomes a cathode-driven half-wave rectifier by self bias in the grid-leak circuit. Cathode feed-

through to the grid may be neutralized by capacitor C_n . Plate feedthrough is minimized by a tuned trap. Since the system is unbalanced for both signal and injection, a low-pass output filter is needed and the d-c component of the color signal is lost.

Figure 2B shows the same unbalanced triode detector with balanced output. By using a bifilar cathode inductance, cathode-to-grid feed through becomes self neutralizing as does grid-to-cathode coupling caused by plate current. Plate-to-grid crosstalk at the color sub-carrier frequency is greatly reduced and occurs mostly at the second harmonic.

Figure 2C illustrates a balanced detector. The output is balanced with respect to signal but a tuned trap is required to keep the local carrier out. Sources S and E may also be reversed. In such a circuit the trap is replaced by a low-pass filter, preferably a π network.

In balanced circuits color difference signal is detected without any d-c pedestal so that the d-c component of the signal is recovered. There are several other forms of such circuits including a double-

balanced type, which removes both signal and injection from the detected output by cancellation rather than by filtering.⁴

Color Phase Fidelity

To evaluate the phase fidelity of a color detector, its ability to display the phase angle α in the specific signal

$$s = S \sin(\omega t + \alpha) \quad (10)$$

is examined where S is constant and α is time variable at less than 500 kc.

If two synchronous product detectors are used to demodulate the signal, the detectors multiply the signal by the factors e_x and e_y .

$$Y = (S^2 + E^2)^{1/2} [1 + m \sin \alpha - \frac{1}{2}m^2 \sin^2 \alpha + \dots] \quad (15B)$$

The first term is a d-c component that is rejected. The second term alone would reproduce a true circle with the radius $R = S/[1 + (S/E)^2]^{1/2}$. The third term is the distortion term

$$\begin{aligned} \Delta X &= - (S^2 + E^2)^{1/2} (m/2)^2 \cos^2 \alpha \\ \Delta Y &= - (S^2 + E^2)^{1/2} (m/2)^2 \sin^2 \alpha \end{aligned} \quad (16)$$

A geometrical relation derived by projection of ΔX and ΔY on the circle perimeter links the distortion terms to the phase error $\Delta\alpha$

$$\Delta\alpha = \alpha - \beta = (\Delta X/R) \sin \alpha - (\Delta Y/R) \cos \alpha \quad (17)$$

Using this relation in Eq. 16, an

injection, there would be no color distortion for blue, red and green; most of it would happen for yellow and cyan.

Figure 4A shows how the color phase error depends on the injection ratio. An E/S value of 6.5 assures a phase accuracy of ± 3 degrees, while ± 2 degrees would require an injection ratio of 10:1.

A similar analysis has been done for the balanced type of pulsed-envelope detector, (Fig. 2C). Here, the detector output is the difference of the envelopes detected by both diodes

$$e_d = \frac{1}{2}(S^2 + E^2 + 2SE \cos \alpha)^{1/2} - \frac{1}{2}(S^2 + E^2 - 2SE \cos \alpha)^{1/2} \quad (20)$$

If this expression is expanded and

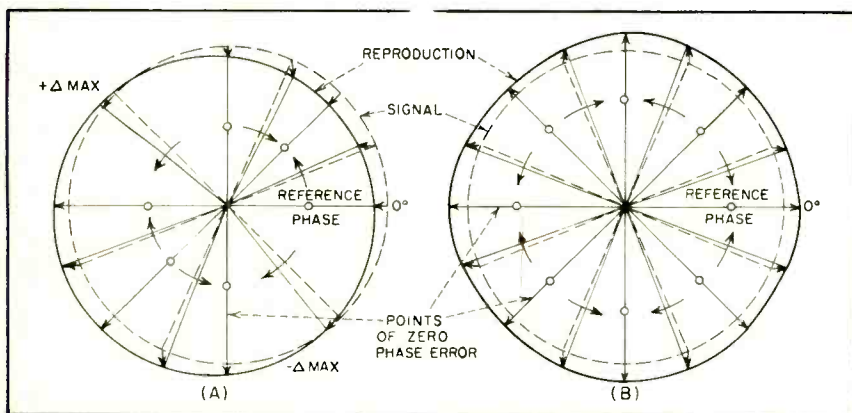

FIG. 3—Phase-error distribution with unbalanced circuit (A) and with balanced circuit (B). Graph can be interpreted in colors if phase of local oscillator is given

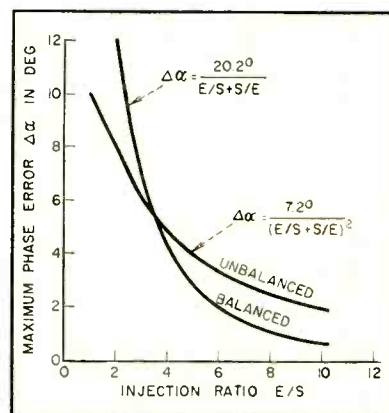

FIG. 4—Maximum phase error of pulsed-envelope detectors

$$e_x = E \sin \omega t \quad (11A)$$

$$e_y = E \cos \omega t \quad (11B)$$

Each low-frequency output becomes

$$\begin{aligned} X &= \frac{1}{2} S \cos \alpha \\ Y &= \frac{1}{2} S \sin \alpha \end{aligned} \quad (12)$$

When applied to an oscilloscope, the angle β is identical with α at any instant and the display is a true circle.

When two pulsed-envelope detectors are employed, the X-coordinate is the envelope of the sum of Eq. 10 and 11A

$$X = (E^2 + S^2)^{1/2} (1 + 2m \cos \alpha)^{1/2} \quad (13A)$$

where

$$m = 1/[(E/S) + (S/E)] \quad (14)$$

Likewise

$$Y = (E^2 + S^2)^{1/2} (1 + 2m \sin \alpha)^{1/2} \quad (13B)$$

This may be expanded

$$X = (S^2 + E^2)^{1/2} [1 + m \cos \alpha - \frac{1}{2}m^2 \cos^2 \alpha + \dots] \quad (15A)$$

expression for the phase error of an unbalanced pulsed-envelope detector is obtained

$$\Delta\alpha = - (\sqrt{2}/4)m \sin 2\alpha \cos(\alpha + 45 \text{ deg}) \quad (18)$$

This equation indicates that phase error is not constant but is rather a function of phase angle. There is no color distortion along the three axes under 0, 45 and 90-deg off sampling phase. The greatest phase error occurs at $+135$ deg and at -45 deg off reference. It amounts to

$$\Delta\alpha_{\text{max}} = 20.2 \text{ deg} / [(E/S) + (S/E)] \quad (19)$$

Phase Errors

Figure 3A shows the angular distribution of phase errors according to Eq. 18. This graph can be interpreted in terms of colors, if the phase of the local oscillator is given. If blue is chosen as the phase of

treated as before, the error distribution of the balanced phase detector is found to be

$$\Delta\alpha = (m/8)^2 \sin 4\alpha \quad (21)$$

as well as the limit of its accuracy

$$\Delta\alpha_{\text{max}} = 7.2 \text{ deg} / [(E/S) + (S/E)]^2 \quad (22)$$

Both data are plotted in Fig. 3B and 4B respectively.

It is found that the balanced phase detector is superior to the unbalanced type in three respects. It offers zero color phase error along four, rather than three, color axes. These axes go through center under multiples of 45 degrees, as counted from local-oscillator phase. The balanced detector also offers better color fidelity for the same injection ratio than does the unbalanced type; its ultimate precision is about twice as good. Finally, it permits d-c recovery and is insensitive to incidental ampli-

tude modulation of the injection.

The unbalanced triode detector (Fig. 2A) is adequate for receiver applications while the circuit of Fig. 2C may be preferred for encoding equipment.

Linearity and Gain

In a color receiver, linearity of the amplitude response is almost as important as phase linearity since it insures independence of color rendition and saturation. Pulsed-envelope detectors are inherently linear in response to small signals even if the rectifying elements have nonlinear characteristics.

For the detector shown in Fig. 2A, power law is assumed for the

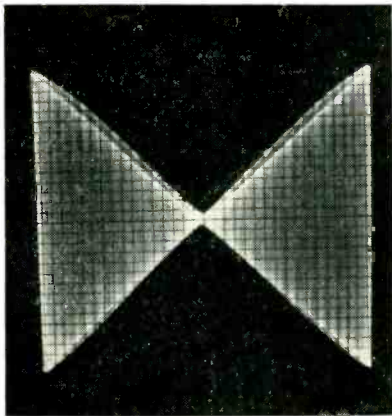

FIG. 5—Display illustrating amplitude linearity of pulsed-envelope detection

triode characteristic

$$i_p/i_0 = (x/|x|)^n \quad (23)$$

where x = grid swing from cutoff and i_0 = plate current at zero grid.

If the tube is biased at cutoff e_c and the grid swing consists of local-oscillator voltage $E \sin \omega t$ and the signal $S \sin \omega t$, both in phase, the plate-current wave is

$$i_p = [(E+S)/e_c]^n i_0 (\sin \omega t)^n \quad \text{for } 0 < \omega t < \pi$$

$$i_p = 0 \quad \text{for } \pi < \omega t < 2\pi \quad (24)$$

The change of the average plate current under the influence of the signal is

$$\Delta i_p = i_0 K_n (E/e_c)^n \{ [1 + (S/E)]^n - 1 \} \quad (25)$$

where K_n is the form factor of the plate current

$$K_n = (1/2\pi) \int_0^\pi (\sin \alpha)^n d\alpha \quad (26)$$

Values of K_n are tabulated below

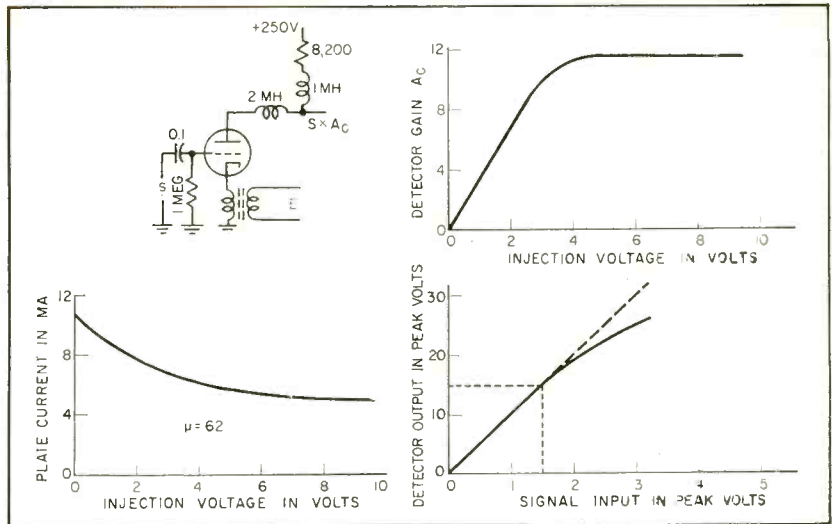

FIG. 6—Performance data for a pulsed-envelope detector using unbalanced triode in a self-biasing circuit with single output

for various exponents of n of the power law, (Eq. 23)

n	K_n
0.5	0.38
1	0.32
1.5	0.28
2	0.25

The linear relation between plate output and signal becomes evident by applying the binomial rule to Eq. 25

$$\Delta i = K_n i_0 \left(\frac{E}{e_c} \right)^n \left(\frac{S}{E} \right)^n \times \left[1 - \frac{n-1}{2} \frac{S}{E} + \frac{(n-1)(n-2)}{6} \left(\frac{S}{E} \right)^2 \dots \right] \quad (27)$$

This expansion indicates linear amplitude response for small signals regardless of the exponent n .

The range of linearity increases with increasing injection E . The eventual deviation from linearity may be either negative or positive, depending upon whether the rectifier characteristic is a root or power law.

Verification

In a test to check this theory a balanced modulator produced a-m at a 60-cps rate on an offset carrier whose frequency was $3.58 + 0.001$ mc. One volt of this signal fed into the grid of a triode like that shown in Fig. 2A while 10 volts of a 3.58-mc carrier were fed to the cathode. The plate output was used as vertical deflection of a cro and the modulating 60-cps sine wave as a time base.

Figure 5 shows the resultant display. This indicates amplitude

linearity as expected. Moreover, it shows symmetry of phase response since the horizontal axis bisects the angle between envelopes.

Equation 27 also gives the gain that can be expected of a synchronous triode. By comparing the linear factor of Eq. 27 with the slope of the characteristic in Eq. 23 at the working point $x = E$, the conversion transconductance g_c of the detector becomes

$$g_c = g_m K_n \quad (28)$$

Here, K_n is the form factor defined in Eq. 26. Values of K_n center around $\frac{1}{3}$.

The conversion gain of a synchronous triode detector in a circuit such as the one shown in Fig. 2A should be about one-third the amplifier gain of the tube in the same circuit. Since no degeneration is used, conversion gains of 10 and more are readily obtained.

Figure 6 presents some data obtained with one section of a 12AT7 triode in the self-biasing circuit Fig. 2A. The drop of plate current to one-half its d-c value indicates class B operation. Gain, phase and amplitude linearity are fully adequate for color decoding.

REFERENCES

- (1) Charles J. Hirsch and Bernard D. Loughlin, General Color-Receiver Design Considerations, *Trans IRE PGTR-2*, March 1953.
- (2) D. H. Pritchard and R. N. Rhodes, Color Television Signal Receiver Demodulators, *BCA Review*, 14, No. 2, p 205, June 1953.
- (3) R. Adler and Charles Heuer, Color Decoder Simplifications Based on a Beam-Deflection Tube, lecture presented RETMA Fall Meeting in Toronto, Oct. 1953.
- (4) Kurt Schlesinger and Leroy W. Nero, Phase Indicator for Color Television, *ELECTRONICS*, p 113, Oct. 1952.

Design of Transistor

Procedure is outlined for choosing optimum circuit and transistor connections for obtaining best combination of distortion, available output power, power supply drain, stage gain and power supply with given transistor characteristics

DESIGN of transistor power amplifiers involves an approach completely different from that used in designing vacuum-tube power amplifiers. The difference is due primarily to the limitation of maximum available transistor power gain to about 40 db.

With vacuum tubes the entire burden of power amplification is left to the final stage; in the transistor amplifier each stage contributes power gain, and power level increases in more or less even steps from stage to stage in the amplifier.

The final or output stage of a transistor power amplifier presents the most challenging problem. To obtain maximum possible power output with acceptable distortion and without exceeding transistor ratings, many factors must be taken into account.

As with vacuum tubes, the designer of transistor power amplifiers has to make a choice of the basic circuit to be used; that is, single-ended class-A, push-pull class-A or push-pull class-B. The choice is further complicated in that, for each of the above circuits, there is a choice of three basic transistor configurations (grounded-base, grounded-emitter or grounded-collector) for each application.

The considerations that lead to a decision are distortion, available power output, power supply drain, stage gain and choice of type of power supply.

Transistor Characteristics

Figure 1 shows the output characteristics for the three transistor configurations. While the characteristics for the grounded-base con-

figuration are extremely linear and evenly spaced, with a small sharp knee at the break point, those for the grounded-emitter and grounded-collector configurations show considerable nonlinearity and unevenness, and also a large well-rounded knee at the break point.

If low distortion is the prime requisite, the grounded-base stage is clearly indicated. Push-pull operation results in cancellation of the even harmonics, and is preferable to the single-ended connection. Class-A operation offers an advantage in that it avoids switching transients that may occur in class-B operation under certain conditions.

Since the collector efficiency of class-B amplifiers is higher than that of class-A amplifiers, power output for the same average collector dissipation is correspondingly higher in class-B. Furthermore, the collector supply current of a class-A amplifier is independent of signal amplitude, while that of a class-B stage varies with the signal. Hence, if maximum available output power and low supply drain are of importance, class-B operation is indicated.

Class-A Amplifiers

Distortion in a transistor output stage is the result of nonlinearities in the input circuit as well as in the output circuit. Due to the extreme linearity of the output characteristics of the grounded-base configuration, the contribution to distortion from this side is very low if reasonable care is taken to avoid overloading.

The input distortion is investigated as follows. The small-signal input impedance of a grounded-base

Table I—Approximate Conditions for Class-B Transistor Amplifiers

	Grounded Base	Grounded Emitter	Grounded Collector
A-C Power Output in Watts	$\frac{aE_c E_e'}{2}$	$\frac{aE_c I_e'}{2}$	$\frac{E_c I_e'}{2}$
D-C Power Input in Watts	$\frac{2aE_c I_e'}{\pi}$	$\frac{2aE_c I_e'}{\pi}$	$\frac{2E_c I_e'}{\pi}$
Efficiency η in Percent	78	78	78
Load Resistance in Ohms	$\frac{4E_c}{aI_e'}$	$\frac{4E_c}{aI_e'}$	$\frac{4E_c}{I_e'}$
Peak Input Resistance in Ohms (per transistor)	$\frac{V_e'}{I_e'}$	$\frac{V_e'}{I_e'(1-a)}$	$\frac{E_c}{I_e'(1-a)}$
Peak A-C Output in Watts	$aE_c I_e'$	$aE_c I_e'$	$E_c I_e'$
Peak A-C Input in Watts	$V_e' I_e'$	$V_e' I_e'(1-a)$	$E_c I_e'(1-a)$
Peak Power Gain	$\frac{aE_c}{V_e'}$	$\frac{aE_c}{(1-a)V_e'}$	$\frac{a}{(1-a)}$

Power Amplifiers

By **S. K. GHANDHI**

Electronics Laboratory
General Electric Company
Syracuse, New York

transistor, for any particular load, may be given approximately by

$$r_i \cong \frac{dE_e}{dI_e} \cong \frac{k_2}{I_e + k_1} \quad (1)$$

where k_1 and k_2 are constants, and E_e and I_e are the emitter voltage and current respectively. For an operating point E_{e1} , I_{e1} , and for a sinusoidal input voltage

$$v_e = v \sin \omega t \quad (2)$$

Eq. 1 may be solved, and the input current obtained as

$$i_e = (I_{e1} + k_1) \left[\exp \left(\frac{v}{k_2} \sin \omega t \right) - 1 \right] \quad (3)$$

Fig. 2A shows the input current waveform resulting from an applied sine wave of voltage. The effect of inserting a resistance R in series with the emitter is shown in Fig 2B. This resistance tends to remove the effect of the nonlinearity. Input circuit distortion can be kept under 2 percent when this resistance is about five times the small-signal input resistance of the transistor. Thus some degree of mismatch is necessary when coupling the driver to the output stage. A power loss of about 2.5 db occurs as a result of this mismatch.

Grounded-Base Circuit

Figure 3 shows the output characteristics for a grounded-base transistor. Also shown, in dotted line, is the contour (rectangular hyperbola) for maximum permissible collector dissipation. Since the voltage across the emitter is very small, emitter dissipation may be neglected, compared to that in the collector. Consequently, the dotted line is to a close approximation the permissible power dissipation for the transistor. The oper-

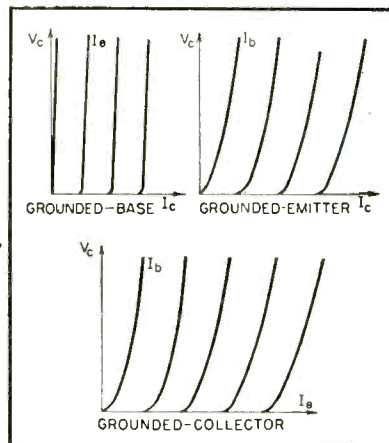

FIG. 1—Transistor output curves for the three possible transistor connections

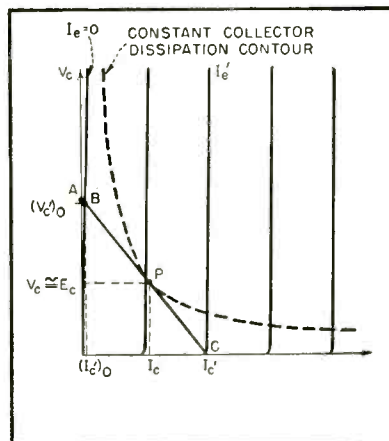

FIG. 3—Output curve for grounded-base transistor, showing operating point

ating point must be chosen to lie on this curve, if the transistor is to be operated at its maximum rating.

The choice of operating point is further restricted, since the maximum collector voltage swing must be less than the permissible peak inverse voltage of the collector diode. This sets the supply voltage to a maximum of one half the permissible peak inverse voltage. Yet another restriction is the fact that beyond a certain value of collector current, the α of a transistor begins to fall off, resulting in a crowding of the collector characteristics. Operation in this region can lead to considerable distortion.

The load line must now be drawn tangential to the hyperbola, subject to the above restrictions on permissible maximum current and voltage

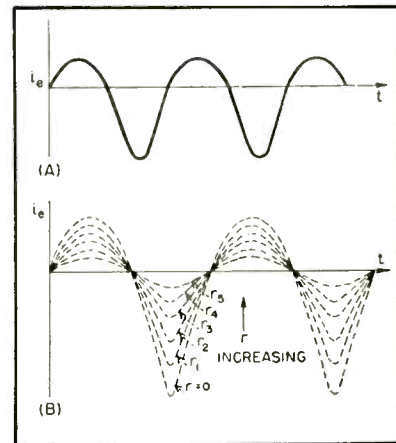

FIG. 2—Input current waveforms with and without compensating resistance

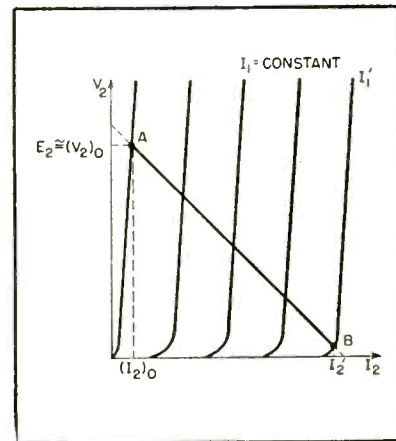

FIG. 4—Curves for analyzing class-B transistor operation

swing. In Fig. 3, P is the operating point, I_e is the operating current, E_e is the supply voltage, $V_e \cong E_e$ is the operating voltage, I_c' is the peak collector current, I_e' is the peak emitter current, $(V_e)'$ is the peak emitter voltage and $(I_c)'$ is the back collector current at the peak voltage swing.

Adjustment of the operating point must be made to correct for the presence of $(I_c)'$, so that $I_c' - I_e = I_e - (I_c)'$, whereupon the positive and negative current swings are of equal magnitude. The load resistance, maximum a-c power output, battery power and collector efficiency are

$$R_L = \frac{(V_e)'}{I_c' - (I_c)'} \cong \frac{E_e}{I_e}$$

$$P_{o(max)} = [I_e - (I_c)'] E_e / 2 \quad (4)$$

$$P_{d-c} = E_c I_c \quad (5)$$

$$\eta = \frac{P_o}{P_{d-c}} = \frac{50[I_c - (I_c')_o]}{I_c} \text{ percent} \quad (6)$$

The efficiency depends on the peak value of the back collector current. Efficiencies as high as 49 percent may be obtained when this current is very small. Under high-level operation, however, the back collector current increases considerably due to heating of the collector junction, and the efficiency usually falls to about 47 percent.

The results for class-A operation in push-pull may be easily obtained from the results for the single-ended case.

In some applications, economy considerations require the use of a single-ended grounded-emitter output stage, since such a stage has a higher power gain. With this configuration the distortion in the collector side, due to crowding of the characteristics, is quite appreciable. It can be seen, however, that this distortion tends to compensate that produced in the emitter circuit, and hence minimum output distortion occurs when the transistor is fed from a constant-voltage source. By way of comparison, using a transistor rated at 100-mw dissipation, it is possible to obtain 45 mw at 2 percent distortion with a grounded-base stage, but only 40 mw at 5 percent distortion with a grounded-emitter stage.

Class-B Operation

Permissible power dissipation of presently-available transistors is relatively low, making class-B operation extremely attractive.

Since distortion may not be of primary importance in class-B operation, all three configurations will have to be considered.

Figure 4 shows a typical transistor output characteristic. The curves are drawn for V_2 versus I_2 , with I_1 as parameter. Here AB is a load line with operating point A at $(V_2)_o$ approximately equal to the battery voltage E_c , since the d-c resistance in the output circuit is neglected. Back diode current is $(I_2)_o$ (at the operating voltage) and I_2' is the peak output current swing, extending to the point B and corresponding to a peak input current I_1' . Under this condition

of operation, the peak inverse voltage on the transistor is twice the value of $(V_2)_o$ when the output is transformer-coupled to the load. With the operating point at A , the zero-signal output circuit dissipation per transistor is approximately $E_2 (I_2)_o$. Under maximum signal conditions, the output signal consists of a series of half-sinusoids of peak value $[I_2' - (I_2)_o]$ resulting in an average d-c current of $1/\pi [I_2' - (I_2)_o]$ over and above the standby current.

Supply power per transistor for maximum signal is

$$P_{d-c} \cong E_2 \left[\frac{1}{\pi} \{ I_2' - (I_2)_o \} + (I_2)_o \right] \quad (7)$$

$$\cong \frac{E_2}{\pi} [I_2' + (I_2)_o(\pi - 1)] \quad (8)$$

The a-c power contribution per transistor is

$$P_o = \frac{E_2 [I_2' - (I_2)_o]}{4} \quad (9)$$

Output circuit efficiency in percent is

$$\eta \cong \frac{P_o}{P_{d-c}} \cong 78 \left[\frac{I_2' - (I_2)_o}{I_2' + (I_2)_o(\pi - 1)} \right] \quad (10)$$

Maximum signal dissipation per transistor is

$$P_D = P_{d-c} - P_o \cong [0.068I_2' + 0.932(I_2)_o]E_2 \quad (11)$$

The effect of the second term is

often comparable to that of the first, especially in high-voltage low-current operation. The load resistance is

$$R_L = \frac{E_2}{I_2'} \cong \frac{0.068E_2^2}{P_D - 0.932E_2(I_2)_o} \quad (12)$$

This is the load resistance per transistor. To obtain the primary impedance of the output transformer, this value must be multiplied by four. For example, for a transistor with a permissible peak inverse voltage of 40 v and a power dissipation of 0.1 w, the load resistance is 275 ohms per transistor and the primary impedance of the output transformer is 1,100 ohms. If $(I_2)_o \ll I_2'$, the various equations may be considerably simplified.

Figure 5 shows the circuit configurations, with the values of v_1 , v_2 , i_1 and i_2 given in terms of the peak transistor voltages and currents as obtained from the appropriate static characteristics. Remembering that $I_c' \cong a I_b'$ and $I_c' \cong b I_b' \cong I_b' a / (1 - a)$, the approximations listed in Table I_c for obtained.

Figure 6 shows V_o versus I_c for a transistor drawn in solid line for I_b constant, and in dashed line for I_b constant. The curves for I_b constant can be used for the grounded-base connection, while those for I_b constant must be used for the grounded-emitter and grounded-collector configurations. Comparison of the curves show that the curves for constant I_b have considerable curvature, and also that the curve for $I_b = 0$ gives a much larger minimum current, by a factor of $1/(1 - a)$, than the curve for $I_b = 0$. The consequence of this is that the peak current swing may be to the point D for the grounded-base configuration, but is limited to C for the other configurations. Also, the operating point for the grounded-base connection may be set at A , while for the other configurations it lies somewhere between A and B , depending on the d-c resistances of the base and emitter, and the driving source.

Comparative Performance

As far as peak power output is concerned where distortion rises rapidly, there is little difference although the grounded-base circuit

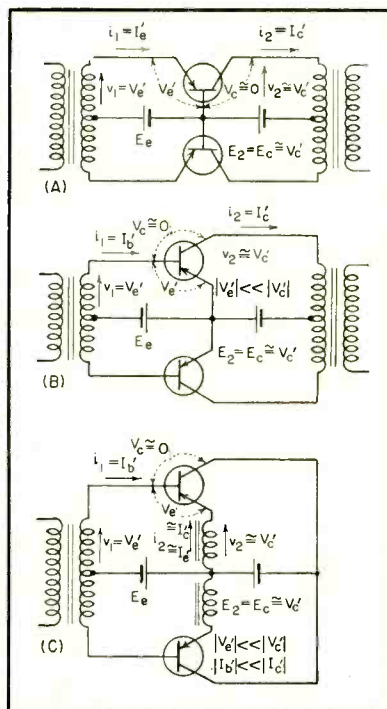

FIG. 5—Circuit configurations for push-pull class-B operation

is somewhat higher since the permissible swing is larger. Standby power may be less for the grounded-base circuit than for the other configurations. Efficiency at maximum output is nearly alike in all cases; efficiency on an equal distortion basis is highest for the grounded-base circuit.

Power gain is the product of the voltage amplification and current amplification, as follows

$$\text{Grounded base: } \frac{a^2 R_L}{r_e + r_b(1-a)}$$

Grounded emitter:

$$\frac{a^2 R_L}{(1-a)[r_e + r_b(1-a)]}$$

Grounded collector: $1/(1-\alpha)$

As long as operation is at high voltage and low currents, the grounded-emitter configuration gives maximum gain.

Equation 12 indicates that the load resistance varies approximately as the square of the supply voltage. Thus, the power gain of the grounded-base and grounded-emitter circuits varies as the square of the supply voltage, while the power gain of the grounded-collector is substantially independent of this voltage. Under low-voltage, high-current operation, the gain of the grounded-collector stage may actually exceed that of the other configurations. In this form of operation, the loss of signal due to the finite forward resistance of the input diode may be considerable, and transistors must be selected for low forward resistance.

Class-B operation in push-pull may be effected very conveniently by the use of matched *pn*p and *npn* transistors with parallel inputs.

One transistor behaves as an amplifier for the positive part of the signal, while the other unit amplifies the negative half. Phase splitting is thus performed automatically. The effect of paralleling the two outputs is to recombine the separate parts of the signal to form the whole. Thus, the load is a single-ended one, and a push-pull output transformer is eliminated.

In connecting the *pn*p and *npn* combinations, it is desirable that all power supplies have a common ground point with the circuit, so as

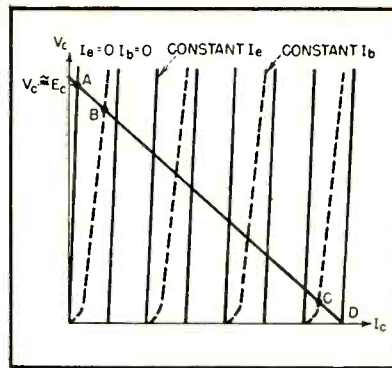

FIG. 6—Curves for constant emitter and constant base currents

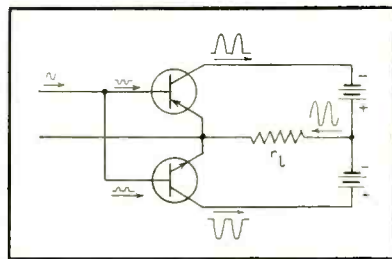

FIG. 7—Complementary symmetry class-B circuit

to allow these supplies to be used for earlier stages. With this restriction, it may be shown that the only circuit that may be used without an input transformer is the grounded-collector, as in Fig. 7.

Examples

By way of example, two designs will be considered. Values given in the examples correspond roughly to those obtained with the GE 2N34 *pn*p transistor.

Example 1—Design a 100-mw low-distortion audio amplifier stage. From linearity considerations, a push-pull class-A grounded-base configuration is desirable. Required power output is 50 mw per transistor. Assume η of 47 percent. Power dissipation per transistor will be $50/0.47 = 106$ mw.

Assuming a collector supply of 20 volts, I_c per transistor = 5.3 ma.

The back diode current at 40 volts may be taken as 0.25 ma when the transistor is dissipating 106 mw. The actual η (Eq. 6) is 47.5 percent. This checks with the assumed value. Load resistance per transistor is approximately $V_c/I_c = 3,800$ ohms. For this load and the appropriate value of the transistor parameters, the input resistance

per transistor¹ is

$$r_{in} \cong r_e + r_b \frac{R_L + r_c(1-a)}{R_L + r_c} \\ \cong 10 \text{ ohms}$$

The reflected source impedance of each transistor in the push-pull stage must be at least 50 ohms if the distortion is to be kept at about 2 percent. The mismatch factor k is equal to $50/10$ or 5. Loss due to mismatch is $4k/(k+1)^2$ or approximately 2.5 db. The power gain of the stage¹ is given by

$$PG = \frac{a^2 r_c R_L}{R_L(r_e + r_b) + r_c[r_e + r_b(1-a)]} \\ \cong 25 \text{ db}$$

and the output distortion will be about 2 percent.

Example 2—Design a 300-mw output stage. This time, a push-pull class-B grounded-emitter stage is indicated. As before, the design is carried out on a per-transistor basis. Under maximum signal conditions, power output per transistor is 150 mw. Assume η of 75 percent. Then supply power per transistor is 200 mw. For a collector supply of 20 volts, the average current per transistor is 10 ma and power dissipation per transistor is 50 mw. The collector current at $I_e = 0$ is approximately 0.1 ma. Collector current at $I_b = 0$ is 5 ma (for an α of 0.98). The zero-signal operating point will lie somewhere between these two limits, depending on the d-c base-to-emitter resistance.

If the stage is driven through a transformer winding, this resistance is low, and the operating point will be close to the $I_e = 0$ line, say at 0.5 ma. From Eq. 8, $I_c' = 30.3$ ma, whence actual $\eta = 74$ percent. This is close enough to the assumed value. From Eq. 12, R_L per transistor $\cong 670$ ohms. The peak input impedance and power gain may be computed with the aid of the characteristic curves and Table I.

This work has been supported by the USAF Air Research and Development Command, USAF Air Materiel Command, Army Signal Corps, and Navy Bureau of Ships, under Contract AF 33 (600)-17793.

REFERENCE

(1) R. F. Shea, "Principles of Transistor Circuits", John Wiley and Sons, New York, 1953.

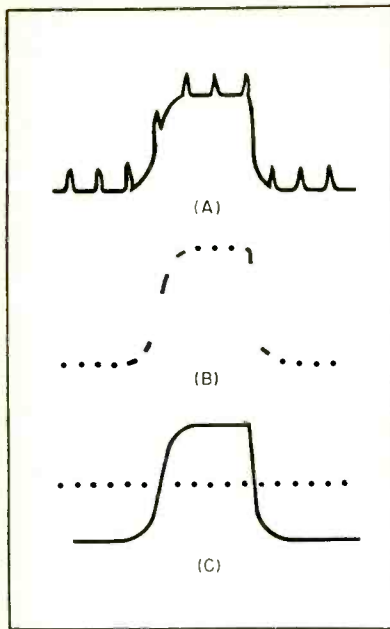

FIG. 1—Time marking by superimposed pips (A), intensity modulator (B) and gated intensity-modulated markers (C)

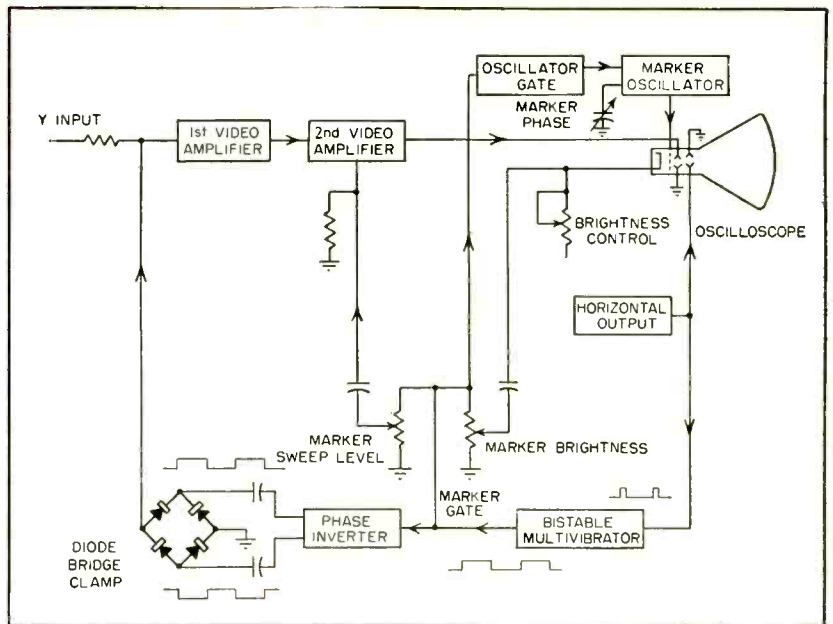

FIG. 2—Block diagram of gated marker system. Oscillator in modified oscilloscope is gated by horizontal output of scope through multivibrator. Diode bridge grounds vertical input during marker sweep presentation

Gated Time Markers

Intensity-modulated dot markers for measuring waveform-time relationships are presented in separate oscilloscope trace without distorting waveform under study. Adding vernier marker oscillator increases accuracy of readings by a factor of ten

USING ALTERNATE CYCLES of the cro horizontal sweep for presenting timing markers and the waveform being measured makes it possible to control the position of the traces in relation to each other. In addition, distortion of the waveform is avoided.

Commonly used methods of measuring waveform-time relationships are Y-axis modulation and Z-axis, or intensity, modulation. Oscilloscope displays utilizing both forms are shown in Fig. 1A and 1B.

The vertical-marker display is generated by superimposing pips of known frequency on the waveform. This method has two drawbacks. The pips tend to mask or distort characteristics of the waveform which are of the same width or narrower than the pips. The other trouble is the difficulty of accurate

By PHILIP STEINBERG*
Chicago, Ill.

measurement. Since the pips have a finite width it is usually hard to determine a reference point on a pip, especially when measuring characteristics of pulses with fast rise and decay times.

The intensity-modulated markers shown in Fig. 1B are an improvement over the vertical markers but still cause some waveform distortion and reference-point difficulties.

The presentation in Fig. 1C has intensity-marker and waveform information completely separated. This is accomplished by time-sharing. Alternate sweeps are used for the incoming waveform and for the intensity-modulated markers. The markers can be moved horizontally or vertically with respect to the pulse, and relative brightness levels

of the sweeps can be varied.

Figure 2 shows a block diagram of the gated-marker circuit, and Fig. 3 is the schematic diagram. A modified oscilloscope having an intensity-marker oscillator is used. A bistable multivibrator in the external circuit is triggered with pulses taken from the horizontal output of the oscilloscope.

The square-wave output of the multivibrator is fed to a phase inverter which drives a diode-bridge clamp circuit. This grounds the vertical input to the oscilloscope during the marker-sweep interval so that no waveform information will pass while the markers are being gated. A 100,000-ohm potentiometer is used for low-frequency compensation by varying the bias current through one of the CK706 diodes.

Separation of the two sweeps is controlled by the marker sweep

*Work done while with Admiral Corp.

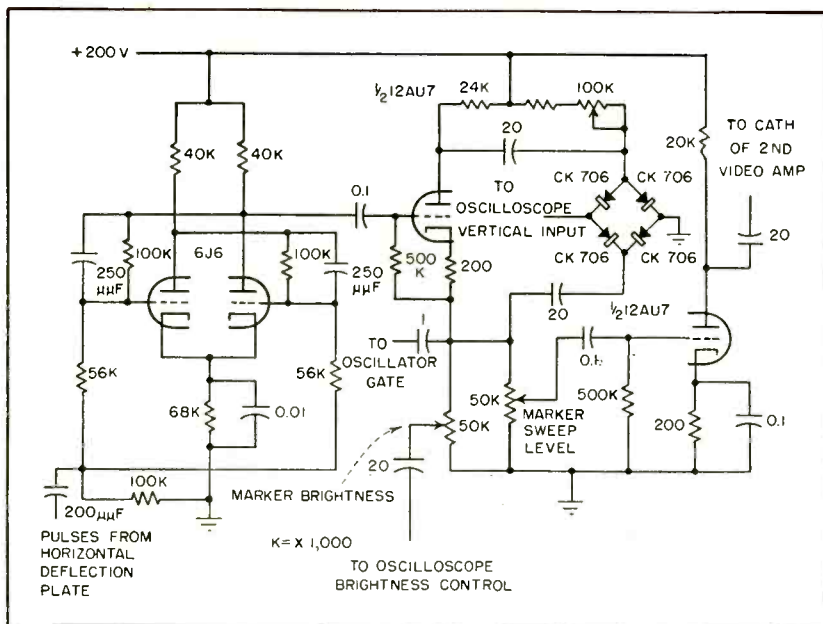

FIG. 3—Gated marker-generator circuit uses multivibrator to present markers and waveform on alternate sweeps. Controls permit adjustment of relative brightness and position of marker sweep

relative to the pulse.

Figure 5 shows the type of display generated by a system using an additional marker oscillator turned on during the pulse sweep time by the negative square-wave portion of the bistable multivibrator output. This corresponds to the time the main oscillator is turned off.

This display makes use of the vernier principle to increase accuracy of pulse measurements by a factor of ten without increasing marker frequency by this factor.

The vernier marker scale is used in a manner similar to mechanical measurements of this type. Assume that the width of the pulse in Fig. 5 is to be measured from the 50-percent amplitude points on the leading and trailing edges, as indicated by points *S* and *T* on the figure. The pulse width lies between 14 and 15 on the main marker scale. The vernier scale, generated by an oscillator at a frequency of $1/0.9$ times the main-scale frequency, has a marker spacing 0.9 of the main-scale spacing. The horizontal-phase control is adjusted to make a dot on the vernier scale coincide with point *T*. The vernier scale is then moved downward by the level control until a dot on the vernier scale corresponds to a dot on the main scale. In this case the third dot is seen to coincide, giving a measurement of 14.3.

For very accurate measurements the vernier method is useful, however, it is not as convenient to use as the gated-marker display.

REFERENCE

- (1) R. S. MacKay, Switch Provides D-C Reference Display, *ELECTRONICS*, p 122, Dec 1952.

for CRO Display

level control connected to the cathode of the phase inverter. This control feeds one section of a 12AU7. The square-wave output of this tube is applied to the cathode of the second video amplifier. A high-impedance source is needed to drive the cathode of the video amplifier so as not to affect the frequency response or gain of the amplifier.

The oscillator-gate and marker-brightness voltages are also taken from the cathode of the phase inverter. The oscillator-gate voltage turns the marker oscillator off and

on with alternate sweeps. Marker-brightness voltage is fed to the brightness control in the oscilloscope to vary relative brightness of alternate sweeps.

Time relationships involved are shown in Fig. 4. The positive output of the multivibrator corresponds to the length of time the diode clamp grounds the vertical input and also to the time the marker oscillator is turned on.

A phase control is added to the marker oscillator so that the markers may be moved horizontally

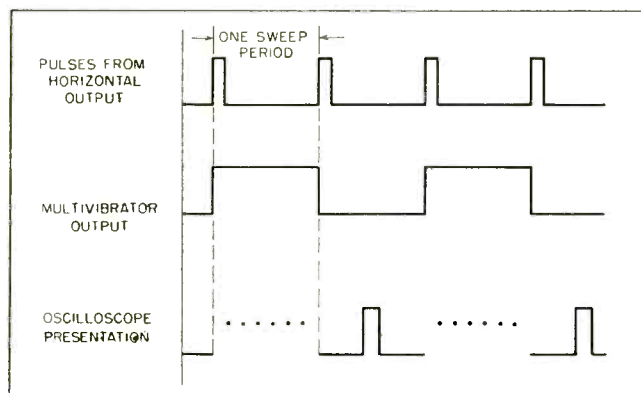

FIG. 4—Time relationships during alternate sweep periods

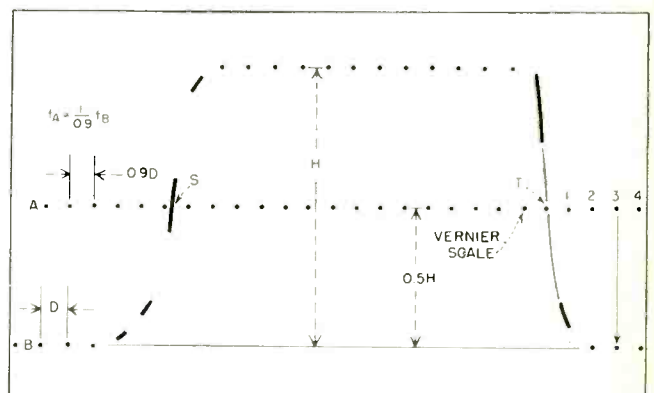

FIG. 5—Vernier scale increases accuracy by a factor of ten

High-speed rotor in vacuum is held in alignment by electronically controlled solenoid to give frictionless bearings that permit speeds up to 50,000,000 rpm, measured by comparing phototube output with WWV signals

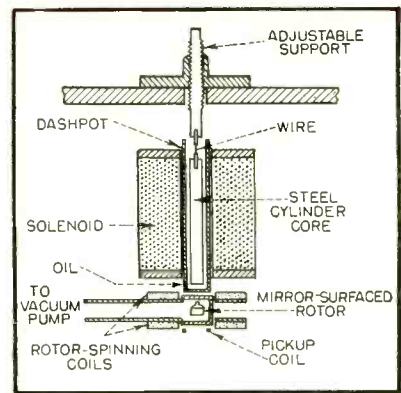
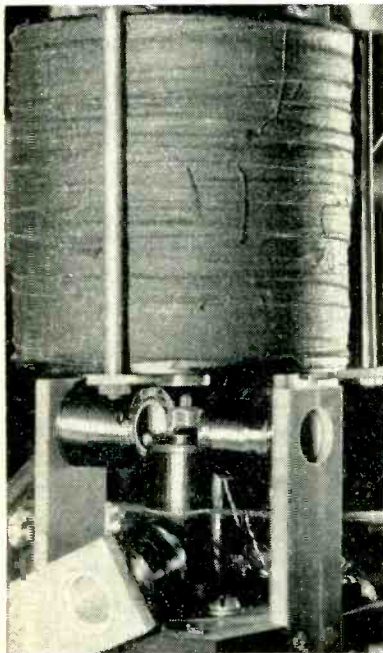
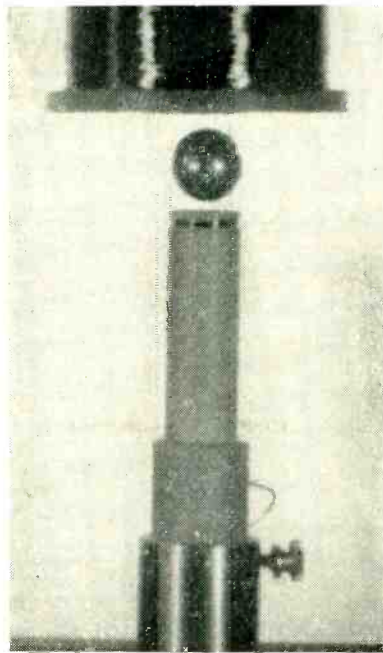

FIG. 1—Suspension for rotating mirror

Magnetic-Suspension



Suspension system for mirror-faced rotor. One of the four drive coils has been removed to show the rotor. Pickup coil is on pedestal directly under rotor



Magnetically suspended $\frac{3}{4}$ -inch steel sphere, with drive coil and vacuum chamber removed. This setup is employed for checking bursting strength

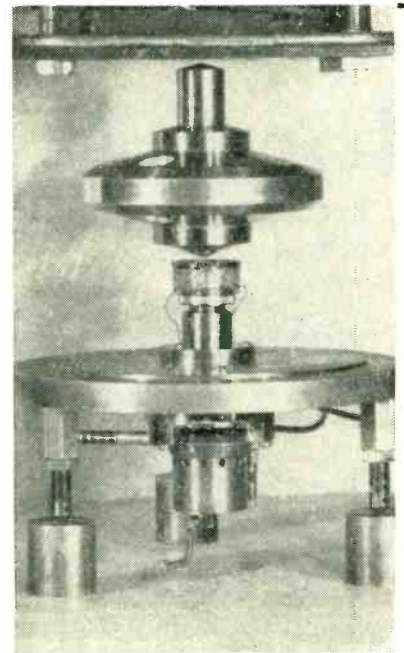

Magnetically suspended ultracentrifuge 7.4 inches in diameter. Height-controlling pickup coil is directly under rotor, with air-turbine drive below

THE PROBLEM of finding suitable bearings for rotating bodies has been of major practical importance since man first started using rotating machinery. The efficiency of most rotating machinery is usually limited by the friction and useful life of the bearings. This is especially true where it is necessary to operate rotors near their bursting speeds.

This paper describes a magnetic support for high-speed rotors which

has been under development at the University of Virginia for more than a decade and a half¹⁻⁷ and which has proven to be an almost ideal support bearing for a wide variety of high speed rotors.⁸⁻¹¹ Essentially, the same support technique is employed in spinning the rotors used in a number of different problems.

The method can be illustrated by referring to Fig. 1, which is a schematic diagram of a high con-

stant-speed rotating mirror arrangement.¹¹ The rotor, made of high-strength ferromagnetic material, contains mirror surfaces and spins at 20,000 rps. Any other type of ferromagnetic rotor could be used in the apparatus instead of the rotating mirror, but it was chosen for illustration here because it demonstrates a simple solution to a difficult rotating mirror problem. The rotor is freely suspended inside a glass vacuum chamber by the

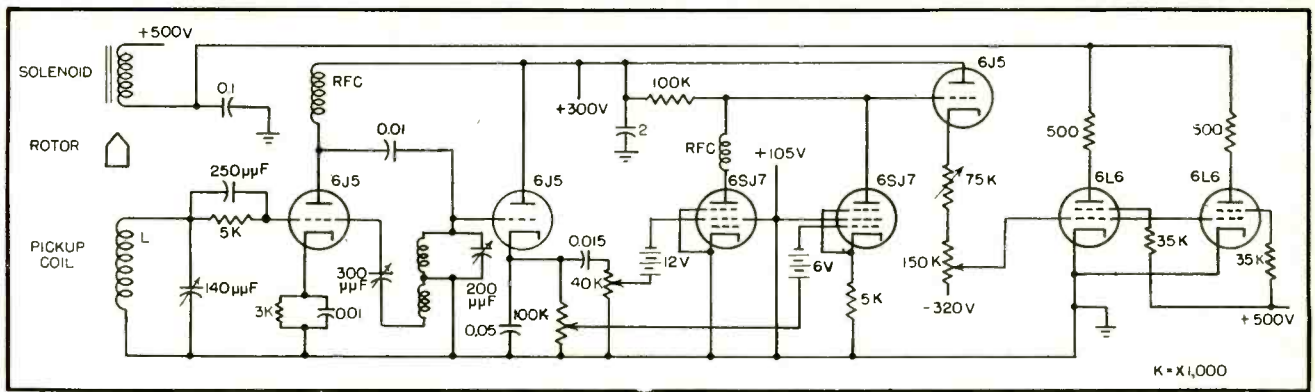

FIG. 2—Support circuit used to suspend small mirror-surfaced rotor in space, eliminating bearing friction

Ultracentrifuge Circuits

axially-symmetrical diverging magnetic field of the solenoid situated above the chamber.

The vertical position of the rotor is maintained by the automatic regulation of the current through the solenoid with a servo circuit. The horizontal position of the rotor is determined by the symmetrical diverging magnetic field. The small pickup coil is the sensing element in the servo circuit, which is so arranged that as the rotor rises the current in the solenoid is decreased and vice versa. The circuit contains an antihunt arrangement which prevents vertical oscillations of the rotor.

Although the rotor automatically seeks the strongest part of the field, which is on the axis of the solenoid, it is necessary to provide horizontal damping to prevent oscillations about the axis of rotation when the rotor is disturbed. This is accomplished by hanging the steel cylindrical core of the solenoid by a small wire from an adjustable support, like a pendulum, in a dashpot of oil. The mass and size of the core depend upon the mass of the rotor and are so chosen that the lower end of the core follows the oscillations of the rotor and damps them out. When properly adjusted, no movement, either horizontal or vertical, can be observed in a 50-power microscope when focused on scratches on the rotor.

By J. W. BEAMS

University of Virginia
Charlottesville, Va.

The rotating mirror shown in Fig. 1 is made of hard, high-strength alloy steel. It is 0.5 inch from the bottom to the tip of the cone, and its six flat mirror faces, each 0.25 inch wide, are covered with a thin coating of aluminum. The cylindrical core of the solenoid is a cold-rolled steel rod 0.44 inch in diameter and 3.88 inches long. The support wire is 0.018-inch piano wire 0.085 inch long. The dashpot is a flat-bottomed glass tube containing SAE No. 10 motor oil. The solenoid is wound on a Bakelite frame with 25,000 turns of No. 28 insulated copper wire. It has an inductance of about 20 henrys and a resistance of approximately 1,000 ohms. The rotor is spun by two pairs of coils which produce a rotating magnetic field.

Support Circuit

Figure 2 shows one of several different circuits that may be used for supporting the rotor. The pickup coil *L* is in the grid circuit of a tuned-grid-tuned-plate 5-mc oscillator. If the oscillator is properly adjusted, a downward movement of the rotor will change the impedance of the pickup coil to lower the amplitude of the oscil-

lation in the circuit. The d-c potential appearing across the cathode resistor is proportional to the amplitude of the oscillations and serves as a measure of rotor height. A portion of this potential is used as the direct error signal.

In parallel with the cathode resistor is an R-C differentiating network which gives a signal across the resistance proportional to the time rate of change of rotor height. This derivative signal effectively damps the up-and-down motion of the rotor.

Error Signal

The error and derivative signals are separately amplified, mixed and applied to the grid of a cathode follower. The combined signal is next applied to the grids of the 6L6 power tubes and regulates the current through the solenoid.

The magnitudes of the error or direct signal and of the derivative signal can be separately adjusted so that their proper relative and absolute values can be found. An exact theoretical analysis of the circuit is rather complicated, but an approximate solution assuming linearity of the elements is not difficult¹². Several different pickup devices may be used instead of the coil in Fig. 1 and 2. A photoelectric pickup is especially useful, and has been used for the magnetic suspension of very small rotors⁹ and

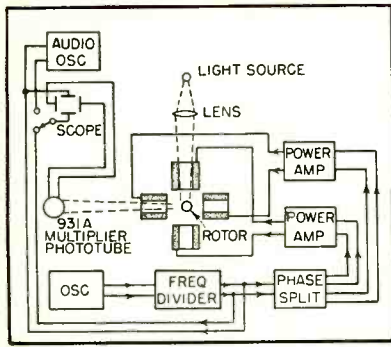

FIG. 3—Method of driving rotor and measuring its speed

in the magnetic-suspension micro-balance.^{9, 18}

The rotor is spun by a rotating magnetic field produced by two pairs of coils outside the vacuum system. Standard power circuits¹¹ produce the alternating current through these coils.

The drive system and the method of measuring the rotor speed are shown in Fig. 3. The oscillator frequency is generated by a 0.1-mc piezoelectric crystal-controlled electron-coupled oscillator. The crystal is thermostatically controlled and the output is calibrated by beating the 100th harmonic with the 10-mc WWV signal. The frequency is determined to about one part in 10^7 , although the oscillator frequency is probably constant to one part in 10^8 . The frequency is then divided by a factor of 5, the result passed through a phase splitter, and the two outputs separately amplified and transformer-coupled to the power circuit which in turn supplies the power to the drive coils for the rotating mirror.

Light is either reflected or scattered from the rotor into a multiplier phototube in such a way that each revolution produces one flash of light on the tube. The output of the tube is amplified and applied to one pair of plates of an oscilloscope. A comparison frequency, supplied by an audio-frequency oscillator during the period of rotor acceleration and by the drive-frequency source or WWV at operating speed, is applied to the other pair of oscilloscope plates. From the resultant Lissajous figure, the rotor speed is determined.

In order to bring the rotor to operating speed, the glass vacuum chamber surrounding the rotor is

evacuated to less than 10^{-6} mm mercury pressure. The support circuit is then turned on and the rotor suspended. The drive circuit is next started and the rotor begins to spin. The rotor operates as a high-resistance armature of an induction motor during the acceleration period. When the speed of the rotor reaches about 50 rps below the frequency of the power source, the rate of acceleration falls off but the rotor continues to increase in speed. If the gas pressure surrounding the rotor is below 10^{-6} mm of mercury the friction is so small that the rotor speed will approach the frequency of the rotating magnetic field, then lock in and spin with the same frequency as that of the oscillator. However, this process usually takes more than an hour.

In practice, when the rotor acceleration begins to decrease, the crystal oscillator is disconnected from the phase-inverter and an audio oscillator substituted whose frequency is about 50 cycles above the frequency of the crystal-controlled drive circuit. The rotor is allowed to accelerate until it reaches a value just above the desired operating speed. The audio oscillator is then disconnected and the crystal control substituted. The rotor soon locks in and operates in the same way as the armature of a synchronous motor.

Because of the very low rotor

friction and the small power input to the rotor, in a few minutes after locking in no observable hunting (less than 10^{-3} radians per sec) can be observed. Since the rotor speed is 10^5 radians per sec, the possible error due to hunting is less than one part in 10^8 . With an input to the drive coils of 150 watts, the rotating mirror accelerates at the rate of about 1,000 rps per minute as long as the slip is greater than 50 cps.

Rotor Temperature

When the rotor is held stationary and the drive circuit operated until temperature equilibrium occurs, the rotor temperature increases less than 10 degrees C. This should give maximum heating. When it is desired to avoid heating in the rotor during the acceleration period, the rotor may be accelerated by magnetizing it transversely and letting it operate like an armature of a synchronous motor in which the drive frequency is increased at the same rate as the rotor speed increases. In this way practically no eddy currents are generated and the temperature of the rotor remains constant. The temperature of the rotor may be determined while it is spinning by measuring its thermal radiation.

Since the axial magnetic field is symmetrical over the rotor, no eddy currents are induced and there is no electromagnetic drag

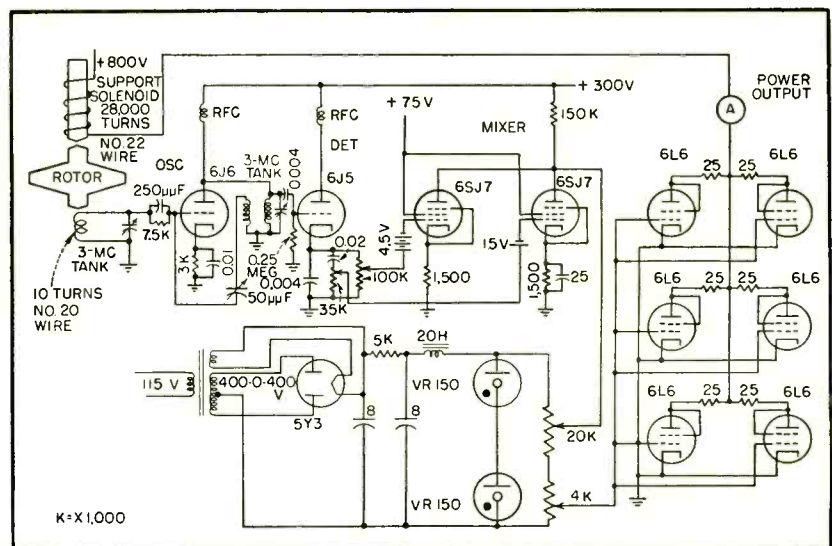

FIG. 4—Support circuit for large rotor (over 2 lb) in which liquid-filled cell can be inserted for analytical research involving sedimentation measurements. Bursting strength of rotor is only factor limiting angular speed

due to the support. There probably is some slight friction, but it is too small to observe. If the rotor is spun to operating speed and then allowed to coast, practically all of the observed deceleration of the rotor can be accounted for as due to residual gaseous friction on the rotor even at gas pressures below 10^{-9} mm of mercury. For a spherical rotor of radius r , density d and absolute temperature T surrounded by a gas of molecular weight M and pressure p , it can be shown that approximately

$$\log_e \frac{N}{N_0} = -\frac{5p}{rd} \left(\frac{M}{2\pi RT} \right)^{1/2} (t - t_0) \quad (1)$$

where N_0 is the number of rps at the time t_0 and N is the number of rps at the time t .

It is interesting to calculate the Q for a magnetically suspended rotor, which equals 2π (total energy of rotor)/(energy lost per cycle). For an all-steel-spherical rotor spinning at 300 rps the observed deceleration was about 1 rps in 4 days when the air pressure surrounding the rotor was less than 10^{-5} mm of mercury, which gives a Q of between 10^8 and 10^9 .

Uses of Magnetic Suspension

The speed of the rotating mirror described above was determined to about one part in 10^7 , which was the estimated reliability of the received frequency from WWV. It spun at 20,000 rps with a constancy which was at least equal to that of the frequency of the thermostated piezoelectric crystal. The mirror therefore should be adaptable to such problems as the measurement of the velocity of light or the study of short-time phenomena which give off light.

The magnetic suspension has been used for spinning rotors which vary in weight from 25,000 grams to 5×10^{-5} gram. The only factor which limits the speed is the strength of the rotor material, provided the critical vibration frequency of the rotor is less than the speed required to explode the rotor.

Table I gives some of the results obtained just before a series of spherical rotors exploded. The spherical rotors were carefully selected steel ball bearings. All of

Table I—Bursting Speeds of Spherical Steel Rotors

Rotor diam in mm	Rotor speed in rpm	Peripheral speed in cm per sec	Centrifugal acceleration in g	Maximum calculated stress in lb per sq in.
3.97	4,420,000	96,000	47,100,000	410,000
2.38	7,410,000	92,500	72,000,000	385,000
1.59	12,660,000	105,000	143,000,000	498,000
0.795	23,160,000	96,500	240,000,000	420,000
0.521	37,980,000	104,000	428,000,000	488,000
0.398	48,000,000	100,000	515,000,000	454,000

these steel rotors that were free from flaws attained approximately the same peripheral speed before exploding. This is in agreement with theory. The maximum stresses, which were at the center of the rotor, were calculated on the basis of elastic theory and hence may be too large. The maximum centrifugal force of over a half-billion times gravity was obtained with the smallest diameter rotor.

This type of ultracentrifuge uses magnetic support in conjunction with an air-driven turbine drive under the rotor. To operate the centrifuge, the brass vacuum chamber is removed and the support circuit of Fig. 4 is adjusted until the rotor is stably supported. This circuit adjustment is not difficult and may be carried out as follows. With the rotor resting and the plate supply to the 6L6's switched off, the grid, plate and neutralizing capacitors are adjusted for maximum output as determined by a high-resistance voltmeter in the detector circuit (200 to 250 volts). The neutralizing capacitor is next adjusted until the voltmeter reads between 60 and 70 volts, care being taken that the oscillator continues to function with the rotor in its lowest position. The output should then increase as the rotor is raised. The plate voltage to the 6L6's is next turned on and the grid bias to the 6SJ7's and the differentiating capacitor varied until the rotor is stably supported, as determined by putting surges on the line. The circuit stays adjusted indefinitely.

The vacuum chamber is next placed in position and the rotor cell filled with the material to be centrifuged. The top plate of the chamber is next sealed on with vacuum wax and the solenoid and core are mounted and adjusted. In

the meantime, the electrical circuits have been allowed to warm up and the cooling fluid started circulating through the cooling coils attached to the chamber. The vacuum pumps are then started and the rotor is supported by the solenoid in its running position. When the pressure in the chamber is 10^{-5} mm of Hg or less, air is admitted to the turbine and the rotor is accelerated until operating speed is reached. The turbine is then disconnected and the rotor continues to coast smoothly during the period of the experiment.

Ultracentrifuge

Another important use of the magnetic suspension is in the vacuum-type ultracentrifuge.⁸ In one instrument, the rotor is 18.8 cm in diameter and carries a sector-shaped cell with quartz windows in which the sedimentation of the material is observed. From these observations, the molecular weights of the substances in solution in the cell may be determined.

REFERENCES

- (1) F. T. Holmes, Axial Magnetic Suspensions, *Rev Sci Inst*, 8, p 444, Nov. 1937.
- (2) F. T. Holmes and J. W. Beams, Frictional Torque of an Axial Magnetic Suspension, *Nature*, 140, p 30, July 1937.
- (3) J. W. Beams and S. A. Black, *Rev Sci Inst*, 10, p 59, 1939.
- (4) C. Skarstrom and J. W. Beams, *Rev Sci Inst*, 11, p 398-403, 1940.
- (5) L. E. MacHattie, Production of High Rotational Speed, *Rev Sci Inst*, 12, p 429, Sept. 1941.
- (6) J. W. Beams, J. L. Young, III and J. W. Moore, The Production of High Centrifugal Fields, *Jour Appl Phys*, 17, p 886, Nov. 1946.
- (7) J. W. Beams, High Centrifugal Fields, *J Wash Acad Sci*, 37, p 221, July 1947.
- (8) J. W. Beams, J. D. Ross and J. F. Dillon, *Rev Sci Inst*, 22, p 77, 1951.
- (9) J. W. Beams, *Rev Sci Inst*, 21, p 182, 1950.
- (10) J. W. Beams, *Proc Soc Exp Stress Analysis*, 7, p 1, 1949.
- (11) J. W. Beams, E. C. Smith and J. M. Watkins, *J S M P T E*, 58, p 159, 1952.
- (12) H. S. Morton, Jr., Dissertation, University of Virginia, 1953.
- (13) J. W. Beams, *Phys Rev*, 78, No. 4, p 471, 1950.

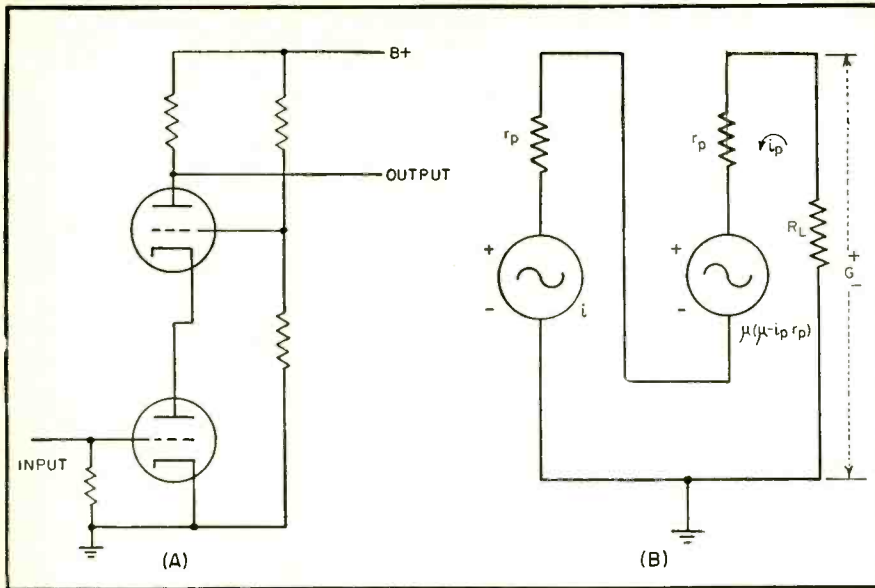

FIG. 1—Basic cascode amplifier circuit as adapted for audio application (A), and its equivalent circuit (B) used in calculations

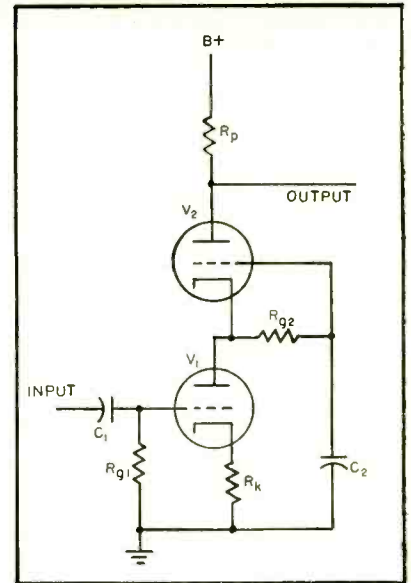

FIG. 2—Grid-leak resistor R_{g2} eliminates critical bias adjustment

Cascode Audio Amplifier

Wallman amplifier circuit used as input stage of audio amplifier has pentode gain qualities with triode noise characteristics. At 30-db gain, equivalent input noise level is -127 dbm. Harmonic distortion is less than one percent

ADAPTING the cascode amplifier circuit to audio-frequency applications results in a stable, low-noise, high-gain amplifier input stage that does not require the use of special or selected tubes. Noise figure shows a 2 to 10 db improvement over that of conventional circuits.

The ideal triode input circuit should have all the improvement in input-stage noise figure over the pentode that is theoretically possible. Stage gain should be of the same order of magnitude as that of a pentode. In addition, the circuit should be stable, with low input capacitance and effective isolation of the input circuit from the output.

The only circuit which meets all of these requirements is the grounded-cathode triode followed by a grounded-grid triode or cascode circuit.¹

Modified for use at audio frequencies, the basic cascode circuit

By R. LEE PRICE

Senior Electronic Engineer
Magnecord, Inc.
Chicago, Ill.

consists of a grounded-cathode triode feeding into the cathode of a grounded-grid triode, as in Fig. 1A. Additional coupling elements are not needed between the two triodes, and since they are in series, the same direct current flows through both tubes.

With this circuit, the upper tube has a fixed d-c grid potential at a-c ground, which tends to hold the lower triode plate potential fixed, but still permits its current to flow in a load resistor. If e_{p1} were really held constant, the current gain of the lower triode would be g_m and the voltage gain from e_{p1} to e_{p2} would be $-g_m R_p$ as in a pentode. Thus, the behavior is similar to a pentode, with the advantage that no screen current, with its accompanying partition noise, is re-

quired. The output conductance of the first tube is of the same order of magnitude as the optimum source conductance for the second tube, so that the full available power gain of the grounded-cathode triode is utilized. The effect of noise due to the high equivalent temperature of r_{p1} is minimized. No physical coupling resistances are needed and effective isolation of input and output circuits and low input capacitance also result.

Figure 1B shows the equivalent circuit of the cascode amplifier using two identical triodes. The gain of this amplifier may be derived as follows. Around the closed loop of Fig. 1B,

$$\mu + \mu(\mu - i_p r_p) = i_p(2r_p + R_L)$$

$$\text{Gain} = i_p R_L = \frac{\mu(1 + \mu)}{1 + \frac{r_p}{R_L}(2 + \mu)}$$

Due to variations in tube characteristics, the bias on the ground-

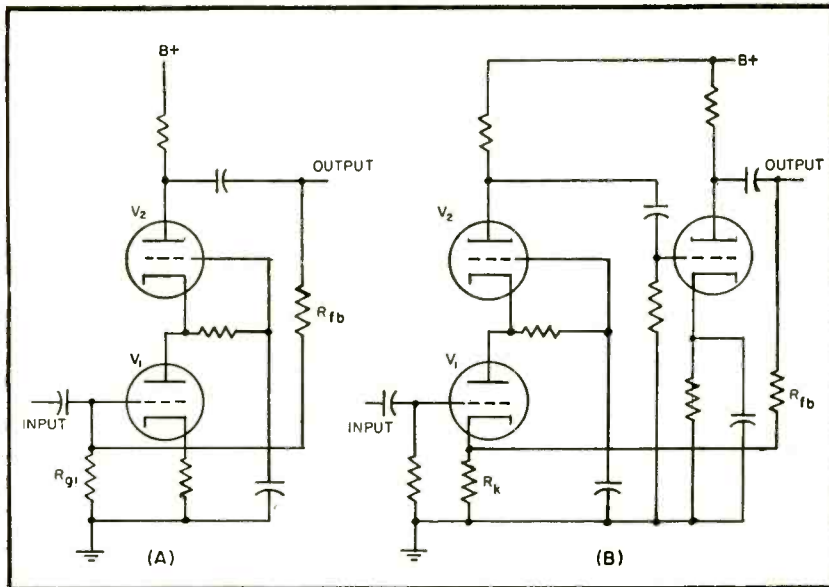

FIG. 3—Feedback around one stage is applied to grid of input tube (A). Two-stage feedback system (B) puts signal on cathode of input tube

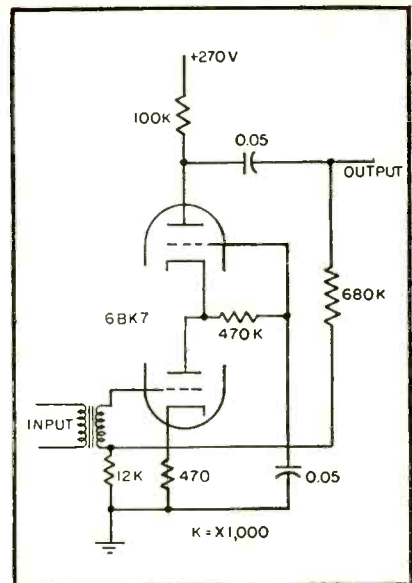

FIG. 4—Cascode amplifier can use 6BQ7, 6BZ7, 6L6386 or 12AU7

has Low Noise Level

ed-grid triode must be adjusted to maintain it slightly negative with respect to its cathode. A modification which overcomes this critical adjustment is shown in Fig. 2. This involves the use of grid-leak or contact-potential bias on the upper triode to replace the voltage divider of Fig. 1. The value of the grid-to-cathode resistor is chosen to maintain the grid-cathode bias at approximately 1 volt negative. The a-c ground potential is maintained on g_2 by bypass capacitor C_2 . With this biasing method, tube variations have little effect on the biasing of either triode.

Feedback

Figure 3 shows two possible methods for applying negative feedback to this amplifier stage. In Fig. 3A, feedback is applied around one stage. Feedback voltage is taken from the plate of the grounded-grid triode, divided by the ratio R_{fb}/R_{g1} and applied to the input grid. Figure 3B shows negative feedback applied over two stages. Signal voltage from the plate of the second stage is divided by the ratio R_{fb}/R_k and applied to the cathode of the input stage. Re-

sistor R_k also provides cathode bias and degeneration for the input stage.

If additional bias is needed on the input grid, it is provided by contact-potential bias across resistor R_{g2} .

Use of negative feedback improves linearity and makes possible the accommodation of larger input signals with little effect on the noise figure of the amplifier.

Use of high-quality components and extreme care in parts location is necessary to avoid noise pickup due to leakage currents or stray fields.

It is advisable to use low-noise resistors such as the deposited-film type. The resistors should be kept in fairly stable thermal equilibrium by avoiding high ambient and operating temperatures.

Performance

Measurements of noise figure and equivalent input noise obtained with this amplifier show a reduction in noise level of from 2 to 10 db over that obtained with conventional triode circuits.

The exact amount of improvement will depend on tubes used

and the frequency characteristic involved. Tube noise in the audio range consists of low-frequency noise due to cathode flicker, medium-frequency noise due mainly to microphonics, and high-frequency noise due to shot effect. Final selection of tubes will depend to a large extent on which of these types of noise it is desired to minimize.

An input amplifier stage using the circuit described is shown in Fig. 4. Measurements show a voltage gain of 30 db with harmonic distortion less than 1 percent at an output level of 15 volts.

Noise figure of this amplifier is approximately 1.5, which is 1.8 db from the thermal agitation noise in the input grid. This corresponds to an equivalent input noise level of approximately -127 dbm.

The author acknowledges the invaluable assistance and suggestions given by William F. Boylan, which contributed greatly to the success of this development.

REFERENCES

- (1) Valley & Wallman, "Vacuum-Tube Amplifiers," p 440, 656, 18, MIT Radiation Laboratory Series, McGraw-Hill Book Co., N. Y., 1948.
- (2) Wallman, Macnee & Gasden, Low Noise Amplifier, *Proc. IRE*, 36, p 700, 1948.

Circular Radar

By **W. D. WHITE**

*Engineering Consultant
Airborne Instruments Laboratory, Inc.
Mineola, N. Y.*

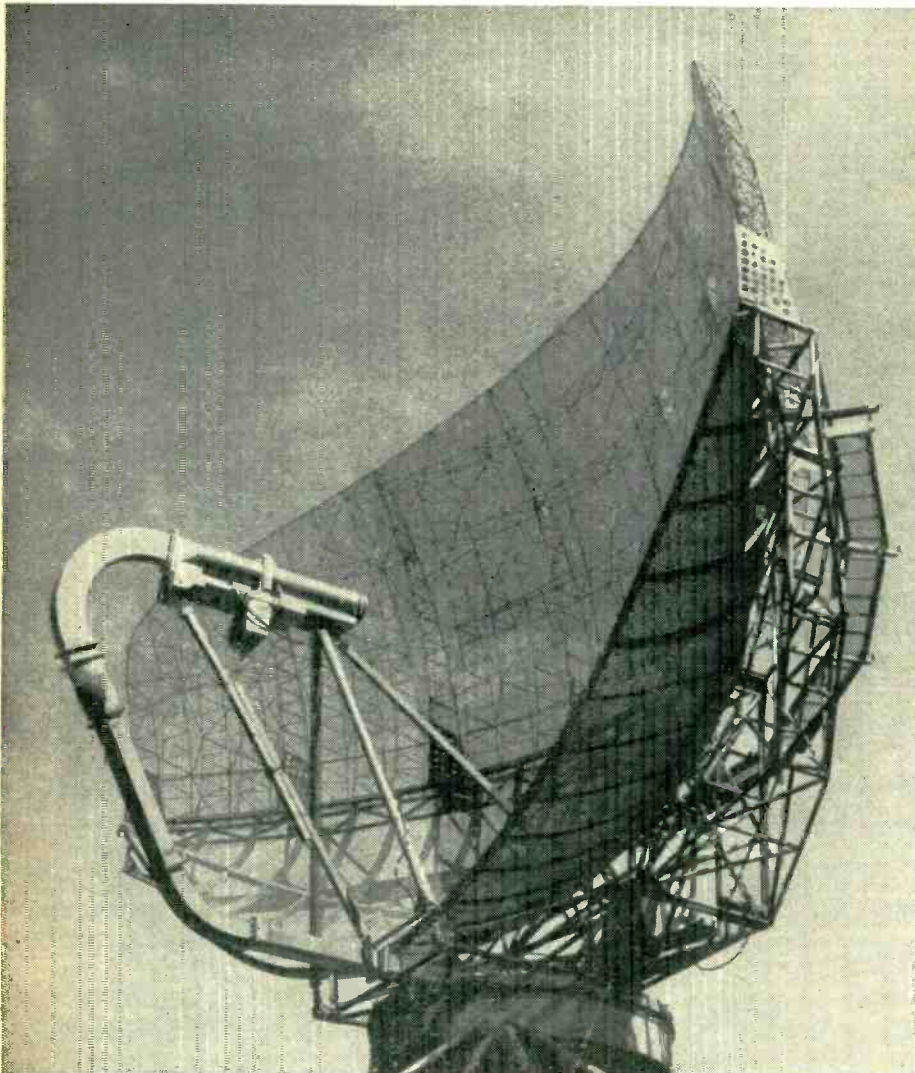

Modified AN/CPS-5 antenna used for experiments with circular polarization

RETURN FROM RAIN or other forms of precipitation can seriously limit the usefulness of radars, such as air-traffic-control systems, which attempt to track targets under all-weather conditions. The use of relatively low radio frequencies, narrow beamwidths, short pulses and special techniques such as pulsed-Doppler, moving-target-indicator systems or airborne transponder beacons may ameliorate the situation. There are many cases, however, for which a further improvement in the ability to track targets through precipitation return is desired.

A technique capable of providing improved discrimination against rain return is the use of circularly

polarized antennas both for transmission and for reception.^{1, 2, 3} This technique is based upon the fact that raindrops, having a tendency toward a spherical shape, act as symmetrical scatterers. Aircraft and other targets of interest, having nonisotropic shapes, tend to reflect a wave whose polarization is distorted from that of the incident wave.

An outgoing right-hand circularly polarized wave will be reflected from a raindrop as a left-hand circularly polarized wave and will be rejected by the right-hand circularly polarized antenna. From an aircraft, however, the reflected energy will generally be elliptically polarized and a portion of the en-

ergy will be received on return.

This principle was verified experimentally at Radiation Laboratory, MIT. Using a K-band radar operating at about 1.25 cm, attenuations of 26 db were obtained on rain return and attenuations of 4 to 8 db on fixed targets. Unfortunately, the project was terminated before complete data could be obtained and no information was available as to the effect on aircraft targets. To obtain more quantitative data, the U. S. Air Force's Air Research and Development Command set up a project carried out by Airborne Instruments Laboratory.⁴

Early in the project, it was decided that a statistical procedure should be used in making measurements on aircraft. Echoes vary so widely with aspect and other factors that single measurements have little meaning. So that the statistical sample might be as large as possible, it was desired that the test radar have good search coverage. In addition, it was desired that the radar have a simple antenna structure, preferably an antenna consisting of a single horn feeding a shaped-dish reflector. Of the radars available at the time, the AN/CPS-5 operating in the 1,300-mc band was considered most nearly to meet all requirements.

The modifications necessary to adapt this radar for circular polarization⁵ consisted of the installation of a circularly polarized feed, modifications to the surface of the reflector and minor modifications to the indicating equipment.

To provide equal reflectivity for both components of the circularly polarized wave, the original diamond-mesh reflector surface was covered with welded wire hardware

Cuts Rain Clutter

Modified 1,300-mc surveillance unit with hardware cloth attached to reflector is equipped with circularly polarized feed. Minor changes are required in indicator. Improvements in target-to-precipitation ratio vary from 8 to 25 db. Aircraft target returns drop only 6 to 8 db under same conditions of operation

cloth having a quarter-inch square mesh. Performance of the antenna was checked by measurements on an X-band model and by measurements of the full-scale primary feed. The azimuth radiation pattern of the modified antenna illustrated corresponds closely to that of the unmodified antenna and a high degree of circularity is maintained throughout the beam.

The ratio of major to minor axis of the polarization ellipse is 1.07-to-1 at the point where the secondary pattern is 10 db below the peak and is much better near the axis of the beam. In elevation, the beam is somewhat sharper than that of the original antenna owing to a difference in the vertical illumination pattern. Good circularity was maintained throughout the csc² portion of the pattern, the eccentricity ratio being about 1.15-to-1 at an elevation angle of 40 degrees above the horizon.

The indicator equipment is modified to show both the circularly polarized and the linearly polarized returns on the same indicator tube. The antenna is arranged so that polarization shifts automatically from linear to circular on alternate scans of the radar. When linear polarization is used, the western half of the sky is displayed on the left-hand portion of the tube in the normal manner. While the antenna rotates through the eastern half of the sky, the tube is blanked and the polarization shifted to circular.

The second scan is then made with the deflection reversed so that although the same western half of sky is scanned, the returns are painted in the right-hand portion of the tube. A differential i-f gain control is provided so that gain can

be independently varied for each polarization. Figure 1 is a photograph of the indicator tube under typical operating conditions; it shows cancellation of a moderately heavy precipitation return. For this picture, the differential gain control was adjusted to provide about 10 db more gain on circular polarization.

Experimental Data

The statistical method used for most of the aircraft-target measurements depended upon the differential gain control. A large number

of indicator photographs was taken with various settings of differential gain. Starting with equal amplitudes, the gain for linear polarization was reduced in 5-db steps, 20 or 30 scans of the radar being photographed at each step. The photographs were then analyzed by counting targets in a given range increment, such as 30 to 50 miles.

A count was made of all targets that appeared on the linearly polarized side of the picture but were missing from the circularly polarized side. Targets present on both sides and targets that appeared on the circularly polarized side but not on the linearly polarized side were also counted. Results were then plotted as a function of differential gain as shown in Fig. 2. The differential gain at which the two curves cross is taken as a measure of the average attenuation caused by circular polarization. A number of runs was made under widely different conditions and although the curves varied in shape, the crossover points agreed within ± 1 db.

Although the tests extended over a four-month period, there were only a few occasions when precipitation could be observed using circular polarization. At those times, the cancellation was found to be from a minimum of 15 db to a maximum in excess of 30 db, the limit of calibration. The occasion, illustrated in Fig. 3, when the cancellation was measured at only 15 db occurred shortly after the radar was placed in operation. It is possible that the poor performance was due in part to a minor misalignment of the antenna.

There is evidence, however, that the poor cancellation on this occasion was due to the nature of the

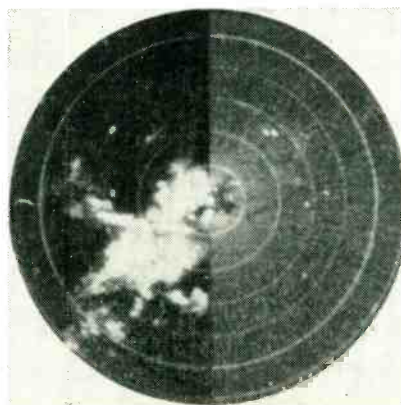

FIG. 1—Indicator tube shows heavy precipitation return (left) and result of circular polarization (right)

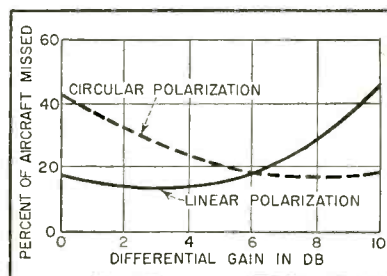

FIG. 2—Missed targets plotted against differential gain

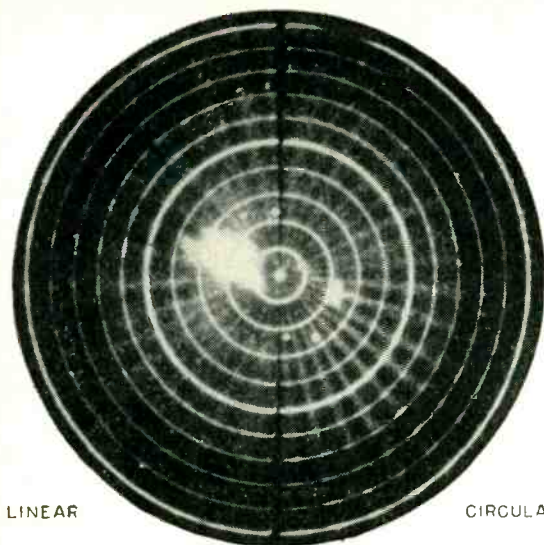

FIG. 3—Low cancellation of precipitation return occasionally occurs even with circular polarization

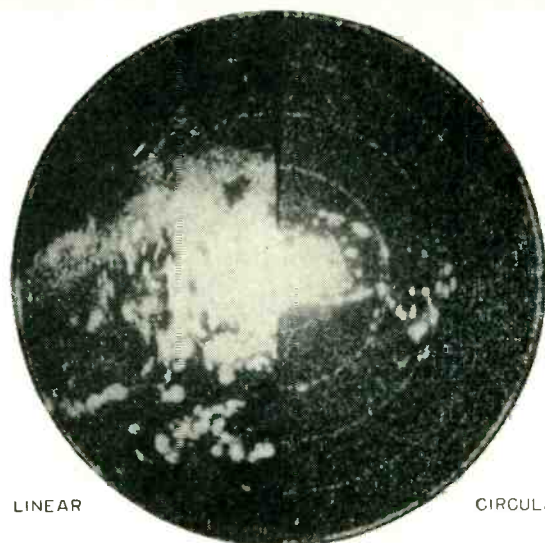

FIG. 4—Virtual elimination of precipitation return by circular polarization without mti assistance

precipitation. Meteorological observations indicated that the predominant source of return was a layer of wet snowflakes occurring at the freezing level, which was at about 4,000 ft. Because wet snowflakes tend to coalesce into large irregular shapes that are definitely non spheroidal, it is possible that 15 db is the greatest cancellation that can be expected under such conditions.

Ground Reflection

Before becoming too enthusiastic about the possibilities of a 30-db cancellation, it is well to consider the effect of ground reflections. Even though an antenna is perfectly circularly polarized and even though the raindrops are perfect spheres, a finite return will be received if a portion of the energy is allowed to be reflected by the ground on its way to or from a target.

Consider an outgoing right-hand wave that proceeds directly to the target and is reflected as a left-hand circularly polarized wave. That portion proceeding directly back from the target will be rejected. If a portion first strikes the ground and is then reflected into the antenna, that portion of the energy will have its sense of rotation reversed a second time and will be accepted.

The seriousness of this phenome-

non depends upon the vertical antenna pattern and the reflection coefficient of the ground. With a given antenna, the cancellation obtained will be a function of the vertical tilt of the beam. To obtain a cancellation of 30 db, it was necessary to tilt the beam higher than would be considered normal. With a lower-than-normal tilt, the same rainstorm was attenuated only 22 db.

The radar used was equipped with a moving-target indicator, MTI. The MTI was not noticed appreciably to reduce rain echoes except in rare instances when the rain had little or no lateral motion. In both Fig. 1 and Fig. 3, the MTI was in operation. Figure 4 is an indicator photograph taken with normal video—no MTI.

Evidence obtained in these tests seems to justify the conclusion that circular polarization provides useful means for improving the ability of a radar to see targets in the presence of precipitation return. Improvements in target-to-precipitation ratio ranging from 8 to 25 db can be obtained with an improvement of 15 to 20 db being representative of what can be expected under normal favorable conditions.

An improvement of 8 db represents a limit that may be encountered for certain forms of precipitation. An improvement of 25 db represents what can be obtained

when the effects of ground reflections can be largely eliminated.

This discrimination is not obtained without paying a price, however. The price is a 6 to 8-db loss in the strength of aircraft returns. For this reason, it is recommended that circular polarization be installed in such a way that it can be removed when not needed.

In certain cases, conversion to circular polarization may be difficult or impossible owing to complicated antenna structures or similar reasons. The use of crossed linear polarization may be considered as a possible alternative. If a transmitting antenna is vertically polarized and its receiving antenna horizontally polarized, for example, the radar will be blind to symmetrical targets and will respond to targets that distort the incident wave.

REFERENCES

- (1) L. N. Ridenour, "Radar System Engineering," MIT Radiation Laboratory Series, 1, p. 84, McGraw-Hill Book Co. Inc., N. Y., 1947.
- (2) V. H. Rumsey, G. A. Deschamps, M. L. Kales, and J. I. Bohnert, Techniques for Handling Elliptically Polarized Waves with Special Reference to Antennas, with an introduction by H. G. Booker, *Proc IRE*, 39, p. 533, May 1951.
- (3) M. G. Morgan and W. R. Evans, Jr., Synthesis and Analysis of Elliptic Polarization Loci in Terms of Space-Quadrature Sinusoidal Components, *Proc IRE*, 39, p. 552, May 1951.
- (4) Contract No. W28-099ac-487 (Restricted) with Rome Air Development Center, Griffiss Air Force Base, Rome, New York.
- (5) W. D. White, Circular Polarization as a Means of Reducing Radar Precipitation Return, 1951 *IRE National Convention*, New York, March 1951.

ETHER SPECTRUM

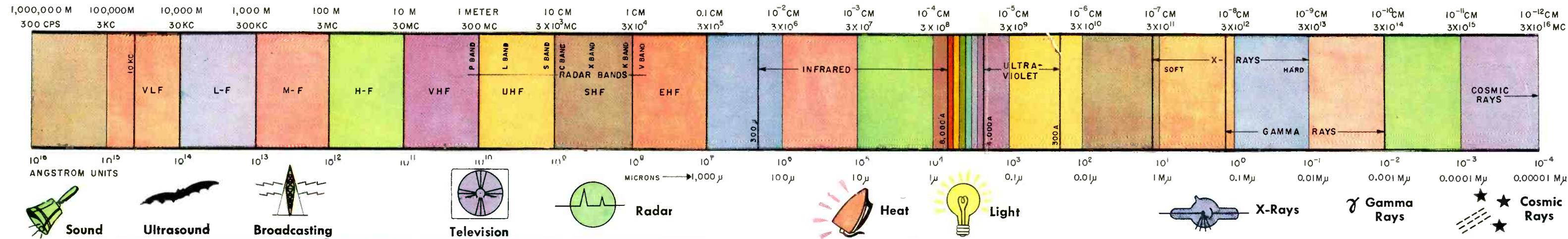

electronics
MARCH · 1954
 © McGraw-Hill Publishing Company

Atlantic City Convention RADIO SPECTRUM Western Hemisphere & Hawaii

Frequency in Megacycles

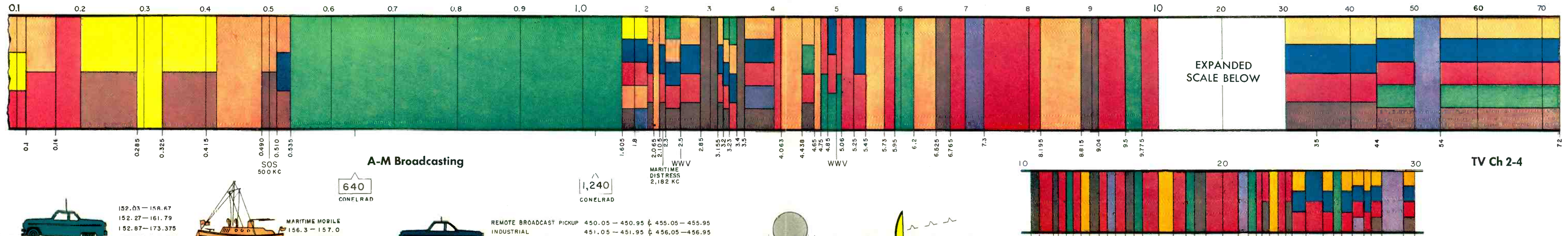

BANDS AVAILABLE FOR DOMESTIC PUBLIC, LAND TRANSPORTATION, INDUSTRIAL AND PUBLIC SAFETY ASSIGNMENTS, RESPECTIVELY

WORLD-WIDE SAFETY AND CALLING 156.8

LAND TRANSPORTATION PUBLIC SAFETY DOMESTIC PUBLIC
 452.05 - 452.95 f 457.05 - 457.95
 453.05 - 453.95 g 458.05 - 458.95
 454.05 - 454.95 h 459.05 - 459.95

Radiosonde 1,680 mc

Racon 3,256 mc

10.1 WWV
 11.175 WWV
 11.4 WWV
 11.7 WWV
 11.975 WWV
 12.33 WWV
 13.2 WWV
 13.36 WWV
 14 WWV
 14.350 WWV
 15 WWV
 15.45 WWV
 16.46 WWV
 17.36 WWV
 17.7 WWV
 17.9 WWV
 18.03 WWV
 21 WWV
 24.45 WWV
 25 WWV
 25.175 WWV
 26 WWV
 26.185 WWV
 27 WWV
 27.22 WWV
 27.35 WWV
 28 WWV
 28.23 WWV
 29.7 WWV

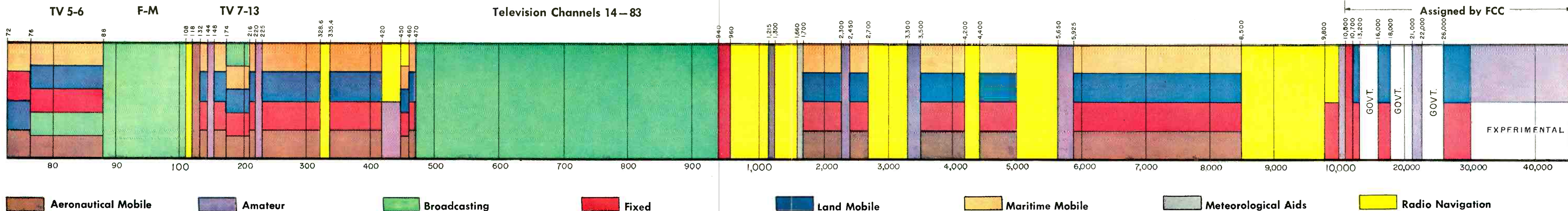

SUBAUDIBLE, AUDIBLE and SUPERAUDIBLE SOUND

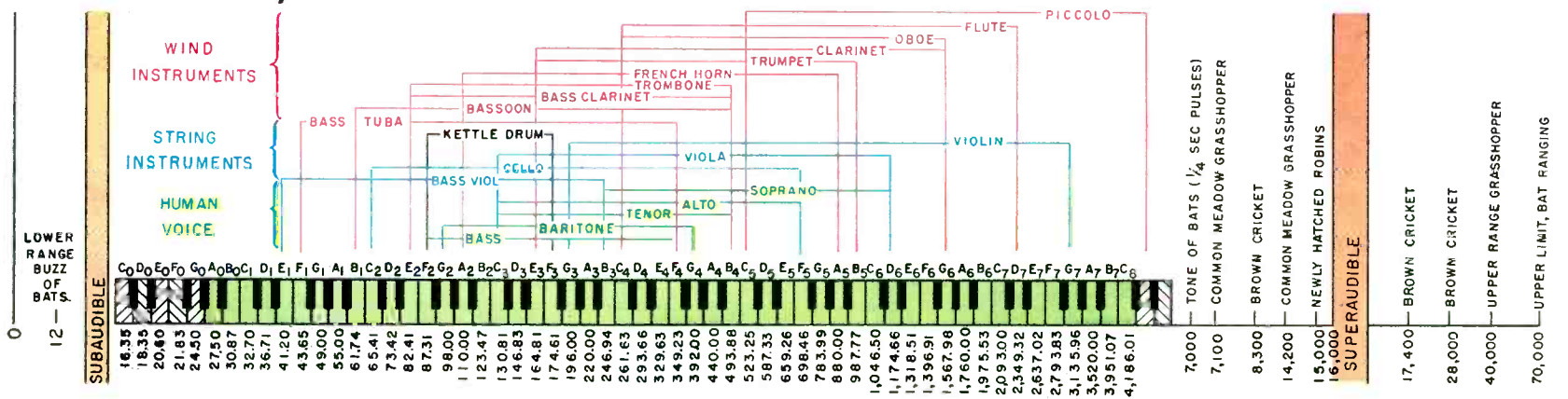

Frequency in Cycles Per Second American Standard Pitch, A₄ = 440. International Pitch, A₄ = 435. Just Scale, A₄ = 426.67.

MICROWAVE ABSORPTION

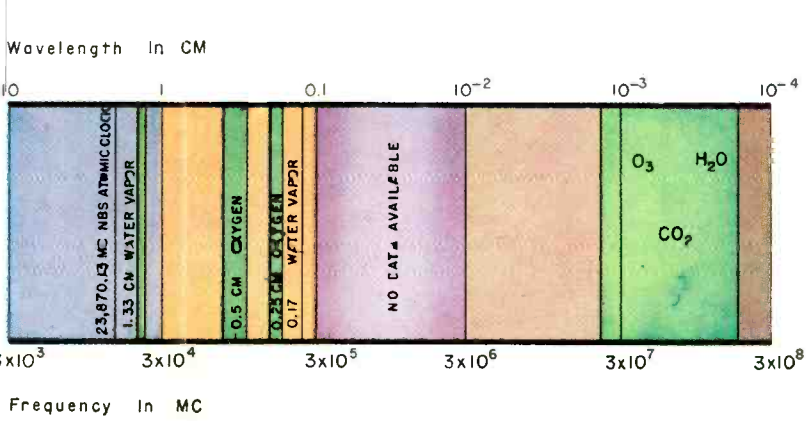

LIGHT SPECTRUM

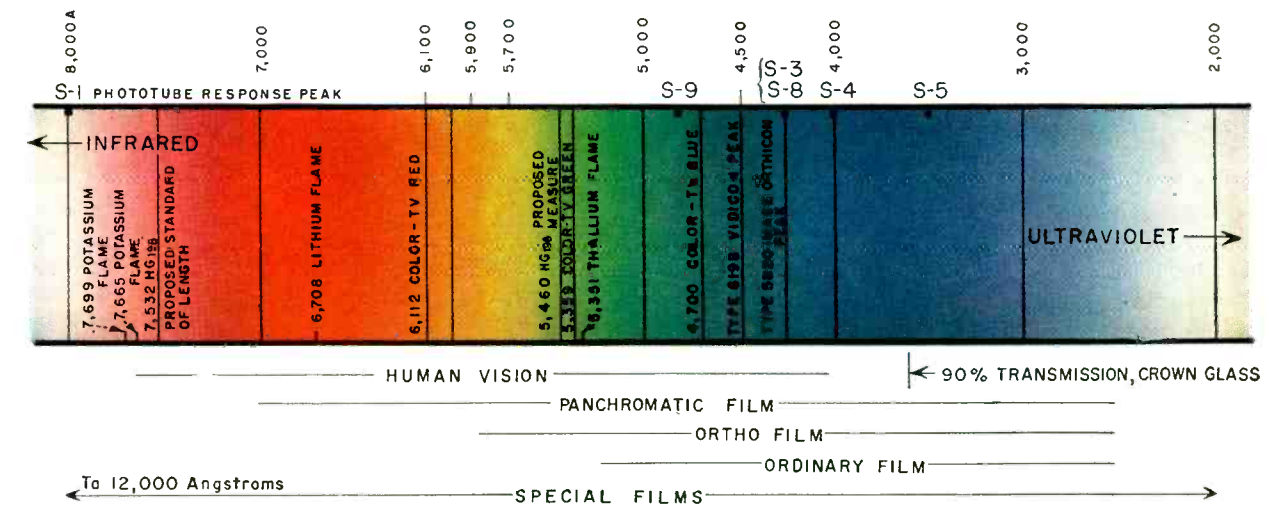

VHF Crystal Grinding

New method improves performance of round quartz frequency-control crystals in the range from 20 to 180 mc. Average series resistance for the type is 14 ohms at 75 mc for third, 40 ohms at 125 mc for fifth and 55 ohms at 175 mc for seventh-harmonic mode. Unwanted modes are diminished

By E. A. GERBER

Signal Corps Engineering Laboratories
Fort Monmouth, N. J.

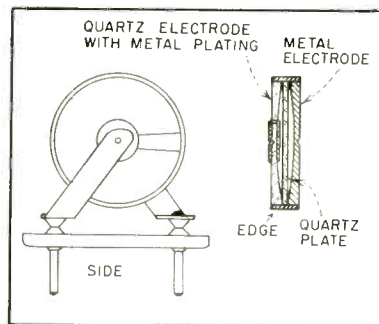

FIG. 1.—Airgap pressure mount for new vhf crystals. Keyhole pattern of gold is sputtered on major surfaces

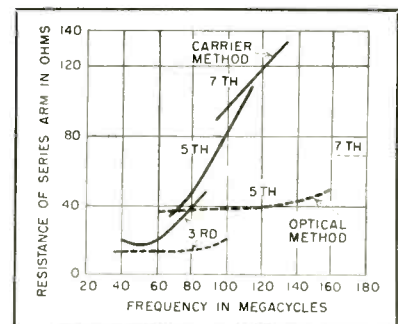

FIG. 2.—Series-arm resistance of AT-cut crystals as function of frequency for different harmonics using two methods

QUARTZ CRYSTAL PLATES vibrating in their thickness shear mode become very thin at high frequencies. A 20-mc AT-cut crystal, for instance, vibrating at its fundamental mode, has a thickness of approximately 80 microns.

To go to even higher frequencies, lapping with conventional methods becomes more and more difficult. Any imperfection of the surface finish has an increasingly bad influence on the quality of such crystals.

This article describes a new finishing method that led to improved crystal units for the frequency range from 40 to 180 mc.

Lapping and Polishing

In conventional lapping methods, crystal blanks are inserted loosely into holes of the carrier, which moves the blanks around between two cast-iron lapping plates.¹ To improve uniformity of the surface, polishing is frequently used. In

this case, the lapping plates are covered with a softer material that allows imbedding of the polishing compound. Thinness of the blanks obtained by these methods is limited by thickness of the carrier. Furthermore, breakage may occur or the surfaces may not develop sufficiently uniformly.

In the final stages of this new method, crystal blanks are fastened to a workholder when they are approximately 0.7 mm thick and brought to the desired thickness on optical lapping and polishing machines, using pitch-covered lapping plates and optical rouge.² Because the use of any cement would be detrimental to the desired final flatness of the blanks, an optical flat is used as the workholder on which the blanks are wrung in on their previously polished first sides. A photograph shows the 10-cm diameter optical flat with crystal blanks whose second sides have been lapped down and polished. The in-

terference fringes produced with a second smaller optical flat placed on top of the crystal blanks show achieved flatness of the crystals.

Optical interference with monochromatic light has also been used with great success to measure the thickness of the polished blanks with an accuracy of approximately 0.025 micron.² This is achieved by observing shift of the fringe pattern on the crystal blanks relative to the fringes on the optical flat by changing the wavelength of light used for observation.

The above accuracy corresponds to a frequency tolerance for the widely used AT-cut of $\Delta f = 0.015 f^2$, where Δf is expressed in kilocycles and f in megacycles. After removing the crystal blank from the flat, no further polishing operations are necessary and the crystal can easily be brought to the desired frequency either by etching or by plating.

Etching is commonly used to remove that portion of the surface

layer of the crystal blanks that has been distorted by lapping. Polishing leaves much less distortion than lapping. It has been found by x-ray diffraction measurements that an etch rate of $\Delta f/f^2 = 0.03$ for AT-cuts is sufficient to remove the distorted layer without increasing the resistance of the crystal. Crystal blanks made as described are mounted in two different ways.

Crystal Mounting

Gold is deposited by sputtering a key-hole pattern on the major surfaces and the plate mounted between wire clips in the HC-6/U crystal holder. It has been found that ion bombardment prior to plating is advantageous to obtain a good adherence of the metal to the polished surfaces. As can be shown, an approximate relation between the thickness of the coating t_p and the frequency change Δf caused by plating is given by the equation

$$(\Delta f \times h)/(f^2 t_p) = (1 + \rho_p/\rho)/2N$$

where h is the number of the harmonic mode, ρ and ρ_p the density of quartz and the plating material respectively and N the frequency constant in $\text{kc} \times \text{cm}$. The value of $(\Delta f \times h)/(f^2 t_p)$ is $0.0245 (\text{kc} \times \text{cm})^{-1}$ for AT-cut crystals and gold plating.

Blanks were pressure mounted as shown in Fig. 1 between electrodes lapped concave with a radius of curvature between two and six meters, the latter dependent upon diameter of the crystal and frequency. One electrode is made of nickel-silver, the other of quartz. The latter was gold plated after lapping. In both cases the diameter of the gold plating was chosen to maintain a static capacitance C_s of approximately $7 \mu\text{f}$.

Results indicated there is not much difference in resistance between pressure-mounted and plated crystal units, even at 160 mc.

Series Resistance

Figure 2 shows a comparison between average values of series resistance of approximately 50 crystal units made by method described and 50 by the conventional carrier method. In the latter case, American Optical Co. M305, corresponding to 3,000-mesh size, was

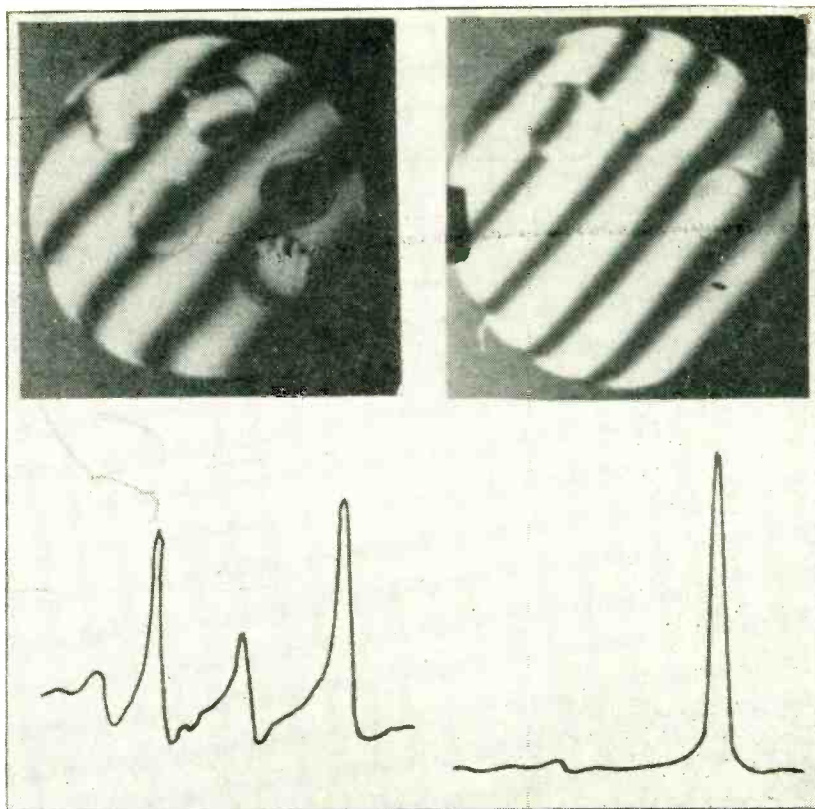

FIG. 3—Mode spectrum and surface condition of 29.14-mc BT-cut crystals vibrating at fundamental. Interference fringes through very thin polished crystals wrung in on optical flat indicates flatness of crystals. Average resistance of crystal at left is 6.3 ohms; that at right is 2.8 ohms

used as the finishing abrasive. The great improvement with the described process, especially at the fifth and seventh harmonic mode, is evident. Because there is no carrier to limit the obtainable thinness of the blanks, it is anticipated that even higher frequencies than 180 mc are within reach for direct crystal control. These and all the following measurements of resistance and response spectrum were carried out with the Signal Corps crystal impedance meter TS-683/TSM and the crystal recording analyzer also developed at the Signal Corps Engineering Laboratories.³

Resistance of a crystal depends upon thickness of the metal coating. If the coating is too thin, its resistance adds to the motional resistance of the crystal. If the plating is too thick, the loading also increases the resistance of the crystal. Thus, a minimum exists for the crystal resistance as a function of plating thickness. This minimum occurs in the case of gold plating at approximately 1 micron for

24 mc, at 0.65 micron for 72 mc and at 0.5 micron for 120 mc, the thickness values being the total for both sides.

Unwanted Modes

Unwanted modes in the vicinity of the main mode in crystal plates vibrating in thickness shear may cause sudden resistance rises (activity dips) at various temperatures. They may also produce sudden frequency changes during the tuning process of the oscillator. Both effects are detrimental to performance of the crystal. These modes result from harmonics of low-frequency flexure and face shear modes that come close to the main thickness mode and are coupled to the latter. The situation is additionally complicated by the existence of secondary thickness shear modes. In rectangular crystals, for instance, the frequencies of the latter modes are influenced by the length and width of the plate as given by an equation derived by Sykes⁴.

At high frequencies, a third type

of unwanted mode becomes apparent, which is illustrated in Fig. 3. The surface conditions of polished crystal plates wrung onto an optical flat are made visible by optical interference. Typical mode spectra are reproduced below their respective interference pictures. Five crystals at the left side are wedge shaped and have peaks or pits on the surfaces. Their spectrum shows several modes close together. The three crystals on the right have an almost flat and uniform surface and exhibit a clean spectrum. Additionally, the resistance of the flat crystals is less than one half that of the crystals with nonuniform surfaces.

The assumption that unwanted modes are due in this case to the nonuniformity of the surface is confirmed by the following observation. If the crystal plates are very thin (thickness $\ll 70$ microns) unwanted modes can still be observed in spite of the fact that the plates look completely flat and parallel in the interferometer. If the frequency distances between the main and the unwanted modes are converted into thickness differences, the latter are always smaller than 0.01 micron.

This value represents the limit to which differences in thickness can be detected by optical interference. Such differences cannot be observed

and therefore cannot be removed, but are doubtless present. This type of unwanted mode can be reproduced with one crystal over and over again, but is always different in different crystals. Additionally, when the surface of the crystal is probed with a small button electrode, single responses can be located at different spots of the crystal surface. Decreasing the size of the electrode has been proved as a means for simplifying the response spectrum.

Power Dissipation

In the manufacture of high-frequency AT-cut crystal units the resistance sometimes increases greatly with decreasing power dissipation within the crystal. At the same time, the frequency decreases. Curves A in Fig. 4 give a typical example. Power dissipation of two milliwatts is assumed to be standard and deviations of resistance and frequency from their values at two milliwatts are plotted versus power level.

Resistance increases so much at low values of power dissipation that the crystal may stop vibrating. The frequency increase with rising power dissipation (which is proportional to the square of the vibrational amplitude) is due to two different factors, temperature rise of the entire crystal and, as Bottom⁵

found, to a mechanical stress set up by excessive heating of the central area of the crystal plate due to the piezoelectric current.

The frequency perturbation caused by the latter effect should be proportional to the power dissipation. The almost straight lines of frequency-change versus power show that the second effect is much more pronounced.

Curves B and C represent measurement on the same crystals made under different conditions. The plating has been removed, the crystals cleaned and measured in the airgap-pressure mounting shown in Fig. 1. As a third step, the crystals were cleaned again, exposed to ion bombardment immediately prior to plating and replated by the sputtering method.

The great difference is apparent. Change of resistance with power level has been decreased to a large extent. It is thought that traces of absorbed moisture and gases trapped between crystal and metal coating cause variation of resistance with amplitude of vibration. It is therefore desirable to clean the crystal plates in vacuum prior to plating either by ion bombardment or by heating.

The power dissipation-frequency curves are also remarkable. Frequency perturbation due to excessive heating of the central area of the crystal plate disappears completely with airgap-pressure mounting. The metal electrode apparently distributes uniformly within the crystal the heat generated in the central area. The airgap in the center reaches a width of only 3.5 microns for a radius of curvature of 6 meters and a blank diameter of 12.5 millimeters and is not detrimental to the heat distribution. The replated crystals (curves C) reveal the same frequency-power level effect as the original crystals.

REFERENCES

- (1) R. A. Heising, "Quartz Crystals for Electrical Circuits", p 290, D. Van Nostrand Co., New York, 1945.
- (2) E. A. Gerber and H. P. Wasshausen, "High Frequency Crystals for Frequency Control—Lapping and Polishing Methods", Signal Corps Engineering Lab. Eng. Report No. E-1080, Sept. 25, 1951.
- (3) E. A. Gerber, Quartz Crystal Measurement at 10 to 180 Megacycles, *Proc IRE*, 40, No. 1, p 36, Jan. 1952.
- (4) Ref. (1), p 218.
- (5) V. E. Bottom *et al.*, Final Report on Contract No. DA36-039 sc-5485, Feb. 29, 1952.

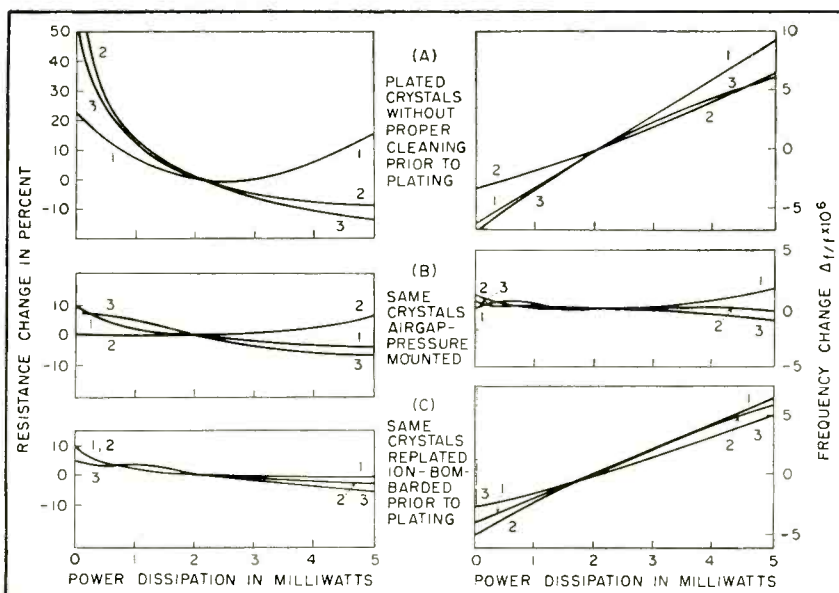

FIG. 4—Resistance and frequency change of three AT-cut 45-mc third overtone crystals as a function of power dissipation within the crystals

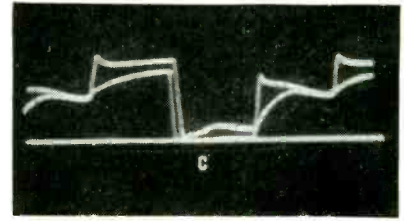
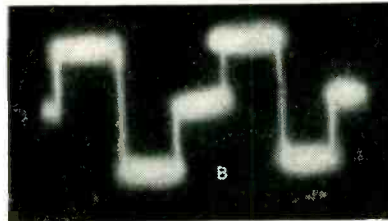
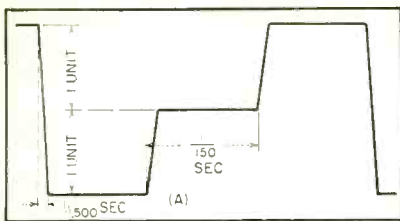

FIG. 1—Ideal current-step waveform (A) and actual waveforms produced working into an ohmic load (B) and into a 3-henry coil (C)

Current-Step

MANY PHASES of the electronics industry require shaped pulses of current as can be obtained from generators similar to the one described herein. For example, in microwave research, rotation of the plane of polarization of electromagnetic waves may be accomplished by subjecting the waves to a varying magnetic field obtained by passing properly-shaped current pulses through a coil.¹ This technique has potential application in directional couplers, t/r boxes, means for preventing overshoot in relay systems and in polarization modulation.

The problem of electronically generating magnetic pulses of long duration is one of long standing,² especially if the desired magnetic field must have intensities in the range of thousands of oersteds.

The current-waveform generator illustrated in the photograph was designed originally for pulsing magnetically controlled color filters that produce sequential light pulses of different colors.^{3,4} The generator produces magnetic pulses of long duration by developing a current-step waveform in a 1.5 to 3-henry coil. This waveform is achieved by suddenly displacing the magnetic energy stored in the inductance causing the current in the coil to drop to zero.

Waveforms

The step generator provides a coil of large inductance with the current waveform shown in Fig. 1A. The actual waveform of the

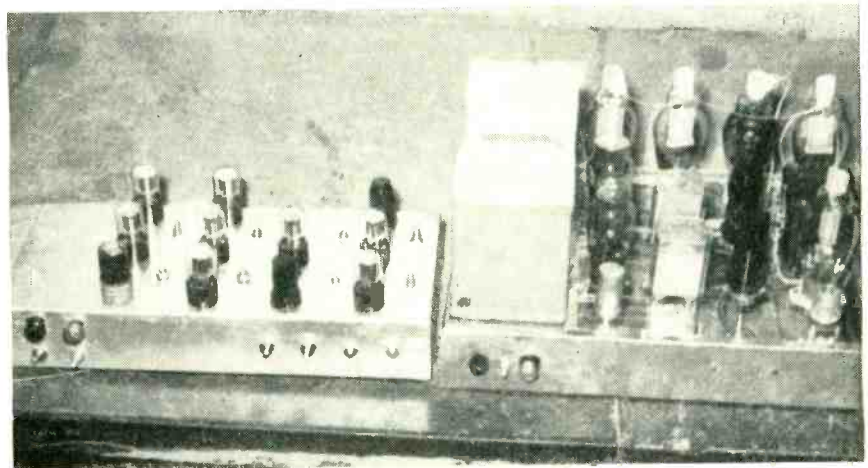

Generator and output chassis. Plastic sheet replaces metal of output chassis for insulation

generator, when working into a predominantly ohmic load, is shown in Fig. 1B. With the largest inductance used, $L = 3$ henry, $R = 300$ ohms, the waveform assumes the shape shown in Fig. 1C. Here the waveform below the step wave is the one obtained when the current-raising high-voltage pulses (to be described later) are not switched in.

During the first $1/150$ second, the generator does not supply current to the coil and during the second $1/150$ second the current rises one current unit, (between 100 and 290 ma depending upon the inductance and the high-voltage supply). In the third $1/150$ second the current rises again by one unit to the maximum current value. The rise time is $1/1,500$ second.

If the basic step-voltage waveform shown in Fig. 2A is impressed on a coil, the resultant cur-

rent waveform will be waveform 1. The inductance of the coil will not permit a sudden rise of current and when the current is at its maximum, energy in the coil will not discharge suddenly. The discharging current will have the waveform indicated.

However, it is possible to produce a sudden current drop, as in waveform 2 by having the energy stored in the coil displaced in oscillatory form into a capacitor. The energy in the capacitor however, must not oscillate back to the coil, but must be absorbed in an auxiliary circuit.

Discharge Circuit

To achieve the sudden current drop, a $0.05\text{-}\mu\text{f}$ capacitor C and a 866A gas-filled diode V_1 are connected to the coil to form a resonant circuit (Fig. 3A). The resonant frequency is between 400

Waveform applied to high-inductance coil provides magnetic pulses of long duration and high intensity. These are necessary to obtain sequential light pulses of different colors from magnetically controlled filters; also in changing polarization plane of microwaves

By V. A. BABITS, S. R. SPENGLER and R. V. MORRIS

Department of Electrical Engineering
Rensselaer Polytechnic Institute
Troy, New York

Waveform Generator

and 600 cps, depending on the inductance of the coil. When the current flows at its maximum value, the coil terminals have the polarity indicated and diode V_1 is nonconducting.

The current generator is then disconnected and the polarity reversed. This reversed voltage makes the plate of the gas diode positive and it conducts.

The oscillatory discharge of the energy stored in the coil now starts. When the current in the coil reaches zero, the capacitor is fully charged, the voltage across the coil drops to zero and V_1 ceases to conduct. The energy now stored in the capacitor is substantially that originally present in the coil.

Discharge of the capacitor is accomplished by V_2 , an 811 triode biased to cutoff and pulsed by an external circuit. The duration of the pulse is slightly longer than 1/150 second and allows time for the capacitor to discharge.

Figure 3 shows the discharge waveform of coil current with the capacitor shorted out and V_1 acting as a shorting diode; the wave-

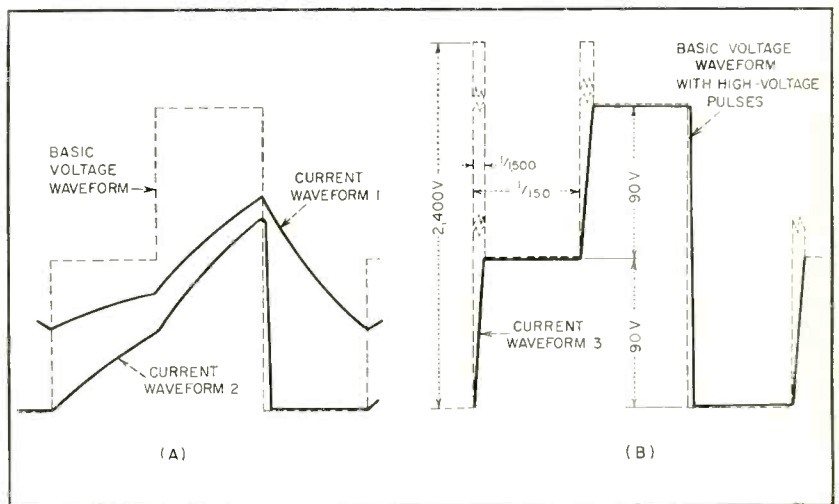

FIG. 2—Formation of current step shows how effects of voltage step and high-voltage pulses add across coil to produce desired waveform

form at the right illustrates the discharge-current waveform when the circuit is in normal operation.

Returning to Fig. 2B, it is seen that if the current is to be raised rapidly to the desired value in the step waveform, it is necessary to switch a high-voltage pulse across the coil. The magnitude of this pulse depends on the inductance of

the coil, the current step desired and the rise time.

Figure 4 shows the complete current-step generator. Functionally, the generator is divided into three sections: the basic step-voltage circuit, the pulse-generating circuit where high-voltage trigger pulses and gate pulses for the discharge circuit are produced, and

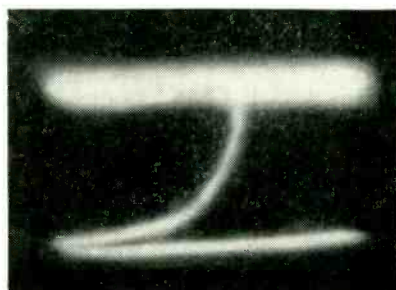
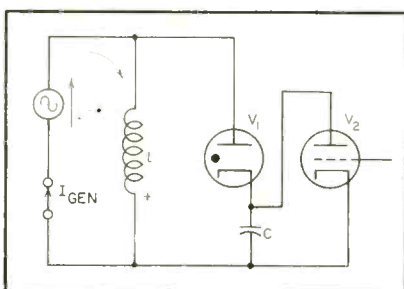
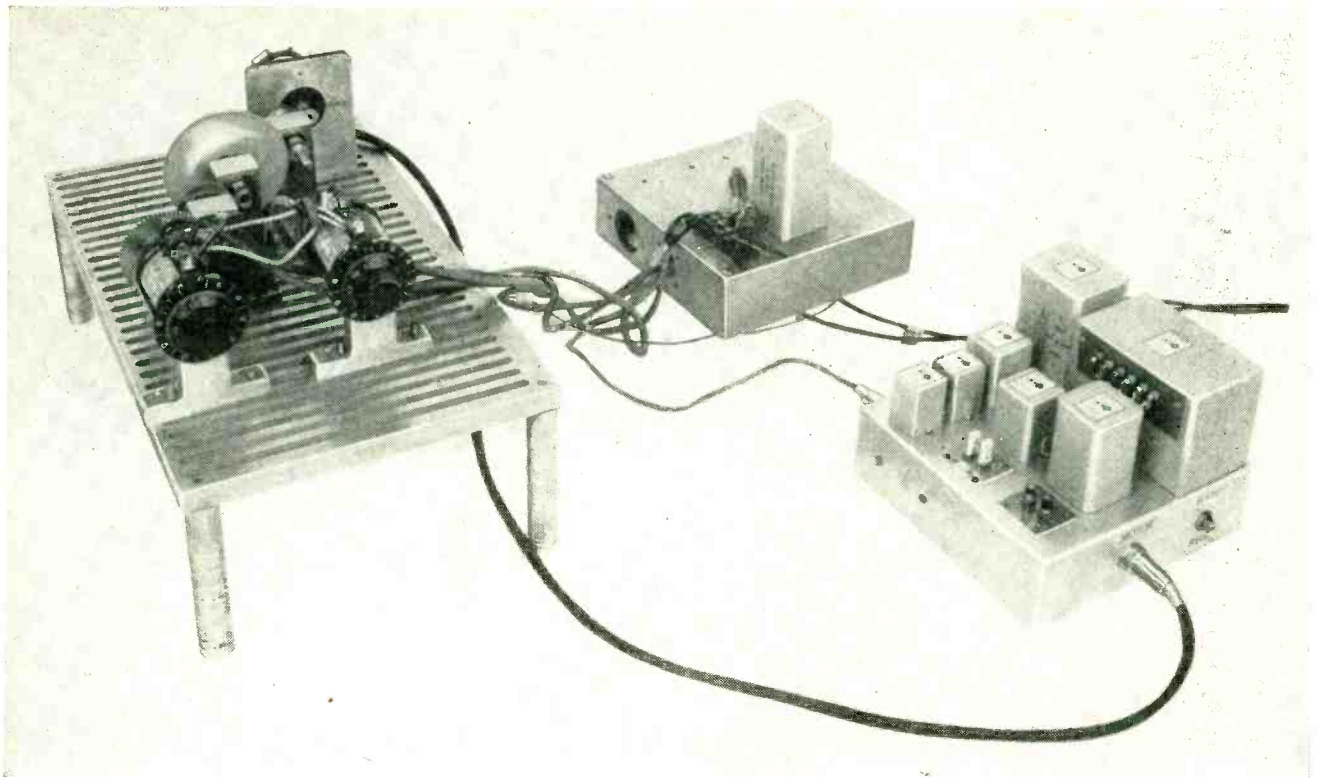

FIG. 3—Coil-discharging circuit. Current-discharge waveform, above, becomes steep, right, when discharge tube is employed



Transistor Preamplifier

SERVOAMPLIFIERS require much higher input impedances than can be practicably obtained in magnetic amplifiers. Also, since the time constant of a magnetic amplifier is proportional to gain, it is difficult to design units having both high sensitivity and sufficient speed of response. Both of these limitations to the application of magnetic servoamplifiers can be overcome by using a preamplifier.

Development of semiconductor devices has made possible the construction of a transistor preamplifier as a replacement for the vacuum-tube preamplifier currently used. The transistor is a natural complement to the magnetic amplifier since it lends itself readily to hermetic sealing, miniaturization and rugged construction. To demonstrate its adaptability to an instrument servo, the system shown in Fig. 1, utilizing the sensing circuit to the left, was chosen.

The preamplifier to be described is operated with a magnetic amplifier in an instrument servosystem

having a static error of less than ± 0.1 percent (± 1 scale division). To meet this requirement the servoamplifier has been designed to have maximum power output when the static error is equal to or greater than one scale division.

The magnetic amplifier chosen for this system had already been designed and found to work satisfactorily with a vacuum-tube preamplifier. The effective input impedance of the magnetic amplifier's differential-control winding (as defined below) is 600 ohms.

The transfer characteristic of the unit in Fig. 2A shows that a phase-sensitive direct current of ± 4 milliamperes results in a control-phase voltage of 120 volts rms, which is rated voltage for the driving motor. Thus the output requirement for the preamplifier is fixed by the magnetic-amplifier characteristics.

The input specifications of the preamplifier are determined by the error-junction characteristic as shown in Fig. 2B. There it appears

that the magnitude of the error voltage, for a displacement of one division, is a function of the input impedance to the preamplifier. The higher the input impedance, the smaller is the power gain required of the preamplifier. This characteristic suggested a junction-type transistor in a grounded-collector circuit for the first stage of the preamplifier.

Operation of the phase-sensitive detector to be described requires that a voltage-gain stage follow the input stage. A junction transistor connected in a grounded-emitter circuit meets required performance criteria. The complete preamplifier is blocked out in Fig. 3.

Phase-Sensitive Detector

Two point-contact transistors, WE type 1768, are connected in a phase-detector circuit as shown in Fig. 4. A split-phase signal of 0.25 volt rms is impressed upon each emitter when the error voltage is 20 millivolts. An a-c voltage of 8 volts rms phased with the error

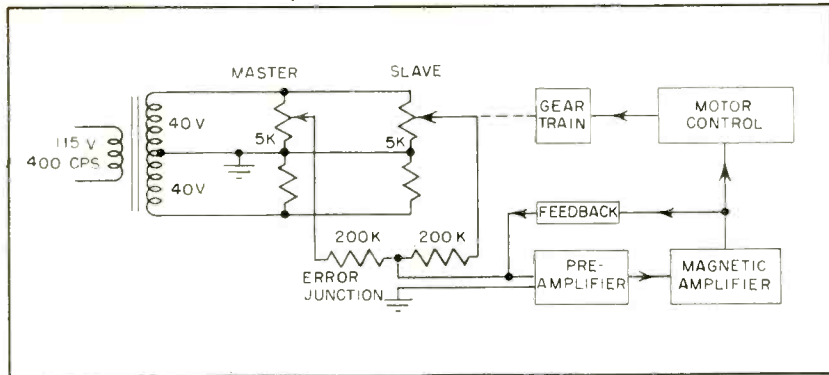

FIG. 1—Block diagram of servo system showing detail of error junction

By **MARCEL B. ZUCCHINO**
Signal Corps Engineering Laboratories
Port Monmouth, New Jersey

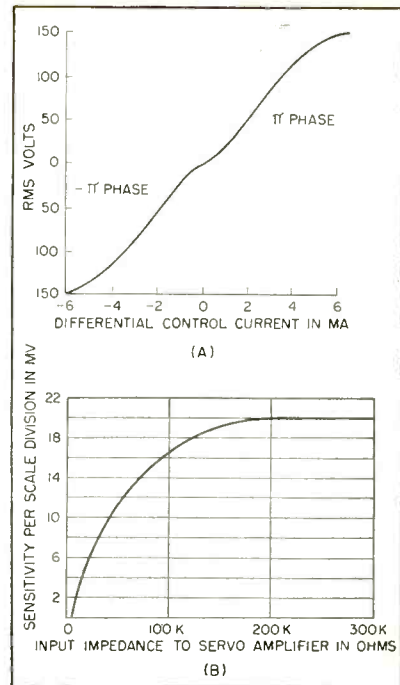

FIG. 2—Magnetic amplifier transfer characteristic (A) and error-junction characteristic (B)

Drives Magnetic Servo

Semiconductor devices permit matching low-impedance magnetic amplifier outputs to high-impedance servocontrols. Transistor preamplifier also overcomes the magnetic amplifier's mutually exclusive characteristics of high sensitivity or high response speed without reliance upon vacuum-tube equipment

voltage is applied to the collectors through 600-ohm resistors and the differential-control windings of the magnetic amplifier.

The differential-control winding on the magnetic amplifier consists in such a manner that the difference between the direct currents flowing in each winding is the effective control current. The control ampere-turns is this difference current multiplied by the number of turns on one of the control windings.

With no signal at the emitter, the collector currents flow in half-wave pulses because each transistor now behaves as a diode in the control circuit. The direct-current component in each control winding is 6 ma, and since these currents flow in

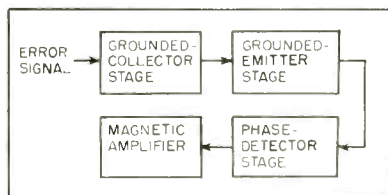

FIG. 3—Semiconductor-preamplifier input to magnetic amplifier

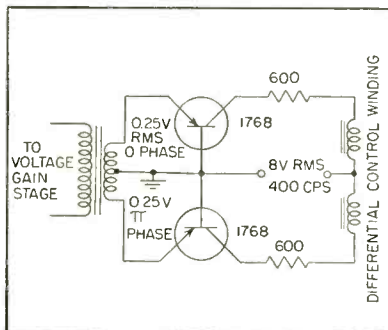

FIG. 4—Transistor phase detector

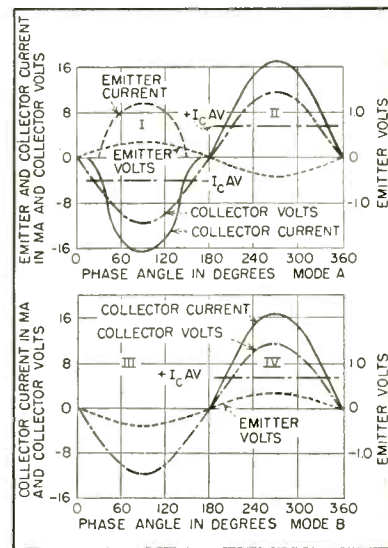

FIG. 5—Operating curves of transistor 1 (A) and transistor 2 (B) are described in text

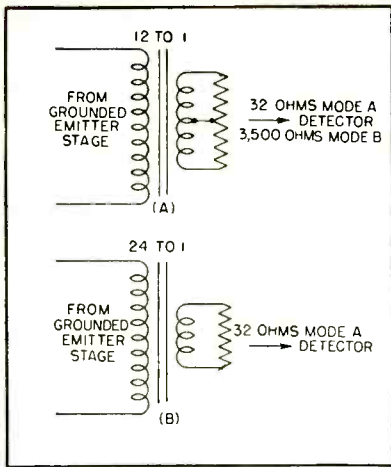

FIG. 6—Mode B load resistance (A) is high, permitting simplified circuit (B)

opposite directions in the differential-control winding, the effective input to the amplifier is zero.

When an error voltage of 0.25 volt rms appears at the emitters, its action on the mode of operation of each transistor is different, since the phase relationship between emitter and collector voltages differs for each case. The modes of operation are shown in Fig. 5.

The data for these figures were taken with varying d-c values in the same manner that the a-c voltages appear in operation. Results predicted by this method check with operating results.

Assume transistor 1 is operating in mode A. For the first half cycle the collector voltage is impressed in the conventional nonconducting direction. The emitter voltage polarity is such that negative collector current is permitted to flow due to the emitter voltage's influence, in a manner known.

During the second half of the cycle, the collector voltage is impressed in the conducting direction and positive collector current flows. During this half cycle the emitter loses control of the collector current.

Average collector current for each half cycle is found graphically and the difference between them is the direct current flowing in one half the differential-control winding of the magnetic amplifier. While transistor 1 is so functioning, transistor 2 operates according to mode B in Fig. 5.

During the first half cycle collector voltage is impressed in the con-

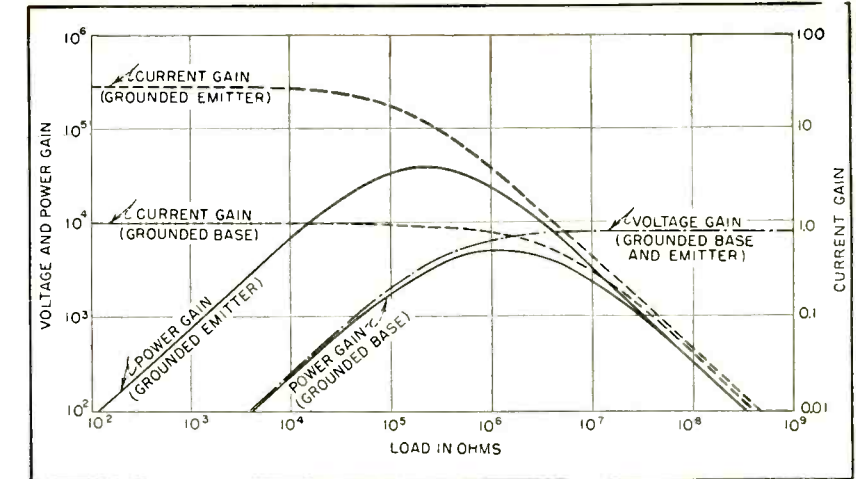

FIG. 7—Gain of transistor stages can be taken from curves shown

ventional nonconducting direction. However, the emitter voltage is of negative polarity and no transistor action occurs.

In the next half cycle, collector voltage is positive and there is positive collector current, while once again the emitter loses control. It is the average value of this positive pulse that flows in the other half of the differential-control winding. The difference between the average current in each collector circuit is the effective control current in the magnetic amplifier.

An examination of the emitter voltage and current characteristics shows that the secondary loading by the transistor operating in mode A is about 32 ohms.

Amplifier Stages

The load impedance to the voltage-gain stage, if an output transformer with an overall turns ratio of 12 to 1 is used, is found in the following manner.

The 3,500-ohm load of mode B is so high compared to the 32-ohm load of mode A that Fig. 6A can be drawn as Fig. 6B with negligible error. The load impedance R_1 reflected to the primary side is 32 ohms multiplied by the turns ratio squared, so $R_1 = 18,500$ ohms.

With R_1 known, the voltage gain of the grounded-emitter stage can be found by referring to Fig. 7. From this, a typical gain is 480.

For a 4-ma signal, the voltage on each emitter of the phase-sensitive detector should be 0.25 volt rms or 0.5 volt rms emitter-to-emitter. Thus the output voltage of

the voltage-gain stage on the primary side of the output transformer should be 6 volts for a displacement of one division. Input voltage to the voltage-gain stage for maximum detector output must then be 6 volts divided by the voltage-gain as found in Fig. 7, or 12.5 millivolts.

Since the grounded-collector stage exhibits a unity voltage gain, it is necessary that the sensitivity of the error junction be equal to 12.5 millivolts per division or greater. Referring to Fig. 2B, this sensitivity will be obtained if the input impedance to the grounded-collector stage is 60,000 ohms or greater.

This input impedance can be practically obtained as shown in Fig. 8. With a load impedance of 18,500 ohms, the input impedance to this stage is about 1,000 ohms.

Figure 9 shows that with a transistor exhibiting a high alpha the input impedance of the grounded-collector stage will be about 90,000 ohms when the load impedance is 1,000 ohms. From Fig. 2B it is found that with this input impedance a sensitivity of 16 millivolts per division can be expected from the error junction. It has been possible, therefore, to build a preamplifier based on the block diagram of Fig. 3 to meet requirements.

Practical Considerations

The final circuit shown in Fig. 10 has a number of special features. External bias of the collector and emitter voltages is chosen in place of self-bias. This was found necessary so that transistors can be in-

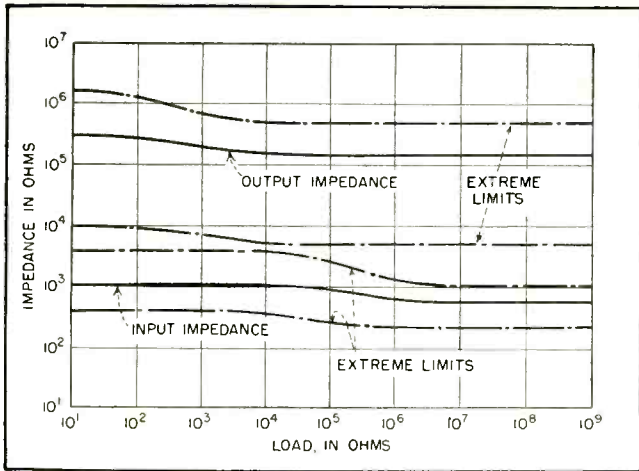

FIG. 8—Input and output impedances of grounded-emitter stage are shown on appropriate curves

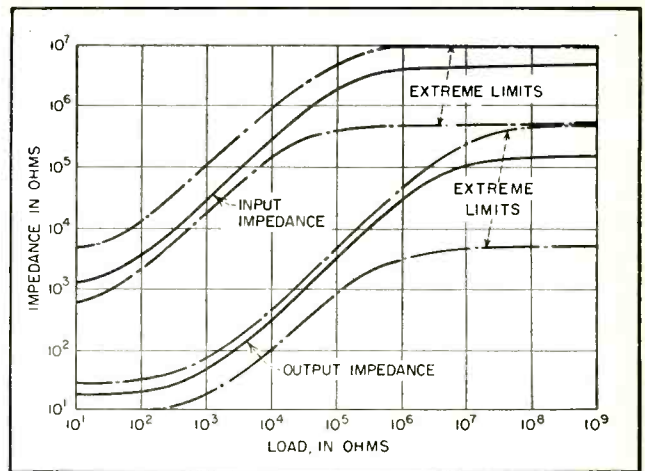

FIG. 9—Input and output impedances of grounded-collector stage are shown for high-alpha transistor

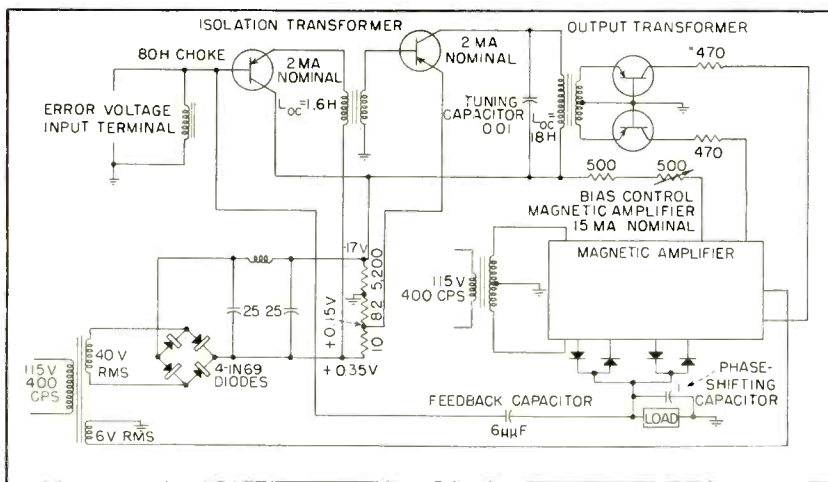

FIG. 10—Tubeless servoamplifier uses transistors to drive magnetic amplifier

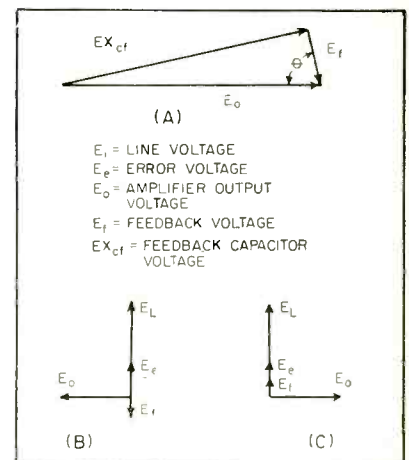

FIG. 11—Vector relationship in feedback circuit. Angle θ approaches 90 deg.

terchanged without adjustment of bias resistors.

The output transformer has an open-circuit inductance of 18 henrys so its 400-cycle reactance will be high compared to that of its load resistance. Miniaturization of this unit is not practical because no power is available to waste in an inefficient transformer.

The interstage transformer is used to isolate d-c bias supplies of the first and second stages. Its open-circuit inductance is 1.6 henrys and it has unity turns ratio. As with the output transformer, miniaturization is not practical.

The input choke shown has an inductance of 80 henrys, presenting to the a-c input signal an impedance sufficiently high to avoid loading effect. This choke provides a low-resistance path to ground for the d-c base current.

The values of d-c bias voltages

shown are nominal. Wide variations from these values are permissible as long as the ratings of the transistors are not surpassed.

Although the preamplifier must sense small voltages, it is subject to very large voltages for short periods of time. During the interval required by the servomotor to correct, signal voltage drives the preamplifier to cutoff. It is not possible for the transistors to be biased for symmetrical clipping as the gain is reduced at such bias points. Resulting distortion, apparently accompanied by an effective phase-shift, prevents the phase detector from functioning properly. On the test model this condition caused the servo to stall if a sudden displacement error were applied.

It is possible, by tuning the primary of the output transformer to 400 cycles, to filter out a sufficient amount of distortion, thereby pre-

venting malfunctioning of the phase detector.

This servosystem is stabilized by feeding back a small portion of the output through a 6- μ f capacitor to the error junction as shown in Fig. 10. The capacitor in the feedback line shifts the voltage 90 deg (Fig. 11A) in addition to the 90-deg change performed by the phase-shifting capacitor across the control phase. Figure 11B shows the vectorial relationship describing the feedback action.

It is possible for the feedback to be positive rather than negative, if the vector relationship is that shown in Fig. 11C. The easiest way to test for proper phasing is arbitrarily to connect the feedback capacitor into the circuit. If the period of oscillation frequency increases, phasing is incorrect.

The invaluable aid of Hitoshi Kajihara is acknowledged.

Electric and Ultrasonic

Summarized data on electrical characteristics of body muscle, fat and blood at various frequencies from 1 mc to 10,000 mc, for guidance in design of more efficient shortwave diathermy, uhf radiation diathermy and ultrasonic medical heating equipment

THE HEALING AND pain-relieving properties of heat have long been recognized. Application of heat causes an increase in blood flow and in many instances hastens the body's processes of recovery. Originally, it was possible to apply heat only to the surface of the body (by hot packs and infrared radiation). Yet, frequently it is the deeper tissues which require treatment. Because of the rapid convection of heat by blood flow, only a small percentage of the heat applied to the surface penetrates to these tissues. If a temperature rise is to be produced in the deep tissues, the heat must be generated at the site where it is needed.

Shortwave Diathermy

Biophysical research in the field of diathermy has proved fruitful. The first answer to the deep-heating problem came during the 1920's, when it was shown that heat could be generated safely and effectively by the use of radio-frequency currents. Measurements of the electrical impedance of a wide variety of body tissues over the frequency range from 1 kc to 100 mc showed that the impedance is strongly frequency-dependent and that the resistivity and dielectric constant of tissues with high water content (such as muscle, liver and brain) are so nearly the same in the shortwave region that the selective heating of any one of these tissues relative to another is impossible.

Fat and bone, however, are exceptions. Their dielectric constants are low compared to those of other tissues and their resistance considerably higher. A region of muscle to be heated is frequently found to lie beneath a layer of subcutaneous fat. The heat generation in

this inhomogeneous tissue configuration can be analyzed by the equivalent circuit of Fig. 1A. Both capacitive and resistive impedance of the fatty layer is higher than that of an equivalent thickness of muscle. Hence, the fat is selectively heated in such an arrangement. A detailed investigation of the impedance values shows that the ratio of heat developed in fat to that in muscle decreases with increasing frequency. However, the ratio remains considerably greater than unity even at the highest frequency which can be utilized in actual patient treatment with r-f currents.

Figure 1B shows the ratio of heat development in fat to that in muscle, calculated on the assumption that the current density in fat and muscle are the same. Where finite electrodes are used, edge effects cause a significant divergence of the field lines. In practice, therefore, the current density in underlying muscle layers is lower than in the fat. The actual ratio of heat development in fat to that in muscle is thus even higher than is indicated in Fig. 1B.

A somewhat different situation exists if energy is applied by the use of an induction field. Here, the eddy currents associated with a magnetic field are used for heating.

The use of long coils for the generation of relatively homogeneous magnetic fields requires low frequencies to achieve resonance. For such low frequencies the eddy currents associated with the alternating magnetic field are too small to heat. On the other hand, if one attempts to decrease the inductance (by using fewer turns or a pancake winding), the magnetic field becomes nonuniform. The field is

strong near the coil windings and consequently surface heating develops. The necessary compromise between high and low-frequency requirements (at present chosen near 27 mc) does not permit substantially greater deep heating than is obtained with the conventional capacitive coupling arrangement indicated in Fig. 1A.

Radiation Diathermy

It is not possible to apply radio-frequency currents at frequencies higher than 100 mc to the human body. This is because the electrodes and cables which connect them with the radio-frequency generator establish a circuit which is too large in size to resonate above 100 mc. On the other hand, without resonance it is difficult to produce sufficiently high currents in the patient and to load the generator properly. In an attempt to reduce the selective fat heating to a more acceptable level, another approach has to be taken.

Electromagnetic radiation using radar techniques was introduced as a form of diathermy after World War II. By 1950, microwave radiation at 2,450 mc had achieved considerable popularity in this country. During the same period ultrasonic radiation was given similar clinical application and became widely accepted by the medical profession in Austria, Germany and Switzerland. Although some preliminary analysis of radiation diathermy—both ultrasonic and electromagnetic—had been undertaken before World War II, only recently have sufficient data become available for a quantitative treatment of the problem.

Bridge techniques have proved satisfactory for measurements of

Deep-Heating Diathermy

By HERMAN P. SCHWAN, EDWIN L. CARSTENSEN and KAM LI

*Electrical Laboratories, Graduate School of Medicine and
Moore School of Electrical Engineering
University of Pennsylvania, Philadelphia, Pa.*

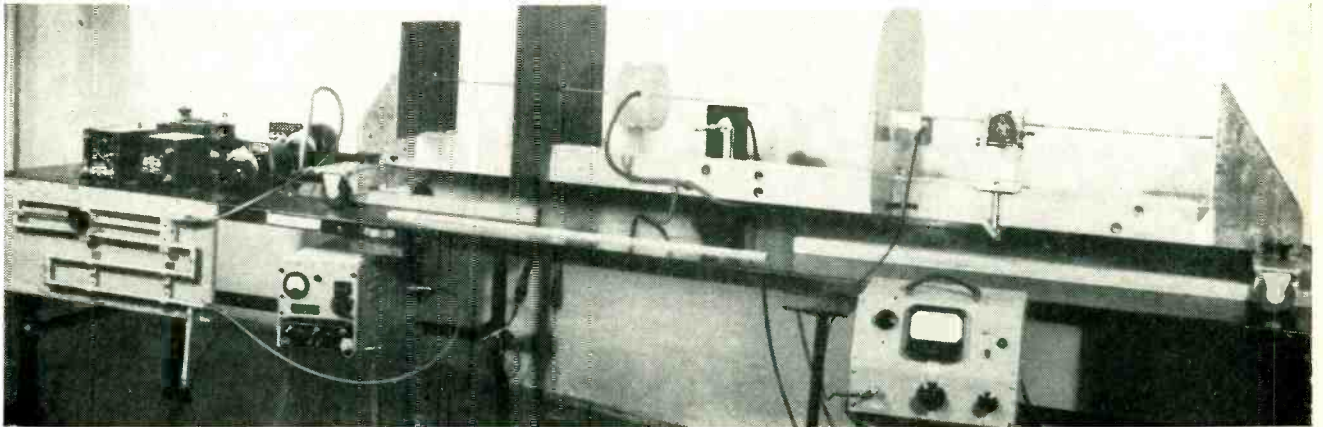

Two-wire transmission-line setup for measuring dielectric properties of biological material. Sample holder is in glass cylinder in center, having thermostatic control of temperature. At left on table are uhf generators, calibrating attenuator, antenna tuning elements and precision frequency meter used in measuring the electrical characteristics of various samples at various frequencies

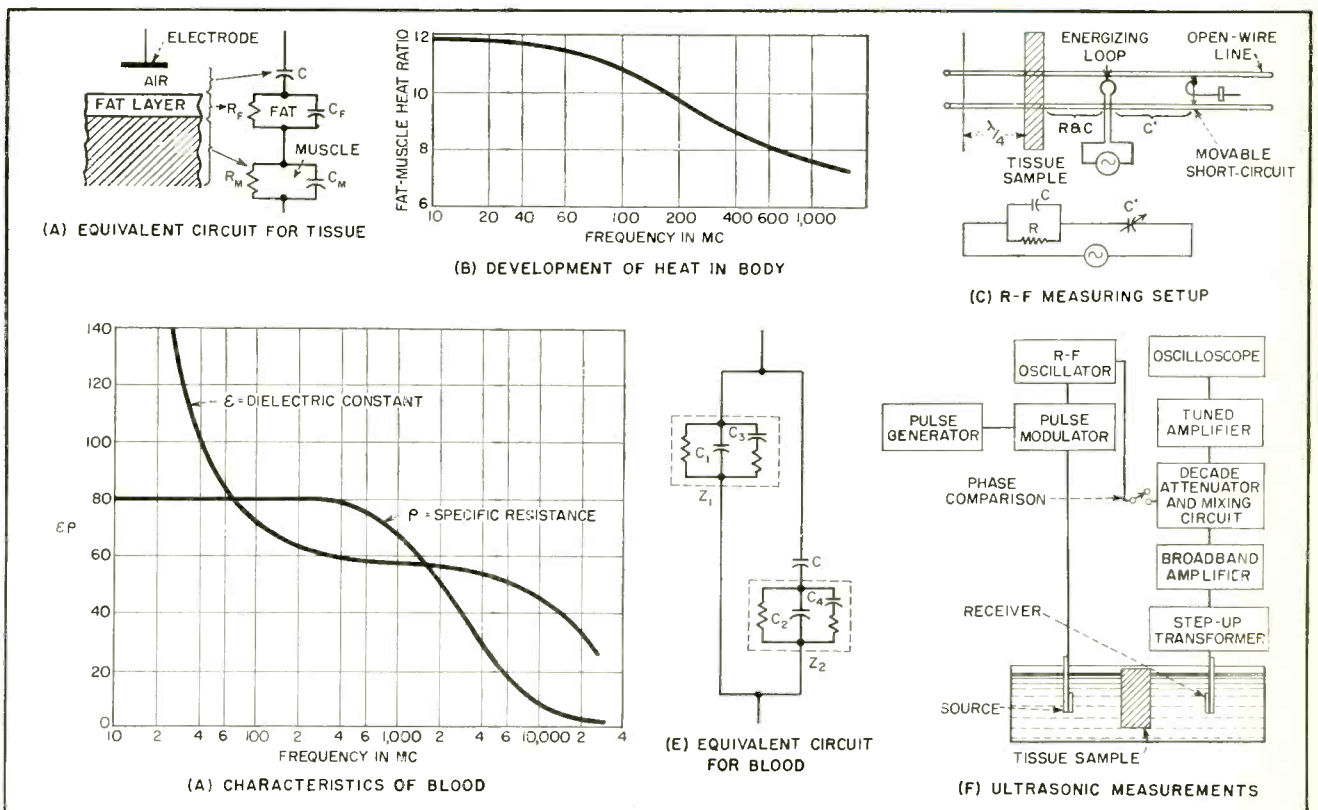

FIG. 1—Measuring techniques and results applicable to heating of human tissue for healing and muscle-relaxing benefits

Table I—Average Measured Electrical Characteristics of Body Tissues

Freq in mc	Dielectric constant relative to air		Specific resistance in ohm-cm	
	Muscle	Fat	Muscle	Fat
100	60	7	110	2,700
300	52	6	90	2,300
1,000	51	4.5	75	1,800
3,000	48	3.4	45	700
10,000	44	3	12	300

Table II—Propagation Constant for Electromagnetic Energy in Body Tissues

Freq. in mc	Propagation constant $\gamma = \alpha + j\beta(\text{cm}^{-1})$			
	Value of α in nepers per cm		Value of β	
	Muscle	Fat	Muscle	Fat
100	0.16	0.04	0.32	0.08
300	0.22	0.05	0.53	0.17
1,000	0.28	0.07	1.4	0.50
3,000	0.56	0.11	4.6	1.3
10,000	3.4	0.27	14.4	3.8

tissue impedance up to frequencies of the order of 100 mc. Measurements of tissue impedance in the range of 100 to 1,000 mc have been made by the special resonance method of Fig. 1C with an open-wire transmission line. The line is loaded on one side by the sample under investigation and terminated on the other end by a movable shorting plate. It is excited at a point between sample and shorted end and the modulated current is picked up by a small loop protruding from the movable shorting plate. The current is then rectified, amplified and metered. The variation of this current with the position of the shorting plate establishes a resonance curve.

By using a resonance principle, a high degree of accuracy has been obtained. The precision of this technique compares favorably with that provided by standard coaxial line techniques. Measurements of body tissues and blood have also been made above 1,000 mc.

Average dielectric constant and resistivity values of fat and muscle at 37 C are summarized in Table I. The values for fat vary considerably due to variation in water content, but muscle data are reproducible within about 5 percent.

Blood has a frequency behavior which is characteristic of tissues with high water content. At low frequencies, the dielectric constant of blood is controlled by the capacitive reactance of the membranes which surround the blood cells. As the frequency increases, the effect of cell membranes is reduced until the dielectric constant approaches that of tissue fluid and plasma, as shown in Fig. 1D. Above 1,000 mc, water itself undergoes a change in dielectric constant.

Figure 1E gives an equivalent circuit which describes the frequency behavior. The partial circuits Z_1 and Z_2 are frequency-independent and purely resistive up to about 1,000 mc. They represent intracellular and extracellular fluid of the cell suspension. The capacitor C represents the electrical equivalent of the cell membranes and is quite large compared to C_1 and C_2 . Capacitors C_1 and C_2 affect the impedances Z_1 and Z_2 above 100 mc and characterize the change in impedance which the fluids themselves undergo at such high frequencies.

From the dielectric properties of the tissues it is possible to compute the complex field propagation constant, $\gamma = \alpha + j\beta$. Table II shows the result for fatty tissues and muscular tissue in terms of attenuation constant α and phase constant β as a function of frequency. Depth of penetration ($\frac{1}{2}\alpha$) in muscular tissue is thus much smaller than in fatty tissue and falls below 1 cm as the frequency exceeds 3,000 mc.

Ultrasonic Properties of Tissue

The method used for measuring the absorption coefficient of fatty tissue is shown in Fig. 1F. Source and receiver transducer are positioned in a vessel which is filled with a suitable coupling liquid. The r-f voltage on the source produces an ultrasonic wave in the liquid which is picked up by the receiver, amplified and presented on an oscilloscope.

A calibrated attenuator in the receiving circuit permits accurate determination of the relative level of the received signals. The transmission loss caused by the insertion of a sample of tissue in the

path between the transducers is equal to the difference between the absorption in the sample and the absorption of the coupling liquid which had been replaced by the sample. This holds if it can be assumed that reflections at the sample-liquid interfaces are negligible. To assure this, a coupling liquid is chosen which has an acoustic impedance almost equal to that of the sample. To avoid standing waves in the test vessel the r-f signal is applied to the source in short pulses.

The velocity of sound in tissue is measured with a method based on the change of phase of the received acoustic signal caused by introduction of a tissue sample. When a tissue sample is inserted between the transducers, coupling liquid is displaced and the acoustic path is changed by $(n + \varphi)$ wavelengths where n is an integer.

For the phase measurements the received pulse is added to a c-w signal from the generator. The change in transducer separation which is necessary to return the relative phase of received pulse (as referred to the c-w signal) to its original value, after insertion of the sample, is a direct measure of φ . Repetition of this measurement over a small range of frequencies is sufficient to determine n .

Absorption data for tissue of high water content have been reported, as also have velocity data for several tissues with high water content and fat. The velocity measurements were based on the time delay of a pulse transmitted through a tissue sample. The values obtained are summarized in Table III.

The introduction of ultrasonic or electromagnetic radiation as

Table III—Average Absorption of Sound Energy in Tissue

Freq in mc	Absorption coeff in nepers per cm	
	Muscle	Fat
1	0.12	0.04
2	0.24	0.10
4	0.48	0.30
6	0.55

forms of diathermy can be justified only if they provide significantly better deep heating than is obtainable by surface heating methods. The depth of penetration of the primary radiation energy is defined as $\frac{1}{2}\alpha$ (where α is the absorption coefficient of the tissue in nepers per cm) or the depth at which the energy is reduced to $1/e$ of its surface value.

Significance of Data

Surface heating methods achieve effecting depths of penetration of 1 to 2 cm. An inspection of Table II shows that to achieve primary depths of penetration in muscular tissue of the order of 2 cm with electromagnetic radiation, it is necessary to use frequencies of the order of 200 to 300 mc. This is considerably lower than the frequency commonly used in clinical practice at present. At these low frequencies the wavelength of the electromagnetic radiation is so great that conventional reflectors for applying energy to the body become unwieldy. This difficulty may be overcome and a more efficient impedance match between generator and body may be obtained if material with a high dielectric constant is used in coupling the uhf generator to the body.

Table III gives average values of the absorption coefficient for ultrasonic energy in tissue at 37 C. From this, it can be determined that 1-mc ultrasonic energy penetrates about 4 cm into muscle (penetration in $\text{cm} = 1/2\alpha$). The problem of matching the generator to the body is even more important in this case. The impedance mismatch between air and tissue is so great that even a thin layer of air between generator and human body would pre-

vent energy transfer into the tissue. It is necessary, therefore, to provide liquid or direct coupling between source transducers and the tissue. The wavelength of sound in tissue at 1 mc is about 1 mm (velocity of sound in meters per second is 1,580 for fat and 1,400 for muscle). Hence, it is possible to achieve almost any desired localization with ultrasonic energy. Electromagnetic radiation, on the other hand, is suitable for heating larger volumes.

The fat-muscle problem has been analyzed for both forms of radiation diathermy. Tissues with high water content are usually surrounded by a layer of subcutaneous fat. The radiation passes first through the skin-fat arrangement and is then partially transmitted into muscular tissue and partially reflected from the fat-muscle interface.

Both forms of radiation tend to favor heating of muscle since the absorption coefficient for fat is lower than for muscle. However, the actual heat development depends upon the geometry and the magnitude of reflection at the fat-muscle interface. About 30 percent of electromagnetic energy is reflected. This gives rise to sizeable standing waves in the fatty layer.

The reflected electromagnetic wave suffers a 180-degree phase shift

at the boundary. This tends to minimize the heating of the fat in the region within a quarter wavelength of the fat-muscle boundary. In the ultrasonic case, standing waves have a negligible effect on heating of the fat. This is in part due to the low reflection coefficient of the fat-muscle boundary for sonic waves and in part due to the very short wavelength of ultrasonic energy.

The actual heat development curves are presented in Fig. 2. Here the heat development per unit volume, relative to that in the muscle at the fat-muscle interface, is plotted as a function of distance from the fat-muscle boundary. The curves show that at high frequencies the rate of heating of parts of the fat can be higher than in the muscle.

Summary

By analytical methods, it is possible to arrive at quantitative answers to many of the problems of diathermy. The analyses, however, must be built upon a knowledge of the electric and acoustic impedance of the various body tissues. Techniques for the determination of these quantities have been developed and measurements performed on a variety of biological materials. The results show that tissues with high water content in general establish a class of materials with comparable impedance values. The impedance of fat differs considerably from tissues.

For both forms of radiation diathermy the ratio of heat development in fat to that in muscle increases with increasing frequency, and can be made considerably smaller than unity if sufficiently low frequencies are used. This is just opposite to the frequency relationship applying to shortwave diathermy.

By using frequencies of the order of 500 mc, it is possible with electromagnetic radiation to penetrate the fat almost completely and to dissipate a large fraction of the total energy in the muscle. Similar results are obtained with ultrasonic energy at 1 mc.

This work was supported by the Office of Naval Research under Contract No. Nonr-551(05).

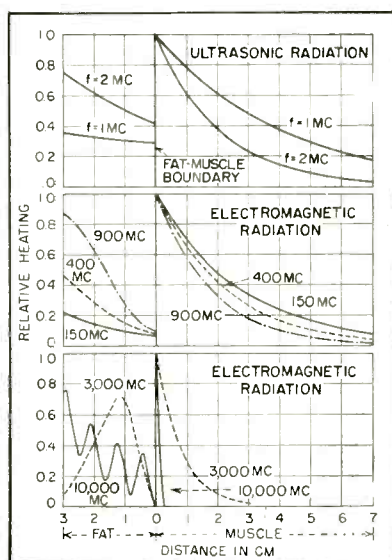

FIG. 2—Heat development per unit volume by ultrasonic and electromagnetic radiation at various frequencies. Standing-wave pattern at 10,000 mc results from partial reflection at fat-muscle boundary

Audio Oscillator

Low-pass and high-pass R-C circuits are combined with two triodes in a feedback arrangement to generate audio frequencies in the range from 11 cps to 100 kc in four bands. Waveform distortion is avoided by limiting feedback through amplified and delayed automatic gain control tube

RESISTANCE-CAPACITANCE oscillators commonly employ Wien-bridge or less frequently, twin-T, parallel-T or phase-shift circuits. Use of each of these circuits for R-C type audio signal generators involves limitations such as lack of symmetry or the requirement for insulation between the ganged-capacitor tuning elements that are used in continuously tuned instruments. Although other frequency-selective R-C circuits are not generally used in audio-frequency generators of the sine-wave type, the possibilities of a different type of circuit design appear attractive.

Circuit Design

Some basic considerations include desirability of incorporating both a high-pass and a low-pass R-C filter in the feedback loop of R-C coupled oscillators to obtain good frequency stability and good sine waveform. If the mechanical design arrangement is to be kept simple, it is also desirable that a variable ganged capacitor be used as the frequency-shifting element and that the common rotor section be kept at ground potential.

In the low-pass section of the circuit, the logical design is to couple signal voltage through a bypassed series resistor to an amplifying device such as an electron tube. Figure 1A shows such a circuit and its frequency response characteristic.

To complete the oscillator, it is necessary to reverse the phase of the output signal of the amplifier, pass the signal through a high-pass filter or equivalent and return it to the input side of the circuit shown in Fig. 1A. This arrangement sets up an oscillatory system that can be

By J. H. OWENS

Tube Dept.
Radio Corp. of America
Harrison, N. J.

used as a signal generator.

In the high-pass filter section of the circuit, a series-connected capacitor is usually required and the resistor is returned to ground. This arrangement is essentially the same as that used in the Wien-bridge and other circuits mentioned. It likewise involves the limitations ascribed to these circuits. These limitations can be avoided by connecting the equivalent of a high-pass filter in place of the conventional filter itself.

By use of a modified grounded-grid amplifier a low-pass filter may be used in such manner as to give the stage a rising high-frequency characteristic. A suitable circuit having high-pass filter action is shown in Fig. 1B. Its frequency

characteristic, shown at the right, is the opposite of that shown in Fig. 1A.

The circuit shown in Fig. 1B is not truly a grounded-grid amplifier; the grid is only partially grounded in a frequency-selective manner. At very low frequencies the grid is practically free to follow the cathode, but at higher frequencies it cannot completely follow the cathode owing to the bypassing action of the capacitor. Because the output signal at the plate is almost entirely dependent upon an a-c voltage difference between the grid and cathode, the output signal becomes greater as the frequency is raised. The R-C grid network, which is a low-pass filter, has the effect of a high-pass filter.

Circuits shown in Fig. 1A and 1B can be combined to form an oscillation generator. The basic overall circuit is shown in Fig. 1C together with its frequency characteristic. It can be seen that the V_1 stage of Fig. 1C has the response characteristic depicted by line Y, which is similar to the characteristic shown in Fig. 1A. Similarly, the V_2 stage of Fig. 1C has the response depicted by line X, which is similar to the characteristic shown in Fig. 1B. Highest response or maximum sensitivity will occur at point Z and oscillations will take place at this discrete frequency.

Operation of Generator

The mechanics of oscillation can best be explained by tracing a signal through the regenerative loop in Fig. 1C. When random noise or any other circuit disturbance increases the voltage at the plate of V_2 slightly, this positive-going voltage is transferred to the grid of V_1

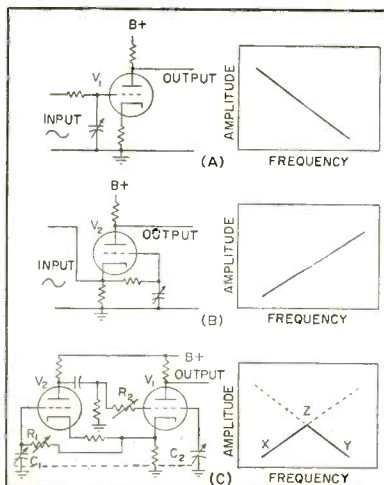

FIG. 1—Development of basic oscillator circuit from low-pass (A), high-pass (B) and combined circuits (C). Frequency response characteristic of each is shown graphically at right

Uses New R-C Design

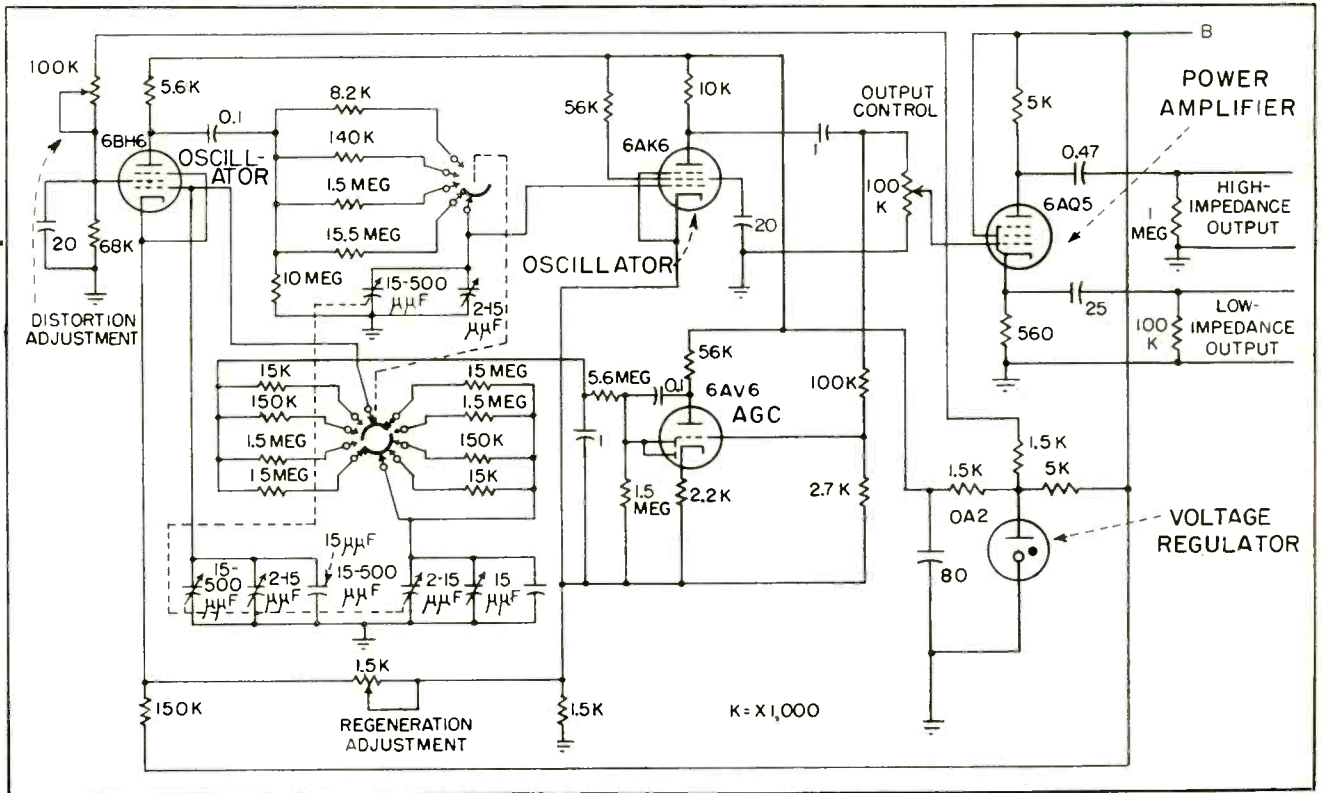

FIG. 2—Elements of a practical audio oscillator using agc in feedback circuit

in the same direction, although its phase is shifted slightly and some attenuation takes place in the R_2C_2 network. The grid of V_1 goes positive causing an increase in the plate current of V_1 and a consequent rise in cathode voltage.

Because the cathodes of V_1 and V_2 are coupled, cathode voltage of V_2 also rises. The cathode of V_1 is connected through a low-pass phase-shifting network to the grid of V_2 . This network attenuates the signal so that a smaller amount reaches the grid of V_2 than reaches the cathode of V_2 . A voltage difference is thus created between the cathode and grid of V_2 ; the cathode becomes more positive than the grid or, effectively, the grid becomes more negative than the cathode.

The negative-going grid causes a reduction in the plate current of V_2 and a consequent increase in the plate voltage. Because this rise in plate voltage is in the same direction as the disturbance that started the chain of events, the circuit is

regenerative and oscillations are generated and sustained.

Like the Wien-bridge, in which $R_1 = R_2$ and $C_1 = C_2$, the circuit of Fig. 1C oscillates at a frequency at which the impedances of R_1 , R_2 , C_1 and C_2 are all equal. Similarly, a ten-times change in R_1 and R_2 or C_1 and C_2 will cause a ten-times frequency change. Optimum operating conditions for this circuit, however, are not necessarily obtained when $C_1 = C_2$ and $R_1 = R_2$. It is often desirable to use filters whose values are not equal.

In common with the Wien-bridge oscillator, this circuit develops the purest sine wave when it is operated at a point near the verge of feedback necessary to sustain oscillations. Some sort of limiting element must be employed to prevent runaway and waveform distortion. Several methods for limiting such a circuit have previously been devised, including the tungsten-filament lamp.

If a lamp were used in this cir-

cuit, it would be connected in the regenerative path directly between the driving cathode of V_1 and the driven cathode of V_2 , rather than in the degenerative feedback path where it is commonly employed in Wien-bridge oscillator circuits.

Commercial Application

A commercial adaptation (Fig. 2) of the circuit shown in Fig. 1C provides stabilization or limiting by use of amplified and delayed agc. The output of the oscillator is sampled, amplified, rectified and filtered. It is then fed to a grid as a negative bias voltage. Any increase in the signal output causes an increase in negative grid bias, reducing the amplification and causing a reduction in output signal voltage.

The effects of a decrease in signal output are exactly the opposite. Output level is maintained at a constant value regardless of normal line-voltage variations and tube drift.

High-Power Pulser

BY LOUIS A. MARZETTA

*Electronics Division
National Bureau of Standards
Washington, D. C.*

CATHODE-EMISSION studies are usually conducted by placing the cathode under investigation in a test diode and measuring diode current as an indication of emission.

Two general systems have been used in the past for applying plate voltage to the diode to obtain current-voltage relationships.¹ In one, continuous current is drawn through the diode, but this system gives rise to excessive heating from the anode. The other system employs rectangular current pulses of successively increasing amplitude. The short duty cycle of the pulses cuts down anode heating,² but the tedious process of plotting characteristics point-by-point on special graph paper limits the usefulness of this system.

Certain other disadvantages inherent in these two methods³ led to the development of the equipment shown in the photograph. A continuous plot of emission characteristics appears on a cathode-ray tube. Figure 1 shows a typical trace for an oxide-coated cathode.

General Description

Since the current normally varies approximately in accordance with the three-halves power of the voltage, optional provision is made to linearize the plot by passing the current signal through a two-thirds-power network. This feature eliminates the point-by-point manual plot of the emission characteristics on two-thirds-power graph paper. Departure from the linearized curve due to temperature limitation becomes more apparent, and the current and voltage at the point of departure can be determined from a calibration marker displayed on the oscilloscope with the $I-E$ plot.

In figure 1 is a sketch of the basic



Complete emission plotter as used in NBS vacuum-tube laboratory

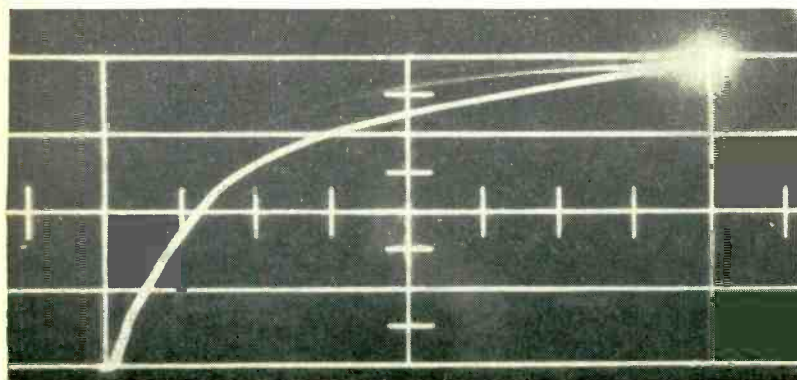

Reproduction from 35-mm oscillograph showing typical emission characteristic

Aids Cathode Studies

Parallel 304TH's force saw-tooth pulses of current through diode using cathode under investigation. Emission characteristics are plotted on cathode-ray tube. Two-thirds-power amplifier compensates for three-halves-power space charge effect to give linear plot

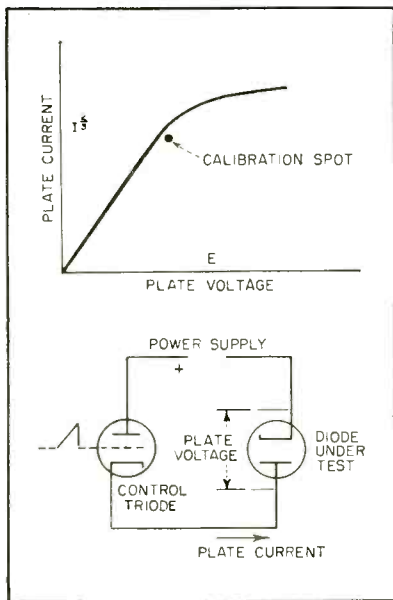

FIG. 1—Typical trace and basic circuit

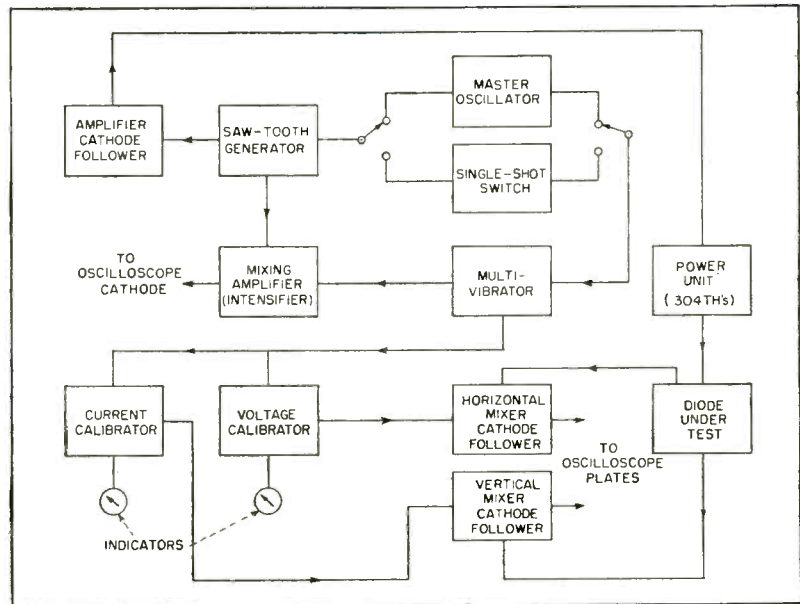

FIG. 2—Block diagram of emission plotter for oxide-coated cathodes

circuit. The diode is subjected to a saw-tooth plate voltage pulse at a low-duty cycle. A signal proportional to this voltage pulse and a signal proportional to the corresponding plate-current pulse are simultaneously applied to the horizontal and vertical deflecting plates of a cathode-ray oscilloscope. The extremely low duty cycle results in negligible amount of heat being contributed to the diode under test. Provision is made for instantaneous plate-current values as high as 10 amperes, and instantaneous plate voltages up to 5,000 volts. The duration of the plot can be selected at either 10 or 100 microseconds.

The control triode is biased near cutoff. At selected intervals the grid potential is raised from cutoff to zero bias in a saw-tooth fashion. The resultant plate current wave shape is determined by the dynamic resistance of the diode. Intensifying signals generated in the instru-

ment are applied to the cathode of the oscilloscope.

Operation is initiated by the master oscillator (Fig. 2) or single-shot switch depending upon the time duration and repetition rate desired. The signal is shaped into a saw-tooth and amplified to a level sufficient to raise the potential of the grids of the 304TH's in the power unit from cutoff to zero bias. The resultant current surge is passed through the diode under test as a short-duration saw-tooth wave. Signals proportional to the instantaneous plate voltage and plate current of the diode under test are directed back into two mixers and thence to the horizontal and vertical plates of the oscilloscope.

Calibration

Prior to triggering of the saw-tooth generator, a pulse is fed to the calibrate multivibrator. The signal then passes to the two calibra-

tors, which measure the amplitude of the calibrating signals and indicate the values on two front-panel meters. Simultaneously, the calibrating pulses are applied to the horizontal and vertical plates of the oscilloscope through the mixers. The resultant calibration mark on the cathode-ray oscilloscope is in the form of a round dot.

The mixing amplifier intensifies the oscilloscope trace during the display of the cathode curve and calibration marker.

Circuit Details

Figure 3 is a schematic diagram of the complete instrument. Two 304TH's are used as the control triodes because they can be operated at high plate potentials and are capable of high emission current. Each tube has a transconductance of 17,000 micromhos, resulting in a large change of plate current for a corresponding moderate

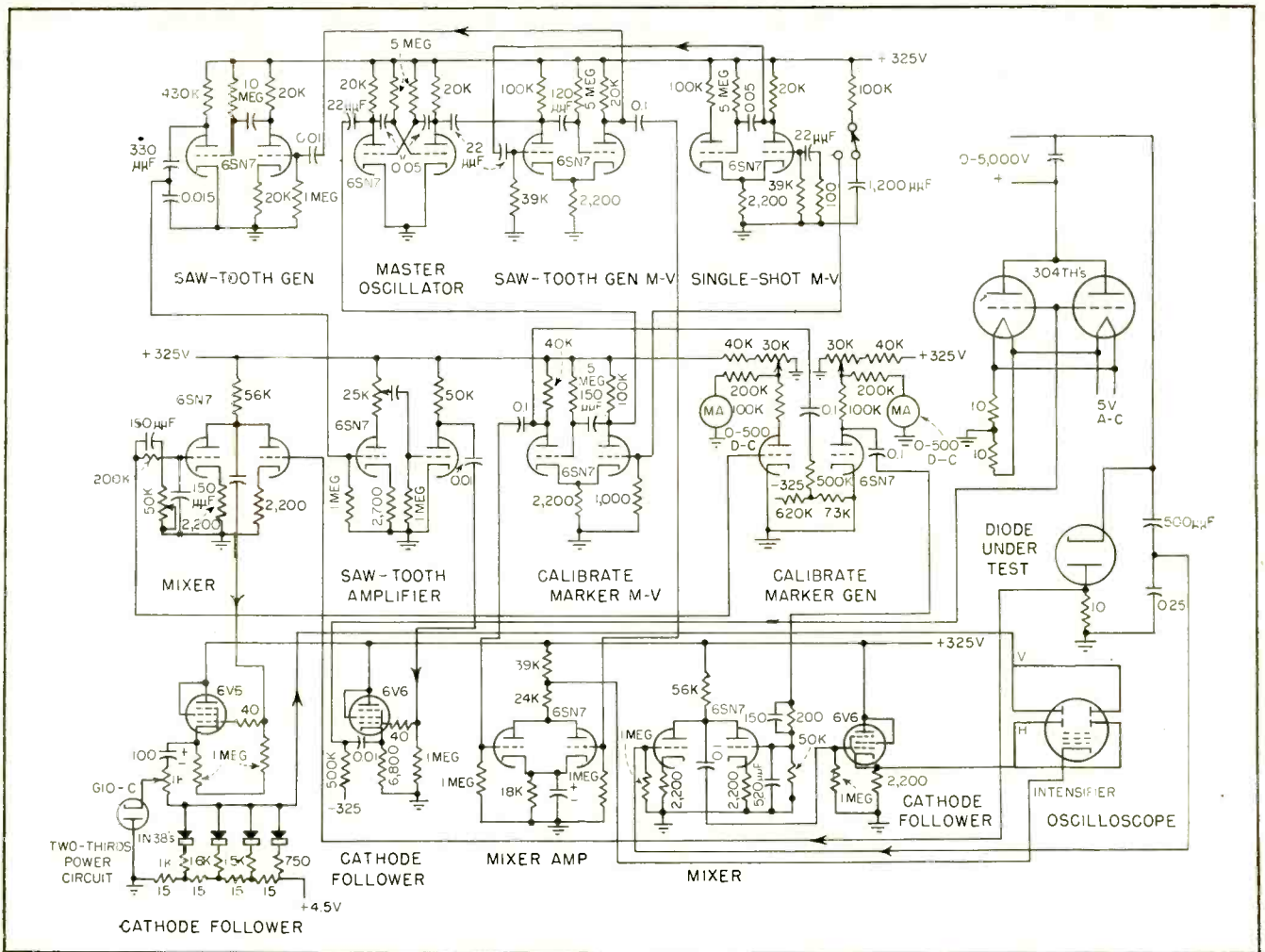
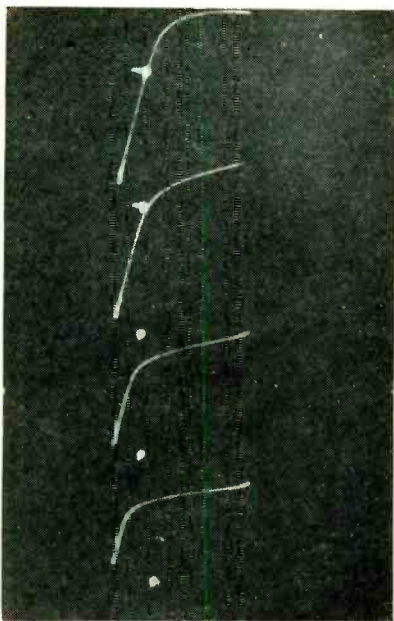

FIG. 3—Circuit diagram of emission plotter. Note that all receiving-type tubes are either 6SN7's or 6V6's



Four typical cathode emission plots arranged to show differences in characteristics

change of grid voltage below zero bias. The emission characteristic plotted is a resultant of the simultaneous comparison of two signal amplitudes.

Because the plot is not dependent on time related functions, the dynamic impedance of the control triodes does not enter the problem. Since there is little grid-current demand, the driving requirements can be satisfied by a 6V6 cathode follower. Additional 304TH's can be paralleled for higher plate-current requirements power.

The high-voltage supply need be only of a low-current design. The average current requirement is low because of the short duty cycle operation.

Figure 3 also shows the network for developing the $I^{2/3}$ vs E function displayed on the oscilloscope. The

network consists of four germanium diodes with a staggered bias arrangement.

The circuit constants have been chosen empirically such as to cause each diode to come into conduction at a different voltage level. The resultant output voltage approximates the input voltage raised to the $\frac{2}{3}$ power. The component values are of low impedance so the network will perform in as short a period as 10 microseconds.

The author wishes to acknowledge the helpful suggestions offered by M. L. Greenough of the National Bureau of Standards' Electronic Instrumentation Section.

REFERENCES

- (1) Ralph Forman and G. F. Rouse, N.E.S. Jour. of Research, No. 46, 1951.
- (2) W. E. Williams, High-Power Square-Pulse Generator, ELECTRONICS, p 144, Oct. 1952
- (3) E. A. Coomes, The Pulsed Properties of Oxide Cathodes, Jour. Applied Phys., p 647, Aug. 1946.

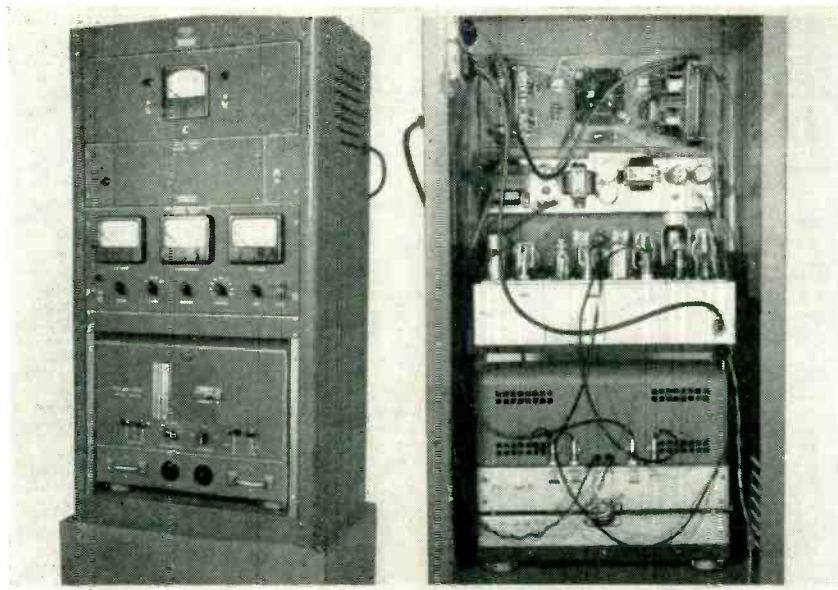

Front and rear views of resistor noise tester show placement of units in rack

By **MILTON E. KOCH, JR.***
*Electrical Test Equipment Engineer
 Centralab Division, Globe-Union Inc.
 Milwaukee, Wis.*

Measuring Noise in Resistors

Laboratory instrument measures total noise and relative noise in composition resistors. Results of investigation are useful in development work and in selection of resistors for special applications

VARIOUS METHODS have been used to measure total noise in resistors to give information about existing resistors and to provide a research tool for development of quieter resistors. The simplest noise-measuring method is to insert the resistor in a high-gain amplifier and measure its output, comparing one resistor with another.

The noise-measuring equipment to be described in this article has an extended low-frequency response with sufficient gain and stability for very low-level measurements. The total noise in microvolts and the relative noise in db above that of a standard resistor can be read directly. Figure 1 is a block diagram of the test equipment.

Direct-current voltage is applied to the test resistor through a series matching resistor and the noise-signal voltage is coupled through a capacitor to the amplifier circuit.

The series resistor is matched as closely as practical to the value of the test resistor. Since noise in this series resistor would also be amplified, wire-wound resistors are used.

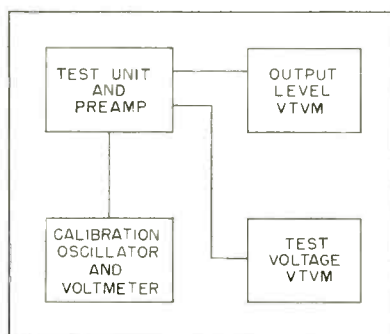

FIG. 1—Block diagram of setup for resistor noise measurement. Test unit contains resistor under test and a bank of matching and reference resistors. Calibration section is a 1,000 cps phase-shift oscillator

Calculations Eliminated

The equivalent circuit of a noisy resistor is a resistance of the same value in series with a noise generator whose output magnitude is a function of the direct current through it. In the testing circuit, the calibration voltage is inserted in series with the test resistor eliminating the calculations necessary with other methods of testing.

The preamplifier unit contains a heavily shielded chamber into which the test resistor is placed. The circuit is shown in Fig. 2. A battery stack and two 23-position

* Now with Lake Co., Milwaukee, Wis.

THE NATURE OF NOISE

The basic portion of resistor noise is due to thermal agitation, or Johnson noise. This can be calculated from the formula $E_j = (4RKT B)^{1/2}$ where E_j is rms noise voltage, R is resistance in ohms, K is Boltzmann's constant (1.38×10^{-23} Joules per degree K), T is Kelvin temperature and B is bandwidth in cps.

Since none of these variables is likely to be zero, this amount of noise is unavoidable in any resistance. Neglecting nonresistive components, this calculated noise would appear across the terminals of a wire-wound resistor.

In addition to thermal noise, any nonhomogeneous resistor carrying direct current generates noise which may far exceed the former. This secondary noise depends on the magnitude of the direct current and the nature of the resistive material. This noise also differs from thermal noise in its spectral distribution. Thermal noise energy is evenly spread over the frequency spectrum, but this secondary noise has most of its energy in the low-audio range. Because of its magnitude and frequency, this type of noise can be troublesome in audio and video equipment.

Experimental data show that for direct currents of less than 10 or 15 microamperes, noise increases linearly with current. A graph of noise against dc voltage is of the form $y = K_1 x + J$, where x is the d-c voltage, J is the thermal noise and K_1 is less than 5 microvolts per volt for quiet resistors. At higher d-c voltages, the noise curve approximates a parabola (the thermal noise being negligible) of the form $y = K_2/x$.

Noisy resistors follow the same pattern, with higher constants. For a noisy 1/megohm resistor

$$\begin{aligned} \text{microvolts noise} &= 70x + 35 \text{ (up to 10 volts)} \\ &= 230/x \text{ (above 10 volts)} \end{aligned}$$

switches provide zero to 520 volts in $1\frac{1}{2}$ -volt steps. Selector switches connect either the test resistor or a reference resistor through a matching wirewound resistor. A NOISE-CALIBRATE switch enables insertion of the calibration voltage in series with the test resistor to duplicate the equivalent noise generator and its load. Another switch disconnects the test-voltage meter from the circuit after the voltage has been adjusted to the desired value.

The input stage of the preamplifier consists of a 5692 tube with the two triode sections in series.

The low-level amplifier and cath-

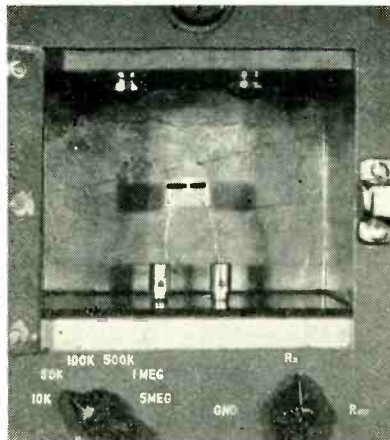

Resistor under test is placed in shielded chamber

ode follower use 6AK5's, with d-c filament supply. The entire pre-amplifier is shielded and shock-mounted.

The preamplifier output is fed through a wide-band amplifier to the metering circuit. The wide-band amplifier uses 6AC7's and a 6SN7, with inverse feedback for gain stabilization.

The d-c voltage applied to the test resistor is measured with a four-range bridge-type vtvm. A 100-megohm input resistance minimizes circuit loading when high values of resistance are being tested.

A 1,000 cps phase-shift oscillator, shown in Fig. 3, supplies calibration voltage. This voltage goes to a metering circuit, then through a calibrated attenuator to the input circuit.

Power Supplies

Plate voltages for the units are furnished by a regulated 300-volt supply, and an electronically stabilized supply. Filament voltages for the preamplifier are obtained from a 6-volt wet battery. The battery supply includes a selenium-rectifier charging circuit and voltmeter for checking the battery. The voltmeter operates from a thermal bridge balanced for both zero and 6.0 volts applied. This results in a linear scale from 6.0 to 6.6 volts and indicates the condition of the battery.

Using this equipment, an investigation was made into the behavior

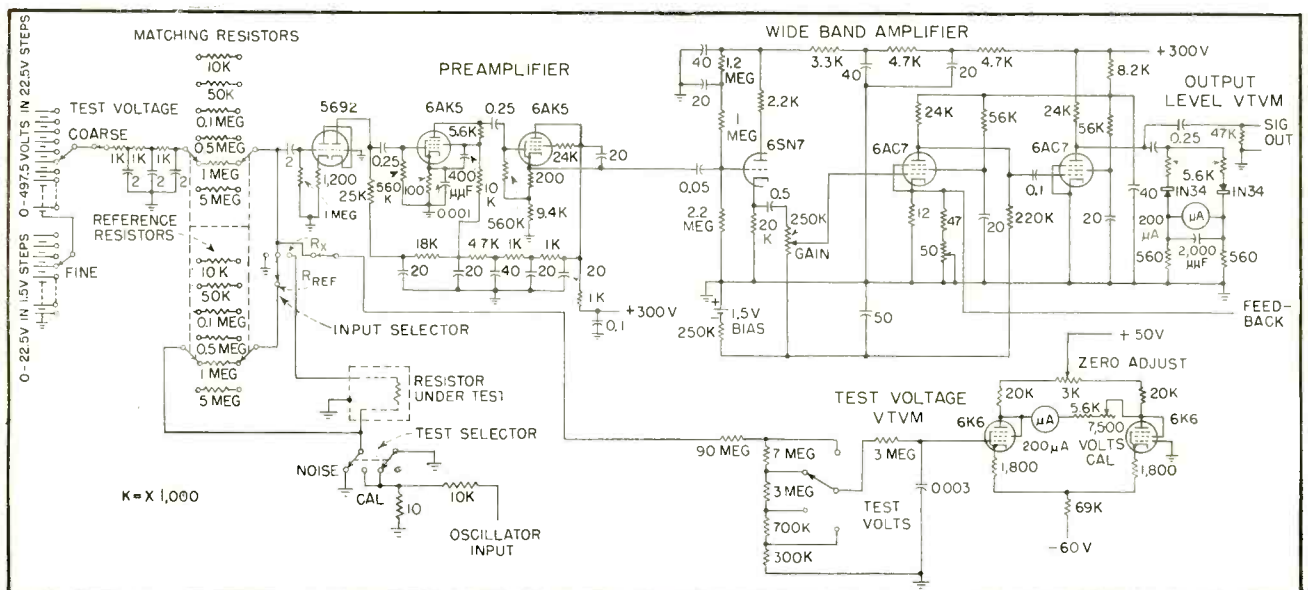

FIG. 2—Noise testing circuit uses tapped battery pack to obtain d-c test voltage. Noise signal is amplified and indicated on output vtvm

Electronically-Tuned Wide-Range Oscillator

Helical transmission line and crystal diodes used as a quarter-wave tuning element in Colpitts oscillator give five-to-one frequency range. Experimental unit tunes from 8.6 to 46 mc in five steps. Electronic switching system permits tuning at rates up to 1,000 per second

By **D. D. KING** and **R. L. KONIGSBERG**

Assistant Director

Research Associate

Radiation Laboratory
Johns Hopkins University
Baltimore, Md.

TUNING an oscillator by changing, electronically, the electrical length of a shorted quarter-wave transmission line provides a method of rapid tuning over a wide frequency range.

Tuning is accomplished by changing the position of the short across the transmission line. Electronically controlled devices or switches are required which can be inserted across the transmission line at desired intervals. Each device should have the property of appearing like an r-f short circuit across the line when a control signal is applied to it. The distance from the input end of the line to any one shorted device determines the tuned frequency, the frequency at which the line looks like an electrical quarter wavelength. Also, each device should approximate an open circuit when it is in the nonconducting state. In this way the presence of the devices will negligibly affect the line constants and Q when viewed at the input terminals.

Two possible shorting devices are the crystal diode and gas discharge tube. However, these elements have had one or more objectionable features which have precluded their use, up to the present time, with the ordinary parallel-line type of

Table I—Constants of Helical Line

Inductance	0.83×10^{-6} henry per inch
Capacitance	0.66×10^{-12} farad per inch
Characteristic impedance	1,120 ohms
β	4.65×10^{-9} radian per inch
Total length of helix	19.5 inches

transmission line in the frequency range from 10 to 500 mc.

Compared to the characteristic impedance of the line, the forward conducting, or short-circuited, r-f resistance is appreciable. What should be a short or zero impedance across the line is in reality a finite impedance with an appreciable re-

sistive component. This resistance tends to destroy the Q of the line, as viewed at its input terminals, and therefore the sharpness of tuning.

To a minor degree, the finite back, or nonconducting, impedance of the device tends to load the line when the device is inoperative and deteriorates the line Q.

Other problems have been the physical size of the transmission line required for quarter-wave operation using an air dielectric and the relatively low characteristic-impedance of available lines. Furthermore, characteristic impedances of open-wire parallel lines much above 500 ohms are not feasible. The

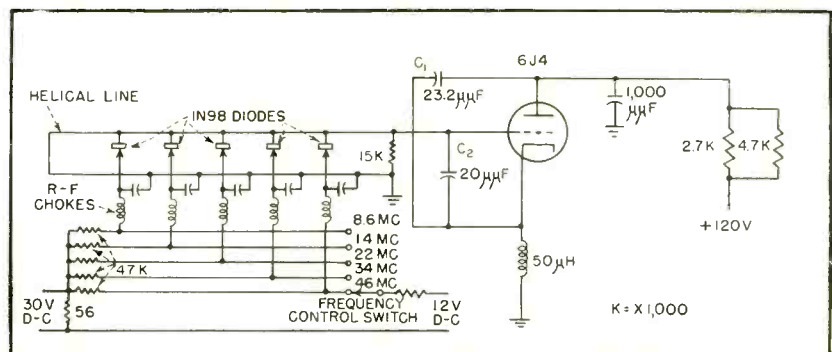
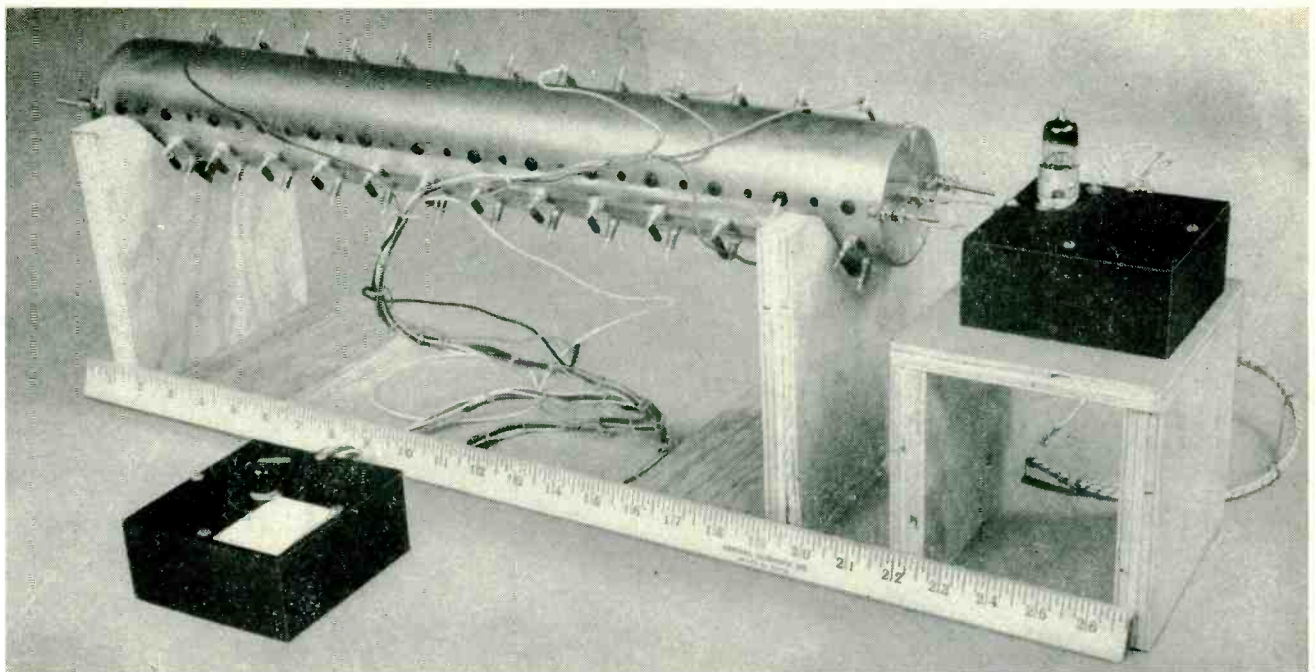

FIG. 1—Germanium diodes short helical transmission line of oscillator at quarter-wavelength intervals. Manual switch can be replaced by electronic unit for high-speed switching



Experimental wide-range oscillator. Transmission line mounted in tubing is shorted by diodes selected by switch in foreground

finite short-circuit impedance of the shorting device would be overcome by a higher characteristic impedance of the line.

Recent developments have overcome most, if not all, of these disadvantages. The 1N98, 1N100 and 1N118 germanium diodes meet the requirements for a shorting device. Measurements indicate that the small-signal r-f forward impedance is about 25 to 30 ohms, and the shunt capacitance is about $0.35 \mu\text{f}$.

By using a helical transmission line in place of the parallel-line type, the space requirements of the tuner can be reduced. In addition, the helical transmission line has a more desirable characteristic impedance,

of the order of 1,000 ohms.

Figure 1 shows a schematic of the electronically tuned oscillator using a helical transmission line and 1N98 diodes. For simplicity the helical line is depicted as a parallel-line type of transmission line. Neglecting shunt capacitance at the input terminals on the order of one μf , the line was designed¹ to work over the approximate frequency range of 17 to over 100 mc, and to have a characteristic impedance of approximately 1,100 ohms. At 17 mc, the quarter-wave length of the helical line is about 19.5 inches compared to about 174 inches for the parallel-line type of transmission line.

Five 1N98 crystal diodes are inserted across the line at points yielding oscillation frequencies in an approximate geometric relation over the operation range. A 5-position frequency selector switch applies proper bias potentials to the diodes. Only one diode is conducting, with a conduction current of approximately 25 ma, at any one switch position, the remaining diodes being biased off with a negative voltage of approximately 30 volts.

The oscillator is basically a Colpitts circuit but some modifica-

tions had to be made to permit operation of the transmission line in the fundamental quarter-wave mode. The oscillator tended to oscillate just as well at a higher frequency corresponding to $\frac{3}{2}$ wavelength and could hop to this higher mode unless precautions were taken. For this reason, it was necessary to add capacitors C_1 and C_2 to the circuit. In addition to loading the circuit, these capacitors reduce both the upper and lower frequency limits of the oscillator.

Operating Range

The measured range of operation was 8.6 to 46 mc, corresponding to a range coverage ratio of greater than 5 to 1. The five selected frequencies were approximately: 8.6, 14, 22, 34 and 46 mc. Because of the loading of the capacitors the observed frequency limits are lower than those calculated by finding those frequencies corresponding to quarter waves existing on the transmission line. By accounting for the effective shunt capacitance loading the input of the tuned line, the oscillator operating frequency can be predicted within a few percent.

No attempt was made to extract useful power from the experimental

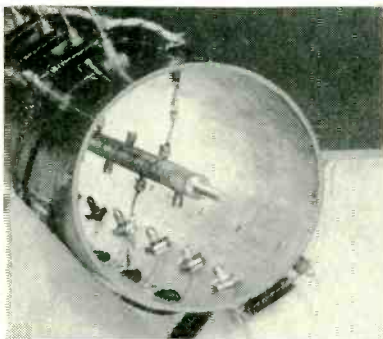

Close-up of helical-line mounting showing connection of diodes to line. Switch-control wires are connected to insulated terminals on tubing

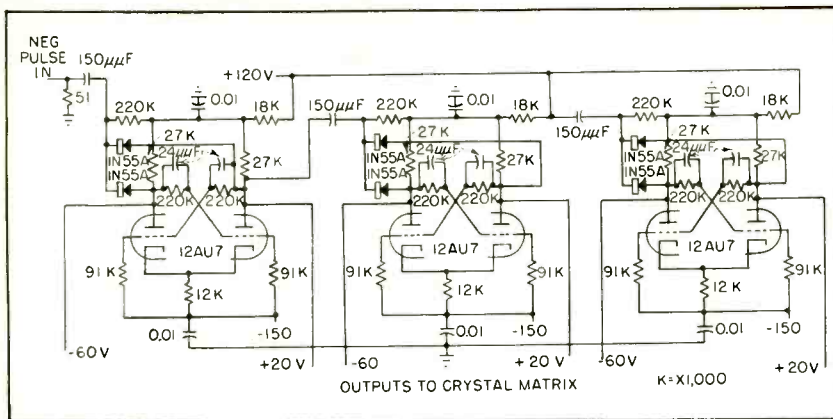

FIG. 2—Scale-of-eight counter triggered from pulse generator supplies biasing voltage to crystal matrix producing eight different output states

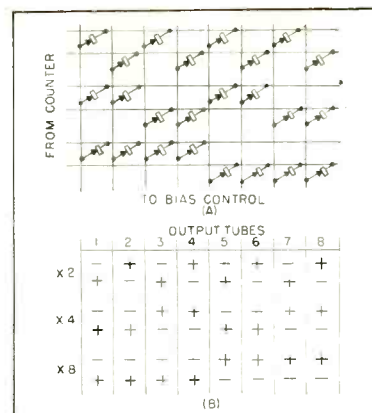

FIG. 3—Crystal matrix (A) produces positive outputs for input states (B)

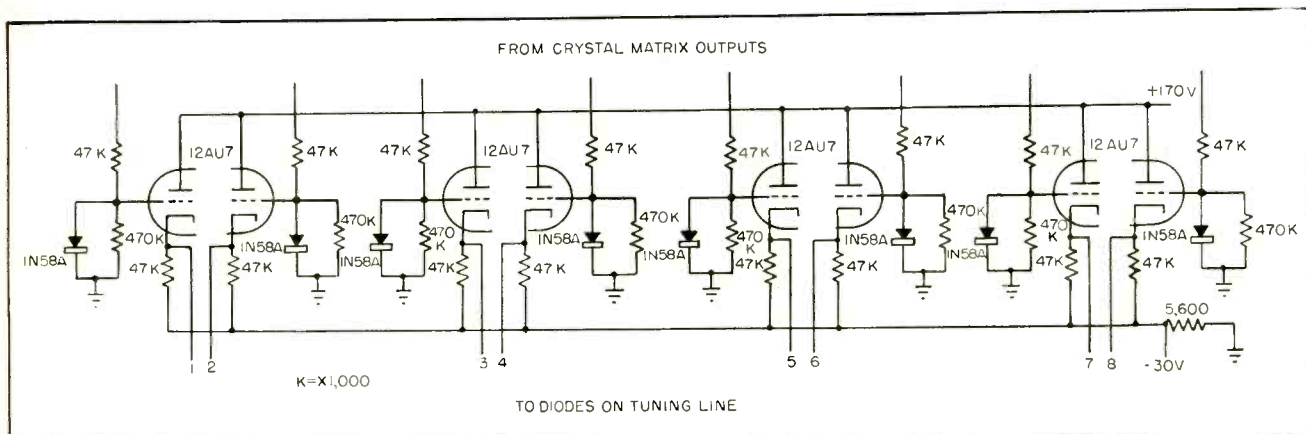

FIG. 4—Bias control tube receiving positive potential from the matrix will conduct, placing a forward bias on diode in tuning circuit

model. Frequency measurements were checked against a calibrated receiver.

Electronic Switching

An electronic switching system developed for use with the electronically tuned oscillator permits switching pulses to be initiated either manually or electronically. For manual operation, a thyratron pulser is used as synchronization for a pulse generator which produces a negative output pulse.

For electronically initiated pulses, the pulse generator may be employed without synchronization. The circuit shown here is suitable for controlling eight frequency-selecting diodes.

The output from the pulse generator actuates the scale-of-eight counter shown in Fig. 2. The counter produces eight different output states upon application of eight successive input pulses.

Each output state consists of a particular combination of the potentials on the output leads. For

each output state fed to the crystal matrix (Fig. 3A), a corresponding matrix output lead will assume a positive potential, the others remaining negative.

The sequence of input states necessary to produce positive potentials on the output leads is shown in the table in Fig. 3B. Successive changes in the input states applied to the matrix cause a positive potential to be stepped successively from matrix output lead 1 to lead 8 and again to lead 1 where the process is repeated.

The matrix output lead having a positive potential causes the corresponding diode-bias control tube (Fig. 4) to conduct. The tube conduction current is employed as the forward-bias current for a diode in the tuned line.

All other tubes in the diode bias control unit are held in the off position by application of large negative potentials to their grid circuits. The corresponding negative output potentials hold the other diodes in the tuned line in the non-

conducting state.

If desired, more switch positions may be provided by additional counters, diode-bias control tubes and crystal diodes in the matrix.¹

Satisfactory operation of the system has been attained at pulse-repetition rates of the order of 1,000 per second. With careful design, this rate may be greatly increased and the time to change oscillator operating frequency may be held to values of the order of 10 or 20 microseconds.

The present tuner is still in the experimental stages. The technique should find many applications in the h-f, vhf and uhf portions of the spectrum.

The experimental circuits were constructed and tested by Michael Dorczak.

REFERENCE

- (1) A. G. Kandoian and W. Sichak, Wide Frequency Range Tuned Circuits and Antennas, paper presented before IRE Convention, March 1953, New York, N. Y.
- (2) D. R. Brown, and N. Rochester, Rectifier Networks for Multiposition Switching, *Proc IRE*, 37, p 139, Feb. 1949.

Staircase Generator Counts Pulses

By NATHAN O. SOKAL and IRA L. RESNICK

*Lincoln Laboratory
Massachusetts Institute of Technology
Cambridge, Mass.*

Simple relay circuit transfers part of capacitor charge to another capacitor on arrival of input pulse, to produce one step of output waveform. Up to 2,000 pulses per second can be counted, giving constant-amplitude steps totaling up to 200 volts

PULSES MAY BE COUNTED or quantized sweep and timing waveforms generated by the staircase-waveform generator to be described in this article. The output of the circuit steps when a pulse is applied to the input and holds at its last level until another input pulse is applied. Used as a counter, the circuit gives an output voltage proportional to total count. As a sweep generator, it produces an output that is either a linear or nonlinear function of time, depending on the sequencing of input pulses.

Stepped waveforms up to 200-v total amplitude may be generated, with less than two percent change of step amplitude from start to finish. With suitable choice of circuit components, up to 2,000 steps per

second may be obtained.

The circuit offers several advantages over others within its frequency range. As a counter it does not require a chain of flip-flops; as a sweep generator, it requires neither a chain of flip-flops with a weighting network¹ nor a large controlled-amplitude pulse as in the usual step-charge circuit.²

Circuit Design

The principle of the staircase-waveform generator is that of a charged capacitor transferring part of its charge to another capacitor. The basic circuit is illustrated in Fig. 1A. Capacitor C_1 charges to E while the relay is deenergized. When the relay is energized the charge on C_1 transfers

to C_2 , producing on C_2 a voltage step

$$\Delta V = \left[\frac{C_1}{(C_2 + C_1)} \right] (E - V)$$

where V is the total accumulated voltage on C_2 . If E is a constant voltage, the waveform (photograph at left) is an exponential with the steps becoming smaller as V increases. If constant-amplitude steps are required, only a few percent of the total waveform may be used. To obtain constant-amplitude steps that add to about 200 v, the bootstrap circuit of Fig. 1B may be employed.

Cathode follower V_1 increases the charging voltage E as V increases keeping the difference $E - V$ almost constant. Thus, nearly constant step size is maintained until the

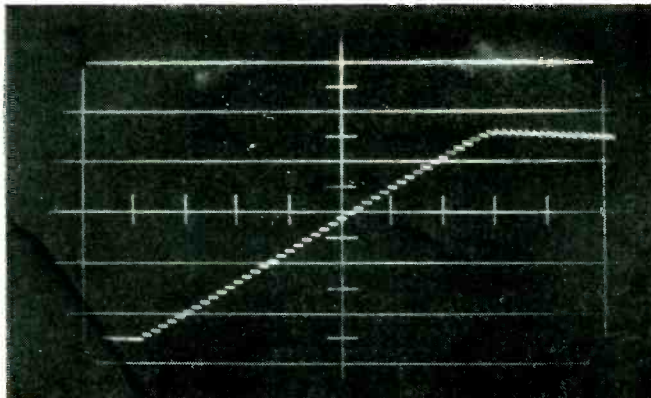
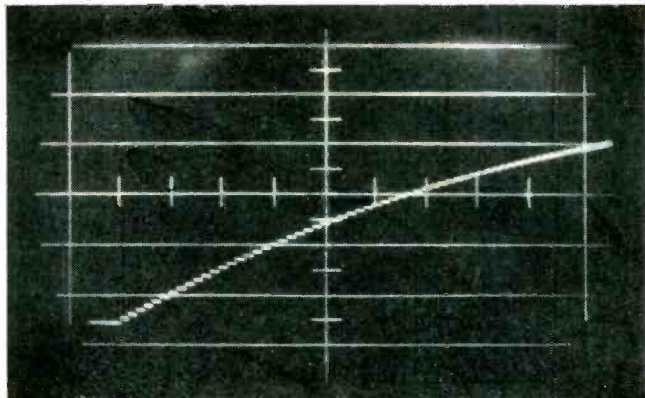

Output waveform (left) of basic circuit, and constant step amplitude obtained (right) when bootstrap circuit is added for linearizing the output. Constant-amplitude steps add up to about 200 volts

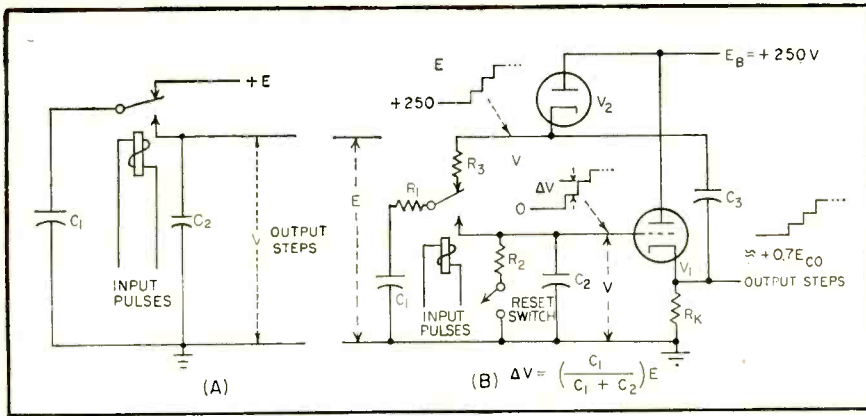

FIG. 1—Basic circuit (A) and linearized bootstrap circuit (B)

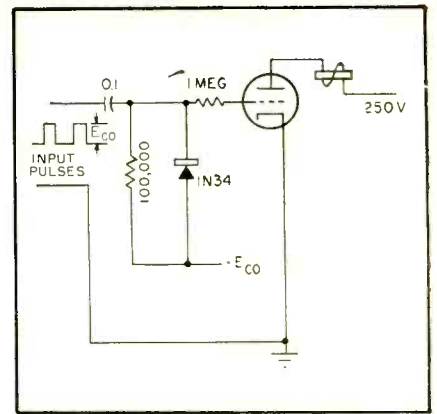

FIG. 2—Relay drive amplifier

cathode follower saturates. The waveform in the photograph at the right has a knee at the top caused by saturation of the cathode follower at about 200-v output. If even larger output voltage is required, a larger plate-supply voltage and/or a larger cathode resistor can be used.

Components

A crystal diode may be used for V_2 if the time constant of its back resistance and C_3 is much larger than the time duration of the waveform. Otherwise a thermionic diode such as a 6AL5 must be used. Capacitor C_3 should be much larger than C_2 to supply charge to C_2 during the cycle, without dropping its own voltage appreciably. To obtain waveforms of long duration, low-leakage mica or oil-filled capacitors should be used. Capacitor C_2 should be sufficiently large so that the grid current of V_1 does not change its voltage excessively during the waveform cycle. For critical applications, V_1 should be selected for low grid current.

Table I lists values of cathode resistance required to obtain at least 200-v total output with a 250-v plate supply for three common tubes, allowing for tube and resistor tolerances. It also gives the minimum possible deviation of the output waveform from a best-fit straight line when equally spaced pulses are applied. If capacitor leakages and grid current are negligible, the deviation of a sweep waveform of amplitude V_{max} from a best-fit straight line is approximately

$$\% \text{ Deviation} = \pm 100 \times 1/8$$

$$\left(\frac{E_{co} + C_2}{E_B + C_3} \right) \frac{V_{max}}{E_B} \text{ if } R_k \gg g_m$$

where $-E_{co}$ is the grid cutoff voltage of the tube, E_n is the plate-supply voltage, and g_m is the transconductance.

Relay Driver

In some applications, pulses will be available to energize the relay coil directly. If not, another tube or the other half of V_1 may be used to energize the relay coil. The circuit is shown in Fig. 2. The IN34 diode clamps the grid to cutoff $-E_{co}$ making the circuit independent of pulse frequency. The one-megohm series grid resistor prevents grid clamping in case of overdrive.

Table II lists maximum stepping frequency f_{max} and minimum pulse duration T_{min} for the circuit of Fig. 2 using various combinations of tubes and relays and a plate supply of 250 v.

If higher stepping frequencies are required, a special high-speed relay should be used driven by a high-voltage source supplying several times the pull-in current. An example is the Stevens-Arnold Millisecc relay type 172 for which pull-in is claimed to occur in 1/3 millisecond and drop-out in 1/10 millisecond.

Pulse Generation

If available pulses are shorter than the minimum, pulses of the required duration may be generated by a single-shot multivibrator of the type illustrated in Fig. 3. A negative input pulse can be ap-

plied to input 1 or a positive pulse to input 2.

Table III lists the required circuit values for 12AU7, 12AT7 and 12AX7 multivibrators with a 250-v plate supply. The maximum and minimum values given for R_1, C_1 take into account the tube and component tolerances. If it is required to make the pulse duration close to the minimum value, a potentiometer

Table I—Component Values for Bootstrap Circuit

Tube type	R_k (ohms)	Min. deviation from linearity
1/2-12AU7	100,000	$\pm 1.3 \frac{V_{max}}{E_B}$
1/2-12AT7	220,000	$\pm 0.3 \frac{V_{max}}{E_B}$
1/2-12AX7	680,000	$\pm 0.2 \frac{V_{max}}{E_B}$

ter should be included in the total value of R_1 to permit individual circuit adjustment. Resistor R_1 is usually between one and ten megohms.

Resetting

The reset switch in Fig. 1B can take any of several forms. When the time interval between resettings is conveniently long, a pair of timer contacts or an ordinary switch can discharge C_2 . If a fast cycle is employed, making it impractical to use these techniques or if the circuit is to be used as a counter a gas or vacuum tube can be used as a switch. If a neon

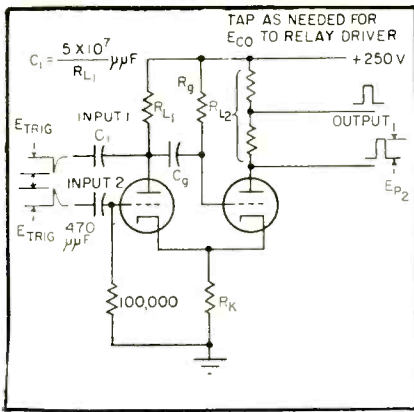

FIG. 3—Single-shot multivibrator

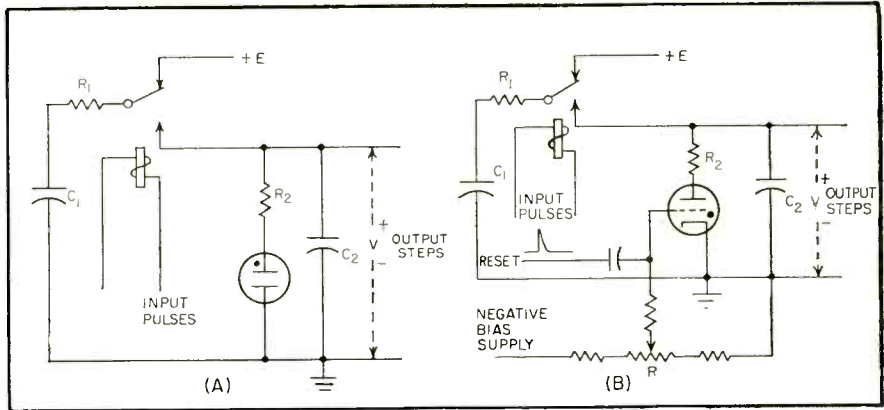

FIG. 4—Neon lamp (A) and thyatron (B) output resetting circuits

lamp is used, as in Fig. 4A, the step size must be adjusted so that the lamp fires after the required number of steps.

Thyatron Control

For more flexible operation, a thyatron may be used as shown in Fig. 4B. Potentiometer R sets the bias so that the tube fires at the desired voltage level on C_2 , or the tube can be fired at any desired time by a positive pulse applied to the grid.

The bootstrap cathode follower may be cut off for a few milliseconds after resetting if C_2 is discharged too rapidly. This means that temporarily the cathode circuit may not follow the grid circuit steps. This should cause little trouble if the circuit is used as a counter since recovery is usually complete long before a reading is

required.

If the circuit is used as a fast-stepping sweep generator, the first few steps may occur while the cathode circuit is recovering. In this case, the steps will be missing in the cathode waveform, although they appear correctly in the grid waveform. In this case, the grid waveform can be used as the output if the following circuit is of high impedance. If a low-impedance output is required, an auxiliary cathode follower with its grid connected to C_2 can be used.

The recovery of the bootstrap cathode follower can be made faster by decreasing R_K and/or connecting R_K to a negative voltage rather than to ground.

Design Notes

The resistors R_1 and R_2 are inserted to limit surge currents

through the switch and relay contacts; 1,000 ohms is usually sufficient. Resistor R_2 limits the transient loading of the cathode follower when recharging C_1 ; R_2 should be large compared with R_K . Time-constant $R_2 C_1$ should be short compared to the time between steps. If the heater of V_1 is supplied from a grounded heater transformer, the rated heater-to-cathode voltage may be exceeded if large waveforms are generated by the circuit. In such cases, a floating heater transformer can be connected to the cathode, or the heater transformer can be biased positive.

This research was supported jointly by the Army, Navy and Air Force.

REFERENCES

- (1) Chance, Hughes, MacNichol, Sayre and Williams, "Waveforms", p. 293. McGraw-Hill Book Co., Inc., N. Y., 1949.
- (2) See reference 1, p. 615.

Table II—Operating Characteristics of Driver Circuit

Potter and Brumfield relay SM5LS, 100,000-ohm coil						
Tube type.....	$\frac{1}{2}$ -12AU7	12AU7	$\frac{1}{2}$ -12AT7	12AT7	$\frac{1}{2}$ -12AX7	12AX7
f_{max}	650 cps	720 cps	650 cps	650 cps	400 cps	650 cps
T_{min}	0.5 msec	0.6 msec	0.5 msec	0.4 msec	1.1 msec	0.6 msec
Sigma relay 41F1000 SK						
Tube type.....	$\frac{1}{2}$ -12AU7	12AU7	$\frac{1}{2}$ -12AT7	12AT7	$\frac{1}{2}$ -12AX7	12AX7
f_{max}	400 cps	400 cps	350 cps	390 cps	280 cps
T_{min}	1.1 msec	0.8 msec	1.3 msec	1.2 msec	1.5 msec

Table III—Component Values for Single-Shot Multivibrator

Tube.....	R_{L1} (ohms)	R_{L2} (ohms)	R_K (ohms)	$R_g C_g$ (min)	$R_g C_g$ (nom)	$R_g C_g$ (max)	$E_{trig,1}$ (volts)	$E_{trig,2}$ (volts)	E_{p2} (volts)
12AU7.....	56,000	8,200	3,300	4.2T	6.3T	14.0T	-45	+35	+70
12AT7.....	56,000	10,000	1,800	3.6T	5.2T	9.6T	-30	+25	+75
12AX7.....	180,000	33,000	4,700	3.6T	4.5T	5.5T	-17	+12	+55

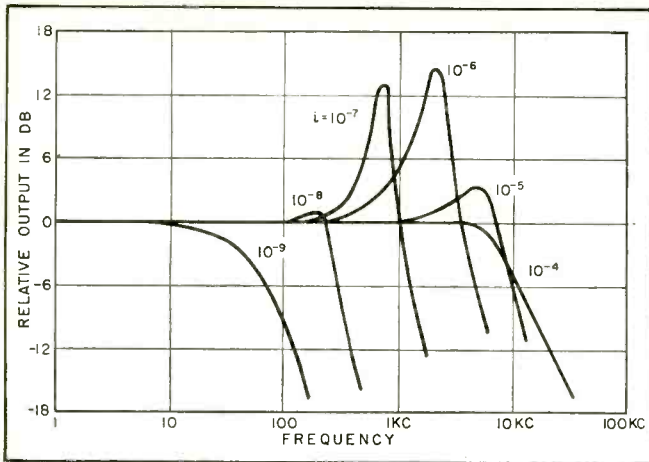

FIG. 1—Frequency response of uncompensated amplifier

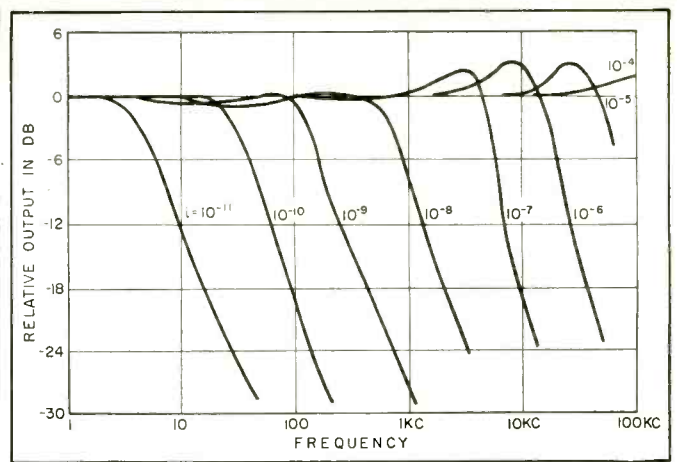

FIG. 2—Response of low-level amplifier after compensation

Logarithmic Amplifier

Feedback amplifier with high-frequency damping provides good transient response in logarithmic amplifier used for current measurements in the range from 10^{-12} to 10^{-4} ampere. Instrument is useful in measuring neutron flux density currents in nuclear reactor operations

LOGARITHMIC AMPLIFIERS are widely used in nuclear reactor studies to measure neutron-flux detector currents over wide ranges of reactor activity. In this application, currents on the order of 10^{-12} to 10^{-4} amperes must be measured. When a differentiating device is incorporated in such amplifiers, a signal proportional to excess reactivity is derived.

Logarithmic characteristics can be obtained by use of a hard-vacuum diode with an output voltage proportional to the log of the input current. However, difficulty is encountered with the time constants of such circuits. Diode resistance is approximately equal to the reciprocal of 10 times the input current. Thus, for an input current of 10^{-12} amp the resistance is 10^{11} ohms. When the input circuit consists of an ion chamber and connecting coaxial cable, input capacitance frequently is in the order of 10^{-9} farad or more.

The dynamic resistance of the ion chamber or other input device

must be at least 100 times higher than the diode resistance so that it may function as a current source. When this condition is met, the time constant of the input circuit becomes simply the diode resistance times the input-circuit capacitance. In the case of an ion chamber with a current of 10^{-12} amp the time constant is 10^{11} ohms times 10^{-9} farad or 100 seconds. This long time constant renders the system useless for most purposes.

Feedback

Use of feedback amplifiers for time-constant reduction is a well-known technique when all time constants are fixed and independent of amplitude. In the ion-chamber circuit the time constant of the input circuit is proportional to input current and becomes equal to the amplifier's forward-gain time constant at some current level unless the amplifier has an extremely wide pass-band. This produces an underdamped response curve, as shown in Fig. 1. A curve such as shown in

Fig. 2 can be obtained by adding proper compensating networks as shown in the circuit of Fig. 3.

Since the input time constant for the ion chamber circuit is 10^8 times 10^{-9} , or 1 μ sec at the highest current level of 10^{-4} amp, it would be necessary to construct a d-c amplifier with a forward time constant of 0.1 μ sec or less to prevent the instability shown in Fig. 1.

A more practical approach to a stable circuit is to reduce forward gain at higher frequencies. This results in less time-constant reduction at higher current levels, where the input time constant is already low and does not require reduction.

The manner in which the forward gain is reduced is dictated by feedback-amplifier design techniques which, when applied to a mathematical analysis of the circuit, show that the reduction must take place so that the forward phase shift of the amplifier never exceed 45 deg until the gain is reduced to unity or less. This results in good transient performance, compromis-

Table I—Amplifier Time Constants with and without Feedback

Input Current	Time Constant (seconds) Without Feedback	Time Constant (seconds) With Feedback
10^{-12}	10^2	0.0043×10^2
10^{-11}	10^1	0.0035×10^1
10^{-10}	10^0	0.0053×10^0
10^{-9}	10^{-1}	0.011×10^{-1}
10^{-8}	10^{-2}	0.023×10^{-2}
10^{-7}	10^{-3}	0.032×10^{-3}
10^{-6}	10^{-4}	0.094×10^{-4}
10^{-5}	10^{-5}	0.28×10^{-5}
10^{-4}	10^{-6}	Not Measured

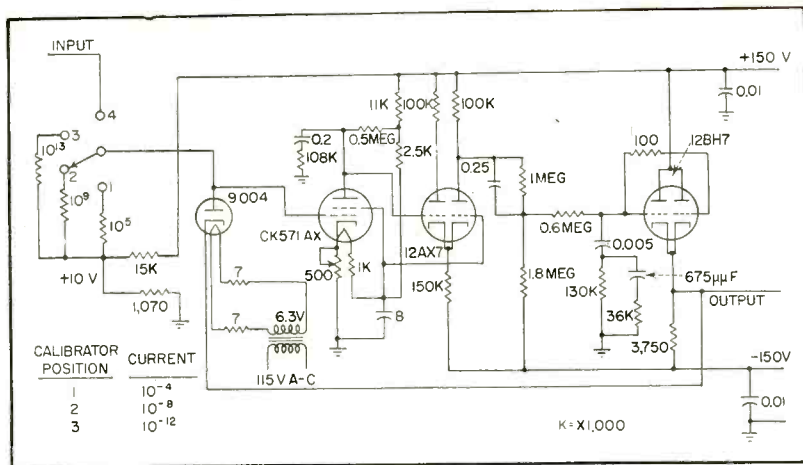

FIG. 3—Logarithmic amplifier circuit. Feedback is applied through diode in input

With Fast Response

By **JAMES A. DE SHONG, JR.**

*Remote Control Engineering Division
Argonne National Laboratory
Lemont, Illinois*

ing the rise time with overshoot.

In usual designs, where all time constants are independent of amplitude, it is necessary only that a phase margin of 45 deg exists where gain passes through unity. The logarithmic-amplifier input time constant has the effect of moving the unity-gain point over a frequency range corresponding to the range of the time-constant variation, thus preventing the use of single point compensation as can be done in normal feedback amplifiers. Therefore, the forward phase shift of the amplifier may not exceed 45 deg at any frequency below the unity-gain frequency if optimum transient performance is to be obtained for all current levels.

Phase shift of an amplifier is proportional to the slope of its amplitude-versus-frequency curve.¹ In this case the desired slope corresponding to 45-deg phase shift is a 0.7 (3 db) reduction in amplitude each time frequency is doubled. The amplifier unity-gain frequency (f_1) must be set for one-half to one-fifth

the frequency where the inherent phase shift of the amplifier itself is 45 deg. From this point the amplitude-versus-frequency curve must not be allowed to rise at a rate exceeding 1.4 times for every octave reduction in frequency. The d-c gain, A_0 , is set by the unity-gain point, the slope required for 45-deg shift and the input time constant at the lowest current which is 10^{11} (R) times 10^{-9} (C) or 100 seconds for the example already cited, at 10^{-12} amperes. It may be calculated from the equation:

$$A_0 = (2\pi f_1 RC)^{1/2} = (200\pi f_1)^{1/2} \text{ for } 10^{-12} \text{ amp.}$$

The frequency f_2 where the downward slope starts may be determined by the relation

$$f_2 = f_1/A_0^2$$

The amplifier circuit shown in Fig. 3 uses resistor-capacitor combinations to produce a satisfactory approximation of the specified characteristics. Circuit gain is 300 and f_2 is 1 cps. Amplitude-versus-frequency curves for the compensated amplifier are shown in Fig. 2.

A comparison of the curves shows that overall performance of the compensated circuit has peak magnitudes of about 1.4 times the reference level as compared to peak magnitudes of about 6 times the reference level for the uncompensated case. In terms of circuit damping factor, frequently used for step-response evaluation², the uncompensated case has a damping factor of only 0.09 where the compensated case has a damping factor of 0.4. This means that a maximum overshoot of about 76 percent will occur in the uncompensated case for $i = 10^{-6}$ where overshoot in the compensated case is only 25 percent for the same current. Table I shows the effectiveness of the amplifier in reducing time constant.

The author extends thanks to W. C. Lipinski for his aid in construction and measurements.

REFERENCES

- (1) H. W. Bode, "Network Analysis and Feedback Amplifier Design", Van Nostrand, New York, 1945.
- (2) H. Chestnut and R. W. Mayer, "Servomechanisms and Regulating System Design", Vol. 1, Wiley & Son, New York, 1951.

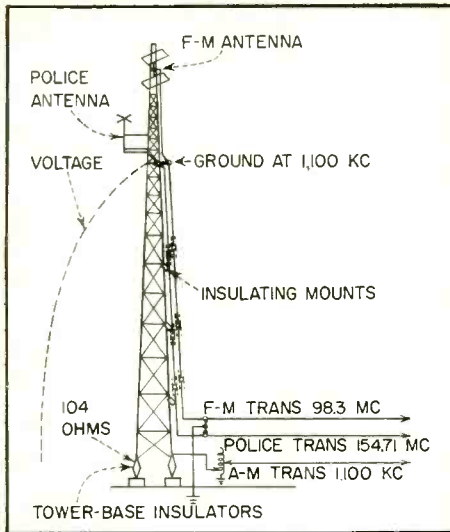

FIG. 1—Quarter-wavelength standard broadcast tower with police and f-m antennas

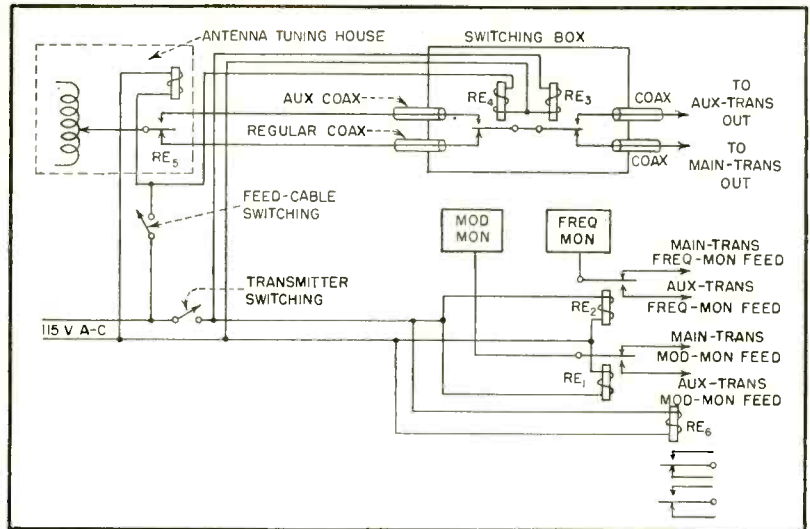

FIG. 2—Switching system permits changeover from main to auxiliary transmitter and from regular to auxiliary antenna feed line

Broadcast Transmitter Switching System

Antenna-changeover relay reduces outage time when switching from main to auxiliary transmitter. Application of simple transmission-line theory permits mounting f-m and police antennas on broadcast tower without intermodulation or use of duplexers

THREE SEPARATE services, police, a-m and f-m broadcast, utilize WHLI's free-standing quarter-wave tower without intermodulation. Figure 1 illustrates the antenna conformation. The tower itself is a quarter wave-length at 1,100 kc, the frequency of WHLI's a-m transmitter, insulated from ground and voltage-fed at the base. A point of ground potential is found near the top.

Solid coaxial line from WHLI-FM's transmitter, which operates on 98.3 mc and flexible coaxial cable fed from the Hempstead Police transmitter at 154.71 mc are run up the tower on insulating mounts. The outer conductors of the cables are bonded together at the base of the tower and grounded. They are also connected to the zero-potential point on the tower. This also provides an efficient means of lightning protection.

By **FRANK KNAACK**
Chief Engineer, WHLI
Hempstead, N. Y.

The police radio antenna is mounted on an outrigger near the ground point while the twin-loop f-m antenna is affixed to the top of the tower.

Transmitter Switching

To reduce outage time in switching from main to auxiliary a-m transmitter operation or from regular to auxiliary transmission line in the event of line failure, a simple relay changeover has been devised. This system is illustrated in Fig. 2. All relays are normally closed for regular operation with the coils de-energized.

The coaxial feeders from main lines from the antenna tuning unit and auxiliary transmitters and also the regular and auxiliary coaxial

terminate in a 4 x 4 x 12-in. copper switching box near the transmitters.

Relays RE_3 and RE_4 are mounted in this box, which is supported by the coaxial feeders. Relay RE_5 is in the antenna tuning unit at the tower base. Frequency and modulation feeds from each transmitter terminate at coaxial switching relays RE_1 and RE_2 .

Changeover is accomplished with transmitter carriers off to eliminate arcing. An a-c line switch operates RE_3 , RE_1 , RE_2 and RE_6 for auxiliary operation. These relays change the transmitter feed to the antenna, the audio feed to the transmitters and the feeds to the frequency and modulation monitors.

In the event of a failure in the transmitter-to-tuning-house coaxial line, a switch controlling RE_4 and RE_5 switches from the regular line to the auxiliary line.

Special "miniaturized"
strips available, actual
size shown.

TERMINAL STRIPS ... BOARDS

The terminal strip, a CINCH engineering "first", is today a *Standard* electronic component. Something of the scope of the CINCH operation in the design and production of metal plastic assemblies is indicated by the terminal boards fabricated to meet exacting armed forces requirements.

CINCH facilities and engineering experience and ability assure the satisfactory fulfillment of any assignment for a terminal strip, board or electronic component.

Consult Cinch!

Photographs within color surface are one-half size, one fourth area of original terminal boards.

Cinch components are available at leading electronic jobbers — *everywhere*.

At the IRE Convention Show,
Booth Nos. 394 and 396.



Cinch
ELECTRONIC
COMPONENTS

CINCH MANUFACTURING CORPORATION

1026 South Homan Ave., Chicago 24, Illinois
Subsidiary of United-Carr Fastener Corporation, Cambridge, Mass

Shunt-Series Peaking

Nomograph solves design equations to give shunt and series inductance values required for given high-frequency cutoff and existing shunt input and output capacitances. Available gain with combination is 80 percent greater than either alone

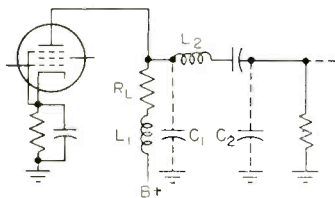

By **JOSEPH F. SODARO**
Los Angeles, California

SHUNT-SERIES peaking is illustrated by the basic circuit shown. This network is often used in television video amplifiers and other pulse systems where greater amplification is required than that obtainable from either shunt or series peaking alone. The gain is 80 percent greater than simple shunt peaking under certain conditions.¹ One of these conditions is that the input capacitance C_2 is twice the output capacitance C_1 .

Design procedure is as follows: measure or estimate C_1 and C_2 taking into account wiring, tube socket, and other strays, and adjust to make $C_2 = 2C_1$ using a shunt trimmer if necessary. Next, choose the desired high-frequency cutoff, f . Total C_1 and C_2 plus strays to obtain C_s . With these values calculate R_L , the load resistance, from

$$R_L = \frac{1.8}{2\pi f C_s} \quad (1)$$

The shunt compensating inductance L_1 is determined next from

$$L_1 = \frac{0.216 R_L}{2\pi f} \quad (2)$$

Finally, the required series in-

ductance is evaluated from

$$L_2 = \frac{0.937 R_L}{2\pi f} \quad (3)$$

Equations 1, 2 and 3 are the other required conditions for 1.8 times simple-shunt gain. These form the basis for the nomograph.

To use the nomograph, construct a straight line from the shunt capacitance value on the C_s scale to the cutoff frequency on the f scale. At the intersections of this line with the R_L , L_1 ,

and L_2 scales read load resistance, shunt inductance, and series inductance values.

As an example, assume a 4-mc high-frequency cutoff is required for a total shunt capacitance of 30 μf . Construct a straight line from 30 on C_s to 4 on f . Read 21 μh on L_1 , 90 μh on L_2 and estimate 2,400 ohms on R_L .

REFERENCES

- (1) D. G. Fink, "Principles of Television Engineering", p 229, McGraw-Hill Book Co., N. Y., 1940.
- (2) K. R. Sturley, "Radio Receiver Design", p 429, Chapman & Hall, 1945.

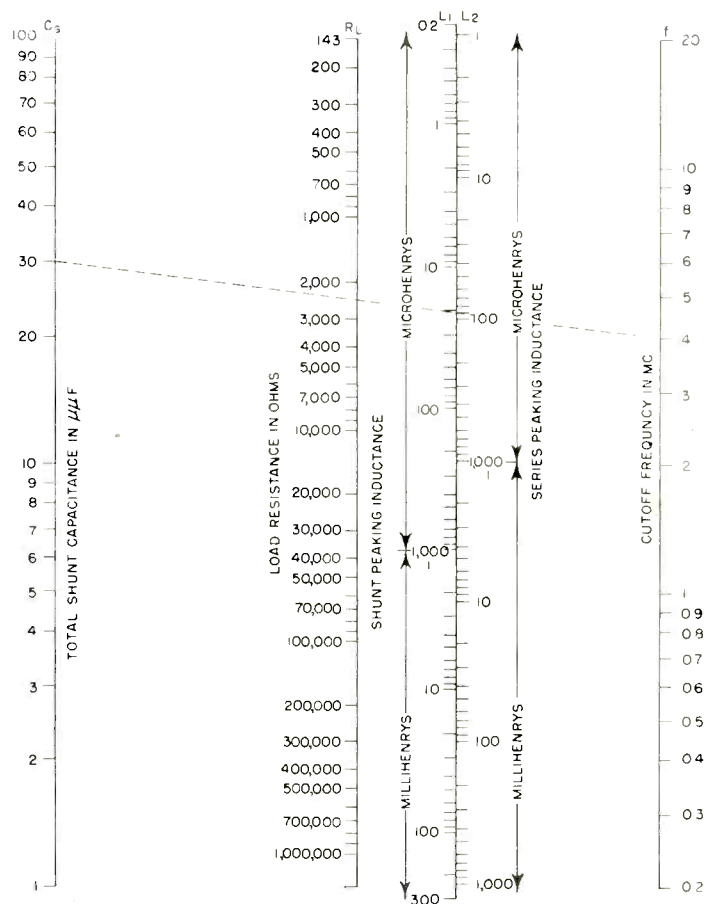

Mallory Capacitors

for printed circuit applications



Mallory FP Electrolytic Capacitors are now available in a construction that is specifically designed for printed electronic circuits. Their mounting prongs and terminals have been adapted for quick, fool-proof production line assembly.

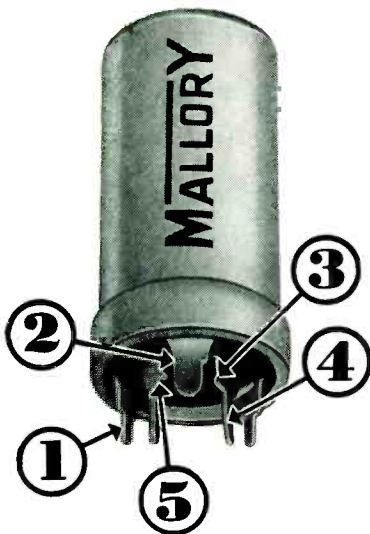

- 1 *Prongs and terminals are smaller . . . take less space . . . hold securely with a small amount of solder. No need for large copper areas in the printed chassis.*
- 2 *Self-positioning. One mounting prong is wider. The capacitor can fit only in its correct position.*
- 3 *Shoulders on prongs hold capacitor clear of chassis, permitting use of printed circuitry on both sides.*
- 4 *Prongs can be automatically spread on insertion by simple jig, insuring strong mechanical mounting prior to soldering.*
- 5 *Positive soldering. Aluminum risers do not extend through chassis. No danger of contaminating solder.*

These refinements of design are one more step in the capacitor developments which Mallory has pioneered, and which have made Mallory FP Capacitors the leader in their field. Write or call us for detailed literature, or for engineering service on your capacitor problems by one of our field specialists.

Expect more . . . Get more from **MALLORY**

★ Parts distributors in all major cities stock Mallory standard components for your convenience.

Serving Industry with These Products:

Electromechanical—Resistors • Switches • Television Tuners • Vibrators
Electrochemical—Capacitors • Rectifiers • Mercury Batteries
Metallurgical—Contacts • Special Metals and Ceramics • Welding Materials



ELECTRONS AT WORK

Edited by ALEXANDER A. MCKENZIE

Radio Locator Guides Helicopter.....	196	Radio Disturbance Warnings.....	224
Sensitive Microphotometer.....	196	Phototube Chopper.....	226
Underwater TV Searches for Comet.....	198	Linear Low-Level Rectifier.....	228
Commutation Factor in Thyatron Circuit Design.....	198	Wheel Balancing by Vibration Pickup.....	236
The Front Cover.....	200	New Compounds for Transistor Research.....	238
Radioactive Snow Gages Determine Runoff.....	200	Voltage-Tuned Microwave Oscillator.....	242
A Video Test Oscillator.....	206	Timer Saves Monitor Batteries.....	250
Spectrum Chart.....	210	Radar Detects Ocean Currents.....	254
Tube Failures in SEAC.....	212	Phantom Microphone.....	254
Vacuum Furnace for Crystal Growing.....	214	High-Voltage Switch from Banana Plugs.....	256
Pedestal-Removing Slicer Circuit.....	220	Pertinent Patents.....	258

OTHER DEPARTMENTS

featured in this issue:

	Page
Production Techniques.....	262
New Products.....	322
Plants and People.....	412
New Books.....	480
Backtalk.....	502



Radio Locator Guides Helicopter

COMPLETELY AUTOMATIC control of a helicopter has been maintained by means of a Raydist continuous-wave radiolocation system and an autopilot. The closed-link system depends upon radio transmissions inherent in the navigation technique.

The aircraft maintained a stable hover for seven minutes at an altitude of 1,100 feet during one portion of the test and several times was landed within one or two feet of the central point.

A small transmitter is installed in the helicopter. Signals from two Raydist relay stations on the ground are compared in one phase-

meter to indicate longitudinal movements of the helicopter, while signals from two other relay stations are compared in a second phase-meter to indicate transverse movement.

Transducer for each of these error indications is a small, low-torque potentiometer attached to the shaft of the respective phase-meters.

As the helicopter, hovering over the reference points drifts to right or left, the transverse phase-meter indicates the movement as rotation of the potentiometer that introduces positive or negative signals to the autopilot. Fore and aft di-

gressions are similarly handled.

Raydist, which is being used to aid underwater oil exploration, is one of the so-called hyperbolic navigation systems (ELECTRONICS, p 186, Nov. 1947; p 70, Aug. 1949.)

Sensitive Microphotometer

By WILLIAM L. CLINK

*Defence Research Board
Physics and Meteorological Section
Suffield Experimental Station
Ralston, Alberta
Canada*

THE UNIT described in this article was constructed to facilitate the use of a microphotometer when measuring density of spectroscopic slides. Essentially, it is a high-voltage power supply for a multiplier phototube and utilizes automatic feedback to maintain a constant output from the phototube. In this way the potential applied to the

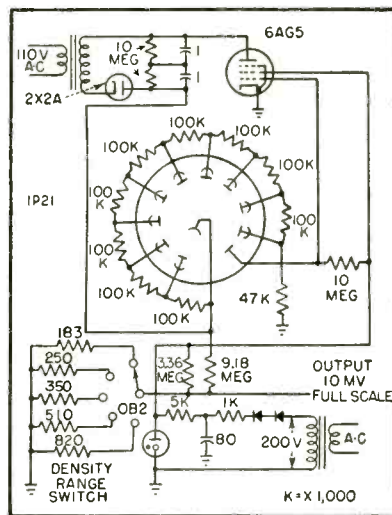
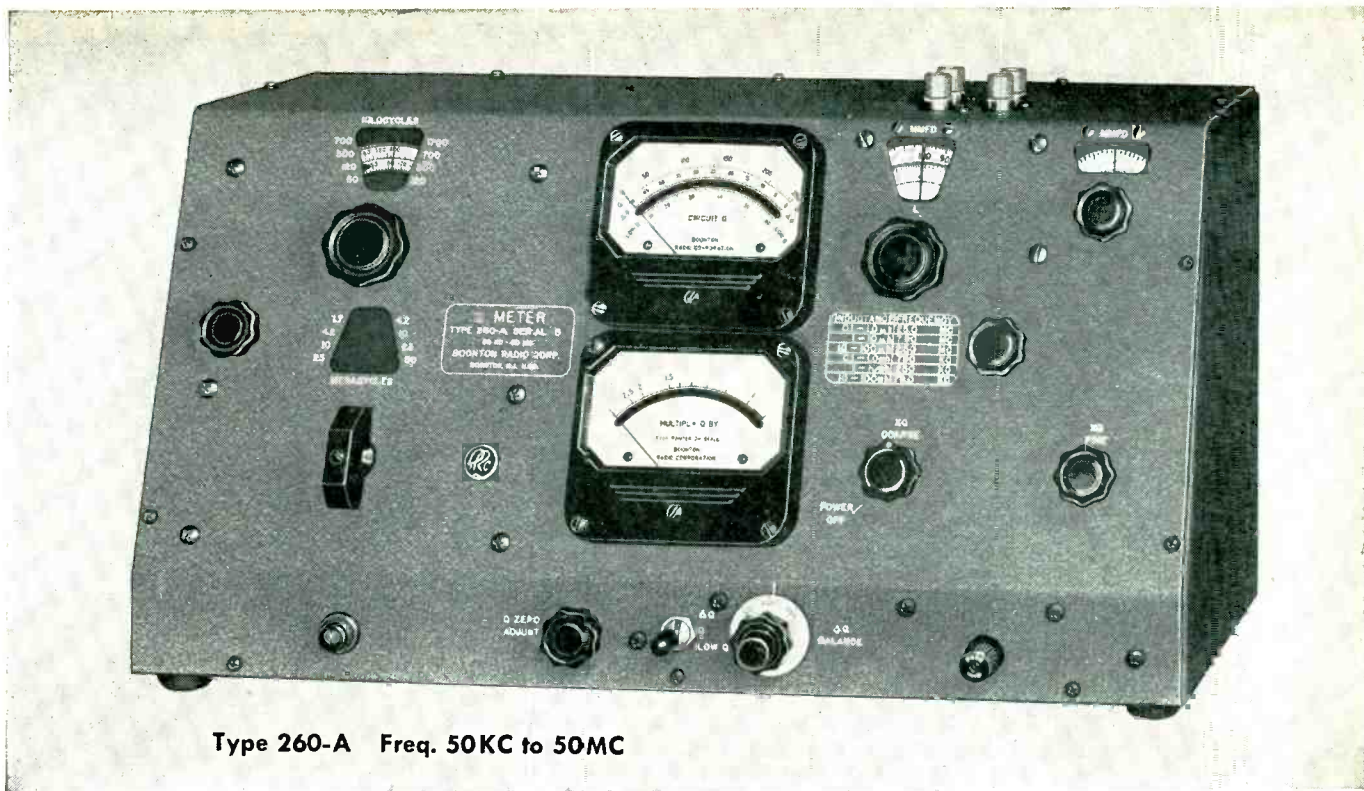

FIG. 1—Circuit of microphotometer



Type 260-A Freq. 50KC to 50MC

18 years of improvements are combined in this NEW Q Meter

NEW FEATURES

- Lo Q Scale permits Q readings down to a value of 10.
- Δ Q Scale reads the difference in Q of two circuits or components up to a value of 125.
- Thermocouple for indicating current inserted into measuring circuit redesigned for high burnout point well above operating current.
- Oscillator maximum output level adjusted to minimize possibility of thermocouple failure.
- Voltage insertion resistor decreased to 0.02 ohms to minimize effect on measuring circuit. New type low reactance metalized coaxial resistor used.
- All indications on large meters with parallax correction and accuracy of $\pm 1\%$ full scale.
- Range switch controls mask and arrow which indicate correct scale on frequency dial.
- Oscillator rigidly supported by casting which supports turret ball bearings and circuit using long life subminiature triode.

Visit us at the I.R.E. Show, 225-227 Instruments Ave.

BOONTON RADIO

BOONTON · N.J. · U.S.A.

Corporation



The Q Meter Type 260-A replaces our Type 160-A, one of Boonton Radio's Q Meters which has been standard equipment in laboratories and on production lines for eighteen years. Many improvements have been made during this time, but several of our ideas for a better instrument were too extensive to put into a model already in production. These ideas were carefully tested for use in a new model. The Q Meter Type 260-A includes all past improvements and the extensive changes that we have accumulated.

SPECIFICATIONS:

FREQUENCY COVERAGE: 50 KC to 50 MC Continuously variable in eight ranges.

FREQUENCY ACCURACY: Approximately $\pm 1\%$.

RANGE OF Q MEASUREMENTS: 10 to 625.

RANGE OF DIFFERENCE Q MEASUREMENTS: 0 to 125.

INTERNAL RESONATING CAPACITANCE RANGE:

Main Tuning Dial: 30 to 450 mmf (direct reading) calibrated in 1.0 mmf

increments from 30 to 100 mmf: 5.0 mmf increments from 100 to 450 mmf.

Vernier: -3.0 to $+3.0$ mmf (direct reading) calibrated in 0.1 mmf increments.

ACCURACY OF RESONATING CAPACITOR:

Main Tuning Dial: Approximately $\pm 1\%$ or 1.0 mmf, whichever is the greater.

Vernier: ± 0.1 mmf.

POWER SUPPLY: 90-130 volts—60 cps (internally regulated).

POWER CONSUMPTION: 65 Watts.

Model available for other Power Supply voltages and frequencies.

Type 103-A Accessory Inductors Available for entire frequency range.

PRICE: \$725 F. O. B. FACTORY



dynode chain is a singular function of the light input to the cathode. The lower-voltage supply incorporating an OB2 voltage regulator tube provides the reference voltage for the feedback circuit and also a constant amount of zero suppression in the output to a 10 millivolt electronic recorder.

This zero suppression amounts to 31 volts per dynode-stage. The zero adjustment is within the optical system of the microphotometer.

Full scale values of density are selected by means of a multiple switch.

Component values have been selected to give density ranges of 1, 1.5, 2, 2.5, and 3.

Calibration of the overall system was carried out using a neutral density wedge with spot checks made with several neutral density filters.

As a density range of 3 was sufficient for scanning photographic emulsions and as the degree of non-linearity was not large, no further attempt at refinement was made.

Underwater TV Searches for Comet

TECHNICIANS lower special 700-pound casing over television camera to protect it during operations 1,000 feet beneath the sea. The casing developed by the Royal Naval Scientific Service, encloses a Pye camera.

Equipment flown to Malta from the United Kingdom is being used by the Royal Navy to identify wreckage of the Comet aircraft recently lost and resting on the ocean bed off the island of Elba in the Mediterranean Sea.

Commutation Factor in Thyatron Circuit Design

D. E. MARSHALL AND
Electronics Engineering Dept.
Westinghouse Electric Corp.
Elmira, N. Y.

C. L. SHACKELFORD
now with
Chatham Electronics
Livingston, N. J.

CLEAN-UP of the inert gas filling of thyatrons seem to depend on the amount of bombardment of tube electrodes by positive ions at negative space potential. To specify the capabilities of an inert gas tube, it is necessary to limit the factors in the design of the circuit which influence this electrode bombardment.

Permissible bombardment of the anode is indicated by the commutation factor.¹ This factor is the

product of the rate of change of negative anode voltage immediately after the end of the current commutation period and the rate of change of current immediately preceding the end of the commutation period. The customary units in which this factor is given are volts per microsecond multiplied by amperes per microsecond. While the physics of clean-up is still not yet completely understood, this em-

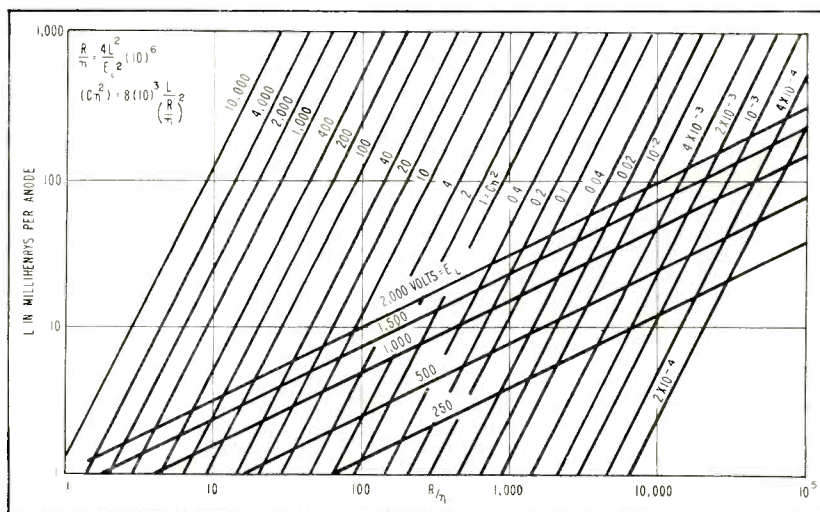
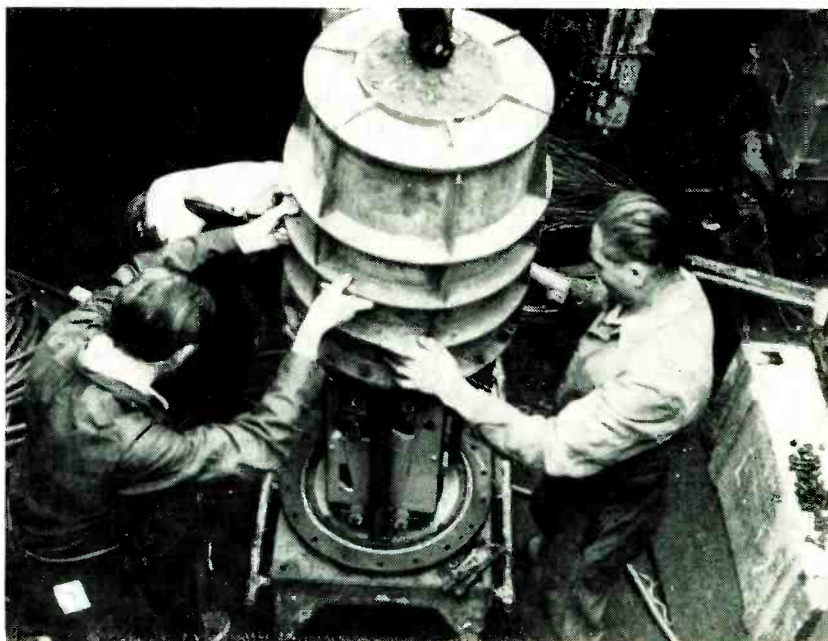

Chart used to determine component values for thyatron cushioning circuit



YOUR .5-FOOT SHELF IS NOT COMPLETE

...without these popular classics for engineers...published in profusion by the Technical Information Service of Helipot Corporation...leading litterateurs of precision potentiometers...as befits the world's largest manufacturer thereof.

Accuracy of Potentiometer Linearity Measurements by Robert McDonald and Irving Hogan...reprint of a research report originally published in the August 1953 issue of *Tele-Tech & Electronic Industries*... a study revealing that calculated linearity-error values are far less reliable than previously believed. Ask for *Data File No. 302A*

Characteristics of Precision Servo Computer Potentiometers by Donald C. Duncan...reprint of a talk presented at the American Institute of Electrical Engineers Conference on Feedback Controls Systems. Ask for *Data File No. 302B*

Computing with Servo-driven Potentiometers by F. R. Bradley and R. D. McCoy...reprinted from *Tele-Tech & Electronic Industries*...an examination of linearity and loading effects in analog systems... showing how errors may be eliminated...practical circuit techniques...restriction of potentiometer range, preloading, unloading with feedback amplifiers. Ask for *Data File No. 302C*

Electrical Noise in Wire-wound Potentiometers by Irving J. Hogan...reprint of a talk presented at the 1952 West Coast I.R.E. Convention...classification of noise by origin, methods of observing and measuring, system of units for expression of noise values. Ask for *Data File No. 302D*

Helipot Condensed Catalog...describes every model of Helipot* precision potentiometer and turns-counting Duodial...includes quick-comparison table of specifications for all series. Ask for *Data File No. 302E*

Helipot Model Selector...this handy device enables you quickly to determine the electrical and mechanical characteristics of all Helipots...provides easy reference to frequently used electrical data. Ask for *M.S. No. 302F*

*T.M. REG. U.S. PAT. OFF. • 275

See our exhibit at the I.R.E. show, March 22 to 25, at Kingsbridge Armory, New York. See our single-turn and multi-turn precision potentiometers, turns-counting Duodials, our new variable delay line and our new digital output transducer.

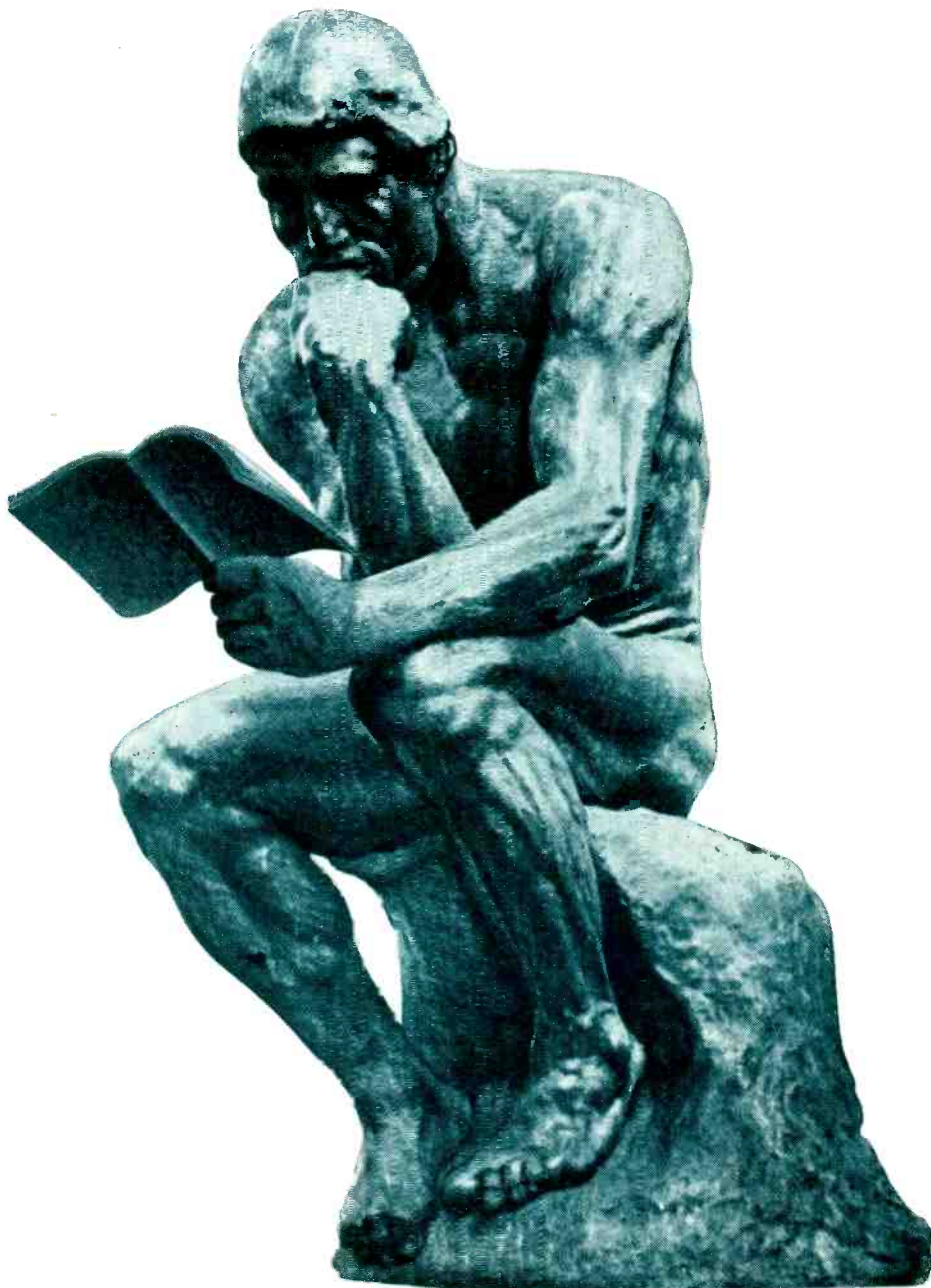

ADAPTED FROM THE THINKER BY RODIN

Helipot corporation

a division of BECKMAN INSTRUMENTS, INC.

SOUTH PASADENA, CALIFORNIA

PLANTS AT SOUTH PASADENA & MOUNTAINSIDE, NEW JERSEY
ENGINEERING REPRESENTATIVES IN PRINCIPAL CITIES

first in precision potentiometers

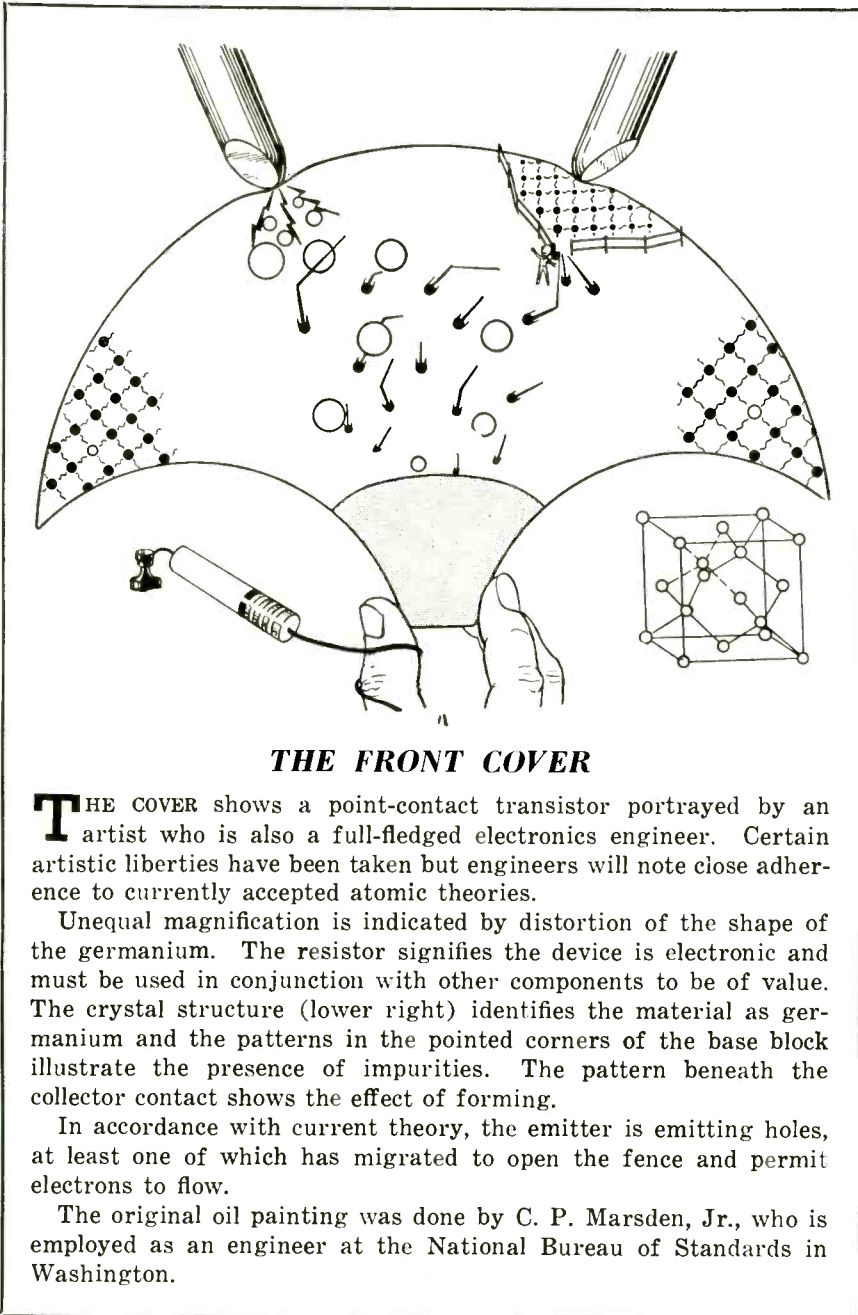

THE FRONT COVER

THE COVER shows a point-contact transistor portrayed by an artist who is also a full-fledged electronics engineer. Certain artistic liberties have been taken but engineers will note close adherence to currently accepted atomic theories.

Unequal magnification is indicated by distortion of the shape of the germanium. The resistor signifies the device is electronic and must be used in conjunction with other components to be of value. The crystal structure (lower right) identifies the material as germanium and the patterns in the pointed corners of the base block illustrate the presence of impurities. The pattern beneath the collector contact shows the effect of forming.

In accordance with current theory, the emitter is emitting holes, at least one of which has migrated to open the fence and permit electrons to flow.

The original oil painting was done by C. P. Marsden, Jr., who is employed as an engineer at the National Bureau of Standards in Washington.

pirical factor has proved valuable as an index of the ability of a tube to withstand clean-up.

Figure 1A shows the waveform of the tube voltage and tube currents in a simple full-wave single-phase rectifier circuit when a reasonable amount of inductance is present in the d-c load circuit. The conditions shown are those corresponding to a phase retard of the grid control of approximately 60 deg. One tube continues to conduct in the forward direction to a time into the inverse half cycle equal to the firing angle when the second tube is fired, whereupon the first tube current is rapidly commutated to zero.

At the end of current conduction, the full voltage of the transformer is suddenly applied across the tube in the inverse direction. The magnitude of this voltage is indicated on the curve as E_i . The current decreases at a rate determined by the distributed capacitance and inductance of the circuit.

Figure 1B shows the usual method used to adjust the voltage change occurring across the tube after commutation to a value that is within the tube rating. The function of the series resistance-capacitance circuit in parallel with the tube is to retard increase of negative voltage across the tube. Values of the constants of this circuit are proportioned with relation to the transformer leakage inductance so as to make the entire transient-voltage rise critically damped. In general, the effect of distributed

Radioactive Snow Gages Determine Runoff

Rugged terrain of the Kings River watershed on the west slope of California's Sierra Nevada makes transmission of weak uhf signals over long distances difficult. Signals from radioactive snow gages are relayed through the transmitter-receiver equipment illustrated to central point. Snow depth is gaged by radiation detector hung in air above radioactive source set flush with ground. Water content of snow attenuates radiation.

Automatic relay station controlled by clock comprises f-m receiving and transmitting equipment. Potential for 1.5-volt filament and 6-volt power source comes from wet cells that last nine months under intermittent service



greater sensitivity . . .

longer wear in partial rotation



SIGMA RELAY 6X

ACTUAL SIZE MPB No. 2A

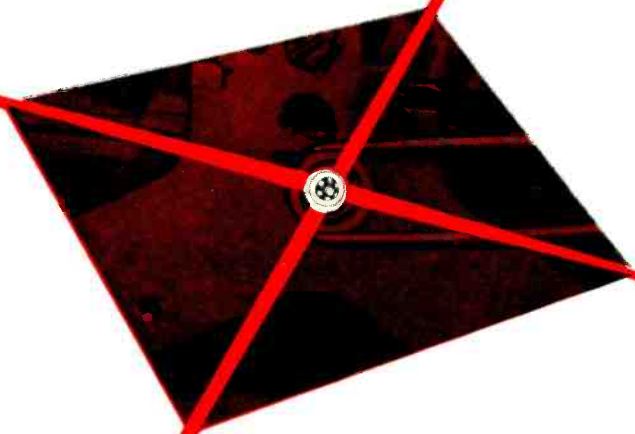

HERE'S **HOW** SIGMA INSTRUMENTS, INC.
builds better relays
with MPB bearings!



OPERATING CONDITIONS — consistently accurate response to equal amounts of current . . . partial shaft rotation . . . strength to withstand severe shock, vibration, plus extreme temperature changes. CRITICAL — wear, low starting torque, trouble-free operation of bearings supporting armature shaft, RESOLVED—by use of 2 MPB No. 2A's, miniature angular contact bearings.

MPB bearings, installed in the redesigned Sigma 6X electrical relay increased sensitivity and consistency of performance. Test sample models completed many million cycles of partial rotation with no variations in performance . . . no bearing wear . . . no adjustment necessary.

“Designing in” MPB bearings can help you get greater accuracy, longer life in your precision mechanisms. For the most complete design information ever offered on miniature ball bearings request, on your letterhead, MPB catalog E54c

Miniature Precision Bearings, Inc.  Keene, New Hampshire

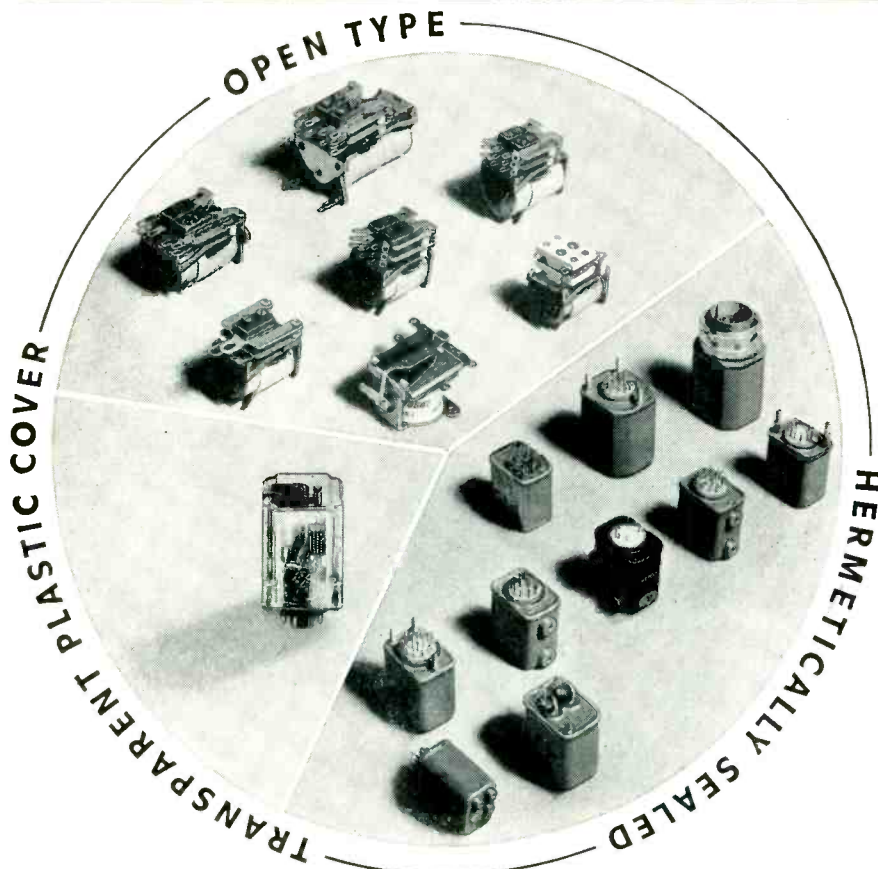

R-B-M Relays

**FOR EVERY ELECTRONIC
APPLICATION**

Meeting Commercial and Government Requirements

OPEN TYPE. Circuit switching — power and dynamotor loads — plate circuit — low capacitance.

HERMETICALLY SEALED. Stud or bushing mounting — solder or plug-in headers — circuit switching — power — low loss applications.

TRANSPARENT PLASTIC COVER. Most R-B-M relays now available in low cost transparent plastic cover.

OTHER PRODUCTS: Motor starting relays and overload protectors for refrigeration, appliance and general purpose motors. Industrial contactors and across-the-line starters. NEMA size 1 and smaller. Low cost general purpose relays. Low voltage D. C. manual and magnetic devices.

VISIT BOOTH 614, KINGSBRIDGE ARMORY
I. R. E. CONVENTION, NEW YORK CITY, MARCH 22-25

R-B-M DIVISION
ESSEX WIRE CORPORATION
Logansport, Indiana

Controls for Electronic,
Refrigeration, Industrial, Appliance,
Communication and
Automotive Industries



capacitance will be largely damped out when the cushioning circuit is used.

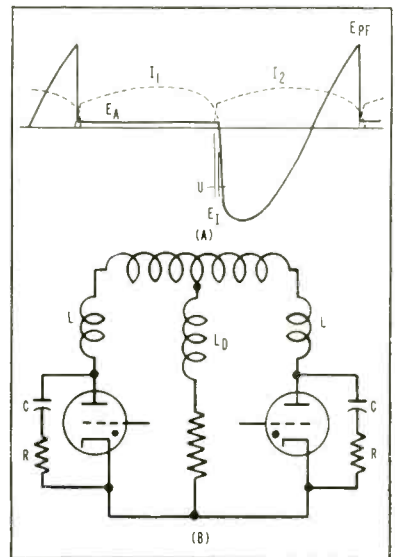

FIG. 1—Current and voltage waves (A) in full-wave thyatron circuit. Cushioning circuit (B) used to control commutation.

The graph shows the method of calculation of the constants of the cushioning circuit as a function of the commutation factor of the tube together with the two formulas on which the chart is based. The upper formula indicates the value of resistance above which the rated commutation factor would be exceeded, as a function of the transformer inductance and the initial inverse voltage of the rectifier circuit. On a logarithmic scale, this formula is represented by straight lines of gradual slope. The inductance of a given transformer can be obtained by test. Moving in until a line corresponding to the initial inverse voltage is reached, the point determined is the ratio of the cushioning circuit resistance and the rated commutation factor.

The value of resistance required, therefore, varies linearly with the value of the rated commutation factor of the tube under consideration. In designing the circuit, the resistance of the cushioning circuit should not be greater than the value determined. Value of the cushioning circuit capacitance is given by the second formula in the upper left-hand corner. This formula is represented by the other system of straight lines on the graph. The point previously obtained also indicates the value of the capacitance

Patent Number 2,659,884

The first fully streamlined radome is the new B-sandwich, designed and currently being manufactured by McMillan Laboratory, Inc., Ipswich, Massachusetts.

By **A. M. BRINK**

McMillan Laboratory, Inc.
Ipswich, Massachusetts

THE NEED for streamlined radomes which introduce negligible radar errors has become acute with the development of supersonic airplanes and precision radar. As more pointed shapes are demanded by the aerodynamicist and more accuracy required by the systems designer, the difficulty of achieving high transmission with ordinary wall constructions such as the foam sandwich or the half wave solid laminate has increased. In addition, errors due to phase distortion and the rotation of polarization by the radome have become appreciable. Tapering of the radome wall, a process which in principle is analogous to grinding optical lenses to special shapes, helps to reduce the phase distortion, but soon introduces unacceptable reflections. Moreover the optimum taper is not the same for the different polarization aspects which a radome encounters.

The first fully streamlined radome to be manufactured is the new B-sandwich. A symmetrical, three-layered, solid wall construction whose core dielectric

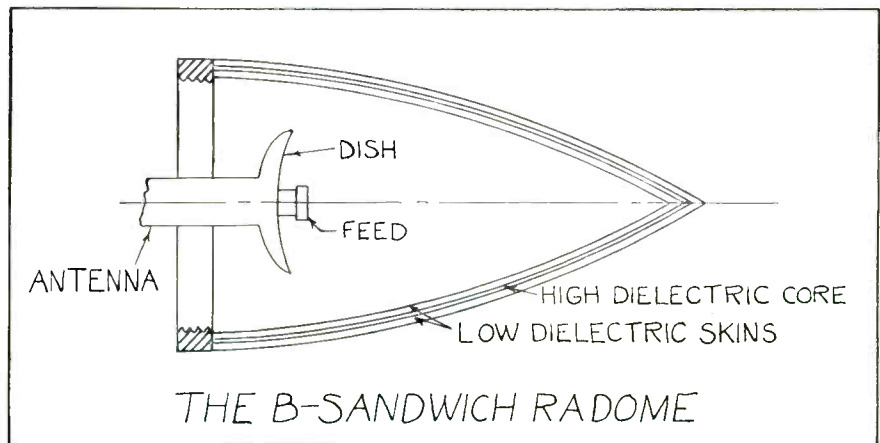

constant exceeds that of its skins, the B-sandwich is a microwave modification of the principle of quarter-wave reflectionless lens coatings possessing additional polarization corrective properties. The designer finds two advantages in the B-sandwich which the ordinary wall lacks. The B-sandwich can be designed for 100% transmission independent of the core thickness and it can be designed to preserve the polarization orientation, also independent of core thickness. The designer may thus introduce a variable taper into the core to correct beam shift without introducing errors from other sources. In addition, the B-sandwich pos-

sesses excellent thermal and mechanical properties for withstanding the extreme rigors of supersonic flight.

The designers and manufacturers of the B-sandwich, McMillan Laboratory, Inc., Ipswich, Massachusetts, have played a vital role in the advancement of radome science since its inception. The laboratory has a well-qualified theoretical group, a design and prototype section, and a well-gearred production division, all ready to help further advancement in this field which daily becomes more essential to the electronics and avionics industry. For further information write: McMillan Laboratory, Inc., Ipswich, Mass.

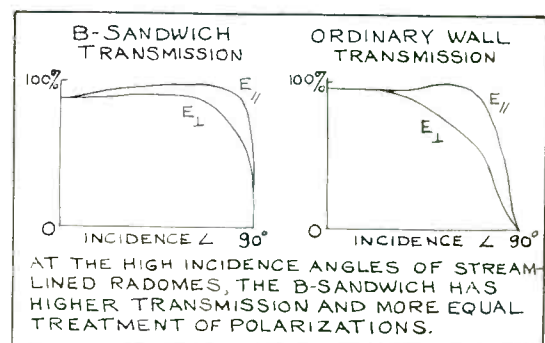
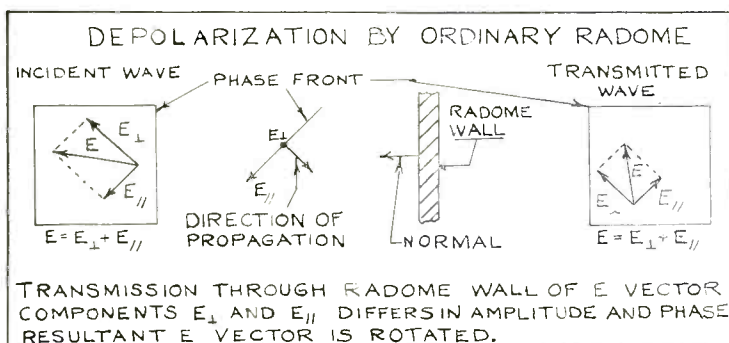

ENGINEERS — If you are interested in a future in this vital field of avionics — McMillan Laboratory, Inc. is interested in you!

Specialists in
SOLDER FLUXES
LEAD & TIN
PRODUCTS
 for Over 50 Years

CEN-TRI-CORE

Energized

ROSIN-FILLED SOLDER

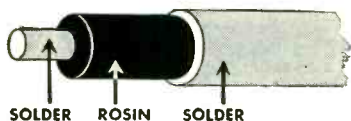

More Joints Per Pound
 With ALPHA CEN-TRI-CORE

EXCLUSIVE FEATURES

- guarantees against rosin voids or skips
- eliminates cold joints and rejects
- available in eight core sizes
- solders to plated or oxidized parts
- simultaneous "wetting flow" and take
- surpasses federal specifications for non corrosiveness and purity
- thin walls insure rapid heat transfer and faster fluxing action

Please consult us on your soldering problems. Trained Field Engineers always available to assist you.

VISIT ALPHA
 AT THE
 I. R. E. SHOW
BOOTH 501

Located in the show on
 Components Ave. &
 Production Road

the Mighty Midgets

SOFT SOLDER PREFORMS

SPEED AUTOMATIC SOLDERING

for flame, oven or induction heating

AVAILABLE IN

CEN-TRI-CORE Energized ROSIN-FILLED
 UNI-CORE Leak-Pruf ACID-FILLED
 SINGLE-CORE, SOLID WIRE,
 SHEET SOLDER

Increase production by use of Soft Solder PREFORMS to eliminate costly hand operations. Insure consistent uniform soldering. PREFORMS are precision made in all shapes, alloys, with or without flux. Special preforms designed for unique applications. We invite your inquiries.

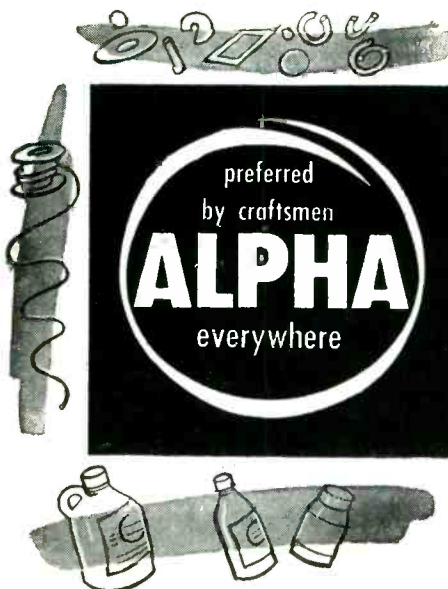

SOLDERING FLUXES

FOR SOLDERING
 ALL TYPES OF METALS

Liquid ROSIN (activated & non-activated) mild and strong general purpose FLUXES, Stainless Steel FLUXES. Laboratory controlled production processes insure uniform quality. There are additional types of soldering FLUXES for special applications. FOR BEST RESULTS ask our technical staff for help with your problems. SAMPLES AVAILABLE. We invite your inquiries.

ALPHA METALS, INC.
 59 Water St., Jersey City 4, N. J.

required for critical damping. It will be noted that the value of this capacitance is inversely proportional to the square of the rated commutating factor. In order to insure at least critical damping, a value of capacitance higher but not lower than this value may be used.

As an example, consider a rectifier to be built around a transformer having 8-millihenrys leakage inductance per anode leg and using tubes having a rated commutation factor of 10. It is required that the tubes commutate to an initial inverse voltage of 1,500 volts. Entering the chart at the 8-mh line, the intersection of this line with the $E_i = 1,500$ -volts line indicates an abscissa, R/τ of 110. Therefore, $R = 1,100$ ohms. This same intersection, interpolated into the set of curves having the greater slope, indicates that $C\tau^2 = 5$. Therefore, for critical damping, $C = 0.05$ microfarad.

The graph indicates the values of circuit constants for cushioning circuits designed to meet the conditions imposed by the rated commutation factor. The next consideration is the power losses in the cushioning circuit itself. This power loss determines the size of the resistor required. Current through the cushioning circuit is composed of two terms, that due to a repeated transient and to a steady-state component. The transient term arises because the steady-state term is not at a zero value at the time when voltage is suddenly applied across the tube. It is therefore necessary for capacitor voltage to rapidly rise from zero to the steady state value.

This can only be done through a large charging current into the capacitor, both at the time of increase and decrease of voltage across the tube. There will, therefore, be two transients occurring each cycle. The transient at the end of commutation will be critically damped and the transient in the beginning of tube conduction will be of exponential form. The reason for the difference in wave shape is that the transformer inductance is in series with the capacitor in the first case and not in the second. In general, the transient components are considerably larger

fine wire

**made
finer!**

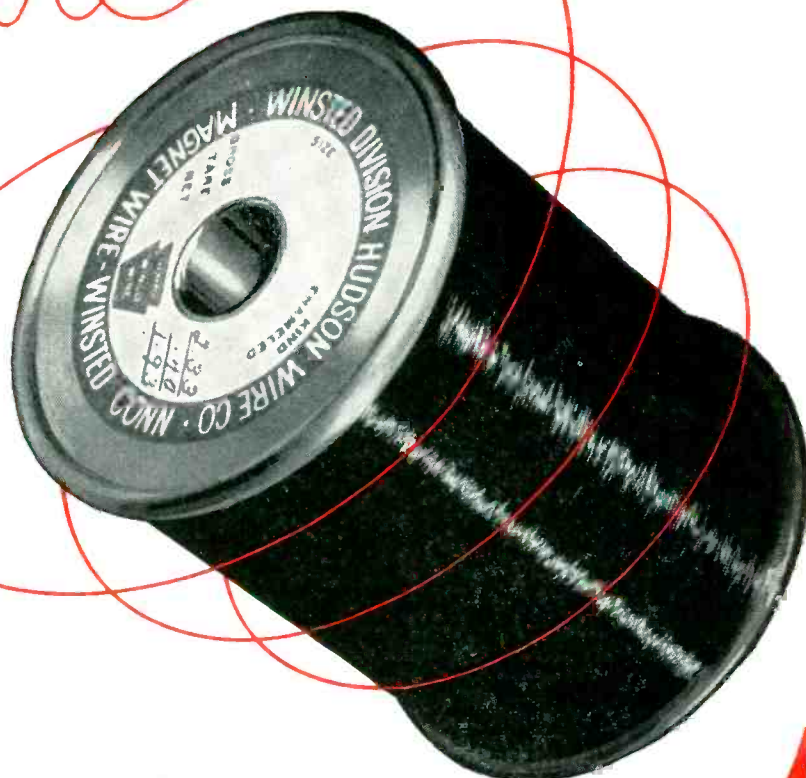

**custom drawn
custom insulated
custom spooled**

to your most exacting requirements

⊙ Backed by fifty years (1903-1953) of fine-wire specialization!
During all this time we have supplied bare and insulated wires to many of the most critical wire users.

Your specifications and requirements for *insulated wires* in the East are processed by our Winsted Division; in the West, the Cassopolis Division has been established to facilitate rapid shipments. Insulators and others requiring *bare wires* should contact the Ossining Division for prompt and efficient service.

Our research and development staff is always available to aid our customers in their requirements.

BARE WIRES

(Ossining Division)

- | | |
|-----------------|--------------------|
| Copper | Tin |
| Brass | Cadmium |
| Bronze | Oxygen-free Copper |
| Phosphor-bronze | Silver |
| Nickel-silver | Fuse |
| Zinc | Silver-plated |
| Lead | Specialties |

TEXTILE-COVERED WIRES

(Winsted Division)

- | | |
|----------|-----------|
| Nylon | Cotton |
| Celanese | Rayon |
| Silk | Fiberglas |

Available on bare or enameled wire; single or double-coated.

INSULATED WIRES

(Winsted and Cassopolis Divisions)

- | | | |
|------------------|--------------|----------------------|
| MATERIALS | TYPES | COVERINGS |
| Copper | Instrument | Plain and Heavy |
| Aluminum | Tubing | Enamel |
| Iron | Litz | Formvar |
| Copper-clad | Multiplied | EZsol (Liquid Nylon) |
| Steel | and Twisted | Cement-coated Enamel |

SPECIAL WIRES

(Ossining Division)

Silver-plated wires in coarse and fine sizes, for high-frequency conduction and high-temperature applications.

Electro-tinned, soft-annealed wire.

Other specialty wires to meet specifications.

HUDSON WIRE COMPANY



Bare Wires Insulated Wires

Winsted Division
Hudson Wire Company
Winsted, Conn.
Phone: Frontier 9-3341

Cassopolis Division
Hudson Wire Company
Cassopolis, Mich.
Phone: Cassopolis 56

Ossining Division
Hudson Wire Company
Ossining, N. Y.
Phone: Ossining 2-4710

EXTREMELY HIGH "Q"

insures
minimum frequency
affect
over a wide spectrum



For
precision
circuitry
in:

Frequency Generators
Analyzer Circuits
Wave Metering Apparatus
Countless Other Electronic
and Industrial Devices

For complete information
on capacitor performance char-
acteristics and recommended appli-
cations, write for Catalog 1117. To get the
help you need for special requirements,
consult Industrial Condenser Corporation's
highly experienced engineering staff. They
will provide specific recommendations, plus
the design and engineering "know how" to
meet your needs.

INDUSTRIAL
CONDENSER CORPORATION

3249 North California Avenue Chicago 18, Illinois

Outstanding Operating Characteristics

**Insulation resist-
ance** at +20° C.
after three minutes
charge: 900,000
megohm micro-
farads

**Insulation resist-
ance** at +75° C.:
78,000 megohm
microfarads

**Insulation resist-
ance** at -75° C.:
In excess of one
million megohm
microfarads

**Change in capaci-
tance** from +25°
C. to -80° C.:
+0.76%

Self time constant
of 10 mfd. capaci-
tor: 4800 hours

Q at 50 kilocycles:
10,000

Power Factor at 1
kc: 0.00025

than the steady-state components. An approximate but adequate ex-
pression for the watts lost in the
resistor of a cushioning circuit on
a common two-phase rectifier is

$$P_r = \frac{E_{in}^2 C}{R^2 \omega^2 C^2 + 1} \left(f \sin^2 (\alpha - \theta) + \frac{\omega^2 CR}{4} \right)$$

Where $\theta = \arctan \omega CR$ and α is
the phase retard angle. The first
term is the transient loss; the sec-
ond, the steady-state loss. The tran-
sient loss is, in general, so much
greater than the steady-state por-
tion that the latter may be ne-
glected with little additional error.

A Video Test Oscillator

By L. FLEMING

Falls Church, Virginia

RESPONSE MEASUREMENTS on oscil-
loscopes and video amplifiers call
for a signal source having a fairly
high output up to several mega-
cycles and fairly constant with re-
spect to frequency. The oscillator
described will cover the range 0.6
mc to 6 mc in one sweep of the dial.
Output is 2 volts maximum at 100
ohms impedance, constant within
 ± 10 percent over the range.

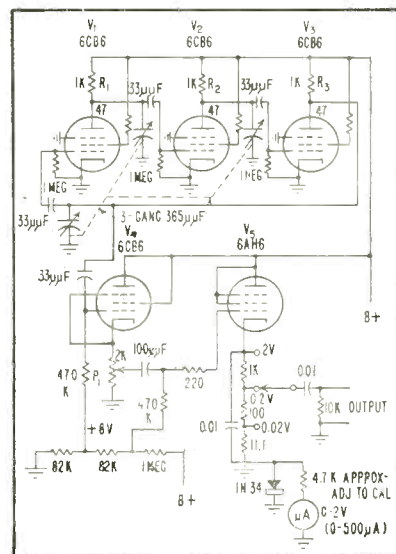

Circuit of the video test oscillator

The device is simple and cheap to
build and will serve as an inexpen-
sive adjunct to any of the commer-
cial audio oscillators that cover the
range below 600 kc.

The complete oscillator circuit is
shown. Pentodes V_1 , V_2 and V_3 com-
prise a three-phase, phase-shift os-
cillator of the phase-lag type. An



MARCUS
dry type
TRANSFORMERS

are
insulated
with
NATVAR

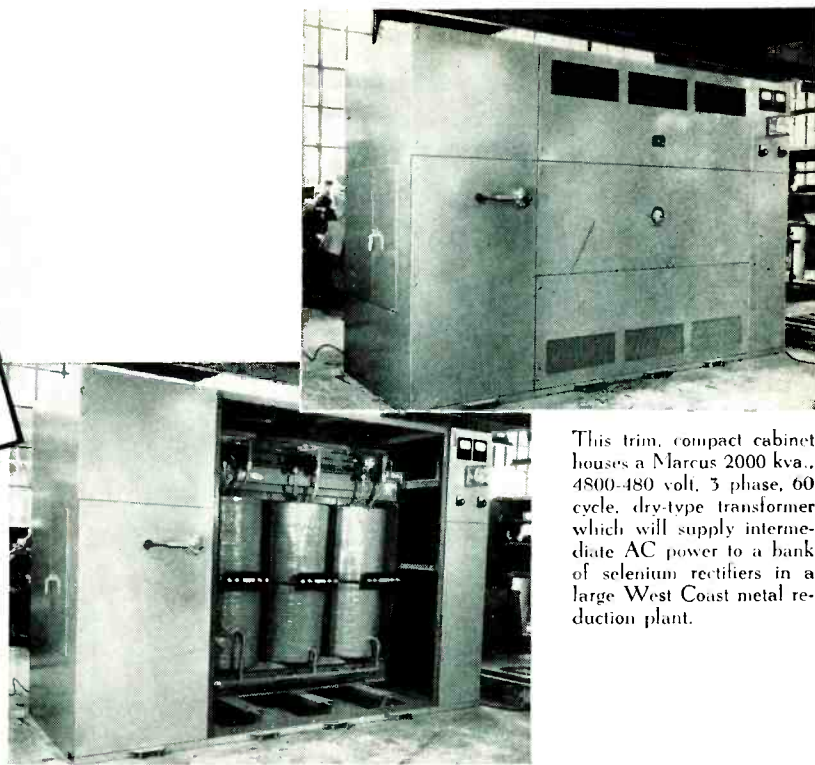

This trim, compact cabinet houses a Marcus 2000 kva., 4800-480 volt, 3 phase, 60 cycle, dry-type transformer which will supply intermediate AC power to a bank of selenium rectifiers in a large West Coast metal reduction plant.

This interior view shows the rugged construction of Marcus industrial unit substations. A Natvar special combination of Quinorgo® firmly bonded to varnished open-weave Fiberglas provides a flexible insulation of high dielectric strength and great mechanical toughness, plus the ability to withstand continuously high operating temperatures. It is used as a layer insulation for the major insulation barrier between primary and secondary, and between core and coils.

SPECIAL INSULATION

Marcus Transformer Co., Inc., Hillside, N. J. manufactures dry-type transformers from 1 to 5000 kva. capacity, engineered for long life and continuous, trouble-free service.

All materials used in their construction are carefully chosen for durability and performance under maximum loads at high temperatures. A Natvar special combination of Quinorgo® and Fiberglas firmly bonded together is used because of its exceptionally good electrical properties, flexibility, mechanical strength, and its ability to withstand heat.

Whether your requirements call for a standard insulating material, available either from your wholesaler's stock or direct from our own, or a special combination, it will pay you to investigate Natvar flexible insulations.



Natvar Products

- Varnished cambric—cloth and tape
- Varnished canvas and duck
- Varnished silk and special rayon
- Varnished—Silicone coated Fiberglas
- Varnished papers—rope and kraft
- Slot cell combinations, Aboglas®
- Varnished-lacquered tubing and sleeving
- Extruded vinyl tubing and tape
- Styroflex® flexible polystyrene tape
- Extruded identification markers

Ask for Catalog No. 22

NATVAR CORPORATION

FORMERLY THE NATIONAL VARNISHED PRODUCTS CORPORATION

TELEPHONE

RAHWAY 7-8800

CABLE ADDRESS

NATVAR: RAHWAY, N. J.

201 RANDOLPH AVENUE • WOODBRIDGE, NEW JERSEY

I'm continually amazed

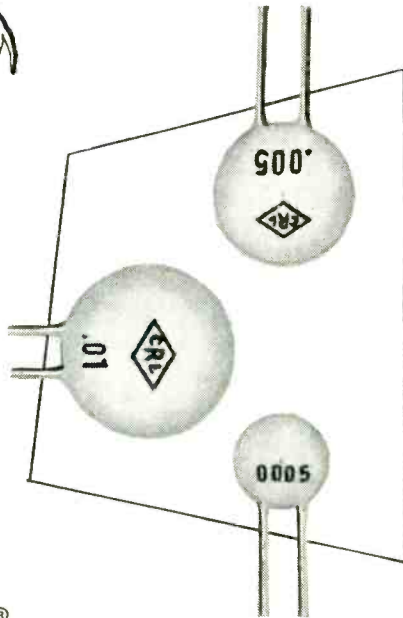

at how

BC Disc Hi-Kaps[®] solve space and design problems

Centralab BC Disc Hi-Kaps can amaze you too — Here's why —

- BC Discs are small in size, cut the third dimension (thickness) to a minimum. (5/32" thin.)
- Stable power factor — Initial, 1.5% at 1 KC.
- High Insulation Resistance—10,000 Megohms.
- Safe Rated Voltages — Rated at 500 VDCW, but tested continuously at 1,250 VDCW. High voltage types to 6000 VDCW available.
- Wide range of capacities — 10mmf to 20,000-mmf.
- No "intermittents" — Positive high temperature bond between ceramic and silver guarantees no movements, plus sure electrical contact.

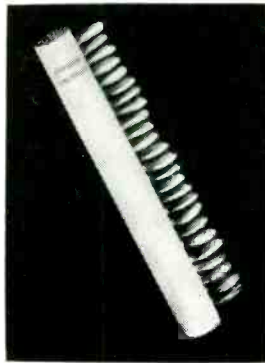

CENTRALAB BC Discs are so small that 25 of them occupy the space of one cigarette.

CENTRALAB knows the ceramic capacitor field better than any other supplier...

- CRL introduced ceramic capacitors in the U.S. many years before any other supplier entered the field.
- Centralab manufactures from basic powders to finished product right in its own plant . . . complete laboratory control over every step in the process.
- CRL has the largest staff of development engineers of any comparable company . . . over 150 men available for consultation on your capacitor problems.
- CRL's many plants are highly mechanized for efficient, quality manufacture, and located strategically for best delivery.

Write now for Bulletin 42-4.

Centralab

A Division of Globe-Union Inc.
914 E. Keefe Avenue • Milwaukee 1, Wisconsin
In Canada: 804 Mt. Pleasant Road, Toronto, Ontario

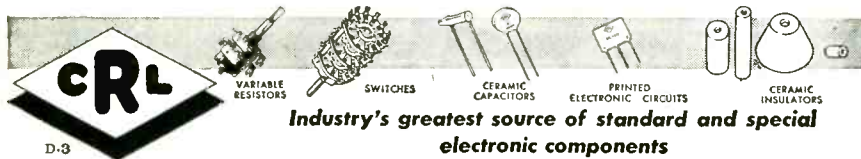

D-3

ordinary three-gang variable capacitor is used for tuning, with each section between a pair of tubes. Tube V_1 is a cathode follower used for isolating the output level control P_1 from the oscillator proper. Tube V_2 is a cathode follower output stage.

Of the known and well-developed types of oscillator circuits (excluding beat-frequency types), the phase-shift circuit of the phase-lag type appears to be the most suitable for video frequencies. In this kind of circuit at high frequencies the phase shifts owing to stray parameters tend to aid oscillation. When the phase-shifting network is all lumped together, however, it is not ordinarily possible to attain a frequency range greater than about 9-to-1 in one sweep of the dial.

When tubes are interspersed between the sections, a range of over 10-to-1 is readily attainable. The gain required per tube is only 2. A complicated embodiment of this circuit is used commercially.

The plate-load resistors of tubes V_1 , V_2 and V_3 serve as the series legs of the frequency-determining network. Interstage coupling capacitors are 33 μf , and their small size serves to keep hum voltage on the plate supply bus from getting to the grids of the tubes. The result is a low value of 60-cycle f-m without the need for heavy plate-supply filtering.

The oscillator tubes operate at plate current levels of around 6 milliamperes. The 47-ohm screen stoppers are necessary to arrest parasitic modes of oscillation. Overly large interstage coupling capacitors may cause relaxation oscillations.

There is an AVC action by virtue of bias from rectified grid current. Distortion is about 10 percent, a value not usually objectionable in video work. Automatic volume control of the type used in radio receivers has been applied to oscillators of this sort but was not deemed in this case worth the extra complication.

The cathode followers V_1 and V_2 are conventional except that the loads P_1 and the step attenuator are connected directly in the d-c cathode path to ground rather than being parallel-fed. The connection

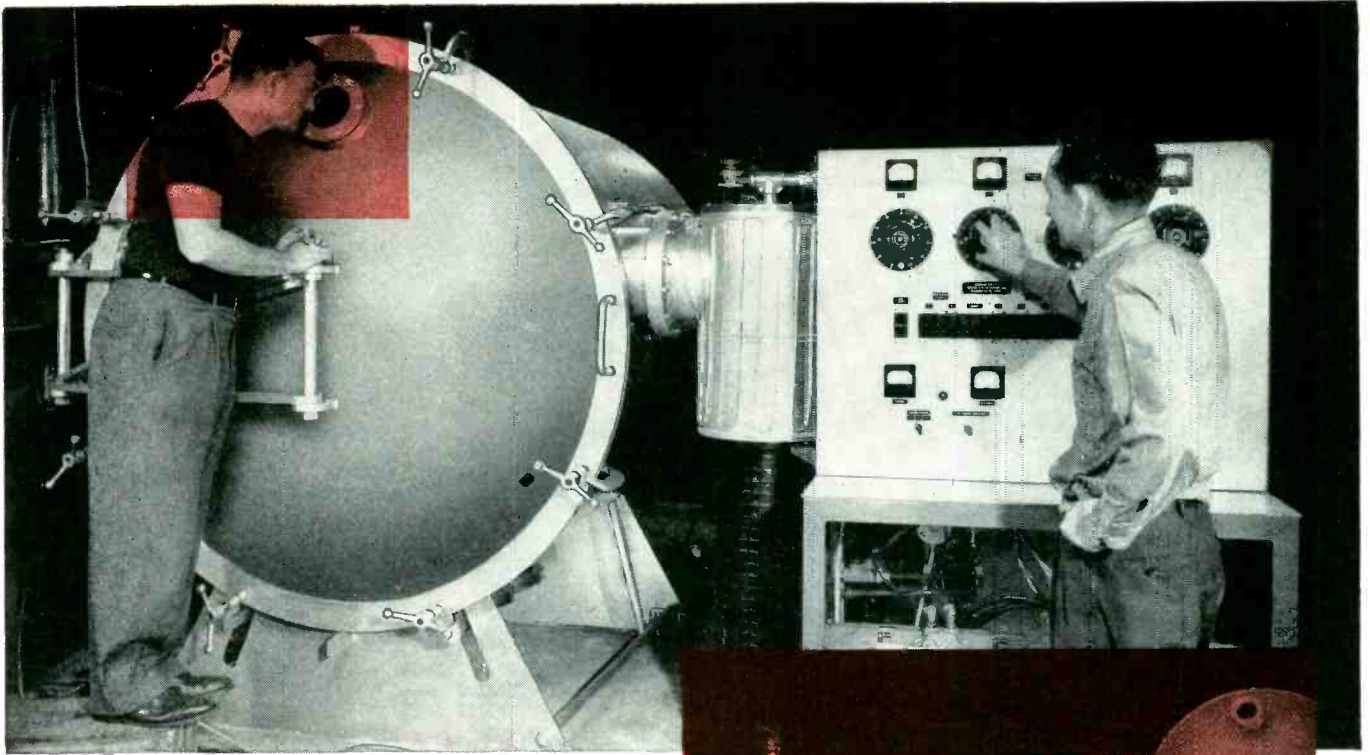

Kinney High Vacuum Pumps (Models DVM 12.8.14 and VSM 5.5.6) are used on this machine — manufactured by Optical Film Engineering Company, Philadelphia, Pa. — for depositing coatings on precision optical lenses, jewelry, plastic novelties, and countless other products. The vacuum system employed by this processing package creates absolute pressures as low as 10^{-6} mm. Hg. With this fast system, processing is carried out within a few minutes after loading, insuring maximum output per hour. Many of these coating machines are serving industries throughout the country.

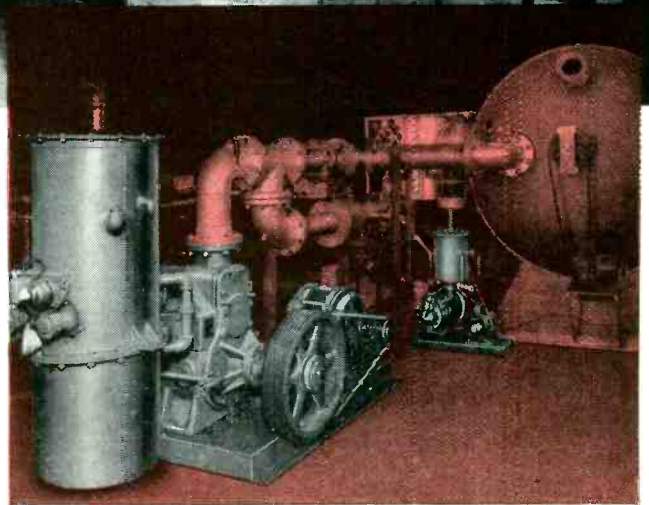

How to get the right vacuum pump

By consulting Kinney, you can choose from our line of 13 Single Stage and Compound vacuum pump models . . . the biggest, most versatile pump line on the market. We can help you size and apply these reliable high vacuum pumps to your vacuum processing operations. Our district offices are staffed with competent vacuum engineers, to assist you.

SEND COUPON TODAY! →

KINNEY MFG. DIVISION

THE NEW YORK AIR BRAKE COMPANY

3565 WASHINGTON STREET • BOSTON 30 • MASS.



Please send Bulletin V-51B describing the complete line of Kinney Vacuum Pumps.

Name

Company

Address

City State

Heiland
**Subminiature
 Galvanometer**
 20th
*Anniversary
 Model*

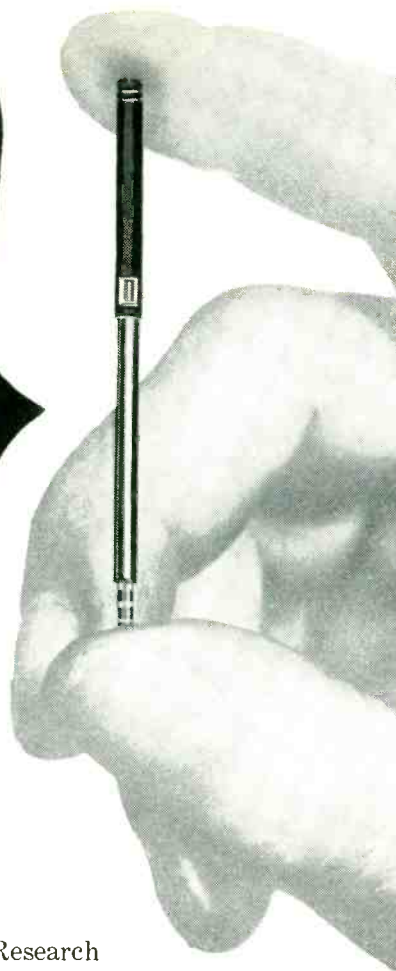

- In the past 20 years Heiland Research Corporation has made many contributions toward increasing the dependability and accuracy of recording oscillographs and oscillograph galvanometers.
- At the same time, the versatility of these instruments has increased to encompass an ever-widening field of applications in research and industry.
- On our 20th anniversary we take pride in announcing a new subminiature galvanometer which will be on exhibit at—

Booth 290 Instruments Avenue
I.R.E. Show
 KINGSBRIDGE ARMORY • NEW YORK CITY
March 22-25

—at which time details concerning specifications and performance characteristics of our new galvanometer will be released.

Heiland Research Corporation

130 EAST FIFTH AVENUE • DENVER, COLORADO

shown permits almost double the signal-handling capacity per milli-ampere of plate current, while noise effects are negligible owing to the high frequencies involved.

Output metering is provided by a half-wave rectifier circuit using a germanium crystal diode. With a full-scale voltage range of 2 volts, the linearity is good. Bridge rectifiers are to be avoided in this type of service at high frequencies, because the meter-to-ground capacitance introduces errors.

The important considerations of record in phase-shift oscillator design are scattered through a wide range of literature. Points of interest are often found in unexpected places. Some information useful in developing the circuit given here was found in the second entry in the bibliography, which relates to the opposite end of the frequency range.

BIBLIOGRAPHY

- R. M. Bartlett, N-Phase Resistance-Capacitance Oscillators, *Proc IRE*, 33, p 511, Aug. 1945.
- Gilbert Smiley, Ultra Low-Frequency Three-Phase Oscillator, *Convention Record of the IRE*, 1953 National Convention, Part 9, p 34.
- Nichols, U. S. Patent 1,442,781.
- Ginton and Hollingsworth, Phase-Shift Oscillators, *Proc IRE*, 29, p 43, Feb. 1941.
- R. W. Johnson, Extending the Frequency Range of the Phase-Shift Oscillator, *Proc IRE*, 33, p 597, Sept. 1945.
- Britton Chance et al. "Waveforms", McGraw-Hill 1949, p 110.
- W. A. Edson, Vacuum-Tube Oscillators, John Wiley & Son, 1953, p 183.
- P. G. Sulzer, The Tapered Phase-Shift Oscillator, *Proc IRE*, 36, p 1,302, Oct. 1948.
- F. Butler, Variable-Frequency R-C Oscillators, *Electronic Engineering*, London, p 140, Apr. 1949.
- F. W. Dawe, Wide-Range Audio Oscillator, *Electronic Engineering*, London, p 246, Aug. 1947.
- L. Fleming, Thermistor-Regulated Low-Frequency Oscillator, *ELECTRONICS*, p 97, Oct. 1946.
- L. Fleming, U. S. Patent 2,586,803, Feb. 26, 1952.
- L. Fleming, U. S. Patent 2,565,490, Aug. 28, 1951.

Spectrum Chart

THE SPECTRUM CHART appearing as an insert to this issue of *ELECTRONICS* on page 160A has as focal point the radio-frequency spectrum according to the allocation of the Atlantic City Convention, 1947.

The central section of the chart gives, in concise form, a key to the allowable uses in the Western Hemisphere and Hawaii. Further aid to the reader is afforded by listings of some specific services assigned within these bands by the

An Insurance Policy that Saves You Manufacturing Costs
Included in every shipment of Erie Capacitors

ERIE®

Quality Certificate

What is an ERIE Quality Certificate?

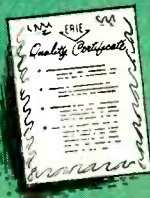

An Erie Quality Certificate is a form that lists the results of both electrical and mechanical tests for every shipment of Erie Capacitors. These tests are made by competent quality control inspectors using modern and precise measuring equipment.

quality control inspectors using modern and precise measuring equipment.

Will it Cut Costs?



YES — With the Quality Certificate you cut costs by reducing incoming inspection. You save the bother, time, and expense of returning faulty material because you are dealing with capacitors of a known quality. You also reduce the risk of putting faulty capacitors in your products.

Here's an Extra Dividend!



Erie Quality Certified capacitors cost you no more than other kinds. You benefit because quality products are always cheaper to use and add quality to your finished products.

Will it Speed Production?

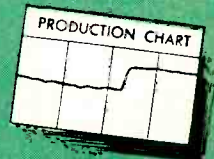

YES — It takes less time for Quality Certified Erie capacitors to get from your receiving doors to your production lines. It eliminates costly trouble-shooting delays on your assembly line and in your inspection of the finished products.

What Does the Quality Certificate Offer?



The Quality Certificate lists the sample size and test results for each inspection sequence or series of inspection tests. The frequency distribution of capacitance values in the sample is also shown. Electrical tests include dielectric strength, insulation resistance, and dissipation factor. Other tests such as temperature coefficient, case insulation breakdown are performed and results listed where applicable. The certificate also contains a complete inspection check list for mechanical and visual items. The sampling tables used are MILITARY STANDARD 105 with AQL's (Acceptable Quality Level) ranging from 0.4% for performance items to 1.5% for non-functional deviations.

Electrical tests include dielectric strength, insulation resistance, and dissipation factor. Other tests such as temperature coefficient, case insulation breakdown are performed and results listed where applicable. The certificate also contains a complete inspection check list for mechanical and visual items. The sampling tables used are MILITARY STANDARD 105 with AQL's (Acceptable Quality Level) ranging from 0.4% for performance items to 1.5% for non-functional deviations.

Again the Pioneer



As in so many other important developments in electronic components, Erie again leads the field. Erie is the first ceramic capacitor manufacturer to give customers this complete quality information with each shipment.

ERIE

RESISTOR CORP.

ERIE RESISTOR CORPORATION . . . ELECTRONICS DIVISION

Main Offices: ERIE, PA.

Sales Offices: Cliffside, N.J. • Philadelphia, Pa. • Chicago, Ill. • Detroit, Mich.
Fort Wayne, Ind. • Los Angeles, Calif. • Toronto, Canada

Factories: ERIE, PA. • LONDON, ENGLAND • TRENTON, ONTARIO • HOLLY SPRINGS, MISS.

DC-AC CHOPPERS

Triple Certified for Military Use

0-500 CPS

1
Each production lot sampled and life tested to prove 1000 hours life while cycled -55°C . to $+85^{\circ}\text{C}$. No guesswork.

2
Every Chopper given not only 1 but 2 complete operating tests at -55°C . $+25^{\circ}\text{C}$. $+85^{\circ}\text{C}$. before shipment. Double proof of stamina. Nothing left to chance.

3
Gold contacts are used for superior results in the vital 0-1½ volt d-c range. No other material will match this fine performance.

Also available
60 cycle types.

All military specifications met. Liberal safety factors to meet emergency conditions.

EXAMPLES:

Frequency tolerance 0-500 cps.
Coil Voltage Tolerance:
 $+30\%$ -20%
Noise level 200 microvolts.

Write today for complete information.
Catalog 280B 0-500 cps
Catalog 246D 60 cps

STEVENS-ARNOLD
INCORPORATED

22 ELKINS STREET, SOUTH BOSTON 27, MASS.

Federal Communications Commission.

A detailed list of frequency assignments, always subject to change, is currently set forth in a 41-page booklet. The interested reader is advised to obtain Part 2 (frequency allocations and radio treaty matters) of the FCC Rules and Regulations from the Government Printing Office, Washington 25, D. C., at a cost of 25¢.

Tube Failures in SEAC

EXTENDED OPERATION of the SEAC computer at the National Bureau of Standards provides means for ascertaining long-term reliability of tubes. Since a standard pulse-repeater stage using a type 6AN5 is a basic building block of the computer, more than two-thirds of the tubes used are of this single type.

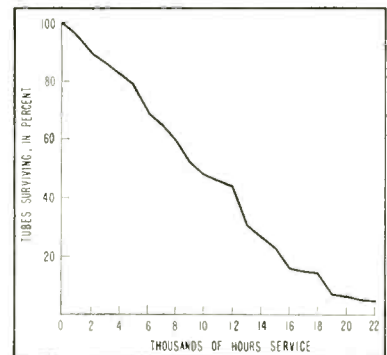

FIG. 1—Survival curve for type 6AN5 tubes used in a computer application is based upon the service of 1,775 tubes

During three years of operation, approximately 2,500 type 6AN5 tubes have been used in the machine and 1,300 have been rejected for various reasons. Since rejections are usually made during maintenance, operation failures owing to tubes have been few except during an early period of excessive heater voltages. During one 15-month interval, it was necessary to replace only 18 tubes during operation time. Approximately 55 percent of all rejections were made on the basis of low emission and undue heater sensitivity.

It has been required that a reduction from 6.3 to 5.7 v in filament potential will not cause more than a 25-percent decrease in plate current. Thus, many otherwise usable

**MOLONEY HiperCore
ELECTRONIC CORES**

CARE BUILDS BETTER CORES

Skill and care mark every operation in the meticulous manufacture of Moloney HiperCore Electronic Cores. Under the watchful eyes of conscientious craftsmen, the windings of cold-rolled oriented silicon steel are annealed in an inert gas atmosphere at carefully controlled temperatures to relieve any stresses that might affect their superior qualities. To prevent physical distortion, the cores are impregnated with a thermo-setting resin that bonds the insulated laminations into rigid, heat resistant units. Because of this planning and care, Moloney HiperCore Electronic Cores can be accurately cut to eliminate many costly operations in your assembly line.

Because Moloney HiperCore Electronic Cores have lower losses and greater flux carrying capacities, they enable you to make a better product. Moloney HiperCore Electronic Cores are *wound* cores that offer the advantages of less weight, less bulk—plus the “extra” that is always found in Moloney products.

ME 53-2.6

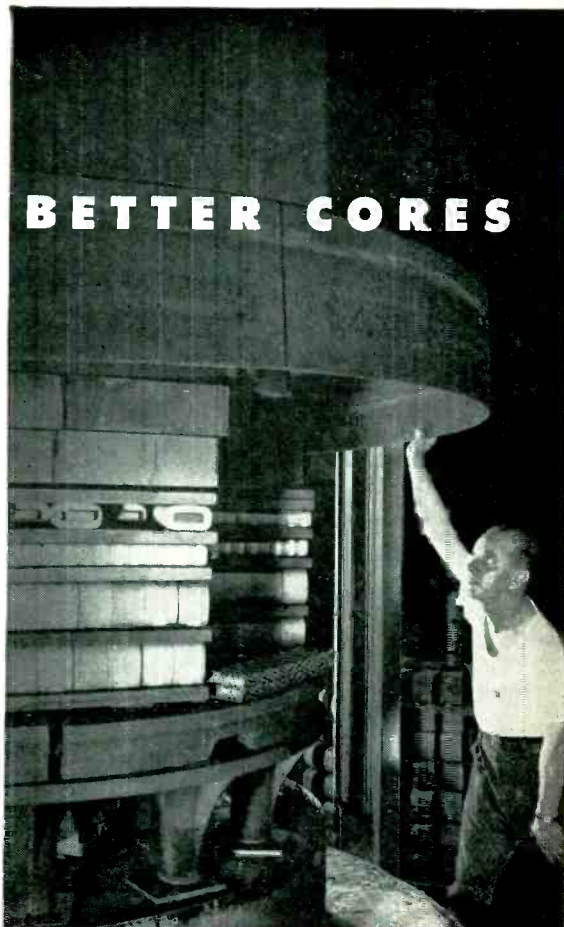

So if *your* product demands *better performance, smaller size and less weight*, specify Moloney Electronic Cores. Available in 1000 standard sizes—or built to your specifications.

Write today for Bulletin SR-205 containing specifications, performance data and prices.



MOLONEY ELECTRIC COMPANY

Manufacturers of Power Transformers • Distribution Transformers • Load Ratio Control Transformers • Step Voltage Regulators • Unit Substations

SALES OFFICES IN ALL PRINCIPAL CITIES • FACTORIES AT ST. LOUIS 20, MISSOURI AND TORONTO, ONTARIO, CANADA

Winchester Electronics

SERIES "K"

CONNECTOR
RECEPTACLES

FOR
PRINTED
CIRCUITS

3-CONTACT
RECEPTACLE

2-CONTACT
RECEPTACLE



K3S

K2S

Use the K2 and K3 individually
... or together ...
or in multiples to suit your
particular requirements.

See them at the
I.R.E. SHOW
388 Microwave
Avenue.

K15S
15-CONTACT
RECEPTACLE

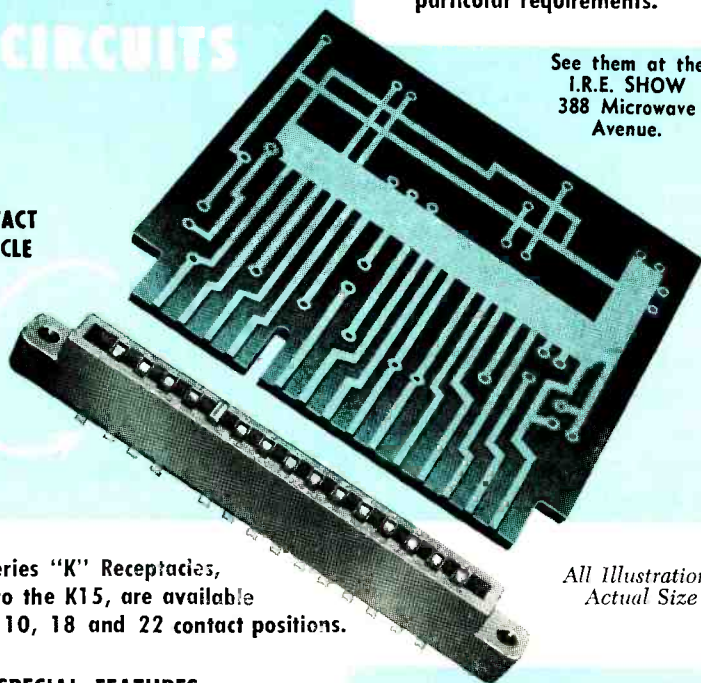

Other Series "K" Receptacles,
similar to the K15, are available
with 6, 10, 18 and 22 contact positions.

All Illustrations
Actual Size

SPECIAL FEATURES:

POLARIZING pin permits engagement in correct position only. *NOTE: Polarizing pin may be substituted for any contact by indicating "dash/letter" of that position to basic code number. Example ... K15S-E 15-position receptacle contains 14 contacts (solder cup type) and one polarizing pin in position "E".*

WIPING ACTION of contacts insures positive contact at all times.

MOLDED MELAMINE bodies, mineral filled, are fungus-proof and provide mechanical strength as well as high arc and dielectric resistance. One-piece molded construction eliminates moisture and dust pockets.

CONTACTS are spring temper phosphor bronze, gold plated over silver plating, for low contact resistance and prevention of corrosion.

Winchester Products and Winchester
Designs are Available Only
From Winchester Electronics, Inc.

SOLDER CUP or WIRE-WRAP TERMINAL CONTACTS...For attaching #20 A.W.G. wires

Receptacles are available either with contacts having cups for soldering, or with contacts with plain terminals for wrapping lead-off wires. Add "S" to basic code number for solder cups (as K15S); add "W" to basic code number for wire-wrap contacts (as K15W).

TUBULAR TERMINAL CONTACTS also available ... for riveting receptacle to printed circuit card. Add "T" to basic code number (as K15T).

Write or phone our Sales Department for full information ... or advise your special requirements.



GLENBROOK, CONN., U.S.A.

West Coast Branch: 1729 WILSHIRE BOULEVARD, SANTA MONICA, CALIFORNIA

tubes were rejected before they caused trouble. As a result, tube-survival curves and cumulative-rejection curves are weighted heavily on the side of heater sensitivity although this requirement is less important than others.

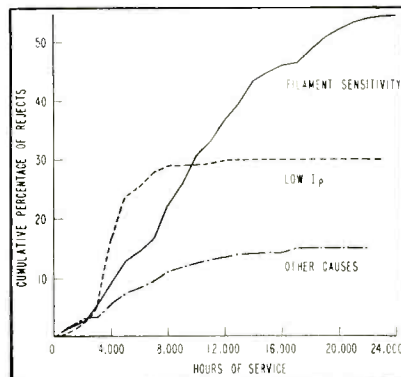

FIG. 2—Cumulative rejection curve for 800 type 6AN5 tubes used in SEAC

Other reasons for rejection were mechanical damage in handling, grid-cathode short circuits, open circuits and microphonics. After 8,000 hours' operation, heater sensitivity was almost the sole cause for rejection. In a group of tubes used in the arithmetic and control units of the computer the median life is approximately 12,000 hours. Median life of 6AN5's in the entire machine is 8,700 hours.

Vacuum Furnace for Crystal Growing

GROWING GERMANIUM CRYSTALS by pulling a seed crystal from a melt of germanium is usually done in an inert atmosphere. Operations in a vacuum would avoid possible contamination by impurities in the gas and eliminate heat loss through conduction.

The crystal pulling equipment described here provides a vacuum better than 10^{-4} mm Hg, maintained during operation, a crucible temperature up to 1,000 deg C for germanium, and independent rotation of both crucible and crystal at variable speeds. Crystals up to 2 inches in diameter and 18 inches long can be grown with withdrawal rate up to 6 inches per hour.

The vacuum system consists of a three-stage oil-diffusion pump and a two-stage mechanical pump.

The vacuum chamber consists of a double-wall welded steel cylinder

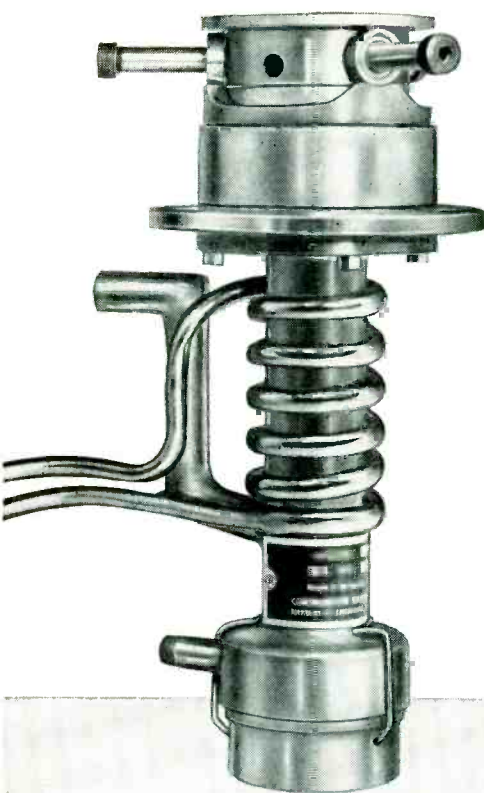

It's easy to convert tube exhaust systems with these pump and port units

For most rotary exhaust machines—

CVC's Oil Diffusion Pump model MB-10 and port type TP-02 offer the maximum compactness and performance:

- Together they measure only 8¾" high; operate through any sweep and sliding valve combinations.
- The pump speed is 10 liters/second; ultimate pressure in the port is 10^{-3} mm Hg or lower; high limiting forepressure is 0.5 mm Hg.
- The two-position *mechanically* operated port and valve with its rugged mounting flange is easily attached to standard rotary machines.
- There's a readily removable jet assembly; jet parts separate to facilitate cleaning.
- The heater operates directly from any 115 volt power supply.

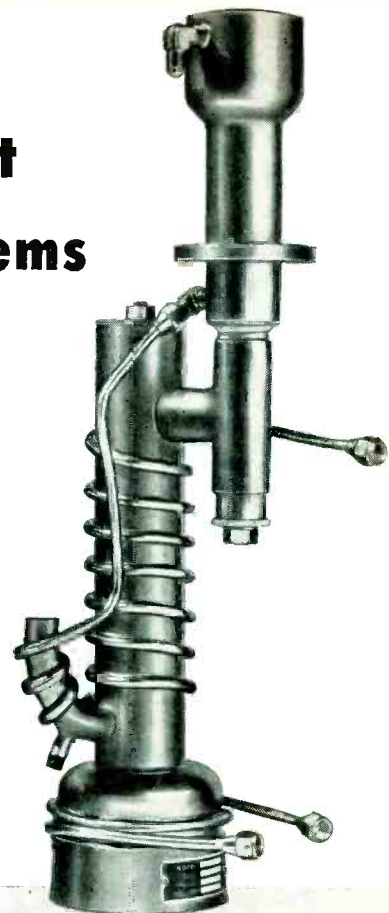

For large size TV picture tube exhaust—

CVC's Fractionating Oil Diffusion Pump type MCF-60 with the quick closing port produces pressures of 10^{-5} mm Hg and lower before getter flash in the large size picture tubes. Illustrated above is *CVC's* model MCF-60-013 (19½" high) having a rated speed of 60 liters/second and provided with:

- Water-cooled port for protection of rubber sealing gasket during bakeout.
- Quick opening compression type tubulation seal.
- Easily removable jet assembly.
- Properly located glass trap and clean-out port.

It's pumps like these that make *CVC* *inline* and *rotary exhaust systems* so efficient and economical to operate.

Whether you require just the pumps or a completely engineered exhaust unit, we welcome the opportunity of talking with you. *Consolidated Vacuum Corporation, Rochester 3, New York* (A subsidiary of Consolidated Engineering Corporation, Pasadena, Calif.)



Consolidated Vacuum Corporation
Rochester 3, N. Y.

designers and manufacturers of high vacuum equipment

SALES OFFICES: PALO ALTO, CALIF. • CHICAGO, ILL. • CAMDEN, N. J. • NEW YORK, N. Y.

SEE US AT THE I.R.E. SHOW • BOOTHS 233 & 235



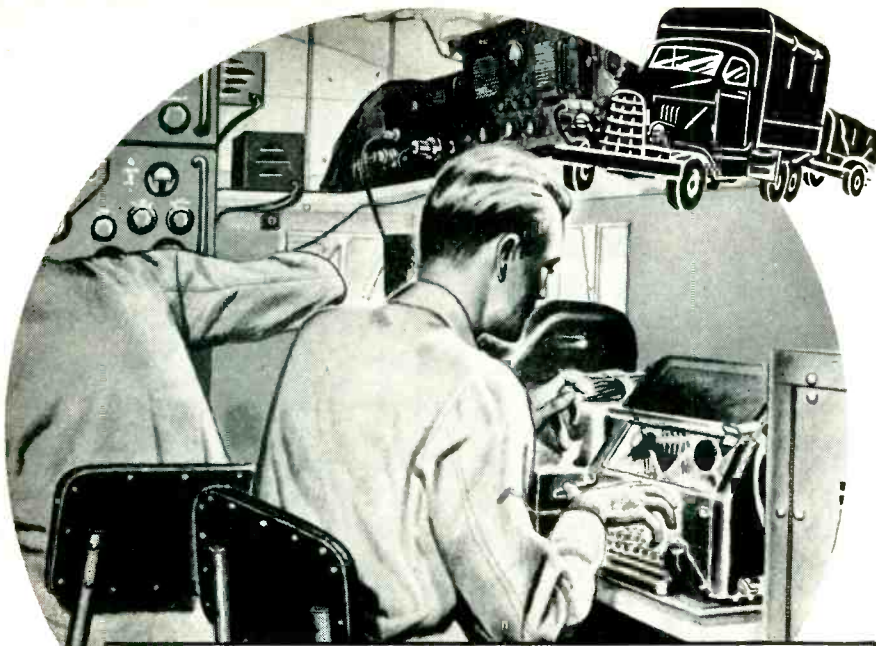

Keeping Communications on the **G-O!**

B&W COMPLETE SYSTEMS FOR

- Frequency-Shift Radio Teletype and Telephone Mobile or Point-to-Point
- V-H-F Radio Relay
- Radio, Radar, Microwave, and Direction Finding

For dependable radio communications . . . linking stations that are fixed or mobile . . . with conventional radio gear or high speed teletype and telephone . . . B&W offers a line of complete systems and special equipment that has been proved and approved by both industry and military.

For example, in the time-tested Mobile Frequency-Shift Radio Teletype Unit illustrated above, B&W has designed and built, from the drawing board up, the necessary:

- Dual Diversity Receivers and Converters
- Frequency-Shift Exciters
- Transmitters
- High Power R-F Amplifiers
- Speech Amplifiers
- Frequency Meters
- Control Units

Once assembled, these units are installed in shelters with all associated equipment, ready for immediate use.

If you have a problem concerning the design or construction of radio communications systems, B&W engineers would like you to take advantage of the same facility. Write for details.

B&W

BARKER & WILLIAMSON, Inc.

237 Fairfield Ave., Upper Darby, Pa.

Visit our Booth at the I.R.E. Show—202 Instruments Avenue

ELECTRONS AT WORK

(continued)

mounted on a steel base plate. The base plate was designed with a flanged extension that is bolted to the vacuum pump.

Commercial graphite pipe stock was used to fabricate the split graphite heater¹, 8 inches long with a 6¼-inch slit. The section opposite the crucible is thinned down to ½-inch thickness to form the high-heat zone.

Semicircular copper electrodes are built up from 3 half-inch thick plates of oxygen-free copper. A ⅝-inch wide recess in the bottom faces receive the split graphite heater. The hollow electrodes are cooled by circulating water through them.

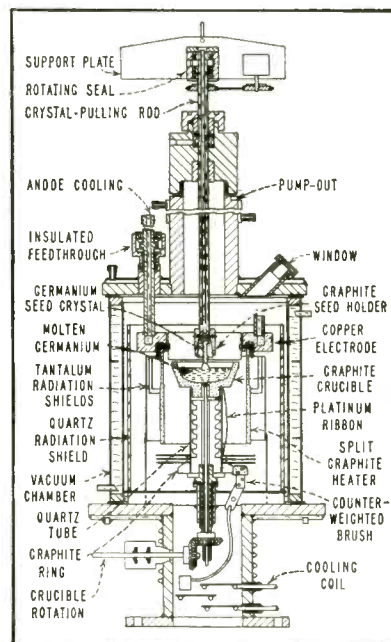

Cross-section of crystal-growing furnace shows method of rotating germanium seed and crucible

A 220-volt, 25-kva variable transformer with a stepdown transformer rated at 8-volts output serves as power supply. Power consumption of the heater under operating conditions is approximately 10 kva (2,000 amps at 5 volts).

Heat losses in the furnace are reduced by a series of radiation shields of tantalum and a cylinder of fused quartz.

The germanium melt is contained in a graphite crucible placed inside the graphite heater and is heated by radiation.

A ¾-inch projection in the base of the crucible fits into a 2-inch diameter fused quartz tube, which minimizes heat conduction and also

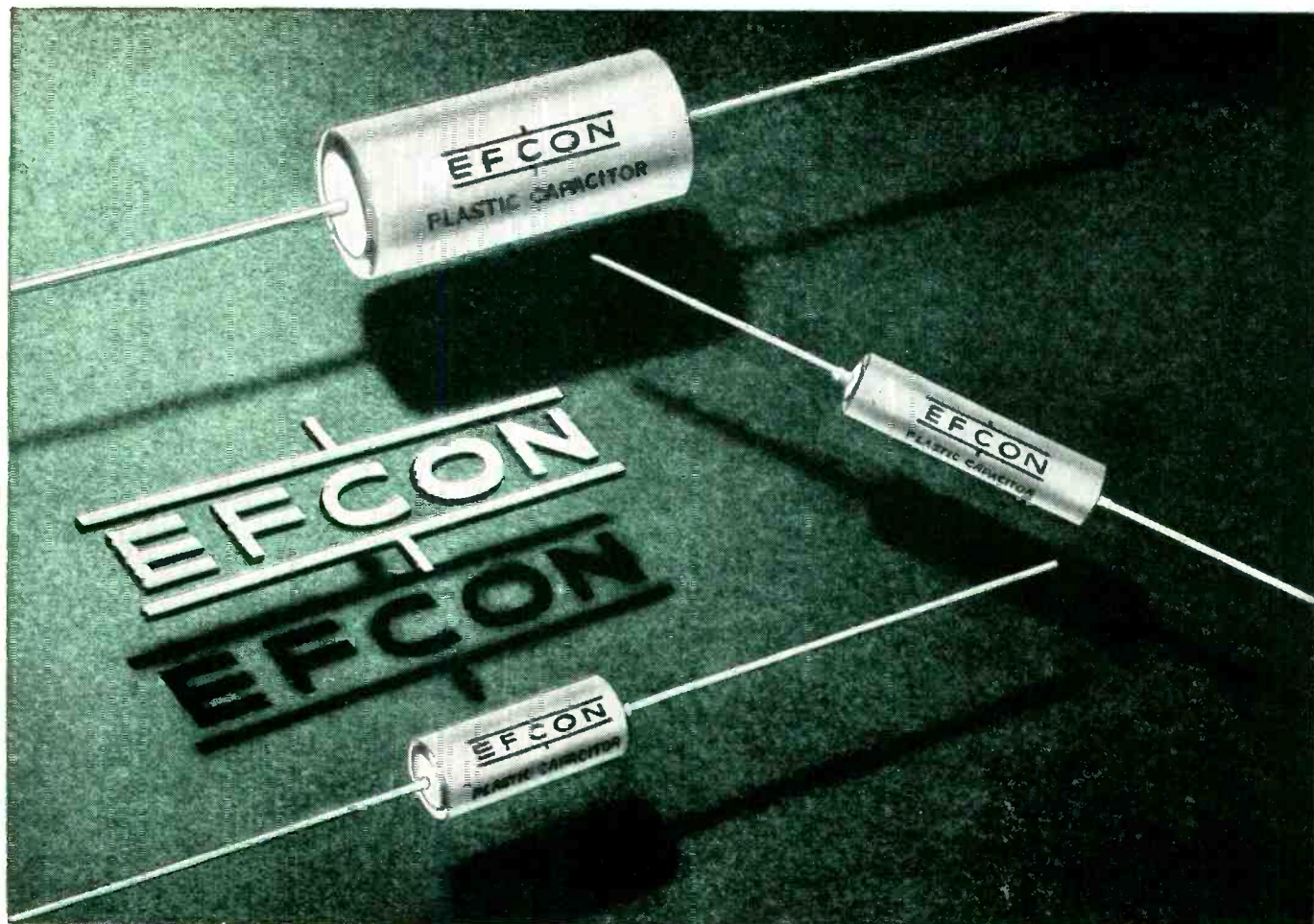

Lower your cost for **CLOSE** tolerance with EFCON[®], type MH, miniature capacitors!

EFCON Performance

Use of "Mylar" results in high stability over an extended temperature range ($-60^{\circ}\text{C}.$ to $+125^{\circ}\text{C}.$) without derating.

Lower power factor and high insulation resistance along with very low dielectric absorption give these capacitors the type of performance required in precision apparatus.

Variation of capacitance with thermal change and life is exceedingly low.

Voltage Breakdown Test

EFCON, Type MH, Plastic Film Capacitors are production tested to withstand a DC voltage of 250% of rated voltage at $25^{\circ}\text{C}.$ between terminals and between terminals and case.

Capacitance

EFCON, in specializing in close tolerance, is equipped to fill orders for non-standard capacitance values to specifications at standard prices.

Also available:

Type WC—"Mylar" polyester film capacitor in wax impregnated cardboard tubes

Type S—molded silvered mica capacitor

Electronic Fabricators, Inc. is proud to present the results of its two years of research, devoted to the development and perfection of a high quality, *close-tolerance* capacitor.

Here it is: the EFCON PLASTIC FILM CAPACITOR, Type MH!

EFCON has dedicated itself to years of research for the sole purpose of meeting the demand of the electronic industry for closer and closer tolerances. EFCON has successfully developed capacitors with tolerances of $\pm 5\%$, $\pm 2\%$ and $\pm 1\%$, in standard production.

The construction of EFCON, Type MH, and the research behind its development, was based on the use of moisture-proof "Mylar"[™] polyester film, providing high insulation resistance together with very low dielectric absorption. Non-inductive extended foil type construction with leads soldered directly to foil to insure minimum contact resistance. Hermetically sealed in metal cases with glass to metal solder/sealed terminals.

For full information write Dept 4A for Technical Publication #154.

ELECTRONIC FABRICATORS, INC.

682 Broadway, New York 12, New York

*DuPont Trademark

**Which part cut costs 78%
and makes customers far happier?**

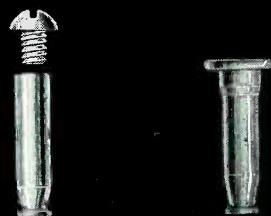

The two-part fastener at left was used to hold the louvres in a line of fluorescent lighting fixtures. The cost of this fastener was high — \$35.00 per thousand — and the customer was left with the time-consuming job of mounting the louvres when the fixture was installed.

The single COLD FORMED part at right now replaces the two-part machined fastener — costs only \$7.50 per thousand — and enables the manufacturer to ship the fixture completely assembled, with every louvre already in place!

The dollar savings have already mounted into the thousands. The gain in customer good-will is priceless!

How many thousands of dollars can COLD-FORMING save you?

Savings like this aren't at all unusual. Milford's COLD FORMING methods are making equally substantial savings for manufacturers throughout American industry . . .

Because Cold Formed Parts Cut Costs:

- 1) They're formed from wire stock without waste or scrap!
- 2) They're produced on high speed automatic equipment!
- 3) They're frequently designed for high speed automatic or semi-automatic application!

Thanks to long experience in

COLD FORMING, Milford engineers, designers and product research experts are ready and able to help you cut small-parts costs substantially. They bring to your service Milford's leadership and know-how in the manufacture of semi-tubular, tubular and special rivets, as well as automatic rivet-setting machines.

So put us to work for you. Do it before, not after, your design is frozen. Chances are we can help you effect some major savings—both in time and money!

Write or phone nearest Milford Plant or Sales Representative!

THE
MILFORD RIVET & MACHINE CO.

MILFORD
CONN.

NORWALK
CALIF.

ELYRIA
OHIO

AURORA
ILLINOIS

HATBORO
PENNA.

electrically isolates the crucible from the base plate.

Rotation of the crucible was thought to be helpful in minimizing any possible temperature difference caused by variation in heat radiation impinging on different sides of the crucible and imposing a stirring action to the melt.

Rotation is imparted to the crucible support by a hollow steel tube supported by a spider and is gear driven through a seal in the side of the base-plate extension. Speeds up to 250 rpm are possible.

The seed of single crystal germanium is mounted in a threaded graphite rod that screws into a graphite holder pinned to the end of the water cooled crystal pulling rod. Direct contact of the seed crystal with the water-cooled surface of the rod is thus effected. The seed crystal is rotated in a direction opposite to that of the crucible.

To maintain a flexible approach to rotation and pulling of the crystal, these motions were separated. The crystal-pulling rod is fastened to a support plate through a rotary seal. A belt driven by a small gear-head motor rotates the crystal pulling rod.

Operation

Once the operating temperature and vacuum are obtained the seed is lowered by the hand crank to a point just above the melt. The hand crank is then disengaged and the seed slowly lowered into the melt by the motorized winch. When a good contact with the melt has been obtained, the winch is reversed and the seed is withdrawn at a rate of approximately 3 inches per hour.

The area where the crystal contacts the molten germanium can be observed through the window. In addition, an electrical means of indicating contact is provided. A small potential is applied to the graphite crucible through platinum wire, graphite ring and counter-weighted brush. The crystal-pulling rod is grounded to complete the circuit. Contact between seed crystal and the melt is indicated by a milliammeter deflection.

This article has been abstracted from a paper entitled "Apparatus for Crystal Pulling in Vacuum Us-

ENGINEERS ...our new brochure tells why

Westinghouse is a career...

No one loses *identity* at Westinghouse. Top management philosophy dictates that every engineer be employed at his *highest skill*; that inventive abilities be stimulated and encouraged; and that *leadership potential* be quickly recognized and developed.

In Baltimore, the AIR ARM AND ELECTRONICS DIVISIONS offer a variety of challenging opportunities, available as the result of long-range expansion programs in the *electronics* and *aviation-electronics* fields.

Many engineers are already building for themselves *key positions* in the organization that has produced some of the country's most advanced scientific developments. Current openings offer a variety of challenging problems requiring engineers with a high degree of originality and ingenuity. Excellent *ground-floor* opportunities exist for men from the B.S. to Ph.D. level.

A few of the many exceptional advantages of a career with Westinghouse:

Professional recognition and industrial stability.

Opportunities, at company expense, for advanced degrees.

Exceedingly liberal patent disclosure compensation.

Salaries individually determined according to experience and ability.

Promotion on basis of individual merit.

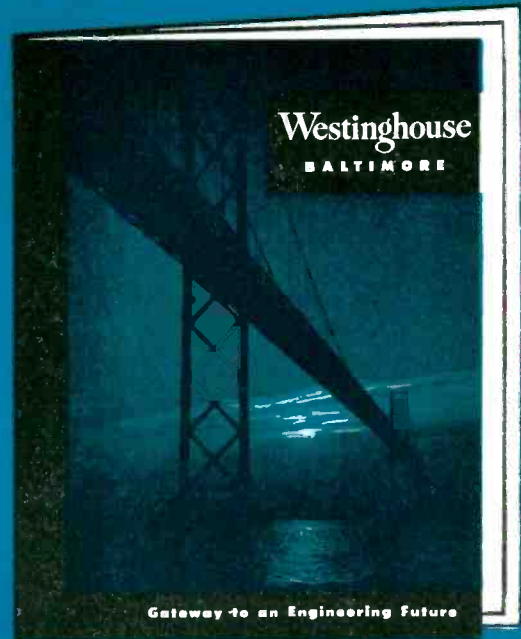

Send Today for

your copy of "Gateway to an Engineering Future."

Electrical Engineers Mechanical Engineers
Physicists Mathematicians
Field Service Engineers

YOU CAN BE SURE...IF IT'S
Westinghouse

AIR ARM & ELECTRONICS DIVISIONS
BALTIMORE, MARYLAND

Mr. R. M. Swisher, Jr.
Employment Supervisor, Dept. M-4
Westinghouse Electric Corporation
109 West Lombard Street
Baltimore 1, Maryland

Please send me a copy of "Gateway to an Engineering Future."

Name _____

Address _____

City _____ State _____

Engineering Field _____

GTC Transformers

demanding for

Unusual Applications

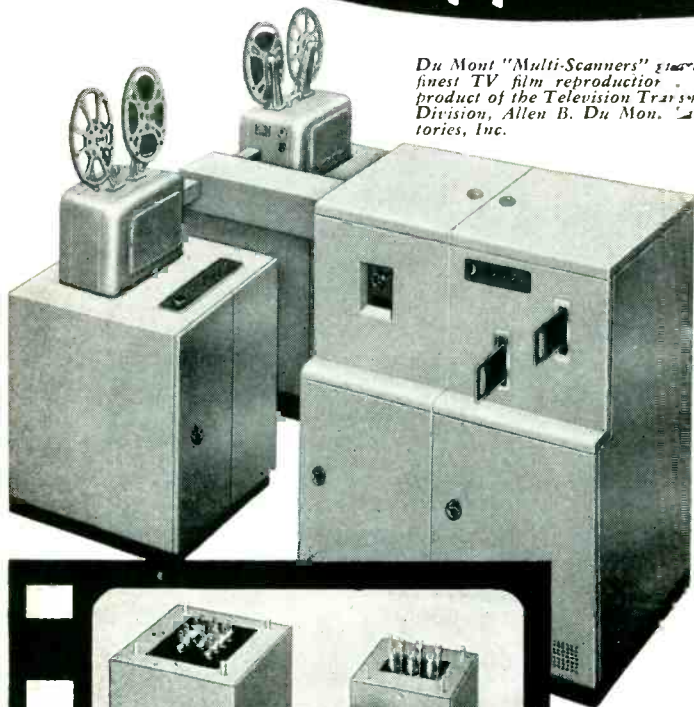

Du Mont "Multi-Scanners" guarantee finest TV film reproducer . . . a product of the Television Transmitter Division, Allen B. Du Mont Laboratories, Inc.

These GTC Transformers are used in Du Mont "Multi-Scanner"

Du Mont, to maintain leadership in television scanner production and development, specifies only the finest parts — including GTC transformers.

Your products undoubtedly necessitate the use of the finest transformers for standard as well as unusual applications . . . why not specify GTC?

We invite your inquiries

GENERAL TRANSFORMER COMPANY

serving industry since 1928

18240 Harwood Avenue, Homewood, Illinois
(Suburb of Chicago)



ing Graphite Resistance Furnace" by K. Lehovec, J. Soled, R. Koch, A. MacDonald and C. Sterns appearing in the *Review of Scientific Instruments*, August 1953.

REFERENCE

(1) Kroll, Schlechten and Yerkes, *Trans Electrochem Soc*, 89, p 317, 2946.

Pedestal-Removing Slicer Circuit

BY NATHAN O. SOKAL
AND GEORGE M. NONNEMAKER
Staff Members, Lincoln Laboratory
Massachusetts Institute of Technology
Cambridge, Mass.

VARIOUS SLICER CIRCUITS have been designed to recover an alternating waveform of constant amplitude from one of varying amplitude. In waveforms containing pedestals, the slicer is offset from zero so that the slice passes through the alternations to be recovered. Such a slicer cannot

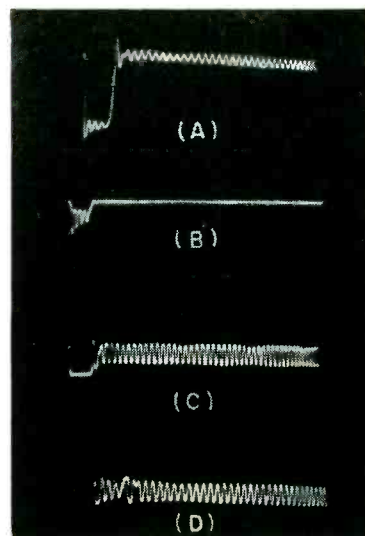

FIG. 1—Waveform (A) as recovered by ordinary slicer (B) and (C) and as recovered by pedestal-removing slicer (D)

recover the alternations when the pedestal amplitude change is greater than the amplitude of the alternations to be recovered. This is shown in Fig. 1A and 1B.

When the pedestal rises and falls slowly compared with the signals mounted on it, a high-pass filter, with a time constant comparable to signal period, preceding the slicer will remove the pedestal without serious attenuation of the signal. However, when the pedestal rises and falls rapidly, the time constant of such a filter should be short compared with the signal period.

Essentially sinusoidal alternations result in considerable attenua-

telling the story of 'dag' dispersions

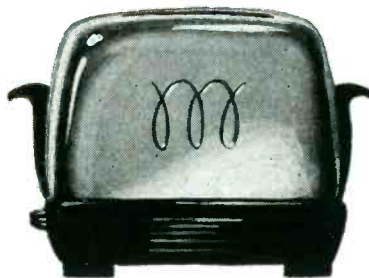

Dry-Film Lubricant Is Ideal For Electrical Mechanisms

If lubrication is difficult because of heating elements or similar conditions . . . and if it must be permanent because it cannot be renewed . . . you need 'dag' colloidal graphite dispersions.

'dag' dispersions, because of graphite's unusual resistance to heat, are ideal for such applications. 'dag' Colloidal Graphite, forming a permanent, slick, adherent, *dry lubricating film*, functions without contaminating the load or affecting delicate electrical and electronic systems.

For switches, relays, and other mechanical components which must work unattended or operate throughout wide temperature ranges, dry films produced by 'dag' dispersions solve the most vexing lubrication problems.

And where a *conductive* lubricant is desired, graphite alone of the commonly used lubricants can provide this unique double service.

To learn how 'dag' dispersions can help you, write for Bulletin No. 433-C3.

Dispersions of molybdenum disulfide are available in various carriers. We are also equipped to do custom dispersing of solids in a wide variety of vehicles.

Acheson Colloids Company

Port Huron, Michigan

...also ACHESON COLLOIDS LIMITED, LONDON, ENGLAND



*try 'dag' resin-bonded dry films
for permanent lubrication*

dag
DISPERSIONS®



FAIRCHILD Transistor Analyzer

Complete—all calibrating circuits built-in.
Needs only standard DC oscilloscope.

Developed by Fairchild in its program for transistorizing Missile Guidance Systems and other intricate electronic circuits.

Rapidly Plots Static and Dynamic Characteristics of ALL Transistors ... point contact and junction. Designed on basic principles, to meet future transistor needs.

Complete Families of Curves obtainable in 10 incremental steps for each of 5 ranges. Sweeping technique shows up anomalies.

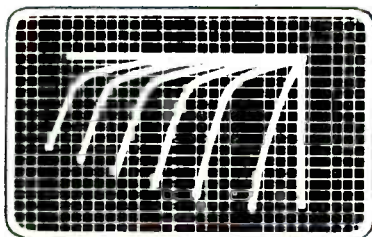

Presents on the Scope:
Alpha vs. Emitter Current
Collector, Emitter and Transfer Characteristics
Collector Characteristics in Grounded Emitter Connection

ENGINE AND AIRPLANE CORPORATION
FAIRCHILD
Guided Missiles Division

Wyandanch, L. I., N. Y.

Other Divisions: Aircraft Division, Hagerstown, Md. • Engine Division, Farmingdale, N. Y.

FAIRCHILD ENGINE & AIRPLANE CORPORATION
GUIDED MISSILES DIVISION, WYANDANCH, L. I., N. Y.

Please send me your Detailed Transistor Analyzer Technical Bulletin.

Name and Company _____

Address _____

City _____ Zone _____ State _____



tion of the signal which must then be reamplified. Spikes resulting from differentiation of the pedestal must also be removed. If the signals are essentially rectangular, only the leading and trailing edges are passed and the pulse trains must be regenerated by a trigger circuit. Another approach is presented here.

The circuit of Fig. 2 removes variable pedestals while recovering and limiting alternations in the waveform.

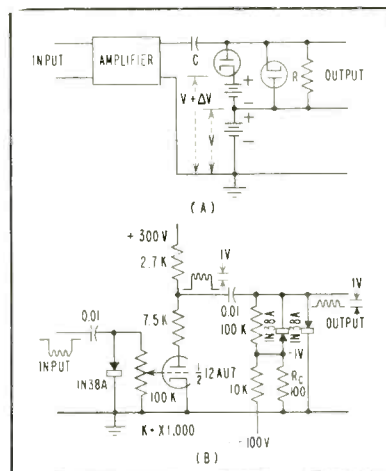
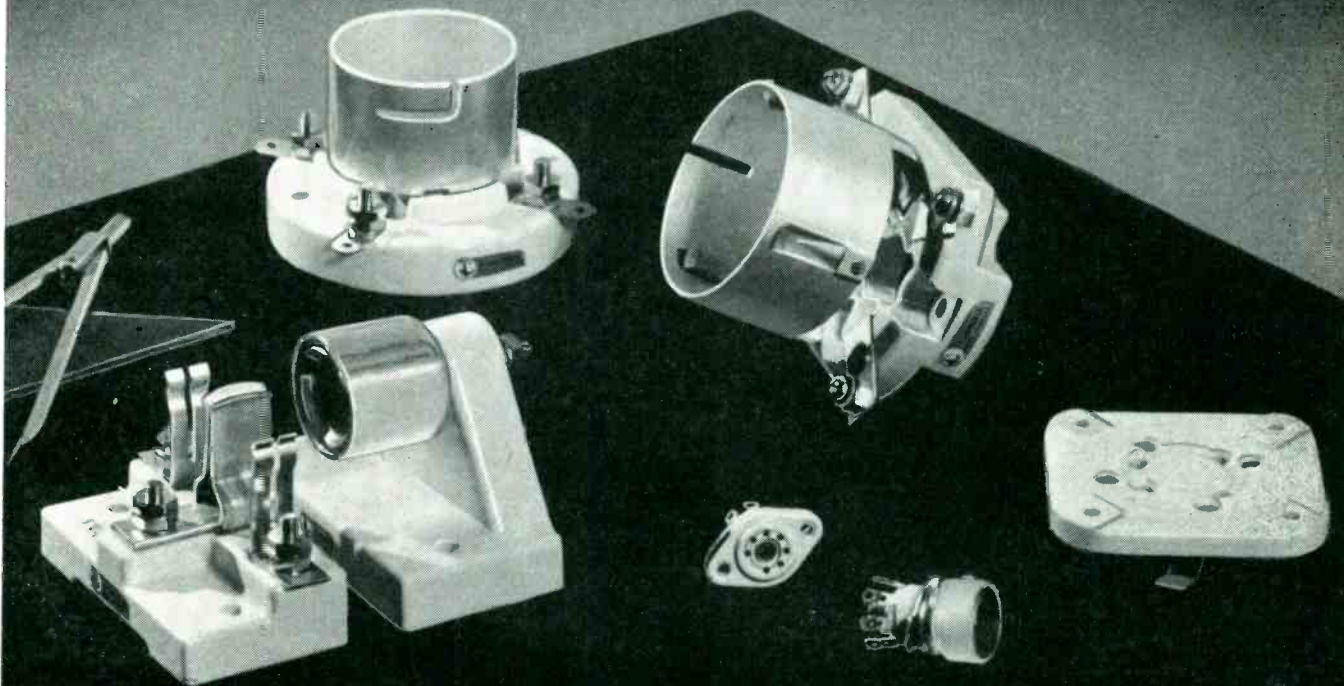

FIG. 2—Simplified circuit of pedestal-removing slicer (A) and circuit showing component values for recovering 1-kc sine wave (B)

The circuit in Fig. 2 consists of two fast-acting clamps; one for positive-going waves and one for negative-going, with a small voltage difference, ΔV , (one volt assumed) between the clamping levels. The input signal is amplified until the smallest variation to be reproduced is then one volt. The amplified signal is applied to the clampers through a coupling capacitor from a low-impedance source. Every alternation of the input signal carries the output from one clamp level to the other, with coupling capacitor C being charged rapidly through the low-impedance signal source and clamp. The output waveform of the circuit is pieced together from the first volt of each positive-going and negative-going wavefront as illustrated in Fig. 3.

Resistor R between the output terminals holds the output voltage near V under no-signal conditions. Here a positive-going wavefront starts circuit operation. If it is desired to start with a negative-going wavefront, R should be re-

Announcement to the industry...



WHY TUBE SOCKET STANDARDIZATION?

A message from the E. F. Johnson Company

Standardization means different things to different people. To you—the design engineer or manufacturer specifying or purchasing tube sockets, Johnson's new standardization program offers three definite advantages.

1. Simplified selection of components.
2. Shorter delivery cycles.
3. Superior sockets at the same or lower cost, due to the elimination of special set-up and tooling charges.

In the past, selection of materials for commercial, industrial, and military sockets resulted in anywhere from 15 to 50 variations of each socket. This program permits the maintenance of stock on industrial and military types as well as standard commercial models. Immediate shipment of small quantities is hereby made possible for development or pre-production runs. Small run set-up charges will thus be eliminated, and manufacturers ordering sockets to their specification will receive equal or superior quality sockets, in most cases at a lower cost.

STANDARD—A standard grade commercial socket for all general requirements. Grade L4 steatite bases, Dow Corning 200 impregnated or white glazed porcelain. Phenolic washers are fungus resistant, glass base melamine. Contact materials vary with tube socket types.

INDUSTRIAL—A higher quality socket incorporating such features as DC 200 impregnated glazed steatite bases and .0005 silver plated contacts with phosphor bronze clips and beryllium copper springs. Aluminum shields on shield base types are irridite No. 14 treated to prevent corrosion.

MILITARY—A top quality socket designed to meet all military requirements. Incorporating the finest materials and plating, glazed steatite bases are DC 200 treated—grade L4 or better. Contacts have phosphor bronze clips and beryllium copper springs, both heavily silver plated. Fungus resistant cushion washers are of glass base melamine. All solder terminal ends—hot tin dipped. Bayonet shield base types have brass shells, .0003 nickel plated. Threaded hardware, .0002 nickel plated—unthreaded hardware, .0003 nickel plated. Entire socket fully protected to meet 200 hour salt spray requirements.



E. F. JOHNSON COMPANY

2310 Second Avenue Southwest • Waseca, Minnesota

CAPACITORS • INDUCTORS • SOCKETS • INSULATORS • PLUGS • JACKS • KNOBS • DIALS AND PILOT LIGHTS

THROUGHOUT THE WORLD OF COMMUNICATIONS

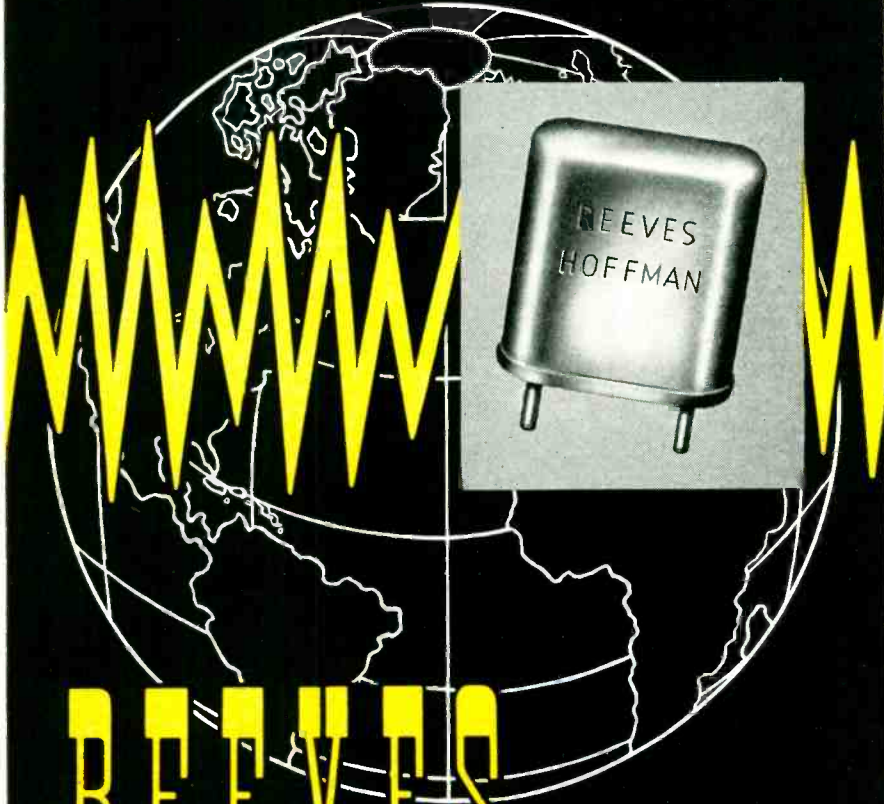

**REEVES
HOFFMAN**
IS A STANDARD OF
PRECISION QUALITY

The name Reeves-Hoffman stands for precise, continuous frequency control in thousands of transmitters and receivers located world-wide.

Reeves-Hoffman Quartz Crystal Units are carefully built to meet the most demanding commercial and military specifications.

For the finest in quartz crystal units from 16 kc to 100 mc, specify . . .

**CHERRY AND NORTH STREETS
CARLISLE, PENNSYLVANIA**
Subsidiary of Claude Neon, Inc.

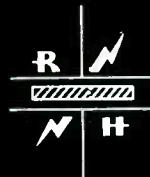

**REEVES
HOFFMAN
CORPORATION**

LICENSED UNDER PATENTS OF THE BELL SYSTEM

turned to the positive clamp voltage.

The grid-cathode diode of the following tube can be used as one of the clamping diodes if the cathode returns to the proper d-c voltage. A diode resistance of about 1,000 ohms is acceptable if the grid current and dissipation do not exceed the ratings of the tube.

The relations among the design parameters are given in the following equations

$$C(R_s + R_f + R_c) \ll T$$

$$C \left(R_s + R \parallel \frac{R_B}{2} \right) \gg T$$

$$E_2 = \left(\frac{R_f + R_c}{R_f + R_c + R_s} \right) E_1$$

$$E_3 = \left[\frac{R \parallel R_B}{R_B + R \parallel R_B} \right] \Delta V$$

where, R_B is diode back resistance, R_f the diode forward resistance, R_c is the clamp voltage source im-

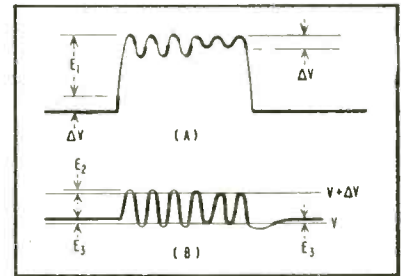

FIG. 3—Output of signal source (A) showing sections of wave used to piece together output of clamper (B)

pedance and R_s = signal source impedance. Other symbols are shown in Fig. 2 and 3. The symbol \parallel means in parallel with.

Work described in this article was supported jointly by the Army, Navy and Air Force under contract with the Massachusetts Institute of Technology.

BIBLIOGRAPHY

- N. W. Mather, Clipping and Clamping Circuits, *ELECTRONICS*, p 111, July 1947.
- M. I. T. Radar School, "Principles of Radar", Second Edition, Chap. 2, McGraw-Hill Book Co., New York, 1946.
- L. B. Arguimbau, "Vacuum-Tube Circuits", p 481 and 536, Wiley & Son, New York, 1948.
- Elmore and Sands, "Electronics-Experimental Techniques", p 99, McGraw-Hill Book Co., New York, 1949.

Radio Disturbance Warnings

SHORT-TERM radio propagation forecasts for the North Pacific area are now being broadcast from WWVH, the National Bureau of

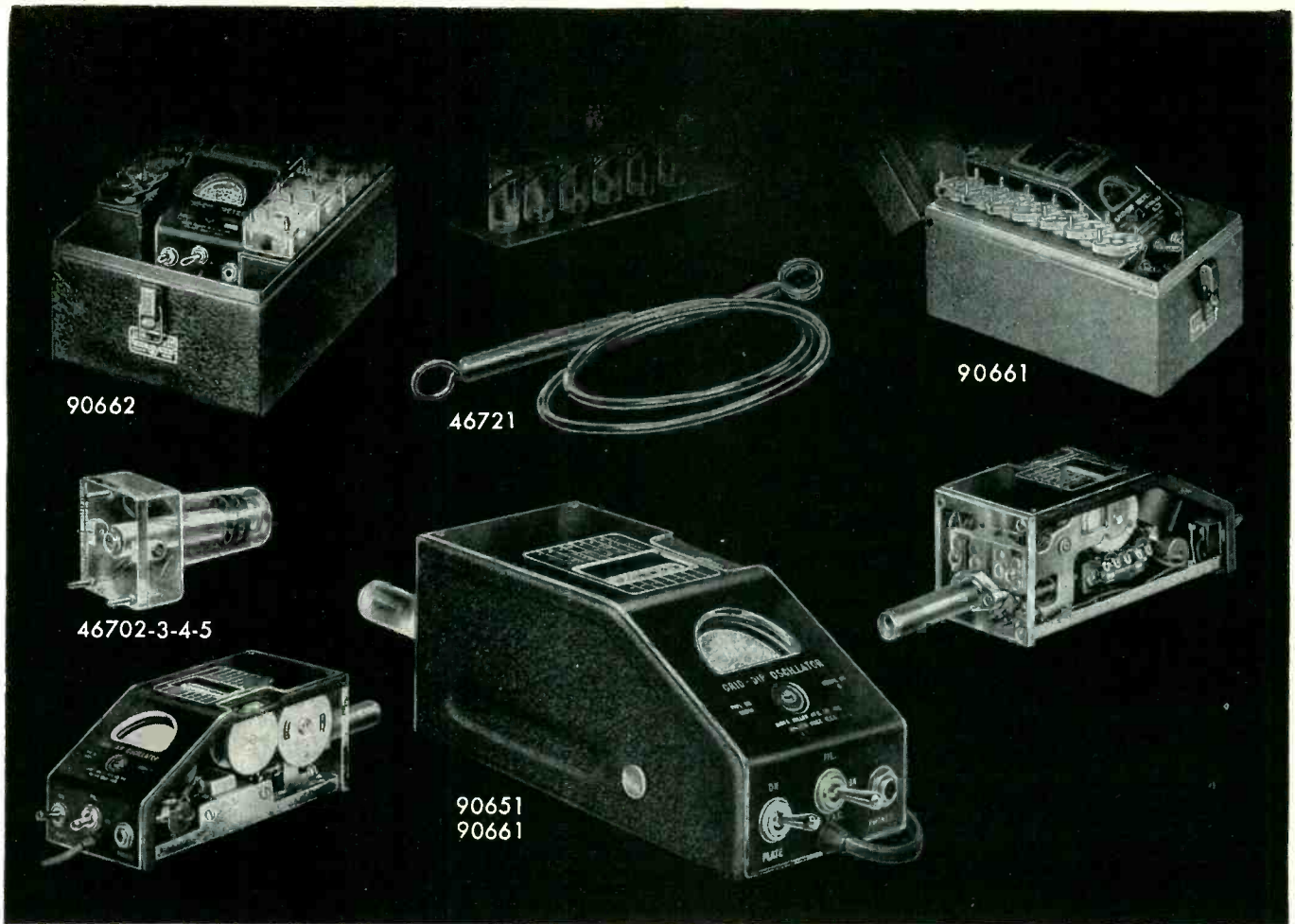

Designed for Application

Grid Dip Meters

Millen Grid Dip Meters are available to meet all various laboratory and servicing requirements.

The 90662 Industrial Grid Dip Meter completely calibrated for laboratory use with a range from 225 kc. to 300 mc. incorporates features desired for both industrial and laboratory application, including three wire grounding type power cord and suitable carrying case.

The 90661 Industrial Grid Dip Meter is similar to the 90662 except for a reduced range of 1.7 to 300 mc. It likewise incorporates the three wire grounding type cord and metal carrying case.

The 90651 Standard Grid Dip Meter is a somewhat less expensive version of the grid dip meter. The calibration while adequate for general usage is not as complete as in the case of the industrial model. It is supplied without grounding lead and without carrying case. The range is 1.7 to 300 mc. Extra inductors available extends range to 220 kc.

The Millen Grid Dip Meter is a calibrated stable RF oscillator unit with a meter to read grid current. The frequency determining coil is plugged into the unit so that it may be used as a probe.

These instruments are complete with a built-in transformer type A.C. power supply and interterminal terminal board to provide connections for battery operation where it is desirable to use the unit on antenna measurements and other usages where A.C. power is not available. Compactness

has been achieved without loss of performance or convenience of usage. The incorporation of the power supply, oscillator and probe into a single unit provides a convenient device for checking all types of circuits. The indicating instrument is a standard 2 inch General Electric instrument with an easy to read scale. The calibrated dial is a large 270° drum dial which provides seven direct reading scales, plus an additional universal scale, all with the same length and readability. Each range has its individual plug-in probe completely enclosed in a contour fitting polystyrene case for assurance of permanence of calibration as well as to prevent any possibility of mechanical damage or of unintentional contact with the components of the circuit being tested.

The Grid Dip Meters may be used as:

1. A Grid Dip Oscillator
2. An Oscillating Detector
3. A Signal Generator
4. An Indicating Absorption Wavemeter

The most common usage of the Grid Dip Meter is as an oscillating frequency meter to determine the resonant frequencies of de-energized tuned circuits.

Size of Grid Dip Meter only (less probe): 7 in. x 3½ in. x 3½ in.

JAMES MILLEN

MAIN OFFICE



MFG. CO., INC.

AND FACTORY

MALDEN, MASSACHUSETTS, U. S. A.

FOR 15 YEARS...
High voltage,
High current
CAPACITANCE
...dependably



● The record of more than 15 years service, in thousands of installations, proves the reliability of the Lapp Gas-Filled Condenser. For duty at high voltages and high currents this unit offers the advantages of extreme compactness . . . low loss . . . high safety factor . . . constant capacitance under temperature variation . . . grounded tuning shaft . . . and rugged sturdiness. Units available in fixed or variable capacitance . . . capacitances to 60,000 mmf; current ratings to 525 amps at 1 mc; voltages to 100 Kv peak. Write for Bulletin 302 with complete description and characteristics data. Lapp Insulator Co., Inc., Radio Specialties Division, 111 Sumner St., Le Roy, N. Y.

Lapp

Standards standard-frequency station in Hawaii.

The notices indicate condition of the ionosphere over the North Pacific at the time of the announcement and what communication conditions are expected to be for the next 12 hours. Only short-wave paths near the auroral zone are considered.

Form of the announcement is similar to that used from WWV for the North Atlantic paths. Broadcasts are made on standard frequencies of 5, 10 and 15 mc at 9 and 39 minutes past each hour. Letters N, U and W signify, respectively, that conditions are normal, unsettled or disturbed at the time of the transmission. The figure following the letter indicates the propagation forecast during the next 12 hours and ranges from 1 (useless) through 5 (fair) to 9 (excellent).

The coded forecasts are sent in Morse code with an audio-frequency modulation of 440 or 600 cycles. These audio frequencies alternate during four-minute periods. Time intervals of precisely one second, in the form of ticks, are continuously transmitted from WWVH.

Phototube Chopper

A HIGH STABILITY chopper-converter uses two phototubes and a neon bulb in a circuit that eliminates moving parts. Input impedance is

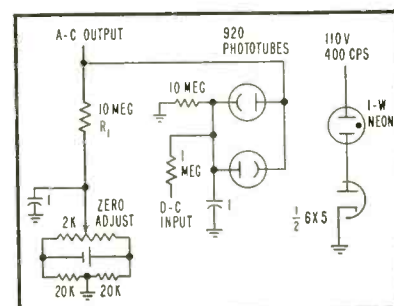

Phototube converter has high stability, no moving parts

high, and the unit can operate over a wide range of frequencies.

A neon bulb is fed by a half-wave rectified a-c voltage at chopping frequency. The cathodes of two phototubes are illuminated by the bulb. The phototubes are connected plate to cathode as shown above. With both tubes receiving the same

TI transistors will FIT in Your Future!

THREE MONTHS AGO we ran this "ad" announcing a major reduction in the physical size of TI hermetically sealed junction transistors. At the Radio Engineering Show in March, TI will show transistors only one-third the size of the one illustrated at the right. This is typical of the rapid progress being made in semiconductor device design. For first-hand information on these and other new TI semiconductor products, visit Booth 776. A real southwestern welcome awaits you there.

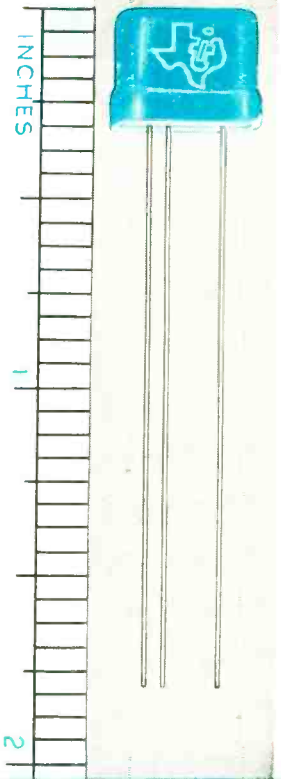

ELECTRICAL DATA:

RATINGS, RECOMMENDED MAXIMUM:

	n-p-n junction transistors			
	type 200	type 201	type 202	
Collector Voltage	30	30	30	volts
Collector Current	5	5	5	ma.
Collector Dissipation (at 25°C)	50	50	50	mw.
Ambient Temperature	50°C	50°C	50°C	

AVERAGE CHARACTERISTICS (AT 25° C.):

	type 200	type 201	type 202	
Collector Voltage	5	5	5	volts
Emitter Current	-1	-1	-1	ma.
Collector Resistance (Minimum)	4	4	4	megohms
Base Resistance	150	170	200	ohms
Emitter Resistance	22	22	35	ohms
Current Amplification Factor* (Minimum)	9	19	49	
Collector Cutoff Current (Maximum)	10	10	10	μa.
Collector Capacitance	15	17	19	μμfd.
Noise Factor** (V _C =2.5 V., I _C =-.5 ma.)	26	23	20	db
Frequency Cutoff** (α _{CO})	90	110	130	m.c.

*Emitter Grounded.

**Noise Factor and Frequency Cutoff are average and individual units may vary.



TEXAS INSTRUMENTS
INCORPORATED
6000 LEMMON AVENUE DALLAS 9, TEXAS

STATISTICAL DISTRIBUTION CURVES
Based on 100 transistors of each type

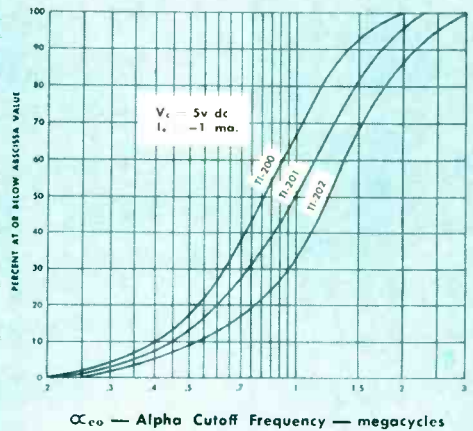

α_{CO} — Alpha Cutoff Frequency — megacycles

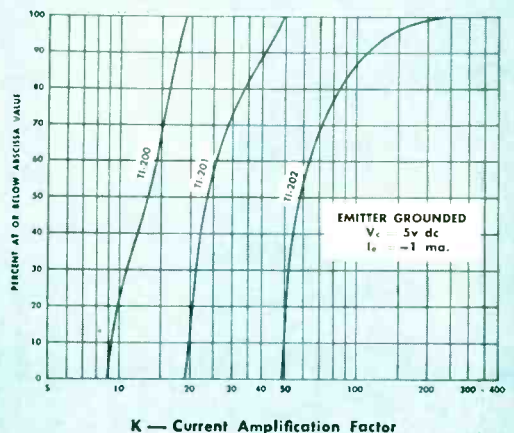

K — Current Amplification Factor



prefer
them
stacked?



300BU-2



300BU-3

Adjust-A-Volt 300BU-2,3 variable auto-transformers

make the most compact and efficient
ganged assemblies available.

Controlling large power for their size, these 2 and 3 gang assemblies are just right for back-of-panel mounted applications like line voltage control of power, heat, speed and light. Open construction makes them easy to connect. For 3-phase operation, use Adjust-A-Volt.

300BU-2—open delta connection—output 0-115V, 3 AMPS or 0-135V, 3 AMPS

300BU-3—Wye connection—output 0-270V, 3 AMPS or 0-230V, 3 AMPS

Toroidal winding has many applications . . . current transformers . . . magnetic amplifiers . . . inductors and units to suit special requirements. Refer your problem to Staco engineers . . . ask for information and quotation.

Get your copy now. Write for new 18-page catalog No. 553-5 on full Adjust-A-Volt line ranging from 0.34 to 16.8 KVA.

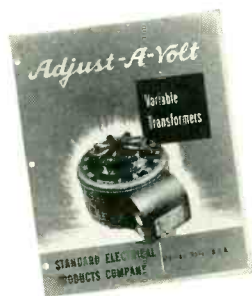

STANDARD ELECTRICAL PRODUCTS COMPANY

2239 E. THIRD ST. • DAYTON, OHIO

amount of light, current will flow around the phototube loop with no external voltage produced.

If a d-c voltage is applied to the loop as shown in the diagram it will oppose the flow through one tube and aid the flow in the other, causing a pulse voltage to appear across the output resistor R_o .

A battery or other voltage source can be used as a zero level adjustment. If the d-c voltage is more positive than the reference, the pulses will be positive. Negative pulses are produced by d-c values below the reference battery potential.

This information has been abstracted from an article "The Photoconverter: A New Electronic Chopper" by R. A. MacMillan and W. G. Field, in the *Review of Scientific Instruments*, Oct. 1953.

Linear Low-Level Rectifier

BY H. SCHARFMAN
Radiation Laboratory
Johns Hopkins University
Baltimore, Md.

NONLINEAR characteristics of vacuum tubes or crystal diodes are used to rectify a-c voltages. With both these devices, however, the d-c component of the output voltage becomes a nonlinear function of the input a-c voltage as the input level drops below about 1 volt. Various compensating and balancing techniques have been used by meter manufacturers for some time.^{1, 2, 3} The circuit described in this article will rectify audio and subaudio sine waves with a linear dynamic range from approximately 50 millivolts rms input to 2 volts rms input. The corresponding output d-c voltage runs from 0.125 volt to 5 volts.

Theory of Operation

The basic circuit is shown in Fig. 1. A high-gain amplifier feeds a cathode follower, which drives the crystal-resistor network. The negative feedback voltage appearing across R_2 is a measure of the sum of the currents flowing through the two crystals. If the gain of the amplifier is sufficiently great, the voltage across R_2 is forced to equal the input voltage. On the positive half of a sine-wave input, crystal A operates on its forward resistance

*"We have used
D-H MANGANIN
for 25 years..."*



DOUBLE-PURPOSE BRIDGE. This Shallcross Model 6320 Wheatstone Limit Bridge can be used both for exact resistance readings and, in production, for rapid checks on percent deviation from an accepted standard. Overall range extends from 0.1 ohms to 111,110,000 ohms. All resistors are D-H Manganin.

Says **SHALLCROSS MANUFACTURING COMPANY**, Collingdale, Pa.: "For 25 years we have been using Driver-Harris Manganin wire in the construction of Wheatstone and other precision bridges. In addition, D-H Manganin alloy has been used in many special standards for research and development laboratories. We feel that the quality of our products and the reputation of our instruments have been greatly enhanced by its use."

Behind statements like these stand Driver-Harris production and drawing techniques, which provide Manganin of such fixed stability that maximum change in resistance between 15°C and 35°C is only about 15 parts per million per degree centigrade—and fre-

quently *less than one-third* this amount. Equally good electrical characteristics are available for ammeter shunt stock operating between 40°C and 60°C.

The experience of Shallcross reflects the experience of a host of manufacturers throughout the country; reflects what *you* can expect from Driver-Harris products, whether Manganin or any of the numerous alloys developed by Driver-Harris for application in the electrical and electronic fields.

Whatever your alloy problem, therefore, let us have your specifications. We'll gladly put at your disposal the skills acquired from 50 years of alloy manufacturing experience . . . make recommendations based on your specific needs.

* T. M. Reg. U. S. Pat. Off.



Sole producers of world-famous Nichrome®

Driver-Harris Company

HARRISON, NEW JERSEY

BRANCHES: Chicago, Detroit, Cleveland, Los Angeles, San Francisco

In Canada: The B. GREENING WIRE COMPANY, Ltd., Hamilton, Ontario.

MAKERS OF THE MOST COMPLETE LINE OF ELECTRIC HEATING, RESISTANCE, AND ELECTRONIC ALLOYS IN THE WORLD

MINIATURIZING YOUR EQUIPMENT?

Specify SIMPLEST, MOST COMPACT

AMPERITE

THERMOSTATIC DELAY RELAYS

MOST ECONOMICAL, HERMETICALLY SEALED



STANDARD



MINIATURE

Provide delays ranging from 2 to 120 seconds.

- Actuated by a heater, they operate on A.C., D.C., or Pulsating Current.

- Hermetically sealed. Not affected by altitude, moisture, or other climate changes.
- Circuits: SPST only—normally open or normally closed.

Amperite Thermostatic Delay Relays are compensated for ambient temperature changes from -55° to $+70^{\circ}\text{C}$. Heaters consume approximately 2 W. and may be operated continuously. The units are most compact, rugged, explosion-proof, long-lived, and — inexpensive!

TYPES: Standard Radio Octal, and 9-Pin Miniature.

PROBLEM? Send for Bulletin No. TR-81

BALLAST-REGULATORS

- Amperite Regulators are designed to keep the current in a circuit *automatically regulated* at a definite value (for example, 0.5 amp).
- For currents of 60 ma. to 5 amps. Operates on A.C., D.C., Pulsating Current.
- Hermetically sealed, light, compact, and most inexpensive.

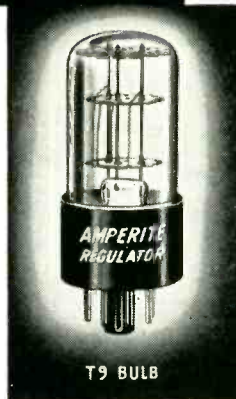
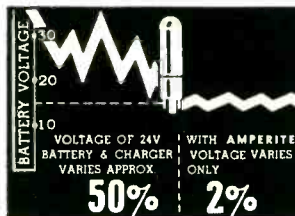
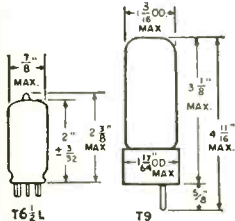

T9 BULB

Maximum Wattage Dissipation: T6 $\frac{1}{2}$ L—5W. T9—10W.

Amperite Regulators are the simplest, most effective method for obtaining *automatic regulation* of current or voltage. *Hermetically sealed*, they are not affected by changes in altitude, ambient temperature (-55° to $+90^{\circ}\text{C}$), or humidity. Rugged; no moving parts; changed as easily as a radio tube.

Write for 4-page Technical Bulletin No. AB-51

AMPERITE CO. Inc., 561 Broadway, New York 12, N. Y.

In Canada: Atlas Radio Corp., Ltd., 560 King St. W., Toronto 2B

and crystal *B* on its back resistance. However, feedback forces the sum of the currents through the two arms to be proportional to input voltage. As crystal *B*, operating on its backward characteristic, can deliver but a small portion of the total current, crystal *A* is forced to deliver almost all the required current. Thus, the current through arm *A* is made proportional to the input voltage. On the negative part of the input cycle, crystal *B* delivers almost the full current in similar fashion.

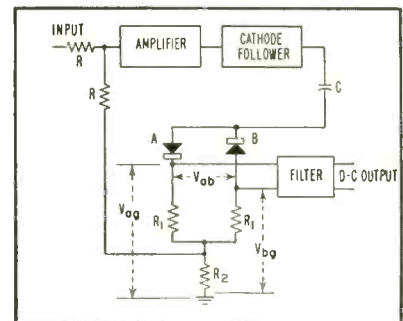

FIG. 1—Feedback rectifier supplies linear d-c output for low a-c input levels

For an sine-wave input, V_{ab} will be a full-wave-rectified sine wave with peaks proportional to peak input voltage. When suitably filtered, the output d-c voltage is proportional to the input peak voltage.

This discussion has assumed that the crystals have a high front-to-back resistance ratio or that the back resistance is linear, the resistors *R*, in series with the crystals are matched and that the d-c leakage through capacitor *C* is negligible. Loop gain must be low and amplifier gain very high. The cathode follower must be capable of supplying the necessary current to the crystal-resistor network at the maximum input voltage.

Performance

A schematic of the actual circuit is shown in Fig. 2, and the results of a linearity check at 1 cps are shown in Fig. 3. The circuit was designed to operate down to 1 cps, but it should be operable over the entire audio range and part of the subaudio (to about $\frac{1}{2}$ cps).

In the linearity test, a 1-cps source fed a precision-resistor divider network whose output was metered by both a vacuum-tube

THE SPOTLIGHT'S
ON THE NEWEST
AND FINEST IN

PRECISION MICROWAVE TEST EQUIPMENT

Now available to you!

Teamed for supreme performance is this FXR assembly of Amplifier, Probe, and Slotted Section. Now—coupled with huge new facilities and years of design and production know-how—FXR makes these units available to you promptly on a fresh-off-the-shelf basis. Each precision unit represents the ultimate in design, performance, and value. Full descriptive literature sent on request.

STANDING WAVE AMPLIFIER

VSWR Range to 100
Noise level less than .03 microvolts
Narrow and wide band operation
Variable, metered bolometer bias
Automatic bolometer protection
Low impedance output jack
Adjustable tilting panel

SLOTTED SECTION

Precision ball bearing action
Hardened races for permanent precision
Tapered slot for high accuracy
Convenient carriage control
Smooth friction drive

PROBE

Frequency range 1.0 to 12.4 Kmc
Convenient, sensitive, dual tuning
Crystal or barretter detector

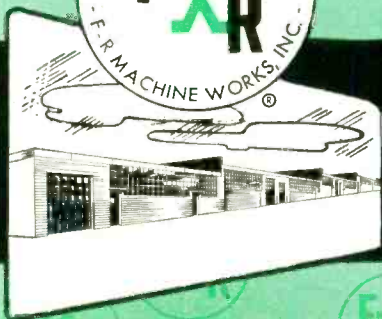
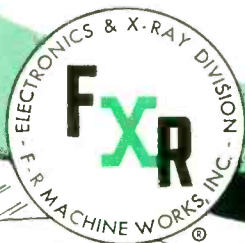
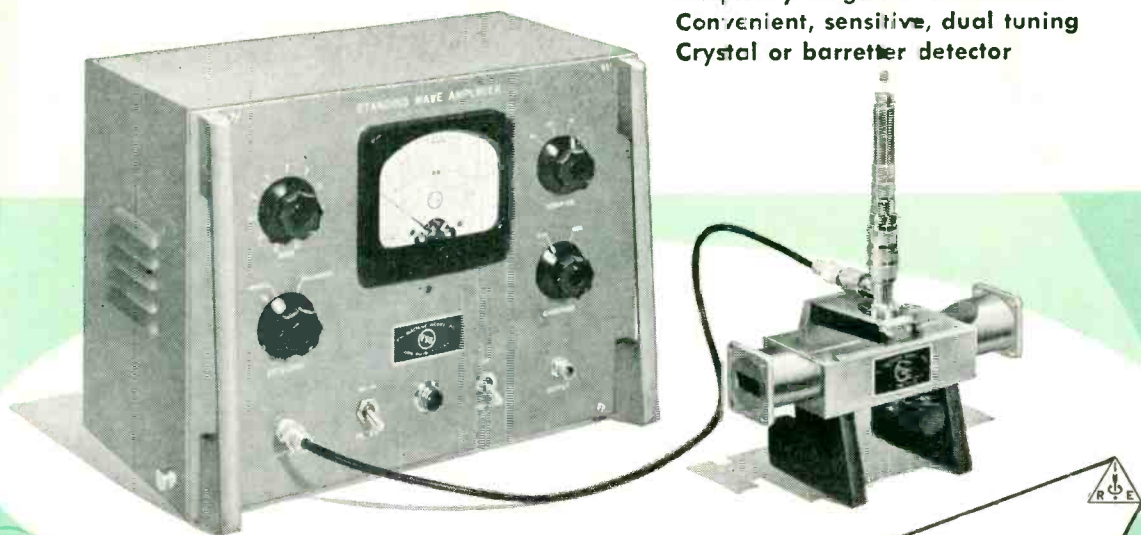

Electronics & X-Ray Division

F-R MACHINE WORKS, Inc.

44-14 ASTORIA BOULEVARD, LONG ISLAND CITY 3, N. Y.

BourNS

presents
the New

TRIMPOT

Trade Mark



An adjustable . . .
Sub-miniature potentiometer
for precise circuit trimming

BourNS TRIMPOT is a wire-wound potentiometer designed for miniaturized equipment. Adjustments of the 25 turn slotted shaft are made with a screw driver.

Accurate electrical settings in increments of $\frac{1}{4}$ to $\frac{1}{2}$ % are easily controlled and are securely retained without the use of lock-nuts.

Vibration of 15G at 10-2000 cps or a sustained acceleration of 100G does not interfere with the dependable performance of the TRIMPOT.

TRIMPOT's can be installed individually or in stacked assemblies with two mounting screws through the eyelets in the body.

BourNS designs and manufactures Linear Motion, Gage Pressure, Differential Pressure, Altitude and Acceleration Potentiometers.

BourNS LABORATORIES

6135 Magnolia Ave., Riverside, California

Technical Bulletin on request, Dept. 12

voltmeter and the feedback rectifier coupled to a d-c voltmeter. The precision-resistor divider ratio is plotted as abscissa, and the normalized meter readings are plotted as the ordinates.

Maximum output voltage of this circuit is limited by maximum allowable crystal current, maximum voltage swing of the cathode follower and the d-c voltage rating of the output coupling capacitor. Over the audio range a maximum d-c output of at least 100 volts should be attainable. In the subaudio range a large output-coupling capacitor is required. Maximum voltage output is limited by the d-c voltage rating of this capacitor unless a negative supply voltage is used.

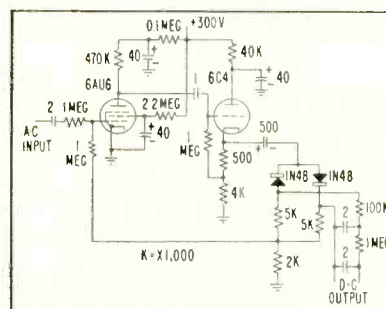
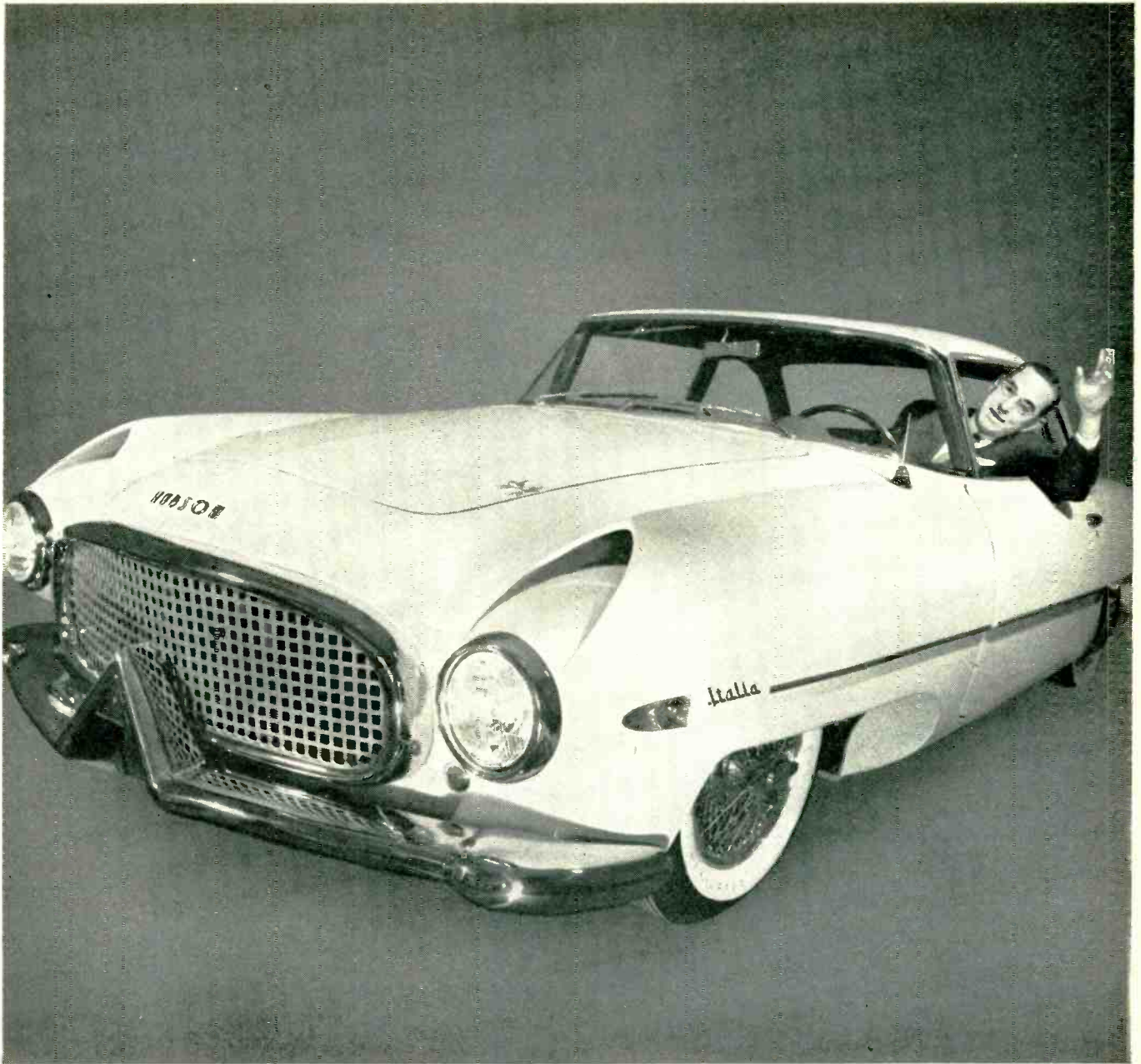

FIG. 2—Low-level rectifier uses matched resistors in crystal dividing network

The low end of the linear dynamic range is limited by the desired degree of linearity, reverse current of the crystals and leakage current of the coupling capacitor. One of the assumptions made in working out the theory of this circuit was that the reverse currents of the crystals were negligible. At very low levels this no longer is valid and despite a high-gain amplifier and large feedback, the reverse current becomes a larger percentage of the total current through the feedback resistor, R_2 , as the input voltage is reduced. Reducing the feedback to increase the voltage across the crystals at low input levels does not increase the linear dynamic range, as the maximum allowable input voltage will be reduced.

The leakage current of the coupling capacitor is usually negligible if the cathode potential of the output cathode follower is near zero and the capacitor is paper or oil-filled. At subaudio frequencies



Taking the wheel of Hudson Motor Car Co.'s "Italia," N. K. VanDerzee, V.P. in Charge of Sales, explains:

How a new Hudson avoids traffic problems!

"Here is the new *Italia*—a look into the future and the latest member of the Hudson family which includes the Hornet, the Wasp, and the Jet," says N. K. VanDerzee.

"But new design naturally creates new traffic problems—in the factory. It's a big job to prevent parts shortages from stalling assembly lines. Air Express is a tremendous help.

"As our Traffic Department puts it: One phone call, and it's a load off our minds. Air Express delivers in a matter of hours. This dependable speed gives us the safety margin we need to keep production rolling. We handle about 2,500 lbs. a month by Air Express. Naturally, we're thinking about speed. But

our records show that most of our Air Express shipments also *cost less* than they would by any other air service!

"Add to this the country-wide coverage and Air Express' ability to pinpoint shipments in transit, and you have some idea of why our Traffic Department turns to Air Express for our most urgent traffic.

"We in Sales are proud of our reputation for on-time deliveries of new cars. In large part, we owe that reputation to our Traffic Department—and Air Express."

It pays to express yourself clearly. Say Air Express! Division of Railway Express Agency.



Air Express



GETS THERE FIRST via U.S. Scheduled Airlines

BETTER PUSH-BUTTON SWITCHES...

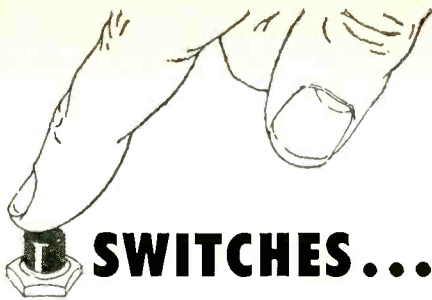

for a better push-button world

A good electrical product deserves a good switch—and, for push-button types in the 15 to 50 ampere range that means Hetherington!

Fully proved on the toughest aviation and military assignments, these sturdy, good-looking little units are commercially adaptable to almost any equipment where a few cents more for a really superior switch is recognized as being sound, far-sighted economy.

HETHERINGTON, INC.
SHARON HILL, PA.

(West Coast Division: 8568 W. Washington Blvd., Culver City, Cal.)



HETHERINGTON *Switches*

Fine push-button and snap-action types
Switch-indicator light combinations
also
Panel indicator lights, aircraft and electrical specialties

Visit our Booth at the I.R.E. Show—736 Airborne Avenue

low-voltage electrolytics must be used and the leakage currents may be sufficiently large to put an appreciable back bias on the crystals. The net effect will be to reduce linearity at low input levels. Leakage current may be reduced by using a negative supply or by reducing the d-c potential of the cathode through decreasing the cathode resistor. The latter technique has the disadvantage of reducing the maximum allowable input signal, but avoids the use of a negative supply.

Other applications

The basic circuit of Fig. 1 may be used in other ways than the above. If R_2 is made much smaller than R_1 the waveform will be a good approximation to half-wave rectification. If this voltage is suitably filtered, the output d-c voltage will be positive and proportional to the

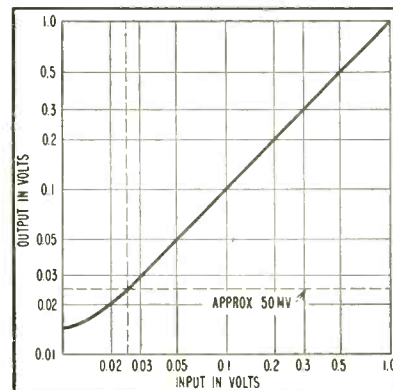

FIG. 3—Response curve of low-level rectifier. Below 50 mv slope is non-linear

input a-c. Similarly V_{02} when suitably filtered will yield a negative d-c voltage proportional to the input a-c. Here then is a method for obtaining balanced d-c voltages from a low-level a-c source. The degree of approximation to a half sine wave depends on the ratio R_1/R_2 , but this should not affect the linearity except to the second order.

For large d-c output voltages R_1/R_2 should be large, but for large R_1/R_2 there is a consequent reduction in the negative feedback. This should be compensated by increasing the amplifier gain to obtain linearity at low-level.

The author wishes to acknowledge the help of R. L. Tanner while at the Boeing Airplane Company, Seattle, Washington, whose work



“out of this world”

... is the only way to describe the latest developments in CLEVITE transistors, diodes and transistor test sets.

skeptical? Come see for yourself, at BOOTH NO. 669 — I.R.E. Show • New York City.

Or, write for detailed information on CLEVITE transistors, diodes and transistor test sets.

TRANSISTOR PRODUCTS, INC.

TELEPHONE: ALGONQUIN 4-0470
CABLE ADDRESS: TRANSISTOR
CODE: UNITED TELEGRAPH-HOUSE



SNOW AND UNION STREETS, BOSTON 35, MASSACHUSETTS
AN OPERATING UNIT OF CLEVITE CORPORATION

TRANSISTORS • DIODES • SEMI-CONDUCTOR MEASURING EQUIPMENT

STILL MORE WAYS TO SQUEEZE PENNIES OUT OF UPSET SPECIALS COSTS

Specially designed upset products are solving thousands of problems. Dozens of design pointers on them are yours for the asking. Send us your sketches, prints, finished products for suggestions.

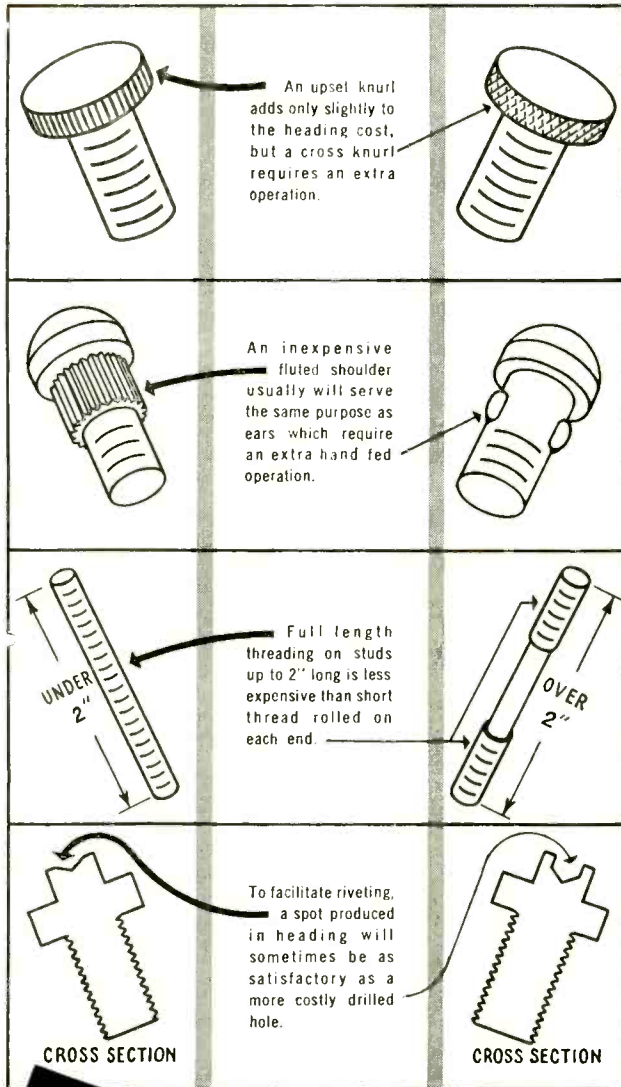

REPRINTS

of this and of previously published charts are available on request for use in drafting and purchasing departments.



MACHINE SCREWS AND SPECIAL FASTENERS ARE OUR BUSINESS



WRITE FOR OUR CATALOG

**THE PROGRESSIVE
MANUFACTURING COMPANY**
50 NORWOOD ST., TORRINGTON, CONN.

contributed greatly to the results reported here. This work was done under contract with the Aircraft Radiation Laboratory of the Wright Air Development Center, U. S. Air Force.

REFERENCES

- (1) S. Ballantine, Electronic Voltmeter Using Feedback, *ELECTRONICS*, p 33, Sept. 1938.
- (2) Hewlett-Packard Co., "Vacuum-Tube Voltmeter Model 400 C, Instruction and Operating Manual."
- (3) R. L. Tanner, Stanford Research Institute, Stanford, California, private communications.

Wheel Balancing By Vibration Pickup

A NEW TECHNIQUE for balancing the wheels of motor vehicles employs a special vibration pickup to actuate an electronically controlled flash tube.

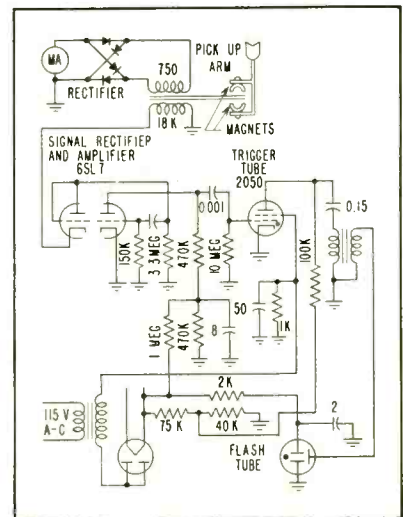

Vibration pickup indicates maximum unbalance on meter and flashes strobe light to identify wheel position at the same instant

Principle of the device depends upon the fact that a proper weight applied at the top of the wheel rim when maximum vibration is detected will reduce unbalance to a minimum. Since a reference mark, such as a chalk line or piece of tape, could only fortuitously occur at the point of proper weight application, the stroboscopic light is used to indicate the position of such mark as the wheel rotates.

After the wheel has been stopped, it is moved by the mechanic to the position previously indicated by the strobe. The weight is then attached to the top of the rim as it rests in this position.

The circuits shown in the diagram indicate how the position of

New Metal Lined CAPACITORS

by **Good-ALL**

Now you can get **ALL Good-All Capacitors**
ENCLOSED in METAL LINED TUBES
impregnated with "Marbelite" plastic

- Practically unaffected by humidity or climatic conditions.
- Eliminates troublesome field failures.
- Low capacitance change with temperature.
- Thermo setting, hard-as-marble, "Marbelite" plastic end-fill provides life-time sealing — eliminates costly pull-outs.
- Extremely durable.
- So Superior they are being used extensively by leading TV and Radio manufacturers of America.

Use **GOOD-ALL METAL LINED CAPACITORS** for every Requirement

Type 503ML Enclosed "Marbelite" Capacitor is impregnated and sealed in hard-as-rock thermo-setting plastic. -50°C to $+100^{\circ}\text{C}$ operating temperature. Popular priced.

Type 520ML Enclosed capacitor is impregnated in highest quality capacitor oil. -50°C to $+85^{\circ}\text{C}$ operating temperature. Designed to meet exacting specifications of ALL TV and Radio circuits.

Type 522ML Enclosed capacitor is impregnated in Miracle "X." (Same high quality impregnant used in more expensive hermetically sealed capacitors.) Extremely high insulation resistance. Capacity change less than 5% over operating range of -55°C to $+125^{\circ}\text{C}$.

Write for complete catalog covering all types of Good-All long-life capacitors. Our engineers are always ready to work with you on any capacitor problems. We write sample orders for your evaluation.

**Trade Mark Registered*



GOOD-ALL ELECTRIC MFG. CO.

114 W. FIRST ST., OGALLALA, NEBRASKA • PHONE 112 OR 113—CABLE ADDRESS "GOODALLA"

for

FASTER ASSEMBLY . . .**LOWER EQUIPMENT and
LABOR COSTS . . .****AND corrosion resistance, too,
when required**

specify

PEM WELD FASTENERS**of steel or STAINLESS steel**

PEM Weld Fasteners are designed for Production. **SHANK** locates and protects threads against weld splatter . . . eliminates retapping.

ENGINEERED PROJECTIONS prevent burnouts in thin sheets.

SIMPLE ELECTRODES . . . no pilots required.

ROUND COMPACT SHAPE . . . no indexing in assembly . . . fit on narrow flanges.

WRITE for literature and samples for trial.

Penn Engineering & Manufacturing Corp.
Doylestown, Pennsylvania

PEM

maximum vibration is determined. A vibration pickup comprises a pair of permanent magnets close to a core upon which are wound two coils. One coil is connected through a copper-oxide rectifier to a sensitive meter. Maximum vibration is indicated by a maximum meter reading.

The other coil is connected through a thermionic rectifier and amplifier to a trigger tube that pulses a flash tube. Maximum vibration likewise initiates the flash to illuminate the tire and its marker for reference.

The information abstracted here has been taken from a technical manual furnished by Stewart-Warner Co.

**New Compounds for
Transistor Research**

INVESTIGATION of the Hall effect and conductivity in indium antimony (InSb) and aluminum antimony (AlSb) indicate that these materials may be of use in transistor applications. Hall effect and conductivity give an indication of the number of charge carriers present and the charge-carrier mobility. The Hall effect occurs when a magnetic field is applied perpendicular to an electric current flowing in a conducting material. A voltage is produced within the conductor whose vector direction is mutually perpendicular to the current and magnetic field. The magnitude of the voltage depends upon the number of charge carriers in the conductor.

Most semiconductors are extrinsic semiconductors depending for their conductivity on impurities within the crystal lattice. The temperature region in which the foreign atoms act as the source of electrical conduction is called the impurity range. At sufficiently elevated temperatures electrons may be thermally excited in the pure material itself. This temperature region is called the intrinsic range.

High charge-carrier mobility is a fundamental property required for transistor action. The ability of the transistor to follow high frequencies depends on how fast the holes travel through the germanium. In high-grade germanium, mobility is

OVER 6,000 ROUTE-MILES of RADIO RELAY SYSTEMS *INSTALLED*

Federal PTM MICROWAVE

*"The FIRST Commercial Radio Relay
System in North America"*

High Points of PTM ENGINEERING and PERFORMANCE

- Pulse-Time Modulation assures maximum circuit reliability.
- Simplest and smallest RF equipment.
- Highest RF power output.
- Fewest tubes—lowest maintenance.
- Simple intermediate drop and insert equipment.
- Simple individual common type channeling units.
- Simple delay line method insures channel synchronization.
- Unaffected by fog, rain, snow, ice, static or magnetic storm.
- High signal-to-noise ratio.
- Outstanding for high quality of voice and other transmission.
- No inter-channel cross-talk due to non-linearity of common elements.
- Energy beamed by non-critical directive parabolic reflectors.
- High power provides large fading margin.
- 99.22% reliability achieved without RF stand-by.

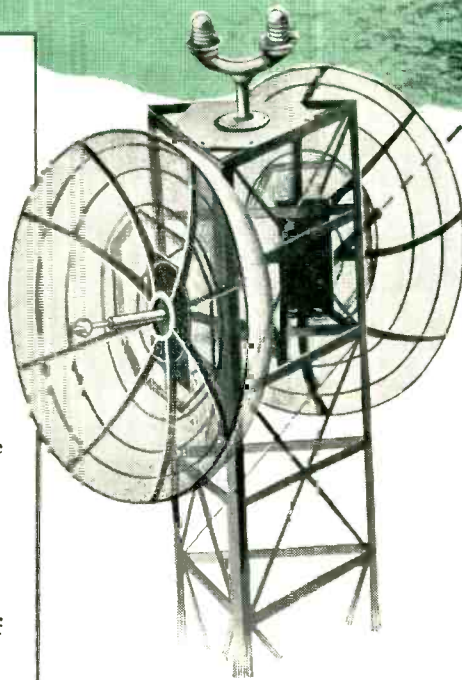

MICROWAVE MOVIES:

Be sure to see Federal's 16 mm. sound-and-color motion pictures:

"Microwave Communications for Power Utilities"... "Pipeline Communications With Microwave"... "Microwave for Modern Telephony"... "Railroad Operation With Microwave"... "Modern Communications With Microwave." Prints shipped without charge for company showings. Write to: *Film Distributing Department.*

SUCCESSFUL operation in many industries proves Federal's PTM is better because of its inherent simplicity...!

Streamlined circuitry—fewer tubes! That's the basis of Federal Pulse-Time Modulation Microwave superiority... for multi-channel radio relay systems of *any* length... over *any* terrain!

Federal PTM gives pipelines, power utilities, telephone companies, railroads and others complete, simultaneous, all-weather voice and signal facilities... without costly line construction and maintenance.

Proved-in services include: toll circuits, dialing, dispatching, telemetering, supervisory and remote control, teleprinter, telegraph, speech-plus-duplex, mobile radio... in fact, *all industrial communications needs.*

Get the facts about Federal PTM... backed by decades of experience in engineering, system planning and turn-key installations. Write to Dept. H-213.

Visit Federal's Exhibit—IRE Show—885-893 Audio Ave. at Broadcast Way

Federal Telephone and Radio Company

PTM AND WIRE TRANSMISSION SALES

100 KINGSLAND ROAD, CLIFTON, N. J.

In Canada: Federal Electric Manufacturing Company, Ltd., Montreal, P. Q.
Export Distributors: International Standard Electric Corp., 67 Broad St., N. Y.



IT'S A FACT...

ITT scientists conducted the *first* successful demonstration of voice communication via *microwave*, March 31, 1931, across the English Channel.

ALLIED

your complete supply source for

**RCA INDUSTRIAL TUBES
& TEST EQUIPMENT**Authorized  Distributor

RCA electron tubes for Industry

Quick Service on All Types. ALLIED maintains in constant stock for *quick shipment*, the world's largest distributor inventory of RCA special-purpose tubes —of all types. We specialize in supplying the tube needs of industrial, broadcast, governmental and other users. Phone, wire or write—we ship from stock to any part of the nation within hours after we receive your order. Save time, effort and money—fill all your tube needs at ALLIED—the complete, dependable electronic supply source for industry.



Always
in stock at
ALLIED

RCA-8008 Rectifier (illustrated). We stock the full line of RCA mercury-vapor rectifiers including 575-A, 673, 816, 857-B, 866-A, 872-A, 5558.

FREE Interchangeability Directory

Send for this valuable guide to the selection of proper RCA tube type replacements. Lists 1600 type designations, covering non-receiving electron tubes. Write for your FREE copy of RCA Guide No. 37 K 046.

Look to ALLIED for RCA: Vacuum Power Tubes • Thyratrons • Cold-Cathode Tubes • Oscillograph Tubes • Vacuum & Gas Rectifiers • Ignitrons • Phototubes • Camera Tubes • Monoscopes

RCA test instruments

For All Lab Requirements. Order your RCA laboratory measurement instruments from our extensive stocks. We specialize in the supply of electronic test and measurement equipment for research, development, maintenance and production requirements. Simplify and speed your purchasing—send us your consolidated orders for RCA Tubes and Test Instruments.

We can supply for quick shipment, all types of RCA test instruments, including the following:

- WO-88A 5" Oscilloscope
- WV-87A Master VoltOhmyst*
- WV-77A Junior VoltOhmyst*
- WR-59B TV Sweep-Generator
- WR-89A Marker Generator
- WR-49A RF Signal Generator
- WA-44A Audio Signal Generator

*T. M. Reg.

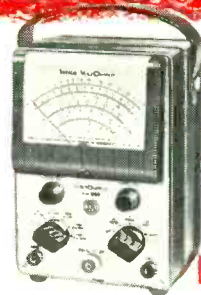

Always
in stock at
ALLIED

WV-97A Senior VoltOhmyst (illustrated)

Improved RCA VTVM. Direct peak-to-peak measurement of complex waves from 0.2 volts to 2000 volts. Overall dc measurement accuracy of $\pm 3\%$ full scale. Measures dc voltages 0.02-1500 volts; rms values of sine wave from 0.1-1500 volts. Frequency response flat from 30 cps to 3 mc.

No. 84 F 075 Net. \$67.50

268-PAGE ALLIED CATALOG

Send today for the complete 1954 ALLIED Catalog—the authoritative buying guide to all electronic supplies for industry. ALLIED carries the world's largest stocks of special tubes, parts, test instruments, audio equipment—complete quality lines of electronic apparatus. Save time, effort and money—simplify your purchasing by sending your orders to ALLIED. Write for our complete Buying Guide today.

ALLIED RADIO CORP.

100 N. WESTERN AVE., Dept., 11-C-4, CHICAGO 80, ILL.

FREE

Everything in Electronics from ONE RELIABLE SOURCE



about 3,000 sq cm per volt sec. For ordinary-size electrodes and spacings this restricts the highest frequency to about 10 or 20 mc.

At room temperatures, carrier mobility is primarily a function of the nature of the crystal lattice, with a small decrease in mobility from impurity scattering of the electron. The number of charge carriers is primarily a function of the sample purity. If a material is found to have a high lattice mobility, its properties can be improved by purification. A material with a low lattice mobility cannot be markedly improved.

Samples of indium antimony investigated by the National Bureau of Standards were not sufficiently pure to give transistor action, but their mobility, 20,000 sq cm per volt sec, is about seven times that of germanium. With sufficiently pure samples, transistor action should be possible at higher frequencies and at higher power levels.

Temperature Change

Another parameter, important with respect to the performance of practical diode and triode semiconductors, is the change in properties with temperature. In a semiconductor the number of charge carriers increases exponentially with temperature. In the impurity range this change is slow because the activation energy for semiconductor conductivity is small. At higher temperatures the intrinsic range is reached. Here changes with temperature are much more rapid because the energy is larger. For a material to be useful, the intrinsic range should not be reached at temperatures normally encountered. The activation energy of germanium is 0.75 ev, and its intrinsic range starts at about 60 deg C for samples of normal purity. Silicon samples of the usual purity, with an activation energy of about 1.1 ev, do not enter the intrinsic range until a temperature of approximately 350 deg C is attained. Unfortunately, pure silicon in single crystal form is hard to obtain because of its chemical activity and high melting point.

Activation energy of indium antimony is about 0.40 ev. This value is too low to allow transistor

**DEVELOPMENT and
DESIGN ENGINEERS
SAY...**

"Specify *Heldor*

—BUSHINGS

hermetic-seal, compression type

—CANS & COVERS

built to meet MIL-T-27 & Commercial Specifications

—ASSEMBLY SERVICE

from assembly of bushings in covers to actual hermetic sealing of your component. "

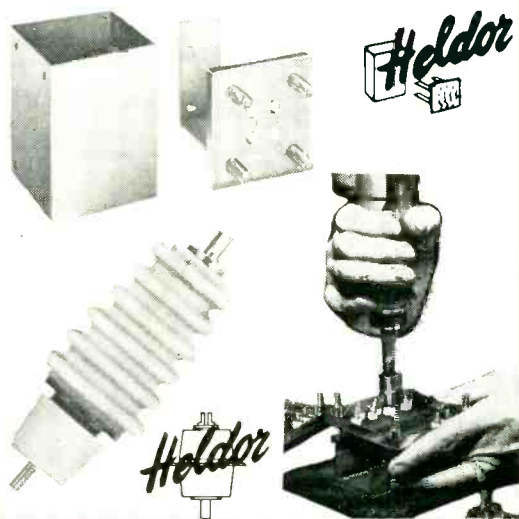

MORE and more development men in the electronic and nuclear fields make their component selection from Helder's line of hundreds of standard and non-standard cans, covers and hermetic-seal bushings because they can find just the right items for their application . . . and, because in the final product, these components will materially reduce costs, speed up production and help to maintain quality. And, these men tip off their production associates to the further economies that are possible when Helder is used for assembly of cans and terminals.

Find out how you can benefit from standardizing on Helder's products and services. Send us your specifications or prints today for a quotation which speaks for itself.

JUST OFF THE PRESS!
New Helder Can &
Terminal Data Brochure!
It's Free! Write for it today!

HELDOR MANUFACTURING CORPORATION



HELDOR BUSHING & TERMINAL CO., INC.

238 Lewis Street

Paterson, N. J.



Visit Booth #863 Audio Avc. I.R.E. Show, March 22-25, 1954

Designed for high-speed pulse observation

...The Tektronix TYPE 517

EXCELLENT TRANSIENT RESPONSE

Risetime—
0.007 μ sec or less.

FAST SWEEPS

0.01 μ sec/cm to
20 μ sec/cm.

HIGH ACCELERATING POTENTIAL

24 KV on
metallized crt.

SENSITIVITY—0.1 v/cm

0.3 μ sec pulse with cable
properly terminated

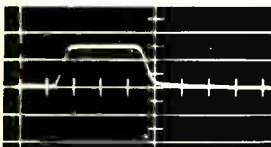

1. 10 mc Oscilloscope



2. Type 517

0.3 μ sec pulse with cable
improperly terminated

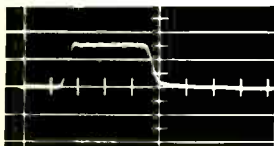

3. 10 mc Oscilloscope

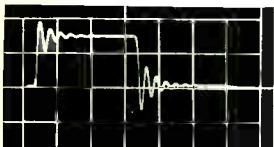

4. Type 517



Type 517 Oscilloscope—\$3500
f.o.b. Portland (Beaverton), Oregon

The waveform photographs at left illustrate the capabilities of the Type 517 in one application dealing with extremely fast-rising pulses. The same 0.3 μ sec pulse is shown in all four photographs—first with a three-foot length of 93-ohm coaxial cable properly terminated (photos 1 and 2), and below with improper output termination (photos 3 and 4). Notice in photo 4 how clearly the Type 517 shows the effects of improper termination on the pulse.

If your project is one that requires an oscilloscope with the faithful transient response, fast sweeps, and high accelerating potential of the Type 517, call your Tektronix Field Engineer or Representative for complete specifications—or write to:



Tektronix Inc.

P. O. Box 831A • Portland 7, Oregon • Cable: TEKTRONIX

See the Type 517 at Booths 129 and 131, Radio Engineering Show

action at elevated temperatures. Gallium antimony, on the other hand, has an activation energy of about 0.86 ev—somewhat greater than germanium; and aluminum antimony appears to have an activation energy greater than 1 ev—slightly larger than the energy of silicon. It is assumed that from the variety of intermetallic compounds available it will be possible to find suitable combinations with proper energy to yield the desired semiconductor characteristics.

Voltage-Tuned Microwave Oscillator



Internal structure of carcinotron. Periodic anode structure can be seen in circular housing

A HIGH-POWER microwave oscillator has been developed using the backward-wave principle. Results obtained with an experimental continuous-wave tube indicate that power output will be in the order of 200 watts with an efficiency of 30 percent. The tube can be tuned over a range from 1,624 mc to 2,740 mc by varying anode voltage. With a 1.5-to-1 vswr load, pulling figure is less than one megacycle in all phase positions.

Backward wave oscillations can be produced by providing an electron beam traveling at substantially the velocity of a reverse wave and adapted to couple energy to a periodic delay line.

In the M-type carcinotron described here, the beam moves in crossed electric and magnetic fields V/d and B respectively. The average translational velocity of the electrons is then $v_e = V/dB$ and the oscillation frequency depends on both the electric and magnetic fields.

Figure 1 illustrates the essential elements of the type M tube. A periodic waveguide anode structure

Famous Kings in History

CHARLEMAGNE first ruled as King of the Franks. In 800 A. D. he was crowned Emperor of the Romans, and his realm was the foundation of the Holy Roman Empire. A forward-looking ruler, Charlemagne established schools of learning and was a liberal patron of the arts and sciences.



FAMOUS KINGS CONNECTORS



UG-27B/U



UG-29B/U



UG-21B/U



UG-58A/U

• N SERIES •

Today Kings Connectors are famous for the important role they play in the field of electronics equipment. The name "Kings" is always your guarantee of the best in "Solid Contact" Connectors. Whatever your connector problem may be, you can depend on King's versatility of skills, extensive facilities and wide-range experience to provide the answer. Your inquiries are invited.



KINGS *Electronics* CO., INC.
40 MARLBOROUGH ROAD, TUCKAHOE 7, N. Y.

SEE OUR EXHIBIT AT THE I.R.E. SHOW, BOGOTS 506-508, COMPONENTS AVENUE

transmits a wave toward the left of the figure and a reverse wave toward the right. This structure is biased positive with respect to the opposing grounded electrode.

An electrode, parallel to the anode structure, is biased to negative (ground) potential. This electrode, called the sole, together with the anode, bound the interaction space. A positively biased electron-collecting electrode (not shown) at the end of the system collects electrons from the electron gun that are captured by the anode.

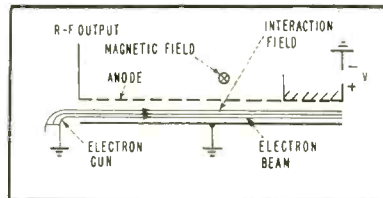

FIG. 1—Operation of carcinotron backward-wave oscillator. With suitable design changes this linear operation can be obtained in a circular tube

An attenuating section at the collector end of the delay line terminates the interaction space. An r-f output system connects the gun end of the delay line to an external load. The magnetic field is normal to the plane of the drawing and uniform throughout the interaction space.

When beam current is increased above a critical value the system begins to oscillate. Frequency of

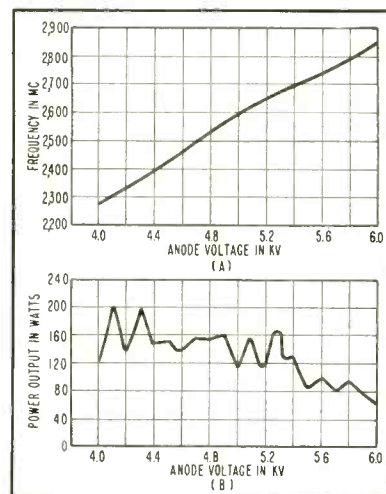

FIG. 2—Effect of varying anode voltage on frequency (A) and power output (B)

oscillation is determined by the dispersion of the delay line and the electron velocity. It is substantially independent of external r-f loading of the tube. Power reaching the load is modified, however, in accord-

for that
"extra measure" of
dependability

Specify

POTTER Radio Noise Filters

especially if:

- 1... your product reputation makes component quality the primary consideration.
- 2... you need flexible production facilities capable of producing small runs of capacitors, engineered to fit your specific needs, quickly and economically.

Send now for this Free Catalog of the complete Potter Line.

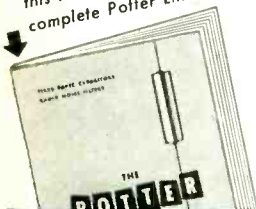

THE POTTER COMPANY

North Chicago, Illinois, U. S. A.

Dept. A

SPECIALISTS IN
FIXED PAPER
CAPACITORS
SINCE 1925

SOUTHERN AFFILIATE:
MICROFARADS, INC.
WESSON, MISS.

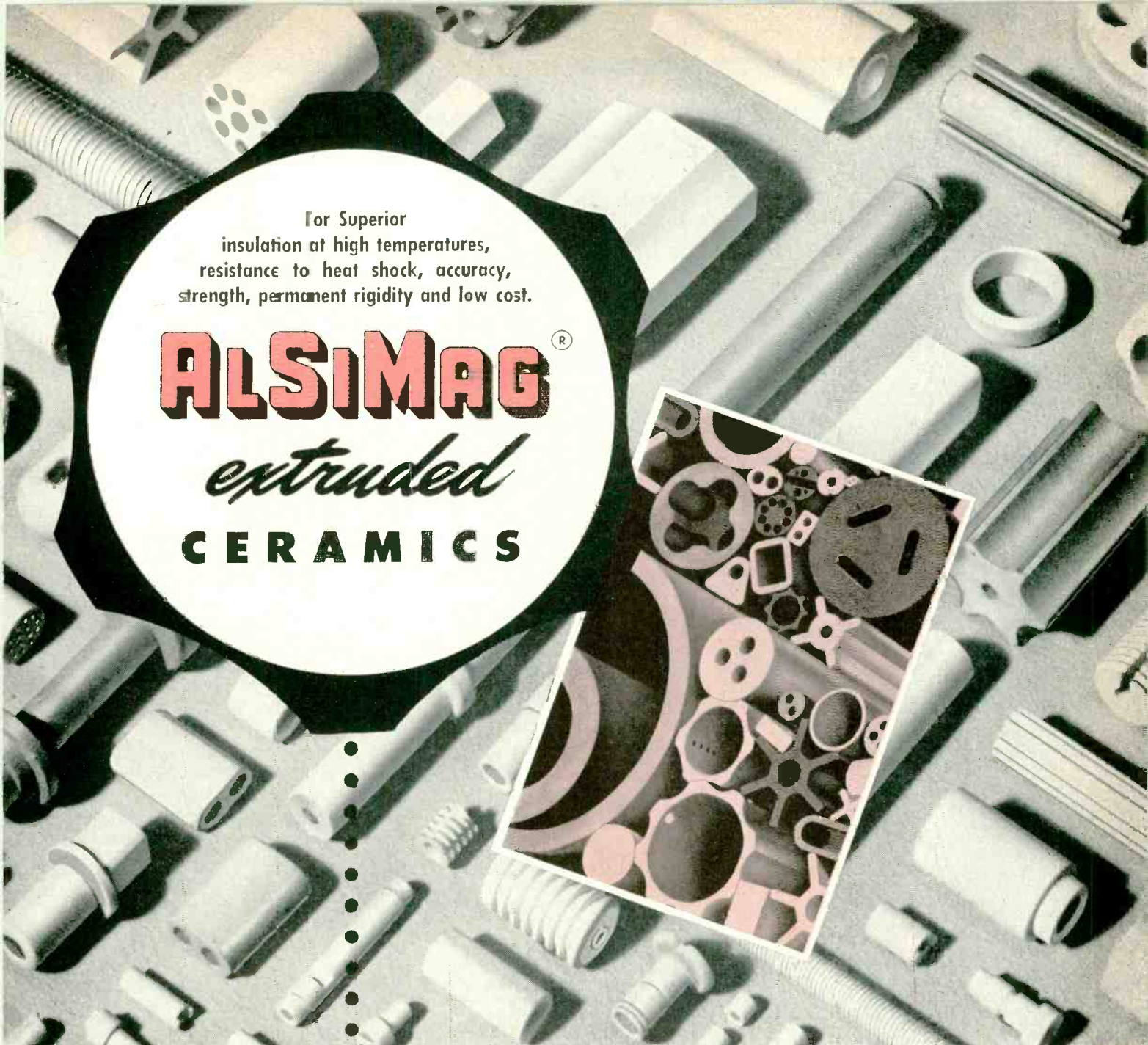

For Superior
insulation at high temperatures,
resistance to heat shock, accuracy,
strength, permanent rigidity and low cost.

ALSiMAG[®]

extruded

CERAMICS

If you will give us details of your requirements our engineers will be glad to submit suggestions without cost or obligation. Try ALSiMag ceramics for best results at low cost.

ALSiMag ceramics can be extruded in uniform cross sections in almost any design. These extruded sections can then be sawed and economically machined before firing. This is the fastest and best way to produce many shapes which seem complex but which are actually quite practical and economical . . . ALSiMag ceramics are not affected by normal operating temperatures of electrical appliances and do not rust, corrode or carbonize. They are uniform physically and dimensionally, are totally and permanently rigid and do not deteriorate with time.

• A SUBSIDIARY OF
MINNESOTA MINING AND
MANUFACTURING COMPANY

52ND YEAR OF CERAMIC LEADERSHIP

AMERICAN LAVA CORPORATION

CHATTANOOGA 5, TENNESSEE

OFFICES: METROPOLITAN AREA: 67T Broad St., Newark, N. J., Mitchell 2-8759 • SYRACUSE, N. Y.: 330 Arlington Ave., Phone 76-5068 • CLEVELAND: 5012 Euclid Ave., Room 2007, Express 1-6685
NEW ENGLAND: 1374 Mass. Ave., Cambridge, Mass., Kirkland 7-4498 • PHILADELPHIA: 1649 N. Broad St., Stevenson 4-2823 • ST. LOUIS: 1123 Washington Ave., Garfield 4959
CHICAGO: 228 N. LaSalle St., Central 6-1721 • SOUTHWEST: John A. Green Co., 6815 Oriole Dr., Dallas 9, Dixon 9918 • LDS ANGELES: 5603 N. Huntington Dr., Capital 1-9114

HOW Berkeley EQUIPMENT HELPED SOLVE A PROBLEM

FOR KILBURG
CORPORATION
SAN MATEO, CALIFORNIA



PROBLEM: To determine opening and closing time of dial telephone contacts to an accuracy of 1/100,000 second, when operated by Kilburg "Dialaphone" automatic dialing system.

SOLUTION: Use of a BERKELEY Time Interval Meter capable of measuring opening, closing and operating time to an accuracy of 1/100,000 second. External selector permits measurement of opening and closing time of any single pulse in the chain of pulses generated by operating the telephone dial. Results are displayed digitally in 1/100,000-second increments for rapid, error-free reading.

RESULTS: The president of the James Kilburg Corporation states that precise data obtained by use of the BERKELEY equipment speeded evaluation of the "Dialaphone" system, with savings in time valued at more than \$10,000. Its simplicity, reliability, accuracy, and speed also permit substantial savings in production-line testing of the "Dialaphone," an instrument used with standard dial phones which automatically dials any number selected from an alphabetical index included with the unit.

MAY WE HELP SOLVE YOUR PROBLEM? If it involves faster, more accurate, easier and simpler ways to measure frequency, flow, pressure, velocity, rpm., time intervals, viscosity, — or high speed counting and counting plus pre-set control — chances are that BERKELEY can help you solve it. Complete data sheets covering many applications in these fields are yours for the asking — check the handy coupon below and mail it now!

M-26

Berkeley

division

BECKMAN INSTRUMENTS INC.
2220 WRIGHT AVE., RICHMOND, CALIF.

Dept. G3, 2200 Wright Ave., Richmond, Calif.

Please send me application data sheets checked

Name _____

Title _____

Address _____

City _____ State _____

MEASUREMENT OF:

- Flow Velocity
 Pressure RPM
 Viscosity Operating Time
 Frequency of _____

COUNTING OR PREDETERMINED COUNTING OF:

CONTROL OF:

- Cutting Stock to Length
 Packaging and Batching

ance with the power-reflection factor of the load. For a 5.8-to-1 load vswr half the power is absorbed by the load and half is reflected.

As the electron beam gives energy to the r-f wave on the anode, it loses potential energy and maintains the same translational velocity. It is injected into the system along the equipotential V_0 , and as it exchanges energy with the wave it moves through successively higher equipotentials until it is captured by the anode at potential V . The electronic efficiency of the system η_e is given, as a first approximation by the relation

$$\eta_e = 1 - \frac{V_0}{V} \quad (10)$$

It is possible to design a tube so that V is of the order of 5 times V_0 , yielding a theoretical electronic efficiency of 80 percent.

In practice, electronic efficiency is a function of the linearity achieved in the electron trajectories. It is further modified by space charge effects and the fact that some of the electrons are captured by the sole and collector.

Overall efficiency of the tube is determined by electronic efficiency and losses in the delay line circuit. Tubes operating at S-band with an overall efficiency of 50 percent have been reported.

Experimental Tube

The photograph shows a circular experimental M-type oscillator designed for operation in the frequency range from about 2,000 to 3,000 mc. While the foregoing discussions concerned a linear model for simplicity, it is possible to construct tubes in a compact circular form, with appropriate modifications. The diameter of the envelope is 4.5 inches; the thickness (which defines the magnet gap) is 1.8 inches; overall height including the bushing is 10.25 inches. The weight is seven pounds, without magnet. The tube was operated in the laboratory using external pole pieces and an electromagnet.

The r-f output was connected to the load by means of a $\frac{7}{8}$ -inch coaxial 46-ohm line. Water cooling was required and was provided by the temporary expedient of a loop

From "The House of Resistors"
comes...

Precise CONTROL

★ Series 52 potentiometers are available in 1 to 18 section tandems. Single shaft, simultaneously controlled.

★ Prong terminals engage with corresponding jacks for plug-in circuitry.

★ Overall tolerances to plus/minus 0.5% where resolution permits. Voltage ratio accuracy of 0.005.

★ Molded low-loss mica-filled phenolic casings. Corrosion-resistant materials and plating throughout.

★ Life of over 1,000,000 cycles. These controls exceed applicable JAN-R-19 specifications.



IT'S EASY TO DO BUSINESS
WITH CLAROSTAT...

Representatives in all principal cities. Wire Western Union — we have a direct wire. Telephone (Dover 979) we have added trunk lines to render service. Teletype — our TWX number is Dover 275-U.



CONTROLS AND RESISTORS
CLAROSTAT MFG. CO., INC., DOVER, NEW HAMPSHIRE
In Canada: Canadian Marconi Co., Ltd., Toronto, Ontario

ENGINEERS AND PHYSICISTS

*Latest developments in your fields
will be presented at the*



NATIONAL CONVENTION AND RADIO ENGINEERING SHOW

New York City, March 22·23·24·25

HEADQUARTERS, WALDORF-ASTORIA HOTEL
EXHIBITS, KINGSBRIDGE ARMORY

*You are cordially
invited to visit
the Hughes exhibits,
Kingsbridge Armory.*

Hughes research, development and manufacturing in the field of advanced electronics have led to significant achievements for the military, as well as for commercial applications.

GROUND and AIRBORNE RADAR
FIRE CONTROL SYSTEMS
GUIDED MISSILE SYSTEMS
AIRBORNE DIGITAL
COMPUTERS
ELECTRONIC BUSINESS
SYSTEMS
MINIATURIZATION and
ADVANCED PACKAGING
COMMUNICATION SYSTEMS
MICROWAVE FERRITE
DEVICES
ANTENNAS and RADOMES
INDICATOR and
MICROWAVE TUBES
SEMICONDUCTOR DEVICES

HUGHES

RESEARCH AND
DEVELOPMENT LABORATORIES

*Culver City
Los Angeles County, California*

of tubing brazed to the cylindrical envelope.

Static measurements of power output and frequency were made as a function of anode voltage at a constant beam current of 165 milliamperes, beginning at a voltage of four kilovolts and increasing in intervals to six kilovolts, where arcing occurred that damaged the uniformity of the anode delay line. These results are shown in Fig. 2.

Over this range of voltage, continuous tuning of frequency was obtained from 2,270 to 2,850 mc with no discontinuities. As far as could be determined, the tube operated at only one frequency for a given anode voltage. At 2,300 mc, power output was 200 watts and overall efficiency 29.2 percent. The magnetic field in the interaction space was 1,230 gauss.

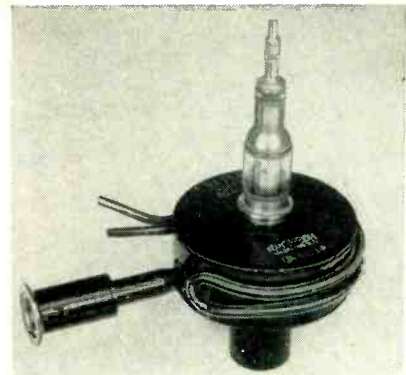

Experimental carcinotron used water cooling tube around housing to control anode temperature

Effects of load variation on frequency was measured. Discontinuities causing a predetermined standing wave ratio were introduced in the coaxial line between the tube and the load. These discontinuities were moved through all phase positions, while their effect on frequency was observed. The tube was operated at 2,300 mc during this test. Variation of frequency was influenced to a certain extent by fluctuations in the magnet and anode power supplies, so that the measurements are here reported are maximum. For a 1.5-to-1 vswr load in all phase positions pulling was less than one mc. At 2.5-to-1 vswr wave ratio it was less than two mc, and at 3.5-to-1 it was less than 2.5 mc.

The information contained in

**I·R·E
NATIONAL
CONVENTION
and
RADIO
ENGINEERING
SHOW**

*New York City
March
22-23-24-25*

See latest developments
in Fusion Sealed semicon-
ductor devices at the

**Hughes
Exhibit**

*Booths
753-755-757
Kingsbridge Armory*

Inspect the new Hughes
Silicon Junction Diode
shown for the first time.
Standard Hughes point-
contact germanium di-
odes in RETMA and
special types will also be
on display.

**HUGHES
DIODES**

**A New
Standard of
Reliability**

*Reliability in semiconductor
devices is determined principally
by permanent freedom from the
two major causes of failure—
moisture penetration of the envelope,
and electrical instability under
extreme operating conditions.*

HUGHES SEMICONDUCTOR DEVICES are designed to pre-
vent such failures through two exclusive features:

1. **Fusion Sealing**—The glass-to-metal seal, proved
in billions of vacuum tubes, is incorporated to
full advantage in semiconductor devices by the
Hughes-developed process of fusion sealing at
high temperature. The result is a rigid *one-piece*
glass envelope impervious to moisture.

2. **100% Testing**—Hughes 100% testing procedures
invite instabilities to occur prior to shipment,
assuring rejection of defective units. Each standard
HUGHES DIODE is temperature-cycled in saturated
water vapor, JAN shock-tested, and electrically
tested under vibration. This testing procedure
insures operation of **HUGHES DIODES** under adverse
conditions of moisture, temperature, vibration
and severe shock.

Reliability of **HUGHES DIODES** has been proved in
advanced airborne military radar and fire control
systems, and for guided missiles. All Hughes semi-
conductor devices are designed to the same high
standards of reliability.

Dimensions of
actual diode
envelope:
0.130" x .265"

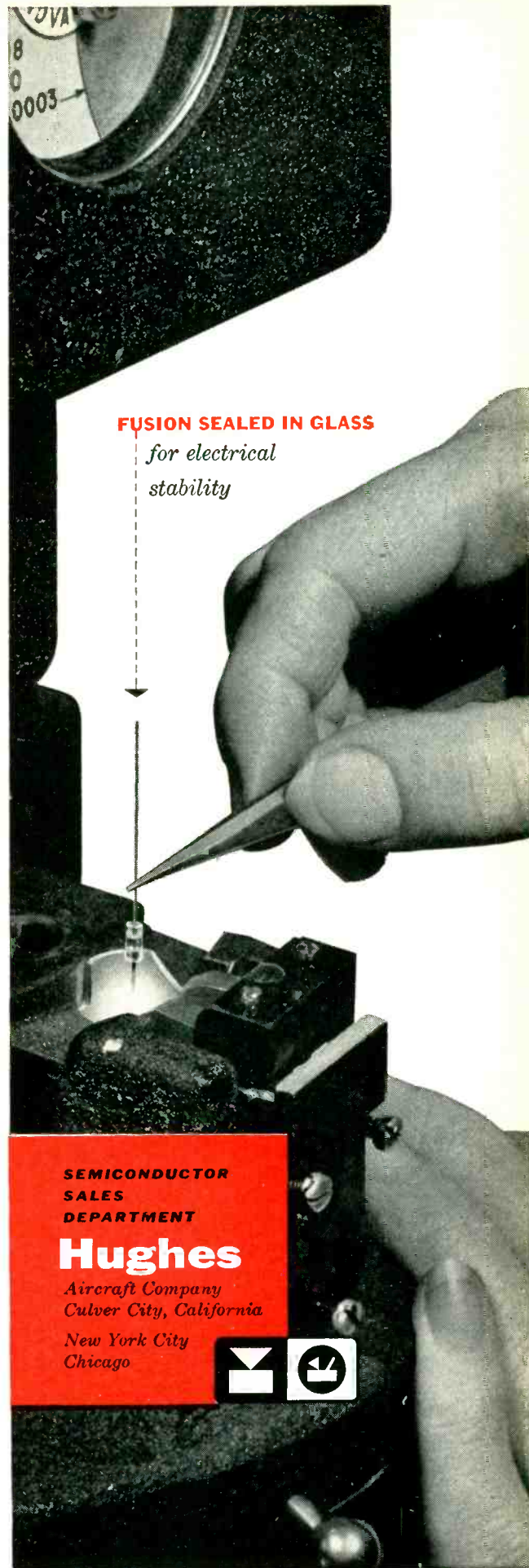

FUSION SEALED IN GLASS
*for electrical
stability*

**SEMICONDUCTOR
SALES
DEPARTMENT**

Hughes

*Aircraft Company
Culver City, California
New York City
Chicago*



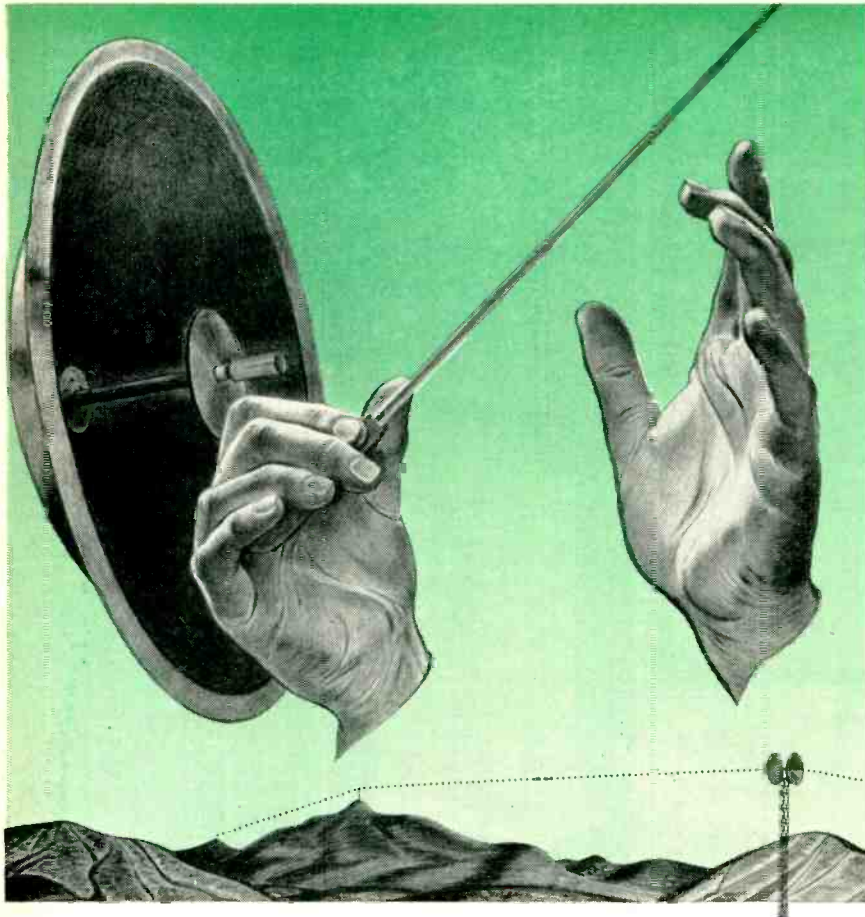

IN RELAY KLYSTRONS, *Quality counts most...*

For performance that measures up to the exacting demands of high frequency relay systems, there can be no compromise with quality. System designers and equipment buyers know that high performance, high frequency systems depend upon klystrons having sufficient power to override noise, excellent frequency stability and long life. Varian klystrons are **designed** and **built** to meet these exacting demands.

VARIAN MEANS PROVED PERFORMANCE...

In the 6000 to 8000 megacycle band, Varian X-26 klystrons outperform all others. Here are five reasons why leading system designers insist on these klystrons for top performance in relay applications:

- **Greater Power** — X-26 high power klystrons are conservatively rated. They will deliver more than rated power without failure.
- **Greater Frequency Stability** — X-26 klystrons have negligible short term drift — long term drift is less than 5 megacycles.
- **Greater Uniformity** — Varian mass production techniques assure uniformity — every klystron is as reliable as a nut and bolt.
- **Longer Life** — X-26 klystrons can be operated at full power for thousands of hours, at low power for years.
- **Less Distortion, Less Noise** — FM distortion and inherent noise are negligible — 60 db below a 1-megacycle deviation.

IN EVERY KLYSTRON APPLICATION, VARIAN GIVES YOU:

- Advanced Design
- Operating Economy
- Proved Performance
- Structural Integrity

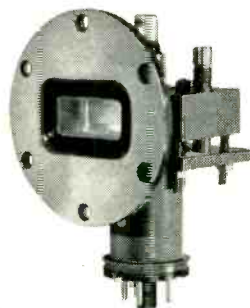

IN KLYSTRONS, THE MARK OF LEADERSHIP IS



VARIAN associates
PALO ALTO 1, CALIFORNIA

Representatives in all principal cities

For more ad information, see Index to Advertisers.

this article was abstracted from the paper "A Voltage-Tuned High Power Microwave Oscillator" by Edward C. Dench, presented at the National Electronics Conference, 1953, Chicago.

Timer Saves Monitor Batteries

BY GEZA ZELINGER*
*Electronics Laboratory
Dept. of Scientific Research
and Development
Ministry of Defence
Haifa, Israel*

AN ELECTRONIC SWITCH using neon lamps to control relay operation is being used to turn on a nonattended battery-operated receiver at regular intervals. The low current consumption of the glow lamps and current saving by the intermittent operation of the receiver has extended the service life of the batteries from about 10 hours to over 100 hours.

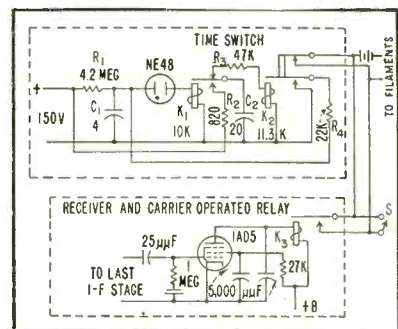

Circuit of the neon time switch. Relay operated from receiver i-f keeps unit in operation while carrier is received

The circuit diagram is shown above. The off and on periods of the switching relay K_1 are independently controlled by R_1C_1 and R_3C_2 respectively. By varying the constants of these resistors and capacitors, the timing periods may be set within wide limits.

The d-c energy required to maintain this timer in continuous operation is approximately twice the sum of the stored energies of the timing capacitors C_1 and C_2 . In an experimental model average input power is about 5 milliwatts.

Operation of the circuit is described below. Capacitor C_1 charges exponentially through R_1 towards the applied voltage. When the po-

*On leave of absence at the Royal Institute of Technology, Stockholm, Sweden



New oscillographs, four or six channel, fit standard 19-inch racks. Direct ink writing unit shown at left; combination ink and electric writing unit shown above.

Announcing... NEW BRUSH OSCILLOGRAPHS OFFER YOU GREATER EASE AND FLEXIBILITY IN MEASUREMENTS

THESE new Brush multichannel oscillographs set a new high in performance. Check these outstanding features:

* **Electrically Controlled Chart Drive:**
Multiple chart speeds • Instantaneous switching
Remote or local control • Best signal resolution
with economy in chart paper.

* **Choice of Mounting:** In standard rack or bench-top console.

* **Choice of Direct Writing Methods:**
Ink or electric.

* **New Accessories:** Event and timing markers
Remote control unit • Dual motor drive to double
number of available chart speeds.

FOR INFORMATION WRITE
*Brush Electronics Company,
Dept. K-3A, 3405 Perkins Ave.,
Cleveland 14, Ohio.*

BRUSH ELECTRONICS

INDUSTRIAL AND RESEARCH INSTRUMENTS
PIEZO-ELECTRIC MATERIALS • ACOUSTIC DEVICES
MAGNETIC RECORDING EQUIPMENT
ULTRASONIC EQUIPMENT



COMPANY

*formerly
The Brush Development Co.
Brush Electronics Company
is an operating unit of
Clevite Corporation.*

New approach to HIGH VOLTAGE SWITCHING

Jennings
-RADIO®
VACUUM ELECTRONIC COMPONENTS

A VACUUM ENCLOSED SWITCH

that can interrupt high voltage AC and DC circuits many thousands of times without introducing a problem of contact life. With their contacts sealed in a vacuum, they offer no fire hazard, no explosion hazard, no oil maintenance, and no contact maintenance. They are many times smaller and lighter than other types of high voltage switches. Their low inertia contacts and vacuum dielectric make possible much faster breaks than can be achieved with heavier types of switchgear.

These JENNINGS VACUUM SWITCHES are designed and field tested for electronic applications up to 75 KV and several hundred amperes. They are available either unmounted or mounted as relays.

I.R.E. SHOW BOOTH
#436 Electronics Ave.

Please send us your circuit conditions and let us suggest a relay to meet your specific switching problem.

Literature mailed on request

tential difference across C_1 reaches the ignition voltage of the neon tube, the tube conducts and the capacitor discharges through the tube and through the windings of relay K_1 . The current pulse closes the lower contacts of the relay until the potential difference across C_1 decays to the extinction voltage of the gas tube.

The time interval between the application of the source voltage and the start of discharge through the neon tube is controlled by the time constant of R_1C_1 . Therefore these components determine the length of the off period in the repetitive cycle.

While the lower contacts of K_1 are closed, C_2 charges to the source voltage through R_2 . Upon extinction of the neon tube, relay K_1 drops back to the normally-closed position, initiating the exponential discharge of C_2 through R_3 and relay K_2 . The constants of R_3C_2 and the sensitivity of K_2 determine the length of the on period.

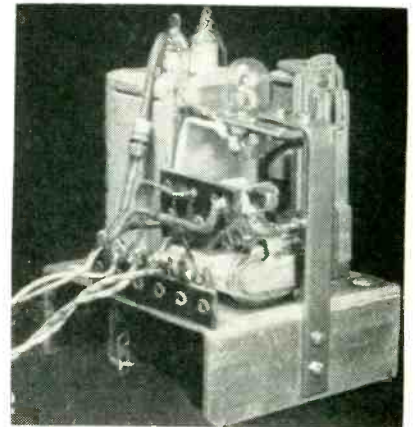

Neon-tube time control unit

Resistor R_1 discharges C_1 during the on period, through the second pair of relay contacts of K_2 , thereby resetting the timer before the start of the next cycle.

The time switch attached to the radio equipment is shown in the photograph. It provides a 20-second off and a 2-second on period. If a carrier signal is received during the on period, the carrier operated relay K_3 in the radio receiver bypasses the timing relay K_2 and the receiver remains on as long as the carrier signal is present. Switch S allows the radio equipment to be used in normal manner.

The development work on glow-discharge-tube controlled electronic

JENNINGS RADIO MANUFACTURING CORPORATION • 970 McLAUGHLIN AVE.
P.O. BOX 1278 • SAN JOSE 8, CALIFORNIA



Bliley.....

**SOLID ULTRASONIC DELAY LINES
FOR PRECISE DELAY INTERVALS**

TYPE SDL-15
1000 YARDS
(3.051 MICROSECONDS)

TYPE SDL-16
2000 YARDS
(6.102 MICROSECONDS)

STANDARD MODELS

For
**1000 or 2000 YARD
MARKER USE**

DESCRIPTION

Frequency 30 mc
Hermetically Sealed Case
Attenuation 26 db into 1000 ohms
Bandwidth 8 mc

Bliley Type SDL-15 (Double Ended)
Bliley Type SDL-16 (Single Ended Ringing Type)

CUSTOM BUILT

For
**ANY DELAY INTERVAL
IN RANGE**
2-2500 MICROSECONDS

FEATURES

Frequency Range 5 - 100 mc
Low Attenuation
Low Spurious Response
Low Temperature Coefficient
Wide Bandwidth

For technical details concerning both
custom built and standard models ask for
Bulletin #45-A.



BLILEY ELECTRIC COMPANY

UNION STATION BLDG., ERIE, PENNSYLVANIA

NOW I-T-E quality I.F. and R.F. transformers and coils

*Custom built to
your specifications*

Long noted for top-quality wire-wound components—precision resistors, power resistors, deflection yokes, and focus coils—I-T-E now adds I.F. and R.F. transformers and coils to its line.

Coils or complete transformers—the simplest to the most complex—are precisely fabricated to your specifications. Versatile coil-winding machinery plus latest-type testing equipment assure close electrical and mechanical tolerances. Components are sturdy—built to “take it”. They’re stable over time, temperature variation, and in humid atmospheres.

Take advantage of I-T-E engineering skill, coil-winding experience, and modern facilities. We will build to your particular specifications . . . and, at a competitive price!

all types of I.F. and R.F. coils • R.F. output transformers • antenna transformers • any stage tuners • buffers • doublers • mixers • R.F. chokes • linearity coils • peaking coils

Get your copy of Catalog R-200 E. It gives complete information about I-T-E wire-wound products.

Write to Resistor Division, Advt. Dept., I-T-E Circuit Breaker Co., 1924 Hamilton St., Phila. 30, Pa.

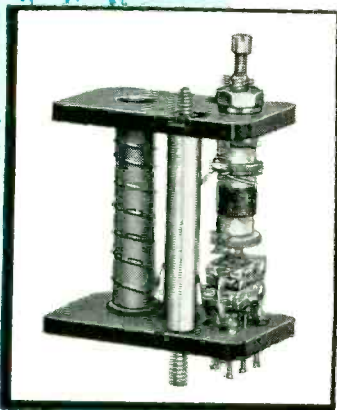
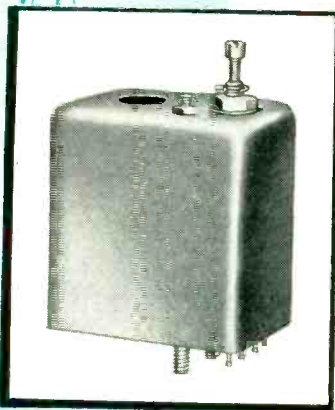

time switches has been done at this Laboratory. Credit is due Ernst D. Bergman, Director for his encouragement, to Y. Shamir for constructive criticism and to M. Tkatch who built experimental models.

Radar Detects Ocean Currents

RADAR REFLECTORS carried by 44-gallon drums are being used by sanitary engineers in Melbourne, Australia, to chart ocean currents, according to *McGraw-Hill World News*.

In order to select a suitable discharge point for city sewers, reflected signals from the floating drums will be plotted on radar screens connected to antennas on nearby cliffs.

Special radar reflectors are said to have been designed at the Melbourne Technical College. Action of the reflectors will not be impaired by their being tossed about in the wind and waves.

After 48 hours, the buoys will be sunk automatically by release of acid that will eat through the metal, allowing the drums to leak water and sink.

Phantom Microphone

TESTS OF airborne radio communication transmitting equipment specified by Radio Technical Commission for Aeronautics require an audio-frequency signal be applied to the appropriate transmitter input terminals. This signal must be applied through a phantom microphone having the impedance and direct-current flow characteristics of the type of microphone for which the transmitter is designed. Such a circuit is given below.

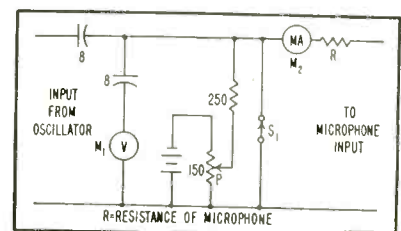

Resistor P is adjusted to give the same reading on M_2 with S_1 open as when it is closed. When S_1 is closed, M_2 measures the d-c microphone current supplied by the



WIRE-WOUND PRODUCTS

Sensitive Controls

The important components for your thermal, light, vacuum or R.F. actuated control systems are now immediately available at RELAY SALES.

ASSEMBLY PRODUCTS

Contact Meter-Relays

A highly sensitive locking relay for control of chemical processes and mechanical operations through either alarm, automatic shut-off or continuous on and off control. Contact Meters automatically maintain upper and lower limits (or both) of temperature, voltage, current, speed, light or liquid flow rate with extreme accuracy. Applications include their use in electronic circuits for quality control of piezo crystals and other components, switching of standby equipment in micro-wave communications, control of carbon feed in arc furnaces, as warning of bearing temperatures in turbines and generators, and a variety of speed controls for machines.

Contact Meter-Relays are current or voltage sensitive down to 2/10 microampere or 1/10 milliwatt. Contact ratings from 100 mils to 1 ampere. They are available in a wide selection of standard types. Special types engineered to your needs. Phone, write or wire Relay Sales for additional information.



TERADO

Miniature Micro Relay
A hermetically sealed sensitive relay, with particular application to airborne equipment, mounts in a standard 7-pin miniature tube socket. Its S.P.S.T. switch will operate on 60 milliwatts. Insulation: 500 Volts between any terminal and ground. Temperature range: +85°C. to -55°C. Shock 50G. Coil resistance, contact current and other specifications to your requirements. Send us your prints.

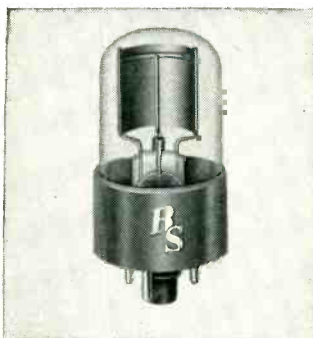

RS Phototubes

Phototubes, either gas filled or vacuum type, are available for all photo cell applications. RS Phototubes have superior operating characteristics in high output current, extreme sensitivity to small variations in light intensity, excellent response in infra-red regions, low dark current—all with notably longer tube life. Write for catalog.

CETRON

Grid Controlled Rectifiers

Due to the ever increasing demand for Grid Controlled Rectifiers, which are so closely allied to relay applications, RELAY SALES has arranged for the distribution of these special purpose tubes made by America's oldest and foremost manufacturer.

Write for New 1954
Relay Sales
Catalog
C-5

JUST OUT!



Immediate Delivery of Relays of all Types

You will receive 24 hour shipment on any material in our huge stock of practically any conceivable type of relay, contactor or motor control. Phone or wire your requirements. Phone SEeley 8-4146



4721 W. Madison St., Chicago 44, Ill.

PROVOCATIVE ANNOUNCEMENT

To Those Who Want **MORE ECONOMY, FLEXIBILITY, ADAPTABILITY**
in Television Equipment



PRECISE ELECTRONIC INSTRUMENTS

UNVEILS

TELEVISION CAMERA SYSTEM

For Industry, Broadcasting, Commerce,
Research, Education, Science!

WHAT OTHER TELEVISION CAMERA SYSTEM HAS

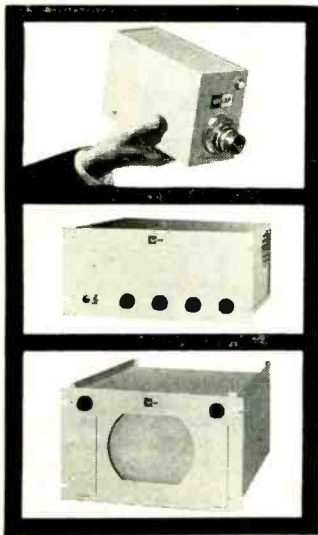

A Camera so small it fits on the palm of your hand?
such sensitivity no extra lighting required?
complete remote-operating adjustments?
ready serviceability - absolute dependability?

PLUS

A Camera Control Unit extremely simple to operate?
all fabrication from plug-in subassemblies
to give faster, easier maintenance?
100% safety factor throughout?

PLUS

A Synchronizer-Monitor Unit producing interlaced pictures?
large enough tube so that no additional receivers are needed?
ability to operate a large number of cameras?

PLUS

See Yourself on the *Advanced* KAY LAB TELEVISION CAMERA SYSTEM

KAY LAB BOOTH - Numbers 261 and 263
1954 I. R. E. SHOW
Kingsbridge Armory
New York City -- March 22 - 25

SEE ALSO AN INFORMATIVE DISPLAY OF OTHER KAY LAB PRECISE
ELECTRONIC INSTRUMENTS AND EQUIPMENT - INCLUDING:
D. C. DECADE AMPLIFIERS
ABSOLUTE D. C. POWER SUPPLIES
METER CALIBRATORS



REPRESENTATIVES IN ALL MAJOR CITIES

Write or wire us for the name of the one nearest you.

KALBFELL LABORATORIES, INC. • 1090 MORENA BLVD. • SAN DIEGO 10, CALIFORNIA

transmitter. This switch must, therefore, be open during tests. Audio frequency input voltage to the transmitter is measured by voltmeter M_1 .

High-Voltage Switch From Banana Plugs

By SAM NEWMAN

and

NORMAN H. BURTON

*U. S. Naval Material Laboratory
New York Naval Shipyard
Brooklyn, New York*

IN RESEARCH involving high voltages it is often desirable to reverse or turn on and off voltages of the order of thousands of volts at a few milliamperes. The problems that arise in designing such a switching device are well known to engineers familiar with high-voltage phenomena.

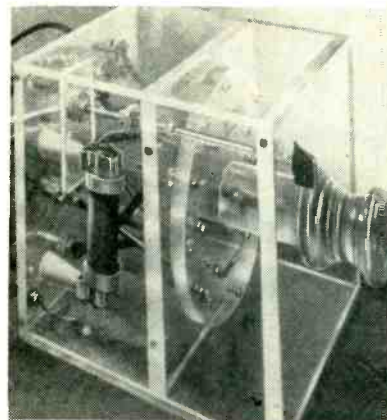

An air type high-voltage switch has been developed at the Navy Material Laboratory that is capable of breaking 25 kv at 1 milliamperes without arcing. The mechanism of the double-throw four-pole switch is shown in the accompanying photograph. The insulating structural material is polystyrene.

The contacts used are split-type banana plugs that align themselves as the switch is closed, assuring good electrical and mechanical contact. A variable tap across the high-voltage bleeder used in conjunction with the electrostatic voltmeter shown in the photograph permits continuous reading and adjustment of voltage without opening the switch.

In operation, the glass knob at right is pulled out, disengaging the banana connectors. The knob is then rotated into the alternate

AMPEX

MAGNETIC RECORDERS

The most complete line of data tape recorders

AMPEX has applied magnetic tape recording to more varied problems in research, testing and control than any other manufacturer of tape equipment. To meet specific demands for broad frequency response, precise timing, extreme tape stability, high shock resistance and reliable transient accuracy, Ampex has built machines of a wide variety of designs. And from this experience has come this line of proven magnetic recorders:

F-M CARRIER TYPE RECORDER — MODEL 306

Explosions, shock waves, geophysical data and other highly transient phenomena can be recorded on the Model 306 with excellent "instantaneous" accuracy. Because the machine uses an fm carrier to modulate the signal, the accuracy of the recording is unaffected by minor tape imperfections.

Also, the Model 306 is able to record the vast majority of all mechanical occurrence, since it covers the extremely useful frequency range from 5000 cycles/sec. down to zero (D.C.).

OPTIONS: One to 14 tracks
Rack, console or combination mounting
Record and playback, record only or playback only

WIDE RANGE DIRECT RECORDER — MODEL 307

With a frequency response from 100 to 100,000 cycles per second, the Model 307 is particularly suited to steady state data occurring over a wide range of frequencies. The 307 has had extensive application in fm-fm telemetering, sharing this field with the Model 500 described below.

OPTIONS: Same as Model 306

PULSE WIDTH RECORDER — MODEL 303

This model can record any type of phenomena that lends itself to pulse width coding. Pulses can range from 60 to 1000 microseconds and will be accurate in duration to closer than 2 microseconds. Since each track on the machine may record commutated data consisting of many channels, it is possible to record hundreds of parallel data channels on one tape on a Model 303 machine.

OPTIONS: Same as Model 306

COMBINATION RECORDERS — MODELS 309, 311, etc.

Special Ampex Data Recorders can incorporate combinations of the heads and electronic circuitry of the 303, 306 and 307. Thus the parallel tracks on the same combination recorder might have the widely differing characteristics of each of those models. For example, on its parallel channels such a recorder might have an overall frequency response of 0 to 100,000 cycles/sec.

OPTIONS: Same as Model 306 (but 2 or more tracks)

"LOW FLUTTER" WIDE RANGE RECORDER — MODEL 500

The Model 500 is a four-track, two-speed magnetic tape recorder designed to achieve extreme stability of tape motion while recording information in the frequency range between 100 and 100,000 cycles. Thus it is able to record fm-fm telemetering data without introducing any objectionable data error from small variations in tape speed. It has the lowest known flutter and wow characteristics of any tape recorder—less than 0.1% peak-to-peak by RDB standards.

Console mounting only
Four tracks only

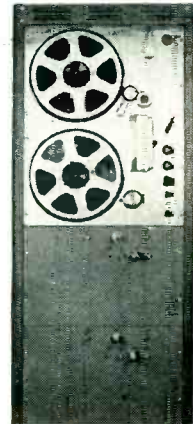

Series 300 data recorder in rack mounting.

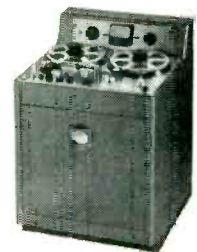

Series 300 data recorder in console mounting. Rack mounting of portions of the electronic components may be necessary on multi-track console mounted recorders.



Ampex Model 500 Recorder

AMPEX CORPORATION
934 Charter St., Redwood City, California

BRANCH OFFICES:
New York, Chicago, Atlanta, San Francisco
and College Park, Maryland (Washington,
D. C., area)

DISTRIBUTORS:
Radio Shack, Boston; Bing Crosby Enterprises, Los Angeles; Southwestern Engineering & Equipment, Dallas and Houston; Canadian General Electric Company in Canada.

AMPEX

MAGNETIC RECORDERS

For specifications and other information, write Dept. E-1535-A

Pick 'DIAMOND H' RELAYS



Shown Actual Size



...FOR HIGHER
VIBRATION
RESISTANCE

Vibration resistance range of "Diamond H" Series R Relays has been more than doubled, extending now from 0 to well over 1,000 cycles per second at 15 "G's."

Continuing engineering developments such as this are constantly broadening the adaptability of Series R Relays for a wide variety of applications . . . guided missiles, jet aircraft, fire control and detection, radar, communications, high speed camera, geophysical and computer apparatus . . . and similar applications requiring positive operation under critical conditions.

Hermetically sealed, miniature aircraft relays, Series R devices are basically 4PDT, but are also available in DPDT and 4PDT with two independent coils, either or both of which will operate the unit. Available with all standard mounting arrangements, including ceramic socket for interchangeability. Their design permits unusually compact grouping and provides a firm bond between relay and chassis. See us for special arrangements.

In their field still the smallest and lightest, (1.6 cu. in., 3.76 oz.) combining highest operating shock resistance (to 50 "G" and higher), widest temperature range (-65° to +200° C.) and greatest ability to break high currents and high voltages, Series R Relays consistently operate over 400,000 cycles without failure at 5 A. and go 3,500 or more under 30 A. at 30 V., D.C., resistive. They carry voltages up to 300 D.C. at 4/10 A. for more than 400,000 cycles. With low

contact loading, life expectancy is 10 million cycles or better.

Operating time is 10 ms. or less; drop out time 3 ms. or less. Coil resistances up to 35,000 ohms are standard; to 50,000 ohms available for special units. Sensitivity approaches 100 mw. at 30 "G" operational shock resistance. Inter-electrode capacitance is less than 5 mmf. contacts to case—less than 2½ mmf. between contacts, even with plug-in type relay and socket.

Designed to meet all requirements of USAF Spec. MIL-R-5757B, they far surpass many. Bulletin R-150, giving basic performance data under varying conditions, is yours on request. Our engineers are prepared to work with you to develop variations to meet your specific requirements. Tell us your needs.

THE HART MANUFACTURING COMPANY

202 Bartholomew Avenue • Hartford, Connecticut

keyed position, which brings the banana plugs into alignment with appropriate banana receptacles.

PERTINENT PATENTS

Two patents in fields of great current interest describe techniques useful in color television and servomechanisms, respectively.

Frequency Converter

Patent 1,769,920 granted Frank Gray and assigned to Bell Telephone Laboratories relates to high-speed picture transmission, composite signal transmission and television.

Described as an "Electro-optical Transmission System", the invention is said to be suitable for stereoscopic, multiple-channel or for color transmission where suitable filters or selective elements are used with a plurality of channels at both the transmitting and receiving stations.

Among twenty claims made, one states, "the method of signaling which comprises successively scanning for a given color a field of view having different tone values, producing from said scanning a composite electric signaling current having one or more groups of frequency components of large amplitude, separately generating a similar composite signaling current by successively scanning for another color the said field the frequency components of which substantially coincide in position with those of the first said composite electric signaling current and electrically shifting the frequency components of one of said signaling currents to fit its components into the frequency positions in between the components of the other of said signaling current."

The patent is dated July 8, 1930.

Damped Servo

A servomechanism that operates saturated without hunting is the subject of patent 2,654,999, "Controlled Damping Servomechanism" granted to Ralph I. Berge.

This servo turns on damping as a function of error magnitude and its rate of decay. Appreciable error removes damping and rate of dim-

Midland

leads again...this time in



COLOR



far in Advance

in the development of
Frequency Control Crystals
and Circuits for COLOR TELEVISION,
Midland is prepared NOW
to supply you in quantity with
Color TV Crystals to
your exact specifications...
and to counsel on all
matters concerned with this subject.

**SEE OUR EXHIBIT in Booth No. 143
Radio Engineering Show, March 22-25
Kingsbridge Armory, New York City.**

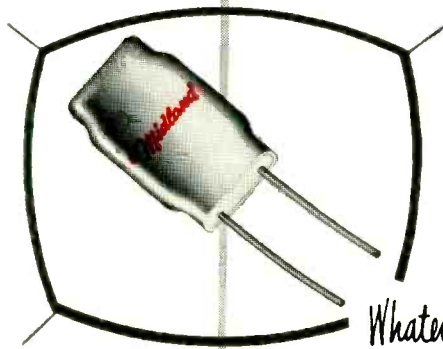

*Whatever your Crystal need, conventional or specialized
When it has to be exactly right, contact*



Midland

MANUFACTURING COMPANY, INC.
3155 Fiberglas Road, Kansas City, Kansas

WORLD'S LARGEST PRODUCER OF QUARTZ CRYSTALS

A.C. or D.C. Feedback with **DIEHL**

LOW INERTIA SERVOMOTORS AND INTEGRALLY-MOUNTED TACHOMETERS

Response and stabilization of *Positioning Systems* can be improved with the Diehl Servomotor and *A.C. Tachometer*.

Analog System integration is facilitated by the use of the Diehl Servomotor with *D.C. Tachometer* combination.

Save space... and eliminate coupling problems and backlash... with these integrally combined units, motor and generator on the same shaft.

Diehl 5-watt output, 2-phase, 115/115 volt, 60 cycle, 2-pole Low Inertia Servomotors are available with a drag-cup type A.C. generator or with a permanent magnet D.C. generator mounted on the Servomotor as an integral unit, as illustrated:

MOTOR WITH A.C. TACHOMETER—NO. S.S. FPE25-67-1

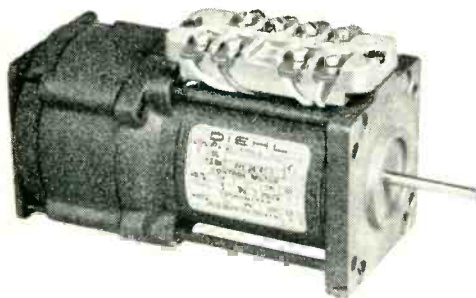

Stalled torque: 5.0 oz. in.
Rotor moment of inertia: 0.18 oz. in.²
Tachometer output: 6 volts/1000 R.P.M.

MOTOR WITH D.C. TACHOMETER—NO. S.S. FPE25-86-1

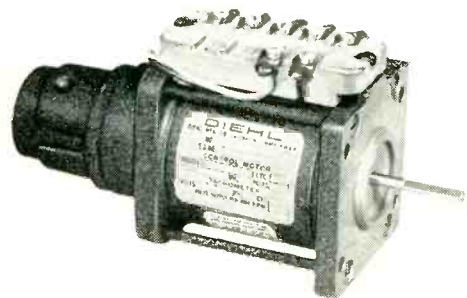

Stalled torque: 5.0 oz. in.
Rotor moment of inertia: 0.18 oz. in.²
Tachometer output: 6.5 volts/1000 R.P.M.

These units are also obtainable for 10 watts output. Both the 5 and 10 watt units can be supplied with control windings for operation directly from the plates of vacuum tubes, or for 400 cycle operation.

Our engineering staff will gladly help you select the units best suited to your specific requirements. A request on your letterhead will bring you a copy of Technical Manual No. EL-0354 describing Diehl Servomotors and related equipment.

Other Available Components:

D.C. SERVO SETS • RESOLVERS
MINIATURE PERMANENT MAGNET D.C. MOTORS
DIEHL MANUFACTURING COMPANY

Electrical Division of THE SINGER MANUFACTURING CO.
Finderne Plant, SOMERVILLE, N. J.

Atlanta Baltimore Boston Chicago Detroit New York Philadelphia Worcester



inition of error causes damping. A block diagram of the system is shown in Fig. 1.

A servo, to operate saturated, will have a torque reversal during transient recovery. To recover without overshoot and no hunting,

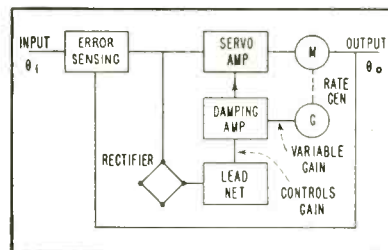

FIG. 1—Servo system damps with rate of diminishing error

torque reversal must occur at precisely the right point. Correct point for a simple second-order system without damping and making a discrete step can be shown. Reversal is fixed by error remaining E and error rate \dot{E} .

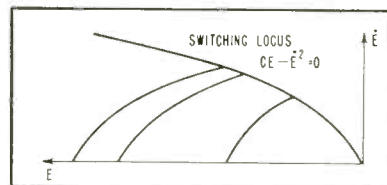

FIG. 2—Locus of points for torque reversals from various size steps

Kinetic energy of the system is $I\dot{E}^2$ and TE is the torque energy required to bring it to a halt. On the phase plane of Fig. 2, locus of points for torque reversals from various size steps form a curve.

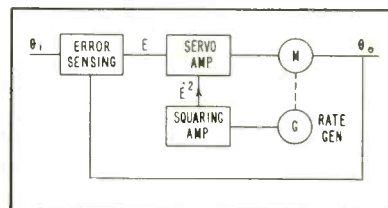
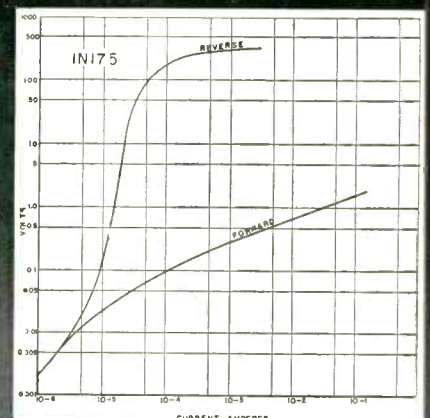
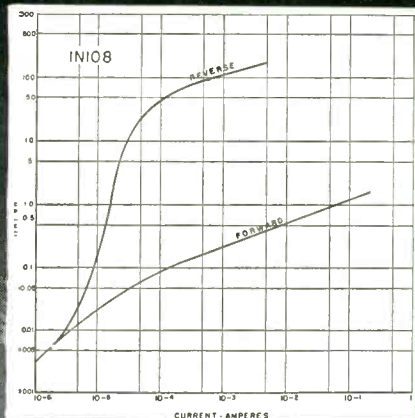
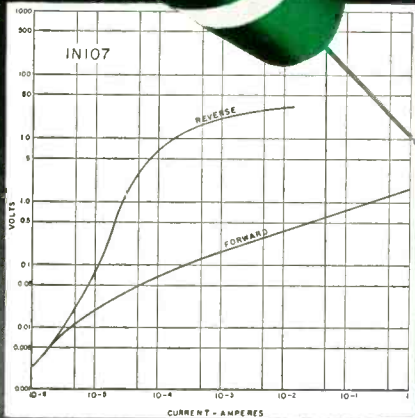

FIG. 3—High-gain saturating amplifier mixes input and output of squaring amplifier

Modifications for friction or other effects is not difficult. It is claimed that a high-gain, saturating amplifier can have E and E^2 mixed properly as input. Such a system is shown in Fig. 3. It takes signal E from the servo differential and E^2 from a rate generator and a squaring amplifier. If noise permits, \dot{E}^2 is differentiated from E .

temperature & low voltage characteristics

NU UNION DIODES



FORWARD & REVERSE CHARACTERISTICS OVER CURRENT & VOLTAGE RANGES

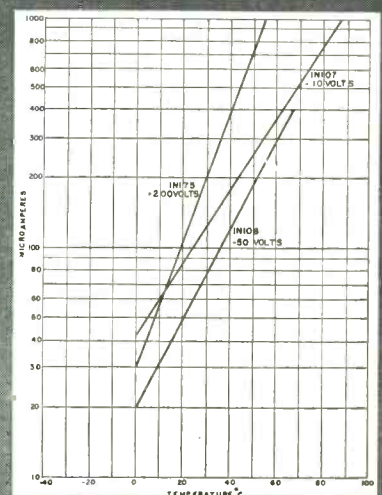
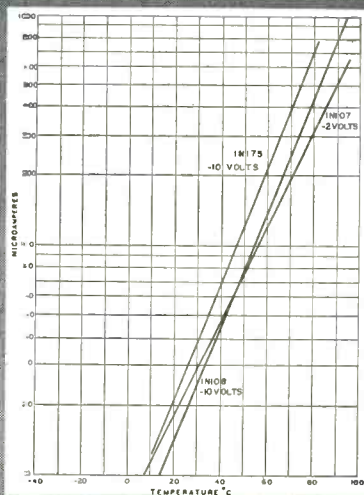
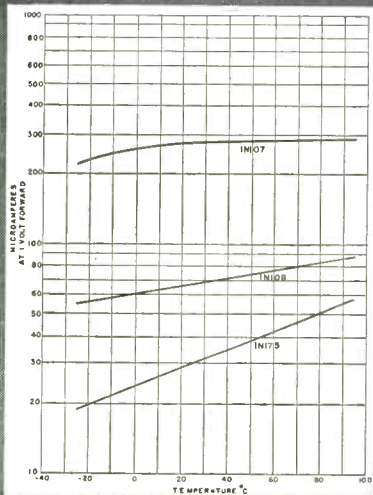

FORWARD & REVERSE CHARACTERISTICS UNDER TEMPERATURE CHANGES

ACTUAL SIZE



Your inquiries are invited on the many uses of Union Diodes exclusive with National Union. You will find that Union Diodes have characteristics particularly useful to the circuit designer interested in small signal and pulse applications. For example, the turn-on and turn-off time of the IN107 is equal or superior to most point-contact diodes.

The accompanying charts show the Union Diode's behavior with temperature variations. Also plotted, over wide ranges of voltage and current, are their forward and reverse characteristics.

Important to you is the fact that Union Diodes are produced by the electronics engineers who helped pioneer the original research and development leading to such devices.



NATIONAL UNION RADIO CORP.
HATBORO, PENNSYLVANIA

Production Techniques

Edited by JOHN MARKUS

Motorized Benchtop and Turntables Aid Job-Lot Assembly	262
Automatic Equipment Turns Over TV Consoles in Cartons.....	264
Vinyl Lacing Cord Reduces Harness Rejects	265
Mass-Production Lapping of Waveguide Flanges.....	267
Self-Adhesive Labels Cut Packaging Inventory	268
Captive Screwdriver for Self-Tapping Screws	270
Inserting Terminals in Tube Stem with Drill Press.....	274
Calibrating Frequency Meters.....	276
Notched Waveguides Speed Assembly of Flanges.....	278
Induction Fusing Techniques for Ceramic Terminals	280

Plastic Curtains for Tools.....	284
Automatic Spiralling of Precision Resistors	284
Resistor-Abrading Machine.....	290
Microprojector Checks Magnetron Alignment	292
Paper Clip Aids Magnetron Assembly.....	296
Shock Mounts Support Loudspeaker Cabinet	298
Continuity Tester for Etched I-F Coils.....	300
Winding VHF Coils.....	302
Adhesive-Clad Copper Cuts Printed Circuit Costs	308
Drying Copper-Clad Sheets.....	312
Winding Grids for Reliable Tubes.....	314
Envelope-Cutting Gage	318
Rubberized Hair Used for Packing TV Camera Tube.....	318

OTHER DEPARTMENTS

featured in this issue

	Page
Electrons At Work.....	196
New Products	322
Plants and People.....	412
New Books	480
Backtalk	502

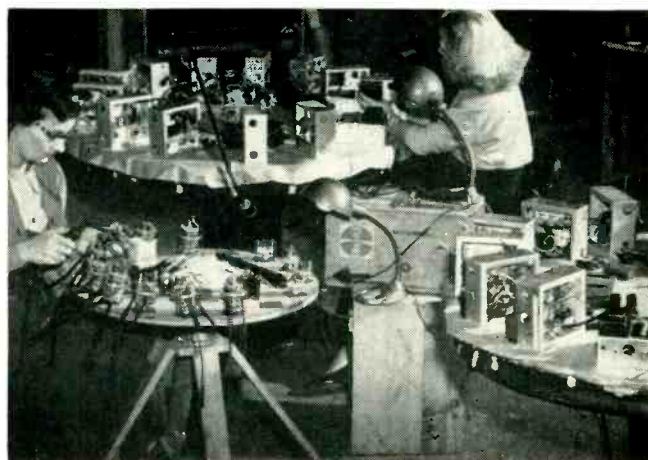

Motorized Benchtop and Turntables Aid Job-Lot Assembly

PRODUCTION of relatively small batches of test instruments, ranging from 10 to 25 identical units, is expedited by breaking down the assembly work into elementary operations, and allowing each operator to do each operation on each unit in turn. Turntables or motor-driven work tables facilitate bringing each unit in turn in front of the operator. The system is used for subassemblies as well as final assembly in the Schenectady, N. Y. plant of Millivac Instrument Corp.

Although each operator does the entire assembly work on a particular instrument, the time spent in preparing or understanding the next elementary operation is divided by the number of instruments on which she is working. She

repeats the same operation from 10 to 25 times, which gives a certain relaxation from the mental strain associated with transition from one step to the next. This gives maximum efficiency for job lot production and greatly reduces assembly errors.

Several different sizes of turntables are used. Most are mounted on roller bearings so they can easily be turned by hand. One 7-foot-diameter table, however, is driven by a small d-c motor controlled by a foot switch so the operator can initiate rotation of the table while picking up parts for the next instrument from the small rack or box alongside her.

On in-line assembly, a 30-foot steel bench frame runs the length

of one wall, with steel top rails on which runs a 15-foot train of 4 flattop cars, coupled to each other and driven by a reversible a-c motor which the operator controls by means of a foot switch. The effect is that of moving the entire workbench top back and forth past the operator as she adds the same part to each instrument in turn, just as is done when using turntables.

Initially, automatic stops and time relays were used to control the positioning of motor-driven benches and turntables. It was found, however, that these slowed up production because they had to be set at a slow enough rate to allow for minor production delays. Leaving the timing up to the op-

let 'er go, skip along,
stick with the "K" brand you know

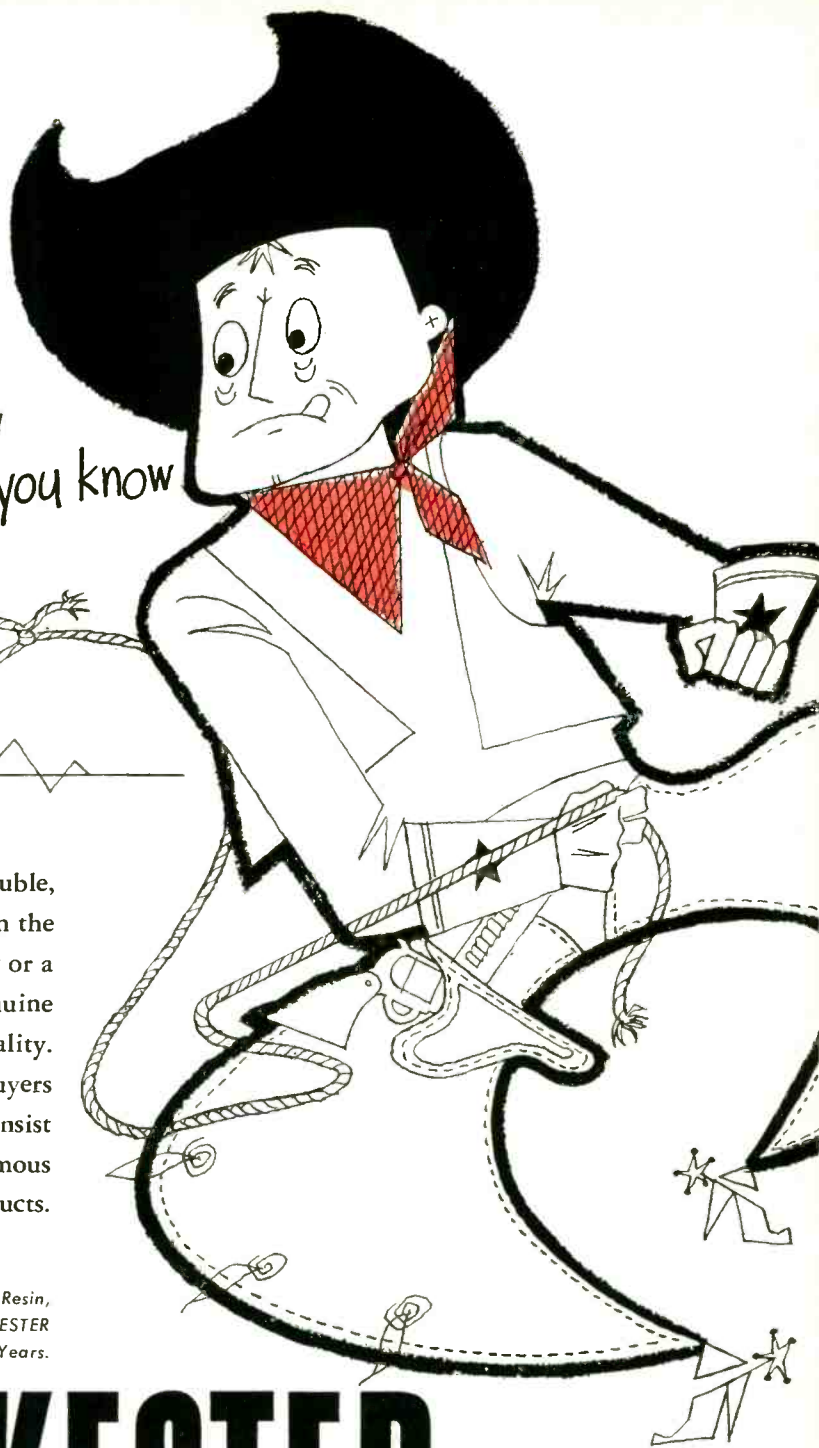
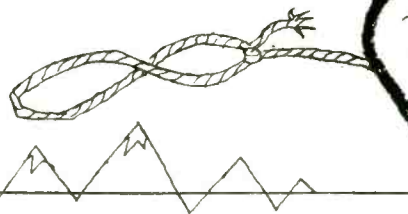

"Maverick" usually spells trouble, on the production line as well as out on the range. Being an unknown quantity or a "Johnny-come-lately," it leaves room for genuine doubt both as to performance and quality. And that's the reason so many experienced buyers — production experts to supervisors — insist on Kester . . . the one "brand" that is synonymous with the best solder and solder products.

Next time, choose one of these famous solder products: "44" Resin, "Resin-Five" and Plastic Rosin — all made only by KESTER . . . Key Name in Flux-Core Solder for More Than 50 Years.



KESTER

S O L D E R C O M P A N Y

4204 WRIGHTWOOD AVENUE, CHICAGO 39, ILLINOIS
NEWARK 5, NEW JERSEY • BRANTFORD, CANADA

erator resulted in greater output and operators welcomed the opportunity to control the mechanism. Errors in wiring are rare. When

they do occur, all units in a batch are generally miswired the same way and the trouble is easily corrected. With the conventional one-

unit-at-a-time assembly previously used, each defective unit had its own private mistake that was much more difficult to locate.

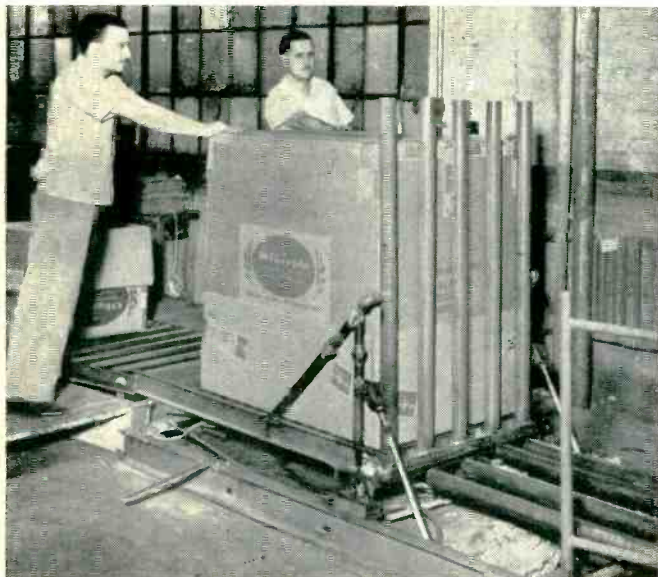

Pushing television receiver onto first turnover section of machine

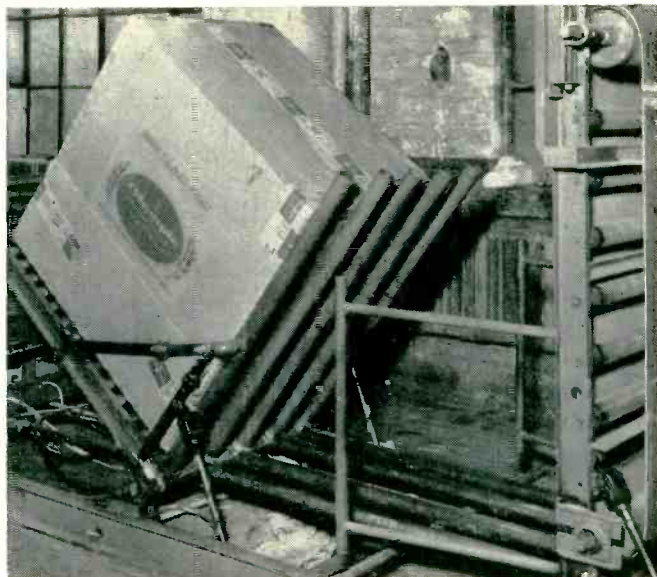

Method of tipping carton with receiver over on its side

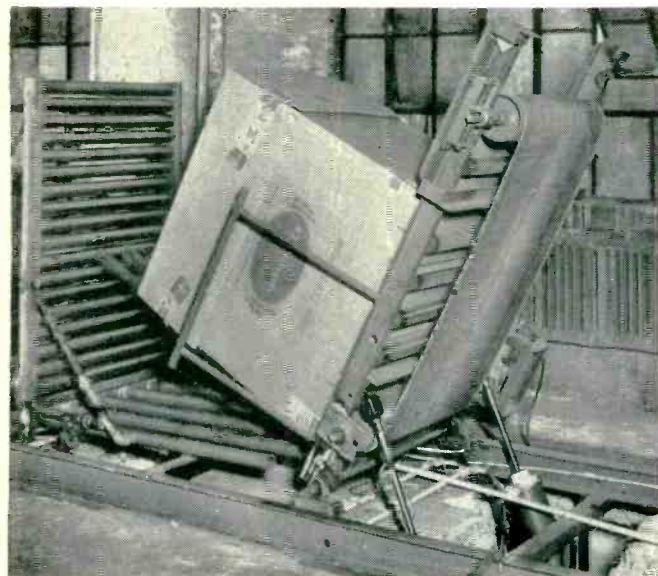

Picking up receiver with fork-like pipes of second section

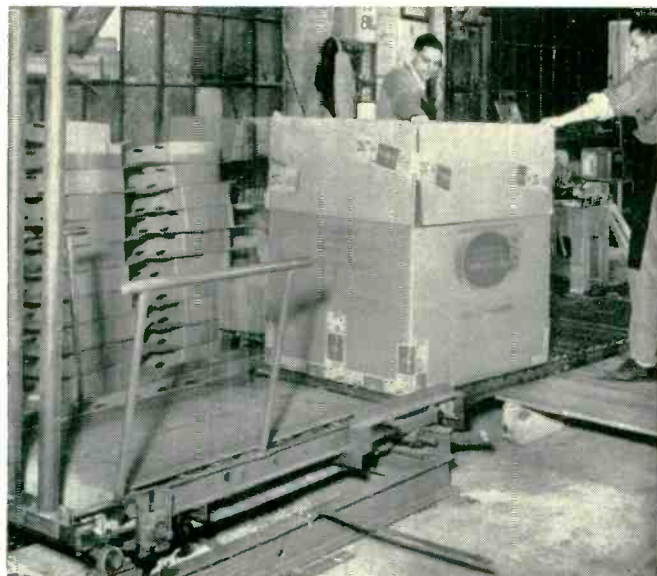

Motorized conveyor pushes upside down carton off machine

Automatic Equipment Turns Over Television Consoles in Cartons

A FLIP-FLOP machine built at a cost of \$3,500 is estimated to give annual savings of \$24,000 in connection with sealing the bottoms of television receiver cartons that may weigh as much as 350 pounds. The combination electric and pneumatic turnover machine was developed

and constructed in the Long Island City, N. Y. plant of Olympic Radio & Television Inc., under the supervision of Benno Bordiga.

The television receiver is brought into the cabinet department on a roller conveyor. The carton is pushed down over the top of the

cabinet in the conventional manner, with the bottom flaps open. Cabinet with carton are then rolled onto the first section of the turnover machine that is set into the conveyor line. Operation of an air valve rotates the carton 90 degrees so that the cabinet is lying on its side

Announcing...

POWERSTAT VARIABLE TRANSFORMERS

TYPE 136 and 236

TYPE 136



- **Higher Ratings** — to meet the demand for POWERSTATS with 20 ampere capacity.
- **Small Size** — “pancake” coil design provides a compact assembly for panel or bench mounting.
- **Easy, Versatile Installation** — 3 sets of mounting holes to suit all needs — simple to change from bench to panel mounting — binding post type terminals provide for any method of connection.
- **Smoother Operation** — self-lubricating nylon bearing shaft support — hand fitted knob.
- **Easy Service** — simply remove plate block for easy access to brush assembly.
- **Rhodium Plated Commutator** — assures smoother performance — longer life — contact surface forever free of oxides — uniform contact drop maintained — corrosion reduced — allows greater overload characteristics.

The complete line of POWERSTATS type 136 and 236 will be on display at the 1954 Radio Engineering Show to be held March 22-25 at the Kingsbridge Armory in New York. Visit The Superior Electric Company's exhibit in Booths 100, 101, 102, 103, 104.

SEE OTHER SIDE FOR MORE FACTS



A Complete Standard Line...

POWERSTATS type 136 and 236 are available in numerous models to meet the requirements of individual applications. Single and three phase assemblies are offered for manually-operated and motor-driven duty in 120, 240 and 480 volt ratings. There are types with exposed terminals, output receptacles, input cord-plugs, fused output — all the features desired for the ultimate in variable transformer design. Write for Bulletin P354.

TYPE 5M136

TYPE 136-2

TYPE 5M136-3

TYPE 5M136-2

TYPE 136-3



POWERSTATS type 136 and 236 are displayed in the Superior Electric's Mobile Display together with all the other products of The Superior Electric Company. See it when it visits your area.

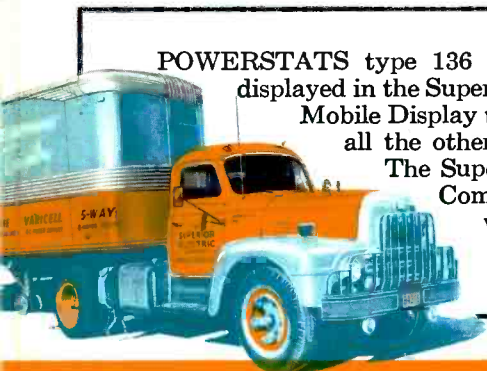

RATINGS — STANDARD POWERSTATS TYPE 136 AND 236

	LINE VOLTAGE	OUTPUT VOLTAGE	MAXIMUM OUTPUT AMPERES	FREQUENCY	TYPE CONNECTION	POWERSTAT TYPE
SINGLE PHASE	120	0-120/140	20	50/60	Exposed Terminals	136
	120	0-120/140	20	50/60	Enclosed Terminals, Fused	F136
	120	0-120/140	20	50/60	Two-Wire Parallel-Bladed Receptacle, Cord & Plug, Fused	2PF136
	120	0-120/140	20	50/60	Three-Wire Parallel-Bladed Receptacle, Cord & Plug Grounded, Fused	3PF136
	120	0-120/140	20	50/60	Two-Wire Twist-Lock Receptacle, Cord & Plug, Fused	2TF136
	120	0-120/140	20	50/60	Three-Wire Twist-Lock Receptacle, Cord & Plug Grounded, Fused	3TF136
	120	0-120/140	40	50/60	Exposed Terminals	136-2P
	120	0-280	9*	50/60	Exposed Terminals	236
	240	0-240/280	9	50/60	Exposed Terminals	236
	240	0-240/280	9	50/60	Enclosed Terminals, Fused	F236
	240	0-240/280	9	50/60	Two-Wire Parallel-Bladed Receptacle, Cord & Plug, Fused	2PF236
	240	0-240/280	9	50/60	Three-Wire Parallel-Bladed Receptacle, Cord & Plug Grounded, Fused	3PF236
	240	0-240/280	9	50/60	Two-Wire Twist-Lock Receptacle, Cord & Plug, Fused	2TF236
	240	0-240/280	9	50/60	Three-Wire Twist-Lock Receptacle, Cord & Plug Grounded, Fused	3TF236
	240	0-240/280	20	50/60	Exposed Terminals	136-2S
	240	0-560	9*	50/60	Exposed Terminals	236-2S
480	0-480/560	9	50/60	Exposed Terminals	236-2S	
THREE PHASE	120	0-120/140	20	50/60	Exposed Terminals	136-2D
	120	0-280	9*	50/60	Exposed Terminals	236-2D
	240	0-240/280	9	50/60	Exposed Terminals	236-2D
	240	0-480	20	50/60	Exposed Terminals	136-3Y
	240	0-560	20	60	Exposed Terminals	136-3Y
	240	0-560	9*	60	Exposed Terminals	236-3Y
	480	0-480	9	50/60	Exposed Terminals	236-3Y
	480	0-560	9	60	Exposed Terminals	236-3Y

*Output current rating applies only at output voltages less than 125% of line voltage. At higher output voltages, the allowable current drops off according to published curve.

on five parallel pipes that moved from vertical to horizontal.

Four interleaving pipes on the next turnover section of the machine now pick up the carton and turn it another 90 degrees onto a belt conveyor section driven by an electric motor. When the belt conveyor has reached its horizontal position the electric motor drive starts automatically and moves the upside down carton out onto the continuation of the roller conveyor. The bottom flaps of the carton are now sealed conventionally to complete the packing job.

The same turnover machine serves equally well for heavy table model receivers. These come down the line on wood boxes, so as to be at a convenient working height for packaging.

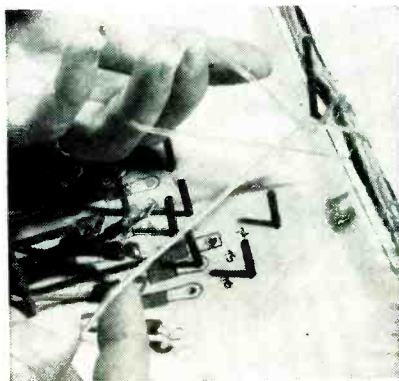

Vinyl Lacing Cord Reduces Harness Rejects

USE OF transparent vinyl plastic lacing cord for wiring harnesses is reported to be giving improved workmanship and fewer rejections in production operations at Packard-Bell Co. of Los Angeles and in other California electronic plants that have tried the new cord. The transparency of the material permits full inspection of the wiring system. Vinyl cord has high tensile strength yet remains sufficiently flexible to permit the wires to expand with heat; this prevents the lacing cord from cutting into the insulation and damaging or exposing the wires. The flexibility also permits removing and replacing one or more faulty wires without relacing the entire assembly.



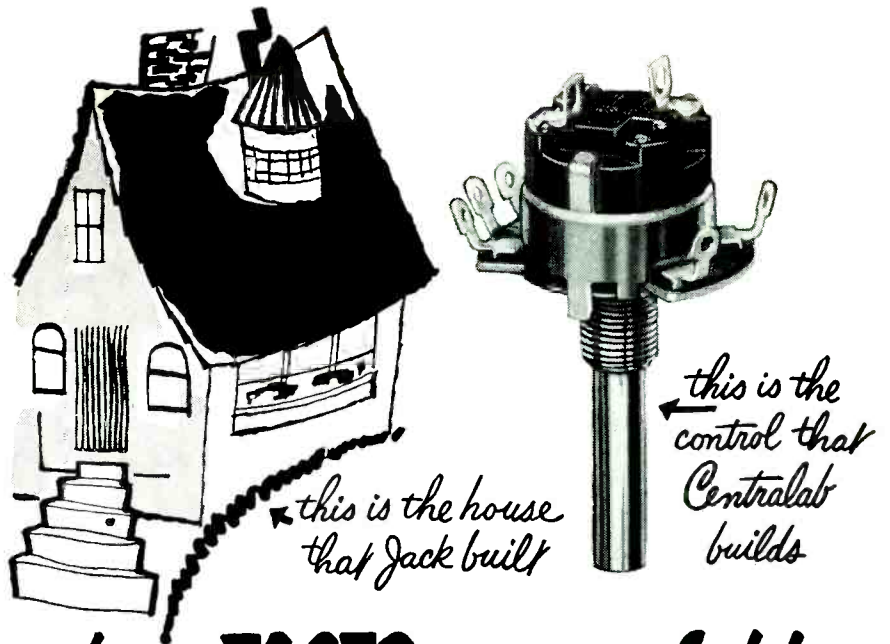











As made by Resin Industries, Santa Barbara, California the



but FACTS... not fable

make the Model 2 Radiohm® industry's finest control

here's how it goes together...

- SWITCH  ... COVER  ... STOP  it's positive. also provides superior switch shielding. Laminated phenolic SHOE  resists humidity. Double wiping CONTACT SPRING  for noiseless rotation.
- TERMINALS  ... velvet-smooth RESISTOR  available in 14 standard tapers. CENTER TERMINAL-COLLECTOR, specially treated for smooth take-off.  BASE  laminated phenolic for high humidity insulation. GROUND PLATE  ... BUSHING  accurately finished to close tolerances for smooth shaft rotation. RETAINING RING 
- ... SHAFT  available in round, flatted, slotted, split-knurl, and finger-tip knurl. ALL ASSEMBLED  the Model 2 is only 15/16" in diameter, rated at 1/2 watt.

VARIETIES AVAILABLE: single or twin, concentric shafts, plain or switch type, with or without taps; control and rotary tap switch combinations.

MANY SWITCH TYPES—Line switches rated 5 or 8 amps @ 125 volts a-c. Six switching combinations for real production flexibility.

NOW! Write for bulletins 42-164 and 42-157. Get all the facts and you'll specify Centralab.

Centralab

A Division of Globe-Union Inc.
914 E. Keefe Avenue • Milwaukee 1, Wisconsin
In Canada: 804 Mt. Pleasant Road, Toronto, Ontario

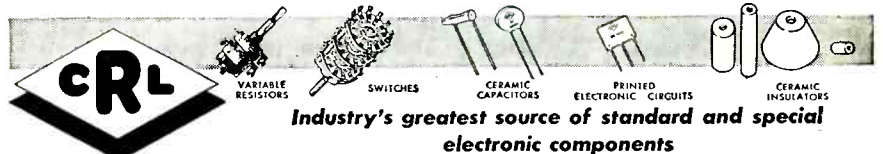

B-4

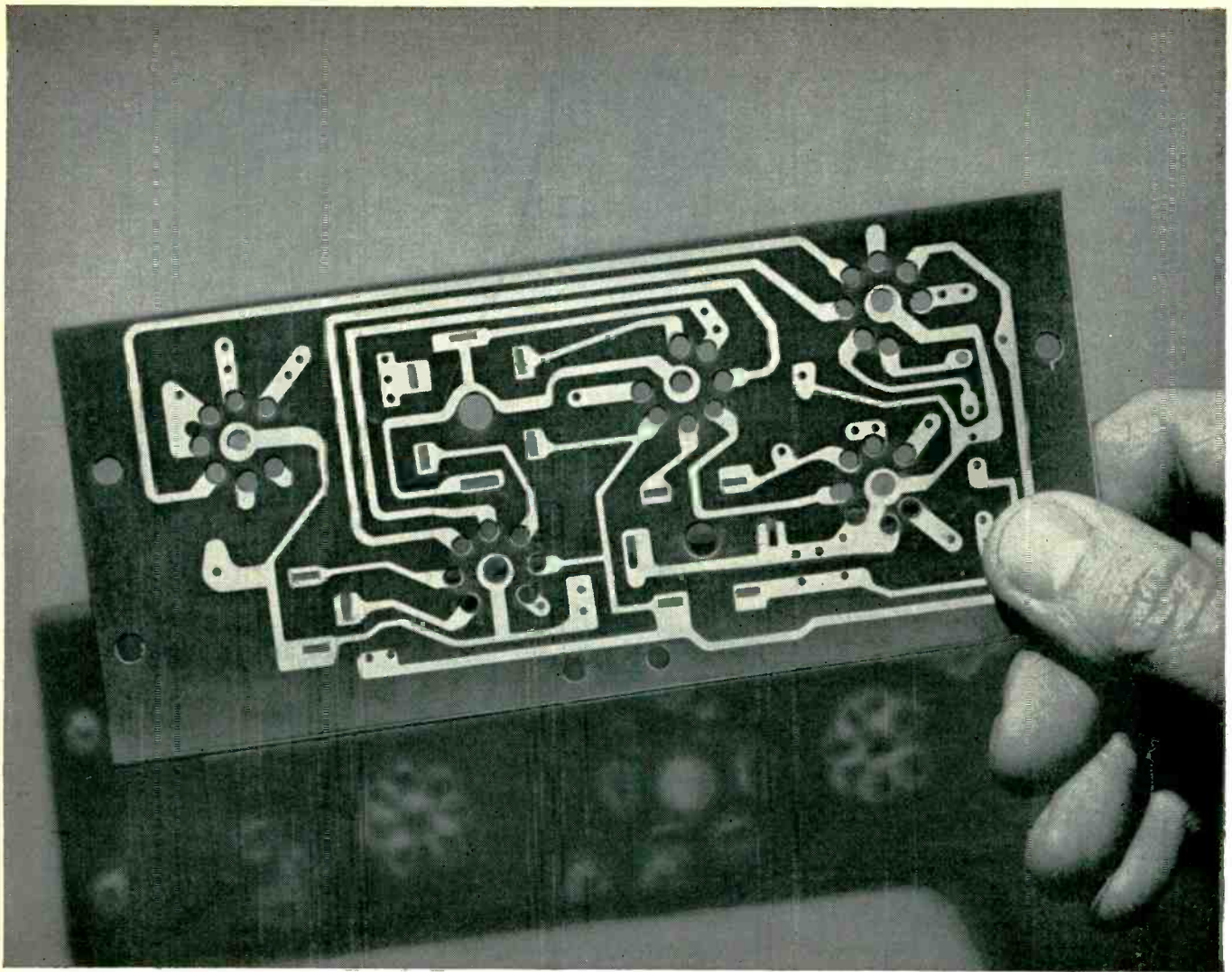

Pattern of things to come

IN ADDITION TO THE PROPERTIES ALREADY MENTIONED IN THE ADVERTISEMENT, SYNTHANE HAS



1. Impact strength. Synthane stands up in mechanical applications where jolts, jars and light shock loads are common. It does not splinter or break readily; will not delaminate.



2. Tensile strength. Synthane is strong in tension and compression.



3. Light weight. Synthane has approximately half the weight of aluminum.



4. Flexural strength. Synthane is suitable for jobs where deflexion, torsion and vibration are present. It has excellent fatigue resistance.



5. Stable Over Wide Temperature Range. Synthane is thermosetting; does not flow as temperature rises, has a low coefficient of thermal expansion.

Here is one of the brightest ideas in electronics—and one of the materials which helped make it possible. The idea is the printed circuit; the material is a laminated plastic called *Synthane*.

For years radio sets were put together by laboriously soldering a forest of wires to terminals. It was a time-consuming and expensive operation. If one connection proved faulty, the whole assembly had to be rechecked.

Then someone came up with the idea of *printing* the circuit with an acid-resisting ink on foil bonded to a base—and etching away the metal not needed. It would be quick, easy and error-proof—if the right base material could be found.

Among many tested, *Synthane* was one sheet material selected. Synthane

has the necessary strength, low moisture absorption, is an excellent insulator and can be punched easily. It bonds securely to metal foil and withstands the etching acid used to remove the excess metal.

The printed circuit is still in development—but it has zoomed into favor for radio, TV, hearing aids, and many other electronic devices. There are now a dozen ways to produce what are still called “printed” circuits. And *Synthane* is an accepted base material for every one of them.

Synthane laminated plastics are available in a variety of grades and colors—in sheets, rods, tubes, and fabricated parts. You are invited to write for information to *Synthane Corporation*, 12 River Road, Oaks, Pa.

SYNTHANE CORPORATION, OAKS, PA.

SYNTHANE
LAMINATED  PLASTICS

vinyl cords are available in a range of sizes and shapes and in either black or transparent. The transparent type in a round cross-section

is usually employed for harnesses. When made with Resinite EP-69, the cord is completely fungus-resistant.



Surfaces of directional couplers and various sizes of waveguides are finished on revolving lapping table. At left a 5-lb lead weight speeds lapping; smaller lead weights are banded onto the couplers (right rear) as counterbalances. A cut-out jig holds the couplers in position

Mass-Production Lapping of Waveguide Flanges

FINISHING of critical surfaces of electronic parts is facilitated by use of a revolving lapping table in the plant of Hewlett-Packard Co., Palo Alto, Calif.

Designed primarily for finishing waveguide flange surfaces, the table produces a slightly convex surface to provide a tighter joint. The 2-ft table has a concavity of about 0.002 in. across its diameter.

Small parts to be lapped are simply placed within one of the containing rings. On larger, odd-shaped pieces, lead weights are rubber-banded on to counterbalance the center of gravity, keeping the surface to be finished square against the lapping table. When more than one larger piece is placed within a single containing ring a cut-out jig is used to keep them from bumping against each other.

Lead weights also are used when feasible to speed the lapping opera-

tion. A single weight may be placed on a large flat piece; on smaller pieces a flat sponge is placed between them and the weight to distribute the load.

The table surface is of cast iron, which is porous enough to take the proper charge of abrasive. The circling rings constantly dress the surface of the table, which rotates at 4 rpm.

The abrasive, carborundum 250-grit suspended in oil, runs down to the table surface via a wire, by surface tension. At first the sediment clogged the valve of the tank that held the suspended abrasive. This problem was solved by installing revolving neoprene rubber paddles in the tank.

Radiating grooves in the table surface counter the tendency of the work to float on the oil; the groove edges force a cutting action.

Before installation of the table the lapping operation was done by

SYNTHANE

laminated plastics at work

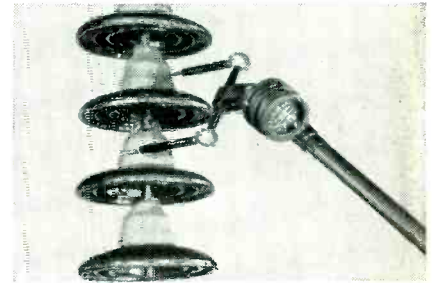

in electrical parts—High dielectric strength of Synthane combined with its light weight is used to advantage in producing high voltage and phase detection equipment.

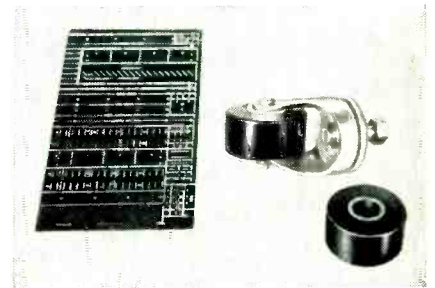

in business machines—Synthane is valued in the construction of business machines for its light weight, strength, dimensional stability, ease of machining and excellence as an insulator. (Left: plug board for electrically-operated business machine; right: caster wheels.)



in packings—The resistance of Synthane to lube oil, gasoline, moisture, corrosive gases and engine sludge—combined with wear resistance and machineability, makes Synthane desirable for packings of many types, like these by Garlock.

What's your PROBLEM?
MAIL COUPON FOR FREE FOLDER

SYNTHANE CORPORATION
12 River Road, Oaks, Pa.

Please send me your free folder describing advantages, properties, uses, and kinds of Synthane plastics.

My name _____
Title _____
Company _____
Address _____
City _____ Zone _____ State _____

For more ad information, see Index to Advertisers...

Amerac announces ! ! !

MODEL 229 WAVEMETER

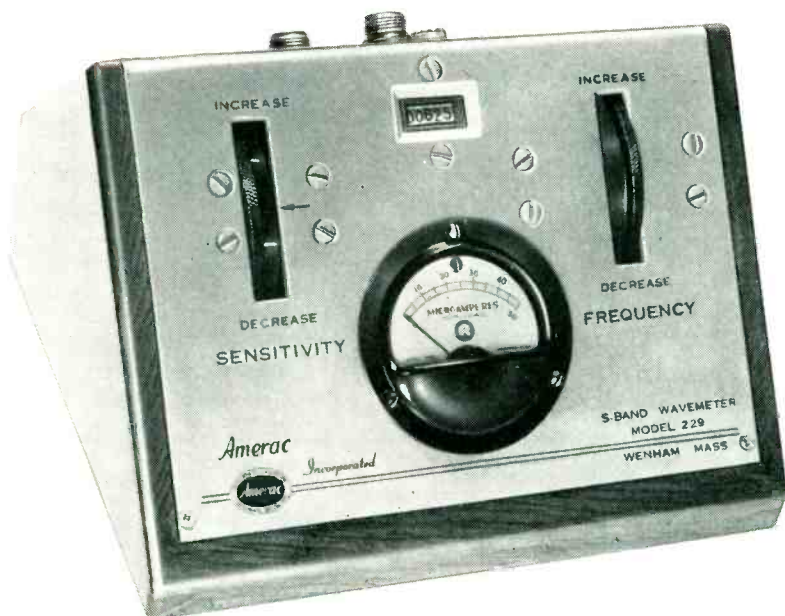

Amerac is pleased to announce our Model 229 S-Band Wavemeter, covering the frequency range of 2.3 to 4.5 KMC by either the transmission or absorption method with an external video output. Such features as the Frequency vs. Counter Reading Table, sloping panel, large diameter control knobs and small overall size (only 8" x 6½" x 5") contribute to an ease and accuracy of operation hitherto not found in such an instrument. Golden anodized aluminum panel fitted to the glossy walnut cabinet presents a pleasing appearance. The Model 229 is indeed a truly versatile wavemeter to be used over a range of frequencies not possible to cover with contemporary wavemeters.

Developing and manufacturing microwave test equipment has been Amerac's business since 1946. Today, as a result of the experience gained through these years, we can provide a wide variety of microwave test equipment featuring accuracy, ease of operation and fine appearance. In addition, Amerac will design and construct test equipment to suit your own specifications. Call on us for experience and equipment of highest calibre in the microwave test field.

Next month see our cavity oscillators utilizing the Sylvania 6BM6 & 6BL6 Klystron as well as the 2C37 & 2C37A UHF Planar Triode tubes.



Amerac Incorporated

116 TOPSFIELD ROAD
WENHAM, MASSACHUSETTS



Revolving lapping table gives slightly convex surface to waveguide flanges. Workman makes visual check on progress of finishing operation. Abrasive is suspended in oil in tank at right, and is fed to the table surface via a wire by surface tension

hand, a method that was unsatisfactory because it was slow and because it was impossible to achieve an absolutely flat surface.

H-P is now enlarging its lapping capacity by building a new table with twice the surface area, 3 ft in diameter.

Self-Adhesive Labels Cut Packaging Inventory

STORAGE space required to maintain an inventory of preprinted boxes for more than a hundred different automatic controls was cut in half by changing to plain boxes and identifying these with preprinted self-adhesive labels at the time they are used. This permitted stocking only a minimum number of basic box sizes in the plant of General Controls Co.

The self-adhesive labels, made by Avery Adhesive Label Corp., identify the product in the box, give specifications when necessary, and in some cases are coded by label color for quick visual identification as well.

The self-adhesive labels are fed automatically from an Avery elec-

Are any of these problems yours?

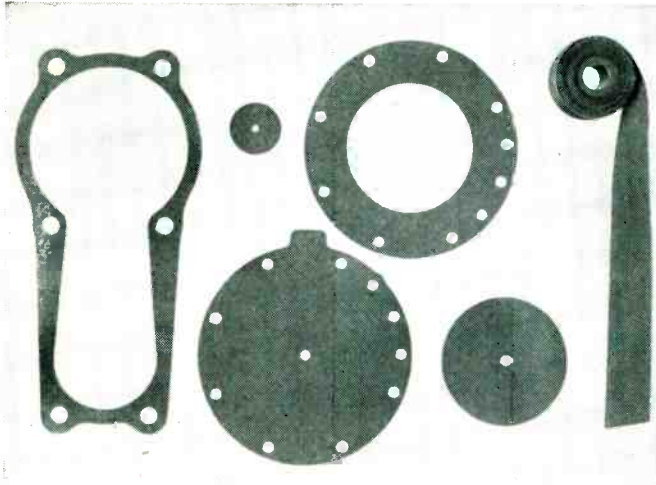

1. Need rubber-like properties for long periods of time under extreme temperatures? EMPIRE® Silicone Rubber Coated Glass Cloth (Class H insulation) is suitable for use over a temperature range of -70°F to 400°F . . . is resistant to thermal shock . . . will not crack, become brittle or deteriorate at high or low temperatures . . . offers good resistance to lubricating oils and most chemicals . . . has good dielectric strength and low power factor.

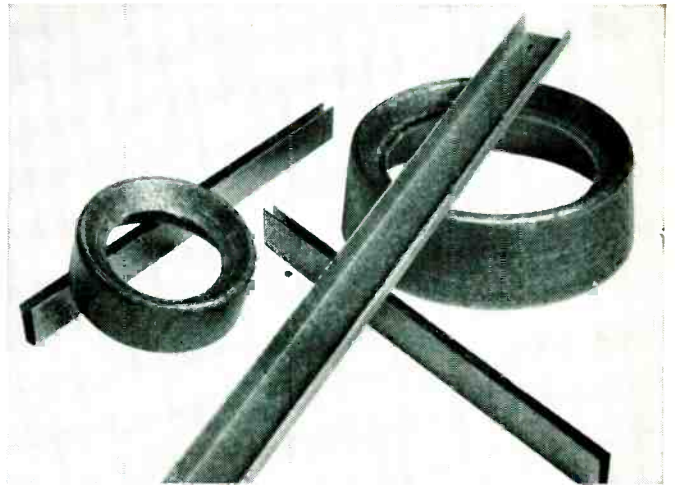

2. Looking for molding plate for Class H installations? Silicone molding plate for Class H applications which could not be produced successfully with regular built-up mica splittings can now be manufactured from ISOMICA® (built-up continuous mica sheets). ISOMICA silicone bonded molding plate has excellent moldability . . . excellent retention of shape . . . and an extremely high degree of homogeneity.

®Trade-mark

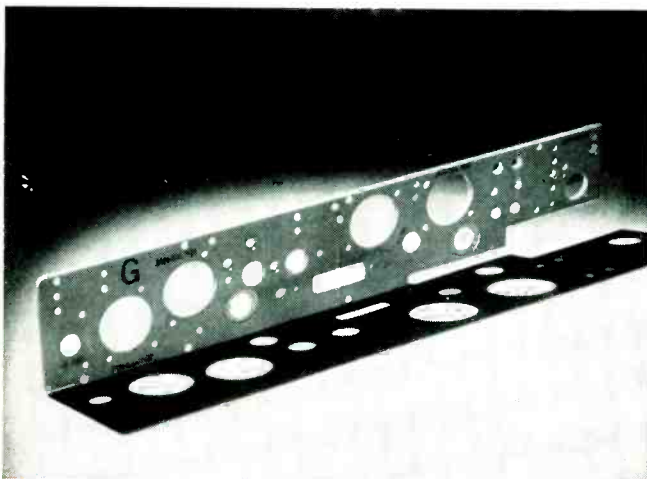

3. Looking for a versatile material with special mechanical, electrical and structural properties? LAMICOID®—a laminated plastic made with various fillers—is available in standard NEMA grades and others, with characteristics such as punching adaptability, heat and moisture resistance, tensile strength, impact strength, low loss factor, high dielectric strength, and properties "custom-made" to your specifications.



4. Want your signs, instrument panels, nameplates and dials to look better, last longer, be easier to install and maintain? DECORATIVE LAMICOID lends itself readily to marking by engraving, sandblasting, silk screen and rubber-plate printing, painting, filling or use of printed matter. Resists wear, aging, weathering, oils, corrosive vapors, moisture and temperature extremes. Wipes clean with a damp cloth.

Whatever electrical insulating materials you need, MICO makes them best. We manufacture all standard types and many special materials, or fabricate parts to your specifications. Send us your blueprints or problems today.



MICA *Insulator* **COMPANY**

Schenectady 1, New York

Offices in Principal Cities

LAMICOID® (Laminated Plastic) • MICANITE® (Built-up Mica) • EMPIRE® (Varnished Fabrics and Paper) • FABRICATED MICA • ISOMICA®

Only A "MULTI-CHANNEL" SCOPE

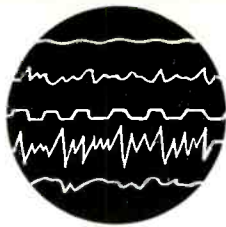

LETS YOU SEE, MEASURE, AND RECORD
Simul-Scopic* SIGNALS LIKE THESE

Take any two simultaneous events . . . the input and output of a circuit, speed and vibration, velocity and acceleration. To compare them you might rig up two ordinary scopes. But from there on in you've got double-trouble. You either get a stiff neck looking from one scope to the



THE STIFF-NECK STINT

other, or you diverge your eyes and let 'er rip.

If you don't happen to be gifted with double vision, you might turn



THE WIDE-EYED WATCH

to science's substitute—an optical system. Now the two traces of light are bounced from the c-r tube faces to a single viewing screen. If you are lucky enough to approach this delicate monstrosity without damaging it by breathing, you still might not find those elusive pips you're after. Somewhere along the long

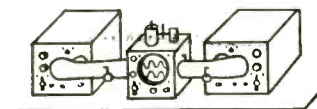

THE OPTICAL OPPRESSION

light path, your signals got all bounced out, maybe right out of the picture.

In case you're also not gifted with a high-frequency switching neck, you can always fall upon an electronic switch. With this built-in gadget, a single tube switches rapidly from one phenomenon to another for you. And the switching is so fast, that two traces appear on the face

of the tube. Although such traces are sometimes optimistically called "dual-trace", only the limitation of your own eyes keeps you from seeing them blink like a neon sign. And if the signal you're after should be faster than the switch, you've missed it. If it's a one-shot measurement, you've had it!



THE MISSED-SWITCH METHOD

These shortcomings become proportionately worse as the number of phenomena you wish to measure increases. An optical system gets bulkier losing more light at the same time, while an electronic switch leaves you less of a chance to catch those high speed transients.

Actually, it's not economical to consider either. Both approach or even exceed the cost of the only practical system—ETC multi-channel oscilloscopes. Through the combination of 2, 3, 4, 6, or even eight electron guns in a single ETC cathode ray tube, you can see all the necessary phenomena on a single screen . . . just as clearly, just as accurately, and just as completely as the presentation on a single channel

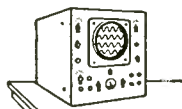

THE Simul-Scopic SYSTEM

scope. There is no other solution so easy to use, so comprehensive in its presentation, and so economically practical. Our new catalog, *Oscillography . . . Key to the Unknown* shows you many more reasons why ETC scopes and tubes are best for simultaneous display. Write for your copy.

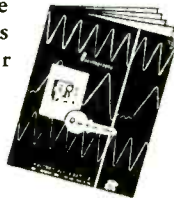

*Simul-Scopic—Two or more simultaneous events which can be observed on a cathode ray tube. (Reg. Applied For.)



electronic tube corporation

1200 E. MERMAID LANE, PHILADELPHIA, 18, PA.
Visit our Booth at the I.R.E. Show—241 Instruments Avenue.

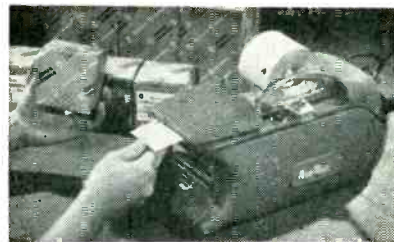

Method of labeling standard sizes of boxes on production lines as they are used. Foot switch is used for operating automatic dispenser

tric dispenser having a rheostat for speed control. A foot switch operates the dispenser, leaving both hands of the operator free for applying labels to packages. Each time the switch is tripped a new label pops out, ready for use without moistening.

The same labeling technique can be used for applying instruction labels and diagrams to electronic equipment.

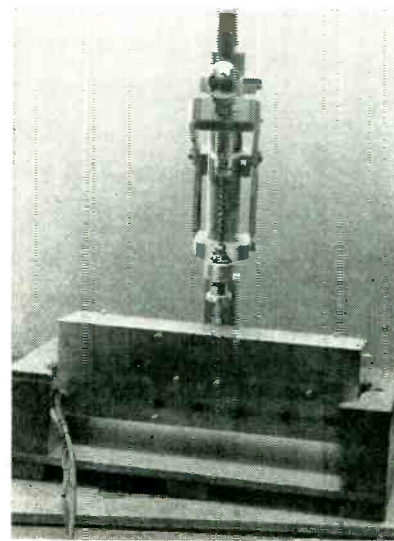

Captive Screwdriver for Self-Tapping Screws

DRIVING of Parker-Kalon self-tapping screws into housings and shields for electronic equipment is expedited by using a captive stand for a No. 135 Yankee spiral-ratchet screwdriver. Once the screw is in position in the hole, a single downward pull of a lever drives the screw home with precise vertical alignment, reducing burred or damaged screws and thereby cutting down rejects. This method of assembly, used in the television plant of E. K. Cole Ltd., Southend-

INTERNATIONAL RECTIFIER CORPORATION

EL SEGUNDO
CALIFORNIA

Selenium

Rectifiers

POWER RECTIFIERS

Widest range in the Industry
Power Factor 95%
Ratings to 250 KW
Efficiency to 87%

Write for
Bulletin
C-349

HIGH VOLTAGE RECTIFIER CARTRIDGE TYPE

Case Diameter: From 1/4" to 1 1/4"
Length: From 1/2" to 12"
Current, Half-wave: 1.5 ma to 60 mc.
Voltage, DC Output: 20 volts to
200,000 volts.

Write for Bulletin H-1

MINIATURE RECTIFIERS

Half-wave, Full wave and
Voltage Doubler Units.
Input Ratings from 25 to
195 volts AC.
DC Output Current from
65 ma to 200 ma.

Write for Bulletin ER-178



HIGH VOLTAGE CARTRIDGE TYPE

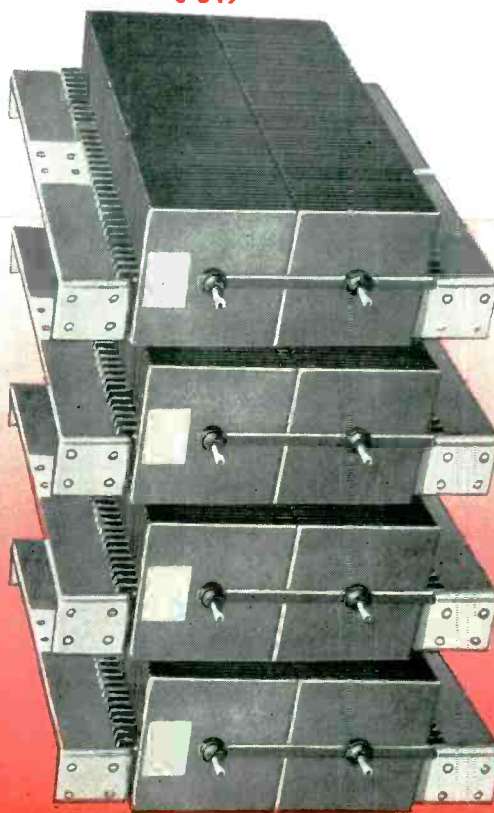

POWER RECTIFIERS



MINIATURE RECTIFIERS

I N T E R N A T I O N A L R E C T I F I E R
C O R P O R A T I O N

General Offices: 1521 E. Grand Ave., El Segundo, Calif. • Phone: Oregon 8-6281
Chicago Branch Office: 205 West Wacker Drive • Phone: Franklin 2-3889
New York Branch Office: 501 Madison Avenue • Phone: Plaza 5-8665



Speeding Electronic Progress

through

CRYSTAL RESEARCH

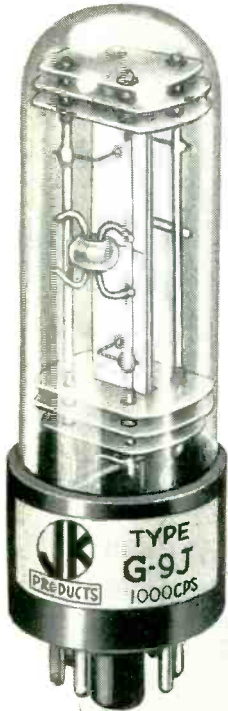

JK Stabilized G-9J Crystal
in the 1000 CPS to 10 kc range

Designing a New Product?

We can serve you best when you consult us at the beginning of your frequency control problems. An early consultation lets you integrate the newest JK developments and findings with your own product design research. Our extensive research facilities are here to serve you.

THE JAMES KNIGHTS COMPANY

Sandwich, Illinois

Visit us at
Booth 516
I.R.E. Convention

CRYSTAL HANDBOOK

A handbook of crystal theory and practice compiled by our research division as an industry service. Copies available at \$1 each.

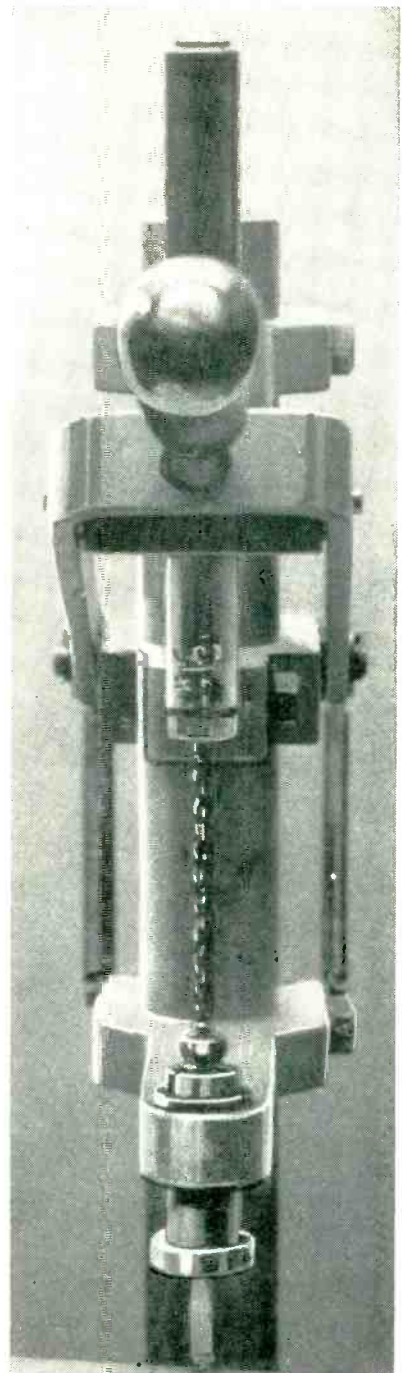

Details of screwdriver mounting

on-Sea, England, also saves time and gives operators increased confidence.

The chassis assemblies are supported in a wood positioning fixture that is easily moved along the workbench. The operator loads the holes with screws by hand, then moves the fixture so a screw is brought under the screwdriver bit. She then locates the bit in the screw slot with her fingers and drives in the screw by pulling down the hand lever. No care is necessary

TUNG-SOL®



exclusive design - completely shockproof

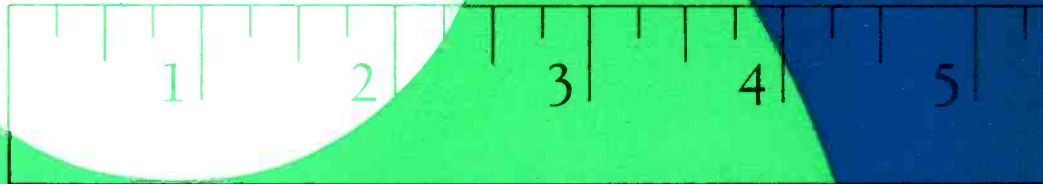
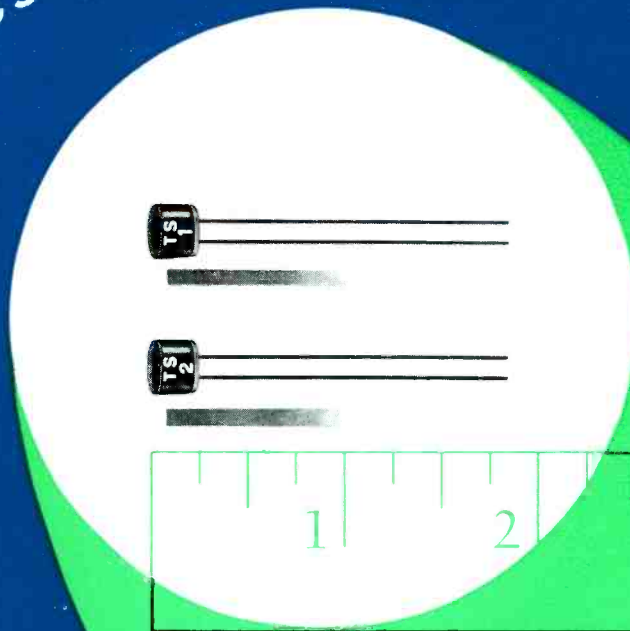

GERMANIUM DIODES

TS SERIES TYPE

see other side for additional information →

TUNG-SOL

TS SERIES TYPE

GERMANIUM DIODES

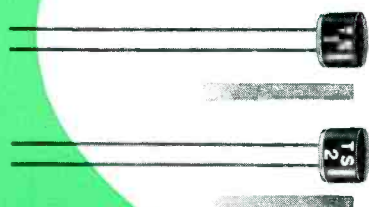

TS 1 — A 40 MC. VIDEO DETECTOR

TS 2 — A UHF MIXER DIODE

RUGGED

MOISTURE PROOF

NO FLAKING PROBLEM

SINGLE CRYSTAL CONSTRUCTION

UNAFFECTED BY COMMON ACIDS AND ALKALIS

LEAD WIRES TIED DIRECTLY TO ACTIVE ELEMENTS

Tung-Sol TS series diodes are assembled on a glass stem $1/4$ " long and $5/32$ " wide. Overall height is less than $3/16$ ". Lead wires are sealed into the glass stem. Moisture cannot penetrate along the leads even after the wire has been flexed many times. This feature is an especially important safeguard against humidity failure.

The "single ended" design of Tung-Sol Diodes permits visual inspection of the crystal and cat-whisker after assembly. Thus, accurate positioning of the whisker wire on the germanium surface is assured—not a matter of chance.

Single crystal germanium is used exclusively for all Tung-Sol Diodes. The wafer is soldered directly to the flattened top end of one lead wire. There is no plating—thus no flaking problem.

The S-shaped whisker is platinum-ruthenium wire, presently the most satisfactory whisker material. It is spot welded to the lead wire.

Both tinned lead wires are tied directly to the active diode elements. There are no intermediate connections—an important consideration for high frequency service.

The insulating case is nylon, selected for its excellent moisture resistant properties. The case is filled through its open top with a special epoxy resin which is equally moisture resistant and is mechanically stable. The resin is unaffected by all common acids and alkalis. This construction produces a completely shockproof diode.

All Tung-Sol Diodes are hot stamped with type number and a polarity bar to indicate the "cathode" or germanium connection. Legibility is permanent.

Tung-Sol Diode design meets all application requirements.

For more information about Tung-Sol TS series type Diodes, write to Commercial Engineering Dept.

TUNG-SOL

ELECTRON TUBES

TUNG-SOL ELECTRIC INC., Newark 4, New Jersey

Sales Offices: Atlanta, Chicago, Columbus, Culver City (Los Angeles), Dallas, Denver, Detroit, Newark, Seattle

TUNG-SOL makes All-Glass Sealed Beam Lamps, Miniature Lamps, Signal Flashers, Picture Tubes, Radio, TV and Special Purpose Electron Tubes and Semiconductor Products.

MARCH, 1954

*Completely
Self-contained
Miniature*

FREQUENCY STANDARD

WITH EXCEPTIONAL ACCURACY

A compact, complete, hermetically sealed frequency standard, presenting these features:—

1. JAN-ized construction throughout.
2. SPACE-**SAVING**, 1½" dia. x 4½" high.
3. **WEIGHT**, approximately 10 ounces.
4. **AVAILABLE** in 400 and 500 cycles.
5. **ACCURACY**—0.002% (15° to 35°C).
6. **SHOCK-MOUNTED** on Silicone rubber.
7. **POWER REQUIRED**, 6 V. at 300 ma.
70 to 200 V. at 1 to 5 ma.

WRITE FOR DESCRIPTIVE LITERATURE,
SPECIFYING "TYPE 2007"

Also, manufacturers of frequency standards, multi-frequency standards, chart-recording chronographs, firing-cycle timers, the Watch-Master Watch Rate Recorder and other high-precision frequency and timing instruments, controlled by our tuning-fork oscillators.

ACTUAL
SIZE



Engineers!
Gear this frequency standard to your designs and help solve climatic, space and weight problems in JAN-ized-MIL equipment

American Time Products, Inc.
580 Fifth Avenue
New York 36, N. Y.

MANUFACTURING UNDER PATENTS OF THE WESTERN ELECTRIC COMPANY

STANDARD

Radio Interference and Field Intensity

MEASURING EQUIPMENT

Complete Frequency Coverage—14kc to 1000 mc!

NM-10A



VLF

14kc to 250kc
Commercial Equivalent of AN/URM-6B.
Very low frequencies.

NM-20B



HF

150kc to 25mc
Commercial Equivalent of AN/PRM-1A.
Self-contained batteries. A.C. supply optional. Includes standard broadcast band, radio range, WWV, and communications frequencies.

NMA-5A



VHF

15mc to 400mc
Commercial Equivalent of TS-587/U.
Frequency range includes FM and TV Bands.

NM-50A



UHF

375mc to 1000mc
Commercial Equivalent of AN/URM-17.
Frequency range includes Citizens Band and UHF color TV Band.

These instruments comply with test equipment requirements of such radio interference specifications as MIL-I-6181, MIL-I-16910, PRO-MIL-STD-225, ASA G63.2, 16E4, AN-I-24a, AN-I-42, AN-I-27a, MIL-I-6722 and others.

STODDART AIRCRAFT RADIO Co., Inc.

6644-A Santa Monica Blvd., Hollywood 38, California • Hollywood 4-9294

to insure that the screws are driven in straight, since the driver is always precisely vertical. The lever is returned to the top of its stroke by a spring counterbalance.

With slippage minimized, it is possible to use the minimum size of hole and thereby obtain maximum thread bite.

Construction of the stand involved removing the standard handle from the screwdriver and replacing it with a bronze tube, the outside diameter of which forms the reciprocating bearing in the top bracket of the fixture. The rotating sleeve of the driver is held in the bottom bracket by a bushing that permits sufficient downward movement to force the screws home and at the same time permits free rotation.

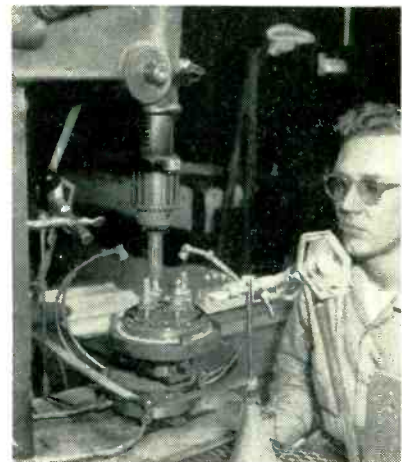

Inserting Terminals in Tube Stem with Drill Press

HEAVY COPPER terminal pins for type 880 power tubes are fused into the glass stem in precisely the correct positions with the aid of a drill press that has been modified for the purpose in the Hicksville, N. Y. plant of Amperex Electronic Corp.

One modification involves adding to the drill press table a lever arrangement that permits moving the glass stem mounted on the table up and down, for working the glass during the terminal fusing operation. The stem mount rotates at the same speed as the drill chuck, to give uniform heating of all sides of a terminal during sealing.

One foot pedal controls gas flow to the torches. A wood cam ar-

Want to punch something?



THEN LOOK at these parts . . . all punched from Taylor Vulcanized Fibre or Laminated Plastics. They are typical of the wide variety of shapes and sizes that can be economically produced to close tolerances.

When you use Taylor Vulcanized Fibre and Laminates for your punched parts, you have a wide range of physical, electrical and mechanical properties to choose from. Vulcanized fibre can be furnished in sheets, rolls and rods . . . laminated plastics in sheets, tubes and rods. A variety of colors and finishes is available.

For switch insulation, brush holders, arc barriers, refrigerator latch gaskets, shielding, relay covers, armature slot insulation, luggage reinforcing strips, and washers . . . just to name a few applications . . . be sure and investigate the advantages of Taylor materials for making punched parts.

A Taylor Engineer will be glad to help you pick the grade of Vulcanized Fibre or Phenol, Melamine or Silicone Laminated Plastics that are best suited to your particular requirements.

Taylor Fibre Co., Norristown, Pennsylvania—La Verne, California.

TAYLOR
Laminated Plastics
Vulcanized Fibre

where frequent opening and closing are required...specify



FASTENERS



TIGHTER

QUICKER

MORE ECONOMICAL

On panels, doors or covers, Camloc Fasteners provide security against opening due to vibration. Originally developed for use in aircraft, Camloc Fasteners have since been adopted by other industries because the basic design offers many advantages. Camloc opens or closes with a quarter turn of the stud, yet the combination of cam, spring and detent provides a uniform locking torque that grips firmly, positively and durably. Camloc Fasteners are easily installed because the cross pin is an integral part of the stud and the stud is quickly inserted with pliers. After installation, when the panel is removed or opened, the stud remains attached to the outer panel so that no part can possibly be lost. Our engineers can help you make the most effective use of Camloc Fasteners, by suggesting the most efficient assembly methods and by determining the minimum number of fasteners required to perform a given job. Your inquiry will receive our prompt attention.

Write for our illustrated brochure containing descriptive information on the basic Camloc fastener line. Address your request to 75 Spring Valley Road, Paramus, N. J.

VIBRATION-PROOF

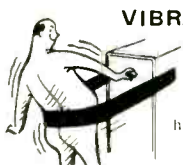

In years of constant use in aircraft—where vibration is always a bugaboo—CAMLOC Fasteners have proven themselves again and again.

POSITIVE LOCKING



Spring loading plus cam action, with a cross pin that can't come out, guarantee CAMLOC Fasteners against accidental opening.

OPEN & CLOSE QUICKLY

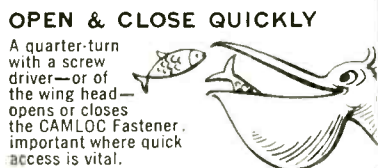

A quarter-turn with a screw driver—or of the wing head—opens or closes the CAMLOC Fastener. important where quick access is vital.

SAVE MONEY 3 WAYS

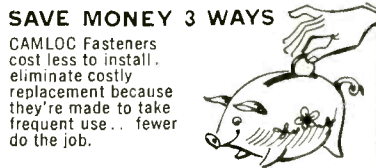

CAMLOC Fasteners cost less to install, eliminate costly replacement because they're made to take frequent use... fewer do the job.

CAMLOC FASTENER CORPORATION

MAIN OFFICE AND FACTORY
PARAMUS, N. J.

WEST COAST OFFICE
5410 WILSHIRE BOULEVARD
LOS ANGELES 36, CALIF.

See us at Booth 880 Radio Engineering Show

range driven by the drill press motor and mounted alongside the press serves to move the torches in and out through metal linkages to give the desired heating pattern. A second foot pedal controls an air valve used to blow out a hole in the center of the stem, for sealing in the vacuum tubulation which is held in the drill press chuck for this purpose after the terminals have been sealed in. A gasket mounting for the stem provides a seal sufficiently tight for this blowing-out operation.

Final positioning of terminal height is precisely controlled by the stop which limits the downward movement of the standard Jacobs chuck on the drill press.

Calibrating Frequency Meters

MICROMETER-DRIVEN frequency meters are calibrated five or more at a time by insertion in a run of waveguide energized by a variable-frequency klystron oscillator, in a production setup employed at Polytechnic Research & Development Co., Inc., Brooklyn, New York.

The calibration frequency is indicated by an audio-frequency marker which is the result of beating a crystal-controlled heterodyne oscillator with the output of a frequency-modulated type 2K25 klystron. The exact klystron frequency is easily determined with a PRD type 554 precision frequency meter which is also in the run of waveguide.

An oscilloscope pattern of power



Operator is here adjusting micrometer of one of the five frequency meters being calibrated simultaneously

Ground-testing electronic equipment keeps 'em safe in the sky

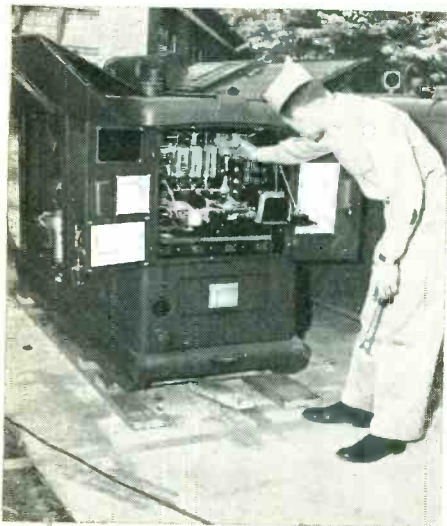

To insure reliable flight performance, electronic equipment—radio, radar and navigational devices—is tested on the ground with power supplied by Regohm-controlled generators.

Engineers of The Hobart Brothers Company, Troy, Ohio, use Regohm regulators for their alternating current ground units. Because this low-cost, compact electro-mechanical controller is unequalled in accuracy. And under severe operating conditions, whether on land, sea or air, Regohm has performed long and unflinchingly.

7 Reasons why Regohm can simplify your control problem

1. **Regohm is small in size**—It is compact, lightweight, position-free. Small size does not limit power-handling capacity.
2. **Regohm is a high-gain power amplifier**—Milliwatt variations in signal energy control energy changes millions of times greater.
3. **Regohm's isolated signal and control circuits end impedance matching problems**—Signal coils may have ratings from 0.01 to 350 amperes. Controlled resistors can have values from zero to infinity.
4. **Regohm will correct system instability**—A reliable, sturdy dashpot aids system damping. It's easily adjusted over a wide range to match dynamic Regohm characteristics to present system.
5. **Regohm's effect can be calculated in advance**—Its response is independent of rest of servo system. Acts as integrating error-rate proportional controller.
6. **Regohm assures continuous control**—In "closed loop" systems a high speed averaging effect occurs as Regohm's armature oscillates over a small amplitude. This provides continuous, stepless control in systems operating at power frequencies and below.
7. **Regohm has long life**—Its life is measured in years. Its plug-in feature simplifies replacement and maintenance; there are no parts to renew or lubricate. Shelf life is virtually unlimited.

Our engineering and research facilities can help you apply Regohm to your control system or regulation problem. Write for Bulletin 505.00, analyzing Regohm's characteristics and applications. Address Dept. E., Electric Regulator Corp., Norwalk, Conn.

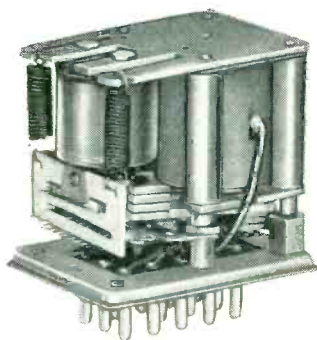

REGOHM



CONTROL COMPONENT IN: Servo systems • battery chargers • airborne controls • portable and stationary generators • marine radar • inverters • locomotive braking systems • mobile telephones • guided missiles • signal and alarm systems • telephone central station equipment • magnetic clutches • railroad communication systems • magnet amplifiers.

output vs frequency is obtained by applying a sawtooth sweep to the klystron reflector voltage. When the marker is visually aligned with the minimum-power point of the dip produced at resonance by one of the frequency meters under calibration, its micrometer setting becomes one point on its calibration curve.

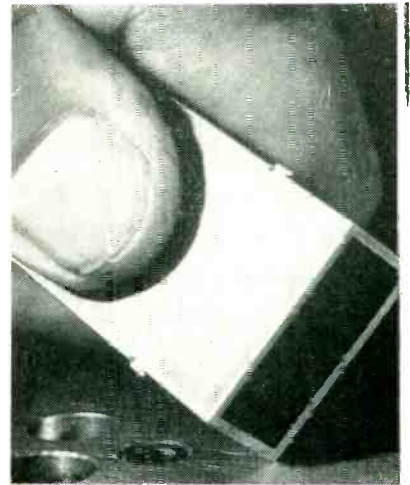

Notched Waveguides Speed Assembly of Flanges

FITTING FLANGES to waveguides is simplified at the Hewlett-Packard Co. plant in Palo Alto, Calif., by forming notches or ears in the guide with a hand-operated arbor press. When the two sections are assembled on an induction heater for brazing, the four ears rest on the ring of the flange, holding the

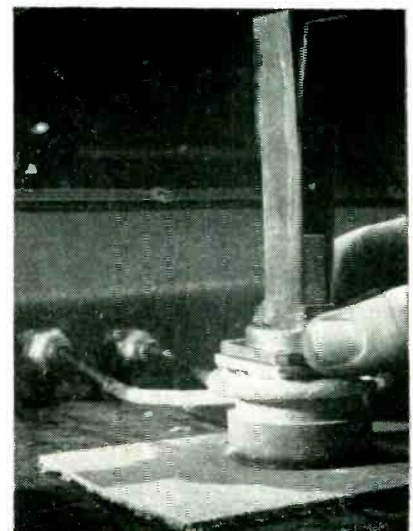

Assembling wave guide and flange on induction brazing fixture

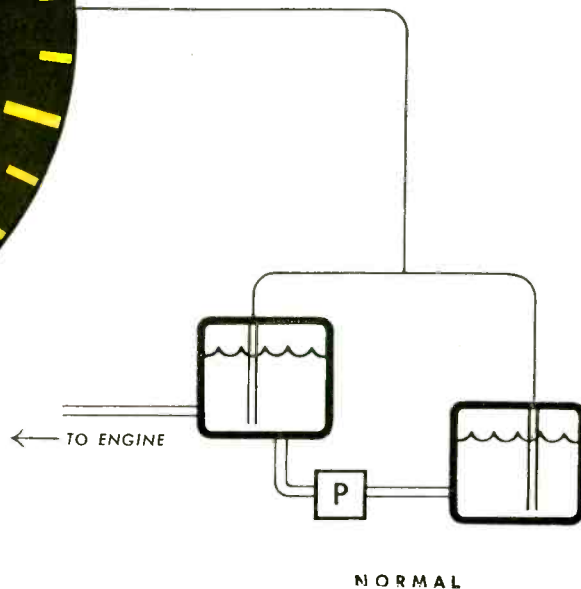

Have you heard about AVIEN'S "LIE DETECTOR"?

In a certain new Douglas airplane the pilot flies over 750 miles an hour. He must know at a glance how much fuel he has. But if the gage merely showed total fuel, it could "lie." This Avien system registers only *engine - available* fuel.

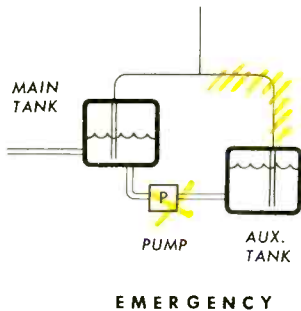

Thus, if the auxiliary tank stops feeding the main tank, the useless contents are automatically dropped from the indicator total.

Avien has built this "lie detecting" function into its Two-Unit Fuel Gage by the simple addition of a level switch—as an *integral part of the Fuel Gage tank unit*. Note that this added function has been accomplished without added components.

Avien has solved such problems for more than 50 different types of aircraft. Essentially, Avien "tailor-makes" each gaging system to meet specific needs, with the same care and skill that went into the original design of the now widely used line of Avien gages.

Maintenance and installation are simplified to "plug-in, plug-out." Precalibration eliminates the cost and risks of field calibration.

Every month, over ten thousand major instrument components for the aviation industry are being produced by Avien.

If you have a gaging problem — fuel, temperature, thrust or otherwise — call on us.



ENGINEERING IN DEPTH

Avien

58 15 NORTHERN BLVD., WOODSIDE 77, N.Y.
AIRCRAFT AND INDUSTRIAL INSTRUMENTATION

the solution to your SPRING PROBLEMS is in our Files

Our files are literally bulging with the solutions to tough spring problems. Chances are, the exact solution to your particular problem is among them. If it isn't, you can be sure our experienced Spring Engineers will arrive at it in short order. Over the years they've turned their hand to the solution of some classic toughies. And over the years, Lewis' facilities, experience and reputation have combined to provide you with a dependable source for the exact spring for the job at the lowest possible cost.

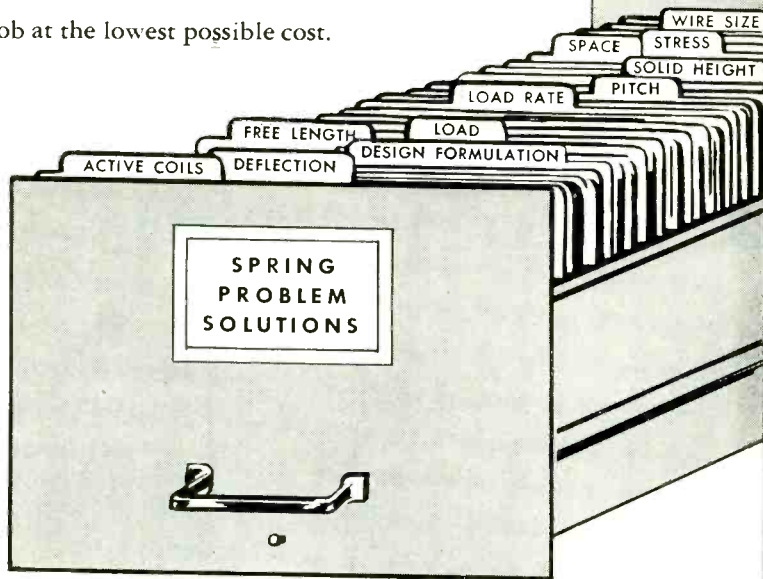

Looking for the solution to a spring problem? Send us drawings, specifications or samples today. No obligation, of course.

LEWIS SPRING & MANUFACTURING CO.
2656 W. NORTH AVE. CHICAGO 47, ILL.

Lewis  **PRECISION
SPRINGS**

The Finest Light Springs and Wireforms of Every Type and Material

vertical member precisely in position. The notches, one on each corner, are produced by four pieces of tool steel within an ear die. Depth of the notch is half the thickness of the waveguide wall.



Operators fill Transite trays with terminal assemblies and place the trays on the conveyor belt for automatic transport through the induction furnace

Induction Fusing Techniques for Ceramic Terminals

TERMINAL parts, including a ceramic preform, a metal body and a rod or tube are fused together by means of specially designed holding fixtures, a conveyor belt system and an induction furnace in the Palo Alto, Calif. plant of Bennett Products Co.

The terminal-holding fixture consists of stainless-steel machined jigs which are mounted on Transite material trays. The jigs are designed to hold the terminal component parts in an exact position during the fusing period, to permit easy extraction of terminals and to withstand repeated usage. The trays are designed with one corner of each end rounded. This particular design permits a column of fixtures to follow around a 90-degree rounded track from the main assembly line onto the induction-furnace belt.

The conveyor-belt system can be adjusted for various speeds to correspond with temperature require-



FILTER ENGINEERING LABORATORY

**NOISE PROBLEMS
SOLVED INSIDE**

Let ASTRON'S Filter Engineering Laboratory analyze your noise suppression problems. We will recommend the proper RF interference filter for your specific needs, or we will *design and produce* a special unit meeting your most exacting electrical and mechanical requirements.

You benefit from ASTRON'S well-earned reputation as the leading manufacturer of quality filters. Employing the finest materials and components, Astron has developed the most modern manufacturing methods which insure production of the right filter for the job and faultless performance.

ASTRON has perfected new techniques of filter miniaturization by using miniature capacitor elements, subminiature metallized paper capacitors, the latest type inductance materials—resulting in high impedance, low voltage drop and minimum heating.

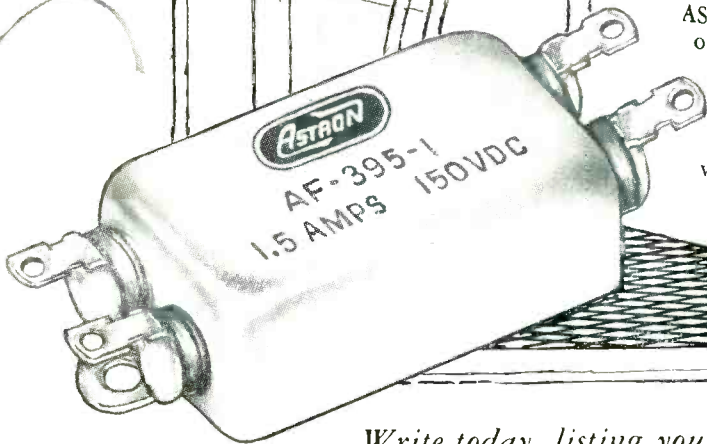

Write today, listing your requirements, to Department E

DEPEND ON . . . INSIST ON

ASTRON CORPORATION

255 Grant Avenue, E. Newark, N. J.

Visit the
ASTRON EXHIBIT
Booth 368
I.R.E.

Radio Engineering Show
March 22-25

Manufacturers of a complete line of capacitors, standard and subminiature filters for every television, radio and electronic application.

Export Division: Rocke International Corp., 13 East 40 St., New York, N. Y. In Canada: Charles W. Pointon, 6 Alcona Ave., Toronto 10, Ontario

TANTALUM CAPACITORS

Not
New...
JUST
BETTER



- Greater Stability
- High-Capacity Rating
- Wider Temperature Range
- Less Space per Mfd.
- Longer Shelf Life

Fansteel

TANTALUM CAPACITORS

Electrically proven in every way, and over a twenty year period, there's really nothing "new" about tantalum capacitors except in the significantly increased demand for them, and the continually expanding list of their applications.

Incorporating a porous tantalum anode assembly, tantalum capacitors derive their unusual stability from the characteristics inherent in tantalum itself—the most stable of all anodic film forming metals. It has been observed consistently that no important changes of characteristics occur in long periods of operation; there is no shelf aging. Large capacity in extremely small size is also an important advantage.

The growing demand for Tantalum Capacitors is being adequately met by Fansteel and other leading manufacturers. Write for current technical bulletins.

NEW...
Power Factor Slide Rule
All plastic, 8" circular rule gives power factor of capacitors from 0.06 to 10,000 mfd., at a glance.



Send a dollar bill with your letterhead to cover partial cost of rule, postage and handling. No C.G.D.s or charges, please.

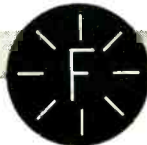

FANSTEEL METALLURGICAL CORPORATION

NORTH CHICAGO, ILLINOIS, U. S. A.

Tantalum Capacitors... Dependable Since 1930

32504C

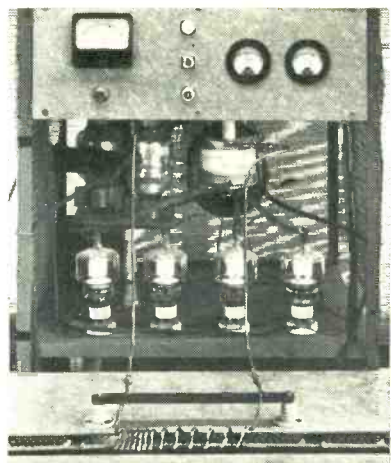

Induction furnace setup used for fusing ceramic to metal in terminals moving through work coil in foreground. Trays of terminals travel from right to left. Wider spacing of turns at right gives preheating before fusing

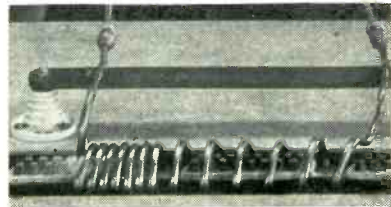

Details of work coil. Terminals on tray emerging at left are still white-hot!

ments for various types of terminals. The part shown requires a belt speed of 13 inches per minute, which results in a daily production of 20,000 terminals during an 8-hour shift.

The special belting material required for the induction furnace is a 1½-inch 4-ply Main ABC Hotstuff belt. The ends of the belt are laced together with fiberglass material and treated with a special silicone heat-resistant varnish.

As the assembled parts flow from the main assembly line onto the induction belt and through the induction-furnace coiled tubing, the ceramic preform is fused to the low-carbon-steel grommet and tubes of the terminal. The stainless-steel jigs heat to 1,500 F and radiate heat to the terminal parts, thereby fusing the ceramic.

The shielded induction unit is designed primarily as a 5-kw r-f generator, using four 304TL tubes in the output with an induction coil attached in parallel with the oscillator coil by means of laminated copper strips.

The special design of the work

THE *NEW* MILLER D-C AMPLIFIER

featuring

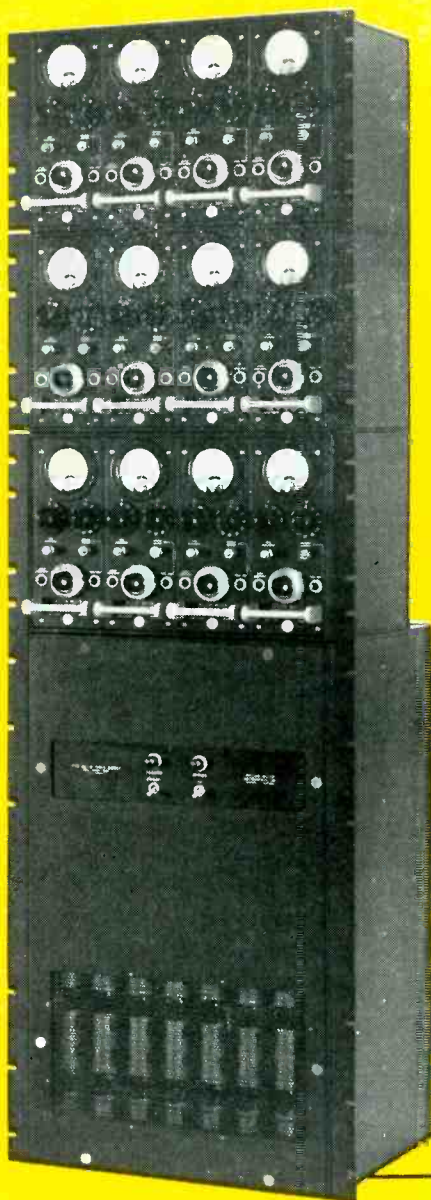

- High Input Impedance
- Wide Band Width
- High Gain—Feedback Stabilized
- Low Drift—Chopper Stabilized

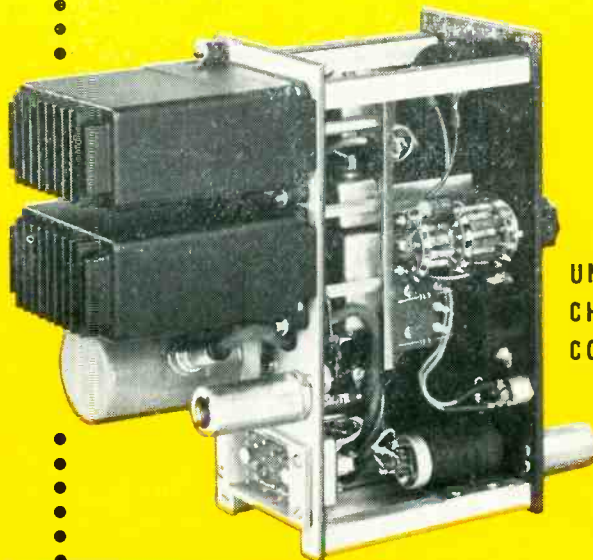

UNITIZED
CHANNEL
CONSTRUCTION

SPECIFICATIONS :

1. Input impedance—100,000 ohms. Output impedance—1,000 ohms.
2. Maximum gain—10,000.
3. Noise figure 50 microvolts rms or less referred to input.
4. D-c drift after initial warmup less than 50 microvolts per hour, referred to input.
5. Frequency response—flat 0 to 10 Kc, down approximately 3 db at 45 Kc.
6. Maximum output signal current ± 10 ma peak short circuit. Maximum output signal voltage ± 100 volts peak open circuit.
7. Power source—115 or 230 $\pm 10\%$ volts, 50-60 cps single phase.

Miller Instruments announce their new DC-1B Amplifier, available in multi-channel with power supply.

You are cordially invited

to visit the Miller Instruments booth at the IRE National Convention, March 22 through 25, in New York City.

WILLIAM MILLER INSTRUMENTS, INC.
CUSTOM INSTRUMENT DESIGNERS AND MANUFACTURERS
325 No. Halstead Avenue • Pasadena 8, California • RYan 1-6317





TURBO

BRAND

MINIATURIZATION WIRE

IN 20 SIZES FOR OPERATING VOLTAGES UP TO 600 VOLTS

Today's miniaturized equipment has brought forward special exacting wiring requirements — special purpose miniaturization wires for chassis hook-up wire and for use as leads in transformers, chokes and other miniaturized electronic components.

TURBO BRAND Miniaturization Wire was specially developed in The William Brand laboratories to meet a use need within the range of -55°C to $+105^{\circ}\text{C}$ and maximum operating voltage of 600 volts rms. This "mini" wire is available in 20 strandings, ranging from 7/38 to 19/25 and in a graduated scale of AWG sizes from 30 to 12. It is available in both solid and stranded — in solid colors or "candy striped" with 1, 2 or 3 tracers.

TURBO INSULATION

TURBO "mini" wire is insulated to withstand the effects of water, oils, aircraft engine fuels, hydraulic fuels, dilute acids, alcohol, alkalis, ethylene glycol and fungus. The primary insulation is **TURBO 540**, an extruded polyvinyl chloride compound. For further protection there is an extruded jacket of nylon over the primary insulation, which gives added resistance to mechanical wear and abrasion.

SPECIAL MINIATURIZATION PROBLEMS

To assist engineering and manufacturing organizations in special problems arising in the use of miniaturization wire, The William Brand Research Department will welcome the opportunity of offering suggested solutions of such problems.

Insulating Material

TURBO

Specialists Since 1920

THE WILLIAM BRAND & CO., INC.

Dept. E-3

Willimantic, Conn., U.S.A., Tel. HArrison 3-1661

TURBOTUF Insulating Tubing and Sleeving • TURBO Insulated Wires • Wire Markers • Extruded Tubing • Varnished Saturated Sleeving and Tubing • Cambric Cloths, Tapes, Papers • Mica

SALES REPRESENTATIVES IN PRINCIPAL CITIES

coil permits terminal parts to pre-heat before reaching the fusing temperature. Favorable stressing conditions in the fused terminals are thereby gained, resulting in a tighter bond between ceramic and metal.



Plastic Curtains for Tools

STORED dies and small tools used in the production of precision test equipment are protected from plant dust by plastic curtains on traverse rods. These 8-gage vinyl sheet curtains were made to order for Hewlett-Packard, Palo Alto, Calif., by Plastic Maid Co. of California.

Automatic Spiralling of Precision Resistors

DEPOSITED-CARBON RESISTOR blanks are automatically spiralled to increase the resistance to a desired higher value. This is done by incorporating electronic measurement and control circuits in the lathe arrangement used for grinding the spiral in the carbon coating on the ceramic blank. This arrangement boosts output of these resistors in the San Juan, Puerto Rico plant of Radell Corp.

The spiralling operation is done before end caps and leads are attached to the coated blanks. The operator picks up a blank with

Hotpoint checks hermetic seals on moving production line

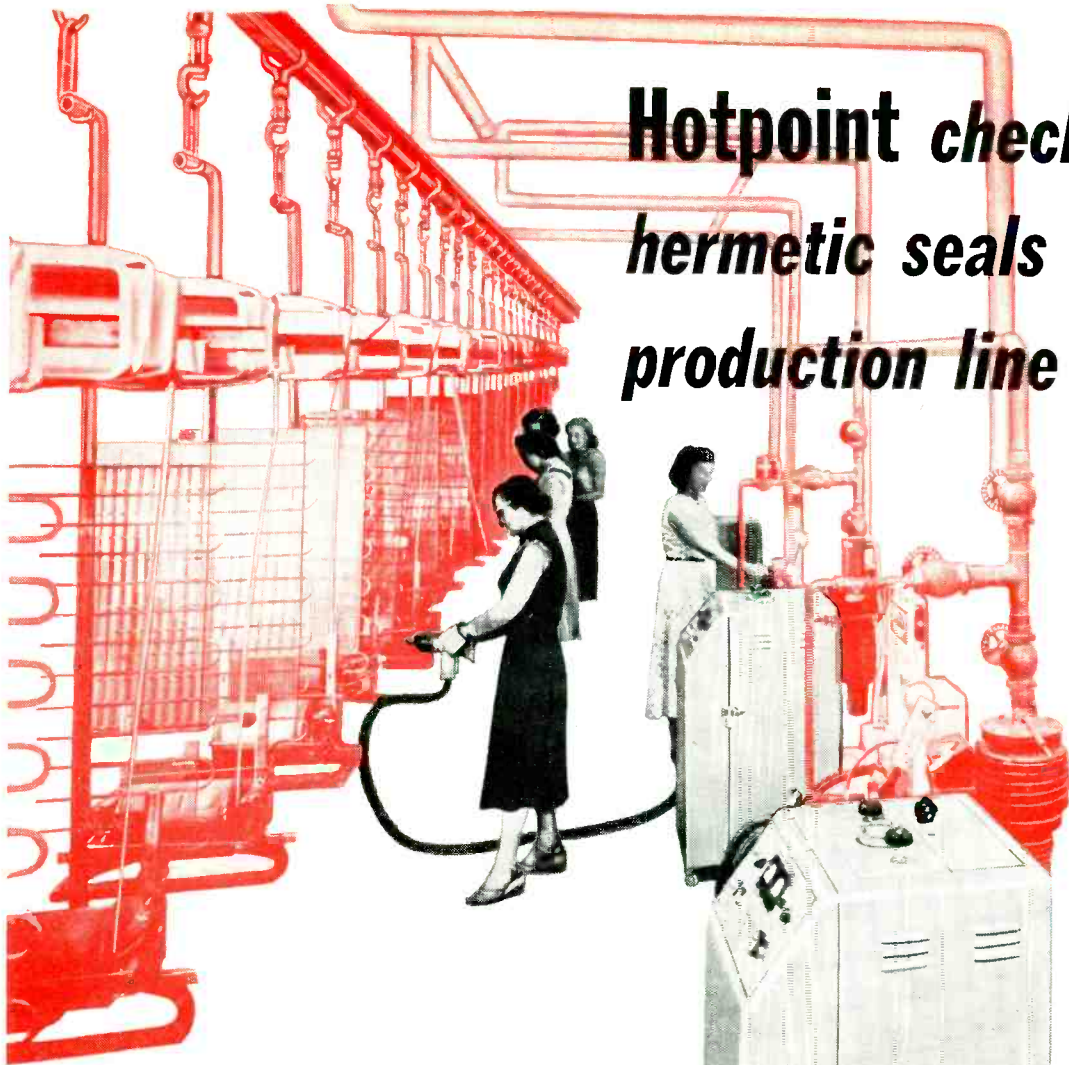

Consolidated Leak Detector

Checking refrigeration systems for leaks at the rate of 100 units per hour is a routine Hotpoint production line procedure. The units are evacuated to approximately 50 microns, sealed and passed under a helium hood. Any leak, even in the micron range, draws a mixture of helium and air into the system. Still moving, the evacuated units are checked with a Consolidated mass spectrometer-type leak detector. The slightest trace of helium sounds an audible alarm and the faulty unit is pulled off the line. These mobile, highly sensitive leak detectors are adaptable to a wide range of operations for production line control of both vacuum and pressure systems.



Completely portable in its light weight, castor equipped cabinet the Consolidated Model 24-101A Leak Detector is an accurate, practical tool for locating leaks wherever vacuum or pressure is used in factory, shop or laboratory. Write for Bulletin CEC-1801B—X13.



Consolidated Engineering CORPORATION

300 North Sierra Madre Villa, Pasadena 15, California

Sales and Service through **CEC INSTRUMENTS, INC.**, a subsidiary with offices in:
Pasadena, New York, Chicago, Washington, D. C., Philadelphia, Dallas.

**ANALYTICAL
INSTRUMENTS
FOR SCIENCE
AND INDUSTRY**

BROAD BAND PULSESCOPE

by

Waterman

MODEL S-6-A

DC CALIBRATION
MARKERS 1-1000 μ S
0-5 mc

Size:
8½" x 6¾" x 13¾"
22 Pounds



ANOTHER EXAMPLE OF **Waterman** PIONEERING ...

The S-6-A BROAD BAND Scope is a PULSESCOPE in performance, POCKETSCOPE in size, and it compares more than favorably with oscilloscopes that are *transportable*, instead of portable. The instrument measures DC as well as AC signals. Unique DC calibration methods permit rapid measurements of either positive or negative AC or DC signals. The scope uses a 3XP1 tube with 1500 volts on the second anode, thus providing a brilliant trace for high speed transients even at low repetition rates. Vertical amplifier sensitivity of 0.2v rms/inch, and response to 5 mc within 3DB . . . pulse rise time of 0.1 μ s . . . internal intensity markers from 1 to 1000 μ s . . . repetitive or trigger sweep from 5 cycles to 500 KC with 5X sweep expansion . . . sweep, marker and DC calibrating voltage available externally. Size 8½ x 6¾ x 13¾ in. Weight 22 lbs. Operates from 50 to 400 cycles at 115 volts AC.

WATERMAN PRODUCTS CO., INC.

PHILADELPHIA 25, PA.
CABLE ADDRESS: POKESCOPE

WATERMAN PRODUCTS INCLUDE

- S-4-C SAR PULSESCOPE®
- S-5-A LAB PULSESCOPE
- S-6-A BROADBAND PULSESCOPE
- S-11-A INDUSTRIAL POKETSCOPE®
- S-12-B JANized RAKSCOPE®
- S-14-A HIGH GAIN POKETSCOPE
- S-14-B WIDE BAND POKETSCOPE
- S-15-A TWIN TUBE POKETSCOPE
- RAYONIC® Cathode Ray Tubes
and Other Associated Equipment

MEMO
Write for
details
today!



WATERMAN PRODUCTS



Automatically-controlled spiralling machine for deposited carbon resistors. Pitch of spiralling is changed by turning hand wheel at top of pitch change box at right

plastic tweezers and inserts it in the lathe while pulling back the spring-loaded insulated tail stock with his left hand. A metal knob on the end of the sliding tail stock shaft simplifies this loading as well as unloading. A phosphor-bronze contact blade bears against the end of the tail stock arbor, and wires of similar material bear against the driven headstock for making contact to the resistor while it is rotating. The wire contacts are needed for the headstock to eliminate the varying resistance to ground through the bearings.

With the resistor in position, the operator flips a switch above the lathe to start the operation. Spiralling is achieved by rotating the resistor and simultaneously sliding the entire lathe at a predetermined rate past the rubbed-bonded rotating carborundum disc. During this operation a limit bridge continually measures the resistance. When this value is a predetermined amount below the desired final value, the electronic control circuit actuates a kickout solenoid that swings the entire lathe away from the cutting wheel. The resistor is then removed, for attachment of leads and abraiding to final value in subsequent operations.

The bed of the improvised lathe is made from standard ball-bearing record changer slides. The lathe itself is bearing-mounted on a single horizontal shaft and is linked to the armature of a solenoid in such a way that the entire lathe can be swung away from the cutting wheel. A shaft about 6 inches

All these from one experienced source

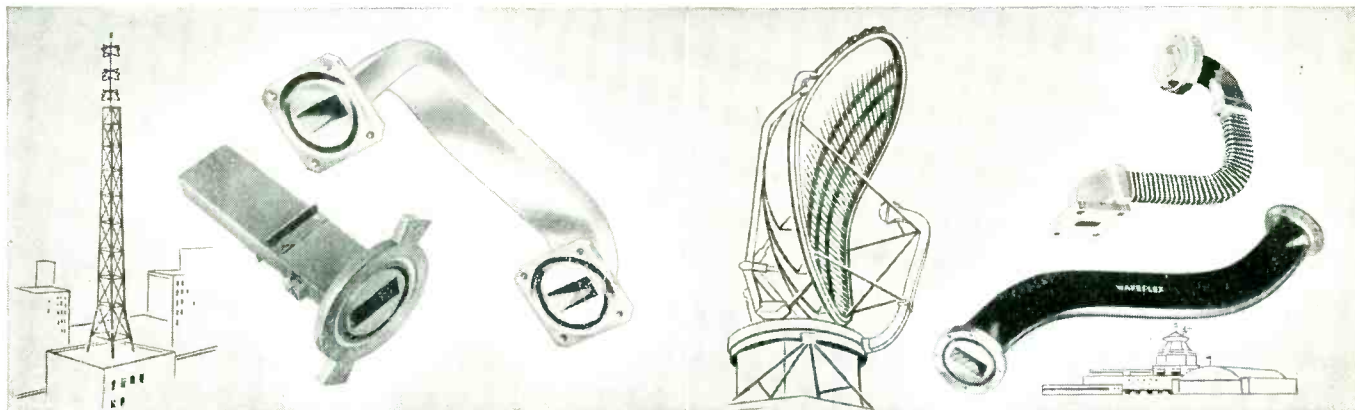

TITEFLEX DESIGNS AND MANUFACTURES—to customer specifications—rigid waveguides and combinations of rigid and flexible waveguides. Where there is, or should be, no movement, or where complicated accessories must be connected, Titeflex *rigid* waveguides are specially recommended.

WAVEFLEX® FLEXIBLE WAVEGUIDES are fabricated to retain critical dimensions — regardless of twisting or bending. Waveflex waveguides make assembly easy, improve design, compensate for expansion or movement. Rubber jacketing protects against weather, corrosion, physical abuse.

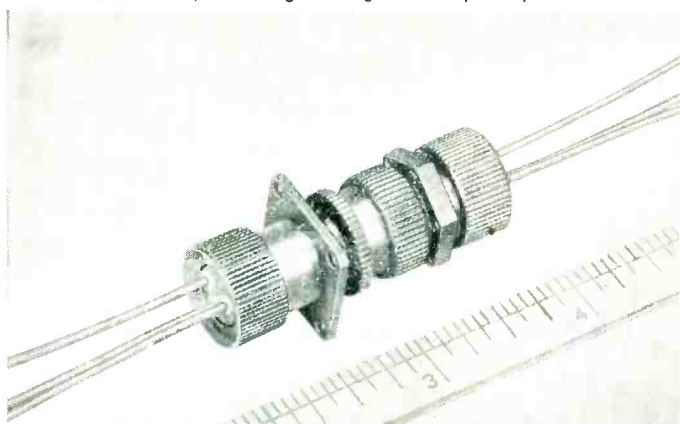

TITEFLEX CONNECTOR—lightweight, corrosion and moisture resistant with temperature ranges of -65°F. to $+400^{\circ}\text{F.}$ This connector's insulation properties will permit 3500 volts at sea level, 1200 volts at 50,000 feet altitude. Connector is available with 2 or 3 pins. 7 amperes. Weight $\frac{2}{3}$ of ounce. Size 2" in length.

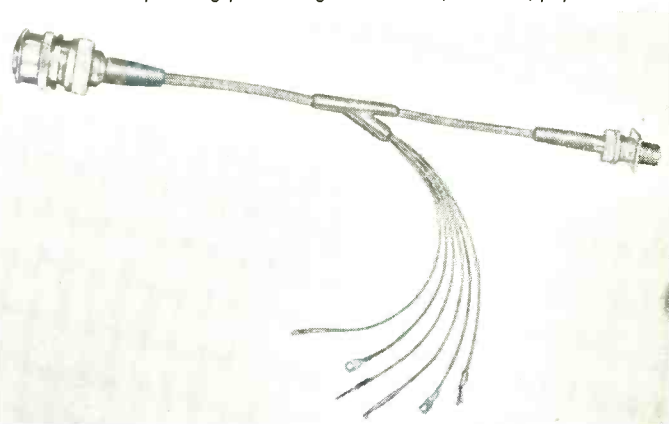

TITEFLEX CUSTOM WIRING SYSTEMS are corrosion resistant, moisture proof, pressure-tight and efficient at temperatures of -65°F. to $+400^{\circ}\text{F.}$ Can be furnished with Titeflex or standard AN connectors for a wide range of service requirements. Can be sheathed with metal braids, fiber glass or nylon—and jacketed with silicone or other compounds.

MORE THAN 37 YEARS of developmental experience make Titeflex a logical source of the components pictured on this page. We are currently in a position to supply connectors and wiring systems to makers of aviation and electronic equipment. If you have a problem requiring our unusual combination of products and engineering, let us quote on your requirements. The coupon will bring you information on our products.

Let Our Family of Products Help Yours

✓ Check products you are interested in.



 <input type="checkbox"/> SEAMED AND SEAMLESS METAL HOSE	 <input type="checkbox"/> PRECISION BELLOWS	 <input type="checkbox"/> IGNITION HARNESS	 <input type="checkbox"/> IGNITION SHIELDING
 <input type="checkbox"/> ELECTRICAL CONNECTORS	 <input type="checkbox"/> RIGID AND FLEXIBLE WAVE GUIDES	 <input type="checkbox"/> WIRING SYSTEMS	 <input type="checkbox"/> FUSES

TITEFLEX, INC.
 524 Frelinghuysen Ave.
 Newark 5, N.J.

Please send me without cost information about the products checked at the left.

NAME _____

TITLE _____

FIRM _____

ADDRESS _____

CITY _____ ZONE _____ STATE _____



STACKED UP CALLS STEALING OPERATING EFFICIENCY?

Now you can solve your problem *economically* with RyCom CFD-B Packaged Units that add 4 additional voice channels to each of your present lines. RyCom Carrier Telephone Equipment *pays for itself* quickly by drastically reducing long distance telephone costs.

Check These RyCom Features:

- Built-in Measuring Panel—for fast over-all system line-ups, even by non-technical personnel. Eliminates need for expensive test equipment . . . testing trips up and down the line.
- Built-In Slope Control—to equalize non-conforming lines.
- Pilot Panel automatically regulates transmission during changing weather conditions.
- RyCom separate panel construction provides maximum accessibility for easy inspection and maintenance.
- Packaged in a single rack. Saves space, saves installation time. Shipped complete in one package ready for easy installation.

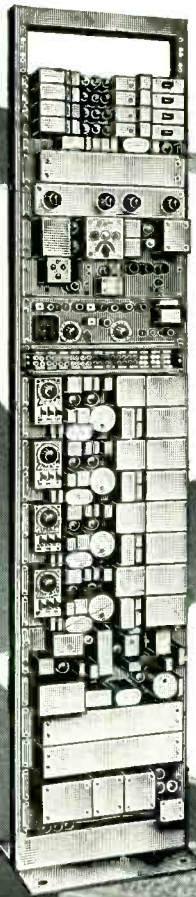

Immediate deliveries now being made. RyCom engineers will be glad to discuss *your* particular installation needs. Write or phone today for complete details, specifications and prices.

Rely on RyCom for Highest Quality at Minimum Cost

RAILWAY COMMUNICATIONS, INC.
RyCom
 Raytown, Missouri, U.S.A.
 Phone FLEMing 2100

Export office: 13 East 40th St., New York 16, N. Y.

For more ad information, see Index to Advertisers.

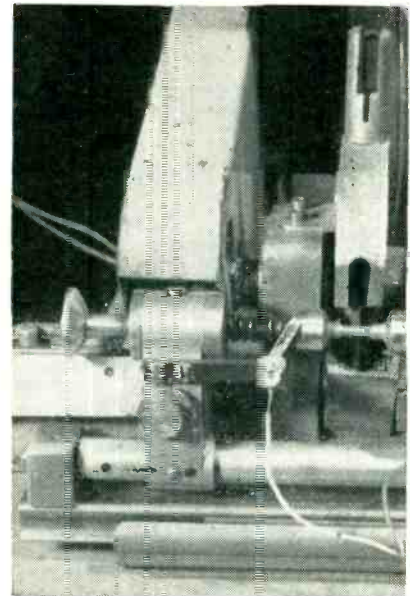

Lathe arrangement, with resistor in position for spiralling. Tailstock is at left

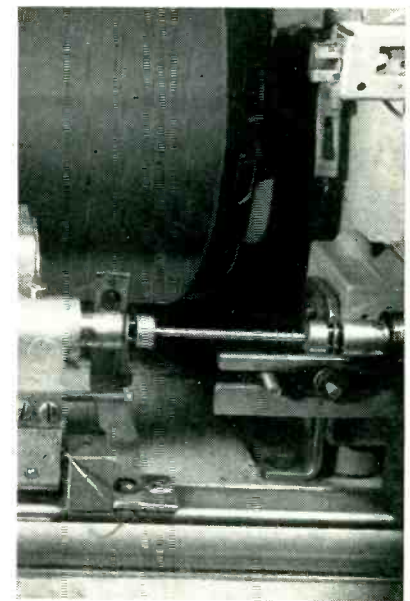

Method of driving headstock of lathe with double-pin coupling, which permits lathe to slide laterally and to swing forward at end of spiralling operation

long, terminating in double pins at each end, transmits power from the lathe drive motor to the headstock while permitting swing-out of the entire lathe. Springs are used to pull the lathe into the cutter when the solenoid is not energized.

To prevent cutting the tailstock electrode in the event of failure of the control system, a cam arrangement is used to push the lathe away from the cutting wheel when the wheel gets too close to the tailstock.

A variable-pitch mechanism at the right end of the lathe permits changing the rate of feed of the

DO YOU KNOW???

Photocircuits

PRODUCES Printed-Circuit
PANELS and Dip Soldered
Electronic Sub-Assemblies

(to your specifications)

with

PLATED-THROUGH HOLES

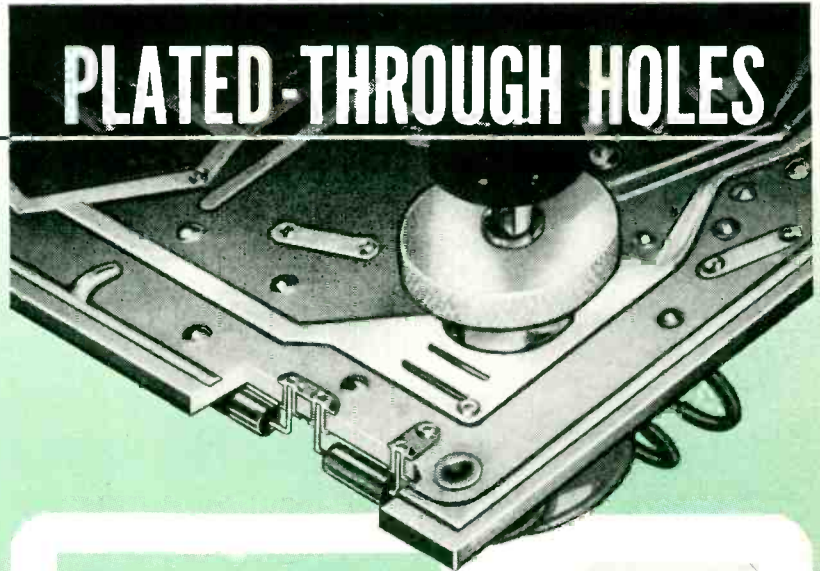

NOW farther COST REDUCTION and PROFIT POTENTIAL accrue from Photocircuits development of cross-through connections by *plating through panel holes*. This is another good reason for having your products engineered and produced by Photocircuits Corporation.

ADVANTAGES:

1) **IMPROVED RELIABILITY**... for cross-through connections between printed circuitry on two sides of a plastic substrate since hole plating is continuous with pattern plating. No hardware need be inserted or soldered to the conductor patterns to achieve through-connection.

2) **COST REDUCTION**. Obviously, since all through-connections are achieved simultaneously by electro-plating, considerable economies are realized.

3) **VIBRATION RESISTANCE**. Dip soldered joints are more easily made and are virtually impervious to shock and vibration.

... PLUS these usual advantages of Photocircuits' Printed Circuits:

- 4) Exact Circuit Reproducibility
- 5) Reduced Assembly Time
- 6) Miniaturization
- 7) Product Improvement

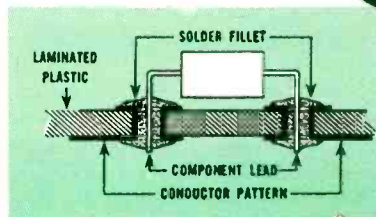
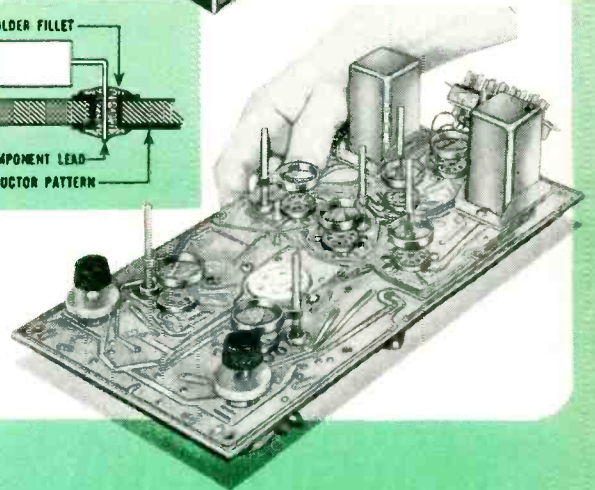

Photo courtesy of Reeves Instrument Corporation



See us at the
I.R.E. SHOW
661-663 Circuits Ave.

For full information
call or write

Photocircuits

CORPORATION



*Trade Mark

Pioneers in Cost-Cutting Printed Circuit Techniques

Dept. E3, GLEN COVE, NEW YORK

Flushing 3-5050 • Glen Cove 4-4000



This
Engineering
Brochure
FREE
on request.

BOSTON: 25 Huntington Ave. • Copley 6-7705
 CHICAGO: 4258 W. Irving Park Rd. • Palisades 5-1170
 PHILADELPHIA: 1531 Spruce St. • Kingsley 5-1205
 ROCHESTER, N. Y.: 3 Juniper St. • Cliver 7635

LOS ANGELES: 6907 1/2 Melrose Ave. • Webster 3-7276
 ROYAL OAK, MICH.: 4512 N. Woodward Ave. • Liberty 9-3810
 CLEVELAND: Fidelity Bldg. • Prospect 2-1552
 TORONTO, CAN.: 290 Lawrence Ave., W. • Orchard 30E3

Koiled Kords* permit EASY SERVICING of In-a-Door or Sliding Units...

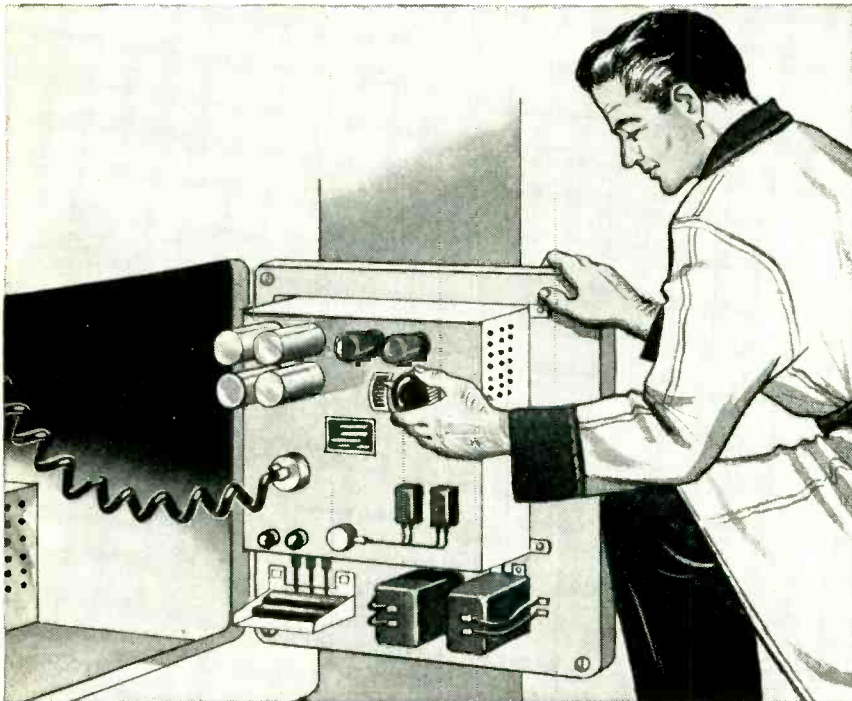

A six inch section of KOILED KORDS retractile cord will extend to more than two feet when pulled and when released will retract immediately to its original neat, compact, spring-like shape. KOILED KORDS solve the problem of carrying current to movable units without having a long trailing cord to foul in the mechanism. They make it possible to retain electrical contact between units when they are pulled out for servicing, facilitating trouble location and correction.

KOILED KORDS extend as needed without looping, dangling or tangling.

KOILED KORDS are compact, neat, attractive, built to withstand continued flexing.

KOILED KORDS are available on special order to your specifications in multi-conductor types up to 37 conductors. Stocked types include 2, 3, 4 and 5 conductor #23 AWG communications cords and 2, 3 and 4 conductor Underwriters' Laboratories approved SO, SJO and SV-neoprene jacketed power cords. KOILED KORDS can be supplied in 48 inch mandrel lengths or prepared into cord sets for attachment to equipment.

WRITE FOR KOILED KORDS APPLICATION BULLETIN SHOWING MANY USES.

Koiled Kords

INCORPORATED

Box K, New Haven 14, Conn.

*KOILED KORDS is the trademark of Koiled Kords, Inc.

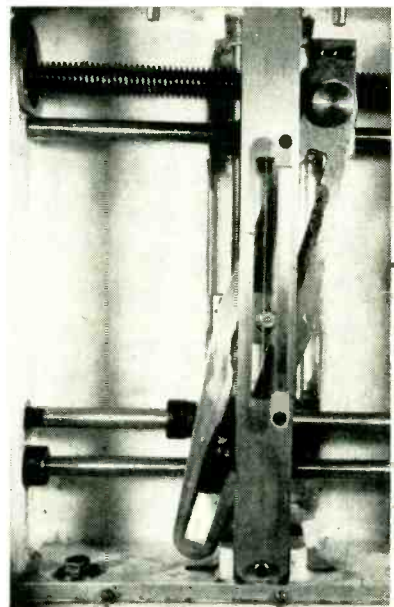

Method of adjusting pitch of spiralling. Feed screw at top moves lower shaft to which lathe is attached, through slotted bar arrangement which is equivalent to proportional dividers

resistor past the cutting wheel. This serves to distribute any desired amount of spiralling uniformly over the length of the resistor.

The operator cranks a hand wheel at the top of the pitch change box to change the spiralling. This wheel moves up or down a pivot that corresponds to the fulcrum of a pair of proportional dividers. One of the slotted bars is fixed in a vertical position. The other slotted bar is linked to the horizontal slide at its lower end and is clamped over the feed screw at the upper end. This feed screw is driven at constant speed by the same motor that drives the grinding wheel and the lathe, through belt drives. Moving the pivot or fulcrum up in the slots makes the lathe move farther per revolution of the feed screw, thereby reducing the number of spiralled turns that are put on a given resistor length.

Resistor-Abrading Machine

A FULLY automatic component-adjusting machine developed by Emerson insures faster and more accurate production of printed electronic circuits. The machine automatically abrades away resistor and capacitor material from printed-circuit units to standardize

Amperex[®] NOW BRINGS YOU 2 NEW RUGGEDIZED TRIODES

**SPECIALLY
DESIGNED FOR
HEAVY DUTY RF
INDUSTRIAL
APPLICATIONS**

TYPE 6333 (WATER COOLED)

Plate Dissipation 10 kilowatts. Furnished with grid connector for direct interchangeability with type 892 without any equipment modifications. Suitable for communications as well as industrial applications. Available in air-cooled version, Type 6445.

TYPE 6446 (WATER COOLED)

A heavy wall triode capable of dissipating 20 kilowatts continuously. Massive anode (7/16" thick), provides high heat storage capacity for heavy intermittent duty. High dissipation reserve allows extreme mismatch of load to tube impedance. The tube is therefore protected against maladjustment or misuse of equipment. Uses only 1/2 the water flow required for type 892, for equivalent anode dissipation. Available in air-cooled version, Type 6447.

OPERATING DATA, 6333

RF POWER AMPLIFIER and OSCILLATOR CLASS C TELEGRAPHY

	MAXIMUM RATING per tube	TYPICAL OPERATION one tube	
AC Filament Voltage	—	22	volts
DC Plate Voltage	15000	12000	volts
DC Grid Voltage	3000	1600	volts
Plate Load Resistance	—	3500	ohms
Peak RF Grid Voltage	—	2600	volts
DC Plate Current	2	1.55	amps
Plate Input	30	18.60	kw
Plate Dissipation	10	4.35	kw
DC Grid Current (approx.)	400	165	ma
Driving Power (approx.)	—	420	watts
Plate Power Output	—	14.25	kw
Tube Power Output	—	745	BTU/min.

OPERATING DATA, 6446

RF INDUSTRIAL OSCILLATOR

(3 PHASE, FULL WAVE, UNFILTERED SUPPLY)

Plate Volts and Input—Max.	100	75	50%
For Frequencies Indicated	5	12.5	20(mc.)

	MAXIMUM RATING per tube	TYPICAL OPERATION one tube	
AC Filament Voltage	—	22	volts
DC Plate Voltage	15000	15000	volts
DC Grid Voltage	— 3000	— 1250	volts
Peak RF Grid Voltage	—	2400	volts
Plate Current	2	2	amps
Plate Input	30	30	kw
Plate Dissipation	20	10	kw
DC Grid Current	400	250	ma
Drive Power (approx.)	—	620	watts
Plate Power Output	—	20	kw
Tube Output	—	1138	BTU/min.

DIRECT INTERELECTRODE CAPACITANCES

Grid to Plate	32	μμf
Grid to Filament	17	μμf
Plate to Filament	1.8	μμf

LIST PRICES:

6333 (Water Cooled)	\$230.00
6445 (Forced Air Cooled)	375.00
6446 (Water Cooled)	255.00
6447 (Forced Air Cooled)	400.00

ACCESSORIES

Tube Type	Water Jacket	Grid Connector
6333	DW-1580	Y-13326 (Supplied with tube without charge)
6446	S-15096	Y-13326 (Supplied with tube without charge)

Complete technical data available from our
Application Engineering Department

POWER TUBE SELECTION CHART

... yours for the asking! Comprehensive, colored chart shows ratings in power output and frequency for typical applications. Also gives a correlated table of FCC frequency allocations. Helps you find, in a moment, the tube or tubes that will fit your industrial and communication jobs.



AMPEREX tubes give you better performance and longer life, Physically and Electrically, through these exclusive RUGGEDIZING techniques:

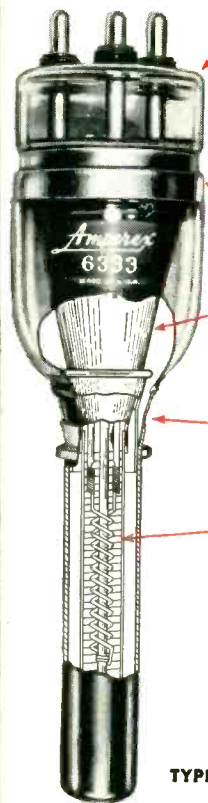

TYPE 6333

1 Rugged, powdered glass stem replaces stem press construction. Runs about 150° cooler, minimizing failure due to thermal shock. Glass matches coefficient of expansion to Kovar over wider temperature ranges minimizing mechanical stress failure.

2 Projecting grid arm eliminated and replaced with strong Kovar ring grid connection.

3 Strong conical internal grid support instead of three-legged riveted construction. This also provides much lower inductance.

4 Fragile copper "feather-edge" glass-to-anode seal replaced by a rugged Kovar seal.

5 New, stronger helical filament provides more uniform heat distribution over the anode surface.

6 7/16 inch thick, high conductivity copper anode for heavy duty applications.

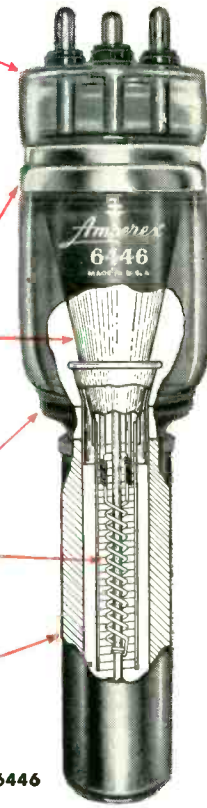

TYPE 6446

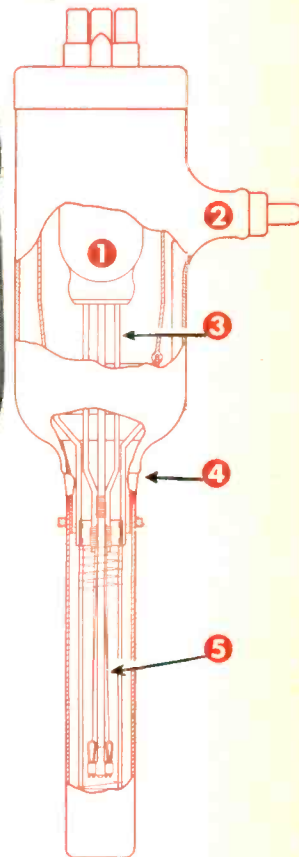

CONVENTIONAL TUBE STRUCTURE

Available At Your Local Parts Distributor

AMPEREX ELECTRONIC CORP.

230 Duffy Ave., Hicksville, Long Island, N. Y.

In Canada: Rogers Majestic Electronics Ltd.

11-19 Brentcliffe Road, Leaside (Toronto) 17

their value to the precise point required. The machine feeds itself with a part to be worked on, examines it to assure its suitability for adjustment, abrades the printed resistor to precise value if usable, conducts a final inspection operation and then again sorts good from bad pieces.

This completely automatic production unit eliminates the considerable number of rejects which are an inevitable result of human handling of the assembly, yields a more uniform product and reduces manufacturing cost.

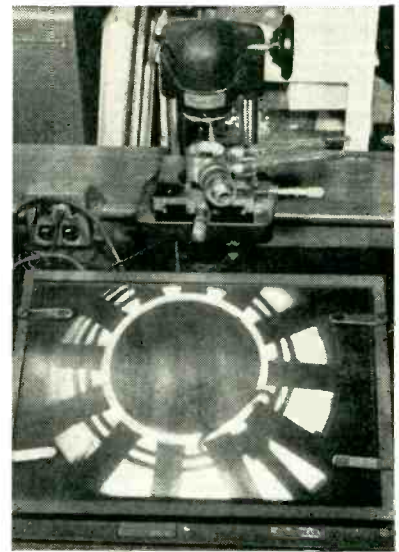

Setup for inspecting cathode-anode concentricity of 12-resonator vane-type structure of tunable magnetron

Microprojector Checks Magnetron Alignment

CONCENTRICITY and alignment of the resonator structure in a type 5586 pulsed tunable magnetron is checked at high magnification with a projection-type optical comparator at Amperex Electronic Corp., Hicksville, N. Y. The tube structure is positioned manually on the stage so the desired portion is projected onto the translucent viewing screen in the foreground. The micrometer adjustments of the stage are now manipulated until the hairline indicator is just touching the inside of the anode on the screen, and the reading of the front micrometer is noted. The focusing wheel in the head of the projector

MILWAUKEE TRANSFORMERS

provide performance that exceeds the demand

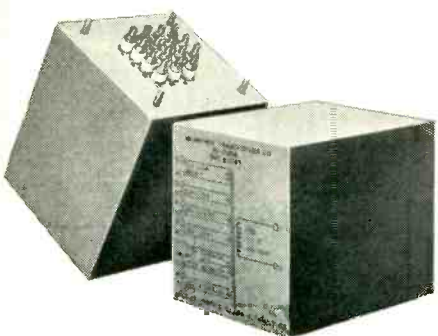

Hermetically sealed components that perform superbly and lastingly in airborne and ground applications.

Yours for the asking—
a well-illustrated brochure describing Milwaukee transformers and production facilities.

Look for **Booth 433**
at the **I. R. E. Show**
in **New York City**
March 22—25 incl.



YOU can get precisely what you want to meet the most stringent applications from Milwaukee Transformer Company. Every Milwaukee unit is made to exceed the requirements of the demand — be it military or commercial — and well over one thousand different transformers have been designed and built for our clients. Engineering, laboratory and production facilities are always ready to answer your call — whatever the need. Phone, wire or write without obligation.

Milwaukee Transformer Co.
5231 N. Hopkins St., Milwaukee 9, Wis.

Representatives

John G. Twist Company
2800 North Milwaukee Avenue
Chicago 18, Illinois
Phone: HUmboldt 9-2550

Robert W. Marshall
6106 Excelsior Blvd.
Minneapolis 16, Minnesota
Phone: MOhawk 9-6444

Harry Appleton Company
136 San Fernando Road
Los Angeles 31, California
Phone: CApitol 1-2171

Vincent J. Brown Company
564 Ellicott Square
Buffalo, New York

Legg-Lungreen Associates
6625 S.E. 76th Avenue
Portland 6, Oregon



DEPENDABILITY and ACCURACY

Collins 51V-2
Glide Slope
Receiver

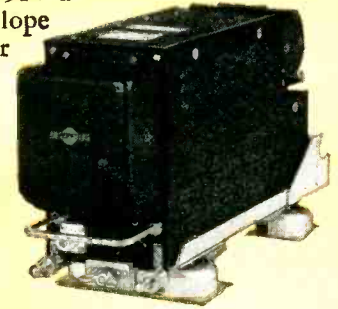

with the NEW *Collins* 51V-2 Glide Slope Receiver

DEVELOPED expressly to meet airline requirements, Collins 51V-2 Receiver together with the Collins type 51R navigation equipment fulfills ILS requirements for commercial and private aircraft.

Negative feedback applied to the two audio stages stabilizes the receiver so that it will perform satisfactorily when the mutual conductance of any or all of the audio tubes is reduced by 50%. AVC voltage on the R.F., I.F. and first audio tubes provides a constant output with varying R.F. input. The AVC characteristic of the receiver is flat from 30 to 100,000 microvolts with standard factory adjustments. These features provide a flat flag current response and allow the flag to be set to very close limits to meet strictest airline requirements. If operating conditions require more or less course softening, a simple screwdriver adjustment of the potentiometer is all that's necessary.

The receiver utilizes a high voltage d-c plate and screen supply obtained from a self-contained dynamotor or 400 cycle a-c power unit. Use of the appropriate dynamotor or a-c power unit makes the receiver operable from a 27.5 volt d-c source or 115 volt, 300-1000 cycle a-c source with 27.5 volts d-c for relays and filaments. The two types of power units are interchangeable.

Another important characteristic is the low value of conducted and radiated interference. Spurious responses are approximately 60 db or more below the level of the desired signal. Precise frequency stability is accomplished through use of a group of twenty crystals for control of the injection oscillator. These crystals are in accordance with MIL-C-3098, except for case marking.

Collins 51V-2 is the successor to the 51V-1, the Glide Slope Receiver noted for its astounding service life. Instrument accuracy of the 51V-2 is unaffected by tube aging. When you install Collins 51V-2, you can be sure of precise instrument approaches for the lifetime of your aircraft.

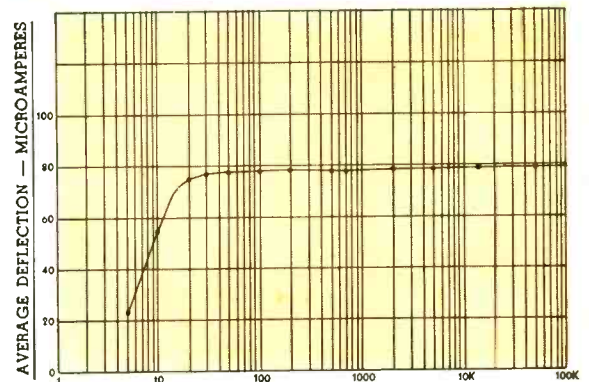

R. F. INPUT — MICROVOLTS
NORMAL RECEIVER DEFLECTION CURVE — (Falls within limits of ARINC Characteristic No. 519 and RTCA Paper 54-50/DO-33)

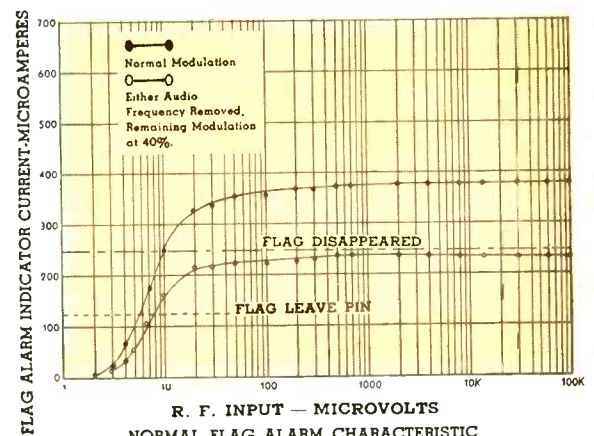

R. F. INPUT — MICROVOLTS
NORMAL FLAG ALARM CHARACTERISTIC

See new Collins
developments in

AVIATION
BROADCAST
COMMUNICATIONS
and
AMATEUR EQUIPMENT
at the
IRE SHOW, MARCH 22 TO 25.

COLLINS RADIO COMPANY

Cedar Rapids, Iowa

11 W. 42nd St., NEW YORK 36

1930 Hi-Line Drive, DALLAS 2

2700 W. Olive Ave., BURBANK



You've been hoping for an EFFICIENT, LOW COST DC POWER SUPPLY



*Here
it is*

THE NEW
**DRESSEN-
BARNES**
MODEL
3-150-L
ONLY
\$95⁰⁰

INCREASE EFFICIENCY OF ENGINEERS AND TECHNICIANS. Now, it is practical to provide individual low-cost, high-performance DC power supplies. Front scale calibration has eliminated need for meters, thus simplifying operation. Sturdy and compact, Dressen-Barnes Model 3-150-L DC power supplies have a wide range of output ratings and applications:

- **OUTPUT:** 1. Zero to 300 volts DC; continuously variable (without switching) from zero to 150 MA.
2. 6.3 volts AC, unregulated at 6 amps.
- **INPUT:** 115 volts AC, 1 phase, 60 cycles.
- **REGULATION:** 1. Better than 1%, from 100 to 300 volts, 10% load to full load, plus or minus 10% line voltage variation.
2. Better than 2%, from 1 to 100 volts, 10% load to full load, plus or minus 10% line voltage variation.
- **STABILITY:** 1. Better than .5%, from 100 to 300 volts.
2. Better than 1%, from 1 to 100 volts.
- **RIPPLE:** Below .01 volts peak to peak at full load.
- **OUTPUT IMPEDANCE:** Less than 1 ohm at full output. (Two units can be mounted on 8 3/4 x 19 panel - specify Model D3-150-L.)

DRESSEN-BARNES SUB-CHASSIS MOUNT NC TYPE



Regulated DC Power Supplies have performance comparable to Model 150 units. Designed to fit into most experimental chassis types, they provide efficient, economical DC power for prototype or production apparatus.

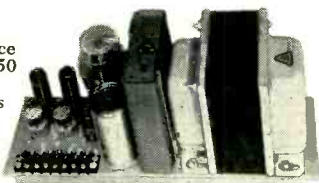

Output ratings range from 150 volts at 20 MA to 500 volts at 6 amps.

FOR INFORMATION SHEET, WRITE TO:

DRESSEN-BARNES Corp.

250 N. Vinedo Ave., Pasadena 8, Calif.
phones: 5Ycamore 3-0691 and RYan 1-7041



PIONEERS IN HIGH VOLTAGE DC POWER SUPPLIES

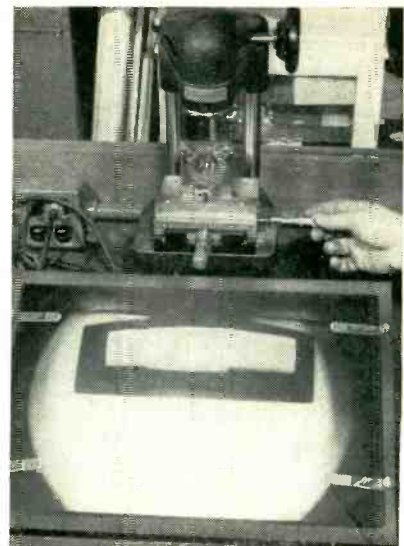

Adjusting side micrometer in setup for checking tuning linearity of magnetron

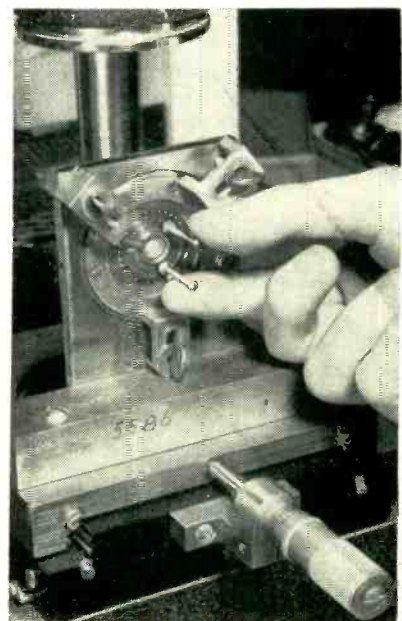

Fixture used on microscope stage for holding magnetron tuning element. Bolts have been inserted temporarily to facilitate rotation of center element

is now adjusted to focus sharply on the cathode and the front micrometer is readjusted until the hairline is tangent to the cathode. The difference between these two readings is then the anode-cathode spacing at that point. This procedure is repeated for the opposite anode segment and for two other segments on a diameter at right angles to the first. The four readings should be equal if the cathode is concentric with the anode.

In another application of this projector, the linearity of move-

A NEW



CONCEPT OF ACCURACY IN THE PRODUCTION OF ALLOY STRIP

RESISTANCE ALLOYS, RODAR, NICKEL, BERALOY AND CUSTOM ALLOYS

**...for all critical applications—
electrical, electronic, instrumentation**



This new plant was designed and built for the production of alloy strip of the highest accuracy. It is equipped with the finest machinery available for the task. Sendzimir Mills assure **FREEDOM FROM CROWN**. Skilled operators, with years of experience, roll to close tolerances and produce finishes to highest **STANDARDS**.

A group of experienced engineers is available to select the correct alloy for your application.

WILBUR B. DRIVER CO.

NEWARK 4, NEW JERSEY



At the I.R.E. Show—
BOOTHS 691-693
CIRCUITS AVENUE

Your Helping Hand



THROUGHOUT

**INDUSTRY..
AND SCIENCE..**

The present availability of VECO THERMISTORS, and varistors, are opening vast new fields in electronic measurement and control circuitry, and are helping engineers to fully utilize the extreme sensitivity and reliability of these new versatile circuit elements.

VECO THERMISTORS ARE RESISTORS WITH AN EXTREMELY HIGH NEGATIVE TEMPERATURE COEFFICIENT OF ELECTRICAL RESISTANCE. They have high stability, and unlimited life when operated within their temperature ratings. These small, compact, shock-resistant, semi-conductors are STOCKED in a wide range of temperature vs. resistance characteristics. VECO thermistors and varistors can also be produced to your specifications. Types of construction include rods, discs, washers, and beads, in a variety of sizes and mountings.

\$5.00 cash or money order will bring you the Model 168 VECO Experimentors' THERMISTOR-VARISTOR package — 7 items and application circuitry — over a \$15.00 value!

Visit Victory at the IRE Show

A request on your business stationery will bring the VECO THERMISTOR DATA BOOK, which contains specific technical information, characteristics, and applications.

CUSTOMER ENGINEERING SERVICE AVAILABLE AT NO CHARGE. However, where unusual problems in thermal conductivity or temperature control may require laboratory development of radically new types of Veco Thermistors, with associated circuits, VECO research and manufacturing know-how may be obtained on contract.

Victory
ENGINEERING
CORPORATION

Springfield Road, Union, N. J.

Manufacturers of:
**TEMPERATURE SENSING DEVICES
COMBUSTION ANALYZERS
ELECTRONIC and THERMAL
CONTROL INSTRUMENTS**

Tel. UNIONVILLE 2-7150

ment of the magnetron tuning element with respect to rotation of the mechanical tuner is checked visually. Here the rotatable tuning element is clamped in position on a fixture that rests on the stage. Screws are temporarily inserted in the tuning element so it can be rotated, and correlation of movement with rotation is checked by moving the hairline indicator with the micrometer adjustment of the stage as before. This gives a visual check of performance over the 2,700–2,900 mc range for which this S-band radar tube is designed.

The microprojector employed is made by R. S. Wilder, Inc., Waltham, Mass. The lamps and lenses are underneath, and a reflecting mirror for controlling focus is mounted in the adjustable head. A projection lamp is also available in the head for use without the mirror in certain shadowgraph applications.

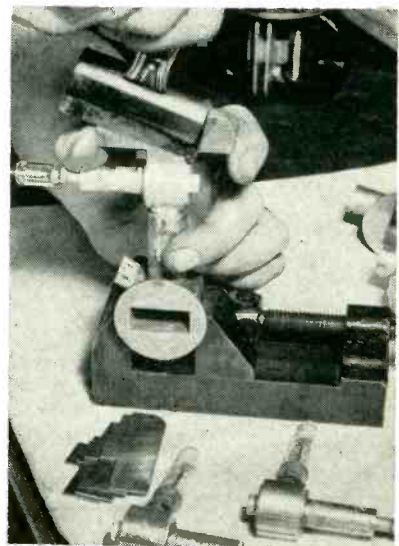

Paper Clip Aids Magnetron Assembly

AN ORDINARY squeeze-type paper clip is used to hold the copper output and radiator fins temporarily in position on type 725 X-band search-radar magnetrons in preparation for soft soldering, at the plant of Amperex Electronic Corp., Hicksville, N. Y. This type of clip is easily applied, applies the required even parallel pressure to the fins, and is just as easily removed

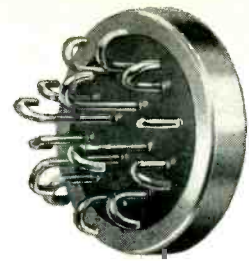

The
Invention
of Compression-Type
Seals is about as
Old as
Grandma's Phonograph—

but Constantin's
Production Facilities
and Methods are
as New as Tomorrow

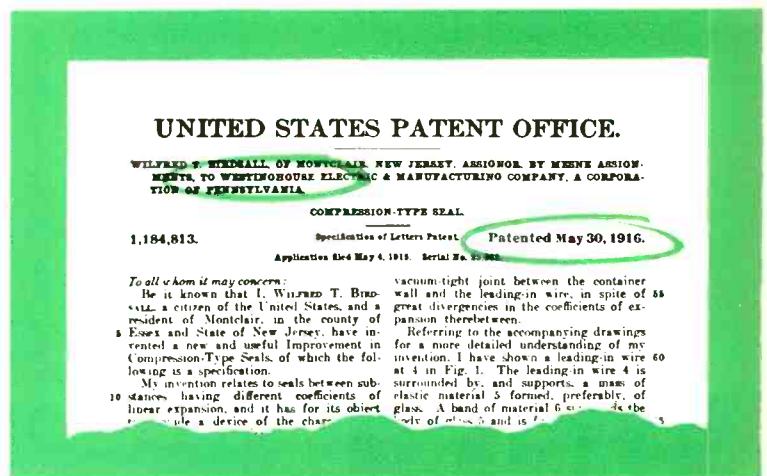

The invention of compression-type seals in general is quite old as evidenced by U. S. Letters Patent No. 1,184,813, issued to Wilfred T. Birdsall and assigned to the Westinghouse Electric and Manufacturing Co. on May 30, 1916, for the original compression-type seals, expired in 1933. It is now public domain.

Yes, the idea of high compression glass to metal seals is thirty-seven years old and public domain. The compression principle can be employed by anyone, but Constantin makes the *quality seal*.

The wise buyer now is concentrating on quality of manufacture and materials. For over eight years L. L. Constantin & Company has been operating the most modern machine shop facilities for die construction, stampings, and bending—a glass department capable of compounding, tableting and sintering—latest ovens for fusing—multi-slide machines for pin fabrication. In this way, our completely self-contained plant operating all under one roof, can produce

true compression seals of highest quality, in addition to our regular line of hard glass to KOVAR and RODAR alloy seals.

We at Constantin realize that adding color to the already pure white glass does not add to the strength, and for identification purposes, whether you buy green, gray, blue, brown or other colors, you will find Constantin seals to be consistently uniform and superior in strength.

Constantin can proudly say that it is not selling an idea. Constantin is selling precision engineered high compression glass-to-metal vacuum seals. See them, test them, and compare.

Seals also available in KOVAR and RODAR alloys to hard glass types.

Also manufacturers of—
MULTI-PIN HEADERS
TERMINALS
TRANSISTOR MOUNTS
MULTI-PIN CON PLUGS
END SEALS
CRYSTAL HOLDERS
VACUUM COATING EQUIPMENT

L. L. Constantin & Co.

MANUFACTURING ENGINEERS

Rt. 46 and Franklin Ave., Lodi, N. J.



See us at the I.R.E. Show—Booths 672, 674, Circuits Avenue



If we
haven't already
made it
we'll
design it
for you . . .

GAMEWELL
PRECISION
POTENTIOMETERS
Linear • Non-Linear

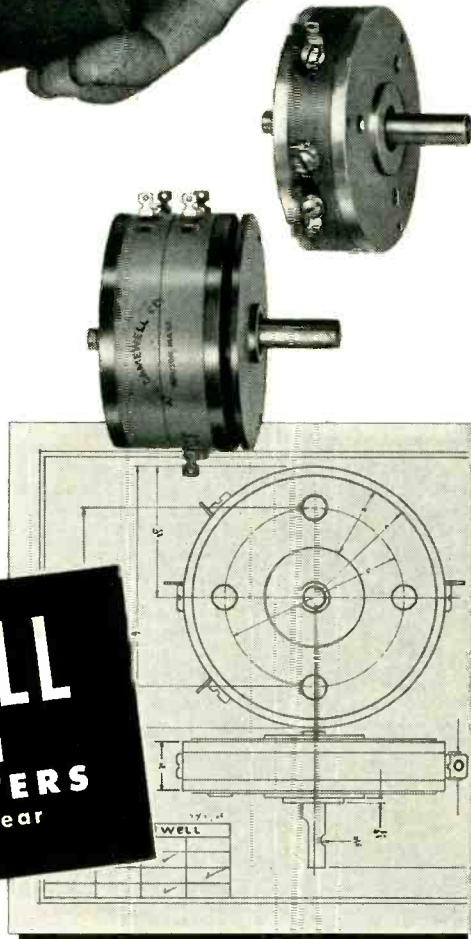

To solve your specific potentiometer problem, send an outline of your specs to Gamewell. You'll get prompt service on your order for a prototype to meet your requirements.

Linear and non-linear Gamewell Precision Potentiometers are described in the booklet shown below. We'll be glad to send you a copy.

THE GAMEWELL COMPANY
NEWTON UPPER FALLS 64, MASSACHUSETTS
In Canada: Northern Electric Co., Ltd., Belleville, Ont.

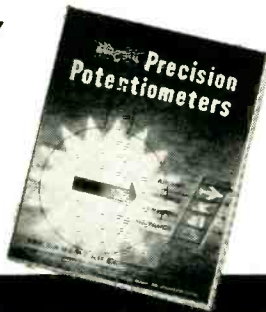

PRECISION POTENTIOMETERS

Manufacturers of precision electrical equipment since 1855

after soldering. A spacer block is placed between the fins before clamping to give precise positioning. During this assembly operation, the magnetron is supported in a No. 217 drill press vise made by Millers Falls Co., Greenfield, Mass.



Example of cabinet design in which speaker enclosure is acoustically isolated from wrought iron legs by eight shock mounts

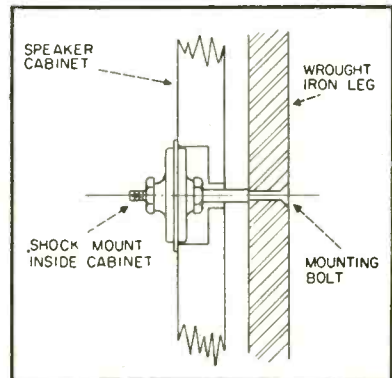

Method of using shock mounts in horizontal position to support cabinet

Shock Mounts Support Loudspeaker Cabinet

THE PROBLEM of preventing transmission of vibration from the loudspeaker enclosure to the associated equipment of a high-fidelity sound system has been solved by using 8 No. 150B8 Lord mounts, rated at 8 pounds each, between the speaker cabinet and the console supports. The technique is employed in the model RC 123 radio-phono cabinet and speaker enclosure made by Jeff Markell Associates, 108 West 14th St., New York 11, N. Y. Solid wrought iron legs are used, to

Introducing **FERRAMIC "Q"**

by **GENERAL CERAMICS**

A NEW HIGH Q, LOW LOSS, HIGH FREQUENCY CORE MATERIAL WITH STABLE CHARACTERISTICS



An ideal Core Material for Antenna Rods, Filter Inductances, Loading Coils, RF Coils and all other Applications Requiring High Performance up to 30 Megacycles.

Ferramic "Q" is an exclusive development of General Ceramics Corp. It was created to overcome the instabilities that characterized previous high performance ferrites. Exhaustive tests prove that Ferramic "Q" is completely stable in respect to age, shock, vibration, temperature. In addition this new material features higher Q and lower losses than former materials at all frequencies up to 30 Megacycles. Cost-wise, Ferramic "Q" offers extremely favorable comparison with competitive materials. For complete details, call, write or wire today.

OUTSTANDING ADVANTAGES OF FERRAMIC "Q" ARE SHOWN IN COMPARATIVE CHARACTERISTICS OF IDENTICAL COILS WITH CORES OF FERRAMICS J AND N, AND THE NEW FERRAMIC "Q" MATERIAL

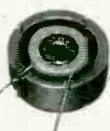

CUP CORE F-261



RING CORE F-108



ANTENNA ROD F-214 — 8" LONG

	L	C	Q
Ferramic J	154	165	50
Ferramic N	120	210	65
Ferramic Q	73	350	175

Coil consists of 20 turns #28 AWG S.F. wire random wound. Cup cores mating surfaces ground (no air gap). Inductance measured in micro-henries, capacitance measured in micro-micro-farads on Boonton Model 260-A Q-Meter. Frequency 1000 Kcs.

	L	C	Q
Ferramic J	90	280	60
Ferramic N	60	425	100
Ferramic Q	35	725	400

Coil consists of 25 turns #20 AWG S.F. wire wound uniformly on toroid. Inductance measured in micro-henries, capacitance measured in micro-micro-farads on Boonton Model 260-A Q Meter. Frequency 1000 Kcs.

	L	C	Q
Ferramic J	340	75	120
Ferramic N	270	95	160
Ferramic Q	210	120	350

Coil consists of solenoid of 85 turns #26 AWG S.F. wire. Space wound along approx. 80% of rod length and centered on rod. Inductance measured in micro-henries, capacitance measured in micro-micro-farads on Boonton Model 260-A Q meter. Frequency 1000 Kcs.

BASIC TOROIDAL MEASUREMENTS

Initial Permeability μ_0 (1Mc)	125
Figure of Merit Q (1Mc)	400 approx.
Loss Factor $\frac{1}{\mu_0 Q}$ (1Mc)	.000020 approx.
$\mu_0 Q$ (5Mc)	.000031
(10Mc)	.000050
(20Mc)	.000097
At the I.R.E. Show BOOTHS 566-568 COMPONENTS AVENUE	Good to over 30 Mc
μ_0 vs Frequency Characteristics	Good to over 30 Mc
Q vs Frequency Characteristics	250
Curie Temperature ($^{\circ}$ C)	+0.08 approx.
Temp. Coeff. of μ_0 (1Mc) %/ $^{\circ}$ C (25 $^{\circ}$ C to 70 $^{\circ}$ C)	-0.75
Temp. Coeff. of Q (Same units as above)	
Saturation Flux Density	2900
Bs (gauss) at Hdc = 25 oersteds	400
Max. Permeability μ max	1.90
Coercive Force Hc (oersteds)	1050
Residual Magnetism Br	

TYPICAL ANTENNA ROD MEASUREMENTS

FREQUENCY	Q	C = mmf.
0.6	334	344
0.8	350	189
1.0	350	120
1.2	338	83
1.4	318	60

TEMPERATURE COEFFICIENTS

Antenna Rod No. F-214 (.330 x 8"). Standard Test Coil — Space wound solenoid 85 turns #26 AWG. Formex copper, occupying approx. 80% of length of rod and centered on rod. (Resonates at 1 Mc. with 120 mmf.)

$$TC = \frac{\% \Delta \mu_0}{\mu_0} (25^{\circ} \text{ to } 75^{\circ} \text{C})$$

Temp. Coeff. of Rod +1.0 to +2.0
Temp. Coeff. of Coil only = 0



General CERAMICS and STEATITE CORP.
TELEPHONE: VALLEY 6-5100
General Offices and Plant: KEASBEY, NEW JERSEY.

MAKERS OF STEATITE, ALUMINA, ZIRCON, PORCELAIN, SOLDERSEAL TERMINALS, LIGHT DUTY REFRACTORIES, CHEMICAL STONWARE, IMPERVIOUS GRAPHITE, FERRAMIC MAGNETIC CORES

Now It's Plug - In Selenium Rectifiers

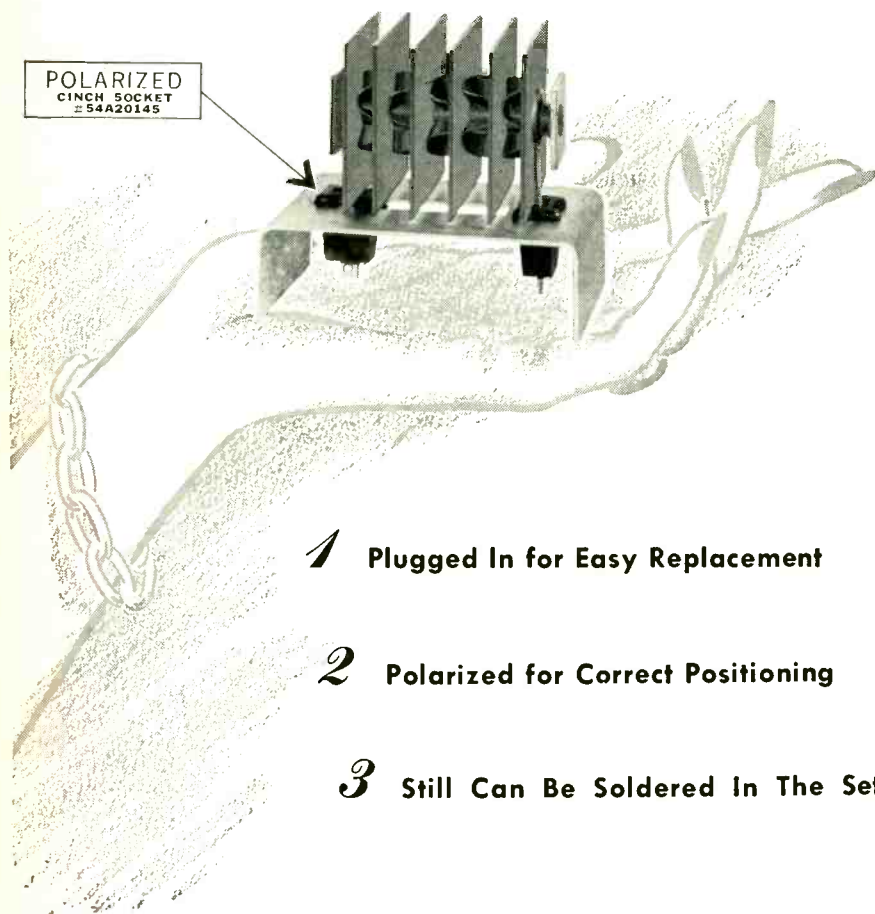

- 1 Plugged In for Easy Replacement
- 2 Polarized for Correct Positioning
- 3 Still Can Be Soldered In The Set

Available In All Sizes. Write for Further Information.



415 N. College Ave., Dept. E-2, Bloomington, Indiana
In Canada - 50 St. Clair Ave., N. W., Toronto

achieve the minimum cross-section of material between speaker and amplifier while still having adequate strength, to minimize transfer of residual vibration from the shock mounts. These mounts are used at 90 degrees from their normal position, hence eight had to be used to reduce the load per mount and prevent sagging.

Each shock mount is placed in a countersunk hole inside the speaker enclosure and is attached to its wrought iron leg by running a bolt through the leg, placing a bushing around the bolt and tightening this with a nut from the outside of the shock mount, then bolting to the shock mount, as shown in the diagram.

Even with a high-power high-fidelity amplifier running wide open to deliver full power to a wide-range 15-inch coaxial high-fidelity speaker in the enclosure, no indication of acoustical feedback through the mounting arrangement could be detected. Production problems have been greatly simplified as compared to other techniques used for this problem, such as bracing the speaker enclosure internally or using baffle panels inside.

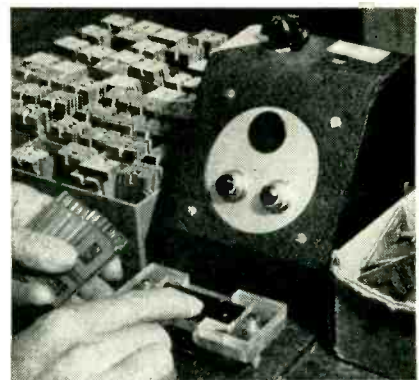

Continuity Tester for Etched I-F Coils

EIGHT different types of single-coil and double-coil etched i-f strips for i-f components can be checked in a single test fixture. The operator merely places a strip face down in a Lucite contact holding fixture and watches two pilot lamps. A selector-switch knob on top of the control box gives a choice of the eight different test circuits required. At each position, each of the coils

We haven't cut corners on **QUALITY CONTROL** to speed deliveries for—











CHESTER
plasticord-plasticote
WIRES & CABLES

Extra shifts, not speed-ups are the way Chester catches up on production to meet your delivery dates. Chester Wires and Cables are never rushed through... every foot is quality controlled according to the highest standards known to the industry. This is the reason Chester Wires and Cables are of uniform quality, always dependable, whether you use a foot or a spool. For an extra measure of reliability, specify Chester, for your next electrical or electronic requirements.

WIRE AND CABLE DATA SHEETS
 Contains complete information on Chester Quality Conductors. Call or write for yours, today!

VISIT US AT THE
 I.R.E. SHOW
 BOOTH 664
 REGENTS AVENUE

CHESTER CABLE CORP.
 C H E S T E R • N E W Y O R K

	JAN-C-76 WIRES* SRIR, SRHV, SRRF, WL
	105°C, 90°C, 80°C UL APPROVED; 120°C*
<i>*Solid colors or spiral marking</i>	
	FLEXIBLE CORD
	TV LEAD-IN WIRES
	COMMUNICATION WIRES & CABLES TO SPECIFICATIONS
	LACQUERED AND NYLON WIRES
	SHIELDED WIRES & CABLES
	INSTRUMENT WIRES
	COAXIAL CABLE
	SPECIAL WIRES & CABLES TO SPECIFICATIONS

"Chester" INVITES INQUIRIES concerning custom constructions including polyethylene, polyvinyl chloride, nylon, braided and lacquered wires, special insulating materials, glass, yarn or any known material. Recommendations will be made without obligation.



Career Opportunities

for

- MECHANICAL ENGINEERS
- ELECTRONICS ENGINEERS
- ELECTRICAL ENGINEERS
- PHYSICISTS
- AERODYNAMICISTS
- MATHEMATICIANS

➤ Sandia Corporation, a subsidiary of the Western Electric Company, offers outstanding opportunities to graduates with Bachelor's or advanced degrees, with or without applicable experience, in the above fields.

➤ Engineers and scientists at Sandia Laboratory, an atomic weapons installation, work as a team at the basic task of applying to military uses certain of the fundamental processes developed by nuclear physicists. This task requires applied research as well as straightforward development and production engineering.

➤ The place of an engineer or scientist on the Sandia team is determined initially by his training, experience, and talents . . . and, in a field where ingenuity and resourcefulness are paramount, he is afforded every opportunity for professional growth and improvement.

➤ Sandia engineers and scientists design and develop complex components and systems that must function properly under environmental conditions that are much more severe than those specified for industrial purposes. They design and develop electronic equipment to collect and analyze test data; they build instruments to measure weapons effects. As part of their work, they are engaged in liaison with the best production and design agencies in the country, and consult with many of the best minds in all fields of science.

➤ Sandia Laboratory, operated by Sandia Corporation under contract with the Atomic Energy Commission, is located in Albuquerque — a modern, mile-high city of 150,000 in the heart of the healthful Southwest. Albuquerque offers a unique combination of metropolitan facilities plus scenic, historic and recreational attractions; and a climate that is sunny, mild, and dry the year around. New residents have little difficulty in obtaining adequate housing.

➤ Liberal employee benefits include paid vacations, sickness benefits, group life insurance, and a contributory retirement plan. Working conditions are excellent, and salaries are commensurate with qualifications.

Make Application to:
PROFESSIONAL EMPLOYMENT
DIVISION C

SANDIA

Corporation

SANDIA BASE • ALBUQUERQUE, NEW MEXICO

is placed in series with a 6-volt pilot lamp, with a power transformer providing the required low a-c voltage for the continuity test. Both pilot lamps glow for an acceptable strip.

Winding VHF Coils

BIFILAR-WOUND coils for use in television tuners are efficiently made in hand-operated jigs at the San Juan, Puerto Rico plant of Radell Corp.

In one setup, used for producing five coils at a time, the operator anchors the end of the wire in a clip at the left side of the jig, then loops the wire in sequence around fifteen pulleys and five studs. Ten of these pulleys, at the rear of the jig, are mounted in adjustable slots; moving these pulleys further



Method of loading five-at-a-time jig for winding single-turn vhf coils that will later be bent around coil form to serve as a bifilar inductance. Operator pulls wire off spool on bench

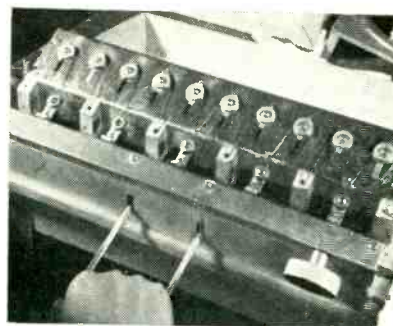

Pushing lever down to cut wire on five coils simultaneously. Knob at r actuates rack-and-gear arrangement twisting five loops of wire

TELECHROME
INCORPORATED

THE ONLY COMPLETE LINE of INSTRUMENTATION for **COLOR TV**



Chromascope
(Signal
Certification)



Phase Slope
(Envelope Delay)
Curve Tracer

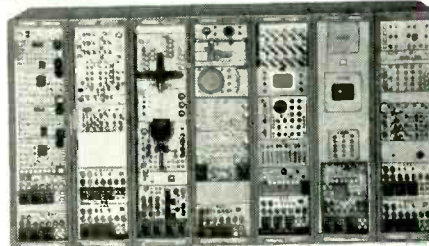

Full facilities — Transmits, receives, monitors,
analyzes composite color pictures

Westinghouse

CROSLLEY



WMAR-TV
Baltimore, Maryland

Gilfillan



Hoffman



AMIZ TV

TUNG-SOL

U.S. Air Force
U.S. Marine Corps
U.S. Navy

In Color TV instrumentation, no other name means as much as Telechrome . . . because no organization can match Telechrome's 3 years of experience in providing color TV generating, testing and broadcasting equipment to these and other prominent manufacturers, laboratories and broadcasters.

Complete equipment for generating color bars; creating encoded and composite pictures from transparencies; color signal certification; transmission, reception, monitoring, and analysis of color pictures — literature on these and more than 100 additional instruments for color TV by TELECHROME are available on request.

TELECHROME
INCORPORATED

The Nation's Leading Supplier of Color TV Equipment
88 Merrick Road Amityville, N. Y.
AMityville 4-4446

DELIVERY 60-90 DAYS

SEE TELECHROME Booths 181-183, THE I. R. E. SHOW

ADVANCED ELECTRONIC DESIGNS...

by **AVION**

FREQUENCY CONVERTER—MODEL 400

A 400-CYCLE POWER SUPPLY BENCH SIZE

- Plugs into 60-cycle line
- Delivers 100 volt-amperes
- Output frequency and amplitude adjustable through entire AN-E-19 Range: 380-420 cps
105-130 volts

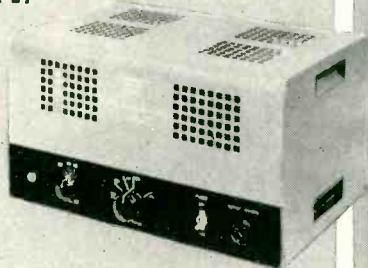

Frequency Regulation: Better than ± 1 cps
Voltage Regulation: Better than $\pm 1\%$
Harmonic Distortion: Total better than 3% } *Independent of power factor*

The small size (17" long x 11½" wide x 9" high), power output (100 V-A), and low cost afford the convenience of using one converter for each bench set-up. Four hundred cycle power handling capacity need be paid for only as required.

PRECISION VOLTAGE REGULATOR—MODEL 116 400-CYCLE

- Regulation: $\pm 0.01\%$ for 0 to 50 VA load variation
 $\pm 0.02\%$ for 0 to 100 VA load variation
(When output set to center of $\pm 10\%$ input voltage variation)
- Developed harmonics: better than 1%
- Transient time constant: better than 0.01 seconds



Low harmonic distortion and low transient time constant result from the use of a push-pull feedback amplifier in the output. These features, together with the unusually high regulation, suggest the superiority of the Model 116 as compared with ordinary 400-cycle regulators.

Send for complete data on these Avion products

OTHER AVION PRODUCTS

Altitude & Air Speed Control Units • Electronic Choppers • Electronic Inverters
Magnetic Memory Systems • Miniature Plug-In Amplifier Units • Miniature Precision Potentiometers
Multron • Power Supplies • Replaceable Subminiature Amplifier Assemblies • Signal Generators



AVION
INSTRUMENT CORP.

Division of American Car and Foundry Company.

299 Highway No. 17 • Paramus, New Jersey

EXPORT REPRESENTATIVE: Racke International Corp., 13 E. 40th Street, New York 16, N. Y.
Cables: "ARLAB" New York • All Codes

CANADIAN REPRESENTATIVE: Aeromotive Engineering Products,
5257 Queen Mary Road, Montreal, Que.

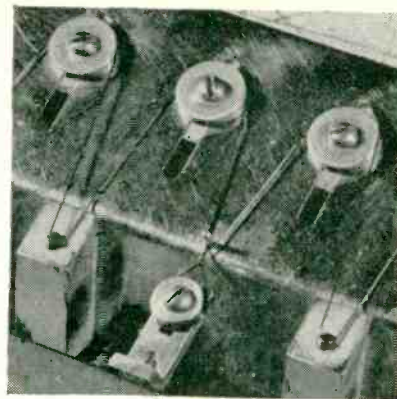

Appearance of studs when retracted to cut coils apart

back increases the lead lengths on the completed coils.

The five pulleys nearest the operator are on rotatable supports. After the wire looping has been completed, the operator turns a knurled knob at the right to move a rack which in turn rotates small gears on each of the five pulley supports. This serves to twist one loop on each coil the desired number of times, with all five loops getting identical twists simultaneously.

After twisting, a lever in front of the jig is pushed down to retract the five studs, each of which has a shearing jaw. This cuts apart the five coils at the desired points simultaneously, and at the same time releases the winding tension. The operator then picks off the finished coils and proceeds to re-load for the next batch.

In another coil-department operation, preliminary forming of wire for vhf television coils is achieved with the aid of a clamping fixture

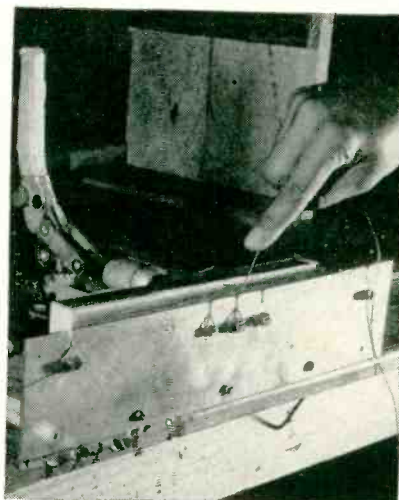

Loading wire into fixture used for producing one vhf coil harness at a time

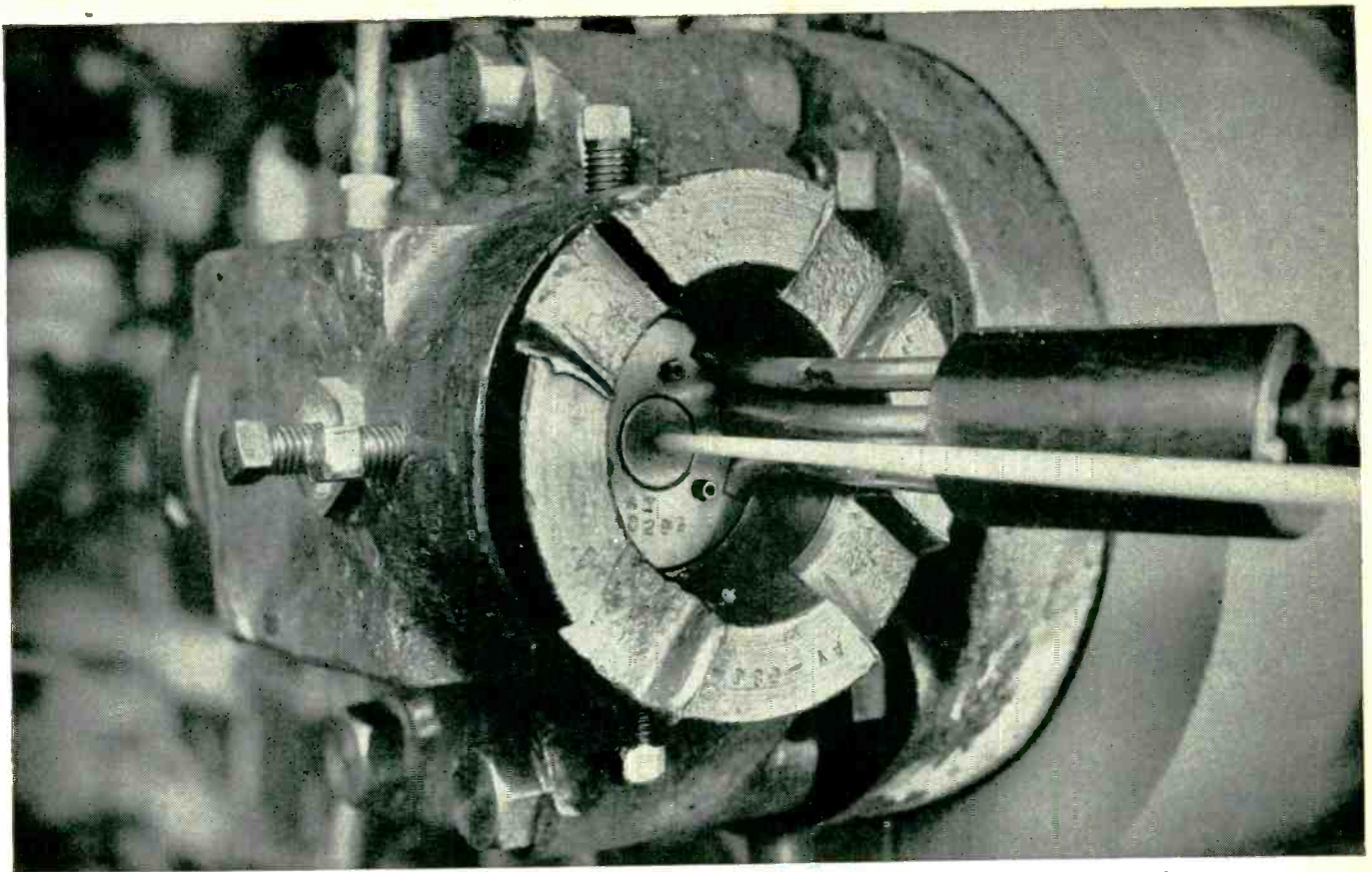

Leaving the die, BAKELITE Cellular Polyethylene expands to twice its volume as it is extruded on to wire. Cellular structure gives better insulation properties, a 50% weight saving, and lower costs by volume, compared with standard polyethylene. Varying degrees of expansion can be formulated.

CELLULAR POLYETHYLENE—LOW-COST INSULATION FOR UHF TELEVISION LEAD-IN WIRE

Making ultra-high-frequency television commercially practical is one job already assured for BAKELITE Cellular Polyethylene, shown above being extruded on to wire.

BAKELITE Cellular Polyethylene is a structure of unconnected cells that actually improves on polyethylene's outstanding electrical properties. Its dielectric constant is lower. It is especially useful at high frequencies, where electrical attenuation and line losses must be reduced.

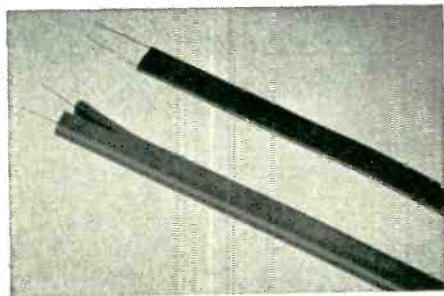

Samples of wire covered with cellular (below) and solid extruded polyethylene. Cellular polyethylene does not replace the solid-type insulation, but is used where electrical requirements are very exacting.

The unicellular composition has unusually high resistance to water penetration. Specific gravity is about half that of solid polyethylene—the lightest commercial plastic—offering notable weight savings in finished wire. UHF wire covered with BAKELITE Cellular Polyethylene is extremely easy to terminate.

The new material can be extruded on to various sizes and types of wire. It retains the chemical resistance of polyethylene, and withstands sea water, most acids, alkalis, and oxidizing agents. For descriptive literature, write Dept. TT-79.

BAKELITE
TRADE-MARK
Polyethylene
WIRE COVERING

BAKELITE COMPANY, A Division of Union Carbide and Carbon Corporation **UCC** 30 East 42nd Street, New York 17, N. Y.
In Canada: Bakelite Company, Division of Union Carbide Canada Limited, Belleville, Ontario

SCREEN BOOTH FILTERS

block radio interference

0.14 TO 15,000 MEGACYCLES

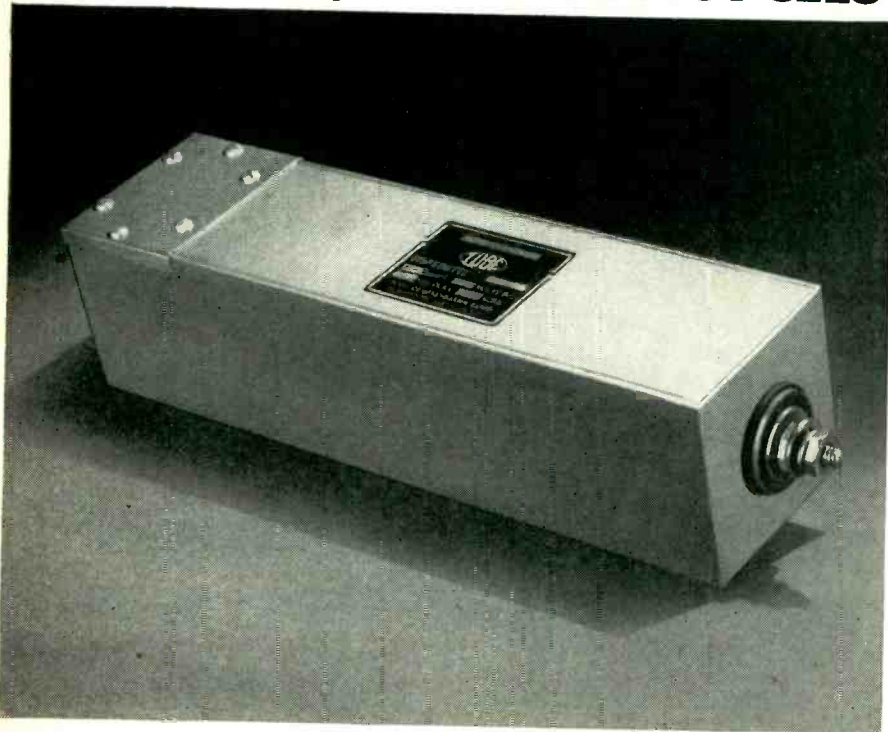

TYPE	AMPS.	CIRCUITS	VOLTAGE RATING	ATTENUATION VS. FREQUENCY RANGE
1752	15	1	500 VAC/1000 VDC	Min. 100 DB from 1000 MC to 15,000 MC
1739	30	2	500 VAC/1000 VDC	Min. 100 DB from 100 KC to 1000 MC
1650-1	50	1	250 VAC/600 VDC	Min. 100 DB from 14 KC to 1000 MC
1755	50	1	500 VAC/1000 VDC	Min. 100 DB from 100 KC to 1000 MC
1753	50	1	500 VAC/1000 VDC	Min. 100 DB from 1000 MC to 15,000 MC
1742	100	1	250 VAC/600 VDC	Min. 100 DB from 100 KC to 1000 MC
1743	100	1	500 VAC/1000 VDC	Min. 100 DB from 100 KC to 1000 MC
1520	100	1	500 VAC/1000 VDC	Min. 100 DB from 1000 MC to 15,000 MC
1738-1	200	1	250 VAC/600 VDC	Min. 100 DB from 100 KC to 1000 MC
1754	250	1	250 VAC/600 VDC	Min. 100 DB from 100 KC to 1000 MC
1756	250	1	500 VAC/1000 VDC	Min. 100 DB from 1000 MC to 15,000 MC

DO YOU KNOW THAT . . . in 1929, Tobe was selling effective power line filters for screen rooms? Ask Tobe for the answers to all radio interference questions; our 25 years' experience can solve your problems.



TOBE DEUTSCHMANN
CORPORATION
NORWOOD, MASSACHUSETTS

PRODUCTION TECHNIQUES

(continued)

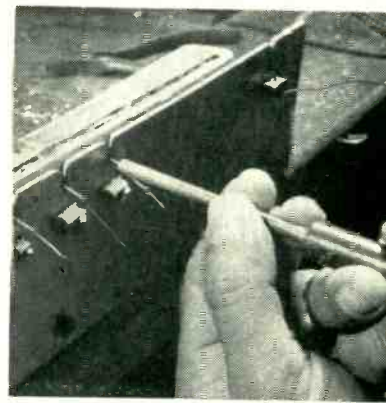

Method of using twisting tool

that is attached to the bench. The wire is strung back and forth through slots and around shaped studs on a vertical metal plate. A cloth-padded wood block is then brought up against the rear of the metal plate and locked in position with a lever-type clamp.

The operator next cuts the three central loops of wire with diagonal cutting pliers and uses a special two-hole tool to twist together the cut ends of each loop. This tool is simply a metal rod having two holes drilled into its end. Each hole flares outward at about 45 degrees so that it comes out the side of the rod. The leads are cut to unequal

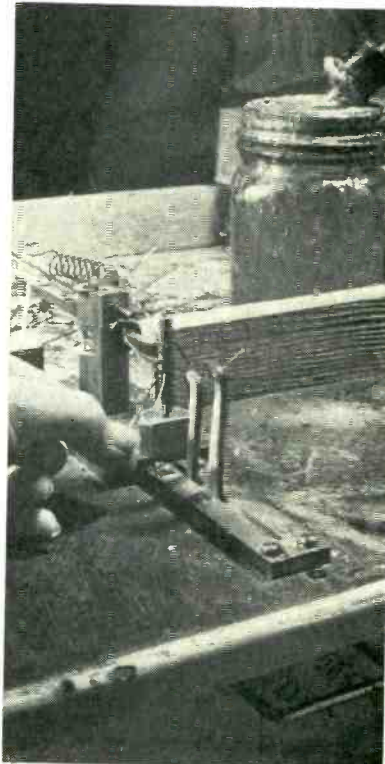

Fixture used for positioning coils accurately during final assembly on form

wherever a **transistor** is used . . .

in

- COMPUTERS • HEARING AIDS
- MINIATURE AIRBORNE EQUIPMENT
- POCKET RADIOS • F-M TRANCEIVERS
- TELEPHONE MESSAGE RECORDERS
- GUIDED MISSILES AND A HOST OF EXPERIMENTAL APPLICATIONS . . .

GRAMER TINYFORMER



OPEN TYPE (actual size)

GRAMER TINYFORMER



CLOSED TYPE (actual size)

THERE'S A JOB FOR GRAMER TINYFORMERS

TRANSISTOR TRANSFORMER

Open Types or Sealed to Specifications

14 Tinyformers available for immediate delivery:

★It is a fact . . . designers of miniature electronic equipment invariably associate Gramer TINYFORMERS with the Transistor. A strong linkage has been established between Gramer TINYFORMERS and the leading manufacturers of hearing aids, miniature electronic airborne equipment and comparable small electronic devices. Check the physical and electrical characteristics of the Standard Open-Type and Mu-Metal Shielded Gramer TINYFORMERS charted to the right. Note the varying range of match impedances from 200,000 to 50 ohms. Consider that Gramer TINYFORMERS have high permeability nickel-alloy cores and nylon bobbins. Their fine copper wire is coated with tough enamel and they are impregnated for moisture resistance. They utilize high temperature (+125°C) plastic flexible lead wire. You see . . . Gramer TINYFORMERS are not just better . . . they *far surpass* all other methods which justifies your selection of Gramer TINYFORMERS *wherever a transistor is used.*

OPEN TYPE PART NO.	MU-METAL SHIELDED NO.	TYPE	MATCH. IMPEDANCE		D.C. RESISTANCE	
			PRI.	SEC.	PRI.	SEC.
M1	M1-S	Interstage	20,000	1,000	1,150	175
M2	M2-S	Interstage	20,000	1,000	930	95
M4	M4-S	Output	600	50	66	7.7
M5	M5-S	Output	400	50	70	9.3
M6	M6-S	Input	200,000	1,000	2,600	135
M7	M7-S	Output	1,000	50/60	160	9
M10	M10-S	Choke	12 Hy. O D.C.		830	

Open Type 1 1/2" x 3/8" x 3/8"

Mu-Metal Shielded Type 1 1/2" x 2 3/4" x 2 3/4"

plus A COMPLETE LINE OF TRANSFORMERS FOR EVERY TYPE OF INDUSTRY
Hermetically Sealed

Meet MIL-T-27 Grade 1, Class A or B; and Grade 2, Class C Specifications.



Send your specifications now for cost-free recommendations



TRANSFORMER CORPORATION

2734 NORTH PULASKI ROAD • CHICAGO 39, ILLINOIS

TRANSFORMERS

PRODUCTION TECHNIQUES

(continued)

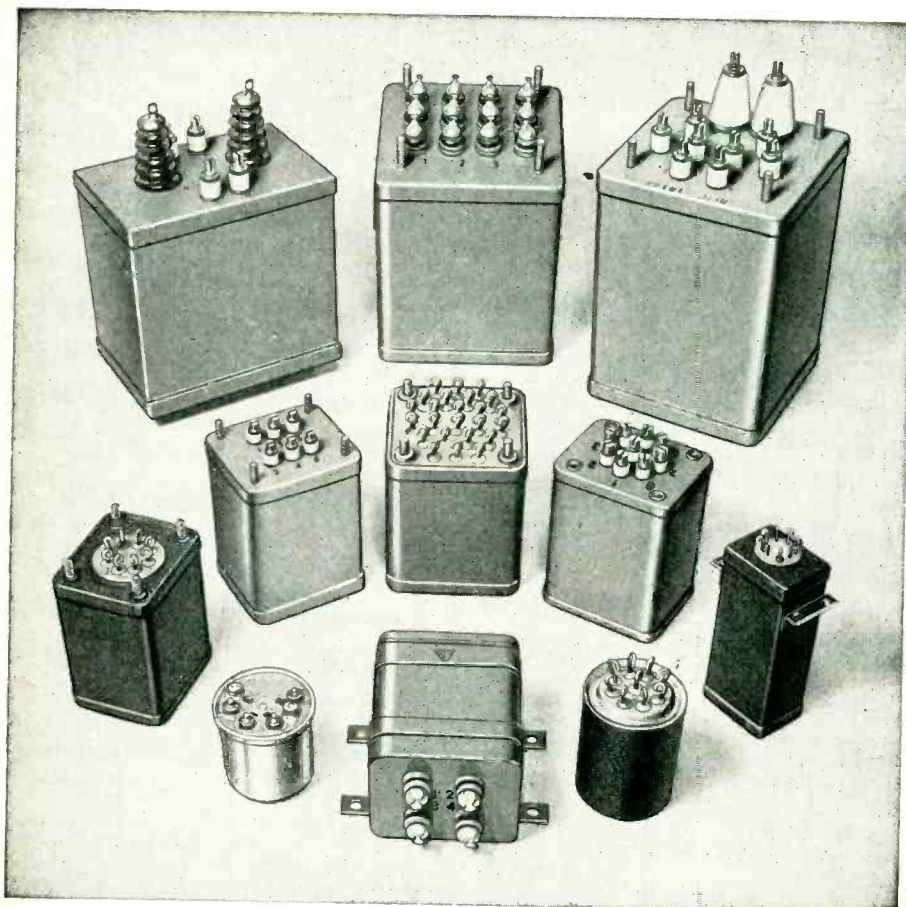

HERMETICALLY SEALED TO MIL-T-27 SPECIFICATIONS

NYT offers a wide variety of transformer types to meet military and civilian specifications, designed and manufactured by specialists in transformer development.

Latest NYT service for customers is a complete test laboratory equipped and approved for on-the-spot MIL-T-27 testing and faster approvals.

**NEW YORK
TRANSFORMER CO., INC.**
ALPHA, NEW JERSEY

lengths. The operator inserts the longer lead in the hole of the tool first, and can then easily insert the short lead in the other hole. Spinning the shaft of the tool between thumb and forefinger of her left hand then serves to twist the leads together quickly.

Final assembly of the coils on a tubular cardboard form is done with the aid of a positioning jig. The empty form is slipped over a vertical metal rod. The operator drops coils on this one after another while operating foot pedals that move in spacing levers or positioning bars, then applies coil dope with a brush to anchor the sections.

Adhesive-Clad Copper Cuts Printed Circuit Costs

THE PRODUCTION of copper-laminated thermosetting sheets for printed circuits is reduced from eight steps to two steps through use of newly available Plymaster adhesive-coated copper made by Rubber & Asbestos Corp., Bloomfield, N. J. The new sheet comes cut to size, pre-cleaned, pre-inspected for surface defects, adhesive-coated, dried to non-tacky condition and pre-inspected for adhesive coverage. The two remaining steps required on the part of the manufacturer are: (1) Lay adhesive-coated copper sheet on base of impregnated paper of previously formed laminate; (2) set in heated press for curing and final lamination.

Although the coated copper costs somewhat more than the uncoated, elimination of the coating procedure in the laminating plant results in savings of up to 75 percent in the production of bases



Laying sheet of pre-coated electrolytic sheet copper on polished platen of press

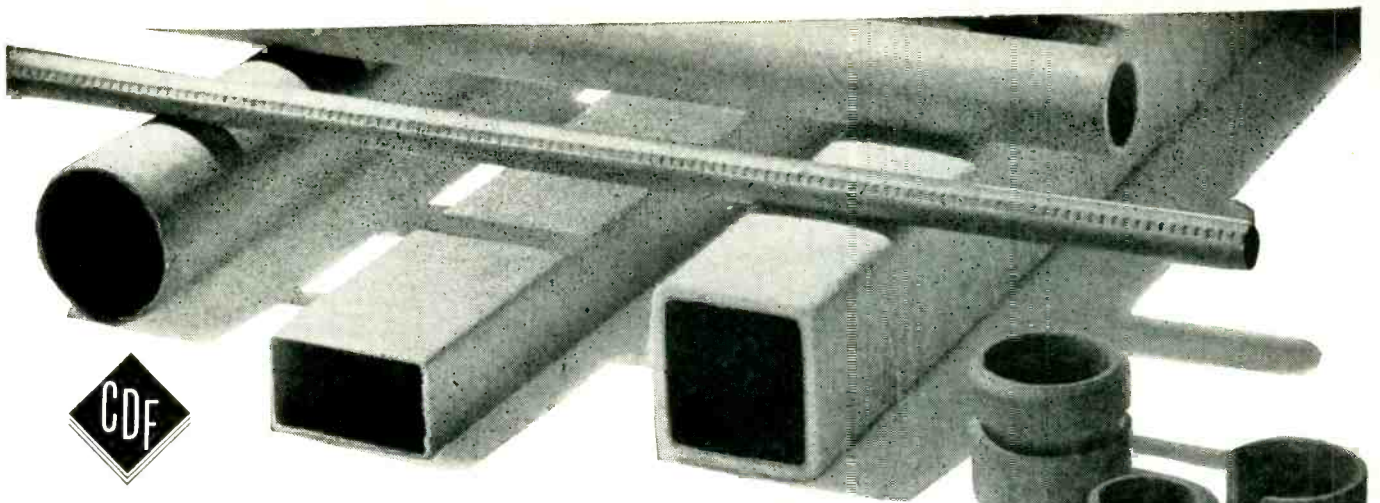

WE MAKE AND FABRICATE ... STRONG, LOW-COST SPIRAL TUBING

Spiral Tubing, another outstanding C-D-F product, is an important new material for the progressive, cost conscious design engineer (and purchasing agent). It is a high strength plastic made from paper or fibre that is spirally wound, then impregnated with phenolic resin or insulating varnishes and carefully cured at high temperatures. The resulting tubes (round, square, rectangular or formed to special shapes) are stiff, sturdy, resistant to crush, with good tensile strength.

This unique product has good dielectric strength with low dielectric loss properties. Moisture resistance and dimensional stability is easily controlled in the manufacturing process. The wide variety of sizes, shapes, forms; the strength; low cost; ease of fabrication; speed of delivery; all combine to make C-D-F Spiral Tubing worthy of your investigation.

SIZES

The round tubing ranges from 3/32 to 8" ID, with wall thicknesses from .0075 to 1/4". The minimum ID of square and rectangular tubing is 3/8", with 2 1/8" the maximum ID. Wall thicknesses range from .010 to 3/32".

Standard lengths are from 2 to 4', with special sizes and grades, plain or impregnated, open for your discussion with our C-D-F sales and engineering staff.

FABRICATION

Spiral Tubing is readily sawed, punched, drilled, tapped, riveted, stamped, painted, depending on the grade; it is suitable for automatic machine operations, but not recommended for conventional machine threading. Waxing or varnish impregnation to improve moisture resistance is usually done on the finished coils by the user.

PRIMARY APPLICATIONS

COIL FORMS OF ANY SIZE OR SHAPE
for tuned or untuned RF, IF, oscillator, and other coils used in radio, television, electronic circuits
for solenoids, relays, circuit breakers
for transformers
for permeability tuners

INSULATORS
for selenium rectifiers
for electric motors
relays

BUSHINGS OR SPACERS
armature shaft spacers
for mechanical support

SHIPPING PROTECTORS AND FOR SPECIALIZED PACKAGING BOBBIN TUBES

BODIES FOR PAINT ROLL APPLICATORS

AS A COMBINATION MATERIAL
with other C-D-F high strength plastics or electrical insulating materials

GRADE SELECTION

C-D-F has mass production facilities for both the manufacture and fabrication of eighteen distinct grades of Spiral Tubing. For example, there's a special punching grade, fine for punching rectangular or square holes near the end of the tube. A relatively soft tube is supplied for difficult stapling or riveting. C-D-F makes high strength automotive electrical bushings from a very hard tubing with high axial compressive strength. Combinations of kraft, chipboard, Diamond "fish paper" Insulation, and other materials are available.

FORMS: ROUND • FORMED • FORMED AND NOTCHED • SQUARE AND RECTANGULAR

THE NAME TO REMEMBER



FOR SPIRAL TUBING

Continental-Diamond Fibre Company

NEWARK 16, DELAWARE

Remember, C-D-F has production know-how, years of experience in electrical insulation. See your C-D-F sales engineer. Write now for new 1953 spiral tubing folder, a workbook showing grades, applications, properties.

For Parts that must be
TAKEN OFF—PUT BACK—BUTTONED TIGHT

LION FASTENERS

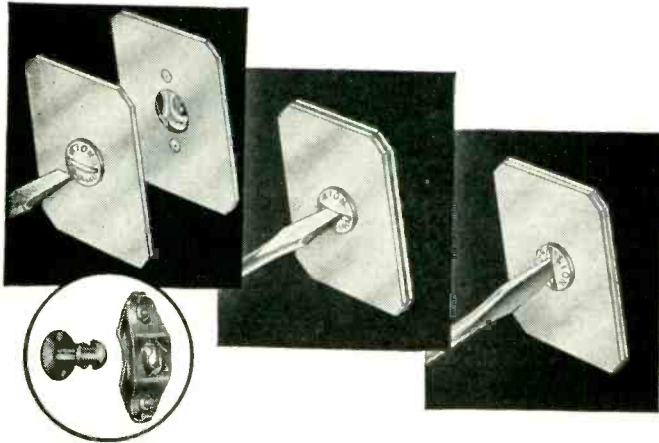

LOCKS TIGHT WITH A QUARTER TURN

Always at correct tension

Lion Fasteners are right for buttoning parts that must be removed repeatedly for inspection, maintenance, or other reasons.

Vibration and shock can't loosen a Lion Fastener. Even an inexperienced service man can't replace it wrong. A quarter turn opens it. Another quarter turn locks it. The tension is designed into it.

Lion Fastener Spring Assembly is quickly spot welded or riveted in place. The stud cannot be lost. It is grommeted tight to the sheet. They will button sheets .040 plus or .020 minus over or under standard rating. The misalignment is as much as .156. The one-piece forged stud is tested to 1425 lbs. Write today for demonstration kit and application data.

TYPICAL APPLICATIONS: INSPECTION PLATES • COWLING
 ELECTRICAL PANELS • CABINETS • DUCTWORK

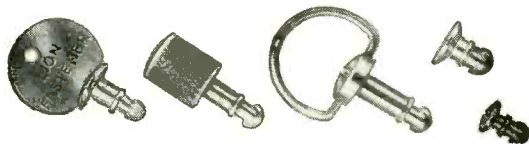

Free DEMONSTRATION KIT contains sample Lion Fasteners to help you visualize their adaptability to your product. Write on your company letterhead. No obligation.



500 MAIN ST., HONEOYE FALLS, N. Y.

In Canada:

A. T. R. Armstrong, 50 St. Clair Ave. West, Toronto

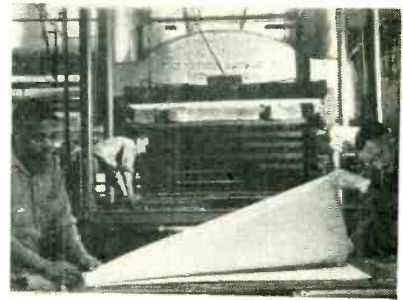

Laying sheets of resin-impregnated paper on adhesive-coated copper



Placing polished press platen, similar to photographic ferrotyping tin, on top of sandwich which may be copper-clad on one or both sides depending on requirements of printed circuit manufacturer for his final product

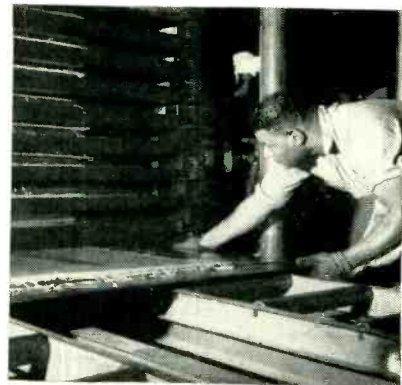

Rolling sandwich into press. Top platen is protected against abrasion by woven asbestos sheet. Roller conveyor section can be raised or lowered for feeding sandwiches into press at different heights without lifting the sandwich

for printed circuits, while yielding bond strengths up to 583 percent better than had been obtained with previously used adhesives. Peel strengths range from 10 to 12 lb per inch consistently after immersion in a 200C molten solder bath. With a special more expensive adhesive that is also available as a coating



See You at the IRE Show
116-118
Military Avenue

(For Years a Standard for Radio and TV)

Offers You FULL RANGE of Finest Quality Laminates

St. Regis Panelyte Industrial Laminates, with phenolic, melamine and silicone resins, have excellent insulating properties for radio, TV and other electronic purposes. Available in sheets, rods, tubes, molded specialties and fabricated parts. Included in this range are metal-clad laminates for the printed circuit industry.

STANDARD GRADES TO GOVERNMENT and INDUSTRY SPECIFICATIONS



Paper Base Insulation



Silicone Fiberglass Insulation

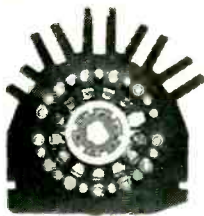

High Insulation Resistance Laminate



Paper Base Tubing

SHEET STOCK			
Panelyte Grade	Nema Grade	DESCRIPTION	GOVERNMENT SPEC.
750	X	Paper Base, Phenolic Resin, Mechanical (PBM)
550	XX	Paper Base, Phenolic Resin, Mechanical & Electrical	MIL-P-3115B (PBG)
520	XXX	Paper Base, Phenolic Resin, Electrical	MIL-P-3115B (PBE)
770	P(XP)	Paper Base, Phenolic Resin, Cold Punching, General Electrical
772	PC	Paper Base, Phenolic Resin, Cold Punching, Secondary Electrical
774	XXP	Paper Base, Phenolic Resin, Hot Punching, Good Electrical
776	XXXP	Paper Base, Phenolic Resin, Hot Punching, High Frequency	MIL-P-3115B (PBE-P)
790	XXXP	Paper Base, Phenolic Resin, Copper-Clad Printed Circuits
900	C	Fabric Base, Phenolic Resin, Mechanical	MIL-P-15035B (FBM)
910	CE	Fabric Base, Phenolic Resin, Good Electrical, Fair Mechanical	MIL-P-15035B (FBG)
940	L	Fabric Base (Fine Weave), Phenolic Resin, Fine Machinability	MIL-P-15035B (FBI)
950	LE	Fabric Base (Fine Weave), Phenolic, Good Electrical, Fair Mechanical	MIL-P-15035B (FBE)
580	A	Asbestos Paper, Phenolic Resin, Heat Resistance, Low Voltage (PBH)
980	AA	Asbestos Cloth, Phenolic Resin, Very High Impact (FBH)
130	G7	Continuous Glass Cloth, Silicone Resin, High Heat Resistance	MIL-P-997 B (GSG)
135	G6	Staple Glass Cloth, Silicone Resin, High Heat Resistance
140	G5	Continuous Glass Cloth, Melamine Resin, Arc Resistance, High Strength	MIL-P-15037 B (GMG)
170	G3	Continuous Glass Cloth, Phenolic Resin, Highest Strength
190	N1	Nylon Cloth, Phenolic Resin, Lowest dielectric & loss factor	MIL-P-15047 B (NPG)
784	Paper Base, Phenolic Resin, Good Insulation Resistance	MIL-P-3115B (PBE-P)
9101	Fabric Base, Phenolic Resin, Low Water Absorption	Navy Spec 33B4
920	Fabric Base (Medium Weave), Phenolic, Good Impact, Good Machinability	MIL-P-15035B (FBM)

ALL ROD AND TUBE TO SPECIFICATION MIL-P-79B.

PANELYTE can be of service anywhere you have use for Industrial Laminates. Would you like a free sample of Panelyte? Or a free copy of the Panelyte Industrial Catalog? Or a visit from a Panelyte engineer? Or all three? No obligation, of course. Just let us know by sending in the coupon below, now.

OTHER PANELYTE PRODUCTS

- 1 DECORATIVE, for table-tops, all horizontal work surfaces, wall-covering, etc. in sizes up to 4' x 10'.
- 2 MOLDED LAMINATED PARTS — refrigerator inner-door panels, breaker strips, specially molded items, breaker frames.
- 3 INJECTION MOLDINGS—32, 48, 60, 200 oz. capacity. Television masks, refrigerator parts, industrial items, etc.
- 4 REINFORCED PLASTICS—



ST. REGIS PAPER COMPANY
230 PARK AVENUE • NEW YORK 17, NEW YORK
Offices in Principal Cities

PANELYTE DIVISION E-354
ST. REGIS PAPER COMPANY
230 Park Avenue, New York 17, New York

Please send me sample of Grade _____ Panelyte.
 Please send Panelyte Industrial Catalog.
 Please have a Panelyte engineer contact me.

Name _____
 Firm Name _____
 Address _____
 City _____ Zone _____ State _____

Clean Sweep

on soldered connections



82% labor reduction in wiring — with this Centralab Printed Electronic Circuit Couplate †

- CRL PC-101 Vertical Integrator reduces wiring connections from 16 to 3.
- Four capacitors — four resistors in one package.
- PC-101 is in CRL stock for IMMEDIATE DELIVERY — as are 30 standard circuit couplates.
- CRL has over 150 specialized engineers for the design and development of P.E.C.'s. They can help you with your circuit problem.
- Hundreds of experienced production personnel and extensive, mechanized facilities produce your requirements whether hundreds or millions of couplates.
- Up to 29 different quality tests are made on each CRL Couplate before shipment.
- Centralab's experience in resistor, capacitor and ceramic materials goes back to 1923 — all these have contributed to the quality of Centralab P.E.C.'s.

Here are some of the reasons why Centralab is your only thoroughly experienced source for Printed Electronic Circuits.

- Centralab has more years of P.E.C.† engineering and production experience than any other supplier. (CRL pioneered Printed Electronic Circuits in the electronic industry.)

 Write now! Before you turn the page. For Centralab's P.E.C. folder and customer specification sheets.

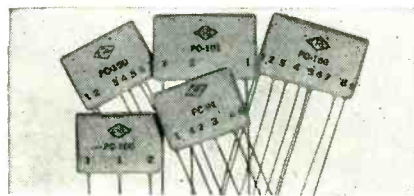

Centralab P.E.C.'s reduce time and cost of installation, stocking and paper work — give you consistent, accurate performance for 100 or 1,000,000 plates.

†Trademark

Centralab

A Division of Globe-Union Inc.
914 E. Keefe Avenue • Milwaukee 1, Wisconsin
In Canada: 804 Mt. Pleasant Road, Toronto, Ontario

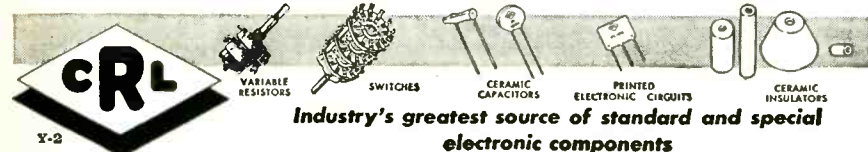

Regulating pressure and heat input to laminating press used for curing

on copper, a peel strength of 25 to 35 lb per inch is achieved with the 235C solder dip test.

Drying Copper-Clad Sheets

FRESHLY applied photographic emulsion on copper-clad plastic sheets for etched circuits is whirled to dryness under infrared lamps in a special heat tank. A large spring steel wire frame serves as a self-adjusting holder for spinning the sheets one at a time in the tank.

Speed of whirling is controlled by a knob on the electronic speed control used with the vertically mounted drive motor. Heat for drying is supplied to the back of the

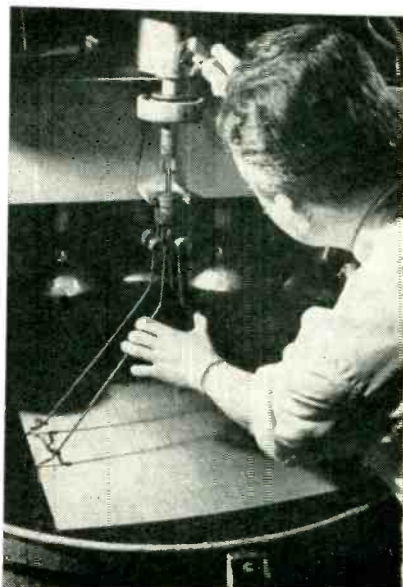

Adjusting speed control for whirling motor. Spring-wire holder grips sheet face downward in tank which collects the surplus emulsion as it is thrown out centrifugally during whirling

3 twin power triodes

A CORDIAL INVITATION
TO VISIT OUR EXHIBIT
I.R.E. SHOW
BOOTHS 474, 476, 478
ELECTRONIC AVENUE

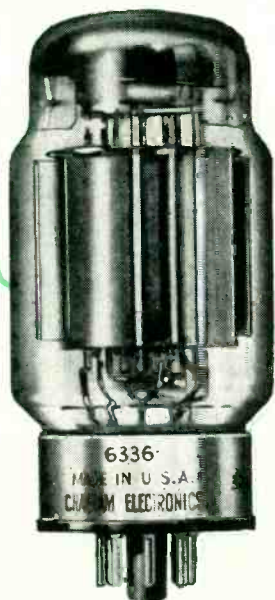
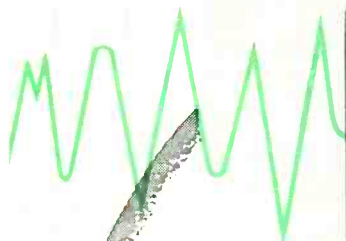

CHATHAM TYPE 6336

NEW TWIN TRIODE
FEATURING HIGH
PLATE DISSIPATION

The new Chatham Type 6336 is a twin power triode with special suitability for voltage regulating applications. Used as a series tube, it will pass a minimum of 150 milliamperes per section with 40 volts, D.C. plate voltage. Special features include a hard glass envelope, an 8-pin button stem with Jumbo Octal Base.

...for voltage
regulation

CHARACTERISTICS (PER SECTION)

- PLATE DISSIPATION: 30 WATTS
- AMPLIFICATION FACTOR: 2.7
- TRANSCONDUCTANCE: 11,000 MICRORHMS
- PLATE RESISTANCE: 250 OHMS
- HEATER REQUIREMENTS: 6.3 V., 4.75 AMPS.



TYPE 6394 TWIN TRIODE

Similar to Type 6336 in every respect except for Heater Requirements which are 26.5 volts, 1.25 amps.

The tubes shown are typical items from the complete Chatham line of general and special purpose tubes. Included in this line are Amplifiers, Mercury and Inert Gas Rectifiers, also Mercury, Inert Gas and Hydrogen Thyratrons.

Most Chatham tubes are available directly from stock and can be supplied promptly. Chatham also designs, develops and manufactures special tubes to exact customer specifications— inquiries are invited.



CHATHAM TYPE 6AS7G IMPROVED TWIN POWER TRIODE —

This Chatham Twin Triode is built to close tolerance — features plate current and GM characteristics held within $\pm 10\%$, very low microphonics, improved triode balance, absence of grid current and greatly reduced plate current drift. Plate current is 125 milliamperes at 40 volts, D.C. plate voltage. The characteristics of this tube recommend it especially for voltage regulation circuits. Base is Medium Shell Octal.

CHARACTERISTICS: (PER SECTION)

- Plate Dissipation: 13 Watts
- Amplification Factor: 2.0
- Transconductance: 7,000 Microhms
- Plate Resistance: 280 Ohms
- Heater Requirements: 6.3 Volts
2.5 Amps.



CHATHAM ELECTRONICS CORP.

Executive and General Offices: LIVINGSTON, NEW JERSEY
Plants and Laboratories: NEWARK and LIVINGSTON, NEW JERSEY

DECADE RESISTANCES & VOLTAGE DIVIDERS

delivered from stock

Accuracy: 10 ohms and
above: $\pm 0.1\%$
1 ohm: $\pm 0.25\%$
0.1 ohm: $\pm 1\%$
0.01 ohm: $\pm 5\%$

Temp. Coeff.: $\pm 0.002\%$ per degree C.
Maximum Load: $\frac{1}{2}$ -watt per step
Frequency Limit: Non-inductive
to 20KC

DECADE RESISTANCE BOXES

Type	Dials	Ohm Steps	Total Resistance—Ohms	Price
817	3	0.01	11.1	\$60.00
818	3	0.1	111	51.00
820	3	1	1,110	56.00
821	3	10	11,100	60.00
822	3	100	111,000	63.00
823	3	1,000	1,110,000	77.00
824	3	10,000	11,100,000	120.00
817-A	4	0.01	111.1	75.00
819	4	0.1	1,111	71.00
825	4	1	11,110	77.00
826	4	10	111,100	79.00
827	4	100	1,111,000	92.00
828	4	1,000	11,110,000	139.00
8285	5	0.1	11,111	94.00
829	5	1	111,110	101.00
830	5	10	1,111,100	113.00
831	5	100	11,111,000	155.00
817-C	6	0.01	11,111.1	105.00
8315	6	0.1	111,111	109.00
832	6	1	1,111,110	121.00
833	6	10	11,111,100	169.00



UNMOUNTED DECADE RESISTANCES

Type	Dials	Ohm Steps	Total Resistance—Ohms	Price
435	1	0.1	1	\$12.00
436	1	1	10	13.25
437	1	10	100	13.25
438	1	100	1,000	15.00
439	1	1,000	10,000	16.00
440	1	10,000	100,000	18.50
441	1	100,000	1,000,000	32.50
442	1	1,000,000	10,000,000	60.00

DECADE VOLTAGE DIVIDERS (Potentiometers)

Type	Dials	Ohm Steps	Total Resistance—Ohms	Price
845	3	1	1,000	98.00
837	4	0.1	1,000	126.00
835	4	1	10,000	132.00
836	4	10	100,000	146.00

See us at the I.R.E. Show, Booths 559 and 561 Components Avenue

SHALLCROSS MANUFACTURING COMPANY

522 Pusey Ave., Collingdale, Pa.

Shallcross

Our 25th Year 1929-1954

Visit our Booths at the I.R.E. Show—559-561 Components Avenue



Drying machine in action, with whirling plastic sheet visible only as white blur in tank

sheet by infrared lamps mounted at the top of the tank. Heat for drying the downward-facing emulsion coating on the sheet is provided by an automatically timed gas burner in the bottom of the tank.



Winding Grids for Reliable Tubes

WHEN the natural tolerance or capability of a grid lathe is greater than the tolerance specification of grids for high-performance reliable-type tubes, 100-percent gaging of the product becomes necessary. When faced with this problem and the necessity for using existing equipment, the quality control department of Tung-Sol under the direction of W. P. Koehel used control charts effectively to achieve maximum yield.

The accompanying curve presents

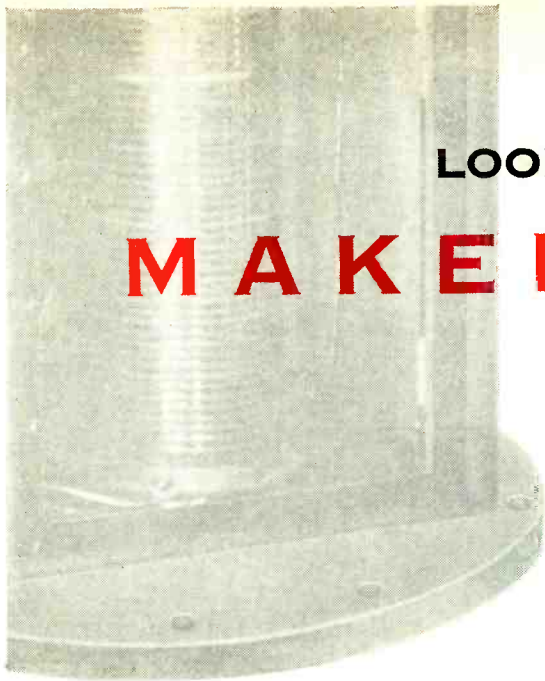

LOOK TO **MAKEPEACE**

FOR ELECTRONIC ASSEMBLIES

WAVE GUIDES AND TUBING:

Rotating Joints, Antenna Feeds, Crystal Mixers, and Special Assemblies are made by MAKEPEACE, specialists in precision drawn wave guide tubing, held to close tolerance to meet exacting electrical specification.

Capacity and engineering time now available for design manufacture of prototypes and production runs. Complete testing facilities at your service.

COLLECTOR RINGS AND BRUSHES

A pioneer in the precious metal slip ring field, Makepeace offers rings in sizes from .050" O. D. up to 48" O. D., in solid or laminated precious metal, to meet any requirement for low electrical noise, low torque, in sensitive rotating members to high current power application.

Specially engineered complete self contained assemblies are available to meet the needs of the designer or manufacturer of Radar and other rotating electro mechanical systems. Facilities include design, engineering, and testing for noise level, corrosion resistance, cross talk, and impedance matching for special circuits.

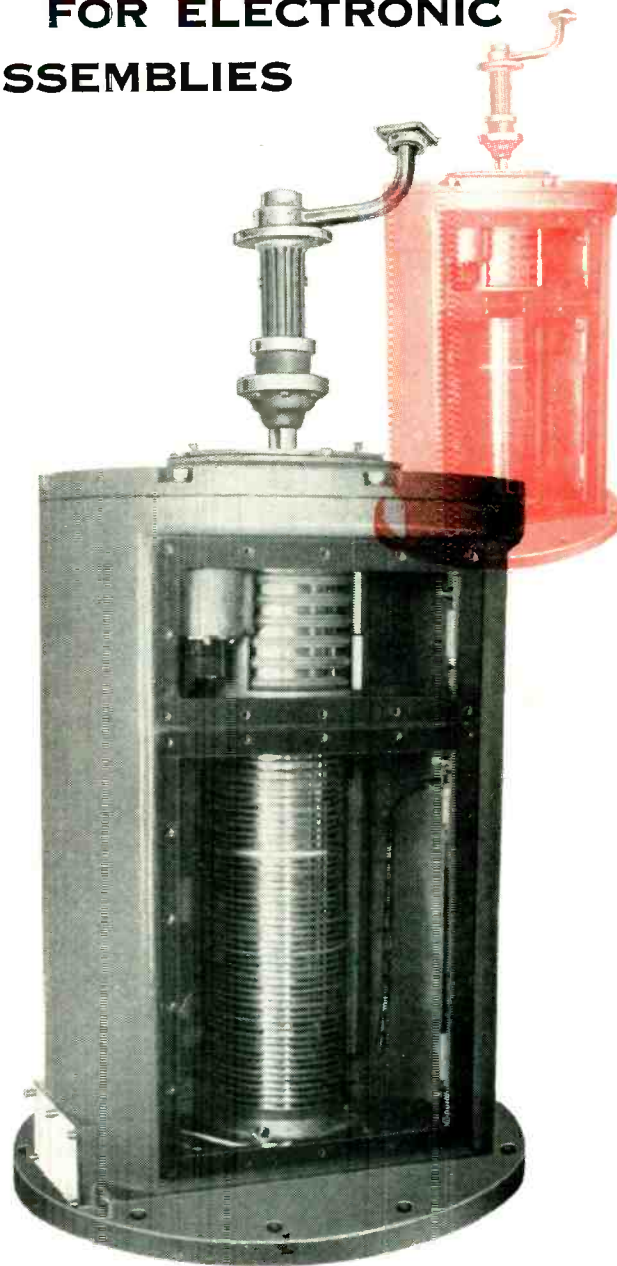

D. E. MAKEPEACE COMPANY

Division of Union Plate and Wire Co.

Attleboro, Mass.

Sales Offices: New York • Chicago • Los Angeles • Columbus

PRECISION RECTANGULAR WAVEGUIDE TUBING • MICROWAVE COMPONENTS • MICROWAVE TRANSMISSION ASSEMBLIES • ELECTRICAL CONTACT MATERIAL • FORMED ELECTRICAL CONTACTS • CROSSBAR WELDED CONTACTS • SLIP RING AND SLIP RING ASSEMBLIES • BRUSH ASSEMBLIES • PRECIOUS METALS CLAD TO BASE METALS • SHEET—TUBING—WIRE AND ASSEMBLIES • SENDZIMIR PRECISION ROLLING
See us at Booths 403, 405—Radio Engineering Show

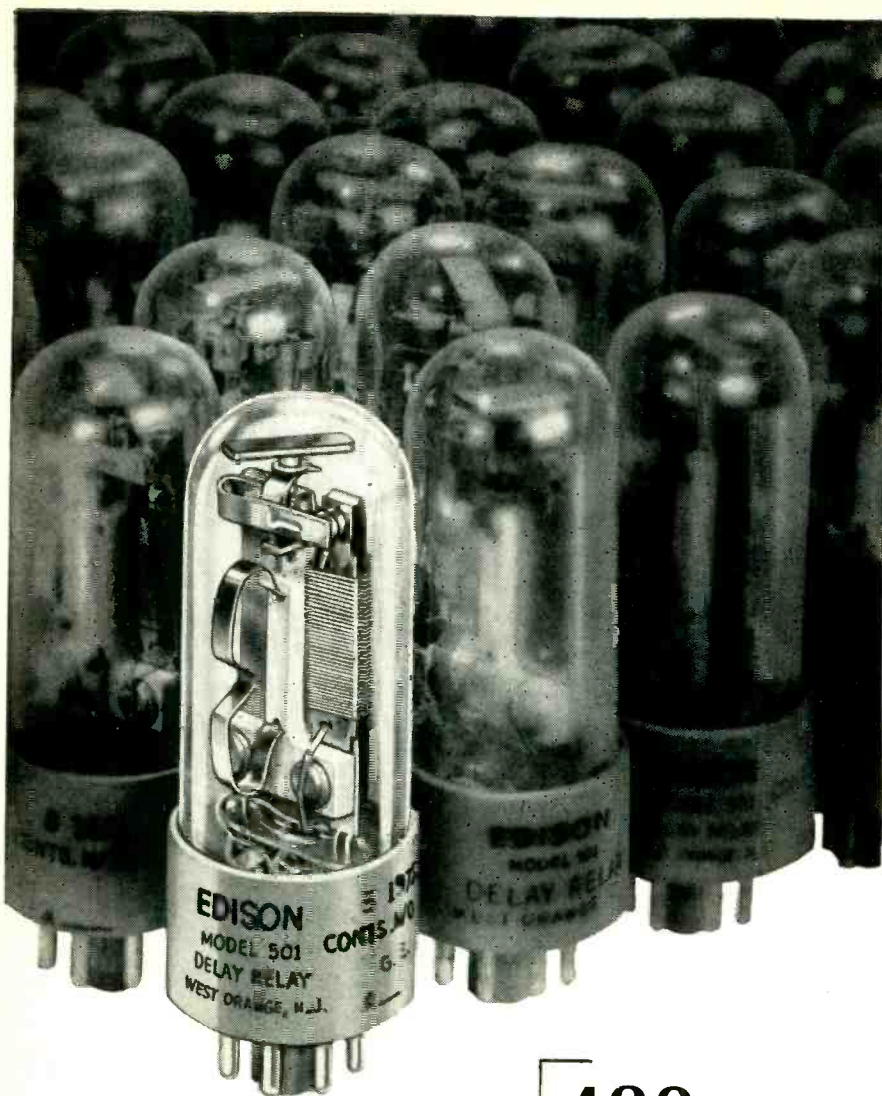

1 Time delay relay with

430 variations!

Here is the Edison Time Delay Relay, Model 501. There are now 430 different variations of this standard model—half of which are in stock and available for immediate delivery!

The reason there are so many variations of the Edison Time Delay Relay is because of Edison's policy to give customers the exact kind of relay to meet each application.

The experience and know-how of eight years in the design and manufacture of time delay relays makes this Edison policy possible.

Investigate Edison's ability to meet your requirements. Select to your certain satisfaction the exact time delay relay from the widest range presently available. Profit

from the resulting reduction of engineering time.

CHECK THESE ADVANTAGES:

- Time Delays from 2 seconds to 300 seconds.
- Ambient compensated from -60 to $+85^{\circ}$ C.
- Heater Voltages from 2.5 to 130 V. AC or DC.
- Meets aircraft vibration and shock requirements.
- Timing is calibrated after sealing for greatest accuracy and production uniformity.

Free Bulletin on Request!

Thomas A Edison
INCORPORATED

Instrument Division

54 Lakeside Ave., West Orange, N. J., U. S. A.



YOU CAN ALWAYS RELY ON EDISON

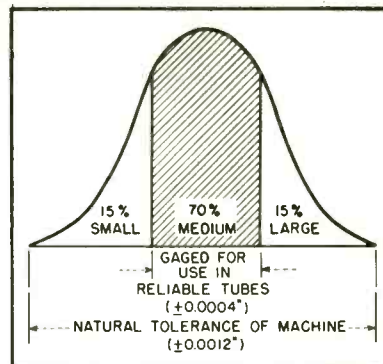

Curve representing normal variation in output diameter of grids wound on grid machine during normal production

the problem graphically, showing that the maximum possible yield is 70 percent. Even this can be achieved only if the grid lathe is adjusted to coincide with the design center of the grid. If the product average is allowed to wander as much as 0.0004 inch above or below design center, a yield of less than 50 percent will result.

Monitoring of the grid lathe production is achieved through use of the Shewhart control chart for average and range. A sample of four grids is drawn at random from production at regular intervals of time, such as hourly. Diameters of these grids are measured with a micrometer, and the average of the four values is plotted in thousandths of an inch on the charts as an estimation of the central tendency or mean of the product. The range, which is the difference between the largest and smallest readings in the sample, is then determined and plotted sep-

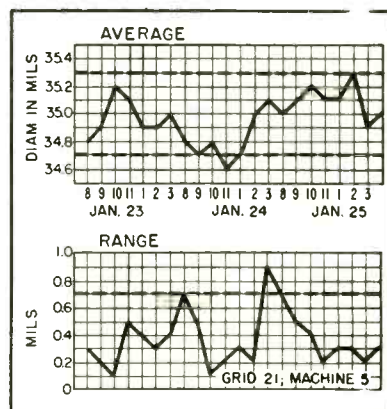

Example of control chart for outside diameter of grids, using hourly sample of four grids. Dashed lines represent control limits. Range went out of control at 3 o'clock Jan. 24 even though average was well centered

From **VERY SMALL...to LARGE CAPACITY**

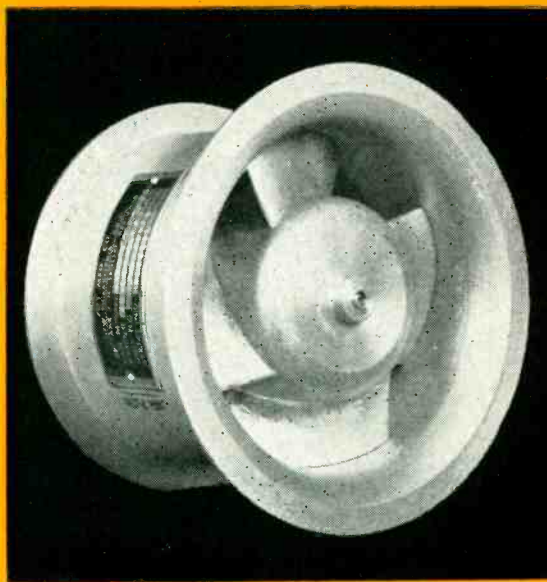
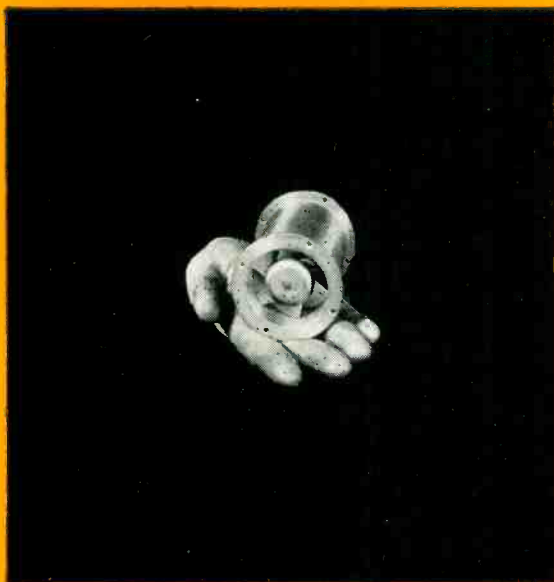

JOY AXIVANE[®] FANS

are available to meet any
ELECTRONIC COOLING NEED

Joy AXIVANE Electronic Cooling Fans are expressly designed to meet the needs of this exacting field of service. They are built in a complete range to suit any requirements, such as: spot cooling of ventilated units where local high-temperature conditions arise; heat removal from pressurized or hermetically-sealed units; or heat removal where space is so restricted that natural ventilation through the unit or over its surface is insufficient. Important operating advantages of these fans are their strength, high resistance to shock and vibration, and efficiency in low or high-pressure service. Aluminum and magnesium construction keeps weight at a minimum.

Available in sizes from 2" I.D. up, these Joy Fans are built to meet all present Air Force

and Naval electronic specifications. They can be furnished with totally enclosed or explosion-proof motors, if desired.

In general, keep these facts in mind: that the light, compact design, low power consumption and high overall efficiency of Joy AXIVANE Fans provide more satisfactory cooling for electronic equipment in either air-borne or surface units. ● If you have a problem in heat dissipation from electronic units, let us place at your disposal JOY's experience as the world's largest manufacturer of vaneaxial-type fans.

Consult a Joy Engineer

Over 100 Years of Engineering Leadership

W&D 1 4064

JOY MANUFACTURING COMPANY

GENERAL OFFICES: HENRY W. OLIVER BUILDING · PITTSBURGH 22, PA.

IN CANADA: JOY MANUFACTURING COMPANY (CANADA) LIMITED, GALT, ONTARIO



This ONE instrument checks RF, IF, and AF performance of receivers

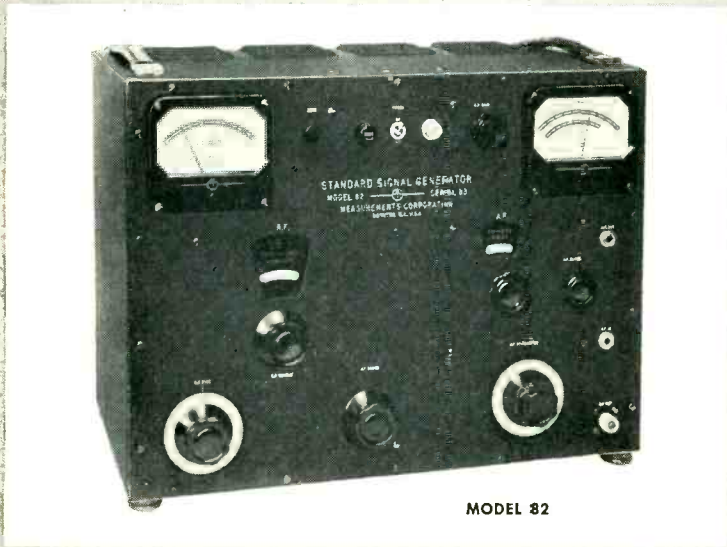

MEASUREMENTS'

Standard Signal Generator

Frequency Range: 20 cycles - 50 mc.

The Model 82 Standard Signal Generator provides extremely wide frequency coverage. It comprises a low-frequency oscillator covering the range from 20 cycles to 200 kc., and a high-frequency oscillator in the range from 80 kc. to 50 mc.

It is designed for audio and radio frequency measurements of AM, FM and television receivers; for testing and checking the frequency response of audio systems; as a driving source for AF and RF bridges; for testing video and wide-band amplifiers.

SPECIFICATIONS:

FREQUENCY RANGE: 20 cps to 200 kc. in four ranges. 80 kc. to 50 mc. in seven ranges, plus one blank range.

FREQUENCY CALIBRATION: Each range individually calibrated. 20 cps to 200 kc. accurate to $\pm 5\%$. 80 kc. to 50 mc. accurate to $\pm 1\%$.

OUTPUT VOLTAGE AND IMPEDANCE: 0-50 v. across 7500 ohms from 20 cycles to 200 kc.; Output voltage and impedance in this range can be reduced by external attenuator. 0.1 μ v. to 1 v. across 50 ohms over most of the range from 80 kc. to 50 mc.

MODULATION: Continuously variable from 0-50% from 20 cycles to 20 kc. from internal variable oscillator or external source.

HARMONIC OUTPUT: Less than 1% from 20 cycles to 20 kc.; 3% or less from 20 kc. to 50 mc.

LEAKAGE AND STRAY FIELD: Less than 1 μ v. from 80 kc. to 50 mc.

POWER SUPPLY: 117 v., 50-60 cycles. 75 watts.

FEATURES:

- Continuous frequency coverage from 20 cycles to 50 mc.
- Direct-reading individually calibrated dials.
- Low harmonic content.
- Accurate, metered output.
- Mutual inductance type attenuator for high frequency oscillator.
- Stray field and leakage negligible.
- Completely self-contained.

arately as an indication of the dispersion or variability.

During 100-percent inspection for reliable tubes, samples are taken more frequently. Range may go out of control even though the average is well centered; this means that the product has excessive variability, with consequent danger that a certain percentage of the grids are outside both upper and lower limits. Machine or operator correction is then necessary.

Envelope-Cutting Gage

A SIMPLE combination holding fixture and gage is used in the Hicksville, N. Y. plant of Amperex Electronic Corp. as a guide for cutting the envelopes for type 450TL

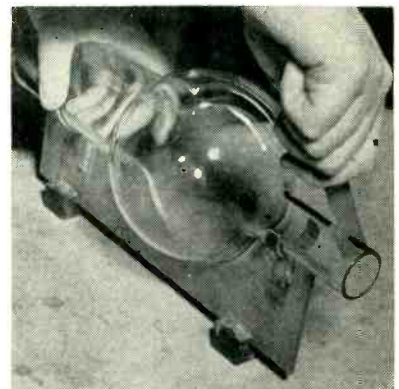

Scribing glass envelope for power triode with file in preparation for breaking off to correct length, using bench fixture as gage

triodes. The operator uses a file to scratch the glass at the correct point, which she determines by looking down through the glass to the end of the gage. The tube is easily rotated in the fixture for scribing entirely around the glass if necessary. After scribing, the glass is broken off by using conventional techniques, such as rotating the scribed line against a red-hot wire.

Rubberized Hair Used for Packing TV Camera Tube

SAFE TRANSIT of \$1,200 television camera tubes for Utiliscope industrial television systems is achieved by means of a protective packaging

Laboratory Standards



MEASUREMENTS CORPORATION
BOONTON · NEW JERSEY

OPTIMUM PERFORMANCE IN VITAL AUTOMATIC PILOT SYSTEM

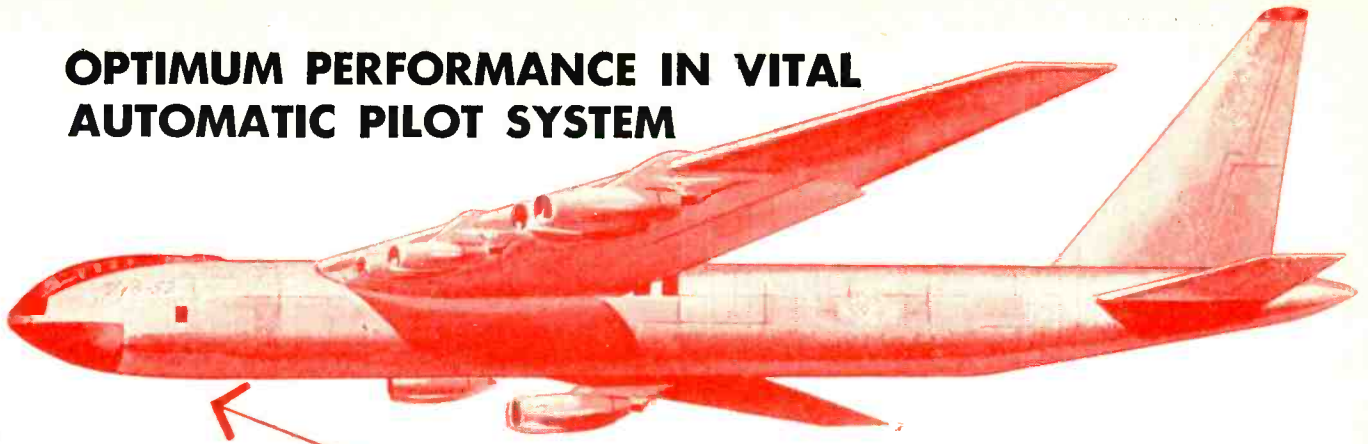

ELECTRO TEC SLIP RING ASSEMBLIES

ONE PIECE UNIT
REPLACES ASSEMBLY OF
MULTIPLE COMPONENTS

*Offering Closer Tolerances,
Absolute Uniformity and the
Ultimate in Miniaturization:*

- ONE PIECE, UNITIZED CONSTRUCTION
- ABSOLUTE MINIMUM FRICTION TORQUE
- DIAMETERS FROM .035" to 24.0"
- MINIMUM 1000 V.A.C. HI-POT INTER-CIRCUIT
- HARD SILVER RINGS PLATED TO PRECISELY MACHINED ONE-PIECE PLASTIC FORM
- SPECIAL SURFACE DEPOSITS PREVENT TARNISH, MINIMIZE FRICTION, BRUSH NOISE AND WEAR

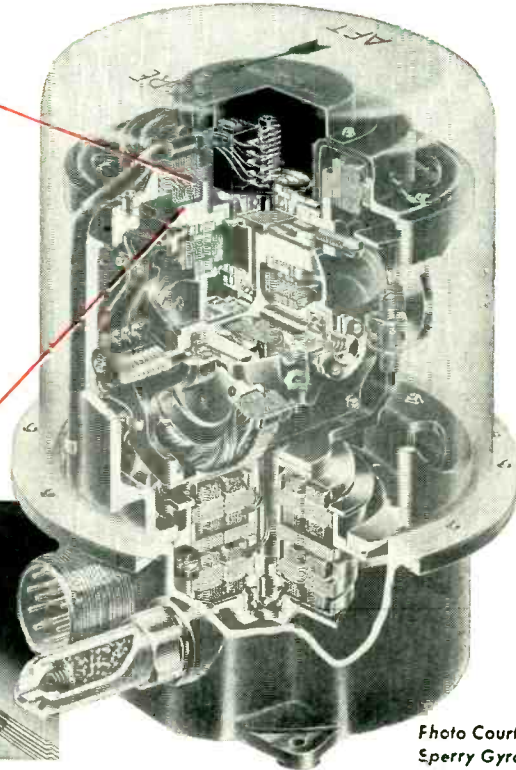

The instrument shown is a Sperry "Gyrosyn" compass which combines the advantages of gyroscopic stability and magnetic correction to provide an accurate directional reference.

*Photo Courtesy
Sperry Gyroscope Company*

—featuring **SUPER DEPENDABILITY!**

The Sperry "Gyrosyn" compass is an outstanding example of precision and dependability. Electro Tec is proud to furnish slip ring assemblies which are consistent with the high accuracy and unfailing performance of this instrument. In this application, as in hundreds of others, Electro Tec meets specifications with a degree of accuracy unattainable with built-up or molding methods of manufacture. This extreme precision plus the many other advantages that result from Electro Tec manufacturing techniques have resulted in leadership throughout the industry. For complete cooperation in applying Electro Tec "know-how" to specific problems call or write the Sales Engineering Department.

AT THE I. R. E. SHOW

A cordial welcome is extended to all to visit us at Booth 133, 135 MILITARY AVENUE, Kingsbridge Armory, New York City, March 22-25 Inclusive.



ELECTRO TEC CORPORATION

SOUTH HACKENSACK • NEW JERSEY

PRODUCTS OF PRECISION CRAFTSMANSHIP BY A NEW AND REVOLUTIONARY PROCESS *

* Patent Pending





MINIMUM AIR GAP BETWEEN
HEEL PIECE AND ARMATURE

NEW } MAXIMUM
THROW
HERE } WITH { MINIMUM
MOVEMENT
HERE } = EFFICIENCY

6QA Phil-trol RELAY

**Adds Sales Appeal and Top
Performance to Your Products**

The new Phil-Trol 6QA Relay has found wide acceptance in a variety of products because of its extreme compactness, capacity and exceptional sensitivity.

The 6QA is only $2\frac{9}{16}$ " long, yet it provides large cubic area for winding (maximum 20,000 ohm coil). Armature ratio and electro magnetic features assure high sensitivity. Phil-Trol 6QA performance equals that of larger telephone type relays. Its construction makes possible mounting and wiring from under the chassis, using less space and saving assembly time and costs.

For added convenience, the Phil-Trol 6QA Relay is available with a plug-in adaptation for use in panels and annunciator racks.



PLUG-IN—
DUST COVERED
TYPE 6QA—(Quick Acting)

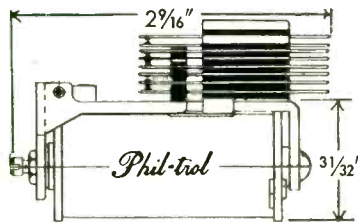

2 MOUNTING HOLES
No. 6-32 N. C. THREADS

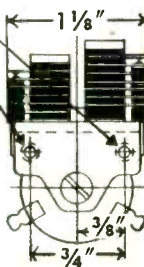

Placing corner-cut tray over terminals of camera tube in sleeve-type box

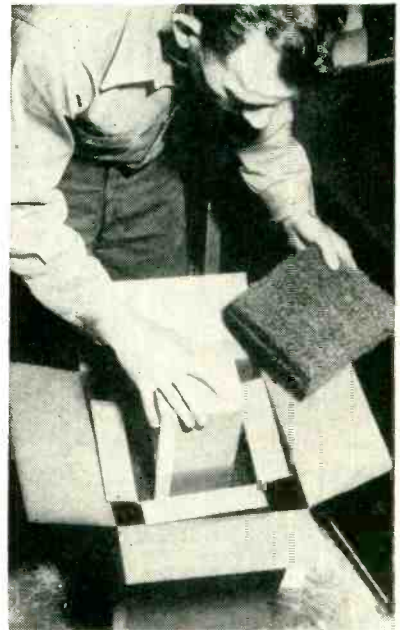

Placing camera tube box in middle container that is lined with rubberized hair pads for absorbing shock

technique involving the use of rubberized hair. The camera tube is first inserted in a sleeve-tight box made by The Fairfield Paper and Container Co. Here a corner-cut tray protects the terminals.

Next, pads of rubberized hair are placed at the bottom of a second air-celled corrugated container, which has spread-out flanges that center it in the third or outer shipping carton. The center container is then lined with pads of rubberized hair and the camera tube box is inserted. After two additional pads have been placed over the camera box, the corrugated outer shipper is sealed and taped to complete the packaging for both domestic and foreign customers of Diamond Power Specialty Corp.

Phil-trol

IS THE REGISTERED TRADE MARK OF
PHILLIPS CONTROL CORP., JOLIET, ILLINOIS
a THOR CORP. SUBSIDIARY
OFFICES IN ALL PRINCIPAL CITIES

PHILLIPS CONTROL CORP., DEPT. E, JOLIET, ILLINOIS
Please send me a free copy of the new Phil-Trol Relay and Actuator Catalog.

Name _____ Title _____
Company _____
Address _____
City _____ Zone _____ State _____

NEW PRODUCTS

Edited by WILLIAM P. O'BRIEN

Control, Testing and Measuring Equipment Described and Illustrated . . . Recent Tubes and Components Are Covered . . . Fifty Available Trade Bulletins Reviewed

OTHER DEPARTMENTS:

featured in this issue:

	Page
Electrons at Work	196
Production Techniques	262
Plants and People	412
New Books	480
Backtalk	502

TRANSISTOR ANALYZER

traces negative resistance curves

POLYPHASE INSTRUMENT Co., Bryn Mawr, Pa. Model TA-2 transistor analyzer, a negative resistance and characteristic curve tracer, has been designed for use with a laboratory type oscilloscope. It will trace all negative resistance curves of both *n*-type and *p*-type point contact transistors. Since all circuit parameters controlling the negative resistance curves are available as metered variables on the front

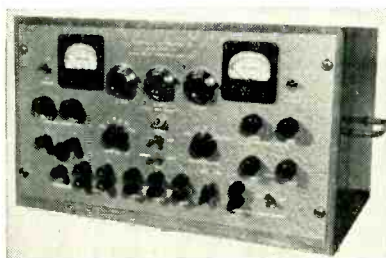

panel, the model TA-2 enables the user visually to design any negative-resistance circuit around

a given transistor in a matter of minutes. It will also determine the applicability of any transistor in a given negative-resistance circuit. The unit will trace the collector characteristics, R_{20} , for both grounded-emitter and grounded-base connections, and transfer characteristic, R_{12} , of *n*-type and *p*-type point contact transistors as well as *npn* and *pn*p junction transistors.

T-W AMPLIFIER TUBE

designed for S-band use

HUGGINS LABORATORIES, 700 Hamilton Ave., Menlo Park, Calif., has developed a broadband S-band amplifier tube to provide voltage amplification from 2 to 4 kmc which does not have to be tracked by a tuning voltage or mechanism. The tube finds its greatest use in applications where wide bandwidth and

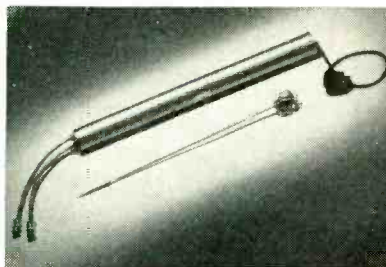

high gain are required at a low level such as r-f preamplifiers, untuned r-f receivers and in laboratory microwave measurement techniques. Special applications require its phase or amplitude modulation ability as well as its wideband pulse amplification capabilities. Approximate operating characteristics over this band are 40-db gain, 20-mw output and 20-db noise figure. The unit requires a 300-gauss field and a 500-v regulated power supply.

MINIATURE TRIPLE DIODE

for use in color tv sets

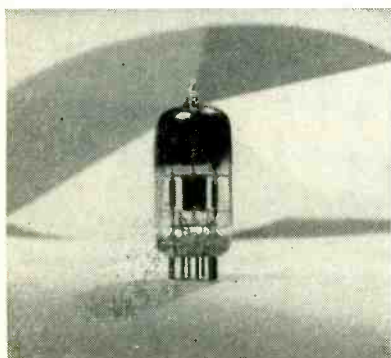

GENERAL ELECTRIC Co., Schenectady, N. Y., has announced development of its first receiving tube type intended primarily for use in color tv sets. Type 6BJ7 is a miniature triple diode whose primary application is as the d-c restorer for the three signal channels of color receivers. Electrical characteristics of each section of the 6BJ7 are similar to those of each section of the 6AL5 twin triode. Maximum

ratings (design center values), are: peak inverse plate voltage, 330 v; peak plate current per plate, 10 ma; d-c output current per plate, 1.0 ma; heater-cathode voltage (heater positive with respect to cathode), 100 v; (heater negative with respect to cathode), 330 v.

BANTAM CRYSTAL with 15 to 100-mc range

BLILEY ELECTRIC Co., Union Station Building, Erie, Pa. With the trend

toward the subminiaturization of communications equipment, the Bantam BX crystal fulfills the need for precision frequency control with a subminiature size crystal unit. It is a hermetically sealed unit with wire leads. Range is 15 mc to 100 mc. The crystal gives the same performance characteristics as MIL types CR-23 or CR-32. The Bantam

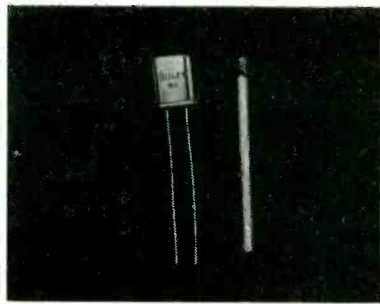

has applications wherever precision performance is required—particularly in multichannel communications operations. The unit may be wired into a miniature socket or soldered to a printed circuit terminal board. Bulletin 46, containing additional technical information, is available by writing on your letterhead.

VHF INTERPOLATOR

generates and measures high frequencies



GERTSCH PRODUCTS, INC., 11846 Mississippi Ave., Los Angeles 25, Calif. Model AM-1 interpolator, when supplied with a standard 100-kc signal, and when used with auxiliary measuring equipment in the range of 1 to 2 mc, provides a system of measurement or generation of frequency in the range of 20 to 1,000 mc, with an accuracy of better than 1 part in 10^7 depending

upon the accuracy of the 100-kc crystal source. In operation, suitably selected harmonics of 1 mc, derived from the 100-kc source, are combined with a 1 to 2-mc oscillator and the result is used to lock an oscillator covering a 20 to 40-mc range. The frequency of this locked oscillator is determined by measuring the frequency of the 1 to 2-mc oscillator in the auxiliary equipment. Complete coverage from 20 through 1,000 mc is obtained by use of the fundamental and harmonics of this locked oscillator.

MAGNETIC MICROPHONE

with built-in transistor preamplifier

REMLER Co. LTD., San Francisco, Calif. Tiny transistors have been applied successfully to the problem of developing a microphone to improve the quality of radio voice communication between pilots and airport control towers. The new unit consists of a magnetic microphone or handset with built-in transistor preamplifier. It has been proved by thousands of hours of



laboratory life tests in temperatures ranging from -60 F to $+125$ F; at 95 to 100 percent humidity and in simulated altitudes up to 50,000 ft. The equipment suppresses extraneous noises and more than triples the range to include voice frequencies from the lower part of the sixth through the ninth octave. It is not necessary to rewire aircraft or other mobile installations to use this microphone. It derives its power supply from the same sources as the carbon microphones now used.

SNAP-ACTING SWITCH

with hinged leaf actuator

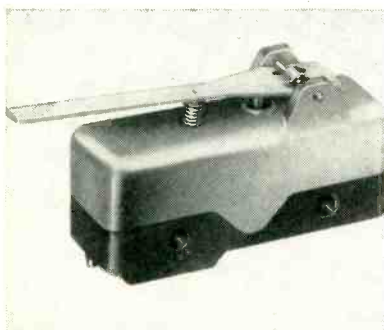

UNIMAX SWITCH DIVISION of the W. L. Maxson Corp., 460 W. 34th St., New York 1, N. Y. Accurate repetition of operate point, in a snap-action switch for use where low operating force is desirable, is provided in the new Unimax type MXT-1 switch. The new design utilizes a rigid level arm pivoted on a bearing pin set in supports integral with the molded cover of

the switch. The actuating arm can be furnished in any desired length and with special bends. The actuator can be modified, by eliminating the coil spring, to permit operation at forces down to 15 grams; this version is designated MBT-1. Because of the long overtravel provided by the lever-arm actuator, this switch is suitable for use in cam- or slide-operated controls. The switch carries a current rating of 15 amperes at 125 v a-c. A data sheet giving dimensions, complete

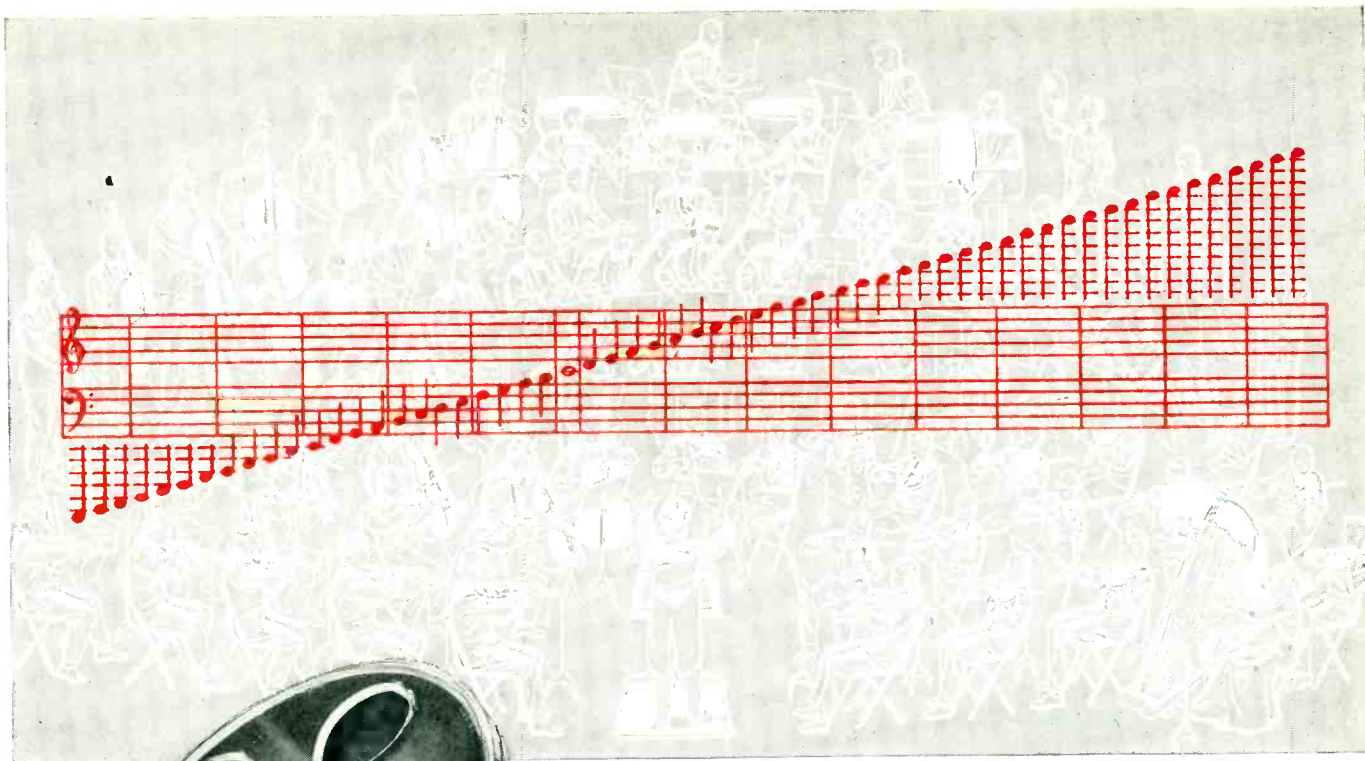

audiotape TRADE MARK

BALANCED PERFORMANCE

Now Available on this
NEW 7" PLASTIC REEL

- 2¼ inch hub
- more area for labeling
- less chance of tape spillage
- greater protection to tape
- rugged, non-warping construction
- distinctive, modern design

*another EXTRA-VALUE feature
at no extra cost!*

*preserves full orchestral balance
throughout the entire audible frequency range*

IN SOUND RECORDING there's nothing that's quite as important as balanced performance. For this is what determines the end result, in terms of listening enjoyment.

Suppose you're recording a symphony orchestra. Every note and overtone of every instrument must come through with the same relative value as in the live performance. And Audiotape's more uniform frequency response preserves this tonal balance to the fullest possible extent.

This means faithful, well-balanced reproduction of all musical instruments, from the lowest rumble of the bass tuba to the highest overtones of the piccolo. It's a factor to which the trained ear is particularly sensitive — an Audiotape advantage that appeals strongly to the most critical professional recordists.

Audiotape's output, frequency response, noise level and distortion are correctly proportioned for the most satisfactory end result — with no compromise on quality anywhere along the line. In performance and in cost, Audiotape speaks for itself.

**audiodiscs
audiotape
audiofilm
audiopoints**



AUDIO DEVICES, Inc.

444 MADISON AVE., NEW YORK 22, N. Y.

Offices in Hollywood — Chicago

Export Dept., 13 East 40th St., New York 16, N. Y., Cables "ARLAB"

electrical ratings and operating characteristics is available.

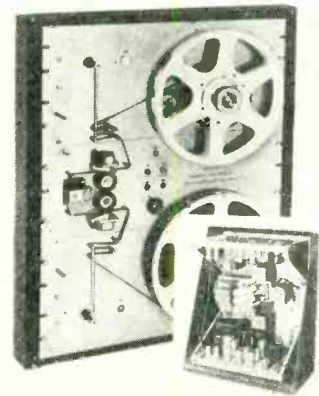

TAPE HANDLER for digital magnetic tape

THE POTTER INSTRUMENT COMPANY, 115 Cuttermill Rd., Great Neck, N. Y., announces the new model 902 digital magnetic tape handler with dual tape speeds of $1\frac{5}{30}$ or $1\frac{5}{60}$ inches per second and 5 msec start and stop times. Tape widths of $\frac{1}{4}$, $\frac{1}{2}$ or $\frac{3}{8}$ inch provide 2, 6 or 8-channel recording. Versions are available for handling teletype tape. Servo-controlled reel drive mechanisms ensure lower tape tension for longer tape life and longer recording head life. Standard 19-inch rack mounting is used.

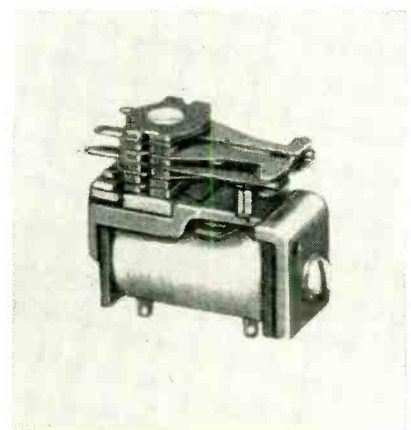

TINY RELAY meets rigid specifications

SIGNAL ENGINEERING & MFG. Co., Long Branch, N. J. The series 80 midget telephone-type relay, a compact, multiple-contact unit with vibration and shock-proof characteristics, is designed to meet rigid

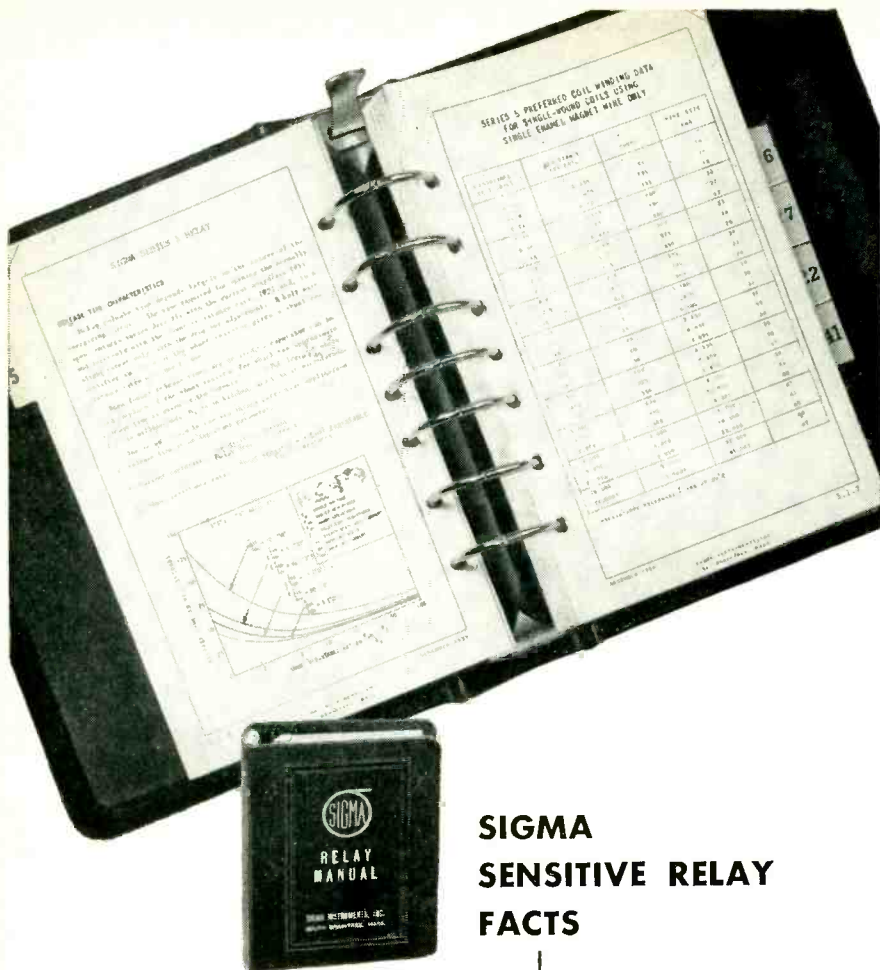

SIGMA SENSITIVE RELAY FACTS

MECHANICAL CONSTRUCTION
OPERATING CHARACTERISTICS
FORCE CURVES
OPERATING TIME CHARACTERISTICS
HOLD TIME CHARACTERISTICS
SENSITIVITY • ADJUSTMENTS
MOUNTINGS • ENCLOSURES
DIMENSIONS • WIRING DIAGRAMS
STANDARDS : OPERATING LIFE
SALT SPRAY • TEMPERATURE CYCLING
HUMIDITY • IMMERSION
BAROMETRIC PRESSURE
MOISTURE RESISTANCE • VIBRATION
ACCELERATION • DIELECTRIC
FINISH • ETC.

The Sigma Relay Manual is frankly patterned after the RCA Tube Hand Book which in our view is one of the best things in the industry. It will be a long time before the Manual, even in its much more limited field of usefulness, achieves anything like the near perfection of its model.

Howsoever, there are here assembled all known facts about each Sigma relay, type, series, and adjustment. Each available combination is tabulated so that it can be selected with foreknowledge of all important attributes, notably including ratings under all test conditions selected for regular proof testing.

Doubly important is the fact that in the Sigma Relay Manual is provided a means whereby—through the regular supplement service—new information can be easily accumulated and disseminated.

The Sigma Manual Service consists of the basic loose leaf manual of approximately 260 pages and additional and replacement pages in groups as issued.

SUBSCRIPTION PRICE IS FIVE DOLLARS,
YEARLY RENEWAL, ONE DOLLAR.

for the solace of those who had only one reason for reading the above and who are disappointed, we have another book for sale more to their taste. "Sigma Instruments Ink" (Ads and selected mail)

Price \$1.00 postpaid

SIGMA

SIGMA INSTRUMENTS, INC.

62 PEARL ST., SO. BRAintree, BOSTON 85, MASS.

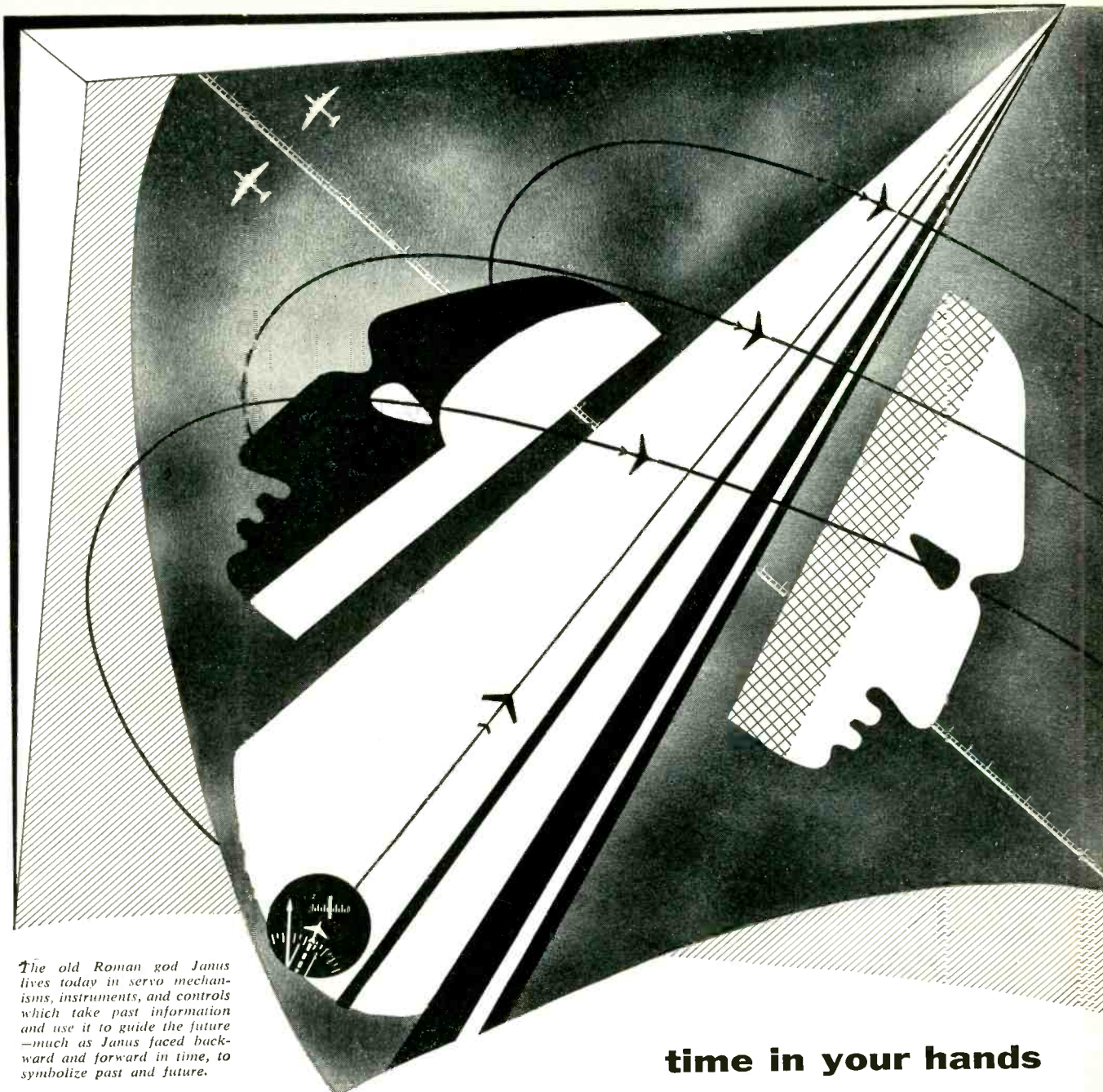

The old Roman god Janus lives today in servo mechanisms, instruments, and controls which take past information and use it to guide the future—much as Janus faced backward and forward in time, to symbolize past and future.

time in your hands

Controlled, predictable flight depends upon data concerning the immediate past of a flight, as well as navigational information for the course ahead. Time is literally in your hands with Kollsman products.

Today our activities encompass four fields:

- AIRCRAFT INSTRUMENTS AND CONTROLS**
- OPTICAL PARTS AND DEVICES**
- MINIATURE AC MOTORS**
- RADIO COMMUNICATIONS AND NAVIGATION EQUIPMENT**

Our manufacturing and research facilities . . . our skills and talents, are available to those seeking solutions to instrumentation and control problems.



kollsman INSTRUMENT CORP.

ELMHURST, NEW YORK • GLENDALE, CALIFORNIA • SUBSIDIARY OF *Standard* COIL PRODUCTS CO. INC.

PHALO *CORDS* ...

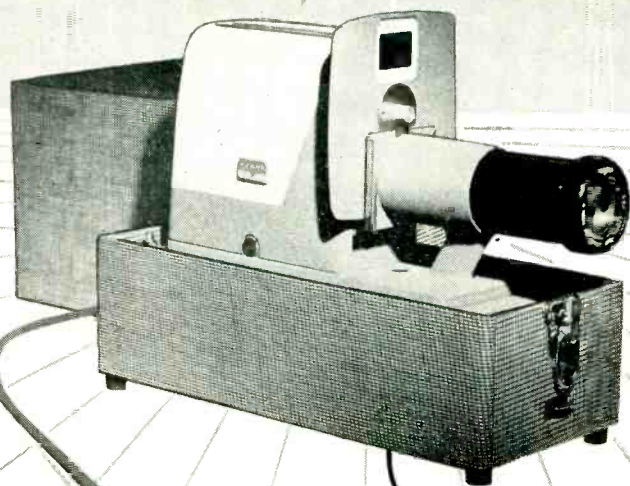

argus

300 Watt Projector

Projecting Themselves Through

QUALITY

argus, world-famous producers of cameras and projectors, depends on PHALOCORD cord sets to carry the current load for their amazing new line of projectors.

Colorfully contrasting PHALOCORD cord sets add a bright, smart touch to the handsome ARGUS projector — but the big reason for their nation-wide demand is, of course, complete dependability on the job!

SPT-2
Green Thermoplastic
Insulation
Matching Plug

Use PHALOCORD and you'll use the finest!

PHALO PLASTICS CORPORATION

CORNER OF COMMERCIAL ST., WORCESTER, MASSACHUSETTS

Insulated Wires, Cables and Cord Set Assemblies

government specifications. Coil windings are rated for d-c voltages up to 115 v. The contacts are palladium and rated at 3 amperes non-inductive load at 24 v d-c or 115 v, 60 cycles. On special order they can be supplied with silver contacts which are rated at 5 amperes. The relays are available in open form for surface mounting or in hermetically sealed containers. The 8614 type, the smallest, in the sealed types, measures 1½ in. × 1½ in. × 1½ in.

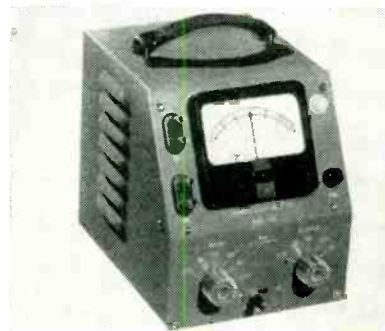

VOLTMETER
for transformation ratios

ARGA DIVISION, BECKMAN INSTRUMENTS, INC., 220 Pasadena Ave., South Pasadena, Calif., has announced a special expanded scale voltmeter for measuring transformation ratios of transformers, synchros and resolvers. The voltmeter is equipped with separate inputs for primary and secondary voltages of 57.3 v, 78 v, 90 v, 105 v and 115 v. Primary or secondary voltages are selected by a switch. Accuracy is ±0.1 percent of input voltage, with the input impedance 10,000 ohms per volt.



CONNECTORS
for printed circuit use

RICHARDSON Co., 5860 Spring Oak Drive, Hollywood 28, Calif., has available a line of printed circuit

Engineered
for
Extrême
Efficiency

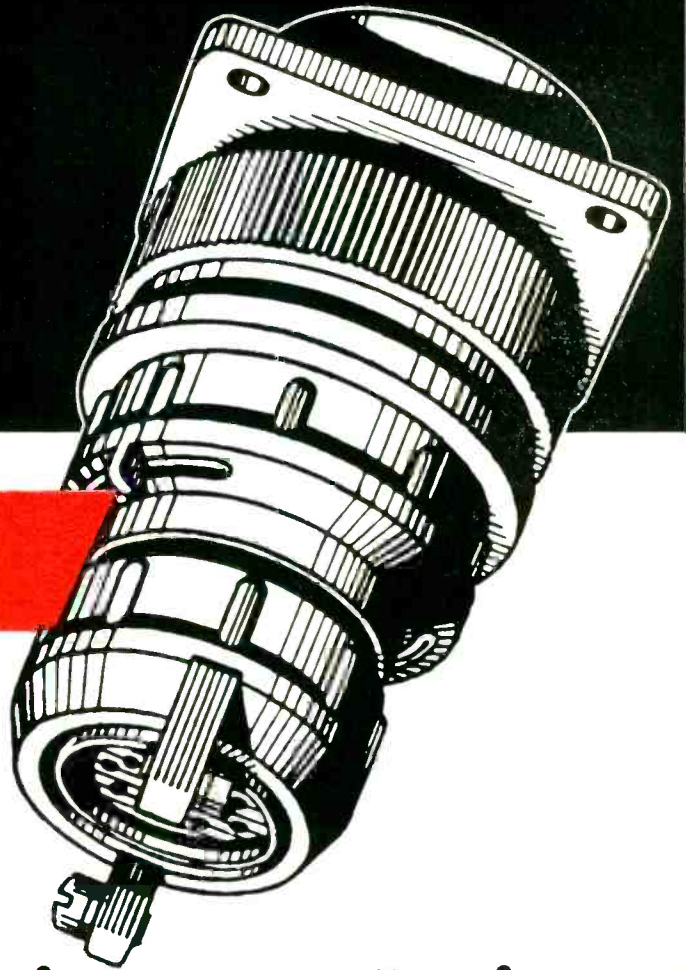

the **NEW**

AN- **E** **Environment Resistant**

Bendix Electrical Connector

The extreme performance requirements of today's high altitude planes are responsible for the development of this new "E" type connector.

The challenge to protect sensitive airborne electronic circuits from thermal shock, surface condensation and extreme vibration has been successfully met by Bendix engineers in this new spaced grommet "E" connector.

This connector is not only designed for performance, but is also engineered for your production needs. The open space in the solder-well area provides ample room for all assembly and soldering operations. Moisture-proofing is accomplished without the use of potting compounds, permitting completely serviceable aircraft harness installations. These features are all accomplished with no appreciable increase in weight over an AN-A/B connector with a cable clamp.

This new "E" connector incorporates the same quality features found in all Bendix-Scintflex electrical connectors.

Our Sales Department will be glad to furnish complete information on request.

Features

- Moisture-proof
- Vibration-proof
- Pressurized
- Corrosion Resistant
- Serviceable

Bendix

SCINTILLA DIVISION of **Bendix**
SIDNEY, NEW YORK

FACTORY BRANCH OFFICES: 117 E. Providencia Ave., Burbank, Calif. • 8401 Cedar Springs Road, Dallas 19, Texas • Stephenson Bldg., 6560 Cass Ave., Detroit 2, Michigan
512 West Avenue, Jenkintown, Pa. • Brouwer Bldg., 176 W. Wisconsin Ave., Milwaukee, Wisc. EXPORT SALES: Bendix International Division, 205 East 42nd St., N. Y. 17, N. Y.

SENSITIVE

**D' Arsonval
METER-RELAY**

Jeweled Moving Coil Armature

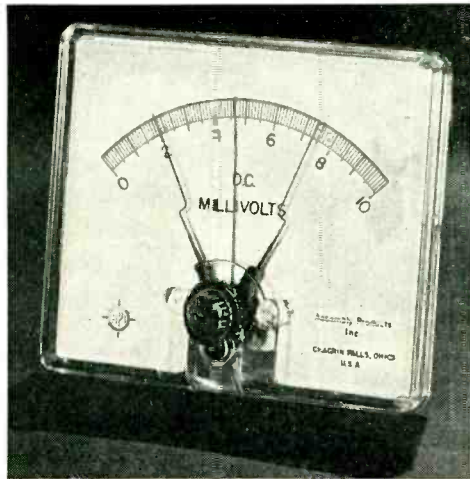

Model 451-C, (4½ inch) double contact, 0/10 DC Millivolts, as used in Vacuum Gauge made by Hastings Instrument Co., Inc., Hampton, Va., used to maintain pressure in a vacuum system.

0.2 Microamperes
(0/20 scale range)

0.05 Millivolts
(0/5 scale range)

A.C. D.C.
(voltage - current)

Thermocouples
(R.F. or temperature)

Adjustable
(90° scale arc)

The contact meter-relay as made by Assembly Products is an indicating meter with built-in micro-contacts which can be set to operate at any point of indication on the scale.



Model 265, plug-in, (non-indicating) hermetically sealed, with shock mounted movement. Suited to marine or aircraft or other mobile installations.

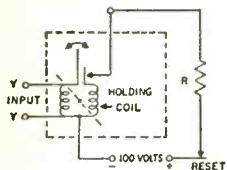

Single contact meter-relay schematic.

Model 263, (2½ inch), double contact, (non-indicating) used in Model 653 SILVERCEL[®] BATTERY CHARGER CONTROL manufactured for the Navy by Franklin Transformer Mfg. Co., Minneapolis, Minn.



Made like a conventional panel meter, it can be substituted for an existing meter in most circuits and will add relay action for over or under limit or automatic control.

A locking coil gives high contact pressure. Spring action in the contacts gives forceful separation. Contacts are released by breaking the circuit to the locking coil, either manually or by an automatic inter-rupter switch.

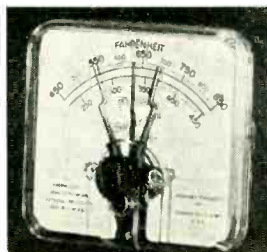

Model 351-C, (3¾ inch), double contact, suppressed zero millivoltmeter, with bimetal compensation for thermocouple reference junction. Dial calibrated 450-850° Fahrenheit (also Centigrade), for Iron-Constantan thermocouple. Used in control of temperature of THERMO DIMPLER made by Zephyr Mfg. Co., Inc., 201 Hindry, Inglewood, Calif.

Send for bulletin 112 listing 11 circuits using meter-relays.

Booth 311
Computer Avenue
At Radio Engineering Show
Kingsbridge Armory
New York City
March 22-25

Model 261-C, (2½ inch), single contact, high limit, 0/200 DC Microamperes as used in Consolidated Engineering Corp., Pasadena, California Model 21-220 Mass Spectrometer.

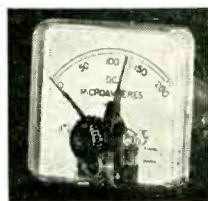

ASSEMBLY PRODUCTS, INC.
P. O. BOX 191
CHAGRIN FALLS 4, OHIO
Phone: CHagrin Falls 7-7374

*Yardney Silvercel—Reg. Trademark of Yardney Electric Corp.

connector receptacles that will accommodate printed circuit boards 0.061 to 0.071 in. The solid one-piece contacts are mounted in Alkyd or Melamine. Permanent set and contact fatigue even under vibration have been eliminated by the design and production processes used. In addition, ample allowances have been made for misalignment of mating boards. The printed circuit connector is presently available in production quantities in 18 and 22 contact configurations. Further information, including dimensional drawings and complete test data are available from the company.

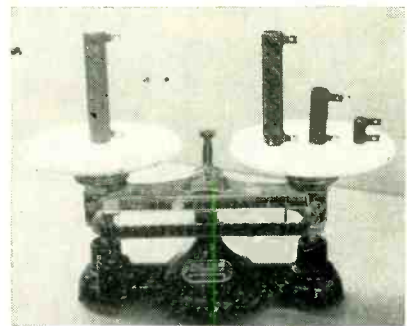

**POWER RESISTORS
of the coreless type**

GENERAL ELECTRIC Co., Syracuse, N. Y. The Kor-les Cool Blue power resistors are up to 50 percent lighter than conventional types and are designed to meet characteristic V of the MIL-R-26B specification. Immediate application will be found in military equipment where reduced size and weight are so important. They are available in standard resistance values within MIL types RW-29, 30, 31, 32, 33, 34 and 35. The resistors are constructed of a ceramic refractory material completely enclosing the wire windings. This construction permits the use of finer wires when necessary for special applications requiring higher than standard ohmic values and closer resistance tolerances. The coating of the resistors is nonorganic, vitreous enamel which will not deteriorate with age and readily withstands the higher operating temperature called for in characteristic V. One 55-w power resistor (as illustrated) out-



Visit us at
BOOTH 105,107
 I.R.E. Show—March 22-25
 Kingsbridge Armory,
 New York City

DON'T MISS THE
Crucible magnet exhibit
AT THE I. R. E. SHOW

Here you'll see a complete line of Alnico magnets embracing virtually every electronic and industrial application.

And if you have a magnet problem, don't hesitate to bring it to us at booth 105,107. After all, our experience dates back to the beginning of Alnico permanent magnets. Since that time we've handled a lot of magnet applications, and we have a wealth of experience to draw upon. It's all yours for the asking.

So be sure and stop at the Crucible booth while you're at the show. The welcome mat is out.



CRUCIBLE first name in special purpose steels

54 years of *Fine* steelmaking **ALNICO PERMANENT MAGNETS**

CRUCIBLE STEEL COMPANY OF AMERICA, GENERAL SALES OFFICES, OLIVER BUILDING, PITTSBURGH, PA.
 STAINLESS • REX HIGH SPEED • TOOL • ALLOY • MAX-EL • SPECIAL PURPOSE STEELS

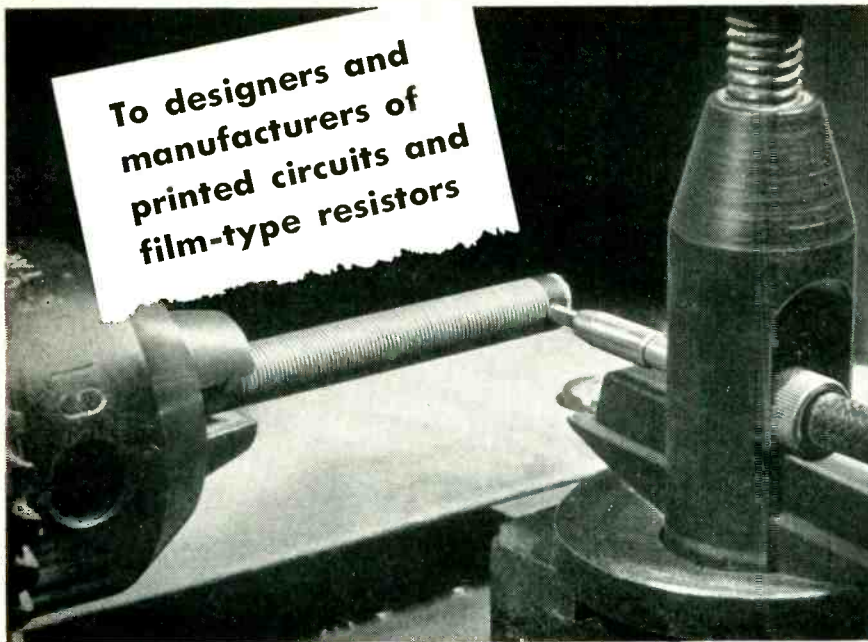

...we offer the

S.S. White

INDUSTRIAL "AIRBRASIVE" UNIT

Harnessing the kinetic energy of a tiny stream of gas-propelled abrasives, the S.S. White "Airbrasive" Unit provides a unique production method for the controlled removal of deposited surface coatings. The "Airbrasive" method is fast, accurate and readily adaptable to mass production methods. It offers unusual savings in time and costs in the production of printed circuits and film-type resistors.

A typical application is illustrated. In this case, the "Airbrasive" Unit is being used to cut a .007" wide spiral groove on a deposited carbon resistor. The "Airbrasive" Unit can be used to equal advantage to "trim" resistance elements of printed circuits.

Why not investigate this outstanding new precision production method? Our engineers will gladly make tests on samples submitted by you, or will arrange a demonstration for you at our New York or California office.

Write for BULLETIN 5307

It contains complete information on the "Airbrasive" Unit as well as details on its application and use.

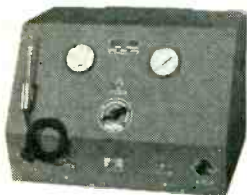

SEE THE "AIRBRASIVE" UNIT at the I.R.E. Show, Kingsbridge Armory, New York, N. Y., March 22-25. Bring your production samples along for a demonstration.

BOOTH 707
AIRBORNE AVENUE

THE *S.S. White* INDUSTRIAL DIVISION
DENTAL MFG. CO.

Dept. EB, 10 East 40th St.
NEW YORK 16, N. Y.



Western District Office • Times Building, Long Beach, California

weighs the Kor-les 55 w, 17 w and 11 w resistors.



PULSE GENERATOR for laboratory use

MARCONI INSTRUMENTS, LTD., 23 Beaver St., New York 4, N. Y. The Solartron pulse generator, Model OPS 100, sets a new standard in the speed and convenience of testing pulse circuitry since pulses can be viewed and measured at any position on the time base trace of a crt. It has been designed as a highly stable source of positive pulses with a very fast rise time, but complete freedom from ringing, droop or overshoot. It produces a positive pulse output of up to 70 v continuously variable in width from 1 to 250 μ sec. The pulse shape is independent of frequency, load conditions, output voltage or output attenuator setting.



V-T VOLTMETER has wide frequency range

COMMUNICATION MEASUREMENTS LABORATORY, INC., 350 Leland Ave., Plainfield, N. J. Model 1520 vtvm is a highly sensitive instrument covering a voltage range from 500

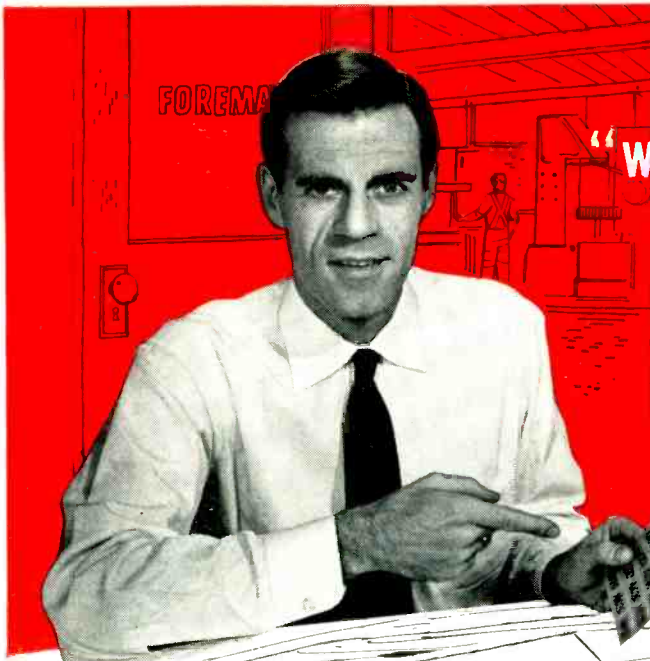

“what a *difference*

AVERY

Kum-Kleen

LABELS *make...*

they're pressure-sensitive!

*they sure speed production...there's no moistening
—no waste motion!”*

Consider these practical labeling advantages!

- *All waste motions are eliminated*—for unlike ordinary labels, Avery Pressure-Sensitive Labels are applied dry! An automatic dispenser pops them out—the operator simply *lays* the label in place on the product or package—without moistening. That's all there is to it!
- *Production line speed*—Avery dispensers speed every type of labeling job—whether it's a single item or a thousand. Labels are fed, *one-at-a-time*, ready for instant application. There's no sorting of loose labels...no messy glueing or licking...no soiled, spoiled packages.
- *They stick, and stay stuck*—Avery Kum-Kleen Labels stick to any clean, smooth surface—*right now*—and will not curl, peel or pop off! That's why Avery Kum-Kleen Pressure-Sensitive Labeling is different...it's practical and economical. Write now for details—free sample labels—case histories!

**SPECIFICALLY
SPEAKING...**

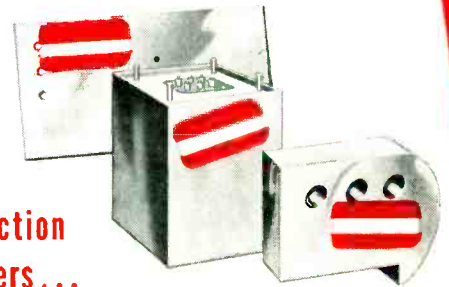

**inspection
stickers...**

An ideal application...removable, Kum-Kleen Inspection Stickers provide a quick, positive means of designating whether an item is accepted, rejected, to be reworked or scrapped. Avery Kum-Kleen Labels are faster, safer and more efficient than chalk, grease pencil or gummed labels...they're quickly applied *without moistening*—and stick tight to all clean, smooth surfaces. They never curl or pop off—yet they're easily peeled off (without leaving a mark) when the job is done!



AVERY
Kum-Kleen
LABELS

Manual or electric models—Avery Dispensers are low in cost and dependable in operation. They're small, trouble-free, and fit into any size or type of production line. They'll work at top efficiency without the use of skilled help, and savings in time and labor often pay more than the cost of the dispenser and labels!

AVERY ADHESIVE LABEL CORP., Custom Div. 131
117 Liberty Street, New York 6 • 608 S. Dearborn Street, Chicago 5
1616 S. California Ave., Monrovia, Calif. • Offices in other principal cities

Please send case histories and free samples Have the Avery Label man call

Name _____
Company _____
Address _____
Our Business Is _____

NEW lower priced FOCOMAG USES SINGLE FERRITE MAGNET

Another **HEPPNER** First

- Lower priced, compact. Cuts receiver costs. Uses only ONE ferrite magnet (an exclusive feature).
- Superior focusing - more uniform field. The sintered ferrite is extremely uniform throughout. Focuses all tubes up to 27".
- Completely shielded. No harmful external field.
- Extended focus range has very fine adjustment to exact focus.
- Built-in centering device.
- Flexible nylon adjusting shaft eliminates breakage.
- Picture positioning lever. You specify mounting arrangement.

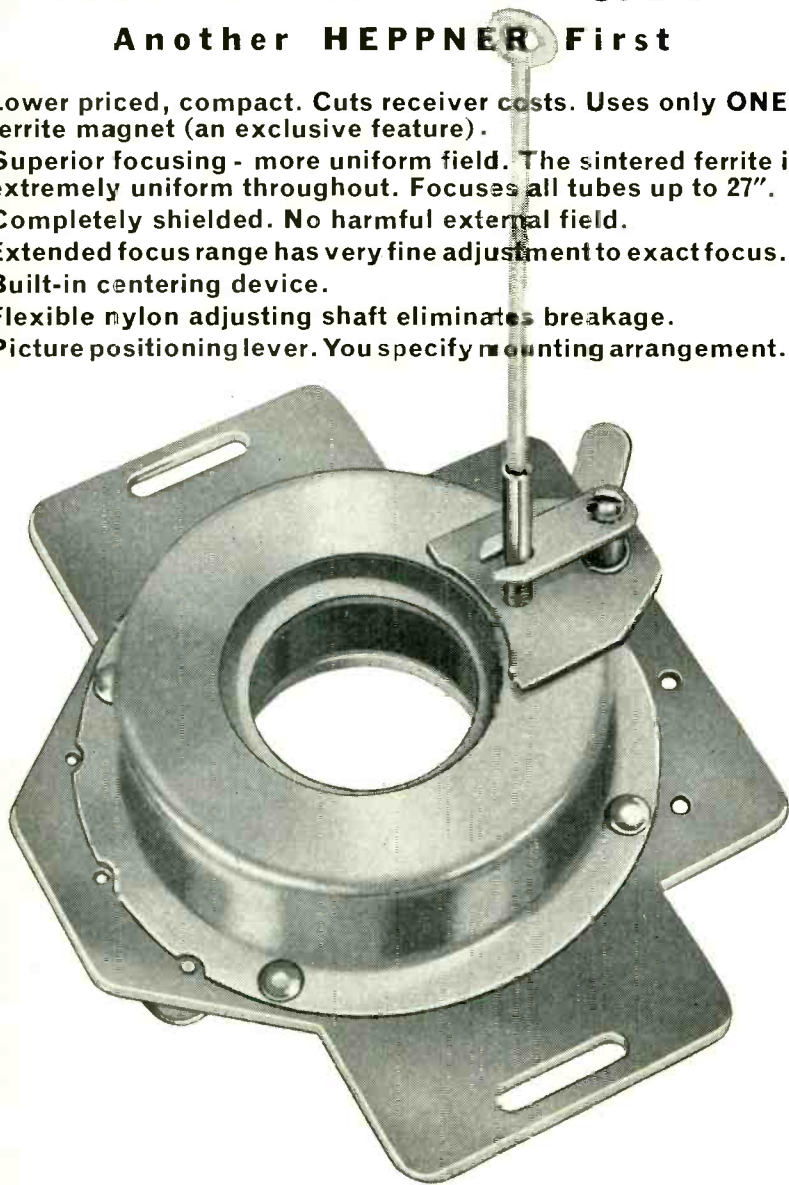

Lower your set costs with this NEW FOCOMAG. Write today for further information.

HEPPNER

MANUFACTURING COMPANY

Round Lake, Illinois (50 Miles Northwest of Chicago)
Phone: 6-2161

SPECIALISTS IN ELECTRO-MAGNETIC DEVICES

Representatives: **John J. Kopple**
60 E. 42nd St., New York 17, N. Y.

James C. Muggleworth
506 Richey Ave., W. Collingswood, N. J.

Ralph Haffey
R. R. 1, U. S. 27, Coldwater Rd.,
Ft. Wayne 8, Indiana

Irv. M. Cochrane Co.
408 So. Alvarado St., Los Angeles, Calif.

NEW PRODUCTS

(continued)

μ v to 500 v rms over a frequency range from 15 cycles to 250 kc. The meter is calibrated both in a-c voltage and decibels. Voltage range of the meter scale is from 0.5 to 5.0 v. Decibel range is from -5 to +17 db based on zero db equaling 1 mw in 600 ohms. The unit is housed in a metal cabinet measuring $5\frac{1}{2} \times 11\frac{1}{2} \times 5\frac{3}{8}$ in. deep. Input impedance is 2 megohms with 15 μ af shunt capacity. Accuracy is ± 2 percent from 15 cps to 250 kc.



R-F CHOKE KIT for lab or experimenting

CAMBRIDGE THERMIONIC CORP., Cambridge, Mass. Type X2082 r-f choke kit contains 14 pie-wound chokes on LPB-3 forms, which have axial leads and are only $\frac{5}{32}$ in. in diameter $\times \frac{1}{2}$ in. long. Windings are $\frac{1}{8}$ in. wide and vary up to $\frac{1}{2}$ in. approximately in diameter. All units are varnish-impregnated for moisture and fungus-proofing. Inductances are the RETMA preferred values from 6.8 microhenries to 1.0 millihenry, while color-coding by the RETMA 3-dot system enables easy recognition of values. A chart on the inside cover of the kit gives all necessary electrical data, together with the C.T.C. part numbers for ordering separately or in bulk.

TRANSFORMER WINDER for heavy-duty use

GEO. STEVENS MFG. Co., INC., Pulaski Rd. at Peterson, Chicago 30, Ill. Model 147-AM transformer winder winds heavy wire in tight, perfectly uniform layers by using a variable transmission. The machine winds power, audio and

New 3/4" Sensitive Relay

APPLICABLE TO PRINTED CIRCUITS

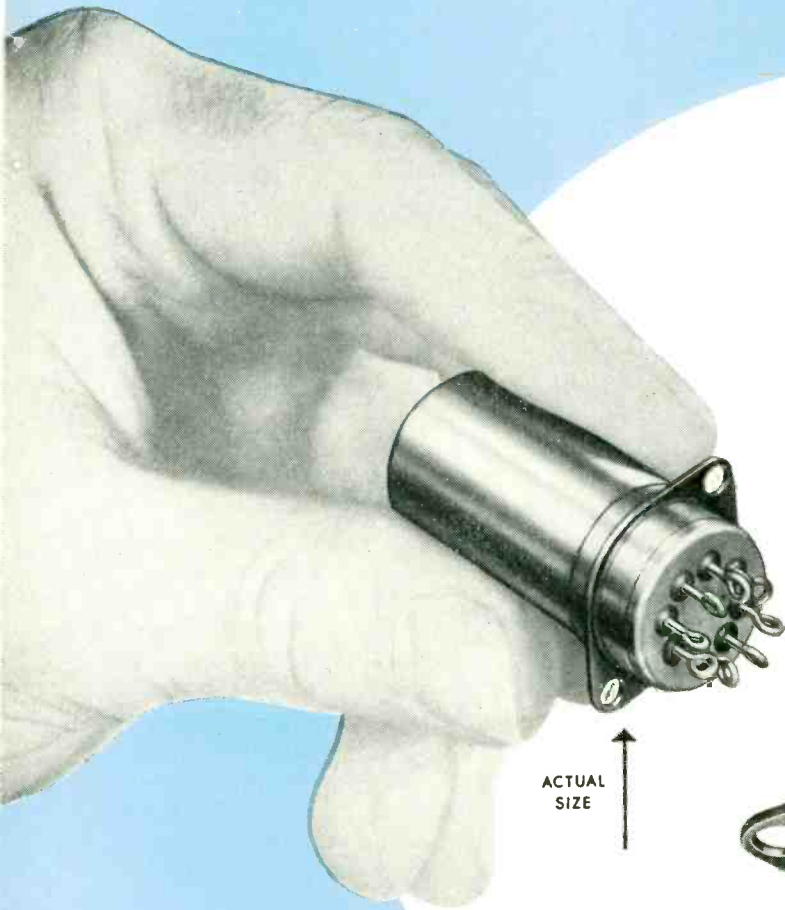

↑
ACTUAL
SIZE



ALLIED TYPE RSH
has sensitivity of
40 milliwatts in D.P.D.T.
and 22 milliwatts in
S.P.D.T.

ELECTRICAL SPECIFICATIONS

CONTACTS: Up to D.P.D.T. rated at 2 amperes
at 26.5 volts DC or 115 volts AC resistive load

COIL: Sensitivity—40 milliwatts D.P.D.T.
22 milliwatts S.P.D.T.

Resistance—up to 14,000 ohms

TEMPERATURE: Minus 60° C to plus 125° C

VIBRATION: 10G up to 500 cycles

SHOCK: 50G plus (operating)

ALTITUDE: 80,000 feet or 1.3 inches of mercury

TERMINAL TYPE: Solder and plug-in printed
circuit.

WEIGHT: 2 ounces

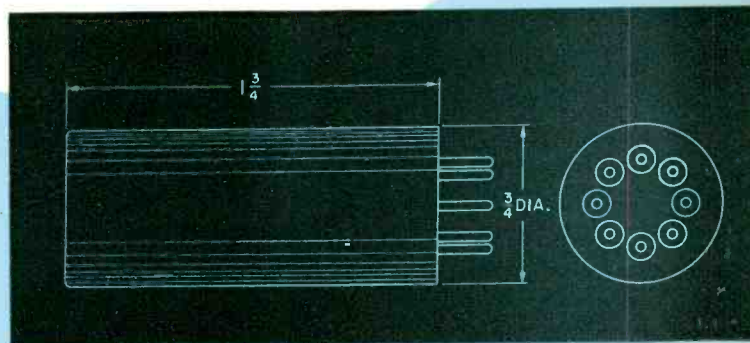

Write for catalog sheet giving complete information

Be sure to see this and other new Allied Control Relays at the IRE Show.

ALLIED CONTROL

ALLIED CONTROL COMPANY, INC., 2 EAST END AVENUE, NEW YORK 21, N. Y.



Multi-Metal makes them Better • Faster • At Lower Cost

SHIELDS • CABINETS • CHASSIS
DUST COVERS • PANELS • FABRICATED ASSEMBLIES
MuMetal • Aluminum • Stainless Steel • Other Alloys

MAGNETIC SHIELDS for CATHODE RAY TUBES

Variety of MuMetal and other magnetic alloys in all standard gauges, hydrogen-annealed to assure maximum shielding efficiency.



TRICOLOR KINESCOPE SHIELDS

Multi-Metal can now deliver one-piece magnetic shields as early as two weeks from receipt of your order.

STANDARD SHIELDS

For popular 2", 3" and 5" tube sizes, Multi-Metal offers speedy delivery of these low cost units complete with light hoods, retainers, cushions and plexiglass windows.

CUSTOM BUILT SHIELDS

... to serve your specific requirements. Our design and engineering staff is always at your service to help work out your problems.

COMPLETE SHEET METAL ASSEMBLIES

ALUMINUM FABRICATION

Complete facilities at Multi-Metal include certified Heliarc welding and Sciaky spotwelding equipment.

CUSTOM BUILT ASSEMBLIES

For communications, airborne and other equipment — including large fabricated units. Send us your prints and specs for prompt quotations.

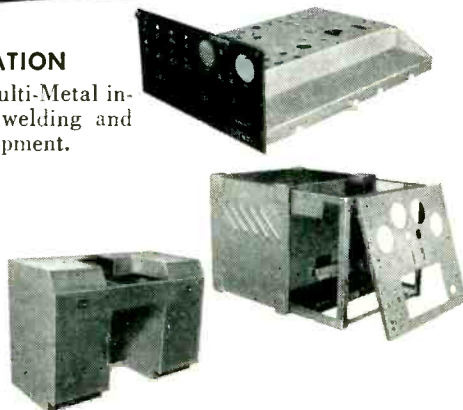

SEE US AT THE
RADIO
ENGINEERING
SHOW
BOOTHS 125-127
MARCH 22-25

You Can Depend on
Multi-Metal
MULTI-METAL WIRE CLOTH COMPANY, INC.

Electronics Division

1350 Garrison Avenue • New York 59, N. Y.

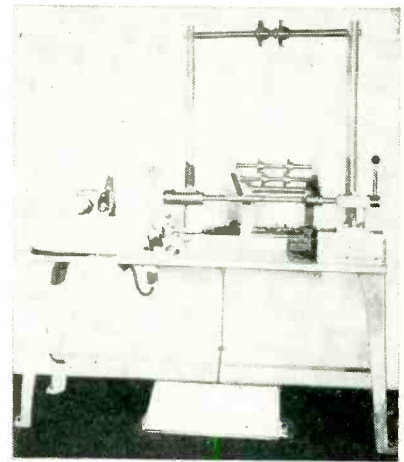

similar types of heavy-duty transformer coils and all types of heavy-duty field coils and bobbins up to 10 in. long and 16 in. outside diameter. An infinite number of wire spacing adjustments throughout the entire range is made possible by the variable transmission. The 1½ in. diameter spindle is designed to withstand all impacts necessary to form insulation around heavy transformer windings. The spindle is supported by taper roller bearings for free running and long life. Six months supply of lubricant is contained in the winding head. Wire sizes handled are 5 to 18 A.W.G. Winding speed is 5 to 85 rpm. A foot treadle varies the winding speed. The unit also features a positive stopping magnetic brake.

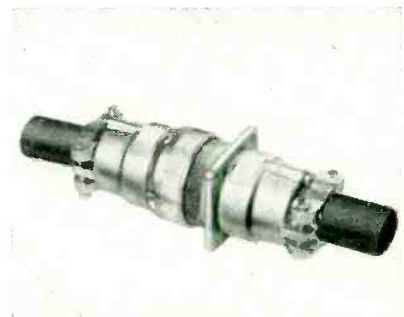

CONNECTORS are multicontact type

CANNON ELECTRIC Co., 3209 Humboldt St., Los Angeles 31, Calif. The new AN-E series of multicontact electric connectors is designed to resist extreme environmental conditions encountered by aircraft, ground and naval operations of the military forces under

New Sub-Miniature Relay

APPLICABLE TO
PRINTED CIRCUITS

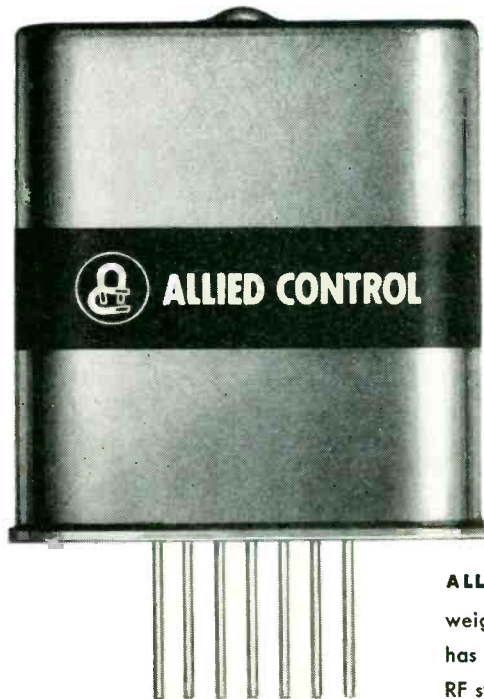
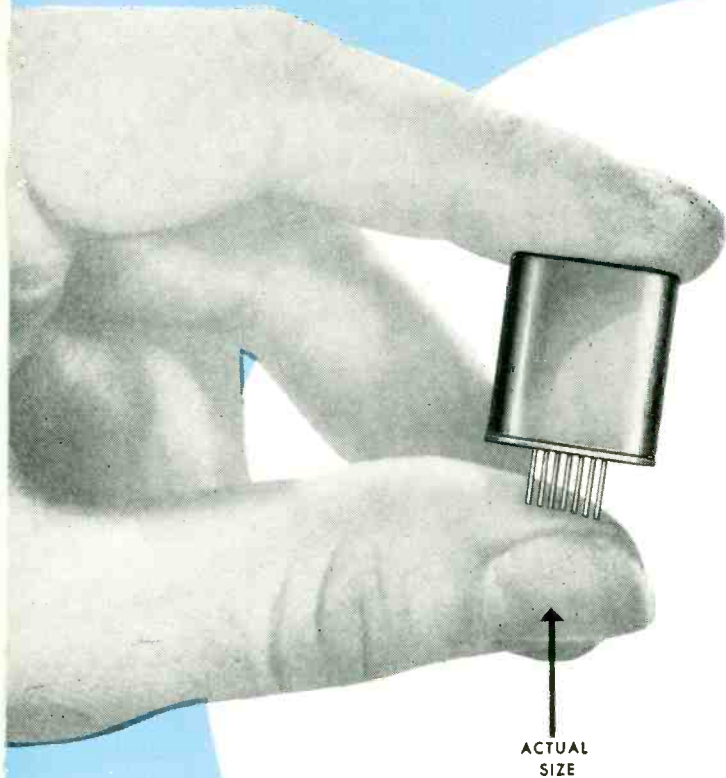

ALLIED TYPE KH RELAY
weighs .032 oz. —
has low capacity for
RF switching

ELECTRICAL SPECIFICATIONS

CONTACTS: Maximum of double pole rated at .25 amperes at 26.5 volts DC or 115 volts AC resistive

COIL: Sensitivity—nominal 1.0 watts, maximum 0.3 watts
Resistance—up to 1500 ohms
Voltage—up to 40 volts DC

TEMPERATURE: Minus 60° C to plus 125° C

VIBRATION: 10G up to 500 cycles

SHOCK: 50G plus (operating)

SPEED OF OPERATION: 1.5 millisecond at nominal voltage direct from battery supply volt and 1 millisecond with series resistance

ALTITUDE: 70,000 feet or 1.3 inches of mercury

TERMINAL TYPES: Printed circuit, solder terminals and plug-in

CAPACITY: No contact to case 0.85 mmf un-energized and 2.1 mmf energized

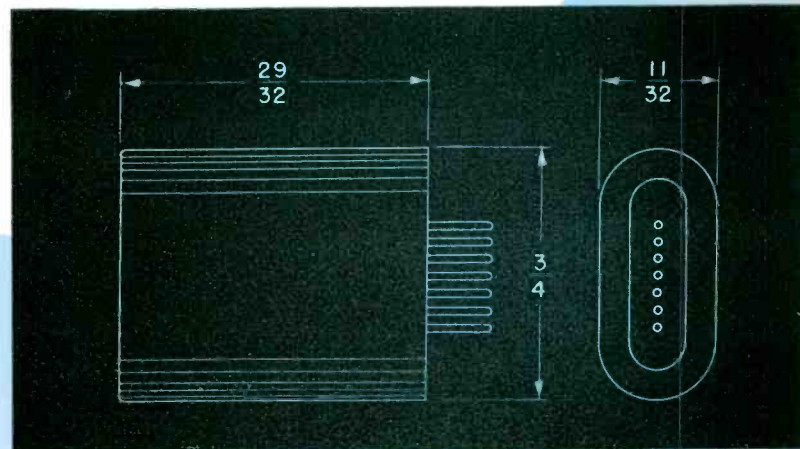

Write for catalog sheet giving complete information

Be sure to see this and other new Allied Control Relays at the IRE Show.

ALLIED CONTROL

ALLIED CONTROL COMPANY, INC., 2 EAST END AVENUE, NEW YORK 21, N. Y.



IN STOCK NOW!

at **CHICAGO**

hermetically sealed
400 CYCLE
TRANSFORMERS
that meet MIL-T-27:
CLASS B* specifications



*85° Ambient—40° Rise.

These rugged, compact transformers have been designed in close cooperation with organizations directly concerned with the development of standards for aircraft communication, guided missile and related equipment. They are engineered to meet future, as well as current requirements for 400 cycle power supplies.

POWER TRANSFORMERS (All primaries 105/115/125 V., 380-1000 cycles)

HIGH VOLTAGE A.C. Volts	SECONDARY D.C. Ma.	RECTIFIER Volts	FILAMENT Amps.	OTHER Volts	FILAMENTS Amps.	CATALOG NUMBER
270-0-270	55	5.0	2	6.3 CT	2	4PHC-55
335-0-335	70	5.0	2	6.3 CT	3	4PHC-70
375-0-375	120	5.0	3	6.3 CT	4	4PHC-120
440-0-440	165	5.0	3	6.3	7.5	4PHC-165
				6.3	3	
				6.3	3	
450-0-450	200	5.0	2	6.3	0.6	4PHC-200A
				6.3	4	
				6.3	4	
550-370-75-0- 75-370-550	300	5.0	6	6.3	0.6	4PHR-300
				6.3 CT	5	
				6.3 CT	1	

FILTER REACTORS

INDUCTANCE (henries)	MAXIMUM D.C. Ma.	D.C. RESISTANCE (ohms)	INSULATION VOLTS RMS	CATALOG NUMBER
2.0	55	160	2,500	4RH-255
2.0	70	240	2,500	4RH-270
2.0	120	105	2,500	4RH-2120
2.0	165	80	2,500	4RH-2165
2.0	200	77	2,500	4RH-2200
2.0	300	49	2,500	4RH-2300

FILAMENT TRANSFORMERS (All primaries 105/115/125 V., 380-1000 cycles)

SEC. VOLTS	SEC. AMPS.	INSULATION VOLTS RMS	CATALOG NUMBER
6.3 CT	3	2,500	4FH-63
6.3 CT	5.5	2,500	4FH-65
6.3 CT	10	2,500	4FH-610
6.3 CT	20	2,500	4FH-620

Write for Chicago Bulletin #32 listing more complete specifications on these units, specially designed for 400 cycle, high-temperature operation.

specification MIL-C-5015A (ASG). The new design provides for higher dielectric strength with greater arc resistance, water repellancy, resistivity, corrosion resistance, and higher potential test voltage and contact current ratings than have previous specifications. Because of the insulator and grommet design, the circuits through the connector are completely sealed from cable to cable. The E type features two available insert materials: a new and lighter polychloroprene material and the latest development in silicones. Shells are of single-piece construction with integral clamps. The angle 90-deg plug has a removable clamp.

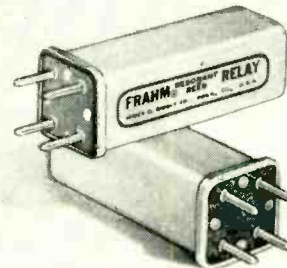

REED RELAYS
are frequency sensitive

JAMES G. BIDDLE Co., 1316 Arch St., Philadelphia 7, Pa. The Frahm resonant reed relay is an electro-mechanical device that responds to an alternating signal having frequency and amplitude values that lie within specified bands. The transmission of a number of control signals over a single circuit is simplified with reed relays, and their use is not limited to wire circuits but may be extended to all types of communication circuits, including radio. In a typical application, a control function is used to turn off or on a series of low-frequency signals (50 to 500 cps). The signal is transmitted either on a wire line, or as a modulated carrier to some remote location where it operates a reed relay to indicate the control function at that point. In the range of 200 to 500 cycles it is possible to operate up to 16 channels with no interference between channels. Where 4 relays are used,



CHICAGO

the World's Toughest Transformers

CHICAGO STANDARD TRANSFORMER CORP.

3501 ADDISON STREET • CHICAGO 18, ILLINOIS

Now— an Irvington
PLASTIC INSULATING TAPE
 with the heat- and oil-resistance of
Temflex® 105 Tubing



Here is a new addition to the Irvington family of insulating tapes — Temflex 105 Plastic Tape, based on the *same* formula that has made Temflex 105 Tubing the leader where service calls for continuous operation in air at 105° C. — or in oil at 90° C.

Temflex 105 Tape is strong and flexible — possesses exceptional elongation. It can be easily hand wound over bus bars, coils, cables — even over very irregular surfaces — or can be used in taping heads. Temflex 105 Tape frequently offers substantial savings as compared with varnished cambric. Easily baked to a homogeneous mass, it also offers cost economies over pressure-sensitive tapes.

Made in thicknesses of .007", .010" and .012"; widths from ½" to 34". Dielectric strength as high as 1200 vpm *even at 100° C.* Tensile strengths up to 3100 psi — elongation 165% to 240%.

You probably know Temflex 105 Tubing — you'll certainly want to learn about Temflex 105 Tape. Write for technical data sheet.

Look to
IRVINGTON

for Insulation Leadership

INSULATING VARNISHES
 VARNISHED CAMBRIC
 VARNISHED PAPER
 VARNISHED FIBERGLAS
 INSULATING TUBING
 CLASS "H" INSULATION



IRVINGTON VARNISH & INSULATOR

DIVISION OF MINNESOTA MINING & MANUFACTURING COMPANY

11 ARGYLE TERRACE, IRVINGTON 11, N. J. • PLANTS: IRVINGTON, N. J.; MONROVIA, CALIF.; HAMILTON, ONTARIO, CANADA



One or a Million...

- How expensive are your design ideas?**
- How accurate are your prototypes?**
- How quickly can you swing from pilot to production?**

Do your design changes run up cost because of prototype "unreliability"? In orders of one or one million, I-S BeCu^{MP} springs measure up to one single standard of performance. This allows you to check your design against production tolerances and tests—without the expense of ordering production quantities. Our "Short-Run" department was set up expressly to handle pilot runs and small production requirements as regular output—instead of treating them as costly "special orders".

I-S Short-Run = Same High Performance—Lower Cost

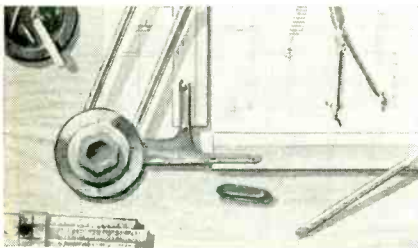

Two Other Important Advantages

- (1) *Our ability to produce a better spring faster and usually at a lower cost.*
- (2) *The specialized ability of our engineers to cooperate with your designers in developing your "problem" springs.*

Like many other leading manufacturers, you will find that these I-S facilities can make significant improvements in your manufacturing processes and in your product. And they most likely will save you money! One thing is certain... it costs nothing to compare—it may cost considerable, *not to!*

The design stage normally poses the basic problems of time and unit costs—plus the uncertainties of performance. By utilizing I-S engineering research and advanced spring-making techniques, you save in testing time and development—as well as in elimination of regular production waste. In addition, you are ready to go into million-plus production, without time-consuming engineering usually involved in the transition from bench-made prototypes to full line production.

For more information on BeCu^{MP} Springs, write today to reserve your copy of our newest catalog—No. 8; for Electronic Components, ask for No. 8-A.



Instrument Specialties Co. Inc.

258 BERGEN BOULEVARD, LITTLE FALLS, NEW JERSEY

Telephone Little Falls 4-0280

BeCu^{MP} = Beryllium Copper, Micro-Processed

1,820 control functions can be handled.



ANALOG COMPUTERS are desk-top size

REEVES INSTRUMENT CORP., 215 E. 91 St., New York 28, N. Y. Models C301 and C302 desk-top electronic analog computers measure 20 × 25 × 20 in. They can solve differential equations or simulate physical systems, up to the sixth order of magnitude. All mathematical operations are performed with better than 0.1-percent accuracy. The units each contain 12 individually chopper-stabilized computing amplifiers identical to those used in the full-size analog computer. These amplifiers have extremely low noise, drift of less than 0.25 mv per day, d-c gains of over 15 million, and full load current over an output voltage range exceeding ±100 v. Automatic true overload indication is provided for each amplifier. Problems are set up on patch boards that plug into the front of the computer. Thus one computer can be used for several problems and by different operators in succession with minimum setup time.

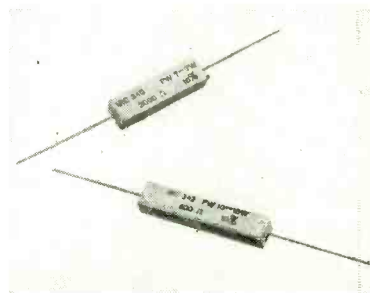

POWER RESISTORS rated at 7 w and 10 w

INTERNATIONAL RESISTANCE CO., 401 N. Broad St., Philadelphia 8,

IDEAS

in the making

Araldite® Bonding, Casting, Coating and Laminating Resins developed by Ciba Research are simplifying manufacturing methods, improving product efficiency, and opening new fields of product development. You will want to know more about them.



(Photo courtesy of Resdel Corporation)

ARALDITE RESINS USED TO MAKE CENTRIFUGAL CAST PIPE WITH EXCEPTIONAL PROPERTIES

Araldite Resins of the "CN" series are formulated especially for casting, potting, impregnating and encapsulating uses. The pipe shown here is available in a wide range of gauges, diameters and lengths. In addition to exceptional toughness, impact and dielectric strength, it offers excellent resistance to chemical attack from circulating corrosive liquids. Araldite cast

pipe of larger diameters with sealed ends is used for storage of chemicals as well. The strong clean pipe is also undergoing tests for supportive structural uses. Araldite Resins of this type achieve outstanding results in castings bonded to metal parts, impregnating of transformers, capacitors, coils, motor windings and other electrical apparatus.

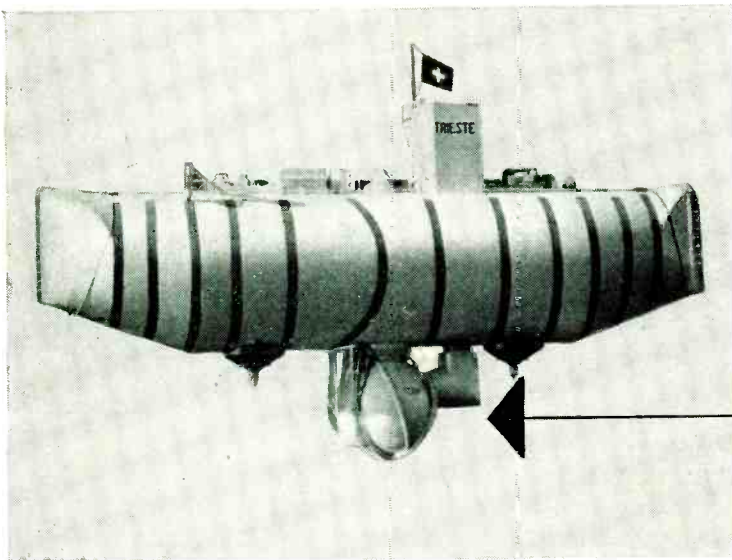

POWER CABLE INSTALLATION PROBLEM SOLVED EFFECTIVELY WITH

ARALDITE RESINS IN "BATHYSPHERE" FOR RECORD-SHATTERING DESCENT

On this newest "Bathysphere" the controls are connected by instrument and power cables which pass through the wall of the cabin to the apparatus located outside the cabin. In the previous "Bathysphere" all motors were controlled through relay circuits. The relays were installed outside the cabin and only small wires were able to pass through the walls. By sealing the openings with Araldite Resins it became possible to simplify the arrangement and put full-sized power cables carrying currents up to 200 amperes through the walls. The Araldite Resin used was simply poured into the space between the walls of the sphere and the cables, where it hardened and formed a seal capable of withstanding the tremendous pressure of the water at the great depth of more than 4,000 meters below the surface of the Mediterranean to which the "Bathysphere" recently descended.

SEND THIS COUPON...or write us on your company letter-head...for complete technical data on the physical properties and recommended procedures for the successful use of Araldite Resins for your fabricating needs.

CIBA

ARALDITE

Epoxies

...FOR SUPERIOR BONDING, CASTING, COATING & LAMINATING RESULTS

CIBA COMPANY INC., PLASTICS DIVISION

627 Greenwich St., New York 14, N. Y.

(In Canada: Ciba Co. Ltd., Ciba Bldg., Montreal)

Please send me Ciba Plastics Technical Bulletins for

BONDING CASTING COATING LAMINATING

Name _____

Company _____ Title _____

Address _____

E-1

new miniaturized tuning fork resonator...

(Model J)

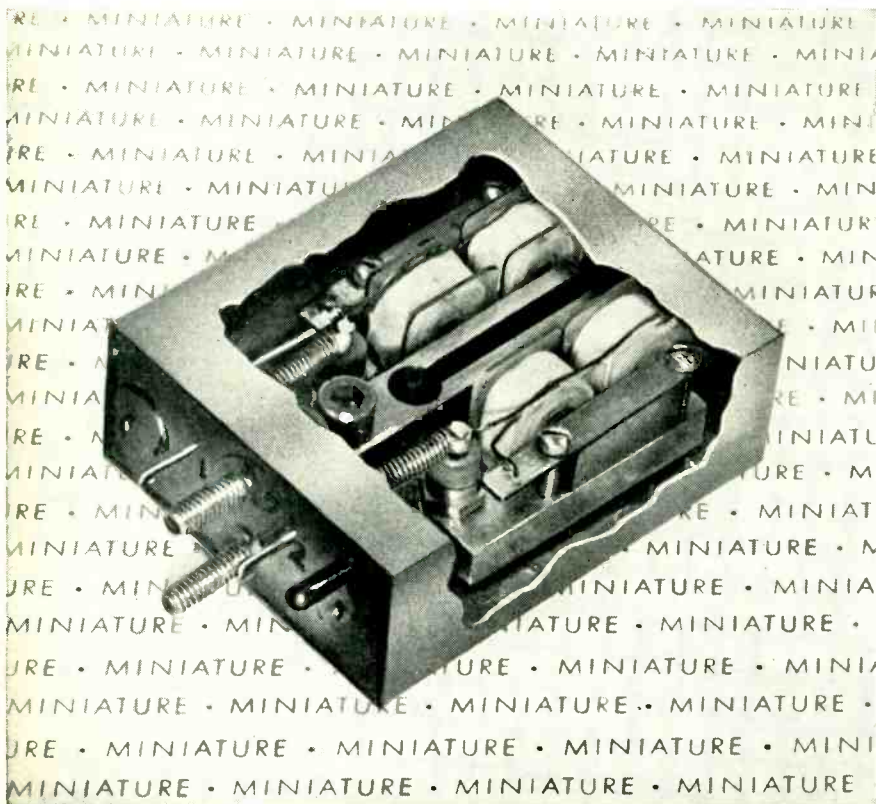

**ILLUSTRATED ACTUAL SIZE
DIMENSIONS 1" x 2 3/4" x 2 1/4"
MAXIMUM WEIGHT—8 OUNCES**

accuracies...

1 part in 10,000 (.01%) or 1 part in 2,000 (.05%),
from -40° to $+85^{\circ}$ Centigrade.

frequencies...

From 400 to 2,000 cycles in either accuracy rating.

construction...

Thermally compensated, solder-sealed and evacuated, completely interchangeable, internally mounted using shock retarding silicone rubber, externally designed for fastening to chassis through silicone rubber grommets thus providing excellent vibration and shock isolation.

For complete information write for Folder No. 102 or telephone HYacinth 2-4800

See us at Booth 611—Radio Engineering Show



Philamon Laboratories Inc.

5717 THIRD AVENUE, BROOKLYN 20, NEW YORK

For more ad information, see Index to Advertisers.

Pa., has announced two new high temperature resistors, types PW-7 and PW-10. Rectangular in shape, they have been designed to allow a high degree of automatic assembly at a low cost. Wire elements are uniformly and tightly wound on glass fibre cores with axial leads $1\frac{1}{2}$ in. long; 0.036 diameter. Body dimensions of the PW-7 are $1\frac{1}{4}$ in. long, $\frac{3}{8}$ in. wide, $\frac{1}{2}$ in. high; the PW-10, $1\frac{1}{2}$ in. long, $\frac{3}{8}$ in. wide and $\frac{1}{2}$ in. high. These element-lead assemblies are sealed into a ceramic case with a special cement which provides a mechanical protective bond between the resistant element, the terminals and the case. Type PW 7 is available from 0.51 ohm to 5,100 ohms; type PW-10 ranges from 1.0 ohm to 8,200 ohms—both in ± 5 -percent and ± 10 -percent tolerance.

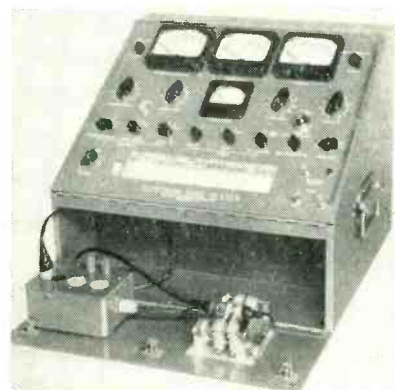

KLYSTRON TESTER is compact and portable

POLARAD ELECTRONICS CORP., 100 Metropolitan Ave., Brooklyn 11, N. Y., announces availability of a commercial klystron tube tester. The unit is a compact, portable instrument, designed to test the performance quality of all commercially available klystron type tubes, both for internal and external cavity construction. It provides complete metering facilities, control adjustments, precautionary means for safe testing at high voltages and convenient tube data charts for rapidly determining control settings. The tube tester has provisions for external modulation so that the klystron tubes may also be dynamically tested with external r-f measuring equipment. The universal power supply may also be used

SLANT your
 requirements to
**INSTRUMENT CORP.
 OF AMERICA**

for miniature

SLIP RING AND COMMUTATOR ASSEMBLIES

This Instrument Corporation of America plant contains the most modern and complete facilities available anywhere in the world for the exclusive production of Miniature Slip-Ring and Commutator Assemblies to precision standards. It is now in full scale production to meet your requirements in the fastest possible time at the lowest possible cost.

**COMPLETE ENGINEERING AND
 PRODUCTION FACILITIES AVAILABLE**

Our assemblies can be supplied at low cost. Quality is the highest in the industry. Dimensional accuracy and other characteristics are excellent and these units are highly recommended for instruments such as synchros, etc.

**ONE PIECE ELECTRO-PLATED
 TYPES FOR EXTREME ACCURACY**

Wherever extreme dimensional precision, accurate concentricity and high dielectric qualities are required, the electro-deposition method is recommended . . . the production of which is licensed under an exclusive arrangement with the Electro Tex Corporation.

**TYPICAL
 SPECIFICATIONS:**

Sizes: .035" to 24"
 Cylindrical or Flat

Cross-sections: .005 to
 .060" or more

Finish: Polish to 4
 Micro-Inches or Better

Breakdown: 1000 V or More
 Hi-Pot Inter-Circuit

Ring Hardness: 75 to 90 Brinell

Rotation Speeds: To Over 12000 RPM

Surface Protection: Palladium and Rhodium or Gold Prevent Tarnish, Minimize Wear

Our engineering staff is at your service at all times for consultation

**INSTRUMENT
 CORPORATION
 OF AMERICA**
 BLACKSBURG • VIRGINIA



ATR INTRODUCES

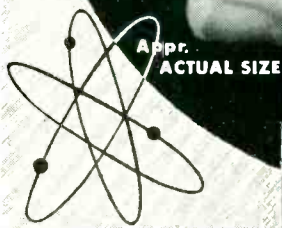
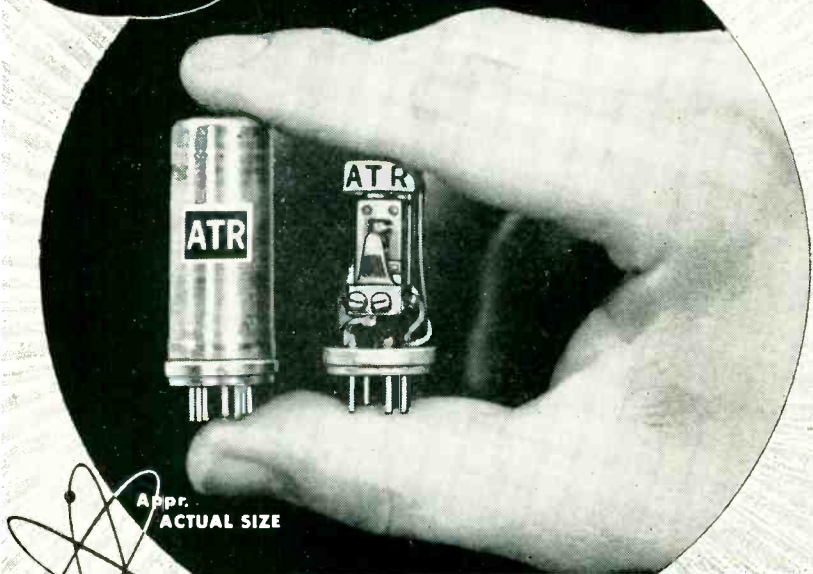

The World's Smallest VIBRATOR

Developed by ATR in cooperation with Squier Signal Laboratory, Signal Corps Engineering Laboratories, Fort Monmouth, New Jersey.

Ideally suited for flash-light cell operated miniature power supplies in conjunction with:

- RADIATION MEASURING DEVICES.
- PHOTO-MULTIPLIER CELLS.
- INFRA-RED DETECTION EQUIPMENT.

SPECIFICATIONS	
Driver coil voltage	1.5, 3, or 6 VDC
Driver coil power	45mw
Frequency	100 cycles
Time efficiency	40% (each side arm)
Seated height	1 1/4 inches
Diameter	5/8 inches
Total volume675 cu. in.
Total weight vibrator assembly	0.3 ounces
Complete structure in container	0.6 ounces
Base 7-pin miniature tube	RETMA Type E7-1

ATR manufactures a complete line of Auto Radio Type Vibrators, Heavy Duty Inverter Type Vibrators, DC-AC Inverters, and Rectifier Power Supplies. Literature Available On Request.

ATR AMERICAN TELEVISION & RADIO CO.
Quality Products Since 1931
 SAINT PAUL 1, MINNESOTA — U.S.A.

for klystron testing purposes outside the instrument.

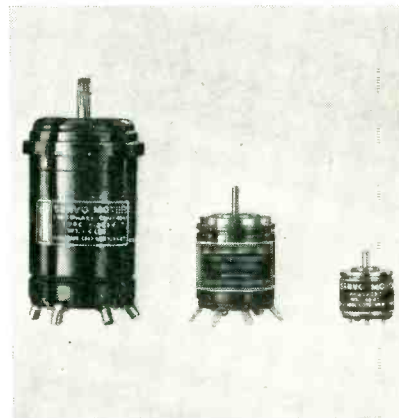

SERVO MOTORS are high-precision units

KETAY MFG. CORP., 555 Broadway, New York 12, N. Y., offers a complete line of high precision synchros, servo motors and resolvers. An illustrated bulletin giving typical characteristics shows that the company's experience also includes: automatic control devices for use in fire control and missile systems; computers and simulators; amplifiers; marine intercom equipment; remote indicators such as ship course indicators, drive angle indicators and salinity indicators; and automatic control systems.



TIME DELAY RELAY is hermetically sealed

AGA DIVISION, Elastic Stop Nut Corp. of America, 1027 Newark Ave., Elizabeth, N. J., has developed a new compact and lightweight, hermetically sealed time delay relay. Originally developed for

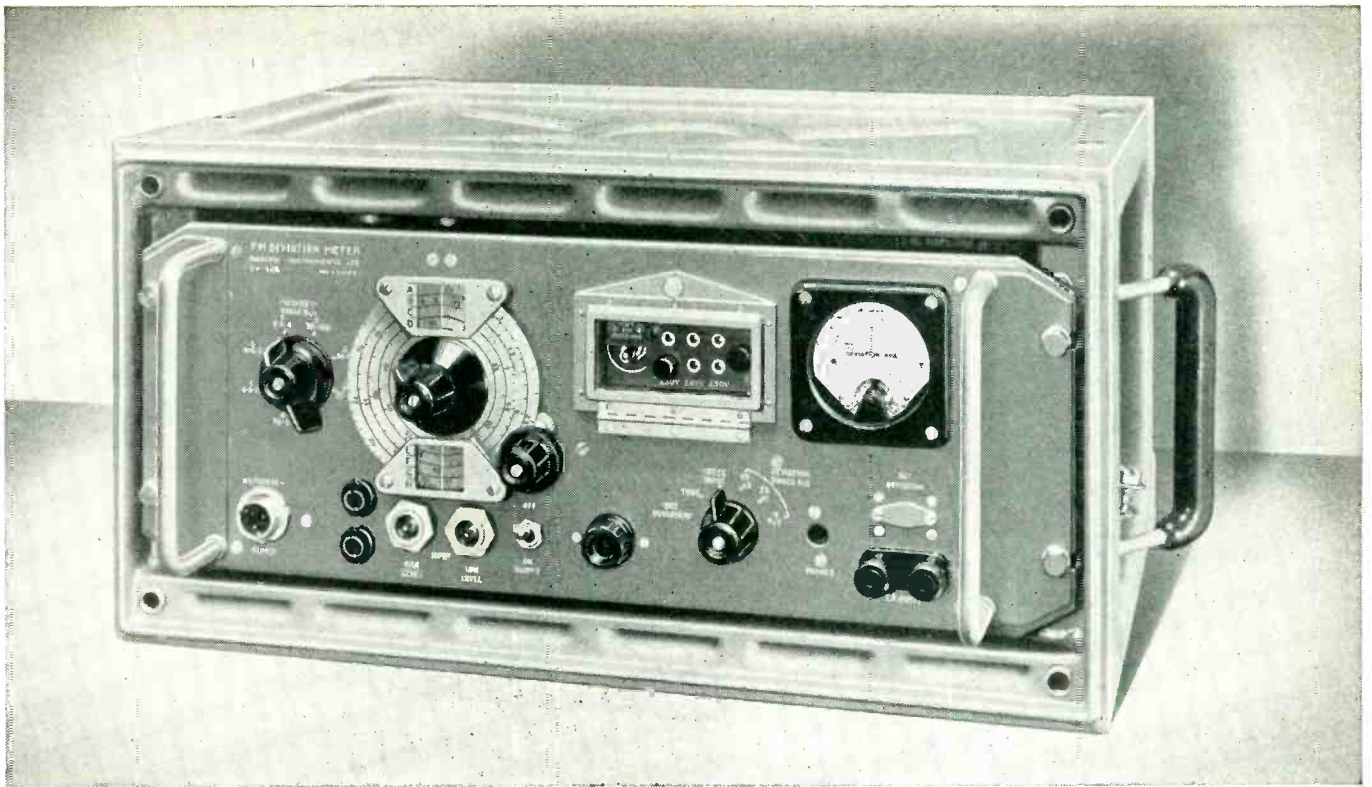

F.M. DEVIATION DIRECTLY MEASURED

THE BESSEL ZERO or "Disappearing Carrier" method of measuring deviation requires complex monitoring equipment, an accurately known modulation frequency, and, finally, mathematical interpretation of results.

With the compact and easy-to-use Marconi Deviation Meter, the modulation frequency need not be known and deviation is directly read on a meter scale.

F. M. DEVIATION METER TYPE TF 934

Carrier Frequency Range: 2.5 to 200 megacycles.

R.F. Input Level: 55 millivolts to 10 volts.

Deviation Measurement Ranges: 0 to ± 5 kc, 0 to ± 25 kc and 0 to ± 75 kc.

Accuracy of Deviation Measurement: $\pm 3\%$ from full-scale to half-scale up to 12 kc and $\pm 6\%$ up to 15 kc.

Full data and prices of any of the items listed below will be mailed immediately on request:

F.M. DEVIATION METER TF 934 • UNIVERSAL BRIDGE TF 868

FM/AM SIGNAL GENERATOR TF 995A • STANDARD SIGNAL GENERATOR TF 867

Also

VACUUM TUBE VOLTMETERS • FREQUENCY STANDARDS • OUTPUT METERS
WAVEMETERS • WAVE ANALYSERS • Q METERS • BEAT FREQUENCY OSCILLATORS

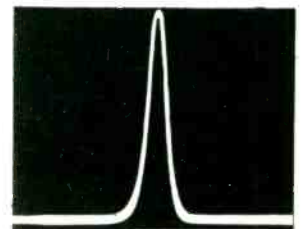

Unmodulated Carrier

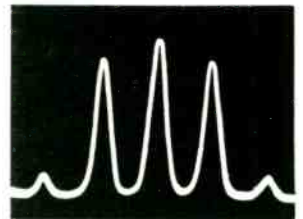

Modulation Index 1.3

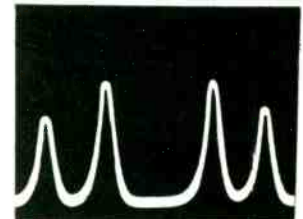

Modulation Index 2.4

The Carrier "Disappears"
BESSEL ZERO METHOD

MARCONI INSTRUMENTS

23-25 BEAVER STREET • NEW YORK 4

CANADA: CANADIAN MARCONI CO., MARCONI BUILDING, 2442 TRENTON AVENUE, MONTREAL

ENGLAND: Head Office: MARCONI INSTRUMENTS LIMITED, ST. ALBANS, HERTFORDSHIRE

Managing Agents in Export: MARCONI'S WIRELESS TELEGRAPH COMPANY LIMITED, MARCONI HOUSE, STRAND, LONDON, W.C.2

Visit us at Booths 260-262, IRE Show

C.65

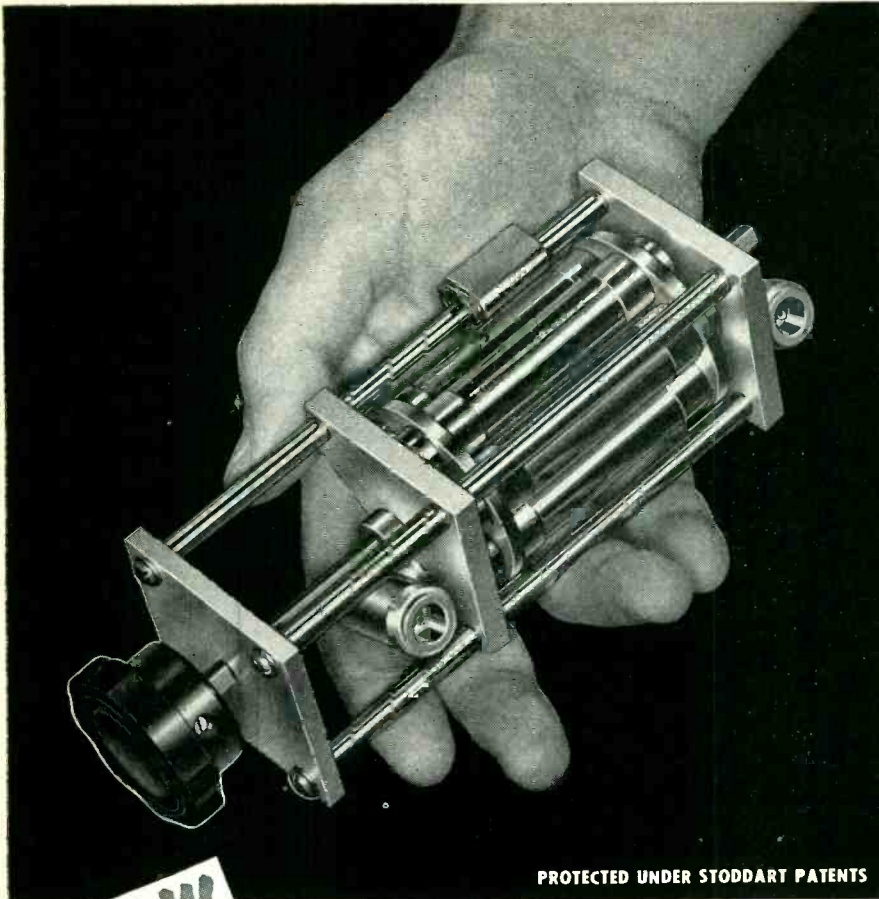

PROTECTED UNDER STODDART PATENTS

NOW

Precision Attenuation to 3000 mc!

TURRET ATTENUATOR featuring "PULL-TURN-PUSH" action

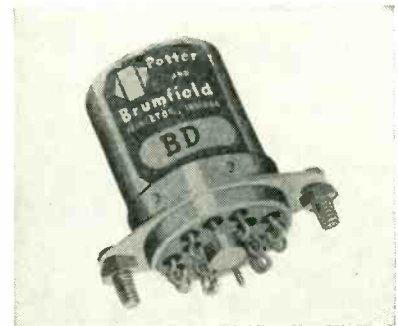

SOLENOID RELAY is a tiny version

POTTER & BRUMFIELD, Princeton, Ind., is manufacturing a new solenoid design of relay. It is a miniaturized version with a dynamically balanced magnetic structure that will withstand extremely high shock and vibration. When tooling is completed it will be offered with up to 6 form C and for either d-c voltage or current actuation to withstand ambient temperatures from -65°C to $+200^{\circ}\text{C}$.

MAGNETIC RELAY is ultrasensitive type

THOMAS A. EDISON, INC., West Orange, N. J., has announced a new ultrasensitive magnetic relay, particularly adapted to use in airborne electronic equipment. Designed to operate on a current input of $50\ \mu\text{a}$ d-c, the new relay requires no amplification when used to detect the output from a thermocouple or photocell and is an ideal null de-



SINGLE "IN-THE-LINE"
ATTENUATOR PADS
and
50 ohm COAXIAL
TERMINATION

FREQUENCY RANGE:

dc to 3000 mc.

CHARACTERISTIC IMPEDANCE:

50 ohms

CONNECTORS:

Type "N" Coaxial female fittings each end

AVAILABLE ATTENUATION:

Any value from .1 db to 60 db

VSWR:

< 1.2 , dc to 3000 mc., for all values from 10 to 60 db

< 1.5 , dc to 3000 mc., for values from .1 to 9 db

ACCURACY:

± 0.5 db

POWER RATING:

One watt sine wave power dissipation

*Send for free bulletin entitled
"Measurement of RF Attenuation"*

*Inquiries invited concerning pads or
turrets with different connector styles*

STODDART AIRCRAFT RADIO Co., Inc.

6644-A Santa Monica Blvd., Hollywood 38, California • Hollywood 4-9294



BOLTING VOICES TOGETHER

Adjusting casing over splice in polyethylene cable. Edges and ends are sealed with a new Butyl rubber compound that won't harden, dry out or lose adhesion even in extreme heat or cold.

More than ever, light, flexible polyethylene sheathed cable developed by Bell Telephone Laboratories is providing speedy answers to the demand for more telephone service.

But at thousands of splices, the sheath must be thoroughly sealed against moisture. Laboratories engineers developed a protective casing which is quickly and simply bolted in place. The edges and ends of the casing are *permanently* sealed with a new compound developed by Laboratories rubber chemists.

Now, economical polyethylene cable can be installed much faster and at lower cost. Here is another example of how Bell Laboratories continually finds ways to keep telephone service high in quality, while the cost stays low.

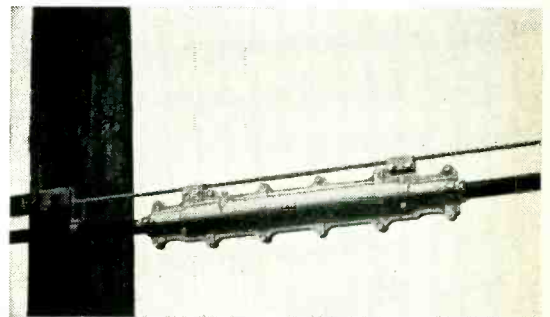

CLOSED CASING IN PLACE

BELL TELEPHONE LABORATORIES



EXPLORING AND INVENTING, DEVISING AND PERFECTING, FOR CONTINUED IMPROVEMENTS AND ECONOMIES IN TELEPHONE SERVICE

For more ad information, see Index to Advertisers.



THREAD PRECISION AND UNIFORMITY INSURED WITH CRAMER TIME CONTROL

The threading accuracy of this Steinle Roll Threading Machine is directly related to the highly dependable Cramer Timers which govern the roll slide movements. This carefully predetermined slide travel must be extremely accurate in order to insure thread precision and uniformity.

The Cramer TE Timer, at left, controls the time of dwell of the roll slide in its forward position, while the one at right dictates the exact loading interval. A simple adjustment of either timer permits slow-down or speed-up of the action. Cramer-controlled threading operations on the Steinle machine

have been speeded to 40 complete cycles per minute without sacrifice of thread accuracy. There has never been a report of timer failure.

The Steinle Machine is widely used by aircraft manufacturers and others who require extremely accurate threads. Cramer Timers are specified as original equipment for these machines due to their unusually high standards of accuracy and dependability.

If you have a time control problem, Cramer can help you. Write for complete information or technical advice.



The overall accuracy of the Type TE (inclusive of setting) is within 2%, with repeat accuracy within 1/2 of 1%. The unit is Underwriters' Laboratories listed for use in industrial control equipment.

A "look inside" will show you why you can always depend on Cramer for outstanding performance. Check the "inside" facts, today.

SPECIALISTS IN TIME CONTROL

the R. W. CRAMER CO., INC.

BOX 3, CENTERBROOK, CONNECTICUT

2CR54R



tector in a bridge circuit. It weighs approximately 2.4 oz. The relay can be calibrated to operate at any value from 50 μ a to 12.5 ma. Coil resistance is from 0.5 ohm to a maximum of 4,300 ohms on standard types. Contacts are spst and spdt, open or closed, with a maximum rating of 350 ma noninductive at 28 v d-c. The metal enclosure is either hermetically sealed or waterproofed by a dry gasket seal. Base is supplied in plug-in, solder lug or printed circuit type.

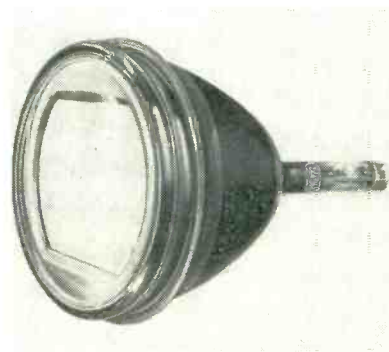

TRICOLOR KINESCOPE for compatible receivers

RADIO CORP. OF AMERICA, Harrison, N. J. The 15-in. type 15GP22 tricolor picture tube produces both color and black-and-white pictures for all-electronic, compatible color-tv systems. The tube is built around a tri-barrel electron gun, which simultaneously fires three streams of electrons; a shadow mask containing nearly 200,000 microscopic holes, through which electron streams are projected to viewing

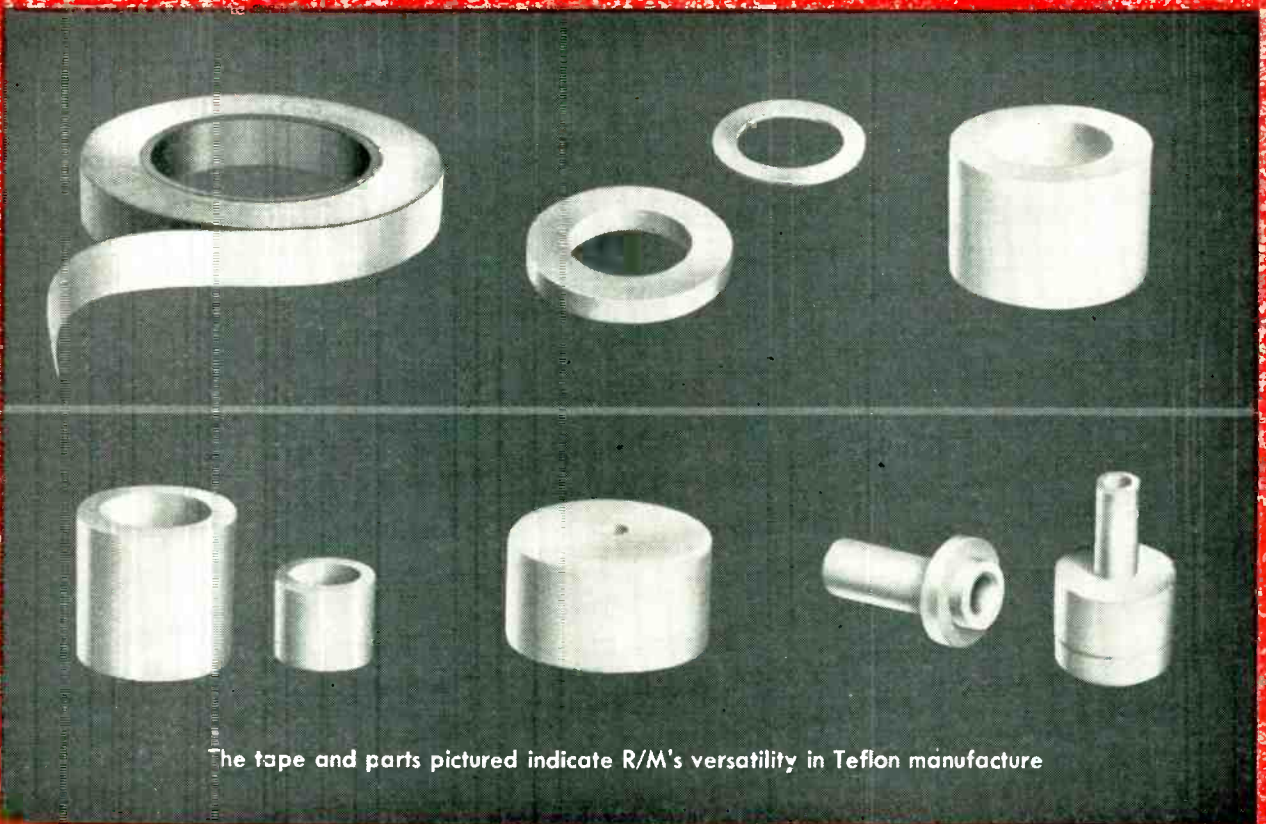

the tape and parts pictured indicate R/M's versatility in Teflon manufacture

R/M Teflon*

**gives you the plus
of R/M's unmatched skill,
experience, facilities**

**Du Pont's trade-mark for its tetrafluoroethylene resin*

Teflon is probably the most important development of the Age of Plastics—its possibilities look endless. Parts made from it are accomplishing things long considered impossible by engineers in the electronics and electrical manufacturing fields.

If you have a problem to be solved, the chances are that R/M, with its unmatched skill, experience and facilities, can solve it. We approach every challenge with the view that nothing is impossible until proved otherwise.

You can rely on R/M for three things: dependable source for Teflon rods, tubes, sheets or tape; fabrication of Teflon parts to your specifications; collaboration in the search for new uses to which this remarkable product can be put.

Teflon Properties: High resistance to acids and gases even at high temperatures • Moisture absorption zero • Unaffected by weather • Excellent heat stability up to 500°F. in continuous operation • As tape, leaves no carbon residue along discharge path • High impact resistance • Nonadhesive • Stretches easily Tensile strength 1500-2500 psi



RAYBESTOS-MANHATTAN, INC.
ASBESTOS TEXTILE DIVISION • MANHEIM, PA.

FACTORIES: Manhelm, Pa. • No. Charleston, S. C. • Passaic, N. J. • Neenah, Wis. • Crawfordsville, Ind. • Peterborough, Ontario, Canada
RAYBESTOS-MANHATTAN, INC., Manufacturers of Asbestos Textiles • Teflon Products • Packings • Brake Linings • Brake Blocks
Clutch Facings • Fan Belts • Radiator Hose • Rubber Covered Equipment • Mechanical Rubber Products • Abrasive and Diamond Wheels
Sintered Metal Products • Bowling Balls

precision-built by Continental Connectors

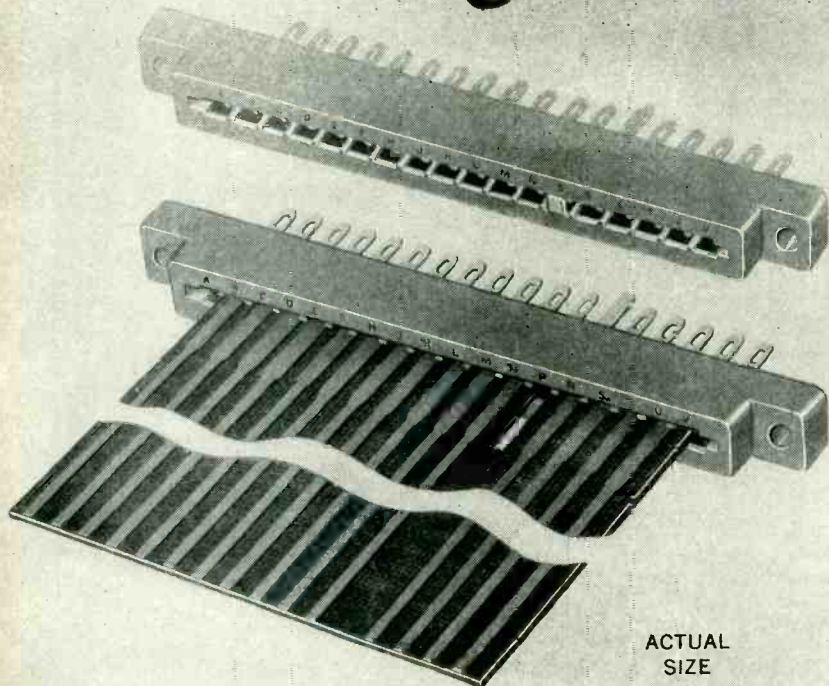

ACTUAL SIZE

PRINTED CIRCUIT CONNECTORS

Series P-C • 15, 18 and 22 contacts in single or double rows

Answers the need for a positive, space-saving connection between printed circuitry and conventional wiring. Permits direct connection to a printed circuit "plug" mounted sub-assembly. (See line drawings) By specifying 22 contacts in a double row connector and using both sides of printed circuit card you have provision for up to 44 individual connections for #16 AWG wire. (Precision phosphor bronze pressure contacts assure a voltage drop of only 20 millivolts maximum at rated currents.) Can be custom-built to suit any card thickness. Available in three insulating materials; Mineral filled Melamine, Plaskon Reinforced (glass) Alkyd type 440-A, and Diallyl Phthalate (blue). For complete details write for Engineering bulletin, Series P-C

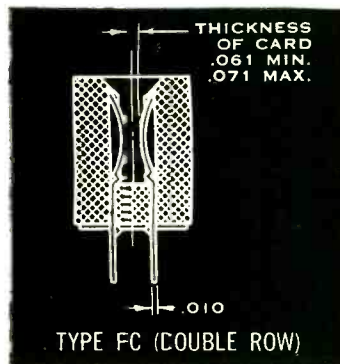
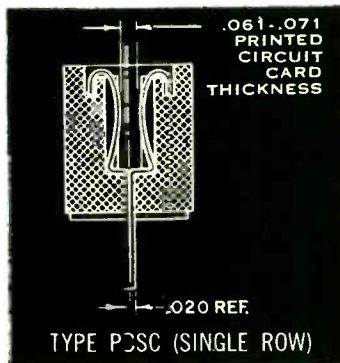

ELECTRONIC SALES DIVISION

DeJUR-AMSCO CORPORATION

Write Dept. EPC3, DeJUR-Amsco Corporation, 45-01 Northern Blvd., Long Island City 1, N. Y.
 See the DeJur line at Booth 200, "Production Road", Radio Engineering Show, Mar. 22-25

screen; and a viewing screen or phosphor-dot plate, which contains approximately 600,000 tiny dots of phosphors. Dots are precisely arranged in triangular groups with single red, green and blue dots in each group. The tube utilizes electrostatic focusing and magnetic deflection, and measures 26½ in. in overall length.

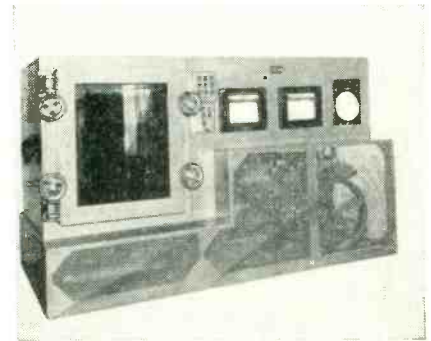

CHAMBER for environment simulation

THE AMERICAN RESEARCH CORP., Bristol, Conn., has announced an environmental simulation chamber that will provide up to 7½ lb per sq in. positive pressure in addition to automatically controlled temperature-altitude-humidity simulation. Temperatures from +185 F to -100 F can be maintained at altitudes up to 60,000 ft. Other features include automatically controlled relative humidity from 20 to 100 percent, automatic control of pressure and altitudes, and automatic draining of all humidity devices below freezing.



HIGH-PASS FILTER eliminates f-m interference

SERVICE INSTRUMENTS Co., 422 So. Dearborn St., Chicago, Ill., has announced the HP2 uhf high-pass filter which is designed to pass uhf frequencies with less than 1 db

every TV station needs

LOW COST COMMERCIALS

that local sponsors can afford

Here's how the GRAY Telop screens out high production costs

Install a Gray Telop as part of your basic TV broadcast equipment for commercials . . . "screen" out high production costs! Use with any television film camera, including the new Vidicon camera. Projects opaque cards, photographs, artwork, 3/4" x 4" transparent glass slides, strip material, **even small objects** . . . pens, watches, cigarette lighters, pipes, etc., or small models of large products.

A Gray Telop . . . at low initial cost . . . projects these economical materials and small objects with all the professional versatility of major "network" effects . . . **without** using costly film strips or live talent. Sponsors' copy can be prepared quickly, easily, for a variety of effects that is virtually unlimited. Gray's Telop will help you to sell more revenue producing commercials . . . Increase Your Profits!



GRAY TELOP I

Seeing is Believing

- Gray Telop projection of commercials must be seen to be appreciated . . .
- You get dual projection, superposition, lap dissolve, fade-out . . . with a single lens system.
- You can project 'cinematic', exciting visual effects for greater audience interest . . .
- Your Gray Telop will pack punch and profit into every minute of your TV commercials . . . at a price that local sponsors can afford!



GRAY TELOP II

GRAY RESEARCH

AND DEVELOPMENT CO. Inc., Hilliard St., Manchester, Conn.
Division of the GRAY MANUFACTURING COMPANY
Originators of the Gray Telephone Pay Station and the
Gray Audograph and PhonAudograph.

WRITE FOR:

Visual proof of the profit making potential of Gray Telops. Request "TV Anytown," the completely illustrated, detailed description of Gray Telops.

VIBRASHOCK RESISTANCE

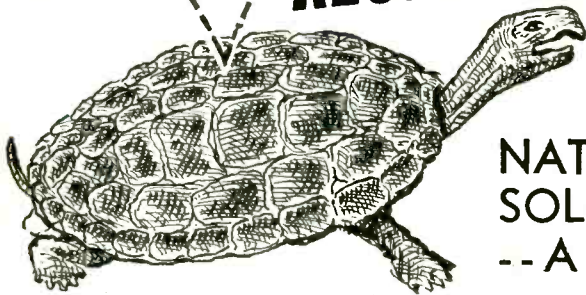

NATURE'S
SOLUTION
-- A SHELL

TO PREVENT VIBRASHOCK IN MULTI-CONTACT CONNECTORS U. S. C. SOLVED THE PROBLEM WITH

MULTI-CONTACT DOUBLE SCREW LOCKING ASSEMBLIES

Quick engagement
and disengagement
with double screw
thread locking

- Preserves performance of sensitively adjusted contacts
- Accessibility to wire junctions with simple disassembly of hood
- Insured electrical and mechanical performance
- No limitations on number of contacts
- Solid hood construction



PAT. APPLIED FOR

Available with
34-50-75 contacts



Let us work out your specific problems.



U. S. COMPONENTS, Inc.

Associated with U. S. Tool and Mfg. Co., Inc.

454-462 East 148th Street, New York 55, N. Y. CYPress 2-6525-6

rejection and rejects all vhf frequencies from 45 to 50 db. The filter eliminates f-m interference on uhf, airport interference on strips, i-f feedthrough, and prevents channel 5 or 6 from interfering on dual conversion, all-channel tuners.

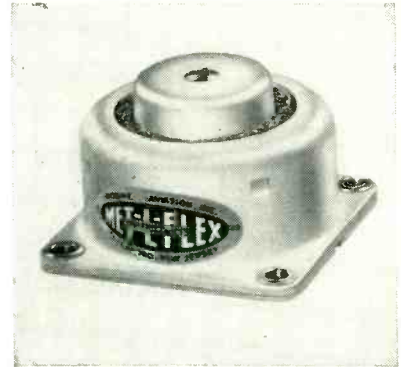

SHOCK MOUNT protects sensitive units

ROBINSON AVIATION, INC., Teterboro, N. J. A new engineered cup type all-metal mount for protecting sensitive equipment from the effects of vibration and shock has been announced. Designed for mobile, shipboard and industrial applications, the new mount (model 1202) employs a resilient cushioning material of metal wire (Met-L-Flex). Fabricated in such a way as to form literally thousands of minute springs with all wires continuous from top to bottom, this cushioning material is inherently and permanently damped and will not pack down or wear out. A unique feature of the mount is the close limiting action created by top and bottom Met-L-Flex buffer pads within the housing. These buffers provide gradual increase in stiffness, plus high damping for positive, negative and radial motion and shock.

GERMANIUM DIODES feature hermetic sealing

RAYTHEON MFG. Co., 55 Chapel St., Newton 58, Mass., has announced hermetically-sealed germanium diodes. The solder-in design is smaller in size and an entirely new plug-in construction is also available. Mechanically, these new

New! A low-cost MARKER GENERATOR

for PRD's VHF-UHF Sweep Frequency Generator



The Type 909 Marker Generator—precision engineered by PRD—provides frequency markers of crystal accuracy, which are added electronically to the response pattern. This is accomplished by connecting the Marker Generator to a special marker injection circuit in PRD's Type 907 Sweep Frequency Oscillator.

UHF Frequency Meter Type 587 provides a method of accurate absolute frequency measurement in the UHF range.

▶ TYPE 909 CRYSTAL MARKER GENERATOR

GENERATOR: Crystal Oscillator, Harmonic Amplifiers
OUTPUT: 2, 10 or 50 mc/s ($\pm 0.1\%$) markers up to 2000 mc/s
OUTPUT CONTROL: Marker amplitude continuously adjustable
OUTPUT IMPEDANCE: Both high and low
RADIATION: Low

▶ TYPE 907 SWEEP FREQUENCY GENERATOR

WIDE RANGE: 40 to 900 mc/s
WIDE SWEEP: At least 40 mc/s for UHF
HIGH OUTPUT: At least 0.3 volts over entire range
OUTPUT IMPEDANCE: 50 or 75 ohms
LOW RADIATION: 10 μ v or less

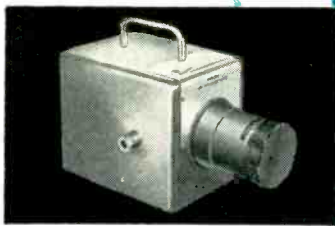
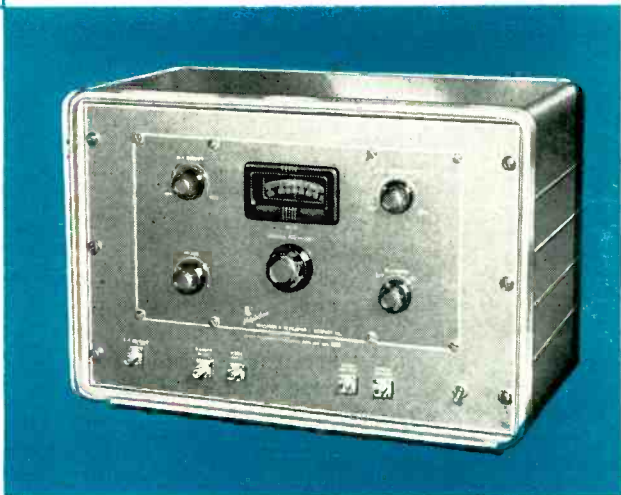

▶ TYPE 587 FREQUENCY METER

CAVITY TYPE METER: May be connected as Reaction or Transmission Type
FREQUENCY RANGE: 400-1000 mc/s
ACCURACY: $\pm 0.2\%$
Q FACTOR: Approx. 1000 (not less than 600)
READING: Direct

Complete data and specifications will be forwarded promptly upon request to Department E-3.

See the Complete Line at the I.R.E. Show
 BOOTHS 293-295
 INSTRUMENTS AVE.

Polytechnic 

RESEARCH & DEVELOPMENT COMPANY, Inc

202 TILLARY STREET, BROOKLYN 1, NEW YORK

MIDWEST SALES OFFICE: 1 SO. NORTHWEST HWY., PARK RIDGE, ILL.
 WESTERN SALES OFFICE: 741½ NO. SEWARD ST., HOLLYWOOD 38, CAL.

new approach to THERMAL RELAY DESIGN

G-V TIME DELAY RELAYS

- Hermetically Sealed
- Still Adjustable
- Amazingly Rugged
- Thoroughly Dependable



G-V ENGINEERING OFFERS A NEW APPROACH TO THERMAL RELAY DESIGN

- Stainless steel mechanism welded into a single integral structure and supported at both ends for unequalled resistance to vibration and shock
- Heater built inside expanding member for maximum efficiency and protection
- Rolling contact action for positive operation
- Easy adjustability where desired
- Precise operation never before available in thermal relays
- Time ranges: 3 seconds to 5 minutes
- Hermetically sealed in metal shell
- Heater voltages up to 230 volts
- Fully temperature compensated
- Suitable for military and industrial use
- Unequalled for ruggedness and precision

U. S. and Foreign Patents Pending

G-V
CONTROLS INC.

The stainless steel structure of G-V Thermal Relays, encased in a metal shell, delivers dependable, trouble-free performance under the most severe operating conditions . . . proved in commercial and military service for three years.

Thermal Relays are the simplest, smallest, lightest, most economical means of introducing a substantial delay into an electrical circuit.

G-V Relays offer performance never before available.

Why not find out by writing today how they can help you. G-V Controls are Thermal Relay specialists. They originated the 7-pin miniature and now make more of these than all other producers combined.

Only G-V offers complete technical data and helpful engineering cooperation on THERMAL TIME DELAY RELAYS.

Write for bulletin and help with your particular problems.

24 Hollywood Plaza
East Orange, New Jersey

Greatly expanded production facilities assure prompt deliveries.



diodes are more rugged and shock resistant. Quality is maintained by a 12-hour high-temperature (105 C) test, a 4-hour low-temperature (-25 C) check, 32 hours of temperature-humidity cycling and complete electrical tests for every diode. Samples of each production lot are put through the JAN-193 humidity tests.

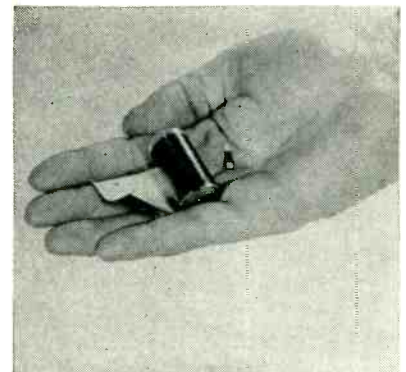

TAPE RESISTORS for printed circuits

SANDERS ASSOCIATES, INC., 137 Canal St., Nashua, N. H., now offers stable tape resistors for a wide range of printed-circuit applications. They are available either as cured, ready-to-use resistors only $\frac{1}{2}$ in. long, $\frac{1}{8}$ in. wide and $\frac{1}{100}$ in. thick, or as uncured, uncured tape rolls. Both types have a resistance range of 100 ohms to 10 megohms. They conform to all JAN-R-11 specifications. The resistors are suitable for semiautomatic applications in which a single operation, requiring less than 1 second (fastens them permanently to the chassis and connects them into the circuit

When Standard Connectors won't do . . .



HIGH TEMPERATURE

Permits continuous operation at 800° F. or over. Plug and receptacle keyed for positive polarization. Lava inserts.

QUICK DISCONNECT

Simply push plug and receptacle together to engage. Pull sleeve on plug shell for instant disconnect. No unscrewing or twisting. Self-polarizing.



PANEL MOUNTING

Monobloc, for small space. Correct alignment of mating pins assured. Easily removable contacts save time and money.

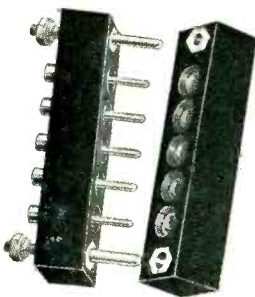

Get

Custom Made

ELECTRICAL CONNECTORS

We design and manufacture connectors for special applications where stock parts would not meet requirements.

If high temperature is your problem, our engineers can design a connector with lava inserts to meet your conditions. Perhaps it is unusual structure, dimensions or installation. Call on Breeze!

Where there is no time for awkward unscrewing or twisting, quick disconnects are indicated. We can provide drawer and panel mounting connectors incorporating removable contacts. These will enable you to repair or service one circuit without disturbing others.

We have the specialized experience and the facilities. Tell us your problem in connectors. Our engineering staff is at your service.

BREEZE

CORPORATIONS, INC.

700 Liberty Avenue, Union, New Jersey

OTHER BREEZE PRECISION PRODUCTS



Ignition Shielding



Flexible Metal Tubing



Aerosol Hose Clamps



Actuators

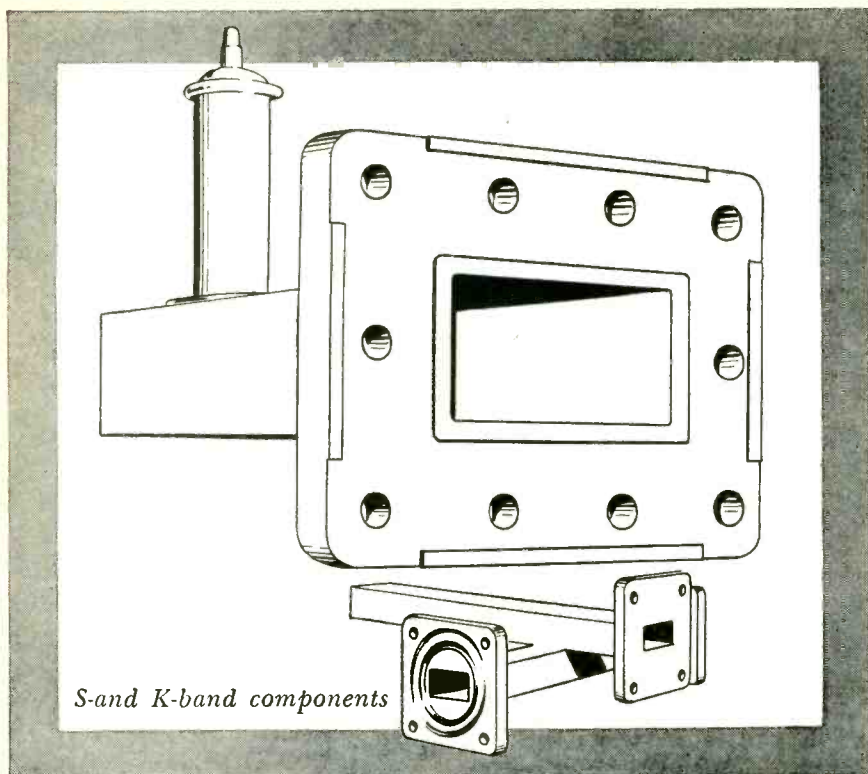

S-and K-band components

how
small
can a
wave
guide
get?

Well, alongside some of the stuff we're working with now, the radar plumbing we used during World War II gets to look like air-conditioning duct. What's more, some of our boys here seem to regard anything below S-band as practically pure D.C. Naturally, we're up to our hips as usual in work on military equipment. However, we do occasionally have some extra creative capacity available, so if you have a problem involving something special in wave guide components (real small ones, too) and like that, maybe we can help. Drop us a line.



L. H. TERPENING COMPANY

DESIGN • RESEARCH • PRODUCTION

Microwave Transmission Lines and Associated Components

16 West 61st St. • New York 23, N. Y. • Circle 6-4760

TRADE MARK



IGNITRON TUBE has thermal protection

NATIONAL ELECTRONICS, INC., Geneva, Ill., has developed in NL-1052, a new size C ignitron tube with thermostatic protection. In a typical application, water flow can stop completely for short periods if the ignitron is heavily loaded, or for periods of several minutes under light load conditions, without damaging the tube in any way and without shutting the equipment down through operation of any protective device. This feature is important in plants with limited or fluctuating water supply as such plants have previously experienced many unnecessary shutdowns. A further refinement of the new system permits substantial water saving by use of a suitable thermostat to control a solenoid-operated water valve. With this arrangement water flows only when the tube becomes warm enough to require cooling.

CHAMBER simulates high altitudes

AMERICAN RESEARCH CORP., Bristol, Conn. The temperature-altitude-humidity chamber illustrated provides an example of the completely automatic controls being developed by the company. This chamber will accurately and automatically deliver simulated altitudes up to

One Source of Supply

by



— for every hermetically sealed termination

Data & Specifications on
E-I multiple headers and sealed leads

ELECTRICAL INDUSTRIES
44 SUMMER AVENUE, NEWARK 4, NEW JERSEY

- 1
- 2
- 3
- 4
- 5
- 6

Specify —

E-I sealed leads and multiple headers

**HUNDREDS OF STANDARD TYPES
AT MASS PRODUCTION PRICES
TO MEET EVERY REQUIREMENT**

— at your fingertips!

Development, production and design engineers will find the complete E-I Data File a helpful addition to company files. The new brochure includes standardized terminations that economically solve all but the most unusual terminal problems. If custom types are required, E-I can supply these quickly, to exact specifications at quantity production prices.

**CALL OR WRITE FOR THE
NEW E-I DATA FILE NOW!**

ELECTRICAL INDUSTRIES

44 SUMMER AVENUE, NEWARK 4, NEW JERSEY

DIVISION OF
AMPEREX
ELECTRONIC CORP.



SEE US AT THE SHOW!
BOOTHS 650-652
CIRCUITS AVENUE

EXPORT AGENTS:

PHILIPS EXPORT CORP., 100 EAST 42nd STREET, NEW YORK 17, N. Y.

1. BULLETIN 949-A

On hermetically sealed terminals. Discusses cushioned glass construction, thermal shock resistance, preferred types and special terminals. Explains code systems and methods of installation.



2. BULLETIN 950-A

On hermetically sealed multiple headers. Explains vacuum tight feature, cushioned glass construction, strain-free qualities. Tin dipped for easy soldering and silicone treated for highest electrical resistance.



3. BULLETIN 951

With complete information on octal type plug-in and multiple headers. Feature a new principle of hermetic sealing. Solid metal blanks insure maximum mechanical strength and rigidity.



4. BULLETIN 952

Complete information on E-I end seals for hermetic sealing condensers, resistors and other tubular electronic and electrical components. Provide a permanent hermetic seal. Completely strain-free.



5. BULLETIN 953

Individual, color-coded hermetically sealed terminals. Available with glass inserts colored in standard, easily identified RMA color codes. Coloring is in the glass —no lacquers or enamels are used.



6. BULLETIN 960

Compression type multiple headers. Super rugged, absolutely rigid and practically indestructible. An exclusive E-I achievement offers vastly greater resistance to shock and vibration. Guaranteed vacuum-tight.



*PATENT PENDING
ALL RIGHTS RESERVED

PRESENTING

POLYPENCO[®] Q-200.5

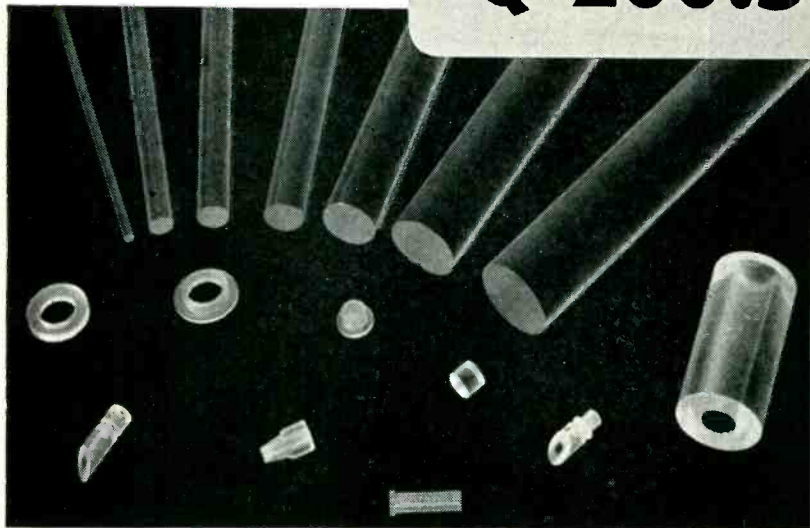

- excellent UHF insulation
- good machining qualities
- dimensionally stable to 400°F
- available in standard shapes

POLYPENCO Q-200.5 is ideal for coaxial spacers, connector beads, stand-off insulators, coil forms, UHF antennae insulators, etc. Its low dissipation factor (less than .0002 at 30 megacycles) remains practically constant over the entire frequency range. It is transparent, light, and resists most chemicals.

POLYPENCO Q-200.5 now joins the family of high quality industrial non-metallic materials supplied by The Polymer Corporation of Penna. It meets the requirements of specification MIL-P-77A (Type E2). Polymer quality controls assure uniform high quality in piece after piece and lot after lot. You can get POLYPENCO Q-200.5 in centerless ground rod up to 1" diameter in 6-8 feet lengths for your own fabrication or we will fabricate it for you.

P

Write for technical bulletin giving data and properties of POLYPENCO Q-200.5.

POLYPENCO Q-200.5

nylon and teflon*
stock shapes, finished parts
also available to your specifications

The POLYMER CORPORATION of Penna. • Reading, Penna.
Warehouse stocks:
Chicago, Ill. • Newton, Mass. • Branford, Conn. • Los Angeles, Calif.

*Trademark for Du Pont tetrafluoroethylene resin

NEW PRODUCTS

(continued)

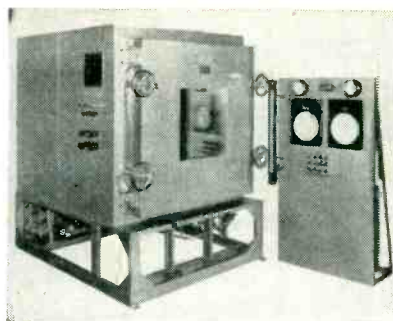

85,000 ft and temperature as low as -85 F. In addition, dew-points can be automatically controlled down to -112 F from 24,000 ft with a temperature of +50 F to 85,000 ft with a temperature of -85 F.

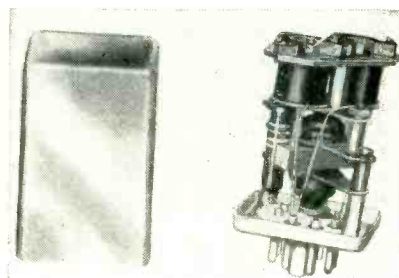

OSCILLATOR CONTROL is miniature tuning fork

JAMES G. BIDDLE Co., 1316 Arch St., Philadelphia 7, Pa. Frahm oscillator controls are miniature tuning forks for use in electronic oscillators to provide stable output frequencies. By their use good sine-wave signals with output better than 1v can be obtained. They are available for any frequency in the range of 50 to 1,000 cps with accuracies in the order of 0.1 percent. A series of standard units is available to match the standard Frahm reed relays. Production and experimental applications include controlling, signaling, monitoring and protection and frequency matching.

D-C AMPLIFIER for computer-circuit use

THE RALPH M. PARSONS Co., 135 W. Danton, Pasadena, Calif. Model 3501 d-c amplifier has been precision designed for use in special-purpose computer circuits where accuracy is of the utmost importance. The d-c drift, noise and non-

SMALLEST HIGH PERFORMANCE BROADCAST PRE-AMP, BOOSTER AMPLIFIER EVER DEVELOPED

Langevin Model 5116



—and it
exceeds FCC
requirements
by a
wide
margin!

- LENGTH 9"
- WIDTH 1 3/8"
- HEIGHT 3 1/8"

Model 5116 is a miniature, plug-in, two stage, low noise, preamplifier or booster amplifier designed for use in radio and TV broadcast systems, recording studios and sound systems. While important space saving has been effected in the design of this amplifier, Langevin sacrificed none of the fine performance and dependability which make the Langevin Model 116-B an industry-wide criterion of excellence. In fact performance characteristics are considerably improved. Included are such quality features as gold-plated plug-in connectors and push-button metering facilities.

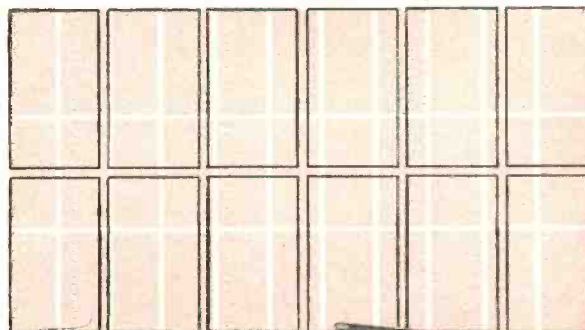

SPACE SAVING THAT REALLY COUNTS!

61% reduction in volume permits mounting of 33 Model 5116 units in the space required by 12 of the very popular Langevin Model 116-B amplifiers.

Photo below, illustrates the extremely compact racking possible with the new Model 5116. Note complete accessibility and uncongested appearance. Units at extreme right are Langevin 5117 Program/Monitor Amplifiers.

WRITE TODAY—

for complete data and specifications on the Langevin line of miniature plug-in equipment including program, booster and monitor amplifiers, power supplies, etc. Please address requests on company letterhead.

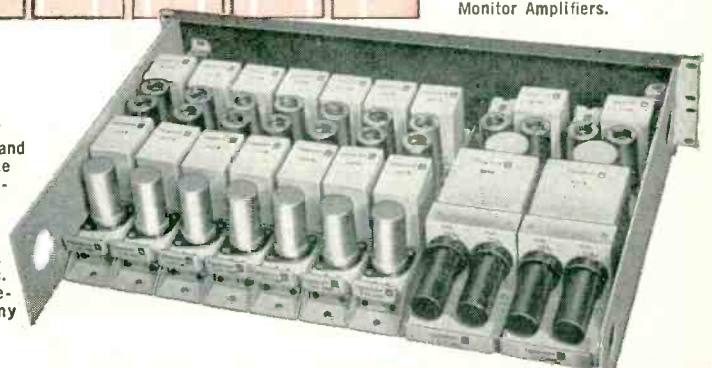

At the I.R.E. Show
Booth 815
Audio Avenue.



LANGEVIN MANUFACTURING CORPORATION

37 WEST 65th STREET, NEW YORK 23, N. Y.

A SUBSIDIARY OF THE W. L. MAXSON CORPORATION

EXPORT DISTRIBUTORS: INTERNATIONAL STANDARD ELECTRIC CORPORATION, 50 CHURCH ST., NEW YORK CITY

LITTON ENGINEERING NEWS



Model 3901 Thermopile

CONVENIENT NEW HIGH ACCURACY EQUIPMENT FOR MICROWAVE POWER MEASUREMENTS

The new Litton 3901 Thermopile offers unique convenience and accuracy in measuring rf power in microwave systems or monitoring temperature changes in cooling systems. In conjunction with rf water loads, it converts temperature differentials of flowing liquids into electrical energy which may be metered or recorded. With a water load of correct flow, average powers from 10 watts to several kilowatts may be measured quickly and precisely. For lower power levels, several thermopiles may be used in series.

Model 3901 employs 30 pairs of copper-advance junctions imbedded in a polyethylene cell. The cell is enclosed in a plastic case sealed with a Fairprene gasket and non-drying cement. The bottom plate is readily removed for servicing. Electrical connections are made through sealed banana plug jacks. Water connections are to 1/4" copper tubing through Uniflare fittings.

Internal resistance of the Thermopile is approximately 5 ohms. Voltage is approximately 1 millivolt per °C. Maximum pressure is 75 lbs. per square inch. The instrument measures 2" x 3" x 6"

long, and weighs 15 ounces. Price: \$75.00. (For further information, request Bulletin A-001.)

X Band Water Load



New Model 4105 Water Load is an efficient, low cost termination for X Band waveguide systems where power must be measured with extreme accuracy. Designed to operate with Litton 3901 Thermopile, Model 4105 covers the frequency range 7,000 to 10,000 mc. SWR is less than 1.2 full range. Maximum power is 1,000 watts cw and 300 kw peak power. Recommended water flow is approximately 1/4 gpm at 300 watts (with 2 mv, 100 μa, 19-to-22 ohm power meter and Litton 3901 Thermopile.)

Model 4105 consists of a glass tube centered vertically and running diagonally across a standard waveguide section. The glass section is terminated in Tygon plastic tubing fitted within Bake-

lite mounting blocks. The load employs a fixed probe with an UG-290/U BNC connector. Price: \$135.00. (For further information, request Bulletin A-023.)

Models 5500, 5501 Variable Phase Changers



Model 5500 is a variable phase standing wave introducer designed for life-testing tubes, pulling figure measurements, etc., in 1 1/4" x 5/8" waveguide.

Model 5501 is a similar equipment designed for 1" x 1/2" X Band systems. Both are equipped for manual or motor drive; through a clutch, manual drive can override motor drive. Both models are offered in two speeds: a slow-speed 115 v 60 cps unit which moves the stub down the line approximately 180 electrical degrees and return 4 times per hour, and a fast 24 volt unit which moves the stub through a similar path approximately 15 times per minute. SWR is pre-set at 1.5 but may be adjusted to any value between 1.02 and 1.6. Both instruments will operate at power levels up to 175-200 kw peak, and are usable up to 225 kw. Average power rating is 500 watts. Price: \$300.00 with AC motor (slow); \$310.00 with DC motor (fast). (For further information, request Bulletin A-007.)

Data subject to change without notice. Prices f.o.b. factory.

2980



LITTON

ENGINEERING LABORATORIES

1049 BRITTAN AVENUE • SAN CARLOS 2, CALIFORNIA • U. S. A.

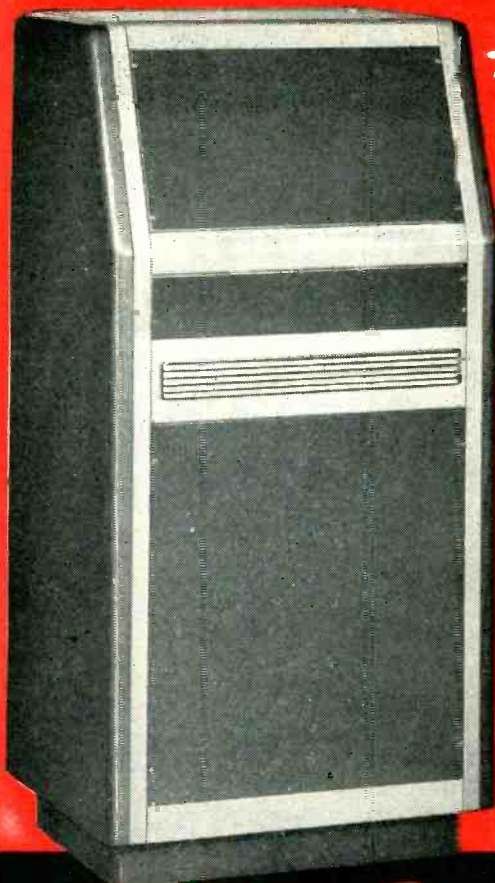

* avoid
high-cost
custom
construction
with
the
NEW...

EMCOR

MODULAR ENCLOSURE SYSTEM



FROM THIS
BASIC FRAME

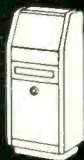

ACHIEVE THIS



OR THIS



OR THIS

NOW every custom construction advantage — beauty, quality, accessibility, great strength — plus endless flexibility — is yours in the EMCOR Modular Enclosure System — at new* low production prices — up to 80% less than custom construction! Units are assembled in only a few minutes with INNERMAN Speed Nuts and hardened Phillips Head Screws — all furnished — even the screwdriver.

For full information on the EMCOR System, EMCOR Stacking and Instrument Cabinets, as well as other EMCOR products write:



Nothing rivals the
beauty of an
EMCOR installation.

EMCOR

ELGIN METALFORMERS CORPORATION

902 NO. LIBERTY ST. • ELGIN, ILLINOIS
PHONE ELGIN 7225

SEE EMCOR DISPLAY • BOOTH 808 • I.R.E. SHOW • N. Y.



TRANSISTOR

is low-noise junction type

RAYTHEON MFG. Co., 55 Chapel St., Newton 58, Mass., has added a low-noise junction transistor to its line of *pnp* junction transistors. The new type, CK727, has an average noise factor of 13 db, an average alpha of 0.97 and an average power amplification of 37 db. Full details are given in a data sheet now available.

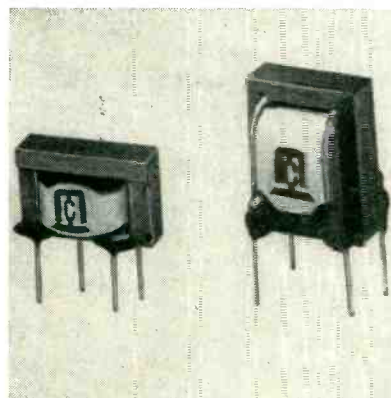

TINY TRANSFORMERS

for printed-circuit use

MICROTRAN Co., 2117 Mott Ave., Far Rockaway, N. Y., has available miniature transformers for use with printed circuits. These units, which range in power handling

VOLTAGE REGULATED POWER SUPPLY



Model 2400

MULTIPLE POWER SUPPLY

OUTPUT	VOLTS	CURRENT	REGULATION	RIPPLE
1	0-150 Bias	0-5 Ma.	*	5 Mv.
2	0-400	0-150 Ma.	0.5%	5 Mv.
3	0-400	0-150 Ma.	0.5%	5 Mv.
2 & 3 Parallel	0-400	0-300 Ma.	0.5%	5 Mv.
2 & 3 Series	0-800	0-150 Ma.	0.5%	5 Mv.
4	6.3 AC	10 Amp.	★	
5	6.3 AC	10 Amp.	★	

REGULATION: As shown in table for both line fluctuations from 105-125 volts and load variation from minimum to maximum current.

*Regulation Bias Supplies: 10 millivolts for line 105-125 volts. 1/2% for load at 150 volts.

★All AC Voltages are unregulated.

KEPCO

LABORATORIES



131-38 SANFORD AVENUE • FLUSHING 55, N. Y.
INDEPENDENCE 1-7000

VISIT OUR BOOTHS AT I.R.E. SHOW — #342-344 COMPUTER AVENUE

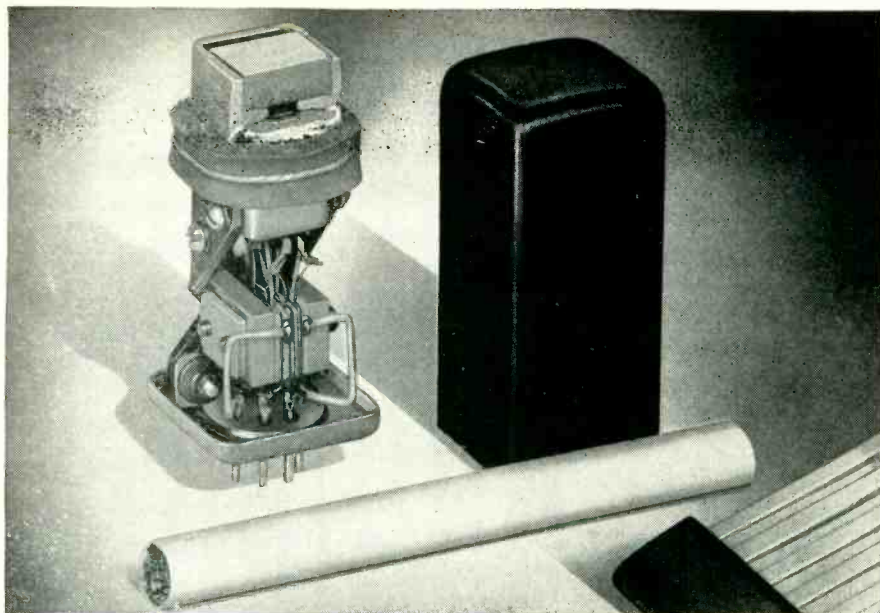

A low-noise chopper, shorter than a cigarette, gives you

PRECISION . . . RELIABILITY . . . VERSATILITY

You get all this with the Honeywell "Minne-Mite"—the new SG6 miniature chopper. It's designed for high performance aircraft and missile application. But it also lends itself to any job that requires a stable, long-life chopper!

This new addition is typical of the fine quality products of the Honeywell Aero Division . . . and here's why:

1. *It's versatile*—can be used as a DC-AC modulator, demodulator, or as a synchronous rectifier.
2. *Reliability*—long life under normal

operating conditions.

3. *It's adjustable*—can be factory adjusted to give an on-time from 35% on to 65% on for either or both contacts.

4. *It's a precision instrument*—quality design guarantees exceptionally clean signals . . . adjustments will not vary over life of chopper.

We'd be happy to send you more information on the new Honeywell SG6 miniature chopper. Just write to: Honeywell Aero Division, Dept. EL-3-53, Minneapolis 13, Minnesota.



Specifications for SG6 Chopper

Description: The SG6 chopper consists of two electrically isolated single pole single throw (SPST) switches, operating independently 180° out of phase, driven by a 400 cycle coil that can be designed for any driving voltage between 1 and 115 volts (higher coil voltages requiring dropping resistors). Hermetically sealed.

Coil Supply: Suggested supply voltage is 6.3 volts, 400 cps when phase correction is not required. Choppers are available with other driving voltages.

Frequency Range: 380-420 CPS.

Phase Lag: The uncompensated output of the contacts lag the coil driving voltage by $30^\circ \pm 10^\circ$.

Power: 0.6 watts, excluding correction circuit.

Size: 15/16" square x 2 1/16" high.

Weight: 2 oz.

Environmental: Tested in accordance with MIL-E-5272A.

Electrical Connection: 7-pin miniature plug-in base or 7-pin solder lug base.

Life: 1000 hours (average) continuous operation.

Contact Rating: Depends on circuit in which chopper is used. All applications should be referred to our Engineering Dept. for consideration. This chopper has been used in circuits with one milli-ampere (nominal) current and 50 volts d.c.

capacities from 8 mw to 2 w, are designed with special soldering tabs so that they may be inserted in a printed circuit terminal board and be mounted and connected by means of dip soldering. Resin impregnation is used to assure superior strength characteristics required for units of this type.



ELECTRONIC RELAY is extremely sensitive

DELTRON INC., P. O. Box 192, Glenside, Pa. Model 300A is an extremely sensitive relay of low cost. Output circuits handle a load or 1,500 w or 2 hp. Normally closed and normally open receptacles are provided on the front panel of the instrument. Thus temperature can be controlled using heating and cooling cycles. By the use of high-quality thermoregulators, with which an electronic relay is essential, control to better than 0.005 C is easily obtained. Two pilot lights indicate which receptacle is energized and also show when the internal relay is operating.

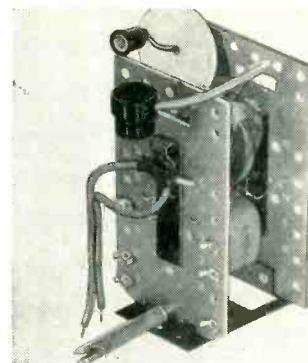

FLYBACK TRANSFORMER services 84 tv models

HALDORSON TRANSFORMER CO.,
4500 Ravenswood Ave., Chicago 40,
Ill. The FB412 flyback transformer

MINNEAPOLIS
Honeywell



Aeronautical Controls



PROVEN: KARP ENCLOSURES ARE YOUR MOST ECONOMICAL BUY

Karp customers, large and small, from coast to coast, know that Karp's complete "package"—ready for components—means lower costs.



Over 300 different jobs go through our plant every day. This volume allows us to apply mass production techniques to every job—whether simple or complex, long run or short—and we pass the savings on to you.

We have over 3000 stock tools and dies and can usually eliminate your new tooling costs entirely. Our press and brake equipment is fast, modern, adapted for quick set-ups. We employ the latest spot, gas, arc and heliarc welding techniques. Our unmatched finishing and sub-assembly facilities give you a com-

plete "package" ready for your components—eliminating the many hidden costs of extra handling. That's why you, *no matter what your needs*, can enjoy the luxury of Karp's quality and service.

We will prove to you that your sheet metal requirements in aluminum or steel can be *individualized and yet be low in cost*. We will prove to you that our complete "package" service will lower your costs. Send us samples, sketch or prints and a prompt quotation will follow.



* See examples of Karp craftsmanship at I.R.E. Show, Mar. 22-25, Booth 349 Computer Blvd. (corner Radio Rd.)

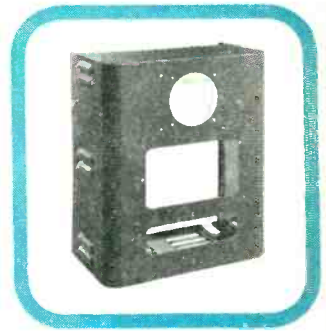
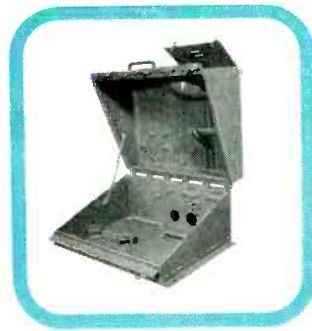
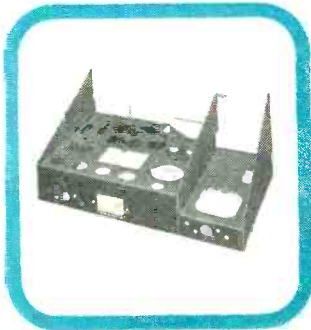

KARP METAL PRODUCTS CO.
Division of H & B American Machine Company
215 63rd STREET, BROOKLYN 20, N. Y.

enclosures reflect the skills within



- FACILITIES FOR ENGINEERED SHEET METAL FABRICATIONS:** in aluminum or steel • long run or short • spot, arc, gas or heliarc welding • any type finish
- Modern plant—3 city blocks long
 - Thousands of dies available
 - Most modern of sheet metal fabricating equipment
 - U. S. Air Force Certified Welding Facilities
 - Air-conditioned spray room... complete baking facilities
 - Complete sub-assembly facilities

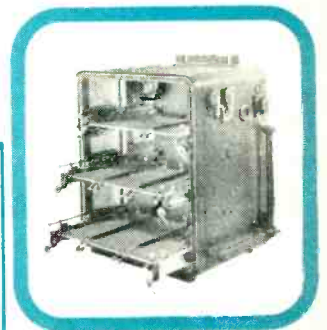

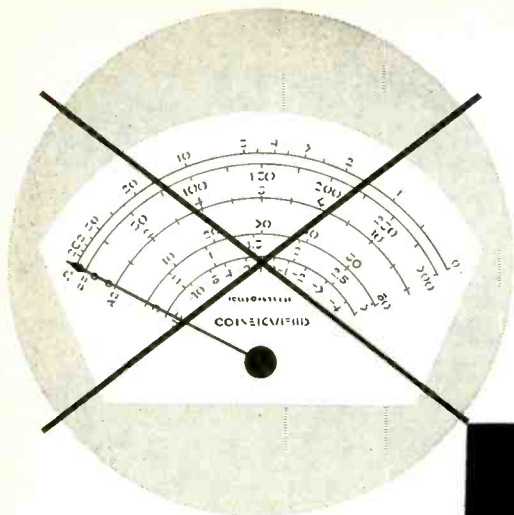

The Digitester \$1185.00

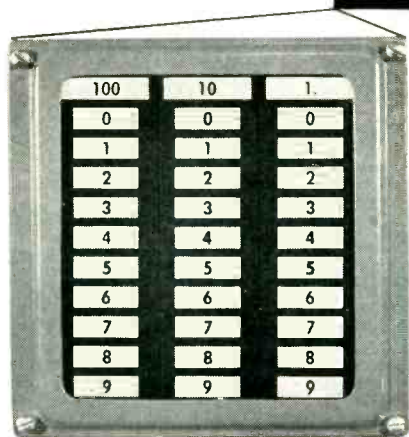

Telecomputing's new digital instrument

measures resistance, voltage and current with push-button speed

The versatile Digitester serves as a combination digital volt-ohm-milliamperemeter, gives you 0.1% accuracy and .8 second speed. In addition, readout is in decimal numbers instead of analog form.

Wide measuring ranges are an important advantage of the Digitester. You can measure up to 10 megohms, 1000 volts, or 1 ampere. Maximum accuracies (lowest scales) are $\pm .01$ ohms; $\pm .00001$ volts; $\pm .01$ microamperes.

Operation does not involve any manual adjusting or balancing. You simply press a panel button to get decimal readout.

A digital ohm meter called the Digitohm is also available at \$985.00. It measures resistance with the same speed, accuracy and wide range as the Digitester.

Specifications on the Digitester and Digitohm will be sent you upon request. Please address inquiries to Preston W. Simms, Dept. E-3.

TELECOMPUTING CORPORATION

BURBANK, CALIFORNIA • Washington, D. C.

Telecomputing invites you to visit its exhibit at the I.R.E. Show in New York, March 22-25, Booths 319 and 321.

For more ad information, see Index to Advertisers.

features a variable-gap width control, tapped age winding and special mounting base. It services 84 models and chassis of the company's tv types. Bulletin 116 describing this new item, and listing all tv models and chassis in which it is an exact replacement, can be obtained from the manufacturer.

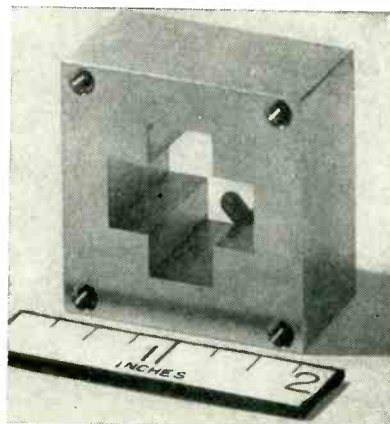

SHORT TWIST for X-band applications

GENERAL PRECISION LABORATORY, INC., 63 Bedford Rd., Pleasantville, N. Y., announces a new broadband impedance matched 90-deg short twist for X band in RG-52/U waveguide size. The tapped holes in twist block faces will determine the angular orientation of the mating UG-40A/U choke flange terminated waveguides so that these members will be at 90 deg to one another. Units are impedance matched to afford a vswr less than 1.22 from 8,500 to 9,500 mc.

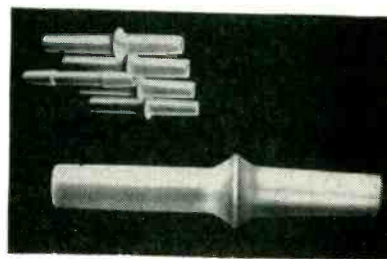

INSULATORS made of fused silica

QUARTZ PRODUCTS CORP., 25 Crows Mill Road, Keasbey, N. J., has introduced fused silica electrical insulators. Fused silica can be subjected to high temperature, high-frequency and the corrosive effect



...curious about

TRANSISTORS?

**We're long past the "Cat's Whisker stage" with Transistors.
Contact Hydro-Aire for consultation **NOW!****

The day has come when the Electronics Industry must examine all vacuum tube applications for the possibility of substituting Transistors. Of course, it will not be a matter of simple replacement; each application must be designed around the Transistor. But the advantages of the Transistor are overwhelming. You get small size and light weight, long life and low cost. In addition, there is an endless potential of entirely new applications still unexplored.

Hydro-Aire is ready to co-operate with you in exploring this fascinating new field. The specialized know-how of our experienced Transistor Development and Application Division is yours for the asking. Our research engineers are waiting to consult with you.*

* Please address your inquiries:

CHIEF CONSULTING ENGINEER

Transistor Development and Application Division

HYDRO-AIRE

Inc.

3000 WINONA AVENUE, BURBANK, CALIF.

Subsidiary of Crane Co.

CONSULTANTS ON TRANSISTOR APPLICATIONS

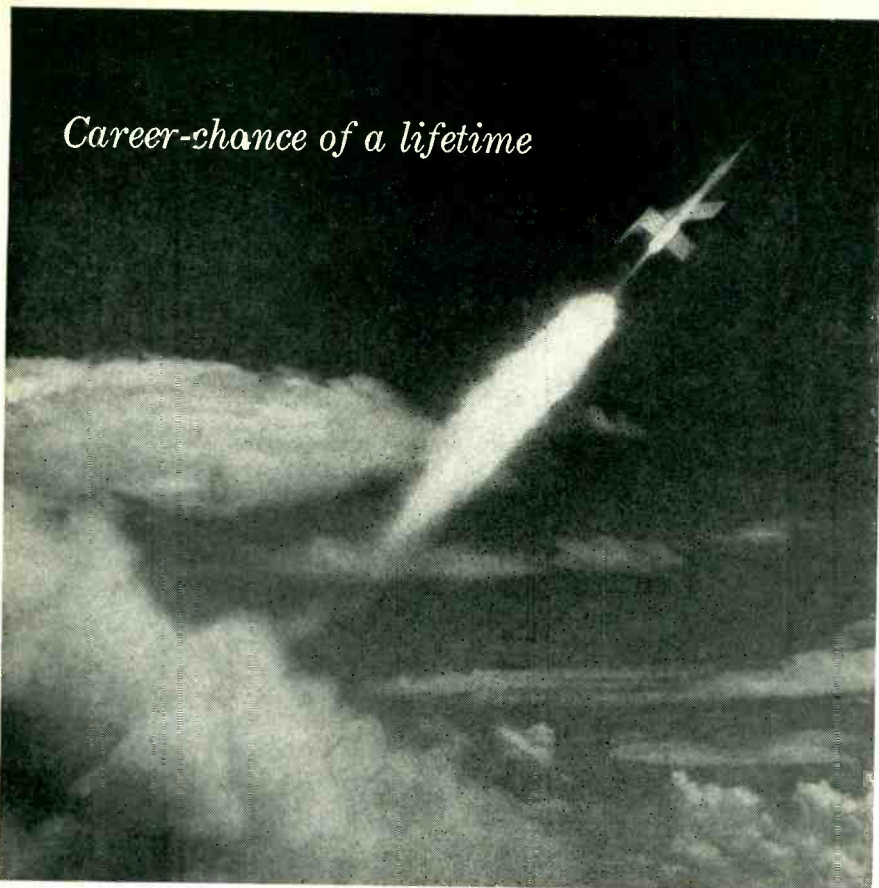

Career-chance of a lifetime

ELECTRONIC ENGINEERS AND ELECTRO-MECHANICAL ENGINEERS

for Lockheed's expanding Missile Systems Division

Recently formed from other Lockheed Engineering organizations to prepare for the era of automatic flight, the Missile Systems Division deals exclusively with missiles and their electro-mechanical systems.

Its expansion has created "ground-floor" openings for

Electronics Engineers experienced in any or all of the following fields:

- Micro-wave techniques**
- Electronic components**
- Circuit design**
- Flight instrumentation**

Electro-Mechanical Engineers with circuit or servomechanisms experience (aircraft or missile experience preferred)

In addition to outstanding career opportunities, the Lockheed Missile Systems Division offers you high salaries commensurate with your experience, generous travel and moving allowances, and a better life for you and your family in Southern California.

Address inquiries to L. R. Osgood, Dept. E-M-3, Lockheed Missile Systems Division, 7701 Woodley Avenue, Van Nuys, California.

LOCKHEED
VAN NUYS, CALIFORNIA

**MISSILE
SYSTEMS
DIVISION**

NEW PRODUCTS

(continued)

of practically all acids. In addition, a new process has been devised for entirely glazing the outside of silica insulators without the addition of flux. The part assumes the appearance of highly polished glass, does not hold dust, and can be easily cleaned when necessary. Silica insulators are finding increasing use for various applications and are now being produced in numerous shapes.

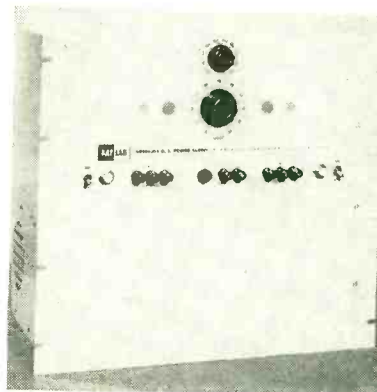

D-C POWER UNITS are extremely stable

KALBFELL LABORATORIES, INC., 1090 Morena Blvd., San Diego 10, Calif. Model 50C-50 power supply incorporates the absolute power supply system. Output voltage is constantly compared and stabilized against the internal standard cell. This system affords the ultimate in long-time stability, combined with 0.01-percent regulation for full load current and 10-percent line changes. Output hum and noise is under 0.5 mv and output impedance is under 0.1 ohm. Other models available cover a wide range of voltage and current.

DIODE-PENTODE for tv receivers

SYLVANIA ELECTRIC PRODUCTS INC., 1740 Broadway, New York 19, N. Y. The diode-pentode vacuum tube, type 6AM8, is similar to a 6CB6 plus one-half a 6AL5 in 9-pin construction. The pentode section has a transconductance of 5,800 in typical operation, and is intended for use as the last video i-f amplifier in tv receivers. Addition of the diode allows the tube to be a combined

Bomac

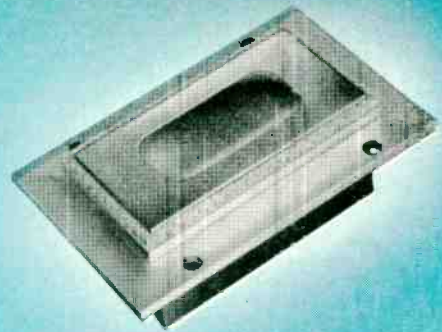

... THE MOST COMPLETE LINE ...

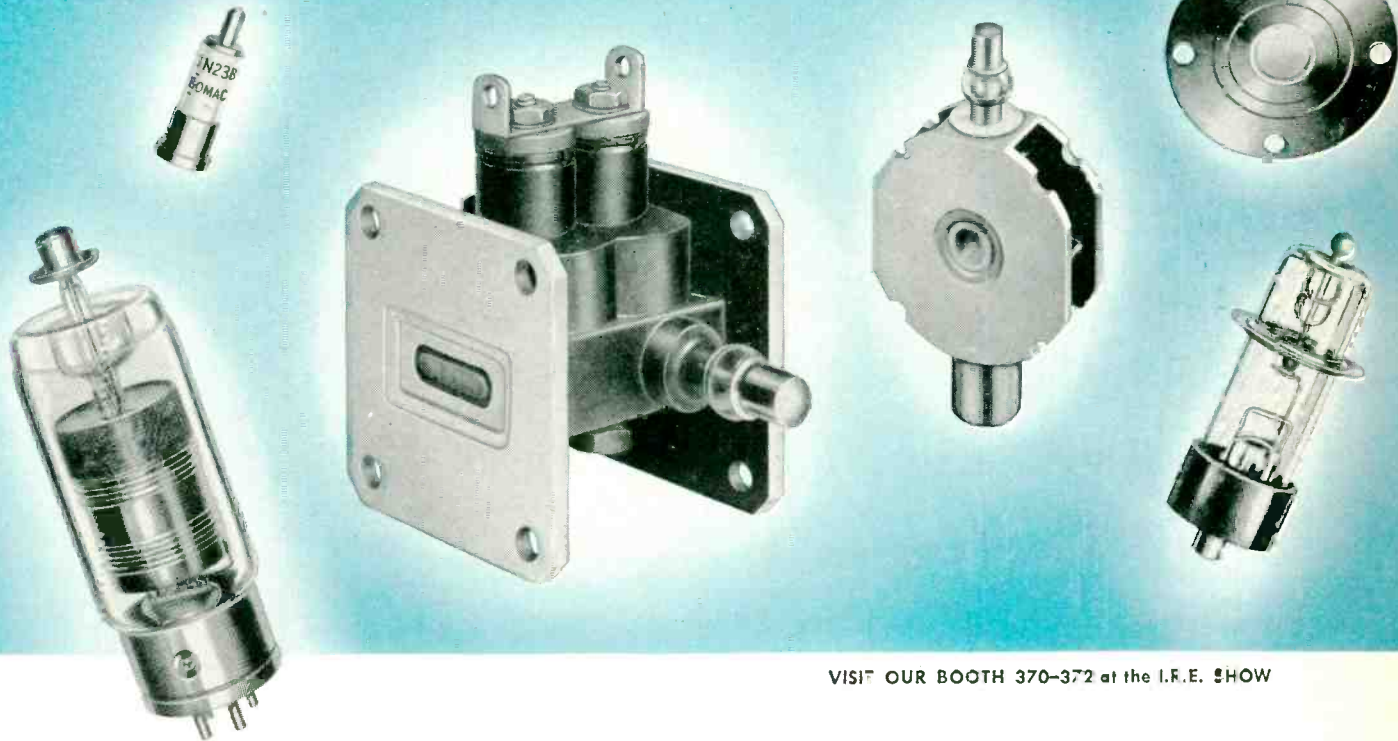

VISIT OUR BOOTH 370-372 at the I.F.E. SHOW

microwave tubes and components

GAS SWITCHING TUBES — Bomac carries the most extensive line of TR, ATR, Pre TR and attenuator tubes available for all frequency bands and power levels.

SHUTTER TUBES — Bomac has introduced a new concept in TR switching, offering continuous crystal protection through wave guide shorting plus TR tube action.

HYDROGEN THYRATRONS — Bomac offers a complete line for use as switch tubes in line type modulators for pulsing magnetrons in radar equipment. Also used for precise triggering at high power levels.

PRESSURIZING WINDOWS — Bomac has windows available for all wave guide sizes, broad band charac-

teristics with low insertion loss, temperature range — 55°C to 100°C and 30 lb./sq. in. pressure differential either direction.

SILICON AND GERMANIUM DIODES — Bomac diodes are manufactured to high standards to assure electrical uniformity, high burnout and humidity resistance.

DUPLEXERS — Bomac's line of dual TR tubes can be supplied with hybrids to make a complete duplexer to customer specifications.

MAGNETRONS — Bomac has available tunable and fixed tuned magnetrons with high peak RF powers for pulsed service in the higher frequency bands.

We invite your inquiries regarding

- ENGINEERING
- DEVELOPMENT
- PRODUCTION

Bomac Laboratories, Inc.

BEVERLY, MASSACHUSETTS

GAS SWITCHING TUBES · DIODES · HYDROGEN THYRATRONS · DUPLEXERS · MAGNETRONS
MODULATORS

Catalog on request.
Write (on your company letterhead)
Dept. E-3 BOMAC
Laboratories, Inc.
Beverly, Mass.

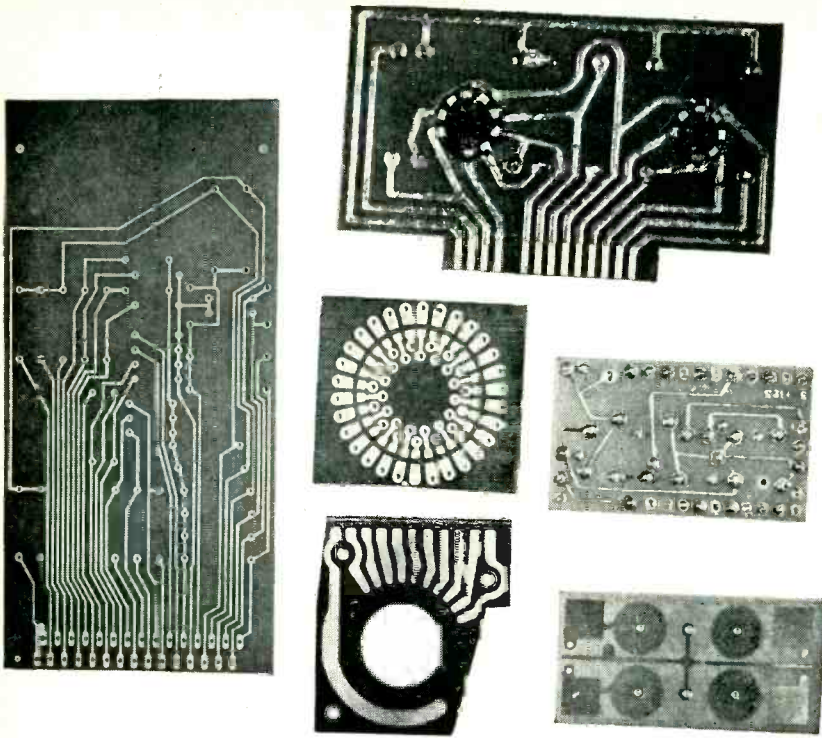

Are You Switching to Printed Circuits? You Need **CASTOMATIC**® Solder!

Printed circuits save on solder and soldering time. In this work you don't use much solder and it doesn't cost much compared to what you are manufacturing. Therefore the solder should be the best quality you can buy . . . Federated **CASTOMATIC** bar solder. Here's why *machine-cast* **CASTOMATIC** is the best:

1. Free of Dross—the patented, pressurized casting system keeps air out; harmful dross-producing oxides are thereby excluded. Solder flows freely through tiniest openings. Your solder bath stays cleaner.
2. Uniform Composition—electronically controlled machine casting eliminates segregation of constituents. Joints are trouble-free. Every bar of a given analysis melts at the same temperature. Each piece of a bar of eutectic solder, for example, will melt at almost exactly 362°F.

Ask for a sample of **CASTOMATIC**. It will prove itself. Just return coupon for prompt action.

Picture courtesy Photocircuits Corp., Glen Cove, N. Y.

Federated Metals Division

AMERICAN SMELTING AND REFINING COMPANY
120 BROADWAY, NEW YORK 5, N. Y.

In Canada: Federated Metals Canada, Ltd., Toronto and Montreal

- Please send a salesman.
 Please send me a sample of **CASTOMATIC** solder.

MY NAME _____ TITLE _____

COMPANY NAME _____

ADDRESS _____

CITY _____ ZONE _____ STATE _____

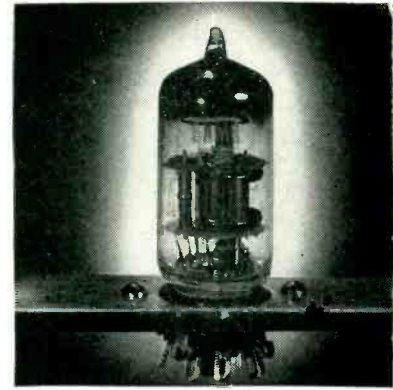

i-f amplifier and video detector, thus aiding in the reduction of tubes used in modern tv receivers.

POWER RECTIFIERS are center-sealed

SARKES TARZIAN INC., Rectifier Division, 415 N. College Ave., Bloomington, Ind., has announced a line of Centre-Seal'd power rectifiers. The outside collector serves as a seal against paint and moisture penetration to the inside or center collector. This provides clean contact between the inside collector and plate surface—a near-zero resistance even after years of operation. Write for complete information.

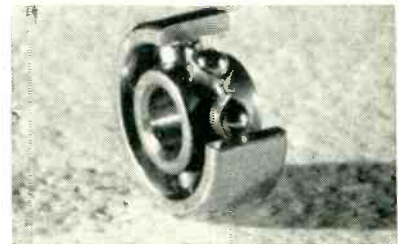

INSTRUMENT BEARING of completely new design

NEW HAMPSHIRE BALL BEARINGS, INC., Peterborough, N. H. The new Micro R2 instrument bearing features a ribbon-type, balanced, cone-controlled retainer. This ribbon retainer cannot wind up, hang up or fall out. The result is a low and repetitive starting torque in one bearing and from one bearing to another. The new retainer is stronger than the old Crown version (L-type) and with higher speed limits. The present Micro R2 has been tested at 90,000 rpm. It is available in the flange type with a straight o.d. This provides

MINIATURE K-TRANS
TELEVISION K-TRANS
COLOR K-TRANS
K-TRANS FOR PRINTED
CIRCUITS
TRANSISTOR K-TRANS

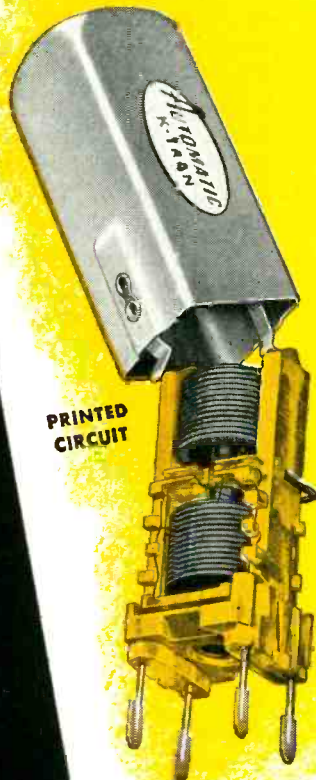
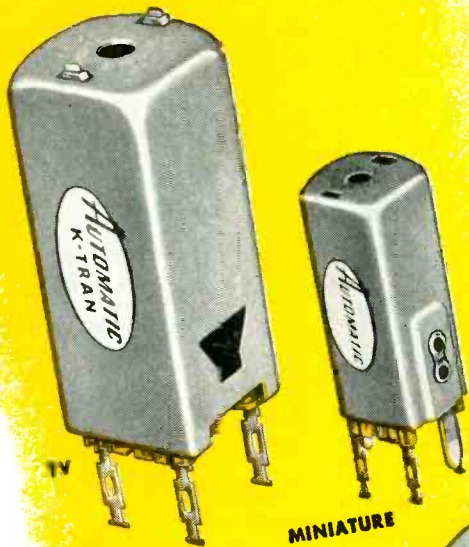

K-TRANS

There is a K-TRAN for every design and every purpose . . . ask us

MASS PRODUCERS OF
ELECTRONIC COMPONENTS

AUTOMATIC
MANUFACTURING
CORPORATION

65 GOUVERNEUR ST., NEWARK 4, N. J.

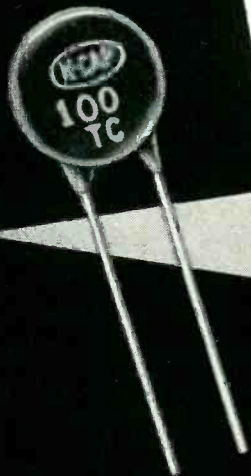

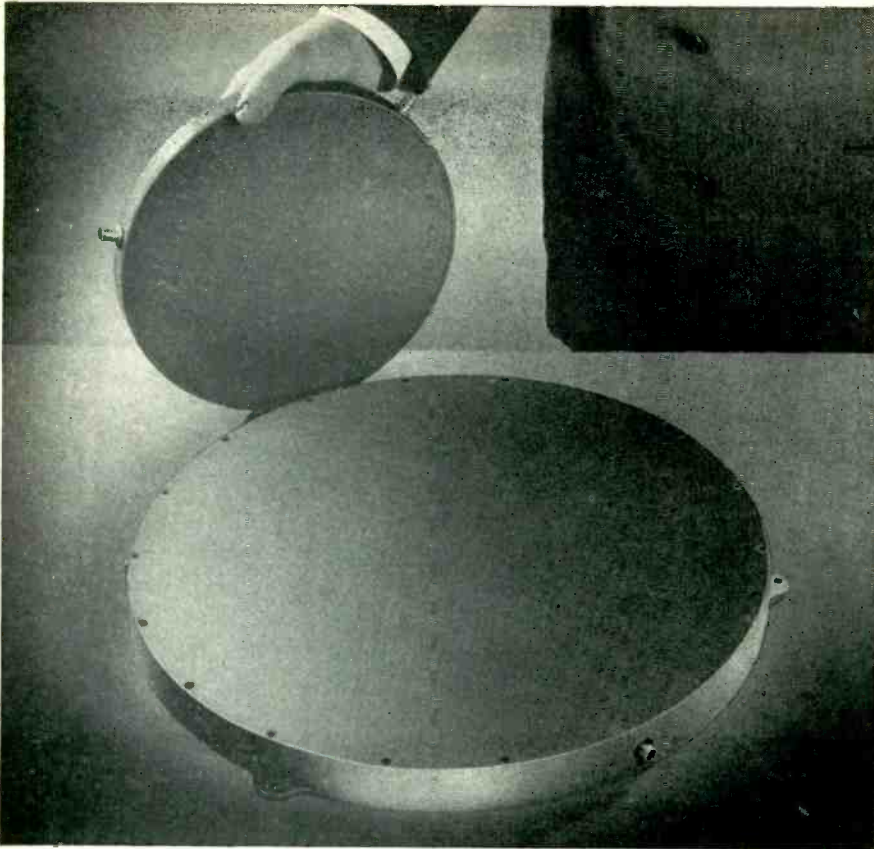

Rear—Corning Delay Line with 1550 microsecond delay, 10" diameter. Front—Corning Delay Line with 2800 microsecond delay, 17½" diameter. Both are lightweight, ruggedly built units.

Announcing...

CORNING Fused Silica Ultrasonic Delay Lines

To meet the needs of electronic equipment manufacturers for rugged, reliable, and accurate solid ultrasonic delay lines, we can now supply Corning Fused Silica Delay Lines designed and manufactured to your own specifications within the following ranges.

- Delay Time 100 to 3000 microseconds within very close limits
- Frequency Range 5 to 60 megacycles
- Spurious Response Up to 60 db below desired signal
- Bandwidths Greater than 50% of carrier frequency are possible
- Temperature Range Storage temperature from -65°C to 85°C without affecting operation

In addition, Corning Fused Silica Delay Lines have low attenuation, smooth pass band, and meet military specifications for shock and vibration.

From manufacturing the fused silica, through precision grinding to final testing and inspection, Corning Fused Silica Delay Lines are produced under our own roof. That way we can control quality and insure reliability from raw materials to finished product. Our engineers will be glad to work with you on any problem you might have involving solid delay lines.

For further details, write to Department E-3.

See the new Corning Fused Silica
Ultrasonic Delay Lines at the
I.R.E. Show, Booth 494.



CORNING GLASS WORKS
CORNING, N.Y.

New Products Division

Corning means research in Glass

simplified housings, easier mounting and solid seating. The maximum break-away is 140 dyne per cm with no special testing and a maximum of 100 with testing, based on a 75-gm thrust load.



STANDOFF TERMINALS are tiny, insulated units

GARDE MFG. CO., Providence, R. I. Tiny, insulated standoff terminals whose Melmac plastic components measure as small as 2/16 in. wide by 3/8 in. long have passed standard shock and vibration tests without any evident damage. They have been tested on seven principal axes at 15 and 25 g for one-hour periods without impairment. The terminals are used primarily as h-v tie-points where insulation is of paramount importance, especially at high altitudes flown by aircraft. The optimum characteristics—dielectric strength, resistance to temperature and atmospheric extremes, and arc resistance—of mineral-filled Melmac 592 plastic are yielded through careful molding, thus assuring satisfactory performance by the small, compact parts.

RECTIFIER STACKS for color tv sets

INTERNATIONAL RECTIFIER CORP., 1521 E. Grand Ave., El Segundo, Calif., announces a series of selenium-rectifier stacks for color-tv sets. These rectifiers are designed for capacitive loads of 600, 700 and 750 ma and are produced for maximum input voltage ratings of 130, 172 and 195 v rms. A bellows-type spring contactor as used in quality industrial rectifiers is employed in the assembly of this series. This affords a lower forward drop, lower

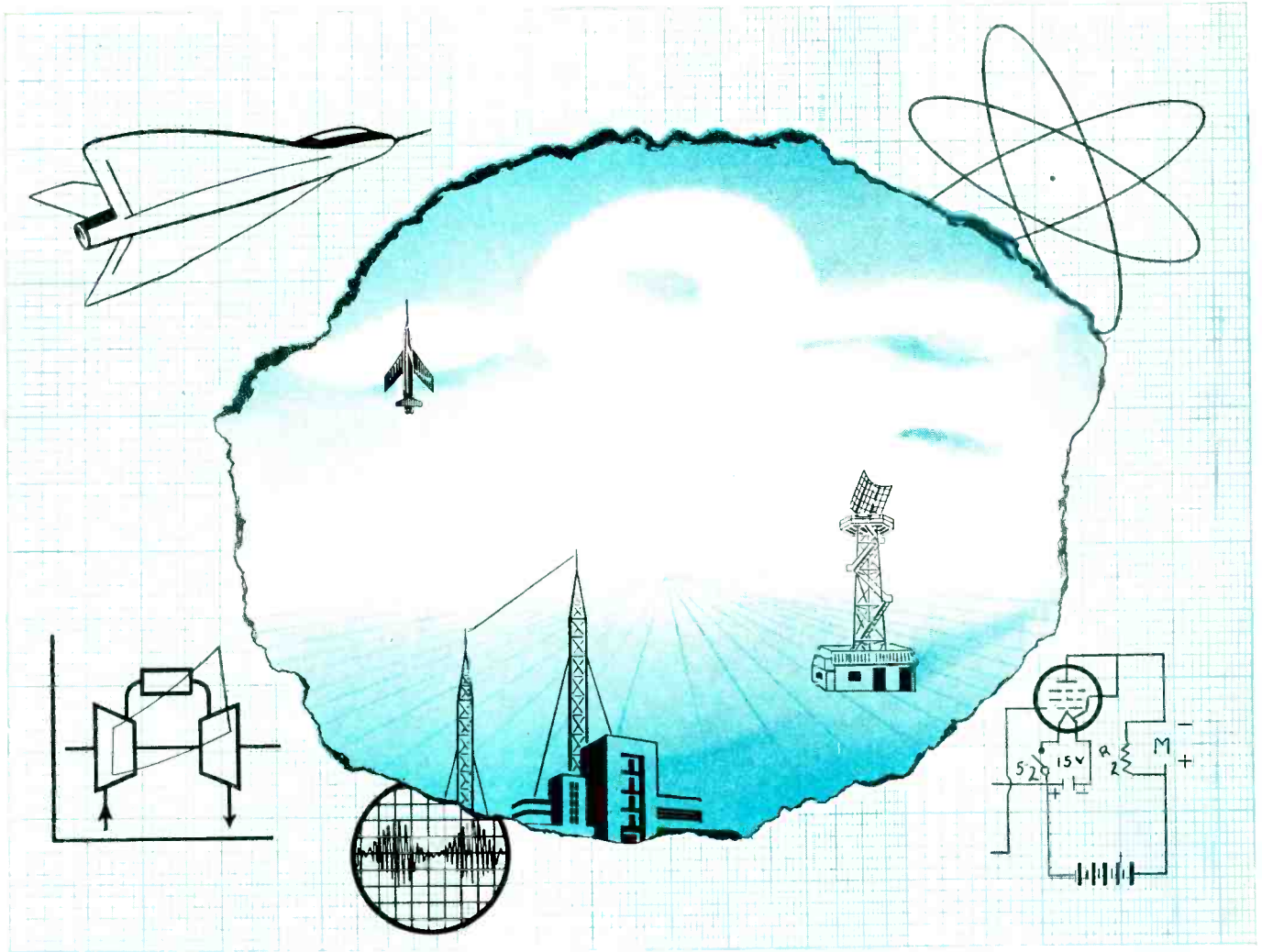

When products are undefined but performance can be specified

... the Special Products Division of I-T-E may be helpful.

We don't claim to solve all development problems to meet performance specifications, but we may have the answer you're looking for. Our record in helping with unusual and advanced developments is impressive. Our current projects range from design, development and fabrication of Radar Antenna Systems to equipment to operate on advanced Thermodynamic theories. Whether your problem is new development—or fabrication with new and hard-to-work alloys—you'll want to know how this unique organization can help you.

Send for Publication SP-100 E3 today.

RADAR ANTENNA SYSTEMS
design, development and fabrication

JET ENGINES
manufacture of major hot-end components

THERMODYNAMICS
design, development and fabrication of
equipment to operate on advanced theories

GUIDED MISSILES
advanced fabricating techniques

TITANIUM
proven welding, forging, forming, spinning
techniques with this hard-to-work metal

SPINNING
combining spinning and drawing to an almost
limitless variety of designs in a wide range
of metals

TECHNOLOGY

ABILITY

FACILITIES

SPECIAL PRODUCTS DIVISION

I-T-E CIRCUIT BREAKER COMPANY

601 E. Erie Avenue • Philadelphia 34, Pa.

Progress through Problem Solutions

SP 102

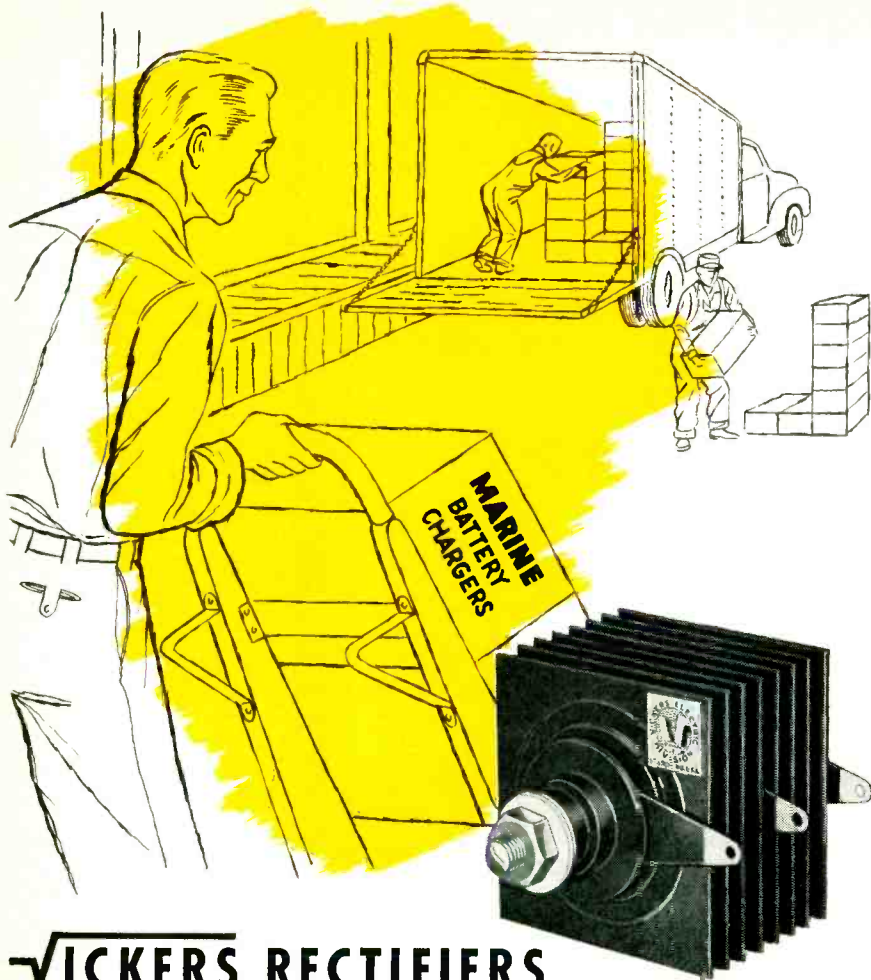

✓VICKERS RECTIFIERS

help manufacturer enter new market

PROBLEM

Exploring new markets, a manufacturer found a market for marine battery chargers. Battery chargers were well suited to his manufacturing facilities. In designing the chargers, however, rectifier problems peculiar to battery-charger circuits were encountered. It appeared that many sizes and types of rectifiers would be needed to provide the current and voltage ratings the market required. Assembly would be complicated, inventories large, cost high. The manufacturer brought his problem to Vickers rectifier engineers.

SOLUTION

A basic group of rectifiers was designed to meet the requirements of the entire line of chargers. Combinations of these basic rectifiers provide the special characteristics required for each model of charger. Eliminating the use of many different rectifiers simplified assembly and reduced inventories. Vickers high-quality rectifiers, designed for the application by experienced rectifier engineers, helped this manufacturer enter a new market profitably.

If you are planning a product that requires DC power from AC sources, Vickers Selenium Rectifiers offer many advantages. Consult experienced Vickers engineers when you have plans or problems. There's no obligation.

Write for Bulletin 3000

VICKERS ELECTRIC DIVISION

VICKERS Inc.

A UNIT OF THE SPERRY CORPORATION
1801 LOCUST STREET • SAINT LOUIS, MISSOURI

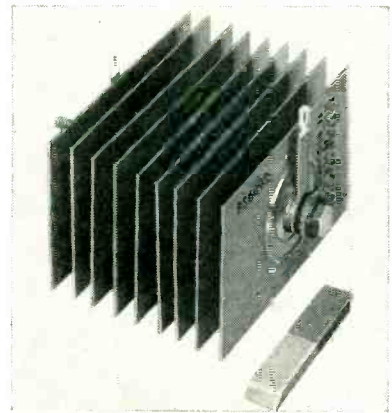

temperature rise and longer life. The size of the plates (2 in. × 3 in.) results in a better form factor, thereby allowing the design engineer wider latitude in chassis layout. Illustrated is a type RS609S rectifier stack rated for 195-v rms input and 600-ma output. Bulletin ER-178 supplement covers the electrical and mechanical specifications of all the units in the series.

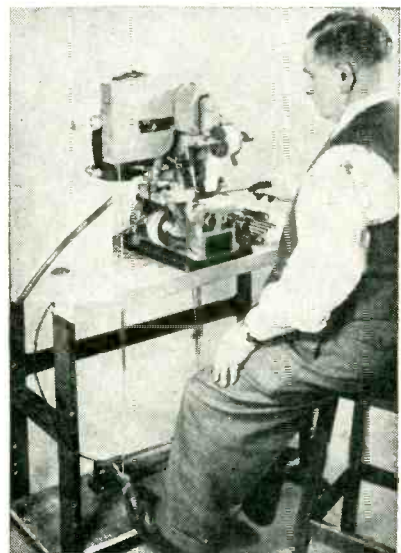

COLOR FOILS for marking wire harness

M. SWIFT & SONS, INC., Hartford, Conn., has announced a new line of color foils formulated especially for marking electrical wire harness made from all types of nylon as well as many other types of military specification wires. It enables aircraft manufacturers to mark wire with color codes (black-white-red-blue-yellow) and at the same time to be sure of positive adhesion to nylon and other special wires. The company is now making these

TIC-TALKS

FEATURE

- NEW METLFILM[®] RESISTANCE
- MINIATURIZATION
- VERSATILITY

RFT Metfilm Trimmer Potentiometer

introduces a revolutionary new principle in potentiometer construction. A deposited metal film provides infinite resolution available through 9000° of adjustment by 25 turns of the adjusting screw. Rugged design and stability under extreme vibration, salt spray and ambient temperature variation are added features.



ACTUAL SIZE

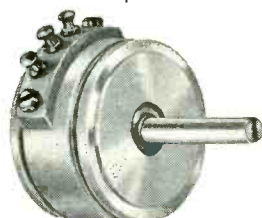

ACTUAL SIZE

RVP 7/8 Precision Miniature Potentiometer

provides close tolerances on the total resistance, electrical rotation angle and linearity. They are furnished with precision servo-type mountings for applications where diminutive size (7/8" diameter), precision, electrical and mechanical accuracy are paramount.

RVH 1 High Temperature Potentiometer

operates at ambient temperature from -55° to +145°C. Pre-aging by temperature cycling assures stability under extreme environmental conditions. High resolution permits precise settings for trimming or calibration, maintained by shaft locking device. Diameter 1".



ACTUAL SIZE



ACTUAL SIZE

RV 1/2 Sub-miniature Potentiometer

(1/2" in diameter) is designed for use in restricted space, where trimming or calibration adjustments must be capable of precise setting and resetting. Stability under extreme environmental conditions is a feature.

RVBC 1% Plug-in Potentiometer

achieves two-way flexibility combining "Unitized" construction with Plug-in mounting. The entire ganged assembly or any individual section may be removed and replaced with ease. Plug-in units are supported by means of front and rear brackets. Units are also available with servo type mounting. A wide range of non-linear as well as linear functions are available. The TIC standard of quality, precision and stability is maintained in this versatile potentiometer. Dual loaded ball bearings in assembly together with unique design of crank-arm and coupling pin assembly minimize torque and radial shaftplay and reduce backlash.

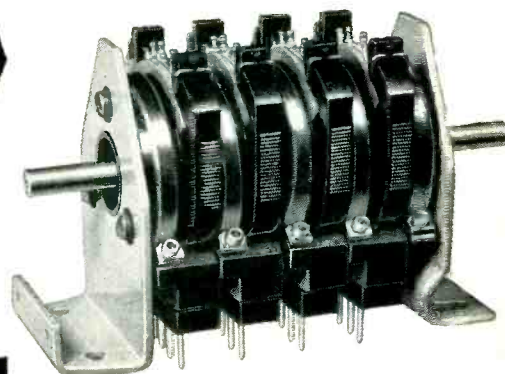

NEW TIC HANDBOOK on PRECISION POTENTIOMETERS



— indexed for easy reference, offers the most comprehensive reference manual available. Discussion of potentiometer criteria enables user to select potentiometer best suited to application. Accumulative for the addition of all new developments in the potentiometer field. Handbooks available @ \$2.00 per copy.

BOOTH 226-228
INSTRUMENTS AVENUE
IRE SHOW

ENGINEERING REPRESENTATIVES

Rochester, New York — Monroe 3143
Binghamton, N.Y. — Binghamton 3-1511
Wood-Ridge, N.J. — Webster 9-7217
New York, N.Y. — Murray Hill 8-5858
Great Neck, L.I., N.Y. — Great Neck 2-9406
Canaan, Connecticut — Taylor 4-7215
Cambridge, Mass. —
Chicago, Ill. — Uptown 8-4141
Dayton, Ohio — Oxmoor 3594
Baltimore, Md. — Plaza 7894
Amprior, Ont., Can. — Amprior 400
Hollywood, Cal. — Hollywood 9-6305
Dallas, Texas — Dixon 9918
ELiot 4-1751

TECHNOLOGY INSTRUMENT CORP.

533 MAIN ST., ACTON, MASS., ACTon 3-7711

NTSC COLOR EQUIPMENT

PRICED RIGHT
BUILT RIGHT
by

Tel-Instrument

**A COMPLETE NTSC COLOR
EQUIPMENT PACKAGE FOR LESS
THAN \$15,000!**

Consists of the following:

- Type 2600 Color Sync and Waveform Generator.
- Type 2610 Matrixer and Encoder.
- Type 2303 Color Monoscope.
- Type 2120-A Color Transmitter.
- Type 2700 Equalizing Filter.
- Type 2401 Color Picture Monitor.

Above equipment includes all power supplies which are of basically new design.

Tel-Instrument the world's leading manufacturer of TV Production and Laboratory Test Equipment, now makes available to the TV industry the first complete NTSC COLOR package based on completely new and integrated circuitry. This equipment is not to be confused with any presently available which is essentially a modification or adaptation of obsolete black and white equipment

This new approach enables *Tel-Instrument* to realize radical economies in manufacture, and still maintain the highest degree of electrical and mechanical standards.

We welcome the opportunity to further acquaint you with complete details concerning our NTSC color package.

TIC

Manufacturers of a Complete Line of TV Test Equipment

Tel-Instrument Co. Inc.

728 GARDEN STREET • CARLSTADT, N. J.

VISIT US AT BOOTH 256-258 RADIO ENGINEERING SHOW

NEW PRODUCTS

(continued)

new products available for wire-marking throughout industry.

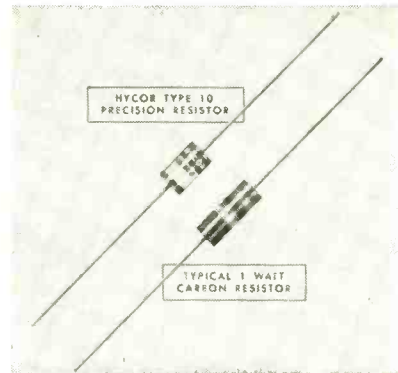

SEALED RESISTORS are plastic-molded

HYCOR Co., INC., 11423 Vanowen St., N. Hollywood, Calif., has announced full-scale production of type 10 accurate wire-wound resistor, molded in plastic. This series H group has a conservative rating of $\frac{1}{2}$ w at ambient temperatures up to 125 C. Dimensions are $\frac{1}{4}$ in. in diameter \times $\frac{1}{8}$ in. long. It is supplied in resistances from 0.1 ohm to 300,000 ohms at tolerances as close as 1/20 of 1 percent. Description of the type 10 and other types up to 1 w are contained in the manufacturers bulletin H.



RESISTORS in plastic jackets

EASTERN PRECISION RESISTOR CORP., Richmond Hill 18, N. Y., announces a line of environment-protected, precision wire-wound resistors, called N-Caps. They are encapsulated in a hermetically sealed, plastic jacket which protects them against the deteriorating effects of salt water as well as the destructive effects of ordinary mechanical shock. They are made to exceed specification MIL-R-93A and due to

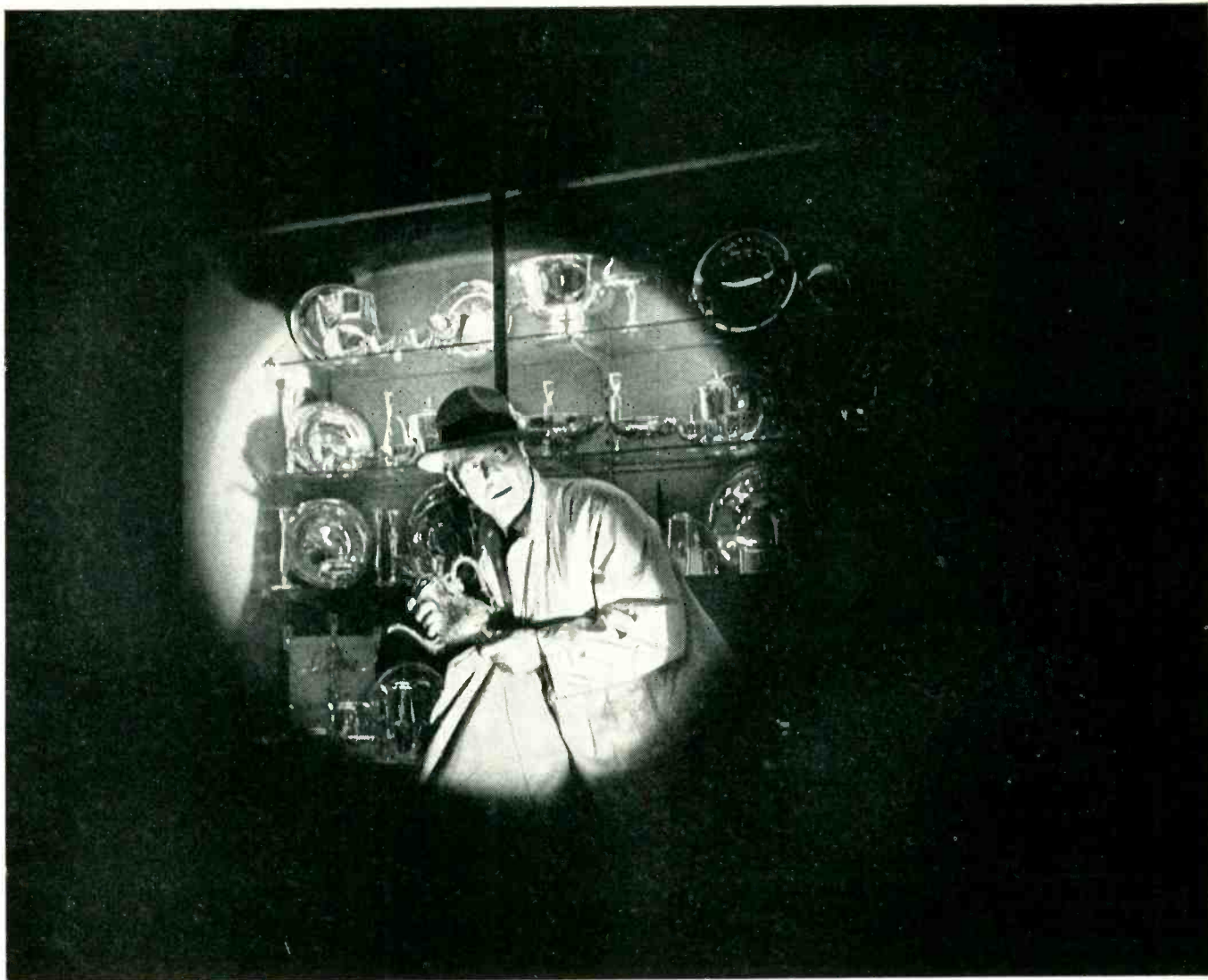

Photographed through courtesy of Macy's New York

CAUGHT!—by Silent Sounds

Suddenly, the lights snap on. Someone yells—

"Don't move or we shoot!"

How had the burglar been detected? No one saw him enter. There was no watchman. And no sign of an alarm system.

No obvious sign, that is. But there was a system—the Alertronic Burglar Alarm.

This unusual protective device operates by sending out 19,200 cycle-a-second sound waves, too high for human ears to hear. The slightest movement of an intruder disturbs these waves of silent sound and activates the alarm. It's so sensitive that even the motion of heated air rising from a fire sets it off.

What produces the vibrations? Two slender nickel rods—and a prin-

ciple of physics called *magnetostriction* (the peculiar way they change size in a changing magnetic field).

Putting magnetostriction to work in this ultrasonic burglar alarm—the first ever to be approved by The Underwriters' Laboratories—wasn't an overnight job. It was twelve years ago that the inventor made his first experiments.

The search for a material with necessary magnetostrictive properties ended when he came to Inco—for nickel proved to be the material he was seeking.

And, as it turned out, he got more

than a metal from Inco . . .

In the years that have passed, he has found Inco always ready to help in supplying information on the physical and mechanical properties of Inco Nickel Alloys and other metals . . . on the technical aspects of magnetostriction . . . and on questions involving metal fabrication.

This same type of friendly cooperation, of course, is available to you for the asking. Let's get together on *your* problem.

The International Nickel Company, Inc.
67 Wall Street New York 5, N. Y.

Inco Nickel Alloys



MONEL® • "R"® MONEL • "K"® MONEL
"KR"® MONEL • "S"® MONEL • INCONEL®
INCONEL "X"® • INCONEL "W"®
INCOLOY® • NIMONIC® ALLOYS • NICKEL
LOW CARBON NICKEL • DURANICKEL®

In CANNON "UA" Audio PLUGS



**gold-plated contacts
really pan out!**

Yes! You get immense satisfaction from gold in any form... and particularly from the performance of the gold-plated contacts in Cannon's modern "UA" Series of audio connectors.

Contacts are heavily gold-plated over standard silver plate... not just "flashed" with a light coating of gold. You get maximum protection from oxidation and deterioration in vital audio circuits... absolute reliability. Cannon has furnished gold-plated contacts for years.

Cannon "UA" Series of audio connectors are the result of the combined efforts of Cannon engineers and outstanding RETMA audio engineers of the country. Plug shells are of steel. Plugs feature Cannon's thumb-pressure LATCHLOCK design... no accidental disconnect. Full-floating socket contacts ease strain on insulator-dielectric during engagement... prolong life. Rubber relief collars and bushings provide shock and moisture protection. Flat-top design assures positive polarization. All "UA" units carry three 15 amp. contacts. Grounding contact engages first.

Cannon manufactures the leading lines of audio connectors. In addition to the "UA" Series, you should investigate our "P," "O," "X," "XK," and "XL" lines for all requirements in audio and video equipment. Connect with Cannon!

Write for Bulletin POS and RJC Price List!

Refer to Dept. 120

CANNON ELECTRIC COMPANY, 3209 Humboldt Street, Los Angeles 31, Calif., Factories in Los Angeles; New Haven; Toronto, Canada; London, England. Representatives and distributors in all principal cities.

I.R.E. Show Booth 546

CANNON ELECTRIC

Since 1915

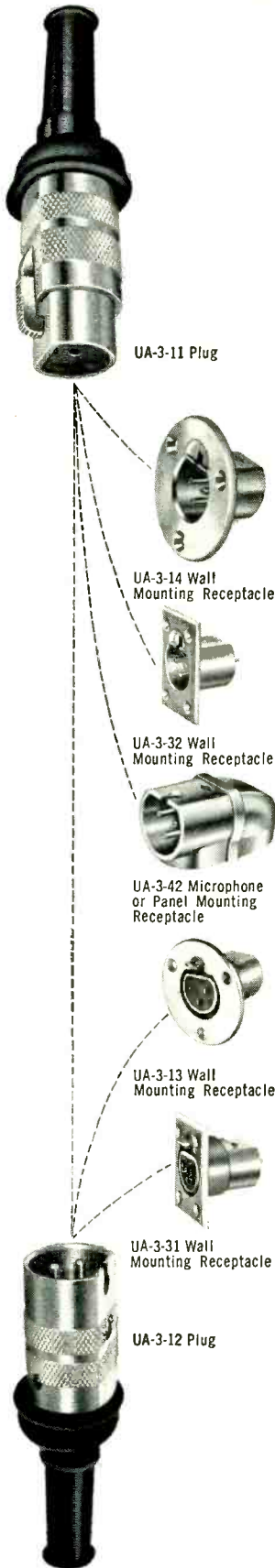

the special encapsulating process, retain their original characteristics over a very long period. The following government sizes are now available: RB 15, 16, 17, 18, 19 and RB 52 series.

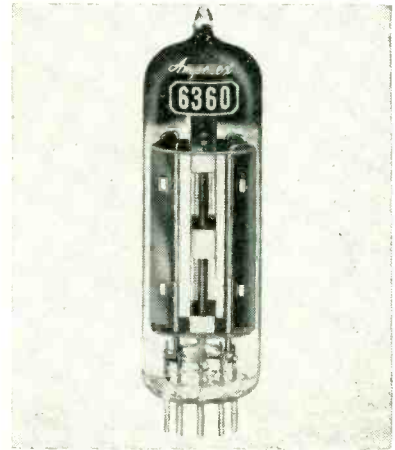

TINY TWIN TETRODE can deliver 16 w at 200 mc

AMPEREX CORP., 230 Duffy Ave., Hicksville, L. I., N. Y. Type 6360 miniature twin tetrode has an overall length of only $3\frac{1}{8}$ in. and is $\frac{3}{8}$ in. in diameter. The tube is very suitable for use in low drain, mobile transmitters and multiplier chains where its ability to increase the power level quickly, and deliver a balanced output make it ideal for driving higher power and higher frequency push-pull stages. It is designed for use as a class-C amplifier and oscillator, frequency multiplier and modulator for frequencies up to 200 mc at maximum ratings. It can deliver 16 w at 200 mc under ICAS conditions. As a frequency tripler from 67 to 200 mc, it can deliver 5 w out under ICAS conditions.

GRAPHIC RECORDER of antenna patterns

SOUND APPARATUS Co., Stirling, N. J. Model PR polar recorder is designed for the recording of antenna patterns and patterns of other directional devices. The chart table is driven by a Selsyn motor which is provided with a gear reduction of 36 to 1, or 100 to 1 ratio, or to the customer's special require-





WESTON

PANEL INSTRUMENTS...

*...outward evidence
of the high quality
built within
fine electronic equipment*

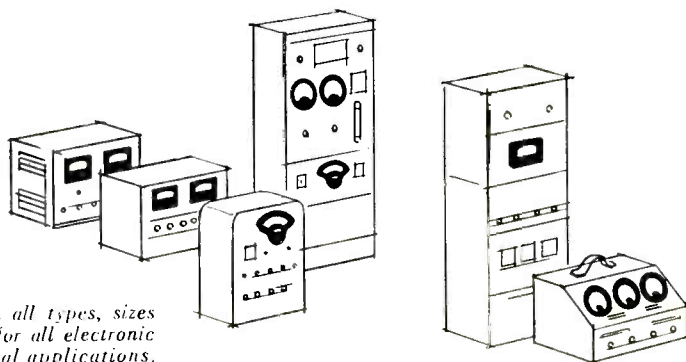

*Available in all types, sizes
and ranges for all electronic
and electrical applications.
Send for the Panel Instru-
ment bulletin.*

WESTON ELECTRICAL INSTRUMENT CORPORATION, 614 Frelinghuysen Avenue, Newark 5, N. J.

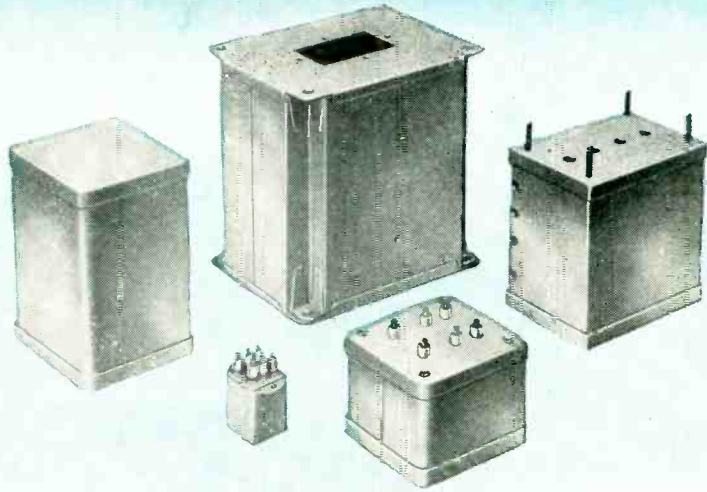

OLYMPIC ONE FOR ALL!

Combined Fabricating and Finishing of Metal Cases and Components for all Industry

- **FABRICATION** . . . Olympic offers standard and special housings, both drawn and fabricated, in steel, brass, copper, aluminum, and Mu-metal. Also, covers, end bells, channels, brackets and flanges. Modification and assembly service.
- **FINISHING** . . . centrifugal hot-tin dipping, cadmium plating, and black oxide finish. Mass-production prices. Stock deliveries. Consolidate your specs with **Olympic** now! See some real products at show booth 336



METAL PRODUCTS COMPANY, INC.
Division 336, ALPHA, NEW JERSEY

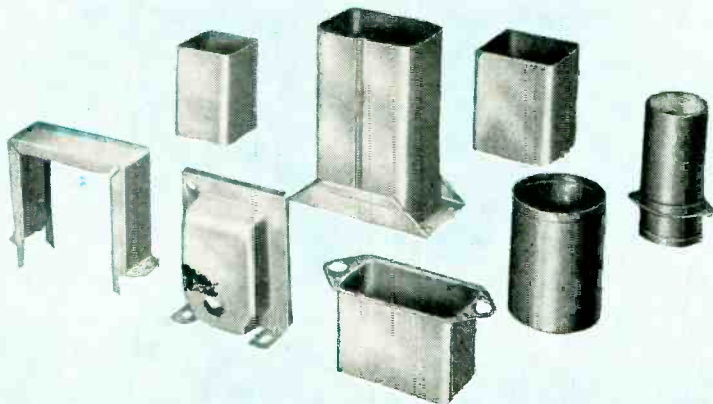

OVER 3,000 SIZES . . . PRECISION - ENGINEERED!

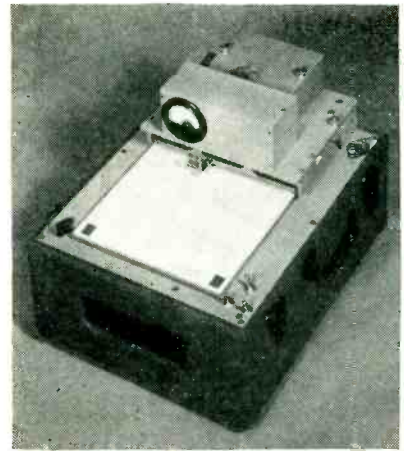

ments. Diameter of the polar chart is $8\frac{1}{4}$ in. Actual recording width is $4\frac{1}{2}$ in. which can be covered from 0 to 20 db up to 0 to 80 db. Interchangeable linear, square root and squaring scales are available. Frequency response is from 20 cps to 200 kc and over. The electronic circuit can be supplied for a-c or for a-c/d-c signal recording.

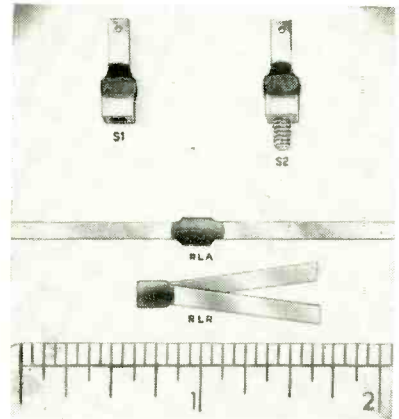

CERAMIC CAPACITORS are tiny uhf type

MUCON CORP., 9 St. Francis St., Newark 5, N. J., shows a new series of uhf subminiature ceramic capacitors developed to reduce inherent series inductance to a minimum. Style S1 is a standoff unit with capacitances ranging from 2 to 10,000 μf . Style S2, also a standoff unit, has capacitances ranging from 2 to 2,000 μf . Styles RLR and RLA, with radial or axial lead ribbon leads respectively are available in body sizes from $\frac{1}{8}$ in. sq to $\frac{3}{8}$ in. sq range in capacitances of 4 to 7,500 μf . The uhf series described can be had in ceramic bodies ranging in dielectric con-

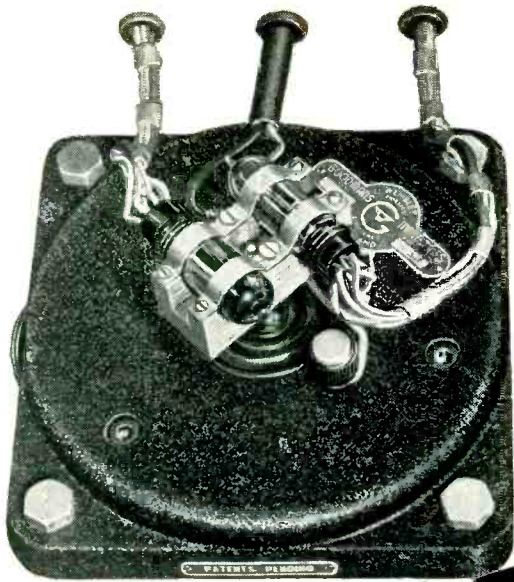

BRIMAR

Pin down

R.N. *

Illustrations by courtesy of Standard Telephones and Cables Limited, England, who say that these Goodmans Permanent Magnet Shakers "have been chosen as they give a faithful reproduction of the input wave form and enable high accelerations at any frequency to be obtained".

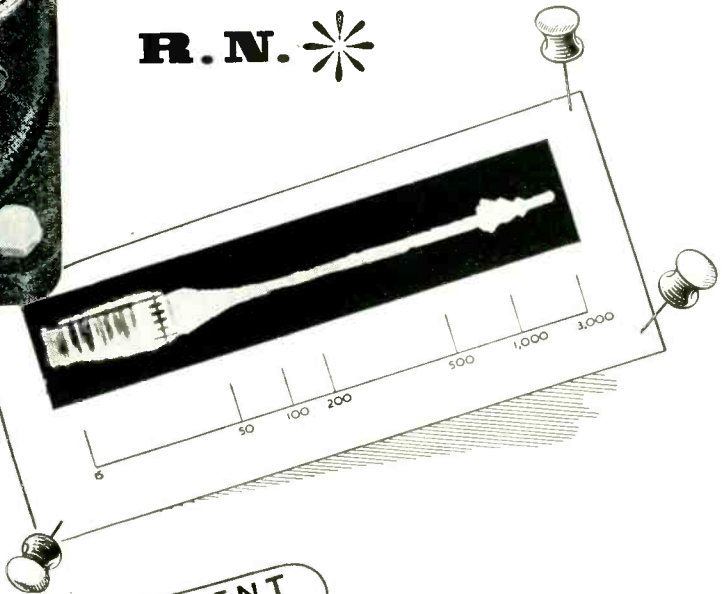

with
GOODMANS

**PERMANENT
MAGNET**

SHAKERS

* **RESONANCE NOISE** describes a particular factor in a tube which can very seriously impair its otherwise good characteristics. Only when "R.N." is negligible can a tube operate strictly according to its published 'curve' and data.

Complete investigation of this phenomenon is only possible by subjecting the tube to *controlled* vibration throughout a wide frequency range. If the tube is operated in a Class A circuit, and the A.C. noise voltage appearing at the anode of the tube is presented on an oscilloscope, a resonance diagram against input frequency can be obtained. By this means it is possible to excite the tube in the range of frequencies 20 to 10,000 c/s, and the resonance noise performance checked. By the use of a twin mounting as illustrated, comparisons of tubes can be made under identical conditions.

Just another of the wide applications of Goodmans Shakers. Perhaps

'CONTROLLED VIBRATION'
can serve you also.



The range includes models developing a force of ± 300 lbs, to the midget model with a force output of ± 2 lbs for optical-cell research and hairspring torque testing etc.

MAIL THIS COUPON

**TO GOODMANS INDUSTRIES LIMITED
AXIOM WORKS, WEMBLEY, MIDDX., ENGLAND**

Please mail me your catalogue and technical data sheets in connection with your PERMANENT MAGNET Shakers.

NAME

COMPANY

CITY ZONE STATE E/U

GOODMANS INDUSTRIES LTD.
AXIOM WORKS • WEMBLEY • MIDDX • ENGLAND

Cables: GOODAXIOM WEMBLEY, MIDDX.

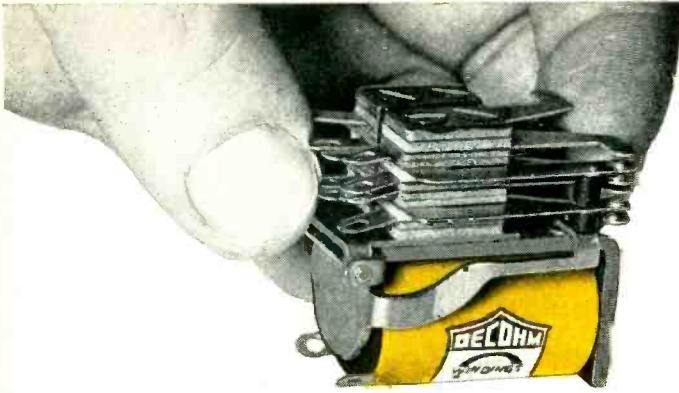

"MOLDED COIL"

**GUARANTEES
PROTECTED
PERFORMANCE**



in a miniaturized telephone type

DECOHM type D-1 RELAY

**Size, Range and Sensitivity Makes the D-1 Relay
Ideal For Military and Industrial Applications!**

The exclusive "molded coil" of the Decohm D-1 Relay protects the coil windings from adverse effects of moisture, oil, fumes, humidity and other ambient operating conditions. The homogeneous mass which seals these windings dissipates heat readily and promotes longer relay life.

Ultra-small, ultra-sensitive — the D-1 is designed to operate at a temperature range of -55°C to $+85^{\circ}\text{C}$.

SPECIFICATIONS

DIMENSIONS: 1-7/16" long x 1" wide. Stack height is variable.

CONTACT COMBINATIONS: Forms A-B-C-D-E.
12 springs maximum.

CONTACT MATERIAL: 18 ga. palladium rated.
3 amps. standard.
1 to 5 amp. contacts available to order.

OPERATING VOLTAGE: 1 to 150 volts DC.

OPERATING TIME: 4 to 5 milliseconds standard.

SENSITIVITY RANGE: 3.5 milliamps operates 1 normally open contact. 9 milliamps operates 4 poles double throw with 35 grams contact pressure.

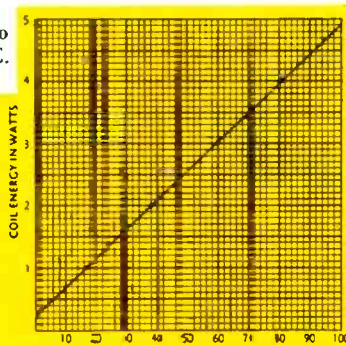

OPERATING CHARACTERISTICS—the graph curve shows the coil temperature rise above ambient with zero to 4 watts applied to the D-1 relay coil.

stant (K) from 16 to 6,000 depending on the properties and capacitance required.



SWR AMPLIFIER has dual input channels

BROWNING LABORATORIES, INC., Winchester, Mass. The TAA-16B swr amplifier determines swr's or compares any two demodulated signals. It features dual input channels with gain sufficient for full-scale meter deflection with less than $2\text{-}\mu\text{v}$ input. It may be used broadband from 500 to 5,000 cycles or may be sharply tuned over this range by panel controls. For use with bolometers, an internal voltage source is supplied and bolometer current for either input is metered and adjustable from the front panel. A crystal protective circuit is incorporated to minimize possibility of burnout due to accidental application of bolometer voltage. The meter scale is calibrated in swr and db of swr with a precision attenuator permitting db of swr readings up to 50 db.



CONDUCTIVITY BRIDGE for test measurements

INDUSTRIAL INSTRUMENTS, INC., 89 Commerce Road, Cedar Grove, N. J. Type RC-16B conductivity bridge features variable sensitivity control



DAVIS ELECTRIC COMPANY

CAPE GIRARDEAU,
MISSOURI

Write for catalog of Decohm products. State your requirements for relay needs, Decohm engineers are available to work on all critical problems.



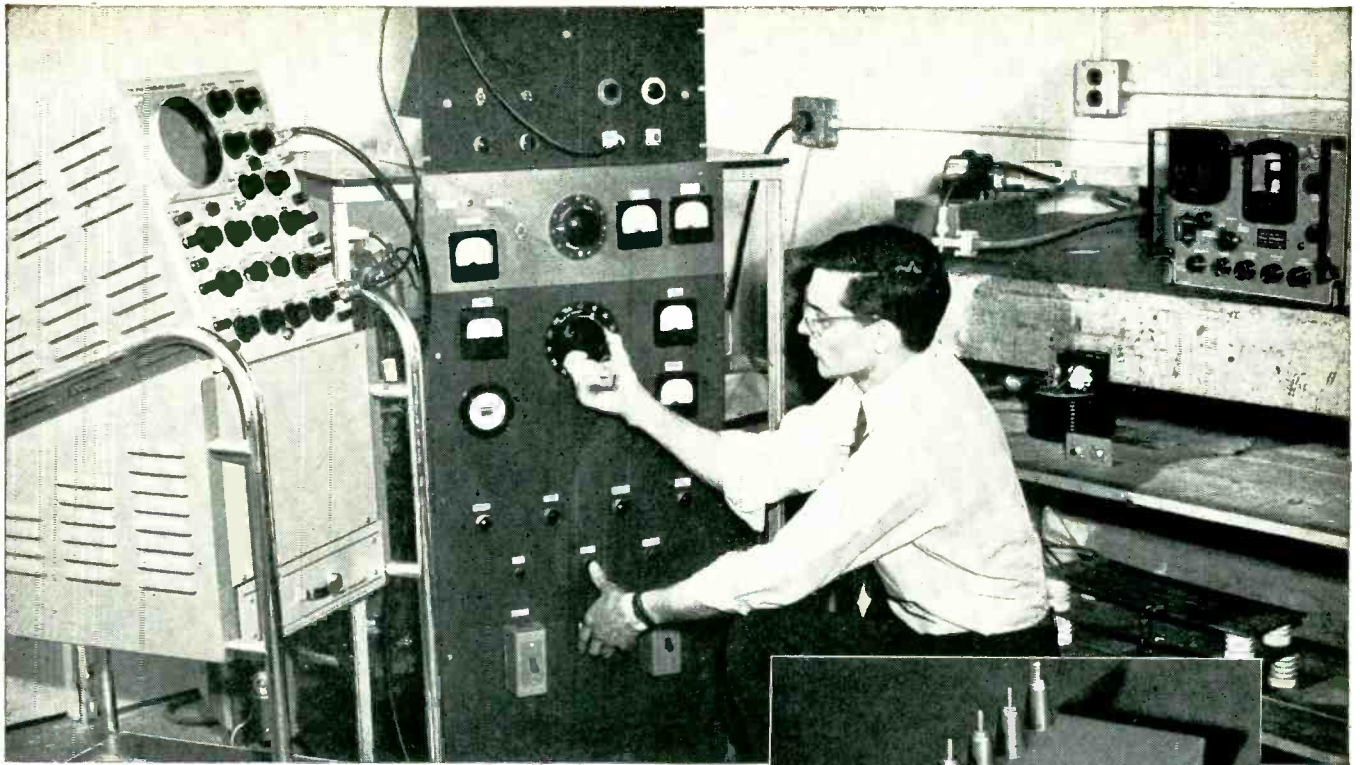

*New Pulse Forming Network
Laboratory Highlights*
200% INCREASE
in production facilities

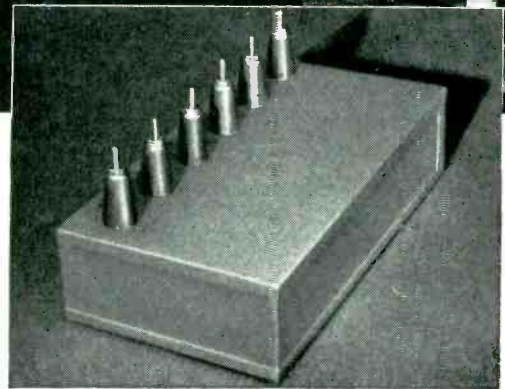

Plasticon Pulse Forming Network

Condenser Products offers the electronic manufacturing industry fast efficient cooperation in all phases of Pulse Forming Network design in its new completely equipped

laboratory. Our enlarged engineering staff provides prompt servicing of inquiries relating to specifications analysis, research and production.



Two complete Plants are now in full operation

Strategically located in Chicago and New Haven, Conn., Condenser Products provides its customers with stepped-up service, efficient delivery scheduling, and complete quality control in volume production.

● VISIT BOOTH 423 ON ELECTRONICS AVE., RADIO ENGINEERING SHOW

Send for catalogue sheets and performance charts on any of these CP products:



*Plasticon
Hi-volt
Power Supplies*



*Plasticon
Glassmikes*



*Plasticon
Rectangulars*



*Plasticon
Metal-clad
Miniatures*



*Plasticon
Pulse
Forming
Networks*



CONDENSER PRODUCTS COMPANY

140 HAMILTON STREET • NEW HAVEN 4, CONN • TELEPHONE: MAIN 4-1174

Division of New Haven Clock & Watch Company

ENGINEERING
BUDGET

CUT DOLLARS FROM YOUR COSTS WITH THE NEW MODULAR SYSTEM

TIME-SAVER

MONEY-SAVER

IDEA STIMULATOR

The units of the MODULAR SYSTEM provide a large number of electronic functions at patchcord-selector switch command: amplifiers, pulse-formers, frequency dividers, electronic counters, etc. Thus, you are freed of circuit details, can think and operate on "block diagram" level. Your thinking is stimulated, while time-consuming, costly design and development work is eliminated. The MODULAR SYSTEM allows special devices to be quickly "patched-up" and then just as easily disassembled. Eliminates troublesome delays and the need for acquiring special-function equipment for one-time application. Complex electronic devices are made available and operating within minutes after you have conceived the need. You'll save time and money with Modulares, cut important dollars from your engineering cost.

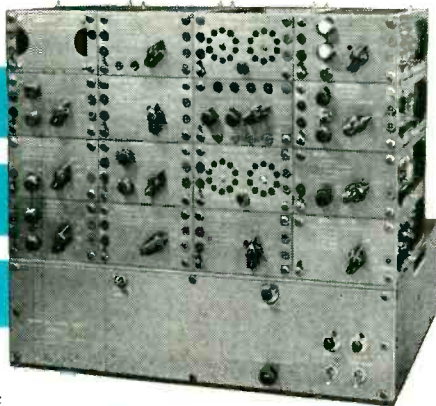

GENERAL CHARACTERISTICS

System: The Modular System consists of sixteen individual Modular units—providing most of the basic elements used in electronic data handling, storage and transmission, together with a power supply and all the necessary patchcords and connectors.

Operation: Units are assembled on the power supply, locked together mechanically and quickly interconnected by patchcords after the desired functions have been selected by multiposition switches.

Frequency: Maximum useful repute is 120 K pps.

Dimensions: Each Modular unit is 2½ inches high by 4½ inches wide by 9 inches deep. Power supply (300 v, 400 ma) is 18 inches wide by 5½ inches high by 14¾ inches deep.

Send for the Modular System catalog today

AUDIO PRODUCTS CORPORATION

Manufacturers and prime contractors
of electronic and
electromechanical equipment

2265 Westwood Boulevard Dept. A 1234
Los Angeles 64, California

See the Modular System demonstrated

BOOTH NO. 856

The Radio Engineering Show, March 22-25, 1954 • Kingsbridge Armory, New York City

NEW PRODUCTS

(continued)

up to a maximum of ½ of 1 percent. Sensitivity is regulated by means of a knob on the front panel. Range of the instrument is from 0.2 ohm to 2,500,000 ohms with an accuracy of within 1 percent of measured resistance. Two bridge source frequencies are available at line frequency and 1,000 cps. The instrument permits faster, more accurate initial balancing. It is entirely self-contained in a portable case. Primary power is 115 v a-c.

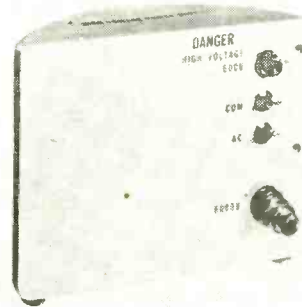

POWER SUPPLY rated at 6,000 v

THE PERKIN ENGINEERING CORP., 345 Kansas St., El Segundo, Calif., has developed a new type of airborne hermetically sealed power supply rated at 6,000 v ± 5 percent with an output current of 100 μ a. The unit is also provided with a d-c output voltage tap at 600 v. and is designed for an a-c input of 100-120 v a-c, 380-420 cps, single phase. Ripple voltage is below 120 v peak-to-peak, and the unit is designed to operate over a temperature range of -55 C to $+85$ C.



STEEL ROLLPIN is corrosion resistant

ELASTIC STOP NUT CORP. OF AMERICA, Union, N. J., has available a new and improved AISI 420

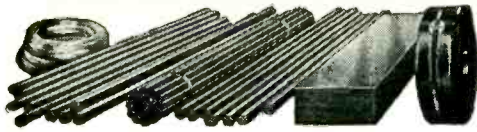

BRIDGEPORT BRASS COMPANY

COPPER ALLOY BULLETIN

BRASS
Bridgeport
CO.

MILLS IN BRIDGEPORT, CONN. AND INDIANAPOLIS, IND.—IN CANADA: NORANDA COPPER AND BRASS LIMITED, MONTREAL

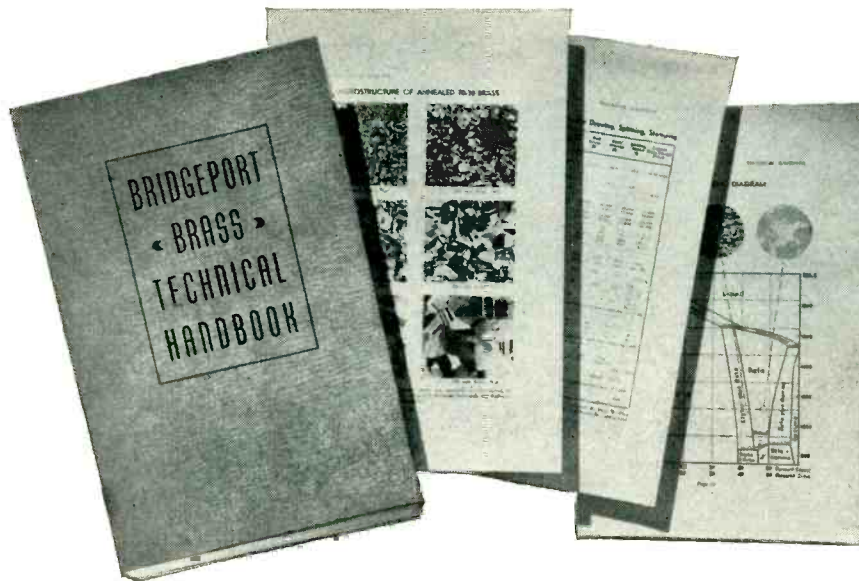

Bridgeport Technical Handbook

To Help Our Customers on Metal Problems

Mass production of tiny but precise metal parts for electronic equipment calls for exacting specifications in brass and copper mill products. The Bridgeport "Technical Handbook" is designed as a ready-reference for product engineers and those responsible for purchasing and fabricating copper and copper-base alloys.

Bridgeport Brass Company recognizes the importance of supplying metal of uniform high-quality for automatic operations. Close cooperation between the fabricator and our technical service department will quickly help with materials to answer performance requirements, cut wasted time and prevent excessive spoilage.

Simplifies Alloy Selection

The Bridgeport "Technical Handbook" is divided into logical, easily read sections covering both general information and specific engineering data.

The first section discusses the numerous coppers and copper-base alloys, their compositions, physical and me-

chanical properties and their uses. It covers in non-technical language such subjects as the copper-zinc alloy system; the effects of additional elements such as lead, tin, aluminum, silicon, manganese, iron, nickel and arsenic on coppers; and the effects of annealing on physical properties. Temper or degree of hardness for sheet, rod, wire and tubing is explained. The causes and prevention of stress corrosion, cracking and hot breaks are discussed.

In addition, the "Technical Handbook" contains information on the importance of the microstructure of rolled and annealed brasses, graphically illustrated by micrographs and curves.

Mill Product Shapes

The following three sections are devoted to mill products—strip and sheet, rod and wire, and tubing. They are further broken down into groups such as Brass and Copper Strip for Drawing, Spinning and Stamping; Rods for Screw Machine Operation; Wire and Rod for Cold Heading; Rods for Hot

Forging; Tubing for Fabrication; and many others.

Each classification lists not only the alloys and their applications, but gives a table of Composition, Mechanical Properties, Physical Constants, Fabrication Properties, as well as the latest specification numbers. By referring to these tables, the purchasing agent and the design engineer can see at a glance the alloys available and their comparative properties. This simplifies alloy selection, saves time and effort.

Hints on Metalworking

The handbook contains a brief but authoritative outline of procedures for working copper-base alloys. There are many diagrams and tables relating to machining, the tools to be used and recommended coolants. Data on Milling, reaming, chasing and sawing are given in concise tabular form with suggested procedures for the different alloys discussed. There are also full sections on drawing and drawing lubricants, annealing, cold heading, soldering, cleaning and dip coloring.

Useful Appendix

To complete the Handbook, almost thirty pages of informative tables are included as an Appendix. These tables cover equivalent weights, temperature conversions, metal melting points, length measurement conversions, and weights of flat products, circles, rod, round wire and copper tubes.

How to Get Your Copy

The Bridgeport "Technical Handbook" is a reliable guide to many problems and situations met by purchasing agents, design engineers and production superintendents in every-day work with copper-base alloys. Your copy will be quickly mailed upon request on company letterhead. And if you are confronted with metal problems not completely answered in the Handbook, do not hesitate to contact our nearest branch office for assistance as well as for your metal requirements. (1593)



What kind of enclosure do you need?

Which shielding material is best?

What is the important difference between attenuation and insertion loss?

How should attenuation be measured?

Why is interchangeability so important?

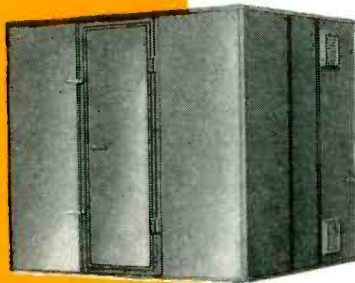

HOW YOU CAN EVALUATE

Shielded Enclosures

Selecting the proper shielded enclosures today is a big job... and no wonder! The unqualified statements and ambiguous terminology of some enclosure manufacturers makes intelligent purchasing extremely difficult.

To eliminate these difficulties, ACE has prepared a definitive booklet: *Evaluating Shielded Enclosures*, by Richard B. Schulz, noted authority on the suppression of r-f interference, and consultant to ACE. Here are free, factual data you should be acquainted with... for only by applying a realistic approach to shielded enclosure selection can you be sure of getting what you pay for.

you always get your money's worth with ACE

ACE long ago eliminated guesswork as a factor in the design of shielded enclosures. Every ACE claim is backed by complete guaranteed test data, for every design is thoroughly analyzed and approved by independent engineering laboratories. Whether

you need a galvanized screen room, a copper screen room, or a solid sheet RFI enclosure (Lindsay Structure), you can depend on top performance when you choose ACE... *first and still foremost in the design and manufacture of every type of shielded enclosure.*



Send for this interesting Free Booklet

A COMPLETE LINE OF ENCLOSURES FOR INDUSTRY, SCIENCE AND MILITARY, FEATURING HIGHEST ATTENUATION, FULL INTERCHANGEABILITY,* INSIDE BOLTING*

(*Patents Pending)

Exceeding JAN-1-225; 16E4 (ships); MIL-16910; MIL-S-4957
(Write for RFI Bulletin No. 1, and ACE Bulletins Nos. 3 & 5)



ACE ENGINEERING & MACHINE CO., INC.

3644 N. Lawrence Street • Philadelphia 40, Pennsylvania
Visit our Booths at the I.R.E. Show—427-429-431 Electronics Ave.

corrosion resistant steel Rollpin that can withstand a 100-hr salt spray test. New processing methods, including passivation, enable it to meet the requirements of AMS7207. The Rollpin is a slotted and chamfered cylindrical spring pin, heat-treated to achieve optimum toughness, resilience and shear strength. Design proportions are so engineered that the self-locking action is achieved in holes drilled to normal production tolerances. Typical uses include pinning gears or pulleys to shafts, as hinge pins, dowels, replacements for cotter pins, and as shafts for small gears.



PRESSURE SWITCHES are miniaturized series

MILLER-ROBINSON Co., 7007 Avalon Blvd., Los Angeles 3, Calif. A miniaturized series of pressure switches suitable for all airborne pressure-control applications is now available in any pressure range from 100 psi to 10,000 psi. The switch weighs approximately $\frac{3}{4}$ oz and occupies a space of less than 1 cu-in. volume. This pressure switch is designed around the newly developed B-tube pressure-sensing element. The B-tube is much more rigid, has a greater ability to withstand higher vibration and G-loads than the Bourdon tube. It is linear and inherently straight-line in operation with very low hysteresis.

AUDIO PENTODE for voltage amplifying

BRITISH INDUSTRIES CORP., 164 Duane St., New York 13, N. Y. Genelex Z729 is a low hum, low

New — at the show. Be sure to see them...

BOOTH NOS. 242 244 246

KAY ELECTRIC COMPANY

MEGA-PIX SR. A crystal controlled TV picture and sound RF signal source for color, black and white. Built-in sound carrier modulating frequency. Standard video input signal required. Price: \$990.00

RADA-PULSER SR. A versatile pulsed-carrier generator with continuously variable calibrated frequency range from 12 mc to 80 mc. Calibrated variable pulse widths from 0.2 to 20 microseconds.

ULTRA-MARKER. Provides very narrow "pip" type crystal positioned marks at UHF TV picture and sound carrier frequencies on every channel or every fourth channel. Price: \$395.00

MODEL UHF MARKA-SWEEP. Combines ULTRA-SWEEP and ULTRA-MARKER in single cabinet. Channels marked on dial, permitting rapid selection of any UHF TV channel with crystal positioned markers. Price: \$945.00



RADA-NODE. Complete radar noise figure measuring equipment, including IF and microwave noise sources, 30 and 60 mc amplifiers, accurately calibrated attenuator and indicating meter. Accuracy to fraction of a db.

TRANSALYZER. A transistor curve plotter designed to provide permanent record of input, transfer and output static characteristics in any of the standard grounded base, emitter and collector connections.



RADALYZER. A radar type receiver with a 30 mc IF for low level microwave measurements. Insertion loss measurements of over 60 db or losses of only 0.2 db are possible.

RADALIGNER. Wide band sweeping oscillator providing two radar swept IF frequencies, CW center frequencies and narrow crystal positioned markers. Metered output of 0.5 volts into 72 ohms. Price: \$750.00

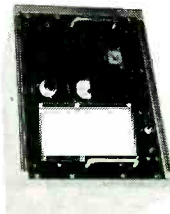

MICROLIATOR. Precisely controlled continuously tunable CW signal source. Range 8500-9600 mc. Frequency maintained through use of intermediate frequency loop system coupled to dial type micrometer tuning control.

ULTRA-PIX. UHF TV crystal controlled picture and sound RF signal source. Covers three UHF channels. Other specifications same as MEGA-PIX SR. Price: \$795.00

MODEL VIDEO TTV MARKA-SWEEP. Combines 8 mc wide video sweeping oscillator with 5 crystal positioned markers and a continuously variable marker. Metered output of 1.5 volts into 72 ohms. Price: \$695.00

XTALATOR. Crystal controlled decade switched oscillator covering 100-500 mc with accuracy better than 0.005%. Decade switching for convenience and perfect resetability plus continuously variable tuning.

NEW MICROWAVE MEGA-NODES. Calibrated random noise sources with new gas tubes that have approx. zero temperature coefficient. RG-91/U waveguide for 12.4-18.0 kmc and RG-53/U for 18.0-26.5 kmc. Price: Waveguide \$295.00, Power Supply \$150.00

All Prices f.o.b.
Pine Brook, New Jersey



IF YOU CAN'T ATTEND THE SHOW — WRITE
KAY ELECTRIC COMPANY
14 MAPLE AVENUE
PINE BROOK, N. J.

PRINTED CIRCUITS

do a **BETTER JOB**
at **LOWER COST**

Everyone in electronics today knows that printed circuits are the real answer to production speed-ups... lower costs... greater profits. Printed circuits can help you in numerous ways — regardless of the product you manufacture.

Davelle invites you to write today and learn how this latest scientific development can reduce costs and solve your production problems. Send us a sketch or print of your product and our engineering staff will design a printed circuit layout for your application. In addition, if you desire price quotations, let us know the quantities involved.

You will find Davelle's printed circuits are priced lower while maintaining highest precision standards of workmanship.

printed... stamped... etched

DAVELLE

LABORATORIES, INC.

SPRINGFIELD GARDENS 13, L. I., N. Y.

Visit Davelle Exhibit at the IRE Show—Booth 804

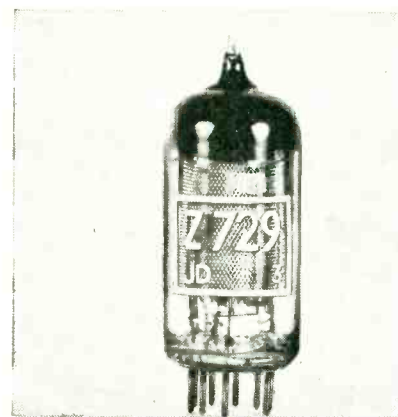

noise, low microphonic, voltage amplifying audio pentode that will fit a standard 9-pin miniature socket. It was expressly designed for use in high-gain audio preamplifier and equalizer stages. Total hum voltage referred to the input grid will not exceed 1.5 μ v. The microphonic characteristic is of such a low order that the tube may be used as the first stage of a high-gain amplifier. The tube has been designed to operate as the input circuit for a low-level microphone or tape recorder. One of many features is an internal shield completely surrounding the tube elements.

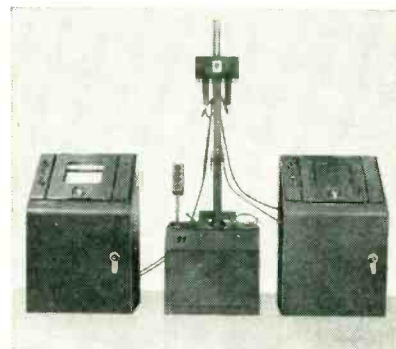

BETA-RAY GAGE for tubing measurement

TRACERLAB INC., 130 High St., Boston 10, Mass., has developed a gage utilizing beta rays from a radioactive source to measure the wall thickness and roundness of tubing. Providing a means of gaging small diameter, thin-walled tubing with extreme accuracy, it will be especially valuable where uniform thickness of the tube walls is important and concentricity must be accurate. A source of beta radiation, moved inside the tube in relation to a sensitive means of detecting radia-

Now— **Moldite Dependability** in all 3!

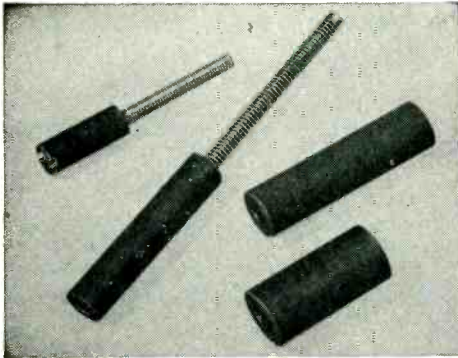

FERRICORES

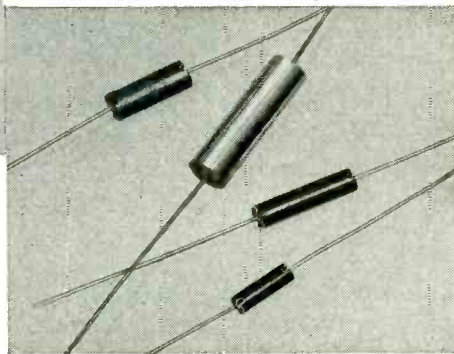

MOLDED COIL FORMS

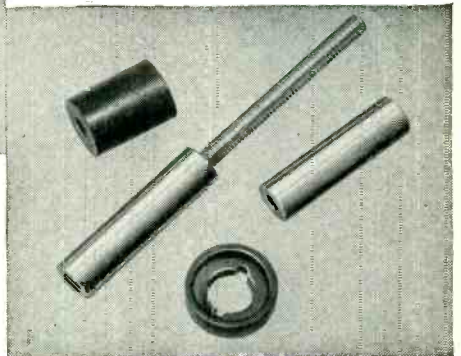

MAGNETIC IRON CORES

Moldite's famed precision production facilities are now devoted to 3 major types of electronic components —to give the industry a superlative core or coil form for every electronic application.

Through years of continued engineering and research Moldite has produced cores of guaranteed dependability, economy, quality and uniformity. Our customers' smooth running production lines tell the story best.

Specify a Moldite core specially designed and precision made for you, with absolute uniformity from first to last.



... Send for our new
Catalog No. 110 —
THE MOST COMPLETE
LINE OF CORES
IN THE INDUSTRY!

- FERRITE CORES
- MOLDED COIL FORMS
(iron and phenolic)
- MAGNETIC IRON CORES
- FILTER CORES
- THREADED CORES
- SLEEVE CORES
- CUP CORES

Samples promptly submitted upon request for design, pre-production, and test purposes

NATIONAL
MOLDITE
COMPANY
 1410 CHESTNUT AVE., HILLSIDE 5, N. J.

Robert T. Murray 614 Central Ave. East Orange, N.J.	Jerry Golten Co. 2750 W. North Ave. Chicago 22, Ill.	Martin P. Andrews Mott Road Fayetteville, N. Y.	Perlmuth-Coleman & Assoc. 1335 South Flower Los Angeles, Cal	Jose Luis Ponte Cardoba 1472 Buenos Aires
---	--	---	--	---

THE SYMBOL OF
Quality
IN TRANSFORMERS

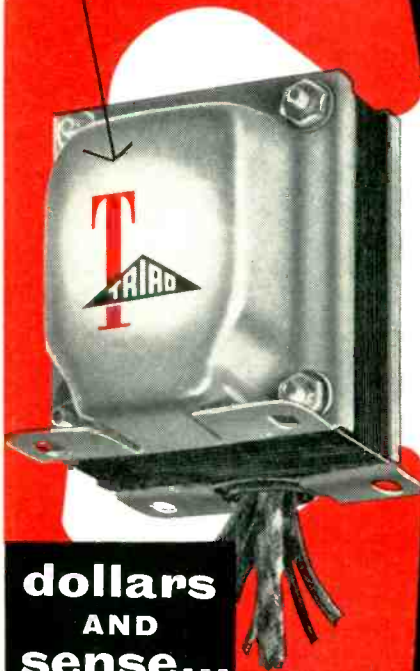

**dollars
AND
sense...**

Triad quality costs no more, and those who buy Triad Transformers get what they pay for.

Superior design — finer materials — precise workmanship — distinctive appearance — continuous and unfailing service. All these contribute to the recognized value of Triad products.

Industry expects and gets — from Triad the finest transformers made.

Triad Transformers are sold by select jobbers in principal cities. Write for Catalog TR-53G.



4055 Redwood Ave., Venice, California

For more ad information, see Index to Advertisers.

tion on the outside of the tube, is the heart of the device. Changes in the thickness of the tube's wall affect the amount of radiation passing through the wall. These changes are readily translated into thickness readings and shown by means of a pen trace on a recorder chart.

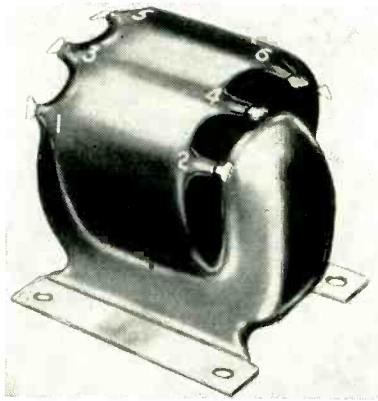

**MARKING METHOD
withstands salt spray tests**

MICROTRAN Co., Division of Crest Laboratories, Inc., 84-11 Rockaway Beach Blvd., Rockaway Beach, N. Y., announces a new method of permanently marking terminal descriptions and schematic diagrams on resin encapsulated or dipped transformers and similar electrical equipment. The process embodies a procedure similar to that used in vitrefying designs on ceramic products. This marking method is designed to withstand the MIL-T-27 salt spray and immersion tests.

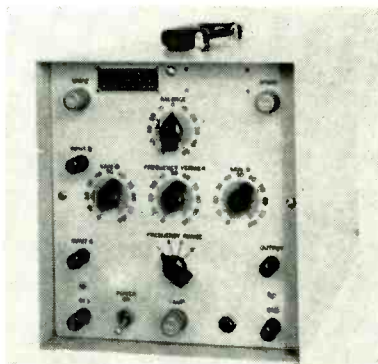

**ELECTRONIC SWITCH
provides 2 patterns on 1 scope**

CHATHAM ELECTRONICS CORP., Livingston, N. J., has announced a portable electronic switch that makes possible simultaneous ob-

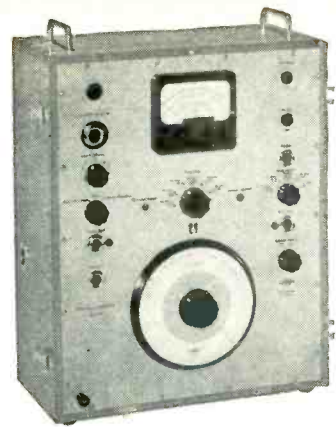

**SAVE TIME
IN FREQUENCY
ANALYSIS**

with the Bruel & Kjaer Audio Frequency Spectrometer, Model BL-2109

This high-gain, precision instrument measures the amplitudes of the frequency components in complex a.c. voltages from 35 to 18,000 cps. The Spectrometer saves hours of engineering time in electrical or acoustical testing.

In addition to 27 fixed third-octave band pass filters covering the audio range, the Spectrometer provides the standard networks for sound level measurements. Any filter or network may be manually selected, or the filters and networks can be scanned automatically in sequence. When used with the Bruel & Kjaer Level Recorder, the audio frequency spectrum of noise, vibrations, strains, complex voltages, tape recordings, etc. are plotted automatically on preprinted chart paper.

For complete specifications on this and other Bruel & Kjaer instruments, write Brush Electronics Company, Dept K-3B, 3405 Perkins Avenue, Cleveland 14, Ohio.

ACOUSTIC AND TEST INSTRUMENTS

Bruel & Kjaer instruments, world famous for their precision and workmanship, are distributed exclusively in the United States and Canada by Brush Electronics Company.

- BL-1012 Beat Frequency Oscillator
- BL-1502 Deviation Test Bridge
- BL-1604 Integration Network for Vibration Pickup BL-4304
- BL-4304 Vibration Pickup
- BL-2002 Heterodyne Voltmeter
- BL-2105 Frequency Analyzer
- BL-2109 Audio Frequency Spectrometer
- BL-2304 Level Recorder
- BL-2423 Megohmmeter and D. C. Voltmeter
- BL-3423 Megohmmeter High Tension Accessory
- BL-4002 Standing Wave Apparatus
- BL-4111 Condenser Microphone
- BL-4120 Microphone Calibration Apparatus and Accessory
- BL-4708 Automatic Frequency Response Tracer

**BRUSH ELECTRONICS
COMPANY**

formerly
The Brush Development Company.
Brush Electronics Company
is an operating unit of
Clevite Corporation.



For more ad information, see Index to Advertisers.

HIGH RESOLUTION · LOW DISTORTION...



NEW

MONO-ACCELERATOR Cathode-Ray Tubes by DU MONT

**TYPE 5AMP—
Cathode-ray Tube**
Low-capacitance deflection
plate connections for high-
frequency applications.
Limited vertical scan.

In the new mono-accelerator Types 5AMP— and 5AQP— cathode-ray tubes, Du Mont has utilized modern principles of cathode-ray tube design combined with the Du Mont Tight-tolerance construction, automatic-focus lens and new high-resolution electron gun to provide a cathode-ray tube with the greatest freedom from distortion and best resolution and linearity yet achieved. Primary advantages of mono-accelerator cathode-ray tubes include virtual freedom from field and spot distortions; high deflection uniformity over the entire tube face; uniform resolution from edge to edge; and practically automatic focus. Both tubes have flat face-plates. The Type 5AQP— is intended for low and medium frequency applications, the Type 5AMP— for high-frequency applications.

SPECIFICATIONS (Typical Operating Conditions)

Type	Accelerator Voltage	Deflection Factors		Useful Vertical Scan	Deflection Factor Uniformity
		D1D2	D3D4		
5AMP—	2500	40-50v/in	22.5-27.5v/in	2½"	1% max.
5AQP—	2500	40-50v/in	31.5-38.5v/in	4"	1% max.

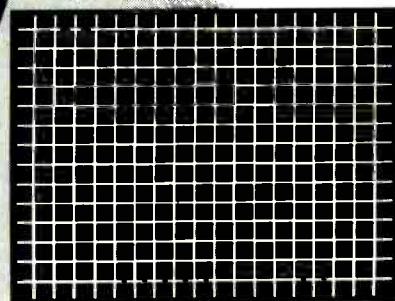

An actual, unretouched linearity bar pattern of the Type 5AMP—. Not an engraved calibrated scale.

DU MONT

For complete specifications write to:

Technical Sales Department, ALLEN B. DU MONT LABORATORIES, INC., 760 Bloomfield Ave., Clifton, N. J.

the **COMPLETELY NEW**

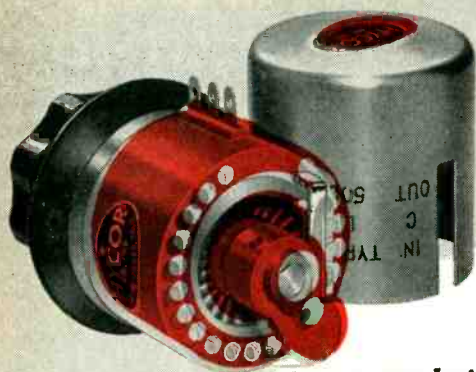

HYCOR VARIABLE ATTENUATOR

... a revolutionary design in attenuators!

- **PROOF** against SHOCK — MOISTURE — TEMPERATURE
 - Withstands ambient temperatures of $-40^{\circ}\text{C}.$ to $+100^{\circ}\text{C}.$; 95% humidity.
 - Resistive elements are accurate, noninductive, wire-wound and hermetically sealed in a special tough plastic compound.
 - Greater power dissipation.
 - Switch surface flat and smooth . . . easy to clean, **BRUSHES CANNOT TRIP**, exceptionally long life.
 - **QUIET** . . . extremely low switch noise level . . . ideal audio mixer controls.
 - "Lubricated for life" bearings.
 - Stock types available with "LADDER," "T," "H," "L" and potentiometer configurations up to 32 steps.
- Send for Bulletin A-2 for specifications and prices.

Representatives:

BEEBE ASSOCIATES
1155 Waukegan Road, Glenview, Illinois
BURLINGAME ASSOCIATES
103 Lafayette Street, New York City
HARRISON J. BLIND
1416 Cord Street, Indianapolis 24, Indiana
G. M. HOWARD & ASSOCIATES
734 Bryant Street, San Francisco 7, California

HYCOR SALES COMPANY
of California

11423 VANOWEN STREET
NORTH HOLLYWOOD, CALIF.

servation of two patterns on the screen of a single cro. Relative positions of the patterns may be varied so that they are either superimposed or separated as desired. Direct comparison of amplitudes, waveforms, frequencies and phase relationships are therefore possible. A square-wave voltage of variable frequency and amplitude is available at the output terminals for use as a test signal in studying the transmission characteristics of v-t amplifiers and other circuits. The electronic switch incorporates direct-coupled amplifiers that are alternately operative and inoperative at a rate determined by the selected switching frequency. The instrument is therefore effective for chopping a d-c signal, making it suitable for transmission through the oscilloscope amplifiers.

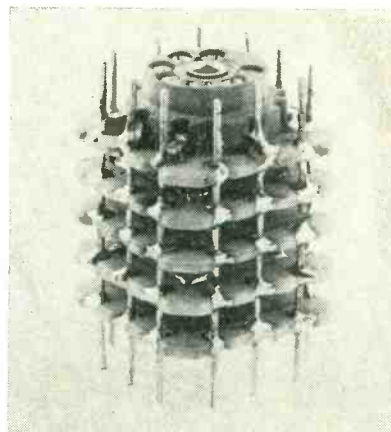

PROJECT TINKERTOY in modular design kit form

COMMUNICATION MEASUREMENTS LABORATORY, INC., 350 Leland Ave., Plainfield, N. J. The first step in the adoption of Project Tinkertoy techniques by industry is the development of assemblies and complete equipments using these modules which are suitable for low-cost automatic production. To satisfy requirements of electronic equipment design engineers, the company has developed and is offering for sale the Project Tinkertoy modular design kit type PT-1000. This kit includes all the special hand tools, materials, chemicals, module parts, and standard accessories necessary for the design and

ELCO CORPORATION

2nd & GLENWOOD, PHILADELPHIA 40, PA.

CORDIALLY INVITES YOU TO ITS CONNECTOR CLINIC

Lexington Hotel, N. Y. C.
March 22—23—24—25, 1954
2 pm to 5 pm Daily

To discuss any and all your
miniature connector problems
and learn how to solve them with
Elco's world-famous "Varicons"

Also Visit our IRE Exhibit

792 Airborne Ave., Kingsbridge Armory
March 22—23—24—25, 1954

To see America's quality-line of
miniature and sub-miniature tube-sockets,
shields and connectors

Look what's happened to the "cat's whiskers"

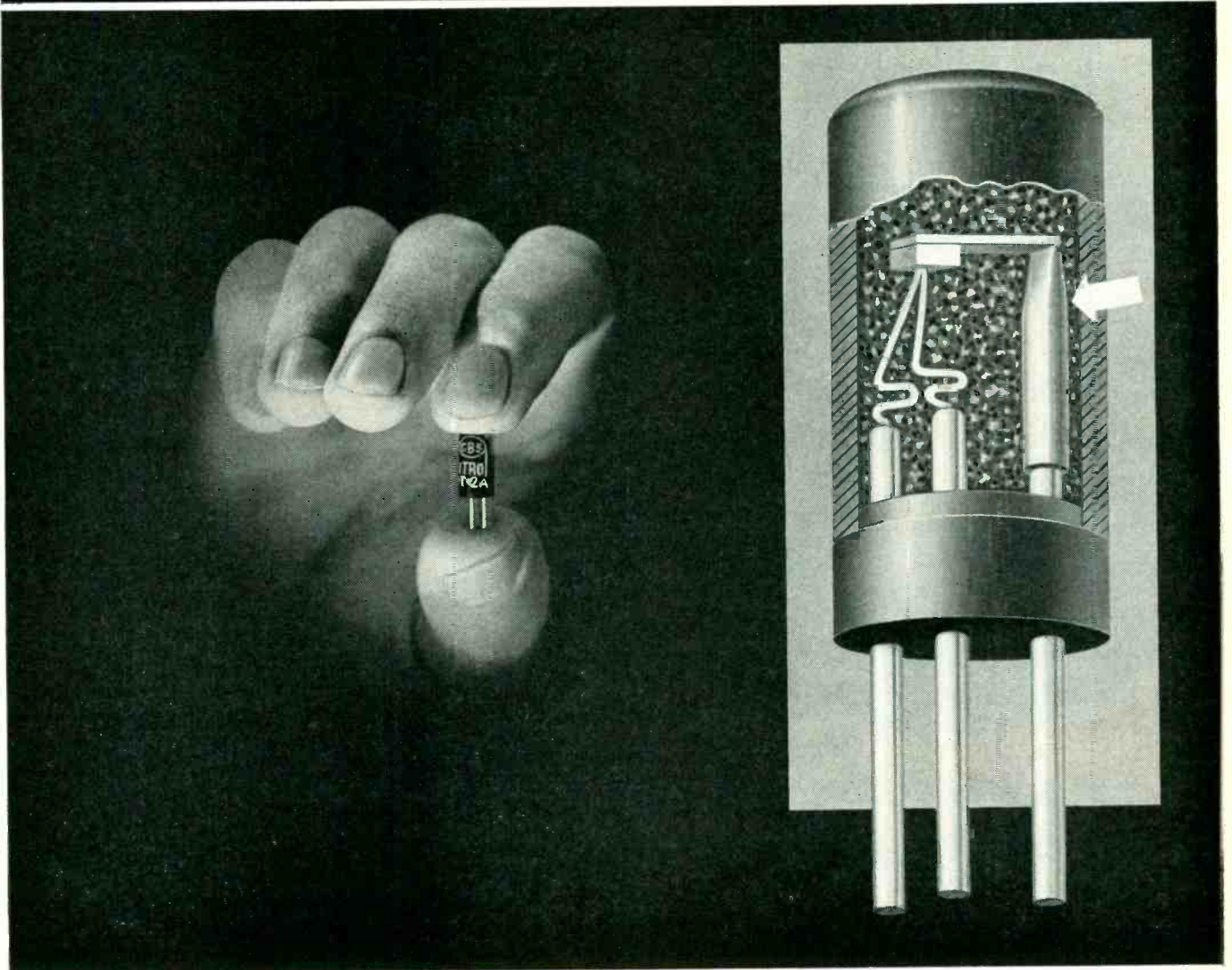

A miracle that can hide behind your thumb-nail is the hottest electronics news in years. Modernized descendant of the Twenties' crystal diode with its cat's whisker, the transistor threatens to send many vacuum tubes the way of old head sets.

No matter which ultimately gets the nod—tube or transistor—Superior will be in there pitching. Superior seamless and Lockseam* nickel cathodes, anodes and grid cups are familiar to you in vacuum tubes. Now Superior tubing is going into transistors.

CBS-Hytron, a division of Columbia Broadcasting System,

Inc., uses Superior tubing for the L-shaped bracket that holds the germanium crystal in their PT-2A point-contact transistor. For this purpose they purchase tiny tubes—.032" I.D. x .003" wall, .193" long, drawn from seamless nickel. Added to the good welding, soldering and formability characteristics of the metal, Superior manufactures the brackets to the close tolerances CBS-Hytron must have.

Whether you are for the old or new order in electronics, if you need an idea or an analysis in small tubing, Superior is the first place to look. Superior Tube Company, Electronics Division, 2500 Germantown Ave., Norristown, Pa.

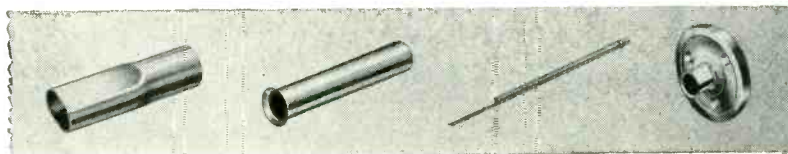

Seamless Nickel Anode. Flattened one end. .500" O.D. x .025" Wall x 1.625" long.

Seamless Nickel Cathode. Round, flanged one end. .070"/.072" I.D. x .0025" Wall. .295" long.

Lockseam* Nickel Cathode. Round, tabbed, single bead. .045" O.D. x .0021" Wall. 27 mm long.

Disc Cathode .121" O.D. .312" long.

Superior
THE BIG NAME IN SMALL TUBING

All analyses .010" to 3/4" O.D.
Certain analyses in Light Walls up to 2 1/2" O.D.

Many types of nickel cathodes—made in Seamless and Lockseam* from nickel strip, disc cathodes, and a wide variety of anodes, grid cups and other tubular fabricated parts are available from Superior. For information and Free Bulletin, address Superior Tube Company, Electronics Division, 2500 Germantown Avenue, Norristown, Pa.
*Manufactured under U.S. Patents.

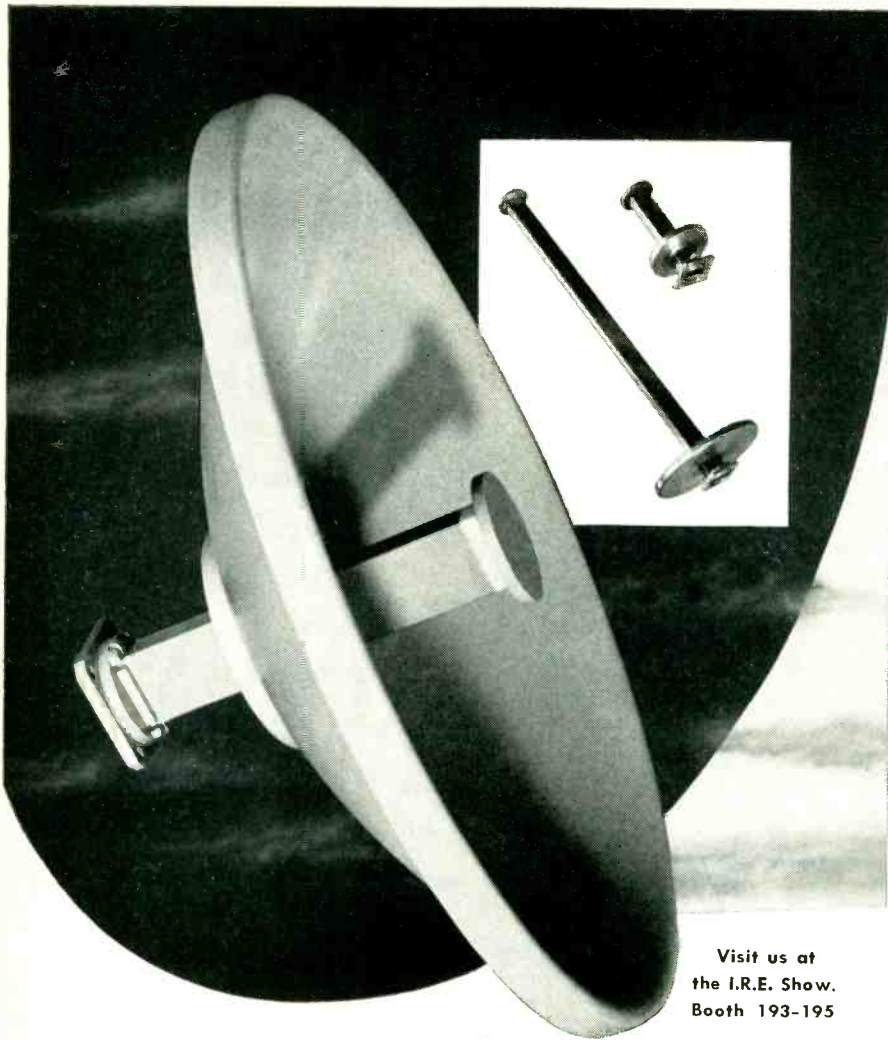

Visit us at
the I.R.E. Show.
Booth 193-195

PARABOLIC ANTENNAS for the X-band

Quick delivery of parabolic antennas for the X-band is now possible. Designed and manufactured by The Gabriel Laboratories, these antennas meet, or better, required civilian and military specifications. Precision reflectors are illuminated by a modified Gabriel wave guide feed — the same Gabriel design which has received universal recognition in the 7000 mc commercial relay band. Large orders can be filled quickly due to the extensive manufacturing facilities of our affiliate, Gabriel Electronics Division.

These antennas are available with dish sizes of 1, 2, 3, 4, and 6 foot diameters — have a standard three or four point adjustable mounting — and are equipped with a UG-40A/U input flange which is suitable for use in pressurized systems. Feed and dish de-icers are also available for extreme weather conditions.

- Frequency coverage (two ranges) — 8900 to 9300 mc; 9300 to 9750 mc.
- VSWR — less than 1.2 :1 throughout each range.
- Each antenna can be spot tuned to a specific frequency, with a VSWR of less than 1.05 :1.

For analysis of your antenna or microwave problem, write or phone NEedham 3-0005.

the **GABRIEL** laboratories

THE GABRIEL COMPANY • 135 CRESCENT ST. • NEEDHAM HEIGHTS, MASS.



construction of Project Tinkertoy modules and subassemblies, or complete end equipment using modular designs.

VOLTAGE REFERENCE is secondary standard cell

GENERAL PRECISION LABORATORY INC., Pleasantville, N. Y. Model PM-300 adjustable voltage reference is an all-electronic secondary standard cell operating from a-c mains to provide a continuously variable d-c supply over the wide range of 0.0001 to 10 v in 3 ranges. It is a precision unit, designed primarily to work with high impedance devices—for d-c amplifier testing, calibration of d-c oscilloscopes and v-t voltmeters, determination of vacuum tube characteristics, and other uses in industrial and research laboratories. It is immune to damage by short circuit. Maximum output impedance is 1,000 ohms, with accuracy maintained at 0.1 percent of full scale. A multiple-turn potentiometer is provided having divisions of 0.001 of full scale. The circuit is operable with input voltages of 105-130 v, 50-60 cycles, with full accuracy.

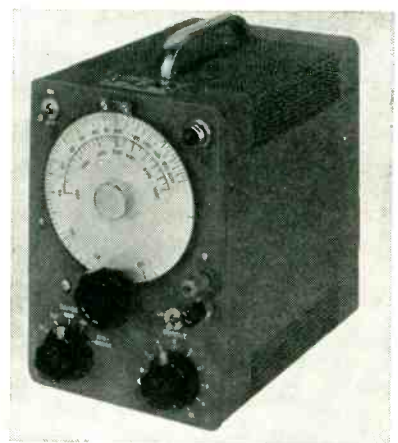

AUDIO OSCILLATOR for 20 cycles to 1 mc

THE CLOUGH-BREngle Co., 6014 Broadway, Chicago 40, Ill. Model 411 oscillator is suitable for making measurements requiring a sine-wave signal over the range from 20 cycles to 1 mc. A resistance-capacitance tuned type oscillator and a cathode follower in the output sys-

tem are employed to provide uniform response. Frequency accuracy is maintained by the use of deposited-carbon resistors in the frequency determining network. Low-level measurements are facilitated by a panel switch which reduces output voltage, distortion and hum output. Other features are good case ventilation, a well-spread dial calibration for ease in reading, and compact size with light weight.

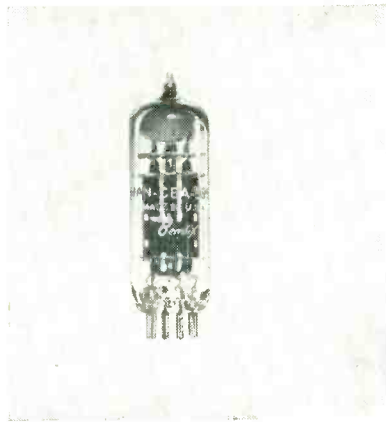

RECTIFIER TUBE is high-vacuum type

BENDIX AVIATION CORP., Red Bank Division, Eatontown, N. J., has announced a new full-wave high-vacuum rectifier tube, JAN-5993. It is run-in tested and aged under vibration with all operating voltages applied in the lab for 45 hours to indicate that it will withstand extreme shock and vibration. These tubes employ a cathode-type structure with extruded ceramic heater insulator and a coil-type heater instead of a filament structure. This construction, along with the ruggedized mount structure, virtually eliminates heater failures, shorts and other adverse effects of shock and vibration. The tube uses a 9-pin base with the electrodes connected to alternate pins. Operation is possible at altitudes up to 80,000 ft. The tube can be mounted in any position.

UHF-TV COMPONENTS in a widely varied line

MICROLAB, 301 S. Ridgewood Road, South Orange, N. J. A Twin-300 line of balanced 300-ohm compon-

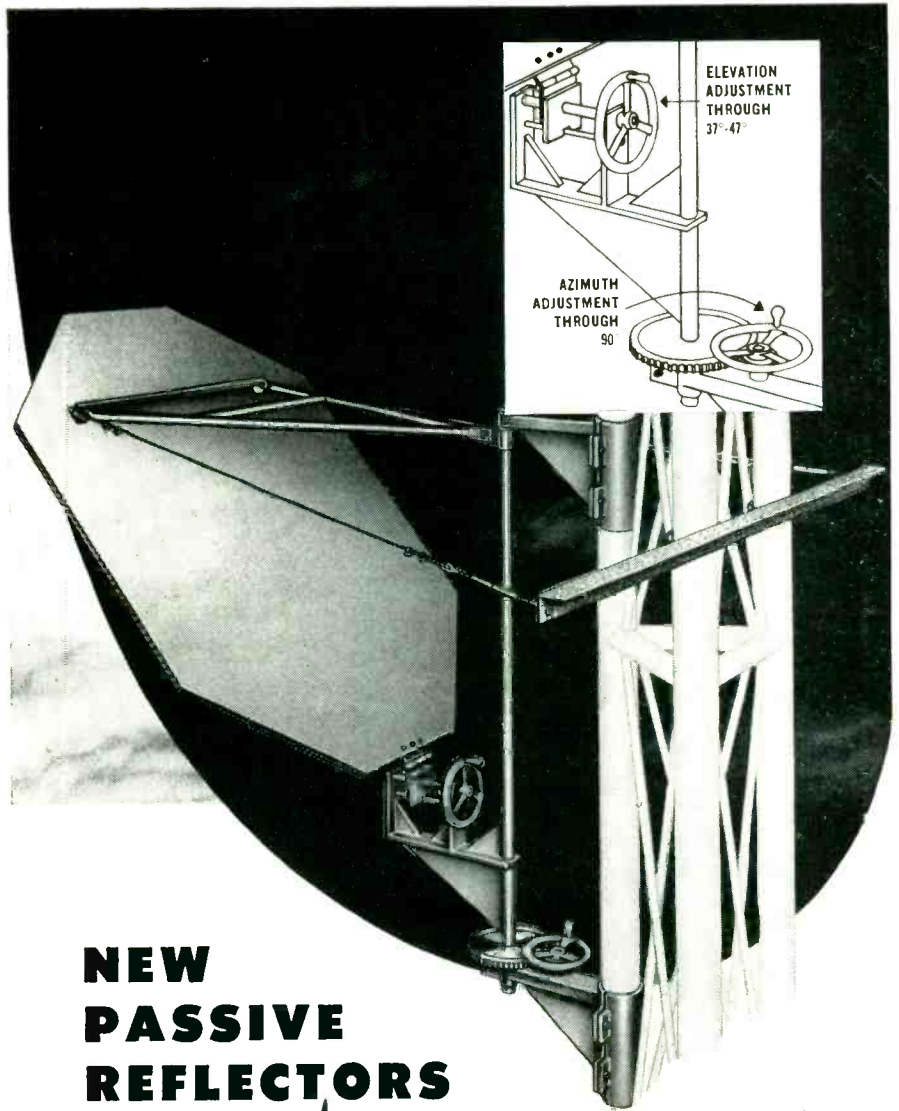

NEW PASSIVE REFLECTORS

cut microwave relay costs

Total costs come down — each time a Gabriel Passive Reflector goes up. Mark these savings in time, manpower, and overall costs of tower installation with this new Gabriel design.

- **Save man hours** — a smaller crew spends less time on each installation. The all-aluminum, heliarc welded unit is easily hoisted into position where adjustable U-clamps have been set at required tower height.
- **Reflector adjustment is fast and precise.** Easily reached hand-crank and gear system gives exact station-to-station directivity through 90° in azimuth, through $\pm 5^\circ$ from 42° in elevation. Turn-buckled guy wires rigidly fix mount and reflector against heavy wind pressures.

New research by our affiliate, The Gabriel Laboratories, has determined optimum reflector size, contour, and shape for greater gain characteristics with specific tower heights and antenna diameters. Reflectors are "sandwich" type, of aluminum sheets and honeycomb core bonded and sealed at edges.

Write for mechanical specifications and specific systems application data. On Display at Booth 193-195 I.R.E. Show.

GABRIEL *electronics division*

FORMERLY WORKSHOP ASSOCIATES DIVISION
THE GABRIEL COMPANY, 210 ENDICOTT STREET, NORWOOD, MASS.



McLAUGHLIN

Single-Sideband Receiving Systems

**PRECISION BANDWIDTH CONTROL OF
SINGLE-SIDEBAND RECEIVERS STOPS JAMMING!**



Exclusive McLAUGHLIN development provides the exact realistic jam-free-bandwidth for all long-range reception of short-wave single-sideband transmissions.

The TYPE MCL-500 Series VARI-SPLITTER equipment has been designed to "patch" into the intermediate-frequency circuit of installed high-quality single-sideband receivers. Its input/output frequency requirements match that of the receiver. Provides separate high/low cutoff controls for each information channel. Jamming attenuation is 60 db, 500 cps outside passband. Models are available with provision to control the passband of one- two- three or four-channel single-sideband signals. Ideally suited for use with the latest multi-channel single-sideband receivers employed in international radio-telephone service, or with FSK telegraph/teletype terminal equipment.



The TYPE MCL-50/50 Series SIGNAL-SPLITTER is a complete variable bandwidth single-sideband converter and is used with general purpose communications receivers to provide the ultimate in reception of double or single-sideband, program, voice or FSK transmissions. Provides exalted carrier reception for full and reduced carrier transmissions; jamming attenuation is 60 db, 500 cps outside passband.

J. L. A. McLAUGHLIN CORPORATION
LA JOLLA, CALIFORNIA, U.S.A.

ents and test equipment has been introduced. It features baluns, attenuators, detectors and terminations suitable for use in the uhf-tv band. The line may be used with existing unbalanced 50 and 75-ohm equipment for complete measurements of balanced 300-ohm systems. Measurements such as gain, loss, impedance, vswr and noise are facilitated on receivers, tuners, antennas, transmission lines, oscillators, amplifiers and similar uhf-tv components. The line is designed to withstand the rigors of production line testing while maintaining the standards of laboratory accuracy. A new 300-ohm connector has been developed and incorporated in the line. The connector is suitable for use from d-c to 2,000 mc. A mating connector may be constructed without special tools or factory parts.

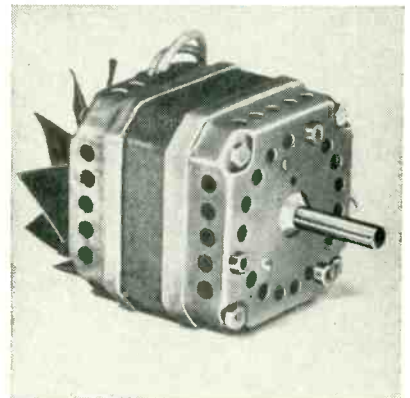

SHADED POLE MOTOR is powerful and compact

ELECTRO ENGINEERING PRODUCTS Co., 609 W. Lake St., Chicago 6, Ill. Model MS-3600 shaded pole motor is specially designed to withstand high temperatures and rough service. It is suited for use as the power source in business machines, industrial instruments, phonographs, vending machines, tape recorders and many other products requiring a dependable, rugged source of power. The motor is a 4-pole, a-c type, and is available in either 2 or 4-coil design. It has self-aligning, oil-impregnated sleeve bearings with a specially designed oil-retaining washer, and dynamically balanced rotors. Heavy insulation on connecting lead wires will easily withstand the abuse and flexing en-

countered even in extra heavy-duty service.

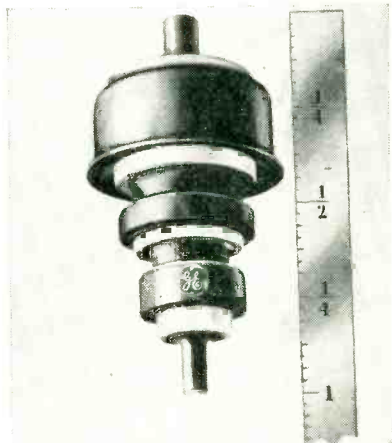

RECEIVING TUBE
has 8.5-db noise figure

GENERAL ELECTRIC Co., Syracuse, N. Y., has available a metal-and-ceramic receiving tube with a noise figure of 8.5 db or better and a power gain of 16 db at 1,200 mc. The type GL-6299 was developed to offer a solution to some of the military uhf designer's high noise-level problems in lower frequency radar equipment. It is a coplanar triode designed specifically for use as a low-level class-A r-f amplifier operating at frequencies as high as 3,000 mc. It is 1 in. long, weighs $\frac{1}{8}$ oz. and is gold-plated to improve conductivity and resist corrosion.

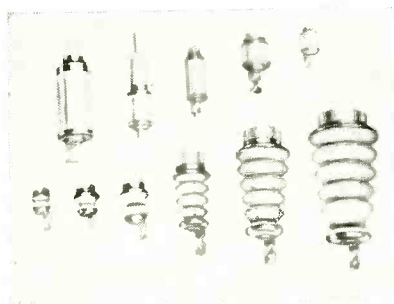

HERMETIC TERMINALS
made of alumina ceramics

GENERAL CERAMICS AND STEATITE CORP., Keasbey, N. J., has available a line of metalized Solderseal hermetic terminals made of alumina ceramics. This new material conforms to the requirements of grade L-5A in accordance with JAN-1-10. Lugs and eyelets are hot-tinned

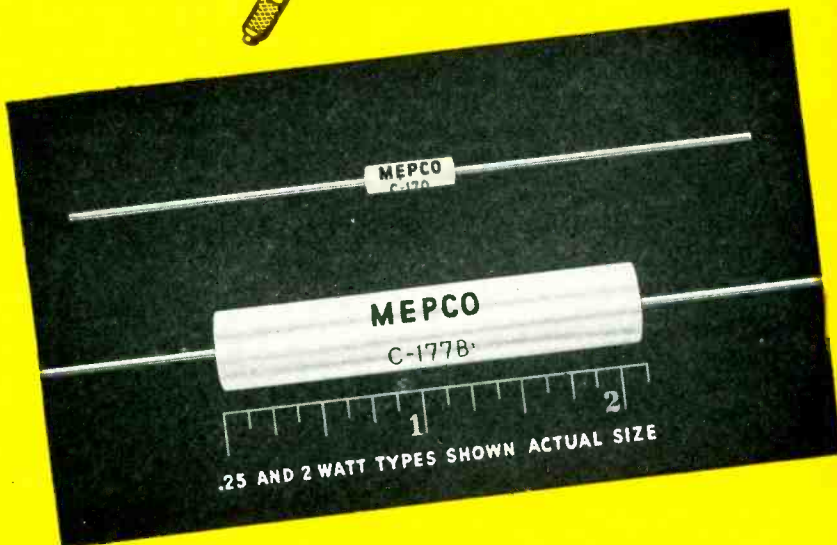

Announcing a complete line of
Deposited Carbon Resistors
HERMETICALLY SEALED

.25 watt to 2 watt ratings

Mepco presents a complete line of Hermetically Sealed deposited carbon resistors with ratings from .25 watts to 2 watts.

These are not the usual varnish coated types. Instead, they are completely sealed in steatite housing, which assures positive moisture protection.

Also available are resin coated types manufactured to MIL-R-10509A, glass enclosed and helium filled high stability types, and high frequency rod and disc units.

Write for complete information. Fill-in and mail the coupon today.

MEPCO, INC.

Morristown,
New Jersey

- Please send me information on Mepco deposited carbon resistors.
- Please send me information on Mepco wire wound resistors.

NAME _____ TITLE _____

COMPANY _____

STREET _____

CITY _____ STATE _____

Why Men Who "Go with Gilfillan" Stay with Gilfillan



Should You Begin Your Lifetime Career Here in '54?

There are many reasons why outstanding engineers build careers at Gilfillan.

With 7 plants located in Southern California, Gilfillan is big enough for every phase of engineering, production and final test—yet not so large an engineer gets lost. You have the satisfaction of following your work through.

Work is interesting. Ideas begin here. We have long range commitments, including designing equipment for all 3 military services, dealing with advanced or

unsolved techniques; and working with problems in coming civilian fields.

You will be given assistance, yet initiative is encouraged. You will have unusual freedom and recognition. You will be paid according to ability, not seniority.

Send for our Gilfillan brochure today. It can be the first step in discovering the all-around, satisfying, *permanent* career you want. Address your request to R. E. Bell, Dept. E-3, Gilfillan Bros., 1815 Venice Blvd., Los Angeles 6, Calif.

In GCA, Radar and Electronics

Research, Design and Production...

The FIRST Name is

Gilfillan
Los Angeles
GCA

brass with metalized areas silver-fired on ceramic. Both lugs and eyelets are copper electroplated and tin fused for soft soldering. Immersion in 60/40 solder at 450 F for 1½ minutes for dip soldering will not injure the metallic coating. The new Solderseal terminals feature high mechanical strength, high resistance to thermal shock and permanent hermetic sealing. Dimensional tolerance is ± 1.5 percent but not less than ± 0.010 in. The new terminals are available in a wide range of standard sizes. Their rms voltage ratings (40-percent relative humidity) range from 3,000 v to 15,000 v.

Literature

Thermoplastics Buyers Guide. The M. W. Kellogg Co., P. O. Box 469, Jersey City 3, N. J. Sources of Kel-F polymer materials, finished products, as well as application services offered by more than 75 U.S. and Canadian companies, are readily available in a quick-reference buyers guide. The 16-page guide permits ready selection of companies specializing in molding and fabricating products of Kel-F, ranging from blown bottles and porous filters to insulated electrical wiring. A special section is devoted to firms qualified to render corrosion control services, based on protective coatings and linings of Kel-F polymer. A master directory section provides complete company names, addresses and the name and telephone number of a company representative to be contacted.

Two-Step Time-Delay Relay. AGA Division, Elastic Stop Nut Corp. of America, Elizabeth, N. J. A new 2-step Agastat pneumatically-controlled time-delay relay is described in bulletin SR4. The 4-page, two-color illustrated bulletin describes the model NET Agastat time-delay relay, designed to introduce either a sequence of time-delay periods, or a momentary impulse, into an electrical circuit. The relay described is available in two

types: with time delay beginning when the coil is energized; or with time delay beginning when the coil is deenergized. Both units discussed are available with spdt, or dpdt, contacts. The bulletin covers operating sequences, lists typical applications, and includes wiring diagrams and mounting dimensions.

Null-Balance Recorder Controller. Fielden Instrument Division of the Robertshaw-Fulton Controls Co., 2920 N. Fourth St., Philadelphia 33, Pa. has prepared a new 8-page fact-filled bulletin No. F-451 describing the a-c null-balance recorder controllers. Designed initially for resistance bulb thermometry, but applicable to many other process variables, the bulletin describes the many design features that make this recorder outstanding in simplicity, feasibility and versatility. The unitized design which leads to low maintenance costs is clearly illustrated. Full specifications are included.

Oscilloscope Dolly. Ainslie Electronic Products Inc., 312 Quincy Ave., Quincy, Mass., has available a single-page bulletin illustrating and describing a scope dolly that is practical, substantially built and attractive in appearance. The dolly described accommodates all scopes up to $14\frac{1}{2} \times 23\frac{1}{2}$ in. Shipping weight, weight of dolly and price are included.

Pocket Slide Rule. Helipot Corp., 916 Meridian Ave., South Pasadena, Calif., has available for the asking a handy pocket-size slide rule. Made of heavy-gage plastic, with a transparent runner, it carries the most-used A, B, C, D and C1 scales. The slide is also useful as a ruler; one edge is calibrated in sixteenths, the other in millimeters. The reverse of the slider bears Ohm's law formulas and a Fahrenheit-Centigrade conversion scale.

Vom's. Simpson Electric Co., 5200 W. Kinzie St., Chicago 44, Ill. A new 4-page brochure describing five of the company's volt-ohm milliammeters and volt-ohm-microammeters is available. The brochure contains complete descriptive data

Just compare!

AEROVOX PRINTED WIRING

FUNCTION
FITTED

Check these Aerovox features against all other forms of printed circuitry:

- (1) Metallic silver conductor mechanically formed.
- (2) Phenolic base material not subjected to acid or chemical deterioration.
- (3) Silver partially imbedded in phenolic base—not dependent on adhesive.
- (4) Readily solderable—either dip or iron soldering.
- (5) Negligible oxidation or tarnishing under normal conditions.
- (6) No surface plating required for most switching circuits or normal protection.
- (7) Temperature range of -65° to $+125^{\circ}$ C. will not affect bond.
- (8) Identically reproducible, due to precision printing technique.
- (9) Available in production—any quantities—meeting any reasonable delivery schedule.

• Obviously different!



GET THE FACTS...

Comprehensive primer on "Printed Wiring" is yours for the asking. Also representative samples. Let us quote on any wiring, switching or commutating requirements. Write on your company letterhead.



AEROVOX CORPORATION
SPECIAL PRODUCTS DIVISION NEW BEDFORD, MASS.

Hi-Q
DIVISION
OLEAN, N. Y.

ACME
ELECTRONICS INC.
MONROVIA, CALIF.

CINEMA
ENGINEERING CO.
BURBANK, CALIF.

In Canada: AEROVOX CANADA LTD., Hamilton, Ont.

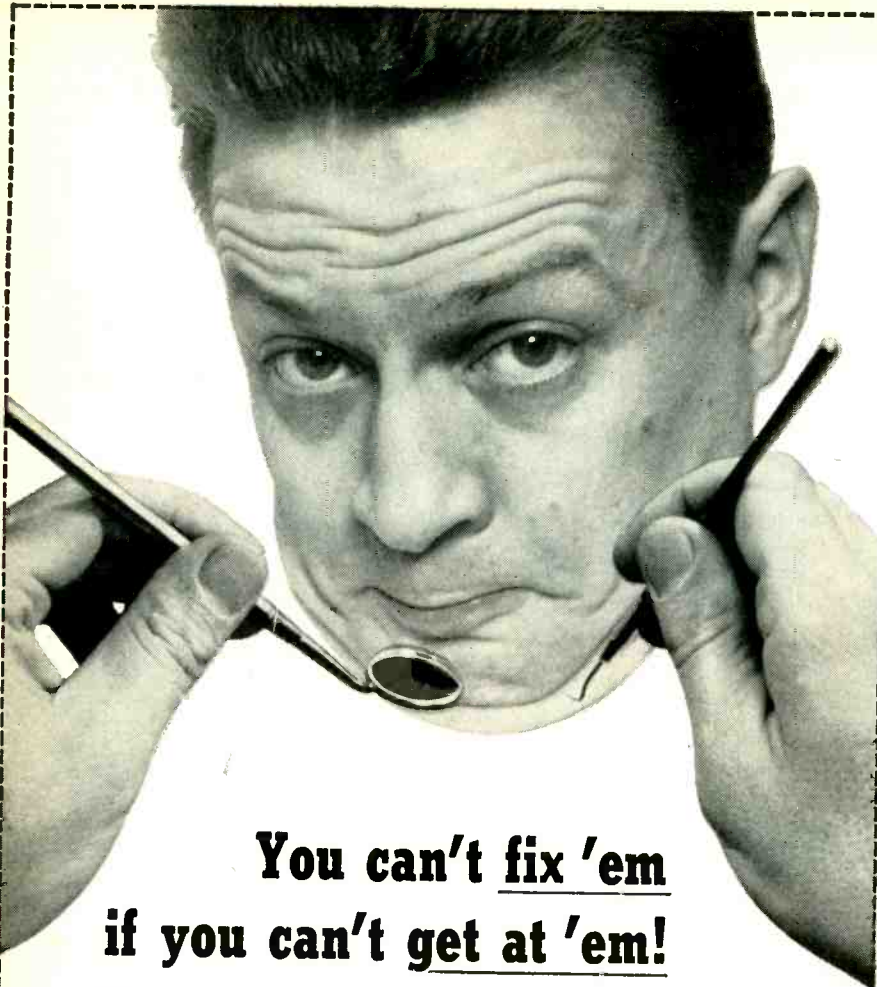

You can't fix 'em if you can't get at 'em!

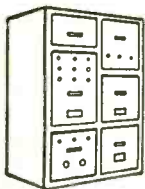

You have to open wide to get at defective components for maintenance or repair. When failure occurs in key electronic components

you want to gain access fast. Fast access is easy when the accessibility is built into the equipment.

Grant Industrial Slides let you open wide, please, in a hurry. Available in stock or custom models.

Write for our Industrial Slide Catalog.

Grant Pulley and Hardware Corporation.

31-73 Whitestone Parkway, Flushing, N. Y.

Grant Industrial Slides

See us at Booth 301-303 at the Show.



about the type 269, a 100,000 ohms-per-volt sensitivity volt-ohm-microammeter. Ask for form A-4 RCS.

Test Probe. Mic-Con Inc., 521 Lehigh Ave., Union, N. J. A recent 4-page brochure contains an illustrated description of a new type test probe. Included are the principle of operation, applications, instructions for lead assembly and ordering information.

Strip Metals. Industrial Division, American Silver Co., Inc., 36-07 Prince St., Flushing 54, N. Y. A new 6-page illustrated brochure describes a single source for a wide variety of thin gage and very close tolerance ferrous, nonferrous and precious strip metals now available in any quantity for all industry. Especially interesting to product designers, materials engineers and purchasing agents is a list of thickness tolerances that the company is capable of holding on beryllium copper strip gages. Included in the brochure are the unique mill limits to which the company cold rolls their metals—metals ranging from aluminum to zirconium, in both solid and composite form. Typical industrial uses of these strip metals the listed. There is also a brief history of the company, together with illustrations of some of their rolling, annealing and slitting facilities.

Miniaturized Photoelectric Units. Ess Instrument Co., Bergenfield, N. J. Bulletin 535 illustrates and describes a new system of miniaturized photoelectric units adapted to process industries. While available for counting, inspecting or monitoring passing objects, the Reflexo discussed was specifically designed to measure and control the sag—and hence the tension—in paper mills. Specifications are included.

Multipoint Recorder-Controller. Fielden Instrument Division, Robertshaw-Fulton Controls Co., 2920 N. Fourth St., Philadelphia 33, Pa. An informative 4-page technical data bulletin covers a line of multipoint circular chart recorders. It describes and illus-

trates many new design features such as the turret pen assembly that makes possible six individual records on a single circular chart. Through a segmental chart drive unit the instrument discussed becomes either a 24, 48 or 96-point multirecord system. Construction features and specifications are also included.

Outdoor Reset Hot Water Controls. Barber-Colman Co., Rockford, Ill. Complete information on electronic controls for hot water heating systems is now available in bulletin F6167. The catalog shows how, by simply turning a knob, the ratio of change in outdoor temperature to change in water temperature can be adjusted. The electronic panels house all adjustments and may be located convenient to operating personnel. The booklet also contains information concerning the use of an optional night depression with morning warmup feature.

Research and Control Instruments. North American Philips Co., Inc., 750 S. Fulton Ave., Mt. Vernon, N. Y., has available a 64-page reference book titled "Research & Control Instruments—X-Ray and Analytical Equipment." In addition to x-ray diffraction, spectrometry and spectrography, the volume covers such components and accessories as tubes, rectifiers and cameras. It also has sections devoted to camera mounting brackets film illuminators and measuring devices, and monochromators. Considerable space is devoted to the EM-100 and EM-75 electron microscopes. There is data also on the Geiger-counter x-ray diffractometer, the 90-degree diffractometer, the x-ray spectrograph and the high and low angle goniometer.

Transistor Batteries. Burgess Battery Co., Freeport, Ill., has recently published a four-page folder covering its developments in the field of transistor batteries. The folder describes the requirements for batteries used in transistor circuit operation, and how the company's batteries meet

Shielding, Inc. customers represent an American who's who

of scientific, educational, industrial, Governmental and Military organizations. A complete list is available on request. *Indicates those who have reordered.

A partial list of users of MULTI-CELL® SHIELDING ROOMS—from current records...

- ELECTRONIC MANUFACTURERS**
- *Air Associates Corporation
 - *General Electric Co. Canada
 - Melpar, Inc.
 - Canada Labs., Inc.
 - R.C.A., Harrison, N. J.
 - Moorestown, N. J.
 - Warner Electric Co. Electric Co.
 - Div. Westinghouse Electronics Div. Baltimore
 - Bell Sound System
 - Allen D. Cardwell Co.
 - *Motorola, Inc.
 - *Raytheon Mfg. Co.
 - Browns Mills, N. J.
 - *R.C.A., Lancaster, Pa.
 - *Sperry-Gyroscope Co.
 - Sylvania Electric Products Co.
 - *Westinghouse Electric Corporation Pittsburgh, Pa.
 - *Admiral Corporation
 - *Bendix Aviation Corporation
 - Eclipse-Pioneer Corporation
 - Northern Electric Co., Ontario
 - *Radio Engineering, Bloomington, Ind.
 - *R.C.A., Camden, N. J.
 - *R.C.A., Western Air Arm
 - *Stewart Air Arm
 - *Westinghouse Elec-
- AVIATION COMPANIES**
- *Boeing Aircraft Co.
 - Vought Aircraft Corporation
 - Aircraft Engineering Corporation
 - Consolidated Vultee Aircraft
 - Public Aviation Corporation
 - Hughes Aircraft Co.
 - *Chance-Gruman
- U. S. GOVERNMENT AGENCIES**
- *USAF
 - *Buair
 - Yards and Docks
 - Radiological Laboratories
 - U. S. Coast Guard
 - Civil Aeronautics Administration
 - Bureau of U. S. Institute of Technology
- UNIVERSITIES**
- University of California
 - Massachusetts Institute of Technology
- MISCELLANEOUS**
- Sound Laboratories
 - Chemical Div. E. I. duPont Engineering, Inc.
 - Avinox Co.
 - Bertke Electric Co.
 - City of Rochester, N. Y.
 - deNemours & Co.
 - Manning-Maxwell-Moore
 - Bell Laboratories
 - Carbide & Carbon
 - Eastman Kodak Co.
 - International Electronic

Plus rooms sold to electrical contractors, State and Municipal agencies and others in manufacturing and experimental fields.

"The talent to create—the skill to produce"

The only rooms that meet standard, approved Military specifications MIL-S-4957 plus JAN-1-225. 16E4 (Ships) MIL-1-1691C in addition to all others for electronic and electronic equipment performance in research, development and production. Attenuation Min. 100 db. from 10 to 10,000 MC, Catalog on request.



SHIELDING, INC.
RIVERSIDE, N. J.

Los Angeles, Calif. — 2924 Selby Avenue • Phone: Vermont 9-6388



Strength like beauty must be more than skin deep



Centralab metallized ceramics have a bond of 2000 psi

- Centralab's bond of non-ferrous metals to ceramic bodies is almost as strong as the material itself.
- Your precision requirements met by combining most desirable properties of metals and ceramic materials with JAN-specified characteristics, including:
 - High dielectric strength — 240 volts per mil.
 - Low loss at high frequency — loss factor at 1 MC — .007.
 - High mechanical strength—18,000 psi, modulus of rupture.
 - Harder than quartz — 7.5 Mohs' scale.
- Impervious to moisture or acids (.005%).

Metallizing is available for variometer rotor bars, feed-thru bushings, hermetically sealed parts, precision-machined units and many other applications. Send Centralab your problem.

Centralab is the leader in ceramic design and development

- 1 Quality ceramics since 1928.
- 2 Largest staff of engineers, physicists, and chemists of any ceramic producer available for consultation.
- 3 Modern, mechanized production facilities for your volume ceramic requirements.



Write now! Before you forget . . . for complete details on Centralab quality ceramics.

Centralab

A Division of Globe-Union Inc.
914 E. Keefe Avenue • Milwaukee 1, Wisconsin
In Canada: 804 Mt. Pleasant Road, Toronto, Ontario

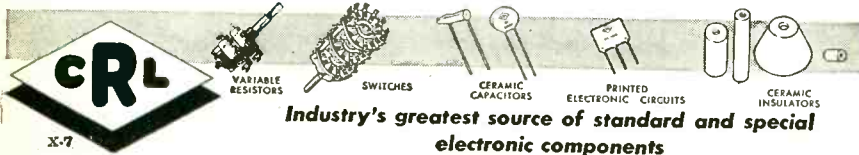

them. Graphs are also used to show the performance of these transistor batteries in comparison to other types and makes. Typical batteries now being used by transistor engineers are illustrated and described.

Insulating Varnishes and Resins. Dow Corning Corp., Midland, Mich. A summary sheet gives a concise comparison of the properties and performance of leading silicone electrical insulating resins. Known as the "Resin Resume", it reviews five coating and impregnating varnishes, an adhesive, and six bonding and laminating resins. Each is described individually, along with its recommended applications. Tables then compare each resin with all the others through nine properties: dielectric strength; weight loss after 3 hours at 250 C, solids content, color, specific gravity, viscosity, drying time, flash point, solvents, thinners and shipping weight. Flex and craze life values, in terms of hours at 250 C, are also given for the impregnating varnishes. Also included are curves showing the thermal life, based on 50-percent retention of dielectric strength, of leading silicone dipping varnishes and cloth coating resins, plus that of class B materials.

Magnetic Amplifiers. Vickers Electric Division, Vickers Inc., 1815 Locust St., St. Louis 3, Mo. Recent bulletins describe two new series of amplifiers, the 2500 and 2700 series. The series discussed supersede the 2400 and 2600 series described in the "Magnetic Amplifier Design Handbook." The 2700 series (high-power) amplifiers make available much higher power ratings than did the 2600 series. Standard 2700 series units rate as high as 11 kw, single phase, and 45 kw, three phase. Control ampere-turn requirements have been reduced approximately 50 percent. Both the 2500 and 2700 series have been designed to take full advantage of improved core materials and provide more consistent electrical characteristics. For greater convenience in mounting and connecting, terminal

blocks on 2500 and 2700 series amplifiers are mounted on the tops of the units.

Electromagnetic Relays. Potter & Brumfield, Princeton, Ind., has published a brochure containing papers selected from those given at a two-day symposium on electromagnetic relays at Oklahoma A & M College, Stillwater, Okla. Virtually all factors pertinent to the design, manufacture and use of relays are covered. With this brochure, the company and the authors of the technical papers have established the first practical basis for a constant interchange of educational material between users, manufacturers, engineers and educators.

Tetrafluoroethylene Resin Finishes. E. I. DuPont de Nemours & Co., Wilmington 98, Del., has available a third revision of a technical bulletin on Teflon tetra fluoroethylene resin finishes. The 12-page bulletin lists 17 successful new Teflon applications in addition to those reported in the earlier edition. They are: agitator paddles, dry ice platens, dye vats, filling equipment, floor tile molds, glass stop cocks, glue pots and dispensers, glueing machines, ladles, mandrels, pails, reels, rubber-boot lasts, size boxes, soap dies and troughs. All new uses are derived from the notable release or anti-sticking property of Teflon, its high corrosion and heat resistance, as well as its low coefficient of friction. The booklet discusses various finishing systems of teflon primers and enamels over metallic and nonmetallic surfaces, application methods, the fusing operation, precautions and handling procedures.

Metal Detector. Bayliss Electronics, 15 Simpson St., Mitcham, Victoria, Australia. A single-sheet bulletin discusses an industrial electronic metal detector that is a scientifically designed automatic inspection apparatus for the detection of ferrous and nonferrous metallic particles in nonmetallic materials, such as foodstuffs, textiles, pharmaceutical products, pulp, tobacco, plastics, rubber,

BALLANTINE

STILL THE FINEST IN ELECTRONIC VOLTMETERS



Ballantine Model 300
SENSITIVE
ELECTRONIC
VOLTMETER
 Featuring a Logarithmic
 Voltage Scale and
 Uniform Decibel Scale

PRICE...\$210.

- Measures 1 millivolt to 100 volts over a frequency range from 10 to 150,000 cycles on a single logarithmic scale by means of a five decade range selector switch.
- Accuracy: 2% at any point on the scale over the ENTIRE RANGE.
- Input Impedance: $\frac{1}{2}$ megohm shunted by 30 mmfds.
- Generous use of negative feedback assures customary Ballantine stability.
- Output jack and output control permit voltmeter to be used as a flat h. gain (70DB) amplifier.
- Available accessories permit range to be extended up to 10,000 volts and down to 20 microvolts.
- Available Precision Shunt Resistors convert voltmeter to microammeter covering range from 1 to 1000 microamperes.

For additional information on the Voltmeter and Ballantine Battery Operated Voltmeters, Wide-Band Voltmeters, Peak to Peak Voltmeters, Decade Amplifiers, Inverters, Multipliers and Precision Shunt Resistors, write for catalog.

BALLANTINE LABORATORIES, INC.

100 FANNY ROAD, BOONTON, NEW JERSEY



ANOTHER FILTER PROBLEM SOLVED!

Sprague Helped Make This Dynamotor Radio Noise-Free

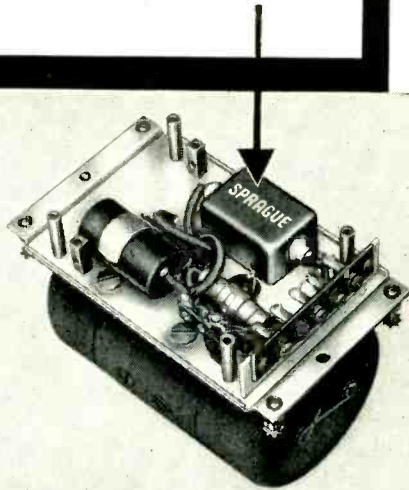

*Photo Courtesy LearCal Div., Lear, Inc.,
Los Angeles, Cal.*

PROBLEM—VHF radio transmitters and receivers (Model LTR-6), as well as Automatic Pilots (Model L-2), both manufactured by the LearCal Division of Lear, Inc., for use in business and private planes, were originally designed to use a Dynamotor Power Supply (Model LD-S). However, early in the development of this precise airborne gear, Lear engineers discovered that arcing of the commutators in the Dynamotor caused intolerable radio frequency noise.

APPROACH—Lear gave Sprague's Radio Noise Suppression Labs in Culver City the problem of designing a special filter to meet Lear's difficult specifications as to size, weight, and performance.

SOLUTION—Sprague Labs designed a tailor-made filter to meet all requirements and completely eliminate the electrical motor noise.

PRODUCTION SCHEDULES for such filters designed by Sprague's California labs are regularly met by Sprague's extensive pilot plant and mass-manufacturing facilities, the former for those sizzling rush orders, the latter for volume needs. For help with your radio noise filter applications, write, wire, or phone Sprague Electric Co., 11325 Washington Blvd., Culver City, Calif. (TEXas 0-7491) or North Adams, Mass. (MOhawk 3-5311).

Sprague on request will provide you with complete application engineering service for optimum results in the use of radio noise filters.

YOU CAN DEPEND ON

SPRAGUE

coal and minerals. Illustrations, chief features, details of operation and specifications are given.

TV Technician's Timesaver. Simpson Electric Co., 5200 W. Kinzie St., Chicago 44, Ill. The first issue of "The Technician's Timesaver" is now being distributed. Purpose of the publication is to show effective shortcuts to tv servicing . . . more practical applications for electronic test equipment. The first issue tells how to adjust a video amplifier and also contains an important announcement about servicing color tv.

Decade Amplifier. Gulton Mfg. Corp., Metuchen, N. J. A single-sheet catalog bulletin illustrates and describes the Glennite model F-408 decade amplifier that features cathode-follower input, low noise, provision for filters, functional block construction, a-c operation and antimicrophonic construction. Complete technical characteristics of the unit are given.

Conversion Chart. Cinema Engineering Co., Division of Aerovox Corp., 1100 Chestnut St., Burbank, Calif., has issued an audio power conversion chart that is printed in card form for hanging on the wall or placing under glass tops of desks. The chart contains three columns: (1) power level in watts; (2) power level in db, zero reference being 1 mw, dbm also expressed as volume units; and (3) voltage across a 600-ohm line. The tabulation may be used in converting from the old db system (zero equals 0.006 w) to dbm, add 7.78 db; when converting from dbm to the old db system, subtract 7.78 db; and for voltages across impedances other than 600-ohm line use the chart voltage from column V; insert in the formula, V times the square root of Z over 600 equals voltage across Z.

House Organ. Nuclear Instrument and Chemical Corp., 229 W. Erie St., Chicago 10, Ill., has recently released the 4th issue of the Nucleus. An article in the issue describes new methods for counting radioactive iodine in the measurements of thyroid function. Also

included are an article on radio-isotope facilities in the general hospital; an article on isotope dilution analysis, and a description of the new radiochromatographic analyzer.

Couplings. Renbrandt, Inc., 98 Kirkland St., Cambridge 38, Mass., has available an 8-page booklet dealing with couplings for servo-mechanisms, computers, breadboards, and electromechanical instruments. The couplings described feature zero backlash, low inertia, high flexibility, versatility and moderate cost. Dimensional data, ordering instructions and set-screw information are included.

Twin-Tetrode Tube. Amperex Electronic Corp., 230 Duffy Ave., Hicksville, L. I., N. Y., has available a new data and application booklet on the twin-tetrode tube, type 5894/AX-9903. The 26-page booklet includes detailed data, application notes, typical performance curves, special features and a description of the tube. The new booklet will be useful to new equipment designers, as well as others using the tetrode.

Trimming Potentiometers. Bourns Laboratories, 6135 Magnolia Ave., Riverside, Calif. A 6-page brochure, No. 3591, describes a new wire-wound trimming potentiometer. Featured are the new standard resistance values from 250 ohms to 25,000 ohms. Detailed specifications cover vibration, acceleration, temperature coefficient of wire and operating temperature range. Included are a resistance-resolution-wire chart, an outline drawing, a wiring diagram and photographs.

Delay Lines. Electrometric, Inc., Woodstock, Ill., has available a new catalog page on distributed constant delay lines for iff, color tv and many other military and commercial applications. Three unique design features are described. A table lists 12 typical delay lines with complete technical data on dimensions not including terminals, maximum delay (one way), maximum rise time, im-

To Serve You Better - Another New Building!

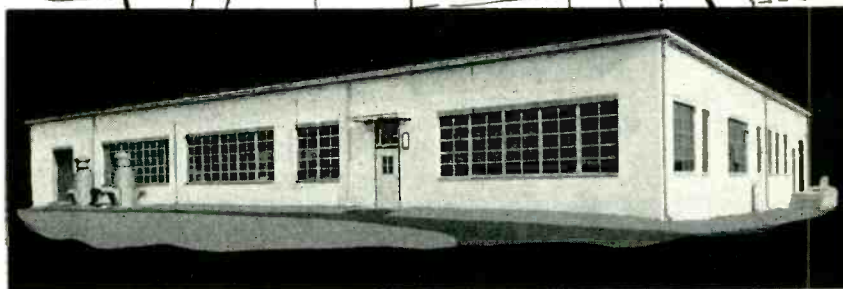
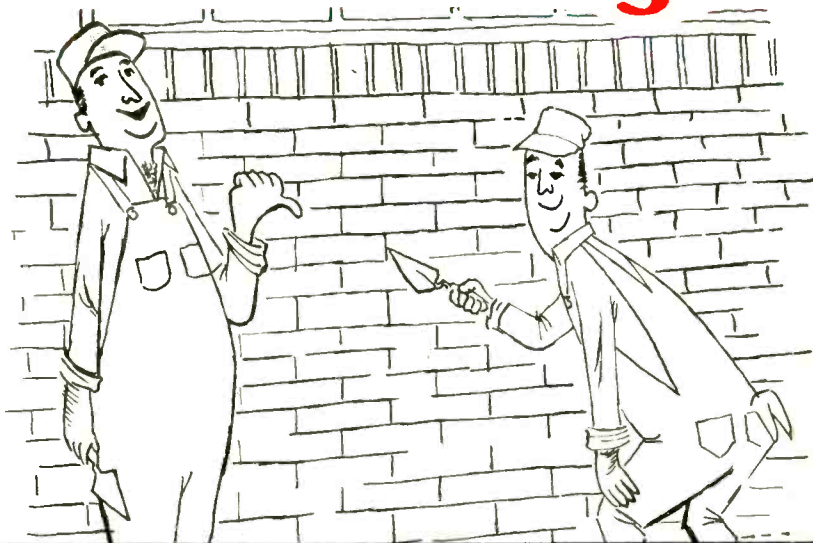

Business has been good. The demands of you designers, engineers, purchasing men, and others have made this new building necessary.

The confidence you've shown is appreciated.

You can be sure, when you need small diameter spiral wound paper tubes of hi-dielectric kraft, fish paper, plastic film, or phenolic impregnated, your requirements can be met with superb service at the lowest possible cost . . . and you already know about the quality of Stone.

Let us hear from you soon.

STONE PAPER TUBE CO.
AFFILIATED WITH
STONIZED PRODUCTS CO., INC.
900-922 Franklin Street, N.E., Washington 17, D. C.

PHOTOCIRCUITS, INC. SELECTS *NEW* HUBBELL *Interlock* TRADE-MARK SUB-MINIATURE CONNECTORS FOR WIRING PRINTED CIRCUITS!

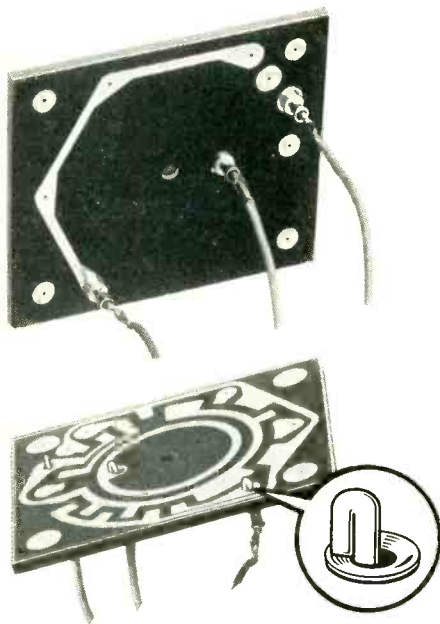

Made for each other! Hubbell Interlock's sub-miniature connectors make wiring of printed circuits fast and safe. Note how Interlock Type "C" Connectors pass through set-in eyelets from back and lock automatically on opposite side. Eyelets manufactured by United Shoe Machinery Corp. Eyelet setting machines are available.

Hubbell Interlock sub-miniature Type "C" Connector. Simplicity of design is the key to its constant low contact resistance and ease of installation features.

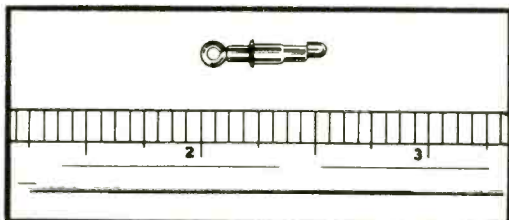

Hubbell Interlock's latest development, the sub-miniature Type "C" Connector, featuring low contact resistance, automatic locking — quick disconnect wiring, found immediate application to another recent advancement in the electronic field — the "printed" circuit. The tiny connectors met every requirement for wiring the illustrated rotary switch plate circuit manufactured by Photocircuits, Inc. of Glen Cove, N.Y. Their automatic locking — quick disconnect feature eliminated difficult soldering and made possible fast, easy wiring maintenance. The exclusive Hubbell Interlock locking mechanism assured a vibration-proof, constant low contact resistance.

For Difficult Wiring Problems Requiring Sub-Miniature Connectors, Our Development Laboratory Will Cooperate With Your Engineers To Adapt Interlock For Your Specific Applications.

See Booth #406 at the IRE Show, Kingsbridge Armory, N.Y.C.



For Further Information, Write Dept. A:

HARVEY HUBBELL, INC.
Interlock Dept., Bridgeport 2, Conn.

pedance, and approximate attenuation. Three delay lines and two hermetically sealed containers are illustrated in the catalog page.

Tapping Screws. Townsend Co., New Brighton, Pa., has issued an 8-page booklet describing in detail seven different types of screws that form their own threads as they enter various types of materials. The booklet also tells how the tapping screws make quick, economical and secure fastenings in materials ranging from plywood to plastics and metals. Featured is a selection chart describing what screws are recommended for these different materials: sheet metal, sheet stainless steel, structural steel, ferrous and nonferrous castings, ferrous and nonferrous forgings, thermosetting and thermoplastic plastics, plastics, plywood and compositions like asbestos. Ask for booklet TL-88.

Instrument Transformers. General Electric Co., Schenectady 5, N. Y., has announced the 1954 edition of its "Instrument Transformer Buyer's Guide," containing basic, up-to-date information on the complete line. The fully illustrated, 96-page publication, GEA-4626G, contains ratings, ASA accuracy classifications, and prices of all GE indoor and outdoor potential and current transformers. Listings of ratio and phase angle tests, together with tables covering the mechanical and thermal limits of current transformers, are included.

Power Resistors. International Resistance Co., 401 N. Broad St., Philadelphia 8, Pa. A new catalog sheet, bulletin P-2, deals with types PW-7 and PW-10 power resistors. Comprehensive data on characteristics, applications, construction, ranges, ratings, tolerance, charts and graphs are included.

Electrical Measuring Instruments. Central Scientific Co., 1700 Irving Park Rd., Chicago 13, Ill. This 12-page bulletin is an excellent guide for the selection of electronic and electrical measuring instruments and accessories for lab

or industrial requirements. A wide variety of instruments is illustrated and described. Typical items included are electronic electrometers, electronic relays, a-f oscillators, Wheatstone bridges, potentiometers, resistance standards, frequency meters, fluxmeters and oscilloscopes.

Epoxy-Resin Laminate. Plastilight Inc., 481 Canal St., Stamford, Conn., has issued a single-page catalog sheet dealing with Epoglas, an epoxy-resin laminate with a glass-cloth filter, designed primarily for use in the electrical and electronic industries. The Epoglas described is supplied in sheets 24 in. x 36 in. and 36 in. x 48 in. and in thicknesses from 0.003 in. through 0.5 in. Illustrations and full technical data are given.

Super-Regulator. Kalbfell Laboratories Inc., 1090 Morena Blvd., San Diego 10, Calif. A single-sheet catalog bulletin deals with the Super-Regulator, an instrument which converts ordinary power supplies to provide extremely low output impedance and ripple. Illustrations, specifications and a list of applications are included.

Sound-Proof Rooms. Industrial Acoustics Co., Inc., 341 Jackson Ave., New York 54, N. Y., has published a brochure describing a series of newly developed prefabricated sound-proof rooms. The rooms described offer a wide application to industry, aircraft manufacturing, motion pictures, radio and tv fields as equipment testing rooms, noisy machinery enclosures, soundproof camera and projector rooms, soundproof audiometric testing rooms and innumerable other applications. Main features are outlined in the brochure.

Medium-Mu Triode. Lewis and Kaufman, Ltd., 50 El Rancho Ave., Los Gatos, Calif. A new data sheet describes the Los Gatos brand 3C24/24G medium-mu triode—a tube having maximum plate dissipation of 25 w and recommended for use as amplifier, modulator or oscillator with maximum ratings

New wideband couplers for measurements 3 to 2,000 mc

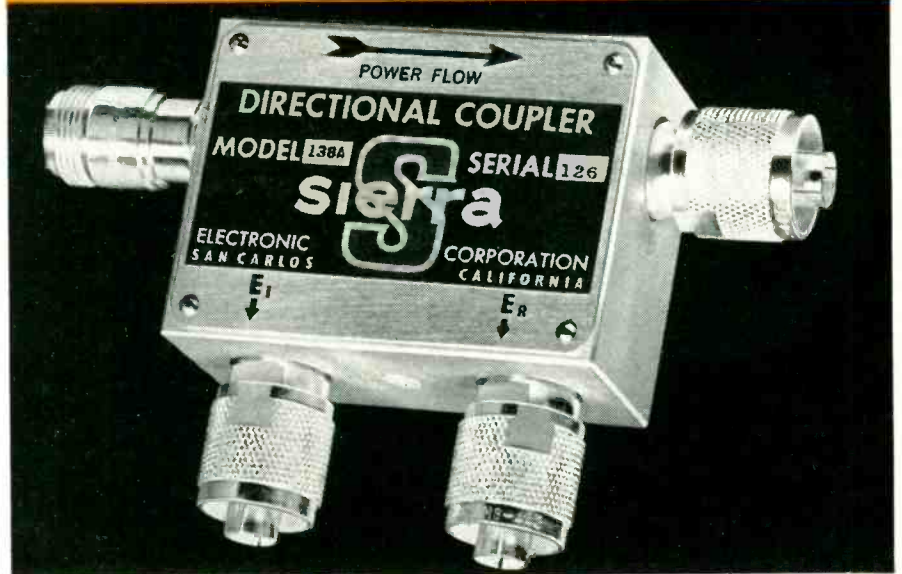

Versatile, accurate Sierra Wideband Directional Couplers are now available in six different models offering a wide choice of coupling factors. Collectively, the instruments cover frequencies from 3 to 2,000 mc; and within this range they make possible all necessary transmission line measurements including reflection coefficient, VSWR and power. The Couplers also permit loads to be matched to lines dynamically by indicating which conditions result in minimization of reflected wave voltages.

Sierra Couplers are sturdily engineered, compact, easy to install and low in cost. They may be used in the laboratory for measurement, or in the field as components in VHF-UHF equipment or other coaxial systems where power and match are monitored continuously.

SPECIFICATIONS

Coupling Factor: (In db \pm 1 db)

MODEL	3 mc	10 mc	30 mc	100 mc	300 mc	1000 mc	2000 mc
137, 137A			73	63	53	43	37
138, 138A			60	50	40	30	
145	52	42	32	22	12		
150			53	43	33	23	

Directivity: 12 db \pm 3 db greater than coupling factor at each frequency.

Impedance: Models 137 and 138 are 51.5 ohms; Models 137A, 138A, 145 and 150 are 50.0 ohms.

Power: Usable to 1000 watts throughout frequency range.

Size: 3½" x 5½"; Type N fittings.

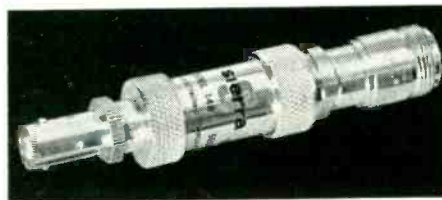

To insure sensitive readout for Sierra VHF-UHF Directional Couplers, new Model 148 Crystal Detector is offered. This instrument has an impedance of 50 ohms and a built-in low pass output filter. It employs a 1N21B crystal, Type N input and BNC output jacks. VSWR is low, only 1.5 at 1,200 mc.

For complete details request Bulletin 104
Data subject to change without notice.



SEE THESE AND OTHER NEW
SIERRA INSTRUMENTS AT I.R.E.

711 AIRBORNE AVE.

sierra

Sierra Electronic Corporation
San Carlos 2, California, U. S. A.

Manufacturers of Carrier Frequency Voltmeters, Wave Analyzers, Line Fault Analyzers, Directional Couplers, Wideband RF Transformers, Custom Radio Transmitters, VHF-UHF Detectors, Variable Impedance Wattmeters, Reflection Coefficient Meters.

phastron

SEALED panel instruments
RUGGEDIZED panel instruments
RUGGEDIZED and SEALED panel instruments



VISIT US AT THE I.R.E. SHOW
Kingsbridge Armory, Bronx, N. Y.
BOOTH 479 ELECTRONICS AVE.

panel meters and null indicators

1 1/2", 2 1/2", 3 1/2" and 4 1/2" sizes.

Built to JAN-I-6 and MIL-R-10304 specifications, these meters incorporate aged Alnico magnets, R.F. shielding, shock mounted jewels, glass-to-metal HERMETIC SEALS and RUGGEDIZED, shock mounted construction.

Manufactured in an air-conditioned, temperature-controlled plant, these Environment Free instruments are available in A.C. and D.C. models.

phastron

HERMETICALLY SEALED

1/4 to 2 watts HERMETICALLY SEALED in glass (the CA-H pictured here) and in a Specification Series (the CA-4R) which exceeds MIL-R-10509 spec. for fixed, accurate resistors.

For equipment subject to extremes of temperature, for high frequency applications and for closely matched units, these conservatively rated resistors provide the utmost in stability, precision and dependability.

100% inspection on each "CARB-OHM" assures conformance to specifications and ratings.

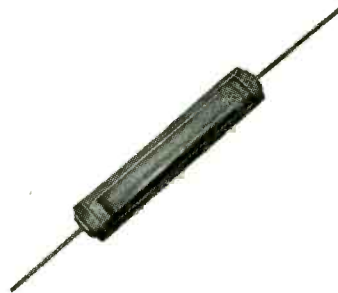

"CARB-OHMS"
deposited carbon resistors

phastron

HERMETICALLY SEALED

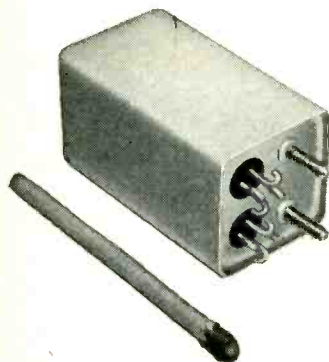

BEST BY ANY COMPARISON

SENSITIVE MINIATURE RELAYS

perfectly counter-balanced armature

Contact arrangements up to and including D.P. D.T. 3 amp at 28 volts D.C., or 100 milliamperes at 150 volts D.C. resistive load.

This miniature HERMETICALLY SEALED relay is designed to operate thru wide ranges of environment including the shock requirements of MIL-E-5400. It will withstand 50 G's acceleration without malfunctioning and its use is recommended wherever extremes of shock, temperature and severe vibration are encountered.

Required coil power as low as 20 milliwatts.
Coil resistance up to 15,000 ohms.
Weight, max. 3.0 oz.

ENVIRONMENT FREE
ELECTRICAL EQUIPMENT by



PHASTRON COMPANY • 151 PASADENA AVE. • SOUTH PASADENA, CALIF.

NEW PRODUCTS

(continued)

to 60 mc. The tube is illustrated; and the data sheet includes outline dimensions, general characteristics and average static performance curves. Operating parameters are tabulated for application as a class-C r-f power amplifier unmodulated; a class-C r-f power amplifier plate-modulated; an r-f double amplifier; and a class-B a-f power amplifier.

Cathode-Follower Probe. Gulton Mfg. Corp., Metuchen, N. J. Bulletin F-400 covers the F-400 Glenite cathode-follower probe that features small size, high input impedance, low power consumption and low-microphonics. The unit illustrated and described is designed for coupling high-impedance dynamic voltage generators such as piezoelectric accelerometers, microphones, strain gages, displacement gages, hydrophones and similar instruments into standard electronic measuring equipment. A dimensional drawing is included.

Liquid Level Controls. Ferrara Inc., 8106 N. Nine Mile Rd., Oak Park 37, Mich. A 6-page illustrated bulletin describing fully a new line of liquid-level controls has been made available. The controls discussed may be obtained in two basic types, electromagnetic and electronic. The electromagnetic unit features a unique circuit employing a d-c operated relay for hum and chatter free operation with a-c in the probe circuit. The electronic unit with less than 2-microamperes current in the probe circuit employs a cold-cathode amplifier for use with liquids having resistivities up to 200 megohms. Full information regarding operating conditions, load ratings, applications and flexibility is available.

Tape Recorder Bulletin. Minnesota Mining and Mfg. Co., 900 Fauquier St., St. Paul 6, Minn. The problems of tape-recorder head alignment and head wear are discussed in a new technical bulletin—"Sound Talk" bulletin No. 27. The 3-page bulletin covers azimuth alignment and tape skewing, importance of head contact, and the

effects of head wear on magnetic tape recording and reproduction. In addition, it includes an 8-step check list for locating the cause of high-frequency response loss due to head problems.

Pulse Instruments. Electro-Pulse, Inc., 11811 Major St., Culver City, Calif., has available a 4-page 2-color brochure on its block unitized multipurpose pulse instruments. The bulletin illustrates and describes 11 models. The block unitization discussed provides change of instrument function by change of rear plug-in cable, and allows expansion of the basic instrument by extending range and application.

Panel Instruments. Q.V.S. Inc., 20 N. 15th St., East Orange, N. J., have available a four-page bulletin providing electrical and mechanical specifications on their panel instruments. Included are three series of sealed instruments in 1½ in., 3½ in. and 4½ in. sizes.

Facilities Brochure. El-Tronics, Inc., Fifth and Noble Streets, Philadelphia 23, Pa. A 12-page booklet describes the company's products, people, plant and performance record in building electronic and nucleonic equipment. The brochure is well illustrated.

Frequency Meters. Frequency Standards, Asbury Park, N. J. A 2-page catalog sheet covers four models of frequency meters—the FS-C-171-A (900-1, 200 mc); FS-C-172-A (1,200-1, 600 mc); FS-C-173-A (1,600-2,250 mc); and FS-C-174-A (1,700-2,550 mc). Included are an illustration, application information, descriptive and technical specifications.

Hysteresis Motors. Collins Radio Co., Cedar Rapids, Iowa, has available reprints of an advertisement illustrating and describing the 370A series of hysteresis motors designed primarily for operation from vacuum tubes. The superior efficiency and high starting torque of the units described make them suited for driving timing mechanisms, magnetic storage drums or any other device which must rotate at an absolutely constant speed re-

This Story is full of Holes...



1808 to be ACCURATE!

WHEN the W. L. Maxson Corp. needed gear train panels for their computing machines, *Universal* got the nod for one important reason! Notwithstanding our years of experience and an enviable record for producing precision work—this job came to us primarily because we had the equipment* to do the job best!

Working to tolerances of $\pm .0005$ between holes, and tolerances of $\pm .0002$ on the holes themselves, interior of holes finished to 4 to 6 micro-inches, this precision boring operation on 24 ST aluminum sheets, is just one of the many jobs of its kind constantly "in work" at our plant.

*The Jig Boring Machine that handled this job, employs an optical measuring system instead of the usual threaded spindle, this machine attains an accuracy undreamed of in other machines.

"Accuracy Is A UNIVERSAL Word"

Our Engineering Staff is Available to Help You Send specifications or blueprints for quotation.



Universal Manufacturing Company, Inc.

402 HILLSIDE AVENUE • HILLSIDE, NEW JERSEY

krohn-hite

presents
the ultimate in
power
amplification

**ultra-low distortion
POWER AMPLIFIER**

delivering
99.99999996%*
distortion free power...



MODEL UF-101

0.005% Harmonic and Intermodulation Distortion at 30 Watts
80 db Feedback controlled from 0.01 cps to 20 mc with conservative gain and phase margin...

POWER OUTPUT
30 watts from 15 cps to 30 kc ± 1 db
FREQUENCY RESPONSE
 ± 0.5 db from 0.5 cps to 30 kc
 ± 3 db from 0.03 cps to 70 kc
TRANSIENT RESPONSE
Excellent at all output impedances
DYNAMIC RANGE.....110 db
OUTPUT IMPEDANCE 2, 4, 8, 16 and 450 ohms
INTERNAL IMPEDANCE
Less than 1/100 of output impedance
INPUT IMPEDANCE
100k potentiometer or 6.8 megohms
VOLTAGE GAIN
14 db or 30 db to 16 ohm output
PRICE...\$350.00

*Typical harmonic distortion at 1000 cps is 0.002% in voltage, or 0.00000004% in power.



See us at I.R.E. Show
Booth 201

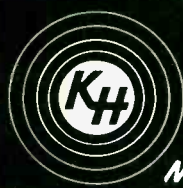

write for free
NEW CATALOG!

krohn-hite
INSTRUMENT COMPANY
580 MASS. AVE., CAMBRIDGE 39, MASS.

For more ad information, see Index to Advertisers.

NEW PRODUCTS

(continued)

ardless of fluctuations in load or line voltage.

Design Engineers' Reference Booklet. I-T-E Circuit Breaker Co., 19th and Hamilton Sts., Philadelphia 30, Pa. Publication No. SP-100 is a 20-page booklet that design engineers and methods engineers will want for information and reference. The booklet shows and tells what the organization is doing to develop products to performance specifications. It discusses radar antenna systems—their design, development and fabrication; jet engines—new fabrication methods for major components of engines; thermodynamics—design, development and fabrication of equipment to operate on advanced theories; guided missiles and new fabricating techniques for airframe members; Titanium—the development of new welding, forging, forming and spinning techniques for this hard-to-work metal.

Connectors. Cannon Electric Co., 3209 Humboldt St., Los Angeles 31, Calif. Bulletin AN-E-1 announces the E series of lightweight, vibration-proof connectors with integral cable clamps and grounding lugs. The publication shows how protection from cable to cable is afforded by inserts and grommets of recently improved lightweight resilient compounds. Dimensional diagrams and photographs are included.

VHF Transmitter. The Collins Radio Co., Cedar Rapids, Iowa. A single-sheet bulletin illustrates and describes the 242F-3 vhf transmitter. With the equipment discussed, an unlimited number of r-f units can be locally controlled. The 278E-1 remote unit described can control transmitter power on-off, audio gain, push-to-talk and frequency selection. Complete specifications are included.

Side-Indicating Panel Meters. International Instruments Inc., P.O. Box 2954, New Haven, 15, Conn. A data sheet gives complete performance information on the miniature side-indicating panel meters. The information included relates to proper specification for manufacturing description, and



**STOP RF LEAKAGE
ON THE
DRAWING BOARD**

... WHEN YOU DESIGN METEX ELECTRONIC WEATHERSTRIPPING INTO YOUR EQUIPMENT YOU GET ITS POSITIVE SHIELDING EFFECTIVENESS — AT MAXIMUM OVERALL ECONOMY

Plan now to take full advantage of *Metex Electronic Weatherstripping's* unusual effectiveness in shielding all types of electronic equipment. Because it is made of knitted wire mesh, *Metex Electronic Weatherstripping* is both conductive and resilient. It assures positive metal-to-metal contact between all mating surfaces. And being resilient it accommodates itself positively to surface inequalities.

In reality, *Metex Electronic Weatherstripping* can do more for you than just shield RF leakage. It can cut the cost of machining mating surfaces to close tolerances. It can eliminate the need for extra fasteners and many other costly means of making joints RF tight.

Applications in which *Metex Electronic Weatherstripping* has already proved its effectiveness include pulse modulator shields, wave-guide choke-flange gaskets, local oscillators on TV sets, dielectric heaters, etc.



For detailed information on METEX ELECTRONIC PRODUCTS, write for FREE copy of "Metex Electronic Weatherstrips" or outline your SPECIFIC shielding problem — it will receive our immediate attention.

**METAL
TEXTILE
CORPORATION**

ROSELLE, NEW JERSEY

For more ad information, see Index to Advertisers.

March, 1954 — ELECTRONICS

includes information of interest to design engineers. The meters described offer 87 percent of the scale length of a standard 2½-in. round panel meter with only 1/10 the panel area. The data sheet describes accuracy as being ±3 percent of full-scale deflection for d-c and ±5 percent for a-c instruments.

Instrument Catalog. El-Tronics, Inc., Fifth and Noble Streets, Philadelphia 23, Pa., has published an illustrated booklet describing a wide line of instruments and accessories for the detection and measurement of radioactivity. Technical specifications are given for scales, counting-rate meters, survey meters and detecting devices. Laboratory planning suggestions are included.

Digital Voltmeter. Non-Linear Systems, Inc., Del Mar, Calif. A 4-page folder illustrates and describes digital voltmeters that present voltage measurements in numerical form with accuracy and speed. Technical data on models are outlined and chief features are included.

Relays. Barth Engineering & Mfg. Co., Milldale, Conn., has issued a bulletin covering a new line of relays which feature snap-action switching contacts, dynamically balanced armatures and construction of high-temperature materials throughout. The relays described are designed for use in aircraft, rockets, missiles, submarines, ships and wherever shock, vibration or temperature are problems.

Proximity Meter-Capacitance Gage. Fielden Instrument Division, Robertshaw Fulton Controls Co., 2920 N. Fourth St., Philadelphia 33, Pa. A 2-page bulletin describes a new and versatile measuring instrument. The compact proximity meter-capacitance gage described compares, measures or monitors dimensions and distortions which were previously impossible to obtain by mechanical means. The device discussed is applicable to both static and dynamic measurements and is sensitive to 0.05 μf or closer.

THE krohn-hite

new UHR* series

POWER SUPPLIES

extremely low dc and ac impedance . . . ruggedized meters



MODEL UHR-220

POSITIVE SUPPLY	
0-500 volts, 0-200 ma	
Regulation	0.001%
Ripple	100 microvolts
Impedance at Any Load . . . dc	0.01 ohms, ac 0.1 ohms in series with 0.1 microhenry (4" of wire)
Transient Response	0.01 millisecond
NEGATIVE SUPPLY	
0-150 volts, 0-5 ma	
Ripple	2 millivolts
FILAMENT SUPPLY	
12.6 volts ac at 4 amps CT	
METERS	2 ranges, 0-50 and 0-500 volts, 0-20 and 0-200 ma
PRICE	\$350.00



MODEL UHR-245

POSITIVE SUPPLY	
0-500 volts, 0-500 ma	
Regulation	0.001%
Ripple	100 microvolts
Impedance at Any Load . . . dc	0.005 ohms, ac 0.05 ohms in series with 0.1 microhenry (4" of wire)
Transient Response	0.01 millisecond
NEGATIVE SUPPLY	
0-150 volts, 0-5 ma	
Ripple	2 millivolts
FILAMENT SUPPLY	
12.6 volts dc at 5 amps	
Ripple	50 millivolts
METERS	Voltmeter, 0-500 volts Ammeter, 0-500 ma
PRICE	\$550.00

MODEL UHR-225

POSITIVE SUPPLY	
150-500 volts, 0-200 ma	
Regulation	0.002%
Ripple	100 microvolts
Impedance at Any Load . . . dc	0.01 ohms, ac 0.1 ohms in series with 0.1 microhenry (4" of wire)
Transient Response	0.01 millisecond
FILAMENT SUPPLY	
12.6 volts ac at 4 amps CT	
METERS	Voltmeter, 0-500 volts Ammeter, 0-200 ma
PRICE	\$300.00

UHR-220 is ideal for
TRANSISTOR RESEARCH

*
Ultra High Regulation over the entire operating range



See us at I.R.E. Show Booth 201

write for free
NEW CATALOG!

krohn-hite
INSTRUMENT COMPANY
580 MASS. AVE., CAMBRIDGE 39, MASS.

PLANTS AND PEOPLE

Edited by WILLIAM G. ARNOLD

1954 IRE Convention sessions and papers are announced . . .
Companies realign engineers and executives . . . More plant
acquisitions are made by manufacturers . . .

OTHER DEPARTMENTS

featured in this issue:

	Page
Electrons at Work	196
Production Techniques	262
New Products	322
New Books	480
Backtalk	502

Program For The 1954 IRE National Convention Is Set

ARRANGEMENTS HAVE been completed by IRE for its 1954 national convention to be held at the Waldorf-Astoria and Shelton Hotels and Kingsbridge Armory in New York City on March 22-25.

The radio engineering show with its 600 exhibits will be housed in Kingsbridge Armory, all on one floor.

Sessions of the complete technical program, described in this issue of *ELECTRONICS*, beginning on page 470, will be held at the Armory and at the Waldorf and Shelton hotels. Buses, free of charge to registrants, will operate at frequent in-

tervals between the locations.

Subway routes from the Waldorf and Shelton to Kingsbridge Armory are listed at the right.

The social features of the convention will get under way on Monday night, March 22, in the Waldorf's grand ballroom. On Wednesday night, March 25, the grand ballroom will be the scene of the annual banquet at which Dr. Alfred N. Goldsmith, editor emeritus and co-founder of the IRE, will receive the Founders Award and will deliver the major address on the topic, "IRE—Past and Future". There will also be an acceptance

speech by Dr. William L. Everitt, recipient of the Medal of Honor.

More than 35,000 engineers and scientists are expected to attend this year's show.

HOW TO GET TO THE SHOW AT KINGSBRIDGE ARMORY

From the Waldorf and Shelton Hotels, walk north on Lexington Avenue to the 51st St. station of the Lexington Avenue IRT (Interborough Rapid Transit) and take the Lexington Avenue IRT local to 86th St. Go to the lower level and take the train marked "Jerome-Woodlawn Express" to Kingsbridge Road and Armory. The Waldorf is located at 50th St. & Park Avenue; the Shelton is located at Lexington Ave. & 49th St.

Electrical Honor Society Initiates Prominent Engineers

THREE OF THE COUNTRY'S top electrical engineers were initiated into Eminent Membership of Eta Kappa Nu Association, honor society for the electrical engineering profession.

They are, left to right: Reinhold Rudenberg, Gordon McKay professor of electrical engineering at Harvard University; W. R. G. Baker, vice-president and general manager of GE's Electronics Division and Marvin J. Kelly, president of Bell Telephone Laboratories.

Elies Elvove, chairman of Eta Kappa Nu's award committee, said Dr. Baker was chosen for Eminent Membership in recognition of his technical achievements and administrative leadership in the field of

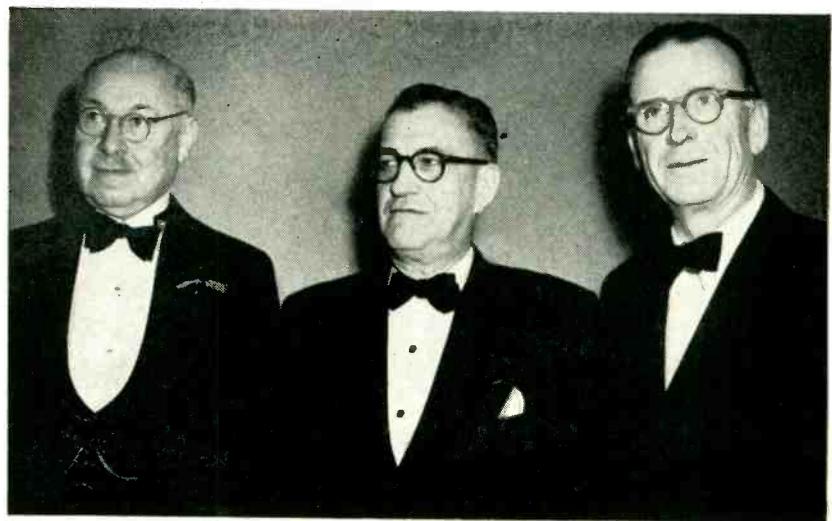

electronics; Dr. Kelly was selected for his distinguished service in directing scientific research and his

many contributions to national scientific and military policy and Dr. Rudenberg for his distin-

LAMBDA'S NEW "600 MA" SERIES

OF HEAVY DUTY, PRECISION REGULATED POWER SUPPLIES

FOUR VOLTAGE RANGES...WITH AND WITHOUT METERS

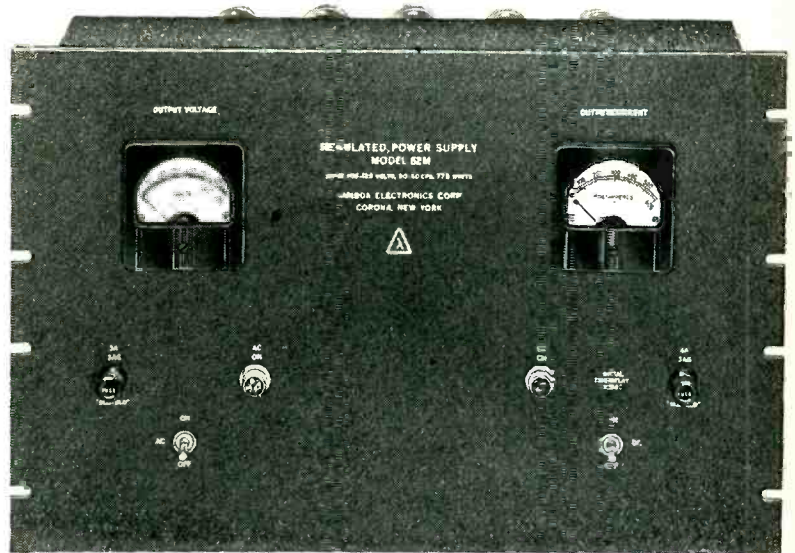
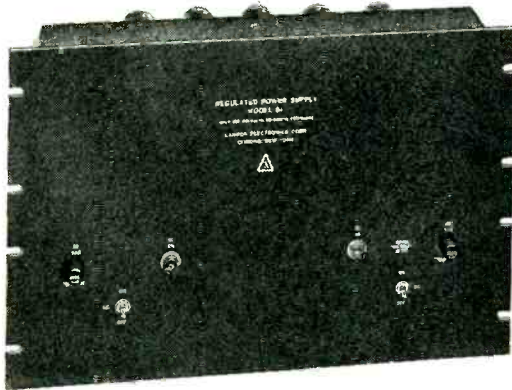

Rack Model 62 (without meters) \$239.50
(Also illustrates Models 63, 64 and 65)

Rack Model 62M (with meters) \$269.50
(Also illustrates Models 63M, 64M and 65M)

These new, compactly engineered LAMBDA models supply load currents up to 600 MA in the following voltage ranges:

Model 62 and 62M 245-305 VDC @ 0-600 MA, regulated
Model 63 and 63M 195-255 VDC @ 0-600 MA, regulated
Model 64 and 64M 100-200 VDC @ 0-600 MA, regulated
Model 65 and 65M 0-100 VDC @ 50-600 MA, regulated

Equipment in the "600 MA" series is designed for standard 19" rack mounting. Efficient design has made possible a panel height of only 12 1/4" with a depth behind panel of only 9". Intended primarily for fixed voltage use, these models are adjustable over the voltage ranges indicated. Models 62, 63, 64 and 65 are excellent sources of power for racks of equipment. Representative applications are for television studio and transmitter equipment, tube ageing

apparatus, computer installations, and multi-channel equipment. These models are well suited to all installations where comparatively large amounts of power are required. They are rated for industrial applications, based on continuous-duty operation at maximum ratings.

SCHEDULE OF PRICES

Model 62	\$239.50	Model 64	\$244.50
Model 62M	269.50	Model 64M	274.50
Model 63	239.50	Model 65	249.50
Model 63M	269.50	Model 65M	279.50

Available for immediate delivery. Prices F.O.B. factory, Corona, N.Y.

SPECIFICATIONS FOR "600 MA" SERIES

Input:
105-125VAC, 50-60C, 775W (Model 62);
715W (Model 63); 875W (Model 64); 585W (Model 65)

DC Output (regulated)
Voltage and currents:

Models	Voltage range*	Current range**
62 & 62M	245-305VDC	0-600MA
63 & 63M	195-255VDC	0-600MA
64 & 64M	100-200VDC	0-600MA
65 & 65M	0-100VDC	50-600MA

*Voltage range for any given model is completely covered in four continuously variable bands.
**Current rating applies over entire voltage range.

Regulation (line) Better than 0.15% or 0.3V
Regulation (load) Better than 0.25% or 0.3V
Impedance Less than 2 ohms
Ripple and Noise Less than 5 millivolts rms
Polarity Either positive or negative may be grounded

AC Output (unregulated):
6.5VAC at 20A (at 115VAC input). Allows for voltage drop in connecting leads. Isolated and ungrounded.

Ambient Temperature and Duty Cycle:
Continuous duty at full load up to 50°C (122°F) ambient.

Controls, Terminals and Overload Protection:

DC output controls: Band-switches and screw-driver adjusting vernier-control, rear of chassis

AC and DC switches: Front panel
External overload protection: AC and DC fuses, front panel

Internal failure protection: Fuses, rear of chassis
Input and output terminals: Barrier terminal block, rear of chassis

Meters:
3 1/2" rectangular voltmeter and milliammeter (Models 62M, 63M, 64M and 65M only).

Voltage Reference Tube:
A stable 5651 voltage reference tube is used to obtain superior long-time voltage stability.

Time-Delay Relay Circuit:
A 30-second time-delay relay circuit is provided to allow tube heaters to come to proper operating temperatures before high-voltage can be applied.

Size, Weight, Panel Finish:
Size: Standard 19" relay-rack mounting
12 1/4" H x 19" W x 9" D
Weight: 70 lb. net; 140 lb., shipping
Panel Finish: Black ripple enamel (standard)

LAMBDA



ELECTRONICS CORP.

103-02 NORTHERN BOULEVARD

CORONA 68, NEW YORK

VISIT THE LAMBDA BOOTHS, 467-469 AT THE I.R.E. SHOW IN NEW YORK

guished record at Harvard and his research and design of electric

motors, conductors and transient performance of power systems.

Dates and Organization Set For 1954 WESCON

THE 1954 WESTERN ELECTRONIC Show & Convention will take place in Los Angeles, August 25-27, according to W. D. Hershberger, newly elected chairman of the WESCON board of directors. The event is co-sponsored by WCEMA and the Los Angeles and San Francisco sections of IRE.

The show will be held in Pan-Pacific Auditorium. Headquarters for the convention, held concurrently with the electronics exhibits, will be in the Ambassador Hotel, Los Angeles.

In addition to Hershberger, who is associated with the University of California at Los Angeles, the new members of the WESCON board for the coming year are as follows: C. F. Wolcott of Gilfillan, vice-chairman; T. P. Walker of Triad, vice-chairman; L. B. Ungar of Ungar Electric, secretary-treasurer; J. H. Landells of Westinghouse, R. A. Huggins of Huggins Labs; W. E. Noller of Lynch Carrier and N. E. Porter of Hewlett-Packard. Heckert Parker of San Francisco will serve as consultant. Mal Mobley, Jr., last year's assistant business manager, has been named business manager. Offices have been opened in Los Angeles.

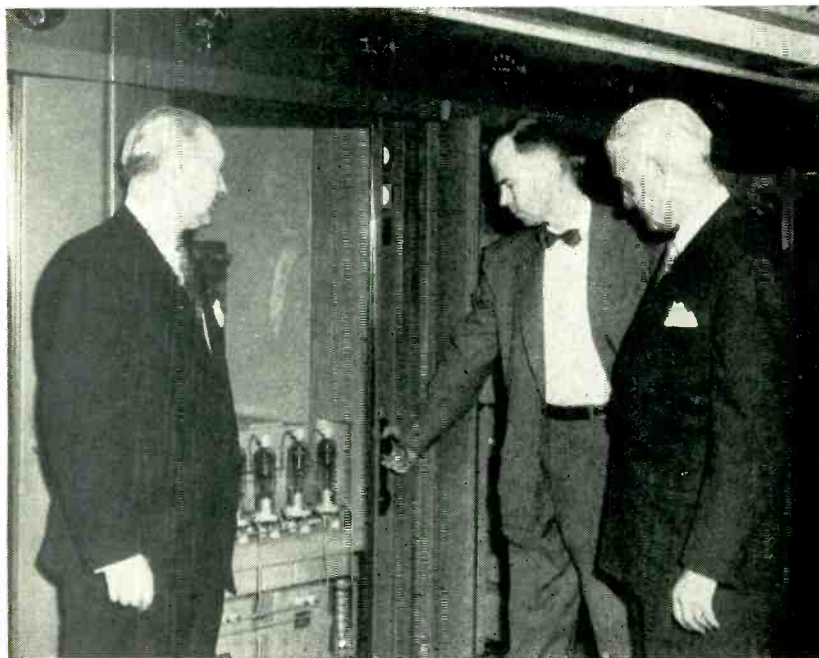

WOR-TV's New Transmitter Goes On The Air

AT THE OPENING TELECAST from WOR-TV's new 50-kw transmitter, located in New York's Empire State Building, officials of Standard Electronics, manufacturers of the in-

stallation, inspected the equipment. Left to right are Ray Kelley, secretary and treasurer; Harry Smith, manager of tv engineering and David T. Bonner, president.



Charles F. Stromeier



Michael F. Callahan



Russell R. Law

CBS Divisions Announce Top Executive Appointments

PROMOTION OF CHARLES F. STROMEIER to the position of president of CBS-Hytron was announced. Peter C. Goldmark was named president of CBS Laboratories.

Stromeier joined the company in 1942 as chief engineer and assistant to the president and was later made vice-president in charge of manufacturing and engineering. He

has been awarded several patents for his developments. Dr. Goldmark was formerly vice-president of CBS Laboratories.

The new CBS-Hytron president

on display . . . and at work . . . demonstrating instruments designed to save money by saving time **the pioneer is the leader**



spotlighting the NEW . . .
at the I. R. E. show - BOOTH 230,232 . . .

PANORAMIC THE PIONEER demonstrates the complete line-up of standard Panoramic Equipment—and introduces new Panoramic Instruments of interest and importance to the electronic field.

Introduction of these new units broadens the already wide range of Panoramic high speed spectrum and waveform analyzers and sweep generators—demonstrating once again that *the pioneer is the leader*.

AT WORK ON YOUR PROBLEMS . . .

PANORAMIC THE PIONEER provides instruments of unsurpassed excellence. Panoramic's specialized models covering audio to microwave frequencies speed and simplify analysis of waveform distortions, sounds, vibrations, spurious oscillations or modulation, response characteristics of filters or transmission lines, characteristics of AM, FM or pulsed signals, or monitoring many frequency channels simultaneously.

A Panoramic Analyzer can provide the answer to your problems. Partial list of organizations whose choice of Panoramic Equipment is a continuing demonstration that *the pioneer is the leader*.

Inquiries invited on Panoramic Spectrum Analyzers for Special Problems.

**10 South Second Ave., Mount Vernon, N. Y.
 MOUNT VERNON 4-3970**

If you cannot attend the show, write for information on Panoramic's new and important Instruments.



- Hotpoint Company
- Idaho Power Co.
- Lockheed Aircraft Corp.
- Massachusetts Institute of Technology
- North American Aviation
- Northrup Aircraft Inc.
- Philco Corp.
- Radio Corporation of America
- Sonotone Corp.
- Sperry-Gyroscope Co.
- U. S. Testing Co., Inc.
- Westinghouse Electric Corp.
- U. S. Army, Fort Bliss, Texas
- National Advisory Committee for Aeronautics
- Naval Ordnance
- Allis-Chalmers Mfg. Co.
- U. S. Atomic Energy Commission
- Bell Aircraft Corporation
- Bell Telephone Laboratory
- Boeing Airplane Company
- University of Chicago
- Cornell University
- California Institute of Technology
- Consolidated Vultee Aircraft Corp.
- E. I. du Pont de Nemours & Co.
- Eastman Kodak Co.—Navy Ordnance Division
- General Motors Corp.

announced the promotion of seven men in the firm to new positions.

Russell R. Law was promoted to the post of director of research and development. He has been serving as technical advisor on research engineering. He had worked in the field of electron optics and holds many patents in the U. S. and abroad. He is credited with the invention of the darkened glass used for the face of tv picture tubes to improve contrast. Among his applied research achievements have been improvements in electron optics, transistors, projection screens, pulse triodes, tri-colored picture tubes and uhf tv transmitters. He joined CBS-Hytron in January, 1953, after 18 years with RCA.

Edgar K. Wimpy was named to the newly created post of director of general engineering at CBS-Hytron. He will have final engineering authority over all products manufactured or sold by CBS-Hytron. He came to the company from Westinghouse in 1946 to serve as chief engineer for the firm's sun lamp division. In 1948, he organized the quality control department and in April, 1950, he was named production director.

Production

Michael F. Callahan was named vice-president in charge of manufacturing for all CBS-Hytron plants. He started with the firm in its Salem, Mass. factory in 1930.

Clifford Hughes, formerly production superintendent of the Newburyport receiving tube plant, was named manager of the plant.

Elwood W. Schafer, in the electronic tube industry since 1925, was named manager of color planning.

J. Farley, who had been doing quality control work, was named director of quality control.

David A. Sokolov, formerly a tube designer for the firm, was appointed supervisor of development of receiving tubes.

In the tv receiver manufacturing division of CBS, Thomas Grieser was appointed assistant to the administrative vice-president. In his new post he will assist in coordinating the administration of the Brooklyn and Long Island City, N. Y. plant operations.

Also in the receiver division, Al-

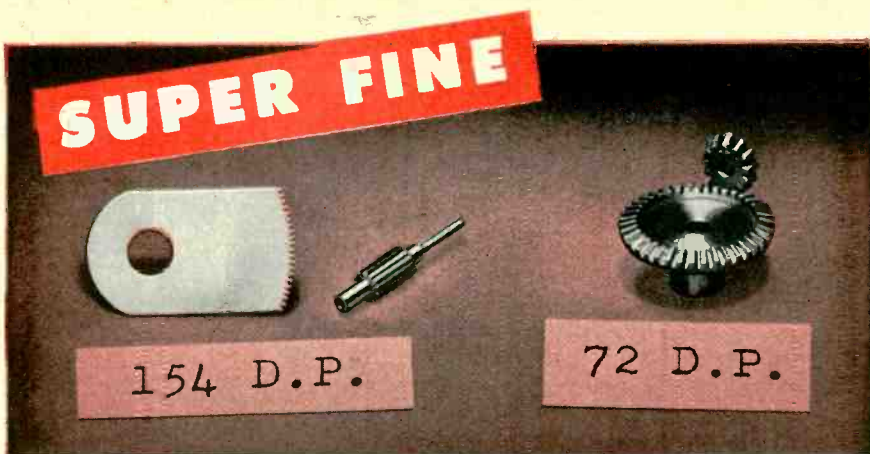

● If your requirements are for extra fine-pitch gears and pinions with precision tolerances, send us your prints for quotation. Beaver Gear engineers are trained to assist you in the design and application of this type gear. Our workmen are specialists in manufacturing small and medium size, fine and extra fine-pitch gears to your most exacting specifications.

MEMBER OF



THE *Finest*



IN GEARS •

Beaver Gear Works Inc.

1021 PARMELE STREET, ROCKFORD, ILLINOIS

Is this your soldering problem, too?

Higher Speed
with Smaller Tips?

The answer is -

HEXA CON
TRADE MARK

**SUPER POWERED
SOLDERING IRONS**

Solder Faster
with Lower Tip Cost!
For example, Cat. P-214 has more speed than conventional 200 watt iron, but takes 1/4" tip instead of 5/8" (only 1/6th the copper).

SIX MODELS TO CHOOSE FROM			
Tip Dia.	Watts	Cat No.	List Price
1/4	100	P-114	\$8.25
1/4	150	P-154	9.00
1/4	200	P-214	10.00
3/8	200	P-238	10.00
1/2	200	P-212	10.00
3/8	300	P-338	13.25

Write for Catalog showing 40 industrial soldering irons of every type and size; no obligation.

HEXA CON ELECTRIC COMPANY
130 WEST CLAY AVENUE, ROSELLE PARK, NEW JERSEY

HEXA CON - Industry's No. 1 Soldering Iron

AVAILABLE for IMMEDIATE DELIVERY...

FTL-30A SLOTTED LINE

THE UTMOST IN
PRECISION
... for VHF-UHF
IMPEDANCE
MEASUREMENTS
in the range of 60 to 1000
megacycles per second
Accuracy $\pm 2\%$

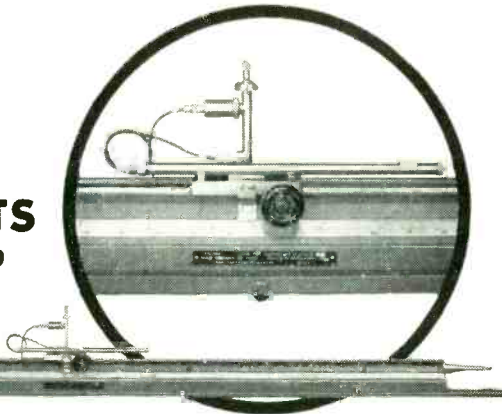

The FTL-30A also covers—with slightly reduced accuracy—the 1000 to 2000 megacycle range. It is a coaxial line 250 centimeters long... having a surge impedance of 51.0 ohms ± 0.5 ohms.

Special design features include: extremely rigid construction... high sensitivity and selectivity due to efficient probe tuning... end connectors adapted to use of Type N connectors... full utility down to 60 megacycles.



For complete details, write for Brochure FTL-30A

Federal Telecommunication Laboratories

A Division of International Telephone and Telegraph Corporation
500 WASHINGTON AVENUE NUTLEY, NEW JERSEY

**YOU CAN'T
SHAKE 'EM LOOSE!**
BUT YOU CAN COOL 'EM OFF...

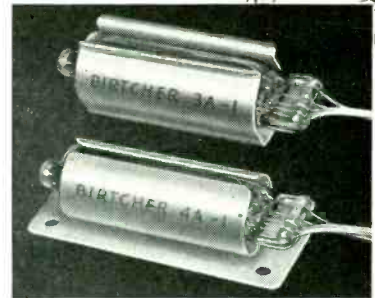

With BIRTCHER

KOOL KLAMPS

BIRTCHER KOOL KLAMPS will help keep your subminiature tubes COOL... and hold them firm and secure, regardless of how they are shaken, or vibrated.

KOOL KLAMPS are made of a specially developed heat treatable alloy 99½% pure silver of high thermal conductivity.

KOOL KLAMPS under certain conditions are able to reduce bulb temperatures as much as 40° C. KOOL KLAMPS have proved of particular value in miniaturized electronic equipment.

Where heat conditions are less critical, beryllium copper KOOL KLAMPS are available.

The BIRTCHER CORPORATION



4371 Valley Blvd.
Los Angeles 32, California

Dept. E-3-4

Please send Bulletin which describes and illustrates Koool Klamps in detail.

Company
Attention of
City State



GET THE *Best*
IN **TEFLON** *
FROM ONE SOURCE

Because Teflon by Ethylene is processed under rigid control in new equipment designed especially for the processing of this material, you are assured of a satisfactory product. It is uniform in density and dimension and free from cracks, voids, and porosity.

Teflon by Ethylene is available in rods, sheets and tubing, in the following size ranges:
Molded Sheets 1/16" to 2" thick by 29¼" x 29¼"
Extruded, Centerless Ground Rod 3/16" to 1"
Extruded Tubing 3/16" to 4" OD inclusive
1/16" to 3½" ID 1/16" Minimum Wall

Molded Rod 1½" to 6"
Molded Tubing 1/8" x 3/8" to 20" x 18¾"
Shaved Tape0025 to .060 thickness and 12" wide

Also economical production of accurately machined parts or special moldings in small experimental quantities or production runs.



ETHYLENE CHEMICAL CORP

251 BROAD STREET
SUMMIT, N. J.

Du Pont Trade-Mark for tetrafluoroethylene resin

DO YOU USE OR MAKE ANY OF THE PRODUCTS IN THIS LISTING?

List of Users

The types of industries listed are all repeat users of **Tru-Lay Push-Pull Controls**. Experimental applications are not shown.

Agricultural Equipment
 Air Conditioning Equipment
 Aircraft & Parts Automobiles
 Bakery Equipment Boats & Ships
 Bottling Machinery
 Brewing & Distilling Equipment
 Business Machines
 Buses & Motor Trucks
 Candy Making Machinery
 Canning Machinery
 Ceramics Machinery
 Chemical Processing Machinery
 Coal Mining Machinery
 Coin Operated Machines
 Construction Machinery
 Dairy Products Machinery
 Dental & Surgical Equipment
 Die Casting Machinery Diesel Engines
 Drinking Water Coolers
 Electrical Appliances
 Electrical Generating Equipment
 Electrical Machinery
 Electrical Transmitting Equipment
 Electronic Equipment
 Elevator Control Panels
 Fire Protection Equipment
 Food Processing Equipment
 Forging Machinery
 Foundry Equipment
 Gas & Oil Production (Test Stands)
 Glass Making Machinery
 Grain Processing Equipment
 Hat Machinery Heating Equipment
 Hydraulic & Pneumatic Equipment
 Ice Cream Making Machinery
 Laundry & Dry Cleaning Equipment
 Leather Working Machinery
 Lumber & Saw Mill Machinery
 Marine Equipment
 Materials Handling Equipment
 Metal Mining Machinery
 Metal Working Machinery—Machine Tools
 Military & Naval Equipment
 Motorcycles & Bicycles
 Nuclear Science Equipment
 Oil Refinery Equipment Ordnance
 Packaging Machinery
 Paint Making Machinery
 Paper Making Machinery
 Photo Equipment (manufacture)
 Plastics Fabricating Machinery
 Plastics Producing Machinery
 Power Plant Equipment
 Printing & Binding Machinery
 Quarrying Machinery
 Radio & Television (manufacture)
 Railroad Equipment
 Road Building & Maintenance Equipment
 Rubber Processing Equipment
 Safety Locks on Fuse Panels
 Sanitation Plumbing (Floor Valves)
 Shoe Machinery Steel Mill Machinery
 Telephone & Telegraph Machinery
 Textile Machinery
 Waterworks Equipment
 Welding Equipment
 Wire Making Machinery
 Woodworking Equipment
 X-Ray Machines

Whether your interest is in a single application of this versatile

PUSH-PULL CONTROL

or in its inclusion as a component of the product you manufacture, we would welcome your request for our **DATA FILE** for your further study.

Because **TRU-LAY PUSH-PULL CONTROLS** are "SOLID as a rod but FLEXIBLE as a wire rope" their use has simplified the design and improved the operation of literally hundreds of products as indicated in the accompanying list of repeat users.

These fine controls are designed, and painstakingly built, to have the qualities of **ACCURACY, HIGH LOAD CAPACITY, FREEDOM FROM TROUBLE, LONG LIFE, FLEXIBILITY . . .** they are frequently and successfully used in conjunction with electrical, hydraulic and air controls . . . they are thoroughly effective under almost any operating condition.

Here are some of the jobs they handle well . . . **HOT** jobs on jets and industrial furnaces . . . **COLD** jobs down to -70°F . . . **WET** jobs in food processing and marine applications . . . **DIRTY** jobs in cement mills and coal mines . . . **CORROSIVE** jobs in chemical processing . . . **HEAVY, TOUGH** jobs on construction machinery . . . **LIGHT DUTY** jobs on business machines, drinking water coolers . . . **REMOTE** jobs 150 feet or more from control point . . . they **DAMPEN VIBRATION** to protect delicate instruments . . . and **LUBRICATION** of the inner, working member is taken care of *for life* during assembly.

• The six booklets and bulletins in this **DATA FILE** will answer further questions you may have about this versatile and dependable tool, and will also provide you with the means of defining to us the application you may be interested in.

bert J. Frankel has been promoted to the position of purchasing agent. He was previously chief buyer for the division. Before that, he was the director of purchases for Tele-tone and Tele King and purchasing agent for Emerson Radio.

Du Mont Announces Expansion Moves

DU MONT LABORATORIES has formed a new communications products division which will develop, manufacture and market mobile radio transmitter and receiver equipment and, at the same time, take over and greatly expand the activities of the television transmitter division.

The new communications products division will continue to develop and manufacture complete studio and tv broadcast equipment.

"Entrance of Du Mont into the field of mobile transmitter and receiver communications," President A. B. Du Mont stated, "signals another step in the continuing diversification of electronic products developed, manufactured and marketed by Du Mont Laboratories. It launches the company as a major competitor on a nationwide basis in a broad new field with many major markets. The new division will comprise two major operating units, the tv transmitter department and the mobile communications department."

Herbert E. Taylor, Jr., who has been manager of the former transmitter division, has been named to head the overall activities of the new division.

Foreign

In the foreign field, A. G. Healing, Ltd. of Melbourne, Australia, has been licensed by Du Mont to manufacture and sell tv receivers in Australia under a Healing brand name. Licensing of the firm by Du Mont anticipates the future establishment of tv broadcasting on the Australian continent.

Known in Australia as a manufacturer and distributor of Healing products and as a manufacturer and distributor for other concerns, Healing has been in existence for 57 years.

In the tv set division, Alfred Y. Bentley has been placed in charge



ACCO

Write for a copy without obligation



**AUTOMOTIVE and AIRCRAFT DIVISION
 AMERICAN CHAIN & CABLE**

601 Stephenson Bldg., Detroit 2
 2216 South Garfield Ave., Los Angeles 22 • Bridgeport 2, Conn.



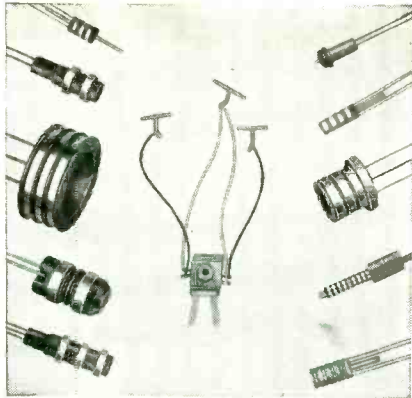

Miniature and Sub-Miniature
SLIP RING ASSEMBLIES
BRUSH BLOCK ASSEMBLIES
COMMUTATORS
 and other
 Electro-Mechanical Components
PRECISION MADE
TO YOUR OWN SPECIFICATIONS

Precision molded products with exacting tolerances in precious and non-precious solid metals of all alloys. All types of Thermo-Plastic and Thermo-Setting materials.

Slip Ring Assemblies fabricated or one-piece precision molded to your specifications in Nylon, Kel-F, Mineral filled Mellamine, Phenolic, and other materials. Rings and leads spot welded or brazed together for positive electrical circuit.

Our Swiss methods and techniques are geared to meet exacting requirements. We invite your inquiries.

COLLECTRON CORPORATION

Murray Hill 2-8473 • 216 East 45th Street • New York 17, N. Y.

NOW...SOLVE YOUR HIGH VOLTAGE PROBLEMS with BETTER EQUIPMENT



34 KW 17,000 V.D.C.



Our years of experience gives you MAGNATRON Heavy Duty High Voltage products... built for longer life and rugged performance

← NEW UNITIZED RECTIFIERS

For high voltage D.C. sources... lower initial cost... minimum upkeep... convenient — ready to connect to AC. line and D.C. load... compact — requires minimum floor space.

AIR . . . OIL . . . ASKAREL

Plate Transformers . Filament Transformers . Filter Reactors . Modulation Transformers . Distribution Transformers . Pulse Transformers . Testing Transformers . Precipitation Transformers . General Purpose Transformers . Hi-Voltage Transformers.



Askarel Immersed Filter Reactor 50,000 Volt Test

WRITE FOR DETAILED INFORMATION

MEETS STANDARDS OF AIEE-NEMA

A NAME SYNONYMOUS WITH EXPERIENCE

MAGNATRON INCORPORATED

TRANSFORMERS AND ELECTRICAL EQUIPMENT
 WALTER GARLICK, JR., PRESIDENT
 246 SCHUYLER AVE., KEARNY, NEW JERSEY



Want to give your '54 electronic equipment greater utility at lower cost?

HERE ARE TECHNIQUES TO SIMPLIFY YOUR JOB

1 To solve problems of hi-voltage and corona suppression

To help you get on a commercial basis, new Alden techniques offer compact connectors that cost only pennies yet actually solve the problems of high voltage and corona suppression better than the bulky, expensive connectors heretofore available. Ask about: A) New Alden 20-pin Picture Tube Connector; B) New Alden Hi-Voltage Disconnects; C) New Alden Hi-Voltage Tube Cap; D) New Alden Hi-Tension Disconnect—all using brand new molding technique providing sealed contacts and long leakage path in ultra-compact economy units.

2 To adapt present equipment to Plug-in Construction

Your "Black Box" units mounted in conventional ways can quickly be changed over to plug-ins using Alden's simple Adapter Kits. Ask about: 1) new Alden Back Connectors which unify all in-out connections into an orderly row that makes and breaks as the equipment plugs in or out, yet is beautifully accessible, spread out and color coded for easy tracing and servicing. 2) Alden Quick-Locking and Fastening Devices to pilot, draw in and eject your plug-in equipment with a turn of the wrist.

3 To design from the ground up with 100% Plug-in Unit Advantages

It's beautifully easy, with Alden's complete range of backbone, nerve and sensing elements, to build any equipment on unitized principles so trouble can be spotted instantly, and 30-second plug-in replacements permit operation to be restored on the spot by user's own personnel. Ask about the Alden Plug-in Packages and Basic Chassis for packages, Sensing Devices for tell-tales, and Back Connectors for making all circuitry clearly traceable units with dynamic color coding so simple it reads like a book.

4 To put circuitry in low-cost, compact vertical planes

You may dream about new wrap-arounds and printed circuitry, but if you're really trying to save space and cut production costs NOW, you can put your circuitry in compact, vertical planes that can be in the low-cost or expendable class. Alden makes it possible with complete range of stock items for circuitry layout: Pre-punched Terminal Boards that take any layout of unique Ratchet-Slot Terminals requiring no pliering or wrap-around, and Card-Mounting Tube Sockets so that complete circuitry can be put on one board.

Send for complete story—get "What's New at Alden's"—make it a point to visit Alden Display at the IRE Show, Booths 185-7.



ALDEN PRODUCTS Co.

3127 N. Main St., Brockton 64, Mass.



Your source for 2K50 REFLEX KLYSTRON TUBES

The new Bendix Red Bank 2K50 is the perfect answer for those who want a thermally-tuned Reflex Klystron tube for K-band operation.

The 2K50 has two primary applications—first, as a local oscillator in small, compact, lightweight, high definition radar and, second, as an oscillator in microwave spectrometers, signal generators and spectrum analyzers.

Because of its thermal feature, the 2K50 may be tuned automatically. Thus, it is ideally suited for difficult locations . . . in aircraft, for example . . . where direct or mechanical tuning is not practical.

Perfection of the complex, ultra-precision 2K50 . . . one of the most difficult electron tubes to manufacture . . . is a tribute to the unique talents of our engineers and production men. It demonstrates why you can depend on Bendix Red Bank for the answer to *any* special-purpose electron tube problem you may have.

MAXIMUM RATINGS

Resonator Voltage	330 volts D.C.
Reflector Voltage	-150 volts D.C.
Tuner Grid Voltage	-50 volts D.C.
Filament Voltage	6.3 ± 8% volts
Gun Cathode Current	28 ma. D.C.
Tuner Cathode Current	10 ma. D.C.

ELECTRICAL CHARACTERISTICS

Heater Voltage (A.C. or D.C.)	6.3 volts
Heater Current755 amps.
Thermal Tuning Range	23216 to 24751 Mc/Sec.
Min. Power Output at 23504 Mc/Sec.	8.5 mW.
Min. Power Output at 23984 Mc/Sec.	10.0 mW.
Min. Power Output at 24464 Mc/Sec.	8.5 mW.
Min. Electronic Tuning at Mid-Band	55 Mc/Sec.

PHYSICAL CHARACTERISTICS

- Dimensions: Maximum seated height 2 1/4" • Base: Small Octal 8-Pin, B8-21, Low Loss Phenolic Wafer • Coupling to Wave Guide: Direct, by means of an insulating fitting • Cooling: Convection • Mounting Position: Any • Cavity: Silver Plated Steel (integral within the bulb) • Bulb: Metal • Output Window: Low loss glass



Manufacturers of Special-Purpose Electron Tubes, Inverters, Dynamotors and Fractional HP D.C. Motors

DIVISION OF



EATONTOWN, N. J.

West Coast Sales and Service: 117 E. Providencia, Burbank, Calif.
Export Sales: Bendix International Division, 205 E. 42nd St., New York 17, N. Y.
Canadian Distributor: Aviation Electric Ltd., P.O. Box 6102, Montreal, P.Q.

of advanced planning for the division. Bentley was head of the division's engineering department for the past year, prior to which he had been chief engineer of the cathode-ray tube division since 1946. He joined the organization in 1945.



Humbert P. Pacini

Humbert P. Pacini was named manager of the engineering department of the tv receiver division.

Pacini, former assistant manager of the engineering department, started with Du Mont in October, 1951, as a consulting engineer. Prior to that, he was a consulting engineer for leading electronic organizations in New York and New Jersey. From Jan., 1946 to June 1950, the Du Mont engineering manager served as assistant radar chief of the Air Forces Electronic Research Laboratory in Cambridge, Mass. Starting with the summer of 1941, he held the post of project engineer on radar systems at Evans Signal Laboratory, U. S. Army Signal Corps.

RCA Promotes Executives And Realigns Divisions

PROMOTIONS AND ORGANIZATION realignments were made at RCA. Four vice-presidents were elevated to the position of executive vice-president and will be in charge of their respective operations.

The organizational changes include the creation of a new consumer products division, a new electronic products division and a consolidation of staff functions for the entire corporation. Present divisions engaged in other activities will continue as before.

Joseph B. Elliott was promoted

NEW HORIZONS

Today's horizons in electronic engineering are limited only by the vision of the individual himself. To those qualified men who desire to stand on the constantly changing frontiers of electronic development, we offer a chance to pioneer and grow with a soundly-established, yet young and progressive company.

• Electronics Field Engineers

Local & Field Assignments Available

At least 5 years' experience in any one of these fields: Servo Mechanisms; Special Weapons; Microwaves; Antennas; Circuit Design; Flight Simulators; Radio Propagation; Electronic Computers and Communications.

Qualified to instruct in the operation and supervise installation, maintenance and repair of Radar, Sonar, Flight Simulators and allied electronic equipment in the field.

Salary and advancement commensurate with ability; liberal vacation, sick leave, 9 paid holidays, group life, sickness and accident insurance plans, and a worthwhile pension system.

STAVID ENGINEERING, INC.

Personnel Office, 312 Park Avenue
Plainfield, N. J.—Plainfield 6-4806

ALL FROM ONE SOURCE!

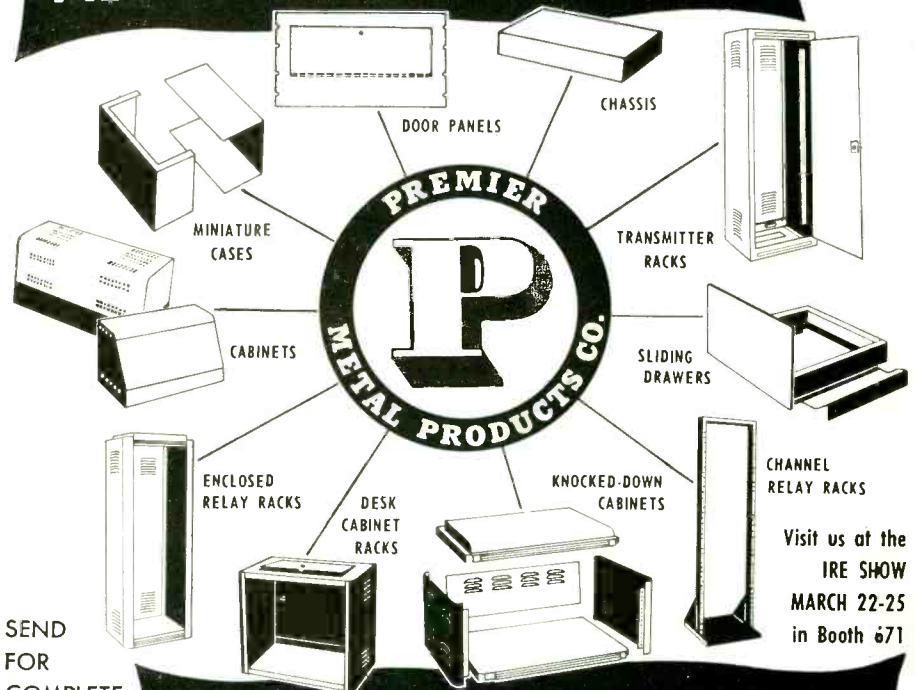

SEND FOR COMPLETE CATALOG

Visit us at the
IRE SHOW
MARCH 22-25
in Booth 671

PREMIER METAL PRODUCTS CO.
3160 WEBSTER AVE., BRONX 67, N. Y.

HERE'S BIG HELP IN TERMINAL WIRING!

The New JONES FANNING STRIP

Connections are made through Fanning Strip, on bench or anywhere apart from barrier strip, and quickly slipped into assembly.

Use with Jones Barrier Terminal Strips, Nos. 141 and 142, for 1 to 20 terminals.

Simplifies soldering. Insures correct connections. Saves time. Ideal for harness or cable assembly. Brass terminals, cadmium plated. Bakelite mounting. Send for complete data.

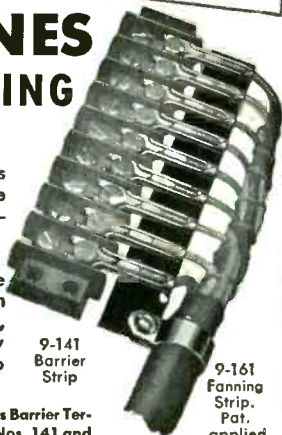

9-141 Barrier Strip

9-161 Fanning Strip. Pat. applied for.

The correct wire to correct terminal every time!

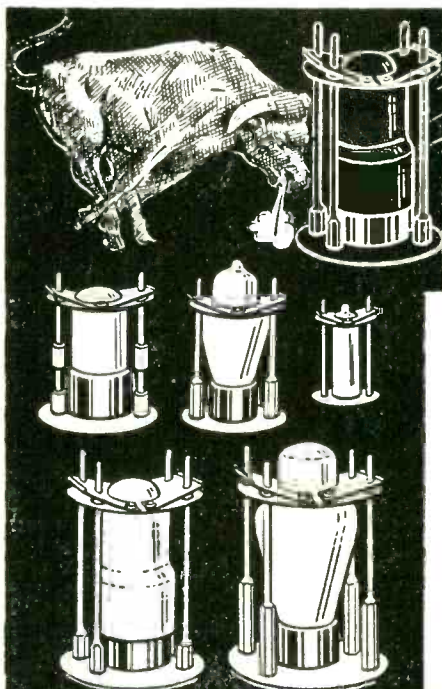

SHOCK PROOF

VACUUM TUBE RETAINERS

These retainers are used to secure Vacuum Tubes and to resist side motion of Vacuum Tubes used in radio equipment which is subject to shock and vibrations. These retainers meet the requirement of all JAN specifications. The insulated portion is made of a melamine base Fibre Glass Phenol which provides 300 volts insulation to ground and withstands a temperature of 350 F. The insulated plate can readily be fastened or released by hand.

Available for envelope types T7, T8, MT8, T9, T12, ST12, T12ZDL, ST14, S14, ST16, T5½, T6½, MT-IC, ST19, T14, ST128CT-9.

Manufacturers of Electronic Components

JAMES IPPOLITO & CO., INC.
401 CONCORD AVENUE, BRONX 54, N. Y.



EVOLUTION of a VTVM ...

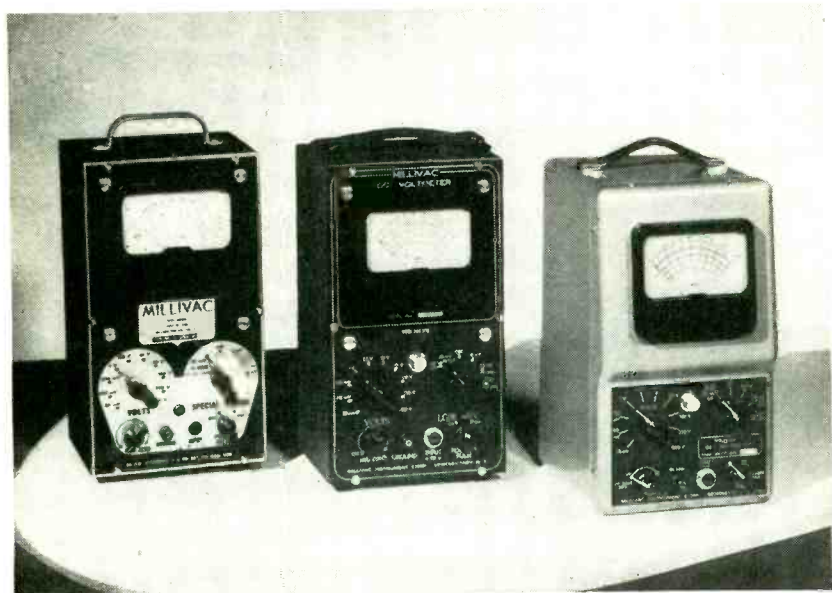

W. Walter Watts

to executive vice-president in charge of consumer products division.

W. Walter Watts was promoted to executive vice-president in charge of electronic products division.

Elmer W. Engstrom was promoted to executive vice-president in charge of the RCA laboratories division.

Charles M. Odorizzi was promoted to executive vice-president in charge of a newly consolidated corporate staff serving all units and subsidiaries of RCA.

Robert A. Seidel was appointed vice-president of RCA's sales and service subsidiaries division, responsible for the activities of RCA Institutes, RCA Service Co. and RCA Victor Distributing Corp.

In the laboratories division, Douglas H. Ewing has been named



E. W. Engstrom

There is a saying: "Clothes make the man," but *external* appearance alone certainly does not make a good vacuum tube voltmeter.

Our new series of sensitive electronic volt and amperemeters for a.c. and d.c. has been thoroughly redesigned, both externally and *internally*.

Even our oldest member, the MV-17 B d.c. millivoltmeter (0-1 mV, lowest range) is now

available in a brand-new suit (tailored by Karp). It is shown above, in front. It has a better dc modulator inside, too.

From the early "ugly duckling", MV-17 A, in the background, it grew into the well known MV-17 B, in the middle. Now it has become the MV-17 C. It outperforms both its predecessors, a typical evolution of electronic test equipment made by a progressive manufacturer.

See our unusual measuring instruments and power supplies at the IRE - Show in New York, Booth 281-283, Instrument Avenue.

MILLIVAC INSTRUMENT CORPORATION
BOX 997, SCHENECTADY, NEW YORK

MOLYBDENUM & TUNGSTEN

Ductile

SHEET - RIBBON - FOIL

Also other basic metals

- Deep Drawing quality Molybdenum sheet
 - Molybdenum tubing
 - Machined parts
-
- Fine wires. Specializing in Molybdenum wire in sizes down to .0006".

For the electron tube, electronic and allied industries.

Let us quote on your requirements.

THE REMBAR COMPANY

P. W. BLACKBURN, President

117 Main Street
DOBBS FERRY, N. Y.

Telephone: DOBbs Ferry 3-6510

XCELITE Hand Tools
PREFERRED BY THE EXPERTS

"I'll Fight the First
Man Who Touches My
New Xcelite TV Standoff Insulator Plier!"

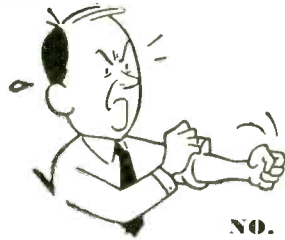

No more tool-snatching! If you want to open and close standoff insulators quick and easy without slipping or skinning your knuckles, buy your OWN Xcelite TV Standoff Insulator Plier! This 10" job is a real steal at only \$4.35, list.

NO. 64 TV STANDOFF INSULATOR PLIER

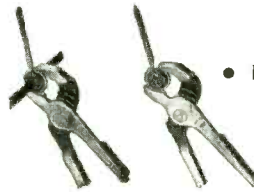

- Heavy-duty • All-Purpose • Forged rib lock design

AND REMEMBER!

Your Xcelite Dealer has a full line of special-purpose radio and TV pliers and snips, ruggedly made for long, hard use.

SEE YOUR XCELITE DEALER NOW!

XCELITE, INCORPORATED
(Formerly Park Metalware Co., Inc.)
Dept. C Orchard Park, N. Y.

For Originality
LOOK TO XCELITE

Over 85% of the torque wrenches
used in industry are

STURTEVANT TORQUE WRENCHES

Read by Sight, Sound or Feel.

- Permanently Accurate
- Practically Indestructible
- Faster—Easier to use
- Automatic Release
- All Capacities

in inch ounces . . . inch
pounds . . . foot pounds
(All Sizes from 0-6000
ft. lbs.)



Every manufacturer, design and production man should have this valuable data. Sent upon request.

P.A. **STURTEVANT CO.**
ADDISON [QUALITY] ILLINOIS

ELECTRONIC COMPONENTS

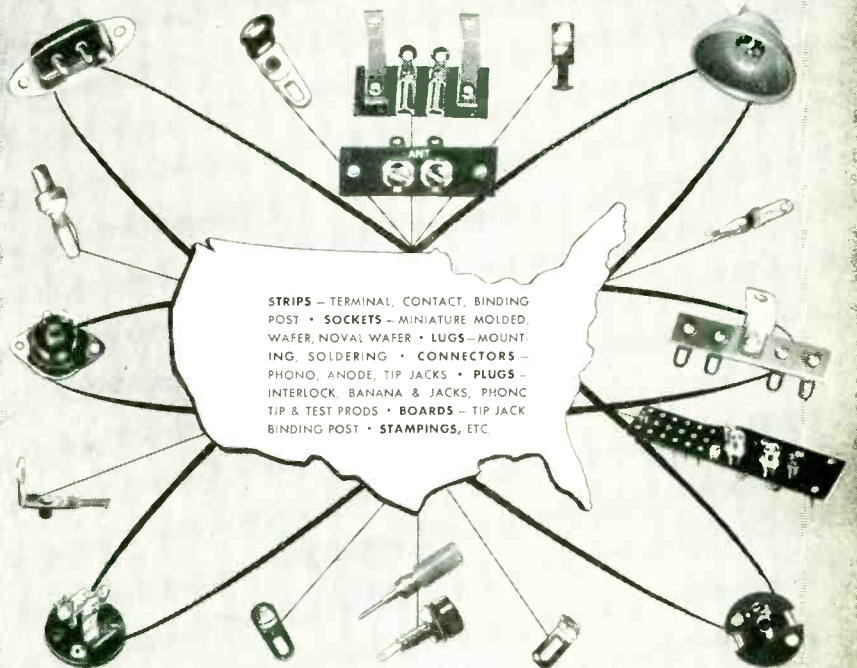

STRIPS — TERMINAL, CONTACT, BINDING POST • SOCKETS — MINIATURE MOLDED, WAFER, NOVAL WAFER • LUGS — MOUNTING, SOLDERING • CONNECTORS — PHONO, ANODE, TIP JACKS • PLUGS — INTERLOCK, BANANA & JACKS, PHONO TIP & TEST PRODS • BOARDS — TIP JACK BINDING POST • STAMPINGS, ETC.

Manufacturers of Electronic components of the highest quality . . . now serving some of the leading manufacturers in the country. For more complete information, send for our catalog.

NATIONAL TEL-TRONICS CORPORATION

35 ST. CASIMIR AVENUE, YONKERS, N. Y. TEL. YONKERS 8-6400

**miniature
precision components
for high-performance**

Servo Systems

Developed and produced by Kearfott, these units exemplify accomplishments of creative engineering teamed with production skill providing performance values of accuracy, speed of response and reliability unique for their size. Advanced design techniques are typified by the unitized stator and housing construction, permitting line-bored relationship of stator and rotor. This makes practical the extremely close concentricity tolerances apparent in improved efficiency of the Servo Motors and the very high accuracy of the companion Synchro. A very rugged structure, stable under extremes of environmental exposure is also provided.

Conforms dimensionally to Navy BuOrd Size II
(Maximum Diameter 1-1/16")

TECHNICAL INFORMATION

Synchro—Available as Control Transformer, Transmitter, Resolver, Differential, for 26 or 115 volt 400 cycle operation. Maximum error tolerance is 7 minutes of arc. The hardened pinion shaft may be used as a spline. Terminals for convenient installation and replacement are provided. Other synchros for 60 cycle operation may be obtained. (Basic Type R500).

Servo Motor—The Servo Motor (Basic Type R119) features a very high torque-to-inertia ratio. Motor input is 3.5 watts per phase at 115 volt 400 cycle. Available with high-impedance control winding for operation directly in plate circuit of an Amplifier. Integral precision gear train can be provided. Many other models available including Servo Motors for 60 cycle duty. (Basic Type R303).

Servo Motor-Generator—The motor described above is available with an integral high performance damping generator, providing an output signal of 1/2 volt per 1000 RPM over a 5500 RPM speed range. (Basic Type R804).

See us at the Radio Engineering Show, Booth 722, Airborne Avenue, March 22-25, Kingsbridge Armory, Bronx, New York.

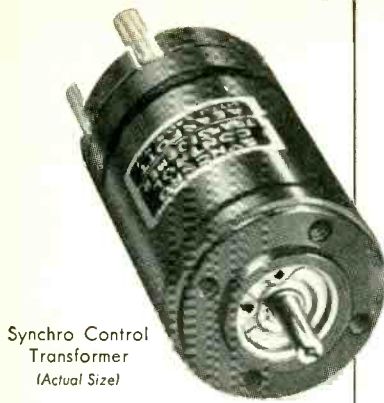

Synchro Control Transformer
(Actual Size)



Geared Servo Motor
(Actual Size)

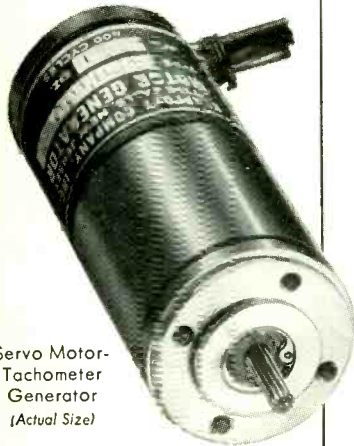

Servo Motor-Tachometer Generator
(Actual Size)

Technical Data on these and other components is available on request.

KEARFOTT COMPONENTS INCLUDE:

Gyros, Servo Motors, Synchros, Servo and Magnetic Amplifiers, Tachometer Generators, Hermetic Rotary Seals, Aircraft Navigational Systems, and other high accuracy mechanical, electrical and electronic components.

KEARFOTT COMPANY, INC., Little Falls, N. J.

Midwest Office: 188 W. Randolph St., Chicago 1, Ill., West Coast Office: 253 N. Vinedo Ave., Pasadena, Calif.

A GENERAL PRECISION EQUIPMENT CORPORATION SUBSIDIARY



Douglas H. Ewing

director of a newly formed physical and chemical research laboratory of the research department. He has been director of research services for the division. From 1949 to 1951, he was director of development for the Air Navigation Development Board of the U. S. He was previously manager of advanced development in the engineering products department of RCA Victor.

Ralph S. Holmes has been appointed director of research contracts, responsible for the administration of governmental and university contracts and supervision of publications of the Labs division. Active in RCA radio and tv research engineering more than 20 years, he is a member of the Signal Corps Research and Development Advisory Board.

Arthur W. Vance has been named director of a newly established special projects research laboratory of the research department of RCA Labs. As a section head of the technical staff, he has directed the research and development of "Project Typhoon", the large analog computer built for the Navy by RCA, from 1948 to 1950. Vance has been associated with RCA research activity since 1930.

IT&T Companies Make New Moves

PARTICIPATION IN A program of conservation designed to eliminate inefficiencies in the manufacturing processes among industries doing business with the Air Force, and to help save the dwindling natural resources of the country, has been launched by the Federal Telephone

UNIFORM PRECISION...

LOWER COST!

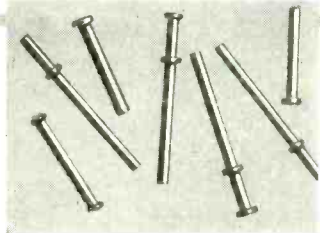
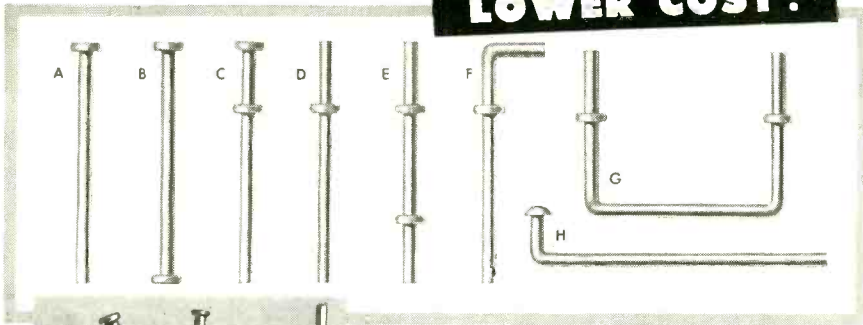

← ACTUAL SIZE

UPSET PINS

Here's high precision production on automatic equipment that delivers continuous uniformity from the first to the millionth unit! Economical production, minimum scrap add up to low piece prices that will surprise you. Upset Pins of the types shown made from any workable metal or alloy . . . in wire diameters from .010" to .090" Flanges accurately positioned to your specifications. Flanges and heads with rounded edges. Send blueprints or samples for estimate.

ART WIRE & STAMPING CO. 1 Boyden Pl., Newark, N. J.

sub-miniature AND moisture-proof

THE ECONOMICAL SOLUTION where moisture proof resistive elements of comparatively small size are required for commercial applications. Type S-15 is $\frac{3}{8}$ " long by $\frac{1}{4}$ " diameter; type S-30 measures $\frac{3}{4}$ " by $\frac{1}{4}$ " diameter. Both types are moisture proof and capable of high performance over long periods of continuous service. IN-RES-CO Resistors for every ordnance or civilian requirement are available at a cost that solves circuit design problems both performance-wise and cost-wise. Check up now, on the complete line of IN-RES-CO quality wire wound resistors.

IN-RES-CO S-15 & S-30 WIRE WOUND RESISTORS

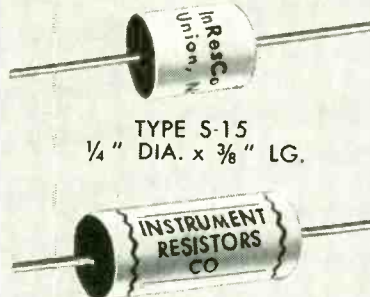

TYPE S-15
 $\frac{1}{4}$ " DIA. x $\frac{3}{8}$ " LG.

TYPE S-30
 $\frac{1}{4}$ " DIA. x $\frac{3}{4}$ " LG.

INSTRUMENT RESISTORS CO.

COMMERCE AVENUE UNION NEW JERSEY

APPLICATION-DESIGNED RESISTORS FOR ELECTRONICS AND INSTRUMENTATION

FOR JAN SPECIFICATION RESISTORS — consult the new illustrated literature describing the complete In-res-co line. Write for your copy today!



ELIMINATE HEADACHES!

...in purchasing

VINYL SLEEVING

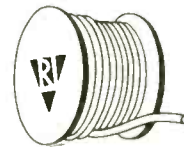

It's far easier to buy vinyl sleeving from Resin Industries for these important reasons: 1. Meticulous compounding by skilled chemists assures strict adherence to exacting specifications. 2. Precision workmanship. 3. Rigid quality control guarantees uniformity. 4. Prompt and understanding service. No wonder Resinite is the largest supplier of vinyl sleeving to the aircraft industry. Write for samples and prices.

Resinite

RESIN INDUSTRIES, INC.

315 Olive St. · Box 1589 · Santa Barbara, Cal.

SPECIALISTS IN VINYL SLEEVING AND TUBING FOR THE AIRCRAFT, ELECTRONICS, AND MEDICAL FIELDS

Resin Industries, Inc.
Box 1589, Santa Barbara, Calif.
Please send samples and prices of sleeving as follows:

Name _____
Firm _____
Address _____
City _____ Zone _____ State _____

FIRST CHOICE OF THOUSANDS!

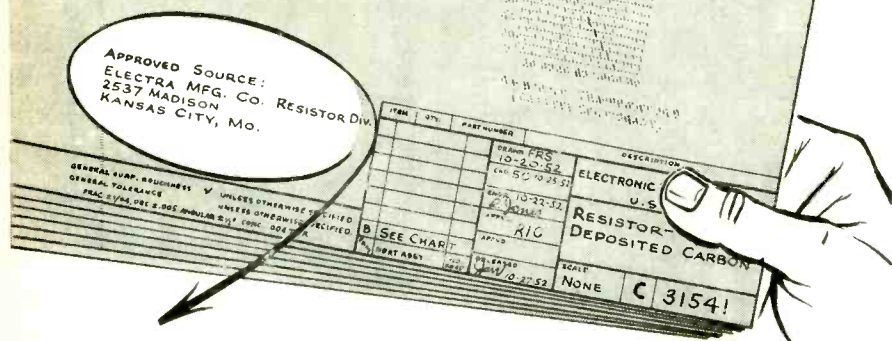

Bird

COMPLETE JEWEL ASSEMBLIES WILL SPEED YOUR PRODUCTION



You'll be time and money ahead if you specify Bird complete jewel assemblies for your product. Rejects are eliminated, jewel breakage is minimized, and Bird jewel assemblies will keep your production running smoothly.

Bird Jewel Assemblies are furnished in the right mounting, rigidly inspected according to your specifications, ready for your assembly operations. Make a test — find out how Bird Jewel Assemblies can help your production. Send us a print of your specifications, and we'll provide samples for your own testing.

Our engineering staff is at your service for all small bearing problems.

Over 40 years of serving industry with Quality jewel bearings

Richard H. Bird & Co., Inc.

Sapphire and glass jewels • Precision glass grinding • Ferrite precision products • Sapphire styli
1 Spruce Street, Waltham 54, Mass.

Are you using a
LACING CORD or
FLAT BRAIDED TAPE
with all these
advantages?

CHECK HERE

- Made of Nylon
- 100% fungus-proof
- Laces tighter with less pull
- Laces faster
- High abrasion resistance
- Low moisture absorption
- Retains desirable malleability of wax and yet has a melting point of over 190°F.
- Non-toxic to humans
- Meets Army, Navy and Civilian "specs"

IF NOT...
Switch to
NYLON

**LACING CORDS and
FLAT BRAIDED TAPES**

MADE BY

HEMINWAY & BARTLETT

The Heminway & Bartlett Mfg. Company
500 Fifth Ave., New York 36, New York.
Sales Offices: Chicago, Philadelphia, Boston,
St. Louis, Cincinnati, San Francisco, Los
Angeles, Charlotte, N. C., Gloversville, N. Y.
Foreign Agent: Turner, Halsey Co., Inc.,
40 Worth Street, New York, New York.
Cable Address: THECOTEX

See us at the IRE Show—Booth 888—Audio Ave.



**NEW
MULTIMETER
KIT**
\$26.50



**SIGNAL
TRACER KIT**
\$23.50



**NEW
SCOPE KIT**
\$59.50



**CONDENSER
CHECKER KIT**
\$19.50



**VACUUM TUBE
VOLTMETER KIT**
\$24.50



**TUBE CHECKER
KIT**
\$29.50



**SIGNAL
GEN. KIT**
\$19.50



**GRID DIP
METER KIT**
\$19.50

Heathkit TEST EQUIPMENT

BUILD YOUR OWN — INCREASE KNOWLEDGE — SAVE MONEY — BUY DIRECT FROM MANUFACTURER . . . Top quality instruments in kit form featuring latest design and circuit developments. Completely detailed step-by-step construction manual — clear pictorials — complete schematics. All sheet metal work punched, formed and finished. Low kit prices include tubes, chassis, cabinet and all necessary constructional components.

Kits for the school — service shop — industrial laboratory — hobbyist, etc.

Write for free catalog for further information.

HEATH COMPANY
BENTON HARBOR 14,
MICHIGAN

For **HIGH FREQUENCY** } *Space Saving Applications*
HIGH VOLTAGE }
GARDE Miniature & Sub-Miniature
INSULATED STAND-OFFS & FEED THROUGHS

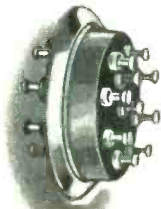

HERMETICALLY SEALED HEADERS

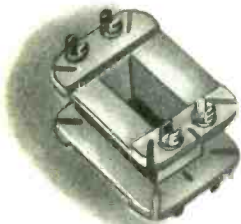
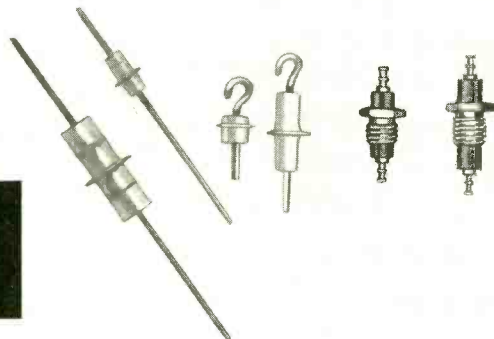
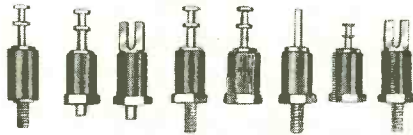
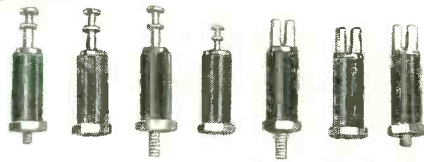

COIL FORMS

CHOICE OF INSULATION CHARACTERISTICS IN ACCORDANCE WITH LATEST MIL-P-14 SPECIFICATIONS.

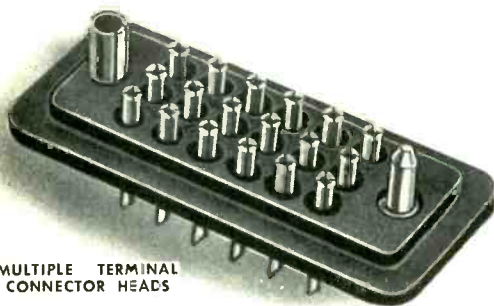

MULTIPLE TERMINAL CONNECTOR HEADS

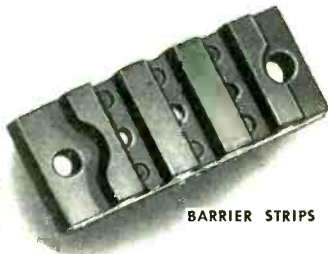

BARRIER STRIPS

For users to properly assess the outstanding features and advantages of Garde Components, samples will be sent on request. A detailed technical catalog is now in preparation. Be sure your name is on our mailing list.

We have complete facilities to accommodate your special requirements, ranging from Engineering Consulting Service to Precision Design and Production.

GARDE MANUFACTURING COMPANY
 MOLDERS OF THERMOPLASTIC AND THERMOSETTING MATERIALS
 588 Eddy Street, Providence 3, Rhode Island -- Sales Representatives in Principal Cities

France and Germany.

IT&T also announced the formation of Capehart Argentina, SAIC, a new company for the manufacture of tv and radio receivers, radio-phonograph combinations, cathode-ray picture tubes and other receiving tubes in Argentina.

The capital of the new company will be supplied 50 percent by IT&T and 50 percent by a group of leading Argentine industrialists. Its original capitalization is 20 million Argentine pesos.

Production is scheduled to begin in April of this year, with a projected production of 1,500 tv receivers monthly. Capehart Argentina will receive technical advice and assistance from IT&T and its Capehart-Farnsworth division in Fort Wayne, Indiana.



Quick Named President Of National Company

JOSEPH H. QUICK has been elected president of the National Company of Malden and Melrose, Mass.

He has had many years of experience in the electronics field, having been associated with RCA, Philco and Sylvania. Since 1946 he has been senior partner in the Work-Factor Co. providing management service to industry. He has been a director and a member of the executive committee of National. He comes to the company from the presidency at Harrington & Richardson Arms Co. of Worcester, Mass.

Quick succeeds C. C. Hornbostel who served as president and treasurer of National and also as a director and member of the exec-

DEPENDABLE *Miniature*
RADIO FILTERS

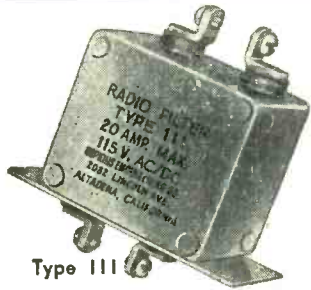

Type III

- Saves space!
- 115 V ac/dc, 20 amp.
- Excellent attenuation
- Feed through installation
- Flange mounting bracket
- Corrosion & fungus resistant

If you have radio interference problems, write or wire us, TODAY!

HOPKINS
Engineering Co.

FACTORY: 2082 Lincoln Ave.,
Altadena, Calif. SYcamore 8-1185
Offices in WASHINGTON, D. C.
and DETROIT

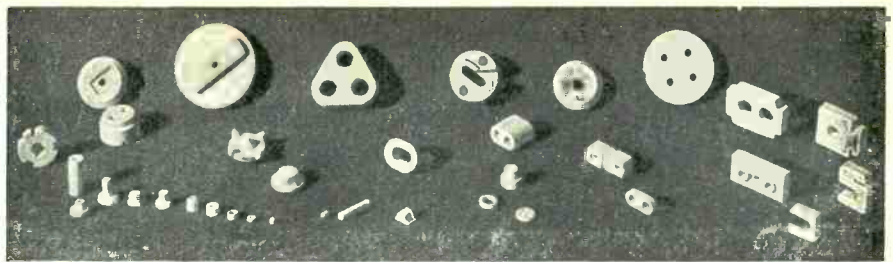

if you're
looking for
**SOMETHING
SPECIAL in
STEATITE**
call on.....

Star

PORCELAIN COMPANY
49 Muirhead Avenue • Trenton 9, N. J.

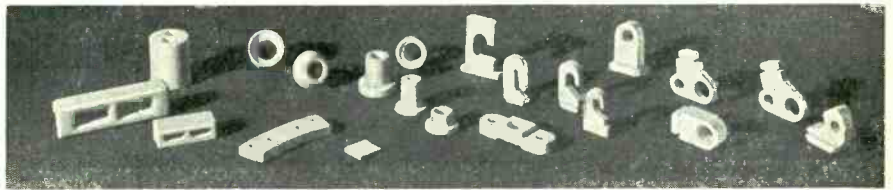

BE SAFE WITH

Q-max
A-27

LOW-LOSS LACQUER & CEMENT

- Q-Max is widely accepted as the standard for R-F circuit components because it is chemically engineered for this sole purpose.
- Q-Max provides a clear, practically loss-free covering, penetrates deeply, seals out moisture, imparts rigidity and promotes electrical stability.
- Q-Max is easy to apply, dries quickly and adheres to practically all materials. It is useful over a wide temperature range and serves as a mild flux on tinned surfaces.
- Q-Max is an ideal impregnant for "high" Q coils. Coil "Q" remains nearly constant from wet application to dry finish. In 1, 5 and 55 gallon containers.

*Communication
Products Company, Inc.*

MARLBORO, NEW JERSEY
(MONMOUTH COUNTY)
Telephone: FReehold 8-1880



in maintaining low-drift frequency stability...
it's the **ANGLE** that counts!

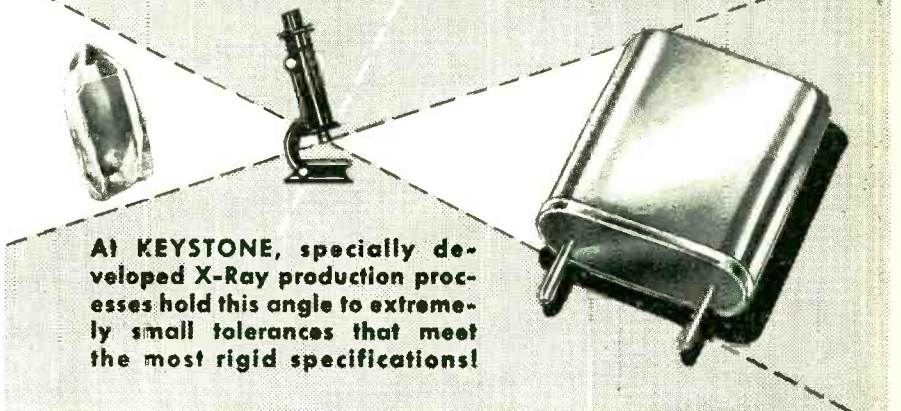

At **KEYSTONE**, specially developed X-Ray production processes hold this angle to extremely small tolerances that meet the most rigid specifications!

KEYSTONE QUARTZ CRYSTALS

Now serving, the world over, in military and commercial frequency control applications . . . have established a solid reputation for reliability.

From rough quartz to finished plug-in unit, Keystone high-precision production techniques and numerous hand operations—make possible exact quality control not obtainable by ordinary methods. Choose Keystone "Performance-Tested" Crystals wherever top reliability is a must!

Consult with us on your specialized design problems, at either your plant or ours. Crystal brochure on request to Dept. E3.

see us at
I.R.E. SHOW
Kingsbridge Armory
N.Y.C.
March 22-25
BOOTH #905



KEYSTONE ELECTRONICS COMPANY
114 Manhattan Street Stamford, Connecticut

**When the job
demands precision**

dimensional accuracy

**— there's no substitute
for MYCALEX®
glass-bonded mica
insulation**

The coil form shown in this RCA-Victor precision tank coil is injection-molded of MYCALEX 410 glass-bonded mica insulation. The coil, operated at approximately 1000 rpm, is subject to high start and stop stresses. The winding contacts a traveling disc and operates at high potential and high frequency. MYCALEX was selected for this application after careful evaluation. The extreme dimensional accuracy, attainable with MYCALEX glass-bonded mica—the unique ceramoplastic—insures perfect contacting and at the same time eliminates balance problems. High dimensional accuracy also affords absolute uniformity of parts, facilitating assembly and replacement. The excellent dielectric properties of MYCALEX insure efficient electrical performance.

—and MYCALEX offers

**OUTSTANDING
SUPERIORITY**

*in almost every
other category!*

- IMMUNITY TO REPEATED ARCING
- PERMANENT DIMENSIONAL STABILITY
- VERY LOW LOSS FACTOR
- EXCELLENT DIELECTRIC STRENGTH
- ZERO MOISTURE ABSORPTION
- UNLIMITED DESIGN FLEXIBILITY

Note: MYCALEX 410 glass-bonded mica, described above, is an exclusive formulation of, and manufactured only by, the Mycalex Corporation of America. It meets all the requirements for Grace L-4B under Joint Army-Navy Specifications JAN-1-10.

For similar economical solutions to your problems, phone or write J. H. DuBois, Vice President-Engineering at the Clifton, N. J. address below.



MYCALEX CORPORATION OF AMERICA

World's largest manufacturer of glass-bonded mica products
Executive Offices: 30 Rockefeller Plaza, New York 20, N. Y.

ADDRESS INQUIRIES TO—

General Offices and Plant: **114** Clifton Blvd., Clifton, N. J.

SEE THE MYCALEX EXHIBIT AT THE I.R.E. SHOW—BOOTHS 651, 653, 655 CIRCUITS AVE.

utive committee. He has resigned from all of these positions.

American Car & Foundry Forms Electronics Division

AMERICAN CAR AND FOUNDRY CO. enlarged its entry into the electronics field with the announcement of its new division, ACF Electronics. The company has an interest in Avion Instrument.

Headquarters for the new division will be in Alexandria, Va. under the direction of ACF's vice-president for manufacturing, James White. The division will be headed by J. G. Reid, Jr., who recently resigned as chief of the Bureau of Standards' electronics division.

Robert L. Henry, director of Project Tinkertoy at the Bureau, plans to join the division in a short time, where he will continue his work in developing and improving machines for the mechanized production of electronics. He recently received the Washington Academy of Sciences annual engineering award in recognition of his work in the development of machine-made electronic circuitry.

The electronics program of ACF Electronics will have as one of its first projects development of improved machines for mechanized production of electronics. The company will limit itself to new machines, leaving the production of the ceramic wafers used in the system to other companies.

Instruments, electronic devices and components for which there is special need will also be among projects planned by the ACF group. Later, work on improving computer design will be undertaken.

Textile Manufacturer Buys Dalmo Victor

SALE OF THE entire stock of Dalmo Victor Co. to Textron Inc. textile manufacturer, has been announced.

Under the terms of the transaction, Dalmo Victor becomes a wholly-owned subsidiary of Textron and maintains intact its present operation and management. The amount of the sale, established on an amortizing basis, was not disclosed. Dalmo Victor's stock was privately held by its officers.

The acquisition by Textron will

Versatile - Compact
Low-Cost
Precise

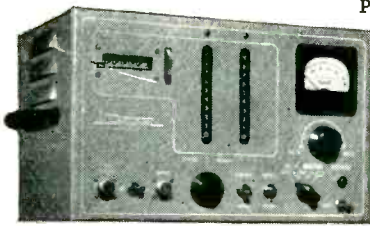

Multi-Purpose LABORATORY
POLI-SCALER

The Detectron DS-606 Poli-Scaler is a complete laboratory scaler of exceptional versatility. Adaptable to GM and scintillation counting and frequency checks. Power supply may be used for either GM input or to operate accessory equipment.

PULSE HEIGHT DISCRIMINATOR INPUT — 2 to 100 V; POSITIVE OR NEGATIVE PULSES — 2 - 100 V Pos. — 2 - 50 V Neg.; RESOLUTION TIME — 5 Microseconds per pulse pair or less; HIGH VOLTAGE POWER — variable in 1 step from 0 to 2.5 kv.; COUNTING RATE — 1,000 per sec. max.; ACCESSORY SOCKETS — for count rate meter and speaker; DIRECT READING — to 99,999,999.

Write for FREE folder Dept. 78

THE *Detectron* CORP.
5420 VINELAND, NO. HOLLYWOOD, CALIF.

☆ SEE ☆
the NEW DEVELOPMENTS
in ☆
coil winding
equipment ☆
AT THE

1954 IRE SHOW
MARCH 22-25
BOOTH 305-402

Coil Winding Equipment Co.

109 AUDREY AVE., OYSTER BAY, NEW YORK

Star Performers



"QUALITY-PLUS"

TRANSFORMERS

For Industrial
and Electronic
Equipment

DESIGNED TO
COMMERCIAL & MILITARY
SPECIFICATIONS (MIL-T-27
and AN-E-19). ALSO
CLASS A, B, H, AND
MINIATURES.

Sample, Short and
Long Runs. Let
us quote on your
specifications.
No obligation.

Delivery as promised!

EPCO
PRODUCTS, INC.
2500 ATLANTIC AVE.
BROOKLYN 7, N. Y.



**REMOTE
TONE-CONTROL
EQUIPMENT**

- TWO WAY SPEECH
- ON-OFF SWITCHING
- DIAL SELECTION

OVER A SINGLE TELEPHONE LINE!

Schuttig S242A and S243A Remote Control Units permit operating remote equipment over lines of unlimited length—through repeaters or radio links.

- No control signals on line during speech transmission.
- No DC on line.
- Operator's Unit controls up to six remote units.
- Only 5¼ inches vertical rack space required at each end of line.

SCHUTTIG and CO., INC.

Ninth and Kearny, N. E.
Washington 17, D. C.

"I use it to take TPR*
on sick Servomechanisms"



*Temperature, Pulse and Respiration

The new **SERVOSCOPE**[®] can save you man-hours

In one convenient instrument, here is test equipment for determining, in design or production phases, the dynamic performance of regulators, governors, process controls, positioning servomechanisms.

Only the **SERVOSCOPE** has all these features:

- Applicable to both AC carrier and DC servo systems.
- Generates:
 1. Sine-wave modulated carrier
 2. Low frequency sine wave
 3. Low frequency square wave
- Built-in electronic sweep with no sweep potentiometer to wear out and require replacement.
- Dynamic frequency control range of 200 to 1.

Write Dept. E-3

Booths 203 and 300 Production Road, IRE Show,
Kingsbridge Armory, Bronx,
March 22 through March 25.

SERVO
CORPORATION OF AMERICA
New Hyde Park, New York

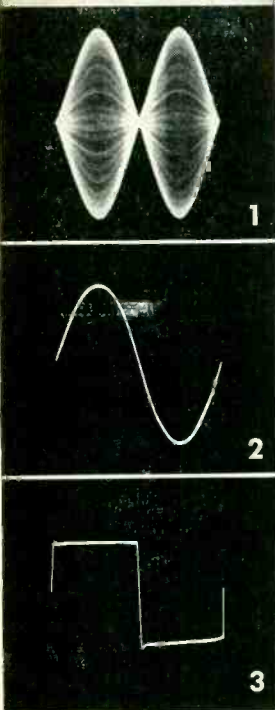

Output wave forms of Servoscope displayed against internal linear sweep generator, frequency 1/2 cycle.

permit Dalmo Victor to expand its operation into related fields, T. I. Moseley, president of Dalmo, said.

Dalmo Victor produces chiefly airborne radar antennas. It has five plants and more than 1,400 employees in San Carlos and Belmont, Calif. Its entire output is under defense contracts and sales volume exceeded \$24 million during the fiscal year ending September 30, 1953.

Since 1942 the company has been engaged in the design, development and production of airborne radar antennas ranging from simple warning types to complex multi-purpose units. It has undertaken design and development of shipborne radar antenna systems and other precision electro-mechanical equipment. The company also manufactures microwave components, specialized fluid magnetic clutches, servomechanisms and stabilization systems.

Greene Named President Of Browning Labs

GARDINER G. GREENE has become president and principal stockholder of Browning Laboratories. G. H. Browning, formerly president, became chairman of the firm's board of directors. William A. Ready, one of the founders and for many years president of National Company, was elected to the board of directors of the company.

Greene is the founder of Workshop Associates, manufacturer of antennas. He headed this company from 1942 until it was merged with the Gabriel Co. in 1951, at which time he became a director and vice-president of the electronics division of Gabriel. He left Gabriel in 1953



G. H. Browning, right, and G. G. Greene

L·R BLOWERS

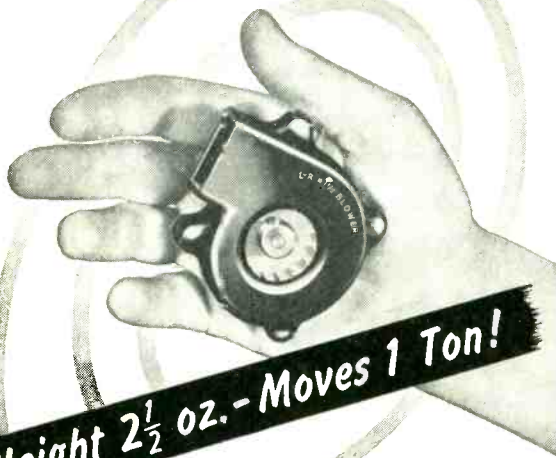

Weight 2½ oz. - Moves 1 Ton!

Engineered for application where space and weight are important factors. If your product — or a component — requires a specific type blower, it will pay you to investigate RIPLEY.

RIPLEY
ESTABLISHED 1936

Superior... through Research

RIPLEY CO., INC., Middletown, Conn.

STERLING

A DEPENDABLE SOURCE
FOR
TRANSFORMERS
MIL-T-27 & COMMERCIAL

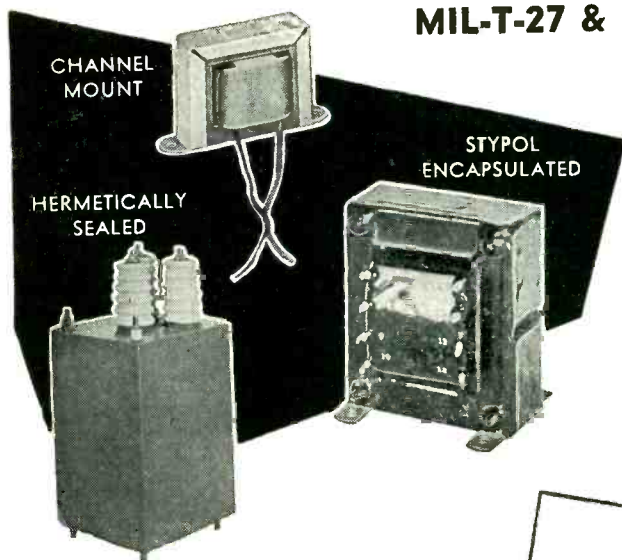

CHANNEL MOUNT

HERMETICALLY SEALED

STYPOL ENCAPSULATED

- Pulse
- Audio
- Power
- Filter Choke
- Filament
- RF Coils

Custom Built to
your Specifications

STERLING
STC TRANSFORMER CORP.
BROOKLYN, N. Y.

297 North 7th St., Brooklyn 11, N. Y.

**WE SOLICIT
SAMPLES AND SHORT
RUN PRODUCTION**

536K Multimeter Kit \$12.90
Wired \$14.90
1000 ohms/volt

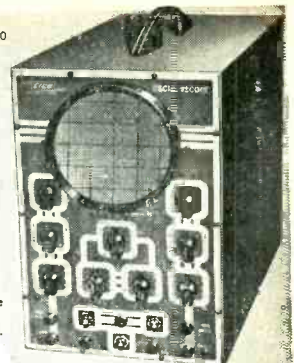

425K 5" Scope
Kit \$44.95
Wired \$79.95

YOU BUILD

EICO

**KITS
IN ONE
EVENING-**

**but they
last a lifetime...
and you
save 50%**

**24 INSTRUMENTS -
the industry's most complete
line of MATCHED
TEST INSTRUMENTS**

¼-million EICO Instruments are now in use the world over! That's the proof of EICO's leadership in Value.

For latest precision engineering, finest components, smart professional appearance, lifetime performance and rock-bottom economy — see and compare the EICO line at your jobber's today before you buy any higher-priced equipment! You'll agree with over 100,000 others that only EICO Kits and Instruments give you the industry's greatest values at lowest cost.

Write NOW for
FREE latest Catalog
E-2



221K VFMV Kit \$25.95
Wired \$49.95



565K Multimeter Kit \$24.95
Wired \$29.95
20,000 ohms/volt



NEW 377K
Sine & Square Wave Audio Gen.
Kit \$31.95. Wired \$49.95

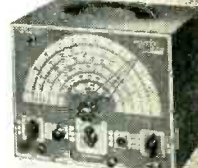

360K Sweep Gen.
Kit \$34.95. Wired \$49.95



1040K Battery Elm.
Kit \$25.95. Wired \$34.95



625K Tube Tester
Kit \$34.95.
Wired \$49.95

**Laboratory
Precision
at Lowest Cost**

Prices 5% higher on West Coast.

EICO

©1952 **INSTRUMENTS & KITS**
ELECTRONIC INSTRUMENT CO., Inc.
84 Withers Street, Brooklyn 11, N. Y.

EXTRA-RIGID CONSTRUCTION IN MINIATURE MOTORS

An Invitation to Management and Design Engineers

While we hope to have the pleasure of seeing you at the I.R.E. show, the opportunity may not present itself. We, therefore, invite you to visit us at our suite at the Roosevelt Hotel, Madison Avenue at 45th Street. We would appreciate you letting us know if you can accept this invitation so we may be fully prepared to extend our very sincere hospitality. We shall be there March 22-25.

David H. Thomas
President

R.S.V.P.

AIR MARINE MOTORS INC.
369 BAYVIEW AVE. Amityville 4-6122 AMITYVILLE, L.I.

West coast factory: 2233 Federal Ave., Los Angeles 64, Calif.

For more ad information, see Index to Advertisers.

and now takes over active management of Browning.

Dr. Browning, founder of the company, has been active in radio and electronics since 1924. His experience prior to establishing Browning Labs in 1937 includes research for National Co., president of Browning-Drake Corp. and electrical engineering consultant.

Roup Elected By Ceramic Engineers

ROLLAND R. ROUP of Globe-Union was elected vice-president of the National Institute of Ceramic Engineers for the remainder of the year 1953-54.

GE Appoints Marketing Personnel, Honors Amateur

A NEW AND ENLARGED BROADCAST equipment marketing staff in the commercial equipment department was announced by GE.

Albert F. Wild, formerly Boston district sales manager for broadcast equipment, was appointed manager of sales.

Charles J. Simon, formerly New York district broadcast equipment sales manager, was appointed manager of product planning.

C. Wesley Michaels, formerly supervisor of marketing services for the department, was named manager of marketing research and administration.

M. Roy Duncan, previously supervisor of field engineering for the department, was appointed man-



Albert F. Wild

PLANS

into PLASTICS

PRECISION MACHINING OF ALL THE PLASTICS

including
POLYSTYRENE • COPOLYMER 1422
BUTYRATE • NYLON • TEFLON • KEL-F

PLASTIC FABRICATING

Printloid is equipped for the complete production of a wide variety of consumer and industrial items in any quantity. We work with any plastic material in sheets, rods and tubes. Die-cutting, deep drawing, stamping, forming, finishing, and assembling in our own plant.

PLASTIC PRINTING

LETTERPRESS • SILK SCREEN • HOT STAMPING

for Containers, Displays, Dials,
Laminated Charts, Machined Parts, Etc.

Ask for brochure illustrating various plastic products fabricated to specification by Printloid.



for the ELECTRONIC INDUSTRIES
Quality

Ribbons STRIPS

**MOLYBDENUM
TUNGSTEN
TANTALUM
FORMED PIECES**

Your Special Metals Rolled to Thin Sizes & Close Tolerances

YOUR INQUIRIES WILL RECEIVE PROMPT ATTENTION

H. CROSS CO.

15 BEEKMAN ST., N. Y. 38, N. Y.
Worth 2-2044 and COrlandt 7-0470

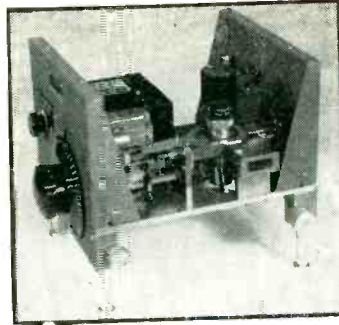

MICROWAVE DEVELOPMENTS

Wheeler Laboratories is an engineering organization offering consulting and engineering services in the fields of radio and radar.

A typical development by the Laboratories is the Model 209 X-band oscillator, shown above with cover removed. This oscillator, whose cavity setting and repeller voltage adjustment are ganged in a single calibrated control, can be tuned rapidly and continuously over the entire 8.5 - 9.6 KMc band with no more than ± 1 db change in output.

At present, Wheeler Laboratories includes a staff of twenty engineers under the personal direction of Harold A. Wheeler, a group of designers, and a model shop; regular additions to the staff are continuing in order to keep pace with our expanding program.

Inquiries are welcomed regarding specialized problems in microwave design; a brief summary of our work is available on request.

Wheeler Laboratories, Inc.

122 Cutter Mill Road, Great Neck, N. Y.
HUnter 2-7876

for maximum economy... 5KW VACUUM TUBE BOMBARDER OR INDUCTION HEATING UNIT

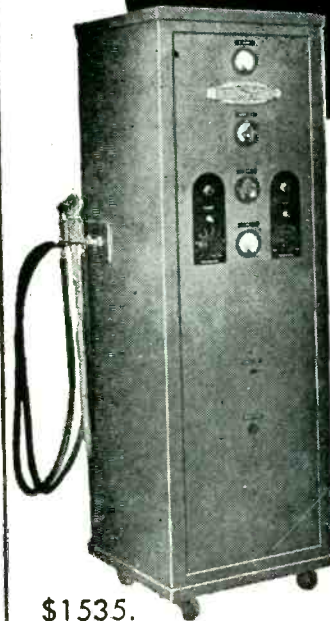

\$1535.

Simple... Easy to Operate... Economical
Standardization of Unit Makes This New Low
Price Possible.

Maximum economies can be obtained only by use of correct frequency and power combinations when applying the techniques of induction heating to manufacturing processes.

It is significant that only Scientific Electric in the present market, can offer you a selection of frequencies depending on power required, in wide power range. 2-3½-5-6-7½-10-12½-15-18-25-40-60 KW (all units above 60 KW are considered custom built). This means that electronic heating equipment produced by Scientific Electric is tailored to your needs... fitted perfectly to the task entrusted to it, enabling you to keep your initial investment in equipment to a minimum while affording you all the proven advantages of electronic heating.

Write now for complete information or send samples of work to be processed. Specify time cycle for your particular job. We will quote on proper size unit for your requirements.

DESIGNERS AND MANUFACTURERS OF HIGH FREQUENCY AND HIGH VOLTAGE EQUIPMENT SINCE 1921

Scientific Electric

105-119 MONROE ST.  GARFIELD, N. J.

MODERN Problems Demand... MODERN SOLUTIONS

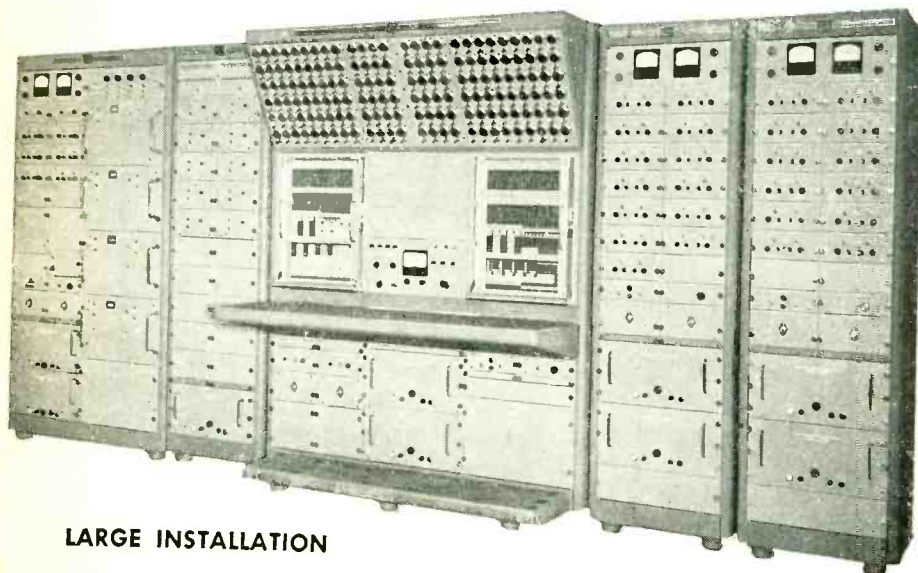

LARGE INSTALLATION

This large computer is used for the rapid solution of aero-dynamic problems. It consists of 50 operational amplifiers, 10 servo multiplying channels, 4 resolving channels, and a control console with two pre-patch bays, 156 attenuators, two voltmeters, and all necessary operational controls.

SINGLE PACKAGE COMPUTER

Our Type 16-31R Computer is a single package computer capable of solving differential equations with many simultaneous elements which are often encountered in the simulation of dynamic systems. It contains 20 operational amplifiers, 4 servo multipliers, thirty-two attenuators, all-metal removable problem board, and complete control panel.

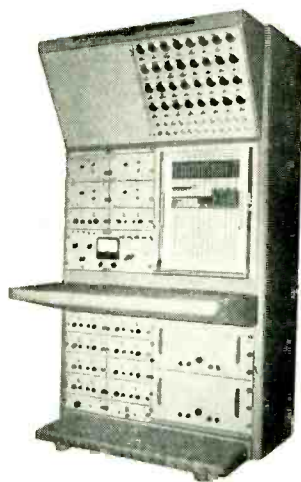

PLOTTING EQUIPMENT

For presentation of problem solutions, the Variplotter Plotting Boards provide an accurate inked record. Typical uses include the automatic plotting of: Analog Computer output; guided missile data; engine performance characteristics; and control of manufacturing processes. With accessory equipment the range of applications can be greatly extended.

Write Dept. E

ELECTRONIC ASSOCIATES INC

LONG BRANCH • NEW JERSEY

Visit our booth 329-333 Computer Avenue at the IRE National Convention
Kingsbridge Armory, New York City

PLANTS AND PEOPLE

(continued)



G. W. DeSousa

anager of product services.

Roy D. Jordan, formerly advertising and sales promotion manager of the commercial and government equipment department, was named manager of the advertising and sales promotion.

Two appointments in the company's tube department marketing organization were announced by Grady L. Roark, department marketing manager.

Named to succeed Roark as manager of equipment tube sales was G. W. DeSousa, formerly manager of tube department marketing administration. Succeeding DeSousa as manager of marketing administration is Milton J. Strehle, previously manager of intra-company sales for the tube department.

GE also announced that its Edison Radio Amateur Award for outstanding amateur radio public service of 1953 will go to J. Stan Surber of Peru, Ind. He is the only regular communications link with home for many servicemen at Arctic weather stations.

Surber, a Chesapeake and Ohio railway dispatcher, has handled over 18,000 messages to the far north since he started his hobby in late 1950. Last year, he transmitted and received over a million and a half words in Morse code to and from such points as T-3, an ice island near the North Pole. Messages go between servicemen's relatives and Surber by mail.

Carborundum To Acquire Stupakoff Ceramic

THE CARBORUNDUM Co. plans to acquire all of the capital stock of



New

★ SENSITIVE RELAY
★ POWER RELAY

ADVANCE SHOWING

During I.R.E. Show Week, March 22-25, BELMONT PLAZA HOTEL, across from Waldorf Astoria, Lexington Avenue.

You are invited to visit us there, or write direct to factory for Catalog No. 3-54.



THE FIVE STAR COMPANY
WEST MAIN STREET
PLANTSVILLE, CONN.

A Full Line

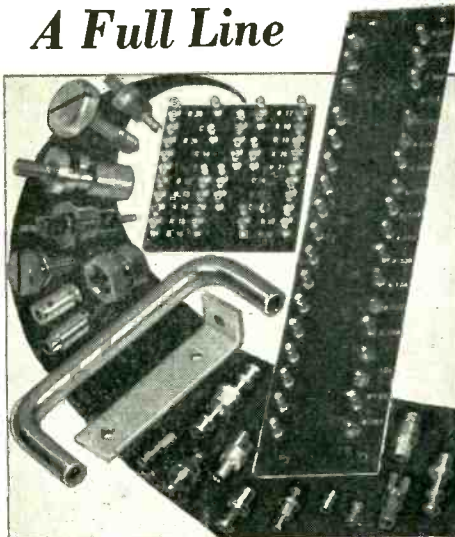

- Terminal Lugs ● Insulated Terminals ● Electronic Hardware
- Handles ● Captive Screws
- Brackets ● Dial Locks ● Spacers
- Shaft Locks ● Binding Posts

Completely assembled terminal boards to meet all government specifications.

Immediate delivery from stock or to order on all items.

Write for Catalog E

CITATION PRODUCTS CO.

233 EAST 146th ST., NEW YORK 51, N. Y.



"P" SERIES
RACKS

- No. P-3613: Overall: 42 1/2" x 22" x 18"
Panel Space: 36 1/4" x 19"
- No. P-6613: Overall: 67 1/2" x 22" x 18"
Panel Space: 61 1/4" x 19"
- No. P-8313: Overall: 83 1/2" x 22" x 18"
Panel Space: 77" x 19"

Par-Metal "P" Series Racks are available on special request up to 28" deep.

"G" SERIES
TRANSMITTER RACKS

- No. G-2218: Overall: 76 1/2" x 22" x 18"
Panel Space: 70" x 19"
- No. G-2219: Overall: 83 1/2" x 22" x 18"
Panel Space: 77" x 19"
- No. G-3624: Overall: 76 1/2" x 33" x 24"
Panel Space: 70" x 30"

"P" and "G" Series RACKS have standard finishes of black ripple, slate grey ripple (or prime coat only).

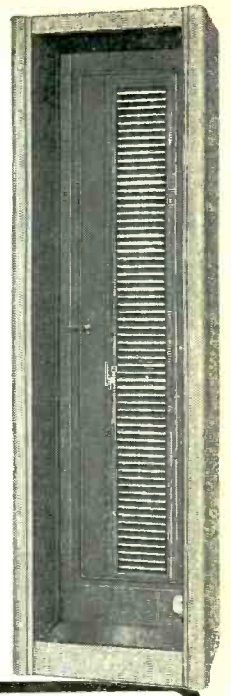

Planning an electronic product? Consult Par-Metal for

RACKS • CABINETS
CHASSIS • PANELS

Made by
Electronic Specialists



WRITE FOR CATALOG!

PAR-METAL

PRODUCTS CORPORATION

32-62 — 49th ST., LONG ISLAND CITY 3, N. Y.
Tel.: Astoria 8-8905

Export Dept.: Rocke International Corp.
13 East 40 Street, New York 16, N. Y.

Fine
ELECTROPLATED
Wires



Preferred for:

- Corrosion Resistance
- Better Solderability
- Suppression of Grid Emission
- Improvement of Electrical Characteristics

GOLD, SILVER, RHODIUM,
PLATINUM and
other metals, applied to
many different types of
wire to meet your
specifications.
Uniform plating,
scientifically
controlled.



SINCE 1907

Write for latest List
of Products

SIGMUND COHN MFG. CO. INC. 121 So. Columbus Avenue, Mt. Vernon, N. Y.

immediate solutions to any
WIRE PROBLEMS!

Typical of the wide variety of high quality wire and wire ribbon which makes Sylvania a leader in the wire-drawing industry.



Sylvania offers wire in diameters, types and alloys for exacting electrical and mechanical requirements

Sylvania's new and extensive facilities now provide wires and wire ribbons for both your electrical and mechanical needs. Available in standard types and sizes . . . or drawn to your own specifications.

For example, you can have cold drawn wire of Nickel or Nickel Alloys, Stainless Steel, Nickel-Clad Steel, and other special-coated wires for high-temperature applications. Sylvania's automatic, precision equipment is capable of drawing wire to .002 of an inch . . . assures uniform close tolerance and highest possible quality.

Also available are wire ribbons, rolled flat or in special shapes including half-round, grooved, or knurled. So, if it's a question of wire, remember

Sylvania welcomes your problems. New illustrated folder tells about Sylvania's advanced wire production and quality-testing methods. For your copy address Dept. 4A-1603, Sylvania today.



Wire is drawn on this Sylvania machine from .100 to .040 inch diameter.

SYLVANIA



Sylvania Electric Products Inc., 1740 Broadway, New York 19, N. Y.

In Canada: Sylvania Electric (Canada) Ltd.
 University Tower Bldg., St. Catherine Street, Montreal, P. Q.

LIGHTING • RADIO • ELECTRONICS • TELEVISION

Stupakoff Ceramic and Manufacturing Co., manufacturers of ceramic and other components.

Maj. Gen. C. F. Robinson, president of Carborundum, said that Stupakoff will continue its operations under its present name and the present organization and personnel of the company will be retained under the direction of S. H. Stupakoff, president.

Carborundum's present Global division manufactures electric heating elements and resistors. "The acquisition of Stupakoff Ceramic and Manufacturing Co.," General Robinson said, "will greatly extend Carborundum's activities in the growing electronics field."

Philco Appoints Hardy And Otter

APPOINTMENT OF Larry F. Hardy as vice-president in charge of product development and John M. Otter as vice-president in charge of consumer product divisions for Philco Corp. was announced by William Balderston, president.

Hardy has been president of the television and radio division of Philco since 1949. Otter has been vice-president and general manager of the refrigeration division since early in 1952.

In his new position, Hardy will be responsible for the development of all Philco product lines, one of the most important phases of the company's activities. He will be jointly responsible with the vice-president of engineering and research for bringing new products from research to public sale.

He joined Philco in 1932 and, for the next five years, represented the company in Chicago and the northwest division. He later became vice-president and general manager of Simplex Radio Co., a Philco subsidiary.

In 1939 Hardy came to Philco headquarters in Philadelphia as manager of small radio sets and then manager of the entire home radio set division. In 1944, he was elected vice-president in charge of the television and radio division and four years ago was named president of the division under the company's divisionalization program.

In his new capacity, Otter will

PROTECTIVE COVERING

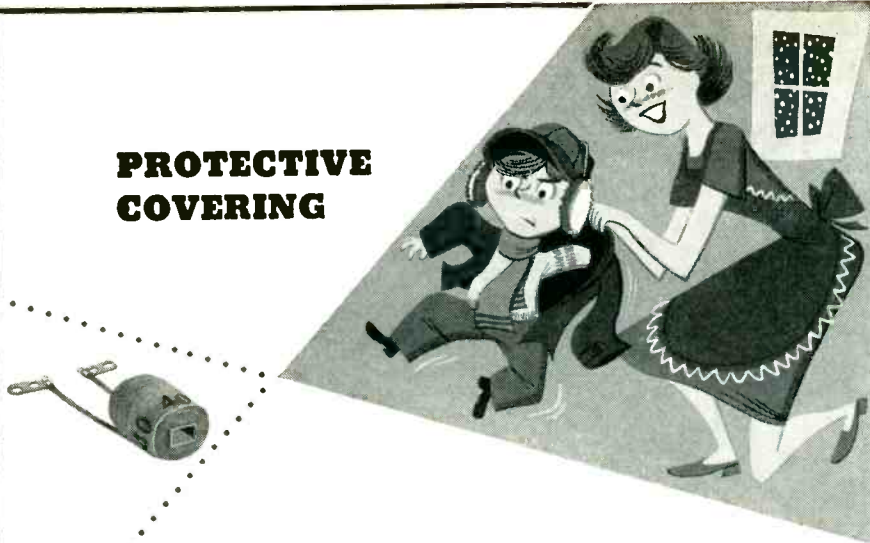

When you design or redesign a coil unit, remember: Proper covering is a coil's first line of physical defense. Have our design engineers recommend the correct covering to protect your coil. Coto-Coil Company, 65 Pavilion Avenue, Providence 5, R. I. New York Office: 10 E. 43rd Street, New York 17.

Coto PRECISION WOUND **Coils**

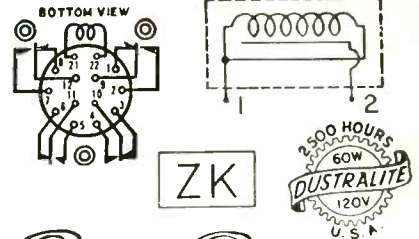

Super Sanitas
FABRIC WALL COVERING

MALLORY
5 MPDIOVDC
5-53



Are better than rubber
3 ways

ENGRAVED Vinylite IS ACID-PROOF

Acid etching inks, used for permanent stamping on metal and all non-porous surfaces will eat away at rubber. Vinylite resists this action . . . gives longer life by far.

ENGRAVED Vinylite STAMP DIES GIVE RAZOR-SHARP IMPRESSIONS EVERY TIME

Opaque inks will clog shallow rubber stamp faces rapidly. Our deep-molded engraved VINYLITE stamp faces have more than three times the depth of ordinary rubber stamps. Markings always remain super sharp . . . the clearly identifying mark that distinguishes and labels your product of quality.

ENGRAVED Vinylite STAMP DIES HAVE CUSHION-LIKE RESILIENCE

Our VINYLITE molding process includes a timed curing that imparts to this versatile plastic all the elasticity of rubber. Resilient VINYLITE STAMP DIES resist abrasive action, conform to irregular surfaces . . . and last much longer! Engraved Vinylite Stamp Dies are adaptable to any automatic or hand marking device. They can be used to stamp on every surface, metal, wood, fabric, paper, plastic, etc.

KRENGEL MANUFACTURING CO., INC.

Dept. 1B, 227 Fulton St., New York 7, N.Y. Tel. CO 7-5714

Please check the following:

Free Vinylite Sample and Price List

Please have salesman call for appointment

NAME
COMPANY
STREET
CITY ZONE STATE

NEW

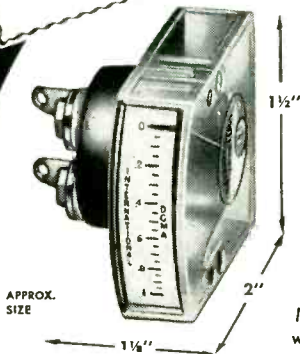

APPROX. SIZE

modernize . . .
miniaturize . . .
functionalize . . .

WITH

international's
EASY-TO-READ
side indicating
panel meters

FEATURES YOU HAVE ALWAYS WANTED

Panel opening only .516" x 1.605" . . . scale 1.3" long . . . horizontal or vertical mounting singly or with scales together . . . dust-tight case . . . and the precision D'Arsonval movement of all international miniature meters.

ENGINEERING DATA SHEETS ARE NOW READY ON THESE METERS:

1" Round Meters; 1 1/2" Round and Square Meters; 1 1/2" VU, DB, and Illuminated Meters; Miniature Multi-testers and Side Indicating Panel Meters.

Just ask for your **FREE** copies today.

international instruments
INCORPORATED
P.O. Box 2954, New Haven 15, Conn.

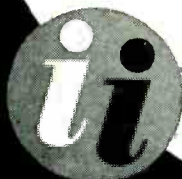

SEE THEM AT
BOOTH 763, I.R.E.
SHOW IN NEW YORK

SAVE WITH S.S. WHITE REMOTE CONTROL FLEXIBLE SHAFTS

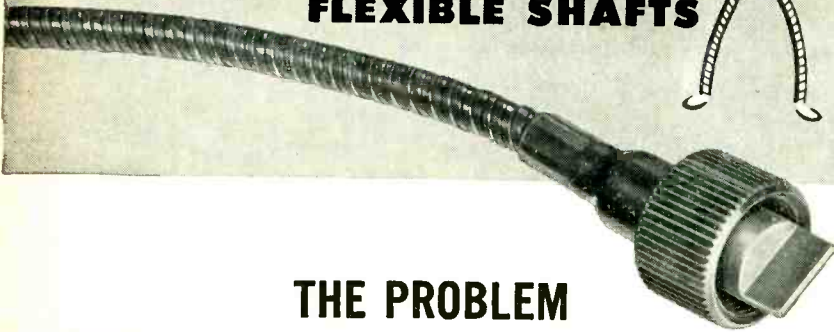

THE PROBLEM

DESIGNING FOR GREATER OPERATING CONVENIENCE

The problem faced by the manufacturer of the automotive clock pictured below is a common one—that of designing a product for greater user-convenience. In this case, the clock had to be mounted in the dashboard where it could be readily seen. The reset knob had to be mounted where it was *easy to get at*. The problem was further complicated by the fact that the clock had to be adaptable to meet the requirements of different dash board arrangements. Faced with these difficulties the manufacturer found that he could save time and money by adopting . . .

THE LOW-COST SOLUTION

AN S.S. WHITE REMOTE CONTROL FLEXIBLE SHAFT



The advantages are obvious. The flexible shaft gives complete freedom in mounting both the clock and the reset knob in the most desirable location. The adaptability of the shaft to all space conditions, the ease with which it can be installed and its smooth, trouble-free operation are all factors which contribute to important savings in manufacturing time and costs.

Take advantage of the cooperation of S.S. White engineers in working out your remote control problems. There's no obligation, and the chances are that they'll be able to point out additional ways to economize through proper flexible shaft selection and application.

Send for This Flexible Shaft Handbook

Included in this handbook are 256 pages of useful facts and data on flexible shafts. You can get a free copy by writing for it direct to us on your business letterhead.



THE S.S. White INDUSTRIAL DIVISION
DENTAL MFG. CO.



Dept. E, 10 East 40th St.

NEW YORK 16, N. Y.

Western District Office • Times Building, Long Beach, California

coordinate the activities of all consumer product divisions including sales, merchandising and distribution of tv, radio and major appliances.

Otter joined Philco in 1926 and has served successively as district sales representative, manager of Philco Distributors in Philadelphia, sales manager of the middle west, vice-president and general sales manager for the entire corporation and, for the past two years, has been vice-president and general manager of the refrigeration division.

Both Hardy and Otter are members of the board of directors.

Standard Coil Plants In Midwest Consolidated

STANDARD COIL PRODUCTS Co. is consolidating its midwest operations for better efficiency and economy of production and distribution. The company has maintained three plants in the Chicago area and a fourth in Aurora, Ill. With its recently expanded facilities at Melrose Park, the company has been able to shift production in its other plants so that its oldest Chicago plant can be closed.



General Wood To Speak On Aviation Electronics

BRIGADIER GENERAL Floyd B. Wood, USAF, will speak on "The Air Weapons System Management Plan and the Electronics Industry", Tuesday, March 23, at the noon-time luncheon of the Professional Group on Aeronautical and Naviga-

AEROCOM MEANS TROUBLE-FREE SERVICE!
From Ground To Air or Point to Point



The model 12GLX-M, 1KW Beacon Transmitter illustrated, operates on a single frequency in the range 200-415 Kcs. Oscillator coil can be supplied crystal-controlled or self-excited. Tone oscillator provides 30% high level modulation for identification when keyed with AeroCom's model AK-3B automatic keyer. The unit can also be voice modulated. Power supply . . . any stable voltage in the range 200-240 volts, 50/60 cycles, single phase. Overall dimensions in CM, 56W x 62D x 177H. Net weight 286 kilos.



3090 DOUGLAS ROAD

MIAMI 33, FLA.

**PUSH-BUTTON
AUDIO OSCILLATOR**

MODEL TO-100

**NEW
ACCURATE
STABLE**

FOR CHECKING

**FM/FM TELEMETERING
SUB-CARRIER EQUIPMENT**

- 20 accurate, fixed centre-frequencies
- Calibrated control for $\pm 10\%$ adjustment
- Indicator for beating external signal
- Low distortion and excellent stability
- Constant voltage low impedance output
- Continuously variable calibrated level
- Standard FM/FM frequencies furnished
- Other frequencies available to order

FOR RAPID PRODUCTION CONTROL TESTS



TELETRONICS LABORATORY INC.

WESTBURY, L. I., N. Y.

MANUFACTURERS OF ELECTRONIC INSTRUMENTS AND PRODUCTION TEST EQUIPMENT

PRECISION

**SYNCHROS
SERVO MOTORS
RATE GENERATORS**

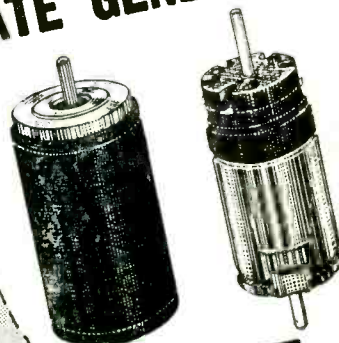

Infra Electronic Corporation is playing an important part in the precision manufacture and assembly of electronic and electro-mechanical system components for the Military.

We invite your inquiry when commercially available units will not meet your system demands.

Custom design, development, and manufacture of Test Sets, Kits and Consoles for pre-flight check out and ground maintenance of airborne systems.

INFRA

Electronic Corp.

Roseland, New Jersey

Manufacturers of Precision Synchros



MINIATURE



MOLDED



CASED



HERMETICALLY SEALED OIL-FILLED



A-LINE



T-LINE

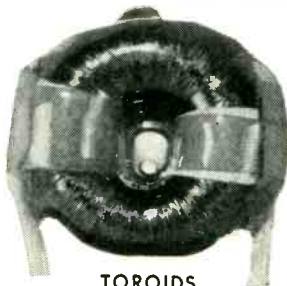

TOROIDS

Kenyon

Standard and Special Transformers engineered to your requirements

INQUIRIES AND SPECIFICATIONS
RECEIVE PROMPT ATTENTION



Kenyon Transformer Co., Inc.
840 Barry St., New York 59

See us at Booth 541—I.R.E. Show
For more ad information, see Index to Advertisers.

tional Electronics, Institute of Radio Engineers, during the national IRE convention in New York. General Wood is Deputy Chief of Staff for Development at the USAF's Air Research & Development Command Hdqtrs., Baltimore.

General Wood will discuss the latest revisions to the original plan under which the airframe manufacturer was charged with purchasing all electronic equipment used in and with his airframe, and their effect on the aviation electronics industry. The talk and luncheon will highlight "Aviation Electronics Days," commemorating the 50th anniversary of powered flight and including three PGANE technical sessions on March 22-23.

Raytheon Personnel Make New Moves

IVAN A. GETTING, vice president, engineering and research, of Raytheon, has been reappointed chairman of the electronics and communications panel of the Scientific Advisory Board, U. S. Air Force, for 1954.

The appointment was made by General N. F. Twining, chief of Staff, USAF. He said, in part: "Both in the solution of the complex technological problems with which we are faced, and in the recognition and exploitation of scientific opportunities which arise, the Air Force is fortunate in being able to utilize your knowledge, experience, time and effort through your work with the SAB."

The appointment of J. Forrest Bigelow as manager of engineering and development for the tv and radio division of Raytheon was also announced. He was formerly in charge of the company's advanced radio and tv development department.

Bigelow joined Raytheon in 1952 after nine years with the Capehart-Farnsworth division of IT&T where he served as supervising engineer of the advanced development group and pioneered in the research in color tv.

He has been instrumental, the company said, in the progress made in the fields of tv camera tubes, airborne tv for military use, design and production of special tv test-

4 Channel
COINCIDENCE ANALYZER
 MODEL 553



Sensitivity—50 millivolts, neg. only
Resolving Time—0.5, 1.0, 1.5, 2.0, 2.5, 3.0 micro-seconds
Output—1/2 volt neg.
Operation—3 channels operate to form positive coincidence; the 4th forms anti-coincidence.
Delayed Coincidence—Provision is made for delaying the events in the 3rd channel to form delayed coincidence.

The model 553 when used with any scaler containing a high voltage supply forms a complete coincidence counting system. No extra amplifiers or power supplies are required. Any possible combination of the 3 coincidence channels and the anti-coincidence channel may be used. The extreme sensitivity of the model 553 permits its use with scintillation probes as well as G. M. and proportional counters. Channel no. 3 is modified to allow delayed coincidence counting which is highly useful for isotope identification and life time measurement. Resolving times are determined solely by lump constant delay networks and are independent of tube characteristics. Amplifiers are stabilized by electronically regulated B supply.

Price F.O.B. Center Moriches, N. Y. \$845.00

NUCLEAR SPECIALTY CO.
 Center Moriches, N. Y.

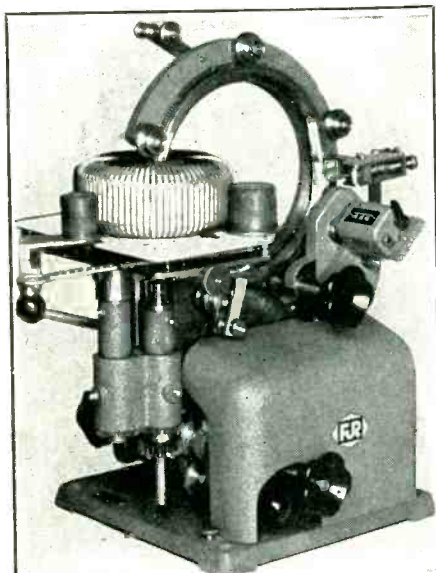

**AUTOMATIC TOROIDAL
 CORE WINDING MACHINES**
 4 DIFFERENT MODELS

LICENSE-FREE

We invite you to see our machines in operation in our showroom, Baldwin, L. I., #3 Foxhurst Road, which is open during the I.R.E. Show from 8 A. M. to 8 P. M., or by appointment. Telephone BA 3-5160.

REX RHEOSTAT CO.
 BALDWIN, L. I., N. Y.

ZOPHAR

WAXES

COMPOUNDS

Zophar Waxes, resins and compounds to impregnate, dip, seal, embed, or pot electronic and electrical equipment or components of all types; radio, television, etc.

Cold flows from 100°F. to 285°F.

Special waxes non-cracking at -76°F.

Compounds meeting Government specifications plain or fungus resistant.

Let us help you with your engineering problems.

ZOPHAR MILLS, INC.
 112-130 26th Street,
 Brooklyn 32, N. Y.

3 WAY PROTECTION

N-CAPS

ENCAPSULATED
 WIRE WOUND
 RESISTORS

HERMETICALLY SEALED

Withstands Effects of Salt Water

Resistance To Mechanical Shock

Maximum Stability for Longest Periods

SURPASSES SPEC. MIL-R-93A

N-Caps are precision wire wound resistors; encapsulated in a hermetically sealed plastic jacket. The encapsulating process is your assurance of utmost protection against the deteriorating effects of salt water and the destructive effects of mechanical shock. N-Caps provide maximum stability over longest periods. Sizes: MIL-R-93A RB15, 16, 17, 18, 19, RB52 Series & specials.

Illustrated Catalog on N-Caps and other precision, wire-wound products contains valuable engineering data. Write for it today.

EASTERN PRECISION RESISTOR CORP.
 Richmond Hill 18, New York

Volkert stampings insure fidelity of millions of radio and TV sets

PRECISE COMPONENTS GO INTO VOLUME CONTROLS FOR IRC

Volkert—leading independent supplier of electron gun parts—is also helping to moderate millions of radio and television sets across the nation.

International Resistance Company of Philadelphia calls on Volkert for all vital stamped components of their volume controls and switches.

Here's why electronics industry leaders like IRC look to Volkert for precision stampings:

Volkert's skill in designing and building its own dies assures them of accurate, volume production. Volkert progressive dies feature interchangeable sections for wider adaptability and economy. Volkert has the most modern automatic production equipment in the industry. These factors, plus Volkert's rigid inspection of stampings at every production stage, hold rejects to a minimum and lower manufacturing costs.

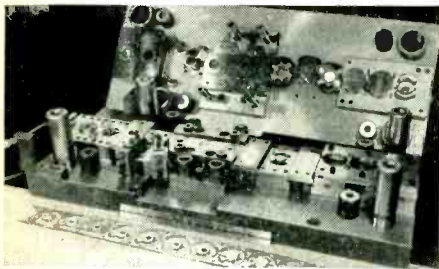

ACCURATE DIES—Volkert-built multi-stage dies like this "13-stage progressive" for stamping control covers assure uniformly high quality in long production runs for many manufacturers.



QUICK, EASY ASSEMBLY—The pay-off on precision comes when components hit the IRC high-speed assembly line. They're accurate; they fit.

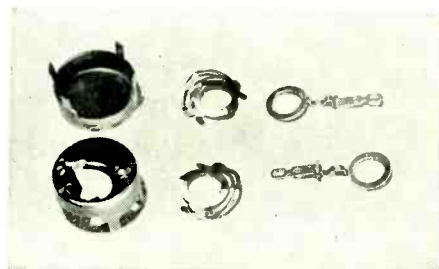

PRECISION STAMPINGS—These covers, contact springs and center terminals were Volkert-made on modern automatic production equipment for International Resistance Company.

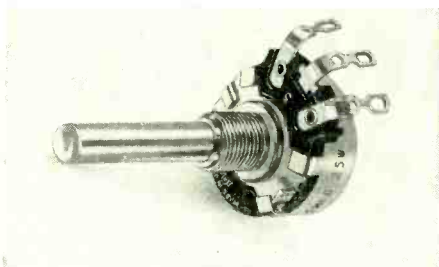

TOP PERFORMANCE—Volkert precision stamped parts contribute to rugged construction and superior performance of this IRC "Q" control.

KEEP ON TOP of the latest precision stamping news in the electronics industry! Write for fact-packed, picture-filled VOLKERT VIEW quarterly. It's free!



Volkert for design... tooling... production and assembly of precision stampings

JOHN VOLKERT METAL STAMPINGS, INC.
222-34 96th Avenue, Queens Village 29, L. I., N. Y.

For more ad information, see Index to Advertisers.

PLANTS AND PEOPLE

(continued)

ing equipment and in the advancement of color tv.

Dick O. Klein, vice-president and general manager of Raytheon Distributors, has been appointed director of marketing for the tv and radio division and assistant vice-president of the parent company.

In the newly created post, Klein will supervise all Raytheon television national sales, advertising and service activities.

Prior to joining the firm early in 1953, Klein had been, successively, general sales manager of the Pressed Steel Car Company appliance division; sales vice-president of Leeson Steel Co. and general sales manager of David Kaufman and Sons, tv and appliance distributor in Baltimore and Washington. Before the war, Klein was sales promotion manager of Packard Motor Car Co., in Chicago.

Globe-Union To Build New Battery Plant

GLOBE-UNION OF MILWAUKEE, manufacturers of storage batteries and electronic component parts, has purchased five acres of land near San Jose, Calif. where it will build a battery manufacturing plant.

The proposed plant, to be constructed in 1954, will be the firm's third west coast battery plant. Others are in Los Angeles and Oregon City, Ore. The new site was purchased from Western Pacific for a reported \$18,000.

Hycon Manufacturing Elects Officers

HARRY OEDEKERK, president of Hycon Mfg. Co. of Pasadena, Calif., producers of photographic and electronic equipment, has been elected chairman of the board of directors of the company. Alden E. Acker, a director and one of the founders of the firm, has been elected president. Oedekerk succeeds Trevor Gardner, assistant to the Secretary of the Air Force, who has resigned as chairman because of increased governmental responsibilities.

Harry E. King, assistant to the president, has been elected a member of the board of directors. E. S. Morrison, assistant secretary-treasurer, has been named secretary-

**An Improved Orientation Head
for the Precision Processing
of Quartz Crystals**



MASTERCRAFT MODEL 600 B-2

This model is fitted with compound dovetail slides and with an all angle table top capable of being inclined 3 1/2 degrees on two planes, which adapts itself to laboratory, production or research work or where a particular technique requires orientation of the X axis in two directions from horizontal. The Z axis may be rotated throughout 360 degrees with orientation within one minute precision.

Write for Complete Catalogue of
Mastercraft Tools.

F & M SALES, INC.
1054 Cahuenga Blvd., Hollywood 38, Calif.

**ELECTRONIC
ENGINEER
WANTED**

**FIELD TEST POSITION
ON
AIR WEAPONS SYSTEM
FOR
GUIDED MISSILE TESTING**
Some Radar Experience Required

SOUTHERN CALIFORNIA

Send Resume to:
FIELD TEST MANAGER

BELL
Aircraft CORPORATION

NAVAL AIR MISSILE
TEST CENTER
Point Mugu, Port Hueneme, California



Wind
Your Coils on the **BEST**
PRECISION
COIL BOBBINS

Exactng quality control and finest materials add up to make PRECISION BOBBINS the best cores for R.F., I.F. coils, solenoids, switches, and other electronic applications.

Count PRECISION BOBBIN advantages:

- Greater Insulation
- Better Heat Dissipation
- Higher Moisture Resistance
- High Strength, Light Weight
- More Winding Space
- Low Unit Cost

PRECISION COIL BOBBINS can be designed to your particular specifications . . . any size, shape, quantity—dielectric kraft, fish paper, cellulose acetate, combinations or phenol impregnated materials. Flanges plain or fitted with leads, slots, holes for terminal wires . . . recessed or embossed to fit any mounting.

Send specifications for free sample and ask for Bobbin Catalog.

Also Mfrs. of PRECISION Paper Tubes

PRECISION PAPER TUBE CO.

2041 W. Charleston St.
Plant No. 2: 79 Chapel St., Hartford, Conn.

Chicago 47, Ill.

ici *Carry-Through
Printed Circuits*

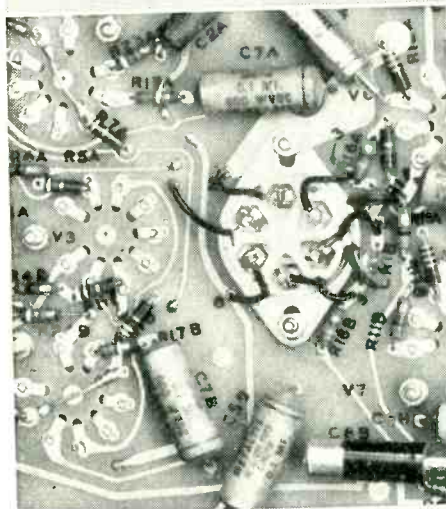

ici *Insulated Circuits*
INCORPORATED

- speed production
- eliminate hardware with I. C. I.

I. C. I. carries the pattern of the printed circuit through the holes to the other side to maintain efficient continuity.

NO hardware . . . with resulting excellent economies plus speeded-up production and more useable space. In a one square foot area of a printed circuit board .125" thick, 150 holes .020" in diameter can be successfully plated through.

I. C. I.'s unparalleled experience and engineering staff are at your disposal. Write, detailing your requirements for specific help and a copy of our thorough, new technical brochure which explains our research, design and conversion services.

I. C. I. also handles complete sub-assemblies as shown.

115 ROOSEVELT AVENUE
BELLEVILLE, NEW JERSEY

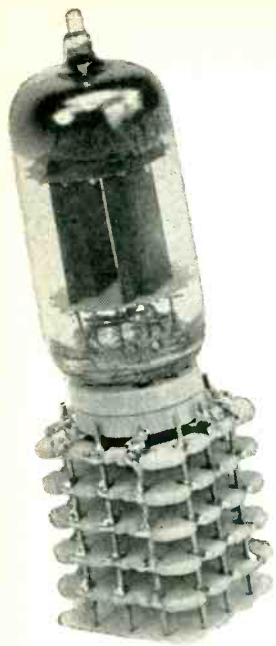

Can you afford not to use the Reliacube?*

MODULAR } PRODUCTION } FOR ELECTRONICS
DESIGN }
 (formerly Project TINKERTOY)

The modular design technique for electronics has been firmly established as being superior in the government's search for a standardized electronic design and production system capable of producing equipment of *increased reliability at low cost and much stronger mechanically*. AND the first commercial adaptations of this technique have been made with tremendous success by Sanders Associates. What's more, *NOW*, the necessary materials and equipment are available to you.—CAN YOU AFFORD NOT TO EMPLOY THESE NEW TECHNIQUES ON YOUR EQUIPMENT???

AVAILABLE NOW:

"RELIACUBES"* (Ceramic modules) and modular components at a cost unbelievably low. Current costs average approximately \$2.00 per module in relatively small quantities. Exact cost of your "RELIACUBES" depends upon production volume and the quantity of components. Send us your requirements for an estimate.

Equipment for the establishment of *your own* semi-mechanized production of modular units. Extensive production equipment, at high costs, is not needed to realize the benefits of the modular technique. Equipment costing approximately \$3000 to \$5000 can produce 300 modules per day!!!!!!

Design services based on: over 2 years of experience in modular design engineering field; highly successful adaptations of *both* military and commercial electronic equipment constructed in the conventional manner, to the modular system; extensive environmental testing of modular units.

SEE THESE NEW PRODUCTS INTRODUCED FOR THE FIRST TIME PLUS:

- "RELIOHMS"—Tape resistors in "ready-to-use" dry tape form—the printed circuit equivalent of conventional carbon resistors. Size— $\frac{1}{2}$ " long; $\frac{1}{8}$ " wide; $\frac{1}{100}$ " thick.
- The "MINICUBE"—A subminiature blower featuring a motor and blower complete in a *ONE INCH CUBE* producing 3 cfm.
- A versatile full wave bridge comparator that can be used as a modulator - demodulator - switch.
- A non-jamming self-clearing 2-stage hydraulic servo valve which is as simple to use as a single-stage valve. Producing an output up to 14HP and a response to 150 cps.

At Booth 703, Production Road • I.R.E. Show, Mar. 22-25, Kingsbridge Armory
or write Dept. S-22 for latest bulletins.



NASHUA, NEW HAMPSHIRE
reliability in electronics



Alden E. Acker

treasurer to succeed Alfred P. Ludwig, also a director. Grover C. Judy continues as general manager of the company and has been named vice-president.

Oedekerker was the founder and principal officer of Oedekerker & Ludwig, rocket manufacturers, recently merged into Hycon.

Stubbe Named General Instrument Chief Engineer

PROMOTION OF Ralph R. Stubbe to the post of chief engineer was announced by Monte Cohen, president of General Instrument.

Cohen cited the key role played by Stubbe in the firm's expanding production of television tuners, especially the uhf-vhf model.

During his 16 years in the electronics industry, Stubbe has been employed by leading companies, including Westinghouse, Hazeltine, NBC and Hoffman Radio.

In another personnel move, General Instrument announced that C. L. Walker has been named manager of its Chicago sales office. Walker, who has been connected with General Instrument and its Sickles division in the midwest for over a year, takes over the duties previously held by B. V. K. French.

Honeywell Elects Three Executives

CHARLES B. SWEATT has been elected to the newly created post of vice-chairman of the board of Minneapolis-Honeywell. Two other officers have been elected executive vice-presidents.

The new executive vice-presi-

MANUFACTURERS OF

Electronics

EQUIPMENT

requiring *immediate factory space*, in units of any size, and *skilled experienced workers* for branch operations are urged to investigate the specialized facilities in

LAWRENCE

MASSACHUSETTS
(Research Center of America)

write to:

**GREATER LAWRENCE
CITIZENS COMMITTEE FOR
INDUSTRIAL DEVELOPMENT**
Lawrence, Massachusetts

Pre-assembled partitions...made to exact specifications...for manufacturers of Radio, Electrical and Electronic components and allied products.

P
P
P
Partitions for
Protective
Packaging

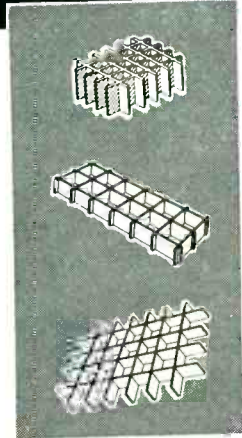

WRITE, PHONE or WIRE
for QUOTATIONS on
YOUR REQUIREMENTS

peter partition corp.
Manufacturers of Cardboard Partitions

19-21 HEYWARD ST.

BROOKLYN 11, N. Y.

Telephone: TRIangle 5-4033

World's
Smallest Coax...

MICRODOT® Connectors & Cable



New pre-production
Kit for Design-in
and experiment

See that your products are design competitive...feature Microdot advantages. Order Microdot Kit #553 today...and save valuable experiment time by having the precise parts you need for multi-stage tests. Satisfaction is assured. Simply clip this advertisement to your letterhead with P.O. or check for \$60. Mail to address below.



MICRODOT
DIVISION OF FELTS CORP.
1826 Fremont St., So. Pasadena, Calif.



Both Connector and Cable in
this box are actual size!

ELECTRONICS — March, 1954

Precision Instruments

SERVOMECHANISMS

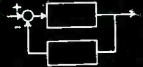

To answer your specific needs for precision electro-mechanical systems, The Ahrendt Instrument Co. offers a combination of the highest calibre engineering talent and the finest production facilities.

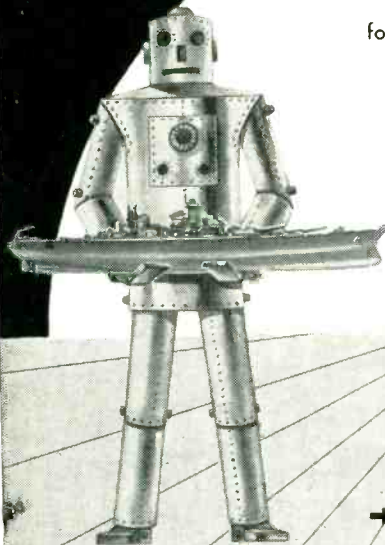

The
AHRENDT
INSTRUMENT
COMPANY

Automatic Control Devices

4910 CALVERT RD., COLLEGE PARK, MD.

For more ad information, see Index to Advertisers.

PARTS • TIME INTERVAL •
TEMPERATURE • VISCOSITY • RPM
TURNS • VOLUME • WEIGHT
FLOW • FREQUENCY • LENGTH
PRESSURE • QUANTITY

3 STEPS TO Automation

- 1 Convert quantity to be controlled into electrical impulses
- 2 Apply impulses to counter set for desired number of counts
- 3 Connect counter output to control device

POTTER PREDETERMINED ELECTRONIC COUNTERS

- HIGH SPEED OPERATION
- INSTANTANEOUS AND AUTOMATIC RESET
- DIRECT DIAL SETTING OF DESIRED COUNT
- FAIL-SAFE OPERATION — NO FALSE COUNTS
- ABSOLUTE ACCURACY
- RUGGEDIZED INDUSTRIAL DESIGN

Let Potter engineers study your control problem.

Potter experience with a wide variety of pickup and control devices is at your disposal.





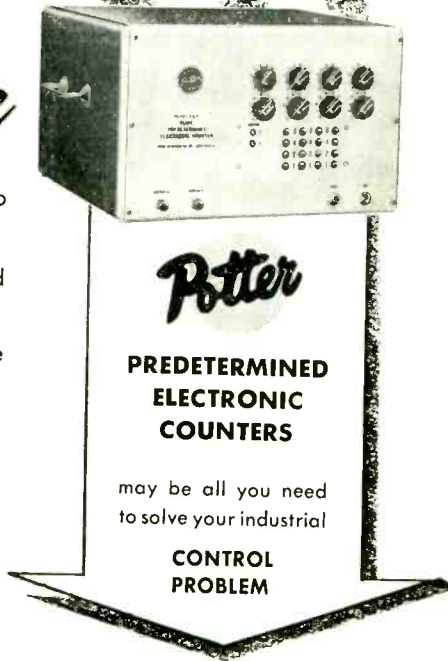

Write today for additional information.

Please direct mail inquiries to Dept. 3-C.

VISIT US AT 346 COMPUTER AVE. IRE



TO CONTROL:

- MOTORS 
- SOLENOIDS 
- CONVEYORS 
- CUTTERS 
- ALARMS 
- VALVES 
- PUMPS 
- OTHER ELECTRONIC EQUIPMENT

dents are Tom McDonald and A. M. Wilson. Both formerly had the title of vice-president. In their new posts, they will assist Paul B. Wishart, president, in carrying out managerial duties at the policy-making level.

Charles B. Sweatt, younger brother of board chairman Harold W. Sweatt, has been an executive of Honeywell since the inception of the presently-formed corporation, serving first as vice-president and, since 1945, as executive vice-president.



Canadian Aviation Appoints Paddon

JOHN W. PADDON has been appointed manager of the commercial division of Canadian Aviation Electronics, it was announced by K. R. Patrick, company president. Paddon's international business background includes service as chief of the electronics division of the Department of Defense Production in Washington, D. C.

Chesapeake Acquires Cardwell Manufacturing

CHESAPEAKE INDUSTRIES has purchased the Allen D. Cardwell Manufacturing Corp., electronics firm with plants in Plainville and Stamford, Conn. It is the fifth subsidiary bought by the firm within 18 months.

Chesapeake also acquired the Grenby Manufacturing Co. parent company of Cardwell.

One hundred percent of the stock in the two companies was purchased from four families of stockholders. President Ralph H. Soby

NOW AVAILABLE FROM STOCK

Model	Single	114	124	134	144	154	164
	Dual	214	224	234	244	254	264
No. of Decades	1	2	3	4	5	6	
Count Capacity	16	100	1,000	10,000	100,000	1,000,000	
(available for each sequence in dual models)							
Count Rate	up to 60,000 per min. (higher rates are available)						
Inputs	2-volt sine wave, 2-volt negative pulse, contact closure. (A wide variety of count detectors is available)						
Outputs	Relay contact and 50-volt pulse						
Reset	Automatic, panel pushbutton, or remote contact closure						



POTTER INSTRUMENT CO., INC.
 115 CUTTER MILL ROAD
 GREAT NECK, N. Y.



Mark your own symbols, numbers, lettering, on your small parts, tools, identification and name plates . . . easily, simply, quickly . . . tracing from a master with the GREEN ENGRAVER.

Widely used in electronic and plastic fields, in machine tool shops and wherever permanent marking is needed. The GREEN ENGRAVER engraves equally well on metals, plastic, wood, hard rubber and glass.

✓ Fact-filled folder on request . . . showing how economies in costs, labor and time are achieved with the GREEN ENGRAVER.

✓ Routs ✓ Models ✓ Profiles ✓ Engraves Etching attachment and other special equipment for industrial uses are available.

Green Instrument Co.
INCORPORATED

363 PUTNAM AVE., CAMBRIDGE, MASS.
See us at Booth 243 at the IRE Show.

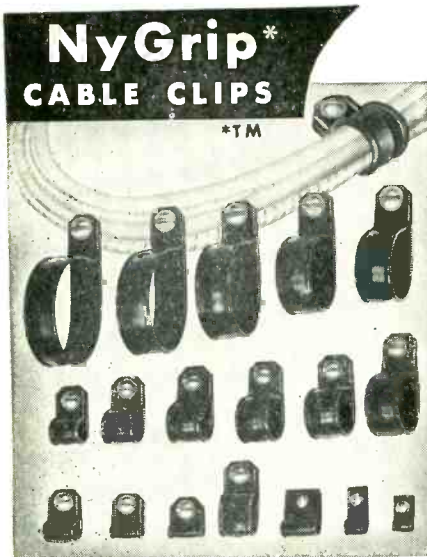

Hold that wiring with these all Nylon cable clips

- ★ Lightweight ★ Tough ★ Strong
- ★ Chemically resistant
- ★ No metal to corrode or cause short circuits
- ★ Easy to apply ★ No sharp edges
- ★ May be used from -60° to 250° F.

Send for samples and literature
WECKESSER COMPANY

5267 N. Avondale Ave. ★ Chicago 30, Illinois

ELECTRONICS — March, 1954

THE "SNAPPER" THERMAL TIME DELAY RELAY

POSITIVE
"SNAP ACTION"

SNAP ACTION (no chattering). Single Pole Double Throw. Lightweight. Low operating temperature. Operates in any position. High contact rating. Gas filled. Low heater current. Durability and long life.

LEADING ELECTRONIC MANUFACTURERS have acknowledged the new ELLY "SNAPPER" as a major advancement in this field, and have already accepted this relay as a standard component of their latest equipment.

Voltage . . . 6.3, 26.5, 115 volts (A.C. or D.C.) or as required.

Ambient Temperature Range . . . -60°C. to +80°C.

Envelope . . . Miniature (7 and 9 pin), or octal (8 pin) metal.

Time Delay Periods . . . Preset from 5 seconds up.

Height . . . 1 3/4" maximum seated.

See us at Booth #89C on Audio Ave.
at I.R.E. Show March 22-25, inclusive.



Send for our
"Bulletin Number Snapper"

ELLY ELECTRONICS CORP.
P. O. BOX 395 . . . FAIR LAWN, NEW JERSEY

Quality . . .



is Standard with Standard Piezo

Standard Piezo guarantees accurate and dependable quartz crystals to meet all private plane or commercial air carrier requirements.

Whether they are high or low in frequency, for use at low or high altitudes, you'll find Standard Piezo quality is consistently superior.

For your crystal requirements, standard or custom, write or call us.



Standard Piezo Co.
CARLISLE, PENNA.
Phone 7495

For more ad information, see Index to Advertisers.

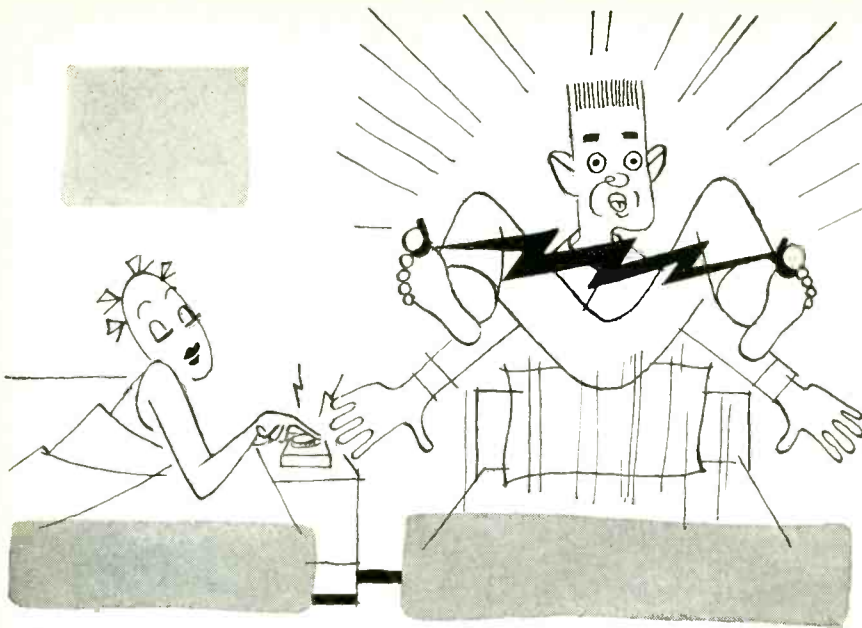

Centralab rotary switches solve a wide variety of electronic applications

Chances are you'll never design an "electronic husband awakener". But the uses for Centralab Rotary Selector Switches are as broad as your imagination

- Available in standard (1 7/8" diameter) or miniature size (1 1/2" diameter).
- Standard or special switching combinations — up to 12 positions or up to 6 poles per section.
- Single or multiple sections.
- Indexing: 30° or 60° (standard or miniature); 90° (standard only).
- Phenolic insulation — NEMA Grade XXXP. MIL Grade P3115B.
- Steatite insulation — JAN Grade L-5 for low loss characteristics.
- Shorting or non-shorting types.
- All hardware heavily cadmium plated.
- Clips and contacts silver plated spring brass.
- Solid silver alloy contacts available.

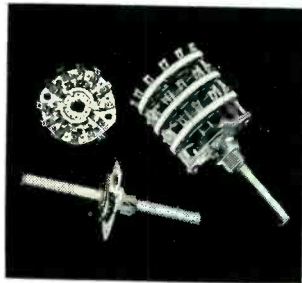
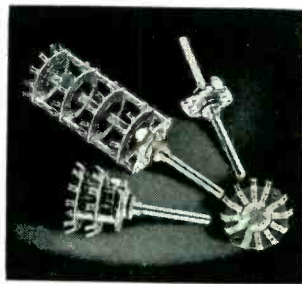

Centralab has complete facilities for volume production of custom switches: Modern, highly mechanized production plants . . . plus Centralab engineering specialists are at your service.



If you need something new . . . come to Centralab . . . we may have it!

Centralab

A Division of Globe-Union Inc.
914 A E. Keefe Avenue • Milwaukee 1, Wisconsin
In Canada: 804 Mt. Pleasant Road, Toronto, Ontario

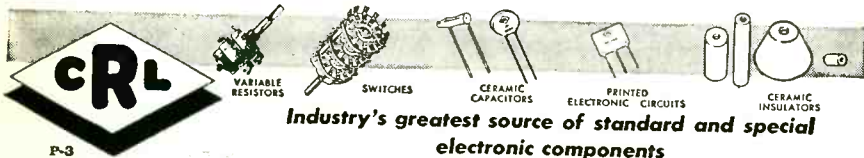

Industry's greatest source of standard and special electronic components

P-3

of Cardwell will be retained as head of the company on a long-term contract and no change in management policies is contemplated.

Cardwell Manufacturing Corp., with headquarters in Plainville, has approximately 300 employees. It turns out four main lines of civilian products in addition to military radar units used in weather forecasting and the Army's guided missile program.

Cardwell's fiscal year, ended September 30, set a record for both gross and net profit in Cardwell's 35 years of existence, Soby said. Gross sales were approximately \$6 million.

Discoverers Of Electron Spin Receive Award

THE 1953 RESEARCH CORPORATION AWARD was made to George E. Uhlenbeck and Samuel A. Goudsmit for their discovery of electron spin which has been acclaimed as one of the more outstanding and far-reaching concepts in modern physics and a cornerstone of present atomic theory.

Although their discovery was made in 1925 and many developments in modern physics have stemmed from it, the Research Corporation Award is the first known public recognition their work has received.

Dr. Uhlenbeck, professor of physics at the University of Michigan, works in the field of statistical mechanics and the theory of beta-ray emissions. Dr. Goudsmit, chairman of the physics department at Brookhaven National Laboratory, works in the field of spectroscopy and atomic theory.

Both came to the U. S. in 1927 from the Netherlands as members of the faculty at the University of Michigan. Dr. Uhlenbeck returned to Holland in 1935 and spent four years as professor of theoretical physics at the University of Utrecht. During the war he did radar research at the Radiation Laboratory at MIT. Dr. Goudsmit remained at the University of Michigan until 1946; during the war he, too, served at the MIT Radiation Laboratory, and later headed a scientific mission to Europe in connection with atom bomb research. Joining the Brook-

haven staff in 1948, he became acting chairman of the physics department in 1951 and chairman in 1952. Since 1950 he has been managing editor of the Physical Review.

Radio Club Of America Elects Officers For 1954

FRANK H. SHEPARD was elected president of the Radio Club of America for 1954. Frank A. Gunther was named vice-president; Joseph J. Stantley, treasurer; O. James Morelock, corresponding secretary and W. Gordon Russell, recording secretary.

Shepard has been a fellow and director of the club for many years. He is a consulting engineer and heads the Shepard Laboratories in Summit, N. J. He has made contributions to radio and hearing aids, industrial instrumentation and controls, feedback systems, ultra-high-speed typing, guided missiles and various restricted projects.

Directors of the club elected to serve for 1954 are: Ernest V. Amy, Edwin H. Armstrong, Ralph H. Batcher, Harry W. Houck, F. A. Klingenschmitt, Jerry Minter and Harry Sadenwater.



Allied International Appoints Conley

ALLIED INTERNATIONAL has appointed E. B. Conley as vice-president and general manager of its manufacturing plant, known as the Allied engineering division. Conley will be in charge of all manufacturing operations in the plant. A new factory, to be completed in February, 1954, in South Norwalk, Conn., will enlarge the company's

Celco

Manufacturers of:
TRANSFORMERS VARIABLE REACTORS
MAGNETIC AMPLIFIERS

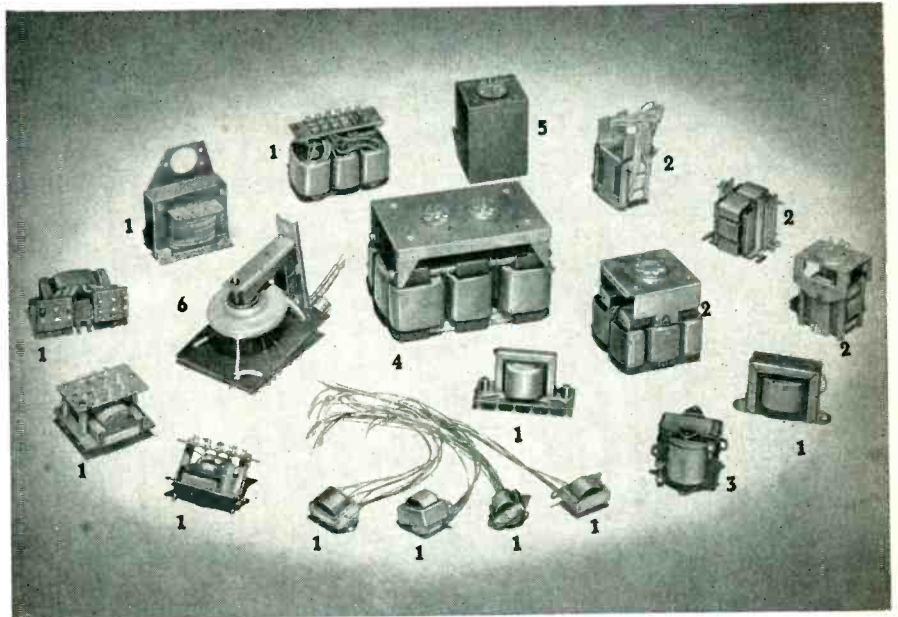

1. OUTPUT, MATCHING, COUPLING, AND POWER SIGNAL 400 CYCLE TRANSFORMERS: used where reliability and miniature size is required, such as control amplifying systems. Supplied with any special lead wires or terminations.
2. DUAL MAGNETIC AMPLIFIERS: all types used in latest 400 cycle aircraft control amplifiers for Servo Systems.
3. VARIABLE REACTOR: used today in tuned resonant circuits for vacuum tube voltage regulating systems. Suitable for experimental laboratory work where a HI-Q and wide range of inductance is required.
4. TRIPLE MAGNETIC AMPLIFIER: used in aircraft automatic pilots, by both the Army Air Force and Navy.
5. HERMETICALLY SEALED TRANSFORMERS: designed to conform to military specifications for hermetically sealed transformers, magnetic amplifiers and reactors.
6. FLY BACK: HORIZONTAL OUTPUT AND HIGH VOLTAGE TELEVISION TRANSFORMER: manufactured for extra quality performance of very low costs.

COMMERCIAL USE

Omni-Range; Dme; Line Course Computers; Automatic Pilots; Navigation; Transmitters and Receivers; Oil Burner Ignition; Fly Back; Vertical Output; Linearity Controls.

MILITARY USE

Servo Amplifiers; Adjustable Reactors; Transistor Magnetic Amplifier; Class H Transformers; Drone Control; Guided Missile; Voltage Control; Marine Control; Sonar; Celco Research.

Celco Gives Prompt Service—send us your requirements for our immediate attention.

Celco

Constantine Engineering Laboratories Co.

ISLAND AVENUE MAHWAH, NEW JERSEY

AUTOMATION

VISIT CML AT THE IRE SHOW

PIONEERS IN ELECTRONIC AUTOMATION

In 1944—It Was the CML Rotobridge
The First Automatic End Equipment Inspector. Dozens Are
in Use Today Throughout the Industry.

In 1954—Another CML First
Project Tinkertoy Automation

1. Let us show you how to redesign your equipment in modular form using the CML PT-1000 modular design kit.
2. Let us point the way to low cost short run production using conventional production line methods.
3. Lastly—if you are a volume producer—you will be interested in our plans for full scale automatic modular production which will provide astounding savings in production costs.

VISIT CML BOOTH 675 AT THE ARMORY FOR OUR EQUIPMENT DISPLAY

COMMUNICATION MEASUREMENTS LABORATORY, Inc.

350 Leland Avenue

Plainfield, New Jersey

MICO

Precision Apparatus

**PORTABLE
PANTOGRAPH
ENGRAVER**

with
SUPERIOR
FEATURES

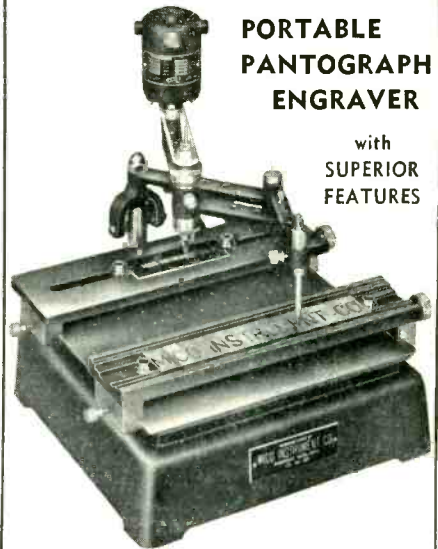

**TOROID COIL WINDERS
UHF COAXIAL WAVEMETERS**

Send for Illustrated Catalogs

MICO INSTRUMENT CO.

76-E Trowbridge St. Cambridge 39, Mass.

NEW-

**SAVE MONEY—and get
EXTREME LOW TEMPERATURE
PROTECTION**



with the **COX "OVERCOAT"**
for **electrolytic condensers**

- HEAT PROTECTION DOWN TO -65°F .
- EASY TO INSTALL.

- SAVES MONEY BY PERMITTING USE OF STANDARD ELECTROLYTIC CONDENSER IN EXTREME TEMPERATURE APPLICATION.

Now, at last, a low-cost, highly efficient electric condenser heater, designed for a snug-fit on electrolytic condensers to provide protection down to -65°F . This Cox Condenser Heater saves money because it can be quickly assembled to a standard electrolytic condenser — no need to use costly extreme low temperature condensers.

Cox Condenser Heaters are now approved as standard components on many leading electronic products. Write for complete data.

COX THERMOWIRE, THERMOPATCH and THERMOSHEET heating elements provide highly efficient heat transfer when cemented in place and are unaffected by temperature change or mechanical shock . . . If you have an electronic equipment heating problem, investigate Cox heating elements. Approved in over 300 military applications. Write for data.

COX & CO., INC.

115 East 23rd St.,
New York 10, N. Y.

Visit Booth No. 819, Audio Avenue at the I.R.E. Show

SOLID
ultra-sonic
DELAY LINES

for
compactness
and stability
over wide
temperature ranges.

See them graphically
demonstrated at the
R. E. Show—Booth 422

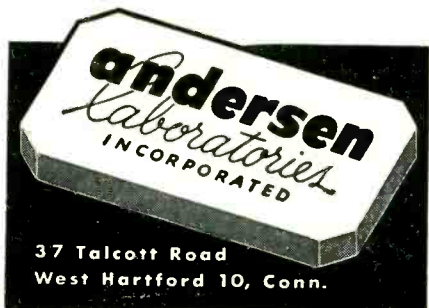

37 Talcott Road
West Hartford 10, Conn.

facilities for the production of electronic and radio equipment for commercial and military use.

Before joining Allied, Conley was associated with the Electric Specialty Co. for thirty years.

Breitwieser Joins Lear As Engineering Head

CHARLES J. BREITWIESER has joined Lear as director of engineering. Reporting directly to president R. M. Mock, he will head Lear's general development and engineering division. The division is engaged in developing new products for the company and in supplementing its engineering and development activities.

Breitwieser comes to Lear from P. R. Mallory & Co. of Indianapolis where he held the post of director of engineering. He was in direct charge of Mallory's central engineering laboratories and coordinated the engineering activities of ten manufacturing divisions.

Prior to joining Mallory, Breitwieser was with Convair for over nine years as chief of electronics and research laboratories, responsible for the electronics and guidance section, guided missile flight test section, engineering test laboratories and the missile and airplane instrumentation section.

Breitwieser has many inventions to his credit in the fields of aircraft and missile control systems, radio communications systems, and electro-therapeutic apparatus.

Operating Committee For Six Groups Is Formed

A GROUP CALLED the Operating Committee has been formed to act as a task group to coordinate the various regional conferences sponsored by individual associations.

The committee, of which W. D. Jenkins of Radio Supply Co. of Richmond, Va. is chairman pro tem, consists of two members representing each of the following groups: Sales Managers Club, Eastern Group; Association of Electronic Parts & Equipment Manufacturers; National Electronic Distributors Association; "The Representatives" of Electronic Products Manufacturers; Radio Electronics Television Manu-

PRECISION *Displays*

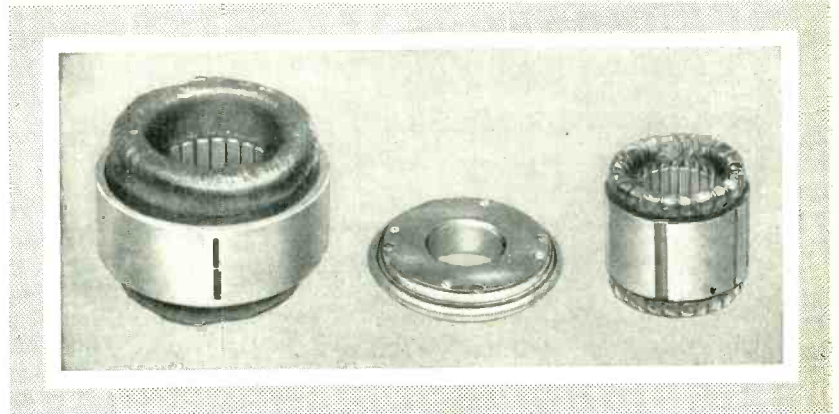

New

Celco

radar
deflection yokes



Celco

Celco is at present supplying the country's leading manufacturers of radar equipment with the latest type deflection yokes made to precise specifications. Units are now being manufactured using high nickel alloy steels punched to close tolerances with complex winding distributions and high voltage insulations.

Send drawings of your designs for quotation and take advantage of the Celco production experience in this specialized field.

OTHER CELCO SPECIALTIES

TRANSFORMERS
MAGNETIC AMPLIFIERS
STATOR WINDINGS
VARIABLE REACTORS
ROTOR CASTINGS

Constantine Engineering Laboratories Co.

70 ISLAND AVENUE,

MAHWAH, NEW JERSEY

DUMONT Plastic Film CAPACITORS

MYLAR (DuPont) FILM

**TYPE
T
DU PONT
MYLAR FILM**

**SMALLER THAN METALLIC UNITS
ECONOMICALLY PRICED**

UNCASED SECTIONS

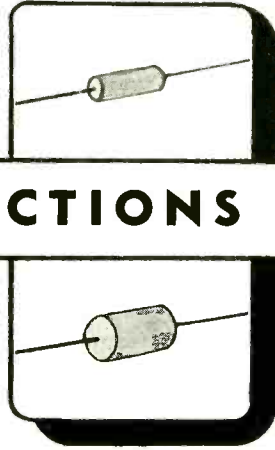

Made with DuPont Mylar Film

TYPE T (MYLAR FILM) GOOD UP TO 135° C

TYPE TF (TEFLON FILM) GOOD UP TO 250° C



Available also in
Metal and Ceramic Tubes
and in Metal Cans
(TYPE CP 70)



- Highly Moisture Resistant
- Tabs Securely Anchored
- "Low Soakage"
- 10,000 Meg. per Mfd. at 85° C
- .01% P. F.
- 1% - 2% - 5% - 10% - 20% Tol.
- Type T. A. - Metal Tube Case
- Type T. B. - Ceramic Case
- Type T 70 - (CP 70 Can)

*Ideal for Computers
etc. Special designs
up to 50,000 volts.*

Several sales territories now open. Contact us for details.

Write for Descriptive Bulletin #40

DUMONT-AIRPLANE & MARINE INSTRUMENTS, Inc.

OFFICE
15 William Street
New York 5, N. Y.

FACTORY
Clearfield
Pennsylvania

factors Association and the West Coast Electronic Manufacturers Association.

The committee's purpose is "to operate and coordinate such regional conferences as the combined task group may from time to time decide to sponsor." In 1954, the operating committee would support and endeavor to cooperate in the running of the Southwestern Conference in January; the Minnesota Conference in June and the Missouri Valley Conference in October, and in 1955 would support and endeavor to cooperate in the running of a Rocky Mountain and Pacific Northwest Conference; a Southeastern Conference and a North East Conference, as well as to designate dates and sites for next year's conferences.

"The Operating Committee may make such revisions as they deem practicable in order to relieve manufacturers of the necessity of participating in a conference in the same area in two successive years," the committee said.

The Operating Committee was set up on recommendations of the industry relations committees of the various associations which worked independently to formulate an overall coordinating plan.

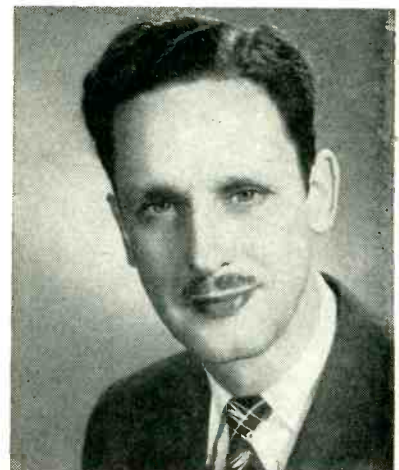

Guthman Names Adler Head Of Engineering

THE EDWIN I. GUTHMAN & Co. of Chicago announced the appointment of Harold J. Adler as vice-president in charge of engineering.

In his new position, Adler will coordinate the engineering activi-

ties of the Guthman Co., in the manufacture of delay lines, coils, yokes, flybacks and other components.

For the past four years, Adler has been the director of engineering for the Hallcrafters Co. of Chicago. He formerly served for 16 years as chief engineer for the Sentinel Radio Co. of Evanston, Ill.

Stanford Offers Electronic Fellowships

FINANCIAL ASSISTANCE IN several forms is available to a substantial number of well-qualified graduate students who wish to work toward a higher degree with a special interest in electronics.

Stanford University has 8 fellowships in the field representing, in total, \$12,800 in financial aid. Research assistantships with incomes ranging from \$1,800 to \$3,000 are also available. Teaching assistantships and research associateships carrying a range of stipends are also available from the university in Stanford, Calif.

Community Antenna Manufacturer Expands

THE ENTRON Co., designers and manufacturers of community and master television systems equipment, has moved from its Washington, D. C. location to a new plant in Bladensburg, Md.

George G. Edlen, vice-president in charge of production, states that the enlarged facilities of the new plant are required by the growing number of orders Entron is receiving for antenna systems equipment. He said that the new quarters will help the firm to fulfill these obligations as well as expand its research and production.

Winners of AIEE Prize Papers Announced

WINNERS OF prizes for technical papers in the science and electronics division of AIEE were announced by H. H. Henline, institute secretary. First prize in the science and electronics division went to E. P. Felch of Bell Labs and J. L. Potter of Rutgers University for their paper "Preliminary Development of a Magnetron Current Standard."

Second prize in the division was

WHAT IS THIS?

- Photo of earth terrain taken from a guided missile?
- A piece of cobalt?
- Close up of leaf structure?

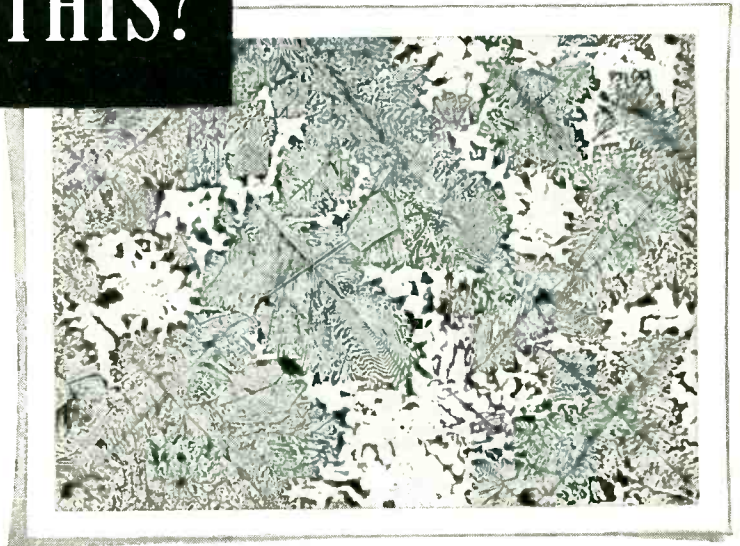

If you answered cobalt you are correct. The illustration is a photomicrograph of a piece of cobalt magnified 80 times.

THE PROBLEM: In making such a photograph the microscope camera must be completely isolated from vibration. Even the slight tremor caused by a step on the laboratory floor can affect the accuracy and clarity of the photograph.

William J. Hacker & Co., Inc., New York, agents for the Reichert Research Metallograph, brought this problem of vibration to Robinson.

THE SOLUTION: Since conventional types of vibration control systems were inadequate, Robinson engineers designed a mounting base employing their exclusive all-metal resilient cushioning material, Met-L-Flex. This mounting system is so sensitive it will isolate vibration from every angle, and keep the camera free-floating and motionless at all times.

Do you have a problem of Vibration Control in your business?

This same engineering know-how and skill can be put to work on your vibration control problem . . . whether it involves precision instruments, electronic or television equipment, aircraft, motor vehicles, home appliances, or industrial machinery of any size or weight.

Unlike old fashioned rubber mountings, Robinson Met-L-Flex* mountings

are unaffected by age, oil, bacteria, water, dust, dirt or temperature extremes. They are inherently damped, and they do not pack down or wear out.

A letter or telegram will bring a Robinson engineer to analyze your particular problem and suggest a solution. Write or wire us immediately. Industrial Division, Dept. E-1.

*MET-L-FLEX is the copyrighted designation for the all-metal resilient cushions developed and pioneered by Robinson.

ROBINSON AVIATION INC.
TETERBORO, NEW JERSEY
Vibration Control Engineers

Visit us at the I.R.E. Convention Booth 751

For more ad information, see Index to Advertisers.

COAXWITCH

COAXIAL SELECTOR SWITCH

50 Ohms—
Type N Connectors—Manually Controlled
Low VSWR—4 Models

CUT-A-WAY VIEW, MODEL 74

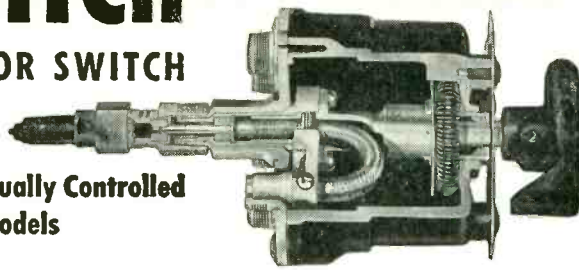

The COAXWITCH is an RF switch for use in coaxial circuits where it is important that the 50 OHM impedance of the cables be maintained. In a circuit sense, this switch consists of two pairs of "N" connectors spaced 4 1/2" apart using RG-8/U as the connecting link. The COAXWITCH itself introduces no VSWR other than that of connectors. Characteristic impedance is maintained thru all switch details. Cut-a-

way view shows that shield as well as center conductor is switched. Beryllium copper contacts, on the gooseneck, mate directly with male "N" (Type UG-21B/U) connectors, which connect directly to back plate of switch. Since all connectors come out in line with axis of switch, right angle connectors are usually unnecessary.

Literature Gladly Sent

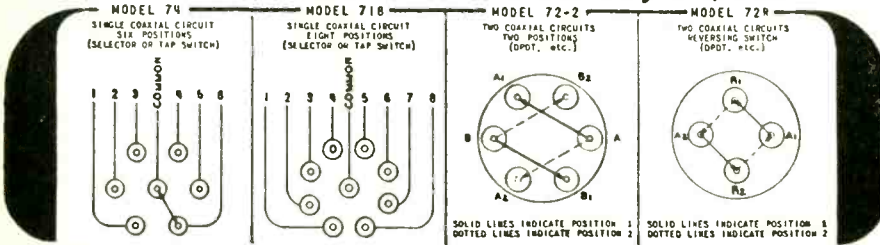

BIRD ELECTRONIC CORP.
1800 EAST 38TH ST., CLEVELAND 14, OHIO
TERMALINE Coaxial Line Instruments

NEELY ENTERPRISES
Hollywood • San Francisco
Albuquerque
EARL LIPSCOMB ASSOCIATES
Dallas • Houston

awarded to A. J. Williams, Jr., and J. F. Payne, Jr., of Leeds and Northrup Co. for the paper "A-C Null-Type Recorder with Balancing Amplifier Which Provides Damping and Suppresses the Quadrature Component."

Irvington Division Changed Its Name

ONE division of Irvington Varnish & Insulator has changed its name from "Fibron" to "Plastics".

The new name will be more descriptive of the activities of the division, officials indicated. While originally it was engaged only in the extrusion of plastic tubings for electrical applications, the field has expanded to include extruded shapes for many industries.



Channel Master Opens New Factory

OFFICIAL OPENING of Channel Master's new \$1.5 million tv antenna plant, with a production potential of over four times its present factory output, took place in Ellenville, N. Y.

In addition to the new factory, the firm's older plant will remain in operation.

The new plant has 115,000 sq ft of floor space and has six separate assembly lines to supplement the two assembly lines in the old plant.

The new factory is a complete aluminum extrusion and tube mill featuring a 2,000-ton extrusion press that enables the firm to manufacture its own aluminum tubing and rod from aluminum billets. A fully equipped metallurgical laboratory has also been established.

Channel Master was founded in 1947 by Joe, Harry, and Lou Res-

ARROW

OVER 75,000 ITEMS
300 STANDARD BRAND LINES
— in stock!

ELECTRONIC SUPPLIES
for Research
Production
Development
Processing
Control
Maintenance

For FAST SERVICE
Phone
Write
Wire
or Teletype

INDUSTRIAL CENTER FOR ELECTRONIC EQUIPMENT

The Nation's MOST COMPLETE Source of Supply!

Depend on **ARROW** for Everything in **ELECTRONICS**

Today's acceleration of demand by industry and government upon electronic equipment suppliers finds ARROW ELECTRONICS in a unique position to furnish urgently required component parts from stock!

ARROW's vast resources of service and supply are at your beck and call. Just one phone call — or letter — places at your disposal our enormous warehouse stocks of goods, our 20 years of experienced technical "know-how" and our procurement and shipping facilities which reach all over the nation. Think of it! Same-day shipments from stock on literally thousands of standard brand products — one invoice and a packaged, consolidated shipment from a single source of supply on ALL of your requirements in the industry! This is service at its finest!

82 CORTLANDY STREET
NEW YORK 7, N. Y.
Dlgbly 9-4714

Western Union
WUX-N. Y.
Direct Wire from Newark, N. J.: Call WX6566

(Branch) **215 FRONT STREET**
HEMPSTEAD, L. I.
HEmpstead 1-1826

Teletype
NY1-472
"AROELECTRO-N. Y."

Cable
WUX-N. Y.

ARROW ELECTRONICS INC.

**PRECISION • STABILITY •
LOW NOISE LEVEL
S.S. WHITE TYPE 65X
MOLDED RESISTORS**

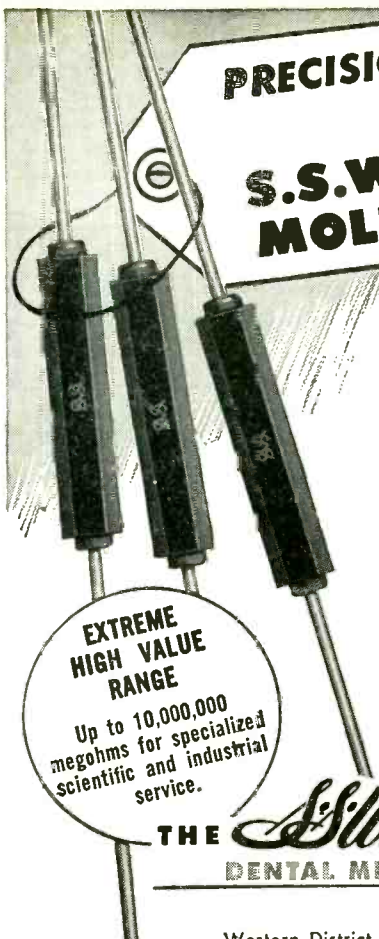

**EXTREME
HIGH VALUE
RANGE**
Up to 10,000,000
megohms for specialized
scientific and industrial
service.

Rating—1 Watt.
Temperature Coefficient—From approx. + 0.1% /°F for 5000 ohm resistors to approx. - 0.2% /°F for 10 megohm resistors.
Voltage Coefficient—Less than 0.02% /Volt.
Upper Temperature Limit—170°F for continuous operation.
Standard Range—1000 ohms to 9 megohms. For general commercial service.
Noise Level—A low noise level is inherent in all 65X resistors. Where noiseless operation is essential, we are equipped to test and guarantee standard range resistors with "less noise than corresponds to a resistance change of 1 part in 1,000,000, for the complete audio frequency range."

Send for Bulletin 4906. It gives full details on S.S. White Molded Resistors. Write for a copy.



THE S.S. White INDUSTRIAL DIVISION
DENTAL MFG. CO.



Dept. R, 10 East 40th St.
NEW YORK 16, N. Y.

Western District Office • Times Building, Long Beach, California

**Rutherford ELECTRONICS CO. MAKES
PRECISION TIMING INSTRUMENTS**

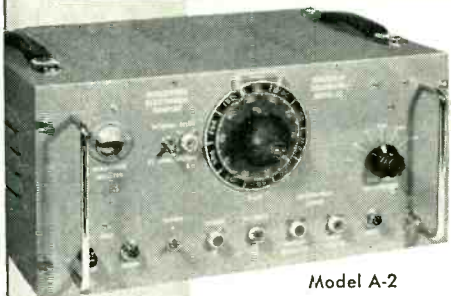

Model A-2

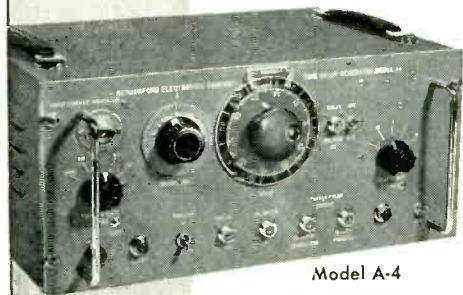

Model A-4



**Our
TIME DELAY
GENERATORS:**

Each provides accurate and variable time intervals in five ranges. They feature low jitter (.008%), linear scales, built-in calibration indicator, 1,000-division dial, small repetition rate effects, blocking oscillator output and wide pulse output.

A-2 — Range: .8 μ s to 100,000 μ s
Get complete data: our Bulletin E-A-2

A-4 — Range: .00001 to 10 secs.
Get complete data: our Bulletin E-A-4

Rutherford ELECTRONICS CO. Telephone: TEXAS 0-4362
3707 S. ROBERTSON BLVD.
CULVER CITY, CALIFORNIA

The
WAVEGUIDE
House

Under our roof are all facilities needed for high quality production of microwave components, supervised by a top-flight engineering staff—quality is controlled every step of the way—

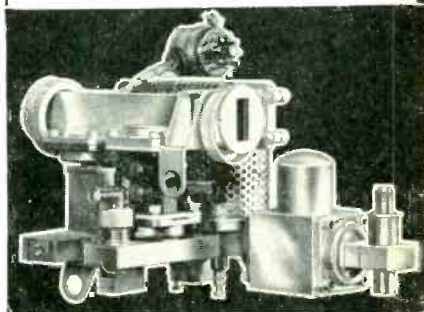

For components from mixer-duplexer combinations to low-cost, high quality link waveguides, consult us!

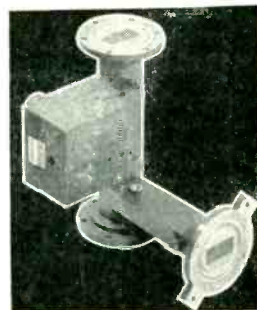

Look us up at
I.R.E. Convention
Kingsbridge Armory, N. Y. C.
Booth: 723 Airborne Ave.

Brochure on request



TRADE MARK

**PREMIER
INSTRUMENT CORP.**

52 West Houston Street
New York 12, N. Y.

UHF IMPULSE GENERATOR ... MODEL IG-115

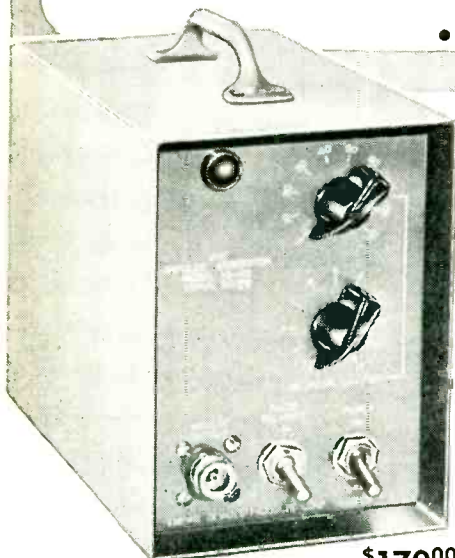

\$170⁰⁰

F. O. B. Bayside, N. Y.

VISIT OUR BOOTH 252
on Instrument Avenue
at the IRE Show

APPLICATIONS:

1. Calibrating standard for noise and field intensity meters.
2. Rapid gain check for TV tuners (VHF and UHF).
3. Noise susceptibility of TV receivers.
4. Bandwidth determination.
5. Receiver alignment.
6. Noise figure measurement.
7. Transient response study.
8. Signal source for broad band distributed amplifiers.
9. Signal source for evaluation of spectrum analyzers.

PULSE WIDTH:

0.0005 microseconds (5×10^{-10} seconds).

FREQUENCY SPECTRUM:

0.01 MC to 1000 MC, flat within $\pm 1/2$ DB.

OUTPUT LEVEL:

100,000 microvolts per megacycle bandwidth, adjustable over a 100 DB range in one DB steps.

PULSE POLARITY:

Reversible by means of a front panel switch.

REPETITION RATE: 60 Cycles.

EMPIRE DEVICES' expert engineering staff is available to give careful attention to your inquiries.

edp **EMPIRE DEVICES PRODUCTS CORPORATION**
38-15 BELL BOULEVARD • BAYSIDE 61, NEW YORK

MANUFACTURERS OF

FIELD INTENSITY METERS • DISTORTION ANALYZERS • IMPULSE GENERATORS • COAXIAL ATTENUATORS • CRYSTAL MIXERS

FOR
FASTER
PUMPING
WITH
SMALLER
PUMPS

INTERNATIONAL HIGH VACUUM COMPOUND PUMPS

New Model 116
16 CFM Free Air
Capacity

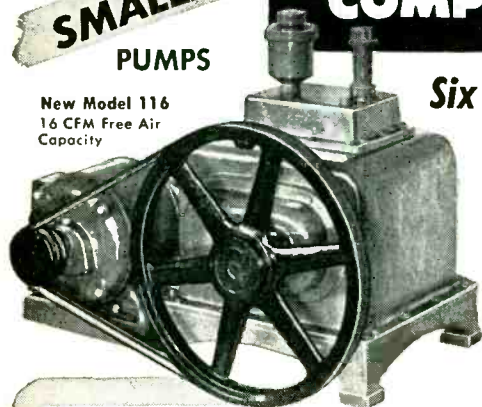

Six Ways a Better Pump:

1. SIMPLIFIED CONSTRUCTION
2. ROTARY VANE
3. AUTOMATIC LUBRICATION
4. HIGH EFFICIENCY
5. QUICK RECOVERY
6. RUGGEDLY BUILT

Speed production and reduce maintenance with these ready-to-operate, high efficiency vacuum pumps!

International rotary vane pumps are extremely compact and operate unusually quiet. Simplified construction and automatic lubrication assure trouble-free operation, long life and low-cost upkeep. Pump mechanisms are totally oil submerged, preventing atmosphere to vacuum leakage.

CAPACITIES UP TO 30 C.F.M.
WRITE FOR LITERATURE TODAY

**International Pump
& Machine Works**
PUMP DIVISION
11-13 GOVERNOR STREET
NEWARK 2, NEW JERSEY

SPECIALIST MANUFACTURERS OF INDUSTRIAL
GLASS-WORKING MACHINERY AND HIGH VACUUM PUMPS FOR
ELECTRONICS, NUCLEONICS AND RESEARCH FOR OVER A QUARTER CENTURY

SEE THE INTERNATIONAL DISPLAY—I.R.E. SHOW—784 AIRBORNE AVENUE.



William Osborn

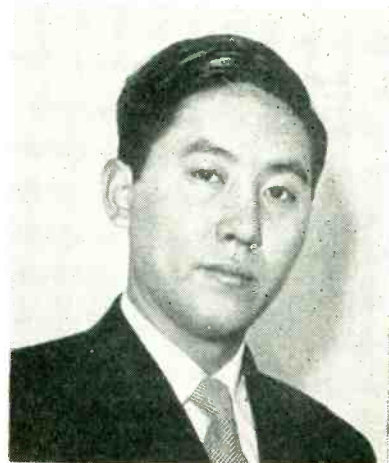

Miao Yung-Miao

nick. Beginning with only six employees, the company's employment rolls are approaching the 1,000 mark.

The company also announced the addition of two engineers to its electrical and mechanical engineering staffs.

William Osborn was named project engineer in the development of new vhf and uhf antenna types. He comes from the University of Virginia's Naval Ordnance Research Laboratory where he conducted radar experiments of a classified nature.

Miao Yung-Miao has been appointed project engineer in the development of mechanical test equipment for antennas. He was last associated with International Harvester Corp. as a test engineer.

RETMA Appoints DeLaFleur, Extends TV Service Course

LOUIS E. DELAFLEUR of the FCC has been named manager of the International Department of RETMA. The position was created

by the RETMA board upon request of the export committee.

DeLaFleur has been with the FCC since 1940 when he began as an assistant monitoring officer in Baltimore. After serving the FCC in other areas, he became chief of the investigation section of the radio intelligence division in 1946 and subsequently served as chief of the frequency utilization and requirements branch of the frequency allocation and treaty division. Since 1947 he has been assistant chief of that division.

The RETMA International Department's operations will be supervised by an executive committee and implemented by two groups of RETMA members engaged in export trade: radio and tv, and electronics, which in turn will have sub-units.

RETMA also announced that a second study course for qualified tv servicemen started in February at the New York Trade School. Sixty students, with at least one year of full-time tv service experience, were selected from the New York area to participate in the course which looks toward bettering the proficiency of tv servicemen.

Chromatic TV Labs Expands Facilities

THE ADDITION of new grid-producing facilities by Chromatic Television Laboratories at Emeryville, Calif. is expected to step up the 1954 output of compatible 21-inch and 24-inch color tv tubes, according to the company.

The grids will be made for use in the large-screen Lawrence color tv tube, now being licensed in both 21-inch and 24-inch rectangular sizes.

An initial annual production rate of more than 25,000 grids is foreseen for the new facilities. CTL has been making grids in a pilot plant operation at Oakland, Calif. for use by licensees and potential licensees, and this operation is being incorporated in the new facilities.

The establishment of the new plant is aimed at enabling licensees of Lawrence tubes to get them into the hands of set manufacturers

Burton Browne advertising

James is the complete source for all vibratory products!*

THE ENGINEER'S STANDARD SINCE 1936

*Send your engineering problems to us

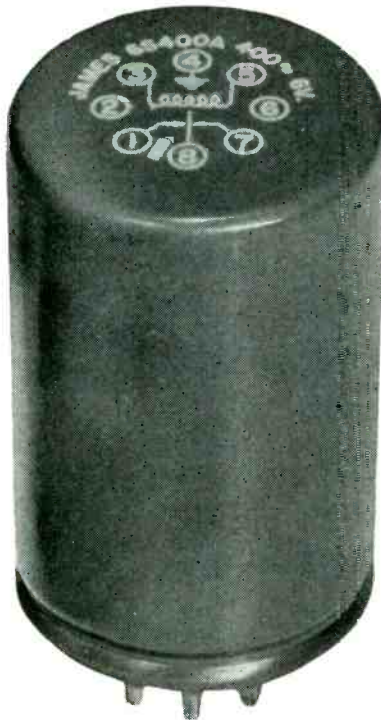

JAMES "S" MODEL CHOPPERS

James hermetically sealed choppers are now available in 60, 100 and 400 CPS models with various operating voltages. These assemblies are designed for rigid military environmental and life specifications.

Your inquiries are solicited for engineering recommendation of JAMES CHOPPERS in your applications.

JAMES
VIBRAPWR COMPANY
4038 N. Rockwell St. • Chicago 18, Ill.

AUTO VIBRATORS • COMMUNICATIONS VIBRATORS • VIBRATOR POWER SUPPLIES • CHOPPERS • VIBRATORY COAXIAL SWITCHES

2 NEW ACHIEVEMENTS

in precise *wire-wound* trimmer potentiometers

Aerohm Micro-miniature Series AP 1/2

- Two watts continuous at 80 degrees C.
- Resistances from 10 ohms to 20,000 ohms.
- Diameter 1/2 inch, depth 1/2 inch.
- Temperature coefficient 0.00002 part per degree C.
- Weight 1/4 ounce.
- Sealed well enough to permit potting.

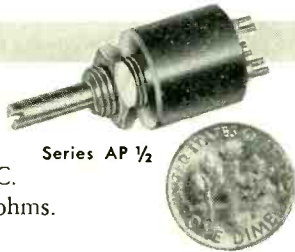

Series AP 1/2

Aerohm Series AP 1 1/8

- Four watts continuous at 80 degrees C.
- Resistances from 10 ohms to 100,000 ohms.
- Diameter 1 1/8 inch, depth 1/2 inch.
- Temperature coefficient 0.00002 part per degree C.
- Weight less than 3/4 ounce.



Series AP 1 1/8

Available also as ganged units.



Series AP 1/2-2



Series AP 1 1/8-2

These new potentiometers embody many features that are usually found only in much more costly units. They are precision machined throughout, with bodies of anodized aluminum, line-reamed phosphor bronze bushings, centerless-ground stainless steel shafts, and gold-plated fork-type terminals. All electrical connections are soldered, except for precious metal sliders and slip rings. All units are fully sealed, and treated with Service-approved moisture-proofing and fungicidal materials.

In addition, all *Aerohm* potentiometers are individually checked through a quality-control system that guarantees you full performance from every unit in your order.

Write for full technical information and prices.

Aerohm CORPORATION

282 MOODY STREET, WALTHAM, MASSACHUSETTS

more quickly and in larger numbers than might otherwise be possible.

Richard Hodgson, president of CTL, said that grids would be sold only to CTL licensees, except for sample quantities for experimental purposes.

The new plant will employ about 200 people and should be in production by the end of March, 1954, Hodgson said. It will be managed by Earl E. Sargent, who has been plant superintendent for CTL tube production, and will be under the general supervision of H. R. Patterson.

Minnesota Mining Promotes Cahill

JOHN E. CAHILL has been appointed supervisor of design engineering of the electrical products group of Minnesota Mining and Manufacturing.

Cahill joined 3M as an engineer in the new products division laboratory in 1948. He has been working with the electrical products group since 1952, specializing in engineering problems concerning sound recording tape.

New Research And Development Firm Founded

PROTECORP IS A new industrial research and development firm founded by Edward Bentley, former vice-president and director of research and development at Instrument Development Laboratories. The company, consisting of former associates of Dr. Bentley, has formed to apply technical knowledge and management principles to the solution of problems in instrumentation, subminiaturization and other fields of physics and engineering.

Bewley Named Dean At Lehigh

LOYAL V. BEWLEY, head of the department of electrical engineering at Lehigh University, was named dean of the College of Engineering.

A member of the faculty since 1940, he has served as secretary of the university's engineering executive committee for the past

PAPER TUBE PRODUCTS TO YOUR EXACT SPECIFICATIONS

NIEMAND BROS. produce many types of paper tube products to meet the varied needs of the electrical and mechanical industries.

Diameters from .093" to 2" and up—wall thicknesses of .003" to .060"—printed or plain—materials such as high dielectric kraft, fish paper, foils, special protective coated and laminated papers.

We also make precision drawn paper caps from .141" to 2" in diameter, as well as special die-cut washers and parts to required specifications.

Our modern, high-speed equipment and improved methods of production result in economy and rapid delivery. Send us your specifications—our highly trained staff will be happy to serve you.

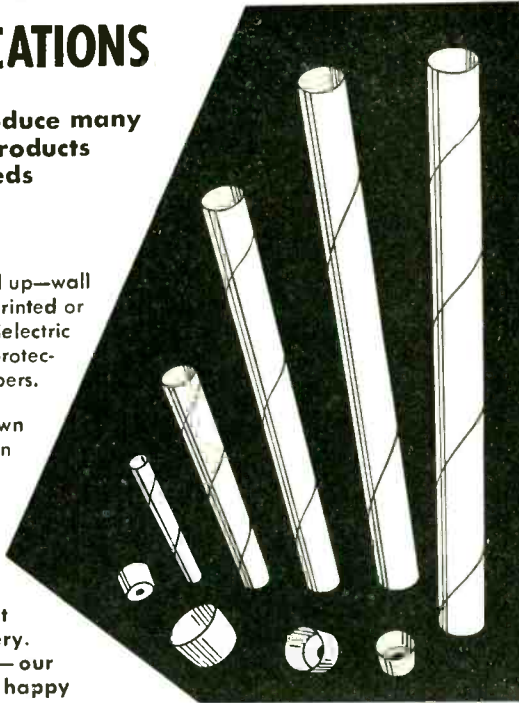

NIEMAND BROS. INC. *Manufacturers of*

PAPER TUBE PRODUCTS

37-03 THIRTY-FIFTH AVENUE • LONG ISLAND CITY 1, N. Y.

"Nielsen" COMPRESSION SPRING DRAW PULL CATCHES WITH SPRINGS CONCEALED

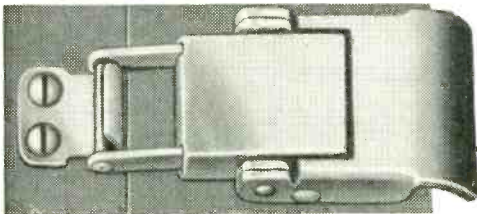

SIZE: 2 1/4" LONG X 1 1/8" WIDE

Get our Folders on Standard Catches and Draw Bolts and other Compression Spring Catches

NIELSEN HARDWARE CORP. 770 Wethersfield Ave., HARTFORD 14, CONN.
AFFILIATED WITH NIELSEN TOOL & DIE CO.

FOR QUALITY HARDWARE — GOOD SERVICE TO YOUR SPECIFICATION

SIGNAL CORPS NO. SC-B-83314

70-Pound Tension at 1/8" Deflection, the established application dimension. Withstands 600-Pound Pull Test.

Nielsen Catches Carry "Certification of Compliance".

DELAY LINES

FIXED & VARIABLE

For: LABORATORY — COLOR TELEVISION COMPUTERS — RADAR — etc.

- Model V103: 0 — 3.0 μ sec variable in 0.05 μ sec steps
 - Model F101: 0.25 μ sec fixed, bandwidth 16 mc;
 - Model F102: 1.0 μ sec fixed, bandwidth 6 mc.
- Accuracies to 1% & Better

CONTROL ELECTRONICS CO., INC.
1927 New York Ave., Huntington Station, Long Island, N. Y.
Tel. HU. 4-7961

Important
SAVINGS
to **VOLUME** users
of small parts

..like these

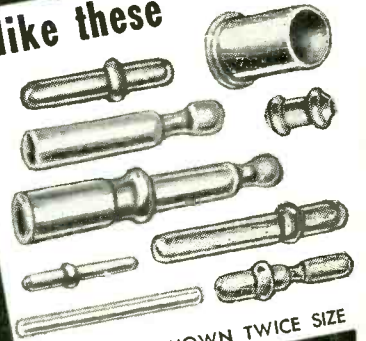

SHOWN TWICE SIZE

thanks to
MULTI-SWAGE

If you need small tubular metal parts like these in large VOLUME, Bead Chain's MULTI-SWAGE Process can mean important savings to you.

Much Cheaper Than Solid Pins

Many prominent users of solid pins for electronic and mechanical purposes have cut costs by switching to Multi-Swaged tubular pins . . . without sacrificing strength or accuracy.

Typical Applications—

As terminals, contacts, bearing pins, stop pins, male-female connections, etc., in a wide variety of products such as Business Machines, Ventilator Louvres, Toys, Radio and Television Apparatus, Terminal-boards, Electric Shavers, Phonograph Pickups, etc.

Send part (up to 1/4" dia. and to 1 1/2" length) and your specs for a quotation or write for DATA BULLETIN.



THE **BEAD CHAIN**® MFG. CO.

88 Mountain Grove St., Bridgeport 5, Conn.

Manufacturers of BEAD CHAIN—the kinkless chain of a thousand uses, for pull and retaining chains and other industrial uses, plumbing, electrical, jewelry, fishing tackle and novelty products.

INCREMENTAL INDUCTANCE

*quickly
simply
accurately*

The new Type 1002-A Incremental Inductance Bridge combines outstanding features of compactness, ease of operation, accuracy, and wide range of measurement. A visual balance indicator allows measurements to be made in a few seconds even in noisy locations. Maximum sensitivity at the balance point greatly improves the accuracy of balance. Only a single balance control is used, with crt indication.



Inductance range is from one to 200 henries. Direct current through the reactor under test is accurately controllable from one to 500 milliamperes, limited only by the resistance of the coil windings. The effect of a change of dc on the inductance value is immediately measurable, by simple re-balancing. The inductance is measured at a constant frequency of 120 cps.

For design and test work on iron-core inductors, transformers, filter chokes, and plate reactors, this compact self-contained instrument is unsurpassed.



*Write today for
technical details
and price information.*

WATERS MANUFACTURING, inc.

Waltham 54, Massachusetts

APPLICATION ENGINEERING OFFICES IN PRINCIPAL CITIES

For more ad information, see Index to Advertisers.

462

PLANTS AND PEOPLE

(continued)

two years. Before joining the Lehigh staff, he served as a research engineer at GE for 17 years. In 1953, he was the recipient of the Hillman Award, given each year to a member of the Lehigh staff "who is deemed to have done most toward advancement of the interests of the university."



Donner Names Corey Research Director

DONNER SCIENTIFIC Co. of Berkeley, Calif., announced the appointment of Victor B. Corey as director of research.

In this capacity, he assumes responsibility for the firm's instrumentation development program and the engineering and research staffs.

Dr. Corey's former associations include the electronics division of Willys Motors as executive engineer, and Cornell Aeronautical Laboratory where he headed the electro-acoustic and electronics sections of the physics department.

Building Products Firm Enters Electronics

THE H. H. ROBERTSON Co., manufacturer of building products, has entered the electronics field with the purchase of controlling interest in International Research and Development Corp. of Columbus, Ohio.

The Columbus company is primarily an electronics research, manufacturing and marketing organization. It produces vibration analysis instruments and balancing equipment for industry. No change in the company's management will

DUAL- BEAM TIGHT-TOLERANCE



**TYPE
5AFP-**

For two completely independent cathode-ray displays, the Du Mont Type 5AFP-Tight-tolerance, Dual-beam Cathode-ray Tube offers very high deflection sensitivity in each of the identical electron guns, and very low interaction between guns.

The greatly tightened tolerances permit such vital specifications as tracking error, or the ability of each beam to respond identically to identical deflection voltages, to be specified. Maximum line width, a measure of resolution; minimum light output, a measure of screen uniformity and cathode uniformity; deflection factor uniformity, a measure of deflection linearity; and interaction factor, a measure of shielding between guns are all specified in the Type 5AFP-.

For complete technical details on this versatile dual-beam cathode-ray tube write to:

**Technical Sales Department
Allen B. Du Mont Laboratories, Inc.
760 Bloomfield Ave., Clifton, N. J.**

DU MONT

For more ad information, see Index to Advertisers.

March, 1954 — ELECTRONICS

result from the stock transaction. International Research is introducing its new device, the Vibratron, a patented portable electronic instrument which is said to simplify troubleshooting in nearly every type of machinery.

The Vibratron does for the engineer what the stethoscope and the X-ray machine do for the physician, according to A. R. Crawford, president of International. "For the first time, a person can not only see but evaluate the ravages of vibration in modern industry," he said.

Dr. Crawford pointed out that the merger will permit continued expansion, including export marketing and manufacturing of the International line in England.

Sylvania Names La Taste And Early

THE APPOINTMENT of Craig La Taste as sales engineer for electronic products has been announced by D. W. Gunn, general sales manager of Sylvania electronic products. A member of the company since 1952, he was previously in the equipment sales engineering training program.

James M. Early was named sales service engineer for the radio and tv picture tube divisions of the company. In his new position, he will conduct service meetings across the country on all phases of radio and tv test equipment and on technical subjects pertaining to the radio and tv fields.

A member of Sylvania since 1952, Early was previously assigned to commercial engineering.

Armour Research Makes New Moves

THE J. C. WARREN CORP. of Freeport, L. I., N. Y., has been licensed by Armour Research Foundation to use Armour patents in the field of magnetic recording.

"The company thus becomes our sixtieth active industrial licensee," John P. Skinner, Armour manager of magnetic recording, said. "It will be on the market soon with a new portable battery-operated model."

The foundation also announced

NEW Carter SLIDE CHART

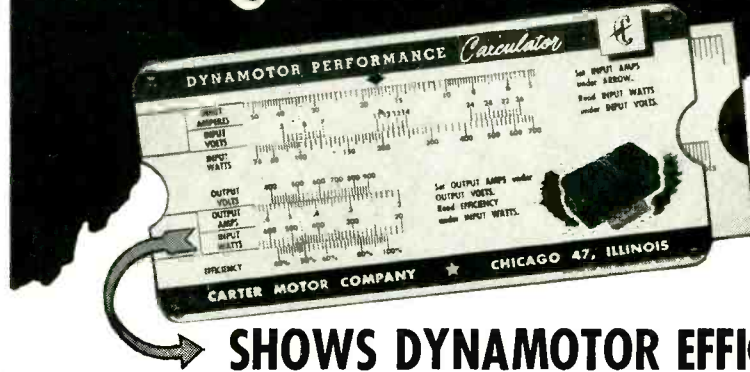

SHOWS DYNAMOTOR EFFICIENCY

25c at a Glance!

AT YOUR RADIO PARTS DISTRIBUTOR OR ELECTRONIC EQUIPMENT SUPPLIER

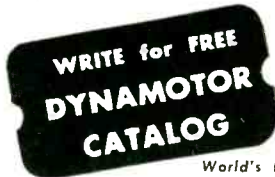

Now it's easy to compare Dynamotor performance efficiency under actual operating conditions. Nameplate information plus this simple slide chart enables you to read instantly the efficiency percentage right from the Calculator scale. Reverse side gives other useful information. Handy 3" x 6" pocket size, color printed on sturdy laminated stock, varnished to resist soil. For sale by radio parts distributors and electronic equipment suppliers, or 25c postpaid.

Carter Motor Co.

2646 N. MAPLEWOOD AVE. CHICAGO 47

World's largest Exclusive Manufacturers of mobile radio rotary power Supplies.

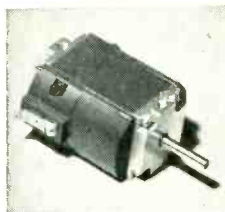

DC MOTOR OR GENERATOR
This small permanent magnet, ball-bearing unit—As a motor: 1/125 H.P. at 6000 RPM continuous duty. As a generator: output 4 watts at 6000 RPM—5 volts per 1000 RPM. Dimensions: 1-29/32" x 1-1/2" x 1-15/100".

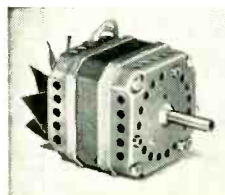

SHADED POLE MOTOR—for sound recorders, air circulators, many other applications. 4-pole, 2 or 4 coil construction. Will operate from 115 volts, 60 cycle a.c.

The RIGHT power supply for mobile equipment is an EEPCO specialty

Outstanding experience in producing rotary electrical equipment to meet rigid specifications is an integral part of every EEPCO product.

Whether your problem involves an industrial or highly developed military unit, EEPCO's complete research and engineering facilities are at your disposal. Contact EEPCO today for special design assistance that can provide you with the best solution.

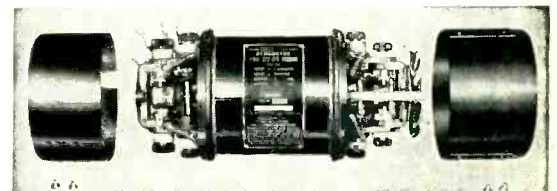

DYNAMOTOR OPERATES FROM 12-24-32 VOLTS
Output of this remarkably compact unit is 500 volts at .100 amperes. Dynamically balanced armature has 4 windings.

ELECTRO ENGINEERING PRODUCTS CO.
609 W. LAKE STREET, CHICAGO 6, ILLINOIS

- P-M DC MOTORS & GENERATORS
- CAPACITOR TYPE MOTORS
- UNIVERSAL MOTORS
- DC MOTORS & GENERATORS
- SHADED POLE MOTORS (2-4-6 Pole)
- P-M AC GENERATORS

MINIATURE *wire-wound* POTENTIOMETERS

*that don't NEED
incoming check*

Problem:

To find a potentiometer that will —

- ... Dissipate 3 watts continuously at 80 degrees C, through 50,000 ohms total resistance.
- ... Occupy no more space than absolutely necessary.
- ... Weigh as little as possible.
- ... Maintain accurate resistance setting, over a wide range of temperatures.
- ... Not require YOU to do production-control checking for the manufacturer.



Solution:

Waters Series RT-7/8 and RTS-7/8 —

- Precision wire-wound construction.
- Three watts continuous, to 80 degrees C.
- Resistances from 10 ohms to 50,000 ohms.
- Diameter 7/8", depth 3/8".
- Weight, approximately 1/2 ounce per section — multiple ganging easily provided.
- Temperature coefficient of resistance 0.002% per degree C.
- Manufactured to rigid military specifications.
- Individually checked through a production quality control system that guarantees you full performance from EVERY unit in your order.



Write today for full technical information and prices.

WATERS MANUFACTURING, inc.

Waltham 54, Massachusetts

APPLICATION ENGINEERING OFFICES IN PRINCIPAL CITIES

For more ad information, see Index to Advertisers.

that Skinner has been appointed a member of the marketing and research committee of the newly organized Magnetic Recording Industry Association.

Three engineers were also appointed to new positions at Armour. Harold L. Garbarino and Robert M. Bergslien were promoted to full electrical engineers. Both have been with the organization since the fall of 1951, Bergslien starting as assistant engineer and Garbarino as associate engineer.

Garbarino was a development engineer with GE before joining the foundation. Bergslien worked as an application engineer with Allis-Chalmers before joining Armour.

Herman H. Chanowitz, formerly a servomechanism engineer with Bell Aircraft, joined the foundation as a full electrical engineer. He will work in the electrical engineering control systems section.



Quackenbush Named By Whitney Blake

R. CLARKE QUACKENBUSH has joined Whitney Blake Co. of New Haven, Conn. as manager of a newly formed electronics division which will develop, manufacture and sell electronic connectors and assemblies.

Quackenbush spent 13 years as a member of the engineering staff of American Phenolic, working in the field of electrical transmission equipment and electronics. He specialized in communication, transmission and lighting equip-

TO A SENIOR ENGINEER

Interested In a
Challenge As Great
As All Tomorrow

If . . .

you're the man we hope you are, you now have a good position. Perhaps you have not thought of a change but will consider the right opportunity.

You have from 5 to 25 years of experience in electronics or an allied field. You desire to do more than just carry assignments to satisfactory conclusions.

You would appreciate an opportunity and the "go ahead" to pioneer . . . with the assistance of your own staff of specialists . . . you now want to know what you personally can achieve through your creative engineering talent.

If you fill these qualifications, we have an opportunity that will fascinate you. You will work on the development of the most interesting electronics equipment with one of the foremost engineering teams in the world. You will work in the Boston Engineering Laboratory located only minutes away from Harvard, MIT and Northeastern Universities, entirely separated from the problems of production. The last word in equipment would be at your fingertips. No richer benefits are offered anywhere . . . regardless of the standards by which you measure.

. . . Are YOU the man we are seeking? If so, phone us or send in a resume to . . .

Don Bradley, Personnel Supervisor

**SYLVANIA
ELECTRIC PRODUCTS INC.**

Boston Engineering Laboratory

70 Forsyth Street, Boston, Mass.

Phone: Kenmore 6-8900

For more ad information, see Index to Advertisers.

March, 1954 — ELECTRONICS

RAWSON ELECTROSTATIC VOLTMETERS



Type 518

Available ranges 100 volts to
35,000 volts

Measure true R.M.S. values on A.C., no wave-
form or frequency errors.

NO POWER CONSUMPTION

Leakage resistance greater than one million
megohms. These meters may be used to
measure **STATIC ELECTRICITY!**

Ideal for measuring high voltage power supplies
with zero current drain. Rugged, well-damped
movement. All elements surrounded by metal
shielding for accuracy and safety.

Write for bulletin

RAWSON ELECTRICAL INSTRUMENT COMPANY

111 POTTER ST. CAMBRIDGE, MASS.

Representatives

Chicago

Los Angeles

QUALITY • QUANTITY • QUICKLY

Type BNC UG-274/U

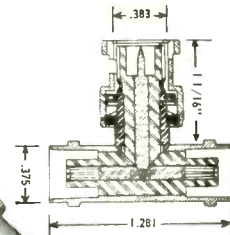
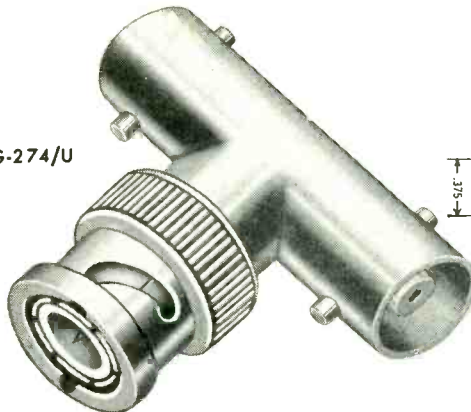

The Right Connection . . . right now!

Dage RF connectors are designed *right*, engineered *right*,
built *right*—and available *now*. Each part is carefully made—
Dage connectors are precision assembled to assure a sure
connection.

Check your specifications—be sure you're *right*—ask for
Dage radio frequency connectors

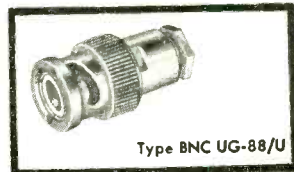

Type BNC UG-88/U

ALWAYS SPECIFY



Dage is versatile . . . any standard or special RF connector
can be quickly produced at Dage. Write for Catalog 101.

RADIO FREQUENCY CONNECTORS

DAGE ELECTRIC COMPANY, INC., 67 NORTH SECOND STREET, BEECH GROVE, IND.

"INDUSTRIAL"

for

ELECTRONIC COMPONENTS

Precision engineered electronic components
and connecting devices for all your needs.

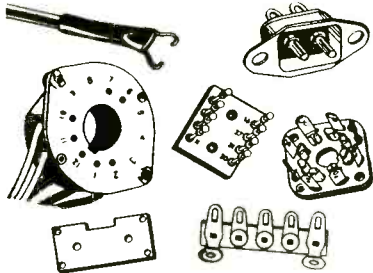

- HALFMOON DUO-DECAL SOCKETS
- ANODE CONNECTORS
- INTERLOCK PLUGS
- LAMINATED TUBE SOCKETS
- TERMINAL STRIPS
- WIRED ASSEMBLIES
- METAL or BAKELITE STAMPINGS
- TERMINAL BOARD ASSEMBLIES
- TUNER STRIPS, SOCKETS and BRACKETS for UHF

VISIT WITH
US AT THE
IRE SHOW
BOOTH 579



Our extensive design and production
facilities are available for developing
your special requirements and applica-
tions. Representatives in principal
cities throughout U.S.A. Call or
write for samples and information.
OREgon 7-1831.

INDUSTRIAL HARDWARE Mfg. Co., Inc.
109 PRINCE STREET • NEW YORK 12, N. Y.

KUTHE

Hydrogen Thyratron TUBES

Kuthe
Laboratories, Inc.
730 South 13th Street
Newark 3, New Jersey
Telephone: Blgelow 2-6000

Visit us at the
RADIO ENGINEERING SHOW
Kingsbridge Armory, N.Y.C.
March 22-25
BOOTH #905

BUDD · STANLEY

RADIO FREQUENCY COMPONENTS

FOR

MICROWAVE APPLICATION

PRODUCTS:

Transmission lines and associated elements in brass and light weight materials manufactured to customer's specifications including antenna feed systems, duplexers, mixers, directional couplers and precision metallized glass attenuators.

MANUFACTURING FACILITIES:

Including model shop, toolroom, fully equipped machine shop, brazing, soldering, plating and painting and a battery of power operated bending machines.

TEST EQUIPMENT:

From 800 to 12600 mcs. in multiple sets enables utilization of assembly line techniques for accurate production testing.

BUDD-STANLEY's experience and manufacturing techniques will fulfill your most exacting requirements for quality radio frequency components for microwave application.

Your inquiries will be given our prompt attention.

BUDD · STANLEY Co. Inc.

43-01 22nd STREET
LONG ISLAND CITY 1, N. Y.



TEL. STILLWELL 6-1706
CABLE ADDRESS "BUDDSTAN"

PLANTS AND PEOPLE

(continued)

ment, connectors and wiring devices and the dielectrics used in their design. He holds a number of patents covering connectors and wiring devices and was one of the developers of the AN connector line.

Before joining Whitney Blake he was engineer in charge of the eastern division of Cannon Electric. He set up the company's plant in East Haven and was in charge of its operation for several years.



Kadison Directs Sealtron Research

FRANKLIN R. KADISON has been appointed director of research and development for the Sealtron Corp. of Cincinnati. He comes to Sealtron from Electrical Industries of Newark, N. J., where he served as assistant to the chief engineer in the hermetic seal division.

Burroughs Establishes Instrument Division

BURROUGHS CORP. has formed an electronic instrument division as a separate manufacturing and marketing operation. It was formerly part of the company's Philadelphia research center. The division produces and markets scientific instruments, including pulse control units, scientific computers and electronic components such as vacuum tubes.

Perry C. Smith, who has been director of the division since it was started, has been named general manager. Lawrence T. LaPatka will serve as sales manager and Herman J. Bruning, Jr. has been appointed chief accountant.

"Products of the electronic in-

ANNOUNCING

the

New

ELMENCO

CM 42

MOLDED MICA CAPACITOR

ACTUAL
SIZE

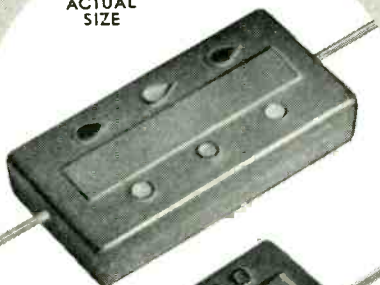

DIMENSIONS

1 1/2" x 1 1/8" x 1/4"
CAPACITY RANGES
.01 TO .025 MFD. 500VDCW
.01 TO .03 MFD. 300VDCW
ALL OTHER ELECTRICAL
SPECIFICATIONS MEET
STANDARDS FOR OUR
MIL-C-5A MOLDED
MICA CAPACITORS

FURTHER DETAILED
INFORMATION UPON REQUEST

A HIGHER CAPACITY MOLDED MICA

WHICH CAN BE WIRED
IN DIRECTLY WITHOUT
NEED OF ADDITIONAL
MOUNTING FACILITIES

SEE US AT THE IRE SHOW

Booth 361 — Mobile Ave.

★ WRITE FOR A FREE CATALOG ★

ARCO

ELECTRONICS INC.

103 LAFAYETTE STREET
NEW YORK 13, N. Y.

For more ad information, see Index to Advertisers.
ELECTRONICS — March, 1954

PLANTS AND PEOPLE

(continued)

strument division have become such an important part of the company's business that its establishment as a separate operation was desirable," John S. Coleman, president, said.



John Jipp Joins Ampex Corp.

JOHN JIPP, FORMERLY with Motorola, has joined Ampex Corp. as manager for instrumentation recorder sales.

Prior to joining Ampex, Jipp established and managed the west coast parts and service depot and had served as southwestern regional sales manager for Motorola. During the second World War he was with the Signal Corps Labs, engaged in design engineering and field research on military radio equipment.

Westinghouse Engineer Honored By Society

ADAM G. KEGEL, a member of the development engineering department of the Westinghouse Air-Arm division in Baltimore, was chosen winner of one of the two runner-up awards in the annual Eta Kappa Nu sponsored competition for the nation's outstanding young electrical engineer. He joined Westinghouse upon graduation in 1947. His first assignment was in the special products development division. He was transferred to the Baltimore Air-Arm division when it was organized in 1951, and was made a project engineer. He played

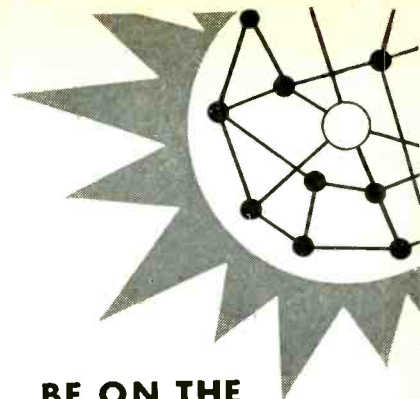

BE ON THE GROUND FLOOR IN *Florida*

Florida wants and needs electronics industries of special types. Florida offers what you need.

Manufacturers of tubes, resistors, coils, expensive transformers, light weight electro-mechanical components and specialized instruments and equipment will find Florida an ideal location.

Manpower of all types and skills is plentiful—and more than 1,965 new residents are moving to Florida every week. The labor climate is excellent.

Plant construction, maintenance and heating costs are lower in Florida because of the mild year-round climate.

Taxes are favorable, too. Florida has no State income tax, no State inheritance tax, no State ad valorem tax.

Florida's importance in Air Force, Army and Navy electronics programs is widely known and proximity to the big Florida operational and experimental bases could be valuable to you. So could its strategic relationship to Southern and Latin-American markets.

A few electronics research and development companies are already established in Florida. There's still room for more such companies on the ground floor.

For dependable information write: Industrial Development Division, State of Florida, 3306B Caldwell Building, Tallahassee, Florida.

you'll always
do better in

Florida

For more ad information, see Index to Advertisers.

an important part in the development of automatic pilots and fire control systems used in guided missiles and in radar for jet aircraft.

Illinois Tool Changes Shakeproof Division

ILLINOIS TOOL WORKS of Chicago has decentralized its Shakeproof division along product lines, physical facilities and organizational responsibilities.

The division has been subdivided into three production units, each housed in its own plant and with its own organizational group, headed by a general manager. These managers report to E. W. Fuller, vice-president, and are responsible for all personnel, engineering, manufacturing and sales promotion functions of their respective subdivisions.

The new general managers are: A. L. Pontius for standard products, C. F. Jensen for special stamped products and S. S. Cathcart for plastic products. Sales functions of the entire division remain under the direction of J. S. Hawley, marketing manager.

American Instrument Opens New Plant

AMERICAN INSTRUMENT Co. of Silver Springs, Md., has erected a 40,000 sq ft plant at Savage, Md., bringing to six the number of plants owned and operated by the company.

The new plant at Savage will be engaged in electronics, mechanical and optical production, and in moisture engineering. Initially, the company plans to employ 300 to 400 workers. Joseph J. Zink, with American for ten years, is superintendent of the new plant.

Beckman Instruments Sets Up German Plant

BECKMAN INSTRUMENTS of S. Pasadena, Calif., has established a new manufacturing subsidiary in Munich, Germany, producing several types of spectrophotometers and pH meters. The new 6,000 sq ft assembly plant will have 37 sales

A CHALLENGE
to the user's ingenuity!

**UNIVERSAL
MEASURING
TEST SET**
for direct currents
**OVER 200
SEPARATE INSTRUMENT
RANGES**

Accuracy .5 of 1%

Will Measure Directly
MICROAMPERES
MILLIAMPERES
AMPERES
MILLIVOLTS VOLTS
from 1 Microampere to
60 Amperes and
1 Millivolt to over 750 Volts

VISIT US
AT THE
I.R.E. SHOW
BOOTH
386

Microwave Ave.



Symbol of Quality

**SENSITIVE RESEARCH
INSTRUMENT CORPORATION**
MOUNT VERNON, N.Y.

ELECTRICAL INSTRUMENTS OF PRECISION SINCE 1927



Can Be Readily Connected In A Few Moments For Use As A
WHEATSTONE BRIDGE
POTENTIOMETER MILLIVOLTMETER & VOLTMETER
ZERO RESISTANCE MICROAMMETER OR MILLIAMMETER
HIGH RESISTANCE VOLTMETER
RADIO FREQUENCY VOLTMETER
RADIO FREQUENCY MILLIAMMETER OR AMMETER
OR USED FOR D.C. POWER MEASUREMENTS,
BRIDGE TYPE A.C. RECTIFIER, CIRCUIT TESTER, ETC.

A Sequential Relay That Counts, Stores or Remembers

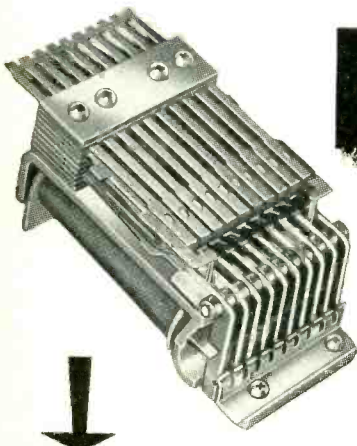

PROVED IN USE!

SEQUENTIAL OPERATION—10 operations in sequence but one relay
DIGITAL STORAGE—Once read-in, stored without power but no latches
TELEMETERING—Counting or controlling from a distance but minimum wiring
COMPUTERS—Series read-in parallel read out
STEPPING—Replaces 2 magnet 10 point stepping switch at pulse rates up to 20 per second

WRITE FOR FREE TECHNICAL DATA TODAY, DEPT. 26-C

KELLOGG DIVISION OF
ITT

KELLOGG SWITCHBOARD AND SUPPLY COMPANY

A Division of International Telephone and Telegraph Corporation
SALES OFFICES: 79 West Monroe Street, Chicago 3, Illinois

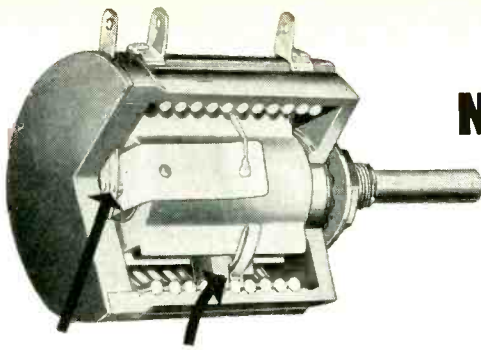

NEY PRECIOUS METAL ALLOY CONTACTS

NEY'S SMALL PARTS PLAY A BIG PART IN PRECISION INSTRUMENTS

The output of any potentiometer is dependent upon the contacts. Illustrated above is a Helipot 10-turn Potentiometer (Model A) using Ney Precious Metal Contacts between the slider and the resistance winding and for the slip ring pick-off, assuring the utmost in linearity and electrical transmission.

The J. M. Ney Company has developed a number of precious Metal Alloys and fabricates these into contacts, wipers, brushes, slip rings, commutator segments and similar components for use in electrical instruments. Ney Precious Metal Alloys have just about ideal physical and electrical properties, high resistance to tarnish, and are unaffected by corrosive atmospheres. Consult the Ney Engineering Department for assistance in selecting the right Ney Precious Metal Alloy which will improve the electrical characteristics, prolong the life and accuracy of your instrument.

THE J. M. NEY COMPANY • 179 ELM STREET, HARTFORD 1, CONN.
Specialists in Precious Metal Metallurgy Since 1812

See our Exhibit Booth 291—Instruments Ave.—I.R.E. SHOW

4NY94B



HARDWARE for ELECTRONICS

ONE SOURCE OF SUPPLY FOR FASTENINGS

We carry in stock thousands of STANDARD and SPECIAL items used in the ELECTRONIC INDUSTRY.

SCREWS—NUTS—WASHERS—TERMINALS—GROMMETS
RIVETS—EYELETS—ACCESSORIES.

SPECIAL Cold Headed Products—Stampings—Screw Machine Parts—Made to order in all metals.

WRITE FOR CATALOG 54.

FEDERAL SCREW PRODUCTS INC.

224-230 W. HURON ST. CHICAGO 10, ILL.

**WE CARRY
IN STOCK...**

**ALL SIZES
ALL SHAPES**

**ALL ALNICO
GRADES**

ALNICO PERMANENT MAGNETS

Cast and Sintered **CARBOLOY** Permanent Magnets

EXPERIMENTAL OR PRODUCTION QUANTITIES

SPECIAL! NEW SERVICE!

We can now drill any shape
or size hole in Alnico

Catalog upon request

AUTHORIZED SALES AND SERVICE

CARBOLOY DEPARTMENT

OF GENERAL ELECTRIC CO.

PERMAG CORP., 210 TAAFFE PL., BROOKLYN 5, N. Y. —Phone: MAin 2-0114

PERMAG
services include:

- ENGINEERING
- PRECISION CUTTING
- PRECISION GRINDING
- MAGNETIZING

**24 HOUR
DELIVERY**

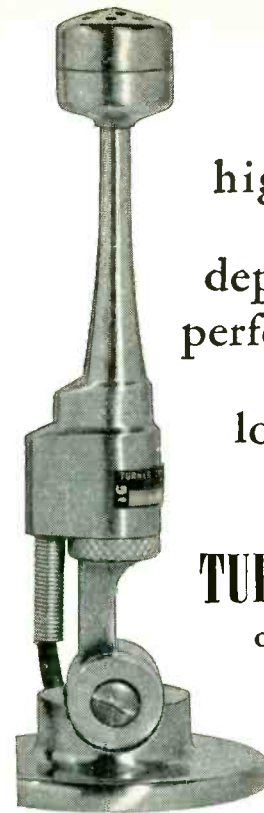

high style
dependable
performance

low price

TURNER 80
on C-4 stand

In design, there is no comparable microphone that equals Turner 80 styling and compactness. Styling that pleases the eye and fits in with modern surroundings. Compactness that makes this microphone convenient and easy to use. You can cradle it in the palm of your hand. Actual size (not including C-4 stand) only 4½" in length.

For PA, home recorder, dictating machine, office and factory call systems and amateur uses, the Turner 80 performance is always dependable.

Sensitivity: Approx. 58 db
below 1 volt/dyne/sq. cm.
Response: 80 to 7000 cps.
Weight: 5 oz. less cable.
Cable: 7 foot attached single
conductor shielded.

C-4 stand gracefully matches
the Turner 80. Both are satin-
chrome plated. Stand won't tip
or slide with weight of cord.

Turner 80 list price-----\$15.95

C-4 stand list price-----\$ 5.75

THE TURNER COMPANY
905 17th St., N.E.
Cedar Rapids, Iowa

EXPORT: Ad Auriema, Inc.,
89 Broad St., New York 4

CANADA: Canadian Marconi Co.,
Toronto, Ont., and Branches

The Heart

of AIRCRAFT CONTROL SYSTEMS

THE MASTER
AIR DATA
COMPUTER

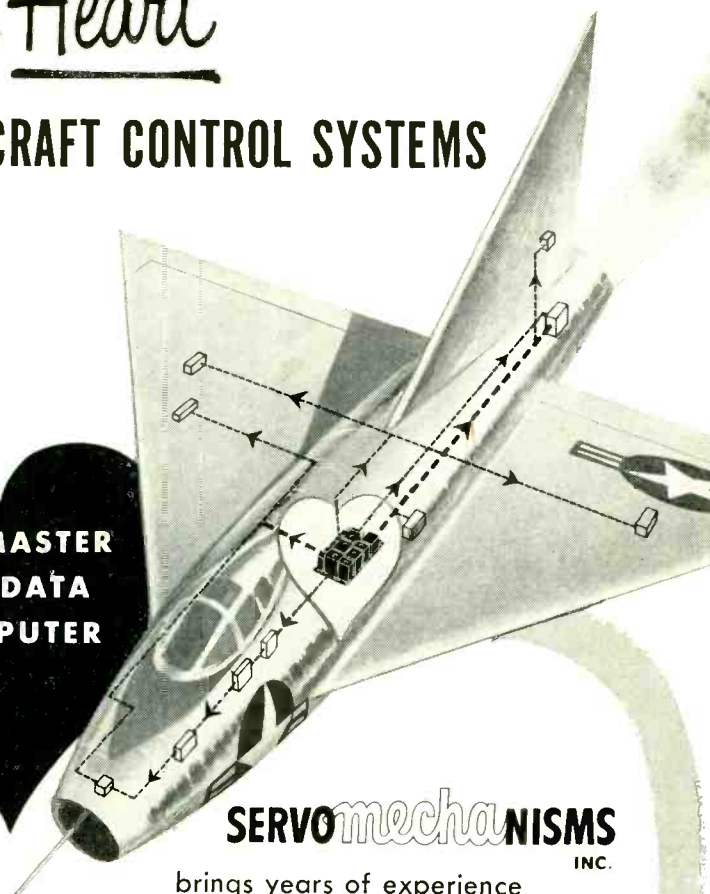

SERVOmechanISMS
INC.

brings years of experience to your specific requirements in centralized air data computation. There is no limit to the number of outputs — the number of functions computed — or the number of services these computers can be designed to perform.

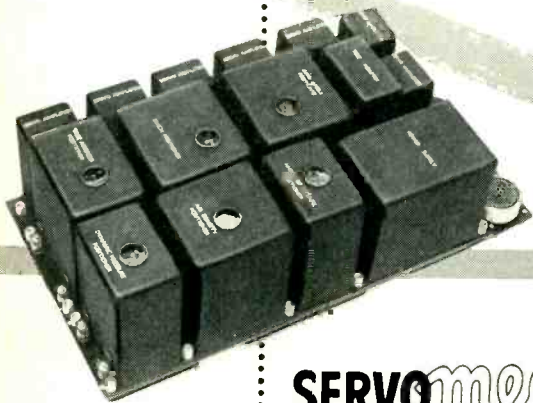

SERVOmechanISMS INC.
PACKAGED FUNCTIONAL COMPONENTS

Visit us at the
New York I. R. E. Show,
March 22-25
Booth 740-742.

Designed and Produced at El Segundo, California
and Westbury, New York

PLANTS AND PEOPLE

(continued)

and production employees.

The Munich sales office will be headquarters for Western European sales, headed by European sales manager Harold H. Zander. It is a unit of the International sales division of Beckman, formed in January, 1954, and headed by Robert T. Jones.

Company plants will ship most instrument parts while the factory is being equipped to carry on a completely integrated operation.

National Union Names Skellett To Board

A. MELVIN SKELLETT, vice-president in charge of manufacturing and engineering of National Union Radio Corp., has been elected to the firm's board of directors.

Before joining National Union in 1944 as head of research, he was associated for 15 years with Bell Telephone Laboratories.

New Relay Company Is Organized

ELLY ELECTRONICS CORP., P. O. Box 395, Fair Lawn, N. J., has been formed to assume all manufacturing and sales of the "SNAPPER" thermal time delay relay, formerly manufactured by Eureka Television and Tube Corp.

The president of Elly is J. George Sauer, formerly general manager of Eureka. The new company is already in production on all types of its relays.

Program For The 1954 IRE National Convention Is Set

FOLLOWING IS THE complete list of technical papers and program events to take place at the 1954 IRE National Convention in New York City on March 22-25:

ANNUAL MEETING OF THE INSTITUTE

Monday, March 22, 10:30 A.M.
Waldorf-Astoria Hotel
Principal Speaker: John D. Ryder

RADIO ENGINEERING SHOW HOURS

Kingsbridge Armory
Monday, March 22, 10 A.M. to 10 P.M.
Tuesday, March 23, 10 A.M. to 10 P.M.
Wednesday, March 24, 10 A.M. to 5 P.M.
Thursday, March 25, 10 A.M. to 10 P.M.

GET-TOGETHER COCKTAIL PARTY

Monday, March 22, 5:30 to 7:30 P.M.,
Waldorf-Astoria Hotel

IRE ANNUAL BANQUET

Wednesday, March 24, 6:45 P.M.

MCGRAW-HILL

Lean
On
Us

whatever
your
publication needs ...

Equipment Manuals — Product Catalogs — Handbooks — Training Aids — Industrial Relations Literature — Procedural Guides — Engineering Presentations — — — and any type of technical literature

use our specialists in — — —
WRITING ... EDITING
ILLUSTRATING ... PRINTING

McGRAW-HILL

Technical Writing Service*
330 West 42nd St., N.Y.C. 36
Longacre 4-3000

*Talk with our representative in Booth 126
at the IRE Show.

For more ad information, see Index to Advertisers.

ELECTRONICS — March, 1954

PLANTS AND PEOPLE

(continued)

Waldorf-Astoria Hotel
Principal Speaker: Alfred N. Goldsmith
Topic: IRE—Past and Future

Monday Afternoon, March 22, 1954

**Symposium: ADVANCE IN
MOBILE COMMUNICATIONS**

Transient Response of Selective Networks and Impulse Noise in Narrow Band FM Receivers by S. P. Lapin and J. J. Suran.

Advances in Petroleum Mobile Communications by L. A. M. Barnette.

A New Approach to 450-170 Mc Communications Equipment by R. W. Tuttle. Operation and Planning on a Utility System by A. B. Buchanan.

**INFORMATION THEORY I—
APPLICATION OF INFORMATION
THEORY TO COMMUNICATION
SYSTEMS**

Theoretical Improvement in Signal to Noise of Television Signals by Equivalent Comb Filter Technique by M. B. Ritterman and M. J. Stateman.

Optical Filters—Their Equivalence To and Difference From Electrical Networks by T. P. Cheatham, Jr. and A. H. Kohlenberg.

Information Theory—Past, Present and Future by R. M. Fano.

Information Losses in Regenerative Pulse Code Systems by W. D. White.

A Gaussian Noise Generator for Frequencies Down to 0.001 Cycles Per Second by D. F. Winter.

**AERONAUTICAL AND NAVIGATION
ELECTRONICS I**

An Impulse Generator for Receiver Performance Measurement by J. H. Vogelmann.

Aerial Methods in Microwave Survey by M. Sheldon and L. Dickerson.

The Development of a Production Radium Tester by R. P. Walcott.

A Correlation Direction Finder for Guided Missile Range Instrumentation by M. S. Friedland and N. Marchand.

Present Status of Microwave Radiometric Receiver Development by R. M. Ringo.

**QUALITY CONTROL AND
RELIABILITY**

Improving Reliability of Electronic Equipment by Effective Analysis of Field Performance by R. R. Landers.

A Survey of Electronic Failure Prediction Techniques by J. H. Muney.

A New Approach to the Attainment of Reliability in the Production of Airborne Electronic Systems by F. Hanusek.

A Method of Testing and Evaluation of Complex Missile Systems by E. J. Althaus, S. C. Morrison, and W. R. Tate.

**RADIO TELEMETRY AND REMOTE
CONTROL I—SYSTEMS AND
ELEMENTS**

Guided Missile Range Instrumentation—A New Electronic Art by M. S. Friedland.

Interpretation of Sequential Samples from Commutated Data by L. L. Rauch.

Comparison of Required Radio Frequency Power in Different Methods of Multiplexing and Modulation by M. H. Nichols.

Flight Testing of an Airborne Digital Computer by E. M. Grabbe and D. W. Burbeck.

Evaluation of Magnetic Tape Equipments for Telemetering Instrumentation by R. E. Rawlins.

**ELECTRONIC COMPONENTS I—
TECHNIQUES**

The Effect of Maintenance on Reliability of Complex Military Electronic Equipment by J. B. Arnold.

Miniaturized Computer Applications of the Hughes Diode by S. G. Lutz.

Subminiaturization Techniques for UHF Communication Equipment by G. Shapiro.

Synthetic Quartz Crystals for the Electronic Industry by D. R. Hale and W. H. Charbonnet.

Application of Precise Components in Permeability Tuned Oscillators by D. M. Hodgkin.

**RADIO COMMUNICATIONS I—
SYMPOSIUM: FACSIMILE**

Facsimile Systems by A. S. Hill.
Operation of International Commercial



**BRUSHES
CONTACTS**

SLIP RINGS

...AND SLIP RING ASSEMBLIES

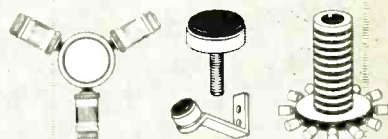

BRUSHES — CONTACTS — ASSEMBLIES

... Use **SILVER GRAPHALLOY** for applications requiring low electrical noise; low and constant contact drop; high current density and minimum wear.

EXTENSIVELY USED IN:

**SELSYNS • GUN FIRE CONTROLS
ROTATING THERMOCOUPLE and
STRAIN GAGE CIRCUITS
ROTATING JOINTS • DYNAMOTORS**

Wide range of grades available for standard and special applications.

Other Graphalloy Products



Oil-free, self-lubricating Bushings and Bearings (applicable —100° to +300° F.; with expansion coefficient half that of steel will not seize shafts at low temperatures); oil-free Piston Rings, Seal Rings, Thrust and Friction Washers, Pump Vanes.

GRAPHITE METALLIZING CORPORATION

1055 NEPPERHAN AVE. • Yonkers, New York

Please send data on Graphalloy BRUSHES and CONTACTS.
 Send data on BUSHINGS.

NAME & TITLE _____
COMPANY _____
STREET _____
CITY _____ ZONE _____ STATE _____

For more ad information, see Index to Advertisers.

Auricon
Hollywood

KINESCOPE RECORDING

with
Guaranteed Results!
OR YOUR
MONEY BACK



**NOW, A DUAL-PURPOSE
AURICON
"SUPER 1200" CAMERA
with TeleVision-Transcription
"TV-T" Shutter...**

...designed for Kinescope Recording...and also shoots regular Live Action 16 mm Sound-On-Film Talking Pictures with no Camera modification! The "Super 1200" Camera with "TV-T" Shutter (Pat. App'd. for 1949) can Kinescope Record a 30 minute continuous show using 1200 foot film magazines. Write today for information and prices.

USE AURICON "TV-T" KINESCOPIES FOR:

- ★ DELAYED RE-BROADCASTING
- ★ SPONSOR PRESENTATIONS
- ★ COMPETITION CHECKS
- ★ PILOT KINESCOPIES
- ★ SHOW-CASE FILMS
- ★ "HOT KINES"
- ★ AIR CHECKS

Auricon 16 mm Sound-On-Film Cameras are sold with a 30-day money-back guarantee. You must be satisfied!

Auricon 50 ft. Kinescope "TV-T" Demonstration Films are available on loan to TV Stations and Film Producers. Please request on your letterhead.



BERNDT-BACH, INC.

7373 Beverly Blvd., Los Angeles 36, Calif.

MANUFACTURERS OF SOUND-ON-FILM
RECORDING EQUIPMENT SINCE 1931

For more ad information, see Index to Advertisers.

PLANTS AND PEOPLE

(continued)

Radiophoto Circuits by M. P. Rehm.
Applications of Facsimile in the USAF by H. R. Johnson.
Application of Cathode-Ray Tubes in Facsimile Systems by W. H. Bliss.

Tuesday Morning, March 23, 1954

**AERONAUTICAL AND NAVIGATIONAL
ELECTRONICS II**

The Digitac Airborne Digital Computer by E. E. Bolles.
A New Fixed-Beam Instrument Approach System for Aircraft by R. A. Hampshire.
The Role of Flight Directors in Present-Day Aircraft by N. L. Graham.
The Navaglobe Long Distance Navigation System by C. T. Clark, R. I. Colin, M. Dishal, I. Gordy, and M. Rogoff.
The N-I Compass by R. C. Rosaler.

ENGINEERING MANAGEMENT I

The Engineer and Return on Investment by S. C. Peek.
Technical Information: Communication for Research by C. De Vore.
A Working Philosophy for Engineering Management by T. G. Slattery.
Organization for Operations Research by F. Weldon.
Training for Operations Research Groups by T. Page.

**RADIO TELEMETRY AND REMOTE
CONTROL II—TELEMETRY**

A 227 Mc Pulse Position Modulation Telemetering System by D. G. Mazur.
Crystal Control Low Distortion FM Telemetering Transmitter by R. E. Rawlins.
A Crystal Controlled FM Telemetry Transmitter by F. N. Reynolds.
A New Subcarrier Oscillator by J. W. Wynn.

AUDIO I—HIGH FIDELITY

Large Area Microphones for Distant Pickup Use by T. Aamodt and F. K. Harvey.
The Enhancement of Music by Reverberation by D. W. Martin.
Some New Developments in High Fidelity Loudspeakers by H. F. Olson and J. Preston.
High Fidelity and the Hearing Process by W. E. Kock.
Some Aspects of Stereophonic Sound in Motion Picture Theaters by R. H. Ranger.

**INFORMATION THEORY II—CODING
AND NOISE**

Matched Filters for Detecting Pulsed Signals in Noise by J. S. Rochefort.
An Experimental Study of the Bandwidth of a Digital Computer by N. R. Scott.
Time-Varying Quasi-Linear Method of Speech Noise Suppression by M. J. DiToro.
Discriminatory Analysis Applied to Speech Sound Recognition by H. L. Stubbs.
A Discussion of Auto-Correlated Error Terms in Time Series Analysis by R. K. Weller.

**BROADCAST AND TV RECEIVERS I—
GENERAL**

Ferrite Cored Antennae by C. A. Grimmett.
Transistor AM Broadcast Receivers by A. P. Stern and J. A. A. Raper.
Wide-Band Amplification with Surface-Barrier Transistors by J. B. Angell.
Automatic Damping in Vertical Deflection Circuits by H. E. Thomas S. DeMars, and M. Jones.
Wide-Range Tuning System, by H. T. Lyman, F. G. Mason, and H. Ross.

**ELECTRONIC COMPONENTS II—
APPLICATION**

Magnetic-Core Delay Cables by D. R. Stein.
Improvements in the Field of Electrolytic Capacitors by D. Altenpohl.
An Investigation of Lowest Resonant Frequency in Commercially Available By-pass Capacitors by D. T. Geiser.
Resolution in Precision Potentiometers by R. J. Sullivan.
Evaluation of Core Materials for Magnetic Amplifier Application by R. D. Teasdale and H. R. Brownell.

Tuesday Afternoon, March 23, 1954

**AERONAUTICAL AND NAVIGATIONAL
ELECTRONICS III**

Operational Analysis of Track-While-

PRESS-WIRELESS CAPACITANCE VOLTAGE DIVIDERS



VD-453
200-100,000
PEAK VOLTS

NEW TIME-SAVERS!

- ★ Permit high voltage pulses to be accurately measured and displayed on standard synchroscope.
- ★ Essential in test of radar modulators, high level pulse transformers, and pulse-forming networks.

VD-359
1,000-35,000
PEAK VOLTS



- WIDE VOLTAGE RANGE
- HIGH ACCURACY (5%)
- VERY LOW DISSIPATION
- LIGHT WEIGHT

Write for complete information!



PRESS WIRELESS

LABORATORIES, INC.
26 West Prospect Place
WEST NEWTON 65, MASS.

PRODUCTS OF EXPERIENCE

For more ad information, see Index to Advertisers.

March, 1954 — ELECTRONICS

**VAPOR BARRIERS
GREASE-PROOF PAPERS
WATER-PROOF CASE LINERS**
TO MILITARY SPECIFICATIONS

**MIL-P-116
MIL-B-131
JAN-B-121
JAN-P-125
MIL-L-10547
MIL-C-6056
MIL-E-6060
AN-B-20
AN-P-13**

Write for information and prices

PROTECTIVE COATINGS, INC.

Atlas Package and Container Corp., Div.
592 River Road Clifton, N. J.

Telephone: (N. Y.) Wisconsin 7-8824
(N. J.) Prescott 9-4860

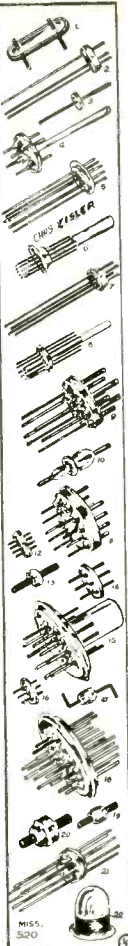

**ELECTRONIC GLASS WORKING EQUIPMENT for
RADIO, TELEVISION TUBES, INCANDESCENT LAMPS,
GLASS LATHES for TELEVISION TUBES**

We make Transformers, Spot and Wire Butt Welders, Wire Cutting Machines and 500 other items, indispensable in your production. Eisler Engineers are constantly developing New Equipment. If you prefer your own designs, let us build them for you. Write to Charles Eisler who has served The Industry over 34 years.

Machines for small Radio Tubes of all kinds.

SEND YOUR GLASS PROBLEMS TO EISLER

**24 POSITION BARREL CAM INDEXING TYPE
TURNTABLE FOR GLASS BUTTONS
MADE BY EISLER**

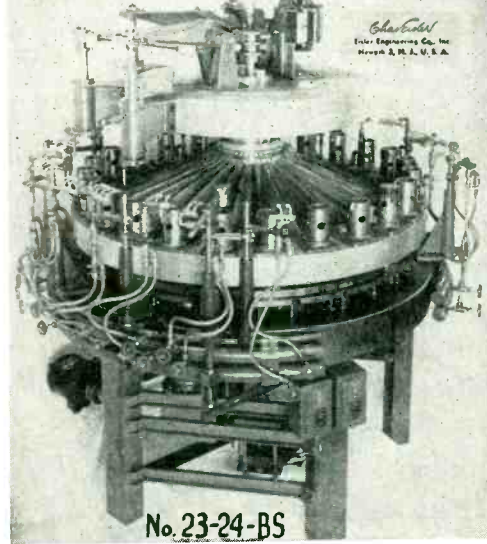

No. 23-24-BS

DR. CHAS. EISLER M.E. PRES.

EISLER ENGINEERING CO., INC.

251 SO. 13TH ST.
NEWARK 3, N. J.

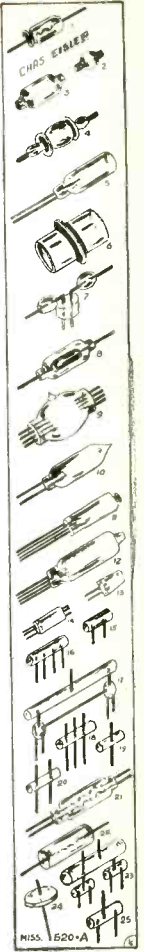

SINCE 1920 QUALITY WENCO PRODUCTS SPADE BOLTS

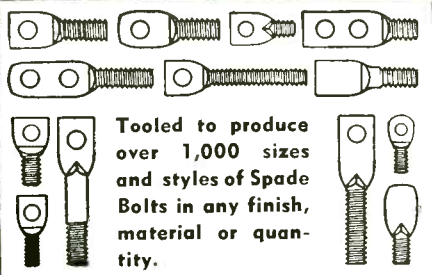

Tooled to produce over 1,000 sizes and styles of Spade Bolts in any finish, material or quantity.

Specialists in Designing and Manufacturing All Purpose Fasteners, Terminals and Mounting Lugs.

OTHER PRODUCTS:

Simplex

Wire Strippers and Cutters

TOOLS AND DIES

METAL STAMPINGS

WIRE SPECIALTIES

REPLACEMENT TIPS for Electric Soldering Irons

Send samples or specifications for quotations. Descriptive bulletin on request.

WENCO MANUFACTURING CO.
1133 W. Hubbard St., Chicago 22, Ill., U.S.A.

**FREQUENCY STANDARDS
MICROMETER
HEADS**

JOB TESTED!



- Precision Built
- Positive Resetting
- Automatic Compensation for Spindle Wear
- Positive Spindle Lock
- Anodized Finish

FIELD CHECKED!

AVAILABLE IN SEVERAL MODELS
—WRITE FOR LITERATURE

This new precision instrument affords the highest degree of accuracy in reading. Elimination of backlash assures positive resetting in either direction of rotation and automatically compensates for wear of spindle and nut thread. Calibrations are large, legible, easy to read. Features include temperature compensation construction, thumb stop to prevent thread jamming and a positive spindle lock. The instrument is easily reset for calibrated instruments.

Frequency Standards
General Offices: ASBURY PARK, NEW JERSEY
PLANTS AT NEW SHREWSBURY AND ASBURY PARK, N. J.
Telephone: ASBURY PARK 1-1718

On display at the
**I.R.E. SHOW
BOOTH 732
AIRBORNE
AVENUE**

Measure and Record Strain with **PRECISION**



6-channel
unit

The Hathaway TYPE RS-10 PRECISION STRAIN INDICATOR

6, 12, 25 or 50 Channels

FOR PRECISION MEASUREMENTS OF STATIC STRAIN

Static strain in 1 to 50 channels can be measured in rapid succession. Individually-calibrated 21-inch dial provides an accuracy of 1/4 percent. Smooth and accurate balancing controls for each channel. Continuously-variable gage-factor adjustment.

FOR RECORDING DYNAMIC STRAIN

The RS-10 can be used with an oscillograph (such as the Hathaway type S14-C) for recording dynamic strain, providing accurate balancing and means for precision calibration of the records.

MULTI-CHANNEL PRECISION MEASUREMENTS OF STATIC STRAIN

DYNAMIC STRAIN RECORDING TO 300 CPS WITHOUT AMPLIFIERS

Write for Catalog Sheet 3H4K for details.

Write for Your Free Copy of Hathaway Engineering News

Hathaway
INSTRUMENT COMPANY
1315 SO. CLARKSON STREET • DENVER 10, COLORADO

Scan Radars by S. J. O'Neil.

A Study of the UHF Omnidirectional Aircraft Antenna Problems and Proposed Methods of Solution by W. Spanos and J. J. Nail.

A Modulator Technique for Producing Short Pulses in High Powered Magnetrans by T. J. Parker.

The Role of Stereo in '3-D' Radar Indicating Systems by W. R. Tower.

An Automatic Antenna Matching Unit by E. W. Schwittek.

ENGINEERING MANAGEMENT II—

Symposium: PERSONNEL TRAINING AND SELECTION FOR ENGINEERING MANAGEMENT

For the Universities by S. C. Hollister.

For Industry by W. R. G. Baker.

For the Government by J. M. Mitchell.

MEDICAL ELECTRONICS

Visualization of the Distribution of Gamma Emitters in-vivo.

By Means of the Gamma Ray Pinhole Camera and Image Amplifier by R. K. Mortimer, H. O. Anger, and C. A. Tobias.

Expansion Chamber for Measurement of Red Cell Permeation by Water by A. K. Solomon and C. V. Paganelli.

Color and Enhanced Contrast X-Ray Images by R. S. MacKay.

Measurement of Slow Neutron Depth Doses by E. Stickley.

Use of Charged Particles to Measure Skin Thickness and Other Surface Properties by F. Hutchinson.

AUDIO II—GENERAL

Some Aspects of Clipped Speech by R. K. Saxe and R. E. Lacy.

A Miniature Unidirectional Microphone by B. B. Bauer and J. W. Medill.

A High Efficiency-High Quality Audio Power Amplifier by A. B. Bereskin.

System Design Factors for Audio Amplifiers by M. V. Kiebert, Jr.

Driver System for Single Ended Push-Pull Amplifiers by C. T. Hall.

INFORMATION THEORY III—SPEECH AND COMPUTATION

Optimize Data Encoding for Digital Computers by W. H. Kautz.

Symbolic Methods in the Design of Delay- and Cycle-Free Logical Nets by G. W. Patterson.

Threshold Detection by B. L. Basore.

The Nature of the Uncorrelated Component of Induced Grid Noise, by T. E. Talpey and A. B. Macnee.

Effect of Limiting on the Information Content of Noisy Signals by G. O. Young and B. Gold.

BROADCAST AND TV RECEIVERS II—COLOR TELEVISION

Self-Balancing Phase Detector for Color Receiver Reference Oscillators by E. G. Clark.

Color Fidelity in TV Receiver Having Nonstandard Primaries by F. J. Bingley.

Color Distortion in Sequential Displays by D. C. Livingston.

Single-Gun Picture Tubes in NTSC Color Television by S. K. Aites and A. P. Stern.

Significance of Some Receiver Errors on Flesh Color Reproduction by H. Weiss.

RADIO COMMUNICATIONS II—GENERAL

System Aspects and Trends of Modern Communication by I. S. Coggeshall.

Predicted Wave Radio Teletype by M. L. Doelz and E. T. Heald.

Design Consideration for FSK Circuits by W. Lyons.

Predicting Interference Levels in Communication Systems by P. G. Wulfsberg.

UHF Diversity System for Long-Range Ship-to-Air Communication by F. J. Altman and J. J. Nail.

Tuesday Evening, March 23, 1954

Medical Electronics Symposium:
ENGINEERING BASED ON
BIOLOGICAL DESIGN

Human Engineering by L. C. Mead.

Information Theory by N. Wiener.

Biological Transducer by S. S. Stevens.

Biological Servomechanisms and Control Circuitry by Q. H. Schmitt.

Audio Seminar: HIGH FIDELITY IN
AUTO ENGINEERING

Microphones by J. K. Hilliard.

Loudspeakers by H. F. Olson.
Room Acoustics by R. L. Hanson.
Broadcasting Systems by J. V. L. Hogan.
Stereophonic System by J. E. Volkman.

Wednesday Morning, March 24, 1954

**NUCLEAR SCIENCE I—Symposium:
PROGRESS REPORT**

Secrecy and the Electronics Engineer by J. G. Beckerley.
Non-Reactor Electronics at Oak Ridge by P. R. Bell.
Brookhaven Electronics Work by W. A. Higginbotham.
Non-Reactor Electronics Work at Argonne by T. Brill.
Non-Reactor Electronics at Los Alamos by R. J. Watts.

ELECTRON DEVICES I—ELECTRON TUBES

The Hollow Cathode in Cylindrical Geometry by B. D. Kumpfer and H. Brett.
The Machining of Tungsten and Its Application in the Fabrication of Philips Dispenser Cathodes by R. Levi.
The GE Post Acceleration Color Tube by C. G. Lob.
Amperex Type EIT Decade Counter Tube by I. Rudich.
A Developmental Thyatron Capable of Current Interruption by Grid Action by E. O. Johnson, W. M. Webster and J. A. Olmstead.

BROADCAST TRANSMISSION SYSTEMS I—

Symposium: TV BROADCASTING
Antenna System for Station WOR-TV (Channel 9) Installed on Empire State Building by G. J. Adams, A. Alford, H. H. Leach, R. Rubin and F. Abel.
A Pulse Distribution System for a TV Network Originating Center by J. S. Auld and A. Gallonio.
Improved TV Clamp Circuit Employing Feedback by K. R. Wendt and W. K. Squires.
High Level Plate Injection Mixer for Use at UHF by R. E. Western.
Coaxial Line Transfer Switch for Television Transmitters by C. F. Schunemann and J. B. Epperson.

ELECTRONIC COMPUTERS I—COMPUTER DESIGN AND TECHNIQUES

The Role of General Purpose Digital Computers in Automatic Control and Information Systems by A. A. Cohen.
Design Features of Current Digital Differential Analyzers by E. L. Brown.
Design Features of the JAINCOMP-C and JAINCOMP-D Electronic Digital Computers by D. H. Jacobs.
A Germanium Tape Reader by R. A. Langevin.
Electrostatic Reading of Perforated Media by S. Lubkin.

**CIRCUIT THEORY I—Symposium:
NETWORK EQUALIZATION**

Limitations on Amplitude Equalizers by H. J. Carlin.
Synthesis of Restively-Terminated RLC Ladder Networks by Er-Chun Ho and D. L. Trautman.
Equalization of Video Cables by P. W. Rounds.
Application of a Minimum Phase Matrix to Adjustable Equalizer Design by W. R. Lundry.
Equalization in the Time Domain by M. S. Corrington, R. W. Sonnenfeldt and M. Murakami.

INSTRUMENTATION I—

Measurements in the Video Frequency Range by W. W. Graustein and An X-Ray and
H. H. Rickert and
A Shielded Two- π Dettinger
and Its Use as a UHF Hybrid Junction by E. W. Matthews, J. Impedance Bridge
High-Speed High- π
Analyzer by N. L. Dur solution Spectrum
Rapid, Precision
nents in the 400-16 npedance Measure-
frequency Range by D. 00 Megacycle Fre-
M. Goodman.

ANTENNAS AND PROPAGATION I—

Empirical Approx-
rent Values for Large-
cheff Arrays by L. L. Be Dolph-Tchebyas-
and I. P. Kaminow. ain, R. S. Wehner
Gain Pattern of
Terminated-Wave-

ELECTRONICS — March, 1954

STAINLESS fasteners in STOCK

All types and sizes of screws (slotted, Phillips, socket, hex head), bolts, nuts, washers, rivets, keys and pins



- Over 9000 items in stock means immediate delivery from one source
- New Garden City plant now operating at top speed and quality
- Unsurpassed facilities for quantity fabrication of specials
- A staff of seasoned engineers always available for consultation
- Pioneers in the manufacture of stainless steel fasteners

WRITE NOW FOR FREE COPY OF 96 PAGE FASTENER MANUAL P10

MANUFACTURERS SINCE 1929
ALLMETAL
SCREW PRODUCTS COMPANY, INC.
GARDEN CITY NEW YORK

AIRCRAFT SERVO COMPONENT



The Type 71-5 Baroresistor is a pressure actuated potentiometer designed for operational use in aircraft. It features:

HERMETICALLY SEALED MECHANISM

The potentiometer winding and operating parts are hermetically sealed in a vacuum. Pressure is applied inside the bellows only. Therefore, the Type 71-5 Baroresistor is not affected by dust, fungi, or moisture.

RUGGEDIZED CONSTRUCTION

A special high force mechanism was developed for the Trans-Sonics Baroresistor to avoid the necessity for employing micro force potentiometer elements. Shock of 30g in any direction will not cause electrical discontinuity.

MACHINE CALIBRATION

Each instrument is calibrated by machine and its performance is automatically recorded as a graph of resistance versus pressure. Every turn of the winding is inspected. All electrical characteristics are automatically checked in an eleven stage inspection cycle.

TECHNICAL REPRESENTATIVES

- | | |
|--|---|
| Los Angeles, Calif.
Telephone:
Cumberland 3-4183 | Dayton, O.
Telephone:
Hemlock 1254 |
| San Carlos, Calif.
Telephone:
Lytell 3-2189 | Seattle, Wash.
Telephone:
Main 7005 |
| Boston, Mass.
Telephone:
Capitol 7-9797 | Houston, Tex.
Telephone:
Monroe 5-5624 |
| St. Louis, Mo.
Telephone:
Sweetbriar 2175 | Cleveland, O.
Telephone:
Yellowstone 2-7849 |
| Detroit, Mich.
Telephone:
Broadway 3-2900 | Home Office: Telephone Lexington 9-2508 |

Condensed Data

Range: 0-14.7 psi, absolute
Resolution: 1/3%
Maximum voltage: 75 volts
Resolution: 1/3%
Accuracy: 2% of full scale

Typical Applications

Servos—Vary servo loop gain as a function of altitude.
Computers—Voltage divider, P total/P static.
Fire Control—Air density measurements.
Telemetering—Pressure transducer.
Recording—Pressure transducer.

Write for Bulletin No. 71-5 for further details Price: \$225.00 Short delivery

TRANS-SONICS, INC.
5 Forest Street Bedford, Mass.

LINEATOR

is years ahead

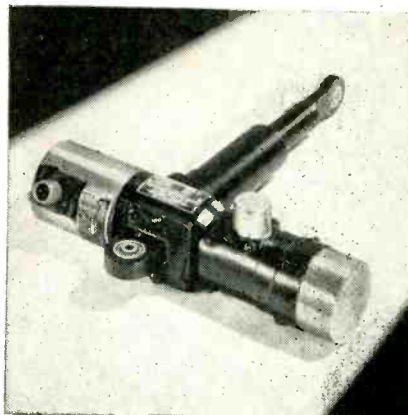

Lineator

The Chance-Vought Cutlass was an advanced design in 1947. It is a leader today. The same is true of Airborne's LINEATOR, which was developed for the Cutlass flight control system. Today, seven years later, there is not another "tee" type linear actuator like it.

The same basic model is used in the latest of the Cutlass series, and in the McDonnell Banshee. Modifications of the LINEATOR are specified equipment in the McDonnell Demon; its Air Force companion, F-101; and the Martin P5M patrol bomber.

Conforming to MIL-A-8064 (USAF), the LINEATOR is most adaptable where light weight and short length, for a given stroke, are desirable features. A ball bearing jack screw enables it to handle 1500 lb. maximum operating load in either tension or compression.

Airborne has set the pace in the actuator field with advanced designs like the LINEATOR. As aircraft configurations change and speeds increase, count on Airborne for more of the same. For information on the LINEATOR and other actuators, see *Electronics* magazine, or write to Airborne in the I.A.S. Catalog.



Accessories Corporation
NEW JERSEY

HILLSIDE 5

guide Slot Antenna by an Equivalent Circuit Method by L. B. Felsen.
A Four Slot Cylindrical Antenna for VOR Service by R. M. Sprague and A. Alfrod.
Trapped Wave Antennas by H. Ehrenspeck, W. Gerbes and F. J. Zucker.
Scattering of Electromagnetic Waves by Wires and Plates by J. Weber.

Wednesday Afternoon, March 24, 1954 NUCLEAR SCIENCE II—Symposium: REACTOR ELECTRONICS

Simulators by K. H. Fischbeck.
Safety Aspects of Control Circuitry by T. Cole.
Instruments Used with Experimental Reactors by E. J. Wade.
Synthesis of Nuclear Control Systems by N. Grace.

ELECTRON DEVICES II— TRANSISTORS

Transistors for High Power Application by J. S. Saby.
A New Type High Temperature Silicon Diode by L. D. Hanley and C. G. Thornton.
Small-Signal Parameters of Grown-Junction Transistors at High Frequencies by R. L. Pritchard and W. N. Coffey.
The Study and Design of Alloyed Junction Transistors by L. J. Giacoletto.
An Analytic Study of α , γ , and h Parameter Accuracies in Transistor Sweep Measurement by H. G. Follingstad.

BROADCAST TRANSMISSION SYSTEMS II— Symposium: COLOR TV BROADCASTING

Color Film Scanner Circuits by J. F. Fisher.
Color Characteristics of a TV Film Scanner by J. H. Haines.
Factors in the Design of Keyed Clamping Circuits by R. N. Rhodes.
Photographic Simulation of Proposed Brightness Modifications for Televising Color Film by J. H. Ladd and W. L. Brewer.
Feasibility and Technique of Storing Color Video Information on Black and White Film by W. L. Hughes.
A System For Recording and Reproducing Television Signals by Means of Magnetic Tape by H. F. Olson, W. D. Houghton, A. R. Morgan, J. Zenel, M. Artzi, J. G. Woodward and J. T. Fischer.

ELECTRONIC COMPUTERS II— COMPUTER COMPONENTS

Considerations for the Selection of Magnetic Core Materials for Digital Computer Elements by O. J. Van Sant.
Magnetic Core Selection Systems by S. Guterman and R. D. Kodis.
Circuits to Perform Logical and Control Functions with Magnetic Cores by S. Guterman, R. D. Kodis and S. Ruhman.
Packaged Logical Circuitry for a 4 MC Computer by N. Zimbel.
Transistor Shift Registers by C. Huang, E. Slobodzinski and B. White.

CIRCUIT THEORY II

The Group-Theoretical Aspect of Linear Four-Pole Theory by W. W. Gaertner.
A Mathematical Technique for the Analysis of Linear Systems by J. R. Ragazzini and A. R. Bergen.
Weighing Functions for Time-Varying Feedback Systems by J. A. Aseltine and R. R. Favreau.
Interconnection of Linear Transducers by H. Kurss.
Dynamic Characteristics of Four-Terminal Networks by W. W. Happ.

INSTRUMENTATION II—Symposium: HIGH FREQUENCY MEASUREMENT AND CONTROL

An Approach to a Company Owned Frequency Standard by J. W. Smith.
Frequency Standard Controlled Wide-Band Oscillator by E. P. Felch, J. O. Israel and O. Kummer.
Performance of the Bell System Standard of Frequency by G. N. Packard.
A Computer-Type Decade Frequency Synthesizer by R. W. Frank.
A High-Speed Digital Frequency Divider of Arbitrary Scale by R. W. Stuart.

ANTENNAS AND PROPAGATION II— MICROWAVE ANTENNAS

Reflections in Microwave Antenna and Their Harmful Effects by P. W. Hannan.
Surface Matching of Dielectric Lenses

NEW! Subminiature Metallized Paper CAPACITORS

Funginert Plastic Encased

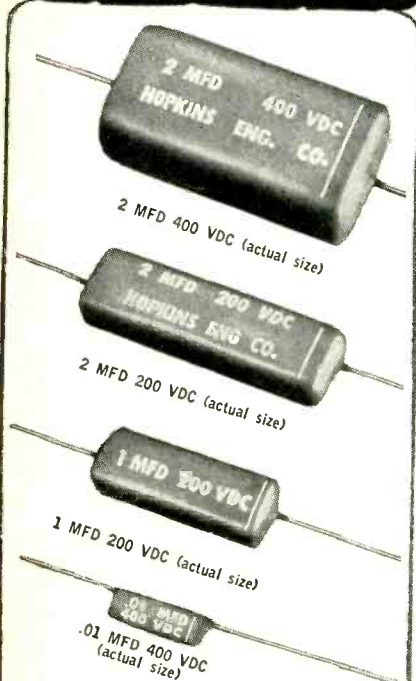

- ✓ Resin impregnated and rectangular shaped for maximum space conservation
- ✓ Completely encased in a non-nutrient plastic for maximum fungus and humidity protection
- ✓ Operating temperature range -55°C to $+100^{\circ}\text{C}$
- ✓ Temperature coefficient $+0.7\%/^{\circ}\text{C}$
- ✓ Excellent capacity retrace

Also available in
HERMETICALLY SEALED
drawn metal containers
(shown approx. 1/2 actual size)



2X1 MFD
100 VDC

Type 159,
1 MFD 400 VDC;
2 MFD 400 VDC

A multiplicity of sizes is available in either plastic encased or hermetically sealed capacitors. Special designed units also made to your exact specifications.

Write or wire us, today!

HOPKINS
Engineering Co.

FACTORY: 2082 Lincoln Ave.
Altadena, Calif. SYcamore 8-1185
Offices in WASHINGTON, D. C.
and DETROIT

DC-7

NEVER BEFORE
such Magnificence . . . such Power
such Performance!



and **NEVER BEFORE**
has the **A. W. HAYDON COMPANY**
been so proud of its contribution . . .



DOUGLAS DC-7,
the ultimate in
comfortable and
safe air travel.
Swift, luxurious,
dependable — the
new **DOUGLAS**
DC-7 justly de-
serves the ac-
colades it is re-
ceiving.

In the never-ending conquest of the vast barriers of space and time, Douglas goes ever forward meeting every challenge that men and machines must face. The newest — and brightest — star in the aviation firmament, the Douglas DC-7, is truly a miracle of the mastery of men over machines . . . and in this great work sixteen A. W. Haydon timing devices play an important part. We at A. W. Haydon take pride in our contribution toward performing a mass of metal and machinery into integrated performance which meets Douglas' high standards. Integrated performance is born of a multitude of small component parts, working in perfect mechanical and electrical coordination. The A. W. Haydon precision timing instruments are a vital part of this vast network.

A. W. Haydon Time Delay Relay is a very important component of the automatic prop feathering system.
A. W. Haydon Time Delay Relay times duration of prop feathering.
A. W. Haydon Repeat Cycle Timer is a vital part of the prop deicing equipment.
A. W. Haydon D.C. Timing Motors are used in the cabin pressurization systems.

When timing poses a problem — consult

(Catalog sent on request)



The A.W. HAYDON COMPANY

23 NORTH ELM STREET
WATERBURY 20, CONNECTICUT

Design and Manufacture of Electro-Mechanical Timing Devices



ohmite



A NAME BUILT ON RESULTS— NOT PROMISES



Schweber ELECTRONICS

122 HERRICKS ROAD, MINEOLA, L. I., N. Y. • GARDEN CITY 7-6520

ARE YOU PARTICULAR?

So are we.
That is why we have
associated ourselves with only
the TOP manufacturers in the industry.

COPAR

INCORPORATED

Precision Component Parts
for Electronics

4950 CALVERT ROAD

COLLEGE PARK, MARYLAND

STANDARD PACKAGED PUSH-PULL MAGNETIC AMPLIFIERS

by

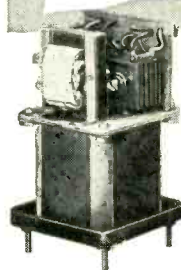

depending on the D.C. input signal polarity.

MAGNETIC AMPLIFIERS—
These high gain, high performance Magnetic Amplifiers are especially suitable to drive two phase induction servo motors requiring from 0.1 watt to 20 watts per phase on either 400 cps or 60 cps powerlines. The output power is either in phase or 180 out of phase with the powerline depending on the D.C. input signal polarity.

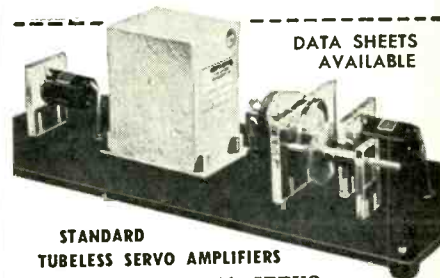

DATA SHEETS
AVAILABLE

**STANDARD
TUBELESS SERVO AMPLIFIERS**

with built-in adjustable SERVO LOOP STABILIZATION. Packaged, completely self-contained, magnetic servo amplifiers for position servo systems where either A.C. or D.C. error signals are available. Designed for instrument type and power type servo systems to work with synchro control transformers or potentiometers and two phase induction servo motors.

New Automatic Universal
**TRANSISTOR
CURVE TRACER**



WRITE FOR
COMPLETE
INFORMATION



USES—
Designing transistor circuits — comparing, matching and selecting — detecting anomalies — studying effects of temperature, age, normal usage, over-loading — detecting failures and cause.

FEATURES

Tests NPN, PNP, Junction, Point Contact types. Dynamically plots entire family of curves simultaneously on standard laboratory DC oscilloscope. Function switch selects: output or transfer curve in grounded base or grounded emitter connection. Calibrating display are always in correct quadrant.

MAGNETIC AMPLIFIERS • INC

An Affiliate of General Ceramics & Steatite Corp.
632 TINTON AVE., NEW YORK 55, N. Y.
Telephone: CYPRESS 2-6410

See us
at

RADAR ROAD &
ELECTRONICS AVE.

Microwave
Assemblies,
Radar Components,
and Precision
Instruments . . .
manufactured to
your Blueprints
and Specifications.



BOOTH No. 426
Radio Engineering Show
MARCH 22-25, 1954
Kingsbridge Armory
New York City

N. R. K. MFG. & ENGINEERING CO.

4601 WEST ADDISON STREET • CHICAGO 41, ILLINOIS

LOW-INERTIA INTEGRATING MOTORS

Low-Inertia Integrating Motors are permanent magnet D.C. motors in which practically all factors likely to affect the linearity of the voltage/speed curve have been eliminated, e.g., friction, iron losses, brush-contact voltage drop. The resulting accuracy is such that they can be used to integrate minute voltages on a time basis. By using a suitable transducer, temperature difference, or any other quantity, can be converted into a voltage signal, which then enables the motor to integrate this figure over time. Low-Inertia Integrating Motors can be used in instrument-type servo-mechanisms for driving light loads, for operating mechanical counters performing integration, or as small power generators. The sensitivity of the motor is such that it will operate directly off a photo-cell or thermo-couple.

Available in 4 types: nominal voltages 1.5 V; 6 V; 12 V; 24 V D.C.

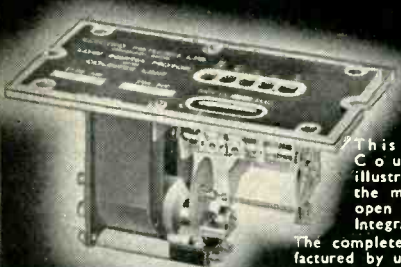
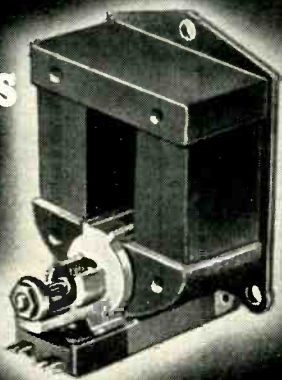

This Mechanical Counter Unit illustrates just one of the many applications open to Low-Inertia Integrating Motors.

The complete unit is manufactured by us in four types and can be supplied to suit D.C. voltages of 1.5, 6, 12 or 24 volts.

Full technical data sent on request

ELECTRO METHODS LTD., STEVENAGE, HERTFORDS-SHIRE, ENGLAND, U.K.
Cables: TROMEDOS, STEVENAGE, HERTS, U.K.



DELIVERED IN U.S.A.
WITHIN 10 DAYS OF
RECEIPT OF ORDER.

by E. M. T. Jones and S. B. Cohn.
Double Parabolic Cylinder Pencil Beam Antenna by R. C. Spencer, F. S. Holt, H. Beauchemin and J. Samson.
Diffuse Radiation in Pencil Beam Antennas by D. Carter.
Theoretical Gain of Flat Microwave Reflectors by D. R. Crosby.

Thursday Morning, March 25, 1954

INDUSTRIAL ELECTRONICS

The Design of Automatic Factories by G. Post.
Industrial Punch Card Automatic Control by W. L. Atwood.
Electronic Automation of a Turret Punch Press by F. M. Rives.
Electronic Flow Measurement and Control by E. Mittelmann.
Photosensitive Germanium Devices and Some Device Applications by R. G. Seed.

CIRCUIT THEORY III—NETWORK SYNTHESIS

Some Techniques for Network Synthesis by G. L. Matthaei.
An Iterative Method for RC Ladder Network Synthesis by R. E. Scott and N. DeClaris.
Networks Terminated in Resistance at Both Input and Output by L. Weinberg.
Approximating Band-Pass Attenuation and Phase Functions by V. H. Grinich.
An Application of Modern Network Synthesis to the Design of Constant-Time-Delay Networks with Low-Q Elements by L. Storch.

ELECTRON DEVICES III—STORAGE TUBES

The Metrechon—A New Halftone Picture Storage Tube with Halftone Display by M. Knoll, H. O. Hook and R. P. Stone.
A High Writing Speed Dark Trace Tube by S. Nozick, N. H. Burton and S. Newman.
A Large Capacity Storage Tube for Digital Computer Application by R. B. DeLano, Jr.
Noise Limitations on Storage Tube Operation by S. Winkler and S. Nozick.

ULTRASONICS I

The Ultrasonic Burglar Alarm System by S. Bagno, J. B. Cooper and E. A. Lrvi.
A Complex Impedance Recorder by H. Sharaf.
Ultrasonic Delay Lines by D. L. Arenberg.
Wide-Band Large-Dynamic-Range Fused-Quartz Delay Lines for Increased-Capacity High Speed Computer Memories by D. A. Spaeth, T. F. Rogers, and S. J. Johnson.
Contour Modes of Plates Excited Piezoelectrically and Determination of Elastic and Piezoelectric Constants by R. Bechmann.

ANTENNAS AND PROPAGATION III

Isotropic Variable Index Media by W. O. Puro and K. S. Kelleher.
The Characteristics of a Vertical Antenna with a Radial Conductor Ground System by J. R. Wait and W. A. Pope.
Toward an Information Theory of Propagation Through Time Varying Media by J. Feinstein.
Comparative 100 MC Measurements at Distances Far Beyond the Radio Horizon by A. P. Barsis.
The Measurement of the Polarization of Radio Waves Reflected from the Ionosphere at Non-Vertical Incidence by G. T. Inouye.

MICROWAVE ELECTRONICS I—FERRITES AND STRIP LINES

Non-Reciprocal Microwave Components by H. N. Chait.
Ferrite Quarter-Wave and Half-Wave Plates at X Band by N. G. Sakiotis.
The Radiation Conductance of a Series Slot in a Strip Transmission Line by A. A. Oliner.
New Techniques for High-Q Strip Microwave Components by E. Fubini, W. Fromm, and H. Keen.
Microwave Applications of High-Q Strip Components by E. Fubini, W. Fromm and H. Keen.

INSTRUMENTATION III

A Novel Approach to Transistor Testing by N. J. Gottfried.
Transistor Frequency Scanner by O. Kummer.
A Simple Transistor Noise and Gain

Spectrum Analyzer

TS-148/UP

EQUAL TO OUR
GOVERNMENT TYPE DESIGNATION
UPM—33



- NEW AND IMPROVED DESIGN
- OUTSTANDING PERFORMANCE
- MORE RUGGED CONSTRUCTION

Specifications . . .

Attenuation (Spectrum Amplitude): 3—70 db uncal.
 Frequency range: 8430 Mcs—9660 Mcs.
 Frequency sweep: 10—30cps continuous.
 Frequency swing (FM sawtooth) of analyzer r-f oscillator: 40—50 Mcs.
 Maximum error: ± 4 Mcs.
 Maximum dispersion of spectrum: 1.5 Mcs per inch.
 Overall i-f bandwidth at half power point: 50 Kcs.
 Sensitivity to CW:

- Spectrum amplified position: 80 db below 1 W per inch deflection on oscilloscope screen.
- Spectrum position: 55 db below 1 W per inch deflection on oscilloscope screen.

 Weight: 86 pounds (complete in armored case with all accessories).

Write or wire for prices
and delivery schedule

G&M EQUIPMENT Co., Inc.

"Where Hi-Quality Is Fundamental"



7309 VARNA AVENUE
NORTH HOLLYWOOD, CALIF.
Phone: POplar 5-4185

For more ad information, see Index to Advertisers.

ELECTRONICS — March, 1954

Test Set by R. W. Carlisle and H. A. Pearson.
 Wide-Band Amplitude Distribution Analysis of Voltage Sources by L. W. Orr.
 A Generator of Uniformly Distributed Random Noise by R. Bernstein, H. Bickel and E. Brookner.

Thursday Afternoon, March 25, 1954 RADIO TELEMETRY AND REMOTE CONTROL—III—REMOTE CONTROL

A Proportional Data Transmission System by W. C. Petrie.
 A Digital Autopilot Coupler by W. L. Exner and A. D. Scarbrough.
 System Compensation with a Digital Computer by J. M. Salzer.
 Binary Control System for Digital-to-Shaft-Position Mechanisms by A. H. Wulfsberg.
 Optimization of Servosystems (for Time-Varying Spectra) by R. C. Lyman and W. P. Caywood, Jr.

CIRCUIT THEORY IV—TRANSISTOR CIRCUITS

A Transistor Analog by R. D. Lohman.
 Junction Transistor Multivibrators and Flips-Flops by E. Sard.
 A Synthesis Procedure for Linear Transistor Circuits by J. R. Burnett.
 Network Partitioning Techniques Applied to the Synthesis of Transistor Amplifiers by H. Markarian.
 A New Equivalent Circuit for Junction Transistors by G. Y. Chu.

ELECTRON DEVICES IV—MICRO-WAVE TUBES

A Voltage-Tunable Magnetron for Operation in the Frequency Range 1500 to 3000 Megacycles by J. A. Boyd.
 Control of Electron-Beam Spread by Positive Ion Traps by E. L. Ginzton and B. Wadia.
 The Multipactor Effect in Klystrons by K. Bol.
 Backward-Wave Oscillator Characteristics by H. R. Johnson.
 The Propagation Properties of Cross-Wound Twin Helices Suitable for Traveling Wave Tubes by M. Chodorow, E. I. Chu and J. R. Nevins, Jr.

ULTRASONICS II

Investigation of Ultrasonic Energy to Industrial Use by A. Boyles.
 The Effects of Ultrasonic Waves on Electrolytes and Electrode Process by S. Barnartt.
 Studies of the Effects of High Frequency Sound on the Brain by P. A. Lindstrom.
 Selective Action of Ultrasound on Nerve Tissue by W. J. Fry.
 Effects of Ultrasound on Living Cell Structure by E. E. Newcomer.

ANTENNAS AND PROPAGATION IV—Symposium: UHF TELEVISION—BOOM OR BUST

FCC Rules and Propagation Data by E. W. Allen.
 Propagation in the UHF TV Band by J. W. Herbstreit.
 Overcoming the Line of Sight Shibboleth with the Air and High Power by T. J. Carroll.
 A Comparison of the Antenna Problems in UHF and VHF TV by L. Krause.

MICROWAVE ELECTRONICS II—COMPONENTS

Design of Stable Tunable Microwave Oscillators by J. G. Stephenson.
 Microwave Measurements with a Lossy Variable Short Circuit by H. M. Aitschuler and A. A. Oliner.
 Survey of Design Techniques and Operating Characteristics of Directional Couplers by P. J. Sferazza.
 Diplexing Filters by M. E. Breese.
 A High Precision Compensated Reference Cavity for C Band by J. Hall and F. McCarthy.

ELECTRONIC COMPUTERS III—DISCUSSION

How can computing machines be made more autonomous?
 How can computing machines be made to repair themselves?
 DISCUSSION LEADERS: N. Rochester, J. Von Neuman, W. B. Huskey, J. W. Mauchly, L. N. Ridenour, C. Shannon, E. F. Moore and A. L. Samuel.

At 600 M.P.H.
He Bets



His Life
On the
Wiring System

For Dependable
Electronic Wiring
Leading Manufacturers Choose
UNILECTRIC Wiring Systems

Year after year . . . for over ten years . . . UNILECTRIC has produced millions of wiring systems for over 150 leading manufacturers of electric and electronic products. If you still fabricate your own electronic wiring it will pay you to investigate UNILECTRIC.

There is Only ONE
Standard of Quality at
UNILECTRIC

This intricate wiring harness for a jet auto pilot must meet the most rigid specifications. A pilot's life and perhaps a major battle depend on it.

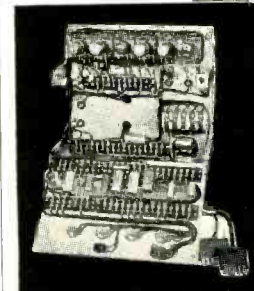
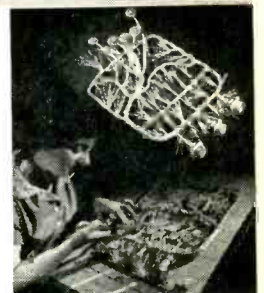

The same workmanship . . . the same standards of quality protect your product wiring and your product's reputation for dependability.

To assure utmost dependability plus cost saving engineering assistance, low-cost production, and "on-schedule delivery", investigate UNILECTRIC today.

UNILECTRIC
QUALITY
Protects Your
Products

Investigate UNILECTRIC Today!



Wiring Systems

Manufactured by
UNITED MANUFACTURING & SERVICE CO.
409 South 6th Street • Milwaukee, Wisconsin

For more ad information, see Index to Advertisers.



FOR THE PRICE OF A PHONE CALL

Use us as another department of your plant. We won't cost you anything when we are NOT working for you.

We think you'll find it an asset to have a source of first-class engineering, designing and precision manufacturing at your beck, for the price of telephoning STillwell 4-3616.

CONRAD & MOSER

Workers in Aluminum,
Brass, Steel & Plastics

DESIGNING
ENGINEERING • MANUFACTURING
MECHANISMS • MACHINES
PARTS • TOOLS • DIES • MOLDS
STAMPINGS • CASTINGS
MACHINING • SHEET METAL
ENCLOSURES & CHASSIS
1/8 to 1/2 NAVY SPEC ALUMINUM
SPOT WELDING AND HELIARC
WELDING.

2 Borden Ave.
Long Island City 1, N.Y.

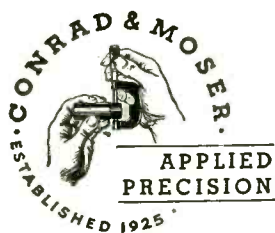

For more ad information, see Index to Advertisers.

NEW BOOKS

Television

BY F. KERKHOFF AND W. WERNER.
Philips Technical Library, Elsevier Press, New York, 1952, 434 + XV pages, \$7.75.

THE TITLE page accurately describes this book as "an introduction to the physical and technical principles of television, with comprehensive descriptions of various electrical circuits." The authors, engineers of the Philips Television Development Laboratory at Eindhoven, are well acquainted with current practice in the many lands in which that organization markets its products. As a result this book is distinguished among those written by Europeans for its lack of bias concerning television standards and methods. The American, British and European (Gerber) systems are given equal attention, and their differences are accurately and fairly presented.

The major part of the book is given to detailed treatment of circuit principles. Realizing that no book on television can hope to keep current with the rapid advances in specific circuits, the authors state their intention to impart knowledge of physical principles of currently applied circuits, which will enable readers to grasp quickly the significance of circuits still to be developed.

The only danger in this plan is that the range of principles attacked may be too broad, and hence not helpful to the reader in selecting topics for detailed study. One example of this is the second chapter, an excellent treatment of electron optics. Two-thirds of the space is devoted to topics of interest primarily to those who design cathode-ray tubes, and only one-third to such matters as yoke and focuser design, of interest to the much larger group interested in receiver design. A similar criticism might be leveled at chapter 5, on relaxation oscillators and phenomena, which covers a much wider field than the television engineer is likely to have need for. Nearly equal space is given to principles and circuits applicable to electric and magnetic scanning, despite the

H-16 CHECKS the CHECKER

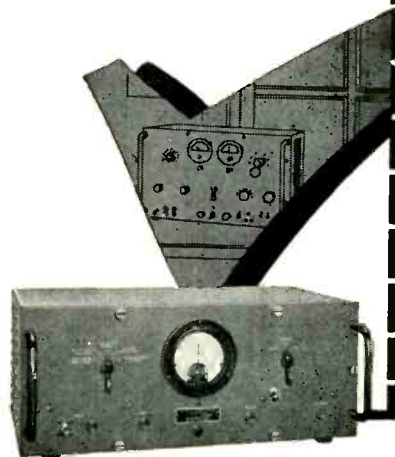

ARC Type H-16 STANDARD COURSE-CHECKER

For Omni Signal Generators

■ This newly developed instrument is a means for checking precisely the phase-accuracy of the modulation on VOR (Omnirange) Signal Generators. Now that the use of omnirange receivers and signal generators is so widespread, it is necessary to have a means of measuring the phase differences between the 30 cps envelope of the 9960 \pm 480 cps reference modulation, and of the 30 cps variable modulation when that difference is required to be 0, 15, 180 or 195 degrees.

■ An important feature of the H-16 is a built-in self-checking circuit to insure .1 degree accuracy. Errors may be read directly on a 3-inch meter, calibrated to read \pm 4 degrees.

Write for detailed specifications



Dependable Airborne
Electronic Equipment
Since 1928

Aircraft Radio Corporation
BOONTON NEW JERSEY

For more ad information, see Index to Advertisers.

March, 1954 — ELECTRONICS

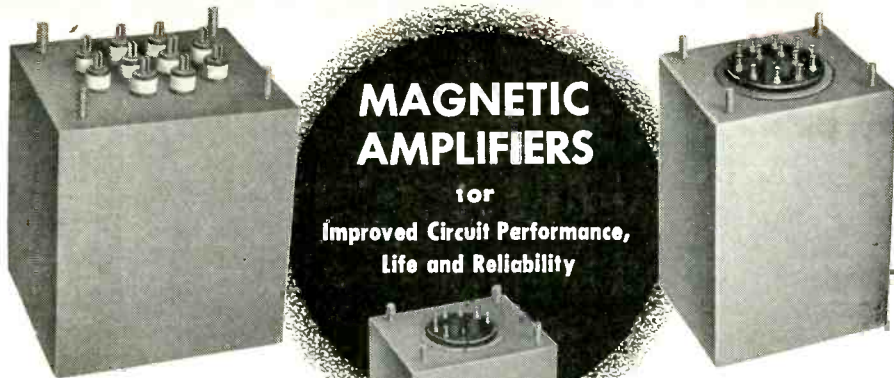

**MAGNETIC
AMPLIFIERS**
for
Improved Circuit Performance,
Life and Reliability

- Rugged ● Dependable
- Hermetically sealed LB case
- Three control windings

- Available in three ranges
- Eliminates need for reference voltage source
- Simplifies wiring

These outstanding Series RG-60-D Magnetic Amplifiers by ATLAS provide extreme ruggedness and unfailing dependability for many voltage control applications. By improving the performance and life of circuits in which they are used, costly maintenance and repairs can be reduced. Competitive in price with other voltage control methods, ATLAS Magnetic Amplifiers have *all* the features you have always desired.

WRITE to Dept. AD for Bulletins for complete specifications.

ATLAS

ATLAS ENGINEERING CO., Inc.

3 EDGEWOOD ST., ROXBURY, MASS.

AEROLITE

VISIT
OUR
HOTEL SHELTON SUITE
During the Show
SEE OUR NEW DISPLAY
Get Our NEW CATALOG

Complete dimensions on practically all products. If you can't visit our suite, write for our catalog—Let us help you solve your problems.

AEROLITE ELECTRONICS CORP.
507-26TH STREET, UNION CITY, NEW JERSEY
TELEPHONES: NEW YORK, N. Y., LONGACRE 4-3359 • UNION CITY, N. J., UNION 3-2955

THE
*Number One
Name*

In Socket Screws & Keys

ALLEN



Don't take it for granted that any hex socket screw is an Allen. Your Allen Distributor *alone* can offer you

1. **ALLENPOINT SET SCREWS** with the new smaller point — proved by impartial laboratory tests to have greater locking power and vibration resistance, plus uniformly high shaft holding power, compared with conventional cup point screws and those with serrated or angled points.
2. **LEADER POINT CAP SCREWS**, for substantially reduced chance of thread injury or damage to threaded holes.
3. **ALLENLOY STEEL** — with the strength and temper to permit the use of smaller sizes, and make button head and flat head screws practical despite necessarily shallower sockets.
4. **ALLEN PROGRESSIVE PRESSUR-FORMING**, producing contoured uncut fiber flow, from head to point. A process originated and perfected by Allen.

Be sure to get Allens in the black and silver striped box, sold only through leading Industrial Distributors. Write us for technical information.



Component Holders

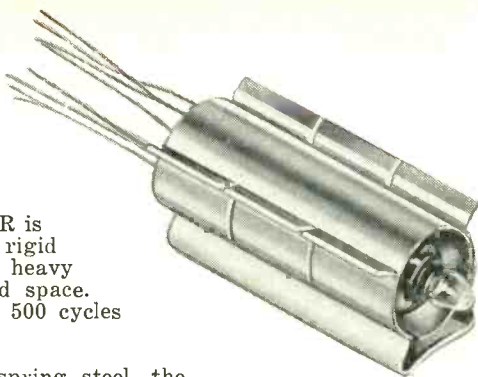

The COMPONENT HOLDER is designed to provide superior rigid mounting for conditions of heavy shock and vibration in limited space. It has been tested to 20G's at 500 cycles without resonant frequencies.

Made of Cadmium Plated spring steel, the COMPONENT HOLDER provides 180° contact surface the full length of the component. Available in following sizes: .175, .195, .235, .260, .312, .375, .391, .400, .562, .670, .750, 1.00, 1.12 with lengths to 2".

The picture shows our light-weight serrated tube holder #16 complete with silver plated tube shield #3A—especially recommended for mounting on a heat-conducting chassis. Ask for #14 tube holder with black finish used without shield where mounting is a non-heat-conducting material. Other holders are available non-serrated for use with Capacitors, Resistors, Wiring or Tubing.

Makers of Vibration and Shock Clips of all types.

Write for descriptive literature, prices and samples: Dept. MH

See us in Booth #313 at the I. R. E. Show.

ATLAS E-E CORPORATION
BEDFORD, MASSACHUSETTS

NEW "PARAFORMED" PAPER TUBES

MAKE YOUR COIL WINDING EASIER! FASTER! BETTER!

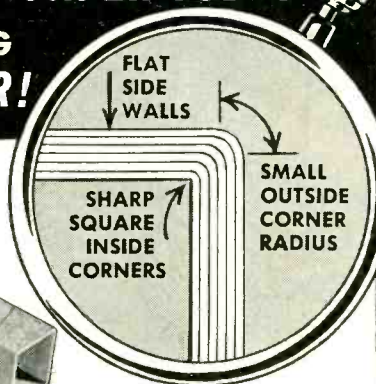

SPIRAL WOUND
NOT DIE FORMED

ANY SIZE—SQUARE OR RECTANGULAR

Entirely new technique in tube making developed and perfected by PARAMOUNT now for the first time solves many coil winding problems, yet costs you no more! Hi-Dielectric. Hi-Strength. Kraft, Fish Paper, Acetate, Red Rope or any combination wound on automatic machines. Produced from stock arbors or special sizes engineered for you.

Write on Company letterhead for Stock Arbor List of over 2000 sizes

- No sharp outside edges to cut wire
- Has full rigidity and physical strength
- Permits winding coils to closer tolerances
- No need for wedges to tighten wire
- Allows faster stacking of wound coils

PARAMOUNT PAPER TUBE CORP.

616 LAFAYETTE STREET, FORT WAYNE 2, INDIANA

Manufacturers of Paper Tubing for the Electrical Industry Since 1931

overwhelming preference for the magnetic method in virtually all post-war receivers and studio equipment.

These defects, relating to emphasis only, are not major ones. Many of the most important circuits are indeed given extended treatment. The sixteen pages in chapter 6 on horizontal output systems for magnetic deflection are an excellent example. On the other side of the ledger is the fact that only one form of horizontal stabilization is described, and this is obsolescent. Stagger tuning of i-f stages is well treated, but not so the cascade circuit and its variants, which are now a basic tool of the television circuit designer.

As is usual in technical treatises from the Netherlands, the authors have a very thorough understanding of fundamentals and an easy way of presenting them. The book, originally written in Dutch, is well translated; of particular importance, in view of the rapid expansion of television service throughout the world, is the fact that editions are available not only in Dutch and English but also in French and German.

Aside from the question of relative emphasis, there can be little quarrel about the range of material covered: scanning and deflection, camera and picture tubes, synchronizing signals and separation methods, relaxation oscillators, deflection circuits, high-voltage ("extra-high-tension") generators, wideband amplifiers, aeriels and transmission lines, optics and methods of image projection, and detailed treatments of two receivers, typical of British (positive modulation) and European (negative modulation) practice. The book gives a bare nod to color television; the chapter on this subject contains only 8 pages and describes systems (CBS field sequential and RCA dot sequential) as of 1949.

The appendices include a glossary of terms, a table of the MKS system of units, conversion tables for units of brightness and illumination and an excellent 12-page list of periodical references.

In summary, this book is a welcome addition to the literature for

its clear and explicit treatment of particular topics but, from the American point of view at least, it is not particularly well-balanced in its selection of material.—DONALD G. FINK, *Philco Corporation, Philadelphia, Pa.*

Synchronization of Reflex-Oscillators

By ALY H. ABDEL DAYEM. *Dr. Sc. techn. Institut Für Hochfrequenz-technik, Eidgenössischen Technischen Hochschule, Zurich (Switzerland), 1953, 110 pages, 10.40 Swiss Franks.*

THIS book, in English, represents a useful contribution to the general theory of the synchronization of oscillators. The analysis applies to vacuum-tube oscillators of all types: however, interest and the experimental work are directed toward the behavior of reflex klystrons. The mutual synchronization of two similar oscillators is treated with unusual thoroughness, and a method is presented for obtaining a coherent output from an arbitrarily large number of separate tubes. The text is clearly written, the mathematical developments are well presented and as simple as the material permits, and the experimental results support the theory.

As the preface states, the analysis is based on the principle of conservation of energy, and is therefore applicable to all possible waveforms of the synchronizing voltage. However, the resulting equations are quite intractable, and practical results are limited to situations where the synchronizing voltage is sinusoidal. In view of this fact it does not appear that a substantial advantage in generality is gained by starting in this way. Subject to the assumption of a symmetrical cubic volt-ampere characteristic, the analysis yields the amplitude as well as the frequency of the output for a wide range of conditions. In this respect it appears to extend existing knowledge.

In his treatment of the synchronization of a klystron the author is somewhat careless of the equivalent circuit. On p 32, it is asserted that the resonator is matched to the line whereas the following development

NEW...PHASE METER

0.5° RELATIVE ACCURACY



TYPE 405

Type 405 Phase Meter is a simple and convenient device for studying phase relationship between two signals. Very suitable for plotting phase-frequency curves on a cathode ray oscilloscope or a mechanical recorder. Ideal for production work.

SPECIFICATIONS

FREQUENCY RESPONSE: 8 cps to 100 kc.

Both the upper and lower limit can be extended with increasing amplitude of both input signals.

PHASE RANGE: There are three ranges with sensitivity of 0-36, 0-90, 0-180 degrees. A panel switch is provided for inserting 180 degrees phase shift in order that the above three ranges may be converted to 180-216, 180-270, and 180-360 degrees.

ACCURACY: The relative accuracy is $\pm 0.5^\circ$; the absolute accuracy is $\pm 2^\circ$ at any range.

INPUT VOLTAGE: 0.3 volt to 70 volts from 8 cps to 100 kc. The lower limit increases exponentially for signals above 20 kc. and below 8 cps.

INPUT IMPEDANCE: 1 megohm shunted with 20 uuf on both input channels.

INPUT POWER: 115 volts or 230 volts rms, $\pm 10\%$, 50-60 cycles, 60 watts.

WRITE FOR DATA!

ADVANCE ELECTRONICS CO., INC.

451 HIGHLAND AVE.

PASSAIC, N. J.

SECON

round •
 oval •
 flat •
 grooved •
 ribbon •

bare •
 insulated •
 plated •

all metals •
 all alloys

precision small wire

for highly engineered applications

... wherever
the element calls
for PRECISION

development and production metallurgists

SECON METALS CORPORATION

7 Intervale Street, White Plains, New York
White Plains 9-4757

Round Wire to 0.00015" diameter. Ribbon rolled to 0.0001" in thickness. Close tolerances held on all specifications.

Write for Pamphlet E

STAR PERFORMANCE

with
STAR AIDS ★ ★ ★

Precision Production Tools

★ Star's precision-fabricated 7- and 9-pin socket wiring plugs and pin straighteners — used and specified by Army, Navy, Air Force Depts and other Governmental Agencies, also leading miniature tube and electronic equipment manufacturers



7-Pin and 9-Pin

STAR MINIATURE WIRING PLUGS

★ For accurate alignment of miniature socket contacts during wiring . . . for preventing contact-clogging by solder, lacquer, etc. Precision cast in one piece of non-corrosive ZAMAK-5 zinc alloy with stainless steel pins.

STAR MINIATURE PIN STRAIGHTENERS

★ For accurate alignment of miniature socket contacts during wiring . . . for preventing contact-clogging by solder, lacquer, etc. Precision cast in one piece of non-corrosive ZAMAK-5 zinc alloy with stainless steel pins. Also available without vertical posts.

Now available from stock—8-pin, round base subminiature pin straighteners and wiring plugs.



7-Pin and 9-Pin

WRITE FOR DATA

★ STAR EXPANSION PRODUCTS COMPANY

(INCORPORATED)

147 CEDAR STREET, NEW YORK 6, N. Y.

MICROWAVE FREQUENCY METER 810

8,200 mc to 12,400 mc

The NARDA model 810 Frequency Meter is a cylindrical cavity type resonator mounted on a section of $1 \times \frac{1}{2}$ waveguide. The cavity is tuned over the complete range by a precision micrometer drive with a vernier which may be read to 0.0001 inch. A calibration table is mounted on the cavity. A reactive dip of at least 10% is obtained at all frequencies in the range. There are no spurious responses or other ambiguities.

SPECIFICATIONS:

Accuracy:	0.1%
Precision:	0.02%
Loaded Q:	7000
Reactive dip:	10% min.

\$110
fob

NEW IMPROVED BOLOMETERS

MODEL
N-610B



MODEL
N-821B



\$9.50
ppd.

\$7.50
ppd.

Data
sheet
LB-3 on
request

DIMENSIONS:
.193" Dia. x
.812" Long.

APPLICATIONS:

Microwave power measurement • Square Law detection • VSWR detection • Attenuator calibration •

FEATURES

N-610B INTERCHANGEABLE with 1N21 and 1N23 crystals in all tuneable probes, waveguide and coaxial crystal detectors.
STANDARDIZED BIAS—8.75 ma. for 200 ohms.
HIGHER BURNOUT RATING—15 mw of rf at rated bias.
RUGGEDIZED—soldered contacts and improved construction.
N-821B INTERCHANGEABLE in all barretter mounts.
RUGGEDIZED CONSTRUCTION—Silver contacts and continuous copolymerstyrene sleeve.
STANDARDIZED BIAS—8.75 ma for 200 ohms.

Write for NARDA Catalog—a COMPLETE line of microwave test equipment.

NARDA

NASSAU RESEARCH & DEVELOPMENT ASSOCIATES INCORPORATED
66 MAIN STREET • MINEOLA, NEW YORK • GARDEN CITY 3-3570

NEW BOOKS

(continued)

and the example of p 43 are based on a mismatch. This error recurs in substantially the same form on p 73.

The major contribution of the book appears to be the mutual synchronization of two similar oscillators, in which the length and properties of the transmission line joining the two resonators play a vital part. This analysis is worked out in some detail and appears to include all the significant parameters. Finally, the synchronization of large groups of oscillators by means of appropriate hybrid junctions represents an ingenious and significant extension of the art.

A bibliography of twelve references, mostly in English, is presented to support and extend the material presented. While these are well chosen, it appears that several important papers are absent. An example of such omission is the highly pertinent 1922 paper of Appleton in the *Proc. Camb. Phil. Soc.*

There are a number of typographical and drafting errors, and a few unfamiliar symbols and word usages. However, these represent no substantial impairment of the value of the work, which is recommended to those interested in this somewhat specialized field.—WILLIAM A. EDSON, *Electronics Research Laboratory, Stanford University, Stanford, California*

Forbes: Telephone Pioneer

BY ARTHUR S. PIER. *Dodd, Mead & Co., New York, 1953, 232 pages, \$4.00.*

WILLIAM H. FORBES was first president of the National Bell Telephone Company, formed in Boston in March 1879 by the amalgamation of the Bell Telephone Company and the New England Telephone Company. Forbes's company grew into the present AT&T. A strong business man and tough disciplinarian, he was the guiding light during the early formative and embattled days of what has turned out to be a stupendous empire.

Although less than a hundred pages of this book are concerned intimately with the telephone phase of Mr. Forbes' life and although it seems that a little more spark could

MODULATOR by MANSON

1-Megawatt

Peak-Power—Model 100T
Hard-Tube Modulator

The POWER-SUPPLY Section supplies 37 KV @ 50 ma, 20 KV @ 100 ma, 10 KV @ 200 ma, or 5 KV @ 300 ma. Any of these ranges is obtainable by switching one lead on the plate transformer. The Power Supply is fully interlocked and protected against A-C and D-C overloads, and may be used independently to run external equipment.

The MODULATOR Section contains three 6D21 Switching Tubes in parallel.

Pulse Width continuously variable from 0.5 to 5.0 microseconds;

Repetition Frequency variable from 30 to 3000 cps, internally or externally synchronized;
Pulse-Current and Voltage-View circuits, as well as Peak-Reading Voltmeter (40-KV peak) are included in the equipment.

MECHANICALLY it is a completely self-contained unit. It has a rigid framework, bench space on top, interlocked doors on three sides giving access to all major components and control panels, and is mounted on casters.

Write for Complete Data

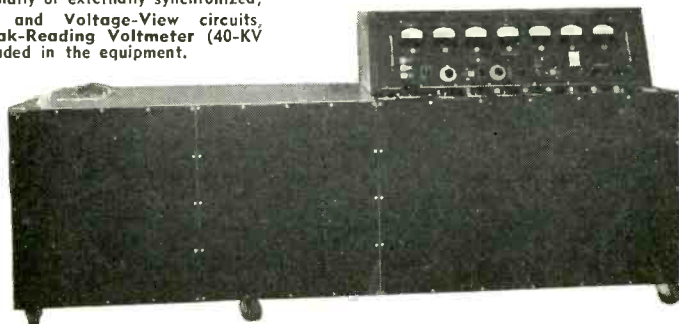

Hard- and Soft-Tube Modulators at all Power Levels built to Specifications.
Your enquiry will be welcomed.

MANSON LABORATORIES

207 Greenwich Avenue • Stamford, Conn.

Industrial Control Devices —
Electronic and
Electro-Mechanical Instruments

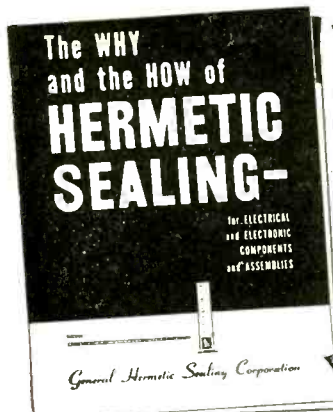

HERMETICALLY SEALED ELECTRICAL and ELECTRONIC COMPONENTS and ASSEMBLIES

- Meet Military Specifications
- Unexcelled High Altitude Operation
- Permanent Protection Against Corrosion, Oxidation, Dust
- Forever Free from Humidity Effects
- Explosion Proof and Fungus Proof
- All assemblies are evacuated, inert gas filled, and 100% Mass Spectrometer Leak tested

Write for folder—The HOW & WHY of Hermetic Sealing

GENERAL HERMETIC SEALING CORPORATION

99 East Hawthorne Ave., Valley Stream, N. Y.
Valley Stream 5-6363

Make your
Ferrites
with

Purified synthetic products of reagent quality. Controlled particle size and shape contribute to effective control of packing and shrinkage. Our know-how can help you accomplish best results.

Manufactured by highly modern processes under rigid laboratory control. This ad clipped to your letterhead will bring a working sample.

HIGH PURITY
MAPICO[®]
RED FERRIC OXIDES
for TOP performance

COLUMBIAN CARBON COMPANY
MAPICO COLOR DIVISION
MANUFACTURER

BINNY & SMITH INC., Distributor
380 MADISON AVENUE, NEW YORK 17, N. Y.

International
CRYSTAL Mfg. Co.

now offers

ONE
DAY
SERVICE

on

QUARTZ CRYSTALS

throughout the range of frequencies from 1500 kilocycles to 50 megacycles. Fundamental Crystals — 1500 KC - 15000 KC. Overtone Crystals — 15 MC - 50 MC.

All orders of less than five units of any one frequency in the range 1500 KC - 50 MC — will be mailed within 24 hours from the time received.

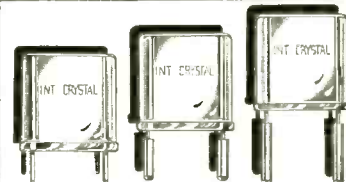

F-605

Pin dia. .050
Pin length. .238

F-609

Pin dia. .095
Pin length. .445

F-612

Pin dia. .125
Pin length. .620

Pin spacing on each of above is .486

WHEN
ORDERING
SPECIFY:

- (1) Frequency
- (2) Holder Type*
- (3) Circuit Data (32 mmf load, series resonance, etc.)
- (4) End Use (Equipment type & manufacturer, development, etc.)

*Adaptors can be supplied for 3/4" pin spacing.

Calibration

All fundamental crystals are calibrated into 32 mmf unless otherwise specified. All overtone crystals are calibrated for series resonance, unless otherwise specified.

All units are calibrated to .0025% or better of their nominal frequency at 25° C.

For further information write, wire or call:

International
CRYSTAL Mfg. Co., Inc.

18 N. Lee
OKLAHOMA CITY, OKLA.
Phone FO 5-1165

Whether it's for the manufacturers, sub-contractors, or assemblers in the electronic manufacturing, instrument or hydraulic divisions in the aircraft industry... we can furnish hardware and fittings to meet all specifications. We are specialists in the fabrication of stainless steel, in both the

PARTS MAKE THE DIFFERENCE...

300 and 400 series... we are able to quote on steel, brass and aluminum parts.

We can deliver to meet your scheduled production requirements or we will not take your order.

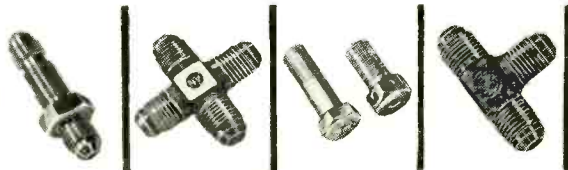

GARRON AIRCRAFT SUPPLY INC.

1133 Broadway, New York 10, N. Y. • Oregon 5-8700

TWX: N.Y. 1-497 • WUX: FAX N.Y.

BUFFALO, N.Y.: 357 Deerfield Ave. (Walter Leney) • PARKSIDE 4922

WICHITA, KANSAS: 2250 S. Glendale (V. A. Spaulding) 72192

LOS ANGELES, CALIF.: 5777 W. Pico Blvd. (T. Louis Snitzer) WEBSTER 1-5566



have been brought into the story of a stirring period of telephone history, it is still interesting and informative. Of course it is not technical at all.—K. H.

A Hyperbolic Protractor for Microwave Impedance Measurements and Other Purposes

By G. A. DESCHAMPS. *Federal Telecommunications Laboratories, Nutley, N. J., 1953, paper cover, 44 p and hyperbolic protractor, \$2.50.*

THE HYPERBOLIC protractor is a new computational aid for the microwave engineer. By means of this protractor and the conception of a modified reflection-coefficient chart called the projective chart, many important computations are reduced to simple semigraphical procedures. The accompanying text seeks to provide elementary instruction in its use by way of presenting detailed solutions to particular problems. General familiarity with two-port networks and the conventional types of charts is assumed.

The reflection-coefficient chart and the projective chart are different projections of the positive-resistance hemisphere of impedance onto a plane. The former is a conformal-mapping projection from circles to circles, while the latter is a normal projection from circles to ellipses (in general). Certain coordinate lines that are circular arcs on the former, become straight lines on the latter, which is an advantage in some graphical computations.

Design of Protractor

The hyperbolic protractor is a transparent sheet ruled with radial lines over one quadrant. It is used to measure hyperbolic distances on the projective chart in a manner analogous to the way in which a circular protractor might be used to measure angular distances on the surface of a sphere. Further, a hyperbolic trigonometry has been developed for figures on the projective chart in a manner analogous to spherical trigonometry. This is useful to the engineer because the hyperbolic distance between any



* VAW METERS

MODEL 101
SUPERSONIC FREQUENCY
RANGE 20 cps to 200,000 cps

MODEL 102
LOW POWER FACTOR
RANGE 20 cps to 20,000 cps

FOR MEASUREMENT OF VOLTS • AMPS • WATTS

MODEL 101

- POWER RANGE: 100 μ W to 9 Kw.
- INPUT IMPEDANCE: 1 MEGOHM.
- VOLTAGE RANGE: FULL SCALE 0.1V to 300V.
- CURRENT RANGE: FULL SCALE .001 to 30A.

MODEL 102

- READS WATTS AT FULL SCALE AT BOTH 10% AND UNITY POWER FACTORS.
- INPUT IMPEDANCE: 1 MEGOHM.
- POWER RANGE: FULL SCALE, 225 μ W to 18 KW.
- VOLTAGE RANGE: FULL SCALE, 1.5V to 600V.
- CURRENT RANGE: FULL SCALE, .0015A to 30A.

WRITE
WIRE
PHONE

FOR POWER and LOSS MEASUREMENTS — in Cables • in Iron Cores • in Transformers — Copper, Core and Impedances • in Classes A, B, C Amplifier Inputs and Outputs • at Aircraft Upper Power Frequencies • in Underwater Sound Equipment • in Loud Speakers • in Synchro, Motor, and General Servo Circuitry • in Carrier Current Equipment • in Complex Waveforms • in Circuit Analysis, both Linear and Non-linear • in Sound and Noise Analysis • These are but a few of the nearly unlimited applications of the VAW meters.

Our Engineers will be happy to discuss the application of the VAW Meter to solve your particular problem. Write Dept. E-10. Literature available on request.

JOHN FLUKE MFG. CO., INC.

1111 WEST NICKERSON STREET

SEATTLE 99, WASHINGTON

Represented by • YEWELL ASSOCIATES, Bridgeport & Boston; HORMAN ASSOCIATES, Washington, D. C.; GERALD B. MILLER CO., Hollywood, San Francisco, Albuquerque, Seattle; M. P. O'DELL CO., Cleveland, Dayton; HUGH MARSH AND CO., Chicago; EARL LIPSCOMB ASSOCIATES, Dallas, Houston; RMC ASSOCIATES, New York, N. Y.; Bogota, N. J.; THE I. E. ROBINSON CO., Upper Darby, Pa.; Asbury Park, N. J.; J. D. RYERSON, Syracuse, N. Y.; H. M. RICHARDSON, Minneapolis, Minn.

*Registered Trademark

two points on the projective chart may be read as swr in db, much as on the radial scale from the center of the usual chart. This procedure obviates some of the intermediate transformations that would be required on the conventional hemisphere chart.

Organization of Text

The text comprises some brief introductory and historical remarks followed by the problems. There are twenty-one of these problems; each is accompanied by one or more clearly drawn full-scale illustrations on which the constructions may be checked at each step using the provided hyperbolic protractor to supplement the ordinary angular protractor. The problems deal with waveguide two-ports and with polarized plane waves. Three may be mentioned by way of example and because their solutions are especially elegant: (1) Measurement of a load through a junction (lossless case and general case); (2) deduction of the iterative parameters of a lossless junction; (3) determination of a load impedance by measurements at three fixed probes.

Value of Appendix

A previous paper by the same author, "New Chart for the Solution of Transmission-Line and Polarization Problems", is reprinted as an appendix, but forms a necessary part of the text. The essential operations of measuring a hyperbolic distance and an elliptic angle are described in this paper. No formal proofs are given and for these the reader is referred to other papers of Mr. Deschamps in the literature. There is also needed a reference to a recommended English text on hyperbolic (projective) geometry.

The arrangement of the text considerably detracts from the inherent value of the material. The reader who has no previous acquaintance with the subject matter sooner or later discovers that the order in which he should have read is: introductory remarks, appendix, problems. The unifying and fundamental concept of projections from a sphere, which the author

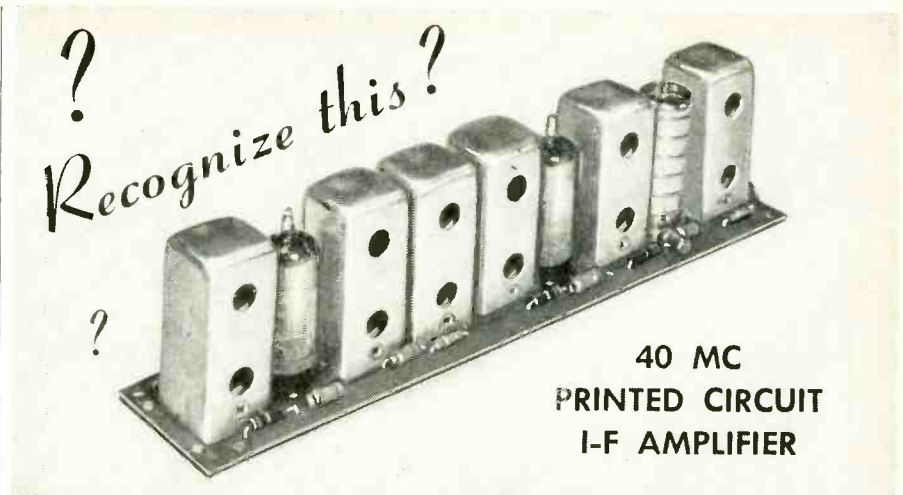

40 MC
PRINTED CIRCUIT
I-F AMPLIFIER

JO'WIL is producing other printed circuit electronic products. We are equipped for full scale manufacturing of your sub-assemblies.

INQUIRIES INVITED

A Pre-Aligned Sub-Assembly for TV Manufacturers

This wide-band high-gain 3 stage amplifier is the heart of high picture fidelity in many modern TV receivers.

JO'WIL ELECTRONICS, INC.

Belfield Ave. & Wister St.,
Philadelphia 44, Pa.

Michigan
4-9580

Beat ^{THE} *Heat* (AN OLD CORNISH CUSTOM)

with

"TEF-COR"

HOOK-UP WIRE



scores another triumph with this tough, super-flexible product that has proven itself under fire.

Heat-resistant to 500° F.

This new super-heat wire, insulated with "TEFLON," is ideal for guided missile, jet and low-tension aircraft applications, transformer and coil leads. Sizes from AWG10 through 28. Also supplied with silver coated copper shields, and to individual customer requirements. Write for further information.

- ◆ Cold-resistant to -67° F
- ◆ High dielectric properties
- ◆ Does not support combustion
- ◆ Impervious to known solvents
- ◆ Perfect concentricity
- ◆ Tough, homogeneous, uniform

Companion to the famous "NOFLAME-COR"

"MADE BY ENGINEERS FOR ENGINEERS"

CORNISH WIRE CO., INC.
50 Church St., New York 7, N. Y.

UNIVERSAL meets exacting DESIGN REQUIREMENTS

in

TOROIDAL COILS

Our specially designed machines now wind Toroidal Coils quicker and with more accuracy than other standard methods. Universal Toroidal Coils in any size wire to your specifications—are economical in materials and possess the smallest external leakage field of all other shapes.

Universal Toroids wound to Mil-T-27 specs.

Wire sizes #42 (.00249 mils) to #10 (.1019 mils).

Excellent Delivery in small or large quantity.

Engineering Service Available.

"ACCURACY IS A UNIVERSAL WORD"

UNIVERSAL  **MANUFACTURING COMPANY, INC.**
Michigan & Monroe Aves., Kenilworth, N. J.

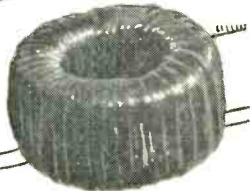
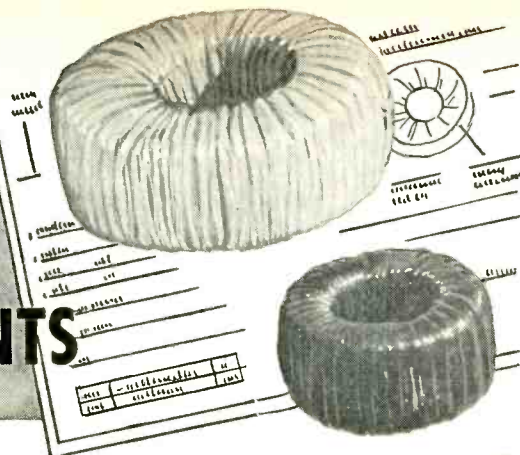

NEW BOOKS

(continued)

has exploited elsewhere, is unfortunately slighted in this text.

Protractor Drawback

The supplied hyperbolic protractor is ruled for a circular field the size of the usual Smith chart (diameter of 7 inches). The auxiliary scales are thoughtfully laid out. The main defect of the protractor on a transparent sheet is that, in the plotting of hyperbolic distance, the transparent sheet always covers the point on the computation paper sheet where a mark must be made. There is described also an alternative form which overcomes this objection by means of a rotary arm.

It appears that the hyperbolic protractor will find a useful place in the microwave laboratory. The concepts which underlie the protractor, in particular the projective chart, appear fruitful and will deepen the understanding of every thoughtful reader.—WALTER K. KAHN AND HAROLD A. WHEELER, *Wheeler Laboratories, Inc., Great Neck, New York.*

Microwave Theory and Techniques

BY HERBERT J. REICH, PHILIP F. ORDUNG, HERBERT L. KRAUSS AND JOHN G. SKALNIK, *all of Yale University. D. Van Nostrand Company, Inc., New York, N. Y., 1953, 901 p., \$12.50.*

THIS is a comprehensive, well-written outline of the principles of microwave generators and other elements. The book starts with vector arithmetic, develops the required field equations, and concludes its first two chapters with discussions of such varied matters as retarded potential, the three basic types of plane waves, skin effect and the transmission line as a wave guide. The treatment is thorough and, granted the student has a basic knowledge of electrical theory and the use of the calculus, is self-sufficient.

There follows a treatment of transmission lines from the classical viewpoint, ending with a discussion of the basis and use of the Smith chart in solving practical problems. Impedance matches by various means such as stubs, exponential lines and line elements are followed by narrowband and wideband baluns. This leads natu-

ULTRA-HIGH PRECISION POLYSTYRENE CAPACITORS

as low as 0.1%
tolerance in most values

CAPACITANCE AVAILABLE—0.05 to 10.0 MFD.

VOLTAGE AVAILABLE—100 to 400 VDC

INSULATION RESISTANCE— 10^6 MEG./MFD.

TEMP. COEFF.—100 P.P.M. per °C (—20° to 140°F)

DIELECTRIC ABSORB.—.015%

DISSIPATION—.0002

Special Values to
Close Tolerances—Our Specialty

SOUTHERN ELECTRONICS CO.

239 W. Orange Grove Avenue, Burbank, Calif.

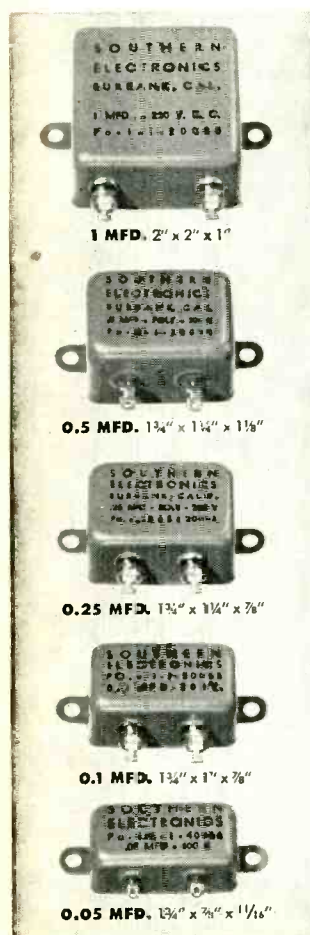

See us at Booth 715, I.R.E. Radio Engineer's Show—March 22-25

F-C-I Polystyrene Capacitors

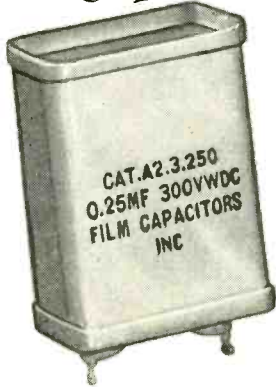

- Low Power Factor .02%
- Low Soakage .02%
- Low Temp. Coefficient -100 ppm/°C
- High Insulation Resistance 10^{12} Ohms/inf
- High Stability

Available in many different types of housings, in ratings from .001 MF up, and 100 volts up.

Excellent delivery on standard and special types.

Capacitors made to your specifications
Write for Catalogue F

film capacitors, inc.
3400 PARK AVENUE, N.Y., N.Y.
Telephone CYpress 2-5180

F-C-I Teflon Capacitors



- Operation to 200° C
- Ultra High IR
- High Stability
- Low Power Factor .02%
- Low Soakage .02%
- Low Temp. Coefficient -50 ppm/°C

Available in many different types of housings, in ratings from .001 MF up, and 100 volts up.

Excellent delivery on standard and special types.

Capacitors made to your specifications
Write for Catalogue F

film capacitors, inc.
3400 PARK AVENUE, N.Y., N.Y.
Telephone CYpress 2-5180

"ACCURACY IS A UNIVERSAL WORD!"

Specify Universal WAVEGUIDE and MICROWAVE COMPONENTS

ATTENUATORS—TERMINATIONS
SIGNAL SOURCE
IMPEDANCE MEASUREMENT
FREQUENCY MEASUREMENT
TRANSMISSION LINE COMPONENTS
DETECTION & POWER MEASUREMENT

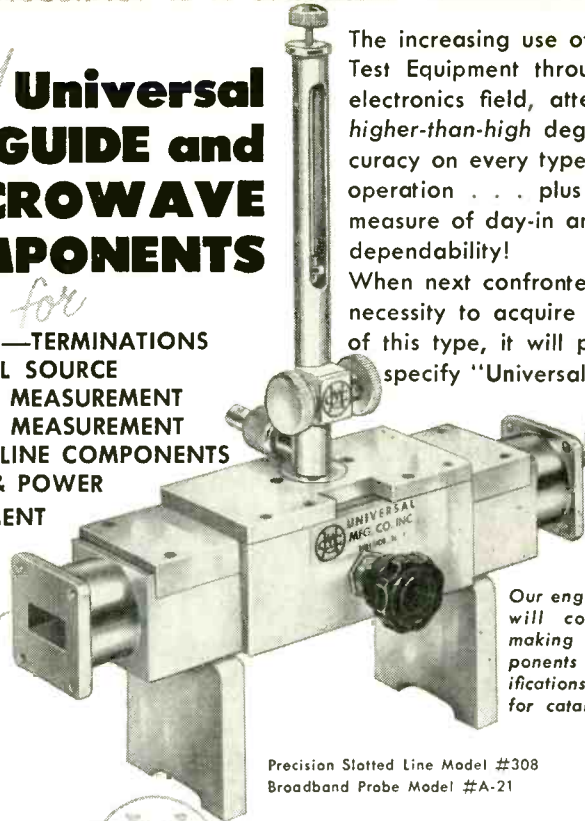

The increasing use of Universal Test Equipment throughout the electronics field, attests to the higher-than-high degree of accuracy on every type of testing operation . . . plus its larger measure of day-in and day-out dependability!

When next confronted with the necessity to acquire equipment of this type, it will pay you to specify "Universal"!

Our engineering staff will cooperate in making custom components to your specifications. Write now for catalog.

Precision Slotted Line Model #308
Broadband Probe Model #A-21

UNIVERSAL MICROWAVE CORPORATION

380 Hillside Ave.

Hillside, N. J.

formerly Universal Manufacturing Company, Inc.

QUARTZ CRYSTALS

FT-243—.093" Pin Dia.—.486" Pin SPC.
FOR HAM AND GENERAL USE

4035 5675 6350 7475 7775	1015 6050 6606 7325 8200
4080 5700 6373 7500 7800	1110 6075 6625 7340 8340
4165 5706 6375 7506 7825	1950 6100 6640 7350 8350
4190 5725 6400 7525 7840	2065 6125 6650 7375 8380
4280 5740 6406 7540 7850	2125 6140 7000 7400 8400
4300 5750 6425 7550 7873	3500 6150 7025 7425 8425
4330 5773 6673 7573 7875	3640 6175 7050 7440 8450
4397 5780 6675 7575 7900	3680 6200 7073 8000 8475
4490 5806 6700 7600 7906	3735 6440 7075 8025 8500
4495 5840 7006 7606 7925	3760 6450 7100 8050 8525
4535 5852 6725 7610 7940	3800 6473 7125 8073 8550
4735 5873 6750 7625 7950	3840 6475 7140 8075 8575
4840 5875 6775 7640 7973	3885 6500 7150 8100 8600
4930 5880 6800 7641 7975	3940 6506 7175 8125 8625
4950 5906 6806 7650 8206	3955 6550 7200 8140 8650
4980 5925 6825 7673 8225	3990 6573 7250 8150 8700
5030 5940 6850 7675 8250	6000 6575 7300 8173 8733
5205 5950 6875 7700 8273	6025 6600 7306 8175
5300 5973 6900 7706 8275	99¢ each .10 for \$8.00
5385 6240 6925 7720 8300	BC746 TUNING UNITS
5379 6250 6950 7725 8325	—Foundation coils and
5437 6273 6975 7740 8630	condensers for 80 meter
5485 6275 7450 7750 8683	VFO or exciter—Less
5500 6300 7473 7773 8690	xtls. — 98¢
5660 6325	

49¢ each .10 for \$4.00

Low Frequency—FT-241A for SSB Lattice Filter etc., .093" Pins, .486" SPC, marked in Channel Nos. 0 to 79, 54th Harmonic and 270 to 389, 72nd, Harmonic, Listed below by Fundamental Frequencies, fractions omitted.

370 393 414 436 498 520	400 459 5910	2030 2290 3155
372 394 415 437 501 522	440 461 6370	2045 2300 3202
374 395 416 438 502 523	441 462 6450	2052 2305 3215
375 396 418 481 503 525	442 463 6470	2065 2320 3232
376 397 419 483 504 526	444 464 6497	2082 2360 3237
377 398 420 484 505 527	445 465 6522	2105 2390 3250
379 401 422 485 506 529	446 466 6547	2125 2415 3322
380 402 423 486 507 530	447 468 6610	2131 2435 3510
381 403 424 487 508 531	448 469 7350	2145 2442 3520
383 404 425 488 509 533	450 470 7380	2155 2532 3550
384 405 426 490 511 534	451 472 7390	2220 2545 3570
385 406 427 491 512 536	452 473 7480	2258 2557 3580
386 407 429 492 513 537	453 474 7580	2260 2660 3945
387 408 430 493 514 538	454 475 7810	2280 2940 3955
388 409 431 494 515	455 476 7930	2282 3035 3995
390 411 433 495 516	456 477	
391 412 434 496 518	457 479	
392 413 435 497 519	458 480	

49¢ each .10 for \$4.00 | 99¢ each .10 for \$8.00

Add 20¢ postage for each 10 crystals or less

SUN
PARTS DISTRIBUTORS, LTD.

520 Tenth St., N.W.—Wash., D. C. Dept. B

PRODUCTS

producers of

UNI-CHASSIS and UNI-LEAD SETS

If you ever "breadboard" circuits, it will pay you to inquire about the UNI-CHASSIS Method for doing the job in less time. More efficient equipment proves your designs at lowest cost. Re-usable, of course.

\$7.50

UNI-CHASSIS only

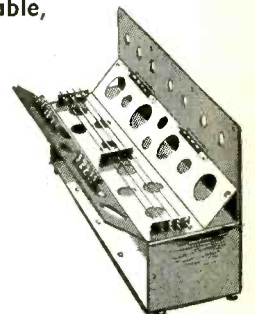

write to

UNI-PRODUCTS

division of UNI-SCIENCE, INC.
Rockville, Maryland

FOR MARKING...



**PLASTIC • METAL
GLASS • PAPER
RUBBER • CERAMIC
CARDBOARD**

*in such products as
Resistors, capacitors,
valves, tubes, labels,
sleeves, spark plugs, car
tons, etc., etc.*

**THESE PRODUCTS
AND MANY OTHERS
OF ALMOST ANY
MATERIAL AND SHAPE
CAN BE IMPRINTED**

ON THE

REJAFIX

MARKING MACHINE

See our Exhibit-
Booth 437—at the
1954 Radio Engi-
neering Show,
March 22-25

Why not send us samples of your products? They will be test-printed and returned to you for your examination!

- REJAFIX HAND-OPERATED MODELS FOR SMALL RUNS. FULLY AUTOMATIC MODELS FOR MASS PRODUCTION.

EST. 1922

POPPER & SONS INC. 300 FOURTH AVENUE
NEW YORK 10, N. Y.

FIRST CHOICE FOR PRECISION MADE TRANSFORMERS

- Precision is two-fold in Acme Electric transformers. Exact mechanical dimensions facilitate installation in limited space. Unvarying electrical characteristics provide for dependable performance.

ACME ELECTRIC CORPORATION
313 WATER ST. • CUBA, N. Y.

West Coast Engineering Laboratories:
1375 W. Jefferson Blvd., Los Angeles, California
In Canada: Acme Electric Corp. Ltd.
50 Northline Road, Toronto, Ontario

Acme Electric
TRANSFORMERS

rally into a discussion of waveguides, approached from the field point of view. The display of the different modes of wave travel and their characteristics is particularly thorough and very useful as a reference. The same thorough treatment continues with waveguide and coaxial-line components with the curious exception of mixers. These are treated quite cursorily. Next follows a satisfactory but not outstanding treatment of antennas. As stated in the preface, much of this waveguide and antenna treatment is largely descriptive, in the interests of conserving space.

A short and snappy, but probably adequate, chapter on measurements is inserted here, almost as an afterthought.

Following this is much of the real meat of the book from a design or use point of view. Chapters on Microwave Resonators, and Amplifiers and Oscillators, precede those on the tubes therefor. Conventional tubes, Klystrons, Reflex Klystrons, Magnetrons, and Electron-Wave Tubes are covered in order. These 415 pages constitute a book in their own right and a very good one.

Conclusions

On the whole, this is a very good book, useful either as a text or a reference. The breadth of the coverage is somewhat indicated by the number of experts required to write it and by the statistics of pages and illustrations. As is inevitable in a group effort, some unevenness appears and my group of reviewers (I thought I should have at least as many as there were authors) would have trimmed some sections and expanded others. These objections, however, are largely trivial and purely matters of opinion.

The problems are well chosen and the text is remarkably free from typographical errors. The bibliography seems adequate.

Some of us object to the typography, finding it tiring to read for any extended period. Another objection is that, since this is offered as a textbook, the authors should give some guide as to the length of time required to cover the material. Alternately they might have sug-



When you need a special-purpose gadget or component of electrical or electro-mechanical nature, THINK OF RAM.

**Designing
Engineering
Testing
Manufacturing**

- Prime contractors to U. S. Air Force and Navy
- Sub-contractors to aircraft and other manufacturers

Ask for Brochure K54



1102 Hilton Road
Ferndale

DETROIT 20, MICHIGAN

For more ad information, see Index to Advertisers.
ELECTRONICS — March, 1954

NEW BOOKS

(continued)

gested what portions could be covered in a stated time. It is inconceivable that the whole book can be covered in a normal senior course, which might be inferred from the preface. If such is the current practice, this reviewer is very grateful for having graduated in a less rugged era.—KNOX MCLWAIN, *Hazeltine Electronics Corp., Little Neck, N. Y.*

Theory of Four-Terminal Networks

EINFÜHRUNG IN DIE VIERPOLTHEORIE DER ELEKTRISCHEN NACHRICHTENTECHNIK, VON PROF. DR. RICHARD FELDTKELLER, S. Hirzel Verlag Stuttgart, Germany, 1953, 6th edition, 186 p, in German, price not given.

FROM the point of view of one working in transistor development, the theory of fourpoles is of particular interest. When the new device was first announced, since its theory was imperfectly understood, it was necessary to deal with it as a circuit element by means of empirical measurements on its terminals. Equivalent circuits were developed and external properties in circuits investigated on this basis. In other words, it was regarded as a fourpole, or network having a pair of input and a pair of output terminals.

Since there are various ways of expressing the properties, one is led to a variety of possible equivalent circuits. Some happen to be more closely related than others to the physics of the transistor, consequently behave more simply and understandably when operating biases or frequencies are varied. On account of considerations of convenience and of avoiding oscillations, some are more easily measured than others. In using such methods, it is useful to have for reference a book such as this in which the general properties of fourpoles are described.

Applications of Fourpoles

Fourpoles are applicable of course to a much wider field than that of transistors. In particular, filters, waveguides, transmission lines and vacuum tubes are usefully dealt with on these terms. Especially at high frequencies, it is difficult to arrive at an accurate equiv-



**Solving Industry's
Dynamic Problems
in planning
design
production
process control**

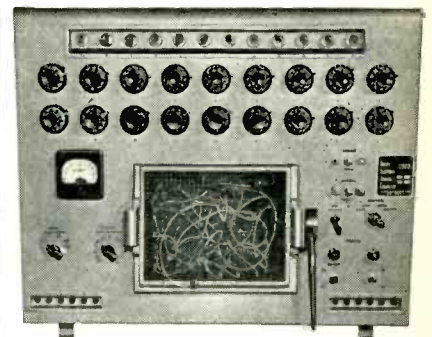

REAC C-300 Series



**Visit Reeves Exhibit
at the IRE Show
March 22-25, 1954**

Booths 341-343-345-347
"Computer Avenue near Radio Road"

**On display and in operation
Reeves' newest
line of analog computers**

REAC C-200

REAC C-300 (Portable)

Scale models of the New Consoles:
REAC C-400

**Working Models of precision
servo components:**

RESOLVERS,

MAGNETIC CLUTCHES,

GYROS

**Precision standard and
miniature mechanical
breadboard parts**

REEVES INSTRUMENT CORP.

Subsidiary of Claude Neon, Inc.

215 East 91st Street
New York 28, N. Y.

Instrumentation for the age of automation
For more ad information, see Index to Advertisers.

IRC DISTRIBUTORS OFFER YOU FASTER, BETTER SERVICE on...

BT INSULATED
COMPOSITION RESISTORS

BW LOW WATTAGE
WIRE WOUND RESISTORS

NEW, MBC MOLDED
BORON-CARBON PRECISTORS

NEW IRC INDUSTRIAL SERVICE PLAN

Independent IRC Electronic Parts Distributors can now give you the benefit of fast, local service on a greater share of your requirements. IRC's Distributor policies and prices have been adjusted to provide for larger quantities; certified quality; and new, insulated, close-tolerance resistors.

BONDED STOCK PROTECTION

Types BT and BW Resistors in quantities of 500 and over, and Type MBC in quantities of 100 and over are supplied by Distributors in FACTORY-SEALED BOXES. Sealing tape bears IRC's certification of the contents. Resistor type, wattage, value and tolerance are clearly identified. Applicable JAN or MIL Specifications are shown. You are assured fresh resistors, dependable quality and adherence to specifications.



LOCAL PROCUREMENT saves you delivery time and shipping charges. Your nearby IRC Distributor is well qualified to serve you. Call him and he'll prove it.



INTERNATIONAL RESISTANCE CO.

403 N. Broad St., Philadelphia 8, Pa.

In Canada:

International Resistance Co., Ltd., Toronto, Licensee

For more ad information, see Index to Advertisers.

492

alent circuit in any other way.

This book, an introductory text, discusses what can be said about a network when all that is known is that it has pairs of input and output terminals and is linear. It gives representations suitable for passive circuits, line and filter sections, examples of matrices and equivalent circuits in simple cases (not including transistors) and transformations between such circuits. A special section discusses the properties of loss-free, purely reactive fourpoles. To those who might be misled by the discussion above, let me repeat: the book does not contain anything explicitly about transistors, but does give background on fourpoles which is applicable to transistors.

The treatment is rather formal and abstract. There are no examples showing the power of the method in practical numerical problems, such as computing transmission in networks known only by empirical measurements on their elements. Consequently, the reader who has particular practical problems to solve may find it a little difficult to choose and evaluate the usefulness of the various representations. However, one may use the book as a reference for various ways of setting up fourpoles and empirical equivalent circuits.—
R. M. RYDER, *Bell Telephone Laboratories, Murray Hill, N. J.*

Relays for Electronic and Industrial Control

BY R. C. WALKER. *Chapman & Hall, Ltd., London 303 p, 1953, 42 shillings.*

A YOUNGER GENERATION of electronic engineers is often without knowledge of or sympathy for the electromagnetic relay. Sometimes wedded to the idea that what must be done without a vacuum tube is scarcely worth doing, they may use a relay with reluctance and with limited success. Problems of contact bounce or arcing arise. Many engineers apparently do not realize that appreciable time delays can be introduced through slow-operate or slow-release relays.

It is for such engineers, as well as for those who appreciate and use the relay as transducer between circuits of unequal power that the sub-

let WILLIAMS help you apply

ferric oxides

to the manufacture of your

FERRITES

You'll be well repaid by getting the facts on a special group of Pure Ferric Oxides, developed by Williams especially for use in the manufacture of ferrites.

Williams Ferric Oxides analyze better than 99% Fe₂O₃. They contain a minimum of impurities. They are available in a broad range of particle sizes and shapes. Among them, we're certain you'll find one that's "just right" for your requirements. The proper application of Ferric Oxides to the manufacture of Ferrites is our specialty.

Tell us your requirements . . . we'll gladly send samples for test. Chances are good that our Ferric Oxide "Know How" can save you considerable time and money. Address Dept. 25, C. K. Williams & Co., Easton, Pa.

WILLIAMS COLORS & PIGMENTS

C. K. WILLIAMS & CO.
Easton, Pa. • East St. Louis, Ill.
Emeryville, Cal.

P.S. We also produce IRN Magnetic Iron powders for the Electronic Core Industry, the Magnetic Tape Recording Industry and others. Write for complete technical information.

For more ad information, see Index to Advertisers.

March, 1954 — ELECTRONICS

Make a **GM** PORTABLE D'ARSONVAL

GALVANOMETER

*the Heart
of Your
Instrument*

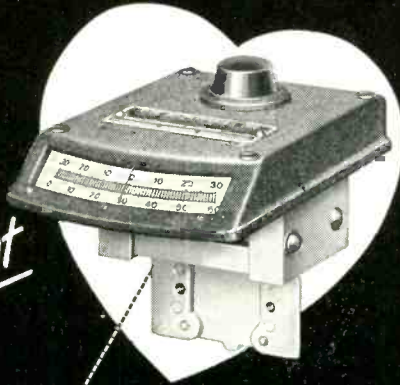

FOR MEASURING LIGHT reflectance and color, the Photovolt Corporation of New York uses a Model 600 G-M Galvanometer for its popular Reflection Meter (left). Whatever your own particular instrument field, you can achieve this same self-contained portability, ruggedness and high sensitivity with G-M Galvanometers. Complete catalog on request.

GM LABORATORIES INC.

In Canada: Cossor (Canada) Ltd., 301 Windsor St., Halifax, N. S.

4336 NORTH KNOX AVE., CHICAGO 41

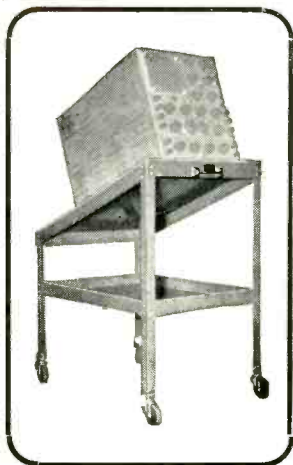

SCOPE DOLLY MODEL 1

- Convenient Height and Viewing Angle
- Adjustable to Hold Portable Scopes
- Ball Bearing Swivel Rubber Tired Casters
- Lightweight Aluminum Construction
- Recommended by Laboratories Wherever Used

\$38.50

FOB Louisville, Ky.

TECHNICAL SERVICE CORP.

1404 W. Market St. Louisville, 3, Kentucky

It's "TREATMENT" that makes **DANO** your Best Bet for Coils

DANO's battery of vacuum impregnating tanks and heat controlled ovens for curing varnish impregnations is always

ways at your service. Yes, Dano coils and Dano customers are always treated in the manner that makes your production pay dividends.

- Form Wound
- Paper Section
- Acetate Bobbin
- Molded Coils
- Bakelite Bobbin
- Cotton Interweave
- Coils for High Temperature Application

Send us samples or specifications with quantity requirements for our recommendations. No obligation!

Also, Transformers Made To Order



THE DANO ELECTRIC CO.
MAIN ST., WINSTED, CONN.

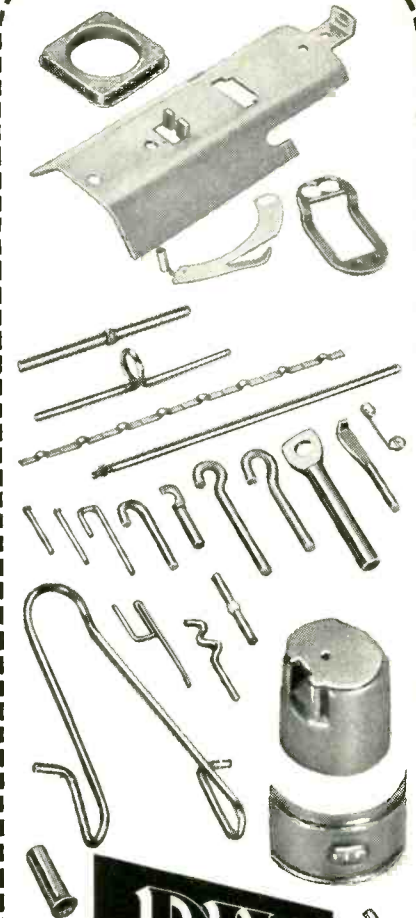

**Dependable • Precision
Wire Forming and
Stamping Specialists**

Precision Parts to meet your Production and Engineering needs. From .002" dia. to .125" dia. Radio tube parts—Stampings—Drawings. Modern facilities, high-production equipment.

Send sketch or print for quotation.



MANUFACTURING CO., Inc.
24-A Bedford Street
Newark 3, New Jersey

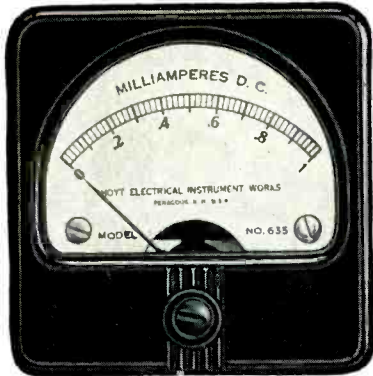
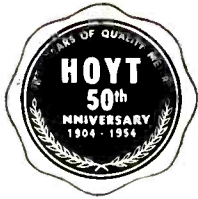

ACCURATE
EASY-TO-READ
RUGGED
DEPENDABLE

Sole
Selling
Agent

BURTON-ROGERS COMPANY
42 CARLETON STREET
CAMBRIDGE 42, MASS., U.S.A.

for YOU . . .
**THE BENEFITS OF
50 YEARS'
EXPERIENCE**

1904 **HOYT** 1954
**ELECTRICAL INDICATING
INSTRUMENTS**

For your particular requirements, HOYT Panel and Portable Meters provide superior service at reasonable cost: Voltmeters - Ammeters - Microammeters . . . Moving-Coil, Repulsion or Rectifier Types . . . Suppressed Zero and Differential Meters . . . all carefully designed and accurately made. Write today for literature and prices on the HOYT Meters you need.

NEW BOOKS

(continued)

ject book, posthumously published, will be extremely useful.

In the ten chapters into which the author divided his subject, there are separate groupings for relay coils, contacts, switching functions, a-c relays and high-speed relays. Other chapters (not necessarily in this order) describe the utility of electronic devices as switching controls, electromagnets, delayed switching, thermal and motor-operated contactors, methods of control and miscellaneous applications ranging from sequential switching to battery-charging protective circuits.

Although certain terms and pieces of equipment may be unfamiliar to engineers in the States, the author defines his terms and circuit symbols so that there can be no reasonable misunderstanding of his text.

While it might be wished that more space had been given the relay as a transducer between vacuum-tube circuits, this subject is covered and the book as a whole should be particularly useful to the industrial control engineer.—A. A. MCK.

**MURPHY & MILLER
Test Cabinets**

BOOTH #288 INSTRUMENT AVE. • IRE Show

See
The New
Design..

Exclusive
New Slope Front . . .
Easier Viewing, Faster
Loading!

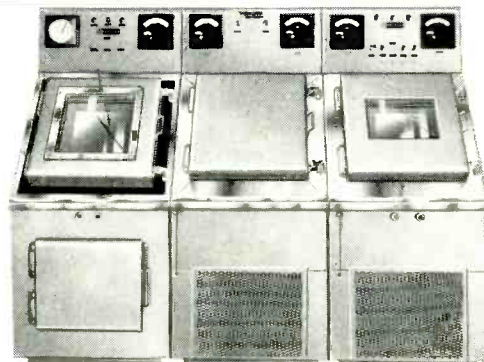

DRY ICE FUNGUS HUMIDITY

These new design Murphy & Miller environmental test units are compact, portable and inexpensive. Any individual unit or combination of units available to meet your requirements. Temperatures from +200° F to -100° F; Humidities from 20 to 95%.

FEATURES:

- Stainless steel test space — approx. 2 cu. ft.
- Forced air circulation
- Automatic temperature and humidity controls
- Slope front design permits easier loading, viewing . . . maintains more uniform test conditions
- Chamber designed to operate on 110 V. connection

See them at the IRE Show or write for complete details and specifications.



MURPHY & MILLER, Inc.

1322 SOUTH MICHIGAN • CHICAGO 5, ILLINOIS

**Electronic Circuitry for
Instruments and Equipment**

By MILTON H. ARONSON. *Instruments Publishing Co., Pittsburgh, Pa., 312 pages, \$4.00, 1953.*

A SERIOUS attempt by an editor to write a "first" book on electronics for those who hope to get their introduction to the subject by this text and for those who wish a refresher. The method employed is to write the essential paragraph and then to write a multiple-choice question on the paragraph on the theory that, if the paragraph develops more than one thought, a multiple-choice test question is impossible. It is an interesting approach; and only the reader can tell how successful a technique it is. The individual chapters were first published in *Instruments*.

The first part of the book naturally deals with such basic matters as circuit elements and phenomena, tubes, rectifiers, amplifier circuits, solid-state amplifiers (magnetic amplifiers, transistors and dielectric amplifiers), oscillators and shaping circuits. Then follow chapters of electronic test equipment,

communication systems including television, scientific and industrial instruments and finally a chapter on military electronics. The last 30-odd pages contain the multiple-choice test questions for the whole volume.—K.H.

Direct-Current Circuits

BY EARLE M. MORECOCK. *McGraw-Hill Book Co., Inc., Second edition. 1953, 388 pages, \$5.00.*

FOR the initial course in electrical curricula in industrial and extension courses, this revised edition of a book first published in 1944 requires only a working knowledge of simple algebra. It starts with the basic structure of matter and ends with a chapter on electrostatics. In between will be found elementary, and easily assimilable, chapters on symbols and wiring diagrams, magnetism and electromagnetism, measuring instruments and methods, batteries, networks and magnetic circuit theory. There are many problems, with the answers given in an appendix. Throughout, the attempt has been to make a text which a beginner can understand. There are some application problems and the reader is given some insight into what d-c circuits perform in the way of service to industry. There is practically no electronics in the book.—K.H.

Microwave Lenses

BY J. BROWN. *Methuen and Co. Ltd., London and John Wiley and Sons, Inc., New York, 1953, 125 p., \$2.00.*

THIS excellent small book on microwave antennas is the latest of the Methuen series of monographs on physical subjects. It deals primarily with the various types of microwave lenses but includes some material on reflectors so as to permit a comparison of these two important types of antennas for microwave use.

Because it covers fairly completely the four main classes of lenses, namely the solid dielectric, artificial dielectric, metal plate and rodded, and the slant plate type, it is recommended reading for engineers engaged in the field of microwave optics and antennas. In addition to chapters on each of the above, there are chapters on wide-

Watch
TENSOLITE
for progress in
ELECTRONIC
WIRING!

For High Dielectric
Strength, specify-

TENSOLON
TEFLON-INSULATED
WIRE & CABLE

- THIN WALL
- 14 COLORS
- FREE-STRIPPING
- EXTRA FLEXIBILITY
- TOUGH TEFLON INSULATION
- TEMPERATURE RATING:
—90° to
+250°C

For an extra margin of dependability at maximum operating temperatures, specify these rugged Teflon insulated hook-up wires. Available in stranded sizes from 20 to 30 AWG with shields and teflon jackets or lacquered braids. Constructed to meet highest government and commercial standards, Tensolon Wires feature the new Tensulanted-Teflon covering that eliminates pin holes and other imperfections.

ASSORTED TENSOLON HIGH-TEMP WIRES
IN LABORATORY AND TEST QUANTITIES

An economical sample kit for designers, engineers, testing departments and development laboratories. Prices on request.

WRITE FOR CATALOG TODAY

TENSOLITE INSULATED WIRE CO., INC., TARRYTOWN, NEW YORK

DON'T MISS THE TENSOLITE EXHIBIT—I.R.E. SHOW—BOOTH 647 CIRCUITS AVE.

**NEW...
EPOXIDE
RESIN
bobbins**

With extraordinary properties, for hermetically-sealed resistor forms.
Leading users of standard and custom-made STEATITE BOBBINS and OTHER STEATITE PRODUCTS made to Commercial or JAN-I-10 specifications,
SPECIFY Thor

Thor Ceramics, Inc.
225 Belleville Avenue, Bloomfield, New Jersey

VISIT BOOTH #334 COMPUTER AVE., I.R.E. SHOW, MARCH 22-25, 1954

BOESCH
Winding Machines

- 1 Automatic Toroidal Coil Winder with Accurate Direct Reading Counter
- 2 Tape Winding Machines for the Taping of Toroidal Cores & Coils
- 3 Semi-Automatic Type Toroidal Coil Winding Machines
- 4 Sub-Miniature Toroidal Coil Winding Machines. Model SM-A designed especially for winding of sub-miniature size coils.

SEE US AT THE IRE SHOW
BOOTHS 705-802
KINGSBRIDGE ARMY, N. Y. C.

**WORLD'S MOST VERSATILE
WINDING MACHINES**

BOESCH
MANUFACTURING CO., INC.
DANBURY, CONN.

angle scanning and non-homogeneous lenses and also chapters on the general subjects of radiation patterns and lens antennas.

Early Work Reviewed

The early work in this country is well covered and much material is included from several British laboratories. The extent of this latter material indicates the large effort abroad and the importance attached there to microwave lens developments. The interesting foreword by Willis Jackson calls attention to the value of optical techniques in the design of microwave radiators for radar and radio relay use. Dr. Jackson suggests that the book is worthy of study not only by radio engineers but by physicists concerned with artificial dielectrics and diffraction phenomena.

The chapter on solid dielectric lenses deals with reflection loss, dielectric loss, tolerances, type of dielectric and certain theoretical concepts such as Debye's theory of non-polar substances. Interesting aspects of nonhomogeneous lenses are considered, with Maxwell's fish-eye and the Luneberg scanner being two examples.

The material by Ruze and that by Friedlander on scanning capabilities of lenses is treated in the chapter "Wide Angle Scanning" and the author arrives at the conclusion (p 118) that "a lens is definitely to be preferred [over a reflector] when . . . wide angle scanning is desired."

Dr. Brown has been very generous to this reviewer in the matter of credits on the artificial dielectric, slant plate and metal plate lenses and these lenses have been treated rather completely. The rodded type of metal plate lens (which Dr. Brown analyzes as the general case of the wire lens) is covered in detail following the original paper by Brown and Jones.

Lens Antennas Well Covered

The final chapter, "Lens Aerials", is perhaps the most important one in the book, as it gives an interesting analysis of the pros and cons of lenses and reflectors, and a good account of the performance to be expected of the various types of

Pat. Pending

Remler

See it at the Show

New
Translucance
Microphone

with TRANSISTOR pre-amplifier

Remler microphone with built-in transistor pre-amplifier reduces noise, yields dramatic improvement in intelligibility. For radio and P.A. in aircraft and other mobile applications. For information contact

REMLER COMPANY LTD. • 2101 BRYANT STREET • SAN FRANCISCO 10, CALIFORNIA
Washington, D. C., Office: Wyatt Building

transistor pre-amplifier

SINCE 1918 • PRECISION IN ELECTRONICS



**COLOR
CRT GUN
MOUNTS**

15 GP 22 mounts
now available in pro-
duction quantities

Superior color guns
are now in use by
leading tube manu-
facturers

Guns for larger tube sizes now
available in sample quantities

For Prompt Information
write or phone

SUPERIOR ELECTRONICS

208 Piaget Ave. Clifton, N. J.
Tel: GRegory 2-2500



**PULSE
IMPEDANCE
BRIDGE**

A valuable new instrument for
laboratory and industrial uses in
the pulse field.

FEATURES:

- Direct reading from 1 to 1110 ohms
- Better than 1% accuracy
- Self-contained pulse generator
- Extreme flexibility
- Use generator or bridge separately

USEFUL FOR:

Measurement, adjustment and production test of pulse networks
and transformers, delay lines, filters, cable surge impedance, etc.
Video cable termination adjustment.

Evaluating pulse and HF characteristics of resistance elements.
Safe, low voltage adjustment of high level pulse modulators.
Production test of complex networks.

MODEL PIB-1 \$595

Write For Full Information

CLEGG LABORATORIES, INC.
LIVINGSTON, N. J.

SQUARE PULSE GENERATOR

**MODEL
300**

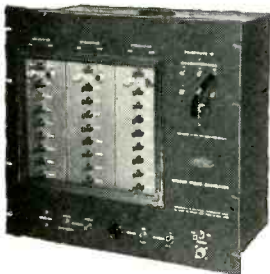

for the
**MILLIMICROSECOND to
MICROSECOND RANGE**

New Basic Test Instruments for NUCLEAR,
RADAR, TV, UHF, and other fields in
which FAST PULSE CIRCUITS are em-
ployed. Three or more pulse outputs
are available in Model 300.

SPECIFICATIONS

- PULSE SHAPE:** square pulse
- RISE TIME:** .001 μ sec. from 10%
to 90% amplitude
- PULSE WIDTH:** .001 μ sec to several
 μ sec.
- PULSE AMPLITUDE:** From 100 volts
to .006 volts in one db steps
- OUTPUT IMP:** Matched to any im-
pedance for standard coax lines
- POWER INPUT:** 105-125 V, 60 cy.
- SIZE:** 17-1/2" x 19" x 10-3/16"



**ELECTRICAL & PHYSICAL
INSTRUMENT CORP.**
42-19 27th Street, L.I.C. 1, N. Y.

HERE IT IS!

**CAST
"TEFLON"
FILM**

**THE ANSWER TO YOUR
DEVELOPMENT PROBLEMS**

"Teflon" Films in thicknesses
from 0.00025" to 0.002"

- Outstanding Dielectric prop-
erties
- Extremely high thermal res-
istance
- Remarkable inertness to cor-
rosive chemicals

Available in continuous roll
lengths of 400 ft.—slit to your
specifications. Attractive dis-
counts on quantity purchases.

Send for latest Price Schedule
and Technical Bulletin.

DILETRIX COMPANY
211-48 Jamaica Av. Queens Village, N. Y.

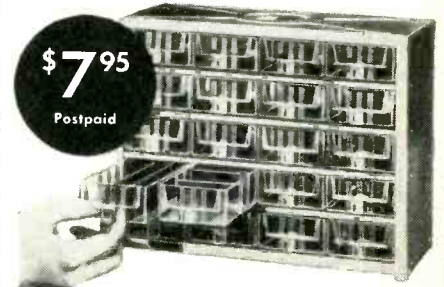

\$7.95
Postpaid

ELECTRONIC PARTS STORAGE

"See Thru" Drawer Cabinets provide the
ideal method for storing resistors, ca-
pacitors, coils, switches and other com-
ponents. Contents visible through
CRYSTAL CLEAR plastic drawers. Ad-
justable dividers make **60 COMPART-
MENTS**. 20 spill-proof drawers, each
5 1/4 L x 2 3/4 W x 1-7/16 H. Cabinet,
10 1/4 H x 12 1/2 W x 6 D, has rubber
feet and silver-grey finish. Re-
fund if not delighted. Postpaid **\$7.95**
32-drawer unit. Postpaid **\$12.95**

MANUFACTURERS: Use for packaging your own
products. Over 750 styles.

GENERAL INDUSTRIAL CO.

5741 Elston Av., Chicago 30, Ill.

GENERAL INDUSTRIAL CO.
5741 Elston, Chicago, Ill.

- Send 20-drawer units @ \$7.95.
- Send 32-drawer units @ \$12.95.
- Send catalog #J-D-53.

Name
Company
Address
City Zone State



P. R. MALLORY & CO. Inc.
MALLORY

**SILVERLYTIC
CAPACITORS
and
MERCURY
BATTERIES**



Ideal for TRANSISTOR CIRCUITS

If you are designing equipment around transistor circuits, Mallory Mercury Batteries will deliver the constant-current, constant-voltage needed for best performance. There is no significant deterioration or loss of energy even after long periods of storage.

Mallory Silverlytic Capacitors are also designed to meet the special requirements of transistor and other low voltage circuits.

For complete data, write to P. R. Mallory & Co. Inc., Indianapolis 6, Indiana.

Available **NOW**
in production
quantities

P. R. MALLORY & CO. Inc.
MALLORY

For more ad information, see Index to Advertisers.

lens arrangements. Thus it is pointed out that the lens-corrected horn (shielded lens), because of the absence of spillover loss, "ranks as one of the most efficient microwave radiators available", (p 115) but it is also stated that "for a small aerial the reflector is simpler mechanically" (p 118), and that "a reflector has higher gain than an ordinary lens but is slightly inferior to a lens-corrected horn" (p 118).

The use of a displaced feed to reduce reflections from the front lens surface is discussed (p 114), but when the shielded lens is described this reflection back into the feed is referred to as the principal disadvantage (p 116). The solution proposed is the insertion of a reflecting strip; however, in the Bell System's horn-lenses for radio relay the displaced feed (tilted lens) has been satisfactorily employed.

The book is well referenced (47 papers and 10 text books) and includes numerous illustrations and four photographic plates. The small format of the book and the easy style makes it very desirable for reading on air or train trips.—WINSTON E. KOCK, *Bell Telephone Laboratories, Murray Hill, N. J.*

THUMBNAIL REVIEWS

How To become A Successful Leader. By Auren Urin. McGraw-Hill Book Co., New York, N. Y., 1953, 239 pages, \$3.50. Expansion of series of articles in *Factory Management and Maintenance*, coordinated to serve as a practical guide aimed at the perennial problems of many executives, particularly those who must guide and enthruse creative engineers: "get the full cooperation of my people, create a more harmonious work atmosphere and increase the effectiveness of my group".

AM-FM Servicing Short-Cuts. By Milton S. Kiver. Howard W. Sams & Co., Inc., Indianapolis, Ind., 1953, 136 pages, paper-covered, \$1.50. Total of 139 actual case histories of unique troubleshooting problems, plus introductory commentary and a concluding chapter on general principles of f-m receiver servicing.

Cours sur les Ondes Ultra-Courtes. By Y. Place. Eyrolles, 61 Boulevard Saint Germaine, Paris, France, 1953, 184 pages, 1,300 francs. Elementary treatise in French dealing with lines,



**THE "Field-Proved" STANDARD
IN COMMUNICATIONS . . .**

INTRODUCES A NEW

TELEPHONE HANDSET

**...the first Handset specially
engineered for two-way
communications**



- 2-Way Radio Communications
- Inter-Com Systems
- Airplane Announce Systems
- P. A. Systems

Specially Designed to Suit Your Specific Applications

Here is a truly modern functional handset specifically designed for 2-way communications! A product of the Shure Laboratories with many years of experience in safety mobile communications, the TH10 Handset brings you these features: . . . the field-proved *controlled reluctance* assembly as a receiver . . . high output *balanced response* carbon transmitter . . . oversized switch chamber providing flexibility in stacking of famous Shure long-life leaf blades . . . handle provides for maximum number of conductors . . . solderless connections for rapid servicing . . . rugged shock resistant handle . . . design smart to the eye, natural in the hand.

The answer to your complex circuitry!



For more complete information
write to
SALES DIVISION

SHURE BROTHERS, Inc.

Manufacturers of Microphones & Acoustic Devices
225 W. HURON ST., CHICAGO 10, ILL.

Cable Address: SHUREMICRO

For more ad information, see Index to Advertisers.

March, 1954 — ELECTRONICS

antennas, tubes, modulation methods and applications of ultra-short waves.

D'électricité Générale, Machines Electriques Problèmes et Exercices. By P. Janet, Gauthier-Villars, 55 Quai des Grands-Augustins, Paris, France, 1953, 407 pages, 2,700 francs, \$8.03. An excellent series of exercises in typical problems involving electrostatics, electromagnetism, magnetic circuits, Ohm's, Kirchhoff's and Joule's laws, d-c and a-c circuits, dynamos and alternating amplifiers—in French.

Coefficients for the Numerical Calculation of LaPlace Transforms. By Herbert E. Salzer, NBS Applied Mathematics Series 30. Superintendent of Documents, U. S. Government Printing Office, Washington, D. C. 1953, 36 pages, \$0.25. Tables which facilitate numerical evaluation of infinite integrals expressible in the form of Laplace transforms such as arise in the theory of heat conduction and in electrical engineering.

UHF Television Antennas, and Converters. By Allen Lytel. John F. Rider Publisher Inc., New York, N. Y., 1953, 128 pages, \$1.80. Explains in simple terms lines, antennas and converters for uhf tv with emphasis on the numerous converters rapidly coming into use which are described by manufacturer and model number.

Elementary Differential Equations. By Lyman M. Kells. Fourth Edition. McGraw-Hill Book Co., New York, N. Y., 1953, 266 pages, \$4.00. Undoubtedly one of the easiest-to-grasp texts on this subject. Many exercises worked out, many problems with answers, many applications to geometry, electrical engineering, and physics with problems arranged in order of difficulty. Aside from its intended use as a school text, it could be satisfactorily used by anyone wishing to brush up or to make a first attempt at the subject.

Audio Reproduction. By David Fidelman. John F. Rider Publisher, New York, N. Y., 1953, 240 pages, \$3.50. Excellent streamlined guide to theory and practice of high fidelity sound. Circuits with constants, enough theory, descriptions of components with some guidance to the selection of working units.

Elements of Radio. Third Edition. By Abraham and William Marcus. Prentice-Hall, Inc., New York, N. Y., 771 pages, \$6.00, 1953. A very elementary book brought up to date by introduction of new material, e.g., transistors, and by revision of older material. First half teaches radio by descriptions of devices used in radio circuits; second half covers electric circuit theory, tube circuits and characteristics.

Radio Data Charts. By R. T. Beatty and J. McG. Sowerly. Iliffe & Sons, Ltd., London, 91 pages, 1953, 7 shillings 6 pence. A series of charts dealing with radio receiver design. There are 43 charts including LCf ; multi-layer and solenoid coil construction, wires to give lowest r-f resistance,

FOR
EASY
TUBE
SIDE
TESTS



SAVE
TIME
EFFORT
MANY
USES

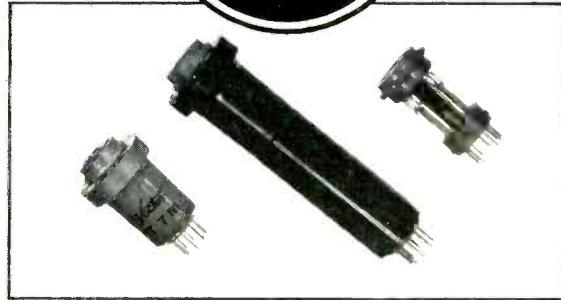

TEST ADAPTERS

Vector Test Adapters are ideal for making measurements from the tube side of electronic equipment. The adapter is inserted between tube and socket, completing the circuit and providing test tabs. The short type (left) is most popular, but for some hard-to-reach locations a long type with shielded leads is available (center). For breaking circuits or changing connections the open "experimenter" type is useful (right). All types are available for octal, 7-pin miniature and 9-pin noval sockets. Kit T-789 combines the three short types in handy carrying case. Available at most distributors.

Send for catalog showing complete line of adapters, socket-turrets, plugs and plug-in units.

REPRESENTATIVES

B. B. Taylor Co., 241 Sunrise Highway, Rockville Centre, N. Y.
R. J. Magnuson, 4258 West Irving Park Road, Chicago 41, Ill.
David H. Ross Company, 534 El Camino Real, San Carlos, Calif.

Vector Electronic Co.

3352 San Fernando Road

Los Angeles 65, California

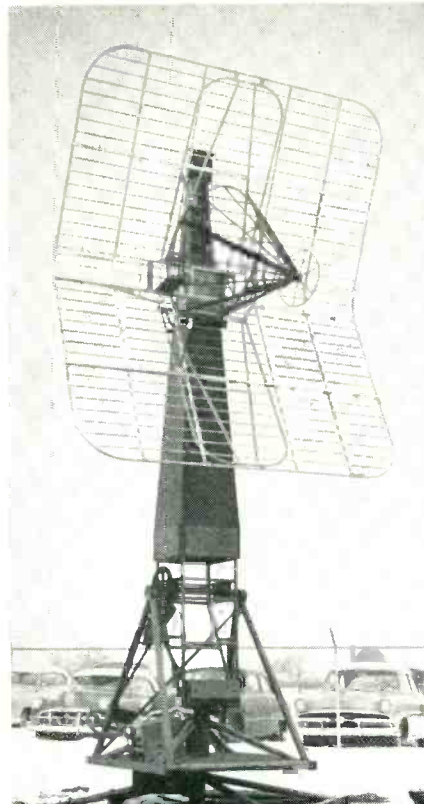

ANTENNA

**PATTERN
MEASUREMENTS**

VHF thru
Microwaves

D&M offers a specialized service for the accurate measurement of antenna radiation patterns. Precise performance data are provided both by an outdoor range of unusual construction as well as by a unique indoor model measurement facility.

D&M designs and manufactures antennas of novel concept to provide unexcelled performance in demanding airborne applications. Why not consult us about your special requirements.

A complete
brochure
may be had
upon request
to Dept. E-2



DORNE AND MARGOLIN

Incorporated

30 SYLVESTER STREET • WESTBURY • LONG ISLAND, N. Y.

universal selectivity data, power transformer design, loud-speaker dividing networks and many others. A very useful compendium.

Table of ArcTan x, 2nd edition, National Bureau of Standards, Applied Mathematics Series 26, 171 pages, U.S. Government Printing Office, Washington, D. C., \$1.75. Computation at small intervals and to a large number of decimal places, plus coefficients for interpolation and a conversion table giving radians converted into degrees and vice versa.

Conductance Curve Design Book. By Keats Pullen, Kann-Ellert Electronics, Inc., 9 South Howard St, Baltimore 1, Md. \$1.00. A collection of dynamic characteristic curves of present-day tubes with instructions on how to use them to determine small and large signal operating characteristics of circuits.

Index, Radiation Laboratory Series, Vol. 28. McGraw-Hill Book Co., 1953, 160 pages, \$4.50. Edited by Keith Henny and with foreword and introductory notes by Vannevar Bush, Karl T. Compton, Lee A. DuBridge and Louis N. Ridenour. A complete index of the contents of the 15,476 pages comprising the popular "Rad Lab Series."

Training Activities in Electronics Establishments, Publication Branch, Bureau of Apprenticeship, U.S. Department of Labor, Washington, 25, D. C., 13 pages free. A progress report on the campaign by the Bureau of Apprenticeship to stimulate training activities in plants engaged in the manufacture of electronic equipment during the period May 1952 and March 1953.

Organizational Position of the Industrial Safety Engineer. Society for Advancement of Management, 74 Fifth Ave., New York 11, N. Y., 30 pages, 1953, \$1.00. A survey of the position of the safety engineer in industry given by the results of a questionnaire to membership of the American Society of Safety Engineers and showing the salary, years of experience, educational background, title within the organization etc., as represented by 418 returned questionnaires.

Radio and TV Test Instruments, Gernsbach Library No. 49. Gernsbach Publications, Inc., 25 West Broadway, New York, 7, N. Y., 128 pages 1953, \$1.50. A handy book of 22 chapters, each written by an expert in the subject on such matters as grid-dip and absorption meters, oscilloscopes, picture tube testers, signal generators, vtm, bridges etc.

Industrial Uses of Radioactive Fission Products. Stanford Research Institute, Stanford Calif. Second Printing, 1953, \$1.50. Findings of a team of economists, market analysis and engineers after studying 60 representative enterprises and descriptions of specific applications of radioactive wastes from nuclear reactor operation.

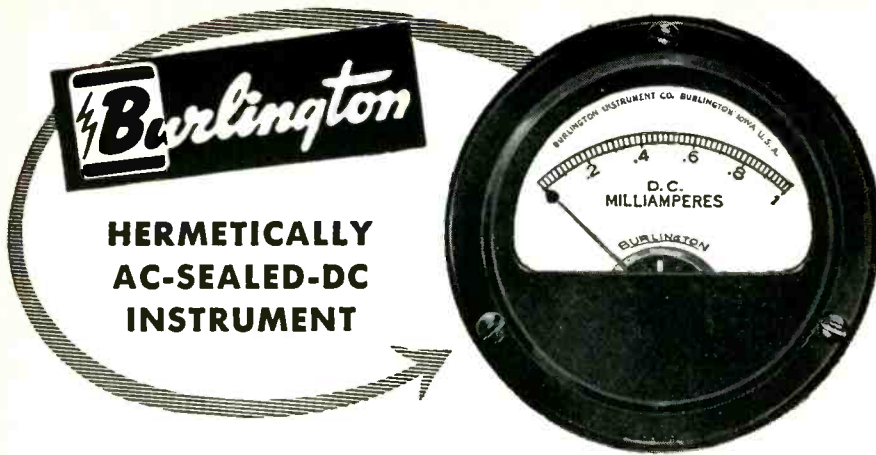

**HERMETICALLY
AC-SEALED-DC
INSTRUMENT**

RUGGED CONSTRUCTION FOR SUPERIOR PERFORMANCE

- Copper — cadmium — dichromate finished case.
- Black satin onodized aluminum bezel.
- Excellent shielding due to case material and construction.
- Double strength clear glass.
- Glass to metal seal under controlled humidity and temperature conditions.
- D'Arsonval permanent magnet type movement for DC applications.
- Magnetically damped, moving iron vane type movement for AC applications.
- Available in 1½" square, 2½" and 3½" round case types.
- Guaranteed for one year against defective workmanship and materials.

Burlington "Hermetically Sealed" Instruments are designed to conform to JAN and MIL specifications.



BURLINGTON INSTRUMENT COMPANY
127 THIRD STREET, BURLINGTON, IOWA

improve your products with **QUALITY COMPONENTS**

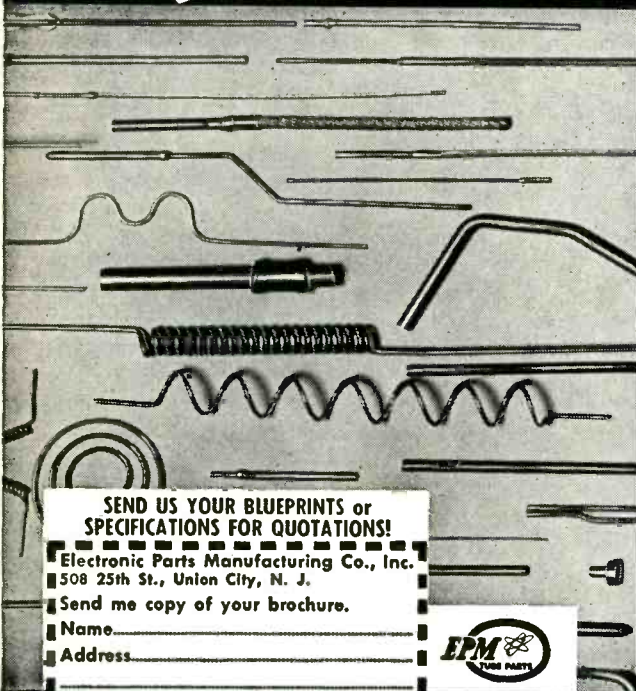

quality
**hand-wound
COILS**
of Tungsten
and Molybdenum

quality
**"precision"
LEADS**
of TUNGSTEN
MOLYBDENUM
NICKEL
NICKEL-CLAD COPPER
and ALLOYS

quality
**MACHINED
TUBE
COMPONENTS**
to customers'
specifications

SEND US YOUR BLUEPRINTS or
SPECIFICATIONS FOR QUOTATIONS!

Electronic Parts Manufacturing Co., Inc.
508 25th St., Union City, N. J.

Send me copy of your brochure.

Name _____

Address _____



ELECTRONIC PARTS MANUFACTURING CO., Inc.
508 25th St., Union City, N. J.

PHAZOR PHASE METER

Pat. Pend.



MODEL
200 A

PRICE
\$349.50
F.O.B.
NEW YORK

- HIGH ACCURACY
- MEASURES FROM 0 TO 360 DEGREES
- READINGS NOT AFFECTED BY NOISE AND HARMONICS
- PHASE SHIFTS OF THE ORDER OF .01° CAN BE MEASURED EMPLOYING SPECIAL CIRCUIT TECHNIQUES
- MEASURES IN-PHASE AND QUADRATURE COMPONENTS SEPARATELY

For further information contact your nearest representative or write for brochure

REPRESENTATIVES

KITTLESON CO., 7614 Melrose Ave., Los Angeles 46, California
 JKM, INCORPORATED, 13 W. Hubbard St., Chicago 10, Illinois
 BROGER INSTRUMENT SALES CO., INC., 739 Bayistan St., Boston 16, Mass.
 F. R. JODON, INC., 2902 Porter St., N.W., Washington 8, D. C.
 G. G. WILLISON CO., 1821 W. Alabama, Houston 6, Texas

INDUSTRIAL TEST EQUIPMENT CO.
 55 E. 11th ST. • NEW YORK 3 • GR. 3-4684

See Us At
IRE SHOW
 —
 309
 Computer
 Avenue

YOURS

for the asking



packed with the latest and most complete information on

performance guaranteed

TAPE WOUND CORES

- 12 Pages of Performance Curves
- Tables of Guaranteed Performance
- Description of Core Matching Service
- Applications — Constructions
- *plus much additional information*

For your copy of the "Performance-Guaranteed" Tape Wound Core Catalog write on your letterhead
 BOX E-1

MAGNETICS, inc.
 Specializing in High Permeability Magnetics
 BUTLER, PA.

SEALING
 DIPPING
 POTTING
 IMPREGNATING



INSULATING
 FUNGUSPROOFING
 MOISTUREPROOFING
 HEAT CONDUCTING

WAXES BIWAX COMPOUNDS

Developed and produced for manufacturers of electronic components and other electrical units.

Specifications and samples available on request.

Information relative to your problem or application will enable us to make suggestions and recommendations.

BIWAX CORPORATION 3445 HOWARD STREET
 SKOKIE, ILLINOIS

chassis trak

at your service

ultra thin — only 7/32" actual thickness

chassis tilts back for servicing ease

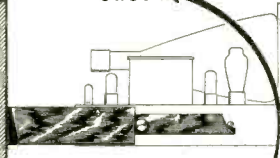

AT YOUR ELECTRONIC PARTS JOBBER

- Supports 175 lbs.
- Extends to 22 7/8"
- Fits all standard chassis and racks
- Chassis instantly removable
- Permanently lubricated
- All hardware included
- Meets JAN salt-spray requirements

CHASSIS-TRAK CORP.
 6250 E. Iona Road
 Indianapolis, Ind.

**EXTRAORDINARY
PERFORMANCE!**

**GIANNINI
SPIRALPOT
POTENTIOMETERS**

Precision slide-wire potentiometers that meet your most exacting demands with $\pm 0.025\%$, $\pm 0.05\%$, $\pm 0.1\%$ linearity—zero based • Infinite resolution • Positive stops without backlash • Resistance from 2 to 25,000 ohms • 1 to 40 shaft turns • Close rotational tolerances • Long life and low noise.

**GIANNINI
Spiralpot
85171A**



With $\pm 0.01\%$ normal linearity when requested 1 to 15 turns— 360° to 5400°
Weights 4 oz., Resistances—2 to 3,750 ohms $\pm 5\%$; 250 ohms/ 360° max. Torque—starting 0.6 oz. in.; running 0.3 oz. in.

**GIANNINI
Spiralpot
85172A**



20 to 40 turns— $7,200^\circ$ to $14,400^\circ$ —Weights 5 oz. Resistances—40 to 10,000 ohms $\pm 5\%$; 250 ohms/ 360° max. Torque—starting 0.6 oz. in.; running 0.3 oz. in.

**GIANNINI
Spiralpot
85173A**



1 to 40 turns— 360° to $14,400^\circ$ —Weights 10 oz., Resistances—5 to 25,000 ohms $\pm 5\%$; 625 ohms/ 360° max. Torque—starting 1.0 oz. in.; running 0.5 oz. in.

Giannini

Special problem? Further information? Please write:
G. M. GIANNINI & CO., INC.
Electro-Mechanical Division
East Orange, New Jersey

BACKTALK

Stereovectorcardiograms

DEAR SIR:
IN THE November 1953 issue of ELECTRONICS in *Electrons at Work* department (p 198), you reported some work by Dr. Arthur C. Guyton of the Mississippi School of Medicine. The article described work done by Dr. Guyton in connection with stereovectorcardiograms. This to my mind is a very practical and productive method of cardiac examination.

I am anxious to obtain the details of the method and incorporate them in the circuitry of a two-gun oscilloscope I am building.

F. E. DAVIS, M.D.
*University of Southern California
School of Medicine
Los Angeles, California*

Engineer Adjudication

DEAR SIR:
YOUR EDITORIAL "Engineers-Lawyers?" in *Cross Talk* for January, was very applicable to one of the most controversial subjects of today. I am referring to color television.

Back when the first television standards for the United States were proposed, the field sequential system of color was the only system of color in current development. There were two factions competing for industrial supremacy in the field of color and, with one having the licensing rights on field sequential color, the other had to push development on a different method. This led to one side claiming color was here and the other side claiming that it was far in the future.

The matter was then decided by the Commission, who took what to its lay thinking was a simple, logical procedure, by just tabling the whole matter of color and letting the issues clear up in due course of time and events.

With that issue settled, the FCC next approved a system of monochrome tv that was incompatible with field sequential color television and in effect thus closed the door on ever being able to equally compare it to other systems. This was nobody's fault, but could have been avoided by applying the circum-



**AIR-SPACED ARTICULATED
CO-AX
CABLES**

offer a unique combination of

- ✓ FRACTIONAL CAPACITANCE
- ✓ HIGH IMPEDANCE
- ✓ MINIMUM ATTENUATION
- ALONG WITH
- ✓ EXCEPTIONAL FLEXIBILITY
- ✓ LIGHT WEIGHT

38 STOCK TYPES

FOR ANY OF YOUR STANDARD OR SPECIAL APPLICATIONS

A few of the very low capacitance types are:

Type No.	Capacitance $\mu\text{F}/\text{ft}$.	Impedance ohms	O.D.
C.44	4.1	252	1.03"
C.4	4.6	229	1.03"
C.33	4.8	220	0.64"
C.3	5.4	197	0.64"
C.22	5.5	184	0.44"
C.2	6.3	171	0.44"
C.II	6.3	173	0.36"
C.I	7.3	150	0.36"

WE ARE SPECIALLY ORGANIZED TO HANDLE DIRECT ORDERS OR ENQUIRIES FROM OVERSEAS

SPOT DELIVERIES FOR U.S.
BILLED IN DOLLARS—SETTLEMENT BY YOUR CHECK CABLE OR AIRMAIL TODAY



**138a GROMWELL RD., LONDON, S.W.7
ENGLAND**

CABLES: TRANSRAD LONDON

For more ad information, see Index to Advertisers.

March, 1954 — ELECTRONICS

stantial foresight of lawyers with engineering comprehension who could grasp the fact that they were in effect outlawing the only workable system of color television then in existence, for broadcasting use in the United States. Commercially, where it does not have to be compatible with a preconceived set of standards, it now thrives as an excellent system with the inherent simplicities of the field sequence of color.

No one was wrong in the procedure; we just needed more engineering comprehension on the adjudication panel where the public interest was being furthered.

HOMER A. RAY, JR.
Weldon & Carr
Washington, D. C.

Teacher vs Engineer

DEAR SIRs:

I HAVE heard many engineers express a desire to go into teaching, but they never make the move. On the other hand, there appear to be many engineers who were formerly teachers.

Besides the matter of pay, could this be because the hiring requirements of educational institutions are more rigid than those of laboratories? And, if so, is such rigidity necessary?

Since the supply and quality of teachers is of such fundamental importance to the engineers themselves and to the national security, it would seem desirable for information and discussion on this aspect of the matter to be more widespread than it now is.

LAWRENCE FLEMING
Falls Church, Virginia

Foreign Transistors

DEAR SIRs:

WE WOULD like to draw your attention to the omission of the name of our company from the list of foreign transistor manufacturers given on page 16 of your December 1953 issue.

We have been established in the semiconductor field for many years and several references to our war-time work on radar mixer crystals are given in the M.I.T. Radiation Laboratory series handbook on crystal rectifiers published by McGraw-Hill Book Co.

We think it will be of interest to your readers to know we are taking

MULTIPLE ASSEMBLIES FOR SMALL PARTS BELONG TO HORSE-AND-BUGGY DAYS

GRIES DIE CASTINGS GIVE YOU TINY PARTS LIKE THESE COMPLETE IN ONE OPERATION

Compare GRC small die castings with assemblies produced by other methods. GRC completely finished parts save you time, labor, money. Cast in one high-speed operation, they open broad opportunities for your new designs. Fast delivery on 100,000 pieces to many millions.



Write today for bulletin and samples. Send prints for quotations.



GRIES REPRODUCER CORP.

151 Beechwood Ave., New Rochelle, N. Y.
• NEW Rochelle 3-8600

World's Foremost Producers of Small Die Castings

Smallest Unlimited
Max. Wt.: 1/2 oz.
Max. Lgth.: 1 3/4 in.

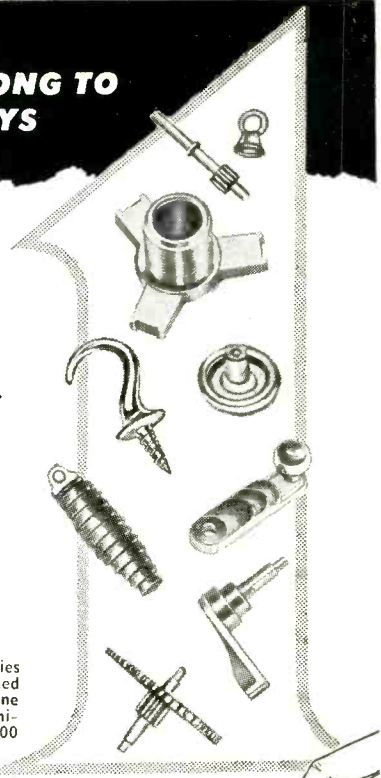

SELENIUM RECTIFIER POWER SUPPLIES

for Aircraft - Mobile - Marine Electrical Equipment

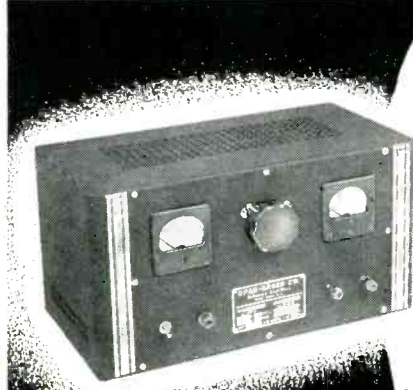

- Typical Applications
- Aircraft Motors
 - Dynamotors & Inverters
 - Relays & Solenoids
 - Battery Charging
 - Electroplating

These OPAD-GREEN General Purpose Power Supplies are designed to furnish an adjustable source of unfiltered D.C. from single phase 50 or 60 cycle A.C. power lines. Stepless output control, overcurrent protection, 2% accuracy meters, aging taps and exclusive Poly-Coated Rectifiers are among the many features of these units.

D.C. OUTPUT**		CATALOG NO.	
VOLTS	AMPERES	115 V.A.C. 60 ~ 1Ø	230 V.A.C. 60 ~ 1Ø
O-6	25.0	K38	—
	50.0	K47	K48
	100.0	K56	K57
O-12	12.5	K65	—
	25.0	K74	K75
	50.0	K83	K84
O-28	10.0	K92	—
	20.0	K101	K102
	40.0	K110	K111

*Continuous Duty



For additional information write for Bulletin No. 147

71-2 WARREN STREET, NEW YORK 7, N. Y.

SENSITIVE RELAYS that R-E-S-I-S-T



SHOCK

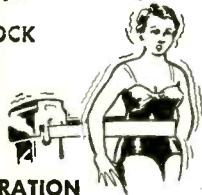

VIBRATION



TEMPERATURE

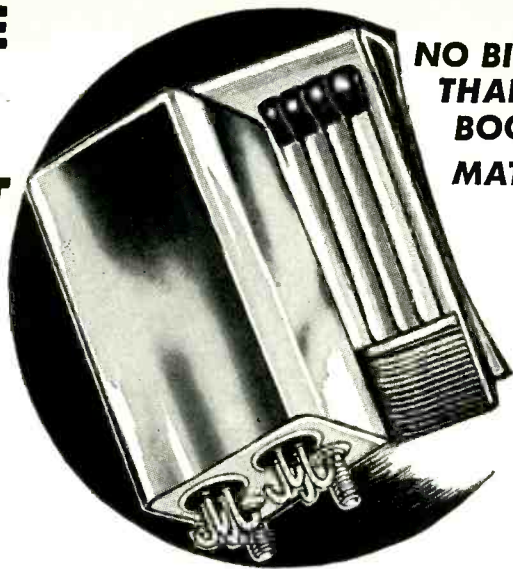

NO BIGGER THAN A BOOK OF MATCHES

Here are miniature sensitive relays—single or double-pole types—which fulfill the most rigid requirements of space, shock, temperature and vibration in both commercial and military applications. The Series 100—105—106 relays are hermetically sealed and have a long life expectancy. Write for Bulletin SR—6

Engineering representatives in principal cities.



i.e.r.c. heat-dissipating miniature TUBE CLAMPING SHIELDS give lower bulb temperatures and increased tube reliability!

I.E.R.C. tube clamping shields solve electron tube heat and vibration problems. Temperature reduction is made possible by conducting heat directly from bulb to the chassis or heat sink providing greater reliability.



Tested, Proven, Accepted...



AVAILABLE!

I.E.R.C. shields will meet environmental requirements for present and future industrial and military electronic equipment.

International

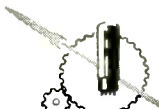

WRITE TODAY! For complete information send inquiries to International Electronic Research Corporation, 175 West Magnolia Boulevard, Burbank, Calif.

electronic research corporation

a leading role in semiconductor research, development and production. We demonstrated laboratory-produced transistors as long as four years ago and have been in factory production for the past year.

H. MAMOTT
Osram Valve & Electronics Department
The General Electric Co. Ltd.
London, England

Space Charge

DEAR SIRS:
THE ARTICLE on "Neutralizing Pentodes in Radar I-F Stages" which appeared in your October '53 issue was indeed interesting, especially because of the simplicity of the method described. I recall, however, an article in the *Electronics at Work* section of an earlier issue which described the effects of space charge on the apparent input capacitance of vacuum tubes. This, like the variable Miller capacitance with which Mr. Tellier was concerned, is a function of tube bias too; it likewise induces changes in pass-band with age action.

For a modern well-designed remote-cutoff pentode the space charge effect may be roughly of the same order of magnitude as the Miller effect, and equally as troublesome. The bandpass-change-with-age problem may be particularly disturbing in the case of high-frequency narrow-band i-f amplifiers and in design of amplifiers for precise phase measurement.

A rather direct method which has proved satisfactory in the solution of this problem is simply to reduce the impedance level at the grid of the controlled stage or stages. This can be done by either a double-tuned or tightly-coupled step-down transformer of suitable turns ratio, with the secondary shunted by a resistor representing the desired impedance. True, some gain is sacrificed; but the design is simple and there are no critical adjustments. The required gain can be made up by adding a stage.

One unit which was built around the ubiquitous 6AU6 used a 10:1 turns ratio and a 50-ohm resistor; another used a 3:1 ratio and an 800-ohm resistor. Both worked well.

LAWRENCE NELSON
Staff Engineer
Diamond Ordnance Fuse Laboratories
Wheaton, Maryland

PROFESSIONAL SERVICES

ALPHA ENGINEERING LABS

TROUBLE-SHOOTING SPECIALISTS
Waveguide tube twisting, bending and forming.
Broaching. Tooling design, improvements and
methods.

ANDRE TEMPE
P. O. Box 107 Phone Budd Lake, N. J.
Hackettstown 340

ANNIS ELECTRIC RESEARCH LABORATORY, INC.

CONSULTING — RESEARCH — DEVELOPMENT
AND DESIGN OF RADIO AND ELECTRONIC
EQUIPMENT

Antennas, Wave Propagation, Information Storage,
Computers, Impedance Matching and Variable
Speed A-C Motors.
P. O. Box 581 1401½ S. Neil St.
Champaign, Ill. Tel. 6-1708

W. J. BROWN

Registered Prof. Engr. Connecticut, Ohio, England

ELECTRONIC CONTROL SYSTEMS
Consulting — Research — Development

INTERNATIONAL CLIENTELE
71 Gurley Road Stamford, Conn.
Stamford 4-4876

CODETYPER LABORATORIES

PRINTED CIRCUITS, EMBEDMENT CELLS
AND MINIATURIZATION ENGINEERS

Redesign your standard product using cost and
labor saving Printed Circuits. We perform all
engineering and supply you with Master Plates for
your production. Reasonable, fast service.

550 Fifth Avenue, New York 19. JUN 4487

CROSBY LABORATORIES, INC.

Murray G. Crosby & Staff

Radio - Electronic
Research Development & Manufacturing
Communications, FM & TV
Robbins Lane, Hicksville, N. Y.
Hicksville 3-3191

EDGERTON, GERMESHAUSEN & GRIER, INC.

Consulting Engineers

Research Development and Manufacture
of Electronic and Stroboscopic Equipment
Specialists in High-Speed Photography
160 Brookline Avenue Boston 15, Mass.

Eldico of New York, Inc.

Pioneers of Television Interference Elimination from
Transmitters, Induction Heaters, Diathermy and
etc.

Donald J. S. Merten & Engineering Staff
44-31 Douglaston Pkwy Douglaston, N. Y.
Bayside 9-8686

ELECTRONIC RESEARCH ASSOCIATES, INC.

"TRANSISTORIZE" YOUR PRODUCT!

Complete Service in consulting, research, develop-
ment, and production on Transistor circuitry,
products and instrumentation.
715 Main Street North Caldwell, N. J.
Caldwell 6-6729

ERCO RADIO LABORATORIES, INC.

Radio Communications Equipment

Engineering - Design - Development - Production
Pioneers in Frequency Shift Telegraph
Garden City • Long Island • New York

When
time
is
short . . .

put the solution of your problems up
to a specialized Consultant whose pro-
fessional card appears on this page. His
broad experience may save you months
of costly experimentation.

ELECTRONICS

330 West 42nd St., New York 18, N. Y.

HANSON-GORRILL-BRIAN INC.

Products & Mfg. Development

ELECTRICAL - ELECTRONIC

HYDRAULIC - MECHANICAL

One Continental Hill Glen Cove, N. Y.
Glen Cove 4-7300

HIGHLAND ENGINEERING CO.

William R. Spittal & Staff

DESIGN, DEVELOPMENT AND MANUFACTURE
OF TRANSFORMERS, CHOKES, ETC.

FOR THE
ELECTRONIC, INDUSTRIAL & ALLIED FIELDS
Main & Urban, Westbury, L. I., N. Y.
WE-7-2983

HOGAN LABORATORIES, INC.

John V. L. Hogan, Pres.

Applied Research, Development, Engineering

Est. 1929. Electronics, Optics, Mechanisms, Fac-
simile Communication, The Circle Digital Computer,
Electro-sensitive recording media, Instrumentation.
155 Perry Street, New York 14. CHelsea 2-7855

INTERFERENCE MEASUREMENT LABORATORY

Interference Study per Government Specifications
Shielded Space for Interference Investigation
Field Surveys for F.C.C. Certification of Induction
and Dielectric Heating Equipment
1844 Utica Avenue Brooklyn 34, New York
Navarre 8-1248

THE KULJIAN CORPORATION

Consultants • Engineers • Constructors

Electronic Control
Specialists

Utility • Industrial • Chemical

1200 N. Broad St., Phila 21, Pa.

Measurements Corporation

Research & Manufacturing Engineers

Harry W. Houck Martial A. Honnell
John M. van Beuren

Specialists in the Design and
Development of Electronic Test Instruments
Boonton, New Jersey

NEW ROCHELLE TOOL CORP.

FOR CERTIFICATION OF INDUCTION
AND DIELECTRIC HEATING EQUIPMENT
IN ACCORDANCE WITH F.C.C. RULINGS

Mobile Test Unit Available Entire U. S.
320 Main St. New Rochelle, New York
Phone NE 2-5555

NIAGARA ELECTRON LABORATORIES

CONSULTATION - DESIGN - CONSTRUCTION
MFG. THE THERMOCAP RELAY

Specializing in solution of problems of electronic
and electro-physical instrumentation for the re-
search of analytical laboratory. Industrial plant
problems also invited.

Andover, New York Cable Address: NIATRONLAB

MAURICE I. PARISIER & CO.

Communications Expert

International Engineering Consulting
RADIO BROADCASTING & COMMUNICATIONS
Planning & Installation Supervision

Communication Equipment for Armed Forces
1475 Broadway New York 36, N.Y. LOngacre 4-5434
Offices: Paris-Buenos Aires — Sao Paulo-Bombay

PICKARD AND BURNS, INC.

Consulting Electronics Engineer

Analysis and Evaluation
of Radio Systems

Research, Development and Production
of Special Electronic Equipment

240 Highland Ave. Needham 94, Mass.

ALBERT PREISMAN

Consulting Engineer

Television, Pulse Techniques, Video
Amplifiers, Phasing Networks,
Industrial Appliances

Affiliated with
MANAGEMENT-TRAINING ASSOCIATES
3308-14th St., N. W. Washington 10, D. C.

JOSEPH RACKER COMPANY

Radar Consultants & Editors

Technical Manuals

Research and Development

140 Nassau Street New York 38, N. Y.
Worth 4-1463

ROTRON RESEARCH CORPORATION

Research and Development

Fluid Dynamics and Heat Transfer.
Exclusively Electronic Applications

Cooling Problems, Heat Exchangers, Fans,
Turbines and Pump Designs
Woodstock, N. Y. Phone 2499

THE TECHNICAL MATERIAL CORPORATION

Communications Consultants

Systems Engineering

General Offices and Laboratory

700 Fenimore Rd., Mamaroneck, N. Y.

WHEELER LABORATORIES, INC.

Radio and Electronics

Consulting—Research—Development
R-F Circuits—Lines—Antennas

Microwave Components—Test Equipment
Harold A. Wheeler and Engineering Staff
Great Neck, N. Y. HUunter 2-7876

YARDNEY LABORATORIES, INC.

Research - Design - Development

Electro-Chemical Generators of Energy

105 Chambers Street Worth 2-5500
New York 7, N. Y.

CONTACTS

FOR THE FIELD OF ELECTRONICS



EISLER MANUFACTURES COMPLETE EQUIPMENT

WELDERS FOR SPOT & WIRE BUTT
 RADIO, TV TUBE EQUIPMENT & REPAIR UNITS
 INCANDESCENT, FLUORESCENT MFG. EQUIPMENT
 NEON SIGN MAKERS EQUIPMENT, GLASS LATHES
 ELECTRONIC EQUIPMENT, VACUUM PUMPS, Etc.
 Wet Glass SLICING & CUTTING MACHINES for Lab Use
 TRANSFORMERS, SPECIAL & STANDARD TYPES

EISLER ENGINEERING CO., INC.

751 So. 13th St.

Newark 3. N. J.



NOW- STEP AHEAD FASTER! AS AN INDUSTRIAL ELECTRONICS TECHNICIAN

Turn your experience into a big, new better-paying career!

Day by day industrial plants are adding more electronic devices—for sorting, counting, checking, almost any control job you can name. Cash in on industry's great need for men who can keep these devices in top working order. Make more money, feel more secure, doing work that is second nature to you. With what you already know about electronics you have a long head start in a field just beginning to boom. GET INTO IT RIGHT NOW with the help of

PRACTICAL INDUSTRIAL ELECTRONICS LIBRARY

4 volumes
 1390 pages
 1050 illus.

\$22.50
 EASY
 TERMS

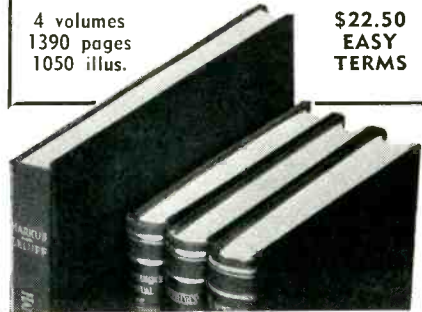

Have you problems in
Metal to Glass Seals?
 NAME IT . . . WE'LL MAKE IT!
 TERMINALS
 HEADERS
 END SEALS . . . SPECIAL ITEMS
 QUALITY PRODUCTS CO.
 387 Charles St., Providence, R. I.

REX RHEOSTAT CO.
 BALDWIN, L. I., N. Y.

NEW REX DOUBLE RHEOSTATS
 and RESISTORS UP TO 2000 WATT.
 WRITE FOR NEW CATALOG NO. 5

Shorted Turn Indicator
 Sensitive, rugged, non-shocking
 for unmounted coils; \$150. f.o.b.
 HUNTINGTON BEACH, CALIF.

KARTRON

MICROMETER FREQUENCY METER
 Measures center frequency of any number
 of transmitters, AM or FM, 0.1 to 175
 MC., 0.0025% accuracy. Price \$220.00.

LAMPKIN LABORATORIES, INC.
 BRADENTON, FLORIDA

FLUXES
 SODERING
 BRAZING & WELDING
 I. B. ALLEN CO. INC. Chicago 31, Ill.
 6751 BRYN MAWR AVE.

TEST EQUIPMENT REPAIRED
 Contractors to U. S. Government
 Repairs and calibration by skilled craftsmen on all
 makes of Meters, Testers, V.T.V.M.'s, Scopes, etc.
 Prompt service. All work guaranteed. For im-
 mediate estimate send instrument by P. O. Ins. to
DOUGLAS INSTRUMENT LABORATORY
 Electrical Instrument Repairers
 176 NORFOLK AVENUE ROXBURY 19, MASS.

ELECTRONIC PRODUCTION
 Detroit area firm has facilities available for
 Electrical and Electronic subcontracting. Your
 inquiries regarding wiring, cabling, testing
 and light machine work on electronic assem-
 blies and sub-assemblies are invited.
 CW-1346, Electronics
 330 W. 42 St., New York 36, N. Y.

TRANSFORMERS AND COILS
 TO ORDER—ANY QUANTITY
 Samples promptly submitted
 A complete Engineering and Mfg. Service.
 Will design and make 1 or 100,000 TRANS-
 FORMERS—Audio, Power, High Volt., etc.
 COILS—HF, Synchro, Spec. Purpose, etc.
 Transformer Div., TRANSVISION, INC. • NEW ROCHELLE, N. Y.

HIGH VOLTAGE POWER SUPPLIES

Available in ranges up to 50,000 volts
 D.C. high or low current regulated or
 unregulated types available.
 Send for catalog E3
PRECISE MEASUREMENTS CO.
 942 KINGS HIGHWAY, BROOKLYN 23, N. Y.
 Phone ES 5-9435

Precision
BLACK ANODIZING
 Specializing in black anodizing, both
 sulphuric and chromic, on all alloys
 and castings.
 All other colors as well.
 GOVERNMENT CERTIFIED
 Contact us for special service.
HENRY and MILLER INDUSTRIES, INC.
 675 Garfield Ave., Jersey City, N. J.
 HEnderson 4-4200

Here's the practical kind of information these 4 volumes show you:

- How to keep the plant's electronic equipment performing as it should
- How to locate and correct tube and circuit troubles quickly and easily
- How to install, service, and maintain even brand new equipment without being stamped by new circuits

Contains:

- Chute's *Electronics in Industry*
- Miller's *Maintenance Manual of Electronic Control*
- Markus & Zeluff's *Handbook of Industrial Electronics Circuits*
- Henney & Fahnestock's *Electron Tubes in Industry*

Shows facts such as:

- How to operate the vacuum-tube voltmeter
- How to correct ignitor misfire
- How to maintain light sources for photo-electric control
- How to protect circuits of welding machines
- How tubes serve in conveyor synchronization, color measurement, etc. and hundreds more

No long sessions on math or theory! Instead you get: Clear explanations of how tubes and tube-operated circuits work in motor controls, welding controls, heat controls, etc. A complete manual that covers all maintenance procedures. A handbook of 433 industrial electronic circuits with each fully described. Troubleshooting charts, tested working methods, step-by-step directions — everything you need to start right now is here.

10 DAYS' FREE EXAMINATION

McGraw-Hill Book Co. 330 W 42 St., NYC 36
 Send me the Practical Industrial Electronics Library for 10 days' examination on approval. In 10 days I will send \$2.50, then \$4.00 a month until \$22.50 is paid. (A saving of \$3.50 under the regular price of \$26.00.) Otherwise I will return books postpaid.

(PRINT)

Name
 Address
 City Zone State
 Company
 Position L-3

This offer applies in U. S. only.

REPLIES (Box No.): Address to office nearest you
 NEW YORK: 330 W. 42nd St. (36)
 CHICAGO: 520 N. Michigan Ave. (11)
 SAN FRANCISCO: 68 Post St. (4)

POSITIONS VACANT

INSTRUMENTATION ENGINEER. Graduate EE with industrial instrumentation design experience for development laboratory of old established company in Mid-West. Servomechanism experience necessary. P-1535, Electronics.

ELECTRONIC ENGINEER, GS-5, \$3410.00 per yr. Duties: installs instrumentation and calibrates and operates instrumentation in existing rocket testing installations. Assists in the design and layout of new instrumentation systems. Applicants should complete U. S. Standard Form # 57, available at any post office, and forward to the Industrial Relations Officer, U. S. Naval Air Rocket Test Station, Lake Denmark, Dover, N. J.

ELECTRONIC ENGINEER, GS-9, \$5060.00 per yr.—Duties: Project Engineer, designs new instrumentation systems and modifies existing systems used in testing rockets or associated components. Directs and supervises other members of the Instrumentation Branch in installing, calibrating, and operating instrumentation systems. Applicants should complete U. S. Standard Form #57, available at any post office, and forward to the Industrial Relations Officer, U. S. Naval Air Rocket Test Station, Lake Denmark, Dover, N. J.

ELECTRONIC ENGINEER, GS-7, \$4205.00 per yr. Duties: cooperates in the design of new instrumentation and modification of existing testing facilities. Performs experiments on instruments and allied equipment to ascertain characteristics of same. Applicants should complete U. S. Standard Form #57, available at any post office, and forward to the Industrial Relations Officer, U. S. Naval Air Rocket Test Station, Lake Denmark, Dover, N. J.

GENERAL ENGINEER (Editing), GS-9, \$5060.00 per yr. Duties: Head of the Technical Publications Branch of the Engineering Services Division of the Engineering Department. Responsible for editing, compiling, preparing for publication and distribution of all technical reports issued by the Engineering Department. Applicants should complete U. S. Standard Form #57, available at any post office, and forward to the Industrial Relations Officer, U. S. Naval Air Rocket Test Station, Lake Denmark, Dover, N. J.

GENERAL ENGINEER (Editing), GS-7, \$4205.00 per yr. Duties: Technical Editor in the Technical Publications Branch. Responsible for assisting the Branch Head in editing, compiling, and preparing for publication all technical reports issued by the Engineering Department. Applicants should complete U. S. Standard Form #57, available at any post office, and forward to the Industrial Relations Officer, U. S. Naval Air Rocket Test Station, Lake Denmark, Dover, N. J.

SELLING OPPORTUNITY OFFERED

LEADING MFR. full line regulated power supplies wishes engineering sales representatives calling electronic mfrs. & laboratories. Northwest, midwest, south & North eastern territories open. Write, giving lines carried & territory covered. RW-1419, Electronics.

POSITIONS WANTED

EXECUTIVE ENGINEER able to take charge of a development group. A sales force or a plant. Fifteen years of experience in manufacturing, development and sales. Eight years with present company. Age 37, married, EE. PW-1681, Electronics.

PATENT ATTORNEY, 30, BEE, LLB, N. Y. Bar, only thesis req'd for MEE: 5 yrs eng exp. 5 yrs patent exp, NY area. PW-1658, Electronics.

MANUFACTURERS

Aggressive sales organization in Middle Atlantic States can provide representation for additional electronic or electrical equipment or parts.

MACLEN CORPORATION
 Manufacturers Representative
 3226 Ninth Street, N.E., Washington 17, D. C.

WANT MORE BUSINESS?

Established technical sales group has capacity for additional items in electronic or electro-mechanical component field. Products need not be established in territory but must have high quality. Company brochure available for your inspection.

WEIGHTMAN & ASSOCIATES
 1405 W. Magnolia Blvd. Burbank, California

COMMUNICATION ENGINEERS

ATTENTION!

The world's largest independent supplier of Carrier equipment offers permanent positions, good starting salaries, and unusual opportunity for progress. If you have had experience in any of the following fields, we can make you a very attractive offer:

1. Carrier Transmission Engineering
2. Carrier Equipment Installation and Maintenance
3. General Transmission Engineering

Write giving full details of your background to Personnel Director

AUTOMATIC ELECTRIC

1033 West Van Buren Street

Chicago 7, Illinois

FIELD ENGINEERS

Young EE graduates with experience in military or private industry required for domestic and overseas positions. \$10 per diem plus liberal overseas bonus. Opportunity for advancement is excellent.

SERVOMECHANISMS, INC.

Post and Stewart Avenues
 WESTBURY, LONG ISLAND, N. Y.

ELECTRICAL SALES ENGINEER

Wanted by nationally known Eastern manufacturer of electrical components. Applicant should have thorough technical sales background and preferably following among electrical and automotive manufacturers in Mid West. Excellent opportunity. Send full resume stating age, education, experience and salary expectation.

P-1760, Electronics
 330 W. 42 St., New York 36, N. Y.

POSITIONS WANTED

ELECT. ENGINEER, B.S. (EE), Reg. PE, married, age 32. Nine years total military and civilian electronic exp. five years circuit design for chemical and biophysical research. Includes two years supervisory. Desires non-military industrial or medical electronic development opportunity. PW-1519, Electronics.

BUSINESS OPPORTUNITY

B.S.E.E., Production Engineer in Electronics industry: would like to manufacture small electro-mechanical devices or parts. Reply MM-1655, Electronics, 520 N. Michigan Ave., Chicago, Illinois.

TUTORING

Correspondence Tutoring; Technical upgrading for technicians, engineering assistants, junior and operating engineers. New methods, simplified systems, fast arithmetic routines, economical cost. "Superior Procedures" Douglas Matthews, 72 Vendola Drive, San Rafael, Calif.

WANTED

ANYTHING within reason that is wanted in the field served by Electronics can be quickly located through bringing it to the attention of thousands of men whose interest is assured because this is the business paper they read.

WANTED

CHIEF ENGINEER

to direct the engineering of medium size nationally known capacitor manufacturer. Capable engineer well versed in the design and development of electrolytic, paper and similar capacitors. Once-in-a-lifetime opportunity. Write giving complete details regarding age, experience, education, etc.

P-1320, Electronics
 520 N. Michigan Ave., Chicago 11, Ill.

CHEMICAL ENGINEER

Experience in Ceramic Type Printed Circuitry Design and Knowledge of Applications thereof Required. Degree Preferred. Write, stating qualifications in full, personal history and salary desired, to

P-1242, Electronics
 1111 Wilshire Blvd., Los Angeles 17, Calif.

Not limited to defense effort.

EXPANDING TUBE PLANT

24 OPENINGS—TO \$15,000

Engineers—Production Men—Cathode Ray Tube Division—A Manufacturer—Unusual oppor. further promotion . . . ASK FOR RAY EDWARDS.

O'SHEA EMPLOYMENT SYSTEM
 64 E. Jackson, Chgo, Ill. Tel. WAbash 2-1884

**E
N
G
I
N
E
E
R
S
&
P
H
Y
S
I
C
I
S
T
S**

for

DEVELOPMENT
and
APPLIED RESEARCH
in

- Radar
- Color Television
- Microwaves
- Antennas
- Servo Systems
- Computers
- Guided Missile Control Systems
- Test Equipment
- Solid State Physics
- Radio
- Vacuum Tubes

Address all inquiries to Employment Director

CAPEHART-FARNSWORTH CO.

(A Division of I. T. & T.)

3701 E. Pontiac Street
Fort Wayne, Indiana

★ IF YOU PLAN TO VISIT THE I.R.E. CONVENTION IN NEW YORK ON MARCH 22, 23 OR 24, MAKE IT A POINT TO CALL OUR SUITE IN THE **HOTEL LEXINGTON** AND ARRANGE A PERSONAL INTERVIEW WITH OUR

MR. JOHN E. GAFFNEY

For Engineers . . .

Clear Horizons ahead

. . . at Goodyear Aircraft Corporation

BUILD YOUR CAREER and help build tomorrow's world with the pioneer and leader in lighter-than-air craft. There's a clear, bright future at Goodyear Aircraft for engineers with talent, aptitude and ambition.

FORCEFUL, CREATIVE THINKING is the key to Goodyear's progressive research and development programs in missiles, electrical and electronic systems, servomechanisms, new special devices and fiber resin laminates. Design and development engineering opportunities are many and varied . . . are now available to capable and imaginative men and women in the field of airships, aircraft and aircraft components.

POSITIONS ARE OPEN in several fields with salaries based on education, ability and experience.

Physicists	Civil engineers
Mechanical engineers	Welding engineers
Aeronautical engineers	Electrical engineers

Openings also exist for personnel with ability and experience in technical editing and writing, art, and motion pictures.

AKRON, HOME OF GOODYEAR AIRCRAFT, is located in the lake region of northeastern Ohio. Cosmopolitan living, year-round sports and recreation, cultural and educational advantages make this thriving city an ideal spot for a pleasant home.

THE TIME TO PLAN A CAREER IS - NOW! Write, giving your qualifications, or requesting an application form.

C. G. Jones, Salary Personnel Department

GOODYEAR AIRCRAFT CORPORATION
AKRON 15, OHIO

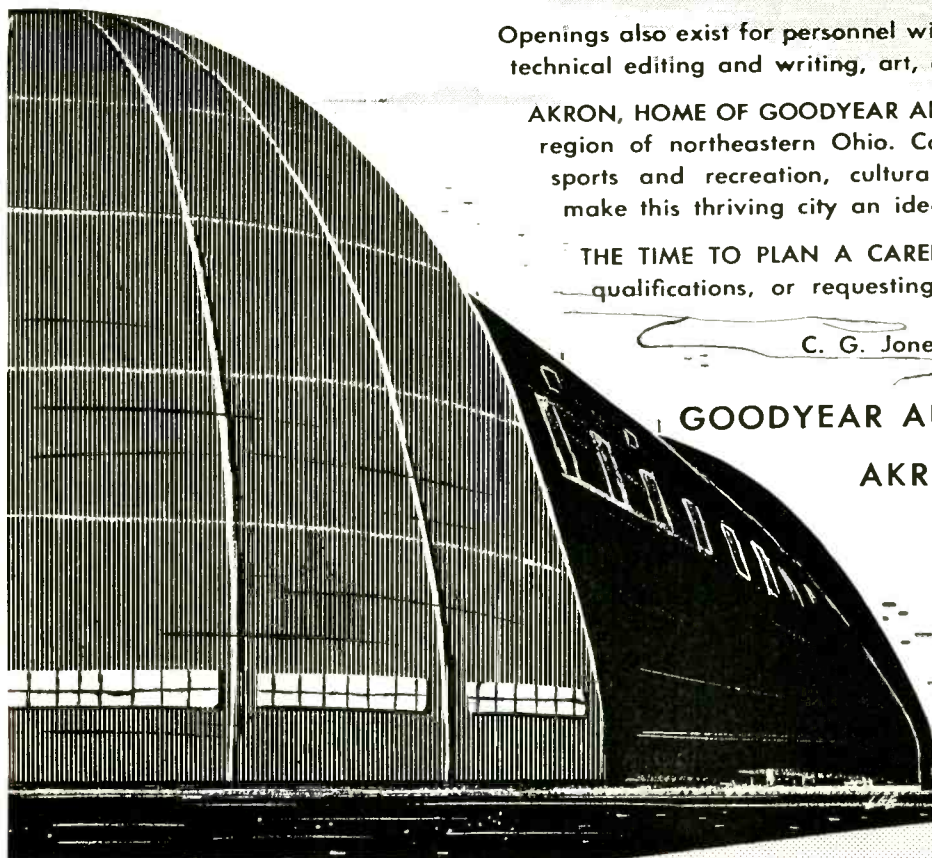

Here are 5 reasons why you will want to come with us if you are a . . .

mechanical engineer

mechanical designer

electrical engineer



1. You can get in "on the ground floor" in the field of electronic computers and associated equipment for use in business machines. This means excellent opportunity for advancement.
2. You can plan your future with a long-established, highly successful Company.
3. You will receive a good salary, plus substantial "fringe" benefits.
4. You and your family will enjoy Dayton . . . a clean, progressive city with outstanding school facilities.
5. You will find NCR a friendly place to work, with employee morale at a high level.

Act at once. Write today to Employment Manager, Department A, describing your education and experience.

THE NATIONAL CASH REGISTER COMPANY, Dayton 9, Ohio

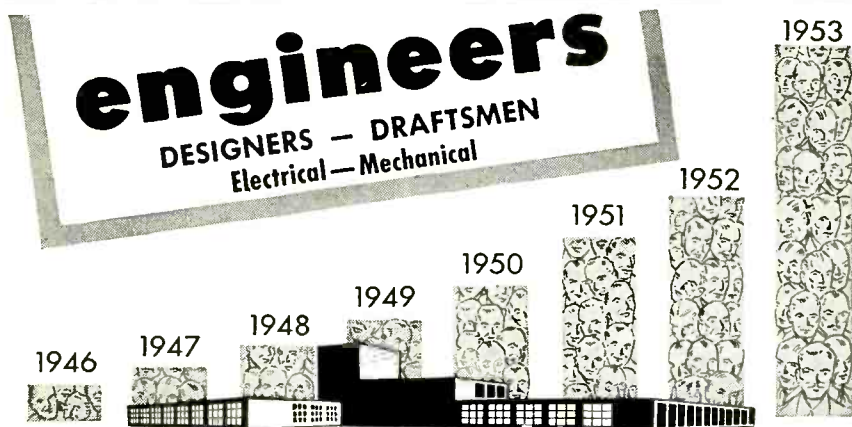

Do YOU belong in this picture of progress?

EXCEPTIONAL project diversification — military and commercial — enables MELPAR to offer you individual recognition, rapid advancement and ground-floor opportunity with a progressive company.

Experience desired in one or more of these or allied fields: Radar • Sonar • Fire Control Systems • Microwave Techniques • Pulse Circuits • Servo Mechanisms • Electro-Mechanical Design • Speech Compression • Small Mechanisms • Antennae Design • Flight Simulators • Subminiature Layout

If you qualify and wish to join this successful, growing organization, write now for further information about a personal interview in your area.

Address: Personnel Director, Dept. E-3.



10 Potter Street, Cambridge, Mass. • 440 Swann Ave., Alexandria, Va.

A SUBSIDIARY OF THE WESTINGHOUSE AIR BRAKE COMPANY

ENGINEERS

Have you developed a "Success Perspective"?

If A year or two of practical experience has given you the youthful maturity that demands more than just a job, you may be interested in our "career opportunities" in color TV, crystal products and electronic tubes.

Submit resume or address request for personal interview to D. Bellat, Personnel Director.

TUNG-SOL ELECTRIC INC.

200 Bloomfield Avenue
Bloomfield, N. J.



*Emblem . . . of Engineering Opportunity . . .
and Professional Progress*

DEVELOPMENT • DESIGN • SYSTEMS ENGINEERING

Consider RCA's engineering opportunities listed below!
For professional association in the field of your choice, write: ➔

John R. Weld, Employment Manager
Dept. 300C Radio Corporation of America
30 Rockefeller Plaza, New York 20, N. Y.

Air Conditioners • Altimeters • Ampule Inspection • Analog Computers • Antenaplex • Antenna Systems • Aviation Radio • Beverage Inspection • Broadcast (AM and FM) • Calibration Equipment • Camera Tubes • Cathode Ray Tubes • Color and Monochrome TV Cameras, Receivers, Studio Equipment, Transmitters • Communications Equipment • Counter Measures • Custom Recordings • Digital Computers • Direction Finders • Early Warning • Electron Microscopes • Electronic Components • Engineering Services • Facsimile Apparatus • Field Services • Gas Tubes • High Fidelity • Industrial Products • Information Displays • Inter-Comm Equipment • Kinescope Tubes • Loran • Microphones • Microwave • Microwave Tubes • Missile Guidance • Mobile Communications • Oscillograph Tubes • Phonograph Records • Photo Tubes • Power Tubes • Public Address Systems • Radar • Radio Receivers • Receiving Tubes • Rectifier Tubes • Semi-Conductors • Servo-Mechanisms • Shoran • Sonar • Sound Film Projectors • Sound Powered Phones • Special Apparatus • Storage Tubes • Tape Recorders • Teletypewriter • Test Equipment • Theater Equipment • Theater Television • Transistors • Tube Parts • "Victrola" Phonographs

Tmke®

M. I. T.

LINCOLN LABORATORY

Staff research positions available for exceptional electrical engineers with advanced training or experience in pulse circuitry and microwave applications.

Please reply to:

Personnel Department, P. O. Box 390,
Cambridge 39, Mass.

Senior and Project Engineers

The Pacific Division, Bendix Aviation Corporation has openings for senior and project engineers in development and production of radar, sonar and telemetering offering excellent opportunities for growth with the corporation and the opportunity to live in Southern California. Positions are open at several levels.

Please Address Inquiries To

W. C. WALKER

ENGINEERING EMPLOYMENT MANAGER

11600 Sherman Way

North Hollywood, California

WANTED

PRODUCT DESIGNER

Experience in Capacitors and Electronic Components Required. Degree preferred but not essential. West Coast's Leading Capacitor Manufacturer. Not limited to defense effort. Write, stating qualifications in full, personal history and salary desired to

P-1241, Electronics

1111 Wilshire Blvd., Los Angeles 17, Calif.

CAREER OPPORTUNITIES for ENGINEERS

Desiring the challenge of interesting and diversified projects—
Wishing to work with congenial associates and modern equipment and facilities—
Seeking permanence of affiliation with a leading company and steady advancement—
Will find these in a career here at **GENERAL MOTORS**.

Positions now are open in **ADVANCED DEVELOPMENT** and **PRODUCT DESIGN**.

COMMERCIAL AUTOMOBILE RADIO

MILITARY RADIO, RADAR AND ELECTRONIC EQUIPMENT

ELECTRONIC COMPONENTS

INTRICATE MECHANISMS such as tuners, telemetering, mechanical linkages, controls, etc.

ACOUSTICS—loud speakers, etc.

Inquiries invited from recent and prospective graduates as well as experienced men with bachelors or advanced degrees in physics, electrical or mechanical engineering.

Salary increases based on merit and initiative.

Vacations with pay, complete insurance and retirement programs.

Relocation expenses paid for those hired.

All inquiries held in confidence and answered—**WRITE** or **APPLY** to
DELCO RADIO DIV. GENERAL MOTORS CORP. Kokomo, Indiana

ENGINEER

A rare opportunity exists with a nationally known manufacturer of capacitors for an electrical engineer or equivalent, experienced with capacitors and capable of directing and handling technical sales and sales correspondence. Write stating age, education, experience, etc.

P-1323, Electronics

520 N. Michigan Ave., Chicago 11, Ill.

ELECTRONIC ENGINEERS

for design & development work
WITH A YOUNG PROGRESSIVE COMPANY

✓ digital techniques

✓ computers

✓ radar

SEND RESUME OF EXPERIENCE AND EDUCATION, WITH SALARY REQUIREMENTS, TO

Electronic Engineering Company of California

180 SOUTH ALVARADO STREET,
LOS ANGELES, 57, CALIFORNIA
DUNKIRK 2-7353



An Opportunity

is offered for intelligent, imaginative engineers and scientists to join the staff of a progressive and self-sustaining, university-affiliated research and development laboratory. We are desirous of expanding our permanent staff in such fields as electronic instrumentation, missile guidance, microwave applications, design of special-purpose electronic computers, and in various other applied research fields of electronics and physics.

Salary structure and benefit programs are on a par with industry. In addition, there are many tangible advantages, such as our self-sponsored internal research policy, of interest to men with ingenuity and initiative.

**CORNELL AERONAUTICAL
LABORATORY, INC.**

BUFFALO 21, NEW YORK



Bendix Aviation Corporation

● **YORK Division . . .**

This NEW division of our nationally-famous corporation has openings for

**ENGINEERS
PHYSICISTS**

Top-flight men in advanced fields of electronic research, development and product engineering are needed for challenging work under ideal conditions in our new, modern plant.

You benefit at Bendix York from our location in the heart of a beautiful suburban area, from high wages, paid vacations and holidays . . . and excellent opportunities for advancement.

Openings at all levels.

Write, Wire or Phone
Department Y-1



**AVIATION CORPORATION ●
YORK DIVISION**

Phone: York 5521

York, Penna.

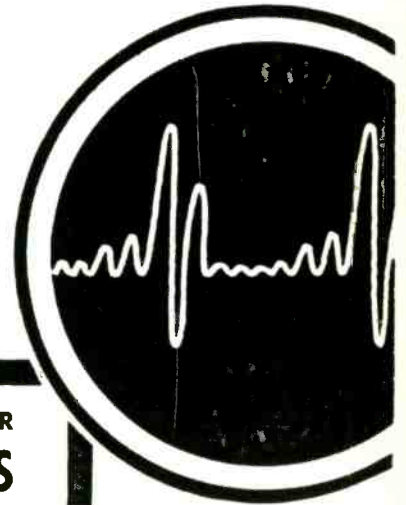
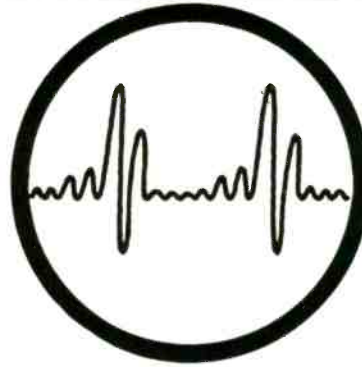

**SPECIAL OPPORTUNITIES FOR
SENIOR ENGINEERS**

Convair in beautiful, sunny San Diego invites you to join an "engineers" engineering department. Interesting, challenging, essential long-range projects in commercial aircraft, military aircraft, missiles, engineering research and electronics development. Positions open in these specialized fields:

- | | |
|-------------------|--------------------|
| Electrical Design | Servo-mechanisms |
| Mechanical Design | Aerodynamics |
| Structural Design | Thermodynamics |
| Structure | Operation Analysis |
| Weights | System Analysis |

Generous travel allowances to those accepted
For free brochure, write Mr. H. T. Brooks,
Engineering Dept. 900

**CONVAIR
IN BEAUTIFUL
SAN DIEGO**

3302 PACIFIC HIWAY
SAN DIEGO 12, CALIFORNIA

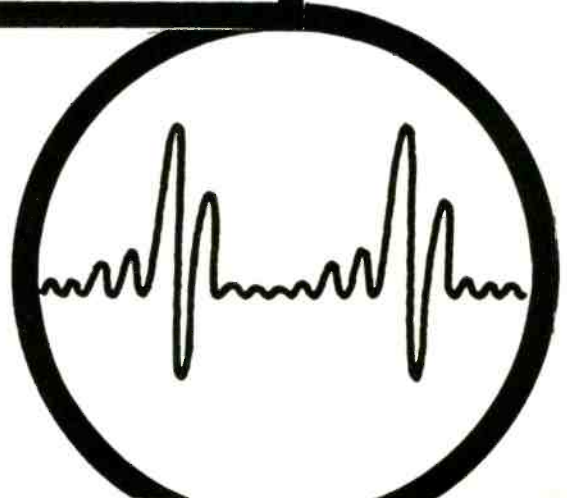



IMAGINATION

Got more than your share? Like to have the freedom to use it, with commensurate recognition? Then, you've come to the right ad!

That is, if you're an electronic or mechanical engineer with practical experience in the electronic industry.

We need engineers with imagination. We're growing and going . . . you're just in time to go with us. You'll enjoy the job plus the advantage of pleasant living conditions in a large, modern city . . . without the disadvantage of big city pressure.

The man to contact is Arthur E. Harrison, Vice-President of Engineering. The time is now! You'll never regret it!

wilcox

Aviation Communications and Navigation
Fourteenth & Chestnut,
Kansas City 27, Mo.

ENGINEERS

**SYSTEMS
RADAR
SERVO
COMPUTER**

BACKGROUND: Responsible positions open for top level development and project engineers with practical and research experience in:

**Advanced Electronic Circuits and Systems
Microwave Radar
Microwave Receivers and Transmitters**



Requirements emphasize advanced analytical and/or management experience on highly complex electronic and electro-mechanical systems.

Kindly send resume and salary requirements to

The W.L. MAXSON Corp.
460 W. 34th St., NEW YORK 1, N.Y.

CHIEF MECHANICAL ENGINEER

This established electronics manufacturer located in the heart of western New York requires a man to head mechanical design group on electronic equipment. Permanent position available for a man with ME degree and experience in electronics or closely allied industry. Fine cultural community in which to live with good schools, homes, and progressive associates. Please write to:

Chief Electronics Engineer
STROMBERG-CARLSON COMPANY
ROCHESTER 3, N. Y.

Why?

ELECTRONICS ENG.

PHYSICISTS

MECHANICAL ENG.

Here Is Why Bendix Radio Is The Place For YOU To Work

Challenging work in The development of:

Radar (Airborne and Ground)
Auto Radio and Test Equip.
Airborne & Mobile Comm. Equip.
Missile Guidance Systems
Computer Applications
Research & Development
(Incl. Transistors and Printed Circuitry)



Excellent salaries.

Semi-annual work reviews with advancement on merit.

Modern, air-conditioned plant located in beautiful suburban area with ample housing, good schools, attractive shopping centers, major league sports.

Numerous employee benefits.

Call, wire or write Mr. L.H. Noggle, Dept. J

Bendix Radio

DIVISION OF BENDIX AVIATION CORPORATION
BALTIMORE-4, MD. Phone VALley 3-2200

RECEIVER ENGINEERS

With Experience in VHF
and UHF Frequencies

Career Opportunities
With Old Established
Central Connecticut Firm

Interesting Projects
Top Salaries
Suburban Living

Replies Held in Strict Confidence
Write or Phone Collect
Personnel Mgr. — SHERwood 7-2741

THE
ALLEN D. CARDWELL MFG. CORP.
Plainville, Connecticut

SALES REPRESENTATIVE needs TWO SALESMEN

Long established Sales Representative carrying well known parts lines is looking for—

A man living in or near Washington, D. C., and a man living in or near New York City.

Prefer a Sales Engineer but will accept a Salesman familiar with Electronics.

These are not desk jobs.

Travel is required in the near vicinity of home, calling on Parts Distributors and Equipment Manufacturers.

Permanent. Good salary and expenses.

My salesmen know of this ad.

ADOLPH SCHWARTZ
ONE EXCHANGE PL.
Jersey City, N. J. DE. 3-2424

SALES MANAGER WANTED

Young growing firm in midwest, manufacturing electronic components, needs capable man as General Sales Mgr. Working knowledge electronic field desirable. Job with unlimited future. Write stating qualifications.

VOKAR CORP. Dexter, Mich.

TRANSISTOR SPECIALISTS

An established manufacturer of communication equipment located in the mid-west needs a physicist specializing in semi-conductors to take charge of transistor development and laboratory manufacture of experimental transistors. Here is a chance for ability to bring tangible results and individual recognition. Ph.D. or equivalent experience. If interested, send resume to

P-1567 Electronics
520 N. Michigan Ave., Chicago 11, Ill.

TRANSFORMER DESIGN ENGINEER Audio & Power

Salaried position—one year minimum design experience required. You should be between 25 and 35 years old.

Write Personnel Manager

COLUMBUS PROCESS CO., INC.
Columbus, Indiana

For further details

Please enclose brief summary of educational background and design experience.

ENGINEERS, EE

- Responsible position involving design and development of H.F. pulse magnetic recording components and systems.
- Also engineers for R.F., I.F. and micro-wave projects.

Small enough to grow...

Large enough to be stable...

These are just two of the advantages of working for Kollsman. In this friendly organization you'll work with intriguing problems concerning the design and development of America's finest aircraft instruments. You'll find the most modern facilities available, and a conveniently located plant only 20 minutes by subway from the heart of Times Square in New York. Not to be overlooked are the generous benefits including paid life, hospitalization, surgical, accident and health insurance.

Please submit resumes to: Employment Manager

KOLLSMAN Instrument Corp.

80-08 45th Ave., Elmhurst, L. I., New York
Phone: NEwtown 9-2900

Stability and opportunity for ELECTRONIC ENGINEERS at the "Laboratory in the Sky"

One of America's leading centers of long-range radio and electronic developments offers outstanding opportunities for accomplishment, advancement and stability. Write for booklet describing projects, facilities and employee benefits.

INTERESTING ASSIGNMENTS IN:

Microwave Links • Pulse Networks • Radar
Direction Finders • Air Navigation Systems
Television Transmitters and Studio Equipment
Antennas • Computers • Guided Missiles
Telephone and Wire Transmission Systems
Microwave and Gas Discharge Tubes • Dielectrics

MAIL THIS COUPON TODAY

Federal
Telecommunication
Laboratories DIVISION OF I.T.T.

A Division of International Telephone
and Telegraph Corporation



Federal Telecommunication
Laboratories
500 Washington Ave., Nutley, N. J.

Please send me a copy of "Your future is with FTL."

Name _____
Address _____
City _____ Zone _____ State _____

ES-3

Westinghouse Expansion Offers You PROFESSIONAL ADVANCEMENT

IMMEDIATE OPENINGS in design, development and application on receiving tubes, power tubes and color cathode ray tubes. Also semi-conductors. Westinghouse is launching a huge expansion program with emphasis in new tube development. This means rapid advancement for you!

WORK CONDITIONS ARE EXCEPTIONAL: Huge new plant and all new equipment. Located at Elmira in the heart of the upstate lake region of New York. With fine schools and housing opportunities available.

Westinghouse offers liberal bonus, stock purchase and retirement pension plans. Opportunity to study advanced courses at company expense.

Write, giving experience to:

Mr. Marvin Mandel
Industrial Relations

Westinghouse Electric Corporation

Box 284, Dept. A

Elmira, New York

PROGRESSIVE ENGINEERS LOOK WEST

Qualified Electronic and Electro-Mechanical engineers find happy association with a Western electronics pioneer and leader.

- DESIGN
- DEVELOPMENT
- PRODUCTION

Commercial and military projects. Radar, DME, Communications, Noise, Test Equipment including color T.V.—Many others with real interest & challenge.

Our representatives will be in New York for personal interviews during week of I.R.E. Convention Mar. 22-27. For advance contact send complete resume with income history & requirements to Engineering Employment Mgr.

Hoffman

LABORATORIES, Inc.

3761 SO. HILL ST.

LOS ANGELES 7, CALIF.

(A Subsidiary of Hoffman Radio Corp.)

production and design ENGINEERS FOR TV COMPONENTS

One of the world's largest manufacturers of electronic components since 1921 — plants in the east and midwest — offers you the opportunity to grow in a dynamic organization.

Are you a qualified engineer, preferably experienced in TV tuners and sweep circuit components?

We invite you to write to us today, detailing your experience in this field.

Address all replies to: Director Industrial Relations
General Instrument Corporation
829 Newark Avenue, Elizabeth, New Jersey

ENGINEER WANTED

Exceptional opportunity with a manufacturer of temperature control instruments for design engineer experienced in electronics. Apply by letter giving age, education, experience and salary required. All letters will be answered and held confidential.

P-1693, Electronics
520 N. Michigan Ave.,
Chicago 11, Ill.

WANTED

ALWAYS BUYING

SMALL AND LARGE LOTS OF
Screws-Nuts-Bolts-Washers
Rivets-Lugs-Eyelets, Etc.
and any & all types of Radio
TV, ELECTRONIC HARDWARE, PARTS etc.

LOUIS E. GANCHER CO.

468-472 WEST B'WAY - NEW YORK 12, N. Y.
"IN RADIO SINCE 1921"

URGENT

Will Buy BC348R Receiver @ \$75.00
BC348H—K and L Receivers \$70.00
Ship via EXPRESS C.O.D., subject to inspection to

H. FINNEGAN
49 Washington Ave., Little Ferry, N. J.

WANTED

Transmitters, Receivers, Panadaptors, Dynamotors, Test Equipment, Technical Manuals, Loading Coils, especially ART-13, ATC, DY-12, DY-17, BC-610, BC-614, BC-939, BC-728, TCS, BC-1031, ARC-1, ARC-3, RTA-1B, LM, BC-221, ARN-7, BC-312, BC-342, BC-348, 32V-2, 75A-1, 30-J, 310B, AR-88, Cash, or trade for new amateur equipment.

ALLTRONICS

Box 19, Boston 1, Mass. Richmond 2-0048, 2-0916

WILL BUY

All ART13/type T47A \$200.00; ART13 type T47 \$150.00; BC348 unmodified \$65.00; BC348 modified \$50.00; APN9 \$200.00; ARC3 complete \$350.00; R77 Receiver \$200.00; ARC1 Radio \$200.00; BC312 \$60.00; BC342 \$60.00; ship via Express C.O.D., subject to inspection to

H. FINNEGAN
49 Washington Ave. Little Ferry, N. J.

WANTED

3B24W TUBES

W-1699, Electronics
330 W. 42 St., New York 36, N. Y.

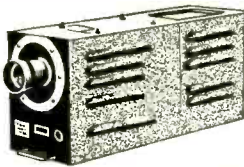

TELEVISION CAMERA

Mfg. DeMott, Type CV-34715 . . . For training and experimental work in the instruction of T.V. techniques. Television studios can adapt it for movie pick-up chain, titles, slides and test patterns. SCANNING: vertical 40-60 FPS, horizontal 13,500-15,800 C.P.S. VIDEO AMPLIFIER: Uses 1848 Iconoscope . . . six stage amplifier and clipper. CAMERA DIMENSIONS: 12 1/2" x 10 1/2" x 2 1/2". WEIGHT: 49 lbs. Used, good condition. . . . \$295.00

SINE-COSINE GENERATORS (Resolvers)

Diehl Type FJE43-9 (Single Phase Rotor). Two stator windings 90° apart, provides two output equal to the sine and cosine of the angular rotor displacement. Input voltage 115 volts, 400 cycle. . . . \$30.00 ea. Diehl Type FPE-43-1 same as FJE-43-9 except it supplies maximum stator voltage of 220 volts with 115 volts applied to rotor. . . . \$25.00 ea.

VOLTAGE GENERATORS (RATE)

ALNICO MIDGET D.C. VOLTAGE GENERATOR Type B-35-D . . . \$17.50
ALNICO MIDGET D.C. VOLTAGE GENERATOR Type B-44-D . . . \$17.50
A.C. GENERATOR: 67 V., 20 Cyc., 2-Phase, .015 Amps. Type PM-1, 1200 R.P.M. . . . \$15.00

400 CYCLE 3-PHASE GENERATOR

120 Volts, 11.7 amps and 28 VDC @ 14.3 amps. Mfg. by HOMELITE . . . equipped with dual V-belt pulley . . . \$275.00

SYNCHRONOUS SELSYNS

110 volt, 60 cycle, brass cased, approx. 4" dia. x 6" long. Mfg. by Diehl and Bendix. Quantities Available. REPEATERS . . . \$20.00 ea. TRANSMITTERS . . . \$20.00 ea.



AUTOSYN MOTOR TYPE 1

115 VAC; 60 cycle; 1-phase; DR. #279 Foot mounted; Mfg. Bendix Aviation Corp. . . . \$15.00 ea.

SYNCHROS

General Electric MOD. 2J15M1; 115-57.5 Volts 400 Cycle . . . \$22.50 ea.
AUTOSYN MTR. KOLLSMAN Type #403; 32 VAC; 60 cycle; single phase . . . \$22.50
AUTOSYN MTR. BENDIX Type #851; 32 VAC; 60 cycle; single phase . . . \$22.50
MICROSYN UNIT, Type 1C-006-A . . . \$35.00
1F Special Repeater (115V-400 Cy.) . . . \$15.00 ea.
2F 3 Generator (115-400 cyc.) . . . \$10.00 ea.
5CY Control Transformer: 90-60 Volt; 60 Cy. . . \$45.00
5F Motor (115/90 Volt-60 cyc.) . . . \$45.00
5SDG Differential Generator (90-94 volts-400 cyc.) . . . \$30.00 ea.
TRANSMITTER, BENDIX C-78248; 115 Volt, 60 Cycle . . . \$25.00 ea.
Differential-C-78249; 115 V., 60 Cy. . . \$5.00
5M MOTOR (115 Volts/60 Cycle) . . . \$22.50
REPEATER, BENDIX C-78410; 115 Volt, 60 Cycle . . . \$37.50 ea.
REPEATER, AC synchronous 115 V., 60 cycle, C-78863 . . . \$15.00 ea.
REPEATER, DIEHL MFG. No. FJE 22-2; 115 Volt; 400 Cy., Secondary 90 V. . . \$27.50
5G GENERATOR (115/90) 60 cycles . . . \$45.00
7G Synchro Generator (115/90 volt; 60 cycle) . . . \$75.00
6G Synchro Generator (115/90 volt; 60 cycle) . . . \$60.00
6DG Synchro Differential Generator (90/90 volt; 60 cycle) . . . \$50.00
215F1 Selsyn Control Transformer: 105-55 Volts; 60 Cycle . . . \$22.50
21D5H1 Selsyn Generator: 115-105 Volts; 60 cycle . . . \$50.00
21J1F1 GENERATOR: 115-57.5 Volt; 400 cycle. . . \$12.50 ea.
21J1H DIFFERENTIAL GENERATOR: 57.5-57.5 Volt; 400 cycle. . . \$12.50 ea.
21J1G1 CONTROL TRANSFORMER: 57.5-57.5 Volt; 400 cycle . . . \$7.50 ea.
215H1 SELSYN GENERATOR: Mfg. G. E., 115-105 Volts, 60 Cycle . . . \$27.50

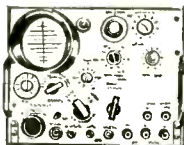

PANORAMIC ADAPTER Model AN/APA-10

Provides four types of presentation: (a) Panoramc (b) Aural (c) Oscillographic (d) Oscillographic. Designed for use with AN/ARR-7, AN/ARR-5, A/N/A P.R. 4, SCR-587 or other equipment with I.F. of 455 kc., 5.2 mc or 30 mc. Includes 21 tubes with 3" scope tube. PRICE . . . \$99.50

**Immediate Delivery
ALL EQUIPMENT FULLY GUARANTEED**
All prices net FOB Pasadena, Calif.

INVERTERS

10563 LELAND ELECTRIC

Output: 115 VAC; 400 cycle; 3-phase, 115 VA; 75 PF. Input: 28.5 VDC; 12 amp. . . . \$59.50

PIONEER 12117

OUTPUT: 28 volts; 400 cycles; 6 volt amperes, 1-Phase. INPUT: 24 VDC; 1 amp. . . . \$25.00 ea.

ALTERNATOR, CARTER

Mfg. Carter Motor Co.; OUTPUT: 7 VAC; 9.7 amp.; 650 cycles, and 295 VDC. 200 amps. INPUT: 26.5 VDC; 10.5 amps; 6500 rpm. . . . \$49.50 ea.

PE 218 LELAND ELECTRIC

Output: 115 VAC; Single Phase; PF 90; 380/500 cycle; 1500 VA. INPUT: 25-28 VDC; 92 amps; 8000 RPM; Exc. Volts. 27.5
BRAND NEW . . . \$39.95 ea.

PE 109 LELAND ELECTRIC

Output: 115 VAC, 400 cyc; single phase; 1.53 amp.; 8000 RPM. Input: 13.5 VDC; 29 amp. . . . \$65.00

MG 153 HOLTZER-CABOT

Input: 24 V. DC. 52 amps. Output: 115 volts — 400 cycles, 3-phase, 750 VA. and 26 Volt — 400 cycle, 250 VA. Voltage and frequency regulated. . . . \$85.00 ea.

PIONEER 12130-3-B

Output: 125.5 VAC; 1.5 amps. 400 cycle single phase, 141 VA. Input: 20-30 VDC, 18-12 amps. Voltage and frequency regulated . . . \$75.00

12116-2-A PIONEER

Output: 115 VAC; 400 cyc.; single phase; 45 amp. Input: 24 VDC 5 amp. . . . \$65.00

10285 LELAND ELECTRIC

Output: 115 Volts AC, 750 V.A., 3 phase, 400 cycle, .90 PF. and 26 volts, 50 amps, single phase, 400 cycle, .40 PF. Input: 27.5 VDC, 60 amps, cont. duty, 6000 RPM. Voltage and Frequency regulated. . . . \$95.00

10486 LELAND ELECTRIC

Output: 115 VAC; 400 Cycle; 3-phase; 175 VA; .80 PF. Input: 27.5 DC; 12.5 amp; Cont. Duty. . . . \$90.00 ea.

PIONEER 10042-1-A

DC INPUT 14 Volts; OUTPUT: 115 Volts; 400 Cycle 1-Phase; 50 Watt. . . . \$75.00

94-32270-A LELAND ELECTRIC

Output: 115 Volts; 190 VA; Single Phase; 400 Cycle; .90 PF. and 26 Volts; 60 VA; 400 Cycle, 40 PF. Input: 27.5 Volts DC 18 amps cont. duty, voltage and freq. regulated . . . \$95.00

PIONEER 12147-1-B

OUTPUT: 115 VAC 400 cycle; Single phase. INPUT: 24-30 VDC; 8 amps . . . \$79.50

MG 149F HOLTZER CABOT

OUTPUT: 28 VAC @ 250 VA; 115V @ 500VA; Single Phase; 400 cycle. INPUT: 24 VDC @ 36 amps . . . \$69.50

EICOR CLASS "A" NO. 1-3012/08-7

OUTPUT: 125 VAC; 400 cycle; single phase; 100 VA. INPUT: 24-30 VDC; 11 amps; Duty int. Voltage and Frequency Regulator . . . \$99.50

HAZELTINE PULSE GENERATOR MODEL 1017

Electrical Characteristics: Pulse Freq: initiating and sliding pulse-external. Pulse Width: initiating and sliding pulses, 10 microseconds. Pulse Amplitude: initiating and sliding pulses, plus 150 volts. Sliding Pulse Delay: variable over full trace length. Sweep Duration: 50, 200, and 1000 microseconds. TUBES: 16-6S47; 3-6AG7; 3-6L6; 2-6J5 st; 2-6SN7 st; 1-5U4 G; 1-6SK7; 1 6Y6G; 1-9J1; 1-9002. Power Input: 110-125 volts, 60 cyc, single phase; batteries none. Dimensions: 13 1/2" x 20 1/2" x 23". Weight 85 lbs. PRICE . . . \$149.50



ALNICO FIELD MOTORS

(Approx. size overall . . . 3 3/4" x 1 1/4" diameter)
DELCO TYPE #5069600: 27.5 volts DC; 250 RPM. . . . \$12.50
DELCO #5069230: 27.5 VDC; 145 rpm. . . . \$12.50
PM Motors Deleco Type #5069371: 27.5 volts; DC Alnico Field; 10,000 R.P.M.; dimensions 1" x 1" x 2" long; shaft extension 1/2" diameter 0.125". . . \$15.00
PIONEER GYRO FLUX GATE AMPLIFIER Type 12076-1-A, complete with tubes. . . . \$22.50

AC CONTROL MOTOR

A. C. SYNCHRONOUS MOTOR Type RBC 2505; Volts 115; Cycles 60; RPM 2; Mfg. HOLTZER CABOT ELECT. Approx. size: 2 1/2" x 2 3/8" x 2 3/8". . . \$15.00 ea.

400 CYCLE MOTORS

EASTERN AIR DEVICES # J33 Synchronous Motor 115 Volt; 400 cycle. . . . \$17.50
PIONEER TYPE CK5 2 Phase; 400 cycles. \$25.00 ea.
EASTERN AIR DEVICES TYPE J494: 115 V; 400; 7000 r.p.m. Single phase 400 cycle. . . . \$17.50 ea.
AIRESEARCH: 115V; 400 CPS; Single phase 6500 RPM; 1.4 amp; Torque 4.6 in. oz.; HP. .03. \$10.00 ea.
EASTERN AIR DEVICES TYPE JM6B: 200 VAC; 1 amp; 3 phase; 400 cycles, 6000 RPM. . . \$12.50 ea.
EASTERN AIR DEVICES, TYPE J31B: 115 V; 400; 1200 Cycle, Single Phase. . . . \$12.50 ea.
AIRESEARCH: AC Induction; 200 V; 3 Phase, 400 Cycle, 2 H.P. 11,000 RPM; 8 amps. . . . \$79.50 ea.
AIRESEARCH: AC Induction, 200 V; 3 Phase, 400 Cycle, 12 H.P. 6500 RPM; 1.5 amps. . . . \$25.00
Electric Motor: PNT-1400-A1-1A Serial No. 207, 208 V., 400 Cycles, 3 Phase Kearfoot Co., Inc. . . \$17.50 ea.

SERVO MOTOR 10047-2-A; 2 Phase; 400 Cycle, with 40-1 Reduction Gear \$17.50

SMALL DC MOTORS

GENERAL ELECTRIC #5BA10AJ18 . . . 27 VDC; RPM 110; 1 oz. FT. . . . \$12.50
DELCO #5069625 . . . 27 VDC; 120 RPM; Governor controlled . . . \$22.50
EMERSON 175; 12 Volt DC; 1/6th HP; 10 amp; 3800 RPM; Approx. size: 2 1/4" x 5". . . \$9.95 ea.
DELCO #5072000: 27.5 VDC; 11.75 rpm. . . \$15.00
DELCO #5068750: 27 VDC; 160 RPM; built-in reduction gears . . . \$12.50 ea.
J. OSTER: series reversible motor: 1/50th H.P.; 10-.000 RPM; 27 1/2 VDC; 2 amps; SPERRY #806069: approx. size 1 1/2" x 3 1/4" . . . \$7.00 ea.
General Electric Type 5AB10AJ37: 27 volts, DC; 5 amps, 8 oz. inches torque; 250 RPM, shunt wound; 4 leads; reversible . . . \$12.50
General Electric, Mod. 5BA10FJ33; 12 oz. inches torque, 12 DC, 56 RPM, 1.02 amp. . . \$15.00 ea.
General Electric Type 5BA10A12C; 27 volts DC; 5 amps, 8 oz. inches torque; 145 RPM; shunt wound; 4 leads; reversible . . . \$12.50
GENERAL ELECTRIC DC MOTOR Mod. 5BA10AJ-64. 160 r.p.m.; 65 amp; 12-oz.-in. torque 27V DC. . . \$12.50
1/4 H.P. MOTOR—Mfg. LEECE-NEVILLE Co.; Type 1454-MO; 24VDC; 4000 RPM; 100 amp. . . \$35.00

115 VOLT GENERATORS

Brand new Eolipse generators: 115 VAC; 9.4 amp; 1000 watts; single phase; 800 cycles, 2400-4200 rpm. DC output is 50 volts at 25 amp. Unit has spline drive shaft and is self-excited . . . \$29.95



MICROPOSITIONER

Barber Colman AYLZ 2133-1 Polarized D.C. Relay; Double Coil Differential sensitive, Alnico P.M. Polarized field, 24V contacts; 5 amps; 28 V. Used for remote positioning, synchronizing, control, etc. \$12.50 ea.

BLOWER

Eastern Air Devices, Type J31B; 115 volt; 400-1200 Cycle; single phase; variable frequency; continuous duty; L & R. #2 blower; approx. 22 cu. ft./min. . . \$15.00



BLOWER: Mfg. John Oster: Type C2A-1B; 27 VDC; .63 amps; 1/100 H.P.; 7000 RPM; Series Wound . . . \$9.95 ea.

BLOWER ASSEMBLY

115 Volt, 400 Cycle, Westinghouse Type FL 17CFM, complete with capacitor. New. . . . \$12.50 ea.

TEST EQUIPMENT TS-45/APM

For measuring relative output power and transmitted freq. of radars and adjusting receivers. Components of the set are a thermistor-type power meter, coaxial line-type freq. meter, a 723A oscillator, attenuator, and a choke coupling. Set is designed for continuous wave operation, with jack provided for external pulsing.

Electrical Characteristics: Freq. Range . . . Airborne X Band. Accuracy: Freq. Meter plus or minus 5 mc.; Power Meter plus or minus 1.5 db. (relative only). Signal input: rf power; minus 10 to plus 37 dbm. Signal Output: C. W. av. power 10 mw (plus 10 dbm). Attenuator: Calibrated, adjustable 0-30 db loss. Power: 110-130 volts, 60-2400 cycles, 55 watts. TUBES: 1-723, 1-6V6, 2-6ZY5G, 1-6SLGT, 1-VR-150-30. Batteries: None. Mechanical Characteristics: 10" x 9 1/2" x 8". Weight: 18 lbs. PRICE . . . \$295.00



BOX 356-X EAST PASADENA STATION • PASADENA 8, CALIFORNIA

AVIONIC INSTRUMENTATION *goes beyond* **DIALS** *and* **POINTERS...**



Current Stock Includes

**INVERTERS • AMPLIFIERS • VOLTAGE REGULATORS
PHASE CHANGERS • TRANSTATS • METERS D.C. & A.C.
SYNCHROS • SERVO MOTORS • AMPLIDYNE
PIONEER AUTOSYNS • RECTIFIERS • G. E. SELSYNS**

Also complete line of FLIGHT, ENGINE & NAVIGATION INSTRUMENTS

AUTHORIZED SALES and SERVICE FOR



**INSTRUMENT
ASSOCIATES**

*Contractors to the U. S. Air Force—
U. S. Navy and Dominion of Canada*

**351 GREAT NECK ROAD, GREAT NECK, N. Y.
Telephone HUter 2-9300**

Write for Catalog NE100

U. S. Export License-2140

Western Union address:
WUX Great Neck, N. Y.

... and so does
... INSTRUMENT ASSOCIATES

a source for

**EMERGENCY REPLACEMENT
 MODIFICATION
 OVERHAUL
 REPAIR
 SALES
 OF**

INSTRUMENTS

INVERTERS

MOTORS

TRANSMITTERS

AMPLIFIERS

RELAYS

GENERATORS

and

ALLIED

COMPONENTS

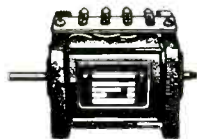
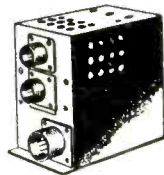
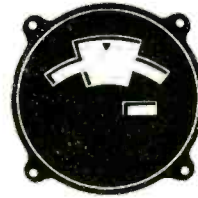
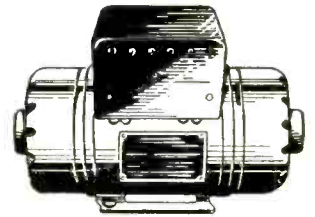

Instrument Associates knows that there is more to an instrument than dials and pointers. Involved in today's instrument panels are Inverters, Transmitters, Amplifiers and a multitude of other electrical and electronic components. Accordingly the laboratories of Instrument Associates are geared to the maintenance and supply of these component units as well as the indicators themselves.

Instrument Associates highly skilled instrument technicians combined with extensive laboratory facilities results in rapid and exacting workmanship. Unusual problems requiring know-how and ability find their solution in our Engineering and Development Department. Whatever your requirements in avionic instruments and their component units look to Instrument Associates for their fulfillment.

C.A.A. APPROVED REPAIR STATION #3564
 INSTRUMENTS CLASS 1, 2, 3, 4,
 LIMITED ACCESSORIES

351 GREAT NECK ROAD, GREAT NECK, N. Y.
Telephone HUnter 2-9300

Western Union address:
 WUX Great Neck, N. Y.

U. S. Export License-2140

Write for Catalog NE100

**INSTRUMENT
 ASSOCIATES**

NEW YORK'S RADIO TUBE EXCHANGE

TYPE	PRICE	TYPE	PRICE	TYPE	PRICE	TYPE	PRICE	TYPE	PRICE	TYPE	PRICE	TYPE	PRICE
OA2	51.00	2J27	15.00	3DP1	7.50	5BP2A	12.00	211	9.95	471A	1.25	803	5.95
OA3	1.10	2J31	24.00	3DP1A	10.00	5BP4	3.95	217C	12.00	527	18.00	805	4.95
OB2	.99	2J32	29.00	3DP1A-52	10.00	5CP1	7.50	242C	10.00	WL530	3.00	807	1.50
OB3	1.10	2J33	32.00	3EP1	5.00	5CP7	6.95	244A	9.50	WL531	22.50	808	1.95
OC3	.96	2J34	36.00	3E29	15.50	5CP7A	14.00	249C	4.25	WL532	1.75	809	2.95
OD3	.89	2J36	90.00	3FP7	5.00	5D21	18.00	250FH	19.95	WL533	15.00	810	3.75
C1B	2.95	2J38	8.95	3HP7	5.00	5FP7	1.95	250TL	12.00	HK654	35.00	811A	10.50
1B21	1.50	2J39	8.95	4A21	2.75	5J1	27.50	274B	2.75	700A/D	10.00	812A	3.95
1B22	1.50	2J40	29.00	3GP1	5.00	5J2	19.50	304TH	10.00	701A	4.50	813	13.75
1B23	6.95	2J42	135.00	4B26	5.40	5JP4	27.50	304TL	10.00	703A	3.95	814	3.75
1B24	12.00	2J49	60.00	4C27	22.50	C6A	11.00	307A	3.50	704A	1.95	815	6.25

TERRIFIC SLASHES in PRICE
up to 70% from PREVIOUS LOW PRICES

1B25	12.00	2J50	55.00	4C28	35.00	C6J	7.50	310A	4.50	705A	1.75	816	1.45
1B26	1.75	2J55	150.00	4E27	16.00	7BP7	5.00	310B	4.95	706AY/FY	25.00	829	11.00
1B27	12.50	2J56	110.00	4J25	150.00	7DP4	9.00	311A	65.00	707A	9.75	829A	12.00
1B32	2.95	2J61	35.00	4J26	150.00	12A2A	50.00	312A	3.50	707B	15.00	829B	15.00
1B38	35.00	2J62	35.00	4J27	150.00	12DP7	24.00	323A	15.00	714AY	18.00	830B	2.00
142	7.50	2K22	15.00	4J28	150.00	LM15	225.00	327A	3.75	715A	4.50	832A	9.95
1B50	23.00	2K23	15.00	4K29	150.00	15E	1.75	328A	6.75	715B	9.00	833A	45.00
1B51	7.50	2K25	27.50	5J30	150.00	15R	.75	350A	10.00	715C	22.50	834	7.50
1B56	35.00	2K26	68.00	4J31	150.00	NE16	.59	350B	5.95	717A	1.50	836	3.95
1B60	35.00	2K28	35.00	4J32	150.00	KY21A	8.25	352A	3.00	718AY/EY	30.00	837	2.75
1N21	1.75	2K29	35.00	4J33	150.00	HK24G	1.50	HK354C	15.00	719A	22.50	838	5.95
1N21B	2.75	2K30	175.00	4J34	100.00	25T	2.95	357A	15.00	720AY/GY 150.00	849	35.00	
1N21C	19.50	2K33A	95.00	4J35	150.00	45 Special	.35	368AS	4.95	721A	3.50	860	3.50
1N22	1.00	2K39	140.00	4J36	150.00	HK39	2.75	371B	1.50	722A	3.50	861	25.00
1N23	1.95	2K41	135.00	4J37	150.00	HP50	1.75	385A	4.50	724A/B	1.50	866A	1.50
1N23A	2.75	2K45	80.00	4J38	150.00	VT52	.35	388A	1.80	724A	1.95	869B	67.50
1N23B	2.75	2K50	175.00	4J39	150.00	HK54	4.50	393A	7.50	724B	2.25	869BX	50.00
1N23C	7.50	2K54	125.00	4J40	150.00	HK72	1.00	394A	3.95	725A	9.00	872A	3.50
1N25	4.50	2K55	125.00	4J41	150.00	FG95	19.95	MX408U	.50	726A	18.00	878	1.50
1N26	6.75	2K56	72.00	4J42	190.00	100TH	7.95	417A	15.00	726B	45.00	879	250.00
1N27	3.50	3AP1A	10.00	4J43	150.00	FG105	20.00	434A	15.00	726C	45.00	880	38.00
1N34A	.79	3BP1	7.20	4J44	150.00	122A	1.75	446A	1.95	728AY/GY	15.00	884	1.50
1N34	2.25	EL3C	5.50	4J45	225.00	203A	7.50	446B	3.95	730A	22.50	885	1.50
2B4	1.25	3C22	99.00	4J46	250.00			450TL	45.00	801A	.90	911A	75.00
2B22	1.75	3C24	1.50	5BP1	3.95			464A	7.50	802	3.95	931A	5.00
2C34	.15	3C31	2.95										

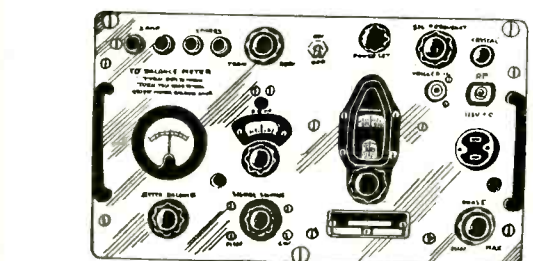

TS-147 C/UP TEST SET
Hard-to-get
X-Band SIGNAL GENERATOR
Now Available

Test Set TS 147 C/UP is a portable Microwave Signal Generator designed for testing and adjusting beacon equipment and radar systems which operate within the frequency range of 8500 MC to 9600 MC.



MICROWAVE TEST EQUIPMENT
TS148/UP
SPECTRUM ANALYZER

Field type X Band Spectrum Analyzer, Band 8430-9580 Megacycles.
 Will Check Frequency and Operation of various X Band equipment such as Radar Magnetrons, Klystrons, TR Boxes. It will also measure pulse width, c-w spectrum width and Q or resonant cavities. Will also check frequency of signal generators in the X band. Can also be used as frequency modulated Signal Generator etc. Available new complete with all accessories, in carrying case.

Other test equipment, used checked out, surplus

- | | | |
|--|-------------------------------------|---|
| TSK1/SE K Band Spectrum Analyzer | TS47/APR 40-400 MC Signal Generator | TS226 Power Meter |
| TS3A/AP Frequency and power meter S Band | TS69/AP Frequency Meter 400-1000MC | TS239A Synchroscope |
| RF4A/AP Phantom Target S Band | TS100 Scope | TS239C Synchroscope |
| TS12/AP VSWR Test Set for X Band | TS102A/AP Range Calibrator | |
| TS13/AP X Band Signal Generator | TS108 Power Load | SURPLUS EQUIPMENT |
| TS14/AP Signal Generator | TS110/AP S Band Echo Box | APA10 Oscilloscope and panoramic receiver |
| TS33/AP X Band Power and Frequency Meter | TS125/AP S Band Power Meter | APA38 Panoramic Receiver |
| TS34/AP Western El Synchroscope | TS126/AP Synchroscope | APS 3 and APS 4 Radar |
| TS35/AP X Band Signal Generator | TS147 X Band Signal Generator | APR4 Receiver |
| TS36/AP X Band Power Meter | TS270 S Band Echo Box | APR5A Microwave Receiver |
| 1-96A Signal Generator | TS174/AP Signal Generator | APT2 Radar Jamming Transmitter |
| TS45 X Band Signal Generator | TS175/AP Signal Generator | APT5 Radar Jamming Transmitter |

MINIMUM ORDER
25 Dollars

YOU CAN REACH US ON TWX NY1-3235

Cables:
TELSERUP

SPECIAL
 Wide Band S Band Signal Generator 2700/3400MC using 2K41 or PD 8365 Klystron, Internal Cavity Attenuator, Precision individually calibrated Frequency measuring Cavity. CW or Pulse Modulated, externally or internally.

Large quantities of quartz crystals mounted and unmounted.
 Crystal Holders: FT243, FT171B others.
 Quartz Crystal Comparators.
 North American Philips Fluoroscopes Type 80.
 Large quantity of Polystyrene beaded coaxial Cable.

LIBERTY ELECTRONICS, INC.
 135 LIBERTY STREET
 NEW YORK 6, N. Y.
 Phone WOrth 4-8262

RELAYS RELAYS RELAYS

MANUFACTURERS—JOBBER—EXPERIMENTERS—LABORATORIES

WRITE OR PHONE WALKER 5-9642 FOR YOUR RELAY REQUIREMENTS

Ask for Mr. Greenberg or Mr. Herzog

We have a large variety of standard types of relays and solenoids for a multiplicity of uses which for various reasons are not listed in our advertising. When inquiring concerning your needs give as much information as possible. Catalog numbers are not sufficient. Give coil voltage; specify AC or DC; give current or resistance; contact current and arrangement.

PRODUCTION QUANTITIES OF MOST ITEMS AVAILABLE. Manufacturing facilities available for prompt delivery of larger quantities of relays made to commercial or JAN specs at competitive prices.

ALL MERCHANDISE IS GUARANTEED AND MAY BE RETURNED FOR FULL CREDIT

A.C. SOLENOIDS



GUARDIAN No. 1: 24 VAC. 6 ohms $\frac{1}{2}$ to $\frac{1}{2}$ " stroke, 6 oz.-in. pull, #R 804.....\$1.95

GUARDIAN No. 4: 115 VAC, 133 ohms $\frac{1}{2}$ to $1\frac{1}{2}$ " stroke, 14 oz.-in. pull, #R805.....3.00

GUARDIAN No. 4: 115 VAC, Intermittent Duty, 49 ohms $\frac{1}{2}$ to $1\frac{1}{2}$ " Stroke, 2 lb.-in. pull, #R904.....3.50

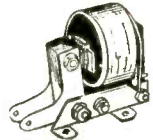

D. W. DAVIS MINIATURE 110 V AC, Intermittent duty, $1\frac{1}{2}$ "x $1\frac{1}{2}$ "x $1\frac{1}{2}$ " stroke, 12 oz.-in. pull, #R178.....1.95

D. W. DAVIS MINIATURE 24V AC, $1\frac{1}{2}$ "x $1\frac{1}{2}$ "x $1\frac{1}{2}$ " stroke, 12 oz.-in. pull, #R179.....1.79

LEACH 980, 110V AC Intermittent duty, $1\frac{1}{2}$ "x $3\frac{1}{2}$ "x $2\frac{1}{2}$ " Hinged type, #R180.....2.25

UNIVERSAL 110V AC, 6-lb. pull, 2x2x $2\frac{1}{2}$ " 1" thrust, #R176.....2.95

A.C. RELAYS

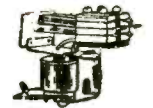

GUARDIAN: 24 VAC, 48 ohm 3A, 1C #R807.....1.49

GUARDIAN: 24 VAC, 48 ohm 2A, 2B 2#R 808...1.49

Guardian	6VAC	2C, 1A	R910	1.95
Sigma 4RZ57	110VAC	1C	R909	1.95
Guardian 200	24VAC	1A†	R274A	1.25
Guardian 200	24VAC	1A, 1C†	R273A	1.49
Clare B19553†	24VAC	2C, 1A	R582	2.75
Leach 1154	50VAC	2A†	R431	2.49
Price 1300: 115VAC; (2C) DPDT; 5 Amp Contacts; #R457P				3.40
Sigma 949: 115VAC; 1B; #R445				4.49
Ward Leonard 105-6512: 115VAC; SPDT; 20 Amp Contacts; #R935				2.50
Allied PO10A115: 115VAC; 4PST 4A; 10 Amp Contacts; #R936				3.95
Potter Brumfield #MRS-A: 115VAC; Intermittent Duty; SPDT; #R937				2.00
Potter Brumfield #SU14A: 115VAC; Intermittent Duty; 3PDT; #R 938				3.00
Advance K1504: 220 VAC; DPDT; #R531				2.00
Advance K1504: 110 VAC; DPDT; #R940				2.00
Guardian 110: 220VAC; 2A; 2B; #R465				2.50
Potter Brumfield KR11A 12-24VAC; DPDT R812 for 6VDC				1.95

* A=Normally Open; B=Normally Closed; C=Double Throw.
† Octal Type Plug Base.
‡ Heavy Duty 10 Amp Contacts.

A.C. ACTUATORS



GUARDIAN 24 VAC 10 ohms #R 809......69

GUARDIAN 24 VAC 15 ohms #R 810......69

GUARDIAN 24 VAC 25 ohm #R 811......69

A.C. RELAY BANK FOR CIGARETTE MACHINES



Guardian No. 53317—Consists of 9 Guardian 24 VAC, 10 ohm relay actuators on metal strip. When each relay is energized the actuator pulls down and is held in place by a mechanical latching arm. It also operates 2 make 1 break contacts. Unit is prewired. #R 803.....7.95

IMPULSE DIAL

To open a normally closed circuit. Ten holes — capacity: 1-10 impulses. Has 3 shunt springs, arranged to make when dial is moved off normal. #D101.....3.50
10 for 30.00



STEPPING SWITCHES

AUTOMATIC ELECTRIC TYPE 13



25 Position: Self Interrupter Springs; Norm. Oper Volts: 25 VDC; Max 30 VDC; 0.6 Amps; 30 Ohm. Three Levels Auto. Elect. RA92; #R900.....17.75

WESTERN ELECTRIC 22 Position: Make & Break Interrupter Springs; Normal Operating Voltage 6VDC; Max 8VDC; 4 ohm; Five Levels #R926.....19.75

WESTERN ELECTRIC 44 Position: Make & Break Interrupter Springs; Normal Operating Voltage 6VDC; Max 8VDC; 4 ohm; Two Circuit Levels #R927.....22.50

Motor Driven

TIME DELAY RELAYS

HAYDON 5901-2; Adjustable Reset timing relay from 0.2 to 1.0 min. in 0.1 sec. steps; SPDT (10 amp) #R931 100V 60 cyc.....7.95

#R932 220V 60 cyc.....7.95

PRICE #4063-7; Adjustable Reset Timer 9 to 54 seconds in 6 sec. steps; DPDT (10 amp) Instantaneous solenoid release, 110V 60 cyc. #R932.....12.95

CRAMER TIME-SWITCH

IC2H: An adjustable time cycle: 2 circuits 110V 60 cps. Contacts 15A. at 110VAC. A knob, pointer & dial can be mounted so that time interval may be PRE-SET, to open 1st circuit from a few minutes up to 60 minutes and 2nd circuit from approx. 70 minutes up to 120 minutes. Cams inside can be adjusted to change time sequence as desired. Contacts may be arranged so that relay circuit will also open after time cycle. Supplied less knob & dial. Knob shaft $\frac{1}{8}$ " L. with $\frac{1}{2}$ "x $3/16$ " stud on end. Size: 3 W. x 4 H. # R933.....5.00
10 for....45.00

AMPERITE THERMOSTATIC DELAY RELAY



NET 2.40 each

Most types from stock. When ordering specify: Voltage—Delay in Seconds—Open or Closed.

Amperite Thermostatic Delay Relays are actuated by a heater AC, DC, or pulsating current. Being hermetically sealed, Amperite Relays are not affected by altitude, moisture, or other atmospheric conditions. At the present time only SPST is available — normally open or normally closed. Available in voltage ratings of 2.5, 5, 6.3, 12, 26 and 115 volts. Delays in seconds are available as follows: 2, 3, 5, 10, 15, 20, 30, 45, 60, 75, 90 and 120 seconds.

WESTERN ELECTRIC MERCURY CONTACT RELAYS

D 171584; SPDT; 1 coil of 4500 ohms plus 24V Heater; High pressure sealed octal plug base. Operating current 6.6 ma; release current 5.2 ma. Overall length— $3\frac{1}{2}$ "; overall diameter — 1-316"; #R1021.....6.95 each
10 for 65 100 for 625

SPECIALS

ALLIED BN18D33; 28VDC 6PDT; 15 Amp Contacts; 175 ohm; #R1011.....5.50

WESTERN ELECTRIC D153835; 28 VDC; SPDT; 100 ohm; High Voltage Keying; 10,000 Volt Insulation; #R1012.....7.50

ALLIED P09D34; 28VDC; 3PDT; 15 Amp Contacts; 230 ohm; #R1013.....3.25

EASTERN AIR DEVICES J31-E17; 400-1600 cycle motor; 115V; 0.65 Amp; Single Phase; 4500 RPM.....7.50

SIGMA GHX2A2A; Differential; 8ma; 1000 ohms; Two Positions; Center Neutral; 2A-2A; #R1014.....12.50

ALLIED SK; 8.5 ma; 4500 ohm; DPDT; #R1015.....2.50

PRICE 1050; 7. ma; 2800 ohm; DPDT; Midget; 1.5 oz; #R1016.....2.25

PRICE 1050; 5. ma; 6500; same as #R1016; #R1017.....2.50

WRITE FOR DETAILS ON OUR X BAND FLEXIBLE WAVE-GUIDE; ROTARY JOINT; TAPERED SECTION; X BAND ANTENNAE, ETC.

KOVAR GLASS TO METAL SEALS HIGH-VOLTAGE FEED THRU

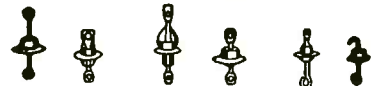

Many types and sizes. Send us your blueprint or sample for our quote. Our prices are a fraction of original factory cost.

SAMPLE KIT 500 postpaid in USA
96 Seals (8 ea. 12 types)
LAB KIT 1500 postpaid in USA
300 Seals (20 types)

AIRCRAFT SOLENOID CONTACTORS

All types B2; B2A; B4; B4A; B5; B5A; B5B; B6A; B6B; B7A; B7B; B8; B9; B11; 1204-1; 1204-3; etc. available from stock in quantities in popular makes at low prices. SEND US YOUR REQUIREMENTS.

CERAMIC INSULATORS, POSTS, ETC. AT FRACTION OF ORIGINAL COST!

Just received—millions of ceramic insulators of all types. Write for catalog.

NOISE & HASH FILTERS

SPRAGUE JX52C; 35 Amps, 100 VDC.....1.10

SPRAGUE JX66; 1 Amp, 130 VAC-400 VDC......60

SPRAGUE JX51N; 10 Amp, 130 VAC-500 VDC......90

SPRAGUE JX71; 7 Amp, 130 VAC, 0-1700 cycles.....1.10

TOBE FILTERETTE 1123; 3 Amp, 60 VDC .35

TERMS:—All prices F.O.B. Our Plant. Rated Firms Net 10 Days; All Others Remittance with Order. Merchandise returnable within 10 days for full credit.

324 CANAL ST., N.Y.C., 13, N.Y. Walker 5-9642

Universal general corp.



COMPASS COMMUNICATIONS CO.

A Division of COMPASS ELECTRONICS CORP.

A WELL-INTEGRATED ORGANIZATION WITH FACILITIES AND TRAINED PERSONNEL FOR—

- DESIGN, MODIFICATION, PRODUCTION, AND TESTING OF COMMUNICATIONS AND RADAR EQUIPMENT
- SUPPLY AND DISTRIBUTION OF ALL TYPES OF EQUIPMENT AND TUBES

WE MAINTAIN OUR OWN FULLY EQUIPPED TESTING LABORATORY TO TEST AND GUARANTEE ANYTHING WE SELL

FIELD TRANSMITTERS

SCR-284—The famous mobile and ground equipment station for field use, complete with all accessories. 3.8–5.8 mcs; 20 watts cw, 5 watts phone.
SCR-510—Mobile, portable FM radio station. Operates from 6, 12, or 24 volt dc supply. 20.0 to 27.9 mcs.
SCR-610—Same as SCR-510, but with built-in speaker; 27.0-38.9 mcs.
SCR-508, 528—Mobile FM radio station, operates from 12 or 24 volt dc. 20.0-27.9 mcs.
SCR-608, 628—Same as SCR-528, but with range: 27.0 to 38.9 mcs.
BC-325—400 watts cw, 100 watts mcw or phone operates from 110 or 220 volts ac. 1.5-18.0 mcs. Master oscillator or crystal control. 5 channels.

We Have Hundreds of the Above Transmitters in Stock

MARINE TRANSMITTERS and RADIO TELEPHONES

TDE—Navy or commercial marine transmitter, complete 110 & 220 volts dc and ac. 125 watts.
TBK—Navy high frequency transmitter, 2-20 mcs; 500 watts output. Supplied complete with m/g and starter for dc or ac operation.
TBM—same transmitter but with speech input equipment to give 350 watts phone.
TBL—Navy all-wave transmitter; 350 watts output; cw and phone. Supplied complete with m/g and starter for dc or ac operation.
TAJ—Navy transmitter, 175-550 kcs; 500 watts output. Supplied complete with m/g and starter for ac or dc operation.
TBN—200-3,000 kcs, complete with 220/440 volt, 3 ph. 50-60c power supply—conservatively rated at 1 kw. output.

ET-8012—RADIOMARINE (RCA) radiotelephone — 75w output, 2-3 mcs—10 channels.

224-B—WESTERN ELECTRIC — radiotelephone, 125w output, 2-3 mcs, 10 channels, telephone dial selection, with selective ringer.

TCS—COLLINS—Navy radiotelephones for shipboard and mobile use, complete with all accessories for operation from 12, 24, 110, 230 volts dc and 110 or 220 volts ac—4 channels—40 watts cw, 20 watts phone—1.5-12.0 mcs.

14C—WESTERN ELECTRIC—800 watts cw—400 watts phone—10 channel automatic dial selection—2.0-22.0 mcs, with 220 volt, 1 ph, 50-60 cycle power supply.

ET-8010—RADIOMARINE (RCA)—Commercial and Coast Guard type transmitter — 350-500 kcs, 200 watts cw, mcw.

ET-8019—RADIOMARINE (RCA)—Commercial and Coast Guard type hf transmitter—200 watt cw, 170 watts mcw—2.0 to 22.1 mcs in 4 bands.

ET-8023—RADIOMARINE (RCA)—Commercial and Coast Guard type hf transmitter—200 watts cw & mcw—2.0 to 22.1 mcs—similar to ET-8019, but in larger console.
FT-102 (or 167BY)—FEDERAL (Mackay)—Commercial and Coast Guard type hf transmitter 2.0 to 22.1 mcs, 200 watts cw and mcw.

SPARE PARTS

FOR MANY OF THESE SETS, COMPLETE AND NEW IN ORIGINAL CASES

SPECIAL PURPOSE and TRANSMITTING TUBES

This Is A Sample Listing • Write for Other Items & Unlisted Prices

Tube#	Selling Price	2K54	150.00	720DY	90.00
O1A	write	2K55	100.00	721A	3.75
OC3	\$1.60	3B24	5.40	723A/B	25.00
OD3	1.50	3B27	10.00	724B	6.50
C1A	6.00	3B28	5.00	725A	write
C1B	7.00	3C31	5.75	730A	45.00
C5B	2.95	3E29	14.00	803	7.00
C6A	write	4C27	25.00	807	1.65
C6F	12.50	4C28	35.00	813	9.00
C6J	write	4D32	22.50	829A	12.00
10Y	.90	4E27	17.50	832A	10.00
VR-92	1.70	4J25	175.00	833A	39.50
1B22	3.95	4J26	175.00	836	3.95
1B23	10.00	4J28	175.00	837	1.45
1B24	write	4J29	175.00	843	.50
1N23B	2.50	4J30	write	849	27.50
2B22	4.95	4J31	175.00	851	45.00
2B26	3.75	4J33	190.00	860	5.00
2C40	18.00	4J34	195.00	861	25.00
2C44	1.20	4J42	225.00	865	1.25
2C43	25.00	4J51	300.00	872A	3.85
2D21	1.70	4J52	285.00	874	1.50
2D29	write	5J23	write	889R	195.00
2E22	3.75	5J26	125.00	891R	210.00
2J21	17.50	5J29	write	892	150.00
2J22	17.50	6C21	29.50	892R	250.00
2J26	27.50	100TH	9.00	2X2879	1.05
2J27	27.50	204A	60.00	1616	2.75
2J31	27.50	211	1.00	1619	.75
2J32	27.50	250TH	30.00	1624	2.00
2J33	35.00	250TL	30.00	1625	.65
2J34	write	304TH	9.75	1626	.75
2J36	100.00	304TL	9.75	1629	.65
2J38	49.50	307A	5.00	1636	1.50
2J39	49.50	339A	35.00	1642	3.50
2J42	75.00	371B	2.50	2050	2.00
2J49	65.00	388A	2.75	5611	100.00
2J50	75.00	415GL	37.50	8012	4.25
2J55	62.50	446A	2.00	8014A	55.00
2J56	145.00	446B	3.75	8020	3.50
2J61	55.00	450TH	45.00	8025	7.00
2J62	55.00	450TL	45.00	9001	1.20
2K22	write	464A	9.50	9002	1.00
2K25	26.00	705A	3.25	9003	1.20
2K26	100.00	706A-GY	45.00	9004	.50
2K29	35.00	707B	12.50	9005	1.90
2K36	write	715B	17.50	9006	.50
2K45	100.00	717A	1.50		
		720	write		

ALL TUBES GUARANTEED • ALL PRICES ARE FOB OUR WAREHOUSE AND SUBJECT TO CHANGE WITHOUT NOTICE

TEST SETS

- TS-3A/AP
- TS-10A and B
- TS-12/AP
- TS-13/AP
- TS-16/AP
- TS-35/AP
- TS-36/AP
- TS-62/AP
- TS-69A
- TS-74/UPM
- TS-89/AP
- TS-100/AP
- TS-101/AP
- TS-125/AP
- TT-173/UR
- TS-278
- TS-323
- OAP
- OBU
- LAE
- LM
- LE-19
- I-46
- I-56
- I-208
- I-222
- SCR-211 and others
- AIRBORNE RADAR
- APS-2
- APS-3
- APS-4
- APS-6
- APS-10
- APS-13
- APS-15
- SCR-717
- SCR-720

TS-69/AP FREQUENCY METER, Range 340-1,000 mcs. Uses 0-200 microammeter; Excellent...\$75.00

This Month's SPECIAL OFFERS

SN-RADAR—10 cm—Compact, light and portable, ranges of 5 and 20 miles. Uses 5CPI scope. Operation is from 115 volts, 60 cycle, but we can supply converter for dc operation...\$850.00 ea

ANTENNA ASSEMBLY—Reflector is a lightweight parabolic cylinder, Ass'y has both manual and motor drive. Ideal unit for labs, classroom demonstration, small craft, etc...\$99.50 ea

APR-4—38-4000 mcs. precision receiver, complete w/5 tuning units. Operates on 115/160...\$1700.00 ea

MAG—10cm. remarkable link radar, portable, operated from 6 volt battery, uses folding antenna and tripod. A pair at...\$1750.00

APS-3—3 cm—Airborne radar for search and homing, 5-in. scope. 10 brand new sets at...\$750.00 ea

APQ-13—Very late model airborne radar set, complete and new. One only at...\$2,950.00

SCR-545—Complete radar set, less vehicle, antenna and power plant, pretty fair condition, sold as-is at \$1,375.00

RECEIVERS and TRANS-CEIVERS

- ARB
- ARC-1
- ARC-3
- ARC-4
- ARC-5
- AR-88
- CR-91
- SLR
- RAK
- RAL
- RAO
- RBB
- RBO
- RBG
- RBL
- REB
- RBM
- RCH
- BC-224
- BC-312
- BC-314
- BC-344
- BC-348

MARINE RADAR

- SA
- SC
- SD
- SF
- SN
- SO-1, 8, 13
- SQ
- VG
- VJ
- YG
- SG
- SJ
- SK
- SL
- YJ
- BG
- BM
- BN

MOTOR GENERATORS CONVERTERS • INVERTERS DYNAMOTORS

We Have One of the Largest Stocks of Electrical Conversion Equipment in the East, including All Types of Rotating Machinery and a Variety of DC and AC Magnetic Starters and Controllers from 100 Watts to 100 Kilowatts

ESCO ROTARY CONVERTERS — Mounted in Steel Drip-Proof Boxes —Type R-1-41. Filtered Input 110 volts, 2.5 amps. 3600 rpm. Output 110/1/60 @ 1.8 amps, 200 watts \$45.00

ESCO MOTOR GENERATORS — Dual unit (a) Input 32 v dc @ 8 amp. Output 110/1/60 @ 1.5 amps, 165 va 150w. 1800 rpm. (b) Input 32 volts dc @ 16 amps. Output 260 volts, 1500 cycles @ 4 amps. Rating 1.05 kva, 3,000 rpm. Filtered. These two units are mtd. together on bed plate, complete with control panel containing switch & 0-50 v dc meter. \$32.50 ea. part.

MOTOR - GENERATOR - ALTERNATOR—Mfr.—Quality Electric Co. Ltd. Input 115/1/60 ac @ 22.5 amps, 1800 rpm. Outputs: #1. 500/1000 v dc, 0.25/0.3 amp., 0.125/0.3 kw. #2 150 v dc, 0.667 amp., 0.1 kw. #3. 115 v ac 0.87 amp., 3000 cycles, 0.1 kva. PF-1...\$245.00

ESCO CONVERTER — Input 110 volts dc. Output 110 volts ac @ 1.2 amps. Brand new...\$45.00

ALLIS CHALMERS CONVERTER 110 volts dc to 110 volts ac @ 1.25 kva output...\$165.00

PINCOR ROTARY CONVERTER — Input 110 volts dc. Output 220/1/60, 0.300 kva; 90 pf; 3000 rpm; cont. duty; 40°C. Filtered for Radio use...\$60.00

CONTINENTAL MOTOR-GENERATOR—350 watts. Type CC-21991—Wt. 148 lbs. Input 115 volts dc @ 5.7 amps, 0.625 hp. Output 115 volts ac 1 ph., 60 cycles @ 3.04 amps, 1800 rpm, 0.85 pf, 40°C temp. rise, sep. excited. Filtered...\$95.00

WESTINGHOUSE ELECTRIC GENERATOR—10 KVA—AC. Output 115/1/60 @ 108.5 amps; 80 pf; 50°C; cont. duty 1800 rpm, sep. excited, 125 dc. DC generator Output 125 volts dc @ 8 amps. This generator is mounted on bed plate with room for motor mounting. It can be driven by any mechanically coupled motor, dc or ac or other drive...\$495.00

MOTOR GENERATOR 800-1D — Input 24-28 volts dc. Output 115 v, 800 cycles at 10.5 amps. Small and compact...\$29.50

M-209 — Holtzer-Cabot — Filtered. Input 115/1/60. Output 115 volts, 3φ, 233 cycles; at 0.4 amps and 24 volts dc at 6.5 amps. 3500 rpm. \$125.00

MG-149 — Holtzer-Cabot Inverter. \$49.50

21F1 SELSYN — 115-57.5v. 400 cycles \$4.45

5F, 5G — SYNCHRO — 115 v, 60 cycles...\$30.00

POWER UNIT TYPE 23 — Rotary transformer, filtered. Input 24 vdc. Output 6.3 volts at 2 amps and 300 volts at 30 ma...\$19.50

And, of course, PE-73, PE-94, PE-98, DM-25, -28, -32, -33, etc.

JUST ARRIVED MOTOR GENERATOR

In: 115 Vac. Out: 220-250 vdc @ Special price...\$50.00

OUR EXPORT DEPARTMENT AVAILABLE FOR SPECIAL SERVICE TO OVERSEAS CUSTOMERS

393 GREENWICH STREET NEW YORK 13, N. Y.
 All phones: BEEKMAN 3-6509 Cable Address: COMPRADIO, N. Y.

COMPLETE LINE OF RECEIVING TUBES

GUARANTEED BRAND NEW

TUBE SPECIALS!

STANDARD BRANDS ONLY

WRITE FOR OUR NEW BULLETIN

Type No.	Price	Type No.	Price	Type No.	Price	Type No.	Price	Type No.	Price	Type No.	Price	Type No.	Price	Type No.	Price	
OA2	\$ 5.95	2449	\$65.00	5CP1	\$4.95	OK-82	\$65.00	39A	\$4.50	575A	\$20.58	677	\$52.25	715B	\$8.95	
OA3	1.25	2450	39.50	5CP7	9.50	VT-62	22.50	5551	\$62.50	579B	14.70	WL-681	3.85	715C	19.50	
OA4G	1.25	2454	67.00	5D23	19.50	RM-63	14.80	WE-274A	5.50	410R	185.00	5550	44.10	717A	1.47	
OB2	1.19	2456	148.50	5D22	14.80	FC-67	14.80	274B	2.85	WE-412A	3.75	HY615	49	700A	24.50	
OB3	1.19	2461	45.25	4-250A	35.00	MY-67	7.85	WE-281A	8.50	417A	16.95	700B	24.50	718AY	45.00	
OC3	1.10	2465	165.00	5FP7	1.95	VT-67	4.80	WE-283A	4.25	434A	24.50	KU-623	39.50	700C	24.50	
OD1	3.95	2K23	37.50	5HP1	5.50	72	1.32	WE-294A	5.75	446	1.75	624	47.00	700D	24.50	
EL-C1B	3.73	3AP1	8.95	5LP4	5.75	304TH	8.75	446A	1.95	531	1.95	KU-627	19.50	701A	6.95	
1B21A	2.65	2K26	78.50	5J26	325.00	RM-75	4.25	304TL	12.95	446B	2.95	KU-629	11.70	703A	5.95	
1B22	2.65	2K25	28.50	5J27	18.50	75T	5.80	307A	4.25	451	1.25	631P1	5.00	704A	9.95	
1B23	9.50	2K29	27.50	5J29	26.50	VR-75	1.15	WE-310A	6.25	471A	2.55	WL-	5.00	705A	2.25	
1B24	12.95	2K33	185.00	5J22	26.50	VR-78	6.4	312A	3.95	473	140.25	632B	26.10	706A	45.00	
1B24 West	12.95	2K33A	195.00	5J4A	26.50	FC-81A	3.95	316A	89	481A	4.31	KU-634	42.50	706B	45.00	
1B24A	39.50	2K55	135.00	5MP1	10.50	WE-346A	2.75	507AX	1.47	509AX	1.25	5551	707A	7.95	706C	45.00
1B25	2.75	2K59	135.00	6-5B	8.85	FC-95	25.00	WE-346A	2.75	507AX	1.47	5551	707A	7.95	706D	45.00
1B27	14.95	3AP4	10.25	6A	6.75	VT-98	1.95	350B	4.95	527	17.50	WL-654	62.50	707B	14.90	
1B29	2.75	3B22	2.75	6AN5	3.58	8F	19.50	WE-356B	5.45	530	22.00	659	82.00	708A	4.75	
1B32	2.75	3B23	135.00	6B	6.75	318A	6.95	318A	6.95	531	7.50	WL-670A	8.70	709A	3.85	
1B35	11.00	3B24	2.50	6C21	27.50	C100E	2.50	371A	5.95	532A	3.75	WL-672	22.00	713A	1.35	
1B36	17.50	3B24W	7.50	6C24	52.50	100TH	9.95	371B	5.95	559	2.50	672A	34.30	714A	10.75	
1B37	14.95	3B25	4.25	5LP4	21.95	WL-101F	1.95	388A	2.95	561A	3.20	KU-676	52.25	715A	6.25	
1B38	32.50	3B26	4.75	6CJ	9.95	WE-101F	1.95									
1B40	4.95	3B27	4.20	6J4	6.85	FC-104	29.95									
1B41	51.94	3B28	7.75	6EL	5561	FC-105	19.95									
1B42	9.80	3BP1	4.75	5528	12.50	FC-105	29.95									
1B49	50.33	3C22	89.50	7-7-11	1.19	VR-105	1.60									
1P21	35.00	3C23	9.85	7BP1	8.65	VU-1115	1.60									
1P23	4.10	3C24	9.85	7BP7	6.40	WE-1186	3.32									
1P24	2.27	3C27	6.95	7BP12	14.95	MY-114B	.75									
1P28	10.00	3C28	13.95	7CP1	14.95	FC-123A	7.75									
1P29	2.89	3C1B-3	7.05	7CP1	14.95	FC-123A	7.75									
1P30	2.85	3C37	32.50	9CP7	11.75	WE-124A	3.80									
1P31	1.34	3C38	12.95	10V	4.50	FC-127A	22.50									
1P32	9.50	3CP1	16.95	10V	4.50	FC-127A	22.50									
1Z1	3.75	3D21	2.98	10T1	8.8	AB-150	12.50									
1Z1A	3.75	3D22	4.85	10V	4.50	CF-150	48.50									
2AP1	8.95	3DP1A	14.75	12DP7	14.75	FC-150	48.50									
2AP5	8.95	3E29	13.75	12GP7	18.50	FC-127	29.50									
2AP6	8.95	3E29	13.75	12MP7	14.75	FC-127	29.50									
2C21	.65	3F7	7.50	13R	6.55	FC-130	39.15									
2C26	.95	3FP7A	6.95	13T4	.85	MF200	16.50									
2C26A	4.95	3HP7	7.85	13R	6.55	1L-200B	65.70									
2C33A	.39	3HP7	7.85	13R	6.55	203A	7.40									
2C34	.49	3JP12	11.50	15G	4.70	203B	6.33									
2C39	22.00	3J31	145.00	15G	4.70	204A	6.33									
2C39A	29.00	3J32A	29.50	15G	4.70	204B	6.33									
2C40	12.00	4-250A	35.00	21-2	.65	21L	12.50									
2C42	13.75	4B22	35.00	RM-21	1.65	21D	.95									
2C44	1.70	4B22	35.00	24G	5.85	21D	.95									
2C45	21.95	4B24	8.95	24G	5.85	21E	12.50									
2C51	5.20	4EL-5B	9.75	FC-27A	8.85	21E	12.50									
2C52	11.75	4EL-5B	9.75	FC-27A	8.85	21E	12.50									
2C53	11.75	4EL-5B	9.75	FC-27A	8.85	21E	12.50									
2E1	1.95	4EL-6CF	8.95	FC32	6.75	21E	12.50									
2E2	1.85	4B32	10.50	F538	22.54	21E	12.50									
2E24	4.10	4C27	17.50	RM34	4.95	227A	4.60									
2E3	3.26	4C28	21.00	35T10N	4.95	WE-231D	2.25									
2E21	8.75	4C35	27.00	35T10N	4.95	WE-231D	2.25									
2J21	9.50	4J36	150.00	4-250A	35.00	232CH	240.00									
2J22	8.95	4K500A	36.00	4-250A	35.00	4K-233A	4.95									
2J27	32.50	4X	115.00	CE-48	1.90	WE-249B	6.50									
2J31	37.50	4X150A	36.00	CE-48	1.90	WE-249B	6.50									
2J32	36.50	4X	115.00	CE-48	1.90	WE-249B	6.50									
2J33	39.50	1000A	129.36	EF-50	.79	WE-249C	5.50									
2J34	37.00	5AP1	2.50	FC-27	8.85	250R	17.50									
2J37	13.70	5AP4	4.75	5A	5.60	250TH	22.50									
2J38	17.50	4EL-C5B	3.95	RM59	2.44	250TL	22.50									
2J39	16.50	5BP1	6.00	QK-60	5.00	WE-254A	5.50									
2J40	34.50	5BP4	5.50	SK-60	6.62	WE-254A	5.50									
2J48	49.50	5C22	47.75	QK-61	65.00	WE-257A	3.77									

"X" BAND ACCESSORIES

AT-48/U Pick Up Horn Antenna \$9.95
 Type "N" Mating Connectors available
 UG-81/U Waveguide to Co-ax Adapter \$12.95
 UG-163/U Adapter \$2.85

SYNCHROS

Size 1, 3, 5, 6, 7 and 8 generators, motors, control transformers, differential generators, and differential motors in stock.

AY-101D	5F	M	C-69406-1
AY-120D	5G	N	C-78248
AY-130D	5N	X	C-78249
1CT	6DG	2J1F1	C-78410
1F	6C	2J1G1	C-78411
5B	7G	2J1H1	C-78415
5CT	7C	C-44968-6	C-79331
5D	A	C-56701	C-78254
5DG	B	C-69405-2	C-78670

SEND FOR COMPLETE LISTING
 SYNCHRO CAPACITORS IN STOCK

PULSE TRANSFORMERS

IN STOCK—IMMEDIATE DELIVERY

UTAH

OA-18	9278	9340
X-12AT	9280	9341
9262	9318	9350

G.E.—K2464; K2468; K2469; K2744B; 68G627; 68G828; 68G929G1; 80G13; 80G152
 WESTINGHOUSE—132AW2; 139DW2F; 166AW2F; 176AW2F; 187AW2F.
 RAYTHEON—UX-7850; UX-10060.
 PHILCO—352-7071; 352-7149; 352-7150; 352-7178; 352-7190; 352-7224.
 W.E.—D-161810; D-163247; D-163325; D-164601.

REVERSIBLE GEAR HEAD MOTORS

G.E. 5BA10AJ65—27.5 VDC .60A 2.35 RPM 8 oz-ft Torque	\$27.50
G.E. 5BA10FJ18—24 VDC .51A 9.5 RPM 10 oz-in Torque	\$22.50
G.E. 5BA10FJ19—24 VDC .51A 56 RPM 12 oz-in Torque	\$22.50
G.E. 5BA10AJ41—PM 24 VDC .55A 140 RPM 10 oz-in Torque	\$19.50
G.E. 5BA10AJ52—27 VDC .7A 145 RPM 14 oz-in Torque	\$19.50
Delco 5069230—PM 27VDC 145 RPM	\$19.50
Delco 5068750—27 VDC 160 RPM	\$22.50
G.E. 5BA10AJ51—27 VDC 160 RPM .65A 8 oz-in Torque	\$19.50
Delco 5069600—PM 27 VDC 250 RPM	\$22.50
G.E. 5BA10AJ8—27 VDC 250 RPM .72A 8 oz-in Torque	\$19.50
Delco 5067127—PM 27.5 VDC 250 RPM	\$22.50
Delco 5068820—PM 27 VDC 250 RPM	\$22.50
G.E. 5BA10AJ37B—27 VDC 250 RPM .8A 8 oz-in Torque	\$19.50

TACHOMETER GENERATOR

Elenco type PM-1M, DC Tachometer Generator—New \$27.50

MERCURY RELAY

SPDT 5 Amp mercury wetted, glass sealed contacts; Oper. coil-36 VDC, 4500 ohms, pulls in at 8 MA; Non-induct. heater Coil-

BIGGEST & BEST in Surplus Communications Eqpt!

WESTERN ELECTRIC 250/350 WATT RADIOTELEPHONE EQPT.

- ★ ALL NEW, UNUSED EQPT. NOT GOV'T. SURPLUS.
- ★ 30 CHANNELS TRANSMIT & RECEIVE, CRYSTAL CONTROL, 2—20 MC RANGE.
- ★ MONITORS 3 SEPARATE CHANNELS SIMULTANEOUSLY.
- ★ MOTOR DRIVEN CHANNEL SWITCHING.
- ★ VOICE OPERATED CARRIER, OR PUSH-TO-TALK, AS DESIRED.
- ★ SALT AIR CORROSION RESISTANT, HERMETICALLY SEALED TRANSFORMERS, ETC.
- ★ IDEAL SUBSTITUTE FOR SCR-299, 399, OR 499 EQPT.

The Model 248A Radiotelephone Equipment was developed at Bell Telephone Laboratories to furnish powerful, dependable radiotelephone communication, especially on the high seas. It is ideal for ship installation, and fixed-radio installation, since its design and construction are of the highest possible degree.

Each 248A Equipment consist of: 1-48A Radiotelephone Transmitter; 1-48A Radio Receiver (cabinet has provision for a total of 3 receivers, the 48A Receiver provides 10 channels in the 2-6 MC range; a 48B Receiver provides 10 channels in the 4 to 20 MC range, available at additional cost. The 2nd and 3rd receiver may be either a 48A or 48B, available at extra cost); 1-43A Control Unit (may be installed remotely); and, 1-104A Antenna Tuning Unit (medium frequency). A 104B Antenna Unit with whip antenna for the higher frequency, is available at additional cost.

The 48A Radiotelephone Transmitter provides 30 channels of transmission, all crystal controlled, and is rated at 250 watts output. However, a Western Electric Modification Kit is supplied with each, which will increase the power to 300/350 watts. Features of this transmitter include automatic variable-gain audio amplifier; sidetone (hearing of one's own voice in the telephone receiver); interlock safety relays; provision for Selective Ringer installation within cabinet (up to 3 units, 1 for each receiver) for automatic selective calling; motor driven switches for channel selection, controlled by the 43A Remote Control Unit which incorporates a telephone handset, monitoring loudspeaker; ventilating fan for cooling and providing filtered air within cabinet; hinged transmitter and individual receivers for easy access to parts, etc.

Operation of this equipment is from 115 V., 50/60 cycles AC.
This equipment is NOT GOVERNMENT SURPLUS, and is NEW—UNUSED. Additional accessories and full spares also available. Priced far below original selling price!!

WRITE FOR DESCRIPTIVE LITERATURE AND PRICES.

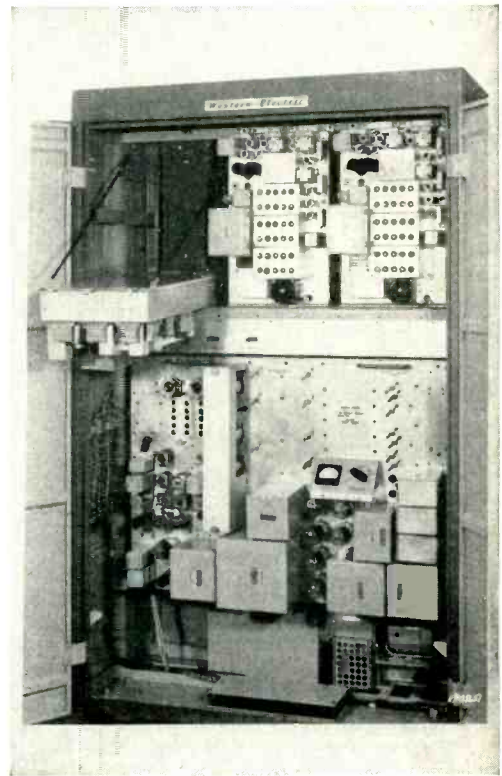

SCR-610 Crystals, in sets (120 channels) or individually. TESTED. Write for PRICES.

EXTRA!

PE-104 POWER SUPPLIES for Receiver of SCR-284, NEW, with Spare Vibrator, Export-Packed. Large Quantity Available. WRITE FOR PRICES.

W. E. MODEL 107A SELECTIVE RINGER

Latest design W.E. Selective Ringer, for use with any size Ship-to-Shore Radiotelephone. Operates from radiotelephone's receiver to ring bell when shore telephone operator has call for you. Compact, easily installed. Dim. 15 3/4" L. x 8 1/2" H. x 5 3/4" W. Nt. 18 lbs. NEW EQPT. with instruction book. PRICE EACH\$135.00

PE-218C, D, E & H INVERTERS, BRAND NEW, 25-28 V. DC Input, 115 V. AC, 400 cycles 1.5 KVA output. WHILE THEY LAST. EACH\$14.95

GE 10 KW POWER AMPLIFIERS with RECTIFIERS

BRAND NEW, not war surplus, 10 KW FM Power Amplifiers with associated separate Power Rectifiers, designed for boosting low power FM broadcasting stations. Can be used for increasing power of television stations (sound portion), or by changing L and C can be converted to power amplifier on other frequencies. Present range 88-108 MC. Rectifier Power Supply delivers approximately 5,000 V. at 18.4 KVA. Operates from 220 V., 50/60 Cycles, 3 phase AC. Power Amplifier uses 2 GL5518 (not supplied) forced-air cooled GE high frequency tubes. Includes internal blower system, reflectometer amplifier (with tubes) and GL-800S rectifier tubes. Beautifully constructed, new equipment at terrific price savings! PRICE, Type BF-3-A 10 KW RF FM Amplifier and Separate Rectifier, less RF Final Tubes...\$4,000.00 RECTIFIER ONLY, if desired. WRITE FOR PRICE.

EXTRA!

PE-104 POWER SUPPLIES for Receiver of SCR-284, NEW, with Spare Vibrator, Export-Packed. Large Quantity Available. WRITE FOR PRICES.

TRANSMITTERS—RECEIVERS, ETC.

TDQ VHF 100-156 MC 50W, AM X-mtr for 110 V. 50/60 C. AC.
V-50/60 C. AC.
BC-797 VHF 110-126 MC. 50W. AM Output for 110 V. 50/60 C. AC.
BC-460 Collins Autotone Transmitter.
250 W. A1. 200 W. A3 or A2, 10-Channels 2-16 mc.
BC-147, 300 W. A1, 4-13.4 mc. 2-channels.
SCR-510/610. FM Trans-Receiver, 20 to 28 and 28 to 37 mc respectively. With PE-117 or 120 Vibrator Power Supply and other accessories.
SCR-619. FM. Trans-Receiver, 27 to 38.9 mc, complete with all accessories, NEW units.
SCR-522. VHF, 4-Channel, 100-156 MC Trans-Receiver. Eqt. for Plane or Ground Communications.
SCR-511. Walky-Talky, 3-6 MC, Crystal Controlled. Trans-Recv. with Plug-in Units for Freq. Changing.
BC-611 and MAB IANDY and WALKIE-TALKIES.
SCR-300 (BC-1000) WALKIE-TALKIES, 40-48 MC 2 channel FM Trans-Receiver.
SCR-284 Field Radio Equipment. A1-A3 emission. Complete with all Accessories.
BC-221 Frequency Mixers. Excellent condition. Complete with crystal and matching Calibration Book.
BC-312/342 Receivers. Like New Units.
BEACHMASTER 250 & 500 WATT SOUND SYSTEMS for Airports, Shipyards, Amusement Parks, Civilian Defense, Etc. Write for Prices and Literature.
TCS X-mtr-Receiver for Ship or Shore.
TCS Accessories available; Remote Controls, Antenna, Loading Coils, Etc.
TBK HF 500W 2-20 Mc. Transmitter with MG. Starter, and Spares.
TAJ 500 W. Output, 175-550 Kc. with M.G. for AC or DC operation.
TAQ. Same as TAJ above but 1,000/1,500 W. output with MG.
TBL 350 W. Output, A1, A3, IF, & H.F. for AC or DC operation.
PE-75U Gas Engine Generators. NEW, w/Spares.
T-21/GR-3-C Sound Ranging Microphones for locating Artillery Fire.
NAA Underwater Beacon Equipment.
APN-4 Loran Eqt. R-9A/APN-4 Receivers and 1D-6A & 6B Indicators, with tubes, crystal, etc. Reconditioned to like-new. WRITE FOR PRICES.
GO-9 100/125 W. JP/HF Ship or Aircraft Transmitter, A1 and A2 Emission. All New with Spares.

WRITE FOR PRICES

CABLE ADDRESS: TELEMARINE, N. Y.

— TELEMARINE — COMMUNICATIONS CO.

3040 W. 21st Street, Brooklyn 24, N. Y.
Phone: ES 2-4300

RECEIVERS

BC-969-T1 Receivers 15 to 150 KC
BC-971-T2 Receivers 100 KC to 20.0 MC
RAK Navy low and Int. Freq. Receivers
RBS Navy low & HF Receivers
BC-224 1.5 to 18.0 MC, similar to BC-348
BC-312, 342 1.5 to 18.0 MC Receivers
BC-1066-A 155-200 MC Receivers
Also, RCK (VHF) VHR-101A (VHF), SCR-F (80-550 KC & 1.9 to 24.0 MC), CRV-45136, APR-4, Etc.
DZ-2 DIRECTION-FINDERS, Aircraft or Marine, 15 to 17.50 KC in 6 bands, for 24/28 V.D.C. operation. With 34" or 55" Loop Extension Shaft. Complete, NEW eqpt. with Dynamotor, Loop, Extension Shaft and Control, Cables, Instruction Manual, etc., all export packed in 2 cases per set.

WRITE FOR PRICES

SCR-296-A SHORE RADAR

Designed to determine accurately range and azimuth of surface craft and to furnish this information for fire (shore battery) control purposes. It is a fixed radar installation with following Specs:
Range—100,000 yards max., Min. 500 yards.
Accuracy—plus or minus 20 yards (max. range).
Azimuth—360 degree. Peak Power 40 KW.
Indicators—5" Class A scope for Range; 3" for Azimuth.
Frequency—700 MC (43 centimeters).
Operation—120 V. 60 cycles A.C.
Excellent, like new material, complete with all amplidydes, servos, synchros, concentric transmission line and plumbing, tubes, spare parts, etc., in 29 cases per set. WRITE FOR PRICES, or further details.

EXPORTERS, GOVERNMENT AGENCIES, INDUSTRIALS!

We have a large stock of Transmitters, Receivers, Walkie-Talkies, VHF Equipment, Ship & Shore Communications, FM Broadcast Stations, Radar, Accessories, etc. Write and tell us of your requirements. Descriptive literature and prices available upon request.

COMMUNICATIONS EQUIPMENT CO.

MICROWAVE COMPONENTS



"S Band,"

RG48/U Waveguide

POWER SPLITTER for use with type 726 or any 10 CM Shepherd Klystron. Energy is fed from Klystron antenna through dual pick-up system to 2 type "N" connectors. \$22.50 EACH

DIRECTIONAL COUPLER. Broadband type "N" Coupling, 20 db. with std flanges, Navy # CABV47AAN-2 (as shown) \$37.50

- LHTR. LIGHTHOUSE ASSEMBLY. Parts of RT39 APG 5 & APG 15, Receiver and Trans. Cavities w/assoc. Tr. Cavity and Type N CPLG. To Recvr. Uses 2C40, 2C43, 1B27, Tunable APX 2400-2700 MGS. Silver Plated. \$32.50
- BEACON LIGHTHOUSE cavity p/o UPN-2 Beacon 10 cm. Mfg. Bernard Rice, each. \$32.50
- MAGNETRON TO WAVEGUIDE Coupler with 721-A Duplexer Cavity, gold plated. \$45.00
- 721A TR BOX complete with tube and tuning plungers \$12.50
- MENALLY KLYSTRON CAVITIES for 701R or 2K28 \$4.00
- WAVEGUIDE TO 1/2" RIGID COAX "DOORKNOR" ADAPTER CHOKE FLANGE SILVER PLATED BROAD BAND \$32.50
- AS14A AP-10 CM Pick up Dipole with "N" Cables \$4.50
- OAJ ECHO BOX, 10 CM TUNABLE. \$4.50
- HOLMDELL-TO-TYPE "N" Male Adapters, W. E. #D107284 \$2.75
- I.F. AMP. STRIP: 30 MC, 30 d.b. gain, 4 MC Bandwidth, uses 6AC7's—with video detector, A.F.C. less tubes \$24.00
- BEACON ANTENNA, ASSI/APN-7 in Lucite Ball. Type "N" feed. \$22.50
- ANTENNA, AT49A/APR: Broadband Conical, 300-3300 MC Type "N" Feed. \$12.50
- "E" PLANE BENDS, 90 deg. less flanges. \$7.50

X Band—

RG 52/U WAVEGUIDE

- HORN FEED, Mounted at end of 1' run. Designed to be used with dish reflector. \$15.00
- VSWR Measuring Section. Consisting of 6" straight section, with 2 pick-up, type "N" Output Jacks. Mounted 1/2" Wave apart. \$8.50
- 1" x 1/2" waveguide in 5' lengths. UG 39 flange to UG40 cover. per length \$7.50
- Rotating-joints supplied either with or without deck mounting. With UG40 flanges. each, \$17.50
- Bulkhead Feed-thru Assembly. \$15.00
- Pressure Gauge Section 15 lb. gauge and press nipple. \$10.00
- Pressure Gauge, 15 lbs. \$2.50
- Directional Coupler, UG-40/U Take off 20db. \$17.50
- TR-ATR Duplexer section for above. \$8.50
- Waveguide Section 12" long choke to cover 45 deg. twist & 2 1/2" radius, 90 deg. bend. \$4.50
- Waveguide Section 2 1/2 ft. long silver plated with choke flange. \$5.75
- Rotary joint choke to choke with deck mounting \$17.50
- 90 degree elbows. "E" plane 2 1/2" radius. \$12.50
- Microwave Receiver, 3 CM. Sensitivity: 10-13μ Watts. Complete with L.O. and AFC Mixer and Waveguide Input Circuits, 6 I.F. Stages give approximately 120 DV gain at a bandwidth of 1.7 MC. Video Bandwidth: 2 MC. Uses latest type AFC circuit. Complete with all tubes, including 723A/B Local Oscillator. \$175.00
- ADAPTER, waveguide to type "N", UG 81/U, p/o TS 12. TS-13, etc. \$14.50
- ADAPTER, UG-163/U round cover to special bit. Flange for TS-45, etc. \$2.50 ea.

1 1/4" x 5/8" WAVEGUIDE

- VSWR SECTION, 6" L, with 2-type "N" pickups mounted 1/2" wave apart. \$7.50
- GG 98B/APA 13 1/2" Flex. Sect. 1 1/2" x 5/8" OD. \$7.50
- X Band Wave GD 1 1/2" x 5/8" O.D. 1/16" wall aluminum. per ft. 75c
- Slug Tuner Attenuator W.E. guide, gold plated. \$6.50
- BI-Directional Coupler. Type "N" Takeoff 25 db. coupling. \$27.95
- BI-Directional Coupler. UG-52. Takeoff 25 db. coupling. \$24.00
- Waveguide-to-Type "N" Adapter. Broadband. \$22.50

JAN WAVEGUIDE FLANGES

- UG 39/U\$1.10
- UG 40/U\$1.25
- UG 40A/U\$1.65
- UG 51/U\$1.65
- UG 52/U\$3.40
- UG 52A/U\$3.40

MICROWAVE MIXER

CV-12/APR-6: Waveguide/mixer unit, 4000-6000 mc. Designed for use with microwave receiver. Has pick up loop for coupling to lighthouse cavity local oscillator. RF input is to 1" x 2" waveguide (contact flange). Output (thru In21 ext.) is from standard 50-ohm coax connector. Brand new, complete with crystal. As shown. \$35.00



MAGNETRONS

Type	Freq. Range (MC)	Peak Power Out (KW)	Duty Ratio	Price
2J21A	3345-9405	50		\$5.75
2J22	3267-3333	265		7.50
2J27	2965-2992	275	.002	19.95
2J31	2820-2860	285	.002	24.50
2J32	2780-2820	285	.002	28.50
2J38*	3249-3263	285		16.50
2J39*	3267-3333	8.7		24.50
2J48	9310-9320	50	.001	24.50
2J49	9000-9160	50	.001	59.50
2J56*	9215-9275	50	.001	132.50
2J61†	3000-3100	35	.002	34.50
2J62†	2914-3010	35	.002	34.50
3J31	24-27MHC	50	.001	85.00
4J34	2740-2780	900	.001	125.00
5J23	1044-1056	475	.001	49.00
700B	690-700	40	.002	22.50
700D	710-720	40	.002	39.75
706EY	3038-3069	200	.001	32.50
706CY	2976-3007	200	.001	32.50
725-A	9345-9405	50	.001	Write
730-A	9345-9405	50	.001	24.50
4J38	3550-3600	750	.001	169.45

*—Packaged with magnet.
†—Tunable over indicated range.

KLYSTRONS

723A	\$12.50	2K25/723A/B	\$27.50
723A/B	19.50	417-A (Sperry)	17.50

70 W. C.W. MAGNETRONS

These tubes provide a simple, rugged, inexpensive source of C.W. energy. An inexpensive power supply is all that's required.

CHARACTERISTICS

Heater: 6.3 v, 3.8 A. Power out: 70 W. CW
Anode V: 1250 V. Anode current: 125 ma.
Pk. Input: 200 Watts Av. input: 100 W

Each tube is packaged with an integral magnet, and is tunable over the range shown below:

TYPE RANGE (MC.)	TYPE RANGE (MC.)
KY 602840-3005	QK 612975-3170
QK 623135-3330	

Price \$85 ea.

-IN STOCK-

- AIA ASH S0-8
- APA-9 BG SG-1
- APA-10 DAS† SJ-1
- APN-3 DBS† TAJ
- APN-7 APT-2 TBK
- APN-9* APT-4 TBL
- APS-2 MKIV SCR520*
- APS-3 MKX SCR521
- APS-4 RC145 SCR518
- APS-6 RC148
- ASD S0-1

* COMPONENTS. † LORAN EQUIPMENT

-TEST SETS-

- TS-10 TS-12 TS-159
- TS-36 TS-56 TS-268
- TS-47 TS-34 TS-270

THERMISTORS

- D-164699 Bead Type DCR: 1525-2550 Ohms @ 75 Deg. F. Coefficient: 2% Per Deg. Fahr. Max. Current 25 MA AC/DC. \$2.50
- D-167332 Bead Type, DCR is 1525-2550 Ohms. Rated 25 MA at .825-1.175 VDC. 1.35
- D-167613 Disk Type DCR: 355 Ohms @ 75 Deg. F. P. M. 2.5%, 1 Watt 1.35
- D-166228 Disk Type 7120 Ohms @ 60°F. 4220 Ohms @ 80°F. 2590 Ohms @ 100°F. 1640 Ohms @ 120°F. 1.35

10 CM R.F. HEAD

Complete R.F. Head and Modulator delivers 50 KW Peak R.F. at 3000 MC. Pulsed delivers 12KW pulse at 12 Amp. to magnetron of .5, 1, or 2 microsec. duration at duty cycle of 001. Unit requires 115V, 400-2400 Cycles, 1 phase @ 3.5A. Also 24-28 VDC @ 2A. External sync. Pulse of 120V Reg'd. Brand New. Complete with schematic and all tubes. \$375.00

3 CM. ECHO BOX

Cavity has a "Q" of 30,000 and is tuned by means of an internal 24 vdc motor. Unit is tunable over a range of 80 mc. When motor is left on, the tuning plunger goes thru the tuning range three times per minute. During the tuning motion, an eccentric cam on the mechanism causes an additional flutter action of the tuning disk at approximately 200 cycles per minute. This flutter range curves about 15 mc. This eliminates need of stopping the motor at the peak of the signal, and also gives a characteristic pattern to the echo signal. Input is to type "N" input jack. **\$32.50**

PULSE NETWORKS

- 15A-1,400-50: 15 KV. "A" CKT, 1 microsec. 400 PPS, 50 ohms imp. \$37.50
- G.E. #3E (3-84-810) (8-2.24-405) 50P4T; 3KV "E" CKT Dual Unit: Unit 1, 3 sections, 0.84 Microsec. 810 PPS, 50 ohms imp.; Unit 2, 8 Sections, 2.24 microsec. 405 PPS 50 ohms imp. \$6.50
- 7-5E3-1-200-67P. 7.5 KV. "E" Circuit, 1 microsec. 200 PPS 67 ohms impedance 3 sections. \$7.50
- 7-5E4-16-60, 67P. 7.5 KV. "E" Circuit, 4 sections 16 microsec. 60 PPS. 67 ohms impedance. \$15.00
- 7-5E3-3-200-67P. 7.5 KV. "E" Circuit, 3 microsec. 200 PPS. ohms imp. 3 sections. \$12.50
- KS8865 CHARGING CHOKE: 115-150 H @ .02A. 32-40H @ .08A. 30,700V Corona Test, 21KV. Test \$37.50
- G.E. 25E5-1-350-50 P2T. "E" CKT. 1 Microsec. Pulse @ 350 PPS. 50 OHMS Impedance. \$69.50
- KS9623 CHARGING CHOKE: 16H @ 75 MA, 380 Ohms DCR, 3000 Vac Test. \$14.95
- SPRAGUE H-615 "E" Circuit 10KV, 0.85 microsec. pulse at 750 PPS. 50 ohms. \$27.50
- SPRAGUE H-618, "E" Circuit, 10KV, 2.2 microsec. pulse at 3.755 PPS—50 ohms. \$27.50

PULSE EQUIPMENT

- MIT. MOD. 3 HARD TUBE PULSER: Output Pulse Power 144 KW (12 KV at 12 AMP). Duty Ratio: .001 max. Pulse duration: 5, 1.0, 2.0 microsec. Input voltage: 115 v. 400 to 2400 cps. Uses: 1-71B, 4-90-1P, 6-72's, 1-7's. New. Less Cover. \$135
- APQ-13 PULSE MODULATOR. Pulse Width .5 to 1.1 Micro Sec. Rep. rate 624 to 1348 Pps. Pk. pwr. out 35 KW Energy 0.018 Joules. \$49.00
- TPS-3 PULSE MODULATOR. Pk. power 50 amp. 24 KW (1200 KW pk); pulse rate 200 PPS. 1.5 microsec. pulse line impedance 50 ohms. Circuit series charging version of DCR Resonance type. Uses two 705-A's as rectifiers, 115 v. 400 cycle input. New with all tubes. \$49.50

PULSE TRANSFORMERS

- RAYTHEON WX 4298E: Primary 4KV., 1.0 UEOC. SEC: 16KV-16 AMP. DUTY RATIO: .001 400 CYCLE FIL. TRANS. "BUILT-IN". \$42.50
- W E C O: KS 9948: Primary 70 ohms; Sec: 50 ohms. Plate Voltage: 18 KV. Part of APQ-13. \$12.50



- GE #K-2449A Primary: 9.33 KV, 50 ohms Imp. Secondary: 28 KV, 450 ohms Imp. Pulse length: 1.0/5 usec @ 635/120 PPS. Pk Power Out: 1,740 KW Bifilar: 1.5 amps (as shown) \$62.50
- GE #K-2748-A. 0.5 usec @ 2000 Pps. Pk. Pwr. out is 32 KV Impedance 40:100 ohm output. Pri. volts 2.3 KV Pk. Sec. volts 11.5 KV Pk. Bifilar ratio at 1.3 Amp. Fitted with magnetron well. \$39.50
- K-2745. Primary: 3.1/2.8 KV, 50 ohms Z. Secondary: 14/12.6 KV 1025 ohms Z. Pulse Length: 0.25/1.0 usec @ 600/600 PPS. Pk. Power 200/150 KW. Bifilar: 1.3 Amp. Has "built-in" magnetron well \$42.50
- K-2461-A. Primary: 3.1/2.6 KV—50 ohms (line). Secondary 14/11.5 KV—1000 ohms Z. Pulse Length: 1 usec @ 600 PPS. Pk. Power Out: 200/130 KW. Bifilar: 1.3 Amp. Fitted with magnetron well \$39.75
- UTAH X-1517-1: Dual Transformer, 2 Wdgs. per section 1:1 Ratio per sec 13 MH inductance 30 ohms DCR. \$7.50
- UTAH X-1507-1: Two sections, 3 Wdgs. per section. 1:1:1 Ratio, 3 MH, 6 ohms DCR per Wdg. \$7.50
- 68G711: Ratio: 4:1 Pri: 200V. Sec. 53V, 1.0 usec Pulse @ 2000 PPS, 0.016 KVA. \$4.50
- TR1049 Ratio: 2:1 Pri. 220 MH, 50 Ohms, sec. 0.75 H. DCR 100 Ohms. \$6.75
- K-904695-501: Ratio 1:1. Pri. Imp. 40 Ohms. Sec. Imp. 40 Ohms. Passes pulse 0.6 usec with 0.05 usec rise. \$8.95
- Ray UX 7896—Pulse Output Pri. 5v sec. 41v. \$7.50
- Ray UX 8442—Pulse Inversion—40v + 40v. \$7.50
- PHILCO 352-7250, 352-7251, 352-7287
- RAYTHEON: UX8693, UX5986 \$5. ea.
- W.E. D-166310, D-166638, KS9800, KS9948.
- UTAH #9262, with Cracked Beads, but will operate at full rated capacity. \$5.00
- UX 8693 (SCS #229627-54); 3 Wdgs. 32 turns #18 wire. DCR is: 362/372/4 ohms. Total voltage 2500 vdc. \$5.00

MOD. MCG BATTLE AMPLIFIER

Entire unit consists of 2-250 watt amplifiers mounted in a 7 ft. cabinet together with tube chock device, 31.50 signal generator, and distribution panel. Both amplifiers feature variable volume compression. Output stage consists of P-P parallel 809's. Used, but in excellent condition, complete with all tubes; operates from 115 v, 60 cy. 1 phase. \$350

MAIL ORDERS PROMPTLY FILLED. ALL PRICES F.O.B. NEW YORK CITY. SEND M.O. OR CHECK. ONLY SHIPPING SENT C.O.D. RATED CONCERNS SEND P. O. ALL MDSE SUBJECT TO PRIOR SALE AND PRICES SUBJECT TO CHANGE WITHOUT NOTICE. PARCELS IN EXCESS OF 20 POUNDS WILL BE SHIPPED VIA CHEAPEST TRUCK OR RAILEX.

131 Liberty St., New York 7, N. Y. Dept E-3 Chas. Rosen Phone: Digby 9-4124

COMMUNICATIONS EQUIPMENT CO.

POWER TRANSFORMERS

Comb. Transformers 115V/50-60 cps Input

CT-013	450-0-450V @ 200 MA, 10V/1.5A, 2.5V 3.5A 5V/3A	6.95
CT-341	115V @ 25V @ 2.5V @ 1.2V @ 1.5A 2x2.5V/3A, 6.3V @ 3A	9.95
CR 825	360VCT .340A 6.3VCT/3.6, 5.3VCT/3A, 2.5/10, 5V/10	.95
CT-071	110V .200A 33/200, 5V/10, 2.5/10	4.95
CT-367	580VCT .050A 5VCT/3A	2.25
CT-403	350VCT .026 A 5V/3A	2.75
CT-931	585VCT .086 A 5V/3A, 6.3V/6A	4.25
CT-456	390VCT 80 MA 6.3V/1.3A, 5V/3A	3.45
CT-442	525VCT 75 MA 5V/2A, 1 CT/2A, 50V/200 MA	3.85
CT-43A	600-0-600V, 0.8A, 2.5VCT/6A, 6.3VCT/1A	6.49
CT7-501	650VCT/200MA, 6.3V/8A, 6.3V/5A	6.49
CT-444	230-0-230V, 0.85A, 5V/3A, 6V/2.5A	3.49

Filament Transformers 115V/50-60 cps Input

Item	Rating	Each
FT-140	5VCT @ 10A 25KV Test	\$22.50
FT-157	4V/16A, 2.5V/2.75A	2.95
FT-101	6V/25A	.79
FT-924	5.25A/21A, 2x7.75V/6.5A	14.95
FT-824	2x25V/2.5A, 16V/1A, 7.2V/7A, 6.4V/10A, 6.4V/2A	8.95
FT-463	6.3VCT/1A, 5VCT/3A, 5VCT/3A	5.49
FT-55-2	7.2V/21.5A, 6.5V/6.85A, 5V/6A, 5V/3A	8.95
FT-38A	6.3/2.5A, 2x2.5V/7A	2.79

Plate Transformers, 115V 60Cy Input

PT 175	550-0-550VAC (400VDC) @ 150MA	\$6.30
PT 157	660-0-660 VAC (500VDC) @ 350-0-350 VAC (400VDC) at 250 MADC	8.70
PT 158	1880-0-1880V (1000VDC) at 125MA Plus 500-0-500 VAC (400VDC) at 150MADC Simult. Ratings	10.80
159	980-0-980 VAC (750VDC) or 800-0-800 VAC (600VDC) at 225 MADC	10.35
PT 167	1400-0-1400 VAC (300MADC) or 1175-0-1175 VAC (1000VDC) at 300MADC	25.80
PT 168	2100-0-2100 VAC (1750VDC) or 1800-0-1800 VAC (1500VDC) at 300MADC	33.00
PT 062	2900-0-2900 VAC (2500VDC) or 2385-0-2385 VAC (2000VDC) at 30MA	48.00

10 KW TRANSMITTER KIT

- 1) Plate XFMR: Amertran 33134. Pri: 198/220/240V, 60 cy., 1 ph. Sec: 3650V, 16.7 KVA, 30 KV Insulation. Oil Immersed.
- 1) Reactor, Modulation. Amertran 33153. 50 H @ 3.0 amps. DCR 80 ohms. Freq. .03 cy. to 10 KC. Level: 63 DB. 40 KC Test. Impedance: 3000 ohms. A great value. Both units (Trans. & Choke) for **\$630**

400 CYCLE TRANSFORMERS

(All Primaries 115V. 400 Cycles)

Stock	Rating	Price
352-7102	6.3V/2.5A	1.45
M-7472426	1450V/1.0MA, 2.5V/.75A, 6.4V/3.9A, 5V/2A, 6.5V/3A, P/O 1D-39/AFG-13	4.95
352-7039	640VCT @ 380MA, 6.3V/.9A, 6.3V/6A 5V/6A	5.49
702724	9800/8600 @ 32MA	8.95
K59584	5000V/290MA, 5V/10A	22.50
K59607	734VCT/177A, 1710VCT/177A	6.79
352-7273	700VCT/350MA, 6.3V/0.9A, 6.3V/2.5A 6.3V/0.8A, 5V/3A	6.95
352-7070	2x2.5V/2.5A (2KV TEST) 6.3V/2.25A, 1200/100/750V. @ .005A	7.45
352-7196	1140/1.25MA, 2.5V/1.75A, 2.5V/1.75A -5KV Test	3.95
352-7176	32VCT/50MA, 4.5V/3A, 6.3VCT/20A, 2x6.3VCT/6A	4.75
RA6400-1	2.5/1.75A, 6.3V/2A -5KV Test	2.39
901692	13V 9A	2.49
901699-501	2.7V @ 4.25A	3.45
901698-501	900V/75MA, 100V/.04A	4.29
IX1855C	900VCT/0.67A, 5V/3A	3.79
RA6405-1	800VCT/65MA, 5VCT/3A	3.69
T-48852	700VCT/806MA/5V/3A, 6V/1.75A	4.25
352-7098	2500V/6MA, 300 VCT, 135MA	5.95
KS 9336	1100V/50MA TAPPED 625V 2.5V/5A	3.95
M-7474319	6.3V/2.7A, 6.3V/.66A, 6.3VCT/21A	4.25
K58984	2V/4.3A, 6.3/2.9A, 1.25V/.02A	2.95
52C080	650VCT/50MA, 6.3VCT/2A, 5VCT/2A	3.75
32332	400VCT/35MA, 6.4V/2.5A, 6.4V/1.5A 1150-0-1150V	2.75
68G631	6VCT/.0006 KVA	1.75
80G198	6.3V/9.1A, 6.3VCT/6.5A, 2.5V/3.5A, 302433A	4.85
KS 9445	592VCT/118MA, 6.3V/8.1A, 5V/2A	5.39
KS 9685	6.4/7.5A, 6.4V/3.8A, 6.4/2.5A ALL CT	4.79
70G30G1	600VCT/36MA	2.65
M-7474318	2100V/.027A	4.95
352-7069	2-2.5V Wdg. at 2.5A, Each Lo-Cap., 22Kv Test	5.95
352-7096	2.5V/1.79A, 5V/3A, 6.5V/6A, 6.5V/1.2A, D/O BC800	
352-7099	360VCT/20MA, 1500V/1MA, 2.5V/1.75A, 6.3V/2.5A, 6.3V/6A, P/O BC-929	6.45
D163253	5200V.002A, 2.5V/5A	5.35
M-7471957	2.5V/20A, 12KV Test	4.85
352-7179	250V/100MA, 6.5V/12ACT 5V/2A	3.45

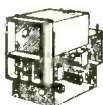

INTERPHONE AMPLIFIER

Easily converted to an ideal inter-Communications set for office, home, or factory. Original. New \$4.75 w/conversion. Diagram

HI-POWER COMPONENTS

Plate Trans. Primary: 115 V, 50-60 Cy. Sec. 17-600 V/144 MA. Has "Built-in" Filter Choke. Oil Immersed. \$115
 Plate Trans. Pri: 198/220/240 V, 60 Cy. 1 Ph. Sec: 3650 V/16.7 KVA, 30 KV Insulation. Oil Imm. Less Gauge. \$335
 Plate Trans. Amertran #31133. Pri: 110/115/120 V/60 Cy/1 Phase. Sec: 3140/1570 V, 2.36 KVA. \$105
 Fil. Trans. Pri: 220 V/60 Cy/1 Phase. Sec: 5 VCT/10A/30 KV Test. \$37.50
 Plate Trans. Raytheon UX6801. Pri: 115 V/60 Cy/1 Ph. Sec: 22,000 V/234 MA/5.35 KVA. Lo-Cap. "Donut" Construction \$135
 Reactor: Raytheon U-11533: 13.5H @ 1.0 Amp., 13.5 KV Test. \$29.95
 Reactor, Modulation: 50 H/3 A/80 Ohms DCR. Response: .03 Cy. to 10 KC. Level: plus 63db. 40 KV Test. Nominal Circuit Impedance: 3000 Ohms. \$350
 Swing Reactor: 9-60 HY/.05-400 MA, 10,000 V. Test-Kenyon. \$14.95
 Transtar: Type TH458G: Input 130/260 V. 50-60 Cy. 1 Ph. Output Range: 0-260 V, 45 A. Max. 11.7 KVA two-unit bank, parallel connected. Completely enclosed in cabinet with handwheel atop. Brand New \$325.00
 Circuit Breaker: ITE Model KJ. Will handle 600 VAC at 115 A. Break time adjustable from instant to 10 minute. Break amperes adjustable from 115 A to 1000% overload. Brand New \$15.00
 Alternator: Louis-Allis Co. Type "AL", 198-C. Output 110/220 V. 1 Ph. 60 Cy. 9 P.F. 1200 RPM, completely self-regulating with built-in exciter. Brand new, original crates \$795.00
 PE-94C Power Supply, Brand New \$6.95
 Plate Trans: #218521-Pri: 115V/1PH/60 Cy. Sec. 7500V/.06A (Half-Wave) SCS #2Z9612.41 \$85.00
 Plate Trans. Amertran #26579; Pri: 105/110/120V, 1 ph./60 Cy. Sec. 3100-0-3100V at 2 KVA. Insulated for 15 KV. Center-Tap Grounded to Case. \$135.00

FILTER CHOKES

Stock	Description	Price
CH-187	Swing, 4-16H, 150MA, 210 ohms, 3KV Test	\$3.90
CH-189	Swing, 4-16H, 250MA, 125 ohms, 3KV Test	6.60
CH-198	Swing, 3-14H, 300MA, 80 ohms, 3KV Test	6.90
CH-CEC117	9-50H/.05-400MA, 10KV Test	14.95
CH-366	20H/3A	6.95
CH-322	.35H/350MA-10 Ohms DCR	2.75
CH-141	Dual 7H/75 MA, 11H/60 MA 5KV DC Test	4.69
CH-119	8.5H/125 MA	2.79
CH-68-1	Dual 120H/17 MA	2.35
CH-8-35	2.5H/380 MA/25 Ohms	1.79
CH-776	1.28H/130 MA/75 ohms	2.25
CH-344	1.5H/145MA/1200V Test	2.35
CH-43A	10HY/15MA-850 ohms DCR	1.75
CH-366	20H/300MA	6.95
CH-989	15HY/15MA-400 ohms DCR	1.95
CH-511	6H/80MA-310 ohms DCR	2.45
CH-3-501	2 x .5H/400MA	2.79
CH-188M	5HY 200MA	1.79
CH-488	10HY .030A	1.19
CH-791	Dual 1.75-.325 HY 100 MA	1.27
CH-22-1	1 HY .100A	1.59
CH-779	.6 HY .490A	1.17
CH-25A	SW .09/.018 HY 3/3A	1.25
CH-922	10000 HY 0 MA	8.95
CH-043	2.2 HY 80 MA	2.75
CH-89A	2 x 1.52H @ 167A	.98
CH-69A	Mult. Choke	1.39
CH-445	SECT. 1. Swing 3-12H/.52-.05A	14.95
CH-170	SECT. 2. Smooth 5H/.52A	2.79
CH-533	SECT. 3. Swing 3.25-18H/138-014A	29.95
	SECT. 4. Smooth 3.4H/138A	
	SECT. 5. Smooth 3.4H/138A	
	SECT. 6. Smooth 3.4H/138A	
	SECT. 7. Smooth 3.4H/138A	
	SECT. 8. Smooth 3.4H/138A	
	SECT. 9. Smooth 3.4H/138A	
	SECT. 10. Smooth 3.4H/138A	
	SECT. 11. Smooth 3.4H/138A	
	SECT. 12. Smooth 3.4H/138A	
	SECT. 13. Smooth 3.4H/138A	
	SECT. 14. Smooth 3.4H/138A	
	SECT. 15. Smooth 3.4H/138A	
	SECT. 16. Smooth 3.4H/138A	
	SECT. 17. Smooth 3.4H/138A	
	SECT. 18. Smooth 3.4H/138A	
	SECT. 19. Smooth 3.4H/138A	
	SECT. 20. Smooth 3.4H/138A	
	SECT. 21. Smooth 3.4H/138A	
	SECT. 22. Smooth 3.4H/138A	
	SECT. 23. Smooth 3.4H/138A	
	SECT. 24. Smooth 3.4H/138A	
	SECT. 25. Smooth 3.4H/138A	
	SECT. 26. Smooth 3.4H/138A	
	SECT. 27. Smooth 3.4H/138A	
	SECT. 28. Smooth 3.4H/138A	
	SECT. 29. Smooth 3.4H/138A	
	SECT. 30. Smooth 3.4H/138A	
	SECT. 31. Smooth 3.4H/138A	
	SECT. 32. Smooth 3.4H/138A	
	SECT. 33. Smooth 3.4H/138A	
	SECT. 34. Smooth 3.4H/138A	
	SECT. 35. Smooth 3.4H/138A	
	SECT. 36. Smooth 3.4H/138A	
	SECT. 37. Smooth 3.4H/138A	
	SECT. 38. Smooth 3.4H/138A	
	SECT. 39. Smooth 3.4H/138A	
	SECT. 40. Smooth 3.4H/138A	
	SECT. 41. Smooth 3.4H/138A	
	SECT. 42. Smooth 3.4H/138A	
	SECT. 43. Smooth 3.4H/138A	
	SECT. 44. Smooth 3.4H/138A	
	SECT. 45. Smooth 3.4H/138A	
	SECT. 46. Smooth 3.4H/138A	
	SECT. 47. Smooth 3.4H/138A	
	SECT. 48. Smooth 3.4H/138A	
	SECT. 49. Smooth 3.4H/138A	
	SECT. 50. Smooth 3.4H/138A	
	SECT. 51. Smooth 3.4H/138A	
	SECT. 52. Smooth 3.4H/138A	
	SECT. 53. Smooth 3.4H/138A	
	SECT. 54. Smooth 3.4H/138A	
	SECT. 55. Smooth 3.4H/138A	
	SECT. 56. Smooth 3.4H/138A	
	SECT. 57. Smooth 3.4H/138A	
	SECT. 58. Smooth 3.4H/138A	
	SECT. 59. Smooth 3.4H/138A	
	SECT. 60. Smooth 3.4H/138A	
	SECT. 61. Smooth 3.4H/138A	
	SECT. 62. Smooth 3.4H/138A	
	SECT. 63. Smooth 3.4H/138A	
	SECT. 64. Smooth 3.4H/138A	
	SECT. 65. Smooth 3.4H/138A	
	SECT. 66. Smooth 3.4H/138A	
	SECT. 67. Smooth 3.4H/138A	
	SECT. 68. Smooth 3.4H/138A	
	SECT. 69. Smooth 3.4H/138A	
	SECT. 70. Smooth 3.4H/138A	
	SECT. 71. Smooth 3.4H/138A	
	SECT. 72. Smooth 3.4H/138A	
	SECT. 73. Smooth 3.4H/138A	
	SECT. 74. Smooth 3.4H/138A	
	SECT. 75. Smooth 3.4H/138A	
	SECT. 76. Smooth 3.4H/138A	
	SECT. 77. Smooth 3.4H/138A	
	SECT. 78. Smooth 3.4H/138A	
	SECT. 79. Smooth 3.4H/138A	
	SECT. 80. Smooth 3.4H/138A	
	SECT. 81. Smooth 3.4H/138A	
	SECT. 82. Smooth 3.4H/138A	
	SECT. 83. Smooth 3.4H/138A	
	SECT. 84. Smooth 3.4H/138A	
	SECT. 85. Smooth 3.4H/138A	
	SECT. 86. Smooth 3.4H/138A	
	SECT. 87. Smooth 3.4H/138A	
	SECT. 88. Smooth 3.4H/138A	
	SECT. 89. Smooth 3.4H/138A	
	SECT. 90. Smooth 3.4H/138A	
	SECT. 91. Smooth 3.4H/138A	
	SECT. 92. Smooth 3.4H/138A	
	SECT. 93. Smooth 3.4H/138A	
	SECT. 94. Smooth 3.4H/138A	
	SECT. 95. Smooth 3.4H/138A	
	SECT. 96. Smooth 3.4H/138A	
	SECT. 97. Smooth 3.4H/138A	
	SECT. 98. Smooth 3.4H/138A	
	SECT. 99. Smooth 3.4H/138A	
	SECT. 100. Smooth 3.4H/138A	

ARTILLERY MICROPHONES

Microphone, Type T-21, condenser type, used to detect sound of Artillery fire or shell detonation. A number of these units are placed in the ground at various field locations in Geometric patterns at intervals up to 2000 yds. Mike unit comprises a condenser head, acoustic chambers, and a 2-stage Audio Amplifier. Requires 6 flashlight Batteries and 1 "C" Battery—Sold less tubes \$32.50

DYNAMOTORS

TYPE	INPUT VOLTS	INPUT AMPS	OUTPUT VOLTS	OUTPUT AMPS	PRICE
DM 416	14	6.2	330	.170	\$6.75
DM 33A	28	7	540	.250	3.95
BD AR 93	28	3.25	375	.150	7.50
23350	27	1.75	285	.075	3.95
B-19 Pack	12	9.4	505	.110	8.95
DA-3A*	28	10	300	.268	6.95
			150	.010	
			14.5	5.	
PE 73 CM	28	19	1000	.350	22.50
BD 693	14	2.8	220	.08	12.95
D-402†	13.5	12.2	300	.200	

FREQUENCY METER 375 to 725 MCS



Model TS-127/U is a compact, self-contained, battery powered, precision (± 1 Mc) frequency meter which provides quick, accurate readings. Requires a standard 1.5V "A" and 45V "B" battery. Has 0-5 Min. time switch. Contains sturdily constructed Hi-Q resonator with average Q of 3000 working directly into detector tube. Uses 957, 186 and 3S4 Tubes. Complete new with inst. book, probe and spare kit of tubes. Less batteries **\$47.50**

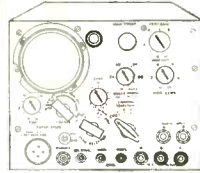

ke. 5.2mc of Δ sec. with 21 tubes including 3" scope tube. Converted for operation on 115 V. 60 cycle source. Price \$145.00 80 page inst. manual of AN/APA-10 available separately for those who wish to study circuits etc. before purchasing **\$2.75**

PANADAPTER

Provides 4 Types of Presentation: (1) Panoramic (2) Aural (3) Oscillographic (4) Oscilloscopic
Designed for use with receiving equipment AN/ARR-7, AN/ARR-5, AN/APR-4, SCR-587, or any receiver with I.F. of 455 Kc. Includes 3" scope on 115 V. 60 cycle source. Price \$145.00 80 page inst. manual of AN/APA-10 available separately for those who wish to study circuits etc. before purchasing **\$2.75**

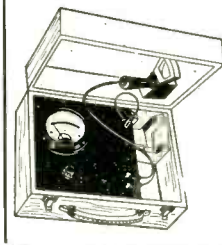

FLUXMETER

Used to calibrate field strength of magnets from 500 to 4000 gauss and indicate polarity. Probe has gap of 1/4". Beautifully built in hardwood case with hinged cover. Instructions for operation on under side of cover. Size 12 3/4 x 9 x 6 in. Ideal for lab and school use. New. An exceptional value **\$24.50**

MOTOR GENERATORS

2 KVA O'Keefe and Merritt. 115DC to 120AC. 50 cy., 1 Ph., Export Crated. New **\$149.50**
MOTOR GENERATOR TYPE T024
Unit of U. S. Navy TCK-7 Transmitter Motor: 2 H.P., 230V. D.C., 10 amps. Generator: 1800V. D.C., 0.4 A., 500V. D.C., 0.35A., 115V. D.C., 1.5A., 12 V. D.C., 2A. 3480 R.P.M. Self excited. Brand new including spare armature. **\$19.50**

ALLIS-CHALMERS 230DC to 115AC
60 cy., 1 Ph., 1.25 KVA. **\$225.00**

INVERTERS

Onan M-G-215H. Navy type PU/13. Input 115/230, 60 cy., 1 Ph. Output: 115, 480 cy., 1 Ph., 1.2Kw and 26V DC at 4 amps. New. **\$295.00**
Onan M-G-0-75. Navy type PU/11. Input: 115/230, 60 cy., 1 Ph. Output: 115, 480 cy., 1 Ph., 5.3 amps. and 28 VDC @ 3.8 Amps. New. **\$225.00**
Leland Elec. Co. PE206A. Input: 28DC at 38 Amps. Output: 80V, 800 cy., 1 Ph., 48V. **\$189.172**
G.E. 18169172. Input: 28DC. Output: 115, 400 cy., 1 Ph., 1.5KVA. New **\$32.50**
G.E. 5AS1315511A. Model 2181. Input: 28DC. Output: 115, 400 cy., 1 Ph., 1.5 KVA. Regulated. New. **\$89.50**
Elec. 74DC to 110AC, 60 cy., 1 Ph. at 2.4 Amps. New. **\$39.50**

DYNAMOTORS

Navy type CAJO-211444. Input: 105 to 130VDC. Output: either 26VDC at 20 amps. or 13VDC at 40 amps. Radio filtered and complete with the line switch. New **\$19.50**
Type PE94CM. For SCR-522. **\$22.00**
new in overseas cases. Has wide band input and output filters. **\$19.50**

AMPLIDYNES

5AM2117. Input 27 VDC @ 15 A. Output 60 VDC @ 2.5 4600 RPM. New **\$22.00**
3AM31N9A. Input 27 VDC @ 4 A. Output 60 VDC @ 8.8 A., 7500 RPM. New **\$23.50**
5AM31N18A. Input 27 VDC @ 4 A. Output 60 VDC @ 8.8 A., 8300 RPM. New **\$12.75**

SMALL D.C. MOTORS

G.E. 5BA50L2A. Armature 27VDC at 8.3 Amps. Field 60VDC at 2.3A RPM 4000. H.P. 0.5. New. **\$27.50**
Oster E-7-5. 27.5DC. 1/20HP. 3600RPM. Shunt Wound. New. **\$9.50**
Dumore Co. type ELBG. 24VDC. 40-1 gear ratio. For type B-4 Intervalometer. New **\$6.75**

400 CY. BLOWERS

Westinghouse Type FL. 115V. 400 cy., 6.700 RPM. Airflow 17C.F.M. New. **\$3.95**

SYNCHROS

Ford Inst. Co. Synchro Differential Generator. Mod. 3 Type 5SDG. 90/90V. 400 cy., Ord. Dr. 173020. New. **\$12.50**
Armour. Synchro Differential Generator. Type 6DG. New. **\$29.50**
Hohart Mfg. Co. Synchro Differential Generator. Type XIX 115V. 60 cy. New. **\$4.95**. 5F, 5G, 5CT also in stock.

D.C. SELSYN MOTOR

Step by step type for use with potentiometer in D.C. Selsyn Control Systems. Bendix Type CAL 14810 (MK1 Mod.) 70 Volts DC input. **\$8.95**

300-1200 MC. XMITTER

AN/APT-5 Brand New in original cases. **\$139.50**

AN-APR-1 RECEIVERS

Less tuning units. Excellent condition. **\$195.00**

METER SPECIALS

G.E. Type DO-50, 3" Sq. Scale reads 0-3 D.C. Basic Mov. 10 MA, F.S.V.=3. New. **\$2.45**
G.E. Type DO-50, 3" Sq. Scale reads 0-3/0-9 V. D.C. Basic Mov. 10 MA, F.S.V.=3. New. **\$2.45**
G.E. Type DO-50, 3" Sq. Scale reads 0-80 Amps. D.C. and F.S.V.=0.50. New. **\$2.45**
G.E. Type DO-50, 3" Sq. Scale reads 0-100 Amps. D.C. and F.S.V.=0.50. New. **\$2.45**

SCR-522 EQUIPMENT

Complete BC-624C receivers and BC-625AM Transmitters including mounting racks, plugs, connectors, dynamotor. Brand new equipment with instruction manuals.

RADAR SETS

MODEL SQ. Portable radar set, 10CM. Operates on 90-130 volt, 60 cy., 1 Ph. "A", "B", and "PP" presentation. Complete with tech manual and full set of operating spare parts.
MODEL SG-1. Consists of complete equipment including Radar Transmitter-Receiver CRP-43AAK-3, Range and Train Indicator CRP-55ABC-3, Control Amplifier CRP-50AAT-1, Motor Dynamo-Amplifier (Amplidyne) CG-21AAV and Antenna Assembly CRP-60AIB-1
MODEL ASG-1 Radar unit consisting of transmitter and converter assembly CRP-43AIC, Antenna Assembly CRP-ACZ, Mounting Base CRP-10ABE, etc.
Spare Parts available for Model SQ and SG-1 Radar.

RADAR ANTENNAS

Type SO-1 (10CM) assembly with reflector, waveguide nozzle, drive motor, etc.
Type SO-3 (3 CM.) Surface Search type with reflector, drive motor, etc., but less plumbing. New in original cases.
Type SO-13. (10CM.) Complete assembly with 24" dish, dipole, drive motor, gearing, etc.

MISC. RADAR EQUIPMENT

Modulator Units for SO-11 (CUZ-50AGD)
Pulsar Units for SD-1
Transmitter-Receiver units SO-13
Spare Parts for SG-1
Spare Parts for SQ
Marker Oscillator crystals in holders **98.35Kc**
Rearing Control Units CRP-23AEK
Synchro Amplifiers-Bendix
90° Waveguide Bends 10CM Bronze
Signal Monitors CRP-60AAN
Repeater Amplifiers CBM-50AFO
Oscillator Tube Cavities for SO-1, 13 etc., 1F303.
10CM Horns, 1 1/2" x 3" waveguide, standard contact flange input, circularly polarized horn output
Duplex Tees #223005-17
Auxiliary Rectifier CABM-20237 (SO 2 Radar)

SO-1 Antenna R.F. Nozzle Assemblies (RF502)
SO-1 Antenna Reflector Assemblies (RF503)
SO-1 Antenna Reflector Assemblies (RF503)
SO-1 Antenna Waveguide Resonance Chamber Assemblies (RF515)
SO-1 RF Coupling Waveguide to Transmitter (Z304)
SO-1 RF System and duplexing cavity (RF301 with V309)

Radar Repeater Adapters
NAVY TYPE CBM-50AFO

A repeater unit for video signals and trigger pulses designed to work in conjunction with standard Navy radar equipments wherein provision is made for operation of remote P.P.I. sets. This adapter provides four video and trigger pulse lines for operating one or more remote P.P.I. control installations. 115 Volts, 60 cycles A.C. Dimensions are 3 1/2 x 21 x 15 in. New **\$97.50**

G. E. BATTERY CHARGER

Charges 54 Cell Battery at from 1 to 10 ampere rate
Input 115V., 60 cy., 1 Phase.
The model 6RC9P18 Copper Oxide battery charger consists of a transformer, a secondary reactor, a copper oxide rectifying element, a ventilating fan, control circuits and auxiliary equipment necessary for proper operations. Transformer tapped for various supply voltage. Eight secondary taps for adjusting charging rate. Built into metal cabinet. Metered. Complete with spare fan and fuses. New in original packing cases. Shipping weight approx. 305 lbs. **\$149.50**

REPAIR PARTS FOR BC-348

(Models H, K, L, R)
Also BC 224 Models F, K. Coils for aut., P.F., det. osc., I.F., c.w. osc. xtal filters, 4 gang cond., front panels, dial assemblies, vol. cons., etc. Write for complete list and free diagram.

9 CONDUCTOR CABLE

Army spec. CO-215 Weatherproof 9 Cond. No. 20 AWG stranded lined copper, plastic ins., color coded, double vinyl jackets with tinned copper braid between. Dia. 9/16" made by G.E. Available 1000, 1500, 2000 ft. reels. Price \$15 ft. Sample 100 ft. Coil. **\$15.00**

G. E. SERVO AMPLIFIERS

Used in B29 planes for Central Station Fire Control Systems B2, B3 and B4. Used to drive Amplidyne 5AM31N9A and Control Motor 5BA50L2A listed in 1st column. New. **\$29.50**

PARABOLOIDS

17 1/2" diameter, spun magnesium dishes, 4 inches deep. Reinforced perimeter. Two sets of mounting brackets on rear. Opening at apex for waveguide dipole assembly 1 1/2 x 1 1/2".
Brand New. **Per Pair \$12.50**

TUBE SPECIALS

1N21B	\$1.95	3BP1	\$3.25
1B24	6.95	3CP1	1.85
2162	23.50	7BP7	2.95
2351	4.50	861	9.50
3B22	1.95	C6J	4.95

SAWTOOTH POT.

Continuous winding 2 rotating and two take off brushes varies voltage to linear sawtooth wave. W.E. No. KS 15138. New **\$3.95**

HIGH VOLT OIL CAPS

Mfd. .001 50 kV Price \$22.50
.025 50 kV 34.50
2 x .025 50 kV 34.50
1.135 7.5 kV 12.95
.25 15 kV 17.50
.25 20 kV 19.50
.25 50 kV 67.50
1. 15 kV 49.95
2. 5.5 kV 12.75
2. 6 kV 14.50

SPECIAL! 1.0 MFD. 7500 VDC oil filled capacitor. Cat. No. 26F681. Only. **\$9.75**

MICA CAPACITORS

High voltage Transmuting types, thousands in stock. Wide selection of sizes, types & ratings. All new and made by top manufacturers. Write for complete listings.

SWEEP GEN CAPACITOR COAXIAL TYPE

High speed ball bearings. Split stator silver plated coaxial type 5/10 mmfd. Brand new. **SPECIAL \$1.95**

SYNCHRO CAPACITORS

.6-.6-G mfd Mark 12, Mod. 2, type 1C **\$1.75**
10-10-10 mfd Mark 1, Mod. 2, type 3C **\$5.65**

HIGH POT TRANSFORMER

Westinghouse. Pri: 115, 60 cy. Sec: 15, 000V C.T., @ .060A, C.T. ungrounded. Excellent for high-potting tests. Size OA 12 1/2 x 8 1/2 W x 9 1/2 D. Weight 67 lbs. Fully enclosed steel case. Price. **\$29.50**

PULSE TRANSFORMERS

KS-9563 Supplies 3500V peak from 807 tube **\$3.95**
High Reactance Trans. G. E. Type Y-3502A-60 cy. Voltage 120-135. Ind. II V. winding 135 by Output: 29.5kV. 22.8KV. Cat. #818055G1 **\$39.50**

60 CYCLE TRANSFORMERS

G. E. Step-Down. 6KVA. Pri: 230/400. Sec: 115/125, 60 cy. Size: 20" x 11" x 9 1/2". Weight 225 lbs. Navy grey finish, integral junction box and mounting brackets **\$125.00**
Plate Trans. Iattheon U-5815. Pri: 440/220, 60 cy. 3 phase. Sec: each phase 1310V @ 0.67A test 6000V. **\$110.00**
Plate Trans. Pri: 115V., 60 cy., 1 Ph. Sec: 1470V. C.T. @ 1.2A tested at 5500V. RMS. Iattheon. Size 12 1/2 x 10 x 10 in. Shipping wt: 150 lbs. New. Price **\$27.50**

400 CYCLE TRANSFORMERS

Auto. 945S-520P 2KVA/ 460/345/200 115. Weight 22 lbs. G. E. Cat. #80G184 **\$4.50**
Fil. IN: 0.75/90/85/105/115/125. Out: 5V3A/5V3A/5V3A/5V6A/6.3V0.5A No. 7249010 **\$1.95**
Plate. KS9560 800 cy. Pri: 115V. Sec: 1350-0-1350 at .057A Elecast shld. Wt. 2.3 lbs. **\$2.95**
Plate & Fil. KS9555. Pri: 115V. Sec: 930-0-930 and three 6.3V windings **\$3.95**
Fil. KS9553. Pri: 115V. Sec: 8.2V1.25A /6.35V1.5A Elecast Shld. Wt. 0.5 lbs. **\$2.95**
Plate & Fil. Pri: 0/80/115V. Sec: 2-1200 V DC @ 1.5MA. Fil Sec: #2=400V DC @ 130MA. Fil Secs: 6.4V4.3A/6.35V. 18MA. (Ins. 1500V) 5V2A/5V2A. **\$4.95**
Plate. Thordarson T46889 500 cy. Pri: 105/120. Sec: 2800-0-2800. 7KV Ins. 1.5KV. **\$29.50**
Misc. types: G.E. #68G665X, #68G666X, #68G667, #68G668X, #80G200, #80G199 each **\$2.00**

REACTORS

KS9589 Retard. 4HY @ 100MA. **\$1.00**
#2C220/R2 Por Kever Unit BC409. **\$3.75**
Multi-Choke 3 hy @ .275A 70 ohms, 17 hy. @ .125A 200 ohms, 17 hy. @ .125A 200 ohms 7 1/2 x 6 x 3 3/4. **\$6.95**

30-10,000 CYCLE MODULATION TRANSF.

For RCA. Type 250-K Broadcast Transmitter (M1-7242) P to P Primary Imp. 15,000 ohms. Secondary Load 5,030 ohms. Size 1 1/4 x 9 1/2 x 1 3/8. Wt. 143 lbs. New. **\$97.50**

ALTITUDE INDICATOR

Type ID-14A/APN-1. Brand New in original cartons. Special. **\$2.95**

FREQUENCY STANDARD

Complete self contained, dual 100/1000 kc crystal, multi-brator and harmonic amplifier. Calibrates with WWV and provides 1000, 100, and 10 kc check points from 10 to 45,000 kc. 115V. 60 cycles. New with instructions. **\$23.95**

TERMS: Rated Concerns Net 30, FOB Bronxville, New York. All Merchandise Guaranteed. Prices Subject to Change

HERSHEL RADIO CO.

LOWEST PRICES ON ALL ELECTRONIC NEEDS

MODULATION and DRIVER TRANSFORMERS



Both Units Only
Modulation trans. 815 class AB2-56 Watt Driver, 6SN7 to Modulator. **\$4.95**

SQUIRREL CAGE BLOWERS

R.E.L. V.D.C. 12 or 24-40 Watt Max. **\$4.95**

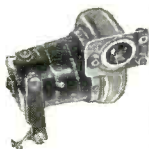

TYPE FL 115V-100 Cycle 6700 R.P.M. Westinghouse Electric. **\$3.95**

BK 22K- RELAY



Only **\$3.95**

Used with SCR-269F-Change Over. Contains 28 Volt Step Relay, 5 Deck, 6 Position Switch. 12V D.P.S.T.

Model S-1 BOMBSIGHT

Made By **SPERRY MFG.**

SPECIAL THIS MONTH ONLY

\$49.50

Contains over 100 Precision Bearings. Ground Optic Lenses, Gears, Motors.

BRAND NEW!

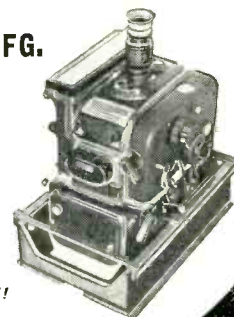

IGNITION COILS
PRI. 150v. Condenser. Discharge SEC. 15.000 Volt. **\$1.29**

I.F. TRANSFORMERS YOUR CHOICE!

95¢

30 MC Silver Slugged T-104-35-110 MC
10 MC 1st. I.F. FM
10 MC 2nd. I.F. FM
T109 5 MC DISC.
50KC & 150KC I.F. Coils
60 MC I.F. Trans Fixed

BUTTERFLY CONDENSERS



YOUR CHOICE **\$4.95**

Type A Freq. Range 76 to 300 MC. Can be used with 955 Tube.
Type B Freq. Range 300 to 1000 MC. Can be used with 368 AS Tube.

DIRECTIONAL GYRO

For A-5 Automatic Pilot



Only **\$24.50**

M-1 Directional Gyro. Made by Sperry Mfg. Brand New!

ARTIFICIAL HORIZON GYRO

MADE BY G-E

\$24.50

Sealed in Original Factory Metal Container.

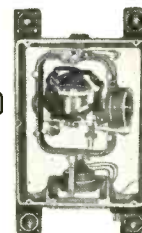

TRANSMITTING MICAS

CAP. MFD.	Volt	Price
.01	8000	\$4.95
.01	2500	.25
.002	3000	.49
.00004	3000	.49
.00005	3000	.49

RESISTORS Your Choice **95c**

OHMS	WATTS
4	200
15	50
500	100
1000 tapped	100
5000	200
10M	150
30M	200
200M	100
1 Neg.	100

PHONOGRAPH CRYSTAL Ceramic Type



Made by Sonotone Mfg. 1.4 Volt output. Sapphire Needle. 50 to 14,000 cycle Freq. Response Hi Fi. Special

Only **\$2.35**

OIL CONDENSERS

MFD.	VDC.	Price
1	5000	\$4.95
1	3000	3.95
.5	2500	1.95
1	6000	6.95
2	6000	9.95

"QUICK SALE" SPECIALS

- A. Microphone MC 253A 49¢
- B. Earphone replacement for H-16 or HS30B Headsets 39¢
- C. Transformer C410 with PL54 Plug. Low to High Impedance 69¢

GO-9 XMITTER

FREQ 3-18 MC & 300 to 600 KC



Only **\$125**

Band Switching 100 Watt Output Brand New. Operates 110 Volt-800 Cycle.

FIL TRANSFORMER

110 volt 60 cy. 4 volt at 16 HMPS. 2.5 v. at 1.75 amps.



\$1.95

POTTER and BRUMFIELD OVERLOAD RELAYS



\$1.95

= 1-5000 Ohms Coil Current 10ma. #2-110V. 60 Cy. AC. Coil S.P.D.T.

RCA OUTPUT TRANSFORMER



ONLY **\$1.95**

P.P. 6L6's 25 Watt
PRI 5000 Ohms Output. Sec. #1 500 Ohms Sec. #2 600 Ohms sidetone 15 to 15,000 cy. Flat Hi Fi special.

C.R.T. TUBES

3AP1	\$4.95
3BP1	5.95
5BP1	5.95
9LP7	6.95

TRANSMITTING & RECEIVING TUBES

814	\$2.69	931A	\$3.95
VT127A	\$3.95	3C24	.89
15E	\$1.50	872A	\$2.69
304T2	\$6.50	8020	\$1.19

MAIL COUPON TODAY

- Gentlemen:
- Please send me your FREE Bulletin listing many other ELECTRONIC SPECIALS.
- Name
- Address
- City
- State

FULL WAVE METER RECTIFIER For use with 0-1 MA Meter **95¢**

HERSHEL RADIO CO.

5245 GRAND RIVER
Detroit 8, Michigan
Phone TYler 8-9400

TERMS: Cash with order or 25% DOWN—BALANCE C.O.D. NET 10 DAYS RATED ACCOUNTS ALL PRICES NET F.O.B. DETROIT

RADIO Surplus Buys

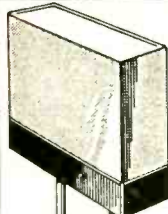

CRYSTALS

... in FT 241-A Holders - 1/2" Pin SPC. Marked 54th OR 72nd Harmonic MC Freq. Listed below by fundamental frequency with fractions omitted.

500 KC Crystals ea. **\$1.50**
1000 KC Crystals ea. **\$3.95**
200 KC Crystals

370	407	444	476	509
372	408	446	477	511
374	409	448	479	512
375	411	447	480	513
376	412	448	481	514
377	413	450	483	515
379	414	451	484	516
380	415	452	485	518
381	416	453	486	519
383	418	454	487	520
384	419	455	488	522
385	420	456	490	523
386	422	457	491	525
387	423	458	492	526
388	424	459	493	527
390	425	461	494	529
391	426	462	495	530
392	427	463	496	531
393	429	464	497	533
394	430	465	498	534
395	431	466	501	536
396	433	468	502	537
397	434	469	503	538
398	435	470	504	540
400	436	472	505	
401	437	473	506	
402	438	474	507	
403	440	475	508	
404	441			
405	442			
406	443			

PLEASE ENCLOSE FULL AMOUNT WITH ORDER QUANTITIES AVAILABLE WRITE FOR YOUR REQUIREMENTS

C & H SALES CO.

BOX 356-DE EAST PASADENA STA. • PASADENA R. CALIF.

WHOLESALE ONLY

**ELECTRONIC COMPONENTS
AIRCRAFT EQUIPMENT
HYDRAULICS**

**RADIO & ELECTRONIC SURPLUS
13933-9 BRUSH STREET
Detroit 3, Mich. TO '9, 3403**

**4 PDT
RELAY**

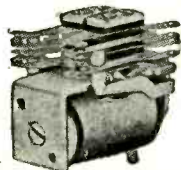

26.5 VDC midget
425 ohm \$2.95

Above frame also in:--
280 ohm @ \$2.75. 12
vic 70 ohm @ \$2.00. DPDT: 12 vdc. 120 ohm @ \$1.95. DPDT 6 vdc. 18 ohm \$1.95. SPST N.O. double break 10 A cont. 5.3 vdc 15 ohm \$1.95
RELAY 3 PDT 24 vdc 250 ohm Clare Type K.5 2.75
CONNECTOR 15 pin Amphenol #26-151. 9.95
250 WATT output xformer WE #K59496. 39.50
S BAND CONVERTER Navy CG-46ABW. 2.45
ISOLATION XFORMER 35 watts 115V. & 6.3 2.45
SYNCHRO MOTOR 1 FS 115/90 v 400 cycles 14.95
MOTOR 400-1800 cyc. 115V EAD J31C. 9.95
SILVER TRMR ERIE TS2a 1.5-7. 4-30. 7-45 .32
LINK MOBILE XMTRS #25UFM 30-40 MC. 49.50
TRANSISTOR or 5 pin sumini socket. .13
PL-144, SO-124, PL-68, AN-3106-10s-2s, 83-1H, Variable Frequency electronic generator 1400 watt output 300-3500 cy. 220/60/in. CML #1400.
CONDENSERS in stock: bathtubs from .02 400v to 2 mfd-600v, upright oils (CP65 pyranols, YAB, etc) from 3x.1-600v to 1 mfd 600v. Large oils from .1-7500v to 1 mfd-2,000v. Also mica, silver mica, variables, trimmers. Write for Bulletin.

EMPIRE ELECTRONICS COMPANY

409 Avenue L, Brooklyn 30, N. Y. Cloverdale 2-4000

HIGH VOLTAGE CONDENSERS

Standard Brands

Ct. No.	MFD	WVDC	Price
26P444	8	2 KV	9.95
23F47	2	4 KV	9.95
25F509G2	1	6 KV	7.50
25F774	1X .1	7.5 KV	8.00
25F450	.1	12 KV	9.50
25F360	.1	12.5 KV	17.50
Interen.	.25	15 KV	19.95
14F91	1.0	15 KV	39.50
Interen.	.5	25 KV	49.50
Interen.	1.0	25 KV	69.50
Fast A6734	1.0	25 KV	89.50
14F71	.25	32.5 KV	60.00

Many other types of oil filled condensers in stock. Write for quotation on your requirements.

HIGH CURRENT MICA CONDENSERS

Ceramic cased, Standard Brand type G1 or similar

Mfd	WVDC	Amp @ 1 mc	Price
.04	1 KV	25	7.50
.08	1.5 KV	35	12.50
.09	1.5 KV	40	15.00
.02	3 KV	21 (600 Kc)	15.00
.00035	6 KV	5	12.50
.00075	6 KV	7	14.50
.0005	6 KV	5	14.00

Type G-2 or Similar

Mfd	WVDC	Amp @ 1 mc	Price
.0012	5 KV	8	17.50
.003	7 KV	15	19.00
.002	10 KV	15	19.50
.00025	10 KV	3	19.50
.0003	10 KV	5	19.50
.0005	10 KV	6	19.50
.00057	10 KV	8	19.50
.00065	10 KV	6	19.50

Type G-3 or Similar

Mfd	WVDC	Amp @ 1 mc	Price
.05	3 KV	50	45.00
.005	5.5 KV	25	45.00
.00015	20 KV	5	36.00
.0012	20 KV	15	36.00

Prices Quoted on the following Mica Condensers are for small quantities. Write for special Quantity Discounts.

Standard Brand type F-2, type 6, or similar \$5.20 each

Mfd	VDC	Amps @ 1 Mc.	Mfd	VDC	Amps @ 1 Mc.
.00005	5 KV	.8	.001	5 KV	4
.00009	5 KV	1	.0012	5 KV	4.5
.0001	5 KV	1.1	.0015	5 KV	5
.00015	5 KV	1.5	.002	5 KV	5
.0002	5 KV	1.7	.002	6 KV	6.5
.00025	5 KV	2.5	.002	6 KV	6.5
.0003	5 KV	2	.0025	5 KV	6
.00035	5 KV	2	.003	2 KV	6
.000375	5 KV	2	.003	3 KV	6
.00039	5 KV	2.7	.004	3 KV	6
.0004	5 KV	2.5	.005	3 KV	5
.0004	5 KV	2.5	.005	5 KV	11
.0005	5 KV	2.5	.01	2 KV	8
.0005	7.5 KV	.2	.02	2 KV	12
.0006	2.5 KV	1.5	.03	2 KV	12
.0006	5 KV	3	.07	1 KV	13
.00072	5 KV	3.5	.12	.5 KV	18
.0008	5 KV	4			
.0008	6 KV	4			

Standard Brand type F-1, type 15L or similar \$3.75 each

Mfd	VDC	Amps @ 1 Mc.	Mfd	VDC	Amps @ 1 Mc.
.00005	3 KV	.6	.0008	3 KV	2.5
.00009	3 KV	.8	.001	3 KV	3
.0001	3 KV	.08	.0012	2 KV	3
.00015	3 KV	1	.00125	2 KV	3
.000175	3 KV	1	.0015	3 KV	3.5
.0002	3 KV	2	.0016	2.5 KV	3.5
.0003	2 KV	8	.002	3 KV	4
.0003	3 KV	2	.0025	3 KV	4.5
.0004	3 KV	2	.003	2 KV	5
.0005	3 KV	2	.004	2 KV	6
.0006	2.5 KV	2	.005	2.5 KV	6.5
.0006	3 KV	2	.006	2 KV	5.5
.000625	3 KV	2.5	.008	1.5 KV	8
.0007	3 KV	2.5	.01	2 KV	14
.00075	3 KV	2.5	.1	1 KV	12

Standard Brand type A, type 9 or similar

mfd	price	mfd	price	mfd	price
.00001	.57	.0003	.64	.002	1.27
.000025	.57	.00035	.64	.0025	1.38
.00005	.57	.0004	.64	.003	1.53
.00006	.57	.0005	.76	.004	1.69
.00015	.57	.00051	.76	.005	1.86
.00015	.57	.00063	.76	.01	2.19
.0002	.60	.001	.87	.015	2.41
.00025	.64	.0015	.87	.02	2.68

All prices FOB Oakland, Calif., subject to change without notice. Terms 25% cash with order. Balance COD.

EMMONS RADIO SUPPLY CO.

405 10th St.

Oakland, Calif.

Phone TWinoaks 3-7411

1200WVDC 2500TVDC

.00005	.48	.001	.57	.008	1.23
.0001	.48	.002	.75	.01	1.41
.00015	.48	.0025	.84	.015	1.74
.0002	.48	.003	.88	.02	2.11
.00025	.48	.004	.93	.025	2.37
.0004	.48	.005	.99	.03	2.43
.0005	.48	.006	1.03		

600WVDC 1200TVDC

.00005	.43	.001	.43	.01	.84
.0001	.43	.002	.49	.015	.91
.00015	.43	.0025	.51	.02	1.06
.0002	.43	.003	.55	.025	1.30
.00025	.43	.004	.60	.03	1.36
.0003	.43	.005	.63	.04	1.75
.0004	.43	.006	.66	.05	2.13
.0005	.43	.008	.73	.06	2.41

LIQUIDATION SALE

We are overstocked on the following items and are liquidating them at far below current surplus prices.

3C23

Grid controlled rectifier tubes. Normal operation 100 to 500 VDC at 1.5 amps. Peak anode 1000V at 6 amps. Unused, guaranteed perfect. \$3.95

Selsyn Motors

Type I-4, C-79331 transmitters. 115V, 60 cy Diehl & Bendix size 6, brass. Unused priced at less than 1/2 market \$9.75 ea

DYNAMOTORS

The dynamotors listed below are either NEW or fully overhauled. Guaranteed.

TYPE	INPUT	OUTPUT	Mils	Price
DM-34	12V	220V	80	\$12.50
DM-35	12V	625V	225	24.50
DM-36	24V	220V	80	12.50
DM-37	24V	625V	225	17.50
DM-64	12V	275V	150	11.50
DM-65	12V	400V	440	22.50
BD-77	12V	1000V	350	25.00
Tcs Rcvr	12V	225V	100	12.50
TCS Xmtr.	12V	400V	180	22.50
TCS Complete power supply, 12VDC input				68.50

MC-203A T coupling New. AAF source inspected @ \$12.50

The dynamotors listed below are NOT overhauled. Guaranteed to operate.

type	input	output	mils	price
DM-32A	28	250	60	2.95
DM-32B	28	250	60	1.95
CBY-21531	28	250	60	1.95
DY2-ARR2	28	250	60	2.95
PE-86	28	250	60	1.45
D-101	27	285	60	1.45
DM-416	28	230	100	2.95
SP-22	28	330	170	3.50
DM-33A	25	350	170	3.50
SS-2669	18	375	150	7.50
BD-83	14	450	60	2.50
DM-414	14	220	80	4.95
DM-416	14	330	170	7.50
	12	400	180	9.50
	12	220	100	5.50
AD7-377	14	425	163	9.50

HEADSETS

New, guaranteed to pass AAF inspection
HS-23 5.75
HS-33 5.95
MC-162A extra ear cushions
new manufacture, per pair. .50

SOUND POWERED HANDSETS

New each \$9.95

PIONEER TORQUE UNITS

12604-3-A Contains CK5 motor & AY43D autogyro Gear ratio, motor to shaft 125:1. Gear ratio shaft to follow-up Autogyro IS-1 \$70.00
12606-1-A Same as above except Gear ratio shaft to follow-up autogyro 30:1. 70.00
12602-1-A Same as 12606-1-A except has base mounting cover for motor & gears 70.00

SPECIAL PURPOSE TUBES

1B24..... 6.75	3DP1..... 2.50	RX-21..... 7.50	328A..... 4.00	709A..... 1.75	832A..... 7.50
1B27..... 11.00	3E29..... 10.75	RK-23..... 2.00	329A..... 7.50	715A..... 3.00	833A..... 28.50
1B32..... 1.25	3EP1..... 4.00	RK-62..... 2.00	348A..... 7.50	715B..... 4.00	836..... 2.50
1B42..... 7.25	3GP1..... 2.50	RK-72..... 1.00	349A..... 7.50	715C..... 16.50	837..... 1.00
2AP1..... 5.50	4B27..... 7.50	RK-73..... 1.00	350A..... 4.00	719A..... 15.00	838..... 2.75
2C33..... 2.25	4C27..... 10.00	F-128A..... 75.00	352A..... 15.00	721A..... 1.75	846..... 125.00
2C39A..... 13.50	4E27..... 13.75	HK-154..... 5.00	354A..... 15.00	723A/B..... 13.50	849..... 20.00
2C40..... 5.75	4J34..... 75.00	VT-158..... 30.00	355A..... 15.00	724A..... 1.50	860..... 2.00
2C44..... 1.00	4J35..... 125.00	FG-190..... 9.50	F-375A..... 12.50	724B..... 1.75	861..... 13.50
2D21..... 1.00	5BP1..... 3.00	HF-200..... 13.50	393A..... 7.50	725A..... 4.00	866A..... 1.00
2E22..... 1.75	5BP4..... 3.00	C-202..... 12.50	394A..... 2.50	726A..... 7.50	869B..... 55.00
2J21A..... 6.50	5CP1..... 3.75	204A..... 25.00	417A..... 7.50	726B..... 35.00	872A..... 2.50
2J26..... 12.50	5D21..... 11.00	205B..... 1.00	GL-434A..... 12.00	726C..... 40.00	878..... 1.25
2J27..... 9.25	5FP7..... 1.00	F-207..... 100.00	446A..... 1.00	728CY-GY..... 13.50	884..... 1.25
2J31..... 19.00	5FP14..... 15.00	217A..... 3.50	446B..... 3.00	802..... 3.00	885..... 1.50
2J32..... 20.00	5JP1..... 13.00	WL-218..... 25.00	450TL..... 37.50	803..... 3.00	892R..... 250.00
2J33..... 20.00	5JP4..... 13.00	250R..... 5.00	WL-460..... 12.00	805..... 3.00	902-P1..... 7.50
2J34..... 18.00	5JP11..... 35.00	251A..... 150.00	464A..... 7.00	807..... 1.25	913..... 10.00
2J36..... 75.00	5J30..... 23.50	253A..... 6.00	WL-468..... 20.00	808..... 1.50	918..... 2.00
2J38..... 8.25	5J32..... 60.00	267B..... 7.00	527..... 15.00	809..... 2.50	923..... 1.00
2J56..... 75.00	5R4GY..... 1.00	271A..... 5.75	WL-530..... 10.00	810..... 9.75	931A..... 4.25
2J61..... 28.50	C6A..... 7.50	274B..... 2.00	WL-531..... 4.75	811..... 2.50	959..... 1.50
2K25..... 19.75	C6L..... 5.50	276A..... 7.50	559..... 1.00	812..... 2.50	CK-1006..... 1.50
3AP1..... 5.00	6BL6..... 50.00	282A..... 7.50	631-P1..... 4.75	813..... 10.00	1614..... 1.50
3BP1..... 3.00	6BM6..... 60.00	283A..... 3.75	700A-D..... 8.50	814..... 2.75	1624..... 1.25
3B22..... 2.25	6C21..... 15.00	286A..... 6.50	701A..... 4.00	815..... 4.50	2050..... 1.25
3B24..... 3.75	6G4..... 4.75	304TH..... 6.75	702A..... 1.50	822..... 17.50	ZB-3200..... 125.00
3B24W..... 7.50	6J4..... 4.75	304TL..... 5.00	702B..... 2.50	826..... 1.00	8002R..... 85.00
3B25..... 3.50	7BP7..... 3.00	307A..... 3.00	705A..... 1.00	828..... 9.00	8012..... 1.75
3B26..... 2.75	9GP7..... 7.50	310A..... 3.00	706AY-GY..... 25.00	829A..... 6.00	8013..... 2.00
3B28..... 4.00	9LP7..... 3.00	311A..... 5.25	707A..... 5.00	829B..... 9.00	8020..... 1.00
3C23..... 6.75	12DP7..... 12.50	313C..... 3.00	707B..... 8.75	830B..... 2.00	8025..... 4.00
3C24/24G..... 1.00	12GP7..... 13.50	323B..... 9.75	708A..... 2.50	832..... 6.50	PD8365..... 50.00

• Prices do not include transportation
• Usual terms apply

western engineers

ELK GROVE, CALIFORNIA
GEORGE WHITING, OWNER

• Unconditional guarantee extended
• Subject to prior disposition

AMERICA'S LARGEST STOCK OF ELECTRICAL CONVERSION EQUIPMENT

400 CYCLE UNITS

BOGUE LABORATORY 400 CYCLE SUPPLY. Motor 7.5 HP, 220/440-3-60 direct-coupled to self-excited alternator output, 5 KVA, 120/208 V, 3φ, 400 Cy. Voltage regulated. Harmonic content less than 1%. NEW. \$1475.00

LELAND MG SET. Consists of 5 HP Motor operated at 220-3-60 direct connected to self exc. alternator with output of 3 KVA, 120/208 V., 3 ph, 400 cyc. PRICE \$750.00

LELAND MG SET Consists of 4 HP Motor operated at 220-3-60 Direct Connected to Self Exc. Alternator with output of 2KVA, 115 V., 1 Phase 400 Cyc. Price \$488.00

GENERAL ELECTRIC FREQUENCY CHANGER. Type MM Motor, Triclad, 20 hp, 220/440-3-60, 3455 rpm. Generator: 220 Volts, 3 ph, 420 cyc., \$1095.00

CARSON PERMO-MAGNET 400 CYCLE M.G.: Motor 7.5 H.P., 220/440-3-60 dir. conn. to alternator 120 volts, 1φ, 400 cyc., 41.6 amps. (no brushes). PRICE \$699.95

ONAN H.F. MG Model MG-0-75, Type PU/11. Input: 115/230 Volts, 1 Ph., 60 Cy. Output: 115 V, 1 Ph., 480 Cy., 5.3 A. Also: 26 V., 5.3 A. PRICE \$189.50

LOUIS-ALLIS 3 UNIT MG SET. Consists of 5 HP motor operated at 220/440-3-60 directly coupled to alternator with output of 115 volts, 1 ph., 400 cyc. and with exciter unit all mounted on steel base. 1.8 K.V.A. Price \$565.00

KATO 400 CYCLE MOTOR GENERATOR SET. Motor operated at 220/440-3-60 V belted to self-excited alternator 500 VA, 115V, 1φ, 400 cyc. 200 RPM. NEW \$475.00

KATO 400 CYCLE MOTOR GENERATOR SET: Motor operated at 220/440-3-60 dir. conn. to self-excited alternator 500 VA, 120/208Y Volts, 3φ, 400 cyc. 3450 RPM. NEW \$465.50

ONAN 400 CYCLE MG Motor: 7½ HP, 220/440-3-60 V-belted to alternator 4 kva, 115v, 1φ, 400 cyc, 2666 rpm. Also delivers 14 vdc, 40 amps, voltage regulated. \$712.00

KATO HIGH FREQUENCY MG Motor: West. 20 HP, 220/440 synchronous V-belted to alternator 10 kw, 220/208 V, 3 ph, 400 cyc. 1714 rpm, self-exc. voltage regulated \$2700.00

LOW VOLTAGE

DIEHL LV MG. Motor: 7.5 HP, 220/440 V, 1750 RPM, 18.4/9.2 amps. Gen: 40 V, 125 amps., 5 KW. PRICE \$595.00

ELECTRO-DYNAMIC LV SET Motor: 220/440, 22.6 hp, 1750 rpm, Fr 364 dir-conn. to generator 15 kw, 32 vdc, 468 amps, shunt wind. \$895.00

STAR MG SET Motor: 40-hp, 220/440, 1200 rpm. Gen: Type F-4072 24/28 vdc, 1000 amps., \$1950.00

BARDCO MOTOR GENERATOR SET. Model #MG5AD, Motor operated at 220-3-60, 7.5 H.P.,

Generator output 5 kw, 125 vdc, compd. vndg. 1750 rpm complete with control cabinet including DC voltmeter, ammeter, rheostat, and AC motor starter. Marine encl., Ball-bearing. NEW. \$590.00

BOGUE ELECTRIC AC-DC MG SET. Motor: 7.5 HP, 220-440-3-60. Direct coupled to 2 Bogus generators with output of 12 VDC at 160 amps, 1.9 KW from each generator. Output can be connected as 12 Volts at 620 amps, or as 24 volts, 160 amps. Price \$455.00

JANETTE ROTARY CONVERTERS. Input: 12 VDC. Output: 110/1/60, 212 VA. Radio filtered, \$72.00

KATO CONVERTER Model 5KA43. 225 kva, 32 vdc to 110/1/60, 3600 rpm, filtered. \$28.75

GENERAL ELECTRIC LV SET Motor: 220/440, 1200 rpm, 25 hp, 1r 405 dir. conn. to generator, 20 vdc, 700 amps, sh. vndg. dir. conn. \$850.00

DIEHL LOW VOLTAGE SET Motor: 220/440, 1750 rpm Gen: 24 vdc, 216 amps. \$720.00

TRANSFORMERS

WESTINGHOUSE PRECIPITRON TRANSFORMER. Style 1246505. Pri. 115 V, 25 cyc. Sec: 7500 VA, 4 MA with tap at 5500 V. Filament windings 2.5 V. PRICE \$14.95

GENERAL ELECTRIC TRANSFORMER. Cat. #75G885, 2.5 KVA, 60 Cy., 1 Ph., Pri: 440. Sec: 110. PRICE \$31.50

GENERAL ELECTRIC TRANSFORMER. Cat. #75G970, 1.6 KVA, 60 Cy., 1 Ph. Pri: 437/460/483. Sec: 115/230. PRICE \$25.50

GENERAL ELECTRIC CURRENT TRANSFORMER. Type #JY-285. Amp. 150-5, Ratio 30:1. Cy. 25/125. PRICE \$13.50

GENERAL ELECTRIC TRANSFORMER. Cat. #78G214, 1 KVA, 60 Cy., 1 Ph. Pri: 437/460/483. Sec: 115/330. PRICE \$22.50

KUHLMAN LOW VOLTAGE TRANSFORMER. 72 KVA, 60 Cycles, 1 Ph. Pri. 460 volts, sec. 18/36 volts, 2000 amps. Tap switch, aircooled, three available \$425.00

GENERAL ELECTRIC STEP-DOWN TRANSFORMER. Cat. 78G600, 60 KVA, 60 Cycles, 1 Ph. Pri. 460 volts, sec. 230 volts. Tapped at 210, 185, 160, 120 volts, aircooled, eight available \$400.00

GENERAL ELECTRIC MULTI-TAP TRANSFORMER. Cat. #7406272, 4 KVA. Pri: 230. Sec: 115. 7 taps in 5 volts steps on output. Auto type. \$55.00

GE THREE PHASE TRANSFORMER. Cat 78G695, 7.04 kva 60 cyc, pri: 220/440, 3φ, delta; sec: 470/50 J-N and 570/115 V, 1φ (2.25 kva for 115 V). \$65.00

INVERTERS

BENDIX 800 CYCLE AERO UNIT. Type 800, DC Input 24-28 vdc, 62 amps, 8000 rpm, Output 115 V, 7 A, 1 Ph, 800 Cycles. \$37.50

PIONEER 12117-6B. Input 24 V, 1 amp, output 26 v, 400 cy, 6 VA, 4 PF. \$22.50

GENERAL ELECTRIC 10486-183. Input 27.5 V, 12.5 amps, 8000 rpm, output 175 VA, 115 V, 3 ph, 400 cy. \$49.50

LELAND ELECTRIC 10563. Input 28.5 vdc, 12 amps, output 115 V, 3 ph, 400 cyc, 115 VA. \$55.00

G. E. INVERTER UNITS, Model 5AT121J2B: Input: 24 VDC, 55 amp, 8800 RPM. Output: 115 Volts, 3 phase, 400 CPS, 750 VA, and secondary output of 26 Volts, single phase, 400 CPS, 250 VA. With automatic voltage and frequency regulation, built in. \$97.50

GENERAL ELECTRIC 400 CYCLE UNITS. Operate at 26 VDC 100 Amp. Output: 115 VAC 1φ, 400 CPS 1500 V.A. With filter system built-in. \$39.50

WINCHARGER PU-7/AP. Input 28 VDC, 160 Amps. Output: 115 VAC, Single ph, 2500 V.A. 400 C.P.S. Frequency and voltage regulation built-in. PRICE \$97.00

HOLTZER-CABOT MG218. Compact 2 bearing units for low current 400 cycle output. Operative at 115 VDC, 2.3 amp. Output: 110 Volts, 1.0 amp. 1 ph, 400 CPS. Brand new. PRICE \$79.50

LELAND INVERTER. Input 25-28 VDC, 52 amps. Output 250 VA, 25-28 VAC 3φ, 400 cyc., 40% P.F. also delivers 750 VA, 115 VAC, 400 cyc., 90% P.F. PRICE \$89.50

LELAND INVERTER: Input 28 VDC, 12.5 amps. Output 115 Volts, 3φ, 400 cyc., 80% P.F. PRICE \$53.50

HOLTZER-CABOT MG 153F: Input: 24 V, DC, 52 amps. Output: 115 volts-400 cycles, 3-phase, 750 VA, and 26 Volt-400 cycle, 250 VA. Voltage and frequency regulated \$95.00 ea.

HIGH FREQ. UNIT. Motor: 24 VDC 50 amp. Alternator: 17 VAC, 1300-1600 cyc. sep. exc. at 24 VDC, 1.25 HIIP, 4000 RPM. Made in Canada by Electric Tamper & Equ. PRICE \$82.50

Alternators only to same specifications as above, sep. exc. at 24 VDC. PRICE \$95.00 ea.

GE 400 CYCLE GENERATOR. General Electric Type 5ASB314J3; 400 cycles out at 115 volts, 7.2 amps; 8,000 rpm.; size 6 long x 6" dia. New \$99.50 ea.

HANCOCK 5-2480

WILLIAM I HORLICK COMPANY

Est. in 1922

266 SUMMER ST.

BOSTON 10 MASS.

IF IT'S FROM ONE FREQUENCY TO ANOTHER; FROM DC TO AC OR AC TO DC, IF IT'S FROM ONE VOLTAGE TO ANOTHER, THEN CALL ON US.

CONDENSERS

GUARANTEED—OIL CONDENSER SPECIALS—GUARANTEED

4 mfd—600V... \$1.45

Type TLA—Brand New
Dims 4 1/2 x 1 1/2 Qua. Disc.

4 mfd—1000V... \$1.50

80 mfd—4KV... 49.50 Dims. 17 1/4" x 10 1/2" x 5" Qua. Dis.

OVER 16,000 SOLD
10 mfd—600 V... \$.98
Three term. bot. mfg. channel type. Dims. 3 3/4" x 2 1/4" x 2". Two 5 mfd. sections rated 400 V at 72 deg "C". Ideal for filter or power factor application. Repeat sales prove this rugged high quality condenser to be of outstanding value. Carton of 24, weight \$.89 12 lbs. Large qua. available

7 mfd—600V... \$1.45

4 mfd—600V... \$1.10

1 mfd—25KV... \$59.95

1 mfd—400V... \$.25

2 mfd—1000V... \$.85

Mfd.	Volts	Price	Mfd.	Volts	Price
.0018	15KV	55.75	2	1000V	1.85
.0023	18KV	5.95	2	1500V	1.69
.005-005*	10KV	4.75	2	2000V	2.80
.01	10KV	22.50	2	2500V	3.95
.012	25KV	5.25	2	3000V	5.80
.02	20KV	17.90	2	4000V	7.95
.025-025*	50KV	55.00	2	5000V	12.50
.02	7500V	4.50	2	7500V	32.95
.03	18KV	1.95	2	12.5KV	59.50
.035	10KV	12.95	2	15KV	1.25
.05	5KV	2.45	2	600V	1.25
.05	7500V	2.95	2	4000V	5.95
.08	12.5KV	15.95	2	150V	1.35
.1	1500V	1.45	3	400V	1.05
.1	2000V	1.35	3	600V	1.25
.1	3000V	1.85	4	600V TLA	1.45
.1	6000V	1.95	4	100V TLA D1	4.00
.1	7500V	1.75	4	1500V	2.65
.1	7500V	3.50	4	2000V	4.35
.1	10KV	9.50	4	2500V	5.95
.1	10KV	12.95	4	3000V	7.55
.1	12KV	14.95	4	4000V	13.95
.1	12KV	16.95	4	4000V	24.95
.1	16KV	16.95	4	7500V	52.50
.1-1	2000V	1.98	4-4	600V	2.40
.1	7500V	1.95	4	30VAC	1.75
15-15	8000V	1.95	5	600V	1.75
.2	10KV	10.95	5	1000V	1.99
.2	15KV	17.95	5	1500V	2.98
3x-2	4000	2.85	6	330VAC	1.75
.25	2000V	1.35	6	600V	1.85
.25	2500V	1.45	6	1000V	2.45
.25	6000V	1.75	6	1500V	3.65
.25	4000V	2.85	6	2000V	3.95
.25	3000V	1.45	6	600V	1.45
.25	15KV	15.95	7	800V	1.99
.25	20KV	19.95	7	1000V	2.49
.25	32.5KV	18.95	7	1500V	3.49
.25	60KV	85.00	8	600V	2.25
.3	2000V	1.45	8	600V Rd	1.79
.4	10KV	19.95	8	1000V AC	3.50
.5	1500V	1.20	8	1000V	3.25
.5	2000V	1.85	8	1500V	4.25
.5	2500V	2.20	8	2000V	4.95
.5	3000V	2.39	8-8	600V	1.75
.5	4000V	3.15	8-8	600V	2.25
.5	5000V	4.15	8	600V	4.85
.5-1	2000V	.90	10	60VAC	5.90
.5-5	600V	.68	10	1000V	4.55
.5-5	1000V	.85	10	1500V	6.95
.5	25KV	55.50	10	2500V	14.95
1	400V	.45	10	6000V	99.50
1	600V	.59	12	1000V	6.75
1	1000V	.69	12	1500V	6.75
1	1500V	1.35	12	2000V	6.95
1	2000V	1.95	12	330VAC	1.75
1	2500V	2.50	15	440VAC	4.95
1	3000V	3.50	15	600V	3.25
1	6000V	8.85	15	1000V	5.35
1	6000V	8.95	15	1500V	6.35
1	7000V	12.60	15	6000V	63.50
1	10KV	27.90	16	1500V	8.85
1	15KV	49.50	20	600V	5.85
1	16KV	49.50	20	330VAC	4.69
1	20KV	59.50	28	1000V	7.50
1	25KV	70.00	30	330VAC	5.25
1	600V	.59	79	4000V	49.50

BATHTUB CONDS.

Mfd.	Volts	Price	Mfd.	Volts	Price
.01-.01	600	.45	3x-25	1000	.70
.02-.02	600	.25	.25	1000	.48
.04-.04	600	.25	3	400	.15
.05	600	.22	5	400	.37
.05-.05	600	.25	5	600	.47
.05-.05	1000	.44	5	1000	.52
.08-.08	600	.25	5	1000	.52
.1	600	.39	2x-5	600	.59
.1	1000	.45	4x-5	600	.69
.1-1	1200	.45	1	1200	.75
.1-1	400	.29	1	300	.30
.1-1	600	.39	1	400	.45
.1-1	1000	.59	1	1000	.85
.1-1	600	.40	1-1	230AC	.49
.1-1	1000	.55	1-1	600	.95
2	1000	.21	2	600	.95
2	600	.95	2	600	.95
2	600	.95	4	100	.49

Trans. MICA CONDENSERS

Mfd.	Vwdc	Price	Mfd.	Vwdc	Price
.00015	2500	.38	.001	1200	.32
.00024	2500	.38	.001	2500	.49
.00025	1200	.30	.001	2500	.49
.00033	600	.24	.001	4500	1.70
.00033	1200	.28	.001	6000	2.50
.00033	2500	.37	.0015	600	.23
.00033	2000	1.30	.0015	2500	.55
.00044	600	.23	.0015	5000	2.50
.00047	2500	.31	.002	600	.27
.00045	600	.23	.002	1200	.39
.00065	1200	.29	.002	2500	.63
.00065	2500	1.33	.0024	6000	2.95
.00068	2500	.27	.0025	600	.28
.00068	1200	.29	.0025	1200	.43
.00068	600	.23	.003	600	.31
.00069	3000	1.35	.003	1200	.54
.001	600	.23	.003	2500	.74
.001	2500	.36	.003	3000	1.85
.001	6000	1.75	.004	600	.29
.0015	600	.23	.004	1200	.48
.0015	2500	.33	.004	2500	.84
.0015	5000	1.95	.005	600	.35
.0015	600	.23	.005	1200	.48
.002	1200	.29	.005	2500	.99
.002	2500	.36	.005	3000	1.90
.0025	600	.23	.008	600	.55
.0025	1200	.20	.008	1200	.55
.0025	2500	.40	.008	1200	.55
.0025	5000	1.95	.01	600	.48
.0027	1200	.28	.01	1200	.73
.0027	2500	.36	.01	2500	1.15
.003	600	.23	.015	600	.55
.004	600	.23	.015	1200	.78
.004	2500	.29	.015	2500	1.25
.0047	2500	.40	.02	600	.57
.005	600	.23	.02	600	.21
.005	1200	.29	.02	1200	1.15
.005	2500	.43	.02	2000	1.50
.005	3000	1.35	.03	600	.67
.0068	2500	.28	.03	600	.67
.0089	1200	.28	.03	1200	1.34

Available in Other Sizes

CHANNEL COND.

Mfd.	Vwdc	Price	Mfd.	Vwdc	Price
.025	600	\$1.19	.25	1000	.45
.05	400	.21	.4	600	.21
.2x-05	600	.30	5	400	.30
.1	500	.28	.5	500	.33
.1	600	.32	.5	600	.42
.1	1000	.52	.5	600	.49
.1	2500	1.25	2x-5	600	.59
.1	400	.34	5	1000	.59
.1	600	.40	1	600	.39
.1	1000	.52	1	600	.58
.1	2000	1.35	1	600	.58
.1	3000	1.95	1	600	.63
.1	4000	2.85	1	600	.63
.1	5000	4.15	1	600	.63
.1	6000	5.90	1	600	.63
.1	7000	8.85	1	600	.63
.1	8000	12.60	1	600	.63
.1	10KV	27.90	1	600	.63
.1	15KV	49.50	1	600	.63
.1	16KV	49.50	1	600	.63
.1	20KV	59.50	1	600	.63
.1	25KV	70.00	1	600	.63
.1	600V	.59	79	80	49.50

Sp. Bathtub Kit \$1.00
—WANTED—
Condensers of all Types in any quantity. Also other standard components.

W.E. CONDENSERS

Mfd	Type	Price	Mfd	Type	Price
.5	141-B	.95	.01	F404-C	1.18
1	D181884A	1.25	1-1	WE 147	1.75
1	000195 D62383	.15	2-2	1-137C	2.25

CONTACTORS

Type	Spec.	Volts	Current	Action	Price
6041HB1A	B8	24 C-H	200	SPST-NO	3.95
6041H139	B8	24 C-H	250	SPST-NO	4.95
6041H11A	C1	24 C-H	60	DPDT-NO	8.55
6041H11B	C1	24 C-H	60	DPDT-NO	8.55
6041H12B	C2	24 C-H	100	DPDT-NO	12.95
9320	M7A	24 Bq.D	50	SPST-NO	3.50
7055-12	B8	12 Cch	50	SPST-NO	3.50
34056	B8	24 C'dian	250	SPST-NO	4.45
WSL-4001	B8	24 A'line	250	SPST-NO	3.95
694R15A	B8	24 Hart	250	SPST-NO	4.45

RELAYS

Type	Volts	Ohms	Current	Action	Price
1017	24 Leach	265	6 @ 115V	SPST	5.69
1027	12 Leach	67	4 @ 115V	DPDT	1.25
1220-DE	24 Leach	95	20	SPST-DH	1.25
1222-BP	24 Leach	160	30	SPST-DH	1.25
1227-B2A	24 Leach	160	25 @ 20V	SPST-NO	1.25
1254M	24 Leach	160	12.5 @ 115V	SPST-NO	1.25
1257	24 Leach	265	12.5 @ 115V	DPDT	1.59
2028	24 Leach	265	12.5 @ 115V	4PDT	2.25
6104	24 Leach	2B	20 @ 220V	SPST	3.65
105-612	115 W-L			DPST	1.50

Write: ART HANKINS, Owner

MONMOUTH RADIO LABORATORIES
Box 159
Long Branch 6-5192

Type "G" Mica CONDENSERS

Mfd	Volts	Price	Mfd	Volts	Price
.0005	3KV	5.00	1	5KV	11.50
.0005	10KV	19.95	.001	20KV	35.95
.0005*	40KV	44.95	.001	25KV	57.50
.001	10KV	15.95	.001	35KV	70.00
.001	10KV	15.95	.002	3KV	5.25
.001	20KV	31.50	.002	6KV	11.95
.001	35KV	44.50	.002	10KV	20.00
.0015	10KV	15.95	.0024	6KV	11.95
.002	6KV	9.95	.0025	12KV	35.95
.002*	25KV	34.95	.0025	15KV	35.95
.0024	6KV	9.95	.0025	26KV	59.50
.0024	6KV	9.95	.003*	6KV	6.95
.0024	6KV	9.95	.003	10KV	17.95
.0024	10KV	19.95	.004	8KV	15.95
.003*	20KV	32.95	.005	10KV	38.95
.003*	25KV	44.50	.00575	10KV	37.50
.0035	25KV	33.95	.01	10KV	10.95
.0035	35KV	59.95	.01*	16KV	44.50
.004	30KV	44.95	.01	15KV	62.50
.0045					

A NEW BUILDING IMPROVED FACILITIES for the manufacture of

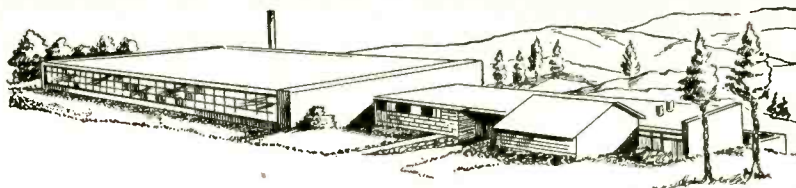

WESTON TEST EQUIPMENT

BC-221 FREQUENCY METER

We are happy to continue to make available the justly famous Heterodyne Frequency Meter—BC-221—in most of its nomenclatures. While we cannot make available to any one customer all of a given number we can agree to supply to any one customer either Modulated or non-Modulated types complete with crystal, spare tube as well as equipment tubes, calibration book and instruction book. These instruments have been carefully remanufactured and are guaranteed in accordance with the Certification supplied with each instrument.

Price for Non-Modulated... \$125.00
for Modulated... 165.00
A.C. Supply for either... 35.00



AN-APA-10	BC-595-TU	1-117	1-212	OAW	TS-32A/TRC-1	TS-89/AP*	TS-148/UP*	TS-218/UP	TS-33
AN-APR-1	BC-1060A	1-122	1-222/A	P4	TS-33/AP	TS-90*	TS-153	TS-220/TSM	TS-359A/U
AN-APR-4	BC-1066A	1-126	1-223/A	P4E	TS-34/AP	TS-92/AP	TS-155	TS-226A	TS-363/U
AN-TSM-4	BC-1201A	1-130A	1-225	SG-8/U	TS-35/AP	TS-96/TPS-1	TS-159-TPK	TS-230B	TS-377/U
AN-UPM-13	BC1203	1-134B	1-233	TAA-16WL	TS-36/AP	TS-98/AP	TS-164/AR	TS-232/TPN-2	TS-389/U
AS-23	BC1236/A	1-135	1-245	TS-1ARR	TS-39/TSM	TS-100/AP	TS-170/ARN-5	TS-239B	TS-418
AT-67	BC-1236/A	1-137A	1E-21A	TS-3AP/AP	TS-45/APM-3	TS-101/AP	TS-173/UR	TS-250/APN	TS-419
AT-68	BC-1277	1-139A	1E-36	TS-8A/U	TS-46/AP	TS-102/AP*	TS-174/U	TS-251	TS-421/U
AT-39	BC-1287A	1-140A	1F-12/C	TS-10A/APN-1	TS-47/APR	TS-108/AP*	TS-175/U*	TS-257/AWR	TS-433/U
AT-48	1-48B	1-145	1S-185	TS-11/AP*	TS-51/APG-4	TS-110/AP	TS-182/UP	TS-263	TS-465/U
BE-67	1-49	1-147	TS-12/AP*	TS-13/AP*	TS-56/AP	TS-113/CP	TS-184/AP	TS-268B*	TS-480/U
BC-221*	1-56	1-153A	LAD	TS-14/AP	TS-59	TS-117/GP*	TS-189/U	TS-270A	TS-505
BC-376	1-61B	1-157A	LAE-2	TS-15B/AP	TS-60/U	TS-118/AP	TS-192/CPM-4	TS-281/TRC-7	TS-589/U
BC-438	1-83A	1-167	LM*	TS-16/APN	TS-61/AP	TS-125/AP*	TS-194/CPM-4	TS-285/GP	TS-615/U
BC-439	1-86A	1-168	LAF	TS-18	TS-62/AP	TS-127/U	TS-195/CPM-4	TS-293	TS-616/U
BC-638	1-95A	1-177	LU-2	TS-19	TS-63/AP	TS-131/AP	TS-197/CPM-4	TS-297*	TS-617/U
BC-639	1-96A	1-178	LU-3	TS-23	TS-64/AP	TS-138	TS-198/CPM-4	TS-301/U	TS-620/U
BC-906D	1-97A	1-186	LZ	TS-23/AP	TS-65A/FM2-1	TS-142APG	TS-203/AP	TS-303/AG	TSX-45E
BC-918B	1-98A	1-196A	ME-6/U	TS-24/APM-3	TS-69A	TS-143/CPM	TS-204/AP	TS-311/FSM-1	TSS-45E
BC-923A	1-106A	1-198A	OA	TS-24/APR-2	TS-76-APM-3	TS-144/TRC-6	TS-205AP	TS-323	TUN-85E
BC-936A	1-114	1-203A	OAA-2	TS-26/TSN-1*	TS-78/U	TS-146	TS-207	TS-324/U	TUN-8MU
BC-949/A	1-115	1-208	OAA-2	TS-27/TSM	TS-87/AP	TS-147/AP*	TS-210/MPM	TS-328	TTX-10RH

WESTON LABORATORIES, INC. HARVARD, MASS.

Cable: WESLAB Tel: HARVARD 250—AYER 300—TWX—193

Harjo Save More in '54! CUTS PRICES TO CLEAR STOCKS!

Check your needs on this list of specially priced aircraft and electronics equipment. Complete stocks—WRITE FOR FREE CATALOG!

TEST EQUIPMENT

TS-11	\$45.00	1E-19	\$200.00
TS-34	300.00	1-222	89.50
TS-47/APR	225.00	1-139A	12.50
TS-50/U	14.95	1-183A Frequency	
TS-89	32.50	Meter	17.50
TS-100	85.00	1-185A Oscillator	
TS-101	7.50	BC-221 Meter	24.50
TS-126	75.00	BC-1287A	89.50
TS-131	14.95	BC-1287A	
TS-184	45.00	(S Band)	125.00
TS-268	37.50	LM	85.00

FLUX METER

500-4000 Gauss—Brand new \$27.50
in lab hardwood cases.

APS 13 COMPLETE 420 MC RADIOPHONE

when converted with our easy-to-follow schematics and instructions. Range in most cases equal to 2 meters. Fine for short-distance communication, ranches, farms, etc.

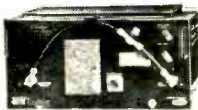

\$4.95

\$14.95 value

Complete with RF sections, conversion booklet, and 30 MO I.F. strip, less tubes, dynamotor.

TRANSmitters & RECEIVERS

ARC-3 complete, certified	\$850.00
BC-640 and BC-639, RA-42	750.00
AN/TRT-1 Mine trans.	100.00
ART-13	350.00
BC-797 ground stas.	900.00
SCR-284	100.00
BC-1333 Marker Recvrs., certifi.	75.00
BC-733D CAATC	35.00
BC-348	145.00
DZ-1 Compass, new	20.00
ARQ-8 Search-Jam equipment Receiver	
Transmitter Control Box (less tubes and blower)	\$35.00
ASB-7 Transmitter—Complete with tubes.	
Fine for 420 MC and TV relay work	7.95
ARB Receivers—Minor parts missing	12.95

FIRST TIME EVER!

RCA Surplus TV CAMERA! only \$295

Complete with 1848 iconoscope and 6-stage video amplifier and clipper. Perfect for use in movie pickup chains and for training and experimental work. UNBEATABLE BARGAIN! Write for complete information!

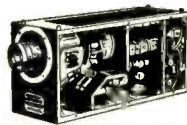

RADAR EQUIPMENT

APS-4 Complete Radar Set with Modulators	\$550.00
SN complete	400.00
MD-12/APQ-13 with tubes	25.00
T2S/TPS-2	75.00
R6S/APN-9	700.00
AN/PPN-1 (Eureka)	50.00
AN/PPN-2 (Eureka)	75.00

POWER SUPPLIES INVERTERS

MG-149F Rotary converters, certifi.	\$ 49.50
RA-34 Hi-voltage for BC-191, etc.	149.50
RA-62 Hi-voltage for SCR-522	125.00
Pincor IKIX Rotary conv (110DC In—110AC out)	10.00
HIGH VOLTAGE POWER SUPPLIES—110 v. 60 cy. in. 1250—1500 v. at 350 ma. out. Heavy duty potted transformers. Oil condensers relay controlled. Compl. in enclosed case, orig. made for navy radar use. Excellent for transmitters and lab use. Priced less than cost of parts.	\$22.50
Ship. wt. 100 lbs.	

FIELD TELEPHONES

EE-108, TP-3 (V.P.C.) Sound Power Field Telephones. Excellent, checked out.	\$29.50
---	---------

TS 45/APM X BAND SIGNAL GENERATOR

Only \$250.00
Now available from HARJO at a price every small lab, school, and service shop can afford!



T116/APTSA UHF Transmitter
Freq. Range 300-1500 mc.
20 w. output—band width 2.5-3 mc.
Complete with tubes and 110 v.
60 cy. fl. transf. New \$175

CERAMIC CONDENSERS \$1 ppd
Kit of 100 asstd. Brand new, standard brands. \$10 value.

MICRO SWITCHES, new. 4 for \$1.00

SCOPE TRANSFORMERS \$2.95

Prim. 110 v. 60 cyc. Sec. 3500 v. 25 ma. 10 KV ins.

Shipping wt. 15 lbs. POWER TRANSFORMERS—

Brand new. 79c.

110 v. 60 cy. prim.

150 v. 30 ma. sec. 6.3-1 Amp. Fil.

FB for grid dip kits, test equip., etc.

WILLARD 6-VOLT BATTERIES \$1.29 4 for \$5.00

1-inch Bullseye and Dial-Lite Sockets 39¢ ea. Candleabra Type (removed for new equip.)

220 v. Candleabra bulbs to fit above 19¢ ea. 7 for \$1.00

METERS

PORTABLE WATT METER Kit contains brand new standard watt meter, and heavy duty labtype case with handle. Complete with instructions. \$50 val. \$9.95
3-IN. Black Dialface 0-750 ma. \$4.50
500-0-500 micro. \$6.50
METER BARGAIN—0-1 MA Full Scale 3-inch Aircraft Instrument Type. Simple conversion sheet furnished. Check this price. You can't afford to miss it! \$1.49 (3 for \$4) ppd.

MORE CASH

paid for your surplus equipment. Get what you want without red tape. Write today. Immediate reply.

Thousands more items in stock. Prompt replies to all inquiries. All shipments F.O.B. Warehouse and subject to prior sale.

FREE! WRITE FOR NEW HARJO CATALOG.

Harjo Sales Co.

Dept. EB

4109 Burbank Blvd., Burbank, Calif.
P. O. Box 1187, Magnolia Park Sta.
Cable: Harjo Phone: Rockwell 9-2411

SELENIUM RECTIFIERS

FULL WAVE BRIDGE

D. C. OUTPUT		A. C. INPUT	CAT. NO.	PRICE		
Volts	Amps.					
0-20	0.5	26	M400	\$2.75		
	1.0		M401	3.65		
	1.5		M402	3.90		
	2.5		M403	5.55		
	4.0		M404	7.45		
	6.0		M405	8.00		
	8.0		M406	9.65		
	12.0		M407	10.25		
	15.0		M408	17.40		
	22.5		M409	18.20		
20-40	0.5	52	M410	5.10		
	1.0		M411	6.85		
	1.5		M412	7.35		
	2.5		M413	10.19		
	4.0		M414	13.95		
	6.0		M415	14.65		
	8.0		M416	18.20		
	12.0		M417	19.05		
	15.0		M418	32.80		
	22.5		M419	34.30		
40-60	0.5	78	M420	6.80		
	1.0		M421	9.80		
	1.5		M422	10.35		
	2.5		M423	13.50		
	4.0		M424	20.00		
	6.0		M425	20.75		
	8.0		M426	26.40		
	12.0		M427	27.50		
	15.0		M428	47.50		
	22.5		M429	49.50		
60-100	0.5	130	M430	9.85		
	1.0		M431	15.50		
	1.5		M432	16.20		
	2.5		M433	20.50		
	4.0		M434	29.65		
	6.0		M435	30.40		
	8.0		M436	42.00		
	12.0		M437	43.85		
	100-120		0.5	156	M438	11.40
			1.0		M439	18.15
1.5		M440	18.90			
2.5		M441	23.95			
4.0		M442	36.00			
6.0		M443	37.00			
8.0		M444	49.60			
12.0		M445	51.80			

FULL WAVE CENTER TAP

D. C. OUTPUT		A. C. INPUT	Cat. No.	Price
Volts	Amps.			
0-10	1.0	13-0-13	M446	1.70
	1.5		M447	2.15
	2.5		M448	3.05
	4.0		M449	3.95
	6.0		M450	4.50
	8.0		M451	5.05
	12.0		M452	5.60
	15.0		M453	8.90
	22.5		M454	10.10

RECTIFIER TRANSFORMERS

SECONDARY		A. C. Input	Cat. No.	Price	
A.C. Volts	Amps.				
16	5	117	T100	5.75	
16	10		T102	8.35	
18 C.T.	14	110/117 125	T108	9.95	
	50		T109	35.00	
	100		T110	60.00	
	2		T103	5.95	
36	5	110/117 125	T104	7.80	
	10		T105	12.95	
	20		T106	28.50	
	35		T107	45.00	
	1.1		115/230	T300	14.00
	2.2			T301	22.00
3.3	T302	30.00			
4.4	T303	38.00			
8.8	T305	54.50			

HI-AMP CHOKES

Amps.	Res.	Type	Price
5 AMP	.03 HY	L41	\$7.95
10 AMP	.015 HY	L42	13.95
20 AMP	.007 HY	L43	28.50

FREE TECHNICAL BULLETIN

- CIRCUITS
- TRANSFORMERS
- CONDENSERS
- RATINGS
- CHOKES
- PRICES

Minimum order \$5.00. All prices are FOB shipping point. Send check or MO. We will ship transportation charges collect. Rated concerns send P.O., Terms Net 10 days.

GATES ELECTRIC

63 WEST BROADWAY
New York, N. Y. Phone WO 2-7587

NEW—LOW—LOW PRICES

ARC-5 COMMAND EQUIPMENT:

R-25/ARC-5 Rec. 1.5 to 3 MC. No Tubes...Used:	\$14.95
R-26/ARC-5 Rec. 3 to 6 MC. No Tubes...Used:	7.95
R-27/ARC-5 Rec. 6 to 9 MC. No Tubes...Used:	6.95
R-28/ARC-5 Rec. 100 to 156 MC. No Tubes...Used:	12.95
T-20/ARC-5 Trans. 4 to 5.3 MC...New:	18.95
T-22/ARC-5 Trans. 7 to 9 MC...Used:	14.95

274-N COMMAND EQUIPMENT:

BC-454 Rec. 3 to 6 MC...Used:	\$10.95
BC-455 Rec. 6 to 9 MC...Used:	9.95
BC-458 Trans. 5.3 to 7 MC...Used:	9.95
BC-459 Trans. 7 to 9 MC...Used:	14.95
BC-456 Modulator...Used:	2.95
FT-225 Mfg. F/BC-456...Used:	5.95
FT-220 3 Rec. Rack...Used:	\$1.50
FT-221 3 Rec. Shock...Used:	50¢
BC-450 3 Rec. Cont. Box...Used:	\$1.50
BC-451 Trans. Cont. Box...Used:	\$1.00
PLUG—Male for rear of Rec. or Trans...Used:	.55
DM-32 Dynamtr F/Rec. 24V, Used:	\$2.95
DM-33 Dynamtr F/Modulator & Trans...Used:	2.95

MOTORS:

24 VDC REVERSIBLE

MOTOR — 3.7 RPM, 40 lb. Torque Motor Size: 5-1/4" x 4-1/32" x 3-5/16". Shaft size: 21/22" x 5/16". Also operates 24 VAC. Philco No. 441-1008...\$5.95



27.5 VDC — 6000 RPM, 1.5 oz. in. Shaft Size: 1-1/2" x 3/4". Motor Size: 2-1/2" x 1-1/2". No. 5089-267...\$6.95
 27 VDC — 1-10 HP — 3500 RPM. Shaft Size: 5/8" x 3/4". Motor Size: 4" x 3-1/2". Air Assoc. No. EE-763...\$6.95
 80 VDC — 1/50 HP — 3000 RPM. Shaft Size: 5/8" x 3/4". Motor Size: 5" x 3". G.E. No. 5 PN3811A10...\$6.95
 28.5 VDC — 1/35 HP — 2200 RPM. Shaft Size: 1-1/2" x 1/2". Motor Size: 4-1/4" x 3-3/4". Electrolux No. 16876...\$5.95

2800 RPM Reversible Motor—Size: 5-1/4" x 3-1/2". Shaft Size: 1" x 3/4". Emerson No. 186-0412—Price \$5.95

GEAR HEAD for above motor. Ball Bearing Geared Shaft, 10 to 1 reduction. Price: \$3.95

COMBINATION Motor & Reduction Gear...\$10.60

21 VAC OPEN FRAME—20 RPM Double Shaft Back Gear Motor with Disengage Clutch. Shaft size: 1-1/2" x 3/16" — \$6.95

24 VAC OPEN FRAME—3 RPM Back Gear Motor. Shaft size: 3/4" x 3/16" — Price: \$5.95

24 VDC REVERSIBLE—5000 RPM with Magnetic Brake. Flange Mount Spine Shaft—size: 3/4" x 3/16". Motor: 4" L. x 2-1/2" Dia. GE Motor only #51A25A132A...Price: \$8.95

24 VDC AIRWAY MOTOR—Model #Z-350. Approx. 5000 RPM. Motor size: 2-1/2" x 1-3/4". Shaft size: 3/4" x 1/2". Price: \$4.95

25 VOLT 60 CYCLE 60 RPM Synchronous Cramer Motor #1147. Shaft size: 1/2" x 1/2". Price: \$1.95

110 VDC 1/70 HP, 1550 RPM. Motor size: 4" x 2-1/4". Shaft size: 1" x 3/16". Redmond #157...\$4.95

6 VDC 1/20 HP, 4000 RPM. Motor size: 5" x 3". Shaft size: 3/4" x 1/4". Redmond #E-56...Price: \$4.95

12 VDC 1/30 HP, 4500 RPM. Motor size: 3" x 2-3/8". Shaft size: 1" x 3/16". Delco #5047520...\$4.95

A.C. INDUCTION MOTOR—115 Volts 60 cycles 1.9 RPM—Torque Oz. In. 75; Watts—9; with variable Multiple Disc Coder Wheel and Micro Switch mounted on Bracket Assy. Holtzer Cabot Motor Type RWC 2505...\$14.95

GEARED HEAD MOTOR—Heavy Duty, 24 VDC 5 Amp, 2-1/2" lb. Torque; 100/200 RPM. Shaft size: 5/16" x 1". Right Angle Drive...\$8.95

TRANSFORMERS—110 V. 60 Cycle Pri.

5 VOLT CT-25A—10,000 V. Ins. OPEN FRAME—6" x 5" x 4-1/2".	\$7.95
Sec. Two 12 V. 4 A. Winding—gives 12 V. 8 A. or 24 V. 4 A.	\$5.95
Sec. 24 V. 1/2 A.	\$1.50
Sec. 24 V. 1 A.	\$1.95
Sec. 24 Volt 6 Amps.	\$5.95
Sec. 6-24 or 30 Volts, 8 Amps.	\$5.95

COAXIAL CABLE CONNECTORS AND CABLES:

RG-8/U (SPECIAL) 51.5 ohm. Same size as RG-8/U. Prices: 1 to 100 ft. @ 8¢ per ft.—100 to 500 ft. @ 7 1/2¢ per ft.—500 to 1000 ft. @ 7¢ per ft.—1000 ft. Rolls (or more) @ 6 1/2¢ per ft.
 RG-34/U—71 ohm. 145 ft. length...\$15.00
 PL-259—Plug ea. end & 32"—RG-54/U—58 ohm. 50¢
 UG-21/U—Plug ea. end & 32"—RG-11/U75 ohm. 50¢
 UG-22/U—with 4" Coaxial Cable...50¢

INSULATING MATERIALS:

PHENOLIC LAMINATED SHEETS—36" x 36" x 1/4". Grade XX Type 1. Black. Price: \$10.00 per Sheet.
 LAMINATED FIBERGLASS Sheets: 40" x 48" x 1/8". \$30.00 ea.
 PLEXIGLASS SQUARES—6" x 7" x 1/4"—3 For \$1.00

FREE SURPLUS CATALOG

LISTING SCORES OF EXCEPTIONAL "BUYS"! SEND FOR YOUR COPY NOW!

ADDRESS DEPT. E • All Prices Are F.O.B., Lima, Ohio • 25% Deposit on C.O.D. Orders

FAIR RADIO SALES • 132 SOUTH MAIN ST. LIMA, OHIO

SOUND POWERED HEAD AND CHEST SET

NAVY TYPE—No Batteries required. Ideal for TV Antenna installations, and many other uses. 20 Ft. Cord. Used—Tested...Each: \$5.95
 WIRE — COMBAT TYPE: 2 Cond. twisted, rubber covered, medium weight. W-130 = 1¢ per ft. FIELD WIRE: 2 Cond. twisted, weatherproof, heavy duty. W-110, 525 Ft. Roll \$4.75. COPPER WELD WIRE: Weatherproof. 2 Cond. solid. 1200 Ft. Roll \$10.00 or 1¢ per ft.



DYNAMOTORS:

INPUT VOLTS	OUTPUT VOLTS	STOCK NO.	USED	NEW
14	230	DM-21	\$9.95	
14	330	BD-87	6.95	\$8.95
14	250	DM-25	6.95	8.95
14	1000	BD-77	22.50	39.95
28	230	DA-1A	3.95	5.95
24	60	DM-32	2.95	6.95
24	275	DM-33	2.95	
28	210	DY-22	7.95	
24	220	DM-53	3.95	
28	1000	PE-73	8.95	
28	300	PE-94	5.95	10.95
		A, B, GM		
		13	3.9A	
14	172	DM-40	6.95	8.95
28	250	PE-86	2.75	8.95
12 or 24	500	USA/0515	4.95	4.95
12 or 24	275	USA/0516	4.95	4.95
13 or 26	400			
	800	025	PE-101C	3.95 4.95
12	150	100	DM-310X	4.95 7.95
6 or 12	500	160	PE-103	29.95 39.95
12	230	90	PE-133	6.95 8.95
18	450	60	SP-175	3.00 4.95

ANTENNA EQUIPMENT

MAST BASES—INSULATED:

MP-132 BASE—Illustrated at left—1" heavy coil spring, 2" insulator. Overall length, 11 1/2". Weight: 2 3/4 lbs. Price: \$3.95
 MP-S-33 BASE—Insulated type with heavy coil spring and 1/2" dia. insulator. Requires 2" hole for mounting. Weight: 9 lbs. Price: \$5.95
 MP-48 BASE—Insulated type base with heavy coil spring. Requires 1 1/2" mounting hole. Weight: 11 lbs. \$6.95
 MP-37 BASE—Insulated type with heavy coil spring; 2" dia. insulator; requires 1 1/2" hole for mounting. Weight: approx. 10 lbs. \$8.95

MAST SECTIONS FOR ABOVE BASES: Tubular steel, copper coated, painted in 3 ft. sections, screw-in type. MS-53 can be used to make any length with MS-52-51-50-49 for taper. Any section, @ 50¢ each. Larger Diameter Section: MS-54...\$1.25

AC TO DC POWER SUPPLY

RECTIFIER POWER SUPPLY—Input 105—125 Volts 60 Cycle; output 24 VDC 3 Amp. 200 Watts. Size: 16-1/2" x 15" x 9-1/2". Used—Tested...\$19.95

INVERTERS:

5D21N3A—27 VDC input; output 110 Volt 400 cycle. 1 Phase 485 VA...\$39.50
 PE-109D—Input 13.5 VDC 20 A; output 115 V 400 cycle, 1 Phase 1.53 Amps...\$59.50
 PU-7/A—Input 28 VDC 160 A; output 115 V 21.6 A 400 cycle 2500 VA...\$89.50
 PE-118—Input 28 VDC 100 A; output 115 V 400 cycle, 1 Phase 1500 VA...Used: \$14.95
 PE-218—Input 28 VDC 100 A; output 115 Volt 400 cycle, 1 Phase 1500 VA...Used: \$24.95
 PE-115 or PE-206—Input 28 VDC 36 A; output 80 Volts 800 cycle 7.2 Amps...Like New: \$12.95
 TYPE 800-1-D—Input 28 Volts 62 A; output 115 V 7 Amps, 1 Phase 800 cycle...Used: \$39.95
 NEW: \$75.00

BLOWERS:

115 Volt 60 cycle BLOWER (pictured)—approx. 100 CFM Dis. 2 1/4" intake; 2" outlet. Quiet running. Motor size: 2 1/2" x 3 1/4". NEW — not Gov't surplus...\$8.95
 Order No. 1C939...
 DUAL BLOWER — Same as RN-520 above, except has blower assembly in each side of motor. Order No. 1C880...\$13.95
 COMPACT TYPE — 108 CFM, motor built inside squirrel case, 4-1/2" Intake: 3-5/8" x 3" Dis. Complete size: 4-1/2" W. x 9-5/8" H. x 8-1/2" D. Order No. 2C067...\$14.50
 FLANGE TYPE — 140 CFM, 3-1/2" Intake: 2-1/2" Dis. Complete size: 8-1/2" W. x 7-1/4" H. x 6-3/4" D. Order No. 1C807...\$13.95
 FLANGE TWIN—275 CFM, 4-1/2" Intake: 3-1/4" x 3" Dis. Complete size: 11-3/4" W. x 9-3/8" H. x 8-1/2" D. No. 2C069...\$21.95



MINIATURE BLOWERS:

24 VDC; Oblong Outlet 1" x 3/8". Dual 20 CFM. \$7.95. Single 10 CFM. \$6.95.



WANTED
ARC-1, 3, ART-13, BC-342, 348, AP510, 15, TS-13, 35, 146, 147, 148, 174, 175, 263 ETC. All SCR, BC, AN, TS. ALL TUBES.

RADALAB
 87-17 124th STREET
 Richmond Hill 18, New York
 Phone Virginia 9-8181-2-3

TERMS—Minimum order \$25.00 all prices FOB New York City. 25% deposit with order, balance COD. Rated firms open account. Prices subject to change without notice.

MOBILE RADIO SCR-508
 10 Channel FM Receiver and Transmitter. Frequency Range 20-27.9mc. Receiver is manually tuned, transmitter is crystal controlled. Consists of 2 BC-603 Receivers, BC-604 Transmitter, FT-237 mount, Box 80 xtals BC-606 Control, A-62 Phantom Ant., Headsets, mike, and antenna. Input 12v DC. SCR-608 also avail. **POR**

AN-GSQ/1A SPEECH SCRAMBLER
 This is a very compact unit designed to be attached to either a radio or telephone circuit to scramble speech or code. This equipment utilizes coded cards in each terminal equipment. Unless the properly numbered card is inserted on the receiving end the speech can not be unscrambled. This provides an excellent privacy system. Complete equipment available consisting of: scrambler, code card set, cables, etc. This equipment can be used with any field or airborne communications equipment. Mfg. Western Electric. **POR**

RF-3A/AP X-BAND FREQUENCY SWEPT MANUALLY TUNED ECHO BOX
 Frequency range 8500-9600mc. This equipment consists of an echo box with a motor mounted on one end which provides a frequency swept response from the echo box enabling it to be easily observed on the Radar indicator. Input 28v DC 5 amps. Can be supplied in 110v 60 cyc AC. **POR**

SCR-291A
 1.5-30mc automatic direction finder. This equipment used to take bearings on transmitters within its freq. range. Complete equipments available comprising the following: BC-1147A Rec., PN 31, Power Panel, BC-1159, automatic bearing goniometer, RC-223 antennae system consisting of 5 masts with legs, MC-412, MC-413 phase inverters callibrating transmitter, cables, 115v 60 cyc gasoline generator. Complete equipment overhauled and guaranteed. **POR**

SCR-506A
 Mobile radio transmitter-receiver covering 2-4.5mc phone and CW. 1090 watts output 5 channel operation. 12 or 24 volt input. Consisting of: BC653, BC622, Rack, dynamotors, microphone headset, antennae and mounts, **POR**

AN/ART-13 AUTO-TUNE AIRCRAFT TRANSMITTER
 This equipment covers the frequency range of 2-18mc. and is automatically tuned 10 channel. Power output is 75 watts CW. 60 watts phone. This equipment consists of T-47 or T47A transmitter, dynamotor power supply, control box, racks, antennae loading unit, etc. **POR**

VE REMOTE PPI INDICATOR
 This is a remote PPI indicator "7 in." screen for use with any Radar for remote viewing. Contains all indicating circuits and is driven by the main Radar. Input 115v 60 cyc. **POR**

AN/ARN-7
 Automatic direction finder covering 100-1750 kc. Comprising Receiver, Loop, Control boxes, Plugs, Mounts, etc. **POR**

AN/PPN-1 REBECCA GROUND BEACON
 This equipment operates on 215 mc and is used in conjunction with AN/APN-2 or SCR-729. Provides a signal enabling the aircraft carrying the APN-2 to home on it. This equipment is completely portable and operates from a 12 volt battery. Complete installations avail. **POR**

AN/APN-3 SHORAN EQUIPMENT
 This equipment is used for navigation, surveying, and automatic blind bombing. Operates in conjunction with AN/CPN-2 ground-beacons. Operating frequency of this equipment is 290mc. The accuracy is plus or minus 10 feet up to its range of 300 miles. We can supply bombing computers, if desired we can supply APN-3 spares. AN-CPN-2 ground-beacons also available. **POR**

SCR-522
 Airborne Transceiver, Freq. 100-156 Mc. This unit is crystal controlled 4 channel. Power output approx. 10 watts. Consists of: BC-624 Receiver, BC-625 Transmitter, FT-244 mount, BC-602 control box, PE-94 dynamotor, antenna, plugs **\$137.50**

AN/APN-2 and SCR-729 equip. avail.
BC-348E CAA and Military approved model.
AN/APT-5 300-1200 mc transmitter 30 watts output. \$169.50
AN/APR-5 1000-3100 mc receiver
BC-639 100-156 mc. POR
AN/APS-10 3cm airborne Radar. POR
AN/UPN-4 3cm portable Radar beacon. POR
TS-13AP 3cm sig. generator
TS-89 Voltage divider
TS-148 3cm spectrum analyzer
TS-62/AP X-Band Echo Box
TS-117/GP S-Band wavemeter

SO-8 S-BAND MARINE RADAR
 This equipment operates in the 10 centimeter FCC approved marine band. Consists of transmitter-receiver, indicator, motor generator, antennae, voltage regulator, etc. Input 115v DC. **POR**

TS-102 A/AP
 This crystal controlled pulse generator produces a square-topped, 50 volt synchronizing pulse of 8 microseconds at a prf of 400, 800, 1600 or 2000 cps, and a triangular marker pulse of 0.4 microseconds duration at a prf corresponding to a pulse-echo distance of 1500 ft. The phase between the marker and sync. pulses is continuously variable from -180 to +150 degrees **POR**

BC 610 TUNING UNITS
TU 49 New 9.75
TU 53 New 9.75

RESISTORS

- ALL MAKES
- ALL OHMAGES
- ALL TOLERANCES

1/2 WATT—1 WATT—2 WATT

AMERICA'S BEST

EB 1/2 W 10% \$2.75 per C
 GB 1 W 10% 4.75 per C
 HB 2 W 10% 7.75 per C

For 5% add 100% Appr.
 Minimum per Item — \$2.00
 Minimum per Order — \$10.00

LEGRI S COMPANY

158 West 99 Street, New York, N. Y.

SPECIAL VALUES

738 Output Power Meter General Radio. Like New \$225.00
 3209-3370 mc. Like New 400.00
 LR-1 Signal Generator 160-30,000 KC. 115VAC, 60 cy. with xtal calibration. Exc. 1,000.00
 Model 225X Hickok Universal crystal controlled Signal Generator. Like New 125.00
 Model 200C Hewlett Packard Audio Generator. Exc. 100.00
 Kay Electric Mega-Sweep. Exc. 250.00
 Kay Electric Mega-Pipper. Exc. 100.00
 R65/APN9 Receiver-Indicator. PUR*
 Du Mont 208B Oscilloscope. Exc. 125.00
 Model 230 Clough Brengele AC Cap. & Res. Turns Ratio Bridge. Exc. 45.00
 Type 728A General Radio Vacuum Tube Voltmeter. Exc. 125.00
 804C Federal or General Radio Signal Gen. 8-330 mc. Exc. 300.00
 General Radio Type 620A Hetrodyne Frequency Meter, panel mounting, 300 kc. to 300 mc. Exc. PUR*
 BC-221 or LM Freq. Meter. Exc. 99.50
 BC-221AK with modulation. Exc. 150.00
 General Electric Dual Regulated Power Supply Type ST9A. New 300.00
 A LARGE STOCK OF ARC-1, AIC-3, ART-13, APN4, APN41B, APR4, ARB, BC-312, BC-342, BC-348, BC433G, BC-611, BC-1308, CRT-3, 196A, 1222, IE-19A, IE-35A, IE-36A, SCR-284, SCR-522, SCR-578, SCR-625, TCS, T19/APQ5, TS-34/AP, TS-100/AP, TS-184/AP, 14C, Plugs and Sel. syns PUR*

*PUR—Price upon request.

WANTED

All types of radio and electronic surplus. We especially need: AP410, APN9, APR4, ARN4, ARC1, ARC3, ART13, ATC BC221, BC348, BC348, BC911, BC721, DY12, DY17, H100, LM10 to LM18, MG149F, MG149H, PU14, R5/ARN7, RSA/ARN7, SCR718C, TCS, TN16, TN17, TN19, TS54, TS59, TS13/AP, TS33, TS35, TS45, TS75, TS76, TS102, TS147/UP, TS148/UP, TS173, TS174, TS175, TS250, TS251, TS323 (ICT, IF, IG, SGT, SDG, SF, SG, SDG, OG, 113V, 60 c.p.s. Selsyns), and all types of Hewlett Packard, General Radio Co., Measurements Corp., Bonton Radio, Ferris, Leeds & Northrup, and other test equipment. Please state accurate description, condition, and your lowest price. Explain modification, if any. We pay freight charges.

YOUR BEST BUYS IN TUBES
ALL—ARE—STANDARD BRANDS

0A2 85	6K7 60	2051 1.09
0A3 99	6L6 G. GA. 95	5651 1.95
0B2 85	6L7 60	5654 2.50
0C3 85	6N7 75	5691 7.75
0D3 85	6SC7 79	5692 7.75
1A7GT 90	6SN7GT 70	5693 5.75
1B3GT 90	6SN7GT 70	7193 29
1B24 6.75	7E6 65	
1B25 7.07	7E7 65	
1B32 1.40	10Y 45	DIODES
1L4 2.45	12A6 45	1N21 1.40
1L5 2.50	12S17GT 75	1N21B 1.65
1P32 3.95	28D7 1.45	1N23 2.50
1P36 3.95	RK60/1641 1.95	1N23A 2.25
1P40 1.50	120A 2.25	1N23B 2.50
1R5 55	121A 2.25	1N26 7.75
1T4 12.50	F123A 6.95	1N38 1.20
2C25 12.00	F127A 17.50	
2C40 7.75	204A 37.50	SCOPE TUBES
2C42 7.50	211/V74C 85	2A1 6.95
2C46 7.50	F6235A 75.00	3A1 4.95
2C51 3.75	304T 6.95	3A2 1.50
2C52 3.50	307A 3.95	3DP1 2.75
2D21 95	CE309 2.50	3CP1 2.75
2E24 2.95	394A 2.50	3P1 30.00
2E26 3.25	701A 5.95	5B1 3.50
2E27 20.00	706B 29.50	5B1A 9.00
2J32 22.00	707A 29.50	5B2 4.25
2J33 27.50	715B 8.00	5HP1 4.25
2J34 18.50	715C 15.00	5HP2 4.25
2J54 47.50	717A 65	5P1 21.75
2J62 32.50	723AB 17.50	5P4 21.75
2K23 19.50	801A 3.15	5P5 19.50
2K28 25.00	807 1.45	5P7 25.00
2K33A 175.00	811 2.80	5R2A 35.00
2M55 99.50	812 2.65	7B1 4.00
2X2/879 45	813 9.25	9GP1 5.00
3A4 55	814 8.25	
3B28 4.95	832A 7.50	
3C31 3.95	833A 29.50	
3C33 8.50	845 6.75	
3C45 9.75	860 2.25	
3E29 10.95	865 95	
3S4 18.55	866A 1.25	
4D22 16.50	872A 2.75	
5D21 11.95	889A 195.00	
5E4GY 1.20	918 2.95	
5Z4 5.75	918 2.95	
6C1 8.75	921 1.75	
6A25 6.25	923 1.75	
6A5 65	931A 3.95	
6A5 69	954 45	
6AT6 49	955 45	
6BQ7A 1.75	955 45	
6C21 18.00	CM1005 55	
6F6 60	2050 1.40	

TOP DOLLAR paid for SURPLUS TUBES— Send list with details.

NEW SPRING CATALOG NOW AVAILABLE

PHOTOCON SALES

417 N. Foothill Blvd. SYcamore 2-4131
 Pasadena 8, Calif. RYan 1-6751

CABLE: Photocon, Pasadena.

ALLIED ELECTRONIC SALES
SPECIALISTS IN ELECTRONIC TUBES

Barclay 7-5839
 74 Cortlandt St., New York 7, N.

SAVE ON TUBES BRAND NEW TUBES GUARANTEED TUBES

CA2 \$0.95	2J27 12.50	3HP7 2.95	5JP1 22.50	250R 8.95	708A 3.95	829B 9.95	5636 8.95
CA3 VR75 1.10	2J31 20.00	3JP1 12.50	5JP2 19.95	250TH 16.50	713A 9.5	830B 2.75	5637 4.00
CA5 3.50	2J32 20.00	3K30 199.50	5JP4 22.50	250TL 15.00	714AY 8.50	832A 9.50	5639 8.95
CB2 1.10	2J33 25.00	3X2500A3 175.00	5JP5 27.50	FG258A 149.50	715A 3.00	836 3.45	5640 9.95
CB3 VR90 1.00	2J34 25.00	4B24 6.95	5J23 39.50	274B 2.75	715B 4.00	837 1.45	5643 write
CC3 VF105 .90	2J36 89.00	4C27 CV92 10.00	5J26 99.50	3003 5.95	715C 16.50	838 3.98	5646 8.95
CD3 VF150 .85	2J42 125.00	4C35 19.00	5J29 10.00	HF300 17.50	717A 90	849 24.50	5651 2.50
1B22 2.00	2J49 85.00		5J30 29.50	304TH 7.95	719A 24.50	851 49.50	5654 1.75
1B23 5.75	2J51 write					852 17.50	5656 14.95
1B24 7.00	2J56 89.50					860 3.50	5657 200.00
1326 2.30	2J61 39.50					861 15.00	5670 3.50
1327 11.00	2J62 25.00					865 .98	5672 1.29
1332 532A 2.98	2K22 17.50					866A 1.30	5676 1.29
1335 7.50	2K23 19.95					869B 55.00	CK5678 1.00
1342 8.25	2K25 20.00	4E27 14.50	5J33 18.50	304TL 7.95	780BY 149.50	872A 2.75	5687 3.75
1363A 42.50	2K26 55.00	4J22 99.50	5NP1 5.95	307A/RK75 3.75	780CY 149.50	874 1.10	5693 4.25
1J21 SM4 4.50	2K28 25.00	4J23 99.50	5R4GY 1.25	310A 3.95	780DY 149.50	884 1.40	5694 2.60
1N21B 2.50	2K33A 199.50	4J26 99.50	5R4WGY 1.60	310B 12.95	780EY 149.50	889R-A 175.00	5702 2.95
1N22 1.25	2K34 139.50	4J27 99.50	6L 5528 6.50	316A 1.25	781A 2.95	891R write	5704 2.50
1N23B 3.25	2K41 125.00	4J28 99.50	6CJ 7.25	327A 4.40	782A 1.95	922 1.25	5718 6.00
1N34A .79	2K45 110.00	4J29 99.50	6AL5W 1.75	331A 7.95	783A 9.95	931A 4.95	5719 8.95
1N38 1.50	2K48 99.50	4J30 199.50	6A57G 3.50	337A write	723A/B 12.00	935 5.50	5727 2.10
1N44 1.10			6BF7 2.50	349A 8.50			5750 3.10
1N47 4.50			6BL6 69.50	350A 4.50			5787 6.00
1N55 2.75			6BM6 69.50	368AS 6.00			CK5787 4.95
1N60 .60			6C21 24.50	371B .75			5814 2.25
1N63 K53 2.39			6F4 3.50	388A 1.49			5840 8.95
1N69 .59			6J4 5.25	393A 6.95			5844 4.50
1P28 7.75			6SU7GT 2.75	394A 3.50			5876 14.95
1P29 2.00			12AY7 1.65	417A 8.50			5902 8.95
1P36 2.75			12DP7 16.95	434A 12.00			5905 12.50
1P39 1.20			12GP7 25.00	446A 1.19			5907 9.00
1Z2 2.75			12HP7 13.50	446B 3.50			5908 9.00
VS-2 7.50			15E 1.75	450TH 44.00			5916 9.00
5AP1 8.50			15R .69	450TL 44.00			5963 1.20
5AS15 4.25			35TG 5.95	464A 10.95			5972 4.50
5B22 2.25			FG57 5559 15.00	CK512AX 1.40	724B 2.75	955 49	6005 2.75
5C21 1=42 .69			RK60 1641 2.25	WL530 16.95	725A 4.50	956 49	6026 2.25
5C36 29.50			RK72 .95	CK536AX .95	726A 12.00	957 49	6110 8.95
5C39 15.00			RK73 .95	575A 13.95	726B 40.00	958A 89	6111 9.50
5C39A 17.50			75T 6.95	KU627 17.50	730A 20.00	959 1.50	6121 9.95
5C40 7.25			75TL 8.95	WL-651 59.50	802 2.95	CK1005 69	6201 4.50
5C42 12.50			83V 1.10	WL652 65739.00	803 80.2	CK1006 1.95	8005 4.95
5C43 14.95			FG95 5560 22.50	KU676 52.00	804 10.95	QK159 149.50	8012 1.95
5C44 .89			VT98 19.95	700 B/C/D 16.50	805 3.25	1616 90	8013 4.95
5C46 17.50			100TH 7.50	706A 2.95	807 1.65	1619 39	8020 1.25
5C51 3.85			HF120 9.95	705A 1.50	808 2.95	1699 39	8025 4.75
5C52 3.75			FG104 29.50	706AY 27.50	809 2.95	2050 1.30	8025A 5.95
5D21 1.15			V-123A 7.79	706BY 27.50	811 2.90	2050W 2.25	9001 1.15
5D21 W 2.49			V-127A 2.75	706CY 27.50	811A 2.90	2051 1.00	9002 .98
5E24 3.30			FG172 29.50	706DY 27.50	812 2.95	5516 5.50	9003 1.50
5E26 3.25			HF200 14.50	706FY 27.50	813 9.95	5611 115.00	9004 .69
5E31 1.40			911/VT4C .95	706GY 27.50	813 9.95	5633 8.95	9005 1.50
5E35 1.40			217C 4.95	707B 13.55	828 9.95	5634 8.95	9006 .49
5J26 12.50			221A 1.95		829 7.00		

YOUR SURPLUS WANTED
We Pay Highest Prices!

SPECIAL!
Vacuum Capacitors
50 mmfd. 15,000 v. \$7.50
12 mmfd. 32,000 v. \$10.00
1.50 mmfd. 32,000 v. \$12.50
100 mmfd. 20,000 v. \$14.00



5" DUAL GUN TUBE SPECIAL!
Long persistency tube. Valued at \$200.00. This tube has been rejected for military use.
Fully guaranteed. Only **\$17.95**

All Prices F.O.B. Los Angeles, subject to change without notice. Minimum order \$5.00.
Orders for \$5.00 should be prepaid in full.

Jsh ELECTRONICS
SALES CO. Dept. EB
7552 Melrose Ave.
Los Angeles 46,
California

Thousands of other types in stock. Send us your requirements. RECEIVING TUBES? We carry a complete line in stock. Standard brands only!

WE BUY AND SELL GOVERNMENT SURPLUS
electronic components, units, wire, etc.
Your Inquiries Invited
LAPIROW BROS.
1649 Hoffman St. Cincinnati 23, Ohio
Kirby 1285

GLASS TUBING
PYREX - NONEX - URANIUM
BULBS & CYLINDERS
WRITE FOR FREE MONTHLY LIST
HOUE SUPPLY COMPANY
PHONE KEYPORT 7-1286
M. R. #1 Box 86X Keyport, N. J.

B7 COCKPIT LAMP
PULL OUT LIGHT
For Aircraft, Boats, Cars and Workshops. Gives White or Red Light. Unit pulls out 6 feet from self-rewind reel. Any Voltage. Mounts Anywhere. Small Bakelite case 3 x 3/4 x 4/4.
\$225 EACH



K-RK-ARC-UG-PL-AN
CONNECTORS
Stock for Immediate Delivery
Connector Corporation
OF AMERICA
Hamilton St., New Haven 11, Conn. Phone: Spruce 7-2513
New York Phone: LExington 2-6254

CAPACITOR SPECIALS
Cat. #22F-391 1 MFD. 600 V DC. .75 ea.
Bahtubs ST CP-53 Case
Cat. #23F-154 1 MFD. 600 V DC. .45 ea.
Channels Oil Filled
Cat. #TJU-10010 1 MFD. 1,000 V DC
Ceramic-Screw Term60 ea.
2J1G1 SELSVNS BRAND NEW
2J1F3 400 CYCLE
RELAYS — SWITCHES — SWITCHETTES —
BLOWERS — ALL TYPES — IN STOCK
NEW YORK ELECTRONICS
218 Fulton St., N. Y. 7, N. Y. Rector 2-4137

RADIO-RESEARCH INSTRUMENT CO.

10 CM. "S" Band

F-28/APN-19 BEACON FILTER CAVITY. 2700-2900mc. Max. 1.5-db loss at ctr. freq over band, 3db at 15 mc band ends. Meets full JAN spec. Gov't source insp. available. Fully calibrated to above spec. \$42.50. Uncalibrated, guaranteed \$28.50. COAXIAL MIXER. Xtal. detector assy designed for beacon revs. Trombone tuned input. "N" fittings. 2 types available-feed thru or take off to xtal. \$17.50. LIGHTHOUSE CAVITY. For 2C40 tube. Tuneable 2700-2900mc w/suitable adj of grid cys. Can be freq. modulated. \$25.00. STANDARD REFERENCE CAVITY. 2650-3050mc. Invar tuning center conductor of 3/4 wave-length. 50 ohm coax "N" input output conn. Imp./sec. stability. Loaded Q between 650 and 3000 w/xmsn loss .5 to 5 db adjustable. Unloaded Q approx 6000. Concentric xmsn type resonator. Tuning mech. lock. \$28.50. CRYSTAL MOUNT. 3/4" std coax. "N" fittings. Holds any IN21 type xtal. Incl. impedance match tuner. \$17.50. FEEDBACK DIPOLE 7/8" coax. for parabola. 1 1/2" o.a. \$14.50. MIXER BLOCK w/p.u. loop. "N" fitting. \$8.50. ECHO BOX. TS-207/UP. 2700-2900mc. micro adj. \$84.50.

10 CM. WAVEMETER

2700-3000mc. Hi-Q coaxial transmission type, N fittings, micrometer head, 3mc. absolute accuracy, w/calib. curve. Factory new \$86.50

Pulse Components

KS-9643 Miniature, perm. core. Z ratio 1:1:1 \$5.00. 145EWP AND 132AWP low volt pulse xtmr. \$5.50 each. D168983 Network 125 ohm, herm sid. \$3.50. LV PULSE 50-4000kc, 120-2350 ohms, term core \$6.50. PULSE CONN. UG180/type rubber insert, male chassis mt. w/12" cable D166389 \$2.00. UG38/trpe male cable mt. \$5.00. UG38/type female w/mtg fig. air to oil \$5.50.

Antenna Drives

COMPLETE. 12rpm clockwise, rotation, 115V 60 cy GE motor, incl sine potentiometer & bearing indicator. \$137.50. GEAR-MOTOR ASSY. Gear speed 95.5, gear ratio 9 to 1, motor speed 860 shunt wd, 6 amp, volts, 250A-125F cont duty. \$84.50 each. MOTOR DRIVE ASSY. 115-VDC motor 1/20 hp, 1725 rpm. Gear box 172 rpm, 11 in. lbs. torque, cpld to 9 in. step down gear. \$35.00. SCR 584 J-K sect. High speed Rotary Joint. \$35.00.

Accessories

PARABOLIC REFLECTOR 4ft. dia. RCA hi gain dish \$84.50. VARIA. COND. 4 gang. 7 to 144 mmf/sec. Ball brg. shaft. \$3.25. PATCHING CABLE. Male type "N" ea. end 3ft. \$2.50. COUNTER DIAL Veeder Root 4 digit. Mech. drive \$75. BATHUB COND. 2x.Imfd 600V side term. Ten for \$175.

COMPUTER TIMER

Mark 8 Timer WE D168508 w/6SN7, 6H6, Network D168180, D167818. New \$27.50

3 CM. "X" Band

CRYSTAL MOUNT. Holds any IN23 type xtal. 1" x 1/2" guide std coax output, UG40 fig input. \$15.00. DIRECTIONAL COUPLER. Uni dir. 20db, type "N" output, UG39fig. to UG40chic. JAN type CG-176/AP. \$25.00. WAVEGUIDE. Std RG-52/U sharp internal corners. Any lgh up to 12 ft. \$1.25 per ft. FLEXIBLE SECTION. Apx 6". UG39 figs. \$10.00. TR-ATR SECTION. Duplexer assy w/UG-39 to UG40 run, iris cpig, cpig to I324 type TR tube. ATU cavity 754 type compl. w/tuning slugs. SO-3 Iadar component. \$8.50. ROTARY JOINT. UG40 choke to choke. w/mounting, plate for easy installation. 360 deg. rotary coupling for lab or high speed scanner. \$12.00

All material guaranteed surplus. Immediate delivery. Budget prices

A complete variety of microwave plumbing is available in most bands. Test accessories and radar system components. WRITE US YOUR REQUIREMENTS. We pride ourselves in our ability to serve the microwave industry. A prompt reply is given to all inquiries. Immediate Delivery.

Telephone: JUdon 6-4691

550 FIFTH AVE., NEW YORK, N. Y.

SPECIAL OF THE MONTH WESTINGHOUSE 0-500 MICROAMMETER. 3 1/2" RD, BAKELITE CASE. MODEL NX35. BRAND NEW 4.97 ea.

WESTON METERS

Model 301, RECTIFIER TYPE
0-150 Volts AC, 1000 ohms per volt
A.C. Round bakelite case. **\$8.97 Ea.**

OTHER WESTON MODEL 301

0-10 Volts DC (1000 ohms/v) 6.97
0-1 Ma (KV Scale) 6.97
0-50 Ma DC 6.97
0-1.5 Mills DC 6.97

Model 731

0-200 Microamps (Spec. Scale) 8.97
0-1 Ma (0-100 Scale) 7.97

Model 506

0-200 Microamps 6.97
0-1 KV with Mult. 6.97

MANY OTHER WESTON RANGES IN STOCK IN MODELS 301, 476, 506 and 731. PLEASE WRITE REQUIREMENTS.

WESTERN ELECTRIC METERS 3 1/2 inch round

0-50 MA 4.97
100-0-100 Microamps DC 4.97
0-1.5 Ma DC 4.97

GENERAL ELECTRIC

0-150 Volt AC—Model A022 6.97
0-3 Amp RF w/thermo—Model D044 6.97
0-5 Amp RF w/thermo—Model D044 6.97
Running Time, 99,999 hours 115v, 60 cy 5.97

WESTON FREQUENCY METER

Model 814. 350 to 450 cycles. 100 to 125 volts. Regularly \$100.00. Our price brand new **\$39.97**

H. V. PLATE TRANSFORMER

Made by Chicago Transformer.
3,000-0-3,000 volts RMS, 300 Ma. Pri. 115 volts 60 cy., Tapped to deliver 2500-0-2500 volts on sec. Type FS full case. New, in original cases \$29.97 ea.

G. E. RELAY CONTROL

(Ideal for Model Controls, Etc.)

Contains a sigma midget 8,000 ohm, relay (trips at less than 2 MA), high impedance choke, bimetal strip, neon pilot and many useful parts. The sensitive relay alone is worth much more than the total low price of **\$1.27 Each 10 for \$9.97**

Panel Meters

NEW GOV'T SURPLUS STANDARD BRANDS 2" METERS
DB meter—10 to +20 \$3.47
1/2" MEYER \$6.97
0-400 Microamps 5.97
0-200 Milliamper 4.57
0-100 Milliamper 4.57
0-1.5 Volts AC 4.97
0-3 Volts AC 4.97
4" METERS \$8.97
0-200 Microamps \$8.97

OIL CONDENSERS

2 MFD—1000 VDC97
2MFD—2000 VDC 2.57
50 MFD—350 VAC 5.97
2 MFD—2500 VDC 3.97
2 MFD—5000 VDC 5.97
1 MFD—750 VDC 1.77
0.1X.01 12 KVDC 2.97
1 MFD—2000 VDC 5.97
15 MFD 5 KVDC 49.97
5 MFD 60 VAC 2.97
5 MFD 10 KVDC 59.97
25 MFD 25 KVDC 17.97
5 MFD 25 KVDC 26.97

NON-INDUCTIVE RESISTORS Ohmite, 250 Ohm, 100 Watt. **57c**

Special, 5 for \$2.57

SOLA CONSTANT VOLT TRANSFORMERS

Input 95-125 V 60 Cy Output Regulated 115V
250 VA \$33.67
500 VA 48.67

WIRE WOUND RESISTOR KITS

25 assorted 10 Watt \$1.95
25 assorted 20 Watt 2.50
50 assorted 5, 10, 20, and 50 Watt 4.95

WIRE WOUND RESISTORS

Stock too long to list. We can supply most sizes, so order what you need.
10 Watts. From 1 Ohm (to 70K Ohms) Ea. \$.15
20 Watts. From 4 Ohms to 50K Ohms Ea. .20
25 Watts. From 1 Ohm to 100K Ohms Ea. .30
50 Watts. From 5 Ohms to 100K Ohms Ea. .40
100 Watts. From 50 Ohms to 100K Ohms Ea. .50

EIMAC VACUUM CONDENSERS

6 MMF 32 KVDC (VC 6-32) \$9.97
12MMF 32 KVDC (VC 12-32) 10.97
50MMF 32 KVDC (VC 50-32) 12.97

Min. Order \$3.00—25% with Order F.O.B. New York

PEAK ELECTRONICS CO.

66 West Broadway, New York 7, N. Y.
Phone WOrth 2-5439

REVERSIBLE GEARED-MOTOR Delco-PM-Permanent Magnet Alnico Field Motor



#5071895 1/4" SHAFT or 11/16 GEAR... **\$17.50**
#5069600 Clamps to hold motor: \$1.50 ea. **\$18.50**

GRAIN OF CORN LAMPS 28 VOLTS

#328 #321
10 for \$3.00 100 for \$25.00

#318 3V AMBER OR CLEAR
10 for \$1.80
100 for \$15.00

LM32 10 for \$4.50
Bausch & Lomb 10 for \$6.50
EXTENSION SOCKET ON CORD & TRANSFORMER FOR LM 32 **\$3.50**

#326 10 for \$3.00
2 1/2 Volts

REDMOND Powerful 5" Blower or Ventilator 115 volts AC 60 cycles 18 watts. For Kitchen — Laboratory. Heat or Cold or Chemicals. **\$8.95**

Ford Spark Coil by Delco-Remy 1/2" \$2.75
SMALL BLOWER OR AGITATOR FOR COOLING T.V. ETC. **\$4.50**
A Miracle Switch that will not leave you in the Dark. Delayed Action Light Switch **\$1.95**

3" Round Elapsed Time Meter **\$13.75**

MARKTIME 5 HOUR SWITCH

A 10 amp. timing device. Pointer moves back to zero after time elapses. Ideal for shutting off radios and TV sets when you go to bed. Limited supply at this special PRICE..... **\$4.90**

Also available in 15 min., 30 min., 1 hr. at \$5.90

10 Seconds to 24 Minutes Timer

A hand wound electric TIMING SWITCH. Pointer moves back to ZERO and shuts off RADIO-TV—Electric Mixer—Photographic Devices—Time Delay etc. Furnished with Calibration Chart and Pointer Knob. Biggest bargain we ever had. **\$1.25**

Genuine TELECHRON Motors
2 RPM \$2
3 RPM
4 RPM
3.6 RPM
1 RPM
60 RPM
8 R.P. Hr.
1 R.P. 2 HP
1 R.P. 12 HP

Laboratory Special 1 of Each Above.

HAYDON SYNCHRO

TIMING MOT
v. 60 cycle 30 RP
v. 60 cycle 1 RPM
230 V. 1 RPM
60 cycle 2 RPM

ALL PRICES F.O.B. N. Y.
EST. 1923 **BLAN**
64F Dey St. New

X-RAY

All types for industrial and ex application. Tubes, cables and neats.
MEDICAL SALVAGE CO.
217 E. 23rd St. New York
Murray Hill 4-4267

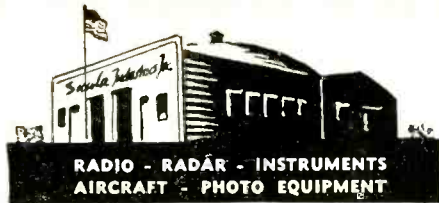

We will Beat All Competition

Airlines and Governments—
Please note, all equipment
meets CAA or government
specifications.

RT-18 (ARC-1) Transceiver
495.00

ARC-3 (Complete
installation) 975.00

AM-26/AIC Amp. 19.50

R-5/ARN-7 R.D.F. 245.00

BC-639 Receiver 245.00

BC-640 Transmitter 895.00

We will Beat All Competition

BC-611 Handy Talkie
110.00

BC-348 Receiver 110.00

BC-221 Freq. Mtr. 99.50

ID-60/APA-10 Ind. 145.00

CRT-3 Dual Channel 75.00

BC-733D Receiver 34.50

APN-9 Loran 850.00

TS-251 Loran Test 650.00

We will Beat All Competition

S-45/APM-3 X Band
Signal Generator 375.00

36 Test Set 49.50

2-1A Volt. Reg. 35.00

9 Mike Adaptor 3.95

4B Antenna 6.75

Antenna 27.50

verter 39.50

nverter 52.50

124 and MC-
Shafts to
length—
Government

or Selsyns,
x and can-
ad test
erial and
equipments
s, antennas.

atalogues on

nc.

Calif.

TUBES:

Industrial
Receiving
Transmitting

SPECIALISTS IN
JAN & RUGGEDIZED
TYPES

Standard Brands Only

Fully Guaranteed

OA2... 85	3C21... 5.00	274B... 2.25	838... 3.25	5702... 2.95
OA3... 1.05	3C23... 6.75	304TH... 7.75	865... .95	5702WA... 4.50
OB2... .85	3C24/24G... 9.5	304TL... 7.75	866A... 1.75	5703... 1.20
OC3... .90	3C45... 11.50	313C... 4.00	872A... 3.50	5703WA... 3.50
OC3W... 3.65	3DP1... 2.80	316A... .80	884... 1.85	5718... 5.00
OD3... .90	3E29... 11.50	TR317... 14.75	885... 1.65	5719... 5.50
OD3W... 3.65	3FP7... 1.75	323B... 8.25	921... 1.85	5720... 23.00
1B24... 9.00	3GP1... 2.70	338A... 28.50	922... 1.60	5725... 1.50
1B24A... 27.50	3HP14... 6.60	359A... 4.50	954... .35	5726... 3.25
1B26... 2.20	4B22... 7.50	388A... 1.50	955... .45	5744... 2.00
1B27... 11.50	4B25... 8.00	394A... 3.00	956... .45	5749... 2.15
1B42... 8.00	4B32... 11.00	GL414... 120.00	959... 1.75	5750... 2.50
1B47... 12.00	4C35... 19.25	GL434A... 14.00	966... 1.50	5751... 2.95
1B63A... 45.00	4J32... 220.00	GL464A... 1.10	1612... 2.00	5763... 1.50
1P21... 49.50	4J36... 140.00	GL464A... 9.50	1614... 1.95	5783... 6.00
1P23... 2.50	ELC5B... 3.50	471A... 2.20	1616... .85	5787... 4.25
1P28... 9.00	5BP1... 3.35	532... 3.50	1619... .35	5814... 1.85
1P40... 1.55	5BP4... 3.35	KU627... 17.00	1620... 6.20	5825... 12.75
1P41... 2.80	5C22... 45.00	700A... 19.95	1625... .30	5829... 2.75
1P42... 5.00	5D21... 12.00	700B... 19.95	1632... .95	5837... 110.00
1Y2... 6.50	5FP7... 1.50	700C... 19.95	1633... .90	5840... 6.00
1Z2... 3.20	5J29... 11.50	700D... 19.95	1636... 2.50	5844... 2.00
2B22... 2.25	5LP5... 17.00	701A... 6.50	1641... 2.00	5881... 2.50
2C33... 4.50	5R4GY... 1.20	702A... 1.75	2050... 1.85	5901... 6.50
2C40... 6.00	5R4WGY... 4.93	703A... 4.50	2050W... 5.95	5902... 11.00
2C43... 14.95	6A27W... 3.25	704A... .85	5545... 35.00	5910... .70
2C44... .98	WE6AK5... 1.25	705A... 1.90	5550... 39.50	5915... 1.20
2C51... 4.85	6AK5W... 1.65	706B... 18.50	5551... 60.00	5932... 8.50
2C53... 13.50	6AL5W... 3.00		5557... 8.50	5937... 24.00
2D21... 1.20	6AQ5W... 3.50		5588... 14.00	5948... 795.00
2D21W... 2.50	6AR6... 2.70		5599... 21.50	5949... 185.00
2J21... 6.50	6AS6... 1.90		5560... 28.00	5956... 60.00
2J22... 5.00	6AS6W... 3.25		5594... 9.00	5957... 60.00
2J26... 13.00	6AS7G... 3.50		5632... 12.15	5958... 60.00
2J31... 20.00	C6J... 7.25		5634... 4.50	5959... 60.00
2J37... 12.00	6F4... 3.50		5636... 7.50	5964... 1.45
2J40... 32.00	6H6WGT... 4.85		5637... 3.00	5995... 6.00
2J50... 20.00	6J4... 5.75		5638... 3.00	6005... 3.50
2J51... 250.00	6J6W... 1.50		5639... 12.00	6072... 5.50
2J54... 62.95	6K4... 2.25		5640... 12.50	6095... write
2J54B... 95.00	6K4A... 5.50		5641... 8.00	6096... write
2J61... 30.00	6L6WGA... 8.45		5642... 1.20	6097... write
2J62... 25.00	7AK7... 7.00		5643... 8.00	6098... write
2K22... 20.00	7C30... 85.00		5644... 12.00	6099... write
2K23... 11.50	9C24... 250.00		5645... 7.50	6101... write
2K25... 27.50	9LP7... 3.50		5646... 7.50	6111... 9.00
2K28... 25.00	15R... .50		5647... 5.50	6112... 9.40
2K29... 24.00	FG17... 6.50		5651... 2.25	6130... 13.35
2K30... 320.00	FG27A... 15.00		728AY, BY, CY, 5651WA... 5.85	6135... 2.75
2K33... 175.00	25Z6WGT... 4.85		DY, EY, or FY 5654... 1.65	6146... 4.85
2K33A... 180.00	28D7... 1.40		5656... 9.25	6163... 3.25
2K34... 140.00	FG32... 14.00		5670... 3.25	6187... 2.50
3B24... 4.00	FG33... 23.00		5676... 1.15	6201... 5.00
3B24W... 11.00	35T... 3.50		5676... 1.15	6336... 11.00
3B25... 3.50	FG105... 18.50		5686... 3.00	6394... 12.50
3B26... 2.75	FG172... 29.95		5687... 2.75	8001... 5.50
3B28... 4.95	215A... 7.50		8011... .75	
3B29... 10.25	249C... 6.00		8013A... 3.95	
3BP1... 3.70	250TH... 16.50		8020... 2.00	
3CP1... 2.00	250TL... 16.50		8025... 5.25	

Complete
Line of
Receiving
TUBES.
Write for
Quotes.

706C... 18.50	707A... 5.00	707B... 9.25	708A... 3.50	709A... 2.65	713A... .90	715B... 4.00	722A... 1.50	723AB... 18.50	5651... 2.25	5651WA... 5.85	5654... 1.65	5656... 9.25	5670... 3.25	5676... 1.15	5686... 3.00	5687... 2.75	5691... 9.50	5692... 8.25	5693... 7.50
---------------	--------------	--------------	--------------	--------------	-------------	--------------	--------------	----------------	--------------	----------------	--------------	--------------	--------------	--------------	--------------	--------------	--------------	--------------	--------------



MILGRAY
ELECTRONICS, INC.

120 Liberty St.
New York 6, N. Y.
REctor 2-1297-8

FOR SALE
HEADSETS, HS-30/U
REMOTE CONTROL UNITS, RM-29
ANTENNA EQUIPMENT, RC-173
DYNAMOTORS, DY-12
DYNAMOTORS, DM-32A
DYNAMOTORS, DM-36
DYNAMOTORS, PE-86
VICTOR-BERNARD INDUSTRIES, INC.
1511 N. 26th St., Phila. 21, Pa.

CONNECTORS
AN-UG
LARGE INVENTORY
ROSE ELECTRONICS, INC.
76 VESEY ST.
New York 7, N. Y. • CO 7-6195

SURPLUS METERS
AND SELECTED COMPONENTS
BRAND NEW—FULLY GUARANTEED
Marion—3" Square—0.5 Mil DC—
3.95 ea.—10 for 35.00
Weston—2" Round—0-200 Microamps—
7.95 ea.—10 for 75.00
Weston—3" Round—0-20 Microamps—
(Condensed Scale) 7.95—10 for 45.00
Cross Point Indicator (2 Separate Micro-
Amp Movements) 4.95—10 for 45.00
BC 221 Freq. Meter—
Excell. Condition—\$89.95
BC 312—Converted to AC—
Good Shape with LS3 Spnr—85.00
We Buy, Sell Surplus Receiving, Special
Purpose Tubes. Large Stock on Hand
Always.
GREENWICH SALES CO.
59 Cortlandt St. - N.Y.7, N.Y. - DI 9-3813

NEVER BEFORE AT THIS PRICE



Frequency 125 - 20,000 kc
Input 12 or 24V DC .6 or .3 Amp and 120-475V 5-20 MA

LM FREQUENCY METER

HETRODYNE MODULATED Complete With Calibration Book While They Last **\$49.50** ONLY

TG-10 KEYS



Automatic Code Training Keyer, originally used for class instruction. Includes a push-pull 6L6 amplifier, variable speed synchronous drive motor and rewind. Tube complement 3-6SJ7, 1-6SN7, 1-5Y3. Dimensions: 25"x19"x11" Limited Quantity **\$24.50**



FREQUENCY STANDARD

Input: 110v 60cy - AC Intervals: 10kc & 200kc Tube Complement: 1-5U4, 2-6SJ7, 2-6N7, 2-6L6. An accurate crystal controlled, multi-vibrator test set for checking frequencies up to 30mc **BRAND NEW \$29.50**

Precision Test Equipment

FROM THE *World's Largest Stock* IMMEDIATE DELIVERY

SIGNAL GENERATORS

TS 13-AP	I-72	I-196
TS 35-AP	I-96	I-208
TS 45-AP	I-122	LAF
TS 120-UP	I-130	804C

Measurements No. 78 Ferris No. 18B

RANGE CALIBRATORS

TS 5-AP	TS 19-AP	TS 102-AP
---------	----------	-----------

FREQUENCY METERS

BC 221	LM	TS 174
--------	----	--------

POWER METERS

TS 33	TS 36	TS 125	I 203
-------	-------	--------	-------

ECHO BOXES

TS 61	TS 62	TS 110	TS 207
-------	-------	--------	--------

DELAY LINES

TS 10 A-B-C	TS 59 AP
-------------	----------

OSCILLATORS

TS 170	BC 376	BC 638
--------	--------	--------

Hewlett Packard 200 B D

OSCILLOSCOPES

TS 34	Dumont	TS 100
-------	--------	--------

208-224-241

SPECTRUM ANALYZERS

TS 148	Marconi TF 890.1
--------	------------------

MISCELLANEOUS

TS 12-AP	TS 89-AP	IE 21
TS 16-APN	TS 118-AP	IE 36
TS 32-TRC-1	TS 184A-AP	I 56
TS 51-APG	TS 251	I 95
TS 56-AP	TS 268-U	I 100
TS 78-U	IE 19	I 139A AN-UPM.1

ASSOCIATED INDUSTRIES
CABLE ADDRESS *Aradiv* LOS ANGELES
6855 TUJUNGA AVENUE
NORTH HOLLYWOOD, CALIF.



CHECK AND COMPARE OUR COMPLETE STOCKS

The following is just a partial list of the current electronic and aircraft equipment now in our warehouse. Write for complete information. Prompt replies to all inquiries.

RC-103 & AN/ARN-5 ILS

New in original cartons. Complete. Consists of all accessories, plus AS-27A, R89B/ARN-5 and BC-733D. Modified to flag alarm.

TBS 4 & 5, NEW, COMPLETE

IE-17 TEST SET F-21/ARA-9
AN/ARN-7 COMPLETE ARC-3
SCR-269 COMPLETE APN-9
AN/ARC-1 VHF EQUIPMENT APN-1

BC-611 & BC-721 HANDIE TALKIES, Plus SPARE PARTS.
Quantity available.

AN/ART-13 EQUIPMENT

ATC XMTR T-47A/ART-13 XMTR
T-47/ART-13 XMTR CU-24 ANT. LOAD
CU-25 ANT. LOAD DY-11 & 12 Dynam't'r
MT-283 MOUNT 0-16 LFO
MT-284 MOUNT ATC DYNAM'T'R
SA-22 ANT. LOAD C-87 CONTROL BOX

AN/APG-13A RADAR

Absolutely complete, brand new

AN/APN-2 MG-153
SCR-729 New APS-2, 3, & 15
TA2J-24 Components
RTA-1B AN/ARC-5 VHF
BC-1016 SCR-274 & ARC-5,
APA-6 INDICATOR Command Equip'm't
APA-11 INDICATOR R-4/ARR-2 Receivers
APA-17 RADAR BC-640 VHF XMTR
HS-33 HEAD SETS, SCR-510
NEW SCR-522
MG-149F & H MG-153

SPARE PARTS

SCR-720 SCR-522
SO-7 AN/ART-13
AN/ARN-7 AN/ARC-1
SCR-269 BC-611

SCR-718 A, AM, B & C

Altimeter equipment—complete

To insure the finest of service and quality of merchandise, we have just recently put into operation our own reconditioning and function-testing plant, complete with all facilities.

WANTED

CFI UNITS ART-13 BC-788
1-152 BC-348 Q & R
TOP DOLLAR PAID

EXPORT INQUIRIES INVITED

We carry an unusually large stock of Airline Equipment, Test Equipment, Radar Sets, etc. Write for our low prices and complete information. We furnish immediate answers to all inquiries. Write today!

V & H ELECTRONIC INDUSTRIES INC.

2033 West Venice Blvd.—Dept. E-23
Los Angeles 6, California
Phone: REpublic 3-1127

OIL CONDENSERS

MFD	V.D.C.	Price	MFD	V.D.C.	Price
1	1000	\$0.32	4	800	.75
1	6000	7.50	5-5	400	.70
2	600	.45	7	600	1.05
2	1000	.55	10	600	1.10
3-3	600	.85	25	600	.22
4	1000	.80	25	6000	.75
4-4	1000	1.10			

BATHTUB CONDENSERS

MFD	V.D.C.	Price	MFD	V.D.C.	Price
.05	600	\$0.19	1-1-1	600	.24
.05-.05	600	.22	1	400	.25
1-1	600	.20	1	600	.28

HEADSETS

Excellent USED BRAND	Price	Price
HS-23 high impedance	\$2.95
HS-33 low impedance	\$4.75
HS-30 low imp (featherwt)	2.45
H-18/U high imp (2 units)	4.95
CD-307A cords, with PL55 plug and JK26 jack, 8' long	1.19

BC-221 FREQUENCY METER

Reconditioned. PERFECT. Complete with tubes and crystal. **\$129.50**



SELSYN 2J1G1

Operates from 67 1/2 V 100 cycles. Suggested wiring for 110 V 60 cycle included. New, tested. Price Each. **\$4.50**

DYNAMOTORS

Type	Input	Output	Excellent Brand Used	Price
DM-32A	28V 1.1A	250V .05A	54.90	57.50
DM-33A	28V 5 A	575V .16A	2.25	3.95
	28V 7 A	540V .25A		
DM-34D	12V 2.8A	220V .080A	14.50	
DM-40	11V 3.4A	172V .138A		7.95
DM-28	28V	224V .07A	3.95	6.95
DM-21	11V	235V .09A	6.85	16.50
PE-73	28V 20A	1000V .350A	9.50	12.50
PE-86	28V 1.25A	250V .060A	2.95	5.50
PE-91A	28V 10A	300V .200A	7.50	11.50
		150V .101A		
PE-94C	28V 10A	300V .200A	10.00	12.75
		150V .101A		
PE-98	14V 21A	300V .200A	22.50	37.50
		150V .101A		
PE-101	13V 12.6A	400V .135A	3.75	4.85
	26V 6.3A	9V AC	1.12A	
PE-103	6V 12V	500V .160A	27.50	44.50
		500V .160A		
PE-104	6V 1A	84V .09A	12.50	14.50
(Vibrator)	12V 5A	51V .03A		
DM-414 (with filter)	14V 2.8A	400A .080A		1*
PS-225 (with filter)	28V 3.2A	375V .150A		
EICOR Dynamotor				
D-401	27V 6.05A	300V .200A		
		18V AC 2.2A		
PE-135AX (with filter)	24V 12A	500V .200A		
GENERATOR				
GN-39-F	14.6V 25A	1000V .350A		
	(16" L, 8" dia. 50 lbs.)			
INVERTERS				
PE-206 Inverter—Leland				
In:	28V DC—38A			
Out:	500V 800 cyc. 80VA. 1 Ph.			
PE-218 Inverter—Leland-Winchar				
In:	28V DC—92A			
Out:	115V 380/500 Cyc. 1500VA			

INTERPHONE /

Easily converted to Communications set or factory. Origin plate with tubes



WILLARD 2

20 AMP. HR. BRAND NEW

1-QUART ELECTRIC Enough For TWO

7-PRONG 2-Volt VLP able And FARE

Please include C.O.D. MIN' F.O.B. Our

CON'

SPECIAL
2K33A... \$185.00 ea.

EMELTONE ELECTRONICS CO.

71 W. Broadway - N. Y. 7, N. Y. Phone REctor 2-1696

SPECIAL
QK-250 \$110.00
QK-249 each
QK-182

Crystal Diodes

Standard Brands Only

CRYSTAL DIODES	OC3-VR150	Price
1N21A	1B21A	2.50
1N21B	1B22	2.50
1N21C	1B23	7.00
1N22	1B24	12.00
1N23	1B25	3.50
1N23A	1B27	13.00
1N23B	1B29	2.75
1N25	1B32	3.25
1N26	1B35	9.00
1N27	1B42	9.00
1N28	4.25 1B63A	60.00
1N31	6.00 C1B	8.00
1N34	1P21	28.00
1N34A	1P28	10.00
1N35	2.20 2B22	1.90
1N38	1.10 2C5A	1.50
1N39	3.00 2C34	.60
1N40	11.50 2C39	20.00
1N41	.62 2C39A	4.00
1N43	1.75 2C40	10.00
1N44	1.50 2C43	17.50
1N48	.62 2C44	1.50
1N51	.50 2C46	30.00
1N52	1.37 2C50	9.00
1N54	12.00 2C59A	12.00
1N58	1.25 2C53	13.00
1N60	.61 2D21	1.25
2AP1	8.00 2E24	3.00
3AP1	10.00 2E26	3.40
3AP1A	12.00 2E27	3.50
3BP1	6.00 2E36	3.50
3CP1	2.00 2I21A	10.50
3DP1-S2	6.00 2I22	10.50
5G1	5.50 2J26	20.00
5BP1	4.50 2J27	20.00
5CP1	6.00 2J31	20.00
5FP7	2.90 2J32	26.00
5GP1	5.20 2J33	25.00
5LP1	20.00 2J34	25.00
7BP7	7.00 2J36	110.00
OA2	1.00 2J37	15.00
OA3-VR75	1.10 2J38	24.00
OB2	.80 2J40	38.00
OB3-VR90	.80 2J42	150.00

SPECIAL PURPOSE TUBES

45.00 5J26	125.00 332A	45.00 724B	1.65 884	1.58 5686	4.50 5687
63.00 5J32	80.00 350A	8.00 725A	10.00 885	1.75 5687	4.00 5702
250.00 5R4G V	1.50 350B	8.00 726A	14.00 933A	6.00 5702	4.45 5703
86.00 6A15	1.65 355A	21.00 726B	49.00 854	1.50 5703	1.90 5704
36.00 6AK5 W	2.00 357A	19.00 726C	69.00 955	.67 5704	2.75 5705
20.00 6AK5	1.00 371A	.85 730A	35.00 956	.55 5718	8.50 5719
24.00 6AN6	3.25 371B	.85 731A	4.50 957	.40 5719	11.00 5720
100.00 6ARE	2.75 388A	3.00 801	2.10 958	.95 5720	18.75 5721
35.00 6AS6	2.25 393A	12.00 802	4.00 958A	1.00 5722	6.25 5723
36.00 6AST G	4.00 394A	1.00 803	4.00 1512	2.00 5725	3.90 5726
185.00 6CJ	9.00 407A	5.00 804	16.00 1613	.80 5726	2.00 5727
100.00 6C21	22.00 408A	3.00 805	3.00 1616	1.50 5734	16.00 5735
150.00 6C24	55.00 417A	12.00 807	1.65 1619	1.50 5751	1.50 5752
125.00 60	2.50 434A	20.00 807W	11.50 1620	6.00 5763	1.50 5764
60 10Y	.80 446A	2.50 808	2.25 1622	2.25 5814	2.50 5829
3.50 12A V7	1.70 450TH	50.00 809	1.50 1624	1.50 5829	3.80 5830
5.50 15E	2.00 451	50.00 810	11.50 1625	.30 5840	9.00 5841
8.50 15R	1.20 458	10.00 811	2.95 1626	.25 5863	14.00 5879
4.50 15R	8.00 471A	26.00 811A	16.50 1627	.85 5879	1.50 5881
4.50 15R	8.00 471A	3.00 812	3.50 1631	1.40 5881	3.00 5882
4.50 15R	8.00 502	73.00 813	11.50 1632	.75 6005	3.25 6006
4.50 15R	6.00 527	15.00 814	3.75 1633	1.00 6012	4.00 6013
4.50 15R	2.50 52J	16.00 815	4.50 1641	2.25 8005	6.75 8006
1.50 RK65	32.00 522A	3.50 816	1.50 1665	1.30 8008	7.10 8009
6.00 75TH	13.00 527	21.00 817	1.50 1666	1.00 8012	2.00 8013
30.00 FG-172	11.00 600	7.00 828	12.00 2051	.80 8013A	5.00 8014
18.00 211 5P	9.00 602	9.00 829B	12.75 5516	7.20 8014A	70.00 8015
12.25 G1-218	30.00 604	7.75 803B	45.27 4527	46.00 8019	4.00 8020
30.00 249B	7.00 700A	7.50 832	7.00 5545	35.00 8020	2.25 8021
25.50 249C	7.00 700B	24.00 833A	9.50 5559	18.50 8025	3.90 8026
30.00 249D	6.00 700C	26.00 834	5.50 5560	27.00 8026	1.20 8027
33.00 250R	20.00 701A	5.80 836	13.00 5563	44.00 9002	.90 9003
100.00 250TH	22.00 701B	5.80 836	3.75 5581	2.25 9003	1.30 9004
140.00 250T	20.00 701C	16.00 807B	5.50 5582	1.50 9005	2.10 9006
5.75 252A	28.00 707B	16.00 808	3.95 5585	150.00 9006	11.00 9007
8.50 253A	20.00 708A	16.00 851	1.25 5633	58.00 9014	11.50 9015
13.00 253B	10.00 709A	6.00 852	10.00 5634	12.75 9016	8.00 9017
5.00 304TH	9.00 715A V	8.00 853	55.00 5635	19.00 9018	56.38 9019
38.00 304TL	9.50 715B	29.00 861	1.45 5638	26.00 9045	12.85 9046
16.50 316A	2.50 717A	1.20 864	4.00 5651	2.50 9047	2.80 9048
21.50 319A	4.00 715C	28.00 866A	90.00 5657	200.00 9049	1.40 9050
190.00 327A	11.00 721A	4.00 869B	3.50 5672	1.40 9051	1.50 9052
47.50 328A	4.00 721B	20.00 876	1.35 5675	13.00 9055	1.75 9056
15.00 322	8.50 724A	3.00 878	56.78 5678	1.20 9057	1.20 9058
15.00 322	8.50 724A	3.00 878	1.19 5679	1.20 9059	9.50 5683

Receiving Tubes

Klystrons, Magnetrons

1.65 884	1.58 5686	4.50 5687
10.00 885	1.75 5687	4.00 5702
14.00 933A	6.00 5702	4.45 5703
49.00 854	1.50 5703	1.90 5704
69.00 955	.67 5704	2.75 5705
35.00 956	.55 5718	8.50 5719
4.50 957	.40 5719	11.00 5720
2.10 958	.95 5720	18.75 5721
4.00 958A	1.00 5722	6.25 5723
4.00 1512	2.00 5725	3.90 5726
16.00 1613	.80 5726	2.00 5727
3.00 1616	1.50 5734	16.00 5735
1.65 1619	1.50 5751	1.50 5752
11.50 1620	6.00 5763	1.50 5764
2.25 1622	2.25 5814	2.50 5829
1.50 1624	1.50 5829	3.80 5830
11.50 1625	.30 5840	9.00 5841
2.95 1626	.25 5863	14.00 5879
16.50 1627	.85 5879	1.50 5881
3.50 1631	1.40 5881	3.00 5882
11.50 1632	.75 6005	3.25 6006
3.75 1633	1.00 6012	4.00 6013
4.50 1641	2.25 8005	6.75 8006
1.50 1665	1.30 8008	7.10 8009
1.50 1666	1.00 8012	2.00 8013
12.00 2051	.80 8013A	5.00 8014
12.75 5516	7.20 8014A	70.00 8015
45.27 4527	46.00 8019	4.00 8020
7.00 5545	35.00 8020	2.25 8021
9.50 5559	18.50 8025	3.90 8026
5.50 5560	27.00 8026	1.20 8027
13.00 5563	44.00 9002	.90 9003
3.75 5581	2.25 9003	1.30 9004
5.50 5582	1.50 9005	2.10 9006
3.95 5585	150.00 9006	11.00 9007
1.25 5633	58.00 9014	11.50 9015
10.00 5634	12.75 9016	8.00 9017
55.00 5635	19.00 9018	56.38 9019
1.45 5638	26.00 9045	12.85 9046
26.00 9045	2.50 9047	2.80 9048
4.00 5651	90.00 9049	1.40 9050
1.35 5675	13.00 9055	1.75 9056
56.78 5678	1.20 9057	1.20 9058
1.19 5679	1.20 9059	9.50 5683

PRICES SUBJECT TO CHANGE ALL ITEMS SUBJECT TO PRIOR SALE WRITE, WIRE OR PHONE CASH PAID FOR YOUR SURPLUS TUBES—SEND LIST AND PRICES

Above listing is only partial. Inquire if your items are not listed.
ATT. EXPORTERS & FOREIGN AGENCIES
Special prices for quantities. We ship all over the world.

CARRIER EQUIPMENT

Western Electric CF-1A 4-channel carrier telephone terminals.
EE-101-A 2-channel 1000/20 cycle carrier ringers.
CFD-B 4-channel carrier pilot regulated telephone terminals complete with four channels 1000/20 cycle ringing.
CFD-B 4-channel pilot regulated telephone repeaters.
C-42-A V. F. telegraph in from 2- to 12-channel terminals.
FMC 1 or 2 channels carrier telephone terminals, automatic regulation, duplex signaling each channel. Carrier frequencies above 35 KC. Ideal for adding channels above type "C".
Complete engineering and installation services offered.

RAILWAY COMMUNICATIONS, INC.
Raytown, Missouri
Telephone: FLEMing 2121

WHY SEARCH? AARON HAS IT!

Call Gene Morasco, Sr.
WA. 1-9188

AARON ELECTRONIC SALES
6025 Mt. Elliott
Detroit 11, Michigan

404-A TUBES NOW AVAILABLE

Brand new 404-A tubes available promptly in limited quantities. Large quantities available with excellent delivery schedules. Factory warranty, fully guaranteed. For prices and information, please contact:

Mr. Robert Corenthall
TERMINAL RADIO CORP.
85 Cortlandt St., New York 7, N. Y.
Phone: WOrth 4-3377

OH, WHERE? ARE PRICES LOWER THAN LOW? GO MOGULL AND SEE!

Huge stocks of FIRST QUALITY, BRAND NEW, GUARANTEED, U.S. Gov't. surplus at unbelievably low prices.

LARGE VARIETIES OF:

- OIL CAPACITORS—all types
- MICA CONDENSERS—high & low volts
- JONES PLUGS—CONNECTORS
- AN—UG—UHF PLUGS & CONNECTORS
- BARRIER STRIPS—Jones, Burke
- BIRTCHE CLAMPS
- SWITCHES—anti cap., toggle, rot., Etc
- MICRO SWITCHES
- POTENTIOMETERS—carbon, w.w., etc.
- STANDARD BRAND POTS—J, JJ, JJJ
- TAP SWITCHES—Ohmite
- RESISTORS—prec., ferr., w.w., carbon
- FUSES & HOLDERS—LINKS—MOUNTS
- INSTRUMENT KNOBS—all types
- MOBILE NOISE FILTERS
- PANEL INSTRUMENTS
- STEATITE INSULATORS
- PILOT LAMPS—ASSEMBLIES
- TUBE SOCKETS
- PHONE JACKS—PLUGS
- RECORDING INST. INKS—SUPPLIES
- AND MANY OTHERS

"BUY WHERE THE BUYERS BUY—WITH CONFIDENCE!" QUOTATIONS CHEERFULLY AND PROMPTLY SUPPLIED.

WRITE—PHONE—WIRE
A. MOGULL CO
17 Warren St. New York 7, N. Y.
WORTH 4-0865

RELAY SPECIALISTS

AUTHORIZED FACTORY DISTRIBUTORS
STRUTHERS-DUNN POTTER & BRUMFIELD

MIDGET RELAY—1/4" Long
DPNO + SPDT—6/12 or 24 v. coll \$1.00/dec.
8 Pole D.T. — BR 18D 39 110 v. DC coll \$6.95
Sigma Relays & Guardian Steppers in Stock

RADIO DEVELOPMENT & SALES CO.
323 ATLANTIC AVE.—ULSTER 5-0488—BKLYN. 1, N.Y.



FOLLOW ARROW FOR MILITARY ELECTRONICS

TRANSMITTER TA-2J-24
High powered crystal controlled, long-range transmitter. Frequency range: 300-600 Kc and 2.9-15 MC. Eight separate channels are provided. New. Send for complete literature. P.U.K.

OSCILLOSCOPE SPECIALS!
DUMONT #224 3 in. \$149.50
DUMONT #225 5 in. 225.00
DUMONT #168 5 in. 87.50
R.C.A. #158 5 in. 87.50
BROWNING ... #P4E 5 in. 195.00

Radar Ask for complete listing of our Radar Equipment

FOLLOW ARROW TO GET HIGHEST PRICES FOR YOUR NEW AND USED RADIO GEAR! What have you to sell? WRITE TODAY!

SOUND POWERED HANDSET
R.C.A. MODEL MI-240
With mounting rack. New \$19.95 ea.

Test Equipment
RECEIVERS—TRANSMITTERS

GOVERNMENTS, AIRLINES AND INDUSTRIALS!
Send for FREE Catalogue No. 112 for complete list of Military, Industrial and Aviation Electronics. WE HAVE THE LARGEST INVENTORY OF SUCH EQUIPMENT IN THE UNITED STATES.

ARROW SALES INC.
Mailing Address: P. O. BOX 3878-E, N. HOLLYWOOD, CALIF.
Office-Warehouse: 7460 VARNA AVENUE, N. HOLLYWOOD, CALIF.
Poplar 5-1810 • Stanley 7-6005 • Cable Address: ARROWSALES

Calvert Electronics Incorporated

59 FOURTH AVENUE, NEW YORK 3, N. Y. OREGON 4-3027

Cable Address
"CALVETRON"



IB5	\$.49	6SF5	.65
1H6G	.65	6SL7GT	.59
1F7G	1.00		
1LA5	.65		
1LC5	.65		
1LG5	.85		
1LH4	.75		
1P5GT	.45		
1Q5GT	.65		
2A3	1.00		
2X2/879	.22		
5Y4G	.55		
5Z3	.55		
5Z4	.99		
6B5	1.19		
6AS7G	3.75		
6F5	.65		
6F6	.59		
6H6	.48		
6J5GT	.48		
6J6	.59		
6J7	.65		
6L5G	.65		
6L6GAY	.99		
6L7G	.45		
6N7GT	.48		
6Q7GT	.65		
6SA7GT	.49		

7A6 .29
SYLVANIA-DUODIODE RECTIFIER

12A6	.59
12SG7	.75
12SK7GT	.55
12SL7GT	.55
14C7	.75
25L6GT	.55
26	.45
28D7	1.45
35Z5GT	.48
43	.59
46	.59
50L6GT	.55
56	.45
57	.55
71A	.55
75	.35
76	.45
77	.55
70L7GT	.89

SPECIAL PURPOSE & TRANSMITTING

KC-4-3 44.00

MFD. BY AMPEREX
in original wooden crates
Equiv. to Westing. WL-616 or Machlett-ML-1000
Designed for use in converting a-c to d-c at high potentials. May be used in smoke and recovery precipitators, in surge generators, for high voltage testing, and for other work where high voltage d-c is desired.

1B24	6.95
1B35	5.75
2C34	.95
2E24	1.75
2J21	4.75
2J21A	5.25

2J22	3.75
2J26	8.95
2X2/879	.22
3BP1	3.75
3E29	9.75
4B26	4.95
4C35	17.75
5CP1	3.75
5D21	12.95
7BP7	3.75
7C4/1203A	.19
15R	.35
23D4	.45
100TH	6.95
101L-W.E.	1.25
101D	1.25
VU-111S	.65
114B	.35

EG-172 17.50
THYRATON
G.E. & R.C.A.

215A	
311A-W.E.	3.25
311B-W.E.	3.95
316A	.45

327A	2.75
371B	.55
373A-W.E.	2.95
374A-W.E.	2.75
404A-W.E.	9.95
407A-W.E.	3.75
408A-W.E.	2.75

416A-W.E. P.U.R.

421A-W.E.	4.75
422A	4.75
464/2C43	5.95
WL-532	1.95
615	3.25
705A	.75
722A	1.25
815	5.95
836	2.75
865	.95
921	.55
955	.35
957	.35
1616	.65
1625	.25

1629 .12

Electron Ray Tuning Indicator

1630	.75
5800-Vic-toreen	4.50
5803-Vic-toreen	2.75
5964	1.25

6035 19.75

Sylvania Band Pass TR

6038	7.95
8011	.75
8020	.95

STANDARD BRANDS ONLY

TRANSMITTERS

RECEIVERS

SPARE PARTS

COMMUNICATION ACCESSORIES

for U. S. Signal Corps and U. S. Navy equipment. All High Quality Materiel, Guaranteed, Available Immediately from Stock.

COMMUNICATION DEVICES CO.

2331 - Twelfth Ave.
New York, 27, N. Y.
Tel: ADironclack 4-6174
CABLE: COMMUNIDEV

CENCO VACUUM PUMPS

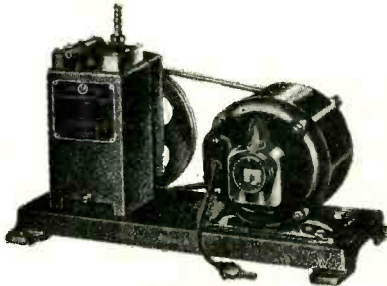

\$39.50

- This is a CENCO-PRESSOVAC #4 single stage with single phase 115 volt 60 cycle 1/4 H.P. motor.
- This is a self-contained vacuum and pressure unit especially designed for general laboratory work.
- The oil-sealed, rotary piston pump is enclosed in a metal housing with built-in Air trap to prevent suck-back when the pump is stopped.
- Another trap removes oil from the exhaust air.
- The pump has a displacement of 34 liters of free air per minute and a vacuum of 1/10 m m of mercury pressure.
- Pump can also be used for pressure work up to 10 lbs. per square inch.
- It is mounted on a substantial metal base 19" by 9" with electric motor, pulleys and V-Belt.
- USED but completely overhauled and tested to meet manufacturer's specifications.
- Unit unconditionally guaranteed. If not completely satisfied return to us, express charges collect, within 30 days and money will be refunded.
- Shipping weight—60 lbs.

MARITIME SWITCHBOARD

Instrument & Accessories
336 CANAL STREET, NEW YORK 13, N. Y.
WOrth 4-8216 (7)

TELEPHONE RELAYS



Large Stock of
CLARE, TYPES C D & E
COOKE, AUTOMATIC—ELECTRIC
ALL TYPES OF COILS AND PILE-UPS
Send Us Your Specs. for Our Quote
CLARE TYPE C STANDARD SIZE SENSITIVE TELEPHONE RELAYS

Coil	Contracts Will Close at	Price
1) 6500 ohms 1A	4 MA	\$2.25 ea.
2) 6500 ohms 1B-1C	4 MA	2.50 ea.
3) 6500 ohms 2A	3.5 MA	2.75 ea.
4) 6500 ohms 3A-1B	4 MA	3.00 ea.
5) 6500 ohms 5A	5 MA	3.25 ea.
6) 6500 ohms 5A-2D	5 MA	3.50 ea.

CLARE TYPE G HALF SIZE SENSITIVE TELEPHONE RELAYS

Coil	Contracts Will Close at	Price
1) 6500 ohms 2A	5 MA	\$2.50 ea.
2) 5800 ohms 3A	4 MA	2.50 ea.
3) 5800 ohms 2B-1C	5 MA	2.50 ea.
4) 4850 ohms 1C	4 MA	2.50 ea.
4) 3600 ohms 1C	6 MA	2.00 ea.
5) 4850 ohms 1A	5 MA	2.00 ea.
6) 3300 ohms (None) ACTUATOR		1.50 ea.

All above Relays may be used for continuous duty operation on 110V. D.C.

OTHER TYPE G TELEPHONE RELAYS

1) 1300 ohms 1A-1C	24 or 48V	\$2.50 ea.
2) 400 ohms 1A	24V	1.65 ea.

CONTACT SYMBOLS
A=Norm. Open B=Norm. Closed C=S.P.D.T.
D=Make Before Break

CLARE TYPE A Tel. Relay. Coll—55 Volts AC 60 cy. Contacts—3PDT (3 form C) Price—\$2.50 ea. Signal Wheellock Relays #KS9065 Coll—2,000 ohms Contacts-1A, 1B, 1C Oper. at 9 MA Price—\$2.75 ea.

MINIATURE TEL. RELAY. 300 ohm, 24 volt SPDT\$1.65 ea.

FIVE Prong CR-2791 G.E. Plug In Relays,
1) C-103C25 2200 ohms SPDT 4.5 MA...\$4.00 ea.
2) C-104B28 700 ohms SPDT 6 MA...\$3.00 ea.

Bulletin #700 Allen Bradley Contactors 110V AC 60 cy. D.P.S.T. N.O. 25 Amps.\$7.50 ea.

Allied BJ6D36 Miniature Relay. 24V. 260 ohm. DPDT\$1.25 ea.

Clare SK-5032 (Herm. Sealed Plug-In Relays. Coll—30 ohms 6 volts Contacts—DPDT. Price \$4.00 ea.

SIGMA TYPE 5F SENSITIVE RELAYS. Has two 70 ohm coils. Contacts—SPDT. Price—\$3.00 ea.

STANDARD BRAND TYPE H TRANS. MICA CONDENSERS

1) .003 MFD	2500v.	DCW	\$.45 ea.
2) .01 MFD	1200v.	DCW	.45 ea.
3) .001 MFD	1200v.	DCW	.35 ea.

Chase

Electronic Supply Co.
105-07 225 St.
Queens Village, N. Y.
HOllis 4-5033

TUBES!

WAREHOUSE CLEARANCE

SPECIAL
FG-27A
\$4.90

Industrial, Special-Purpose, Receiving Tubes, Give-Away Prices!

0C3/VR-105	\$0.79
0D3/VR-150	.69
1A3	.78
1A5GT	.62
1B22	1.11
1B24	7.95
1B27	9.95
1B32/532A	1.75
1N21	.69
1N22	.95
1N27	.95
1P23	1.95
1R4	.39
1T4	.49
2A3	.75
2AP1	7.50
2B22	1.50
2C33	2.75
2C40	9.95
2E22	1.50
2J21	4.95
2J21A	5.95
2J22	6.50
2J27	8.95
2J34	19.95
2J50	49.50
2J55	65.00
2X2	.59
2X2A	1.10
3A4	.69
3B7/1291	.62
3C23	8.50
3C24	1.95
3DP1	2.50
3D6/1299	.62
3EP1	3.50
3FP1	1.69
3GP1	2.50
3JP12	7.95

4B22/EL5B	5.50
4B25/EL6CF	5.50
EL/C5B	5.50
EL/C6A	5.50
4J36	95.00
4J37	95.00
5B1	4.69
5D21	11.50
5FP7	1.65
5JP2	12.50
6AC7	.79
6AG7	.79
6AJ5	.95
6AJ6	.79
6B6G	.55
6C6	.55
6C8G	.55
6H6	.49
6K7	.45
6SC7	.75
6SH7GT	.59
6SH7	.59
7C4/1203A	.55
7E5/1201	.69
7E6	.45
10Y	.79
12A6	.69
12C8	.59
12J5GT	.40
12SF7	.40
12SJ7GT	.40
14H7	.49
14J7	.49
15R	.55
CE22	.69
RK-25	2.10
23D4	.45
FG-27A	4.90
30SP	.39
45SP	.35
53A	1.00
QK-59	50.00
QK-60	50.00
QK-61	50.00
71A	.45
QK-72	50.00
RK-72/CRP72	.85

FG-90	2.50
100TH	7.50
VR-105	.79
112A	.39
VT-127A	1.50
VR-150	.69
211/VT4C	.79
227A	3.50
274B	1.95
EL-302.5	1.00
304TH	9.95
GL-316A	1.69
350A	2.95
371A	1.95
388A	1.95
394A	2.50
WL-417A	12.50
GL-434A	12.50
GL-446A	1.50
464A	3.95
CK-501X	.59
532A	1.95
GL-605	35.00
WL-653B	45.00
ZP-653	35.00
705A	1.50
706AB	12.50
706AY	16.50
707A	6.50
721A	1.50
723AB	14.95
724A	1.25
724B	1.50
725A	5.50
726A	9.95
801	.75

803	3.10
804	8.50
805	2.50
807	1.35
810	9.95
811	2.10
813	8.95
814	2.25
815	3.00
816	1.10
826	1.95
830B	1.95
832	6.95
832A	7.95
838	2.50
866A	1.00
872A	1.95
884	1.00
902P1	4.50
954	.29
CK-1089	.45
957	.29
1616	.75
1619	.49
1624	1.00
1625	.49
1629	.55
1655/65C7	.75
1846	50.00
2051	.79
8005	4.25
9001	.95
9002	.85
9003	.99
9004	.39
9006	.34

FREE!

New 1954 electronic parts mail-order catalog! Better than ever!

RADIO SHACK

CORPORATION Dept. 2E
167 Washington St., Boston 8, Mass.

Transmitters: BC-610-E, ART-13, TCS-12
Receivers: BC-312, BC-342, BC-348, TCS.
Frequency Meters: BC-221, LM.
New equipment and components by Hammarlund, Harvey Wells, E. F. Johnson, & National.

ALLTRONICS
Box 19, Boston 1, Mass.
Richmond 2-0048, 2-0916

TS-670

Spectrum Analyzer & Frequency Standard
100 KC XTAL in oven 940-2020 MC Contained in two 7 ft enclosed cabinets.
JERRELL ELECTRONIC, INC.
1970 Neva Drive Dayton 4, Ohio

WANTED TUBES STERN ELECTRIC TYPES

Special Purpose, T.R. & Receiving Tubes

All Brands Contact

W-1776, ELECTRONICS
42nd St., New York 36, N. Y.

SEARCHLIGHT" Advertisements

by March 2nd will appear in the subject to limitations of space

Classified Advertising Division
ELECTRONICS

42nd St. New York 36, N. Y.

LOOK HERE!

HOW LOW CAN PRICES BE?

GO MOGULL AND SEE!

Huge stocks of FIRST QUALITY, BRAND NEW, GUARANTEED, U. S. Gov't. surplus at unbelievably prices.

LARGE VARIETIES OF:

- OIL CAPACITORS—all types
- MICA CONDENSERS—high & low Volts
- JONES PLUGS—CONNECTORS
- AN—UG—UHF PLUGS & CONNECTORS
- BARRIER STRIPS—Jones, Burke
- BIRTCHES CLAMPS
- SWITCHES—anti cap., toggle, rot., Etc
- MICRO SWITCHES
- POTENTIOMETERS—carbon, ww, etc.
- Standard Brand Pots, J, JJ, JJJ.
- TAP SWITCHES—Ohmite
- RESISTORS—prec., ferr. w.w., carbon
- FUSES—HOLDERS—LINKS—MOUNTS
- INSTRUMENT KNOBS—all types
- MOBILE NOISE FILTERS
- PANEL INSTRUMENTS
- STEATITE INSULATORS
- PILOT LAMPS—ASSEMBLIES
- TUBE SOCKETS
- PHONE JACKS—PLUGS
- RECORDING INST. INKS—SUPPLIES
- AND MANY OTHERS

"BUY WHERE THE BUYERS BUY—WITH CONFIDENCE!" QUOTATIONS CHEERFULLY AND PROMPTLY SUPPLIED.

WRITE—PHONE—WRITE

A. MOGULL CO.

17 Warren St. New York 7, N. Y.
WORTH 4-0865

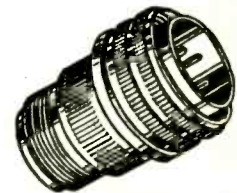

AN 3106 A

All Shell Sizes & Types

WILGREEN INDUSTRIES is making scheduled deliveries to many firms. Can we do the same for you?

"UG" Connectors in Stock

* ON ACCEPTED COMMITMENTS

Wilgreen Industries

99 MURRAY ST. N. Y. 7, N. Y.
Worth 4-2490-1-2

THE Electro INDEX

INDEX

SEARCHLIGHT

MARCH, 1954

This index is published as a convenience to the readers. Care is taken to make it accurate but ELECTRONICS assumes no responsibility for errors or omissions.

CAPACITORS

Table listing capacitor specifications including Mfd., Volts, Price, and various model numbers like 15.5K, 100025, 001, etc.

SELSYNS—SYNCHROS

Table listing Selsyn and Synchro specifications including model numbers like 1CT, 1MCT, 1G, and 1MG, along with their descriptions and prices.

Only a small portion of our tremendous Electronic inventories. Allow us to quote on any of your requirements. Prices FOB Boston subject to change without notice. All merchandise fully guaranteed.

ELECTRO Sales Company Inc.

50 EASTERN AVE., BOSTON 13, MASS. CAPITOL 7-3456

PROFESSIONAL SERVICES

Table listing Professional Services such as Positions Vacant, Selling Opportunities Offered, etc.

BUSINESS OPPORTUNITIES

Table listing Business Opportunities like Offered.

EQUIPMENT

Table listing Equipment such as Used or Surplus New, For Sale.

WANTED

Table listing items wanted.

ADVERTISERS INDEX

Table listing Advertisers such as Aaron Electronics Sales, Algaradio Electronics Co., etc.

Table listing Advertisers such as Barry Electronics Corp, Bendix Aviation Corp., etc.

Table listing Advertisers such as Calvert Electronics Inc., Capehart-Farnsworth Co., etc.

Table listing Advertisers such as Delco Radio Division General Motors Corp.

Table listing Advertisers such as Electro Sales Co., Inc., Electronic Engineering Co. of California, etc.

Table listing Advertisers such as Fair Radio Sales, Federal Telecommunication Labs, etc.

Table listing Advertisers such as Gancher, Louis E., Gates Electric, etc.

TO THE ADVERTISERS

MARCH, 1954

SEARCHLIGHT SECTION (Classified Advertising) H. E. Hilty, Mgr.

Table listing advertisers and their corresponding page numbers, including Harjo Sales Co., Instrument Associates, JSH Sales Corp., Kollsman Instrument Co., Laprow Bros., National Cash Register Co., O'Shea Employment System, Peak Electronics Co., Radalab, Schwartz, Adolph, and others.

"ELECTRO'S TUBE INDEX"

Main tube index table listing various vacuum tube types (e.g., 6AL5, 6AR5, 6AV6, 6X4, 6X5, 6X6, 6X8, 6X9, 6X4, 6X5, 6X6, 6X8, 6X9, 6X4, 6X5, 6X6, 6X8, 6X9) and their prices.

Electro INDEX to Electronic Component VALUES

These listings represent only a small portion of our tremendous tube inventory. We carry a complete line of guaranteed, standard brand only, tubes of all types for receiving, transmitting, and special purpose uses. Please allow us to quote on any of your requirements, whether large or small. Prices subject to change without notice. Terms: a) rated firms open, all other Cod. Prices f. o. b. Boston. Minimum order \$10.

ELECTRO Sales Company Inc. logo and address: 50 EASTERN AVE., BOSTON 13, MASS. CAPITOL 7-3456

HI-VOLTAGE HI-MEG RESISTORS
 75MEG "MVP" 10W 10KV. 79c; 10 for \$5.00
 2MEG "MVP" 1/4W 5KV. 89c; 10 for \$7.50
 2MEG "MVP" 1/4W 5KV. 89c; 10 for \$7.50
 2.5MEG "MVA" 20W 25KV. 1.50; 10 for \$12.50
 2.5MEG "MVT" 5W 7.5KV. 89c; 10 for \$7.50
 75MEG "MVP" 10W 10KV. 79c; 10 for \$5.00
 10MEG "MVP" 10W 10KV. 1.69; 10 for \$15.00
 12MEG 10W 10KV. 1.69; 10 for \$15.00
 20MEG "MVP" 10W 10KV. 1.69; 10 for \$15.00
 60MEG "MVE" 25W 40KV. 2.75; 10 for \$25.00
 100MEG "MVP" 10W 10KV. 2.25; 10 for \$20.00

MICROWAVE FLANGES AND WAVE GUIDE
 UG39 to UG40 "X" Band Adapter Flange to Choke. Sperry Dgen. \$1.25; 6 for \$6.
 UG40/U Choke Broad Band. \$1.25; 6 for \$6.
 UG51/U Choke. \$1.25; 6 for \$6.
 UG52/U Choke to Pin Flange \$2.50; 6 for \$12.
 UG52/U Round 2 1/4" OD With Indexing Slot \$1.50; 6 for \$8.
WRITE FOR WAVE GUIDE LIST

LINER SAWTOOTH DC POTENTIOMETER KS15138
 Electric power is supplied through 2 fixed taps 180° apart. 2 rotating wipers, and take-off brushes are provided for output voltage. Varying position of the brushes, varies the output voltage in accordance with a linear sawtooth wave. Special. **\$2.95**

FILAMENT TRANS.
 6.3V/2A @ 79c; 2 for \$1.49; 10 for \$11.08
 2.5V/2A @ 79c; 2 for \$1.49; 10 for \$11.08
 2.5V/10A 5K VINS. \$6.98; 3 for \$18.
 5V/10A 12.5 K VINS. \$6.98; 3 for \$18.
 5V/13A 5 K VINS UTC 5-50. 4.49
 7.5V/12A CSD 15 K VINS. 10.95; 2 for 17.50
 24V/12A CSD @ 51.98 2 for 10.95
 2X12V/2A or 24V/2A @ 53.89 2 for 6.98
 42.5V/2A Sel. Rect. Xfmr. \$3.49; 2 for 2.95
 42.5V/2A Hm. Rect. Xfmr. \$3.49; 2 for 2.95
 PRI/220/440V Hm. Rect. 3x2.5V/5A 2.5V/15A. 4.95

TRANSFORMERS
 All 115 V 60 Cyc Input TV & CR Pwr Xfmr up to 20' tubes. Hi Volt 75 to 20 Kv. (quadrupler etc.) All full range. \$1.98 to \$12.00
 300 VDC/275MA Full-wave. 6.4V/1.9A
 5.4V/8A. 2.6V/3A. Hypertal Core. Oil Impreg. \$4.98
 1000VCT/50MA. 795VCT/80MA. 360VCT/65MA
 2.5KVA/3A. 6.3V/1A. 6.3VCT/3A CSD VINS
 CAN BE USED IN X-100, X-101, X-102
 SPECIAL \$4.00 2 for \$7. 6 for \$19
 950VCT/100MA. 5V/2.5A. 5V/5A. 45V/1A
 10V/1.5A WESTERN R. 30. 3 for \$13
 450VCT/148MA. 2X2.5V/2A. XCENT 1800V
 DIBLER TWO. 5V/2.5A. 5V/5A. 6.3V/3A
 450VCT/148MA. 2X2.5V/2A. XCENT 1800V
 DIBLER TWO. 5V/2.5A. 5V/5A. 6.3V/3A
 Double Half Shell
 780VCT/250MA. 6V/8A. 12.6V/8.5A. \$7.95
 780VCT/250MA. 6V/8A. 12.6V/8.5A. \$7.95
 PHORADON. 5V/2.5A. 2 for \$9. 6 for \$24
 770VCT/200MA. 6V/8A. 12.6V/8.5A. \$6.95
 770V/2.5MA. 6V/3A. 6.3V/3A. HELD Ind. \$2.25
 FILTER PARTS 4/soaps. \$2.95
 700VCT/120MA. 2 for \$3.98; 10 for \$25.95
 Price
 700VCT/70MA. 6VCT/3A. 6.3VCT/2.5A. \$1.00
 680VCT/200MA. 6V/8A. 6.3V/3A. 78V/1A. \$12.00
 600VCT/50MA. 6V/3A. 6V/1.5A. 5V/1A. \$2.49
 120VCT/90MA. 6.3V/1A. W/INPUTS 6. \$1.49
 24. 115VDC & 115 & 380 VAC @ \$1.49

POWER RELAY
 G.E. CR211/C22/Q Heavy Duty Electric Relay. 3 Pole. Single Throw. Normally Open. Contact 1/2" x 1/2" x 1/2". Rated 50 Amp. Input 220V/110V/60Cyc. Usable Transmitters. Power Circuits or Motor Starting. For Motors Up to 25 HP G.E. Price \$72. "TAB" SPECIAL \$18.00; 6 for \$98.

FILTER CHOKES
 12Hy/200mA/3KVins. 2.25
 10Hy/75mA. 1.25
 10Hy/125mA/UT/Cad. 1.98
 10Hy/125mA/UT/Cad. 1.98
 60Hy/125mA/Cad/Hid. 4.89
 20Hy/300mA or 15Hy/400mA/12KVins. Kenyon. 8.95
 Dual 2 Hy/800mA USN. 95c; 2 for 1.49
 4Hy/175mA 280 Ohm. \$1.49; 2 for 1.49
 10 Hy/100mA Freed. 1.39

METER SALE
 0-30 VDC/AN. \$2.95; 10 for \$8.00
 0-60 ADC "AN" Type Mte Lens Shunt. 2.95; 2 for 5.00
 0-150 VAC/DC. 1.25; 3 for 3.75
 RA35/Watk. \$1.98
 0-1 MADC Watschs 2 1/2". \$1.98
 RA35. \$1.98
 0-1 MADC Mini 1 1/2" Dia. \$2.95; 2 for \$8
 0-500 MADC/2 1/2". Rnd Trip/let 221 T. 4.98
 1-120 MA R 2 1/2". Weston 301. 11.98
 0-800 MADC/3 1/2". Rnd. \$4.99; 2 for 7.98
 300-0-300 Micro Ammeter Galvanometer. 50 Div Scale. Hi-Torque 3 1/2". Rnd Hook. \$4.49

ELECTROLYTIC CONDENSERS
 2X 20MFD/450VDC. 69c; 3 for \$1.95
 2X 15MFD/450VDC. 58c; 3 for 2.50
 3X 20MFD/400VDC. 79c; 2 for 1.29
 100MFD/450VDC. 79c; 2 for 1.29
 25MFD/450VDC. 79c; 2 for 1.29
 45MFD/450VDC. 79c; 2 for 1.29
 100MFD/450VDC/25V. 3 for 1.00
 50 m/350Vds PP. 3 for 1.00
 30-15-10 m/250Vdc. 5 for 1.00
 30-20m/250-25Vdc. 5 for 1.00
 30-2x20m/450-25Vdc. 5 for 1.00

PRECISION LAB POTENTIOMETER
 WIRE WOUND 30.000 OHM 25. WATT 6% DIAMETER GEN. RADIO TYPE 433AC
 Price. \$2.95; 2 for \$5.00; 10 for \$20.00.

TRANSFORMERS SPECIAL!
 6.3 Volts 3 1/2 Amp Continuous Duty, 115 V 60 cyc
 Size: 2 1/2x1 1/2x1 1/4 W. Mtu Ctr 2% Heavy Duty Channel Mounting RM, 5M, Mgrs, Labors Dirs. order now. \$1.76 value Special \$1.00; 12 for \$10.; 50 for \$36.

PRECISION RESISTORS
 CP's AND CPT's 1% ACCURACY MANUFACTURED TO "JAN" SPECIFICATIONS
 Take advantage of these tremendous savings. Normally sold for 80c to 89c. Order these new 1% "Wilkor" Carbofilm Hi-Stability, Low Temp Coat. Resistors at a fraction of mfgs. price. 1/2 million in stock. 100,000 on order. 22 meg. Order any value you need.
 CP's 1/2 Watt. 12 for \$1.25; 100/50; 1000/572
 CPT's 1/2 Watt. 68/12 for \$1.60; 100/572
 Indicate second & third choice, also may be written or parallel for value desired.

"TAB"
 THAT'S A BUY

"TAB" GRAB BAG
 Veeder Root Counter 3 Digit. 85c; 3 for \$1.98
 Reder Root Counter 5 1/2 Digit. 85c; 3 for \$1.98
 Band Pass Filters 60, 150 Cyo. 3 for \$4.00
 Shock Mount Load Asorted. 5 for \$1.00
 Miller C.E. 100 Amps. 60V. \$1.98; 2 for \$2.50
 Switch & Pole Single Throw 10A/120V Bakelite Cased W/Pointer Knob. 98c; 3 for 2.69; 10 for \$7
 Helipot 30,000 Ohm 10 Turn 0.5% 50KAZ. \$7.98
 Helipot 30,000 Ohm 10 Turn 0.1% 50KAZ. \$7.98
 Micropot 20,000 Ohm 10 Turn 0.1% \$7.98

LAB OR HI-POWER SUPPLY
 Sola constant voltage filament & power transformer with rectifier tubes, filter condensers, chokes. New Mfg'd By Dumont Furnishes 400VDC/250MA to filter system & 4V/6A 3% Regulated, 12.6VCT/6 Amp or 26.3V/6 Amp (Common Tap) New Bulk Ready to Use. \$59.00 Value. Special. **\$18.98**

RELAY SALE
 DDDT Clare SK6010, Octal Base, 18-28V 2AMP Cts. Nitrogen Sid \$2.89
 DP 18V/2A 115VDC. \$1.39
 Same & Rectifier for 115VAC. \$1.98
 SPST Min 115VAC/3A. 98c; 3 for \$2.75
 SPDT 6VDC/5A. \$1.49; 2 for \$2.49
 SPNO 115VAC/15A. \$1.98; 2 for \$3.50
 DPDT & SPNO 12VDC/10A cts \$2.25; 2 for \$3.75

INFRARED SNOOPSCOPE
 See in Dark Tube. Hi-Sensitivity simplified design 2" dia. Wilmitte screen—Resolution up to 350 lines/inch. Complete tube & tube. see. \$7.98; 2 for \$13.98
 Snoopscope Pwr Supply 1800VDC/35MA. Using Dribler Crkt. Transformer, Rectifier, Sockets, Resistors Capacitors and Diagram \$15.69; 2 for \$28.98

POWER RELAY
 G.E. CR211/C22/Q Heavy Duty Electric Relay. 3 Pole. Single Throw. Normally Open. Contact 1/2" x 1/2" x 1/2". Rated 50 Amp. Input 220V/110V/60Cyc. Usable Transmitters. Power Circuits or Motor Starting. For Motors Up to 25 HP G.E. Price \$72. "TAB" SPECIAL \$18.00; 6 for \$98.

TUBES

0A2	50.88	4J31	99.51	6S17	58	FG166	48.49	866A	1.50
0A3/VR75	1.04	4J52	199.99	6S17GT	58	FG172	48.49	866B	1.50
0B2	1.37	EL52D	15.99	6SL7GT	64	211/VT4C	8.97	867	2.59
0C3/VR90	1.32	EC52/CS6	38.95	6S07GT	68	RK215	7.98	925	2.14
0C3/VR105	.92	5D21	14.98	6SR7	62	250TH	18.97	CK1005	.68
0C3/VR150	.82	5D21	14.98	6SR7	68	250TH	17.75	1613	.62
1B3/AR15	1.82	5R4GV	1.20	6T8	88	250TH	18.97	1613	.62
1B22	2.87	5R4GVW	1.75	8A4	88	300TH	8.90	1625	.32
1B23	1.82	5R4GVW	1.75	8A4	88	300TH	8.90	1625	.32
1B24	1.82	5R4GVW	1.75	8A4	88	300TH	8.90	1625	.32
1B25	1.82	5R4GVW	1.75	8A4	88	300TH	8.90	1625	.32
1B26	1.82	5R4GVW	1.75	8A4	88	300TH	8.90	1625	.32
1B27	11.98	5V4G	5.95	6V6GT	59	WL47A	8.48	1634	1.18
1B28	24.45	6A5	1.49	6V6GT	52	417A/5842	18.50	1635	1.69
1B29	1.82	5R4GV	1.20	6T8	88	250TH	18.97	1613	.62
1B30	1.82	5R4GVW	1.75	8A4	88	300TH	8.90	1625	.32
1B31	1.82	5R4GVW	1.75	8A4	88	300TH	8.90	1625	.32
1B32	1.82	5R4GVW	1.75	8A4	88	300TH	8.90	1625	.32
1B33	1.82	5R4GVW	1.75	8A4	88	300TH	8.90	1625	.32
1B34	1.82	5R4GVW	1.75	8A4	88	300TH	8.90	1625	.32
1B35	1.82	5R4GVW	1.75	8A4	88	300TH	8.90	1625	.32
1B36	1.82	5R4GVW	1.75	8A4	88	300TH	8.90	1625	.32
1B37	1.82	5R4GVW	1.75	8A4	88	300TH	8.90	1625	.32
1B38	1.82	5R4GVW	1.75	8A4	88	300TH	8.90	1625	.32
1B39	1.82	5R4GVW	1.75	8A4	88	300TH	8.90	1625	.32
1B40	1.82	5R4GVW	1.75	8A4	88	300TH	8.90	1625	.32
1B41	1.82	5R4GVW	1.75	8A4	88	300TH	8.90	1625	.32
1B42	1.82	5R4GVW	1.75	8A4	88	300TH	8.90	1625	.32
1B43	1.82	5R4GVW	1.75	8A4	88	300TH	8.90	1625	.32
1B44	1.82	5R4GVW	1.75	8A4	88	300TH	8.90	1625	.32
1B45	1.82	5R4GVW	1.75	8A4	88	300TH	8.90	1625	.32
1B46	1.82	5R4GVW	1.75	8A4	88	300TH	8.90	1625	.32
1B47	1.82	5R4GVW	1.75	8A4	88	300TH	8.90	1625	.32
1B48	1.82	5R4GVW	1.75	8A4	88	300TH	8.90	1625	.32
1B49	1.82	5R4GVW	1.75	8A4	88	300TH	8.90	1625	.32
1B50	1.82	5R4GVW	1.75	8A4	88	300TH	8.90	1625	.32
1B51	1.82	5R4GVW	1.75	8A4	88	300TH	8.90	1625	.32
1B52	1.82	5R4GVW	1.75	8A4	88	300TH	8.90	1625	.32
1B53	1.82	5R4GVW	1.75	8A4	88	300TH	8.90	1625	.32
1B54	1.82	5R4GVW	1.75	8A4	88	300TH	8.90	1625	.32
1B55	1.82	5R4GVW	1.75	8A4	88	300TH	8.90	1625	.32
1B56	1.82	5R4GVW	1.75	8A4	88	300TH	8.90	1625	.32
1B57	1.82	5R4GVW	1.75	8A4	88	300TH	8.90	1625	.32
1B58	1.82	5R4GVW	1.75	8A4	88	300TH	8.90	1625	.32
1B59	1.82	5R4GVW	1.75	8A4	88	300TH	8.90	1625	.32
1B60	1.82	5R4GVW	1.75	8A4	88	300TH	8.90	1625	.32
1B61	1.82	5R4GVW	1.75	8A4	88	300TH	8.90	1625	.32
1B62	1.82	5R4GVW	1.75	8A4	88	300TH	8.90	1625	.32
1B63	1.82	5R4GVW	1.75	8A4	88	300TH	8.90	1625	.32
1B64	1.82	5R4GVW	1.75	8A4	88	300TH	8.90	1625	.32
1B65	1.82	5R4GVW	1.75	8A4	88	300TH	8.90	1625	.32
1B66	1.82	5R4GVW	1.75	8A4	88	300TH	8.90	1625	.32
1B67	1.82	5R4GVW	1.75	8A4	88	300TH	8.90	1625	.32
1B68	1.82	5R4GVW	1.75	8A4	88	300TH	8.90	1625	.32
1B69	1.82	5R4GVW	1.75	8A4	88	300TH	8.90	1625	.32
1B70	1.82	5R4GVW	1.75	8A4	88	300TH	8.90	1625	.32
1B71	1.82	5R4GVW	1.75	8A4	88	300TH	8.90	1625	.32
1B72	1.82	5R4GVW	1.75	8A4	88	300TH	8.90	1625	.32
1B73	1.82	5R4GVW	1.75	8A4	88	300TH	8.90	1625	.32
1B74	1.82	5R4GVW	1.75	8A4	88	300TH	8.90	1625	.32
1B75	1.82	5R4GVW	1.75	8A4	88	300TH	8.90	1625	.32
1B76	1.82	5R4GVW	1.75	8A4	88	300TH	8.90	1625	.32
1B77	1.82	5R4GVW	1.75	8A4	88	300TH	8.90	1625	.32
1B78	1.82	5R4GVW	1.75	8A4	88	300TH	8.90	1625	.32
1B79	1.82	5R4GVW	1.75	8A4	88	300TH	8.90	1625	.32
1B80	1.82	5R4GVW	1.75	8A4	88	300TH	8.90	1625	.32
1B81	1.82	5R4GVW	1.75	8A4	88	300TH	8.90	1625	.32
1B82	1.82	5R4GVW	1.75	8A4	88	300TH	8.90	1625	.32
1B83	1.82	5R4GVW	1.75	8A4	88	300TH	8.90	1625	.32
1B84	1.82	5R4GVW	1.75	8A4	88	300TH	8.90	1625	.32
1B85	1.82	5R4GVW	1.75	8A4	88	300TH	8.90	1625	.32
1B86	1.82	5R4GVW	1.75	8A4	88	300TH	8.90	1625	.32
1B87	1.82	5R4GVW	1.75	8A4	88	300TH	8.90	1625	.32
1B88	1.82	5R4GVW	1.75	8A4	88	300TH	8.90	1625	.32
1B89	1.82	5R4GVW	1.75	8A4	88	300TH	8.90	1625	.32
1B90	1.82	5R4GVW	1.75	8A4	88	300TH	8.90	1625	.32
1B91	1.82	5R4GVW	1.75	8A4	88	300TH	8.90	1625	.32
1B92	1.82	5R4GVW	1.75	8A4	88	300TH	8.90	1625	.32
1B93	1.82	5R4GV							

INDEX TO ADVERTISERS

TO GET ADDITIONAL INFORMATION ON ADVERTISEMENTS, turn to the **READER SERVICE** postcard at the end of this index. Simply strike out the inquiry code number corresponding to the inquiry code number of the advertisers shown below. Completely fill in all the required information, detach the postcard and mail.

INQUIRY

▼CODE NO.

1. Ace Engineering & Machine Co., Inc.	386
2. Acheson Colloids Company.....	221
3. Acme Electric Corporation.....	490
4. Advance Electronics Co., Inc.....	483
5. Aerohm Corporation.....	460
6. Aerolite Electronics Corp.....	481
7. Aeronautical Communications Equipment, Inc.	441
8. Aerovox Corporation.....	399
9. Ahrendt Instrument Co., The.....	447
10. Airborne Accessories Corp.	476
11. Airborne Instruments Laboratories, Inc.	52, 63
12. Aircraft-Marine Products, Inc.....	52, 53
13. Aircraft Radio Corporation.....	480
14. Aireco, Inc.	553
15. Air Marine Motors Inc.	434
16. Airpax Products Company.....	87
17. Alden Products Co.	419
18. Allen-Bradley Co.	33
19. Allen Co., Inc., L. B.	506
20. Allen Manufacturing Company.....	481
21. Allied Control Company, Inc.....	335
22. Allied Control Company, Inc.....	337
23. Allied Radio Corporation.....	240
24. Allmetal Screw Products Co., Inc....	475
25. Alpha Metals, Inc.	204
26. Amerac, Inc.	268
27. Automotive & Aircraft Div. American Chain & Cable.....	418
28. American Lava Corporation.....	245
29. American Phenolic Corporation 48A, 48B	
30. American Television & Radio Co....	344
31. American Time Products, Inc.....	273
32. Amperex Electronic Corporation....	291
33. Amperite Co., Inc.	230
34. Ampex Corporation.....	257
35. Andersen Laboratories, Inc.....	452
36. Applied Science Corporation of Princeton	38
37. Arco Electronics Inc.....	467
38. Arnold Engineering Company.....	11
39. Arrow Electronics, Inc.....	456
40. Art Wire & Stamping Company.....	425
41. Assembly Products, Inc.....	330
42. Astron Corporation.....	281
43. Atlas E-E Corporation.....	482
44. Atlas Engineering Co., Inc.....	481
45. Audio Devices, Inc.	325
46. Audio Products Corp.....	384
47. Automatic Manufacturing Corp.....	371
48. Avery Adhesive Label Corp.....	333
49. Avien-Knickerbocker, Inc. Aviation Engineering Div.	279
50. Avion Instrument Corp.....	304
51. Bakelite Co., Div. of Union Carbide & Carbon Company.....	305

INQUIRY

▼CODE NO.

52. Ballantine Laboratories, Inc.....	403
53. Barker & Williamson, Inc.....	216
54. Barry Corporation.....	15
55. Bead Chain Mfg. Company.....	461
56. Beaver Gear Works, Inc.....	416
57. Bell Aircraft Corporation.....	445
58. Bell Telephone Laboratories.....	347
59. Bendix Radio Corporation Div.....	113
Bendix Aviation Corporation	
60. Red Bank Div.	420
61. Scintilla Div.	329
62. Berkeley Div., Beckman Instrument Inc.	246
63. Berndt-Bach, Inc.....	472
64. Bird & Co., Inc., Richard H.....	427
65. Bird Electronic Corporation.....	456
66. Birtcher Corporation.....	417
67. Biwax Corporation.....	501
68. Bliley Electric Company.....	253
69. Boesch Manufacturing Co., Inc.....	496
70. Bomac Laboratories, Inc.....	369
71. Boonton Radio Corporation.....	197
72. Borg Corporation, George.....	80
73. Bourns Laboratories.....	232
74. Brand & Co., Inc., William.....	284
75. Breeze Corporations, Inc.....	355
76. Bridgeport Brass Company.....	385
77. Brush Electronics Company.....	251
78. Brush Electronics Company.....	390
79. Budd Stanley Co., Inc.....	466
80. Burlington Instrument Company... 500	
81. Burnell & Company.....	21
82. Burton-Rogers Company.....	494
83. Bussmann Manufacturing Co.....	90
84. Cambridge Thermionic Corp.....	34
85. Camloc Fastener Corporation.....	276
86. Cannon Electric Company.....	378
87. Carboloy, Department of General Electric Company.....	58, 59
88. Carter Motor Company.....	463
89. CBS-Hytron, Div. Columbia Broadcasting System, Inc.....	99
90. Centralab, Div. of Globe-Union Inc..	208
91. Centralab, Div. of Globe-Union Inc..	265
92. Centralab, Div. of Globe-Union Inc..	312
93. Centralab, Div. of Globe-Union Inc..	402
94. Centralab, Div. of Globe-Union Inc..	450
95. Chassis-Trak Corporation.....	501
96. Chatham Electronics Corp.....	313
97. Chester Cable Corporation.....	301
98. Chicago Standard Transformer Corporation.....	338
99. Chicago Telephone Supply Corp. 108, 109	
100. Ciba Company, Inc.	341
101. Cinch Manufacturing Corp.....	193
102. Citation Products Company.....	437

Lockheed in California
calling...

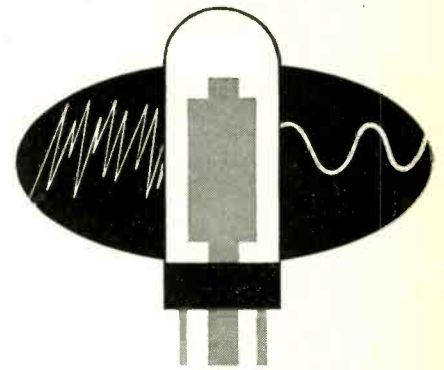

ELECTRONICS RESEARCH Engineers

Lockheed's expanding development program in nuclear energy, supersonic fighters, jet transports and other classified projects has created unusual career opportunities for Electronics Research Engineers experienced in any or all of the following fields:

1. Circuit design
2. Airborne radar systems research
3. Airborne antenna design

The positions require a degree or equivalent in electrical engineering or physics.

There are also career openings for Jr. Engineers for Electronic Research. No experience is necessary although a degree is required.

In addition to excellent career opportunities, Lockheed offers you:

1. High salaries, commensurate with your experience
2. Generous travel and moving allowances
3. A chance for you and your family to enjoy life in Southern California.

INTERVIEWS AT I.R.E. SHOW

For those engineers attending the I.R.E. convention, Lockheed Representatives Paul Morgan and Charles Strack will be available at the Hotel Lexington day and night on March 22 and 23.

If you are unable to attend the convention, address inquiries to Paul Morgan, Dept. EE-3, at Lockheed's Burbank plant.



For more ad information, see Index to Advertisers.

JELLIFF

ALLOY 800 RESISTANCE WIRE

for miniaturized precision-instrument components

the ideal resistance wire for

fixed and variable resistors of high ohmage — resistance boxes and bridges — voltmeter and wattmeter multipliers — and other miniature wire-wound units.

Where space is at a premium and performance is a "must" — these outstanding qualities of Jelliff Alloy 800 will assure that your products conform to the tightest specs.

High resistivity, 800 ohms/cm — Low Temperature Coefficient, ± 20 ppm/ $^{\circ}$ C — Non-Magnetic — Highly Stable Electrically and Mechanically — Diameters from 0.0009" to 0.0056" — Bare, enameled or oxidized, or insulated with silk, Nylon or cotton — Solders and Winds easily.

For Complete Data Address
Department 17



THE C. O. JELLIFF

MANUFACTURING CORP. SOUTHPORT, CONN.

*plot and read out
your test data
on a single
instrument...*



WITH THE NEW AUTOGRAF RECORDER/CURVE-FOLLOWER

THE AUTOGRAF, a portable 2-axis servo-driven X-Y recorder, plots test data on 8½"x 11" graph paper automatically. With full scale sensitivities of 5MV to 100V, the Autograf is used to plot a wide variety of laboratory and shop measurements.

for full details write: F. L. MOSELEY CO.
409 N. Fair Oaks Avenue
Pasadena 3, California

- The Autograf with curve-follower attachment reads out, electrically, data from drawn graphs.
- As a computer input table it generates, as a potentiometer setting, the function Y from a graph of the relationship $Y=f(X)$.
- As an aid in all phases of data handling, the Autograf Curve-follower furnishes a simple, accurate method of reducing empirical data to electrical form.

Choice of Autograf models.

1. As a Recorder only.
2. As a Recorder and Curve-follower.
3. Either model available as a rack-mounting unit.

INQUIRY

▼CODE NO.

103. Clarostat Mfg. Co., Inc.	247
104. Clegg Laboratories, Inc.	497
105. Cleveland Container Company	55
106. Clifford Manufacturing Co.	65
107. Cohn Mfg. Co., Inc., Sigmund	437
108. Coil Winding Equipment Co.	431
109. Collectron Corporation	419
110. Collins Radio Company	293
111. Columbian Carbon Company	485
112. Communication Accessories Co.	29
113. Communication Measurements Laboratories, Inc.	452
114. Communication Products Co., Inc.	429
115. Condenser Products Co., Div. of New Haven Clock & Watch Co.	383
116. Conrad & Moser	480
117. Consolidated Engineering Corp.	285
118. Consolidated Vacuum Corp.	215
119. Constantin & Co., L. L.	297
120. Constantine Engineering Laboratories Company	451
121. Constantine Engineering Laboratories Company	453
122. Continental Connectors, De Jur-Amsco Corporation	126
123. Continental-Diamond Fibre Co.	309
124. Control Electronics Co., Inc.	461
125. Control Engineering Corp.	105
126. Copar Incorporated	477
127. Cornell-Dubilier Electric Corp.	51
128. Corning Glass Works	372
129. Cornish Wire Co., Inc.	487
130. Coto-Coil Company	439
131. Cox & Company, Inc.	452
132. Cramer Co., Inc., R. W.	318
133. Cross Co., H.	435
134. Crucible Steel Co., of America	331

135. Dage Electric Co., Inc.	465
136. Dalmo Victor	61
137. Dano Electric Company	493
138. Davelle Laboratories, Inc.	388
139. Daven Company	3rd Cover
140. Davis Electric Company	382
141. De Jur-Amsco Corporation	127
142. De Jur-Amsco Corporation	350
143. Detectron Corporation, The	431
144. Diehl Manufacturing Company	260
145. Dillectrix Company	497
146. Dorne & Margolin, Inc.	499
147. Douglas Instrument Laboratory	506
148. Douglas Microwave Co., Inc.	551
149. Dressen-Barnes Corporation	294
150. Driver Co., Wilbur B.	295
151. Driver-Harris Company	229
152. Dumont Airplane & Marine Instruments, Inc.	454
Dumont Laboratories, Inc., Allen B.	
153. Technical Sales Dept.	80A, 80B
154. Technical Sales Dept.	391
155. Technical Sales Dept.	462

156. Eastern Precision Resistor Corp.	443
157. Edison, Inc., Thomas A.	316
158. Elser Engineering Co., Inc.	473

**INQUIRY
▼CODE NO.**

159. Eisler Engineering Co., Inc.	500
160. Eitel-McCullough, Inc.	93
161. Elco Corporation	392
162. Electra Manufacturing Co.	426
163. Electric Regulator Corp.	278
164. Electrical Industries, Div. of Amperex Corporation	357
165. Electrical & Physical Instrument Corporation	497
166. Electro Motive Mfg. Co., Inc.	79
167. Electro Engineering Products Co.	163
168. Electro Methods Ltd.	478
169. Electro Tec Corporation	319
170. Electronic Associates Inc.	436
171. Electronic Fabricators, Inc.	217
172. Electronic Instrument Co., Inc.	433
173. Electronic Parts Mfg. Co., Inc.	500
174. Electronic Transformer Co.	84
175. Electronic Tube Corporation	270
176. Elgin Metalformers Corp.	362
177. Elly Electronics Corporation	440
178. Empire Devices Products Corp.	458
179. Engineering Co., The	552
180. Epeo Products, Inc.	431
181. Erie Resistor Corporation	211
182. Ethylene Chemical Corporation	417
183. F & M Sales, Inc.	445
184. F-R Machine Works, Inc.	231
185. Fairchild Camera & Instrument Corporation	42, 43
186. Fairchild Engine & Airplane Corporation	222
187. Fansteel Metallurgical Corp.	282
188. Federal Screw Products Inc.	469
189. Federal Telecommunication Laboratories	417
190. Federal Telephone & Radio Co.	239
191. Federated Metals, Div. American Smelting & Refining Co.	370
192. Film Capacitors, Inc.	489
193. Filtron Company, Inc.	45
194. Five Star Company, The	437
195. Fluke Mfg. Co., Inc., John	486
196. Ford Instrument Co.	74
197. Freed Transformer Co., Inc.	71
198. Frequency Standards	473
199. Furst Electronics	549
200. G & M Equipment Co., Inc.	479
201. G-M Laboratories Inc.	493
202. G-V Controls Inc.	354
203. Gabriel Laboratories, Div. of Gabriel Company	394
204. Gabriel Electronics, Div. of Gabriel Company	395
205. Gamewell Company, The	298
206. Garde Manufacturing Company	428
207. Garron Aircraft Supply Inc.	486
208. General Ceramic & Steatite Corporation	299
General Electric Company	
209. Apparatus Dept.	46, 47
210. Apparatus Dept.	68, 69
211. Electronics Dept.	115

"Wow-Meter"

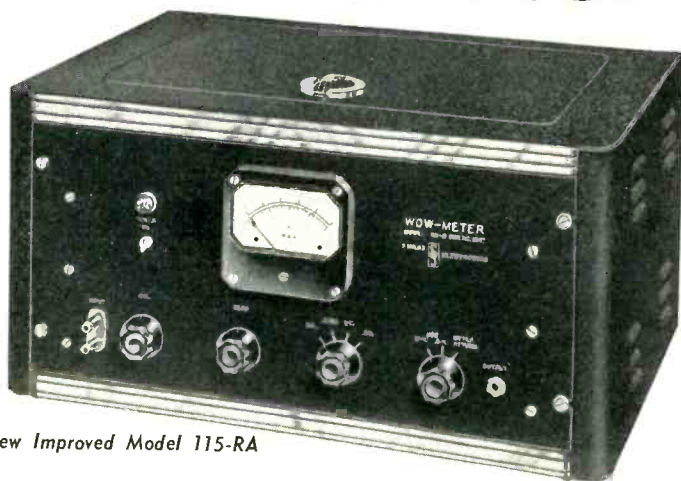

New Improved Model 115-RA

Improved direct-reading instrument simplifies measurements of wow and flutter in speed of phonograph turntables, wire and tape recorders, motion picture projectors and similar recording or reproducing mechanisms. It is the only meter in existence providing direct, steady indication of meter pointer on scale.

The Furst Model 115-RA with improved stability is suitable for both laboratory and production application and eliminates complex test set-ups.

A switch on the front panel permits selection of low frequency cut-off and corresponding meter damping for use on slow speed turntables.

Frequency Response: 1/2 to 120 cycles or 10 to 120 cycles

Sensitivity: 0.2, 0.5, and 2.0% Wow Full Scale

Inquiries invited on our line of Regulated Power Supplies



FURST ELECTRONICS

3322 W. Lawrence Ave., Chicago 25, Illinois

See Us At Booth 416 Electronic Avenue, Radio Engineering Show

Get It FREE...

Use It!



Your Helping Hand!

Most Complete
Electronic
BUYING GUIDE

FREE! 1954 HUDSON
MASTER CATALOG

... your helping hand for Everything in Electronic Equipment. Over 1000 pages of the latest in Radio, TV and Industrial Electronics. High Fidelity and PA Sound Equipment PLUS JAN Type Electronic Components. If it's new... HUDSON has it FIRST! Leading Authorized Distributor in the East. Our new Catalog is Quick, Convenient... Time and Money Saving! ONE Complete Dependable Source... ONE Order...

*One Call
for All!*



Three Great Fully Stocked Salesrooms to Serve You!

Adjoining Radio City 48 West 48 St. New York 36 Circle 6-4060	Downtown New York 212 Fulton St. New York 7 Circle 6-4060	In New Jersey 35 William St. Newark 2, N. J. MARket 4-5151
--	--	---

HEADQUARTERS FOR RCA



TUBES • PARTS • BATTERIES
TEST EQUIPMENT

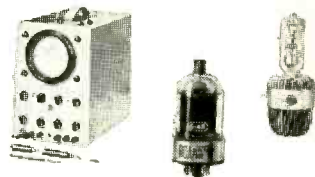

Engineers, Purchasing Managers, Qualified Executives... You NEED our Great New Catalog in your daily work — Send in your request today, on your company letterhead, for YOUR FREE COPY. Dept M-3

TEST CHAMBERS

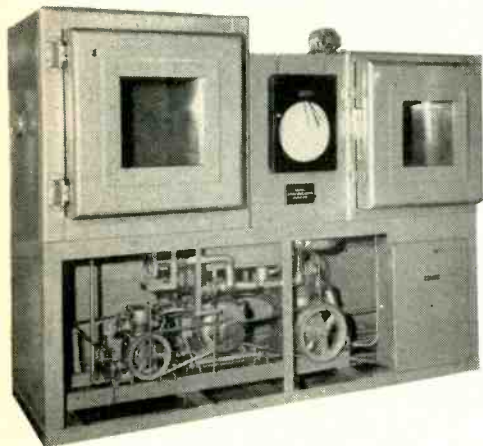

HIGH & LOW TEMPERATURES

CONTROLLED HUMIDITY

- -150°F. to +200°F.
- 20% to 95% R.H.
- 1 cu. ft. to 75 cu. ft. cabinets

**Walk-in Rooms
Temperature Baths**

Electronic or pneumatic recording or indicating control systems

**CUSTOM CHAMBERS
built to specifications.**

Years of Satisfactory Service

**55 Washington Avenue
Carlstadt, New Jersey**



PULSE TRANSFORMERS... A FIELD PIONEERED and DEVELOPED BY... UTAH

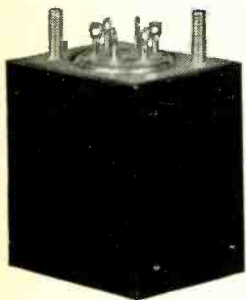

**33 MODELS OF THE
MOST POPULAR PULSE
TRANSFORMERS IN STOCK
IMMEDIATE DELIVERY**

TYPE
Plate
Filament
Plate and Filament
Filter Reactors
Pulse
Audio

CONSTRUCTION
Core-and-Coil
Compound filled
Hypersil Loop
Hermetically Sealed
Fosterite

APPLICATION
Radar
Guided Missile
Communications
Radio
Television
Sound Installation

Complete Fosterite Process—Varnish and Wax Impregnating

For Radio and Television Transformers—Line Matching—Impedance Matching—Write Dept. E for Utah Catalog T 100

UTAH RADIO PRODUCTS CO., INC.
HUNTINGTON, INDIANA

INQUIRY ▼CODE NO.

212. Tube Dept.	89
213. Tube Dept.	122, 123
214. General Hermetic Sealing Corp.	485
215. General Industrial Company.	497
216. General Radio Company.	17
217. General Transformer Company.	220
218. Giannini & Co., Inc., G. M.	502
219. Gillilan Brothers.	398
220. Glenco Corporation.	110
221. Good-All Electric Mfg. Co.	237
222. Goodmans Industries Limited.	381
223. Gramer Transformer Corp.	307
224. Grant Pulley & Hardware Corp.	400
225. Graphite Metallizing Corp.	471
226. Gray Research & Development Co.	351
227. Greater Lawrence Citizens Committee.	447
228. Green Instrument Co., Inc.	449
229. Greibach Instruments Corp.	111
230. Gries Reproducer Corp.	503
231. Gulton Manufacturing Corp.	111
232. Hammarlund Mfg. Co., Inc.	23
233. Hardwick Hindle, Inc.	101
234. Hart Manufacturing Co.	258
235. Harvey Hubbell, Inc.	406
236. Hathaway Instrument Company.	474
237. Hayden Company, A. W.	477
238. Heath Company.	427
239. Heiland Research Corp.	210
240. Helder Manufacturing Corp.	241
241. Hellpot Corporation, Div. of Beckman Instruments Inc.	199
242. Heminway & Bartlett Mfg. Co.	427
243. Henry & Miller Industries Inc.	506
244. Heppner Manufacturing Company.	334
245. Hermetic Seal Products Company.	321
246. Hetherington, Inc.	234
247. Hewlett-Packard Company.	35, 36, 37
248. Hexacon Electric Company.	416
249. Hopkins Engineering Company.	429
250. Hopkins Engineering Company.	476
251. Hudson Radio & Television Corp.	549
252. Hudson Tool & Die Co., Inc.	60
253. Hudson Wire Company.	205
254. Hughes Aircraft Company.	249
Hughes Research & Development Laboratories.	248
255. Hycor Sales Company of Calif.	392
256. Hydro-Aire, Inc.	367
I-T-E Circuit Breaker Co.	
257. Resistor Div.	254
258. Special Products Div.	373
259. Indiana Steel Products Co.	94
260. Industrial Condenser Corp.	206
261. Industrial Development Div. State of Florida.	467
262. Industrial Hardware Mfg. Co., Inc.	465
263. Industrial Test Equipment Co.	501
264. Industrial Timer Corp.	44
265. Infra Electronic Corp.	441
266. Institute of Radio Engineers, The.	102
267. Instrument Corp. of America.	343
268. Instrument Resistors Co.	425

**INQUIRY
▼CODE NO.**

269. Instrument Specialties Co., Inc.....	340
270. Insulated Circuits Inc.....	445
271. International Crystal Mfg. Co., Inc..	485
272. International Electronic Research Corporation	504
273. International Instruments Inc.....	439
274. International Nickel Co., Inc.....	377
275. International Pump & Machine Works	458
276. International Rectifier Corp.....	271
277. International Resistance Co.....	30, 31
278. International Resistance Co.....	492
279. Ippolito & Co., Inc., James.....	421
280. Irvington Varnish & Insulator Div. of Minnesota Mining & Mfg. Co.....	339

281. James Vibrapowr Company.....	459
282. Jelliff Mfg. Co., C. O.....	548
283. Jennings Radio Manufacturing Corp.	252
284. Johnson Company, E. F.....	223
285. Jones Div. Howard B. Cinch Manu- facturing Co.	421
286. Jo'wil Electronics Inc.....	487
287. Joy Manufacturing Co.....	317

A New Production Tool...
Streamlined to cut testing costs up to 75%!

**A
GENERAL UTILITY
COMPARISON
BRIDGE**

**MODEL A
Circuit Matcher**
(12" x 17" x 16" High
45 lbs.)

*Call or write for
demonstration*



- Use your prototype as a "standard"
- Compare Circuits by AC & DC Bridge Test
- Adapts through Sockets, Plugs, etc.
- Point to Point Ohmmeter Test

Send for detailed specification and application bulletin.

McSHAN DEVELOPMENT CORPORATION
71 MURRAY STREET • NEW YORK 7, N. Y.
WOrth 2-4547



**the FIRST
the SMALLEST
and still the BEST**

- Waveforms 510-B

MINIATURE OSCILLATOR

- 18 cycles — 1.1 Megacycles
- Briefcase Portable
- Less than 0.2% distortion
- 600 Ohm transformer available

Precision in **miniature**

ALSO—NEW the still more versatile 512
ONE CYCLE.....to.....500 KC
TWO WATTS.....0.1% distortion

SEE IT NOW AT THE I.R.E. SHOW

Waveforms, inc.

333 Sixth Avenue, New York 14, N. Y.

"Spotlight the New"
at the
RADIO ENGINEERING SHOW
EXHIBITOR

706 Airborne Ave.

March 22-25, 1954 • Kingsbridge Armory, New York City

MICROWAVE

**Test Equipment-Components
Transmission Lines**

Our engineering department is moving to the show, expressly to meet with you and to discuss your engineering problems.

Ask to see our new catalog — the most complete and comprehensive in our field.

Please note our new address.



MICROWAVE Co., Inc.

11 BEECHWOOD AVE.

NEW ROCHELLE, N. Y. • NEW Rochelle 6-6900

DANIEL KONDAKJIAN TUNGSTEN LEADS—TUBES BASES

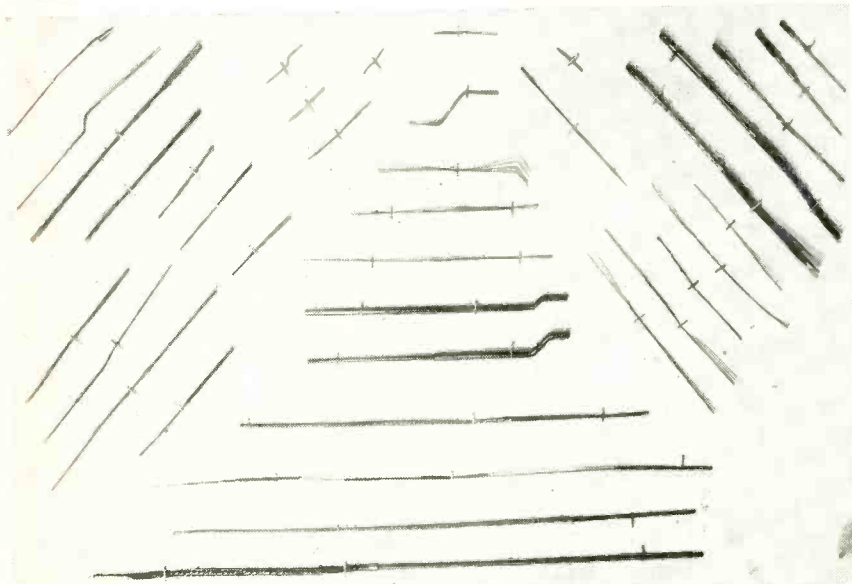

TUNGSTEN LEAD-IN WIRES

Quality leads make quality tubes . . . and for over 30 years The Engineering Co., under personal supervision of Daniel Kondakjian, has been making quality precision lead-in wires for vacuum tight seals, for lamps, radio tubes, electronic devices and other special applications. Precision machines, capable of holding these fine wires so that they are accurately located and carefully spaced, assure high operating efficiency and uniformity in the finished product.

Parts are made to customer's blue prints or specifications. Specializing in leads of tungsten, moly, nickel, nickel clad copper and copper alloys. Send us your blue prints or specifications. Kovar leads and stampings.

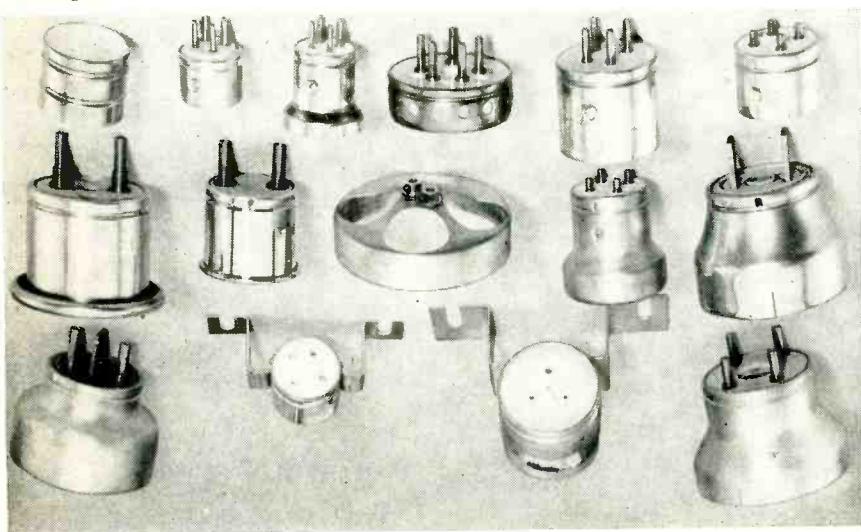

ELECTRON TUBE BASES

The quality and performance of electron tubes depend upon quality bases and caps. We make all types, including an all-glazed ceramic base. Our hydrogen-tube bases go up to 6.25 diameter. Precision equipment and careful inspection in our plant assure the finest quality in caps and bases. Our engineers will be happy to serve you in any problem.

THE ENGINEERING CO.

27 WRIGHT STREET, NEWARK, 5, NEW JERSEY



INQUIRY

▼ CODE NO.

288. Kable Engineering Co.	13
289. Kalbfell Laboratories Inc.	256
290. Karp Metal Products Co., Div. of H & B American Machine Co.	365
291. Kartron	506
292. Kaupp & Sons, C. B.	83
293. Kay Electric Company	387
294. Kearfott Company, Inc.	424
295. Keller Tool Company	56, 57
296. Kellogg Switchboard & Supply Co.	468
297. Kenyon Transformer Co., Inc.	442
298. Kepco Laboratories	363
299. Kester Solder Company	263
300. Ketay Manufacturing Corp.	32A, 32B, 32C, 32D
301. Keystone Electronics Co.	429
302. Kings Electronics Co., Inc.	243
303. Kinney Mfg. Div. New York Air Brake Company, The	209
304. Knights Company, James	272
305. Koiled Kords Incorporated	290
306. Kollsman Instrument Corp.	327
307. Krengel Manufacturing Co., Inc.	439
308. Krohn-Hite Instrument Co.	410
309. Krohn-Hite Instrument Co.	411
310. Kuthe Laboratories Inc.	465
311. Lambda Electronics Corp.	413
312. Lampkin Laboratories, Inc.	506
313. Langevin Manufacturing Corp.	359
314. Lapp Insulator Co., Inc.	226
315. Leach Relay Company	360
316. Lewis Spring & Mfg. Company	280
317. Lion Fasteners, Inc.	310
318. Litton Engineering Laboratories	361
319. Lockheed Aircraft Corporation	547
320. Lockheed Missile Systems Div.	368
321. Magnetic Amplifiers, Inc.	477
322. Magnetics Inc.	501
323. Magnetran Incorporated	419
324. Makepeace Company, D. E.	315
325. Mallory & Co., Inc., P. R.	66
326. Mallory & Co., Inc., P. R.	128
327. Mallory & Co., Inc., P. R.	195
328. Mallory & Co., Inc., P. R.	498
329. Manson Laboratories	485
330. Marconi Instruments	345
331. Martin Company, Glenn L.	117
332. M. B. Manufacturing Co., Inc.	100
333. McGraw-Hill Book Company	506
334. McGraw-Hill Technical Writing Service	471
335. McLaughlin Corporation, J. L. A.	396
336. McMillan Laboratory, Inc.	203
337. McShan Development Corporation	551
338. Measurements Corporation	318

INQUIRY
▼CODE NO.

339. Mepeco, Inc.	397
340. Metal Textile Corporation.....	410
341. Metals & Controls Corp., General Plate Div.	104
342. Mica Insulator Company.....	269
343. Micamold Radio Corporation.....	118
344. Mico Instrument Company.....	452
345. Micro Switch, A Div. of Minneapolis- Honeywell Regulator Co.....	48
346. Microdot Div. of Felts Corp.....	447
347. Microwave Associates, Inc.....	95
348. Midland Mfg. Co., Inc.....	259
349. Milford Rivet & Machine Co.....	218
350. Millen Mfg. Co., Inc., James.....	225
351. Miller Instruments, William.....	283
352. Millivac Instrument Corp.....	422
353. Milwaukee Transformer Company... 292 Minneapolis-Honeywell Regulator Company	
354. Aero Division	361
355. Industrial Div.	78
356. Miniature Precision Bearings, Inc..	201
357. Moloney Electric Company.....	213
358. Moseley Company, F. J.....	548
359. Muirhead & Co., Ltd.....	3
360. Multi-Metal Wire Cloth Co., Inc....	336
361. Murphy & Miller, Inc.....	494
362. Mycalex Corp. of America.....	430
363. N.R.K. Mfg. & Engineering Co.....	478
364. Nassau Research & Development As- sociates, Inc.	484
365. National Moldite Co.....	389
366. National Tel-Tronics Corp.	423
367. National Union Radio Corp.....	261
368. Natvar Corporation	207
369. New London Instrument Co.....	96
370. New York Transformer Company, Inc.	308
371. Ney Company, J. M., The.....	469
372. Nielsen Hardware Corporation.....	461
373. Niemand Brothers, Inc.....	461
374. Northern Radio Co., Inc.....	106, 107
375. Nuclear Specialty Company.....	413
376. Olympic Metal Products Co., Inc... 380	
377. Opad-Green Company	503
378. Panoramic Radio Products Inc.....	415
379. Paramount Paper Tube Corporation. 482	
380. Par-Metal Products Corporation.... 437	
381. Penn Engineering & Mfg. Corp..... 238	

GENERAL  ELECTRIC chose AIRECO, INC.

TO DESIGN, ENGINEER AND INSTALL ENVIRONMENTAL EQUIPMENT IN THEIR NEW FRENCH ROAD PLANT AT UTICA, NEW YORK

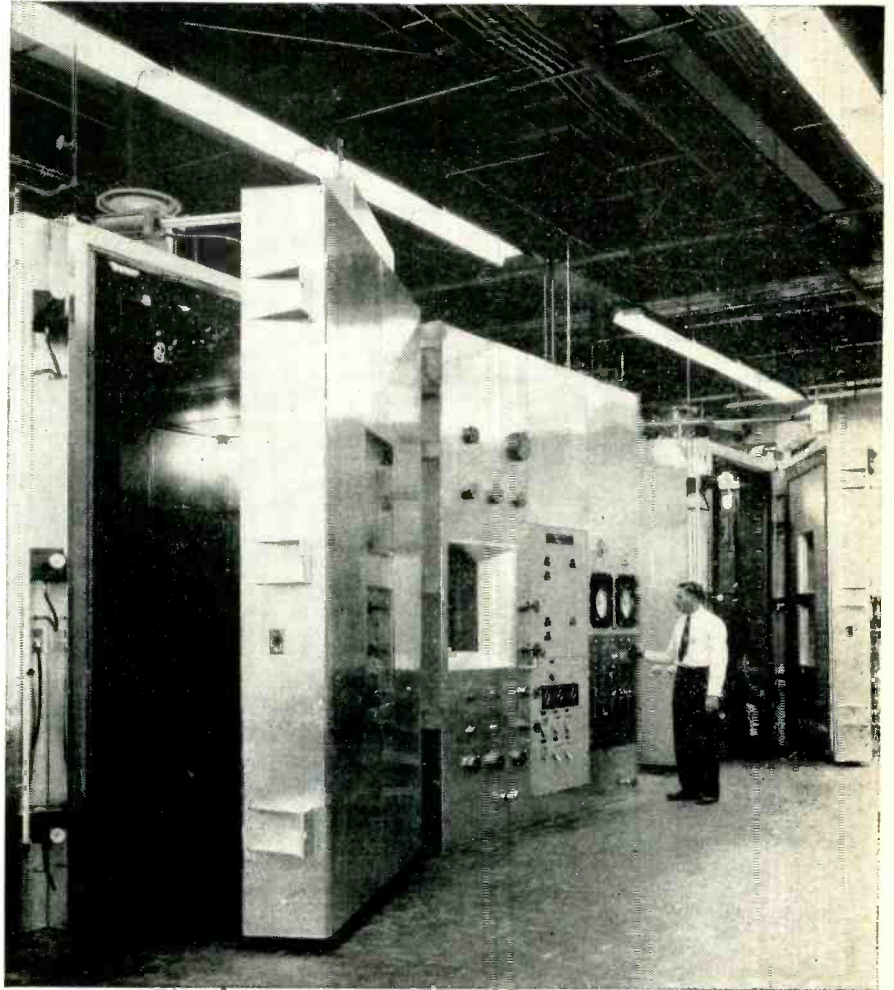

Custom Built
ENVIRONMENTAL TESTING EQUIPMENT

AIRECO, INC. are designers and builders of Environmental Testing Equipment and Weapons Ranges for maintaining thermo, sub-zero and stratosphere conditions. Information gained by these tests further the program and development of Aircraft, Guided Missiles, Firing Equipment and Component Parts. Each one is individually designed for its specific purposes and will produce and maintain temperatures from -150° F. to +250° F. altitudes from sea level to 140,000 feet and humidity from 20% to 95%.

AIRECO, INC. will design, engineer and install "Custom-Built" Test Equipment to meet your special requirements. All installations are backed by a One Year Service Guarantee. You supply the requirements and AIRECO, INC. will do the complete installation.

If your problem is not a catalogue item consult AIRECO, INC. All AIRECO, INC. equipment has built-in additional capacity to take care of ever-changing M.I.L. specifications.



2315 Second Ave. Carman

Schenectady, New York

Telephone: Schenectady 3-3673-74

a complete service to the electronics industry

Fluorocarbon Products, Inc., a division of the United States Gasket Company, offers a complete line of components, parts, materials and special assemblies for the electrical and electronics industries—incorporating duPont TEFLON and Kellogg's KEL-F, the outstanding Fluorocarbon plastics.

As pioneer fabricators of these materials, U.S.G. offers techniques in Quality Control and materials application worthy of your attention.

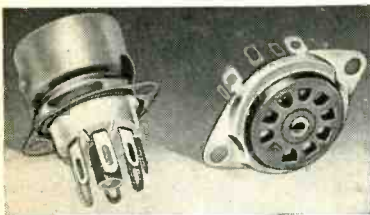

7 and 9-pin Miniature Chemelec Tube Sockets. Teflon or Kel-F Bodies. Saddle or can types. Catalog Nos. SO-427 and SO-439

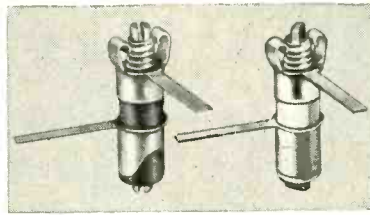

Tubular Miniature Chemelec Trimmers for low inductance and straight-line, noise-free adjustment. High temperature polystyrene or Teflon insulated. Catalog Nos. TR-535 and TR-535X



Miniature stand-off insulators. Teflon insulated. Screw, stud, rivet or compression mounted. Catalog No. TE-400.

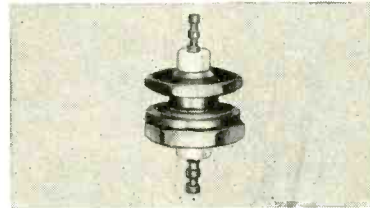

Chemelec Miniature Feed-Through Insulators, threaded metal body type Teflon insulated. Catalog No. CF-406

UNITED STATES

FLUOROCARBON PRODUCTS INC. DIVISION
CAMDEN 1, NEW JERSEY



PRECISION MOLDED AND MACHINED PARTS
AND ASSEMBLIES TO CUSTOMERS SPECIFICATIONS

INQUIRY

▼CODE NO.

382. Permag Corporation	469
383. Peter Partiton Corporation	447
384. Phalo Plastics Corporation	328
385. Phaotron Company	408
386. Phelps Dodge Copper Products Corp., Inca Mfg. Div.	26, 27
387. Philamon Laboratories Inc.	342
388. Phillips Control Corp.	320
389. Photocircuits Corp.	289
390. Pix Manufacturing Co., Inc.	493
391. Polarad Electronics Corp.	49
392. Polymer Corporation of Penna.	358
393. Polytechnic Research & Dev. Co., Inc.	353
394. Popper & Sons, Inc.	490
395. Potter Company, The	244
396. Potter & Brumfield	96A, 96B
397. Potter Instrument Co., Inc.	448
398. Precise Measurements Co.	506
399. Precision Apparatus Co., Inc.	550
400. Precision Paper Tube Co.	445
401. Premier Instrument Corp.	457
402. Premier Metal Products Co.	421
403. Press Wireless Laboratories, Inc.	472
404. Printloid, Inc.	435
405. Progressive Manufacturing Co.	236
406. Protective Coatings, Inc.	473
407. Pyroferic Co., Inc.	121
408. Quality Products Co.	506
409. R.B.M. Div. Essex Wire Corp.	202
410. Radio City Products Co., Inc.	114
411. Radio Corporation of America	4th Cover
412. Radio Materials Corporation	116
413. Radio Receptor Co., Inc.	103
414. Railway Communications Inc.	288
415. Railway Express Agency, Air Ex- press Div.	233
416. Ram Meter, Inc.	491
417. Rawson Electrical Instrument Co.	465
418. Raybestos-Manhattan, Inc.	349
419. Raytheon Manufacturing Co.	19
420. Reeves Hoffman Corporation	224
421. Reeves Instrument Corporation	491
422. Relay Sales	255
423. Rembar Company, The	423
424. Remler Company, Ltd.	496
425. Research Development Manufacture Inc.	86
426. Resin Industries Inc.	425
427. Revere Copper & Brass Inc.	124

**INQUIRY
▼CODE NO.**

428. Rex Rheostat Company.....	443
429. Rex Rheostat Company.....	506
430. Ripley Co., Inc.....	433
431. Robinson Aviation, Inc.....	455
432. Rome Cable Corporation.....	92
433. Rutherford Electronics Co.....	457

434. St. Regis Paper Company, Panelyte Div.....	311
435. Sanborn Company.....	75
436. Sanders Associates, Inc.....	446
437. Sandia Corporation.....	302
438. Sarkes Tarzian, Inc. Rectifier Div....	300
439. Schuttig & Co., Inc.....	431
440. Schweber Electronics.....	477
441. Scientific Electric Div. of "S" Corru- gated Quenched Gap Co.....	435
61. Scintilla Div. Bendix Aviation Corp.	329
442. Sealtron Corporation.....	120
443. Secon Metals Corp.....	483
444. Sensitive Research Instrument Cor- poration.....	468
445. Servo Corporation of America.....	432
446. Servomechanisms, Inc.....	470
447. Shallcross Manufacturing Co.....	314
448. Shielding Inc.....	401
449. Shure Brothers, Inc.....	498
Sigma Instruments, Inc.....	326
450. Sierra Electronic Corp.....	407
451. Signal Engineering Mfg. Co.....	504
452. Sola Electric Company.....	54
453. Sorensen & Co., Inc.....	2
454. Southern Electronics Co.....	488
455. Sprague Electric Company.....	9
456. Sprague Electric Company.....	76
457. Sprague Electric Company.....	404
458. Stackpole Carbon Company.....	40, 41
459. Standard Cabinet Company.....	550
460. Standard Electrical Products Co....	228
461. Standard Piezo Company.....	449
462. Star Expansion Products Co., Inc....	484
463. Star Porcelain Company.....	429
464. Stavid Engineering, Inc.....	421
465. Sterling Transformer Corp.....	433
466. Stevens-Arnold Inc.....	212
467. Stoddart Aircraft Radio Co., Inc....	274
468. Stoddart Aircraft Radio Co., Inc....	316
469. Stone Paper Tube Co.....	405
470. Stupakoff Ceramic & Mfg. Co.....	39
471. Sturtevant Company, P. A.....	423
472. Sun Parts Distributors, Ltd.....	489
473. Superior Electric Company... 264A, 264B	
474. Superior Electronics.....	497
475. Superior Tube Company.....	393
476. Sylvania Electric Products, Inc....	7
477. Sylvania Electric Products, Inc....	323

C hemelec

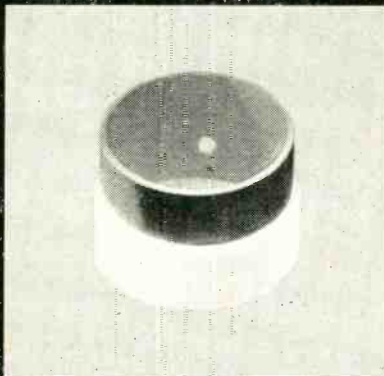
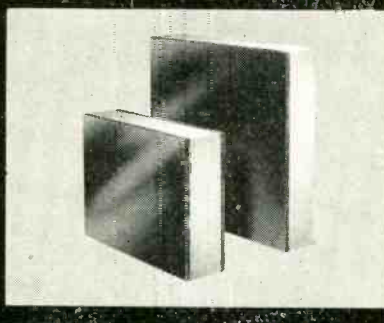
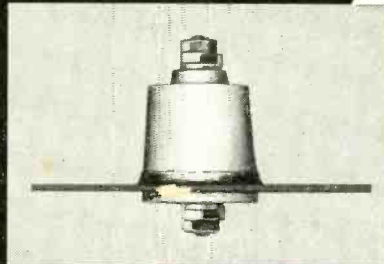

*components
parts • materials
special assemblies*

Feed-Through Insulators, Chemelec Multi-Bond, Teflon-metal Hermetic Solder seal and gasket types. Catalog Nos. CF-400 and CF-414.

Chemelec Multi-Bond is Teflon with an interlocking metallized surface which permits soldering for hermetic sealing or with a specially prepared surface for cementing with commercial adhesives. Catalog Nos. MI-424 and MI-443.

Chemelec Special Electronic components and assemblies employ various original techniques of molding Teflon around metallic structures, applying metal inserts in Teflon, and the development of stand-off, feed-through and mounting hardware which permits Teflon to replace other conventional insulating materials.



GASKET COMPANY

FABRICATORS OF *du Pont* TEFLON, Kellogg KEL-F AND OTHER PLASTICS

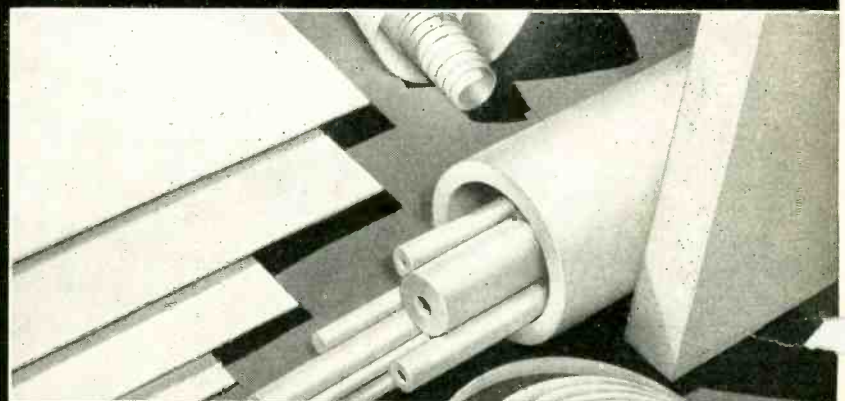

MOST COMPLETE LINE OF QUALITY CONTROLLED SHEETS. BARS. CYLINDERS. TAPE. RODS. TUBING

You **KNOW** Your
Tubes Are Tested
when you use the

PRECISION
SERIES 10-12
Electronamic
TUBE PERFORMANCE TESTER
with 12 ELEMENT free-point
Master Lever Selector System

To test modern tubes for only one characteristic will not necessarily reveal overall performance capabilities. Tube circuits look for more than just Mutual Conductance or other single factor.

In the Precision Electronamic Circuit, the tube PERFORMS under appropriately phased and selected individual element potentials, encompassing a wide range of plate family characteristic curves. This complete Path of Operation is integrated by the indicating meter in the positive PERFORMANCE terms of Replace-Weak-Good.

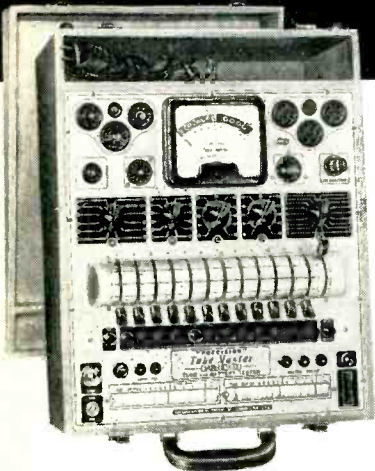

MODEL 10-12-P: in sloping, portable hardwood case with tool compartment and hinged removable cover. Size 13 3/4 x 17 1/4 x 6 3/4". . . \$107.50
Also in counter or rack-panel mounts.

- ★ Facilities to 12 element prongs.
- ★ Filament voltages from 3/4 to 117 volts.
- ★ Tests Noval 9 pins; 5 and 7 pin acorns; double-capped H.F. amplifiers; low power transmitting tubes; etc. Regardless of filament or any other element pin positions.
- ★ Isolates each tube element regardless of multiple pin positions.
- ★ Dual short check sensitivity permits special purpose tube selection.
- ★ Battery Tests under dynamic load conditions.
- ★ Built-in Dual-Window, brass-g geared roller chart.
- ★ 4 1/2" Full Vision Meter.

See Model 10-2 and other Precision electronic test instruments at leading radio parts distributors. Write for new, 1954 catalog.

Precision Apparatus Co., INC.
92-27 HORACE HARDING BLVD. • ELMHURST 12, N. Y.

Export: 458 B'way, N.Y.C., U.S.A. Cables: MORHANEX
In Canada: Atlas Radio Corp. Ltd., Toronto, Ontario

For more ad information, see Index to Advertisers.

INQUIRY
▼CODE NO.

178. Sylvania Electric Products, Inc.	438
479. Sylvania Electric Products, Inc.	464
480. Synthane Corporation	266
481. Synthane Corporation	267

482. Taylor Fibre Company	275
483. Technical Service Corp.	493
484. Technitrol Engineering Co.	82
485. Technology Instrument Corp.	97
486. Technology Instrument Corp.	375
487. Tektronix Inc.	242
488. Tel-Instrument Co., Inc.	376
489. Telechrome, Inc.	303
490. Telechron Department, General Electric Company	50
491. Telecomputing Corporation	366
492. Teletronics Laboratory Inc.	411
493. Tensolite Insulated Wire Company, Inc.	495
494. Terpening Company, L. H.	356
495. Texas Instruments Inc.	227
496. Thor Ceramics, Inc.	495
497. Titeldex, Inc.	287
498. Tobe Deutschmann Corporation	306
499. Trad Television Corporation	98
500. Transistor Products, Inc.	235
501. Transformer Div., Transvision Inc.	506
502. Transradio Ltd.	502
503. Trans-Sonics, Inc.	475
504. Triad Transformer Corp.	390
505. Triplett Electrical Instrument Co.	81
506. Tung-Sol Electric, Inc. 272A, 272B	
507. Turner Company, The	469

508. Ucinite Company	61
51. Union Carbide & Carbon Corp., Bakelite Div.	305
509. Uni-Products, Div. of Uni-Science Inc.	489
510. United Manufacturing & Service Company	479
511. U. S. Components, Inc.	352
512. United States Gasket Co. 554, 555	
513. U. S. Motors Corporation	91
514. United Transformer Co. 2nd Cover	
515. Universal Manufacturing Co., Inc.	409
516. Universal Manufacturing Co., Inc.	488

INQUIRY
▼CODE NO.

517. Universal Microwave Corp.	489
518. University Loudspeakers Inc.	32
519. Utah Radio Products Co., Inc.	550

520. Varflex Corporation	88
521. Varian Associates	250
522. Vector Electronic Co.	499
523. Veeder-Root Inc.	70
524. Vibro-Ceramics Corp.	110
525. Vickers Electric Div. Vickers Inc.	374
526. Victoreen Instrument Co.	112
527. Victory Engineering Corp.	296
528. Volkert & Schaffer	28
529. Volkert Metal Stampings, Inc., John	444
530. Waldes Kohinor, Inc.	67
531. Ward Leonard Electric Co. 64A, 64B	
532. Warren Wire Co.	119
533. Waterman Products Co., Inc. 72, 73	
534. Waterman Products Co., Inc.	286
535. Waters Manufacturing Inc.	462
536. Waters Manufacturing Inc.	464
537. Waveforms, Inc.	551
538. Waveline, Inc.	85
539. Weckesser Company	449
540. Wenco Manufacturing Co.	473
541. Weston Electrical Instrument Corp.	379
542. Westinghouse Electric Corp.	25
543. Westinghouse Electric Corp.	77
544. Westinghouse Electric Corp.	219
545. Wheeler Laboratories, Inc.	435
546. White Dental Mfg. Co., S. S.	332
547. White Dental Mfg. Co., S. S.	440
548. White Dental Mfg. Co., S. S.	457
549. Williams & Co., C. K.	492
550. Winchester Electronics Inc.	214

551. Xcelite, Inc.	423
----------------------------	-----

552. Yardney Electric Corp.	277
553. Zophar Mills, Inc.	443