

electronics

JANUARY • 1954

PRICE 75 CENTS

A MCGRAW-HILL PUBLICATION



TESTING MAGNETIC DECISION ELEMENTS

FOR Higher Fidelity*

THE Linear Standard SERIES

The ever increasing use of wide range equipment for broadcast service has reached the point where the major limiting factor is the frequency range of the transformers employed. UTC Linear Standard components represent the closest approach to the ideal transformer from the standpoint of uniform frequency response, low wave form distortion, high efficiency, thorough shielding, and dependability. Typical LS units are described below.

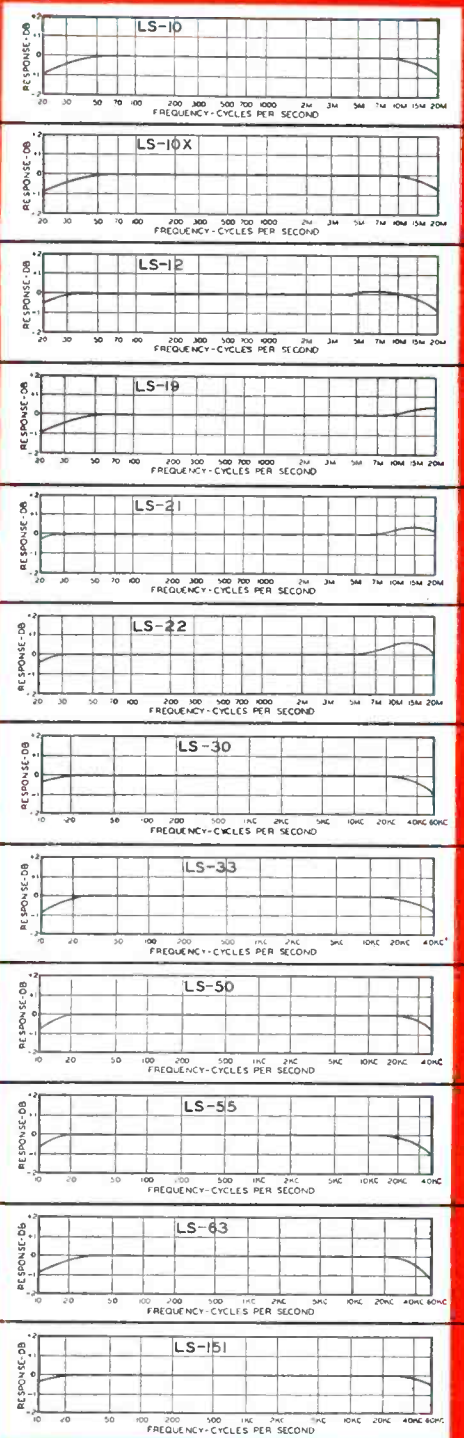

INPUT TRANSFORMERS

Type No.	Application	Primary Impedance	Secondary Impedance	± 1 db from	Max. † Level	Relative* hum	Unbal. DC in prim'y	Case No.	List Price
LS-10	Low impedance mike, pickup, or multiple line to grid	50, 125/150, 200, 250, 333, 500/600 ohms	60,000 ohms in two sections	20-20,000	+10 DB	-74 DB	.5 MA	LS-1	\$25.00
LS-10X	As above	As above	50,000 ohms	20-20,000	+10 DB	-92 DB-Q	.5 MA	LS-1	35.00
LS-12	Low impedance mike, pickup, or multiple line to push pull grids	50, 125/150, 200, 250, 333, 500/600 ohms	120,000 ohms overall, in two sections	20-20,000	+10 DB	-74 DB	.5 MA	LS-1	28.00
LS-12X	As above	As above	80,000 ohms overall, split	20-20,000	+10 DB	-92 DB-Q	.5 MA	LS-1	35.00
LS-15X	Three isolated lines or pads to one or two grids	30, 50, 200, 250 ohms each primary	60,000 ohms overall, in two sections	20-20,000	+10 DB	-92 DB-Q	.5 MA	LS-1	37.00

Case Size	LS-1	LS-2
Length	3 1/8"	4 1/2"
Width	2 5/8"	3 1/2"
Height	3 1/4"	4 3/8"

INTERSTAGE AND MATCHING TRANSFORMERS

Type No.	Application	Primary Impedance	Secondary Impedance	Response	Max. † Level	Relative* hum	Unbal. DC in prim'y	Case No.	List Price
LS-19	Single plate to push pull grids like 2A3, 6L6, 300A. Split secondary	15,000 ohms	95,000 ohms; 1.25:1 each side	± 1 db 20-20,000	+12 DB	-50 DB	0 MA	LS-1	\$26.00
LS-21	Single plate to push pull grids. Split pri. and sec.	15,000 ohms	135,000 ohms; 3:1 overall	± 1 db 20-20,000	+10 DB	-74 DB	0 MA	LS-1	26.00
LS-25	Push pull plates to push pull grids. Medium-level. Split primary and sec.	30,000 ohms plate to plate	50,000 ohms; turn ratio 1.3:1 overall	± 1 db 20-20,000	+15 DB	-74 DB	1 MA	LS-1	32.00
LS-30	Mixing, low impedance mike, pickup, or multiple line to multiple line	50, 125/150, 200, 250, 333, 500/600 ohms	50, 125/150, 200, 250, 333, 500/600 ohms	± 1 db 20-20,000	+15 DB	-74 DB	.5 MA	LS-1	26.00
LS-33	High level line matching	1.2, 2.5, 5, 7.5, 10, 15, 20, 30, 50, 125, 200, 250, 333, 500/600	50, 125, 200, 250, 333, 500/600 ohms	± .2 db 20-20,000	15 watts			LS-2	30.00

OUTPUT TRANSFORMERS

Type No.	Application	Primary Impedance	Secondary Impedance	Response	Max. † Level	Relative* hum	Unbal. DC in prim'y	Case No.	List Price
LS-50	Single plate to multiple line	15,000 ohms	50, 125/150, 200, 250, 333, 500/600	± 1 db 20-20,000	+15 DB	-74 DB	0 MA	LS-1	\$26.00
LS-52	Push pull 245, 250, 6V6 or 245 A prime	8,000 ohms	500, 333, 250, 200, 125, 50, 30, 20, 15, 10, 7.5, 5, 2.5, 1.2	± 2 db 15 watts 25-20,000				LS-2	35.00
LS-55	Push pull 2A3's, 6A5G's, 300A's, 275A's, 6A3's, 6L6's, 6AS7G	5,000 ohms plate to plate and 3,000 ohms plate to plate	500, 333, 250, 200, 125, 50, 30, 20, 15, 10, 7.5, 5, 2.5, 1.2	± .2 db 20 watts 25-20,000				LS-2	35.00
LS-63	Push pull 6F6, class B 46's, 6AS7G, 807-TR, 1614-TR	10,000 ohms plate to plate and 6,000 ohms plate to plate	30, 20, 15, 10, 7.5, 5, 2.5, 1.2	± .2 db 15 watts 25-20,000				LS-2	25.00
LS-151	Bridging from 50 to 500 ohm line to line	16,000 ohms, bridging	50, 125/150, 200, 250, 333, 500/600	± 1 db 15-30,000	+18 DB	-74 DB	1 MA	LS-1	27.00

The values of unbalanced DC shown will effect approximately 1.5 DB loss at 30 cycles.
 * Comparison of hum balanced unit with shielding to normal uncased type. Q Multiple alloy magnetic shield, † 6 MW as ODB reference.

United Transformer Co.
 150 VARICK STREET • NEW YORK 13, N. Y.

EXPORT DIVISION: 13 EAST 40th STREET, NEW YORK 16, N. Y. CABLES: "ARLAB"

* UTC LINEAR STANDARD transformers are the ONLY audio units with a GUARANTEED uniform response... ± 1 DP from 20 to 20,000 cycles.

electronics

JANUARY • 1954
A McGRAW-HILL
PUBLICATION

TESTING MAGNETIC DECISION ELEMENTS—Production setup for testing three types of basic potted plug-in elements made by The Minnesota Electronics Corp., St. Paul, for building entire arithmetic, program, control and memory sections of any digital computer (see p 200)

Figures of the Month	4
<i>Includes Electronic Output Index, a business barometer for management</i>	
Industry Report	5
<i>Top-level news, trends and market interpretations</i>	
Designing Radomes for Supersonic Speeds , by Samuel S. Oleesky	130
<i>Honeycomb, foam and sandwich materials withstand gunblast and weather effect at speeds over 700 mph</i>	
Detecting Voids in Insulating Tape , by Roy E. Anderson	136
<i>Automatic inspection of insulating tape boosts production and cuts rejects</i>	
Camera Adapter for TV Receivers , by L. E. Flory, W. S. Pike and G. W. Gray	141
<i>Compact camera unit brings closed-circuit television to home and office</i>	
Power Transistors for Audio Output Circuits , by L. J. Giacometto	144
<i>Discusses factors influencing typical power transistors and analyzes their effect</i>	
Rocket-Borne Servo Tracks the Sun , by D. S. Stacey, G. A. Stith, R. A. Nidey and W. B. Pietenpol	149
<i>Biaxial solar pointing control aims ultraviolet spectrograph</i>	
Automatically Deiced X-Band Beacon Antenna , by C. Edgar Thomas, Jr.	152
<i>Antenna for ground-based radar beacon withstands severe weather while providing optimum radiation pattern</i>	
Conelrad Receiver With Built-in Alarm , by Robert E. Quenstedt	156
<i>Design of high-reliability receiver with integral carrier-failure alarm, for use in controlled broadcast stations</i>	
Cascading Transistor Amplifier Stages , by Abraham Coblenz and Harry L. Owens	158
<i>Gives practical equations for calculating characteristics of various combinations</i>	
Negative Inductance Cuts Magnetic-Amplifier Lag , by George M. Ettinger	162
<i>Performance is improved by balancing out control-circuit inductance</i>	
Phantastron Computes Pulse-Width Ratios , by L. D. Findley	164
<i>Circuit calculates width ratio of two simultaneous pulses</i>	
Stable Power Supplies for Microwave Standards , by William P. Ernst	168
<i>Klystron frequency standards use driftless comparison circuits to obtain voltage stability of 20 parts in a million</i>	
Salinity Meter for Sonar Measurements , by Kenneth E. Harwell and Donald W. Hood	172
<i>Meter uses r-f signal to measure salt content, eliminating electrode fouling and polarization problems</i>	
A-M System Measures Microwave Attenuation , by John Korewick	175
<i>Audio-modulation substitution technique measures 40-db attenuation</i>	
Transistors in Telemetry , by Fred M. Riddle	178
<i>Experimental circuits for f-m/f-m telemetering</i>	
Magnetic Amplifier Uses Conventional Inductors , by A. I. Bennett, Jr.	181
<i>Control circuits are constructed using several common transformer types</i>	
Broadband Rotary Waveguide Attenuator , by B. P. Hand	184
<i>Unit provides secondary standard of attenuation for frequencies up to 50 kmc</i>	
Submerged Repeaters Use Stabilized Power , by A. Atherton	186
<i>Tandem control circuits compensate for earth currents in power supply for undersea amplifiers</i>	
Video Amplifier Design Charts (Reference Sheet) , by W. K. Squires and H. L. Newman	190
<i>Parameters are derived from optimum transient response analysis curves</i>	
Crosstalk	129
Electrons at Work	196
Production Techniques	250
New Products	290
Plants and People	332
New Books	383
Backtalk	399
Index to Advertisers	448

W. W. MacDONALD, Editor; **VIN ZELUFF**, Managing Editor; John Markus, A. A. McKenzie, Associate Editors; William P. O'Brien, John M. Carroll, William G. Arnold, David A. Findlay, Assistant Editors; Marilyn Wood, Gloria J. Filippone, Arlene Schilp, Editorial Assistants; Keith Henney, Consulting Editor; Gladys T. Montgomery, Washington Editor; Harry Phillips, Art Director; Eleanor Luke, Art Assistant

H. W. MATEER, Publisher; **WALLACE B. BLOOD**, Manager; R. S. Quint, Buyers' Guide Manager; Frank H. Ward, Business Manager; H. E. Hilty, Classified Manager; D. H. Miller, James Girdwood, New York; Wm. S. Hodgkinson, New England; Warren W. Shew, Philadelphia; Charles Wardner, James T. Hauptli, Chicago; J. L. Phillips, Cleveland; T. H. Carmody, R. C. Alcorn, San Francisco; Carl W. Dysinger, Los Angeles; Robert H. Sidur, Atlanta



January, 1954

ELECTRONICS
Member ABC and AEP

Vol. 27, No. 1



Published monthly with an additional issue in June by McGraw-Hill Publishing Company, Inc., James H. McGraw (1860-1948), Founder. Publication Office, 99-129 North Broadway, Albany 1, N. Y.

Executive, Editorial and Advertising Offices: McGraw-Hill Building, 330 W. 42 St., New York 36, N. Y. Donald C. McGraw, President; Willard Chevallier, Executive Vice-President; Joseph A. Gerardi, Vice-President and Treasurer; John J. Cooke, Secretary; Paul Montgomery, Senior Vice-President, Publication Division; Ralph B. Smith, Vice-President and Editorial Director; Nelson Bond, Vice-President and Director of Advertising; J. E. Blackburn, Jr., Vice-President and Director of Circulation.

Subscriptions: Address correspondence to Electronics—Subscription Service, 99-129 N. Broadway, Albany 1, N. Y., or 330 W. 42nd St., New York 36, N. Y. Allow one month for change of address. Subscriptions are solicited only from persons engaged in theory, research, design, production, maintenance and use of electronic and industrial control components, parts and end products. Position and company connection must be indicated on subscription orders.

Single copies 75¢ for United States and possessions, and Canada; \$1.50 for Latin America; \$2.00 for all other foreign countries. Buyers' Guide \$2.00. Subscription rates—United States and possessions, \$6.00 a year; \$9.00 for two years. Canada, \$10.00 a year; \$16.00 for two years. Other western hemisphere countries, \$15.00 a year; \$25.00 for two years. All other countries \$20.00 a year; \$30.00 for two years. Entered as second class matter August 29, 1936, at the Post Office at Albany, N. Y., under act of Mar. 3, 1879. Printed in U.S.A. Copyright 1953 by McGraw-Hill Publishing Co., Inc.—All Rights Reserved. BRANCH OFFICES: 520 North Michigan Avenue, Chicago 11, Ill.; 68 Post Street, San Francisco 4; McGraw-Hill House, London, E.C. 4; Washington, D. C. 4; Philadelphia 3; Cleveland 15; Detroit 26; St. Louis 8; Boston 18; 1321 Rhoades-Haverty Bldg., Atlanta 3, Ga.; 1111 Wilshire Blvd., Los Angeles 17; 738-9 Oliver Building, Pittsburgh 22. ELECTRONICS is indexed regularly in The Engineering Index.

$$I = KE^{3.5}$$

**Problem: To hold
I (light intensity)
at a constant value
when E (voltage)
has random
variation of $\pm 10\%$**

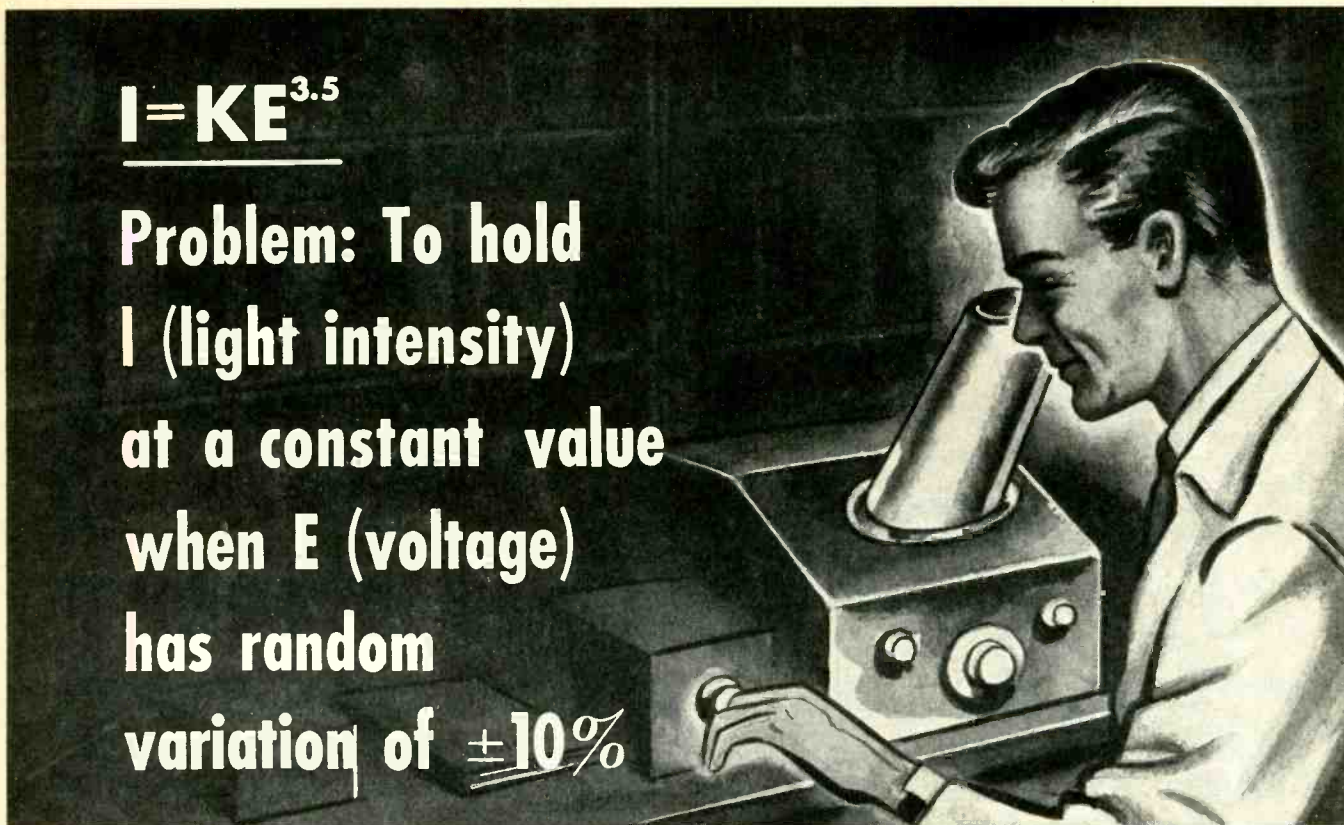

There is obviously no solution to the problem as stated. It follows, then, that where voltage is as critical as in the above formula, untold man-hours of research, test, design, or production may be completely wasted unless E can be accurately controlled. Whether E or its equivalent in any formula is AC (60-cycle or 400-cycle) or DC, Sorensen electronic regulating equipment is designed to make the results of your work more accurate and your time more fruitful. Instruments are available from stock to fit a very large variety of applications.

AC REGULATORS — Capacities from 150VA to 15KVA, regulation accuracy $\pm 0.1\%$ with good waveform. A precision model regulates to $\pm 0.01\%$ and has a capacity of 1000VA.

DC POWER SOURCES — The well-known Sorensen NOBATRONS* are available in many different models, providing 6 to 200 volts DC at 5 to 350 amperes. This line includes dual supplies and the highly versatile RANGERS (wide-range-variable DC sources). Regulation accuracy is $\pm 0.25\%$. A full line of B-supplies provide high-voltage, low-current DC regulated $\pm 0.5\%$.

MAGNETIC AMPLIFIER POWER SUPPLIES — These instruments provide regulated DC power at heavy currents. Since they are tubeless, maintenance is at a minimum.

FREQUENCY CHANGERS — Sorensen electronic frequency changers convert 60-cycle to 400-cycle (adjustable $\pm 10\%$) quietly and with great accuracy. They are portable and eliminate the special wiring required with rotating equipment.

Literature describing the Sorensen line of electronic power regulating equipment is yours for the asking. Write Sorensen & Co., Inc., 375 Fairfield Avenue, Stamford, Conn. In Europe, write directly to Sorensen A. G., Gartenstrasse 26, Zurich 2, Switzerland.

SORENSEN

*Reg. U. S. Pat. Off.

SORENSEN & COMPANY

• 375 FAIRFIELD AVENUE

• STAMFORD, CONN.

THIS INTERESTING QUARTERLY WILL BE MAILED FREE TO ANY PART OF THE WORLD

AUSTRALIA

Messrs. Watson Victor Limited,
9-13, Bligh Street,
Sydney, N.S.W.

BELGIUM

Paul Groeninckx,
Avenue Hansen-Soulie, 4-6,
Brussels.

CANADA

Muirhead & Co. Ltd.,
Beckenham,
Kent, England.

DENMARK

Ditz Schweitzer,
Norre Voldgade, 48,
Copenhagen, K.

FRANCE

Jacques Pérès Fils,
4, Avenue de l'Opera,
Paris I.

HOLLAND

Geo. C. F. Kauderer,
Muiden.

INDIA

Adair, Dutt & Co. (India) Ltd.,
5, Dalhousie Square,
Calcutta.

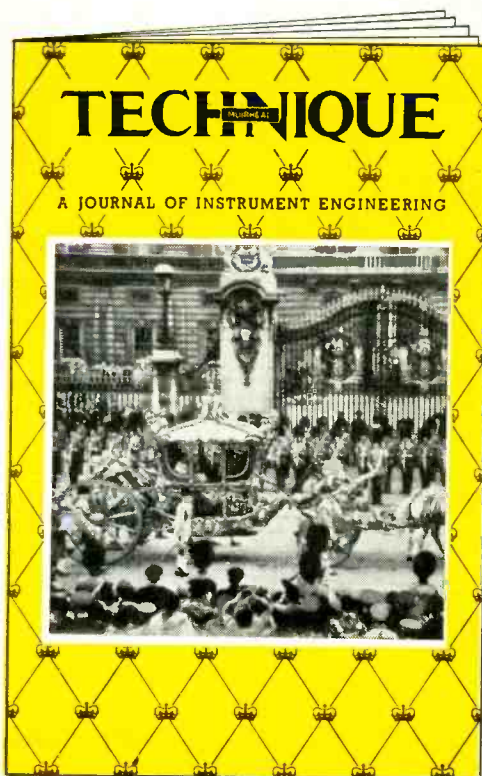

ITALY

Ing. Silvio Garrone,
Piazza Della Marina, 1,
Rome.

NEW ZEALAND

Richardson, McCabe & Co. Ltd.,
P.O. Box 792,
Wellington.

NORWAY

J. L. Nerlien A/S,
Nedre Slottsgt. 13,
Oslo.

SOUTH AFRICA

Johnson & Phillips South Africa
(Pty.) Limited,
P.O. Box 552,
Germiston.

SWEDEN

Ingenjorsfirma Hugo Tillquist,
Nybrotkajen 7, Postbox 7026,
Stockholm 7.

SWITZERLAND

MEGEX ZURICH GmbH,
Badenerstrasse 584,
Zurich 48.

U.S.A.

Muirhead & Co. Ltd.,
Beckenham,
Kent, England.

TECHNIQUE IS ALSO PUBLISHED IN FRENCH. IF THIS EDITION IS
REQUIRED, MARK YOUR COUPON "EDITION FRANÇAISE"

FILL IN THIS COUPON AND MAIL TO US OR OUR AGENT

(SEE LIST ABOVE)

*Please mail me, free of charge,
the quarterly journal
of instrument engineering
"TECHNIQUE"
published by
Muirhead & Co., Limited*

NAME _____
POSITION _____
COMPANY _____
ADDRESS _____

ELECTRONICS 105

MUIRHEAD & CO. LTD.
PRECISION ELECTRICAL INSTRUMENT MAKERS
BECKENHAM · KENT · ENGLAND

Telegrams and Cables: MUIRHEAD BECKENHAM.

PRECISION
MUIRHEAD
ELECTRICAL INSTRUMENTS

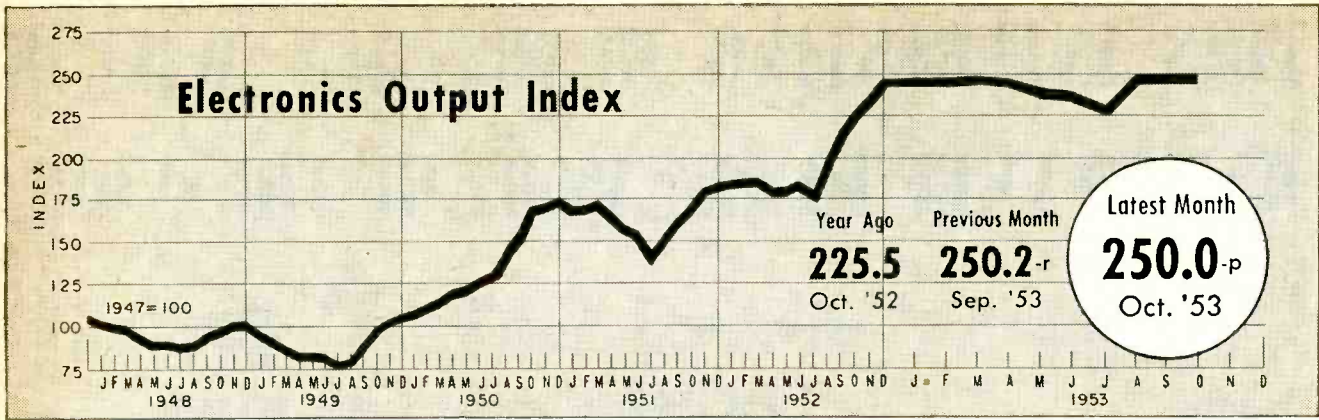

FIGURES OF THE MONTH

	Year Ago	Previous Month	Latest Month
RECEIVER PRODUCTION			
(Source: RETMA)			
Oct. '52	Sept. '53	Oct. '53	
Television sets	724,117	770,085	680,433
Home sets	314,459	529,427	370,178
Clock Radios	180,841	182,417	189,230
Portable sets	113,552	147,355	135,009
Auto sets	163,494	357,326	358,076

	Year Ago	Previous Month	Latest Month
RECEIVER SALES			
(Source: RETMA)			
Oct. '52	Sept. '53	Oct. '53	
Television sets, units	847,219	753,953	621,768
Radio sets (except auto)	580,077	650,898	385,229

	Year Ago	Previous Month	Latest Month
RECEIVING TUBE SALES			
(Source: RETMA)			
Oct. '52	Sept. '53	Oct. '53	
Receiv. tubes, total units	41,880,318	38,929,539	34,928,108
Receiving tubes, new sets	29,132,068	25,277,061	23,028,120
Rec. tubes, replacement	8,791,404	10,923,386	9,509,908
Receiving tubes, gov't.	3,105,005	720,081	439,691
Receiving tubes, export	851,841	2,009,011	1,950,389
Picture tubes, to mfrs.	862,431	685,666	719,055

	Year Ago	Previous Month	Latest Month
SEMICONDUCTOR SALES			
(Source: RETMA)			
Oct. '52	Sept. '53	Oct. '53	
Germanium Diodes	870,555	772,381	

	Quarterly Figures		
	Year Ago	Previous Quarter	Latest Quarter
INDUSTRIAL TUBE SALES			
(Source: NEMA)			
2nd '52	1st '53	2nd '53	
Vacuum (non-receiving)	\$12,110,000	\$11,340,000	\$10,400,000
Gas or vapor	\$3,150,000	\$3,140,000	\$3,300,000
Phototubes	\$480,000	\$930,000	\$700,000
Magnetrons and velocity modulation tubes	\$9,830,000	\$10,070,000	\$10,500,000
Gaps and T/R boxes	\$2,140,000	\$2,050,000	\$1,700,000

	Year Ago	Previous Month	Latest Month
TV AUDIENCE			
(Source: NBC Research Dept.)			
Nov. '52	Oct. '53	Nov. '53	
Sets in Use—total	19,751,200	25,690,000	26,364,000

	Nov. '52	Oct. '53	Nov. '53
BROADCAST STATIONS			
(Source: FCC)			
TV Stations on Air	116	315	334
TV Stns CPs—not on air	114	230	216
TV Stns—Applications	836	424	236
AM Stations on Air	2,374	2,497	2,509
AM Stns CPs—not on air	139	106	113
AM Stns—Applications	250	187	185
FM Stations on Air	626	566	561
FM Stns CPs—not on air	14	20	20
FM Stns—Applications	9	5	5

	Oct. '52	Sept. '53	Oct. '53
COMMUNICATION AUTHORIZATIONS			
(Source: FCC)			
Aeronautical	33,630	42,427	42,974
Marine	37,914	42,931	43,292
Police, fire, etc.	11,772	14,094	14,315
Industrial	15,090	18,868	19,287
Land Transportation	5,346	6,201	6,287
Amateur	116,102	113,909	114,275
Citizens Radio	1,788	3,987	4,026
Disaster	80	251	254
Experimental	519	476	480
Common carrier	1,032	1,327	1,374

	Sept. '52	Aug. '53	Sept. '53
EMPLOYMENT AND PAYROLLS			
(Source: Bur. Labor Statistics)			
Prod. workers, comm. equip.	367,300	401,600-r	408,200
Av. wkly. earnings, comm.	\$67.60	\$68.06-r	\$68.38
Av. wkly. earnings, radio	\$63.46	\$65.69	\$66.17
Av. wkly. hours, comm.	41.7	41.0	40.7
Av. wkly. hours, radio	41.1	40.3	40.1

	Nov. '52	Oct. '53	Nov. '53
STOCK PRICE AVERAGES			
(Source: Standard and Poor's)			
Radio—TV & Electronics	321.9	272.1	261.8
Radio Broadcasters	300.3	272.2	261.1

p—provisional; r—revised

FIGURES OF THE YEAR

	1952 Total
Television set production	6,096,279
Radio set production	10,934,872
Television set sales	6,144,990
Radio set sales (except auto)	6,878,547
Receiving tube sales	368,519,243
Cathode-ray tube sales	6,120,292

TOTALS FOR THE FIRST TEN MONTHS

	1952	1953	Percent Change
Television set production	4,394,708	6,204,803	+41.2
Radio set production	7,461,881	11,201,656	+50.1
Television set sales	4,291,893	4,922,128	+14.7
Radio set sales (except auto)	4,877,059	4,911,415	+07.0
Receiving tube sales	287,569,947	382,080,558	+32.8
Cathode-ray tube sales	3,982,763	6,647,857	+66.9

INDUSTRY REPORT

electronics—JANUARY • 1954

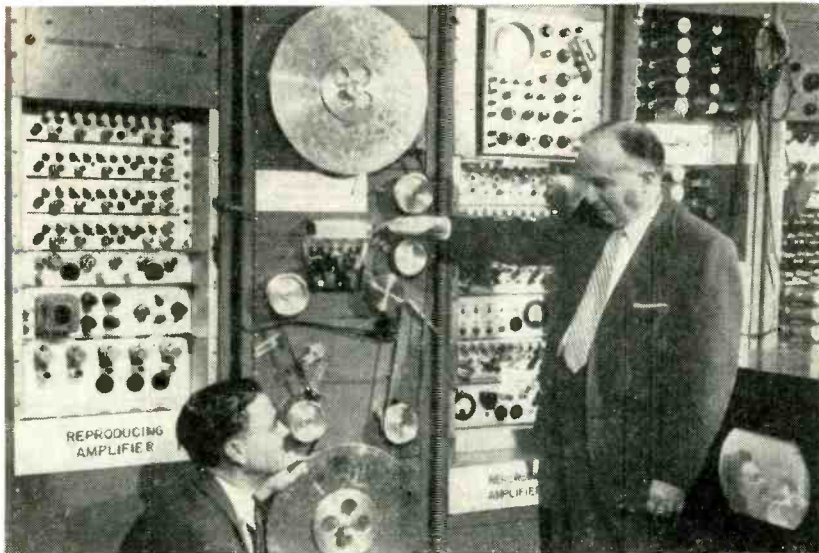

VIDEO TAPE RECORDING equipment demonstrated by RCA engineers W. D. Houghton and H. F. Olson handles b-w and color experimentally as . . .

ording to engineers who viewed it.

The test program originated by NBC in New York City was sent over a 45-mile microwave circuit to Princeton where it was viewed and recorded simultaneously. The recording was immediately played back through an adjacent receiver so that direct comparison was possible. Later, the complete recording was played back. Viewers found it good.

► **How It Works**—In principle, video recording is the same as that for sound. However, audio signals range from 20 to 20,000 cycles, whereas picture signals extend to about 4,000,000 cycles. To accommodate the higher frequencies, it is at present necessary to speed up the tape to 30 feet a second (as compared with audio's 15 inches a second). The recording and reproducing heads must be specially designed and made. The tape transport mechanism must move at extremely constant speed.

Rebroadcasts over a television transmitter requires relatively simple additional equipment. En-

Electronic Movies Forge Ahead

Sarnoff confident video tape development will be commercial within two years time

MAGNETIC-TAPE recording of color television pictures recently demonstrated by RCA at Princeton Lab may prove the key to commercial colorcasts in the near future, ac-

ELECTRONIGRAPHS—A Year-End Glance at Electronics Industry Figures

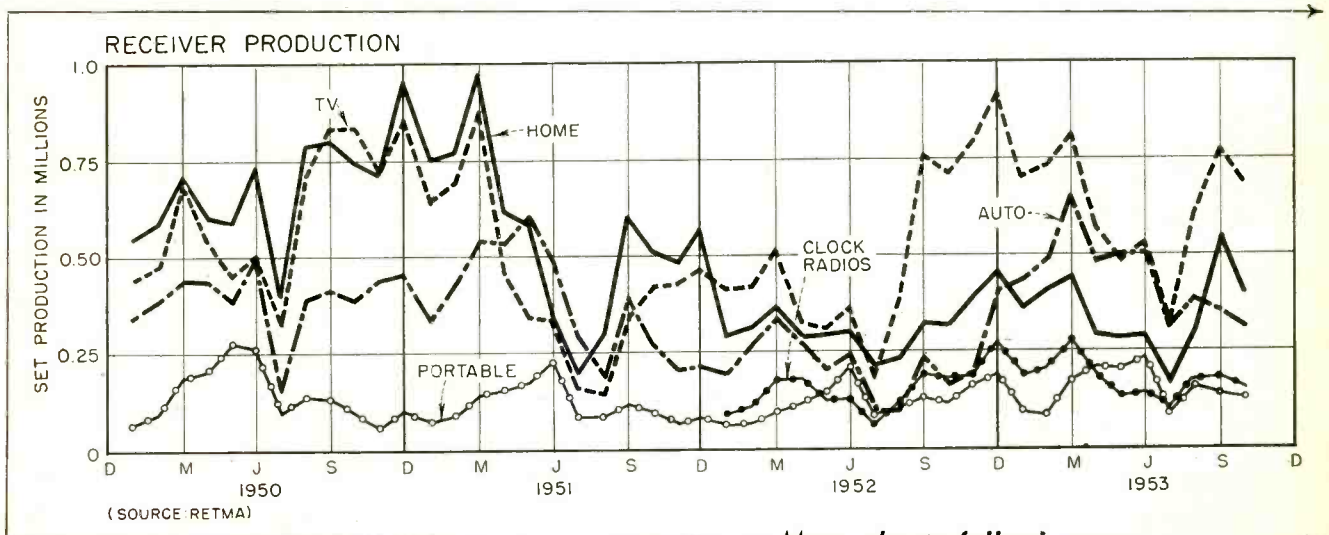

More charts following

gineers know how to do it and foresee no difficulties.

For the demonstration, five parallel channels were magnetically recorded on a single half-inch plastic tape coated with a special iron rust. There was a channel for each primary color (red, green and blue), for the synchronizing signal and for the sound.

Each channel can handle up to 3,000,000 cycles. Black-and-white television was reproduced with two channels on a quarter-inch tape.

► **What It Saves**—Tape itself costs more than equivalent film for any given length show. However, film processing (unnecessary with tape) bring the costs about level. But tape can be magnetically erased and reused—perhaps as much as 25 times. Over the long run, then, use of tape becomes cheaper. RCA's E. W. Engstrom foresees the day when tape for a monochrome show will cost less than 20 percent that of film, while color tape expense may be less than 10 percent of film.

For the future, Engstrom hopes to reduce tape travel from 30 to 20 feet a second. Present reels are 17 inches and contain 5 minutes of program. At the slower speed, a 15-minute program can be made to fit a 19-inch reel.

Color TV Timetable

As predicted, color decision by FCC made Dec. 17, will become legal around third week in January . . . 30 days after publication in official Federal Register . . .

Networking full color to 13 cities is guaranteed to NBC by AT&T for Jan. 1 Tournament of Roses . . . Pasadena will be linked to Washington, Wilmington and Baltimore as well as 10 other big cities . . .

DuMont has just delivered color slide scanner to CBS but is mum about adapting its continuous film device to color . . . RCA held color-tv seminar in Camden for engineers and

consultants of their transmitter customers . . .

GE plans limited production of planar shadow-mask tube in first quarter of '54 . . .

Thomas Electronics in Passaic, N. J. announced signing with Chromatic to make Lawrence tube . . . radiation from this type is now claimed well below FCC specs.

Network engineers point to 920-ke beat in picture caused in intercarrier monochrome receivers by strong 3.58-mc color subcarrier versus 4.5-mc sound . . . sets with sound traps ahead of video detector are apparently not affected.

Radio-TV Makers Eye Last Quarter

Proportion of total sales volume in last 3 months of 1953 may be lower than in 1952

RADIO and tv sales for 1953's last months will have to really zoom to

equal 1952's fourth quarter record. In that year, the last three months accounted for over 43 percent of the total year's sales.

In 1951 and 1950 the proportion was about 35 percent. Radio sales also hit their peak in these months,

(Continued on page 8)

ELECTRONIGRAPHS Continued

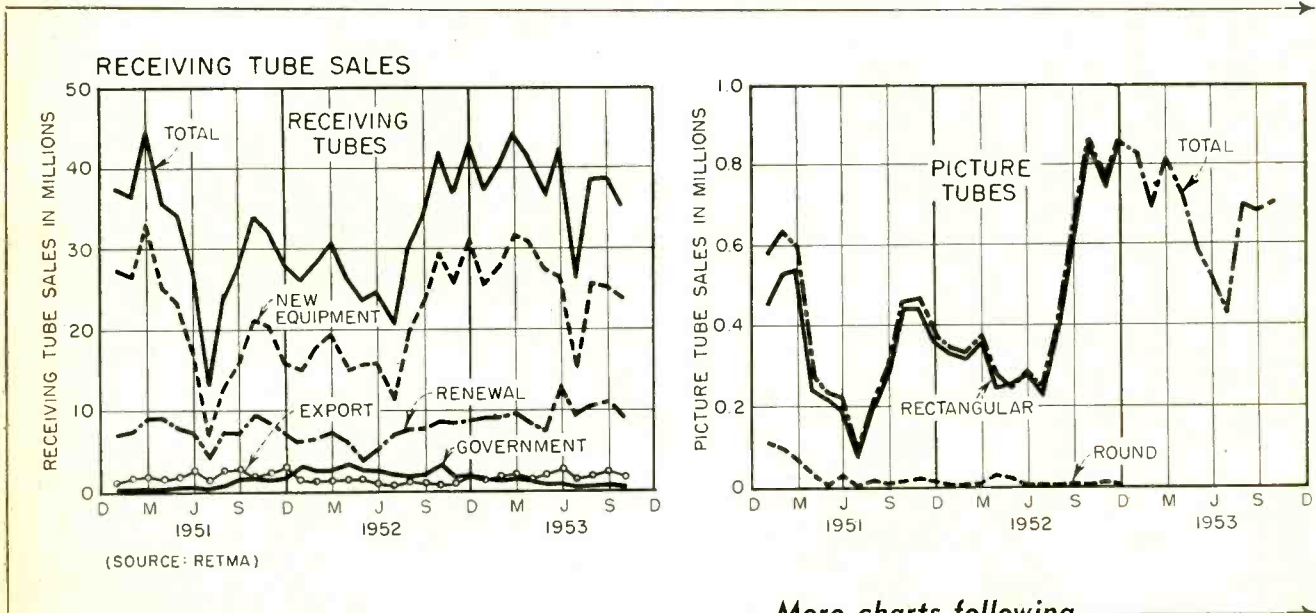



TYPE 5794

Designed for continuous wave operation, this tube oscillates inside a cavity tuned to a fixed frequency of 1680 mc. This low Mu tube with its special heater at 5.2V is capable of delivering a power of 300 mw.

Sylvania now offers

2 DEPENDABLE PENCIL TUBES

TYPE 5876

This tube is a high Mu triode designed for continuous wave operation up to 3000 megacycles in either lumped constant or external cavity type circuits.



The improved quality is just one more reason why you should specify Sylvania for your equipment. Let us send you complete engineering data on these tubes including electrical ratings, characteristics, and typical operating conditions. The coupon is for your convenience. Mail it now.

SYLVANIA

Sylvania Electric Products Inc., 1740 Broadway, New York 19, N. Y.

LIGHTING • RADIO • ELECTRONICS • TELEVISION

In Canada: Sylvania Electric (Canada) Ltd.
University Tower Bldg., St. Catherine Street, Montreal, P. Q.

 Sylvania Electric Products Inc.
Dept. 4E-1601, 1740 Broadway
New York 19, N. Y.
Please send me complete engineering data sheets
on Sylvania Pencil Tubes 5794 and 5876.

Name _____
Street _____
City _____ Zone _____ State _____

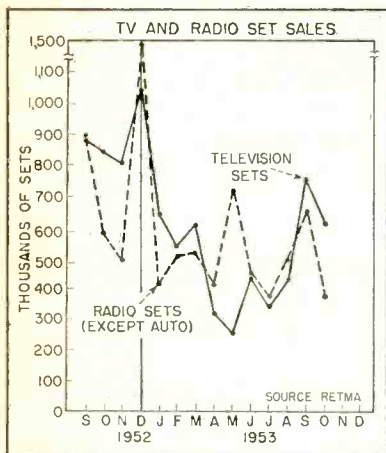

as shown in the chart, although summer percentages are higher than for tv.

► **Goals**—Radio and tv final sales figures for November and December will have to be even higher than 1952's record to keep the total fourth quarter sales equal to its total in 1952. October's record shows that tv retail sales were 225,000 units below those of 1952 and radio sets sold dropped by nearly 195,000. To maintain 1952's last quarter sales percentage, November and December figures will have to account for sales of over 2.6 million sets. To equal 1952's sales in units alone will take over 2 million sets. Radio also has a hard row to hoe to keep up with 1952 sales. Over 2.1 million radios were sold in 1952's last two months.

► **Outlook**—Despite the seemingly unbelievable rate at which tv and radio sets must move in the final months of 1953 and various let-up signs that appeared, some set manufacturers find that sales in the last two months are passing 1952's fast pace. Emerson reports its distributor sales to dealers during the

week ending December 4, 1953 were the highest in the past three years, topping the previous high week in the period by 11 percent. GE also reports that radio and tv set sales to dealers from Nov. 9 through Nov. 24 exceed by 25 percent those of any other two-week period in its history.

Citizens Radio Gets Transceiver

FCC type-approved unit produces 0.5 watt at 465 mc from batteries or a-c power pack

RADIO COMMUNICATION for the average citizen became a reality last month when Stewart Warner announced the "Portafone." The transceiver is similar in size and shape to a telephone handset and operates within the Citizens Band, where no operators' licenses are required.

Since the new transceiver is FCC type approved (for class-B service), obtaining the required station license becomes a mere formality. Frequency tolerance is better than 0.5 percent at 465 mc for temperatures from zero to 25 deg F and a wide range of battery voltages and humidity values.

Receiver portion of the set is a



Power pack setup for fixed operation

two-tube superregenerative circuit having a sensitivity of 12 microvolts and an output of about 15 milliwatts to the earpiece. Power for the handset can be obtained from port-

(Continued on page 10)

ELECTRONIGRAPHS Continued

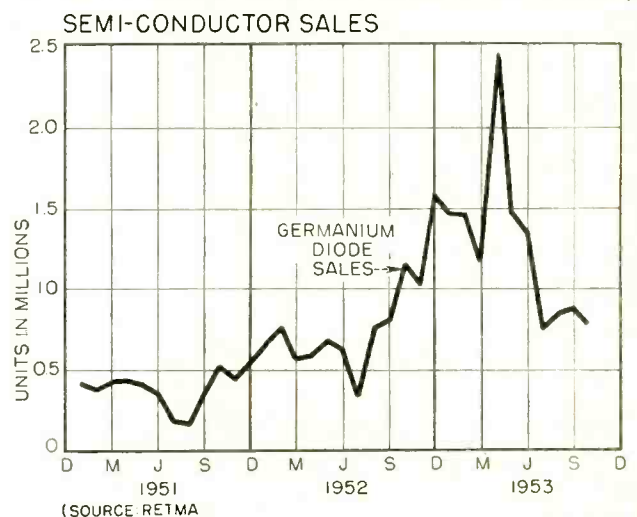
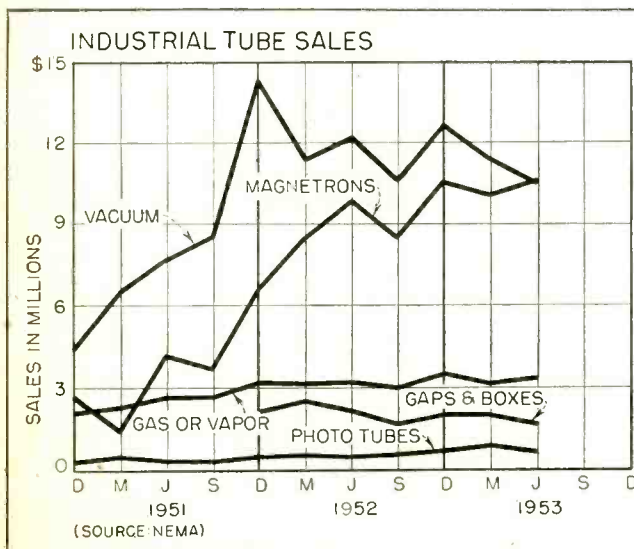

More charts following

**HERMETICALLY SEALED
METAL-ENCASED**

PRECISION CERAMIC CAPACITORS

with

HIGH STABILITY

for critical circuits

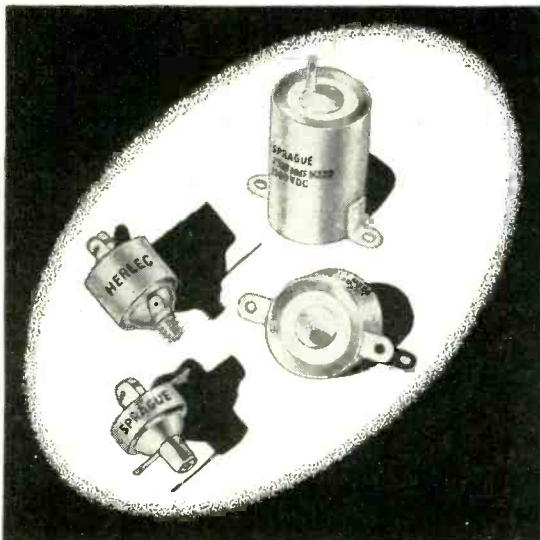

Sprague, on request, will provide you with complete application engineering service and assistance for optimum results in the use of precision ceramic capacitors.

IF YOUR problem is one of circuit stability in precision oscillators or of close capacitance tolerances in electronic instrumentation, have you investigated the advantages of Sprague-Herlec Precision Ceramic Capacitors?

These unique capacitors offer not only top capacitance and temperature stability but stability with applied voltage, uniform retrace characteristics, and high "Q". They are available in capacitance tolerances as close as $\pm 1\%$ and temperature coefficient tolerances as close as ± 10 ppm/ $^{\circ}\text{C}$ in regular production quantities.

Mechanically, they are small in size, sealed against atmospheric humidity, and resistant to vibration and shock. Standard operating temperature range is from -55°C to $+85^{\circ}\text{C}$.

Sprague-Herlec Precision Ceramics are available in all standard temperature coefficients from P100 to N750, and can also be manufactured to any exact intermediate coefficient required for balancing other circuit constants. When used in combination with Sprague Durameg[®] Accurate Wire-Wound Resistors, it is possible to achieve stability heretofore impracticable in mass-produced electronic equipment. Sprague can furnish you either these R-C network components or complete network subassemblies to meet your tolerance requirements.

For complete details on Sprague-Herlec Precision Ceramic Capacitors, write for Engineering Bulletins 603-B and 607-A to Sprague Electric Co., 35 Marshall Street, North Adams, Mass. or Herlec^{*} Corporation, Grafton, Wisconsin.

*THE HERLEC CORP. IS A WHOLLY-OWNED SUBSIDIARY OF THE SPRAGUE ELECTRIC CO.

SPRAGUE

WORLD'S LARGEST CAPACITOR MANUFACTURER

EXPORT FOR THE AMERICAS: SPRAGUE ELECTRIC INTERNATIONAL LTD., NORTH ADAMS, MASS. CABLE: SPREXINT

able battery packs, vibrator packs or a-c supplies. Cost for a pair of units complete with batteries is a little over two hundred dollars.

Electronics Industry Looks At TV For '54

ESTIMATES of the volume of tv sets, both monochrome and color, that would be produced and sold by the set industry in 1954 were made by RETMA members representing three segments of the industry.

The radio-tv industry committee of the association made estimates of black and white set production that averaged 4,860,000. Black and white sales estimates ranged from 3.5 million to 6,360,000 for an average of 4.9 million sets. Color set production estimates averaged 192,600 with a range of 50,000 to 650,000. Radio set production was expected to reach 10,390,000.

RETMA's sales managers committee saw 5 million black-and-white tv set sales being made in 1954 and color output of 120,000

The tube division of RETMA was the most optimistic of the three groups in its estimates for 1954. Black-and-white set production estimates averaged 5.1 million with a range of from 4 million to 10 million sets. Color set estimates ranged from 30,000 to 400,000 for an average of 171,000.

Electroplated Transistors Announced

New manufacturing process yields high-frequency units with reproducible characteristics

STILL another method for manufacturing transistors is that of an electroplating process developed by Philco engineers. The technique is capable of producing transistors with consistent characteristics superior to those obtained in units made by other methods.

► **Polarized Jets**—The Philco transistors are formed electrochemically. Two tiny jets of indium sulphate are directed onto opposite sides of a thin strip of germanium. The streams are connected to one terminal of a d-c electroplating source and the germanium to the other.

Initially the polarity of the source is fixed so germanium is forced into solution and washed away, leaving depressions on opposite sides of the germanium strip. When enough germanium is eaten away to leave a thickness of 200 millionths of an inch, the polarity of the voltage source is reversed. This causes metallic indium to be plated onto the germanium.

The indium deposits formed become emitter and collector of a junction transistor by virtue of an effect which causes the germanium

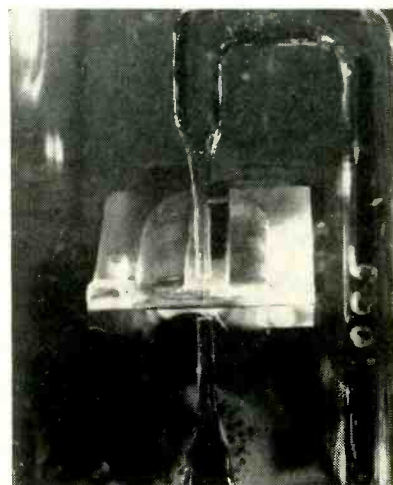

Closeup of surface barrier transistor process shows thin stream of solution

near the surface of the deposited indium to take on an impurity character opposite to that of the germanium base. Thus the name, surface barrier transistor.

► **High Frequencies**—The extreme close spacing obtainable results in extension of useful frequency range from 10 to 100 times that obtainable with junction transistors made by processes currently in use. The technique used to determine the exact moment when the desired base thickness is reached is accurate to 0.00001 inch. According to Philco engineers, the process is

(Continued on page 14)

ELECTRONIGRAPHS Continued

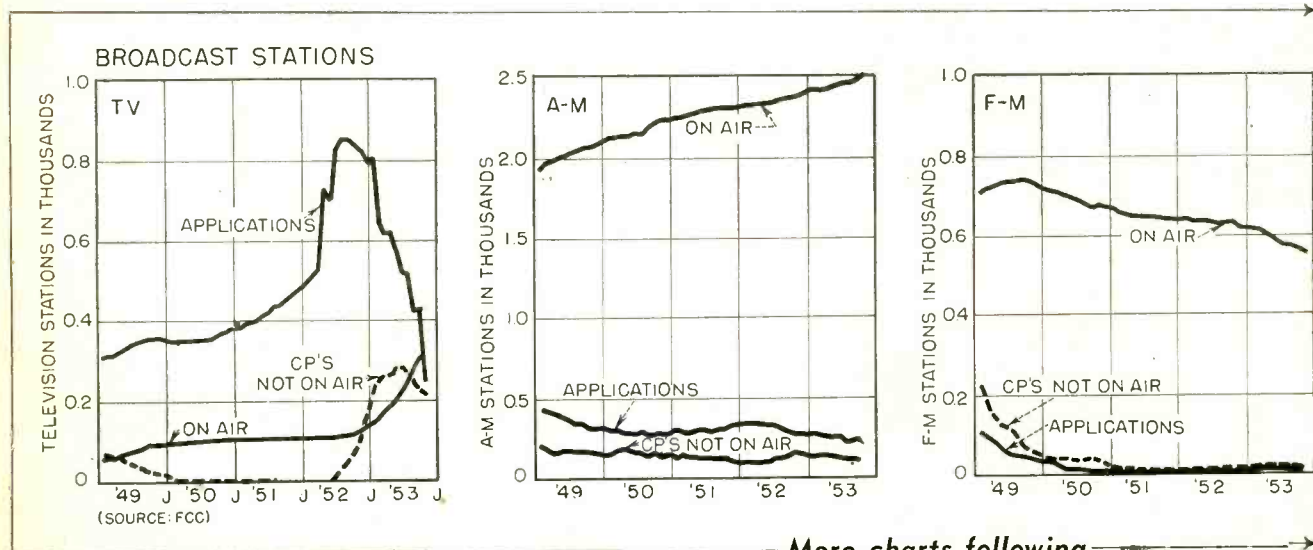

TO GAIN THE MOST IN

performance

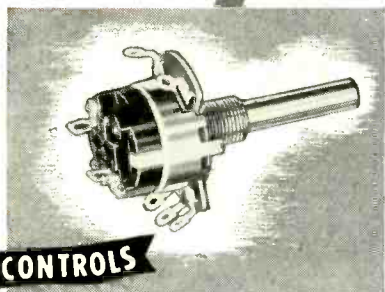

CONTROLS

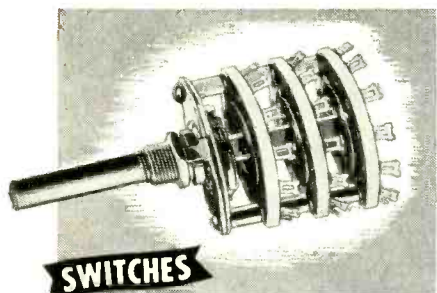

SWITCHES

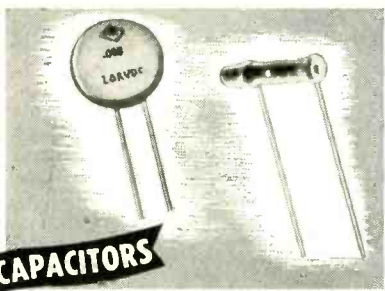

CAPACITORS

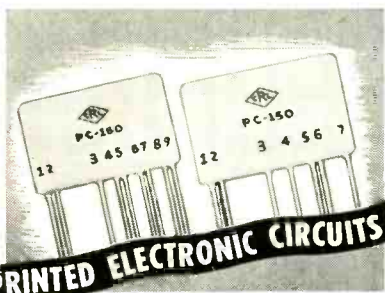

PRINTED ELECTRONIC CIRCUITS

...you're invited to concentrate your 5 major electronic component problems with the industry's most experienced and No. 1 electronic component source

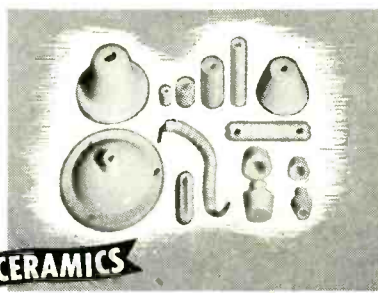

CERAMICS

see next 2 pages for details



1 VARIABLE RESISTORS

- to meet your requirements

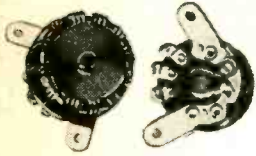

Model 1 Radiohm®
Miniature

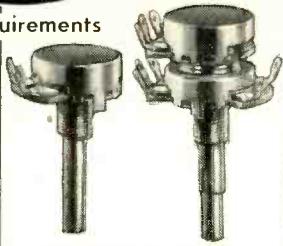

Model 2 Radiohm

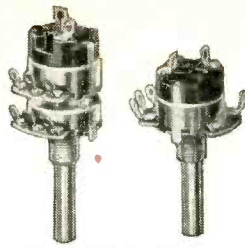

Model 2 Radiohm
(including JAN types)



Wirewound Radiohm
Three watts



Model 2 EXPRESS (†)
for immediate
production needs

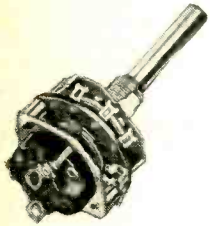

Series 20 Miniature
with a. c. line switch



Series 30
Dual Concentric
Switch and Control

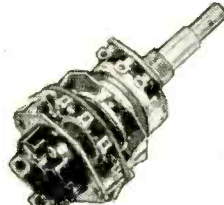

Series 30
Dual Concentric
Control and Switch

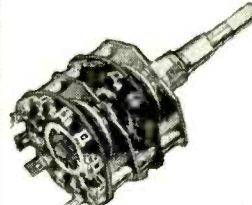

Series 30
Dual Concentric
Dual Switch

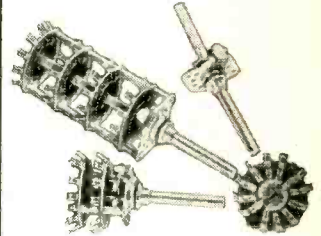

Standard Phenolic



Lever Switch

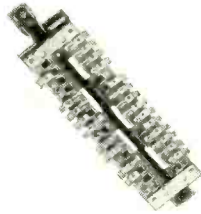

Slide Switch



Industrial Switch Kit

3 CAPACITORS

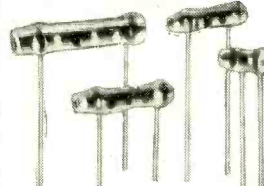

BC Tubular

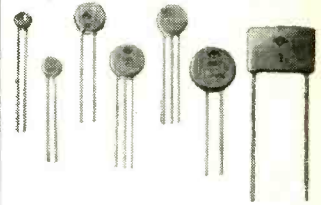

BC Discs

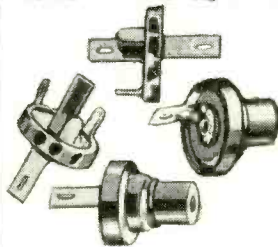

Button-Style



Feed-Thru HI-KAPS®



Miniature
Feed-Thru HI-KAPS®

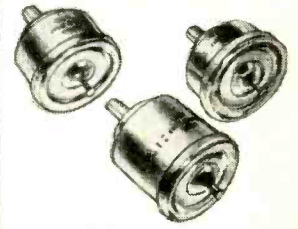

High Accuracy
Capacitors

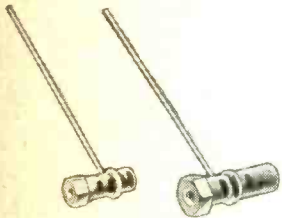

Stand-off

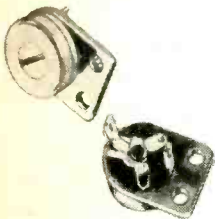

Ceramic Trimmers

4 PRINTED ELECTRONIC CIRCUITS



Ceramic Min-Kaps®

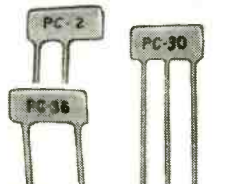

Miniature Resistor and
Resistor-Capacitor Units

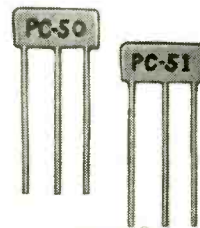

Filpec®
(balanced load
diode filter)

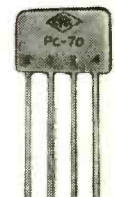

Standard Triode
Couplate®

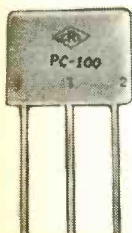

Vertical Integrator



Special Plates
to suit manufacturer's
requirements

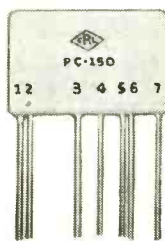

Audet®
Audio-detector plate

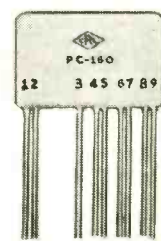

Pendet (†)
(Pentode detector
coupler)

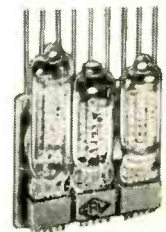

Model II Ampec®
Standard 3-stage
amplifier

2 SWITCHES
- 100's of variations possible

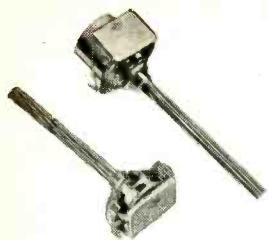

Compentrol †
Infinitely variable
loudness control

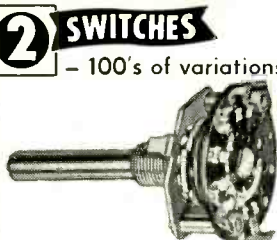

Series 20 Miniature
Phenolic insulation



Series 20 Miniature
Ceramic insulation

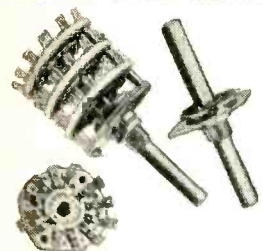

Standard Ceramic



Tone Switch

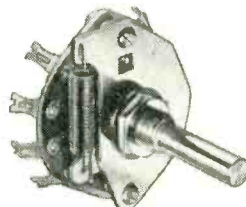

Spring Return Switch

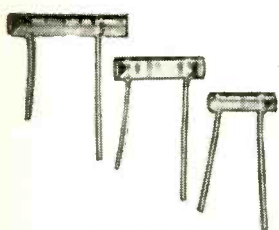

TC Tubular

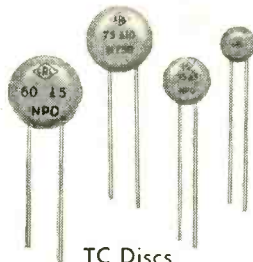

TC Discs

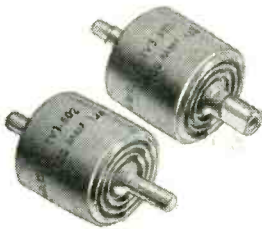

TV HI-VO-KAPS®

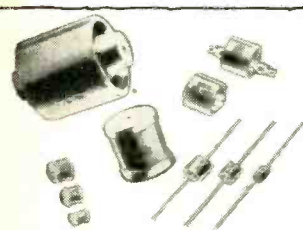

Transmitting
Capacitors

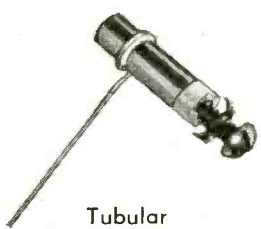

Tubular
Ceramic Trimmer

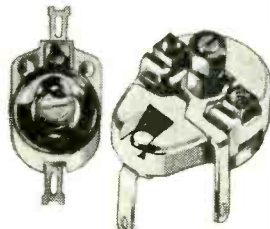

Ceramic Trimmers

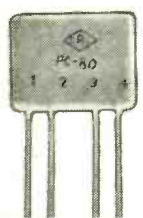

Midget Triode
Couplate (†)

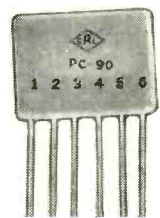

Pentode Couplates (†)

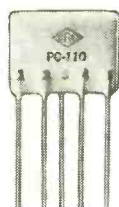

Filplate®
(by-pass & filter
application)

5 CERAMICS



Model III Ampec®
Miniature 3-stage
amplifier



Custom Ceramics
(Steatite, Centradite,
Zirconite.)



Metalized Ceramics

For Sale!

**These and 100,001
other Centralab quality
electronic components**

WHETHER you buy electronic components in small lots or by the carload — no other single manufacturer can offer you such a *wide choice* in standard or special units. That's why Centralab is the industry's No. 1 electronic components source. Consider these facts:

- Centralab has pioneered more electronic "firsts" than any other manufacturer in the field.
- Introduced Printed Electronic Circuits — more than 30,000,000 in use, offering a new concept in reducing extra parts, time, errors and costs.
- Centralab ceramics are second to none — you can obtain grade L5 and L6 Steatite.
- You can count on the production facilities of seven conveniently located plants.
- Over 200 research and production engineers are constantly seeking to improve present CRL products.
- Unparalleled engineering assistance offered in the development of components for specific TV, FM, military and commercial electronic requirements.

You can rely on Centralab electronic components. Each is the result of more than 30 years' experience working in cooperation with manufacturers all over the world. For complete performance data on products shown — and engineering specifications — check information wanted and mail the coupon.

†Trademark

Centralab

A Division of Globe-Union Inc.
Milwaukee 1, Wisconsin
In Canada, Box 208, Ajax, Canada

Centralab, A Division of Globe-Union Inc.
914-A E. Keefe Ave., Milwaukee 1, Wis.

Please send me information on these Centralab products:
 Controls Switches Capacitors
 Printed Electronic Circuits Ceramics

Name.....Title.....

Company.....

Address.....

City.....Zone.....State.....

readily adaptable to production, but no statement was made as to when units would be available on a large scale for commercial application by electronic manufacturers.

The preliminary planning and experimental work which led to the development of the process was sponsored partly by the Navy Bureau of Ships.

cated by the computer, a slight course change is sent to the pilot which causes his arrival to be delayed until an unoccupied time interval presents itself—30 seconds later if no other plane has that interval reserved.

Volscan System Shown by Air Force

Computers channel airplanes into nonconflicting landing sequence

INSTRUMENT LANDINGS in low-visibility weather are commonplace today. However, many serious, and sometimes disastrous, delays occur because of the lack of means for channeling large numbers of aircraft into position for blind landing approaches.

The Air Force Cambridge Research Center has unveiled a new system, called VOLSCAN, which fills in the missing link between radio navigation aids and blind landing systems.

► **How it Works**—A pilot approaching his destination radios from about 40 miles out, telling the volscan operator of his intentions to land. She picks him up on a radar ppi scope and sets automatic tracking equipment in motion. The automatic tracking equipment also feeds information into computers that predict the exact moment when that aircraft would reach the

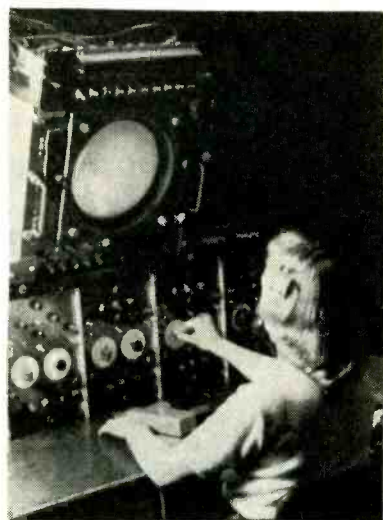

Nerve center of volscan is ppi radar

threshold of the instrument landing system if he took the most direct route.

The computer consults its memory system to see if that time is reserved for a plane having called in previously. If not, the pilot is given a direct course to fly and continues his approach and landing.

If, however, another plane is scheduled to land at the time indi-

► **Cost**—Using volscan, up to 120 arrivals and departures can be handled each hour. The equipment is complex and somewhat expensive, but the Air Force points out a single B-36 saved by volscan would pay for installations at 40 air bases. A recent crash of six jets in Japan, which might have been prevented by volscan, cost the government approximately \$5,400,000, enough to equip every major U. S. base with volscan.

TV Makers and Stations Get Set For Color

Industry varies in stages of equipment readiness with broadcasters slightly behind

RECEIVER manufacturers and tv broadcasters have moved ahead at varying speeds in getting ready for the advent of color television. All major tv set manufacturers have color tv production equipment on hand in some degree and some are

(Continued on page 16)

ELECTRONIGRAPHS Continued

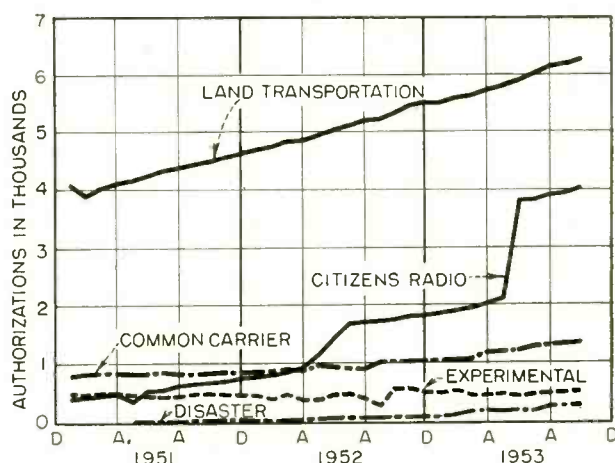
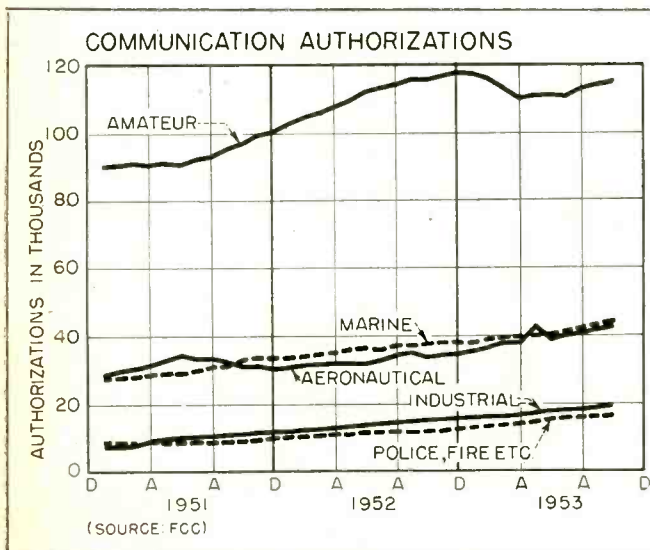

More charts following

SHOCK, VIBRATION and NOISE



DO YOU WANT Complete DATA?

CATALOG 523-A. Air-damped Barrymounts for shock and vibration protection of military airborne equipment.

BULLETIN 532. Vibration isolator Type 915, for isolating vibration and noise caused by high-speed motors or motor-driven equipment.

BULLETIN 533. Medium-impact shock machine Type 150-400 VD, for qualification and acceptance shock tests up to 77g.

BULLETIN 534. Series M44 ALL-METL vibration isolators and Series TOMA mounting bases, for military airborne equipment under extreme operating conditions.

BULLETIN 535. Component shock machine Type 20 VI, for qualification and acceptance shock tests up to 210g.



"LOOK — NO LAGGING!"
Increasing profits through the use of the new Leveling Barrymount for industrial machinery.

BULLETIN 536. Series M64 ALL-METL vibration isolators and Series AOMA and NOMA mounting bases, for military airborne equipment under extreme operating conditions.

BULLETIN 537. Series 262/633 vibration isolators, for isolating vibration and noise caused by medium-speed motors or motor-driven machinery.

BULLETIN 538. Series 670/297 shock and vibration isolators, for isolating shock caused by impact-type machines, and vibration and noise caused by heavy rotating or reciprocating machines.

Here are complete engineering data, application information, and pointers to profits in every field of shock and vibration isolation. Write TODAY for your free copies of the ones *you* need.

THE **BARRY** CORP.

707 PLEASANT ST., WATERTOWN 72, MASSACHUSETTS

SALES REPRESENTATIVES IN

Atlanta Baltimore Chicago Cleveland Dallas Dayton Detroit Los Angeles Minneapolis New York
Philadelphia Phoenix Rochester St. Louis San Francisco Seattle Toronto Washington

using their first few costly samples for demonstration promotions. Raytheon has just announced plans to have four color sets in operation for the colorcast of the Tournament of Roses parade in Pasadena, Calif.

► **Broadcasters**—As a whole, the broadcasting fraternity is lagging behind receiver manufacturers in jumping on the color band wagon. Status of color in tv broadcasting is indicated by the fact that only two of the major tv networks have regular color studios completely equipped. NBC has three studios ready for colorcasting and CBS has two. DuMont has its experimental set up for use and ABC has not as yet announced its color studio plans.

Despite the lag in color studio readiness, a number of individual stations are set for broadcasting network tv programs in color. It is expected that 20 stations will carry the Tournament of Roses parade in color on New Year's day. AT&T is reported to be set to deliver the parade colorcast to 13 cities and stations.

► **Future**—Number of color equipped tv stations is expected to increase much faster in the next few months. It is estimated that about 100 tv stations will be equipped by the end of April for network color programs.

How Electronics Plants Grew In 1953

Tube plants, parts facilities, receiver and instrument expansions led the parade

OVER \$150 million was spent for new plants and equipment during 1953, it is estimated. How this money was spent is seen in an analysis of plant expansions announced by major manufacturers in the field.

► **Tubes**—Plant and facility expansions by tube manufacturers led all other segments of the industry in growth in 1953. Eleven tube manufacturers announced major expansions during the year which added over two-million sq ft of space for manufacturing. Most expansions were for picture tube production although receiving and industrial tube expansion was also important. Companies with top tube expansions included GE, Raytheon, Sylvania and Westinghouse. Glass tube envelope manufacturers also made substantial plant expansions during the year.

► **Parts**—One noticeable expansion move was that of capacitor manufacturers who announced plant extensions in North Carolina. Four

major manufacturers, Cornell Dubilier, IRC, Pyramid and Sprague all expanded plants there in 1953.

► **Sets & Labs**—Ten major tv set manufacturers expanded facilities during 1953 with expenditures totaling over \$10 million. Largest single plant expansion was made by Sylvania with a 416,000 sq ft plant in New York. Zenith and Motorola both set \$3 million expansions for the year.

Ten instrument manufacturers also made major expansions during 1953, mostly in California. Floor space added by major firms in the field totaled over 500,000 sq ft.

More than ten companies expanded laboratory research facilities during the year. Some of the companies were not primarily in the electronics field but expansions were made specifically for electronics research. Several new firms were formed during the year for electronics research only. Some non-profit and independent research companies were among the leaders in growth.

► **From Other Fields**—A number of companies not previously associated with the electronics industry

(Continued on page 18)

ELECTRONIGRAPHS Continued

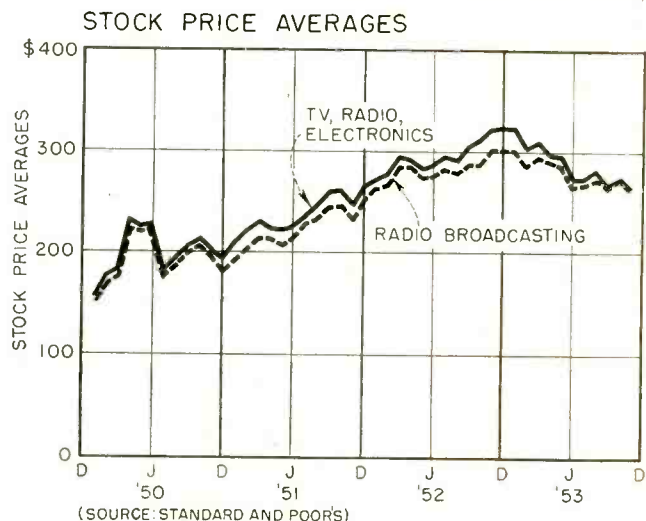
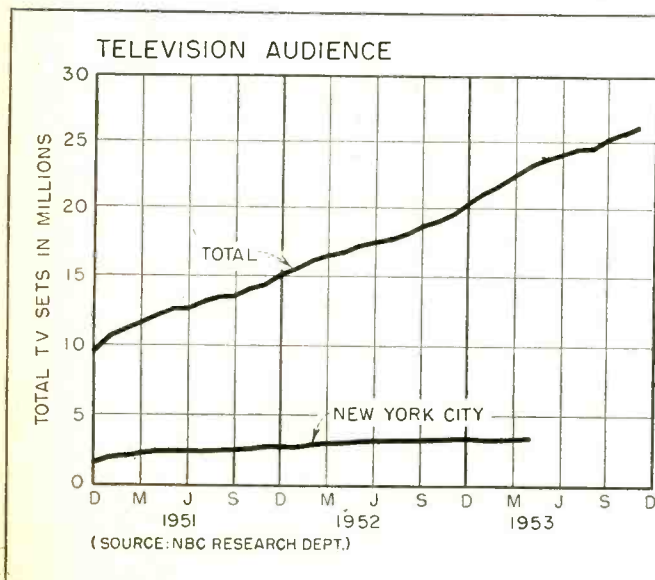

More charts following

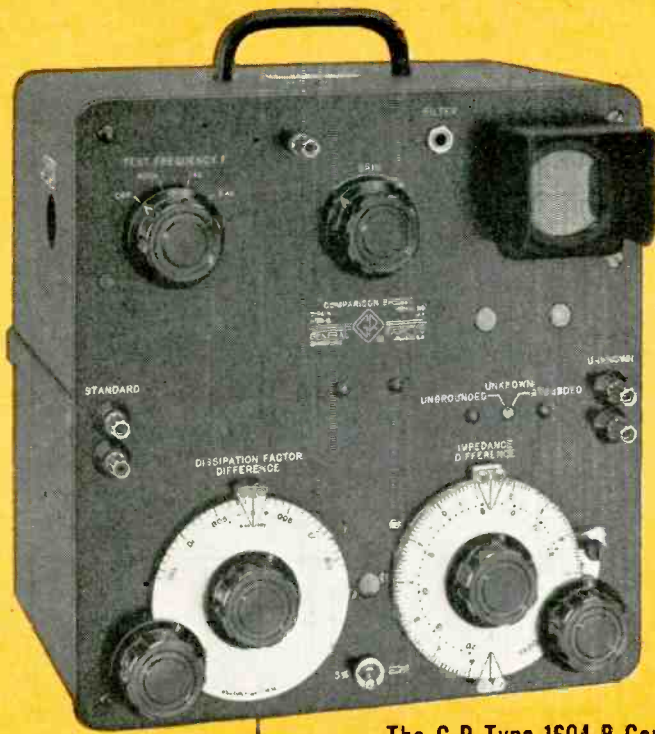

The G-R Type 1604-B Comparison Bridge

is a direct-reading instrument which makes possible the rapid measurement of impedance and dissipation factor of R-L-C components, rheostats, capacitance trimmers and other impedances. Basic measurement accuracy is *one-tenth of one percent* . . . more than required for most measurements.

*This Versatile Instrument is Useful
for Many Other Types of Work*

Checking tracking of condensers and potentiometers to very close tolerances — locating the position at which windings are to be center-tapped — measuring small capacitors in the 1 μf range — adjusting one component to the value of another, rapidly and reliably

In any laboratory or shop, the Comparison Bridge will prove invaluable for checking, selecting and pairing components within given tolerances — the approach to balance is continuously and instantly indicated.

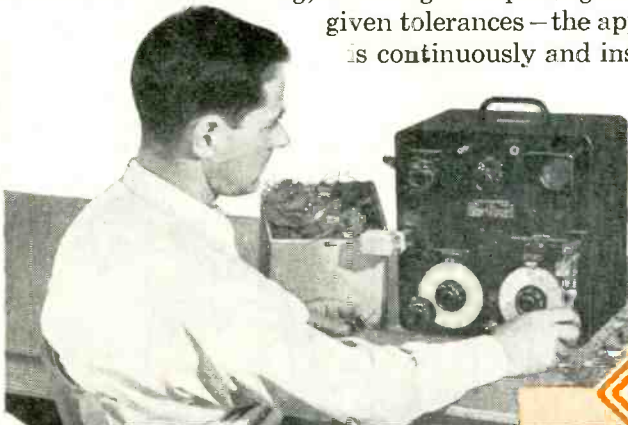

GENERAL RADIO Company

275 Massachusetts Avenue, Cambridge 39, Massachusetts, U. S. A.
90 West St. NEW YORK 6 • 920 S. Michigan Ave. CHICAGO 5 • 1060 N. Seward St. LOS ANGELES 38

Since 1915

Manufacturers of Electronic Apparatus
for Science and Industry



- Admittance Meters ☆ Coaxial Elements ☆ Decade Capacitors
- ☆ Decade Inductors ☆ Decade Resistors ☆ Distortion Meters
- ☆ Frequency Meters ☆ Frequency Standards ☆ Impedance Bridges
- ☆ Modulation Meters ☆ Oscillators ☆ Variacs ☆ Light Meters
- ☆ Megohmmeters ☆ Motor Controls ☆ Noise Meters ☆ Null Detectors
- ☆ Precision Capacitors ☆ Pulse Generators ☆ Signal Generators
- ☆ Vibration Meters ☆ Stroboscopes ☆ Wave Filters ☆ U-H-F Measuring Equipment
- ☆ V-T Voltmeters ☆ Wave Analyzers ☆ Polariscopes

SPEED

Production Testing

of Resistors — Inductors
Capacitors — Impedances

FEATURES

★ Instrument is completely self-contained and ready for operation — includes internal oscillator, bridge circuit and high-gain non-linear amplifier terminated in a cathode-ray-tube detector.

★ Three Measuring Frequencies — 400 c, 1 kc or 5 kc, selected by panel switch.

★ Two IMPEDANCE DIFFERENCE Dial Ranges — 0 to $\pm 5\%$ range for accurate measurements; 0 to $\pm 20\%$ for determining whether components are within the common 20% tolerances.

★ Accuracy and Range of Impedance Measurements

The range over which the basic $\pm 0.1\%$ accuracy applies for resistors, inductors and capacitors is given below. At the more extreme values of impedance, measurements are less accurate.

Frequency	Resistance	Inductance	Capacitance
400 c	2 Ω to 20 M Ω	2 mh to 1500 h	100 μf to 50 $\mu\mu\text{f}$
1 kc	2 Ω to 20 M Ω	1 mh to 250 h	30 μf to 50 $\mu\mu\text{f}$
5 kc	4 Ω to 2 M Ω	200 μh to 10 h	2 μf to 50 $\mu\mu\text{f}$

On the 20% deviation range, accuracy is $\pm 0.5\%$ over the same impedance range.

★ DISSIPATION FACTOR RANGE and Accuracy

Frequency	Range	Accuracy
400 c	$\pm .006$	$\pm (0.0002 + 2\% \text{ impedance diff.})$
1 kc	$\pm .015$	$\pm (0.0005 + 2\% \text{ impedance diff.})$
5 kc	$\pm .075$	$\pm (0.0025 + 2\% \text{ impedance diff.})$

★ CRO visual Detector — horizontal band of light is used as the indicator — highly non-linear detector amplifier keeps indication on scope over wide ranges of unbalance — continual resetting of gain control is eliminated.

★ Zero Adjustment — adjustable index mark on scope can be offset and locked to compensate for deviation of the standard from the desired nominal value — permits use of any component as a standard of comparison.

★ Anyone can be taught to operate the instrument in a very short time.

★ Measurements can be made with unknown grounded or ungrounded, as desired.

★ Dimensions — 12" x 14 1/4" x 10"; Net Weight is 22 1/2 lbs.

1604-B Comparison Bridge \$390.00

**HIGH-SPEED SORTING with the
COMPARISON BRIDGE**

Both dials are set to zero, and the cathode-ray-tube adjustable indicator is offset to the desired tolerance to give a visual "go, no-go" indication. As rapidly as each component is plugged into the unknown terminals . . . a few seconds at most . . . the detector indicates whether the unit is acceptable.

entered the field during 1953. More than 15 companies in fields as widely diversified as safety matches and textiles acquired interests in electronics. Reason given by most outside firms is that they feel electronics is a growth industry and they want to share in it to stabilize the cycles of their main business.

Eight Stations Acquire TV Network Service

WITH the addition of eight stations during the past month, network television service is now available to 233 stations in 145 cities.

The recently connected stations include: WCIA-TV, Champaign, Ill.; KGTV, Des Moines, Ia.; WIBW-TV, Topeka, Kan.; WNOW-TV, York, Pa.; WKJG, Ft. Wayne, Ind.; KFOR-TV, Lincoln, Neb.; WWOR-TV, Worcester, Mass.; and WTOV-TV, Norfolk, Va.

► **Radio Relay**—Network television facilities were also augmented this past month when an eleven-station microwave system covering the 298 miles between Atlanta, Ga. and Jacksonville, Fla. was placed in operation.

The telephone company also announced plans to add two television channels, one westbound and one eastbound, on their Albany to Buffalo, N. Y. radio relay system.

Cathode-Ray Tube Exports Boom

Volume to foreign markets five times '52 exports and is seen going higher in 1954

GROWTH of the electronics industry abroad, particularly television, is mirrored in the greatly increased cathode-ray tube export sales made by U. S. tube manufacturers. For the first ten months of 1953, volume of all types of c-r tubes sold abroad totaled 382,025 units valued at \$8.1 million compared to 83,372 units valued at \$1.6 million sold for export in all of 1952.

► **Size**—Over 46.9 percent of all picture tube export shipments in the first ten months of 1953 were in the 16 through 18-inch sizes. This size group led in sales until October, 1953 when the 19 to 21-inch group took the lead and accounted for 48.9 percent of total unit sales and more than 57 percent of total export dollar value in the first ten months of 1953. In 1952, the percentage for the 16 and 17-inch sizes was approximately 54 percent while 18-inch and larger size tubes accounted for about 30 percent. Thus, the trend to larger size screens is moving upward fast in export markets as it has in the U. S. since tv's introduction.

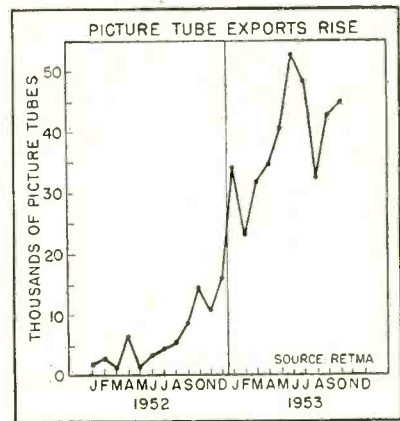

► **Future**—Picture-tube manufacturers here expect the export market to keep growing with the development of foreign television. But they also expect greater foreign competition. According to E. A. Marx of DuMont, who recently returned from Europe, there are three large c-r tube manufacturers in France and the number may increase considerably in the near future.

Some c-r tubes are being made in Italy but most glass blanks are being imported from the U. S. or Holland. In Germany, one of the largest radio manufacturers in Europe has concluded contracts with U. S. c-r tube manufacturers so that further activity can also be expected from that country.

(Continued on page 20)

ELECTRONIGRAPHS

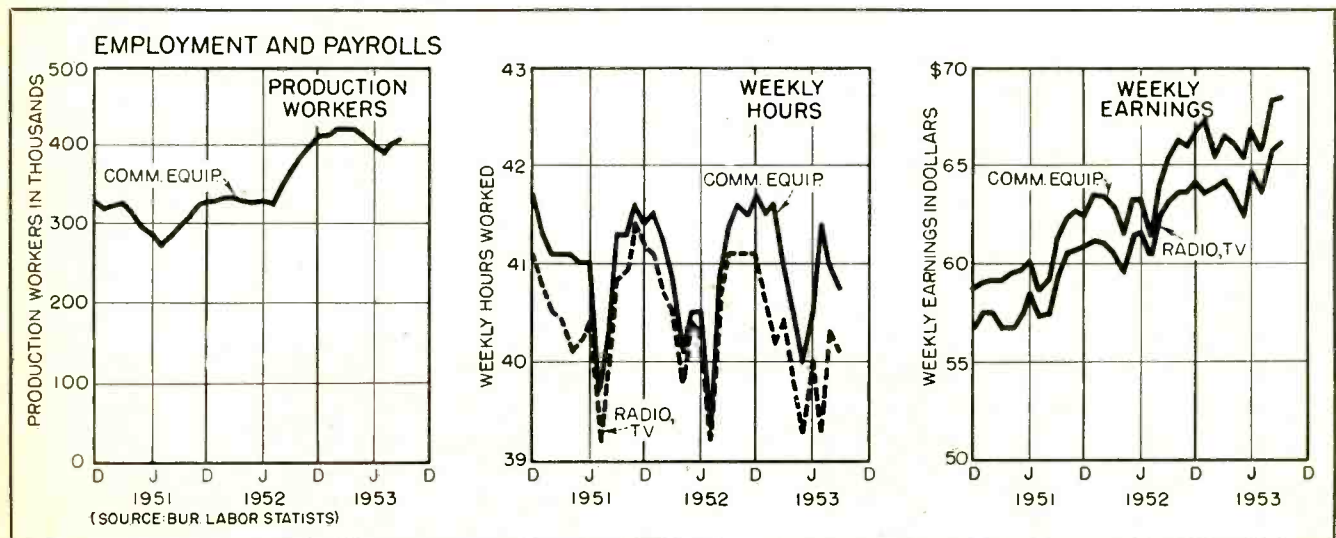



presents the
FIRST ANNUAL REPORT on
transistors

Hundreds of thousands of RAYTHEON Junction Transistors are now in actual commercial use... several times more than all other makes combined! Furthermore, one year's field experience has demonstrated that the moisture resistance of Raytheon's specially developed glass-plastic package is completely satisfactory!

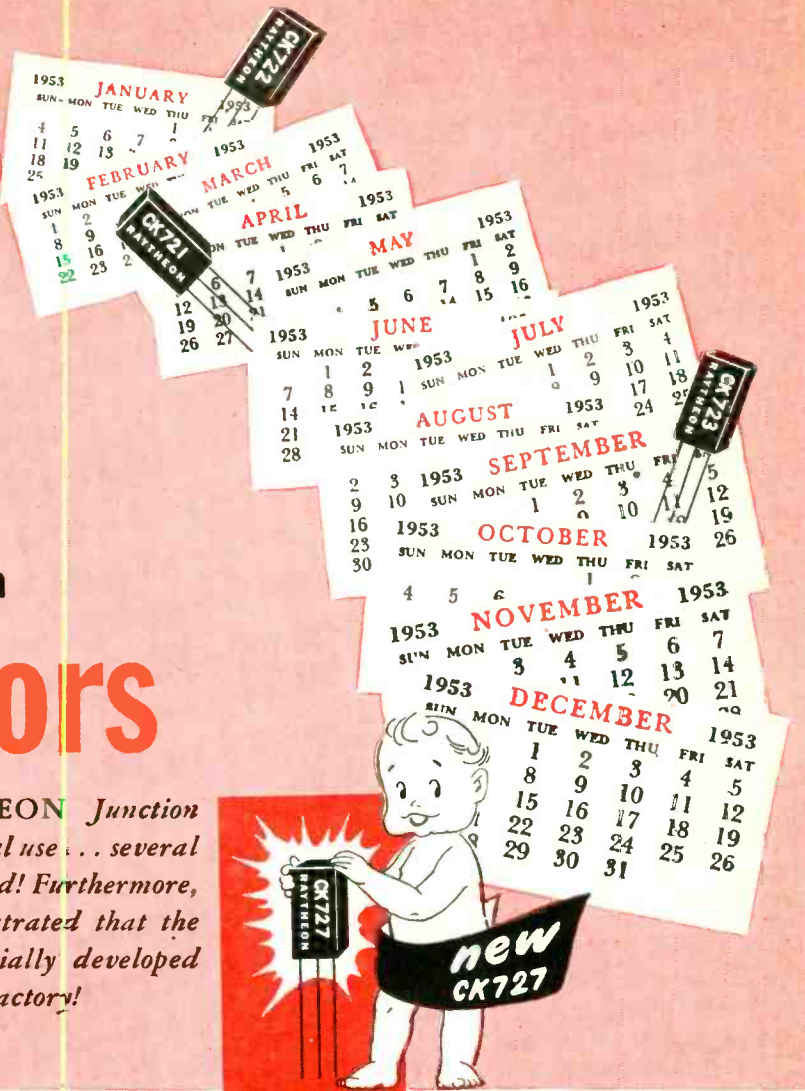

For critical applications, the new CK727 Raytheon junction transistor offers the low average noise factor of only 15 db. plus all the desirable performance characteristics of the popular and highly successful CK721.

For complete characteristics on CK727, get in touch with our nearest office.

AVERAGE CHARACTERISTICS AT 30°C				
	CK721	CK722	CK723	CK727
Collector Voltage (volts)	-5	-6	-6	-1.5
Collector Current (ma.)	-2	-2	-2	-0.5
Alpha	.975	.90	.90	.975
Cut-off Current (approx.) (μ a)	10	25	10	5
Noise Factor (Max.) (db.)*	30	—	30	18
Collector Resistance (meg.)	0.7	0.5	0.5	1.0
Base Resistance (ohms)	350	150	150	800

*Common emitter circuit with $R_{in}=1000$ ohms; $R_{out}=20000$ ohms.

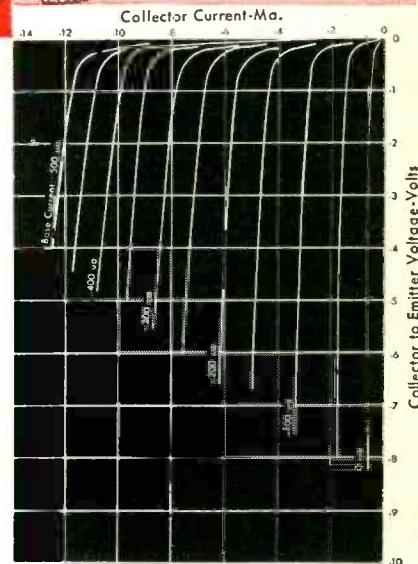

GROUNDING Emitter
 Typical Collector Characteristics



Excellence in Electronics

RAYTHEON MANUFACTURING COMPANY

Receiving Tube Division — for application information call

Newton, Mass. Bigelow 4-7500 • Chicago, Ill. National 2-2775 • New York, N. Y. Whitehall 3-4980 • Los Angeles, Calif. Richmond 7-4321

RAYTHEON MAKES ALL THESE:

RELIABLE SUBMINIATURE AND MINIATURE TUBES • SEMICONDUCTOR DIODES AND TRANSISTORS • NUCLEONIC TUBES • MICROWAVE TUBES • RECEIVING AND PICTURE TUBES

Hearing Aid Companies Set For Big Year

Transistorized aids gain in sales and may represent the bulk of output in 1954

JANUARY, 1954 marks the first anniversary of the commercial debut of transistors in the hearing aid industry.

► **Sales**—According to the American Hearing Aid Association, between 130,000 and 150,000 hearing aids were produced in 1953 and about 50 percent of them were transistorized. In 1954, manufacturers expect an even larger percentage of production to be of the transistor type. However, tube aids are not expected to drop completely out of the picture, because certain types of deafness, according to the manufacturers, are better handled by the tube-type aid.

► **Companies**—About 35 manufacturers are in the field and it is estimated that 15 of them are producing transistor-type hearing aids. Six companies are estimated to do 85 percent of the total business. They are Acousticon, Audovox, Bell, Maico, Radio Ear and Sonotone.

These companies sell to about 1,500 full-time hearing aid dealers and there are another 1,500 dealers who sell aids on a part-time basis or along with other products.

► **Future**—The hearing aid industry expects sales of all aids to increase 15 to 20 percent in 1954. With transistor aids selling retail about 45 percent higher than tube types, dollar volume in sales is expected to be much more substantial.

Manufacturers are quick to point out that the increase in sales dollar volume is not directly transferred into larger profits. They estimate that the cost of manufacture for transistorized aids is about 85 percent higher than that of the tube types. Some allied components, they say, are as much as seven times more expensive.



VACUUM TUBES will be put to work at three-mile depths, when . . .

Telephone Cable Spans Atlantic

Work starts immediately on \$35 million coaxial cable linking New York and London

RESULTS of a 25-year development project will assist AT & T and British Post Office engineers in fabricating and laying a 2,000-mile coaxial telephone cable across the North Atlantic. The project, which will cost \$35-million and take three years to complete, is a joint undertaking of AT & T, the British Post Office and the Canadian Overseas Telecommunication Corp.

The cable will handle 36 simultaneous conversations and triple existing radiotelephone circuit capacity. Although adequate for radio program use, the cable's bandwidth will be too narrow for television.

► **Route**—The complete route from New York to London will include: land line to Portland, Me.; microwave radio relay to Nova Scotia; underwater cable to Newfoundland; deep-sea cable to Oban, Scotland and thence to London by British land-line circuits.

► **Design**—Core of the cable will be a $\frac{3}{8}$ -in. flexible copper tube surrounded with polyethylene dielectric and a flexible copper outer con-

ductor. Additional protection will be afforded by a wrapping of copper foil and a heavy outer coating of jute and armoring wire. Overall outside diameter will be $1\frac{1}{2}$ in.

► **Repeaters**—The deep-sea cable will have over 100 vacuum-tube repeater amplifiers. Each repeater will contain three tubes and will be housed in a flexible copper tube 7 ft long and $1\frac{1}{2}$ in. in diameter. Power for the amplifiers will be carried over coaxial conductors.

Kaiser-Sanders Relationship Clarified

CLARIFICATION of the business relationship between Sanders Associates of Nashua, N. H. and Kaiser Manufacturing Corp. came last month when Sanders stated that it "is not and never has been either financially or corporate wise affiliated with any organization, company, or corporation. The company is an independent entity and has no control whatever from outside interests."

Confusion arose when Kaiser designated the division it formed in Nashua, N. H. in 1952 as the Kaiser-Sanders Electronics Division of Kaiser Manufacturing
(Continued on page 22)

RIGHT ON TOP

Burnell records a few of its most recent engineering achievements in Toroids and Filter Networks.



SIDE BAND FILTERS

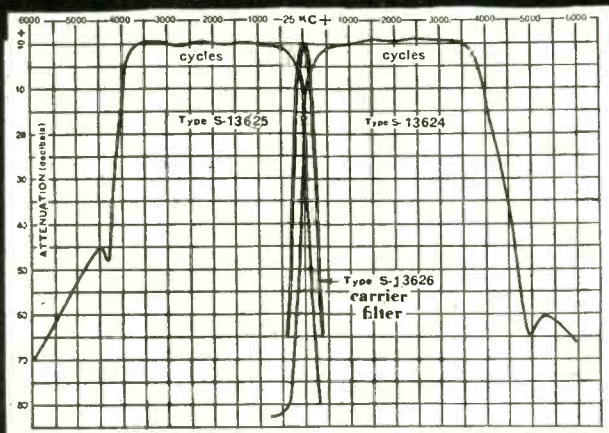

Our most recent engineering achievement in communications filters has already stirred the interest of the leading receiver manufacturers in the country.

Our new side band filters which eliminate, for most applications, the necessity for expensive crystal filters are expected to accelerate the advancement of single side band communications.

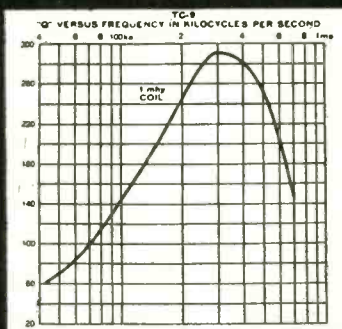

SUB MINIATURE TOROIDS

Toroids for intermediate frequencies of 100KC to 1 megacycle. A wide variety of coils ranging in size from 1/2 inch provides high Q in the frequency range between audio and RF.

The tiny toroid about the size of a dime has been welcomed by designers of sub miniature electronic equipment for the transistor, guided missile and printed circuit field.

PLUG IN DECADES

An entirely new development in inductance decades eliminating disadvantages of switch boxes. Inductance units plugged together in various combinations providing decade steps of inductance with minimum number of units required.

MINIATURE TELEMETERING FILTERS

In recognizing the need for miniaturization of the presently bulky telemetering equipment, our engineering staff has succeeded in reducing the size of telemetering filters to as little as 25 to 50% of the original volume.

BURNELL & COMPANY is very pleased to announce that it now has available a 12 page catalog which includes valuable and complete information on toroids, high quality coils, and various audio filter networks.

The catalog includes complete descriptions, attenuation and Q curves that will prove valuable for equipment design engineers.

Write for Catalog 101-A.

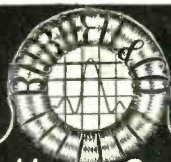

Burnell & Company
YONKERS 2, NEW YORK
CABLE ADDRESS "BURNELL"

**Exclusive Manufacturers of
Communications Network Components**

Corp. According to Sanders, this was done because of the proximity of operations, and intent to utilize the electronic research engineering services of Sanders Associates. Sanders accepted subcontracts for electronic research from the Kaiser organization and this has been the

only relationship between the two organizations.

According to Sanders, with the merger of the Willys and Kaiser organizations, the name Kaiser-Sanders Division was replaced by Kaiser Electronics Division, Willys Motors, Inc.

Metal Detector Sales Progress

Business in electronic prospecting, treasure finding, industrial units totals over \$16 million

OVERLOOKED by all but a few in the electronic field is the business of detecting and locating concealed, imbedded, buried or otherwise invisible metal objects. One widely publicized use, for frisking visitors to prisons, is peanuts dollarwise compared to sales in the four major categories—pipeline locators, treasure finders, industrial tramp metal detectors and medical units.

► **Buried Pipes and Treasure**—Approximately 100,000 portable battery-operated electronic metal detectors have been sold in the past 25 years, at an average price of \$150 each. Sales breakdown is roughly 50,000 to public utilities for locating buried pipes and cables, 15,000 to prospectors for finding metallic ore bodies and 35,000 to individuals seeking their fortune in buried treasure. Prices of units range from \$75 to \$425, depending on sensitivity, depth penetration and width of coverage pattern.

Units that will locate sunken outboard engines, pirate treasure or other metal objects dropped in water are in demand, but so far only custom-built waterproof units have been available. One manufacturer reports, however, that a waterproof unit is in the works.

The SCR-625 metallic mine detector of World War II made a sizeable dent in the post-war market for commercial buried-metal locators, but has now just about vanished from the surplus market. Only an estimated 300 units remain in trade channels throughout the country. Current price is around \$100 as compared to \$65 a year ago, with likelihood of higher prices as the supply dwindles.

► **Tramp Metal**—Industrial plants have about 900 installations costing an average of \$1,200 each for find-

(Continued on page 24)

Broadcasters Hit Record Billings

Sales set record highs with tv up and radio down slightly; FCC sets new limitations

GROSS time charges for the four major tv and radio networks during the first ten months of 1953 reached a total of \$311.4 million for the highest combined billings on record for any previous year.

In 1952 the total for the whole year for radio and tv nets was \$302.6 million. Network tv billings were largely responsible for the rise with a billing total of \$178.9 million as against \$146.2 million in 1952. Network radio lagged slightly with charges \$1.5 million under last year's ten months total of \$134 million.

October tv billings were largely responsible for the new record. They reached \$23.4 million for the best single month volume by about \$5 million that network tv ever experienced.

► **Nets**—According to Publisher's Information Bureau figures, which are guides to trends in network sales, all four of the major tv networks had higher sales in the first ten months of 1953. CBS led in the period in tv gross billings with \$77.3 million. NBC followed with \$76.9 million in tv for the period. But it led in October sales by almost \$1 million to set a new record in monthly billings. ABC and DuMont followed in 10 months tv billings with \$16.0 million and \$8.5 million respectively.

In radio, through October, individual network sales showed diverging trends. ABC and NBC showed increased billings over the

first ten months of 1952 while CBS and MBS dropped slightly. Gross time charges for the four radio networks during the period were: ABC, \$24.1 million; CBS, \$51.4 million; Mutual, \$18.9 million and NBC, \$38.0 million.

► **FCC**—As network broadcasters glowed over their new sales records, FCC issued a new limitation on station ownership. CBS was the only network affected by the ruling because it has interests in 8 radio stations, 5 tv stations and 3 tv cps.

The commission set a limitation for any one owner of having an interest in more than 7 a-m stations; 7 commercial f-m stations and 5 commercial tv stations because a holder of small interest "may exert a considerable influence on the station's operations and because of the difficulty of determining from the face of the application what the extent of the influence will be." Heretofore there has been no limitation on a-m station ownership; commercial f-m ownership was limited to 6 stations and tv remained at 5 outlets.

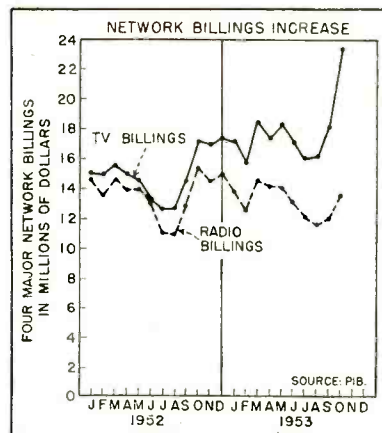

*To help you meet
the Tolerance Squeeze*

QUALITY CAPACITORS BUILT BY HAMMARLUND

Performance requirements for electronic products — commercial, industrial and military — are becoming more difficult to meet. Specifications call for the finest quality components available to fulfill exacting equipment tolerances.

Hammarlund variable capacitors have been designed and built for more than 25 years to meet the most demanding of requirements. Check the general characteristics of these outstanding variables:

- Rotor and stator plates of brass stock soldered, not staked, to their supports to permanently insure perfect contact and prevent loosening of plates.
- Stator supports soldered into eyelets assembled to steatite insulators.
- Terminals hot-tinned for ease in soldering.
- Insulators of low-loss steatite, impregnated with DC 200 silicone fluid to prevent absorption of moisture.
- Rotor and stator assemblies nickel or silver-plated.
- Rotor contact springs of beryllium copper or phosphor bronze, and nickel or silver-plated.
- Precision soldering fixtures and assembly jigs used in fabricating to assure absolute uniformity of plate spacing.

These are basic reasons why Hammarlund capacitors should be used where highest dependability is required. Convince yourself in your engineering models and you will specify them for production.

For detailed information on Hammarlund variable capacitors write for this latest catalog. It includes complete drawings and specifications on all standard units. Ask for bulletin C20.



HAMMARLUND

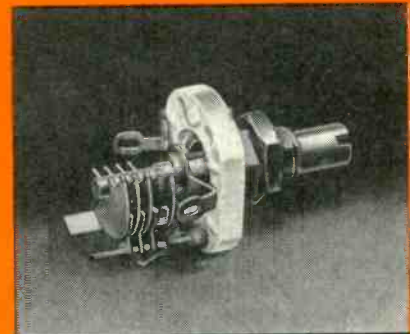

Miniature "MAC"
Variable Capacitor

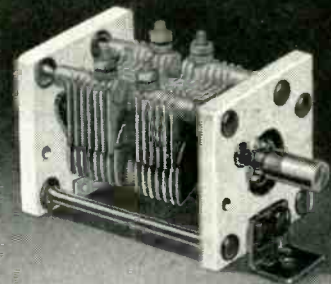

"VU" Capacitor
For Up to 500 Mc



Special 3-Gang
Precision Capacitor

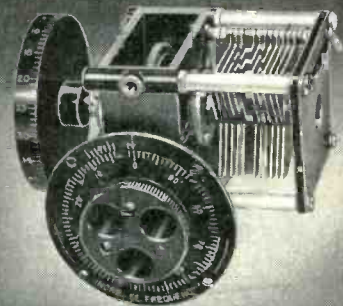

Precision Frequency
Meter Capacitor

THE HAMMARLUND MANUFACTURING COMPANY, INC.
Main Plant and Offices: 460 W. 34th ST., N. Y. 1, N. Y.
Midwest Sales Office: 605 N. Michigan, Chicago 11, Ill. • Export Sales Office: 13 E. 40th St., N. Y.

ing stray metal. Most are in food and confectionery plants. The next three markets are the plastics molding industry, rock and ore crushing, and the tobacco industry.

Prices range from \$450 to \$2,200 per unit, plus relatively low installation costs. The under-\$500 units are useful for packaged-product lines since wrapped or boxed candies, cereals and other foodstuffs on conveyor belts can go through relatively small search coils.

Electric solenoids or air cylinders are used to push metal-bearing packages off the line.

Food processors buy metal detectors primarily to protect their reputation and business, and secondarily to avert lawsuits. Detector units find way more metal than is indicated by customer complaints.

► **Medical Units**—Pinpointing the location of metal in the human body calls for specialized equipment that can be used during surgery to supplement preliminary x-ray findings. Since publication of first details of a successful instrument for this purpose (*ELECTRONICS*, p 114, May 1943), approximately 1,000 of the instruments have been sold by one company at an average price of around \$700. Biggest customer is the military, though many hospitals have units on hand for emergencies.

Navy Clarifies U.S. Manufacturing Specs

ELECTRONIC manufacturers who have done business with the U. S. government and experienced difficulty in interpreting U. S. manufacturing specifications can now obtain a guide for understanding them.

Written especially for commercial firms by Navy's Bureau of Ships, the guide covers both federal and military specs. It is being published in three sections covering specifications, qualified products lists and standards and is expected to be helpful to all manufacturers engaged in government business.

Electronics Research Enters Other Fields

Companies in sixteen other industries list electronics as major research specialty

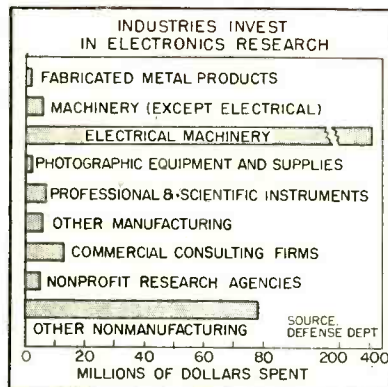

TOTAL of 277 companies in 16 industry classifications, ranging from the chemical field to machinery manufacturing, spent \$531 million mainly on electronics research, according to a survey of 1,953 firms made by the Department of Labor in 1951. A total of 144 of the companies that listed electronics as the main research specialty were in the electrical machinery classification, under which electronics firms are included. But of those outside the electronics field, 133 companies still listed electronics as their main research specialty.

► **Breakdown**—As shown in the chart, substantial money was spent by companies in other industries for electronics research. Two chemical manufacturers, two in aircraft, two glass companies and one in metals spent the bulk of \$13.7 million on electronics research. Four firms in the fabricated metal products field spent \$597,000 mainly on electronics and seven machinery manufacturers spent over \$2.9 million. Five photographic equipment companies spent nearly \$1.0 million during the year and 42 other scientific instrument firms spent \$6.3 million. Eight companies in other manufacturing lines spent \$5.6 million bringing the

total for all manufacturing to \$435.0 million.

Non-manufacturing firms spent nearly \$96.5 million on research in electronics. A total of \$12.6 million was spent by commercial consulting firms in the field and three non-profit research agencies spent over \$5.4 million. Eleven other non-manufacturing companies spent \$78.6 million on research that was largely in the electronics field.

Financial Roundup

DESPITE the decline in electronic stock prices that has been evident since the beginning of 1953, electronic manufacturers continued to report healthy profits in 1953. For the first nine months of the year, net profits for twelve companies were as follows:

Company	1953	1952
Circle Wire	\$1,529,679	\$1,644,135
IT&T	14,926,304	15,324,144
W. L. Maxson (12m)	1,085,000	526,000
Philco	15,418,000	6,037,000
Reliance Electric (12m)	1,832,778	1,816,140
Sangamo	1,633,077	1,427,745
Servomechanisms	276,613	243,556
Standard Coil	3,306,963	1,963,945
TelAutograph	203,791	154,686
Thompson Products	7,463,109	6,101,678
Tung-Sol	1,423,284	1,288,324
Weston Instrument	825,395	810,080

American Car & Foundry, which entered the electronics field in 1953 with an investment in Avion Instrument, reported net profits for the first nine months of \$1,954,660 compared to \$4,225,302 during the same period in 1952. Burroughs Corp., which became more active in the electronic computer field in 1953, reported net profits for the first nine months of \$5,310,105 compared to \$5,764,172 in the first three quarters of 1952.

► **Securities**—General Precision Equipment offered 108,167 shares of \$2.90 cumulative convertible preferred stock, without par value, at a rate of one preferred for six common. Proceeds will be used for expansion through the acquisition of companies, to repay bank loans and to increase general corporate funds.

Laboratory of Electronic Engineering of Washington D. C. filed with SEC covering 17,523 shares of

(Continued on page 26)



ELECTRONIC TEST INSTRUMENTS



TEST VOLTAGE PROBLEMS 1/100 cps to 10 mc?

Hewlett-Packard has 17 different oscillator models. Some are highly specialized, others are all-purpose instruments. Almost certainly, there's a model to meet your exact requirements. All are precision instruments of highest quality. All embody the famous RC circuit pioneered by *-hp-*. Check the table below for the oscillator that can help you most. Then write us for complete operating and application details.

-hp- 200CD AUDIO OSCILLATOR

World standard for electronic or electrical measurements, now redesigned with wider range, lighter weight, smaller size. Use for any lab, field or production problem in sub-audio, audio, telephony, carrier, supersonic, telemetering or rf measurement fields. Highest stability, low distortion, constant output, no zero set while operating. With carrying strap for bench or portable use; or for rack mounting.

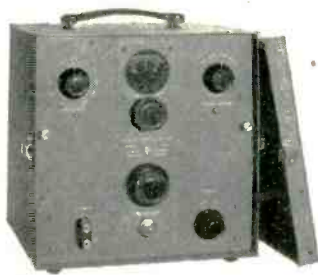

-hp- 204A Battery-Operated Oscillator

Precision instrument for measurements 2 cps to 20 kc where ac power is not available. Compact, light weight, weather-proofed—extra rugged construction for field duty. Frequencies set and read directly on large dial. Particularly useful for telephone or remote broadcast line checks, strain gauge applications, telemetering and geophysical measurements. Provides completely hum-free signal. Operates from flashlight and 45-volt batteries. Output stable and constant throughout range.

Instrument	Primary Uses	Frequency range	Output	Price
-hp- 200AB	Audio tests	20 cps to 40 kc	1 watt/24.5v	\$120.00
-hp- 200CD	Audio and ultrasonic tests	5 cps to 600 kc	160 mw/20v open circuit	150.00
-hp- 200H	Carrier current, telephone tests	60 cps to 600 kc	10 mw/1v	350.00
-hp- 200I	Interpolation, frequency measurements	6 cps to 6 kc	100 mw/10v	225.00
-hp- 201B	High quality audio tests	20 cps to 20 kc	3w/42.5v	250.00
-hp- 202A	Low frequency measurements	.01 cps to 1 kc	20 mw/10v	450.00
-hp- 202B	Low frequency measurements	1/2 cps to 50 kc	100 mw/10v	350.00
-hp- 202D	Low frequency measurements	2 cps to 70 kc	100 mw/10v	275.00
-hp- 204A	Portable, battery operated	2 cps to 20 kc	2.5 mw/5v	175.00
-hp- 205A	High power audio tests	20 cps to 20 kc	5 watts	390.00
-hp- 205AG	High power tests, gain measurements	20 cps to 20 kc	5 watts	425.00
-hp- 205AH	High power supersonic tests	1 kc to 100 kc	5 watts	550.00
-hp- 206A	High quality, high accuracy audio tests	20 cps to 20 kc	+15 dbm	550.00
-hp- 230A	Carrier test oscillator	35 cps to 35 kc	+14 dbm/600 ohms	275.00
-hp- 233A	Carrier test oscillator	50 cps to 500 kc	3w/600 ohms	475.00
-hp- 234A	Carrier test oscillator	160 cps to 160 kc	+14 dbm/600 ohms	300.00
-hp- 650A	Wide range video tests	10 cps to 10 mc	15 mw/3v	475.00



-hp- 650A Resistance-Tuned Oscillator

Highly stable, wide band (10 cps to 10 mc) oscillator particularly useful for testing television amplifiers, receiver alignment, bridge or carrier circuits, wide band systems; determining tuned circuit response. Operates independently of line or tube changes, requires no zero setting. Output flat within 1 db throughout range, monitored with VTVM. 60 db attenuator adjusts in 10 db steps.



-hp- 202A Low Frequency Function Generator

Compact, convenient, all-purpose source of transient-free voltages between 1/100 cps and 1 kc. Provides distortion-free signals for vibration studies, servo applications, medical and geophysical work and other subsonic problems. Generates sine, square or triangular waves. Output 10 v RMS, balanced or single ended, 1% distortion, constant within 0.2 db.

Data subject to change without notice. Prices f. o. b. factory

HEWLETT-PACKARD COMPANY

2711A PAGE MILL ROAD • PALO ALTO, CALIFORNIA, U. S. A.

SALES REPRESENTATIVES IN PRINCIPAL CITIES

Export: Frazar & Hansen, Ltd., New York City, San Francisco, Los Angeles



Instruments for Complete Coverage

class A common stock to be offered at par (\$10 per share). Proceeds are to be used for working capital.

Power Condenser And Electronic Corp. filed with SEC covering 47,000 shares of common (par \$1), the proceeds of which are to be used to finance the corporations research program and for laboratory equipment.

Trad Television filed with SEC covering 2,400,000 shares of common stock (par 1 cent), to be offered at 12.5 cents a share. Proceeds are for working capital.

CAA Ponders Dropping Older Radio Ranges

ON THE BEAM, to those who fly planes, refers to the characteristics of the four-course radio range. Interlocked Morse characters A (dot-dash) and N (dash-dot), audible on either side of a center line, merge into a continuous dash when aircraft are on the beam, flying squarely towards the transmitter.

► **More Courses**—Besides operating 335 of these low-frequency ranges, Civil Aeronautics Administration has 369 of a newer vhf type known as very high-frequency omnidirectional range (VOR). Although a VOR does not, in practice, supply 360 beams, it does provide about 90 as compared with the radio-range's four. There are other advantages.

CAA now proposes to shut down 64 of the older ranges, in accordance with a modernization program begun in 1948. Pointing out that about 19,000 vhf receivers have been produced and more than 1,700 have been installed in the scheduled air-carrier fleet, F. B. Lee, Administrator of Civil Aeronautics, believes some of the older ranges can be abandoned.

"Since this means that more than half the 32,000 civil aircraft equipped with two-way radio are potentially capable of performing instrument flight by means of vhf facilities," said Mr. Lee, "conditions are appropriate to accelerate our decommissioning program without endangering safety."

MEETINGS

- JAN.18-22, 1954: Winter Meeting of AIEE, Hotel Statler, New York, N. Y.
- JAN. 26, 27, 1954: AIEE Scintillation Counters Conference, Washington, D. C.
- JAN. 1954: Conference on Radio Astronomy, Carnegie Institute of Washington, California Institute of Technology and National Science Foundation, Washington, D. C.
- FEB. 4-6, 1954: Sixth Annual IRE Conference And Electronics Show, Hotel Tulsa, Tulsa, Oklahoma.
- FEB. 4-6: West Coast Audio Fair, Los Angeles, Calif.
- FEB. 11-12, 1954: Joint IRE, AIEE, ACM West Coast Computer Conference, Ambassador Hotel, Los Angeles, Calif.
- FEB. 18-19: IRE, AIEE Conference on Transistor Circuits, Philadelphia, Pa.
- MAR. 22-25: IRE National Convention, Waldorf-Astoria Hotel and Kingsbridge Armory, New York, N. Y.
- APRIL 22-23, 1954: AIEE Conference On Feedback Control, Claridge Hotel, Atlantic City, N. J.
- APRIL 24, 1954: Eighth Annual Spring Technical Conference, Cincinnati IRE, Cincinnati.
- APRIL 27-29: AIEE Electronic Components Conference, Washington, D. C.
- MAY 4-6: The 1954 Electronic Components Symposium, Department of Interior auditorium, Washington, D. C.
- MAY 5-7: 1954: Third International Aviation Trade Show, 71st. Regiment Armory, New York, N. Y.
- MAY 7-8: New England Radio Engineering Meeting, IRE, Sheraton Plaza Hotel, Boston, Mass.
- MAY 17-20: 1954 Electronic Parts show, Conrad Hilton Hotel, Chicago, Ill.
- MAY 24-26, 1954: AIEE Conference On Telemetering, Morrison Hotel, Chicago, Ill.
- MAY 25-27: Eighth NARTB Broadcast Engineering Conference, Palmer House, Chicago, Ill.
- JULY 6-9, 1954: International Conference On Electron Microscopy, Joint Commission on Electron Microscopy of International Council of Scientific Unions, London, England.
- JULY 8-12: British IRE 1954 Convention, Christ Church, Oxford, England.
- AUG. 24-SEPT. 4: National Radio Show of Great Britain, Earls Court, London, England.
- AUG. 26-28: 1954 Western Electronic Show & Convention, Los Angeles, Calif.
- SEPT. 1-16: Golden Jubilee Meeting of the International Electrotechnical Commission, University of Pennsylvania, Philadelphia, Pa.
- SEPT. 13-24: 1954: First International Instrument Congress And Exposition, Commercial Museum and Convention Hall, Philadelphia, Pa.
- SEPT. 1954: International Scientific Radio Union, Amsterdam, Netherlands.
- SEPT. 30-OCT. 2, 1954: Second Annual International Sight and Sound Exposition, Palmer House Hotel, Chicago, Ill.

Industry Shorts

- **Petition** of manufacturer's committee to FCC asks for reassignment of 40 Citizens Radio frequencies to a proposed Manufacturers Radio Service. They also ask for point-to-point authorizations to link separated operating centers. Fifty-six large companies support the petition.
- **Tele-meter** pay-to-see tv made its commercial debut in Palm Springs, Calif. to 70 customers who paid \$21.75 for meter installation and \$1.35 to see a first-run movie.
- **Intermetall** Desellschaft of Dusseldorf, Germany plans a U. S. affiliate in New York City to sell transistors and crystal products.
- **Navy** will shortly release tool

drawings for modular design of electronic equipment developed under Project Tinkertoy, through OTS, Dept. of Commerce. Industry can use it without license.

► **Aircraft** factories have appealed to FCC for more frequencies for use by vehicles feeding parts to airplane production lines.

► **Sales** of GE diamond styli increased 400 percent during the first nine months of 1953 compared to the same period in 1952.

► **Survey** of 545 Sarkes-Tarzian employees reveals that although over 85 percent would be willing to pay \$500 for a color tv set, a larger percentage would wait two years for the price to come down to \$300.

Westinghouse Ignitron Gives 16 Years' Trouble-Free Service



In the Westinghouse plant in Elmira, N. Y., Donald E. Marshall, Section Manager of Gas and Industrial Tube Development, holds a KU-671 Ignitron retired after more than 32,000 hours service.

This rugged old Westinghouse Ignitron was finally retired after 16 years' service only because re-design of resistance welding equipment made a modern Westinghouse Ignitron simpler to use; it is still operable. An exclusive Westinghouse design, the KU-671 was developed in 1937 a few years after Westinghouse engineers first invented the Ignitron—it was the first Ignitron type to be sealed, its predecessors being continuously pumped while in service. (Even some of those earlier Westinghouse tubes are still in active service—pumps and all!)

To an electronic equipment designer such performance means two things:

First, a Westinghouse Ignitron designed into a circuit means reliability and long service with-

out repair, replacement, or down-time due to failure—just as when Westinghouse invented and developed the tube.

Second, the wide variety of modern metal-encased Ignitrons by Westinghouse offers designers of resistance welding and power rectification equipment and inverters possibilities not yet fully explored.

Since the first Ignitron, Westinghouse continued to forge ahead and adapt its Ignitrons to new, more difficult and more exacting applications. Through continuing research and development, Westinghouse has maintained leadership through the years.

For the latest application data, or for design aids or suggestions, write to Department A-1014 at the address below, or call your nearest Westinghouse Electronic Tube sales office.

ET-95050

YOU CAN BE SURE...IF IT'S
Westinghouse

RELIASTRON TUBES
TM

WESTINGHOUSE ELECTRIC CORPORATION, ELECTRONIC TUBE DIVISION, ELMIRA, N. Y.



DESIGNER'S

Thyrite* resistance material offers new answer to many circuit problems

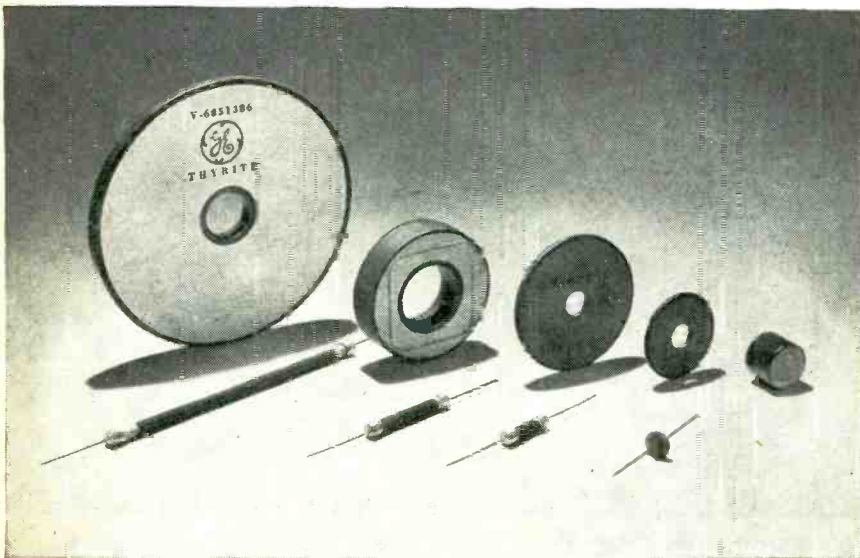

Here's a silicon-carbide ceramic material, dense and mechanically strong, having non-linear resistance in which I varies as E^n —the current varies as a power of the applied voltage. General Electric Thyrite resistance characteristic is stable and substantially independent of polarity or frequency. Because of this notable electrical property, it has solved many important circuit problems in electronic applications. Available in disk-type, rod-type, or miniature resistors, Thyrite material can also be successfully molded to meet your special needs. Unaffected by pressure or vibration, it can operate in temperatures up to 150 C. Its special coating compound minimizes the effect of humidity. See Bulletin GEA-4138.

*Reg. Trade-mark of the General Electric Company.

Drawn-oval capacitors reduce size, weight, and cost of your equipment

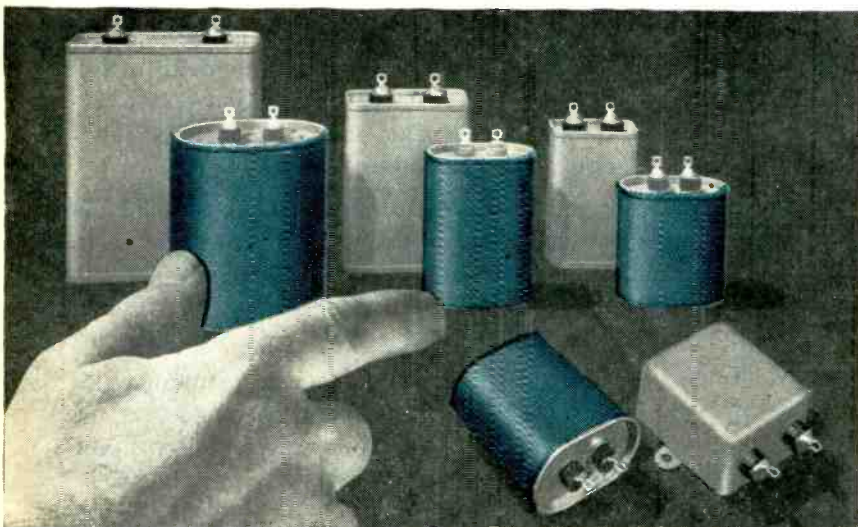

This full line of General Electric paper-dielectric capacitors features size and weight reductions up to 30 percent! They are also mechanically stronger than conventional types because of their drawn-steel containers with cover attached by double-rolled seam. You get space and cost savings plus improved reliability. Moreover, shipments arrive faster. Sturdy brackets offer versatility of mounting. Dual-rated (both a-c and d-c), these versatile capacitors are designed to replace styles CP 53 and CP 70, in ratings from 1 to 10 muf, 600 to 1500 volts d-c and 330 to 660 volts a-c. For more information check Bulletin GEA-5777.

GENERAL ELECTRIC

DIGEST

TIMELY HIGHLIGHTS ON G-E COMPONENTS



Withstands vibration

Now the improved General Electric hermetically sealed relay withstands vibration forces of 10g from 10 to 500 cycles per second, offers extra protection against permanent breakdown due to voltage surges. Coil ratings up to 10,000 ohms. Contact configurations available include 4-pole double-throw and 6-pole single throw. See Bulletin GEA-5729.

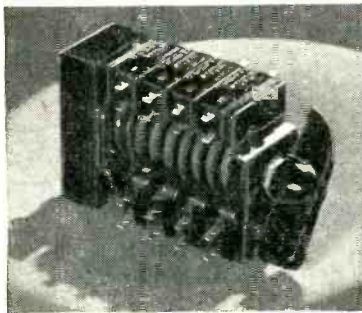

Controls 20 circuits

Compact, lightweight and easy to mount, these G-E cam-operated selector switches help solve many intricate circuit-combination or sequencing problems . . . control from one to 20 circuits, in any operating sequence within the limits of 12 positions . . . operate at altitudes up to 50,000 feet, and in temperatures from 200 F to -70 F. Check Bulletin GEA-4493.

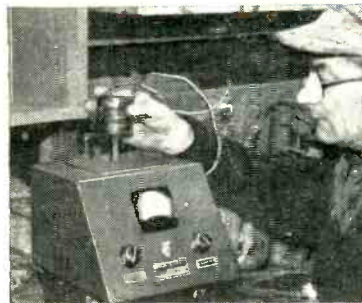

Quickly locates shorts

Minimize the hazards of short circuits quickly, easily with General Electric low-voltage coil testers. These portable units are designed to test coils before assembly in relays, radios, small transformers and instruments. They maintain accurate on-the-spot service for long use. Can also be used to detect open circuits. See Bulletin GEC-964.

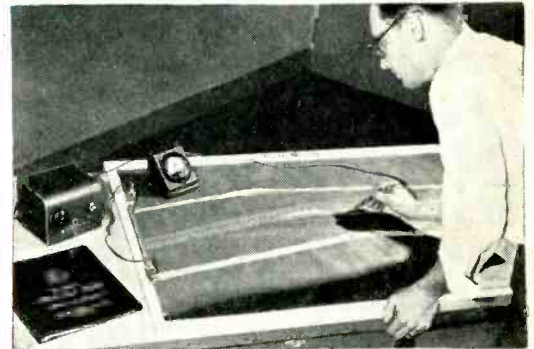

G-E analog plotter helps solve complex field problems — fast

Now you can simplify and speed up those complex field studies by using General Electric's analog field plotter. By means of electric current flow patterns set up in a sheet of thin conducting paper, over-all operation of plotting in two dimensional fields is greatly simplified. Problems in electrostatics, electromagnetics, and many other fields are rapidly solved with this sensitive, versatile plotting board and the complete package of components necessary for making field studies. It needs only low-voltage d-c supply, which eliminates shock hazard, and is not affected by line-voltage variations. Explanation and instructions are covered in a 50-page manual accompanying the plotter. For full details, see Bulletin GEC-851.



EQUIPMENT FOR ELECTRONIC MANUFACTURERS

Components

Meters, Instruments
Dynamometers
Capacitors
Transformers
Pulse-forming networks
Delay lines
Reactors
Thyrite material
Motor-generator sets
Inductors
Resistors
Voltage stabilizers

Fractional-hp motors
Rectifiers
Timers
Indicating lights
Control switches
Generators
Selsyns
Relays
Amplidyne
Amplistats
Terminal boards
Push buttons
Photovoltaic cells
Glass bushings

Development and Production Equipment

Soldering irons
Resistance-welding
control
Current-limited high-
potential tester
Insulation testers
Vacuum-tube voltmeter
Photoelectric recorder
Demagnetizers

General Electric Company, Apparatus Sales Division
Section A 667-27, Schenectady 5, New York

Please send me the following bulletins:

- for reference only for planning an immediate project
- GEA-4138 Thyrite Resistance Material
 - GEA-4493 Selector Switches
 - GEA-5729 Hermetically Sealed Relays
 - GEA-5777 Drawn-oval Capacitors
 - GEC-851 Analog Field Plotter
 - GEC-964 Low-voltage Coil Tester

Name _____

Company _____

City _____ State _____

KEPCO

VOLTAGE REGULATED POWER SUPPLIES

VOLTS	CURRENT	REGU- LATION	RIPPLE	6.3 V.† AC. CT.	MODEL
0-1500	0-200 Ma.	0.5%	20 Mv.		1520
0-1200	0-20 Ma.	0.1%	10 Mv.	10 Amp.	1220
0-1000	0-500 Ma.	0.5%	20 Mv.		1350
200-1000	0-500 Ma.	0.5%	20 Mv.		1250
0-1000	0-50 Ma.	0.1%	10 Mv.	10 Amp.	1020
0-600	0-3 Amp.	0.5%	10 Mv.		780
0-600	0-2.25 Amp.	0.5%	10 Mv.		770
0-600	0-1.5 Amp.	0.5%	10 Mv.		760
0-600	0-750 Ma.	0.5%	10 Mv.		750
0-600	0-300 Ma.	0.5%	10 Mv.	10 Amp.	615
0-150 Bias	0-5 Ma.	*	5 Mv.		
0-600	0-300 Ma.	0.5%	10 Mv.	10 Amp.	500R
#1 0-600	0-200 Ma.	0.5%	5 Mv.	10 Amp.	800
#2 0-600	0-200 Ma.	0.5%	5 Mv.	10 Amp.	
0-600	0-200 Ma.	0.5%	5 Mv.	10 Amp.	815
0-150 Bias	0-5 Ma.	*	5 Mv.		
#1 200-500	0-200 Ma.	0.5%	5 Mv.	6 Amp.	510
#2 200-500	0-200 Ma.	0.5%	5 Mv.	6 Amp.	
200-500	0-200 Ma.	0.5%	5 Mv.	6 Amp.	245
0-400	0-150 Ma.	0.5%	5 Mv.	10 Amp.	2400
0-400	0-150 Ma.	0.5%	5 Mv.	10 Amp.	
0-150 Bias	0-5 Ma.	*	5 Mv.		
0-400	0-150 Ma.	0.5%	5 Mv.	10 Amp.	400
0-150	0-5 Ma.	*	5 Mv.		
100-400	0-150 Ma.	0.5%	5 Mv.	10 Amp.	141
100-400	0-150 Ma.	0.01%	1 Mv.	10 Amp.	2000
0-350	0-3 Amp.	0.5%	10 Mv.		730
0-350	0-2.25 Amp.	0.5%	10 Mv.		720
0-350	0-1.5 Amp.	0.5%	10 Mv.		710
0-350	0-750 Ma.	0.5%	10 Mv.		700
100-325	0-150 Ma.	0.5%	5 Mv.	10 Amp.	131
0-150 Bias	0-5 Ma.	*	5 Mv.		
0-300	0-150 Ma.	0.5%	5 Mv.	5 Amp.	315
0-150 Bias	0-5 Ma.	*	5 Mv.		
0-150	0-50 Ma.	0.5%	5 Mv.		150
3-30	0-30 Amp.	0.5%	0.1%		3030
1-13	0-10 Amp.	0.5%	10 Mv.		3200
0.3-3	0-100 Ma.	5 Mv.	1 Mv.		3100

WORKMANSHIP

Workmanship is of a quality with the highest existing production standards and best instrument electronic practices consistent with the intended use of the item as a continuous duty voltage regulated power supply. Oil filled paper condensers and resistor-board construction are included in the design.

FOR NEW POWER SUPPLY CATALOG — WRITE DEPT. No. 789

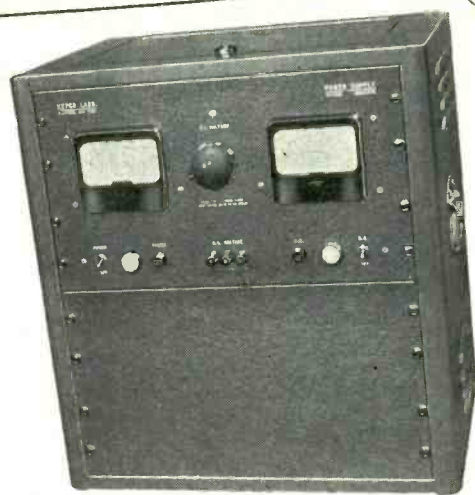

MODEL 700

OUTPUT DC: 0-350 volts, 750 ma.

REGULATION: ½% for both line, 105-125 volts, and load variations, 0-750 ma.

RIPPLE: 10 millivolts.

This unit is available delivering: }
 1.50 amp.—Model 710
 2.25 amp.—Model 720
 3.00 amp.—Model 730

KEPCO

Voltage Regulated Power Supplies are conservatively rated. The regulation specified for each unit is available under all line and load conditions within the range of the instrument.

DC POWER SUPPLY SPECIFICATIONS

REGULATION: As shown in table for both line fluctuations from 105-125 volts and load variations from minimum to maximum current.

***REGULATION FOR BIAS SUPPLIES:** 10 millivolts for line 105-125 volts. ½% for load at 150 volts.

†All A.C. Voltages are unregulated.

All units are metered except Models 131, 315 and 3100.

All units are designed for relay rack mounting or bench use.

MANUFACTURERS OF ELECTRONIC EQUIPMENT • RESEARCH • DEVELOPMENT

KEPCO

LABORATORIES

131-38 SANFORD AVENUE • FLUSHING 55, N.Y.

YOU CAN AFFORD to use Hermetic Seals

**COSTS IN THE PAST 3 YEARS HAVE BEEN CUT AS MUCH AS 50%
BY THE WORLD'S LARGEST PRODUCER OF GLASS-METAL HEADERS**

 For many years most hermetic seals were channeled into special purpose applications for components used under extremes of climatic conditions. Because they have increased the working life of so many controls no matter what the operating difficulties were, their use has grown apace.

HERMETIC SEAL PRODUCTS CO. has always been the pioneer in this greatly expanding new activity. They have had a substantial head start in developing new mass-production methods and techniques and now can offer glass-metal seals for applications that were never before possible. Particularly, since costs have been dropped as much as 50% in the past 3 years. That's why we urge all manufacturers to discover for themselves the real economies now available in the application of hermetic seals to their production of rectifiers; relays; communication components; geological equipment; aircraft and airport instruments; frequency control devices; hearing aids; switches; resistors; transistors; germanium products; coils; radio and TV parts; transformers; and other related parts.

 In addition to the present lower cost of hermetic seals, there are also many other advantages that will be derived from their use. Less expensive parts that will still perform with maximum efficiency may be used in enclosures because entire units can be completely protected . . . sealed in by glass-metal headers.

Going a step further, HERMETIC's new VAC-TITE* Compression components for hermetic sealing. The complete header can be soldered right into the can, effecting additional savings in handling and assembly operations. Servicing is simplified. You merely remove the part to be replaced and insert a complete new hermetically sealed unit.

Because hermetic sealing brings so many advantages in price and ease of production to manufacturers of commercial components, write today detailing your requirements so that our design engineers may provide you with suggestions and seals for the parts you are making . . . in small or large quantities.

*VAC-TITE is HERMETIC's new vacuum proof compression-construction, glass to metal seal. In addition to special shapes, many standard sizes such as .800 O.D. and .900 O.D. multi-terminal headers and a large variety of individual terminals are available in VAC-TITE Compression Seals.

FIRST AND FOREMOST IN MINIATURIZATION

HERMETIC SEAL PRODUCTS CO. 31 South Sixth Street, Newark 7, New Jersey



TYPE J BRADLEYOMETER
2 WATT



ENLARGED VIEW

TYPE G BRADLEYOMETER
1/3 WATT



ACTUAL SIZE

**Type G
Bradleyometers**

Made with two types of bushings . . . the standard bushing and straight shaft for knob control, and the split bushing with lock nut and slotted shaft for shaft lock applications. Metal parts are all of corrosion resistant materials.

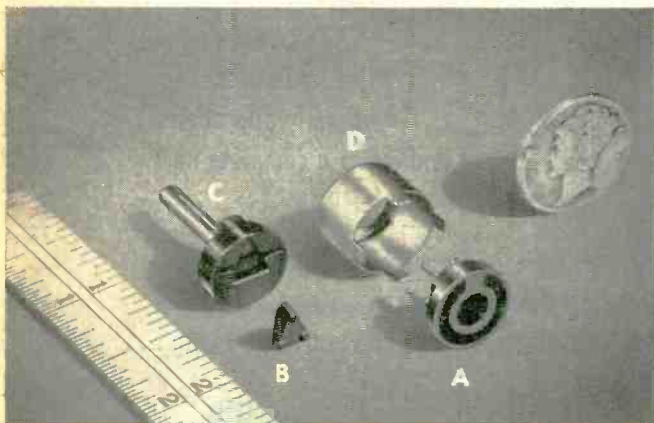

**Type G
Bradleyometer
Component
Parts**

A—Resistor element—molded in one piece with resistor and terminals. No rivets or welds—no maintenance problems.
B—Carbon brush—which fits into triangular opening in rotor and makes contact with resistor ring at any point.
C—Rotor and shaft—showing triangular opening or recess for holding the brush; a spring keeps brush firmly against the resistor element.
D—Metal case made of corrosion resistant metal. Diameter—1/2 inch.

**SMALLEST MOLDED
ADJUSTABLE RESISTOR**

• ONLY 1/2" DIAMETER •

for Rheostat or Potentiometer Service

The Type J Bradleyometer has long been recognized as the top quality, 2-watt, adjustable resistor for electronic applications. Since it has a solid MOLDED composition resistor . . . and is not a paint or spray type unit . . . its characteristics remain permanent even after long use.

The new, Type G Bradleyometer . . . only 1/2 inch in diameter and rated at 1/3 watt . . . offers the same advantages of construction and noiseless performance as the bigger, Type J unit. Its solid MOLDED resistor element can be made to satisfy any resistance-rotation curve. The carbon contact brush assures quiet operation, even improving with long service.

Maximum or total resistance values range from 100 ohms to 5 megohms. Maximum continuous power for the entire element in circuit is 0.33 watt. Maximum continuous volts—350 RMS. Maximum current—0.1 ampere.

Samples can be supplied for qualification tests.

Allen-Bradley Co.
110 W. Greenfield Ave., Milwaukee 4, Wis.

ALLEN-BRADLEY

FIXED & ADJUSTABLE RADIO RESISTORS



Sold exclusively to manufacturers of radio and electronic equipment

TUNG-SOL®



DAMPER DIODE



*for TV use with picture
tubes having 90° deflection*

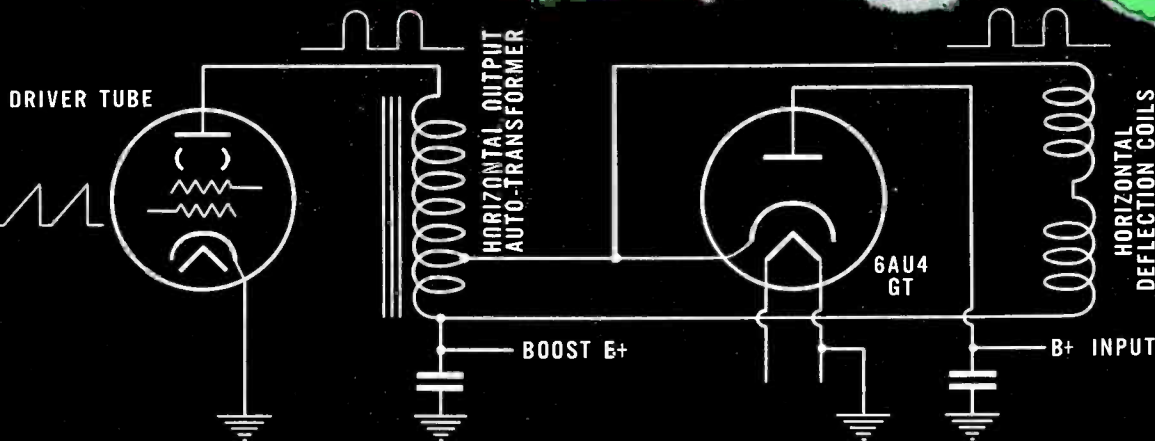

see other side for additional information →

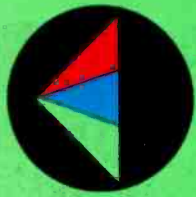

6AU4 GT



DAMPER DIODE

*A Tung-Sol Designed
and Developed Tube*

DIRECT INTERELECTRODE CAPACITANCES

Heater to Cathode: (H to K)	4.0	μf
Plate to cathode and heater: P to (H+K)	8.5	μf
Cathode to plate and heater: K to (P+H)	11.5	μf

RATINGS ^A

Interpreted according to RTMA Standard M8-210

DAMPER DIODE ^B

Heater voltage	6.3	VOLTS
Maximum heater cathode voltage:		
Heater negative with respect to cathode		
DC	900	VOLTS
Total DC and peak (absolute maximum)	4 500	VOLTS
Heater positive with respect to cathode		
DC	100	VOLTS
Total DC and peak	300	VOLTS
Maximum peak inverse plate voltage (absolute maximum)	4 500	VOLTS
Maximum DC plate current	175	MA.
Maximum steady state peak plate current	1 050	MA.
Maximum plate dissipation	6.0	WATTS
Average tube voltage drop (with tube conducting 350 MA.)	25	VOLTS

^A All values are evaluated on the design center system except where absolute maximum is stated.

^B For installation in a 525-line, 30-frame system as described in "STANDARDS OF GOOD ENGINEERING PRACTICE FOR TELEVISION BROADCASTING STATIONS: FEDERAL COMMUNICATIONS COMMISSION." The duty cycle of the horizontal voltage pulse, not to exceed 15% of scanning cycle.

The TUNG-SOL engineering which has produced the 6AU4GT is constantly at work on a multitude of special electron tube developments for industry. Many exceptionally efficient general and special purpose tubes have resulted. Information about these and other types is available on request to TUNG-SOL Commercial Engineering Department.



HERE is an entirely new Damper Diode designed to keep pace with the development of the large screen 90° deflection picture tube. Wider deflection angles and the increased second anode voltage so necessary to maintain picture brightness require higher deflection power and increased circuit efficiency. The 175 ma. rating of type 6AU4GT is more than adequate—with ample safety factor—for these new designs. "Stretching" the ratings of tubes designed for 70° deflection service is not sound engineering and invariably leads to production troubles and jeopardizes the service life in the field. This new tube is the answer.

The 6AU4GT retains the many features which have established the 6AX4GT as a favorite for the 70° deflection designs. Insulation between heater and cathode designed to withstand the full pulse plate-to-cathode voltage eliminates the need for separate power transformer windings insulated for high voltage. Improvements in the heater-cathode insulation have decreased the warm-up time and resulted in improved reliability. The 6AU4GT is produced under the same careful manufacturing techniques and the thorough quality control which the industry has come to expect from the Tung-Sol organization.

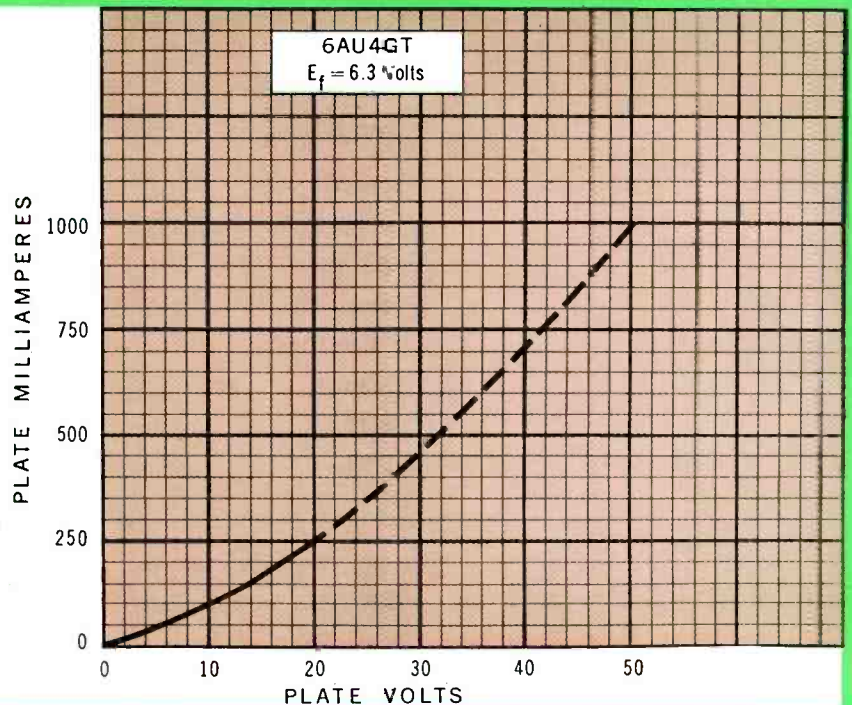

TUNG-SOL ELECTRON TUBES

TUNG-SOL ELECTRIC INC., Newark 4, New Jersey

Sales Offices: Atlanta, Chicago, Columbus, Culver City (Los Angeles), Dallas, Denver, Detroit, Newark, Seattle

TUNG-SOL makes All-Glass Sealed Beam Lamps, Miniature Lamps, Signal Flashers, Picture Tubes, Radio, TV and Special Purpose Electron Tubes and Semiconductor Products.

JANUARY, 1954

Behind the radar curtain that guards our shores

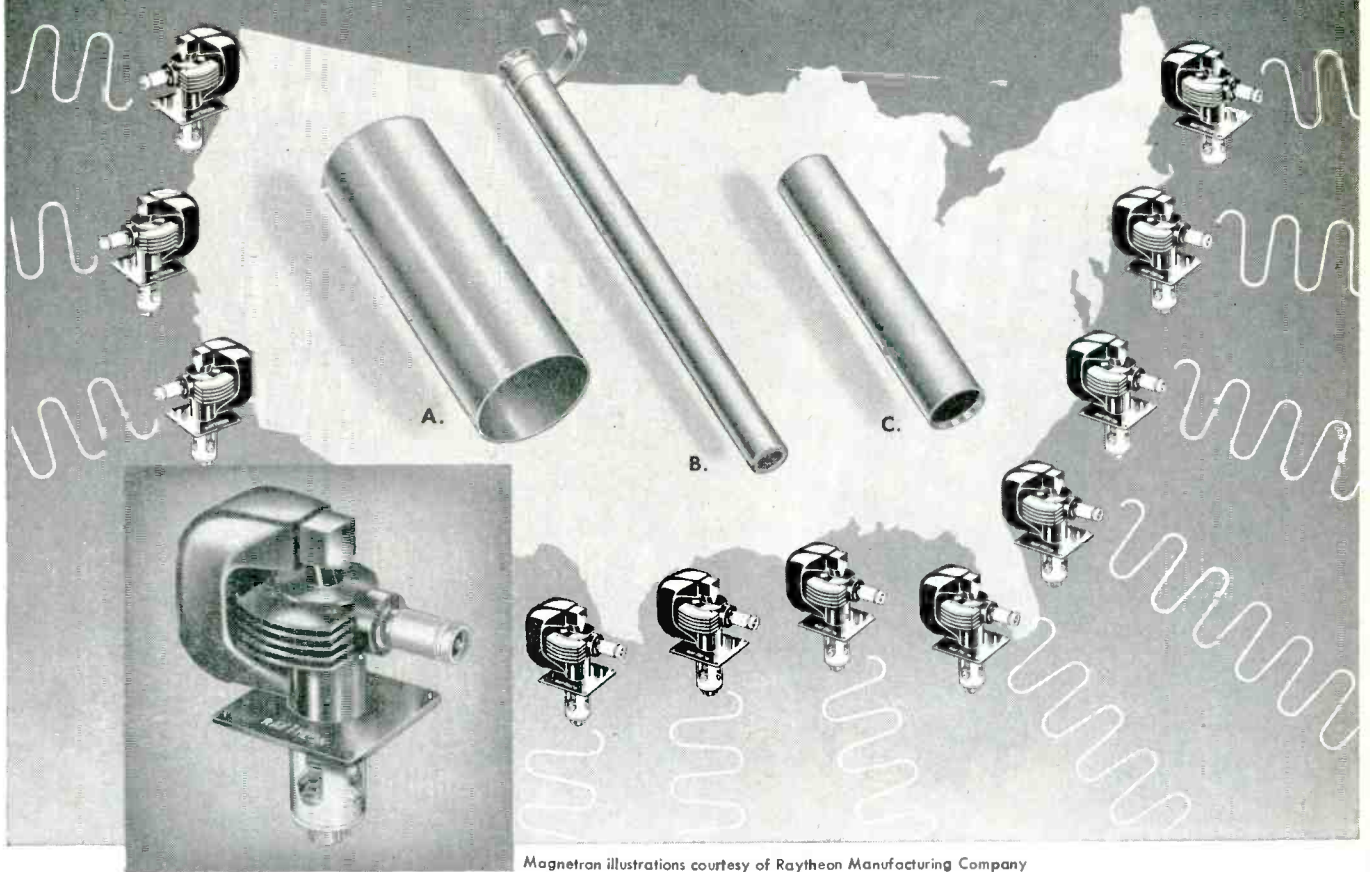

Magnetron illustrations courtesy of Raytheon Manufacturing Company

Source of UHF waves that make possible the radar screen guarding our continental perimeter is the magnetron.

Essential elements of the magnetron, and the anodes and cathodes of the companion direct-reading oscilloscope are produced by Superior Tube Company. For example, in the Raytheon magnetron above, Superior furnishes: A. The cathode (heart of the magnetron); B. The anode; C. The sleeve on the wave trap (or choke) assembly.

All of these parts are made from Superior seamless nickel tubing. As a matter of fact, there is Superior tubing in every one of the 400 different types of Raytheon magnetrons—a record possible only because of great satisfaction with Superior alloys, fabrication, deliveries and service. Put *your* chief dependence upon Superior. Superior Tube Company, 2500 Germantown Ave., Norristown, Pa.



Seamless Nickel Cathode. Oval, double bead. .025" x .048" x .003" Wall. 12mm long.

Lockseam* Nickel Cathode Round, vertical emboss. .045" OD x .0021" Wall. 26.5 mm long.

Disc Cathode* .121" OD, .312" long.

No. 2 Grid Cup, 305 Stainless Steel, Rolled edge. .499" OD x .010" Wall x .262" long.



All analyses .010" to 5/8" OD.

Certain analyses in Light Walls up to 2 1/16" OD.

Many other types of nickel cathodes—such as Lockseam*, made from nickel strip, disc cathodes, and a wide variety of stainless anodes, grid cups and other tubular fabricated parts are available from Superior. For information and free literature on these products as well as Cathaloy A-30, A-31**; our latest Cathode Alloys, address Superior Tube Company, Electronics Division, 2500 Germantown Avenue, Norristown, Pa.

*Manufactured under U.S. Patents
**U.S. Trademark applied for

DU MONT[®]

MULTIPLIER PHOTOTUBES

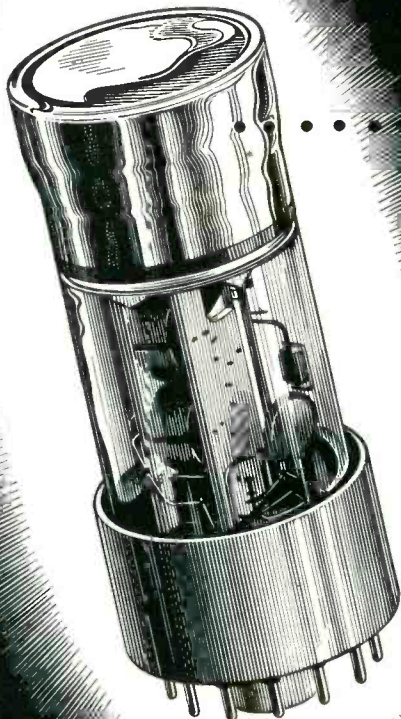

 **Guaranteed Minimum Specifications**

 **Low Dark Current**

 **Stability**

 **High Cathode Sensitivity**

Published specifications are not an average evaluation, but the *minimum* characteristics of *every* Du Mont Multiplier Phototube. Each Du Mont Multiplier Phototube is *guaranteed* to meet or better these specifications.

Whether your needs are for high average output current, good resolution, high signal-to-noise ratio, very high amplification, or any combination of these—you'll find them all in the Du Mont Multiplier Phototube.

For detailed information or specifications write to:

TECHNICAL SALES DEPARTMENT
ALLEN B. DU MONT LABORATORIES, INC.
760 BLOOMFIELD AVE., CLIFTON, N. J.



for all
continuous-motion
or single-frame
**OSCILLOGRAPH
RECORDING**



the
**TYPE
321**

OSCILLOGRAPH-RECORD CAMERA

- Continuous motion recording over the entire range of laboratory applications, including the most highly specialized investigations • Film speeds from 1 to 10,800 inches per minute. Film motion either horizontal or vertical • Overall accuracy of film speed guaranteed within 2% at proper line frequency • Friction film drive for simple loading. Permits use of perforated or unperforated film or paper • Single-frame recording of any phenomenon, including high-speed, single transients. Coated f/1.5 lens enables recording of spot-writing rates up to 35 inches/ μ sec from cathode-ray tube operated at 12,000 volts • Built-in timing lamp • Built-in illuminated data card • Simultaneous viewing and recording • Mounts quickly and easily on any standard 5-inch cathode-ray oscillograph • Delivery FROM STOCK.

(For 60-cycle power) **PRICE \$875**

DU MONT

ALLEN B. DU MONT LABORATORIES, INC., INSTRUMENT DIVISION, 760 BLOOMFIELD AVE., CLIFTON, N. J.

ELECTRONICS — January, 1954

Want more information? Use post card on last page.

SPECIFICATIONS

Optical System: Wollensak f/1.5 coated Raptar lens. Image reduction ratio 4.5.

Shutter: Permits "Time" and "Bulb." Provision for remote operation.

Writing-rate Capability: 35 in./ μ sec with Type P11 screen at 12,000 volts.

Film Speed: Variable in steps of: 0.8; 1.6; 2.5; 4.9; 7.4; 14.8; 22.2; 44.4; 66.6; 133.3; 200; 400; 600; 1200; 1800; and 3600 in/min with rolls up to 400 feet in length. Also 5400 and 10,800 in/min with film strips up to 10 feet in length. Accuracy of film speed within 2% at proper line frequency.

Recording Material: Perforated or unperforated 35 mm film or recording paper in lengths up to 400 ft.

WRITE for "Techniques of Photo-Recording," a 36-page handbook on cathode-ray photography.

Seven years a SELETRON CUSTOMER!

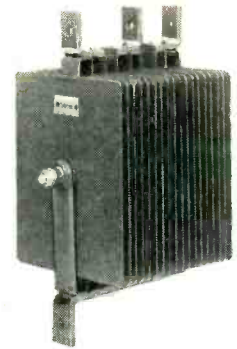

Seletron SELENIUM RECTIFIERS

When the problem is industrial rectification, a great number of rectification specialists such as Richardson-Allen Corporation look to SELETRON to do a lasting, dependable job. Need we amplify? The record speaks for itself.

SELETRON Selenium Rectifiers are available up the line from miniatures for Radio and TV and other electronic circuits, all the way to large power stacks required by heavy industry.

Do you need information on a problem in a rectification? We'll gladly help without obligation if you drop us a note today... and study our catalog in Sweet's Product Design File. We also manufacture germanium diodes and transistors.

CABLE ADDRESS: RIALRECT N.Y.

TELEPHONE: FLUSHING 1-7211

RICHARDSON-ALLEN CORPORATION
RECTIFIER SPECIALISTS

110-15 FIFTEENTH AVENUE
COLLEGE POINT, LONG ISLAND
NEW YORK

October 19, 1953.

Mr. Julian Loebenstein, Sales Manager
Seletron and Germanium Division,
Radio Receptor Company, Inc.,
251 West 19th Street,
New York 11, N. Y.

Dear Mr. Loebenstein:

We are planning a considerably expanded production for the new year and would like to know whether we can depend upon you for much heavier deliveries of the rectifiers we shall need.

Naturally we guard our reputation as manufacturers of power supplies carefully and, therefore, all components used must rank tops in their class -- with special attention to the rectifier stacks since the performance of our equipment depends so largely on them.

For the past seven years your Seletron selenium rectifiers have done a splendid job for us in applications for low voltage electroplating, and for power supplies of 110/220 volts. Both types of use involve individual jobs running into many kilowatts.

We are very greatly pleased with both your product and service which have helped result in repeated reorders from our customers and, therefore, want to be able to count on you to take care of our growing business.

Sincerely yours,
RICHARDSON-ALLEN CORPORATION
Harry Walker
Harry Walker,
Vice President.

HW:lk

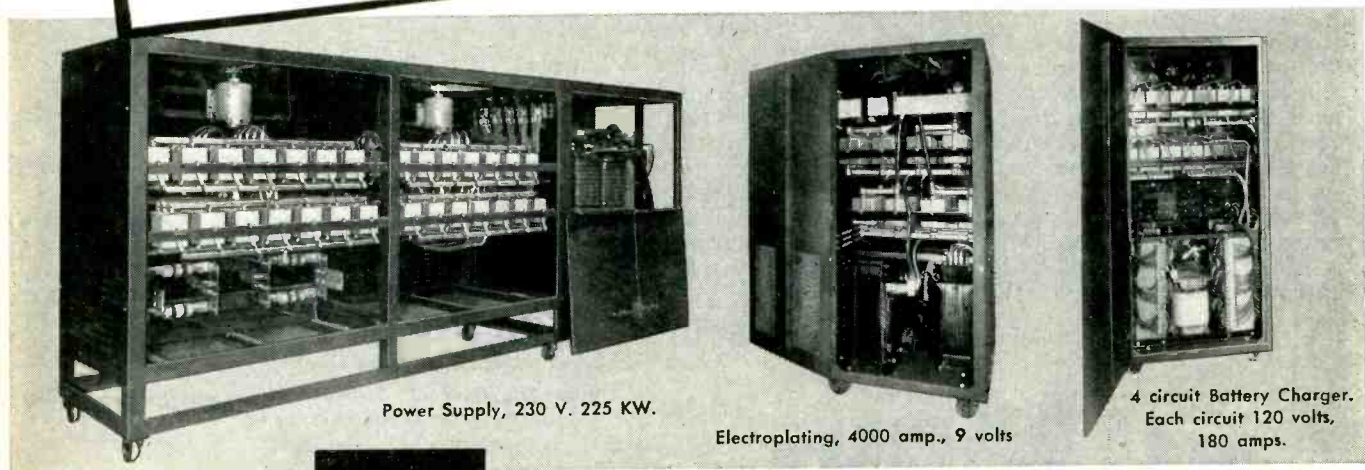

Power Supply, 230 V. 225 KW.

Electroplating, 4000 amp., 9 volts

4 circuit Battery Charger.
Each circuit 120 volts,
180 amps.

Seletron
and Germanium
Division



RADIO RECEPTOR COMPANY, Inc.

In Radio & Electronics since 1922

SALES OFFICE: 251 WEST 19th STREET, NEW YORK 11 • FACTORIES IN BROOKLYN, N. Y.



**THIS KARP VAULT
OF 3,000 TOOLS & DIES...**

Can Save You the Total Tooling Cost for Your Cabinet, Enclosure or Chassis

No Other Sheet Metal Fabricator Offers This Plus—During our business life beginning in 1925 we have invested in and accumulated thousands of the tools and dies used to produce sheet metal cabinets, chassis, housings and enclosures.

These Dies are Available to All Karp Customers—All of these Karp-owned dies are carefully recorded in our die books and catalogued in our die vaults. When our Engineering Department estimates your inquiry or methodizes your job—from your sketch, sample or drawings—they specify use of these stock tools and dies where possible.

Since our selection is so large, we are usually able to eliminate tooling costs entirely, a substantial saving for you.

Read "American Machinist's" 16-Page Article on Karp—This McGraw-Hill metal-working magazine, in its issue for December 7, 1953, described and illustrated the methods, facilities and skills which have made Karp the electronics industry's leading sheet metal fabricator. We will be glad to send you a reprint. It will convince you, we are sure, to consider Karp for your next job, whether it involves small quantities or large. Write for that reprint today.

KARP METAL PRODUCTS CO., Division of H & B American Machine Co.
215 63RD STREET • BROOKLYN 20, N. Y.

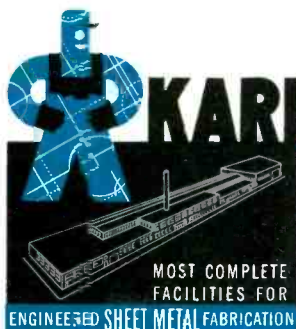
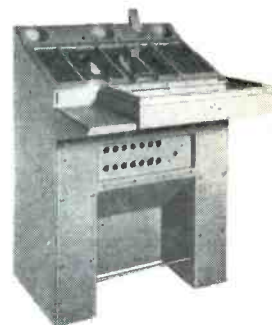

ENCLOSURES REFLECT THE SKILLS WITHIN

FACILITIES FOR ENGINEERED SHEET METAL FABRICATIONS: in aluminum or steel • long run or short • spot, arc, gas or heliarc welding • any type finish

- Modern plant—3 city blocks long
- Thousands of dies available
- Most modern of sheet metal fabricating equipment
- U. S. Air Force Certified Welding Facilities
- Air-conditioned spray room... complete baking facilities
- Complete sub-assembly facilities

Come Again



Radio - Electronic Men!

Just as you have been coming since 1945 to the IRE National Convention and Radio Engineering Show — coming by the thousands, 35,642 in '53 — so come again to see and hear all that is new in the engineering advances of your industry.

▲ Fifty-four in '54!

— 243 scientific and engineering papers will be presented, skillfully grouped by related interests into 54 technical sessions. More than half these sessions are organized by IRE Professional Groups, thus making the IRE National a federation of 21 conferences in one. The whole provides a practical summary of radio-electronic progress.

▲ **600 Exhibitors "spotlight the new!"** — A mile and a half of exhibits line the avenues of this show, intriguingly named for the elements of radio — such as "Instruments," "Components," "Airborne," "Radar," "Transistor," "Audio," "Microwave," etc., filling the four acres of the great Kingsbridge Armory to capacity. An expanding radio industry shows why it is growing by proving how engineering research pays out in new products. The exhibits themselves are an education, condensed to one place — reviewed in four days.

▲ Kingsbridge is the solution!

Only the combined facilities of the Waldorf-Astoria Hotel, plus the three great halls in the Kingsbridge Armory, seating 906, 720, and 500 respectively, are able to keep pace with the increased technical papers program of the IRE Convention. The show had to move because the U. S. Treasury took over Grand Central Palace. The immense Kingsbridge Armory, connected to the very satisfactory Lexington Avenue Hotel area by direct express subway, serves well to expand the already outgrown exhibit facilities of the Palace and pro-

vide space for 200 new firms to exhibit, as well as seat greater audiences at the high-interest sessions. In addition to the subways, free busses leave the Waldorf every ten minutes in which you may travel in the congenial company of fellow engineers, direct to Kingsbridge.

▲ **Admission by registration only!** Registration serves for the four day period. It is \$1. for IRE members, \$3. for non-members, covering sessions and exhibits. Social events priced separately.

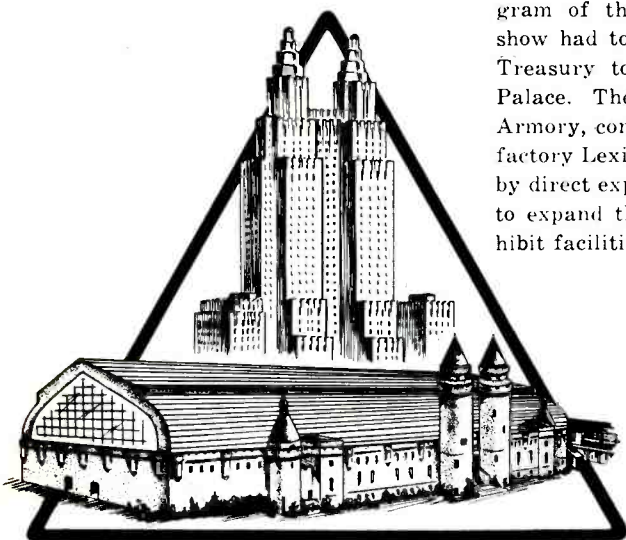

Waldorf-Astoria and Kingsbridge Armory

March 22-25, 1954

**The IRE National Convention
and
Radio Engineering Show**

THE INSTITUTE OF RADIO ENGINEERS

1 East 79th Street, New York City

"INTERFERENCE FREE" means

FILTERED by

FILTRON

FA 782—12 CIRCUITS
From .1 AMP to 15 AMP
28 VDC to 115 VAC, 400 CPS
Range 150 KC to 150 MC
Hermetically sealed

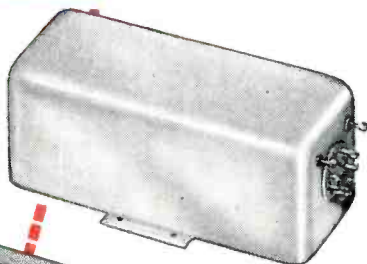

FA 1034A—18 CIRCUITS
From .5 AMP to 3 AMP
28 VDC to 115 VAC, 0-1000 CPS
Range 150 KC to 400 MC
Hermetically sealed

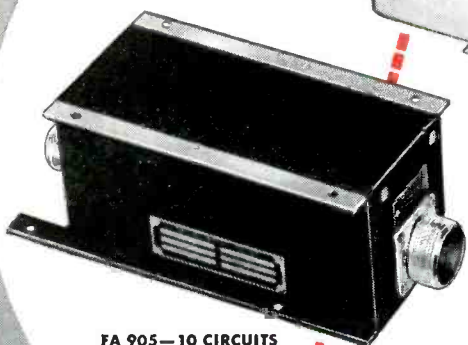
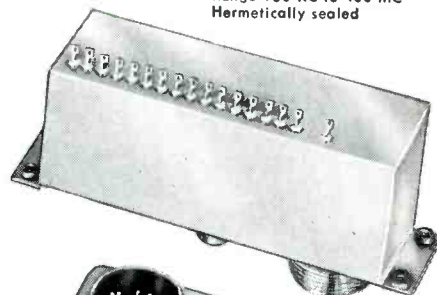

FA 905—10 CIRCUITS
From 4 MA to 5 AMPS
28 VDC to 600 VDC
Range 150 KC to 400 MC
Hermetically sealed

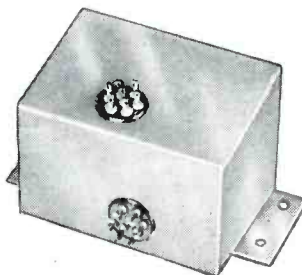

FA 512—7 CIRCUITS
From 100 MA to 5 AMP
100 VDC to 115 VAC
Hermetically sealed

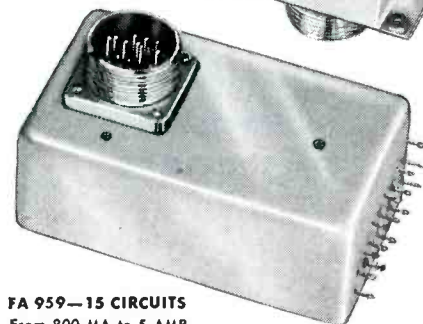

FA 959—15 CIRCUITS
From 800 MA to 5 AMP
115 VAC, 400 CPS
Range 150 KC to 400 MC
Hermetically sealed

Representative multi-section, high attenuation, hermetically sealed R.F. Interference Filters for space saving, simple installation and light weight applications.

THE newest types of Interference-Free Radar, Interference-Free Radio Transmitters, Interference-Free Receivers, Interference-Free Motor-Generator Sets, Interference-Free Inverters, Interference-Free Aircraft, Interference-Free Electronic Systems and numerous other "restricted" equipments incorporate FILTERS BY FILTRON.

Our complete engineering and manufacturing organization is devoted exclusively to the research, design

and production of RF interference filters to make YOUR products noise-free.

The Filtron Company is a complete engineering and manufacturing organization that pioneered the development of special filter types: subminiatures, high attenuation, completely hermetically sealed, high altitude, high temperature and wide-band multi-section units. Today we are producing more filters than ever before.

ENGINEERING: FILTRON'S highly specialized filter engineers will discuss, test, and design RF filters to make your products "noise-free". They will meet with you at your plant, or in our own shielded laboratories.

TEST & DEVELOPMENT: FILTRON'S test and development facilities are equipped with ALL interference-measuring and test equipment, in strict accordance with all Military Specifications.

MANUFACTURING: FILTRON'S modern production facilities comprise the following departments: Capacitor Manufacturing Division • Coil Winding Division • Tool and Die Departments • Environmental Test Department • Metal Drawing, Fabricating and Stamping Departments.

WHEN YOU HAVE A RF FILTER PROBLEM, CONSULT FILTRON—THE MOST DEPENDABLE NAME IN RF INTERFERENCE FILTERS.

SALES REPRESENTATIVES

G. S. Marshall Co., Pasadena, Cal. • Roy J. Magnuson, Chicago, Ill. • Massey Associates, Inc., Narbeth, Pa., Washington, D. C. • Holliday-Hathaway, Cambridge, Mass., Canaan, Conn., New York, N. Y., Great Neck, N. Y., Rochester, N. Y., Binghamton, N. Y., Wood-Ridge, N. J.

An inquiry on your company letterhead will receive prompt attention.

INTERFERENCE FREE

means
FILTERED
by

FILTRON CO., INC. • FLUSHING, LONG ISLAND, NEW YORK

LARGEST EXCLUSIVE MANUFACTURERS OF RF INTERFERENCE FILTERS

Now—
Moldite Dependability
 in all 3!



FERRICORES

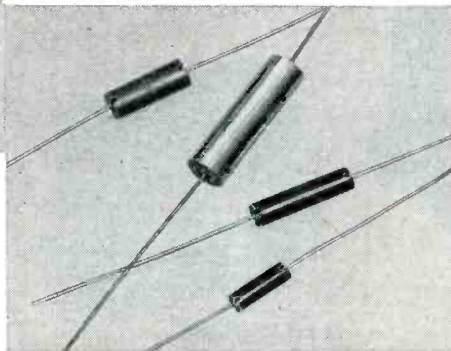

MOLDED COIL FORMS

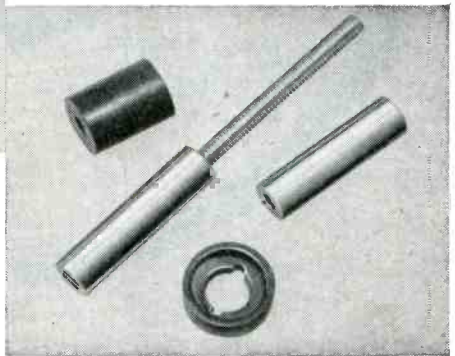

MAGNETIC IRON CORES

Moldite's famed precision production facilities are now devoted to 3 major types of electronic components —to give the industry a superlative core or coil form for every electronic application.

Through years of continued engineering and research Moldite has produced cores of guaranteed dependability, economy, quality and uniformity. Our customers' smooth running production lines tell the story best.

Specify a Moldite core specially designed and precision made for you, with absolute uniformity from first to last.

- FERRITE CORES
- MOLDED COIL FORMS
(iron and phenolic)
- MAGNETIC IRON CORES
- FILTER CORES
- THREADED CORES
- SLEEVE CORES
- CUP CORES

Samples promptly submitted upon request for design, pre-production, and test purposes



... Send for our new
Catalog No. 110 —
THE MOST COMPLETE
LINE OF CORES
IN THE INDUSTRY!

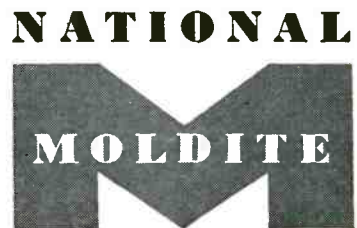

COMPANY
 1410 CHESTNUT AVE., HILLSIDE 5, N. J.

- | | | | | |
|---|--|---|--|---|
| Robert T. Murray
614 Central Ave.
East Orange, N.J. | Jerry Golten Co.
2750 W. North Ave.
Chicago 22, Ill. | Martin P. Andrews
Mott Road
Fayetteville, N. Y. | Perlmuth-Coleman & Assoc.
1335 South Flower
Los Angeles, Cal | Jose Luis Ponte
Cardoba 1472
Buenos Aires |
|---|--|---|--|---|

Want more information? Use post card on last page.

January, 1954 — ELECTRONICS

FOR THE FIRST TIME

A COMPLETE PRESSURE PICTURE

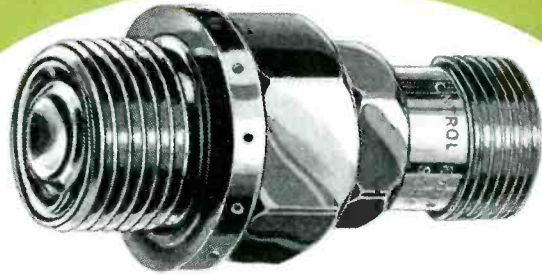

NORWOOD CONTROLS Type EP Pressure Pickup

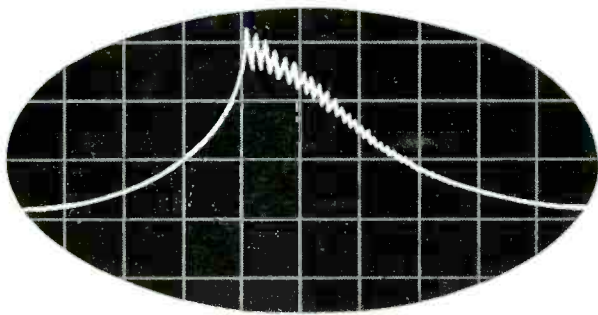

Versatility — for use in dynamic systems . . . tested and proven on gasoline and diesel engines . . . jet engines . . . rocket motors . . . blast measurements . . . high pressure, high temperature chemical reactions . . . hydraulic and pneumatic systems.

Full Scale Pressures — 500, 1,000, 2,000, 3,000, 5,000, 10,000 psi . . . response down to 0 psi absolute with 1% of full scale accuracy and temperature compensation.

High Frequency Response—flat to 20,000 cps . . . natural frequency up to 45,000 cps.

Flush Catenary Diaphragm — reduces changes in volume of pressure chamber to a minimum.

A word about NORWOOD CONTROLS — This name stands for an expanding line of commercial instruments for the measurement of pressure, flow, temperature and weight. It represents a fresh concept of creative engineering which, combined with New England manufacturing skill, is establishing new frontiers in the field of instrumentation.



CONTROL ENGINEERING CORPORATION
564 Providence Highway, Norwood, Massachusetts

Norwood Controls representatives are located in principal cities.
Complete technical information will be supplied upon request.



Stable, Low-Noise Carbon Controls in ANY Combination You Want

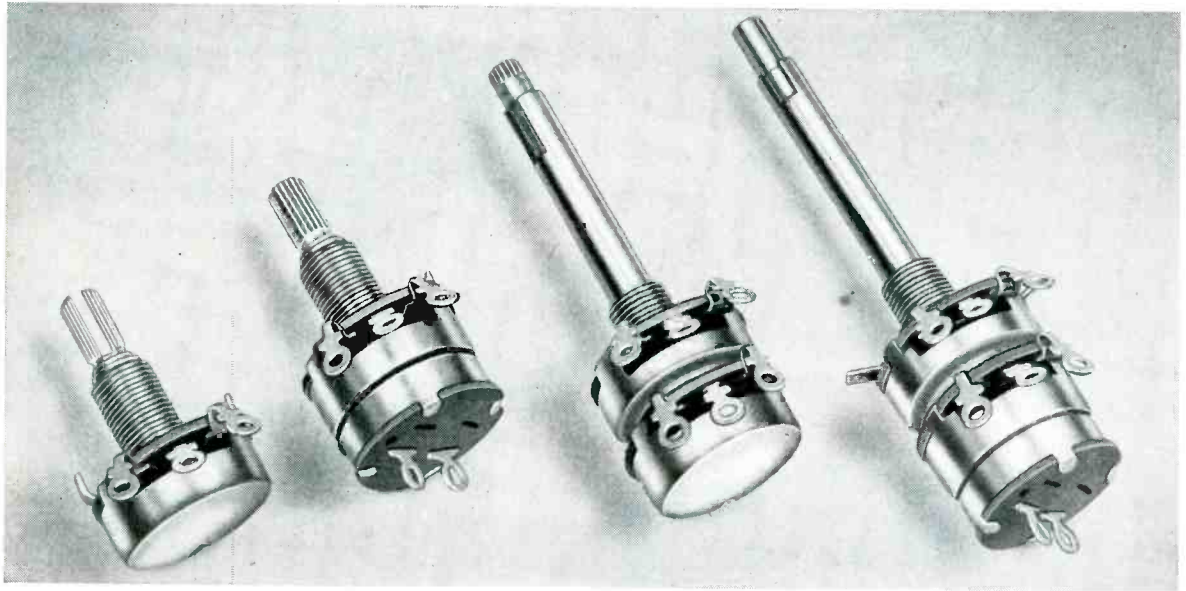

You don't have to compromise with quality to get the carbon controls your application requires. For Mallory Controls are available in a complete range of constructions, including single, dual concentric and dual tandem types . . . with or without switch.

Their noise level is unusually low, resistance values are unusually stable, and humidity drift is held to 10% . . . thanks to carbon elements with a high degree of surface smoothness and unusual density. Switches are built for long, trouble-free service, with special silver contactors and heavy gauge terminals.

Mallory Controls are built with ample ruggedness to stand any production line handling.

Expect more . . .

Get more

from **MALLORY**

Parts distributors in all major cities stock Mallory standard components for your convenience.

Serving Industry with These Products:

Electromechanical—Resistors • Switches • Television Tuners • Vibrators
Electrochemical—Capacitors • Rectifiers • Mercury Batteries
Metallurgical—Contacts • Special Metals and Ceramics • Welding Materials

They incorporate such mechanical features as welded assembly, vibration-proof clinched terminals, and heavy gauge fastenings.

Write today for the new catalog that describes all Mallory fixed and variable resistors . . . including both carbon and wire-wound types.



CUSTOM-BUILT CONTROLS

The control illustrated is typical of the many special types which Mallory manufactures. Designed for service adjustments in television receivers, it is a tab-mounted, bushingless model with a phenolic shaft . . . for especially economical mounting.

We'll be glad to consult with you on any special adaptations to fit your individual resistor requirements . . . also, to analyze your circuits for opportunities for resistor cost reduction.

P. R. MALLORY & CO. Inc.
MALLORY

P. R. MALLORY & CO., Inc., INDIANAPOLIS 6, INDIANA



BROADBAND MICROWAVE POWER SIGNALS

*as fast
as you
can turn
the dial*

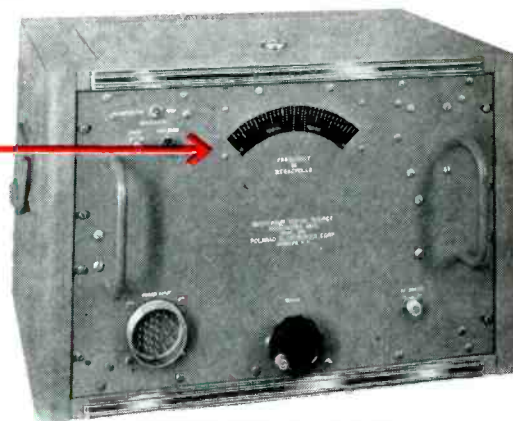

POLARAD Microwave Signal Source

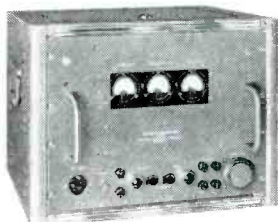

Model KX, Klystron Power Supply, especially designed for Polarad Signal Sources. Works with all 5 models. Has special 1000 cps square wave output for modulating purposes.

Make microwave measurements rapidly.

No mode charts or slide rule interpolations.

Turn only one dial and read the frequency *directly* on the dial with assured power output throughout the entire range.

Polarad's automatic tracking mechanism corrects reflector voltages for you as the klystron cavity is being tuned. Frequency accuracy is within 1%.

There are 5 models available, covering the range—650 to 10,750 mc... each has approximately a 2:1 frequency range with continuous tuning... power output: 10 to 100 mw... external modulation: square wave or fm... temperature compensated klystron tube. *Immediate delivery on all models.*

Polarad Microwave Signal Sources save engineering man hours in the laboratory and in the factory.

Unusual economy and accuracy in making antenna and transmission loss measurements and standing wave determinations in the laboratory—excellent for microwave component testing in the factory. Write for a complete catalog and data today.

MINIMUM POWER AVAILABLE FROM POLARAD SIGNAL SOURCES IN THE RANGE OF 650 TO 10,750 MC

FREQUENCY RANGE	MODEL	MODEL	MODEL	MODEL	MODEL
	SSR	SSL	SSS	SSM	SSX
650-1300MC		1050-2350MC	2200-4550MC	4350-8750MC	8000-10,750MC
MINIMUM POWER AVAILABLE (mw)	150	80	15	10	13
} Low Range	400	150	60	70	30
	} Middle Range	100	100	40	15
} High Range					

Signal Sources in the range 10,750 to 50,000 mc available on special order.



POLARAD ELECTRONICS CORPORATION

100 METROPOLITAN AVENUE, BROOKLYN 11, NEW YORK

REPRESENTATIVES: Albuquerque • Annprior, Canada • Atlanta • Boston • Chicago • Cleveland • Fort Worth • Kansas City • Los Angeles • New York • Philadelphia • San Francisco • Seattle • St. Paul • Syracuse • Washington, D. C.

Now It's

Plug - In

Selenium Rectifiers

POLARIZED
CINCH SOCKET NO 9221

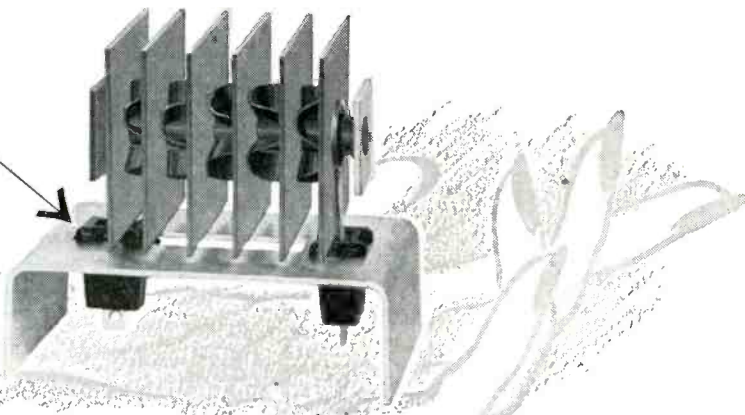

1 Plugged In for Easy Replacement

2 Polarized for Correct Positioning

3 Still Can Be Soldered In The Set

Available In All Sizes.

Write for Further Information.



RECTIFIER DIVISION

415 N. College Ave., Dept. E-1, Bloomington, Indiana

In Canada - 50 St. Clair Ave., N. W., Toronto

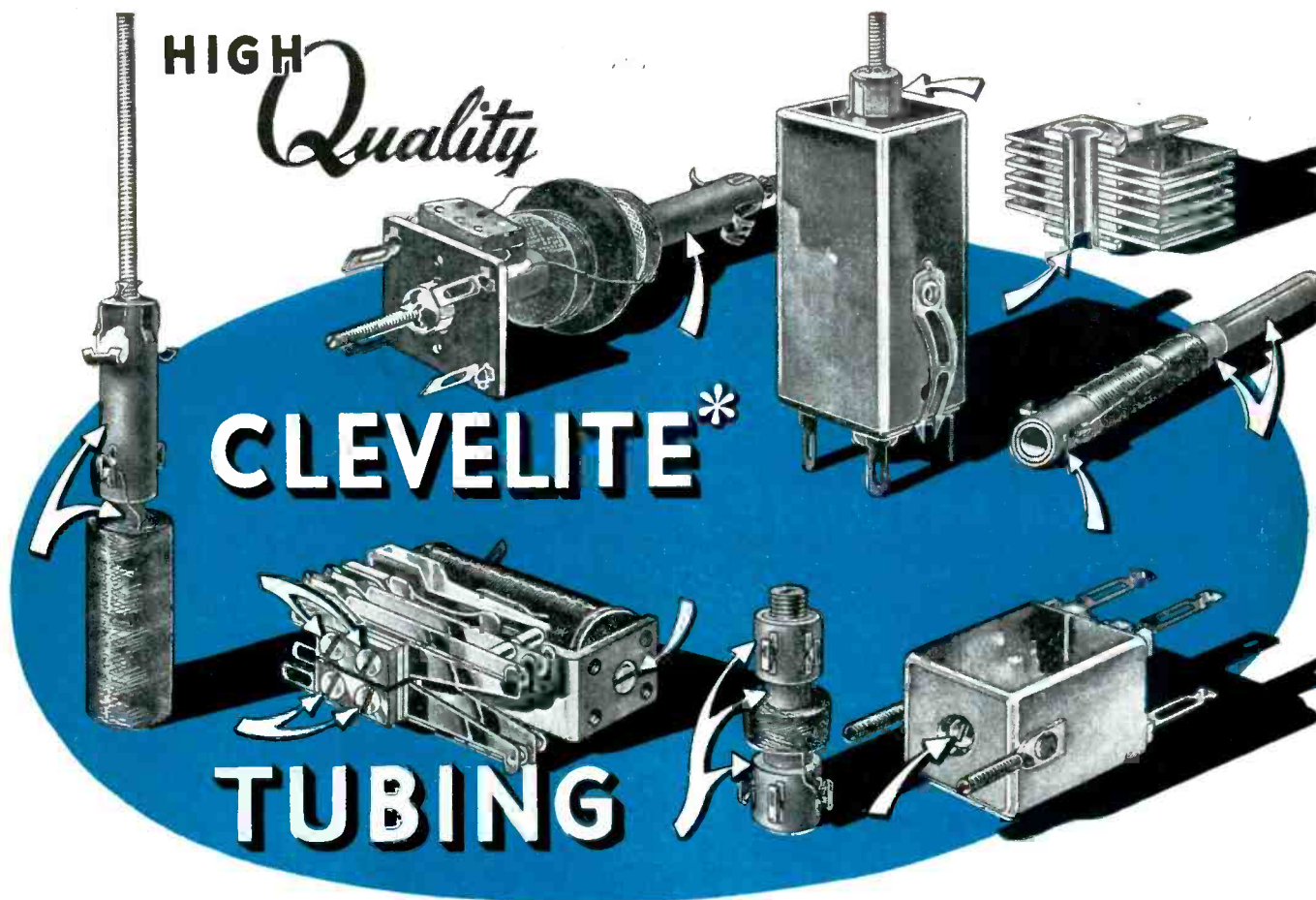

ENSURES BETTER PERFORMANCE AT LOWER PRODUCTION COSTS

ITS CHARACTERISTICS
INCLUDE:

High Dielectric
Strength . . .



Low Moisture
Absorption . . .



Mechanical Strength . . .



Low Loss and Good
Machinability.



Ask for our new
Clevelite Folder.

CLEVELITE is known for its dependability—uniformity—and ability to meet required tolerances, which are particularly important in coil forms, collars, bushings, spacers, tubes and many other products. Available in diameters, wall thickness and lengths as desired.

Prompt deliveries are ensured by our large production facilities.

Tell us Your needs. Our Research and Engineering Laboratory is at your service.

WHY PAY MORE? For the best . . .
Call CLEVELAND!

* Reg. U. S. Pat. Off.

The **CLEVELAND CONTAINER Co.**
6201 BARBERTON AVE. CLEVELAND 2, OHIO

PLANTS AND SALES OFFICES at Chicago, Detroit, Memphis, Plymouth, Wisc., Ogdensburg, N. Y., Jamesburg, N. J.
ABRASIVE DIVISION at Cleveland, Ohio
CANADIAN PLANT: The Cleveland Container, Canada, Ltd., Prescott, Ontario



REPRESENTATIVES

NEW YORK AREA R. T. MURRAY, 604 CENTRAL AVE., EAST ORANGE, N. J.
NEW ENGLAND R. S. PETTIGREW & CO., 62 LA SALLE RD., WEST HARTFORD, CONN.
CHICAGO AREA PLASTIC TUBING SALES, 5215 N. RAVENSWOOD AVE., CHICAGO
WEST COAST IRV. M. COCHRANE CO., 408 S. ALVARADO ST., LOS ANGELES

**STONIZED Spiral Phenolic
Tubes can give YOU many
of the best characteristics
of tubing you now use—
at much less cost!**

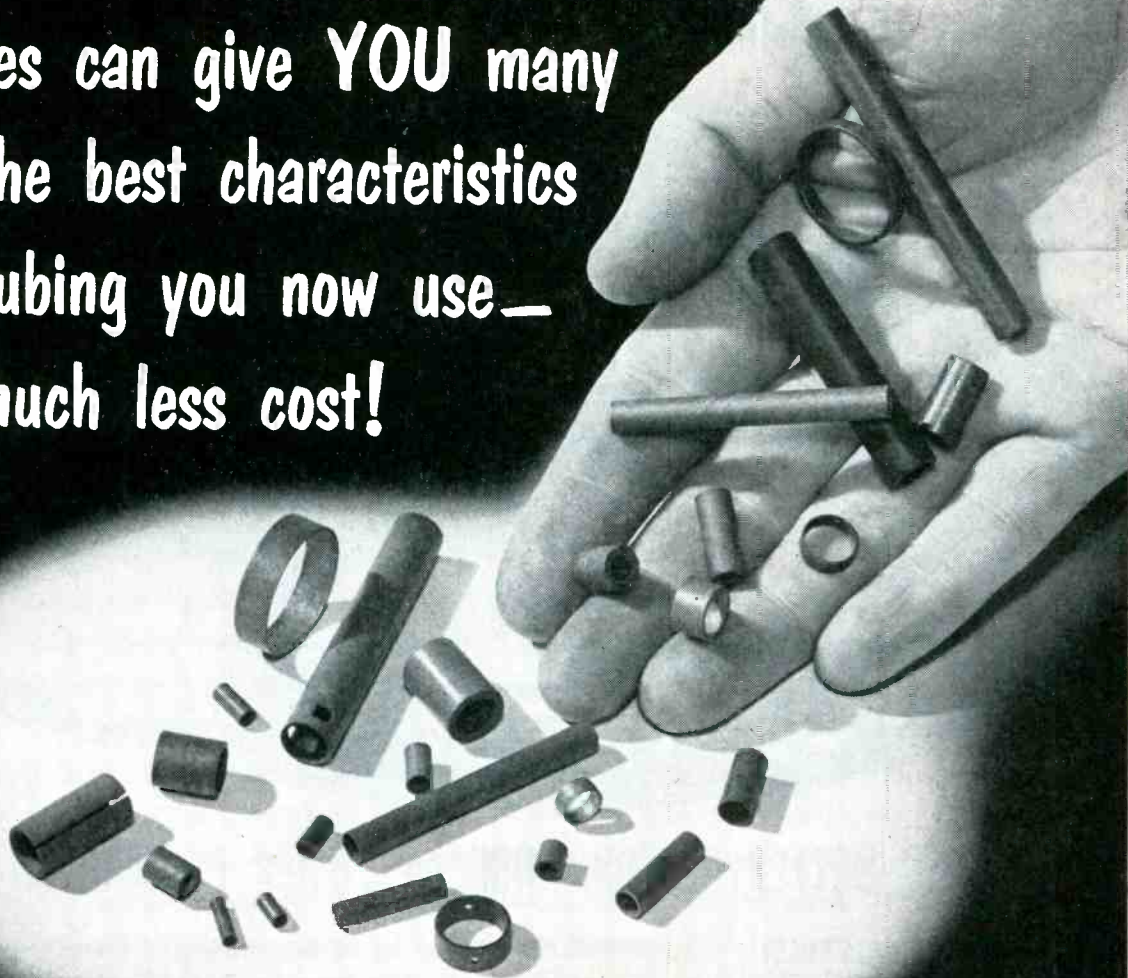

It is true that tubing of other materials costs you far more than STONIZED Spiral Phenolic Tubes. Upon close examination of your specifications, you may find that the very characteristics for which you bought your present tubing are present in our STONIZED tubes.

These paper-base phenolic tubes with high dielectric strength, low moisture absorption, and good dimensional stability are available in various grades which can be punched, notched, slotted, printed or have specially formed ends.

STONIZED Spiral Phenolic Tubes can be furnished in various wall thicknesses and lengths with inside diameters as low as $\frac{1}{16}$ "

Our quality controlled manufacturing process enables us to furnish you with a custom-made product at a mass production price.

A phone call or letter to us today may mean a considerable saving to you.

STONE PAPER TUBE COMPANY, INCORPORATED
STONIZED PRODUCTS COMPANY, INC.

900-922 Franklin Street, N. E., Washington 17, D. C.

TESTS PROVE EFFICIENT OPERATION —BELOW ZERO AND AT 100°C!



ACTUAL SIZE

VACUUM

JUNCTION TRANSISTORS

WELL deserved recognition has been given General Electric's new vacuum sealed junction transistors throughout the entire engineering world. For here is a product with performance characteristics *second to none*. Designed for mass production at *low cost*, new G-E transistors ideally answer the needs of multiple commercial and military applications. Include this *tested and proved superior* product in your design plans now!

For complete specifications and additional information write today! *General Electric Company, Section 414, Electronics Park, Syracuse, New York.*

DESIGN FEATURES:

VACUUM SEALED JUNCTION...contaminating gases permanently eliminated!

WELDED SEAM CONSTRUCTION...free from solder-flux contamination.

HIGH POWER OUTPUT...case design makes possible a collector dissipation of 150 MW.

HIGH FREQUENCY PERFORMANCE...specifications cover operation at audio and supersonic frequencies.

HERMETIC SEAL...unaffected by moisture.

HIGH TEMPERATURE OPERATION...rated for a maximum junction temperature of 100°C.

LONG LIFE...stable performance throughout the life of your equipment.

SMALL SIZE...extremely compact design provides added flexibility for all applications.



● To demonstrate positive elimination of temperature and humidity restrictions this transistor was operated as the heart of a miniature radio transmitter while frozen in a cake of ice which was then melted and converted into boiling water. Above J. H. Sweeney, Manager of Marketing, G-E Germanium Products, demonstrates the unique system.

NEWS FROM OUR ADVANCED DEVELOPMENT LABORATORIES

● Silicon junction rectifiers are capable of operating at relatively high temperatures. Heretofore, this advantage has been offset by high forward resistance compared to germanium. General Electric laboratories have recently succeeded in making 1 mm² silicon junctions having a forward resistance of only 1 ohm at 1.5 amperes.

GENERAL  ELECTRIC

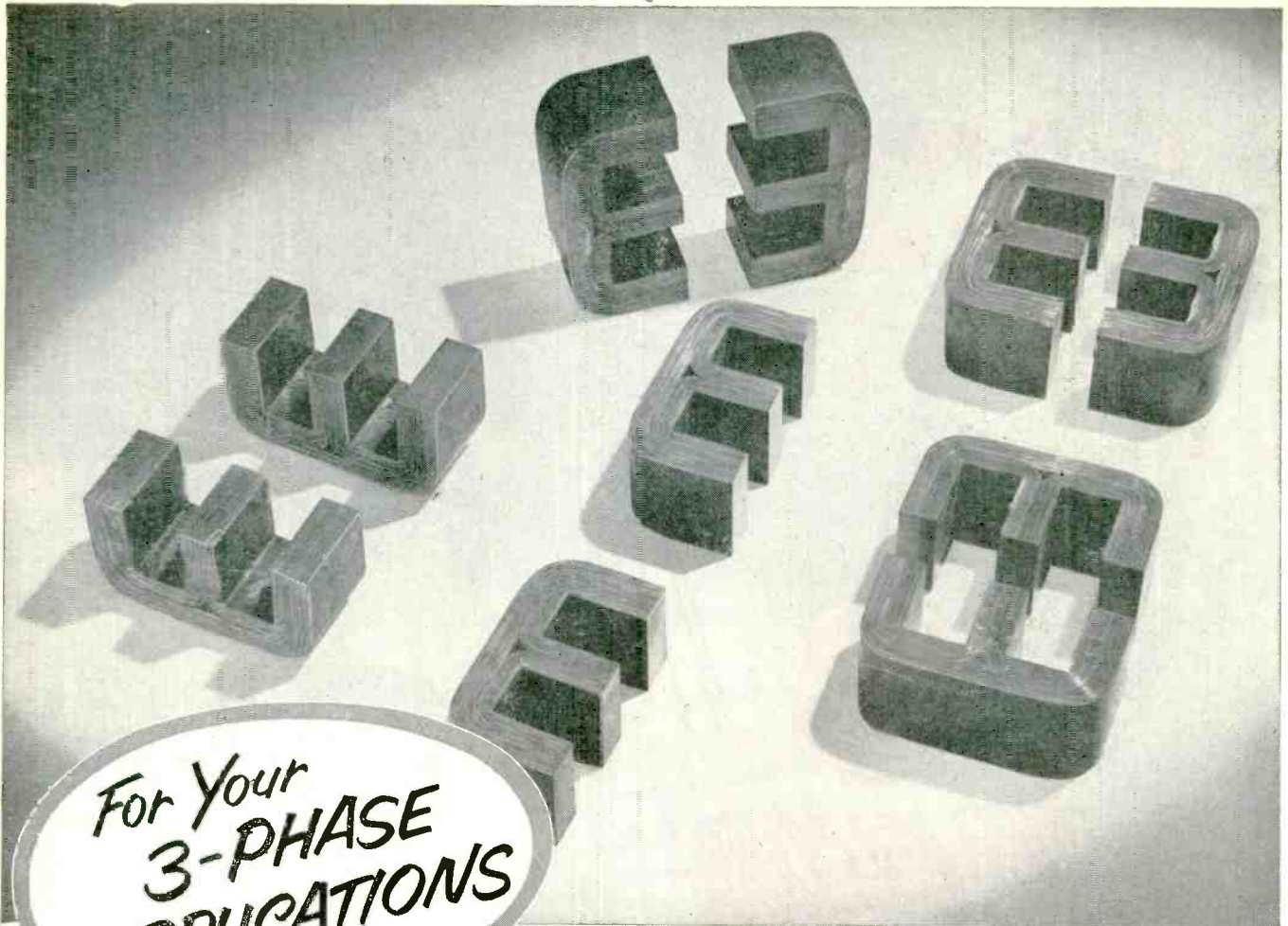

For Your
3-PHASE
APPLICATIONS

Arnold E-CORES

made from **SILECTRON** strip
(*grain-oriented silicon steel*)

The use of "E" cores, wound from grain-oriented silicon steel, results in weight and size reduction as well as higher efficiency and possible cost savings. "E" cores can be supplied in a variety of window sizes and core areas from 1, 2, 4 or 12-mil Silectron strip, for high or low frequency 3-phase applications. • All Arnold cores are made by precision methods, and carefully tested under closely controlled conditions to assure highest quality and reliability. *We'll welcome your inquiries.*

WRITE FOR BULLETIN TC-105

W&D 4658



C-Cores to meet any requirement

For your single-phase applications, Arnold "C"-Cores are available in any shape and quantity, and in any size from fractions of an ounce to hundreds of pounds . . . wound from Silectron strip in a wide range of ultra-thin and heavier gauges. (Sizes up to 10 lbs. in 12-mil strip; to any weight in thinner gauges.)

THE ARNOLD ENGINEERING COMPANY



SUBSIDIARY OF ALLEGHENY LUDLUM STEEL CORPORATION

General Office & Plant: Marengo, Illinois

DISTRICT SALES OFFICES . . . New York: 350 Fifth Ave.

Los Angeles: 3450 Wilshire Blvd.

Boston: 200 Berkeley St.

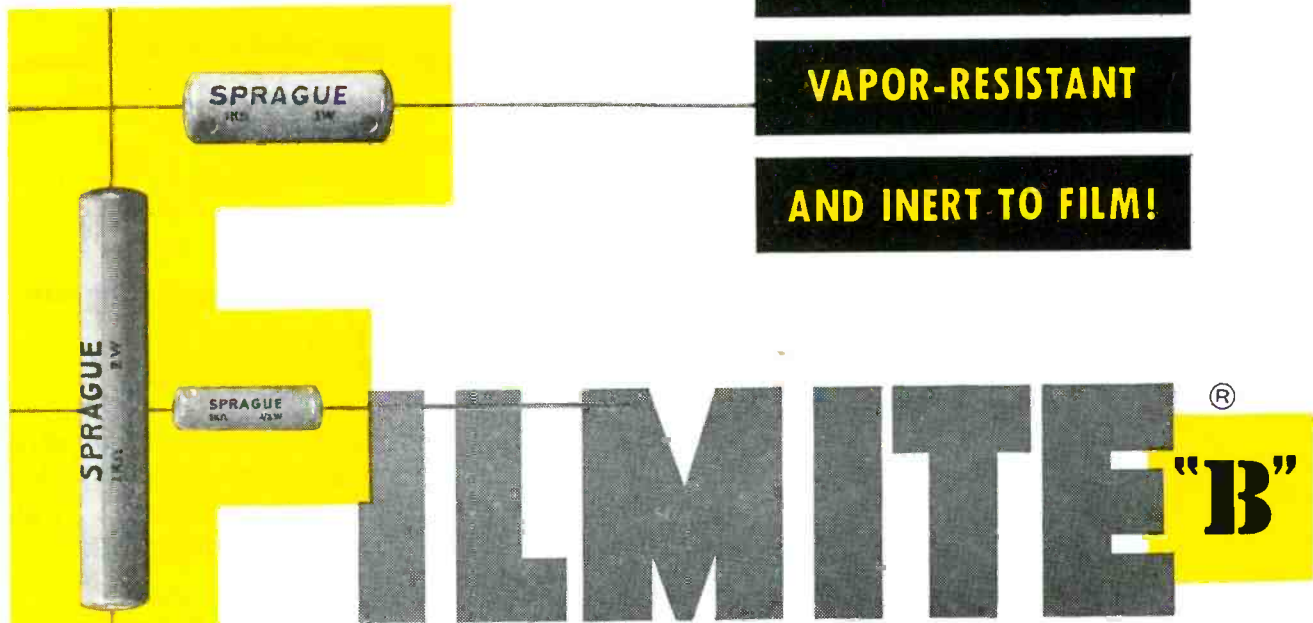

- MOLDED JACKET IS**
- MOISTURE-RESISTANT**
- VAPOR-RESISTANT**
- AND INERT TO FILM!**

DEPENDABLE BORO-CARBON RESISTORS
... IN 1/2, 1, AND 2 WATT RATINGS

Now for the first time you can obtain a superior yet relatively low cost film-type resistor for military electronic gear—resistors that not only meet the severe performance requirements of Military Specification MIL-R-10509A, but are capable of full voltage dissipation at 70°C ambient!

Sprague Type 4E, 5E, and 6E Filmite B resistors are housed in a dense molded jacket which not only provides unexcelled physical protection for the film resistance element but serves as a barrier to moisture and vapor, the twin enemies of all film-type resistors.

Boro-carbon films are unusually sensitive to moisture. Protection against moisture in any form is a primary requirement for successful long term stability of resistance. The low-loss phenolic housings on molded Filmite resistors not only shed water but are vapor resistant and inert to the film material. There

is minimum possibility of field failure through electrolytic action and penetration of moisture or vapor through the dense molded jacket.

Other features of molded Filmite B resistors are special low-contact-resistance, low noise end terminations held rigidly in place on special ceramic cores, extremely low temperature and voltage coefficients of resistance, and excellent load-life and high frequency characteristics.

For complete engineering data, write for Engineering Bulletin No. 130 to:

SPRAGUE ELECTRIC COMPANY
35 Marshall Street, North Adams, Mass.

SPRAGUE TYPE NO.	WATTAGE RATING	DIMENSIONS (INCHES)		RESISTANCE (OHMS)		VOLTAGE (Max.)
		L	D	Min.	Max.	
4E	1/2	3/4	1/4	100	1 Meg.	350
5E	1	1 1/8	3/8	100	2 Meg.	500
6E	2	2 3/8	3/8	200	10 Meg.	750

Standard Resistance Tolerances: 1 2 and 5%

SPRAGUE

PIONEERS IN ELECTRIC AND ELECTRONIC DEVELOPMENT

NORTH ADAMS, MASSACHUSETTS

EXPORT FOR THE AMERICAS: SPRAGUE ELECTRIC INTERNATIONAL LTD., NORTH ADAMS, MASS. CABLE: SPREXINT

"Drop that Soldering"

Revolutionary new method wraps connections
so tightly that
soldering is unnecessary

Here is a method that produces electrical connections more reliable than the most skillfully soldered connections . . . in a fraction of the time . . . at a fraction of the cost. Operator training takes only minutes instead of days.

By replacing hand operations with pneumatic or electric Wire-Wrap Tools, you get consistently uniform connections all through the day. Rejects are greatly reduced . . . inspection becomes simple . . . production costs are cut.

Investigate this revolutionary new process—write for Bulletin No. 11, today.

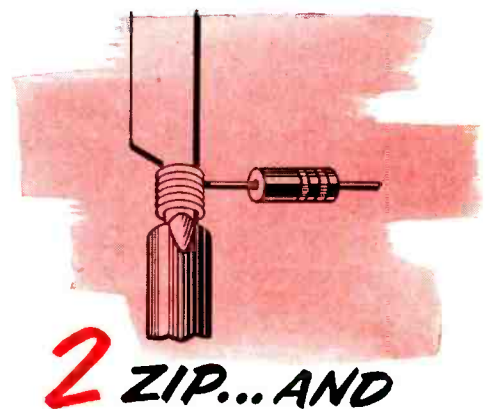
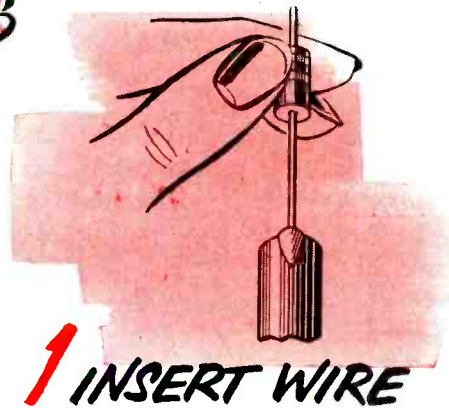

Wire-Wrap Tools

are now available from Keller—
the original manufacturer



Iron, Sister!!

THIS NEW
Wire-Wrap Tool
MAKES SOLDERLESS CONNECTIONS
...in half the time!

Manufactured under patent
license agreement with
Western Electric Company
Incorporated

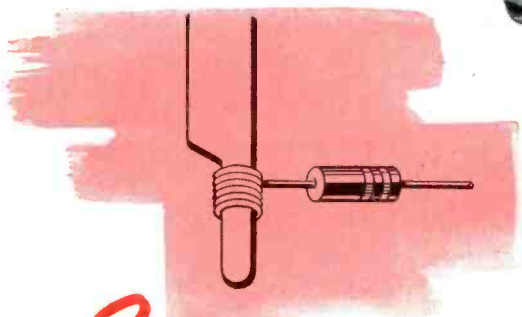

3 IT'S FASTENED

KELLER
Wire-Wrap
TOOLS
Wire-Wrap Division

KELLER TOOL CO.
Grand Haven, Michigan

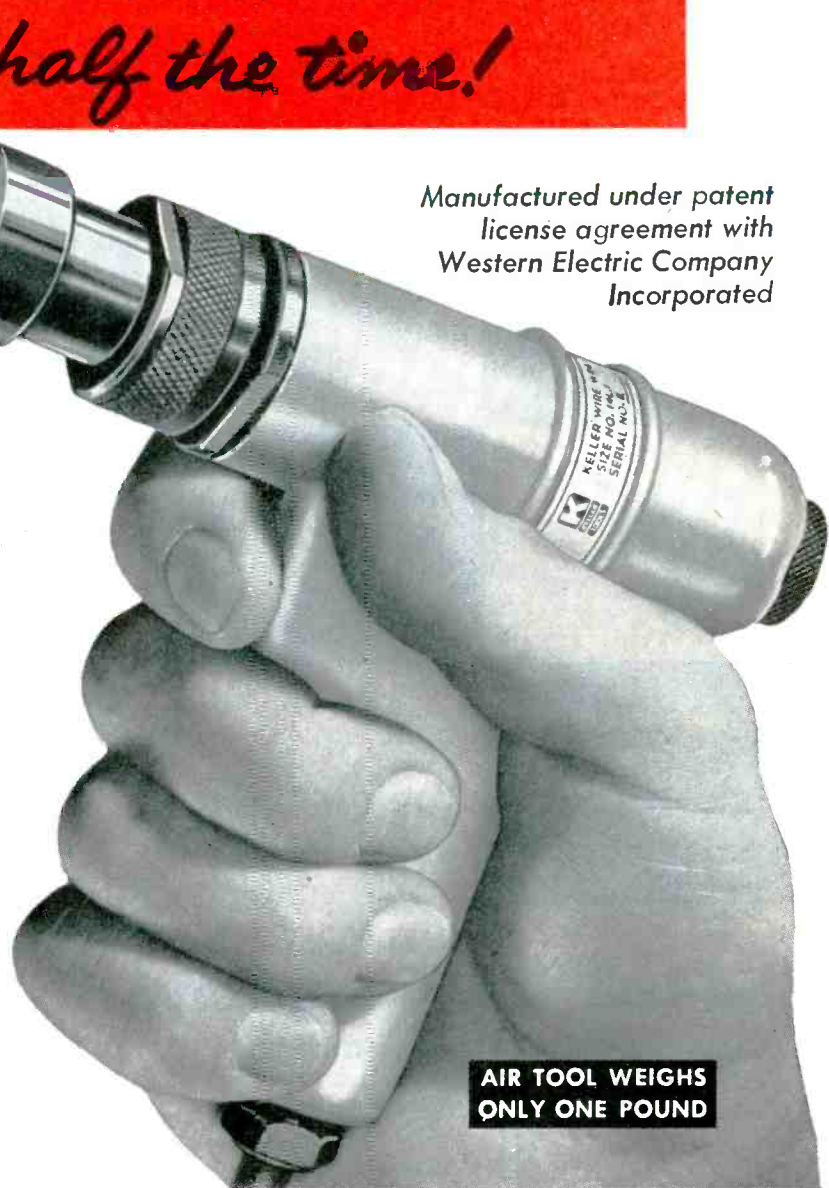

**AIR TOOL WEIGHS
ONLY ONE POUND**

Ucinite Electrical Assemblies

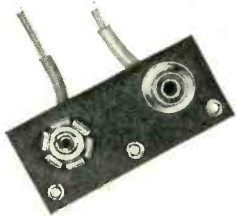

BATTERY CONNECTORS

Wired snap-on units for use with batteries equipped with United-Carr electrical snap fasteners. Wiring to customer's specifications.



BANANA PINS

Four sizes of plugs with one-piece beryllium copper springs. Adaptable mounting ends in threaded, staking, or solder lug types. Similar Mating Jacks also available.

SHOCK MOUNTS

Offered in several sizes—brackets and durometer of rubber bushings can be varied. With threaded Teenuts or plain bushings. Insulated versions if needed.



ANODE CONNECTORS

Plug button contacts for positive, firm connections. Corona resistant neoprene or silicon shields in straight or right angle types. Wiring to customer's specifications.



TUBE CAPS

Positive gripping, heat treated steel springs in corona resistant metal housing. Insulated or non-insulated. Wired to specifications. Type shown has silicon shield for special application.



TUBE SOCKETS

Ceramic octals and special types. Ring or saddle mounting. Open ended plates for shock mounting with rubber grommets. J A N types.

SWITCHES

Oak type switches manufactured as a licensee. Variety of rotary and push-button assemblies to specifications.

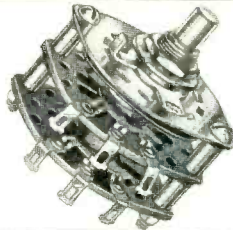

SNAP SWITCHES

Precision, momentary contact push-button switches. Small and dependable. Several circuit arrangements. Water tight version shown.



TEST JACK

Ucinite's quality jack for .080 probes. Beryllium copper contacts. Nylon insulation in colors. Metal shell for firm dependable mounting.

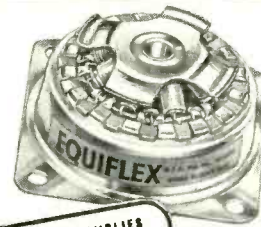

VIBRATION ISOLATORS

Equiflex (1 to 1 ratio) metal mounts ensure long life, fit small spaces, can be used in any direction. Three sizes, cup or plate mountings.

METAL STAMPINGS

Volume production in Metal stampings. Years of engineering and tooling skill available to solve your particular problem.

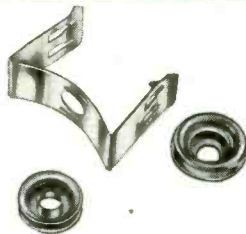

With years of specialized experience in the electronics field and complete facilities for the volume production of small metal stampings as well as the assembly of metal to plastic and ceramic components, Ucinite is fully equipped to supply you with special electrical parts and assemblies... designed, assembled, wired and marked to your specifications. For complete design, engineering and production service, call your nearest Ucinite field engineer.

The UCINITE Company

DIVISION OF UNITED-CARR FASTENER CORP.

Newtonville 60, Massachusetts

telling the story of 'dag' dispersions

**Here is a
CRT Exterior Wall Coating
that's Fast-Drying,
Adherent, Opaque**

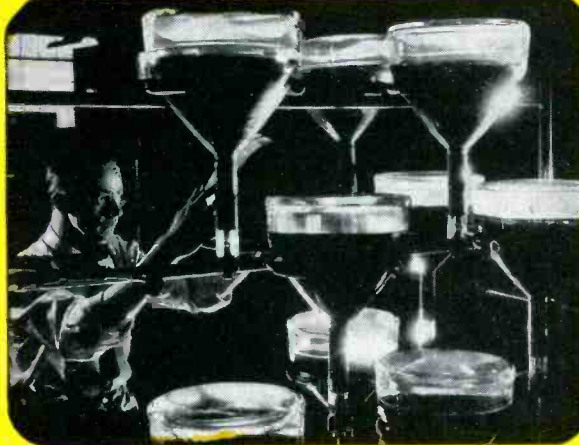

'dag' Exterior Wall Coating is a dispersion of extremely fine graphite in lacquer.

It is easily applied by spraying, and dries for handling in 2 to 3 minutes. Maximum adhesion is obtained by drying at room temperature for 24 hours... with the same result from infra-red at 100°C. for ½ hour.

The coating obtained is as smooth as the glass itself and as black as coal. Its adhesion is so good that scratching it is almost an impossibility. Water won't loosen it either.

Acheson Colloids can also supply appropriate dispersions for coating interiors of tubes.

You can have more detailed data by asking for Bulletin No. 433-5 A.

Dispersions of molybdenum disulfide are available in various carriers. We are also equipped to do custom dispersing of solids in a wide variety of vehicles.



Acheson Colloids Company, Port Huron, Mich.

... also **ACHESON COLLOIDS LIMITED, LONDON, ENGLAND**
Units of Acheson Industries, Inc.



*try resin-bonded dry graphite films
for permanent lubrication*

WHAT ABOUT Encapsulated

PRECISION WIREWOUND RESISTORS?

Engineers, buyers, and purchasing agents during the past year have had thrust upon them something new to consider in the precision wirewound resistor field. Verbally and through the medium of advertising it has been relentlessly stated that encapsulated resistors exceed and surpass MIL-R-93A and JAN-R-93 specifications, but frequently without proof of performance. Quite to the contrary, there have been production difficulties, overnight changes in encapsulating materials, and reluctance to reveal just what these encapsulation materials were. As evidenced by previous messages in this series, Shallcross believes it better to reveal than conceal!

The hobbins and the coating in Shallcross "P" type wirewound encapsulated resistors are the same mineral filled, pigmented epoxy resin. The material is "hot" curing, which simply means that it cures at a much higher temperature than "cold" resin. Some "cold" resin resistors now on the market have one major failing, they become deformed after temperature cycling. Shallcross encapsulated resistors remain unaffected.

The efficient Shallcross encapsulation results in a sealed resistor with a physical configuration (see sketch) providing maximum winding area and leakage paths, minimum size and weight, and aesthetically, retention of the visual identity of a precision wirewound resistor. The seal of Shallcross "P" type resistors cannot be broken by flexure of the lugs. The lugs are designed so that excessive flexure will result in bending of the lug *outside* of the encapsulation.

Shallcross "P" type encapsulated resistors pass military qualification approval tests easily and are

the only resistors to date to pass the more stringent qualification approval tests of a leading eastern manufacturer of electronic equipment. This test requires 24 temperature cycles from -65°C to

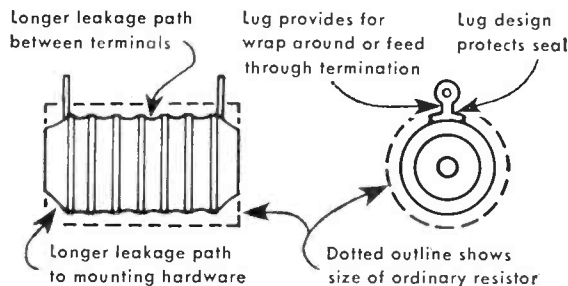

$+100^{\circ}\text{C}$ as compared with only 5 cycles from -55°C to $+85^{\circ}\text{C}$ required by MIL-R-93A. In qualification approval tests more rigid than MIL-R-93A, another leading eastern airborne electronic manufacturer reports that Shallcross "P" type resistors passed all tests without failure. Three other manufacturers tested had from one to nine failures in each test.

The "P" type sealed resistors are unquestionably the most outstanding development in sealed precision wirewound resistors since Shallcross patented the sealed-in steatite "1100" series in 1945. Both the old "1100" series and the new lower cost "P" types pass the immersion cycling tests of JAN-R-93, Characteristic A.

Test data, available styles and ratings for Shallcross "P" type resistors are yours for the asking.

Write for Engineering Bulletin L-30.

1929 Our twenty-fifth year 1954

SHALLCROSS MANUFACTURING COMPANY • 522 PUSEY AVENUE, COLLINGDALE, PA.

The fifth of a series to promote a better understanding of the performance characteristics of precision wire-wound resistors.

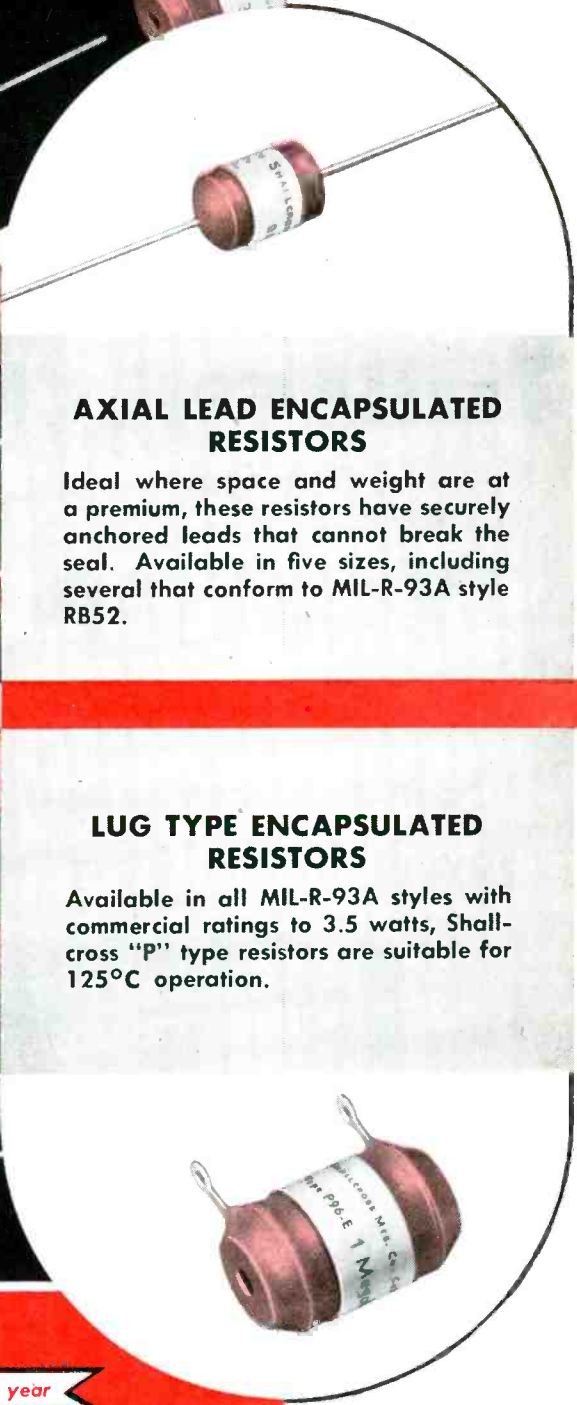
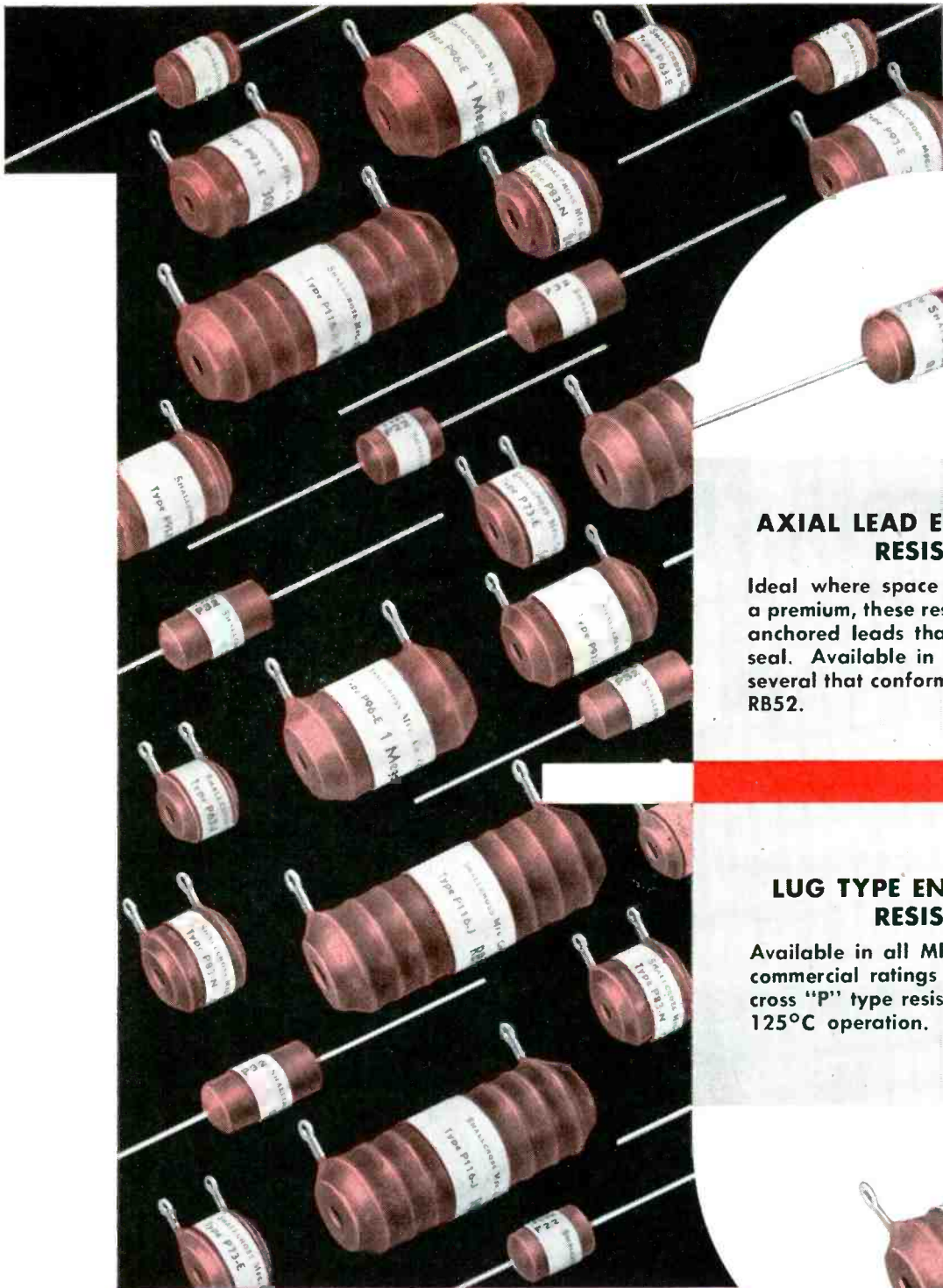

AXIAL LEAD ENCAPSULATED RESISTORS

Ideal where space and weight are at a premium, these resistors have securely anchored leads that cannot break the seal. Available in five sizes, including several that conform to MIL-R-93A style RB52.

LUG TYPE ENCAPSULATED RESISTORS

Available in all MIL-R-93A styles with commercial ratings to 3.5 watts, Shallcross "P" type resistors are suitable for 125°C operation.

Our
 twenty-fifth year
Shallcross

NEW

truly functional

TUBE CHECKER

by

WESTON

with new features for
greater accuracy and time-
saving facility in all testing

- Provides accurate meter measurement of leakage resistance as high as 5 megohms between tube elements.
- Permits high transconductance measurements, with ranges 3000/6000/12000/24000 micromhos.
- Multiple switching protects against early obsolescence, allows making any combination of tube connections.
- Element switching permits checking and comparing individual sections of twin-section tubes without changing selector switch.
- Only *one* socket for each type tube base eliminates plugging tubes into wrong sockets.
- Sockets for all type bases . . . including acorn and 7 and 8 pin subminiatures.
- 19 filament voltage settings—.65 to 115 volts. 5 plate voltages—20 to 177 volts. A 45-volt source for testing subminiature types.
- Grid bias, plate voltage and meter sensitivity adjustable.
- Large, readable fan-shaped meter . . . new roll chart with complete, up-to-date data on all tubes.

Complete data on the new Model 981 Type 2 available in bulletin form. Write . . . WESTON Electrical Instrument Corporation, 614 Frelinghuysen Avenue, Newark 5, New Jersey.

5539

Available through leading distributors

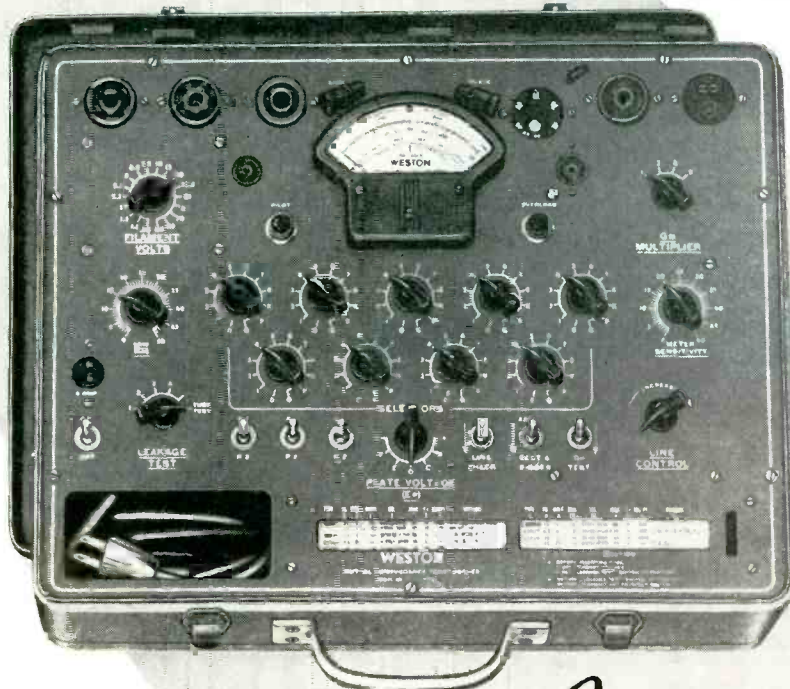

WESTON
Model 981 Type 2

WESTON *Instruments*

Now for TV-transmitter builders, a cost-saving G-E SERVICE

HIGH-GAIN U-H-F TUBES FOR EVERY STAGE, DRIVE TO FINAL!



G-E SERVICE—specific tube design service—helps you build real economy into your new transmitters . . . because G-E high-gain power tubes mean *fewer intermediate stages*. With their low drive requirements, these advanced u-h-f types reduce circuitry—save tubes and components—so keep down the cost of your equipment. Lower power bills, less maintenance, are plusses you can offer cost-conscious station operators.

G-E SERVICE brings you a complete line of up-to-900-mc high-gain tubes, 250 w to 12 kw. *Service at your door!* G-E engineers will be glad to work side-by-side with your designers on tube applications. You may draw freely on their specialized knowledge and experience. Wire or write *General Electric Company, Tube Department, Schenectady 5, New York.*



LOW DRIVE, HIGH GAIN SEE FIGURES BELOW!
YOU CUT DOWN ON INTERMEDIATE TUBE STAGES, REDUCE USERS' POWER BILLS.

GL-6283 TETRODE	GL-6019 TETRODE	GL-6183 TETRODE	GL-6182 TETRODE	GL-6237 THROUGH GL-6242, KLYSTRONS
250 W OUTPUT	1 KW OUTPUT	1 KW OUTPUT	5 KW OUTPUT	12 KW OUTPUT
POWER GAIN 7.1	POWER GAIN 10	POWER GAIN 10	POWER GAIN 16.6	POWER GAIN 200

10 TUBES
250 w to 12 kw
(Approx power output, typical operation, broadband TV service, sync-level conditions.)

GENERAL ELECTRIC

163-1A1

*"We have used
D-H MANGANIN
for 25 years..."*



DOUBLE-PURPOSE BRIDGE. This Shallcross Model 6320 Wheatstone Limit Bridge can be used both for exact resistance readings and, in production, for rapid checks on percent deviation from an accepted standard. Overall range extends from 0.1 ohms to 111,110,000 ohms. All resistors are D-H Manganin.

Says **SHALLCROSS MANUFACTURING COMPANY**, Collingdale, Pa.: "For 25 years we have been using Driver-Harris Manganin wire in the construction of Wheatstone and other precision bridges. In addition, D-H Manganin alloy has been used in many special standards for research and development laboratories. We feel that the quality of our products and the reputation of our instruments have been greatly enhanced by its use."

Behind statements like these stand Driver-Harris production and drawing techniques, which provide Manganin of such fixed stability that maximum change in resistance between 15°C and 35°C is only about 15 parts per million per degree centigrade—and fre-

quently *less than one-third* this amount. Equally good electrical characteristics are available for ammeter shunt stock operating between 40°C and 60°C.

The experience of Shallcross reflects the experience of a host of manufacturers throughout the country; reflects what *you* can expect from Driver-Harris products, whether Manganin or any of the numerous alloys developed by Driver-Harris for application in the electrical and electronic fields.

Whatever your alloy problem, therefore, let us have your specifications. We'll gladly put at your disposal the skills acquired from 50 years of alloy manufacturing experience . . . make recommendations based on your specific needs.

* T. M. Reg. U. S. Pat. Off.



Sole producers of world-famous Nichrome*

Driver-Harris Company

HARRISON, NEW JERSEY

BRANCHES: Chicago, Detroit, Cleveland, Los Angeles, San Francisco

In Canada: The B. GREENING WIRE COMPANY, Ltd., Hamilton, Ontario.

MAKERS OF THE MOST COMPLETE LINE OF ELECTRIC HEATING, RESISTANCE, AND ELECTRONIC ALLOYS IN THE WORLD

Heldor

is Still your

BEST BUY

for

PROVEN quality-control volume production methods enable Heldor to deliver cans, terminals and assembled components — made to meet MIL-T-27 or commercial specifications — at definite savings . . . in money, time and responsibility.

With a record of past performances second to none, Heldor offers you comparable savings on your requirements. Get the facts by sending your specifications or prints for an "eye-opening" quotation. Do it now.



● HERMETIC SEAL BUSHINGS



● COMPLETE ASSEMBLY SERVICE

● CANS and COVERS



MAIL COUPON TODAY

Please send data on: Cans Bushings
 Assembly Service Bushings
 Name Title.....
 Company
 Address

HELDOR MANUFACTURING CORPORATION



HELDOR BUSHING & TERMINAL CO., INC.
 238 Lewis Street • Paterson, N. J.



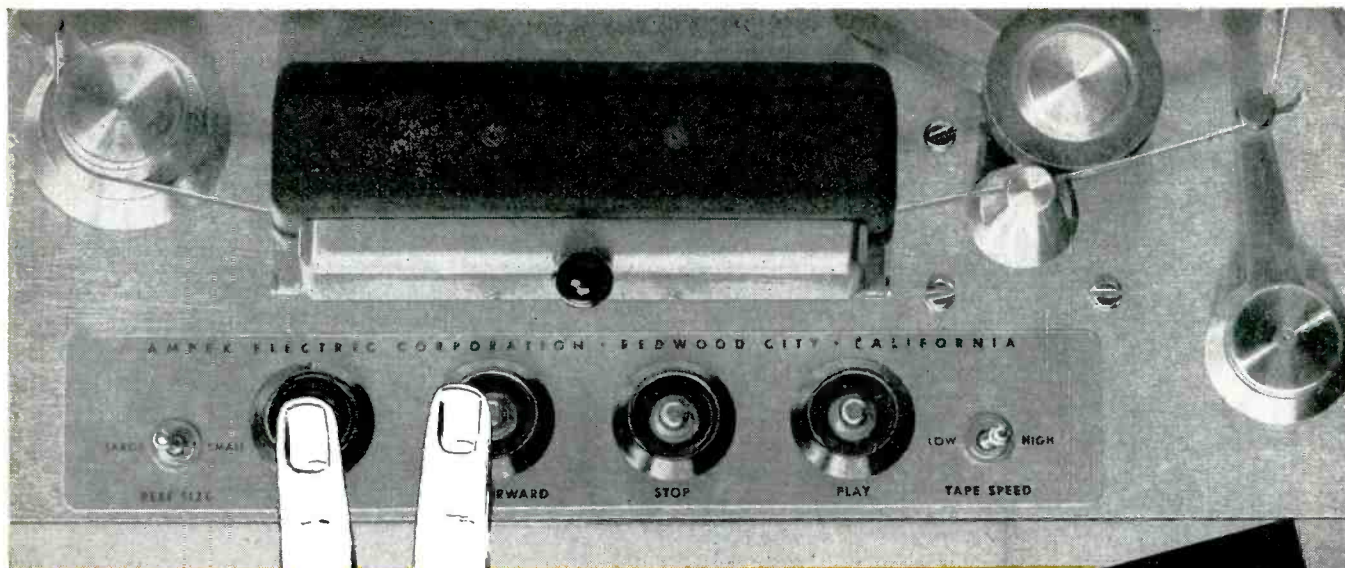

these pushbuttons are fast on cues...

They're the controls on the new AMPEX 350 Tape Recorder

Their quick, positive action will give station operators a new "sureness" with tape. Cueing is exact; editing is faster; fumbling is out. Remote control is available too. Responsiveness has always been a part of the Ampex Standard of Excellence—but now it is better than ever, making the AMPEX 350 truly the NEWEST OF THE BEST.

● **STARTING WITH A SPLIT SYLLABLE**

From pressing of the start button to stable tape motion takes 1/10th second. Tape can be backed off from starting cues as little as one to two inches. Precise starts become routine. Reliability is supreme.

● **STOPPING WITHIN TWO INCHES**

Even at 15 inches per second, the tape stops within less than two inches after the button is pressed. Band type brakes give positive stops; no drift or tape spillage can occur.

● **EASIER CUEING AND EDITING**

The Model 350 can be shuttled rapidly between fast forward and rewind without stopping. Cues for starting, editing or dubbing are speedily located. And for convenient editing, the capstan drives on the "pull side" of the heads.

● **ADJUSTMENT FOR REEL SIZES**

A new switch selects proper tape tension either for 10½-inch NARTB reels or for 5 or 7-inch plastic RMA reels. Proper tension means longer tape life, more accurate timing and truer performance.



AMPEX MODEL 350

The new slant puts all controls within easy reach of any operator, tall or short.

Recorders from \$975; Model 350 from \$1095; Reproducers from \$495. For further information write today to Dept. E-1279-A



IF YOU PLAN FOR TOMORROW,
BUY AN AMPEX TODAY

934 CHARTER STREET, REDWOOD CITY, CALIFORNIA
Distributors in principal cities; distribution in Canada
by Canadian General Electric Company

the SLIDE RULE and the HACKSAW

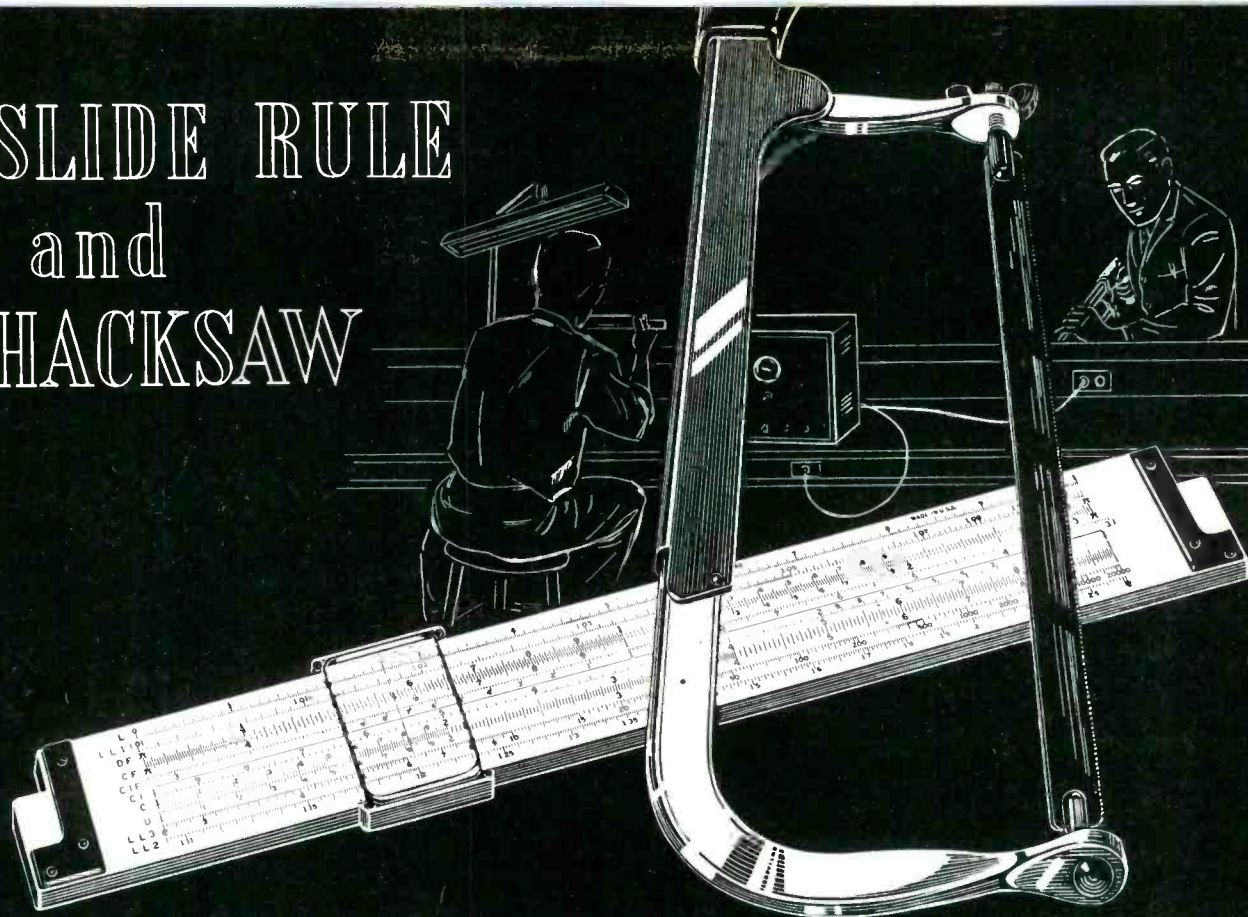

work together at DALMO VICTOR

Typical DV Development

ANTENNA
REFLECTORS

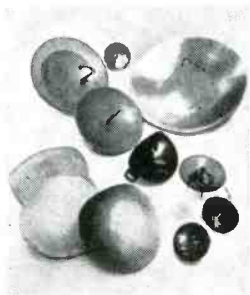

Special skills in calculating the shape and making samples of reflectors such as pictured above, for search, ground-mapping, tracking and other radar applications have contributed to Dalmo Victor's position today as the nation's leading designer and manufacturer of airborne radar antennas. Since 1942, when Dalmo Victor built its first unit, some 40 different antennas have been designed and developed by the company, and 15 of these have already gone into production.

Instead of waiting for mechanical modifications to go through drafting and production channels, a research technician at Dalmo Victor has little hesitation about laying down his slide rule and picking up a hacksaw. A constant will to get things done accounts for the remarkable speed of development and production projects at Dalmo Victor.

Both the theoretical and practical activities of this unique specialist organization are available for the solution of new design-through-production engineering problems relating to complex, lightweight, electromechanical systems for airborne and other specialized applications.

DALMO VICTOR

SAN CARLOS · CALIFORNIA

DV

DOWN - TO - EARTH ELECTROMECHANICAL ENGINEERING

A NEW TERMINATION TECHNIQUE FOR . . .

- BUSINESS MACHINES
- COMPUTERS
- CONNECTOR PLUGS

- MULTI-CIRCUIT COMPONENTS
- SIGNAL APPARATUS
- PRINTED CIRCUITS

AMP

ROUND* TAPER

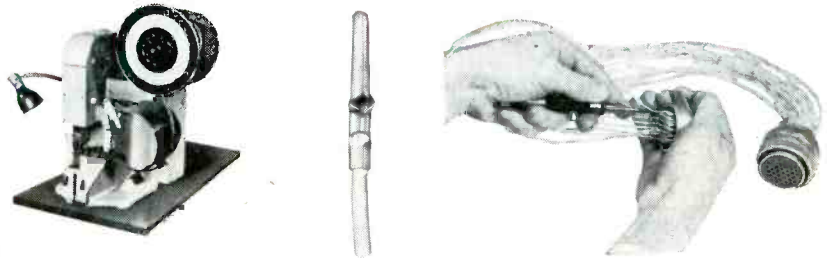

Here at last is a connector which combines miniature size and self-locking action! To make electrical connections, simply press AMP Taper Pins into mating receptacles. The pins are almost as small as the wire itself, yet when securely inserted will maintain their connection even up to the point of wire failure. Salt spray and vibration tests show initial contact resistances of only 0.5 to 1.0 milliohms increasing to a maximum of 2.63 milliohms after 160 hours of cycling.

New applications are being found every day for these versatile connectors—over a billion pins are in the field in computers and associated business machines alone!

Uses include termination of printed circuits, speaker disconnects, UHF antennae filters and tuners, Germanium diodes and TV high voltage fuses etc. Extraordinary security under vibration makes them excellent for attaching wires to crowded multiple contact "AN" connectors in aircraft. Write for "TAPER TECHNIQUE" Folder.

**For relays, switches, multi-circuit components, and other applications where a flat tab is more adaptable, see AMP Taper Tab Receptacles.*

AMP Taper pins, rolled from strip stock to very close tolerances, are wound on reels ready for use in AMP Automatic Wire Terminators. Pins can be applied as fast as operator can insert wire with speeds reported as high as 4,000 per hour! Spring type installation tool will seat pins firmly in mating receptacles.

Photo courtesy Remington Rand, Inc. 

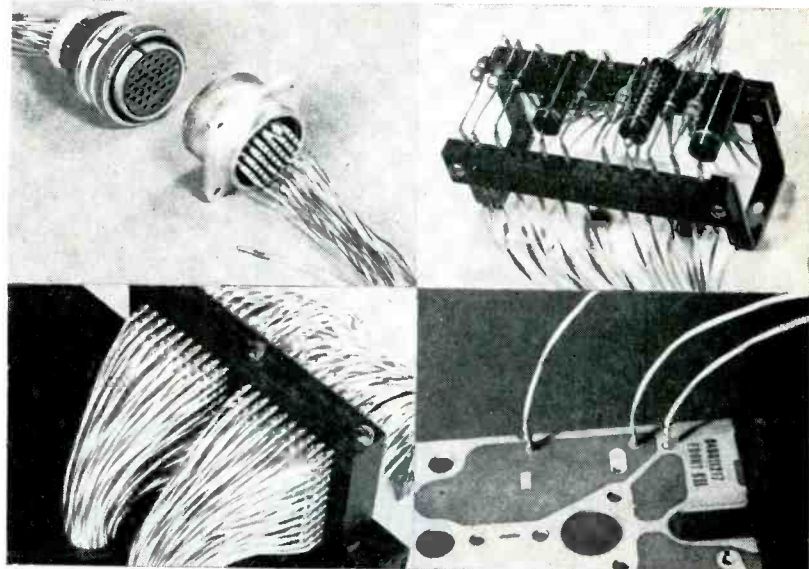



PINS

AMP

AMP Trade Mark Reg. U.S. Pat. Off.

© AMP

AIRCRAFT-MARINE PRODUCTS, INC.
ELECTRONICS DIVISION
2100 Paxton Street, Harrisburg, Pa.

Aircraft-Marine Products of Canada, Ltd.
1764 Avenue Rd., Toronto 12, Ontario, Canada

TAYLOR Built-up Vulcanized Fibre

is a new material made of many plies of homogeneous vulcanized fibre bonded together with a special resin developed in Taylor Laboratories. It can be machined with the same facility as homogeneous fibre, has high dielectric strength and is available in any thickness desired. Can be furnished in various colors.

Want to make something of it?

Make it into many products that require physical and electrical qualities that are equal to, or better than, that of the equivalent thickness of homogeneous fibre. The arc resistance at the adhesive line is equal to that of the fibre itself. The adhesive is unaffected by abrupt changes in relative humidity. It gives built-up fibre greater stability . . . resistance to distortion caused by atmospheric conditions. Edge splitting tests have proven the adhesive stronger than the fibre.

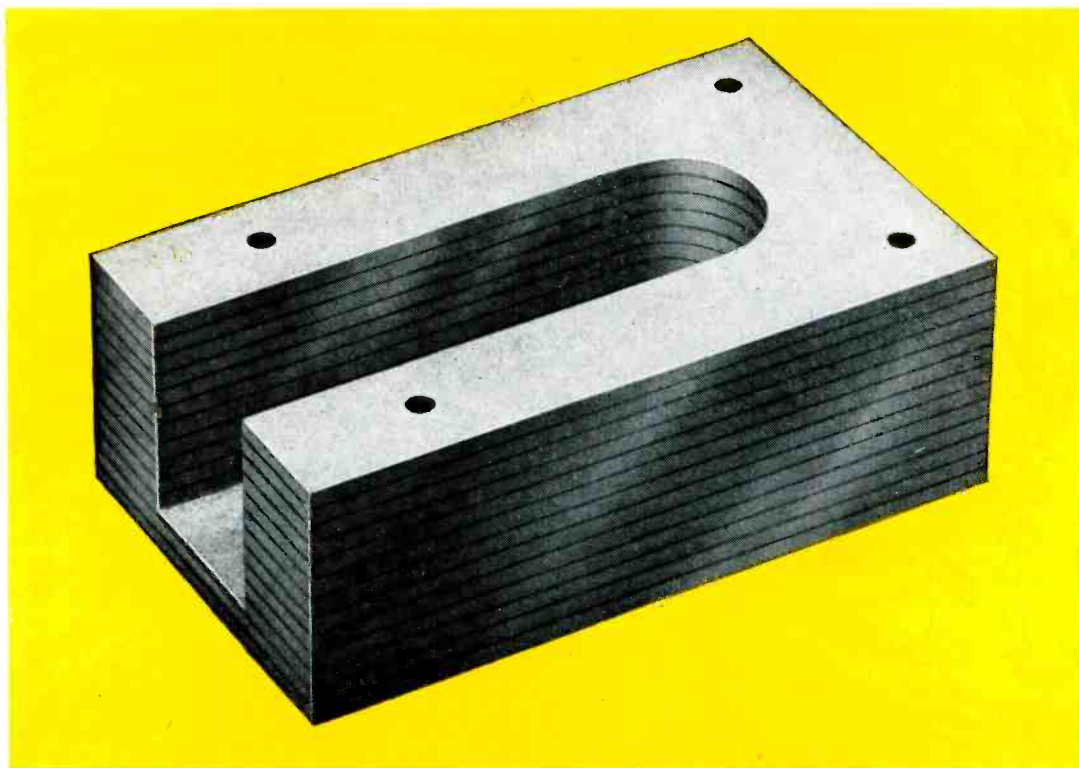

Make it from 45" x 56" sheets in any thickness desired. The thickness of individual plies can be varied to suit your particular requirements.

Make sure you get complete information on this versatile new material. Call your Taylor engineer . . . he will be glad to work with you . . . see where it can fit into your products. Let him go over your requirements for laminated plastics also. He may be able to suggest ways that *Taylor Phenol, Melamine and Silicone Laminated Plastics* can do a better job . . . lower your costs.

Taylor Fibre Co., Norristown, Pennsylvania—La Verne, California

TAYLOR
Laminated Plastics
Vulcanized Fibre

Are you designing any electronic equipment that should have —

- ① Easy installation and maintenance by non-technical personnel?
- ② Widest possible use by being instantly interchangeable between machines?

See how easily these features were built into this electronic punch press protection equipment with the Alden Serve-A-Unit Kit.

① In 30 seconds, user's own personnel can install plug-in protection unit . . . replace with spare . . . or shift it to another machine.

② With plug-in receptacle for electronic protection unit installed at each press, 8 actual electronic units are enough to serve the requirements of 14 presses, because all presses are not simultaneously active, and each electronic unit can instantly be moved anywhere to cover the active presses . . . or replace an inoperable unit.

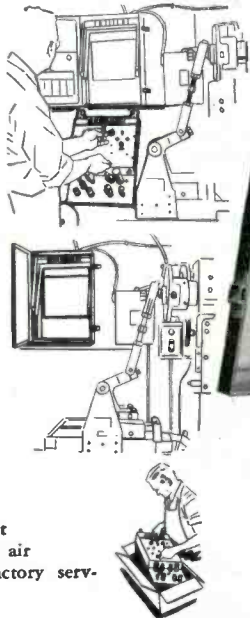

Inoperable unit easily shipable air express for factory servicing.

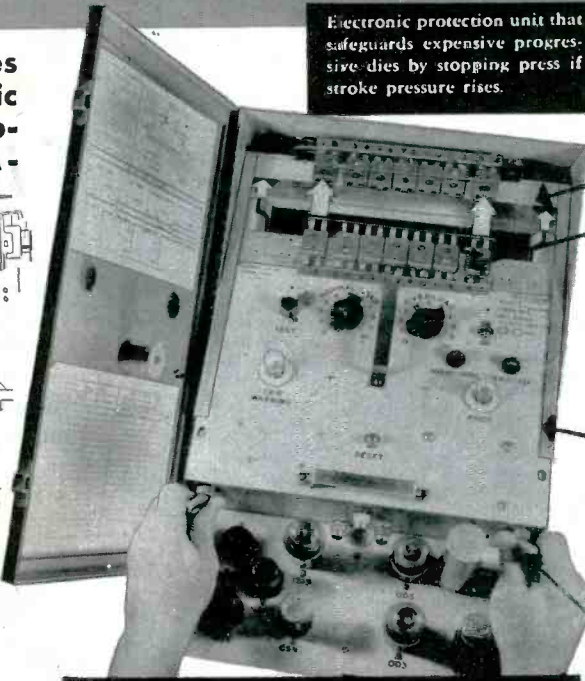

Electronic protection unit that safeguards expensive progressive dies by stopping press if stroke pressure rises.

- (A) ALDEN LOCK FRAME mounts mating Alden Back Connectors and engages pilot heads of Alden Serve-A-Unit Locks.
- (B) ALDEN SLIDE-IN BACK CONNECTORS spread all leads out accessibly at central check point, color coded and symbolized for easy identification and first-level service checks by user's personnel.
- (C) ALDEN SIDE RAILS guide plug-in unit into position until pilot heads of Serve-A-Unit Locks take over.
- (D) ALDEN SERVE-A-UNIT LOCKS pilot, draw in, lock and eject complete plug-in unit, with a half turn of the wrist.

See how Alden Components for Plug-in Unit Construction make it easy to build USER SATISFACTION into your equipment.

WITH ALDEN COMPONENTS, YOUR CIRCUITRY EASILY BECOMES PLUG-IN UNITS

Design your circuitry as compact vertical planes — It's as simple as this —

ALDEN PREPUNCHED TERMINAL MOUNTING CARDS cut to proper sizes for 7-pin, 9-pin, 11-pin and 20-pin packages. Or in 3' strips for chassis — cut it off as you require.

ALDEN MINIATURE STAKING TERMINALS Lay out in any pattern on Terminal Mounting Cards; ratchet slots hold elements for soldering without pliering or wrap-around.

ALDEN JUMPER STRIP stakes right under Terminals providing common circuit without soldering.

ALDEN CARD-MTG. TUBE SOCKETS for min. 7-pin, 9-pin and octal tubes.

FOR PACKAGES

FOR CHASSIS

These vertical planes fit beautifully into plug-ins — It's as simple as this —

4 SIZES OF PLUG-IN PACKAGES

Alden standard Bases, Lids, Handles, Cans, Sockets for 7, 9, 11 and 20-pin packages house Terminal Card Circuitry with tremendous flexibility for endless variety of open and shielded packages. . . making it easy and inexpensive to give your equipment reliability in service with instantly replaceable plug-ins for all sub-units.

7-pin 9-pin 11-pin 20-pin Package components and matching sockets.

ALDEN PLUG-IN PACKAGE

4 SIZES OF ALDEN BASIC CHASSIS
2", 4", 8", 17"

Your circuitry on Terminal Card strips snaps right into Alden Basic Chassis. Vertical mounting and hinged front panel give beautiful accessibility and space saving. Chassis can be plugged interchangeably into Standard Racks, Alden Uni-Racks, Alden Portable Cases. Alden Rack Adapter mates Standard Rack to Chassis.

Plugged into Standard Rack with Rack Adapter

Mount in Alden Uni-Racks

Plugged into Portable Cases

Alden Universal Rack Adapter

— and assign to each unit a tiny tell-tale to spot trouble instantly — It's as simple as this —

See how compact front panel easily mounts six tiny Alden Sensing Elements — specifically designed to lick the problem of having only a small amount of space. Assembled by simplest methods.

ALDEN MINI-TEST POINT JACK
For checking critical voltages from front of panel.

ALDEN "PAN-i-LITE"
Miniature indicator light with unbreakable I-piere light-lens unit replaceable from front.

ALDEN "FUSE-LITE"
Fuse blows — Lite glows. Simply unscrew 1-piece light-lens unit and blown fuse comes out with it.

GET THE COMPLETE STORY — REQUEST "ALDEN HANDBOOK" — SENT FREE

ALDEN PRODUCTS COMPANY 127 North Main Street, Brockton, Mass.



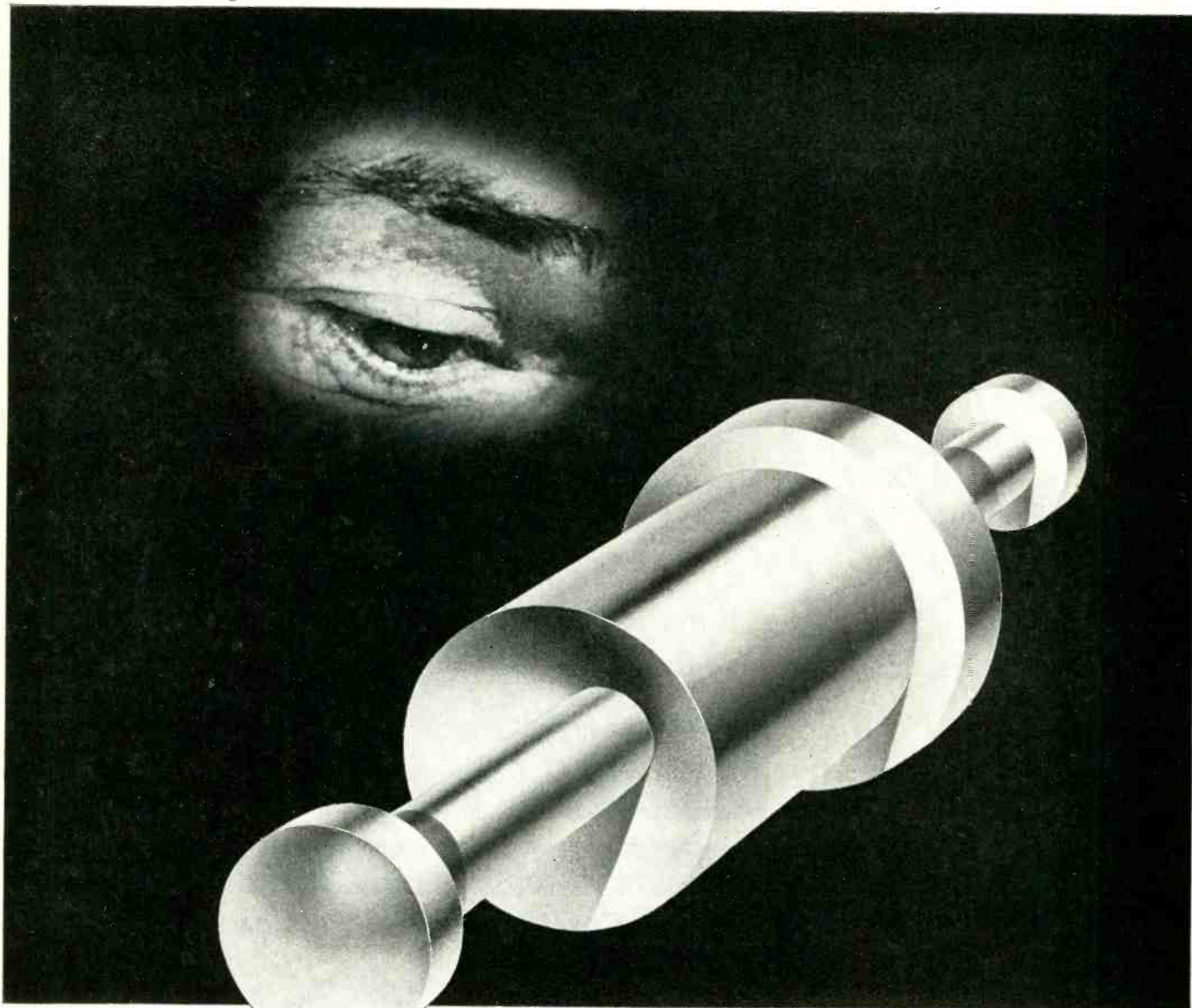

The "skin" we love to watch

The "skin," or plated coating, on CTC terminals gets extremely close scrutiny from our quality control engineers. And we take pleasure in this careful watching because —

We know, as a result, that you can depend on CTC terminals for electroplated coatings of guaranteed minimum thickness — whether to government specifications or your own.

Our "watching" of these coatings includes periodic bend tests for adhesion, and periodic microscopic inspection of cross sections for coating thickness. These are but two of many examples of quality control that enable us to offer customers *guaranteed* electronic components . . . custom or standard.

Besides terminals, we pay close attention to the production of CTC terminal boards, capacitors, swagers, hardware, insulated terminals, coil forms and coils. For all specifications and prices, write to Cambridge Thermionic Corporation, 437 Concord Avenue, Cambridge 38,

Mass. West Coast Manufacturers contact: E. V. Roberts, 5068 West Washington Blvd., Los Angeles 16 and 988 Market St., San Francisco, California.

Terminal Data: Our standard terminal line includes 30 types, each in varied shank lengths. Made of silver plated brass, coated with water dip lacquer to keep them chemically clean for soldering. Also available: combination screw and solder terminals in 3 sizes, and a complete line of phenolic and ceramic insulated terminals. All materials, processes and finishes meet applicable government specifications. Special order finishes include hot tin, electrotin, cadmium plate or gold plate.

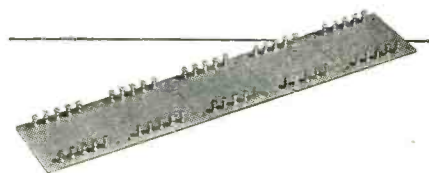

Standard CTC Terminal Boards as well as those made to your own specifications by CTC are available. Standard in cotton fabric phenolic, nylon phenolic or grade L-5 silicone impregnated ceramic. Custom made in cloth, paper phenolic, melamine, or silicone fibreglas laminates, imprinted as required and lacquered or varnished to specifications MIL-V-173 and JAN-T-152.

CTC

CAMBRIDGE THERMIONIC CORPORATION

*makers of guaranteed electronic components,
custom or standard*

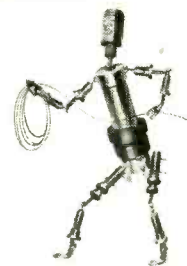



ELECTRONIC TEST INSTRUMENTS

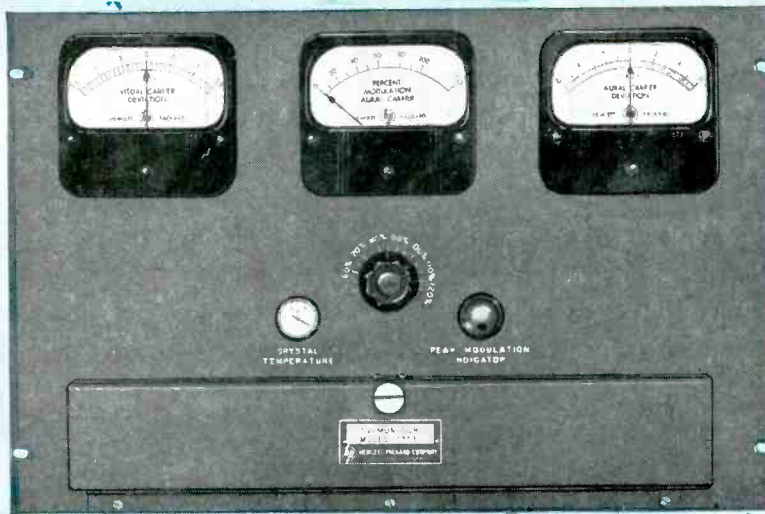

TV MONITOR MODEL 335E

All channels 2 to 83

Exceeds F. C. C. requirements

12 1/4" high; rack mounted

High stability, accuracy,
long-term dependability

Monitors visual, aural frequencies;
percentage aural modulation

New!

Small, low-cost monitor for all TV channels gives continuous, precise indication without adjustment

The unusually compact, low-cost Model 335E occupies just 12 1/4" of a standard relay rack. Yet it accurately and continuously performs all VHF and UHF television monitoring functions including visual and aural carrier frequency and aural carrier percentage modulation measurement.

Carefully engineered crystal reference oscillators provide accuracy in excess of F. C. C. requirements for all channels. Because discriminator accuracy does not depend on a tuned circuit, no time-consuming adjustments are required during operation. It is never necessary to reset carrier level or realign circuits. Proper operation of the monitor can be checked conveniently by controls located behind the front panel cover.

Trouble-Free Dependability

The monitor is specifically designed to operate at full accuracy over long periods of time without maintenance. Highest quality components and construction are used throughout. A new chassis design increases accessibility of components and makes possible cool operation

Copyright 1953 Hewlett-Packard Co.

through forced ventilation. Extra features include provision for remote indicating meters, remote peak modulation indicator lamp, and a demodulated signal for aural monitoring.

The instrument also includes a front-panel crystal temperature indicator and illuminated meter faces. It fits a standard relay rack, and can be color finished to match your transmitter installation.

SPECIFICATIONS

AURAL FREQUENCY MONITOR

Deviation Meter Range: +6 kc to -6 kc.

Accuracy: Better than $\pm 1,000$ cps for at least 10 days.

AURAL MODULATION METER

Modulation Range: Meter reads full scale on 33.3 kc swing. Calibrated to 100% at 25 kc swing; 133% at 33.3 kc swing.

Accuracy: Within 5% of mod. full scale.

Meter Characteristics: Meter damped in accordance F.C.C. requirements. Reads peak value of modulation peak of duration between 40 and 90 milliseconds. Meter returns from full reading to 10% of full value within 500 to 800 msec.

Frequency Response: Flat within $\pm 1/2$ db, 50 to 15,000 cps.

MODULATION PEAK INDICATOR

Peak Flash Range: From 50% to 120% modulation (25 kc = 100%).

VIDEO FREQUENCY MONITOR

Deviation Meter Range: +1.5 to -1.5 kc.

Accuracy: Better than ± 500 cps for at least 10 days.

AUDIO OUTPUT

Frequency Range: 50 to 15,000 cps. Response flat within $\pm 1/2$ db. Standard 75 μ sec de-emphasis circuit.

Distortion: Less than 0.25% at 100% modulation.

Output Voltage: 10 volts into 20,000 ohms at 100% modulation (low frequencies).

Monitoring Output: 1 milliwatt into 600 ohms, balanced, at 100% modulation (low frequencies).

Residual Noise: At least 70 db below output level corresponding to 100% modulation (low frequencies).

GENERAL

Frequency Range: Channels 2 to 83 inclusive, including offset channels.

R. F. Power Required: Approx. 1 watt.

External Meter Indication: Available for aural carrier deviation, video carrier deviation, aural modulation percentage and peak indication.

Size: 12 1/4" x 19" x 13". Rack mounting.

Power: 115 volts, 50/60 cps, 180 watts.

Price: \$1,950.00 f.o.b. factory.

Data subject to change without notice

HEWLETT-PACKARD CO.

2757A Page Mill Road, Palo Alto, California, U. S. A.
SALES AND ENGINEERING REPRESENTATIVES
IN PRINCIPAL CITIES



Instruments for Complete Coverage

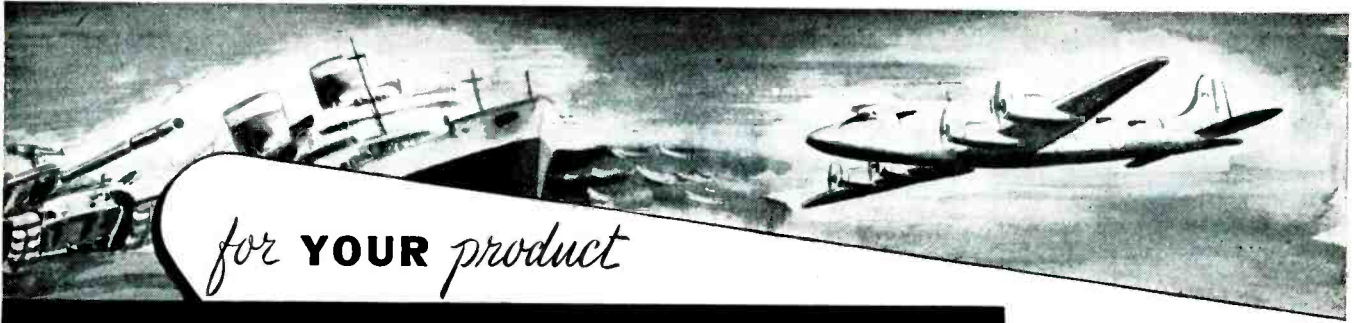

for **YOUR** product

WHICH PILOT LIGHT DO YOU NEED?

DIALCO

THE BIG ONE

This Pilot Light Assembly was first made to accommodate the *S-11 lamp* and was intended for use in the cabs of great diesel locomotives.

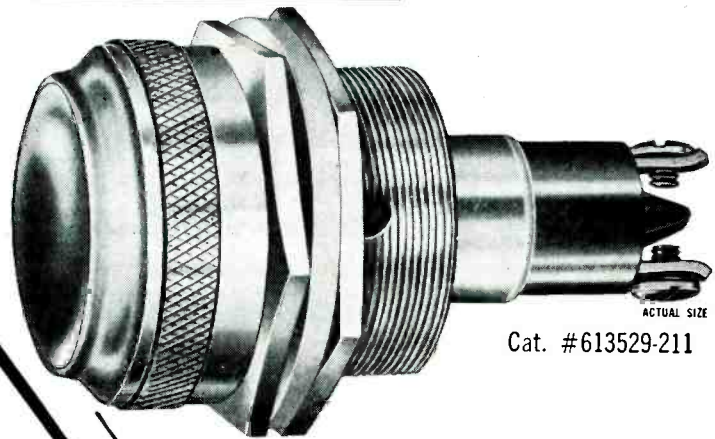

ACTUAL SIZE

Cat. #613529-211

Dialco HAS THE COMPLETE LINE OF INDICATOR and PANEL LIGHTS

This **BIG** one

or

this **LITTLE** one

THE LITTLE ONE

The miniaturization program on defense products required the development of this *sub-miniature* light. It is used on communication equipment and aircraft. Midget flanged base bulbs to fit are rated 1.3, 6, 12, and 28 volts.



ACTUAL SIZE

Cat. #8-1930-621

Samples

to suit your own special conditions and requirements will be sent promptly and *without cost*. Just outline your needs. Let our engineering department assist in selecting the *right lamp* and the *best pilot light* for YOU.



Write for the Dialco **HANDBOOK** of PILOT LIGHTS

Foremost Manufacturer of Pilot Lights.

DIALIGHT CORPORATION

60 STEWART AVE., BROOKLYN 37, N. Y.

HYACINTH 7-7600

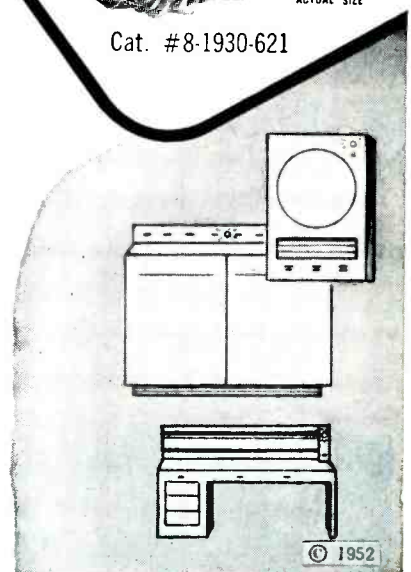

© 1952

If you are in Electronics you are going to need Transistors.

The time to investigate is **NOW!**

From now on the use of Transistors is going to spread rapidly. Their advantages in simplifying design are unique. Their potential applications are endless.

Whenever you think of vacuum tubes, from now on you should consider the possibility of substituting Transistors. True, the characteristics of the Transistor do not lend themselves to direct replacement of tubes in existing circuitry; each new application must be designed around the Transistor. What makes the Transistor so overwhelmingly worthwhile is its small size and light weight, long life and low cost. In addition, the Transistor's versatility of function opens up a broad new field of applications never before possible.

By consulting with Hydro-Aire now you get a head start in exploring the possibilities that Transistors hold for you. Hydro-Aire's specialized research know-how and experience in such important techniques as true hermetic sealing are at your disposal. Our engineers are waiting to consult with you—now.*

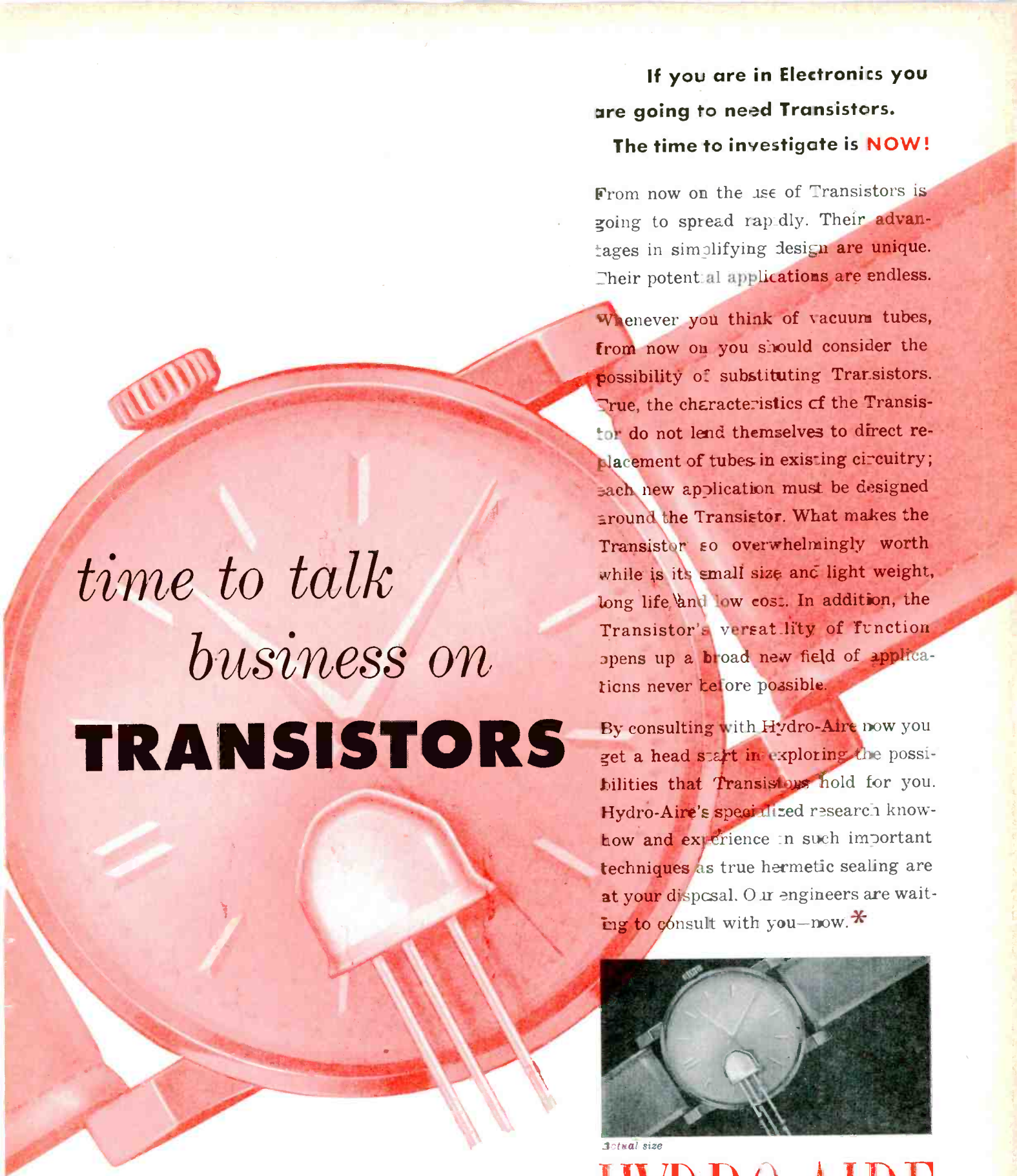

*time to talk
business on*
TRANSISTORS

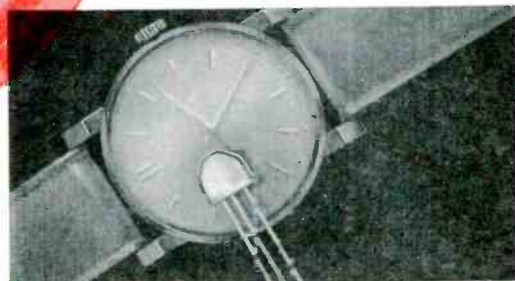

Actual size

* Please address your inquiries: CHIEF CONSULTING ENGINEER,
Transistor Development and Application Division,
Hydro-Aire, Inc.,
3000 Winona Avenue, Burbank, Calif.

HYDRO-AIRE Inc.

BURBANK, CALIF.

Subsidiary of Crane Co.

CONSULTANTS IN TRANSISTOR APPLICATIONS

Another example of Sanborn Oscillographic Recording Versatility

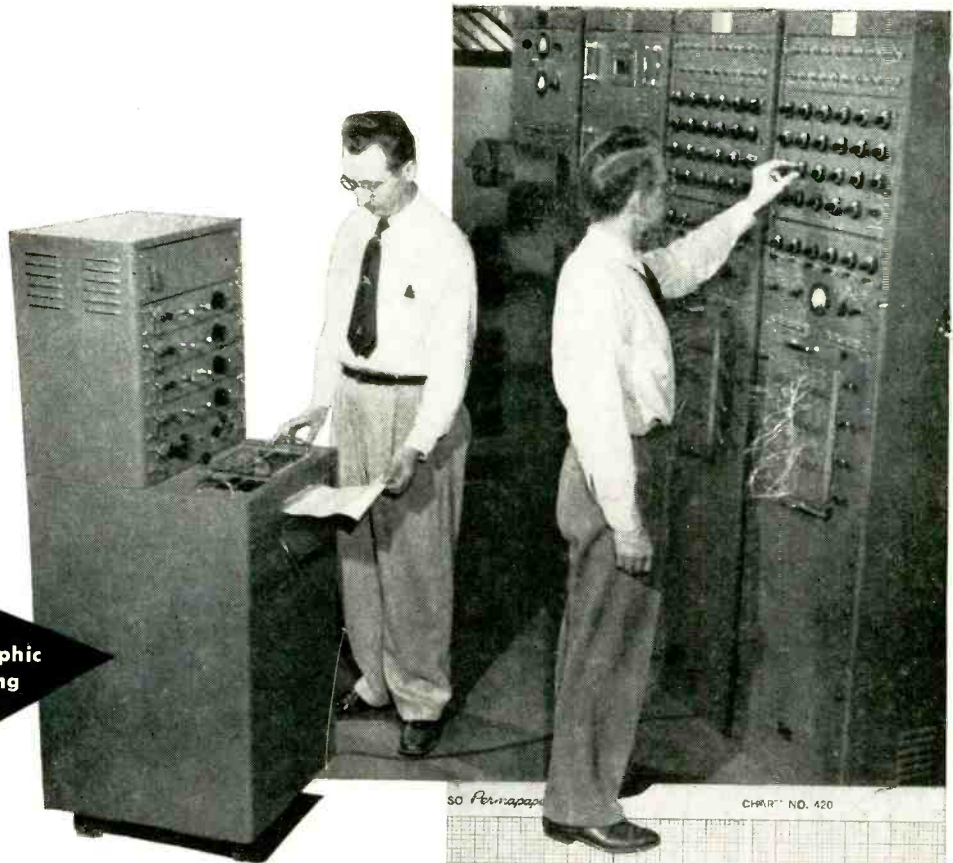

Four-channel recording correlates simulated jet bomber airspeed and altitude conditions

At Eclipse-Pioneer, engineers make good use of Sanborn 4-channel recording systems in conjunction with high precision analogue computers to establish performance criteria for automatic flight systems and components.

At other laboratories Sanborn Systems are being used to record such phenomena as: stress, strain, pressure, displacement, thickness, velocity, acceleration, current, voltage, temperature, torque, light, flow, force, load, position, rpm, radiation and tension.

SANBORN OSCILLOGRAPH RECORDING SYSTEMS HAVE MANY APPLICATIONS.

They are used in a great many different fields where accurate and permanent graphic registration of almost any electrical phenomena (whose frequency range is zero to 100 cycles per second) is required.

Sanborn Systems are widely used because of the availability and ready interchangeability of amplifiers and preamplifiers, as well as such Sanborn advantages as: inkless recording in true rectangular coordinates, high torque movement, time and code markers and wide choice of paper speeds. In addition, a basic choice of systems, 1-, 2-, and 4-channels, provides a system to fulfill almost any laboratory requirements.

WRITE FOR CATALOG

Sanborn Company
INDUSTRIAL DIVISION

CAMBRIDGE 39, MASSACHUSETTS, U.S.A.

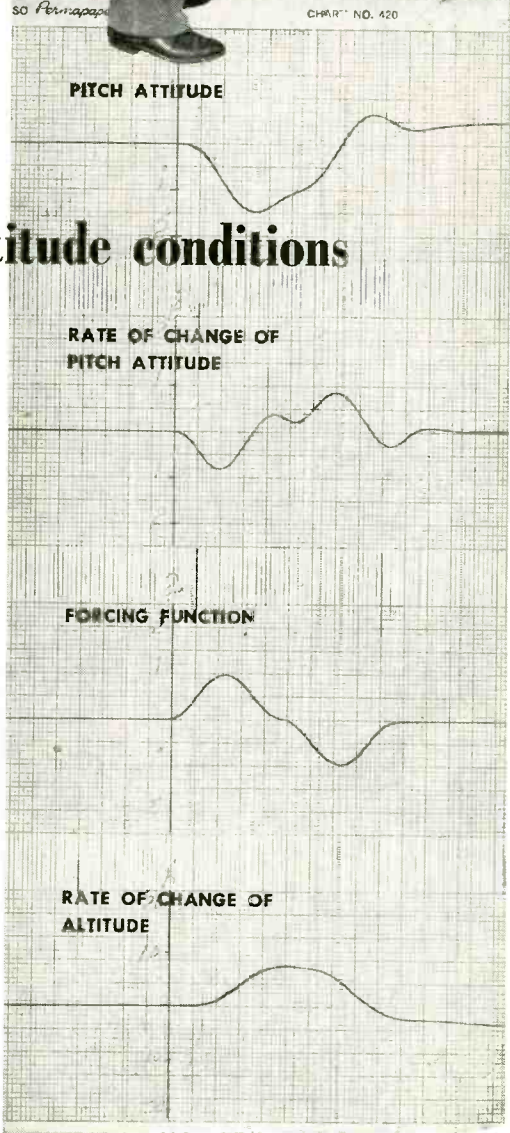

ALSiMAG[®]

ULTRA LOW LOSS

COIL FORMS

ALSiMag coil forms are accurately made to your design and specifications. The range of sizes and designs is almost unlimited. Minimum tooling charges. Take advantage of our very broad experience on coil forms. Send blue prints and outline operating conditions for recommendations. No cost or obligation.

52ND YEAR OF CERAMIC LEADERSHIP

AMERICAN LAVA CORPORATION

A Subsidiary of Minnesota Mining and Manufacturing Company

CHATTANOOGA 5, TENNESSEE

OFFICES: METROPOLITAN AREA: 671 Broad St., Newark, N. J., Mitchell 2-8159
SYRACUSE, N. Y.: 330 Arlington Ave., Phone 76-5068 • CLEVELAND: 5012 Euclid
Ave., Room 2007, Express 1-6685 • NEW ENGLAND: 1374
Mass. Ave., Cambridge, Mass., Kirkland 7-4498 • PHILA-
DELPHIA: 1649 N. Broad St., Steveson 4-2823 • ST.
LOUIS: 1123 Washington Ave., Garfield 4959 • CHICAGO:
223 N. LaSalle St., Central
6-1721 • SOUTHWEST:
John A. Green Co., 6815
Orrole Dr., Dallas 9, Dixon
9918 • LOS ANGELES:
5603 N. Huntington Dr.,
Capital 1-9114



NEW! FOR PRINTED COMPLETE LINE

- 1 FOR AUTOMATION: EXCLUSIVE NEW Self-Supporting Snap-in Bracket Mounting. (See Type YGC-B45.)
- 2 NEW Twist-ear Mounting. (See Types XP45 and UPM45.)
- 3 PLUG-IN BLADE-TYPE TERMINALS for vertical or horizontal mounting of control to printed circuit panel. (See all photos)

- 4 Threaded Bushing Mounting. (See Types XGC-45, GC-U45 and *miniaturized* U70.)

Consultation without obligation available on variable resistors for your printed circuit applications. Write today.

VERTICALLY MOUNTED to Printed Circuit Panel. Shaft above panel. (Types YGC-B45, XP45 and XGC-45.)

- NO shaft protection needed during soldering.
- PARALLEL terminals permit *small* round connecting holes instead of *large* elongated slots necessary for fan shaped terminals.
- Terminals available in 7/8" or 1-1/32" lengths from control's center.

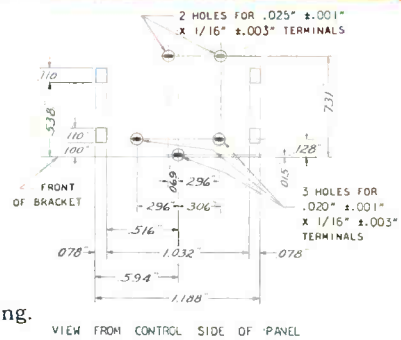
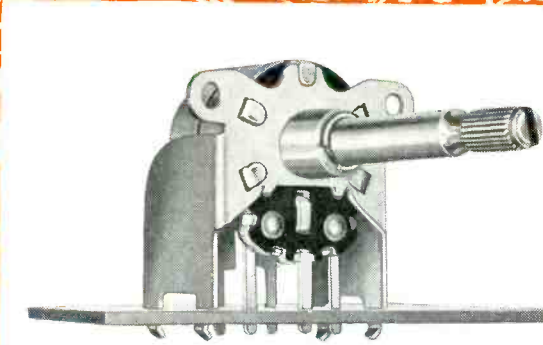

Suggested panel piercing.

Type YGC-B45 FOR AUTOMATION: EXCLUSIVE NEW Self-Supporting Snap-in Bracket

- Snaps instantly into place.
- Stays firmly put during soldering. Solder permanently anchors control to circuit panel.
- Terminal connections cannot loosen; bracket prevents mounting or operating strain on control or switch terminals.

- No mounting hardware, no separate supporting panel needed.
- No strain on printed circuit panel. Anchor tabs attach bracket to cabinet.
- Adequate clearance for circuit paths provided by ample spacing between terminals and by design of mounting legs on bracket.

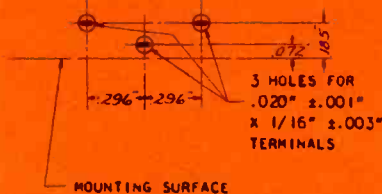

Suggested panel piercing.

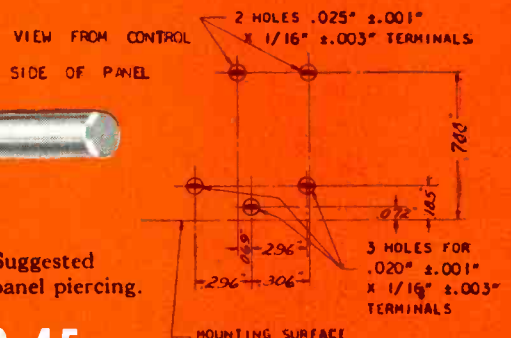
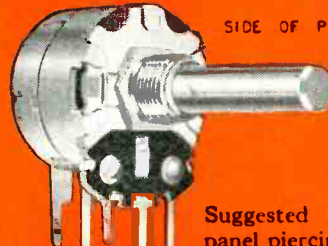

Suggested panel piercing.

Type XP45

For TV preset control applications using a mounting chassis to support printed circuit panel. Twisting 2 ears holds control rigidly to mounting chassis. Available in finger adjusted shaft lengths of 1/2", 5/8", 11/16", 7/8" and 1" from control's mounting surface. Also available with recessed screw driver slotted shaft (Type XPM45).

Type XGC-45

For applications using a mounting chassis to support printed circuit panel. Threaded bushing mounting

All controls illustrated actual size.

CIRCUITS OF VARIABLE RESISTORS



HORIZONTALLY MOUNTED

to Printed Circuit Panel. Shaft extends through panel. (Types U70, GC-U45 and UPM45.)

Type U70 (Miniaturized)

Threaded bushing mounting. Terminals extend perpendicularly $5/32"$ from control's mounting surface.



Type GC-U45

Threaded bushing mounting. Terminals extend perpendicularly $7/32"$ from control's mounting surface. Available with or without associated switches.



Type UPM45

For TV preset control applications. Recessed screw-driver slotted shaft remains solder-free during panel dipping. Control may be held rigidly to panel before soldering by twisting 2 ears. If ears are left straight, the solder will permanently anchor control to circuit panel. Terminals extend perpendicularly $7/32"$ from control's mounting surface.

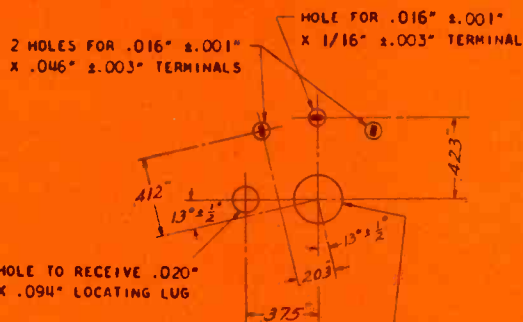

Suggested panel piercing.

CLEARANCE HOLE FOR $1/4"$ DIA. THREADED BUSHING

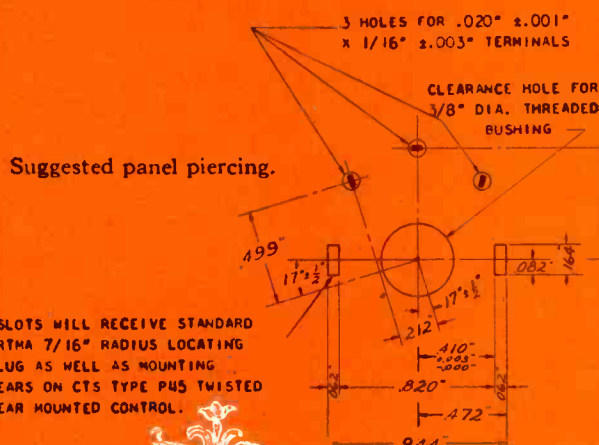

Suggested panel piercing.

*Specialists in Precision Mass Production
of Variable Resistors. Founded 1896.*



**CHICAGO TELEPHONE SUPPLY
Corporation**

ELKHART · INDIANA

REPRESENTATIVES

Henry E. Sanders, McClatchy Bldg.,
69th & Market St.,
Upper Darby, Penna.
Phone: Flanders 2-4420

W. S. Harmon Company,
1638 So. La Cienega Blvd.,
Los Angeles 35, California
Phone: Bradshaw 2-3321

John A. Green Company, 6815 Oriole Drive,
Dallas 9, Texas

CANADIAN MANUFACTURING AFFILIATE

C. C. Meredith & Co., Ltd.,
Streetsville, Ontario

SOUTH AMERICA

Jose Luis Pontet,
Buenos Aires, Argentina
Montevideo, Uruguay · Rio de Janeiro,
Brazil · Sao Paulo, Brazil

OTHER EXPORT

Sylvan Ginsbury,
8 West 40th Street,
New York 18, N. Y.

**FOR FASTER
LOW-COST
ALUMINIZING**

NRC 4-Position Aluminizing Bench

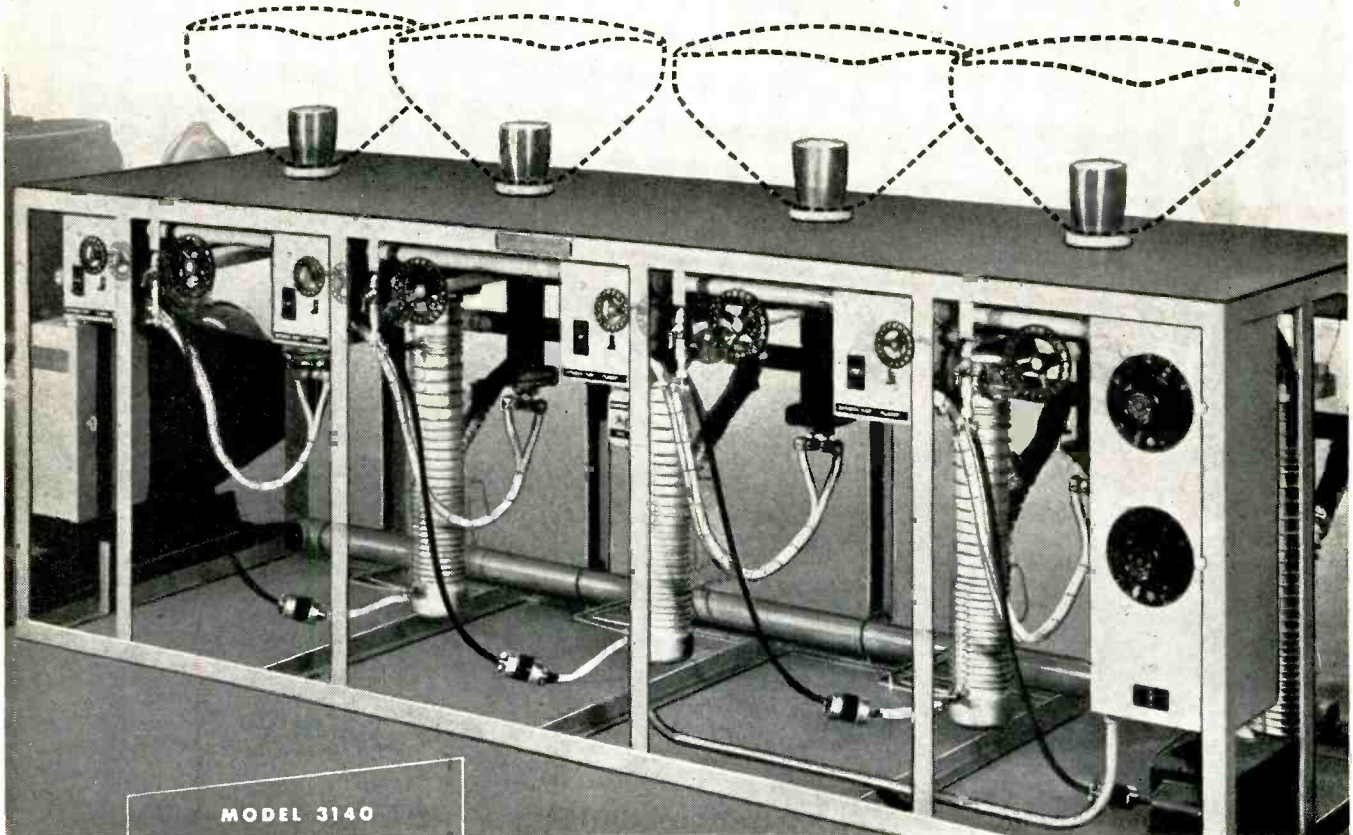

MODEL 3140

Only \$8153 f.o.b. Newton, Mass.

This bench is today's ultimate for high-speed, low-cost aluminizing of television tubes. . . . Equipped with a high through-put Booster Pump, it has greater capacity and a shorter cycle. . . . The two mechanical pumps are the NRC Gas Ballast type. One roughs, one backs. Neither is affected by water vapor. Eliminates necessity of reclaiming oil. . . . All parts readily accessible for easy cleaning. . . . Write for further details.

INDUSTRIAL RESEARCH

CHEMISTRY, METALLURGY
HIGH VACUUM ENGINEERING



PROCESS DEVELOPMENT

PHYSICS, DEHYDRATION
DISTILLATION, VACUUM COATING

National Research Corporation

EQUIPMENT DIVISION

SEVENTY MEMORIAL DRIVE, CAMBRIDGE 42, MASSACHUSETTS

**THERE'S A C-D CERAMIC
FOR EVERY NEED**

Consistently Dependable
Cornell-Dubilier
ceramic capacitors



TUBULAR



DISC



HIGH VOLTAGE

**The only ceramics with the
"MILLION DOLLAR BODY"**

Only C-D can give you the "million dollar body", made by the exclusive C-D process in the world's most modern ceramic body plant — C-D's own. This close control under one roof, from raw powder to finished product, results in greater stability and uniformity, extra durability and extended service life—even down to the tiniest disc or tubular. Engineering samples sent on request. A wide range of designs in all capacity and voltage ratings available. We welcome inquiries on special design and application problems. Write to: *Cornell-Dubilier Electric Corp., Dept. K 14 South Plainfield, New Jersey.*

THERE ARE MORE C-D CAPACITORS IN USE TODAY THAN ANY OTHER MAKE

**CORNELL
DUBILIER** *Capacitors*

PLANTS IN SOUTH PLAINFIELD, N. J.; NEW BEDFORD, WORCESTER AND CAMBRIDGE, MASS.; PROVIDENCE AND HOPE VALLEY, R. I.; INDIANAPOLIS, IND.; FOUQUAY SPRINGS AND SANFORD, N. C.; AND SUBSIDIARY, THE RADIART CORPORATION, CLEVELAND, OHIO



ANTENNAS



ROTORS



CAPACITORS



VIBRATORS



CONVERTERS

These instruments and components *can speed your research*

Listed here are some of the many special types of *ElectroniK* instruments and Honeywell components which are helping research men to measure, record and control in thousands of research projects. For information on how they can be utilized in your own work, write to MINNEAPOLIS-HONEYWELL REGULATOR CO., Industrial Division, Wayne & Windrim Aves., Philadelphia 44, Pa.

Special ElectroniK recording instruments of interest to research men:

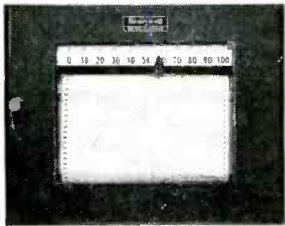

FUNCTION PLOTTER—automatically plots the relationship, $y=f(x)$, between any two variables that can be converted to electrical signals.

TWO-PEN RECORDER: simultaneously records two variables on a single chart . . . both pens can traverse full width of 11-inch chart.

ADJUSTABLE SPAN RECORDER: span can be adjusted over a 50/1 range . . . zero can be suppressed as much as 100% of maximum span.

1/2-SECOND RECORDER: for recording rapidly-changing variables; full 11-inch scale pen movement in only 1/2 second. Chart speeds from 1 inch to 14,400 inches per hour available.

NARROW SPAN RECORDER: measures spans as narrow as 100 microvolts without external pre-amplifier . . . completely self-contained.

Electronic components for laboratory use:

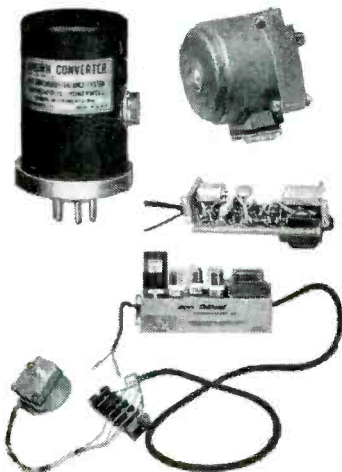

BROWN CONVERTERS: transform low-level d-c signals into 60 or 400-cycle alternating voltages . . . Unaffected by atmospheric pressure.

BROWN SERVO AMPLIFIER SYSTEMS: consist of converter, amplifier and servo motor . . . Sensitivities of 2.0, 0.5, and 0.05 microvolts are available, with corresponding voltage gains of 10^6 , 4×10^6 and 40×10^6 .

BROWN 60-CYCLE 2-PHASE SERVO MOTORS: Provide positive positioning . . . totally enclosed, self lubricated. Maximum torque: 27 RPM motor—85 oz.-in., 54 RPM motor—43 oz.-in.; 162 RPM motor—19 oz.-in.; 333 RPM motor—4 oz.-in.

MINNEAPOLIS
Honeywell
BROWN INSTRUMENTS

First in Controls



INTERNATIONAL CRYSTAL Mfg. Co.

now offers

ONE DAY SERVICE

on

QUARTZ CRYSTALS

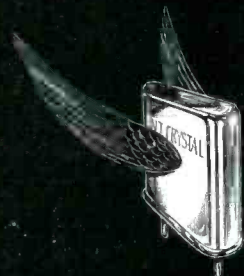

throughout the range of frequencies from 1500 kilocycles to 50 megacycles. Fundamental Crystals — 1500 KC - 15000 KC. Overtone Crystals — 15 MC - 50 MC.

All orders of less than five units of any one frequency in the range 1500 KC - 50 MC will be mailed within **24 hours** from the time received.

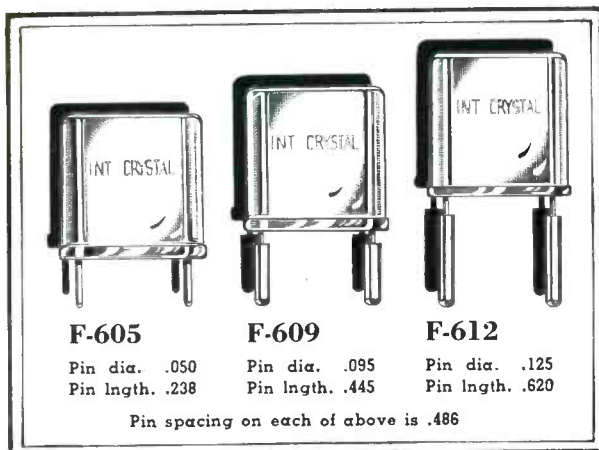

Calibration

All fundamental crystals are calibrated into 32 mmf unless otherwise specified. All overtone crystals are calibrated for series resonance, unless otherwise specified.

All units are calibrated to .0025% or better of their nominal frequency at 25° C.

WHEN ORDERING SPECIFY:

- (1) Frequency
- (2) Holder Type*
- (3) Circuit Data (32 mmf load, series resonance, etc.)
- (4) End Use (Equipment type & manufacturer, development, etc.)

*Adaptors can be supplied for 3/4" pin spacing.

For further information write, wire or call:

International / **CRYSTAL Mfg. Co., Inc.** 18 N. Lee Phone FO 5-1165
OKLAHOMA CITY, OKLA.

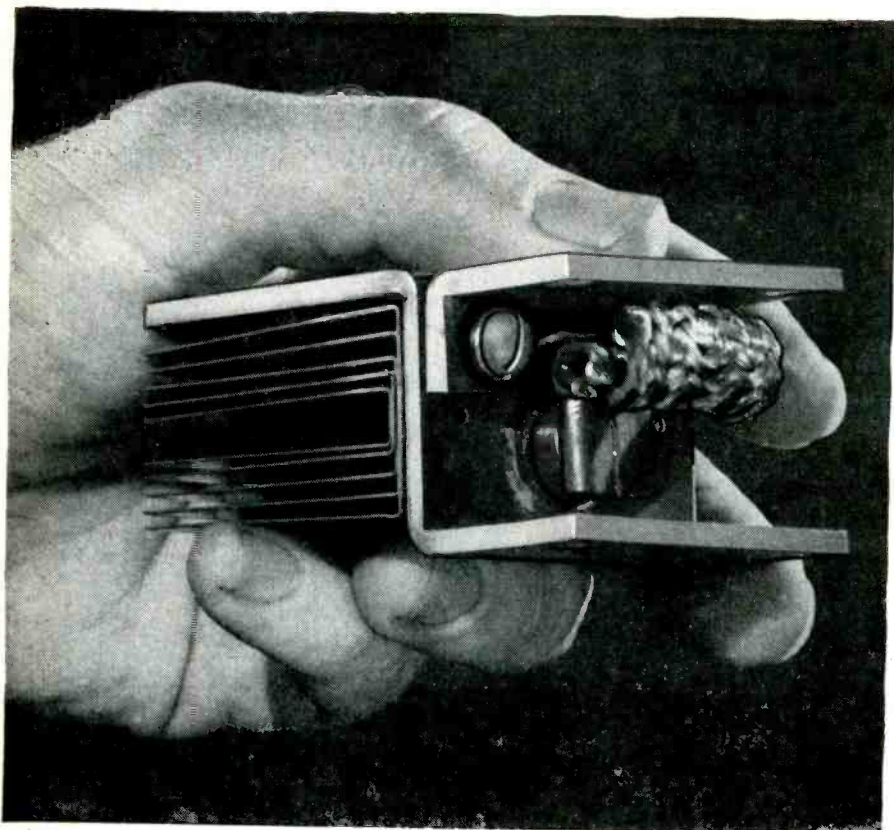

THIS NEW MIDGET GERMANIUM RECTIFIER HAS AN OUTPUT OF OVER TWO KILOWATTS

Get High Power and Save Space With G-E Germanium Rectifiers

Germanium is a material to stimulate the imagination, so endless are its possible applications. Germanium rectifiers, pioneered by General Electric, offer design engineers tremendous possibilities for product improvement. Combining extreme compactness with the highest efficiency of any metallic rectifier known, G-E germanium cells show practically no aging. D-C power supplies for welders, battery chargers, and electrochemical processes are just a few of the possible applications.

COMPACT—The compactness of germanium rectifiers makes possible real savings in space, volume, and weight. The dime-sized cell, pictured above with its heat exchanger, has a rating of two kilowatts with air cooling at a rate of 1000 fpm. Six of these tiny rectifiers connected in a three-phase bridge will deliver up to

65 volts d-c with a rated capacity of over 14 kw. To do a comparable job with selenium would take six stacks of 30 cells each, or a total of 180 selenium plates.

OTHER RATINGS—Besides the rectifier illustrated above, two other types are available. One is a sealed convection-cooled unit with a half-wave rating of 0.4 amperes d-c output with up to 125 r.m.s. volts a-c input. A second is the plate-mounted convection or fan-cooled rectifier with half-wave ratings of from 4 to 20 amperes d-c output. All assemblies can be used in doubler, center-tap, and full-wave bridge circuits with corresponding increases in ratings.

MORE INFORMATION is available from your nearest G-E Apparatus Sales Office, or write Section 461-32, General Electric, Schenectady 5, N. Y.

You can put your confidence in—

GENERAL  ELECTRIC

METALLIC RECTIFIER FACTS FOR ENGINEERS

Germanium

The Rectifier of the Future
by C. E. Hamann

Seldom if ever has the rectifier industry experienced such widespread interest in a new development as has occurred with germanium. While much is being written of the capabilities of germanium in the low current area of diodes and transistors, its possibilities in high-power applications are equally amazing.

Perhaps a simple comparison with selenium of the relative current densities will serve to illustrate its fantastic properties as a power rectifier. It is standard industry practice to operate selenium in a 3-phase bridge circuit at a current density of 75 milliamperes per square centimeter of cell area. With an adequate air-cooling system this current density may safely be doubled.

Germanium is presently being operated successfully at a current density of 75 amperes per square centimeter of cell area with every indication that

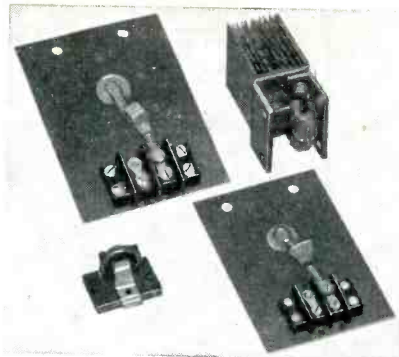

the top limit of capability has not yet been reached. Considering that germanium is also being operated at r.m.s. voltages per cell more than double that of the best available selenium, it will be seen that its power capabilities are at least 1000 times greater than selenium on a cell area basis.

The reason for this phenomenal ability lies in its inherently high efficiency which in turn means very little heat loss to be dissipated. The cell operating efficiency is in the range of 98 to 99 percent.

C. E. Hamann
General Electric Company

Hysteresis Motors

by **COLLINS**

*New 370A Series Motors Designed
Primarily For Operation
From Vacuum Tubes*

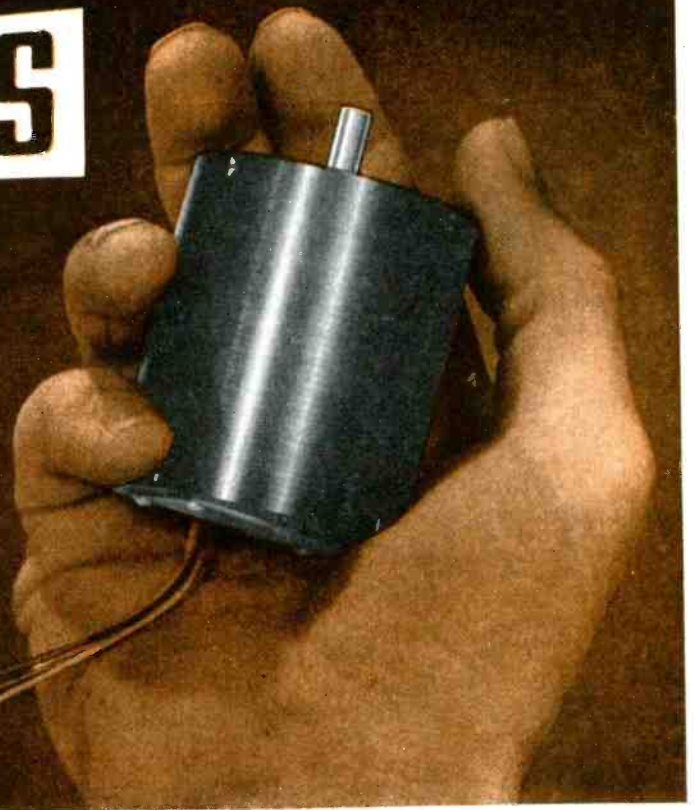

OUTSTANDING FEATURES of the latest addition to the Collins line of Industrial Components:

- high starting torques
- frequency ranges: 0 - 1000 cps, 0 - 500 cps, 60 cps, 400 cps
- absolute synchronous rotation

The superior efficiency and high starting torque of the Collins 370A-Series Hysteresis Motors make them suited for driving timing mechanisms, magnetic storage drums or any other device which must rotate at an absolutely constant speed regardless of fluctuations in load or line voltage. These motors have split windings for operation directly from the plate circuits of two

push-pull direct-coupled amplifiers driven 90 degrees out of phase, eliminating bulky, frequency-limiting output transformers.

Typical of this latest Collins Industrial Component is the Type 370A-1 Wide-Band Hysteresis Synchronous Motor, particularly adaptable to operation in automatic frequency control systems with error signals from zero to as high as 1000 cps producing synchronous rotation from motionless to 30,000 rpm.

Other standard models of the 370A-Series include:

Type 370A-2; similar to 370A-1 but with higher torque; 0-500 cps frequency range.

Type 370A-3; single frequency, 60 cps; 1800 rpm.

Type 370A-4; single frequency, 400 cps; 12000 rpm.

Write today for complete information.

COLLINS RADIO COMPANY
Cedar Rapids, Iowa



11 W. 42nd Street,
NEW YORK 36

1930 Hi-Line Drive,
DALLAS 2

2700 W. Olive Avenue,
BURBANK

introducing the GOODMANS PERMANENT MAGNET SHAKERS

THESE shakers provide vibratory sinusoidal forces of frequency and amplitude by which specific vibratory conditions can accurately be simulated. They provide the means of assessing the effects of sudden acceleration on materials, structures and components; and are being extensively applied to FATIGUE TESTING, ELECTRICAL COMPONENT TESTING, FLEXURE TESTING OF PLASTICS, ETC., and SPECIALISED GUIDED WEAPON RESEARCH. For certain pre-knowledge of vibration and its effects consult GOODMANS.

MODEL 390A A medium duty model producing an alternating force of approximately ± 25 lbs.
 Thrust Force factor 4.7 lbs. per amp.
 Max. Continuous Current Rating (R.M.S.) 2 amps. uncooled; 4 amps. with air cooling of approx. 5 lbs. per sq. in.
 Stroke 0.5 in total excursion.
 Impedance 8 ohms matching.
 Frequency Range Up to 10,000 c/s.
 Weight of Moving System 0.16 lbs.
 Stray Fields Operating zone less than 100 gauss.
 Flux Density 11,000 gauss.
 Weight 26 lbs.

MODEL 790 For Vibrating heavy components, and is capable of producing a force of ± 50 lbs.
 This unit has a force factor of approximately 9.2 lbs. per amp. and a total current capacity, with air cooling, of 4 amps. (R.M.S.).
 Stroke 0.5 in total excursion.
 Impedance 24 ohms matching (approx.)
 Frequency Range Up to 5,000 c/s.
 Weight of Moving System 0.5 lbs. (approx.)
 Stray Fields Operating zone less than 100 gauss.
 Flux Density 11,000 gauss.
 Total Weight 70 lbs. (inc. trunnion)

MODEL 8/600
 For the vibration of heavy loads or complete assemblies. Has a total force of approximately ± 300 lbs.
 Stroke 1 in. total excursion.
 Impedance to suit driving equipment.
 Frequency Range Up to 3,000 c/s.
 Weight of Moving System 6 lb. (approx.)
 Stray Fields Operating zone less than 25 gauss.
 Flux Density 10,000 gauss.
 Total Weight 4 cwt. (approx.)
 This unit can be fitted with (a) built in air cooling blower (b) switch to give high or low impedance armature coil and (c) pick-up unit for monitoring wave form and amplitude.

MODEL V47 for the vibration of very light electronic components, optical-cell research, hair-spring torque testing etc.
 Thrust Force factor 0.9 lbs. per amp.
 Max. Continuous Current Rating (R.M.S.) 1.5 amps.; 2.0 amps. up to 2 min. duration.
 Stroke 0.2 in total excursion.
 Impedance Varies with frequency and load between 3 and 10 ohms. Up to 10,000 c/s.
 Frequency Range Up to 10,000 c/s.
 Weight of Moving System 6.5 grams.
 Stray Fields Operating zone less than 25 gauss.
 Flux Density 11,000 gauss.
 Weight 2 lbs.

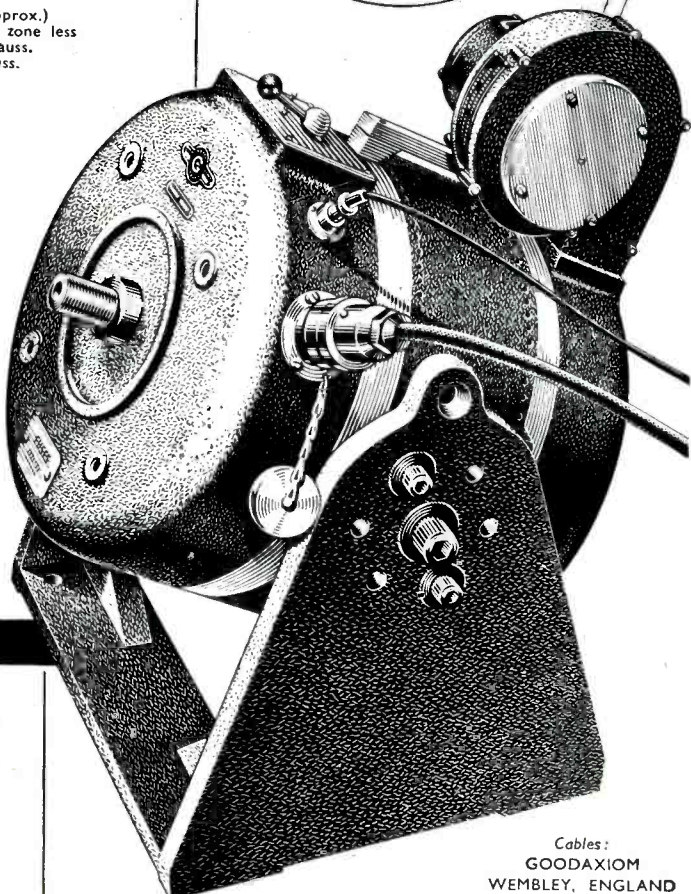
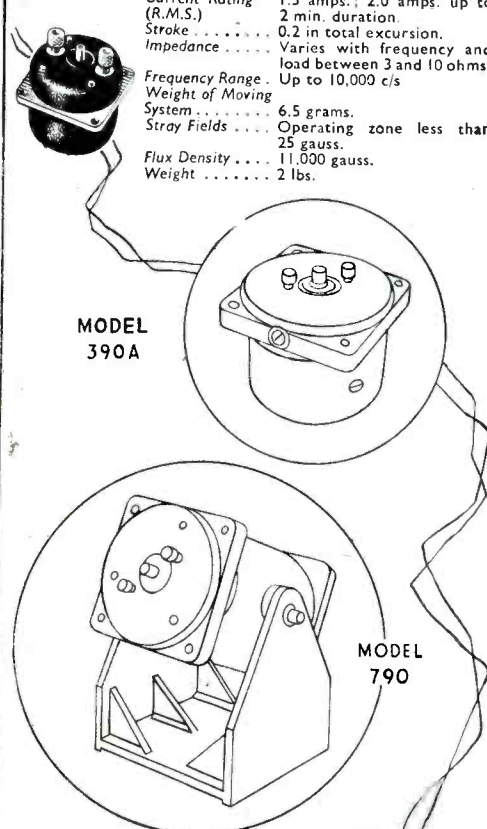

Cables:
 GOODAXIOM
 WEMBLEY, ENGLAND

GOODMANS INDUSTRIES LTD
 AXIOM WORKS · WEMBLEY · MIDDX · ENGLAND

DRIVING EQUIPMENT
 A range of appropriate driving equipments is available and takes the form of High-Power Amplifiers, Stabilised Power Supply Units and precision R.C. Oscillators specifically designed to give continuous power output to drive the particular shaker concerned.

MAIL THIS COUPON

To **GOODMANS INDUSTRIES LIMITED**
 AXIOM WORKS, WEMBLEY, MIDDX., ENGLAND

Please mail me your catalogue and technical data sheets in connection with your PERMANENT MAGNET Shakers.

NAME

COMPANY

CITY ZONE STATE E/U

KELLOGG SWITCHBOARD



GENERAL ELECTRIC

Air Associates

Motorola

WILCOX ELECTRIC COMPANY

HUGHES



UNION PACIFIC RAILROAD

Bendix
AVIATION CORPORATION

SANGAMO ELECTRIC COMPANY

CROSLEY

Western Electric

Westinghouse

MELPAR, INC.



RADIO CORPORATION of AMERICA

...and many more!



C-A-C MOLDED TOROIDS

Stocked in Standard Inductances
for immediate delivery...



NEW!

With the new molded toroid simplifying mounting problems and with the resultant demand increasing daily, C-A-C now offers an added convenience to buyers by stocking standard types for immediate delivery.

Write for file of complete specifications and listing of stocked inductances. C-A-C molded toroids meet the performance requirements of Military specifications.

Why is it?...

From a modest beginning five years ago, Communication Accessories Company has grown to one of the largest exclusive toroid coil winding producers in the U. S. today. Why?

We like to think that this growth is due to the thorough, careful handling we apply to each coil . . . and because of the particular skill of our people. Whatever the reason, we'll continue — doing the best we know how — thankful for the trust that important companies have placed in us.

write for this catalog →

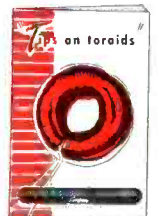

COMMUNICATION ACCESSORIES *Company*

HICKMAN MILLS, MISSOURI

New!

VARY-TALLY

Multiple-Unit Reset Counter



DESIGNED TO COUNT ANYTHING COUNTABLE

this new Vary-Tally can be supplied in any combination up to 6 banks high, 12 units wide, with the counting units arranged compactly on stands in tiers. Now check these special features of Veeder-Root design and construction:

- Easily Readable from any Angle . . . Bold Figures Always Centered in Window . . . No Glare . . . Figures not Covered by Fingers in Operator
- Easily Portable, yet Ruggedly Built for Long Wear
- Separate Counting Units Can be Rotated like Tires on a Car, to Distribute Wear Evenly
- All Parts Corrosion-Resistant
- Working Parts of Hardened Steel
- Operator Not Affected by Extreme Heat or Cold
- Individual Tag Above Each Counter-Window — Not Strip Tabs
- Veeder-Root Quality in Every Part

Now what's on your mind, that Vary-Tally can help you count? Write for news sheet and prices.

'The Name that Counts'



VEEDER-ROOT INC.

HARTFORD 2, CONNECTICUT

Chicago 6, Ill. • New York 19, N. Y. • Greenville, S. C. • Montreal 2, Canada • Dundee, Scotland • Offices and Agents in Principal Cities

Build-up for Super-Rugged Service-

NEW **E-I** COMPRESSION

sealed leads AND multiple headers

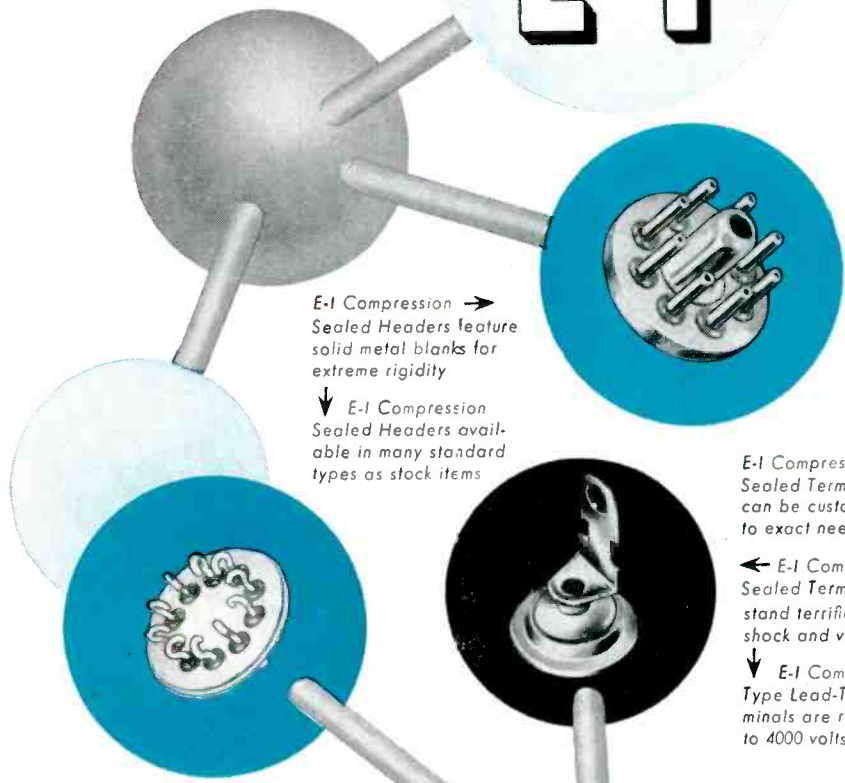

E-I Compression →
Sealed Headers feature
solid metal blanks for
extreme rigidity

↓ E-I Compression
Sealed Headers avail-
able in many standard
types as stock items

E-I Compression →
Sealed Terminations
can be custom-built
to exact needs

← E-I Compression
Sealed Terminations
stand terrific abuse
shock and vibration

↓ E-I Compression
Type Lead-Thru Ter-
minations are rated up
to 4000 volts rms

Compression Sealed Terminations are an exclusive E-I development that is revolutionizing the industry. Featuring solid metal blanks and glass inserts sealed under compression, these components demonstrate extraordinary immunity to shock and vibration. They are for all practical purposes indestructible. In addition to pioneering this type of termination, E-I has built-up a comprehensive line of standardized items that solve most terminal problems with stock item economy. Custom types, too, are available on short notice.

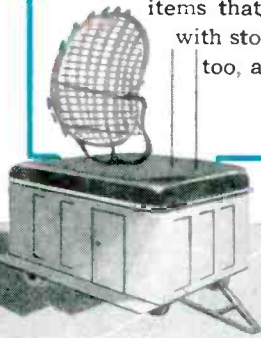

PATENT PENDING
ALL RIGHTS RESERVED

DIVISION OF AMPEREX
ELECTRONIC CORPORATION



ELECTRICAL INDUSTRIES

44 SUMMER AVENUE, NEWARK 4, NEW JERSEY

EXPORT AGENTS: PHILIPS EXPORT CORP., 100 EAST 42nd STREET, NEW YORK 17, N. Y.

Sterling announces...
an entirely **NEW** line of
MOLDED OPEN TYPE TRANSFORMERS

THE
CLIPPER
SERIES

Built to pass MIL-T-27 specifications,
including Grade I humidity tests,
and to operate continuously
at 175° (Class H)

Result: Savings up to 50%
in space and weight
without sacrifice in
performance.

Never before
have open transformers
been built
to pass these specifications.

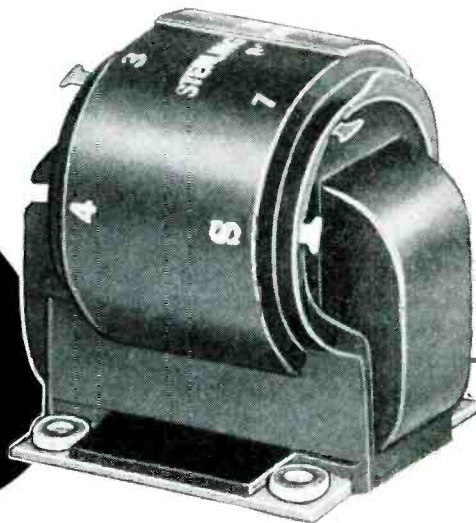

Write For Complete Information

299 North 7th Street, Brooklyn 11, N. Y.

Now available

the revolutionary
ELECTRO TEC
 process* for your
LARGE
SLIP RING ASSEMBLIES

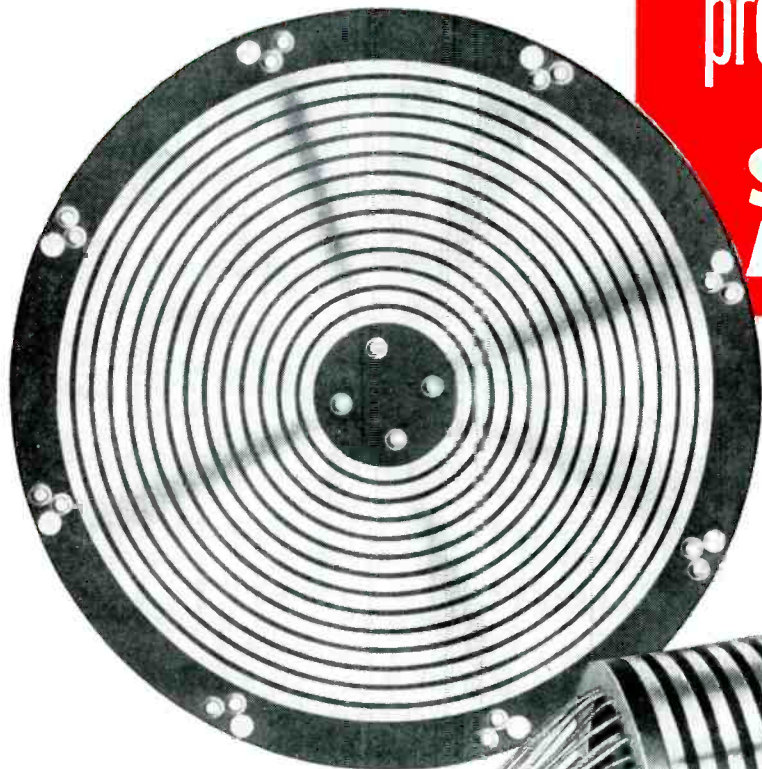

featuring

- LOWER COST • CLOSER TOLERANCES
- ONE-PIECE CONSTRUCTION • JEWEL-LIKE FINISH • UNIFORM RING HARDNESS
- REDUCED WEIGHT



**Now a Complete Service
 in all sizes of Slip Ring Assemblies**

→ An assembly with 14 concentric, hard silver rings electro deposited into machined plastic blank. Dovetail locks rings in place. Machined blank insures accuracy. Diameter approx. 11", thickness approx. 5/16".

→ Cylindrical assembly with 25 rings. Three wide rings accommodate large contact area brushes for high current capacity. Length 14", O.D. approx. 5 3/8".

→ An assembly with 30 rings of various widths to accommodate various current requirements. Unit is approx. 4-5/16" long, designed for flange mounting.

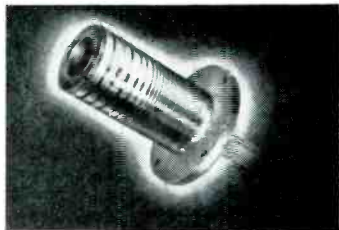

→ Cylinder type assembly approx. 3 3/4" long with 24 hard silver rings. 1 3/8" O.D. with wall thickness less than 1/4".



***PATENTS
 PENDING**

Our Engineering Department is available for consultation on any of your slip ring problems without obligation.



ELECTRO TEC CORPORATION
 SOUTH HACKENSACK • NEW JERSEY

ELECTRO TEC is now tooled up, with new expanded facilities for production of large Slip Ring Assemblies to exact customer specification. Sizes range up to 24" in diameter, either cylindrical or disc type.

The exclusive ELECTRO TEC PROCESS*—the electro-deposition of hard silver rings into an accurately machined plastic blank—consistently yields a high degree of dimensional accuracy, excellent concentricity, and a jewel-like ring finish. This process also eliminates expensive tooling and mold charges, frequently lowers costs to 30% of other methods of manufacture. The silver rings are uniformly hard for long life—75-90 Brinell.

ELECTRO TEC one-piece construction precludes dimensional variation due to accumulated errors. The plastic base is fully cured before rings are plated into it, thus preventing separation of base material from the rings.

ELECTRO TEC LARGE SLIP RING Assemblies are widely used in Radar Equipment, Fire Control Systems, Test Tables and many other critical applications. Light weight combined with rugged durability recommends their use in airborne applications.

Every user knows the ELECTRO TEC reputation for quality and superiority in miniature and sub-miniature slip ring assemblies.

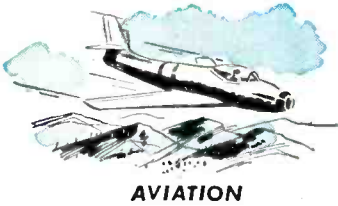
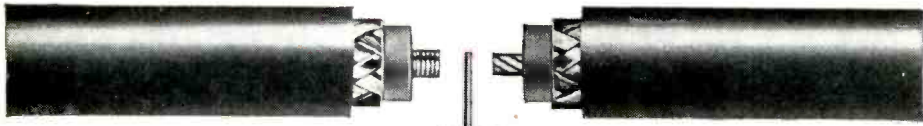

AVIATION



MARINE

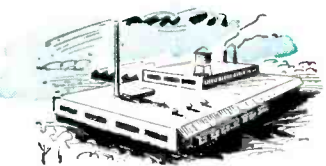

INDUSTRIAL



BROADCASTING



RADIO-TV LEAD-INS



TEST EQUIPMENT

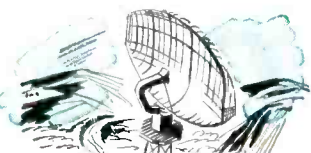

RADAR, PULSE,
EXPERIMENTAL EQUIP-
MENT AND SPECIAL TYPES



TRUSTWORTHY TRANSMISSION

For Every HF • VHF • UHF Application

With *Federal's* QUALITY-CONTROLLED COAXIAL CABLES

Whatever your field of application . . . whatever your transmission line requirement . . . Federal is ready to serve you. If the cable you need doesn't exist, Federal will cooperate with you in developing and producing it in any quantity!

Federal offers you one of the nation's most diverse stocks of RG type cables—including the Federal-developed low-temperature, non-contaminating thermoplastic jacket.

Quality-controlled throughout the entire manufacturing process, Federal cables bring *trustworthy transmission* to every electronic application . . . *plus* top flexibility and superior resistance to abrasion, weathering and corrosion.

Before you specify cable—or complete cable assemblies—for any general or military application, get the facts and figures from Federal. *We have the answer or we can get it!*

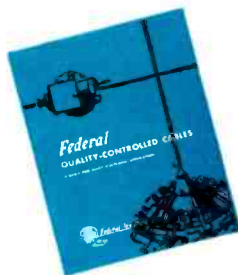

FEDERAL HAS A NEW CABLE CATALOGUE

This new 28-page buying guide contains a world of up-to-date information on Federal's quality-controlled cables, plus numerous useful tables and diagrams. For your free copy, write to Federal today, Dept. D-713A.

Manufacturer of America's most complete line of solid dielectric cables

Federal Telephone and Radio Company



SELENIUM-INTELIN DEPARTMENT • 100 KINGSLAND ROAD, CLIFTON, N. J.

In Canada: Federal Electric Manufacturing Company, Ltd., Montreal, P. Q.
Expert Distributors: International Standard Electric Corp., 67 Broad St., N. Y.

TYPICAL CHARACTERISTICS

MECHANICAL DATA		ELECTRICAL DATA	
Weight	1.45 oz.	No load speed	6,500 RPM
Rotor inertia	.46 gm-cm ²	Stall torque	.3 oz.-in.
Theoretical acceleration	49,000 RAD/SEC ²	Maximum output	.490 W.
		Single phasing	None
DATA AT STALL		CONTROL PHASE	
Voltage (volts)	26	26	
Frequency (cycles)	400	400	
Current (ma.)	166	166	
Power input (watts)	3.1	3.1	
Power factor	.63	.63	
R—ohms	98.5	98.5	
X—ohms	123	123	
Z—ohms	157	157	



Servo Motor the size of a Penny

ACTUAL SIZE

Ketay's Experience helps you

Servo Motor in a size 23 Frame, 6 watt



1/2 SCALE

TYPICAL CHARACTERISTICS

MECHANICAL DATA		ELECTRICAL DATA	
Weight	1.6 lbs.	No load speed	3,500 RPM
Rotor inertia	20.0 gm-cm ²	Stall torque	7.5 oz.-in.
Theoretical acceleration	26,500 RAD/SEC ²	Maximum output	6.0 W.
		Single phasing	None
DATA AT STALL		CONTROL PHASE	
Voltage (volts)	115	Series	Parallel
Frequency (cycles)	60	115	57.5
Current (ma.)	175	60	60
Power input (watts)	14.0	175	350
Power factor	0.70	14.0	14.0
R—ohms	460	0.70	0.70
X—ohms	470	460	115
Z—ohms	660	470	117
		660	164

Also for 115V or 230V operation on control phase.

Check these Servo Motors against your needs

Ketay offers a complete line of high precision **SYNCHROS, SERVO MOTORS** and **RESOLVERS**.

Ketay's experience also includes: automatic control devices for use in fire control and missile systems; computers and simulators; amplifiers; marine inter-communication equipment; remote indicators such as ship course indicators, drive angle indicators and salinity indicators; and automatic control systems.

Mail coupon today for bulletin containing specifications on 100 types of Synchros, Servo Motors and Resolvers.

Servo Motor in a size 15 Frame, 60 cycle, 115 volt



ACTUAL SIZE

TYPICAL CHARACTERISTICS

MECHANICAL DATA		ELECTRICAL DATA	
Weight	7.3 oz.	No load speed	3,300 RPM
Rotor inertia	3.03 gm-cm ²	Stall torque	1.45 oz.-in.
Theoretical acceleration	33,800 RAD/SEC ²	Maximum output	1.23 W.
		Single phasing	None
DATA AT STALL		CONTROL PHASE	
Voltage (volts)	115	Series	Parallel
Frequency (cycles)	60	115	57.5
Current (ma.)	53	60	60
Power input (watts)	5.0	53	106
Power factor	.82	5.0	5.0
R—ohms	1780	.82	.82
X—ohms	1240	1780	445
Z—ohms	2170	1240	310
		2170	542



**DESIGN
DEVELOPMENT
MANUFACTURE**
... of precision instruments
components, systems.

MANUFACTURING CORPORATION

Executive Offices West Coast Sales
555 Broadway • 12833 Simms Avenue
New York 12, N. Y. Hawthorne, California

New York Division • Kinetix Instrument Division • Pacific Division
Electronic Instrument Division • Research & Development Division

Ketay Manufacturing Corp.
555 Broadway, New York 12, N. Y.

NAME

POSITION

COMPANY

ADDRESS

CITY STATE

Send data on

My current projects are



Interference from his amateur radio transmitter on the TV set drove Mr. Jack Saperstein from the house to the car. Then he discovered Metex TVI-20-S Monel shielding and cut out the interference. Now he can operate within two feet of the TV set. Manufactured of corrosion-resisting Monel by the Metal Textile Corporation, Roselle, N. J., TVI-20-S shielding material is sold in 20-ft. lengths by several large radio supply houses.

How Monel saved a ham from the role of a TVI villain

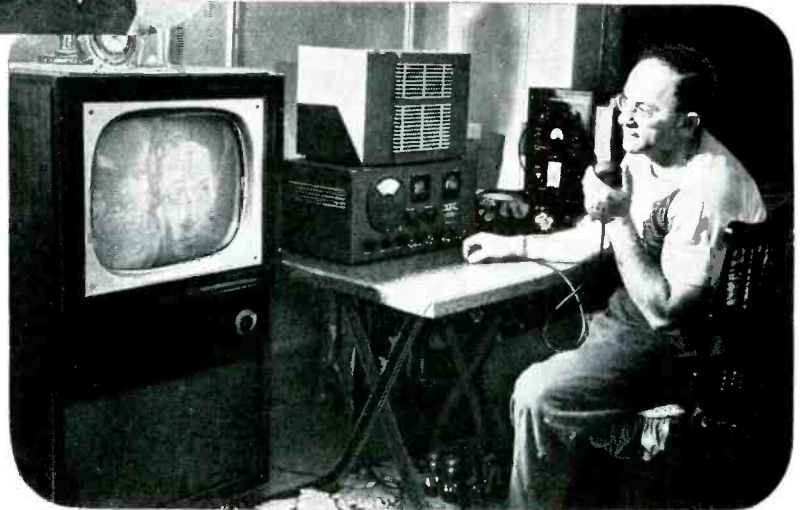

Mr. Jack Saperstein of Newark, New Jersey, was in a pickle!

He operates a television and radio repair business in a heavily populated area. At the same time he has his own amateur station.

The two just didn't mix — when he operated his station on the 10 meter band, the second harmonic interfered not only with his own TV set but, worse yet, with those of his neighbors. Because of this, he was losing their good will.

He couldn't afford to give up the repair business and he didn't want to give up the station.

What to do?

After trying various ways to stop the leakage, he found a temporary solution by moving the station into the trunk of his car. The filters kept leakage off the antenna, and the lid of the trunk sealed in the second harmonic. But still he couldn't use the set in his house.

Then he heard about Metex "Electronic Weather-Stripping," a knitted Monel shielding material which has been widely used for shielding Army, Navy, Air Corps, and industrial equipment. Metal Textile Corporation packages this same material for hams in rolls of 20 feet per box under the name of TVI-20-S.

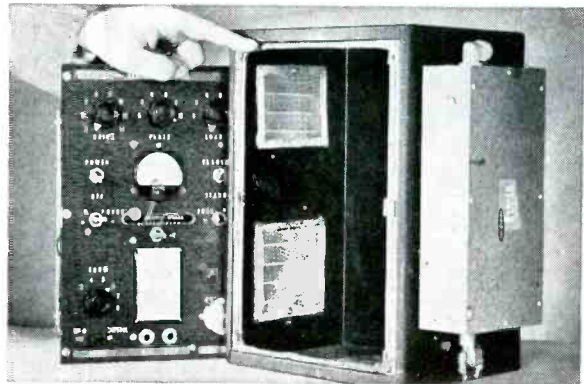

He put this resilient, conductive RF gasketing around the openings in his set (see photo), and found that he could operate on ten meters within two feet of his TV set, tuned to Channel 2, without interference.

The International Nickel Company, Inc.
67 Wall Street
New York 5, N. Y.

Inco Nickel Alloys **INCO**

Monel® • "R"® Monel • "K"® Monel • "KR"® Monel
"S"® Monel • Inconel® • Inconel "X"® • Inconel "W"® • Incoloy®
Nimonic® Alloys • Nickel • Low Carbon Nickel • Duranickel®



Lab Samples from

STACKPOLE

... assure accurate engineering
plus efficient production

QUALITY-CONTROLLED COMPONENTS

- FIXED RESISTORS
- VARIABLE RESISTORS
- SPECIAL RESISTORS
- POWDERED IRON CORES
- CERAMAG®
- FERROMAGNETIC CORES
- MOLDED COIL FORMS
- FIXED COMPOSITION CAPACITORS
- TUBE ANODES
- CARBON DISCS (Voltage Regulators)
- LINE SWITCHES
- SLIDE and ROTARY-ACTION SWITCHES

Laboratory samples of Stackpole components are exactly what samples should be—true and accurate reflections of the product when made in quantities and bought for use on your production line.

Stackpole was one of the earliest pioneers in strict statistical quality control. This, plus many unique manufacturing techniques and facilities evolved over years of carbon, graphite and metal powder product specialization, means that the sample you get from Stackpole matches your specifications to the fullest possible extent.

Equally important, and regardless of size, shape or quantity, each production unit is a "twin" of the sample on which your engineering and production calculations were based.

Write for Engineering Data Bulletin on any type. Samples to quantity users on receipt of full information.

Electronic Components Division
STACKPOLE CARBON COMPANY
St. Marys, Pa.

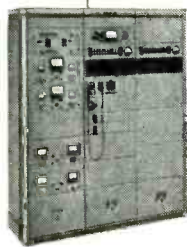
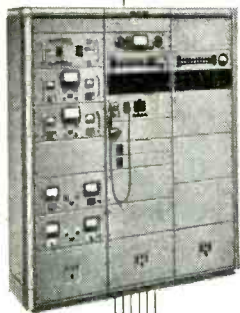
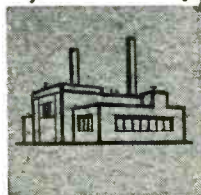
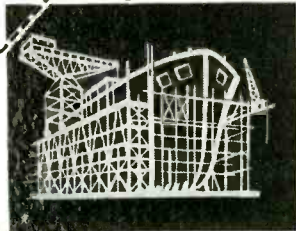
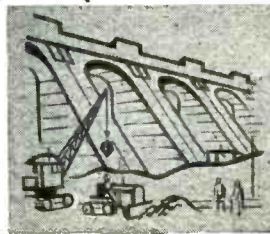
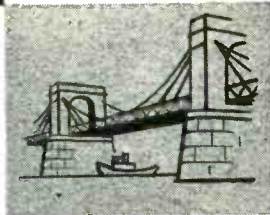
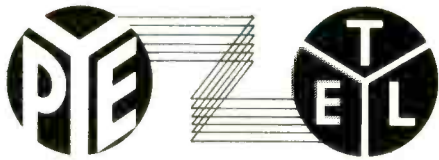

PYE-ERICSSON MULTIPLEX VHF RADIO TELEPHONE SYSTEM

The Pye-Ericsson V.H.F. multiplex radiotelephone system is already making its contribution towards the rapid expansion of telecommunications in overseas territories. Primarily developed to give telephone communication where wire and cable circuits are impracticable or, as is more often the case, uneconomical, the multiplex system provides a link that is invulnerable to both natural hazard and pilferage. The Pye-Ericsson system retains the well established carrier technique and this, in conjunction with the inherent reliability of the equipment, assures simplicity of maintenance.

PYE LTD.
CAMBRIDGE
ENGLAND

PYE
TELECOMMUNICATIONS
CAMBRIDGE
ENGLAND



ERICSSON
TELEPHONES LIMITED
BEESTON NOTTINGHAM
ENGLAND

ERICSSON TELEPHONES LTD.
22 LINCOLN'S INN FIELDS
LONDON W.C.2. ENGLAND

Bomac

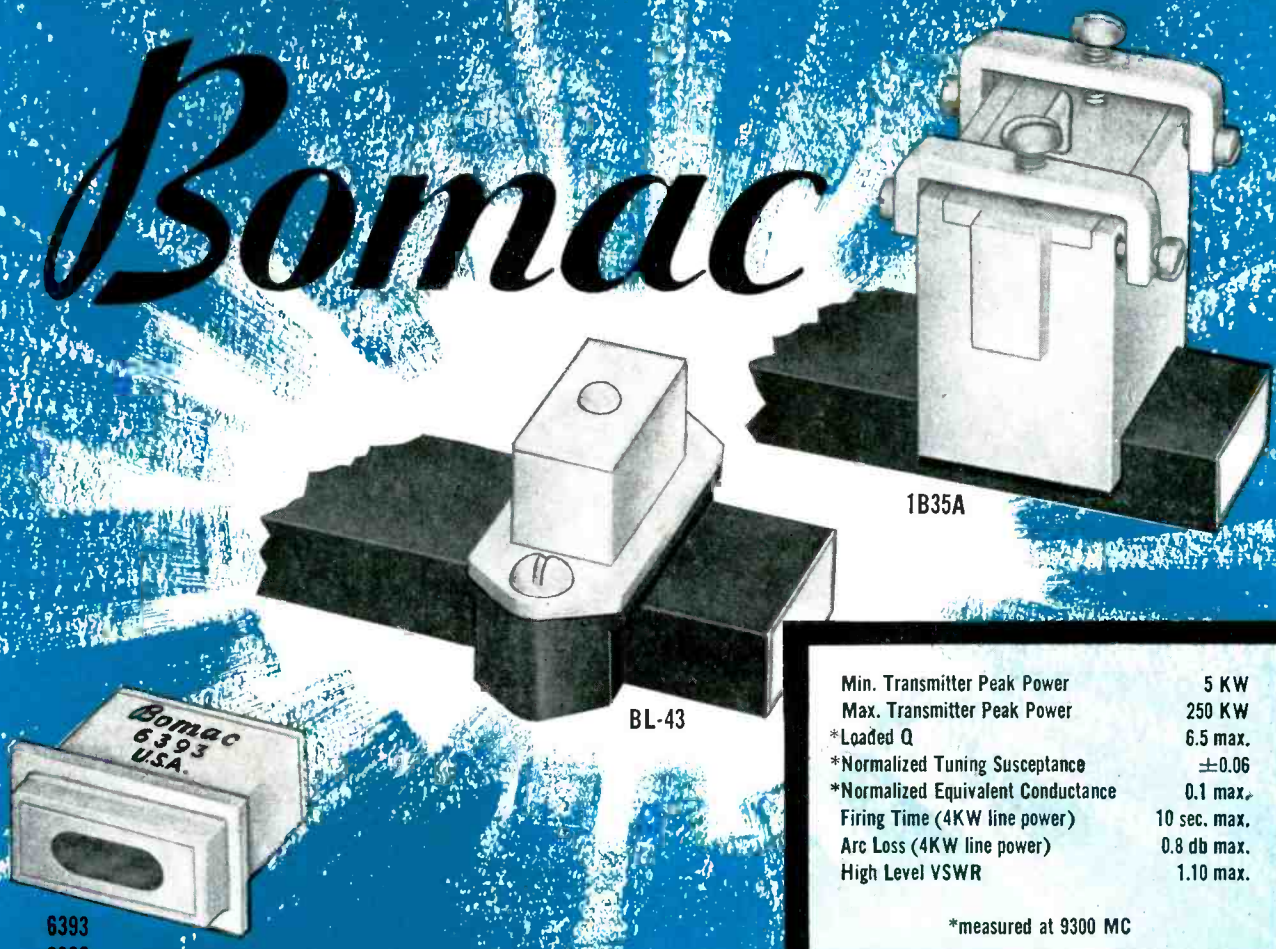

6393
6369
6396

Min. Transmitter Peak Power	5 KW
Max. Transmitter Peak Power	250 KW
*Loaded Q	6.5 max.
*Normalized Tuning Susceptance	±0.06
*Normalized Equivalent Conductance	0.1 max.
Firing Time (4KW line power)	10 sec. max.
Arc Loss (4KW line power)	0.8 db max.
High Level VSWR	1.10 max.

*measured at 9300 MC

CHARACTERISTICS OF THE BL-43

X band ATR tubes

Another outstanding example of Bomac's continuous program of miniaturization and development is the new BL-43 (contact type) ATR switching tube. Its electrical characteristics are identical with the standard 1B35A, but structurally it offers several important advantages.

The 1B35A seats in a large "well" type socket where the electrical contact depends on a $\frac{1}{2}$ choke. In contrast, the BL-43 eliminates the well socket and its awkward yoke clamps. Size and weight are cut to the minimum. The flange is mounted close to the

window and contacts the seat directly. A special copper-rubber gasket insures excellent electrical contact, eliminates sparking at high powers and allows pressurization of the wave guide.

Several Bomac contact ATR tubes for X band are made for either E or H plane mounting (see illustration). The seat and method of mounting are left to the equipment designer. These tubes include:

#6393 — electrical characteristics same as 1B35A

#6369 — electrical characteristics same as 1B37A

#6396 — tuned to 9300 MC in .200" x .900" ID Wave Guide

We invite your inquiries regarding

- ENGINEERING
- DEVELOPMENT
- PRODUCTION

Bomac Laboratories, Inc.

BEVERLY, MASSACHUSETTS

GAS SWITCHING TUBES · DIODES · HYDROGEN THYRATRONS · DUPLEXERS · MAGNETRONS
· MODULATORS ·

Catalog on request.
Write (on your company letterhead)
Dept. E-1 BOMAC
Laboratories, Inc.
Beverly, Mass.

How many of these electrical insulation problems do you have?

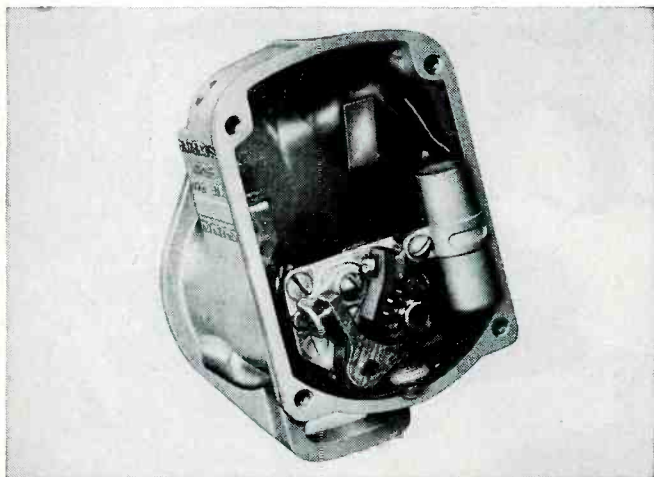

1. Looking for an efficient coil wrapping for small spaces? EMPIRE® varnished bias-cut nylon tape is highly flexible, strong and efficient . . . makes a thin insulation of unusually high dielectric strength with good resistance to oil and water.

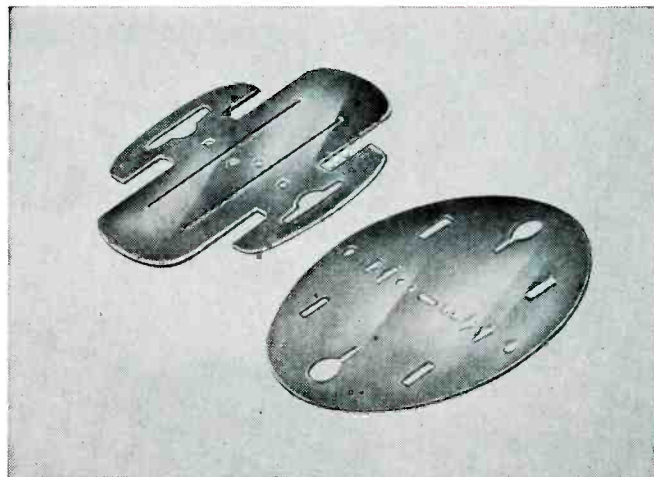

2. Need accurately punched mica stampings for filament, grid and plate supports? MICO produces mica stampings to extremely fine tolerances. Whenever you need precision-fabricated mica parts of the highest quality, call on MICO.



3. Looking for a better material for wiring diagrams, controls, instruments, dials and nameplates? DECORATIVE LAMICOID® resists wear, aging, weathering, oils, corrosive vapors, moisture and temperature extremes. Won't warp, check or chip. Good electrical properties. Wipes clean with a damp cloth.

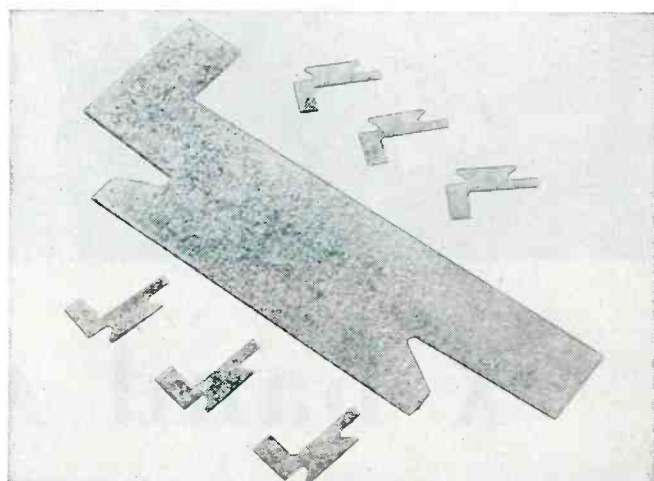

4. Need a class H segment plate that's easy to work with? ISOMICA* Segment Plate — made of built-up continuous mica sheet — shows no tendency to split or flake. Small segments of heavy thickness may be punched, and larger segments can be accurately sawed, milled, punched, etc.

Whatever electrical insulation material you need — standard or special — class A to class H — MICO makes it best. We manufacture it, cut it to size, or fabricate it to your specification. Send us your blueprints or problems today.

*Trade-mark



MICA Insulator COMPANY

Schenectady 1, New York

Offices in Principal Cities

LAMICOID® (Laminated Plastic) • MICANITE® (Built-up Mica) • EMPIRE® (Varnished Fabrics and Paper) • FABRICATED MICA • ISOMICA*

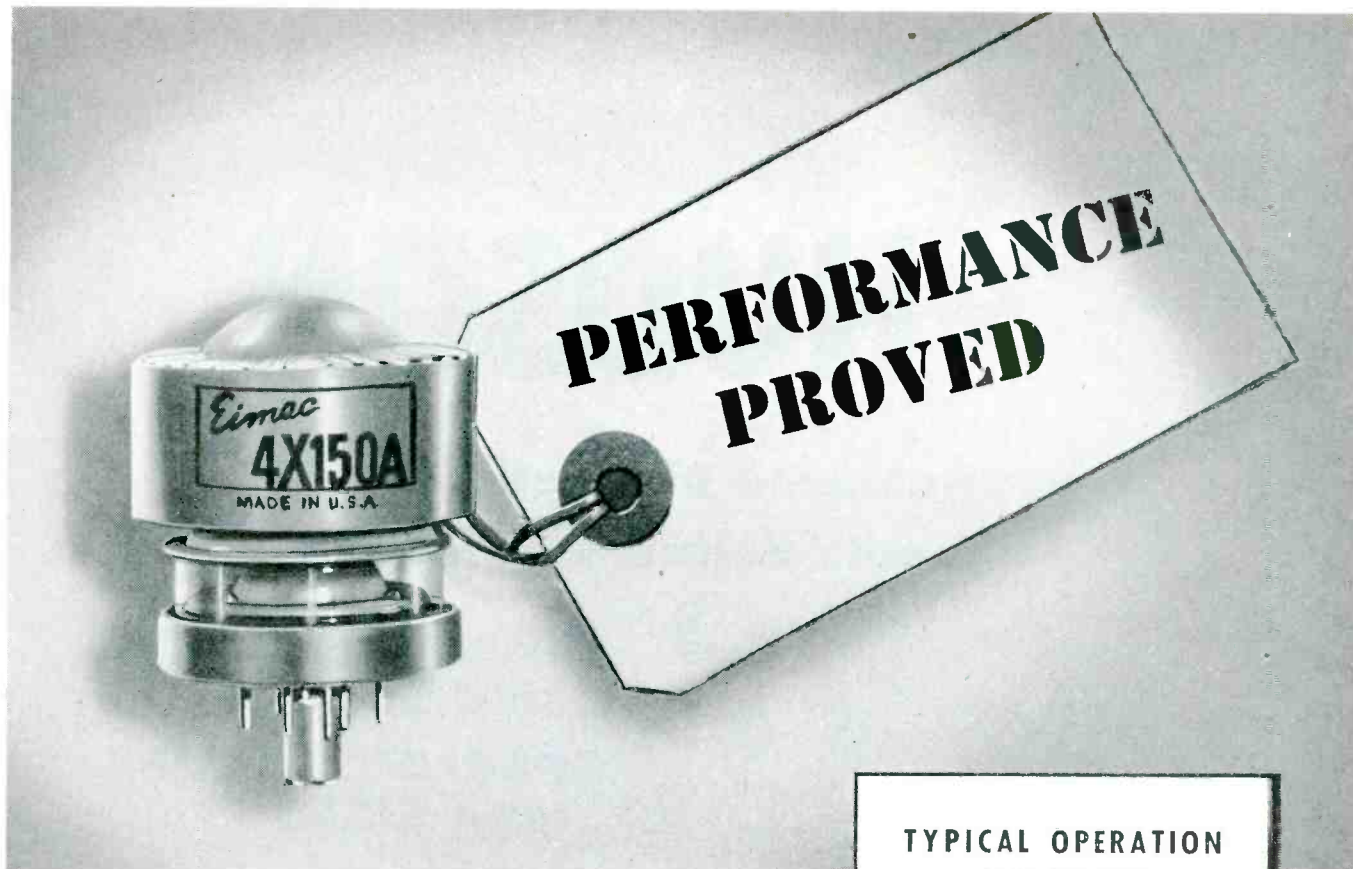

Eimac designed, Eimac produced — 4X150A radial-beam power tetrodes have given Eimac quality performance for more than five years in both fixed and mobile application in military and civilian transmitters. Rugged and compact, the 4X150A is the most powerful tube for its size that operates into UHF. Excellent power gain and stability with low plate voltages, plus simple circuit requirements, have made the 4X150A one of the most versatile tubes in the transmitting field.

Another Eimac development is the 4X150D, especially designed for the 24-28 volt electrical systems of mobile and airborne equipment. Other than a heater rating of 26.5 volts at 0.57 amperes, the 4X150D is identical to the 4X150A. It is recommended that both tubes be used with low inductance 4X150A air-system sockets which come in two models — with or without grounded cathode connections.

TYPICAL OPERATION

Radio-Frequency

Power Amplifier or Oscillator

Class C Telegraphy or FM Telephony
(Key-down conditions, per tube)

Frequencies up to 165 Mc.

D-C Plate Voltage	1000 volts
D-C Screen Voltage	250 volts
D-C Grid Voltage	—110 volts
D-C Plate Current	200 ma
D-C Screen Current	25 ma
D-C Grid Current	10 ma
Driving Power (approx.)	1 watt
Power Input	200 watts
Useful Power Output	150 watts

500 Mc. Coaxial Cavity

D-C Plate Voltage	1000 volts
D-C Screen Voltage	250 volts
D-C Grid Voltage	—80 volts
D-C Plate Current	200 ma
D-C Screen Current	7 ma
D-C Grid Current	10 ma
Driving Power (approx.)	20 watts
Plate Power Input	200 watts
Plate Power Output	120 watts

For further information contact
our Application Engineering Department



EITEL - McCULLOUGH, INC.
SAN BRUNO, CALIFORNIA

Export Agents: Frazer & Hansen, 301 Clay St., San Francisco, California



HUDSON

"Balanced Production"
meets delivery schedules on —

**STANDARD CASES
and COVERS**

**SPECIAL SHAPES
and SIZES**

**QUALITY METAL
STAMPINGS**

PRECISION DRAWN CLOSURES AND QUALITY METAL STAMPING! Several hundred standard shapes and sizes, with numerous optional features are "in stock" at Hudson. Not only is prompt service assured by Hudson closure standardization but costs reflect the savings of mass production methods. Engineers, designers and purchasing men will find it pays to check with Hudson first on any closure problem. All parts made from selected metal stocks, expertly formed to specifications. **STANDARD DESIGNS SPEED DELIVERIES AND REDUCE COSTS!**

As you want them —
When you want them —
ON THE NOSE!

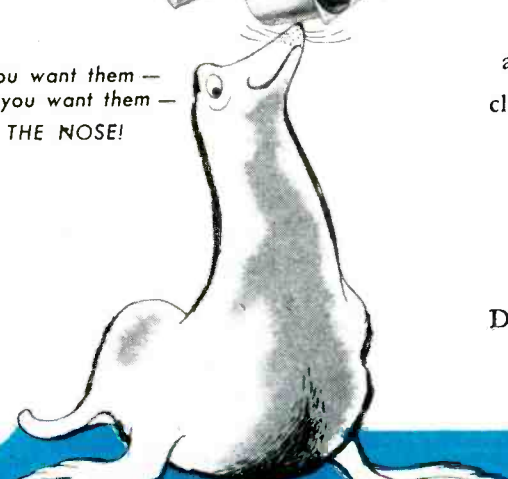

PRECISION DRAWN
CLOSURES AND QUALITY
METAL STAMPINGS
FOR ELECTRONICS



**HUDSON TOOL and
DIE COMPANY · Inc**

118-122 SO. FOURTEENTH STREET, NEWARK 7, NEW JERSEY

ASK FOR YOUR COPY TODAY! New engineer-designer file catalog includes complete information on economical HUDSON standard and special closures. Call or write without obligation —



IDEAS that started in a HEAT EXCHANGER

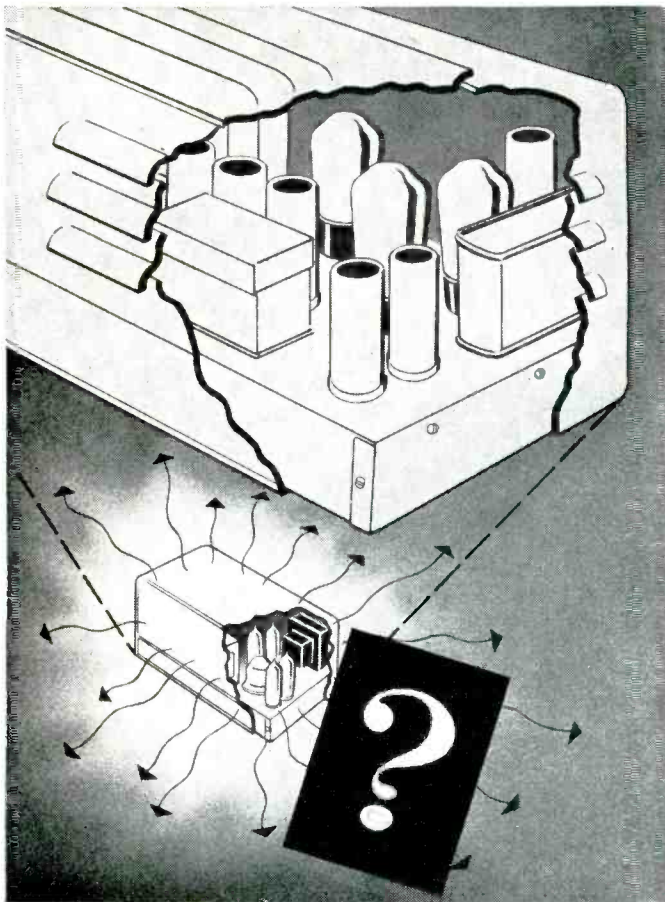

THE PROBLEM

New high-efficiency electronic units (lower unit in above panel) occupy as little as one-twentieth the space of older, air-cooled types (upper unit) — but they generate just as much heat. And since their hermetic sealing prevents direct cooling by air flow, temperatures would rise far beyond safe limits unless the heat were removed and dissipated elsewhere. At the same time, cooling equipment must be kept light and compact enough for aircraft use.

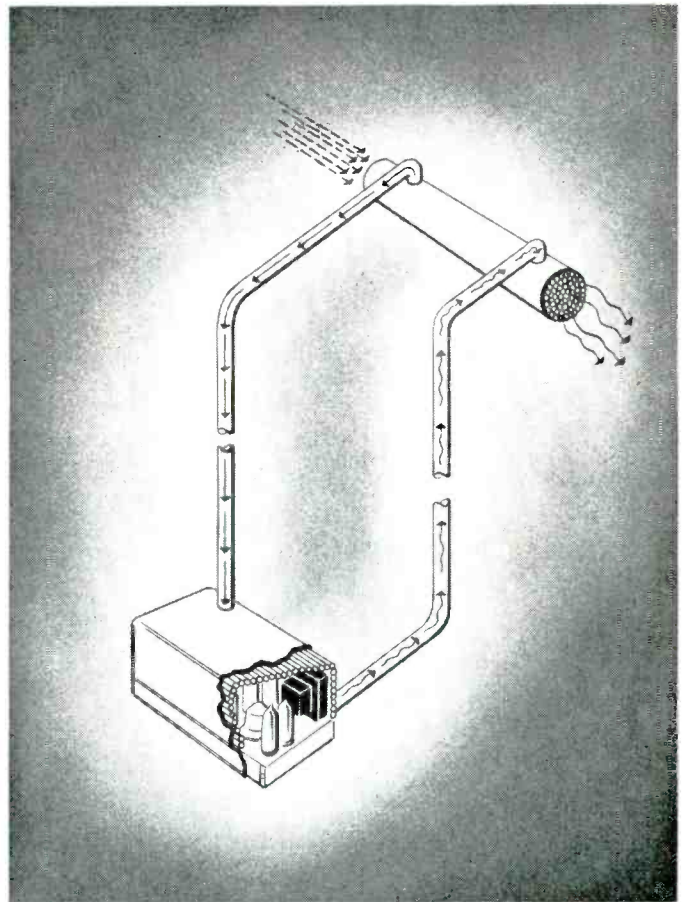

THE SOLUTION

Working with a leading manufacturer of electronic equipment, Clifford engineers designed the case of this aircraft electronic unit as a liquid heat exchanger. Heat is extracted by connecting with a second exchanger of the air-flow type, as shown. In jet-engined planes, however, heat is preferably dissipated by a liquid-to-liquid cooler into the fuel oil — thereby reducing drag on the plane and pre-heating the oil. Made entirely of aluminum, these Clifford heat exchange units combine thorough cooling with minimum size and weight.

You may have a cooling problem

Your own manufacture may or may not include aircraft applications. But now or later you may be looking for the best way of dissipating heat generated by high wattage elements in small spaces.

Then it will pay you to talk things over with Clifford engineers. These experts in a highly specialized field have developed successful liquid coolers for every type of aircraft — which includes some of the severest and most unusual working conditions any cooler is ever required to meet.

Clifford Feather Weights, for example, are the only all-brazed type of oil cooler. Their superior weight-strength ratio is the result of a patented brazing method and pre-testing in Clifford's wind tunnel laboratory — largest and most modern in its field.

Take advantage of Clifford's long

record of finding the most efficient and economical answers to the toughest cooling problems. Write to Clifford Manufacturing Company, 119 Grove Street, Waltham 54, Massachusetts. *Division of Standard-Thomson Corporation.* Sales offices in New York; Detroit; Chicago; Los Angeles; Waltham, Massachusetts.

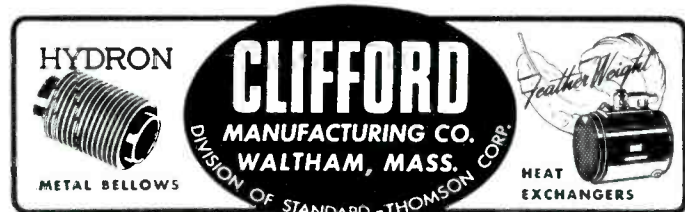



PRODUCTS *wired for life*

with

WARREN WIRE

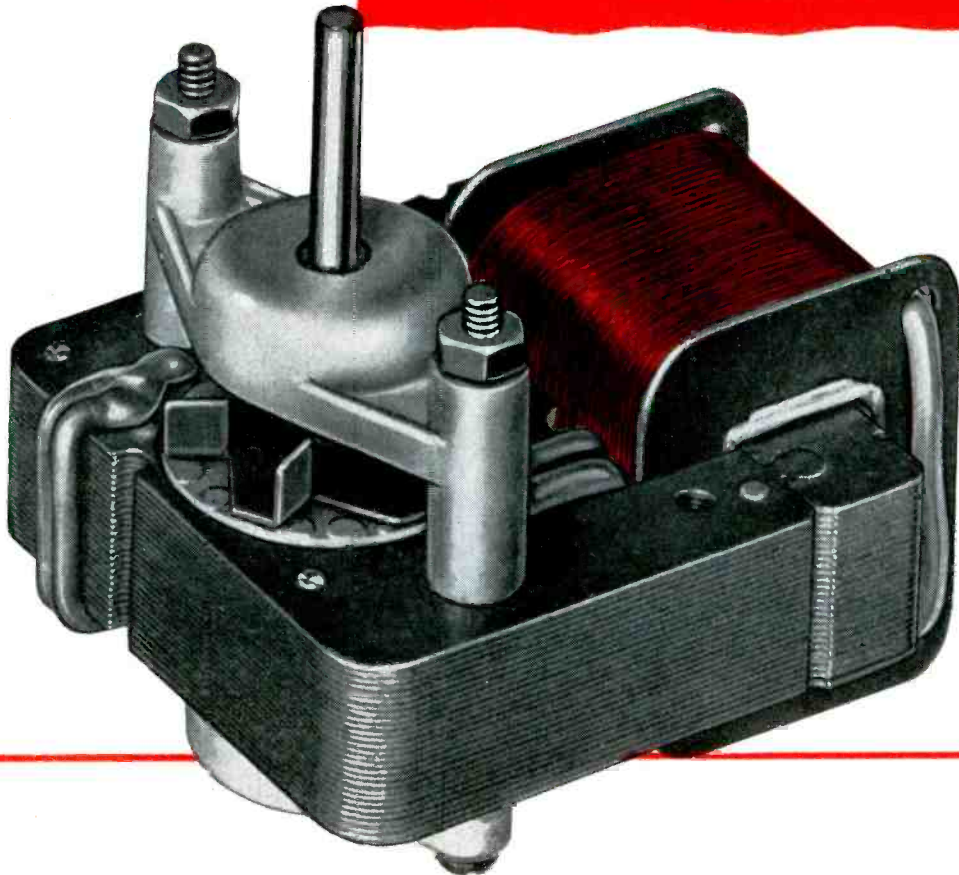

The General Industries line of Smooth-Power Motors meets the most exacting demands for smoothness and dependability through the combination of advanced design . . . unrelenting research . . . sound engineering . . . skilled craftsmanship . . . the use of the finest materials! Here, as in the manufacture of many other fine electric and electronic products, Warren Wire is used for its easy handling, efficiency and dependability.

There's a Warren Wire Engineer near you trained to help you solve your wire problems right in your own plant. There is no obligation, of course.

NEW! Send for our new "Magnet Wire Reference Tables" Chart



WARREN WIRE COMPANY

Plant and Main Office: POWNAL, VERMONT

NEW YORK • SYRACUSE • NEW HAVEN • PHILADELPHIA • PITTSBURGH • CLEVELAND
DETROIT • CHICAGO • ST. LOUIS • ST. PAUL • LOS ANGELES • SAN FRANCISCO

Manufacturers of Plain Enamel, Nylon, Formvar, Teflon and Served Magnet Wires . . . Teflon Hook-up and Lead Wire . . . Tinned and Bare Copper Wire.



Powdered iron cores for all miniature applications

Our design engineers have an impressive record of success in developing new miniature types of cores for highly specialized applications, and are ready to take on your toughest problem jobs. Our engineering consultant service is yours without cost. Pyroferric works to closest electrical and mechanical tolerances, on newly-developed pilot models and quantity production runs. You are assured of uniformity, strict quality control and rigid conformity to specifications.

Pyroferric makes iron cores in a complete size range from the smallest to the largest, for all applications. M. P. A. data sheets and tables give complete information including recommended sizes and tolerances as well as a cross-reference index of manufacturers' material designations.



PYROFERRIC
 PYROFERRIC BLDG. BRONX BOULEVARD
 at 216th St., N.Y.C. 67

Please send me M.P.A. data sheets and tables No. 305.

Write on your letterhead for latest Catalog No. 23J

NAME _____ TITLE _____ FIRM _____
 ADDRESS _____ CITY _____ STATE _____

Presenting *INDOX I... A*

NEW CERAMIC PERMANENT MAGNET

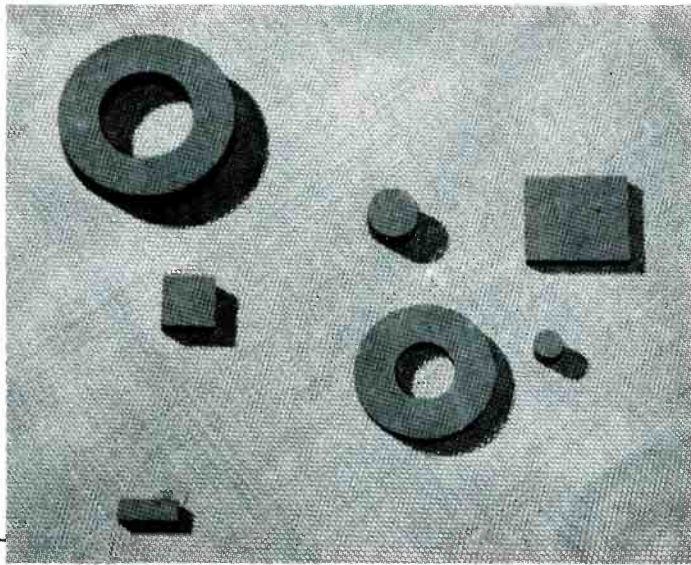

▲ Typical INDOX I Permanent Magnets

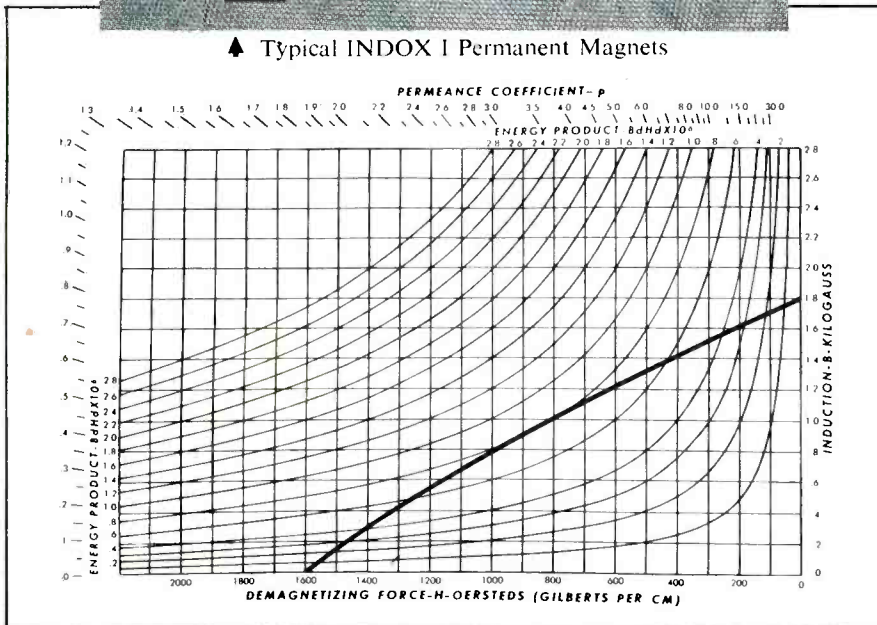

▲ Demagnetization and Energy Product Curve for INDOX I

**... Opens
New Fields for
Product Designs**

*INVESTIGATE THESE
CHARACTERISTICS*

- Higher coercive force than any other commercial permanent magnet material.
- Negligible hysteresis and eddy-current losses in magnetic circuits having an alternating-current component.
- High electrical resistivity.
- No critical materials required.
- Lightweight.
- Magnetization practical prior to assembly.

Let our forty-three years of accumulated permanent magnet experience help you to utilize this new magnet in your products. Write to Dept. 1A for complete details.

INDIANA PERMANENT MAGNETS

THE INDIANA STEEL PRODUCTS COMPANY • VALPARAISO, INDIANA

WORLD'S LARGEST MANUFACTURER OF PERMANENT MAGNETS

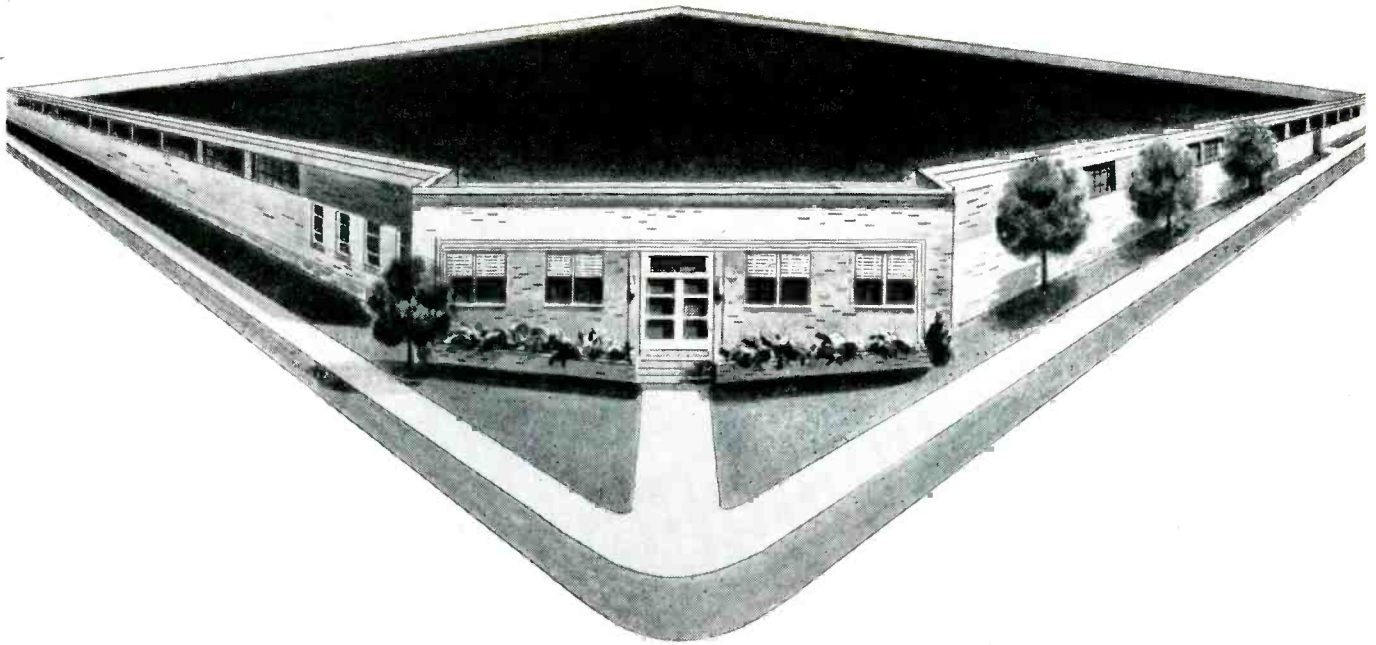

here's what's behind the  crystal that's so far ahead

The Midland Factory shown above is the world's largest plant devoted exclusively to producing crystals for frequency control. It is equipped with the finest and most complete production and testing machinery ever developed for this purpose. Here Midland pioneered development of crystals for color television, and is now ready for full-scale production.

All this is important to you for just one good reason: Every Midland crystal you use has been produced by such advanced techniques and under such rigid quality controls that you can be sure it will prove its completely reliable quality under every operating stress.

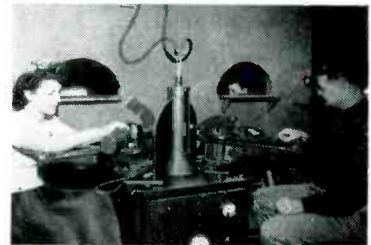

Midland Critical Quality Control extends through every step of crystal production, and includes precise angular control by X-ray. Uniform accuracy is maintained to the millionth part of an inch.

*Whatever your Crystal need, conventional or highly specialized,
When it has to be exactly right, contact*



Midland MANUFACTURING COMPANY, INC.
3155 Fiberglas Road, Kansas City, Kansas

WORLD'S LARGEST PRODUCER OF QUARTZ CRYSTALS

Klystron Tubes and

WIDE RANGE REFLECTS 16 YEARS OF
EXPERIENCE IN MICROWAVE FIELD



KLYSTRONS

Frequency Range from 750 megacycles to 26,000 megacycles.



LOCAL OSCILLATOR SRU-55

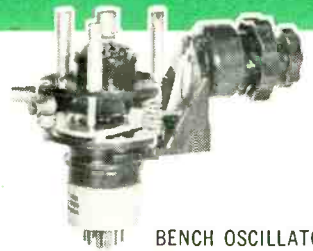

BENCH OSCILLATOR 2K41



LOCAL OSCILLATOR 5981



COMMUNICATIONS AMPLIFIER STC-67



RADIO RELAY
TRANSMITTER SRC-43



RADIO RELAY
TRANSMITTER SAC-19

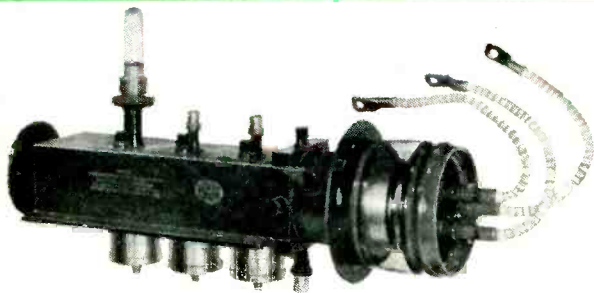

HIGH POWER
TRANSMITTER SAS-28

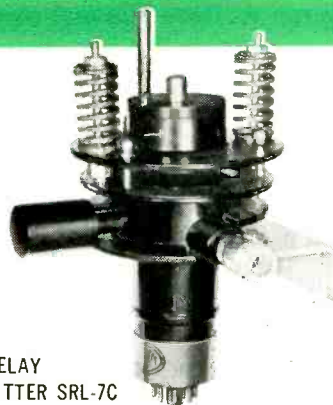

RADIO RELAY
TRANSMITTER SRL-7C



RADIO RELAY
TRANSMITTER SAC-41



HIGH POWER
TRANSMITTER SAC-33



HIGH POWER
TRANSMITTER SAL-39

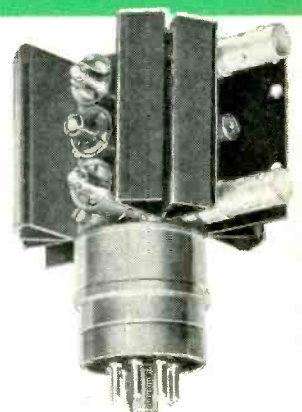

HIGH POWER
TRANSMITTER SAC-9

Microline* Instruments

Since 1938, when Sperry sponsored the development of the Klystron, this company has extended its application to tubes for low, medium and high-power applications. As a pioneer in microwave measuring techniques, Sperry has developed Microline instruments which include every type of device essential to precise measurement in the entire microwave field. Research and development are continuous at Sperry and the results are always available to you.

RT. M. REG. U.S. PAT. OFF.

*Microline**

Test equipment covering 500 megacycles to 40,000 megacycles in 7/8 inch coaxial line and 8 waveguide sizes.



ATTENUATOR
152A



DETECTING SECTION 364

MIXER 337C

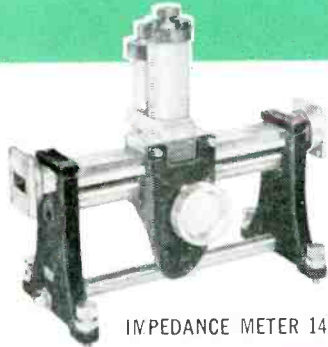

IMPEDANCE METER 145

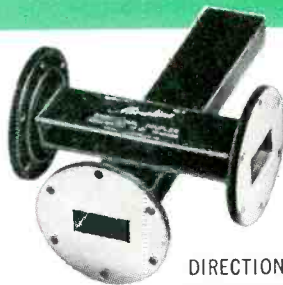

DIRECTIONAL
COUPLER 209



FREQUENCY
METER 28B

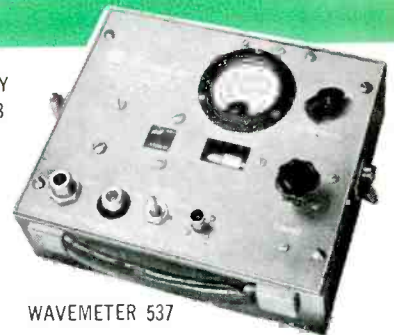

WAVEMETER 537



RADAR RANGE CALIBRATOR UPM-11



VSWR TEST SET 539



RADAR TEST SET 38A



KLYSTRON
POWER SUPPLY 555

On these pages, only one item in each product line is illustrated. Also included in the Sperry line, but not illustrated, are the following additional Microline instruments: Barretter and Thermistor Mounts, Barretter Elements, Impedance Transformers, Terminations, Adapters, Wattmeter Bridges and Adjustable Shorts. For complete details write our nearest district office.

SPERRY GYROSCOPE COMPANY
DIVISION OF THE SPERRY CORPORATION
Great Neck, New York

Cleveland • New Orleans • Brooklyn • Los Angeles • San Francisco • Seattle
In Canada—Sperry Gyroscope Co., Limited, Montreal, Quebec

**UNDISTORTED
100%
MODULATION
AM
WITHOUT
FM
WITH THE
STANDARD SIGNAL
GENERATOR
TYPE TF867**

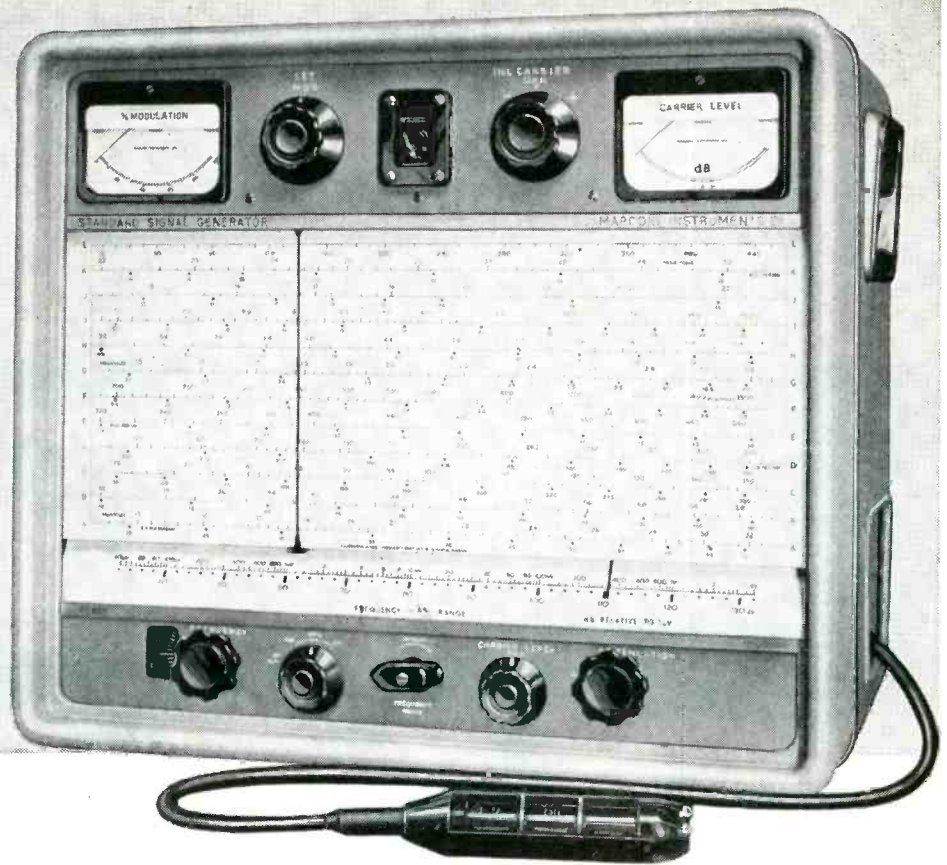

EXCELLENT amplitude modulation is an outstanding feature — a.m. accompanied by unmeasurable f.m. Other features include :

Wide Range: 15 kc to 30 mc on 15 ft. high-discrimination full-vision scale.

Crystal Accuracy: 0.01% with built-in 1 mc harmonic source.

High Output: 4 volts down to 0.4 microvolts.

Flexible Modulation: Internal 400 and 1,000 cps, external 50-10,000 cps within a db.

Also incorporated : Automatic level control, overall negative feed-back from r.f. output to modulation input, modulation monitoring by dual-rectification and variable impedance termination with animated diagram.

A signal generator also ideal as a video oscillator for wide-band television systems.

Full data and prices of any of the items listed below will be mailed immediately on request.

STANDARD SIGNAL GENERATOR TF 867 · FM/AM SIGNAL GENERATOR TF 995
UNIVERSAL BRIDGE TF 868 · FM DEVIATION METER TF 934
VACUUM TUBE VOLTMETERS · FREQUENCY STANDARDS · OUTPUT METERS
WAVEMETERS · WAVE ANALYSERS · Q METERS · BEAT FREQUENCY OSCILLATORS

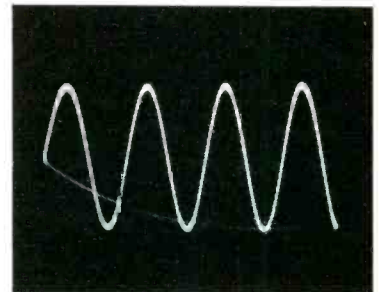

15 kc Unmodulated Carrier showing good waveform.

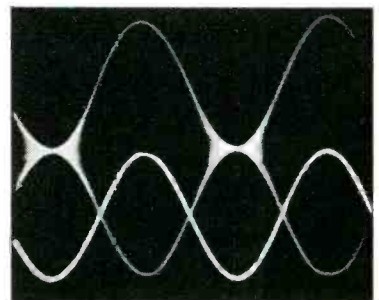

320 kc Carrier modulated at 400 cps — audio source on lower trace shows fidelity.

TEST OSCILLOGRAMS

MARCONI INSTRUMENTS

23-25 BEAVER STREET · NEW YORK 4

CANADA: CANADIAN MARCONI CO., MARCONI BUILDING, 2442 TRÉNTON AVENUE, MONTREAL.

ENGLAND: Head Office: MARCONI INSTRUMENTS LIMITED, ST. ALBANS, HERTFORDSHIRE

Managing Agents in Export: MARCONI'S WIRELESS TELEGRAPH COMPANY LIMITED, MARCONI HOUSE, STRAND, LONDON, W.C.2



This is all you need to install AVIEN'S TWO-UNIT FUEL GAGE

You need no field calibration, no complicated data, and no "experts" to install this simplified system.

When it's time to install Avien's Two-Unit Fuel Gage, all you will require are simple tools.

You won't need calibration instruments, complex field data, or specially trained personnel. The Avien gage will have been precalibrated for your aircraft, so installation becomes as simple as "plug-in, plug-out."

This quick and easy installation avoids costly, time-consuming calibration on the flight-line.

You will also find Avien's Two-Unit Gage an advantage for replacement and repair. You can keep it in regular stock, ready for immediate use.

This ease of installation is just one of the factors which have made Avien's Two-Unit Gage the most talked-about system in the industry.

Because the system is reduced to a sensing unit and indicating unit, it weighs 50% less than previous three-

unit systems. Fewer wires and connectors are needed. 158 separate parts are eliminated. Maintenance problems are brought to the minimum.

And it costs less.

With the industry's need for smaller units — and with the industry's problem of smaller budgets — the Avien Two-Unit Fuel Gage arrives at the right moment.

Every month, Avien produces over ten thousand major instrument components for the aviation industry.

If you haven't yet inquired about the Two-Unit Gage, right now is the time to do so.



AVIATION ENGINEERING DIVISION
AVIEN - KNICKERBOCKER, INC.
58-15 NORTHERN BOULEVARD, WOODSIDE, L. I., N. Y.



Precision, high-speed winding equipment for IRC elements

ONLY IRC WINDING SKILL OFFERS

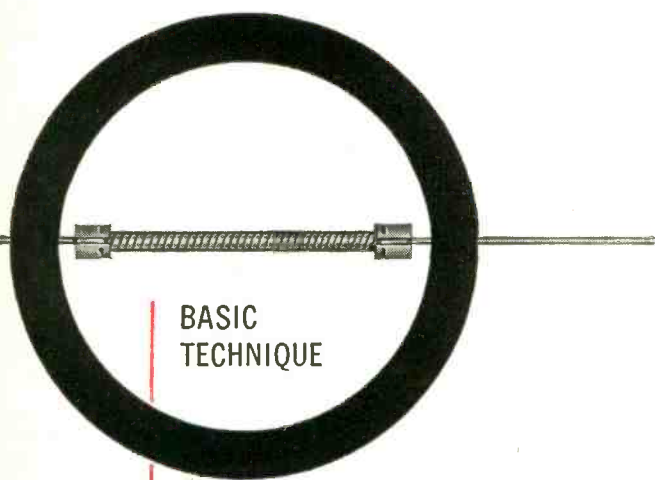

BASIC TECHNIQUE

Wire element is uniformly and tightly wound on an insulated core. Axial leads or other terminations are secured to element by automatic machinery. Insulated housing may be used or omitted.

If you seek savings in component costs,
IRC's winding skill may serve your need.
IRC's mastery of winding wire elements
dates back more than 25 years. Today,
it provides a wide variety of unique units
that offer realistic possibilities for
savings. Cost-conscious IRC engineers
will gladly analyze your requirements.



14c savings per car

Type AW Wire Wound resistors save automobile manufacturers an average of 14c per car. For quantity requirements, these low-cost windings can be made specially to suit individual designs. This adaptability has proved profitable to numerous appliance manufacturers.

low cost—low wattage

Type BW insulated wire winds offer excellent stability in low ranges—at low prices. Leading instrument manufacturers attest to their superiority. 1/2, 1 and 2 watt sizes are equivalent to Jan types RU-3, RU-4 and RU-6.

50% savings

IRC Insulated Chokes offer savings up to 50% over ordinary types. Available in two sizes, they are fully protected against humidity, abrasion, assembly damage and danger of shorting to chassis. A favorite source of savings for TV and radio set manufacturers.

NEW specifications



MIL-R-93A AMENDMENT 1

Government specifications for precision wire wound resistors have been revised. MIL-R-93A Amendment 1 is the new rigid standard.

IRC PRECISION WIRE WOUNDS

meet and beat these new specifications. They are equivalent to Mil types RB-15 through 19.

MAXIMUM STABILITY

Temperature cycling even beyond Mil requirements has only negligible effect. Send for new technical bulletin.

THESE SAVINGS

inexpensive solution

4-watt Insulated Power Wire Wounds with axial leads can save several cents over conventional power resistors. Inorganic core and high-temperature plastic housing allow safe operation up to 165° C. Widely used in toys, juke boxes and amusement devices.

Boron & Deposited Carbon Precision Resistors • Power Resistors • Voltmeter Multipliers • Low Wattage Wire Wounds • Insulated Composition Resistors • Volume Controls •

Whenever the Circuit Says

Precision Wire Wounds • Ultra HF and Hi-Voltage Resistors • Low Value Capacitors • Selenium Rectifiers • Insulated Chokes • Hermetic Sealing Terminals •



INTERNATIONAL RESISTANCE CO.
403 N. Broad St., Philadelphia 8, Pa.

In Canada: International Resistance Co., Ltd., Toronto, Licensee

Send me technical data on: Precision Wire Wounds; Insulated Chokes; BW Resistors; 4-Watt Power Resistors

Name _____
Title _____
Company _____
Address _____
City _____ State _____

Put your product here →
 to shake-test it
 with 10,000 lbs
 force

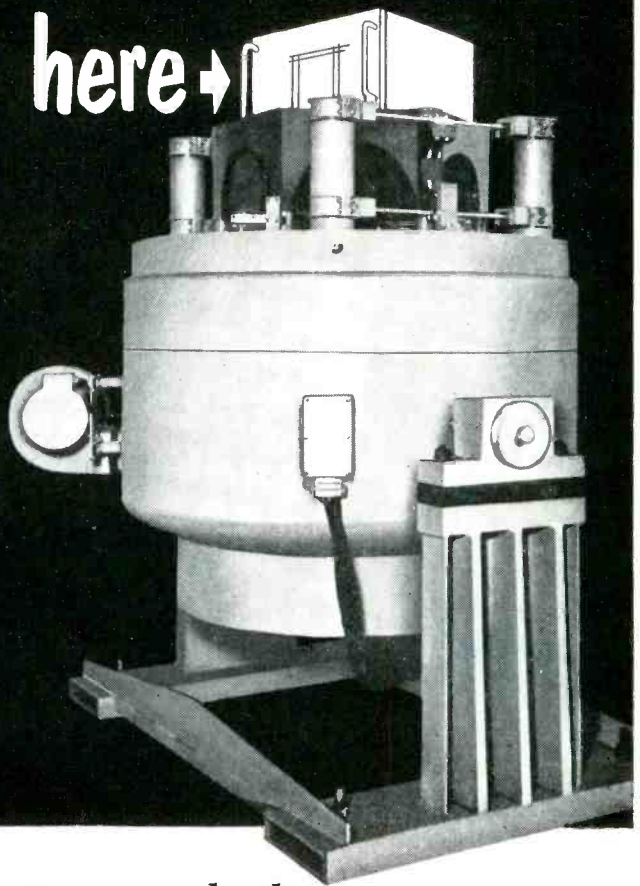

*MB produces the largest exciter ever built
 to meet heavy duty vibration test specifications*

THERE'S nothing like a good shaking to test out structural designs, electronic equipment, instruments or complete assemblies for faults or flaws. In fact, for many products put to military use, such tests are *specified*. However, since *all* products encounter some vibration or shock in service, many engineering departments use an MB Exciter to test all designs. By so doing, the "bugs" are discovered in the test laboratory instead of out in the field, at cost of good will.

Largest in the line of MB electromagnetic shakers, the Model C-100 shown delivers at least 5 tons continuous force. Its performance permits heavy duty vibration testing to MIL-E-5272 and other specifications. It incorporates a number of unusual design features for easy, quick, convenient opera-

tion—including interlocking controls for complete safety and provisions for cycling tests.

HOW TO HANDLE LARGE MASSES

MB can show you a setup of vibration exciter and resonating beam that multiplies the capacity of versatile MB Exciters many fold. Shaker being used in this fatigue strength test of aircraft engine mounts is the model S-3 rated at 200 lbs. Others available down to 10 lbs. force output.

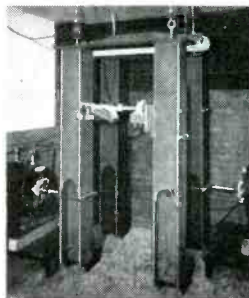

Vibration is MB's specialty. You're invited to draw on the benefits of this specialization — and get highly qualified products for testing and control, and technical help on your problem.



Valuable bulletins for test engineers
 Calibrating vibration pickups to 2000 cps is comprehensively covered in MB Bulletin No. C-11-1. Bulletin No. 1-VE-1 describes vibration exciters and details their specifications. Write today.

THE MB MANUFACTURING COMPANY, INC.
 1060 State Street, New Haven 11, Conn.

HEADQUARTERS FOR PRODUCTS TO INDUCE VIBRATION...TO MEASURE IT...TO ISOLATE IT

2 Truarc self-locking rings replace threaded plugs. Save 6¢ per unit, speed assembly by 140%.

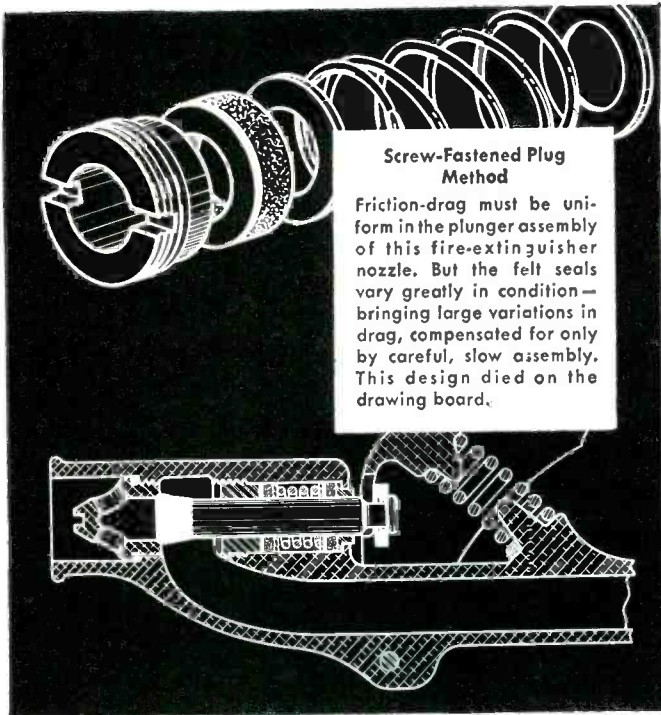

Screw-Fastened Plug Method

Friction-drag must be uniform in the plunger assembly of this fire-extinguisher nozzle. But the felt seals vary greatly in condition—bringing large variations in drag, compensated for only by careful, slow assembly. This design died on the drawing board.

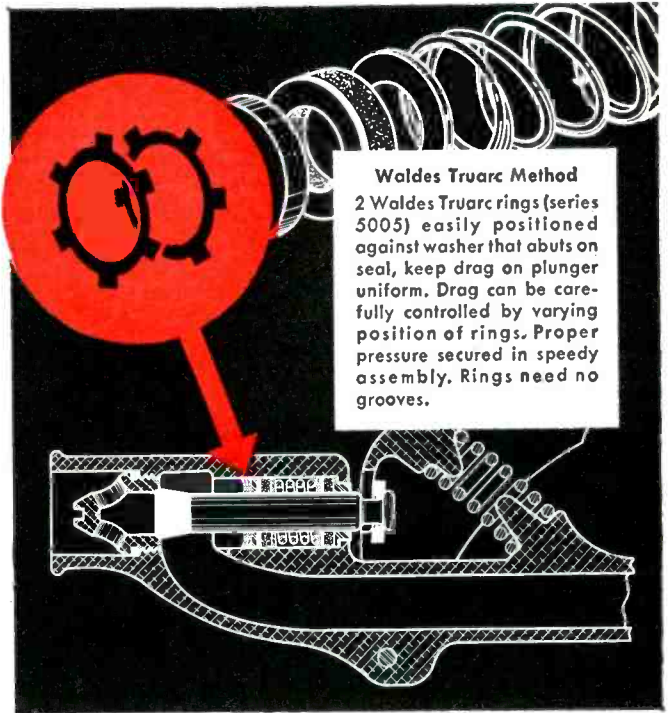

Waldes Truarc Method

2 Waldes Truarc rings (series 5005) easily positioned against washer that abuts on seal, keep drag on plunger uniform. Drag can be carefully controlled by varying position of rings. Proper pressure secured in speedy assembly. Rings need no grooves.

Ansul Chemical Company's new watertight precision nozzle for their dry chemical fire extinguisher replaces conventional stainless steel plug with two Waldes Truarc Self-Locking Retaining Rings and washer. Rings hold entire nozzle packing securely in place—keep friction drag of plunger uniform. Adjustable in final assembly, Truarc rings speed production from 25 to 60 units per hour. They save 6¢ per unit in overall costs, 1/8" in length.

Redesign with Waldes Truarc Rings and you, too, will save on assembly,

time, improve product performance, facilitate easier servicing of whatever you make.

Wherever you use machined shoulders, bolts, snap rings, cotter pins, there's a Waldes Truarc Retaining Ring designed to do a better job of holding parts together. They're precision-engineered... quick and easy to assemble and disassemble. They give a never-failing grip. Find out what Truarc Rings can do for you. Send your blueprints to Waldes Truarc engineers for individual attention, without obligation.

WALDES TRUARC RINGS MADE THESE SAVINGS POSSIBLE—

Discarded Design		Truarc Design	
Parts:	Cost Per Unit	Parts:	Cost Per Unit
threaded stainless steel plug	\$0.0675	2 rings	\$0.0146
Direct Labor	\$0.0350	1 washer	\$0.0280
	\$0.1025		\$0.0426

Total savings per unit with Truarc Rings \$0.0599

For precision internal grooving and undercutting... Waldes Truarc Internal Grooving Tool.

SEND FOR NEW CATALOG

WALDES TRUARC

REG. U. S. PAT. OFF.

RETAINING RINGS



Waldes Kohinoor, Inc., 47-16 Austel Place, L. I. C. 1, N. Y.

Please send me the new Waldes Truarc Retaining Ring catalog. E-016

(Please print)

Name.....

Title.....

Company.....

Business Address.....

City.....Zone.....State.....

WALDES KOHINOOR, INC., LONG ISLAND CITY 1, NEW YORK

WALDES TRUARC RETAINING RINGS AND PLIERS ARE PROTECTED BY ONE OR MORE OF THE FOLLOWING U. S. PATENTS: 2,382,947; 2,382,948; 2,416,852; 2,420,921; 2,428,341; 2,439,785; 2,441,846; 2,455,165; 2,483,380; 2,483,383; 2,487,802; 2,487,803; 2,491,306; 2,509,081 AND OTHER PATENTS PENDING.

THE LATEST DESIGN IN CONVEYER SCREEN BAKE OVENS

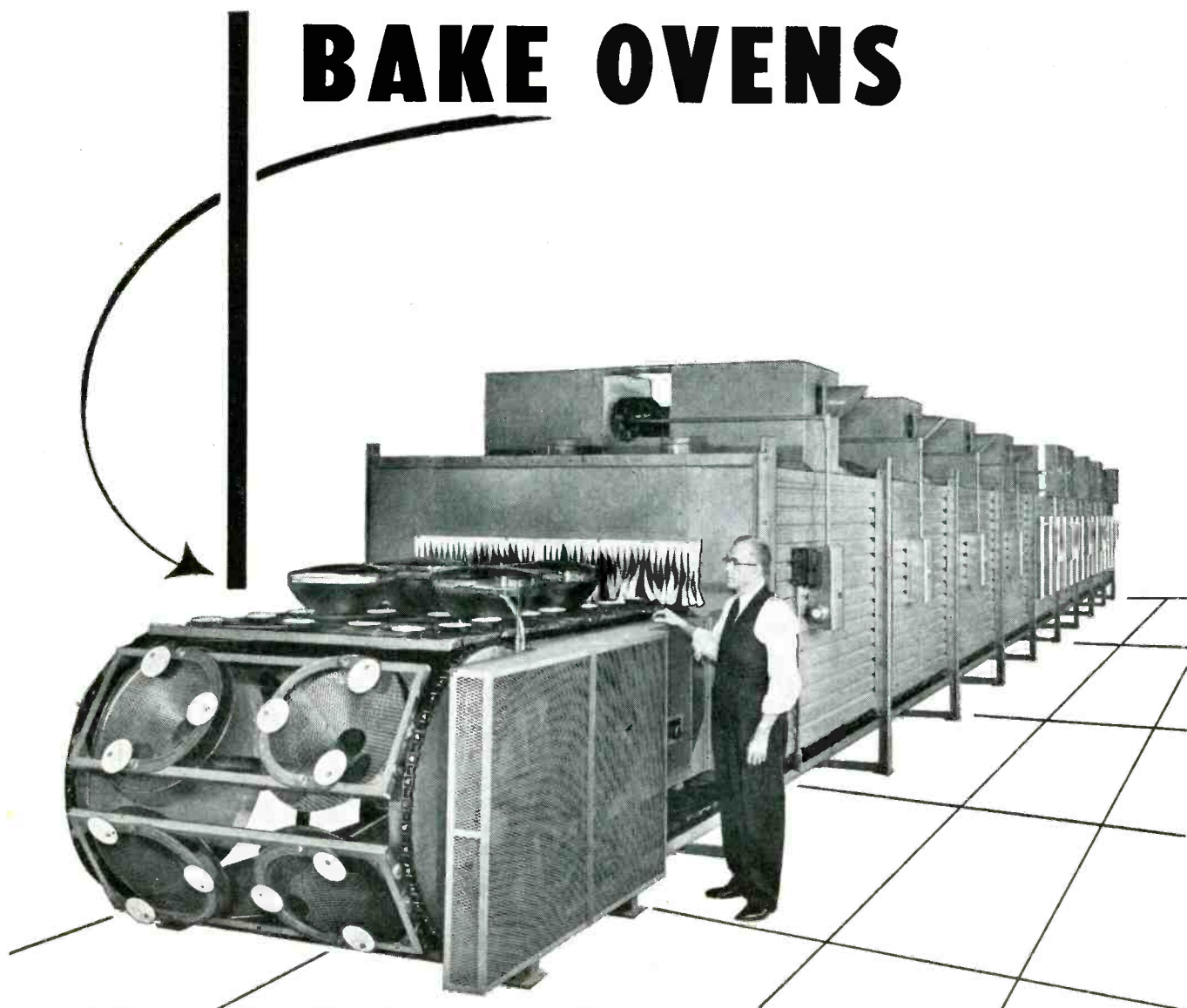

with a built-in purging system to
handle 21"-24" and 27" aluminized
cathode ray tubes



STEINER-IVES CO.

SPRINGFIELD ROAD • UNION, N. J.

NATVAR 400 means this Stator is SET FOR *LONG LIFE*

Fairbanks-Morse has been building high dependability power generating equipment for 50 years. They have safeguarded the "name worth remembering" by sound engineering and workmanship, and careful selection of materials.

To insulate and protect stator coils of alternators, Fairbanks-Morse uses "Natvar 400" extruded tape because of its consistently good electrical and physical properties, and resistance to high temperatures.

If reliability is important to you, it will pay you to use Natvar flexible insulations. They are dependably uniform no matter when or where purchased, and are immediately available either from your wholesaler's stock or direct from our own.



Natvar Products

- Varnished cambric—cloth and tape
- Varnished canvas and duck
- Varnished silk and special rayon
- Varnished—Silicone coated Fiberglas
- Varnished papers—rope and kraft
- Slot cell combinations, Aboglas®
- Varnished-lacquered tubing and sleeving
- Extruded vinyl tubing and tape
- Styroflex® flexible polystyrene tape
- Extruded identification markers

Ask for Catalog No. 22



Stator showing open slot construction of the Fairbanks-Morse Type TGZO Alternator, 1405 kva — 300 r.p.m. — 3 phase — 60 cycle — 2400/4160 volts — 80% p.f. — for direct connection to a diesel or dual-fuel engine, for utility, municipal and industrial power generation. Since they are frequently subjected to prolonged overloads in this type of service, they are designed for 50°C temperature rise above 40°C ambient. Coils, insulated and protected with "Natvar 400" extruded tape are tested at 9320 volts for one minute.

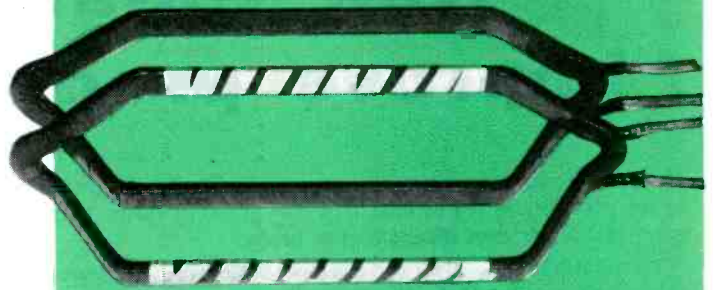

Two form wound coils for a Fairbanks-Morse 4160 volt Alternator. Lower coil has end sections insulated with "Natvar 400" extruded tape. Slot section is wound with a sacrifice tape, which is later removed and entire coil is wound with linen tape. Upper view of coil shows completed form, after final varnish dip and bake, ready for insertion in stator.

NATVAR CORPORATION

FORMERLY THE NATIONAL VARNISHED PRODUCTS CORPORATION

TELEPHONE

RAHWAY 7-8800

CABLE ADDRESS

NATVAR: RAHWAY, N. J.

201 RANDOLPH AVENUE • WOODBRIDGE, NEW JERSEY

New Jobs
for the World's
Most Useful
Metal
—*Straits Tin*



Tin mining in Malaya. Here a test boring is being removed.

New tin-alloy platings improve products, cut costs

The number of new ways you can use Straits Tin to make better products at lower cost is today growing faster than ever, and lower cost means higher profit.

New tin-alloy platings, for example, are giving increased protection against corrosion to steel.

Tin-zinc and tin-cadmium platings have been found to be many times as resistant to corrosion as either zinc or cadmium alone.

Tin-copper electrocoatings are increasingly useful. Red bronze can now be used as a more durable undercoating for chrome—white bronze for applications similar to those of silver plate.

And because tin is as handsome as it's adaptable, a new tin-nickel alloy is proving itself a more attractive, more corrosion-resistant decorative plating than the conventional chromium on nickel copper.

New plating alloys represent just one of the ways Straits Tin can do more for you today.

Over a third of the global tin output is mined and smelted in Malaya. Known as Straits Tin, this metal is over 99.87%

pure, and is world-famous for its absolute reliability of grade.

Whether you're planning a new product, working to improve an old one, or simply seeking ways to avoid the squeeze between rising manufacturing costs and resistance to higher product prices, a careful reappraisal of the properties of Straits Tin may uncover a profitable answer to your problem.

Write now for any information you may need about versatile, plentiful, economical Straits Tin.

A free copy of our new bulletin
"How Straits Tin Can Help You,"
is yours for the asking.



THE MALAYAN TIN BUREAU

Dept. 385, 1028 Connecticut Ave., Washington 6, D.C.

SEE SEALTRON FOR SEALS

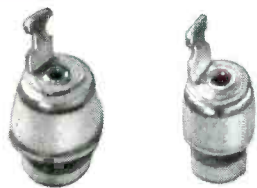

ALUMINA (CERAMIC) SEALS—

Metallized—ready for soldering. Extremely resistant to mechanical and thermal shock—meet top military specifications. Feed-through types.



GLASS-TO-METAL HERMETIC SEALS—

World's most complete line—over 1600 types and sizes, some small enough to be mounted on 1/8" centers. Protect vital electrical assemblies from moisture, atmospheric changes, corrosion, dirt, leakage. Also used as feed-through and stand-off terminals.

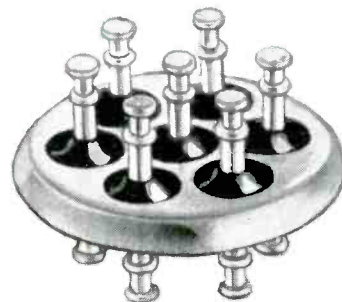

MULTIPLE HEADERS—

610 types always available—wide range of styles, shapes, pin arrangements. Can be incorporated into any panel or chassis requiring multiple connections. Fit standard receptacles. If required our engineers will design and build specially.

USE SEALTRON SEAL-SERVICE

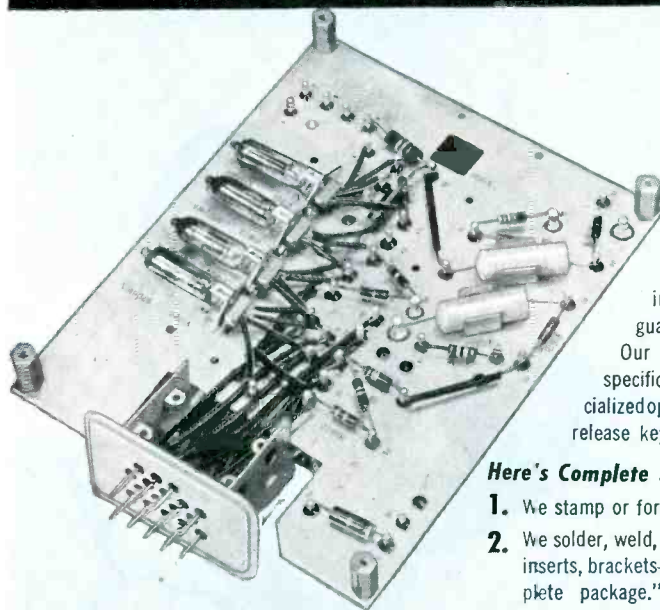

SEAL ASSEMBLIES:

Sealtron will solder seals into your assemblies, will guarantee hermetic perfection. Our technicians build to your specifications—eliminate your specialized operations, cut down overhead; release key personnel for other work.

Here's Complete Seal Assembly Service—

1. We stamp or form brackets and panels.
2. We solder, weld, or braze seals. Mount studs, inserts, brackets—all components—into complete package." Ready-to-use.
3. We supply feed-through or stand-off seals.

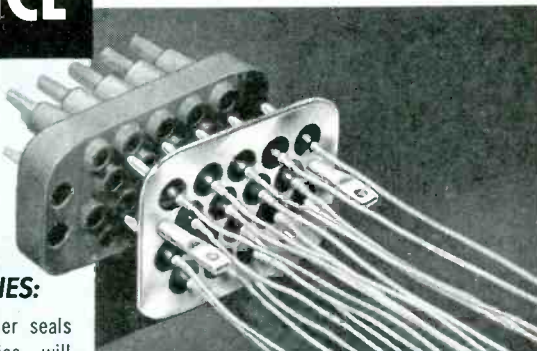

FLEXIBLE LEAD WIRES BUILT INTO MULTIPLE HEADERS

Sealtron welds flexible lead wires right into multiple headers. Eliminates difficult soldering in "close quarters"—saves space. Sealtron "Built-in" leads meet AN specifications, eliminate space-taking mechanical attachments required with soft-soldered leads, takes up as little as 3/32" on back of panel.



METALLIZATION

Metallized glass and ceramic windows, tubes, discs, rods, coil forms—for use in hermetically sealed units. Built to your specifications—ready for soldering.

Our engineers are always ready to help you with design problems, will develop special seals, seal assemblies, metallized units to suit your needs.

SEND FOR CATALOG TODAY!

SEALTRON CORPORATION

9701 READING ROAD • CINCINNATI 15, OHIO

ELECTRONICS — January, 1954

Want more information? Use post card on last page.



this timekeeper never takes

time off



RUNNING TIME METERS

... record total operating time or down-time on any circuit, machine or system. Widely used for life test experimentation in laboratories and for preventive maintenance programs, especially as applied to such things as machines, power equipment, tools, vacuum tubes, fluorescent lamp installations, nuclear measurements, etc. Made in six standard 25, 50, and 60 cycle A.C. models — 400 cy., D.C. and sealed type also available. Write for information.

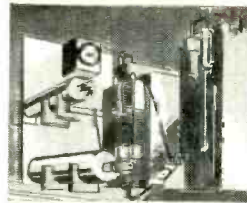

Laboratory life testing.

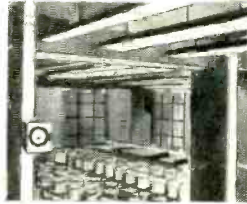

Indicates most efficient time to replace fluorescent lamps.

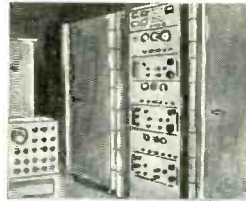

Replacement of vacuum tubes for radio transmitter.

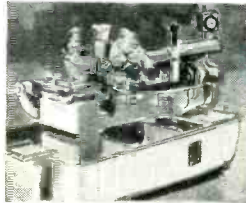

Records down-time on automatic screw machine.

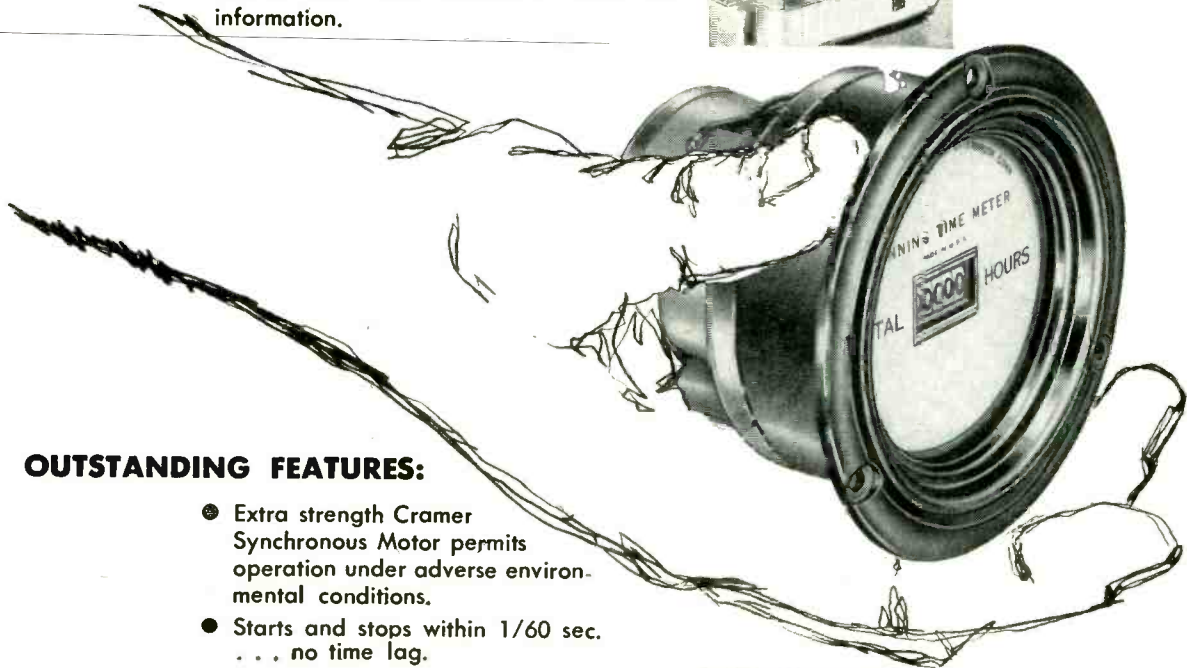

OUTSTANDING FEATURES:

- Extra strength Cramer Synchronous Motor permits operation under adverse environmental conditions.
- Starts and stops within 1/60 sec. . . . no time lag.
- Convenient meter-type mounting.
- Precision-built 5-digit counter.
- Reset feature if desired.

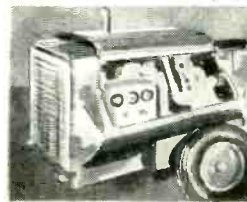

Determines need for maintenance on portable power unit.

the

R. W. CRAMER COMPANY • BOX 3 CENTERBROOK, CONN.
SPECIALISTS IN TIME CONTROL

11CR53

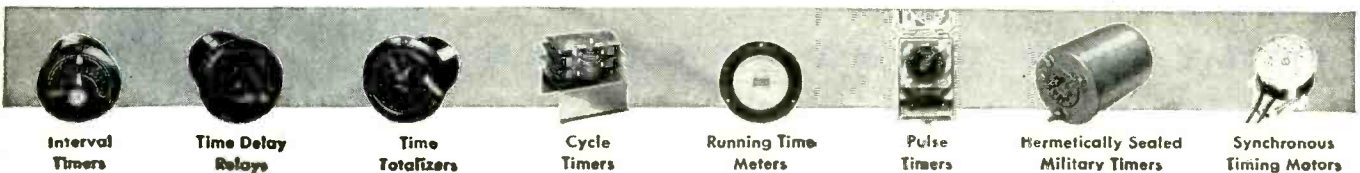

ELECTROLYTICS

FROM THE

Specialist
IN THE FIELD!



LARGEST MIDWEST MANUFACTURER CELEBRATES 20th YEAR HAS PRODUCED MILLIONS OF CAPACITORS

ILLINOIS CONDENSER CO. manufactures the finest electrolytic capacitors in the entire industry!

This specialization is important to YOU! It means that ILLINOIS electrolytics are the most advanced in the field, incorporating design and manufacturing excellence found in no others.

ILLINOIS "firsts" are many since they have pioneered and are still pioneering in this important field of electronics. A few of these advancements are: rugged all aluminum internal structure, exclusive patented phenolic molded cap structures with molded in terminals, balanced and neutral electrolytes for long life and wide temperature ranges.

That's why ILLINOIS capacitors are first choice of service engineers as well as most leading manufacturers of electronic equipment. You'll find ILLINOIS capacitors in TV-Radio and communications around the world.

Chances are ILLINOIS manufactures just the electrolytic you need for your product — and if not, who is better qualified to design and build one to your exact specifications?

Your Jobber can supply you with any standard ILLINOIS electrolytic — so be sure to see him first!

Write — TODAY — for ILLINOIS CONDENSER's new catalog which lists more than 400 different electrolytics. In addition it contains a wealth of electrolytic capacitor information!



ILLINOIS CONDENSER COMPANY

1616 N. THROOP STREET CHICAGO 22, ILLINOIS

Reg. U.S. Pat. Off.



Let **JOY** handle Your **FAN ENGINEERING** on **ELECTRONIC COOLING PROBLEMS**

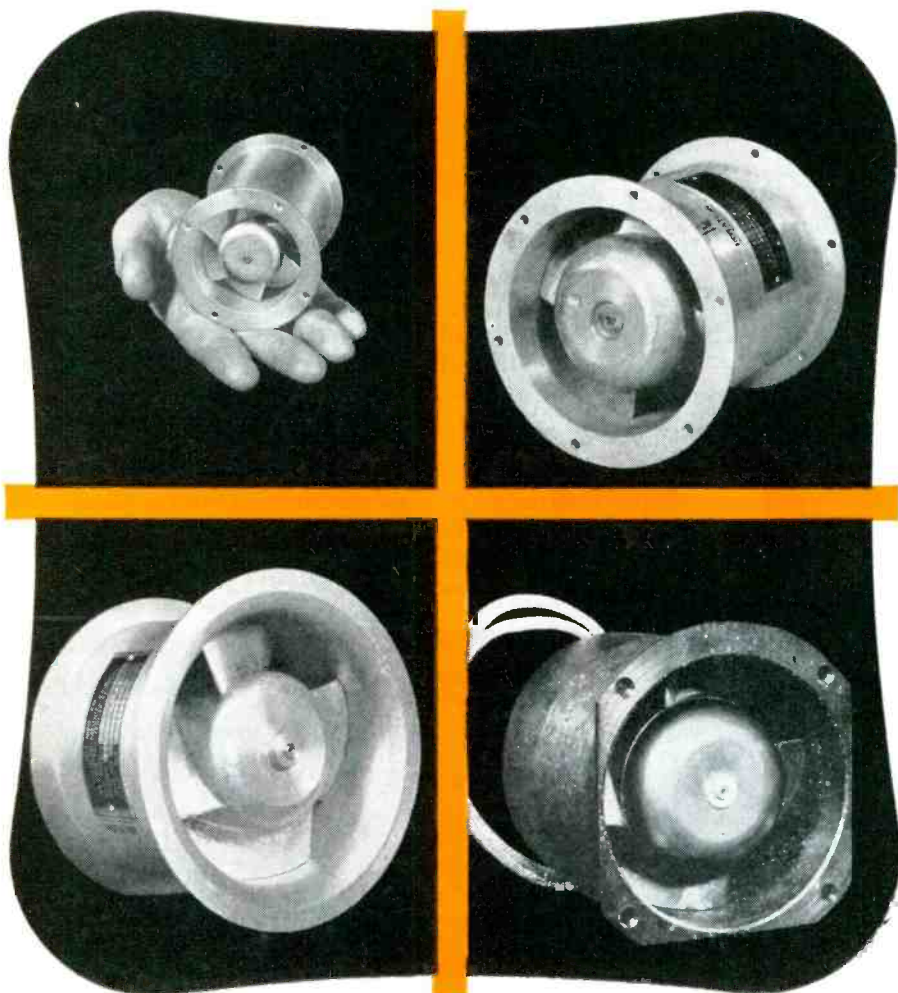

*Reg. U. S. Pat. Office

W&B 1-4010

JOY AXIVANE* Fans offer you advantages in electronic equipment cooling which have been thoroughly proved in service. The higher pressure-output of these vaneaxial blowers generally permits more compact arrangement of the equipment. Additional advantages are: light weight, high strength, high shock and vibration resistance, and high efficiency in low or high pressure service.

For minimum weight, JOY electronic cooling fans are made of aluminum, magnesium, or combinations of these metals. They are designed to meet all present Air Force and Naval electronic specifications, and are available in fan sizes from 2" I.D. up. Totally-enclosed or explosion-proof motors can be furnished where required.

● If you have a problem in heat dissipation from electronic units, no matter what the service conditions may be, let us place at your disposal JOY'S experience as the world's largest manufacturers of vaneaxial-type fans.

*Consult a Joy
Engineer*

Over 100 Years
of Engineering Leadership



JOY MANUFACTURING COMPANY

GENERAL OFFICES: HENRY W. OLIVER BUILDING · PITTSBURGH 22, PA.

IN CANADA: JOY MANUFACTURING COMPANY (CANADA) LIMITED, GALT, ONTARIO

For
Your Exact
Fuse Needs
there's
A BUSS
FUSE

BUSS is the one source for any fuse you need: — standard type, dual-element (slow blowing), renewable and one-time types . . . in sizes from 1/500 ampere up.

BUSS Fuses can be relied upon for dependable electrical protection, elimination of needless blows, and top quality in every detail because — EVERY BUSS and FUSETRON FUSE USED IN THE ELECTRONIC TRADE IS ELECTRONICALLY TESTED. The sensitive testing device rejects any fuse that is not correctly calibrated, properly constructed and right in all physical dimensions.

That's why manufacturers and service organizations for over 38 years have turned to BUSS for their fuse needs — no matter how exacting.

Should you have a special problem in electrical protection, BUSS places at your service the world's largest fuse research laboratory and its engineers.

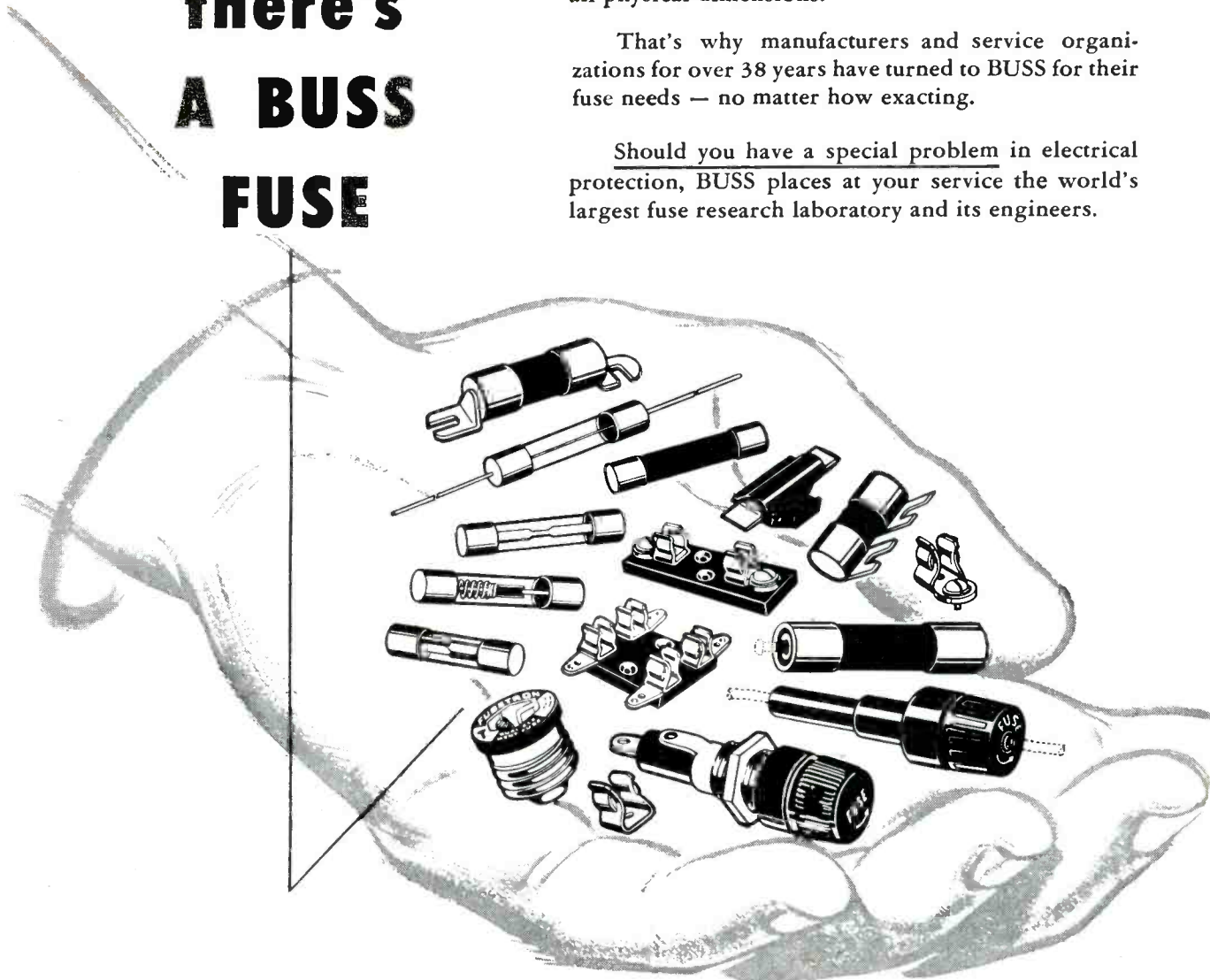

For
Full
Information
Mail
this
Coupon

BUSSMANN Mfg. Co. (Division of McGraw Electric Co.)
University at Jefferson, St. Louis 7, Mo.

Please send me bulletin SFB containing facts on
BUSS small dimension fuses and fuse holders.

Name _____
Title _____
Company _____
Address _____
City & Zone _____ State _____ 154

ELRC

precision connectors by Continental

THESE CONNECTORS ARE ACTUAL SIZE

- Series SM-20.....Sub-Miniature Rectangular Connectors
 - Series 20.....Miniature Rectangular Connectors
 - Series H-20Hermetical Seal Miniature Rectangular Connectors
 - Series C-20.....Miniature Hexagonal Connectors (Vibration Proof)
 - Series EZ-16.....Easy Release Power Connectors (Spring Loaded contacts)
 - Series 16.....Rectangular Power Connectors
 - Series 14.....Rectangular Power Connectors
 - Series PC.....Printed Circuit Connectors
 - Miniature Precision Stand-offs
- SPECIAL DESIGNS—submit your connector problems to our engineering department.

Continental Connectors

ELECTRONIC SALES DIVISION DeJUR-AMSCO CORPORATION

WRITE DEPT. EC-1, DE JUR-AMSCO CORPORATION
45-01 Northern Blvd., Long Island City 1, N. Y.



Capacitors shown 2 1/2 times actual size

CM-15 EL-MENCO CAPACITORS are only 9/32"x1/2"x3/16"...but they give DOUBLE VALUE PER DOLLAR

ALL fixed mica El-Menco capacitors are *factory-tested at double their working voltage*. Couldn't that mean that they'll last twice as long as other capacitors which cost no less? They also meet all significant requirements of JAN-C-5. So, you can depend on them to perform perfectly on all military and civilian electronic applications. Our tiny CM-15 silvered mica capacitors come in capacities from 2 to 420 mmf. at 500vDCw — 2 to 500 mmf. at 300vDCw. Our other types run all the way up to 10,000 mmf. It will pay you to compare El-Menco capacitors with all others — performance-wise, price-wise. *The Electro Motive Manufacturing Co., Inc., Willimantic, Conn.*

Electro Motive is now supplying special silvered mica films for the electronic and communication industries in any quantity — just send us your specifications.

Jobbers and distributors are requested to write for information to Arco Electronics, Inc., 103 Lafayette St., New York, N. Y. — large stocks on hand — spot shipments for immediate delivery. Sole Agent for Jobbers and Distributors in U. S. and Canada.

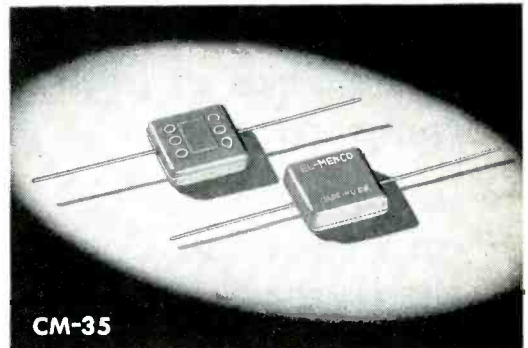

CM-35

WRITE FOR FREE SAMPLES AND CATALOG ON YOUR FIRM'S LETTERHEAD



MOLDED MICA EL-MENCO CAPACITORS MICA TRIMMER

Foreign and Electronic Manufacturers Get Information Direct from our Export Dept. at Willimantic, Conn.
THE ELECTRO MOTIVE MFG. CO., INC. WILLIMANTIC, CONNECTICUT

Let us show you how
GENERAL PLATE
Fabricated
PLATINUM-GROUP
 Composite Metal Parts and
 Assemblies...

- **Increase Strength**
- **Reduce Weight**
- **Provide Corrosion Resistance at high temperatures**
- **Increase Electrical and Thermal Conductivity**

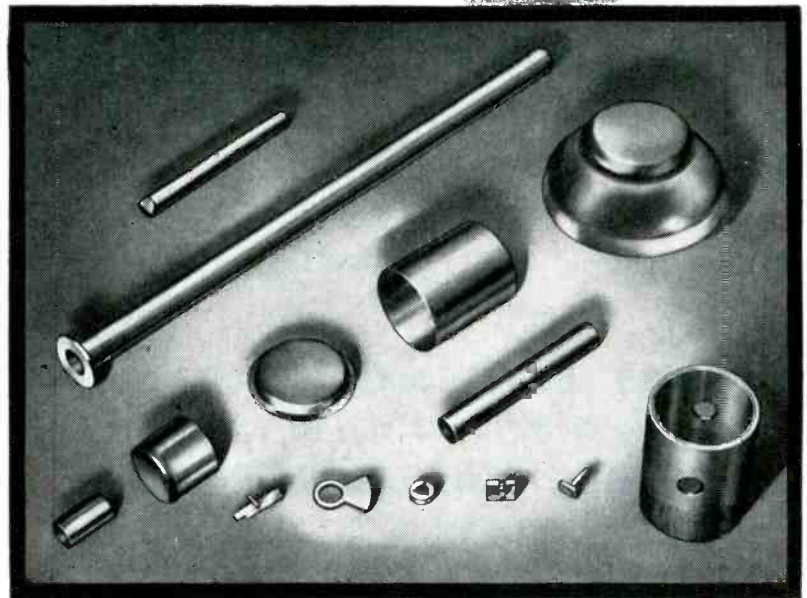

Typical parts fabricated from platinum-group composite metals

...and Reduce Material Costs!

By letting General Plate fabricate your platinum-group metal parts and assemblies, you will save money, time, and trouble... needless dies and other equipment costs and scrap disposal are eliminated... experimental and assembly adjustments are crossed from your books. The finished parts are made to your exact specifications and shipped to you ready for installation.

General Plate's complete fabricating facilities blank, stamp, form, spin, draw, turn, and mill parts; and produce staked, welded, or brazed assemblies.

Typical fabricated products include platinum-tipped contacts and contact assemblies, collector rings, linings for vessels, custom-made crucibles, thermocouple wires, electrodes, etc.

General Plate also produces platinum-group metals in solid and composite form in sheet, wire, tubing, foil, and gauze. In composite form, the noble metal provides the necessary performance characteristics, the

base metal greatly reduces costs without sacrificing the desirable characteristics of the pure noble metals.

In addition, General Plate has complete modern assaying and refining facilities which include a complete refinery for the recovery of platinum and platinum-group metals.

Send in your specific problems for discussion and ask for Bulletin PR718.

**You can profit by using
 General Plate Composite Metals!**

**METALS & CONTROLS CORPORATION
 GENERAL PLATE DIVISION**

31 FOREST STREET, ATTLEBORO, MASSACHUSETTS

*Efficiency
Contact*

UNITED VACUUM CAPACITORS

*feature
Wide Circumference,
Low Resistance
Contacts*

These new high amperage capacitors represent the best design achievement for heavy power requirements.

Large periphery terminals and contacts (2" diameter) result in extremely low temperature coefficient and provide for low-resistance connection to circuitry. Thermal conduction and temperature dissipation are increased over 800% as compared with conventional mounting methods. Oxygen free, high conductivity copper is used for all internal active areas as well as for external terminals.

These are available in 5 different type numbers, each rated for 35KV breakdown; 100 amperes RMS. New smaller overall physical dimensions are 5¼" length and 2¾" diameter.

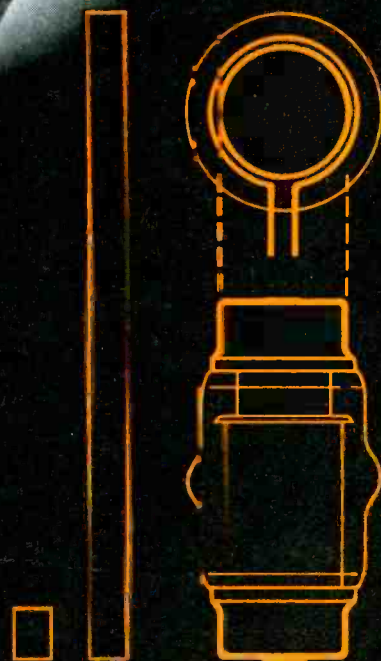

Comparison of contact areas between old (left) and new type (right) capacitors is illustrated by the two vertical bars, showing better than 12 to 1 gain. Moreover, 100% overall contact, despite temperature changes, is assured by new constant-pressure clamp rings supplied with capacitors.

TRIPPLET 630 Volt-Ohm-Mil-Ammeter

"speaks" for itself in any company

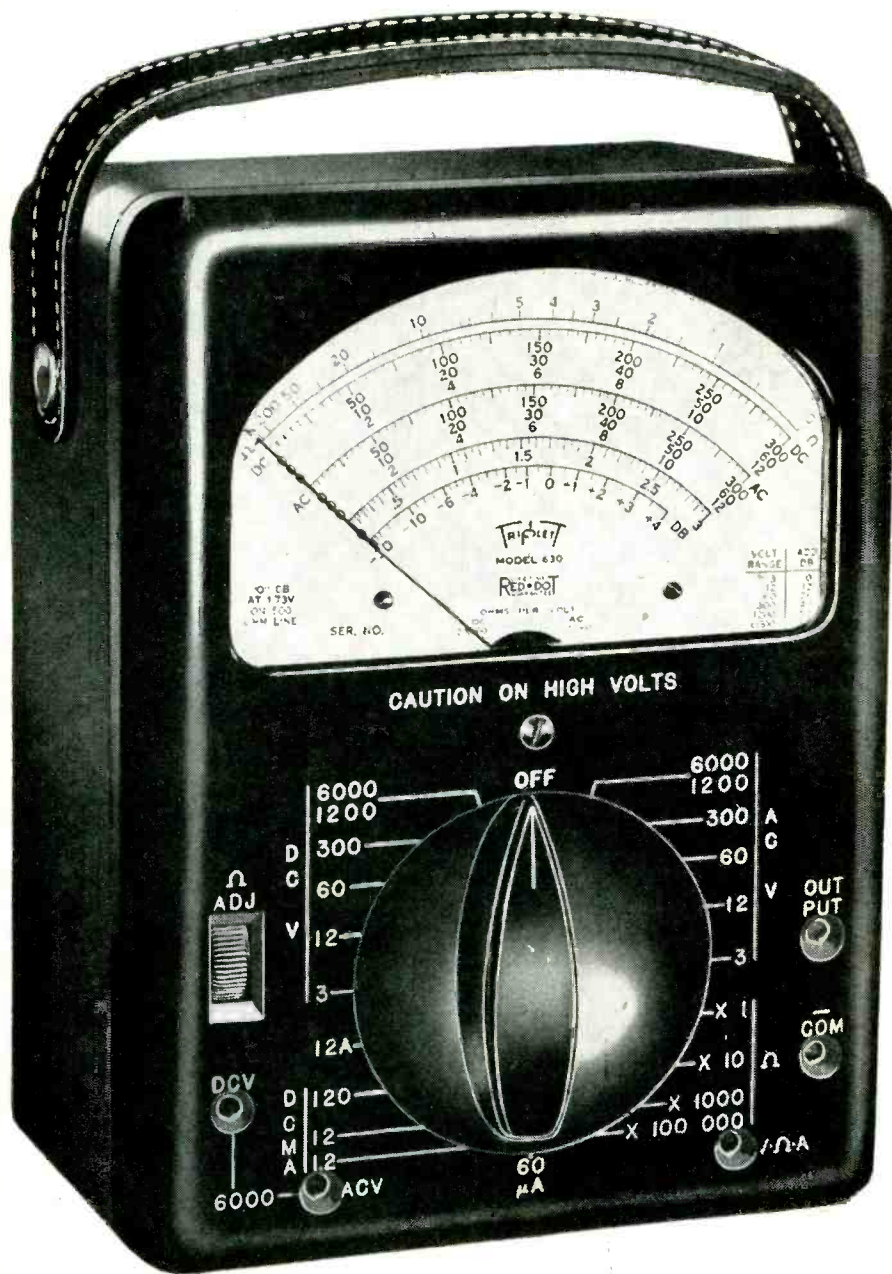

ing to desired circuit thru a single $2\frac{1}{2}$ " knob flush with the face panel. The molded switch itself embodies the most advanced engineering practices. Fully enclosed, the silvered contacts are kept permanently clean. Its rugged construction means stronger performance and longer life.

These two factors are but samples of the many ways in which on-the-job needs have been anticipated and provided for in a beautiful streamlined tester. It provides A.C.-D.C. Volts, D.C. Micro-amperes, Milli-amperes, Amperes, Ohms, Megohms, Decibel and Out Put readings in a no-short design embodying interior construction with all direct connections; no harness cabling. Its fool-proof unit switch construction houses precision resistors in insulated recesses in direct connection with switch contacts.

Study the following Ranges and descriptions and compare them point by point with any similar instrument for conclusive proof that Triplet 630 "speaks" for itself in any company.

Ranges

D.C. Volts: 0-3-12-60-300-1200—at 20,000 Ohms/Volt (For Greater Accuracy on TV and other High Resistance Circuits.)

A.C. Volts: 0-3-12-60-300-1200-6000—at 5,000 Ohms/Volt

(For Greater Accuracy in Audio and other High Impedance A.C. Circuits.)

Decibels: -30, +4, +16, +30, +44, +56, +70. (For Direct Reading of Output Levels.)

D.C. Microamperes: 0-60—at 250 Millivolts.

D.C. Milliamperes: 0-1.2-12-120—at 250 Millivolts.

D.C. Amperes: 0-12—at 250 Millivolts.

***Ohms:** 0-1,000-10,000—(4.44 at center scale).

***Megohms:** 0-1-100—(4,400-440,000 center scale).

Output: Condenser in series with A.C. Volt ranges.

**Resistance ranges are compensated for greatest accuracy over wide battery voltage variations. Series Ohmmeter circuits for all ranges to eliminate possibility of battery drain when leaving switch in Ohms position.*

TRIPPLET 630 Volt - Ohm - Mil - Ammeter has many significant advantages and features that make it stand distinctly apart from similar instruments in its price class. Actually in components, in engineering, in minutely accurate performance, Triplet 630 closely approaches laboratory standards.

Since the scales of any VOM comprise the means by which it makes its multiple services most valuable, the legibility and easy-read-ability are of prime importance. Triplet engineers have created in Triplet 630 the longest scales available in this size tester. (The upper arc by actual measurement is four and three-eighths inches.)

This long-scale factor accounts for the ease with which precise readings are easily made. Further legibility is gained by use of black and red scale markings. D.C. and D.B. are black and white. A.C. and Ohm markings are red on white. Ohms from one hundred million to one-tenth ohm mark the range of this amazing scale. On low ohms, center scale reading is 4.5 ohms.

The Single Switch

Further indication of the practical skill and engineering "know-how" behind Triplet 630 is the Single Switch. Its simplicity of operation assures no burn-outs thru momentary memory lapses. There is instant switch-

Get a Triplet 630 into your own hands at your distributor. U.S.A. Dealer Net \$3950

**TRIPPLET ELECTRICAL INSTRUMENT COMPANY
BLUFFTON, OHIO**

TRIPPLET

FIRST CHOICE AGAIN!

GPL

WNCT picks GPL cameras for TOP QUALITY PLUS ECONOMY



■ WNCT goes on the air in Greenville, N. C., with GPL studio and film equipment. On Channel 9, WNCT covers the rich eastern North Carolina tobacco and agricultural markets totaling close to 1,000,000 people.

"In this type of market," says A. Hartwell Campbell, general manager of WNCT, we shopped for not just quality but economy in cameras. That was a big factor in picking GPL.

"We checked with other stations, some with GPL chains, some with other makes. They confirmed our decision GPL was the best. The price was competitive, but we got all the GPL extras from picture quality to ruggedness, plus the economy mainly made possible by remote control operations.

"GPL projectors were the logical choice, to give us quality plus economy again for films as well as live shows."

TV equipment that produces the best picture, and still gives a station owner economy, deserves consideration. Try these cameras, under your own operating conditions. Study the remote control features and compare operating costs. You'll discover how GPL can save you money . . . with the best.

Malcolm Nicholson, film editor of WNCT threads one of two GPL PA-100A projectors used by WNCT. Projectors have 4,000-foot capacity, and are remotely controlled.

WNCT's home nears completion in Greenville. Station has 100,000 watt video signal and 50,000 watt audio. The antenna towers 874 feet above the surrounding terrain.

WNCT engineers Bill Elks (left) and Heber Adams during practice sessions before completion of 35 x 50-foot studio. Lens change, focus and iris adjustment can be handled from control room, at any time as desired.

A phone call, wire or letter will bring complete information on cameras, projectors, transmitters, the new Watson-GPL vari-focal lens and all other TV equipment for studio or field.



General Precision Laboratory

INCORPORATED
PLEASANTVILLE NEW YORK



Export Department:
13 East 40th St., New York City
Cable address: Arlab

Cable address: Prelab

Camera Chains • Film Chains • Field and Studio Equipment • Theatre TV Equipment • GPL-Continental Transmitters

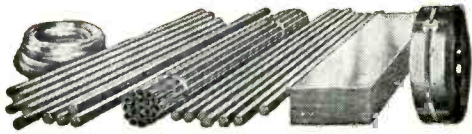

BRIDGEPORT BRASS COMPANY

COPPER ALLOY BULLETIN

BRASS
Bridgeport
CO.

MILLS IN BRIDGEPORT, CONN. AND INDIANAPOLIS, IND. — IN CANADA: NORANDA COPPER AND BRASS LIMITED, MONTREAL



The Production Control Quantometer can make a complete analysis of copper-base alloys in approximately four minutes as compared to several hours by the chemical method.

Bridgeport's Laboratory Service Scientific Controls Protect Users of Mill Products

Uniform high quality of brass mill products is essential to modern metal-working practice, as cost of operation and salability of end product often depend upon it. Strict laboratory controls protect users of sheet, rod, wire, and tubing; help economical production; and govern uniformity.

Scientific tests are made of incoming raw materials, castings analyzed, and outgoing finished orders checked. This procedure assures conformity with specified composition, dimensions, temper, and other physical properties.

Quantometer Speeds Analysis

How the Bridgeport Laboratory keeps abreast of up-to-date testing methods is well exemplified by the Production Control Quantometer. With this new, automatic, electronic spectrometer, alloy composition is determined in a matter of minutes. Samples obtained from the molten stream during pouring are speedily delivered to the Quantometer room by a specially designed, pneumatic tube system.

A small test sample casting is machined for a smooth surface and placed on the platform of the Quantometer

where it receives an electrical discharge. The resulting gaseous vapor of the melted metal has a luminosity which is broken up by a grating into wavelengths of light. These rays strike photomultiplier tubes arranged to receive light corresponding to the elements desired in the analysis. These tubes develop voltage which is registered on a strip chart recorder and converted into terms of calibrated concentrations by means of a calculating device. The complete cycle of machining, loading, calculating, and recording requires approximately 4 minutes. This remarkable instrument is operated in an air-conditioned room with temperature and humidity controlled to assure accurate performance.

With many thousands of pounds of metal being cast daily, speed is essential in testing composition so that any offmixture can be detected and corrected immediately.

Analyses are made of every alloy cast and other physical tests such as hardness, grain size, tensile strength, yield strength, elongation, are made when required.

Corrosion Studies Beneficial

Corrosion is probably the greatest enemy of metals. A specially trained staff studies the effects of corrosion so that more suitable metals can be recommended for longer service life. Electro-chemical studies are made in the laboratory, along with alternate immersion, total immersion, impingement and stress corrosion testing in acid, base, salt and organic solutions and gases. Field tests and examinations of corroded tubes are also performed.

Research Very Important

Bridgeport's consistent research program comprises studies of new processes and methods of production as well as possible new products; development of new alloys and improvement of old ones; comparison testing, etc., and study of the fundamentals of forming operations.

Experimental work also covers welding, machining, strain analysis, heat treatment, as well as evaluations of coolants, lubricants and metal cleaning.

Technical Service

Our experienced technical service staff can help customers on their metal problems in many ways:

1. To make sure that the correct alloy and temper are used on standard items.
2. To improve existing products by using stronger, more corrosion-resisting alloys.
3. To help designers to specify the correct copper-base alloys when bringing out new products.
4. To help reduce finishing costs by recommending the correct temper or grain size for minimum polishing effort.
5. To help reduce machining costs by recommending the proper free machining alloys.
6. To increase service life of tube installations by recommending more corrosion-resisting alloys.

If you have not yet used Bridgeport's laboratory controlled mill products, contact our nearest District Office. Write for your copy of Bridgeport's "Technical Handbook," using your company stationery. (1172)

WRITE EAI

FOR

FOR



PRECISION
ANALOG
COMPUTER

Precision Analog Computer

Designed to meet the demand for a highly accurate, dependable, and versatile general-purpose analog computer for solving problems in dynamics for industrial, research, educational, and military groups. Features a new high-gain, low-drift, contact-stabilized d-c amplifier with outstanding frequency response and power output characteristics; centralized operation from a control console which houses the problem board and its bay, attenuators, initial condition potentiometers, limiters, and other operating controls; precision network

components contained in a controlled environment to insure reliable and accurate performance; a grounded 1800 position problem board which confines all terminal leakages to ground.

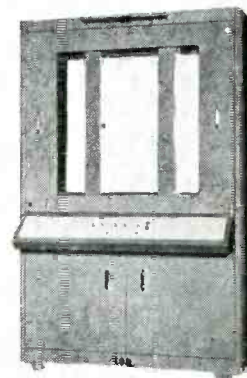

VARIPLOTTER
MODEL 205J

Variplotter - MODELS 205G and H



VARIPLOTTER
MODELS 205G AND H

A self-balancing potentiometer type recorder designed to record one variable d-c voltage as a function of a second variable d-c voltage. Model 205G is a single pen board that will present a single X vs. Y plot. Model 205H has an additional arm and pen allowing it to record two independent sets of X vs. Y data simultaneously. Static error is .05 per cent of full scale at 70 degrees Fahrenheit. Dynamic error averages .05 per cent of full scale plus the static error. Standard sensitivity is 50 millivolts per inch or 1.5 volts for full scale deflection of 30 inches. Maximum writing speed is 8-1/2 inches per second. Continuously variable uncalibrated scale factor and parallax controls are provided for each axis.

Variplotter - MODEL 205J

Essentially the same characteristics as the Models 205G and H described above except that the plotting surface is vertical. The plotted result, in the form of an inked line, is presented on a 30 inch square of paper which is held firmly to the plotting surface by a unique vacuum system. Static error is .05 per cent of full scale at 70 degrees Fahrenheit and dynamic error average .05 per cent of full-scale plus the static error. Maximum writing speed is 8-1/2 inches per second. Standard sensitivity is 50 milli-volts per inch or 1.5 volts for full-scale deflection of 30 inches. Where floor space is limited, the MODEL 205J Variplotter is recommended for your recording needs such as analog computer output, guided missile data, engine performance, etc.

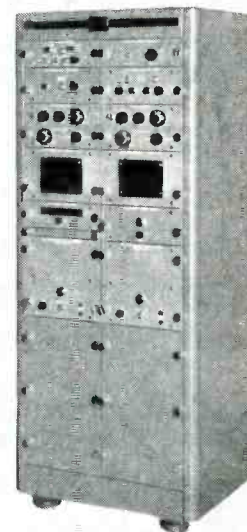

DIGI-VERTER GROUP
TYPE 17-31A

Digi-Verter Group - TYPE 17-31A



FUNCTIONAL
POTENTIOMETERS

The Digi-Verter can be used to convert digital information, such as that obtained from card reading machines or tabular lists, into analog form suitable for presentation as a point plot on a Variplotter plotting board. It is designed to accept two four-decimal digit numbers and their signs from an IBM machine such as Type 513, 517, 519, 523, etc. Complete operating controls include power switch, feed switch, input switch, storage clear, and scale factor and parallax controls for both X and Y. Scale factor will provide plot expansion up to 10 times and parallax controls allow the zero-zero origin to be located anywhere on the plotting surface. The complete digital plotting system consists of the Digi-Verter, Data Input Keyboard, Model 205G Variplotter plotting board

Functional Potentiometers

There are two models of sine-cosine potentiometers available—Type 462 which is a single unit and Type 315 which provides two sets of sine-cosine functions. Accuracy is within .15% of the theoretical voltage for all points throughout 360° of shaft rotation. Angular resolution is .005% of 360° and electrical resolution, expressed as a percentage of the total voltage applied across one 90 degree quadrant is with .05%.

LONG BRANCH,



NEW JERSEY

MEPCO

PRECISION RESISTORS

MIL-R-93A NEW SEALED TYPES

Over 2 years of laboratory development and testing were required to achieve a sealed resistor design up to Mepeco's standard of quality. No sacrifice of our standard time-proven features has been made in order to perfect this sealed resistor.

Completely hermetically sealed, these resistors provide perfect protection against immersion and high humidity.

All requirements of MIL-R-93A and JAN-R-93 are exceeded.

The operating temperature is -65°C to $+125^{\circ}\text{C}$. Temperature coefficients of $\pm .003\%$ / $^{\circ}\text{C}$ to $\pm .017\%$ / $^{\circ}\text{C}$ depending upon your requirements. (Refer to MIL-R-93A).

Other sizes available on special order.

MIL-R-93A JAN-R-93 STANDARD TYPES

Our standard time proven JAN, MIL and Commercial lug terminal resistor.

Manufactured and 100% tested in accordance with the applicable specifications, these resistors are used by every major electronic equipment manufacturer in the country.

Reversed and balanced PI-windings for low inductance, with use of only the finest resistance alloys.

Impregnated with approval fungus, moisture and salt waterproofing compounds.

JAN approved non-hygroscopic steatite bobbin, specially treated prior to winding in order to provide additional protection for fine enameled wire.

Protective fungi resistant acetate label.

Rigid hot solder coated brass terminals for easier soldering.

WIRE TERMINAL TYPES

Designed for direct connection into circuit without use of additional leads.

These resistors are of the same basic construction and materials as standard JAN and MIL types therefore providing equal dependability and long life.

Low Temperature Coefficient alloys provide $\pm .003\%$ / $^{\circ}\text{C}$ from -65°C to $+125^{\circ}\text{C}$ unless otherwise specified by your requirements.

Resistance tolerances range from $\pm 1\%$ down to $\pm .02\%$. Sets of matched resistors can be supplied $\pm .005\%$ or lower.

Special types not shown can be manufactured to your exact specifications.

JAN-R-29 METER MULTIPLIERS

Surpass all requirements of JAN-R-29

HERMETICALLY SEALED: Insures dependable operation under most severe moisture conditions.

STEATITE PROTECTIVE CASING: Glazed surface prevents high voltage leakage.

WINDINGS: "Certified" low temperature coefficient resistance alloys properly "aged" to provide long term stability.

REPLACEABLE INTERNAL SECTIONS: Eliminate complete loss of unit if damaged.

FERRULE TERMINALS: Heavy nickel plated brass. Corrosive resistant. Fit standard fuse clips.

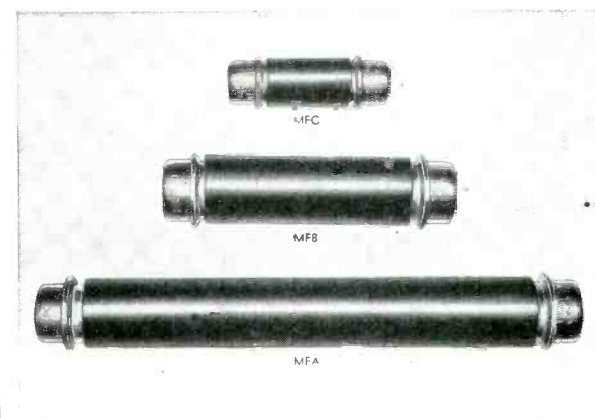
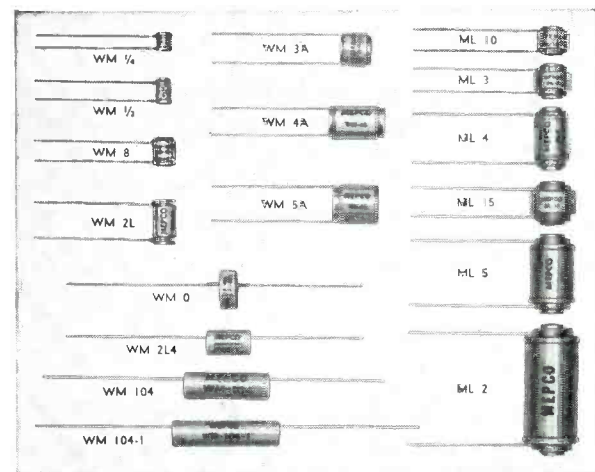
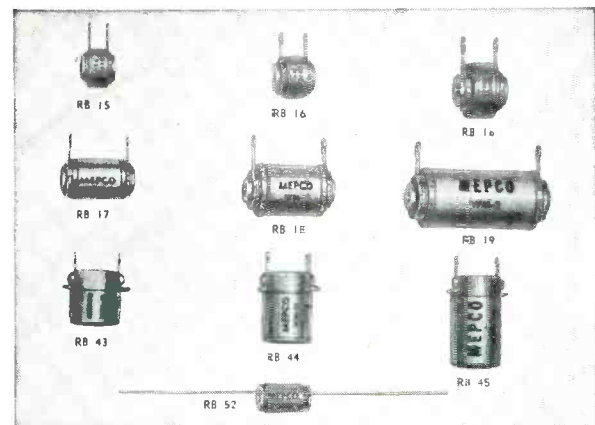
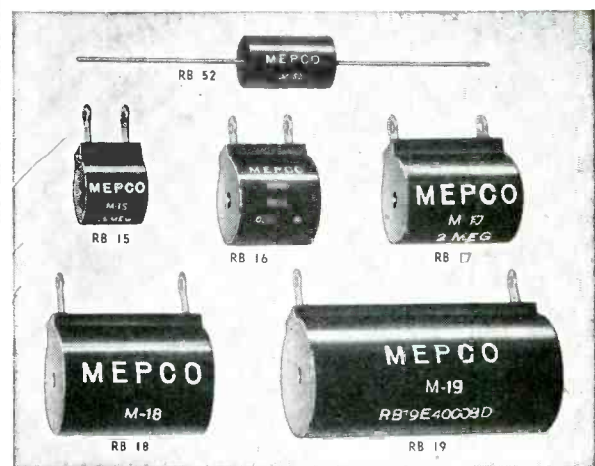

MEPCO, INC. MORRISTOWN, N. J.

ONLY THE LFE 401 OSCILLOSCOPE

Offers all these Important Features

HIGH SENSITIVITY AND WIDE FREQUENCY RESPONSE OF Y-AXIS AMPLIFIER

The vertical amplifier of the 401 provides uniform frequency response and high sensitivity from D-C. Coupled with a sensitivity of 15 Mv./cm peak to peak at both D-C and A-C is a response characteristic which is 3 db. down at 10 Mc. and 12 db. at 20 Mc. Alignment of the amplifier is for best transient response, resulting in no overshoot for pulses of short duration and fast rise time. An example of the wide band response of the amplifier is shown in the accompanying photographs.

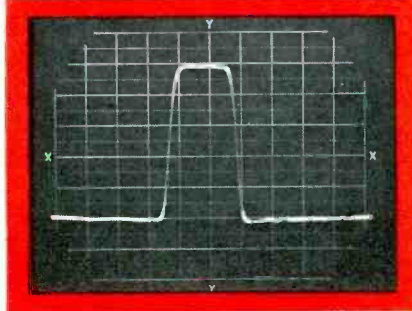
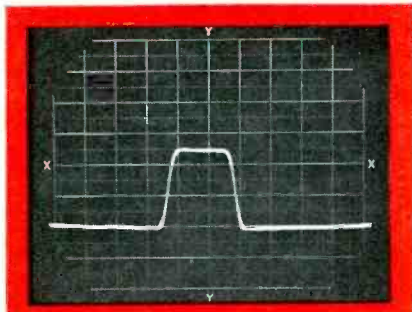
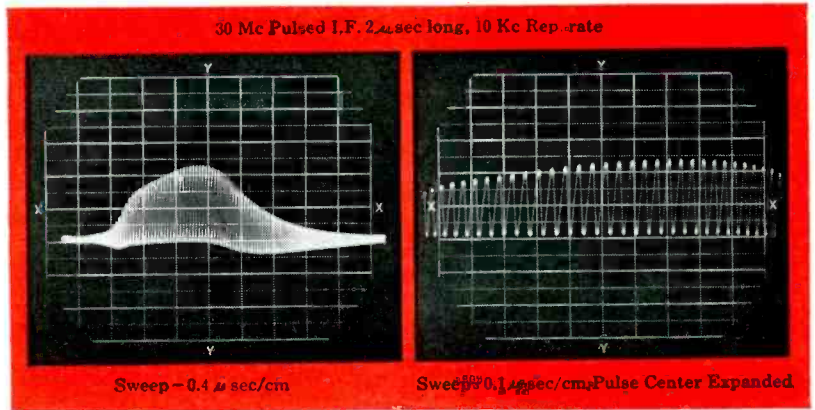

37.5 Mv., 0.2 μ sec width, 1 μ sec sweep full scale

75 Mv., 0.2 μ sec width, 1 μ sec sweep full scale

TRIGGER GENERATOR with variable repetition rate from 500 to 5000 cps.

POSITIVE & NEGATIVE UNDELAYED TRIGGERS and a **POSITIVE DELAYED TRIGGER** are externally available.

LINEARITY OF VERTICAL DEFLECTION

The vertical amplifier provides up to 2.5 inches positive or negative uni-polar deflection without serious compression; at 3 inches, the compression is approximately 15%. The accompanying photographs illustrate transient response and linearity of deflection.

SWEEP DELAY The accurately calibrated delay of the 401 provides means for measuring pulse widths, time intervals between pulses, accurately calibrating sweeps and other useful applications wherein accurate time measurements are required.

The absolute value of delay is accurate to within 1% of the full scale calibration. The incremental accuracy is good to within 0.1% of full scale calibration.

Additional Features:

An **INPUT TERMINATION SWITCH** for terminating transmission lines at the oscilloscope.

A **FOLDING STAND** for convenient viewing.

FUNCTIONALLY COLORED KNOBS for easier location of controls.

Write for Complete Information

Designed and built for electronic engineers, the 401, with its high gain and wide band characteristics, and its versatility, satisfies the ever-increasing requirements of the rapidly growing electronics industry for the ideal medium priced oscilloscope.

SPECIFICATIONS

Y-Axis

Deflection Sens. - 15 Mv./cm, p-p

Frequency Response - DC to 10 Mc

Transient Response - Rise Time (10%-90%) 0.035 μ sec

Signal Delay - 0.25 μ sec

Input line terminations - 52, 72 or 93 ohms, or no termination

Input Imp. - Direct - 1 megohm, 30 μ μ f

Probe - 10 megohms, 10 μ μ f

X-Axis

Sweep Range - 0.01 sec/cm to 0.1 μ sec/cm

Delay Sweep Range - 5-5000 μ sec in three adjustable ranges.

Triggers - Internal or External, + and -, trigger generator, or 60 cycles, undelayed or delayed triggers may be used.

Built-in trigger generator with repetition rate from 500-5000 cps.

General

Low Capacity probe

Functionally colored control knobs

Folding stand for better viewing

Adjustable scale lighting

Facilities for mounting cameras

PRICE: \$895.00



LABORATORY for ELECTRONICS, INC.

75-3 PITTS STREET • BOSTON 14, MASS.

PRECISION ELECTRONIC EQUIPMENT • OSCILLOSCOPES • MAGNETOMETERS • COMPUTERS • MICROWAVE OSCILLATORS

PHELPS DODGE UP-TO-DATE SIMPLIFIES YOUR MAGNET



First for Lasting Quality—from Mine to Market!

WAREHOUSE SERVICE

WIRE INVENTORY PROBLEM



 **COMPLETE WAREHOUSE STOCKS**
*strategically located on East Coast,
West Coast and in Central Region.*

 **OVERNIGHT DELIVERY TO THE
MAJOR MARKETS**

 **"ONE-PHONE-CALL" SERVICE**
*via nearest Phelps Dodge district
office. See list below:*

◆ ◆ ◆
Atlanta, Ga. • Boston, Mass. • Charlotte, N. C. • Chicago, Ill.
Cincinnati, Ohio • Cleveland, Ohio • Dallas, Texas • Detroit, Mich.
Fort Wayne, Ind. • Houston, Texas • Kansas City, Mo.
Los Angeles, Calif. • Milwaukee, Wis. • New Orleans, La.
New York, N. Y. • Philadelphia, Pa. • Pittsburgh, Pa. • Portland, Ore.
San Francisco, Calif. • Seattle, Wash. • St. Louis, Mo. • Washington, D. C.



PHELPS DODGE COPPER PRODUCTS
CORPORATION

INCA MANUFACTURING DIVISION
FORT WAYNE, INDIANA

NOW...

NOW They're Available for Prompt Delivery! from **STANDARD STOCK**... at **MALLORY**



FLAT FACED CONTACTS



RADIUS FACED CONTACTS

Part No.	Material	Quantity	Price	Part No.	Material	Quantity	Price
100	100
101	101
102	102
103	103
104	104
105	105
106	106
107	107
108	108
109	109
110	110
111	111
112	112
113	113
114	114
115	115
116	116
117	117
118	118
119	119
120	120

MALLORY "FIRST"!

FOR COMPLETE CATALOG INFORMATION ON ALL OUR PRODUCTS SEE NEXT PAGE

IMMEDIATE DELIVERY of FINE-SILVER CONTACTS ... from MALLORY STOCK!

Here is another Mallory "first"! A standard stock program on fine-silver headed rivet contacts makes possible immediate shipment of most requirements.

Engineering analysis of thousands of customer prints resulted in the selection of 70 flat and radius faced fine-silver headed rivet contacts to be carried in stock. These designs are suited to thousands of varying applications. The advantages to our customers are obvious...

- **Prompt shipment, normally within 24 hours.**
- **Saving in time and cost of special designs and tooling.**
- **Immediate availability of samples, where required.**
- **Ready availability of small quantities for pilot runs and job orders.**

Write today for the leaflet listing dimensions, prices and part numbers of the 70 standard stock Mallory Contacts. It has been designed for quick checking against your present requirements and also for reference in your new design work.

If the special nature of your design requires special contacts, call on the specialized experience of Mallory engineers. Modern facilities and a complete range of materials are available to produce contacts or contact assemblies to meet your requirements.

Expect more... Get more from **MALLORY** P. R. MALLORY & CO. INC.

P. R. MALLORY & CO. Inc.
MALLORY
 P. R. MALLORY & CO., Inc., INDIANAPOLIS 6, INDIANA

Serving Industry with These Products:
Electromechanical—Resistors • Switches • Television Tuners • Vibrators
Electrochemical—Capacitors • Rectifiers • Mercury Batteries
Metallurgical—Contacts • Special Metals and Ceramics • Welding Materials

CROSS
TALK

► **BIG JIM** . . . We run 25 watts on the ham bands and thought it was pretty lush to operate a half kilowatt before the war, so it was a thrill to watch RCA's General Sarnoff transmit Admiral Carney's first official message to the fleet from Navy's new 1,200,000-watt transmitter (p 98, Dec. 1952) northeast of Seattle. The old man has not lost his skill with a key. We understand he has one on his desk, uses it occasionally for short-haul work around the office.

Jim Creek Valley is in the clouds through much of the winter season, so 1,000-foot leads running straight up to the antenna disappeared in the mist before reaching the mountaintop-to-mountaintop catenaries. Nearest thing we've ever seen to the proverbial skyhook or, if you prefer a simpler simile, the Indian rope trick.

There is a conventional television receiver in the shadow of the most powerful radio transmitter in the world and it operates beautifully during transmissions. Interference with other services has yet to be reported, despite the fact that there are no harmonic filters of any kind in NLK's antenna circuit. Designer J. C. Walter told us this is because the station operates on a very low frequency (14.5 to 35 kc) into an extremely efficient antenna that just won't soak up power anywhere else.

► **TEACHERS' PAY** . . . A Central Intelligence Agency man tells us, on the record, that the Russians are rapidly building up their supply of engineers by every possible means. Aside from military requirements, it seems they now need them to design consumer goods that the people have reluctantly done without. The current lull in pressures applied to other countries may be due to the need for consolidation inside the Soviet Union.

Key to the training of engineers in any country is good teachers. We met a lot of them recently at Rensselaer Polytechnic's Industrial Council, and one thing crept in between the lines of most conversations. Many American educators are in the profession because they feel more than the average man and woman that they have an important mission to perform. This fact notwithstanding, unless something is done to raise teachers' pay nearer the levels paid people with comparable qualifications by industry the quality as well as the quantity of available educators will steadily decline.

► **ENGINEER-LAWYERS?** . . . Columbia University is using a \$50,000 grant from our industry's Major Armstrong to study the technical data upon which certain court decisions have been based. The question: How right have the

courts been when rendering decisions revolving around complex scientific subjects?

Says the Major: "It has been my observation over a long period of years that public bodies, in order to discharge their functions, are frequently required to make findings of fact on technical and scientific matters that are beyond the comprehension of laymen. The techniques involved in the ascertaining of such facts have not been adequately developed, with the result that important decisions sometimes have been made, and important actions taken, upon erroneous findings of fact in technical and scientific fields."

► **COMING ATTRACTIONS** . . . Our survey of subscriber needs continues and, in general, you say: "Give us more of the same."

The editors of *ELECTRONICS* plan to add three extras in this new year. There will be, before spring, a four-page foldout that should have considerable reference value. Around mid-summer we hope to start a series of articles (now that the transistor series is out of the way) that will be "must" reading for assemblers of just about any kind of electronic gear. And in the fall there will be an extensive insert dealing in a practical way with the specific problems of a particular group of engineers who have hitherto been served more or less in passing.

Designing Radomes

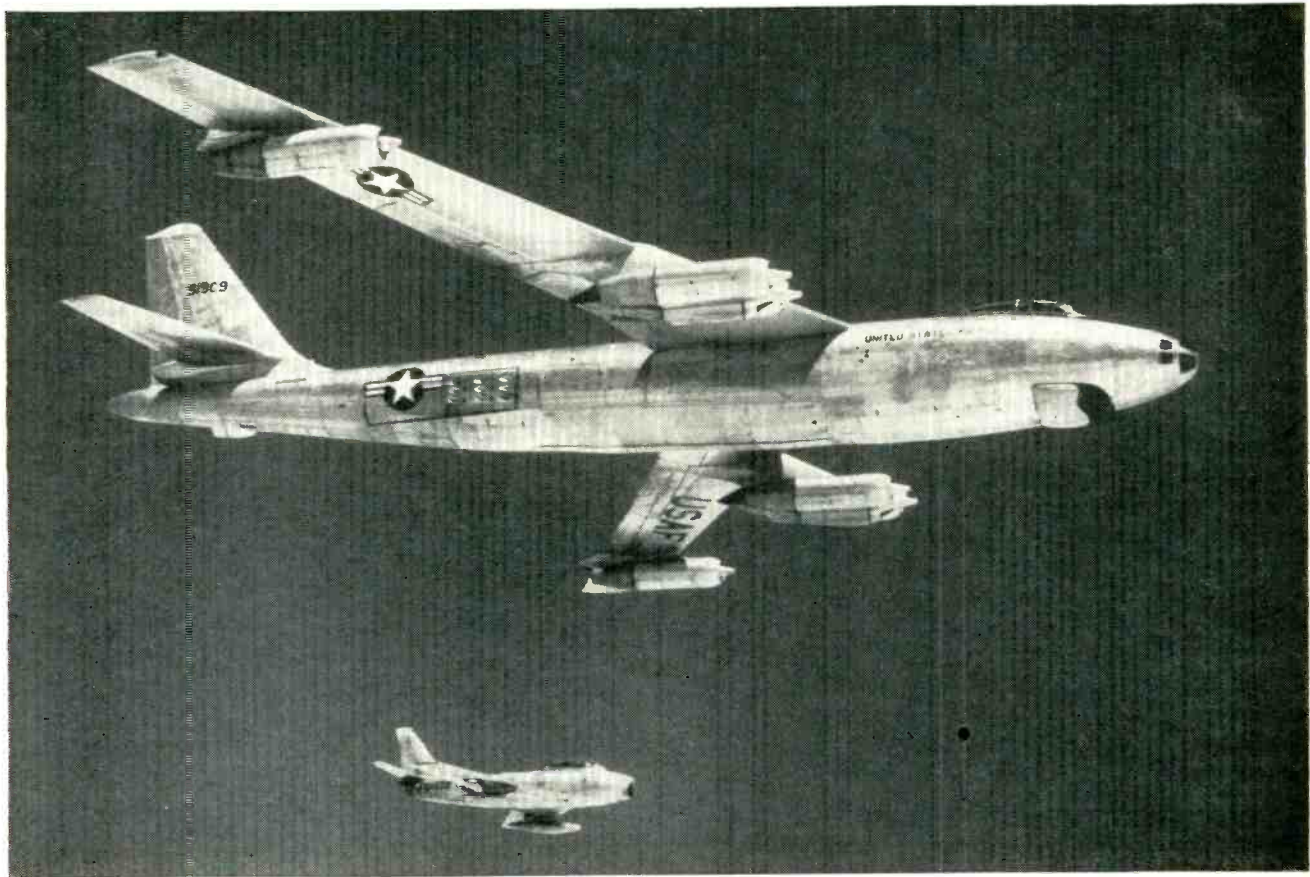

With the exception of radar-steered missiles, radomes on these two planes take about the toughest punishment of any on planes in production today. For the Boeing B-47 Stratojet, the bombing and navigation radome is almost directly under the pilot; a later model B-47 also has a tail radome for gunfire control. Flying below is the North American F-86 Sabre with a nose radome

New honeycomb, foam and sandwich materials form radomes that transmit radar signals with minimum boresight shift, absorption and reflection loss, yet withstand effects of hail, icing, rain, wind, temperature, static charges and gunblast at supersonic speeds and stratospheric altitudes of modern military aircraft

UNIFIED DESIGN of an airborne radar radiating system, from the magnetron all the way through to the antenna and radome, is today a necessity. No one element of the system can be reasonably considered to the complete disregard of the other elements, since the interdependence of all contributes vitally to the efficient performance of the entire system. This is particularly true of the radome through which the outgoing and incoming pulses must pass.

To the aeronautical engineer the

radome is merely a plastic disfiguration of his airframe. To the structural designer, it is a potential weak spot in an otherwise all-metal fuselage. To the gunner, it is a part of the radar system that contributes—or is responsible for—errors in the accuracy of his automatic gun-laying equipment. To the electronic engineer, it is a dielectric housing that affects the electromagnetic fields in the vicinity of the antenna to the extent that the major lobe of the radiation pattern may be distorted and the

side lobes increased, displaced or otherwise modified.

The first radomes were hemispherical and were fabricated from molded plywood. They reflected considerable energy back into the antenna. The usual result of such reflection was the failure of the magnetron and with it, the collapse of the radar system.

New materials then made their entry into the field of radome design. One of them involved a combination of fibrous glass, in both woven and unwoven form, with

for Supersonic Speeds

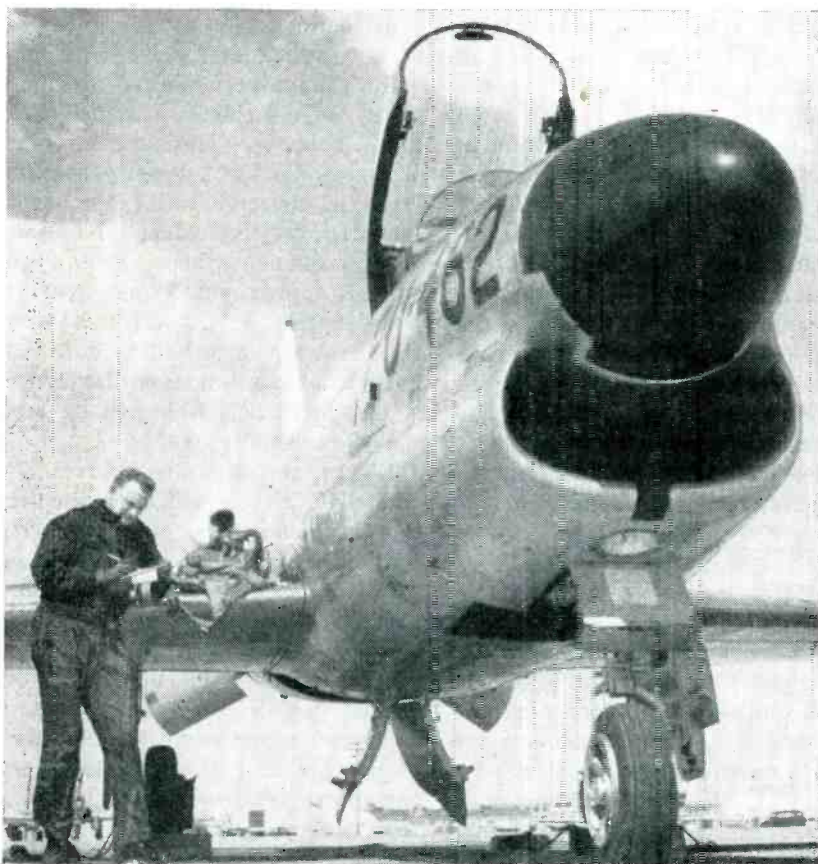

Official Air Force photo showing nose radome of F-86 interceptor. The radome is designed to withstand transonic speeds at high altitudes. Radar here is used for both search and gunfire control on attack missions.

By **SAMUEL S. OLEESKY**

*Vice-President and Chief Scientist
Micronics, Inc.
Gardena, Calif.*

thermosetting organic resins added.

As a design goal, the engineer visualizes a radome which will not deflect, attenuate or distort the radar beam. It will not cause a mismatch in the antenna system. It will not discriminate between polarizations. Local transmission efficiencies must be high, with reflections low. Transmission efficiencies must be, as far as possible, independent of incidence angle.

Radome efficiency is the ratio of output to input. In other words, it is the answer to the question of

how much of the microwave energy that impinges upon the inside surface of the radome wall continues through to its destination and returns to the radar antenna. This answer depends, of course, upon the loss caused by the dielectric material in the radiation field. This divides into three components—reflection, absorption and scattering or diffraction losses. Modern construction techniques minimize all these losses.

Several types of construction have evolved for today's radomes.

Where low frequencies in the microwave region are considered, it is possible to use the thin-wall construction, where the radome wall is thinner than 0.1 wavelength. At normal incidence, a wavelength in the dielectric is approximately equal to the wavelength in free space divided by the square root of the dielectric constant of the wall. Where other than normal incidence angles are considered—by far the majority of cases—a correction factor must be applied.

A second type of construction is the sandwich wall. This consists of two very thin skins of dense material, such as resin-impregnated glass cloth, separated by a spacing medium of low density. The latter may be air, a honeycomb structure of glass cloth or paper, or an expanded material such as foamed resin. The use of simple air space between the skins has been practically abandoned for the construction of radomes.

A third type of construction is the half-wave wall, whose thickness is one-half wavelength in the dielectric at the angle of incidence involved.

Acceptable Losses

With the careful quality control of modern radome fabrication, a surprisingly large percentage of the radomes in use today have transmission efficiencies greater than 90 percent, and many approach 97 or 98-percent efficiency. In cases of high-incidence radomes, occasioned by the streamlining required for sonic speeds, 85 percent becomes an acceptable figure.

Since most of the current radome materials are of extremely low loss, the reflection from the wall is the greatest contributor to decreased efficiency. In general, a 10-percent power reflection is the maximum acceptable. However, geometrical optics determines how much of the reflected energy returns to the antenna and back into the system. It is this reflected energy which causes magnetron pulling and system

failure. Consequently, it is the system engineer who can best specify the acceptability of the reflected energy.

For any given material and any chosen angle of incidence, it is possible to design a radome wall with reflection closely approaching zero. However, since most antennas scan in azimuth while passing through various angles of tilt, an angle of incidence chosen for a particular point on the radome will change constantly as the antenna's position changes. The optimum thicknesses for average incidence angles must therefore be determined.

Design Procedure

As an example, start with an arbitrary paraboloidal antenna in a hemispherical radome, as shown in Fig. 1. Ray 1, starting at the edge of the dish, intersects the wall at point *a* at an angle θ_1 , which is complex because of the double curvature of the hemisphere at that point. Ray 2, starting closer to the center of the dish, has an incidence angle θ_2 at its point of intersection *b*, which is different from the angle at *a*. Ray 3, starting at the dish center, strikes the wall at point *c* with normal incidence, if the dish is centered in the radome.

First of all, the average angle of incidence is not one-third the sum of the three angles, for they are but typical rays. The power illumination contour of the reflector dish must also be considered. This may be represented as a $(\sin x)/x$ function, with the power at the edge 10 or 20 db below the maximum power at the center. Under these

conditions, weightings must be applied to the various rays, depending upon their contribution to the total energy. For that purpose, the radome surface must be divided into small differential areas and the weighted value of the incidence angle at each area determined. Next, an integrated average of all of these weighted angles is obtained. The procedure is repeated for each position of the antenna in scan and elevation, to get the optimum angle of incidence for each point. This is tedious, but it results in the design of a radome with optimum properties.

If making a thin-wall radome, the reflection and expected transmission efficiency at the critical areas must be computed next, to make certain that the radome will meet the specifications if the fabricating tolerances are maintained.

Honeycomb Sandwiches

If designing a sandwich radome for a search-type radar, the odds are that it will be a honeycomb sandwich, since extreme accuracy of the radar system is not a serious problem. Honeycomb radomes are made by a process which uses only one mold, usually conforming to the outside contour. The molding pressure is applied by flexible bags, either evacuated, pressurized or both. Since the honeycomb core is sliced from blocks on a bandsaw, it is most convenient to use a uniform wall thickness, as tapering of the slices is expensive.

A sandwich thickness is chosen that will provide the best possible transmission over the widest range

of incidence angles. There are detailed mathematical procedures for determining the optimum core thickness. In some cases, it is possible to determine approximately, from curves similar to those in Fig. 2, the acceptable range of incidence angles for any given choice of core thickness. Here two sets of data have been plotted as functions of incidence angle and core thickness. The curves represent the amount of power reflection from the dielectric wall. The lower set of curves give values for a first-order radome whose skins are spaced approximately one-quarter wavelength apart. With a core thickness x_1 , there will be zero reflection at an angle of incidence θ_a and that reflection will be less than 5 percent from θ_a to θ_c .

Where aerodynamic loads indicate that the core thickness chosen is insufficient to provide the strength required, it may be necessary to use a second-order thickness, which is approximately three-quarter wavelength. This is represented by the upper set of curves, which gives an optimum thickness x_2 for angle θ_a . Because of greater wall losses the slope of the curves is greater and the effective range of angles has been reduced. This problem becomes more critical at higher radar frequencies due to reduction in the magnitude of the quarter-wavelength dimension.

Gunnery Radar Problems

Where gunnery radar equipment is concerned, the effect of the dielectric wall on the wavefront must be

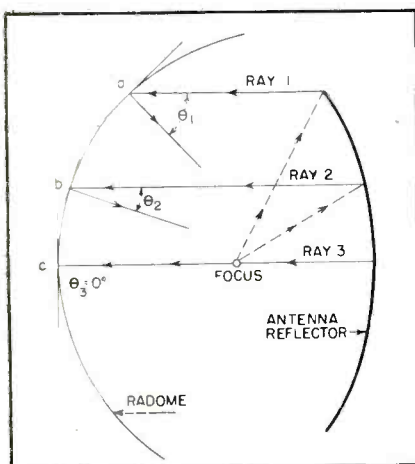

FIG. 1—Finding average angle of incidence in typical radome layout

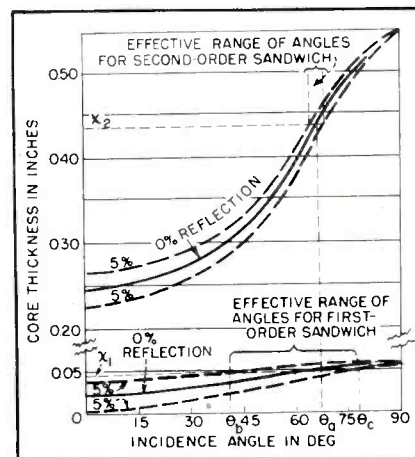

FIG. 2—Optimum-core-thickness chart for two types of sandwiches

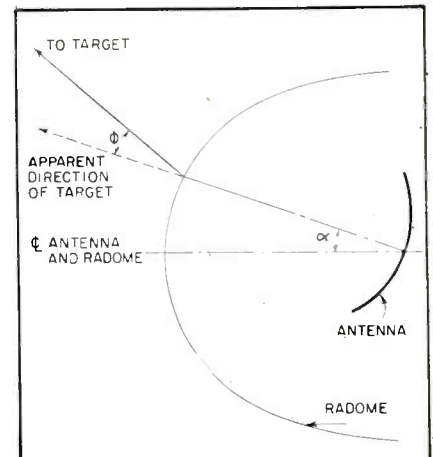
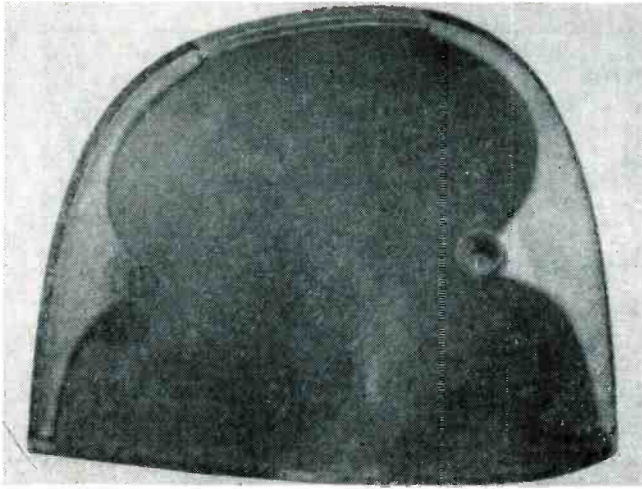
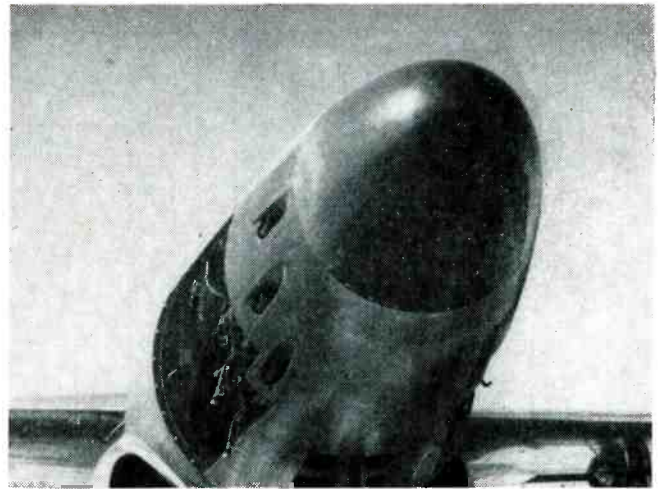

FIG. 3—Boresight error caused by curve radome in gunnery radar



Anti-ice radome for Fairchild C-119 airplane. Hot-air manifolds on each side act with molded anti-icing channels to warm plastic surface and break up ice on solid-wall construction



In addition to withstanding speeds over Mach 1 in all weather conditions, the nose radome of this Northrop Scorpion F-89 must be immune to muzzle blasts of six 20-mm cannon

considered to a much more precise degree. The problem is illustrated by Fig. 3, which represents an antenna in a radome. With the antenna tilted at an angle α , the system shows an echo from some target. It would be logical to assume that the bearing of the target from the airplane is precisely that angle α . However, because of the presence of the radome wall, an additional shift of the radar beam has been introduced. This is shown, in exaggerated form, as the angle ϕ . This error angle is known as the beam-bending angle, the bore-sight shift, the crossover-point shift and various other names. All of them refer to the fact that the radar beam is not going in the direction which the antenna seems to indicate. As a consequence of this deviation, the information fed by the antenna servo system to the gun computers is erroneous and a miss results.

Foamed-in-Place Radomes

One of the solutions to this bore-sight shift has been the manufacture of the foamed-in-place sandwich radome. This is, in general, a more expensive method of fabrication than the honeycomb procedure, but is usually dictated by the necessity for a more homogeneous core material. Most foams in current use are of the alkyd-isocyanate type, in which a thermosetting organic resin of the alkyd family is reacted with foaming agents such as tolylene di-isocyan-

ate to produce a rigid, homogeneous, low-loss foam with discrete cells that are resistant to the passage of moisture. Earlier foams, mostly carbonates, had interconnecting cells which encouraged the flow of water and water vapor, to the detriment of the radome's electrical properties.

For foamed-in-place radome construction, a more costly tooling setup is required. Usually, one set of metal or cast phenolic tools is used to preform the radome skins. After the skins are made and measured to determine their compliance with design thickness specifications, they are placed on a set of matched metal tools, usually on a large hydraulic press or on some type of lifting device that can locate the male plug accurately with respect to the female cavity. The resin foaming batter is poured into the female skin and the plug is lowered into place. Spacer blocks are used to maintain core dimensions when the entire assembly is bolted together. Heavy bolts are required to withstand the tremendous pressures exerted by the foaming mass. After the foam has risen to fill the space between the skins, it is subjected to a cure cycle which develops its full physical properties.

With foamed-in-place construction, it is possible to take full advantage of any thickness variations that may be required by different angles of incidence over the wall area. Thus, a virtual tapered-wall construction can be built into each

radome with no more effort than would be required for uniform wall thickness. Good control of bore-sight shift has been achieved by this method of construction.

Half-Wave Radomes

The half-wave radome wall is rapidly gaining prominence. Here, the use of either vacuum-bag molding techniques or matched tooling may be determined by the economic considerations of prototype fabrication or mass production. Again, tapered-wall advantages may be realized where required. Where weight offers an obstacle to the use of normal materials in the half-wave construction—and weight is usually critical in aircraft design—modifications to the resin or glass filler may be made to raise the dielectric constant of the laminate, thus reducing the necessary thickness to achieve the half-wave criterion.

Design Calculations

Table I gives a method of determining the reflection coefficient from an air-dielectric interface.

The impedance concept is used to compute the optimum spacing of the skins of a sandwich. If a plane-polarized wave is transmitted by the radar system, it must be ascertained whether that polarization is parallel or perpendicular. The microwave ray *AO* and the perpendicular *OB* to the dielectric sheet in Fig. 4 determine what is known as the plane of incidence. When the

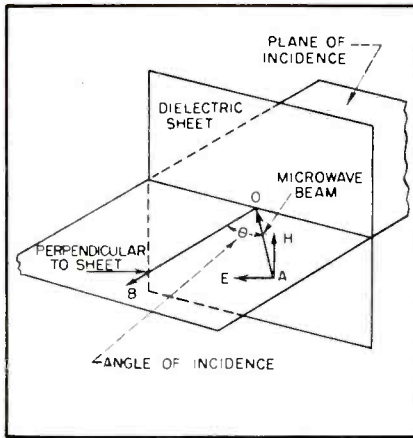

FIG. 4—Identification of polarization of transmitted radar wave

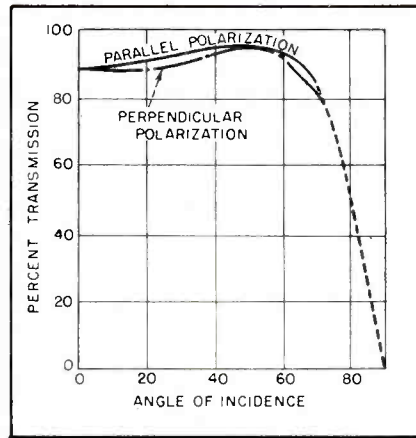

FIG. 5—Transmission efficiency curves for dielectric radome panel

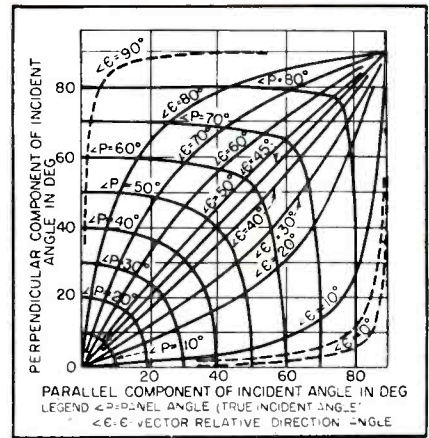

FIG. 6—Relative polarization and incidence-angle components chart

electric or *E*-vector lies in or parallel to that plane, the polarization is defined as parallel. When the *E*-vector is perpendicular to the plane of incidence, the polarization is perpendicular. These are respectively called horizontal and vertical polarization.

Except at normal incidence, the transmission of a given panel will differ at parallel polarization from its transmission at perpendicular polarization. Figure 5 shows a pair of typical curves for such transmission efficiencies.

In working with compound curvature, which exists in almost all radomes, the designer must realize that neither true parallel nor true perpendicular polarization exists. Actually, there is within the radome a complex resultant polarization at the point of ray incidence. Figure 6 gives a method for ascertaining the true polarization angle when both components of the incidence angle are determined from plan and elevation views of the ray study.

Where a circularly polarized wave is radiated, the effect of phase-shift on the circularity of the polarization must be determined. A relatively simple method² of obtaining a first approximation for the phase shift is given in Table II. Only the dielectric constant of the panel is considered, the loss tangent being neglected. While such an approach is useful for the purpose, no material is lossless in fact. A loss tangent of 0.02 can result in an absorption loss as high as 30 percent. Consequently, any

design work based on the lossless approach should be verified by the measurement of experimental panels prior to construction of the radome.

A knowledge of the insertion phase retardation will enable the radome designer to predict probable boresight error and compensate properly in the construction techniques.

Weather Problems

In the course of normal flight, an airplane occasionally encounters a hailstorm. The resistance of the common plastic radome to the impact of hailstones while traveling at 300 or more miles an hour is not so good. However, by the proper choice of rigid and flexible resins in a blend, together with special weaves of glass fabric, it was possible to develop a nose radome for the DC-4 and DC-6 which withstood the impact of two-inch ice pellets moving at 360 mph. Hundreds of these radomes were built without a single reported failure in flight.

A radome covered with ice is useless. One solution, developed by the Douglas Aircraft Co., is a fluted-core construction that supplants honeycomb where icing problems are expected. Here, the core is built with parallel channels designed in a maze that permits the passage of hot air between the skins. Thus the outer surface is kept at a temperature sufficiently high to prevent ice accretion.³

The temperatures encountered in supersonic flight impose a severe

test upon common plastics used for radomes. Organic resins in current use can seldom withstand, for any protracted period, temperatures as high as 300 F. Missile noses may reach 1,000 F or more. Several approaches to this problem have been pursued. One involves the use of glasses and ceramics with special electrical properties. Another suggests the use of the fluorinated ethylenes, such as DuPont's Teflon (polytetrafluoroethylene) and Kellogg's Kel-F (polymonochlorotrifluoroethylene). Both of these materials offer properties not available in alkyd or polyester resins.

Table I—Calculation of Reflection at Radome Interface

THE REFLECTION occurring when electromagnetic radiation passes from one medium to another may be readily calculated from the following four equations if the dielectric constants of the two media are known (β = relative dielectric constant), together with the loss tangent ($\tan \delta$) of each medium and the angle of incidence θ of the energy beam.

$$Q = \sqrt{\beta - \sin^2 \theta} \quad (1)$$

$$L = \frac{\beta \tan \delta}{2Q^2} \quad (2)$$

$$\bar{Z} = \frac{(1 - jL) \cos \theta}{Q} \quad (3)$$

$$r = \frac{1 - \bar{Z}}{1 + \bar{Z}} \quad (4)$$

Here \bar{Z} is the apparent impedance and r is the reflection at the interface, both in vector form. The values of Q and L are constants for the particular values of the parameters, and are used later in computing the phase shift.

Another problem besides that of physical properties must also be considered. The dielectric constant and loss tangent of most conventional radome materials are both functions of temperature. Consequently, a design that may give optimum performance at room temperature may be completely inadequate at the elevated temperatures of high-speed flight.^{4,5}

The problem of rain erosion is another serious one. At subsonic and supersonic speeds, plastic—and metal—structures are rapidly washed away by even light rainfall. A new radome or wing leading edge may be completely eroded in just a few minutes. To counteract this, both Goodyear Tire and Rubber Co. and Gates Engineering Co. have developed synthetic coatings that may be applied in very thin layers over the outside surfaces. These coatings give a tremendous extension in life expectancy to the plastic parts.

At the speeds of current aircraft through humid and dry atmosphere, exceedingly high electrostatic charges are built up on the surfaces of the radomes. From time to time, the potentials become high enough to cause discharge, either by arc or leakoff. In either case, the

concomitant electromagnetic radiation is sufficient to paralyze the radio-communications systems of the airplane, as well as the direction finders and other vital equipment. The conductive coating used for this purpose must be a compromise of several factors. If the resistivity is too low, the charge leakoff will be rapid but the radar transmission will be seriously degraded, if not completely nullified. If the resistivity is too high, no static-suppressing effect will be obtained. In addition, this coating must be compatible with the rain-erosion-resistant coating previously applied.

Coatings must be considered in computing the thickness of the outer skin when designing a radome sandwich.

Shock Problems

A radome is sometimes mounted in such a position on the airplane that the gun muzzles are only an inch or two from the surface of the radome. The shock wave, combined with the corrosive gases of explosion, rapidly cause delamination with subsequent failure of the radome.

To help in eliminating that source of difficulty, Zenith Plastics

Co., Gardena, California, has developed Zenofam G, a modified isocyanate foam that has been built into hundreds of sandwich radomes without a single reported failure caused by gunblast. Other constructions, involving nylon cloth sandwiches, have been tried with a moderate degree of success.

The wave slap on the nose of a large flying boat is another problem for the radome designer when his radome is the nose. Special types of construction have been devised for that problem too, as well as for the many others that arise during the design of modern airborne radar systems.

REFERENCES

- (1) S. Wolin, Electrical Design of Lossy High-Incidence Radomes, U. S. Naval Air Development Center report ADC EL-123-50.
- (2) M. C. Horton, W. E. L. Boyce and E. O. Hartig, Optical Theory for Microwave Transmission through Dielectric Wall Structures, paper presented at URSI meeting on Microwave Optics, McGill Univ., June 1953.
- (3) S. S. Oleesky, A Study of the Problem of Anti-Icing for Radomes and its Possible Solutions, U. S. Naval Air Development Center report No. ADC EL-86-50.
- (4) S. S. Oleesky, The Effect of Elevated Temperature on Transmission of Microwave Energy Through Dielectric Sheets, U. S. Naval Air Development Center report No. ADS-EL-148-49.
- (5) S. S. Oleesky, Development of a High-Temperature Missile Radome, U. S. Naval Air Development Center report No. ADC EL-10-51.

Table II—Calculation of Phase Shift Produced by Radome

FOR APPROXIMATION of phase shift, the insertion phase function Φ represents the retardation in phase resulting from insertion of the dielectric sheet in the field. The transmission coefficient function T represents the amplitude of the transmitted wave with respect to the incident wave. For any arbitrary incidence angle θ , the functions Φ and T may be determined from

$$|T|^2 = \frac{(1 - r_{12}^2)^2}{(1 - r_{12}^2)^2 + 4r_{12}^2 \sin^2 \phi} \quad (5)$$

$$\Phi = \tan^{-1} \left[\frac{(1 + r_{12}^2) \tan \phi}{(1 - r_{12}^2)} \right] - \frac{2\pi d}{\lambda} \cos \theta \quad (6)$$

where $\phi = (2\pi d/\lambda) \sqrt{\epsilon' - \sin^2 \theta}$, $\epsilon' = \epsilon_1/\epsilon_0$, ϵ_1 = dielectric constant of sheet, ϵ_0 = dielectric constant of surrounding medium, d = sheet thickness and λ = wavelength. The reflection coefficients r_{12} and r_{21} may be determined from the boundary conditions imposed upon the field vectors of the plane wave at the dielectric interface, r_{12} being equal to $-r_{21}$.

For perpendicular polarization

$$r_{12} = \frac{\cos \theta - \sqrt{\epsilon' - \sin^2 \theta}}{\cos \theta + \sqrt{\epsilon' - \sin^2 \theta}} \quad (8)$$

$$\Phi = \tan^{-1} \left(\frac{\epsilon' - 1}{\cos \theta \sqrt{\epsilon' - 1 + \cos^2 \theta}} \right) - \frac{2\pi d}{\lambda} \cos \theta \quad (9)$$

For parallel polarization

$$r_{12} = \frac{\epsilon' \cos \theta - \sqrt{\epsilon' - \sin^2 \theta}}{\epsilon' \cos \theta + \sqrt{\epsilon' - \sin^2 \theta}} \quad (10)$$

$$\Phi = \tan^{-1} \left[\frac{\epsilon' + (\epsilon')^2 \cos^2 \theta}{2\epsilon' \cos \theta \sqrt{\epsilon' - 1 + \cos^2 \theta}} \right] - \frac{2\pi d}{\lambda} \cos \theta \quad (11)$$

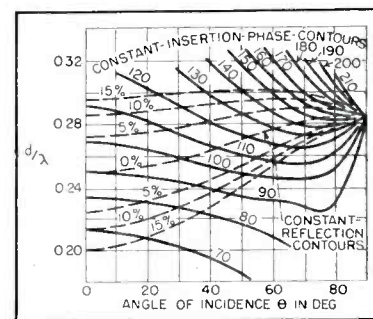

From these values the accompanying sets of curves were prepared, to give graphically the information required for design purposes. These are for a single dielectric sheet, with $\epsilon' = 4.0$ and perpendicular polarization. Ideally, the insertion phase should be independent of incidence angle and polarization.

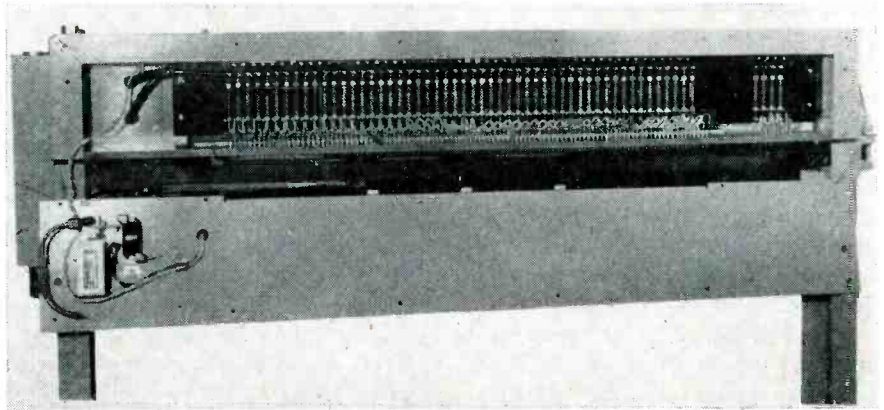
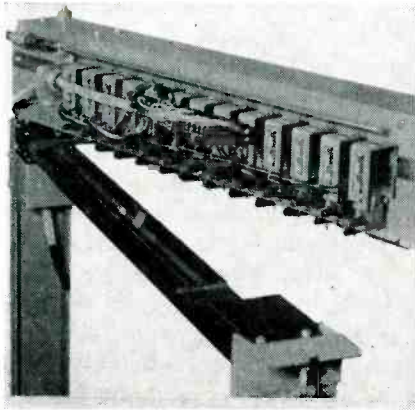

Views of detecting head, showing marking-circuit solenoids, high-voltage electrodes and voltage-dropping resistors

Automatic void detector for inspecting mica insulating tape doubles production and cuts reject rate. Spark discharges through voids are counted and measured, giving ratio of void to total tape area. Largest voids are dye-marked for subsequent hand-patching

Detecting Voids

By **ROY E. ANDERSON**

*General Electric Co.
Schenectady, New York*

DESIGNED TO GIVE a continuous indication of the ratio of void area to total area, the void detector shown in Fig. 1 can also dye-mark all voids that exceed a selected size. These functions are performed before the top layer of paper is applied so that corrective measures may be taken.

The dye-marking function did not prove valuable when inspecting

machine-laid mica tape since skilled operators who could see the voids directly found the marks distracting. However, the marker function would be very helpful when inspecting a material that does not require continuous correction.

Voids are detected by measuring the current in arcs formed when voids are present between high-voltage electrodes. The detection elements are pointed electrodes spaced 0.15-inch above the tape and plane electrodes in contact with the underside. The points are spaced

4-inch apart across the 27-inch width of tape. A d-c potential of 7,500 volts is applied to the points so that a current flows when a void passes between a point and plane, while no current flows when good mica is between them. A 200-megohm resistor in series with each point allows it to function independently of all the others. When one point breaks down, the voltage drop due to its current flow is across its own series resistor and the high voltage is still applied to the other detector electrodes.

ELECTRONIC INSPECTION CUTS REJECTS, BOOSTS PRODUCTION

Use of automatic inspection equipment can sometimes turn a losing manufacturing process into a profitable one. The equipment to be described detects voids in sheet insulating materials. Its first application has been in inspecting machine-laid mica tape.

- ▶ Use of this equipment enabled the manufacturer to increase his mica insulating tape production to 260 percent of former level.
- ▶ During the first year after installing the machine, there were no customer rejects. Previously, the average monthly customer rejection rate was 5 percent.
- ▶ Only the solution of a materials-handling problem remains before this machine that locates and evaluates flaws can be teamed with a device to patch the voids and thus provide almost fully automatic manufacture of tape.
- ▶ The void detector illustrates a general approach to flaw detection that is important to the development of automation

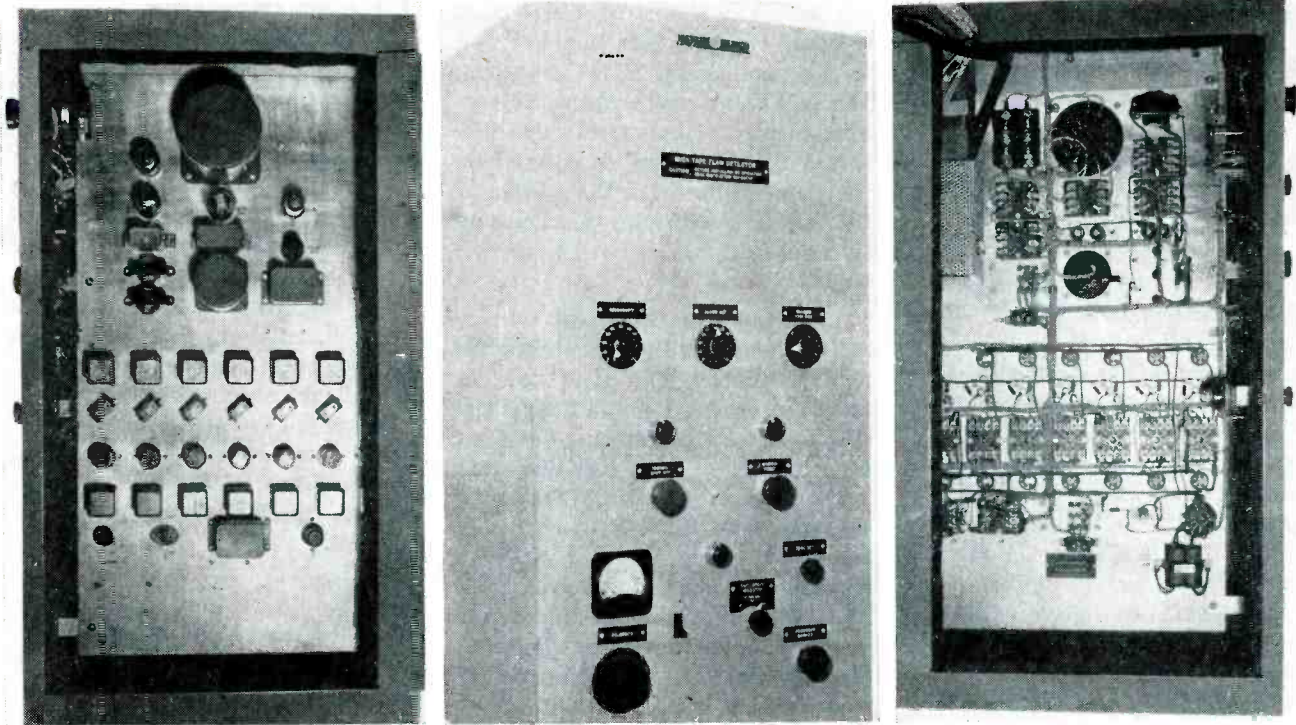

Flaw-detector control console. Vertical rack mounting is used. Left-hand door gives access to tubes; right-hand door, to circuit wiring

In Insulating Tape

If the tape were uncharged as it moved between the detecting electrodes, it would absorb a charge. The current required to supply the charge would be of the same order of magnitude as the current due to voids. To keep charging current out of the void-detecting circuits, the tape is precharged by a set of electrodes similar to the detecting electrodes, but located so that the tape must pass between the charging set just before it passes between the detecting electrodes.

Marking Circuits

To mark the larger voids within an inch of their position, the bottom plane electrode in the detecting circuit is divided into two-inch lengths across the tape. Each of these thirteen plane electrodes is connected to a marking circuit like that shown in Fig. 2A. Each marking circuit operates a marking mechanism whenever a void exceeding a pre-selected minimum size passes between the electrodes. The marking circuits operate independently of

the speed of the tape machine over the range of ten to thirty feet per minute.

When good tape passes between the detecting electrodes, no current flows in R_1 (Fig. 2A). The voltage on the grid of the type-5691 tube V_1 is then the sum of a negative voltage established by the position of R_2 and a smaller positive voltage established by R_3 . The sum of these voltages is a function of the minimum void size that is to be marked and of the speed of the tape machine. Bias values for minimum void sizes of $\frac{1}{2}$ in. \times $\frac{1}{2}$ in. and $\frac{3}{4}$ in. \times $\frac{1}{2}$ in. are shown in Fig. 2B. The dashed lines are the negative voltages established by R_2 . The solid lines are the total bias voltages.

When a void comes between the upper and lower detecting electrodes, a current roughly proportional to the width of the void flows in the grid circuit of V_1 . If the void is of such a width that one point conducts, the current is ten microamperes. If two points

conduct, the current is twenty microamperes. It is proportionately greater for wider voids.

The effect of the void current on the grid voltage of V_1 is shown in Fig. 2C. Two bias levels are shown, one for a $\frac{1}{2}$ in. \times $\frac{1}{2}$ in. void size at a tape speed of 14 ft per minute and the other for $\frac{1}{2}$ in. \times $\frac{1}{2}$ in. void size at 28 ft per minute. Bias voltages are automatically adjusted for tape speed so that no manual control is operated when going from one tape speed to another.

When a $\frac{1}{2}$ in. \times $\frac{1}{2}$ in. void comes between the detecting electrodes, a twenty-microampere current flows in the grid circuit of V_1 . Capacitor C_1 starts to charge toward forty volts. By the end of time A, the grid of V_1 will have reached conduction. Tube V_1 is so operated that there is just two volts difference in grid voltage from cutoff to full conduction. Therefore V_1 closes the relay in its plate circuit at the end of time A, which is the time required for a $\frac{1}{2}$ in. \times $\frac{1}{2}$ in. void to

pass through the detector electrodes at 28 ft per minute. If the tape is moving at 14 ft per minute, C_1 again charges toward forty volts, but since it starts at a lower voltage, time B is required for the grid voltage to reach conduction. Time B is the time required for a $\frac{1}{2}$ in. \times $\frac{1}{2}$ in. void to pass through the electrodes at 14 ft per minute.

The lowest curve in Fig. 2C shows what happens if a smaller void passes through the electrodes when the minimum-void-size control is set to permit only voids $\frac{1}{2}$ in. \times $\frac{1}{2}$ in. and larger to be marked. A $\frac{1}{4}$ in. \times $\frac{1}{4}$ in. void will cause C_1 to charge toward twenty volts. At 14 ft per minute, the time required for the small void to pass through is time A . The grid voltage is still far below conduction when the void leaves the electrodes.

The relays in the plate circuits

of the marking-circuit tubes open solenoid valves that can be seen in the photograph of the detecting head. When a valve opens, it permits a drop of fluorescein dye dissolved in alcohol to be ejected on the tape in line with the middle of the bottom electrode section and therefore within one inch of the void.

Quality Indicator

The quality-indicator circuit has been made possible both a large increase in production and the virtual elimination of customer rejections. It produces a meter reading that is proportional to ratio of void area to tape area. It also provides a signal to a recorder that makes a permanent record of the tape quality. The quality-indicating meter is mounted so that it is visible to the tape-machine operators at all times. Since it gives an indication

of the quality of the tape being made at each moment, it is possible for the tape-machine operators always to operate the machine at maximum speed for the prevailing conditions. The permanent record is examined by the chief inspector. He uses it to determine whether or not there are any rolls of tape that should be down-graded or rejected.

The quality-indicator circuit is diagrammed in Fig. 3. The blocks indicate the relationship of the quality-indicator circuit to the other circuits. The d-c current path is indicated by arrows. The total void current from all thirteen marking circuits flows through an averaging circuit consisting of a potentiometer R_1 and the 10- μ f capacitor. A portion of the voltage developed across the potentiometer is applied to the grid of the type-5692 tube V_1 . This tube is connected in one arm of a bridge circuit. Current flowing in potentiometer R_1 unbalances the bridge and causes a current to flow through the tape-quality indicator, and also through a recorder.

Potentiometer R_1 in the grid circuit of V_1 serves as a sensitivity control. The tape quality required for full-scale deflection of the quality-control indicator and recorder may be varied over a wide range. This is an advantage because it is possible to have the same reading be the reject level for all grades.

The bias is established on the grid of V_1 by a voltage divider consisting of R_2 , R_3 and R_4 . Potentiometer R_4 is the zero-set control used to adjust the bias on V_1 so that the readings of the quality-indicator and recorder are zero when perfect tape is between the detecting electrodes.

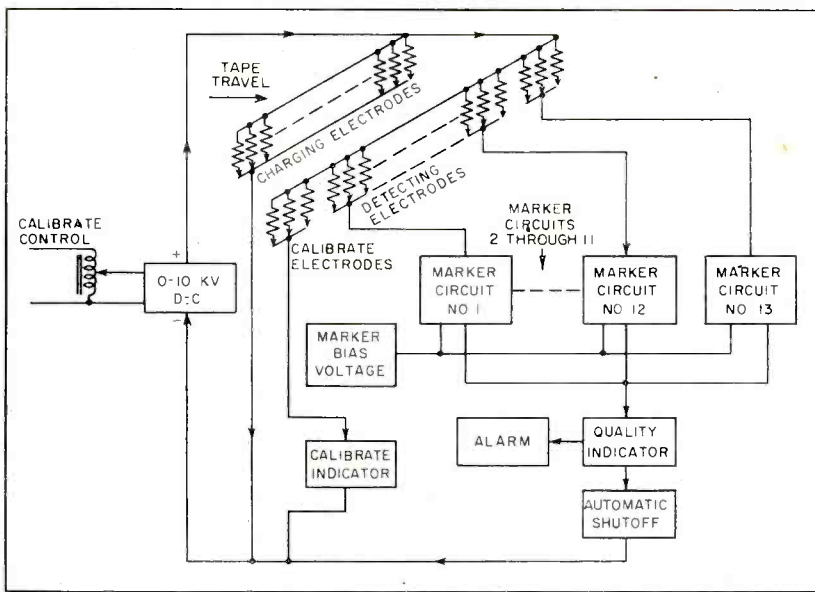

Fig. 1—Block diagram of automatic void detector gives electrical relationship of circuits between detecting, indicating and calibrating

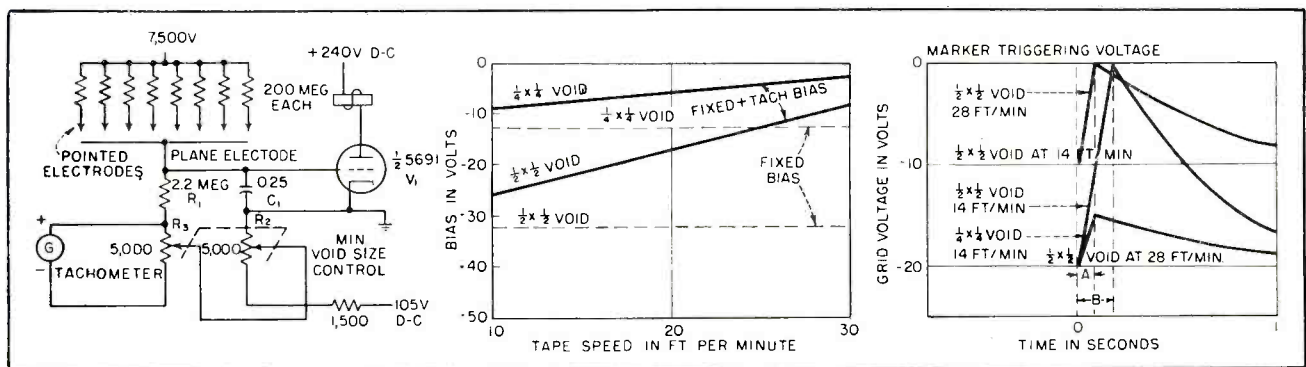
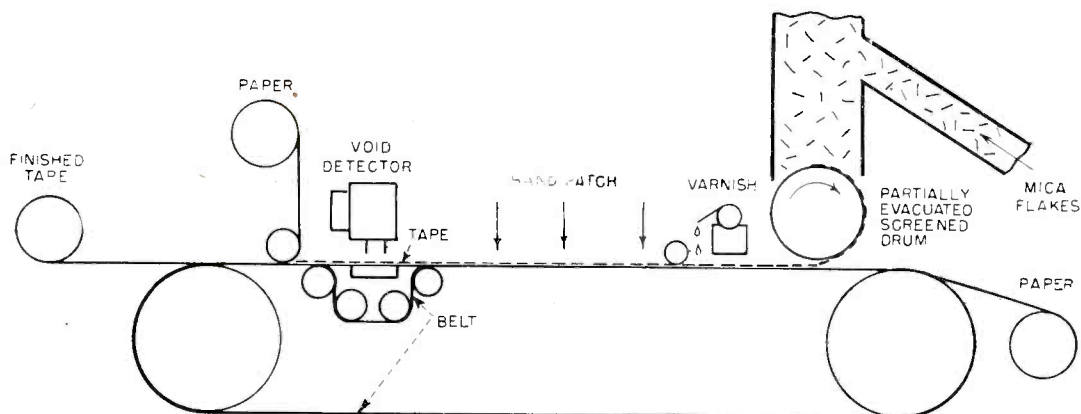

FIG. 2—Basic marker circuit (A), grid-bias voltages (B) and grid waveform (C) that results when a void is detected



HOW MICA TAPE IS MANUFACTURED

Mica tape consists of a layer of mica splittings sandwiched between two layers of paper or cloth bonded together with varnish or a similar insulating binder. Mica tape is manufactured in several grades:

- (1) **High-Quality Tapes**—Large mica flakes are laid by hand with such care that there are practically no voids.
- (2) **Machine-Laid Tapes**—These tapes are not intended to be entirely free from voids. The tape is wound several layers thick on electric motor or generator conductors so that the probability of voids overlapping to form a weak point is exceedingly small.

Machine-laid tape is made in the manner illustrated in the drawing. Mica splittings about the size of a half dollar fall like snowflakes onto a partially evacuated screened drum. The drum deposits the flakes on a moving web of varnish-soaked paper.

Numerous voids are left and a crew of six to eight operators hand-patch most of the voids as the tape moves past them on a belt. Not all voids are patched, however, and it would not be economically practical to do so. The highest grade machine-laid tape has an average of 50 voids in an area 27-in. wide and 10-ft long. The poorest grade of tape has about 250 voids in the same area. Most voids are very small but some are larger than a dime.

After hand-patching, a top layer of varnish-soaked paper is placed over the flakes and the tape wound onto a revolving steel cylinder

The information on the recorder chart must be identified with the portion of the tape to which it corresponds. This is accomplished by operating one of the recorder-marker pushbuttons that cause R_s to be shorted and the bridge to be unbalanced. This in turn causes a large deflection of the recorder pen.

The remote recorder-marker control is mounted on the tape machine near the windup roll. When the tape-machine operator cuts the tape on the fly at the end of a roll, he presses the recorder-marker pushbutton. He then writes on the recorder chart the number of the roll being made on the machine. The recorder chart thus indicates the beginning and the end of each roll by a large deflection.

Auxiliary Circuits

An alarm circuit is provided that can be adjusted to sound an alarm for any desired reading of the tape-quality indicator. It is used to alert the operators if the quality of the tape falls below specifications. The signal for operating the alarm circuit is derived from the plate of

the tube in the quality-indicating circuit. The alarm circuit employs a thyatron that conducts and sounds an electric horn whenever the quality indicator shows an excessive ratio of void area to total area.

An automatic-shutoff circuit de-energizes the detecting electrodes when an excessively large current passes between them such as would be the case if the tape were run out of the machine. The circuit is included to prevent the markers from pouring fluid onto the belt.

The automatic-shutoff circuit employs a thyatron that is cut off when the total electrode current exceeds 500 microamperes. When the tube is cut off, it permits relay contacts to open and turn off the high-voltage power source.

Stability

Current in spark discharges is inherently unstable. It varies with humidity and perhaps with other ambient conditions. To insure that the indications are truly a measure of tape quality, a calibrating means



Operators hand-patching mica insulating tape. Void-detector console and strip-chart recorder are at left, with detecting head and quality indicator at right

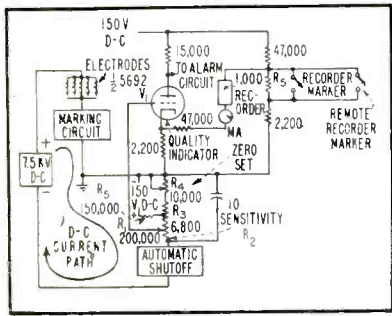

FIG. 3—Quality-indicator circuit

is provided. This is done by a set of eight pointed electrodes above a separate bottom plane electrode like the ones in the detecting circuit. The calibrate electrodes are beyond the edge of the tape. The bottom electrode in the calibrate circuit is not connected with the marking or quality-indicating circuits but is returned directly to the negative terminal of the supply through a microammeter. This is the calibrate meter shown in Fig. 1. The high voltage is adjusted by the variable autotransformer identified as the calibrate control (Fig. 1) until the reading on the calibrate

meter is 80 microamperes.

To minimize the effects of high humidity, a heater is provided inside the upper electrode housing. A stream of air at approximately 10 cubic feet per minute is directed past the heater and exhausted through holes between the charging and detecting electrodes. The heater, which is turned on only in very humid weather, lowers the relative humidity in the vicinity of the electrodes.

The air stream, which always flows when the void detector is in operation, keeps the upper electrodes clean and also prevents accumulation of inflammable vapors of toluol, the varnish solvent.

The air is not necessary as a safety measure, however. Repeated tests in the laboratory indicate that it is not possible to ignite any concentration of toluol vapor or the fluid itself with sparks having a current magnitude of 100 microamperes. To provide an ample safety factor, the current in the individual arcs is limited to 200 microamperes by the 200-megohm

resistors in series with the resistance of the air gap. The auxiliary circuits may be seen in Fig. 4.

Physical Description

The construction of the detector electrode housing is shown in the photograph. When the head is locked in place over the lower electrode plate on the mica-tape machine, it occupies only seven inches along the belt. It is made so that the upper part can be pivoted away from the tape machine to facilitate threading tape through the detector.

The control cabinet is also pictured in photographs. All the operating controls except the heater switch and a remote recorder-marker push-button are located on the front panel. The electronic circuits are mounted on a vertical panel that is in a plane perpendicular to the front control panel. This type of construction provides easy access when the cabinet is mounted in the assigned factory space.

Performance

Before the void detector could be accepted as the standard by which tape quality could be judged, a long trial period was necessary to prove that the instrument was stable over long periods of time and changing conditions and that the readings were truly a measure of tape quality.

To prove this, a special piece of hand-laid tape was punched with definite ratios of void area to total tape area and run through the void detector at different speeds and on different days. The recorder charts of these runs show readings proportional to void area. Charts made on different days agree even to the smallest details. There is no evidence of any change in reading with change in speed of the tape machine.

Another test is made at frequent intervals to test the condition of the points and their spacing. After the instrument is calibrated, different groups of four electrodes are permitted to conduct. The quality indications for each group of four are compared with those for the other groups and with the indications obtained when the same test was made previously.

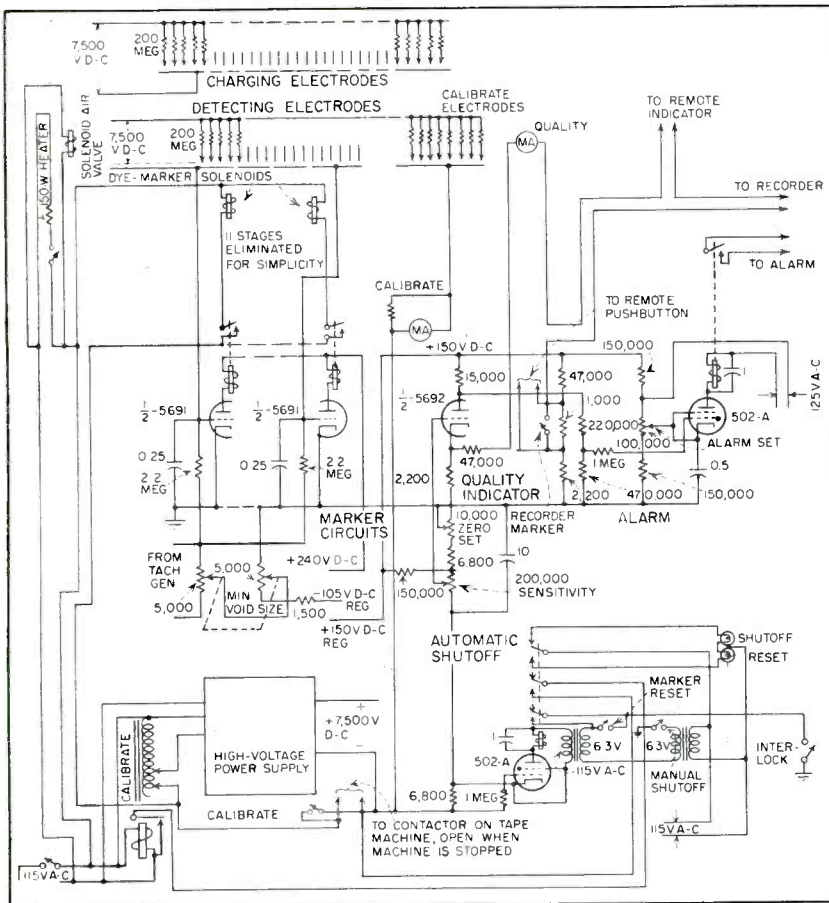

FIG. 4—Complete schematic shows automatic-shutoff and calibrating circuits

By L. E. FLORY,

W. S. PIKE

and G. W. GRAY

RCA Laboratories Division
Princeton, New Jersey

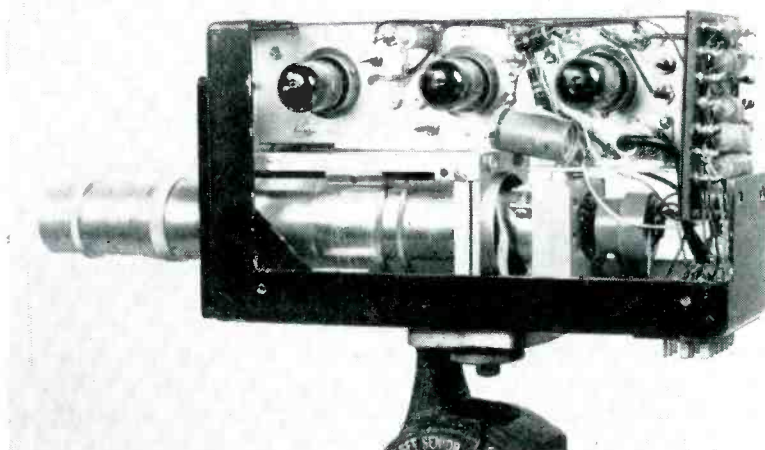

Vidicon pickup tube constitutes heart of compact television camera unit

Camera Adapter for TV Receivers

Compact industrial-type television camera for home and business transmits video signals over cable to standard home receiver. Video rides on vhf carrier corresponding to an unused television channel. Receiver supplies both d-c and scanning voltages

CLOSED-CIRCUIT television finds increasing use in industry, medicine, business and education.^{1,2} Although compact industrial-tv equipment has been developed,³ costs have often limited its range of application, particularly for classroom teaching,^{4,5} home use and everyday business activity.

The camera adapter to be described operates in conjunction with a standard home tv receiver. It consists of a compact Vidicon camera unit and control box. Video signals are transmitted to the receiver on a vhf carrier by cable. Scanning and d-c voltages for the camera are derived from receiver circuits. Adaptation to the receiver may

generally be made by plug-in adapters for tube sockets and the deflection coils plug on the receiver chassis.

Amplifier

Figure 1 is a schematic diagram of the camera-adapter setup. The 6U8 triode-pentodes conserve space and offer the most video gain available in a single envelope. The circuit consists of a four-stage video amplifier driving a modulator electron coupled to a vhf oscillator. Tubes $V_{1,4}$ and $V_{7,8}$ are conventional single-peaked video amplifiers; $V_{2,3}$ is a frequency-compensating stage to compensate for the loss of high frequencies at the input to the

amplifier. The inductance of L is adjusted so its natural resonance in the circuit is above the normal pass band of the amplifier. The gain of this stage can be made to increase with frequency from essentially zero at low frequencies to a gain limited by the impedance of the coil and associated circuit at the top of the pass band. The low-frequency gain is adjusted by variable resistor R in series with the inductance. By adjusting this resistor the shape of the gain characteristic of this stage can be made to match closely the attenuation characteristic of the input circuit.

Tube $V_{2,7}$ is a conventional double-peaked stage; $V_{3,8}$ is connected with

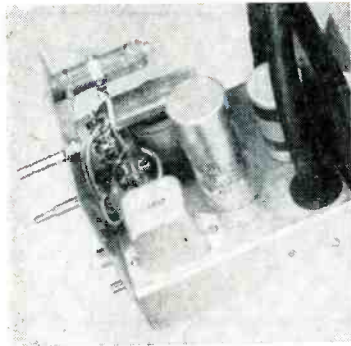

Control box contains no tubes; has necessary controls for adjustment of receiver-derived voltages for optimum camera operation

0 to -100 control grid. Most modern receivers do not have a negative supply so it is necessary to elevate the camera-tube cathode above ground to obtain control-grid bias.

Voltage Supply

Such receivers do, however, have a stiff low-voltage supply running between +120 and 160 volts. This is conveniently bled to 100 volts since the total cathode plus bleeder current need not run more than 2 or 3 ma. Likewise, practically all receivers have a boosted-B voltage of 400 to 500 volts that can supply voltage above cathode for acceleration and focus.

Normal B-supply voltage in receivers is usually between 220 and

280 volts. This can be dropped by an R-C decoupling filter to 150 volts for the camera amplifier. The axial 40-gauss magnetic field necessary for focusing the camera tube is provided by a permanent magnet made up of four Alnico rods set at the corners of square iron pole plates. The entire cage surrounding the camera tube can be seen in the photograph.

Blanking

It is necessary to blank the camera-tube beam during vertical and horizontal fly-back to prevent the generation of spurious signals. Horizontal blanking is accomplished by applying the 10-volt positive pulse across the camera horizontal coils to the cathode of the camera tube.

To obtain a vertical pulse adequate for blanking, a pulse transformer, which may be of the blocking-oscillator type, is connected across the receiver vertical coils. The transformer may be connected to give a negative pulse on the secondary for the particular pulse direction on the receiver coil. This is important since vertical pulse amplitude and polarity have been found to vary with different makes of receivers. The base line may be straightened and the pulse lengthened by a biased crystal rectifier and an R-C circuit. The

negative pulse is then applied to the camera control grid.

Control Unit

The camera contains the pickup tube and the amplifier-modulated oscillator unit. At the receiver end of the connecting cable is a control box containing the necessary controls to operate the camera, the horizontal transformer, vertical blanking circuits and miscellaneous dropping resistors, plus a heater transformer for the camera. There are no tubes in the control box.

Adaptation

To make the adaptation of the camera to a receiver as simple as possible, all connections to the receiver are made whenever possible by adapters placed under tubes and in the deflection plug.

In practically all receivers in which the deflecting coils are connected to the chassis by a plug, the adaptation can be made with no alteration of the receiver since all the other voltages appear at some of the tube pins.

In receivers without a deflection plug the necessary wires to the deflection coils can be cut and a connector inserted without removal of the chassis. Necessary voltage adjustments are made in the control box. Actual adaptation of several current receivers has been made and a study has been made of many others. No difficulty is anticipated in adapting the camera to any of them.

The authors acknowledge the continued interest and inspiration of V. K. Zworykin under whose direction the work was done. They are also indebted to J. M. Morgan of RCA Laboratories for his help in design of deflection components and to Frank Janda of the RCA Victor Division for his work in building early models of this equipment.

REFERENCES

- (1) R. C. Webb and J. M. Morgan, Simplified Television for Industry, *ELECTRONICS*, June 1950.
- (2) V. K. Zworykin and L. E. Flory, Television in Medicine and Biology, *Electrical Engineering*, Jan. 1952.
- (3) P. K. Weimer, S. V. Fergue and R. R. Goodrich, The Vidicon, A Photoconductive Camera Tube, *ELECTRONICS*, May 1950.
- (4) L. E. Flory, The Television Microscope, Cold Spring Harbor Symposium on Quantitative Biology, Vol. XVI, 1951.
- (5) V. K. Zworykin, L. E. Flory and R. E. Shroder, Ultraviolet Television Microscopy, *ELECTRONICS*, Sept. 1952.

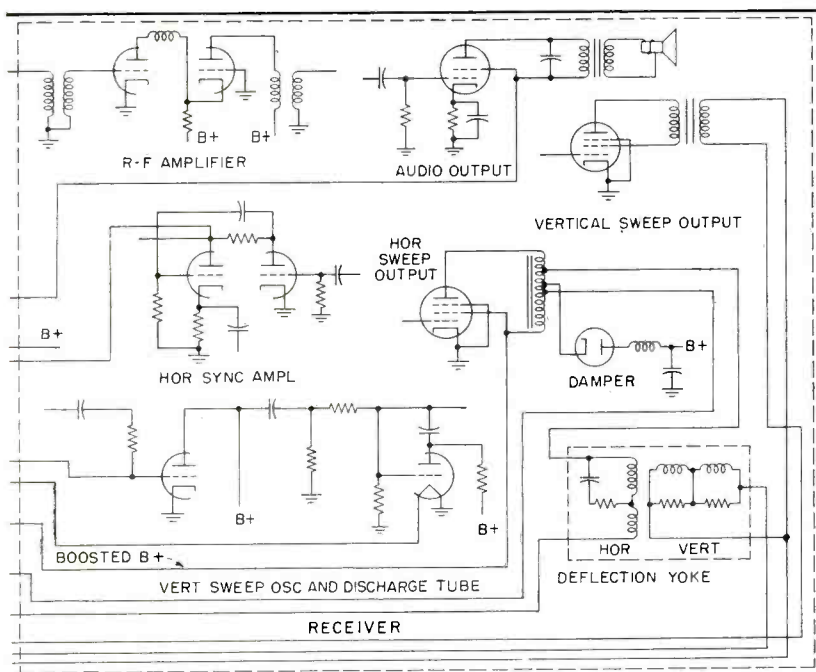

box and home television receiver

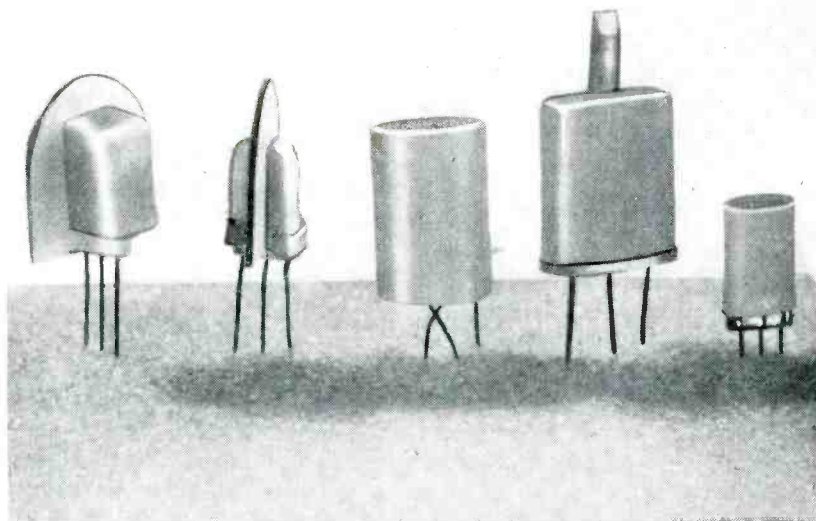

Typical power junction transistors. Second from right and center transistors are discussed in text and shown in detail in Fig. 1. Unit on far right is small transistor encased in plastic; two on left have radiating fins connected to base and emitter

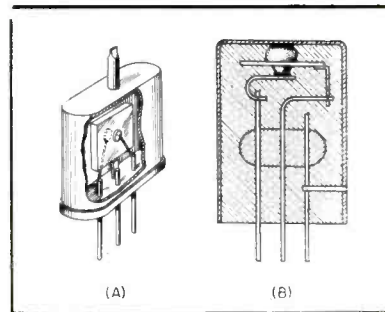

FIG. 1—Assembly details of liquid-cooled (A) and metallic-conduction cooled (B) power transistors

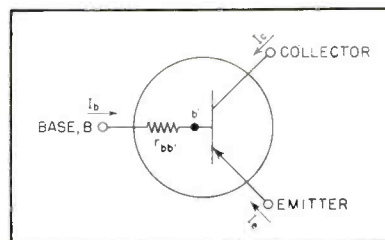

FIG. 2—Diagram shows intrinsic transistor together with extrinsic base-lead resistance found in practical units

Power Transistors for

DEPENDENCE of transistor characteristics on temperature presents a difficult problem to equipment designers, especially those involved in power circuit work where unavoidable internal power losses may be appreciable.

This article presents a method for analysis of transistor power amplifiers. For purposes of illustration, calculations have been carried out using a typical experimental power transistor. The method of calculation is developed generally so that circuit design using other junction transistor types can be readily carried out.

General Types

The photograph shows several experimental power transistors. The liquid-filled enclosure, shown in detail in Fig. 1A, is a reasonably simple and effective method of construction. The transistor is fabricated by standard techniques and then encased in a liquid-filled metal shell. Heat generated by the transistor is transferred to the metal

By **L. J. GIACOLETTO**

*Radio Corporation of America
RCA Laboratories Division
Princeton, New Jersey*

shell by the liquid coolant. Benzene, toluene, and xylene are suitable liquids. Toluene has proved the most successful due to its low viscosity and relatively high boiling point. In addition to the simple method of construction, the liquid-enclosed power transistors have been particularly attractive because the germanium junctions suffer very little deterioration.

The use of a liquid, particularly an inflammable liquid, is not a very satisfactory solution for most applications. Consequently, the method of construction shown in Fig. 1B was developed. Here, a large metal surface is soldered directly to the germanium assembly. Heat is transferred to the large metal surface by metallic conduction with very little drop in temperature. The metal surface may be soldered to any of the three trans-

istor elements and then encased in plastic for mechanical and environmental protection. The sketch shows a metal cup soldered to the collector.

Maximum Dissipation

Heat transfer² can take place by radiation, conduction and convection. All three of these processes are potentially of importance in the removal of heat from a power transistor. Using heat transfer equations to calculate the effects of radiation, conduction and convection heat powers, the total heat power transfer for the cup power transistor previously mentioned is 1.28 watts for a 50-degree C temperature rise above a 25-degree ambient temperature. For these operating conditions, the cup power transistor can be rated as having a maximum power dissipation of approximately one watt.

This maximum power rating depends to a considerable extent upon the maximum permissible operating temperature, which has been

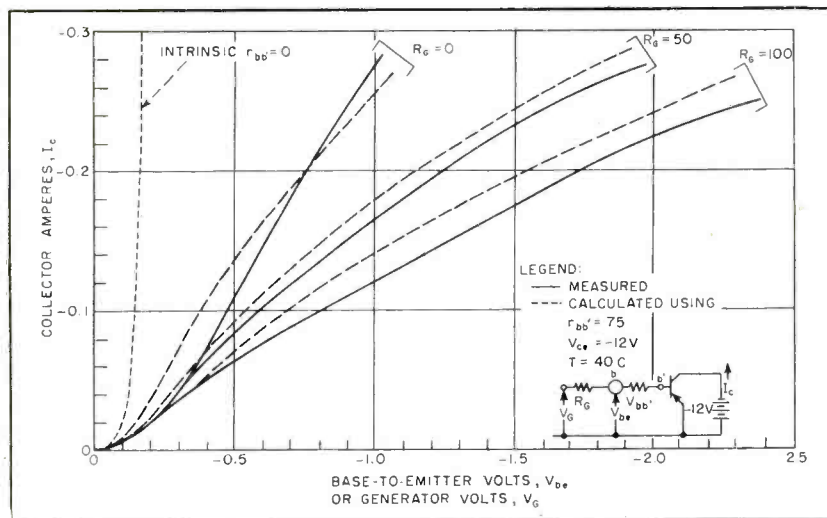

FIG. 3—Static transfer characteristics for power transistor

Table I—Power Junction Transistor Coefficients and Saturation Currents

Temp. °C	25°	40°	50°	75°
g_{ee}	2.1	8.3	18	101
$g_{ce} = g_{cc}$	-1.9	-7.5	-16	-91
g_{ee}	3.0	12	26	116
g_{be}	-0.21	-0.86	-1.9	-10
I_{es}	0.054	0.22	0.51	3.0
$I_{cs} = I_{ce}$	-0.048	-0.20	-0.47	-2.7
I_{cc}	0.077	0.32	0.74	4.4
I_{be}	-0.0055	-0.023	-0.053	-0.31
I_{es}	"	"	"	"
I_{cs}	-0.029	-0.12	-0.28	-1.7
I_{be}	0.035	0.14	0.33	2.0

Analysis of operating characteristics of typical power transistors and influence of finite base-lead resistance, temperature, frequency, and generator resistance. Biasing problems for typical audio power output stages are also considered

Audio Output Circuits

arbitrarily picked at 75 C. The maximum permissible operating temperature will depend rather critically upon the changes in operating characteristics with temperature, an item to be considered subsequently, and upon life test data.

The operation of a junction transistor has been analyzed². Careful measurements of small-signal junction transistors indicated that Shockley's analysis may be used for quantitative results if it is applied to an ideal intrinsic transistor. The actual transistor has certain extrinsic elements which must be added to the intrinsic transistor. A very important extrinsic element is a base-lead resistance, r_{bb} , shown diagrammatically in Fig. 2.

One of the basic assumptions of Shockley's analysis is that the minority carrier density is much smaller than the majority carrier density throughout the base region. This assumption is hardly satisfied by power transistors where the minority carrier density is gen-

erally many times the majority carrier density. Nevertheless, as will be seen, many of the gross aspects of power-transistor characteristics are given by the Shockley analysis. In those cases where there is a considerable difference, use can be made of modified analyses¹ to determine the appropriate results.

According to Shockley's analysis, the d-c characteristics of a junction transistor are given by equations

$$I_e - I_{es} = \frac{1}{\Lambda} \left[g_{ee} \epsilon^{\Lambda} V_{eb}' + g_{ce} \epsilon^{\Lambda} V_{cb}' \right] \quad (1)$$

$$I_c - I_{cs} = \frac{1}{\Lambda} \left[g_{ce} \epsilon^{\Lambda} V_{eb}' + g_{cc} \epsilon^{\Lambda} V_{cb}' \right] \quad (2)$$

In these equations I_e and I_c are the emitter and collector d-c currents respectively and V_{eb}' and V_{cb}' are the emitter-to-internal-base and collector-to-internal-base d-c voltages respectively. The four g 's are d-c conductance coefficients which can be considered similar to the permeance coefficient employed in electron tube studies. These d-c conductance coefficients must not be

confused with a-c conductance parameters although the coefficients can be measured³ by the same means employed for measuring the a-c parameters when the d-c terminal voltages and currents are both zero. The Greek letter Λ is used in place of e/kT where e is the charge of an electron in coulombs, k is Boltzmann's constant in joules per degree K , and T is the operating temperature in degrees Kelvin (At room temperature, 27 C (300 K), $\Lambda = -38.6$ volts⁻¹ for electrons and $+38.6$ volts⁻¹ for holes.)⁴ Currents I_{es} and I_{cs} are the emitter and collector saturation currents, respectively, and represent currents due to thermally-generated carriers in the base that flow to the emitter and collector when both are biased more than a few tenths of a volt in the reverse direction. Thus

$$I_{es} = -\frac{1}{\Lambda} (g_{ee} + g_{ce}) \quad (3)$$

$$I_{cs} = -\frac{1}{\Lambda} (g_{ce} + g_{cc}) \quad (4)$$

If the collector-to-internal-base

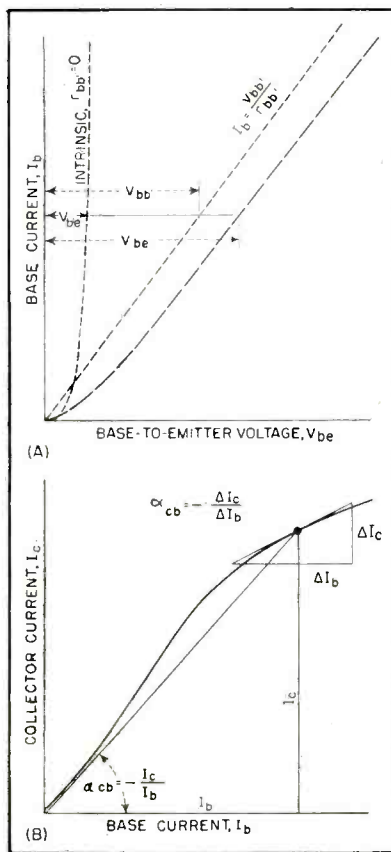

FIG. 4—Construction of base characteristics (A) and d-c and a-c collector-to-base current amplification factors (B)

voltage is always more than a few tenths of a volt in the reverse direction, (collector always in the saturation region) the contribution of the last term of Eq. 1 and 2 is negligible compared to the first term. For this condition

$$I_e = I_{es} + I_{ee} \epsilon^{-\Delta V_{be}'} \quad (5)$$

$$I_c = I_{cs} + I_{ce} \epsilon^{-\Delta V_{be}'} \quad (6)$$

and

$$i = -(I_e + I_c) = I_{bs} + I_{be} \epsilon^{-\Delta V_{be}'} \quad (7)$$

In the equations, the d-c current coefficients are related to the corresponding d-c conductance coefficients by

$$I_{ee} = \frac{g_{ee}}{\Lambda} \quad (8)$$

$$I_{ce} = \frac{g_{ce}}{\Lambda} \quad (9)$$

$$I_{be} = \frac{g_{be}}{\Lambda} = -\frac{g_{ee} + g_{ce}}{\Lambda} \quad (10)$$

The base saturation current is the base current that flows for emitter and collector saturation currents. Thus

$$I_{bs} = -(I_{es} + I_{cs}) \\ = \frac{1}{\Lambda} (g_{ee} + g_{ce} + g_{es} + g_{cs}) \quad (11)$$

Since the d-c conductance coefficients are measurements of a passive element, it is always necessary that $g_{ec} = g_{ce}$. Equations 5, 6 and 7 have been written in terms of the internal base-to-emitter voltage in anticipation of studies of operating characteristics of a common-emitter circuit.

If the d-c conductance coefficients are known, the intrinsic-transistor characteristics can be readily computed by means of Eq. 5, 6 and 7. This has been done for the collector current for a typical power transistor, and the results are shown by the dotted curve in Fig. 3.

The measured d-c conductance coefficients used in these calculations together with the corresponding d-c current coefficients and saturation currents are tabulated in Table I under the appropriate temperature heading of 40 C. The dotted curve of Fig. 3 can be considered to be the intrinsic transfer characteristic of the transistor; that is, the transfer characteristic that would be obtainable if $r_{bb'}$ were zero.

Of considerably greater importance is the actual transfer characteristic. The voltage drop that occurs across $r_{bb'}$ must now be introduced. Equations 6 and 7 can be written in terms of the applied base-to-emitter voltage as

$$I_c = I_{cs} + I_{ce} \epsilon^{-\Lambda(V_{be} - r_{bb'} I_b)} \quad (12)$$

$$I_b = I_{bs} + I_{be} \epsilon^{-\Lambda(V_{be} - r_{bb'} I_b)} \quad (13)$$

If $r_{bb'}$ is known, the actual characteristics can then be determined.

The graphical relationship between the intrinsic and actual base characteristic is shown in Fig. 4A. The actual base-to-emitter voltage is obtained by adding to the intrinsic voltage V_{be} the voltage drop $V_{bb'}$ across the base-lead resistance. The latter voltage will generally be several times larger than the former, particularly at larger currents, so that the base characteristics will be essentially linear. That is the base current will be approximately linearly related to the base-to-emitter voltage. Actual transfer characteristics can be obtained by a similar graphical construction with the use of the base characteristics. An alternate method of calculation is to use the relationship between collector current and the base current. This relationship can be ex-

pressed in terms of a d-c current-amplification factor α_{cb} defined as

$$\alpha_{cb} = -\frac{I_c}{I_b} \quad (14)$$

Figure 4B shows how the d-c and a-c collector-to-base current-amplification factors are related to the currents. As shown in Fig. 5, the d-c current-amplification factor decreases approximately hyperbolically at larger collector currents. This drop-off is an important aspect of power-transistor operation and can be explained by modified analyses.⁴ With the aid of Fig. 5 the actual transfer characteristics can be determined since by combining Eq. 12 and 14

$$I_c = I_{cs} + I_{ce} \epsilon^{-\Lambda(V_{be} + \frac{r_{bb'}}{\alpha_{cb}} I_b)} \quad (15)$$

The actual transfer characteristics determined by this manner are shown by the dashed curve labelled $R_{bb'} = 0$ in Fig. 3. For comparison purposes the measured transfer characteristics are shown by the corresponding solid line in the same figure.

Base-lead resistance can be measured directly by small-signal methods, but for the purposes described herein, it can best be determined by fitting a calculated characteristic to a measured characteristic.

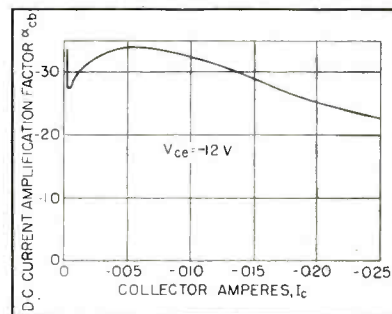

Fig. 5—Amplification factor (d-c) as a function of collector current

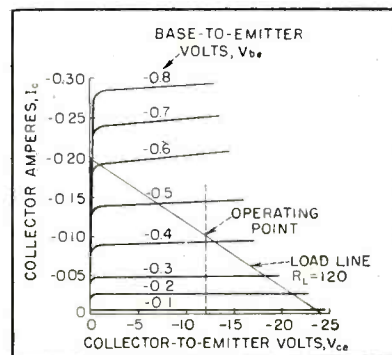

FIG. 6—Output load characteristics

The implication thus far has been that the base-lead resistance $r_{bb'}$ is independent of current. This is not exactly the case as $r_{bb'}$ will decrease somewhat as the collector current is increased. This, in part, accounts for the discrepancy between the calculated and measured transfer characteristics of Fig. 3.

Most calculations on power transistors can best be carried out with the aid of the transfer characteristics. Occasionally the base and collector characteristics may be of interest. The base characteristics as shown in Fig. 4A have already been considered. The collector characteristics for the power transistor under consideration are shown in Fig. 6. These curves will be employed subsequently in considering the optimum output loading of the transistor.

Frequency Characteristics

For small-signal operation the input equivalent circuit has the form shown in Fig. 7. The resistor marked $r_{b'e}$ represents the flow of carriers to the base and is reciprocally proportional to base current. For a power transistor operating at a collector current of 100 ma, $r_{b'e}$ would be of the order of 10 ohms. Capacitor $C_{b'e}$ represents the storage of charge carriers in the base region. Its value is directly proportional to the square of the base thickness and to emitter current. Accordingly the actual value of $C_{b'e}$ will depend greatly upon the base thickness. As an example, for a base thickness of 0.002 in. $C_{b'e}$ would be of the order of 0.5 μ f at a collector current of 100 ma. On a small-signal basis, $C_{b'e}$ will have a pronounced frequency effect. For large-signal operation, $r_{b'e}$ and $C_{b'e}$ will vary with the applied signal. It is this variation together with similar variations in other reactive elements that complicate even an approximate study of large-signal frequency characteristics.

Temperature Effects

Germanium is a semiconductor, and as such exhibits a pronounced temperature-resistivity variation.⁶ The relatively impure germanium customarily employed in transistors will generally exhibit an increase in resistivity with temperature at ap-

proximately room temperature. At higher temperatures the impure germanium decreases in resistivity with increasing temperature in the same manner as pure germanium.

The manner in which temperature enters into transistor operation can be ascertained with the aid of Eq. 11 and 12. The transistor characteristics will be affected by temperature variations due to a change in the value of Λ . In addition, the saturation currents, I_{cs} and I_{bs} , and the current coefficients, I_{ce} and I_{be} , change rapidly with temperature.

The saturation currents and current coefficients have a common multiplier of the form

$$\frac{1}{\Lambda} \frac{b}{(1+b)^2} \frac{\sigma_i^2}{\sigma_b} \frac{A}{W_b}$$

where b is the ratio of electron to hole mobility and is essentially independent of temperature; A and W_b are the cross-sectional area and base thickness which are also independent of temperature.

The temperature dependent terms are contained in the factor $\sigma_i^2(\Lambda\sigma_b)$ where σ_i is the pure germanium conductivity, σ_b is the germanium conductivity of the impure germanium employed in the transistor base, and Λ as already defined is e/kT . If the saturation currents and current coefficients are known at one temperature, their values at some other temperature can be determined by applying a suitable temperature correction factor. For convenience, this temperature correction factor which is approximately the same for both n and p germanium normalized to room temperature of 25 C is given in Fig. 8. It is apparent from the values of the temperature correction factor that the saturation currents and current coefficients will change rapidly with temperature. The data in Table I exhibit this very rapid variation with temperature.

Fortunately, the actual transistor characteristics are not quite so sensitive to temperature changes. As temperature is increased, I_{cs} and I_{bs} increase rapidly, but Λ decreases, and since Λ enters as a positive exponent some of the increase in I_{cs} and I_{bs} is compensated. The temperature stability of a junction transistor is adversely affected by the presence of $r_{bb'}$. As the temperature is increased, base current decreases. The resulting change in voltage across $r_{bb'}$ is in such a direction as to further increase the collector current. The decrease in base current with increase in temperature is due to the presence of I_{bs} in Eq. 13. Current I_{bs} has a sign opposite of I_{be} and its increase with temperature is uncompensated. Accordingly, as the temperature is increased, I_{bs} contributes a progressively larger share to I_b and may actually produce a reversal in the direction of I_b .

The manner in which the calculated transfer characteristics change with temperature is shown

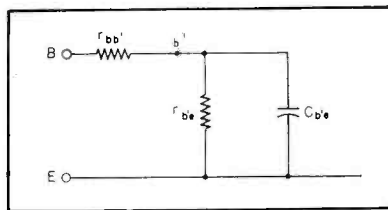

FIG. 7—Input equivalent circuit for small-signal transistor operation

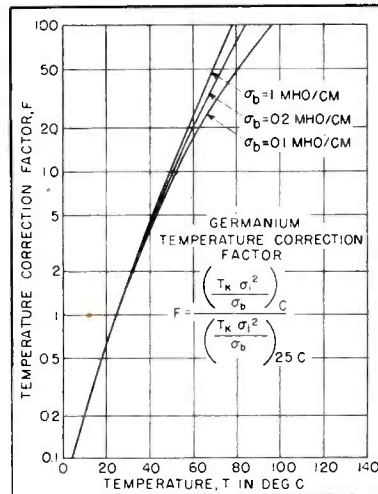

FIG. 8—Curves for finding germanium temperature correction factor

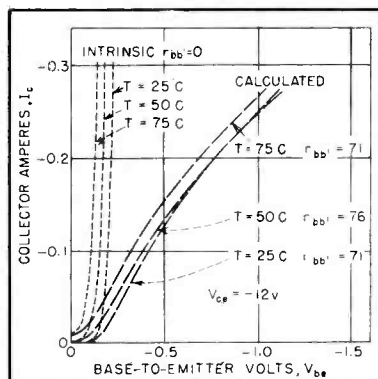

FIG. 9—Change in static transfer characteristics with temperature

in Fig. 9. For these calculations, it was assumed that the transistor was made of 4 ohm-cm *n*-type germanium. Maximum resistivity of this material occurs at approximately 50 C, and the resistivities at 25 C and 75 C are about equal.

Audio Output Stage

In the design of an output stage the d-c power supply voltage is usually specified. Let this be 12 volts. Generally, the d-c supply voltage will be limited to about half the collector breakdown voltage.

The maximum power dissipation for the cup transistor has been determined to be 1.28 watts for a 50 C temperature rise above 25 C ambient. Thus, a static collector current of 100 ma can be accommodated. For maximum power output an output resistance of 120 ohms is indicated. A resistance of this value is shown by the load line in Fig. 6. A maximum a-c power output of about 0.6 watt can be expected.

Additional details concerning the output stage can be obtained by referring to the transfer characteristics in Fig. 3. The transfer curve (solid curve marked $R_G = 0$) shows that a base-to-emitter bias voltage of -0.48 volt is required for the 100-ma operating point. A peak driving voltage of $0.76 - 0.48 = 0.28$ volt is required. Since the input resistance will consist mostly of r_{bb}' , the a-c input power will be approximately 5.2×10^{-4} watt and the power gain 1,150 or 30.6 db. These calculations are approximate. With the aid of the transfer characteristics output distortion can be computed.⁷

The preceding calculations are based upon a zero resistance signal source. This will normally not be the case. The actual situation ($R_G > 0$) is similar to a vacuum tube being driven into grid conduction resulting in increased distortion plus an increase in driving voltage required for full output. Frequency response also suffers from the presence of R_G .

The circuit operation when $R_G > 0$ can be determined by Thevenin's theorem, considering the source as a voltage generator V_G in series with R_G . In the tran-

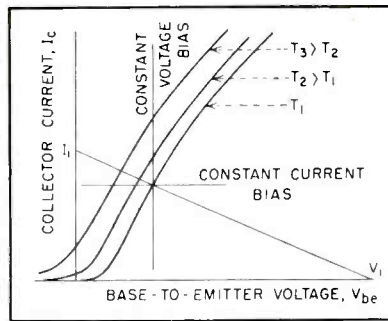

FIG. 10—Curves show effect of changes in temperature on bias

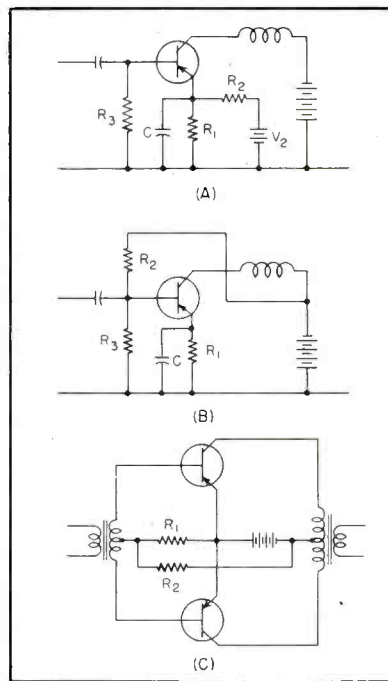

FIG. 11—Bias arrangements for typical audio output power amplifiers

sistor circuit R_G is in series with r_{bb}' and the two can be lumped together and considered part of the transistor. The result is a transistor with a larger effective r_{bb}' being driven from a generator of zero internal resistance. The transfer characteristics for the new transistor can be constructed in the same manner as already described. Figure 3 shows two transfer characteristics determined in this manner when $R_G = 50$ and 100 ohms. The base-to-emitter voltage includes the voltage drop across R_G and is therefore the generator voltage. The corresponding measured transfer characteristics are also shown.

To get satisfactory operation over a range of temperatures, the biasing of the output stage must

be given careful attention. Figure 10 indicates the change in the operating point with changes in temperature. For stability, constant-current bias has the most advantages even though it is more difficult and expensive to achieve. An absolute constant-current bias is not feasible; an intermediate bias condition is generally used.

Two methods of obtaining intermediate bias for class-A operation are shown in Fig. 11A and 11B. The biasing of a push-pull class-B stage is somewhat less complicated. A typical arrangement is shown in Fig. 11C. Since the base current will generally decrease as the temperature is increased (Fig. 9), the base bias with the circuit of Fig. 11C will tend to increase as the temperature is increased. The net result of these two effects will be to cause the quiescent collector current to increase. This factor must be taken into account in designing the class-B stage to insure that operation remains within the maximum limitations of the transistor. One method of achieving stability is to use a temperature-sensitive resistor for R_1 or R_2 .

Complementary symmetry circuits¹⁰ provide numerous additional circuit possibilities for audio output stages using power transistors. For example, the relatively simple biasing requirements of the push-pull amplifier can be taken advantage of without addition of bulk and weight in the form of transformers.

REFERENCES

- (1) These units are the work of D. A. Jenny and L. D. Armstrong, RCA Laboratories, Princeton, N. J.
- (2) William H. McAdams, "Heat Transmission," McGraw-Hill Book Co., New York.
- (3) W. Shockley, M. Sparks and G. K. Teal, P-N Junction Transistors, *Phys Rev*, p 151, July 1951.
- (4) W. M. Webster, On the Variation of Junction Transistor Current-Amplification Factor with Emitter Current, submitted for publication in *Proc IRE*.
- (5) L. J. Giacoletto, Bridges Measure Transistor Parameters, *ELECTRONICS*, p 144, Nov. 1953.
- (6) P. G. Herkart and J. Kurshan, Theoretical Resistivity and Hall Coefficient of Impure Germanium Near Room Temperature, *RCA Rev*, Sept. 1953.
- (7) F. E. Terman, "Radio Engineer's Handbook", p 380, McGraw-Hill Book Co., N. Y.
- (8) Stabilization method used by L. E. Barton of RCA Laboratories in a class-B output stage of portable personal receiver.
- (9) G. C. Sziklai, Symmetrical Properties of Transistors and Their Application, *Proc IRE*, p 717, June 1953.
- (10) R. D. Lohman, Complementary Symmetry Transistor Circuits, *ELECTRONICS*, p 140, Sept. 1953.

Rocket-Borne Servo Tracks the Sun

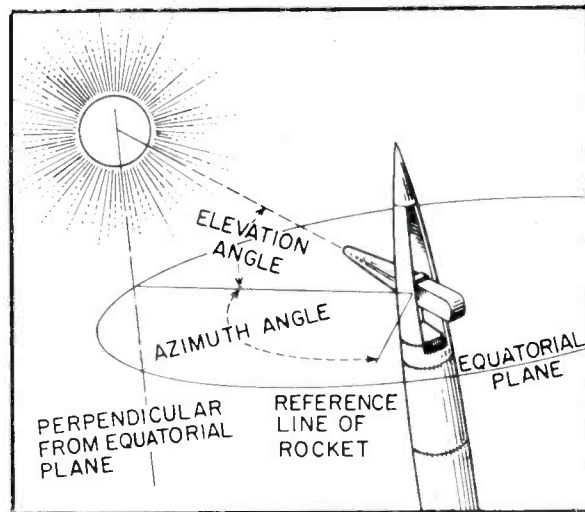

Solar pointing control mounted in nose cone of rocket

Spectrograph mounted in nose cone of Aerobee rocket is continually aimed at sun by biaxial servo system. Deviation is detected by balanced phototube system with coarse and fine control. Selection of components for rocket-borne instrumentation is described

By D. S. STACEY, G. A. STITH, R. A. NIDEY and W. B. PIETENPOL

Department of Physics, University of Colorado, Boulder, Colo.

SOLAR RADIATION in the far ultraviolet spectrum is almost wholly absorbed in the earth's atmosphere and its study on the surface of the earth is impossible.

Radiation of these wavelengths may be studied by instruments mounted in research rockets.^{1,2,3}

The biaxial solar pointing control

to be described in this article is installed in the nose cone of one such rocket, the Aerobee, and keeps the instruments aligned with the sun despite gyrations of the vehicle in flight.

A spectrograph aimed by the pointing control made the first known observation of the Lyman-

alpha hydrogen line at a wavelength of 1,216 angstroms.⁴

General Description

To correct for the deviation of the missile, the solar pointing control is rotated about two axes by servos. The entire forward end of the nose cone is rotated about the

longitudinal axis of the rocket by an azimuth servo. Within this section the instrument is pivoted about an axis perpendicular to the azimuth axis by an elevation servo. The two servo systems are similar but operate independently.

Until the rocket has cleared the major part of the atmosphere and the air loads have become negligible, the instrument is stowed parallel to the rocket axis behind streamlined doors. Then the doors are jettisoned and servo operation starts.

The basic servo systems are shown in Fig. 1 and 2. The eye systems, each comprised of an array of phototubes, produce voltages that correspond to the errors in pointing. After traversing suitable lead and lag networks, these voltages are applied to amplifiers. The amplifiers drive a field-control motor in the case of the elevation servo and a magnetic-clutch system in the case of the azimuth. As a result, the instrument swings to the target with speed and little overshoot. From then on, in normal flight, the unit continually points at the sun until the rocket re-enters the effective atmosphere. The instrument then retracts to the stowed position in preparation for landing.

Eye System

To detect an error in pointing, a balanced phototube system is used.⁶ For each servo, there is a coarse eye and a fine eye. The coarse eye, with a sensitivity of about $\frac{1}{2}$ volt per degree, is used to detect large errors and determines the transient response. The fine eye, with a sensitivity of about $\frac{1}{2}$ volt per minute, determines the ultimate accuracy.

Response Network

A d-c servo system was chosen in preference to an a-c system because the d-c system is simpler and considerably lighter and because high-performance requirements on both transient response and ultimate accuracy necessitate derivative damping as well as integral control. These are more easily realized in a d-c than in an a-c system. Drift, the principal disadvantage of most d-c systems, contributes a negligible error.

Amplifiers

The two amplifiers receive d-c push-pull signals and produce enough current to drive the motor systems. The voltage gain required is low and the main problem is to keep drift to a negligible value. Under the worst supply-voltage conditions encountered in flight, the amplifier drift is equivalent to a pointing error of 0.5 minute of arc, which is small compared to other sources of error.

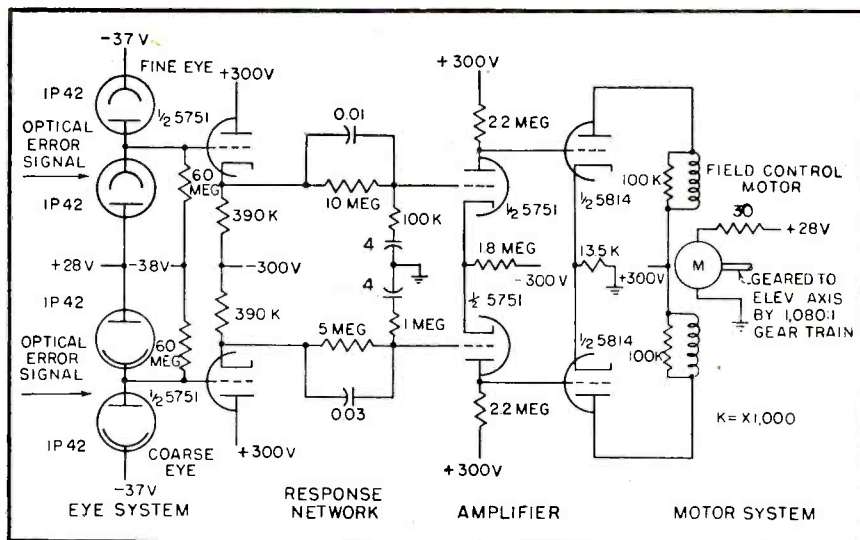

FIG. 1—Elevation servo system is geared to elevation axis by 1.080-to-1 train

Inasmuch as the rocket may be spinning as fast as 90 rpm when servo operation starts, the catching ability of the azimuth servo has to be exceptional. This requires use of appreciable lead control and system elements that have negligible time delay. Also, to reduce pointing errors, integral control is used. This reduces not only velocity errors but in the presence of friction also reduces static errors.

For each servo there is an output voltage from the coarse eye and one from the fine eye. These signals are balanced against change in supply voltages but are essentially single ended. Because of different functions and different loop gains, they require different response networks.

The output of the response networks is fed to a push-pull amplifier that effectively adds them. Thus the advantage of a balanced system is realized in spite of the separation of eye systems.

The selection of tubes for rocket work is still a problem. Severe vibrations of unknown magnitude are present during takeoff. All tubes are aged fifty hours and then put through a shake test. At present the selection of types is based upon previous tests plus operating failures. In some cases high-reliability tubes have been an improvement—in other cases they have had a record inferior to ordinary types.

Motor System

The choice of motor units to power the servos is determined by the performance to be delivered. The elevation servo has a design accuracy of one minute of arc and a response speed of 10 rpm. Several seconds may be needed to zero-in on the target. A field-control motor drives the instrument through a precision gear train with a ratio of 1,080 to 1.

While the backlash can be adjusted to give one minute of arc accuracy, it is easier and cheaper to provide a small amount of spring torque on the output shaft. Thus, even when the servo is on target, backlash and its associated problems are removed inasmuch as the motor must still exert a torque through the gear train.

The azimuth servo is also designed for one-minute accuracy, but much higher speed of response. Because of the spin of the rocket the azimuth servo must be able to

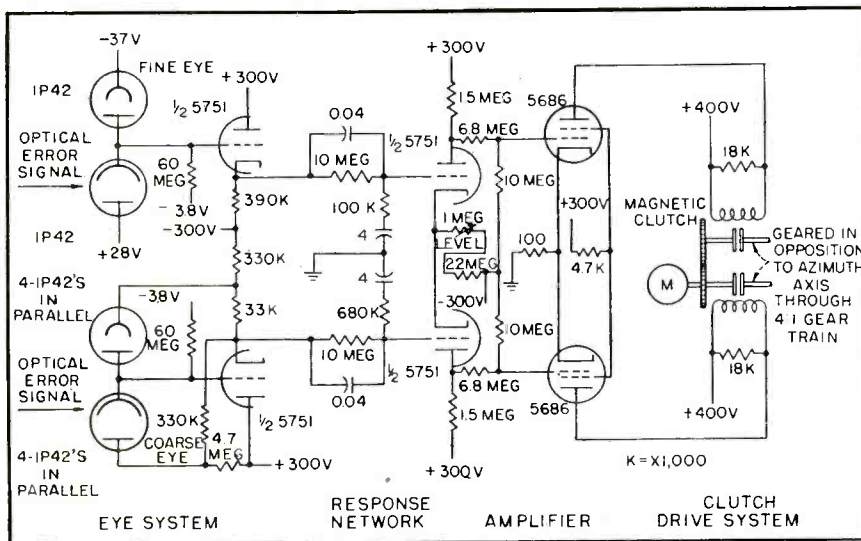

FIG. 2—Azimuth channel output controls magnetic clutch on azimuth drive motor

catch with complete reliability a target moving at 1.5 rps. A 28-volt motor with a flywheel, for stability, drives a gear train that in turn drives two counterrotating magnetic clutches.

Gears and Clutches

The output gears of these clutches are connected to the azimuth drive shaft. Current in the coil of one clutch drives the azimuth one way while current in the other drives the azimuth the other way. Because of small residual drag, the backlash is always taken out. This system gives a smooth, powerful drive with excellent accuracy capabilities.

Programing

Although the altitude of the rocket is the fundamental criterion for starting and stopping operations, it cannot be measured with ease and reliability. Therefore the sequence of operations is controlled by a timer. The timer is a governor-controlled d-c motor. Cams driven by the timing motor through a reduction-gear train actuate a bank of snap-action in sequence.

Telemetry

Up to 120 separate voltages may be telemetered by an ASCOP commutator in conjunction with the AFCRC beacon-telemetry system. Each voltage is sampled for

6 milliseconds 2.5 times a second. Commutation segments may be combined to give longer or more frequent sampling.

The ASCOP commutator has two channels with 60 sampling segments. The commutator output goes to the AFCRC beacon-telemetry system. Each of the two beacon-telemetry channels has a working range of 0 to 5 volts d-c.

Normally, one channel is devoted to the instrument being pointed and one to the pointing control. Thus the complete operation of the nose-cone unit may be monitored.

Accuracy of Pointing

The pointing control was designed for an ultimate accuracy of plus or minus one minute of arc. At present there are a number of factors that contribute to produce a larger error. Some of these can be removed by careful adjustment while others require refinement of components.

Photosight

The present series of pointing controls is rated conservatively at 30 minutes of arc. During flight this accuracy is continuously monitored by an independent photoelectric sight.

The output from the sight is telemetered to the ground. On a recent flight, the measured error during operation did not exceed 15 minutes of arc. With each succeeding unit the accuracy is being im-

proved and the design accuracy may soon be achieved.

Two biaxial solar pointing controls have reached operating altitude. One was partially successful. The azimuth servo performed satisfactorily but the elevation servo did not operate because of failure of an elevation eye phototube, apparently at takeoff.

Instruments

The second was successful, producing an accuracy of fifteen minutes of arc. The first one carried an instrument provided by the University of Rhode Island and designed to measure total solar radiation. This experiment will be repeated in the near future.

The second pointing control carried an ultraviolet spectrograph provided by the University of Colorado. The scientific data obtained from this flight, including the picture of the Lyman-alpha hydrogen line,⁶ were presented to the American Physical Society during the January 1953 meeting in Boston.

A solar monochromatic camera⁷ was flown in a pointing control in a rocket that did not reach operating altitude.

A rocket-borne coronagraph has been tentatively designed by the University of Colorado.

Development of the pointing control has been due to the efforts of a team of workers. The work was directed by a planning board consisting of W. B. Pietenpol, project supervisor; F. C. Walz, J. M. Jackson and D. S. Stacey. Section heads were: R. H. Crawford, W. E. Lowrey, R. A. Nidey, W. A. Rense, C. E. Sheldon, G. A. Stith and M. O. Williams. The project is sponsored by the Air Research and Development Command under contract W19-122 ac-9.

REFERENCES

- (1) Harry L. Clark, Sun Follower for V-2 Rockets, *ELECTRONICS*, p 71, Oct. 1950.
- (2) Joseph Kaplan, The Earth's Atmosphere, *Amer Scientist*, 41, p 49, Jan. 1953.
- (3) F. L. Whipple, Results of Rocket and Meteor Research, *Bull Amer Meteorological Soc.*, 33, p 13, Jan. 1952.
- (4) 61, p 57, Feb. 1953.
- (5) Refer to reports submitted to Air Force Cambridge Research Center, 230 Albany Street, Cambridge, Massachusetts, Attention: CRHU.
- (6) W. B. Pietenpol, W. A. Rense, F. C. Walz, D. S. Stacey and J. M. Jackson, Lyman-alpha Line Photographed in the Sun's Spectrum, *Phys. Rev.*, 90, Apr. 1, 1953.
- (7) W. B. Pietenol, Solar Monochromatic Camera, *Colo-Wyo Acad of Sci Journ.*, 4, p 41, Oct. 1950.

Automatically Deiced

Ground-based beacon antenna for 9,220-9,430-mc band provides omnidirectional azimuth pattern and narrow vertical beamwidth. Radome deices automatically and is built to withstand wind velocities exceeding 150 knots without damage

By **C. EDGAR THOMAS, JR.**

*Electronics Department
The Glen L. Martin Company
Baltimore, Maryland*

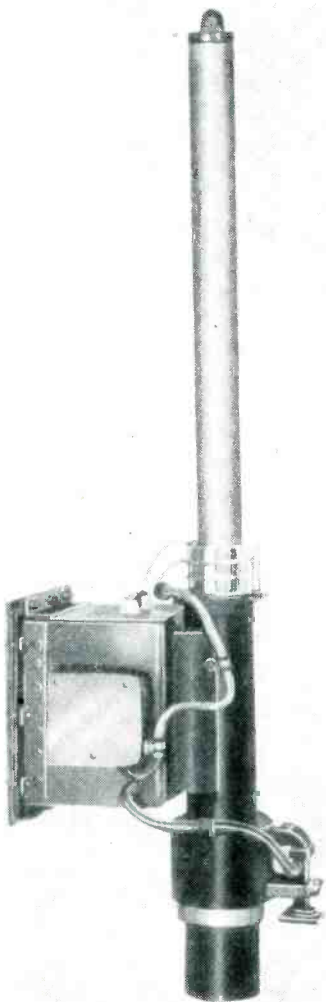

Beacon antenna with fiber glass radome in place. Automatic deicing circuit is located in housing at left

PROTECTION from the elements and a radiation pattern ideal for its use in ground-based aircraft beacons characterize the microwave antenna shown in the photograph.

The antenna is horizontally polarized with an essentially omnidirectional azimuth pattern. In the vertical plane, the beam maximum is tilted upward from the horizon. The assembly incorporates circuits for automatically deicing the radome. The structure can withstand wind velocities exceeding 150 knots. The antenna has been tested for five months under the severe weather conditions atop Mount Washington in New Hampshire. During this period, the radome was kept continually ice-free and the structure withstood wind gusts greater than 175 mph.

The antenna was required to be horizontally polarized with an essentially omnidirectional azimuth pattern. In the vertical plane, the half-power beamwidth was to be three to five degrees with the beam maximum elevated between one and one and one-half degrees above the horizon.

Means were required for automatically deicing the radome under all weather conditions and the antenna and radome structures were designed mechanically to withstand wind velocities in excess of 150 knots without damage.

Electrically the antenna is an omnidirectional slotted array composed of a relatively thin X-band waveguide with pairs of shunt slots placed opposite each other on the broad faces of the guide. The slots are spaced on half the guide wavelength and offset on alternate sides of guide centerline. The antenna presents a small cross-section, desirable for low wind loading and small deicing heat requirements. Table I summarizes the antenna's electrical and mechanical characteristics.

Slot Radiation

Figure 1 indicates how an omnidirectional radiation pattern is obtained. In Fig. 1A two slots are shown, one on each side of an infinitely thin hollow metal sheet with their narrow dimensions in the plane of the illustration. These are excited in opposite phase as shown by the voltage vectors across the slots.

These slots will radiate uniformly around their respective half-circles. If the metal sheet is removed some distance from the slots, the radiation fields will form a continuous circle with no discontinuity, as shown in Fig. 1B. In Fig. 1C the infinitely thin metal sheet has been replaced by a thin waveguide with the pair of slots offset from guide centerline. The radiation field from

X-Band Beacon Antenna

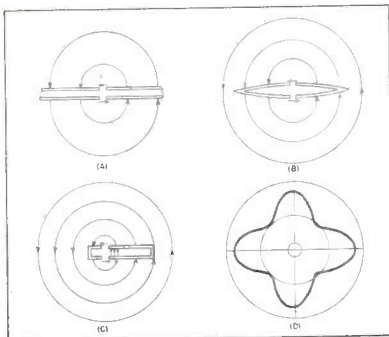

FIG. 1—Antenna radiation pattern

Table I—Antenna Performance Over the Band, 9,220 to 9,430 mc

Elevation pattern	Half-power beamwidth 3.0 to 3.3 deg Tilt, 1.0 to 1.3 deg above horizon
Azimuth pattern	Circularity ratio (max radiated power/min radiated power) less than 2 to 1
Gain	21.5 db
Impedance	Voltage-standing-wave ratio less than 1.7 over band; less than 1.4 at 9,310 mc
Peak power capacity	40 kw
Wind loading	150 knots
Radome deicing	240 watts, automatically controlled

this slotted waveguide approximates the idealized condition of Fig. 1B.

Measurements show that for a slotted waveguide 1 in. \times 0.25 in. outside diameter, the radiation pattern is circular within a ratio of 2 to 1 as shown in Fig. 1D. Thicker waveguides give less circular patterns and thinner waveguides are increasingly difficult to manufacture.

The specified beamwidth requires an array of twenty slot pairs with an overall length of approximately 20 inches. The array is composed of two halves fed at the center. Each half of the array, consisting of ten pairs of slots, is designed to have a low input voltage-standing-wave ratio over the specified frequency band. Measurements made of the conductance of slots of several widths and offsets from the waveguide centerline indicated that slots $\frac{1}{8}$ inch wide and 0.600 inch long, offset 1/16 inch from the guide centerline, would provide the desired input impedance.

Beam Tilt

The variation of beam-tilt angle for a conventional end-fed array exceeded the specified tolerance of one-half degree over the required frequency band. Two antenna designs were developed that were capable of producing the required upward beam tilt with little varia-

tion of tilt angle versus frequency. In both antenna designs, the slot arrays were driven at the center so that the variations of the phase front as a function of frequency would be symmetrical along the antenna's length and would produce no variations in beam-tilt angle.

Preliminary Design

The first antenna design utilized a slot array in which the spacing of slot elements in the upper half of the array was slightly greater than $\lambda_g/2$ and in the lower half was slightly less than $\lambda_g/2$, as shown in Fig. 2A. Beam tilt in this antenna is produced by the conical phase front of the radiated energy. The feed point is chosen to produce no discontinuity at the array center for the midband frequency. The phase front is not uniformly retarded along the array at other frequencies, but the deviation from a straight line varies symmetrically about the antenna feedpoint as shown and produces no variation in beam tilt above the horizon, although slight beam broadening occurs.

The second antenna design producing no beam tilt variation utilized an array in which the upper and lower halves have identical slot spacings of $\lambda_g/2$, but in which the feedpoint of the array is displaced a fraction of a wavelength downward along the axis of the waveguide

from the midpoint of the array. Beam tilt in this second antenna is produced by the phase difference between antenna halves, as shown in Fig. 2B.

In this design, the phase front from each antenna half is tilted at frequencies above or below midband frequency but the tilt varies symmetrically about the feedpoint. Because of this symmetry, the antenna pattern maintains its constant tilt with respect to the horizon.

The second antenna design unfortunately causes increasingly high side lobes as the beam tilt is increased, because of the abrupt phase discontinuity at the center of the array. Measurements show that the beam tilt cannot be held constant over the required frequency band with antennas of the first design. The variation of beam tilt is apparently caused by the dissimilarity of input impedances of the antenna halves as a function of frequency, causing a power split at the array feedpoint which varies both in phase and amplitude as a function of frequency.

Final Design

For this reason, the final antenna design utilizes identical antenna halves, with the feedpoint displaced to produce the desired beam tilt. Figure 3A shows the vertical radiation pattern of the centerfed antenna and Fig 3B shows the verti-

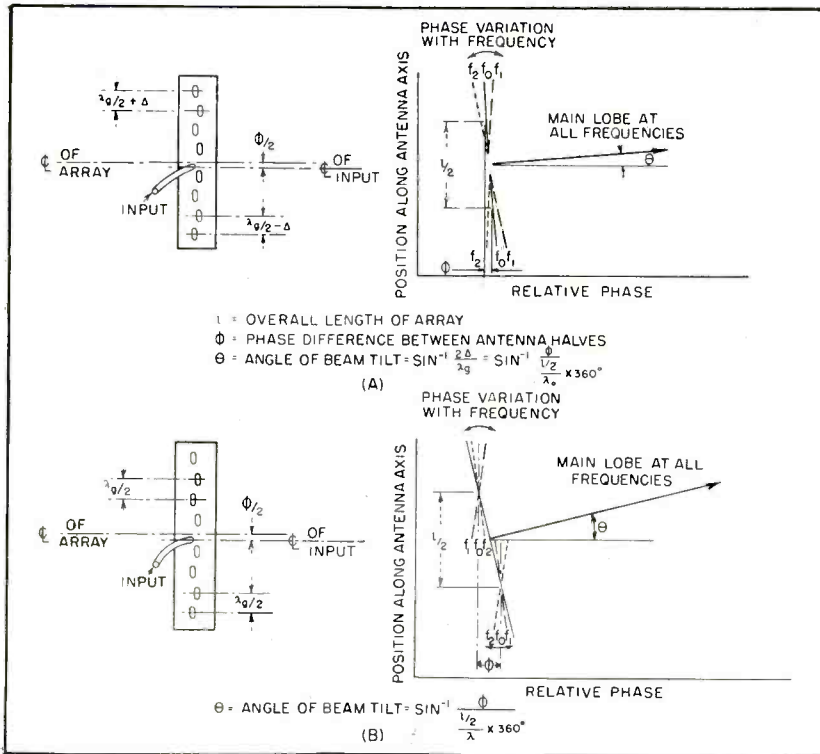

FIG. 2.—Beam tilt and physical conformation of antenna having different slot spacings top and bottom (A) and one having identical halves (B)

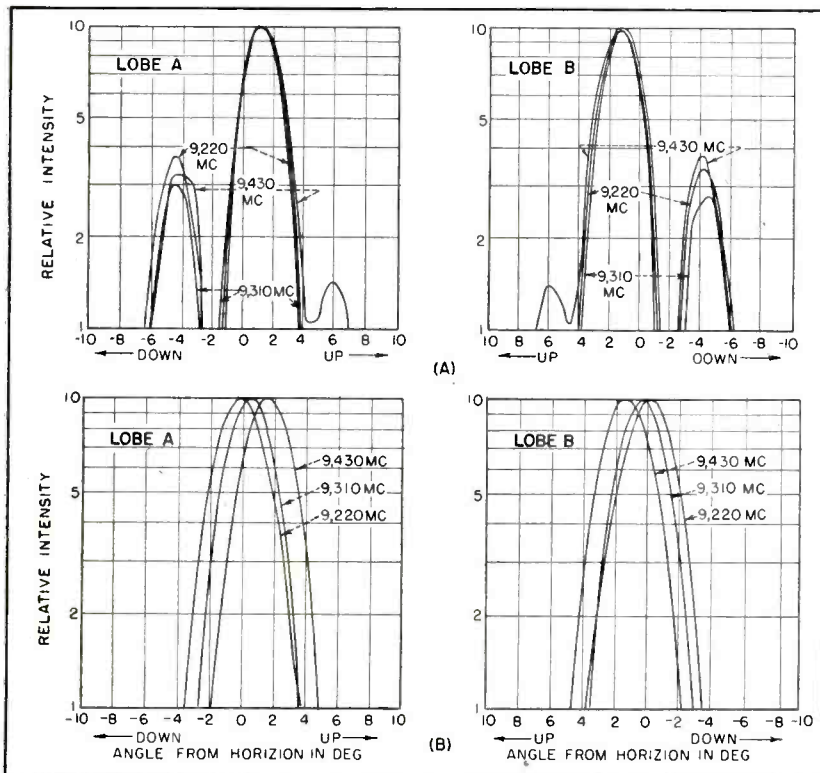

FIG. 3.—Vertical radiation pattern of center-fed array (A) and endfed array (B) illustrate how beam energy is concentrated in a narrow lobe

cal radiation pattern of an endfed array of approximately the same overall length. The variation of beam tilt of the centered array is less than $\frac{1}{2}$ degree while that of the end-fed array is 2 degrees over the specified 210-mc bandwidth.

Feed System

Design of a feed system for the center-fed array was carried out simultaneously with design of the radiating elements. The requirements for the feed were that it should divide the power equally to each antenna half with equal phase. The best means for accomplishing this was found to be a coaxial-to-waveguide transition consisting of an E-plane post across the waveguide at the feed point of the array. This transition forms a shunt junction that produces the required equal-power split by its symmetry. To retain the small antenna cross-section, this coaxial feed line is carried down one narrow edge of the waveguide to the bottom of the array, where a second conventional coaxial-to-waveguide transition provides a waveguide input to the antenna. Figure 4 illustrates the antenna feed system.

Radome

The deicing radome for the antenna is a thin-wall cylindrical housing of laminated fiber glass. Radome dimensions were so chosen that they satisfied requirements of high mechanical rigidity, small heated area and small effect on antenna impedance and azimuth pattern.

Several experimental thin-wall radomes were made, whose diameters ranged from $1\frac{1}{4}$ inches to $2\frac{1}{2}$ inches. Figure 5A shows the input admittance as a function of frequency for the 10 slot-pair half-length antennas with radomes of different diameters. The smallest admittance spread was obtained with a radome having a $1\frac{3}{4}$ -inch inside diameter.

Figure 5B shows the input admittance as a function of frequency for the same antenna with radomes of $1\frac{3}{4}$ -inch inside diameter and several wall thicknesses. The effect of radome thickness is small up to

0.055 inch when the admittance starts to spread out again.

The circularity deteriorates steadily with increasing radome diameter. This effect necessitated a compromise choice of radome diameter. The requirements of pattern and impedance were best met with a radome having a 1 $\frac{1}{8}$ -inch inside diameter and 0.055-inch wall. Impedance-matching irises were designed to give the optimum input voltage-standing-wave ratio with this radome.

Mechanical Design

The required mechanical strength of the radome was obtained with an ample safety factor with the chosen radome dimensions. The radome is molded from thermosetting resin and fiber glass cloth wound on a split mandrel with a clamshell outer mold.

Molded flanges at the top and bottom of the radome provide mechanical attachment to the antenna; O-rings clamped against both end flanges provide a pressure seal.

The heat required for deicing the radome was determined from studies of the rate of icing in severe weather. This data indicated a heat requirement of about 450 watts but the problem of overheating the radome under relatively high ambient temperatures and low icing rates made it necessary to limit the radome heat in the final antenna to 240 watts.

Heating Elements

The radome is heated by Nichrome wires embedded under the top layers of the fiber glass laminate. These wires were placed parallel to the radome axis, normal to the polarization of the radiated energy and have no measurable effect on the radiation pattern.

A single length of the Nichrome wire is run up and down the radome

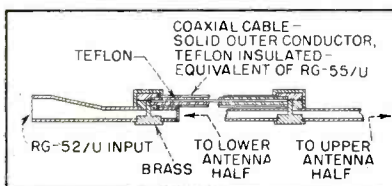

FIG. 4—Feed for center-fed array

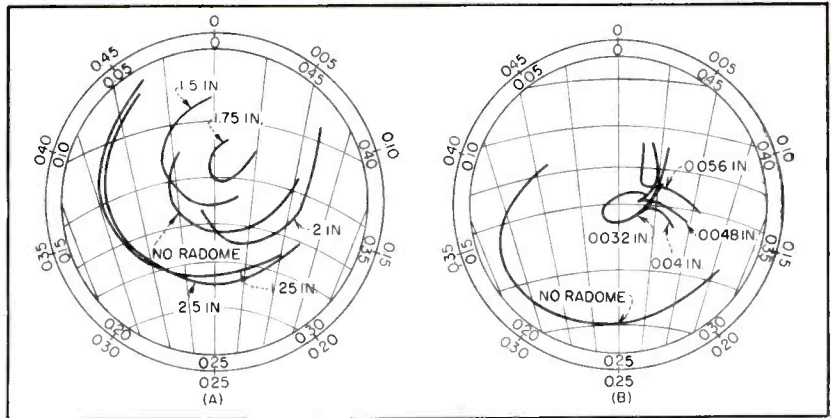

FIG. 5—Effect on input admittance of radome diameter (A) and radome thickness (B)

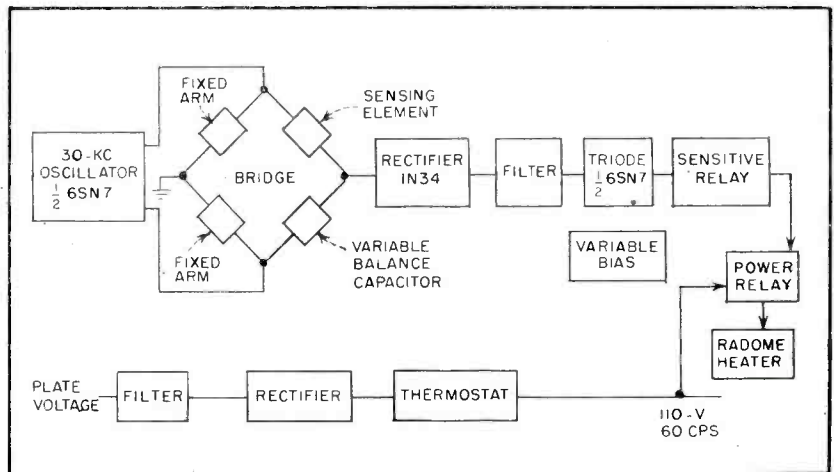

FIG. 6—Radome deicing control circuit depends for its operation upon balanced reactance bridge. Sensing element is air-dielectric capacitor exposed to weather

fourteen times with the wires spaced about $\frac{3}{8}$ inch apart. Flexible insulated leads are molded into the fiber glass to provide weatherproof electrical connections to the radome heater.

Deicing Control

An automatic deicing control that energizes the radome heating element under any icing conditions consists of an ice-sensing bridge circuit operating at approximately 30 kc, an unbalance-signal amplifier and a relay to actuate the radome heater, as shown in the block diagram in Fig. 6. The bridge circuit consists of two capacitors and the center-tapped secondary of the oscillator tank coil.

One capacitive arm of the bridge circuit is a parallel-plate air-dielectric capacitor mounted around the base of the radome and exposed to

the weather. The other capacitive arm is a small air-dielectric capacitor mounted inside the control housing.

Snow, ice or water on the plates of the external capacitor produce an unbalance signal in the bridge circuit that is rectified, amplified and used to actuate a relay controlling the radome heating element. The radome heater removes ice from both the radome surface and the ice-sensing capacitor. When the ice and water are completely removed, balance is restored to the bridge and the radome heater is turned off automatically. The deicing control is mounted in a pressurized housing at the base of the antenna assembly, as shown in the photograph. The antenna was designed under Contract AF 28-(099)-85 sponsored by Rome Air Development Center, USAF.

Conelrad Receiver With

Design and construction of highly reliable broadcast-band receiver having internal carrier-failure alarm, for use in controlled broadcast stations required to monitor regional parent station of Civil Defense system. Cost of required components is under \$100

WITH THE ADVENT of Conelrad operation, additional equipment requirements are presented not only to commercial broadcast stations but also to Civil Defense radio operating and monitoring facilities. To date, little information has been available on the alarm equipment directly associated with the monitoring of the regional parent stations.

While this particular receiver was designed for operation at the controlled broadcast stations, it has application wherever an alarm indicating removal of the parent-station carrier is required.

Those alarm circuits which have appeared in various technical publications are almost without exception of the accessory type, designed to be added to existing receiving equipment. This feature has been found a source of difficulty. If the existing receiver is of broadcast monitoring quality, the receiver expense is too high or there is hesitancy to modify for fear of reducing the quality of operation. If the available receiver is of the home type, the quality is such that it does not meet the stringent requirements of continuous operation.

The design requirements for the requisite receiver are identical to those for any communications receiver. There are, however, several additional requirements that must be met for specific Conelrad operation. For single-unit operation, the receiver-alarm should operate as an integral unit with no external alarm devices required. The unit should operate completely from the power-line supply, without external battery packs or auxiliary units. Con-

ventional tuning and adjustment are essential, with no critical alarm adjustment. The alarm should function positively, either as a result of carrier or internal receiver failure. The entire receiver should require no special components or fabrication facilities. For this reason, the component selection has been restricted to standard replacement types, observing a high safety factor. Cost of the complete unit is less than one hundred dollars, excluding labor.

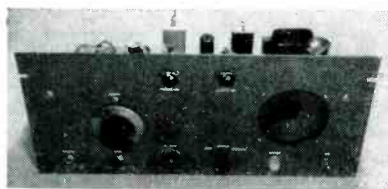

Appearance of receiver as constructed for mounting on standard rack

Although the circuit features could be added to an existing receiver, the advisability of this is questionable since the labor involved is considerable and the ultimate results doubtful.

Receiver Circuit

The block diagram of the receiver is shown in Fig. 1. The basic receiver design is conventional with the exception of the alarm, control and signaling circuits. A number of special modifications are applied to certain stages for this particular design and application, as shown in Fig. 2.

The receiver, as originally conceived, was to be operated in close proximity to a broadcast trans-

mitter. To prevent receiver blocking, a series wave trap across the primary of the antenna transformer is tuned to the transmitter frequency.

To reduce further extraneous pickup, the receiver should be completely shielded, including a chassis bottom plate and a low-impedance shielded antenna transmission line. The antenna requirement is not critical, although the length of the antenna should be as short as possible, consistent with the desired parent-station signal strength and the problem of locally caused receiver blocking.

For flexibility, continuous tuning is employed rather than fixed crystal-controlled frequencies. For simplicity, a 0-1 vernier dial is used instead of the usual 550-1,700 kc scale. This simplification eliminates problems in receiver tracking and at the same time permits use of a small logging chart for those dial settings required for operation. For stability, afc is used, resulting in operational frequency stability comparable to crystal control. After a short initial warmup, the receiver holds frequency over an ambient temperature range of better than 70 deg F.

Two stages of i-f amplification are used for selectivity. The i-f transformers are of the iron-core input type. It is important that only iron-core input transformers be used, because of their under-coupled characteristic. For amplifier stability, a 68,000-ohm resistor shunts the secondary of the first i-f transformer.

Since the maximum gain possible with these transformers is not re-

Built-In Alarm

By **ROBERT E. QUENSTEDT**

General Manager
Radio Communication Service
Washington, D. C.

quired, the overall i-f gain is reduced to an optimum value by low screen voltage on V_4 and V_5 . The selectivity of the i-f strip is narrower than that of a conventional receiver to prevent erratic afc operation during signal fading, station riding and adjacent-channel interference. Although there is an apparent lack of stage decoupling throughout, the receiver is perfectly stable. There can not be, however, a trace of regeneration in any stage if the alarm threshold is to be stable.

The discriminator furnishes the afc and avc control voltages as well as the demodulated audio voltage and the triggering voltage for the thyatron control circuit. The lower portion of the discriminator load resistor may be replaced by a potentiometer if an adjustable alarm threshold is required.

The actual value of the time constant for the alarm triggering voltage, roughly 90 seconds, is determined by R_1 and C_1 . A large time constant is required to prevent triggering during deep fades and momentary carrier interruptions caused by the parent transmitter leaving the air due to automatic

overload recycling or changeover of antenna arrays during the broadcast day.

Alarm Circuit

The alarm triggering circuit is a 2051 triode-connected thyatron operated as a degenerative d-c amplifier across an electromechanical lockup circuit. During normal operation (carrier on), relay K_1 is energized and the green pilot lamp across its contacts illuminated. When the signal is removed, the control bias applied to the thyatron ceases and K_1 drops out due to the increased voltage drop across R_2 . Now K_2 is energized, illuminating a red pilot lamp and removing the 2051 plate voltage. Reset of the alarm is accomplished by de-energizing K_2 with a pushbutton switch. The alarm will not reset

unless there is a carrier present or the cathode of the thyatron is opened.

The aural alarm is supplied by the receiver through its speaker. A regenerative feedback loop between the cathode of the first audio stage and the secondary winding of the output transformer converts the audio stages into an oscillator operating at roughly 400 cps. When K_2 is energized, the loop is closed and simultaneously the cathode circuit of the i-f stages is opened. The presence of the second-detector output and the alarm tone produces an unpleasant garble which is eliminated by this circuit arrangement.

With the circuit parameters specified, the audio oscillator frequency is roughly 400 cps. The secondary connections to the output transformer must be phased by trial and error to determine the regenerative loop.

Preliminary receiver alignment, including the afc circuit, is conventional. The latter may be aligned either by using a sweep generator or the carrier displacement method.

The receiver has been in continuous operation for over 18 months without circuit or component failure, aside from normal tube replacement.

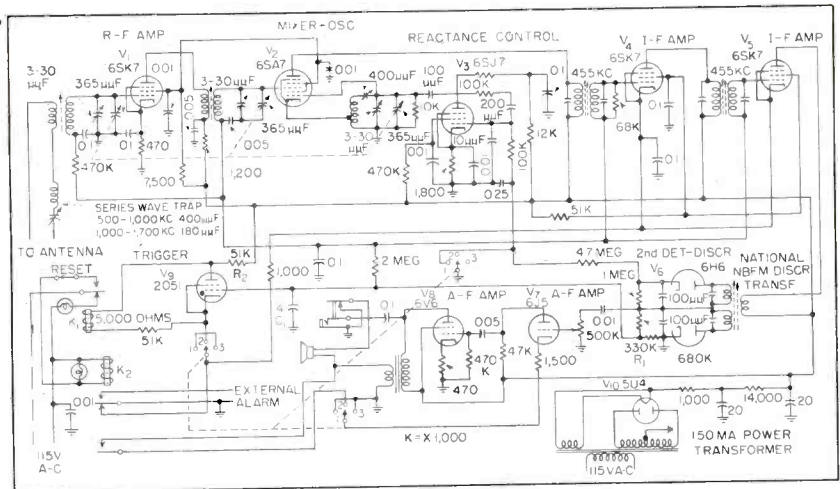

FIG. 2—Complete circuit of receiver. Switch positions are as follows: 1—afc disabled to permit tuning; 2—monitoring, with afc operating, for direct operating check of receiver; 3—normal operating position, in which alarm will sound for carrier or receiver failure as required for Conelrad operation

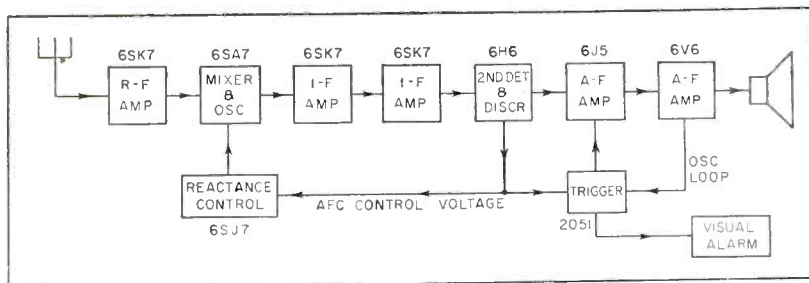

FIG. 1—Block diagram of receiver. Feedback loop from output stage converts audio amplifier to oscillator to produce loudspeaker howl when alarm is triggered

Cascading Transistor

Part XI

By ABRAHAM COBLENZ and HARRY L. OWENS

*Signal Corps Engineering Laboratories
Fort Monmouth, New Jersey*

ALTHOUGH TRANSISTORS are capable of high voltage, current and power gains, particularly in selected methods of connection, many applications require more than one stage of amplification. The transistor is adaptable to cascade connections where its resistive character permits economies in size, weight, power and additional components required.

Possible Arrangements

There are nine possible interconnections for cascading two transistor stages. These may be summarized as follows:

GB \uparrow to \downarrow GB* GE \uparrow to \downarrow GB** CC \downarrow to \downarrow GB*
GB \uparrow to \uparrow GE* GE \uparrow to \uparrow GE* GC \downarrow to \uparrow GE*
GB \uparrow to \uparrow GC* GE \uparrow to \uparrow GC GC \downarrow to \uparrow GC

Of these, not all are practicable. Those marked with a single asterisk cause difficulty by virtue of inherent instability when point-contact transistors are used. While

certain techniques may be applied to stabilize these circuits, the use of such techniques often introduces even more serious difficulties. The double asterisks indicate a combination involving serious impedance mismatch between stages. The arrows indicate high (above 1,000 ohms) or low (below 1,000 ohms) impedances (input when placed at left, output at right).

Equivalent circuits for each configuration appear in the table on the following pages. Coupling capacitors and d-c voltage sources are eliminated, and identical transistors are assumed for reasons of simplicity. Also, the load resistor of the first stage is eliminated since it is invariably much larger than the output impedance of the first stage or the input resistance of the second.

Solution of basic loop equations for the various circuit parameters yields some rather cumbersome ex-

pressions. However, certain simplifications which introduce negligible errors shorten these expressions to the forms shown on the following pages.

General Theorems

It can be shown that for cascaded transistor amplifiers the load impedance of the first stage is the input impedance of the second. Also, the output resistance of the second stage is obtained using the output resistance of the first stage as the generator resistance of the second.

In computing the voltage gain of the second stage, in a cascaded arrangement, the second stage may be considered to operate from a source of zero impedance, if, when computing the gain of the first stage, it is assumed that its load resistance is the input resistance of the second.

In computing power gains of two cascaded transistor stages, when the power gain of the first stage is computed using the input resistance of the second as a load for the first, the power gain of the second stage is obtained by multiplying the ratio of the load resistance to the input resistance of the second stage by the ratio of the squares of the coefficients of the loop II and III currents, respectively (see equivalent circuits) in the Kirchhoff's equation for loop III.

Typical Values

Table I is a summary of the characteristics of typical two-stage transistor amplifiers using typical operating parameters ap-

Previous Articles in this Series

- Part I—Transistors: Theory and Application, Mar. 1953, p 98.
- Part II—Energy Levels in Transistor Electronics, Apr. 1953, p 138.
- Part III—Physical Properties of Electrons in Solids, May 1953, p 162.
- Part IV—Transistor Action in Germanium and Silicon, June 1953, p 166.
- Part V—Point-Contact Transistor Operation, July 1953, p 158.
- Part VI—Operation of Junction Transistors, Aug. 1953, p 156.
- Part VII—Equivalent Transistor Circuits and Equations, Sept. 1953, p 156.
- Part VIII—Small-Signal Transistor Operation, Oct. 1953, p 158.
- Part IX—Grounded Emitter and Collector Circuits, Nov. 1953, p 166.
- Part X—Switching Circuits Using the Transistor, Dec. 1953, p 186.
- PART XI—This completes the series of articles on transistor electronics by Coblenz and Owens. The entire series, plus some additional material prepared by the authors, will be published in book form by the McGraw-Hill Book Company early in 1954.

Amplifier Stages

Circuit equations for practical configurations of transistor amplifiers are presented in convenient table form for reference. Typical values are given to guide designer in picking right combination for a particular application

Table I—Typical Values of Circuit Parameters for Transistors in Cascade

Circuit		R_i (ohms)	R_o (ohms)	VG (1st stage)	VG (2nd stage)	VG_o (over- all)	CG (1st stage)	CG (2nd stage)	CG_o (over- all)	PG (1st stage)	PG (2nd stage)	PG_o (over- all)		
GB to GB	pc	-6	14,560	0.7	133	93	-2.35	1	-2.35	6.78	133	900	U	C
	j	45	1 meg	0.156	990	155	-0.96	0.87	-0.84	0.55	860	472	S	C
GB to GE	pc	165	-19,400	35	-133	-4,650	-6.96	-230	162	73.5	31,100	2,280,000	U	V
	j	1,000	40,000	1.23	1.015	1,210	-0.96	-6.85	6.56	4.36	6,720	29,600	S	C
GB to GC	pc	268	-7,800	45.6	0.998	45.5	-0.017	100	-1.75	2.07	100	207	U	C
	j	245	14,000	535	1	535	-0.56	7.14	-4	788	7.3	5,760	S	C
GE to GB	pc	5	15,300	0.52	133	69	-1.74	1	-1.74	3.54	133	470	S*	C
	j	1,125	1 meg	-1.31	980	-1,290	24.3	0.872	21.2	39.2	845	33,200	S	V
GE to GE	pc	620	-20,400	-73.5	-133	9,720	2.33	-233	-545	304	31,160	9,450,000	U	C
	j	1,175	44,000	-10.22	-985	10,100	23.9	-6.85	-164	302	6,700	2,040,000	S	C
GE to GC	pc	273	122,000	-45.5	1	-45.5	0.017	100	1.74	2.07	100	207	S	V
	j	557	2,300	-86	1	-86	1.27	7.14	9.1	2,000	7.3	14,600	S	V
GC to GB	pc	-10	26,000	-0.292	133	-40	0.76	1	0.76	1.135	133	151	U	V
	j	2,400	26,000	0.75	985	740	-25	0.872	-21.8	12.8	845	10,900	S	C
GC to GE	pc	34,500	-24,000	0.98	-133	-130	-0.975	-230	224	0.054	31,000	1,720	U	V
	j	40,000	82,500	0.975	-985	-958	-24.5	-6.86	168	2.69	6,740	18,100	S	V
GC to GC	pc	15,270	700	0.99	0.994	0.98	0.007	-100	-0.75	0.001	100	0.1	S	C
	j	947,000	50	1	1	1	1.33	-7.14	-9.52	0.002	7.26	0.02	S	C

Abbreviations: pc, point contact; j, junction; U, unstable; S, stable; C, current phase reversal; V, voltage phase reversal.

plied to the equations given. Table I also shows whether a particular configuration is stable or unstable and whether or not a phase shift occurs from input to output.

In general, the values shown in the table must be considered to represent approximations, but these are sufficiently close to be suitable for general design decisions.

Results obtainable in practice will differ from values given for two principal reasons: variation of

r_o with temperature and the use of low values of d-c biasing resistors. The latter errors are unimportant for values under 2,000 ohms. Errors due to changes in r_o can be quite substantial.

The GE to GE connection is capable of the highest orders of power, voltage and current gains, with very satisfactory magnitudes of input and output impedances (for junction transistors). The GE to GB, GB to GE and GC to GE

are runners-up—again, for junction units. The only cascading connection that appears to be stable for point-contact transistors is the GE to GC, but gains are unimpressive and no particular improvement over a single unit is realized by the combination. The GE to GB connection cannot be considered unconditionally stable, since the input resistance (with point-contact units) is five ohms; too close to negative values for comfort.

Tabulation of Circuit Equations Appears on Following Pages →

Table II—Approximate Expressions for Operating Characteristics of

Circuit	Simplified Equivalent Circuit	Approximate Expressions for Input and Output Resistance
Grounded Base to Grounded Base		$R_i \cong r_e + r_b - \frac{r_b (r_b + r_m) (R_L + r_c + r_b)}{(2r_b + r_e + r_c) (R_L + r_c + r_b) - r_b (r_b + r_m)}$ $R_o \cong r_c - \frac{r_b r_m (R_g + r_b + r_e)}{(R_g + r_e + r_b) r_c - r_b r_m}$
Grounded Base to Grounded Emitter		$R_i \cong r_e + r_b - \frac{r_b r_m (R_L + r_e + r_c - r_m)}{(R_L + r_e + r_c - r_m) r_c + r_e r_m}$ $R_o \cong r_c - r_m + \frac{(R_g + r_b + r_e) r_m r_e}{(R_g + r_e + r_b) r_c - r_m r_b}$
Grounded Emitter to Grounded Base		$R_i \cong r_b + r_e + \frac{r_e r_m (R_L + r_c + r_b)}{(r_c - r_m) (R_L + r_c) - r_b r_m}$ $R_o \cong r_c - \frac{(R_g + r_e + r_b) r_m r_b}{(R_g + r_e + r_b) (r_c - r_m) + r_e r_m}$
Grounded Emitter to Grounded Emitter		$R_i \cong r_b + r_e + \frac{r_e r_m (R_L + r_e + r_c - r_m)}{(r_c - r_m) (R_L + r_e + r_c - r_m) + r_e r_m}$ $R_o \cong r_c - r_m + \frac{r_e r_m (R_g + r_b + r_e)}{(R_g + r_b + r_e) (r_c - r_m) + r_e r_m}$
Grounded Emitter to Grounded Collector		$R_i \cong r_e + r_b + \frac{r_e r_m (R_L + r_e + r_c - r_m)}{(2r_c - r_m) (R_L + r_e + r_c - r_m) - r_c - r_m}$ $R_o \cong r_c - r_m - \frac{(R_g + r_b + r_e) (r_c - r_m) r_e}{(R_g + r_b + r_e) (2r_c - r_m + r_e r_m)}$
Grounded Collector to Grounded Emitter		$R_i \cong r_c - \frac{r_c (r_c - r_m) (R_L + r_e + r_c - r_m)}{(R_L + r_e + r_c - r_m) (2r_e + r_b + r_c - r_m) - r_e r_m}$ $R_o = r_c - r_m + \frac{(R_g + r_b + r_e) r_m r_e}{(R_g + r_b + r_e) (2r_e + r_b + r_c - r_m) - r_e (r_c - r_m)}$

Cascaded Transistor Amplifiers (continued from page 159)

Approximate Gain Expressions for Cascaded Stages	Remarks
$VG_o \cong \frac{(r_b + r_m)^2 R_L}{(R_g + r_e + r_b)(R_L + r_b + r_c)(2r_b + r_e + r_c) - r_b(r_b + r_m)(R_L + R_g + 2r_b + r_e + r_c)}$ $PG_o \cong \frac{4 R_g R_L (r_m + r_b)^4}{[R_g + r_e + r_b](R_L + r_b + r_c)(r_e + r_c + 2r_b) - r_b(r_b + r_m)(R_L + r_b + r_c)^2}$ $CG_o = \frac{-(r_b + r_m)^2}{(2r_b + r_e + r_c)(R_L + r_b + r_e) - r_b(r_b + r_m)} = \frac{-r_m^2}{(R_L + r_c)r_e - r_b r_m}$	<p>GB to GB</p> <p>Gains not particularly impressive. Negative R_i for point-contact transistors indicates instability in that connection. For junction units, R_i is lower than for any other configuration.</p>
$VG_o \cong \frac{-r_m^2 R_L}{(R_g + r_e + r_b)[(R_L + r_e + r_c - r_m)r_e + r_e r_m] - r_b r_m (R_L + r_e + r_c - r_m)}$ $CG_o \cong \frac{r_m (R_L + r_e + r_c - r_m)}{r_c (R_L + r_e + r_c - r_m) + r_e r_m}$ $PG_o \cong \frac{4 R_L R_g r_m^2}{(R_g + r_e + r_b)[(R_L + r_e + r_c - r_m)r_e + r_e r_m] - r_b r_m (R_L + r_e + r_c - r_m)^2}$	<p>GB to GE</p> <p>Input resistance is higher than for single GB stage, but negative R_o indicates instability for point-contact units. For junction units, R_i is about 1,000 ohms with fair gain.</p>
$VG_o \cong \frac{-r_m^2 R_L}{(R_L + r_c)[(R_g + r_b + r_e)(r_c - r_m) - r_e r_m]}$ $CG_o \cong \frac{r_m^2}{(r_c - r_m)(R_L + r_c) - r_b r_m}$ $PG_o \cong \frac{4 R_g R_L r_m^4}{\{(R_L + r_c)[(R_g + r_e + r_b)(r_c - r_m) - r_e r_m]\}^2}$	<p>GE to GB</p> <p>Both R_i and R_o are positive for point-contact transistors. This configuration offers high voltage and power gains using junction units. Input resistance may be negative for point-contact units.</p>
$VG_o \cong \frac{r_m^2 R_L}{(R_g + r_b + r_e)[(r_c - r_m)(R_L + r_e + r_c - r_m) - r_e r_m] + r_e r_m (R_L + r_e + r_c - r_m)}$ $CG_o \cong \frac{-r_m^2}{(r_c - r_m)(R_L + r_e + r_c - r_m) + r_e r_m}$ $PG_o \cong \frac{4 R_g R_L r_m^4}{\{(R_g + r_b + r_e)[(r_c - r_m)(R_L + r_e + r_c - r_m) - r_e r_m] + (R_L + r_e + r_c - r_m)r_e r_m\}^2}$	<p>GE to GE</p> <p>Best arrangement. Both R_i and R_o above 1,000 ohms. Offers high voltage, current and power gains for junction units. Requires stabilizing resistance for use with point-contact transistors.</p>
$VG_o \cong \frac{-r_e r_m R_L}{(R_g + r_b + r_e)[(2r_c - r_m)(R_L + r_e + r_c - r_m) - r_e(r_c - r_m)] + r_e r_m (R_L + r_e + r_c - r_m)}$ $CG_o \cong \frac{r_e r_m}{(2r_c - r_m)(R_L + r_e + r_c - r_m) - r_e(r_c - r_m)}$ $PG_o = \frac{4 R_g R_L r_m^2 r_c^2}{\{(R_g + r_b + r_e)[(2r_c - r_m)(R_L + r_e + r_c - r_m) - r_e(r_c - r_m)] + r_e r_m (R_L + r_e + r_c - r_m)\}^2}$	<p>GE to GC</p> <p>Stable with point-contact transistors. Gains available are limited, but unconditional stability warrants use in many applications where gain requirements are not too severe.</p>
$VG_o = \frac{-r_e r_m R_L}{(R_g + r_b + r_e)[(2r_e + r_b + r_c - r_m)(R_L + r_e + r_c - r_m) + r_e r_m] - r_c(r_c - r_m)(R_L + r_e + r_c - r_m)}$ $CG_o \cong \frac{r_e r_m}{(2r_e + r_b + r_c - r_m)(R_L + r_e + r_c - r_m) + r_e r_m}$ $PG_o = \frac{4 R_g R_L r_c^2 r_m^2}{\{(R_g + r_b + r_e)[(2r_e + r_b + r_c - r_m)(R_L + r_e + r_c - r_m) + r_e r_m] - r_c(r_c - r_m)(R_L + r_e + r_c - r_m)\}^2}$	<p>GC to GE</p> <p>Third best arrangement. Very high input impedance offers advantages when used with crystal microphones, pickups and other high-impedance devices. Good voltage and power gains available.</p>

Uncompensated

Compensated

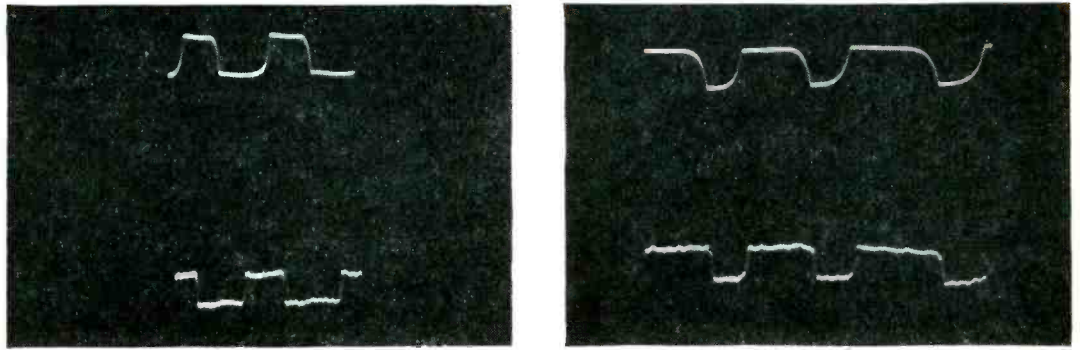

Oscillograms illustrate improvement in response to square-wave inputs at 60, 180, 240 and 300-cps repetition

Negative Inductance Cuts

Magnetic-amplifier lag due to inductance of control winding is completely eliminated by introducing electronically-produced negative inductance in control circuit to balance control-winding inductance. Added tube may be replaced by transistor

By **GEORGE M. ETTINGER***

London, England

BANDWIDTH LIMITATION, or slow response, of magnetic amplifiers has two causes: the time constant of the control circuits, and the relatively low excitation frequencies dictated by eddy-current effects in the magnetic cores. In magnetic amplifiers for servomechanisms and audio-frequency systems, the effect

of control-circuit time constant usually predominates.

Several methods have been developed^{1, 2, 3} for reducing magnetic-amplifier time constant. The circuit here described employs a negative-inductance arrangement by which the effect of control-circuit inductance may be reduced to any desired extent, or eliminated entirely. This method of compensation causes substantially no loss of magnetic-amplifier sensitivity.

Principle of Operation

An uncompensated magnetic-amplifier circuit is shown in Fig. 1A. Given a control-circuit inductance L_c henrys, and a control-circuit resistance R_c ohms, the time constant is L_c/R_c seconds and the pulse rise time is $2.3 L_c/R_c$. Figure 1B shows the same circuit with the addition of a negative inductance of magnitude $-L_c$ henrys. The control-circuit time constant is now $(L_c - L_c)/R_c$ seconds, or zero. The bandwidth of the compensated magnetic amplifier is limited only by the excitation frequency.

Figure 2 shows a circuit constructed to test the negative-inductance

compensation method. Square voltage pulses at various repetition rates are injected into the control circuit of a magnetic amplifier through a low resistance. The current pulses are displayed on an oscilloscope. A switch is provided to make the negative inductance inoperative, so compensated and uncompensated response can be compared.

The results are shown in the oscillograms. The upper set of traces shows the uncompensated response; a pulse rise time of 13 milliseconds is found. The lower traces show the compensated response. The pulse rise time, in this case, is only 2 milliseconds. Comparison of the upper and lower pulse trains shows that there has been negligible loss of sensitivity.

The circuit of Fig. 2 was tested with sine-wave input from a high-impedance source. Curve A Fig. 3 shows the variation of voltage drop across the circuit when no compensation is provided. The voltage rises at the rate of 6 db per

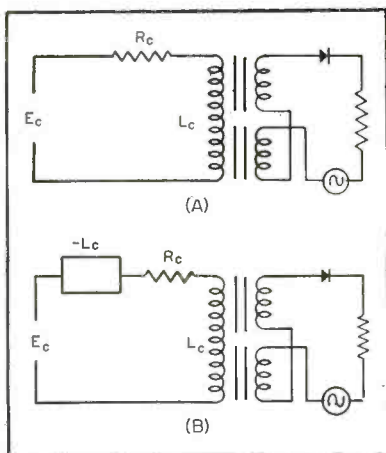
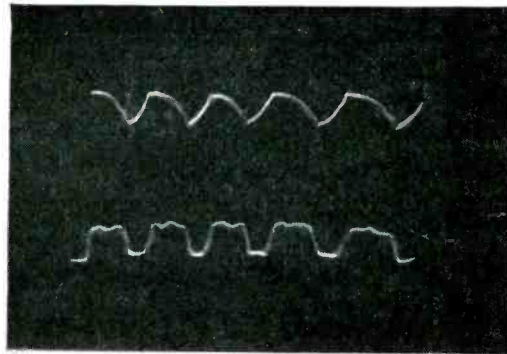
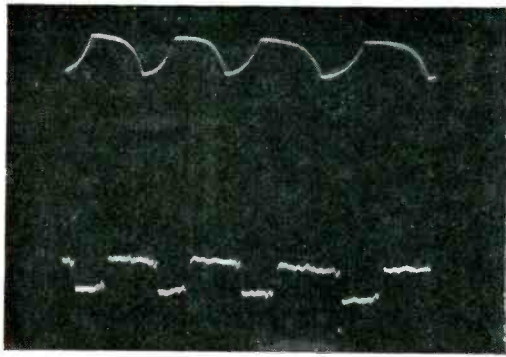

FIG. 1—Basic magnetic-amplifier circuits with and without compensation

* Work described in this article was done while author was with Standard Electronic Research Corp., New York, N. Y.



Uncompensated

Compensated

rates achieved by introduction of compensating negative inductance in control circuit of magnetic amplifier

Magnetic-Amplifier Lag

octave from a break point at 25 cps. Curve *B* shows performance with complete cancellation by means of a negative inductance. There is no increase of voltage drop up to 2 kc; above this frequency, the response of the experimental negative inductance falls off. Curve *C* shows the response of the circuit when the negative inductance is set to a magnitude approximately twice as great as that of the positive inductance L_c . In this case, the amplitude of the voltage is similar to that obtained without compensation, but the phase is reversed. Therefore the voltage across the negative inductance lags the current by almost ninety degrees.

Negative Inductance

Details of the negative-inductance circuit are given in Fig. 4. It comprises a 10-ohm series resistance across which is developed a voltage proportional to current i flowing in the circuit, a simple vacuum-tube amplifier and an iron-core mutual inductance. If the mutual conductance of the vacuum tube is G , and the mutual inductance has a magnitude M henrys, then the voltage across its secondary is Md/dt (iRG) or $MGR di/dt$. The mutual inductance is connected to have a negative sign, so that the secondary voltage becomes $-MGR di/dt$, which may be written

$-L'di/dt$. The circuit behaves as a negative inductance of magnitude $-L'$ henrys.

The magnitude of the negative inductance depends on the mutual conductance of the tube. A simple method of varying the negative inductance is available by varying the bias on one of the electrodes of the tube. It is an important feature of the negative-inductance compensating circuit that it does not affect the d-c or very-low-frequency performance of a magnetic amplifier or other system in which it is connected. Thus, the d-c stability of a magnetic amplifier is not reduced in any way by the negative-inductance compensation.

The negative inductance described may be used to increase the bandwidth of any inductive device. Besides magnetic amplifiers, there may be considered systems employing electromechanical relays or electroacoustical transducers.

Transistors may ultimately replace the vacuum tube in the negative inductance circuit.

Thanks are due to F. Fua, Standard Electronic Research Corporation, for much helpful advice and criticism.

BIBLIOGRAPHY

- (1) R. A. Ramey, *AIEE Tech. Paper* 51-217, 1951.
- (2) Sidney B. Cohen, Analysis and Design of Self-Saturable Magnetic Amplifiers, *Proc IRE*, p 1,009, Sept. 1951.
- (3) G. M. Ettinger, "Magnetic Amplifiers," Chapter VI, John Wiley and Sons, Inc., 1953.

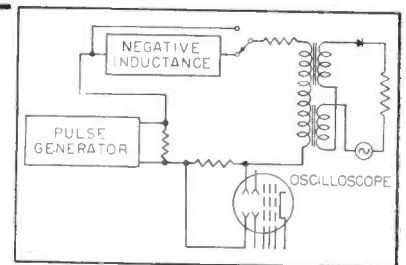

FIG. 2—Test circuit for negative-inductance compensation system

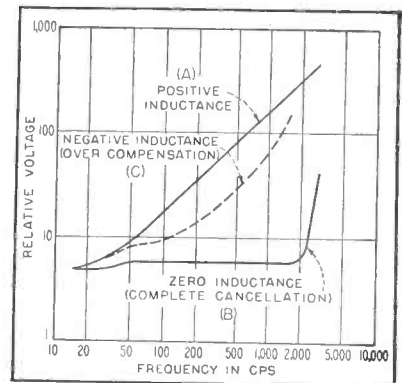

FIG. 3—Curves show performance of negative-inductance circuit with sine-wave input to magnetic amplifier

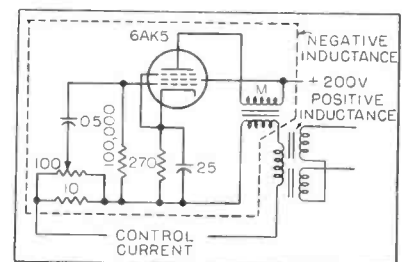

FIG. 4—Details of negative-inductance circuit; 100-ohm potentiometer varies value of negative inductance

Phantastron Computes

Phantastron divider computes width ratio of two pulses occurring simultaneously in separate channels. Developed for an experimental radar system, the computer can measure the ratio of any two quantities from which a voltage signal can be obtained

By L. D. FINDLEY

Midwest Research Institute
Kansas City, Mo.

IN AN EXPERIMENTAL radar system, it was necessary to determine the ratio of the widths of pulses occurring simultaneously in two channels. The pulses had a repetition rate of about 20 pps and could vary in width over a 10-to-1 range. Since the ratio of widths of one pulse pair bore no relation to the ratios of following or preceding pairs, the computer had to determine a pulse-width ratio and then clear itself in readiness for the succeeding pulse pair.

The pulse-width ratio computer developed uses a phantastron circuit as the divider element. It computes the ratio for two simultaneously appearing pulses whose durations range between 0.1 and 1 millisecond; its output is readily converted to digital form for recording and the pulses may have repetition rates up to 20 pps. Computation accuracy is about two to three percent.

Other Applications

The computer can easily be converted to more general use. Suggested uses include: rapid measurement of phase shift or delay in a circuit in which the signal frequency can vary over wide limits; setting two signals to a predetermined ratio of amplitude, frequency or phase; and measuring the ratio of any two quantities from which voltage signals, albeit transient ones, may be obtained.

Phantastron Divider

The principal element of the computer is a phantastron,¹ the basic circuit of which is shown in

Fig. 1. The circuit can be described more completely as an externally gated Miller integrator. Operation of the phantastron is covered in detail in the cited reference. The duration, Δt , of the positive pulse of screen voltage is given by

$$\Delta t = R_1 C_1 (E'_1 - e_2 - e_1) / (E'_2 + e_2) \quad (1)$$

The value of e_2 corresponds approximately to the cutoff voltage of V_3 , and is dependent to a large extent upon the voltage at which the suppressor of V_3 is clamped during the discharge of C . If the suppressor can be clamped at zero bias or, preferably, some slightly positive bias during the discharge of C , the value of e_2 will remain fairly constant for wide variations of plate voltage and E'_1 .

The trailing edge of the positive screen pulse is not as abrupt as would be desired. However, if the portion of the pulse between two fixed voltage levels is selected by clipping circuits and amplified, a reasonably square pulse will result. The duration of this amplified portion of the pulse corresponds to the time that the screen voltage is greater than the lower clipping level. Since the suppressor voltage is clamped at a given bias and the control voltage is held constant by feedback, the plate voltage corresponding to a screen voltage equal to the lower clipping level is fixed in value. This value of plate voltage is e_1 in Eq. 1.

If the values of e_1 and e_2 are fixed, Δt in Eq. 1 will then be a function only of E'_1 and E'_2 , and e_1 and e_2 can be introduced as bias voltages on the inputs to the phantastron

divider circuit.

Assume that a positive voltage E_1 is applied in place of E'_1 , and is based on a bias voltage equal to $(e_1 + e_2)$. Also, assume another positive voltage E_2 replacing E'_2 and based on a bias voltage equal to e_2 . Then

$$E'_1 = E_1 + e_1 + e_2 \quad (2)$$

and

$$E'_2 = E_2 - e_2 \quad (3)$$

Equation 1 will then reduce to

$$\Delta t = R_1 C_1 (E_1 / E_2) \quad (4)$$

Therefore, by proper d-c bias at the inputs, the duration of the phantastron's screen-voltage pulse can be made proportional to the ratio of two input voltages.

D-C Voltage Ratio Computer

As the first step in design, a computer circuit was built and checked on d-c voltage inputs. The circuit is given in Fig. 2. It consists of two input cathode followers V_1 and V_2 , a phantastron divider circuit V_3 , V_4 and V_5 , a clipper and amplifier V_6 , a suppressor enabling circuit V_7 and V_{8A} and an output circuit V_{8B} and V_9 .

The input cathode followers serve the dual purpose of furnishing high-impedance inputs to the computer and of supplying proper bias levels. These bias values can be obtained by the choice of operating points for the constant-current triodes, V_{1B} and V_{2B} . For the circuit values shown in Fig. 2, it was found experimentally that the plates of V_{1B} and V_{2B} should rest at about +4.0 and -4.7 volts, respectively, when the input voltages to the

Pulse-Width Ratios

triode grids are equal to zero.

The phantastron divider circuit is essentially the same as shown in Fig. 1. A constant-current triode V_{1b} was added to increase the range of constant-gain operation of the cathode follower V_{1a} . The diode V_{2b} was added to provide a low-impedance path for recharging C at the end of the computing cycle.

Dual triode V_3 is a limiting clipper circuit for marking a fixed voltage level on the trailing edge of the phantastron screen-voltage pulse. When the pulse decreases on its trailing edge to a value where the first section of V_3 becomes unsaturated, the positive feedback across the tube causes the plate voltage of the second section to decrease rapidly. This negative transition triggers the control multivibrator V_7 and disables the suppressor of the phantastron. The point at which the trailing edge is marked is determined by the bias voltage across R_1 .

Control bias for the suppressor of the phantastron is supplied by the bistable multivibrator V_7 through a cathode follower V_{8a} . The cycle of the computer is initiated by a negative trigger pulse into this multivibrator. Until this pulse is applied, the suppressor is held at about -20 volts and afterwards at about $+5$ volts. The positive bias on the phantastron suppressor is maintained until the disabling trigger pulse from V_6 is applied to the multivibrator. The suppressor voltage is thus a square-wave replica of the screen-voltage pulse and is used as the output pulse of the divider.

Conversion of the positive output pulse to digital form is accomplished by applying it to the suppressor of a 6AS6 gate tube V_6 . Short pulses of fixed repetition rate are constantly applied to the control grid of this tube so the number of pulses appearing at the plate is a measure of the duration of the enabling pulse on the suppressor.

The pulses at the plate can be counted with a suitable counter, and the count recorded. By adjusting the value of R_2 and the repetition rate of the pulses on the control grid of V_6 , any desired calibration count representing unity or other chosen ratio of the input voltages can be obtained. For the values of C , R_2 , and R_3 shown in Fig. 2, the output pulse for equal input voltages can be varied from about 1.6 to 2.1 milliseconds by adjusting R_3 .

Circuit Performance

The circuit shown in Fig. 2 was checked experimentally using various values of d-c voltages E_1 and E_2 . The pulses applied at the control grid of V_6 had a repetition rate of about 200 kc and the output pulses at the plate were counted with a four-stage decade counter. Values from 10 to 180 volts were used for E_1 , and from 25 to 250 volts for E_2 . These voltages were measured to an accuracy of ± 0.5 percent. The results obtained using this circuit to calculate the ratios for many values of E_1 and E_2 were then analyzed to determine the accuracy of computation.

The value of the pulse width obtained when $E_1 = E_2 = 150$ volts was used as the calibration point. This value was called Δt_{cal} . The measured values of pulse widths

Δt_{meas} obtained for the various ratios of E_1 and E_2 were then compared with an expected value, Δt , given by

$$\Delta t_0 = \Delta t_{cal} (E_1/E_2) \quad (5)$$

The results showed that the standard deviation of the function

$$\xi = \Delta t_{meas}/\Delta t_0 \quad (6)$$

from unity was about 0.017, or the probable error was about ± 0.011 .

This means that approximately 68 percent of the pulse widths measured were within ± 1.7 percent of the value that would have been obtained if the relation between the input voltage ratio (E_1/E_2) and the pulse width were linear. This accuracy was adequate for the intended use of the computer. The operation of the circuit for values of E_1 and E_2 outside the ranges of 10 to 180 volts and 25 to 250 volts, respectively, was not satisfactory. The deviation from linearity outside these ranges became several percent.

The sampling rate of this computer is dependent upon the output pulse duration and the recharging time of C . Because of the low-impedance charging path through the diode V_{2b} the circuit is ready for another computing cycle within a fraction of a millisecond after the end of the output pulse.

The circuit shown in Fig. 2 is

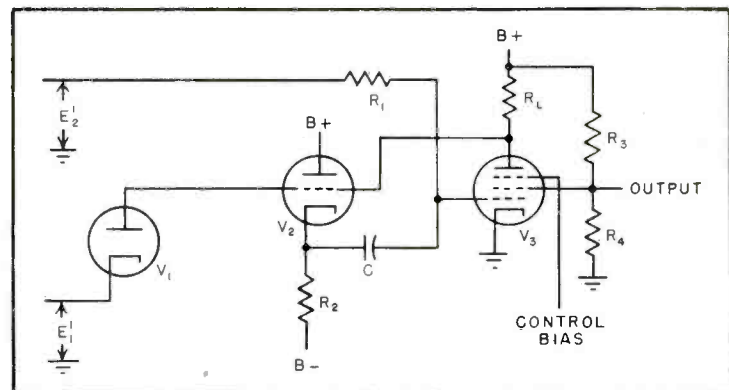

FIG. 1—Basic phantastron circuit

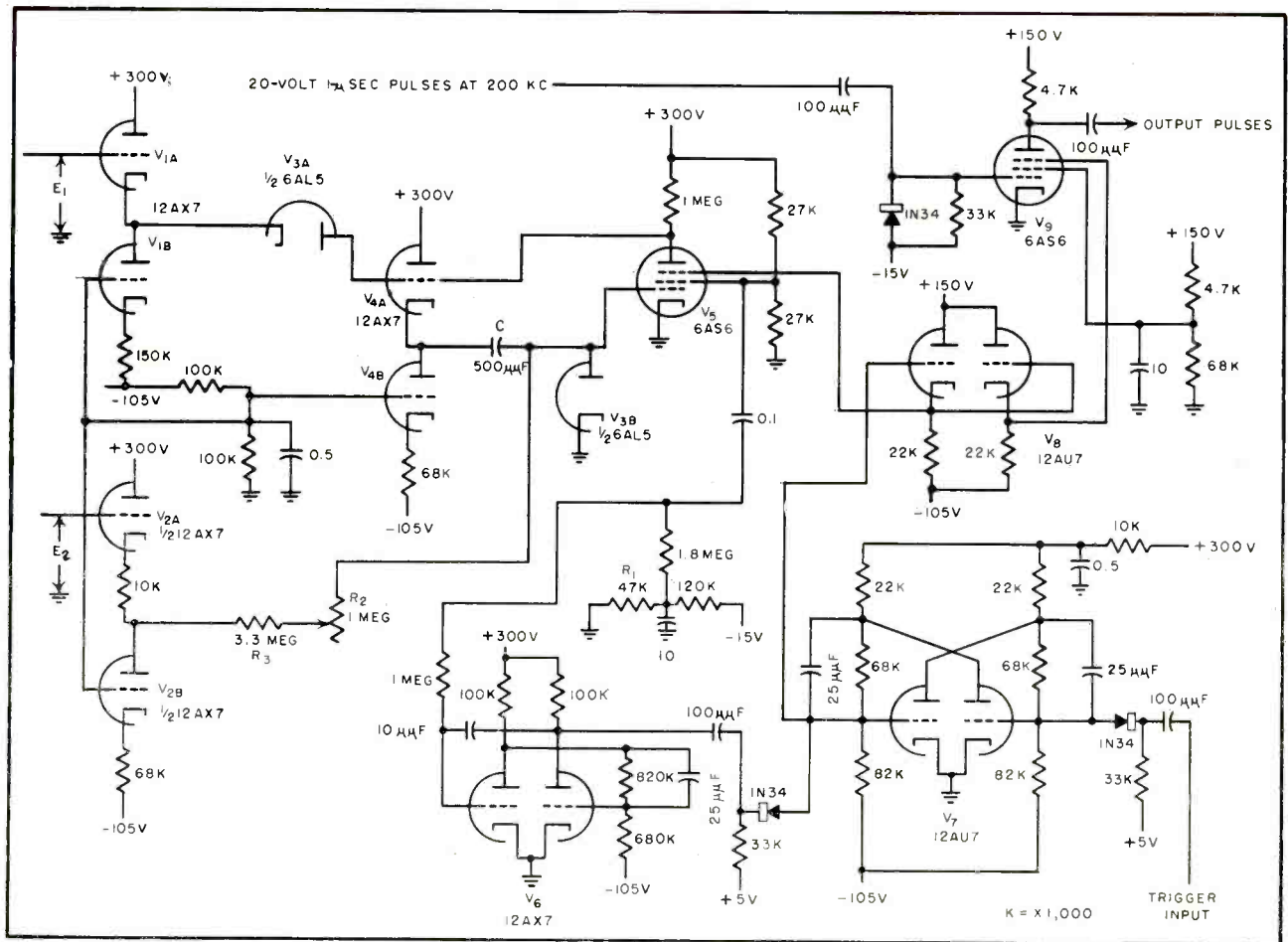

FIG. 2—Ratio computer for d-c voltages uses phantatron divider

primarily for use with direct voltages applied as E_1 and E_2 . However, within certain limitations, the input voltages can vary during the computing cycle. Voltage E_1 can increase at any rate during the cycle, but must not decrease faster than the discharge of C . If it decreases too fast, C will be partially discharged through diode V_{3A} . Voltage E_2 cannot vary to any appreciable extent during the computing cycle without disturbing the accuracy of the computation. Between cycles, the only limitation is that E_1 must not vary faster than C can charge or discharge.

Pulse-Width Ratio Computer

The circuit of Fig. 2 was adapted for the determination of pulse-width ratios by preceding it with circuits for converting pulse widths into stored direct voltages. The conversion was accomplished by sawtooth generators followed by rectifiers and capacitors to store

the peak values of the generated waves.

A schematic diagram of a complete pulse-width ratio computer is given in Fig. 3. With the component values given, input pulse 1 may have any duration between 0.045 and 0.9 millisecond; pulse 2 may vary from 0.1 to 1.0 millisecond. The two extremes in the output pulse count will be of the order of 16 and 3,200, their actual value being dependent upon the setting of the variable resistor in the phantatron circuit. Over this range of input-pulse durations, the computing accuracy of the circuit is of the order of ± 2.5 percent.

Tubes V_1 , V_{2A} , V_{3A} and V_{4A} form the bootstrap sawtooth generator for input pulse 1 and V_{2B} , V_{3B} , V_5 and V_{6A} serve the same purpose for pulse 2. The two generating circuits are identical; the negative input pulses open switch tubes V_{2A} and V_{2B} and positive waveforms are generated whose durations corre-

spond to that of their respective input pulses. The slope of each wave is about 200 volts per millisecond and the calculated maximum deviation from linearity is about one percent for a 200-volt sawtooth wave. The waves are rectified by V_{4B} and V_{6B} and the peak values stored in the two 0.01- μ f, 1-percent capacitors. Tubes V_{7A} and V_{7B} serve as discharging switches across these capacitors.

The switch-control multivibrator V_6 is triggered from the first leading edge of the two pulses through a diode mixing circuit and trigger tube V_{8A} . The output of the monostable multivibrator is a negative pulse to the switch tubes V_{7A} and V_{7B} opening the discharge circuit across the storage capacitors. The discharge circuits must be opened long enough for the stored voltages to be held for the duration of the computing cycle. In Fig. 3, the period of the multivibrator is about 35 milliseconds, which is sufficient

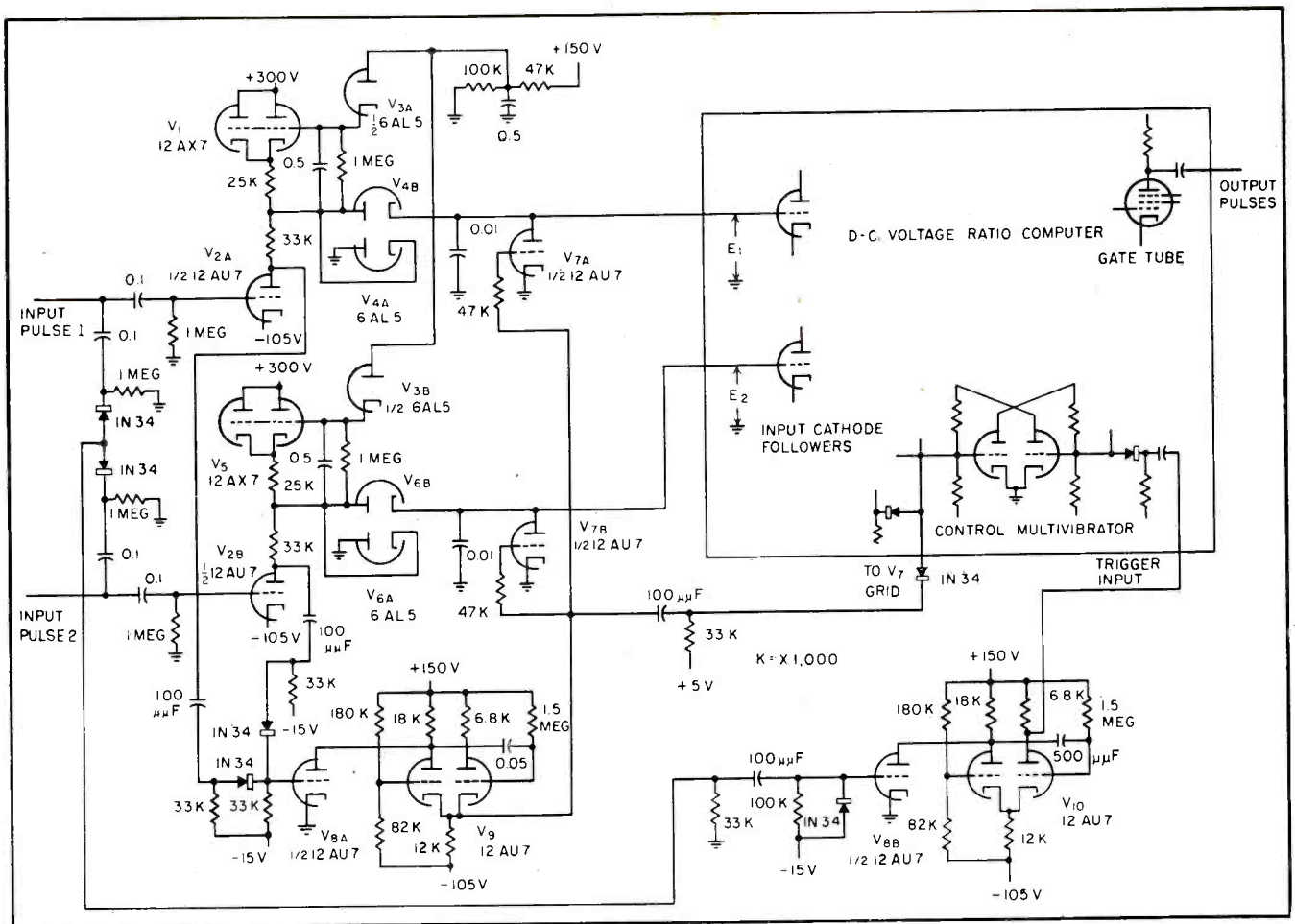

FIG. 3—Complete pulse-width ratio computer includes sawtooth generators to convert pulse widths to d-c voltages

for all expected ratios of input-pulse duration.

Increasing Accuracy

More accurate results were obtained when the start of the computing cycle of the phantastron divider was delayed slightly after storing the peak voltages of the sawtooth waves. The delay multivibrator V_{10} with a period of about 250 microseconds supplies the delayed trigger pulse for the phantastron circuit. It is triggered from the last trailing edge of the input pulses by a diode mixing circuit and trigger tube V_{8B} . The design of this mixing circuit makes it necessary that the pulses overlap.

An extra triggering pulse is supplied to the suppressor-control multivibrator of the direct voltage ratio computer from the output of V_6 . This is a safety trigger pulse to prevent the computer from missing more than one sampling cycle.

If the screen pulse from the

phantastron circuit fails to disable its suppressor through the control multivibrator, the output gate remains open and following input pulses are not correctly handled. This may occur if either or both input pulses are too narrow. However, the safety trigger pulse will disable the suppressor at the same time the storage capacitors are discharged. Pulses whose durations are outside the limits of computer capabilities may give erroneous answers, but the safety trigger will prevent interference with the computation for succeeding pulse pairs.

The sampling rate of this computer is determined by the period of the switch-control multivibrator V_6 . With a period of about 35 milliseconds as in the circuit of Fig. 3, a sampling rate of 20 computations per second is easily obtained.

The computer will compute the ratio of two simultaneously appearing pulses the durations of which are in the order of 0.1 to 1 milli-

second. The output is in a form that is readily converted to digital form for recording and the pulses may have a repetition rate up to 20 cps. Accuracy of computation is about two to three percent but by means of more complex circuits it could probably be increased by a significant factor.

Although designed for a special purpose, the computer may easily be adapted for more general use. Suggested uses include: rapid and direct measurement of phase shift or delay and setting two signals to a predetermined ratio of amplitude frequency or phase.

Acknowledgement is gratefully given to R. R. Hancox and H. L. Stout, under whose supervision this work was performed, for their many comments and criticisms.

REFERENCE

- (1) B. Chance, V. Hughes, E. F. Mac-Nichol, D. Sayre and F. C. Williams, "Waveforms", MIT Rad Lab Series, Vol. 19, 1st ed., p 195, McGraw-Hill Book Co., Inc., New York, 1949.

Stable Power Supplies

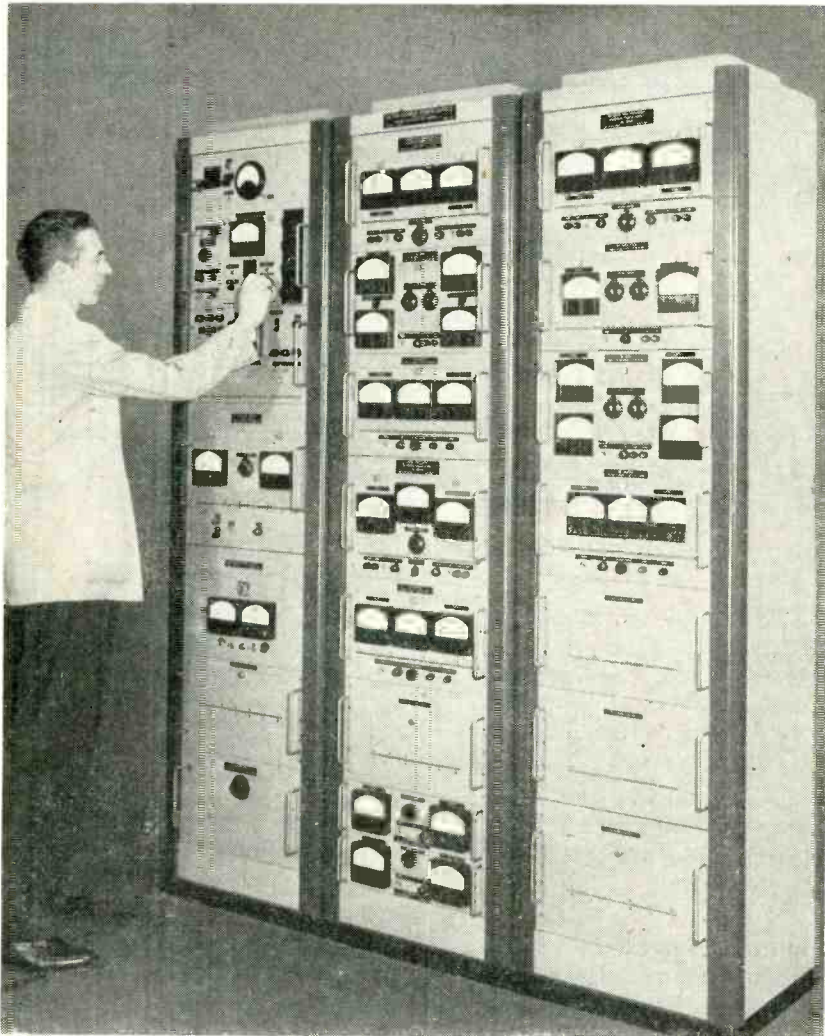

Ultrastable power supplies are mounted in three racks. Rack at left holds general-purpose supply, heater supply and stability monitor. Center rack contains supplies for superhigh-frequency and local oscillators, and right unit houses supplies for extremely-high-frequency klystrons used as frequency standards

PRIMARY and secondary standards of electrical quantities at microwave frequencies require power sources of very high stability. The power-supply system described in this article has been designed and built for the microwave standards section of the National Bureau of Standards to provide highly stabilized voltages for the operation of superhigh-frequency, extremely-high-frequency and local-oscillator klystron tubes. Application and specifications of the various supplies in the system are given in Table I.

Except for the low-voltage heater supplies, all of the electronically

regulated units use a degenerative-type regulating circuit¹ shown in block diagram, Fig. 1.

A bleeder sampling circuit samples a portion of the output voltage equal to the reference voltage. This bleeder is a linear network of special low-temperature-coefficient wire-wound resistors. In the variable-voltage supplies the voltage control is part of the sampling circuit and here again the wire used in the 10-turn potentiometer has a low temperature coefficient, on the order of 0.002 percent.

To keep the heat rise of the resistors a minimum, the current in the sampling circuit is only about

By **WILLIAM P. ERNST**

*Project Engineer
Chatham Electronics Corp.
Livingston, N. J.*

10 percent of the maximum allowed by the resistor power rating.

To provide stability and reliability, mercury-cell batteries are used as a reference source. These batteries, Mallory type-IR cells, are made into 100-volt packs. These packs show a voltage change over a 10-minute period of about 18 parts per million under a current drain of 500 microamperes. Under actual operating conditions the reference-battery drain is 1 microampere, resulting in a lower drift.

To keep temperature effects a minimum, all reference batteries are stored in a thermally insulated box at the bottom of the relay rack.

Comparison Circuits

The difference between the sample voltage E_s and the reference voltage, E_r is applied to the comparison amplifiers. Any change in the sample voltage will be amplified and fed to the control element, which will oppose the initial change.

The comparison circuit is divided into two branches, the d-c amplifier and the modulator comparison circuit. The circuits of these units are shown in Fig. 2.

A two-stage balanced d-c amplifier using 12AX7 twin triodes provides high gain and low drift. Plate current of a balanced amplifier is least affected by changes in filament voltage², particularly if the plate current is kept small. Potentiometer R_3 in the common cathode lead of V_1 is used to set the operating point to provide maximum regulation and minimum hum. To keep the plates of V_1 close to balance, the plate load resistors are 1-percent carbon-film resistors. The cathode of V_2 is maintained at grid potential by the voltage across cathode resistor R_4 .

The modulator comparison circuit³ consists of a 60-cycle chopper

for Microwave Standards

Driftless comparison circuits and battery reference sources cover a supply range from 6.3 to 3,000 volts for klystron frequency standards. Voltage stability is on the order of 20 parts in a million, comparable to battery operation

and a two-stage a-c amplifier. This circuit corrects for any drift in the balanced d-c amplifier due to heater-voltage variation and provides fast response to correct for line or load changes.

The inputs to the d-c and modulator comparison circuits are in parallel and any change in E , is fed simultaneously to both circuits. This voltage difference is applied to filter R_3C_2 that isolates the input to the d-c amplifier from the chopper signal. Series resistor R_1 limits the current drawn from the reference batteries for large error voltages. The chopper converts any error voltage into a square wave, which is applied to the input of a-c amplifier V_3 .

After two stages of amplification, the square-wave signal is fed back to the other pole on the chopper and rectified. This half-wave rectified pulse is changed to a d-c voltage by the two-stage filter R_3C_1 and R_3C_3 . The amplified error voltage is 180 deg out of phase with the initial error voltage and is applied to the opposite grid of V_1 . Thus, for any error voltage, the plates of V_1 will swing in opposite directions and the grids of V_2 will follow the same voltage swing.

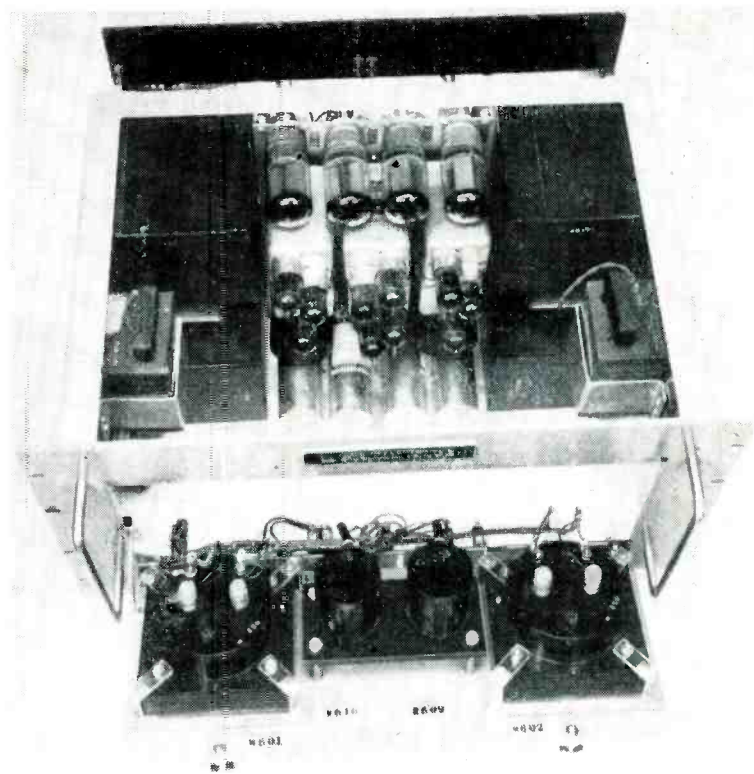

Components mounted on vertical U-shaped chassis are reached through front-panel doors. Vertical chassis makes tubes and wiring readily accessible

This swing in voltage is added in the common cathode resistor R_1 of V_2 . Capacitor C_0 lowers the frequency response of the a-c amplifier to prevent instability.

Filters

The time constant of the filter network R_3C_1 , R_3C_3 must be low enough to permit rapid response to large error voltages. Normally this time constant is approximately ten times the time constant of R_3C_2 . The d-c gain of the modulator comparison circuit is approximately 10, and it is by this factor that the drift is reduced. Overall gain of the combination is equal to the product of the separate gains, which is approximately 15,000.

The control element is essentially

a variable impedance. In most of the supplies a triode-connected 5881 beam-power amplifier is used.

In those supplies having wide-range voltage variation, 400 to 1,500 volts and 1,500 to 3,500 volts, a system must be incorporated to hold the voltage across the control element within its operating range. This is accomplished by varying the unregulated d-c voltage as well as the output voltage. A variable transformer in the primary circuit of the plate transformer is ganged to the output-voltage control through an appropriate gear train, to maintain a constant voltage across the control element over the entire voltage range.

Figure 3 shows the schematic diagram of the regulated heater

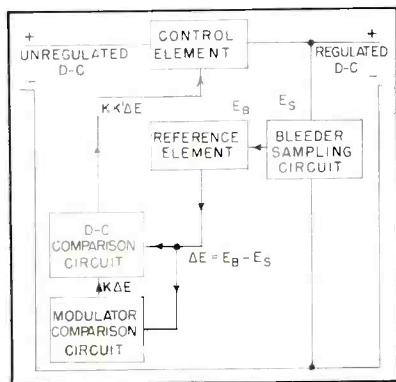

FIG. 1—Block diagram of basic regulating circuit. Modulator comparison circuit corrects for drift in d-c comparator

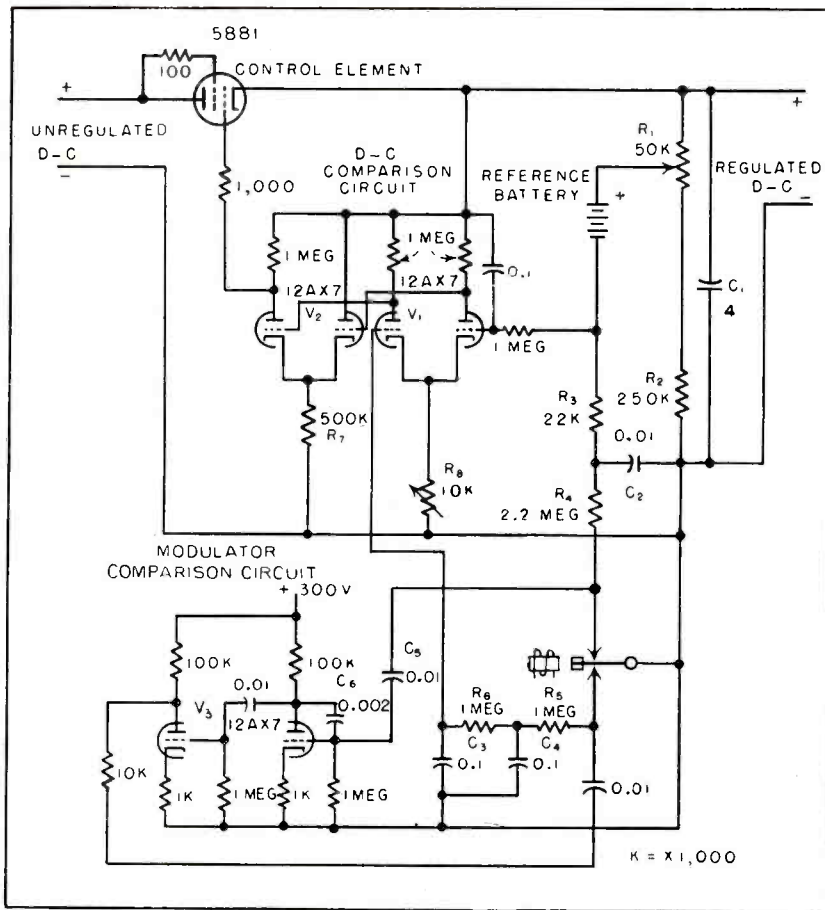
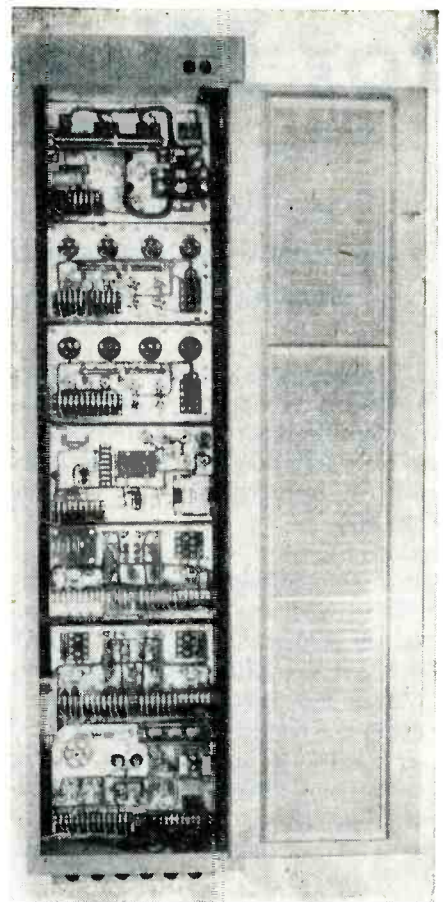

FIG. 2—Circuit of d-c amplifier and modulator comparison circuits. Number of paralleled control-element tubes used depends on current requirements



Wiring of power supplies is accessible through the back of the cabinets

Table I—Specifications for Ultrastable Power Supplies

Power Supply	Unit	D-C output voltage	Output current	Type	Maximum output impedance 0 to 50 kc	Maximum ripple and noise	Line-voltage* regulation	Static stability drift in 10 min
Superhigh-frequency klystron	beam	400 to 1,500 v	180 ma	electronic	2.5 ohms	2 mv	0.002%	20 mv
	reflector	0 to 1,100 v	0.05 ma	battery
	heater	dual 0-300 v 6.3 to 7.3 v	30 ma 3 amps	electronic electronic	0.5 ohm 0.03 ohm	0.5 mv 10 mv	0.002% 0.03%	5 mv 1 mv
Extremely-high-frequency klystron	beam	1,500 to 3,500 v	100 ma	electronic	10 ohms	3 mv	0.005%	30 mv
	reflector	dual 0 to 400 v	10 ma	electronic	0.5 ohm	0.5 mv	0.005%	10 mv
	grid	dual 0 to 400 v	10 ma	electronic	0.5 ohm	0.5 mv	0.005%	10 mv
	heater	6.3 to 7.3 v	3 amps	electronic	0.03 ohm	10 mv	0.03%	1 mv
Local-oscillator klystron	beam	200 to 400 v	120 ma	electronic	0.5 ohm	0.5 mv	0.002%	5 mv
	reflector	0 to 800 v	0.05 ma	battery
	heater	6.3 to 7.3 v	3 amps	electronic	0.03 ohm	10 mv	0.03%	1 mv
General purpose	300 v	500 ma	electronic	0.5 ohm	0.5 mv	0.002%	5 mv

* Maximum drift that will occur during line-voltage changes from 110 to 120 volts.

supply using a saturable reactor as a control element. The reactance of the reactor depends upon the magnitude of d-c current through the control winding in the plate circuit of the 6AS7 triode. The plate

current of this tube is controlled by a d-c amplifier similar to those used in the high-voltage supplies. This d-c amplifier monitors the output of the heater supply through a reference battery. Any tendency of the

heater voltage to change will be counteracted by the saturable reactor.

If the output of the heater supply tends to decrease due to an increased load, then through the

reference battery, this change appears as a negative voltage on the grid of the first d-c amplifier. The action of the amplifier will make the grid of the 6AS7 triode go positive and increase plate current. Since the d-c control winding of the reactor is in the plate circuit of the 6AS7, this increase in current will decrease the reactance of the saturable reactor.

The reactor is placed in the primary circuit of the heater supply, controlling the voltage applied to the low-voltage transformer. Hence, when the reactance of the reactor is decreased, a higher voltage is applied to compensate for the initial decrease of the low-voltage output.

A self-saturating rectifier prevents the a-c current through the reactor from reversing and opposing the flux set up by the d-c current in the control winding. This feature permits operation of the reactor over a wider range of control.

Drift Measurements

A null-balance method of measuring the drift voltage is incorporated in the system for monitoring any of the supplies. Figure 4 shows a block diagram of this setup.

The output of the power supply under test is compared with a bank of reference batteries through a resistive dividing network. The resistance of the balance network can be varied so that a 10-turn fine-balance control has a 100-millivolt-per-turn sensitivity for any applied voltage up to 1,500 volts. The difference or drift voltage is measured by an electronic zero-center millivoltmeter with a sensitivity of 5-millivolts per scale division.

The 1-megohm input impedance of the meter circuit has a very small loading effect on the batteries under large-unbalance condition. The 100-volt battery packs have an internal resistance of approximately 1,000 ohms. If the battery potential is 50 millivolts above the potential of the power supply under test, a 1-megohm resistance will cause a current of 50×10^{-9} ampere to flow from the battery.

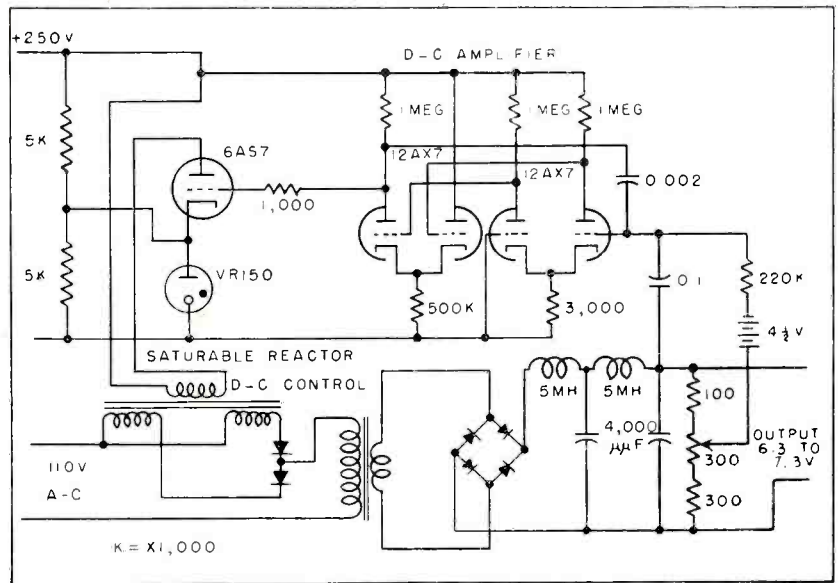

FIG. 3—Circuit of heater power supply using saturable reactor as control element

For one 100-volt battery the drop in its terminal voltage will be $E_b = R_i \times i_b = 1,000 \times 50 \times 10^{-9} = 50$ microvolts. This change in battery voltage is 1,000 times smaller than the initial change to be measured, and results in negligible error when measuring the difference voltage.

For long-time-stability measurements, a continuous recording system is used. The difference voltage is fed to a d-c converter that changes the small d-c difference voltage to a 60-cycle sine wave. The phase and amplitude of the wave depend on the polarity and magnitude of the d-c voltage. This sine wave is applied to a phase detector that provides a balanced d-c voltage of sufficient amplitude to drive a zero-center recording milliammeter. By controlling the gain of the d-c converter, full-scale sensitivities of 0.25, 2.5, 25, 250 and 2,500 millivolts can be obtained on the recorder unit.

Construction

To simplify wiring and maintenance, all of the d-c and a-c amplifiers are constructed as plug-in units. An attempt has been made to standardize the amplifiers used in the various regulated supplies to permit interchangeability for rapid location of circuit failures. All chassis are U-shaped with components mounted in a vertical plane. All circuits and output voltages are available at the rear of

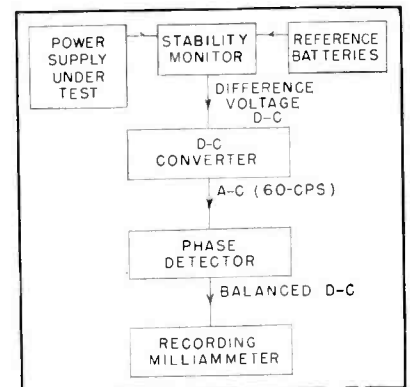

FIG. 4—Drift-measuring system uses a null-balance arrangement to monitor power supply voltage change

each rack. Tubes and plug-in units are accessible through front-panel doors.

The extreme stability and regulation obtainable from this power-supply system can be seen from the data in Table I. In most cases the static stability figures indicated are conservative. For instance, the average drift after a one-hour warmup for the general-purpose supply is less than 1 millivolt per hour over an 8-hour period. Under full-load conditions these power supplies have the stability of a battery under a microampere load.

REFERENCES

- (1) Frank J. Lupo, Voltage Regulator, U. S. Patent 2,595,572.
- (2) Greenwood, Holdam and MacRae, "Electronic Instruments," Vol. 21, MIT Rad. Lab. Series, p 511, McGraw-Hill, 1948.
- (3) Edwin Goldberg, Stabilization of Wide-Band Direct-Coupled Amplifiers, *RCA Review*, p 296, June 1950.
- (4) Bradley and McCoy, Driftless D-C Amplifiers, *ELECTRONICS*, p 144, Apr 1952.

Salinity Meter for

Conductivity-measuring device uses r-f signal to determine salt content of ocean water without immersion of electrodes. Problems of polarization and electrode fouling are eliminated. Precision is ± 0.04 over range of 5 to 35 parts per thousand

PRECISE measurement of the salinity of ocean water is necessary for computations of refraction gradients and sound velocities in sonar operations, in determinations of dynamic heights for ocean current predictions, and as an aid in biological, chemical and geological studies.

The term salinity, as generally used, denotes the number of grams of dissolved solids per kilogram of sea water.¹ The average salinity of ocean water is approximately 35 parts per thousand, but may vary from 33.5 to 37 parts per thousand.² In lagoons and estuaries, value ranging from 1 to 100 parts per thousand can sometimes be found.

Chemical analysis for halides³ is the procedure commonly used for making highly accurate salinity determinations. This method, however, is slow, expensive and inadequate for many purposes.

At constant temperatures the conductivity of ocean water varies rapidly with salinity and can be used to accurately indicate salinity. Instruments^{4,5} for measuring conductivity have been built, but since they operated at audio frequencies it was necessary to have the electrodes in direct contact with the water sample. Fouling and polarization difficulties have prevented these instruments from attaining widespread use.

R-F Conductivity

The conductivity of ocean water has been accurately determined at 1,000 cycles⁶ and it is believed that these values do not change with increasing frequency until frequencies in the neighborhood on the or-

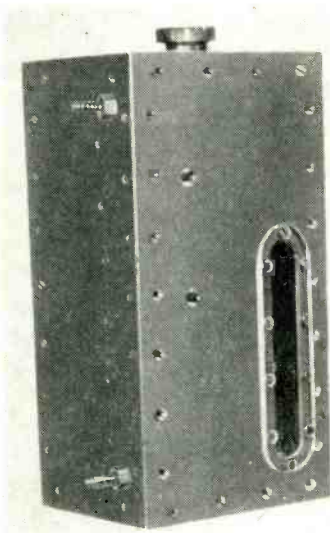

Absorption cell has window on front of aluminum body for observing water-temperature thermometer in test chamber

der of 100 mc are approached.⁷

The use of r-f current for conductivity measurements provides the advantage that the electrodes need not be placed in direct contact with the water,⁸ thus eliminating corrosion and polarization problems.

General Design

Conductivity is measured in a glass tube of about 10 mm inside

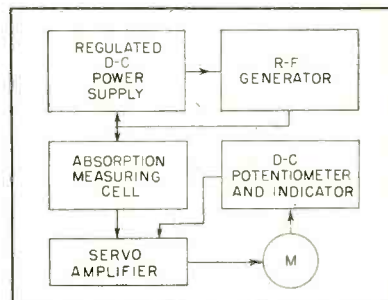

FIG. 1—Block diagram of the r-f salinity measuring instrument

diameter and 120 mm long. A band of metal about 20 mm long is fused to the outside of the tube near each end to form electrodes. A 14-mc signal from a stabilized source is passed across the electrodes through the solution and then rectified with a crystal rectifier. The resulting d-c voltage provides an indication of the salinity of the sample.

The block diagram in Fig. 1 shows the units of the salinity instrument. The circuit is given in Fig. 2.

The r-f generator consists of a modified Pierce oscillator operating at 7.0 mc, followed by an amplifier doubling to 14.0 mc. Stabilization is obtained by rectifying a fraction of the r-f output with a pair of 1N34 germanium diodes. This control voltage is added to the normal reference voltage from the OD3 regulator tube in the power supply. The voltage is polarized so that a decrease in r-f output voltage will cause an increase in plate-supply voltage.

The reference voltage from the OD3 tube will undergo small changes with line voltage fluctuations, but these variations are partially compensated for since the measuring potentiometer is supplied with current from this same tube.

The d-c voltage resulting from rectification of the r-f current through the cell is measured with a d-c chopper-type servo-amplifier driving a potentiometer through a two-phase motor.

A precision ten-turn helical potentiometer is used with a 1,000-division dial. Since it is desired to read salinity with a precision of one part in 2,000; high and low poten-

Sonar Measurements

By **KENNETH E. HARWELL** and **DONALD W. HOOD**

*Texas A. and M. Research Foundation
and the Department of Oceanography
College Station, Texas*

tial ranges are provided, making 1,000 divisions available for each range.

Salinity-Measuring Cell

The salinity-measuring cell is shown in Fig. 3. Both active electrodes are operated above ground potential, but the incoming and outgoing streams of water must be grounded to prevent radiation and body-capacitance effects. Isolating sections were made of 5-mm o-d glass tubing about 420 mm long and folded to conserve space. Additional electrodes on the outer ends of the isolating tubes bypass the small amount of r-f current that comes through the isolating sections.

A rigid case of $\frac{3}{8}$ -inch aluminum plate is used because even slight changes in case dimensions will alter electrode-to-ground capacitance and introduce relatively large errors into the salinity readings.

The r-f current through the sample tube is measured by a 1N34 germanium diode in a peak-reading circuit connected across a precision 50-ohm r-f resistor. For calibration, an impedance consisting of small high-quality capacitors may be switched into the measuring circuit.

High sensitivity requires a large percentage change in d-c output voltage for a given change of conductivity. If the total series impedance of the measuring circuit is large compared to the resistance of the sample tube, the change in sample conductivity will be a small percentage of the total impedance and sensitivity will be low. All impedances in the measuring circuit are made small compared to that of the measuring tube in order

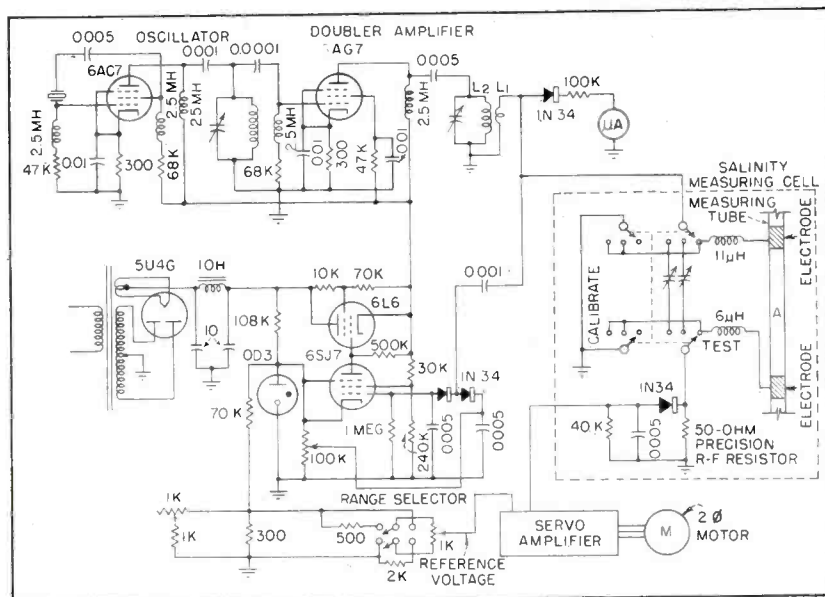

FIG. 2—Circuit of salinity meter has plate supply voltage controlled by output of oscillator section. Servo amplifier drives indicator potentiometer

to obtain the maximum sensitivity.

A relation between the resistance in the measuring tube and the d-c output voltage was derived. The relationship between the inter-electrode capacitance and d-c output was also derived by circuit analysis. The analysis showed that the instrument is sensitive only to changes in conductivity and that the normal changes in dielectric

constant of ocean water produce negligible changes in reading. Experimental data obtained thus far has confirmed theoretical analysis within the limits of experimental error.

Temperature Effects

Conductivity of sea water changes rapidly with temperature, approximately 2.1 per cent per degree centigrade, while salinity is practically unaffected. Because of this large coefficient it is necessary to measure the temperature of the sample with an accuracy comparable to that of the conductivity measurements. A change in temperature of 1.34 deg C causes a change in conductivity equivalent to a change of one part per thousand in salinity in the

Table I—Accuracy of Salinity Measurements

	Salinity in parts per thousand	
	15	35
Sensitivity in parts per scale division	0.020	0.017
Precision	±0.02	±0.04

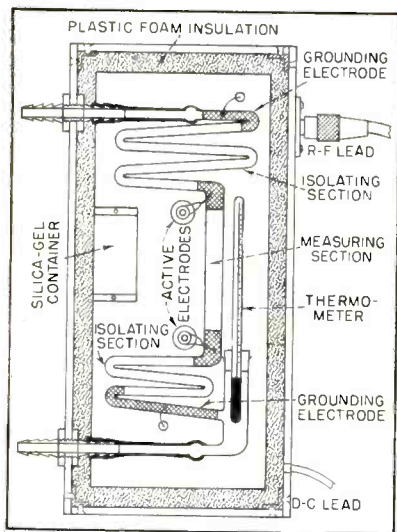

FIG. 3—Cross-section of absorption cell shows folded isolation sections and placement of electrodes

high salinity range. Since it is often desired to measure salinity with a precision of 0.01 to 0.05 parts per thousand, the temperature must be measured to approximately 0.01 deg C.

The temperature of the sample in the present instrument is measured with a mercury thermometer inside the cell case, visible through a narrow plastic window. To avoid temperature changes caused by heat absorption while the sample is in the cell, the cell case is lined with plastic foam insulation. A container of silica gel mounted in the case dehydrates the air to eliminate condensation on the glass tube between the electrodes.

The oscillator and r-f amplifier are tuned to optimum output and plate voltage is adjusted to a value

well below maximum. The r-f output voltage, about 2 volts, is obtained by adjusting the coupling between the pickup coil and the amplifier tank coil.

Instrument Operation

A sample of water having a salinity near the maximum value to be measured is placed in the measuring tube and the potentiometer is adjusted to an arbitrary high scale reading by changing the potentiometer d-c voltage or by readjusting the r-f coupling coil. The standard impedance is then switched into the measuring circuit to replace the sample tube and this impedance is adjusted to give an arbitrary reading near the high end of the scale. The standard is not changed during any given series of runs, but is frequently switched into the circuit to check scale reading for drift or other errors. The potentiometer is adjusted to give the same reading each time the standard impedance is in the circuit, establishing a fixed relation between scale reading and conductivity.

Calibration

A series of solutions covering a range of salinities were used to calibrate the instrument over the salinity range from 5 to 38 parts per thousand and a temperature range from 10 to 38 deg C.

These calibration data were used to plot the curves shown in Fig. 4 and Fig. 5 and to obtain the data given in Table I.

Neither family of curves fit any

simple equation very closely, thus a temperature compensator or other type of simple electrical calculator will not be useful where precision measurements are required.

This instrument is adequate for a large percentage of the salinity measurements ordinarily made, although its precision of ± 0.04 mil is somewhat less than that obtainable by chemical analysis.

The accuracy of the instrument seems to be limited by the stability of the r-f output voltage, accuracy of temperature measurements and instability of the germanium diodes. Because of these limitations it is doubtful that the accuracy can be very greatly increased.

Acknowledgement is due W. T. Matzen of the Electrical Engineering Department of Texas A and M College for his work on the circuit analysis, and to the U. S. Navy, Bureau of Ships for sponsorship of this project under Contract NObsr-57244.

REFERENCES

- (1) Forch, Knudsen and Sorensen, Berichte uber die Konstantenbestimmungen zur Aufstellung der hydrographischen Tabellen, *D. Kgl. Danske Vidensk Selsk. Skrifter, 6. Raekke, naturvidensk. og mathem., afd. 12*, p 151, 1902.
- (2) Sverdrup, Johnson and Fleming, "The Oceans," Prentice-Hall Inc., New York, 1946.
- (3) *Determination of Chlorinity by the Knudsen Method*, Woods Hole Oceanographic Institution, Woods Hole, Massachusetts, 1946.
- (4) A. W. Jacobson, *Am. Inst. Elec. Eng.*, 67, p 714, 1948.
- (5) Wenner, Smith and Soule, *J. Res., National Bureau of Standards, Wash., D. C.*, 5, p 711, 1930.
- (6) B. D. Thomas, T. G. Thompson, and C. L. Utterback, *Conseil Perm. Intern. p. L' Explor. de la Mer, Journ. du conseil*, 9, p 28, 1934.
- (7) R. Cooper, *J. Inst. Elec. Eng.*, 93, Part III, p 69, 1946.
- (8) G. G. Blake, "Conductimetric Analysis at Radio Frequency", Chapman and Hall, Ltd., London, 1950.

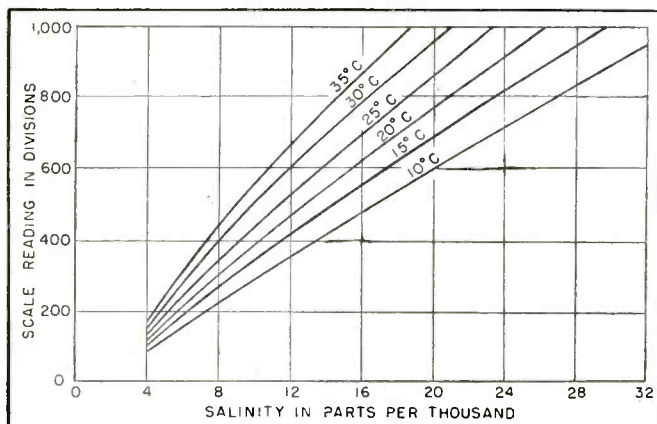

FIG. 4—Salinity calibration chart for low range of salinity meter

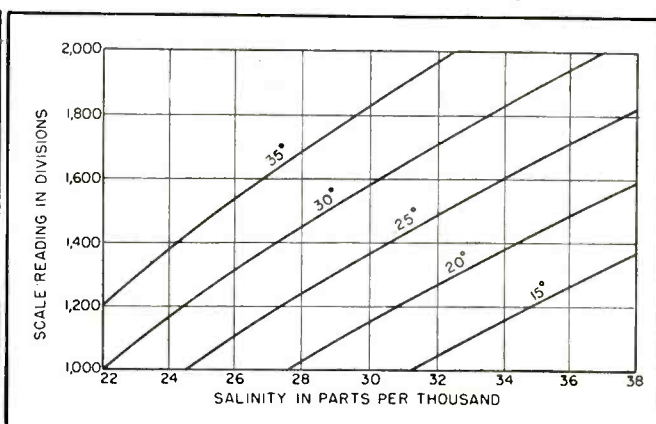

FIG. 5—High range calibration chart for salinity indicator

A-M System Measures Microwave Attenuation

Inherently simple audio-modulation substitution system measures up to 40-db attenuation from 200 to 40,000 mc. Output indicator detects 0.01-db changes. Electrical and mechanical design features minimize noise and instability

By JOHN KOREWICK

*Sperry Gyroscope Company
Great Neck, New York*

AUDIO-MODULATION SUBSTITUTION measurement of microwave attenuation is useful over the frequency range from 200 to 40,000 mc and can measure up to 40 db. In the system to be described, several novel electrical and mechanical design features are incorporated to reduce the detrimental effects of noise and instability.

A simplified block diagram of the system is shown in Fig. 1. The audio-modulated klystron oscillator provides a stable source of r-f power and the barretter is a square-law detector. Any attenuation of the microwave carrier results in a linearly proportional change of the superimposed modulation.

The modulated r-f power develops an a-f voltage across the barretter. This voltage passes through the audio attenuator, is amplified and then measured by the output-level indicator. This level, once selected, is held constant by matching any change produced by the unknown microwave attenuator being tested with an equal and opposite change produced by the standard audio-substitution attenuator. The change in the microwave power level at the barretter is then equal to the

change indicated by the calibrated audio attenuator.

The basic principles involved in this method are relatively simple. However, a careful analysis has disclosed many possible sources of error. This article summarizes the improvements that have been made in the measurement system in use at the present time.

Barretter

The particular use of the barretter in this system should not be confused with its use in the measurement of microwave power.

Ordinarily a barretter is used in conjunction with a bridge circuit to measure microwave power. In this system, however, it is used as a detector to recover modulation from a carrier.

The detecting ability of a barretter is based on the physical property that its resistance is a function of temperature. The static characteristics of a typical barretter are such that the rate of change of resistance with applied power is linear over a major portion of the operating range.

Generally, a quiescent operating

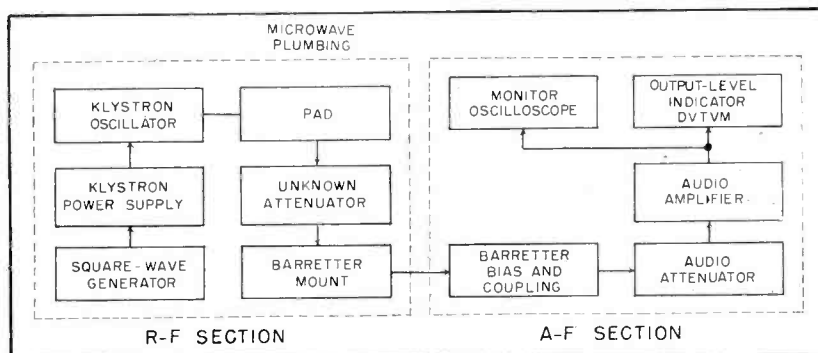

FIG. 1—Audio-modulation substitution system for microwave attenuation measurements. Barretter is used as a-m detector

point is chosen by biasing the barretter with d-c power. The sensitivity of the barretter, expressed in ohms per watt, is primarily a function of the slope of the resistance-power characteristic at this quiescent point modified by the type of biasing circuit used.

Application of modulated r-f power to the barretter causes temperature changes and corresponding resistance changes in accordance with the modulation. When this variable resistance is fed from a constant-current source, the voltage developed across it is directly proportional to the change in resistance ΔR . Since ΔR is directly proportional to the applied r-f power, the output voltage is directly proportional to the applied r-f power. Complications arising from the physical and electrical characteristics of the barretter cause negligible error when the applied r-f power is much less than the d-c bias power.

The circuit in use for barretter bias and coupling is the result of a number of compromises in attempting to obtain a voltage-transfer device that is linear and relatively noise-free for the maximum possible signal-to-noise ratio.

D-C Bias

Figure 2A is a diagram showing the bias and coupling arrangement. The a-c coupling circuit consisting of a 2,000- μ f capacitor blocks d-c from the audio attenuator and provides a low impedance to the barretter output signal.

Constant bias current is obtained from three parallel 45-v B-batteries in series with a high-resistance potentiometer. This constant-current source has a maximum current change of less than 0.1 percent over the resistance range of the barretter.

A Thevenin's equivalent a-c circuit (Fig. 2B) shows that the effective lossless-generator voltage is the voltage developed across the barretter and the effective series-generator impedance is the internal resistance of the barretter.

When the barretter is properly biased with the 200-ohm audio at-

tenuator coupled to the circuit, and only low microwave power is being detected, the voltage across the attenuator input e_A is almost half the value of the voltage developed across the barretter e_B .

However, when the microwave attenuation of the measured component is removed from the r-f portion of the system during a measurement, the power level at the barretter increases from some fraction of a microwatt to possibly a milliwatt. Such a change in r-f power results in an increase of about seven ohms in the internal impedance of the barretter which changes the voltage-transfer ratio. This change represents a maximum since the maximum power is always limited to less than 1 mw to avoid nonlinearity effects in the barretter. Curves showing the magnitude of this effect on the measurements are shown in Fig. 3. The actual measurement error Δ db as a function of range and maximum power level is about 0.02 to 0.03 db.

Attenuator

The drum-type audio-attenuator is electrostatically shielded and has four dials calibrated in decibels. It has a characteristic impedance of 200 ohms and a range of 0 to 110 db with increments of 10, 1.0, 0.1 and 0.01 db. The insertion loss at the zero setting is less than 0.01 db.

The design accuracy in db is ± 0.1 percent from d-c to 10 kc. Laboratory calibration showed the accuracy at d-c to be better than design accuracy.

In a measurement the actual microwave attenuation is half the calibrated increment of the audio attenuator. This factor is required because the r-f power ratio at the barretter is measured as a ratio of output voltages that are directly proportional to the applied power rather than to the square root of the applied power as in a linear circuit.

The attenuator is designed for operation with a 200-ohm resistive termination at both input and output terminals. Although the amplifier input impedance is not exactly a 200-ohm resistive load, it has been shown that adjustment of the attenuator will change the actual transmission loss of the attenuator by increments equal to the calibration steps of the attenuator regardless of the load impedance as long as a 10-db loss is maintained in the attenuator.

The use of small signal voltages implies the use of a high-gain amplifier. However, gain is limited by the input noise level of the amplifier. This includes noise developed in connecting the barretter to the amplifier, extraneous audio pickup and thermal noise.

By using the present barretter bias and coupling circuit, noise from this source is reduced considerably. Since the audio attenuator is a passive network and well shielded, it contributes no extraneous noise.

Amplifier

Direct control of input noise level is possible by use of narrow-band techniques. An amplifier tuned to a low audio frequency was selected so that a bandwidth of 10 cps could be utilized. This necessitated a low a-f modulation voltage, which in turn satisfied the required relationship for the barretter, namely, that the pulse length be much greater than the thermal time constant of the barretter.

The thermal time constant of the

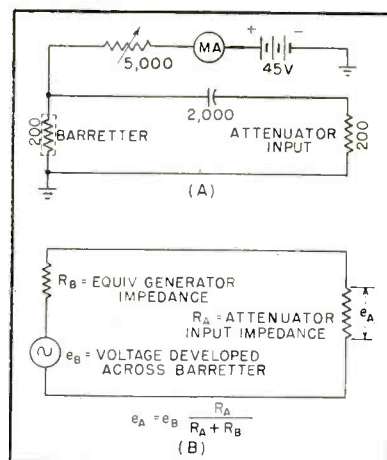

FIG. 2—Bias and coupling circuit (A) and Thevenin's equivalent circuit (B)

barretter is approximately 320 μ sec. The modulation frequency is 100 cps giving a pulse length of 5,000 μ sec.

The amplifier has four resistance-coupled stages but the input to the first stage is coupled through a specially shielded, high-gain input transformer. A 60-cps parallel-T rejection filter is inserted between the second and third stages to discriminate against hum pickup. Another parallel-T filter provides degenerative feedback in the third stage at all frequencies except the tuned frequency. The amplifier is shielded electrostatically and mounted on springs to avoid microphonic disturbances. Its power supply is mounted on a separate chassis.

The electrical specifications of the amplifier are: gain 3,000,000, noise input 1.2×10^{-8} volt, peak frequency 100 cps, bandwidth 10 cps, input impedance 200 ohms.

With an amplifier input noise level of 1.2×10^{-8} volt, an r-f power level at the barretter of about 0.1 μ w can be detected. This power level compensates for the 6-db voltage loss in the barretter coupling circuit and the 10-db padding in the attenuator and will still provide an input signal voltage almost 100 times the input noise level. Hence, up to 40 db can be measured and the power level at the barretter can still be kept below 1 mw.

Output-Level Indicator

The output-level indicator used in the system is a differential vacuum-tube voltmeter similar to a unit in use at the National Bureau of Standards. It has a maximum differential sensitivity of 0.2 db for full-scale deflection and it is possible to detect changes in output of less than 0.01 db. Such an indicator permits the evaluation of any noise, jitter or instability in the system and improves the readability for small changes in level.

The heart of the indicator is the differential tube, a dual triode having a common cathode resistance and equal plate load resistances. Connected between the plates of the two triodes is a microammeter re-

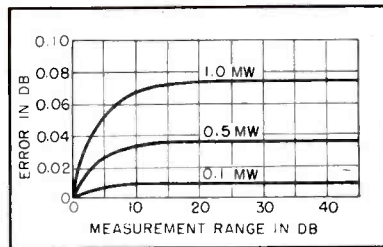

FIG. 3—Voltage transfer error in barretter coupling unit as a function of range and power level

quiring a current of 100 μ a for full-scale deflection. A difference in conduction in the two triodes as controlled by the grid potentials results in a difference in voltage level at the plates.

The meter is balanced initially at the center of the dial with the level of one grid fixed by a d-c battery. The other grid is biased by the signal input after amplification and rectification.

Square-Wave Modulator

The 100-cps modulation frequency meets the barretter's thermal-time-constant requirements and also permits use of a narrow-bandwidth amplifier. However, in using such a highly selective amplifier, it was found that the frequency stability of a free-running multivibrator was inadequate.

This problem was overcome by using an overdriven amplifier excited from the 100-cps multivibrator of a primary frequency standard whose frequency stability is better than one part in ten million. The amplifier itself has a regulated power supply and a low-impedance cathode-follower output. The output is a square wave of 50-percent duty cycle with a rise time of less than 3 μ sec. This rise time is desirable in modulating the klystron to avoid any frequency modulation of the signal source. The output amplitude is variable from 0 to 100 volts, which is sufficient to provide 100-percent amplitude modulation.

Minimizing Noise

To maintain a low noise level at the input of the amplifier, it has been necessary to operate the system in a shielded room. In those circuits where one side is intended

to operate at ground potential, it is necessary that only one point in that side of the circuit is connected to an external or earth ground. In the case of coaxial cables where the outer sheath has the dual function of being an r-f shield and also part of the active circuit, the entire system interconnected by the cable is connected to external ground at only one point. Other pieces of equipment connected by the cable must be isolated from ground to avoid noise and hum pickup caused by ground loops.

The hum pickup from the stray magnetic fields of the various power supplies, oscilloscopes and amplifiers used in the system are eliminated by a trial and error procedure.

Another source of noise and jitter is the effect of waveguide slots in tuners and open secondary arms of directional couplers. Such openings in the waveguide plumbing are subject to erratic changes of air pressure due to klystron blowers or air conditioning ducts in the proximity of the system. When the air in the waveguide at these openings is subjected to such conditions, this turbulence is transmitted through the air inside the line to disturb the air surrounding the barretter cartridge. This upsets the rate of heat dissipation of the barretter at an audio rate, and an a-c noise voltage can be developed across the barretter.

If such waveguide components must be used in a system, waveguide openings should be sealed with tape to prevent any noise pickup from this source.

Crosschecks on this system have been checked to better than 0.1 db. These crosschecks were made with reference standards calibrated at the National Bureau of Standards and also by the 30-mc sweep-frequency heterodyne substitution measurement system.

BIBLIOGRAPHY

- A. Melloh, Errors in the Calibrated Losses of Symmetrical Resistance Networks, *Proc IRE*, 29, p 387, Jul. 1941.
- C. G. Montgomery, "Techniques of Microwave Measurements," Vol. II, MIT Rad. Lab Series, McGraw-Hill Book Co., Inc., New York, 1947.

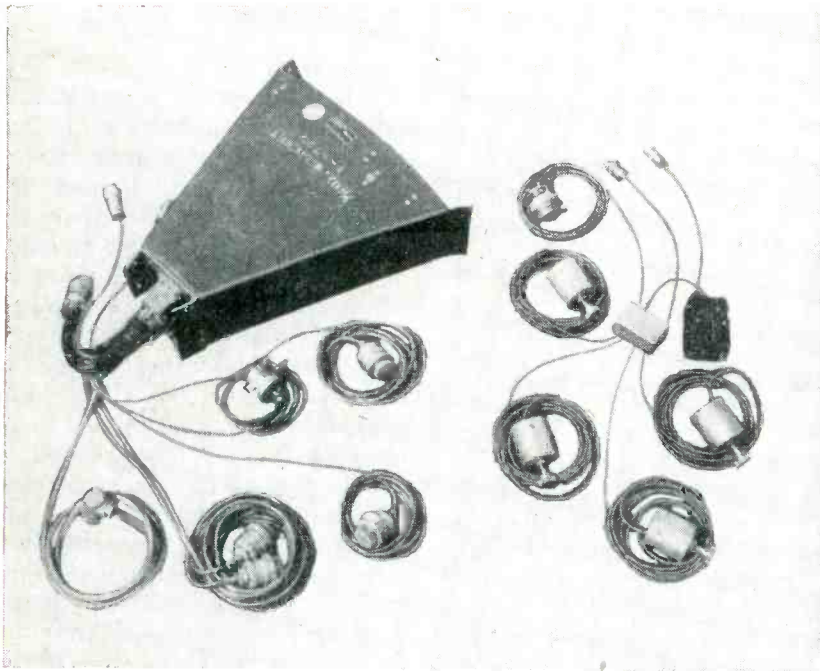

Comparison of tube (left) and transistor (right) telemetering systems having comparable capacity illustrates space saved by new design

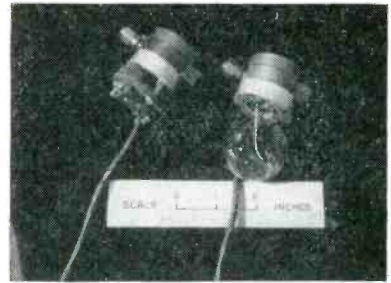

Detail of resistance-controlled oscillator assembly using a junction transistor

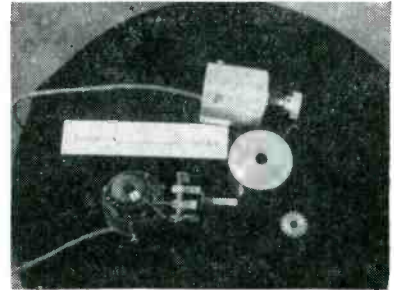

Inductance-controlled transistor oscillator shown mounted on gage

Transistors in Telemetry

Transistorized oscillator circuits for f-m/f-m telemetering are mounted in same can with electromechanical transducer. Equipment is light, compact and efficient in operation. Telemeter equipment is shortlived hence long-term transistor instability presents no problem

EXAMINATION of an f-m/f-m telemetering system shows that transistors can be used as information oscillators. It is possible to make the transducer and electronic circuit a unit complete in itself. The f-m/f-m telemetering system carries information by frequency modulation of a sine-wave oscillator. Full bandwidth for a particular channel is 15 percent of the frequency of oscillation. The transmitting end of the system consists of an audio oscillator for each

By FRED M. RIDDLE

*Research Engineer
Jet Propulsion Laboratory
California Institute of Technology
Pasadena, California*

information channel and an r-f transmitter which is modulated by the mixed audio frequencies.

Information of interest modulates the oscillator frequency of operation. Transducers commercially available provide a change of resistance, inductance, or capacitance

with variation of the parameter to be measured.

In general, then, all of the advantages of transistors can be utilized in making oscillators for the f-m/f-m telemetering system. The variation of transistor parameters with temperature is the only disadvantage that affects the use of transistors in this application. Such variation produces a change in frequency with change of transistor temperature. This has been the primary problem in developing sat-

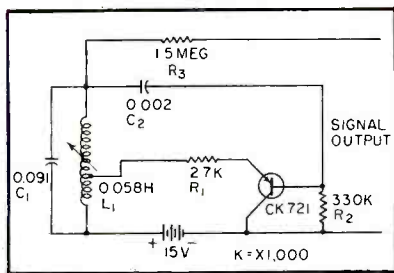

FIG. 1—Inductance-controlled transistor oscillator for use in telemetry

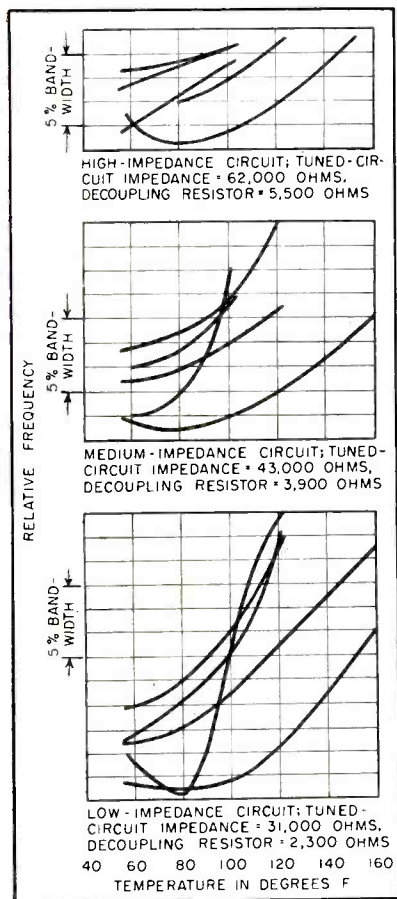

FIG. 2—Curves illustrate performance of inductance-controlled oscillator

isfactory transistor telemetering circuits.

Circuits Developed

Some of the more successful circuits using transistors with commercially available gages are now described in detail. Oscillators must be sensitive to variation in either resistance, reactance or voltage. Development of circuits to respond to these parameters was approached in the order of minimum expected difficulty. The first circuit to be

developed was an oscillator that changes frequency with a changing reactance. The variable-inductance gage is made part of the tuned circuit. A number of different circuits work satisfactorily; however, the one having the most advantages is shown in Fig. 1.

This is essentially a Hartley oscillator with the tuned circuit between collector and base and with transistor driving power applied between base and emitter. Variable-inductance L_1 is a commercially available gage that responds to changes in pressure, mechanical motion or acceleration. The inductance change is large enough to provide a tuned-circuit resonant frequency change of 15 percent.

Frequency of operation is set by selecting the proper value of C_1 . Resistor R_1 serves two purposes: (1) it decouples the low emitter-to-base impedance of the transistor so that it does not load the tuned circuit and (2) it regulates the feedback from the tuned circuit to the transistor. Capacitor C_2 blocks direct current from the base. The resistor R_2 is used in conjunction with the 15-volt battery as a constant-current supply to adjust the transistor operating point. The output is taken through decoupling resistor R_3 , which is large enough in magnitude to permit use of resistance mixing with other channels. In this case the output leads of all the oscillators may tie directly to the grid resistor of the modulator tube in the transmitter.

Performance of these units is uniform so that they may be made and used without individual adjustment. Selection of transistors is necessary, however. The transistors are selected on a breadboard circuit using the amplitude of output as a quality indicator. No units were found which would give more than 10 volts across the tuned circuit. Of twenty units tested, none failed to oscillate but five gave low output voltages. Collector current drawn by the transistors averages 1 milliampere. Total power required by the circuit is 15 milliwatts.

Temperature Effects

The variation of oscillator frequency with transistor temperature is a major problem. Informa-

tion to be telemetered causes a frequency shift in the oscillator; thus any random change due to temperature variation is false information. The object in development of transistor circuits has been to obtain less than 1/2-percent-frequency drift over a temperature range of 60 to 140 F. In terms of the channel bandwidth 1/2-percent drift corresponds to 3-percent error introduced into the data. If 3 to 5-percent accuracy of the telemetered information can be tolerated, oscillator drift of 3 percent is acceptable.

Actually the situation is not as bad as just indicated. The useful life of the telemeter is generally so short that very little temperature change occurs while information is being sent. The frequency of the operation is known at the start of the data recording. Usually the initial conditions are also known so that a zero can be established. Data are accurate if these conditions are met because there is little time during the use of the telemeter for the transistor to heat up and cause a frequency drift.

In spite of the accuracy just described, frequency drift is of major concern. An indication of the stability is shown in Fig. 2. These data are taken using the inductance-controlled oscillator circuit of Fig. 1. The three sets of curves correspond to three different tuned-circuit impedances. Five transistors were checked in each of the circuits.

The curves indicate that the high-impedance tuned circuit has the greatest stability. The condition of greater stability is due to the fact that, with the higher-impedance tuned circuit, greater decoupling between the tuned circuit and transistor is possible. As these curves show, oscillation ceases at fairly low transistor temperatures, and it is necessary to compromise between oscillator stability and reliable transistor operation by increasing the coupling between tuned circuit and transistor.

Resistance Circuits

A variable resistance can be used to control frequency in several ways. Two methods which look promising for use with transistors are: (1) controlling reactance

across an L-C tuned circuit by a series or shunt resistance associated with a small percentage of the reactance or (2) using resistance directly in a resistance-capacitance or phase-shift oscillator.

The first method is successful and works according to theoretical calculations. A resistance-capacitance transistor oscillator has not been tested at the time of this writing.

Experimental work has been done with the resistance associated with the capacitor in Figs. 3A and 3B. For a controlling variable resistance of 5,000 ohms, which is a reasonable value for gages of this type, Fig. 3B gives the highest Q and the best waveform. A high L/C ratio is used so that the circuit reactance is high and the effect of the resistance on the circuit Q is a minimum. In Fig. 3B the tuned-circuit Q varies from approximately 5 to 5.5 as the resistance gage varies from 0 to 5,000 ohms.

In order that the circuit in Fig. 3A work with equal success, the gage resistance would have to be about 20,000 ohms. The high resistance is necessary in order to raise the circuit Q high enough to maintain oscillations with a majority of the transistors. A further disadvantage is poor wave shape, which is due to the low Q of the first circuit. Figure 3B gives a very good wave shape throughout the range of the controlling resistor. Maximum harmonic distortion is 5 percent second and 2 percent third. Temperature stability should be the same order of magnitude as that of the variable-inductance oscillator already described.

Voltage Circuit

Developing a stable voltage-sensitive transistor oscillator is more involved than in the case of the previous oscillator types. The stability required can be approached only by holding the transistors at a fixed temperature. The circuit (Fig. 4) used is similar in appearance to a vacuum-tube multivibrator. This is a bistable circuit that is highly regenerative. Triggering is accomplished by decay of base-to-emitter current through inductance-resistance circuits. When this current drops to the collector voltage-cutoff

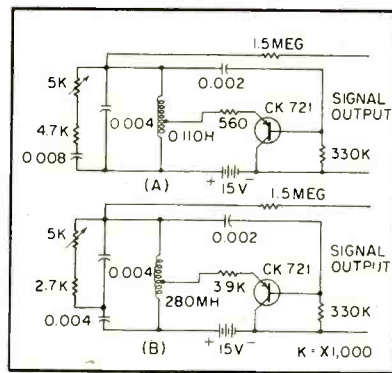

FIG. 3—Two typical resistance-controlled junction-transistor oscillators for telemetering service

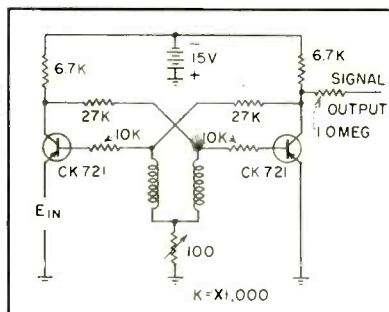

FIG. 4—Voltage-controlled oscillator operates on multivibrator principle

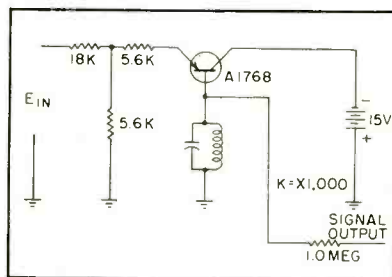

FIG. 5—Measurement of instantaneous voltage change is readily achieved using a point-contact transistor negative-resistance oscillator

point, the system flips to the opposite state. The output voltage is a square wave and requires filtering before mixing with other signals.

The voltage sensitivity of this circuit is high, and the input impedance is low. Full bandwidth ($df/f = 15$ percent) is obtained with 0.1-volt input. An ideal device for use with this circuit is a thermocouple.

At the present state of development this circuit is impractical where good accuracy is required. By using temperature control of the transistors, stability of 5 percent of bandwidth could be obtained. One advantage of transistor multivibra-

tors over vacuum-tube multivibrators is their frequency insensitivity to shock and vibration.

Successful voltage oscillators for measuring instantaneous changes in voltage where the measurement of interest is the magnitude of the change have been built, using point-contact transistors. These circuits give an indication of a switch closure, commutated voltages, or some sort of yes or no information. In the proper circuit the point-contact transistor has a negative-resistance effect in the base lead. When a parallel L-C tuned circuit is placed in the base lead, the circuit oscillates. The resistance in the emitter-to-base loop adjusts the transistor operating point on the negative-resistance curve. This type of circuit is shown in Fig. 5. The frequency of this oscillator changes with a change in operating point. The change is due to the variation in loading on the L-C circuit. Frequency of operation goes down as the resistance across the tuned circuit decreases.

The circuit is necessarily a low-Q circuit, and hence drift with temperature is quite large. Such drift does not cause difficulty, however, in the measurement of instantaneous voltage changes.

The big advantage of the transistor circuits is the compactness of packaging obtainable. Since transducers are fairly large and solid, they can be used as a mechanical support for the circuit-component package. In a typical case the transistor and associated circuit are wired without using terminals or mechanical support of the components. This assembly is then potted against a circular disk having two feed-through terminals. These terminals are used for mounting the tuning capacitor which adjusts the operating frequency. The completely assembled unit is fastened directly to the gage. The unit is complete in itself. The cable takes power to the unit and brings the signal out.

This paper presents the results of one phase of research carried out at the Jet Propulsion Laboratory, California Institute of Technology, under Contract No. DA-04-495-Ord 18, sponsored by the Department of the Army, Ordnance Corps.

Magnetic Amplifier Uses Conventional Inductors

Reasonably high power gain, speed of response and power-handling ability are obtained with magnetic amplifiers made from readily available components. Power-supply, photo-flash and television high-voltage transformers are used as saturable reactors

By **A. I. BENNETT, JR.**

Westinghouse Research Laboratories
East Pittsburgh, Pa.

MAGNETIC AMPLIFIERS having reasonable gain, speed of response and power-handling ability can be constructed from standard power transformers.

Power or photoflash transformers used as reactors in a parallel-connected self-saturating circuit have given power gains exceeding 2,000 per stage, outputs of over 50 watts and response times of 4 to 5 cycles. In addition to a pair of transformers, the complete magnetic-amplifier circuit requires only a pair of diodes, preferably of the semiconductor type, and possibly a pair of capacitors. Such a circuit offers an inexpensive and satisfactory method for controlling moderate powers—50 to 100 watts—with small control powers. The circuit can easily be driven by receiving-type tubes.

The self-saturating parallel-connected magnetic-amplifier circuit is shown in Fig. 1. The transformer *T* is chosen to match the output to the load. The other two transformers, shown as *R*, are the saturable reactors; they may be standard power-supply transformers having a 110-volt primary, high-voltage secondary and one or more filament

windings, the latter being connected series aiding to form a single filament winding.

Considering first the circuit with the rectifiers replaced by short circuits, the primaries are connected in parallel. A lead of one of the high-voltage windings is connected to a lead of the other and a high-impedance a-c voltmeter connected across the remaining high-voltage terminals. A low voltage is then applied to the power-source terminals and the voltage read at the high-voltage terminals. This voltage should be the difference rather than the sum of the secondary voltages. If it is not, the leads on either a primary or a secondary must be inter-

changed. The voltage across the control terminals *CC* with full input voltage applied should then be small, no more than ten volts with 1,800-volt secondaries. The filament loop is then closed, connection being made such that no current flows in the closed loop. Finally the rectifiers are added.

Circuit Operation

When there is no control current flowing in the control windings, the cores are saturated by the direct current in the primary loop. As a result of this saturation, there is effectively a low impedance between terminals *ZZ* and the voltage at the primary of *T* is high—typically about 70 percent of the voltage at the power source.

If direct current is now made to flow in the control loop in a direction such as to oppose the saturating effect of the direct current in the primary loop, the cores will become less highly saturated and the effective impedance *ZZ* will increase, reducing the voltage at *T*. The power gain may be over 2,000 with typical components. The control-loop current can be increased until it exactly cancels the effect of

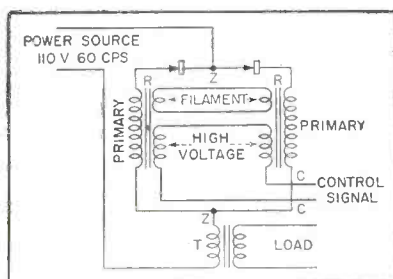

FIG. 1—Self-saturating parallel-connected magnetic amplifier

the primary-loop d-c, at which time the impedance ZZ becomes the parallel combination of the primary inductances and the voltage at T is a minimum. Further increases in control current tend to saturate the cores in the opposite direction, increasing the output voltage again. Such a minimum in the output voltage versus control current is illustrated in Fig. 2A.

If the control current is applied in a direction to aid the primary direct current in further saturating the cores, relatively little increase in output voltage occurs. This indicates that with no control current the cores are already near full saturation. This effect may, however, be modified.

Operating Point

A minimum of output power typically occurs at some control cur-

rent and the circuit can be operated with power gain on the sloping portions of the curve on either side of the minimum. Usually the operating region giving highest gain is to the left of the minimum. Cases may occur in which the other side of the valley is useful or use may be made of the fact that some of these curves exhibit several maxima and minima, such as the curve in Fig. 2C, for $4 \mu\text{f}$ across each of the primaries of R (Fig. 1).

If the rectifiers were not in the primary circuit, the primary voltages and hence the h-v secondary voltages would be equal on both transformers and there would be no a-c voltage at control terminals CC . When the rectifiers are inserted, the primaries are no longer in parallel and the h-v secondary voltages do not quite cancel. In a typical case of a transformer hav-

ing 600-volt secondaries, the a-c voltage across terminals CC may be sixty volts or more.

Filament Loop

When the filament loop is closed the voltages across both filament secondaries must be equal and the h-v secondary voltages are equalized as well as the primary voltages. The first of these effects reduces the a-c voltage at CC . The sixty-volt figure mentioned above may thus be reduced to twenty or thirty volts. The second effect equalizes the primary voltages, and hence reduces the inverse voltage applied to the rectifiers. Both these benefits could also have been obtained by placing a sufficiently large capacitor across CC but only at the expense of an increase in response time of the amplifier as well as the cost of an extra component. The

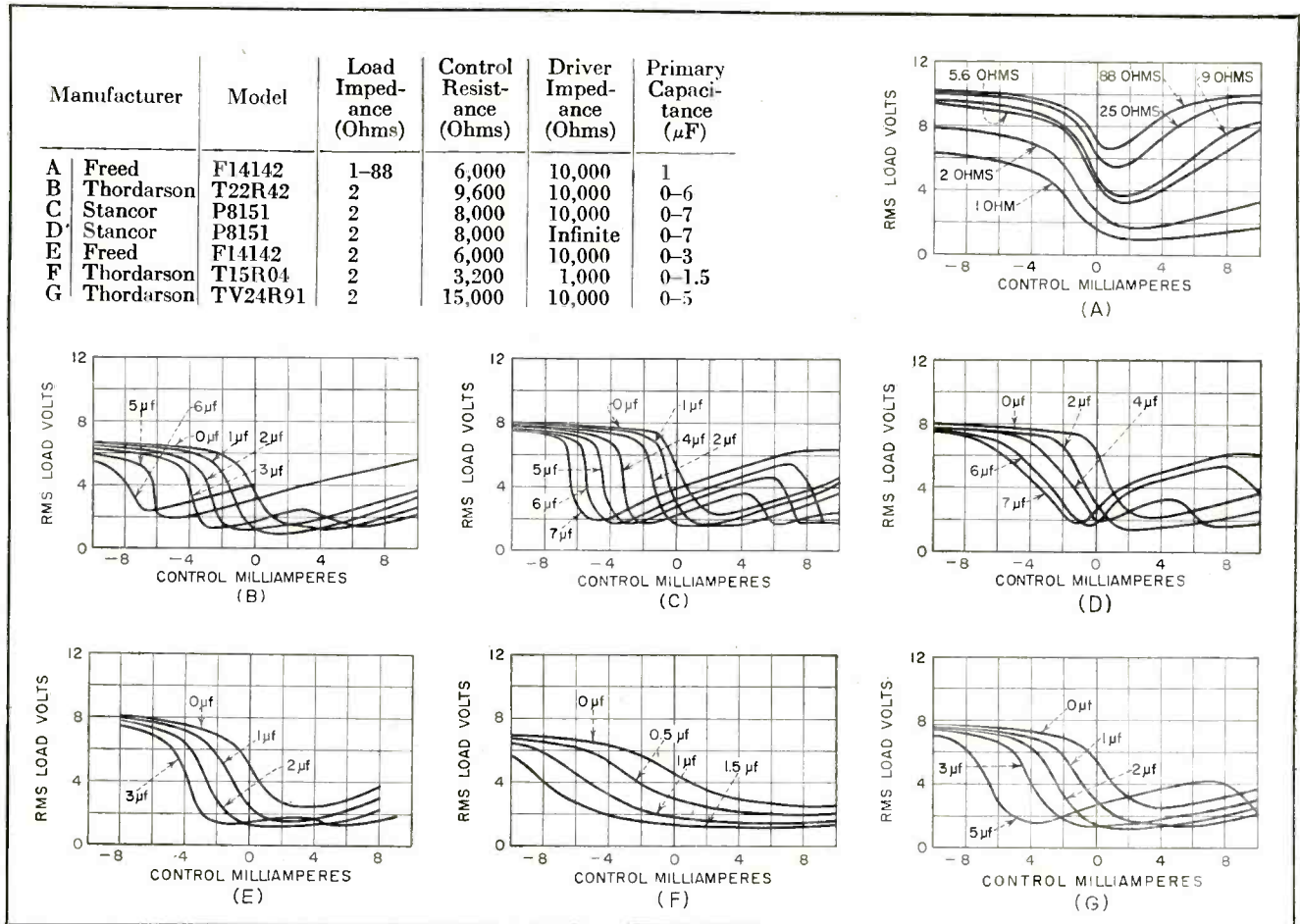

FIG. 2—Characteristics of magnetic-amplifier circuits constructed using common transformer types

filament connection appears to have little effect on response time, which has been observed to be 4 or 5 cycles.

Primary Resonance

With the circuit in Fig. 1, the output voltage at T can not be reduced below a certain minimum. This minimum can be further reduced by placing across each primary sufficient capacitance to resonate the primary inductances at the supply frequency thus raising the impedance ZZ and consequently lowering the output voltage.

The capacitors have also the effect of shifting the output voltage versus control-current curves along the control-current axis by an amount depending on the capacitance used and in a direction such as to move the operating region through the origin and past it. This behavior is shown in the accompanying curves. With a proper choice of capacitors, the operating range may be placed on either side of the origin or partially on each.

The capacitors do not seem to have much effect on the response time. Placing a single capacitor across ZZ does not have an equivalent effect. Apparently such a capacitor cannot circulate the required magnetizing current through the rectifiers in the back direction. It is, however, possible to obtain nearly identical results if all the capacitance is placed across either one of the primaries. Magnetizing current for the other core is then supplied by the filament-winding cross-connection.

Rectifier Types

Semiconductor area-contact rectifiers are most suitable for use in the primary circuit. The back-voltage applied to them is small of the order of one or two volts. The back resistance at this point should be large enough to make the reverse current very small compared to the forward current on the next half cycle. This forward current will depend on the load and its peak value is the peak primary current through T . It is believed that most dry-disk rectifiers of suitable

forward-current and inverse-voltage characteristics will give comparable performance.

Photoflash transformers such as the Thordarson T22R42 or high-voltage television power transformers such as the Stancor P8151 will yield power gains above 2,000.

A circuit using the Thordarson T15R04, a power transformer with a 510-volt 25-ma secondary, gave a power gain of about 700 and a ratio of maximum to minimum output power smaller by a factor of two than that of the higher-voltage transformers. This ratio is about ten for h-v transformers.

Transformer Types

Some control characteristic curves are given for a number of transformers, Fig. 2. Transformer T in Fig. 1 was a Thordarson-T21F18 10-volt filament transformer, whose secondary is the load winding; the transformers used as R were the Freed-14142, Thordarson-T22R42, Stancor-P8151, Thordarson-T15R04 and Thordarson-TV24R91 types. The resistance of the driving source for most of the curves was about 10,000 ohms. The curve for a constant-current driving source shows considerable difference from the curves with finite source impedance. Effect of varying load impedance can be seen in Fig. 2A. The capacitances specified in Fig. 2 are in parallel with the primaries of R (Fig. 1).

Other Transformers

For many applications photoflash transformers will be satisfactory although for powers of one hundred watts or so it may be necessary to use television power transformers. Transformers for this purpose should have a secondary of as high a voltage as possible and a core of small cross-section as long as this does not limit the output power too severely. This insures that the cores will saturate on a small control current. An examination of the $B-H$ curves of a half-dozen different types and sizes of power transformers showed almost no significant differences. Audio-transformer cores appeared very

difficult to saturate and thus not suitable for magnetic-amplifier work.

If the transformers have more than one filament winding, it is possible to modify the circuit by using one set of filament windings as described above and a second set, connected in the same manner as the high-voltage windings, as a second input, to which either feedback or a separate signal may be applied. Feedback if positive increases the gain, nonlinearity and response time of the circuit, and behaves conversely if negative. To apply feedback of this type it is necessary to rectify the output. Such a connection can be used to produce a bistable circuit or flip-flop or can be used as an oscillator. If the transformers have two high-voltage secondaries, these can be used in the same manner.

Since the input impedance is the control-loop resistance and inductance in series, it is best to drive the amplifier with a high-impedance source such as a pentode if most rapid response is desired. However, the shape of the control characteristics is dependent upon the internal impedance of the control circuit, as is evident by comparison of Fig. 2C and 2D. In some applications it may be desirable to drive from a low or medium-impedance source.

Applications

One application for this amplifier as a source of controlled filament-heating power for an ionization gage, with the control signal derived from the electron emission from the filament and so applied as to keep the emission constant. The circuit has also been used as a controlled power source for a small oven, deriving the control signal from a resistance thermometer in the oven and thus controlling oven temperature. The circuits also offer a means of introducing students to magnetic amplifiers at reasonable cost.

The author is indebted to many of his co-workers for numerous invaluable discussions during the preparation of this material.

Broadband Rotary

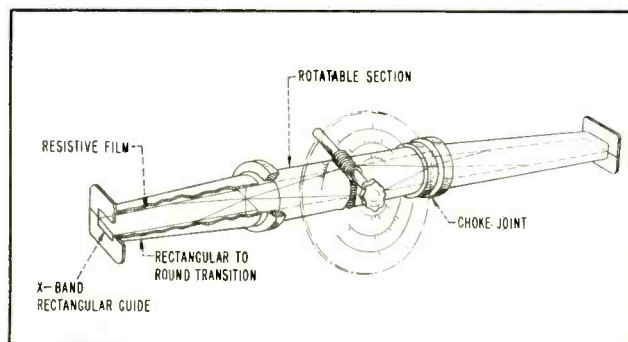
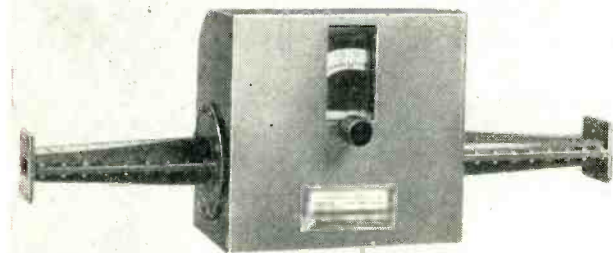

Commercial prototype (left) and cross-section (right) of the rotating waveguide resistive-film attenuator that fits X-band waveguide

THE ROTARY ATTENUATOR, described by Southworth¹, offers substantial advantages for use at X-band frequencies and above. Although using resistive films, it has a law readily calculable and independent of frequency. Phase shift through the unit is independent of setting. Furthermore, it should be easy to construct for use up to perhaps 50 kmc.

The principle of operation is shown in Fig. 1. The attenuator consists of three sections of round waveguide with a resistive film stretched across a diameter of each. The films at each end are in line with each other and fixed at right angles to the E -field of an incoming wave. The center section is free to rotate axially. When all three films are in line, there is no current flow in the films and no attenuation.

When the center section is rotated through an angle θ , voltage E may be regarded as made up of two components, $E \sin \theta$ in the plane of the film, $E \cos \theta$ at right angles to it. The function of the center film is to attenuate the sine component as completely as possible, leaving at its output only $E \cos \theta$, oriented at an angle θ with respect to the input. The purpose of the output-end film is to restore the original polarization. The component $E \cos \theta$ is again split into

By B. P. HAND

*Development Engineer
Hewlett-Packard Co.
Palo Alto, Calif.*

two components, with $E \cos \theta \sin \theta$ being absorbed and $E \cos^2 \theta$ emerging. Hence the law of attenuation is $db = 40 \log \cos \theta$. The input-end film is included to make the unit bilateral.

Signal Leakage

This ideal behavior is modified by inevitable imperfections. The center film cannot be made to have infinite attenuation. Figure 2 shows the effect of a small signal leaking through in the plane of the film. The straight line shows the ideal characteristic, while the curves are typical of what actually happens at different frequencies. Depending upon relative phases and magnitudes, cancellation or addition takes place at high values of attenuation and the curves depart from the ideal. At 90-deg rotation each curve ends up at the value of attenuation the center film has at that frequency. It can be seen that if a sufficiently large margin is left between the maximum attenuation possible and the maximum calibration point, leakage through the center film has negligible effect on the calibration. Furthermore, the re-

sistivity of the film is not required to be extremely stable as in ordinary resistive-film attenuators.

A second imperfection is the effect of reflections from the film ends. Any component in the output due to this cause must be the result of at least two reflections. An analysis of the output signal resulting from multiple reflections within the unit plus some small transmission through the center film yields a series of terms of which only the first few are significant. With typical values for these quantities, the output signal may be expressed very closely by

$$E_{out} \approx E \cos^2 \theta (1 \pm 2B^2 \sin^2 \theta) \pm EA \sin^2 \theta \quad (1)$$

where A is the transmission coefficient through the center film, B the reflection coefficient (assumed the same for all points of reflection). The relative phases of these quantities are quite impossible to predict, so only the worst cases are considered, where the spurious signals both add to or subtract from the desired signal. The ratio of actual output to ideal output then is

$$\frac{E_{out}}{E \cos^2 \theta} \approx 1 \pm (2B^2 \sin^2 \theta + A \tan^2 \theta) \quad (2)$$

From this it is seen that the requirements on reflections are not stringent, as this term can attain a maximum value of only $2B^2$. The effect of finite attenuation is much

Waveguide Attenuator

Suitable for secondary standard of attenuation at frequencies up to 50 kilomegacycles, new device employs resistive films. Characteristics are independent of frequency, and phase shift is independent of setting. Error is less than 1 percent up to 50 db

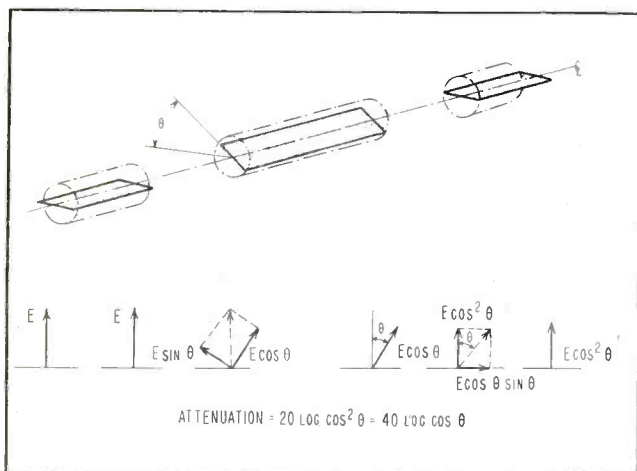

FIG. 1—Principle of operation depends upon three sections of round waveguide with resistive films. Center section rotates to increase attenuation through the system

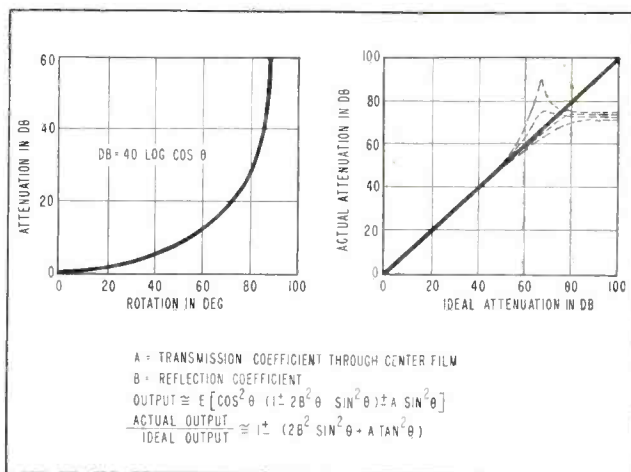

FIG. 2—Attenuation vs center-section rotation (left). Effects of small-signal leakage cause departure from ideal straight-line attenuation (right). Dashed-line humps show possible departures

more serious, as shown by the tangent factor. It turns out that for reasonable accuracy A must be small enough to give about a 20-db margin over the maximum calibration point, as is illustrated in Fig. 2.

An experimental rotary attenuator for X-band embodying these principles is illustrated. The resistive films are evaporated on 2-mil mica, which is clamped between waveguide halves to insure centering. The end sections consist of rectangular-to-round waveguide transitions. Choke joints allow the center section to be rotated. The center-film attenuation is 70 db or more over the entire band from 8.2 to 12.4 kilomegacycles. Reflections are all 5 percent or less.

Performance of this unit is illustrated in Fig. 3A, where the upper

and lower limits of the shaded area indicate the maximum positive and negative errors encountered anywhere in the band at each setting.

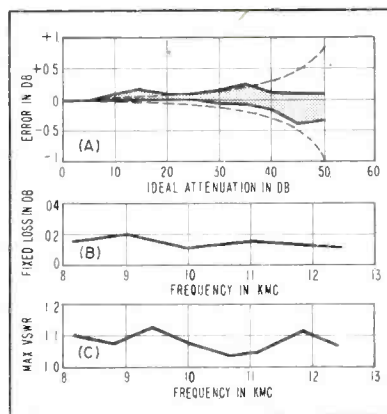

FIG. 3—Maximum errors (A), fixed loss (B) and maximum vswr (C) for rotary attenuator

In terms of db, the error is no greater than 1 percent up to the value of 50 db. It seems likely that calibration can be carried somewhat farther, but eventually accuracy is inherently limited by the fact that successive small increments of angle cause larger and larger increments of attenuation.

Figure 3B shows the fixed loss (loss at zero setting), and Fig. 3C the maximum vswr at any setting. Variation in phase shift is less than one-half degree from zero to 40 db. Undoubtedly it is worse at 50 db, but could not be checked accurately at such a low level.

REFERENCE

- (1) G. C. Southworth, "Principles and Applications of Waveguide Transmissions," p 374, D. Van Nostrand, New York. Inventor of this type of attenuator was the late A. E. Bowen, of Bell Telephone Laboratories.

Submerged Repeaters

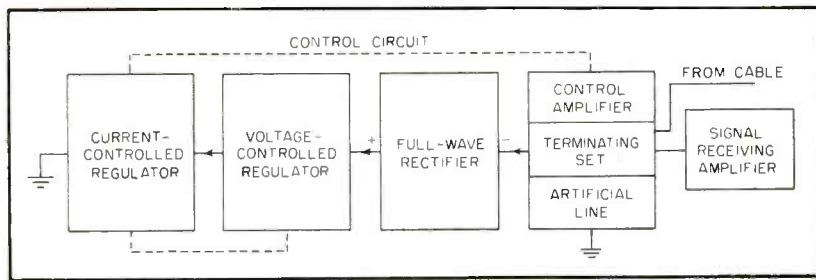

FIG. 1—Block layout of cable-terminating units for submerged repeaters

By A. ATHERTON

The Western Union Telegraph Co.
New York, N. Y.

VACUUM-TUBE TELEGRAPH REPEATERS have recently been connected into each of a number of transatlantic submarine cables at points on the edge of the continental shelves and are submerged there under many fathoms of sea water. All electric current to each repeater is fed over the cable conductor itself from the end toward which the repeater sends the amplified telegraph signals. Current returns by a ground path to the source.

Joint use of the single cable core for telegraph signals and for power supply offers no great technical difficulty. Geographical location of the cables is such, however, that high differences of potential often occur between remote ground connections. The current path to the repeater is therefore subject to disturbances that may either increase or decrease the source potential needed to maintain a given current.

Current Control

Repeaters require a nearly constant current in their circuits. The potential applied to the cable must remain unaffected by any change of voltage of the power available to the station. It must, at the same time, automatically increase or decrease as earth potentials vary. A special rectifier was found to offer the best solution of the problem. As finally designed, the rectifier and its auxiliary control equipment deliver a current of approximately one-third ampere to the cable with a variation of less than one milliampere throughout wide swings both of primary source voltage and earth-current potentials.

A typical cable from Newfound-

land lies at a depth of a few hundred feet for about 150 miles eastward and then the bottom contour falls rather abruptly to a far deeper level. The repeater is placed sufficiently beyond the turning point to lie more than 1,500 feet below sea level. Here the residue of disturbance at signal frequency is very small so that relatively high gains can be utilized.

Signal currents arriving at the repeater, as well as the amplified signal currents leaving it, return by ground paths. Earth potentials normally rise and fall at frequencies so low as not to interfere appreciably with signals at the telegraph frequencies.

At the shore station, a cable-terminating set links the cable to the power source and provides a balancing artificial line. This unit shields sensitive receiving equipment from signal distortions that might result from transient disturbances in the direct voltage applied. In this set is a current measuring tube that initiates a proper correction if the cable current should depart from its normal value.

The repeater requires 0.32 ampere. In the example given, cable resistance to the repeater plus the resistance of the latter totals 700 ohms. It may be assumed that earth potential is normally zero but that differences exceeding 200 volts may arise between the remote ground connections.

The cable-terminal equipment consists of several components shown in Fig. 1. The cable core and an artificial line connect to the terminating set from the line side and the negative pole of the recti-

fier attaches at the power side. The positive pole of the rectifier leads serially through two banks of control tubes finally making connection to ground. The current-reading electron tube provides continuous grid control to an amplifier.

Output of the amplifier fixes the drop across the bank of current-controlled tubes. This bank of tubes may also adjust the drop across the second bank, designated voltage-controlled tubes. In addition, the latter bank provides automatic compensation for any change of potential across the rectifier itself.

Terminating Set

Employing a circuit similar to that of an impedance bridge, an artificial-line network is used having the same impedance characteristic to direct current and moderately low-frequency transients as does the cable circuit itself. In the terminating set these comprise paired bridge arms of about 500 ohms each.

Assuming that the only potential in the system results from the power source, and that the artificial line is a reasonable simulation of the cable itself, equal currents, whether steady or variant, will appear in both. Potentials at *A* and *B* will therefore vary alike and no drop will exist across them.

The signal-receiving amplifier connected across these two points is thus insensitive to any change of voltage at the power source. However, signal currents reaching the terminating set from the cable affect the potential at *A* far more than at *B*. The resulting differences of potential appear at the in-

Use Stabilized Power

Remote undersea amplifiers powered from shore obtain current from regulated supply that holds 0.32-amp current constant within less than one ma. Tandem control circuits compensate for earth currents and a-c line variations

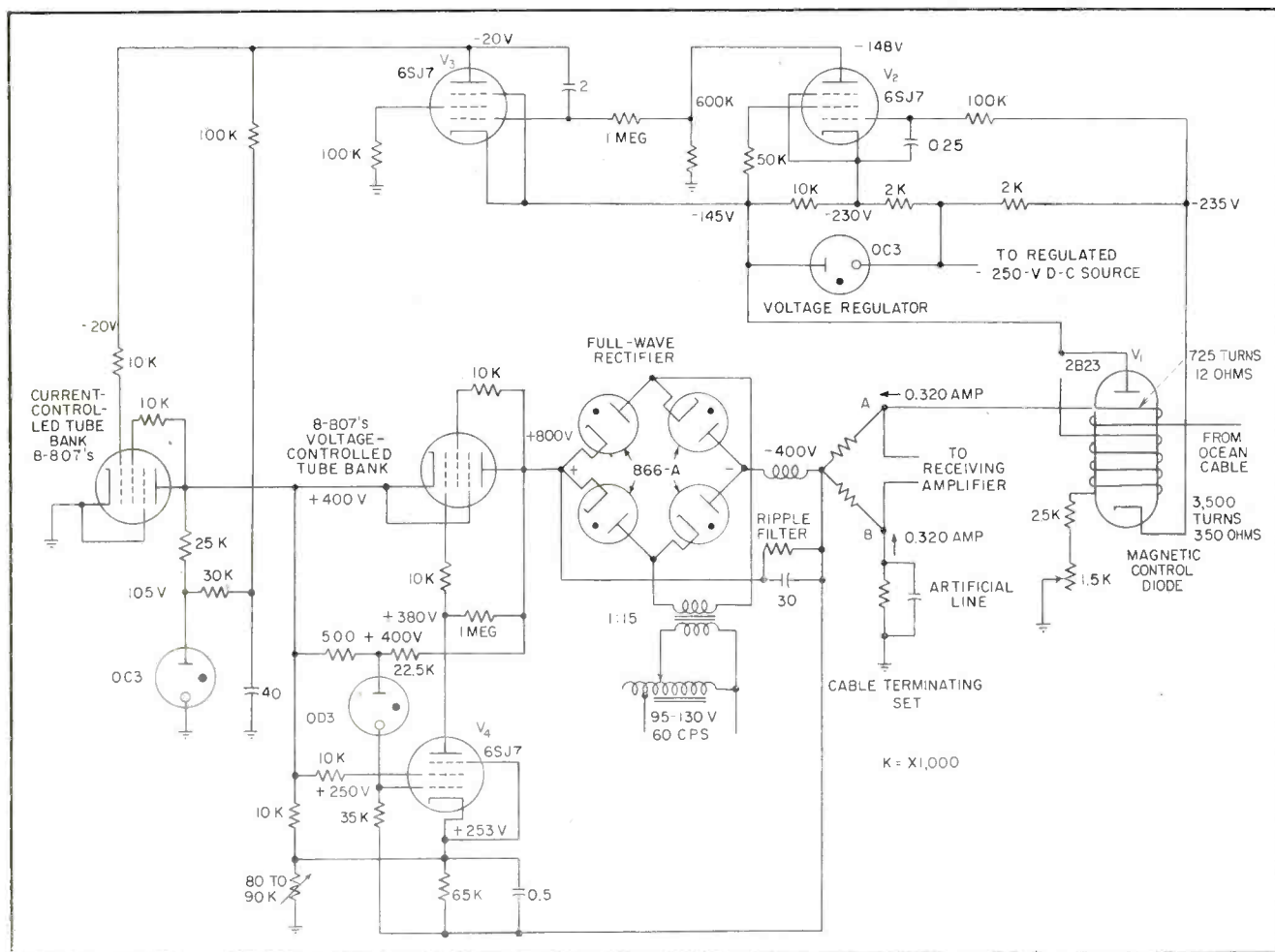

FIG. 2—Combined power source and regulating circuits that hold remote-repeater current stable

put of the signal amplifier. Direct current to line will differ from that to artificial line whenever earth potential exists.

The terminal amplifier is insensitive to the slow drift in these currents and no severe problem is involved on that account.

Current flowing in the cable circuit is carried through one of two coils associated with V_1 shown at the extreme right in Fig. 2. In

the glass envelope of this tube, the anode and cathode are mounted on concentric axes and, in the absence of any magnetic field, behavior is similar to that in other diodes. If the lines of a magnetic field parallel the axis of the tube, electrons are forced from their normal radial paths into a spiral trajectory.

When the magnetic field strength is increased sufficiently, this tra-

jectory will be turned back on the cathode to reduce anode-cathode current flow. There is little change of anode current with increasing magnetic field until a critical magnetization is reached. Beyond this, anode current drops off rapidly with increasing fields.

The tube has two coils outside the glass envelope. These are axially concentric with the tube elements and are enclosed in a steel

shell that decreases magnetic reluctance and shields the tube from stray magnetic fields. The second coil carries a local current from a constant-voltage source to permit adjustment to the cutoff region.

The cathode-anode path is made part of a potentiometer arrangement that causes the cathode potential to become more negative if the joint ampere-turns in the two coils should increase. Tube V_1 is coupled to V_2 and V_3 , which act as a two-stage direct-current amplifier.

A closely regulated 250-volt source supplies current to all circuits. Tube V_1 has the plate-impedance vs ampere-turn curve shown in Fig. 3. The biasing winding provides an adjustment range of some 60 ampere-turns about a normal of 150 ampere-turns. The line winding, with normal current flow, is activated by 230 ampere-turns.

Control Characteristics

Current is directed through the two coils so that the magnetic effects are additive. Plate impedance increases slightly as the ampere-turns increase until a total magnetization equivalent to about 350 ampere-turns is reached. Beyond this, the impedance climbs rapidly. Adjustment provided in the biasing winding is broad enough to ensure that total magnetization can be made just sufficient that a small variation of current in the line coil will produce a large variation of plate resistance.

The drop across the plate-cathode circuit of V_1 and its series 2,000-ohm resistor is held constant by a 105-volt regulator tube. The junction of tube cathode and resistor is used to establish the grid potential of V_2 . The cathode potential of the latter is fixed by a voltage divider across the voltage-regulator tube. Grid bias on V_2 is normally about 5 volts.

If the cable current should increase, plate impedance of V_1 will increase and cathode potential will become more negative. This will increase the grid bias of V_2 , causing its plate voltage to become less negative. Grid potential of V_3 follows, causing plate potential to fall rapidly in that tube. This latter plate

potential determines impedance of the main current-regulating tubes.

The two amplifier tubes together offer a voltage amplification of nearly 1,000. One milliamperere of current change in the line coil of V_1 changes the plate current about 0.1 milliamperere thus changing the cathode potential approximately 0.2 volt. A change of 25 volts or so at the plate of V_3 is sufficient for all control purposes and actual current change in the line coil of V_1 is therefore not allowed to vary more than a fraction of one milliamperere.

Location of repeaters and character of cable affects the potential

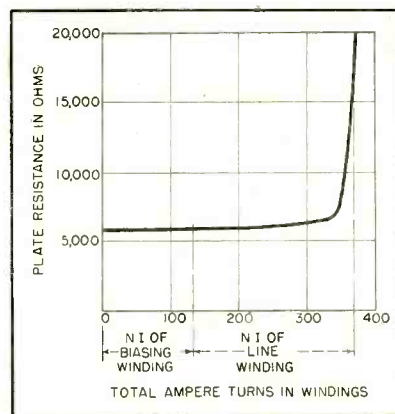

FIG. 3—Plate-impedance versus magnetization curves for magnetically controlled diode in power supply

at which the requisite repeater current can be delivered. A typical case will be assumed in which, under stable conditions, the potential at the apex of the terminating set is 400 volts negative to ground and the current flowing through the set is 0.64 ampere. It is assumed that potentials as high as 300 volts poled either way may arise between the terminal-set ground and the deep-water ground at the repeater. Figure 4 shows the necessary apex potential and current and the total power delivery to the cable system needed to maintain a line current of 0.32 ampere for a wide range of earth potentials. Only those portions of the curves between earth potential limits of plus or minus 300 volts are of interest.

For this set of conditions, the rectifier voltage would be made approximately 1,200 volts and each of the two regulating tube banks

would normally drop this potential by about 400 volts to leave 400 volts available at the apex.

From Fig. 3 it is seen that the plate potential at V_3 is also the grid voltage of the current-controlled tube bank. Under normal conditions about 0.08 ampere flows in the plate circuit of each tube with a consequent drop of 400 volts.

A resistor in series with a voltage-regulator tube is bridged from plates to cathodes of these tubes, the anode of the regulator tube providing a constant-voltage plate-current supply for V_3 . The smaller series resistor and the 40-microfarad shunting capacitors avoid rectifier ripple voltage at the plate of V_3 and together with the 100,000-ohm resistor reduce the plate voltage of V_3 to about -20 volts with normal plate current.

This plate voltage is also the grid voltage of the tubes in the regulating bank. As in the amplifier itself, any change in grid voltage will change the drop across the plate-cathode circuit of the current-controlled regulator tubes. In an actual operating case, the drop will be increased or decreased until equilibrium is reached and line current is steady at a value close to the normally correct one.

Additional Regulation

A single regulating bank has sufficient adjustment range to handle 200 volts or less. Because more correction than this may be needed, a second regulating bank is added. Compensation for cable-current change may then be spread over both banks and the second, or voltage-controlled bank, can be used as well to correct for any voltage change that may occur in the primary a-c source to the rectifier.

In Fig. 2 the rectifier is shown operating at 1,200-volt output. The tandem regulator banks maintain the positive pole of the rectifier at 800 volts above ground potential and the negative pole and terminal set apex are held at 400 volts below ground potential. Another amplifier tube V_4 is included together with a 150-volt reference voltage-regulator tube.

The cathode of V_4 connects into a network that links plate and cathode circuit of the current-controlled

regulator tube and the negative bus of the rectifier. The cathode potential can be set to any normal value desired and can be made to vary linearly with the plate voltage of the current-controlled tubes. Grid potential of V_4 is maintained at a value nearly 150 volts less positive than plate voltage.

Double Regulation

If a change occurs in the plate voltage of the current-controlled regulator tubes, grid bias of V_4 is altered at the same time. When voltage increases, the grid potential of V_4 rises more than does the cathode potential and grid bias is decreased.

With decreased voltage the bias is increased. The plate of V_4 draws its current through a high resistance from the plate circuit of the voltage-controlled regulator bank. Plate potential of V_4 is used for grid control of that bank.

Any variation of plate voltage in the one regulating bank is, through this linkage, reflected in the other. The drop in the two rise or fall together whenever line current variation changes the control condition. Proper selection of all components permits equalizing the change in the two banks so a required 300-volt change will be made by a 150-volt correction in each.

The voltage-regulator tube through which the grid potential of V_4 is controlled connects to a potentiometer that bridges plates and cathodes of the voltage-controlled tubes. The resistor connected to the plate is of much higher resistance than the other so the anode voltage of the regulator tube is near that of the plates of the current-regulated bank. However, a change in plate voltage of the voltage-controlled tubes makes a proportionate change in the voltage at the grid of V_4 . Assuming the drop across the current-controlled regulator remains unchanged, grid bias of V_4 will have been changed. Resistors are chosen so a change of voltage at the plate of the voltage-regulator tube will produce an equal and opposing plate-cathode drop in the bank.

No noticeable current change need occur in rectifier or load circuit. The correction is effected en-

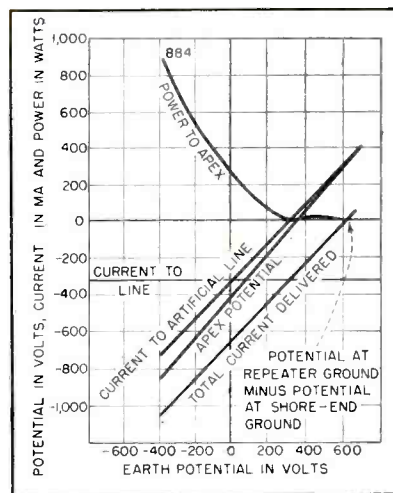

FIG. 4—Potential in volts, current in milliamperes and power in watts as affected by earth potential on undersea cable using remote repeater

tirely by rectifier voltage and its reflection into the control-amplifier tube V_4 . At the worst, any current change that can occur is of short duration.

Ripple Voltage

The L - C filter reduces ripple voltage across the main rectifier to about one percent of the d-c potential (10 volts or more). Actual measurement at the cable-set apex indicates the residual there is about 50 millivolts. The use of a neutralizing artificial line reduces this until the disturbance to incoming signals is negligible.

The general plan by which the voltage-controlled bank compensates for primary voltage changes is employed in the 250-volt direct-current source to the current-control amplifier circuits. There almost perfect voltage stabilization is necessary because of the high-gain requirement in a critical type of amplifier. A small-capacity rectifier together with a single regulating tube, a reference-voltage regulator tube and amplifying tube used as described maintain a dependable 250-volt output at all times.

Power Source

While it is necessary that the power source detect small variations of line current and make automatic voltage compensation, it is equally necessary that incoming cable signals shall not be distorted. Overcompensation and cyclic hunt-

ing must be avoided. A number of shunting capacitors helps to make the arrangement less sensitive at signal frequencies but the most effective of these is a fairly large capacitor across plate and control grid of the second-stage amplifier tube V_3 . The capacitance coupling at that point acts as a transient negative feedback, making the entire amplifier deliberate in its response. The absorption tubes operate with sufficient slowness to avoid overthrow.

Magnetic Diode Action

The cable current may be stabilized to the exact level desired by adjustment of the steady bias current in the magnetically-controlled diode. If the line current is low, a decrease of bias current will effect an increase; if it is high an increase of bias current will correct the condition.

It was assumed in discussion that the rectifier output potential would be 1,200 volts and that the two absorption tube banks would reduce this to 400 volts at cable-set apex. For an actual installation, that line potential likely would not be correct. Earth-current potentials to be expected might be appreciably lower, or available commercial power might be more or less stable than assumed. If the actual range of variation is less, some advantages are gained by narrowing the range of compensation. The absorption banks will not function correctly if plate-cathode potentials are reduced much below 170 volts. The rectifier voltage must be sufficient to provide the maximum need of the cable equipment plus a minimum of 340 volts.

Network components can be selected for any range needed. For example, if earth potentials in excess of 100 volts are not expected, the nominal drop of each of the absorption banks might be reduced to about 300 volts with the voltage-controlled bank automatically compensating for primary voltage changes up to 15 percent and the current-controlled bank providing all compensation for earth potential. The power required would thereby be reduced and the life of the weaker components would be increased.

Video Amplifier

Optimum transient response analysis yields design curves that permit rapid determination of parameters and evaluation of circuit performance for video amplifiers using conventional types of peaking networks. Typical examples are worked out in detail

By **W. K. SQUIRES**
and **H. L. NEWMAN**

Radio and Television Division
Sylvania Electric Products Inc.
Buffalo, New York

OF THE VARIOUS elements of television systems, the low-pass or video amplifier has probably received the most extensive investigation. The majority of the analytical work¹ has been confined to the determination of the steady-state characteristics of the various coupling networks employed. Only recently has attention been focused on the transient response.^{2,3,4}

The purpose of this paper is to show how transient analysis can provide the engineer with a direct, reliable method of resolving circuit limitations and performance specifications into an optimum video amplifier design.

The problem of attaining an optimum design is as follows: certain definite performance criteria are established; that is, gain, maximum rise time and overshoot permissible. Generally, stray circuit capacitances can be evaluated or at least estimated. The problem thus narrows down to determining the type and number of tubes to employ and the best coupling network configuration. Finally, the constants of the various circuit elements must be ascertained.

General Procedure

The general analytical procedure used in preparing the accompanying design curves was as follows: an equivalent circuit was drawn for each video coupling configuration considered, including the effect of inductance losses and distributed capacitances. Then, circuit equations were written in Laplace forms^{5,6} and solved for the relative

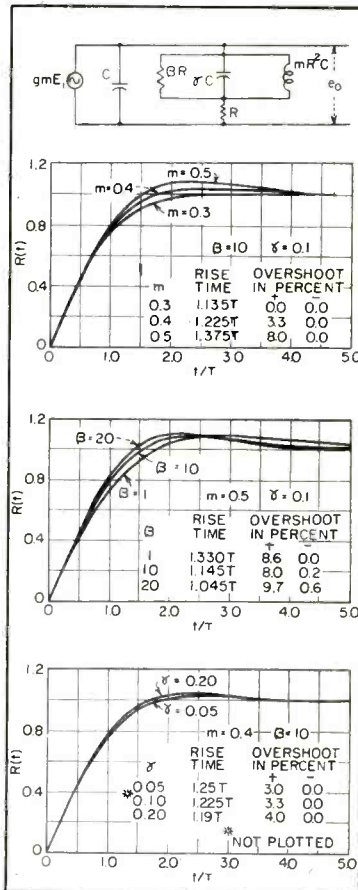

FIG. 1—Pentode shunt peaking

response to an input step function.

In most cases, the large number of energy storage elements appearing in the circuit resulted in expressions in S of high degree which would not afford a general time solution. Consequently, numerical values for each of the various parameters were chosen, and time solutions obtained and plotted for a large number of numerical cases. From these individual solutions, optimal values of the parameters were deduced and checked not only by trial time solutions but also by experimental work with model circuits. These values are presented in the design curves.

The video coupling circuits con-

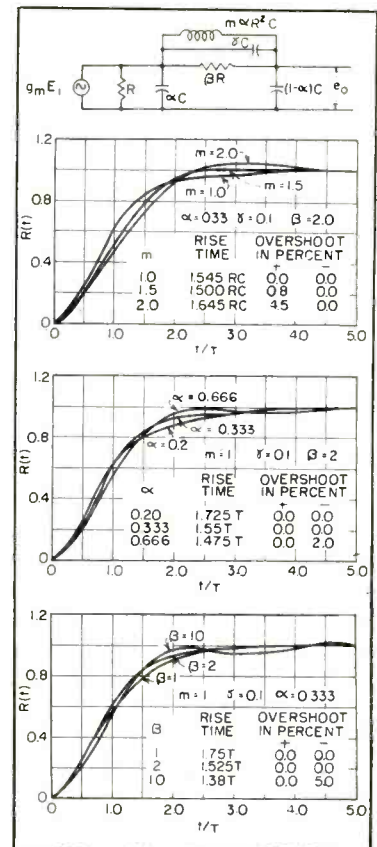

FIG. 2—Pentode series peaking

sidered were those usually described as shunt, series and combination (shunt plus series) peaked. Both triode and pentode equivalent generators were included, and in the case of the triode, families of curves were plotted to study the effect of low plate resistances.

Pentode Peaking

The simplest case is the shunt-peaked pentode having the equivalent circuit shown in Fig. 1. All circuit elements are expressed in parametric form; for example, the distributed capacitance of the shunt inductance is simply γC . As has been observed by many workers, it can be seen that an optimum value

Design Charts

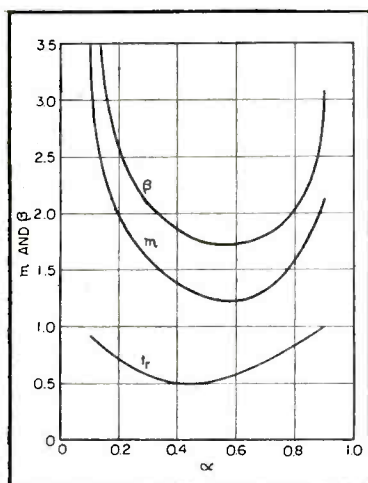

FIG. 3—Design curves for pentode series peaking for optimum m , β and t_r ($\gamma = 0.1$)

of m lies close to 0.4. It can also be seen that distributed capacitance across the inductance causes no difficulty until γ exceeds 0.2. Since β represents the relative loss of the inductance, the effect of coils of low Q can be determined. The curves in Fig. 1 show the effect of varying m , β and γ .

The equivalent circuit for pentode series peaking is shown in Fig. 2. As the value of α is not generally under the control of the designer, optimum values for the various parameters have been obtained and these are plotted in the design curves of Fig. 3. For any value of α , the curves give the values of m and β to produce the minimum rise time for a maximum overshoot of one percent. It should be observed that values of α near 0.4 offer the shortest rise times. From Fig. 2 the effect of varying m , α and β can be determined for use in practical circuit design.

A combination of the shunt and series peaked circuits is shown in Fig. 4. In this case there are six energy storage elements, and as would be expected, this relatively complicated circuit is very sensitive to changes in parameters. However, if the constants are properly chosen, much shorter rise times are possible than can be obtained with the simpler circuits.

Because of the large number of

parameters and the difficulty in solving even specific numerical cases of the circuit equation, the attainment of optimum conditions for all values of α is not a simple task. Although further analytical work is still in progress, Fig. 4A shows the effect of varying both the series and shunt inductances while Fig. 4B gives optimum values for the parameters to produce minimum rise times with small overshoot for various values of α .

In all of the cases presented above, the pentode has been considered as a constant-current generator. When it is necessary to consider the effects of low plate resistances, the triode equivalent generator (the constant voltage source with finite series resistance) should be adopted. Although this approach is most valuable for triode representation, it is also useful for the analysis of low-plate-resistance pentodes.

Triode Peaking

The equivalent circuit with the triode plate resistance given parametrically as ρR is shown in Fig. 5 along with relative response for various values of the parameters.

The effect of changing ρ is particularly interesting; as may be deduced from these curves and as will be shown later, the performance of the triode is superior to that of the pentode when plate-supply power and peak output voltage become important.

The equivalent triode series peaking circuit is shown in Fig. 6. The circuit has the relative response for various values of the parameters given in the curves of Fig. 6. From the analysis of many such curves, optimum relations of the parameters are obtained and plotted in Fig. 7. When these optimums are utilized, the resulting rise times are those given by Fig. 8. All responses resulting from the use of these values have overshoots of less than one percent.

The triode combination peaked circuit is shown in Fig. 9. Of all the circuits analyzed, the triode combination is by far the most involved. At the present time, insufficient data has been obtained to attain optimum relations as given in other cases. However, typical curves which will permit some understanding and application of this

(Continued on p 192)

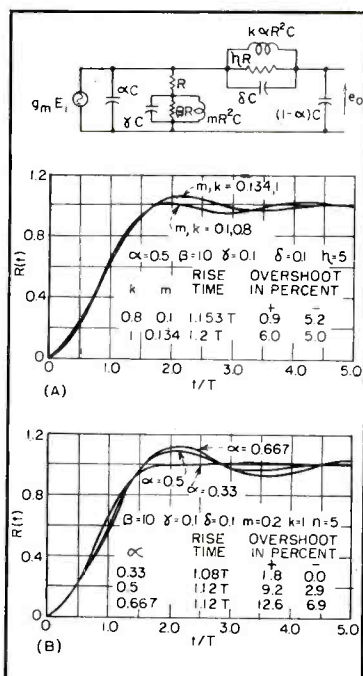

FIG. 4—Pentode combination peaking

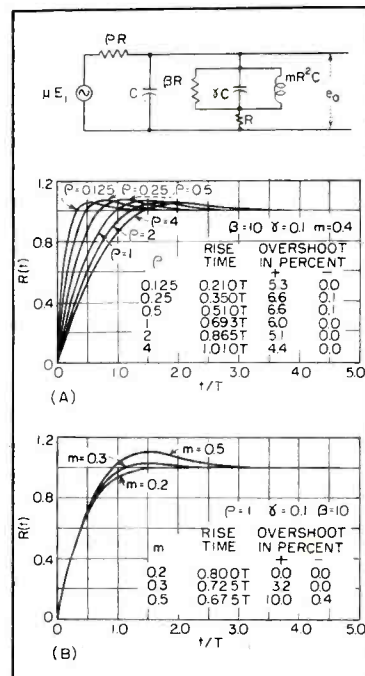

FIG. 5—Triode shunt peaking

Video Amplifier Design Charts

(Continued from p 191)

circuit are given. Figure 9A shows the effect of changing α while the result of varying k is shown in Fig. 9B.

Figures of Merit

When the response of the video coupling circuits is known, the remaining step in formulating the design procedure is to provide some method of selecting the best tube for the particular application. At least from the standpoint of tube performance, this can be done with the aid of figures of merit. From these merit figures contemporary tubes can be evaluated and their figures tabulated for different applications. This has been done but the tabulation is so extensive as to be prohibitive here.⁷

Although a general design procedure applicable to the majority of situations can be outlined, certain limitations are unavoidable. As all of the optimum relations previously described are for very small overshoot cases, the overall response of multistage amplifiers can be determined from the well known rule^{4,6} that the overshoot stays practically constant and the rise time is equal to the square root of the sum of the squares of the individual stage rise times.

The procedure that will be described is intended for single-stage design but with consideration of system problems it can be employed with multistage amplifiers. It is clear that no design procedure can take into account all the probabilities of individual problems such as cost, space and maintenance factors, but it can provide a general technical approach which should simplify the organization of the overall design problem.

Typical Problem

To illustrate the design procedure, let it be required to design a single-stage video amplifier having maximum possible voltage gain, less than one percent overshoot and a rise time of 0.1 microsecond. The stage is to work into a load having a total input capacitance of 20 μf ;

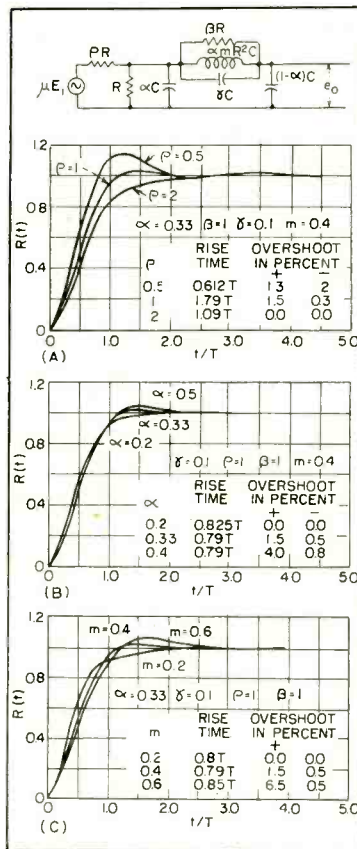

FIG. 6—Triode series peaking

the stray capacitance at the output of the tube itself is estimated to be 8 μf . The coupling network is to be relatively simple of adjustment.

These performance requirements indicate that series peaking should be used since this configuration yields low rise time and only moderate circuit complication. Calculations will be made for both pentodes and triodes, with the former being considered first.

Reference to the figures of merit for pentodes used for voltage gain indicates that the 6AH6 represents the best choice of tubes for this application. The significant data for this tube are: $g_m = 9,000$ μmhos , $C_{out} = 2.0$ μf , $C = 2.0 + 8.0 + 20.0 = 30.0$ μf , $\alpha C = 2.0 + 8.0 = 10.0$ μf and $\alpha = 0.333$. Then, from Fig. 3, $t_r = 1.51 RC$, $m = 1.5$ and $\beta = 2.0$.

Therefore $R = 0.1 \times 10^{-6} / 1.51 \times 30 \times 10^{-12} = 2,210$ ohms
 $L = mR^2C = 0.333 \times 1.5 \times$

$$(2,210)^2 \times 30 \times 10^{-12} = 73.3 \mu\text{h}$$

$$R = 2.0 \times 2,210 = 4,420 \text{ ohms}$$

$$\text{gain} = g_m R = 19.9$$

This completes the design of the pentode stage. The triode stage is approached in a similar manner. The 12AV7 is found from the figures of merit to be the best tube and has the following characteristics: $\mu = 41$, $r_p = 4,800$ ohms and $C_{out} = 0.45$ μf so that $C = 0.45 + 8.0 + 20.0 = 28.45$ μf giving, $\alpha C = 845$ μf and $\alpha = 0.297$.

From this point, the design procedure for triodes is not quite as straightforward as that for pentodes since t_r is a function of both α and ρ . A rapidly convergent trial and error process can be used to determine ρ and R as follows: assume $\rho = 0.5$. Then $R = r_p / \rho = 9,600$ ohms. From Fig. 7 and 8, $t_r = 0.54 RC$, and $R = 0.1 \times 10^{-6} / 0.54 \times 28.45 \times 10^{-12} = 6,250$ ohms.

This means the assumed value of ρ is too small: assume $\rho = 1.0$, which requires $R = 4,800$ ohms.

Again, from Fig. 7 and 8, $t_r = 0.77 RC$, and $R = 4,570$ ohms. This is still too low. Another trial indicates that a value of $\rho = 1.08$ is probably correct. This is found to be so and yields a value $R = 4,450$ ohms. Then, from Fig. 7 and 8, $m = 0.42$ and $\beta = 1.05$. The values

(Continued on p 194)

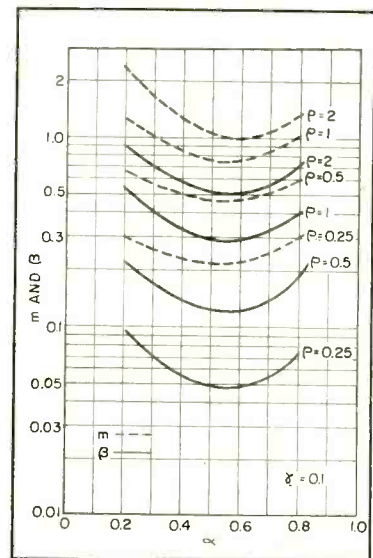

FIG. 7—Triode series peaking curves for determining optimum m and β

SOCKETS - CONNECTORS - PLUGS WHENEVER REQUIREMENTS ARE MOST EXACTING . . . CONSULT CINCH--



QUANTITY PRODUCTION*

of low loss mica components is exclusively a Cinch feature, a contributing factor in the choice of Cinch electronic components as STANDARD.

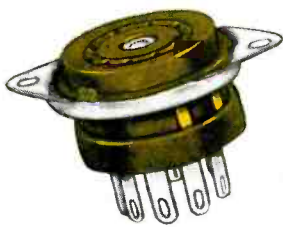

Cinch components are available of leading electronic jobbers—everywhere.

Flexibility of Cinch design and production meets emergencies and changes in application . . . supplies custom made components to fit when occasion demands. Precision-built metal plastic assemblies, such as the Plexicon socket equipped with ceramic condensers, the Magnal, the Diheptal . . . are in constant and continuous production. Cinch demonstrates ability to hold tolerances on mica moldings, to mold high dielectric powders, to meet the most exacting requirements in metal plastic assemblies. Consult Cinch!



Cinch
ELECTRONIC
COMPONENTS

CINCH MANUFACTURING CORPORATION

1026 South Homan Ave., Chicago 24, Illinois

Subsidiary of United-Carr Fastener Corporation, Cambridge, Mass.

(Continued from p 192)

of the actual constants are calculated

$$L = mR^2C = 70.5 \mu\text{h}$$

$$\beta R = 1.05 \times 4,450 = 4,670 \text{ ohms}$$

$$\text{gain} = \mu / (1 + \rho) = 41 / 2.08 = 19.7$$

Special Characteristics

Examination of any of the triode response curves showing the results of varying ρ , discloses the fact that as ρ increases so does the rise time. If at the same time reference is made to typical triode characteristic curves, it can be seen that r_p and consequently ρ varies very rapidly with grid voltage, particularly in the region near cut-off. As a result, the rise time of the triode amplifier is a function of its driving voltage; when the grid voltage is far negative, the rise time is long, decreasing as the grid voltage becomes less negative.

Over the normal operating range of typical triodes when used as video amplifiers in class A, this effect is relatively negligible as the variation of ρ is slight.

However, this characteristic of variable rise time can be exploited when triodes are used to amplify an asymmetrical voltage such as a video signal. If a video signal of sufficient amplitude, with the synchronizing signal polarized negative, is applied to the grid of a triode amplifier the rise time of the stage will be longer during synchronizing time than during picture time. It is possible under these circumstances to have the fast rise time necessary to good video amplification and at the same time have a slow rise time, or narrow bandwidth channel, for the synchronizing signal.

As a ratio of maximum to minimum rise time of the order of five is possible, it can be seen that large improvements in signal-to-noise ratio for the synchronizing signal can be obtained. The design of a triode stage to be operated in this manner is made with the same procedure previously described and the rise time and subsequent bandwidth reduction determined from

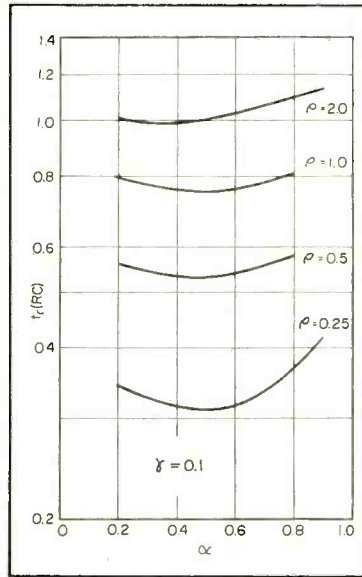

FIG. 8—Triode series peaking curves for determining optimum t_r .

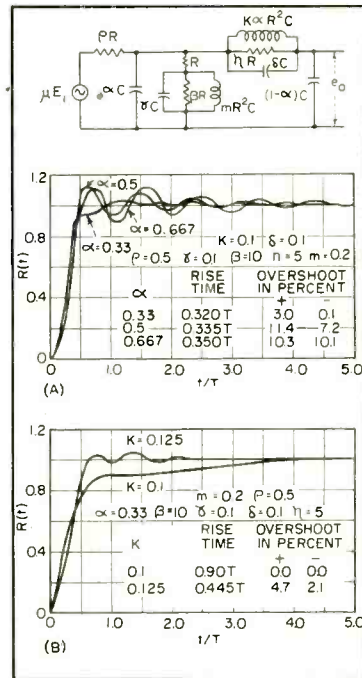

FIG. 9—Triode combination peaking

the optimum curves for the peaking circuit.

From the transient analysis of several video coupling networks, relationships among the various parameters have been obtained to produce optimum transient responses. When these optimum relationships are combined with applicable figures of merit, a de-

sign procedure is formulated which permits direct and concise design of both pentode and triode amplifiers.

Summary and Conclusion

From study of the triode response curves and experience with actual circuits, it is clear that the triode amplifier is quite superior to the pentode when the attainment of maximum output voltage is the major criterion. For the same plate supply power and tube dissipation, a triode, properly peaked, can produce from two to three times as much voltage output as a pentode. Of course the problems of cascading and driving the triode are relatively complex, but in many applications the increase in complexity would be a small price to pay for the increase in overall performance. In addition, the triode offers certain advantages in synchronizing signal-to-noise ratio.

From the standpoint of circuit synthesis, the use of the direct solution of circuit equations in terms of their primary functions, in this case reproduction of transients, leads to simple and interpretable design formulation.

The authors are particularly indebted to Karl R. Wendt for his general guidance and criticism and to Laverne H. Hardy for his extensive assistance in the analytical work.

BIBLIOGRAPHY

- (1) S. W. Seeley and C. N. Kimball, Analysis and Design of Video Amplifiers, *RCA Review*, Oct. 1937 and Jan. 1939.
- (2) H. E. Kallmann, R. E. Spencer and C. P. Singer, Transient Response, *Proc. IRE*, 33, p 169, March 1945.
- (3) A. V. Bedford and F. L. Fredendall, Analysis, Synthesis and Evaluation of the Transient Response of Television Apparatus, *Proc. IRE*, 30, Oct. 1942.
- (4) A. V. Bedford and G. L. Fredendall, Transient Response of Multistage Video-Frequency Amplifiers, *Proc. IRE*, 27, p 277, Apr. 1939.
- (5) S. Moskowitz and J. Racker, "Pulse Techniques", Prentice-Hall, Inc., New York, 1951.
- (6) M. F. Gardner and J. L. Barnes, "Transients in Linear Systems", John Wiley & Sons, Inc., New York, 1942.
- (7) The tabulations of figures of merit for the majority of contemporary tubes for both voltage gain and voltage output and for a wide range of circuit capacitances are available from Sylvania Electric Products Inc., Technical Relations Department, Bayside, New York.
- (8) G. E. Valley, Jr. and Henry Wallman, "Vacuum Tube Amplifiers", MIT Rad. Lab. Series, McGraw-Hill Book Company, Inc., New York, 1948.

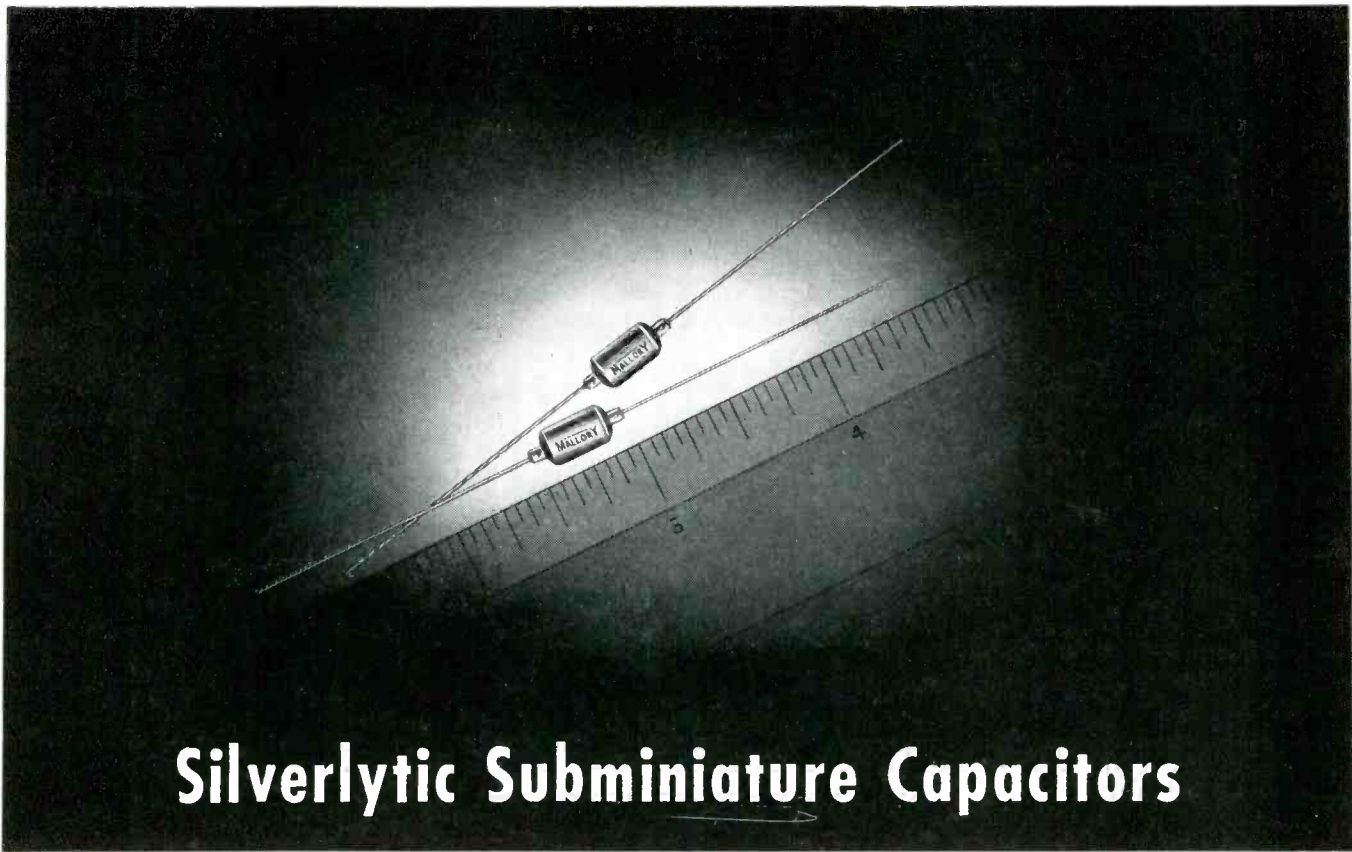

Silverlytic Subminiature Capacitors

Save Space in Transistor Circuits

Specifications for Silverlytic Capacitors

Available ratings:

1 mfd.	4 volts DC Max.
2 mfd.	5 volts DC Max.
1 mfd.	10 volts DC Max.
.5 mfd.	10 volts DC Max.
.3 mfd.	10 volts DC Max.
.2 mfd.	10 volts DC Max.
.1 mfd.	10 volts DC Max.

Temperature range: -30° C to $+65^{\circ}$ C

Capacity tolerance: -10% to $+$ infinity

Max. leakage current: 2 microamps, after 5 min. at rated voltage

In a case smaller than the eraser on a lead pencil, Mallory Silverlytics provide a capacity of up to four microfarads. They're the ideal answer to capacitor problems in transistor circuits and other miniaturized low-voltage applications.

The case is only $\frac{1}{32}$ inch in diameter and $\frac{3}{8}$ inch long. Axial leads of No. 26 bare tinned wire are furnished for self-supported mounting.

Despite their tiny size, Silverlytics actually exceed the characteristics of their larger predecessors. They embody the years of research and production experience which have made Mallory electrolytic capacitors the leading choice of manufacturers of electronic equipment. Write to Mallory today for complete technical information.

Expect more... Get more from **MALLORY**

Parts distributors in all major cities stock Mallory standard components for your convenience.



Serving Industry with These Products.

Electromechanical—Resistors • Switches • Television Tuners • Vibrators
 Electrochemical—Capacitors • Rectifiers • Mercury Batteries
 Metallurgical—Contacts • Special Metals and Ceramics • Welding Materials

ELECTRONS AT WORK

Edited by ALEXANDER A. McKENZIE

Shell Gage Draws Graph of Fault	196	Variable Balanced D-C With Low Output Impedance	212
Converted Limousine Aids TV Pickup	196	Battery-Powered A-C Voltmeter	216
Analyzer Totals Remote Audience Interest	198	AGC For Transistor Amplifiers	224
The Front Cover	200	British Electronic Developments	228
Testing Magnetic Decision Elements	200	Phase Transducer Uses High-Speed Relays	234
Normalized General Purpose Audio Amplifier	203	Pertinent Patents	236
High Sensitivity D-C Breaker Amplifier	206		

OTHER DEPARTMENTS

featured in this issue:

	Page
Production Techniques	250
New Products	290
Plants and People	332
New Books	383
Backtalk	399

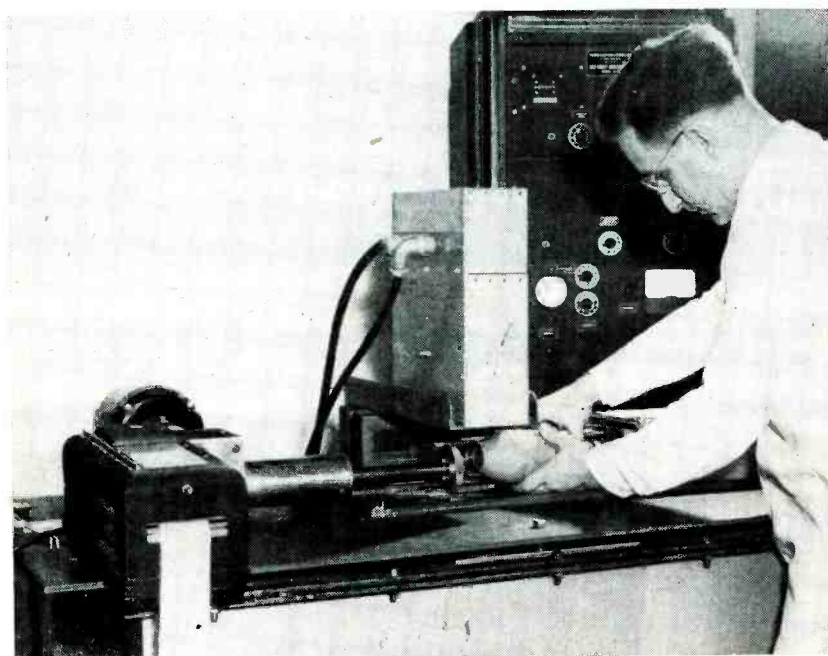

Shell Gage Draws Graph of Fault

A PHOTOELECTRIC METHOD is employed in a new shell-inspection gage wherein x-rays, after passing through the part under test, strike a pair of potassium iodide scintillation crystals that emit visible light approximately proportional to the x-ray intensity. The light from the crystals is brought to the cathodes of secondary emission phototubes whose output is amplified and ap-

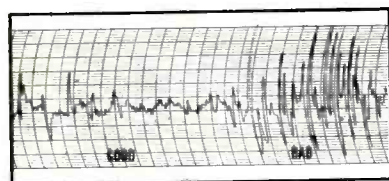

Graphic record on tape shows defects

plied to a d-c meter and a chart recorder.

To eliminate variations due to line-voltage changes, the whole system is operated as a self-balancing bridge where output is substantially independent of excitation voltage and varies only when unbalance between the bridge elements is present.

Projectiles of 3.5-inch diameter, having a 1/8-inch steel casing, were to be inspected for the presence of cavities in their filling. To scan the complete volume, it was found desirable to employ a helical scanning method, with two fixed scintillation crystals a small distance apart. A scanning pitch of 3/16

inch was chosen, and the speed of rotation adjusted so that faults 3/16 inch apart would produce signal pulses separated by 0.2 second, which could be handled by an electronic system having a bandwidth greater than 5 cycles per second.

One of the x-ray beams passes through the center of the projectile; the other beam is some distance off center. This arrangement is necessary to avoid a blind spot that exists with symmetrical beams where a small cylindrical volume around the center line is never inspected.

Converted Limousine Aids TV Pickup

BY LAWRENCE WEILAND
Project Engineer
Audio-Video Engineering
National Broadcasting Co.
New York, N. Y.

BECAUSE A CONVENTIONAL TV pickup truck is often too bulky to be allowed within convenient viewing distance of a public event, NBC has converted a Cadillac into a mobile pickup. Known as the Traveling Eye, the unit contains a field sync generator, image orthicon camera, modified hand-held vidicon, relay transmitter, diplexer and audio amplifier. In addition, the car carries two-way 450-mc communications equipment, 26-mc program feedback and cueing receiver and 3.5-kw gasoline-driven motor generator.

Operating crew includes driver-cameraman, cameraman, operator to point the link transmitter head, announcer and control engineer. The entire equipment was first used

MEASURES

A Completely Self-Contained

RF BRIDGE

500kc to 250mc

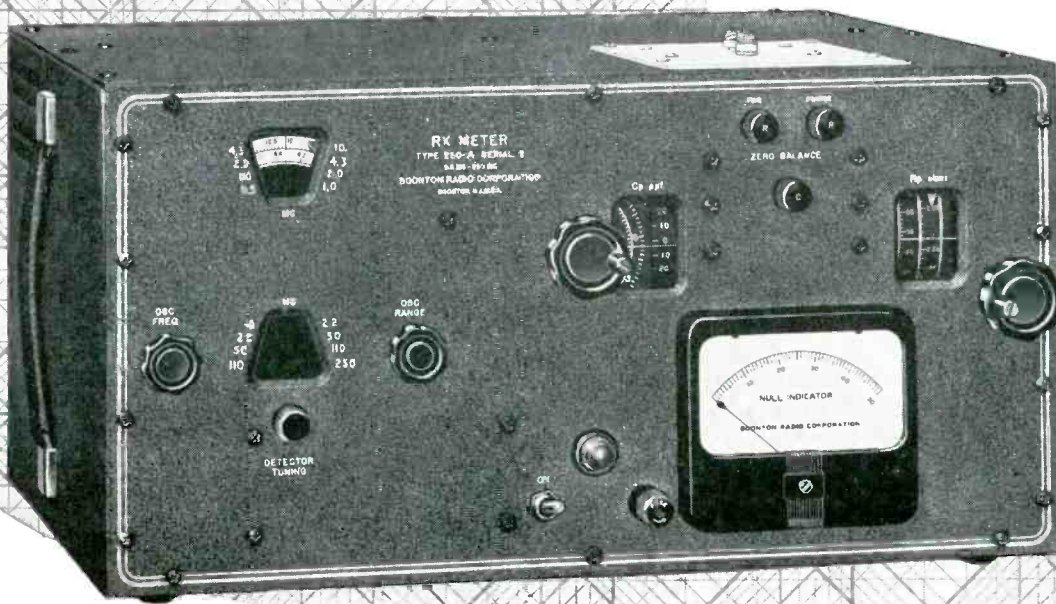

RX METER TYPE 250-A

- SAVES valuable engineering labor: makes RF bridge measurements a "means to an end" rather than an end in themselves.
- INCLUDES self-contained test oscillator, local oscillator, Schering bridge, detector, and null indicator.
- INDICATES directly equivalent parallel resistance and capacitance (or inductance) of any two-terminal network.
- MEASURES dynamic and static systems under actual operating conditions.
- CONNECTS to unknown from convenient binding posts or Type N coaxial (with use of accessory adapter).

SPECIFICATIONS

FREQUENCY RANGE: 500 KC to 250 MC in eight ranges.

FREQUENCY ACCURACY: $\pm 1\%$.

RESISTANCE RANGE (R_p): 15 to 100,000 ohms.

RESISTANCE ACCURACY (R_p): $\pm \left\{ 2 + \frac{Fmc}{200} + \frac{R_p}{5000} + \frac{Q}{20} \right\} \% = 0.2$ ohms.

CAPACITANCE RANGE (C_p): -100 mmf to +20 mmf.

CAPACITANCE ACCURACY (C_p): $\pm \left\{ 0.5 + 0.0002 F^2 mc \right\} \% = 0.15$ mmf.

TEST VOLTAGE: 0 volts D. C. (Up to 50 ma. may be passed through unknown terminals).
0.1-0.5 volts R. F. (may be conveniently reduced to 20 mv.).

POWER REQUIREMENTS: 105-125 volts, 50/60 cps, 60 watts (internally regulated).

MEASUREMENT APPLICATIONS

Resistors
Transistors
Tubes
Tuned Circuits
Diodes
Transmission Lines
Antennas
Coils
Capacitors
Chokes
Receivers
Filters
Transmitters
Attenuators
Pads



RESISTORS



DIODES



COILS



TUBES



CAPACITORS



TRANSISTORS

BOONTON RADIO

BOONTON · N · J · U · S · A

Corporation



Price: \$1250.00 F.O.B. Boonton, N. J.

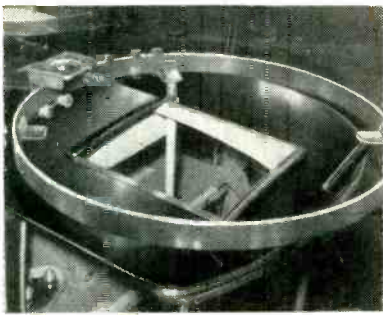

Stainless steel ring and carriage permits aiming camera or transmitter in any desired azimuthal direction

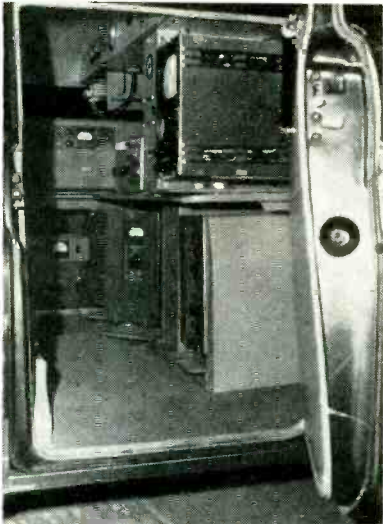

Control section of the telemobile is behind the driver's seat of limousine

to cover the Inaugural parade in Washington. At that time, the microwave relay receiver was located on the Capitol dome, from

which point the program was relayed to the tv broadcast transmitter.

Among many structural changes made to the limousine in order to accommodate tv equipment and operating crew, several are of particular interest. Surmounting two waterproof hatches let into the roof of the car are two machined stainless steel rings upon each of which a specially designed carriage rolls.

A standard camera panning head mounts on this carriage, which is equipped with a quick-acting lock, enabling the camera man or transmitter man to rotate equipment through a complete circle. Both rings are identical to permit interchange of camera and transmitter positions.

Interior trim is a compromise between ruggedness and sound absorption qualities. An absorbent flannel-like cloth was chosen for the head liner and the space between that and the roof is lined with glass wool.

Noise reduction is effectively increased by use of a newly developed miniature pressure microphone. Noise level is better than 40 db below program, despite the power plant in the rear trunk.

Windows in the rear were replaced with a very heavily tinted green glass to permit the control operator to adjust his kinescopes. Two side windows were equipped



Ambient noise level is effectively reduced with new type microphone

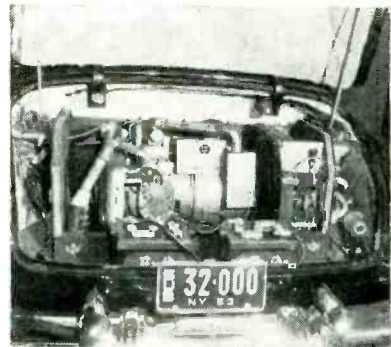

A gas-engine driven 115-volt power supply runs standard video equipment

with black shades.

Because the car is designed to operate at slow speed for long periods, a different ratio axle was used. A five-bladed fan, new drive pulleys for higher fan speed and a shroud on the motor side of the radiator permit adequate engine cooling.

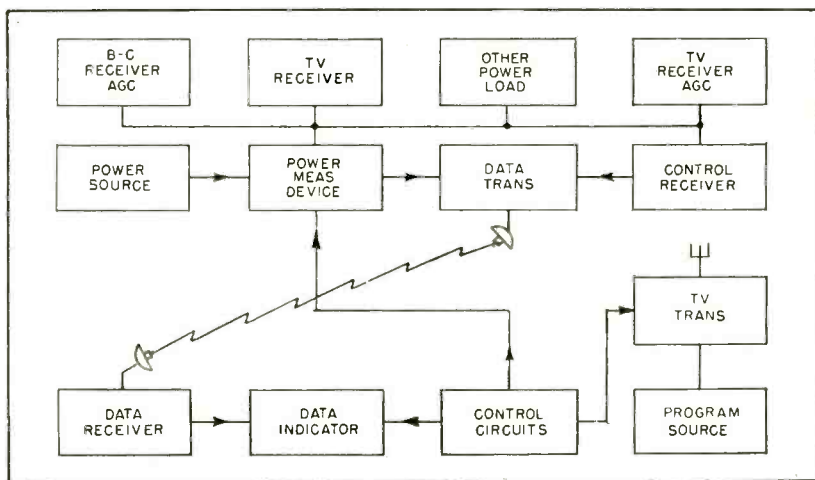

Analyzer Totals Remote Audience Interest

COMMERCIAL ENTERTAINMENT better means of audience analysis. broadcasters must continually seek A means that could provide a broad-

cast radio or tv station with an indication of the extent of its audience directly and instantaneously is disclosed in patent 2,636,671, issued to R. E. Shelby and assigned to the Radio Corporation of America.

Power Reduction

The simplified block diagram of the invention is shown in Fig. 1. The inventor proposed that each transmitter be momentarily reduced in power, which would result in a change in the agc voltage applied to certain circuits of a tv or voice-modulated broadcast receiver tuned to the broadcast. The resultant difference of plate current drawn by the tubes under the control of the agc bias will result in a small change in the power consumption of the receiver from the

HELIPOT ANNOUNCES NEW DUODIAL SERIES

A number of special features have been designed into the new RB series Duodials made by Helipot Corporation of South Pasadena, California, and Mountainside, New Jersey.

Special Features... Reduced torque and easier reading result from unique jump-action gearing between inner and outer dials. Vibration-proof locking mechanism is provided. RB series Duodials are delivered completely assembled... are easily mounted on panel or directly on device. Attractive finish... lustrous satin-chrome and polished black nylon... adds distinction and quality "feel" wherever used.

Other Series... Other Duodials include the W series... most often used to drive primary controls; the R series; and the miniature, half-ounce SR101.

General Features... The Duodial consists of two coaxial dials... and a knob integral with the inner dial. The inner dial is calibrated to count hundredths of each turn... the outer dial is calibrated to count the number of completed turns. The knob and inner dial are fastened directly to the shaft of a rotating device to count its turns... the critical readings of the inner dial are, therefore, free from backlash. Also... since the Duodial can be rotated by either the knob or the shaft... it will set a device to a desired number of turns... or will count precisely the full and partial revolutions of a power-driven device.

Duodials are cleanly designed... attractively finished... in a variety of types and sizes... several with locking mechanisms.

Data File... For information and specifications on all Duodials, write for Data File No. 102.

Helipot makes a complete line of single-turn and multi-turn precision potentiometers, and turns-counting Duodials. Many models are regularly carried in stock for immediate shipment.

the Right Combination with your...

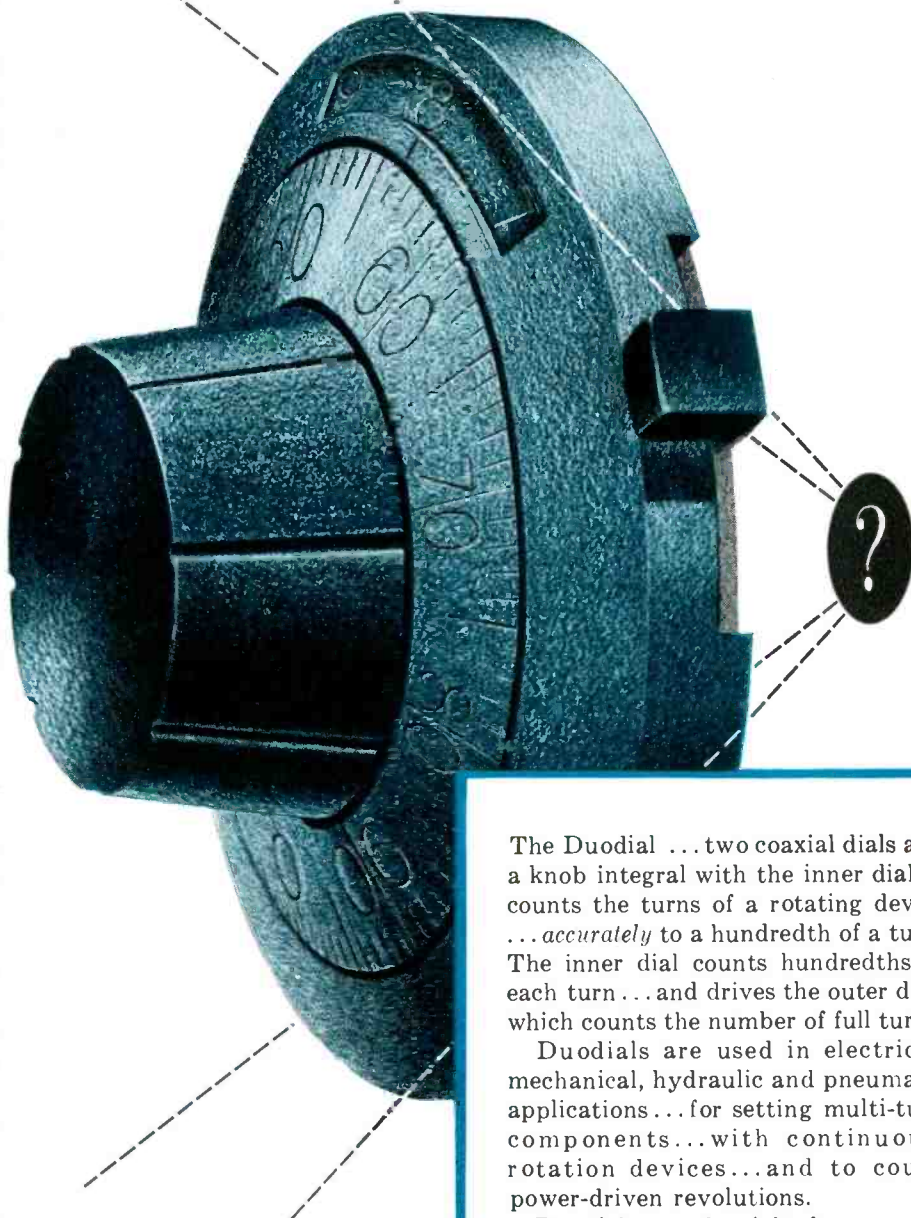

The Duodial... two coaxial dials and a knob integral with the inner dial... counts the turns of a rotating device... *accurately* to a hundredth of a turn. The inner dial counts hundredths of each turn... and drives the outer dial, which counts the number of full turns.

Duodials are used in electrical, mechanical, hydraulic and pneumatic applications... for setting multi-turn components... with continuous-rotation devices... and to count power-driven revolutions.

Duodials may be right for use with *your* product. A Duodial is *always* right in combination with a Helipot* precision potentiometer.

Helipot corporation

*T. M. Reg. U. S. Pat. Off. • 241

a division of **BECKMAN INSTRUMENTS, INC.**
SOUTH PASADENA, CALIFORNIA
PLANTS AT SOUTH PASADENA & MOUNTAINSIDE, NEW JERSEY
ENGINEERING REPRESENTATIVES IN PRINCIPAL CITIES
first in precision potentiometers

centrally located power source.

It is claimed that, with sensitive power-measuring equipment in the power stations supplying the area in which the audience measurement is to be made, a measurable difference in the area power consumption will be detected.

It is recognized that the number of receivers affected may not be known but that correlation with other audience measurement survey

techniques will give valuable indication. It is further recognized by the inventor that some receivers may be battery operated and a number may not be equipped with age or ave systems.

Tie-in circuits between the broadcaster and the power stations enable the broadcaster to have a direct indication upon the performance of the audience measurement test and also for the broadcaster to initiate

the test. The test would be made in no more than a second and can be initiated during a program lull or station break.

Advantages of the Shelby proposal are that no special devices are required to be installed in the consumer's receiver and that the test can be carried out entirely independent of the receiver—in fact entirely without the knowledge of the audience at any time.

THE FRONT COVER

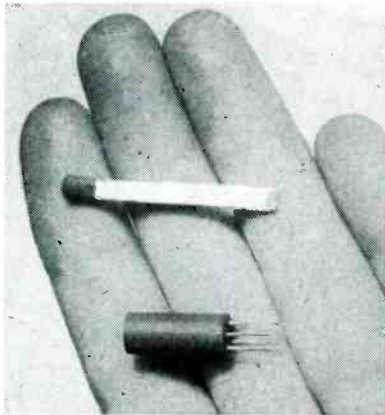
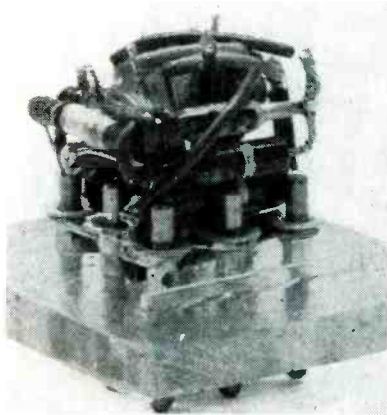

Decision element is shown before potting (left). New lightweight subminiature element for airborne computers is compared (right) with paper match. Electrical characteristics are described in the article below

Testing Magnetic Decision Elements

By JOHN D. GOODELL,
The Minnesota Electronics Corp.,
St. Paul, Minnesota

MAGNETIC DECISION ELEMENTS are basic computer building blocks incorporating the functions of logical operators as well as power gain, pulse shaping and temporary storage for synchronization in each element. Using only type A (a mixer) and type S (a negative coincidence circuit), it is possible to construct the arithmetic, program and high-

speed memory sections of any digital computer.^{1, 2}

The basic operation of these elements depends on half-cycle amplifier principles, storage properties of rectangular-hysteresis-loop magnetic materials and cancellation techniques for obtaining logical negation. An input 1 produces an output 0, while an input 0 produces an output 1.

The cover photograph shows a plugboard containing approximately 1,000 magnetic decision elements. These elements are connected in various configurations to form basic computing structures such as shift registers, adders, flip-flop memory sections, delay lines, commutators and recirculating-loop-pattern generators. The element to be tested is inserted in a fixture connected to a switching arrangement that allows it to be sub-

stituted for various elements on the board.

Thus, it may be operated rapidly under practically all of the various conditions that may be encountered in practice in order to provide a complete final production check. Decision elements are used to operate sensitive relay circuits directly, thus facilitating simple visual observations of performance.

The yellow elements are the type A and the blue elements type S. The green cubes contain only diodes, for convenience in mixing a multiplicity of inputs when necessary.

Characteristics of Elements

Each decision element may be driven from several sources. Information travel through series chains of elements is at a rate of 100 kc. Average power consumption is approximately 0.5 watt per element.

For special applications, such as airborne computers where weight and size are of primary significance, the cubic volume per decision element has been reduced by a factor of more than ten, with an appropriate reduction in power consumption.

Components consist of diodes, re-

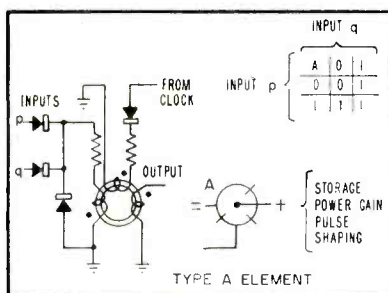

FIG. 1—Circuit of type A element

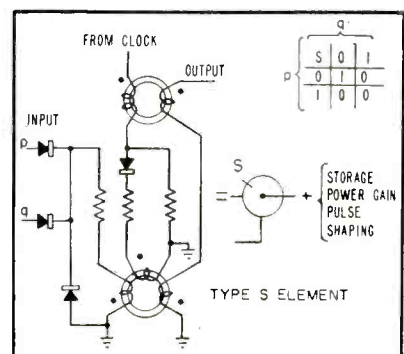
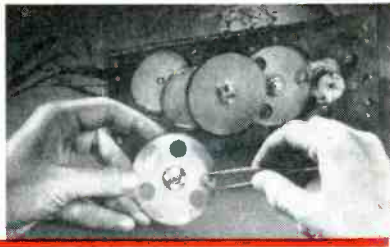



FIG. 2—Circuit of type S element

HERE'S HOW



BENDIX RADIO AND AKELEY CAMERA

**cut frictional torque,
save space . . . with**



RADAR ANTENNA ROTATOR
Designed by Bendix Radio and manufactured by Akeley Camera. Uses MPB miniature ball bearings.

OPERATING CONDITIONS — low frictional torque at gear speeds of 1065 and 1200 rpm, extremely limited space, plus necessary prevention of radial play and tilting of gears. Resolved by use of 2 ultra-precision MPB bearings, o.d. .3125 in., bore .1250 in.

ENGINEERING DRAWING MPB BEARING 518C

M P *recision* B earings

MPB bearings can help you



Design engineers, designers of precision equipment of all types — here is the most complete information ever offered on miniature ball bearings. It may help you solve a design problem . . . or spark a new-product-idea. Write on your letterhead for new MPB catalog E 54a.



Also available to qualified groups: the 16mm, sound-color film, "Mighty Miniatures" — the story behind the production of ultra-precise MPB bearings.

Miniature Precision Bearings, Incorporated

Keene



New Hampshire

QUALITY

the unwritten SPECIFICATION

At AMPHENOL, each component, beginning in design and continuing through engineering, production, inspection and delivery, has on its blueprint an unwritten specification. It's a small word, yet it covers the most important single ingredient in an AMPHENOL product—"Quality."

At AMPHENOL, the design of a new component or the modification of an existing component has as its basis a concern for quality. How can it be designed to perform best? What materials will provide this performance? These are very real questions asked in the Designing Department at AMPHENOL—questions that must be satisfactorily answered before a design can be released. Product engineers continue with this concern. They may spot improvements in a component which will insure higher quality—and these will be incorporated. Finally, Production and Inspection keep a quality-wise eye on the component during the manufacturing process.

The results of this continuing *emphasis on quality* are the famous AMPHENOL components. Whether it is a socket, a connector or a cable, the final component that is delivered to you is the finest you can buy and is as surely marked with the unwritten specification "Quality" as the original blueprint.

NEW! CATALOG B-3

The new, revised AMPHENOL general catalog B-3 will be sent upon request. It contains illustrations and specifications on the over 9,000 items now manufactured by the AMERICAN PHENOLIC CORPORATION.



AMPHENOL

AMERICAN PHENOLIC CORPORATION
chicago 50, illinois

sistors and inductors. The magnetic cores are toroids wound with $\frac{1}{8}$ -mil thick ribbon of grain-oriented, essentially rectangular-hysteresis-loop materials. Power is derived entirely from the clock-type pulse generator that also serves to provide synchronization in two out-of-phase 100-kc strings of 5-micro-second pulses.

Type A Element (Yellow)

The basic operation of a type A unit may be explained with reference to Fig. 1. In this structure, information signals sensed to swing the flux from 0 toward 1 are applied to the input diodes. The diodes function as a mixing circuit. The input stores information in the magnetic material by driving it to saturation in the sense 1 or leaving it in the sense 0 (conventionally the material is assumed initially to be in the zero sense).

Subsequently, a clock pulse is applied through the clock winding sensed to drive the flux in the 0 sense. If there has been no input signal there will be no significant change in flux from the application of the clock winding and the output signal will be 0. If the input signal has driven the material to saturation in the sense 1, then the clock signal will drive it back to 0 and the change of flux will produce an output signal 1.

Power gain in this circuit is obtained by differential loading of the output circuit. The diode in the output circuit is oriented so that the input signal sees an open circuit across the output winding, hence has only to supply energy to move the flux from 0 to 1. When the clock pulse is applied it sees only the forward resistance of this diode and is required not only to move the flux back from 1 to 0 but also to supply current to the load. Pulse shaping is obtained in terms of the integral of the output signal, which is sharply defined and limited by the magnitude of flux it is possible to swing from saturation to saturation.

Type S Element (Blue)

The type S circuit consists essentially of two type A units arranged

as shown in Fig. 2 and driven from a common phase of clock source. The input of one A is driven continually from the opposite phase of clock pulse so that this A generates a constant stream of 1's. The output of the two elements are connected in series opposing. Thus, if an output appears from both of them simultaneously, cancellation will take place.

The A with its output winding in opposition to the one that is driven continually at the input from an appropriate source of clock pulses is the one to which the intelligence input is applied. Thus, if there is a 0 (no intelligence pulse) on either of the input lines, the output will be a 1. This may be described as the coincidence of two 0's—or somewhat less accurately as negative coincidence. If there is a pulse on either or both of the input lines, the output will be 0. This satisfies the matrix for the logical factor S.

REFERENCES

- (1) John D. Goodell, The Foundations of Computing Machinery, *Journal of Computing Systems*, 1, No. 1, June 1952.
- (2) Tenny Lode, A Universal Decision Element, *Journal of Computing Systems*, 1, No. 2, Jan. 1953.

Normalized General Purpose Audio Amplifier

IN TESTING microwave antennas the modulation frequency of the test signal from a transmitter varies from a few hundred cycles to a few thousand cycles, this modulation frequency being fixed for any one test or series of tests. The antenna under test is generally used as a receiving antenna on a rotating mount and the energy picked up goes to a bolometer or crystal. The modulation frequency output is a direct measure of the microwave energy picked up.

This procedure requires a high-gain, linear audio amplifier with good signal-to-noise ratio and preferably with automatic normalization.

The primary purpose of automatic normalization is to compensate for errors introduced by

AN CONNECTORS

AMPHENOL is the leading manufacturer of approved AN connectors. These feature premium material, and careful inspection assures that each connector measures up to and beyond specifications.

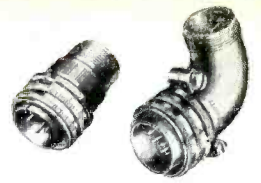

RF CONNECTORS

AMPHENOL RF connectors provide never failing continuity and extremely low-loss—are unsurpassed for mechanical design and electrical efficiency.

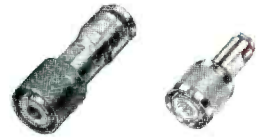

POWER CONNECTORS

AMPHENOL's lightweight and compact power connectors are built to stand rough handling. They are 100% shock-proof and can be relied upon for electrical connections in all appliances and machinery.



AUDIO CONNECTORS

AMPHENOL microphone connectors have been standard with leading microphone manufacturers for years. Providing unique interchanging coupling rings, they give mating connections at every junction.



RACK & PANEL CONNECTORS

AMPHENOL 26 series rack and panel connectors have the added strength needed for their efficient operation and safety features which include interlocking barriers to prevent accidental shorting.



BLUE RIBBON CONNECTORS

AMPHENOL Blue Ribbon connectors represent a new solution to the problem of providing quick disconnection for electronic sub-assemblies, incorporate gold finished contacts and new sturdy dielectric.

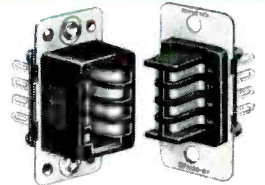

RG TYPE COAXIAL CABLES

AMPHENOL RG coaxial cables are made with low-loss polyethylene dielectrics. Precision extrusion guarantees strict end-to-end uniformity—constant inspection insures top quality.

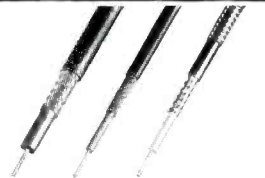

MINIATURE CONNECTORS

AMPHENOL miniature connectors provide high-quality interconnection of miniature electronic equipment. They are made with the same skill and care that characterizes all AMPHENOL components.

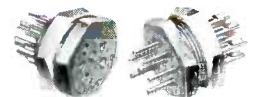

SOCKETS

AMPHENOL MIP sockets have unique construction features. The plate is molded directly into the bakelite body, cannot come loose or vibrate—speeds up production, reduces breakage.

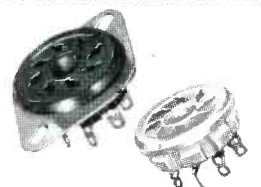

AMPHENOL

AMERICAN PHENOLIC CORPORATION
chicago 50, illinois

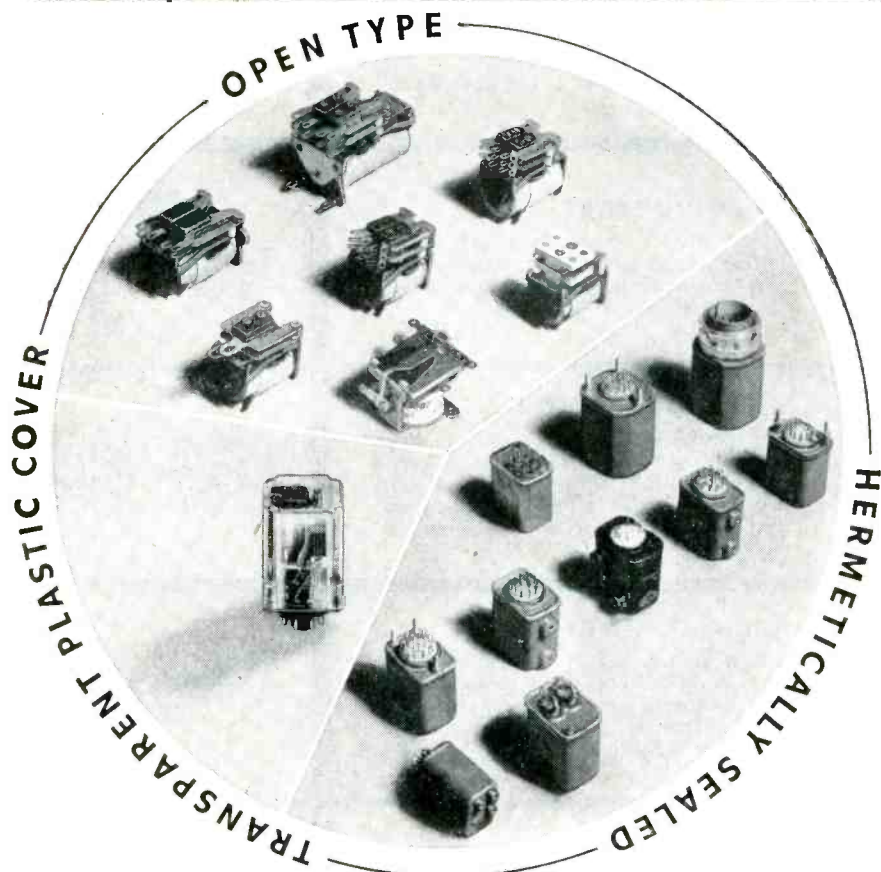

R-B-M Relays

FOR EVERY ELECTRONIC APPLICATION

Meeting Commercial and Government Requirements

OPEN TYPE. Circuit switching — power and dynamotor loads — plate circuit — low capacitance.

HERMETICALLY SEALED. Stud or bushing mounting — solder or plug-in headers — circuit switching — power — low loss applications.

TRANSPARENT PLASTIC COVER. Most R-B-M relays now available in low cost transparent plastic cover.

OTHER PRODUCTS: Motor starting relays and overload protectors for refrigeration, appliance and general purpose motors. Industrial contactors and across-the-line starters. NEMA size 1 and smaller. Low cost general purpose relays. Low voltage D.C. manual and magnetic devices.

Let R-B-M engineering and production facilities serve you. Contact us immediately — Phone 5121

R-B-M DIVISION
ESSEX WIRE CORPORATION
Logansport, Indiana

*Controls for Electronic,
Refrigeration, Industrial, Appliance,
Communication and
Automotive Industries*

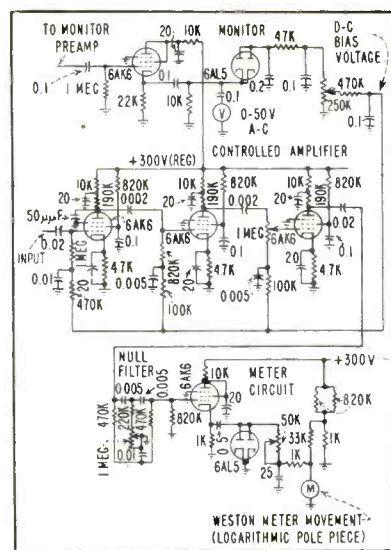

FIG. 1—Monitor circuit controls bias on amplifier to normalize output for transmitted power variations

transmitter power output variation. At present it is necessary to monitor the transmitter and then normalize all readings and graphs from the monitor readings.

If some voltage proportional to transmitted power is used to control the gain of the main amplifier, then automatic normalization is achieved. This was done, in the circuit of Fig. 1, by amplifying and rectifying such a voltage and using the d-c output to vary the bias on a portion of the main amplifier. The monitoring voltage can be obtained directly from the transmitter or be picked up by an auxiliary antenna and bolometer.

This monitoring circuit gives a pure d-c output up to 23 volts, which varies linearly with the a-c input from the monitor preamplifier. Response is uniform from 400 to 5,000 cps with the constants shown. The monitor meter shows when the normalizing range is reached. Adjustment is made by the monitor preamplifier gain control.

Signal Meter Circuits

Since a linear decibel scale was wanted, it was decided to build a linear circuit and use a logarithmic responding meter such as the shaped pole-piece Weston meter movement. The circuit was adapted from the Ballantine voltmeter circuit without the feedback, using a simple cathode follower to give a good linear voltage response. Due to the prevalence of

FREED

Instruments & Transformers

Famous
For

QUALITY • DEPENDABILITY • ACCURACY

FREED MILITARY PULSE TRANSFORMERS IN STOCK FOR IMMEDIATE DELIVERY

HERMETICALLY SEALED PULSE TRANSFORMERS for use in blocking oscillators, low level interstage coupling, and modulator outputs. Made in accordance with MIL-T-27 specifications. These pulse transformers are designed for maximum power, efficiency and optimum pulse performance. Balanced coil structures permit series or parallel connection of windings for turn ratios other than unity. Pulse characteristics, voltages and impedance levels will depend upon interconnections made.



DM-12



DM-18



DM-8



DM-01

CATALOG NUMBER	APPLICATION	PULSE VOLTAGE KILVOLTS	PULSE DURATION MICRO-SECONDS	DUTY RATIO	TEST VOLTAGE KV., RMS	CHARACTERISTIC IMPEDANCE OHMS	CASE SIZE
MPT-1	Blocking oscillator or interstage coupling	0.25/0.25/0.25	0.2-1.0	.004	0.7	250	DM-12
MPT-2	Blocking oscillator or interstage coupling	0.25/0.25	0.2-1.0	.004	0.7	250	DM-12
MPT-3	Blocking oscillator or interstage coupling	0.5/0.5/0.5	0.2-1.5	.002	1.0	250	DM-18
MPT-4	Blocking oscillator or interstage coupling	0.5/0.5	0.2-1.5	.002	1.0	250	DM-18
MPT-5	Blocking oscillator or interstage coupling	0.5/0.5/0.5	0.5-2.0	.002	1.0	500	DM-12
MPT-6	Blocking oscillator or interstage coupling	0.5/0.5/0.5	0.5-2.0	.002	1.0	500	DM-12
MPT-7	Blocking oscillator, interstage coupling or low power output	0.7/0.7/0.7	0.5-1.5	.002	1.5	200	DM-18
MPT-8	Blocking oscillator, interstage coupling or low power output	0.7/0.7	0.5-1.5	.002	1.5	200	DM-18
MPT-9	Blocking oscillator, interstage coupling or low power output	1.0/1.0/1.0	0.7-3.5	.002	2.0	200	DM-18
MPT-10	Blocking oscillator, interstage coupling or low power output	1.0/1.0	0.7-3.5	.002	2.0	200	DM-18
MPT-11	Blocking oscillator, interstage coupling or low power output	1.0/1.0/1.0	1.0-5.0	.002	2.0	500	DM-01
MPT-12	Blocking oscillator, interstage coupling or low power output	0.15/0.15 0.3/0.3	0.2-1.0	.004	0.7	700	DM-8

SEND FOR COMPLETE CATALOG OF
FREED INSTRUMENTS AND TRANSFORMERS



No. 1030
Low Frequency
"Q" Indicator

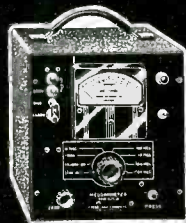

No. 1020B
Megohmmeter



Decade
Inductors



No. 1040
Vacuum Tube Voltmeter



No. 1210
Null Detector &
Vacuum Tube Voltmeter



No. 1010
Comparison Bridge



No. 1110A
Incremental Inductance
Bridge

FREED TRANSFORMER CO., INC.

1722 WEIRFIELD ST. (RIDGEWOOD) BROOKLYN 27, N.Y.

if you want stable
and trouble-free

120 VOLT DRIVE CHOPPERS

that can be corrected
to zero phase angle

Normal angle is 80° ; with an external .039 mfd. capacitor a ZERO angle is obtained, drive to square wave. Permanently hermetically sealed, SPDT contacts. Residual noise less 5 mv. rms. at $\frac{1}{2}$ megohm circuit impedance. Contacts rated to 100 V, 2ma., tho this current may be exceeded by 10 to 100 times this value for short intervals; the voltage may be as high as 200 V. Normally 380 to 420 cycles, and -10 to 85°C , unit may be operated over much wider frequency ranges and temperatures down to -55°C with excellent reliability. Meets 10g vibration, 50g acceleration. Specs. can be altered to special needs. Consult our engineers.

Write for Specification 107 . . . data sheet A-580

use AIRPAX

A580 400 cycle
choppers



60-cycle pickup in the Laboratory, a 60-cycle, twin-T, null filter was inserted ahead of the meter circuit.

The material presented was abstracted from NRL Report No. R-3219 by R. P. Lett.

High Sensitivity D-C Breaker Amplifier

BY MAX D. LISTON

Liston-Becker Instrument Co.
Stamford, Conn.

AMPLIFICATION of extremely small d-c voltages by a conventional direct-coupled amplifier is limited by excessive drift and noise. Slight changes in emission or other characteristics of the input tube will produce drift. All tubes have noise that corresponds to several thousand ohms in the grid circuit so the noise level of conventional amplifiers is considerably above that which would be predicted from Johnson noise considerations when working directly from low-impedance input circuits.

To overcome these difficulties the chopper or breaker type amplifier, shown in Fig. 1, is used. A contact interrupter sends the input current through alternate halves of the primary of an input transformer. The alternating voltage produced in the secondary excites the grid of a conventional RC coupled amplifier. The output of this amplifier is connected to a similar breaker that synchronously rectifies the output to form a d-c voltage whose voltage and polarity is an amplified function of the input voltage.

Synchronous rectification also has the desirable feature that only signals or noise having components the same as the breaker frequency will add to produce d-c in the output. This results in a high discrimination against noise and induced signals originating in both the input circuit and in the amplifier.

Success of the breaker type amplifier is largely determined by input-circuit design. The zero stability of this type amplifier is no longer limited by the stability of tube characteristics but by thermal potentials, stray currents and electrostatic potentials. At input im-

Precision Designed for LOWEST VSWR!

PRD microwave TRANSMISSION LINE components

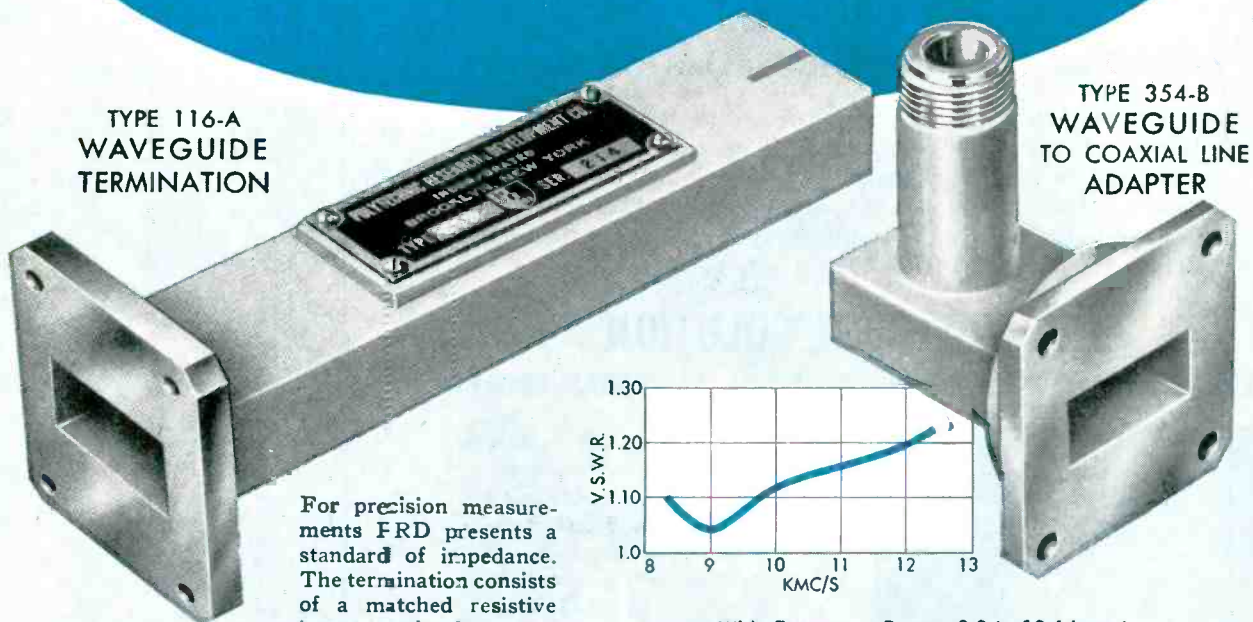

TYPE 116-A
WAVEGUIDE
TERMINATION

TYPE 354-B
WAVEGUIDE
TO COAXIAL LINE
ADAPTER

For precision measurements FRD presents a standard of impedance. The termination consists of a matched resistive insert terminating a section of RG-52/U waveguide. Each insert is tested to insure that its VSWR is less than 1.01. Dimensions of the waveguide are maintained so that its characteristic impedance is within 0.5 percent of nominal. Flange faces are milled flat and the screw holes are referenced to the center line.

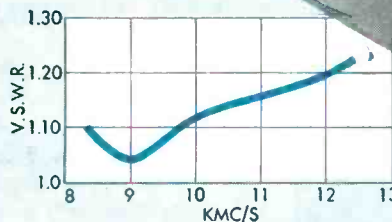

- Frequency Range: 8.2 to 12.4 kmc/s
- Very Low VSWR: Less than 1.015
- Stable Characteristics
- Rugged
- Waveguide Type: RG-52/U
- Flange Type: UG-39/U

- Wide Frequency Range: 8.2 to 12.4 kmc/s
- Low VSWR: (See curve)
- Waveguide Type: RG-52/U
- Flange Type: UG-39/U
- Coaxial Connector: Mates with UG-21B/U or equivalent

The Type 354-B Adapter is designed for making minimum reflection connections between waveguide and coaxial line. Typical VSWR is shown in the curve. The low VSWR assures least disturbance of the electrical properties of mating components.

CHECK WITH PRD FOR QUALITY-BUILT TEST EQUIPMENT

The components shown are typical of the very complete PRD line of precision-built Microwave Test Components. Standard items available include Attenuators, Terminations, Slotted Sections, Transmission Line Components, Frequency Measuring Devices, Detection and Power Measuring Elements, Signal Sources and Receivers, etc. Write today for the PRD illustrated catalog. Address Dept. E-1.

Polytechnic **RESEARCH**



& DEVELOPMENT COMPANY • Inc

55 JOHNSON STREET, BROOKLYN 1, NEW YORK

WESTERN SALES OFFICE:
741 1/2 North Seward St.
Hollywood 38, California

SAVE WITH S.S. WHITE REMOTE CONTROL FLEXIBLE SHAFTS

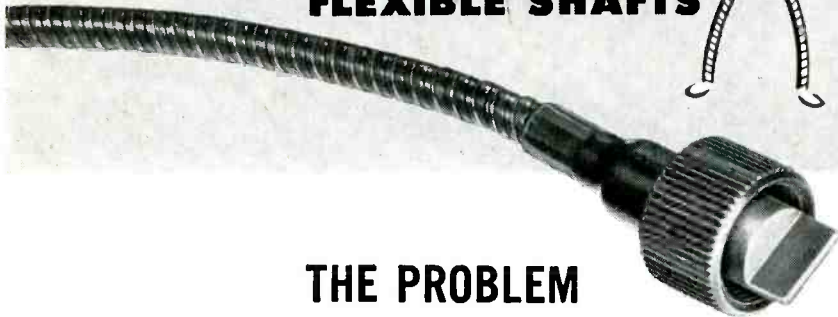

THE PROBLEM

DESIGNING FOR LOWER INSTALLATION COSTS

A design engineer wanted to incorporate a manually controlled trip odometer into an automobile speedometer assembly. When it came to designing the control linkage between the knob and the odometer, he was faced with the problem of selecting a method which would be economical both from the standpoint of materials and from the standpoint of easy installation. That's why he chose —

THE LOW-COST SOLUTION

AN S.S. WHITE REMOTE CONTROL FLEXIBLE SHAFT



The adaptability of the flexible shaft control allowed the speedometer to be properly positioned on the dashboard and the odometer reset knob to be placed where the user could readily operate it. Furthermore, the use of the shaft eliminated time-consuming alignment problems—resulting in important savings in assembly time and costs — and what is equally important, contributed to a design which adequately met customer acceptance.

It will pay you to investigate the cost-reducing possibilities of using S.S. White flexible shafts on your own remote control applications.

Here's Important Design Information

The 256-page Flexible Shaft Handbook has full details on how to select and apply flexible shafts. A copy will be sent free if you write for it direct to us on your business letterhead.



THE S.S. White INDUSTRIAL DIVISION
DENTAL MFG. CO.



Dept. E, 10 East 40th St.
NEW YORK 16, N.Y.

Western District Office • Times Building, Long Beach, California

pedances below 2,000 ohms the chief difficulty is stray thermal potentials. In the amplifier described here, thermal potentials are reduced to a minimum by eliminating all unnecessary solder junctions. Those that cannot be eliminated are made with a special low-thermal solder designed to match the thermal-electric properties of the copper wire employed in the primary. The breaker contacts are designed to prevent rubbing that would generate heat. The gold contacts are also selected to match the thermal electric properties of the input copper circuits. The en-

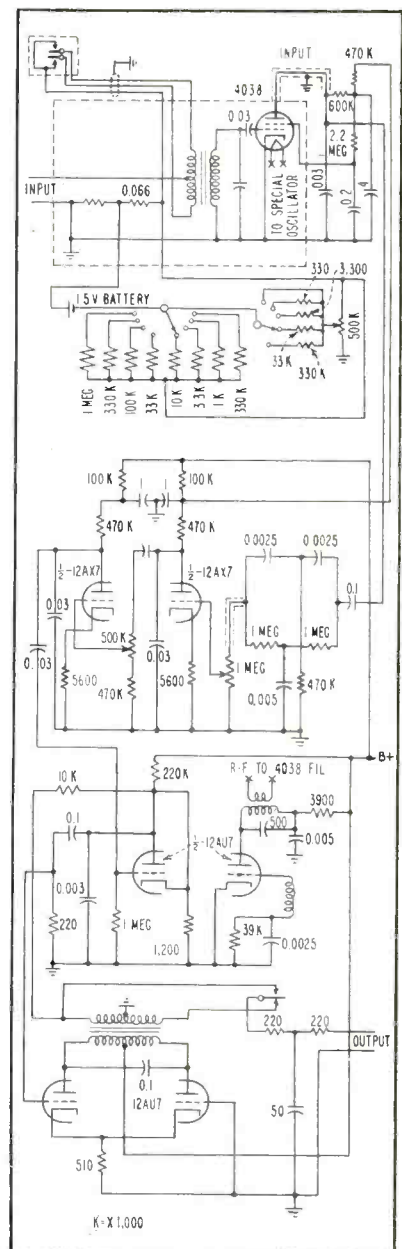
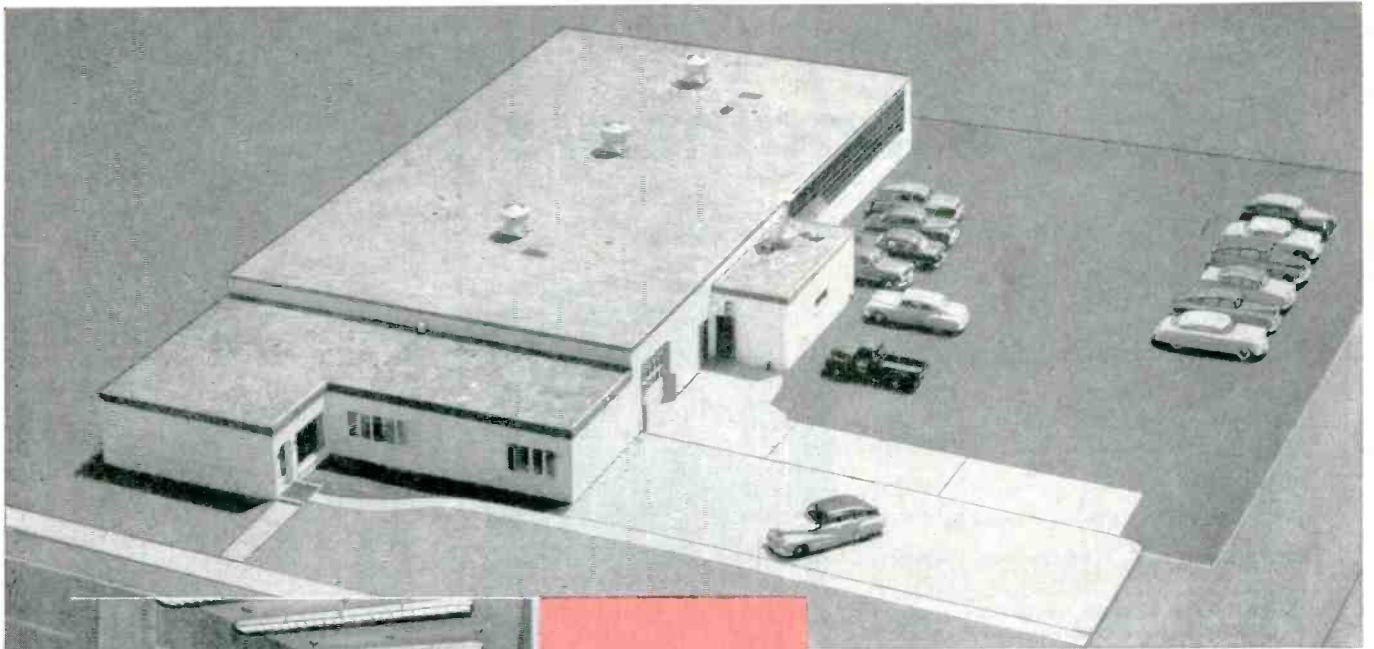

FIG. 1—Sensitive d-c amplifier uses breaker in input to convert low-level d-c into an alternating signal

New Home for **HERMASEAL**



The large, pleasant reception room offers a friendly welcome to visitors at Hermaseal.



All equipment in the modern Hermaseal plant is of the newest type. Shown here are sealing oven equipment, atmosphere generators and annealing ovens.



One of the assembly lines with punch press department in background. Nimble, experienced fingers assemble complex special design multi-terminal headers prior to glass-to-metal sealing operation.

Designed in every detail to give you the finest of service on your glass-to-metal seal requirements.

Hermaseal's new, 11,000 sq. ft. plant is completely modern in layout and equipment. It was planned specifically for both mass production, to assure prompt delivery, and highest quality glass-to-metal sealing, vacuum pumping and hermetic assemblies.



New, Complete Hermaseal Catalog

Write for your copy of this useful 24-page catalog. It's loaded with facts, specifications, drawings, photos, of standard and special terminals, headers and other quality Hermaseal products.



THE HERMASEAL COMPANY, INC.

ELKHART 10, INDIANA



**BALLANTINE
ELECTRONIC VOLTMETERS**
for

Color TV Engineers

A *Sensitive* WIDE-BAND ELECTRONIC VOLTMETER

for
Television Video Circuits

VIDEO RANGE 15cps-6mc.
VOLTAGE RANGE 1mv-1000v.
INPUT IMPEDANCE 11megs shunted by 7.5 μ f
ACCURACY 3% to 3mc; 5% above.

when used without probe, sensitivity is increased to 100 microvolts but impedance is reduced to 1meg shunted by 25 μ f.

MODEL 314
Price \$285



A *Sensitive* PEAK-TO-PEAK ELECTRONIC VOLTMETER

for
Television Pulse Circuits

VOLTAGE RANGE 1mv-1000v pk-to-pk
FREQUENCY RANGE (Sine Wave)... 10cps-100kc
PULSE WIDTH 3 μ sec-250 μ sec
MIN REP RATE 20 pulses per sec
INPUT IMPEDANCE 2meg shunted by 8 μ f*
ACCURACY 5% for pulses

*Shunt capacitance is 15 μ f on two most sensitive ranges.

MODEL 305
Price \$280

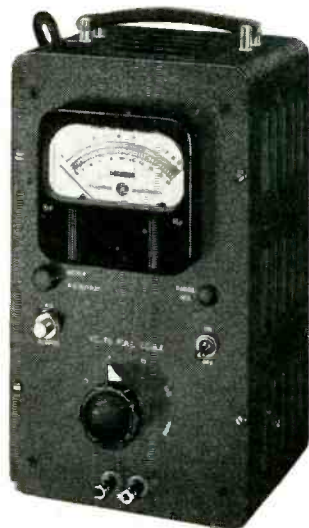

Both Instruments Feature

- Single logarithmic voltage scale with decade range switching.
- Same accuracy of reading at ALL points on the scale.

WORLD'S LEADING ELECTRONIC MEASURING INSTRUMENTS

Write for complete information for this and other
Ballantine Electronic Measuring Instruments.

BALLANTINE LABORATORIES, INC.

100 FANNY ROAD, BOONTON, NEW JERSEY

tire breaker unit is shielded to minimize the effects of temperature change.

The input transformer must have a minimum shunting effect on the input circuit. The effective input circuit impedance must also be increased to a point well above the tube noise. In the breaker amplifier this reflected secondary impedance is always above 10 megohms. This is accomplished in a transformer working at 8 cycles a second.

Noise caused by heater-cathode currents prevents the use of conventional cathode-resistor bias at low frequencies. Battery-fixed bias was employed on the first instruments. This produced satisfactory results, but the batteries became noisy in time and careful selection of tubes was necessary. Also, the life of the preamplifier tube was short since the bias did not adjust for changes in tube characteristics. In an effort to overcome these difficulties a floating grid was tried. This worked satisfactorily since the grid would automatically adjust to the potential which gives no grid current. This is the optimum operating point for this type circuit.

Although the floating grid eliminated the need for preamplifier tube selection and replacement, the system had one bad feature. Severe overloads (1,000 times or greater than the normal signal) would cause the bias to be lost temporarily and as long as 30 minutes were sometimes required for the instrument to recover its normal gain. A 750-megohm resistance was added that does not interfere with the normal self-biasing of the circuit but does reduce the recovery time to a maximum of 10 seconds.

The preamplifier-stage filament is heated by r-f. This has been found cheaper than a d-c supply and more reliable. Tube voltages in the preamplifiers are: 4.5 volts for the heaters, 40 volts on the plate and 20 volts on the screen. This minimizes gas noise and has been found to give more satisfactory operation at this low level than rated operating conditions.

Several considerations influence the choice of the breaker frequency. Where rapid overall response is re-

MOLONEY *HiperCore* ELECTRONIC CORES Products of Painsstaking Precision

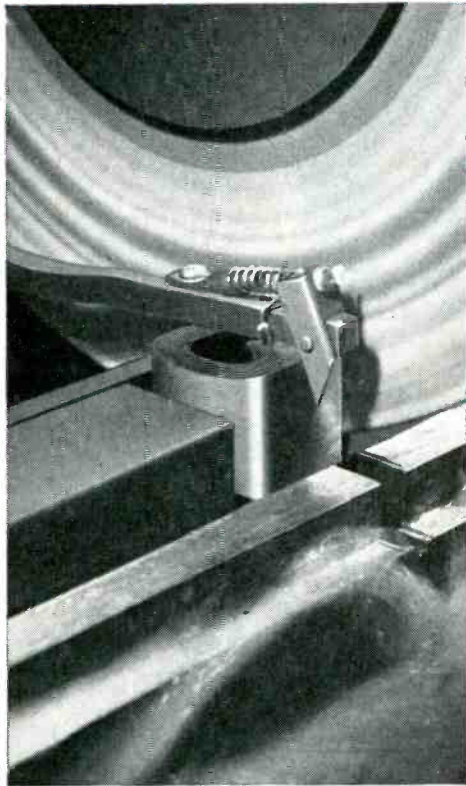

The painstaking precision with which Moloney Electronic Cores are produced is perhaps best demonstrated by the methods used in marking and cutting the cores.

Each core is stamped with diagonal lines assuring quick, positive identification between core halves after cutting. Accurate cutting-grinding machines cut the cores to such close tolerances that the resulting core faces can be reassembled with a maximum air gap of only .0005" per leg.

All this care and precision results in uniform electrical characteristics which assure you of greatly improved efficiency of core performance for your products. Moloney HiperCore Electronic Cores are wound cores of cold-rolled oriented silicon steel, and give better performance with important savings in size and weight, and have greater flux carrying capacity with lower losses... and they are *uniform* in these advantages.

MEB3-3E



Rigid production controls guarantee the high quality of Moloney HiperCore Electronic Cores. Available in any quantity in any of more than 1000 standard sizes or to your own special specifications if desired. Write today for Bulletin SR-205 containing specifications, performance data and prices.



MOLONEY ELECTRIC COMPANY

Manufacturers of Power Transformers • Distribution Transformers • Load Ratio Control Transformers • Step Voltage Regulators • Unit Substations

SALES OFFICES IN ALL PRINCIPAL CITIES • FACTORIES AT ST. LOUIS, MO. AND TORONTO, ONT., CANADA

ELECTRONICS — January, 1954

Want more information? Use post card on last page.

211

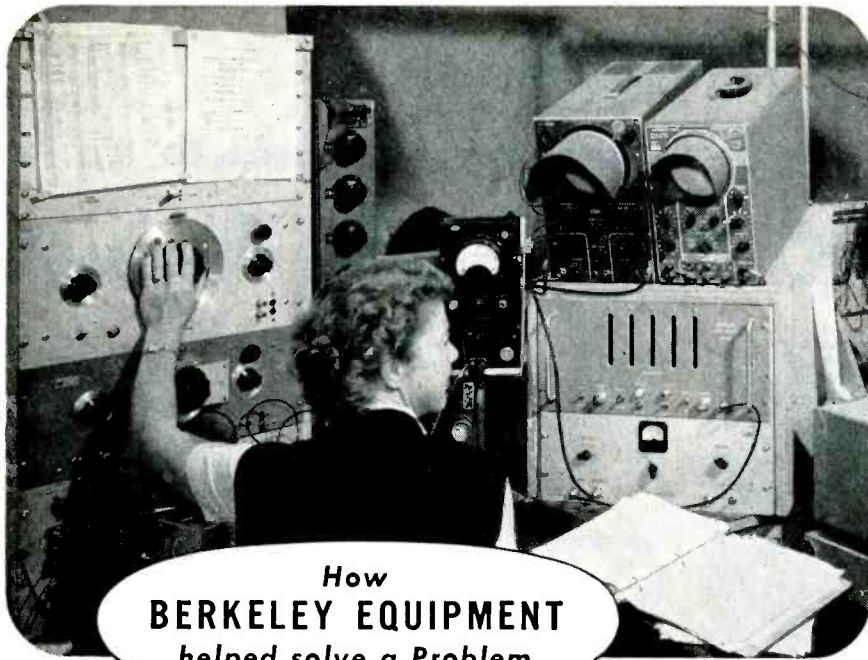

**How
BERKELEY EQUIPMENT
helped solve a Problem**

for Lenkurt Electric Co., San Carlos, Calif.

PROBLEM: Increasing speed and accuracy in determining characteristics of filters and meshes at production-line test stands. Required: determination of frequency to an accuracy of ± 1 cycle.

SOLUTION: Use of a BERKELEY EPUT (Events-Per-Unit-Time) Meter to determine frequency, displaying results in direct-reading digital form, with an accuracy of ± 1 cycle.

RESULTS: Frequency checks are now made in 30 seconds, as against 5 to 10 minutes formerly required. Previous high possibility of error now virtually negligible. Substantial reduction in training required for test stand operators.

**May we help
solve your
problem?**

If it involves faster, more accurate, easier and simpler ways to measure frequency, flow, pressure, velocity, rpm., time intervals, viscosity—or high speed counting and counting plus pre-set control—chances are that BERKELEY can help you solve it. Complete data sheets covering many applications in these fields are yours for the asking—check the handy coupon below and mail it *now!*

M-22

Berkeley

division

BECKMAN INSTRUMENTS INC.
2200 WRIGHT AVE., RICHMOND, CALIF.

Dept. _____, 2200 Wright Ave., Richmond, Calif.

Please send me application data sheets checked

Name _____

Title _____

Address _____

City _____ State _____

MEASUREMENT OF:

- Flow Velocity
 Pressure RPM
 Viscosity Operating Time
 Frequency of _____

COUNTING OR
PREDETERMINED COUNTING OF:

CONTROL OF:

- Cutting Stock to Length
 Packaging and Batching

quired a high breaker speed is required. It is also desirable to avoid frequencies near power-line frequency or its harmonics. At the low levels for which this instrument is designed, induced voltages from power lines are usually many times larger than the signal being measured.

Amplifiers have been built with breaker frequencies from 2,000 to 8 cps. The 8-cps units are definitely superior both from discrimination of induced signals and from the standpoint of breaker life. Discrimination of better than 1,000 to 1 is obtained from this arrangement. Eighty cycles is employed where higher speed of response is required. Higher breaker speeds have been found to be short-lived and undependable.

The noise level of this amplifier closely approaches the theoretical limit, 0.003 μ v peak to peak. Zero drift is less than 0.005 μ v per day. The maximum offset from zero is 0.01 μ v.

Variable Balanced D-C With Low Output Impedance

BY HERBERT HELLERMAN

*Syracuse University
Syracuse, N. Y.*

IN APPLICATIONS involving d-c analogue computers it is sometimes necessary to obtain a pair of d-c voltages which are equal and opposite in polarity with respect to ground. In many such applications the magnitude of the balanced output must be a function of a potentiometer shaft angle and must be zero for zero shaft angle. Furthermore, it is often necessary to have low output impedances from each of the balanced terminals to ground so that a function potentiometer or other low-impedance device may be connected at the output terminals without destroying the accuracy.

Basically the problem is as shown in Fig. 1A. The input impedance Z_i should be very high so that loading error on the input potentiometer P is small. The output impedances from points b_1 and b_2 should be very low so that R_L need not be very high in resistance.

The solution to this problem is

The *ultimate* in Flat Temperature Response in high-K

ERIE K-LOK*



STYLE	CAPACITANCE RANGE—MMF
831	220-530
801	530-820
811	820-2400
821	2400-4700

Tolerances: $\pm 5\%$, $\pm 10\%$, $\pm 20\%$.

NOTE THESE FEATURES:

- Flat temperature characteristic. Greatest capacitance change from 25°C value:
 - +5%, -5% from -55°C to +105°C
 - +5%, -10% from -55°C to +125°C
- Stability with age: 1% maximum decrease in capacitance per decade of time
- Low voltage coefficient: Capacity change less than 5% from zero to rated voltage
- Negligible piezo-electric effect
- Life rating: Up to 1000 VDCW at 85°C; 500 VDCW at 125°C
- Power factor: 1½% maximum
- Insulation resistance: 10,000 megohms minimum
- Low loss phenolic dip for moisture seal and mechanical ruggedness
- ERIE K-LOK can be used on special order in supplying various high voltage disc capacitors and printed circuits

Samples available on request

The ERIE K-LOK marks a significant advance in ceramic capacitor design and application. It marks the culmination of several years of development activity with the single objective of producing a ceramic capacitor with truly premium performance characteristics.

*TRADE MARK

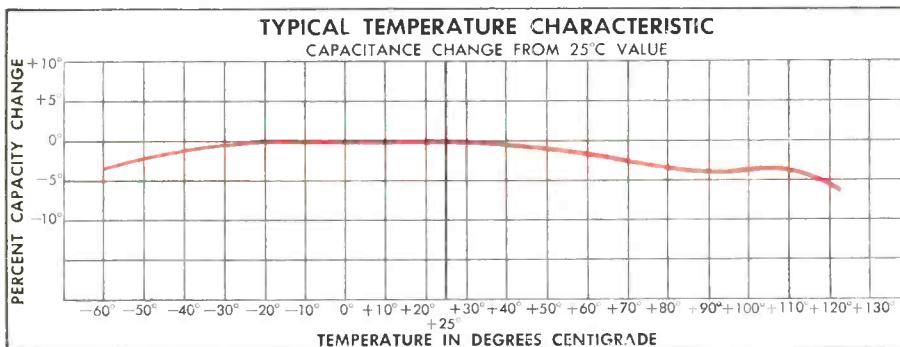

ERIE components are stocked by leading electronic distributors everywhere.



ERIE RESISTOR CORPORATION . . . ELECTRONICS DIVISION

Main Offices: ERIE, PA.

Sales Offices: Cliffside, N. J. • Philadelphia, Pa. • Buffalo, N. Y. • Chicago, Ill.
Detroit, Mich. • Cincinnati, Ohio • Los Angeles, Calif.

Factories: ERIE, PA. • LONDON, ENGLAND • TORONTO, CANADA

Looking for ANSWERS on ANTENNAS?

GABRIEL, first source of supply for most of the nation's manufacturers, offers you these excellent antenna design and manufacturing facilities.



TEST

Gabriel's three major test pattern ranges — an 1130' range, a 2000' range, and 3200' range — are fully equipped with transmitting towers, an array of revolving mounts, and complete pattern recording instruments.

This 16-bay VHF antenna, shown at right, modified for production from prototype design of Federal Telecommunication Laboratories, is typical of Gabriel engineering and manufacturing that can help you.

DESIGN

Gabriel design has paced the growth of antenna development. Outstanding are its Parabolic Microwave Antennas for 940, 2000, and 7000 MC bands, and new Gabriel Coscant UHF Broadcast models featuring null fill-in.



PRODUCTION

WRITE . . . for your specific requirements, or for bulletins on Gabriel Microwave, UHF and Communication Antennas.

GABRIEL ELECTRONICS DIV.

Formerly Workshop Associates Division
THE GABRIEL CO., Endicott St., Norwood, Mass.

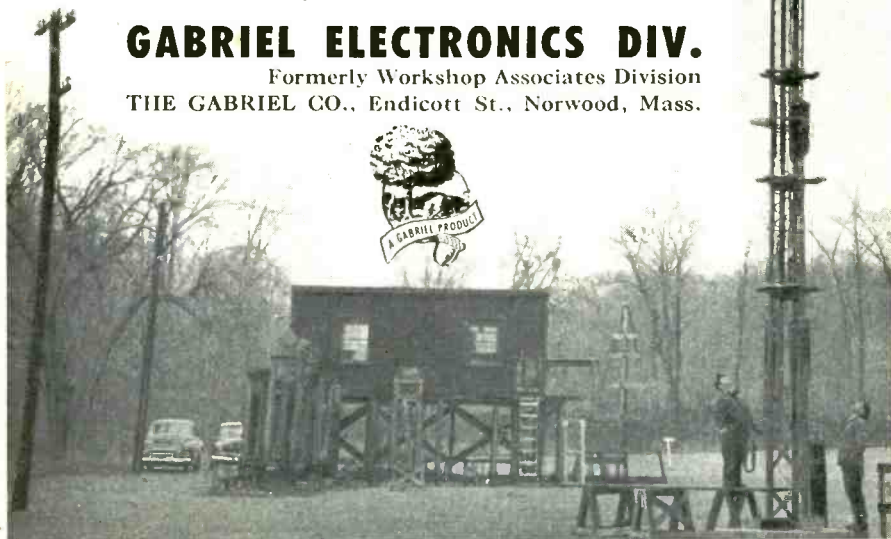

fairly easy if one or more of the above requirements is relaxed, however, the need for all the above conditions to be satisfied represents an important practical problem.

A circuit based on a simple principle has been developed which meets all of these specifications. The idea is illustrated in Fig. 1B and consists of connecting the potentiometer output to the grid of a cathode follower and the cathode-follower output to a d-c feedback amplifier with a gain of -1 . The load R_L is tied between the output of the cathode follower and the output of the feedback amplifier. In this system, potential E_o is sufficiently negative to make E_{b1} zero when $E_p = 0$ (The potentiometer dial at zero) A zero adjustment in the d-c amplifier makes the potential at point b_2 zero when the potential at point b_1 is zero. If K_o , the forward gain of the amplifier is very large then

$$\frac{\Delta E_{b2}}{\Delta E_{b1}} = -\frac{R_1}{R_2}$$

by making $R_1 = R_2$, E_{b2} is equal to $-E_{b1}$. The output impedances from terminals b_1 and b_2 to ground are low. If the gain K_o is very large, the output impedance from b_2 to ground is negligible and it can be shown that

$$E_{b1} = E_p \left[\frac{K_i}{1 + \frac{2Z_{b1}}{R_L} + \frac{Z_{b1}}{R_1}} \right] = -E_{b2}$$

where $K_i = E_{b1}/E_p$ the open-circuit gain of the input circuit, and Z_{b1} is the output impedance from b_1 to ground.

The output potentials are balanced and proportional to the input E_p . The proportionality constant is fairly close to unity in most practical cases. This formula was derived on the basis that $K_o \gg 1$. If this condition is satisfied, the balance is substantially independent of R_L or the input circuit feeding the point b_1 . However, the magnitude of the output voltage does depend somewhat upon these quantities. Care must be taken in the design of the output stage of K_o so that it can deliver the necessary d-c current to R_L . If desired a small potentiometer

Bendix Builds a Better cable clamp *the* **AN3057B**

**Inexpensive
Efficient
Versatile**

The new Bendix AN approved AN3057B cable clamp is now available. Engineered by Bendix to the highest quality standards, this cable clamp offers major design improvements. The clamping action is radial and completely eliminates wire strain and chafing by holding the wire bundle firmly in rubber. This clamp will accommodate a wide range of wire bundle sizes, but an even greater range can be handled through the use of the Bendix AN3420A accessory telescoping sleeve.

The new AN3057B cable clamp will also waterproof multi-conductor rubber covered cable on the rear of a connector, or where moisture-proof entrance through a bulkhead or into an equipment box is required.

This versatile clamp is a product of the Scintilla Magneto Division of Bendix Aviation Corporation and is a companion AN accessory to the world famous Bendix Scinflex line of electrical connectors. Write our Sales Department for details.

Bendix

SCINTILLA DIVISION of **Bendix**
SIDNEY, NEW YORK AVIATION CORPORATION

FACTORY BRANCH OFFICES: 117 E. Providencia Ave., Burbank, Calif.
• 582 Market Street, San Francisco 4, California • Stephenson Bldg.,
6560 Cass Avenue, Detroit 2, Michigan • 512 West Avenue, Jenkin-
town, Pa. • Brouwer Bldg., 176 W. Wisconsin Avenue, Milwaukee,
Wisconsin. EXPORT SALES: Bendix International Division, 205 East 42nd
St., New York 17, N. Y.

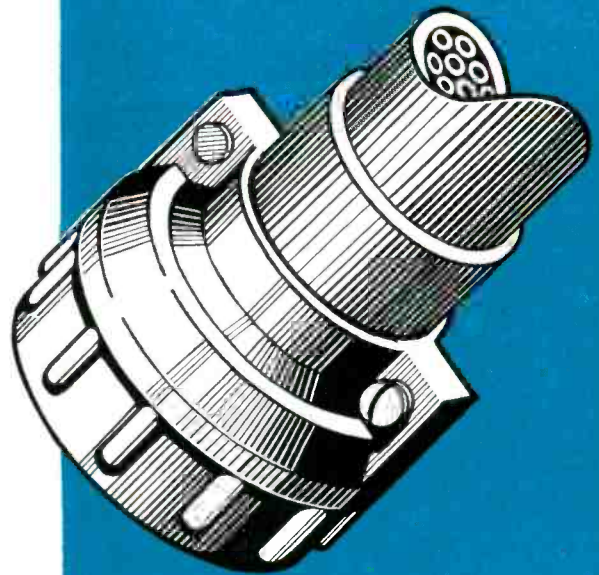
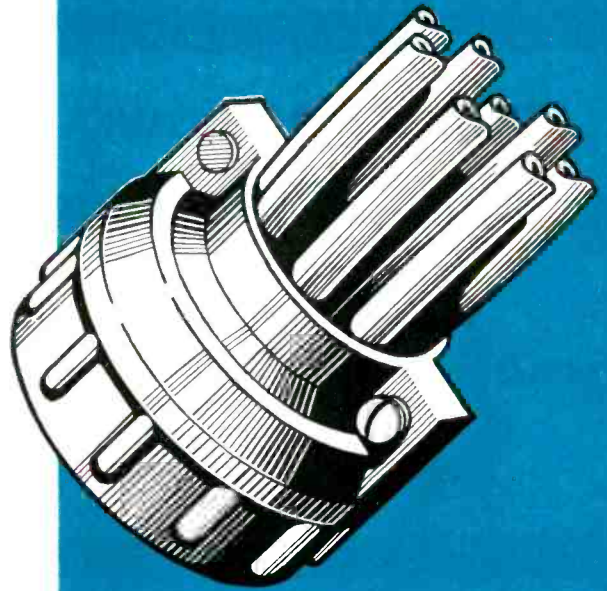

Outstanding Features

- Neoprene gland.
- Centered clamping action.
- Increased close down.
- Positive grounding feature.
- Cadmium plated die-cast aluminum nut.
- Shorter over-all length.
- Waterproofs multi-conductor cable.
- Immediate delivery.

ONLY KAY LAB MULTI-PURPOSE

ABSOLUTE DC POWER SUPPLIES

PROVIDE

.01%

STABILITY
REGULATION
CALIBRATION

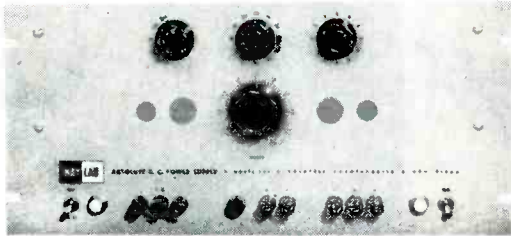

SPECIFICATIONS:

Long Time Stability; 100 parts per million
Short Time Stability; 50 parts per million per hour
Output Impedance; under 0.1 ohms
Output Hum and Noise; under 0.5 millivolt
Load Regulation Factor; .01%
Line Regulation Factor; .01%
Response Time; 1.0 milliseconds
Bias Supply; 0 to 150 volts

STANDARD POWER SUPPLIES

Model	Range	Current	Output Voltage	Filament Control	Filament Current	Overall Dimensions W H D	Output Voltage Cal.
30C-15	10-300V	150 ma.	VB	3	19x 8-3/4x20-1/4	0.1%	
30C-25		250 ma.	VB	5	19x 8-3/4x20-1/4	0.1%	
30C-50		500 ma.	VB	10	19x17-1/2x13-1/4	0.1%	
30C-100		1 amp.	VB	10	19x17-1/2x20-1/4	0.1%	
50C-25	10-500V	250 ma.	VB	5	19x 8-3/4x20-1/4	0.1%	
50C-50		500 ma.	VB	10	19x17-1/2x13-1/4	0.1%	
50C-100		1 amp.	VB	10	19x26-1/4x20-1/4	0.1%	

OUTPUT VOLTAGE CONTROL

VA . . . Output variable in one volt steps variable between steps by a potentiometer.
VB . . . Output variable in ten volt steps adjustable between steps by a potentiometer.

Fixed voltage and constant current models available.
Voltage and current calibrators available.

These units are absolute sources of D. C. voltage independent of line voltage and output load variations. The output voltage is constantly compared against the internal standard cell and thus, absolute calibration and stability with reference to the cell is insured.

SEND NOW FOR FREE DETAILS AND NAME OF NEAREST REPRESENTATIVE.

PRECISE ELECTRONIC INSTRUMENTS

KAY LAB

Kalbfell Laboratories Inc., 1090 Morena Blvd., San Diego 10, Calif.

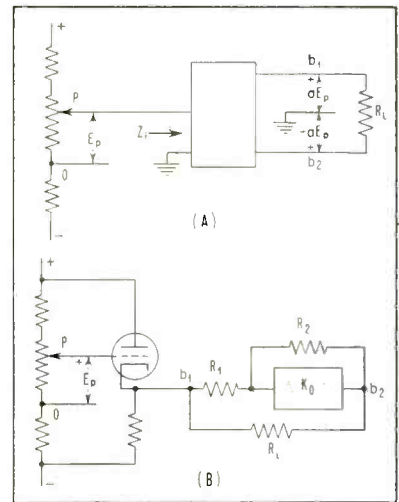

FIG. 1—The problem of obtaining a high input impedance to minimize loading error on potentiometer (A) is solved by use of cathode follower circuit (B) as described in accompanying text

can be placed in the cathode lead of the input cathode follower to do the zeroing of point b_1 . If this is done, point O may be grounded. The effect of this resistor on the balance is negligible, and the effect on the magnitude of the output can be calculated by finding the new value of Z_{in} and K_L due to the addition of this resistor and substituting in the formula.

A circuit utilizing these principles was used to obtain balanced outputs from zero to ± 50 volts across an R_L that was a 16K sinusoidal potentiometer. Resistors R_1 and R_2 were each 500K 1-percent wire-wound. The amplifier K_L consisted of a 12AX7 tube and a 12AU7, giving a gain of several thousand.

The total power-supply drain was 20 ma from the positive supply. The unbalance was not greater than 1 percent. The critical values of resistance are R_1 and R_2 , the two feedback resistors.

Battery-Powered A-C Voltmeter

By L. FLEMING
Falls Church, Virginia

PORTABILITY and complete isolation from power lines are requirements that point to the use of battery-powered instruments. Stability demands the employment of



John F. Lawson, General Service Manager of the Otis Elevator Company, tells why:

He hates to see you walk!

"People don't like to climb stairs," says Mr. Lawson, "and we don't want them to do it!

"When we sign an Otis maintenance contract with a building owner, we not only promise to keep his elevators in good running condition—we promise the *fastest possible* service.

"To keep this pledge—and to save many people many steps—we have thousands of parts in reserve in warehouses throughout the country. But in an emergency we deliver replacement parts from the most convenient point. These frequently go by the *fastest possible* way—via Air Express.

"We use Air Express on an average of six times a day. Everything from small but vital contacts and switches to heavy windings in weights from one to 700 pounds goes Air Express—and gets there fast!

"Air Express is a big factor in making Otis maintenance a service on which our customers can depend. Yet we've found that, in most of our weights and distances, Air Express dependability is priced *lower* than any other air service!"

It pays to express yourself clearly. Say Air Express! Division of Railway Express Agency.



Air Express



GETS THERE FIRST via U.S. Scheduled Airlines

ever meet
one of
our
Spring Engineers?

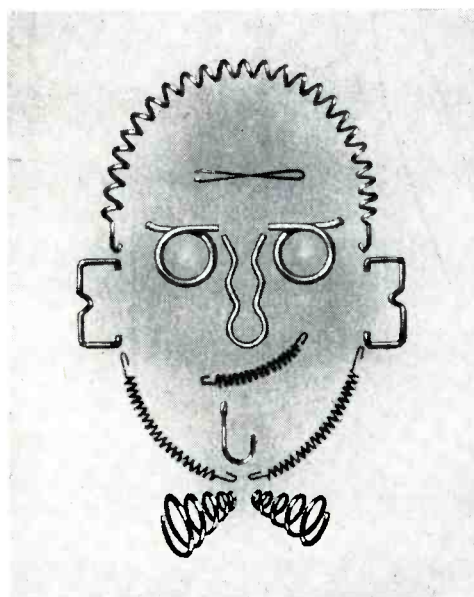

IF YOU HAVEN'T, perhaps it's time you did. Our Spring Engineers don't have torsion springs for eyes or wire forms for ears, to be sure, but they know just about

everything there is to know about designing the right spring for the job. That's hardly surprising in view of the thousands of tough spring problems that have been solved at lower cost by Lewis Spring Engineers.

If a spring is a vital part of your product, get acquainted with one of our Spring Engineers. Chances are good that he can show you how to realize maximum product performance at minimum cost with a Lewis spring that's engineered to the job. Behind his recommendation stand the experience, facilities and reputation of a company geared to serve you quickly and well.

LEWIS SPRING & MANUFACTURING COMPANY
2656 W. NORTH AVE. CHICAGO 47, ILL.

Lewis  PRECISION
SPRINGS

The Finest Light Springs and Wireforms of Every Type and Material

negative feedback. Most feedback circuits, however, when applied to filamentary tubes, call for separate A batteries for different stages in the circuit.

A battery-powered electronic a-c voltmeter has been described by the writer¹, which employed a feedback loop extending from the plate of the third stage to the screen of the first stage, thus permitting a common battery supply for all three filaments. Screen feedback, however, has considerable disadvantages. For the best stability of calibration with respect to tube changes, the feedback voltage should be introduced directly in series with the input.

The circuit described here does this, while preserving the simplicity and low battery drain of

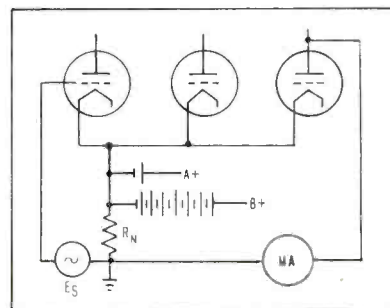
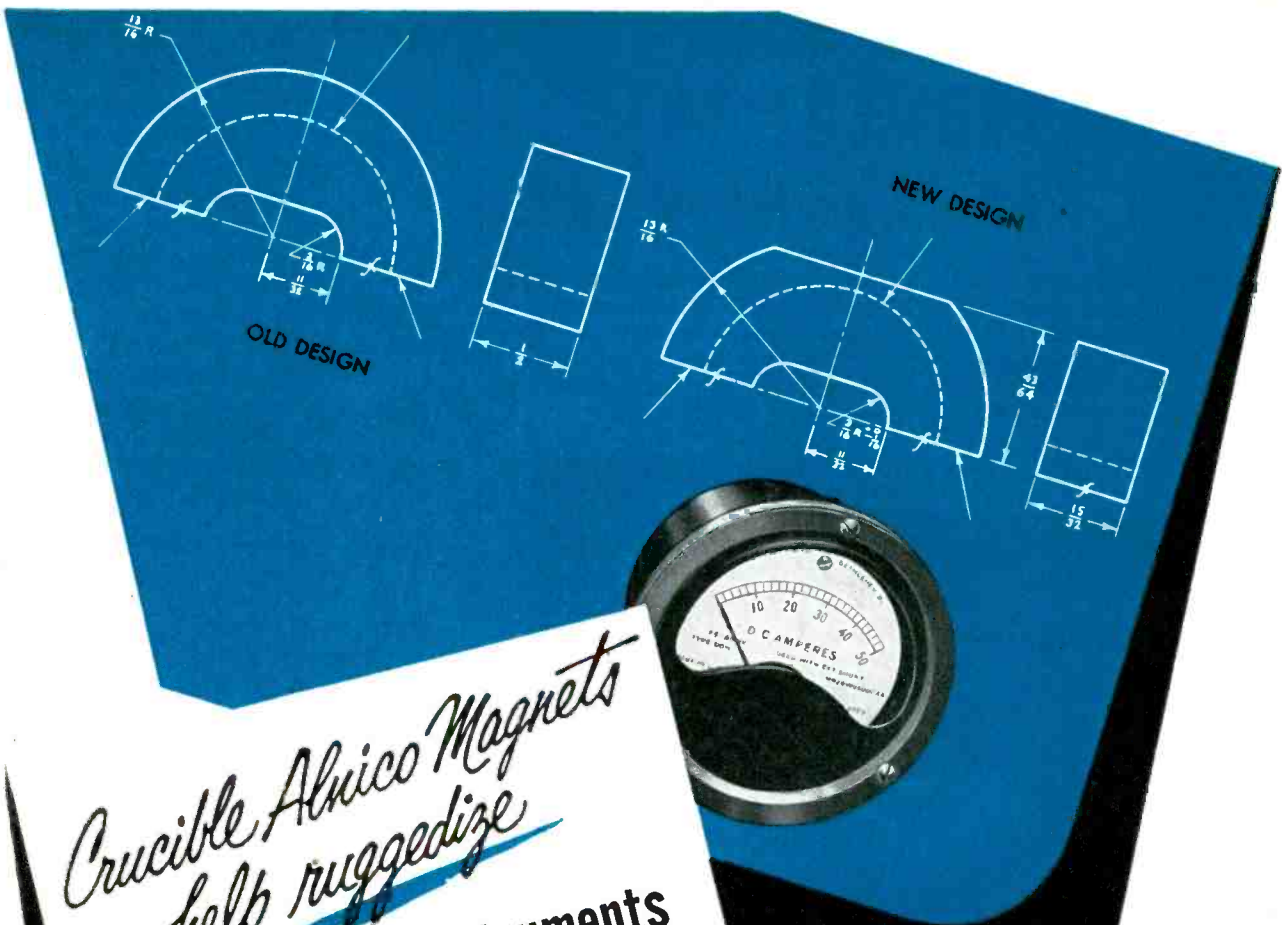

FIG. 1—Elementary feedback circuit for three stages and common A and B batteries described in text

the earlier design. Figure 1 shows the basic circuit idea, and Fig. 2 the complete circuit.

Overall characteristics are: full-scale sensitivity, 4 millivolts to 40 volts in 5 ranges; frequency range (for 5 percent error), 7 cycles to 40 kc; input impedance, 50 megohms shunted by 50 μ f; battery requirements, 1.5 v at 150 ma and 67 v at 0.8 ma. The circuit is designable to a wide variety of characteristics.

In an amplifier having an odd number of stages, a feedback impedance R_n is made common to both the input and the output circuits. The load in the output circuit is a rectifier-type meter and a voltage proportional to the current through the meter is introduced in series with the input. It may be noted that this arrangement is not equivalent to a cathode resistor common to all three stages. The negative



*Crucible Alnico Magnets
help ruggedize*

Roller-Smith Instruments

13% smaller—same magnetic strength

When the Roller-Smith Corporation decided to ruggedize their electrical instruments to meet Military Specifications, they discovered that they needed a smaller permanent magnet — one that would do the same job as the old one they were using.

They called on Crucible's technical service for assistance. In short order, Roller-Smith's objective was attained. For through improved design, and better quality control in production, Crucible developed an alnico magnet that was 13.5% smaller and lighter than the previous one . . . but with the same magnetic strength.

The Roller-Smith story is typical of the many cases solved with Crucible Alnico Magnets, because Crucible magnets have the highest gap flux per unit of weight of any on the market. Crucible has been the leading producer of Alnico Permanent Magnets since the industry started. When you have a magnet problem, call on Crucible.

CRUCIBLE

first name in special purpose steels

54 years of *Fine* steelmaking

PERMANENT ALNICO MAGNETS

CRUCIBLE STEEL COMPANY OF AMERICA, GENERAL SALES' OFFICES, OLIVER BUILDING, PITTSBURGH, PA.

STAINLESS • REX HIGH SPEED • TOOL • ALLOY • MACHINERY • SPECIAL PURPOSE STEELS

AN INSTRUMENT THAT LEFT A PERMANENT MARK

Being 3,000 times more sensitive than ordinary vacuum tube voltmeters for DC (0-1 mV instead of the customary 0-3 V lowest scale), Millivac's MV-17B, for the past 5

years, has truly set a new standard for expected VTVM performance.

Many laboratories, today, will not settle for less than Millivac when buying electronic test equipment.



For more information concerning this instrument and other sensitive vacuum tube millivoltmeters for DC, low frequency and high frequency write to:

MILLIVAC INSTRUMENT CORPORATION

P.O. BOX 997, 444 SECOND STREET, SCHENECTADY, NEW YORK

"Time Progresses—So Do We"

sides of both the filament and the plate supplies are connected directly together, and the signal voltage across R_n is common only to the input and output circuits.

The input and output both have a common terminal, indicated by the ground sign. Thus this type of feedback can be used in an amplifier as well as in a vtvm.

Whereas in an ordinary amplifier a ground terminal is common to the input, the output, and the power supply, the present circuit is able to ground only two.

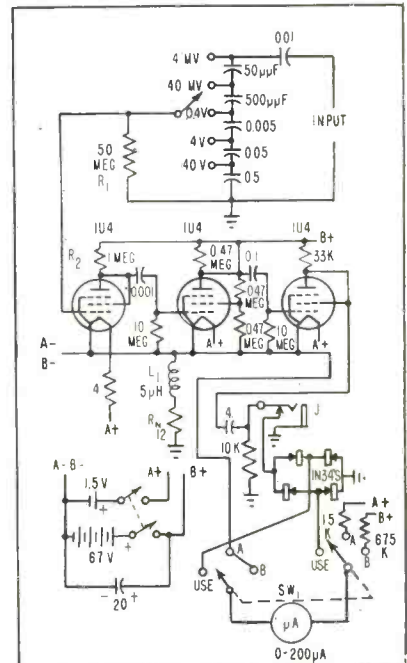

FIG. 2—Capacitive attenuator permits high-resistive input impedance in a-c vtvm using feedback circuit

In a practical three-stage device this is not, however, a serious drawback. The capacitance between an ordinary set of small radio batteries and a metal cabinet is only about 40 μf at most. The feedback resistor R_n in a three-stage amplifier is generally of the order of a few ohms, so that capacitance effects in a shielded case, or noise pickup in an unshielded case, are not important. An adaptation of this scheme has been used successfully in a single-tube, battery-powered cathode follower².

The sensitivity of a vtvm of this type³ is given by

$$\frac{I}{e} = \frac{A_1 A_2 G_{m3}}{1 + R_n A_1 A_2 G_{m3}}$$

where I = a-c signal current through recti-

Is the wire in your product aiding or hindering production?

Even little points of product superiority can make a big difference in your over-all production costs.

Sangamo Electric Company, of Springfield, Illinois, for example, found that in wiring up their meters and time switches with Rome Synthinol 901 thermoplastic hook-up wire, they were able to speed up production because of the "tight lay" of the stranding and the perfect anneal of the conductor. Compact connections were possible in less time.

In addition, Rome Synthinol 901 provides high resistance to moisture, flame, acids, oils and solvents, plus extreme resistance to

heat deformation, shrinkage and cracking, as well as improved solderability. Such attention to quality is basic policy with Rome Cable. Whether you need a special hook-up wire or a complex multi-conductor cable, Rome has the engineering skill and production facilities to give you exactly what you want.

Rome Synthinol 901 hook-up wire carries Underwriters' Laboratories Appliance Wiring Material Labels and is approved for use in appliances where exposed to air at temperatures up to 105° C. Available as solid or stranded in a wide range of permanently clear colors.

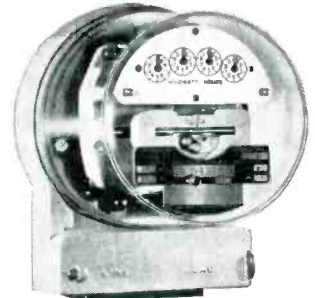
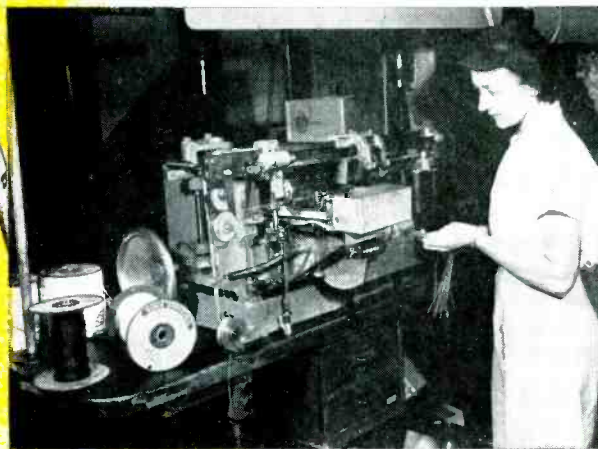
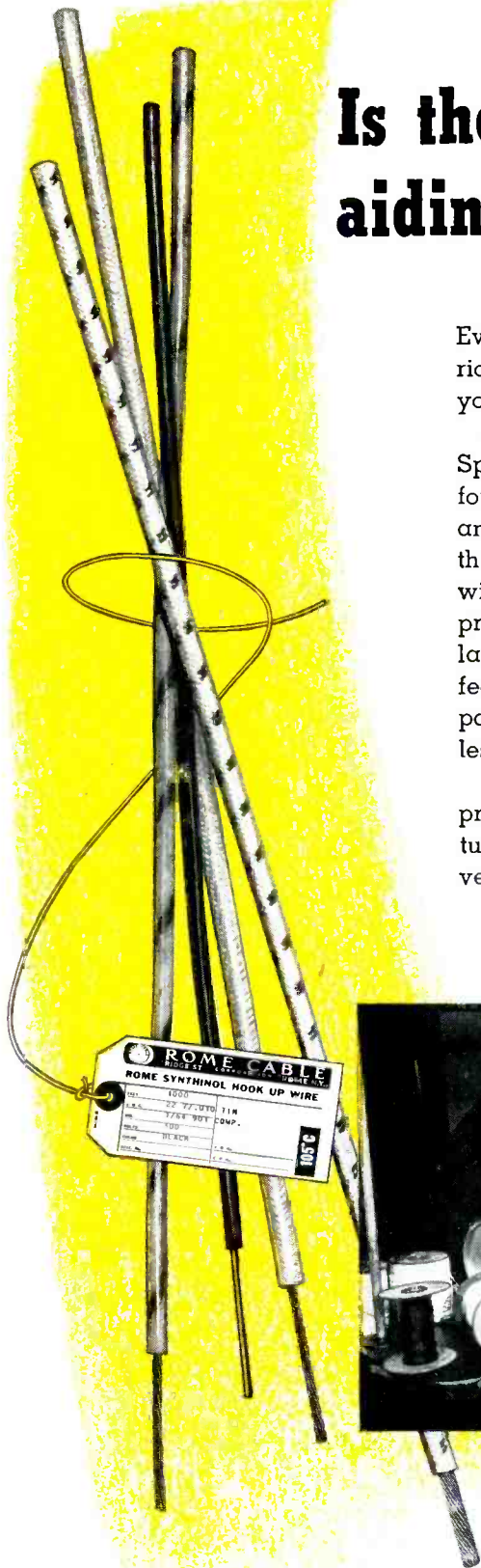

Here operator is stripping Rome Synthinol 901 wire to make leads for the potential coil in Sangamo Electric's Type "J" meter. The special thermo-plastic compound assures dependable service life under severe operating conditions.

It Costs Less to Buy the Best



ROME CABLE
Corporation
 ROME • NEW YORK
 and
 TORRANCE • CALIFORNIA

ROME CABLE CORPORATION, Dept. EL-1, Rome, N. Y.
 Please send me information on Rome Synthinol 901.

Name Title

Company

Address

City Zone State

Leach RELAYS

**TROUBLE-FREE
PERFORMANCE**

"as specified"

Because all *Leach* Relays are *quality engineered* for dependable duty... they are specified *first* by leading manufacturers of industrial equipment of all types. If your equipment demands relays that are first and foremost, more dependable and longer lasting, specify *Leach* Relays... they're more dependable... *performance proves it*. Whatever your relay control problem... it's a challenge to *Leach*. Illustrated are but a few of the wide selection *Leach* provides industry, as standard equipment.

RELAYS SHOWN ABOVE CAN BE SUPPLIED WITH VARIOUS CONTACT ARRANGEMENTS. WRITE FOR DETAILS.

BETTER CONTROLS THROUGH BETTER RELAYS

✓ MOTOR STARTING RELAY



✓ OVERLOAD TRIP LIGHT DUTY



✓ HERMETICALLY SEALED



✓ MIDGET LATCHING RELAY



✓ RADIO AND HIGH VOLTAGE



✓ ANTENNA TRANSFER



✓ MULTIPOLE RELAY

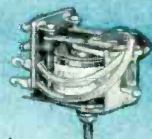

✓ MIDGET RELAY



✓ CIRCUIT CONTROL

meter used in the device
 e = input signal voltage
 A_1 = voltage gain of first stage
 A_2 = voltage gain of second stage
 G_{m3} = transconductance of third stage.

When the gain-transconductance product $A_1 A_2 G_{m3}$ is large, the sensitivity I/e approaches the simple quantity $1/R_n$.

The practical circuit having the specific characteristics listed earlier is shown in Fig. 2. The tubes are the commonest type of filamentary voltage amplifier pentode. Two are triode-connected, the other, the second stage, connected as a pentode with a loose voltage divider supplying the voltage to its screen, so that the operating point does not depend critically on the cutoff characteristic of the tube.

The third stage is triode-connected because it normally operates as a current amplifier into a low-impedance load, the meter. Thus its voltage gain is low, and Miller-effect capacitance is small.

The triode connection of the first stage was dictated by the original application of the instrument, the measurement of the output of piezoelectric accelerometers. These transducers have a capacitive internal impedance of the order of a few hundred μmf . To preserve low-frequency response, the resistive component of the vtvm hence had to be high. That is the reason for the 50-megohm grid resistor R_1 . To enhance the stability of this first tube with this high grid resistance, it was operated at a rather low level of plate current.

Low-plate-current operation of tubes reduces ion currents more than proportionately, an expedient long used in electrometer-type circuits. The high plate-load resistance R_2 , used to keep the d-c plate current low, unfortunately drops the high-frequency response as well. The droop at high frequencies is not as bad with the tube in triode connection as in pentode connection, because in the former mode the comparatively low dynamic plate resistance of the tube shunts the load R_2 .

The high input resistance requirement leads naturally to the consideration of a capacitive input

LEACH RELAY CO.

5915 AVALON BOULEVARD, LOS ANGELES 3, CALIFORNIA

Representatives in Principal Cities of U. S. and Canada

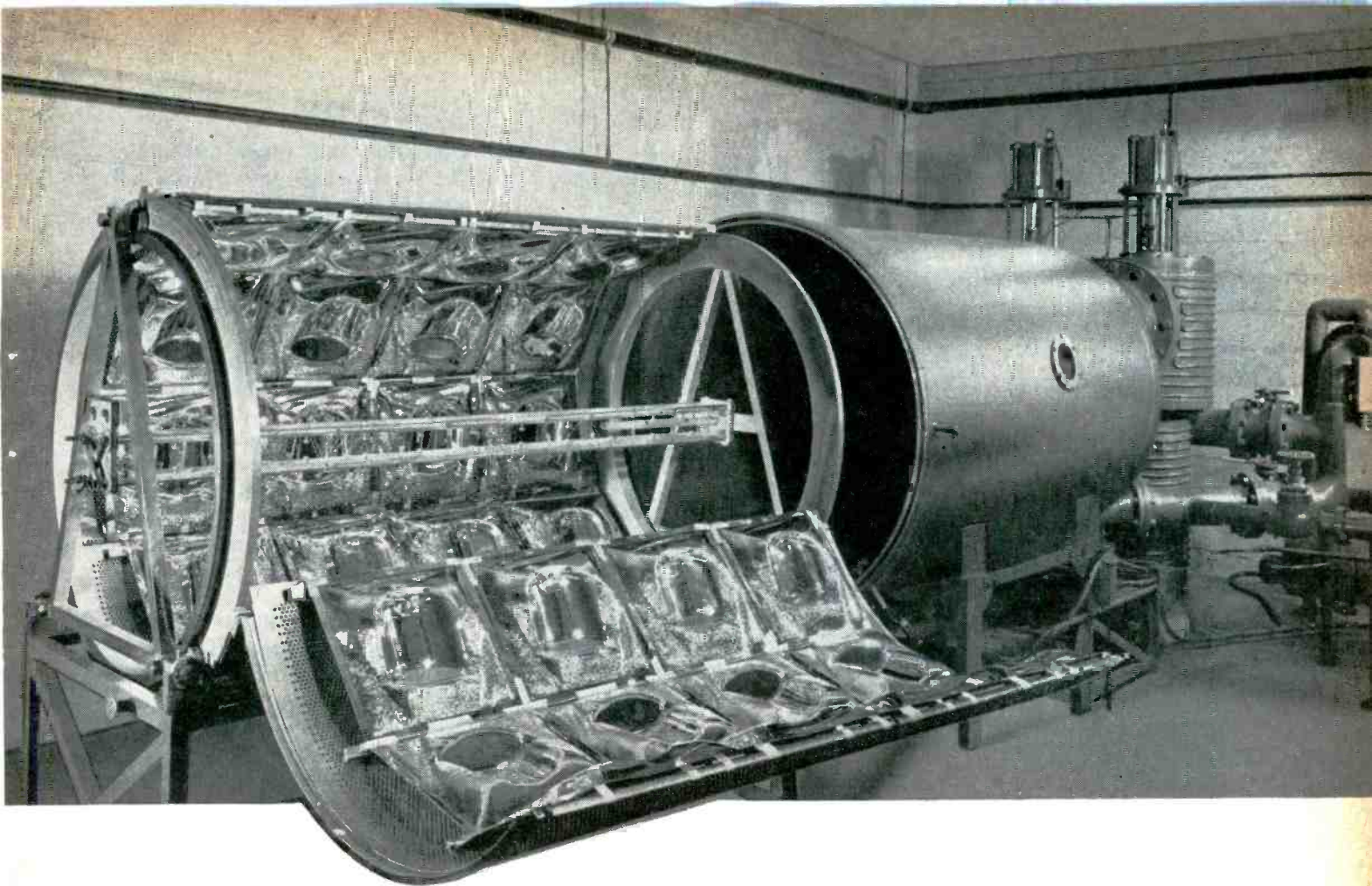

Now available for aluminizing color TV tube components . . .

***CVC* high vacuum coaters**

Large *CVC* high vacuum coaters, similar to those used for metallizing plastics, are now available for aluminizing color TV tube faceplates and faceplate inserts.

Units such as the *CVC* LC1-48A, illustrated above, are easy and economical to operate. Pieces are loaded on an extra-long cylindrical fixture which opens to permit easy attachment at a convenient working level.

The entire fixture is rolled into the vacuum chamber, the door closed, and, in a matter of

minutes, the load is coated with aluminum. Three cycles per hour are easy, four are possible.

To help you get ready for color TV tube production on a mass production basis, we can furnish you with this type of equipment, with inline aluminizing systems, or with stationary individual unit systems.

For information on any application of high vacuum to color TV tube production, write to *Consolidated Vacuum Corporation, Rochester 3, N. Y.* (a subsidiary of Consolidated Engineering Corporation, Pasadena, California.)



Consolidated Vacuum Corporation

Rochester 3, N. Y.

designers and manufacturers of high vacuum equipment

SALES OFFICES: PALO ALTO, CALIF. • CHICAGO, ILL. • CAMDEN, N. J. • NEW YORK, N. Y.

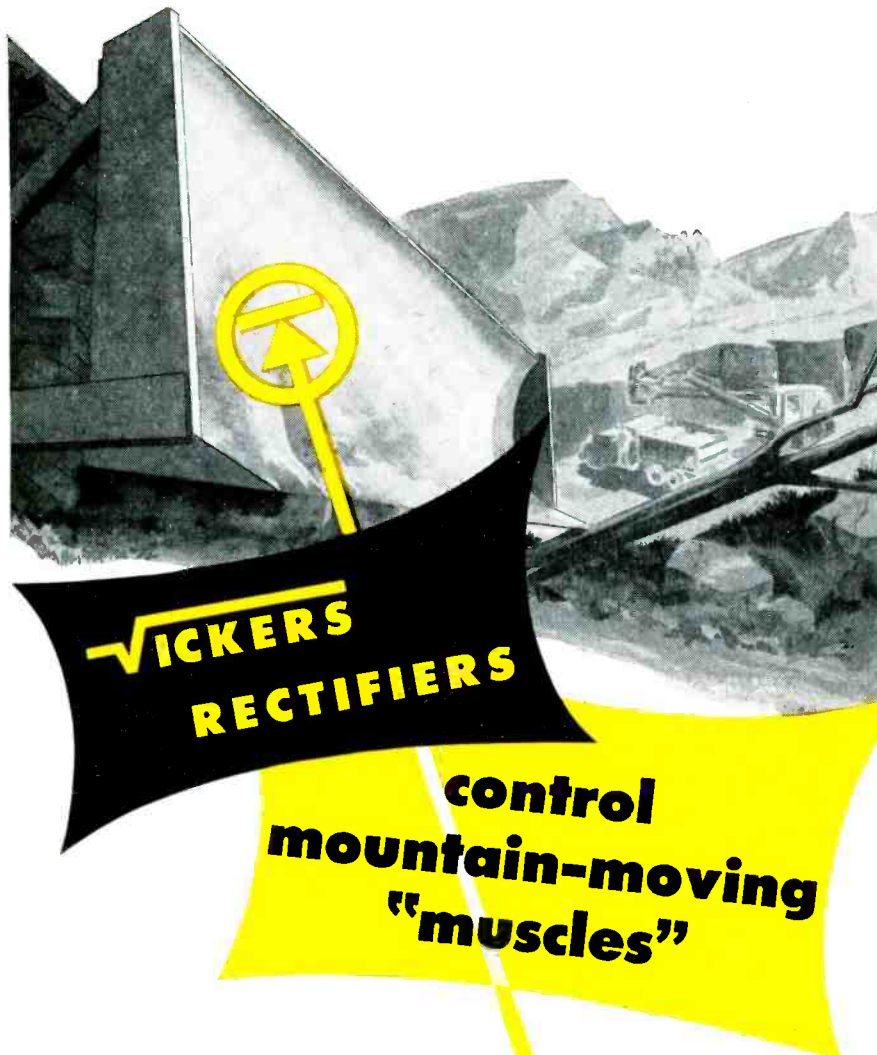

the PROBLEM

Growing "muscle power" of heavy earth-moving equipment called for more and better control. DC control systems seemed to be the answer, but they would have to be dependable in arctic cold and tropical heat, jolting through dust or rain, twenty-four hours a day, without complicated maintenance. The manufacturer brought his problem to Vickers Electric Division engineers: "Can you help us work out DC systems that will meet our needs?"

the SOLUTION

Working with the manufacturer, experienced Vickers engineers helped develop control, regulating and battery-charging systems that are dependable, with minimum maintenance, in this punishing service. Quality Vickers Selenium Rectifiers, *engineered to the problem*, provided the "muscle control" that helps keep construction on schedule, around the world.

Vickers Selenium Rectifier quality starts with raw materials and is carefully maintained through every step of manufacture. The experience of Vickers engineers, who have solved thousands of circuit problems by system-engineering dependable Vickers rectifiers to the application, is at your disposal, without obligation.

Write for Bulletin 3000.



VICKERS ELECTRIC DIVISION

VICKERS Inc.

A UNIT OF THE SPERRY CORPORATION
1801 LOCUST STREET • SAINT LOUIS, MISSOURI

attenuator for range switching. The decade steps shown work out satisfactorily. The shunt input capacitance is only 50 μf , but the lowest capacitance seen by the first grid is 500 μf . It is interesting to note that a capacitive attenuator is theoretically flat up to infinite frequency. Its errors occur at low frequencies, due to the shunt load resistance across the attenuator.

The feedback impedance in this practical case is a 12-ohm resistor in series with a small inductance. The latter is a phase corrector used to flatten out a peak in the response near 30 kc. The feedback factor is about 15 db.

Regenerative peaks in the low-frequency region are the most common difficulty in circuits of this type. The disparity in the various interstage coupling capacitances indicates a practical solution.

The signal rectifier is a full-wave bridge using four germanium diodes. The cheaper half-bridge is satisfactory where gain and power consumption are not at a premium; its sensitivity approaches half the value of a full bridge.

Midband sensitivity of the complete vtvm is slightly affected by changes in battery voltage due to aging. However, the high internal resistance of an old B battery tends to introduce a regenerative peak at the low frequency limit of the band. This trouble is eliminated by an electrolytic capacitor.

A built-in switch circuit is incorporated to permit checking the battery voltages with the indicating meter. A jack *J* adapts the instrument to use as an amplifier, having an output impedance of 10,000 ohms.

REFERENCES

- (1) L. Fleming, Sensitive A-C VTVM, *ELECTRONICS*, p 122, Dec. 1950.
- (2) L. Fleming, Battery-Operated Cathode Follower, *ELECTRONICS*, p 178, May 1950.
- (3) L. Fleming, A-C Voltmeter for Built-in Instrumentation, *ELECTRONICS*, p 152, Sept. 1950.
- (4) L. Fleming, A Ceramic Accelerometer of Wide Frequency Range, *Jour Instrument Soc America*, 24, p 968, July 1951.

AGC for Transistor Amplifiers

IN A PAPER entitled "Automatic Gain Control of Junction Transis-

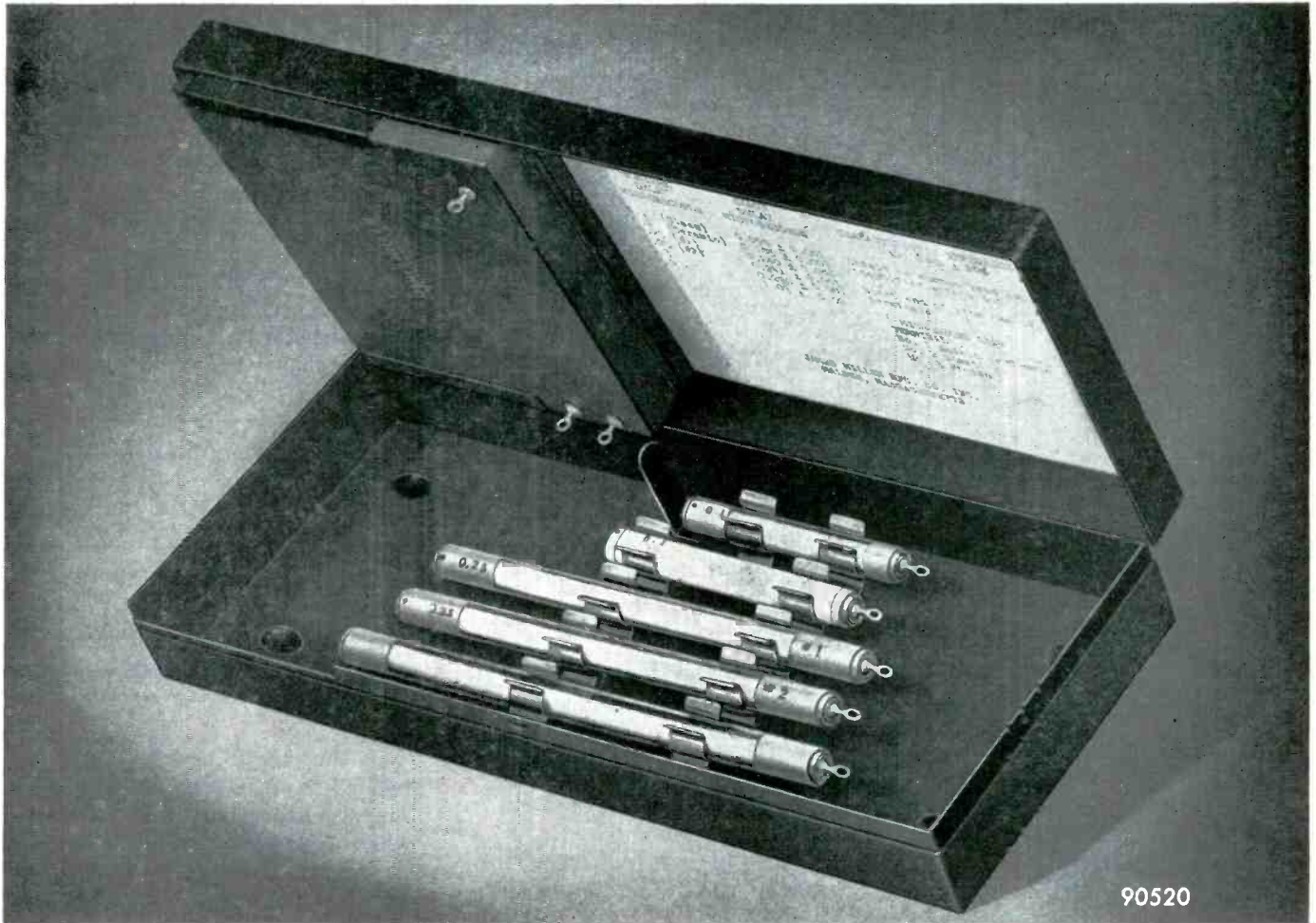

90520

LABORATORY DELAY LINE STANDARDS

The Millen delay line kit effectively provides a means for the development and design engineer to check the affect of various delays in their actual development setups without the time loss and expense of producing separate lines for each trial. Increased requirement for time delay circuits in radar, color television and other modern electronic applications has presented a problem to the design and development engineer as it has been both time consuming and expensive to obtain delay lines for developmental work as each line was necessarily cut to the estimated delay and any change in requirements necessitated the fabrication of a new delay line. The Millen delay line kit is designed to provide a ready means of obtaining various delays from .10 microseconds through 2 microseconds in increments of .05 microseconds except at the extreme ends of this range. The lines may be used repeatedly without deterioration as they are hermetically sealed, the smaller lines in glass tubes, the 1 microsecond line in a metal container.

Actual delay as measured by phase shift method are marked on each delay line. The laboratory calibration of each delay line is accurate to ± 0.002 microseconds on a 1 of the .10 microsecond, .25 microsecond and .03 microsecond lines and ± 0.01 microsecond on the 1 microsecond line. Combination of delay lines supplied makes possible the following delays:

0.10 μ s.	0.55 μ s.	1.10 μ s.	1.55 μ s.
0.20	0.60	.30	1.50
0.25	0.65	.25	1.55
0.30	0.70	.30	1.70
0.35	0.75	.35	1.75
0.40	0.80	.40	1.30
0.45	0.90	.45	1.90
0.50	1.00	.50	2.00

Characteristic impedance — 1350 ohms $\pm 20\%$.

Each set consists of:

NOMINAL DELAY	TOL.	CALIBRATION TOLERANCE
2—.10 μ s.	± 0.01 μ s.	± 0.002 μ s.
2—.25 μ s.	± 0.025 μ s.	± 0.002 μ s.
1—.30 μ s.	± 0.03 μ s.	± 0.002 μ s.
1—.00 μ s.	± 0.05 μ s.	± 0.01 μ s.

PHYSICAL DIMENSIONS:

0.1 μ s.	$1\frac{1}{32}$ " dia. x $4\frac{1}{8}$ " long
0.25 μ s.	$1\frac{1}{32}$ " dia. x $2\frac{3}{8}$ " long
0.30 μ s.	$1\frac{1}{32}$ " dia. x $2\frac{3}{8}$ " long
1.00 μ s.	$2\frac{3}{4}$ " x $4\frac{3}{4}$ " x 1"

All seven lines are mounted in a metal case $9\frac{1}{2}$ " x 5" x $1\frac{3}{4}$ " for convenience in storing and safety in handling.

JAMES MILLEN MFG. CO., INC.

MAIN OFFICE AND FACTORY

MALDEN, MASSACHUSETTS, U. S. A.

a klystron is the HEART of airborne radar...

At the blue-cold altitudes of jet fighters and guided missiles, corona problems cause plenty of trouble. Without the protection of a pressurized enclosure, ordinary klystrons fail. "Heart failure" has the same results, whether in human beings or in radar.

VARIAN OVERCOMES HIGH ALTITUDE PROBLEMS...

Varian perfected the molded silicone seal for x-band radar klystrons which completely solves high altitude problems. With this seal, Varian klystrons withstand severe pressure and temperature differentials **without** short circuits, **without** frequency variation and **without** use of a separate pressure system.

Design leadership that solves tough application problems **first** is a Varian habit — the reason why radar equipment designers turn to Varian when klystron performance is a critical factor.

PERFORMANCE PROVES DESIGN LEADERSHIP...

Only Varian klystrons are wholly successful in unpressurized airborne radar systems. These seven outstanding features show why:

- Exclusive Silicone Seal
- Non-Microphonic Characteristics
- Low Voltage Operation
- Rapid Warm-Up
- Negligible Barometric-Frequency Coefficient
- Extremely Low Noise
- Rugged Construction

For high altitude applications, specify these production klystrons:

- VA-6312/V-270
- VA-6314/V-290
- VA-6315/V-153
- VA-6316/V-151



IN KLYSTRONS, THE MARK OF LEADERSHIP IS
VARIAN associates
PALO ALTO 1, CALIFORNIA
Representatives in all principal cities

tor Amplifiers", presented at the National Electronics Conference F. H. Blecher of Bell Labs described a method for applying age to transistor circuits.

Although the absolute value of emitter resistance varies from transistor to transistor, it was found that in practically all cases it would vary inversely with emitter current. By varying emitter resistance the gain of the transistor can be changed.

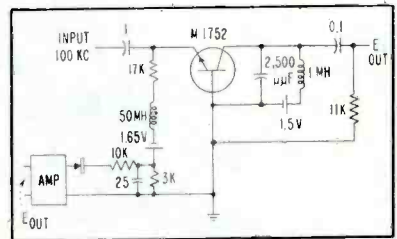

FIG. 1—Amplifier circuit with gain controlled by varying emitter resistance

In the circuit of Fig. 1, age is applied to an r-f or i-f amplifier. The circuit assumes that the stage will be followed by additional stages of amplification before audio detection. The d-c voltage from the detector is used as the gain-control voltage. The emitter bias circuit is arranged so the emitter current will be decreased when the gain-control voltage is increased.

Since the emitter bias current is decreased when input signal increases, the amplifier tends to distort unless low signal levels are

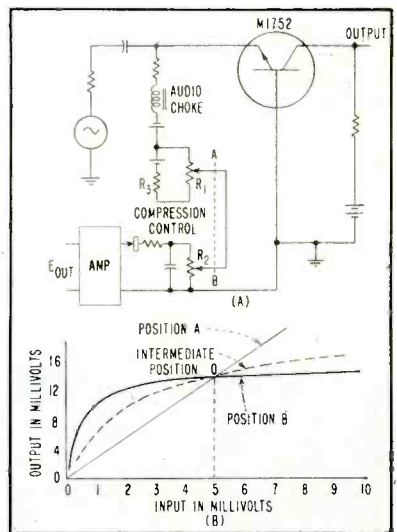

FIG. 2—Audio volume compressor (A) and input-versus-output curves (B) for setting of the control potentiometer

FREQUENCY STANDARDS

Modular system

DESIGNED AS A

The Type 2001-2 series provides frequencies from 30 to 30,000 cycles with an accuracy of .001% (at room temperatures) in units suitable for integration with instruments of your own design — or for panel rack mounting with your own power sources — or for line operation.

WHICH WILL MEET YOUR
CUSTOM NEEDS
FROM A COMBINATION OF
STOCK UNITS

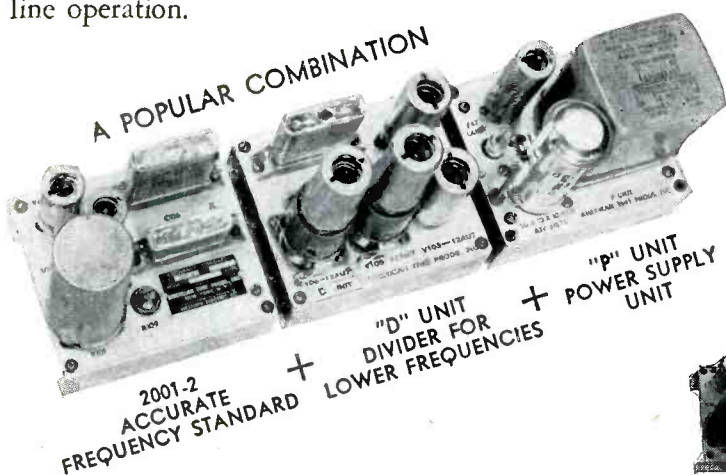

TYPICAL COMBINATIONS

2001-2	2001-2 + M
2001-2 + L	2001-2 + M + P
2001-2 + L + P	2001-2 + L + P + R
2001-2 + H	2001-2 + H + P + R
2001-2 + H + P	2001-2 + M + P + R



TYPE "2001-2" FREQUENCY STANDARD

Frequencies, 200 to 3,000 cycles. Output, approximate sine wave at 5 volts.

ACCESSORY UNITS



"L" UNIT. DIVIDER, (MULTI-VIBRATOR TYPE)
Provides frequencies from 30 to 200, controlled by the 2001-2 unit. Output, approx. 5V. Approx. sine wave.



"M" UNIT AMPLIFIER
Provides 2 watts at 6 and 110 volts.



"D" UNIT. DIVIDER, (COUNTER TYPE)
Provides 40 to 200 cycles controlled by the 2001-2 unit. (fail safe)



"P" UNIT POWER SUPPLY
Provides power for combinations of units illustrated, if other sources are inconvenient or not available.



"H" UNIT MULTIPLIER
Provides frequencies from 3,000 to 30,000 cycles, controlled by the 2001-2 unit. Output, approximately 5 volts.



"R" UNIT PANEL MOUNTING
Accommodates up to three units. Standard size is 8 3/4 inches high, 19 inches long.

For details, please request our "Type 2001-2" Booklet.

American Time Products, Inc.

580 Fifth Avenue

New York 36, N. Y.

OPERATING UNDER PATENTS OF WESTERN ELECTRIC COMPANY

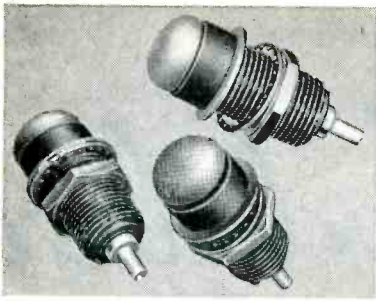
**EDGE-LIT PANEL MOUNTING****Series L2000**

Designed for MIL-P-7788 panels. Sturdily constructed with integral molded-in terminal and snug-fitting plastic lens that will not vibrate loose. Easy to mount. Write for Hetherington Bulletin L1.

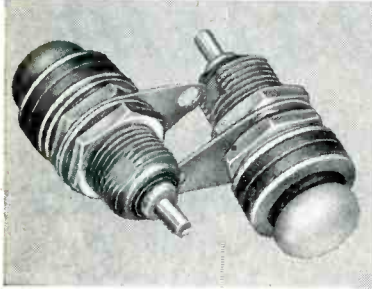
**REGULAR PANEL MOUNTING****Series L1000**

Combines exceptionally small size and light weight with durable construction. Unaffected by heavy shock or vibration. Effectively sealed against moisture. Terminal is molded into the assembly. Write today for Hetherington Bulletin L1.

for
maximum dependability

specify

HETHERINGTON
INDICATOR LIGHTS

In addition to the standard indicator lights illustrated, Hetherington produces many adaptations and "specials" for military as well as commercial needs. Write for details on any type.

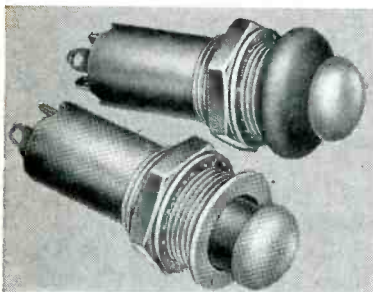
**"PUSH-TO-TEST" INDICATORS****Series L3000**

Widely used in military aircraft and ideally adapted to many industrial uses. Bulb is lit by pressing spring-mounted plastic lens button. Supplied with or without silicone rubber boot for moisture protection. Write for Hetherington Bulletin L1.

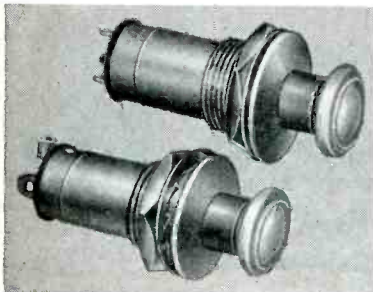
**SWITCHES****WITH BUILT-IN LIGHTS . . .**

in a variety of types and switching arrangements save weight and panel space. Write for Hetherington catalog.

HETHERINGTON, INC.

SHARON HILL, PA.

West Coast Division, 8568 W. Washington Blvd.,
Culver City, Cal.

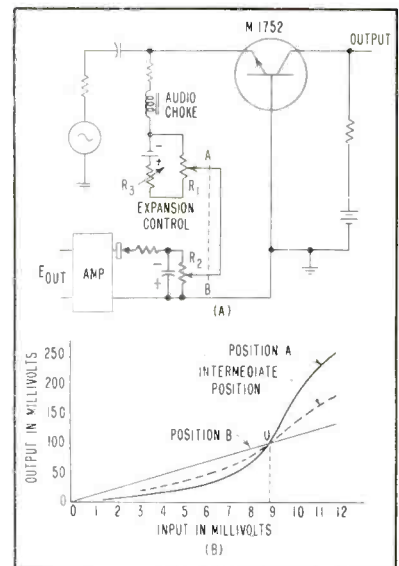

FIG. 3—Volume expander circuit (A) and range of expansion obtainable (B)

used. In the circuit shown, 15 mv is the largest signal that can be handled without raising the distortion above 2 percent.

If the tuned circuit is replaced with a load resistor and a 3-volt collector supply, a compressor amplifier suitable for audio use is obtained. This circuit is shown in Fig. 2A. Compression is controlled by the dual potentiometer R_1R_2 as shown in Fig. 2B. Slope of the operating line can be controlled by potentiometer R_3 .

The volume-expander circuit of Fig. 3A is similar to the compressor circuit of Fig. 2 except that the emitter bias circuit is arranged so emitter current will increase as the gain-control voltage is increased. Expansion is controlled by R_1R_2 over the range indicated in Fig. 3B.

British Electronic Developments

By J. H. JUPE

"Rogart", Hillside Road
Chorleywood
Herts., England

RECENT new applications of vacuum tubes and other electronic equipment have extended the usefulness of existing devices and made possible new techniques in various scientific fields.

Flying-Spot Microscope

An electronic device attracting attention in Britain is the newly de-

Available in quantity — NOW!

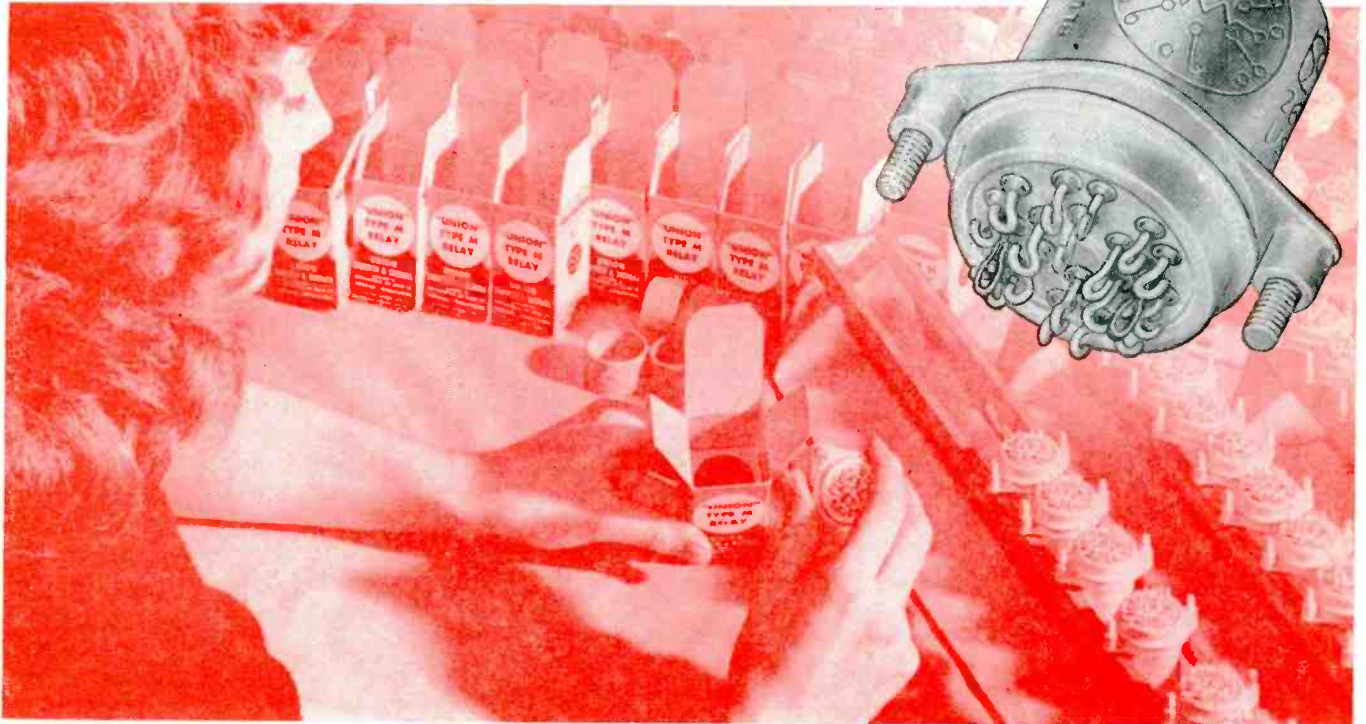

UNION TYPE M MINIATURE RELAYS

MEET ALL REQUIREMENTS OF MILITARY SPECIFICATIONS MIL-R-5757 A & B

TYPICAL PERFORMANCE DATA

Service Temperature	-65°C to 125°C	-55°C to 85°C
Style FM (6-pole)	303125	303085
Style FM (4-pole)	312570	
Coil Resistance	325 ohms	325 ohms
Nominal Voltage	26.5	26.5
Max. Pull-In Voltage at Max. Rated Temperature	18	18
Max. Drop-Out Voltage at Max. Rated Temperature	13	13
Service	Continuous	
Shock	40 G's for 10 milliseconds	
Vibration	10 to 55 cycles per sec.— 0.060 total excursion	
Life Expectancy	1,000,000 operations minimum	
Contact Rating	2 amps. at 26.5 Volts— Resistive Load	
Breakdown Voltage at Sea Level	1000 volts a.c. between case and contacts or coil	

Now, you can buy Union type M miniature relays in quantity. And due to our large production facilities, you can expect a delivery date that will meet your needs. Both 6-pole and 4-pole doublethrow models are available. They meet all requirements of Military Specifications MIL-R-5757 A & B.

Here are the facts: shock load rating for the Union type M relay is 40 G's for 10 milliseconds, and this figure is obtained with the relay deenergized. This is an important point to remember, because some relays are shock-rated with the relay energized, resulting in a stiffer assembly with a higher (and non-comparable) G rating.

Breakdown voltage at sea level is 1000 volts between case and coil or contacts, a figure unmatched by any known comparable relay. The low 18-volt pull-in voltage is given for maximum rated temperature. You do not have to allow for temperature rise when you use this design figure.

This relay, weighing only 3½ ounces, is hermetically sealed containing nitrogen under pressure.

GENERAL APPARATUS SALES

UNION SWITCH & SIGNAL

DIVISION OF WESTINGHOUSE AIR BRAKE COMPANY

PITTSBURGH 18



PENNSYLVANIA

NEW YORK

CHICAGO

ST. LOUIS

SAN FRANCISCO

General Apparatus Sales Department IR-67
Union Switch & Signal Division
Westinghouse Air Brake Company
Pittsburgh 18, Pa.

Please send additional information on Union type M relays.

Name Title

Company

Address

City, Zone & State



Speeding Electronic Progress through

crystal research

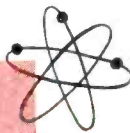

The JK type G-9 is available with flexure mode crystals from 4 to 80 kc, providing rugged, precise frequency control at temperatures in the -40° to $+70^{\circ}$ C. range. These crystals have a high ratio of capacities (C_o/C) resulting in a high degree of isolation from associated circuitry. Consult us for application and engineering information.

JK STABILIZED G-9 CRYSTAL
in the 4 to 80 kc range

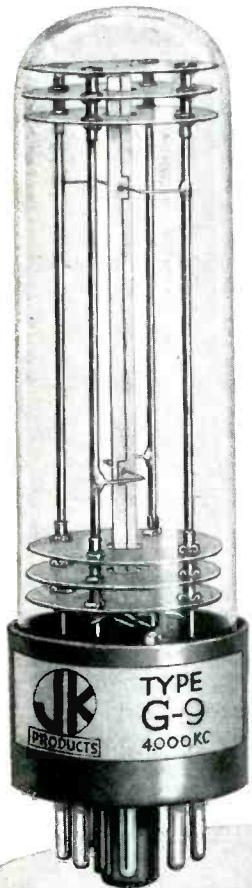

Did you know?

Crystals such as this are made over two inches long but less than $\frac{1}{8}$ " wide with four separate 24K gold electrodes. The performance of JK Crystals requires mechanical tolerances so close that they must be checked with equipment that will measure one part in ten million. Produced in an immaculate, airconditioned plant, JK Crystals for the Critical are hermetically sealed in an evacuated glass holder to maintain their precise frequency accuracy.

**THE JAMES KNIGHTS
COMPANY**
SANDWICH, ILLINOIS



veloped flying spot microscope. This instrument has been designed to overcome a number of disadvantages inherent in the usual microscope techniques and is capable of presenting a picture of high definition and large magnification to multiple audiences.

Electronically, it is a near relative of modern television systems and consists of a cathode-ray scanning tube with an optically-ground flat face is coated with a blue-violet fluorescent powder. An unmodulated 405-line raster is generated on the screen and this raster, by straightforward optical means, is reduced and made to scan a very small area of the specimen under examination.

The transmitted light, which is modulated according to the light density and the configurations of the specimen, falls upon a sensitive multiplier phototube, the output of which is amplified and is made to modulate another raster on a large, normal cathode-ray tube. The two rasters are synchronized so that the picture built up on the viewing screen is a faithful copy of the specimen scanned.

Advantages of the flying-spot microscope are several. The specimen can be viewed by large audiences.

Contrast of the specimen can be varied by electronic means. This eliminates need for specimens to be stained. For subjects that cannot be stained, satisfactory contrast can be obtained.

In normal microscope work, use of high light intensity can cause the specimen to become damaged or distorted. With the flying-spot instruments, this trouble is eliminated because while the peak intensity of the spot is high, its speed is also high and therefore the average intensity is low.

By using ultraviolet radiation from the scanning tube and a photoelectric tube sensitive to ultraviolet, it is possible to obtain resolution equal to that obtained with photographic emulsions, but with the extra advantage of direct viewing and ease of operation.

The use of a flat-faced viewing tube enables tracings of the specimen image to be made. The appara-

NEW... VERSATILE VIDEO SWEEPING OSCILLATOR PROVIDES...

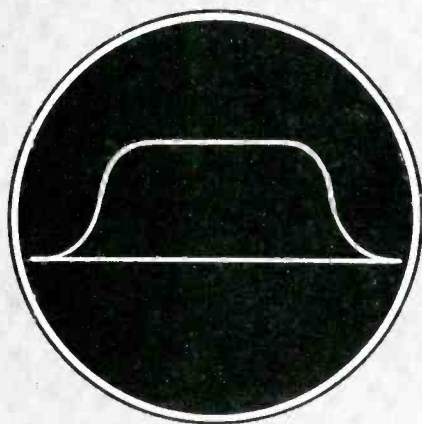

Single Sweep
50 kc to 8 mc

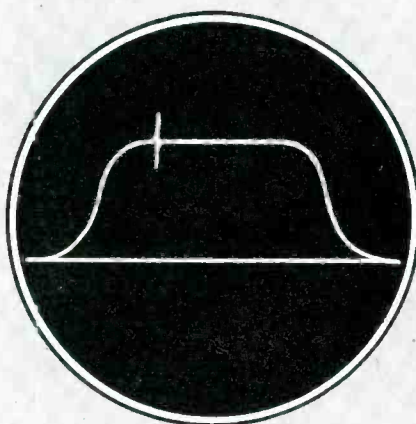

Sweep with Variable
OR Crystal-Positioned
Marker

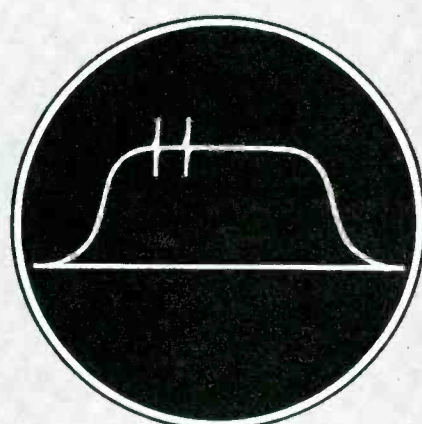

Sweep with Variable
AND Crystal-Positioned
Markers

HIGH LEVEL (1.5 volts) METERED OUTPUT

- Combines all-electronic sweep covering the whole TV video frequency band with variable marker plus five crystal positioned markers.
- Zero level baseline produced on oscilloscope pattern.



Model Video TTV MARKA-SWEEP

- CW Oscillator variable from 50 kc to 8 mc, accurate within 1/2 of 1 per cent.

SPECIFICATIONS

SWEEP RANGE: 50 kc to 8 mc.

SWEEP: All electronic linear sawtooth. Sweep repetition rate is adjustable around and may be synchronized to the power line.

MARKERS: CW — A continuously variable CW signal covering the frequency range from 50 kc to 8 mc is provided. The frequency dial is calibrated in 0.1 mc divisions and is accurate within 1/2 of 1%.

Crystal Positioned—Five Crystal positioned marks are provided at 0.20, 0.75, 1.25, 4.0 and 6.0 mc. If desired, special crystal positioned marks may be substituted for standard ones.

DIMENSIONS: Standard rack-mounting panel, 10 1/2" x 19"; depth 16 1/2". (If ordered in cabinet, 11 3/4" x 22" x 16 1/2")

AMPLITUDE MODULATION WHILE SWEEPING: Less than 0.05 db/mc.

OUTPUT VOLTAGE: Sweep, CW and Crystal frequencies—each 4.2 volts peak-to-peak, into 72 ohms (1.5 volts, r.m.s.). Peak-to-peak reading voltmeter provided at output, accurate within approximately 5%.

OUTPUT ATTENUATORS: Switched: 20 db, 20 db, 10 db, 3 db. Continuous: Approximately 26 db.

MARKER OUTPUT CONTROL: Continuously variable, approx. 5 db.

WEIGHT: 40 pounds. (With cabinet, 65 pounds).

CATALOG NO.: 151-A

PRICE: \$695.00 f.o.b. factory, for rack mounting. (Special crystal positioned marks substituted at \$10.00 each). Note: Cabinet \$35.00 extra.



KAY ELECTRIC COMPANY

14 Maple Avenue

Phone CAldwell 6-4000

Pine Brook, New Jersey

tus can also be used for automatic and rapid counting or sorting.

Photocell Smoke Indicators

One of the difficulties in using photoelectric devices for the indication of smoke is that spurious readings can often be obtained due to the gradual build-up of soot and dust on lenses and windows and due to transient conditions caused by fluctuations of line voltage or the momentary passage of relatively large pieces of material through the beam.

In practice, the only indications of importance to the boilerhouse attendant are those caused by a fairly rapid and sustained decrease in the photoelectric current, caused by smoke. A new method of segregating the wanted variation is obtained by applying the input from the cell to the ends of a potential divider composed of two high resistances connected in series.

The value of one resistance is chosen to be several times as large as the other and has a capacitor connected in parallel with it. A small capacitor is connected across the whole potential divider and the output is taken from the smaller of the two resistances.

Ionization Manometer

A new method of measuring the degree of vacuum in pumped systems depends on measurement of the changes of current flowing in an ionized gas discharge in the system. The measuring device of glass contains a cylindrical cold-cathode electrode, with a number of metal baffle plates joined to the cathode in such a way that the whole vessel is divided into a number of chambers, which communicate with each other via a central hole in each baffle.

The anode is a fine wire, mounted so as to run centrally through the holes. A d-c voltage between 2,500 and 5,000 v is applied between anode and cathode, depending on the degree of vacuum to be measured. Finally, the whole device is surrounded by a solenoid energized from a d-c source.

The current flowing between the anode and cathode is measured by amplifying the voltage drop across

HINDE & DAUCH

for over 50 years has been giving **YOU**

handsome and dependable
corrugated boxes



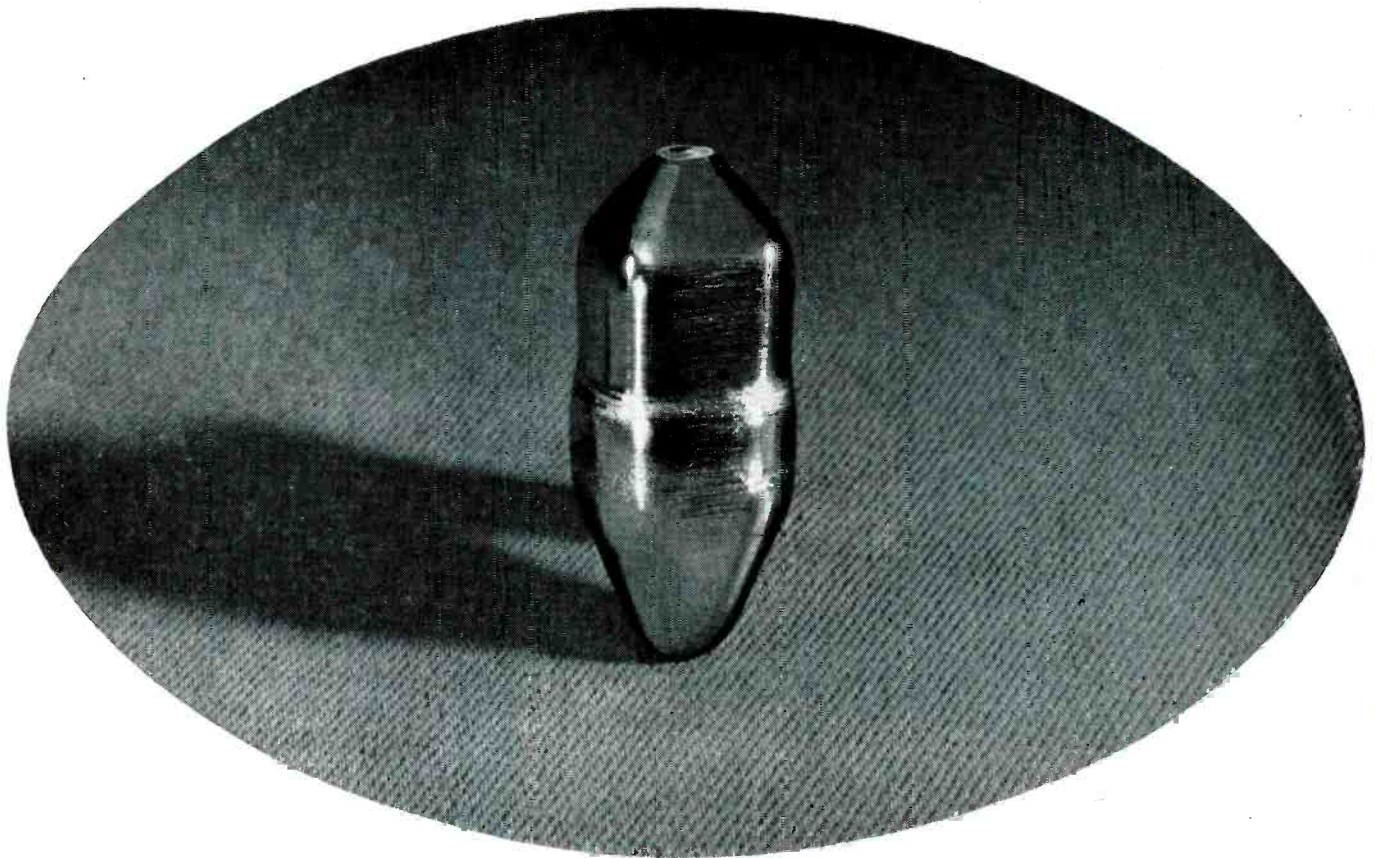

Germanium crystal grown at Bell Telephone Laboratories (life size). It is sliced into hundreds of minute pieces to make *Transistors*. Transistor action depends on the flow of positive current-carriers as well as electrons, which are negative. Arsenic—a few parts per 100,000,000—added to germanium produces prescribed excess of electrons. With gallium added, positive carriers predominate. Latest junction type *Transistor* uses both kinds of germanium in the form of a sandwich.

THEY GREW IT FOR TRANSISTORS

Heart of a *Transistor*—Bell Telephone Laboratories' new pea-size amplifier—is a tiny piece of germanium. If *Transistors* are to do their many jobs well, this germanium must be of virtually perfect crystalline structure and uniform chemical composition. But it doesn't come that way in nature.

So—Bell scientists devised a new way to *grow* the kind of crystals they need, from a melt made of the natural product. By adding tiny amounts of special alloying substances to the melt, they produce germanium that is precisely tailored for specific uses in the telephone system.

This original technique is another example of the way Bell Laboratories makes basic discoveries—in this case the *Transistor* itself—and then follows up with practical ways to make them work for better telephone service.

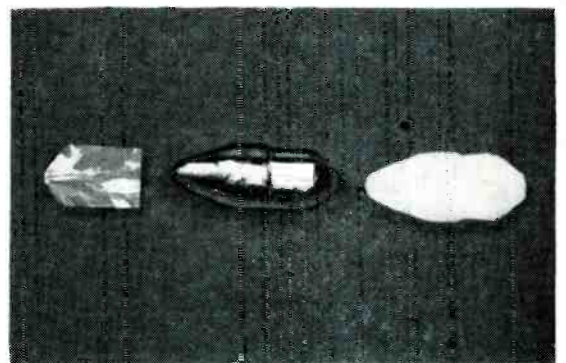

Section of natural germanium, left, shows varying crystal structure. At right is sectioned single crystal grown at Bell Laboratories.

IMPROVING TELEPHONE SERVICE FOR AMERICA PROVIDES CAREERS FOR
CREATIVE MEN IN SCIENTIFIC AND TECHNICAL FIELDS

BELL TELEPHONE LABORATORIES



Want more information? Use post card on last page.

TAKING THE SHACKLES OFF MICROWAVE

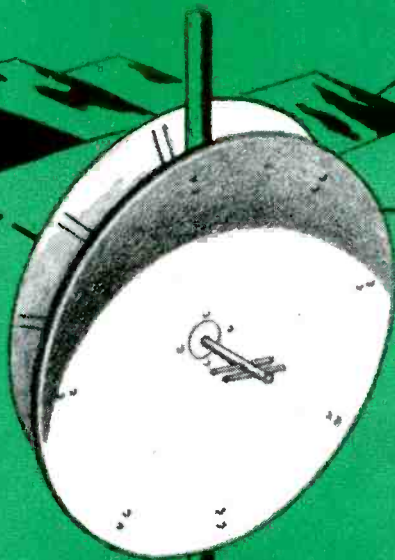

Until a few years ago, full utilization of microwave communications was hampered by the lack of multiplexing equipment which provided necessary transmission quality and flexibility of arrangements. Lenkurt helped remove these "shackles" by providing multiplex equipment for radio using frequency division techniques to achieve the desired objectives.

Frequency division multiplexing, highly developed for wire-line and cable telephone carrier equipment, has many advantages for microwave systems. With each channel occupying a separate portion of the frequency spectrum, individual channels or groups of channels can easily be dropped out at repeater points and terminated or arranged for party-line operation. Total frequency spectrum is conserved because groups of channels can be transmitted with much less r-f bandwidth than is required for other multiplexing methods.

Radio channelizing equipment by Lenkurt, leading independent manufacturer of telephone carrier systems, provides from 4 to 72 toll-quality voice channels over a single radio transmission path. It is widely used with the VHF and microwave equipment of major radio manufacturers.

Lenkurt

LENKURT ELECTRIC CO.
SAN CARLOS 1, CALIFORNIA

a 2-megohm resistor connected in series with the anode.

It is claimed that the above form of construction causes the electrons to follow a helical path in and out of the various chambers, ensuring a large number of collisions with residual gas molecules, a high degree of ionization and thus high sensitivity of vacuum measurement.

Phase Transducer Uses High-Speed Relay

BY DESMOND E. S. ISLE

*Late GPO Engineering Dept.
London, England*

ELECTRONIC phase-measuring devices base their comparative action on the output of a limiting amplifier, followed by a gating tube or tubes, which accept the additive component of the limiter square-wave output. This equipment is necessarily complicated inasmuch as it needs all usual ancillary power supplies.

The high-speed relay system described here needs a minimum of attendant equipment. Input frequency may be as low as is practicable with any indicator.

Two high-speed relays with coils rewound to 3,000 ohms are used. The contacts are connected as in Fig. 1 with alternating voltages applied directly across the windings of each relay. This system gives a direct reading of phase on the indicating meter, which is a normal voltmeter calibrated from 180 deg

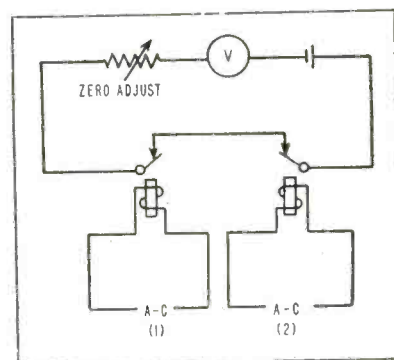
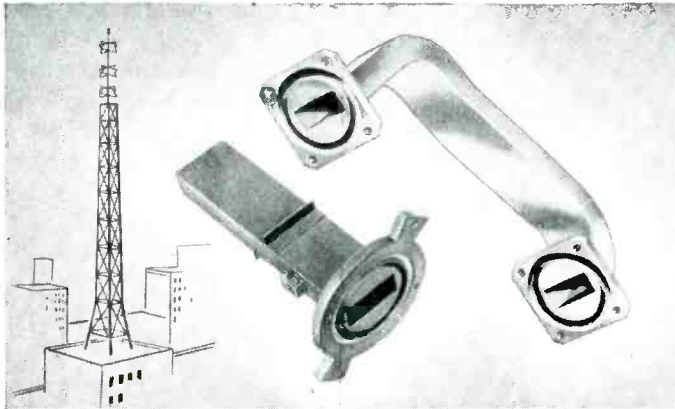

FIG. 1—Phase transducer circuit

to zero. A stable source of d-c feeds the indicator. A potentiometer is adjusted to give zero phase angle with both relays connected to the

All these from one experienced source



TITIFLEX DESIGNS AND MANUFACTURES—to customer specifications—rigid waveguides and combinations of rigid and flexible waveguides. Where there is, or should be, no movement, or where complicated accessories must be connected, Titeflex rigid waveguides are specially recommended.

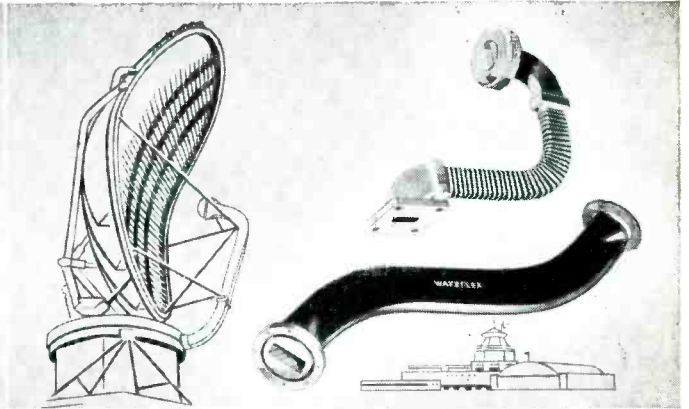

WAVEFLEX® FLEXIBLE WAVEGUIDES are fabricated to retain critical dimensions — regardless of twisting or bending. Waveflex waveguides make assembly easy, improve design, compensate for expansion or movement. Rubber jacketing protects against weather, corrosion, physical abuse.

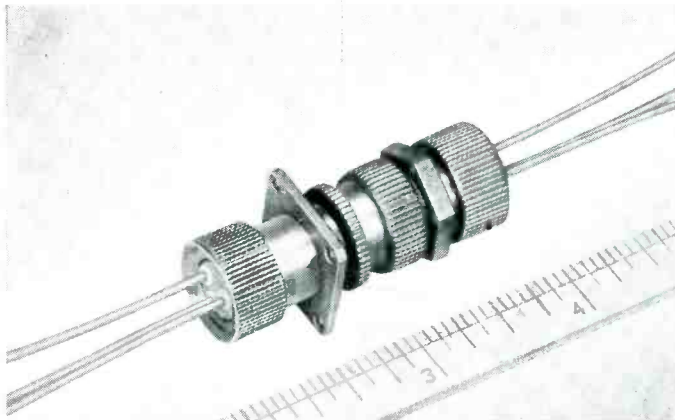

TITIFLEX CONNECTOR—lightweight, corrosion and moisture resistant with temperature ranges of -65°F. to $+400^{\circ}\text{F.}$ This connector's insulation properties will permit 3500 volts at sea level, 1200 volts at 50,000 feet altitude. Connector is available with 2 or 3 pins. 7 amperes. Weight $\frac{3}{4}$ of ounce. Size 2" in length.

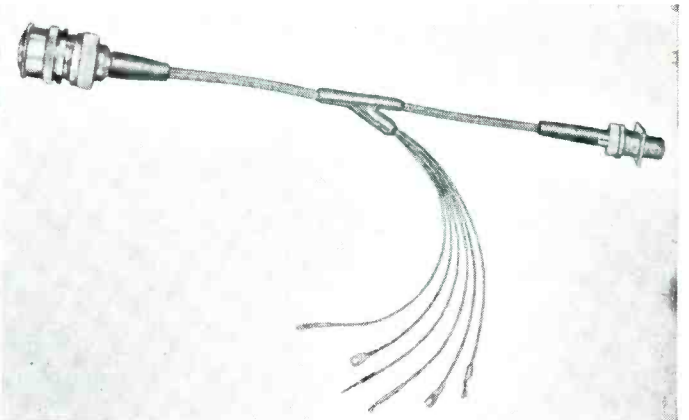

TITIFLEX CUSTOM WIRING SYSTEMS are corrosion resistant, moisture proof, pressure-tight and efficient at temperatures of -65°F. to $+400^{\circ}\text{F.}$ Can be furnished with Titeflex or standard AN connectors for a wide range of service requirements. Can be sheathed with metal braids, fiber glass or nylon—and jacketed with silicone or other compounds.

MORE THAN 37 YEARS of developmental experience make Titeflex a logical source of the components pictured on this page. We are currently in a position to supply connectors and wiring systems to makers of aviation and electronic equipment. If you have a problem requiring our unusual combination of products and engineering, let us quote on your requirements. The coupon will bring you information on our products.

Let Our Family of Products Help Yours

✓ Check products you are interested in.

<input type="checkbox"/> SEAMED AND SEAMLESS METAL HOSE	<input type="checkbox"/> PRECISION BELLOWS	<input type="checkbox"/> IGNITION HARNESS	<input type="checkbox"/> IGNITION SHIELDING
<input type="checkbox"/> ELECTRICAL CONNECTORS	<input type="checkbox"/> RIGID AND FLEXIBLE WAVE GUIDES	<input type="checkbox"/> WIRING SYSTEMS	<input type="checkbox"/> FUSES

TITIFLEX, INC.
524 Frelinghuysen Ave.
Newark 5, N.J.

Please send me without cost information about the products checked at the left.

NAME _____

TITLE _____

FIRM _____

ADDRESS _____

CITY _____ ZONE _____ STATE _____

WHY DOES G-V

Produce More Miniature

Thermal Time Delay Relays

Than All Other Manufacturers Combined?

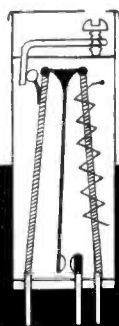

G-V ENGINEERING OFFERS A NEW APPROACH TO THERMAL RELAY DESIGN

- Stainless steel mechanism welded into a single integral structure and supported at both ends for unequalled resistance to vibration and shock
- Heater built inside expanding member for maximum efficiency and protection
- Rolling contact action for positive operation
- Easy adjustability where desired
- Precise operation never before available in thermal relays
- Time ranges: 3 seconds to 5 minutes
- Hermetically sealed in metal shell
- Heater voltages up to 230 volts
- Fully temperature compensated
- Suitable for military and industrial use
- Unequalled for ruggedness and precision

U. S. and Foreign Patents Pending

Because G-V RELAYS have been ...

Adopted as a production component by scores of principal producers of electronic equipment.

Delivered for use on over 150 Government contracts.

In successful field use for two years.



Only G-V offers complete technical data and helpful engineering cooperation on **THERMAL TIME DELAY RELAYS.**

Rapidly expanding production facilities assure prompt deliveries.

Write for bulletin and help with your particular problems.

G-V CONTROLS INC. 24 Hollywood Plaza
East Orange, New Jersey

same supply source of a-c power.

The maximum frequency at which the relays will produce a square-wave output, may be increased by careful adjustment and by removing surplus metal from the armature. This is not necessary below 350 cycles. An optimum frequency for this transducer is 60

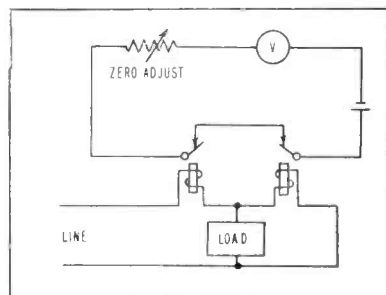

FIG. 2—Power factor indicating circuit

cycles, and therefore it is suitable for use on power supply lines.

A modification to one of the relays, shown in Fig. 2, gives a circuit suitable for power-factor indication by integrating voltage against current over alternate half-cycles of the supply waveform.

One relay winding (of high impedance) is directly across the supply, and the low-impedance winding of the second relay, is in series with the test load. Thus one relay responds to line voltage, and the second responds to the voltage across the relay. As the latter is in phase with the load, due to the winding being of negligible inductance, power factor is indicated.

The relays have proven very reliable in operation, and maintain adjustment over long periods. Contact bounce is avoided by using a contact travel of approximately 4 to 5 thousandths of an inch, thus limiting armature-inertia effects.

PERTINENT PATENTS

A MEANS for microwave modulation is the subject of an invention by S. Freedman and G. Fonda-Bonardi awarded patent 2,640,964.

UHF Frequency Modulator

The invention describes a means of frequency modulating uhf oscil-

Designed to Replace Paper Capacitors



For Dependability and Longer Life

Type JL DISCAPS, another first from the RMC Technical Ceramic Laboratories, are especially engineered to replace paper capacitors up to .005 MFD in coupling applications or wherever a stable capacity is required. The maximum capacity change between +25° C and +100° C is only ± 7.5% of capacity at 25° C. Type JL DISCAPS are available in tolerances of ± 10% or ± 20%.

For by-pass applications requiring capacities up to .01 MFD you can take advantage of the longer life and dependability of ceramic capacitors by specifying RMC Type E DISCAPS.

Because RMC DISCAPS are of smaller size and are easier to wire into circuits they provide additional economies in assembly operations.

SPECIFICATIONS

POWER FACTOR: 1% max. @ 1 K C (initial)
 POWER FACTOR: 2.5% max @ 1 K C, after humidity
 WORKING VOLTAGE: 1000 V.D.C.
 TEST VOLTAGE (FLASH): 2000 V.D.C.
 LEADS: No. 22 tinned copper (.026 dia.)
 INSULATION: Durez phenolic—vacuum waxed
 INITIAL LEAKAGE RESISTANCE: Guaranteed higher than 7500 megohms
 AFTER HUMIDITY LEAKAGE RESISTANCE: Guaranteed higher than 1000 megohms
 CAPACITY TOLERANCE: ± 10% ± 20% at 25° C

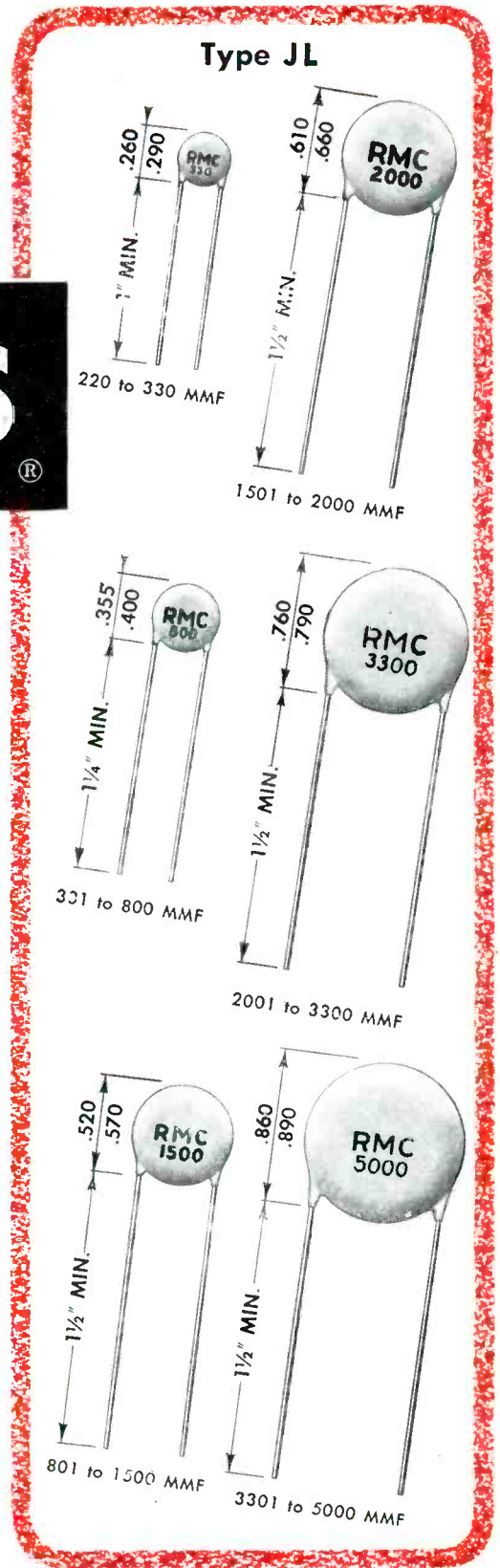
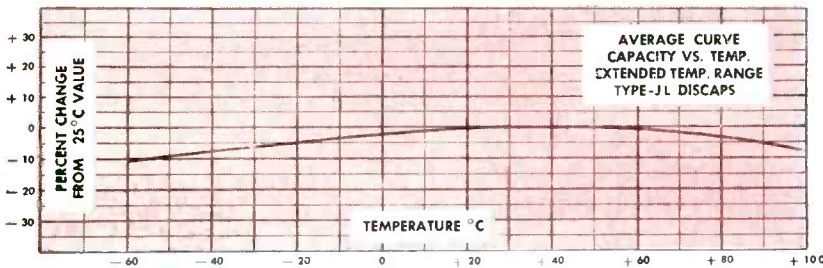

SEND FOR SAMPLES AND TECHNICAL DATA



RADIO MATERIALS CORPORATION

GENERAL OFFICE: 3325 N. California Ave., Chicago 18, Ill.

FACTORIES AT CHICAGO, ILL. AND ATTICA, IND.

DISTRIBUTORS: Contact Jobbers Sales Co., 146 Broadway, Paterson 1, N. J.

TRANSFORMERS

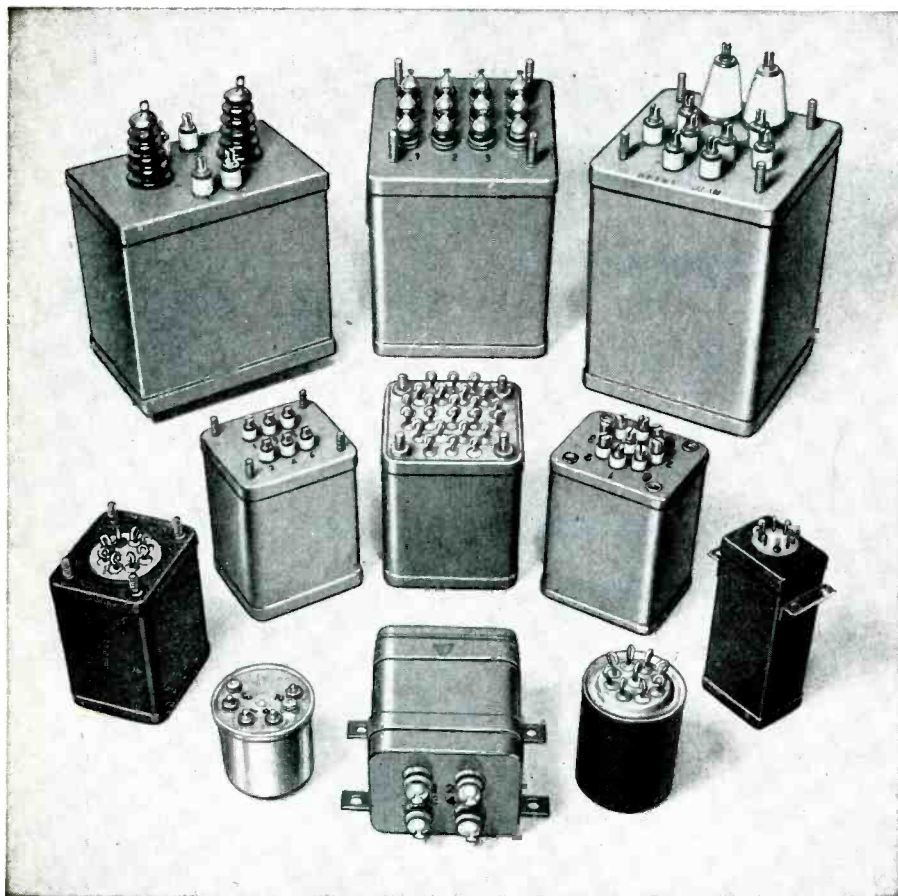

HERMETICALLY SEALED TO MIL-T-27 SPECIFICATIONS

NYT offers a wide variety of transformer types to meet military and civilian specifications, designed and manufactured by specialists in transformer development.

Latest NYT service for customers is a complete test laboratory equipped and approved for on-the-spot MIL-T-27 testing and faster approvals.

**NEW YORK
TRANSFORMER CO., INC.**
ALPHA, NEW JERSEY

lators in which the familiar reactance-tube devices may not be used effectively.

As shown in Fig. 1, an electrodynamic driver reminiscent of the dynamic loudspeaker mechanism is attached to a resonant tank or chamber in a microwave generator. A diaphragm of the electrodynamic modulator varies the chamber dimensions and accordingly varies the frequency transmitted out to

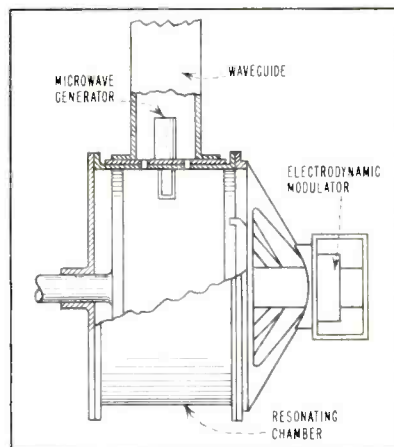

FIG. 1—Cavity is frequency modulated

the load through the waveguide.

Figure 2 illustrates the simple way in which the system may be operated with a telephone unit. Figure 3 shows the structure of the modulator.

Watch Tester

Herald B. Greening of Toronto, Canada, has developed a stroboscopic "Means for Testing the Accuracy of Watches". United States patent 2,640,350 has been granted for the invention.

As can be seen in the diagram of Fig. 4, a standard channel and a test channel are provided, both powered from the same source.

A standard watch is placed on the microphone of the standard channel, and its ticks are amplified in a two-stage amplifier to drive a relay *F* that controls the motion of slotted wheel *Q*.

The test watch is placed on the other microphone. Its ticks are amplified to drive relay *W*, which, in turn, controls the motion of slotted disk *P*, similar to *Q* and on a common shaft with *Q*.

A d-c energized light source is



for **POWER RESISTOR** needs

COME TO . . .

Greenohm* HEADQUARTERS



Power Resistor Decade Box — any resistance from 1 ohm to 999,999 ohms—in working circuit.



'Standees'* or above-chassis-mounted power resistors in ceramic casings, with Greenohm cement filling.

The toughest power resistors made! That's why you find Greenohms in radio-electronic and electrical assemblies noted for dependable performance and longest life.

These green-colored power resistors are available in *standard* and *special* types. Protected by the exclusive cold-setting inorganic cement, these units withstand severe overloads and extreme temperature changes without altering their resistance values or appearance. Resistance windings remain unimpaired in the manufacturing process.

Your needs most likely can be met by the extensive selection of fixed and adjustable Greenohms. But if your needs are extraordinary, then Clarostat is prepared to design your special power resistors and to deliver any quantities to meet any assembly schedules.

Engineering Bulletin on Greenohms, sent on request. Let us have your power resistor requirements for engineering collaboration, quotations, delivery schedules.

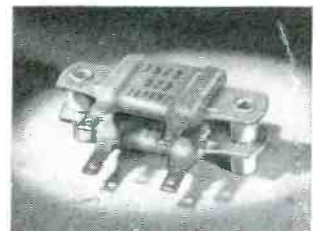

Stacked Greenohms for banking several power resistor sections.



Typical of special Greenohms — a screw-base resistor with handy knob for fast replacement, in changing resistance values.

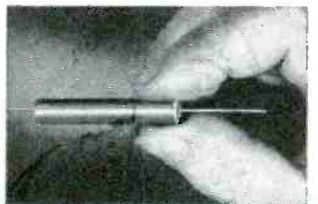

Greenohm Junior or miniature resistor in ceramic casing filled with Greenohm cement.

STAND PAT WITH

CLAROSTAT

Controls & Resistors

CLAROSTAT MFG. CO., INC., DOVER, NEW HAMPSHIRE
In Canada: Canadian Marconi Co., Ltd., Toronto, Ontario.

*Trade-marks

placed behind disk *Q* so that when the slots of *Q* and slots of *P* are aligned, the light will be visible

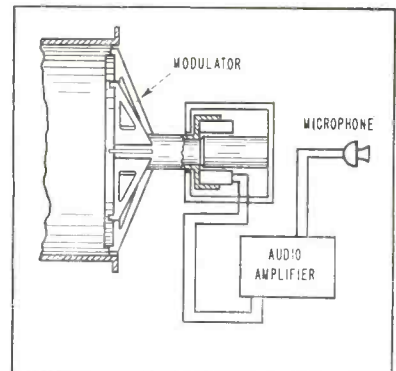

FIG. 2—Simple circuit of uhf voice modulator vibrates cavity

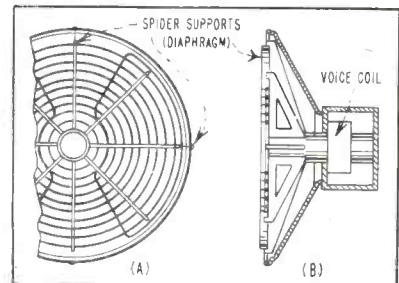

FIG. 3—Structure of the modulator (A) and voice-coil driver (B) used with cavity is similar to loudspeaker

CONDENSED SPECIFICATIONS

Sinusoidal Type	
RL-11C	RL-14MS
Total Resistance (ohms)	16,000 ± 10% 35,400 ± 1%
Approx. % Resistance within brush circle	85% 99 ± ¼%
Angle of Rotation	360° 360°
Torque (Approximate)	¾ oz.-in. 2 oz.-in.
Wire	80 Ni-20 Cr 80 Ni-20 Cr
Resolution	0.4° 0.2°
Angular Accuracy	± 0.6° ± 0.5°
Amplitude Accuracy	± 0.8% ± 0.6%
Maximum Volts across winding	150 350
Maximum Speed	60 RPM 60 RPM
Expected Life	350,000 cycles 200,000 cycles
Diameter	2 5/8" 4 3/8"
Length	1 25/32" 4 11/32"
Shaft Size & Length	3/16" - 1" ¼" - 1 ¼"
Weight	4.75 oz. 1.8 lb.

through them. Alternatively, disk *P* is marked so light through *Q* slots will show on *P* at the marks.

A standard watch tick rate is 5 per second, giving a total of 300 per minute. Each of the disks has eight slots, or marks, providing a total of 2,400 possible coincidence flashes per minute where an observer might see the light through two slots aligned at the center of scale *X*.

If the test watch and standard watch are exactly in synchronism, the light flash coincidences are seen through the disk at the exact center of the scale. If the tick rate of the watch exceeds or is less than the standard, the incorrect rate will result in the coincidence of the two slots to right or left of center on the scale.

As in a stroboscope, the light lines visible will move right or left at a rate determined by the deviation indicated in terms of seconds of error in 24 hours. By permitting



PRECISION POTENTIOMETERS

Linear and Non-Linear

Linear and non-linear units are described in the Gamewell Precision Potentiometer booklet. The booklet also contains a convenient glossary of terms used in conjunction with precision potentiometers. Write for your copy.

To solve your specific precision potentiometer problem, send your specs and sample orders to Gamewell. With over 97 years of experience in manufacturing precision electrical products, Gamewell can provide the answer promptly.

THE GAMEWELL COMPANY
Newton Upper Falls 64, Massachusetts



PRECISION POTENTIOMETERS

Manufacturers of precision electrical equipment since 1855

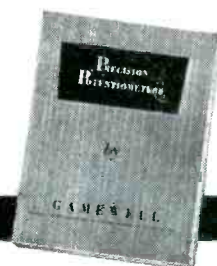

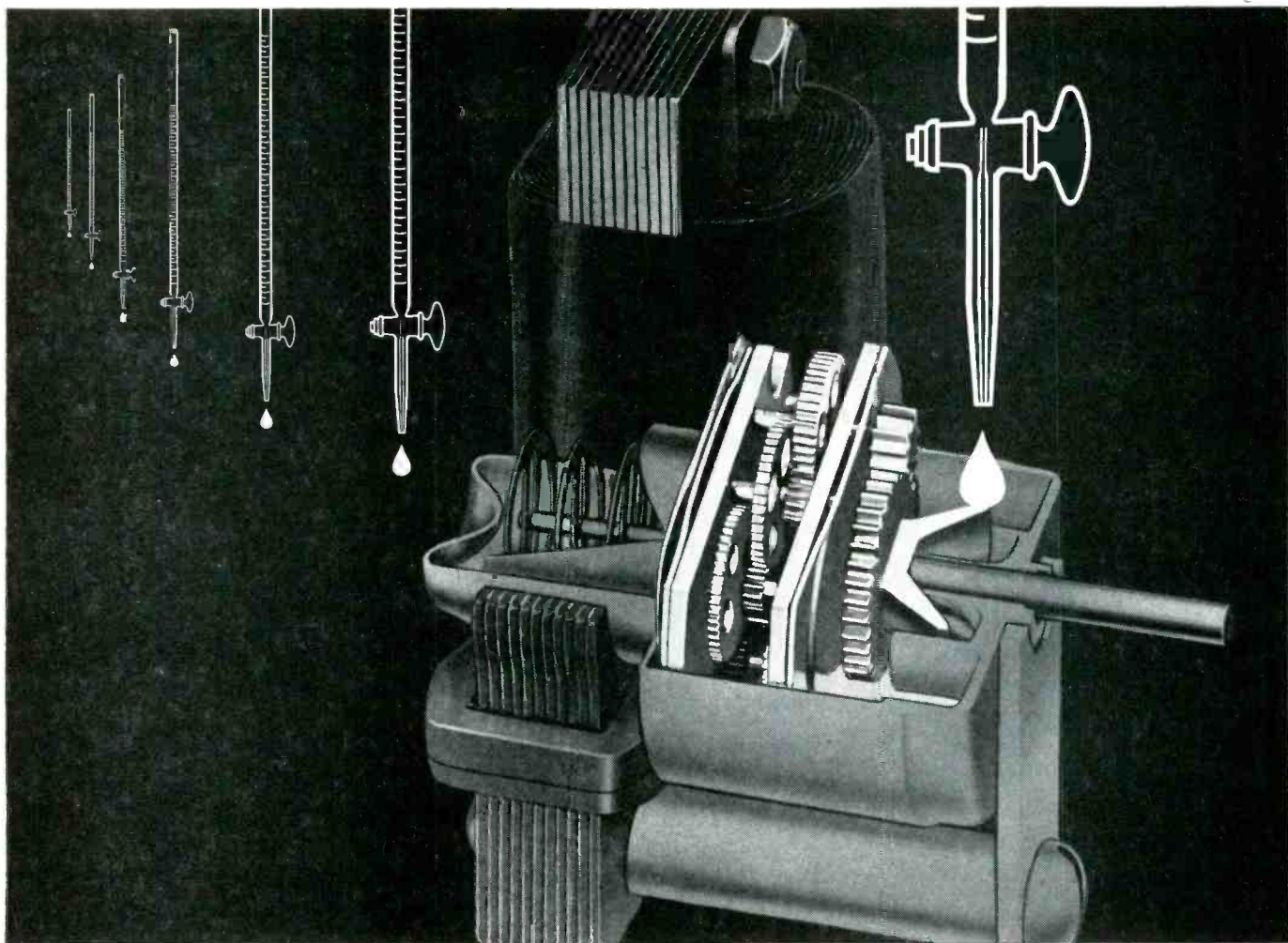

***MORE** evidence of the extra **VALUE** in **TELECHRON** timing motors...*

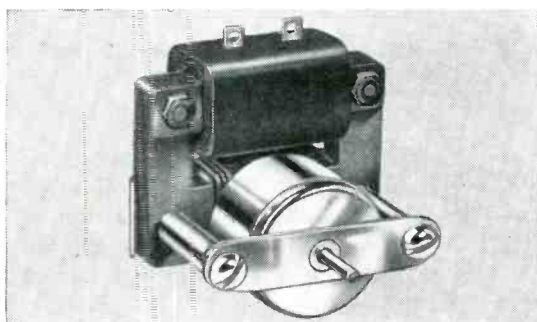

Telechron motors play a major part in switching many of America's jobs to "automatic." They are unmatched in the field of electric timing with such features as lightweight rotors for instant starting... open-air design for cool running... and truly synchronous performance.



Big production by our automatic screw machines—typical of our large motor plant capacity—plus an experienced engineering staff, assure speed in deliveries.

CONTROLLED, SEALED-IN LUBRICATION LASTS THE LIFE OF THE MOTOR

Too much oil interferes with a timing motor's accuracy. Too little causes excessive wear. The key factor in the instant starting and long life of a Telechron timing motor is its unique controlled system of lubrication.

Each Telechron motor carries a lifetime reservoir of oil sealed in its rotor unit. Capillary action carries the oil to bearings, where its flow is controlled to all moving parts.

This exclusive lubrication system is one reason why—rating for rating—a Telechron timing motor will outlast and outperform any other synchronous timing motor made.

Telechron timing motors come in a wide range of speeds and torque ratings, for any standard AC power source. Write for full details about our Application Engineering Service. Telechron Department, General Electric Co., 41 Homer Ave., Ashland, Mass.





"L-LT" indicates knob-actuated locking. Knob (LT) may be on either plug or receptacle.

Plug QRE12P-LT

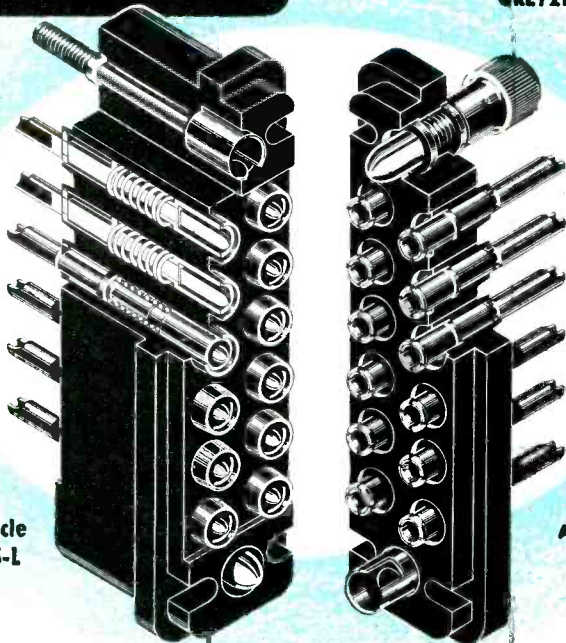

Receptacle QRE12S-L

ACTUAL SIZE

QRE CONNECTORS

- for HIGH CURRENT
- HIGH ARC RESISTANCE
- HIGH DIELECTRIC
- RUGGEDNESS
- COMPACTNESS
- QUICK DISCONNECT

High acceptance is also a feature of Winchester Electronics' Connectors resulting from the exceptional service they give in critical applications. These patented* Connectors have the following **SPECIAL FEATURES:**

POLARIZING: Heavy guide pilot and socket insure self-alignment of contacts as well as polarization.

SELF-ALIGNING: Individually floating contacts assure self-alignment.

QUICK-DISCONNECTING: Individually spring loaded contacts enable ease of separation. Forcing, which results in damage, is eliminated and special levers are not required.

PRECISION MACHINED CONTACTS: Pins from brass bar (QQ-B611) and sockets from spring temper phosphor bronze bar (QQB-746a). They

are gold plated over silver for consistent low contact resistance, reduction of corrosion and ease of soldering.

MOLDED MELAMINE BODIES: (MIL-P-14) Mineral-filled and fungus-proof. Provide mechanical strength as well as high arc and dielectric resistance.

MONOBLOC† CONSTRUCTION: Eliminates unnecessary creepage paths, moisture and dust pockets, and provides stronger molded parts.

HOODS, CONNECTOR CLAMPS AND MOUNTING BRACKETS AVAILABLE.

WINCHESTER PRODUCTS AND WINCHESTER DESIGNS ARE AVAILABLE ONLY FROM WINCHESTER ELECTRONICS, INCORPORATED.

QRE Connectors are available with 6, 12, 18, 24, 34 and 208 contacts.
*Patent Number 2,466,370 †Trade Mark

Wire or write our Sales Department about your special requirements.

West Coast Branch: 1729 WILSHIRE BOULEVARD
SANTA MONICA, CALIFORNIA



GLENBROOK, CONN., U.S.A.

the test to continue for a minute and counting the number of coincidence lines the drift covers in the period observed, the error in minutes per month may be observed.

Recording Coil Driver

In patent 2,638,401 issued to J. Lukacs for an electrocardiograph, there is shown a novel technique for driving a low-impedance recording coil directly without any transformation means. The patent is as-

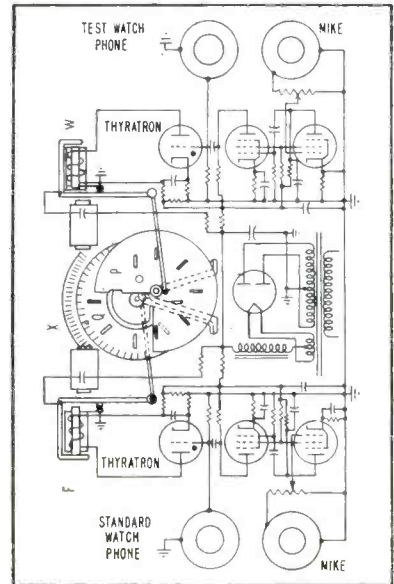

FIG. 4—Circuit and mechanical detail of watch timer using thyratrons

signed to Technicon Cardiograph Corp. of New York. The diagram of Fig. 5 shows the connection of the recording coil between the cathodes of the p-p bridge output network.

The difficulties of properly matching the impedances of the plates of output stages to such devices as recording heads are well known in

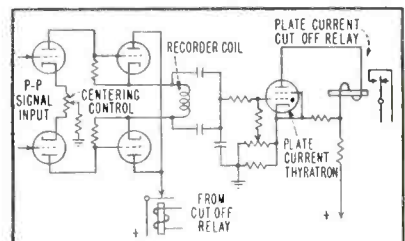
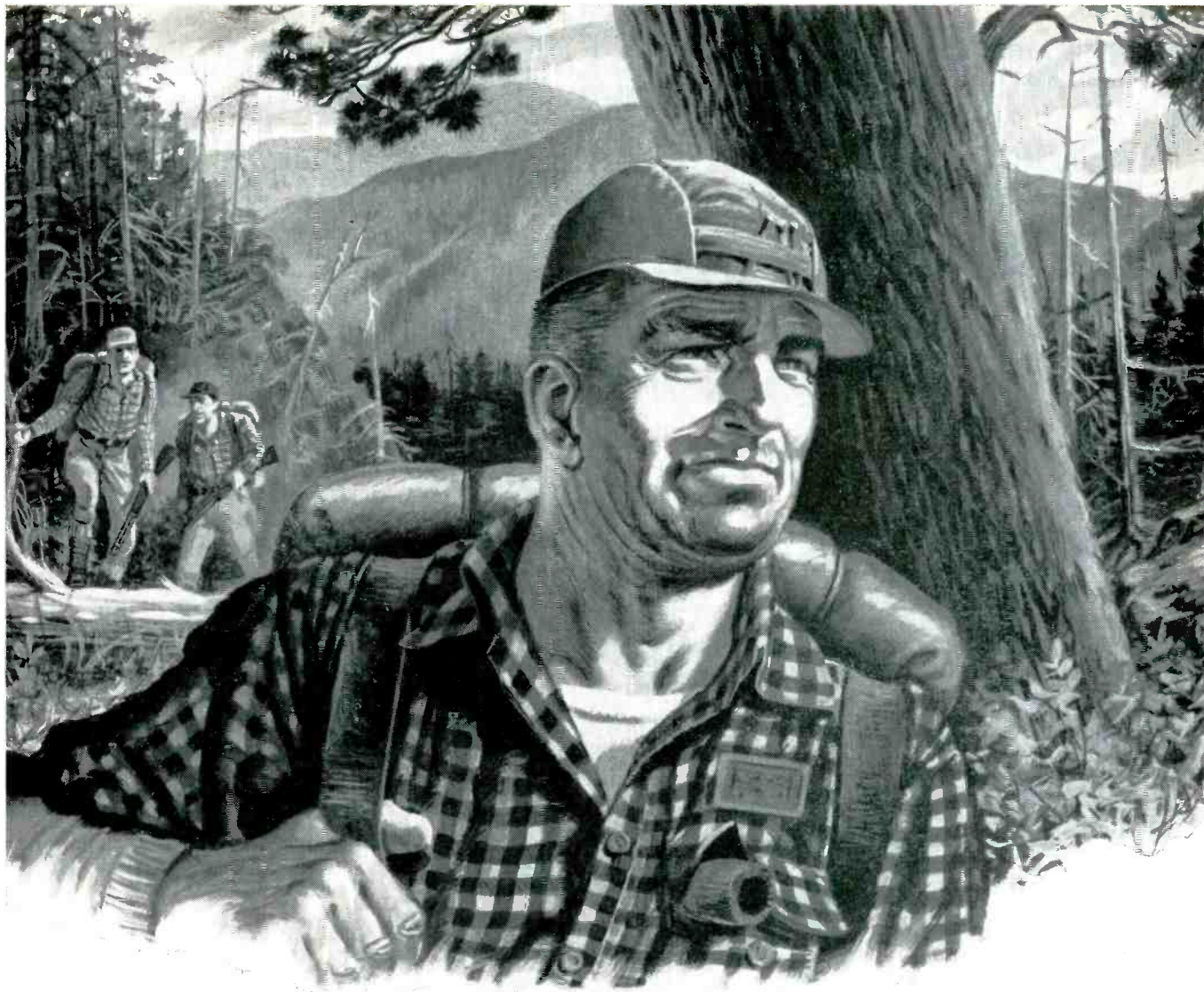

FIG. 5—Low-impedance coil is driven by special circuit for use in recording



You know he'll never lose you . . .

YOUR GUIDE . . . you *know* he'll take you where you want to go, by the quickest, easiest route. That's exactly what Bristol Brass aims to do . . . to get your order to you the same way. And that takes experience and *character* . . . both in the company and in its product.

Matter of fact, that's why so many people keep standing orders with Bristol Brass . . . because they know those orders will never get lost.

They'll be where they're supposed to be, right on time, and *right* according to specifications . . . be it sheet, rod or wire.

. . . .

The BRISTOL BRASS CORPORATION, makers of Brass since 1850 in Bristol, Conn. Offices or warehouses in Boston, Chicago, Cleveland, Dayton, Detroit, Los Angeles, Milwaukee, New York, Philadelphia, Pittsburgh, Providence, Rochester.

"Bristol-Fashion" means **Brass at its Best**

GTC Transformers

demande for

Unusual Applications

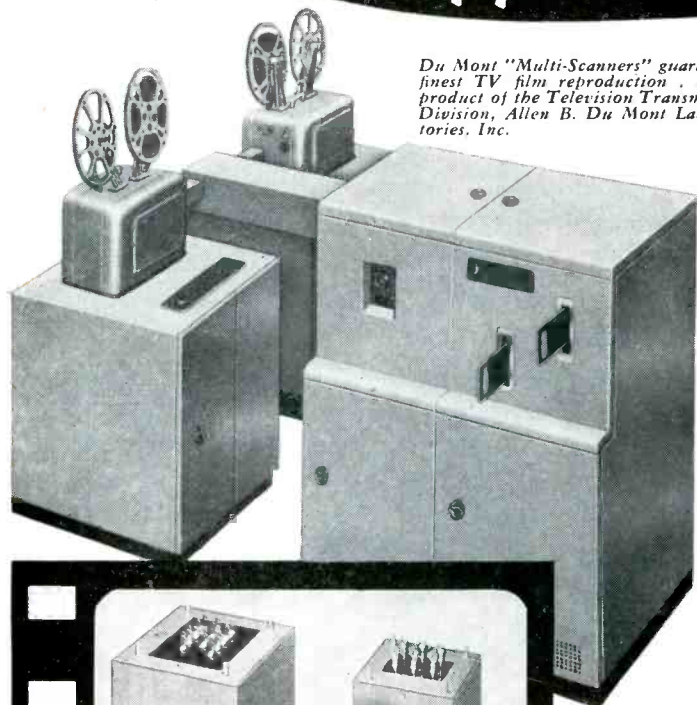

Du Mont "Multi-Scanners" guarantee finest TV film reproduction . . . a product of the Television Transmitter Division, Allen B. Du Mont Laboratories, Inc.

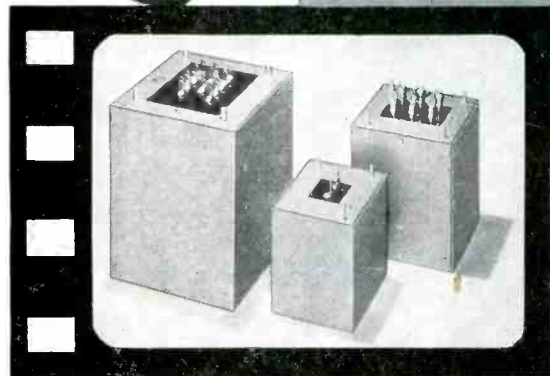

These GTC Transformers are used in Du Mont "Multi-Scanners"

Du Mont, to maintain leadership in television scanner production and development, specifies only the finest parts — including GTC transformers.

Your products undoubtedly necessitate the use of the finest transformers for standard as well as unusual applications . . . why not specify GTC?

We invite your inquiries

GENERAL TRANSFORMER COMPANY

serving industry since 1928

18240 Harwood Avenue, Homewood, Illinois
(Suburb of Chicago)



the art. In the Lukacs invention this difficulty is overcome by driving the recorder coil directly despite its low impedance.

The circuit at first glance seems to have no d-c return through the cathodes of the output stage. Further examination shows that the d-c amplifier technique is applied here in push-pull and the input push-pull stage is in series with the output push-pull stage, thereby providing the d-c return for the output stage through the input stage. In the quiescent condition there will be a balance in the cross currents through the recorder coil.

In the presence of a signal there is a differential current that deflects the coil or any armature that may be associated with it. The thyatron stage upon the application of too great a signal to the output amplifier will draw an increased plate current beyond a preset value whereupon plate current is removed from the output stage. Time delay means hold off the return of operation for several seconds. Thus the recording stylus is prevented from being too forcibly driven against

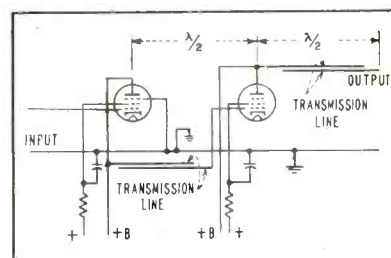

FIG. 6—UHF amplifier uses internal line structure for coupling

the limit stops of the recording device.

UHF Amplifier

Patent 2,639,335 was granted to D. B. Reeves for an "Ultrahigh Frequency Amplifier". The patent is assigned to the National Union Radio Corporation of Orange, N. J.

The invention consists mainly in a novel layout for uhf amplifiers employing vacuum tubes assembled within line structures so that the lengths of the coupling connections between the tubes and the distances between the tubes are dimensionally

The tape and parts pictured are typical of R/M Teflon manufacture



R/M Teflon*

gives you the plus of R/M's unmatched skill, experience, facilities

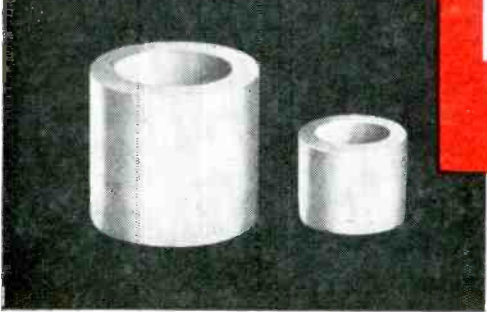
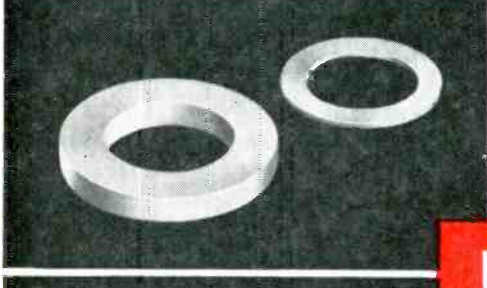
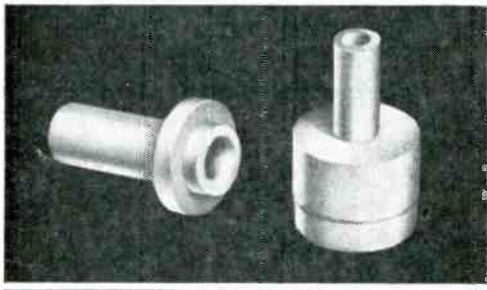
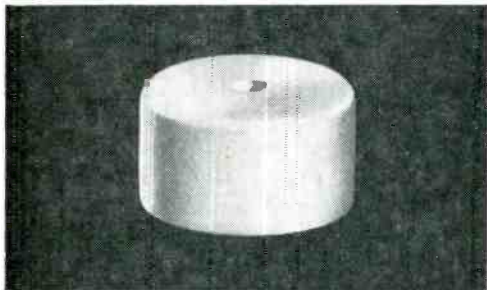
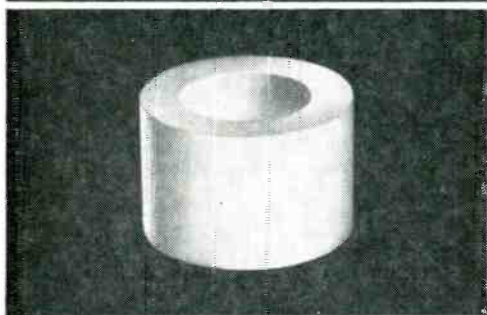

It is difficult to write about Teflon without appearing to exaggerate. For in many different ways this almost magic plastic—the most important derivative of the new wonder chemical fluorocarbon—is making the seemingly impossible possible. Parts made of R/M Teflon have already brought many startling improvements to the electronics and electrical manufacturing fields. And everyone working with it senses that the surface has barely been scratched—that hundreds of applications remain to be revealed.

There undoubtedly are ways in which Teflon can be profitably put to use in your own plant. So we have this suggestion to make to you: consider the properties of Teflon listed below—then get in touch with us if you think that any of them might make a contribution to your operation. We will fabricate parts to your own specifications or supply you with Teflon in the form of rods, sheets, tubes or tape.

Properties

High resistance to acids and gases even at high temperatures • Moisture absorption zero • Unaffected by weather • Excellent heat stability up to 500°F. in continuous operation • As tape, leaves no carbon residue along discharge path • High impact resistance • Nonadhesive • Stretches easily • Tensile strength 1500-2500 psi

**Du Pont's trade-mark for its tetrafluoroethylene resin*



RAYBESTOS-MANHATTAN, INC.

ASBESTOS TEXTILE DIVISION

MANHEIM, PA.

FACTORIES: Manheim, Pa.; No. Charleston, S.C.; Passaic, N.J.; Neenah, Wis.; Crawfordsville, Ind.; Peterborough, Ontario, Canada

RAYBESTOS-MANHATTAN, INC., Manufacturers of Asbestos Textiles • Teflon Products • Packings • Brake Linings • Brake Blocks • Clutch Facings • Fan Belts • Radiator Hose • Rubber Covered Equipment Mechanical Rubber Products • Abrasive and Diamond Wheels • Sintered Metal Products • Bowling Balls

MOUNT 6 OPEN RELAYS IN THIS SPACE

DECOHM TYPE D-3

miniaturized telephone type

"Molded Coil" Relay

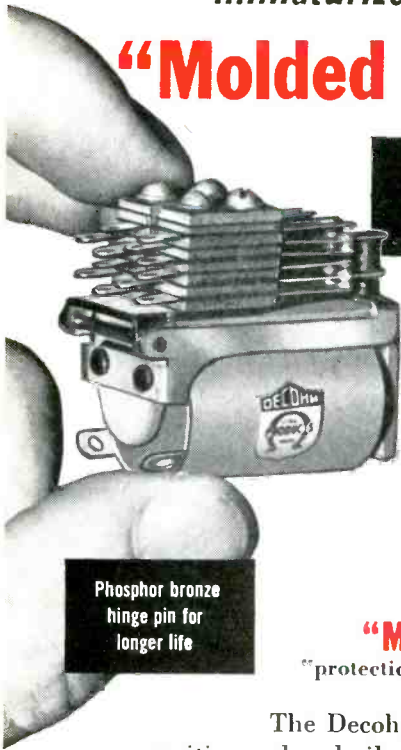

Nickel silver
springs used

Twin or single
contacts rated
from 1 to 5 amps

Coil resistance
1 to 10,000 ohms

Dimensions:
11/16 x 1-3/8 x
1-7/16 inches

Phosphor bronze
hinge pin for
longer life

"Molded Coil" construction provides
"protection plus" in a competitively priced relay!

The Decohm D-3 relay is a small, compact, highly sensitive relay built to meet exacting military standards. Its size, range and sensitivity make it an ideal relay for all types of communications, aeronautical and industrial applications. The coil of the D-3 is sealed in a homogeneous mass which makes it impervious to most adverse ambient operating conditions. The molded coil dissipates heat readily and promotes longer relay life.

SPECIFICATIONS

CONTACT COMBINATIONS: Forms A-B-C-D-E-F-G-H
12 springs maximum
CONTACT MATERIAL: 2 amp. twin palladium contacts
are standard
OPERATING VOLTAGE: 1 to 150 volts DC
OPERATING TIME: .002 sec. min. to .035 sec. max.
.004 seconds standard
COIL PROTECTION: Coil completely imbedded in mold-
ed plastic. Withstands roughest moisture and humidity require-
ments and temperatures from -70 C to +140 C. Will operate
one normally open contact on 1/8 watt, or 4 double throw con-
tacts on less than 1 watt and still meet a 10G vibration test.

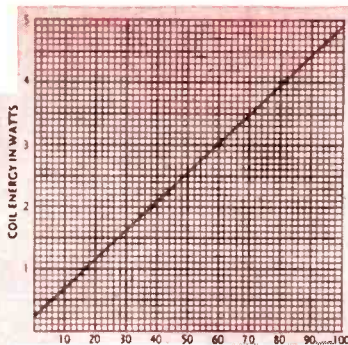

OPERATING CHARACTERISTICS — The graph curve shows coil temperature rise above ambient with zero to 4 watts applied to the D-3 relay coil.

Write for catalog of Decohm products. State your requirements for relay needs, Decohm engineers available to work on all critical problems.



DAVIS ELECTRIC COMPANY
Cape Girardeau, Missouri

Manufacturers of

"Molded Coil" and Hermetically Sealed Relays, TV Yokes, Electrical Assemblies

related to the wavelength of the frequencies at which the amplifier operates.

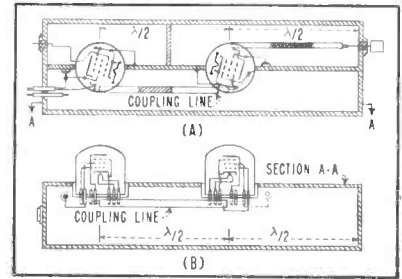

FIG. 7—UHF-line tube for receiver (A) is shown in cross-section (B)

The schematic diagram of Fig. 6 and the assembly drawings of Fig. 7 clearly show the inventor's idea as applied to a two-stage ultrahigh-frequency amplifier.

The inventor claims that his invention provides means of obtaining greater than critical coupling required for wide-band amplifiers in the range above 300 megacycles, such as may be useful for vhf tv receivers.

The assembly technique takes into consideration the terminals, and lead connections at the critical portions of the circuit where the desired resonance would be affected thereby.

Seismic Relay

A radio relay system for "Seismic Surveying" has been awarded patent 2,640,186. The inventor is A. F. Hasbrook. His patent is assigned to Olive S. Petty of San Antonio, Texas.

Seismological technique is used in the oil industry to determine the subsurface structure of an area. Measurements are made by detonating a charge at some point remote from variously placed measuring instruments, which record the characteristics of the shock waves generated by the blast.

For accurate measurement the exact time of the detonation must be known. To bridge the great distances radio has been used to transmit a signal at the instant of detonation. It has been found that noise and static frequently caused

HOW TO TEACH A MISSILE to read a map

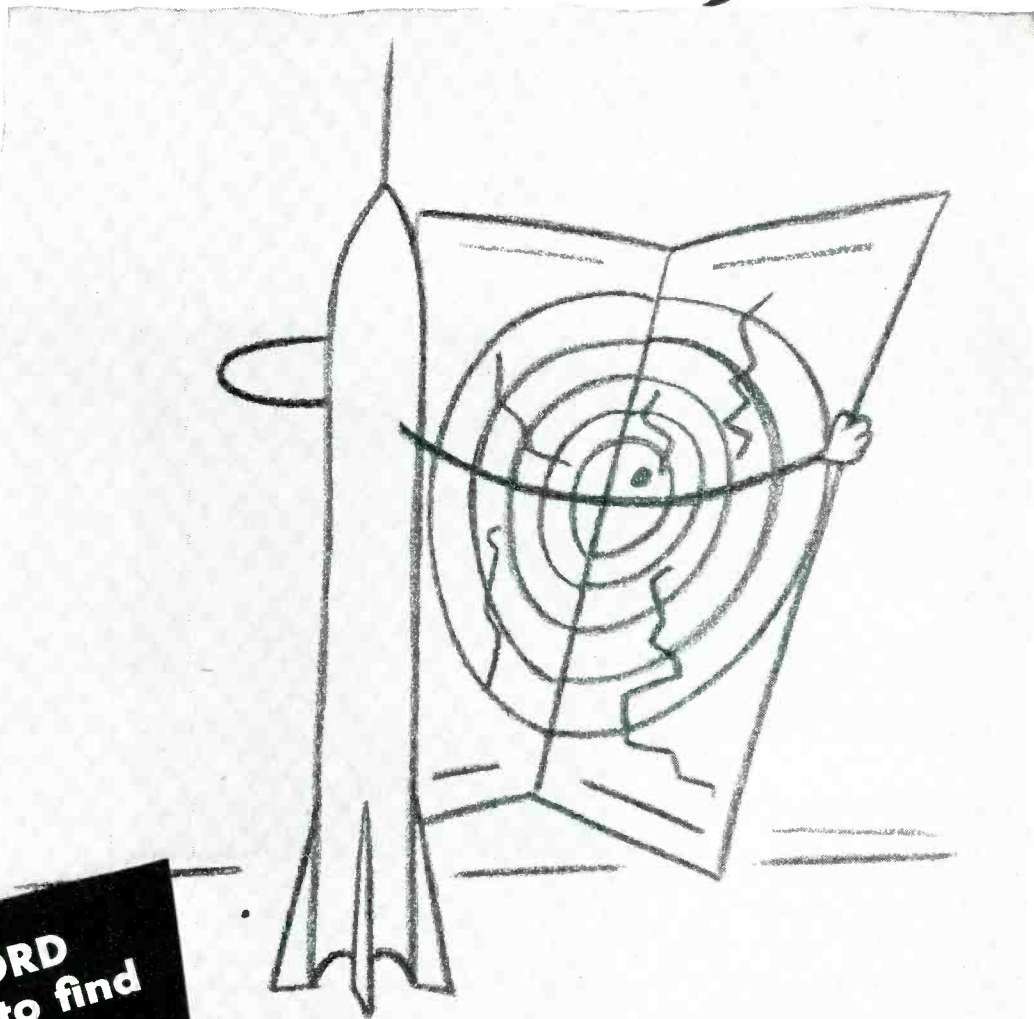

**...and FORD
was asked to find
the answer**

Zwish! And off goes a missile. But where? And how to stay on the right track? And how to *find* the target? That's the problem Ford Instrument is helping to solve.

This is typical of the problems that Ford has been given by the Armed Forces since 1915. For from the vast engineering and production facilities of the Ford Instrument Company, come the mechanical, hydraulic, electromechanical, magnetic and electronic instruments that bring us our "tomorrows" today. Control problems of both Industry and the Military are Ford specialties.



You can see why a job with Ford Instrument offers young engineers a challenge. If you can qualify, there may be a spot for you in automatic control development at Ford. Write for brochure about products or job opportunities. State your preference.



FORD INSTRUMENT COMPANY

DIVISION OF THE SPERRY CORPORATION
31-10 Thomson Avenue, Long Island City 1, N. Y.

FOR
EFFICIENT COOLING
OF HIGH-POWER
TUBES



WATER-COOLED

• For carrying cooling water which must undergo a change in potential, use of Lapp porcelain eliminates troubles arising from water contamination and conductivity, sludging and electrolytic attack of fittings. Lapp porcelain Water Coils or Lapp Porcelain Pipe assure permanent cleanness and high resistance of cooling water—for positive cooling and long tube life.



AIR-COOLED

• Now available as a standardized line, Lapp insulating supports for mounting forced-air-cooled tubes facilitate design . . . make for economical production, easy interchangeability, availability of replacement parts. Sizes for all standard high-power tubes.

Write for Bulletin 301, with complete description and specification data. Lapp Insulator Co., Inc., Radio Specialties Division, 109 Sumner St., Le Roy, N. Y.

Lapp

the signal to be obscured, upsetting the measurement.

The inventor's technique for overcoming the problem is to provide a time-break modulating signal for the transmitter, which is derived from the firing circuit for the detonation of the charge. The signal is in the form of a series of damped waves initiated by the break pulse. The damped waves are acted upon by a pulse shaper and the resulting pulses combined with the time-break pulse so as to distinguish the time break pulse by its polarity.

As a feature of the invention, the transmission to the recording station of the time-break signals produced as above may be effected by applying the series of pulses to a carrier wave, generation or radiation of the carrier being initiated by the original time-break pulse. The following series of damped waves is applied as modulation of the carrier. Thus, the instant of arrival of the carrier wave at the remote recording station denotes the true time break whereas the

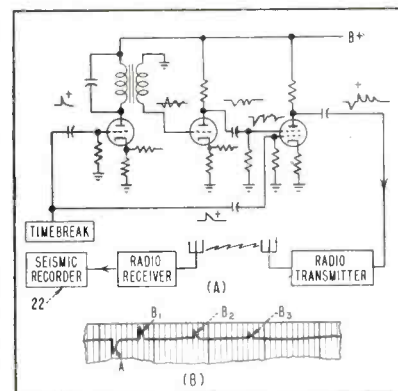

FIG. 8—Ringing circuit provides seismic time signal (A) as recorded (B)

succeeding series of pulses affords an accurate record from which the time break may be determined if static should obscure the carrier at the instant of the time break.

The circuit of the pulse generator of the invention is shown in Fig. 8A. The waves at various parts of the circuit are shown.

In Fig. 8B a chart shows the time-break signal at A and the opposite polarity damped pulses at B₁, B₂, and B₃.

NEW POWER

PNP

JUNCTION TRANSISTOR

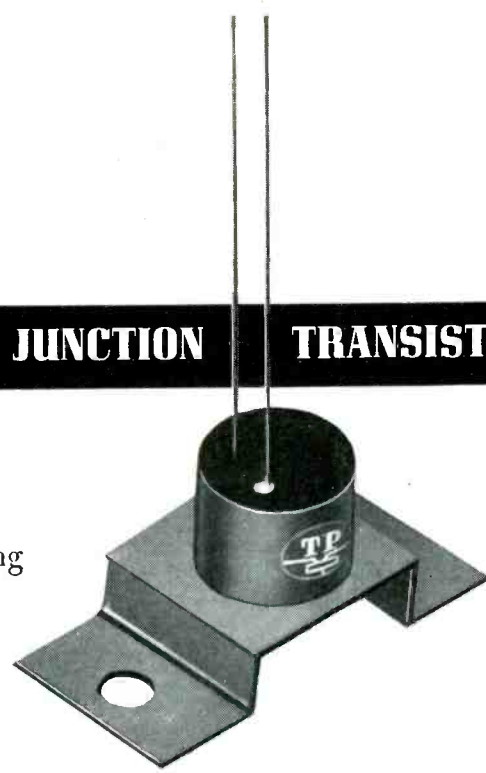

Transistor Products, Inc. is now offering the first commercially available Power Junction Transistor. Specifically designed for use in Class B audio circuits requiring two watts of power output, it can also be used as a Class A amplifier at reduced ratings.

ELECTRICAL DATA

Typical operating conditions: Class B, common emitter, no heat sink. (values are for two units)

Collector voltage	45v.
Collector current (no signal)	less than 5 ma.
Collector current (maximum signal)	90 ma.
Emitter control (no signal)	0 ma.
Load impedance (collector-collector)	2000 ohms
Input impedance (base-base) approximately	10 ohms
Driving power	200 mw.
Output power	more than 2 watts
Power gain*	more than 10 db.
Efficiency	more than 50%

*While these units will operate Class B at collector voltages less than 45 V., the power gain drops as the collector voltage is reduced. Operation below 30 volts is not recommended.

Maximum Ratings (in 25°C. free air):

Collector voltage	45v.
Collector current	50 ma. (without heat sink) 100 ma. (with heat sink)
Collector dissipation	2.25 watts (without heat sink) 4.50 watts (with heat sink)
Operating frequency	10 kc. max.

FOR MORE INFORMATION mail this coupon today

Transistor Products, Inc., Snow and Union Sts., Boston 35, Mass., Dept. E1
(An operating unit of Clevite Corporation)

Please send me data sheet on the X-78 Power Junction Transistor.

Send other material on transistors and diodes.

NAME.....

TITLE.....

COMPANY.....

ADDRESS.....

CITY AND ZONE.....STATE.....

TRANSISTOR PRODUCTS, INC.

AN OPERATING UNIT OF CLEVITE CORPORATION



SNOW AND UNION STREETS, BOSTON 35. MASSACHUSETTS

Production Techniques

Edited by JOHN MARKUS

Simple Metal Jig Speeds Insertion Of Tube Leads In Octal Base.....	250	Lead-Coiling Tool	266
Wire-Holding Pliers Minimize Assembly Rejects	250	Installing Thread Inserts In X-Ray Housings	270
Lamp And Switch System Controls Cathode Spraying	252	Preparing Teflon Cable.....	272
Permanent Time Track For Magnetic Memory Drum	260	Tube Pin Cutter	280
Pilot Production Line Makes Color TV Tubes	260	Metal-To-Ceramic Seals For Magnetron Waveguides	282
		Wire-Coding Methods.....	287

OTHER DEPARTMENTS

featured in this issue:

	Page
Electrons At Work.....	196
New Products	290
Plants and People.....	332
New Books	383
Backtalk	399

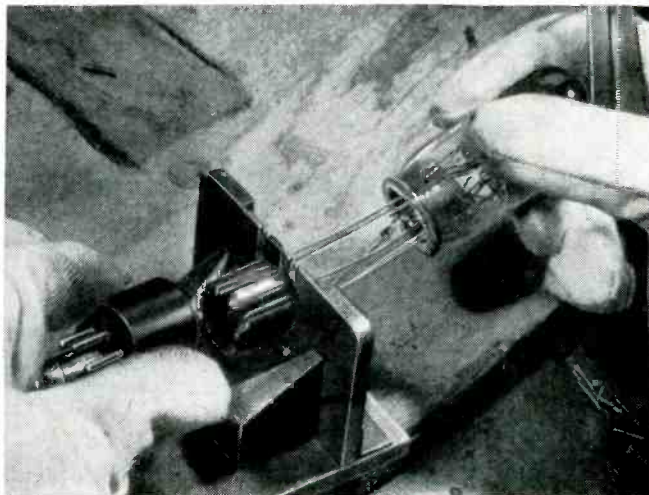
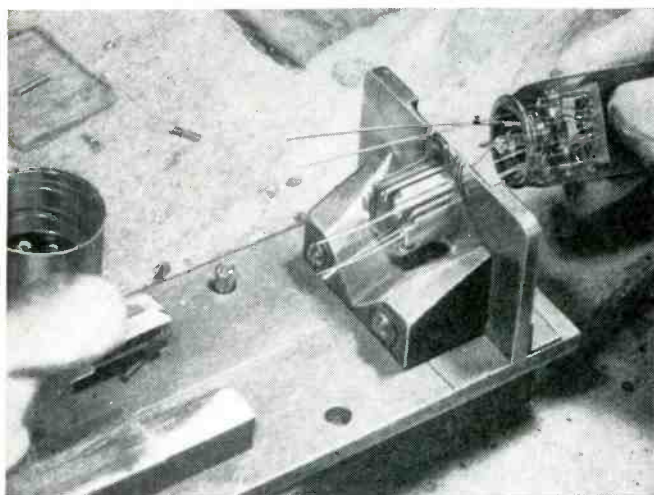

Simple Metal Jig Speeds Insertion Of Tube Leads in Octal Base

THE EQUIVALENT of threading eight needles at a time is achieved in Tung-Sol's Bloomfield, N. J. plant with a metal jig that accurately positions up to eight tube leads so the octal base can be pushed over them in one smooth motion. This automatic base lead wire inserter has greatly speeded up the cementing of bases to tube envelopes and has at the same time reduced rejects due to leads in wrong pins.

Both hands are used for the

assembly operation. With her left hand the operator picks up a tube base on which cement has previously been applied in another operation. With her right hand the operator picks up a finished tube envelope, indexes it visually so the electrode structure and leads are in a predetermined correct position, then drops the leads one by one into their correct slots in the jig.

While positioning the leads, the operator inserts the base in a posi-

tioning device that is grooved for the aligning key. She now pulls back the tube slightly with her right hand so the ends of the leads do not project beyond the jig, then slides the base up with her left hand and pushes the tube in. The base fixture slides on rails, and the aligning key arrangement insures that the leads enter the correct base pins. Tube and base are now lifted straight up out of the jig and pushed together firmly.

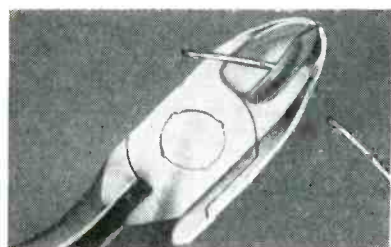

Wire-Holding Pliers Minimize Assembly Rejects

ADDITION of a plastic cushion to the jaws of Utica side-cutting pliers makes these pliers equivalent to a third hand for holding the short end of a lead during and after cutting. This eliminates possible

troubles from snips of wires falling into a chassis and becoming lodged there temporarily, to cause short-circuits later.

When cutting springs or hardened steel wire, this cushion-throat



CAREFUL, MAESTRO,
DON'T FIDDLE AWAY
YOUR REPUTATION!

Yes, you can make one false note and be all washed up . . . with the name you've spent years building, quickly consigned to oblivion. We at Kester know the importance of consistency . . . make sure that the solder alloy and especially the flux formula never varies, never changes. Kester never experiments at the expense of the solder user!

For best results in efficient, economical soldering, remember this Solder Trio: "44" Resin, "Resin-Five" and Plastic Rosin—all made by KESTER . . . Key Name in Flux-Core Solder for More Than 50 Years.

KESTER

S O L D E R C O M P A N Y

4204 WRIGHTWOOD AVENUE, CHICAGO 39, ILLINOIS
NEWARK 5, NEW JERSEY • BRANTFORD, CANADA



feature keeps the wire from flying off and hitting nearby personnel.

The cushion is tough, rubbery red Plastisol, bonded to the throat

areas of the pliers. As the pliers close, the Plastisol cushion grips the short end of the wire tightly, holding it as the cut is made.

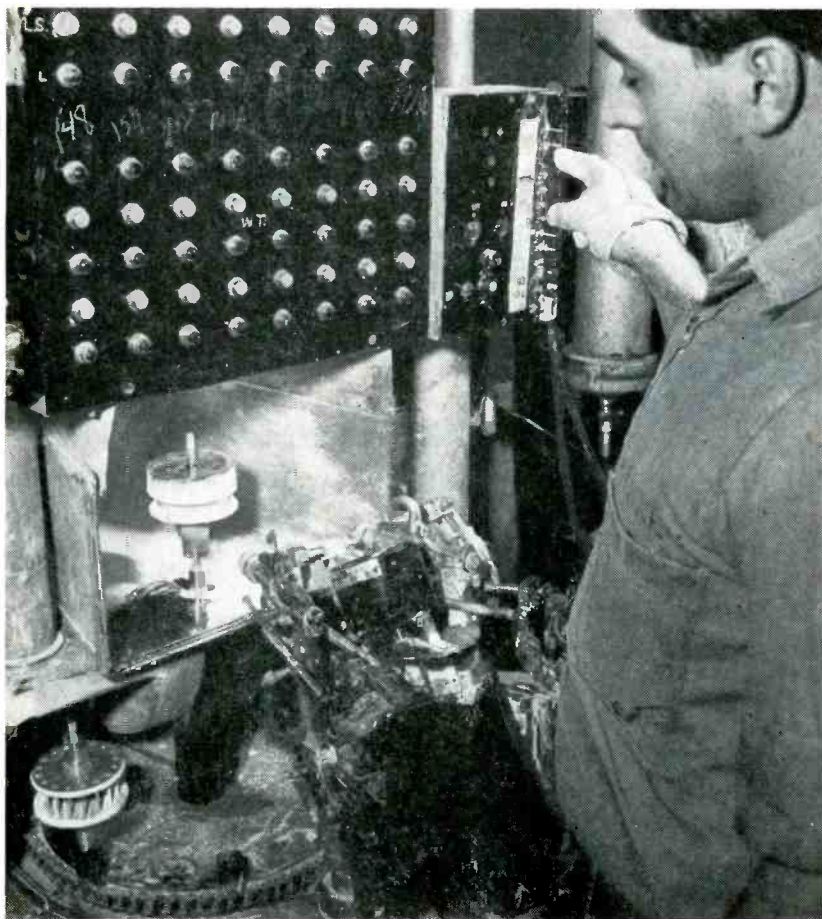

Lamp-and-Switch System Controls Cathode Spraying

PANEL indicator lamps in front of the operator at the cathode spraying position are actuated by quality control inspectors who measure the highly critical diameter and coating weight of finished cathode sleeves in the Bloomfield, N. J. plant of Tung-Sol Electric Inc.

If the average readings are within the dotted lines of the control chart, a green light is given. If the average falls between the dotted and solid lines, the upper or lower yellow warning light is given. If the average falls above or below the area bounded by the solid control limit lines, the upper or lower red light is given, and all spraying on that cathode type must stop until a corrective adjustment in spray

time or spray pattern is made.

As many as eight different cathode types may be sprayed at the same time. Each cathode has its own control chart and system of operating lights for both coated diameter and weight, which enables immediate correction to be made at the first sign of excessive variation. The actual quality determination is completed in less than five minutes after the spraying is accomplished. Considerable reduction in material waste and greater uniformity of the product are a direct result of this control system.

Pushbutton switches on a panel at the right of the lamp bank enable the spray operator to vary the spray time in accordance with the

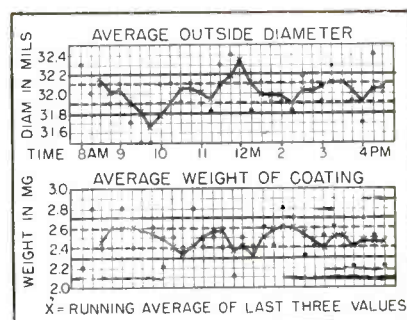

Example of portion of control chart used for plotting result of sampling inspection for outside diameter and coating weight of coated cathodes. Sample size is 3 cathodes, taken every 20 minutes

indications of the lamps. Changes in spray time serve to change both the weight and outside diameter of the finished cathode. The control switches are connected to the various contacts of an electric timer made by Industrial Timer Corp., Newark, N. J. The timer in turn actuates a solenoid that is connected through coil springs to the trigger of the spray gun.

Two solenoid-controlled guns are used, with nozzles adjusted for different spray patterns to get adequate coverage without wasting material while spraying up to eight different sizes and shapes of cathodes in as many different types of masking holders. The holders are cylindrical in shape, and are rotated at 120 rpm by an electric motor during spraying to achieve uniform coating. Pushing the button for a particular type of cathode automatically actuates the proper spray gun through the proper timer.

The spray material employed is a

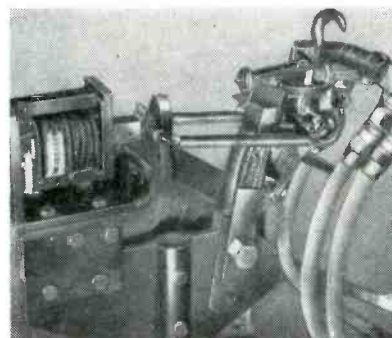

Method of mounting solenoid to actuate trigger of spray gun. Movement of solenoid armature is transmitted to trigger through two paralleled screen door springs to minimize vibration and shock

A maker of high fidelity audio amplifiers wrote us:

"We need a coupling capacitor for a low level high gain stage. Capacitance must be constant from 10 to 100,000 cps. Leakage resistance minimum of 100,000 megohms."



"CP" engineers prescribed an LAG capacitor with insulation resistance greater than one million megohms and capacitance constant within 1/10 of 1% from DC to 100,000 cps.



Solution:

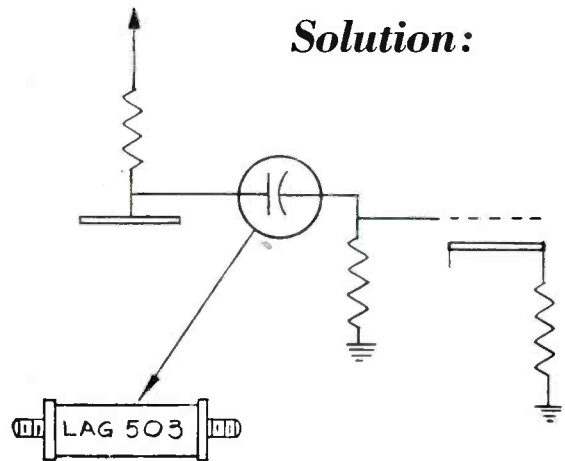

Your engineering problem will receive the immediate attention of our design and specification engineers.

"CPs" type L laboratory capacitors are available in Glassmike style container (Type LAG) for low values of capacitance; in rectangular lead-coated steel container (Type LAC) for large values of capacitance. Suggested additional applications are: multivibrators, video amplifiers, and frequency indicating devices.

Send for catalogue sheets and performance charts on any of these CP products:



Plasticon Hi-volt Power Supplies



Plasticon Glassmikes



Plasticon Rectangulars



Plasticon Metal-clad Miniatures

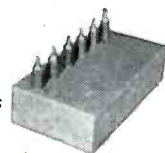

Plasticon Pulse Forming Networks



CONDENSER PRODUCTS COMPANY

140 HAMILTON STREET • NEW HAVEN 4, CONN. • TELEPHONE: MAIN 4-1174

Division of New Haven Clock & Watch Company

the **Waterman** HIGH GAIN INDUSTRIAL POCKETSCOPE®

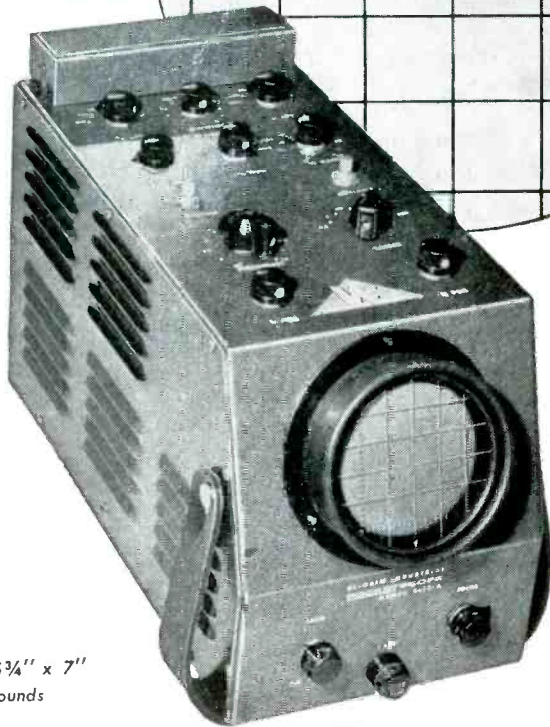

MODEL
S-14-A

Size:
12" x 5 3/4" x 7"
12 3/4 Pounds

ANOTHER EXAMPLE OF *Waterman* PIONEERING...

The HIGH GAIN POCKETSCOPE, model S-14-A, is an outstanding achievement in the field of oscilloscopes. The high vertical and horizontal sensitivities of 10 and 15 millivolts rms/inch respectively; frequency responses within -2 db from DC to 200 KC; non-frequency discriminating attenuators and gain controls; plus individual calibration voltages are but a few of the heretofore unobtainable characteristics of DC coupled oscil-

losopes. The sweep is operated in either a repetitive or trigger mode over a range from 0.5 cycles to beyond 50 KC with synchronization polarity optional. All this and portability too! The incredibly small size and light weight of the S-14-A now permits "on-the-spot" use of the oscilloscope in all industrial, medical, and communications fields. Its rugged construction assures "laboratory performance" regardless of environment.



Measuring cathode diameter with micrometer. Weight of coating is measured with precision balance in background. Pushbutton switches above bench control lamps in front of spray operator in background, to give him a continuous visual indication of product quality

WATERMAN PRODUCTS CO., INC. PHILADELPHIA 25, PA.

CABLE ADDRESS: POKETSCOPE

WATERMAN PRODUCTS INCLUDE

- | | |
|-------------------|--------------------|
| S-4-A SAR | <u>PULSESCOPE®</u> |
| S-5-A LAB | <u>PULSESCOPE</u> |
| S-11-A INDUSTRIAL | <u>POCKETSCOPE</u> |
| S-12-B JANized | <u>RAKSCOPE®</u> |
| S-14-B HIGH GAIN | <u>POCKETSCOPE</u> |
| S-15-A TWIN TUBE | <u>POCKETSCOPE</u> |

Also RAYONIC® Cathode
Ray Tubes and Other
Associated Equipment

holders are designed to take 17 to 75 of the cathodes, depending on their size. Each holder has a vertical shaft which fits into the chuck of the spinning motor during spraying. This shaft drops into the drilled hole in the metal block on the chain conveyor for transport after spraying.

The chain conveyor takes freshly sprayed cathodes into an electric oven for drying. Drying temperature is 150-175F, with a circulating

MEMO...
Write for details today!

WATERMAN PRODUCTS

Send for this *Free* **SAMPLE FOLDER...**

Contains
25
 different Test Samples of
 high-dielectric
INSULATING
TUBING and SLEEVING



INCLUDES SAMPLES AND DESCRIPTIONS OF THE FOLLOWING...

VARGLAS SILICONE Class H insulating materials were pioneered by our Laboratory. Retain flexibility, electrical properties and mechanical strength in temperatures ranging from -85°F. to 500°F. Available in tubing, sleeving, lead wire, tying cord.

PERMAFIL-IMPREGNATED VARGLAS TUBING Fiberglass braid coated with General Electric's Permafil resin. Extremely tough, resistant to solvents and elevated temperatures, highly flexible. Can be bent or twisted with little or no loss of dielectric strength. Coils and standard 36" lengths.

VARGLAS SLEEVING AND TUBING Numerous types and grades—including synthetic-treated, varnished, lacquered, saturated, litewall and others.

VARGLAS NON-FRAY SLEEVING Fiberglass braid normalized to remove all organic impurities. It will withstand temperatures up to 1200°F. Recommended where dielectric properties are not paramount. Three types available.

VARFLO TUBING AND SLEEVING Vinyl-coated Fiberglas in full range of sizes, colors and grades. Extremely flexible with excellent heat aging qualities. Low priced.

VARFLEX COTTON TUBING AND SLEEVING Varnish or lacquer impregnated—for applications where MIL-I-3190 Class A materials are specified. All NEMA grades.

SYNTHOLVAR EXTRUDED TUBING Made in various standard formulations of vinyl polymers. Has high dielectric and tensile strength—will not support combustion nor absorb moisture. Type EG Approved under MIL-I-631A. Several others to meet special requirements.

NEW! VARGLAS SILICONE RUBBER SLEEVING AND TUBING—the culmination of 5 years of research—for applications requiring extraordinary flexibility. Details on request.



MAIL COUPON TODAY FOR SAMPLES!

VARFLEX CORPORATION,
 308 N. Jay St., Rome, N. Y.

Please send me free folder containing samples of your electrical sleeving and tubing.

I am particularly interested in insulation for:

NAME.....

COMPANY.....

STREET.....

CITY..... ZONE..... STATE.....

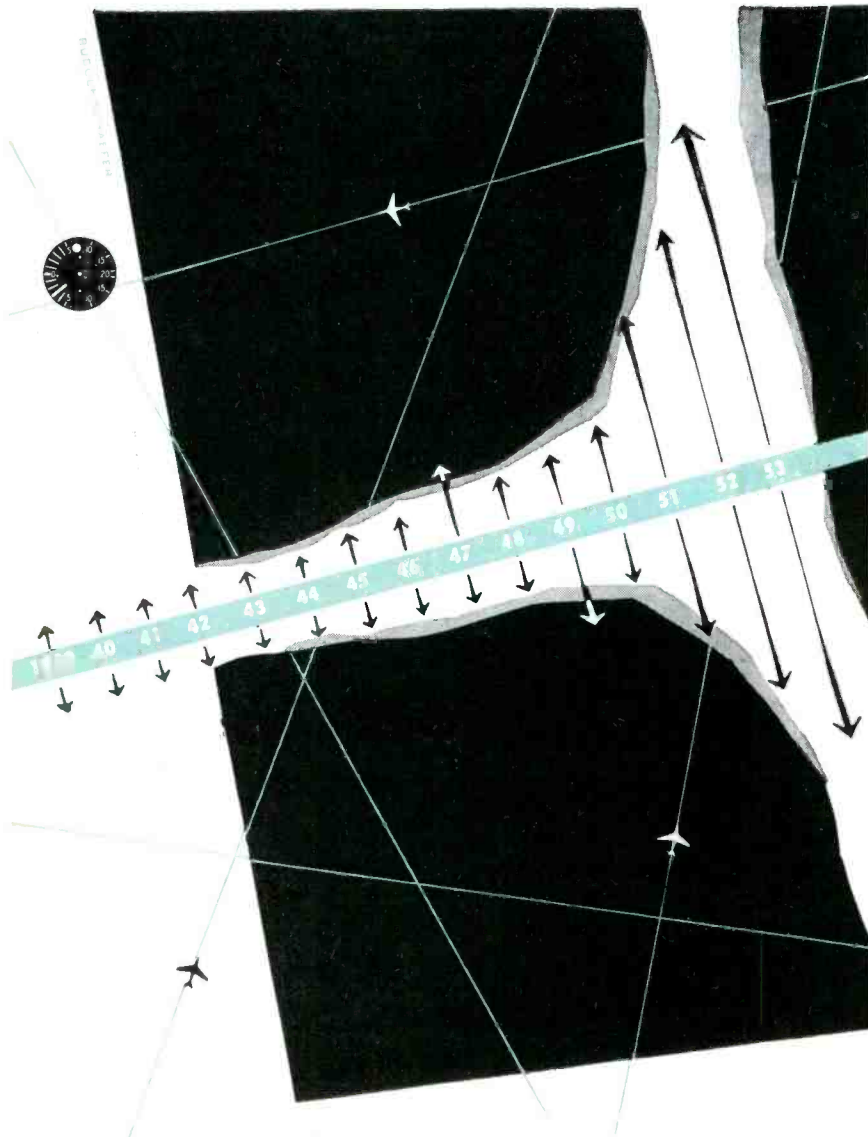

growth

Due to our long experience, the demand for our engineering services in designing new precision devices and systems has increased tremendously. Our activities now embrace the four distinct yet allied fields of

- ✦ AIRCRAFT INSTRUMENTS AND CONTROLS
- ✦ OPTICAL PARTS AND DEVICES
- ✦ MINIATURE AC MOTORS
- ✦ RADIO COMMUNICATIONS AND NAVIGATION EQUIPMENT

Current production is largely destined for our defense forces; but our research facilities, our skills and talents, are available to scientists seeking solutions to instrumentation and control problems.



kollsman INSTRUMENT CORP.

ELMHURST, NEW YORK • GLENDALE, CALIFORNIA • SUBSIOIARY OF *Standard* COIL PRODUCTS CO., INC.



Loading uncoated cathode sleeves in rotary holder preparatory to spraying. Roller chain conveyor brings holders back to operator for unloading after spraying and baking. Finished cathodes are placed in the self-stacking molded plastic trays at rear on bench

air blower to carry off moisture.

After drying, operators take the top plates off the holders and carefully place the finished cathodes in individual compartments of molded plastic trays made especially for the purpose, then reload with uncoated cathodes. Loaded holders are carried to the spray position by the conveyor, where the operator transfers them one by one to the spray booth for application of the cathode coating material.

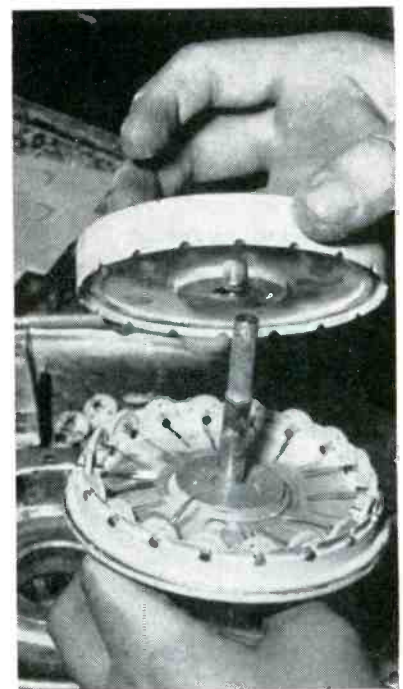

Combination rotary masking and spraying holder for cathodes of television picture tubes, holding 20 pieces

Exciting and New
yet . . . Backed Up With
 Plenty of Experience

posed by
LISA LOUGHLIN
 selected as one of the
 10 top models in the
 U. S. by Esquire
 Magazine



insl-x

INSULATING SPRAY

Higher dielectric strength than any other
 insulating spray on the market!

Proven by twenty years of use by
 leading component parts manufacturers!

Now packaged in easy-to-use
 Spra-tainer especially for you!



\$1.79
 LIST
 12 OZ.

Available in clear, aluminum,
 gloss & flat black

INSL-X E-33 FOR SAFELY HANDLING "HOT" WIRES

Do away with the uncertain protection of taped tool handles. Insl-x E-33, the material used by major utility companies for insulating linesmen's tools, is now available to you! Just dip tool handles—Insl-x E-33 dries to a tough, smooth coating that provides absolute protection. In bright red for quick, positive tool identification.

Insl-x E-26 insulating spray makes it possible to completely insulate electrical equipment, parts and wiring in a matter of minutes. Produced exclusively for the electrical trades, Insl-x sprays a coating one mil thick, with extra high dielectric strength.

Insl-x E-26 is recommended for insulating and reduction of heating on both round and square bus bars; Sealing transformer and coil leads; Spraying motor controllers, starters and switches; Insulating and moisture proofing terminal assemblies; Sealing selenium rectifiers and resistors; Insulating all permanent electrical connections; Spraying finish

coat on motor coils; Spraying household master switch and fuse box; Improving arc and moisture resistance of molded and laminated phenolic parts.

Use Insl-x, the material designed to do one specific job—INSULATE.

TECHNICAL DATA

Dielectric strength 800 to 1200 v/m • Drying time, 3 to 5 minutes • Hardness excellent • Adhesion excellent on all conventional assembly surfaces including ceramic, anodized aluminum, and phenolic • Chemical resistance excellent • Water resistance excellent • Flexibility excellent.

See your jobber, or write for complete technical data, Dept. 401

INSL-X SALES COMPANY, 26 Rittenhouse Place, Ardmore, Pennsylvania

Insl-x Products are available in bulk for spray, dip, and brush application.

SENSITIVE

**D' Arsonval
METER-RELAY**

Jeweled Moving Coil Armature

0.2 Microamperes
(0/20 scale range)

0.05 Millivolts
(0/5 scale range)

A.C. D.C.
(voltage - current)

Thermocouples
(R.F. or temperature)

Adjustable
(90° scale arc)

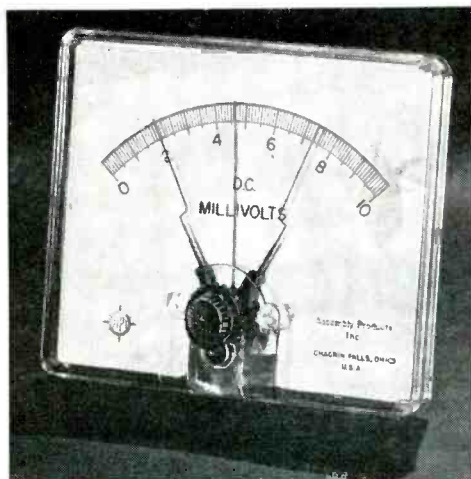

Model 451-C, (4½ inch) double contact, 0/10 DC Millivolts, as used in Vacuum Gauge made by Hastings Instrument Co., Inc., Hampton, Va., used to maintain pressure in a vacuum system.

The contact meter-relay as made by Assembly Products is an indicating meter with built-in micro-contacts which can be set to operate at any point of indication on the scale.



Model 265, plug-in, (non-indicating) hermetically sealed, with shock mounted movement. Suited to marine or aircraft or other mobile installations.

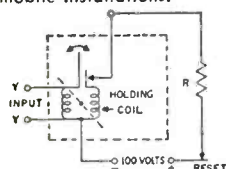

Single contact meter-relay schematic.

Model 263, (2½ inch), double contact, (non-indicating) used in Model 653 SILVERCEL BATTERY CHARGER CONTROL manufactured for the Navy by Franklin Transformer Mfg. Co., Minneapolis, Minn.

Made like a conventional panel meter, it can be substituted for an existing meter in most circuits and will add relay action for over or under limit or automatic control.

A locking coil gives high contact pressure. Spring action in the contacts gives forceful separation. Contacts are released by breaking the circuit to the locking coil, either manually or by an automatic inter-rupter switch.

Send for bulletin 112 listing 11 circuits using meter-relays.

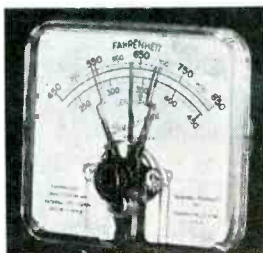

Model 351-C, (3¾ inch), double contact, suppressed zero millivoltmeter, with bimetal compensation for thermocouple reference junction. Dial calibrated 450-850° Fahrenheit (also Centigrade), for Iron-Constantan thermocouple. Used in control of temperature of THERMO DIMPLER made by Zephyr Mfg. Co., Inc., 201 Hindry, Inglewood, Calif.

Model 261-C, (2½ inch), single contact, high limit, 0/200 DC Microamperes as used in Consolidated Engineering Corp., Pasadena, California Model 21-220 Mass Spectrometer.

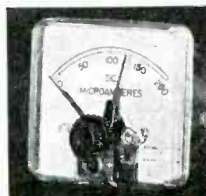

ASSEMBLY PRODUCTS, INC.
P. O. BOX 191
CHAGRIN FALLS 4, OHIO
Phone: CHagrin Falls 7-7374

During unloading of the rotary holders, samples are drawn periodically for measurement of coated diameter and weight. A running average chart is kept by the inspector for both of these characteristics. Each measurement taken is marked on the chart by a point. By visual

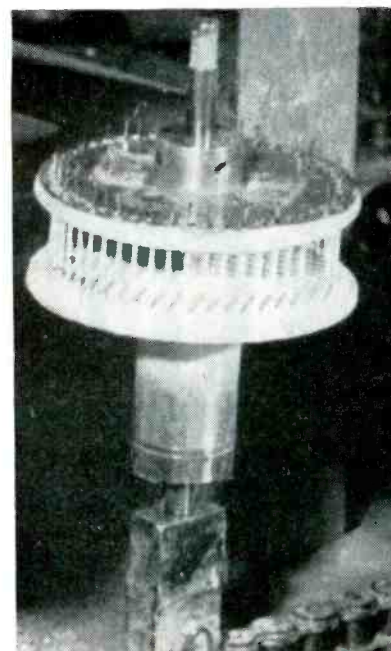

Fifty-cathode rotary holder is moved through drying oven by chain conveyor after spraying cathodes in spray booth

estimation, this point is then averaged with the last two measured values and the result is plotted as an \bar{x} , to form the running average chart. The curve is drawn through the \bar{x} 's, rather than through individual points, to guide the operator in punching the pushbutton switches just above her work position. These switches control the lamps on the indicator panel in front of the spray booth operator.

Cathode diameter is measured with a micrometer mounted in its own wood box for cleanliness. Cathode coating weight is determined by weighing the finished cathode with a Roller-Smith precision balance, then brushing off the coating and weighing the cathode sleeve itself. The difference between these values is recorded as the weight of the coating. The scale of the balance is so designed that this differ-

Standardized for your convenience!

General Ceramics ALUMINA CERAMIC*

*Conforms to the requirements of Grade L-5A in accordance with JAN-1-10.

SOLDERSEAL HERMETIC TERMINALS

THE ITEMS SHOWN ARE STANDARD STOCK TERMINALS. DIMENSIONAL TOLERANCE, $\pm 1\frac{1}{2}\%$ BUT NOT LESS THAN $\pm .010"$

featuring

- High Mechanical Strength
- Resistance to Thermal Shock
- Fast, Easy Installation
- Permanent Hermetic Sealing

THIS TYPE TERMINAL ON DAL-4267, 4269

DAL4270 DAL4271

DAL4267 DAL4268 DAL4269

PART NUMBER	VOLTS RMS†	DIMENSIONS								
		A	B	C	D	E	F	G	H	J
DAL4267	4000	.547	.375	.281	.093	.125	.234	.046	.084	.250
DAL4268	5000	.687	.422	.312	.109	.250	.359	.069	.171	.281
DAL4269	8000	.875	.687	.562	.125	.156	.250	.046	.093	.531
DAL4270*	10000	1.187	.937	.437	.500	.234	.312	-	-	.375
DAL4271	15000	1.531	1.250	.937	.312	.281	.453	.090	.187	.781

*Note: Part No. DAL4270 employs solid thru-stud threaded at each end.

THIS TYPE TERMINAL ON DAL-4264, 4265, 4266

DAL4266 DAL4265

DAL4264 DAL4263 DAL4262 DAL4261

■ METALLIZED SURFACE
--- GLAZED SURFACE

PART NUMBER	VOLTS RMS†	DIMENSIONS								
		A	B	C	D	E	F	G	H	J
DAL4261	3000	.672	.391	.282	.109	.250	.312	.067	-	.171
DAL4262	4000	.750	.468	.312	.156	.312	.437	.067	-	.160
DAL4263	7000	.968	.687	.500	.187	.375	.500	.055	.156	.812
DAL4264	14000	1.343	1.250	.907	.343	.490	.625	.128	.250	1.250
DAL4265	18000	2.218	1.750	1.407	.343	.656	.937	.118	.312	1.250
DAL4266	22000	2.655	2.187	1.844	.343	.812	1.187	.128	.375	1.640

140% Relative Humidity

These terminals are made of glazed Alumina Ceramic. Lugs and eyelets are hot tinned brass and metallized areas are silver fired on ceramic, copper electroplated and tin fused for soft soldering. Im-

mersion in 60/40 solder at 450°F for 1½ minutes for dip soldering will not injure the metallic coating. For complete information and quotations call, write or wire today.



General CERAMICS and STEATITE CORP.
 VALLEY 6-5100
 GENERAL OFFICES and PLANT: KEASBEY, NEW JERSEY

MAKERS OF STEATITE, ALUMINA, ZIRCON, PORCELAIN, SOLDERSEAL TERMINALS, LIGHT DUTY REFRACTORIES, CHEMICAL STONWARE, IMPERVIOUS GRAPHITE, FERRAMIC MAGNETIC CORES



What kind of enclosure do you need?
Which shielding material is best?
What is the important difference between attenuation and insertion loss?

How should attenuation be measured?
Why is interchangeability so important?

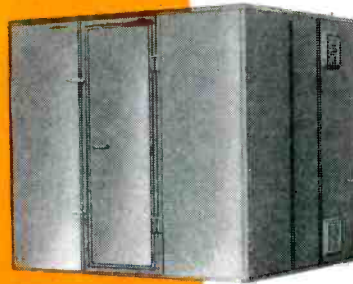

HOW YOU CAN EVALUATE Shielded Enclosures

Selecting the proper shielded enclosures today is a big job . . . and no wonder! The unqualified statements and ambiguous terminology of some enclosure manufacturers makes intelligent purchasing extremely difficult.

To eliminate these difficulties, ACE has prepared a definitive booklet: *Your Money's Worth in Shielded Enclosures*, by Richard B. Schulz, noted authority on the suppression of r-f interference, and consultant to ACE. Here are free, factual data you should be acquainted with . . . for only by applying a realistic approach to shielded enclosure selection can you be sure of getting what you pay for.

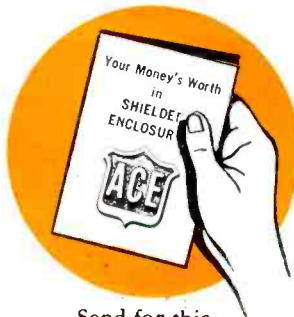

Send for this interesting **Free Booklet**

you always get your money's worth with ACE

ACE long ago eliminated guesswork as a factor in the design of shielded enclosures. Every ACE claim is backed by complete guaranteed test data, for every design is thoroughly analyzed and approved by independent engineering laboratories. Whether

you need a galvanized screen room, a copper screen room, or a solid sheet RFI enclosure (Lindsay Structure), you can depend on top performance when you choose ACE . . . *first and still foremost in the design and manufacture of every type of shielded enclosure.*

A COMPLETE LINE OF ENCLOSURES FOR INDUSTRY, SCIENCE AND MILITARY,
 FEATURING HIGHEST ATTENUATION, FULL INTERCHANGEABILITY,* INSIDE BOLTING*

(*Patents Pending)

Exceeding JAN-1-225; 16E4 (ships); MIL-16910; MIL-S-4957
 (Write for RFI Bulletin No. 1, and ACE Bulletins Nos. 3 & 5)



ACE ENGINEERING & MACHINE CO., INC.

3644 N. Lawrence Street • Philadelphia 23, Pennsylvania

ence can be read directly on a movable accessory scale, the zero of which is set to the reading of the coated cathode.

The balance is mounted on a heavy steel pipe which goes through a large hole in the bench and is embedded in the poured concrete floor. This arrangement prevents bench vibrations from affecting scale readings.

Permanent Time Track for Magnetic Memory Drum

TO ELIMINATE the possibility that the high-precision timing pulse track on a magnetic drum memory might be accidentally wiped out or erased as a result of a connection mistake, a permanent track is used for this purpose by Librascope Inc., Glendale, California. This is achieved by milling precise slots in the circumference of the drum at one end, then filling these slots with magnetic powder.

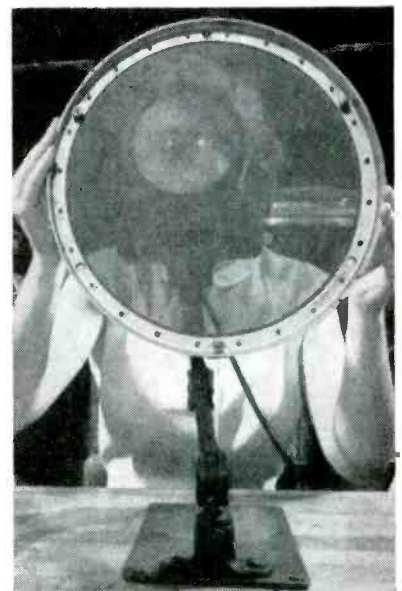

Pilot Production Line Makes Color TV Tubes

SEEMINGLY endless inspections characterize production facilities in RCA's Lancaster, Pa. pilot plant for tricolor television picture tubes. Most critical of all operations is applying the tiny red, blue and green phosphor dots in a highly precise pattern on the screen of the



CAPACITORS

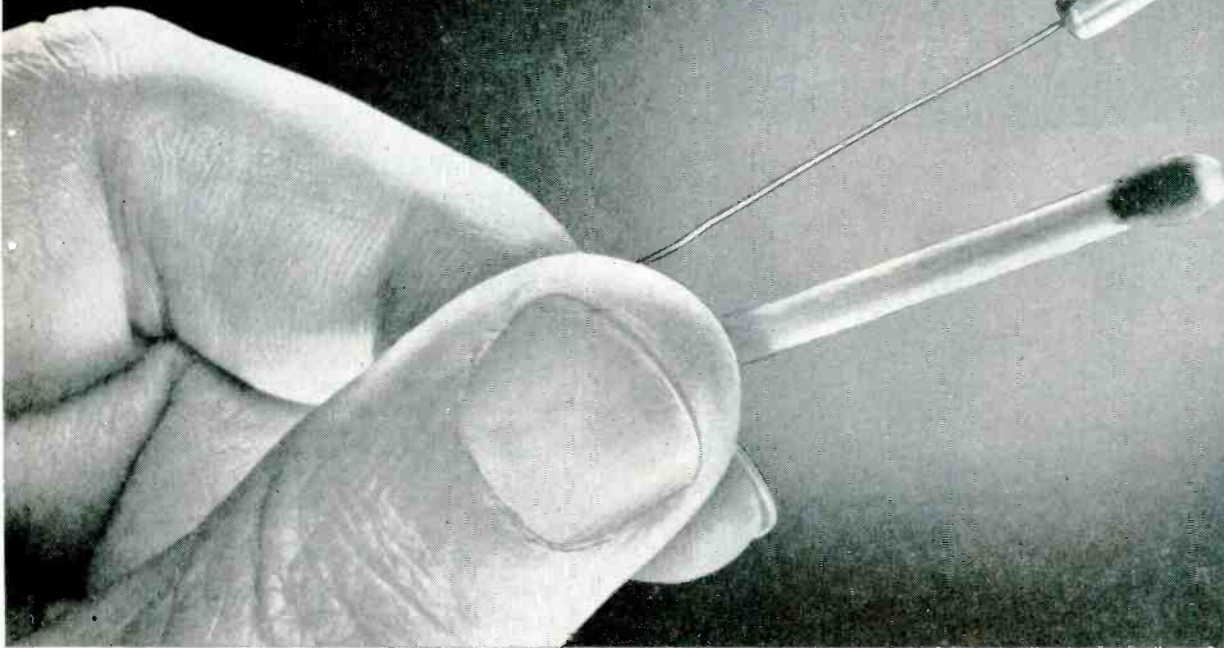

G. E. ANNOUNCES a new line of Micro-miniature Tantalum Capacitors

For low-voltage d-c applications

General Electric's new *Micro-miniature* Tantalum capacitors combine *smaller-than-subminiature* size, large capacitance and low leakage current. They permit new design flexibility in low-voltage, d-c circuits . . . particularly transistorized subminiature assemblies where space is at a premium, such as hearing aids.

SUPERIOR PERFORMANCE. *Micro-miniature* Tantalum capacitors outperform aluminum electrolytics in electrical stability, operating and shelf life, because of the inert characteristics of tantalum metal and the stability of its oxide. They gain added reliability from the use of silver cases, a non-acid electrolyte, and complete sealing that prevents leaking and contamination of the interior.

WIDE TEMPERATURE RANGE. *Micro-miniature* Tantalums can operate over a -20 C to +50 C range—may be stored at -65 C. With some capacitance derating, they can operate well below -20 C. At -55 C, units rated 10 volts and above will maintain at least 65% of their 25 C value. They also perform satisfactorily above +50 C with some life limitations.

AVAILABILITY. Designed especially for non-resonant, non-critical applications such as coupling, by-pass and filtering, *Micro-miniature* Tantalums can be obtained in sample lots 2 to 3 weeks after your order is received at the factory. Production lots can be shipped 6 to 8 weeks after your order is received. For more information, see your G-E Apparatus Sales Representative or write for bulletin GEA-6065 to General Electric Company, Section 442-14, Schenectady 5, N. Y.

Progress is our most important product

GENERAL  ELECTRIC

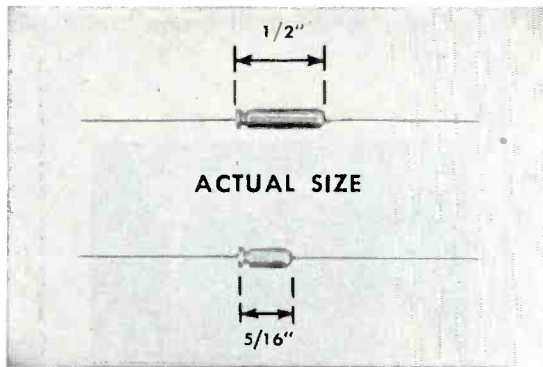

LARGE CAPACITANCE and small size make *Micro-miniature* Tantalums valuable where space is at a premium. Diameters are .125 inches.

Working volts d-c	Maximum muf	
	5/16" Length	1/2" Length
4	2.0	4.0
6	1.5	3.0
8	1.0	2.0
16	.5	1.0

NOTE: Ratings based on -50% +75% tolerance.

For Parts that must be
TAKEN OFF — PUT BACK — BUTTONED TIGHT

LION FASTENERS

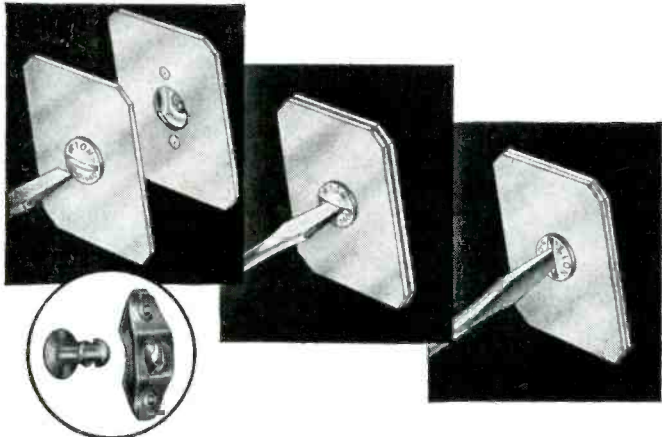

LOCKS TIGHT WITH A QUARTER TURN
Always at correct tension

Lion Fasteners are *right* for buttoning parts that must be removed repeatedly for inspection, maintenance, or other reasons.

Vibration and shock can't loosen a Lion Fastener. Even an inexperienced service man can't replace it wrong. A quarter turn opens it. Another quarter turn locks it. The tension is *designed* into it.

Lion Fastener Spring Assembly is quickly spot welded or riveted in place. The stud cannot be lost. It is grommeted tight to the sheet. They will button sheets .040 plus or .020 minus over or under standard rating. The misalignment is as much as .156. The one-piece forged stud is tested to 1425 lbs. Write today for demonstration kit and application data.

TYPICAL APPLICATIONS: INSPECTION PLATES • COWLING
 ELECTRICAL PANELS • CABINETS • DUCTWORK



Free DEMONSTRATION KIT contains sample Lion Fasteners to help you visualize their adaptability to your product. Write on your company letterhead. No obligation.

LION
FASTENERS, INC.
 500 MAIN ST., HONEOYE FALLS, N. Y.
In Canada:
 A. T. R. Armstrong Co., 50 St. Clair Ave. West, Toronto



Tricolor electron gun is assembled on jig immediately in front of operator, and entire jig is then swung forward into flames of torches for fusion of parts while operator rotates gun slowly by turning knurled knobs with hands

tube. A powerful bench-mounted magnifying glass aids operators in checking this screen for mechanical defects such as smears. A similar lens serves for inspecting the mesh of the shadow mask used in conjunction with the color screen.

Simplification of the many highly intricate production processes is the goal at present, pending FCC approval of color television standards for the industry. Duplicate facilities involving different techniques are often set up to com-

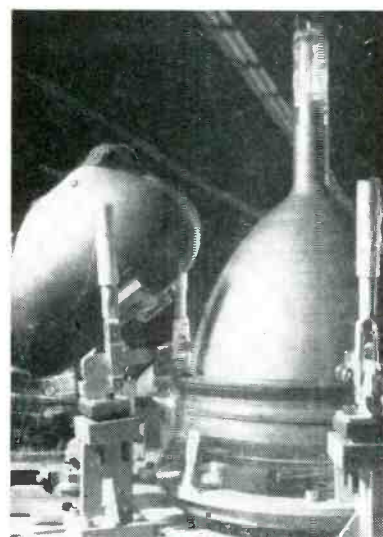

Method of joining tricolor television picture tube faceplate to main cone with Heliarc welding. Motor rotates tube automatically past welding arc. Operator who monitors operation is protected from glare of arc welder's mask



New MICROWAVE Diodes

Associates INCORPORATED

TYPE	CENTER FREQUENCY (mc)	MAX. CONVER. LOSS (db)	MAX. NOISE RATIO (times)	VSWR (max.)	IF IMPEDANCE (OHMS)
*1N21B	3060	6.5	2.0	-	200-800
*1N21C	3060	5.5	1.5	-	200-800
*1N150	6750	6.0	2.0	1.5	250-500
*1N160	6750	6.5	2.7	-	200-800
*1N23B	9375	6.5	2.7	-	200-800
*1N23C	9375	6.0	2.0	1.5	325-475
1N78	16000	7.5	2.5	-	325-625
1N26	23984	8.5	2.5	-	300-600
1N53	>30000	8.5	2.5	-	400-800

* Also available with reversed polarity

New MICROWAVE silicon diodes insure greatly improved receiver performance throughout the centimeter and millimeter wavelengths.

Lower overall noise figures and broader bandwidth operation are inherent in all of our diode line. The uniformity of the new 1N23C, 1N150, and the reversed polarity, 1N23CR and 1N150R allow their direct use in balanced mixers without pair selection. Overall noise figures of better than 10 db. are typical with these types. The 1N150 and 1N160 are specifically designed for broadband, low noise operation in the popular common carrier frequencies from 6000 to 7000 mcs.

SEND FOR DATA

Write for detailed specifications and catalog literature describing our diodes, magnetrons, TR and ATR tubes and waveguide components.

MICROWAVE ASSOCIATES INCORPORATED
22 Cummington Street, Boston 15, Mass.
Telephone: Copley 7-4441



PRINTED CIRCUITS

do a **BETTER JOB**
at **LOWER COST**

Everyone in electronics today knows that printed circuits are the real answer to production speed-ups... lower costs... greater profits. Printed circuits can help you in numerous ways — regardless of the product you manufacture.

Davelle invites you to write today and learn how this latest scientific development can reduce costs and solve your production problems. Send us a sketch or print of your product and our engineering staff will design a printed circuit layout for your application. In addition, if you desire price quotations, let us know the quantities involved.

You will find Davelle's printed circuits are priced lower while maintaining highest precision standards of workmanship.

printed... stamped... etched



SPRINGFIELD GARDENS 13, L. I., N. Y.



Applying blue phosphor mix to screen through gelatin stencil or frame

pare results. These are generally related to production of the screen and mask, since the remainder of the color tube differs little from conventional black-and-white picture tubes.

A silk-screening technique, like that employed in the reproduction of art prints, is used to apply minute phosphor dots to the glass screen. The phosphorous chemical mix, beaten to the consistency of thick cream, is squeegee-squeezed



Use of Veeco mass-spectrometer leak detector (made by Vacuum-Electronic Engineering Co., New Hyde Park, N. Y.) to make certain that weld which joins cone to faceplate of RCA color picture tube is vacuum-tight at all points

Sensitive Controls

The important components for your thermal, light, vacuum or R.F. actuated control systems are now immediately available at RELAY SALES.

ASSEMBLY PRODUCTS

Contact Meter-Relays

A highly sensitive locking relay for control of chemical processes and mechanical operations through either alarm, automatic shut-off or continuous on and off control. Contact Meters automatically maintain upper and lower limits (or both) of temperature, voltage, current, speed, light or liquid flow rate with extreme accuracy. Applications include their use in electronic circuits for quality control of piezo crystals and other components, switching of standby equipment in micro-wave communications, control of carbon feed in arc furnaces, as warning of bearing temperatures in turbines and generators, and a variety of speed controls for machines.

Contact Meter-Relays are current or voltage sensitive down to 2/10 microampere or 1/10 milliwatt. Contact ratings from 100 mils to 1 ampere. They are available in a wide selection of standard types. Special types engineered to your needs. Phone, write or wire Relay Sales for additional information.



TERADO

Miniature Micro Relay
A hermetically sealed sensitive relay, with particular application to airborne equipment, mounts in a standard 7-pin miniature tube socket. Its S.P.S.T. switch will operate on 60 milliwatts. Insulation: 500 Volts between any terminal and ground. Temperature range: +85°C. to -55°C. Shock 50G. Coil resistance, contact current and other specifications to your requirements. Send us your prints.



RS Phototubes

Phototubes, either gas filled or vacuum type, are available for all photo cell applications. RS Phototubes have superior operating characteristics in high output current, extreme sensitivity to small variations in light intensity, excellent response in infra-red regions, low dark current—all with notably longer tube life. Write for catalog.

CETRON

Grid Controlled Rectifiers

Due to the ever increasing demand for Grid Controlled Rectifiers, which are so closely allied to relay applications, RELAY SALES has arranged for the distribution of these special purpose tubes made by America's oldest and foremost manufacturer.

*Write for New 1954
Relay Sales
Catalog
C-5*

JUST OUT!



Immediate Delivery of Relays of all Types

You will receive 24 hour shipment on any material in our huge stock of practically any conceivable type of relay, contactor or motor control. Phone or wire your requirements.

Phone
SEeley
8-4146



4721 W. Madison St., Chicago 44, Ill.

E. E. or PHYSICS GRADUATES

with experience in

RADAR or ELECTRONICS

Here's a new kind of career

One of the nation's leading electronics organizations is creating openings for an entirely new kind of career. Read here what this offers you:

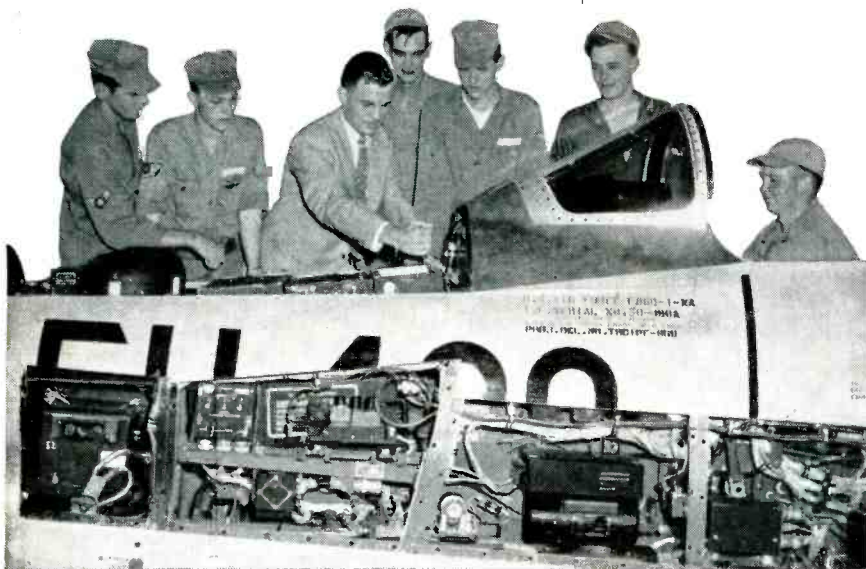

THE COMPANY

Hughes Research and Development Laboratories, located in Southern California, are currently engaged in the development of advanced radar systems, electronic computers, and guided missiles.

YOUR POSITION

You will serve as a technical advisor to those using Hughes equipment, to help insure successful operation of our equipment in the field.

YOUR TRAINING

On joining our organization, you will work in the Laboratories for several months—until thoroughly familiar with the equipment.

WHERE YOU WORK

After your period of training (at full pay), you may

(1) remain at the Laboratories in Southern California in an instructional or administrative capacity, (2) become the Hughes representative at a company where our equipment is being installed, or (3) be the Hughes representative at a military base in this country or overseas (single men overseas). Compensation for traveling and moving household effects. Married men keep their families with them.

YOUR FUTURE

You will gain broad experience that will increase your value to us as we further expand in the field of electronics. Large-scale commercial employment of electronic systems within the next few years is inevitable.

Hughes Field Engineer G. R. Chambers instructing a group of Air Force technicians in the operation and maintenance of Hughes equipment.

How to apply:

If you are under 35 years of age, and if you have an E. E. or Physics degree, with some experience in radar or electronics,

write to...

HUGHES

RESEARCH AND DEVELOPMENT LABORATORIES

SCIENTIFIC AND
ENGINEERING STAFF

Culver City, Los Angeles
County, California

Assurance is required that the relocation of the applicant will not cause the disruption of an urgent military project.



Testing finished tubes for phosphor-dot brightness with photoelectric light meter on swinging arm. Protective square glass window is suspended by counter-balanced chains, to permit easy raising for removing and installing tube

through a gelatin stencil for deposition as precisely formed dots on the screen below. The sequence involves applying one color to a batch of screens at the squeegee position, then putting the batch through two times more for application of the other two colors. The fixture used for screening is designed to give precise positioning of each screen, so that it has exactly the same position all three times. For the second and third colors, micrometer feed adjustments move the gelatin stencil vertically and horizontally a precise small amount, to insure that the red, blue and green dots will be equally spaced in a geometric pattern.

Lead-Coiling Tool

BY P. C. BOIRE
Chief Engineer
Measuring Engineering Ltd.
Aurpior, Ontario

To MINIMIZE changes in the characteristics of small electronic parts, such as crystal diodes, by heat being conducted along the leads when soldering, the leads are coiled up instead of being cut off.

A special tool was developed to coil the leads of components neatly at high speed. To make this tool, a hole was first drilled in a metal block to match the shape of the

**HUGHES
DIODES**



A New Standard of Reliability

Reliability in a germanium diode is determined principally by permanent freedom from the two major causes of diode failure—moisture penetration of the diode envelope, and electrical instability under extreme operating conditions.

HUGHES GERMANIUM DIODES are designed to prevent such failures through two exclusive features:

1. Fusion Sealing—The glass-to-metal seal, proved in billions of vacuum tubes, is incorporated to full advantage in diode manufacture by the Hughes-developed process of fusion sealing at high temperature. The result is a rigid one-piece glass envelope impervious to moisture.

2. 100% Testing—Hughes 100% testing procedures invite instabilities to occur prior to shipment,

assuring rejection of defective diodes. Each **HUGHES DIODE** is humidity-cycled, temperature-cycled, JAN shock-tested, and electrically tested under vibration. This testing procedure insures operation of **HUGHES DIODES** under adverse conditions of moisture, temperature, vibration and severe shock.

Reliability of **HUGHES DIODES** has been proved in advanced airborne military radar and fire control systems, and for guided missiles.

HUGHES GERMANIUM DIODE ELECTRICAL SPECIFICATIONS AT 25° C.

Description	RETMA Type	Test Peak Inverse Voltage* (volts)	Maximum Inverse Working Voltage (volts)	Minimum Forward Current @ +1 v (ma)	Maximum Inverse Current (ma)
High Peak	1N55B	190	150	5.0	0.500 @ -150 v
	1N68A	130	100	3.0	0.625 @ -100 v
High Back Resistance	1N67A	100	80	4.0	0.005 @ -5 v; 0.050 @ -50 v
	1N99	100	80	10.0	0.005 @ -5 v; 0.050 @ -50 v
	1N100	100	80	20.0	0.005 @ -5 v; 0.050 @ -50 v
High Back Resistance	1N89	100	80	3.5	0.008 @ -5 v; 0.100 @ -50 v
	1N97	100	80	10.0	0.008 @ -5 v; 0.100 @ -50 v
	1N98	100	80	20.0	0.008 @ -5 v; 0.100 @ -50 v
High Back Resistance	1N116	75	60	5.0	0.100 @ -50 v
	1N117	75	60	10.0	0.100 @ -50 v
	1N118	75	60	20.0	0.100 @ -50 v
General Purpose	1N90	75	60	5.0	0.800 @ -50 v
	1N95	75	60	10.0	0.800 @ -50 v
	1N96	75	60	20.0	0.800 @ -50 v
JAN Types	1N126**	75	60	5.0	0.050 @ -10 v; 0.850 @ -50 v
	1N127†	125	100	3.0	0.025 @ -10 v; 0.300 @ -50 v
	1N128‡	50	40	3.0	0.010 @ -10 v

*That voltage at which dynamic resistance is zero under specified conditions. Each Hughes Diode is subjected to a voltage rising linearly at 90 volts per second.

**Formerly 1N69A. †Formerly 1N70A. ‡Formerly 1N81A.

HUGHES DIODES are also supplied 100% factory-tested to a wide range of customer-specified characteristics, including high-temperature requirements.

FUSION SEALED IN GLASS

*for electrical
stability*

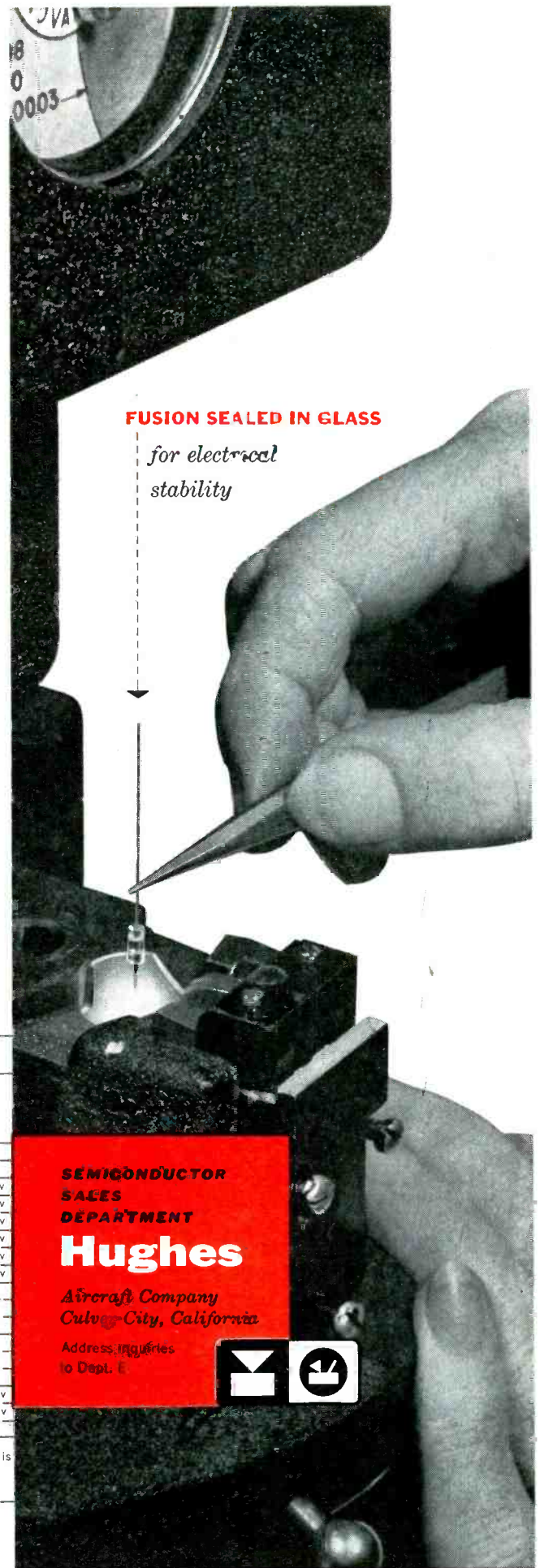

**SEMICONDUCTOR
SALES
DEPARTMENT**

Hughes

*Aircraft Company
Culver City, California*

Address inquiries
to Dept. E

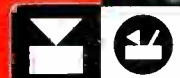

SCREEN BOOTH FILTERS

block radio interference

UP TO 1,000 MEGACYCLES

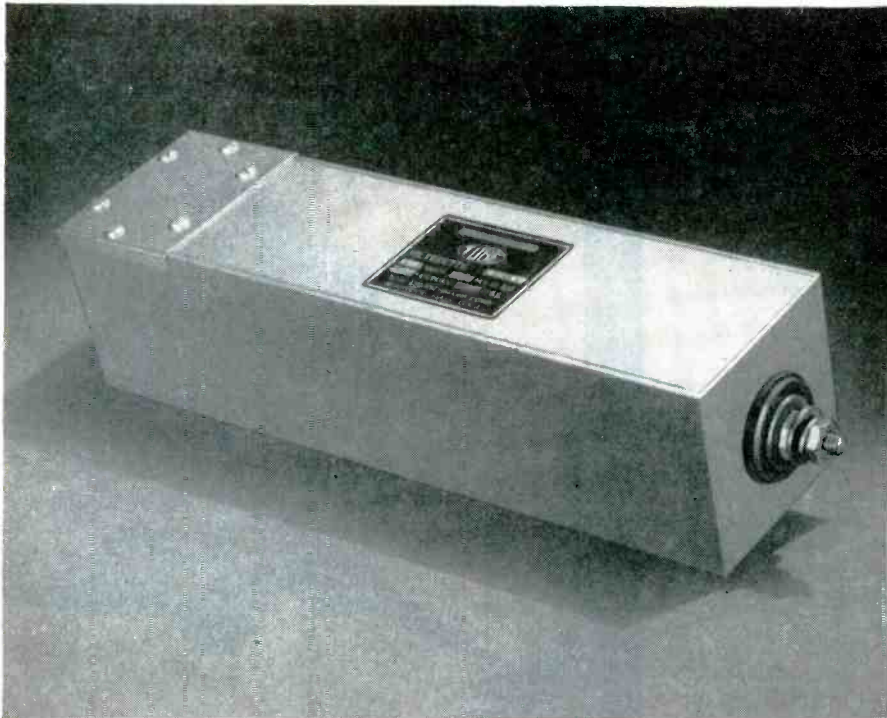

More than 100 db attenuation from 1000 megacycles down to 100 kilocycles is provided by the new series of Tobe screen room filters. Our exclusive UHF/SHF filter, used in conjunction with these new filters, extends the 100 db attenuation range through 15,000 megacycles. The line filters are available in current ratings from 15 to 250 amperes and voltage ratings from 28 volts d-c to 500 volts a-c or 1000 volts d-c. Each unit is contained in a sturdy metal case with convenient shielded output terminal. Write for data sheet giving dimension and performance specifications.

DO YOU KNOW THAT . . . in 1929, Tobe was selling effective power line filters for screen rooms? Ask Tobe for the answers to all radio interference questions; our 25 years' experience can solve your problems.



TOBE DEUTSCHMANN
CORPORATION
NORWOOD, MASSACHUSETTS

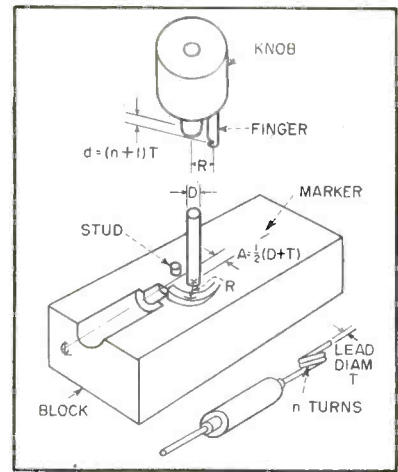

Construction of lead-coiling tool



Using tool for placing heat-blocking coils in leads of a crystal diode

electronic part. The block was then mounted in a lathe and turned down so as to expose the hole and form a recess for the part; turning was carried out to a distance of half the lead diameter below the center line, so that the lead of a part rested on the top of the block when the part was in the recess. During this machining operation, a ridge with an average radius R was left on the surface of the block, as shown in the diagram. The ridge was then filed down so as to leave an inclined plane on one side.

A hole for the winding spindle was drilled at a distance $A = \frac{1}{2}(D + T)$ from the center line of the recess for the part, where D is winding spindle diameter and T is lead diameter. Another hole was drilled for a small stud that is pressed in the block to keep the lead straight at the start.

The knob used as the winding



Information Wanted...

about your uses for **C-D-F METAL CLADS**

Grade of laminate
 Sheet size
 Overall thickness
 Thickness tolerances
 a. Standard NEMA
 b. Closer tolerances requiring sanding
 Metal: Copper Aluminum
 Other Thickness
 Metal facing: One side Both sides
 Minimum bond strength
 Punching requirements
 Any other specifications

Did you know that C-D-F supplies a full range of metal clad laminates in both Dilecto and Teflon grades? With mounting interest in printed circuits it pays to consider the respective advantages of these new C-D-F materials . . . it also pays to line up all the Information Wanted facts and discuss your specific application with your C-D-F sales engineer (Offices in principal cities). He's a good man to know!

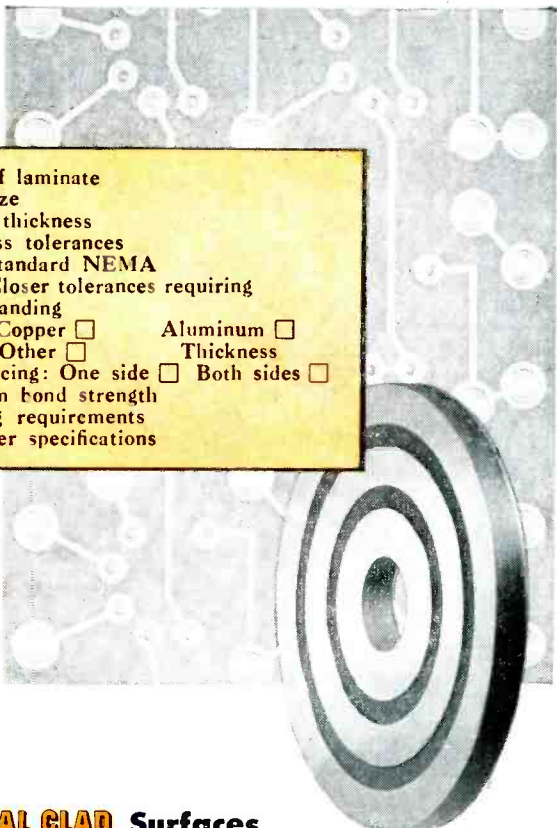

Dilecto METAL CLADS

Printed circuits depend upon stable, uniform core material and Dilecto has years of proven insulation service (Dilecto is a laminated thermosetting plastic made only by C-D-F from paper, cotton, glass or asbestos fabric base, or a mat base). Normally phenolic or melamine impregnating resins are used for METAL CLAD sheet stock. There are many grades of Dilecto, but only the better electrical grades are supplied with metal foil surfaces. Outstanding is C-D-F grade XXXP-26, a hot punching grade with high insulation resistance, low and stable dielectric losses and excellent moisture resistance. Green color. New C-D-F Catalog GF-53 gives complete data on Dilecto grades. Write for your copy today.

Teflon* METAL CLADS

Glass fiber cloth is first coated with Teflon resin and laminated into C-D-F GB-112T sheet stock. This base withstands high heat (200°C. maximum operating temperature) with the dissipation factor and dielectric constant extremely low over a wide frequency range. No adhesive film is needed to bond metal to the Teflon laminate, thus the inherently good electrical properties of the core material are maintained. GB-112T has practically zero water absorption, so a METAL CLAD with this core offers consistent high insulation resistance with excellent stability of dielectric loss properties.

METAL GLAD Surfaces

Copper foil (usually .00135" or .0027" thick) is bonded on one or both faces of the sheet grade of Dilecto selected. The foil used is a special grade of electrolytic deposition copper particularly adaptable for cementing onto laminated materials. An adhesive film is placed between the metal and the Dilecto, and cemented during the pressing and curing cycle. When closer tolerances are required C-D-F sands the Dilecto to the required thickness before bonding. Aluminum, silver, or other alloys of various metals may be supplied.

Better Bond Strengths

One of the most important physical properties of a metal clad product is its peel strength, the pounds pull required to separate the foil surface from the core material. Working with years of laminating know-how, C-D-F has been successful in obtaining the following average test values for its METAL CLAD sheet stocks:

	Lbs. pull per 1" width
XXXP-26 plus .00135" copper	5 to 8
XXXP-26 plus .0027" copper	7 to 10
XXXP-26 plus .0015" aluminum	9 to 12
GB-112 Teflon plus .00135" copper	6 to 9

Sheet sizes: Dilecto grades — 38 x 38", 38 x 42"
 Teflon grades — 16 x 36"

THE NAME TO REMEMBER . . . FOR PRINTED CIRCUIT METAL CLAD STOCK

Continental-Diamond Fibre Company
 NEWARK 16, DELAWARE



*DU PONT TRADE MARK

Write for new C-D-F General Catalog GF-53, new C-D-F Teflon folder T-52, and talk METAL CLADS with your C-D-F sales engineer.

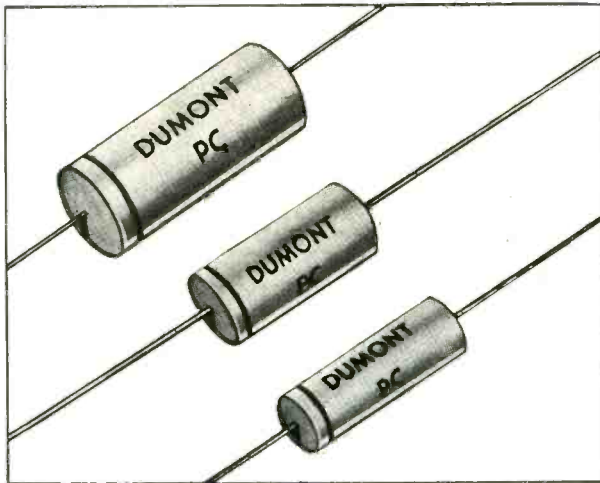

TUBULARS WITHOUT WAX?

Yes! *the* **DUMONT**
NEW "PC"

**OIL IMPREGNATED PAPER TUBULARS
ENCASED IN CERAMIC TUBES . . .**

• • • • • eliminates wax coatings through the use of completely moisture resistant Steatite tubes and a specially developed exclusive end seal that effects a perfect bond between the tube and the terminal.

Months of exhaustive laboratory tests and field trials prove that the Dumont "PC" Tubular withstands the severest operating conditions.



CONTINUOUS OPERATION AT 100° C.

**LEAKAGE RESISTANCE OF
10,000 Meg. per Mfd.**

**UNEQUALED LIFE AND
HUMIDITY CHARACTERISTICS**

WRITE TO-DAY FOR BULLETIN No. 37

DUMONT-AIRPLANE & MARINE INSTRUMENTS, Inc.

OFFICE
15 William Street
New York 5, N. Y.

FACTORY
Clearfield
Pennsylvania

tool has a sleeve and drilled hole that fit over the spindle. A projecting finger on the knob has a groove in its end to guide the lead as it is coiled. The difference d between the height of the groove and the sleeve is equal to $(n + 1) T$, where n is the desired number of turns.

In production, the block is mounted in a vise, the part is laid in the hole and the knob is put over the spindle. When the knob is turned clockwise to coil the lead, it is automatically lifted up by the inclined ridge to avoid hitting the part. The finger rides up on the ridge. On the last quarter-turn, the knob must be held down to bring the windings close together. A mark on the surface of the block indicates the end of turning, with the end of the lead acting as pointer.



Installing Thread Inserts in X-Ray Housings

IN THE production of aluminum housings for x-ray tubes, Machlett has found that it costs less to install wire screw thread inserts in every threaded hole than it does to inspect and salvage units having damaged threads. Four equally-

SLANT your
 requirements to
**INSTRUMENT CORP.
 OF AMERICA**

for miniature

SLIP RING AND COMMUTATOR ASSEMBLIES

This Instrument Corporation of America plant contains the most modern and complete facilities available anywhere in the world for the exclusive production of Miniature Slip-Ring and Commutator Assemblies to precision standards. It is now in full scale production to meet your requirements in the fastest possible time at the lowest possible cost.

COMPLETE ENGINEERING AND PRODUCTION FACILITIES AVAILABLE

Our assemblies can be supplied at low cost. Quality is the highest in the industry. Dimensional accuracy and other characteristics are excellent and these units are highly recommended for instruments such as synchros, etc.

ONE PIECE ELECTRO-PLATED TYPES FOR EXTREME ACCURACY

Wherever extreme dimensional precision, accurate concentricity and high dielectric qualities are required, the electro-deposition method is recommended . . . the production of which is licensed under an exclusive arrangement with the Electro Tec Corporation.



TYPICAL SPECIFICATIONS:

Sizes: .035" to 24"
 Cylindrical or Flat

Cross-sections: .005 to .060" or more

Finish: Polish to 4 Micro-Inches or Better

Breakdown: 1000 V or More
 Hi-Pot Inter-Circuit

Ring Hardness: 75 to 90 Brinell

Rotation Speeds: To Over 12000 RPM

Surface Protection: Palladium and Rhodium or Gold Prevent Tarnish, Minimize Wear

Our engineering staff is at your service at all times for consultation

INSTRUMENT CORPORATION OF AMERICA
 BLACKSBURG • VIRGINIA

UNDER EXCLUSIVE LICENSE OF ELECTRO TEC CORPORATION

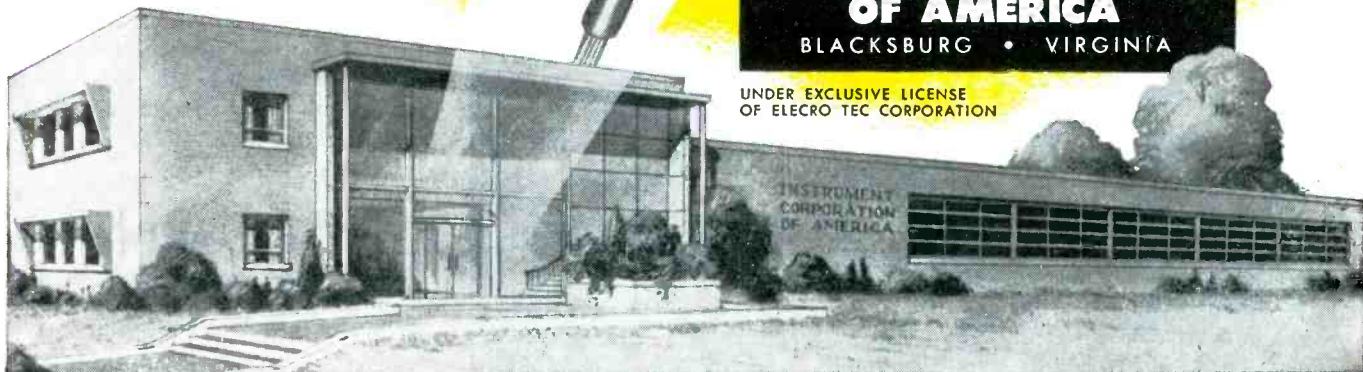

Color TV makes an extra demand on the quality of the quartz crystal unit. The crystal must be sensitive to synchronizing signals and have high stability over extended periods of time and range in temperatures. It must be carefully shaped and adjusted to follow the "burst".

REEVES CRYSTAL UNITS
MEAN SHARPER
COLOR CONTROL
HOFFMAN IN COLOR TV

Because of their high quality and reliability of performance, Reeves-Hoffman RH-7BTV crystal units are being used by engineers throughout the country in making preproduction models and pilot runs of color TV equipment.

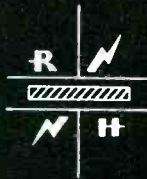

REEVES

HOFFMAN Corporation

Subsidiary of Claude Neon, Inc.

CHERRY AND NORTH STREETS
CARLISLE 2, PENNSYLVANIA

LICENSED UNDER PATENTS OF THE BELL SYSTEM



Use of Heli-Coil inserting tool for quick seating of wire thread insert in a tapped hole in x-ray tube housing. Cap screws can then be installed conventionally during assembly of the housing, as shown in first photo

spaced holes in the housing are drilled and tapped, then fitted with size 10-32 spiral spring steel inserts made by Heli-Corp., Danbury, Conn. A special inserting tool is used to obtain quick seating of the insert in the tapped hole. Once the insert expands in the hole, it is self-locking and provides much greater resistance to wear than is obtained with the aluminum threads directly.

Threaded holes in aluminum housings of x-ray tubes are often damaged as a result of maintenance operations in the field. In order to salvage a housing with damaged threads it became necessary to return it to the factory. Now, with inserts installed in the equipment during manufacture, this condition is eliminated and better customer relations result.

Preparing Teflon Cable

RECOMMENDED procedures for preparing Teflon cable for r-f cables are described and pictured in the booklet "Assembly Procedures,"



he's working
for you

THIS FELLOW IS TRAINED IN YOUR BUSINESS. His main duty is to travel the country — and world — penetrating the plants, laboratories and management councils . . . reporting back to you every significant innovation in technology, selling tactics, management strategy. He functions as your all-seeing, all-hearing, all-reporting business communications system.

THE MAN WE MEAN IS A COMPOSITE of the editorial staff of this magazine. For, obviously, no one individual could ever accomplish such a vast business news job. It's the result of many qualified men of diversified and specialized talents.

AND, THERE'S ANOTHER SIDE TO THIS "COMPOSITE MAN," another complete news service which complements the editorial section of this magazine — the advertising pages. It's been said that in a business publication the editorial pages tell "how they do it" — "they" being all the industry's front line of innovators and improvers — and the advertising pages tell "with what." Each issue unfolds an industrial exposition before you — giving a ready panorama of up-to-date tools, materials, equipment.

SUCH A "MAN" IS ON YOUR PAYROLL. Be sure to "listen" regularly and carefully to the practical business information he gathers.



McGraw-Hill PUBLICATIONS

ELECTRONICS — January, 1954

Why LAMBDA laboratory power supplies are among the most FREQUENTLY RECOMMENDED



RACK MODEL 28
Standard rack mounting.
Panel size 5 1/4" x 19".
Weight 16 lbs.

SPECIFICATIONS:

Input: 105-125 Volts AC, 50-60 cycles, 120 watts.

DC Output: Continuously variable from 200 to 325 Volts DC regulated from 0 to 100 ma max. Either positive or negative side of supply may be grounded.

DC Voltage Regulation: Output constant to better than 1% for loads from zero to full load and line voltage variations from 105 to 125 volts.

Noise and Ripple Output: Less than 10 millivolts rms for above ratings.

AC Output: 6.3 Volts AC at 3A unregulated.

ALSO AVAILABLE NOW:
Model 28-M, with voltmeter and milliammeter.

Lambda power supplies are made by engineers who pioneered in this field and have continued to specialize in it. Used by many of the country's leading laboratories, Lambda units are recommended by them for value, versatility and dependable performance. Models for many purposes. Conservatively rated, constructed for long, trouble-free service, priced moderately. Fully guaranteed.

LAMBDA ELECTRONICS CORP.

103-02 NORTHERN BOULEVARD
CORONA 68, NEW YORK



SEND FOR NEW CATALOG. Comprehensive, authoritative, up-to-the-minute. An important addition to your power supply reference library.

Versatile - Compact
Low-Cost
Precise

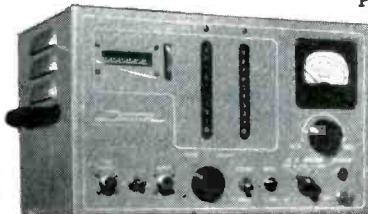

Multi-Purpose LABORATORY POLI-SCALER

The Detectron DS-606 Poli-Scaler is a complete laboratory scaler of exceptional versatility. Adaptable to GM and scintillation counting and frequency checks. Power supply may be used for either GM input or to operate accessory equipment.

PULSE HEIGHT DISCRIMINATOR INPUT — 2 to 100 V; **POSITIVE OR NEGATIVE PULSES** — 2 - 100 V Pos. — 2 - 50 V Neg.; **RESOLUTION TIME** — 5 Microseconds per pulse pair or less; **HIGH VOLTAGE POWER** — variable in 1 step from 0 to 2.5 kv.; **COUNTING RATE** — 1,000 per sec. max.; **ACCESSORY SOCKETS** — for count rate meter and speaker; **DIRECT READING** — to 99,999,999.

Write for FREE folder Dept. 78

THE *Detectron* CORP.
5420 VINELAND, NO. HOLLYWOOD, CALIF.

WANTED FOR CASH!

(1). Line of electronic, electro-mechanical, optical instruments or devices, (Measurement, test or control.) with established markets. Strong preference for fully production-engineered products ready for manufacture and marketing.

(2). Assets and good will of an instrument company retiring from business. Any situation into six figures is of interest.

(3). We invite correspondence from engineers with ideas for products in these categories. Appropriate cash or royalty arrangements upon acceptance and proof of merit.

We are a new West Coast instrument company, staffed by seasoned executives, financially responsible and ready to talk business. Write, wire or telephone our representative:

Clayton F. Bane
2748 Junipero Serra Blvd.
San Francisco 25, Calif.
Phone: PLaza 5-8315

Want more information? Use post card on last page.



Your source

for JAN 2K50

REFLEX KLYSTRON TUBES

The new Bendix Red Bank JAN 2K50 is the perfect answer for those who want a thermally-tuned Reflex Klystron tube for K-band operation.

The JAN 2K50 has two primary applications—first, as a local oscillator in small, compact, lightweight, high-definition radar and, second, as an oscillator in microwave spectrometers, signal generators and spectrum analyzers.

Because of its thermal feature, the JAN 2K50 may be tuned automatically. Thus, it is ideally suited for difficult locations . . . in aircraft, for example . . . where direct or mechanical tuning is not practical.

Perfection of the complex, ultra-precision JAN 2K50 . . . one of the most difficult electron tubes to manufacture . . . is a tribute to the unique talents of our engineers and production men. It demonstrates why you can depend on Bendix Red Bank for the answer to *any* special-purpose electron tube problem you may have.

MAXIMUM RATINGS

Resonator Voltage	330 volts D.C.
Reflector Voltage	—150 volts D.C.
Tuner Grid Voltage	—50 volts D.C.
Filament Voltage	6.3 ± 8% volts
Gun Cathode Current	28 ma. D.C.
Tuner Cathode Current	10 ma. D.C.

ELECTRICAL CHARACTERISTICS

Heater Voltage (A.C. or D.C.)	6.3 volts
Heater Current755 amps.
Thermal Tuning Range	23216 to 24751 Mc/Sec.
Min. Power Output at 23504 Mc/Sec.	8.5 mW.
Min. Power Output at 23984 Mc/Sec.	10.0 mW.
Min. Power Output at 24464 Mc/Sec.	8.5 mW.
Min. Electronic Tuning at Mid-Band	55 Mc/Sec.

PHYSICAL CHARACTERISTICS

- Dimensions: Maximum seated height 2 1/4" • Base: Small Octal 8-Pin, B8-21, Low Loss Phenolic Wafer • Coupling to Wave Guide: Direct, by means of an insulating fitting • Cooling: Convection • Mounting Position: Any • Cavity: Silver Plated Steel (integral within the bulb) • Bulb: Metal • Output Window: Low loss glass

Manufacturers of Special-Purpose Electron Tubes, Inverters, Dynamotors and Fractional HP D.C. Motors

DIVISION OF



EATONTOWN, N. J.

West Coast Sales and Service: 117 E. Providencia, Burbank, Calif.

Export Sales: Bendix International Division, 205 E. 42nd St., New York 17, N. Y.

available from American Phenolic Corp., Chicago, Ill. These apply to multiple-conductor and single-conductor cables which have an outer covering or jacket of Teflon surrounding the braided-wire shield.

In the knife-and-scissors procedure used for small runs, the first step is rolling the cable under the knife so as to make a cut around the circumference for removing the

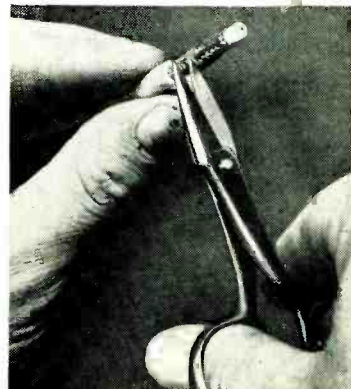

Cutting braided shield with scissors after first pushing back the braid

desired length of jacket. The knife is then used to make a lateral cut to the end of the cable, so that the outer covering can be peeled off easily with fingers. When making both cuts, the knife must be carefully controlled so that the cable shield is not damaged. A razor-sharp knife is essential.

To remove a portion of the exposed length of shield, push the shield back to create a bulge so that small pointed scissors can be inserted for snipping the shield wires.

To remove a portion of the exposed dielectric, the knife is then used to make a cut around the circumference, almost but not quite to the conductor. The dielectric can then be pulled off with pliers.

Air-Operated Strippers

For larger production runs of cable, an air-operated stripping device has been made by Amphenol for its own use, to remove jacketing of multiple-conductor cable. It can be adjusted also to remove jacketing, shield and dielectric of coaxial cable. Adjustments are pro-

100%
Automatic
Oil-Sealing
System

NEW!
Super-Efficient
Kinney-Swirl
Oil Separator

TOP
Performance —
High Pumping
Speed

NEW!
Mechanical
Shaft Seal

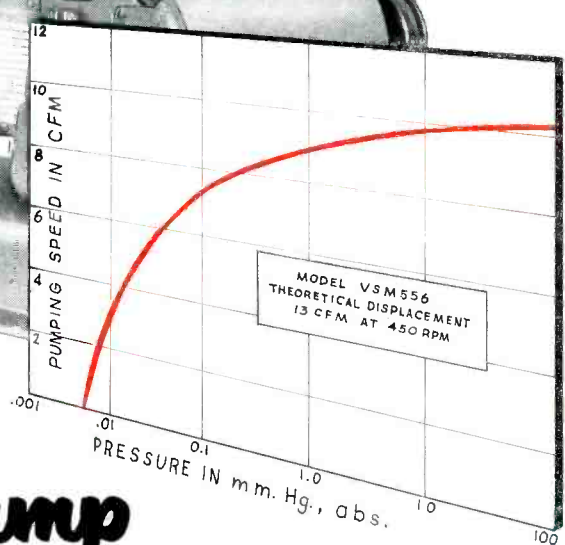
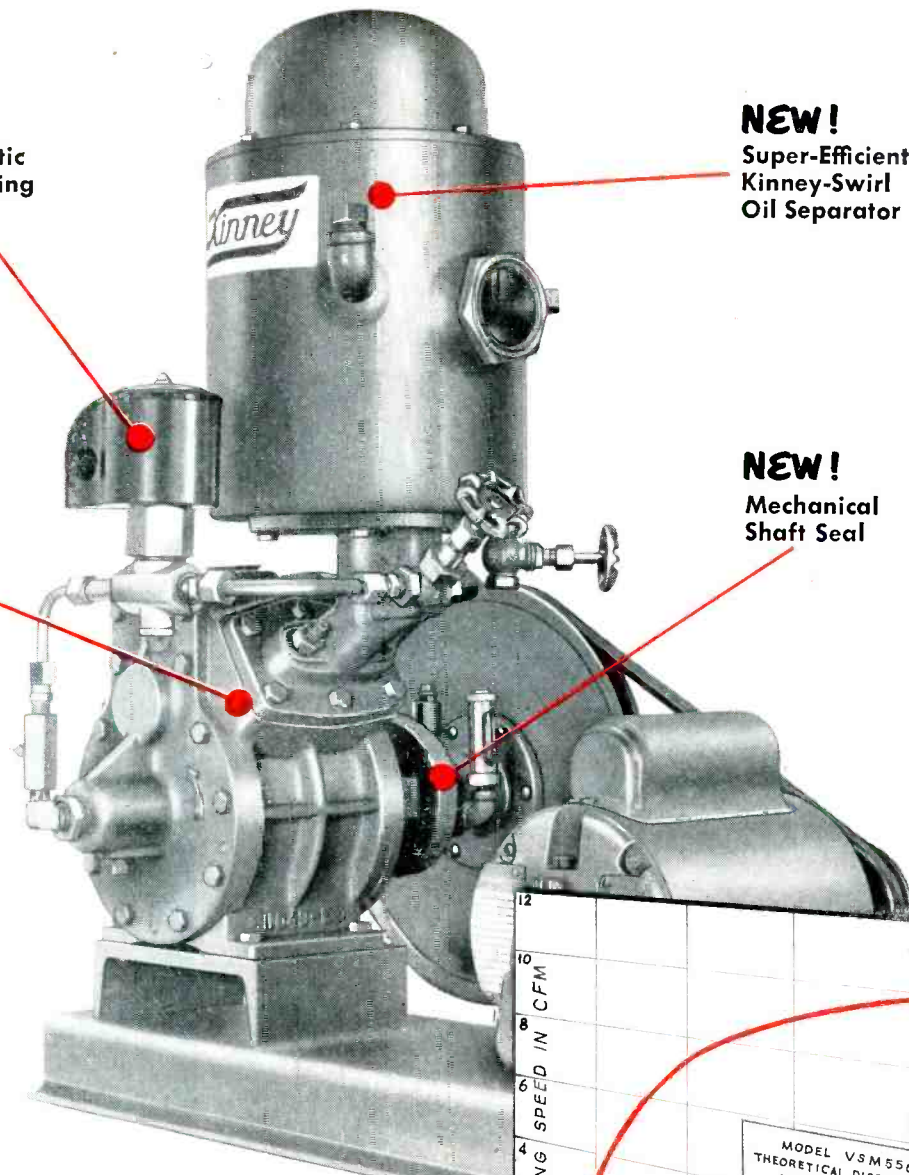

Take a new look at this vacuum pump

It's Kinney Model VSM 556 . . . 13 cubic feet of free air displacement. Model VSM 556 is now serving in many of the nation's foremost vacuum processing systems. Look at its outstanding features — and at its high pumping speed. Check your own vacuum requirements . . . and then come to Kinney for the most vacuum pump for your money. Send coupon for complete details.

KINNEY MFG. DIVISION
THE NEW YORK AIR BRAKE COMPANY

3565 WASHINGTON STREET • BOSTON 30 • MASS.

- Please send Bulletin V-51B describing the complete line of Kinney Vacuum Pumps.
- Please have your vacuum engineer call at our plant.

Name

Company

Address

City State



which **SCREW** is best for this job?

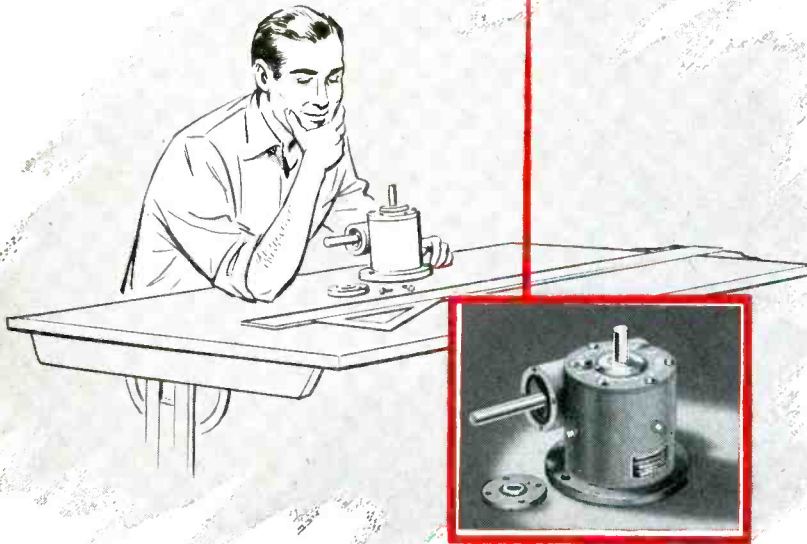

whatever type and size you select

pheoll makes it!

OVER 10,000 standard sizes, types, head styles and finishes are offered in Pheoll's complete line of screws, bolts and nuts. You can benefit through simplified ordering and stocking . . . centralized purchasing. Call Pheoll on your next order.

PHEOLL



SCREWS

NUTS

BOLTS

SPECIAL COLD HEADED PRODUCTS

PHEOLL MANUFACTURING CO.
5700 ROOSEVELT ROAD, CHICAGO 50, ILLINOIS

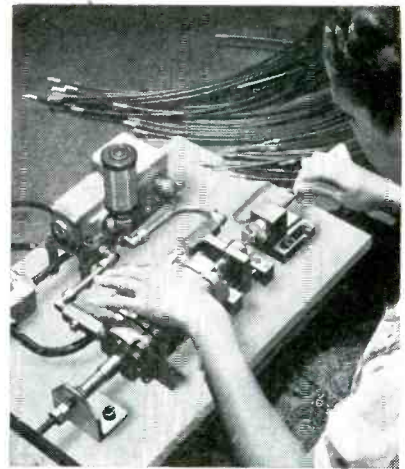

Air-operated automatic jacket stripper for Teflon cable used in radar equipment



Air-operated braid cutter and stripper

vided for depth of cut as well as length of cut. Once the machine is adjusted, the operator merely inserts the cable and depresses the foot-operated air valve to complete the operation.

Another Amphenol design is an air-operated device that serves for removing the shield from coaxial cables automatically and accurately at high speed. The operator inserts the cable with her right hand and operates the air valve with her left hand. For this machine, the outer jacket must first be removed at another setup.

Manually-Operated Stripper

A manually-operated jacket-stripping device is available from Ideal Industries, Sycamore, Ill. that provides the leverage necessary to

DOUBLE BARREL Advertising

Advertising men agree—to do a complete advertising job you need the double effect of both Display Advertising and Direct Mail.

Display Advertising keeps your name before the public and builds prestige.

Direct Mail supplements your Display Advertising. It pin-points your message right to the executive you want to reach—the person who buys or influences the purchases.

More and more companies are constantly increasing their use of Direct Mail because it does a job that no other form of advertising will do.

McGraw-Hill has a special Direct Mail Service that permits the use of McGraw-Hill lists for mailings. Our names give complete coverage in all the industries served by McGraw-Hill publications—gives your message the undivided personal attention of the top-notch executives in the industrial firms. They put you in direct touch with the men who make policy decisions..

In view of present day difficulties in maintaining your own mailing lists, our efficient personalized service is particularly important in securing the comprehensive market coverage you need and want.

Ask for more detailed information today. You'll be surprised at the low over-all cost and the tested effectiveness of these hand-picked selections.



Dept. A

**McGraw-Hill
Publishing Co., Inc.**

330 West 42nd Street
New York 18, N. Y.

A Sequential Relay That Counts, Stores or Remembers

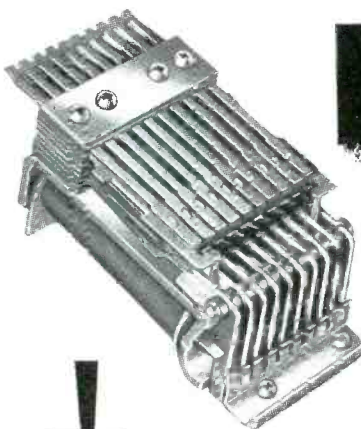

KELLOGG MAGNETIC IMPLUSE COUNTER

PROVED IN USE!

SEQUENTIAL OPERATION—10 operations in sequence but one relay plus coil

DIGITAL STORAGE—Once read-in, stored without power but no latches

TELEMETERING—Counting or controlling from a distance but minimum wiring

COMPUTERS—Series read-in parallel read out

STEPPING—Replaces 2 magnet IC point stepping switch at pulse rates up to 20 per second

WRITE FOR FREE TECHNICAL DATA TODAY, DEPT. 26-A

KELLOGG DIVISION OF
IT&T

KELLOGG SWITCHBOARD AND SUPPLY COMPANY

A Division of International Telephone and Telegraph Corporation
SALES OFFICES: 79 West Monroe Street, Chicago 3, Illinois

ELECTROPLATED Wires



Preferred For:

Corrosion Resistance...

Better Solderability...

Suppression of Grid Emission...

Improvement of Electrical Characteristics

GOLD, SILVER, RHODIUM, PLATINUM
and other metals, applied to many different
types of wire to meet your specifications.
Uniform plating, scientifically controlled.

Write for Latest List of Products

SINCE  1901

SIGMUND COHN MFG. CO. INC. 121 So. Columbus Avenue, Mt. Vernon, N. Y.

PEM WELD FASTENERS

MAKE SENSE because
they SAVE DOLLARS

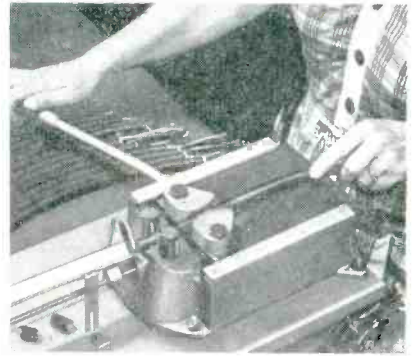
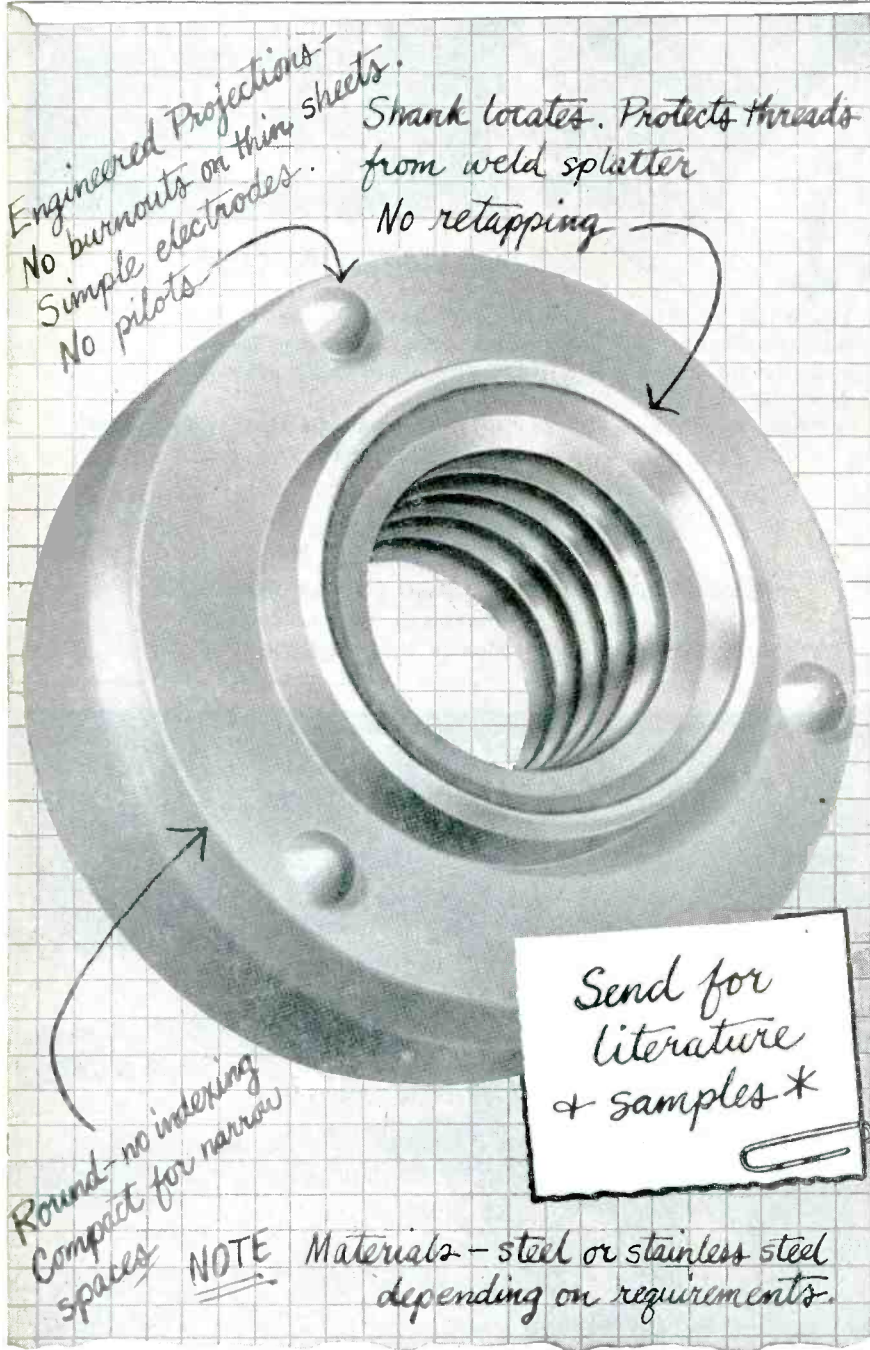

Manually-operated jacket remover for heavy cable having several conductors

remove cable jacketing having a wide range of wall thicknesses. Springs keep the gripping jaws and cutting blades apart in-between operations, so that the operator can push the cable between them up to an adjustable stop in a V trough. When the cable is in position, one pull of the lever makes the cutting jaws dig in the correct distance and then actuates corrugated gripping jaws that pull the cable away from the cutting blade.

Shield Combing and Flaring

Many applications require that the shield of a cable be combed out, so that the strands will be parallel to each other rather than braided. A wire brush on the shaft of an electric motor does this job quickly. For safety, a transparent plastic shield should be mounted over the brush, with a slot cut into it for insertion of the cable. A short length of copper tubing is anchored to a wood block at the bottom of the slot with a pipe clamp, to provide a support for the cable as it is being combed. This pipe also serves to give the optimum angle for effi-



Motor-driven wire-brush setup for combing braided shield on cable

* Penn Engineering & Manufacturing Corp., Doylestown, Pa.

PEM



DEPENDABLE *Miniature*
RADIO FILTERS

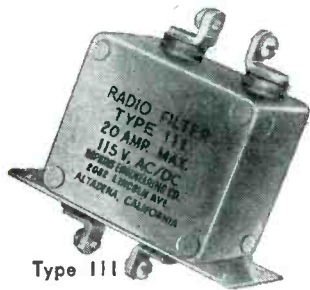

Type III

- Saves space!
- 115 V ac/dc, 20 amp.
- Excellent attenuation
- Feed through installation
- Flange mounting bracket
- Corrosion & fungus resistant

If you have radio interference problems, write or wire us, TODAY!

HOPKINS
Engineering Co.

FACTORY: 2082 Lincoln Ave.,
Altadena, Calif. SYcamore 8-1185
Offices in WASHINGTON, D. C.
and DETROIT

**ETCHED
ELECTRONIC
CIRCUITS**

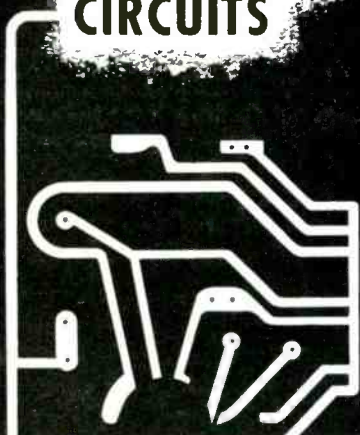

Detailed etched circuits and screen grids, expertly produced to your most precise specifications. guarantee outstanding economy, greater dependability for the television, radio or electronic device manufacturer.

Send us your problem

ALLIED PHOTO ENGRAVERS, INC.
153 W. HURON STREET • CHICAGO, ILL.
DEPT. E

is this your timing problem?

**Sorry! A. W. Haydon Company
Can't Help Your Timing Here.**

Only a "pro" and practice can straighten you out!

But - - -

We are the "pro's" for precision timing. Come to us with these timing problems. You'll find that we have solved more complex A.C. and D.C. timing problems than just about anybody else. Maybe we have already solved yours. It costs you nothing to find out. Write for catalog.



Precision Instruments

SERVOMECHANISMS

To answer your specific needs for precision electro-mechanical systems,

The Ahrendt Instrument Co. offers a combination of the highest calibre engineering talent and the finest production facilities.

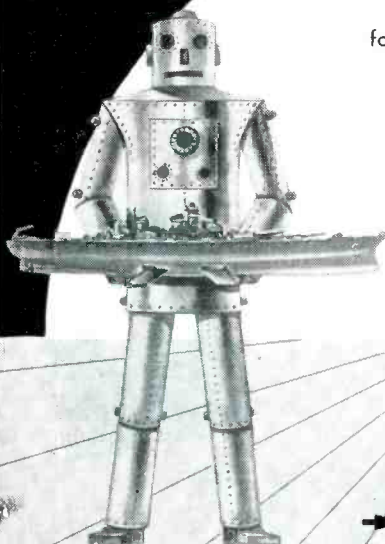

The
**AHRENDT
INSTRUMENT
COMPANY**

Automatic Control Devices
4910 CALVERT RD., COLLEGE PARK, MD.

**Rockbestos says:
"thanks for
KULGRID"**



ROCKBESTOS PRODUCTS CORPORATION
NEW HAVEN 4 CONNECTICUT

August 18, 1953

Mr. Philip Pritchard, Division General Sales Manager
Sylvania Electric Products Inc.
Parts Division
2nd Avenue
Warren, Pennsylvania

Dear Phil:

I have been meaning to write you this letter for quite some time, but up till now I just haven't had the opportunity.

Primarily, I would like to say "Thanks for Kulgrid."

As you are well aware, we have been using Kulgrid wire ever since we ran into some problems in the manufacture of components for aircraft engines and in the making of galley ranges for the Navy.

What we were looking for was a wire which had good conductivity yet was able to withstand high temperature without flaking or corroding. We found the answer with "Kulgrid" and have used it ever since.

We are extremely grateful for your assistance in helping us clear the hurdles on this problem and we are sure that Sylvania Kulgrid and Rockbestos Products will have a very happy association for many years to come.

Very truly yours,
ROCKBESTOS PRODUCTS CORPORATION

H. O. Anderson
H. O. Anderson
Vice President in Charge of Sales

HOA:hmf

Rockbestos Products Corporation is another important modern manufacturer that appreciates the fine performance and durability of KULGRID . . . Sylvania's nickel-clad copper wire.

Kulgrid's tough nickel coating resists corrosion and guards the copper core from deterioration, while assuring excellent electrical conductivity. You'll find Kulgrid ideal for high-temperature wiring in electric furnaces, stoves, industrial ovens, and many aircraft applications. Available in single or stranded forms. New illustrated booklet gives full details. For your file copy, address: Sylvania Electric Products Inc., Dept. 4A-1601, 1740 Broadway, New York 19, N. Y.



SYLVANIA

LIGHTING • RADIO • ELECTRONICS • TELEVISION

In Canada: Sylvania Electric (Canada) Ltd., University Tower Bldg., St. Catherine St., Montreal, P. Q.



Motor-driven flaring tool for pushing back braided metal shield on cable



Cable-cutting power saw with guard

cient combing of strands.

A similar motor setup, having a flaring tool mounted on the end of the shaft, can be used to fold back the shield on a coaxial cable efficiently at high speed. Here a different flaring tool must be used for each size of cable.

Cable-Cutting Saw

Large-diameter cables, as well as flexible aluminum conduit, can be cut effectively with a high-speed fine-tooth power saw. For general production use, a saw like that shown will prove safe as well as satisfactory.

Tube Pin Cutter

THE FASTEST and most practical method that could be found by Raytheon engineers for cutting the leads or pins of subminiature tubes to predetermined short lengths was

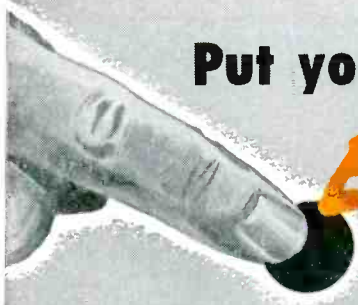

Put your finger on

EXTRA DEPENDABILITY

by specifying...

CHESTER means dependability *plus* in wires and cables for every electronic and electrical application. The compounds used in all CHESTER Wire and Cable constructions are made in the CHESTER plant. Thus, complete control over selection of raw materials and manufacturing techniques, provides full control of quality... your assurance of uniformity in every foot of conductor bearing the CHESTER label!

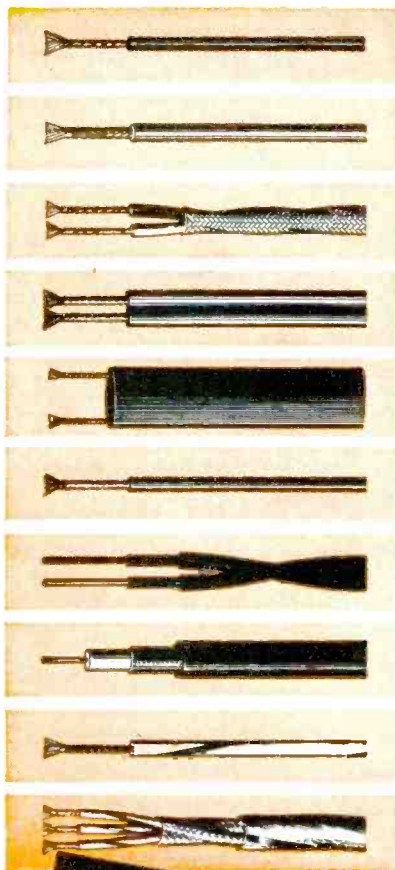

- JAN-C-76 WIRES* SRIR, SRHV, SRRF, WL
- 105°C, 90°C, 80°C, UL APPROVED; 120°C*
- SHIELDED WIRES & CABLES
- FLEXIBLE CORD
- TV LEAD-IN WIRES
- INSTRUMENT WIRES
- COMMUNICATION WIRES & CABLES TO SPECIFICATION
- COAXIAL CABLE
- LACQUERED AND NYLON COVERED WIRES
- SPECIAL WIRES & CABLES TO SPECIFICATIONS

CUSTOM CONSTRUCTIONS
to specification using Polyethylene, Polyvinyl chloride, Nylon, Braided and Lacquered Wires, Special Insulating Materials, Glass, Yarn, etc. Inquiries invited.

**Solid colors or spiral marking*

ASK "*Chesty*" FOR the New Chester Literature. Complete data on wires and cables for electrical and electronic wiring. Request yours, today!



REGISTERED U.S. PAT. OFF.

CHESTER CABLE CORP.

C H E S T E R • N E W Y O R K

20,000
VOLTS

VICTOREEN'S VOLTAGE REGULATOR TUBES

Cover the Range from
50 Volts to 20,000 Volts.

A single voltage regulator tube may readily replace a complex and expensive regulating circuit. Investigate the advantages of a reliable, long-life Victoreen tube • for voltage regulation of power supplies • as voltage reference for control of higher currents • for voltage limiting to prevent circuit overloading • in voltage adjustment for fine control of precision power supplies. A single VR tube is space saving, too.

**HIGH VOLTAGE
REGULATORS**
5000 to 20,000
Volts



Maximum current 1000 μ a
Regulation
1.5% per 250 μ a

**HIGH VOLTAGE
REGULATORS**
3000 to 5000
Volts

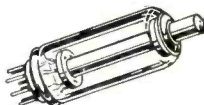

Maximum Current 250 μ a
Regulation
5-55 μ a is 1.5%

**HIGH VOLTAGE
REGULATORS**
400 to 2500
Volts



Maximum Current 100 μ a
Regulation
5-55 μ a is 1.5%

GLOW TUBES
57 Volts



Maximum Current 800 μ a
Regulation
200-800 μ a is 3.0%

**ADJUSTABLE
REGULATORS**
645 to 705
Volts



Maximum Current 55 μ a
Regulation
5-55 μ a is 3%

DISTRIBUTORS

Allied Radio Corp., Chicago, Illinois
W. D. Brill Co., Oakland, California
Gifford-Brown, Des Moines, Iowa
Harrison Equipment Co., Houston, Texas
Industrial & Electronics Supply, Dallas, Texas
Radio Shack Corp., Boston, Massachusetts
Southeastern Radio Supply Co., Raleigh, No. Carolina
Terminal Radio Corp., New York City, New York
W. & W. Distributing Co., Memphis, Tennessee

WEST COAST REPRESENTATIVE

Carlton Engineering Co.
Los Angeles-San Francisco, California

EXPORT DISTRIBUTOR

Terminal Radio Corp., New York City, New York
Cable TERMRADIO

WRITE FOR FACTUAL DATA SHEETS ON THESE AS WELL AS
YOUR OTHER COMPONENT REQUIREMENTS



The Victoreen Instrument Co.

3800 PERKINS AVE. • CLEVELAND 14, OHIO



Setup for trimming tube pins. Operator must have both hands on operating controls of press as shown before shearing blade can come down. Sponge rubber pad set into descending blade mount serves to hold tube in position

use of a heavy-duty bench-type pneumatic press. With an appropriate holding fixture, this snips off the pins with a tolerance of plus or minus 0.0100 inch.

Metal-to-Ceramic Seals for Magnetron Waveguides

BY N. E. PRYSLAK

*Tube Department
Radio Corporation of America
Harrison, N. J.*

THE TUNGSTEN-IRON metalizing process used in the construction of the sandwich-type metal-to-ceramic seals was developed primarily for use in the construction of vacuum-tight output windows for magnetrons and other microwave electron tubes. Tubes having ceramic windows can be processed during exhaust at higher bakeout temperatures (650 to 700 C), and parts can be brazed to the main section of the tube in a hydrogen furnace with the window in place.

The seal consists of a rectangular ceramic window interposed between two metallic window frames and brazed to the inner walls of a rectangular waveguide. The wave-

*Years of experience
proves to users . . .*

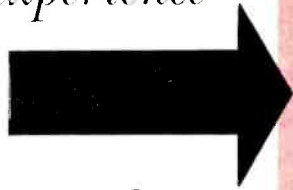

the dependability of *

KOVAR

Glass-sealing Alloy

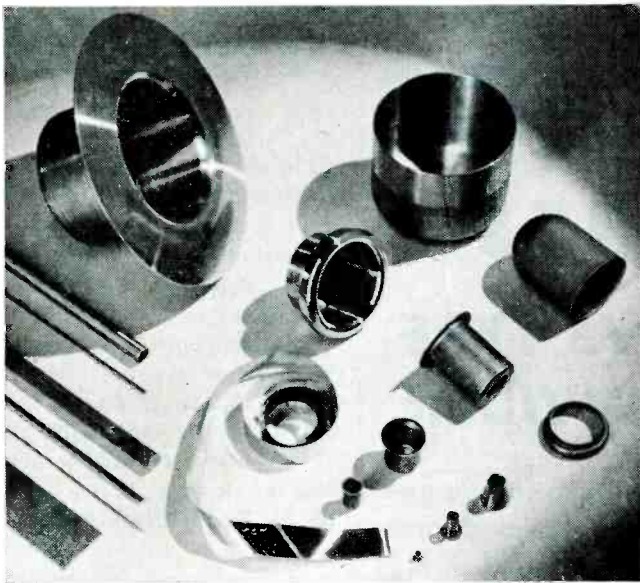

* Westinghouse Trade Mark No. 337,962











The ideal alloy for glass sealing, Kovar matches the expansivity of certain hard glasses over the entire working temperature range. It resists mercury attack, has ample mechanical strength and seals readily. A permanent and impervious bond is obtained by a closely controlled thickness of oxide on Kovar alloy interfused with hard glass.

Kovar is a cobalt, nickel, iron alloy, manufactured under very carefully controlled conditions, and supplied by Stupakoff in the form of: SHEET, ROD, WIRE, FOIL, TUBING, EYE-LETS, LEADS and FABRICATED SHAPES. The prominent users of KOVAR and the length of time they have employed this metal are convincing proof of satisfaction.

Full information on the use of Kovar is given in Stupakoff Bulletin 145, which we will send upon request.

Stupakoff CERAMIC & MFG. CO.

Latrobe, Pennsylvania

-  18 YEARS
-  18 YEARS
- Western Electric** 18 YEARS
- 16 YEARS
-  12 YEARS
-  18 YEARS
- Eimac* REG. U. S. PAT. OFF. **TUBES** 13 YEARS
-  11 YEARS
-  15 YEARS
- Bomac* 6 YEARS
-  18 YEARS
-  5 YEARS
-  18 YEARS
-  7 YEARS
- SPERRY** 13 YEARS



FOR
**HIGH VOLTAGE
 MEASUREMENTS**

**JENNINGS' CAPACITIVE TYPE
 VACUUM VOLTAGE DIVIDER**

These newly designed JENNINGS' VOLTAGE DIVIDERS can be used to measure continuous or pulsed voltages up to 60 KV peak at practically any desired voltage division ratio. They can be used at high frequencies because the low voltage probe is shielded and because the input loading capacitance can be as low as 1.5 mmfd. They can also be used at frequencies down to 60 cycles.

RF transmission line voltages and push-pull output voltages up to 120 KV peak-to-peak can be measured by using these dividers in a balanced-to-ground arrangement.

Applications include:

- Measuring RF tank and transmission line voltages
- Viewing output of high voltage pulse generators
- Viewing output wave shape of high voltage aircraft magnetos.

Literature mailed on request

**JENNINGS RADIO MANUFACTURING CORPORATION • 970 McLAUGHLIN AVE.
 P.O. BOX 1278 • SAN JOSE 8, CALIFORNIA**

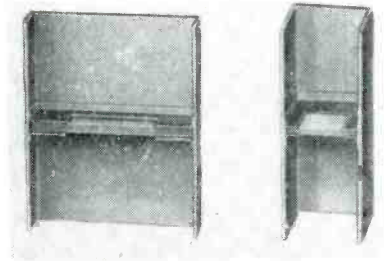

FIG. 1—Typical rectangular output waveguide used with microwave tubes

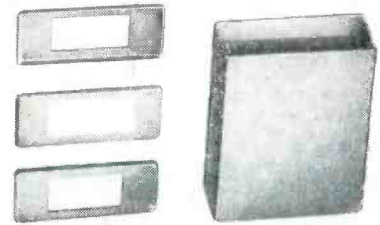

FIG. 2—Component parts of output window assembly for rectangular waveguide section that is brazed to tube

guide shown in Fig. 1 is made of 0.020-inch nickel-iron alloy No. 52, is 1½ inches long and has internal dimensions of 0.400 inch and 0.900 inch. Alloy No. 52 contains 51-percent nickel and 49-percent iron.

The component parts of the output window assembly used in this waveguide are shown in Fig. 2. The two window frames, also made of No. 52 alloy, are 0.005 inch thick. The outer edge of each frame is flanged to facilitate brazing to the inner wall of the waveguide.

The thickness of the ceramic window has been varied from 0.020 inch to 0.060 inch in experimental assemblies. Both Alsimag 243 ceramic and an RCA developmental forsterite ceramic have been used. The thermal-expansion characteristics of both ceramics and of the nickel-iron alloy No. 52 are shown in Fig. 3. The slight difference between the expansion characteristics of Alsimag 243 and the RCA forsterite is probably due to the use of different materials as fluxing agents. This slight difference did not affect the properties of experimental seals.

The portion of ceramic to be metalized must be free of any contaminating material if an adherent

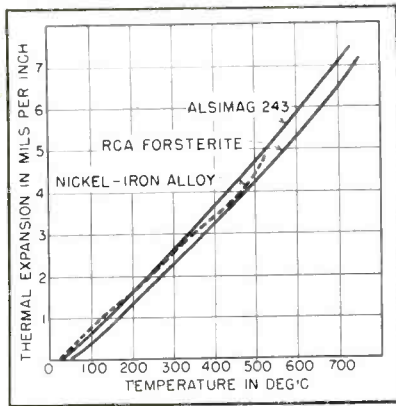

FIG. 3—Thermal expansion characteristics of ceramics and metal used in sandwich-type seal for tubes

bond is to be formed between the metallic powder and the ceramic. The ceramic windows are degreased in an alkaline cleaner, thoroughly rinsed in water, immersed in a dilute solution of 25-percent nitric acid, washed in water again and then dried. After the ceramic is cleaned, the active portion of the window is masked out, and the remaining area is painted with the tungsten-iron mixture.

The tungsten and iron powders used in metalizing the ceramic have particle sizes in the order of one to four microns. The mixture of powder used contains 90-percent tungsten and 10-percent iron by weight. The powder is mixed with a binder composed of nitrocellulose, diatol and diethyl oxalate into a paste having the consistency of paint. This paste is then painted on the ceramic with a camel-hair brush to a thickness of 0.001 to 0.002 inch. Coatings heavier than 0.002 inch often tend to result in peeling of the metallic surface. If desired, the tungsten-iron powder mixture may be diluted to the proper consistency and sprayed on the ceramic.

The coated ceramic is fired in a molybdenum-wound muffle furnace at a temperature of 1,345 C for 15 minutes to form a bond between the tungsten-iron powder and the ceramic. Various atmospheres have been used during the firing process. Forming gas (30-percent hydrogen and 70-percent nitrogen), wet hydrogen and line hydrogen having a dew point of approximately —60

INSTALL

FOR

COLOR TV

For more than 3 years TELECHROME has been providing color TV generating, testing and broadcasting equipment to the television industry's most prominent manufacturers, research laboratories, and broadcasters.

Complete equipment for generating color bars; creating encoded and composite pictures from transparencies; color signal certification; transmission, reception, monitoring, and analysis of color pictures — literature on these and more than 100 additional instruments for color TV by TELECHROME are available on request.

All TELECHROME equipment is guaranteed to meet NTSC and FCC specifications.



The Nation's Leading Supplier of Color TV Equipment

88 Merrick Road Amityville, N. Y.
Amityville 4-4446

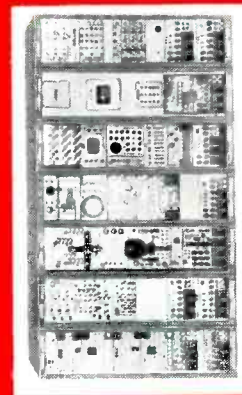

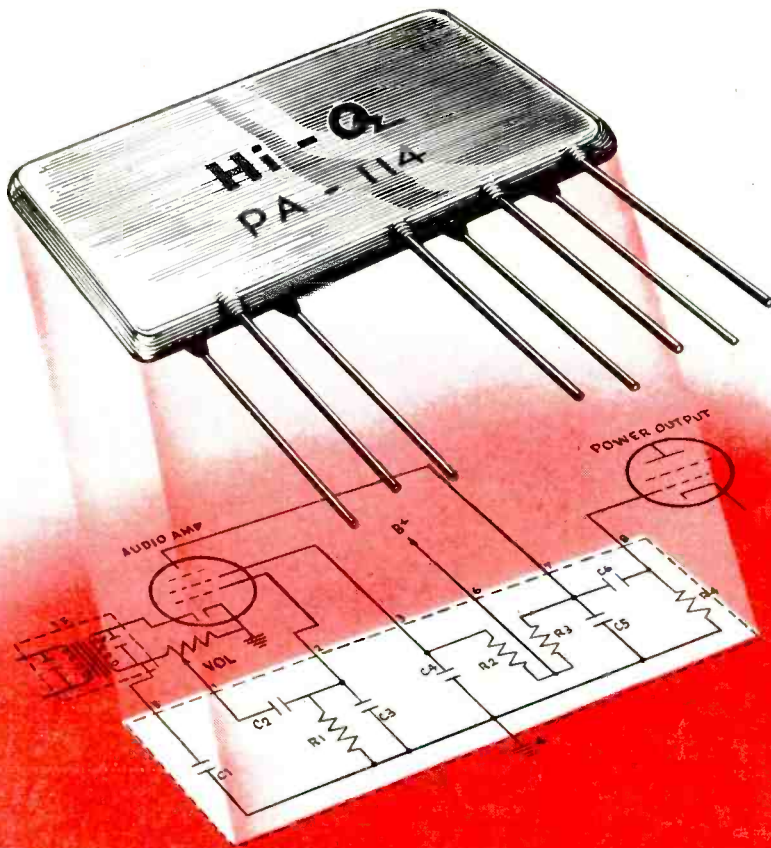

SO LITTLE includes
SO MUCH...

Hi-Q® *plate assemblies*



The most versatile of electronic components! The combination of capacitors and resistors which can be incorporated in these thin ceramic wafers, is limited only by the K of the material and the physical size. Type PA-114 shown, for instance, contains all the fixed constants necessary for the pentode second detector and audio amplifier circuit.

Hi-Q Plate Assemblies not only contribute to dependable miniaturization, but also simplify assembly by reducing the number of soldered leads. Wide choice of standard types. And of course any special types to meet special needs.

GET THE FACTS...

Engineering bulletin on Hi-Q Plate Assemblies, with concise specifications, dimensions and circuit diagrams, is yours for the asking. Our plate assembly specialists will gladly collaborate on your particular requirements.



AEROVOX CORPORATION

OLEAN, N. Y.
ACME Electronics, Inc. Monrovia, Calif.
CINEMA Engineering Co. Burbank, Calif.
AEROVOX Corporation New Bedford, Mass.

In Canada: AEROVOX CANADA LTD., Hamilton, Ont.

have all given satisfactory results. Reduced temperatures, in the order of 1,200 C, may also be used for sintering provided the firing time is increased.

After the sintering treatment, the metallic surface of the ceramic is polished with a fine wire brush to remove any loose particles and is washed. The metalized area is then plated with nickel or copper to a thickness of about 0.0001 to 0.0002

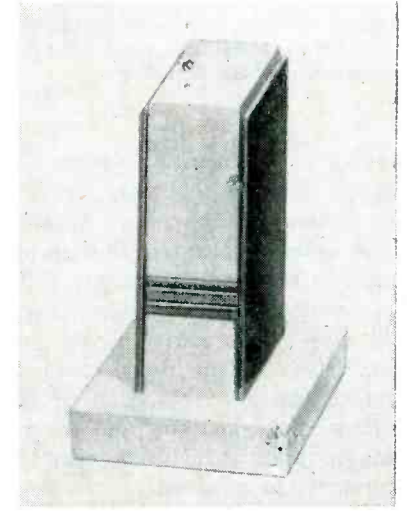

FIG. 4—Parts of output window assembly mounted on jig for brazing

inch to insure better wettability during the brazing process.

Metal-to-Ceramic Brazing

The component parts of the output window assembly are mounted on a suitable jig preparatory to brazing, as shown in Fig. 4. One wall of the waveguide has been cut away in this assembly to show how the parts are stacked in the jig. The mounting jig is made of Nichrome and is lightly sprayed with a coating of alundum to prevent sticking to the inner wall of the waveguide during brazing. The upper portion of the jig serves as a weight to insure intimate contact between the ceramic and the window frames and to prevent warping of the metal parts.

The brazing material used in this seal consists of a piece of oxygen-free high-conductivity copper having a thickness of 0.005 inch, interposed between the ceramic and each

window frame. Pure silver and a silver-copper eutectic solder have also been used as the brazing medium with satisfactory results.

The assembly is brazed in a hydrogen muffle furnace at 1,100 C for approximately 10 minutes. The time of brazing may vary depending on the mass of the part being

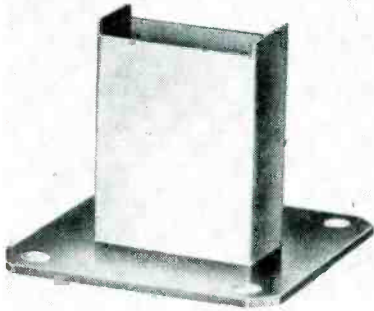

Finished waveguide window with flange

brazed. The amount of brazing material used as solder is important; too small an amount may cause an incomplete braze, while an excess amount may alter the expansion characteristics of the metal at the braze joint and cause the ceramic to fracture or strip from the metal.

It is desirable that the metalized portion of the ceramic be kept at least 0.020 inch away from the edge of the window-frame opening. If the metalized portion is too close to the opening, solder may creep beyond the edge of the frame, thus altering the window size and changing the electrical properties of the waveguide.

The unflanged end of the completed waveguide is brazed directly to the output connection of a microwave tube. Copper is usually used as the brazing medium in this seal, so that subsequent brazings may be made to the waveguide with solders having lower melting points.

The author wishes to thank D. G. Burnside of the RCA Laboratories at Princeton, N. J. for his guidance in the use of the tungsten-iron metalizing technique.

Wire-Coding Methods

IDENTIFICATION of individual wires in cables, harnesses and in conventionally wired circuits can be achieved in many different ways. There is generally one most efficient

get the facts...

January 1954

M	T	W	T	F	S
				1	2
4	5	6	7	8	9
11	12	13	14	15	16
18	19	20	21	22	23
25	26	27	28	29	30

February 1954

S	M	T	W	T	F	S
		2	3	4	5	6
9	10	11	12	13	14	15
17	18	19	20	21	22	23
25	26	27	28	29	30	31

March 1954

S	M	T	W	T	F	S
					2	3
5	6	7	8	9	10	11
13	14	15	16	17	18	19
21	22	23	24	25	26	27
28	29	30	31			

April 1954

M	T	W	T	F	S
			1	2	3
5	6	7	8	9	10
12	13	14	15	16	17
19	20	21	22	23	24
26	27	28	29	30	

June 1954

S	M	T	W	T	F
		1	2	3	4
6	7	8	9	10	11
13	14	15	16	17	18
20	21	22	23	24	25
27	28	29	30		

July 1954

M	T	W	T	F	S
				1	2
5	6	7	8	9	10
12	13	14	15	16	17
19	20	21	22	23	24
26	27	28	29	30	31

September 1954

S	M	T	W	T	F
				1	2
5	6	7	8	9	10
13	14	15	16	17	18
20	21	22	23	24	25
27	28	29	30		

October 1954

M	T	W	T	F	S
				1	2
4	5	6	7	8	9
11	12	13	14	15	16
18	19	20	21	22	23
25	26	27	28	29	30

December 1954

M	T	W	T	F	S
				1	2
5	6	7	8	9	10
12	13	14	15	16	17
19	20	21	22	23	24
26	27	28	29	30	31

AEROVOX

RESEARCH WORKER

The New Frontier in Radio

By Dr. Engineering (Princeton University)

Millimeter Waves
The New Frontier in Radio

Illustration: MILLIMETER WAVES OF CONCENTRIC CIRCULARS

AEROVOX The Super Of The Complete Capacitor Lines

MONTH
after
MONTH
after
MONTH



Timely data is just as important to you as timely components. That's the purpose of the Aerovox Research Worker—the monthly capsule of up-to-the-minute radio-electronic "know-how".

Among its "firsts" have been the workings of Radar; transistors; the technique of UHF signals; UHF instrumentation; the latest in TV antennas; color TV; high fidelity sound reproduction; plus self-calculating charts, tables, etc., etc.

Month after month after month you keep abreast of latest radio-electronic developments through the Aerovox Research Worker.

And it's yours for the asking!

How to get the
AEROVOX RESEARCH WORKER

Write on your business letterhead for a free subscription. Or ask our sales representative for a subscription card. Aerovox will be happy indeed to contribute to your fund of practical radio-electronic "know-how" by this means.



AEROVOX CORPORATION

NEW BEDFORD, MASS.

Hi-Q
Division
Olean, N.Y.

ACME
Electronics, Inc.
Monrovia, Calif.

CINEMA
Engineering Co.
Burbank, Calif.

In Canada: AEROVOX CANADA LTD., Hamilton, Ont.

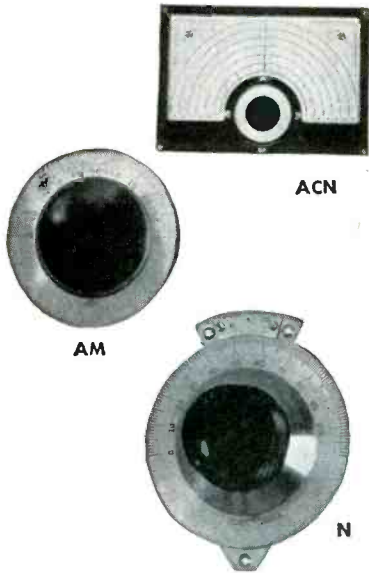

POPULAR NATIONAL DIALS

For years, National dials have been the popular choice of amateurs, experimenters and commercial users because of their smooth, velvety action, easily-read scales, and quality construction. Many dials, like the N and ACN dials shown, can be specially calibrated or supplied with blank scales for commercial application. Write for drawings and prices.

POPULAR NATIONAL KNOBS

Clear, functional, chrome-and-plastic styling and sturdy construction make these the most popular knobs of their type ever produced. All fit 1/4" shafts. For commercial applications, they can be supplied in special colors and with special calibrations. Write for drawings and prices.



Write for drawings



Simple wood block arrangement for holding different colors of wires used in cable plug. Cork sleeve covers almost entire length of pencil-type soldering iron, to give improved grip and minimize accidental burning of hands or fingers

and most economical method for each type of wire covering and each application. Four of the most widely used means of coating electronic wiring are illustrated by

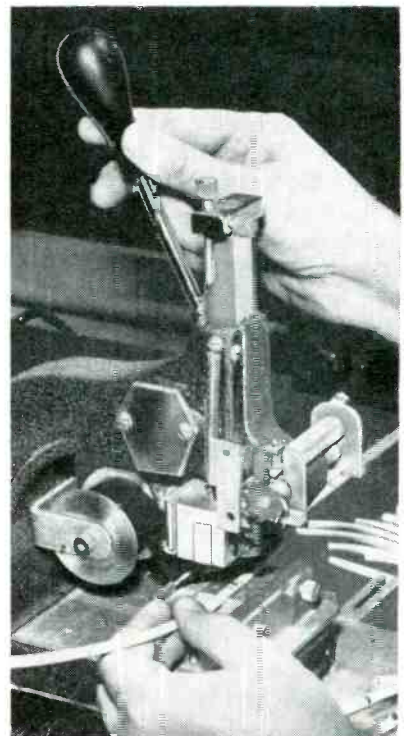

Placing identifying codes directly on wires with Kingsley hot-stamping machine. Ink-bearing tape advances automatically each time lever of machine is actuated by bringing lever arm forward



Use of hot-stamped black vinyl sleeving for identifying correcting wires

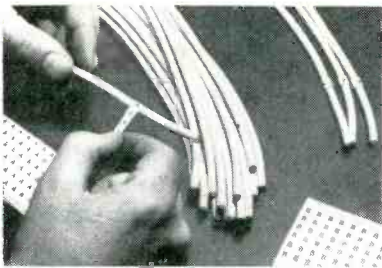

Use of imprinted tape for identifying wires during assembly and in field

Amphenol in their recent catalog.

For internal circuits of radio, television and communication equipment, coding is usually accomplished by using differently colored wires. These are generally cut to length and stripped automatically, then placed in holders, bins or racks within easy reach of the operator on the assembly line.

Black or colored vinyl sleeving can readily be hot-stamped with a circuit code number or letter with the Kingsley machine or its equivalent. The stamping can be done on long lengths, and the sleeving then cut or chopped into the required shorter lengths conventionally for application to the leads requiring identification.

Imprinted Scotch tape is widely used for wire coding. Many different types of tape are available, with various dispensing arrangements, and with either standard printing or custom lettering.

Wiring designations can be printed directly on most types of insulation with the Kingsley machine. Different colors of printing tape are available, so that tape with dark ink can be used on light-colored wire and vice-versa.

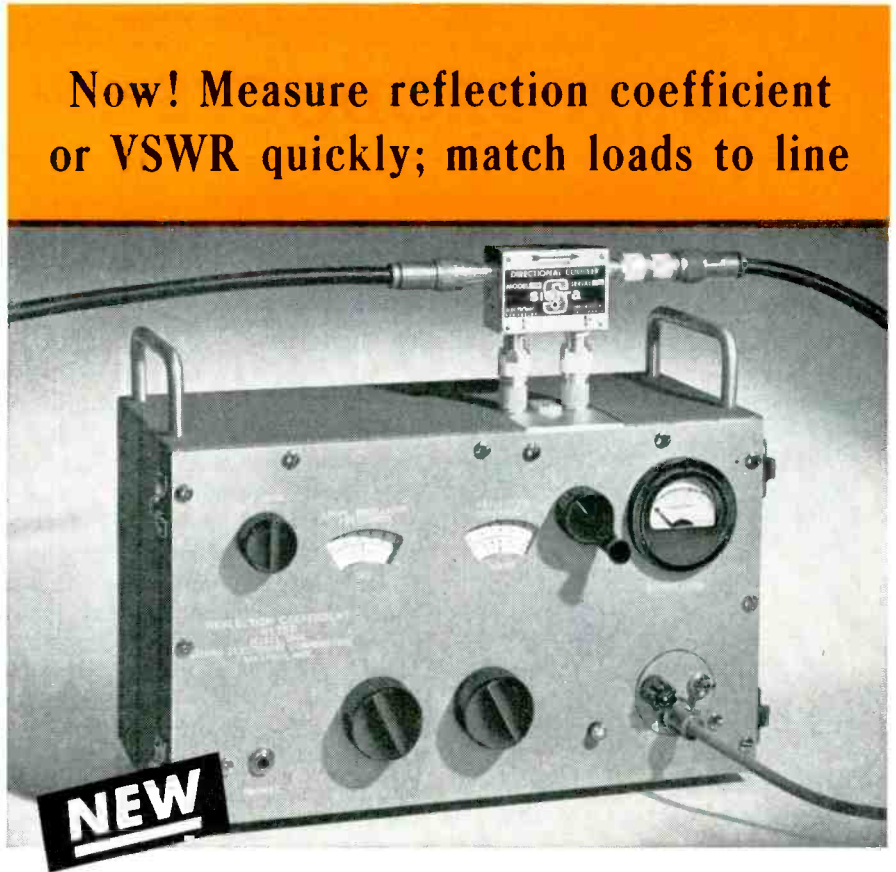

Model 136A Reflection Coefficient Meter

New Model 136A Reflection Coefficient Meter is a compact, moderately-priced instrument designed for quick, simple measurement of transmission line reflection coefficient or VSWR. It also provides a highly convenient method of matching loads to line to minimize reflected power, and may be used as a wide range laboratory receiver. The instrument is very simple to operate and particularly designed for rapid, accurate use by non-technical personnel.

Model 136A Meters use standard Sierra Wideband Directional Couplers to sample incident and reflected voltage in the transmission line under test. A superheterodyne vacuum tube voltmeter may be switched to either the incident or reflected coupler output. In the incident voltage position, a precision attenuator (calibrated directly in reflection coefficient and VSWR) is inserted in the IF amplifier circuit. The Meter's frequency range is 32 to 1125 mc. Sufficient sensitivity is provided for use with available signal sources.

For complete details, see your local Sierra sales engineer, or write direct for Bulletin 106.



Sierra Electronic Corporation

San Carlos 2, California, U.S.A.

Sales representatives in major cities

Manufacturers of Carrier Frequency Voltmeters, Wave Analyzers, Line Fault Analyzers, Directional Couplers, Wideband RF Transformers, Custom Radio Transmitters, VHF-UHF Detectors, Variable Impedance Wattmeters, Reflection Coefficient Meters.

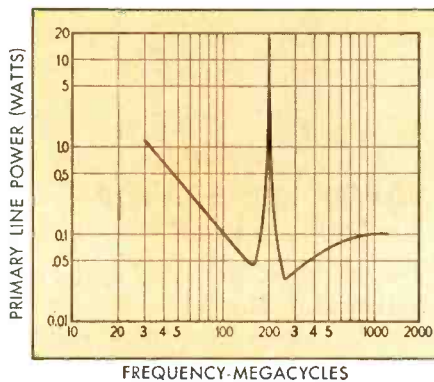

Figure 1. Sensitivity, Model 136A. Primary line CW power required to read reflection coefficient .02 as function of frequency. (Values for Sierra Models 138 and 138A Couplers).

Data subject to change without notice.

2960



NEW PRODUCTS

Edited by WILLIAM P. O'BRIEN

Control, Testing and Measuring Equipment Described and Illustrated . . . Recent Tubes and Components Are Covered . . . Fifty-Two Bulletins Reviewed

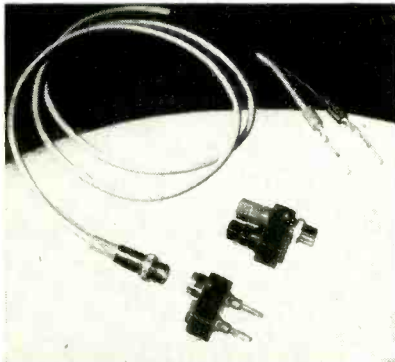

CONVERSION PLUGS aid interconnections in lab

MILLIVAC INSTRUMENT CORP., 444 Second St., Schenectady 6, N. Y., offers two new conversion plugs to simplify interconnections between measuring instruments and other electronic laboratory equipment having old-style $\frac{3}{4}$ -in.-spaced banana plugs, or the corresponding jack-type terminals, with other instruments having new-style concentric Amphenol terminals and plugs. The CP-122 (Amphenol-to-spaced jacks) and CP-221 (spaced-plugs-to-Amphenol) enable users to plug old equipment into new meters and scopes or to use the shielded clip lead, CL-101, for older equipment having spaced terminals. All Millivac instruments are equipped with concentric plugs.



D-C AMPLIFIER weighs 10 oz

ELECTRO-MECHANICAL RESEARCH, INC., P. O. Box 307, Ridgefield,

Conn. Model 55A subminiature stabilized d-c amplifier is designed for telemetering or recording the outputs of thermocouples and d-c excited strain gages. Frequency response is ± 2 percent from d-c to 10 kc. Gain is 1,000. Noise is less than $25 \mu\text{v}$ rms equivalent input signal at normal ambient temperatures. Drift is an output zero offset which does not exceed $\pm 25 \mu\text{v}$ equivalent input signal. Nominal input range is 0 to ± 5 mv. Output impedance is less than 50 ohms. Input and output are referred to ground. Including its nine-pin octal plug, overall dimensions are $5\frac{1}{2}$ in. \times $1\frac{7}{8}$ in. \times $1\frac{1}{8}$ in.

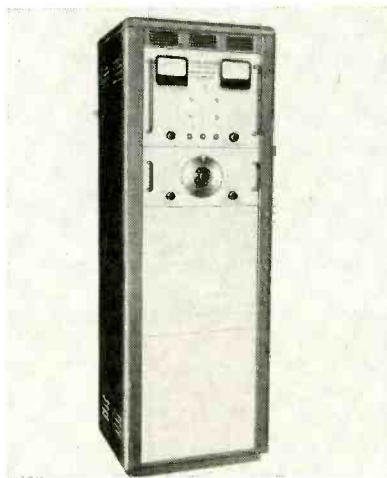

POWER GENERATOR has 500-v-a output

INDUSTRONICS, Box 424, Arlington Heights, Ill. Model 1000A variable-frequency power generator will deliver 500 va over a wide portion of the audio spectrum. Excellent voltage regulation is maintained over the entire voltage range of 0 to 250 v. Maximum power is available at any voltage between 25 and 250 v. The system consists of an audio

OTHER DEPARTMENTS

featured in this issue:

	Page
Electrons At Work	196
Production Techniques	250
Plants and People	332
New Books	383
Backtalk	399

oscillator driving a linear high-power amplifier followed by stabilizing and voltage-control networks. Complete technical specifications and operation data are available in a single-sheet bulletin.

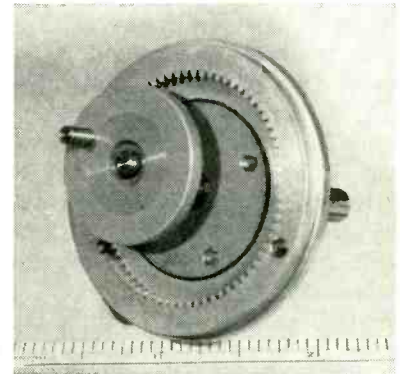

SINE-COSINE DEVICE for analog computers

LIBRASCOPE, INC., 1607 Flower St., Glendale, Calif., announces the sine-cosine mechanism, a new component for analog computers, which accurately converts angular rotational movements into linear sine or cosine movements. It offers instantaneous solutions to problems of changing variables involving vector components, range and bearing computation, flight computation and many other trigonometric functions. Design features include positive preset indexing (3 position, 90 deg. apart), low friction, high accuracy and simplicity of design in a completely self-contained unit. The mechanism has a conventional 3-lug

INTRODUCING

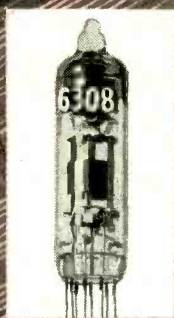

THE...

6308

SUBMINIATURE VOLTAGE REFERENCE TUBE

Another Sylvania Premium Subminiature Tube!
Type 6308 subminiature is a cold cathode, glow discharge diode . . .
especially designed by Sylvania for voltage reference applications.

Initial reports from engineers who have made comparative tests indicate that such critical performance factors as stability, drift, repeatability and voltage jump have been better attained with the 6308 than with other tube types of this classification.

This tube incorporates the excellent performance features of the Sylvania premium subminiature line and

will provide dependable service under severe environmental conditions. Before selecting a voltage reference tube for your particular application, we urge you to check the ratings and controlled characteristics of the Sylvania 6308. For further information, call your Sylvania Sales Engineer or write Dept. 4R-1601 at the address below.

ELECTRICAL DATA

RATINGS—Absolute Values

Maximum Operating Current (dc)	3.5 ma
Minimum Operating Current (dc)	1.5 ma
Maximum Shunting Capacitance	0.02 uf
Maximum Starting Voltage (dc)	115 volts

CHARACTERISTICS

Operating Voltage ¹ (dc)	87 volts
Voltage Regulation (max.)	3 volts
Drift ²	200 mv
Stability ³	5 mv
Repeatability ⁴	150 mv
Voltage Jump ⁵	50 mv

Maximum Average Temperature Coefficient of DC Operating Voltage:

-20 °C to +25 °C Ambient	-15 mv/°C
+25 °C to +60 °C Ambient	-5 mv/°C

Notes:

- (1) Anode voltage drop may range between 82 and 92 volts for any tube.
- (2) Maximum operating voltage change during one hour of operation, at any specific value of current within operating range.
- (3) Maximum operating voltage fluctuation having a frequency of 10 cps or greater, at any specific value of current within the operating range.
- (4) Maximum shift in operating voltage between successive firings of tube.
- (5) Maximum sudden jump in operating voltage when operating current is varied slowly over specified range.



Sylvania Electric Products Inc., 1740 Broadway, New York 19, N. Y.
In Canada: Sylvania Electric (Canada) Ltd., University Tower Bldg., St. Catherine Street, Montreal, P. Q.

LIGHTING • RADIO • ELECTRONICS • TELEVISION

arrangement for mounting, weighs 2 oz and is accurate to 0.2-percent full scale.

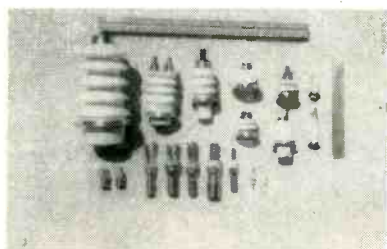

HERMETIC TERMINALS are high-temperature units

THE CERAMASEAL CO., Box 25, New Lebanon Center, New York, has available hermetic high-temperature terminals, produced by brazing metal members on to high-alumina ceramic, using a new sealing process and using BT as the bonding alloy. They have been used at 350 C and higher temperatures are possible with the use of other alloys. Thermal shock resistance is also high. The size range and general configuration of the terminals are shown. To date, the largest made by the company is about 6 in. tall by about 3 in. in diameter, but larger and longer types are possible.

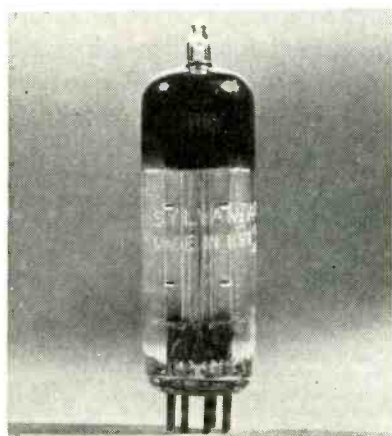

DISCRIMINATOR TUBE is gated-beam type

SYLVANIA ELECTRIC PRODUCTS INC., 1740 Broadway, New York 19, N. Y. Type 6BN6 gated-beam discriminator tube performs the function of limiter, discriminator and audio amplifier. The T-5½ miniature is quite different in its characteristics from the usual amplifier pentode.

Because of its sharply focused electron beam, the first control grid has a step-shaped control characteristic, the plate current rising abruptly from zero the sharply defined maximum as the grid voltage changes from negative to positive. The second control grid has similar properties, controlling plate current from a cutoff condition at negative bias up to a slightly positive condition. Beyond this point it loses control of the plate current which is limited to a level defined by the first control grid and the electron beam.

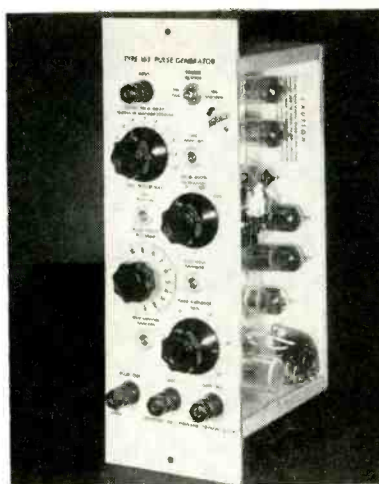

PULSE GENERATOR features fast rise

TEKTRONIX, INC., P. O. Box 831, Portland 7, Oregon. Type 163 pulse generator is a new addition to the type 160 series of special waveform generators. It is designed to supply rectangular pulses of less than 0.2- μ sec rise time when triggered by either a positive pulse or a negative-going sawtooth from an external source. A positive pulse of calibrated continuously-variable amplitude from 0 to 25 v peak to peak, and a positive gate of 25 v fixed amplitude are supplied. The pulse and gate are identical in other characteristics. Duration is calibrated and is continuously variable from 1 μ sec to 10,000 μ sec. When triggered by a sawtooth voltage, the output may be delayed a calibrated interval from 0 to 100 percent of the duration of the sawtooth. Decay time is 0.2 μ sec and overshoot can be adjusted to zero.



TINY CAMERA TUBE for commercial tv

RADIO CORP OF AMERICA, Harrison, N. J. Type 6326 film-pickup Vidicon measures only 1 in. in diameter and 6½ in. in length. It makes possible simpler, more compact, lower-cost tv film cameras and associated equipment for broadcast film pickup. It has a resolution capability of approximately 600 lines and needs only one-third to one-half the light requirements of an iconoscope for televising motion-picture films. For televising transparencies and opaques, the light requirement is only one-twentieth of that needed for film pickup. It is the first tv film-pickup camera tube to develop a signal-to-noise ratio sufficiently high to allow effective use of aperture correction, an operating technique for increasing the clarity of fine details in the transmitted picture.



ELECTRONIC COUNTER has million-count capacity

ATOMIC INSTRUMENT Co., 84 Massachusetts Ave., Cambridge 39, Mass. Model 162A glow-transfer counter has a maximum capacity of 1,000,000 counts with a speed range of 0 to 5,000 counts per sec. All counting, indication and transfer are done within the cold-cathode glow tubes upon which the counter is based. These tubes have bright-red neon glows opposite numbered circular spacings (0 to 9) to show accumulated count. Two units can be run in cascade, with one of the units feeding millions into the other. A

audiotape TRADE MARK now available

on new

Fiberglas

10½" reel

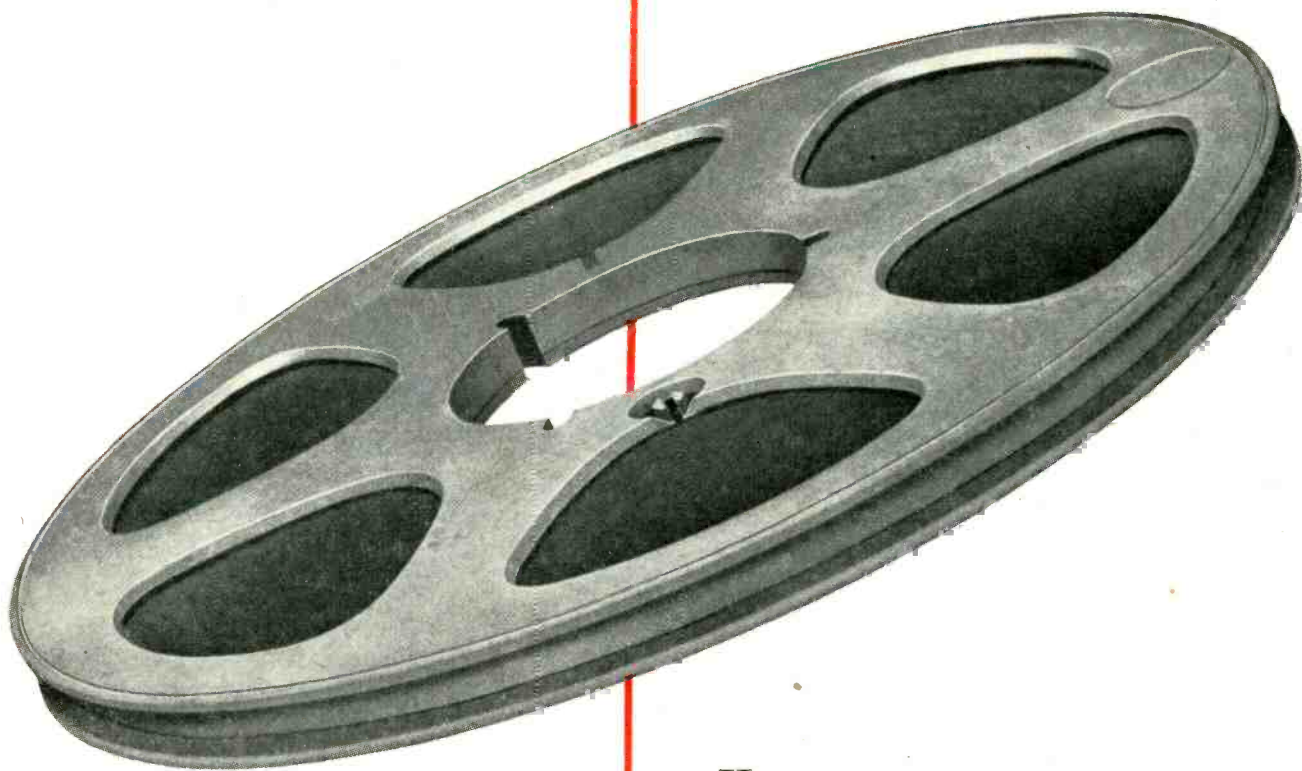

SOLID, ONE-PIECE CONSTRUCTION

STANDARD N.A.B. HUB DIAMETER

25% LIGHTER THAN ALUMINUM REEL

HAS SMOOTHER FLANGE EDGES

WILL NOT BEND

RESISTS WARPING AND DISTORTION

PRACTICALLY INDESTRUCTIBLE

HERE'S A NEW 2500-foot reel with a number of improved design features that will appeal to many tape recordists.

Audiotape can now be supplied on this light-weight Fiberglas reel at *no increase in price*. For a trial order, get in touch with your nearest Audio distributor. If he doesn't have the new reels in stock, have him contact our New York, Chicago or Hollywood office and we'll see that your requirements are promptly filled.

This is another example of how Audiotape gives you *extra value* at no extra cost. Its performance speaks for itself. Output, frequency response, noise level and distortion are correctly proportioned for the most satisfactory end result—with no compromise on quality anywhere along the line.

AUDIO DEVICES, Inc.

444 MADISON AVE., NEW YORK 22, N. Y.

Offices in Hollywood — Chicago

Export Dept., 13 East 40th St., New York 16, N. Y., Cables "ARLAB"



**audiodiscs
audiotape
audiofilm
audiopoints**

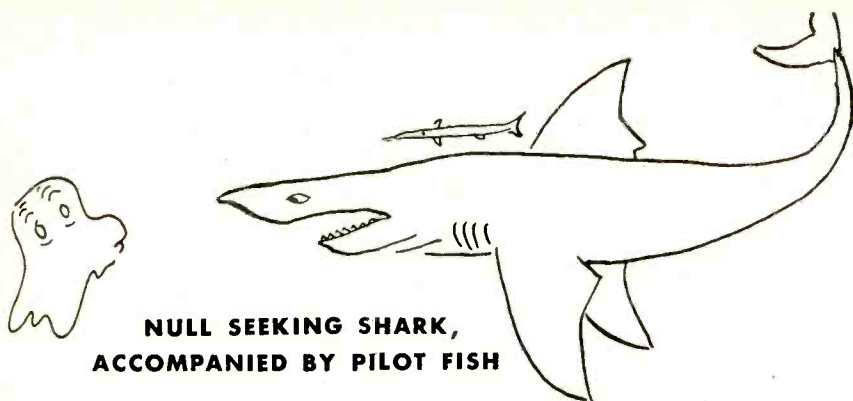

jack in the rear of the chassis provides for remote-control connection. The instrument will accept positive or negative pulses or sine waves of 4 to 60 v, depending on control setting.

Like the pilot fish, Sigma has been darting along with the Electronic Sharks for many years, now leading, now following. The metaphor goes as far as you like.

In the matter of three-position or "null-seeking" relays, it's been mostly a case of the blind leading the blind down the garden path. With no coil signal, such relays are supposed to have a neutral condition with all switches open; circuits are to be made "to the left" for "minus" coil signals and "to the right" for "plus".

Our earliest attempt, the DP 1, had no positive centering or detent action; its armature moved a few thousandths proportionately to coil current and haphazardly with temperature, vibration, and the Zodiac. Contact pressure and reliability was 0.00983.

This was, of course, followed by the DP 2 which was twice as bad. Next came the 6FX, which actually is a serviceable device, doing very well as the output of a servo in a ship-steering device. Along similar lines, the 7JOX followed but is not notoriously reliable. (That blinding-flash-followed-by-dull-roar you just witnessed was some 7JOX users hitting the cosmic ceiling.)



The point to all this history is that we have never done a good job on a three-position relay, nor made any money on one. To this should be added that neither has anybody else so far as we know. Quite recently the government has developed one with all the virtues of the DP 1, only smaller.* . . . So we decided we'd have to do the job for insurance against the day the government is 480,932 units behind schedule.

Watch out, now. Here, like a lead balloon, comes some selling.

We are now announcing two new three-position relays. They will soon be available in sample quantities, no questions asked. (We're tired of asking a lot of fool questions about circuits and besides, there aren't any New Frontiers in this racket any more anyway.) They are supposed to have positive centering, be able to resist 10 or 15 g's at all the frequencies, and be thermally stable; and they may well once and for all make some of the circuits for which they are intended reliable.



23JOX & 23JMX 1 1/8 x 1 1/8 x 2 1/2 Base: Octal & Magnal	73JSX & 73JNX 3/4 Round x 1 1/8 High Base: 7- and 9-pin miniature
Single coils up to 14,000 ohms Double coils up to 4,000 ohms Contacts DPDT and SPDT, 2 amp. rating Operate: 12 MW DPDT 8 MW SPDT single coil Release: 2 MW single coil	Single coils up to 7,000 ohms Double coils up to 3,500 ohms Contacts SPDT, 1 amp. rating Operate: 10 MW single coil Release: 1 MW single coil

Both types have all contacts open when no coil signal is present. One set of contacts makes on one polarity, the other, on the other.

If you're seeking a null-seeking relay, your troubles have just started. We dare you to write for preliminary dope sheets and application data.

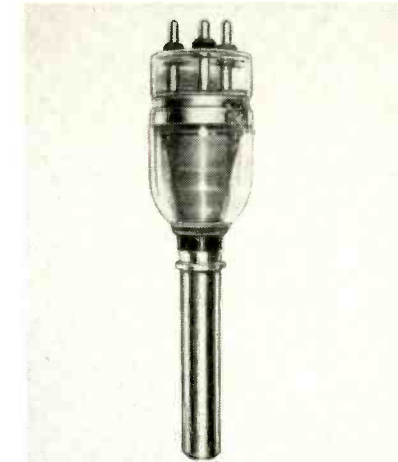

RUGGEDIZED TRIODE is improvement on type 892

AMPEREX ELECTRONIC CORP., 230 Duffy Ave., Hicksville, L. I., N. Y. Incorporating the latest developments in tube design and techniques, the type 6333 fills the requirements of the industrial and communication fields for a tube that is completely interchangeable with the 892 prototype and yet is superior in mechanical construction, performance and shock-resistance qualities. Among the outstanding features of the new tube are a powered glass stem, Kovar grid ring, shorter overall length, internal conical grid support, Kovar anode seal, spiral filament and lower inductance.

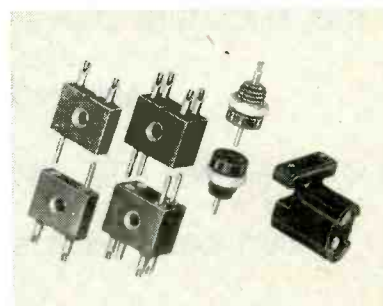

CONNECTORS feature special design

DEJUR-AMSCO CORP., 45-01 Northern Blvd., Long Island City 1, N. Y.,

SIGMA

SIGMA INSTRUMENTS, INC.

62 PEARL ST., SO. BRAintree, BOSTON 85, MASS.

* WE MEAN EXACTLY THE VIRTUES OF THE DP 1.

has added four special-design connectors to its Continental line. The miniature rectangular 2 and 4-contact reverse pin and socket connectors are particularly adaptable to small equipment because of their novel countersunk side-mounting arrangement. The one-pin round connector is extremely small and light and completely devoid of excess hardware. The two-contact high-voltage socket has an unusual shape and close mating tolerances. All are available in three different insulating materials: mineral-filled Melamine; Plascon fiber-glass reinforced Alkyd, type 440-A; and Diallyl Phthalate. Contacts are silver and gold plated and normally have solder wells for No. 20 AWG wire.



SILICON DIODES for 6,750 mc

MICROWAVE ASSOCIATES, INC., 22 Cumington St., Boston 15, Mass. Four new cartridge-type silicon diodes have been developed for mixer use in microwave systems utilizing RG 50/U waveguide. These diodes are physically interchangeable with the standard 1N23B and 1N21B but are designed for optimum performance at 6,750 mc in the P-570 mixer. In this mixer the 1N150 diode presents a match of better than 1.5 to 1 at 1 mw level. The 1N150 and its reversed polarity counterpart are manufactured to such narrow limits that they can be used in balanced mixers without selection. In such mixers noise figures of approximately 10 db are obtainable over broader bandwidths than possible with 1N23C diodes at this wavelength. The 1N160

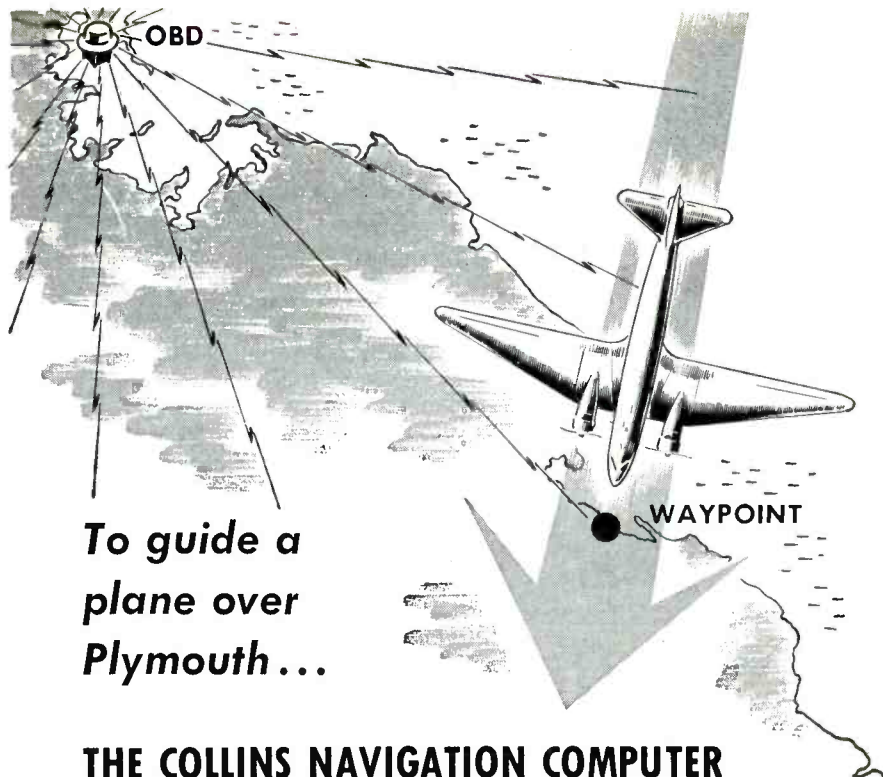

**To guide a
plane over
Plymouth...**

THE COLLINS NAVIGATION COMPUTER DEPENDS ON THE ACCURACY OF FAIRCHILD POTENTIOMETERS

To guide a plane over Plymouth, Massachusetts, or over any waypoint within range of an omni-bearing-distance navigational station, Collins Radio Company has developed the Type CA1477 computer. In this computer, two 3-gang and one 2-gang Fairchild Type 747 potentiometers are set by the pilot or by servomechanisms to supply output voltages to the computing elements.

These Fairchild potentiometers were selected by Collins because they have the high electrical and mechanical accuracy necessary for such an exacting computing job. The inherent long-life characteristics of these potentiometers were also important because the computers have to stay in service over a wide range of operating conditions.

If you're designing a computer or other equipment that requires potentiometers with high electrical and mechanical accuracy, write the Potentiometer Division, Fairchild Camera and Instrument Corporation, 225 Park Avenue, Hicksville, Long Island, Department 140-44A.



The FAIRCHILD TYPE 747 POTENTIOMETER

This potentiometer was modified to meet Collins' exact needs. If you have a specialized application, let Fairchild design the potentiometer to fit your requirements.

FAIRCHILD
PRECISION POTENTIOMETERS

Only A "MULTI-CHANNEL" SCOPE

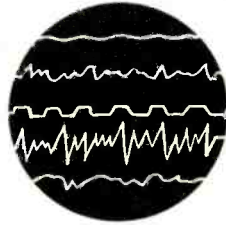

LETS YOU SEE, MEASURE, AND RECORD
Simul-Scopic* SIGNALS LIKE THESE

Take any two simultaneous events . . . the input and output of a circuit, speed and vibration, velocity and acceleration. To compare them you might rig up two ordinary scopes. But from there on in you've got double-trouble. You either get a stiff neck looking from one scope to the



THE STIFF-NECK STINT

other, or you diverge your eyes and let 'er rip.

If you don't happen to be gifted with double vision, you might turn



THE WIDE-EYED WATCH

to science's substitute—an optical system. Now the two traces of light are bounced from the c-r tube faces to a single viewing screen. If you are lucky enough to approach this delicate monstrosity without damaging it by breathing, you still might not find those elusive pips you're after. Somewhere along the long

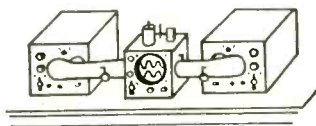

THE OPTICAL OPPRESSION

light path, your signals got all bounced out, maybe right out of the picture.

In case you're also not gifted with a high-frequency switching neck, you can always fall upon an electronic switch. With this built-in gadget, a single tube switches rapidly from one phenomenon to another for you. And the switching is so fast, that two traces appear on the face

of the tube. Although such traces are sometimes optimistically called "dual-trace", only the limitation of your own eyes keeps you from seeing them blink like a neon sign. And if the signal you're after should be faster than the switch, you've missed it. If it's a one-shot measurement, you've had it!

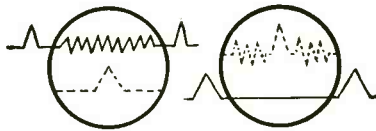

THE MISSED-SWITCH METHOD

These shortcomings become proportionately worse as the number of phenomena you wish to measure increases. An optical system gets bulkier losing more light at the same time, while an electronic switch leaves you less of a chance to catch those high speed transients.

Actually, it's not economical to consider either. Both approach or even exceed the cost of the only practical system—ETC multi-channel oscilloscopes. Through the combination of 2, 3, 4, 6, or even eight electron guns in a single ETC cathode ray tube, you can see all the necessary phenomena on a single screen . . . just as clearly, just as accurately, and just as completely as the presentation on a single channel

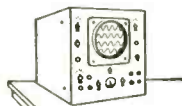

THE Simul-Scopic SYSTEM

scope. There is no other solution so easy to use, so comprehensive in its presentation, and so economically practical. Our new catalog, *Oscillography . . . Key to the Unknown* shows you many more reasons why ETC scopes and tubes are best for simultaneous display. Write for your copy.

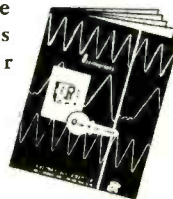

*Simul-Scopic—Two or more simultaneous events which can be observed on a cathode ray tube. (Reg. Applied For.)

electronic tube corporation

1200 E. MERMAID LANE, PHILADELPHIA, 18, PA.

(SD7000) and 1N160R (SD7000R) are similar to the 1N150 but are designed to slightly higher test limits.

MICROPHONES used with transistor circuits

SHURE BROTHERS, INC., 225 W. Huron St., Chicago 10, Ill., announces the MC series of magnetic microphones with a 1-in. diameter, and immune to varying conditions of heat and humidity. These controlled reluctance microphones were specifically designed for use with transistor circuits; but they are applicable to other devices—such as small, compact amplifiers and transmitters, as well as dictating equipment. Models MC10 and MC11 are similar, but MC11 has a mu-metal shield ring for reducing hum pickup. Both are identical in size: 1 in. in diameter, $\frac{3}{8}$ in. in thickness.

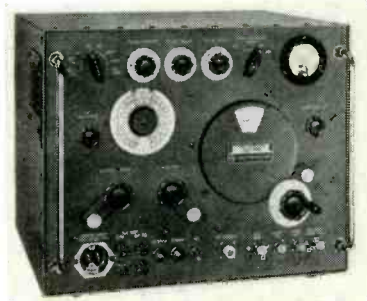

SIGNAL GENERATOR covers 7 to 11 kmc range

HEWLETT-PACKARD Co., 395 Page Mill Rd., Palo Alto, Calif. Model 620A signal generator offers direct frequency setting and readings from 7 to 11 kmc. It is designed to simplify all shf measurements including sensitivity, selectivity, rejection, signal-to-noise ratio, conversion gain, swr, antenna gain and transmission-line characteristics. It may also be used for slotted lines, waveguide and filter networks. It includes internal or external pulse modulation, internal square-wave modulation, frequency modulation and c-w output. Pulse width is variable from 0.5 to 10 μ sec and repetition rate is 40 to 4,000 pps. On internal f-m, the instrument provides a sawtooth sweep variable between 40 and 4,000 cps. For external f-m,

capacitive coupling is provided to the repeller of the klystron oscillator.

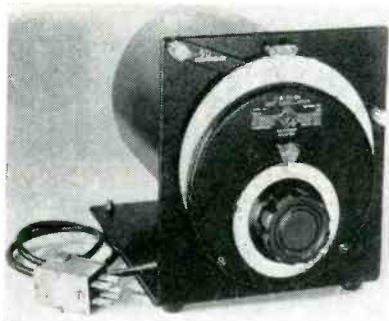

UNIT OSCILLATOR spans 0.5 to 50 mc

GENERAL RADIO Co., 275 Massachusetts Ave., Cambridge 39, Mass. Type 1211-A unit oscillator has a frequency span from 0.5 to 50 mc, covered in two 10-to-1 logarithmic ranges. Frequency is read directly from a 6-in. dial, with a slow-motion-drive dial indicating frequency increments of 0.2 percent per division. Output power is well over 1 w over the 0.5-to-5-mc range and is at least 0.2 w over the 5-to-50-mc range. Construction of the unit provides very effective shielding so that the instrument can be used as a power source in bridge measurements.

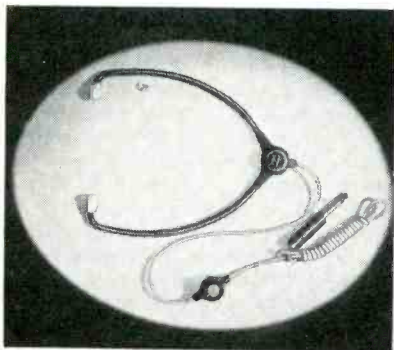

HEADSET weighs only 1.2 oz

TELEX, INC., Telex Park, St. Paul, Minn. Designed for professional, business and technical use, the Monoset (under-the-chin headset) is made of tough, durable Tenite and has an exclusive volume control for group-hearing system applications. Weighing only 1.2 oz, it has removable plastic eartips and a miniature, plug-in cord attachment. Sensitiv-

PRECISION-MADE...FOR DEPENDABILITY



WIRE-WOUND RESISTORS

There are many makes of resistors—but there is only one I-T-E quality. I-T-E wire-wound power resistors and precision resistors are especially designed and precision-built to meet the exacting standards required for critical electronic applications.



I-T-E fabrication combines laboratory precision and close quality control with modern production methods. As a result, you can obtain the exact type of high quality resistor you want—in any quantity you need.

I-T-E POWER RESISTORS

Non-hygroscopic ceramic foundations are in accordance with JAN specifications.

Purest resistance wires are uniformly wound to prevent shorted turns and excessive hot spots. All connections silver-soldered.

Vitreous enamel coating (organic if required) provides a glazed moisture-repellent surface with fast heat-dissipation qualities.

Advanced production methods assure high stability, long life.

Standard Tolerance: $\pm 10\%$, $\pm 5\%$ and less made to order.

Standard fixed resistors:

5-200 watts

Adjustable resistors:

10-200 watts

Oval resistors:

30-75 watts

Ferrule resistors:

12-200 watts

Special resistors:
built to specifications

I-T-E PRECISION RESISTORS

High-quality wire alloys are used—free from particles of impurity and grain growth.

Automatic precision winding assures even tension—eliminates hot spots.

Hermetic or vacuum-impregnated sealing protects against destructive effects of salts, moisture, and atmospheric conditions.

Accelerated aging process prior to calibration assures accuracy.

Critical quality control eliminates all resistors which do not come up to high I-T-E standards.

Standard Tolerance: $\pm 1\%$. Available in specified tolerances down to $\pm 0.05\%$.

TYPE A:

lightweight, hermetically sealed—for precision operation up to 125° C. Surpass JAN R-93 A, Characteristic A, and MIL-R-93 A specifications.

TYPE B:

vacuum-impregnated, moisture-resistant. For JAN R-93, Characteristic B, specifications.

RATINGS from 0.01 ohm — 10 megohms, 0.125 — 5 watts.

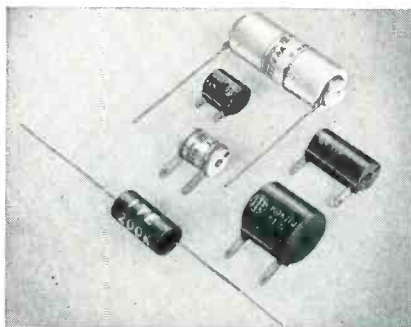

High sensitivity Deflection Yokes and compact, high-quality Focus Coils are also available in many types and ratings

FOR DETAILS—



WRITE FOR CATALOG
R-100.

WIRE-WOUND RESISTORS

RESISTOR DIVISION OF I-T-E CIRCUIT BREAKER CO.

1924 HAMILTON ST. • PHILADELPHIA 30, PA.

STABILITY! ACCURACY! PRECISION!

Carefully crafted for matchless performance, Silicohm and Dalohm resistors are designed and made to survive the most severe environmental, shock and vibration conditions.

Silicohm

Miniature Wire Wound POWER RESISTORS

Complete welded construction from terminal to terminal. Temperature coefficient 0.00002/deg. C. Ranges from 0.1 Ohm to 55,000 Ohms, depending on Type. Tolerance 0.05%, 0.1%, 0.25%, 0.5%, 1%, 3%, 5%.

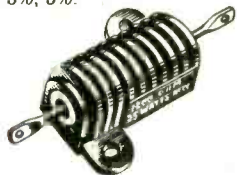

RH TYPE — Available in 25, 50 and 250 watt sizes. Silicone sealed in die-cast, black anodized radiator finned housing for maximum heat dissipation.

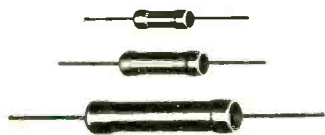

RS TYPE — Available in 2 watt, 5 watt, and 10 watt sizes. Silicone sealed offering maximum resistance to abrasion, high thermal conductivity and high di-electric strength.

DALOHM DEPOSITED CARBON RESISTORS



Dalohm precision deposited carbon resistors offer the best in accuracy, stability, dependable performance and economy. Available in 1/2 watt, 1 watt and 2 watt sizes.

Write, Wire or Phone George Risk,
1300 28th Ave., Columbus, Nebr.
for price and delivery.
Phone 2139.



DALE PRODUCTS, INC.

In Canada: Teletronics Corp., Ltd.
Toronto and Montreal

Want more information? Use post card on last page.

NEW PRODUCTS

(continued)

ity is 88 db above 0.000204 dynes per sq cm for 10- μ w input. An exclusive feature is the volume control mounted in the lightweight cord that clips to the lapel or pocket and permits use of a series of Monosets on one line. Literature is available.



TOROID COIL fits in tiny case

TORWICO ELECTRONICS, INC., 961 Frelinghuysen Ave., Newark, N. J. Extremely fine wire winding now makes it possible to put 18,000 turns of No. 46 AWG wire on the new miniature 20-henry toroid coils so that the coils can be housed in a very small hermetically sealed case, 1 1/8 maximum o.d. by 1/4 in. high. A 6/32 mounting stud is provided with the terminals that presents a nonturning or locking feature, when mounted in the chassis.

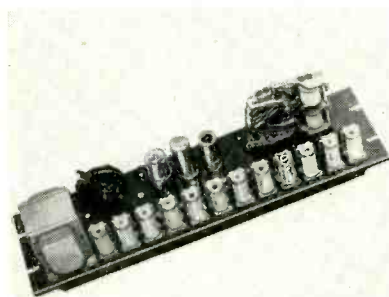

REMOTE SWITCHER is pulse-counting unit

THE HAMMARLUND MFG. CO., INC.,
460 W. 34th St., New York 1, N. Y.,

SHURE

THE "Field-Proved" STANDARD
IN COMMUNICATIONS...
INTRODUCES A NEW

TELEPHONE HANDSET

...the first Handset specially
engineered for two-way
communications



- 2-Way Radio Communications
- Inter-Com Systems
- Airplane Announce Systems
- P. A. Systems

Specially Designed to Suit Your Specific Applications

Here is a truly modern functional handset specifically designed for 2-way communications! A product of the Shure Laboratories with many years of experience in safety mobile communications, the TH10 Handset brings you these features: ... the field-proved controlled reluctance assembly as a receiver ... high output balanced response carbon transmitter ... oversize switch cavity providing flexibility in stacking of famous Shure long-life leaf blades ... cored handle for maximum number of conductors ... no solder connections ... rugged shock resistant handle ... design smart to the eye, natural in the hand. The answer to your complex circuitry!

SHURE

For more complete information
write to

SALES DIVISION

SHURE BROTHERS, Inc.

Manufacturers of Microphones & Acoustic Devices

225 W. HURON ST., CHICAGO 10, ILL.

Cable Address: SHUREMICRO

Want more information? Use post card on last page.

January, 1954 — ELECTRONICS

is producing a remote-control terminal unit that responds to and channelizes telephone-dial-actuated pulses to perform selective switching operations. It is applicable to control and signaling operations by railroads, public utilities, refineries, pipelines and many other industrial organizations. The PCU-2 pulse counting unit is operated from a telephone-type dial at the control center over a transmission media using either audio tone or d-c telegraph signals. A typical application is in its use for selecting any one of 10 telemetering circuits when only one transmission circuit is available for sending metered information. In this case the PCU-2 selects the metering circuit requested from the control point. It may also be used for controlling transmitters, receivers, lights, motors and any other item that can be adapted to electrical control.

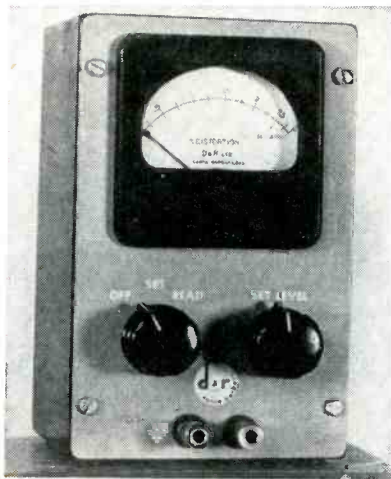

DISTORTION METER is a portable unit

D. & R, LTD., 402 E. Gutierrez St., Santa Barbara, Calif. Model DM-1 portable distortion meter is a precision, self-contained unit, so compact that it can be easily held in one hand. It measures at a single frequency, and differs radically from most distortion measuring equipment in that the filter suppresses a band of frequencies, making it unnecessary to balance for a null. Readings may be taken rapidly and are completely independent of flutter produced by the recording medium. The unit meets all requirements of NARTB tape noise-

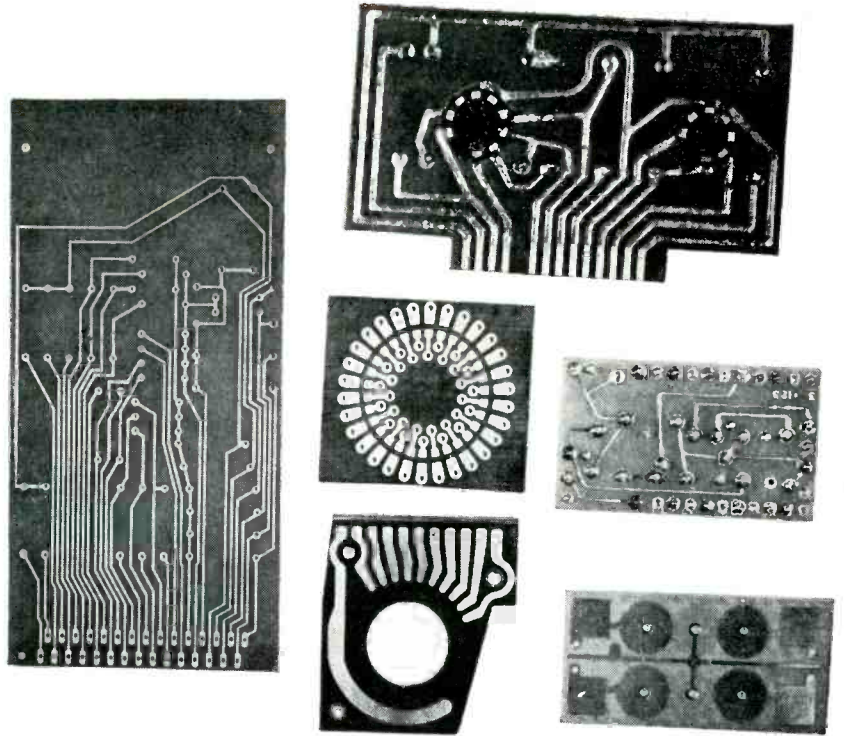

**Are You Switching to Printed Circuits?
You Need CASTOMATIC® Solder!**

Printed circuits save on solder and soldering time. In this work you don't use much solder and it doesn't cost much compared to what you are manufacturing. Therefore the solder should be the best quality you can buy . . . Federated CASTOMATIC bar solder. Here's why machine-cast CASTOMATIC is the best:

1. Free of Dross—the patented, pressurized casting system keeps air out; harmful dross-producing oxides are thereby excluded. Solder flows freely through tiniest openings. Your solder bath stays cleaner.
2. Uniform Composition—electronically controlled machine casting eliminates segregation of constituents. Joints are trouble-free. Every bar of a given analysis melts at the same temperature. Each piece of a bar of eutectic solder, for example, will melt at almost exactly 362°F.

Ask for a sample of CASTOMATIC. It will prove itself. Just return coupon for prompt action.

Picture courtesy Photocircuits Corp., Glen Cove, N. Y.

Federated Metals Division

AMERICAN SMELTING AND REFINING COMPANY
120 BROADWAY, NEW YORK 5, N. Y.

In Canada: Federated Metals Canada, Ltd., Toronto and Montreal

- Please send a salesman.
- Please send me a sample of CASTOMATIC solder.



MY NAME _____ TITLE _____

COMPANY NAME _____

ADDRESS _____

CITY _____ ZONE _____ STATE _____

Ceramic Insulated for LOW LOSS... MINIMUM CREEPAGE NEW TYPE 2C TAP SWITCHES

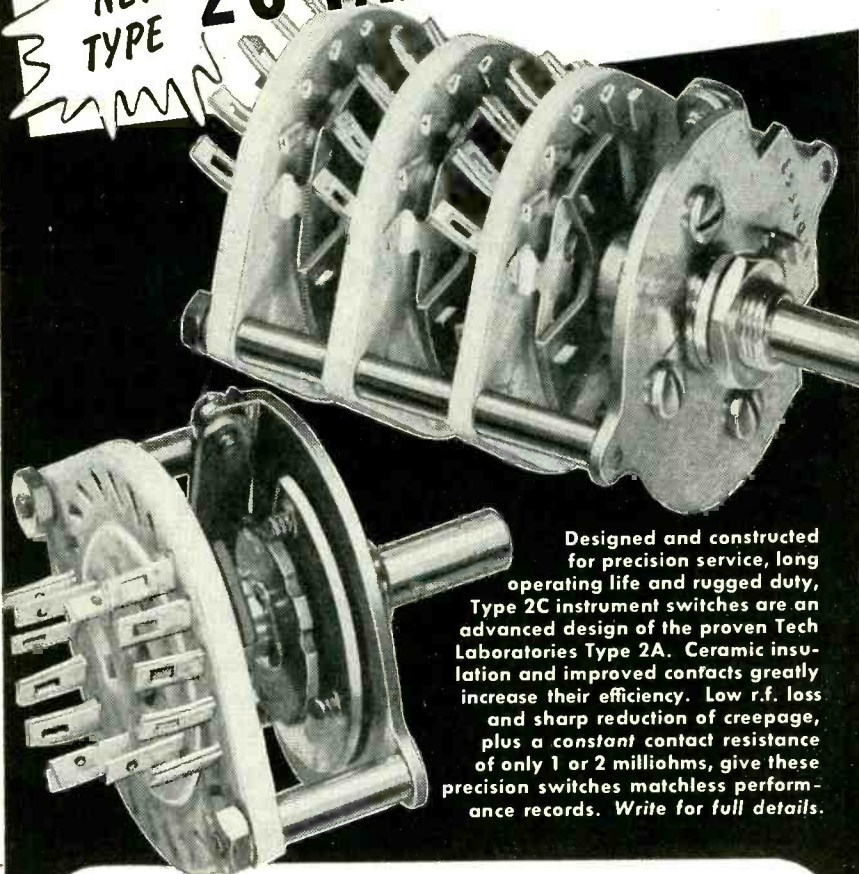

Designed and constructed for precision service, long operating life and rugged duty, Type 2C instrument switches are an advanced design of the proven Tech Laboratories Type 2A. Ceramic insulation and improved contacts greatly increase their efficiency. Low r.f. loss and sharp reduction of creepage, plus a constant contact resistance of only 1 or 2 milliohms, give these precision switches matchless performance records. Write for full details.

SPECIFICATIONS

Contact resistance: 1-2 milliohms

Contact material: Silver alloy

Contact design: Laminated wiper arm, self-cleaning, shorting or non-shorting

No. of contacts: 2 to 24 single pole, shorting or non-shorting
2 to 11 double pole, shorting or non-shorting
2 to 5 triple pole, shorting or non-shorting

Spacing: 15° or 20°, shorting or non-shorting

No. of poles per deck: 1 to 4

No. of decks: According to requirements

Life: 200,000 cycles, min.

Current carrying cap.: 3 amp.

Max. operating voltage: 120 V., a.c.

Mounting: Single hole, 3/8"-32 bushing, standard length for up to 1/4" panel, special lengths to order

Size: 1 3/4" dia.

Detent: Ball and spring

Weight: Approx. 1 oz. per deck



Manufacturers of Precision Electrical Resistance Instruments
PALISADES PARK, NEW JERSEY

level measurement. It is especially suited for production and maintenance requirements in radio broadcasting stations, tv stations, recording studios, audio equipment plants and for high-fidelity technicians and enthusiasts.

VARIABLE CAPACITOR for 500 mc and higher

TRI-POINT MFG. & DEVELOPMENT Co., 401 Grand St., Brooklyn, N. Y., has announced a new uhf Teflon variable capacitor for 500 mc and higher. Advantages include: heat resistance (even soldering will not affect the capacitor); extremely low dielectric loss; nonabsorbency of moisture under all conditions; minimum shrinkage in production; no effect on the Q of any coil or line with which the capacitor is used. Capacitance will not change through vibration once the screw is set. These capacitors come in a wide range of values.



DATA RECORDER features speed and accuracy

BARNES DEVELOPMENT Co., 213 W. Baltimore Pike, Lansdowne, Pa. A new model data recorder takes 100 identifiable readings on an 8 1/2 x 11 in. chart. The chart may be removed and replaced with accurate indexing. This permits the collection of test data, taken at different times, on a single chart. Simplicity of operation permits a nontechnical operator to take up to 600 bridge readings an hour. The unit can be used for any bridge or potentiometric type measurement. The print drive servo has a sensitivity of 25 μv. Full scale spans as low as 15 mv are practical. A typical

use is in production control or acceptance testing of resistors.

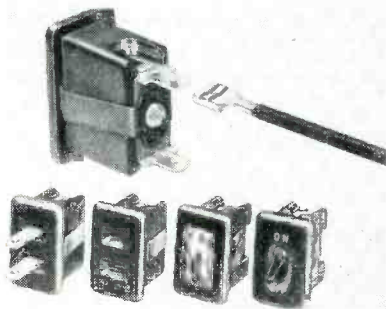

SNAP-IN DEVICES
with spade terminals

THE HART MFG. CO., 110 Bartholomew Ave., Hartford, Conn. Diamond H snap-in switches, outlets, pilot lights and interconnecting load plugs are now available with spade terminals for A-MP quick-connectors as well as with standard screw terminals. These snap-ins are simply pushed into mounting holes where spring clips hold them firmly in place. Switches are rated at 15 and 20 amperes, 125 v; 10 amperes, 250 v a-c, and also are available with horsepower ratings. Pilots are rated 115 v or 230 v a-c.

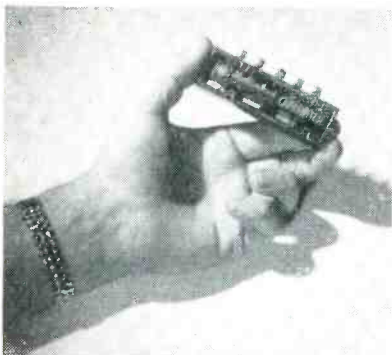

NONMAGNETIC RELAY
has new operating design

MULLENBACH ELECTRICAL MFG. CO., 2300 E. 27th St., Los Angeles 58, Mass. The Capaswitch is basically an ultrasensitive, nonmagnetic d-c relay with unusual current carrying capacity. An entirely new operating principle is used to provide the mechanical energy to open and close the contacts. Instead of the conventional electromagnetic armature, it uses an electrostrictive capacitive element (0.05 μ f), requiring only

Want a rugged high frequency capacitor able to withstand extreme vibration?

CERAMIC SOLDERED*

SPECIFY JOHNSON
TYPE "L" CAPACITORS

Single

Butterfly

CERAMIC SOLDERED*

An important forward step in variable capacitor design. Bonding points on steatite end frames are subjected to a special metalizing process; then stator rods and rotor bearing are soldered (under carefully controlled heat) directly to the steatite. Resulting bond is permanent and vibration proof.

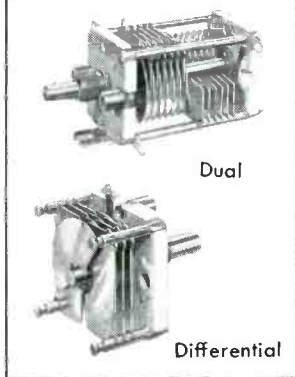

Full soldered construction and rugged design make JOHNSON type L high frequency capacitors the perfect choice for any electronic application requiring extreme stability and rigidity. Rotor bearing, stator rods, and structural tie rods are soldered direct to 3/16" steatite end frames. Tests prove resulting ceramic to metal bond is stronger than the rugged end frames themselves . . . won't loosen or break loose in roughest vibration . . . rotor and stator alignment is permanent, capacity wobble is eliminated.

OTHER DESIGN FEATURES

Extra thick (.020) brass plates and large diameter (1/8") stator rods for extremely low inertia mass . . . special split sleeve tension bearing and silver plated beryllium copper wiring contact for constant torque and smooth silent capacity variation even at highest frequencies. Standard spacing .030 rated at 1,500 volts peak DC breakdown; over 500 volts peak at 50,000 feet altitude. Panel space required 1 3/8" square. Mounting posts tapped 6-32 on 1-3/32" centers. Shaft is 1/4" with screwdriver slot. Standard plating corrosion-resistant bright alloy.

Write today for quotations or additional data

E. F. JOHNSON COMPANY

CAPACITORS • INDUCTORS • SOCKETS • INSULATORS • PLUGS • JACKS • KNOBS • DIALS AND PILOT LIGHTS

231 SECOND AVENUE SOUTHWEST • WASECA, MINNESOTA

STEVENS

snap-action thermostats for wide or narrow differentials

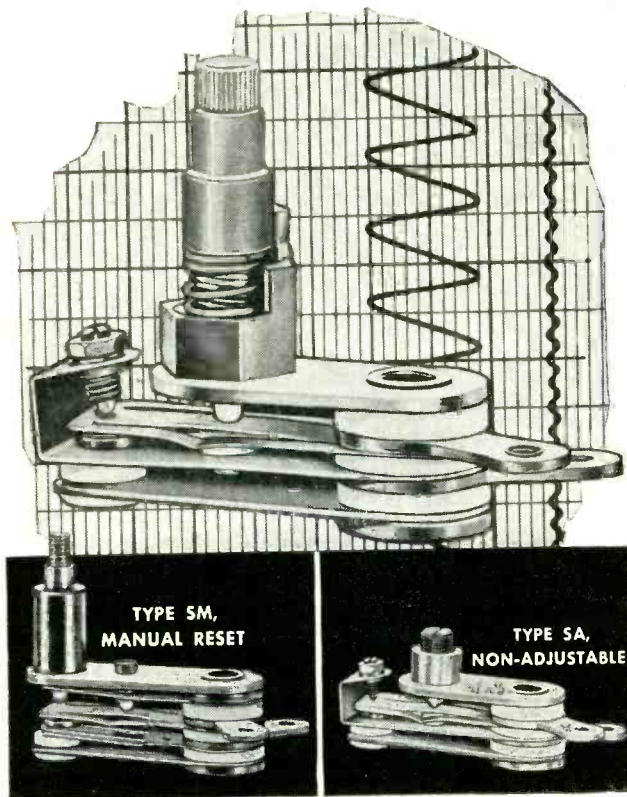

If your product requires sensitive, snap-action control characteristics, better check Stevens Type SA thermostats *first*. For these small, snap-acting thermostats can be used with differentials as wide as 100°F . . . or as narrow as 10°F. Furthermore, standard models are available in adjustable, non-adjustable, manual reset, or single-pole double-throw styles.

You can't beat Stevens Type SA thermostats for sensitive, precise response because they feature an electrically independent bimetal element in metallic contact with the mounting base. Contact pressure is positive until actual instant contacts snap open. Available with virtually any type terminal arrangement, Type SA thermostats are mechanically interchangeable with the widely used Stevens Type S thermostats.

To protect the performance of your product, always specify Stevens Type SA thermostats—they perform better, last longer. Request Bulletin L-6397.

*Patents Applied For

A-7200

STEVENS manufacturing company, inc.
MANSFIELD, OHIO

0.5 mw-second of operating power (150 v d-c) to close the contacts, and less than 0.1 mw to hold them closed. The present unit weighs only 2 oz and measures 3½ in. long, 1½ in. wide including terminals, and ¼ in. thick. Model A Capaswitch is a spdt relay, rated at 1 ampere, 110 v a-c noninductive load.

MICROWAVE ANTENNA for field broadcast use

RADIO CORP. OF AMERICA, Camden, N. J., has announced a 2-ft parabolic reflector designed to meet broadcasting demands for a microwave dish that is readily portable through narrow passages or through small apertures to reach the desired field transmitting point. The MI-26182-51 reflector is a light-weight antenna, easy to manipulate, and especially designed for very short hops within the city such as street to building top, building to building or remote truck to building top. It provides good performance in transmission paths of up to 5 miles.



ROTARY SWITCH has 8 poles on one deck

THE DAVEN CO., 191 Central Ave., Newark, N. J. Type 87-EM rotary switch has 8 poles on one deck, a feature made possible by the company's knee-action rotor, which gives uniform contact pressure and low contact resistance throughout the life of the switch. The unit measures 2½ in. in diameter, and is 1¼ in. deep. It is available in multiple deck arrangements if required. From 1 to 5 positions per pole are available with shorting-type action;

up to 3 positions per pole with non-shorting action. A 15-deg spacing is used between live positions with the shorting-type action; 30-deg spacing with nonshorting action. Current-carrying capacity of the switch is 15 amperes.

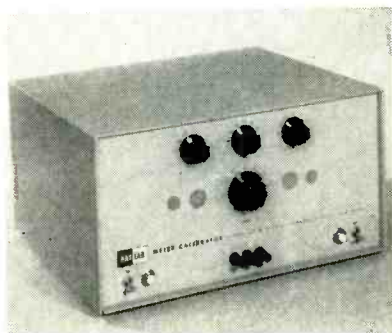

METER CALIBRATORS available in four models

KALBFELL LABORATORIES, INC., 1090 Morena Blvd., San Diego 10, Calif. Models M30B-1 and M30B-1Z are precision voltage calibrators affording calibrated output voltage from 1 to 300 v variable in 1-volt steps and variable between steps by a calibrated potentiometer. Model M10A-10 is a combination voltage and current calibrator supplying 0 to 100 v at 100 ma maximum, variable in 0.1-v steps; and 0 to 100 ma at 100 v maximum, variable in 0.1-ma steps. Model M100A-20 is a current and voltage calibrator with a voltage range from 0 to 1,000 v at 200 ma maximum and four current ranges. The output current ranges are 0.1, 1.0, 10 and 100 ma with a capacity of 1,000 v maximum. The M10A-10 and M100A-20 employ a special circuit that allows for the adjustment of the output voltage and current down to zero.

SSB FILTERS for amateur use

BURNELL & Co., 45 Warburton Ave., Yonkers 2, N. Y., has released a single-sideband filter that will appeal to amateur users and manufacturers of low-cost commercial sideband receivers. The type S-15000 consists of stabilized toroids and other high-quality components that will attenuate a 50-kc carrier 20 db and most of the upper sideband, 40 db. Audio response through the

Why Corning High-Temperature Film-Type Resistors

*are more rugged,
more stable*

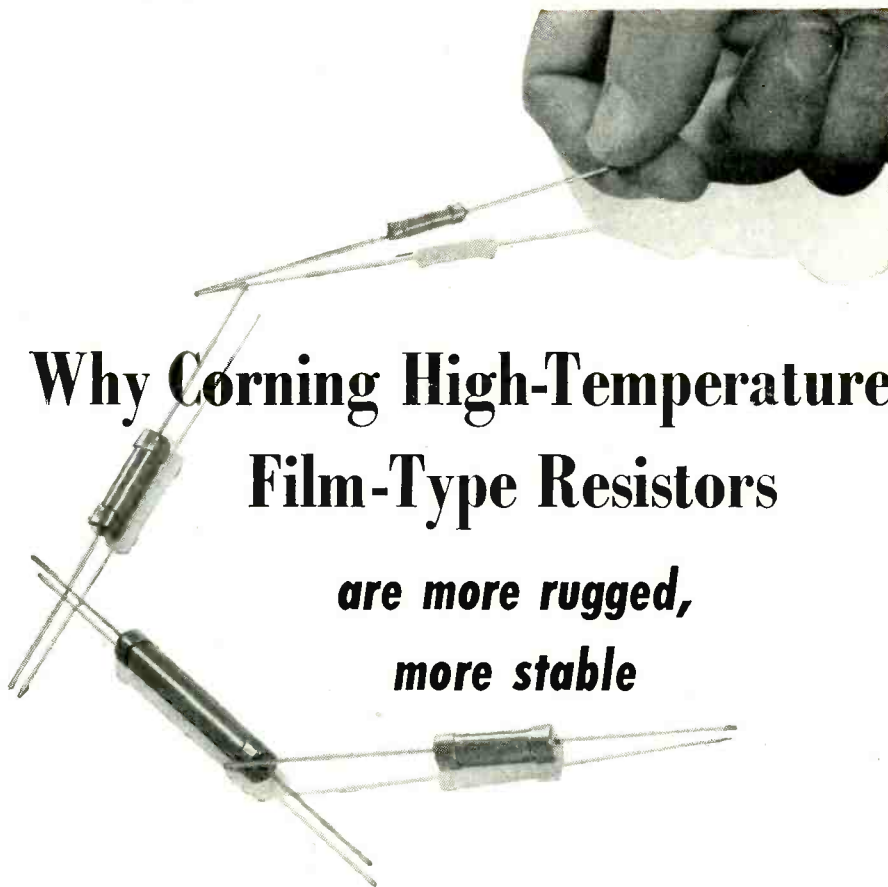

The answer lies in the way we make them. The base material is a special heat-resistant glass that not only has excellent temperature and electrical characteristics but is tough enough to withstand real abuse.

The film material, too, is entirely new for resistors. Fired in at red heat, it becomes an integral part of the glass form. And it's so stable it can be cycled from near absolute zero to red heat with little effect in its electrical properties.

Silver bands are fired in for terminations that have low resistance and low noise characteristics. And silver plated end caps are expansion fitted over the silver terminations to give a silver-to-silver contact that is both electrically and mechanically sound.

Then, a silicone varnish is baked onto the resistor which completely reduces the risk of entrapped moisture, gives better protection against external moisture and humidity and abrasion. The unit can be rubbed with a nail file without materially affecting its electrical characteristics.

It all adds up to this. If you want a high-temperature resistor that's electrically stable, mechanically rugged, then investigate Corning Type S Resistors. They can be operated at ambient temperatures up to 200°C. and at higher power levels to save space. The thin film construction and inherent stability provide excellent high-frequency characteristics. Normal resistance tolerance is 2%.

Get the details by sending the coupon below.



CORNING GLASS WORKS DEPT. EL.-1, CORNING, N. Y.

Please send me information on:

- CORNING (High-Temperature) Type S Resistors, CORNING (Accurate Grade) Type N Resistors,
 CORNING Load Resistors.

Name..... Title.....

Company.....

City..... Zone..... State.....



THREADED I. F. CORE

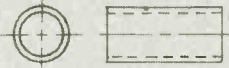

SLEEVE CORE



"E" CORE



TOROID



CUP CORE



DUMBELL CORE

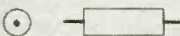

IRON CORE COIL FORM



PLAIN CORE



INSERT CORE



TUNING CORE

Radio Core Quality Control

All Radio Cores manufactured are produced with special attention to both mechanical and electrical tolerances, resulting in lower incoming inspection and assembly costs on the part of the customer.

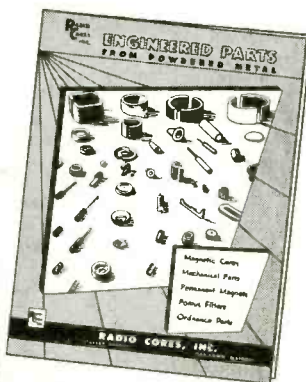

Detailed Radio Core information, samples, designs and specific costs may be obtained by writing Department No. E-1-54S

Write for "Engineered Radio Cores" Technical Data Booklet No. E-1-54

Radio Cores, Inc.

9540-50 Tulley Avenue Oak Lawn, Illinois



filter would be 300 cycles to 3,300 cycles.



REFLEX KLYSTRON is thermally tuned

BENDIX AVIATION CORP., Red Bank Div., Eatontown, N. J., has announced a thermally tuned klystron tube designed for K-band operation. The JAN 2K50 will operate over a frequency range of 23,504 mc to 24,464 mc with a minimum power output of 8.5 mw. It will tune this range in 1.2 to 2.6 seconds. The tube is tuned by varying the grid bias voltage of a triode section incorporated in a metal envelope. The plate of the triode section is attached to the klystron structure. Thermal expansion of the plate, caused by variations of plate current, is transmitted to the cavity of the klystron. This results in a change in the gap spacing and consequently the frequency.



COIL FORMS are resin impregnated

RESINITE CORP., 2035 W. Charleston St., Chicago 47, Ill. Resin-impregnated coil forms are now available in all colors for color-coding of circuits and components. This means to easy identification not only

simplifies circuit tracing and repairs but is of material assistance in assembly and production. Known as Resinite AC, the coil forms combine the mechanical and dielectric advantages of phenolics with the high dielectric strength, moisture resistant and noncorrosive properties of cellulose acetate. They are shatterproof and impervious to electrolytic corrosion. Their volume resistivity, power factor and thermal characteristics make them exceptionally adapted to vhf, uhf and other applications involving strenuous operating conditions.

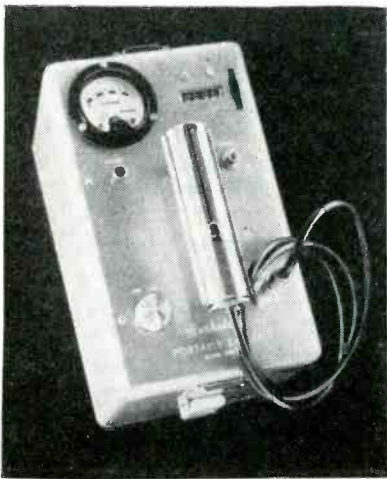

PORTABLE SCALER is battery operated

BERKELEY, DIVISION OF BECKMAN INSTRUMENTS INC., 2200 Wright Ave., Richmond, Calif. Model 2080 battery-operated portable scaler provides a field instrument for accurate measurement of very low beta or gamma radiation levels where the source-to-background ratio is small. The instrument contains an electronic scale-of-eight and a four-digit resettable register. The electronic scaling binaries use subminiature tubes and are designed for low battery drain and maximum reliability. A meter is used for interpolation of the binary count. The h-v supply is of the vibrator type and is regulated at 900 v by a corona-discharge tube. A selection of Geiger tubes and probes is available for use with the instrument. Hand-operated cabinet latches are used so that batteries can be replaced without tools. The instrument weighs 16 lb and meas-

Attention!! • EXECUTIVES • SALESMEN • PUBLIC OFFICIALS
• POLICEMEN • FIREMEN • OUTDOOR MEN
REPORTERS • FIELD INSPECTORS • DOCTORS • LAWYERS, ETC.

DICTATE IN YOUR CAR



with **ATR**

INVERTERS

for changing your battery current to A.C. Household CURRENT Anywhere . . . in your own car!!

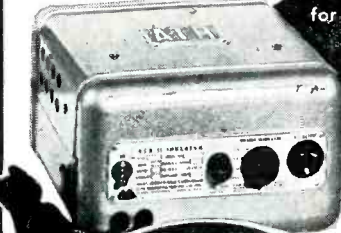

Announcing! NEW MODELS NEW PRICES

ATR INVERTERS . . . especially designed for operating standard 110 volt A.C. Tape Recorders, Wire Recorders, Dictating Machines and Electric Razors IN YOUR CAR.

EASY TO INSTALL EASY TO OPERATE

A VALUABLE TIME SAVER FOR:

- TRAVELING SALESMEN**—Dictate reports in your own car. Send your dictated reports in daily to your home office or sales manager.
- FIELD INSPECTORS & INVESTIGATORS**—Dictate your field inspection reports in the field—on the spot. Give the complete story factually and completely. Include your clients recordings also.
- LAWYERS**—Record evidence in the field at your client's premises. Obtain factual and complete witness reports, etc.
- EXECUTIVES**—Dictate in your car all business matters while on trips for pleasure or business.
- PUBLIC OFFICIALS**—Dictate complete field reports in your car. Obtain recorded opinions and expressions of Mr. Public in the field. Dictate your business reports while traveling.
- ADVERTISING AGENCIES**—Use AC operated animated or illuminated displays in or on the car.
- FISHERMEN & HUNTERS**—Use your electric razor on camping trips, operating in your car. Also small home radios and other electrical or electronic items.
- CAMPERS**—Make your camping and outing trips more exciting using mix-masters, tape recorders, or wire recorders operating from your car battery.
- WAREHOUSE & MATERIAL HANDLERS**—Dictate your inventory and material handling reports on the scene, in the warehouse, yard, or wherever you may be.

FREE !ATR INVERTER!

. . . given away every 30 days to lucky registrant of preceding month. Mail a postcard as your registration request today!

Announcing!
NEW ATR INVERTERS

New models New features New prices
WRITE FOR NEW FREE LITERATURE

See your jobber or write factory

✓ NEW MODELS ✓ NEW DESIGNS ✓ NEW LITERATURE

"A" Battery Eliminators, DC-AC Inverters, Auto Radio Vibrators



AMERICAN TELEVISION & RADIO Co.

Quality Products Since 1931

SAINT PAUL 1, MINNESOTA—U. S. A.

INCREASE SALES EFFICIENCY!
DICTATE SALES REPORTS ACCURATELY AND PROMPTLY!
SAVE TIME!

the World's
toughest
transformers
 are made by

CHICAGO

they're
Sealed-in-Steel
 they're
True-to-Ratings

FOR EVERY APPLICATION. CHICAGO "Sealed-in-Steel" Transformers are available in 3 mountings for every modern circuit application: Power, Bias, Filament, Filter Reactor, Audio, MIL-T-27, Step-down. Optimum toughness with a wide extra margin of dependability makes CHICAGO transformers the logical choice for industrial and military research and instrumentation, for prototype production, amateur and commercial broadcasting, communications, high fidelity and public address applications. Ask for CHICAGO Transformers—the world's toughest—at your electronic parts distributor.

FREE CHICAGO CATALOG

You'll want the full details on CHICAGO's complete "Sealed-in-Steel" transformer line. There is a unit available for every modern circuit requirement. Write for your Free copy of Catalog CT-153, or get it from your electronic parts distributor.



CHICAGO STANDARD TRANSFORMER CORP.

3501 ADDISON STREET • CHICAGO 18, ILLINOIS

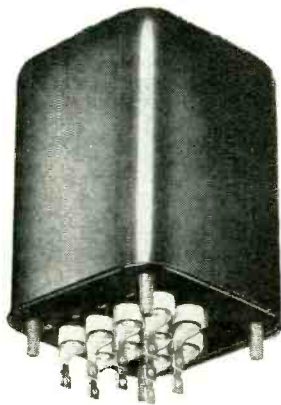

H-TYPE. Steel base cover is deep-seal soldered into case. Terminals hermetically sealed. Stud-mounted unit. Meets all MIL-T-27 specs.

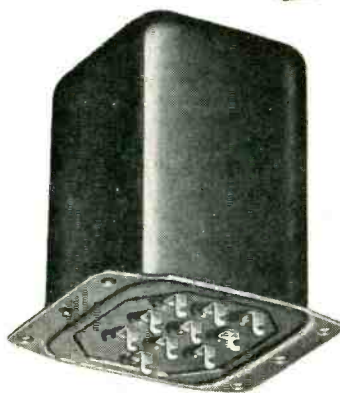

S-TYPE. Steel base cover fitted with phenolic terminal board. Convenient numbered solder lug terminals. Flange-mounted unit.

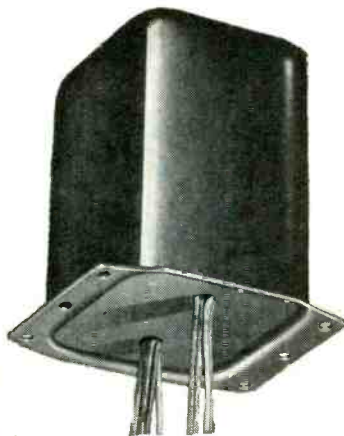

C-TYPE. With 10" color-coded stripped and tinned leads brought out through fibre board base cover. Flange-mounted unit.

NEW PRODUCTS

(continued)

ures 11 in. × 6½ in. × 8 in. overall size. Maximum counting rate is 100 counts per sec and battery life is 60 hours in intermittent use.

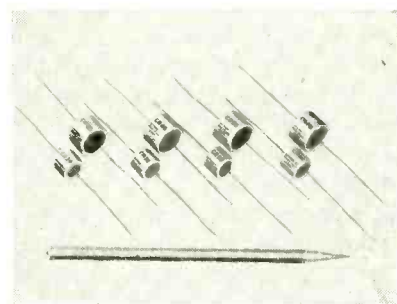

SELENIUM RECTIFIERS
 are small and compact

INTERNATIONAL RECTIFIER CORP., 1521 E. Grand Ave., El Segundo, Calif., has developed a series of miniaturized selenium rectifiers expressly for use in the production of tv boosters and uhf converters for original equipment manufacturers. The CR series selenium rectifiers consist of a number of cells assembled within a cylindrical aluminum tubing and provided with pigtail copper leads for easy wiring into crowded spaces. The smallest unit, type CR-15, is 0.5 in. in diameter and 0.6 in. long, while the largest unit has a diameter of 0.75 in. and is 0.6 in. long. These miniature selenium rectifiers are rated for maximum rms input voltages of 130 and 160 for operation into a capacitive load. Bulletin ER-181 covers both the mechanical and electrical specifications of the line.

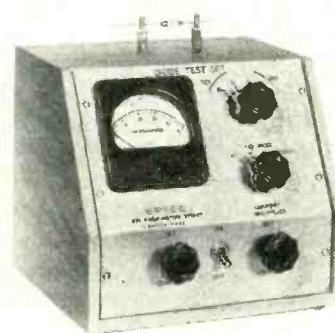

DIODE TEST SET
 operates from 95 to 125 v a-c

ELECTRONICS PRODUCTION SERVICE Co., 871 Washington St., Canton,

Mass. Designed to fulfill the varying needs of laboratory development, production quality control and system maintenance, model D102 is a flexible semiconductor test unit. Capable of testing under actual operating conditions, it is useful not only for checking miniature or power, germanium or selenium rectifiers but also for determining transistor parameters. It consists of variable voltage and current sources, a precision metering unit and a versatile switching arrangement which permits rapid selection of any operating-test condition and then high-speed determination of diode forward-backward characteristics.

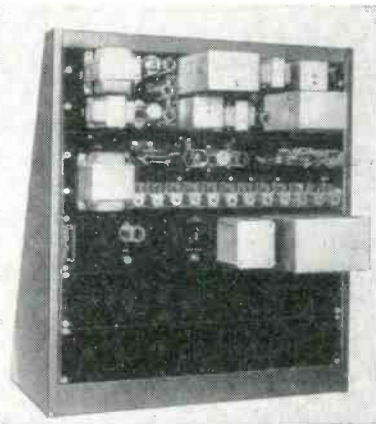

CONTROL SYSTEM
for aircraft communications

HAMMARLUND MFG. CO., INC., 460 W. 34th St., New York 1, N. Y., is manufacturing a remote-control system using tones in the a-f spectrum, and eliminating the need for d-c circuitry. It is intended for operating airline radio transmitting and receiving equipment located away from control points both at airports and along the air routes. The system requires only a single telephone line having conventional voice characteristics to carry all the standard operations required for rapid switching between transmitter and receiver, and for switching between equipment groups to cover the various frequency channels. A h-f radio signal or a microwave link are equally suitable as transmission media. The dispatcher may select up to 10 transmitter-receiver combinations, any one of which may be operated as a com-

**SPECIALISTS IN
THE DESIGN AND
MANUFACTURE OF**

- Electro-Acoustic Devices
- Custom Printed and "Packaged" Circuitry
- Plastic Molding
- Coil Winding
- Transformers
- Electronic Component Assemblies







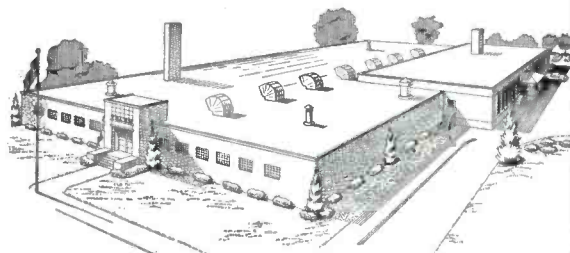

**COMPONENT
RELIABILITY
and
MINIATURIZATION**

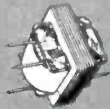
**TELEX, INC.
ELECTRO-ACOUSTIC
DIVISION**

**CAN MEET YOUR MOST
EXACTING DESIGN AND
PRODUCTION REQUIREMENTS**

The Electro-Acoustic Division of Telex, Inc., offers you an expertly staffed, modern laboratory, engineering know-how and the finest in production facilities. The variety of special skills at your disposal in Telex personnel and plant facilities means quick and cost-saving solutions for your design and production problems.

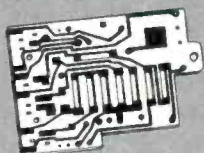

	MIDGET TRANSFORMER
	MOLDED BOBBINS
	MIDGET RECEIVERS
	ENCAPSULATED PLUG-IN TRANSFORMER
	SPECIALTY MOLDING
	COIL ASSEMBLIES
	PRINTED CIRCUITS
	MOLDED KNOBS & CAPS
	DECADE RESISTOR
<p>WRITE, WIRE OR PHONE: J. R. Anderson Electro-Acoustic Division TELEX, INC. Telex Park, St. Paul, Minn. Phone - Nestor 7211</p>	

Design in Confidence

with

DIEHL

LOW INERTIA A.C. SERVO MOTORS...

... for Feedback Control Systems

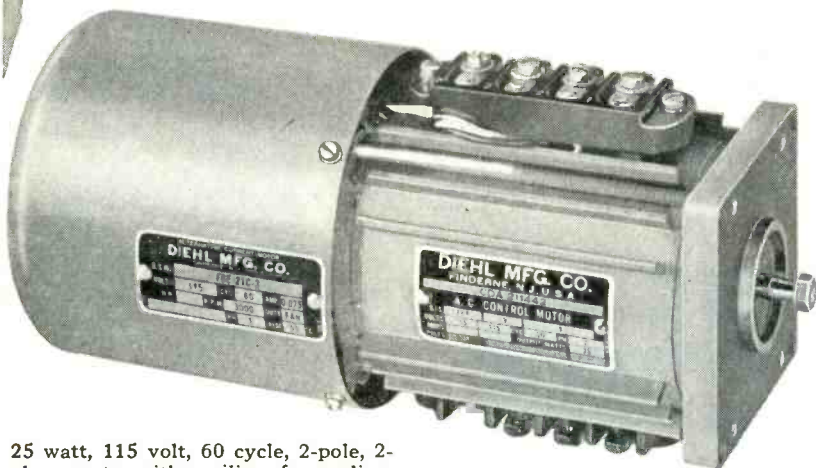

25 watt, 115 volt, 60 cycle, 2-pole, 2-phase motor with auxiliary fan cooling. One of the many Diehl Low Inertia A.C. Servo Motors available.

CONSIDER THESE FEATURES

- High starting torque
- Low rotor moment of inertia
- Widest selection of ratings
- Samples of many sizes available from stock
- Engineering assistance offered when desired
- Production quantities available in a reasonable time — at a reasonable price.

Diehl originated the Low Inertia A.C. Squirrel Cage Induction Motor — and Diehl's leadership in the field is still being maintained!

Originally designed for high-performance military servo systems, these motors are now being extensively used in the armed services with various types of electronic equipment. In industry, too, Diehl Servo Motors and components are being successfully applied in the design of automatic controls and a wide variety of other applications where optimum performance at reasonable cost is essential.

Meeting all appropriate JAN specifications, the two-phase servo motors can be supplied in sizes ranging from 2 watts to 750 watts mechanical output, 60 or 400 cycle supply. The smaller sizes include units with integrally-mounted tachometer generators for feedback. Many of the ratings are available with the control winding impedance specially designed for operation directly from the plates of electron tubes. Samples of most 60 cycle, and some 400 cycle, units are available for immediate shipment.

Our engineering staff will gladly help you select the motors best suited to your specific requirements. A request on your letterhead will bring you a copy of Technical Manual No. EL-0154 describing Diehl Servo Motors and related equipment.

Other Available Components:

D.C. SERVO SETS • RESOLVERS
MINIATURE PERMANENT MAGNET D.C. MOTORS
DIEHL MANUFACTURING COMPANY

Electrical Division of THE SINGER MANUFACTURING CO.
Finderne Plant, SOMERVILLE, N. J.

Atlanta Baltimore Boston Chicago Detroit New York Philadelphia Worcester

NEW PRODUCTS

(continued)

plete communications facility on a press-to-talk basis.

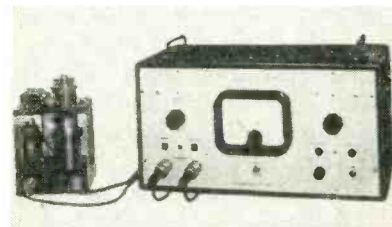

ELECTROMETER is vibrating-reed type

MARCONI INSTRUMENTS LTD., 25 Beaver St., New York 4, N. Y. The vibrating-reed electrometer is a line-operated instrument for the measurement of small currents and voltages encountered in medical, chemical and allied research. A vibrating-reed transducer of extremely high input impedance converts the d-c signal to a-c. This is then amplified and fed to a phase-sensitive rectifier. Input resistance is greater than 10^{10} ohms. Accuracy is ± 1 percent on all ranges. Ranges are 0 to 1 mv, 0 to 10 mv, 0 to 100 mv and 0 to 1 v. Drift is less than ± 100 μ v per day.

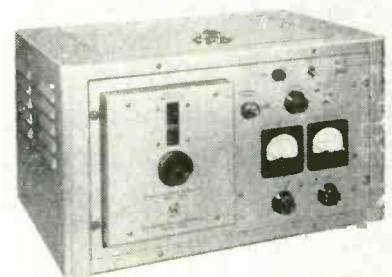

S-BAND OSCILLATOR is ultrastable unit

LABORATORY FOR ELECTRONICS, INC., 75 Pitts St., Boston 14, Mass. Model 803 ultrastable microwave oscillator features an S-band oscillator stabilized for long-term drift of one part in 10^5 . The unit also features a frequency-calibrated dial, means for modulation and a self-contained power supply. Main elements are a klystron oscillator, a stabilizing monitor loop that consists of a calibrated dual-mode reference cavity and a feedback amplifier. Frequency coverage is 2,700 to 2,950 mc. Pulse modulation is possible when stabilization is removed, and 25-percent

modulation when stabilized. The attenuator provides 100-db range of control. Power output is 15 mw from a type N output connector. Power consumption is 150 w.



RESISTORS
are precision, wire-wound

EASTERN PRECISION RESISTOR CORP., 130-11 90th Ave., Richmond Hill 18, N. Y. Type SS-5 low-capacity, precision, wire-wound resistors, with capacitance controlled to 0.5 μ f on a 1.0 megohm resistor, are designed for manufacturers and designers of test equipment, electronic computers, meters and other precision electronic instruments. These units are also being manufactured in matched sets of four to meet capacitance and temperature-coefficient tracking requirements for use in high-frequency bridges and high repetition rate computer circuits.



TINY CONNECTOR
is 18-contact unit

WINCHESTER ELECTRONICS, INC., Glenbrook, Conn. The MAQRE 18 miniaturized quick-disconnecting electrical connector features space and weight saving characteristics without sacrifice of current capacity or voltage breakdown. Particularly suitable for rack and panel mounting, floating contacts have 0.073-in. diameter solder cups for No. 16



IN 20 SIZES FOR OPERATING VOLTAGES UP TO 600 VOLTS

Today's miniaturized equipment has brought forward special exacting wiring requirements — special purpose miniaturization wires for chassis hook-up wire and for use as leads in transformers, chokes and other miniaturized electronic components.

TURBO BRAND Miniaturization Wire was specially developed in The William Brand laboratories to meet a use need within the range of -55° C to $+105^{\circ}$ C and maximum operating voltage of 600 volts rms. This "mini" wire is available in 20 strandings, ranging from 7/38 to 19/25 and in a graduated scale of AWG sizes from 30 to 12. It is available in both solid and stranded — in solid colors or "candy striped" with 1, 2 or 3 tracers.

TURBO INSULATION

TURBO "mini" wire is insulated to withstand the effects of water, oils, aircraft engine fuels, hydraulic fuels, dilute acids, alcohol, alkalis, ethylene glycol and fungus. The primary insulation is TURBO 540, an extruded polyvinyl chloride compound. For further protection there is an extruded jacket of nylon over the primary insulation, which gives added resistance to mechanical wear and abrasion.

SPECIAL MINIATURIZATION PROBLEMS

To assist engineering and manufacturing organizations in special problems arising in the use of miniaturization wire, The William Brand Research Department will welcome the opportunity of offering suggested solutions of such problems.

Insulating Material

TURBO

Specialists Since 1920

THE WILLIAM BRAND & CO., INC.

Dept. E-1 Willimantic, Conn., U.S.A., Tel. HARRISON 3-1661

TURBOTUF Insulating Tubing and Sleeving · TURBO Insulated Wires · Wire Markers · Extruded Tubing · Varnished Saturated Sleeving and Tubing · Cambric Cloths, Tapes, Papers · Mica

SALES REPRESENTATIVES IN PRINCIPAL CITIES

TANTALUM CAPACITORS...

...basic in current electronic trend..



Fansteel TANTALUM CAPACITORS

- Premium Performance and Life
- Minimum Space per Mfd.
- Wide Temperature Limits
- Infinite Shelf Life
- Proven Reliability Since 1930

Now, through the use of tantalum, new high standards of electrolytic capacitor performance are available. The tantalum oxide film is the most stable dielectric, chemically and electrically, yet discovered. As a result, Tantalum Capacitors offer advantages not found in any other electrolytic type — long life, space saving, wide temperature range excellent frequency characteristics, no shelf aging.

Tantalum Capacitors are made by Fansteel and other leading capacitor manufacturers. Ask for current information bulletins on Fansteel Tantalum Capacitors.



FANSTEEL METALLURGICAL CORPORATION

NORTH CHICAGO, ILLINOIS, U. S. A.

Tantalum Capacitors... Dependable Since 1930



32503C

NEW PRODUCTS

(continued)

AWG and assure proper play for self-alignment. Contact arrangement allows engagement in the correct position only, thus making polarization positive. Spring-loaded contacts provide quick disengagement. Voltage breakdown between contacts at sea level is 5,400 v d-c; at 60,000-ft altitude, 1,350 v d-c. Weight of receptacle is 1.8 oz; plug, 1.1 oz.

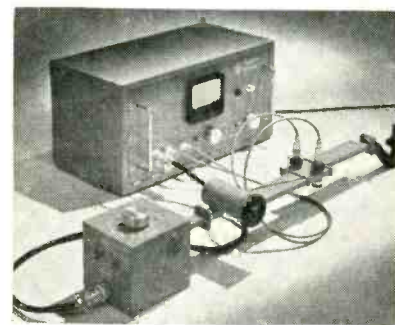

VSWR METER tests waveguide components

COLOR TELEVISION INC., 935 E. San Carlos Ave., San Carlos, Calif. Laboratory or production-line testing of waveguide components is performed rapidly with the model 110A X-band vswr indicator. Covering a frequency band from 8,500 to 9,600 mc, the new unit offers a number of advantages over slotted-line measuring techniques. The instrument includes an oscillator, an accurate wavemeter to supplement the approximate direct-reading dial of the oscillator, a forward and reversed directional coupler with bolometer take-offs for source and reflected power and a direct reading ratiometer having dual scales calibrated directly in vswr—1.06 to 1.3 and 1.3 to 2.5.

POWER METER for d-c through X-band

POLARAD ELECTRONICS CORP., 100 Metropolitan Ave., Brooklyn 11, N. Y., announces a new type of power meter that measures rms power over the frequency range of d-c through X-band without the use of frequency limited bolometer mounts. Utilizing a power sensitive element that does not employ a hot wire barretter or other delicate



elements, the meter can withstand 150 percent overload without burn-out or other ill effects. The same power sensitive element is used for the entire frequency range, obviating the need for replaceable components. The probe is connected permanently to the meter, while the other side may be fastened directly to the equipment under test, thus avoiding the errors involved in r-f connecting cables.



COMPARATOR tests component impedances

INDUSTRIAL TEST EQUIPMENT CO., 55 E. 11th St., New York 3, N. Y., has developed impedance comparator model 60. The instrument was designed for production-line testing of resistors, capacitors and inductors. The percentage deviation from a standard component of the component under test is read on a large meter. Four ranges are provided: 1-percent, 5-percent, 10-percent and 20-percent full scale. One simple linear scale serves for all ranges. No zero adjustment is required and the range calibration is readily performed by means of a built-in standard. Component impedances from 1 ohm to 5 megohms at 60 cps may be compared. The built-in

TIC's tiny duo..

Similar in appearance - different in application!

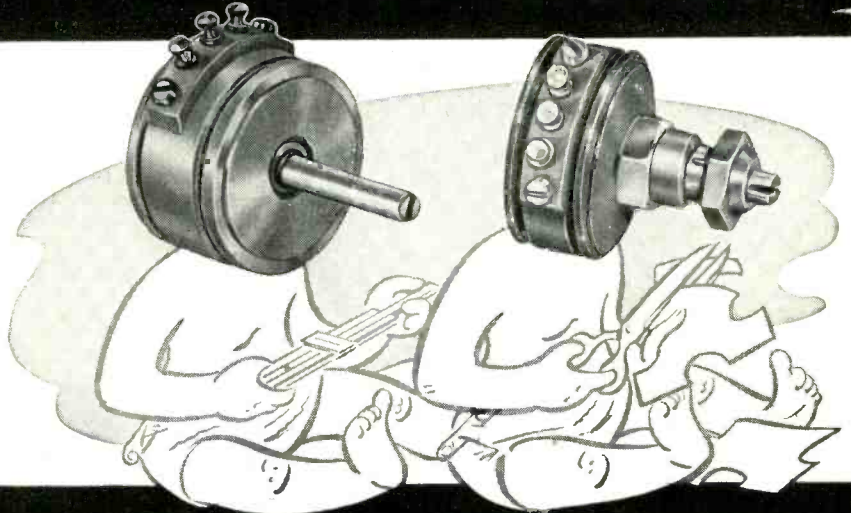

RVP7/8 Precision Potentiometer for Computation

RV7/8 Trimmer Potentiometer for Adjustment

TIC's tiny duo — for your needs in diversified applications of miniature potentiometers.

Type RVP7/8 provides accuracies approaching those of larger potentiometers commonly used in computing and control instrumentation. TYPE RV7/8 provides reliability, stability and positive setting for calibration and trimming adjustments.

TIC characteristic quality is embodied in both miniature potentiometers.

Rugged Aluminum Base
Corrosion Resistant Finish
Patented Ganging Method

Wide Resistance Range
High Resolution
Low Noise

Specifications common to both RVP7/8 and RV7/8:

Resistance Range: 100 ohms — 40,000 ohms
Resistance Tolerance: $\pm 5\%$ Standard
Power Rating: 2 watts at 25° C
Ambient Temperature Range: -55° C to +80° C.
Temperature Coefficient of Resistance Wire: .00002 per degree C.
Resolution: Optimum for each resistance value

RVP7/8 Specific data:

Linearity: $\pm 2\%$ of total resistance standard, less than 1% of total resistance on special orders.
Electrical Rotation: 320° $\pm 5\%$ Standard
Rotational Life: 1,000,000 complete cycles at 60 rpm
Mounting: Precision servo-type.

RV7/8 Specific data:

RV7/8 Mounting: Threaded bushing with locking device for maintaining precise setting under extreme environmental conditions.

Write for new RV7/8 Bulletin 12-3.

ENGINEERING REPRESENTATIVES

Chicago, Ill. — Uptown 8-1141
Rochester, N. Y. — Monroe 3143
Canaan, Conn. — Taylor 4-7215
Dayton, Ohio — Michigan 8721
Baltimore, Md. — Plaza 7694

Arnprior, Ont., Can. — Arnprior 400
New York, N. Y. — Murray Hill 8-5858
Cambridge, Mass. — Eliot 4-1751
Hollywood, Cal. — Hollywood 9-6305
Dallas, Texas — Dixon 9918
Binghamton, N. Y. — Binghamton 3-1511

TECHNOLOGY INSTRUMENT CORP.

533 MAIN STREET • ACTON, MASS. • TELEPHONE • ACTon 3-7711

Wing blade handle on threaded center shaft for easy connecting and disconnecting. Stronger—the center post is inserted after molding operation.

Watertight and pressurized, note rubber bushings and sealing rings.

Pin and socket barrel assemblies may be replaced in same fitting.

All contacts machined from copper base alloy stock silver-plated. Beryllium spring on socket contacts.

Insulator material type CMG to MIL-P-14 Spec.

Cap and collar removable for easy wiring.

Resilient bushing applies pressure to relief bushing and cable.

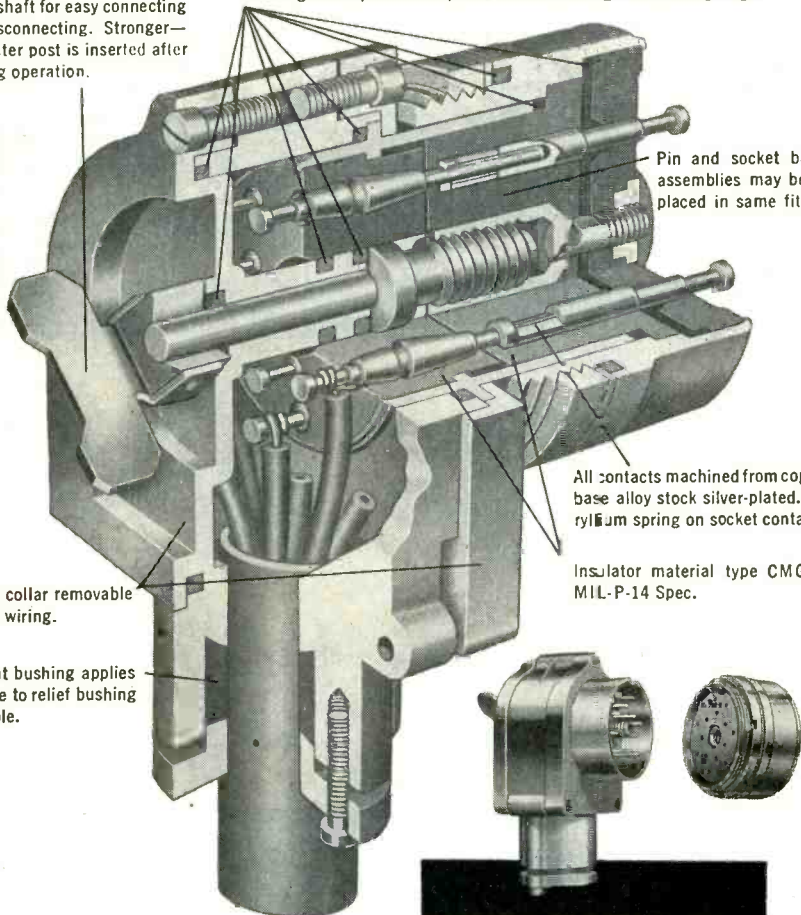

*Here's why those
in the know demand —*

**CANNON
PLUGS**

TYPE 2E Sealed Power Connector (Signal Corps numbers U-112/U to U-118/U) is typical of Cannon's foresighted engineering to do a better job. The 2E Series is designed for heavy duty service on Signal Corps power units for audio equipment.

Features:

- a. Longer contact engaging length.
- b. Thicker inserts of greater tensile strength to reduce breakage.
- c. Closed entry socket contacts.
- d. Special sealing rings which do not require sealing compound or gaskets.
- e. Efficient neoprene clamp gland.

Manufactured in accordance with Specification MIL-C-1252 (Sig. C) the 2E Series Plug has cable clamping provision from 0.205 to 0.770 inclusive. Quick connect and discon-

nect are accomplished by a wing handle and threaded center screw that can be operated by gloved hands in extreme climatic conditions. Two shell sizes accommodate four insert arrangements of 4, 9, and 19 contacts. Watertight and pressurized, with rugged construction, Cannon's 2E Sealed Power Connectors are built for long life and trouble-free service and are adaptable to industrial application. Write for Advance Bulletin No. 2E-1.



CANNON ELECTRIC

Since 1915

CANNON ELECTRIC COMPANY, LOS ANGELES 31, CALIFORNIA
Factories in Los Angeles; New Haven; Toronto, Canada; London, England.
Representatives in principal cities. Address inquiries to Cannon Electric Company Dept. 1-120, Los Angeles 31, California.



regulator permits line-voltage variations from 105 to 125 v, 60 cps.

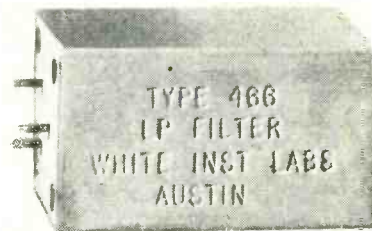

**REJECTION NETWORKS
of the twin-T type**

WHITE INSTRUMENT LABORATORIES, Austin, Texas. The series 500 networks are R-C rejecting filters of the standard twin-T type. Stable with both temperature and time, they are constructed of low temperature coefficient components, matched for minimum drift. Circuit parameters are selected to give best Q or notch sharpness consistent with adequate output. They are designed especially for circuits having both input and output resistance loading. Standard null frequencies are 60 and 400 cycles, with special null frequencies available. Different impedance levels permit matching to all ordinary electronic circuits. Each network is fully tested and cast in plastic for stability and ease of mounting. Full engineering details are given in bulletin 500.



**SIGNAL GENERATOR
for radar testing**

POLARAD ELECTRONICS CORP., 100 Metropolitan Ave., Brooklyn 11, N. Y. A new all-purpose KU-band signal generator provides means for the complete testing of radar or associated equipment in the 15.75

to 16.25-kmc range. It consists of a reflex klystron tube and the associated plumbing as well as the necessary attenuating devices and an absorption-type wavemeter. Internal modulation circuitry provides both pulsed and f-m modulation of the klystron oscillator and a temperature-compensated thermistor bridge is incorporated in the unit for measuring both power output of the oscillator and the r-f input for testing of transmitters. Frequency measurements are accurate up to ± 10 mc. Power measurements with correction are accurate to ± 1.5 db.



LINEAR AMPLIFIER modifies the Oak Ridge A1

RADIATION COUNTER LABORATORIES, INC., 5122 W. Grove St., Skokie, Ill., is producing the A1C linear amplifier, mark 15, made and tested exactly to ORNL specification Q-1302. It retains the versatile features of the Oak Ridge A1 linear amplifier and is modified for spectrometry applications. Modifications to the amplifier are as follows: (1) Higher counting rate may be achieved in spectrometry applications. (2) There is an improved overload response. (3) The output signal linearity is improved for spectrometry applications. (4) More precise settings may be achieved by a ten-turn pulse height selecting potentiometer. (5) The pulse height selector output is negative, and is 20 or more volts in amplitude.

BRIDGE-BALANCE UNIT is automatic-calibrating

B & F INSTRUMENTS, INC., 4732 N. Broad St., Philadelphia 41, Pa. Model 12-200 adjustable bridge-



TYPE 704-A Secondary Phase Standard



Precision Electronic Phase Shifter

- Shifts phase of sinusoidal signal by any angle from 0° to 360° in four 90° ranges.
 - Waveform, frequency, and amplitude characteristics of signal essentially unaffected by phase shift.
 - Absolute accuracy $\pm 2^\circ$ *
 - Incremental accuracy $\pm 0.1^\circ$ *
 - Linear dials individually hand calibrated. Incremental dial has .025° basic divisions.
 - Negligible distortion, noise, and phase jitter.
 - Excellent long-term stability.
 - High impedance input, low impedance output from cathode follower.
 - Standard frequencies of 60, 400, 1000 and 20,000 cps.
 - Units available for any single frequency between 60 cps and 20 kc.
- *Accuracies dependent on frequency remaining within $\pm 0.2\%$ of instrument's rated frequency.

Especially suitable for measurements with:

- | | |
|------------------------------|---------------|
| Phase shifting capacitors | Servo systems |
| Time base circuits | Synchros |
| Transmission networks | Resolvers |
| Multi-phase voltage rotation | Power factor |
| Phase detector circuits | Gyros |
| AC thyatron control | CRO sweeps |
| Feed back amplifiers | |

ENGINEERING REPRESENTATIVES

- | | |
|--------------------------------------|--|
| Chicago, Ill. — Uptown 8-1141 | Arnprior, Ont., Can. — Arnprior 400 |
| Waltham, Mass. — Waltham 5-6900 | Hollywood, Cal. — Hollywood 9-6305 |
| Rochester, N. Y. — Monroe 3143 | Dallas, Texas — Dixon 9918 |
| Dayton, Ohio — Michigan 8721 | Roseland, New Jersey — Caldwell 6-4545 |
| Silver Springs, Md. — Juniper 5-7550 | Wyncote, Pa. — Livingston 8-5480 |

TECHNOLOGY INSTRUMENT CORP.

533 Main Street · Acton, Massachusetts · Telephone: ACTon 3-7711

NOW!...from the world's largest producer of gyros...

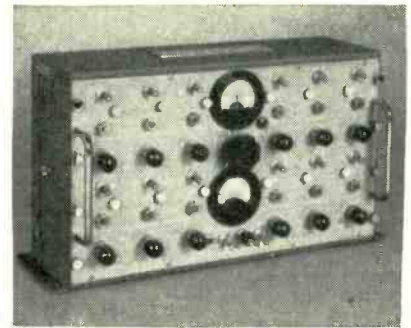

balance and calibrating unit was designed in the field for use with recording oscillographs to obtain time histories and dynamic measurements required to test and evaluate present-day aircraft. Aside from flight testing, wherever oscillographs or similar devices are used for the direct recording, without amplifiers, of strains, loads, accelerations, forces, pressures and control positions, the unit can be utilized to provide the means of connecting and adjusting any resistant-type pickup to any oscillograph galvanometer. It is built in units of 12 channels. Two or more units can be used in large installations.

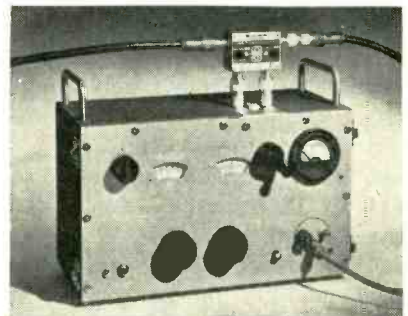

VSWR METER matches loads to line

SIERRA ELECTRONIC CORP., 1050 Brittan Ave., San Carlos 2, Calif. Model 136A reflection coefficient meter is a compact instrument designed for rapid measurement of reflection coefficient and vswr. It provides a convenient method of matching loads to lines to minimize reflected power, and also may be used as a wide-range laboratory receiver for general measurement purposes. The instrument includes a local oscillator continuously tunable from 92 to 355 mc and an i-f amplifier centered at 60 ± 2 mc. Each instrument is supplied with a detachable

RATE GYRO

Type No. 15814-1-A

MOTOR: 26 volts, 400 cps, 3 phase with rated speed of 22,000 rpm and a rotor moment of inertia of 175 gram-cm².

PICKOFF: 26 volts, 400 cps, single phase with "E" type variable coupling. With resistive load of 10,000 ohms, tuned output is 6 to 7 volts at maximum rate. Null is 30 millivolts with an armature travel of 2½° to 3° either side of null.

DAMPING: Accomplished by fluid flotation of gimbal. Damping factor is 0.5 to 0.7 of critical, but values up to and including 1.0 of critical can be provided.

NATURAL FREQUENCY: 50-55 cps (undamped).

WARM-UP TIME: One minute.

RANGE: Maximum rate is $450 \pm 20\%$ second. Minimum detectable rate is less than 1.5°/second. Other maximums and minimums are available.

ENVIRONMENTAL CHARACTERISTICS: —20°F. to 140°F. temperature operating range. Maximum shock is 60 g. Vibration operating range of 5 g. from 20 to 300 cps. Positive hermetic seal.

WEIGHT: 13.5 ounces complete with mounting bracket and electrical connector.

FREE GYRO

Type No. 14108-1-A

MOTOR: 26 volts, 400 cps, 3 phase with rated speed of 22,000 rpm and a rotor moment of inertia of 1260 gram-cm².

DRIFT RATE: Will not exceed 1° per minute when subjected to Scorsby test at amplitude of $\pm 15^\circ$ and rate of approximately 6 cpm (corrected for earth's rotation).

PICKOFF: Autosyn* type with peak value of 20 volts. Initial slope of output voltage curve about null position is 0.35 volts per degree \pm ten per cent. Phase shift is less than 20 degrees. Residual voltage is less than 50 mv.

WARM-UP TIME: Within two minutes.

OPERATING LIFE: Rated at 500 hours.

ENVIRONMENTAL CHARACTERISTICS: Maximum operating temperature of 195°F. and a minimum of —20°F. Maximum allowable shock is 60 g. with maximum operating vibration of 7 g. (from 10 to 500 cps). Maximum excursion not to exceed 0.5 inches. Positive hermetic seal.

WEIGHT: Approximately 4.2 lbs.

CAGING AND UNCAGING: Can be caged remotely by applying 26 volts, 400 cps, single phase and 28 volts DC power. Will cage from any position of gimbals within 30 seconds with gyro rotor at full speed. Application of 28 volts DC will uncage within 0.1 seconds.

*REGISTERED TRADE-MARK BENDIX AVIATION CORPORATION.

Out of Eclipse-Pioneer's vast engineering and production experience come these two new, better gyros for specialized missile and aircraft needs. We will welcome your inquiry for further details.

WRITE DEPARTMENT C
ECLIPSE-PIONEER
Teterboro, New Jersey • Division of

West Coast Office: 117 E. Providencia, Burbank, Calif.
Export Sales: Bendix International Division, 205 E. 42nd St., New York 17, N. Y.

directional coupler for insertion into the transmission line under test. Reflection coefficient and vswr are read directly on a front panel dial. The unit operates from a 105/120 v 60-cycle power supply.



POTENTIOMETER
permits 2 to 10-unit coupling

MAUREY INSTRUMENT CO., 2452 E. 72nd St., Chicago 49, Ill. Type 2X precision potentiometer is available for servomechanisms, recording or indicating instruments. A new device permits coupling from 2 to 10 units without requiring a special length shaft. It is made for ball bearings or oilite bearings as specified. Linear resistance is 100 to 100,000 ohms with 0.5 linearity. It is also made with adjustable taps for experimental purposes. Nonlinear potentiometers are also available on special requirements.

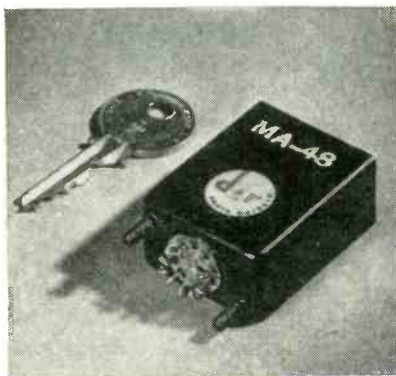

MAGNETIC AMPLIFIER
weighs 3 oz, delivers 25 w

D & R LTD., 402 E. Gutierrez St., Santa Barbara, Calif. Extremely high power handling capability for their size and weight characterize a new line of miniaturized magnetic amplifiers. Through the use of special core materials, winding techniques and mountings coupled with

MINIATURIZING YOUR EQUIPMENT?

Specify *SIMPLEST, MOST COMPACT*
AMPERITE
**THERMOSTATIC
DELAY RELAYS**

MOST ECONOMICAL, HERMETICALLY SEALED



STANDARD



MINIATURE

Provide delays ranging from 2 to 120 seconds.

- Actuated by a heater, they operate on A.C., D.C., or Pulsating Current.

- Hermetically sealed. Not affected by altitude, moisture, or other climate changes.

- Circuits: SPST only — normally open or normally closed.

Amperite Thermostatic Delay Relays are compensated for ambient temperature changes from -55° to +70°C. Heaters consume approximately 2 W. and may be operated continuously. The units are most compact, rugged, explosion-proof, long-lived, and — inexpensive!

TYPES: Standard Radio Octal, and 9-Pin Miniature.

PROBLEM? Send for Bulletin No. TR-81

BALLAST-REGULATORS

- Amperite Regulators are designed to keep the current in a circuit *automatically regulated* at a definite value (for example, 0.5 amp).
- For currents of 60 ma. to 5 amps. Operates on A.C., D.C., Pulsating Current.
- Hermetically sealed, light, compact, and most inexpensive.

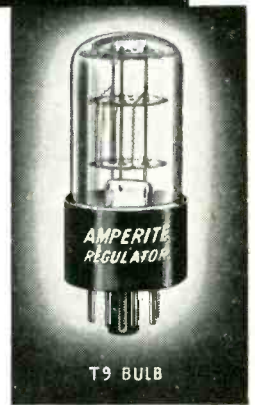
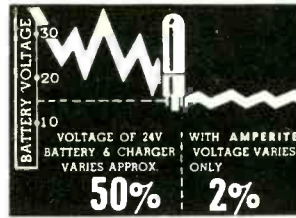
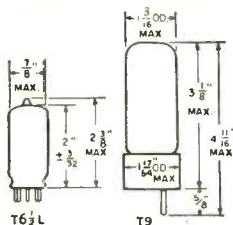

Maximum Wattage Dissipation: T6 1/2 L—5W. T9—10W.

Amperite Regulators are the simplest, most effective method for obtaining *automatic regulation* of current or voltage. Hermetically sealed, they are not affected by changes in altitude, ambient temperature (-55° to +90°C), or humidity. Rugged; no moving parts; changed as easily as a radio tube.

Write for 4-page Technical Bulletin No. AB-51



AMPERITE CO. Inc., 561 Broadway, New York 12, N. Y.

In Canada: Atlas Radio Corp., Ltd., 560 King St. W., Toronto 2B

NEW!

Brown-Hill

12-POSITION MINIATURIZED SWITCHES

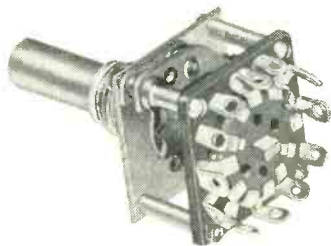

ACTUAL SIZE — 3/4 INCH SQUARE
BABY SWITCH

OTHER Brown-Hill SWITCHES



12-POSITION
MINI-SWITCH



18-POSITION
STANDARD



24-POSITION
STANDARD

R-F ELECTRONICS, INC.

291 N. E. 61st STREET, MIAMI 37, FLORIDA

Where you require small size . . . maximum stability—you need Brown-Hill *miniaturized* switches. The Baby-Switch, illustrated above, is the smallest switch of its type ever commercially produced. The Baby and Mini-Switch are available with either phenolic or ceramic wafers designed to exacting military specifications.

Both the miniaturized and standard size models have low contact resistance . . . inductance . . . and capacitance that remains constant. Here's why:

- Rotor blades and stator contacts are stamped of silver — insuring constant low resistance and high current rating.
- Dow-Corning 200 impregnated steatite or MIL-SPEC phenolic are used as dielectric—for lowest loss and moisture absorption.
- Detent wheel and rotor locked to common shaft —for accuracy in positioning.
- Stainless steel rollers—for long life.
- Wiper blades on the 18-position and 24-position standard size switches are made of solid, fine silver laminated to phosphor bronze — for long lasting springiness and positive contact.

**AND THEIR PRICE IS LOW . . . FOR
WE SPECIALIZE IN SWITCHES ONLY!**

Write for complete information . . . sample switches available on 30-day memo.

NEW PRODUCTS

(continued)

the use of h-f a-c power, it is possible to attain rapid response time and high power handling capability in a very small, lightweight unit. The company now manufactures a line of miniaturized 4,000 and 2,000-cycle magnetic amplifiers, in addition to its standard line of 400 and 60-cycle units. The unit illustrated, model MA-48, weighs only 3 oz, yet delivers a power output conservatively rated at 25 w, with rapid response time and high power gain.

TWIN-WIRE LEAD-IN eliminates dampness

PLASTOID CORP., Long Island City, N. Y., has introduced Foamline, a tv twin-wire lead-in calculated to eliminate dampness, the chief factor in signal dissipation. The new product is built with millions of tiny, foamlike air cells that protect the wire leads so moisture cannot affect performance. The air dielectric principle is maintained. Foamline also simplifies installation since the ends do not have to be sealed.

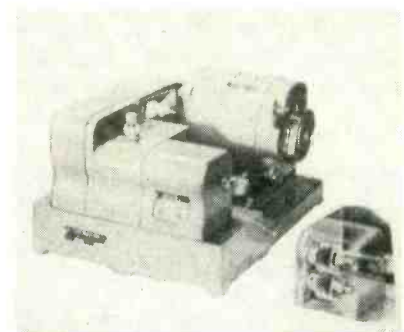

WIRE SCRAPER is a high-speed unit

GEO. STEVENS MFG. Co., INC., Pulaski Road at Peterson, Chicago 30, Ill., has available a high-speed wire scraper with a brush speed of 3,400 rpm. Model 105 is specially designed for rapidly and cleanly stripping textile serving and enamel from multistrand wire up to No. 44 and single-strand wire from 16 B&S to 40 B&S. A new flat belt drive permits quieter operation and greater speed. Wire is cleanly stripped to within 1/4 in. of the coil by passing through a safety guard between 2 wire brushes. Cleaning

pressure is regulated by adjusting the top brush closer to or farther from the lower brush. Wire brushes are available from stock in wire sizes of 0.0025, 0.003, 0.004, 0.006 and 0.008 in., 1½-in. o.d., ¾-in. face and ⅜-in. hole.

Literature _____

Electronic Test Equipment. Cal-Tronics Corp., 11305 Hindry Ave., Los Angeles 45, Calif. "Electronic Test Equipment" is the title of a new 12-page bulletin that describes the company, its services and facilities, and contains 8 pages of illustrations and description of various types of test equipment built by the company. Included in the equipment shown are a synchronizer test unit, electronic control amplifier test unit, computer systems test unit and signal data converter test unit.

Stainless Steel Fastenings. Star Stainless Screw Co., 190-A Union Ave., Paterson 2, N. J., has released a new catalog itemizing their large, varied inventory in a manner that assures split-second selection. It includes their in-stock inventory of cap screws, nuts, washers, machine screws, sheet metal screws, set screws and pipe fittings for manufacturers of electronic and electrical equipment, measuring instruments, aircraft, as well as the chemical, food and paper industry and general manufacturing. A special page is devoted to suggested short cuts in ordering that help keep costs down. The back cover has a chart that explains AN specifications and a decimal equivalent chart.

General-Purpose Oscillograph. General Electric Co., Schenectady 5, N. Y., has available a new publication, GEC-449B, on the general-purpose oscillograph. For use in investigation, design and testing, the type PM-10 oscillograph described permits simultaneous records to be made of voltage, current, time, speed, pressure, strain and sound. Features and operation of the equip-

50 WATTS OF R-F "BOTTLED UP"!

M. O. P. A.
6C4 OSC.
829-B AMPLIFIER

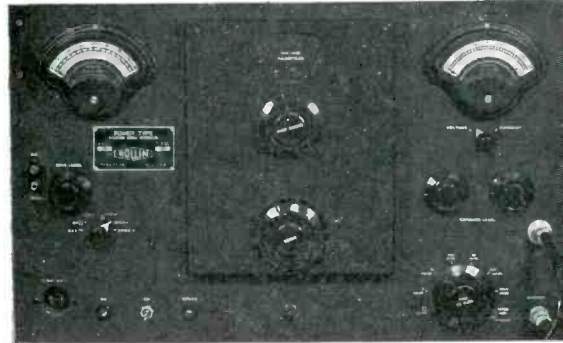

POWER TO DRIVE AN ANTENNA
160 db
MICROVOLTS TO MEASURE RECEIVER SENSITIVITY

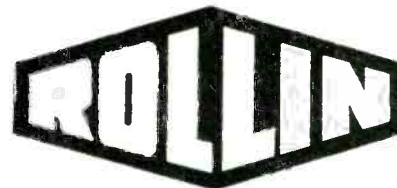

MODEL 20 POWER TYPE STANDARD SIGNAL GENERATOR

- 10 WATTS MAXIMUM R-F OUTPUT — LOW IMPEDANCE.
- 160 DB RANGE OF ATTENUATION — 15.0 VOLTS TO 0.10 UV.
- CURRENT OUTPUT UP TO 1.0 AMPERES.
- MASTER OSCILLATOR — TUNED POWER AMPLIFIER CIRCUIT.
- 8 BAND SPREAD TUNING RANGES — 85 Kc TO 40.0 Mc.
- DIAL CALIBRATED AT INTERVALS OF 1% IN FREQUENCY.
- LEAKAGE FIELDS LESS THAN .1 UV/METER.

Write for details



THE ROLLIN COMPANY
2010 LINCOLN AVENUE • PASADENA 3, CALIF.

MODIFICATION NOTES

TO USERS OF TYPE 511A, TYPE 512, and TYPE 514 OSCILLOSCOPES

Tektronix now uses RCA's new 5ABP Cathode-Ray Tube in these oscilloscopes. This new CR Tube is better in many ways than the old 5CP. It has about twice the vertical sensitivity, 20% more horizontal sensitivity, lower deflection plate capacitance, less pattern distortion, and a flat face. It is directly interchangeable with the old 5CP; so if you wish you can use this new tube in your old scope simply by plugging it in.

You can do better, though, by replacing a few parts and making some adjustments so that front-panel dials and calibrations will still read right. Because this new tube greatly improves the performance of your scope, we think you'll want to make use of it. To make it as easy as we can for you, we have put up kits of all the parts you will need. The kits, including the new CR Tube, graticule, all necessary components, and easy-to-follow instructions, will help you bring your old scope right up to date. We pay the shipping cost.

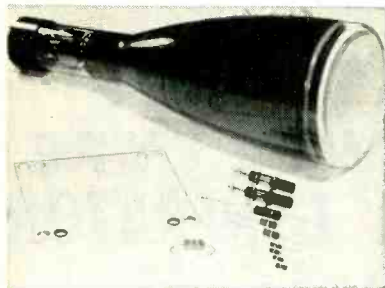

K511AB—for Type 511A Oscilloscopes:

Doubles the vertical sensitivity, doubles the linear vertical deflection, reduces errors due to parallax. Kit contains 5ABP1 cathode-ray tube, 6 cm graticule, all other components required to effect the change.

Modification Kit K511AB (P1) . . \$36.00
(with P7 or P11 phosphor 40.00)

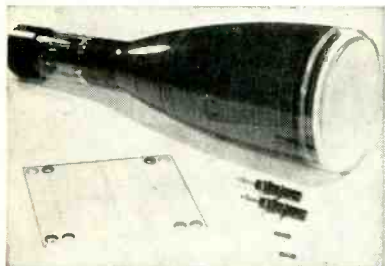

K512AB—for Type 512 Oscilloscopes:

Doubles the linear vertical deflection, decreases errors due to parallax. Kit contains 5ABP7 cathode-ray tube, 8 cm graticule, all other components required to effect the change.

Modification Kit K512AB (P7) . . \$39.50
(with P1 phosphor 35.50)

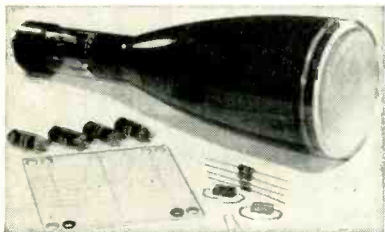

K514AB—for Type 514 Oscilloscopes:

Doubles the linear vertical deflection, decreases errors due to parallax, reduces dc-shift. Kit contains 5ABP1 cathode-ray tube, 6 cm graticule, four 6AU6's, all other components required to effect the change.

Modification Kit K514AB (P1) . . \$37.50
(with P7 or P11 phosphor 41.50)

Kit prices include transportation costs. To make sure you get the right parts, please include Oscilloscope TYPE and SERIAL NUMBER when ordering. Immediate shipment. Please send orders directly to:



**Field Engineering Department
Tektronix, Inc.**

P. O. BOX 831A • PORTLAND 7, OREGON

ment are explained in the 12-page bulletin, which also contains descriptive information, pricing data and information on accessory equipment. Other company electric instruments for industrial and central station use also are listed.

Microwave Nomograms and Charts. Airtron, Inc., Linden, N. J., has published a new 20-page booklet of waveguide engineering data and curves. The publication represents practical techniques and approaches developed by the company's engineering staff in designing and using waveguide components such as mixers, duplexers, flexible and rigid waveguides, directional couplers and allied accessories. The charts should prove useful to many communications, broadcast and radar engineers in simplifying their day-to-day handling of microwave problems.

Horizontal Deflection Amplifier. CBS-Hytron, Danvers, Mass. A technical information sheet describing the performance of the 6CU6 horizontal deflection amplifier—a tube designed especially for heavy-duty use—was recently prepared. The 6CU6 described (rated for continuous tv service) is interchangeable with the older type 6BQ6GT. Although it has electrical characteristics identical with those of the 6BQ6GT, it will live much longer, because of its conservative ratings and generous safety factors.

Broadcast Remote Control. Hammarlund Mfg. Co., Inc., 460 W. 34th St., New York 1, N. Y., has available a brochure describing its remote control equipment for broadcast transmitters. The control equipment discussed makes use of audio tones for complete control and metering of the remote transmitter including nine possible control functions and nine telemetering functions. It makes use of recognized principles of telemetering and requires only a single circuit which may be wire, radio or microwave. No d-c line is needed.

Electronic Components. Stackpole Carbon Co., St. Marys, Pa. Catalog RC-9 contains a wealth of helpful information on the complete line of fixed and variable composition resistors, line and slide switches,

fixed composition capacitors, powdered iron cores, molded coil forms and Ceramag ferromagnetic cores manufactured by the company. Complete electrical and mechanical specifications, dimensions and application data for all components are given in this 56-page catalog. The section on iron cores alone contains over a dozen informative pages on the selection and use of standard, threaded, sleeve, side-molded and cup cores. Descriptions of several new applications for Ceramag ferromagnetic cores are included.

Comparison Bridge. Southwestern Industrial Electronics Co., Inc., 2831 Post Oak Road, Houston 19, Texas. A 4-page catalog bulletin covers the model E-1 comparison bridge which provides a means of comparing resistors, capacitors and inductances with standard units, indicating percentage deviation directly. Applications, special features, circuit description, electrical and mechanical specifications and a schematic diagram are included.

Connector Bulletin. Cannon Electric Co., 3209 Humboldt St., Los Angeles 31, Calif., has issued a completely revised and redesigned bulletin on its XL series of low-level sound connectors. This 4-page, 2-color bulletin contains detailed technical information and is fully illustrated with dimensional sketches, sectional drawings and exploded views of the plug and receptacle. The connectors described are standard equipment on microphones, amplifiers, tape recorders, data recorders, oscillographs and many other electrical devices. Seventeen different assemblies and two insert arrangements are cataloged.

Microwave and TV Instrumentation. Polarad Electronics Corp., 100 Metropolitan Ave., Brooklyn 11, N. Y. A new brochure covers latest developments in microwave and tv instrumentation. The first section of the catalog deals with microwave test equipment covering frequencies from 10 to 31,000 mc and includes signal sources and generators, spectrum

DC-AC CHOPPERS

Triple Certified for Military Use
0-500 CPS

Each production lot sampled and life tested to prove 1000 hours life while cycled -55°C. to +85°C. No guesswork.

Every Chopper given not only 1 but 2 complete operating tests at -55°C. +25°C. +85°C. before shipment. Double proof of stamina. Nothing left to chance.

Gold contacts are used for superior results in the vital 0-1½ volt d-c range. No other material will match this fine performance.

Also available 60 cycle types.

All military specifications met. Liberal safety factors to meet emergency conditions.

Write today for complete information.
Catalog 280B 0-500 cps
Catalog 246D 60 cps

EXAMPLES:
Frequency tolerance 0-500 cps.
Coil Voltage Tolerance:
+30% -20%
Noise level 200 microvolts.



STEVENS-ARNOLD
INCORPORATED

22 ELKINS STREET, SOUTH BOSTON 27, MASS.

Precision ATTENUATION to 3000 mc!

- VSWR less than 1.2 at all frequencies to 3000 mc.
- **TURRET ATTENUATOR** featuring "Pull - Turn - Push" action with 0, 10, 20, 30, 40, 50 DB steps.
- Accuracy ± 0.5 DB, no correction charts necessary.
- 50 ohm coaxial circuit. Type N Connectors.

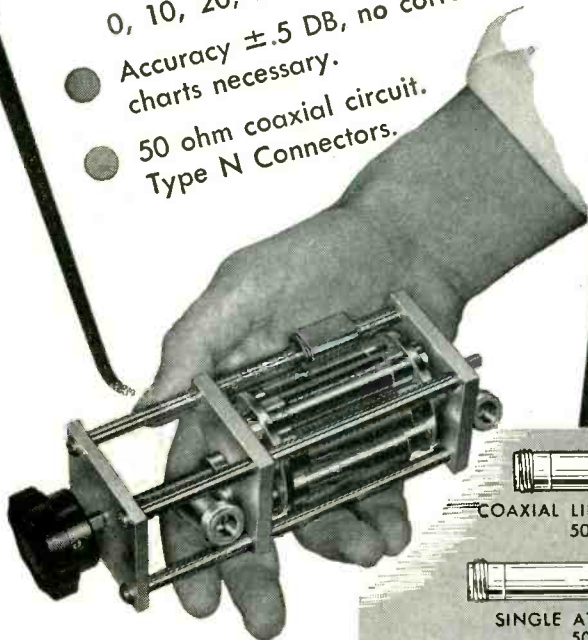

Inquiries are invited concerning single pads and turrets having other characteristics

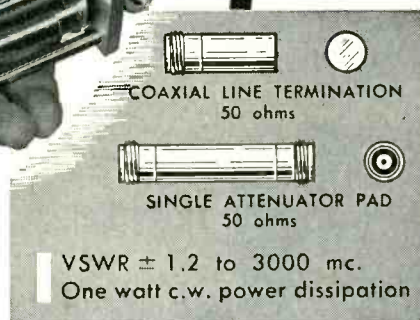

STODDART AIRCRAFT RADIO CO., INC.

6644-A SANTA MONICA BLVD., HOLLYWOOD 39, CALIFORNIA
Hollywood 4-9294

analyzers, microwave receivers and wide-band video amplifiers. The second section of the catalog describes the company's tv studio and test equipment. Technical specifications are set forth for a complete line of picture-generating equipment as well as picture and waveform monitors, both portable and lab type units being available. The radio cue system, used extensively for intrastudio wireless communication, and a complete line of regulated power supplies are also included in the latter section. An up-to-date price list, as well as ordering information, is provided in the catalog.

Watertight Panel Instruments. DeJur-Amsco Corp., 45-01 Northern Blvd., Long Island City 1, N. Y., has available two technical bulletins on its 1½-in. watertight panel instruments. Included are illustrations, schematic drawings, general specifications, tables of standard ranges and approximate resistances, special features and complete ordering information for the round (model 120) and square (model 112) panel instruments.

Radiation Detection Equipment. Radiation Counter Laboratories, Inc., 5122 W. Grove St., Skokie, Ill. Catalog No. 15 is a comprehensive, illustrated guide for selection of radiation-detection equipment. The brochure is divided into three sections. Section I covers electronic equipment, including scalars, special electronic instruments and nuclear-reactor control equipment. Section II is devoted to radiation-counter tubes of all types, scintillation counting equipment, health instruments and accessories. Section III covers glass apparatus, scintillating crystals and liquids, special chemicals and gases and thin films. All items in Section III are products of Wakefield Industries, Inc. General information about the companies and their research facilities are included.

Monoset. Telex, Inc., Telex Park, St. Paul, Minn., has issued new literature on the Monoset (under-the-chin headphone) covering specifications and applications of the unit to professional, commercial and

institutional use. The catalog sheet (form 381003) illustrates the equipment and describes exclusive features.

Miniature Gage Pressure Potentiometer. Bourns Laboratories, 6135 Magnolia Ave., Riverside, Calif. A 4-page brochure, No. 3553, describes a new miniature gage-pressure potentiometer in standard ranges from 0 to 100 and 0 to 5,000 psi. Photographs illustrate the method of accurately transmitting the movement of the bourdon tube to the sliding contact of the wire-wound potentiometer. Diagrams, curves, charts and outline drawings provide additional technical information. The detailed specifications include such items as linearity, hysteresis, resolution, life expectancy and the effect of vibration, acceleration and temperature.

Voltmeter. Southwestern Industrial Electronics Co., Inc., 2831 Post Oak Road, Houston 19, Texas. Versatility and accuracy are the outstanding features of the model R-1 voltmeter discussed in a recent 4-page folder. Included in the illustrated bulletin are a complete description, technical specifications, a simplified version of the basic circuit arrangement and a listing of some of the company's other instruments.

Magnet Wire. Hitemp Wires, Inc., 26 Windsor Ave., Mineola, Long Island, N. Y., has available literature announcing its magnet wire that is insulated with Dow Corning's DC-1360 silicone resin in sizes 22 to 42 AWG. The wire described is suitable for continuous service at temperatures ranging up to 200 C and has excellent resistance to scrape abrasion.

Connector Bulletin. Cannon Electric Co., 3209 Humboldt St., Los Angeles 31, Calif., has issued a completely revised and redesigned bulletin on its XL series of low-level sound connectors. The 4-page 2-color bulletin contains detailed technical information and is fully illustrated with dimensional sketches, sectional drawings and exploded views of the plug and receptacle. The connectors described

STACKED UP CALLS STEALING OPERATING EFFICIENCY?

Now you can solve your problem *economically* with RyCom CFD-B Packaged Units that add 4 additional voice channels to each of your present lines. RyCom Carrier Telephone Equipment *pays for itself* quickly by drastically reducing long distance telephone costs.

Check These RyCom Features:

- Built-in Measuring Panel—for fast over-all system line-ups, even by non-technical personnel. Eliminates need for expensive test equipment . . . testing trips up and down the line.
- Built-In Slope Control—to equalize non-conforming lines.
- Pilot Panel automatically regulates transmission during changing weather conditions.
- RyCom separate panel construction provides maximum accessibility for easy inspection and maintenance.
- Packaged in a single rack. Saves space, saves installation time. Shipped complete in one package ready for easy installation.

Immediate deliveries now being made.

RyCom engineers will be glad to discuss *your* particular installation needs. Write or phone today for complete details, specifications and prices.

Rely on RyCom for Highest Quality at Minimum Cost

RyCom RAILWAY COMMUNICATIONS, INC.
Raytown, Missouri, U.S.A.
Phone FLEMing 2100

Expert office: 13 East 40th St., New York 16, N. Y.

Want more information? Use post card on last page.

KEARFOTT COMPONENTS

— essential for
modern controls

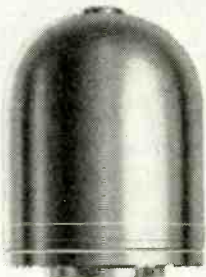

(shown 1/4 size)

GYROS

Vertical, Free and Rate Gyros provide the utmost in performance under extreme environmental and operational conditions. Hermetically sealed in dry, inert gas, these Gyros are characterized by compactness, vertical accuracy and low drift rates. They are accepted as the standard in airborne radar, camera stabilization and missile guidance applications.

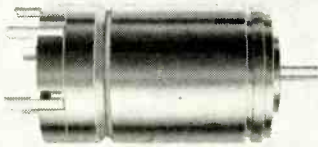

(shown 3/4 size)

SYNCHROS

For use as transmitters, control transformers, repeaters, resolvers and differentials. Synchros with maximum diameter of 1 1/16", available from production, with maximum error of seven minutes of arc. Unique design eliminates rotor to stator eccentricity errors and provides dependable service under extreme environmental conditions.



(shown 1/2 size)

SERVO MOTORS

High torque—low inertia servo motors are available in ranges from 31/32" to 1 3/4" in diameter. Also integral combinations including damping and computing tachometers. Geared servo motors, in the same diameters, can be provided to meet the highest performance.

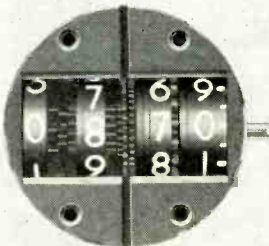

(shown full size)

OTHER PRODUCTS

In addition to the precision Angle Counter shown, many other mechanical and electro-mechanical devices are available from regular or special production. Kearfott's long years of experience in the design and production of precision instruments and components are at your service.

Bulletin #53 describes the many services, components and products the Kearfott Organization offers you. Write for a copy TODAY



KEARFOTT COMPONENTS INCLUDE:

Gyros, Servo Motors, Synchros, Servo and Magnetic Amplifiers, Tachometer Generators, Hermetic Rotary Seals, Aircraft Navigational Systems, and other high accuracy mechanical, electrical and electronic components.

Kearfott

SINCE 1917

CREATIVE ENGINEERING
PRODUCTION ACHIEVEMENT

KEARFOTT COMPANY, INC., 1150 McBride Ave., Little Falls, N. J.

Midwest Office: 188 W. Randolph St., Chicago 1, Illinois

West Coast Office: 253 N. Vineda Ave., Pasadena, Calif.

A General Precision Equipment Corporation Subsidiary

are standard equipment on micro-phones, amplifiers, tape recorders, data recorders, oscillographs and many other electrical devices of leading manufacturers. Seventeen different assemblies and two insert arrangements are cataloged.

Ceramic Capacitors. Centralab, a division of Glove-Union Inc., 900 E. Keefe Ave., Milwaukee 1, Wisc. Five new and revised catalog sheets covering special types of ceramic capacitors are now available. Each illustrates and gives technical specifications for a particular type. Bulletin 42-4R deals with BC disk capacitors; bulletin 42-101R, ceramic trimmers; bulletin 42-59R, tubular trimmers; bulletin 42-206, feed-through capacitors; and bulletin 42-123R, high-accuracy capacitors.

Punched-Card Computer. Remington Rand Inc., 315 Fourth Ave., New York 10, N. Y. Full details on the electronic punched-card computer are provided in a new, illustrated 6-page brochure. The machine described features universal calculating ability, flexible programming, removable control panels, built-in automatic verification of results, alphabetical reproduction, summarized accumulation, sequence checking, dual-control sorting and high-speed punching of results.

Amplistats. General Electric Co., Schenectady 5, N. Y., has available an 8-page bulletin on amplistats (self-saturating magnetic amplifiers) for high-gain d-c amplification in industrial, educational, and laboratory control and instrumentation circuits. The booklet (GEA-5950) shows typical GE units, explains theory of their operation, defines terms, and describes amplistat characteristics with graphs and charts. Listed are 1-va amplistat, 40-va industrial amplistat, 40-va educational-laboratory amplistat, and 400-cycle plug-in amplistat.

Fiber Catalog. Continental-Diamond Fibre Co., Newark, Del., has available catalog GF-54, a 12-page illustrated booklet, that not only describes the company's prod-

ucts and many of their uses, but also contains detailed technical data in tabular form for quick, easy reference. Technical data include information on tensile, flexural, shearing, Izod impact, compressive and dielectric strengths, water-absorption rates minimum densities, arc resistance, Rockwell hardness, specific gravity, bonding strength, maximum constant-operating temperatures, loss factors and insulation resistance. Many other products are featured in the catalog.

Variable Transformers. Standard Electrical Products Co., 2240 E. Third St., Dayton, Ohio. An 18-page catalog illustrates and describes the full line of Adjust-A-Volt variable transformers. Design and construction details, dimensions and performance characteristics of the various models of auto, isolated and metered variable transformers for built-in and bench applications and for radio and tv servicing are included. The catalog covers the transformers in standard bench or panel mountings, as well as ganged assemblies. Terminal and tap arrangements as well as circuit diagrams are included along with a convenient index of specifications and applications for all single-phase and three-phase transformers covered by the catalog. The many uses for toroidal winding are discussed in a special section.

Glass Catalog. The Lancaster Lens Co., Lancaster, Ohio, has issued an illustrated 8-page catalog showing a wide variety of glass-part applications. To aid the design engineer in taking advantage of the many special characteristics of glass, 21 case histories are recorded. Each includes a photograph of the glass part and a brief explanation of the advantages of the type of glass used for that particular application. Among the items discussed in this section are lenses and reflectors, tv bulb parts and other electronic components, instrument faces and panels, appliance parts, dials and nameplates. Other sections of the catalog outline the physical properties that give glass almost un-

ONE SOURCE

for every Wire and Cable requirement

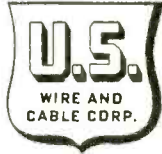



No. RH-11
High Frequency Cable



No. ML-18
Instrument Wire



No. M-20
Microphone Cable

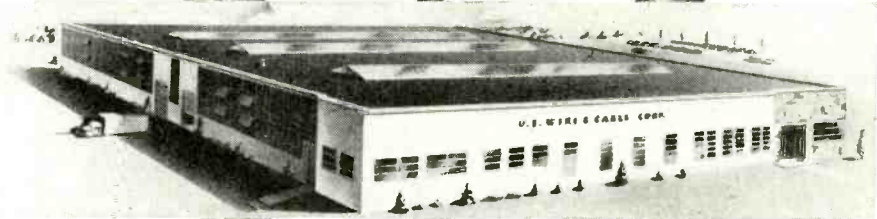



No. LR-5900
Radio Hook-Up Wire



No. M-22
Microphone Cable



No. 1500
Tubular Twin Lead

Electronic and Communication... Electrical and Industrial... in every field U.S. Wire and Cable plays an active part as a dependable manufacturer. Products of our new enlarged factory surpass all standard field and laboratory tests. Of our extensive line, the items shown here are only representative. We invite your inquiries for our Catalogue and further information.

HIGH FREQUENCY COAXIAL CABLES: These cables not only conform to, but in most cases surpass, JAN-C-17-A specifications for RG type cables. Our continual laboratory tests assure you that these cables will exceed your requirements in the Electrical, Electronic, and Industrial uses to which they will be applied.

INSTRUMENT and RADIO HOOK-UP WIRES: Furnished with Nylon, Polyethylene, Vinyl or other types of plastic insulation, or without jacket. UNDERWRITERS' LABORATORIES approved, these wires are used for Control Wiring, Automatic Dispens-

ing Machines, and in Radio & TV Equipment.

MICROPHONE and INTERCOM CABLES: A complete selection of Shielded and Unshielded types which can be used for Lead-in, Phono Pick Ups, Speaker Installations, and Public Address purposes in the Radio industry.

TV ANTENNA WIRES: Designed in all shapes (Flat, Round, Twin Leads, Tubular) to fulfill the requirements of Television, Mobile Communications, UHF, VHF, Community Antenna Systems, Antenna Rotor Leads, and other Electronic purposes.

UNITED STATES WIRE & CABLE CORP.

PROGRESS AND MONROE STREETS
UNION, NEW JERSEY

Consult us about your
wire and cable problems.
Catalog on request.

Representatives in Principal Cities

just right

for built-in applications

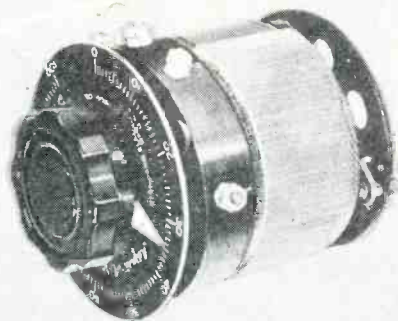

Adjust-A-Volt 300BU variable auto-transformers

This versatile unit smoothly controls plenty of power for its size. Highly efficient, small and compact, the 300BU is designed for panel-mounted applications like line voltage control for power supplies and instruments, control of heat in small ovens, motor speed control and light intensity variation. New design brush assembly, pre-adjusted at the factory, maintains constant pressure from full-brush to no-brush . . . assures longer life, more reliable operation. Ganged assemblies are available.



3 wire fused unit for 2 KVA duty

Sturdy, attractive Type 3PF1500B Adjust-A-Volt for over-voltage connection—suitable for bench or panel mounting. Equipped with 3 prong plug-cord, output receptacle and fuse.



get your copy NOW

Write for new 18-page catalog No. 553-5 on full Adjust-A-Volt line ranging from 0.34 to 16.8 KVA. Full specifications, circuit diagrams, prices.

STANDARD ELECTRICAL PRODUCTS COMPANY

2239 E. THIRD ST. • DAYTON, OHIO

limited design potential, list the production and finishing processes available at the company, and discuss the basic types of commercial and industrial glass, their general properties and common applications.

Electronic Controls. Barber-Colman Co., Rockford, Ill. Catalog F 6166 describes the flexibility of the company's electronic controls for heating, ventilating and air conditioning. Descriptive information concerning the ultrasensitive microrelay that simplifies the amplifier is also included. The catalog also contains a complete description of the various elements required for system application and illustrates their usage.

Mass Spectrometer. General Electric Co., Schenectady 5, N. Y., has available a new 12-page, two-color bulletin (GEC-587A) on the use of the mass spectrometer for chemical analysis by mass separation. It contains photographs and diagrams of the equipment, describes the component parts, explains operation procedures, and lists range, resolution and system specifications. Sample recorder strip charts show the spectra of various chemical mixtures, and installation, maintenance and modification information is provided.

Tube Selection Chart. Amperex Electronic Corp., 230 Duffy Ave., Hicksville, L. I., N. Y., has prepared a comprehensive, 3-color chart to make possible the quick selection of rectifiers, thyratrons and ignitrons for practically any condition of service. This 15-in. × 16½-in. chart shows the rating in peak inverse voltage vs maximum average forward current for the tubes in their usual operation. Typical rectifier circuits and associated calculation factors are shown on the chart's reverse side. Once a tube has been chosen from the chart, its special features may be checked on data sheets.

R-F Power and VSWR Equipment. M. C. Jones Electronics Co., Inc., Bristol, Conn. A new 48-page 2-color catalog contains information on the use of each series of r-f power and

vswr instruments, absorption-type, r-f wattmeters, r-f load resistors, station guardians and Micro Match accessories. Photographs and typical circuit diagrams are included for each series. The publication contains technical data to guide the engineer in selecting Micro Match equipment to meet his requirements. Ordering information is supplied so that the buyer will be assisted in interpreting engineering requirements in terms of specific models.

Sheet Metal Products & Electronic Components. Bud Radio, Inc., 2118 E. 55th St., Cleveland 3, Ohio, has published a new catalog of sheet metal products and electronic components. The 52-page catalog illustrates and describes the company's complete line. To insure ease of selection and ordering, complete sizing information is given on each product. Suggestions for uses and applications are also included.

Power-Tube Chart. Amperex Electronic Corp., Hicksville, L. I., N. Y., has prepared a 3-color, 15 in. × 16½ in. chart that shows the rating in power output vs frequency for Amperex power tubes in typical operation. The chart includes the FCC frequency allocations and associated applications correlated with tube performance. This comprehensive chart, coded in color, is planned for quick use and easy readability. At a glance, it is possible to find the Amperex tube or tubes that will meet the general requirements for practically any r-f or audio operation. The special features of each tube may then be checked on data sheets, also available from the company.

Solderless Terminals & Connectors. Aircraft-Marine Products, Inc., 2100 Paxton St., Harrisburg, Pa. The "Big Story in the Little Book" is a novel solution to the problem of making technical writing appealing as well as informative. Solderless terminals and connectors are the subject of this story in verse, with the highlights of the company's wire-termination process stressed in an easy-to-read manner. The booklet is amply supplemented with photographs and cartoons picturing the connectors

Relay contacts last longer when protected by

EDISON TIME DELAY RELAY

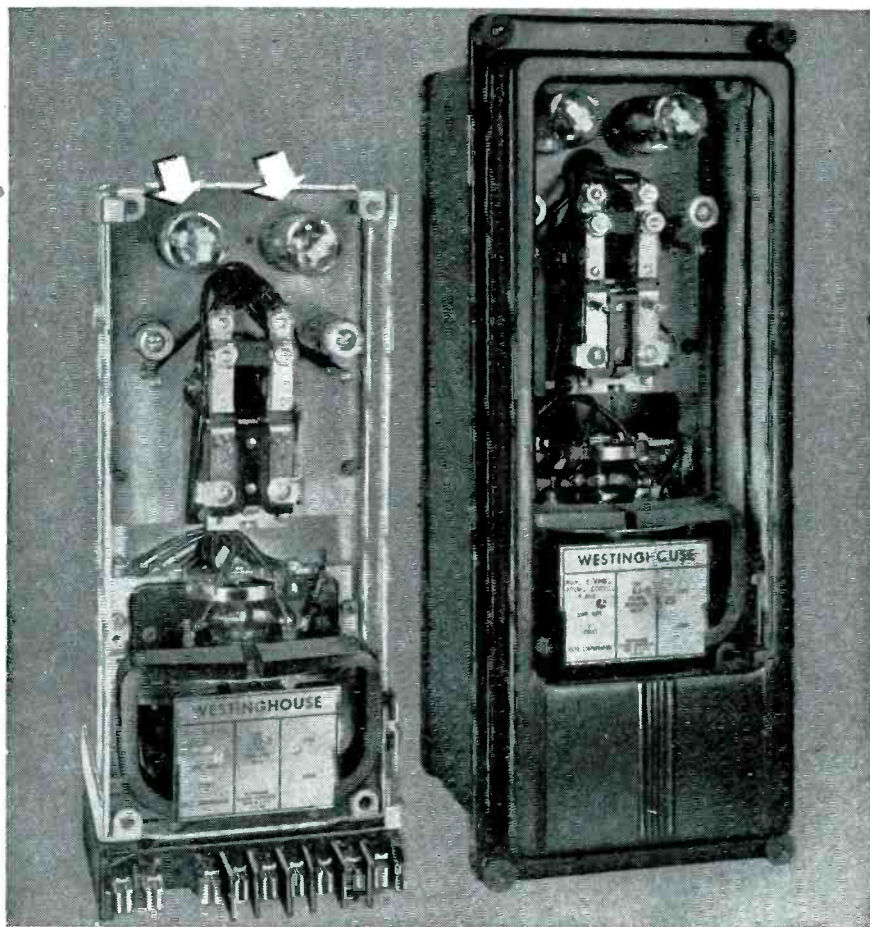

New Westinghouse Capacitor Control uses two EDISON Time Delay Relays to prolong the life of the auxiliary switching relay.

THIS NEW Westinghouse Capacitor Control senses the need of a utility power system for reactive kilovolt amperes and energizes circuits to connect the capacitor bank to the bus. The reverse function is performed when the capacitor bank is no longer required.

THE FUNCTION of the Edison Time Delay Relay is to hold off energization of the auxiliary relay until the change in the system is of a permanent nature. Any intermittent operation of the sensing relay is ignored until enough accumulated energy is stored in the bimetal of the time delay relay to close its contacts.

THE EDISON Time Delay Relay not only reduces the number of operations of the auxiliary relay but also eliminates unnecessary chatter and false switching of the capacitor bank to the line.

FOR FREE LITERATURE describing the many uses for this and other Edison products write to:

Thomas A Edison
INCORPORATED

Instrument Division
54 Lakeside Avenue
West Orange, New Jersey



YOU CAN ALWAYS RELY ON EDISON

and tools as well as the carefully controlled installation process.

Tube Characteristics. Tung-Sol Electric Inc., Newark 4, N. J. The first 166 pages of the 19th edition of the electronic-tube characteristics manual contain all the technical information about receiving and c-r tubes required by engineers and servicemen for every-day use. Six different colored pages are used to separate the many charts, diagrams and technical data for easy reference. In the back of the manual there is a special 20-page section containing basic marketing information.

Data-Reduction Equipment. Clary Multiplier Corp., San Gabriel, Calif. Equipment for the reduction, handling and printing of data in electronic systems for industry, laboratory, business and accounting operations is described in a new 6-page illustrated folder. Products listed in the brochure, with information on equipment features, practical applications and specifications, are the digital readout machine, electrical pulse-data recording combination, analog-to-digital converter, electrical input keyboard, binary-to-decimal conversion machine, printing timer and plug-in units for a number of specific requirements.

Meters & Special Apparatus. Sterling Mfg. Co., 7201 Wentworth Ave., Cleveland 2, Ohio. A file folder of information sheets describes electrical, mechanical and electronic meters and all special apparatus manufactured by the company. In addition to illustrations and listings of the standard line of a-c and d-c voltmeters, ammeters, milliammeters, resistance meters and pocket meters, the folder includes special pages devoted to typical examples of Sterling meters developed for specific adaptations.

Thermistors. Carboly Department of General Electric Co., Detroit 32, Mich. Latest information on methods of using thermistors, heat-sensitive electrical resistors with negative temperature coefficient, as well as a description of a new physical demonstration of

PRECISION-ENGINEERED
HOUSINGS
DESIGNED FOR
ELECTRONICS

MORE THAN 3000 SIZES,
IN A COMPLETE RANGE
OF METALS—**STEEL,
BRASS, ALUMINUM,
Mu-METAL.**

OLYMPIC HOUSINGS are designed for easy assembly. Minimum variations in dimensions at any stage. Built-in flexibility assures modification and fabrication to meet blueprint specifications.

- **Delivery from stock—no shipping delays**

- **Tooling costs eliminated**

OLYMPIC HOUSINGS are engineered to incorporate three major elements of construction—*Uniformity, Strength, Compactness.*

On your next project—let OLYMPIC craftsmen give you facts, figures and specifications. Send for new illustrated folder E4 today.

STANDARDIZE WITH OLYMPIC

OLYMPIC

METAL PRODUCTS COMPANY, INC.
ALPHA, NEW JERSEY

permanent magnet properties, is available in 4 technical data sheets: TH-9, TH-10, TH-11, and PM-116. The reports describe thermistor applications in radio-set surge protection (TH-11), contactless switches in overload protective devices (TH-11), temperature compensation (TH-10), warning signals (TH-9), and controlled automation (TH-9). They each include manufacturing, operating, selection and engineering-assistance data. The report on magnetic principles (PM-116) discusses magnetic suspension, torque control, driving and braking with permanent magnets.

Magnetic-Deflection Yoke. Syntronic Instruments, Inc., 100 Industrial Road, Addison, Ill., has issued a catalog page describing its new Y29 magnetic-deflection yoke for testing c-r tubes. Four types are described, ranging in deflection angle from 50 deg to 90 deg. Complete data include dimensional drawing, mechanical and electrical characteristics, a table listing horizontal-vertical coil inductance combinations and construction details. Additional information includes number of tubes which may be continuously tested without yoke damage or failure and the unconditional one-year guarantee.

Fastening Specialties. Southco Division, South Chester Corp., 1400 Finance Bldg., Philadelphia 2, Pa., has issued a fully-illustrated, 24-page handbook describing fastening specialties. A section is devoted to each of 7 different fastener types: screw fasteners, blind rivets, adjustable-pawl fasteners, door latches, spring-grip fasteners, anchor nuts and door-retaining springs. Each section has photographs, drawings, tables of dimensions and size, and descriptions. Copies of catalog B2 may be obtained for the writing.

Electron Microscope. North American Philips Co., Inc., 750 South Fulton Ave., Mount Vernon, N. Y. A new 4-page folder titled "Some Reasons Why the World's Most Powerful Electron Microscope Deserves Your Consideration" is now available. Forty-four typical applications are listed together with

Cutting and shaping fragile crystals...

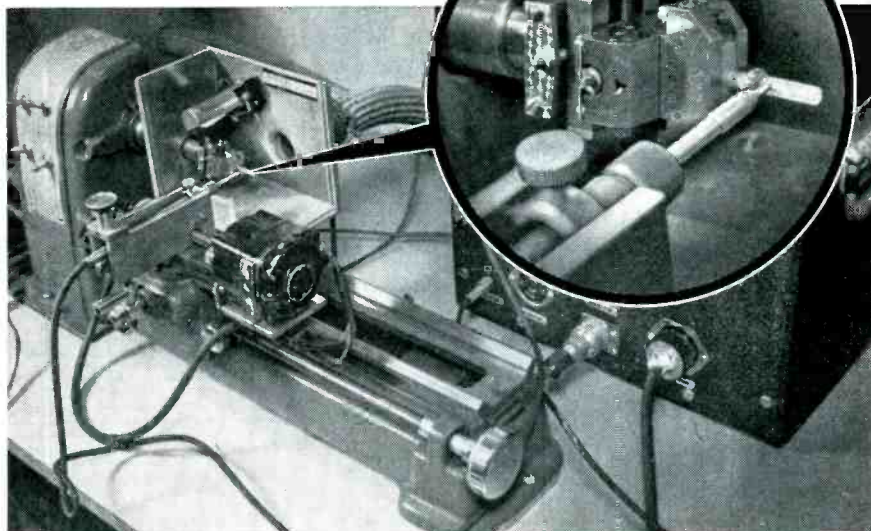

...another way the electronics industry uses

THE S.S. White INDUSTRIAL "AIRBRASIVE" UNIT

The S.S. White "Airbrasive" Unit is opening-up vast, new approaches in the development of improved electronic components by providing a practical solution to many of the difficult "problem-jobs" encountered in producing these parts. Cutting spiral bands on film-type resistors, cutting germanium, accurately removing deposited surface coatings, and drilling thin sections of glass and other hard, brittle materials are but a few of the difficult jobs now made practical by this highly versatile, precision machine.

For example, exasperating difficulties had been encountered in cutting and shaping crystals for X-ray and neutron diffraction work. Ordinary cutting and grinding operations were prone to cause fracture. One laboratory applied the S.S. White "Airbrasive" Unit to this task and reported, "There is absolutely no other convenient way to do crystal-shaping for our work than by means of the Unit." The crystals are first manually cut into sections of

roughly correct size with the "Airbrasive" Unit. Then, as illustrated, the rough crystal is mounted on a standard goniometer head and oriented optically or by X-ray. The goniometer head is placed on a small lathe, and the "Airbrasive" tool is mounted on a toolholder. Fragile materials have been successfully shaped into accurate cylinders with diameters to a fraction of a mm and lengths of 1.5 to 2 cm. S.S. White engineers will be glad to conduct tests on any of your parts and will advise you as to the suitability of the "Airbrasive" Unit for your needs.



The "Airbrasive" Unit operates on 110 V, 60 cycle A.C. current. Any DRY cylinder gas can be used as a propellant.

WRITE FOR BULLETIN 5307 It contains complete facts and data on how the "Airbrasive" Unit operates and how it can be adapted to specific operations.



THE S.S. White INDUSTRIAL DIVISION
DENTAL MFG. CO.



Dept. EB, 10 East 40th St.
NEW YORK 16, N. Y.

Western District Office • Times Building, Long Beach, California

STANCOR ULTRA-MINIATURE TRANSFORMERS for TRANSISTOR CIRCUITS ...

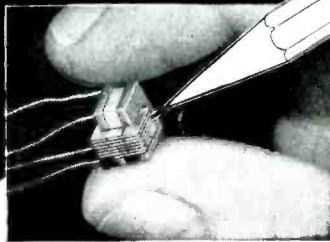

If you are having space problems with your transistor circuitry, consider these Stancor transformers as a means of solving your difficulties.

In addition to the units shown below, special transistor transformers, designed and built to your specifications by Stancor engineers, can be supplied in quantities of five or more.

These five Stancor ultra-miniature transformers, designed especially for transistor applications, are available through your local Stancor distributor. The smallest weighs 0.07 ounce and measures $\frac{1}{4}$ " x $\frac{3}{8}$ " x $\frac{3}{8}$ ". The largest weighs only 0.10 ounce and measures $\frac{3}{8}$ " x $\frac{3}{8}$ " x $\frac{3}{8}$ ".

Part No.	Application	Pri. Imp.	Sec. Imp.	Pri. DC Res.	Sec. DC Res.
UM-110	Interstage	20,000	1,000	1675	285
UM-111	Output or matching	1,000	50/60	120	9.0
UM-112	High imp. mic. input	200,000	1,000	4000	195
UM-113	Interstage	20,000	1,000	1350	205
UM-114	Output or matching	500	50/60	70	9.0

Write for Stancor Bulletin 462R listing complete data and performance curves on these units.



CHICAGO STANDARD TRANSFORMER CORPORATION

3578 ELSTON AVENUE • CHICAGO 18, ILLINOIS
EXPORT SALES: Roburn Agencies, Inc., 39 Warren Street, New York 7, N. Y.

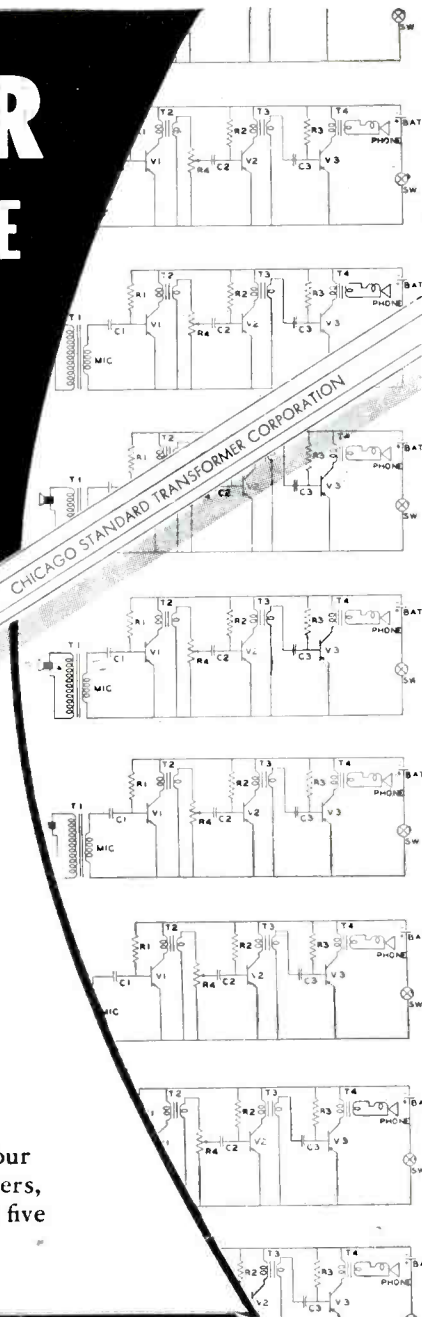

design and operating information concerning the viewing screen, accelerating potential, magnification, electron diffraction, focus determination and control, image stability, resolution and other features.

Radio Communication Equipments. General Electric Co., Syracuse, N. Y. Ten new bulletins describe the latest improvements in many of the company's radio communication equipments for industrial and civil defense applications, taxicabs, utilities, police and fire departments. The bulletins cover 6 base-station combinations and 4 mobile combinations. The base stations described are 60-watt units for operation in the 25 to 50-mc band, and 50-watt units for operation in the 152 to 174-mc band. There are three types in each band, designed for floor, desk and pole mounting. The mobile combinations are all for operation in the 152 to 174-mc band. They include two 10-watt units, a 30-watt and a 50-watt unit.

Unitizing Electronic Equipment. Alden Products Co., 117 N. Main St., Brockton 64, Mass. The 1954 edition of the handbook, "Ideas-Techniques-Designs," is packed with new standard components for unitizing electronic equipment. It provides new data and planning sheets on plug-in packages and basic chassis for unitizing equipment and giving it 30-second interchangeability. Further improvements and newer components for indicating and monitoring operation of electronic equipment with tiny tell-tales are described. New models of connectors and interconnecting systems that allow dynamic color-coding for easy circuit tracing have been added. The booklet is available to manufacturers and designers writing on their letterhead.

Installation of Master TV Systems. Blonder-Tongue Laboratories, Inc., 526 North Ave., Westfield, N. J., has released a new manual—"How to Install Master TV Systems." Included are complete instructions and diagrams covering every phase of the planning and installation. Each step is clearly explained and illustrated—antenna installation,

choice of transmission lines, signal amplification and distribution to tv sets. Simplified charts show the installer how to calculate transmission-line losses, change decibels to voltage gain and make up all types of attenuation pads. An actual example outlines the calculations of signal level provided to one set in a system. An additional table gives the gain, maximum input level, size and power consumption of all the company's electronic units.

Audio Amplifier. Westinghouse Electric Corp., Box 2099, Pittsburgh 30, Pa. Bulletin DB85-950 describes the type FG 5 or 10-kw variable-frequency audio amplifier. Applications of the amplifier are suggested. The unit discussed will amplify 30 to 10,000-cycle signals as much as a million times. Design and construction features and operation of the equipment are described. Complete electrical characteristics of the amplifier are included.

Ultrasonic Cleaning for Industry. General Electric Co., Schenectady 5, N. Y. How the ultrasonic generator works, the principles of high-frequency sound cleaning, and examples of present applications are explained in bulletin GEA-6056. The two-color, four-page publication explains how the ultrasonic action of the generator hastens cleaning by as much as 100 times. Photographs and drawings show components of the equipment and the generator in use.

Wire Connector. Ideal Industries, Inc., Sycamore, Ill. A recent catalog sheet gives a complete description and specification on a new all-plastic screw-on wire connector. The connector discussed is designed for low-cost connections of No. 14, 16 and 18 wires, and is available in two sizes, A-1 and A-3. The plastic used has both high impact strength for mechanical security and excellent dielectric properties.

Variable Resistors. Centralab, 900 E. Keefe Ave., Milwaukee 1, Wisc. Catalog form 42-164 covers models 1 and 2 variable resistors. Model 1

A New Production Tool...

Streamlined to cut testing costs up to 75%!

MODEL-A CIRCUIT MATCHER

A
GENERAL UTILITY
COMPARISON
BRIDGE

- Use your prototype as a "Standard"
- Analyze Circuits by AC & DC Bridge Test
- Adapts through Sockets, Plugs, etc.
- Point to Point Ohmmeter

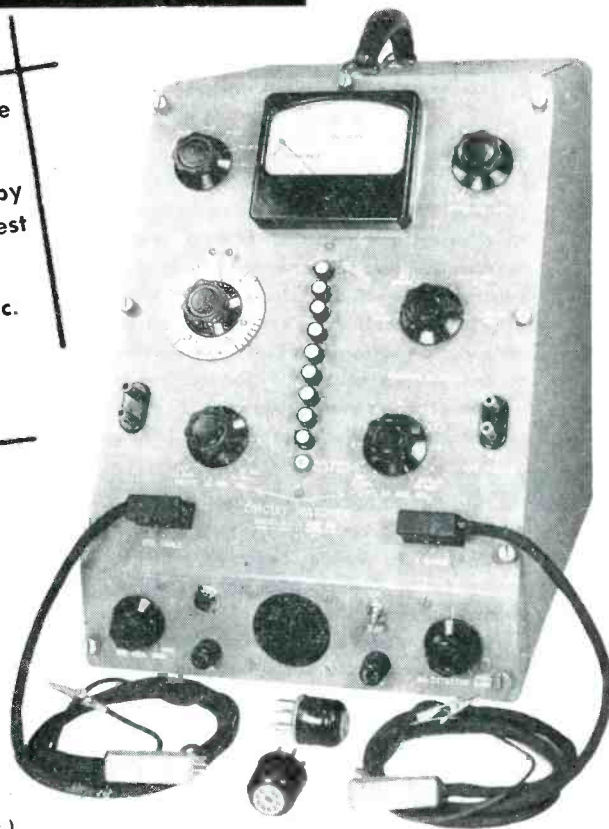

(12" x 17" x 16" High, 45 lbs.)

- The "CIRCUIT MATCHER" bridge compares production assemblies with a prototype "standard" in terms of per cent deviation.
- Subassemblies etc. may be compared by plugging into corresponding tube sockets, plugs, jacks, cable connectors, etc.
- Special test cables with novel end plugs and mating adapters to the usual tube sockets are provided. Others available on special order.
- An unskilled operator may systematically perform the tests and rapidly record the errors for a technician to analyze and correct.
- Pushbutton selection is provided for a group of 9 test points. Connectors over 9 points may be checked by using multiple adapters.
- Separate AC and DC bridge operation isolates reactive and resistive errors with an accuracy of $\pm 1\%$ over a wide impedance range. Circuit deviations up to $\pm 22\%$ can be read directly.
- A built-in ohmmeter provides direct point to point resistance measurement in either "standard" or test unit.
- Instrument is complete with bridge supplies and balance indicators.
- Conservatively designed and ruggedly built with the best materials.

A detailed specification and application bulletin is available on request, on your company letterhead.

McSHAN DEVELOPMENT CORPORATION

TEST EQUIPMENT • SPECIAL DEVICES • CONSULTANTS
71 MURRAY STREET • NEW YORK 7, N. Y.
WOrth 2-4547

- ENGINEERS
Test Equipment Design
Production Planning
Aeronautical
Mechanical
Electronics
- PHYSICISTS
- TECHNICAL WRITERS

WORK ON THE FRONT LINE OF THE NATION'S VITAL DEFENSE PROGRAM. Sandia Corporation is engaged in the development and production of atomic weapons—a challenging new field that offers opportunities in research and development to men with Bachelor's or advanced degrees, with or without applicable experience. Here you can work with able colleagues, eminent consultants and superior facilities on advanced projects of high importance — and also build a permanent career in a rapidly expanding field with a company that recognizes individual ability and initiative.

LIVE IN ALBUQUERQUE, THE HEART OF THE SUNNY SOUTHWEST. Located in the historic Rio Grande Valley at the foot of the Sandia Mountains, mile-high Albuquerque is famous for its climate—mild, dry and sunny the year around. A modern, cosmopolitan city of 150,000, Albuquerque offers unique advantages as a place in which to live. Albuquerque's schools, churches, theaters, parks, and modern shopping facilities afford advantages of metropolitan life—yet hunting, fishing, skiing and a multitude of scenic and historic attractions may all be found within a few hours' drive of the city. New residents have little difficulty in obtaining adequate housing.

ENJOY THESE OTHER IMPORTANT ADVANTAGES. These are permanent positions with Sandia Corporation, a subsidiary of the Western Electric Company, which operates Sandia Laboratory under contract with the Atomic Energy Commission. Working conditions are excellent, and salaries are commensurate with qualifications. Liberal employee benefits include paid vacations, sickness benefits, group life insurance, and a contributory retirement plan. This is not a Civil Service appointment.

Make Application to:

PROFESSIONAL EMPLOYMENT
DIVISION C

SANDIA
Corporation

SANDIA BASE • ALBUQUERQUE, NEW MEXICO

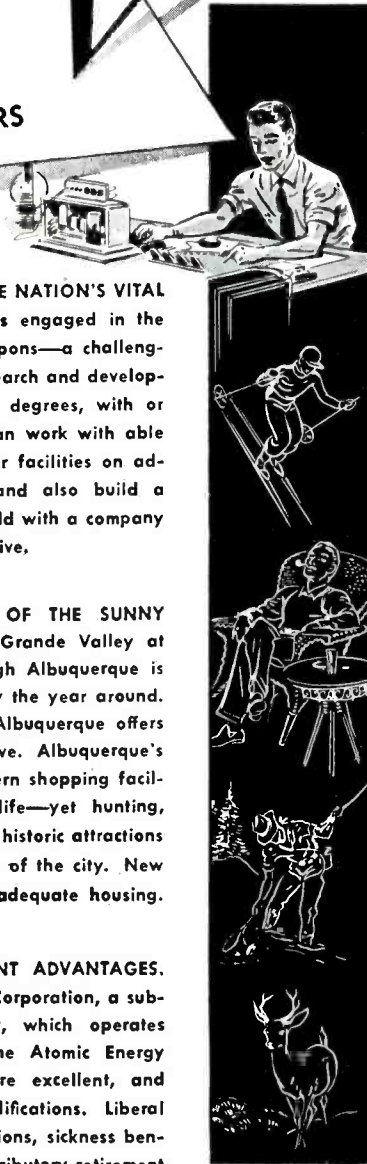

controls described are subminiature size units, $\frac{5}{8}$ in. in diameter, rated at 0.1 w. They are designed for hearing-aid, subminiature radio and microwave equipment. The model 2 control discussed is a standard $\frac{1}{8}$ in. diameter unit, rated at 0.5 w. This unit is available from 250 ohms to 10 megohms in any of 14 standard tapers.

Products Catalog. General Cement Mfg. Co., 904 Taylor St., Rockford, Ill., recently released catalog No. 156. Printed in two colors, the 64-page catalog gives detailed descriptions, specifications and prices of a complete line of radio, tv and electronic products. All products are listed by types in handy index for quick easy reference. More than 3,000 items in over 150 different classifications are included.

Alloy Data. Cerro de Pasco Corp., 40 Wall St., New York 5, N. Y. Data sheet E-14 describes the use of Cerroseal-35, an alloy of indium and tin that softens at approximately 240 F and is liquid above 260 F. Because of its extremely low vapor pressure, Cerroseal-35 can be used in high-vacuum apparatus requiring a seal between glass and glass or glass and metal. Besides adhering to glass, the alloy described will also adhere to mica, quartz, thermosetting plastics and some glazed ceramics.

Absolute D-C Power Supplies. Kalbfell Laboratories Inc., 1090 Morena Blvd., San Diego, 10, Calif., has available an illustrated mailing piece dealing with its absolute d-c power supplies. Included are a full description of the system's circuit, technical specifications and a list of applications.

Dynamotor Catalog. Carter Motor Co., 2646 N. Maplewood Ave., Chicago 47, Ill. Catalog No. 753 consists of 28 illustrated pages giving complete electrical and mechanical specifications on all the company's dynamotors, including performance and oscillograph charts and dimensional diagrams. A number of newly developed items are shown in the catalog. The new change-a-volt dynamotors are listed with complete mechanical and electrical

specifications. Shown also is the recently developed heavy-duty genemotor.

Electronics Equipment. Westinghouse Electric Corp., Box 2099, Pittsburgh 30, Pa. Booklet B-6093 is a 16-page summary of equipment available for use in the electronics industry. It gives descriptions, applications and operating ranges for such equipment as surge comparison testers, portable balancers and vibrographs, magnetic amplifiers, transistors, capacitors, relays and many others. The booklet also gives information on such semifinished material as transformer cores and magnetic materials and alloys. Designed to give users an idea of what equipment is available, the booklet also gives terse technical data.

Permanent Magnets. Carboly Department of General Electric Co., Detroit 32, Mich. Latest information on the uses, design, properties and manufacture of Alnico permanent magnets, sintered grade 5, is available in the 6-page technical report PM-111. The report offers charts, graphs and photomicrographs in explanation of magnetic and physical characteristics of the magnets, and a table of tolerances to aid the designer. The company's engineering development and application service is also described.

Sine-Cosine Mechanism. Librascope, Inc., 1607 Flower St., Glendale, Calif. Catalog sheet 304062 covers the hollow shaft differential, a miniaturized precision computer element. Chief features of this sine-cosine mechanism, a precision angle resolver for analog computers, are listed. Application and engineering data are included.

Wide-Band D-C Amplifier. Furst Electronics, 3322 W. Lawrence Ave., Chicago 25, Ill. A single-sheet bulletin contains an illustrated description and outstanding features of the model 220 wide-band d-c amplifier. The unit described was designed specifically to increase the sensitivity of c-r oscilloscopes with extended 1-f response. Complete technical specifications are included.



DESTINATION... KNOWN

A pigeon "homes" by instinct—not so with a guided missile. Instinct is replaced with a myriad of electronic devices, servo mechanisms and antennas.

Pickard & Burns, Inc., is equipped, through personnel and facilities, to design and develop the various electronic equipments for guided missiles and many other types of military and non-military systems.

Essentially, Pickard & Burns, Inc. is a research, consulting, design and development organization with extensive laboratories and custom manufacturing facilities. It specializes in radio and microwave communications, antennas, radar and other phases of electronics. If you have problems in any of these categories, we shall be pleased to discuss them with you in complete confidence and without obligation.

For further information, write for our brochure



PICKARD & BURNS
INCORPORATED

240 Highland Avenue, Needham 94, Mass.

PLANTS AND PEOPLE

Edited by WILLIAM G. ARNOLD

Industry and professional associations make new moves . . .
 Manufacturers announce new plant and facility expansions . . .
 Electronic engineers and executives advance

OTHER DEPARTMENTS featured in this issue:

	Page
Electrons At Work	196
Production Techniques	250
New Products	290
New Books	383
Backtalk	399

Institute of Radio Engineers Elects Officers for 1954

WILLIAM R. HEWLETT, vice-president of Hewlett-Packard Co. of Palo Alto, Calif., was elected president of the IRE for 1954. He succeeds James W. McRae, president of the Sandia Corp. and vice-president of Western Electric, as head of the international society of over 35,000 radio engineers and scientists.

Maurice J. H. Ponte, director of Compagnie Generale de Telegraphie Sans Fil, of Paris, France, will succeed S. R. Kantebet, general manager of the Government of India Overseas Communications, as IRE vice-president in recognition of the international character of

the Institute's membership and activities.

Elected as directors for the 1954-1956 term are Axel G. Jensen, director of tv research for Bell Labs and George Rappaport, chief engineer of Counter-measures Branch, Aircraft Radiation Lab. in Dayton.

Regional directors elected for 1954-1955 are as follows: North Atlantic, Lucius E. Parkard, president of Technical Instrument Corp.; Central Atlantic, Harry W. Wells, chairman of Upper Atmosphere Section, Carnegie Institution of Washington, D. C.; Central, Charles J. Marshall, chief scientist, Search Radar Branch, Wright-Pat-

erson Air Force Base; Pacific, Joseph M. Pettit, associate professor of electrical engineering at Stanford University.

William R. Hewlett was engaged in electro-medical research in Palo Alto, Calif., from 1936 to 1938. In 1939 he joined David Packard in organizing Hewlett-Packard.

In 1942 he was called to active duty in the Army and was assigned to the technical division of the Office of the Chief Signal Officer in Washington, D. C. for the next three years. He was then transferred to the new development division of the War Department's Special Staff where he served as

THIRTIETH BOARD OF DIRECTORS AND OFFICERS OF RETMA 1953-54

The following table lists the individuals shown in the portraits, based on their captions:

M. C. Benig	Max F. Balcom	J. R. Elliott	Paul V. Garino	M. J. Hoffman Vice President	R. E. Carlson Vice President	R. S. Alexander Vice President	Allen B. Dumont	Larry F. Hardy	Robert I. Bell	F. R. Luck	Benjamin Abrams	
Robert C. Barr	W. A. MacDonald	Ray S. Sparrow	M. E. Hoffman	Leslie F. Muter Treasurer	Glen McDaniel President and General Counsel	Robert C. Sprague Chairman of the Board	James D. Secrest Executive Vice President and Secretary	W. B. G. Baker Director Engineering Dept.	Myrt Lette	Harry A. Eble	Franc Froemmann	
W. J. McEligan	Frank W. Godeker, Jr.	Herlan B. Foulke	J. J. Kahn	B. W. Cooper	Sidney Herman Vice President	John W. Van Allen General Counsel Emeritus	E. G. Zerler Vice President	E. K. Foster	Lloyd H. Coffin	A. D. Hammond, Jr.	E. Altkuler	G. Richard Frying
L. F. Cramer	Harbord W. Clough	T. G. Erikson	W. Marvin Ouse	L. S. Baiter	Fred D. Wilson	Sam Harris	R. E. Cramer, Jr.	Floyd W. Bell	H. C. Morris	W. S. Persons	Harold L. George	D. S. W. Kail



PRECISION ENGINEERING
CUSTOM MANUFACTURING

THE TYPE 20

An Instantaneous Reading BROAD-BAND SWR INDICATOR

The complete SWR Indicator System consists of two separate Scanning Oscillators covering the 400-900 Mc and 900-1350 Mc bands, a Reflectometer with a standard matched 50-ohm load, a Ratio Measuring Unit, interconnecting and power cables. The

unknown load is connected to the Reflectometer, and the outputs of the Ratio Measuring Unit are connected to an oscilloscope (not supplied). Frequency is presented on the oscilloscope on the X axis, and SWR over the entire band is presented on the Y axis.

TYPE 20 SYSTEM:

ALL Type 21 Ratio Measuring Unit with self-contained power supply and overlay for 5 inch oscilloscope.

ALL Type 22 Reflectometer with precision 50-ohm reference load.

ALL Type 23 400-900 Mc Scanning Oscillator with self-contained power supply.

ALL Type 24 900-1350 Mc Scanning Oscillator with self-contained power supply.

Complete set of interconnecting cables.

(These units comprise the complete ALL Type 20 Broad-Band SWR Indicator System. Each unit may also be purchased individually as needed.)

SWR INDICATION:

Normal 1.0 to ∞ and, on expanded scale, 1.0 to 6.0. Automatically presented on calibrated oscilloscope scale at 56 presentations per minute. Direct-reading SWR meter for single-frequency manual use.

ACCURACY:

$\pm 10\%$ of SWR indication
 $\pm 1\%$ of Frequency indication

PRECISION REFERENCE LOAD:

50 ohms having maximum SWR of 1.05 over the two bands.

SIZE:

Each unit in carrying case is 11" high by 22" wide by 11½" deep. The height of the stacked system is 33" high with oscilloscope alongside.

Reflectometer size: 6" x 10" x 4"

All units are designed for rack mounting.

WEIGHT:

Low or high frequency system - 70 pounds.
Complete system - 100 pounds.

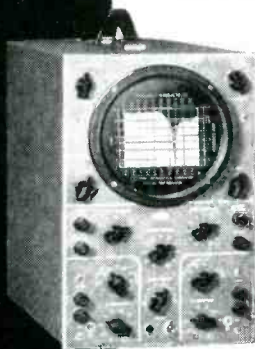
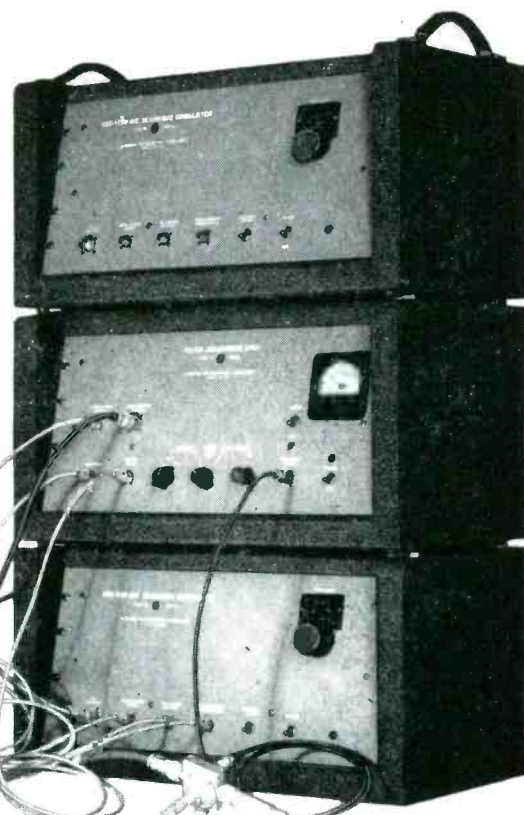

PRICE:

TYPE 20 SWR INDICATOR SYSTEM, COMPLETE WITH INTERCONNECTING CABLES less oscilloscope

Low Frequency System	\$2,980
High Frequency System	\$2,980
Complete High and Low Frequency Systems	\$4,200

F.O.B. Mineola

Prices for individual units may be obtained upon request.

- Instantly measures standing-wave ratio over the 400-900 Mc and 900-1350 Mc bands.
- Eliminates tedious point-by-point data taking.
- Adjust antennas, transmission systems, filters, networks, receivers while under test.
- The Scanning Oscillators may be used separately as sources of r-f power, automatically scanned or manually adjusted to the desired frequency, giving 200-milliwatt minimum power output over the band into a 50-ohm resistive load.

Write for complete details



AIRBORNE INSTRUMENTS LABORATORY

INCORPORATED

160 OLD COUNTRY ROAD, MINEOLA, L. I., N. Y.



William R. Hewlett

head of the electronics section. In 1945 he was a member of the Compton Mission, which was sent to Japan immediately after surrender to form a quick appraisal of the Japanese scientific war effort. In December of that year he returned to the Hewlett-Packard Co. and has since continued his activities there.

IRE also announced its awards for 1954. Alda V. Bedford of RCA Labs. was awarded the Vladimir K. Zworykin Television Prize Award for 1954 "for his contributions to

the principle of mixed highs and its application to color television."

The Institute's Morris Liebmann Memorial Prize was bestowed on Robert R. Warnecke, technical director of *Companie Generale de Telegraphie Sans Fil* of Paris, France, "for his many valuable contributions and scientific advancements in the field of electron tubes, and in particular, the magnetron class of traveling-wave tubes."

Harold A. Zahl, director of research of the Signal Corps Engineering Labs, Fort Monmouth, N.J., was named to receive the Harry Diamond Memorial Award for 1954 "for his technical contributions, his long service and his leadership in the U. S. Army Signal Corps research program."

Alfred N. Goldsmith, editor of the IRE, was awarded the Founders Award "for outstanding contributions to the radio engineering profession through wise and courageous leadership in the planning and administration of technical developments which have greatly increased the impact of electronics on the public welfare."

The awards will be presented at the Institute's annual banquet.

RETMA Expands Membership Services

AT ITS three-day industry conference in Chicago, RETMA created an international department and authorized the employment of special counsel for the newly-established electronics industry committee.

Discussions of the possible effects of the expected early approval of the NTSC color tv standards by the FCC occupied many of the group meetings.

The board of directors unanimously adopted a resolution commending the work of the NTSC in developing the recommended tv color specifications after W. R. G. Baker, its chairman, reported that the NTSC will be dissolved following the FCC decision on its petition. Whatever further standardization work is required will be carried on by a television systems committee of the RETMA engineering department, Dr. Baker said.

A. Blumenkrantz, chairman of the board of General Instrument, was elected a director by the parts division executive committee, and Louis Hausman, vice-president of CBS-Columbia, was elected to the set division executive committee. Chairman F. R. Lack of the electronics industry committee recently appointed Joseph H. Gillies, a vice-president of Philco, director of the government relations department.

Chairman William M. Adams, of the export committee, said the international department will be governed by an executive committee representing both radio-tv and electronics interests, and will comprise various product sections. An export manager will be employed and stationed at RETMA headquarters.

The electronics industry committee voted to establish a military end equipment section in the technical products division as the first step in its expansion of the association's organizational framework under the EIC.

The television committee, under chairman W. R. G. Baker, decided to continue its activities despite the completion of the standardization

Electronic Leaders Attend Industrial Council

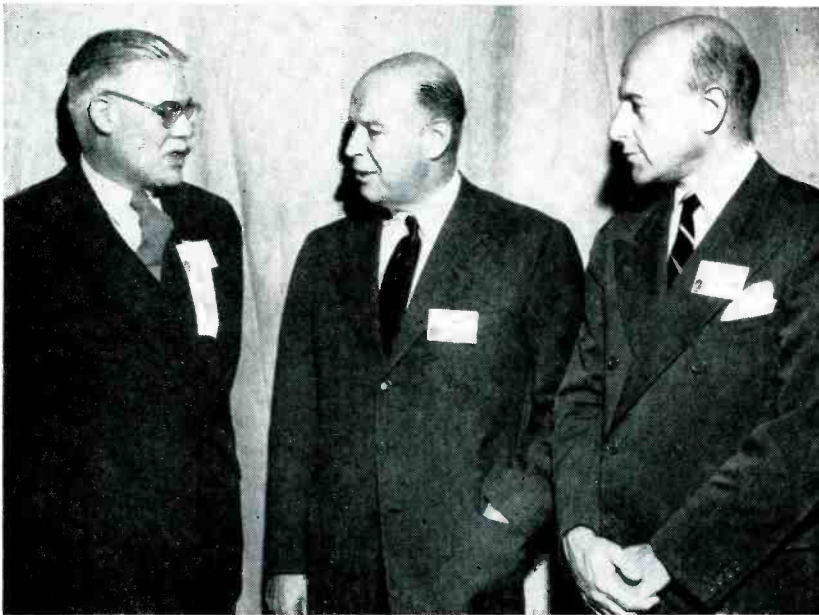

Among the 200 executives who attended the third session of The Industrial Council at Rensselaer Polytechnic Institute to discuss the Electronics-Electrical industry with the more than 600 social science teachers in attendance were, left to right: Robert Paxton, executive vice-president of GE, Allen B. DuMont, president of DuMont and Charles F. Adams, Jr., president of Raytheon. Objective of the Council is to achieve a wider understanding between industry and education

"PROJECT TINKERTOY" MODULAR DESIGN KIT

the key to modular equipment design

Make your own modular assemblies such as the unit shown here, using the CML Type PT-1000 modular design kit. Modules are mounted on etched circuit plates, which are also made with the PT-1000 kit.

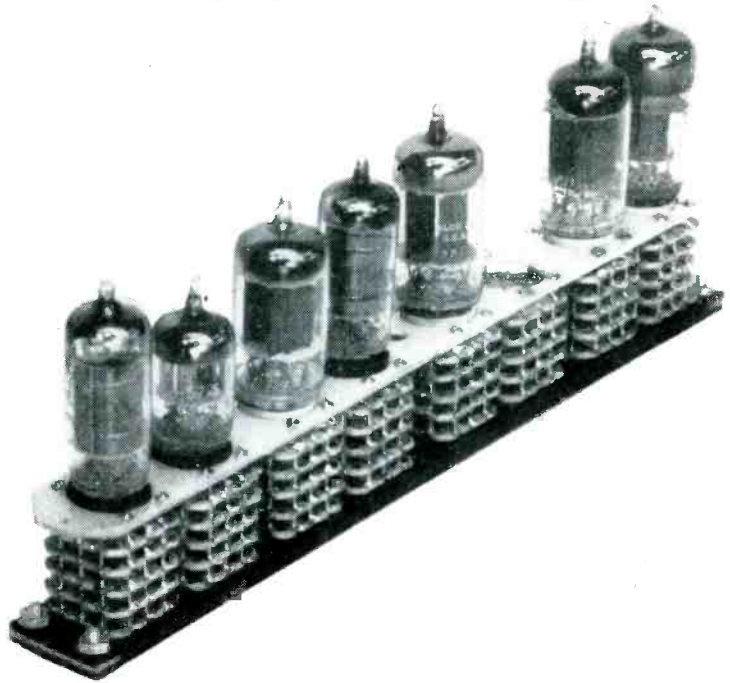

CML, a pioneer contractor to the National Bureau of Standards on this Navy sponsored project, is proud to present to the industry our Type PT-1000 Project Tinkertoy Modular Design Kit.

With this kit, you can design and build Project Tinkertoy Modules, complete assemblies, and end items in Project Tinkertoy Modular Form. All you need is the PT-1000 Kit, the conventional test equipment used in design work, and 20 feet of laboratory bench space.

The CML PT-1000 kit contains over 50 different items. You get 26 special tools peculiar to the process, materials to build over 200 modules including wafers, 7 and 9 pin miniature sockets, tape resistors, ceramic condenser bodies, chemicals, screens, etching facilities, drafting aids, etc.

There's nothing else to buy. Just follow the simple detailed instructions and you can start design work the moment the PT-1000 Kit is delivered to you.

Once your designs are completed and tested, the advantages of low-cost, high-quality production, which the Project Tinkertoy Automatic Production and Testing Machines provide, will be available to your company. Several components manufacturers are planning to fill production requirements for modules.

**WRITE TODAY FOR DESCRIPTIVE BULLETIN
ON THE CML TYPE PT-1000 KIT**

COMMUNICATION MEASUREMENTS LABORATORY, INC.

350 LELAND AVE., PLAINFIELD N. J.

Phone Plainfield 4-5712

for that
"extra measure" of
dependability

Specify

POTTER capacitors

especially if:

- 1... your product reputation makes component quality the primary consideration.
- 2... you need flexible production facilities capable of producing small runs of capacitors, engineered to fit your specific needs, quickly and economically.

Send now for
this Free Catalog of the
complete Potter Line.

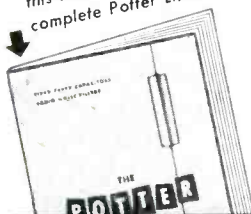

THE
potter
COMPANY

North Chicago, Illinois, U. S. A.

Dept. A

RADIO NOISE FILTERS

SPECIALISTS IN
FIXED PAPER
CAPACITORS
SINCE 1925

SOUTHERN AFFILIATE:
MICROFARADS, INC.
WESSON, MISS.

work of the NTSC, and asked Dr. Baker to remain as chairman.

President Glen McDaniel, after discussing controversial portions of the proposed trade practice rules for the radio-tv manufacturing industry, was directed by the set division executive committee to renew the Association's opposition to several of the recommended rules at the FTC hearings.

The parts division executive committee, under chairman Matt Little, approved a recommendation of the phonograph cartridge and pickup section that RETMA undertake an investigation of subsidies and other benefits accorded phonograph equipment and accessory manufacturers in foreign countries now competing with American manufacturers in the domestic market. Six sections and the newly established jobber relations committee held meetings. Under chairman J. A. Milling, the jobber committee's objective is to deal with problems and develop programs to effect a better understanding between parts manufacturers and distributors.

High Fidelity

Floyd Bell, chairman of the executive committee of the amplifier and sound equipment division, reported to the RETMA board that the high-fidelity equipment section and an engineering department committee had been unable to develop a recommended definition of high-fidelity as requested by the FTC for inclusion in the pending trade practice rules. The engineering department will continue its efforts, however, to develop technical standards for high-fidelity components.

Early dissemination of technical information on the servicing of color receivers was planned by the service committee under chairman H. J. Schulman. A three-week "Teacher Training Seminar" for tv service instructors was planned for the summer of 1954.

Robert C. Sprague, board chairman of RETMA, announced the re-appointment of Fred D. Wilson of the DuKane Corp. as chairman of the school equipment committee.

At its annual fall meeting in Toronto, Canada, RETMA honored

Mrs. Martha E. Kinzie of GE, secretary for NTSC, "for her untiring efforts on behalf of the NTSC in the formulation of a successful compatible standard for color tv."

Executives Advance At Du Mont

THREE new vice-presidents were appointed at Allen B. Du Mont Laboratories. They are Thomas T. Goldsmith, Jr., vice-president of research; Irving G. Rosenberg, vice-president of tubes and government and C. Edwin Williams, vice-president of instruments and transmitters.

Dr. Goldsmith, who joined



Thomas T. Goldsmith, Jr.

Du Mont in 1936 as director of research, is a member of the board of directors and is also president and a director of Du Mont of Canada, the company's wholly-owned Canadian subsidiary.

I. G. Rosenberg, former director of operations for the receiver and cathode-ray tube divisions, joined the company in 1942 as a production-control specialist. He became manager of the cathode-ray tube division in 1946. In 1950, when the tube plant was moved, he supervised the planning and layout of production facilities capable of producing 1 million cathode-ray tubes a year.

C. E. Williams, who was formerly director of operations for the com-

Now a NEW
"Pencil Point" SOLDERING TOOL
 FOR SMALL OR MINIATURE WORK

IDEAL Thermo-Tip

**INSTANT HEAT—
 PINPOINT ACCURACY!
 NOTHING TO HOLD
 BUT AN ELECTRODE
 "PENCIL"**

Tips Screw In to Fit the Job
DOUBLE METALLIC
DOUBLE CARBON

Other Tips Available

Pencil-Thin
 FOR EASIER, FASTER SOLDERING OF:

- Electronic Circuits and Parts
- Terminals
- Aircraft Connectors
- Radio and TV Chassis
- Pin Type Plugs
- Instruments
- Wire-to-Wire
- Printed Circuits

Here is an all-new production tool expressly designed to make small and miniature soldering simpler and surer than ever before. It is so fast that some joints can now be soldered in less than 1 second! . . . so much lighter and easier to handle than soldering irons or guns that a woman can use it all day long without fatigue! Check this unique combination of features against your job requirements:

GETS INTO SMALL, TIGHT SPOTS because of smaller electrode pencil.

NO HEAT DAMAGE—instant resistance heating makes sound joints before resistors, condensers, printed circuits, terminal fibre, etc., can be damaged. Pinpoints the heat!

NO "COLD FLOW JOINTS"—resistance principle *requires* that metal be heated before the solder will flow. Tap switch adjust heat as needed.

SAFE—soldering pencil uses harmless (6v) voltage and high amperage from separate step-down transformer.

LESS FIRE HAZARD—electrodes are hot only when in use.

LESS REPLACEMENT COST—only low cost electrodes to buy.

TIPS FOR EVERY SMALL JOB
 —2 sizes of double carbon, single carbon with ground clamp, double metallic. May also BE USED AS SOLDERING IRON
 —two sizes of chisel tip irons.

SOLD THROUGH LEADING DISTRIBUTORS

IDEAL INDUSTRIES, Inc.
 1055 Park Avenue, Sycamore, Illinois
 Please send catalog data on NEW IDEAL THERMO-TIP.

NAME.....
 COMPANY.....
 CITY.....ZONE...STATE.....
 ADDRESS.....

MAIL FOR FURTHER DATA

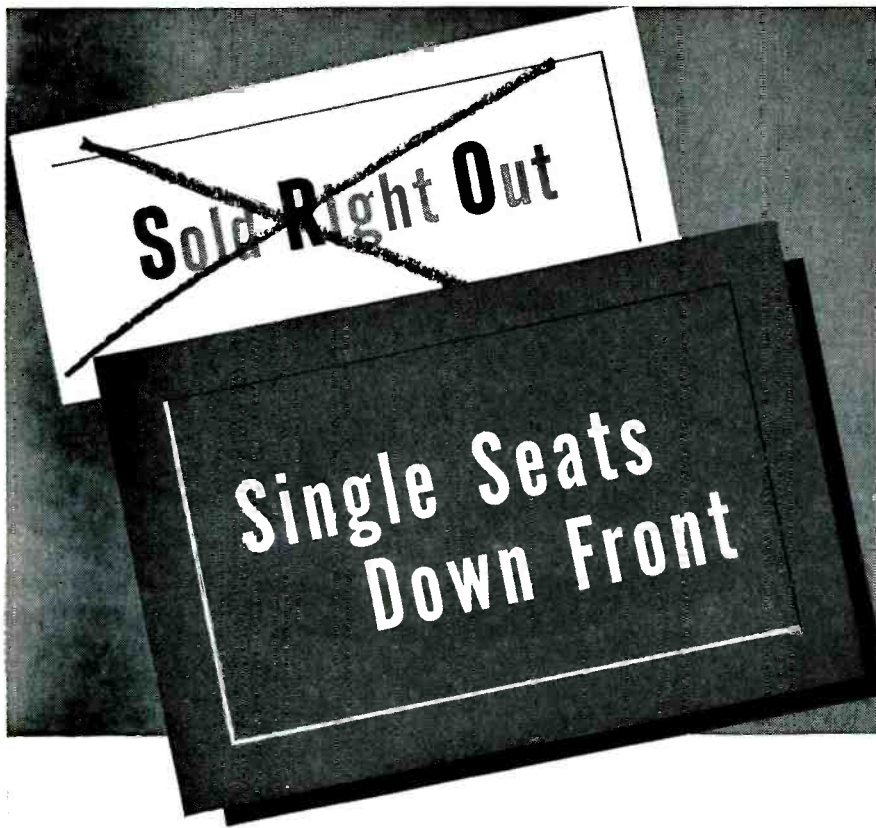

Our previous series of advertisements in this publication explained, in theatrical parlance, that our design and production facilities were pretty well "sold out" by the requirements of our present customers.

Now, we are happy to say (because we enjoy making new friends) that some of the heat has been taken off, and we are able to announce "Limited seating available"—as they say at the box office.

We shall be happy to talk with you about your present and/or future needs.



L. H. Terpeneing Company
DESIGN • RESEARCH • PRODUCTION
 Microwave Transmission Lines and Associated Components
 16 W. 61st St. • New York 23, N. Y. • Circle 6-4760

TRADE MARK



Irving G. Rosenberg

pany's instrument and transmitter divisions as well as director of government and special contracts, joined Du Mont in 1945 as general manager of the company. Prior to that he had four years war service in Washington, D. C. as staff member of the radio and radar division of the War Production Board.

Promotion of P. S. Christaldi from assistant manager to manager of the instrument division of Du Mont, replacing Rudolf Feldt who has resigned, was also announced by A. B. Du Mont, president.

Dr. Christaldi has been associated with Du Mont since 1936. His first duties were in the field of cathode-ray tube and cathode-ray oscillograph development. He was appointed chief engineer of the company in 1941, and in 1947 became engineering manager of the instrument division. He was made



C. Edwin Williams



Mark your own symbols, numbers, lettering, on your small parts, tools, identification and name plates . . . easily, simply, quickly . . . tracing from a master with the GREEN ENGRAVER.

Widely used in electronic and plastic fields, in machine tool shops and wherever permanent marking is needed. The GREEN ENGRAVER engraves equally well on metals, plastic, wood, hard rubber and glass.

✓ Fact-filled folder on request . . . showing how economies in costs, labor and time are achieved with the GREEN ENGRAVER.

✓ Routs ✓ Models ✓ Profiles ✓ Engraves Etching attachment and other special equipment for industrial uses are available.

Green Instrument Co.
INCORPORATED

363 PUTNAM AVE., CAMBRIDGE, MASS.

ULTRA-MINIATURE

TYPICAL CAPACITY*
Type P6-125—125 mfd. 6 v. dc.wv

CAPACITORS

TYPICAL CAPACITY*
Type P25-25—25 mfd. 25 v. dc.wv

of a quality and economy

TYPICAL CAPACITY*
Type P50-5—5 mfd. 50 v. dc.wv

never before available

*Available in 23 capacity and voltage types.

TYPICAL CAPACITY*
Type P6-8—8 mfd. 6 v. dc.wv

All Illustrated Actual Size.

EXCLUSIVE EUROPEAN SOURCE

Immediate delivery From U. S. Warehouse!

Tiny capacitors for transistor and similar applications, produced by one of Europe's largest factories, of a quality and price unattainable in America, in these sizes. Humidity and temperature tests, plus experience of satisfied users, prove many quality advantages.

NEW

ultra-miniature type P-6-1 (1 mfd. 6-V DC WV, size 1/8" x 1/2") made especially for Hearing Aid manufacturers.

Four size groups—1) 11/64" dia., 2) 16/64" dia., 3 and 4) 23/64" dia. All 11/16" can-lengths (excluding seal) except 4, which is 1 9/32". Leads 1 3/8" long.

Write for data sheets and samples.

BARCO, Incorporated

Milwaukee 1 Wis.

Tel: Broadway 6-8515

Western Union Desk-Fax

COMCO

Communications Systems with *Customized* quality

Proven thru the daily operation of thousands of COMCO transmitters and receivers giving reliable service under all operating conditions.

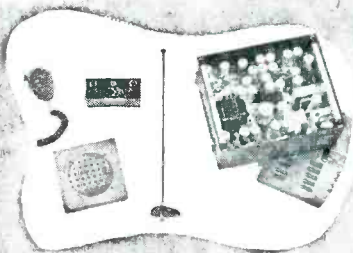

VHF-FM MOBILE PACKAGE

A COMPLETE LINE OF TWO-WAY RADIO EQUIPMENT

- VHF-FM mobile and base stations
- Remote control equipment & relay stations
- VHF-FM two-way aircraft equipment
- Aeronautical ground station equipment
- VHF-AM mobile unit for airport vehicles
- VHF antennas and other accessories

For details contact your nearest COMCO dealer



Manufacturers of Radio and Electronic Equipment
COMMUNICATIONS COMPANY, INC.
CORAL GABLES 34, FLORIDA



NEW MULTIMETER KIT
\$26⁵⁰



SIGNAL TRACER KIT
\$23⁵⁰



NEW SCOPE KIT
\$59⁵⁰

Heathkit TEST EQUIPMENT



CONDENSER CHECKER KIT
\$19⁵⁰



VACUUM TUBE VOLTMETER KIT
\$24⁵⁰



TUBE CHECKER KIT
\$29⁵⁰



SIGNAL GEN. KIT
\$19⁵⁰



GRID DIP METER KIT
\$19⁵⁰

HEATH COMPANY

BENTON HARBOR 14,
MICHIGAN

PHALO *Cords*...

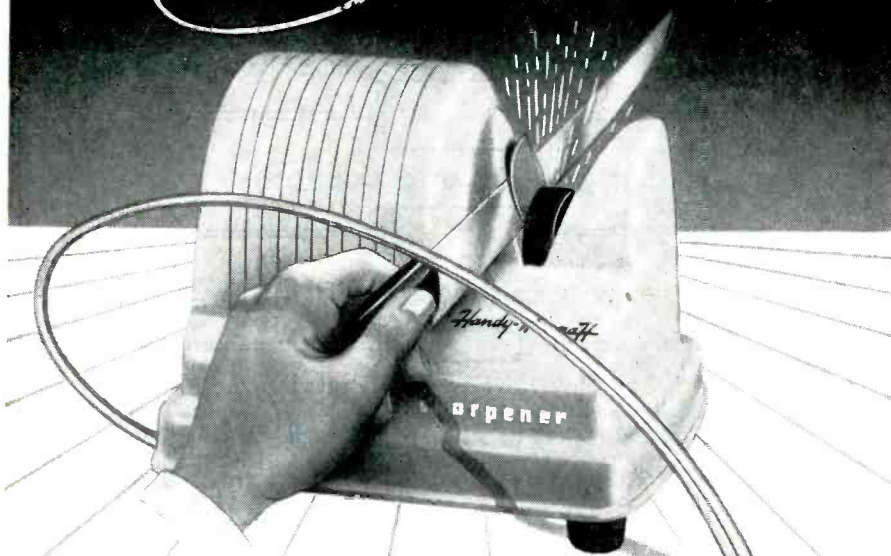

Look Sharp—Are Sharp—
on the New

Handy-Hannah*

ELECTRIC
KNIFE SHARPENER

Built to deliver super sharp, daily performance for a long, long life time, Phalo-Cord cord sets at the same time give this handsome Handy Hannah Electric Knife Sharpener, a smart finishing touch.

Look around you . . . you'll find more and more quality electrical and electronic products depending on Phalo-Cord cord sets to carry the current load.

Join the growing trend to Phalo-Cord cord sets . . . Tailor-Made or standard . . . no finer cord-sets available!

SPT-2
IVORY

*Handy Hannah Electric Knife Sharpener is a product of Standard Products Corporation, Whitman, Mass.

PHALO PLASTICS CORPORATION

CORNER OF COMMERCIAL ST., WORCESTER, MASSACHUSETTS

Insulated Wires, Cables and Cord Set Assemblies



P. S. Christaldi

assistant manager of the division in 1952.

In the broadcasting division of the company, Dr. DuMont announced the appointment of Ted Bergmann as director of broadcasting succeeding Chris J. Witting who has resigned from that position to become president of Westinghouse Radio Stations on January 1, 1954. Bergmann is a veteran member of the DuMont organization and for the past six months has been general manager of the network.

As chairman of the contract standardization committee of the National Association of Radio and Television Broadcasters, he was instrumental in helping to standardize tv time contracts for the industry, a system currently being used by most tv stations in the U. S.

Sylvania Makes Expansion Moves

SYLVANIA will undertake studies, laboratory experiments and field tests of electronic equipment under a contract with the Army Signal Corps at its electronics defense laboratory now under construction in Mountain View, Calif.

When in full operation, the 60,000 sq ft lab will employ approximately 250 persons, most of whom will be scientists and engineers.

The firm also announced that construction of a 200,000 sq ft plant extension for the manufacture of large size (24 and 27-inch) tv picture tubes and for pilot-line production of color tubes is nearing

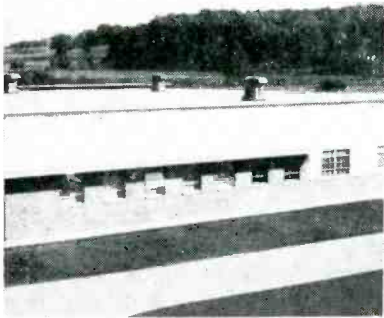

Sylvania's electronics defense lab

completion in Seneca Falls, N. Y. The new extension will bring the company's picture tube manufacturing space to 687,000 sq ft.

Although 82,000 sq ft of the new addition is planned for color screen work, production of color tv tubes, equipment development and storage, W. H. Lamb, general manager of the tv picture tube division, said that it is too early to predict just when the company will fully equip and operate this section of the plant for complete color work. At the present time the company intends only to continue its experimentation and operation of a pilot production line for color tubes and color screens. The Seneca Falls plant is the only Sylvania plant at which color work is being developed. At present, Sylvania employs 1,400 employees there with a monthly payroll of \$570,000.

A. W. Keen has been appointed as commercial engineering manager of the tv picture tube division, according to R. K. Gessford, Sr., chief engineer of the division. He has been with Sylvania since 1933 and previously was manager of the application coordination section at the company's research center in Bayside, L. I., N. Y. Prior to this, he was assistant manager of the product development lab.

American Research Forms New Company

AMERICAN RESEARCH AND DEVELOPMENT CORP. has formed the Product Development Corp. in Boston. Merrill Griswold, chairman of the executive committee and a director of American Research, was elected

MILWAUKEE TRANSFORMERS



**A TYPE FOR EVERY NEED
A PERFORMANCE TO EXCEED
EVERY DEMAND!**

Hermetically Sealed Components That Perform Superbly and Lastingly in Airborne and Ground Applications.



WRITE FOR FREE BROCHURE

AUDIO, POWER, PULSE TRANSFORMERS REACTORS — FILTER NETWORKS

Custom Engineered to rigid MIL T-27 government and commercial requirements.

MILWAUKEE TRANSFORMER CO.

5231 NORTH HOPKINS STREET
MILWAUKEE 9, WISCONSIN



*how to
PICK UP
2,900,000 BTU
without
"wiggling"
the flame*

..solved by a **KIRK AND BLUM**
ventilation system!

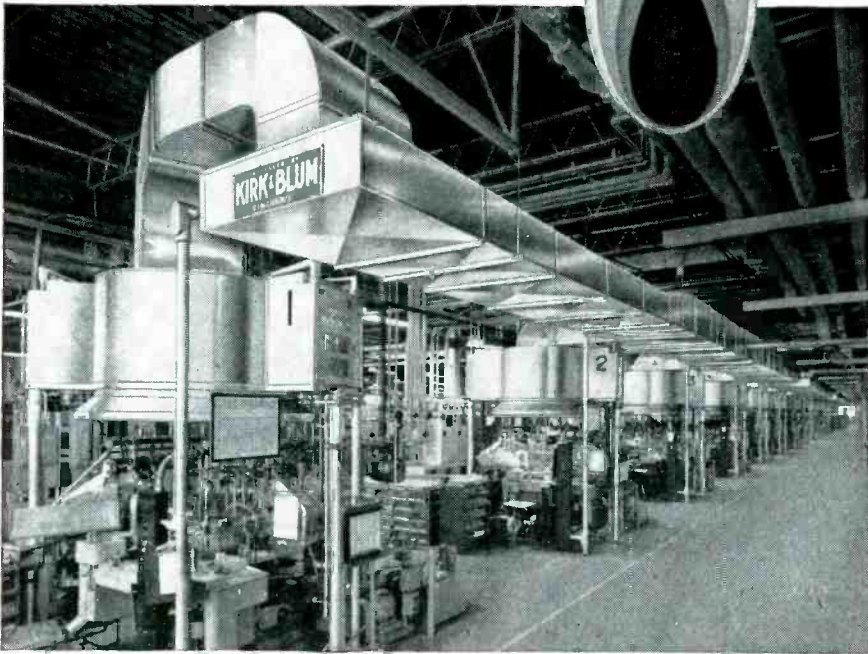

Above—Battery of RCA Seallex machines. Heat from glass sealing and evacuating operations on electron tubes is collected by aluminum hoods and duct-work.

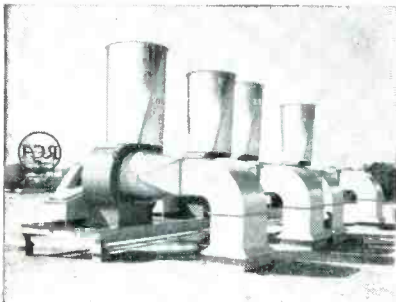

One of a number of batteries of roof-top fans which exhaust vented air from 10 identical systems.

KIRK AND BLUM
VENTILATION SYSTEMS

Heat can be a headache in any plant. Here, in a midwestern tube plant of RCA Victor Division, Radio Corporation of America, glass sealing and forming operations require plenty of heat of all kinds—induced, radiated and reflected. For the comfort and safety of workers, this heat must be removed but without disturbing the play of gas flames on delicate parts.

KIRK & BLUM engineers achieved a fine balance, removing 2,900,000 BTU hourly and without distorting the delicate flames.

Whatever your ventilation problem... heat, dust or fumes... the best, lowest-cost solution involves more than a fan, motor and some lengths of duct. Put it up to experts... The Kirk & Blum Mfg. Co., 3211 Forrer Ave., Cincinnati 9, Ohio.

chairman and John F. Rockett, Jr. was named president.

The new firm will offer a product consulting service. Processes, products and existing enterprises will be referred to companies for acquisition.

Griswold is chairman of the board of trustees of Massachusetts Investors Trust and chairman of the board of directors of Massachusetts Investors Growth Stock Fund.

Rockett is former head of commercial research at the electronics division of American Machine and Foundry Company.

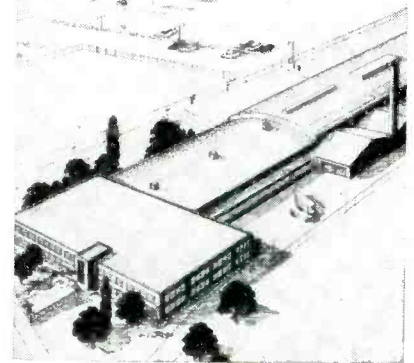

Magnetics Readies New Plant

THE NEW plant of Magnetics, Inc. just outside of Butler, Pa., is scheduled to be in full operation early in January, 1954.

Research and development laboratories as well as its engineering and general offices will be housed in the administration-building section of the new plant. Assembly and fabrication shops, a heat treatment room, and a rolling mill for high-permeability steels are included in the new facilities.

Tape wound cores, permalloy-dust cores, magnetic laminations, shields, magnetic amplifiers and magnetometers will be produced in the new plant and facilities are included for dry hydrogen annealing of components on an industrial contract basis.

The company also announced that Thomas G. Wilson has joined the engineering development staff. He was previously with the U. S. Naval Research Lab. in Washington, D. C. where he spent over four years on

Make a **GM** PORTABLE D'ARSONVAL
GALVANOMETER

*the Heart
of Your
Instrument*

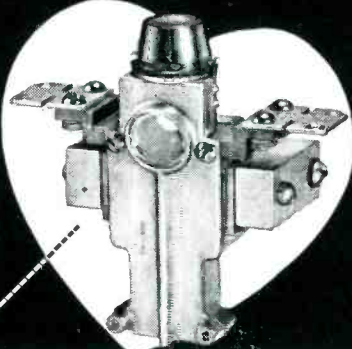
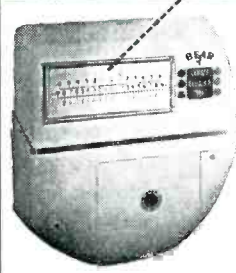
IN THE AUTOMOTIVE FIELD, the Bear Manufacturing Co. of Rock Island, Ill. uses Series 500 G-M Galvanometers in its new remote-reading Electric Wheel Alignment System (left). Whatever your own particular instrument field, you can achieve this same self-contained portability, ruggedness and high sensitivity with G-M Galvanometers. Complete catalog on request.

GM LABORATORIES • INC.

4336 NORTH KNOX AVE., CHICAGO 41
 In Canada: Cossor (Canada) Ltd., 301 Windsor Street, Halifax, N. S.

SWEEPS BETWEEN
 4 AND 220 MC
 IN 4 BANDS



The heart of a sweep generator is the device used to vary the oscillator frequency. The Type 6XBK2 *INCREDUCTOR controllable inductor contains four current-controlled signal windings and provides for electronic sweep between 4 and 220 mc on four bands, all on fundamentals.

SPECIFICATIONS

Band	Frequency Ratio	Nominal Inductance
1	2.5:1	25 μ h
2	2.0:1	2.5 μ h
3	1.5:1	.50 μ h
4	1.1:1	.07 μ h

Over-all dimensions: 3 1/4" x 2 1/2" x 2 3/4"
 Approximate weight: 12 oz.

A Colpitts oscillator circuit utilizing a 12AT7 is recommended. Starting frequency within each band may be set with a 75 μ mf dual capacitor. The graph below shows the obtainable sweep at any starting frequency between 4 and 200 mc.

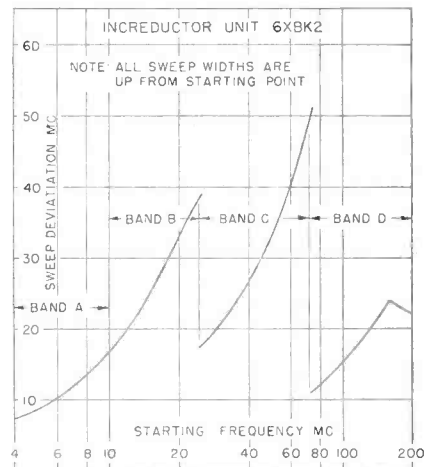

* Trademark

PRICE: \$19.50

CGS Laboratories, inc.



391 LUDLOW STREET
 STAMFORD, CONNECTICUT

**WHEN SO MUCH
 depends on
 SO LITTLE...**

it pays to specify
KEYSTONE
 "Performance-Tested"
PIEZO CRYSTALS

More than a Million Keystone Crystals, now in use the world over for frequency control in military and commercial communications equipment — have established a solid reputation for Top Reliability!

Our huge and continuing production of conventional quartz crystal types insures prompt filling of your orders — be they large or small.

For your specialized requirements, a qualified member of our engineering staff is available for consultation with you — at YOUR plant or ours. We welcome your inquiries.

Literature on request to Dept. E-1

**NEW!
 COLOR TV
 CRYSTALS**

Now Available!
 Write for Information.

KEYSTONE ELECTRONICS COMPANY
 114 Manhattan Street Stamford, Connecticut



STANDARD

Radio Interference and Field Intensity

MEASURING EQUIPMENT

Complete Frequency Coverage—14kc to 1000 mc!

NM-10A

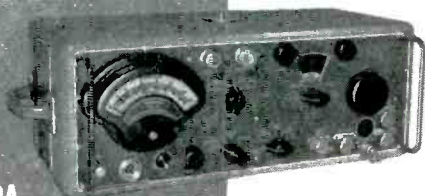

VLF

14kc to 250kc

Commercial Equivalent of AN/URM-6B.

Very low frequencies.

NM-20B



HF

150kc to 25mc

Commercial Equivalent of AN/PRM-1A. Self-contained batteries. A.C. supply optional. Includes standard broadcast band, radio range, WWV, and communications frequencies.

NMA-5A

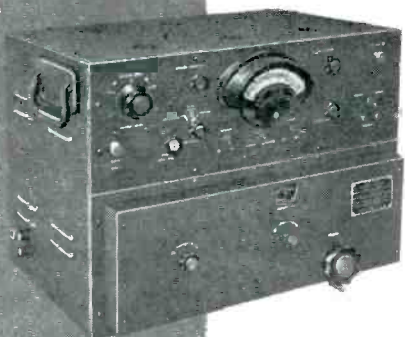

VHF

15mc to 400mc

Commercial Equivalent of TS-587/U.

Frequency range includes FM and TV Bands.

NM-50A

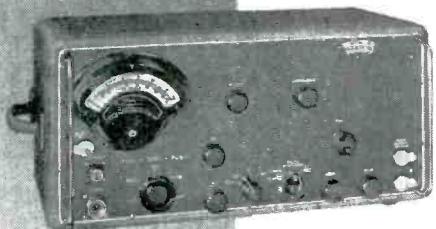

UHF

375mc to 1000mc

Commercial Equivalent of AN/URM-17.

Frequency range includes Citizens Band and UHF color TV Band.

These instruments comply with test equipment requirements of such radio interference specifications as MIL-I-6181, MIL-I-16910, PRO-MIL-STD-225, ASA C63.2, 16E4, AN-I-24a, AN-I-42, AN-I-27a, MIL-I-6722 and others.

STODDART AIRCRAFT RADIO Co., Inc.

6644-A Santa Monica Blvd., Hollywood 38, California • Hollywood 4-9294

basic and applied research on magnetic amplifiers. Prior to this he worked on equipment design for supersonic wind tunnel measurements for the Naval Ordnance Lab.

Servomechanisms Makes Expansion Moves

A NEW component division in Westbury, Long Island, N. Y. has been formed by Servomechanisms. It will produce miniature servo and instrument motors, mechanical development apparatus and various other products associated with the electronic and instrument industries.

R. F. Redemske, vice-president of the company, has been appointed division manager. Other appointments include: H. W. Brede, customer liaison director; S. Davis, development engineer; W. Berg, production manager; E. Kares, chief accountant and R. J. Corby, purchasing agent.

The company also acquired Industrial Electronics of Canada. The new subsidiary will continue to operate under its own name and to produce its line of electronic equipment. The engineering department of Industrial and its manufacturing facilities will be expanded. It will merchandise Servomechanism products in Canada along with products of other U. S. and European companies.

Alexander S. Mackie will continue as president of Industrial as will Donald L. Stewart as treasurer with the added duties of secretary. Croydon H. Hartley, sales director of Servomechanisms, has been appointed vice-president.

Norden Laboratories Appoints Thompson

L. T. E. THOMPSON has been appointed executive vice-president in charge of Norden Laboratories' three operating divisions. Dr. Thompson has just resumed full-time duties with Norden after serving as vice-chairman of the Research and Development Board of the Department of Defense and re-

cently as consultant to the Assistant Secretary of Defense for Research and Development.

Prior to his appointment as executive vice-president, he served as vice-president of Norden in charge of its research and development division in White Plains, N. Y. His new duties will extend his responsibilities to the product engineering division and the manufacturing division.

Before joining Norden, he was technical director of the Naval Ordnance Test Station at Inyokern, Calif.

Dutch Firm Plans Latin Subsidiary

THE 27-year-old Dutch firm, Van der Heen, manufacturers of "Erres" radios and television sets, plans to establish a subsidiary plant in Latin America. President Cornelius Kroon, who has made a tour of 17 countries to investigate the prospective market, said his firm regards Venezuela favorably and feels it has a great future.



Kelly Honored by Industrial Research

MERVIN J. KELLY, president of Bell Telephone Laboratories, was named to receive the Industrial Research Institute Medal for 1954.

The medal, awarded annually since 1945, is given for "outstanding accomplishment in leadership in or management of industrial research which contributes broadly

U. S. C. 900 Series Connectors Years of Proven Performance

900MG Plug "L" Terminals 900MLG Plug Loop Terminals 900FG

901MG 901FG

902MG Gold Plated Contacts 902FG Gold Plated Contacts
902MS Silver Plated Contacts 902FS Silver Plated Contacts

904M 904F

903M 903F

970-M14RC 970-F14
Also available in 20 contacts

902MGRC 902FG5C
(4) Types of Hoods for male and female connectors available with rear and side cable entrance—flush and recessed types.

U. S. C. 900 Series connectors are Compact, Lightweight, Polarized Rack and Panel types, with years of **proven performance** in application to Aircraft Communication, Portable Equipment and Instrumentation.

High compression, solid moldings of M. F. E. or M. M. E. type materials are in accordance with MIL-P-14D specifications.

Available in goldplated or silverplated contacts, special designs with different number of contacts and with Co-ax.

Let us work out your specific problems.

900 Series Brochures available on request.

See us at the IRE Show—booth 625

U. S. COMPONENTS, Inc.
Associated with U. S. Tool and Mfg. Co., Inc.
454-462 East 148th Street, New York 55, N. Y. CYPress 2-6525-6

MYCALEX
glass-bonded mica
insulation penetrates
the design barrier
of

temperature endurance!

ALSO OFFERS THESE
 IMPORTANT ADVANTAGES—

- VERY LOW THERMAL CONDUCTIVITY
- LOW COEFFICIENT OF EXPANSION
- DIMENSIONAL ACCURACY
- ZERO MOISTURE ABSORPTION
- PERMANENT DIMENSIONAL STABILITY

2000° F
FLAME TEST
FOR 20
MINUTES!



This fire wall Electrical Connector designed, developed and manufactured by the Scintilla Magneto Division Bendix Aviation Corporation, carries vital propeller control circuits through the fire wall of aircraft. Its ability to resist flame must equal or exceed that of the fire wall itself. Tests prove that this connector which uses MYCALEX 410 and MYCALEX 410X glass-bonded mica inserts is the best solution for this application. MYCALEX insert connectors provide a full 20 minute flame barrier under direct exposure to a 2000° F flame . . . 20 minutes that could spell the difference between total loss and safe landing. For complete information on product improvement with MYCALEX, phone or write J. H. Du Bois, Vice President-Engineering, at address below.



MYCALEX CORPORATION OF AMERICA

World's Largest Manufacturer of Glass-Bonded Mica Products
 Executive Offices: 30 Rockefeller Plaza, New York 20, N. Y.
 ADDRESS INQUIRIES TO—

General Offices and Plant: **114** Clifton Blvd., Clifton, N. J.™

to the development of industry or the public welfare.”

Announcement of the award was made by Allen Abrams, president of the Institute and vice-president of the Marathon Corp. of Rothschild, Wis., at the Institute's fall meeting in Detroit, Mich. Official presentation of the medal will be made at an Institute dinner to be held April 22, 1954 in San Francisco.

Dr. Kelly began his Bell System career as a research physicist with the Western Electric Co. in 1918 and became associated with Bell Labs when it was incorporated in 1925. He later served as development director of transmission instruments and electronics and in 1936 was appointed director of research. In 1944 he was appointed executive vice-president, and in 1951, president of the laboratories.

**RCA Consolidates
 Tube Sales Activities**

THE Tube Department of RCA Victor has organized an overall marketing operation that unifies all sales and commercial activities.

Four new marketing divisions have been established. They are: receiving tube and transistor marketing; cathode-ray and power tube marketing; electronic components marketing and parts and equipment marketing.

Lawrence S. Thees, formerly general sales manager, has been elevated to the post of general commercial manager. A veteran of 37 years sales experience, he will now be responsible for the RCA Tube



Lawrence S. Thees



Style 18 (Medium),
500 yd. spools,
black or natural.

for lacings that stay put!

GUDELACE

BRAIDED NYLON LACING TAPE*

A New and Revolutionary Type of Lacing

- Saves time, saves money, greatly reduces the number of rejects
- Won't "bite through" insulation
- Won't cut wiremen's fingers or cause dermatitis
- Ties easier, ties tighter and cuts down on slipping of knots



Let **GUDELACE** answer your lacing problems.

Write for **FREE**
samples and prices.

GUDEBROD BROS. SILK CO., INC.
Electronics Division, Dept A

Main Office: 12 South 12th Street, Philadelphia 7, Pa.
225 West 34th Street, New York 1, N.Y.

*Patent Pending.

Rutherford ELECTRONICS CO. MAKES PRECISION TIMING INSTRUMENTS



Model A-2

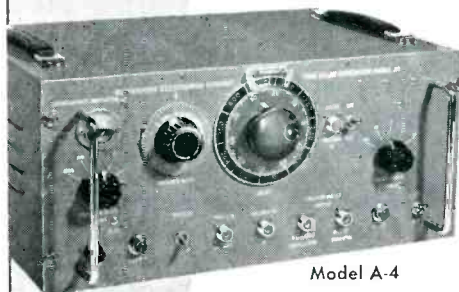

Model A-4



Our TIME DELAY GENERATORS:

Each provides accurate and variable time intervals in five ranges. They feature low jitter (.008%), linear scales, built-in calibration indicator, 1,000-division dial, small repetition rate effects, blocking oscillator output and wide pulse output.

A-2 — Range: .8 μ s to 100,000 μ s
Get complete data: our Bulletin E-A-2

A-4 — Range: .00001 to 10 secs.
Get complete data: our Bulletin E-A-4

Rutherford ELECTRONICS CO. Telephone: TEXAS 0-4362
3707 S. ROBERTSON BLVD.
CULVER CITY, CALIFORNIA

NEW! Subminiature Metallized Paper CAPACITORS

Funginert Plastic Encased

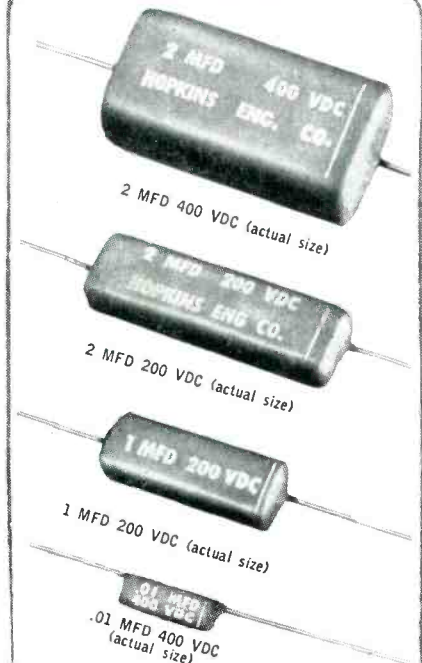

- ✓ Resin impregnated and rectangular shaped for maximum space conservation
- ✓ Completely encased in a non-nutrient plastic for maximum fungus and humidity protection
- ✓ Operating temperature range -55°C to $+100^{\circ}\text{C}$
- ✓ Temperature coefficient $\pm .07\%/^{\circ}\text{C}$
- ✓ Excellent capacity retrace

Also available in
HERMETICALLY SEALED
drawn metal containers
(shown approx. $1/2$ actual size)

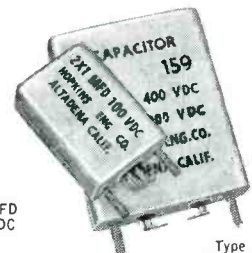

Type 159,
1 MFD 400 VDC;
2 MFD 400 VDC

2X1 MFD
100 VDC

A multiplicity of sizes is available in either plastic encased or hermetically sealed capacitors. Special designed units also made to your exact specifications.

Write or wire us, today!

HOPKINS
Engineering Co.

FACTORY: 2082 Lincoln Ave.
Altadena, Calif. SYcamore 8-1185
Offices in WASHINGTON, D. C.
and DETROIT

Tenney

"EXPEDITED ENGINEERING"

pays off for
JEFFERSON PROVING GROUND
Madison, Indiana

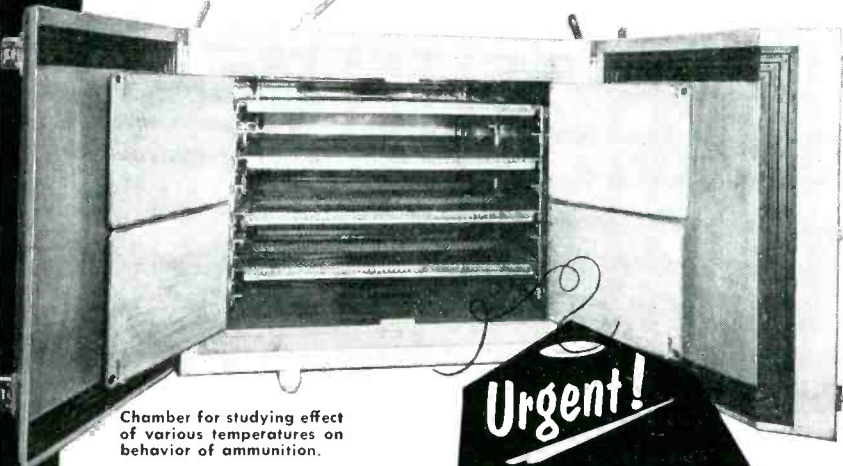

Chamber for studying effect of various temperatures on behavior of ammunition.

SPECIFICATIONS

Temp. Range: -100°F. to 200°F.
Pull-down: 90°F. to -70°F. in 45 min.
Dimensions: 5' W. x 4' H. x 9' D.
Power: 115-volts, 20 amps.
Weight: 3350 lb.

Urgent!

8 units needed. Deliver first 2 in 60 days.

Tenney DELIVERY:
Total order in 55 days!

The problem was urgent: The Army Ordnance Corps needed — fast — eight "conditioning boxes", in which Artillery ammunition could be subjected to extreme hot-and-cold temperatures before being test-fired at Jefferson Proving Ground. These chambers had to meet all the requirements — had to be shockproof — had to be completely portable. And TENNEY had to design, build and deliver the first two units within 60 days!

Tenney engineers designed a unit using dry-ice coolers, electric heaters, air circulation and precise thermostatic controls. Construction was rushed and completion of the first unit showed that performance far exceeded contract specifications — pull-down was held at -70°F. for 18 hours with no additional dry ice. Then production rolled . . . and the Army received all 8 units 5 days before the first 2 were due!

This is typical of Tenney's "Expedited Engineering," a policy based on years of meeting and solving problems in the design and construction of precision refrigeration, heating, and environmental test equipment. With this background, and manufacturing facilities keyed to meet all possible conditions, exacting specifications are speedily translated into well-engineered equipment . . . and delivered on time.

Testing troubles? Talk 'em over with



Tenney

ENGINEERING, INC.

Dept. A 26 AVENUE B, NEWARK 5, N. J.

3296

Plants: Newark, N. J., Union, N. J., and Baltimore, Md.
Los Angeles Representative: GEORGE THORSON & CO.
Engineers and Manufacturers of Automatic Environmental Test Equipment



Douglas Y. Smith

Department's overall commercial viewpoint and policies and for developing long-range planning.

Direct marketing operations will be under the supervision of Douglas Y. Smith, formerly manager of sales operations, who has been advanced to the new post of general marketing manager.

He will have direct administrative responsibility for the four marketing divisions, a separate sales division and two sales-service divisions. Smith has been with RCA for nearly 25 years.

Kenneth G. Bucklin, formerly product administration manager for receiving tubes, has been promoted to manager of the new receiving tube and transistor marketing division. Michael J. Carroll, for the past four years equipment sales manager for electronic components, now becomes manager of the electronic components marketing division. Leonard J. Battaglia, formerly manager of the renewal sales field force, has been promoted to manager of the parts and equipment marketing division.

Raytheon Appoints New Personnel

WILLIAM C. BROWN, manager of Raytheon's magnetron research and development laboratories, and William T. Welsh, sales manager of the power tube division, have been appointed assistant vice-presidents.

Brown joined Raytheon in 1940, working first in the small tube section of the receiving tube division. Subsequently he worked on high frequency triodes, which were used in radiosonde balloon transmitters. In 1941 he was transferred to the

equipment division to work on microwave components. The following year he worked for the power tube division and eventually was in charge of the magnetron research and development facilities still under his direction.

Welsh joined Raytheon in 1941 at its receiving tube plant in Newton, Mass. Then he joined the sales staff of the power tube group which shortly gained the status of a separate division of the company. After war service, he returned to Raytheon in 1945 as a junior engineer in the quality check department. He has been on the road as a sales representative introducing the "Microtherm" diathermy machine and has been sales manager for that product. He was appointed sales manager of the power tube division in September, 1952.

In the television and radio division of the company, Stanley S. Crane was appointed director of engineering and research for the special products group, according to Raul H. Frye, general manager of special products. Crane has been with the company since 1944 and had previously been chief engineer of the special products radar division.

Also in the tv and radio division, David Bell was appointed manager of the quality control department. He was associated with the Capehart-Farnsworth Co. as manager of quality control.

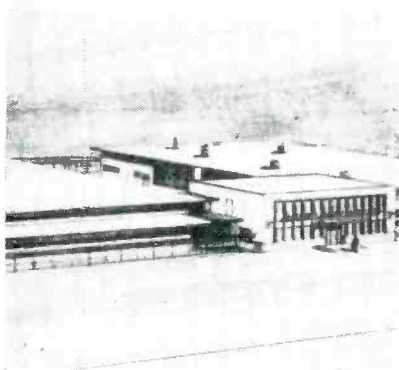

Diamond Power Opens New Laboratory

THE ELECTRONICS division of the Diamond Power Specialty Corp. has moved into its new electronics laboratory in Lancaster, Ohio. The



Amplifier System

The most complete, yet easiest to operate amplifier system ever developed for oscillographic recording

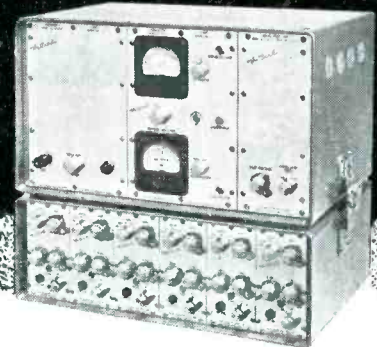

Model 119 Carrier and Linear or Integrating Amplifier System.

Heiland's model 119 Amplifier System, used in conjunction with Heiland Recording Oscillographs, has received wide acclaim from engineers for its extreme versatility, accuracy and simplicity of operation in the amplification of static and dynamic current phenomena.

This small, compact instrument, which can be provided for either rack, table, or shock mounting with available accessories, is housed in a rugged, yet lightweight cast aluminum case finished in attractive silver-gray gloss enamel. For complete specifications write or wire for our Bulletin 107.

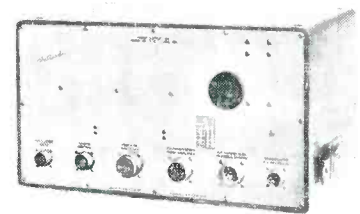

Power Supply Assembly (Rear View)

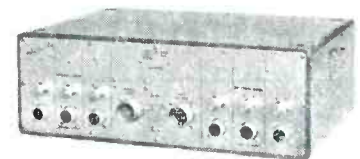

Amplifier Assembly (Rear View)

Complete information on other Heiland products will be supplied on request.

Heiland Research Corporation 130 East Fifth Ave., Denver, Colorado

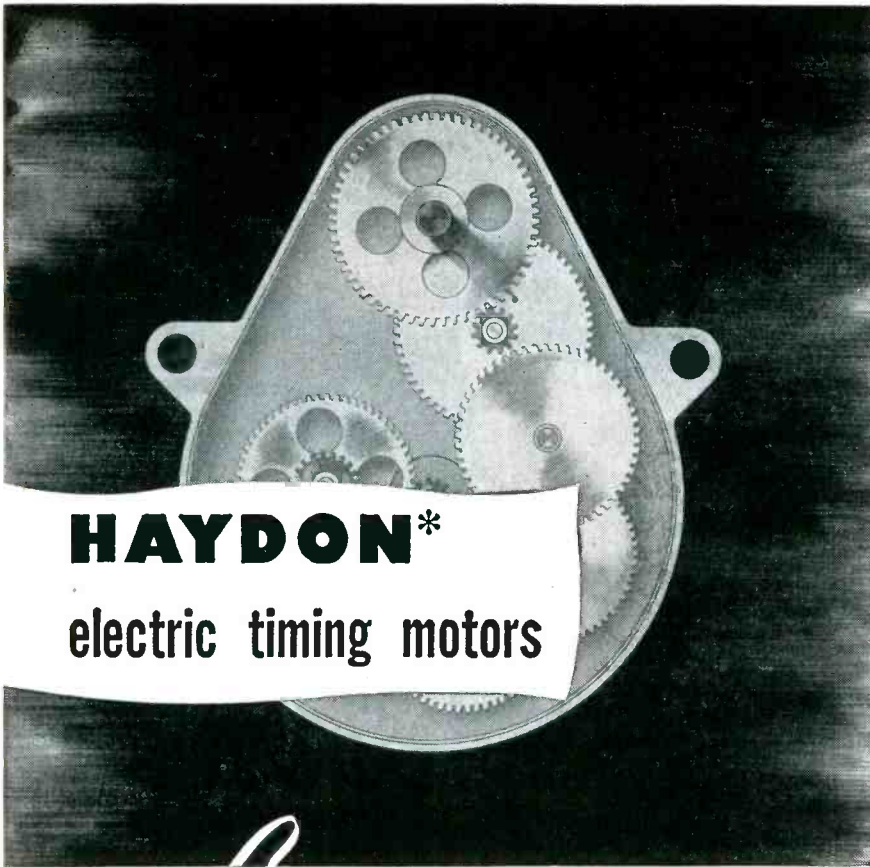

HAYDON*

electric timing motors

Leaders in the Field

OF TIMING COMPONENTS

HAYDON, in addition to its own extensive development, engineering and production facilities has the backing of the basic research facilities of the General Time Corporation. The wide experience of associated companies, Westclox, Seth Thomas, Stromberg Time and Western Clock are also available.

These wide resources have resulted in HAYDON's unquestioned leadership in the field of timing.

Write for Catalog No. 322, Electric Timing Motors

Other literature available on request on Timing Devices, Clock Movements, 400 cycle Elapsed Time Indicators, 400 cycle Time Delay Relay, 400 cycle Motors, D.C. Motors.

*TRADEMARK Reg. U. S. Pat. Off.



HAYDON

AT TORRINGTON

HEADQUARTERS FOR

TIMING

HAYDON Mfg. Co., Inc.

Subsidiary of GENERAL TIME CORP.

2425 ELM STREET
TORRINGTON, CONNECTICUT

new building, which has approximately 30,000 sq ft of floor space, is being used for the continuing development and construction of the Diamond "Utiliscope" and for the development of other electronic instruments and controls. Problems relating to the application of this equipment in various basic industries are also carried through preliminary stages. Another important activity is electronic-tube development.

A mass-spectrometer type of leak detector, which will detect leakage at the rate of 1 cc in 31 years, is part of the lab's new equipment.

Kaiser and Willys Electronics Combine

CONSOLIDATION of the electronics research and production facilities formerly operated as separate Kaiser and Willys divisions was announced by Edgar F. Kaiser, president of Kaiser and Willys Motors.

He also announced the appointment of Clay P. Bedford as vice-president in charge of the new division, which includes Willys electronics plants at Toledo, Ohio and Anderson, Ind., and Kaiser facilities at Nashua, N. H. and Arlington, Va.

John W. McGee, who has been manager of Willys electronics operations, will be general manager of the new expanded division. McGee has a background of 15 years in radio and electronics engineering, including service with the Air Material Command at Wright Field, Ohio and Lear, Inc.

Bedford has been associated with various Kaiser enterprises for some time. During the war he was engaged in shipbuilding activities on the west coast and, in 1945, he joined Kaiser-Frazer Corp. as vice-president in charge of manufacturing. He served as a special assistant to the director of defense mobilization and the Secretary of Defense, in Washington, from the spring of 1951 until the summer of 1952. Upon leaving Washington, he became president and director of Chase Aircraft Co., a position he still holds.

It is expected that the combining of the engineering and research departments will permit under-

SINCE 1920
QUALITY
WENCO
PRODUCTS

SPADE BOLTS

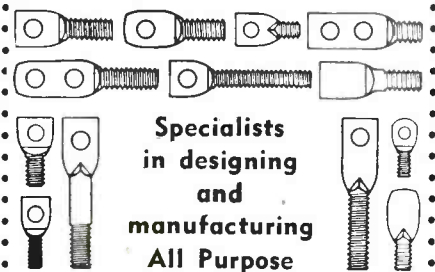

Specialists
in designing
and
manufacturing
All Purpose

Fasteners, Terminals and Mounting Lugs. Tooled to produce over 1,000 sizes and styles of Spade Bolts in any finish, material or quantity.

**WE ALSO MAKE
SIMPLEX WIRE STRIPPERS
AND CUTTERS**

TOOLS AND DIES

METAL STAMPINGS

WIRE SPECIALTIES

**REPLACEMENT TIPS FOR
ELECTRIC SOLDERING IRONS**

Send samples or specifications for quotations. Descriptive bulletin on request.

WENCO MANUFACTURING CO.
1133 W. Hubbard St., Chicago 22, Ill., U.S.A.

ZOPHAR

WAXES

COMPOUNDS

Zophar Waxes, resins and compounds to impregnate, dip, seal, embed, or pot electronic and electrical equipment or components of all types; radio, television, etc.

Cold flows from 100°F. to 285°F.

Special waxes non-cracking at -76°F.

Compounds meeting Government specifications plain or fungus resistant.

Let us help you with your engineering problems.

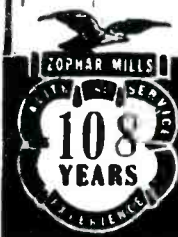

ZOPHAR MILLS, INC.
112-130 26th Street,
Brooklyn 32, N. Y.

Excellent Opportunities for Graduate

ENGINEERS

• Electronic & Mechanical

Experience in Design and Development of Radar and Sonar necessary.

Senior Engineers with Degree or equivalent and at least 5 years' experience in any one of following fields: Microwave, circuit design, filter network design, precision components (capacitors - resistors), and communications.

Broad knowledge of Search and Fire Control Systems; Servo Mechanisms, Special Weapons, Microwave, Antennas and Antenna Mounts, etc. Mechanical Engineer should also have experience in packaging of Electronic Equipment to Gov't. specifications including design of complex cabinets, shock mounts and sway brace structures.

• Field Engineers

Qualified to instruct in the operation and supervise installation, maintenance and repair of Radar, Sonar and allied electronic equipments in the Field.

Senior engineers with degree or equivalent and at least 5 years' experience in flight simulators, radar and sonar trainers.

A chance to grow with a young and progressive company; salary and advancement commensurate with ability; liberal vacation, sick leave, 9 paid holidays, group life, sickness and accident insurance plans, and a worthwhile pension system.

STAVID

ENGINEERING, INC.

PERSONNEL: 312 PARK AVENUE
Plainfield, N. J., PLainfield 6-4806

NOW! CHANGE SOLDERING
IRON ELEMENTS *IN A JIFFY!*

with

HEXACON
TRADE MARK

*Patent
Applied For

Readily Removable Terminal* does the trick!

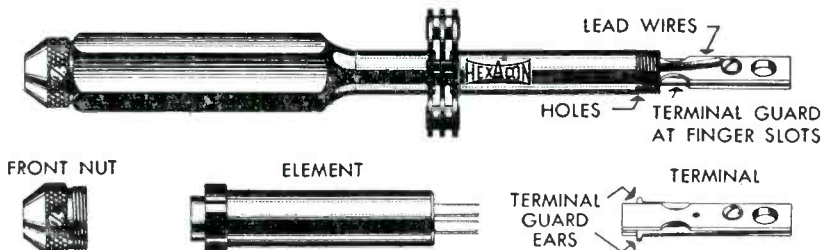

ALSO NEW!
BRASS-SHEATHED
ELEMENTS
Easier to replace -
Better Protection

Write for catalog showing 40 industrial soldering irons of every type and size; there is no obligation.

Quick-change terminal can be removed in a second or two, permitting replacement of element in a fraction of the usual time. By simply depressing terminal guard at the finger slots, the terminal comes out in a jiffy - no longer necessary to fish element lead wires around terminal.

HEXACON - Industry's No. 1 Soldering Iron

HEXACON ELECTRIC COMPANY
130 W. CLAY AVE., ROSELLE PARK, NEW JERSEY

taking over-all electronics projects for both civilian and military purposes, according to Bedford, and will provide an opportunity to make maximum use of the Tinker-toy development on which Kaiser electronics has been engaged for the Bureau of Standards and the U. S. Navy.

Pacific Bendix Builds New Plant

CONSTRUCTION of a new engineering building at Bendix Aviation's Pacific division plant in North Hollywood, Calif. was recently started. The building will be two stories high, providing 23,000 sq ft of floor space. Its design facilitates future additions to the building. The Pacific division airborne radar and hydraulic engineering departments will be housed in the building which is slated for completion in February, 1954.



Lewis Named Vice-President of Prodelin

ROBERT F. LEWIS, formerly technical director of Prodelin, designers and manufacturers of telephone and tv antennas and transmission lines, located in Kearney, N. J., has been appointed vice-president of the company.

He joined RCA in 1933 and later transferred to their research division where he was engaged in antenna studies until 1939. He worked for CBS on tv problems associated with antennas and radio-frequency filters. While serving as a member of the Harvard Radio Research Laboratories, he was commissioned a Major and was placed

TERMALINE COAXIAL LOAD RESISTORS

50 ohms DC to 4000 mc—5 watts to 2500 watts

The constant resistance (Low VSWR) of the TERMALINE resistor make it the ideal dummy load and standard resistor at UHF and VHF. Design is such that normal reactance is put to work producing a pure resistance over an extremely wide frequency range. Acting as a "bottomless pit" for RF energy, thousands of TERMALINE units are in daily use in high frequency applications.

Model	Cont. Power Rating	Input Connector
80F	5 watts	UG-23B/U
80M	5 watts	UG-21B/U
80A	20 watts	UG-23B/U
81	50 watts	UG-23B/U
81B	80 watts	UG-23B/U
82	500 watts	Adaptor to fit UG-21B/U supplied
82A	500 watts	
82C	2500 watts	

Adaptors or cable assemblies for standard coaxial line available.

ALL TERMALINE units, except Model 82C, are self-cooled. Substantial quantity discounts.

LITERATURE UPON REQUEST



VERY HANDY in lab and production test. At signal generator levels and below 5 watts, this is the last word for low VSWR.

6" x 8 1/2" x 17"



BIRD ELECTRONIC CORP.
1800 EAST 38TH ST., CLEVELAND 14, OHIO
TERMALINE Coaxial Line Instruments

NEELY ENTERPRISES
Hollywood • San Francisco
Albuquerque
EARL LIPSCOMB ASSOCIATES
Dallas • Houston

HEAT RESISTANT WIRES FOR EVERY APPLICATION . . .



WIRE FOR HOT JOBS

From laboratory to power plant insulated resistance wire finds many uses. If you have a need for such wire, tell us about your requirements.

We manufacture a variety of heat resisting insulated wires.

- HEATING UNITS
- HEATING ELEMENT
- RESISTANCE LINE CORD
- THERMOCOUPLE WIRE
- ASBESTOS LEAD & FIXTURE WIRE
- INSULATED RESISTANCE WIRE
- FIBERGLAS INSULATED WIRE
- WIRE TO ANY SPECIFICATIONS

Send your electronic control, communications or appliance wiring specifications for a recommended solution by our engineers.

FOR A TRIAL ORDER OR A CARLOAD consult



THE LEWIS ENGINEERING CO.
Wire Division
NAUGATUCK CONNECTICUT

in charge of the antenna activities of the American-British Laboratories in England and on the Continent during World War II. He also was a member of the engineering staff of Federal Telephone and Radio, later transferring to Federal Telecommunications Labs.

Triad Transformer Appoints Graham

GRANT GRAHAM, previously in jobber sales for Triad Transformer Corp. of Venice, Calif., has been selected to fill the newly-created post in the firm of product applications engineer. In his new position he will work in an advisory capacity with design engineers, assisting them in transformer application problems.

Triad inaugurated the plan when it was learned that manufacturers and engineers would welcome assistance in their design and application problems as they affected transformers.

Armour Research Appoints Wachowski

HILLARD M. WACHOWSKI, former assistant professor of electrical engineering at Northwestern University, has been appointed an electrical engineer at Armour Research Foundation of the Illinois Institute of Technology.

He will work with the communications and radio-frequency applications section of the electrical engineering department.

Stanford University Sets Microwave Plans

A STEPPED-UP program of microwave research sparked by construction of a new \$200,000 microwave laboratory with 15,000 sq ft of space was announced by Stanford University. It is hoped the new lab will be completed by the spring of 1954.

The staff of the new lab will number about 75. The present building will be used for full-time nuclear research and will be known as the High Energy Physics Laboratory, directed by W. K. H. Panofsky.

An underground radiation vault will be built for the new lab. Lab

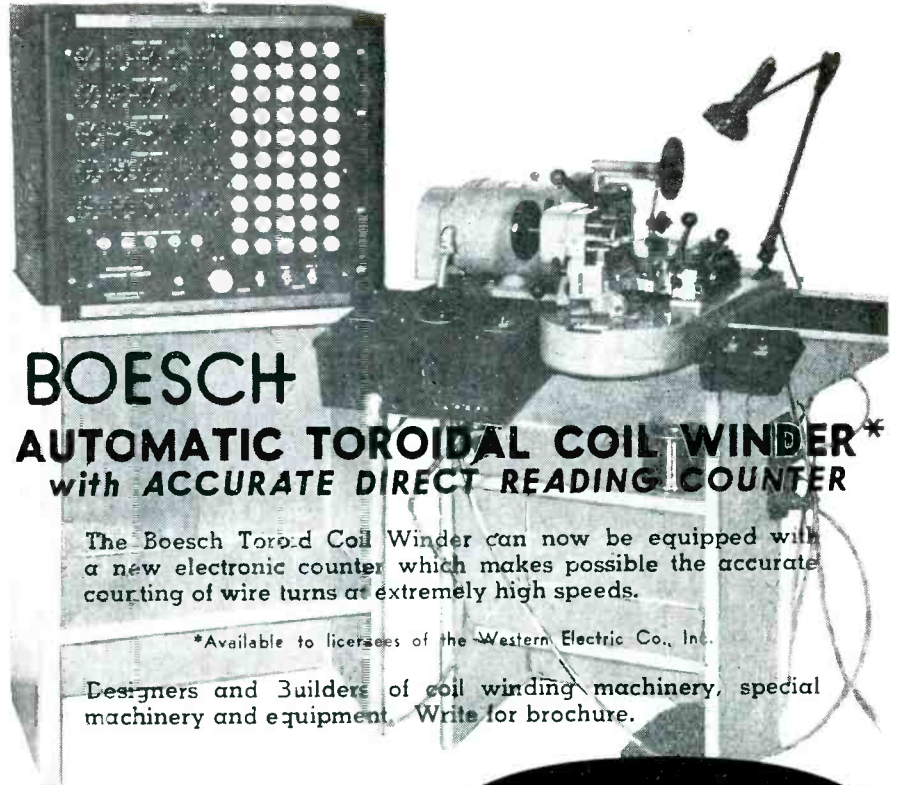

**BOESCH
AUTOMATIC TOROIDAL COIL WINDER*
with ACCURATE DIRECT READING COUNTER**

The Boesch Toroid Coil Winder can now be equipped with a new electronic counter which makes possible the accurate counting of wire turns at extremely high speeds.

*Available to licensees of the Western Electric Co., Inc.

Designers and Builders of coil winding machinery, special machinery and equipment. Write for brochure.

WORLD'S MOST VERSATILE
WINDING MACHINES

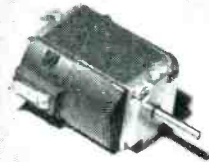

DC MOTOR OR GENERATOR
This small permanent magnet, ball-bearing unit—As a motor: 1/125 H.P. at 6000 RPM continuous duty. As a generator: output 4 watts at 6000 RPM—5 volts per 1000 RPM. Dimensions: 1.29/32" x 1-1/2" x 1-15/100".

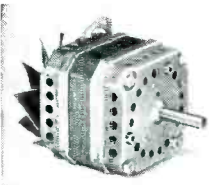

SHADED POLE MOTOR — for sound recorders, air circulators, many other applications. 4-pole, 2 or 4 coil construction. Will operate from 115 volts, 60 cycle a.c.

**The RIGHT power supply
for mobile equipment
is an EEPCO specialty**

Outstanding experience in producing rotary electrical equipment to meet rigid specifications is an integral part of every EEPCO product.

Whether your problem involves an industrial or highly developed military unit, EEPCO's complete research and engineering facilities are at your disposal. Contact EEPCO today for special design assistance that can provide you with the best solution.

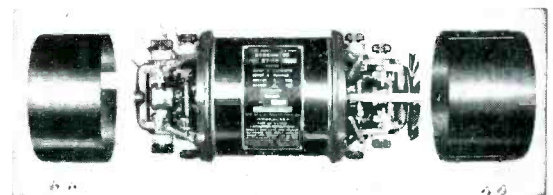

DYNAMOTOR OPERATES FROM 12-24-32 VOLTS
Output of this remarkably compact unit is 500 volts at .100 amperes. Dynamically balanced armature has 4 windings.

ELECTRO ENGINEERING PRODUCTS CO.
609 W. LAKE STREET, CHICAGO 6, ILLINOIS

- P-M DC MOTORS & GENERATORS
- CAPACITOR TYPE MOTORS
- UNIVERSAL MOTORS
- DC MOTORS & GENERATORS
- SHADED POLE MOTORS (2-4 Pole)
- P-M AC GENERATORS

Amerac announces!!!

MODEL 229 WAVEMETER



Amerac is pleased to announce our Model 229 S-Band Wavemeter, covering the frequency range of 2.3 to 4.5 KMC by either the transmission or absorption method with an external video output. Such features as the Frequency vs. Counter Reading Table, sloping panel, large diameter control knobs and small overall size (only 8" x 6½" x 5") contribute to an ease and accuracy of operation hitherto not found in such an instrument. Golden anodized aluminum panel fitted to the glossy walnut cabinet presents a pleasing appearance. The Model 229 is indeed a truly versatile wavemeter to be used over a range of frequencies not possible to cover with contemporary wavemeters.

Developing and manufacturing microwave test equipment has been Amerac's business since 1946. Today, as a result of the experience gained through these years, we can provide a wide variety of microwave test equipment featuring accuracy, ease of operation and fine appearance. In addition, Amerac will design and construct test equipment to suit your own specifications. Call on us for experience and equipment of highest calibre in the microwave test field.

Next month see our cavity oscillators utilizing the Sylvania 6BM6 & 6BL6 Klystron as well as the 2C37 & 2C37A UHF Planar Triode tubes.

Amerac

Incorporated



WENHAM, MASS.

director E. L. Ginzton said a 70-million-volt linear accelerator is planned. The accelerator will be located in a trench inside the building with its electron beam piped into the subterranean chamber, located at an outside corner. Dr. Ginzton emphasized that medical use of the vault for radiation therapy of cancer and other diseases is unlikely for several years. However, a six-million-volt medical linear accelerator being built at the Stanford School of Medicine is expected to provide such treatment by the end of 1954.

Hull Named Capehart Research Head

HARVARD L. HULL has been appointed vice-president and general manager of the research and development division of Capehart-Farnsworth. Philo T. Farnsworth, vice-president and technical director, will continue to be in charge of special research activities.

Dr. Hull, who has been active in atomic energy research since 1943, was director of the Argonne National Laboratory's division of remote control engineering before joining Capehart. While at Argonne, he took an active part in the organization of the lab on a post-war basis. Earlier he was director of process improvement for Tennessee Eastman. From 1933 to 1943 he was associated with Sperry in a variety of positions including those of project engineer, research engineer and director of remote control development. He was responsible for the development of a wide variety of remote control equipment for gyro-compasses, searchlights, anti-aircraft guns and bombsights.

American Research Names Augustyn

AMERICAN RESEARCH CORP. of Bristol, Conn., announced the appointment of Thaddeus Augustyn as vice-president. He will supervise production and engineering for the company.

He resigned as works manager of Bowser Technical Refrigeration, where he has been one of the

NEW!

Compact,
hermetically
sealed

AGASTAT

trademark

TIME DELAY RELAYS

2 1/8" square, 4" high.
Weights 1.2 lbs.

The SF AGASTAT is a solenoid operated, pneumatically-controlled time delay relay. It is hermetically sealed in an enclosure only 2 1/8 inches square by 4 inches high. It weighs only 1.2 pounds.

Originally developed for aircraft use, the SF is ideal wherever control devices must operate in wet, corrosive, dusty or explosive atmospheres, and for applications involving shock, vibration or acceleration. It is not affected by freezing temperatures. Time delay range from approximately 30 milliseconds to more than one minute. Completely adjustable throughout this range.

Write for details and application engineering assistance.

Address Dept. A-13-14

AGA
DIVISION

Elastic Stop Nut Corporation
of America

1027 Newark Avenue, Elizabeth, New Jersey
Pioneers in pneumatic timing.

MAGNETIC AMPLIFIERS

for

Improved Circuit Performance,
Life and Reliability

- Rugged ● Dependable
- Hermetically sealed
LB case
- Three control windings

- Available in three ranges
- Eliminates need for refer-
ence voltage source
- Simplifies wiring

These outstanding Series RG-60-D Magnetic Amplifiers by ATLAS provide extreme ruggedness and unfailing dependability for many voltage control applications. By improving the performance and life of circuits in which they are used, costly maintenance and repairs can be reduced. Competitive in price with other voltage control methods, ATLAS Magnetic Amplifiers have *all* the features you have always desired.

WRITE to Dept. AD for Bulletins for complete specifications.

ATLAS

ATLAS ENGINEERING CO., Inc.

3 EDGEWOOD ST., ROXBURY, MASS.

Precisely
fabricated
to the most
*Critical
Tolerances*
for electronic devices



Miniature and Subminiature
Radio Tubes-Television Tubes
Hearing Aid Tubes

Our technical skill will improve the performance of condensers, neon electrodes, soldering irons, electrical appliances, gauge glasses, diaphragms, stoves, mica washers, and for all other mica applications.

We guarantee that the quality of our mica will reduce your shrinkage costs!

Send for our "HANDBOOK
on FABRICATED
NATURAL
MICA"



Quality—



Since 1929

INDUSTRIAL MICA CORPORATION

225 So. Van Brunt St.
Englewood, New Jersey

NTSC COLOR EQUIPMENT

PRICED RIGHT
BUILT RIGHT
by

Tel-Instrument

**A COMPLETE NTSC COLOR
EQUIPMENT PACKAGE FOR LESS
THAN \$16,000!**

Consists of the following:

- Type 2600 Color Sync and Waveform Generator.
- Type 2610 Matrixer and Encoder.
- Type 2303 Color Monoscope.
- Type 2121 Color Transmitter.
- Type 2700 Equalizing Filter.
- Type 2400 Color Picture Monitor.

Above equipment includes all power supplies which are of basically new design.

Tel-Instrument the world's leading manufacturer of TV Production and Laboratory Test Equipment, now makes available to the TV industry the first complete NTSC COLOR package based on completely new and integrated circuitry. This equipment is not to be confused with any presently available which is essentially a modification or adaptation of obsolete black and white equipment

This new approach enables *Tel-Instrument* to realize radical economies in manufacture, and still maintain the highest degree of electrical and mechanical standards.

We welcome the opportunity to further acquaint you with complete details concerning our NTSC color package.

Reprints of "What Design Engineers need to know about the NTSC color TELEVISION STANDARDS" available on request



Manufacturers of a Complete Line of TV Test Equipment

Tel-Instrument Co. Inc.

728 GARDEN STREET • CARLSTADT, N. J.

pioneers in the development of environmental test equipment since 1946. His background in the industry has also included the posts of chief draftsman, coordinating engineer and production manager.

Minneapolis-Honeywell Adds Factory Space

MINNEAPOLIS-HONEYWELL REGULATOR CO. has taken a six-month lease on manufacturing space at Tucson Municipal Airport in Tucson, Ariz.

The company plans to use the facilities to insure uninterrupted work on its jet fighter electronic equipment during the winter months. Increased volume of jet work has taxed the company's main flight center in Minneapolis.

Stevens Doubles Plant Area

GEO. STEVENS MANUFACTURING Co. of Chicago has completed an addition which doubles the area of the present plant. The new space is being used for manufacturing high-speed coil winders and for an enlarged engineering and design department.

Gray Research Names Winlund

EDMOND S. WINLUND has been appointed chief engineer of Gray Research and Development Co.

He was formerly associated with RCA and Westinghouse and is experienced in the design and application of radio broadcast transmitters, marine radar devices and dielectric and other industrial heating equipment. He is a specialist in radio and microwave equipment for railroads.

Stanford Research Acquires Microwave

STANFORD RESEARCH INSTITUTE has acquired the facilities of the Microwave Engineering Co. of Los Angeles, located at the top of Mount Lee in the Hollywood district.

The new facility will be integrated as part of SRI's Engineering Division's Radio Systems Laboratory, and will be known as the Mount Lee Laboratory of Stanford

AT LAST! FUNGUS-PROOF NYLON LACING CORD and FLAT BRAIDED TAPE

No more problems from mold and micro-organisms! For Heminway & Bartlett's Nylon Lacing Cords and Flat Braided Tapes are completely fungus-proof. In addition, they have high abrasion-resistance and low moisture absorption. Their finish has the desirable malleability of wax and is non-toxic to humans. Samples gladly sent on request.

Meet Army, Navy and Civilian "Specs"

EST. 1888



HEMINWAY & BARTLETT

The Heminway & Bartlett Mfg. Co., 500 Fifth Ave., N.Y. 36, N.Y.
Sales Offices: Chicago, Phila., Boston, St. Louis, Cincinnati,
San Francisco, Los Angeles, Charlotte, N. C., Gloversville, N. Y.
Foreign Agent: Turner, Halsey Co., Inc., 40 Worth Street,
New York, N.Y. Cable Address: THECOTEX

SHOCK PROOF

VACUUM TUBE RETAINERS

These retainers are used to secure Vacuum Tubes and to resist side motion of Vacuum Tubes used in radio equipment which is subject to shock and vibrations. These retainers meet the requirement of all JAN specifications. The insulated portion is made of a melamine base Fibre Glass Phenol which provides 300 volts insulation to ground and withstands a temperature of 350 F. The insulated plate can readily be fastened or released by hand.

Available for envelope types T7, T8, MT8, T9, T12, ST12, T12ZDL, ST14, S14, ST16, T5½, T6½, MT-IC, ST19, T14, ST128CT-9.

*Manufacturers of
Electronic Components*

JAMES IPPOLITO & CO., INC.

401 CONCORD AVENUE, BRONX 54, N. Y.

BUTTON STEM MACHINERY

for all tube sizes...
in any production
speed

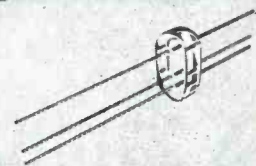

You can produce button stems for sub-miniature, miniature, standard, cathode ray and power tubes (as well as crystal diodes and transistors), at any rate you specify on one of Kahle's machines.

Kahle button stem machines cover the complete range from single head to fully automatic 24 head units that incorporate Kahle's own famous precision high speed index mechanisms. Kahle maintains strict confidence while building machinery for its customer's products.

Kahle has contributed to the electronics and glass industries for more than 40 years... today serves all the major electronic tube producers in this country as well as those in many other nations.

*Let Kahle solve your
button stem problem.
Write today.*

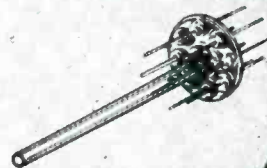

Kahle

ENGINEERING COMPANY
1310 SEVENTH STREET
NORTH BERGEN, N. J.



a familiar Sight at OSTER'S

On charts like this the manufacturing quality at Oster is graphed constantly to maintain uniformity of product and the outstanding performance the Aviation industry demands.

Throughout the Oster plant charts like this one are an integral part of the manufacturing processes.

Whether you buy

**BLOWERS • MOTORS • ACTUATORS
SERVOS • SYNCHROS**

You can rest assured that every phase of manufacture is carefully controlled to assure you of the highest quality of products required by the aviation industry.

You Can Depend on SAFER
Flight . . . EXTRA Fight
with OSTER Products



Want more information? Use post card on last page.

Research Institute.

Present laboratory facilities will be augmented for additional work on radomes and antenna systems for guided missiles. Also contemplated is fuller use of the antenna measuring range to take advantage of the favorable geographical location.

Robert Krausz, former vice-president and chief engineer of Microwave, has been appointed to head the operation. Microwave's engineering staff of 15 also has been retained.

Ampex Organizes Loudspeaker Firm

THE AMPEX CORP. has organized a wholly-owned subsidiary, the Ampex Loudspeaker Co.

With manufacturing facilities in North Hollywood, Calif., the new firm's initial output will consist solely of theatrical loudspeakers. The company was formed to fulfill commitments to equip theaters with integrated multidirectional sound systems used with the new 3-D and wide-screen techniques.

Ampex loudspeakers are being built under license from the James B. Lansing Sound Corp. Thomas L. Taggart, comptroller, has been temporarily reassigned as manager of the loudspeaker subsidiary.

More Companies Become RETMA Members

FOURTEEN new members, 13 active and one associate, were admitted to RETMA membership by the board of directors bringing total membership to 362, the highest in RETMA history. New members are:

The Alton Co. of Union City, N. J. (Associate); Andrews Tower Co. of Fort Worth, Texas; Avionex Electronics Corp. of Burbank, Calif.; Cal-Tronics of Los Angeles, Calif.; Chromatic Television Laboratories of New York, N. Y.; Don Good of South Pasadena, Calif.; R. L. Drake Co. of Dayton, Ohio; International Instruments of West Haven, Conn.; Olympic Radio & Television of Long Island City, N. Y.; Rek-O-Kut of Long Island City, N. Y.; Swett & Sibley of Cambridge, Mass.; T. J. Mfg. Corp. of Martinsville, Ind.; Transistor



STOP RF LEAKAGE ON THE DRAWING BOARD

... WHEN YOU DESIGN METEX ELECTRONIC WEATHERSTRIPPING INTO YOUR EQUIPMENT YOU GET ITS POSITIVE SHIELDING EFFECTIVENESS — AT MAXIMUM OVERALL ECONOMY

Plan now to take full advantage of *Metex Electronic Weatherstripping's* unusual effectiveness in shielding all types of electronic equipment. Because it is made of knitted wire mesh, *Metex Electronic Weatherstripping* is both conductive and resilient. It assures positive metal-to-metal contact between all mating surfaces. And being resilient it accommodates itself positively to surface inequalities.

In reality, *Metex Electronic Weatherstripping* can do more for you than just shield RF leakage. It can cut the cost of machining mating surfaces to close tolerances. It can eliminate the need for extra fasteners and many other costly means of making joints RF tight.

Applications in which *Metex Electronic Weatherstripping* has already proved its effectiveness include pulse modulator shields, wave-guide choke-flange gaskets, local oscillators on TV sets, dielectric heaters, etc.

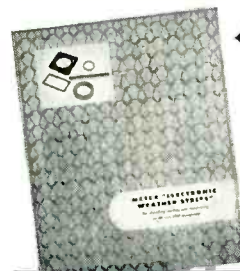

For detailed information on METEX ELECTRONIC PRODUCTS, write for FREE copy of "Metex Electronic Weatherstrips" or outline your SPECIFIC shielding problem — it will receive our immediate attention.



Want more information? Use post card on last page.

PLANS

into PLASTICS

PRECISION MACHINING OF ALL THE PLASTICS

including
POLYSTYRENE • COPOLYMER 1422
BUTYRATE • NYLON • TEFLON • KEL-F

PLASTIC FABRICATING

Printloid is equipped for the complete production of a wide variety of consumer and industrial items in any quantity. We work with any plastic material in sheets, rods and tubes. Die-cutting, deep drawing, stamping, forming, finishing, and assembling in our own plant.

PLASTIC PRINTING

LETTERPRESS • SILK SCREEN • HOT STAMPING

for Containers, Displays, Dials, Laminated Charts, Machined Parts, Etc.

Ask for brochure illustrating various plastic products fabricated to specification by Printloid.



Quality

Ribbons STRIPS

MOLYBDENUM
TUNGSTEN
TANTALUM
FORMED PIECES

Your Special
Metals Rolled
to Thin Sizes &
Close Tolerances

YOUR INQUIRIES WILL
RECEIVE PROMPT ATTENTION

H. CROSS CO.

15 BEEKMAN ST., N. Y. 38, N. Y.
Worth 2-2044 and COrtlandt 7-0470

the COMPLETELY NEW

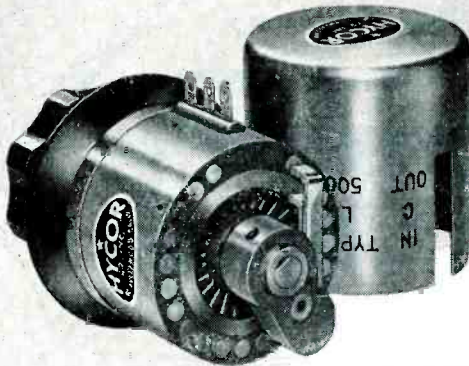

HYCOR

VARIABLE ATTENUATOR

... a revolutionary design in attenuators!

- PROOF against SHOCK — MOISTURE — TEMPERATURE
- Withstands ambient temperatures of -40°C. to $+100^{\circ}\text{C.}$; 95% humidity.
- Resistive elements are accurate, noninductive, wire-wound and hermetically sealed in a special tough plastic compound.
- Greater power dissipation.
- Switch surface flat and smooth . . . easy to clean, BRUSHES CANNOT YRIP, exceptionally long life.
- QUIET . . . extremely low switch noise level . . . ideal audio mixer controls.
- "Lubricated for life" bearings.
- Stock types available with "LADDER," "T," "H," "L" and potentiometer configurations up to 32 steps.

Send for Bulletin A-2 for specifications and prices.

Representatives:

BEEBE ASSOCIATES
5707 W. Lake St., Chicago, Illinois
BURLINGAME ASSOCIATES
103 Lafayette Street, New York City
HARRISON J. BLIND
1616 Cord Street, Indianapolis 24, Indiana

HYCOR SALES COMPANY of California

11423 VANOWEN STREET
NORTH HOLLYWOOD, CALIF.

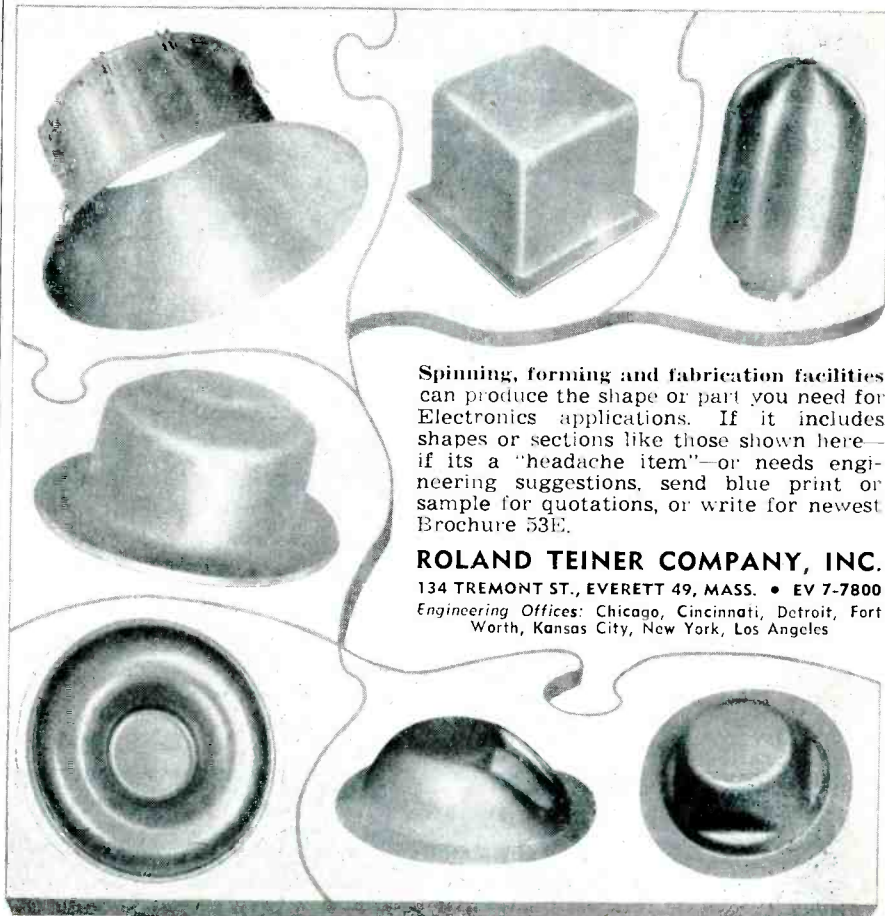

Spinning, forming and fabrication facilities can produce the shape or part you need for Electronics applications. If it includes shapes or sections like those shown here—if its a "headache item"—or needs engineering suggestions, send blue print or sample for quotations, or write for newest Brochure 53E.

ROLAND TEINER COMPANY, INC.

134 TREMONT ST., EVERETT 49, MASS. • EV 7-7800
Engineering Offices: Chicago, Cincinnati, Detroit, Fort Worth, Kansas City, New York, Los Angeles

Watch
TENSOLITE
for progress in
**ELECTRONIC
WIRING!**

**For High Dielectric
Strength, specify -**

TENSOLON TEFLON-INSULATED **WIRE & CABLE**

- THIN WALL
- 14 COLORS
- FREE-STRIPPING
- EXTRA FLEXIBILITY
- TOUGH TEFLON INSULATION
- TEMPERATURE RATING:
-90° to +250°C

For an extra margin of dependability at maximum operating temperatures, specify these rugged Teflon insulated hook-up wires. Available in stranded sizes from 20 to 30 AWG with shields and teflon jackets or lacquered braids. Constructed to meet highest government and commercial standards, Tensolon Wires feature the new Tensulanted-Teflon covering that eliminates pin holes and other imperfections.

ASSORTED TENSOLON HIGH-TEMP WIRES
IN LABORATORY AND TEST QUANTITIES

An economical sample kit for designers, engineers, testing departments and development laboratories. Prices on request.

WRITE FOR CATALOG TODAY

TENSOLITE INSULATED WIRE CO., INC., TARRYTOWN, NEW YORK

GERMANIUM DIODE TEST SET

**Accurate
LAB MEASUREMENTS**
**Rapid
INSPECTION TESTING**

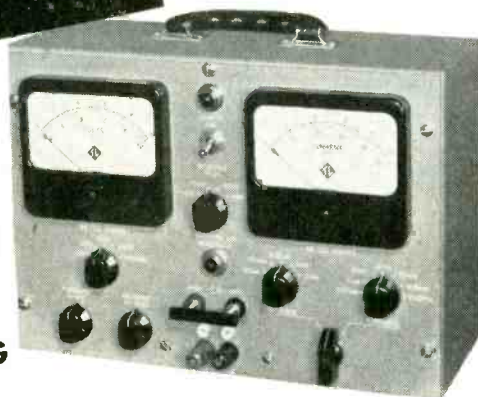

**MODEL
DT-100**

- Pre-set regulated reverse voltages
- -10, -50, -100, 0-150 volts at 5 ma
- Forward current to 500 ma at 1.0 volt
- Controls interlocked for routine tests
- Reversed or shorted diode indication
- Test fixture allows quick connections
- Provision for accessory diode heater

TELETRONICS LABORATORY INC.
WESTBURY, L. I., N. Y.

MANUFACTURERS OF ELECTRONIC INSTRUMENTS AND PRODUCTION TEST EQUIPMENT

Products of Boston, Mass. and U M & F Manufacturing Corp. of North Hollywood, Calif.

NEMA Elects New Officers

J. H. JEWELL, vice-president of Westinghouse, was elected president of the National Electrical Manufacturers Association at their annual meeting to succeed L. G. Hall, president of Stackpole Carbon Co.

Vice-presidents named by meeting delegates are: J. L. Busey, vice-president of GE; J. W. Corey, president of Reliance Electric; W. A. Elliott, president of Elliott Co.; F. F. Loock, president of Allen-Bradley Co. and Hoyt Post Steele, executive vice-president of Benjamin Electric. Re-elected as treasurer is A. F. Metz, president of Okonite.

Radio Condenser Appoints Chiefs

JOSEPH S. ROBB has been appointed director of engineering in charge of all engineering functions at Radio Condenser Co. of Camden, N. J.

Melvin V. Weiss has been named chief engineer of special apparatus and tv and Jack Teaf has been named chief engineer of the auto tuner division.

Pentron Increases Production Facilities

ADDITIONAL manufacturing facilities have been leased by Pentron Corp. in Chicago for assembly operations devoted to manufacturing magnetic recording heads, amplifiers and related components.

The extra capacity will supplement the facilities of Pentron's main plant. The two locations provide floor space of 47,000 sq ft.

GE Organizes New Groups, Opens Tube Warehouse

REORGANIZATION of government electronics activities of the GE Electronics Division was announced by W. R. G. Baker, vice-president and general manager of the division.

Two new departments have been

"INDUSTRIAL"

for ELECTRONIC COMPONENTS

Precision engineered electronic components and connecting devices for all your needs.

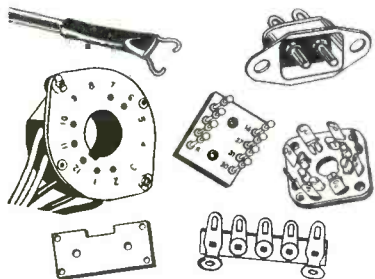

- ANODE CONNECTORS
- INTERLOCK PLUGS
- LAMINATED TUBE SOCKETS
- TERMINAL STRIPS
- WIRED ASSEMBLIES
- METAL or BAKELITE STAMPINGS
- TERMINAL BOARD ASSEMBLIES
- SCREW MACHINE PARTS

— NEW ITEMS —

- TUNER STRIPS, SOCKETS and BRACKETS for UHF



Our extensive design and production facilities are available for developing your special requirements and applications. Representatives in principal cities throughout U.S.A.
Your 1954 reference catalog ready now. Write for it today. Dept. E-1.

INDUSTRIAL HARDWARE Mfg. Co., Inc.
109 PRINCE STREET • NEW YORK 12, N. Y.

Hundreds of standard **JONES** TERMINAL PANELS Complete equipment for SPECIALS



Send your specifications for prompt quotation

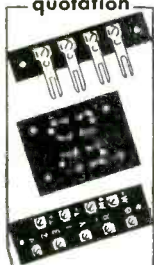

Several pages of Jones Catalog No. 17 illustrate standard and special panels we are constantly producing. Latest special equipment enables us promptly to produce practically any panel required. Send print or description for prices, without obligation. Hundreds of standard terminal strips also listed. Send for Catalog with engineering drawings data.

**JONES MEANS
Proven QUALITY**

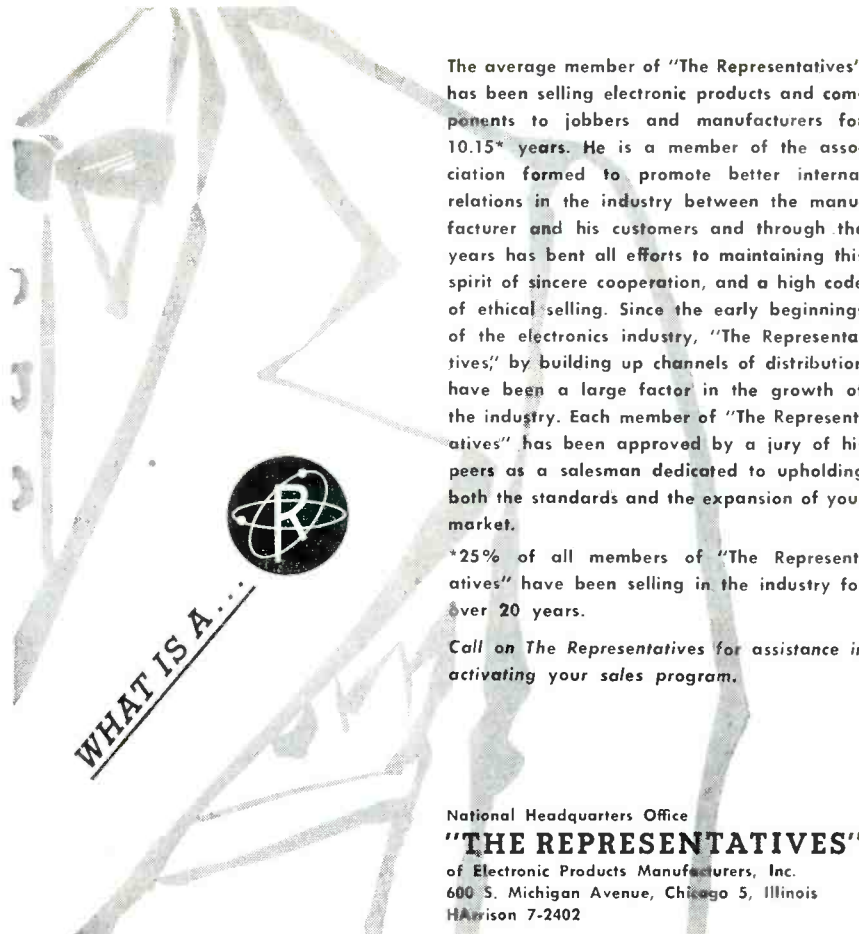
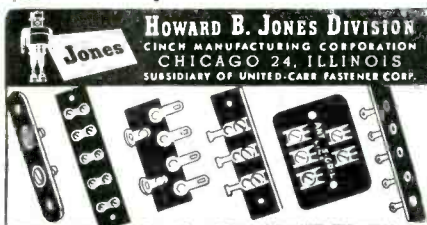

WHAT IS A...

The average member of "The Representatives" has been selling electronic products and components to jobbers and manufacturers for 10.15* years. He is a member of the association formed to promote better internal relations in the industry between the manufacturer and his customers and through the years has bent all efforts to maintaining this spirit of sincere cooperation, and a high code of ethical selling. Since the early beginnings of the electronics industry, "The Representatives," by building up channels of distribution have been a large factor in the growth of the industry. Each member of "The Representatives" has been approved by a jury of his peers as a salesman dedicated to upholding both the standards and the expansion of your market.

*25% of all members of "The Representatives" have been selling in the industry for over 20 years.

Call on The Representatives for assistance in activating your sales program.

National Headquarters Office
"THE REPRESENTATIVES"
of Electronic Products Manufacturers, Inc.
600 S. Michigan Avenue, Chicago 5, Illinois
HARISON 7-2402

emi DEKADIAL for accurate resistance, capacitance, inductance. Readings to four significant figures.

RANGE SELECTOR: seven positions

CIRCUIT SELECTOR: six positions

Universal **BINDING POSTS** connect to all bridge arms

DETECTOR SWITCH

GENERATOR SWITCH

DISSIPATION FACTOR and "Q" DIAL

7.5 μ a - 0 - 7.5 μ a GALVANOMETER

emi

IMPEDANCE BRIDGE

Wide Range

Resistance: 1 milliohm to 11 megohms
Capacitance: 1 mmf to 1100 mfs.
Impedance: 1 mh to 1100 henrys

Exceptional Accuracy

Resistance: $\pm 0.1\%$
Capacitance: $\pm 0.25\%$
Inductance: $\pm 1.0\%$

◆

**SHOWN
MODEL 250-C1
\$340**

9" x 11" x 11" over-all. Convenient operation from battery, or from AC power lines with E.M.I. accessory amplifier.

◆

Write to factory for literature and analysis of your needs.

ELECTRO-MEASUREMENTS, INC.
Formerly BROWN ELECTRO-MEASUREMENT CORP.

**4312 S. E. Stark St.
PORTLAND 15, OREGON**

WHEN

DESIGN ENGINEERS TALK SHOP TODAY THEY TALK

miniaturization



... because miniaturization meets today's demands for increased performance from smaller, lighter equipment. It saves vital space and weight on aircraft, guided missile and many similar applications ... and it is bringing new portability and usability to countless types of commercial and industrial equipment.

If your miniaturization problem involves instrumentation, we can help. International Instruments is devoted exclusively to the design, development and production of miniature instruments and has created many important "firsts". We offer a complete line of 1" and 1½" Meters featuring accuracy and dependability comparable to conventional sized meters ... plus far greater resistance to shock and vibration. Special scales and ranges can be provided to meet practically any electrical measuring requirement. Use the coupon below to send for data sheets covering our standard instruments — or ask our Engineering Department to help with your special needs.



MODEL 153



MODEL 150



MODEL 100



**international
instruments**

INCORPORATED

P.O. BOX 2954, NEW HAVEN 15, CONN.

- Please send data sheets covering your standard instruments.
- Arrange to have your representative call.

NAME _____

POSITION _____

COMPANY _____

CO. ADDRESS _____

CITY _____

ZONE _____ STATE _____

Want more information? Use post card on last page.

PLANTS AND PEOPLE

(continued)

created to handle engineering and manufacturing functions of the division's government business. All marketing functions will continue to be handled by the division's government equipment marketing section.



J. J. Farrell

John J. Farrell, who joined GE in 1913 and has been in charge of heavy military electronic equipment since 1952, was appointed general manager of the new heavy military electronic equipment department.

Herman F. Konig, who joined GE in 1932 and has headed light military electronic equipment activities since 1952, was named general manager of the new light military electronic equipment department.

Venard M. Lucas will continue as manager of the government equipment marketing section, with headquarters at Syracuse.

The three units were previously part of the division's government equipment department, which has been discontinued. George R. Metcalf, who was general manager of that department, has joined the company's engineering services division in New York as a consultant to C. H. Linder, vice-president of engineering.

The newly formed germanium products unit of the GE Electronics Division's commercial equipment department set up its marketing organization under James H.

Thousands of these **MAGNA** BIT HOLDERS*

cut costs

4 ways

FOR POWER AND SPIRAL SCREWDRIVERS



1. Cuts labor costs. No hand starting, no pre-positioning of screws. Bit holds screw firmly. High energy permanent magnet energizes bit with 10 times ordinary "pull".

2. Cuts bit costs ... through use of long-wearing super hard, low-cost interchangeable insert bits.

3. Cuts bit wear and replacement since the energized bit seats itself positively in the screw slot or recess.

4. Eliminates loss of time and material caused by dropped screws.



Bit holders available for all makes of power and spiral drivers. Also super hardened tool steel insert bits for all types and sizes of screws.

Permanently Magnetic Magna-Tip Hand Screw Drivers*... bits for all types and sizes of screws and Magna-Tip Hex Drivers for hex head screws.

* U.S. Patent No. 2,550,775.



Write for folder 95-E, information and prices:

MAGNA DRIVER CORP.
779 WASHINGTON ST., BUFFALO 3, N. Y.

Want more information? Use post card on last page.

January, 1954 — ELECTRONICS

For SPECIFIED PERFORMANCE Specify JELLIFF RESISTANCE WIRE

COMPLETE CONTROL OF MANUFACTURE . . .

A WIDE RANGE OF EXPERIENCE . . .

A WIDE RANGE OF ALLOYS . . .

make JELLIFF the ideal source of
Resistance Wire to assure your Product's

Performance According to Specs.

*Precision resistors—rheostats—
relays—thermocouples—ohmmeters
—bridges—high-temperature fur-
naces can all benefit from the
PLUS-PERFORMANCE of
JELLIFF RESISTANCE WIRE*



Detailed Enquiries Welcomed. Address Dept. 17

Specify MEYERCORD DECAL Transfers



— for long
day-after-day
production runs—

— for difficult
highly-specialized
applications



**Meyercord Laboratory and Production Experience
— PLUS Unexcelled Service — to Serve You Better!**

Sometimes we are too prone to tell our friends about the spectacular achievements of Meyercord in solving those "impossible" decal transfer applications . . . like the new E-51 aircraft decals that resist up to 900 degree temperatures of jet engines, as well as the ravages of strong solvents and aircraft fuels. Specialized decal applications are a mighty important part of our business . . . but we're still first and foremost in the business of supplying standard Meyercord nameplate and identification decals. Whether you make typewriters, appliances, electrical conduit . . .

any product that is turned out on long-time production runs, be sure to investigate the advantages of Meyercord decal *uniformity, fine quality and unbeatable service* on your production line.

Send for This Manual of MEYERCORD DECAL NAMEPLATES

Shows hundreds of uses for durable, washable decal nameplates . . . as trademarks, instruction charts or diagrams—in any size, colors, or design. The Meyercord Nameplate Manual is FREE . . . but request it on your business letterhead, please.

THE MEYERCORD CO.
World's Largest Decalomania Manufacturers

DEPT. N-303, 5323 WEST LAKE STREET
CHICAGO 44, ILLINOIS

PRECISION



SYNCHROS SERVO MOTORS RATE GENERATORS

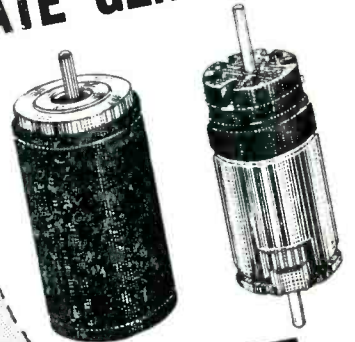

Infra Electronic Corporation is playing an important part in the precision manufacture and assembly of electronic and electro-mechanical system components for the Military.

We invite your inquiry when commercially available units will not meet your system demands.

Custom design, development, and manufacture of Test Sets, Kits and Consoles for pre-flight check out and ground maintenance of airborne systems.

INFRA

Electronic Corp.

== Roseland, New Jersey ==

Manufacturers of Precision Synchros



Only the manufacturer of *genuine* Bead Chain offers you a new, more versatile belt drive that will accurately time and control the movement of all types of devices. Among such applications are radio and television tuners, recorders, air conditioners and timing devices. Costly gearing mechanisms can be eliminated and efficiently replaced by the specially designed sprockets that accurately fit the individual beads *without slippage and backlash*. Friction is at a minimum and tensile strength of the Bead Chain belt (from 15 to 200 lbs.) is very high in proportion to size and weight.

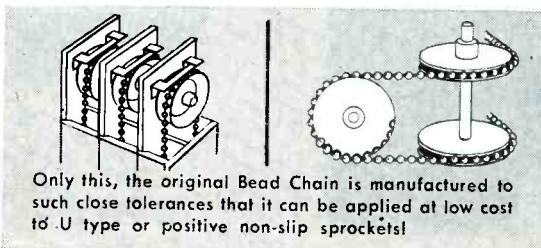

Only this, the original Bead Chain is manufactured to such close tolerances that it can be applied at low cost to U type or positive non-slip sprockets!

B Write to us today for detailed information about sprockets and Bead Chain belts. It can save you a lot of time and money later.

THE BEAD CHAIN MANUFACTURING CO.
88 Mountain Grove St., Bridgeport, Conn.

Please send me information about
Bead Chain sprocket drives.

NAME.....

TITLE.....

ADDRESS.....



THE BEAD CHAIN MANUFACTURING CO., Bridgeport 5, Conn.
original and world's largest producers of Bead Chain



Herman F. Konig

Sweeney, manager of marketing for germanium products.

Richard H. Rudolph was appointed manager of sales. He has been sales manager for precision and laboratory test instruments since 1948.

Edwin O. Vandeven was named manager of marketing administration. He has been commercial engineer for germanium products since 1951.

Guy O. Whelchel was appointed manager of marketing administration and research. He has been engaged in marketing administration for the commercial equipment department since 1951.

Samuel R. Tedford, who has been a section leader in the advertising section of the commercial equipment department since 1950, was named manager of advertising and sales promotion.

In other activities, GE opened its new tube warehouse in Los Angeles. A prediction that the future growth of the electronics industry in the West Coast region may be "several times the growth of the rest of the country," was made by J. Milton Lang, general manager of the GE tube department, at the opening of the new 25,000 sq ft building.

The new warehouse, under the management of W. E. Morrison, was built in accord with GE specifications and will be occupied by the company under long-term

MO-BRAZE

A high temperature brazing powder for rapid formation of strong joints

molybdenum to molybdenum
molybdenum to tungsten
tungsten to tungsten

No volatilization in hydrogen or high vacuum

For full information
Write or phone

AMERICAN ELECTRO METAL CORPORATION

320 Yonkers Ave.

Yonkers, N. Y.

YOnkers 8-2211

AIRCRAFT SERVO COMPONENT



Condensed Data

Range: 0-14.7 psi, absolute
Resistance: 7500 ohms
Maximum voltage: 75 volts
Resolution: 1/4%
Accuracy: 2% of full scale

Typical Applications

Servos—Vary servo loop gain as a function of altitude.
Computers—Voltage divider, P total/P static.
Fire Control—Air density measurements.
Telemetry—Pressure transducer.
Recording—Pressure transducer.

Write for
Bulletin No.
71-5 for
further details

Price:
\$225.00
Short delivery

The Type 71-5 Baroresistor is a pressure actuated potentiometer designed for operational use in aircraft. It features:

HERMETICALLY SEALED MECHANISM

The potentiometer winding and operating parts are hermetically sealed in a vacuum. Pressure is applied inside the bellows only. Therefore, the Type 71-5 Baroresistor is not affected by dust, fungi, or moisture.

RUGGEDIZED CONSTRUCTION

A special high force mechanism was developed for the Trans-Sonics Baroresistor to avoid the necessity for employing micro force potentiometer elements. Shock of 30g in any direction will not cause electrical discontinuity.

MACHINE CALIBRATION

Each instrument is calibrated by machine and its performance is automatically recorded as a graph of resistance versus pressure. Every turn of the winding is inspected. All electrical characteristics are automatically checked in an eleven stage inspection cycle.

TECHNICAL REPRESENTATIVES

Los Angeles, Calif. Telephone: Cumberland 3-4183	Dayton, O. Telephone: Hemlock 1254
San Carlos, Calif. Telephone: Lytell 3-2189	Seattle, Wash. Telephone: Main 7005
Boston, Mass. Telephone: Capitol 7-9797	Houston, Tex. Telephone: Manroe 5-5624
St. Louis, Mo. Telephone: Sweetbriar 2175	Cleveland, O. Telephone: Yellowstone 2-7849
Detroit, Mich. Telephone: Broadway 3-2900	
Home Office: Telephone Lexington 9-2508	

TRANS SONICS, INC.
5 Forest Street Bedford, Mass.



PRECISION RF STEP ATTENUATOR*

Model AT-120 0 to 1000 MC

Small, rugged ladder attenuator achieves attenuation accuracy and low vswr from dc to uhf. Suitable for all signal and sweep generators in this frequency range.

Care in design assures maximum flexibility in mounting, drive, and types of input and output connections.

Easily adaptable for inclusion in different types of test equipment and in laboratory and production test applications.

MAXIMUM STEPS

Ten (eleven contact positions)

ATTENUATION RANGE

Up to 120 db total

OUTPUT IMPEDANCE

50 or 75 ohms nominal

INPUT IMPEDANCE

100 or 150 ohms nominal
50 or 75 ohms optional

INPUT AND OUTPUT VSWR

1.1 to 1000 mc at 50 ohms

Quick delivery on Standard Models. Prompt attention given to special requirements.

*PAT. PENDING

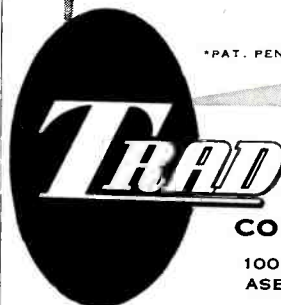

**TELEVISION
CORPORATION**

1001 FIRST AVENUE,
ASBURY PARK, N. J.

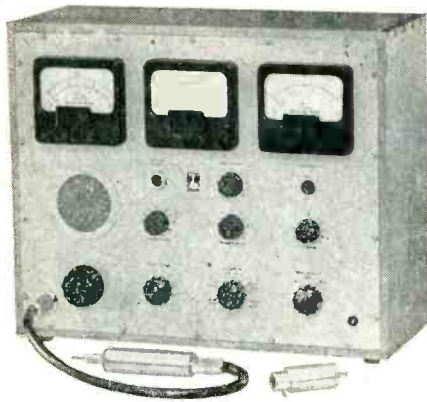

MEASURE HIGH-FREQUENCY VOLTAGES

with the **BRUEL & KJAER**
Heterodyne Voltmeter

This selective vacuum tube voltmeter is particularly useful in radio, radar and television circuit measurements, signal generator control, and monitoring of coaxial carrier frequency systems. It is designed for the measurement of high-frequency voltages and has very high sensitivity for measuring extremely small R. F. voltages.

All measurements are made through a test probe. The input voltage is indicated on one meter, and the degree of amplitude modulation of the signal on a second meter. Normal sensitivity is in the microvolt and millivolt range; however, by using an external attenuator this range can be extended to a maximum of 10 volts.

For specifications on the Model BL-2002 Heterodyne Voltmeter and information on the complete line of Bruel & Kjaer Instruments, write Brush Electronics Company, Dept. K-1, 3405 Perkins Avenue, Cleveland 14, Ohio. Outside U.S.A. and Canada, address Bruel & Kjaer, Naerum, Denmark.

ACOUSTIC AND TEST INSTRUMENTS

Bruel & Kjaer instruments, world famous for their precision and workmanship, are distributed exclusively in the United States and Canada by Brush Electronics Company.

- BL-1012 Beat Frequency Oscillator
- BL-1502 Deviation Test Bridge
- BL-1604 Integration Network for Vibration Pickup BL-4304
- BL-4304 Vibration Pickup
- BL-2105 Frequency Analyzer
- BL-2109 Audio Frequency Spectrometer
- BL-2304 Level Recorder
- BL-2423 Megohmmeter and D. C. Voltmeter
- BL-3423 Megohmmeter High Tension Accessory
- BL-4002 Standing Wave Apparatus
- BL-4111 Condenser Microphone
- BL-4120 Microphone Calibration Apparatus and Accessory
- BL-4703 Automatic Frequency Response Tracer

BRUSH ELECTRONICS COMPANY



formerly
The Brush Development Company.
Brush Electronics Company
is an operating unit of
Clevite Corporation.

Want more information? Use post card on last page.

lease. The building also houses GE western sales offices as well as commercial service offices and a commercial engineering laboratory.

NYU Expands Electronics Curriculum

A BROADENED program at NYU's College of Engineering consists of fall and spring courses in amplifier coupling networks and vacuum tube and transistor circuits, and a fall course in theory of fractional horsepower and servo motors. Courses are designed particularly for electronics engineers engaged in radar circuitry, servomechanism component design and allied fields.

CBS-Columbia Becomes Division of CBS

WILLIAM S. PALEY, chairman of the board of the Columbia Broadcasting System, announced that the activities previously carried on by CBS-Columbia as a subsidiary will be carried on by the organization as a division of CBS under the designation of CBS-Columbia. He stated that the organizational change was made to simplify the over-all corporate structure and to permit greater integration of activities of CBS-Columbia with CBS.

In the new division Frank R. Day has been named production engineer in the industrial engineering department. He has had more than 30 years experience in the radio-tv field and has been plant and production manager for U.S. Television Corp. and also headed production testing for Pilot.

In the special products unit of the division, Robert G. Horner, George Wass and Harold Metter all have been named to color tv receiver design and production engineering assignments.

I-T-E Moves Special Products Division

THE SPECIAL products division of the I-T-E Circuit Breaker Co. of Philadelphia moved from the company's main plant to a separate plant in the city.

The new plant houses not only the offices of the special products



AIR-SPACED ARTICULATED CO-AX CABLES

offer a unique combination of

- ✓ FRACTIONAL CAPACITANCE
- ✓ HIGH IMPEDANCE
- ✓ MINIMUM ATTENUATION
- ALONG WITH
- ✓ EXCEPTIONAL FLEXIBILITY
- ✓ LIGHT WEIGHT

38 STOCK TYPES

FOR ANY OF YOUR STANDARD OR SPECIAL APPLICATIONS

A few of the very low capacitance types are:

Type No.	Capacitance $\mu\text{F}/\text{ft.}$	Impedance ohms	O.D.
C.44	4.1	252	1.03"
C.4	4.6	229	1.03"
C.33	4.8	220	0.64"
C.3	5.4	197	0.64"
C.22	5.5	184	0.44"
C.2	6.3	171	0.44"
C.11	6.3	173	0.36"
C.1	7.3	150	0.36"

WE ARE SPECIALLY ORGANIZED TO HANDLE DIRECT ORDERS OR ENQUIRIES FROM OVERSEAS

SPOT DELIVERIES FOR U.S.
BILLED IN DOLLARS—SETTLEMENT BY YOUR CHECK
CABLE OR AIRMAIL TODAY



138A GROMWELL RD., LONDON, S.W.7
ENGLAND

CABLES: TRANSRAD LONDON

Want more information? Use post card on last page.



ELECTRONICALLY
REGULATED

Laboratory
POWER SUPPLIES



BENCH MODEL 50

0-500 VDC • 0-500 MA
CONTINUOUSLY VARIABLE

A general-purpose, heavy-duty precision-regulated power supply for bench use. Incorporates stable 5651 reference tube, overload circuit-breakers, time-delay tube protection.

Also available for standard rack mounting (Model 50-R. Panel size 10½" x 19". Depth 14¼").

Specifications*

- INPUT: . . . 105-125 VAC, 50-60c
- OUTPUT VOLTAGES
- 0-500 VDC, 0-500 MA
- Regulation (line): . . . < 0.15%
- Regulation (load): . . . < 0.5%
- Internal Impedance: . . . < 2 ohms
- Ripple and Noise: . . . < 8 mv rms
- Polarity: + or - may be grounded
- 0-50 VDC, 0-200 VDC . . . bias
- Regulation (line): . . . < 0.1%
- Internal Imped: 32,500 ohms max
- Ripple and Noise: . . . < 5 mv rms
- 6.3 VAC, 5A unregulated
- 6.3 VAC, 5A unregulated
- STABLE • DEPENDABLE
- MODERATELY PRICED

LAMBDA

ELECTRONICS CORP.
CORONA 68, NEW YORK

*For complete specifications on these and other models write for catalog L-50.

coil
designing?



When your design specifies coils, get in touch with us. As coil experts, we co-operate with design engineers to produce prototypes. Use our 35 years of experience to save time, effort and money. Coto-Coil Company, 65 Pavilion Avenue, Providence 5, R. I. New York Office: 10 E. 43rd Street, New York 17.



a mere 0.0003%
of Radio Shack's inventory

of technical electronic supplies!



How many are immediately available from stock in YOUR vicinity?

- (1) Solenoid, (2) Screen Booth Filter, (3) Printco Component, (4) Mercury Counter, (5) Transistor Transformer, (6) Temperature Indicator, (7) Dosimeter Charger, (8) 2KV Supply, (9) Micropositioner.

New!
Free!
224-page
Catalog

RADIO SHACK CORP. 167 Washington St.
Boston 8, Mass.

Name _____ Company _____

Address _____

MODULATOR by MANSON

2.5 MEGAWATT peak power—Model 200T
Hydrogen-Thyratron Modulator

The Modulator functions at various pulse widths and frequencies up to the indicated peak power, or maximum average power of 5 kilowatts.

The **POWER-SUPPLY** Section supplies 10 KV at 0.5 amperes, and is fully interlocked and protected against DC or AC overload so that it may be used independently for external equipment if desired.

The **PULSER** includes an adjustable filament supply for magnetrons, internally- or externally-synchronized JAN triggers for 5C22 or 1907 Hydrogen-Thyratron switch tubes, pulse-current and voltage-view circuits, and peak-reading voltmeter capable of measuring up to 40-KV output pulses.

MECHANICALLY, the complete unit is on casters, and is contained in a rigid framework with bench space on top and interlocked doors on three sides. Layout permits ready interchange of pulse transformers, pulse-forming network, and charging choke.

Complete Data in Bulletin E-1

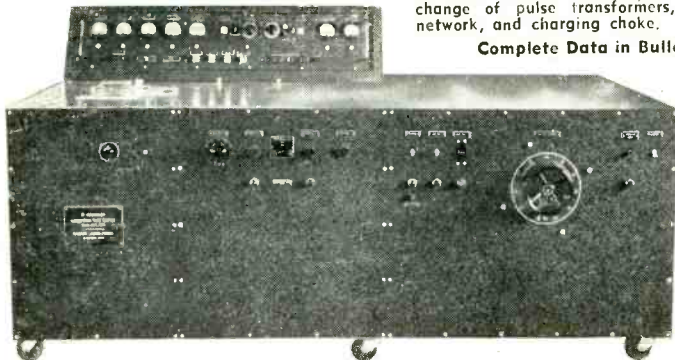

Hard- or Soft-Tube Modulators at all power levels built to specifications.
Your inquiry is invited.

MANSON LABORATORIES / Industrial Control Devices —
Electronic and
Electro-Mechanical Instruments

207 Greenwich Avenue • Stamford, Conn.

division but also the company's facilities for assembling jet engine components. With other buildings of the division, a total of 185,000 sq ft for manufacturing and 16,000 sq ft for office area is now used.

Photo Chemical Opens California Company

Photo Chemical products of New York City opened an affiliate, Photo Chemical Products of California, in Santa Monica. According to Henry G. Renaud, president, the California operation will concentrate its activities in printed electronic circuit applications and development of phosphor screens for color tv kinescopes. The West Coast operation will also continue the manufacture of aircraft instrument dials and electronic panels using their "Wrinlay" process.

John Lesser, formerly production manager of Multi-Metal Wire Cloth Co. of New York City, has been elected vice-president and general manager of the California plant.

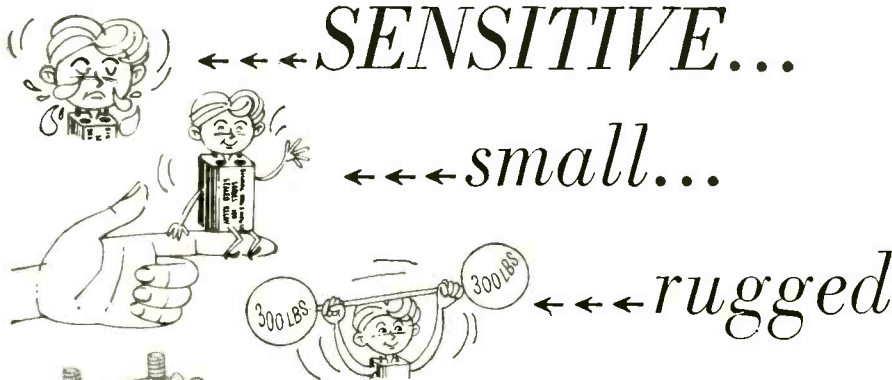

←←← **SENSITIVE...**

←←← *small...*

←←← *rugged*



THE NEW SERIES 100 RELAY (Hermetically Sealed)

One of the greatest challenges in the field of electronics is the designing of components small enough and rugged enough for today's and tomorrow's "miracle" machines and equipment.

The engineers of the Signal Engineering & Mfg. Co., always alert to this challenge, now offer the new Series 100 Miniature Relay which is among the smallest and most sensitive of the double-pole type. It maintains high precision under varying conditions and is ideally suited to such equipment as military guided missile controls which must withstand extremes of shock, vibration, and temperature.

Write now for Bulletin SR-6



DIMENSIONS
1" x 1" x 1 3/4"

Engineering
Representatives
in Principal Cities.

Superex Operates Rayburne Corp.

SUPEREX ELECTRONICS CORP. of Yonkers, N. Y. is operating Rayburne Corp. (formerly Grayburne) also at Yonkers, and will market the combined lines of electronic components and equipment under the Superex name.

Headed by Daniel Schulman and Marvin Buchalter, Superex has been engaged in the manufacture of electronic equipment for the civilian and military fields.

Electronic Engineers Needed by Navy

THERE are current research vacancies at the Naval Research Laboratory in grades GS-5 to GS-12 with basic entrance salaries from \$3,410 to \$7,040 per year. A Bachelor's degree in an appropriate field is required and applicants with graduate degrees are particularly desired. Post graduate research experience in electronics will be given

QUARTZ CRYSTALS

FT-243-.093" Pin Dia.—.486" Pin Spc
FOR HAM AND GENERAL USE

4035 5725 6300 6925 7750	1015 3005 6140 7106#8140
4080 5740 6306 6940 7773	1110 3010 6150 7125 8150
4110 5750 6325 6950 7775	1150 3202 6173 7140 8173
4165 5760 6335 6973 7800	1525 3215 6175 7150 8175
4190 5773 6340 6975 7825	1915 3237 6200 7173 8200
4255 5775 6350 7450 7840	1930 3245 6440 7175 8340
4280 5800 6373 7473 7850	1940 3250 6450 7200 8350
4300 5806 6375 7475 7873	1950 3460 6473 7230 8375
4397 5825 6400 7500 7875	2065 3500 6475 7225 8380
4450 5840 6406 7506 7900	2105 3540 6500 7273 8400
4490 5850 6425 7525 7906	2118 3590 6506 7275 8425
4495 5852 6673 7540 7925	2125 3640 6525 7300 8430
4780 5873 6675 7550 7940	2140 3680 6540 7306 8450
4845 5875 6700 7573 7950	2145 3720 6550 7325 8460
4930 5880 6706 7575 7973	2305 3735 6573 7340 8475
5030 5900 6725 7600 7975	2320 3760 6575 7350 8483
5205 5906 6740 7606 8206	2390 3800 6600 7375 8500
5235 5925 6750 7610 8225	2415 3840 6606 7400 8525
5250 5940 6773 7625 8240	2430 3885 6625 7425 8550
5300 5950 6775 7640 8250	2442 3995 6640 7440 8575
5305 5973 6800 7641 8273	2460 6000 6650 8000 8583
5333 5975 6806 7650 8275	2532 6025 7000 8006 8600
5385 6206 6825 7673 8300	2545 6040 7006 8025 8625
5485 6225 6840 7675 8306	2557 6050 7025 8050 8650
5500 6240 6850 7700 8325	2605 6073 7040 8073 8733
5675 6250 6873 7706	2738 6075 7050 8075
5677 6255 6875 7720	2785 6100 7073 8100
5700 6273 6900 7725	2895 6106 7075 8106
5706 6275 6905 7740	2940 6125 7100 8125

49¢ each . . . 10 for 54.00 99¢ each . . . 10 for 58.00

Low Frequency—FT-241A for 5SB, LA
Lattice Filter etc., .093" Pins, 1A
.486" SPC, marked in Channel SCR
Nos. 0 to 79, 54th Harmonic and 522
270 to 380, 72nd Harmonic, Listed P
below by Fundamental Frequencies, 1/2" S
fractions omitted.

370 393 414 436 498 520 400 459	5910 2030 2300 3155
372 394 415 437 501 522 440 461	6370 2045 2305 3202
374 395 416 438 502 523 441 462	6450 2052 2320 3215
375 396 418 481 503 524 442 463	6470 2065 2360 3232
376 397 419 483 504 526 444 464	6497 2082 2390 3237
377 398 420 484 505 527 445 465	6522 2105 2415 3250
379 401 422 485 506 529 446 466	6547 2125 2435 3222
380 402 423 486 507 530 447 468	6610 2131 2442 3510
381 403 424 487 508 531 448 469	6750 2155 2545 3550
383 404 425 488 509 533 450 470	7390 2220 2557 3570
384 405 426 490 511 534 451 472	7480 2258 2660 3580
385 406 427 491 512 536 452 473	7580 2260 2940 2945
386 407 429 492 513 537 453 474	7810 2280 3035 3955
387 408 430 493 514 538 454 475	7930 2322 3120 3970
388 409 431 494 515 455 476	2290 3150 3995
390 411 433 495 516 456 477	
391 412 434 496 518 457 479	
392 413 435 497 519 458 480	

49¢ each . . . 10 for 54.00 99¢ each . . . 10 for 58.00

add 20¢ postage for every 10 crystals (or less).

BC-746 TUNING
UNITS — foundation
coils and condenser
for 80 meter VFO or
exciter — less xtals.
98¢

SUN

Parts Distributors, Ltd.

520 Tenth St. N.W.—Wash., D.C., Dept. E



Measurements Corporation
MODEL 82

STANDARD SIGNAL GENERATOR

20 Cycles to 50 Mc.

FREQUENCY RANGE: 20 cycles to 200 Kc. in four ranges. 80 Kc. to 50 Mc. in seven ranges.

OUTPUT VOLTAGE: 0 to 50 volts across 7500 ohms from 20 cycles to 200 Kc. 0.1 microvolt to 1 volt across 50 ohms over most of range from 80 Kc. to 50 Mc.

MODULATION: Continuously variable 0 to 50% from 20 cycles to 20 Kc.

POWER SUPPLY: 117 volts, 50/60 cycles, 75 watts.

DIMENSIONS: 15" x 19" x 12".
Weight, 50 lbs.

MEASUREMENTS CORPORATION

BOONTON



NEW JERSEY

IF IT'S NEW . . . IF IT'S NEWS . . . IT'S FROM **ELCO**

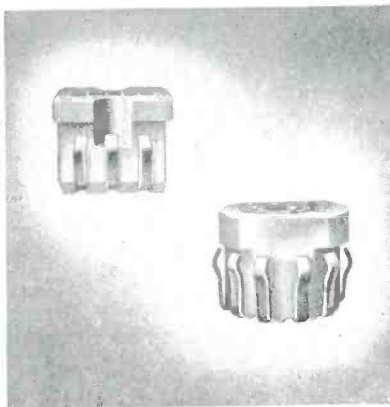

Elco Corporation now introduces a sub-miniature printed-circuit socket to take its place beside Elco's other superior products. Here illustrated are Elco's 5-contact in-line, and 8-contact round-type for tubes. Also available are 3-contact and 4-contact in-line subminiatures for transistor applications; as well as 6 and 7-contact for tubes. Elco's new design automatically centers the tube-pins in position, eliminating strain on the tube

body. Insertion pressures are low enough to allow easy insertion of the tube pins, yet a positive contact retention holds the tube securely in the socket under vibration. This also provides excellent circuit performance. Insulator construction with barriers provides a longer creepage path between contacts. Electrical and mechanical efficiency and stability are maintained consistent with Elco's high record for quality. Full technical data is yours upon request; as is information regarding Elco's complete quality-line of miniature and subminiature tube-sockets, shields and Varicons—the sensational miniature connectors now available with covers, brackets and handles.

For Catalog Sheets, Call GARfield 6-6620 or Write ELCO Corp., 190 W. Glenwood, Phila. 40, Pa.

STOCK KNOBS IN ANY QUANTITY

... AND NEVER A TOOL CHARGE!



GEE-LAR—The House of Knobs
—has hundreds of styles and
patterns in stock at all times.
Whatever your needs . . . whether
for production, lab or experi-
ment . . . you can get them faster
and at lower cost from GEE-LAR.

WRITE TODAY
for Gee-Lar Catalog

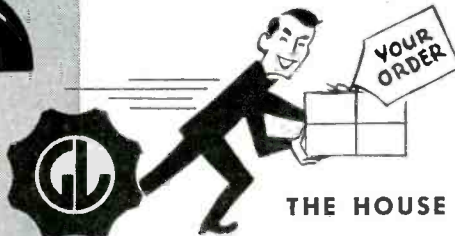

THE HOUSE OF KNOBS

GEE-LAR MANUFACTURING COMPANY

1332 10TH AVENUE • ROCKFORD, ILLINOIS

NEY'S SMALL PARTS PLAY A BIG PART IN PRECISION INSTRUMENTS

The Ward Leonard Electric Company's New Plunger Potentiometer-Type Rheostat, illustrated at the right, uses a sliding contact made of one of Ney's Precious Metal Alloys.

Paliney #7* Slider

The J. M. Ney Company has developed a number of precious metal alloys which are fabricated into contacts, wipers, brushes, slip rings, commutator segments, and similar components for use in electrical instruments. These Ney Precious Metal Alloys have just about ideal physical and electrical properties, high resistance to tarnish, and are unaffected by most corrosive atmospheres. Consult the Ney Engineering Department for help in selecting the right Ney Precious Metal Alloy which will improve and prolong the life and accuracy of your instruments.

*Reg. trade-mark

15NY53B

THE J. M. NEY COMPANY • 179 Elm St., Hartford 1, Conn.
Specialists in Precious Metal Metallurgy Since 1812

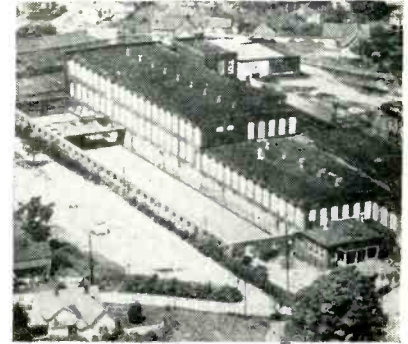
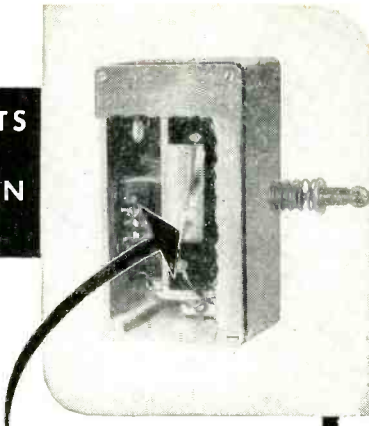

Pyramid Acquires Southern Plant

A PLANT in Gastonia, N. C. has been taken over by Pyramid Electric of North Bergen, N. J. as part of its current expansion program. The factory consists of 160,000 sq ft of floor space. It is now in process of renovation and will begin operation in January, 1954 employing approximately 1,000 persons in the manufacture of paper, motor starting and ceramic capacitors.

Packard-Bell Names Michaels

EDWARD L. MICHAELS has been appointed supervisor of Packard-Bell's advance development group which is engaged in research and development of color tv and the possible applications of transistors and printed circuits to radio and tv receivers.

He comes to the company from the Pomona division of Convair where he was supervisor of the control system design group engaged in research on the application of transistors. Prior to that he was a member of the research staffs of the Rauland Corp. and Cook Research Labs in Chicago.

While with Rauland he engaged principally in development of the

TOPS! AEROCOM'S DUAL AUTOMATIC PACKAGE-TYPE RADIO BEACON!

This aerophare, for unattended service, consists of two 100 watt (or 50 watt) transmitters with keyer, automatic transfer and antenna tuner.

Frequency range 200 — 415 kcs., crystal controlled (self-excited oscillator coils available). High-level plate modulation of final amplifier is used, giving 40% tone modulation in 100 watt transmitter and 60% in 50 watt model. Microphone P-T switch interrupts tone, permitting voice operation.

This unit can be operated in air temperature range — 35°C to +45°C using 3B25 rectifiers; humidity up to 95%.

The "stand-by" transmitter is selected when main transmitter suffers loss (or low level) of carrier power or modulation. Audible indication in monitoring receiver tells which transmitter is in operation.

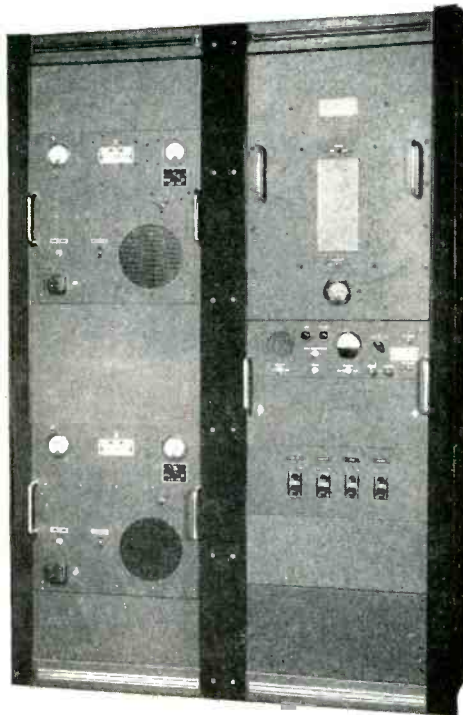

AER - O - COM
Reg. U.S. Pat. Off.

3090 DOUGLAS ROAD

MIAMI 33, FLA.

color tv picture tube. At Cook he was senior project engineer in charge of Aerobee rocket instrumentation.



Texas Instruments Officials Open New Plant

J. E. JONSSON and Eugene McDermott, president and chairman of the board of Texas Instruments, congratulate each other during the ceremonies which marked the completion of the firm's recent plant expansion. Located in Dallas, Texas, the company now has nearly 200,000 sq ft of plant area, including the new 90,000 sq ft addition, devoted to the manufacture of precision electronic, electro-mechanical and geophysical equipment.

Net sales of the company have climbed from under \$5 million in 1948 to an estimated \$30 million for 1953. Employees now number over 2,000.

Raymond Engineering Appoints Thompson

HORACE H. RAYMOND, president and founder of Raymond Engineering Laboratory of Middletown, Conn., announced the appointment of Lincoln Thompson as a vice-president of the company. The appointment will permit Raymond to devote full time to inventive projects.

Thompson joined the research department of Victor Talking Machine Co. in 1923 and in 1925 left to become assistant to W. H. Bristol, president of the Bristol Co., where he was instrumental in developing talking pictures and elec-



NEW

Allenpoint Set Screws

WITH SCIENTIFICALLY-DESIGNED SMALLER CUP POINTS

Tested comparatively by United States Testing Company* with standard cup point screws and screws with angled and serrated points, the new Allenpoint demonstrated (1) greater locking power at all measured installation vs removal torque pressures, (2) uniformly high shaft holding power in torque resistance tests, (3) unmatched performance under vibration, and (4) more complete shaft contact pattern. Sold only by leading Industrial Distributors. Write for more facts about the results of these important tests of set screw performance.

*Report No. E 5576, March 17, 1953.



ALLEN

MANUFACTURING COMPANY
Hartford 2, Connecticut, U.S.A.



Want more information? Use post card on last page.



New!

model 440A

push-button oscillator

from 0.01 cps to 100 kc

CONTINUOUS FREQUENCY COVERAGE
SINE WAVE AND SQUARE WAVE

- distortion 0.1%
- calibration ± 1.0%
- amplitude . . . ± .25db
- hum 0.1%

PRICE
\$495.00



write

krohn-hite

INSTRUMENT COMPANY

580 MASS. AVE., CAMBRIDGE 39, MASS.

for free new **CATALOG!**

NEW! IMPROVED!

model 330A

ultra-low frequency band-pass filter

from 0.02 cps to 20 kc

CONTINUOUSLY VARIABLE CENTER FREQUENCY AND BAND WIDTH

- Band Width: Variable
- Insertion Loss: 0 db
- from 0.02 to 2,000 cps.,
- Slope: 24 db/octave
- or 0.2 to 20,000 cps.
- Noise: 100 microvol



PRICE
\$450.00



MICROWAVE DEVELOPMENTS

Wheeler Laboratories is an engineering organization which offers consulting and engineering services in the fields of radio and radar.

Inquiries are welcomed regarding the solution of unusual or specialized problems in microwave design; a brief summary of our work to date is available on request.

Under the personal direction of Harold A. Wheeler, the Laboratories have enjoyed a steady growth since 1947, concentrating on development of microwave components and equipment to fill the specific needs of our clients. To meet this expanding program, the staff has been increasing through the regular addition of particularly capable young engineers, and the laboratory facilities are presently being augmented to include a field station for testing antennas.

Your inquiry will receive our prompt and courteous attention.

Wheeler Laboratories, Inc.

122 Cutter Mill Road, Great Neck, N. Y.
Great Neck 2-7806

tronic devices.

In 1932 he made the first practical talking book records for the blind and also founded a small company to develop and manufacture sound recording devices. By 1940 he had perfected an electronic disc dictating machine and The Sound Scriber Corp. was begun to manufacture and market it. He served as president of the company from 1940 to 1950. He developed the recently announced Sound Scriber 24-hour recorder. He has received nearly forty patents in the electronic and sound recording field.

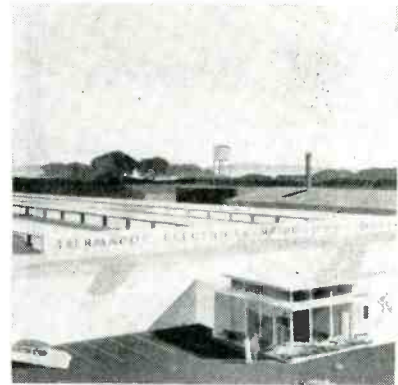

Production Underway At Thermador Plant

THE NEWLY occupied 77,000 sq ft plant of the electronics division of Thermador Electrical Manufacturing of Los Angeles is now in full operation according to Robert Singleton, plant manager.

Built on an 8-acre site, the new plant has 5,000 sq ft devoted to offices and engineering staff rooms. Other facilities are complete die and tool shops, a battery of high-speed automatic presses for lamination stamping, heat treating and annealing ovens, vacuum impregnation equipment and laboratory testing facilities that can simulate varying climatic, humidity and temperature conditions that might be encountered anywhere.

Thor Corp. Buys Phillips Control

THOR CORP., major appliance manufacturer, has purchased the Phillips Control Corp. of Joliet, Ill., maker of components for the elec-

Bird

COMPLETE JEWEL ASSEMBLIES WILL SPEED YOUR PRODUCTION

You'll be time and money ahead if you specify Bird complete jewel assemblies for your product. Rejects are eliminated, jewel breakage is minimized, and Bird jewel assemblies will keep your production running smoothly.

Bird Jewel Assemblies are furnished in the right mounting, rigidly inspected according to your specifications, ready for your assembly operations. Make a test — find out how Bird Jewel Assemblies can help your production. Send us a print of your specifications, and we'll provide samples for your own testing.

Our engineering staff is at your service for all small bearing problems.

Over 40 years of serving industry with Quality jewel bearings

Richard H. Bird & Co., Inc.

Sapphire and glass jewels • Precision glass grinding • Ferrite precision products • Sapphire styli

1 Spruce Street, Waltham 54, Mass.

First Again!

Kings tireless research and product development achieves another "first."

GOLD PLATED CONTACTS

in Coaxial Connectors at No Extra Cost

- Eliminates Corrosion
- Eliminates Tarnish
- Makes Soldering to Cable Easier Both in the Field and On the Assembly Line
- Recommended by All Branches of the Armed Services!

KINGS Electronics Co., Inc.
40 MARBLEDALE ROAD • TUCKAHOE, NEW YORK

☆ model 1200

☆ continuous duty

REVERSIBLE DC MOTORS

18 to 30 volts with or without brake . . .

- Ambient temperature: — 55° C to + 105° C.
- Size: 1.25 in. diameter, 2.18 in. long.
- Weighs 5.3 ounces . . . without brake.

We can manufacture these motors to meet your specifications. This particular motor is used on an actuator for aircraft use.

*Let's discuss your need!
Write or wire us, TODAY*

MOTORDYNE  **INC.**

Dept. J, 2661 S. Myrtle Ave.
MONROVIA, CALIFORNIA

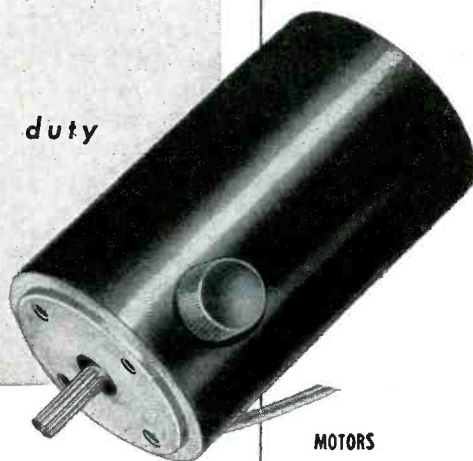

MOTORS
GENERATORS
RELAYS
TRANSFORMERS
SPEED CONTROL GOVERNORS
MAGNETIC SERVO AMPLIFIERS
MAGNETIC CONTROLS & CIRCUITS



AND HOW!!

MY COSTS ARE

WAY DOWN

THE MIGHTY MIDGET is made in all shapes, sizes and alloys with or without self-flux



SOFT SOLDER PREFORMS

MADE BY

ALPHA

SPEED AUTOMATIC SOLDERING

for flame, oven or induction heating

Increase Production • Melts Faster • Guarantee Product Precision • With or Without Self-Flux • Save Labor Costs • Designed For Your Application • All Sizes, Shapes, Alloys Stronger, Smoother Joints

Alpha's preformed solders, in any shape or size, cut many hours from your production time. You can select washers, rings, coils, cut shapes, drops, pellets, solder foil, to fit your specific needs. They save you considerable money and materials in repetitive soldering processes.

AVAILABLE IN

- ★ CEN-TRI-CORE ENERGIZED
- ★ TRI-CORE LEAK-PRUF
- ★ ROSIN-FILLED
- ★ ACID-FILLED
- ★ SINGLE-CORE
- ★ SOLID WIRE
- ★ SHEET SOLDER

Please consult us on your soldering problems. Trained Field Engineers always available to assist you. Small or large quantities.



for further information

write . . .

ALPHA METALS, INC.

59 Water St., Jersey City 4, N. J.

Specialists IN SOLDER For Over 50 Years

there's a
BIRTCHEK CLAMP
for *almost*
every purpose!

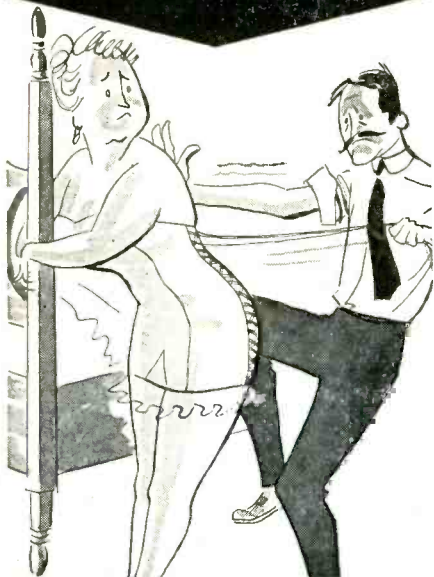

NEW SUB-MINIATURE TUBE CLAMPS

The Birtcher KOOL KLAMPS were developed for use under conditions of extreme heat and severe vibration and shock. Made from a heat treatable silver alloy of high thermal conductivity, reducing bulb temperatures by as much as 40° C, KOOL KLAMPS are improving the reliability of miniaturized electronic equipment.

The Birtcher Corporation, world's largest producer of electro-surgical devices, maintains a separate division for the manufacture and sale of tube and component clamps.

The BIRTCHEK CORPORATION

4371 Valley Blvd.
Los Angeles 32, California



Please send catalog and samples by *return mail*.

Company _____ E-1-4

Attention of: _____

Address _____

City _____ State _____

Want more information? Use post card on last page.

tronics industry.

Raymond J. Hurley, Thor board chairman, said Phillips would be operated as a wholly-owned subsidiary of Thor. John E. Moseman, Phillips founder and president, will remain as president of the subsidiary, and all other members of the Phillips organization will retain their present positions.

Phillips Control represents Thor's third major acquisition in the past 12 months. The company earlier had purchased Century Vitreous Enamel and Leeson Steel Products.

Hurley said that with its new subsidiary, Thor will enter the industrial field for the first time. Its present customers are retail customers.

He said that the Phillips research program would be expanded as a result of the availability of additional working capital.

Varo Names Wible

PAUL E. WIBLE has joined Varo Manufacturing Co. as a project engineer conducting research and development in electronics.

Previously he was associated with the Naval Ordnance plant at Indianapolis. He has worked in the field of closed loop devices and on transistor applications in that field.



Waltham Watch Names Sverre Johannesen

COMMANDER SVERRE JOHANNESSEN has been named assistant to the president of Waltham Watch Co. to head up servicing and development of military and industrial contracts for the instrument division of the

let **WILLIAMS**
help you apply

ferric oxides

to the manufacture
of your

FERRITES

You'll be well repaid by getting the facts on a special group of Pure Ferric Oxides, developed by Williams especially for use in the manufacture of ferrites.

Williams Ferric Oxides analyze better than 99% Fe₂O₃. They contain a minimum of impurities. They are available in a broad range of particle sizes and shapes. Among them, we're certain you'll find one that's "just right" for your requirements. The proper application of Ferric Oxides to the manufacture of Ferrites is our specialty.

Tell us your requirements . . . we'll gladly send samples for test. Chances are good that our Ferric Oxide "Know How" can save you considerable time and money. Address Dept. 25, C. K. Williams & Co., Easton, Pa.

WILLIAMS
COLORS & PIGMENTS

C. K. WILLIAMS & CO.

Easton, Pa. • East St. Louis, Ill.
Emeryville, Cal.

P.S. We also produce IRN Magnetic Iron powders for the Electronic Core Industry, the Magnetic Tape Recording Industry and others. Write for complete technical information.

Want more information? Use post card on last page.

January, 1954 — ELECTRONICS

company, it was announced by Teviah Sachs, Waltham president.

Just released from active duty in the U.S. Navy after being recalled during the Korean emergency, Johannesen represented the military on critical production problems of precision instruments and other components affecting aircraft production schedules while assigned to the Aircraft Production Resources Agency and the Navy Bureau of Aeronautics. He has previously been associated with U.S. Gauge and Bendix Aviation.



DuBois Elected Mycalex Director

J. HARRY DUBOIS, Mycalex vice-president of engineering, was elected a director of the corporation, it was announced by president Jerome Taishoff. His election fills the vacancy left by the recent retirement of James L. Robertson, director, after 22 years of continuous service.

During his earlier career, DuBois held various engineering and executive positions with GE, later was vice-president of Shaw Insulator and manager of new-product development of Plax Corp. He has been vice-president of Mycalex since the beginning of 1952.

Superior Tube Acquires Fine Tubes of England

SUPERIOR TUBE Co. of Norristown, Pa. has purchased a controlling interest in Fine Tubes of Surrey, England.

Founded in 1943, Fine Tubes has grown rapidly and is considered to be one of the U. K.'s largest producers of seamless nickel cathodes

New!

**MODEL 411
Extended Range
Audio Oscillator**

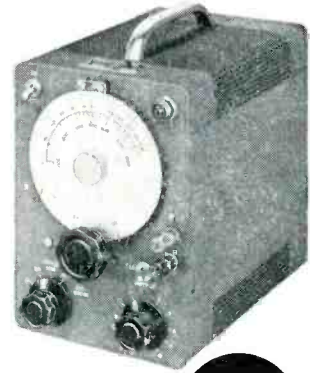

- Wide Range—20 cycles to 1000 KC
- Compact Size—6" Wide x 3½" High x 3½" Deep
- Light Weight—13½ lbs.
- Low Distortion—less than 1% over most of range
- High Stability
- Uniform Output—± .5 db. to 100 KC
- Vernier Driven Dial
- 48° of Dial Calibration
- Competitively Priced

Write for literature and prices



THE CLOUGH-BRENGLE CO.

6014 BROADWAY • CHICAGO 40, ILLINOIS

MICROTRAN® engineers to your needs...



Cased Miniature



Sealed Miniature



Pulse



Hermetically Sealed



Molded



Encapsulated

Custom built to your specifications... sample and short run production solicited... designed to meet MIL-T-27, ANE-19 and commercial specifications.

Stock items available for immediate delivery... let us quote on your requirements... no obligation.

Write for detailed catalog.

MICROTRAN CO.
84-13 Blvd., Rockaway Beach 93, New York

2 NEW ACHIEVEMENTS

in precise *wire-wound* trimmer potentiometers

Aerohm Micro-miniature Series AP 1/2

- Two watts continuous at 80 degrees C.
- Resistances from 10 ohms to 20,000 ohms.
- Diameter 1/2 inch, depth 1/2 inch.
- Temperature coefficient 0.00002 part per degree C.
- Weight 1/4 ounce.
- Sealed well enough to permit potting.

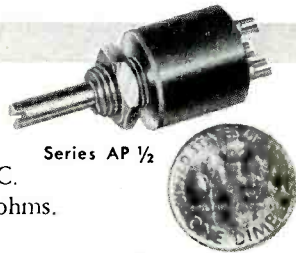

Series AP 1/2

Aerohm Series AP 1 1/8

- Four watts continuous at 80 degrees C.
- Resistances from 10 ohms to 100,000 ohms.
- Diameter 1 1/8 inch, depth 1/2 inch.
- Temperature coefficient 0.00002 part per degree C.
- Weight less than 3/4 ounce.

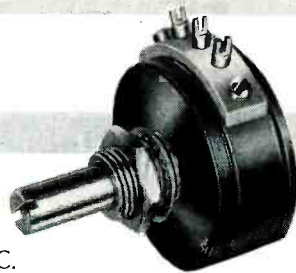

Series AP 1 1/8

Available also as ganged units.

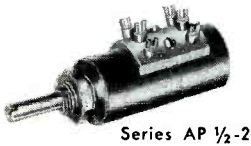

Series AP 1/2-2

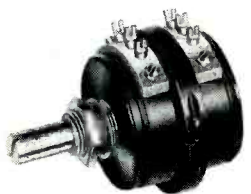

Series AP 1 1/8-2

These new potentiometers embody many features that are usually found only in much more costly units. They are precision machined throughout, with bodies of anodized aluminum, line-reamed phosphor bronze bushings, centerless-ground stainless steel shafts, and gold-plated fork-type terminals. All electrical connections are soldered, except for precious metal sliders and slip rings. All units are fully sealed, and treated with Service-approved moisture-proofing and fungicidal materials.

In addition, all *Aerohm* potentiometers are individually checked through a quality-control system that guarantees you full performance from every unit in your order.

Write for full technical information and prices.

***Aerohm* CORPORATION**
282 MOODY STREET, WALTHAM, MASSACHUSETTS

and other electronic parts.

Superior expects to gain from the purchase an entree to foreign markets that cannot be served from the U. S.

Malcolm A. Rowe, who has been managing director of Fine Tubes for several years, will continue to serve the company in that capacity.

Cuckler Named Engineering Head

LEE E. CUCKLER has been appointed manager of the engineering department at Fielden Instrument Division of the Robertshaw-Fulton Controls Company and is responsible for all application engineering and technical services. Prior to joining Fielden, he was head of the textile and paper group of the application engineering department at Brown Instrument Division, Minneapolis-Honeywell from 1943 to 1952.

King Appointed By Hydro-Aire

LESLIE E. KING has been named a project engineer at Hydro-Aire, west-coast transistor manufacturer, according to H. H. Rhoads, president of the company, and will be in charge of transistor research and development.

King served as a Commander with the U. S. Navy during World War II. Among other assignments, he was executive officer of the electronic field service group of the Naval Research Laboratory in Washington, D. C. More recently he has been associated with the Glenn L. Martin Co. and Consolidated Vultee in research and development work on guided missiles.

Caltech Appoints Lester M. Field

LESTER M. FIELD of Stanford University has been appointed professor of electrical engineering at the California Institute of Technology, where he has been a visiting professor since January, 1953.

At Caltech he has set up an electron tube and microwave laboratory, with support from private industry and the Office of Naval Research, and is continuing his re-

MOLYBDENUM & TUNGSTEN

Ductile

SHEET - RIBBON - FOIL

Also other basic metals.

- Deep Drawing quality Molybdenum sheet
 - Molybdenum tubing
 - Machined parts
-
- Fine wires. Specializing in Molybdenum wire in sizes down to .0006".

For the electron tube, electronic and allied industries.

Let us quote on your requirements.

THE REMBAR COMPANY

P. W. Blackburn, President

117 Main Street

DOBBS FERRY, N. Y.

Telephone: Dobbs Ferry 3-6510

ALFAX UNIVERSAL RECORDING PAPER

For the first time, there is available an indelible recording paper—ALFAX—that is NOT subject to humidity, temperature or capillary action problems usually associated with pen and ink or papers marked by arcing or heat.

ELECTRICITY IS THE INK THAT MARKS ALFAX

Alfax paper can be marked by current as low as one volt and is instantaneous, permanent and stable. Highly sensitive Alfax is capable of fourteen steps by simply varying the current through the paper.

Alfax is the only paper that is capable of high speed recording, stable before or after recording, is non-transferable, has low current consumption at high speeds, can record at high humidity over all temperature ranges, is smudge proof and nontoxic, width from 1/4" to 72".

Alfax opens a whole new field of monitoring and recording of phenomena which never before have been done easily and cheaply.

THIS MONTH'S EXAMPLE

Using "electricity as the ink" a 3/8" stylus traveling across Alfax paper at 1/3

mile per minute produces 4 ft. wide bulletin emerging at rate of 3 feet per minute. Operated by ordinary AC current.

Request Booklet—describe your problem

Alfax Paper & Engineering Co.

Alden Research Center,
Westboro, Mass.

ENGINEERING SERVICE TO
RECORDER MANUFACTURERS



VECO COMPONENTS

Simplify

CIRCUITRY

- DISC
- BEAD
- WASHER
- ROD TYPES

Have You considered all the possibilities of designing for compactness, simplicity, and increased sensitivity?

VECO THERMISTORS, as components, are supplying the solutions to many design and circuitry problems. Investigate today!

A request on business stationery will bring the **VECO THERMISTOR DATA BOOK**

Some Practical Uses: Time delay • Gas analysis • Volume limiting • Surge protection • Vacuum manometry • Flow measurement • Temperature control • Temperature measurement • Radar power measurement • Temperature compensation • Oscillator stabilization • new applications being developed.

VECO VARISTORS react instantaneously to current or voltage changes, and have innumerable uses such as arc suppressing and regulating source voltages.

VECO GAS ANALYSIS CELLS employ Veco glass-coated Thermistors as sensing and reference elements (no open wires, therefore no corrosion).

Manufacturers of:
ELECTRONIC & THERMAL CONTROL INSTRUMENTS
TEMPERATURE SENSING DEVICES
COMBUSTION ANALYZERS

Tel. Unionville 2-7150

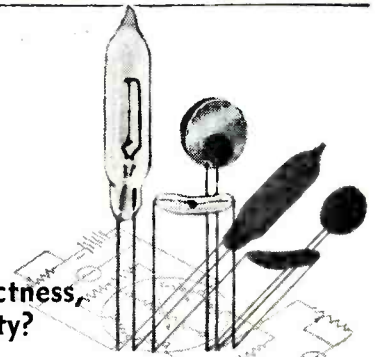

Victory

ENGINEERING CORPORATION

Springfield Road, Union, N. J.

Priced Right!

WIRE FORMS

& Metal Stampings

High-speed, quality production with custom-made precision. Wire formed to any shape for every need.

WIRE FORMS

.0015 to .125 diameter

STRAIGHTENING & CUTTING

Perfect straight lengths to 12 ft.

.0015 to .125 diameter

SMALL METAL STAMPINGS

.0025 to .035 thickness

.062 to 3 inches wide

Specializing in Production of Parts for Electronic, Cathode Ray Tubes & Transistors

Write for illustrated folder.

Send Blueprints or Samples for Estimate.

ART WIRE and STAMPING COMPANY

1 BOYDEN PLACE
NEWARK 2, N. J.

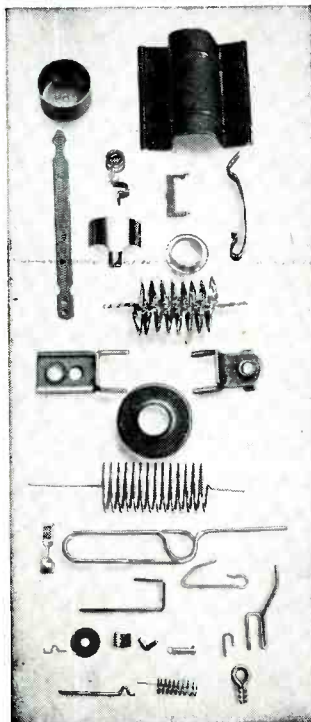

INCREMENTAL INDUCTANCE

*quickly
simply
accurately*

The new Type 1002-A Incremental Inductance Bridge combines outstanding features of compactness, ease of operation, accuracy, and wide range of measurement. A visual balance indicator allows measurements to be made in a few seconds even in noisy locations. Maximum sensitivity at the balance point greatly improves the accuracy of balance. Only a single balance control is used, with crt indication.



Inductance range is from one to 200 henries. Direct current through the reactor under test is accurately controllable from one to 500 milliamperes, limited only by the resistance of the coil windings. The effect of a change of dc on the inductance value is immediately measurable, by simple rebalancing. The inductance is measured at a constant frequency of 120 cps.

For design and test work on iron-core inductors, transformers, filter chokes, and plate reactors, this compact self-contained instrument is unsurpassed.



Write today for technical details and price information.

WATERS MANUFACTURING, inc.

Waltham 54, Massachusetts

APPLICATION ENGINEERING OFFICES IN PRINCIPAL CITIES

Want more information? Use post card on last page.

378

PLANTS AND PEOPLE

(continued)

search on microwave amplification and interaction processes.

Dr. Field, 35, worked at the Bell Telephone Laboratories from 1945 to 1947 in the field of magnetron development and electron dynamics. With Dr. J. H. Pierce, he developed the practical traveling-wave tubes.

He joined the Stanford faculty in 1946 and four years later became its youngest full professor when he was promoted from the rank of associated professor of electrical engineering at the age of 32.



Lear Appoints Chief Engineer

J. C. OWEN has been appointed chief engineer of instrument products for Lear's Grand Rapids division.

Prior to joining the company, Owen was with Bendix Aviation for a period of 12 years. There he was senior engineer in charge of systems engineering activities.

In his capacity as chief engineer, he will direct all engineering activities involving instrument products and will concentrate on the development of new products and the broadening of the current line.

In effect, Owen's activities and responsibilities will parallel those of T. K. Greenlee, chief engineer of electromechanical products. Greenlee was previously chief engineer of Barber-Colman in charge of actuator and controls development.

American Machine Makes New Moves

RALPH H. ANDERSON has been appointed staff engineer at Sterling Engineering in Laconia, N. H.,

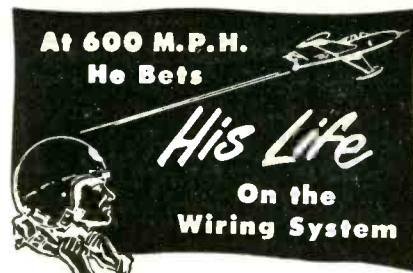

**For Dependable
Electronic Wiring
Leading Manufacturers Choose
UNILECTRIC Wiring Systems**

Year after year . . . for over ten years . . . UNILECTRIC has produced millions of wiring systems for over 150 leading manufacturers of electric and electronic products. If you still fabricate your own electronic wiring it will pay you to investigate UNILECTRIC.

**There is Only ONE
Standard of Quality at
UNILECTRIC**

This intricate wiring harness for a jet auto pilot must meet the most rigid specifications. A pilot's life and perhaps a major battle depend on it.

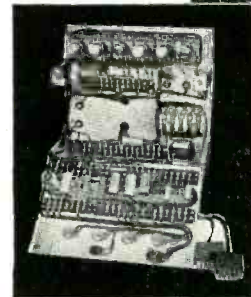

The same workmanship . . . the same standards of quality protect your product wiring and your product's reputation for dependability.

To assure utmost dependability plus cost saving engineering assistance, low-cost production, and "on-schedule delivery", investigate UNILECTRIC today.

**UNILECTRIC
QUALITY
Protects Your
Products**

Investigate UNILECTRIC Today!

**UNILECTRIC
WIRING SYSTEMS**

Manufactured by
UNITED MANUFACTURING & SERVICE CO.
409 South 6th Street • Milwaukee, Wisconsin

Want more information? Use post card on last page.

January, 1954 — ELECTRONICS

electrical relay subsidiary of American Machine and Foundry.

Formerly associated with Crystal Research and Cambridge Thermionic Corp., Anderson was a technologist for 8 years working with piezoelectric gauges for measuring large transient pressures. Prior to working for these companies, he did analytical work at MIT Labs.

In other actions AMF moved the battery section of its Raleigh, N. C. engineering labs into new quarters there representing twice the area it formerly occupied. The new lab of 3,600 sq ft is engaged in work on \$900,000 worth of governmental and commercial contracts involving research and development of special purpose power sources for use in such military items as guided missiles, torpedoes and jet aircraft.



Measurements Names Chief Engineer

MARTIAL A. HONNELL has been elected a vice-president and chief engineer of Measurements Corp. of Boonton, N. J. He will be in charge of engineering design and development.

As professor of electrical engineering at Georgia Institute of Technology from 1937 to 1953, he was in charge of communications and electronics and has acted as consulting engineer to industry, broadcasting stations and government sponsored projects.

New Metals Company Formed

P. W. BLACKBURN, formerly with North American Philips, has announced the formation of his own company, The Rembar Co. in Dobbs

ULTRASONIC SPECTRUM ANALYSIS

USES

- Ultrasonic Vibration Measurements
- Harmonic Analysis
- Cross Modulation Studies
- Noise Investigations
- Determining Transmission Characteristics of Lines and Filters
- Monitoring Communications Carrier Systems
- Checking Interference, Spurious Modulation, Parasitics, Effects of load changes, shock, humidity, component variations, etc. upon frequency stability.
- Telemetering

SPECIFICATIONS

Frequency Range: 2KC-300 KC, stabilized linear scale
 Scanning Width: Continuously variable from 200KC to zero
 Four Input Voltage Ranges: 0.05V. to 50V. Full scale readings from 1 millivolt to 50 volts
 Amplitude Scale: Linear and two decade log
 Amplitude Accuracy: Within 1 db. Residual harmonics suppressed by at least 50 db.
 Resolution: Continuously variable, 2KC at maximum scanning width, 500 c.p.s. for scanning width below 8KC.

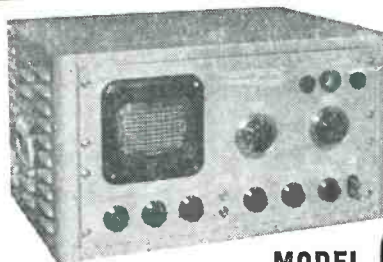

EASY FAST SB-7

MODEL PANORAMIC ULTRASONIC ANALYZER

An invaluable new direct reading instrument for simplifying ultrasonic investigations, the SB-7 provides continuous high speed panoramic displays of the frequency, amplitude and characteristics of signals between 2KC and 300KC. The SB-7 allows simultaneous observations of many signals within a band up to 200KC wide. Special control features enable selection and highly detailed examination of narrower bands which may contain signals separated by less than 500 c.p.s. SB-7 is unique in that it provides rapid indications of random changes in energy distribution. WRITE NOW for Complete Information, Price, Delivery 10 South Second Ave., Mount Vernon, N.Y. Mount Vernon 4-3970



GET THE *Best* IN TEFLON* FROM ONE SOURCE



Because Teflon by Ethylene is processed under rigid control in new equipment designed especially for the processing of this material, you are assured of a satisfactory product. It is uniform in density and dimension and free from cracks, voids, and porosity.

Teflon by Ethylene is available in rods, sheets and tubing, in the following size ranges:

Molded Sheets	1/16" to 2" thick by 2 1/4" x 29 1/4"
Extruded, Centerless Ground Rod	3/16" to 1" OD inclusive
Extruded Tubing	3/16" to 4" OD inclusive
Molded Rod	1/16" to 3/2" ID 1/16" Minimum Wall
Molded Tubing	1 1/2" x 3/8" to 20" x 18 3/4"
Shaved Tape	.0025 to .060 thickness and 12" wide

Also economical production of accurately machined parts or special moldings in small experimental quantities or production runs.



ETHYLENE CHEMICAL CORP

* Du Pont Trade-Mark for tetrafluorethylene resin

251 BROAD STREET
SUMMIT, N. J.

MINIATURE *wire-wound* POTENTIOMETERS

*that don't NEED
incoming check*

Problem:

To find a potentiometer that will —

- ... Dissipate 3 watts continuously at 80 degrees C, through 50,000 ohms total resistance.
- ... Occupy no more space than absolutely necessary.
- ... Weigh as little as possible.
- ... Maintain accurate resistance setting, over a wide range of temperatures.
- ... Not require YOU to do production-control checking for the manufacturer.



Solution:

Waters Series RT-7/8 and RTS-7/8 —

- Precision wire-wound construction.
- Three watts continuous, to 80 degrees C.
- Resistances from 10 ohms to 50,000 ohms.
- Diameter 7/8", depth 3/8".
- Weight, approximately 1/2 ounce per section — multiple ganging easily provided.
- Temperature coefficient of resistance 0.002% per degree C.
- Manufactured to rigid military specifications.
- Individually checked through a production quality control system that guarantees you full performance from EVERY unit in your order.



Write today for full technical information and prices.

WATERS MANUFACTURING, inc.

Waltham 54, Massachusetts

APPLICATION ENGINEERING OFFICES IN PRINCIPAL CITIES

Want more information? Use post card on last page.

Ferry, N. Y. The firm will specialize in molybdenum and tungsten sheet, ribbon and foil plus other basic metals and fine wires for the electronic and allied industries.

Burroughs Research Center Progresses

JOHN S. COLEMAN, President of Burroughs Corporation of Detroit, laid the cornerstone of the new \$2,000,000 Burroughs Research Center in suburban Philadelphia. The building is scheduled for completion by Spring, 1954. Construction of the 105,000 sq ft structure was begun in July 1952.

The Burroughs Research Center will continue basic research and development in electronics, electromechanics, magnetics and related fields. Research activities are now being carried on in downtown Philadelphia.

Approximately 350 employees will be on the staff in the new air-conditioned laboratory at Paoli. It is expected that some units will begin occupying the Research Center early in 1954.

Consolidated Makes Executive Promotions

CONSOLIDATED ENGINEERING CORPORATION took steps to raise its electronic computer development group to company divisional status.

James R. Bradburn, who will become vice-president in charge of Consolidated's computer division, was selected to head the development, production and research activities of the company's electronic digital computer and to introduce it to industry for general industrial and commercial use.

Joseph H. Lancor, Jr., will succeed Bradburn as vice-president in charge of engineering and Walter B. Claus will move into the post vacated by Lancor as director of Consolidated's transducer division.

Bradburn joined Consolidated Engineering in 1945 as treasurer and assistant to the president. He has served as vice-president in charge of engineering since 1948. Prior to World War II service as a major in Army ordnance, Bradburn served in engineering and ex-

Spectrum Analyzer

TS-148/UP

EQUAL TO OUR
GOVERNMENT TYPE DESIGNATION
UPM—33

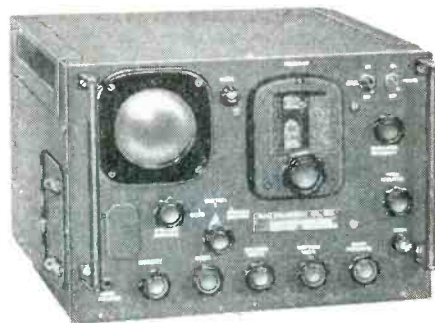

- NEW AND IMPROVED DESIGN
- OUTSTANDING PERFORMANCE
- MORE RUGGED CONSTRUCTION

Specifications . . .

- Attenuation (Spectrum Amplitude): 3—70 db uncal.
- Frequency range: 8430 Mcs—9660 Mcs.
- Frequency sweep: 10—30cps continuous.
- Frequency swing (FM sawtooth) of analyzer r-f oscillator: 40—50 Mcs.
- Maximum error: ±4 Mcs.
- Maximum dispersion of spectrum: 1.5 Mcs per inch.
- Overall i-f bandwidth at half power point: 50 Kcs.
- Sensitivity to CW:
 - a. Spectrum amplified position: 80 db below 1 W per inch deflection on oscilloscope screen.
 - b. Spectrum position: 55 db below 1 W per inch deflection on oscilloscope screen.
- Weight: 86 pounds (complete in armored case with all accessories).

Write or wire for prices and delivery schedule

G&M EQUIPMENT Co., Inc.

"Where Hi-Quality Is Fundamental"



7309 VARNA AVENUE
NORTH HOLLYWOOD, CALIF.
Phone: **POplar 5-4185**

Want more information? Use post card on last page.



**How to keep
informed on
the "with what"
part of
your business**

AT YOUR FINGER TIPS, issue after issue, is one of your richest veins of job information—advertising. You might call it the "with what" type—which dovetails the "how" of the editorial pages. Easy to read, talking your language, geared specifically to the betterment of your business, this is the kind of practical data which may well help you do a job quicker, better—save your company money.

Each advertiser is obviously doing his level best to give you helpful information. By showing, through the advertising pages, how his product or service can benefit you and your company, he is taking his most efficient way toward a sale.

Add up all the advertisers and you've got a gold mine of current, on-the-job information. Yours for the reading are a wealth of data and facts on the very latest in products, services, tools . . . product developments, materials, processes, methods.

You, too, have a big stake in the advertising pages. Read them regularly, carefully to keep job-informed on the "with what" part of your business.

**McGraw-Hill
PUBLICATIONS**



**ELECTRONIC GLASS WORKING EQUIPMENT for RADIO, TELEVISION TUBES,
INCANDESCENT LAMPS, GLASS LATHES for TELEVISION TUBES**

We make Transformers, Spot and Wire Butt Welders, Wire Cutting Machines and 500 other items, indispensable in your production. Eisler Engineers are constantly developing New Equipment. If you prefer your own designs, let us build them for you. Write to Charles Eisler who has served The Industry over 33 years.

Machines for small Radio Tubes of all kinds:

High Temperature Hydrogen Electric Furnaces

Hydrogen atmosphere heating chamber, hydrogen drying tower, water cooled unloading chamber, heat control with air cooled transformer with 11 position tap switch. Automatic temperature control (optional) standard furnaces from 1" bore 1800° C. to 8" bore 1100° C. Molybdenum wound heating units, loading and unloading chambers equipped with safety doors. Supplied with hydrogen flow gauges. Made to order in many sizes.

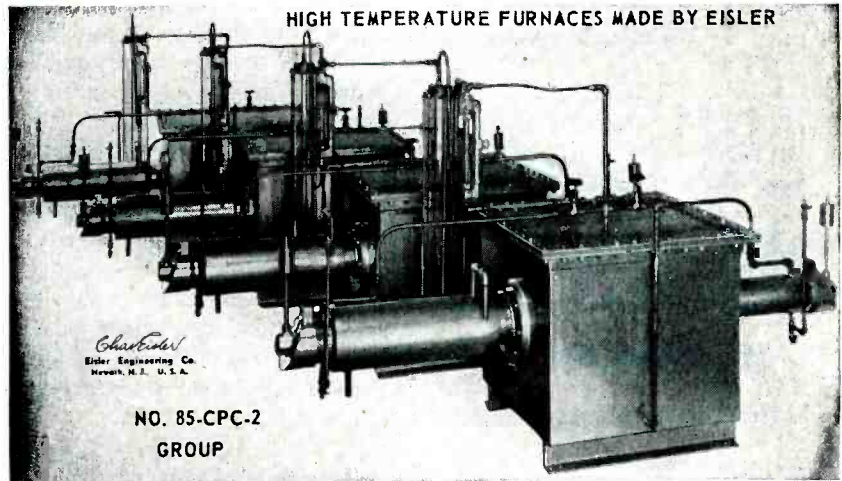

HIGH TEMPERATURE FURNACES MADE BY EISLER

Charles Eisler
Eisler Engineering Co.
Newark, N.J., U.S.A.

NO. 85-CPC-2
GROUP

EISLER ENGINEERING CO., Inc. 751 So. 13th St.
Newark 3, N. J.

DELAY LINES

FIXED & VARIABLE

for: **LABORATORY
COLOR TELEVISION
COMPUTERS, RADAR, etc.**

Model V103: 0—3.0 usec variable in 0.05 usec steps
Model F101: 0.25 usec fixed, bandwidth 16 mc;
Model F102: 1.0 usec fixed, bandwidth 6 mc.
Accuracies to 1% & Better

CONTROL ELECTRONICS CO. INC.

1927 New York Avenue, Huntington Station, Long Island, N.Y.
Tel. HU.4-7961

SEALING
DIPPING
POTTING
IMPREGNATING



INSULATING
FUNGUSPROOFING
MOISTUREPROOFING
HEAT CONDUCTING

WAXES BIWAX COMPOUNDS

Developed and produced for manufacturers of electronic components and other electrical units.

Specifications and samples available on request.

Information relative to your problem or application will enable us to make suggestions and recommendations.

BIWAX CORPORATION

3445 HOWARD STREET
SKOKIE, ILLINOIS



BRUSHES CONTACTS

SLIP RINGS

...AND SLIP RING ASSEMBLIES

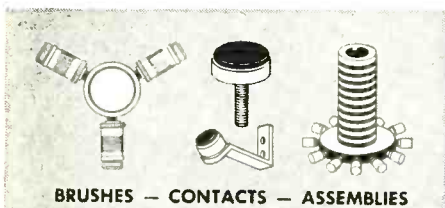

BRUSHES — CONTACTS — ASSEMBLIES

... Use **SILVER GRAPHALLOY** for applications requiring low electrical noise; low and constant contact drop; high current density and minimum wear.

EXTENSIVELY USED IN:

**SELSYNS • GUN FIRE CONTROLS
ROTATING THERMOCOUPLE and
STRAIN GAGE CIRCUITS
ROTATING JOINTS • DYNAMOTORS**

Wide range of grades available for standard and special applications.

Other Graphalloy Products



OIL-FREE self-lubricating Bushings, Bearings, Piston Rings, Seal Rings, Thrust and Friction Washers, Pump Vanes.

GRAPHITE METALLIZING CORPORATION

1055 NEPPERHAN AVE. • Yonkers, New York

- Please send data on Graphalloy BRUSHES and CONTACTS.
 Send data on BUSHINGS.

NAME & TITLE _____
COMPANY _____
STREET _____
CITY _____ ZONE _____ STATE _____

Want more information? Use post card on last page.

ective posts with GE and the Eastman Kodak Company.

Joining Consolidated in 1951 to head activities of the company's transducer group, Joseph Lancor, Jr., was later named director of the transducer division. He has held executive and research posts with Lancor Electric and Sperry.

New Parts Firm Organized

THE Permonite Manufacturing Company has been organized by Morris Perlman, who recently resigned as president of General Laminated Products Company of Chicago.

The new company will manufacture and sell terminal strips, tube sockets, kinescope sockets, pin plugs and connectors, special assemblies and fabricated parts for the electronic, radio, television, general electrical and automotive parts industries.

A new Permonite factory is under construction on two and a half acres of land bought by the company approximately 70 miles southeast of Chicago. Completion of the building, containing approximately 16,000 sq ft of floor space, and installation of machinery and equipment was scheduled for November.

Buggie Promotes Engineers

ADVANCEMENTS of top engineering and production personnel were made by H. H. Buggie, Inc. of Toledo, Ohio.

C. H. Sharp has been promoted to general manager of the company. Previously he was production manager and has been associated with the company since 1934.

C. R. Thorpe has been assigned the post of chief engineer. He has been with the company since 1933 in development, engineering and production capacities. More recently he has been sales manager.

R. J. Melcher is now special project engineer coordinating the development of electronic components of advanced design for special application. He has been with the company since 1934 and most recently served as chief engineer.



PRECISION ELECTRONIC SYSTEMS

RADIO

- Direction Finders
Electronic Goniometer
- Signal Generators
Crystal Control
1 kc to 150 mc.
- Spectrum Generator
Marker Pulses
.5 to 50mc.

CONTROLS

- Servoscope
- Servoboard
- System Synthesis
- Reluctance Amplifiers
- 60 ✓ Servo Amplifier
- Plug-in Component Assemblies

RADIATION

- Servotherm Bolometers
- Bolometer Preamplifiers
- Thermistor Power Supply
- Servotherm Pyrometers

Write today for complete information

SERVO

CORPORATION
OF AMERICA

NEW HYDE PARK, N. Y.

Want more information? Use post card on last page.

January, 1954 — ELECTRONICS



TELEVISION FUNDAMENTALS

Just Published!

Written by General Electric Co. experts, this book gives a simple presentation of basic TV principles that a radio technician must know to advance to TV service and installation work. The treatment is sound and theoretical, describing each element of the receiver from antenna to picture tube. Includes practical installation procedures.

and trouble-shooting charts for quick spotting of receiver faults. By Kenneth Fowler and Harold B. Lippert, both of the General Electric Co. 524 pp., 444 illus., \$7.00

TELEVISION BROADCASTING

Just Published!

Practical manual for radio engineers, operations personnel, and others interested in the technical aspects of television broadcasting. Covers in detail the equipment, facilities, and techniques involved in the running of a television studio—topics such as lighting, staging, television recording, and color television equipment. Gives a valuable insight into the whole field without the use of complex mathematics. By Howard Chinn, Columbia Broadcasting System. 688 pp., 346 illus., \$10.00



ENGINEERING ELECTRONICS

Just Published!

Theoretical and practical treatment of electronics brings you the kind of knowledge you will use in numerous practical applications. Quickly previews subject then stresses linear equivalent circuit theorem, graphical analyses, determination of operation conditions, use of tube manuals. Gives derivations rather than unsupported statements and is full of practical examples. Explains transistors with diagrams and discussion of static characteristics for a typical transistor. By George E. Hoppel and Wilfred M. Hesselberth, Assoc. Profs. of Elec. Eng. Purdue U. 508 pp., 458 illus., \$7.50

FUNDAMENTALS OF ELECTRONIC MOTION

Just Published!

Develops methods of analyzing electron tubes from the tube-user's viewpoint. Shows how fundamentals are applied in determining electron motions under various circumstances to derive measurable characteristics of electronic devices. Emphasizes powers and limitations of available analysis methods rather than devices. By Willis W. Harman, Assoc. Prof. of Elec. Eng., Stanford U. 319 pp., 225 illus., \$6.50

—SEE THESE BOOKS 10 DAYS FREE—

McGraw-Hill Book Co., Inc., 330 W. 42 St., NYC 36
Send me book(s) checked below for 10 days' examination on approval. In 10 days I will remit for book(s) I keep, plus few cents for delivery, and return unwanted book(s) postpaid. (We pay for delivery if you remit with this coupon; same return privilege.)

- Fowler & Lippert—TV Fundamentals—\$7.00
- Chinn—TV Broadcasting—\$10.00
- Hoppel & Hesselberth—Eng. Electronics—\$7.50
- Harman—Electronic Motion—\$6.50

(Print)
Name

Address

City Zone State

Company

Position L-1

This offer applies to U. S. only.

Want more information? Use post card on last page.

ELECTRONICS — January, 1954

NEW BOOKS

Electronic Organs

BY ROBERT L. EBY, *Technical Director, House of Organs, Hollywood, California. Van Kampen Press, Inc., Wheaton, Illinois, 213 pages, 1953, \$5.00.*

It is probably true that "in the last 15 years many more electronic organs have been produced in the United States than all the pipe organs ever built in this country." But at least a few musicians will argue the statement that these organs are "rapidly being accepted as true musical instruments."

This book will be useful to anyone considering buying an electric organ. It has extensive data (155 pages) taken from sales and service literature of six well-known makes as well as briefer mention (18 pages) of lesser known and discontinued types, plus a few foreign makes. The Table of Contents (4 pages) covers, for each of the major types: General Description, Consoles, Registration, Tone Generators, Mixers, Couplers, Amplifiers, Loudspeaker Systems, Installation, Care and Maintenance, and Models Summary Chart. The List of Illustrations is also complete (6 pages). There is no topical index.

The first and last chapters, though short, are outstanding: "I. History of Electronic Organs" (4 pages), and "IX. Selecting an Electronic Organ" (3 pages). The last page of the last chapter is a "Comprehensive Reference Chart of Leading Electronic Organs." This is concentrated and valuable information.

One major fault of the book is that it has no criticism of any electronic organ. For instance, an item of considerable interest is the attack and decay time of the electronic organ tone as contrasted with that of the wind-blown pipe. Undoubtedly the electronic organ can be made to equal the pipe with suitable circuits, and oscillograms of both the electronic and regular pipe will prove the similarity. However, a typical statement (page 36 of the Allen organ) is "the oscillator components are so designed that

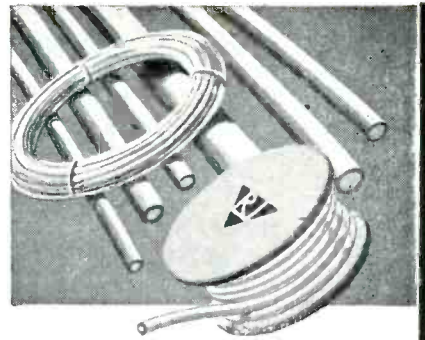

YOU GET BOTH WITH RESINITE

1. A superior insulation sleeving that fully meets Military & Air Force Specifications, and
2. A service that eliminates your headaches in purchasing and inspection.

For instance, a Quality Control and Inspection Department — independent of production — tests and maintains permanent records of inspection on every shipment.

This is just another important reason why Resinite Quality Control assures acceptance by your customers.

Yes, it's easy to do business with Resin Industries — the leading supplier of specification sleeving and tubing to the aircraft & electronics industries. Write for specification data and samples.

Resinite

RESIN INDUSTRIES, INC.

315 olive st. • box 1589 • santa barbara, cal.

SPECIALISTS IN VINYL SLEEVING AND TUBING FOR THE AIRCRAFT, ELECTRONICS AND MEDICAL FIELDS

Want more information? Use post card on last page.



TRANSFORMERS

" Fill Your Need to a "

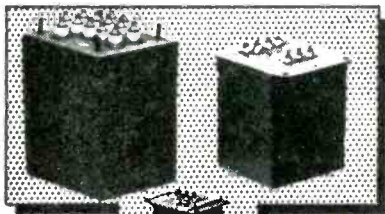

For INDUSTRIAL and ELECTRONIC EQUIPMENT

SAMPLE SHORT and LONG RUNS

Let us quote on your Specifications, no obligation

Delivery as Promised!

DESIGNED TO COMMERCIAL AND MILITARY SPECIFICATIONS (MIL-T-27 and AN-E-19)

EPCO Products Inc.

2500 Atlantic Ave.
Brooklyn 7, New York

REGULATED HIGH VOLTAGE POWER SUPPLY

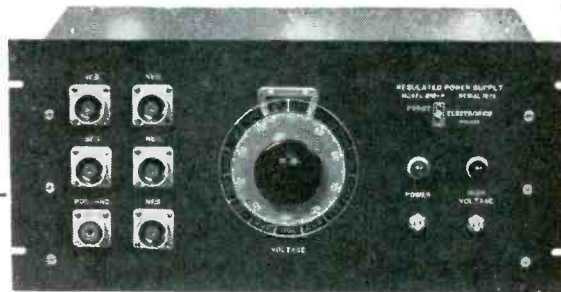

Provides Electronically Regulated, Continuously Adjustable Voltages from 150 to 1500 VDC at 0-5 Milliamperes

This unit is specially designed to supply proper power for making precise quantitative measurements with photomultiplier tubes, klystrons and similar applications.

Voltages are held to close limits even with wide line voltage and load variations.

No meter is required. Accurate voltage readings are made directly from a 15 turn vernier dial which is calibrated to read 1 volt per scale division.

See the Model 810-P and other Furst Power Supplies at the I.R.E. Convention - Booth 416

MODEL 810-P SPECIFICATIONS

- OUTPUT VOLTAGE: 150 to 1500 VDC at 0-5 Milliamperes.
- REGULATION: Output voltage varies less than .01% per volt change of line voltage and less than .1 volt with variation of output current from 0 to 5 Milliamperes.
- RIPPLE: Less than 5 Millivolts r.m.s.

Positive output terminal is grounded. 5 negative output connectors (type AN-3102A-18-16-s) are connected in parallel and mounted on front panel.

WRITE FOR DESCRIPTIVE BULLETIN

FURST ELECTRONICS

3324 W. Lawrence, Chicago 25, Illinois

BE SAFE WITH Q-max A-27

LOW-LOSS LACQUER & CEMENT

• Q-Max is widely accepted as the standard for R-F circuit components because it is chemically engineered for this sole purpose.

• Q-Max provides a clear, practically loss-free covering, penetrates deeply, seals out moisture, imparts rigidity and promotes electrical stability.

• Q-Max is easy to apply, dries quickly and adheres to practically all materials. It is useful over a wide temperature range and serves as a mild flux on tinned surfaces.

• Q-Max is an ideal impregnant for "high" Q coils. Coil "Q" remains nearly constant from wet application to dry finish. In 1, 5 and 55 gallon containers.

Communication Products Company, Inc.

MARLBORO, NEW JERSEY (MONMOUTH COUNTY)

Telephone: Freehold 8-1880



It's "TREATMENT" that makes DANO your Best Bet for Coils

DANO's battery of vacuum impregnating tanks and heat controlled ovens for curing varnish impregnations is always at your service. Yes, Dano coils and Dano customers are always treated in the manner that makes your production pay dividends.

Send us samples or specifications with quantity requirements for our recommendations. No obligation!

Also, Transformers Made To Order

- Form Wound
- Paper Section
- Acetate Bobbin
- Molded Coils
- Bakelite Bobbin
- Cotton Interweave
- Coils for High Temperature Application

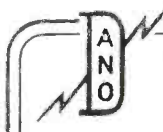

THE DANO ELECTRIC CO.

MAIN ST., WINSTED, CONN.

COPAR INCORPORATED

Precision Component Parts for Electronics

4950 CALVERT ROAD

COLLEGE PARK, MARYLAND

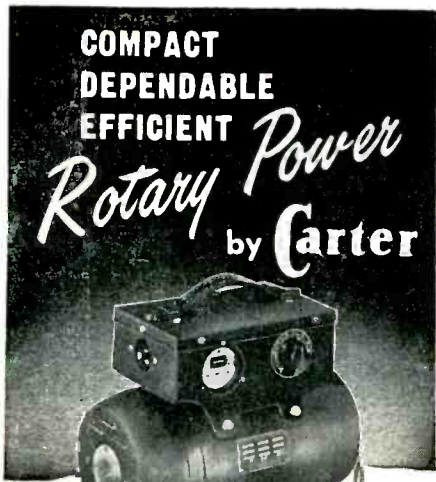

**COMPACT
DEPENDABLE
EFFICIENT**
Rotary Power
by **Carter**

THE NEW

Custom

DC-AC CONVERTER

These latest of all Carter DC to AC Converters are specially engineered for professional and commercial applications requiring a high capacity source of 60 cycle AC from a DC power supply. Operates from storage batteries, or from DC line voltage. Three "Custom" models, delivering 300, 400, or 500 watts 115 or 220 V. AC. Wide range of input voltage, 12, 24, 32, 64, 110 or 230 V. DC. Unequaled capacity for operating professional recording, sound movie equipment and large screen TV receivers. Available with or without manual frequency control feature.



MAIL COUPON FOR CATALOG

Carter Rotary Power Supplies are made in a wide variety of types and capacities for communications, laboratory and industrial applications. Used in aircraft, marine, and mobile radio, geophysical instruments, ignition, timing, etc. **MAIL COUPON NOW** for complete Dynamotor and Converter Catalogs, with specifications and performance charts on the complete line.

Carter MOTOR CO.
2646 N. Maplewood Ave.
Chicago 47



Carter Motor Co.
2646 N. Maplewood Ave., Chicago 47
Please send new catalogs containing complete information on Carter "Custom" Converters and other Rotary Power Supplies.

Name _____
Address _____
City _____ State _____

Want more information? Use post card on last page.

NEW BOOKS

(continued)

(Wurlitzer) to a 1/4-page single paragraph (Minshall-Estey). This information, if segregated in a comprehensive chapter covering all types, would be of value to all users of loudspeakers, not necessarily restricted to organs.

Most of the figures are clear and interesting. In a few cases the extreme reduction in size requires a magnifying glass for reading. Both figures on page 130 have capital letters less than 3/16 inch high.

If this book is to have a new edition, this reviewer would make an earnest plea (1) to examine all figures for too-small-to-read print, (2) to include a comprehensive index, and (3) to expand Chapter IX with a critical appraisal, indicating what is good, and what is less desirable in each type of electronic organ.—**RICHARD C. HITCHCOCK**, *Buhl Planetarium, Pittsburgh, Pa.*

An Introduction To Scientific Research

By **E. BRIGHT WILSON, JR.** *McGraw-Hill Book Co., Inc., New York, 1952, 375 + xi pages, \$6.00.*

THE RESEARCH WORKER in the physical sciences is apt to be an individualist. Well trained in his speciality but comparatively ignorant of others, he tends to distrust books confined to the generalities of science as being too abstract to aid him in his everyday problems. This attitude has been reinforced by the recent appearance of several books on research organization which, for lack of a better phrase, can be tagged as "teacher's college" books, excessively taken up with the form, as against the substance, of science.

Professor Wilson's book is an outstanding exception. Drawing on his concrete experience of professor of chemistry at Harvard, (his special interests according to "American Men of Science" are quantum mechanics in chemistry, molecular dynamics, infrared, microwave and Raman spectroscopy, and the physics of explosives), the author has larded his book with a great variety of examples which dispel the academic atmosphere of "research in general."

Aside from this refreshing display of specific applications of broad

HOW

Barnstead

PURE WATER

HELPS

RCA

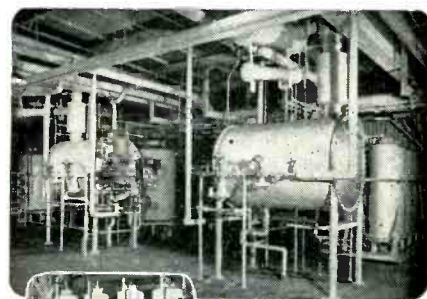

RCA requires Pure Water . . . copper-free to an extreme degree and free from organic impurities for trouble-free TV picture tubes. That is why RCA makes use of Barnstead 200 gph double-effect Stills in combination with Barnstead 1000 gph Demineralizers.

**LIKE RCA...
THOUSANDS OF
PLANTS THE WORLD
OVER MAKE USE OF
BARNSTEAD EQUIP-
MENT FOR OBTAINING
PURE WATER**

If you use water, in any of countless manufacturing and processing operations, you will find that Barnstead equipment producing either demineralized or distilled water, or both, will insure better products, consistent results, fewer rejects; and will cut your costs in many ways. Join the thousands of companies the world over who look to Barnstead for the solution to their Pure Water problems. Write today stating your problem. Our engineers will make recommendations without obligation . . . recommendations that will cut costs and increase production.



84 Lanesville Terrace, Boston 31, Mass.
Want more information? Use post card on last page.

January, 1954 — ELECTRONICS

principles, Professor Wilson has done a masterful job of selecting those topics which are possessed in common by research projects. The chapter headings confirm this judgment: choice of statement of a research problem, searching the literature, elementary scientific method, the design of experiments, the design of apparatus, the execution of experiments, classification, sampling and measurement, the analysis of experimental data, errors of measurements, probability, randomness and logic, mathematical work, numerical computations, and reporting the results.

A Human Book

Mathematical symbolism is used when necessary, but only then. As a result the book can be read without difficulty by college seniors. But it is much more likely to be appreciated by the research worker in his first year or two of professional work. Such novitiates will take much comfort in the many ways (cited as concrete examples in the book) in which research data can be misinterpreted by experts. The advice in the direction of assistants is definite. For example, on page 136, the author says "If you want Jones to clean the muck out of the vacuum pump, don't just politely hint that it might be a good idea if someone did it." (This from Harvard!) In this, and in countless other manifestations, the book is "human", and a pleasure to read.

As is usually the case when a really outstanding book appears (this one rates with the classics), the need for it has existed for some time. The vast increase in the number of young people taking up research as a career, the steadily growing support of industrial research by companies who once disdained it, not to mention the apparently permanent assignment of large public funds in support of pure and applied research—all these indicate that practitioners of the art must be carefully selected, and broadly trained to make the most of every hour and every dollar.

The selection process is still too haphazard. Professor Kubie of Yale, addressing himself to the problems of a scientific career from the viewpoint of a psychiatrist

TAKE NO CHANCES WITH VITAL EQUIPMENT... *Specify*

SERIES 6918 or 6924

RACKS by PAR-METAL

18½" or 24" DEEP, for 19" WIDE PANELS

- Panel Spaces: 61¼", 70", or 77" high.
- Finished in Prime Coat, Black Wrinkle, Grey Lacquer, Grey Wrinkle.
- Series 6918 or 6924 Racks may be used in "rows" or "gangs," as corner trims are removable from front of cabinet.
- Standard shelves and roller trucks are manufactured by us for use with these Racks.

THESE RACKS ARE MODERATELY PRICED and AVAILABLE FOR SHIPMENT FROM STOCK

Planning an electronic product? Consult Par-Metal for

**RACKS • CABINETS
CHASSIS • PANELS**

Remember, Par-Metal equipment is made by electronic specialists, not just a sheet metal shop.

Made by
*Electronic
Specialists!*



Our P-6924 Rack as used by Gai-Tronics, Inc., Reading, Pa.

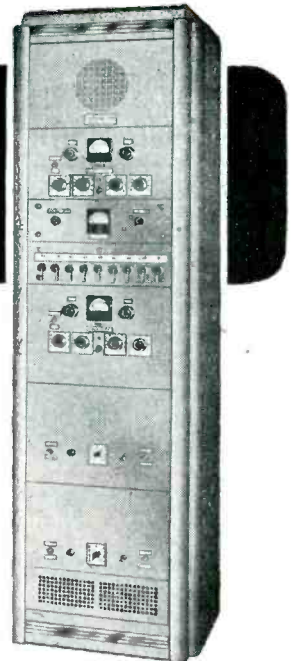

PAR-METAL

PRODUCTS CORPORATION

32-62 — 49th ST., LONG ISLAND CITY 3, N. Y.

Tel.: Astoria 8-8905

Export Dept.: Roche International Corp.
13 East 40 Street, New York 16, N. Y.

WRITE FOR CATALOG!

STAR STEATITE

for Your Electronic Needs

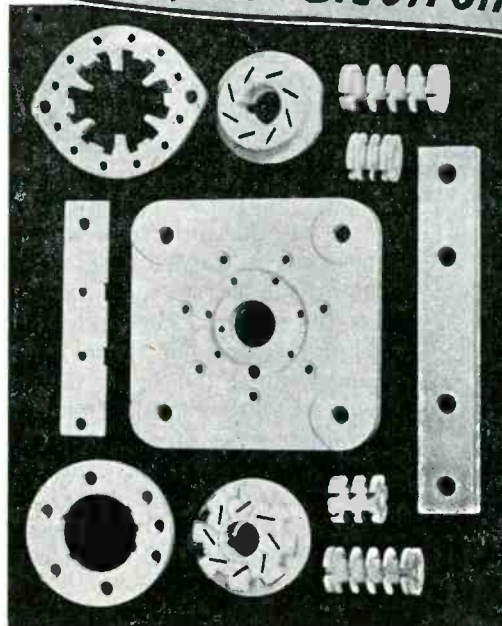

STAR low-loss STEATITE has proved an ideal insulation for electronic applications. It is a strong, dense material with excellent dielectric and mechanical strength.

Every STAR STEATITE part is engineered for your specific job and precision made to meet demands for dimensional accuracy. And STAR'S facilities for volume output assure you a steady flow of material to maintain your production schedules.

Star

PORCELAIN COMPANY

49 Muirhead Avenue • Trenton 9, N. J.

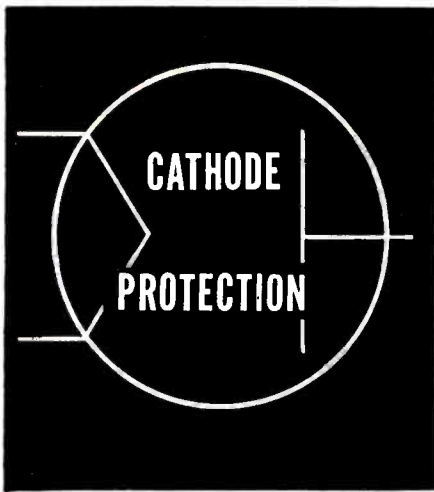

... with
**Silic-O-Netic TIME
DELAY RELAYS**



TIME DELAY is a basic requirement of many common electronic circuits. Thyratrons and gas filled rectifier tubes, particularly, must be protected to obtain any semblance of satisfactory life.

The facts are simple:

Time delay permits the tube to heat before the load is applied; otherwise a coating forms on the cathode which quickly destroys its effectiveness.



Operating principle is explained in Bulletin 5001A. Send for your copy.

HEINEMANN Silic-O-Netic Time Delay Relays have a unique combination of characteristics ideally suited to cathode protection. They are both low cost and fully dependable; small in size and lightweight. They are all metal, yet the time element is hermetically sealed . . . forever free of dirt and not subject to a fatigue factor. **Silic-O-Netic** Relays employ no thermal elements . . . thus they are not affected by the normal ambient temperature variations of electronic equipment.

**don't use heat
... USE POWER**

HEINEMANN

ELECTRIC COMPANY

97 Plum Street Trenton 2, N.J.
Want more information? Use post card on last page.

NEW BOOKS

(continued)

(*American Scientist*, October 1953, p 596), points out that many young men enter scientific life because they are unable to compete in early youth in social and athletic pursuits. This situation will no doubt be remedied as the financial and social rewards of devotion to scientific research fall more in line with those of the business executive or the individual professional man.

However selected, students of research science need the broad point of view and wide range of abilities implicit in Professor Wilson's program of study. His book should be read by every graduate student in the physical sciences who plans to make a living in research work, by every young worker in the field, and by their supervisors. As much as any book can, it will take the place of having been inspired by direct, personal association with a great teacher.—DONALD G. FINK, *Philco Corporation, Phila., Pa.*

**Luminescence and the
Scintillation Counter**

BY S. C. CURRAN, *Academic Press, Inc., New York*, 219 pages, 1953, \$5.80.

Scintillation Counters

BY J. B. BIRKS, *McGraw-Hill Book Co., New York*, 1953, 148 pages, \$4.50.

AFTER a period of several years, in which the worker in nuclear science who wished to take advantage of the exceptional capabilities of the scintillation counter in his research had to depend on gossip and the widely scattered periodical literature for his information, it is a pleasure to report that there are now available two very useful books on the subject. The first of these, "Luminescence and the Scintillation Counter", is by S. C. Curran, who has also published extensively on other types of counters, and the second, "Scintillation Counters", is by J. B. Birks, and is the second volume in the "Electrons and Waves" series of monographs under the editorship of D. W. Fry.

After a short introductory chapter covering the history and general features of the scintillation counter, Professor Curran discusses the various types of radiation and their interaction with matter. Chapter



SERVES IN
NAVY'S HUP-2

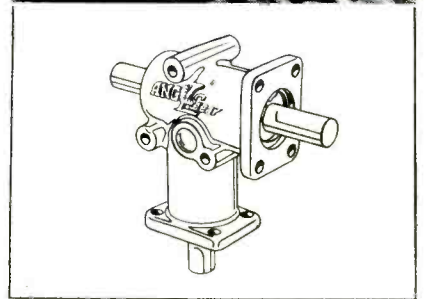
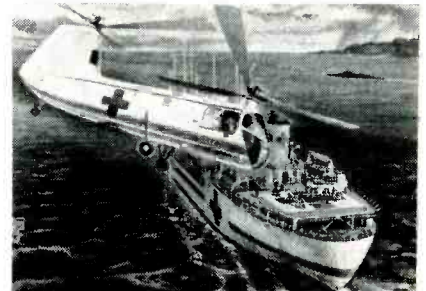

This right angle drive is part of the control system for the fuel shut-off valve. ANGLgear is often the choice when compact design and high capacity are required. These qualities make it a favorite among designers—specified equipment in many aircraft.

Model R-300 is rated at 1/3 hp at 1800 rpm—Model R-320 at 1 hp. Both models have hardened gears and ball bearings, are lubricated for life. Both are made with 1:1 ratio and with 2-way or 3-way shaft extensions.

ANGLgears are described fully in the I.A.S. Aeronautical Engineering Catalog. Refer to this publication for complete information, or write us direct.



ACCESSORIES CORPORATION

1414 Chestnut Avenue
Hillside 5, New Jersey

Want more information? Use post card on last page.

January, 1954 — ELECTRONICS

ULTRA-HIGH PRECISION POLYSTYRENE CAPACITORS

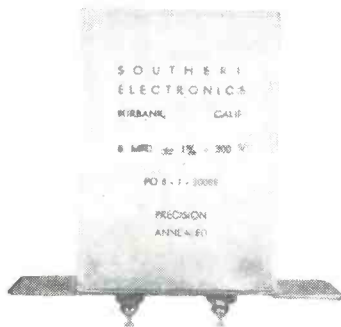

8 or 10 MFD 3"x2 1/8"x4 3/8"

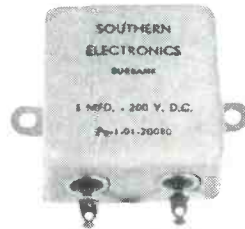

1 MFD 2"x1"x2"

IN
SMALLEST
CASES
and
CLOSEST
TOLERANCES

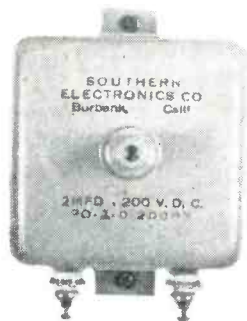

2 MFD 3"x1 1/8"x3"

The Following Specifications Apply to All Capacitances
.05 to 10 MFD, including Special Values

Voltage Available—100 to 400 VDC.	Dielectric Absorb .015%; Dissipation .0002
Insulation Resistance—10 ⁸ MEG./-MFD.	Hermetically Sealed
Temp. Coeff.—100 P.P.M. Per °C (-20° to 140° F)	Insulated with Teflon

Standard Tolerance 1%. Available .5%, .25%, .1% on 1 MFD to 10 MFD

BRACKETS ATTACHED TO FIT YOUR APPLICATIONS

SOUTHERN ELECTRONICS COMPANY

239 W. Orange Grove Ave.

Burbank, Calif.

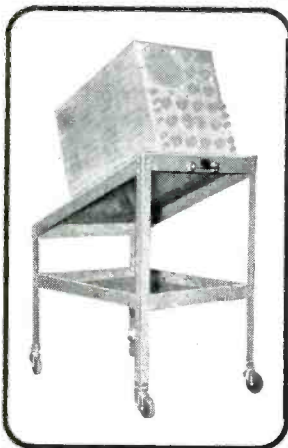

SCOPE DOLLY MODEL 1

- Convenient Height and Viewing Angle
- Adjustable to Hold Portable Scopes
- Ball Bearing Swivel Rubber Tired Casters
- Lightweight Aluminum Construction
- Recommended by Laboratories Wherever Used

\$38.50

FOB Louisville, Ky.

TECHNICAL SERVICE CORP.

1404 W. Market St.

Louisville 3, Kentucky

Cosmic

**ELECTROLYTIC
and
PAPER TUBULAR
CONDENSERS**

FOR
**A.C. D.C. SETS
PHONOGRAPHS**
etc.

CONDENSER SPECIALISTS SINCE 1923

COSMIC RADIO CORPORATION
853 Whittier St., Bronx, N. Y.
Phone LUdlow 9-3360

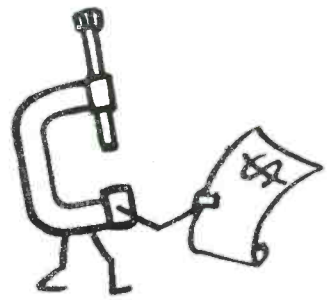

PRECISION PAYS

Precision may look expensive at first, but it saves money in assembly and maintenance.

You may have learned the cost of working with parts that *almost* fit — or gear trains with stickiness or backlash. We stand for “profitable precision in industry”.

CONRAD & MOSER

Workers in Aluminum, Brass, Steel & Plastics

DESIGNING
ENGINEERING • MANUFACTURING
MECHANISMS • MACHINES
PARTS • TOOLS • DIES • MOLDS
STAMPINGS • CASTINGS
MACHINING • SHEET METAL
ENCLOSURES & CHASSIS
1/8 to 1/2 NAVY SPEC ALUMINUM
SPOT WELDING AND HELIARC
WELDING.

2 Borden Ave.
Long Island City 1, N. Y.

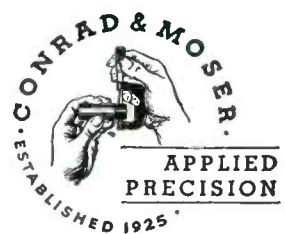

Illustrated
Actual
Size

SEE

the advantages in performance and economy that are yours with

SMALL NYLON COIL BOBBINS

These plastic moldings are more uniform, more accurate, less expensive . . .

- THE SUPERIOR RESULT OF

an exclusive single cavity molding method which assures low mold and maintenance costs. Only from Gries can you get the many advantages of

GRIES' PAT'D MOLDING METHOD

Write for sample of Gries coil bobbins and similar small parts in nylon and other thermoplastics

Send Specifications for Prompt Quotation

GRIES REPRODUCER CORP.

151 Beechwood Ave. New Rochelle, N. Y. Phone: New Rochelle 3-8600



Max. Wgt.
.025 oz
Max. length 1"
SMALLNESS
UNLIMITED



for maximum economy... 5KW VACUUM TUBE BOMBARDER OR INDUCTION HEATING UNIT

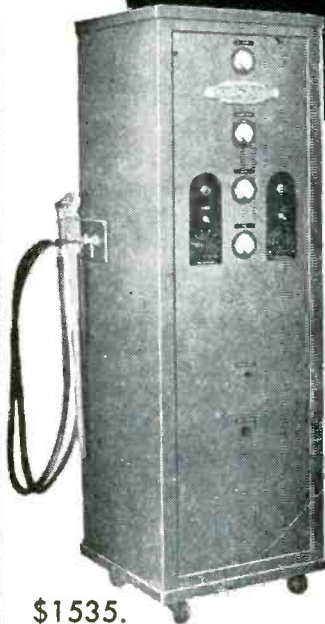

\$1535.

Simple... Easy to Operate... Economical
Standardization of Unit Makes This New Low
Price Possible.

Maximum economies can be obtained only by use of correct frequency and power combinations when applying the techniques of induction heating to manufacturing processes.

It is significant that only Scientific Electric in the present market, can offer you a selection of frequencies depending on power required, in wide power range. 2-3½-5-6-7½-10-12½-15-18-25-40-60 KW (all units above 60 KW are considered custom built). This means that electronic heating equipment produced by Scientific Electric is tailored to your needs... fitted perfectly to the task entrusted to it, enabling you to keep your initial investment in equipment to a minimum while affording you all the proven advantages of electronic heating.

Write now for complete information or send samples of work to be processed. Specify time cycle for your particular job. We will quote on proper size unit for your requirements.

DESIGNERS AND MANUFACTURERS OF HIGH FREQUENCY AND HIGH VOLTAGE EQUIPMENT SINCE 1921

Scientific Electric

105-119 MONROE ST.  GARFIELD, N. J.

three is devoted to secondary emission, chapter four to the electron multiplier and chapter five to the characteristics of commercial multiplier phototubes. The next four chapters are concerned with the luminescence of solids, the fluorescence of organic solids and liquids, the preparation of scintillating crystals and liquids, and the properties of crystals and liquids. Chapter ten covers the various typical applications of scintillation counters with remarks on miscellaneous special techniques which have been found useful. Next comes a short discussion of the applications of multiplier tubes (as distinct from scintillation counter assemblies), and at the end a chapter on circuitry for scintillation counters.

In his introduction Professor Birks devotes a very little space to the general methods of radiation detection and to scintillation counter history, and proceeds directly to discuss the modern scintillation counter. Next comes a chapter on scintillation counter principles, ranging from absorption of the incident radiation to the multiplication process, followed by a discussion of multiplier phototubes. In Chapter four the topics of pulse height and time resolution are treated briefly. Next comes a discussion of inorganic phosphors followed by organic crystalline phosphors and organic plastic and solution phosphors. The final chapter covers the applications of scintillation counters in such fields as particle detection, spectrometry of gamma radiation and studies of isomers and mesons.

Both books contain extensive bibliographies and, as might be expected when an attempt is made to treat such a complex subject in a small volume, the reader must be prepared to consult the periodical literature for complete information on most topics. Probably the chief value of these books is that they offer in convenient form a critical guide to the literature. However, the reader should not get the impression that this is all they comprise. Birks' book, for example, contains considerable material on the problem of energy transfer in organic crystals, including much

previously unpublished work by the author. Curran, on the other hand, has stuck less rigorously to the subject of the scintillation process and has provided more collateral information which might be most helpful to the reader with little background in nuclear science.

Although the reviewer sympathizes with the authors in their attempts to cover so much material in little space, he cannot refrain from remarking that more on the circuitry required in scintillation counting would have been helpful. While it is obvious that the phosphor and multiplier phototube are the most important components of a counting system, it is also evident that one cannot achieve a good result unless the electronics is right. And in many respects the scintillation counter imposes far more stringent requirements on the circuitry than does the more familiar Geiger-Müller tube. Apart from this understandable shortcoming, both books appear to be remarkably complete and up-to-date. Professor Birks' publishers in particular are to be congratulated on their speed in getting out his book, which compares favorably with journal publication in many cases.—J. B. HORNER KUPER, *Brookhaven National Laboratory.*

Principles of Transistor Circuits

EDITED BY RICHARD F. SHEA, *John Wiley & Sons, New York, 535 pages, 1953, \$11.00.*

UNTIL about a year ago, literature on transistor circuits and applications was almost as scarce as the transistors themselves. Then, gradually, good technical information began to flow into periodicals; now, completing the last phase, a good circuits book is available.

This long-awaited book is the result of the collective efforts of R. F. Shea and nine of his Electronics Park associates. The adage of too many cooks definitely does not apply to this project, for virtually no duplication or confusion is evident.

In fact, the organization of material is exceptional, and the easy-to-read writing style is maintained

QUALITY • QUANTITY • QUICKLY

Type BNC UG-274/U

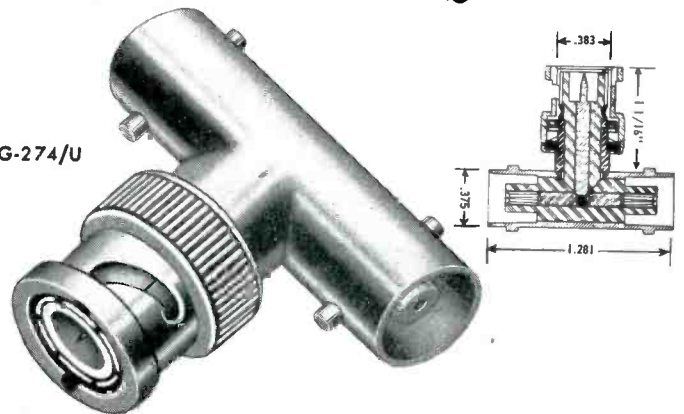

The Right Connection . . . right now!

Dage RF connectors are designed *right*, engineered *right*, built *right*—and available *now*. Each part is carefully made—Dage connectors are precision assembled to assure a sure connection.

Check your specifications—be sure you're *right*—ask for Dage radio frequency connectors

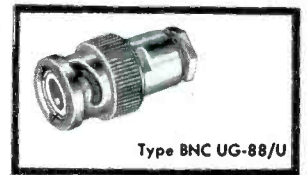

Type BNC UG-88/U

ALWAYS SPECIFY



Dage is versatile . . . any standard or special RF connector can be quickly produced at Dage. Write for Catalog 101.

RADIO FREQUENCY CONNECTORS

DAGE ELECTRIC COMPANY, INC., 67 NORTH SECOND STREET, BEECH GROVE, IND.

ARCTIC COLD
or
TROPIC HEAT

In every corner of the globe . . . Standard Piezo Crystals are functioning with complete fidelity . . . just as faithfully as they did in their final, comprehensive inspection in our plant. Standard Piezo Crystals are truly masterpieces of precision . . . the rugged, *accurate* and *dependable* end-product of an exacting and vigorous system of manufacture, inspection and quality control. Quality is *standard* with Standard Piezo.

Let our engineers help you with your Crystal needs. Send specifications or an outline of your requirements.

Synonymous with Quality

Standard Piezo Co.
CARLISLE PENNSYLVANIA
Phone 1495

ONLY
MAGNETICS inc.

OFFERS

performance-

guaranteed

MAGNETIC LAMINATIONS

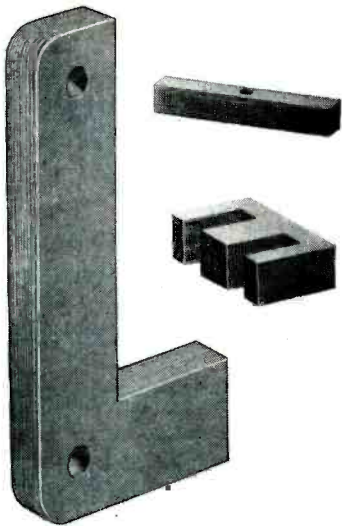

PREMIUM LAMINATIONS AT STANDARD PRICES

Boost production and slash costs with Performance-Guaranteed Magnetic Laminations, offered only by Magnetics, Inc. Burr-free and flat, made from all commercially available high permeability magnetic materials, premium performance is guaranteed by skilled heat treatment, including dry hydrogen anneal when necessary. And they cost no more!

PROGRESSIVE TUNGSTEN CARBIDE and HI-CARBON, HI-CHROME DIES

All tooling facilities for any requirement enable Magnetics, Inc. to meet your every need, including rapid quotation on special dies.

free

ENGINEERING SERVICE

Write for Catalog ML-100



Dept. E-5 BUTLER, PA.

Want more information? Use post card on last page.

NEW BOOKS

(continued)

throughout the 22 chapters of the book. An excellent balance between words and mathematics has been employed; where both become unwieldy or difficult to interpret, curves are provided. The latter technique is especially helpful in describing effects of changes in transistor parameters on circuit performance. Instead of having to try high, medium and low values of parameters in transistor equations to determine trends, the reader simply consults the appropriate curve for the entire picture. This technique is, of course, not original with this book, but its generous use is one of the factors that makes the book so valuable.

In each discussion, practical aspects are emphasized. In comparing types and combinations of circuits, consideration is given to power-supply simplicity, most efficient use of transistor characteristics and reduction in number of components. Typical examples are used to illustrate validity of design techniques discussed. Each chapter includes a series of excellent problems ideally suited for ensuring thorough understanding of the material presented.

The subjects discussed are best described by listing chapter headings. They are as follows:

Chapter Heading	Number of Pages
Semiconductor Principles	22
Forms, Types and Characteristics of Transistors	4
Transistors as Low-Frequency Circuit Elements	36
Basic Principles of the Amplifier Stage	29
Junction Transistor Multistage Amplifiers	16
Bias Stabilization	33
Power Amplifiers	31
Direct-Current Amplifiers	18
Transistors as High-Frequency Circuit Elements	19
Basic Principles of High-Frequency Operation	29
High-Frequency Circuit Design	22
Video Amplifiers	17
Oscillators	15
Circuit Design by Duality	10
Matrix Methods of Circuit Analysis	39
Feedback Amplifiers	24
Transient Analysis	30
Large-Signal Operation	14
Computer Circuits	24
Noise in Transistors	6
Associated Semiconductor Devices	30
Small-Signal Parameter Measurement	22
Appendix	
Matrix Algebra	6
Definitions of Terms	4
Bibliography	8

The book is not without faults. It is unfortunate that only ten lines of text and one small drawing are devoted to describing the important techniques made possible by the symmetrical properties of pnp and npn transistors. The section "De-

... TO A SENIOR ENGINEER

Interested In a Challenge As Great As All Tomorrow

If . . .

you're the man we hope you are, you now have a good position. Perhaps you have not thought of a change but will consider the right opportunity.

You have from 5 to 25 years of experience in electronics or an allied field. You desire to do more than just carry assignments to satisfactory conclusions.

You would appreciate an opportunity and the "go ahead" to pioneer . . . with the assistance of your own staff of specialists . . . you now want to know what you personally can achieve through your creative engineering talent.

If you fill these qualifications, we have an opportunity that will fascinate you. You will work on the development of the most interesting electronics equipment with one of the foremost engineering teams in the world. You will work in the Boston Engineering Laboratory located only minutes away from Harvard, MIT and Northeastern Universities, entirely separated from the problems of production. The last word in equipment would be at your fingertips. No richer benefits are offered anywhere . . . regardless of the standards by which you measure.

. . . Are YOU the man we are seeking? If so, phone us or send in a resume to . . .

Don Bradley, Personnel Supervisor

SYLVANIA ELECTRIC PRODUCTS INC.

Boston Engineering Laboratory
70 Forsyth Street, Boston, Mass.
Phone: Kenmore 6-8900

Want more information? Use post card on last page.

January, 1954 — ELECTRONICS

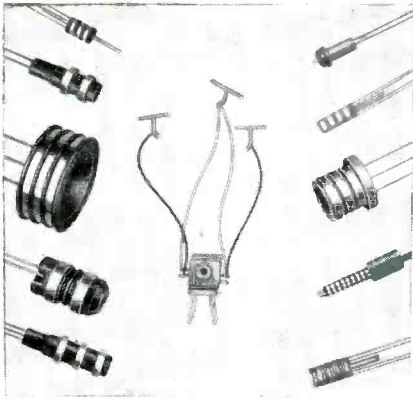

Miniature and Sub-Miniature
SLIP RING ASSEMBLIES
BRUSH BLOCK ASSEMBLIES
COMMUTATORS

and other
 Electro-Mechanical Components

PRECISION MADE
TO YOUR OWN SPECIFICATIONS

Precision molded products with exacting tolerances in precious and non-precious solid metals of all alloys. All types of Thermo-Plastic and Thermo-Setting materials.

Slip Ring Assemblies fabricated or one-piece precision molded to your specifications in Nylon, Kel-F, Mineral filled Mellamine, Phenolic, and other materials. Rings and leads spot welded or brazed together for positive electrical circuit.

Our Swiss methods and techniques are geared to meet exacting requirements. We invite your inquiries.

COLLECTRON CORPORATION

MUrray Hill 2-8473 • 216 East 45th Street • New York 17, N. Y.

"Nielsen" **COMPRESSION SPRING DRAW PULL CATCHES WITH SPRINGS CONCEALED**

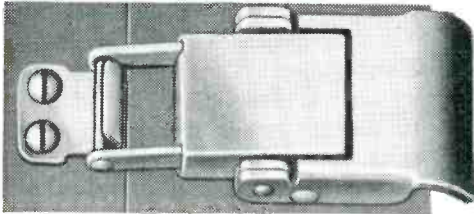

SIZE: 2 3/4" LONG X 1 1/8" WIDE

Get our Folders on Standard Catches and Draw Bolts and other Compression Spring Catches

NIELSEN HARDWARE CORP. 770 Wethersfield Ave., HARTFORD 14, CONN.
 AFFILIATED WITH NIELSEN TOOL & DIE CO.

FOR QUALITY HARDWARE — GOOD SERVICE TO YOUR SPECIFICATION

SIGNAL CORPS NO. SC-B-83314

70-Pound Tension at 1/8" Deflection, the established application dimension.

Withstands 600-Pound Pull Test.

Nielsen Catches Carry "Certification of Compliance".

DOUBLE BARREL ADVERTISING

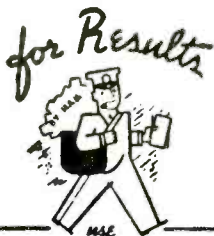

Mc GRAW-HILL
 DIRECT MAIL LIST SERVICE

Advertising men agree — to do a complete advertising job you need the double effect of both Display Advertising and Direct Mail.

Display Advertising keeps your name before the public and builds prestige.

Direct Mail supplements your Display Advertising. It pin-points your message right to the executive you want to reach — the person who buys or influences the purchases.

Ask for more detail information today. You'll be surprised at the low overall cost and the tested effectiveness of those hand-picked selections.

McGraw-Hill Publishing Co., Inc.

330 West 42nd Street

New York 36, New York

for high permeability applications

now — the first time
 available . . .

PERFORMANCE GUARANTEED

TAPE WOUND CORES

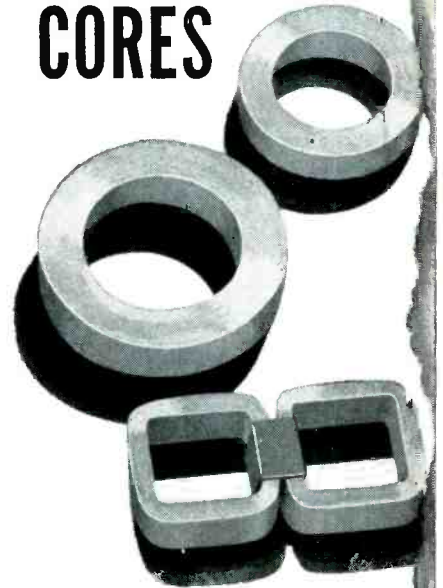

ONLY MAGNETICS, INC.

offers Performance-Guaranteed Tape Wound Cores. Guaranteed performance to specifications means truly economical production of high permeability magnetic devices in your plant . . . and controlled buying by your purchasing department. If you haven't investigated Performance-Guaranteed Tape Wound Cores, why not let us send you the complete story?

FACTORY CORE MATCHING

For applications in which closely matched characteristics are required, save time and money by using the Magnetics, Inc. factory core matching service.

free engineering design service for high permeability magnetic applications

Magnetics, Inc. engineering is second to none in the field of high permeability magnetics. Services are free to customers.

Write for full information

MAGNETICS, inc.

Specializing in High Permeability Magnetics

Dept. E-2 BUTLER, PA.

FREQUENCY METERS

by **FREQUENCY STANDARDS**

NEW BOOKS

(continued)

MODELS AVAILABLE:
FS-C-171-A
 900 to 1200 MCS.
FS-C-172-A
 1200 to 1600 MCS.
FS-C-173-A
 1600 to 2250 MCS.
FS-C-174-A
 1700 to 2550 MCS.



— for Field and Laboratory Use

- **ACCURACY** — Better than .05% from 20°F to 120°F.
- **SENSITIVITY** — Usable indication with 1 milliwatt input. Adjustable to accommodate higher levels.
- **INDICATOR** — 50 MICRO-AMMETER
- **INPUT** — 50 ohm Type N connector
- **EXTERNAL DC OUTPUT** — Pin jacks
- **OVERALL DIMENSIONS** 6½" x 9¾" x 7"
- **WEIGHT** — ONLY 4 LBS.

COMPLETE, PORTABLE INSTRUMENTS — Designed for both laboratory and field work, these precision meters are supplied complete with microammeter, sensitivity control and calibration charts. All are mounted in a hardwood carrying case with removable lid.

CAVITY UNITS SUPPLIED SEPARATELY — Complete cavity units can be supplied for installation in your equipment with several types of mounting brackets. Write for additional information.

Frequency Standards

General Offices: ASBURY PARK, NEW JERSEY
 PLANTS AT NEW SHREWSBURY AND ASBURY PARK, N. J.

Telephone: ASBURY PARK 1-1718



definition of Terms" is rather sketchy, and the Chapter entitled, "Associated Semiconductor Devices" reads somewhat like a catalog.

However, such derogatory remarks should be followed rapidly with a statement that, with the exception of the first criticism mentioned, the faults are minor. The book will prove extremely useful to the practicing engineer seeking to employ transistors and to design circuits around them. The book will unquestionably find extensive use in colleges and universities in both graduate and undergraduate courses in transistor electronics—in this role it has no rival.—J.D.F.

Mikrowellenbandfiltern Im Hohlleiter

BY VON DR. SC. TECHN. FUAD SURIAL ATIYA, Dipl. Elektroingenieur, B. Sc. Hons. Mitteilungen Aus Dem Institut Für Hochfrequenztechnik An Der Eidgenössischen Technischen Hochschule in Zürich, Herausgegeben von Prof. Dr. F. Tank, Nr. 17, 99 pages + 14 pages of tables (Curves), date of printing not stated (probably 1952), but analysis developed during 1949-50; Verlag Leemann Zürich; price 12.50 Swiss francs.

THIS is an interesting monograph. It reports the work of an Egyptian study at the Eidgenössischen Technischen Hochschule in Zürich, Switzerland. The subject matter, which received its earliest elaboration at the hands of English physicists, has achieved its highest development here in the United States.

Since the treatment consists for the most part of an analysis or extension of published work, it is not elementary. The reader will require familiarity with the material in "Wave Guides*" by H. R. L. Lamont, or an equivalent introductory survey to be able to readily appreciate the content. The citations of published work, parts of which are referred to as background for each topic in the monograph, have been selected carefully. These reveal a striking pattern; nine are American texts, seven on microwaves and two slightly more general; three are German texts on electrical circuit theory, with three references to circuit theory articles in the *Journal of Mathematics and Phys-*

*"Wave Guides", by H. R. L. Lamont, 118 p. Third Edition, Methuen and Co., Ltd., London, 1950.

*the spider web's slender thread
 — a precision miracle of nature ...*

SECON FINE WIRE & RIBBON

*— a precision achievement
 of scientific research and
 metallurgical engineering*

SECON specializes in the research, development and production of base, rare and precious metals and alloys — to close tolerances and for highly engineered applications.

Extremely close tolerances can be held on: resistance, tensile strength, elongation, surface appearance, special spooling, purity, torque, linearity, composition, cross section, weight per unit length, etc. — all to your particular requirements.

The SECON plant is a complete metallurgical unit for the initial selection of pure metals and alloy components, through melting, production, quality control and final completion into precision wire and ribbon.

We gladly offer consultation and recommendations on your special problems. Write for Pamphlet **E**

SECON development and production metallurgists

SECON METALS CORPORATION
 7 Intervale Street, White Plains, New York
 White Plains 9-4757

... for wherever the element calls for PRECISION

ics. The remaining references, ten from the *Proceedings Institute of Radio Engineers*, five from the *Journal Institution of Electrical Engineers* (British), four from the *Bell System Technical Journal* and a few scattered are, for the most part, published technical developments in the field. Two references to the work of F. Staub at Zürich represent stages in the development of which this report is a part. In forty-two citations we have nine German and thirty-three English.

It is probable that the actual progress in waveguide research and development is, to a degree greater than this bibliography suggests, a United States project. However, it is highly desirable that the development within this country be appraised by someone outside our national boundary. The choice of an Egyptian in a Swiss University is most fortunate, because Switzerland in the center of Western Europe is tending to become a communication exchange, as Egypt no doubt will be between Asia and Africa.

This text seeks to collate and organize material connected with waveguide band-pass filters. The work, proceeding from a short introduction, summarizes the necessary definitions and terminology of microwave circuits. Next, the properties of waveguides and cavity resonators are considered. Frequency and reactance transformations are then reviewed and applied to cavity resonator circuits which with direct or $\lambda/4$ coupling form microwave filters.

Four-terminal network synthesis for a prescribed attenuation function, which is taken up on page 37, describes the essential problem of the whole monograph in terms of Cauer's methods. To further its application a general separation of filters into classes is made, and the forms of the formulas for each class are stated. Examples of filters in these various classes are then taken up, and the possibilities of variable band width with fixed mid-band frequency are discussed. Measurement methods and results are mentioned.

The two developments which are the special project of this publication are the presentation of general

better all around...

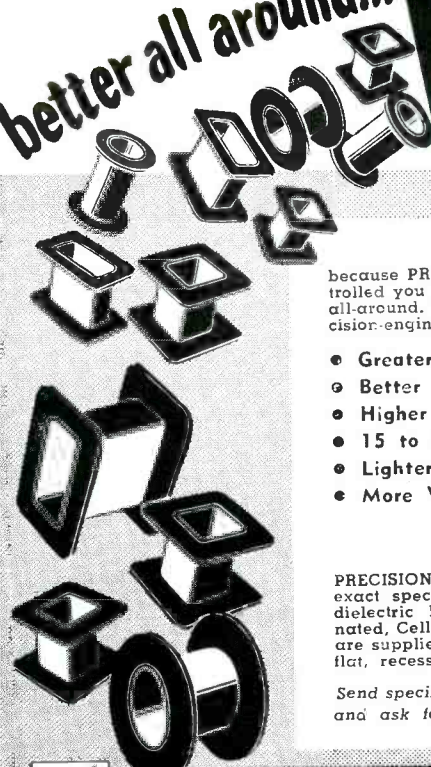

Precision COIL BOBBINS

because PRECISION Coil Bobbins are quality controlled you can be sure they'll improve your coils all-around. Every PRECISION Coil Bobbin is precision-engineered to give you:

- Greater Insulation
- Better Heat Dissipation
- Higher Moisture Resistance
- 15 to 20% Greater Strength
- Lighter Weight
- More Winding Space

All at lower unit cost!

PRECISION Coil Bobbins can be designed to your exact specifications . . . any size or shape in dielectric Kraft or Fish Paper, phenol impregnated, Cellulose Acetate or Combinations. Flanges are supplied plain or fitted with leads, slots, holes flat, recessed or embossed to fit any mounting.

Send specifications for free sample—
and ask for new Arbor list of over 2000 sizes.



PRECISION PAPER TUBE CO.

2041 W. Charleston St. Chicago, 47, Ill.
Plant No. 2, 79 Chapel St., Hartford, Conn.
Also Mfrs. of PRECISION Paper Tubes

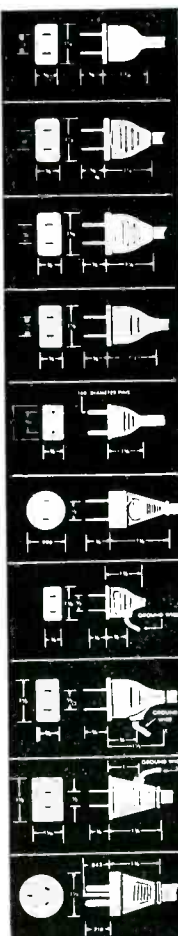

GLUTTONS for PUNISHMENT



CUSTOM

CORD SETS

RUBBER . . . PLASTIC . . .
NEOPRENE . . .

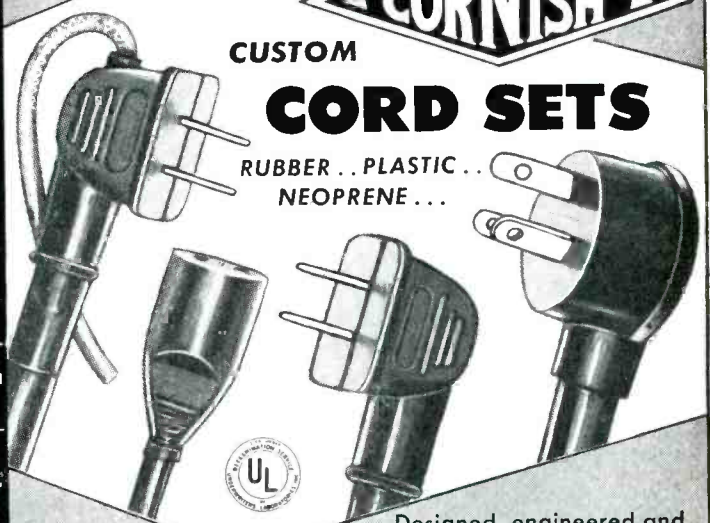

Designed, engineered and produced for YOUR products! For a delicate "walkie-talkie" or a huge arc welding unit . . . put your wire problems up to CORNISH experts!

Also
"NOFLAME-COR"
The Television
Hookup Wire

MADE BY ENGINEERS FOR ENGINEERS

CORNISH WIRE CO., INC.
50 Church St. New York 7, N. Y.

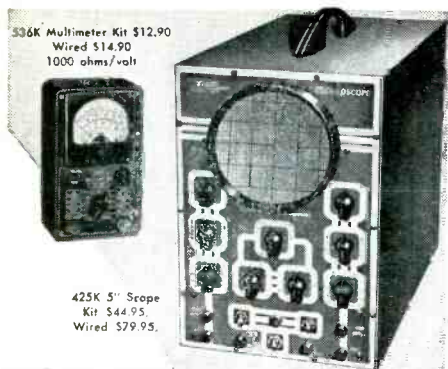

**YOU BUILD
EICO
KITS
IN ONE
EVENING—
but they
last a lifetime...
and you
save 50%
24 INSTRUMENTS—
the industry's most complete
line of MATCHED
TEST INSTRUMENTS**

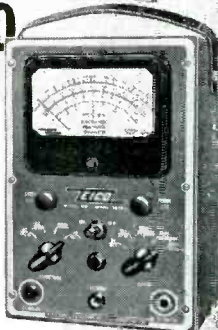

221K VTVM Kit \$25.95.
Wired \$49.95



565K Multimeter Kit \$24.95.
Wired \$29.95.
20,000 ohms/volt.



NEW 377K
Sine & Square Wave Audio Gen.
Kit \$31.95. Wired \$49.95



360K Sweep Gen.
Kit \$34.95. Wired \$49.95.



1000K Battery Eff.
Kit \$25.95. Wired \$34.95.

**Laboratory
Precision
at Lowest Cost**

Prices 5% higher on West Coast.

Write NOW for
FREE latest Catalog
E-1



625K Tube Tester
Kit \$34.95.
Wired \$49.95.



©1952 **INSTRUMENTS & KITS**
ELECTRONIC INSTRUMENT CO., Inc.
84 Withers Street, Brooklyn 11, N. Y.

NEW BOOKS

(continued)

design curves computed for filters made up of two to six resonators. There are fourteen tables (actually curve sets) which present this data. The filter here under consideration is really a group of resonators directly in tandem or coupled by $\lambda/4$ elements. The second microwave filter type of novelty utilizes T-circuits to produce series and parallel circuits.

The effort here, as is usual in microwave network theory, is to relate input and output quantities for microwave networks without, at every step in the process, using the electromagnetic field equations; that is, develop a circuit analysis for microwave structures and a set of appropriate theorems. The result is certainly interesting and should be useful to American designers.—B. A. KINGSBURY, *Bell Telephone Laboratories, Inc.*

THUMBNAIL REVIEWS

Storage Battery Technical Service Manual. Association of American Battery Manufacturers, 2706 First National Tower, Akron, Ohio. 44 pages 1953, \$0.30. Third edition of a widely distributed manual telling how a battery is constructed, how it works, how to maintain it, how to make certain repairs, plus a section on car generator systems.

Synchro Systems Manual. Aeronautical Radio, Inc., 1523 L Street, N. W., Washington, 5 D. C., 1953, \$3.00 single copies. \$1.00 in lots of 50 or more. Fourth printing of what is known as the "Bible of navigation synchro instrumentation".

Statistical Quality Control and Acceptance Sampling. U. S. Ordnance Corps, Office of Technical Service, U. S. Department of Commerce, Washington 25, D. C., 103 pages, 1952, \$2.00. This is Ordnance Inspection Handbook ORD-M 608-9 and reviews the fundamentals of governing sampling procedures, gives a study of statistical methods with tables showing how to tabulate and classify measurements. Useful anyone having jobs requiring sampling or statistical methods.

Natural Logarithms, 0 to 5, to 16 Places. National Bureau of Standards Applied Mathematics Series 31 (revision of MT10), 501 pages, 1953, \$3.25 from Government Printing Office, Washington 25, D. C. A reissue of Volume III of a 4-volume table published in 1941. The intervals are 0.0001 and the tables are useful to mathematician, physicist and engineer.

Radio's Master 1953. (18th) Edition, 1,370 pages, 8 1/2 x 10 1/2, 1953, \$6.50 from the publishers or \$1.95 from certain distributors. United Catalog Publish-

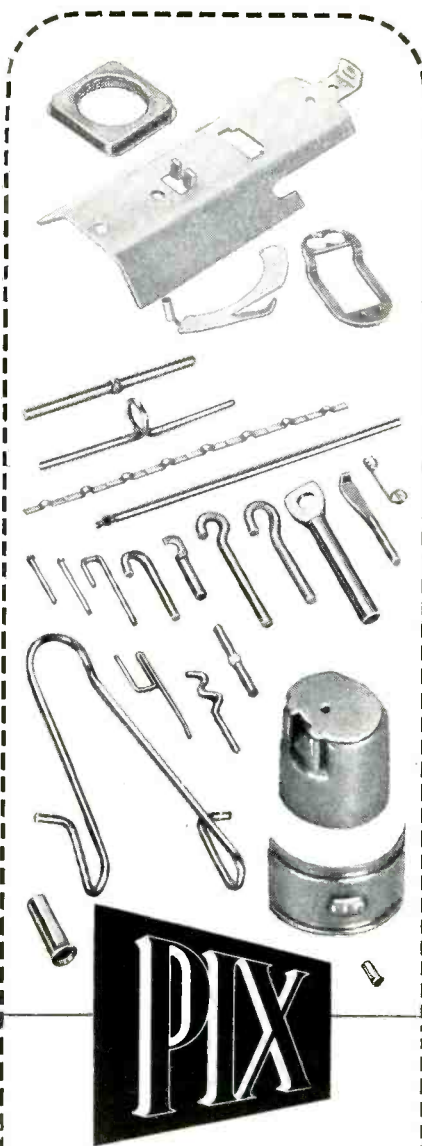

**Dependable • Precision
Wire Forming and
Stamping Specialists**

Precision Parts to meet your
Production and Engineering
needs. From .002" dia. to
.125" dia. Radio tube parts—
Stampings—Drawings. Mod-
ern facilities, high-produc-
tion equipment.

Send sketch or print
for quotation.



MANUFACTURING CO., Inc.
24-A Bedford Street
Newark 3, New Jersey

Want more information? Use post card on last page.

January, 1954 — ELECTRONICS

Square Wave Generator



AEL Model 5226

A low cost, stable instrument, which produces a square wave at 400 or 1000 c.p.s., this generator is suitable for many tests and experiments. Used to modulate RF signals by means of a crystal modulator in series with the output of a signal generator, it replaces expensive audio oscillators when making precise standing wave measurements.

Frequency 400 or 1000 c.p.s. which is tuneable over a $\pm 10\%$ range by a front panel control.

Amplitude The output is adjustable in amplitude from 0 to 50 volts peak-to-peak, no load, or 12 volts peak-to-peak into a 600 ohm load.

Stability Amplitude and frequency are constant $\pm 2\%$ for line variations of 105 to 120 volts.

Input 115 volts at 60 c.p.s.

Price, \$55.00, F.O.B. Philadelphia, Pennsylvania

American Electronic Laboratories
INCORPORATED
641 Arch Street, Philadelphia 6, Pa.

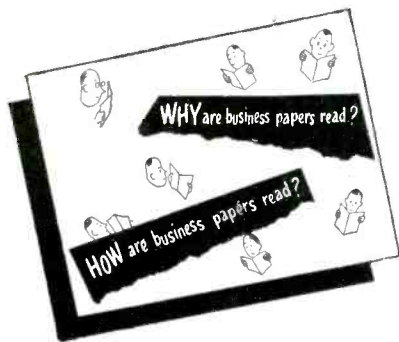

A copy of this quick-reading, 8-page booklet is yours for the asking. It contains many facts on the benefits derived from your business paper and tips on how to read more profitably. Write for the "WHY and HOW booklet."

McGraw-Hill Publishing Company, Room 2710, 330 West 42nd St., New York 36, N. Y.

PRECISION • STABILITY • LOW NOISE LEVEL S.S. WHITE TYPE 65X MOLDED RESISTORS

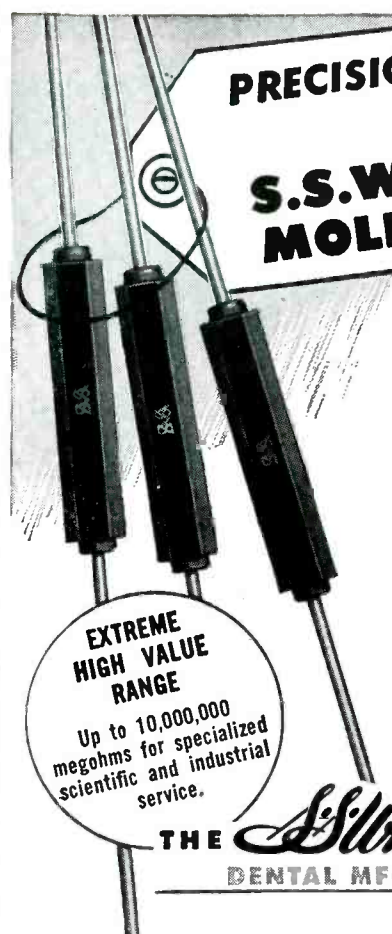

EXTREME HIGH VALUE RANGE
Up to 10,000,000 megohms for specialized scientific and industrial service.

Rating—1 Watt.
Temperature Coefficient—From approx. + 0.1 % /°F for 5000 ohm resistors to approx. - 0.2 % /°F for 10 megohm resistors.
Voltage Coefficient—Less than 0.02 % /Volt.
Upper Temperature Limit—170°F for continuous operation.
Standard Range—1000 ohms to 9 meg-ohms. For general commercial service.
Noise Level—A low noise level is inherent in all 65X resistors. Where noiseless operation is essential, we are equipped to test and guarantee standard range resistors with "less noise than corresponds to a resistance change of 1 part in 1,000,000, for the complete audio frequency range."

Send for Bulletin 4906. It gives full details on S.S. White Molded Resistors. Write for a copy.



THE S.S. White INDUSTRIAL DIVISION
DENTAL MFG. CO. Dept. R, 10 East 40th St. NEW YORK 16, N. Y.

Western District Office • Times Building, Long Beach, California

Make your Ferrites with

Purified synthetic products of reagent quality. Controlled particle size and shape contribute to effective control of packing and shrinkage. Our know-how can help you accomplish best results.

Manufactured by highly modern processes under rigid laboratory control. This ad clipped to your letterhead will bring a working sample.

HIGH PURITY
MAPICO
RED FERRIC OXIDES
for TOP performance

COLUMBIAN CARBON COMPANY
MAPICO COLOR DIVISION
MANUFACTURER

BINNEY & SMITH CO., Distributor
380 MADISON AVENUE, NEW YORK 17, N. Y.

SLIDE-CONTACT RHEOSTATS AND RESISTORS



REX RHEOSTAT CO.
BALDWIN, L. I., N. Y.

ASK FOR CATALOG 5

PROVEN BY EXACTING LABORATORY TESTS

NEW BOOKS

(continued)

**MINIMUM
R F
INTERFERENCE**

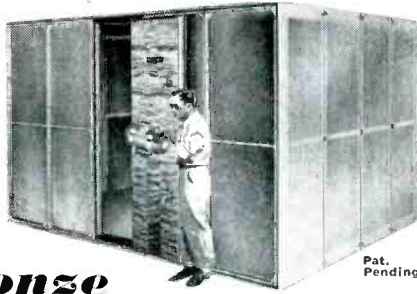

Bronze

LINDGREN DOUBLE SHIELDED PORTABLE SCREEN ROOMS

EASY TO ASSEMBLE . . . and easy to take apart for storage or re-location.

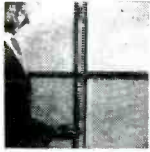

LEAK PROOF DOORS Wedge shaped like refrigerator doors, to assure tight shield.



FLOOR CONSTRUCTION Standard load 140 lbs. per sq. ft. Up to 2000 lbs. available.



Guaranteed attenuation 126—128 DB in Bronze . . . 142—146 DB in Copper . . . practically level over the entire frequency range, 15 KCS to 1000 MCS, and excellent results are had at frequencies up to 10,000 MCS . . . highest ever known!

Lindgren true double shielded portable screen rooms meet the exacting requirements set up by Industry, Armed Forces, and Laboratories (JAN-1-225; 16E4; MIL 16910; MIL-S-4957). Here is a truly double shield—made in sections, easily assembled or taken down. No soldering required. Excellent metal to metal contact is made with low impedance contacting.

Don't take chances with improvised screen rooms. Get the best . . . guaranteed to meet government specifications. 10 standard sizes . . . or built to your requirements.

ERIK A. LINDGREN & ASSO.

4515-17 N. Ravenswood Ave.

SU 4-0710

Chicago 40, Ill.

—Established 1939—

WRITE for illustrated circular, specifications, performance charts, and price list.

NOW...SOLVE YOUR HIGH VOLTAGE PROBLEMS with BETTER EQUIPMENT



34 KW 17,000 V.D.C.



Our years of experience gives you MAGNATRAN Heavy Duty High Voltage products . . . built for longer life and rugged performance

← NEW UNITIZED RECTIFIERS

For high voltage D.C. sources . . . lower initial cost . . . minimum upkeep . . . convenient—ready to connect to AC. line and D.C. load . . . compact—requires minimum floor space.

AIR . . . OIL . . . ASKAREL

Plate Transformers. Filament Transformers. Filter Reactors. Modulation Transformers. Distribution Transformers. Pulse Transformers. Testing Transformers. Precipitation Transformers. General Purpose Transformers. Hi-Voltage Transformers.



Askarel Immersed Filter Reactor 50,000 Volt Test

WRITE FOR DETAILED INFORMATION

MEETS STANDARDS OF AIEE-NEMA

A NAME SYNONYMOUS WITH EXPERIENCE

MAGNATRAN INCORPORATED

TRANSFORMERS AND ELECTRICAL EQUIPMENT

WALTER GARLICK, JR., PRESIDENT

246 SCHUYLER AVE., KEARNY, NEW JERSEY



ers, 110 Lafayette St., New York 13, N. Y. A jumbo catalog of electronic parts and equipment arranged by manufacturers. More than 85,000 items are cataloged.

Fundamental Mathematics. By Virgil S. Mallory and Kenneth C. Skeen. Prentice-Hall, Inc., New York, N. Y., 1953, 128 pages, paper bound, large format, \$1.95. An interesting practice-book with hundreds of problems in the fundamental operations of addition, multiplication, measuring angles, fractions, decimals, reading and drawing graphs, areas and volumes. Useful for vocational and junior-high schools. The problems are practical in nature, some involving home budgets, figuring insurance, and depreciation.

Die Laplace-Transformation und ihre Anwendung. By Paul Funk, Hans Sagen and Franz Selig, Technischen Hochschule, Vienna. Franz Deuticke, Vienna, 106 pages, \$2.40, 1953. A paper-bound treatise, in German, on the theory and applications of the now-familiar Laplace transform.

Temperature Measurement in Engineering. By H. Dean Baker, E. A. Ryder and N. H. Baker. John Wiley & Sons, Inc., New York, N. Y., 1953, 179 pages, \$3.75. The first of a two-volume series on the theoretical and practical problems of temperature measurement. Volume I covers the general introduction to the subject and then deals with the details of measurement by means of thermocouples. The book is non-mathematical and practical. Volume II will cover the measurement of very high and very low temperatures where the thermocouple does not have the superiority it possesses for measuring the internal temperature of solids discussed in Volume I.

How to Troubleshoot a TV Receiver. By J. Richard Johnson. John F. Rider Publisher, Inc., 480 Canal Street, New York 3, N. Y., 128 pages, 5½ x 8½, 1953, \$1.80. How to interpret circuit symbols, how to use servicing information, how to set up a shop and get started.

How to Use Signal & Sweep Generators. By J. Richard Johnson. John F. Rider Publisher, Inc., 480 Canal St., New York 13, N. Y., 137 pages, 1953, \$2.10. Types of equipment available, principles of operation, functions of controls, setting up and adjusting generators for various applications, and maintenance of generators.

Fundamental Processes of Electrical Contact Phenomena. By F. Llewellyn Jones, Professor of Physics, University of Wales. Radio Research Special Report No. 24, HMSO, London, 1953, 66 pages, 3 shillings. Serious and useful study dealing with contact phenomena, arcs, approach and separation of contacts, sealed contacts and measurements. Some mathematics.

TV Repair Techniques. Gernsback Publications, Inc., 25 W. Broadway, New York 7, N. Y., 128 pages, \$1.50. Compilation of television troubleshooting articles culled from *Radio-Electronics* magazine.

the most widely used
**Electronic Supply
Guide**

FREE SEND FOR IT

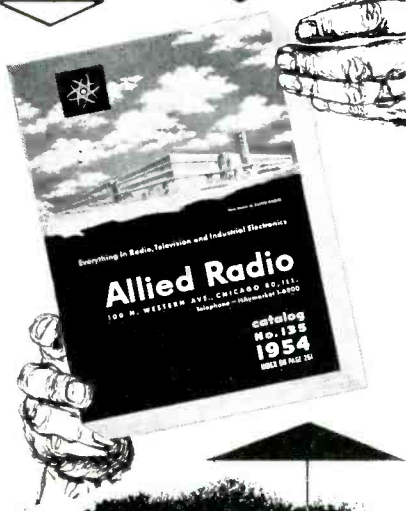

**ALLIED'S
COMPLETE 268-PAGE
1954 CATALOG**

**World's largest stocks of
ELECTRONIC SUPPLIES
FOR INDUSTRY**

Simplify and speed your purchasing of electronic supplies and equipment. Send your orders to us for quick shipment from the world's largest stocks of special-purpose electron tubes, test instruments, audio equipment, electronic parts (transformers, capacitors, controls, etc.). Our expert Industrial supply service saves you time, effort and money. Send today for your Free ALLIED Catalog—the complete, up-to-date guide to the world's largest stocks of Electronic Supplies for Industrial use.

one complete
dependable source
for everything
in electronics

ALLIED RADIO
100 N. Western Ave., Dept. 11-A-4
Chicago 80, Illinois



Want more information? Use post card on last page.
ELECTRONICS — January, 1954

BACKTALK

Untried Ideas

DEAR SIRs:

I AM enclosing for your consideration a number of electronic techniques. As they are all purely theoretical in nature (no practical examples, etc.), I am submitting them as an aid to the art.

D. SACHS
Hollywood, California

(Editor's Note: It is contrary to the policy of ELECTRONICS to publish untried ideas. However, several of those suggested by Mr. Sachs seemed worthy of being brought to the attention of our readers, and we are printing these herewith. We invite comments from readers. We will also consider publication of other such ideas in this department if these appear to meet with approval.)

Modulation Method. The circuit appearing in Fig. 1 illustrates a possible means of modulating a transmitter on the transmission line

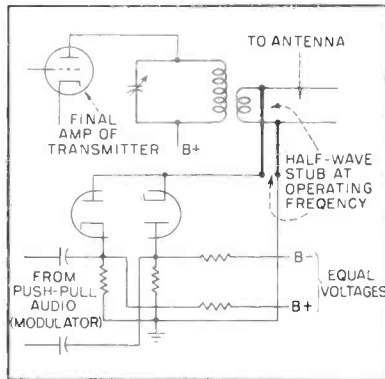
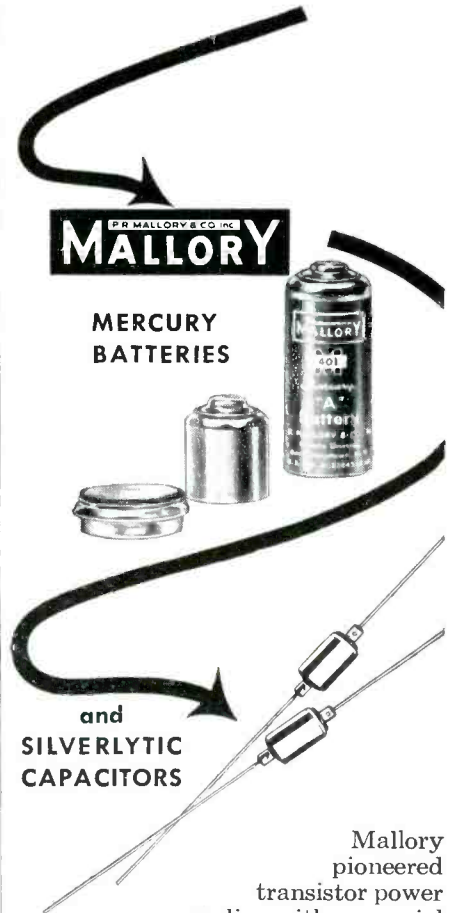

FIG. 1—Transmission-line modulation

itself. At an appropriate place on the line, a half-wavelength stub connects to the line and is terminated at the other end in the circuit as shown. Both diodes act as a variable short across the stub, the impedance of which varies at the modulating voltage rate. Diodes are biased (B+ and B-) so that with no modulation, medium conduction occurs.

Cutting Plastic Sheet. The technique illustrated in Fig. 2 is an electronic means of forming patterns or holes in sheets of plastic

DESIGNED
Especially for
**TRANSISTOR
CIRCUITS**



and
**SILVERLYTIC
CAPACITORS**

Mallory pioneered transistor power supplies with a special line of Mercury Batteries that deliver the constant-current, constant-voltage necessary for the best performance of transistor circuits. In addition, Mallory Batteries offer unusually long shelf life and high ratio of energy to size and weight.

Tiny, specially-developed Mallory Silverlytic Capacitors also meet every requirement of low voltage transistor applications.

For complete data, write or call P. R. MALLORY & CO. INC., Indianapolis 6, Indiana.

Available NOW

IN PRODUCTION
QUANTITIES



Want more information? Use post card on last page.

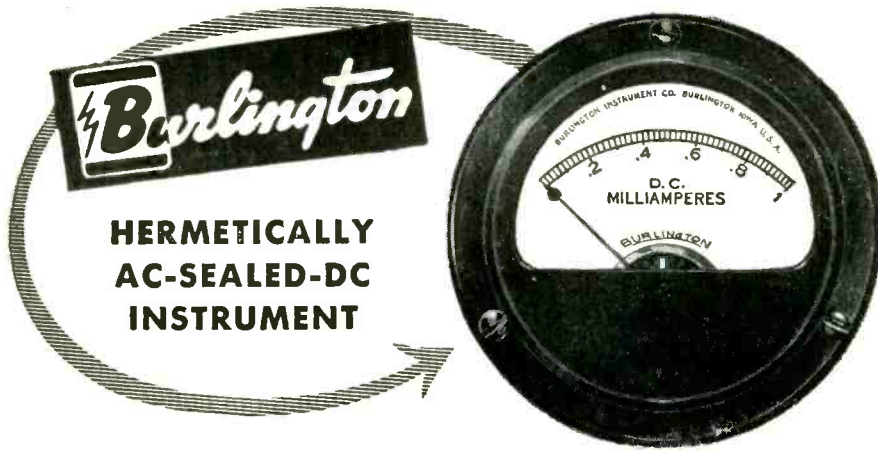

**HERMETICALLY
AC-SEALED-DC
INSTRUMENT**

**RUGGED CONSTRUCTION FOR
SUPERIOR PERFORMANCE**

- Copper — cadmium — dichromate finished case.
- Black satin onodized aluminum bezel.
- Excellent shielding due to case material and construction.
- Double strength clear glass.
- Glass to metal seal under controlled humidity and temperature conditions.
- D'Arsonval permanent magnet type movement for DC applications.
- Magnetically damped, moving iron vane type movement for AC applications.
- Available in 1½" square, 2½" and 3½" round case types.
- Guaranteed for one year against defective workmanship and materials.

Burlington "Hermetically Sealed" Instruments are designed to conform to JAN and MIL specifications.

B **BURLINGTON INSTRUMENT COMPANY**
127 THIRD STREET, BURLINGTON, IOWA

**improve your products
with QUALITY COMPONENTS**

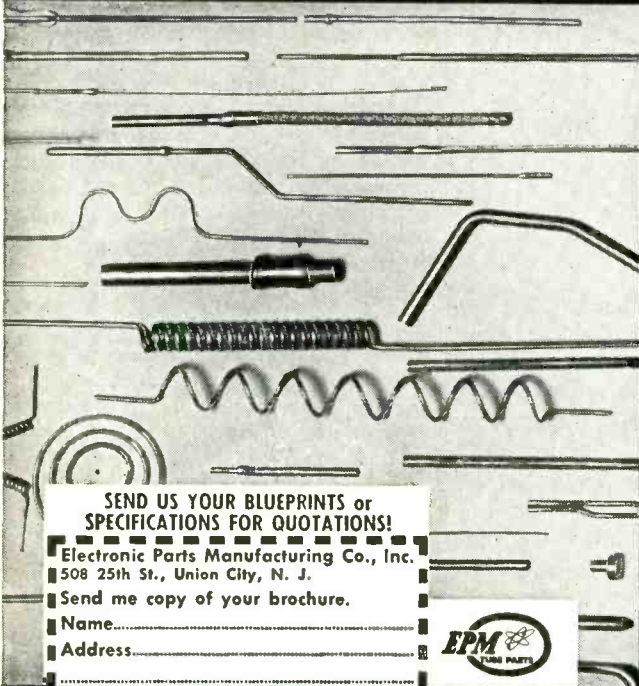

quality
**hand-wound
COILS**
of Tungsten
and Molybdenum

quality
**"precision"
LEADS**
of TUNGSTEN
MOLYBDENUM
NICKEL
NICKEL-CLAD COPPER
and ALLOYS

quality
**MACHINED
TUBE
COMPONENTS**
to customers'
specifications

SEND US YOUR BLUEPRINTS or SPECIFICATIONS FOR QUOTATIONS!
Electronic Parts Manufacturing Co., Inc.
508 25th St., Union City, N. J.
Send me copy of your brochure.
Name.....
Address.....

ELECTRONIC PARTS MANUFACTURING CO., Inc.
508 25th St., Union City, N. J.

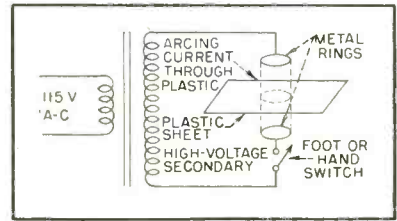

FIG. 2—Electronic cutting method

or similar material. A very high voltage forces an arcing current through the material. Spaced closely on either side of the material is a pair of rings (for round holes) or any other pattern shape. High voltage will cause arcing and the pattern will literally be burned out of the material. A foot or hand switch operates the unit, which could be similar in shape and size to a drill press.

Counter Circuit. Figure 3 shows a different technique for a counting circuit. It is essentially the same as the conventional diode counter

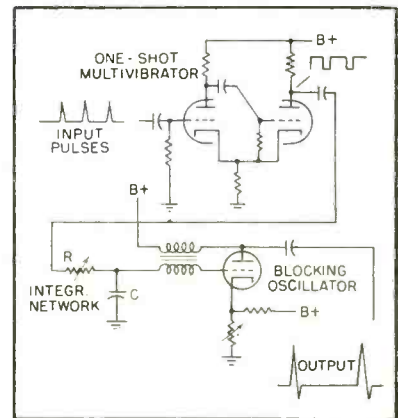

FIG. 3—Counter circuit proposal

circuit, except that the diodes are replaced by an R-C integrating network. Also, the input pulses are used to trigger a one-shot multivibrator to provide the pulses shown for integration. The R-C time constant may be varied, according to the frequency required, with the variable R. Essentially, the function is similar to a tv vertical integrating network, except in this case a counting system is employed.

AFC System. An electromechanical automatic-frequency-control system is illustrated in Fig. 4. If the frequency increases, the output of the discriminator becomes posi-

Over 85% of the torque wrenches used in industry are

STURTEVANT TORQUE WRENCHES

Read by Sight, Sound or Feel.

- Permanently Accurate
- Practically Indestructible
- Faster—Easier to use
- Automatic Release
- All Capacities

in inch ounces . . . inch pounds . . . foot pounds
(All Sizes from 0-6000 ft. lbs.)



Every manufacturer, design and production man should have this valuable data. Sent upon request.

PA **STURTEVANT CO.**
ADDISON QUALITY ILLINOIS

F-C-I Polystyrene Capacitors



CAT. A2.3.250
0.25MF 300VWDC
FILM CAPACITORS INC.

- Low Power Factor .02%
- Low Soakage .02%
- Low Temp. Coefficient—100 ppm/°C
- High Insulation Resistance 10¹⁰ ohms/mf
- High Stability

Available in many different types of housings, in ratings from .001 MF up, and 100 volts up.

Excellent delivery on standard and special types.

Capacitors made to your specifications
Write for Catalogue F

film capacitors, inc.

3400 PARK AVENUE, N.Y., N.Y.
Telephone **CY**press 2-5180

Want more information? Use post card on last page.
ELECTRONICS — January, 1954

BACKTALK

(continued)

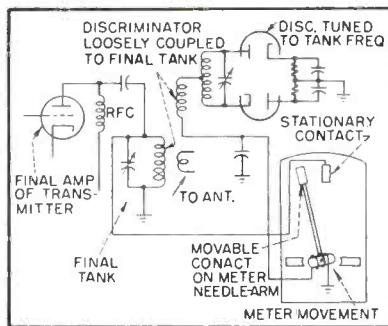

FIG. 4—Electromechanical afc system

tive. This will move the meter needle and contact closer to the stationary contact, thus throwing more capacitance across the tank circuit which tends to offset the drift. A frequency decrease will cause the opposite effect and will balance the tank.

Mixed Feedback

DEAR SIRS:

I WOULD like to comment on the article "Multiple Feedback Audio Amplifier" appearing in *ELECTRONICS* for November 1953, on page 148. First, the statement that a tetrode output stage requires more feedback to equal the distortion performance of a triode stage is not borne out by a study of the curves in the tube manuals or by experience. This, however, is a minor point compared to the other one which is in reference to the plate-to-grid feedback.

It should be noted that plate-to-grid feedback does not reduce the gain of the stage around which it is connected, but rather it reduces the gain of the preceding stage by reducing the load impedance into which it works. This puts serious limitations on the places where such a feedback system may be used.

In the circuit shown in the article, the plate load on the 6AU6 tubes is less than 15,000 ohms if the two sides of the system are balanced. Since at least 15 volts peak are necessary to drive the 1614's, a rather large plate current excursion is required of the 6AU6's. Thus it is quite possible that the feedback adds more distortion than it removes.

As mentioned in Mr. Good's letter

Measurements Corporation

MODEL 59 MEGACYCLE METER



The only grid-dip meter covering the wide range of 2.2 Mc. to 400 Mc.

FREQUENCY CALIBRATION: ±2%

For determining the resonant frequency of tuned circuits, antennas, transmission lines, bypass condensers, chokes, etc. For measuring inductance and capacitance. May also be used as an auxiliary signal generator; for signal tracing and many other applications.

Complete data on request.

MEASUREMENTS CORPORATION

BOONTON NEW JERSEY

F-C-I Teflon Capacitors

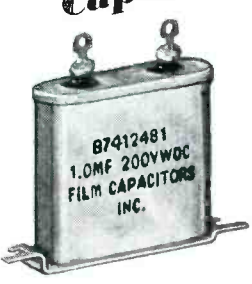

B7412481
1.0MF 200VWDC
FILM CAPACITORS INC.

- Operation to 200° C
- Ultra High IR
- High Stability
- Low Power Factor .02%
- Low Soakage .02%
- Low Temp. Coefficient—50 ppm/°C

Available in many different types of housings, in ratings from .001 MF up, and 100 volts up.

Excellent delivery on standard and special types.

Capacitors made to your specifications
Write for Catalogue F

film capacitors, inc.

3400 PARK AVENUE, N.Y., N.Y.
Telephone **CY**press 2-5180

Want more information? Use post card on last page.

AVAILABLE for IMMEDIATE DELIVERY...

FTL-30A SLOTTED LINE

THE UTMOST IN
PRECISION
... for VHF-UHF
IMPEDANCE
MEASUREMENTS

in the range of 60 to 1000
megacycles per second
Accuracy $\pm 2\%$

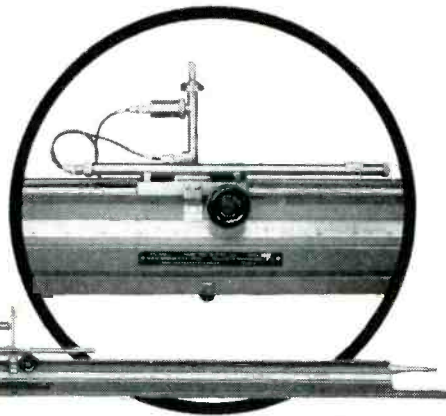

The FTL-30A also covers—with slightly reduced accuracy—the 1000 to 2000 megacycle range. It is a coaxial line 250 centimeters long... having a surge impedance of 51.0 ohms ± 0.5 ohms.

Special design features include: extremely rigid construction... high sensitivity and selectivity due to efficient probe tuning... end connectors adapted to use of Type N connectors... full utility down to 60 megacycles.

For complete details, write for Brochure FTL-30A



Federal Telecommunication Laboratories

A Division of International Telephone and Telegraph Corporation
500 WASHINGTON AVENUE NUTLEY, NEW JERSEY

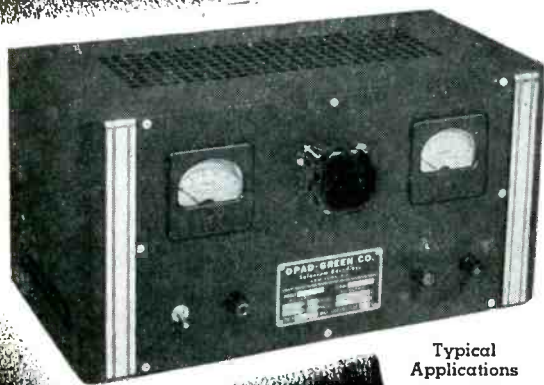

These OPAD-GREEN General Purpose Power Supplies are designed to furnish an adjustable source of unfiltered D.C. from single phase 50 or 60 cycle A.C. power lines. Stepless output control, overcurrent protection, 2% accuracy meters, aging taps and exclusive Poly-Koated Rectifiers are among the many features of these units.

- Typical Applications
- Aircraft Motors
 - Dynamotors & Inverters
 - Relays & Solenoids
 - Battery Charging
 - Electroplating



Opad-Green
COMPANY

For additional information write for Bulletin No. 147

71-2 WARREN STREET, NEW YORK 7, N. Y.

SELENIUM RECTIFIER POWER SUPPLIES

for

Aircraft - Mobile - Marine
Electrical Equipment

D.C. OUTPUT		CATALOG NO.	
VOLTS	AMPERES	115 V.A.C. 60 ~ 18	230 V.A.C. 60 ~ 18
O-6	25.0	K38	—
	50.0	K47	K48
	100.0	K56	K57
O-12	12.5	K65	—
	25.0	K74	K75
	50.0	K83	K84
O-28	10.0	K92	—
	20.0	K101	K102
	40.0	K110	K111

BACKTALK

(continued)

in the *Backtalk* department of the October 1952 issue of *ELECTRONICS*, the coupling between the halves of the output transformer requires that any push-pull feedback from

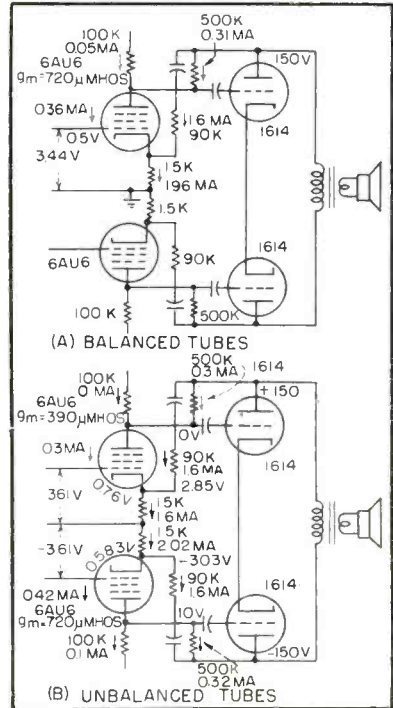

Circuits illustrating W. B. Bernard's letter. Voltages and currents shown are signal components only; in balanced case they are identical in the two halves of the circuit

the output tube plate be very accurately balanced to preserve balanced drive to the two output tubes. This is fairly difficult when the elements of the feedback network are fixed resistors, which are reasonably stable, but when tubes are included as part of the network the problem becomes impossible.

Because the plate signal of an output tube in a push-pull stage is to the first approximation independent of the drive to the output tube, a 45-percent change in the characteristics of one of the 6AU6's will totally cut off the drive to one of the output tubes.

A Kirchhoff's law analysis of one side of the circuit shows that where a 6AU6 g_m of 700 micromhos might give normal operation, a g_m of 400 micromhos will give a zero signal to the grid of the associated output tube, considering that in both cases the other 6AU6 has a g_m of 700 mi-

PROFESSIONAL SERVICES

Consulting—Patents—Design—Development—Measurement

in

Radio, Audio, Industrial Electronic Appliances

ANNIS ELECTRIC RESEARCH LABORATORY, INC.

CONSULTING—RESEARCH—DEVELOPMENT
AND DESIGN OF RADIO AND ELECTRONIC
EQUIPMENT
Antennas, Wave Propagation, Information Storage,
Computers, Impedance Matching and Variable
Speed A-C Motors.
P. O. Box 581 1401½ S. Nell St.
Champaign, Ill. Tel. 6-1708

Professional Assistance . . .
*in solving your most difficult prob-
lems in the specialized field of
electronic devices is offered by
consultants whose cards appear on
this page.*

MAURICE I. PARISIER & CO.

Communications Expert
International Engineering Consulting
RADIO BROADCASTING & COMMUNICATIONS
Planning & Installation Supervision
Communication Equipment for Armed Forces
1475 Broadway New York 36, N.Y. LOngaere 4-5434
Offices: Paris-Buenos Aires — Sao Paulo-Bombay

W. J. BROWN

Registered Prof. Engr. Connecticut, Ohio, England
ELECTRONIC CONTROL SYSTEMS
Consulting — Research — Development
INTERNATIONAL CLIENTELE
71 Gurley Road Stamford, Conn.
Stamford 4-4876

HIGHLAND ENGINEERING CO.

William R. Spittal & Staff
DESIGN, DEVELOPMENT AND MANUFACTURE
OF TRANSFORMERS, CHOKES, ETC.
FOR THE
ELECTRONIC, INDUSTRIAL & ALLIED FIELDS
Main & Urban, Westbury, L. I., N. Y.
WE-7-2983

PICKARD AND BURNS, INC.

Consulting Electronics Engineer
Analysis and Evaluation
of Radio Systems
Research, Development and Production
of Special Electronic Equipment
240 Highland Ave. Needham 94, Mass.

CROSBY LABORATORIES, INC.

Murray G. Crosby & Staff
Radio - Electronic
Research Development & Manufacturing
Communications, FM & TV
Robbins Lane, Hicksville, N. Y.
Hicksville 3-3191

HOGAN LABORATORIES, INC.

John V. L. Hogan, Pres.
Applied Research, Development, Engineering
Est. 1929. Electronics, Optics, Mechanisms, Fac-
simile Communication, Digital Computers (Circle).
Electro-sensitive recording media, Instrumentation.
155 Perry Street, New York 14. CHelsea 2-7855

ALBERT PREISMAN

Consulting Engineer
Television, Pulse Techniques, Video
Amplifiers, Phasing Networks,
Industrial Appliances
Affiliated with
MANAGEMENT-TRAINING ASSOCIATES
3308-14th St., N. W. Washington 10, D. C.

Eldico of New York, Inc.

Pioneers of Television Interference Elimination from
Transmitters, Induction Heaters, Diathermy and
etc.
Donald J. S. Merten & Engineering Staff
44-31 Douglaston Pkwy Douglaston, N. Y.
Bayside 9-8686

INTERFERENCE MEASUREMENT LABORATORY

Interference Study per Government Specifications
Shielded Space for Interference Investigation
Field Surveys for F.C.C. Certification of Induction
and Dielectric Heating Equipment
1844 Utica Avenue Brooklyn 34, New York
Navarre 8-1248

JOSEPH RACKER COMPANY

Radar Consultants & Editors
Technical Manuals
Research and Development
140 Nassau Street, New York 38, N. Y.
Worth 4-1463

ELECTRONIC RESEARCH ASSOCIATES, INC.

"TRANSISTORIZE" YOUR PRODUCT!
Complete Service in consulting, research, devel-
opment, and production on Transistor circuitry,
products, and instrumentation.
715 Main Street North Caldwell, N.J.
Caldwell 6-6729

THE KULJIAN CORPORATION

Consultants • Engineers • Constructors
Electronic Control
Specialists
Utility • Industrial • Chemical
1200 N. Broad St., Phila 21, Pa.

ROTRON RESEARCH CORPORATION

Research and Development
Fluid Dynamics and Heat Transfer.
Exclusively Electronic Applications
Cooling Problems, Heat Exchangers, Fans,
Turbines and Pump Designs
Woodstock, N. Y. Phone 2408

ERCO RADIO LABORATORIES, INC.

Radio Communications Equipment
Engineering - Design - Development - Production
Pioneers in Frequency Shift Telegraph
Garden City • Long Island • New York

Measurements Corporation

Research & Manufacturing Engineers
Harry W. Houck Jerry B. Minter
John M. van Beuren
Specialists in the Design and
Development of Electronic Test Instruments
Boonton, New Jersey

THE TECHNICAL MATERIEL CORPORATION

Communications Consultants
Systems Engineering
General Offices and Laboratory
700 Fenimore Rd., Manaroneck, N. Y.

HARRIS GALLAY

Consultant
Electronic Project Development for Industry
Day, Week and Duration of Project Services
Our Laboratory Facilities Optional
Plymouth 9-4237 60 Perry St., Belleville 9, N. J.

NEW ROCHELLE TOOL CORP.

FOR CERTIFICATION OF INDUCTION
AND DIELECTRIC HEATING EQUIPMENT
IN ACCORDANCE WITH F.C.C. RULINGS
Mobile Test Unit Available Entire U. S.
320 Main St. New Rochelle, New York
Phone NE 2-5555

WHEELER LABORATORIES, INC.

Radio and Electronics
Consulting—Research—Development
R-F Circuits—Lines—Antennas
Microwave Components—Test Equipment
Harold A. Wheeler and Engineering Staff
Great Neck, N. Y. Great Neck 2-7806

HANSON-GORRILL-BRIAN INC.

Products & Mfg. Development
ELECTRICAL - ELECTRONIC
HYDRAULIC - MECHANICAL
One Continental Hill Glen Cove, N. Y.
Glen Cove 4-7300

NIAGARA ELECTRON LABORATORIES

CONSULTATION - DESIGN - CONSTRUCTION
MFG. THE THERMOCAP RELAY
Specializing in solution of problems of electronic
and electro-physical instrumentation for the re-
search of analytical laboratory. Industrial plant
problems also invited.
Andover, New York Cable Address: NIATRONLAB

YARDNEY LABORATORIES, INC.

Research - Design - Development
Electro-Chemical Generators of Energy
105 Chambers Street Worth 2-3534, 35, 36
New York 7, N. Y.

ASCO[®] RELAYS

MAGNETICALLY HELD RELAY?
MECHANICALLY HELD RELAY?



Make It a Mechanically Held Relay IF

- a. The relay must 'stay put' on loss of line voltage, or under low voltage conditions
- b. AC hum cannot be tolerated
- c. Coil loss is undesirable

ASCO Electrically Operated Mechanically Held Relays are laced in either position by sturdy mechanical linkages—no delicate hooks or latches to be damaged. They are operated by a single coil mechanism, positive in each direction.

ASCO Engineers will be glad to help work out your 'relay' requirements and to furnish you with a complete control unit, if desired. ASCO offers 'single source responsibility' for Solenoid Valves and Electromagnetic Controls . . . a responsibility backed by 65 years of work in the design and manufacture of Electromagnetic Controls.

AVAILABILITY
10 amps, up to 12 poles normally open, 12 poles normally closed.
25 amps, up to 6 poles normally open, 6 poles normally closed.
Other ASCO Relays include power, voltage-frequency sensitive, time delay, close differential, reverse current.

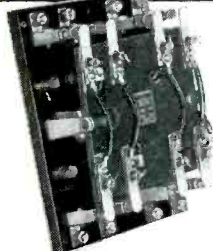

Automatic Switch Co.

355-L LAKESIDE AVENUE · ORANGE, NEW JERSEY

cromhos and that the circuits are otherwise balanced (see the accompanying circuit diagram). While this effect is counteracted to some extent by the increased drive to the 6AU6 grids, because of the overall feedback loop, the effect is emphasized by the lowering of the effective plate load resistance on the weaker tube and the raising of the plate load resistance on the stronger tube. Any stabilizing effect of the unby-passed 6AU6 cathode resistors is minimized by the plate-to-cathode feedback path.

To put it briefly, I am still waiting to see something which is an improvement over a pentode voltage amplifier direct-coupled to a split-load phase inverter driving two 6L6 tetrodes or four 6V6 tetrodes, with about 20 db of feedback from the voice coil tap in use to the cathode of the voltage amplifier. I have tested a number of fancier ones but I think I'll keep on using the ones I have.

W. B. BERNARD
San Diego, California

Fitting Title

DEAR SIR:

IT IS UNUSUAL to find an article in a wholly technical magazine which would be of interest to any *man* in any field.

Such an article is found in your October 1953 issue of *ELECTRONICS*.

I refer specifically to the item by John J. Dougherty, Lt. USN on page 232 of that issue, entitled "Shape Factor as a Criterion of Skirt Selectivity."

WILLIAM R. MURPHY,
Philadelphia, Penna.

(Editor's Note: Normally, we prefer short titles for articles, but we couldn't resist leaving this one just as it came from the author.)

Erratum

ON PAGE 348 of the November issue a statement appeared to the effect that the new Amperex twin tetrode type 6252 "works efficiently with a power output of 112 watts at 600 mc." This rating appears to have been somewhat optimistic; it should have read 12 watts.

SPACE SAVERS FOR
MODERN CIRCUITRY —
MONEY SAVERS FOR
PRODUCTION ECONOMICS —

IN-RES-CO TYPE IR WIRE WOUND RESISTORS

The practical, low cost solution for circuit designers striving for the sub-miniature. Type IR units offer precision resistance values capable of retaining stability through long periods of continuous or intermittent service. Type IR resistors are available at prices based on mass production methods of manufacture. Wound to a tolerance of $\pm 1\%$, they are permanently accurate. Conservative ratings allow ample safety margin in all classes of service. Special Bakelite forms eliminate shrinking, swelling and temperature effects. IN-RES-CO moisture and fungus proof coating offers absolute protection against climatic extremes. Specify IR Type resistors for all applications where precision performance and limited space are important determining factors.



INSTRUMENT RESISTORS CO.

COMMERCE AVENUE



UNION NEW JERSEY

APPLICATION-DESIGNED RESISTORS FOR ELECTRONICS AND INSTRUMENTATION

WRITE FOR NEW RESISTOR HANDBOOK — Contains complete data and recommended applications for resistors for every purpose.



CONTACTS

FOR THE FIELD OF ELECTRONICS

ELECTRICAL COILS

Bobbin, spool, form, layer, interleaved, interwoven types. Made of any material, any finish, for any application.

Send blue-prints and specifications for prompt quotation.



THE FIVE STAR COMPANY

West Main Street
Plantsville, Conn.

FM MODULATION METER

Measures maximum modulation deviation on mobile-system FM transmitters, all frequencies, 25 to 200 MC. Price \$240.00.

LAMPKIN LABORATORIES, INC.

BRADENTON, FLORIDA

One inexpensive modern device . . .

can frequently help speed up operation and maintenance or production.

One product advertised in the "Contacts" Section may be the answer to your problem . . . a real money-saver.

To be informed—and reminded—on modern aids to economical operation, maintenance and production, check "Contacts" advertising regularly . . . every issue.

Auricon Hollywood

16mm SOUND-ON-FILM EQUIPMENT FOR TELEVISION NEWSREELS, TV FILM INSERTS AND KINESCOPE RECORDINGS . . . SOLD WITH A 30-DAY MONEY-BACK GUARANTEE. YOU MUST BE SATISFIED!

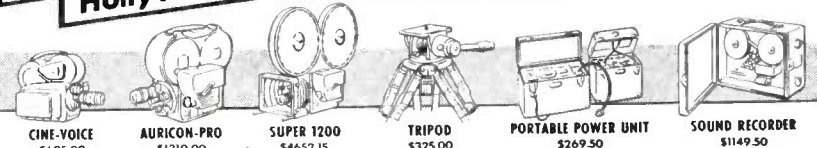

CINE-VOICE
\$695.00

AURICON-PRO
\$1310.00

SUPER 1200
\$4652.15

TRIPOD
\$325.00

PORTABLE POWER UNIT
\$269.50

SOUND RECORDER
\$1149.50

WRITE FOR FREE ILLUSTRATED INFORMATION

BERNDT-BACH, Inc.
7373 Beverly Blvd., Los Angeles 36, Calif.

MANUFACTURERS OF SOUND-ON-FILM RECORDING EQUIPMENT SINCE 1931

Have you problems in **Metal to Glass Seals?**

NAME IT . . . WE'LL MAKE IT!

TERMINALS
HEADERS

END SEALS . . . SPECIAL ITEMS

QUALITY PRODUCTS CO.

387 Charles St., Providence, R. I.



FLUXES
SODERING
BRAZING & WELDING
L. B. ALLEN CO. INC.

Chicago 31, Ill.

6751 BRYN MAWR AVE.

HIGH VOLTAGE POWER SUPPLIES



Many standard models available — fast deliveries. With or without built in kilovoltmeters. Regulated or unregulated types available. Prompt quotations on your special requirements.

SEND FOR CATALOGUE "E"

PRECISE MEASUREMENTS CO.
942 Kings Highway, Brooklyn 23, New York
Phone ES 5-9435

EISLER MANUFACTURES COMPLETE EQUIPMENT

WELDERS FOR SPOT & WIRE BUTT
RADIO, TV TUBE EQUIPMENT & REPAIR UNITS
INCANDESCENT, FLUORESCENT MFG. EQUIPMENT
NEON SIGN MAKERS EQUIPMENT, GLASS LATHES
ELECTRONIC EQUIPMENT, VACUUM PUMPS, Etc.
Wet Glass SLICING & CUTTING MACHINES for Lab Use
TRANSFORMERS, SPECIAL & STANDARD TYPES

EISLER ENGINEERING CO., INC.

751 So. 13th St.

Newark 3, N. J.

Shorted Turn Indicator

Sensitive, rugged, non-shocking
for unmounted coils; \$150. f.o.b.
HUNTINGTON BEACH, CALIF.

KARTRON

This CONTACTS Section

supplements other advertising in this issue with these additional announcements of products essential to efficient and economical production and maintenance. Make a habit of checking this page, each issue.

REX RHEOSTAT CO.

BALDWIN, L. J., N. Y.

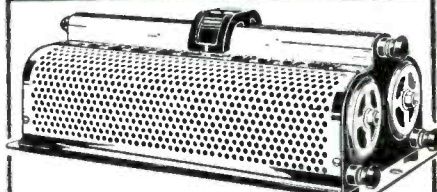

NEW REX DOUBLE RHEOSTATS

and RESISTORS UP TO 2000 WATT.
WRITE FOR NEW CATALOG NO. 3

REPLIES (Box No.): Address to office nearest you
 NEW YORK: 330 W. 32nd St. (36)
 CHICAGO: 520 N. Michigan Ave. (11)
 SAN FRANCISCO: 68 Post St. (4)

POSITIONS VACANT

PHYSICIST—SPECIALIZING in antenna design and analysis. Writing ability desirable. Permanent position in excellent location. Advancement commensurate with ability and results. State qualifications, salary desired, and availability in first letter. Telrex, Inc., Box 879, Asbury Park, New Jersey.

ENGINEER OR Physicist for Instrumentation on experimental projects involving measurement of dynamic and transient phenomena. Good knowledge of theory of instruments and three years of instrument experience required. Some military work (U. S. Citizens only.) Mobility handicaps acceptable. Write Engineering Mechanics Department, Southwest Research Institute, P. O. Box 2296, San Antonio, Texas.

A **RESEARCH Scientist**, Canadian citizen or British Subject, is required for a Laboratory in Toronto, Ontario, engaged in voice communications. Audiology Acoustics research, M.A., M.Sc. or Ph.D. in Speech, Speech Science and Psychology with experience and training in Speech, Audiology, Acoustics and Experimental Psychology is required. Salary to be commensurate with Qualifications, experience and ability. Replies should refer to competition 53-DRML-5 and should be addressed to P. O. Box 62, Postal Station "K" Toronto, Ontario.

TRANSFORMER PLANT or Production Manager, N. Y. Metropolitan area. An excellent opportunity for a man familiar with transformer winding and manufacture with a growing company of approx. 35 people. P-1093, Electronics.

SELLING OPPORTUNITIES OFFERED

MANUFACTURERS' REPRESENTATIVES wanted by young progressive component manufacturer (toroidal transformers and filters). Write stating present line and territory. RW-1046, Electronics.

MANUFACTURER OF Graphite Interior Cathode-Ray Tube Coatings wants representative now regularly calling on tube manufacturers to handle these products as sideline. RW-1029, Electronics.

POSITIONS WANTED

ELECTRONICS PROJECT Engineer; BEE, MEE, BBA; 10 years comprehensive experience planning, development, application electronic automatic control systems involving computers, data handling, processing, displays; creative and administrative ability; seeks non-defense opportunity. PW-1038, Electronics.

M.S. IN Electronics, microwave and computer experience, seeks non-military sales, applications, or production engineering position. PW-1021, Electronics.

ARMY OFFICER, release in Feb. 1954, seeking position as engineering rep., sales eng., etc. Foreign assignment preferred. 5 years military and civilian experience in electronics, including supervision. PW-1010, Electronics.

ELECTRONIC ENGINEER, BEE, MSEE. Single. Age 30. Looking for responsible position in R & D or administrative engineering. Five years experience cover test equipment, microwave measurements, vhf transmitters, contract monitoring etc. PW-1006, Electronics.

ELECTRONIC ENGINEER: Ten years experience with servo mechanisms, analogue computers, automatic test equipment, and general electronic applications. Broad knowledge of guided missile systems. Desires a semi-administrative or supervisory position with a progressive organization. PW-9878, Electronics.

PLANTS AND PROPERTIES

INDUSTRIAL BUILDING, Gastonia, N. C.—52,500 sq. ft., mill construction, wired, sprinklered, steam heat, rail siding. For lease. Write Gastonia Industrial Diversification Commission, Box 823-E, Gastonia, N. C.

TUTORING

PRIVATE TUTORING: Technical upgrading for technicians, engineering assistants, junior and operating engineers. New methods, simplified systems, fast arithmetic routines, economical cost. "Superior Procedures" Douglas Matthews, 72 Vendola Drive, San Rafael, Calif.

**OFFICIAL PROPOSAL
 ADVERTISEMENT—PAGE 408**

SEARCHLIGHT SECTION

(Classified Advertising)

**EMPLOYMENT: "OPPORTUNITIES" EQUIPMENT
 BUSINESS: USED OR RESALE**

ENGINEERS

LEAR, INCORPORATED, leading designers and producers of high precision electrical, electronic and mechanical aircraft accessory devices and instruments

Seeks exceptional men trained in these aviation related engineering fields . . .

- Missile Control
- Gyro Instruments
- Autopilots
- Servomechanisms
- Electrical Design
- Mechanical Design
- Electronic Circuitry

For responsible development and design engineering positions in our Grand Rapids Division. Senior and junior level men can utilize their maximum skills and work with recognized specialists in highly advanced engineering fields.



Write to:

**Personnel Manager G.R. Division
 LEAR, INCORPORATED
 110 IONIA N.W.
 GRAND RAPIDS 2, MICH.**

**ELECTRONIC DEVELOPMENT
 IS MOVING WEST***

ENGINEERS—Take this opportunity to join the staff of a Western electronics pioneer & leader.

Creative ability finds expression with us!

- **RESEARCH** Broad project variety in special receivers, transmitters & other devices.
- **DEVELOPMENT** Advanced design techniques.
- **PRODUCTION**

* Figures show 20% U. S. activity in So. California

Relocation expenses—excellent working conditions—Central location. Scheduled reviews & advances. Fine insurance plan. Move should not disturb urgent military projects.

Send complete resume with income history & requirements to engineering employment mgr.

Hoffman LABORATORIES, Inc.

3761 SO. HILL ST. LOS ANGELES 7, CALIF.
 (A Subsidiary of Hoffman Radio Corp.)

6 YG. ENGINEERS
 Electrical or Electronic Educ.

STARTING RANGE \$450 TO \$600
 Non-defense-Very fine aggressive co. needs 6 yg. men with executive potential

ASK FOR RAY EDWARDS

O'SHEA EMPLOYMENT SYSTEM
 64 E. Jackson, Chgo., Ill. Tel. WAbash 2-1884

WANT MORE BUSINESS?

Established technical sales group has capacity for additional items in electronic or electro-mechanical component field. Products need not be established in territory but must have high quality. Company brochure available for your inspection.

WEIGHTMAN & ASSOCIATES

1405 W. Magnolia Blvd. Burbank, California

**SOUTHERN CALIFORNIA
 MANUFACTURERS' REPRESENTATIVE**
 (Engineering and Sales)

Available covering Electronic & Aircraft Industries desires an Electronic Parts or Components Line.

RA-9985, Electronics
 1111 Wilshire Blvd., Los Angeles 17, Calif.

MANUFACTURERS

Aggressive sales organization in Middle Atlantic States can provide representation for additional electronic or electrical equipment or parts.

MACLEN CORPORATION

Manufacturers Representative
 3226 Ninth Street, N.E. Washington 17, D. C.



Help Build Tomorrow's World TODAY!

GOODYEAR AIRCRAFT CORPORATION, pioneer and leader in lighter-than-air craft, offers you a new employment opportunity with a well-established and fast-growing company where "careers are planned."

DESIGN AND DEVELOPMENT engineering opportunities are available for capable and imaginative men and women in the field of airships, aircraft and aircraft components.

RESEARCH AND DEVELOPMENT projects — missiles, electric and electronics systems, servomechanisms, new special devices, fiber resin laminates — all present an urgent need for engineers with fresh talent, aptitude and ambition.

POSITIONS ARE OPEN at several levels in various fields with salaries based on education, ability and experience.

Physicists	Civil engineers
Mechanical engineers	Electrical engineers
Aeronautical engineers	Technical editors
Welding engineers	Technical illustrators

AKRON, THE HOME OF GOODYEAR AIRCRAFT, is located in the lake region of northeastern Ohio. Cosmopolitan living, year-round sports and recreation, cultural and educational advantages make this thriving city an ideal spot for a pleasant home.

YES, BUILD YOUR FUTURE — TODAY! Write, giving your qualifications, or requesting an application form.

C. G. Jones, Salary Personnel Department

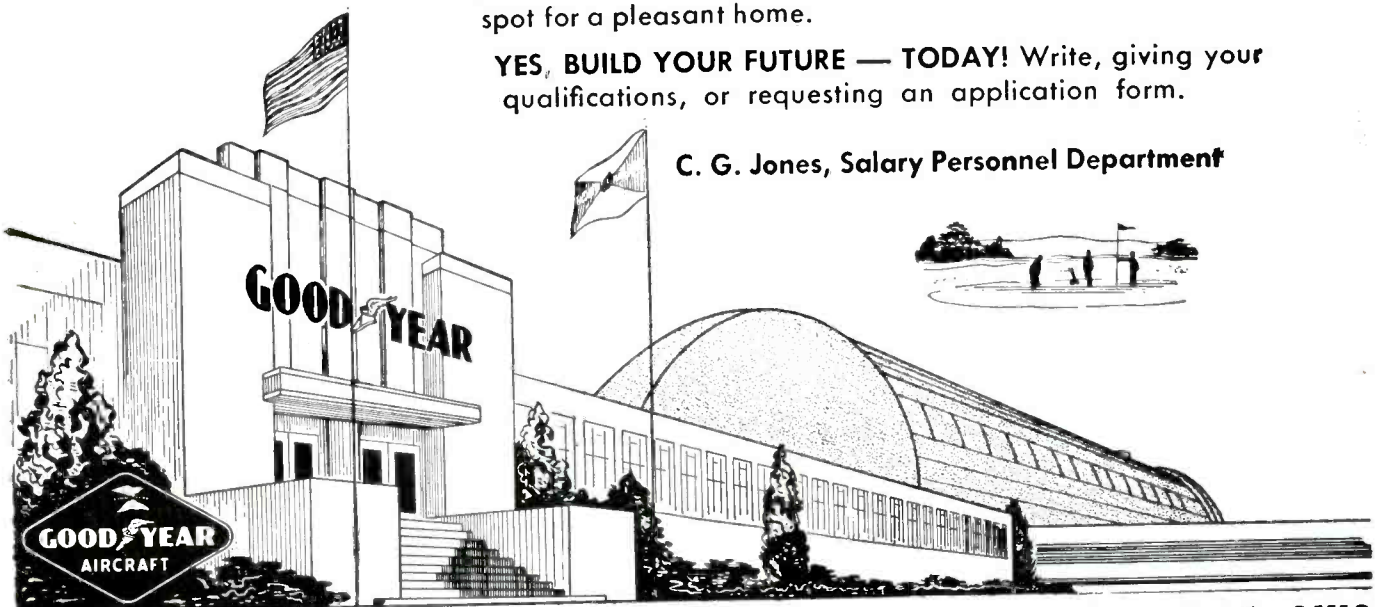

GOODYEAR AIRCRAFT CORPORATION, 1210 MASSILLON RD., AKRON 15, OHIO

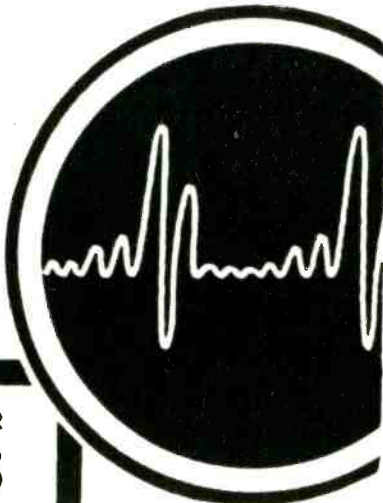
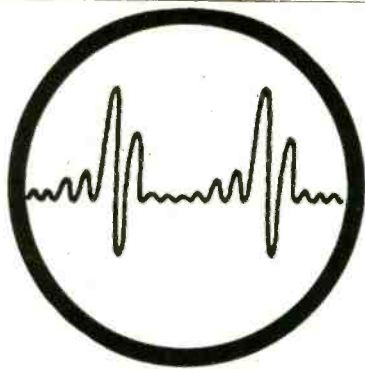

SPECIAL OPPORTUNITIES FOR SENIOR ENGINEERS

Convair in beautiful, sunny San Diego invites you to join an "engineers" engineering department. Interesting, challenging, essential long-range projects in commercial aircraft, military aircraft, missiles, engineering research and electronics development. Positions open in these specialized fields:

- Electrical Design
- Mechanical Design
- Structural Design
- Structures
- Weights
- Servo-mechanisms
- Aerodynamics
- Thermodynamics
- Operation Analysis
- System Analysis

Generous travel allowances to those accepted. For free brochure, write Mr. H. T. Brooks, Engineering Dept. 900

CONVAIR
IN BEAUTIFUL
SAN DIEGO

3302 PACIFIC HIWAY
SAN DIEGO 12, CALIFORNIA

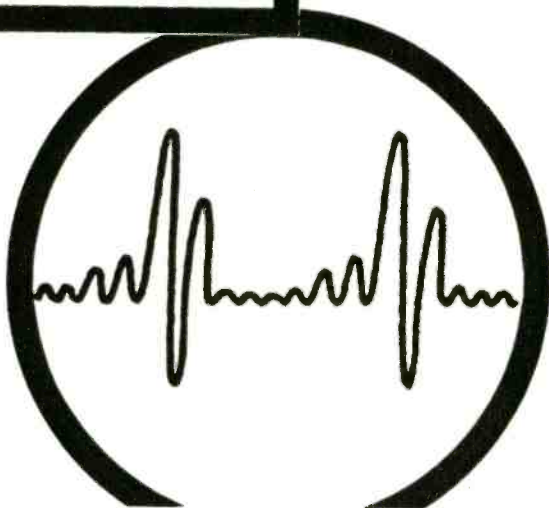

OFFICIAL PROPOSALS

Bids: January 7, 1954

OHIO TURNPIKE COMMISSION
139 East Gay Street
Columbus 15, Ohio

Contracts RC-1A and RC-1B

Sealed Proposals will be received by the Ohio Turnpike Commission for the designing, furnishing, installation, and maintenance for a period of seven years, of a radio-communication system, consisting essentially of nine microwave communication stations, eight very-high-frequency communication base stations, seventeen very-high-frequency communication fixed stations, and approximately seventy-five very-high-frequency mobile stations, for Ohio Turnpike Project No. 1.

Contract RC-1A provides for the sale of the completed radio-communication system to the Ohio Turnpike Commission and for maintenance services for a period of seven years.

Contract RC-1B provides for the rental of the completed radio-communication system to the Ohio Turnpike Commission for a fixed monthly rental and for maintenance services, all for a period of seven years.

Copies of the Special Provisions and accompanying profiles, drawings, maps, and copies of the General Specifications for Contracts RC-1A and RC-1B will be available on or about November 6, 1953, and thereafter (and in any event no later than November 10, 1953) for public inspection or purchase at the office of the Chief Engineer, Ohio Turnpike Commission, 139 East Gay Street, Columbus 15, Ohio. These documents may be purchased from said Chief Engineer for the following sums per set, which sums are non-returnable:

- General Specifications for Ohio Turnpike Project No. 1..... \$5.00
- Proposal and Affidavits for Contracts RC-1A and RC-1B, and attached Notice to Bidders, Instructions to Bidders, Special Provisions applying to said Contracts, form of Contract, form of Performance Bond, form of Maintenance Bond, and Schedule of Wage Rates for Contract RC-1A..... \$5.00
- Profiles, drawings, and maps..... \$2.00

All Proposals must be on the form prescribed by the Commission, must be accompanied by the required supporting technical data, and must comply with the terms and conditions set forth in the Contract Documents.

Each Proposal must be accompanied by a Proposal Guaranty in the form of a certified check or checks on a solvent bank or banks, payable to the order of the Ohio Turnpike Commission, in the amount of \$40,000.00.

If a Bidder bids on both Contracts RC-1A and RC-1B, one certified check in the amount of \$40,000.00 will suffice. The Commission may at any time cash any such check. Each such check, or the proceeds thereof, will be held by the Commission as a guaranty that, if any Proposal guaranteed thereby is accepted, a Contract will be entered into and the performance of the Proposal secured. Each such check, or the proceeds thereof, will be returned or forfeited as provided in G-3.03 and G-3.06 of the General Specifications.

All bids must be received on or before 10:00 A.M., Eastern Standard Time, January 7, 1954, in the office of the Ohio Turnpike Commission, 139 East Gay Street, Columbus 15, Ohio. At said hour, all Proposals will be publicly opened and read at said office.

Contracts RC-1A and RC-1B are alternate contracts and only one will be awarded. The award of the Contract, if any award be made, will be to the lowest and best Bidder whose Proposal complies with all the prescribed requirements. In determining which bid is lowest and best, especially as such determination involves any decision as between awarding Contract RC-1A and awarding Contract RC-1B, the Commission may consider the possible benefits and detriments of ownership of equipment versus the rental thereof. The Commission reserves the right to reject any or all Proposals and to waive technicalities.

OHIO TURNPIKE COMMISSION

**"Opportunity" Advertising:
Think
"SEARCHLIGHT"
First**

ENGINEERS:

**DOES YOUR
PRESENT JOB
GIVE YOU**

ALL THESE

RCA

CAREER

ADVANTAGES?

**POSITIONS NOW OPEN FOR
SENIOR DEVELOPMENT
AND DESIGN ENGINEERS:**

- ✓ ELECTRONIC . . .
- ✓ COMMUNICATIONS . . .
- ✓ MECHANICAL . . .
- ✓ COMPUTER . . .
- ✓ ELECTRON TUBE . . .

**PERSONAL INTERVIEWS ARRANGED
IN YOUR CITY.** A copy of our booklet
"Challenge and Opportunity," describing the role of the
engineer in RCA, will be mailed upon request. Please
send a complete resume of your education and
experience to:

MR. JOHN R. WELD,
Employment Manager,
Dept. 300A
Radio Corporation of America
30 Rockefeller Plaza
New York 20, N. Y.

CHECK SHEET

Yes	No	
<input type="checkbox"/>	<input type="checkbox"/>	PROFESSIONAL RECOGNITION AND PRESTIGE?
<input type="checkbox"/>	<input type="checkbox"/>	ADVANCEMENT IN STATUS?
<input type="checkbox"/>	<input type="checkbox"/>	SECURITY AND STABILITY?
<input type="checkbox"/>	<input type="checkbox"/>	CHALLENGE AND OPPORTUNITY?
<input type="checkbox"/>	<input type="checkbox"/>	HIGH SALARY SCALE AND OPPORTUNITIES FOR PROMOTION?
<input type="checkbox"/>	<input type="checkbox"/>	EXCELLENT SUBURBAN HOUSING AT REASONABLE COST?
<input type="checkbox"/>	<input type="checkbox"/>	FACILITIES FOR PROFESSIONAL ADVANCEMENT?
<input type="checkbox"/>	<input type="checkbox"/>	UNEXCELLED TECHNICAL AND LABORATORY FACILITIES?
<input type="checkbox"/>	<input type="checkbox"/>	ASSOCIATION WITH TOP SCIENTISTS?
<input type="checkbox"/>	<input type="checkbox"/>	TUITION REFUND PLAN FOR ADVANCED STUDY?
<input type="checkbox"/>	<input type="checkbox"/>	MILITARY OR COMMERCIAL OPPORTUNITY?
<input type="checkbox"/>	<input type="checkbox"/>	MODERATE COST OF LIVING?
<input type="checkbox"/>	<input type="checkbox"/>	MODERN RETIREMENT PLAN?
<input type="checkbox"/>	<input type="checkbox"/>	COMPANY-PAID LIFE INSURANCE?
<input type="checkbox"/>	<input type="checkbox"/>	COMPANY-PAID LIBERAL HOSPITAL, SURGICAL AND DISABILITY PLAN (FAMILY BENEFITS)?
<input type="checkbox"/>	<input type="checkbox"/>	LIBERAL VACATION PLAN?
<input type="checkbox"/>	<input type="checkbox"/>	LIBERAL HOLIDAY SCHEDULE?
<input type="checkbox"/>	<input type="checkbox"/>	PROFESSIONAL STATUS AND UTILIZATION OF YOUR EDUCATION AND EXPERIENCE?



RADIO CORPORATION of AMERICA

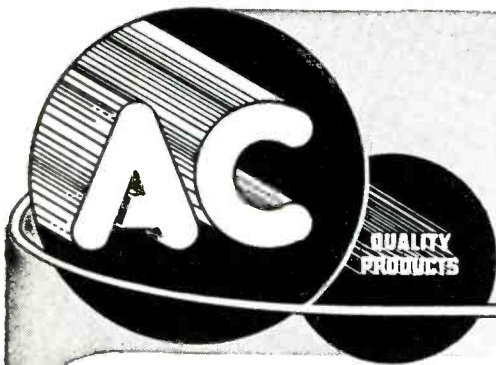

ENGINEERS

**ELECTRONIC
SERVO**

DESIGNERS

**ELECTRO—
MECHANICAL**

**"AC" OFFERS
A Challenge to Men
of Resourcefulness**

FIELD ENGINEERS

• For recent college graduates, here are positions with a challenge —

ASSIGNMENT — you will assist in the installation, operation, and maintenance of our equipment at aircraft plants and Air Force bases. The work will include liaison between AC and the customer, training of customer personnel, analysis of problems, and recommendations for improvements. Many of these outstanding openings are one-year overseas assignments.

YOUR BACKGROUND — your educational background can be in any of the fields of AE, EE, ME, Physics, or equivalent. To be successful in these positions you should have a definite interest in people as individuals and be willing to relocate to field assignments. Single men given preference.

TRAINING — our theoretical and applied in-plant training (here in Milwaukee) will prepare you for these assignments.

In addition to your salary, you will receive a field allowance — and a substantial bonus if selected for overseas assignment . . . if you're looking for an opportunity with a "present" and a future write us for further facts.

We need men of high caliber, experienced in the field of airborne automatic electro-mechanical control equipment. You will be engaged in the manufacture and development of highly complex equipment of the most advanced type in a steadily expanding division of our company—a division with 20 years of successful operation in the precision instrument field. We offer many advantages to those who join our organization—**SALARY** increases are based on merit and initiative . . . **two weeks VACATION** with pay . . . **HOSPITALIZATION BENEFITS** . . . **LIVING and RECREATIONAL FACILITIES** are among the best anywhere along Lake Michigan . . . **POSITIONS ARE PERMANENT** due to long-range manufacturing and development programs . . . in short—here at our "AC" Milwaukee plant you get small company advancement opportunities with large company employe benefits . . . **EXPENSES** incident to interviews are all absorbed by us.

For less experienced engineering graduates, we have a Junior Engineer Training Program which makes it possible for you to become acquainted with all phases of our company . . . you can also take advantage of educational opportunities for advanced degrees at Marquette University and the University of Wisconsin.

We answer ALL inquiries . . . write or apply

AC SPARK PLUG DIVISION
GENERAL MOTORS CORPORATION
1925 E. KENILWORTH PLACE • MILWAUKEE 2, WISCONSIN

Why?

ELECTRONICS ENG.

PHYSICISTS

MECHANICAL ENG.

**Here Is Why Bendix Radio Is
The Place For YOU To Work**

**Challenging work in
The development of:**

- Radar (Airborne and Ground)
- Auto Radio and Test Equip.
- Airborne & Mobile Comm. Equip.
- Missile Guidance Systems
- Computer Applications
- Research & Development
(Incl. Transistors and Printed Circuitry)



Excellent salaries.

Semi-annual work reviews with advancement on merit.

Modern, air-conditioned plant located in beautiful suburban area with ample housing, good schools, attractive shopping centers, major league sports.

Numerous employee benefits.

Call, wire or write Mr. L. H. Noggle, Dept. J

Bendix Radio

DIVISION OF BENDIX AVIATION CORPORATION
BALTIMORE-4, MD. Phone VALley 3-2200

ELECTRONIC ENGINEERS & PHYSICISTS

Our expanding staff assures permanent positions and excellent opportunities for personal and professional growth in

RESEARCH AND DEVELOPMENT

- Radar & Radio Communication
- Electronic Instrumentation
- Analog & Digital Computers
- Guided Missiles
- Servomechanisms
- Electric Machines & Devices

Send resume to:

Mr. J. A. Metzger

ARMOUR RESEARCH FOUNDATION
of Illinois Institute of Technology
10 W. 35th Street
Chicago 16, Illinois



are you an engineer at this crossroads?

Never in the history of the electronics industry has it been more important for engineers to choose the right path for their careers to follow.

Everyone has done a lot of military work... but now the industry must find new markets in the industrial field!

As a leader in the production of industrial electronic equipment, Westinghouse has the necessary sales, distribution and field engineers organized to enter these new markets. We need research, design and development men to turn out the products. Now is the time to get into our organization, so that you'll be in on the ground floor as the industrial field expands!

Investigate the real future! Salaries at Westinghouse are open, commensurate with experience and ability. In addition to the usual employee benefits, we offer a stimulating patent-award plan and excellent opportunities for advanced study and degrees. Write for information today!

To apply send resume of education and experience to
R. M. Swisher, Jr.
Employment Supervisor, Dept. J.7.
Westinghouse Electric Corporation
109 West Lombard Street
Baltimore 1, Maryland

NUCLEAR REACTOR CONTROL ENGINEERS

Duties: Design, development, and application of electronic circuitry including vacuum tubes and magnetic amplifiers as applied to the control of nuclear reactors.

Requirements: Three or more years experience and a B.S. degree in Electrical Engineering or in Physics.

SENIOR RADAR ENGINEERS

Duties: Applied research, development, and design of advanced radar, fire control and missile guidance equipment. Openings exist in the fields of local oscillators and associated circuitry, indicators, feed-back problems (closed-loop electronic circuits), pulsed circuits, video, simulators, i.f. strips, and in analysis of complex radar.

Requirements: Three or more years experience and a B. S. degree in Electrical Engineering or in Physics.

SENIOR COMMUNICATIONS ENGINEERS

Duties: Applied research, development, and design of advanced communications equipment and systems. Openings exist in the fields of automatic transmitters and communications circuitry.

Requirements: Three or more years experience and a B. S. degree in Electrical Engineering or in Physics.

TRANSFORMER DESIGN ENGINEER

Duties: The applied research, development and design of audio transformers, modulation transformers and reactors, electric-wave filters, iron-core radio frequency transformers, radio frequency chokes, etc.

Requirements: Three or more years experience and a B. S. degree in Electrical Engineering or in Physics.

OR if you have experience in the fields of antennas, rf plumbing, magnetic amplifiers, technical writing, or in high frequency heating design and application, please apply.



Westinghouse

ELECTRONICS DIVISION

BALTIMORE, MARYLAND

SENIOR DEVELOPMENT ENGINEERS

Have You the LONG-RANGE VIEW?

We Can Offer: challenging and satisfying work, in the best of surroundings; quick recognition of ability; excellent salary and generous company benefits; a 25 year record of stability of employment; a country location on our own private airport; attractive neighboring communities in a hilly, lake region, readily accessible to New York City.

You Should Have: sound basic training and about 10 years' development experience in radio communication, navigation or allied fields; fertility of ideas and ability to translate them into practical forms embodying sound mechanical design; an appreciation of the importance of simplicity; and a desire to perform creative development work in a small engineering group.

Write or phone

Vice President, Research & Development

AIRCRAFT RADIO CORPORATION

BOONTON



New Jersey

senior engineers...

in whose hands is your future?

MELPAR has an unparalleled opportunity to offer you—rapid progress and sound future—varied project assignments under the guidance of nationally known engineers. In addition to numerous and challenging projects—both military and industrial—Melpar is Research Headquarters for the Westinghouse Air Brake Company and its affiliates.

If you can qualify—high achievement, financial security and gracious living await you here! Melpar is located in the beautiful Virginia suburbs, just a few minutes from the Nation's Capital. A grand place to build a grand future! Let's discuss it all in detail.

THREE TO FIVE YEARS
EXPERIENCE IS DESIRED
IN ONE OR MORE OF
THESE OR ALLIED FIELDS

Radar • Sonar • Fire Control Systems • Micro-Wave Techniques • Pulse Circuits • Servo Mechanisms • Electro-Mechanical Design • Speech Compression • Small Mechanisms • Antennae Design • Flight Simulators

FOR PERSONAL INTERVIEW

in your area, write Personnel Director, Dept. E-154

melpar
INCORPORATED

440 SWANN AVENUE, ALEXANDRIA, VIRGINIA

THE RESEARCH LABORATORY OF WESTINGHOUSE AIR BRAKE CO. AND ITS SUBSIDIARIES

ELECTRONIC ENGINEERS

Motorola research laboratories, located in the healthful climate of Arizona's Valley of the Sun, has several openings for experienced engineers in the following fields.

VHF, UHF and Microwave Systems, Components, and Circuitry.

Antennas, Waveguides and Cavity Oscillators.

Radars, Beacons, Missile Guidance, and Communications.

Mechanical Design of Missile-borne and Vehicular Equipment.

Desire men with B.S. degree or above. Salary commensurate with education and experience. Free health, accident and free hospitalization. Profit sharing and many other employee benefits. Ideal working conditions, facilities now being expanded. Permanent positions. Plenty of reasonably priced housing, good schools, mild and sunny climate.

Our representatives will be in New York within the next month for interviews. Write giving details, so appointment can be arranged.

MOTOROLA RESEARCH LABORATORY

Attn. J. A. Chambers, Mgr.

3102 NORTH 56TH STREET

PHOENIX, ARIZONA

Here are 5 reasons why you will want to come with us if you are a . . .

mechanical engineer

mechanical designer

electrical engineer

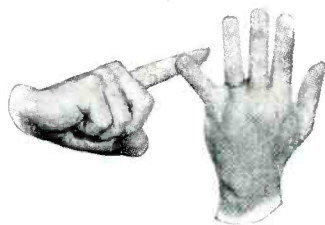

1. You can get in "on the ground floor" in the field of electronic computers and associated equipment for use in business machines. This means excellent opportunity for advancement.
2. You can plan your future with a long-established, highly successful Company.
3. You will receive a good salary, plus substantial "fringe" benefits.
4. You and your family will enjoy Dayton . . . a clean, progressive city with outstanding school facilities.
5. You will find NCR a friendly place to work, with employee morale at a high level.

Act at once. Write today to Employment Manager, Department A, describing your education and experience.

THE NATIONAL CASH REGISTER COMPANY, Dayton 9, Ohio

Bendix Aviation Corporation

● YORK Division

This NEW division of our nationally-famous corporation has openings for

**ENGINEERS
PHYSICISTS**

Top-flight men in advanced fields of electronic research, development and product engineering are needed for challenging work under ideal conditions in our new, modern plant.

You benefit at Bendix York from our location in the heart of a beautiful suburban area, from high wages, paid vacations and holidays . . . and excellent opportunities for advancement.

Openings at all levels.

Write, Wire or Phone
Department Y-1



**AVIATION CORPORATION
YORK DIVISION**

Phone: York 5521 York, Penna.

**Stability and opportunity for
ELECTRONIC ENGINEERS
at the "Laboratory in the Sky"**

One of America's leading centers of long-range radio and electronic developments offers outstanding opportunities for accomplishment, advancement and stability. Write for booklet describing projects, facilities and employee benefits.

INTERESTING ASSIGNMENTS IN:

- Microwave Links • Pulse Networks • Radar
- Direction Finders • Air Navigation Systems
- Television Transmitters and Studio Equipment
- Antennas • Computers • Guided Missiles
- Telephone and Wire Transmission Systems
- Microwave and Gas Discharge Tubes • Dielectrics

MAIL THIS COUPON TODAY

*Federal
Telecommunication
Laboratories*

A Division of International Telephone
and Telegraph Corporation



Federal Telecommunication Laboratories
500 Washington Ave., Nutley, N. J.
Please send me a copy of "Your future is with FTL."

Name _____
Address _____
City _____ Zone _____ State _____

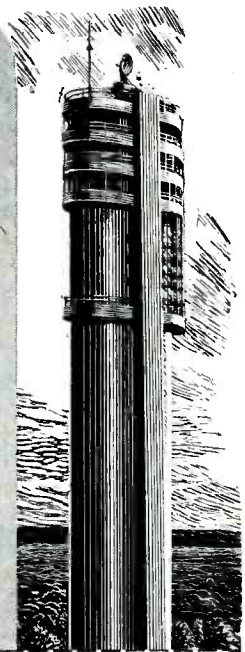

Electronic Research Opportunities

The Cook Research Laboratories, division of the Cook Electric Company, one of the nation's foremost research organizations requires the services of several outstanding scientists. Positions are permanent:

STAFF ENGINEERS

- ELECTRONICS •
- MECHANICS •

Openings also exist for top level personnel in the following fields:

RADAR & PULSE SYSTEMS

(VHF-UHF Development Experience)

SERVO

(Hydraulic Background)

AERODYNAMICS AERO DESIGN

Excellent Starting Salaries
Ideal Working Conditions

A Technical Turnover of Less Than 1/6 the National Average

- A staff composed of a group of engineers and scientists eminently qualified in their respective fields, and with whom you would be proud to be associated.

Contact or write Mr. D. M. Halliday

COOK RESEARCH LABORATORIES
8100 N. Monticello Ave.
Skokie, Illinois

COOK ELECTRIC CO.

2700 N. Southport Chicago, Ill.
(Electrical and mechanical engineering and manufacturing since 1897)

ENGINEERS

SYSTEMS
RADAR
SERVO
COMPUTER

BACKGROUND: Responsible positions open for top level development and project engineers with practical and research experience in:

Advanced Electronic Circuits and Systems
Microwave Radar
Microwave Receivers and Transmitters



Requirements emphasize advanced analytical and/or management experience on highly complex electronic and electro-mechanical systems.

Kindly send resume and salary requirements to

The W.L. MAXSON Corp.
460 W. 34th ST., NEW YORK 1, N.Y.



IMAGINATION

Got more than your share? Like to have the freedom to use it, with commensurate recognition? Then, you've come to the right ad!

That is, if you're an electronic or mechanical engineer with practical experience in the electronic industry.

We need engineers with imagination. We're growing and going . . . you're just in time to go with us. You'll enjoy the job plus the advantage of pleasant living conditions in a large, modern city . . . without the disadvantage of big city pressure.

The man to contact is Arthur E. Harrison, Vice-President of Engineering. The time is now! You'll never regret it!

wilcox

Aviation Communications and Navigation
Fourteenth & Chestnut,
Kansas City 27, Mo.

VITRO CORP. of AMERICA ENGINEERS

Senior Staff

Career Opportunities
with

Established Engineering Organization

PRODUCT ENGINEERING
SYSTEMS DEVELOPMENT
SYSTEMS ENGINEERING
ENGINEERING STUDIES
MECHANICAL DESIGN

GUIDED MISSILES RADAR FIRE CONTROL
UNDERWATER ORDNANCE SYSTEMS

Suburban location adjacent to Washington, D. C.
Affords pleasant living conditions
Accessible to three Universities offering graduate training

Please address inquiries to

Personnel Department
Silver Spring Laboratory

VITRO CORP. OF AMERICA

962 WAYNE AVE.

SILVER SPRING, MD.

Executive Offices—233 Broadway, New York, N. Y.

CAREER OPPORTUNITIES *for* ENGINEERS

Desiring the challenge of interesting and diversified projects—
 Wishing to work with congenial associates and modern equipment and facilities—
 Seeking permanence of affiliation with a leading company and steady advancement—
 Will find these in a career here at GENERAL MOTORS.

Positions now are open in **ADVANCED DEVELOPMENT** and **PRODUCT DESIGN**.
COMMERCIAL AUTOMOBILE RADIO

MILITARY RADIO, RADAR AND ELECTRONIC EQUIPMENT
ELECTRONIC COMPONENTS

INTRICATE MECHANISMS such as tuners, telemetering,
 mechanical linkages, controls, etc.

ACOUSTICS—loud speakers, etc.

Inquiries invited from recent and prospective graduates as well as experienced men
 with bachelors or advanced degrees in physics, electrical or mechanical engineering.
 Salary increases based on merit and initiative.
 Vacations with pay, complete insurance and retirement programs.
 Relocation expenses paid for those hired.

All inquiries held in confidence and answered—**WRITE or APPLY to**
DELCO RADIO DIV. GENERAL MOTORS CORP. Kokomo, Indiana

Senior and Project Engineers

The Pacific Division, Bendix Aviation Corporation has openings
 for senior and project engineers in development and production
 of radar, sonar and telemetering offering excellent opportunities
 for growth with the corporation and the opportunity to live in
 Southern California. Positions are open at several levels.

Please Address Inquiries To

W. C. WALKER

ENGINEERING EMPLOYMENT MANAGER

11600 Sherman Way

North Hollywood, California

BOONTON RADIO CORPORATION HAS AN OPENING FOR A SENIOR DEVELOPMENT ENGINEER

Q-Meters, FM Signal Generators, and test instruments for commercial aircraft
 navigation systems are typical of the precision calibrated circuits which Boonton
 Radio Corporation produces. You will be expected to make significant develop-
 ment contributions in additional new fields, reflecting credit to yourself and to
 Boonton Radio. You will enjoy your association with a small, mature, respected
 charter member of the electronics industry which is preponderately concerned
 with commercial activity. We are located in the Lake Land Region of North-
 ern New Jersey.

1. Minimum of 7 to 10 years' experience in radio development and design. Project administration desirable.
2. Good theoretical grasp, but capable of rapidly developing practical methods of implementing theory.
3. Initiative, ingenuity, and thoroughness at a high professional level are essential.

Reply to: Manager of Development Engineering

Boonton Radio Corporation, Boonton, N.J.

OPPORTUNITY

If you have
ELECTRONIC EXPERIENCE
plus
SALES PERSONALITY
 and are
AN ORGANIST
 and are
YOUNG and ENERGETIC

Your unusual combination of abilities
 may qualify you for a TOP sales
 engineering position with a famous
 manufacturer of electronic organs.

SW-9868, ELECTRONICS
 330 W. 42nd St., New York 36, N. Y.

HELP WANTED

This established radio & television
 manufacturing firm in Western New
 York has openings for:

- Test Engineers**
- Technicians**
- Trouble Shooters**
- Aligners**

Applications should contain details
 of past experience. Write to

Personnel Manager, H. E. Dudley

STROMBERG-CARLSON COMPANY

Rochester 3, New York

WANTED

Technical Sales Representative

With substantial working background in electronic
 circuitry to represent a leading manufacturer of
 electronic components and assemblies to firms utiliz-
 ing products in military and industrial applica-
 tions. Many territories available throughout U. S.
 Address reply to:

RW-9910, Electronics
 330 W. 42 St., New York 36, N. Y.

When *Answering* BOX NUMBERS...

to expedite the handling of your
 correspondence and avoid confu-
 sion, please do not address a
 single reply to more than one in-
 dividual box number. Be sure to
 address separate replies for each
 advertisement.

RECEIVER ENGINEERS MECHANICAL ENGINEERS DRAFTSMEN

Career Opportunities
With Old Established
Central Connecticut Firm

Interesting Projects
Top Salaries
Suburban Living

We Need Men Experienced
in Servo Mechanisms
UHF, VHF, Microwave,
Receivers, Transmitters
Variable Capacitors

Replies Held in Strict Confidence
Write Or Phone Collect
Personnel Mgr.—Sherwood 7-2741

THE
ALLEN D. CARDWELL MFG. CORP.
Plainville, Connecticut

WANTED

INSTRUMENTATION SPECIALIST

To be in charge of electronic instrumentation in connection with research and development of liquid propellants. Permanent salaried position with expanding group in the research department of a major chemical company located in the northeast. Requirements include: 2 years of college plus 3 years of experience or equivalent. Experience with electronic circuitry, high frequency transient pressure measurement, and some knowledge of liquid propellants or chemistry desired. Send complete resume to

P-9565, Electronics

330 W. 42 St., New York 36, N. Y.

IF

you are experienced in DESIGN OF FILTERS

Here is an opportunity for an engineer to join fast growing electronics company with national connections.

Experience should be with Lo Pass, High Pass, and Band Pass and include familiarity with testing techniques.

Congenial working conditions, and benefits.

P-1066, Electronics

520 N. Michigan Ave., Chicago 11, Ill.

SALES ENGINEER

Wanted, with electro-mechanical experience, to assist sales organization for Metropolitan N. Y. area handling products of a number of manufacturers of precision components for the automatic control instrument field. No previous selling experience necessary. Send resume and suggested salary or commission arrangement.

P-9907, Electronics

330 W. 42 St., New York 36, N. Y.

ELECTRONIC ENGINEERS

for design & development work
WITH A YOUNG PROGRESSIVE COMPANY

- ✓ digital techniques
- ✓ computers
- ✓ radar

SEND RESUME OF EXPERIENCE AND EDUCATION, WITH SALARY REQUIREMENTS, TO

Electronic Engineering Company of California
180 SOUTH ALVARADO STREET,
LOS ANGELES, 57, CALIFORNIA
DUMKIRK 2-7353



ENGINEERS, E E

- For development and design of H.F. pulse magnetic recording components and systems.
- For component and system development work in airborne navigational equipment.



DESIGNERS

- For work in the design of electro-mechanical navigational computers.

YOU'LL FIND THESE ADVANTAGES AT KOLLSMAN:

- An organization small enough to provide diversity and recognition of achievement, large enough for stability.
- An informal friendly atmosphere, and the best facilities available in modern laboratories.
- Convenient location in a quiet residential area only 20 minutes from the heart of New York.
- Free life, hospitalization, surgical, accident and health insurance.



Why not find out what Kollsman has to offer you?

Send resumes to: Employment Manager

KOLLSMAN INSTRUMENT CORP.

80-08 45th Avenue

Elmhurst, Long Island, N. Y.

SENIOR ENGINEER

To supervise group of 5-10 persons developing analog computers of electro-mechanical type. Applicant should be familiar with feedback control systems of analog to digital conversion devices. The successful applicant will probably have a M.S. degree in electrical engineering as well as a broad working knowledge of mechanical engineering.

The Research Laboratories are engaged principally in the development of new types of electrical, mechanical, hydraulic, and chemical devices for ultimate production by other manufacturing divisions of the Corporation.

Applicants for this position will be invited to inspect our laboratory facilities and to meet the members of our technical staff.

Please send brief resume to:

Personnel Department

BENDIX AVIATION CORPORATION RESEARCH LABORATORIES

4855 Fourth Avenue

Detroit 1, Michigan

AVIONIC INSTRUMENTATION *goes beyond* **DIALS and POINTERS...**

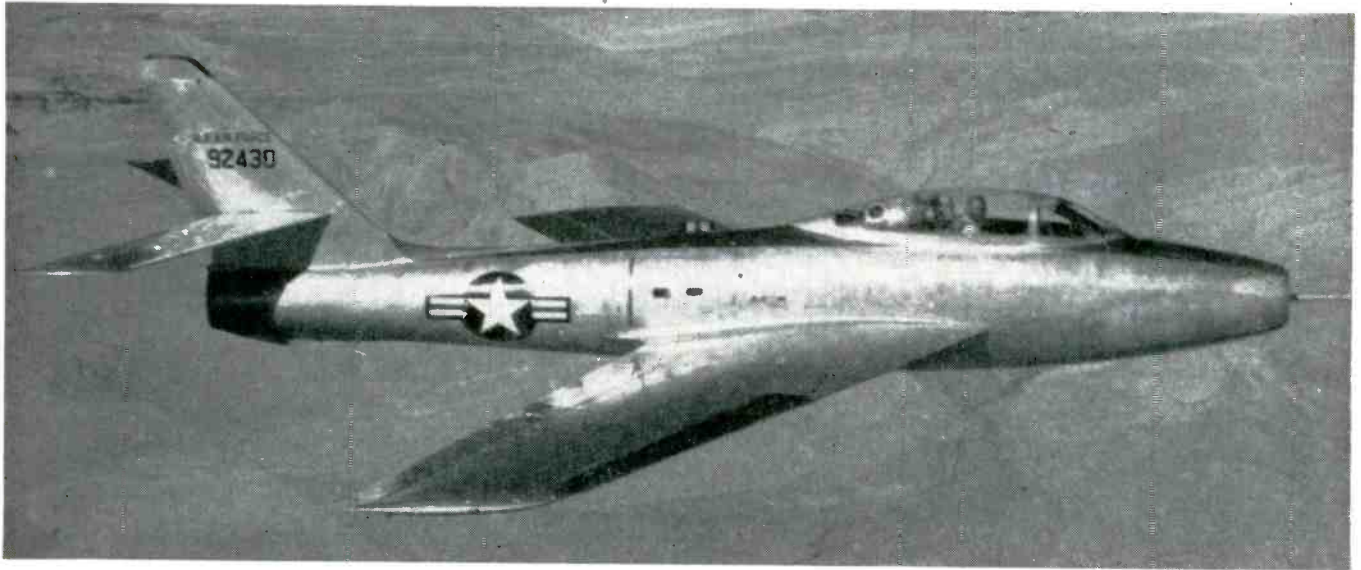

Current Stock Includes

**INVERTERS • AMPLIFIERS • VOLTAGE REGULATORS
PHASE CHANGERS • TRANSTATS • METERS D.C. & A.C.
SYNCHROS • SERVO MOTORS • AMPLIDYNE
PIONEER AUTOSYNS • RECTIFIERS • G. E. SELSYNS**

Also complete line of FLIGHT, ENGINE & NAVIGATION INSTRUMENTS

AUTHORIZED SALES and SERVICE FOR



INSTRUMENT ASSOCIATES

*Contractors to the U. S. Air Force—
U. S. Navy and Dominion of Canada*

**351 GREAT NECK ROAD, GREAT NECK, N. Y.
Telephone HUter 2-9300**

Write for Catalog NE100

U. S. Export License-2140

Western Union address:
WUX Great Neck, N. Y.

... and so does

... INSTRUMENT ASSOCIATES

a source for

**EMERGENCY REPLACEMENT
MODIFICATION
OVERHAUL
REPAIR
SALES
OF**

**INSTRUMENTS
INVERTERS
MOTORS
TRANSMITTERS
AMPLIFIERS
RELAYS
GENERATORS
and
ALLIED
COMPONENTS**

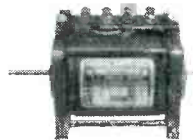
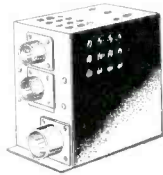
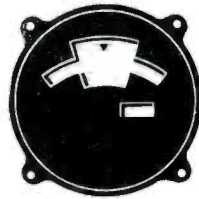
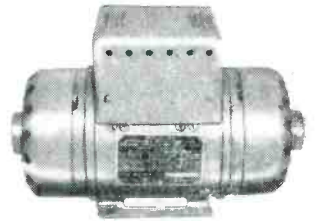

Instrument Associates knows that there is more to an instrument than dials and pointers. Involved in today's instrument panels are Inverters, Transmitters, Amplifiers and a multitude of other electrical and electronic components. Accordingly the laboratories of Instrument Associates are geared to the maintenance and supply of these component units as well as the indicators themselves.

Instrument Associates highly skilled instrument technicians combined with extensive laboratory facilities results in rapid and exacting workmanship. Unusual problems requiring know-how and ability find their solution in our Engineering and Development Department. Whatever your requirements in avionic instruments and their component units look to Instrument Associates for their fulfillment.

C.A.A. APPROVED REPAIR STATION #3564
INSTRUMENTS CLASS 1, 2, 3, 4,
LIMITED ACCESSORIES

351 GREAT NECK ROAD, GREAT NECK, N. Y.
Telephone HUnter 2-9300

**INSTRUMENT
ASSOCIATES**

Western Union address:
WUX Great Neck, N. Y.

U. S. Export License-2140

Write for Catalog NE100



COMPASS

COMMUNICATIONS COMPANY

A Division of COMPASS ELECTRONICS CORP.

WE MAINTAIN
OUR OWN FULLY
EQUIPPED TESTING
LABORATORY TO
TEST AND GUARANTEE
ANYTHING WE SELL

A WELL-INTEGRATED ORGANIZATION WITH FACILITIES AND TRAINED PERSONNEL FOR—

- DESIGN, MODIFICATION, PRODUCTION, AND TESTING OF COMMUNICATIONS AND RADAR EQUIPMENT
- SUPPLY AND DISTRIBUTION OF ALL TYPES OF EQUIPMENT AND TUBES

COMPASS has one of the largest and most diversified stocks of government surplus equipment—in its own warehouses

MARINE, GROUND AND AIRBORNE—RADIO, RADAR AND SONAR—IN STOCK

AND **SPARE PARTS** FOR

SA — SD — SF — SG — SJ — SN — SO — SQ

BO — BN — BM — YO — YJ

BATTLE ANNOUNCING EQUIPMENT

RECEIVERS

- ARB
- ARC-1
- ARC-3
- ARC-4
- ARC-5
- AR-88
- CR-91
- SLR
- RAK
- RAL
- RAO
- RBB
- RBO
- RBG
- RBL
- RBA
- RBM
- RCH
- BC-224
- BC-312
- BC-314
- BC-344
- BC-348

AIRBORNE
RADAR

- APS-2
- APS-3
- APS-4
- APS-6
- APS-10
- APS-13
- APS-15
- SCR-717
- SCR-720

FIELD
EQUIPMENT

- SCR-191
- 274
- 300
- 375
- 399
- 536
- 694
- 808
- 828
- BC-654
- 603
- 604
- 610E
- 683
- 684
- 923
- 924
- 1000
- 1306

ROTATING
MACHINERY

Thousands of converters, inverters, dynamotors, and motor-generator sets in stock. Also spare parts.

RADAR

SCR-545

COMPLETE
WITH SPARE PARTS

RADAR
BEACONS

- AN/CPN 3 cm.
- AN/CPN-8 10 cm.
- YJ and YG for shipboard use
- AN/CPN-6 3 cm.

TEST
SETS

- TS-3A/AP
- TS-10A and B
- TS-12/AP
- TS-13/AP
- TS-16/AP
- TS-35/AP
- TS-36/AP
- TS-62/AP
- TS-69A
- TS-74/UPM
- TS-89/AP
- TS-100/AP
- TS-101/AP
- TS-125/AP
- TS-173/UR
- TS-278
- TS-323
- OAA
- OAP
- OBU
- LAE
- LM
- LU
- IE-19
- I-46
- I-56
- I-208
- I-222
- SCR-211 and others

FIELD TRANSMITTERS

SCR-284—The famous mobile and ground equipment station for field use, complete with all accessories. Range 3.8—5.8 mcs; 20 watts cw, 5 watts phone.

SCR-510—Mobile, portable FM radio station. Operates from 6, 12, or 24 volt dc supply. Frequency range: 20.0 to 27.9 mcs.

SCR-610—Same as SCR-510, but with built-in speaker and range of 27.0-38.9 mcs.

SCR-508, 528—Mobile FM radio station, operates from 12 or 24 volt dc. Frequency range: 20.0-27.9 mcs.

SCR-608, 628—Same as SCR-528, but with range: 27.0 to 38.9 mcs.

BC-325—400 watts c.w., 100 watts new or voice operates from 110 or 220 volts ac. Freq. range: 1.5-18.0 mcs. Master oscillator or crystal control.

14C—400 watts phone or 800 watts c.w. Operates from 220 volts ac. Freq. range: 2.0-18.1 mcs. Has automatic dial selection of anyone of ten preset channels. Mfr. Western Electric.

MARINE TRANSMITTERS

TCS—Collins mfd. Navy radiotelephones for shipboard and mobile use, complete with all accessories for operation from 12, 24, 110, 230 volts d.c. and 110 or 220 volts a.c.

TDE—Navy or commercial marine transmitters, complete 110 & 220 volts d.c. and a.c.

TBK—Navy high frequency transmitter, 2-20 mcs; 500 watts output. Supplied complete with m/g and starter for d.c. or a.c. operation.

TBM—same transmitter but with speech input equipment to give 350 watts phone.

TBL—Navy all-wave transmitter; 350 watts output; CW and phone. Supplied complete with m/g and starter for d.c. or a.c. operation.

TAJ—Navy intermediate freq. transmitter, 175-550 kcs; 500 watts output. Supplied complete with m/g and starter for a.c. or d.c. operation.

TBN—200-3,000 kcs, complete with 220/440 volt, 3 ph. 50-60c power supply—conservatively rated at 1 kw. output.

393 GREENWICH STREET

All Phones: BEEKMAN 3-6509

NEW YORK 13, N. Y.

Cable Address: COMPRADIO, N. Y.

SPECIAL ATTENTION TO OVERSEAS INQUIRIES

MARINE
TRANSMITTERS

- TAJ
- TAQ
- TBL
- TBK
- TBM
- TBN
- TCE
- TCP
- TDE
- TDQ
- TDO

MARINE
RADAR

- SA
- SC
- SD
- SF
- SN
- SO-1, 8, and 13
- SQ
- VJ
- VG
- YJ
- BG
- BM
- BN
- SJ
- SK
- SL

SPECIAL NOTICE

Because too large a percentage of our new building is employed in the storage of articles which we have not had time to merchandise and because we need the same space for the installation of a sheet metal shop and a transformer shop we are listing below articles of general interest priced way beneath the competitive market. Quantities are limited so those whose orders reach us first will be served first.

RECEIVERS

Description	Frequency Range	Unit Price
CW-3	to be adjusted	39.00
Hammerlund Super Pros	200KC—20 MC	150.00 to 250.00
RBZ	5.7—13 MC	29.00
BC-1206	75 MC	12.50
BC-1333	75 MC	19.00
BC-1033	75 MC	19.00
BC-1023-A	75 MC	21.00
NC100RSD	2—30 MC	120.00
BC-652-A	2—6 MC	69.00
RCF	.2—30 MC	135.00
Mackay Model 128A	15—660 KC	105.00
RU-17	187—455 KC	15.00
NC-44	.6—30 MC	50.00
NC-110	20—500 MC	40.00
NC-100XA	.3—17 MC	105.00
National HRO-50-T	100—155 MC	145.00
BC-639 with RA 42 Power Supply	100 KC—155 MC	240.00
BC-923A	27—39 MC	79.00
R-100	90—1500 KC	240.00
BC-348		100.00
AN/SPR-2A	1000—3000 MC	500.00
AN/APR-4	30—4000 MC	2,225.00
RT-7/APN-1		59.00
BC-1269	144—600 MC	920.00

SIGNAL GENERATORS

Description	Frequency Range	Unit Price
TS-47/APR	40—500 MC	160.00
BR-102A	S-Band	440.00
LAE	520—1300 MC	970.00
LAF	900—600 MC	780.00
BC-277A	2700—3400 MC	275.00
TS-418	400—1000 MC	1,450.00
P-500A	175 KC—50 MC	660.00
Federal Model 605CS	9.5 KC—50 MC	440.00
TS-13	X-Band	1,275.00
TS-45	X-Band	440.00
TS-14	S-Band	575.00
I-208	1.9—4.5 MC/19-46 MC	990.00

SLOTTED LINES

Description	Frequency Range	Unit Price
TS-56 (50 ohm input)	325—625 MC	220.00
TS-12 (plumbing & amplifier)	X-Band	550.00
OAK	S-Band	720.00

FREQUENCY METERS

Description	Frequency Range	Unit Price
TS-173/UR	90—450 MC	575.00
TS-174	20—250 MC	435.00
TS-175	80—1000 MC	435.00
BC-221	200 KC—20 MC	125.00 and up

SYNCHROSCOPES

Description	Unit Price
TS-143/CPM-1	490.00
Sylvania P-4	240.00
Browning P-4	240.00
TS-34	350.00
TS-34A	450.00
TS-64A	450.00
TS-170	330.00
Raytheon Lab WX-4718	190.00
TS-100	550.00
BC-1060	360.00
DuMont Type 247	460.00
DuMont Type 224	175.00

SPECIAL TEST SETS

Description	Unit Price
I-203	210.00
TS-170	210.00
BC-376H	205.00
TS-15	190.00
I-86 A	140.00
BE-67	24.00
I-225	40.00
TS-8/U	39.00
TS-32-A	21.00
I-222	105.00

Plus hundreds of pieces too numerous to mention. If you are test equipment minded call WESLAB collect and state your problems.

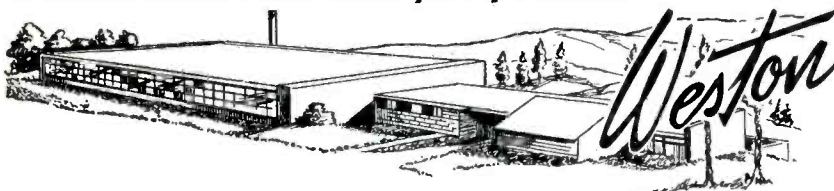

LABORATORIES, INC.

HARVARD, MASS.

Tel: HARVARD 250—AYER 300—TWX HARV 193

Cable: WESLAB

NEW YORK'S RADIO TUBE EXCHANGE

TYPE	PRICE	TYPE	PRICE	TYPE	PRICE	TYPE	PRICE	TYPE	PRICE	TYPE	PRICE
OA2	51.40	2125	27.75	3GP1	5.50	15R	.95	385A	4.95	801A	1.00
OA3	1.10	2127	29.95	4B26	6.95	NE16	.66	388A	2.95	802	4.25
OB2	1.35	2131	29.95	4C27	25.00	FG17	6.95	394A	5.00	803	7.95
OC3	1.25	2132	69.95	4C28	35.00	KY21A	8.75	MX408U	1.75	805	5.95
OD3	1.25	2133	69.95	4E27	17.50	FG33	12.95	417A	17.95	807	1.69
C1B	3.95	2134	69.95	4J25	199.00	45 Special	.35	446A	1.95	808	3.50
1B21A	2.75	2136	105.00	4J26	199.00	35T	3.50	464A	5.40	810	11.00
1B22	3.95	2138	17.95	4J27	199.00	45 Special	.35	464B	5.40	811A	3.95
1B23	9.95	2139	12.50	4J28	199.00	RK39	2.95	450TL	45.00	813	9.95
1B24	15.00	2140	35.00	4J29	199.00	HF50	1.75	464A	9.95	814	9.95
1B26	2.95	2142	150.00	4J30	199.00	VT52	.25	471A	2.75	815	3.50
1B27	13.50	2149	109.00	4J31	199.00	RK72	1.10	527	25.00	829	12.95
1B32	4.10	2150	95.00	4J32	199.00	100TH	1.95	WL530	3.50	829A	13.95
1B42	19.95	2161	45.00	4J33	199.00	FG95	24.95	WL533	17.50	829B	15.95
1B50	25.00	2162	45.00	4J34	199.00	FG105	24.00	700A/D	25.00	830B	2.50
1B51	9.95	2K25	29.50	4J35	199.00	203A	8.95	701A	7.50	832A	9.95
1B56	49.95	2K28	37.50	4J36	199.00	211	.95	703A	5.00	833A	49.95
1B60	69.95	2K29	37.50	4J37	199.00	217C	18.00	705A	3.95	834	7.95
1N21	1.35	2K39	150.00	4J38	199.00	242C	10.00	706AY/FY	45.00	836	4.95
1N21A	1.75	2K41	150.00	4J39	199.00	244A	12.95	707A	17.95	837	2.95
1N21B	4.25	2K45	149.50	4J40	199.00	249C	4.95	714AY	17.95	838	6.95
1N21C	23.00	2K48	170.00	4J41	199.00	250TH	22.50	715A	7.95	845	5.99
1N22	1.75	2K50	350.00	4J42	250.00	250TL	19.95	715C	25.00	849	52.50
1N23	2.00	2K54	200.00	4J51	350.00	274A	3.00	717A	1.95	860	4.95
1N23A	2.75	2K55	200.00	4J53	350.00	274B	3.00	718AY/EY	48.05	866A	1.79
1N23B	4.25	2K56	180.00	CSB	3.95	304TH	10.00	721A	29.50	869BX	69.00
1N34A	9.95	2V3G	2.10	5BP1	6.95	304TL	12.00	722A	3.95	872A	3.95
1N43	2.50	3BP1	7.50	5BP4	6.95	307A	4.95	724A	4.95	880	300.00
2B4	1.50	3BP2	5.50	5CP1	6.95	310A	5.95	724B	6.95	884	1.95
2B22	1.95	3B24W	7.50	5D21	21.00	310B	6.75	725A	9.95	885	1.75
2B26	3.75	EL3C	5.95	5J1P	27.50	312A	6.95	726A	24.00	889R	199.50
2C34	.35	3C22	120.00	5J22	19.50	312A	6.95	726B	56.00	914	75.00
2C40	16.00	3C31	3.95	5J4	27.50	323A	15.00	726C	69.00	931A	5.00
2C44	.90	3DP1A	10.95	WE6AK5	2.50	327A	3.95	728AY/GY	27.00	954	.35
2C46	12.00	3DP1-52	12.00	C6A	12.50	328A	6.95	730A	24.00	955	.55
2D21	1.75	3EP1	7.50	C6J	10.95	350A	10.00				
2E22	2.25	3E29	15.50	7BP7	7.95	350B	3.95				
2E30	2.75	3FP7	7.50	7DP4	10.00	352A	3.00				
2J21A	17.95	3HP7	7.50	12AP4	55.00	357A	15.00				
2J22	17.95	4A21	2.75	12DP7	25.00	368AS	5.00				
				15E	1.95	371B	1.95				

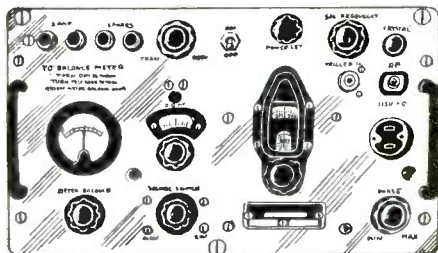

TS-147 C/UP TEST SET Hard-to-get X-Band SIGNAL GENERATOR Now Available

Test Set TS 147 C/UP is a portable Microwave Signal Generator designed for testing and adjusting beacon equipment and radar systems which operate within the frequency range of 8500 MC to 9600 MC.

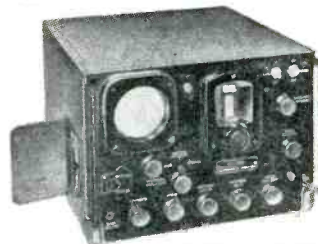

MICROWAVE TEST EQUIPMENT TS148/UP SPECTRUM ANALYZER

Field type X Band Spectrum Analyzer, Band 8430-9580 Megacycles.

Will check Frequency and Operation of various X Band equipment such as Radar Magnetrons, Klystrons, TR Boxes. It will also measure pulse width, c-w spectrum width and Q or resonant cavities. Will also check frequency of signal generators in the X band. Can also be used as frequency modulated Signal Generator etc. Available new complete with all accessories, in carrying case.

Other test equipment, used checked out, surplus.

- TSK1/SE K Band Spectrum Analyzer
- TS3A/AP Frequency and power meter S Band
- RF4A/AP Phantom Target S Band
- TS12/AP VSWR Test Set for X Band
- TS13/AP X Band Signal Generator
- TS14/AP Signal Generator
- TS33/AP X Band Power and Frequency Meter
- TS34/AP Western El Synchroscope
- T35/AP X Band Signal Generator
- TS36/AP X Band Power Meter
- 1-96A Signal Generator
- TS45 X Band Signal Generator

- TS47/APR 40-400 MC Signal Generator
- TS69/AP Frequency Meter 400-1000 MC
- TS100 Scope
- TS102A/AP Range Calibrator
- TS108 Power Load
- TS110/AP S Band Echo Box
- TS125/AP S Band Power Meter
- TS126/AP Synchroscope
- TS147 X Band Signal Generator
- TS270 S Band Echo Box
- TS174/AP Signal Generator
- TS175/AP Signal Generator

- TS226 Power Meter
- TS239A Synchroscope
- TS239C Synchroscope

SURPLUS EQUIPMENT

- APA10 Oscilloscope and panoramic receiver
- APA38 Panoramic Receiver
- APS 3 and APS 4 Radar
- APR4 Receiver
- APR5A Microwave Receiver
- APT2 Radar Jamming Transmitter
- APT5 Radar Jamming Transmitter

MINIMUM ORDER
25 Dollars

YOU CAN REACH US ON TWX NY1-3235

Cables:
TELSERSUP

SPECIAL

Wide Band S Band Signal Generator 2700/3400MC using 2K41 or PD 8365 Klystron, Internal Cavity Attenuator, Precision individually calibrated Free frequency measuring Cavity. CW or Pulse Modulated, externally or internally.

Large quantities of quartz crystals mounted and unmounted.

Crystal Holders: FT243, FT171B others.

Quartz Crystal Comparators.

North American Philips Fluoroscopes Type 80.

Large quantity of Polystyrene beaded coaxial Cable.



LIBERTY ELECTRONICS, INC.

135 LIBERTY STREET NEW YORK 6, N. Y.
PHONE WORTH 4-8202

Reliance Specials

COAXIAL CONNECTORS

A full line of JAN approved connectors in stock



83-1AC	\$0.42	PL-274	\$1.10	UG-88/U	\$0.90
83-1AP	.30	PL-275	2.10	UG-89/U	1.10
83-1B	.35	SO-239	.40	UG-102/U	.80
83-1H	1.10	UG-13/U	1.70	UG-103/U	1.68
83-1HF	.12	UG-18B/U	1.05	UG-104/U	.64
83-1HP	.22	UG-20B/U	1.50	UG-105/U	1.50
83-1J	.73	UG-21/U	.85	UG-106/U	.15
83-1R	.40	UG-21B/U	1.00	UG-107B/U	2.75
83-1RTY	.65	UG-21C/U	1.05	UG-146/U	2.00
83-18C	.45	UG-21D/U	1.45	UG-167/U	3.75
83-1SPN	.50	UG-22/U	1.30	UG-175/U	.12
83-1T	1.30	UG-22A/U	1.50	UG-176/U	.12
83-2A	1.95	UG-22B/U	1.20	UG-185/U	.95
83-2P	2.10	UG-23/U	1.20	UG-196/U	1.65
83-2R	1.65	UG-23B/U	1.50	UG-203/U	.65
83-22AP	2.40	UG-23C/U	1.10	UG-224/U	1.15
83-22P	2.10	UG-24/U	1.30	UG-255/U	1.95
83-22J	1.40	UG-27/U	1.25	UG-260/U	.85
83-22S	.68	UG-27A/U	2.25	UG-261/U	1.10
83-22SP	.80	UG-27B/U	2.95	UG-262/U	1.10
83-22T	1.95	UG-28A/U	2.95	UG-273/U	1.45
83-188	.12	UG-29B/U	1.75	UG-274/U	2.30
83-185	.12	UG-30/U	1.10	UG-290/U	.90
CW-123A/U	.45	UG-57B/U	1.85	UG-291/U	.95
M-358	1.30	UG-58/U	.70	UG-306/U	2.65
M-359	.30	UG-58A/U	.90	UG-414/U	1.95
M-359A	.65	UG-59A/U	1.90	UG-499/U	1.25
PL-258	.75	UG-88/U	1.75	UG-625/U	1.35
PL-259	.45	UG-85/U	1.65		
PL-259A	.50	UG-87/U	1.40		

NEW COAXIAL CABLES Jan approved

RG5/U*	Price per 1000 ft.	RG22/U*	Price per 1000 ft.
RG5/U*	\$140.00	RG22/U*	\$150.00
RG6/U*	180.00	RG22A/U	285.00
RG7/U*	85.00	RG24/U	675.00
RG8/U*	100.00	RG26/U	475.00
RG9/U*	250.00	RG29/U	350.00
RG9A/U	330.00	RG34/U*	300.00
RG10/U*	240.00	RG35/U*	900.00
RG11/U*	100.00	RG41/U*	295.00
RG11A/U*	150.00	RG54A/U	97.00
RG12/U*	240.00	RG55/U*	130.00
RG13/U*	215.00	RG57/U*	325.00
RG14/U*	650.00	RG58/U*	50.00
RG18/U*	900.00	RG58A/U*	70.00
RG19/U*	1,250.00	RG59/U*	60.00
RG20/U*	1,450.00	RG62/U*	75.00
RG21/U*	220.00	RG77/U*	100.00

Add 25% for orders less than 500 feet. *No minimum order—other 250 minimum.



UNIVERSAL JOINTS ALUMINUM

1/4" hole, 1/2" O.D. 1-1/4" long with two 6/32 tapped set-screw holes EACH .80¢

3/16" hole, 3/8" O.D. 1-1/4" long with two 6/32 tapped set-screw holes EACH .80¢

FIXED COMPOSITION RESISTORS

Type EB 1/2W 10%	6¢ ea.	\$4.00 per C
EB 1/2W 5%	12¢ ea.	8.00 per C
Type GB 1W 10%	9¢ ea.	7.00 per C
GB 1W 5%	18¢ ea.	14.00 per C
Type HB 2W 10%	12¢ ea.	9.00 per C
HB 2W 5%	24¢ ea.	18.00 per C

AVAILABLE IN ALL STANDARD RMA VALUES

POSTAGE STAMP MICAS

Available in All Standard RMA Values

PLAIN	SILVER
5 mmf to 910 mmf..... 5¢	5 mmf to 910 mmf..... 10¢
.001 to .0013 mfd..... 8¢	.001 to .002 mfd..... 20¢
.0015 to .0056 mfd..... 15¢	.0022 to .0091 mfd..... 50¢
.0062 to .0091 mfd..... 20¢	.01 mfd..... 95¢
.01 mfd..... 28¢	

AIRCRAFT GENERATORS

OUTPUT—115 VAC 10.4 AMPS 800-1400 CY 1 PH. PLUS 30 VDC 60 AMPS. \$29.50
 OUTPUT 30 VDC 15 AMPS 2500-4500 RPM 9" L x 8" DIA SPLINE SHAFT 3/4 x 1-1/4" WT 16 lbs. \$15.50
 OUTPUT 28 VDC 140 AMPS 2500-4500 RPM. \$38.50

STORAGE BATTERIES

BB-54 Willard 2 volt 20 amp. hrs. built in charge 100 lots \$1.75 ea. 1000 lots \$1.50 ea.
 Indicator 4 x 3 x 5/8 high—BRAND NEW \$1.95 ea.
 BB-212/U 2 volt 40 amp. hrs. 6% x 2% x 4 3/8 high BRAND NEW \$2.35 ea.
 NT-6 6 VOLT 3.5 AMP Hrs. 3x x 1-3/4 x 2-3/8" \$1.95 ea.
 ALL BATTERIES SHIPPED DRY

PULSE TRANSFORMERS

UTAH 9262 3 windings—peak 200 VDC Current 10 MA. Turns Ratio 1-1-1 Impedance Variable 0-5000 ohm \$12.50 ea.
 MANY OTHER PULSE TRANSFORMERS IN STOCK DATA UPON REQUEST

W.E. D-150734

PHASE SHIFT CAPACITOR

.75 to 2.75 mmfd 4 stators—single rotor—continuously variable phase shift 0-360 deg. \$19.50 ea.

TERMS—Cash with Order or 25% Deposit—All Balance C.O.D. Net 10 Days if Rated Accounts. All Prices are Net F.O.B. Our Warehouse.

PRECISION RESISTORS

(WIRE WOUND SPPOOL TYPE)

1/4 watt 1% tolerance WW3 or Equal 35¢ ea.	20K			
.250 5.26	19.37 105.8	414.3	5000	20K
.334 7.4	20 123.8	705	5900	25K
.502 9.1	25 125	723	6500	30K
.557 10.48	30 130	750	7000	32.89K
.627 10.84	46 147.5	855	7500	33.3K
1.760 11.1	50 160	1000	8000	35.89K
1 11.25	50 210	2193	8500	36K
1.01 11.74	55.1 220.4	2200	8800	37K
2.53 12.32	62.54 235	2250	10K	40K
2 13	75 260	2500	12K-2%	47K
2.04 13.02	79.81 270	2850	14.82K	50K
2.5 13.15	87 298.3	3427	15K	59K
3 13.52	97.8 301.3	4000	15.75K	59.15K
3.5 13.89	100 366.6	4300	16.7K	79.01K
4 14.98	100 445.1	4517	17K	125K
1 watt 1% tolerance WW4 or Equal 45¢ ea.	50K			
.861 3.39 20	270 2000 7000	50K		
1.01 5.1 28	425 2200 8000	55K		
2.55 5.21 38	1250 3300 9000	80K		
2.58 12 50	1750 6000 20K			
1 watt 1% tolerance WW4 or Equal 60¢ ea.	600K			
100K 12K 150K	250K 320K 500K	600K		
1 watt	WW5 or Equal	65¢ ea.		
84K-2% 522K-1%	645K-1% 700K-1%	1 meg-5%		

1 MEG 1 WATT 1% WW5 \$1.50

SOUND POWERED HANDSET



Brand New
 TS-10 Type—includes 5 ft. cord. USES NO BATTERIES OR EXTERNAL POWER SOURCE \$9.48 ea.

SOUND POWERED HEAD & CHEST SET

Navy Type M Head and Chest Set. For Work Requiring Free Use of Hands. Heavy Duty—Consists of Headset with 2 Phones and Chest Mike. Includes 20 Ft. Rubber Cord. BRAND NEW. EACH \$14.88 Same as above except used exc. condition. Each \$5.95

OIL FILLED CONDENSERS

MFD	V.D.C.	Price	MFD	V.D.C.	Price
5.2	50	\$0.39	0.5	2,000	\$1.65
3 x 3	400	1.00	12	2,000	7.95
4	500	.85	0.25	3,000	2.52
1	600	.55	0.5	3,000	2.40
0.5-0.5	600	.40	2	3,000	4.50
2	600	.69	2	4,000	7.95
4	600	.89	2	5,000	7.95
8	600	1.85	1	5,000	4.88
10	600	3.25	0.03-0.03	6,000	1.50
4 x 3	600	2.50	1	6,000	9.95
4	1,000	1.59	0.02-0.02	7,000	1.55
1	1,000	.69	0.1	7,000	1.79
2	1,000	.99	0.1-0.1	7,000	5.95
3	1,000	1.70	0.1	7,500	2.25
1	1,500	1.45	0.075-0.075	8,000	6.50
0.02	2,000	.65	0.15-0.15	8,000	6.95
0.1-0.1	2,000	1.30	0.25	20,000	19.95
0.1-0.5	2,000	.95			

OIL FILLED AC CONDENSERS

MFD	V.A.C.	Price	MFD	V.A.C.	Price
7.5	220	\$1.95	15	440	\$5.25
20	220	3.95	1	660	2.95
1	236	.49	2	660	3.50
4	236	1.60	3	660	3.60
8	236	1.95	4	660	3.75
3	330	1.45	5	660	3.85
4	330	2.25	6	660	4.25
20	330	6.75	8	660	4.50
25	330	7.50			.69
4.4	375	2.15			

High Current Filament Transformer

Amertran type-W Pri. 105-125 V. 60 cy. 1 Phase—Sec. 5V. 190 amps.—97 KVA 35 KV. RMS Insul. Test 7x10x 12; Wt. 80 lbs. Ideal For Use As Arc Welder. SPECIAL \$29.50 ea. Kenyon S-14940 S.C. #Z29943-1073 Pri. 105-125 V. 60 Cy. Sec. 5V. 115 Amps. \$19.50 ea.

RAYTHEON PLATE TRANSFORMER TYPE U8355A

PRI. 110V/220V/440V/880V/1760V
 SEC #1 300V @ 4 AMPS. SEC. #2 300V @ 4 AMPS.
 1780 RMS TEST. 9% x 9 1/2% x 8 1/2% HIGH. \$19.95

Choke 10 hy

400 MA
 90 OHMS
 HERMETICALLY SEALED
 5 1/4 x 4 1/2 x 4H. \$4.88

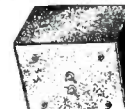

MERKLE-KORFF GEAR REDUCTION UNITS

Type SG15-3B Flexo-Action. High torque. Precision gears. #RM-10 ratio 108-1 input shaft 3/16 output 3/16 \$3.95 ea.
 #RM-11 ratio 296-1 input shaft 3/16 output 1/4 \$3.95 ea.

10 MA DC METER 3" rd DeJur #310.....	\$3.95
1 MA DC METER 3" rd DeJur #310.....	\$5.75
5 AMP AC METER 4" rd JBTT #132.....	\$4.11
500 W DC METER 2 1/2" rd G.E.....	\$2.95
30 VDC METER 2 1/2" rd G.E.....	\$3.95
500 MICROAMP DC METER 2 1/2" rd SUN.....	\$4.30
AT-4/ARN-1 ALTIMETER ANTENNA NEW.....	\$9.75
RT-7/APN-1 ALTIMETER EXC. USED.....	\$25.00
WE D 17584 MERCURY RELAY.....	\$8.75
AT-48/UP-3 CM HORN ANTENNA.....	\$9.95
INVERTER VDC TO 110VAC 60 CY 75W.....	\$22.95
IN34 CRYSTAL.....	.66
1 RPM TIMING MOTOR HAYDON 115 VAC.....	\$1.95
8 RPM TIMING MOTOR INGRAHAM 115 VAC.....	\$1.79
.05 MFD 600 VDC bathtub cond. side term.....	30¢
.06 MFD 1000 VDC bathtub cond. side term.....	35¢
1 MFD 600 VDC bathtub cond. bottom term.....	39¢
2 x .1 MFD 600 VDC bathtub cond. side term.....	39¢
3 x .1 MFD 600 VDC bathtub cond. side term.....	49¢
.25 MFD 400 VDC bathtub cond. side term.....	35¢
.5 MFD 600 VDC bathtub cond. side term.....	49¢
1 MFD 600 VDC bathtub cond. side term.....	59¢
2 MFD 600 VDC bathtub cond. side term.....	\$1.25
RG 8-2/U COAX CABLE New Gov't Surplus 100 Ft.....	\$5.95
BC-221 FREQ. METER uncalibrated.....	\$80.00
VERNIER DRUM for BC-221 0-50 180°.....	95¢
VERNIER DIAL for BC-221 0-100 360°.....	\$1.50
BLANK CALIBRATION BOOK for BC-221.....	\$4.95
BC-221 MAIN TUNING COND. specify model.....	\$19.95
BC-221 CASE used good condition.....	\$4.95
PRECISION POT 12 ohm 4 watt DeJur #282.....	\$1.75
PRECISION POT 20 ohm 4 watt DeJur #292.....	\$1.75
PRECISION POT 50 ohm 4 watt DeJur #282.....	\$1.75
PRECISION POT 500 ohm 4 watt Centralab #48-501.....	\$1.79
PRECISION POT 2000 ohm 6 watt DeJur #280.....	\$2.50
PRECISION POT 6000 ohm 6 watt DeJur #280.....	\$2.50
PRECISION POT 5000 ohm 8 watt Muter #314A.....	\$2.50
PRECISION POT 6000 ohm 8 watt Muter #314A.....	\$2.50
PRECISION POT 5000 ohm 12 watt DeJur #271-T.....	\$3.50
SET SCREWS Allen 4-40 x 3/4".....	\$1.75/C
SET SCREWS Allen 4-40 x 3/16".....	\$1.75/C
SET SCREWS slotted 8-32 x 3/16".....	\$1.35/C
SET SCREWS square head 8-32 x 5/16".....	\$1.35/C
LUCKY MAN'S PLIERS 8" with side cutters.....	\$1.69
DUCK BIL PLIERS 5 1/2".....	\$1.99
CK-5517/1013 cold cathode tube.....	\$2.25
32 MFD 2500 VDC photoflash cond.....	\$15.80
30 MFD 2500 VDC photoflash cond.....	\$14.75
2X2 TUBES 80L or KenRad.....	2 for \$1.00
6SN7 TUBES 50L or KenRad.....	3 for \$2.20
5BPI Cathode ray tube.....	\$5.50
200 1/2 W RESISTORS Ass't. all insulated.....	\$2.50
5 lbs. HARDWARE Ass't. nuts, bolts etc.....	\$2.00
GEAR ASS'T. 100 gears, bushings etc.....	\$6.50
RHEOSTAT 25V 145 ohm 7/16" shaft.....	89¢
RHEOSTAT 25V 370 ohm 7/16" shaft.....	\$1.09
RHEOSTAT 50V 400 ohm 7/16" shaft.....	\$1.09
RHEOSTAT 50V 8 ohm 8 D. shaft.....	\$1.09
RHEOSTAT 50V 12 ohm 7/16" shaft.....	\$1.39
RHEOSTAT 50V 90 ohm 1" shaft.....	\$1.39
RHEOSTAT 50V 123 ohm 7/16" shaft.....	\$1.39
RHEOSTAT 50V 200 ohm 7/16" shaft.....	\$1.39
RHEOSTAT 50V 300 ohm 7/16" shaft.....	\$1.39
RHEOSTAT 50V 2000 ohm 7/16" shaft.....	\$1.79
SELENIUM RECTIFIER 20 MA 115V full wave.....	\$1.79
SELENIUM RECTIFIER 100 MA 115V half wave.....	91¢
DM33A dynamotor new.....	\$5.95
THROAT MIKE MT81-A new with PL-68.....	\$1.99
GLYPHAT CEMENT G.E. #1280.....	Qt. can \$1.15
FERRIS SIG. GEN. #47A 40 mc xtal controlled.....	\$69.95
W-110B Field Wire twisted pair 1/2 mile coil.....	\$7.95
W-110B Field Wire twisted pair 1 mile coil.....	\$14.95

SELSYN MOTORS

50 V. 50 Cy. High Torque. Connect in Series. For Use On 110 V. 60 Cy. Approx. 3-3/8" dia. x 5-3/4" L. Like New. ONLY \$12.95 PAIR Army Ordnance Type C-78243 115V. 60 Cy. Transmitter. Approx. 3-3/8" dia. x 5-3/4" L. Like new. EACH \$27.50

DIFFERENTIAL Used \$4.95

115 V., 60 Cycle New \$9.95 #C78249



3 3/8" dia. x 5 3/

WRITE FOR OUR FREE BULLETIN MORE GOOD ITEMS

GUARANTEED BRAND NEW

ELECTRONIC RESEARCH TUBE SPECIALS

STANDARD BRANDS ONLY

WRITE FOR OUR FREE BULLETIN MORE GOOD ITEMS

Table listing various electronic tubes with columns for Receiving Tubes, Type No., Price, and Trans-mitting and special Purpose Tubes.

Crystal Diodes

Generators and Inverters table listing models like Pioneer 1216-3A Generator and various inverter specifications.

Oil Filled Condensers table listing MFD, VDC, Price, and other specifications for various capacitor models.

Coaxial Connectors table listing models like 83-1AC, 83-1AP, and various connector specifications.

Reversible Gear Head Motors table listing models like G.E. 58A10AJ65 and motor specifications.

Oilmites and Low Inertia Servo Motors table listing models like MFD, VDC, Price, and servo motor specifications.

Coaxial Cable table listing models like RG-58/U, RG-59/U, and cable specifications.

Tachometer Generator Elinco type PM-1M, DC Tachometer Generator—New \$27.50

ELECTRONIC RESEARCH LABORATORIES PHILA. 6, PA. 715-19 ARCH ST. Telephone Branch - MARKET 7-6771-2-3

AIR COMPRESSOR, AIRCRAFT

Rated pressure 1000 PSI, measures 13 1/2" x 9 1/2", driven by 27 VDC-1/3rd HP series wound motor 11,000 RPM; 17 amp; cont. duty Mfg. General Electric Mod. #5BA40EJ28B. \$29.95 ea.



G. E. GENERATORS

General Electric Type 5-ASB-31J3; 400 cycles out at 115 volts; 7.2 amps; 8,000 rpm.; size 6" long x 6" dia. \$89.50 ea.

SINE-COSINE GENERATORS

(Resolvers)

Diehl Type FJE43-9 (Single Phase Rotor). Two stator windings 90° apart, provides two output equal to the sine and cosine of the angular rotor displacement. Input voltage 115 volts, 400 cycle. \$30.00 ea.
Diehl Type FPE-43-1 same as FJE-43-9 except it supplies maximum stator voltage of 220 volts with 115 volt supplied to rotor. \$25.00 ea.

VOLTAGE GENERATORS (RATE)

ALNICO MIDGET D.C. VOLTAGE GENERATOR Type B-35-D. \$17.50
ALNICO MIDGET D.C. VOLTAGE GENERATOR Type B-44-D. \$17.50
A.C. GENERATOR: 87 V., 20 Cyc., 2-Phase. \$15.00
Amps. Type PM-1, 1200 R.P.M. \$15.00

SYNCHRONOUS SELSYNS

110 volt, 60 cycle, brass cased, approx. 4" dia. x 6" long. Mfg. by Diehl and Bendix.
Quantities Available.
REPEATERS. \$20.00 ea.
TRANSMITTERS. \$20.00 ea.

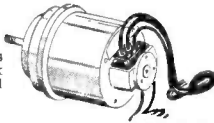

AUTOSYN MOTOR TYPE 1

115 VAC; 60 cycle; 1-phase; DR. # 4279 Foot mounted; Mfg. Bendix Aviation Corp. \$15.00 ea.

SESYN GENERATORS

General Electric MOD. 2J15M1; 115-57.5 Volts 400 Cycle. \$22.50 ea.

SYNCHROS

AUTOSYN MTR. KOLLSMAN Type #403; 32 VAC; 60 cycle; single phase. \$22.50
AUTOSYN MTR. BENDIX Type #851; 32 VAC; 60 cycle; single phase. \$22.50
MICROSYN UNIT, Type 1C-006-A. \$35.00
1F Special Repeater (115V-400 Cy.). \$15.00 ea.
2J1F 3 Generator (115-400 cyc.). \$10.00 ea.
SCT Control Transformer: 90-50 Volt; 60 Cy. \$45.00
SF Motor (115/90 Volt-60 cyc.). \$45.00
5/DG Differential Generator (90-94 volts-400 TRANSMITTER, BENDIX C-78248; 115 Volt, 60 Cycle. \$25.00 ea.
Cyc.). \$30.00
Differential-C-78249; 115 V., 60 Cy. \$5.00
5N MOTOR (115 Volts/60 Cycle). \$22.50
REPEATER, BENDIX C-78410; 115 Volt, 60 Cycle. \$37.50 ea.
REPEATER, AC synchronous 115 V., 60 cycle. C-78863. \$15.00 ea.
REPEATER, DIEHL MFG. No. FJE 22-2; 115 Volt; 400 Cy.; Secondary 90 V. \$27.50
5G GENERATOR (115/90) 60 cycles. \$45.00
7G Synchro Generator (115/90 volt; 60 cycle). \$75.00
6G Synchro Generator (115/90 volt; 60 cycle). \$60.00
6DG Synchro Differential Generator (90/100 volt; 60 cycle). \$50.00
2-JF5-J Selsyn Control Transformer: 105-55 Volts; 60 Cycle. \$50.00
51D5HAI Selsyn Generator: 115-105 Volts; 60 cycle. \$50.00
2J1FI GENERATOR: 115-57.5 Volt; 400 cycle. \$12.50 ea.
2J1HI DIFFERENTIAL GENERATOR: 57.5-57.5 Volt; 400 cycle. \$12.50 ea.
2J1GI CONTROL TRANSFORMER: 57.5-57.5 Volt; 400 cycle. \$7.50 ea.

PIONEER TORQUE UNITS

TYPE 12604-3-A: Same as 12606-1-A except it has a 30:1 ratio between output shaft and input. Auto-syn. \$10.00 ea.
TYPE 12602-1-A: Same as 12606-1-A except it has base mountin gtype cover for motor and gear train. \$70.00 ea.
TYPE 12606-1-A: Contain CK5 Motor coupled to output shaft through 125:1 gear reduction train. Output shaft coupled to autosyn. follow-up (AY13). Ratio of output shaft to follow-up Autosyn is 15:1. \$70.00 ea.

Immediate Delivery

ALL EQUIPMENT FULLY GUARANTEED

All prices net FOB Pasadena, Calif.

INVERTERS

10563 LELAND ELECTRIC

Output: 115 VAC; 400 cycle; 3-phase; 115 VA; 75 PF. Input: 28.5 VDC; 12 amp. \$59.50

PIONEER 12117

OUTPUT: 26 volts; 400 cycles; 6 volt amperes, 1-Phase. INPUT: 24 VDC; 1 amp. \$25.00 ea.

ALTERNATOR, CARTER

Mfg. Carter Motor Co.; OUTPUT: 7 VAC; 9.7 amp.; 650 cycles, and 295 VDC. 200 amps. INPUT: 26.5 VDC; 10.5 amps; 6500 rpm. \$49.50 ea.

PE 218 LELAND ELECTRIC

Output: 115 VAC; Single Phase; PF 90; 380/500 cycle; 1500 VA. INPUT: 25-28 VDC; 92 amps; 8000 RPM; Exc. Volts 27.5 BRAND NEW. \$39.95 ea.

PE 109 LELAND ELECTRIC

Output: 115 VAC, 400 cyc; single phase; 1.53 amp.; 3600 RPM. Input: 13.5 VDC; 29 amp. \$65.00

MG 153 HOLTZER-CABOT

Input: 24 V. DC, 52 amps; Output: 115 volts-400 cycles, 3-phase, 750 VA, and 26 Volt-400 cycle, 250 VA. Voltage and frequency regulated. \$95.00 ea.

PIONEER 12130-3-B

Output: 125.5 VAC; 1.15 amps, 400 cycle single phase. 141 VA. Input: 30-30 VDC, 18-12 amps. Voltage and frequency regulated. \$75.00

12116-2-A PIONEER

Output: 115 VAC; 400 cyc.; single phase; 45 amp. Input: 24 VDC 5 amp. \$65.00

10285 LELAND ELECTRIC

Output: 115 Volts AC, 750 V.A., 3 phase, 400 cycle, .90 PF, and 26 volts, 50 amps, single phase, 400 cycle, .40 PF. Input: 27.5 VDC, 60 amps, cont. duty, 3000 RPM. Voltage and Frequency regulated. \$95.00

10486 LELAND ELECTRIC

Output: 115 VAC; 400 Cycle; 3-phase; 175 VA; .80 PF. Input: 27.5 DC; 12.5 amp; Cont. Duty. \$90.00 ea.

PIONEER 10042-1-A

DC INPUT 14 Volts; OUTPUT: 110 Volts; 400 Cycle 1-Phase; 60 Watt. \$75.00

94-32270-A LELAND ELECTRIC

Output: 115 Volts; 190 VA; Single Phase; 400 Cycle; .90 PF, and 26 Volts; 60 VA; 400 Cycle; .40 PF. Input: 27.5 Volts DC 18 amps cont. duty, voltage and freq. regulated. \$95.00

PIONEER 12147-1-B

OUTPUT: 115 VAC 400 cycle; Single phase. INPUT: 24-30 VDC; 8 amps. \$79.50

MG 149F HOLTZER-CABOT

OUTPUT: 26 VAC @ 250 VA; 115V @ 500VA; Single Phase; 400 cycle. INPUT: 24 VDC @ 36 amps. \$75.00

EICOR CLASS "A" NO. 1-3012/08-7

OUTPUT: 125 VAC; 400 cycle; single-phase; 100 VA. INPUT: 24-30 VDC; 11 amps; Duty int. Voltage and Frequency Regulator. \$99.50



POWER RHEOSTATS

Standard Brands: 5 Ohms; 100 Watt; 4.48 amps 100 Ohms; 100 Watt; 1.0 amp.
Boxed. Brand New with Knob \$2.50 each—or—\$25.00 per Doz.

PIONEER AUTOSYNS

AY-1. 26 Volt-400 Cycle. \$6.95
AY-5. 26 Volt-400 Cycle. \$7.95
AY27D. \$12.50
AY6-26 Volt-400 cyc. \$4.95 ea.
AY30D-26 Volt-400 cyc. \$25.00 ea.
AY14D. \$10.00
AY34. \$20.00
AY20-26 Volt-400 cyc. \$12.50 ea.

MIDGET TYPE NT-6 WILLARD 6V. STORAGE BATTERIES Dry Charged

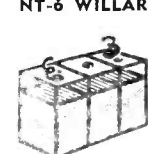

3 Amp-Hour rating. Transparent plastic case. SIZE: 3 3/8" x 1-13/16" x 2 3/8". Weight approx. 1 1/4 lbs. Uses standard electrolyte. Regularly lists at \$12.00 each. NOW, unused. \$2.49 ea.; Four for \$8.50; Quantities; 36 or more \$1.85 each.



ALNICO FIELD MOTORS

(Approx. size overall . . . 3 3/4" x 1 1/4" diameter)
DELCO TYPE #5069600; 27.5 volts DC; 250 RPM. \$19.95
Type #5069371; 27.5 volts; DC
Alnico Field; 10,000 R.P.M.; dimensions 1" x 1" x 2" long; shaft extension 3/8" diameter 0.125". \$15.00

PIONEER GYRO FLUX GATE AMPLIFIER

Type 120/6-1-A, complete with tubes. \$22.50

AC CONTROL MOTOR

A. C. SYNCHRONOUS MOTOR Type RBC 2505; Volts 115; Cycles 60; RPM 2; Mfg. HOLTZER CABOT ELECT. Approx. size: 2 1/2" x 2 1/2" x 2 1/2". \$15.00 ea.

400 CYCLE MOTORS

PIONEER: TYPE CK5 2 Phase; 400 cycles. \$25.00 ea.
EASTERN AIR DEVICES TYPE J9A; 115 V.; 0.1A; 7000 r.p.m. Single phase 400 cycle. \$17.50 ea.
AIRSEARCH: 115V; 400 CPS; Single phase 6500 RPM; 1.4 amp; Torque 4.6 in. oz.; IIP .03. \$10.00 ea.
EASTERN AIR DEVICES TYPE JM6B; 200 VAC; 1 amp; 3 phase; 400 cycles, 6000 RPM. \$12.50 ea.
EASTERN AIR DEVICES TYPE J31B; 115 V.; 400-1200 Cycle. Single Phase. \$12.50 ea.
AIRSEARCH: AC induction, 200 V; 3 Phase, 400 Cycle, 2 I.P.; 11,000 RPM; 8 amps. \$79.50 ea.
AIRSEARCH: AC Induction, 200 V; 3 Phase, 400 Cycle, 12 I.P.; 6000 RPM; 1.5 amps. \$25.00
Electric Motor: INT-1400-AI-1A Serial No. 207, 208 V., 400 Cycles, 3 Phase Kearfoot Co., Inc. \$17.50 ea.

SERVO MOTOR 10047-2-A; 2 Phase; 400 Cycle, with 40-1 Reduction Gear \$17.50

SMALL DC MOTORS

EMERSON #174; 12 Volt DC; 1/6th HP; 10 amp; 3500 RPM; Approx. size: 2 1/2" x 3 1/2". \$9.95 ea.
DELCO #5072900; 27.5 VDC; 11.75 rpm. \$15.00
DELCO #5068750; constant speed; 27 VDC; 160 RPM; built-in reduction gears and governor. \$12.50 ea.
J. OSTER: series reversible motor: 1/50th H.P.; 10-000 RPM; 27 1/2 VDC; 2 amps; SPERRY #806069; approx. size 1 1/2" x 3 1/2". \$7.00 ea.
General Electric Type 5BA10A137; 27 volts, DC; 5 amps, 8 oz. inches torque; 250 RPM. shunt wound; 4 leads; reversible. \$15.00 ea.
General Electric, Mod. 5BA10FJ33; 12 oz. inches torque, 12 DC, 50 RPM, 1.02 amp. \$15.00 ea.
General Electric Type 5BA10AJ52C; 27 volts DC; 5 amps, 8 oz. inches torque; 145 RPM; shunt wound; 4 leads; reversible. \$15.00 ea.
GENERAL ELECTRIC DC MOTOR Mod. 5BA10AJ61. 160 r.p.m.; 65 amp; 12 oz.-in. torque; 27V DC. \$19.95 ea.
2 1/4 H.P. MOTOR—Mfg. LEECE-NEVILLE Co; Type 1454-MO; 24VDC; 4000 RPM; 100 amp; 350. \$35.00

115 VLT GENERATORS

Brand new Eclipse generators: 115 VAC; 9.4 amp; 1000 watts; single phase; 800 cycles, 2100-4200 rpm. DC output is 30 volts at 25 amp. Unit has spline drive shaft and is self-excited. \$29.95

MICROPOSITIONER

Barber Colman AYLZ 2133-1 Polarized D.C. Relay: Double Coil Differential sensitive, Alnico P.M. Polarized field, 24V contacts; 5 amps; 28 V. Used for remote positioning, synchronizing, control, etc. \$12.50 ea.

BLOWER

Eastern Air Devices, Type J31B; 115 volt; 400-1200 Cycle; single phase; variable frequency; continuous duty; L & R. #2 blower; approx. 22 cu. ft./min. \$15.00

BLOWER ASSEMBLY

115 Volt, 400 Cycle, Westinghouse Type FL 17CFM, complete wit capacitor. New. \$12.50 ea.



SENSITIVE ALTIMETER

Pioneer Sensitive altimeters, 0-35,000 ft. range calibrated in 100's of feet. Barometric setting adjustment. No hook-up required. \$12.95 ea.

BLACK LIGHT KITS

Ultra-Violet Fluorescence

Now . . . build your own black light lamp equipment at a new low cost with these easy-to-assemble components. Kit contains: Ultra-Violet tube brackets, ballast, starter, wire, plug and wiring diagram.

4-Watt Kit-(5 1/2" tube). \$3.00
8-Watt Kit-(12" tube). \$4.00

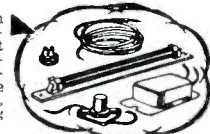

C and H Sales Company

BOX 356-X EAST PASADENA STATION • PASADENA 8, CALIFORNIA

COMMUNICATIONS EQUIPMENT CO.



INTERPHONE AMPLIFIER

Easily converted to an Ideal Inter-Communications set for office, home, or factory. Original. New w/conversion. Diagram. **\$4.75**

HI-POWER COMPONENTS

Plate Trans. Primary: 115 V, 50-60 Cy., Sec. 17-600 V/144 MA. Has "Bilt-in" Filter Choke. Oil Immersed. **\$115**
 Plate Trans. Pri: 198/220/240 V, 60 Cy, 1 Ph. Sec: 3650 V/16.7 KVA, 30 KV Insulation. Oil-Immersed, Less Oil Gauge **\$335**
 Plate Trans. Amertran #31133. Pri: 110/115/120 V/60 Cy/1 Phase. Sec: 3140/1570 V, 2.36 KVA. **\$65**
 Fil. Trans. Pri: 220 V/60 Cy/1 Phase. Sec: 5 VCT/10A/30 KV Test. **\$37.50**
 Plate Trans. Raytheon UX6801. Pri: 115 V/60 Cy/1 Ph. Sec: 22,000 V/234 MA/5.35 KVA. Lo-Cap. "Donut" Construction **\$135**
 Reactor: Raytheon U-11533: 13.5 H @ 1.0 Amp., 13.5 KV Test
 Reactor, Modulation: 50 H/3 A/80 Ohms DCR. Response: 03 Cy—10 KC. Level: plus 63db. 40 KV Test. Nominal Circuit Impedance: 3000 Ohms **\$350**
 Swing Reactor: 9-60 HY/05—400 MA, 10,000 V. Test—Kenyon **\$14.95**
 Transtar: Type TH45BG: Input 130/260 V, 50-60 Cy. 1 Ph. Output Range: 0-260 V, 45 A. Max. 11.7 KVA two-unit bank, parallel connected. Completely enclosed in cabinet with handwheel atop. Brand New **\$325.00**
 Circuit Breaker: ITE Model KJ. Will handle 600 VAC at 115 A. Break time adjustable from instant. to 10 minute. Break amperes adjustable from 115 A to 1000% overload. Brand New. **\$15.00**
 Alternator: Louis-Allis Co. Type "AL", 198-C. Output 110/220 V—1 Ph. 60 Cy. .9 P.F. 1200 RPM, completely self-regulating with built-in exciter. Brand new, original crates **\$795.00**

SELSYNS

115 VAC 60 CYCLES 1 PHASE
 1—Transmitter #C-78248 } Per Set
 1—Differential #C-78249 } **\$24.50**
 Transmitter Units Only **\$17.50 ea.**

UPRIGHT OIL CAP

MFD	Each
220VAC/600VDC	
6.2	\$1.29
15	3.49
330VAC/1000VDC	
15	3.79
1000VDC	
5	.69
5.5	1.19
1	1.49
4-1.5	2.19
1.5	1.39
1500 WVDC	
1	1.59
1.5	1.59
2	1.79
2000 WVDC	
1	1.79
2500 WVDC	
.5	2.98
4000 WVDC	
.15	6.95
4800 WVDC	
.1-1	4.79
6000 WVDC	
.1	3.69
.15	3.89
1.5	10.98
7000 WVDC	
.1-1	3.79
1	9.95
8000 WVDC	
.075-.075	3.79
10K VDC	
.0016	8.95
15K VDC	
.015	7.95
20K VDC	
.25	17.50
25K VDC	
1	85.00

NON-POLAR CAPACITORS

A. C. ELECTROLYTICS

CAP.	VAC.	PRICE
13-15	220-	\$1.20
20-24	110-	1.00
26-30	220-	1.35
43-65	110-	1.25
43-48	110-	1.25
50-75	110-	1.25
53-60	220-	1.50
61-69	320-	1.60
64-72	110-	1.25
72-87	110-	1.25
75-84	110-	1.25
88-106	110-	1.50
107-129	110-	1.65
130-157	110-	1.75
130-150	70-	1.50
130-180	110-	1.85
159-191	110-	1.85
161-180	110-	1.75
189-210	110-	1.95
200-220	110-	1.95
270-300	110-	2.10
324-360	110-	2.40
378-420	175-	3.00
432-480	110-	2.75
485-540	110-	2.85

932 PHOTO TUBE



Gas Phototube having SI response, particularly sensitive to Red and Near Infrared Radiation. Can be used with Incandescent light source. Send for data. **75¢**

POWER TRANSFORMERS

Comb. Transformers—115V/50-60 cps Input

Item	Rating	Each
CT-129	0-0-650V @ 150 MA, 6.3V/4A, 2.5VCT/5A	5.79
CT-013	50-0-450V @ 200 MA, 10V/1.5A, 2.5V/3.5A 5V/3A	6.95
CT-341	1050 10N/A, 6.25V @ 5MA, 26V @ 4.5A 2x2.5V/3A, 6.3V @ 3A	9.95
CR 825	360VCT .340A 6.3VCT/3.6 6.3VCT/3A	3.95
CT-071	110V .200A 33/200, 5V/10, 2.5/10	4.95
CT-367	580VCT .050A 5VCT/3A	2.25
CT-403	350VCT .026 A 5V/3A	2.75
CT-931	585VCT .086 A 5V/3A, 6.3V/6A	4.25
CT-456	390VCT 80 MA 6.3V/1.3A, 5V/3A	3.45
CT-931	585VCT 86 MA 5V/3A, 6 V/6A	4.95
CT-442	525VCT 75 MA 5V/2A, 1 CT/2A, 50V/200 MA	3.85
CT-43A	600-0-600V/0.8A, 2.5VCT/6A, 6.3VCT/1A	6.45
CT7-501	650VCT/200MA, 6.3V/8A, 6.3V/5A	6.49
CT-444	230-0-230V/0.85A, 5V/3A, 6V/2.5A	3.49

Filament Transformers—115V50-60 cps Input

Item	Rating	Each
FT-140	5VCT @ 10A 25KV Test.	\$22.50
FT-157	4V/16A, 2.5V/2.75A	2.95
FT-101	6V/.25A	.79
FT-924	5.25A/21A, 2x7.75V/6.5A	14.95
FT-824	2x26V/2.5A, 16V/1A, 7.2V/7A, 6.4V/10A,	8.95
FT-463	6.3VCT/1A, 5VCT/3A, 5VCT/3A	5.49
FT-55-2	7.2V/21.5A, 6.2V/6.85A, 5V/6A, 5V/3A	8.95
FT-38A	6.3/2.5A, 2x2.5V/7A	2.79

Plate Transformers, 115V 60Cy Input

Item	Rating	Each
PT 175	550-0-550VAC, (400VDC) @ 150MA	\$6.30
PT 157	660-0-660 VAC, (500VDC) or 550-0-550 VAC (400VDC) at 250 MADC	8.70
PT 158	1080-0-1080V (500VDC) at 125MA Plus 500-0-500 VAC (400VDC) at 150MADC Simult. Ratings.	10.80
PT 159	900-0-900 VAC (750VDC) or 800-0-800 VAC (600VDC) at 225 MADC	10.35
PT 167	1400-0-1400 VAC (300MADC) or 1175-0-1175 VAC (300VDC) at 300MADC	25.80
PT 168	2100-0-2100 VAC (1750VDC) or 1800-0-1800 VAC (1500VDC) at 300MADC	33.00
PT 062	2900-0-2900 VAC (2500VDC) or 2385-0-2385 VAC (2000VDC) at 300MA	48.00

10 KW TRANSMITTER KIT

1) Plate XFMR: Amertran 33134. Pri: 198/220/240V, 60 cy., 1 ph. Sec: 3650V, 16.7 KVA, 30 KV insulation. Oil Immersed.
 1) Reactor, Modulation. Amertran 33153. 50 H @ 3.0 ohms, DCR=80 ohms, Freq.—03 cy. to 10 KC. Level: 63 DB, 40 KV Test. Impedance: 3000 ohms. A great value.
 Both units (Trans & Choke) for **\$630.00**

400 CYCLE TRANSFORMERS

(All Primaries 115V, 400 Cycles)

Stock	Rating	Price
352-7102	6.3V/2.5A	1.45
M-7472426	1450V/1.0MA, 2.5V/75A, 6.4V/3.9A, 6.4V/2A, 6.5V/3A, P/O 1D-39/ APG-13	4.95
352-7039	640VCT @ 380MA, 6.3V/.9A, 6.3V/6A 5V/6A	5.49
702724	9800/8600 @ 32MA	8.95
KS9584	5000V/290MA, 5V/10A	22.50
KS9607	730VCT/177A, 1710VCT/177A	6.79
352-7273	700VCT/350MA, 6.3V/0.9A, 6.3V/2.5A, 6.3V/.08A, 5V/CA	6.95
352-7070	2x2.5V/2.5A (2KV TEST) 6.3V/2.25A, 1200/100/750V. @ .005A	7.45
352-7196	1140/1.25MA, 2.5V/1.75A, 2.5V/1.75A 5V/1V Test.	3.95
352-7176	320VCT/50MA, 4.5V/3A, 6.3VCT/20A, 2x6.3VCT/6A	4.75
RA6400-1	2-5.1, 7.5A, 6.3V/2A—5KV Test.	2.39
901692	13V 9A	2.49
901699-501	2.7V @ 4.25A	3.45
901698-501	900V/75MA, 100V/0.4A	4.29
UJ-8855C	900VCT/0.67A, 5V/3A	3.79
RA6405-1	800VCT/65MA, 5VCT/3A	3.69
T-48852	700VCT/806MA/5V/3A, 6V/1.75A	4.25
352-7098	2500V/MA, 300 VCT, 135MA	5.95
KS 9336	1100V/50MA TAPPED 625V, 5V/5A	3.95
M-7474319	6.3V/2.7A, 6.3V/6.6A, 6.3VCT/21A 27V/4.3A, 6.3/2.9A, 1.25V/.02A	4.25
KS8984	650VCT/50MA, 6.3VCT/2A, 5VCT/2A	3.75
52C080	400VCT/35MA, 6.4V/2.5A, 6.4V/.15A	3.85
32332	1150-0-1150V	2.75
68G631	6VCT/.0006 KVA	1.75
80G198	6.3V/9.1A, 6.3VCT/6.5A, 2.5V/3.5A, 2.5/3.5A	4.85
302433A	59.2VCT/118MA, 6.3V/8.1A, 5V/2A, 6.4/7.5A, 6.4V/3.8A, 6.4/2.5A	5.39
KS 9445	ALL CT	4.79
KS 9685	600VCT/36MA	2.65
70G30G1	2100V/.027A	4.95
M-7474318	2-2.5V Wdgs. at 2.5A, Each Lo-Cap., 22KV Test	5.95
352-7096	2.5V1.75A, 5V/3A, 6.5V/6A, 6.5V/1.2A, P/O BC800	
352-7099	360VCT/20MA, 1500V/1MA, 2.5V/1.75A, 6.3V/2.5A, 6.3V/6A, P/O BC-929	6.45
D163253	5200V/.002A, 2.5V/5A	5.35
M-7471957	1.75A, 6.3V/2.5A, 6.3V/6A, P/O BC-929	4.85
352-71797	2.5V/20A, 12KV Test.	4.85
	250V/100MA, 6.5V/12ACT 5V/2A	3.45

DYNAMOTORS

TYPE	INPUT VOLTS	INPUT AMPS	OUTPUT VOLTS	OUTPUT AMPS	PRICE
DM 416	14	6.2	330	170	\$6.75
DM 33A	28	7	540	250	3.95
BD AR 93	28	3.25	375	150	7.50
23350	27	1.75	285	075	3.95
B-19 Pack	12	9.4	500	110	8.95
DA-3A*	28	10	300	260	6.95
			150	010	
			14.5	5	
PE 73 CM	28	18	1000	350	22.50
BD 69†	14	2.8	220	08	12.95
D-402†	13.5	12.2	300	8.8VAC	12.50
SP 175	18	3.2	450	06	4.49
DM 25†	12	2.3	250	05	6.95
PE-94C Power Supply, Brand New					\$6.95
† Less Filter					* Replacement for PE 94.
† Used, Excellent					

INVERTERS

PE-218-H: Input: 25/28 vdc, 92 amp. Output: 115v, 350/500 cy 1500 volt-amperes. NEW. **\$37.50**
 PE-206: Input: 28 vdc, 36 amps. Output: 80 v 800 cy. 500 volt-amps. Dim: 13"x5"x10". **\$22.50**
 New NAVY COR-211095: Input 22-30 VDC/75-60A. OUTPUT: 115V/400 CY. 1 KVA/8.7A. RPM: 4800 With coupling provision for motor. Brand New. Original packing. **\$150.00**

SELENIUM RECTIFIERS*

Current (Continuous)	18/14 Volts	36/28 Volts	54/42 Volts	130/100 Volts
1 Amp.	\$1.35	\$2.15	\$3.70	\$8.50
2 Amps.	2.20	3.60	5.40	10.50
2 1/2 Amps.			6.00	13.00
4 Amps.	4.25	7.95	12.95	25.25
6 Amps.	4.75	9.00	13.50	33.00
10 Amps.	6.75	12.75	20.00	44.95
12 Amps.	8.50	16.25	20.50	49.00
20 Amps.	13.25	25.50	38.00	79.50
24 Amps.	16.25	32.50	45.00	90.00
30 Amps.	20.00	38.50		
36 Amps.	25.00	48.50		

* F. W. Bridge

BARRYMOUNTS



C-2045 **45¢**
 C-2060 each
 C-2070 **\$35/100**
 C-2090

APN-3 SPARE PARTS

K-901684-501: SCS #229632.306, Trans.	\$2.49
K-901685-501: SCS #229631.238, Trans.	2.25
K-901692-503: SCS #229617-70, Xfmr, Fil.	2.49
K-901699-501: SCS #229617-68, Fil. Xfmr.	3.45
K-901698-501: SCS #229618-38, Plate Xfmr.	4.29
K-901695-501: SCS #229627-19, Pulse Xfmr.	3.50

BAND PASS FILTERS

INPUT IMPEDANCE: 2000 OHMS. OUTPUT: TO GRID. AVAILABLE IN FOLLOWING RANGES:

CHANNEL	F1	F2*	F2*
5	1155	830	1620
7	2270	1620	3180
12	3180	2270	4450
8	3180	2270	4450
9	4450	3180	6230
10	6230	4450	720

* F1: Center Freq. In CPS; F1 and F2 are lower and upper limits (CPS) respectively, at -20 db points. Price, \$4.95 Each

JAN/UG CONNECTORS

UG 9/U	50.85	UG 58/U	\$0.70
UG 10/U	.95	UG 89/U	1.05
UG 21/U	.80	UG 102/U	.75
UG 22B/U	1.25	UG 188/U	1.15
UG 22/U	1.20	UG 254/U	2.50
UG 27/U	1.20	UG 261/U	1.10
UG 27A/U	2.25	D-166366.	.75

SPARES FOR APN-9

Power Trans., Pt. No. 352-7295-2 **\$4.95 each**
 Counter Trans., T111, T112, T117, Pt. No. 352-725

COMMUNICATIONS EQUIPMENT CO.

PULSE NETWORKS

15A-1.400-50: 15 KV, "A" CKT, 1 microsec. 400 PPS, 50 ohms Imp. \$37.50
 G.E. #3E (8-84-810) (8-2.24-405) 50P4T; 3KV "E" CKT Dual Unit; Unit 1, 3 sections, 0.84 Microsec. 810 PPS, 50 ohms Imp.; Unit 2, 8 Sections, 2.24 microsec. 405 PPS 50 ohms Imp. \$6.50
 7-5E3-1-200-67P. 7.5 KV "E" Circuit, 1 microsec. 200 PPS 67 ohms Impedance 3 sections. \$7.50
 7-5E4-16-60, 67P, 7.5 KV "E" Circuit, 4 sections 16 microsec. 60 PPS, 67 ohms Impedance. \$15.00
 7-5E3-3-200-67P. 7.5 KV "E" Circuit, 3 microsec. 200 PPS, ohms Imp. 3 sections. \$12.50
 K5863 CHARGING CHOKE: 115-150 H @ .02A, 32-40H @ .08A, 30,700V Corona Test, 21KV Test. \$37.50
 G.E. 25E5-1-350-50 P2T, "E" CKT, 1 Microsec. Pulse @ 350 PPS, 50 OHMS Impedance. \$69.50
 K59623 CHARGING CHOKE: 16H @ 75 MA, 350 Ohms DCR, 900V Vac. Test. \$14.95
 G.E. 6E5-5-200 50 PPT, 6 KV, "E" Circuit, 0.5 usec/2000 PPS/50 ohms/2 sections. \$7.50

PULSE EQUIPMENT

MIT. MOD. 3 HARD TUBE PULSER: Output Pulse Power 144 KW 12 KV at 12 Amp. Duty Ratio: .001 max. Pulse duration: 5, 1.0, 2.0 microsec. Input voltage: 115 v. 400 to 2400 cps. Uses: 1-71B, 4-89-B, 3-72's, 1-73. New. Less Cover—\$135
 APQ-13 PULSE MODULATOR. Pulse Width .5 to 1.1 Micro Sec. Rep. rate 624 to 1348 Pps. Pk. pwr. out 85 KW Energy 0.018 Joules. \$49.00
 TPS-3 PULSE MODULATOR. Pk. power 50 amp. 24 KW (1200 KW pk): pulse rate 200 PPS, 1.5 microsec. pulse line impedance 50 ohms. Circuit series charging version of DC Resonance type. Uses two 705-A's as rectifiers, 115 v. 400 cycle input. New with all tubes. \$49.50
 SPRAGUE H-615 "E" Circuit 10KV, 0.85 microsec pulse at 750 PPS 50 ohms. \$27.50
 SPRAGUE H-616, "E" Circuit, 10KV 2.2 microsec pulse at 3.755 PPS—50 ohms. \$27.50

PULSE TRANSFORMERS



GE #K-2449A
 Primary: 9.33 KV, 50 ohms Imp.
 Secondary: 28 KV, 450 ohms
 Pulse length: 1.0/5 usec @ 635/120 PPS Pk. Power Out: 1.740 KW
 Bifilar: 1.5 amps (as shown) \$62.50
 GE #K-2748-A. 0.5 usec @ 2000 Pps. Pk. Pwr. out is 32 KW Impedance 40:100 ohm output. Pri. volts 2.5 KV Pk. Sec. volts 11.5 KV Pk. Bifilar rated at 1.5 Amp. Fitted with magnetron well. \$39.50
 K-2745. Primary: 3.1/2.8 KV, 50 ohms Z. Secondary: 14/12.6 KV 1025 ohms Z. Pulse Length: 0.25/1.0 usec @ 600/600 PPS. Pk. Power 200/150 KW. Bifilar: 1.5 Amp. Has "built-in" magnetron well. \$42.50
 K-2461-A. Primary: 3.1/2.6 KV—50 ohms (line). Secondary 14/11.5 KV—1000 ohms Z. Pulse Length: 1 usec @ 600 PPS. Pk. Power Out: 200/130 KW. Bifilar: 1.5 Amp. Fitted with magnetron well. \$39.75
 UTAH X-1517-1: Dual Transformer, 2 Wdgs. per section 1:1 Ratio per sec 13 MH Inductance 30 ohms DCR \$7.50
 UTAH X-1507-1: Two sections, 3 Wdgs. per section. 1:1:1 Ratio, 3 MH, 6 ohms DCR per Wdg. \$7.50
 6B6711: Ratio: 4:1 Pri. 200V. Sec. 53V, 1.0 usec Pulse @ 2000 PPS. 0.016 KV. \$4.50
 TR1049 Ratio: 2:1 Pri. 220 MH, 50 Ohms, sec. 0.75 H. DCR 100 Ohms. \$6.75
 K-901695-501: Ratio 1:1. Pri. Imp. 40 Ohm, Sec. Imp. 40 Ohms. Passes pulse 0.6 usec with 0.05 usec rise \$9.95
 Ray UX 7896—Pulse Output Pri. 5v. sec. 41v. \$7.50
 Ray UX 8405—Pulse Inversion 40v + 40v. \$7.50
 PHILCO 352-7250, 352-7251, 352-7287 \$5 ea.
 RAYTHEON: UX8693, UX5986 \$5 ea.
 W.E.: D-166310, D-166638, KS9800, KS9948.
 UTAH #9262, with Cracked Beads, but will operate at full rated capacity. \$5.00
 UX 8693 (SCS #273927-54): 3 Wdgs, 32 turns #18 wire. DCR is: 362/372/4 ohms. Tot. voltage 2500 vdc. \$5.00
 D-166173: Input: 50 ohms Z. Output: 900 ohms Z. Wdgs. Freq. range 10 kc-2mc. P/O AN/ATQ-13 \$12.50

10 CM R.F. HEAD

Complete R.F. Head and Modulator delivers 50 KW Peak R.F. at 3000 MC. Pulsar delivers 12KV pulse at 12 Amp. to magnetron of .5, 1, or 2 microsec. duration at duty cycle of 001. Unit requires 115V, 400-2400 Cycles, 1 phase @ 3.5A. Also 24-28 VDC @ 2A. External sync. Pulse of 120V Reg'd. Brand New. Complete with schematic and all tubes. \$375.00

THERMISTORS

D-164699 Bead Type DCR: 1525-2550 Ohms @ 75 Deg. F. Coefficient: 2% Per Deg. Fahr. Max. Current 25 MA AC/DC. \$2.50
 D-167332 Bead Type, DCR is 1525-2550 Ohms. Rated 25 MA at 325-1.175 VDC. \$1.50
 D-167813 Disk Type DCR: 355 Ohms @ 75 Deg. F. P. M. 2.5/1 Watt. \$1.50
 D-166228 Disk Type 718 Ohms @ 60°F, 4220 Ohms @ 80°F, 2590 Ohms @ 100°F, 1640 Ohms @ 120°F. \$1.50

MAGNETRONS

Type	Freq. Range (MC)	Peak Power Out (KW)	Duty Ratio	Price
2J12A	9345-9405	50		\$8.75
2J22	3267-3333	265		7.50
2J27	2965-2992	275	.002	19.95
2J31	2820-2860	285	.002	24.50
2J32	2780-2820	285	.002	28.50
2J38	3249-3263	8		16.50
2J39	3267-3333	8		24.50
2J48	9310-9320	50	.001	24.50
2J49	9000-9160	50	.001	59.50
2J56*	9215-9275	50	.001	132.50
2J61†	3000-3100	35	.002	34.50
2J62†	2914-3010	35	.002	34.50
700E†	690-700	40	.002	22.50
706D	710-720	40	.002	39.75
706EY	3038-3069	200	.001	32.50
706CY	2976-3007	200	.001	32.50
725-A	9345-9405	50	.001	Write
730-A	9345-9405	50	.001	24.50
4J38	3550-3600	750	.001	169.45

* Packaged with magnet.
 † Tunable over indicated range.
 QK 60, 61, 62—\$85 ea.

KLYSTRONS

723A \$12.50 | 2K25/723A/B \$27.50
 723A/B 19.50 | 417-A (Sperry) 17.50

JUST ARRIVED!! MAGNETRONS

5123 \$49 | QK-253 \$249
 4134 \$125 | 3131 \$85

TEST SETS

TS 12/AP, UNITS 1 & 2 \$450
 TS 47/APR, 50-500MC. \$250

BC 1203 MODULATOR

Provides 200-4,000 PPS. Swept time: 100 to 2,500 microsec. in 4 steps fixed mod. pulse, suppression pulse, sliding modulating pulse, blanking voltage, marker pulse, sweep voltages, calibration voltages, fil. voltages. Operates 115 vac. 50-60 cy. Provides various type of voltage pulse outputs for the modulation of a signal generator such as General Radio #804B or #804C used in depot bench testing of SCR 695, SCR 595, and SCR 535. New. Complete with tubes \$150

RADAR SETS

SO-1

18 deg. in vert. plane. Operates from 115 vdc. Set consists of following: antenna, modulator, xmt-recv, PPI unit, accessory control, and rectifier power unit.

MK 10

Uses conical scanning for accurate pointing. Max. range is 20,000 yards with an error of pm 15 yds pm 1% of range. Pointing accuracy is pm .25 deg. Pulse dur. 0.5 usec. at prr of 3600 cps. Pk. power output is 25 KW. Primary power consumption is 1300 watts. Operates from 115V, 60 CPS Source. BRAND NEW, COMPLETE WITH SPARES AND INSTRUCTION MANUAL \$850.00

SQ

SE

SN

IFF SETS

RC 148 RC 184 Navy BM
 RC 145 RC 188

PRICE ON REQUEST

MICROWAVE COMPONENTS



"S Band," RG48/U Waveguide

POWER SPLITTER for use with type 726 or any 10 CM Shepherd Klystron. Energy is fed from Klystron antenna through dual pick-up system to 2 type "N" connectors. \$22.50 EACH
 DIRECTIONAL COUPLER. Broadband. Type "N" Coupling, 20 db. with std. flanges. Navy #CAV47AAN-2 (as shown) \$37.50

LHTR, LIGHTHOUSE ASSEMBLY. Part of RT39 APG 5 & APG 15. Receiver and Trans. Cavities w/assoc Tr. Cavity and Type N CPLG. To Recv. Uses 2C40, 2C43, 1B27. Tunable APX 2400-2700 MGS. Silver Plated. \$32.50
 BEACON LIGHTHOUSE cavity p/o UPN-2 Beacon 10 cm. Mfg. Bernard Rice, each. \$47.50
 MAGNETRON TO WAVEGUIDE Coupler with 721-A Duplexer Cavity, gold plated. \$49.00
 RT-30 APG-5 10 cm. lighthouse Rf head o/x xmit. using 60K5 (2C40, 2C43, 1B27 lineup) w/Tube. 721A TR BOX complete with tube and tuning plungers. \$12.50
 McNALLY KLYSTRON CAVITIES for 707B or 2K28 \$4.00
 WAVEGUIDE TO 3/4" RIGID COAX "DOORKNOB" ADAPTER CHOKED FLANGE, SILVER PLATED BROAD BAND \$32.50
 ASI4A AP-10 CM Pick up Dipole with "N" Cables \$4.50
 OAJ ECHO BOX, 10 CM TUNABLE \$22.50
 HOLMDELL-TO-TYPE "N" Male Adapters, W.E. #D167284 \$7.75
 I.F. AMP. STRIP, 30 MC, 90 db. 4 MC Bandwidth. Uses 6AC7's—with video detector, A.F.C. less tubes \$24.50
 POLYROD ANTENNA, AS31/APN-7 in Lucite Ball. Type "N" feed \$22.50
 ANTENNA, AT49A/APR: Broadband Conical. 3000 MC Type "N" Feed \$12.50
 "E" PLANE BENDS, 90 deg. less flanges. \$7.50

X Band— RG 52/U WAVEGUIDE

VSWR Measuring Section. Consisting of 6" straight section, with 2 pick-up, Type "N" Output Jacks. Mounted 1/2 Wave apart. \$8.50
 1" x 1/2" waveguide in 5' lengths, UG 89 flanges to UG40 cover per length \$7.50
 Rotating Joints supplied either with or without 5.0c mounting. Using UG40 flanges. each, \$17.50
 Bulkhead Feed-thru Assembly. \$15.00
 Pressure Gauge Section 15 lb. gauge and press nipple \$10.00
 Pressure Gauge, 15 lbs. \$2.50
 Directional Coupler, UG-40/U Take off 20db. \$17.50
 TR-ATR Duplexer section for above. \$8.50
 Waveguide Section 12" long choke to cover 45 deg. twist & 2 1/2" radius 90 deg. bend. \$4.50
 Waveguide Section 2 1/2 ft. long silver plated with choke flange \$5.75
 Rotary Joint choke to choke with deck mounting 90 degree elbows. "E" or "H" plane 2 1/2" radius \$17.50
 Microwave Receiver, 3 CM. Sensitivity: 10-15uV. Watts. Complete with L.O. and AFC Mixer and Waveguide Input Circuits. 6 I.F. Stages give approximately 120 DV gain at a bandwidth of 1.7 MC. Video Bandwidth: 2 MC. Uses latest type AFC circuit. Complete with all tubes, including 723A/B Local Oscillator \$175.00
 ADAPTER, Waveguide to Type "N", UG 81/U, p/o TS 12 TS-13, Etc. \$27.50
 ADAPTER, UG-163/U round cover to special hd. Flange for TS-45, etc. \$2.50 ea.

1 1/4" x 5/8" WAVEGUIDE

CG 98B/APQ 13 12" Flex. Sect. 1 1/4" x 5/8" OD 110.00
 X Band Wave GD 1 1/4" x 5/8" O.D. 1/16" wall aluminum per ft. 75¢
 Slug Tuner Attenuator W.E. guide, gold plated. \$6.50
 Bi-Directional Coupler, Type "N" Takeoff 25 db. coupling \$27.95
 Bi-Directional Coupler, UG-52. Takeoff 25 db. coupling \$24.95
 Waveguide-to-Type "N" Adapter, Broadband. \$22.50

WAVEGUIDE FLANGES

UG 39/U \$1.10 | UG 51/U \$1.65
 UG 40/U \$1.25 | UG 52/U \$3.40
 UG 40A/U \$1.65 | UG 52A/U \$3.40

MICROWAVE MIXER

CV-12/APR-6: Waveguide/mixer unit, 4000-6000 mc. Designed for use with microwave receiver. Has pick up loop for coupling to lighthouse cavity local oscillator. RF input is 1" x 2" waveguide (contact flange). Output (thru In21 xtl.) is from standard 50-ohm coax connector. Brand new, complete with crystal. As shown \$35.00

MAIL ORDERS PROMPTLY FILLED. ALL PRICES F.O.B. NEW YORK CITY. SEND M.O. OR CHECK. ONLY SHIPPING SENT C.O.D. RATED CONCERNS SEND P. O. ALL MDSE. SUBJECT TO PRIOR SALE AND PRICES SUBJECT TO CHANGE WITHOUT NOTICE. PARCELS IN EXCESS OF 20 POUNDS WILL BE SHIPPED VIA CHEAPEST TRUCK OR RAIL.

131 Liberty St., New York 7, N. Y. Dept E-1 Ches. Rosen Phone: DIgby 9-4124

RELAYS

RELAYS

RELAYS

JOBBER—EXPERIMENTERS—LABORATORIES

WRITE OR PHONE WALKER 5-9642 FOR YOUR RELAY REQUIREMENTS
Ask for Mr. Greenberg or Mr. Herzog

We have a large variety of standard types of relays and solenoids for a multiplicity of uses which for various reasons are not listed in our advertising. When inquiring concerning your needs give as much information as possible. Catalog numbers are not sufficient. Give coil voltage; specify AC or DC; give current or resistance; contact current and arrangement.

ALL MERCHANDISE IS GUARANTEED AND MAY BE RETURNED FOR FULL CREDIT

HERMETICALLY SEALED RELAYS



CLARE SERIES 5000: Clare SK Relay enclosed in hermetically sealed cylindrical can 1 1/2" di. x 2 1/2" h. All relays in this series are provided with a standard RMA octal plug base.

Stock No.	Type	Volts D.C.	MA	Contacts	Ohms	Price each
R438	5018	24	80	3A	300	5.95
R928	5023A	24	80	2C	300	6.95
R440	5036	36	15	2A, 1C	2450	6.95
R441	5094	36	12	2A 1C	2850	6.95
R929	5123	24	80	2C	300	7.25
R442	5167	75	30	1C(5amp)	2500	6.95

CLARE 15001: 115VAC, 60-400 cyc; DPST (2A); #R453. 6.95

CLARE 15006: 115VAC, 60-400 cyc; SPDT (1C); #R454. 6.95

ALLIED & PRICE 5709-27HX: 24VDC; DPDT; 625 ohm; Octal Plug Base; #R449. 6.95

ALLIED PRHX: 24VDC; 2A, 1B, (10 amp); 300 ohm; #R450. 6.95

ADVANCE A874-1Y: 6VDC; SPST (1A); 36 ohm; Solder Lug Terminals; #R443. 4.95

SIGMA 949: 115VAC; SPST, n.c. (1B); #R445. 4.95

SIGMA 71257: 6VDC; SPDT; 47 ohm; #R448. 5.95

STRUTHERS DUNN 181CX100: 12VDC; 3As; 3Bs; 150 ohm; #R679. 6.95

STRUTHERS DUNN 181BBX100: 6VDC; 2As; 2Cs; 36 ohm; #R447. 6.95

4PDT SEALED AN TYPE: 24VDC; 425 ohm; (4C); Standard Makes; #R446. 5.95

STEVENS ARNOLD Millisec Relay Type 328: 24VDC; 1B, 1C; 1600 ohm; Solder Head Terminals; #R930. 9.95

SIGMA 44H: 4 ma pull-in, 2.5 ma hold; SPDT; 5-prong Plug Base; #R444 2000 ohm; RTMA. 4.25

SIGMA 4RJ-47G: 3VDC; SPDT; 47 ohm; Solder Head Terminals; #R448. 5.95

SIGMA SRJ100S: 1.5VDC; SPDT; 100 ohm; Solder Head Terminals; #R1001. 6.95

SIGMA 5RJ2000G: 2.3 ma; SPDT; 2000 ohm; #R1005. 7.50

SIGMA 5RJ5000G: 1.4 ma pull in, 0.4 ma hold; SPDT; 5000 ohm; #R281. 6.95

AND MANY OTHERS

WESTERN ELECTRIC MERCURY CONTACT RELAYS

D 171584; SPDT; 24V Heater; 1 coil of 4500 ohms; operating current 6.6 ma; release current 5.2 ma. Overall length—3 3/4"; overall diameter—1-3/16". #R1021. \$6.95 each
10 for \$65 100 for \$625

Motor Driven

TIME DELAY RELAYS

HAYDON 5901-2: Adjustable Reset timing relay from 0.2 to 1.0 mln. in 0.1 min. steps; SPDT (10 amp) #R931 100V 60 cyc. \$7.95 #R466 220V 60 cyc. \$7.95

PRICE 4063-7: Adjustable Reset Timer 9 to 54 seconds in 6 sec. steps; DPDT (10 amp) Instantaneous solenoid release; 110V 60 cyc. #R932 \$12.95

LORD SHOCKMOUNTS

Stock No.	Series	Center Hole	LB	Other Data	Each
SM11	100	1/8"	1	Monel	.12
S12	100	1/8"	2	Steel Base	.12
SB12	100	Stud	2	Steel Base	.12
S14	100	1/8"	4	Steel	.12
S18	100	3/16"	8	Steel	.15
ST54	150	1/4"	4	Stainless	.20
SM54	150	1/4"	10	Steel	.25
S60	150	1/4"	4	Steel	.20
S83	150	1/4"	33	Steel	.30
S110	200	3/8"	10	Steel	.28
SM120	200	3/8"	20	Monel	.35
SM145	200	3/8"	45	Monel	.45
S279	275	3/8"	250	Steel	1.00
PD53	100PH	1/8"	3	Dural	.20
P54	150PH	1/8"	4	Steel	.25
P56	150PH	1/4"	6	Steel	.20
PS106	200PH	1/4"	6	Steel	.20
PL106*	200PH	1/4"	6	Steel	.25
PT106	200PH	1/4"	6	Stainless	.35
PT120	250PH	3/8"	20	Stainless	.40

*with ground lug

OTHER MOUNTS

ST75	150	Goodyear	1/4"	25	Stainless	.25	
P100	200PH	U.S. Rubber with tapered nozzle	1/2"	long	Steel	.25	
S2030	C2030	Barry	1/4"	30	Steel Fr.	1.00	
S2335	C2335	Barry	3/8"	35	Steel Fr.	1.00	
S912	Lord	2 hole Mtg Centers	1 1/2"				
S908	Lord	Slotted 4 hole Mtg Centers	1 1/2"	12	Steel	.15	
S904	Lord	2 Hole Mtg Centers	1 1/2"	8	Stainless	.25	
S800	Cylindrical	Rubber 1" Dia x 3/4" high two 1/4"-20 x 1/2" steel screws vulcanized in center.	U. S. Rubber	1/4"	4	Steel	.10
S801	Cylindrical	Rubber 1 1/2" x 1 1/2" high with two 5/16"-18 x 1/2" steel screws vulcanized in center.	U. S. Rubber				15¢
S803	3/4" Dia.	without Mtg Shell	Lord	1/8"	2	Steel	.10
P101	200PH	U.S. Rubber	1/4"	45150C	Steel	.25	

General Description of Series Numbers
100—1" Mounting Centers
150—1 1/2" Mounting Centers
200—2" Mounting Centers
250—2 1/2" Mounting Centers
PH—Cup type shock mount

FERRULE AND OTHER WIRE WOUND RESISTORS AT A FRACTION OF MANUFACTURERS' ORIGINAL COST!



IMMEDIATE DELIVERY

From Our Wide Assortment from 0.2 Ohms to 15 Megohms.

ENAMEL • GLASS FIXED • ADJUSTABLE

New and in Perfect Condition. Nearly all made to JAN Specifications.

Send us your requirements. We have 250,000 wire wound resistors in a large variety of sizes in stock.

TERMS:—All prices F.O.B. Our Plant. Rated Firms Net 10 Days; All Others Remittance with Order.

Merchandise returnable within 10 days for full credit.

Orders Under \$10 Remittance With Order. Plus A proximate shipping charges (overage will be returned).

324 CANAL ST., N.Y.C., 13, N.Y. WALKER 5-9642

Universal general corp.

READY FOR IMMEDIATE DELIVERY!

Quantities of the following types of Relays:

ALLIED—Most numbers



TYPE C TELEPHONE RELAYS



MINIATURE AIRCRAFT



GUARDIAN Series 110, 120, 125, 155, 165, 405, 415 and Series R Steppers



LEACH

AIRCRAFT SOLENOID CONTACTORS

All types B2; B2A; B4; B4A; B5; B5A; B5B; B6A; B6B; B7A; B7B; B8; B9; B11; 1204-1; 1204-3, etc. available from stock in quantities in popular makes at low prices. SEND US YOUR REQUIREMENTS.

IMPULSE DIAL

To open a normally closed circuit. Ten holes—capacity: 1-10 impulses. Has 3 shunt springs, arranged to make when dial is moved off normal. #D101 \$4.95



STEPPING SWITCHES

AUTOMATIC ELECTRIC TYPE 13



25 Position; Self Interrupter Springs; Norm. Oper Volts: 25 VDC; Max 30 VDC; 0.6 Amps; 30 Ohm. Three Levels Auto. Elect. RA92; #R900 \$17.75

WESTERN ELECTRIC 22 Position: Make & Break Interrupter Springs; Normal Operating Voltage 6VDC; Max 8VDC 4 ohm; Five Levels #R926 \$19.75

WESTERN ELECTRIC 44 Position: Make & Break Interrupter Springs; Normal Operating Voltage 6VDC; Max 8VDC; 4 ohm; Two Circuit Levels #R927 \$22.50

KOVAR GLASS TO METAL SEALS HIGH-VOLTAGE FEED THRU



Many types and sizes. Send us your blueprint or sample for our quote. Our prices are a fraction of original factory cost.

SAMPLE KIT 96 Seals (8 ea. 12 types) 500 postpaid in USA
LAB KIT 300 Seals (20 types) 1500 postpaid in USA

SELENIUM RECTIFIERS

Full-Wave Bridge Types

Current (Continuous)	18/14 Volts	36/28 Volts	54/42 Volts	130/100 Volts
1 Amp.	\$1.35	\$2.15	\$3.70	\$8.50
2 Amps.	2.20	3.60	5.40	10.50
2 1/2 Amps.	3.10	4.20	6.00	13.00
4 Amps.	4.25	7.95	12.95	25.25
6 Amps.	4.75	9.00	13.50	33.00
10 Amps.	6.75	12.75	20.00	44.95
12 Amps.	8.50	16.25	20.50	49.00
20 Amps.	13.25	25.50	38.00	87.50
24 Amps.	16.25	32.50	45.00	95.00
30 Amps.	20.00	38.50
36 Amps.	25.00	48.50

We can build other Rectifiers and Transformers to your Electrical and Mechanical specs. Immediate Delivery!

NEW SELENIUM RECTIFIER TRANSFORMERS
 Pri: 115 V., 60 cycles in. SFC: 9, 12, 18, 24, and 36 volts.
 Continuous Ratings.....

4 Amps.....	\$8.75
12 Amps.....	16.75
24 Amps.....	35.75
30 Amps.....	45.00
50 Amps.....	59.75

NEW SELENIUM RECTIFIER CHOKES

2 Amps.—.06 Hy.—4 ohms.....	\$3.95
4 Amps.—.07 Hy.—6 ohm.....	\$7.95
12 Amps.—.01 Hy.—1 ohm.....	\$14.95
24 Amps.—.004 Hy.—.025 ohm.....	\$29.95

FILTER CAPACITORS

Capacity	W. Voltage	Ea.
500 MFD.	50 V.	.85
1000 MFD.	15 V.	.35
6000 MFD.	15 V.	1.50

VICTORENE VXR-130.
 Subminiature Voltage Regulator. Brand new in cellophane bag. Used as stabilizer in battery R. F. supplies; for voltage reference & limiting circuits; for D.C. Amplifier Coupling. Nominal volts: 130... Max. DC Starting Voltage: 200 Regulation: 1 to 2.5 Ia. ± 1%. You will find many uses for these units—Reg. only \$4.75 Ten for \$7.00

* New Ereo 4 Channel Ship-to-Shore Marine Transmitter — Receiver — F.C.C. Approved Brand New. Complete, less xtals @ \$179.50 Write for Full Details

WESTERN ELECTRIC CHOKES
 NEW—HERMETICALLY SEALED
 SMOOTHING 8 Henries @ 300 MA. 75 Ohms
 1 1/2" x 5 1/4" x 5". W.E. # KS 9476... \$4.75
 SWINGING from 4 to 7 Henries. 200 to 700 MA. 42 Ohms, 5" x 5 1/2" x 5". W.E. KS13063. \$4.75

W. E. HERM. SEALED POWER TRANSFORMER
 Type D175847, Primary 115 AC, 60 Cy. Secondary 1000 VCT @ 500 MA. 5 V @ 5 Amps. (20 KV Insul) 5 1/4" x 5 1/4" x 6 1/2". Brand new.....\$8.50

FLUXMETER

Used to calibrate field strength of magnets from 500 to 4000 gauss and indicate polarity. Probe has gap of 1/4". Beautifully built in hardwood case with lined cover. Instructions for operation on under side of cover. Size 12 1/2 x 9 x 6 in. Ideal for lab and school use. New. An exceptional value at...\$19.95

FULLY GUARANTEED

TUBE SPECIALS

STANDARD BRANDS ONLY

Type	Price	Type	Price	Type	Price	Type	Price	Type	Price	Type	Price
OA2	\$.87	2J34	18.50	5BP1	3.35	6CD6G	1.80	12A6	.75	80	.64
OA3/VRT5	1.03	2J37	12.00	5BP4	3.35	6CL6	1.10	12AL5	.70	81	.95
OB2	.85	2J39	6.95	5C22	37.50	6CS6 5915	1.10	12AT6	.50	82	.85
OB3/VR90	.90	2J40	32.00	5D21	11.98	6F4	3.50	12AT7	.83	83	.78
OC3/VRI05	.91	2J50	18.35	WLS5D22	41.25	6F5	.68	12A7	.79	101V (WE)	1.11
OD3/VRI50	.89	2J52	62.95	4-250A	41.25	6F6V	.65	12AV6	.50	84 6/24	5.84
WZ4	.50	2J54B	95.00	5FP7	1.25	6F8G	.90	12AV7	.90	93BR	.90
LE4	.85	2J55	62.50	5GP1	3.35	6G12	.90	12AW6	.88	C-100E	5.50
1A3	.70	2J61	29.50	5J29	11.50	6H6	.52	12AX4GT	.90	100-TH	5.95
1A7GT	.66	2J62	25.00	5J30	29.50	6J4	4.95	12AX7	.70	101V (WE)	2.20
1AX2	1.05	2K22	19.50	5J22	19.75	6J5M	.50	12AY7	1.70	101V (WE)	2.20
1B3GT	.85	2K23	11.40	5J27	22.75	6J5GT	.65	12B7	1.10	117GT	1.65
1B22	1.20	2K25	20.20	5LP5	17.00	6B6	.75	12BA6	.65	102-F (WE)	2.25
1B23	5.75	2K28	25.00	5RAGY	1.20	6J7M	.70	12BE6	.64	FG-105	17.50
1B24	7.15	2K29	23.00	5RAWGY	1.60	6K4 5K4A	2.25	12BH7	.85	VU-111	.88
1B26	2.20	2K30	41.0R	320.00	5TP4 (RCA)	35.00	6K6CT	.59	12BY7	1.05	
1B27	11.50	2K33	175.00	5T4	1.40	6M7	.60	12BZ7	.70	HY-114B	1.50
1B32	1.45	2K33A	195.00	5V4G	.56	6L5C	.90	12CP7	15.25	117GT	1.65
1B35	8.00	2K34	139.50	5V4G	.92	6L6G	1.05	12DA7	.64	117A4GT	1.55
1B42	8.25	2K2	.33	5W4	.80	6L6GA	1.05	12SC7	.85	C-120	9.90
1B46	1.85	2K2A	1.39	5Y4G	.75	6L6V	1.38	12SG7	.78	103-A	8.00
1B63	39.50	5Y3GT	.44	5Y3GT	.56	6M7	1.10	117GT	1.65	701A	6.50
1C6	.45	3A4	.59	5Y4G	.56	6M7	1.10	117GT	1.65	701A	6.50
1G6GT	.60	3A5	.85	5Z3	.60	6M7	1.10	117GT	1.65	701A	6.50
1H4G	.60	3A5	.85	5Z3	.60	6M7	1.10	117GT	1.65	701A	6.50
1L6G	.55	3AP1	5.00	5Z4	1.05	6M7	1.10	117GT	1.65	701A	6.50
1L4	.45	3B2 / 1291	2.45	5A3	1.12	6M7	1.10	117GT	1.65	701A	6.50
1L6	1.10	3B24	3.95	EL6CF	7.95	6M7	1.10	117GT	1.65	701A	6.50
1LN5	.73	3B25	3.50	6CJ	10.75	6L7M	.85	12SH7	.63	227/227A	.63
1N21 B	1.90	3B26	2.75	6C21	24.95	6N7	.75	12S17	.75	227	.75
1N23A	1.95	3B27	4.95	6-4/6-4B	.39	6P7G	.85	12SK7	.61	RX232	3.20
1N23B	2.20	3B28	4.95	6AB	.65	6S4	.58	12SN7GT	.75	RX233A	3.35
1N31	7.25	3B29	10.50	6AB	.90	6S7M	.95	12SQ7	.55	245A	2.25
1N34A	.78	3BP11	7.75	6AC7	1.04	6SD7GT	.80	15E	.80	QK249	120.00
1N38	1.20	3C23	6.75	6AF4	1.20	6SA7GT	.64	15-R	.50	250-TH	25.75
1N38A	.95	3C24 24G	.90	6AG5	.71	6SA7GT	.64	19AP4A	.64	19AP4A	.64
1N44 400B	1.50	3C27	3.50	6AH4GT	1.88	6S7	.60	19B6G6	2.05	271-A	6.30
1N45 400C	1.95	3C33	8.75	6AH6	1.88	6S7	.65	20-4	1.20	5551	55.00
1N48	.50	3C31 C1B	3.50	6AJ5	1.30	6S7J	.58	22	.99	275-A (WE)	5.95
1N54	.85	3C31	11.75	6AJ6	1.30	6S7M	.61	23D4	.85	HF-300	17.50
1N64	.68	3CP1	2.00	6AK5	.79	6SK7M	.61	24-A	.61	24-A	.61
1N69	.65	3D6	4.00	6AK5	.79	6SK7GT	.61	24-A	.61	24-A	.61
1P23	2.50	3DP1	2.75	6AK5W	1.50	6SL7GT	.64	25AV5	1.20	304-TL	8.75
1P28	1.90	3DP1A	6.50	6AK6	.90	6S7GT	.73	25AG	1.15	305A	4.50
1P40	1.55	3DP1-S2	3.75	6AL5	.55	6S07	.58	25BQ6GT	1.25	306A	3.95
1P42	5.00	3E29	11.50	6AN4	.59	6SR7	.59	25L6GT	.62	TR17	14.75
1Q6	.75	3FP7	1.75	6AQ5	.55	6S57	.83	25Z6GT	.59	310-A (WE)	3.75
1R4	.67	3GP1	2.70	6AQ6	.65	6T8	.89	26	.55	311-A (WE)	5.95
1R5	.75	3HP14	6.60	6AR5	.75	6U5 6G5	.75	27	.55	316-A	8.01
1S4	1.70	3J30	95.00	6AR6	2.70	6UB	.90	28D7	1.55	328-A	4.05
1S5	.75	3J31	75.00	6AS5	.70	6V3	1.15	35A5	.62	332-A	25.50
1T4	.75	3L4	.90	6AS6	2.15	6V6-GT	.61	35B5	.60	350-A	4.90
1U4	.50	3Q4	.60	6AS7G	3.45	6V6M	1.35	35C5	.62	359-A (WE)	4.00
1U5	.70	3QS7	.84	6AT6	.48	6W4CT	.59	35L6GT	.65	371-B (WE)	3.75
1V	.65	3RP1	7.50	6AU5GT	1.00	6W6CT	.75	35W4	.45	373-A (WE)	3.75
1V2	.65	3S4	.65	6AV6	.59	6X4	.50	35Y4	.55	374-A (WE)	3.30
1X2A	.85	3B4	.68	6AV6	.48	6X5GT	.50	35Z5GT	.48	387-A (WE)	2.75
1Z2	3.20	3X2500A3	135.00	6AX4GT	.72	6AX5	.72	42	.75	388-A	1.25
2AP1	5.70	4A1	1.15	6B4G	1.15	7A4	.70	45 (Special)	.40	394-A (WE)	7.75
2B22	2.25	4B22	7.50	6B8	.75	7A7	.74	47	.80	403-B (WE)	5.00
2C21	1.05	4B25	6.80	6B6	.60	7B8	.67	50A5	.75	404-A (WE)	12.95
2C22	.40	4B25	6.80	6B8	.60	7B8	.67	50B5	.65	407-A (WE)	4.95
2C33	4.50	EL6CF	7.95	6BE6	.63	7BP7	4.25	50C5	.65	408-A (WE)	3.00
2C39	22.50	4B28	1.79	6B6G	1.79	7B8	.75	50L6GT	.65	416-A	12.95
2C39A	19.50	6E225	3.95	6B7	1.65	7C4	.29	50V6	.73	417-A (WE)	12.95
2C40	6.00	4C27	12.75	6B7	.80	7C5	.69	50V7	.69	50V7	12.00
2C43	14.95	4C35	19.25	6B6	.70	7C6	.69	53A	4.95	418-A	8.27
2C44	.98	WL4D21/	30.25	6BK7	1.10	7C23	.65	00 RK59	1.20	421-A	5.95
2C51	3.85	4-125A	.60	6BL7GT	1.00	7C30	.85	00 WL-SK60	5.15	422-A	5.95
2C52	3.75	4D22	18.50	6BN6	1.20	7E5	.39	QK-60	60.00	GL-434-A	14.75
2D21	1.17	4E27	220.00	6BQ6GT	1.17	7E6	.55	QK-61	60.00	GL-485A	1.10
2E24	3.30	4J36	140.00	6BQ7A	1.23	7F7	.80	VR-65	1.50	WL-450	HT3.00
2E26	3.40	4J37	195.00	6BYS6	1.50	7H7	.70	70L7GT	1.00	GL-451	3.00
2E30	2.25	4J37	195.00	6BYS7	1.98	QK-72	250.00	464-A	.95	471-A	2.20
2J21 / 2J21A	6.50	4J63	195.00	6BZ7	1.28	9LP7	3.50	RKX-73	.90	WL-481A	4.30
2J22	5.00	4X150A	29.35	6C4	.50	10 (Special)	.95	75	.65	CK-501LX	1.25
2J26	13.00	CSB	3.50	6C5	.50	10T1	.75	76	.60	WL-502A	1.25
2J27	9.70	5A4	1.50	6C6	.65	12A/112	.65	12A	.70	WL-530	13.00
2J31	20.00	5AW4	2.75	6C6	.65	12A5	1.25	78	.75	WL-531	5.00
2J32	22.00	5A6	2.75	6CB6	.65	12A5	1.25	78	.75	WL-531	5.00

WRITE FOR QUOTATIONS ON UNLISTED TYPES.

Terms: F.O.B. N.Y. C.—25% Deposit with order or send full remittance to save C.O.D. charges — Rated Firms (D. & B.) Net 10 Days—All merchandise guaranteed. CABLE: BARRY-LECT. N. Y. PHONE RECTOR 2-2562.

AUTHORIZED DISTRIBUTORS FOR WESTINGHOUSE (WL) AND FOR CBS-HYTRON (CBS) TUBES

BARRY ELECTRONICS CORP.

136-C LIBERTY ST. N. Y. 6, N. Y.

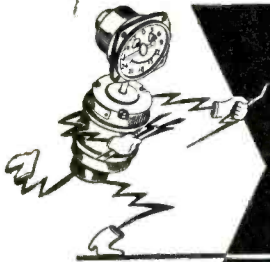

IMMEDIATE SHIPMENT

from Servo-Tek

SYNCHROS • DC MOTORS • AC MOTORS • INVERTERS
SERVO MOTORS • ACTUATORS • GEAR MOTORS • GENERATORS

Guaranteed to Meet
Original Manufacturers' Specifications

DELCO 250 RPM. MOTOR

NO. 5071895

27.5 volts d-c. Reversible two lead permanent magnet motor, 45 in.-oz stall torque. 8 in.-oz operating torque. 1-3/8" diam. x 3-1/4" long. 1/4" shaft extends 3/8". Also in stock similar PM motors with output speeds of 120, 145, 190 rpm. Weighs 7 oz.

SA-342 \$24.50

I-82-F RADIO COMPASS INDICATOR



Fairchild Instrument. 5 inch 0 to 360 degree dial. 26 volts-400 cycles single phase. May be operated on 10 to 15 volts 60 cycles. Kollsman design.

SA-284 \$9.50

400 CYCLE TRANSTAT



Input 115 volts, 400 cycles single phase. Output 75 to 120 volts at 6.0 amp. Completely enclosed with AN connector for input and output. Locking device for permanent setting.

SA-368 \$4.75

MOTORIZED MODULATING TEMPERATURE CONTROL



White-Rodgers Type 6203X. 24 volts d-c at .4 amp. Adjustable temperature range of 340 to 550

degrees F with a differential of 30 degrees. 30 seconds for 90 degree rotation. 1/4" output shaft extends 1/2". 10-3/4" x 2-3/4" x 3-1/2".

SA-393 \$24.50

ELINCO PM-2



Permanent magnet type. Voltage guaranteed lineal with speed within 1%. Generates approximately 1.75 volts per 100 rpm. (DC output voltage). Use for rate generator in servo-system or as tachometer generator. Use to 2000 rpm.

SA-53 \$29.50

1/3 HP ADJUSTABLE SPEED DRIVE



Stepless speed range of 50 to 1750 rpm with the turn of a knob. Complete system consists of rectifier cabinet, remote control station and motor. Operates from 220 volts single phase line. A fortunate purchase of 150 motors allows us to sell this drive at a fraction of the cost of comparable drives. Priced at a low low of..... \$159.00



C-1 AUTOPILOT SERVO

28 volt d-c shunt motor runs continually at 2250 rpm. Two electric clutches connect the motor shaft through a reduction gear and differential gear to the output drum, which rotates clockwise or counter-clockwise. The output shaft speed is 15 rpm at 300 in./lb. torque maximum. Two electrically operated brakes hold the unit in a locked position so that there is no free-wheeling, and provides fast stopping.

SA-180 \$49.50

TYPE AYLZ 3055S MICROPOSITIONER

Barber-Colman. Polarized d-c relay. Double coil differential current sensitive. Alnico (P.M.) Field. Use for remote control, positioning etc.

SA-437 \$6.75

BROWN BALANCING MOTOR



Minneapolis Honeywell reversible two phase gearhead servo motor. 115 volts 60 cycles. Models with the following speeds available: 27, 60, 54, 18-20, 35-40, 162, 30, 110-130, 180, 17, and 25. Total input 13.5 watts. 4 watts on amplifier phase.

SA-436 \$19.50

PRESSURE WARNING SWITCH



Exhibit Supply Co.—Range 80-160 psi. Pressure activates normally open Micro Switch. 2-1/4" x 1-1/4" x 4-3/4".

SA-373 \$1.75

DRAFTING MACHINES



VECTOR PLOTTING MACHINE

—Manufactured for the Navy for Aircraft Navigation. 18" arms with approximately 18" scale.

SA-375B \$14.50

MODIFIED MACHINE—The same machine as listed above except modified to handle standard scales as sold by Bruning and supplied with the machine. One 18" and one 12" scale.

SA-375A \$34.35

DIEHL PM MOTOR



Type FD6-21 -27.5 volts d-c single shaft with speed of 10,000 rpm WE No. KS-15098L01. Ideal for models, blowers, etc.

SA-433 \$8.75

RADIO CONTROLLED SERVO UNIT

Used in Glide Bomb, complete from receiver to actuators which move control surfaces. Contains the following major components:

1. Receiving set #AN/CRW-3 (BC-455) with DM-32A Dynamotor. Frequency range 6.0 to 9.1 mc.
2. Multi-channel servo amplifier (Amplifier Selector AM-41/CRW-3).
3. Barber Colman 14 volt d-c rotary actuator.
4. White Rogers rotary actuator. 5.24-volt d-c Gyro.
6. Heating unit.

SA-387A \$69.50

SA-387B As above but with BC-454 receiver. Frequency range 3 to 6 mc.

THREE PHASE INVERTER



Leland Type 10563—115 va inverter input 28 volts d-c at 28 amps. Output 115 volts 400 cycles at .75 power factor. Both voltages and frequency adjustable. Weighs only 8.7 lbs.

SA-159 \$59.50

PIONEER PRECISION AUTOSYNS



Pioneer Type AY101D Transmitter or Control Transformer for controlled servo circuits. 26 volts 400 cycles single phase. Weighs 5 oz.

SA-24 \$19.50

We also have in stock Type AY201-3B, AY231-3-B, AY-131D and AY223.

WRITE FOR LISTING

Prices F.O.B. Hawthorne

Telephone: HAWthorne 7-3100

1086 GOFFLE ROAD
HAWTHORNE, NEW JERSEY
Cable Address: SERVOTEK



TALLEN SELLS IN QUANTITY

At Huge Savings For You

**PLUGS • CONNECTORS
CLAMPS • AMPHENOLS
CANNONS • MELAMINE**

 **80% OFF**

WE HAVE ALL TYPES WITH CORDS AND CABLES, OR WITHOUT

WE HAVE SERIES OF
3100 3104
3102 3108
WE HAVE SERIES OF PL, UG, SO
WE HAVE SERIES OF 3057

WE HAVE OVER 1 MILLION IN STOCK in over 3000 TYPES!!

Get Our Low, Low price...

WIRE, WRITE, PHONE!!



BC 966 Complete 1FF with Cables, Mounts-Plugs35.00
Pilot balloon targets ML 350/AP.....25
A5 pilot director indicator New....5.50
MG 149 FiltersNew 5.00
Micro Switch WZ7RTCNew .20
Vibrators for EE 101 ANew .75
We have Vibrators VB1 to VB13
BC929 OscilloscopesNew 20.00
Loops LP 21Lousy 5.00
Loop MN 20 ENew 2.50
Tubes FG322.00
DM33New 2.50
PE 218Checked 9.50

GENERATOR

E 78 Signal Generator..... **60.00**

MC125 Remote TurnerNew .50
MC124 CableNew 1.50
MC215 CableNew .60
Control Boxes BC434New 3.50
Recorder for underwater sound equipment60.00
Transmitter-Aircraft T9/APQ-2, 115v, 400 cy. 26VDC NEW20.00
Radar Transmitter T-26/APT-2, 115v, 400 cy. 200 WattsNew 30.00
Corner Radar ReflectorNew 3.00
TS10 Test Set, New20.00 ea.
TS16 Test Set, New20.00 ea.
TS 309/U Sweep Gen..... New 115.00
Bias Meters 1-97A6.50
Neoprene tubing 5/16" I.D. x 7/64" Wall 80 ft lengths1.00
T 201 Transformer for ARC-3 . . .New .75
Navy Type Sound Powered Phones Head & Chest SetsUsed 1.50



CRYSTALS

FT 241 A
Set of 80 for SCR 508-510

20.00

per set

Set of 120 for SCR 608-610

35.00

per set

ANTENNAS

AT 37 Antennas **2.50**
AT 38 Antennas **2.50**
AN 104 Iron **1.00**
AN 104 Copper **2.50**

BENDIX SALE

TA-2 Transmitters\$75.00
RA-2 Receivers75.00
MP10E Power Supply for above... 30.00
MR44A Shock Mount for RA-2..... 10.00
MT56B Shock Mount for TA2..... 10.00

60,000 Used Headsets on sale \$1.00 each
HS 18—HS 30—HS 38

ARC-1 10 Channel\$650.00
" 20 "750.00
" 50 "850.00
ARC-3 Receivers600.00
" Transmitter200.00



Balloons 4 ft. Diam. 1.50
Balloons 6 ft. Diam. 2.50
Balloons 3 ft. Diam. 1.00
Balloons 13 ft. Diam. 3.50
Kite Army 2.50

300 ft. Antenna Wire for use with Kite or Balloon on Reel 1.50

HYDROGEN GENERATORS to inflate balloons. .3.50 ea.

This is only a partial listing. We have a quantity inventory on our shelves consisting of Coils—Relays—Condensers—Transformers—Radio and Radio Receivers and Transmitters—Handsets—Headsets—Microphones etc. etc. All are ready for IMMEDIATE DELIVERY.



TALLEN CO., INC.

159 CARLTON AVE., BROOKLYN 5, N.Y. TRIangle 5-8241

GOVERNMENT SURPLUS PUMPS!

Brand new Cenco Megavac Vacuum Pumps, Model 92010A, complete with connecting cord, hose assembly and attachment plug. Specially priced at \$137.50 each, f.o.b. New York.

MEDICAL SALVAGE CO., Inc.
217 East 23rd St.

New York 10, N. Y. MUrray Hill 4-4267

PLUG SALE 35¢ each

PL-P-61 PL - 88 CFD 49133
PL-P-62 PL-P-104 CFD 49134
PL-P-63 PL-P-112 6578/CZR
PL-P-64 CFD 49062 MX2/ARR2
FT - 135

PL-54-15c. ea. JK-24-10c. ea. JK-29-10c. ea.

Micro Switch #15MI—50c. each
ACRO SWITCH—#X07—5L—39c. each
CENTRALAB #B16—RADIOHM MINIATURE Controls—10,000 ohms—49c. each

All brand new—F.O.B. N. Y. Warehouse

M. SWEDGAL

149 Church St. New York 7, N. Y.

CONNECTORS AN-UG

LARGE INVENTORY

ROSE ELECTRONICS, INC.

76 VESEY ST.

New York 7, N. Y. • CO 7-6195

ELECTRONIC VALUES FROM TALLEN

For Quantity Users Only

HEADSETS



HS 33 New 4.50 ea.
HS 23 New 3.50 ea.

COMPONENT PARTS

For . . .

ARC-1
ARC-3
ART-13
R5/ARN-7
SCR 522
SCR 284
SCR 543

We also have . . .

RELAYS
TRANSFORMERS
COILS
CAPACITORS
CONTROL BOXES

S.O.S. TRANSMITTER

(Gibson Girl)

with all components,
complete and new 20.00 ea.

TRANSMITTER alone
10.00 ea.

CD 365 with 2ea PL 108 . . . New \$1.00
CD 307 with PL 55 and JK 26 . . . New .65
CD 508A New 1.50
CD 605 5 1/2 ft. New .05
CD 620 New .25
BC 348 Coils New 6.50
BC 1267A New 35.00
BC 221 good for parts each 15.00
BC 456 New 3.50
SCR 274 Transmitters . . . BC 457, BC 458
Used 4.50
SCR 269 Instruction Book 1.50
SCR 518 Motor ML 4115-6 New 6.50
PL 55 New .40
PL 68 New .90
PL 151 A50
PL 152 A50

CONTACTOR

BC 608 A New 5.00

RA 105A New 35.00
ET 8023 DI New 575.00
Motors PE 94 New 4.00
RM 29 complete Good 9.50
LIP Microphone MC 419 New .35
TBX Ship to Shore Rec-Trans New 30.00
T30 Throat Mikes . . . Used .25, New .50
APS-4 Trans Rec Complete 300.00
ARC Autotunes New 6.50
R5/ARN-7 Coils New 4.50
12 Volt Blower Motor New 4.00
Handsets TS14 Complete New 4.50
Handset Rec or Trans Capsules New .50

TUNING UNITS

TU . . . 5, 6, 7, 8,
9, 10, 22, 26
TU-10 New 2.50
BC-610 New 12.50

PLUG SALE

Over
One Million
In Stock!

All Type

AN 3100—
3102—
3106—
3108—

ARC—
AC—
GK—
10H/
SKL—
SO—
WK—

PL 108
112
150
151
169
171
172

50c
each



TALLEN CO., INC.

159 CARLTON AVE., BROOKLYN 5, N.Y. TRIangle 5-8241

TELETYPE

Available now
Models 14's, 15's and 19's
Reconditioned. Prices on request.

Electronics Corporation
of Nebraska
3327 Star
Lincoln, Nebraska
Phones 2-8214, 6-5233

WHOLESALE ONLY

ELECTRONIC COMPONENTS
AIRCRAFT EQUIPMENT
HYDRAULICS

RADIO & ELECTRONIC SURPLUS
13933-9 BRUSH STREET
Detroit 3, Mich. TO 3, 3403

CARRIER EQUIPMENT

Western Electric CF-1A 4-channel carrier telephone terminals.
EE-101-A 2-channel 1000/20 cycle carrier ringers.
CFD-B 4-channel carrier pilot regulated telephone terminals complete with four channels 1000/20 cycle ringing.
CFD-B 4-channel pilot regulated telephone repeaters.
C-42-A V. F. telegraph in from 2- to 12-channel terminals.
FMC 1 or 2 channels carrier telephone terminals, automatic regulation, duplex signaling each channel. Carrier frequencies above 35 KC. Ideal for adding channels above type "C".
Complete engineering and installation services offered.

RAILWAY COMMUNICATIONS, INC.
Raytown, Missouri
Telephone: FLEMing 2121

SAVE ON TUBES BRAND NEW TUBES GUARANTEED TUBES

OA2	50.95	2J33	25.00	4J26	99.50
OA3/VR75	1.10	2J34	25.00	4J27	99.50
OB2	1.10	2J36	89.00	4J28	99.50
OB3/VR90	1.00	2J42	110.00	4J29	99.50
OC3/VR105	.95	2J48	24.50	4J30	99.50
OD3/VR150	.85	2J49	85.00	4J31	99.50
1B22	2.00	2J56	89.50	4J34	149.50
1B23	6.50	2J61	39.50	4J42	99.50
1B24	7.50	2J62	35.00		
1B26	2.30	2K22	23.95		
1B27	12.00	2K25	23.95		
1B32/532A	2.38	2K26	55.00		
1B35	7.50	2K28	32.00		
1B38	29.50	2K34	150.00		
1B42	17.50	2K41	125.00		
1B44	29.50	2K45	110.00		
1B51	9.50	2K48	89.50		
1D21/5N4	4.50	3B22	2.95		
1N21B	2.50	3B23	4.05		
1N22	1.25	3B24	4.75		
1N23B	3.25	3B25	3.50		
1N34A	.79	3B26	3.50		
1N38	1.50	3B28	5.95		
1N44	1.10	3C22	72.50		
1N47	4.50				
1N55	2.75				
1N58A	1.25				
1N60	.60				
1N63/K63	2.38				
1N69	1.25				
1N70	2.40				
1P28	6.75				
1Z2	1.75				
VS-2	9.50				
2A515	4.25				
2C21/1642	.69				
2C39	12.50				
2C39A	14.50				
2C40	7.25				
2C42	12.50				
2C43	14.95				
2C44	1.10				
2C46	19.95				
2C51	3.90				
2C52	3.95				
2D21	1.25				
2D21W	2.49				
2E22	2.75				
2E24	3.50				
2E26	3.25				
2J21A	7.95				
2J22	6.95				
2J26	14.95				
2J27	12.95				
2J31	25.00				
2J32	25.00				

5NP1	5.95	221A	1.95	706CY	29.50	811A	2.90	1625	.39
5R4GY	1.25	235A	75.00	706DY	39.50	812	2.95	1626	.39
5T4	1.50	250R	8.95	706FY	39.50	813	10.95	1629	.39
C2L/5528	6.50	250TH	16.50	706GY	39.55	814	2.75	1642	.69
CGJ	7.50	250TL	15.00	707A	7.90	826	1.95	1644	.89
GALSW	1.75	FC253A	89.50	707B	13.55	828	9.95	2050	1.30
GA57G	3.50	FC258A	149.50	708A	3.95	829	7.00	2051	1.10
6BF7	2.50	274B	3.25	713A	.95	832	9.95	5516	5.50

YOUR SURPLUS WANTED
We Pay Highest Prices!

4J52	199.50	6BL6	69.50	300B	5.95	714AY	8.50
4-125A	22.00	6BM6	69.50	304TH	7.95	715A	6.70
4X150A	27.50	6C21	19.95	304TL	7.95	715B	8.00
4-250A	32.00	6F4	3.95	307A/RK75	3.75	715C	18.00
4X500	75.00	6J4	5.25	310A	3.95	717A	.90
CSB	7.50	6K4	3.00	310B	12.95	719A	24.50
SAP1	4.50	6SU7GT	2.75	316A	1.25	720BY	249.50
SBP1	4.50	XSWG	1.80	327A	4.50	720DY	249.50
SBP4	4.50	7C23	69.50	331A	10.95	721A	2.95
SCP1	7.50	12AY7	1.80	349A	8.50	722A	1.95
		12DP7	16.95	350A	4.50		
		12GP7	25.00	368AS	6.00		
		12HP7	13.50	371B	.75		
		15E	1.75	374B	4.95		
		15R	.69	388A	1.49		
		FG17/5557	3.95	394A	3.95		
		35TG	8.50	417A	8.50		
		EF50	9.95	434A	15.00		
		FG57/5559	.75	446A	1.19		
		RK60/1641	15.00	446B	3.50		
		RK72	2.25	450TL	37.50		
		RT73	.95	464A	10.95		
		ST	1.50	469	13.95		
		75TL	6.95	WL530	18.95		
		83V	8.95	531	5.75		
		FG95/5560	1.10	CK536AX	.95		
		VT98	22.50	559	1.19		
		98R	19.95	575A	13.95		
		100TH	5.95	KU627	17.50		
		VU-111	9.50	WL652/657	39.00		
		HF120	.95	KU676	39.50		
		VF-123A	9.95	KU677	75.00		
		VF-127A	7.79	702A	75.00		
		FG172	2.75	700/B/C/D	16.50		
		HF200	29.50	702A	2.75		
		204A	14.50	703A	4.75		
		211/VT4C	49.50	705A	1.50		
		217C	.95	706AY	39.50		
			4.95	706RY	39.50		

SPECIAL! Vacuum Capacitors

50 mmfd. 15,000 v.	57.50
12 mmfd. 32,000 v.	510.00
50 mmfd. 32,000 v.	512.50
100 mmfd. 20,000 v.	514.50

RECEIVING TUBES?
WE HAVE ALL TYPES
IN STOCK
Standard Brands Only!

723A	9.95	874	1.10	9505	17.50
723A/B	15.95	878	1.95	9563	1.20
724B	2.75	884	1.40	9572	4.50
725A	4.50	893R-A	175.00	6005	4.50
726A	12.00	929	1.25	6026	2.25
726B	40.00	931A	4.95	6121	9.95
726C	49.50	935	5.50	6201	4.50
730A	20.00	954	.33	8005	4.95
801A	3.75	956	.49	8013	4.95
804	10.95	957	.49	8020	1.25
805	3.25	958A	.69	8025	4.75
807	1.65	959	1.75	8025A	4.75
807W/5933	7.95	CK1005	.69	9001	1.15
	2.95	CK1006	1.95	9002	.98
		CK159	149.50	9003	1.15
		1633	.89	9004	1.69
		1616	.90	9005	1.50
		1619	.39	9006	.49

All Prices F.O.B. Los Angeles, subject to change without notice. Minimum order \$3.00



ELECTRONICS
Dept. E-32
7552 Melrose Ave.
Los Angeles 46,
California

Thousands of other types in stock. Send us your requirements.

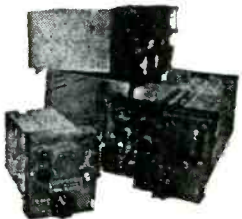

AN/APR-4 LABORATORY RECEIVERS

Complete with all five Tuning Units, covering the range 38 to 4,000 Mc.; wideband discone and other antennas, wavetraps, mobile accessories, 100 page technical manual, etc. Versatile, accurate, compact—the aristocrat of lab receivers in this range. Write for data sheet and quotations.

We have a large variety of other hard-to-get equipment, including microwave, aircraft, communications, radar; and laboratory electronics of all kinds. Quality standards maintained. Get our quotations!

We will buy any Electronic Material at top prices. SCHOOLS—unload your dusty surplus for cash or credit.

ENGINEERING ASSOCIATES

434 PATTERSON ROAD

DAYTON 9, OHIO

K-RK-ARC-UG-PL-AN

CONNECTORS

In Stock for Immediate Delivery

Connector Corporation

OF AMERICA

137 Hamilton St., New Haven 11, Conn. Phone: Spruce 7-2513
New York Phone: LExington 2-6254

RESISTORS*

- ALL MAKES
- ALL OHMAGES
- ALL TOLERANCES

1/2 WATT—1 WATT—2 WATT

AMERICA'S BEST

EB 1/2 W 10%	.03 each
GB 1 W 10%	.06 each
HB 2 W 10%	.09 each

For 5% add 100%
Minimum per Item — \$2.00
Minimum per Order — \$10.00

LEGRI S COMPANY

158 West 99 Street, New York, N. Y.

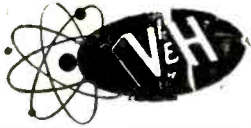

CHECK AND COMPARE OUR COMPLETE STOCKS

The following is just a partial list of the current electronic and aircraft equipment now in our warehouse. Write for complete information. Prompt replies to all inquiries.

RC-103 & AN/ARN-5 ILS

New in original cartons. Complete. Consists of all accessories, plus AS-27A, R89B/ARN-5 and BC-733D. Modified to flag alarm.

TBS 4 & 5, NEW, COMPLETE

1E-17 TEST SET F-21/ARA-9
AN/ARN-7 COMPLETE ARC-3
SCR-269 COMPLETE APN-9
AN/ARC-1 VHF EQUIPMENT APN-1

BC-611 & BC-721 HANDIE TALKIES, Plus SPARE PARTS.
Quantity available.

AN/ART-13 EQUIPMENT

ATC XMTR T-47A/ART-13 XMTR
T-47/ART-13 XMTR CU-24 ANT. LOAD
CU-25 ANT. LOAD DY-11 & 12 Dynam't'r
MT-283 MOUNT 0-16 LFO
MT-284 MOUNT ATC DYNAM'T'R
SA-22 ANT. LOAD C-87 CONTROL BOX

AN/APG-13A RADAR

Absolutely complete, brand new

AN/APN-2	MG-153
SCR-729 New	APS-2, 3, & 15
TA2J-24	Components
RTA-1B	AN/ARC-5 VHF
BC-1016	SCR-274 & ARC-5,
APA-6 INDICATOR	Command Equipm't
APA-11 INDICATOR	R-4/ARR-2 Receivers
APA-17. RADAR	BC-640 VHF XMTR
HS-33 HEAD SETS,	SCR-510
NEW	SCR-522
MG-149F & H	MG-153
SPARE PARTS	
SCR-720	SCR-522
SO-7	AN/ART-13
AN/ARN-7	AN/ARC-1
SCR-269	BC-611

SCR-718 A, AM, B & C

Altimeter equipment—complete

To insure the finest of service and quality of merchandise, we have just recently put into operation our own reconditioning and function-testing plant, complete with all facilities.

WANTED

CFI UNITS ART-13 BC-788
1-152 BC-348 Q & R
TOP DOLLAR PAID

EXPORT INQUIRIES INVITED

We carry an unusually large stock of Airline Equipment, Test Equipment, Radar Sets, etc. Write for our low prices and complete information. We furnish immediate answers to all inquiries. Write today!

V & H

ELECTRONIC INDUSTRIES INC.

2033 West Venice Blvd.—Dept. E-23
Los Angeles 6, California
Phone: REpublic 3-1127

TEST EQUIPMENT

Spectrum Analyzer, Model TSX-4SE-8500-9600 MC., calibrated linear below cut-off attenuator, calibrated frequency meter, tuned mixer, 4 I.F. stages, 3 video stages, overall gain 125 db., regulated power supply.

Spectrum Analyzer, same as above but modified for 100 to 1000 MC frequency range.

X Band VSWR Test Set, TS-12, complete with linear amplifier, direct reading VSWR meter, slotted waveguide with gear driven traveling probe, matched termination and various adapters, with carrying case.

R. F. Power Meter—1 to 600 MC 0-15 and 0-60 Watt scales. May be used as dummy load for 0 to 1000 MC.—100 W maximum.

VSWR less than 1.1 from 0 600 MC., less than 1.3 from 600 to 1000 MC.

X Band Pick up Horn, AT48/UP with coax fitting.

TS-45/APM-3 Signal Generator 8700-9500 MC, 110V 60-800 cps.

TS-35A/AP X Band Signal Generator, pulsed, calibrated power meter, frequency meter, calibrated attenuator, 110V 60-800 cps.

30 MC I.F. Strip, Video and Audio Amplifier and 115 volt 60-2600 cps Power Supply, Bandwidth 10 MC, new, part of SPR-2 receiver.

High Pass Filter, F-29/SPR-2, Cuts off at 1000 MC. and below; used for receivers above 1000 MC.

TS-125 Calibrated S Band Power Meter with attenuator.

TS-110 S Band Echo Box 2400 to 2700 MC., Portable.

S Band Signal Generator Cavity with cut-off attenuator, 2300 to 2950 MC., 2C40 Tube, with modulator chassis.

VD-20K Voltage Divider for measuring high video pulses, ratio's 1:10 and 1:100, transmission flat within 2db 150 cps to 5 MC.

Waveguide Below Cut-off Attenuator L101-A, UHF connectors at each end, calibration 30-100 db.

TAA-16 Tuned Linear Audio Amplifier, 300 to 8000 cps. output meter reads direct in VSWR or Power DB. Regulated power supply, 110V 60 cps.

FPM 3 X Band Power and Frequency Meter, frequency meter 8500 to 9600 MC., accuracy ± 4 MC absolute, ± 0.5 MC on frequency difference up to 660 MC. Calibrated attenuator 0-30 db, power measuring range .1 to 1000 MW, pulsed or CW without external attenuator, video detector, self-contained battery powered, portable, with coaxial and waveguide adaptors.

T85/APT 5, 300 to 1600 MC, 40 watt noise modulated transmitter.

110-330 MC Oscillator Butterfly.

80-300 MC. Mixer Butterfly with socket for 955 (used as diode).

100-800 MC. Oscillator Butterfly with 703 tube mounted on it.

Field Intensity Meter, RCA 308A, 120 to 18000 KC.

S Band Signal Generator—2K28 Klystron, self-pulsed or ext. triggered.

Mark 5, "S" Band Signal General—2.4 to 3.4 KMC 2C40 Oscillator, Motor tuned.

X Band Receiver, tuneable, waveguide input 9200-9600 MC.

QX Checker, Boonton, Type 110.-A.

Synscope—Sylvania Model 5.

Synscope—Model P4.

D.C. Amplifier—TS 580/U-GR Model 715 AM.

Sweep Speed Calibrator, 200 KC, 1 MC, 5 MC.

Tuning Units P/O APR-4 TN16 30-80 MC, TN17 80-300 MC., TN18 300-1000 MC, TN19 1000-2200 MC., TN54 2200-4000 MC.

AN/APR 1 Receiver, used with above tuning units. 110V 60 cycle.

Measurements 75 Standard Signal Generator, Calibrated output, 124 to 510 MC.

Rotary Joints, Coaxial, S Band.

Antenna, Coaxial, pressurized S Band. Can be used with parabolic reflector.

Microfilter—Ferris Model 10B + 10C.

F.M. Test Set—X Band, with wavemeter and wattmeter, 110V 60 cycle AC.

Recording Ammeter—Esterline Angus 0-5MA.

Recording Ammeter—Esterline Angus 0-1MA.

TS-36—8.5 to 9.6 KMC Power Meter .1-000 MW.

TS 33 8.7 to 9.5 KMC Frequency Meter and Video Detector.

K Band—slotted line, gear driven traveling probe.

K Band—Attenuator 27 to 34 KMC.

K Band—Misc. Waveguide + Waveguide components.

Dummy Loads.

TS-13/AP Consists of Signal Generator "Xa" Band, Wavemeter + wattmeter.

TS-14—Test Set for "SA" Band radar—uses 2C40 oscillator, self-contained, power monitor, self-pulsed 115V 60-800 cycles.

Impedance Bridge—Type TBX-1BR 8.5 to 9.6 KMC—CRT Indicator.

Video Amplifier, 25 watts.

Vacuum tube Bridge, General Radio 561D

S Band crystal mixer, tuneable.

Klystron Power supplies with or without modulation.

Calibrator Model 3 (MIT).

TS-226 peak power meter.

TS-305 peak power meter.

TS-231 HI Power Dummy Load.

TS-184 Signal Generator.

TS-278 Signal Generator.

HIGH POWERED DUMMY LOADS

X Band, 1 1/4" x 5/8" guide, choke or plain flange, dissipates 350 watts average power continuously in still air. VSWR less than 1.15 between 7 and 10 KMC, weight 5 1/4 pounds.

X Band, 1/2" x 1" guide, choke flange, dissipates 250 watts average power continuously in still air, VSWR less than 1.15 between 8.2x12.4 KMC, weight 3 1/4 pounds.

X Band 1 1/4" x 3/8" guide, plain flange, dissipates 200 watts average power continuously in still air, VSWR less than

1.15 between 7-10 KMC, weight 3 1/4 pounds.

X Band, 1 1/4" x 5/8" guide, plain flange, dissipates 250 watts average power continuously in still air, weight 2 pounds 4 ounces.

S Band, 1 1/2" x 3" guide dissipates 1,500 average power in still air, VSWR less than 1.15 between 2, 5 to 3.7 KMC, choke flange, weight 13 pounds.

K Band, VSWR less than 1.15 dissipates 50 watts average power.

NIBUR SALES CORPORATION

P. O. Box 811

Red Bank, New Jersey

Telephone: Red Bank 6-5810

Biggest & Best in Surplus Communications

WE 248-A RADIOTELEPHONE EQP'T. 250/350 Watts, 2-20 MC, 30 Channels Transmit and Receive all crystal-controlled, monitors 3 separate channels simultaneously, uses standard modern type tubes. COMPLETE, NEW (Not Gov't. Surplus). Operates from 110 Volts, 50/60 Cycles AC. IDEAL FOR SHIP RADIOTELEPHONE OR FIXED-RADIO INSTALLATION. WRITE FOR DESCRIPTIVE LITERATURE AND PRICE.

GE 10 KW RF POWER AMPLIFIERS, 88-108 MC, Class "C", with separate Rectifier Power Supply. Operation from 220 V., 3-phase, 50/60 Cycles AC. Easily modified for other frequencies. NEW, Not Gov't. Surplus WRITE FOR DESCRIPTIVE LITERATURE AND PRICE.

EXTRA!

PE-104 POWER SUPPLIES for Receiver or SCR-284, NEW, with Spare Vibrator, Export-Practical. Large Quantity Available. WRITE FOR PRICES.

CLOSE-OUT SPECIALS!!

PE-218C, D, E & H INVERTERS, BRAND NEW, 25-28 V. DC Input, 115 V. AC, 400 cycles 1.5 KVA output. WHILE THEY LAST. EACH \$10.00

APR-4 RECEIVER, With TN-16 and TN-17 Tuning Units. Excellent Condition. \$585.00

2J27 MAGNETRONS, NEW, Original Packaging. EACH \$9.50

APN-4 LORAN EQP'T. Consisting of R-9A/APN-4 and LD-6A (or B) Indicator units only. PER SET \$100.00

All Prices FOB Our Address.

TRANSMITTERS—RECEIVERS, ETC.

TDQ VHF 100-156 MC 50W. AM X-mtr for 110 V. 50/60 C. AC.

BC-797 VHF 110-126 MC. 50W. AM Output for 110 V. 50/60 C. AC.

SCR-510/610. FM Trans-Receiver, 20 to 28 and 28 to 37 mc respectively. With PE-117 or 120 Vibrator Power Supply and other accessories.

SCR-619. FM Trans-Receiver, 27 to 38.9 mc, complete with all accessories. NEW units.

SCR-522. VHF 4 Channel 100-156 MC Trans-Recv. Eqt. for Plane or Ground Communications.

SCR-511. Walky-Talky, 3-6 MC. Crystal Controlled Trans-Recv. with Plug-In Units for Freq. Changing.

BC-611 and MAB HANDY and WALKIE-TALKIES.

SCR-300 (BC-1000) WALKIE-TALKIES, 40-48 MC 2 channel FM Trans-Receiver.

SCR-284 Field Radio Equipment. A1-A3 emission. Complete with all Accessories.

BC-221 Frequency Mixers, Excellent condition. Complete with crystal and matching Calibration Book.

BC-312/342 Receivers. Like New Units.

BEACHMASTER 250 & 500 WATT SOUND SYSTEMS for Airports, Shipyards, Amusement Parks, Civilian Defense, Etc. Write for Prices and Literature.

TCS X-mtr-Receiver for Ship or Shore.

TBK HF 500W 2-20 Mc. Transmitter with MG. Starter, and Spares.

TAJ 500 W. Output, 175-550 Kc. with M.G. for AC or DC operation.

TAQ. Same as TAJ above but 1,000/1,500 W. output with MG.

TBL 350 W. Output, A1, A3, IF, & I.F. for AC or DC operation.

APN-4 Loran Eqp't. R-9A/APN-4 Receivers and LD-6A & 6B Indicators, with tubes, crystal, etc. Re-conditioned to like new.

WRITE FOR PRICES.

GO-9 100/125 W. IF, HF Ship or Aircraft Transmitter, A1 and A2 Emission. All New with Spares.

DZ-2 DIRECTION-FINDERS. Aircraft or Marine, 15 to 1750KC in 6 bands for 24/28 V.D.C. operation with 34" or 55" Loop Extension Shaft. Complete. NEW eqpt. with Dynamotor, Loop Extension shaft and Control. Cables, Instruction Manual, etc., all export packed in 2 cases per set.

WRITE FOR PRICES

EXPORTERS, GOVERNMENT AGENCIES, INDUSTRIALS!

We have a large stock of Transmitters, Receivers, Walkie-Talkies, VHF Equipment, Ship & Shore Communications, FM Broadcast Stations, Radar, Accessories, etc. Write and tell us of your requirements. Descriptive literature and prices available upon request.

ALL MATERIAL SUBJECT TO PRIOR SALE!

CABLE ADDRESS: TELEMARINE, N. Y.

TELEMARINE COMMUNICATIONS CO.

3040 W. 21st Street, Brooklyn 24, N. Y.
Phone: ES 2-4300

RADIO-RESEARCH INSTRUMENT CO.

CRYSTAL MOUNT. Holds any IN23 type xtal. 1" x 1/2" guide std coax output, UG40 fig input. \$19.50

DIRECTIONAL COUPLER. Uni dir. 20db, type "N" output, UG39fig. to UG40chk. JAN type CG-176/AP. \$39.50

WAVEGUIDE. Std RG-52/U sharp internal corners. Any lgh up to 12 ft. \$1.25 per ft.

3 CM. "X" Band

BEND 90 DEGREE. E or H plane. Std radius. UG39cvt to UG40chk. Silver plated. \$10.50

TWIST 90 DEGREE. UG39 to UG40. Silver plated. \$7.50

FLEXIBLE SECTION. Apx 6', UG39 figs. \$14.50

TR-ATR SECTION. Duplexer assy w/UG-39 to UG40 run, iris cplg, cplg to B24 type TR tube, ATR cavity 724 type compl. w/tuning slugs. SO-3 Radar component. \$12.50

ROTARY JOINT. UG40 choke to choke, w/mounting plate for easy installation. 360 deg. rotary coupling for lab or high speed scanner. \$14.50

Accessories

PARABOLIC REFLECTOR 4ft. dia. RCA hi gain dish \$84.50

SELSYN 2J1G1. 57.5V-57.5V 400cy w/connector \$8.50

VARIA. COND. 4 gang. 7 to 144 mmf/sect. Ball brg. shaft. \$3.25

PATCHING CABLE. Male type "N" ea. end 3ft. \$2.50

COUNTER DIAL Veeder Root 4 digit. Mech. drive \$7.50

BATHUB COND. 2x.lmfd 600V side term. CD ten for 1.75

APR-4 BUTTERFLY 221151-3, 7 rotors 8 strators \$15 ea.

MINIATURE IF 455kc \$1.85

Antenna Drives

COMPLETE. 12rpm clockwise rotation, 115V 60 cy GE motor, incl sine potentiometer & bearing indicator. \$137.50

GEAR-MOTOR ASSY. Gear speed 95.5, gear ratio 9 to 1, motor speed 860 shunt wd, 6 amp, volts, 250A-125F cont duty. \$64.50 each

MOTOR DRIVE ASSY. 115-VDC motor 1/20hp, 1725 rpm. Gear box 172 rpm, 11 in. lbs. torque, cpd to 9 in. step down gear. \$35.00

Pulse Components

KS-9643 Miniature, perm. core. Z ratio 1:1:1. \$5.00

145EWP AND 132AWP low volt pulse xtmr. \$5.50 each

D168983 Network 125 ohm, herm sid. \$3.50

LV PULSE 50-4000kc, 120-2350 ohms, perm core \$6.50

PULSE CONN. UG180/type rubber insert, male chassis mt. w/12" cable D166389 \$2.00

UG36/type male cable mt. \$5.00

UG38/type female w/mtg fig. air to oil \$5.50

SCR 584 lw. spd. rotary joint \$75. J-K sect. \$35.

F-28/APN-19 FILTER CAVITY. 2700-2900mc. Max 1.5-db loss at ctr. freq over band, 3db at 15 mc band ends. Meets full JAN spec. Gov't source insp. available. Fully calibrated to above spec. \$42.50 each. Uncalibrated, guaranteed \$28.50

MIXER BLOCK w/p.u. loop. "N" fitting. \$8.50

ECHO BOX. TS-207/UP, 2700-2900mc. micro adj. \$64.50

PICKUP DIPOLE in lucite ball, type "N" output 3" o.a. \$3.75

UG53, UG54, UG65/66 flanges, RG48 rf. angle bends "E", available. \$3.50 ea.

10 CM. "S" Band

COAXIAL MIXER. Xtal detector assy designed for beacon rcvrs. Trombone tuned input. "N" fittings. 2 types available-feed thru or take off to xtal. \$17.50

LIGHTHOUSE CAVITY. For 2C40 tube. Tuneable 2700-2900mcs w/suitable adj of grid cylinders. Can be freq. modulated. \$25.00

2C40 tube, JAN. \$11.25

IN21B crystal \$3.25

DOALL MIXER assy. pick-up loop, xtal mt. \$5.50

STANDARD-REFERENCE CAVITY. 2650-3050mc.

Invar tuning center conductor of 3/4 wave-lgh. 50 ohm coax "N" input output conn. lmc./sec. stability. Loaded Q between 650 and 3000 w/ xmsn loss .5 to 5 db adjustable. Unloaded Q apx 6000. Concentric xmsn type resonator. Tuning mech. lock. \$28.50

CRYSTAL MOUNT. 3/8" std coax. "N" fittings. Holds any IN21 type xtal. Incl. impedance match tuner. \$17.50

FEEDBACK DIPOLE 7/8" coax. for parabola. 1 1/2" o.a. \$14.50

A complete variety of microwave plumbing is available in most bands incl. test accessories and radar system components. WRITE US YOUR REQUIREMENTS. We pride ourselves in our ability to serve the microwave industry. A prompt reply is given to all inquiries.

Telephone: Judson 6-4691

550 FIFTH AVENUE, NEW YORK, N. Y.

RADIO Surplus Buys

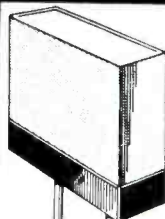

CRYSTALS

... in FT 241-A Holders—1/2" Pin SPC. Marked 54th OR 72nd Harmonic MC Freq. Listed below by fundamental frequency with fractions omitted.

500 KC Crystals ea. \$1.50
1000 KC Crystals ea. \$3.95
200 KC Crystals

370	407	444	476	509
372	408	445	477	511
374	409	446	479	512
375	411	447	480	513
376	412	448	481	514
377	413	450	483	515
379	414	451	484	516
380	415	452	485	518
381	416	453	486	519
383	418	454	487	520
384	419	455	488	522
385	420	456	490	523
386	422	457	491	525
387	423	458	492	526
388	424	459	493	527
390	425	461	494	529
391	426	462	495	530
392	427	463	496	531
393	429	464	497	533
394	430	465	498	534
395	431	466	501	536
396	433	468	502	537
397	434	469	503	538
398	435	470	504	540
400	436	472	505	
401	437	473	506	
402	438	474	507	
403	440	475	508	
404	441			
405	442			
406	443			

\$5 Per Doz. Postpaid

PLEASE ENCLOSE FULL AMOUNT WITH ORDER
QUANTITIES AVAILABLE
WRITE FOR YOUR REQUIREMENTS

C & H SALES CO.

BOX 356-DE EAST PASADENA STA. • PASADENA 8, CALIF.

NEW — AN/APR4 — USED

RECEIVERS

With following TUNING UNITS in stock.. TN16 -17-18-54

We buy any electronic material at top prices!

Write for our new Bulletin

Shipments FOB warehouse. 20% Deposit on orders. Minimum order \$5.00. Illinois residents, add regular sales tax to remittance. Prices subject to change without notice.

R W ELECTRONICS

Dept. EL, 1712-14 S. Michigan Ave.

Chicago 16, Ill.

PHONE: HARRISON 7-9374

GLASS TUBING

PYREX - NONEX - URANIUM BULBS & CYLINDERS
WRITE FOR FREE MONTHLY LIST

HOUE SUPPLY COMPANY

PHONE KEYPORT 7-1286
M. R. #1 Box 86X Keyport, N. J.

HIGH FREQUENCY EQUIPMENT

Leland-Murray MG set, 2KVA, 1-ph., 400-cy., 115V, alternator, direct-driven by NEW 311H motor, 220V, 3-ph., 60-cy. With NEW voltage regulator. \$595.00. GOOD WAVE FORM MG sets of many sizes and frequencies in stock for immediate delivery. Your inquiries are invited.

EDWARD WOLF COMPANY
P. O. Box 82 Mattapan 26, Mass.
BLUehills 8-1254

**OVER 250,000
TYPE J
POTENTIOMETERS
55¢ EACH**

(To Quantity Buyers)
75¢ in Smaller Quantities
10¢ Extra for Locking Bushing

Ohms	Shaft	Bushing	Ohms	Shaft	Bushing
50	3/8 S	3/4 L	20K	1/4 R	3/4 L
60	3/8 R	3/4 L	20K	3/8 S	3/4 L
70	3/8 R	3/4 L	25K	2 3/8 F	3/4 L
100	3/8 S	3/4 L	25K	3/8 S	3/4 L
100	2 3/8 P	3/4 L	25K	3/8 R	3/4 L
200	3/8 S	3/4 L	25K	2 3/8 F	3/4 L
400	3/8 S	3/4 L	30K	3/8 S	3/4 L
500	3/8 S	3/4 L	50K	3/8 S	3/4 L
500	3/8 R	3/4 L	50K	3/8 S	3/4 L
500	3/8 S	3/4 L	50K	1/4 R	3/4 L
1000	3/8 S	3/4 L	50K	3/8 S	3/4 L
1000	3/8 S	3/4 L	50K	3/8 S	3/4 L
1300	3/8 S	3/4 L	50K	3/8 S	3/4 L
1500	3/8 S	3/4 L	50K	3/8 S	3/4 L
1500	3/8 S	3/4 L	50K	3/8 S	3/4 L
1500	3/8 S	3/4 L	60K	3/8 S	3/4 L
2000	3/8 S	3/4 L	60K	3/8 S	3/4 L
2000	3/8 S	3/4 L	70K	3/8 S	3/4 L
2000	3/8 S	3/4 L	100K	3/8 R	3/4 L
2500	3/8 S	3/4 L	100K	3/8 F	3/4 L
2500	3/8 S	3/4 L	100K	3/8 R	3/4 L
2500	1 S	3/4 L	100K	3/8 S	3/4 L
2500	3/8 S	3/4 L	150K	3/8 S	3/4 L
3500	3/8 S	3/4 L	150K	1 S	3/4 L
5000	3/8 S	3/4 L	150K	3/8 R	3/4 L
5000	3/8 R	3/4 L	200K	3/8 F	3/4 L
5000	3/8 S	3/4 L	200K	3/8 R	3/4 L
5000	3/8 S	3/4 L	200K	3/8 R	3/4 L
5000	1 S	3/4 L	200K	3/8 S	3/4 L
7500	3/8 S	3/4 L	200K	3/8 S	3/4 L
10K	3/8 R	3/4 L	200K	3/8 S	3/4 L
10K	3/8 R	3/4 L	200K	3/8 S	3/4 L
10K	3/8 R	3/4 L	250K	3/8 S	3/4 L
10K	3/8 R	3/4 L	250K	3/8 S	3/4 L
10K	3/8 S	3/4 L	250K	3/8 S	3/4 L
10K	3/8 S	3/4 L	300K	2 3/8 F	3/4 L
10K	3/8 F	3/4 L	500K	3/8 S	3/4 L
10K	3/8 F	3/4 L	500K	2 3/8 F	3/4 L
10K	3/8 R	3/4 L	500K	2 3/8 F	3/4 L
10K	2 3/8 R	3/4 L	1 Meg	3/8 S	3/4 L
10K	2 3/8 R	3/4 L	1 Meg	3/8 S	3/4 L
15K	3/8 S	3/4 L	1 Meg	3/8 S	3/4 L
15K	3/8 S	3/4 L	1 Meg	2 3/8 F	3/4 L
20K	1 3/8 S	3/4 L	1 Meg	3/8 S	3/4 L
20K	3/8 S	3/4 L	4 Meg	3/8 S	3/4 L
20K	3/8 R	3/4 L	5 Meg	2 3/8 F	3/4 L
20K	3/8 R	3/4 L			

TYPE "JJ"—\$1.25 EA.
(\$.150 in Small Quantities)
**SEE DECEMBER ISSUE
FOR OHMAGES**

**OVER 500,000
CARBON & WIRE-WOUND
POTENTIOMETERS**

(All standard brands)

Carbon Pots:	13¢ ea.
2 Watt: Wire Wound	20¢ ea.
4 Watt: Wire Wound	30¢ ea.

(To Quantity Buyers)

All Values Available in Screwdriver and Knobs.

**OVER 100,000
ELECTROLYTICS
BATHTUB TYPE**

10¢ EACH

(To Quantity Buyers)

MFD	Style	Style	MFD	Style	Style
10/10/30	Volt.	Terminals	25	250	Terminals
10/10/30	25	Side	50	25	Top*
12/12	50	Side	100	25	Side
16/16/16	250	Side	100	50	Top
20	50	Side	200/200	9	Side
20	350	Side			
25	50	Side*			
25	50	Top*			

Largest Stock of Oil Filled Condensers in the East in Bathtub, Rectangular and Round Types. Send Us Your Requirements.

**Industrial
Assembly Corp.**
46 Howard St., New York 13, N. Y.
Phone CAnal 6-3474

HIGH VOLTAGE CONDENSERS

Cat. No.	MFD	WVDC	
G.E. 26F444	8	2 KV	9.95
G.E. 23F47	2	4 KV	9.95
G.E. 25F509G2	.1	6 KV	7.50
G.E. 25F774	.1X .1	7 KV	8.00
G.E. 25F450	.1	7.5 KV	7.50
G.E. 25F360	.1	12 KV	9.50
C.D.	.65	12.5 KV	17.50
Intercon	.25	15 KV	19.95
G.E. 14F91	1.0	15 KV	39.50
Intercon	.5	25 KV	49.50
Intercon	1.0	25 KV	49.50
Fast A6734	1.0	25 KV	89.50
G.E. 14F71	.25	32.5 KV	60.00

8x8x8mfd, 500WVDC
Special \$2.69
Many other types of oil filled condensers in stock. Write for quotation on your requirements.

HIGH CURRENT MICA CONDENSERS

Ceramic cased, Sangamo type G1 or similar

Mfd	WVDC	Amp @ 1 mc	
.04	1 KV	25	7.50
.08	1.5 KV	35	12.50
.09	1.5 KV	40	15.00
.02	3 KV	21 (600 Kc)	15.00
.00035	6 KV	7	12.50
.00075	6 KV	7	14.50
.0005	6 KV	5	14.00

Type G-2 or Similar

.0012	5 KV	8	17.50
.003	7 KV	15	19.00
.0002	10 KV	3	19.50
.00025	10 KV	3	19.50
.0003	10 KV	5	19.50
.0005	10 KV	6	19.50
.00057	10 KV	8	19.50
.00065	10 KV	6	19.50

Type G-3 or Similar

.05	3KV	50	45.00
.005	5.5 KV	25	45.00
.00015	20 KV	5	36.00
.0012	20 KV	15	36.00

Sangamo type F-2, C-D type 6, or similar
\$5.20 each

Mfd	VDC	Amps @ 1 Mc.	Mfd	VDC	Amps @ 1 Mc.
.00005	5 KV	.8	.001	5 KV	4
.00009	5 KV	.8	.0012	5 KV	4.5
.0001	5 KV	.8	.0015	5 KV	5
.00015	5 KV	1.5	.002	5 KV	6
.0002	5 KV	1.7	.002	6 KV	6.5
.00025	5 KV	2.5	.002	6 KV	6.5
.0003	5 KV	2	.0025	5 KV	6
.00035	5 KV	2	.003	2 KV	6
.000375	5 KV	2	.003	3 KV	6
.00039	5 KV	2.7	.004	3 KV	6
.0004	5 KV	2.5	.005	3 KV	6
.0005	5 KV	2.5	.005	5 KV	11
.0005	7.5 KV	3	.01	2 KV	8
.0006	2.5 KV	1.5	.02	2 KV	12
.0006	5 KV	3	.03	2 KV	12
.00072	5 KV	3.5	.07	1 KV	13
.0008	5 KV	4	.12	.5 KV	18
.0008	6 KV	4			

Sangamo type F-1, C-D type 15L or similar
\$3.75 each

.00005	3 KV	.6	.0008	3 KV	2.5
.00009	3 KV	.8	.001	3 KV	3
.0001	3 KV	.08	.0012	2 KV	3
.00015	3 KV	1	.00125	2 KV	3
.00025	3 KV	1	.0015	3 KV	3.5
.00027	3 KV	2	.0016	2.5 KV	3.5
.0003	2 KV	8	.002	3 KV	4.5
.0003	3 KV	2	.0025	2 KV	4.5
.0004	3 KV	4	.003	2 KV	5
.0005	3 KV	2	.004	2 KV	5
.0006	2.5 KV	2	.005	2.5 KV	6.5
.0006	3 KV	2	.006	2 KV	5.5
.000625	3 KV	2.5	.008	1.5 KV	8
.0007	3 KV	2.5	.01	2 KV	14
.00075	3 KV	2.5	.1	1 KV	12

Sangamo type A, C-D type 9 or similar
2500WVDC 5000TVDC

mfd	price	mfd	price
.00001	.57	.00051	.76
.000025	.57	.00063	.76
.00005	.57	.001	.87
.00006	.57	.0015	.87
.0001	.57	.002	1.27
.00015	.57	.0025	1.38
.0002	.64	.003	1.53
.00025	.64	.004	1.69
.0003	.64	.005	1.86
.00035	.64	.01	2.19
.0004	.64	.015	2.41
.0005	.76	.02	2.68

All prices FOB Oakland, Calif., subject to change without notice.
Terms 25% cash with order. Balance COD.

EMMONS RADIO SUPPLY CO.
405 10th St. Oakland, Calif.
Phone TWinoaks 3-7411

1200WVDC 2500TVDC

.00005	.48	.003	.88
.0001	.48	.004	.93
.00015	.48	.005	.99
.0002	.48	.006	1.03
.00025	.48	.008	1.23
.0004	.48	.01	1.41
.0005	.48	.015	1.74
.001	.57	.02	2.11
.002	.75	.025	2.37
.0025	.84	.03	2.43

600WVDC 1200TVDC

.00005	.43	.004	.60
.0001	.43	.005	.63
.00015	.43	.006	.66
.0002	.43	.008	.73
.00025	.43	.01	.84
.0003	.43	.015	.91
.0004	.43	.02	1.06
.0005	.43	.025	1.30
.001	.43	.03	1.66
.002	.49	.04	1.75
.0025	.51	.05	2.13
.003	.55	.06	2.41

DYNAMOTORS

The dynamotors listed below are either NEW or fully overhauled. Guaranteed.

TYPE	INPUT	OUTPUT	Mils	
DM-34	12V	220V	80	\$12.50
DM-35	12V	625V	225	24.50
DM-36	24V	220V	80	12.50
DM-37	24V	625V	225	17.50
DM-64	12V	275V	150	11.50
DM-65	12V	400V	440	22.50
BD-77	12V	1000V	350	25.00
TCS Rcvr.	12V	225V	100	12.50
TCS Xmtr.	12V	440V	200	22.50

TCS Complete power supply, 12VDC input. 68.50

MC-203A T coupling New. AAF source inspected @ \$12.50

The dynamotors listed below are NOT overhauled. Guaranteed to operate.

type	input	output	mils	price
DM-32A	28	250	60	2.95
GBY-21531	28	250	60	1.95
DY2-ARR2	28	250	60	1.95
PE-86	28	250	60	2.95
D-101	27	285	60	1.45
	28	230	100	2.95
DM-416	28	330	170	3.50
SP-22	28	330	170	3.50
DM-33A	25	875	160	3.50
SS-2669	18	450	150	2.50
BD-83	14	375	150	7.50
DM-414	14	220	80	4.95
DM-416	14	330	170	7.50
	12	400	180	9.50
	12	220	100	5.50
AD7-377	14	425	163	9.50

HEADSETS

New, guaranteed to pass AAF inspection
HS-23 5.75
HS-33 5.95
MC-162A extra ear cushions
new manufacture, per pair.50

PIONEER TORQUE UNITS

12604-3-A Contains CK5 motor & AY43D autosyn Gear ratio, motor to shaft 125:1. Gear ratio shaft to follow-up Autosyn 15-1..... \$70.00
12606-1-A Same as above except Gear ratio shaft to follow-up autosyn 30:1. 70.00
12602-1-A Same as 12606-1-A except has base mounting cover for motor & gears. 70.00
12077-1-A Pioneer Amplifier..... 35.00

PIONEER AUTOSYNS

AY-1 26V 400cy \$6.95
AY-5 26V 400cy 8.95
AY-6 26V 400cy 3.95
AY-30D 26V 400cy Generates signal to amplifier 12077-1-A..... 25.00
AY-43D or DW cancels signal from amplifier #12077-1-A..... 25.00

SOUND POWERED HANDSETS
New each \$9.95

BEACHMASTER 250 Watt Audio Amplifier with bank of 9 35 watt speakers, cables, mike, tubes. Operates on 110 V AC 60 cycles. Like new. \$395.00
BEACHMASTER AMPLIFIERS are available as originally delivered to the Navy, with 1500 Watt gas engine driven generator & complete spares, all packed in 6 waterproof cases, all new.....\$895.00

400 V TRANSFORMERS

All primaries 115V 400cy
UX8486A 5V/5A/13,500VRMS \$3.50
UX8306A 6V/3.7A/1780VRMS 2.50
UX8302C 6.3V/

SEARCHLIGHT SECTION

WANTED
ARC-1, 3, ART-13, BC-342, 348, APS-10, 15, TS-13, 35, 146, 147, 148, 174, 175, 263 ETC. All SCR, BC, AN, TS. ALL TUBES.

MOBILE RADIO
SCR-508
10 Channel FM Receiver and Transmitter. Frequency Range 20-27.9mc. Receiver is manually tuned, transmitter is crystal controlled. Consists of 2 BC-603 Receivers, BC-604 Transmitter, FT-237 mount, Box 80 xtals BC-606 Control, A-63 Phantom Ant., Headsets, mike, and antenna. Input 12v DC. SCR-608 also available. **POR**

SCR-291A
 1.5-30mc automatic direction finder. This equipment used to take bearings on transmitters within its freq. range. Complete equipments available comprising the following: BC-1147A Rec. PN 31, Power Panel, BC-1159, automatic bearing goniometer, RC-223 antennae system consisting of 5 masts with legs, MC-412, MC-413 phase inverters calibrating transmitter, cables, 115v 60 cyc gasoline generator. Complete equipment overhauled and guaranteed. **POR**

VE REMOTE PPI INDICATOR
 This is a remote PPI indicator "7 in." screen for use with any Radar for remote viewing. Contains all indicating circuits and is driven by the main Radar. Input 115v 60 cyc. **POR**

AN/APN-3 SHORAN EQUIPMENT. Used for navigation surveying and bombing equipments. Equipment operates with AN/CPN-2 ground beacons. Operating frequency 290mc. Accuracy is up to 300 miles. **POR**
 AN/CPN-2 Ground Beacon Available.

SCR-718C ABSOLUTE RADAR ALTIMETER. Operates 110v 400 cyc. Range 0-50,000 ft. in 2 ranges. Complete installations. **POR**

RADALAB
 87-17 124th STREET
 Richmond Hill 18, New York
 Phone Virginia 9-8181-2-3

SPEECH SCRAMBLERS
AN/GSQ-1A
 A very compact unit designed to be attached to either a radio or telephone circuit to scramble speech. Utilizes coded cards on each end unless the proper card is inserted in the receiving end; the speech cannot be unscrambled. Complete equipment available comprising scrambler, code card set, cables, etc. Can be used with SCR-506, 508, 808, 284 etc. **POR**

SCR-506A
 Mobile radio transmitter-receiver covering 2-4.5mc phone and CW. 10-90 watts output 5 channel operation. 12 or 24 volt input. Consisting of: BC653, BC652, Rack, dynamotors, microphone headset, antennae and mounts, etc. **POR**

AN/ARN-7
 Automatic direction finder covering 100-1750 kc. Comprising Receiver, Loop, Control boxes, Plugs, Mounts, etc

SCR-522
 Airborne Transceiver. Freq. 100-156 Mc. This unit is crystal controlled 4 channel. Power output approx. 10 watts. Consists of: BC-624 Receiver, BC-625 Transmitter, FT-214 mount, BC-602 control box, PE-94 dynamotor, antenna, plugs **\$137.50**
 12 volt installations available. **POR**

TS-102 AP
 This crystal controlled pulse generator produces a square-topped, 50 volt synchronizing pulse of .8 microsecond at a prf of 400, 800, 1600 or 2000 cps. and a triangular marker pulse of 0.4 microsecond duration at a prf corresponding to a pulse-echo distance of 1500 ft. The phase between the marker and sync. pulses is continuously variable from -180 to +180 degrees.

TERMS—Minimum order \$25.00 all prices FOB New York City. 25% deposit with order, balance COD. Rated firms open account. Prices subject to change without notice.

AN/CRT-4 Sono-buoy used with AN/ARR-16 receiver. Rotates in water and sends magnetic bearing signals to receiver to locate submarines. **POR**

B-29 central fire control system. Electronic and optical computer and sighting head type P-4. This equipment is used to direct guns in the B-29 from a central station. Brand New. Mfg. Sperry. **POR**

AN/APR-4 38-4000 mc precision receiver consists of receiver and five tuning units to cover the full range. Each tuning unit is calibrated directly in mc. Input 115v 60 cyc. **POR**

AN/APA-11 Pulse Analyzer. Will measure and display on CR tube pulse rate, width, duration. **POR**

BC-348R CAA and Military approved model. **POR**
AN/AIT-5 300-1200 mc transmitter 30 watts output. **\$169.50**

AN/APR-5 1000-3100 mc receiver
BC-639 100-156 mc. **POR**

AN/APS-10 3cm airborne navigation Radar. **POR**
AN/APS-15 3cm bombing Radar. **POR**

AN/UPN-1 3cm portable Radar beacon. **POR**
AN/CRN-2 Portable ILS system. **POR**

TS-250/APN CAA approved altimeter test set.
TS-13AP 3cm sig. generator
TS-146 3cm sig. generator
TS-35 3cm sig. generator
TS-89 Voltage divider
TS-148 3cm spectrum analyzer
BC-221 Freq. meter

TS-62 ECHO BOX
 A portable ringing cavity for microwave research; the unit has a frequency range from 9320 to 9420 mc. with a Q of 50,000 to 80,000. The echo box is used for relative power measurements, spectrum analysis, frequency checks, tests for unstable operation and a host of other applications in the laboratory.

SPECIAL VALUES
 783 Output Power Meter General Radio Like New **\$225.00**
 LR-1 Signal Generator 160-30,000 KC. 115 VAC. 60 cy. with xtal calibration. **Exc. 1200.00**
 Model 289X Hickok Universal crystal controlled Signal Generator. Like New **125.00**
 Model 200E Hewlett Packard Audio Generator. **Exc. 100.00**
 Model 210AR Hewlett-Packard Square Wave Signal Generator. **Exc. 100.00**
 T67/ARC-3 Transmitter, Receiver, Mounts, and Modulator with Dynamotor. **PUR* 150.00**
 R65/APN9 Receiver-Indicator. Like New **PUR* 125.00**
 DuMont 206B Oscilloscope. **Exc. PUR* 125.00**
 RTA-1B Bendix Transmitter. **PUR* 300.00**
 Model 230 Clough Brengle AC Cap and Res. Turns Ratio Bridge. **Exc. 45.00**
 Type 726A General Radio Vacuum Tube Voltmeter. **Exc. 125.00**
 804C Federal or General Radio Signal Gen. 8-330 mc. **Exc. 300.00**
 BC-221 or LM Freq. Meter. **Exc. 99.50**
 BC-221AK with modulation. **Exc. 150.00**
 General Electric Dual Regulated Power Supply Type ST9A. **New 300.00**
 Type 724A Precision Wavemeter General Radio, 1.6KC to 50MC. **Exc. 175.00**

A LARGE STOCK OF ARC-1, ARC-3, ART-13, APN4, APN4B, APR4, ARB, BC-312, BC-342, BC-348, BC-433G, BC-611, BC-1306, CRT-3, 196A, 1222, IE-19A, IE-35A, IE-36A, SCR-284, SCR-522, SCR-578, SCR-625, TCS, T19/APQ5, TS-34/AP, TS-100/AP, TS-184/AP, 14C, Plugs and Selsyns. **PUR* 11E
 * PUR—Price upon request.**

WANTED
 All types of radio and electronic surplus. We especially need: APA10, APNS, APR4, ARN4, ARC1, ARC3, ART13, ATC, BC221, BC342, BC348, BC611, BC721, DY12, DY17, I100, LM10 to LM18, MG149F, MG149H, PU14, R5/ARN7, R5A/ARN7, SCR718C, TCS, TN16, TN17, TN19, TN54, TS3, TS13/AP, TS33, TS35, TS45, TS75, TS76, TS102, TS147/UP, TS148/UP, TS173, TS174, TS175, TS250, TS251, TS323, 10CT, 1F, 1G, 5CT, 5DG, 5F, 5C, 6DC, 6G, 115V, 60 c.p.s. Selsyns), and all types of Hewlett Packard, General Radio Co., Measurements Corp., Boonton Radio, Ferris, Leeds & Northrup, and other test equipment.
 Please state accurate description, condition and your lowest price. Explain modification, if any. We pay freight charges.

NEW CATALOG NOW AVAILABLE
PHOTOCON SALES
 417 N. Foothill Blvd., Pasadena 2, California
 SYcamore 2-4131
 RY 1-6751
CABLE: PHOTOCON, PASADENA

TUBES! SMASHING LOW PRICES!

OC3/VR105 \$.99	JP12 7.95	305P .48	707A 9.95
OD3/VR150 .85	4B22/EL5B 5.50	455P .45	721A 2.45
1A3 .78	4B25/EL6CF 5.50	53A 2.50	723AB 22.50
1A5GT .62	EL/C5B 5.50	OK59 65.00	724A 2.55
1B22 1.95	EL/C6A 5.50	OK60 65.00	724B 2.95
1B24 9.10	4J36 145.00	OK61 65.00	725A 8.50
1B27 13.50	4J37 145.00	71A .69	726A 13.50
1B32/532A 2.19	5B11 4.69	OK72 1.25	801 .85
1N21 1.00	5D21 18.50	RK72/CRP72 1.00	803 3.95
1N22 1.19	5FP7 1.65	FG90 4.50	804 10.50
1N23 1.19	5JP2 19.50	100TH 10.50	805 3.95
1N27 1.65	6AC7 .89	VR105 .99	807 1.65
1P23 2.75	6AG7 .99	112A .49	810 10.95
1R4 .59	6AJ5 1.25	VT127 2.10	811 2.85
1T4 .59	6AJ6 1.00	VR150 .85	813 8.95
2A3 .95	6B6G .75	211/VT4C 1.25	814 2.79
2AP1 7.50	6C6 .74	227A 4.50	815 3.40
2B22 2.25	6C8G .74	274B 2.95	816 1.25
2C33/RX233 2.75	6H6 .59	EL-302.5 1.50	826 1.25
2C40 14.50	6K7 .63	304TH 13.95	830B 2.65
2E22 2.25	6SC7 .97	304TL 19.50	832 7.95
2J21 7.95	6SH7GT .79	GL-316A 2.50	832A 9.50
2J21A 8.50	6SH7 .79	350A 4.50	838 3.50
2J22 9.50	7C4/1203A .75	359A 1.50	866A 1.00
2J27 14.95	7E5/1201 .89	371B 2.95	872A 3.65
2J34 29.95	7E6 .55	388A 2.50	884 1.25
2J50 69.50	10Y 1.30	394A 3.50	902P1 5.50
2J55 84.50	12A6 .85	WL-417A 19.50	954 .45
2X2 .69	12C8 .79	GL434A 19.50	CK-1089 .75
2X2A 1.50	12J5GT .52	GL-446A 2.50	957 .45
3A4 .79	12SF7 .59	464A 6.75	1616 1.25
3B7/1291 .62	12S/7GT .55	CK-501X .69	1619 .75
3C23 9.50	14H7 .59	532A/1B32 2.25	1624 1.45
3C24/24G 1.95	14J7 .69	GL-605 49.95	1625 1.00
3DP1 3.50	15R .75	WL-653B 69.00	1629 .79
3D6/1299 .62	CE22 .95	ZP653 50.00	1655/65C7 .97
3EP1 4.50	RK25 3.69	705A 2.95	1846 95.00
3FP7 2.95	23D4 .65	706AB 19.50	2051 .95
3GP1 3.95	FG27A 6.50	706AY 27.50	8005 5.85

Box 11E IT'S EASIER TO ORDER BY MAIL!

RADIO SHACK CORPORATION
 167 Washington St., Boston 8, Mass.

Better than ever! Save money and time with Radio Shack's new 1954 electronic parts mail-order catalog! 224 pages!



GRAIN OF WHEAT LAMPS
 #318 CLEAR and AMBER
 #328 6 V. .2 amp.
 100 for \$25.00 10 for \$3.00

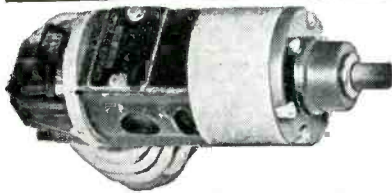

Perhaps the smallest reversible GEARED-MOTOR in the world

Delco-PM-Permanent Magnet Alnico Field Motor 250 RPM, 27 volts, 110 ma. Speed depending on the voltage. Designed to be used in bombsights, automatic pilots, etc. Cost at the factory \$26.10. Delivery 4 months.
 #5071895 3/4" shaft, and some with 11/16" gear.
OUR PRICE, Immediate Delivery!! \$17.50
 Clamps to hold motor: \$1.50 ea.

#5069600..... \$18.50

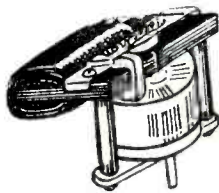

Genuine TELECHRON Motors

- 2 RPM..... \$2.90
- 3 RPM..... 3.90
- 4 RPM..... 3.90
- 3.6 RPM.... 3.15
- 1 RPM..... 3.95
- 60 RPM.... 4.30
- 3 R.P. Hr. . 2.85
- 1 R.P. 12 Hr. 4.25

1800 RPM SYNCHRONOUS Motor: 115 \$4.50
 volts AC, 18 watts 1 1/4 lbs.; 2" x 3" x 2"



MARKTIME 5 HOUR SWITCH

A 10 amp. timing device. Pointer moves back to zero after time elapses. Ideal for shutting off radios and TV sets when you go to bed. Limited supply at this special PRICE \$4.90

Also available in 15 min., 30 min., 1 hr. at \$5.90

10 Seconds to 24 Minutes Timer

A hand wound electric TIMING SWITCH. Pointer moves back to ZERO and shuts off RADIO-TV-Electric Mixer-Photographic Devices-Time Delay etc. Furnished with Calibration Chart and Pointer Knob. Biggest \$1.25 bargain we ever had.....



3" Round Elapsed Time Meter \$13.75
 Westinghouse Square \$16.00

NEON-Argon Lamps Micro-Switches • Relays • Solenoids

HAYDON SYNCHRONOUS TIMING MOTOR
 110 v. 60 cycle 30 RPM..... \$2.60
 110 v. 60 cycle 1/10 RPM... \$2.35
 110 v. 60 cycle 1 RPM..... \$2.85
 220 v. 60 cycle 2 RPM..... \$1.65

ZENITH Motorized Remote control made for T.V. but ideal for opening doors—windows—Turntables—Gadgets—Tuning Radios. Complete with Transformer 16 ft. cable and reversing button. \$8.95
 A few more left.....

ALL PRICES F.O.B. N. Y.

EST. 1923 **BLAN** EST. 1923
 64-D Dey St. New York 7, N. Y.

X-RAY

All types for industrial and experimental application. Tubes, cables and components.
MEDICAL SALVAGE CO., INC.
 217 E. 23rd St. New York 10, N. Y.
 Murray Hill 4-4267

AC TO DC POWER SUPPLY

RECTIFIER POWER SUPPLY—Input 105—125 Volts 60 Cycle; output 24 VDC 3 Amp. 200 Watts. Size: 16-1/4" x 15" x 9-1/2". Used—Tested..... \$19.95

SOUND POWERED HEAD And CHEST SET

NAVY TYPE—No Batteries required. Ideal for TV Antenna installations, and many other uses. 20 Ft. Cord. Used—Tested..... Each: \$6.95
WIRE—COMBAT TYPE: 2 Cond. twisted, rubber covered, medium weight, W-130 @ 1¢ per ft. **FIELD WIRE:** 2 Cond. twisted, weatherproof, heavy duty, W-110, 525 Ft. Roll \$4.75. **COPPER WELD WIRE:** Weatherproof. 2 Cond. solid. 1200 Ft. Roll \$10.00 or 1¢ per ft.



INVERTERS:

- 5D21N3A—27 VDC input; output 110 Volt 400 cycle, 1 Phase 485 VA..... \$39.50
- PE-109D—Input 13.5 VDC 29 A; output 115 V 400 cycle, 1 Phase 1.53 Amps..... \$59.50
- PU-7/AP—Input 28 VDC 160 A; output 115 V 210 A 400 cycle 2500 VA..... \$39.50
- PE-119—Input 28 VDC 100 A; output 115 V 400 cycle, 1 Phase 1500 VA..... Used: \$14.95 NEW: \$24.95
- PE-218—Input 28 VDC 100 A; output 115 Volt 400 cycle, 1 Phase 1500 VA..... Used: \$24.95 NEW: \$49.95
- PE-115 or PE-206—Input 28 VDC 36 A; output 80 Volts 800 cycle 7.2 Amps..... Like New: \$12.95
- TYPE 800-1-D—Input 28 Volts 62 A; output 115 V 7 Amps, 1 Phase 800 cycle..... Used: \$39.95 NEW: \$69.95

BLOWERS

115 Volt 60 cycle BLOWER (pictured) — approx. 100 CFM Dis. 2 1/2" Intake; 2" outlet. Quiet running. Motor size: 2 1/2" x 3 3/4". NEW — not Gov't surplus. \$8.95
 Order No. 1C939..... Same as RX-520 above, except DUAL BLOWER — approx. 100 CFM. Like New: \$12.95
 has blower assembly in each side of motor. Order No. 1C880..... \$13.95
COMPACT TYPE — 108 CFM, motor built inside squirrel case, 4-1/2" Intake: 3-3/4" x 3" Dis. Complete size: 4-1/4" W. x 9-3/4" H. x 8-3/4" D. Order No. 2C087..... \$14.50
FLANGE TYPE — 140 CFM, 2-1/2" Intake: 2-1/2" Dis. Complete size: 8-1/2" W. x 7-3/4" H. x 6-3/4" D. Order No. 1C807..... \$13.95
FLANGE TWIN — 275 CFM, 4-1/2" Intake: 3-1/2" x 3" Dis. Complete size: 11-3/4" W. x 9-3/4" H. x 8-1/16" D. No. 2C069..... \$21.95



MINIATURE BLOWERS:

24 VDC; Oblong Outlet 1 7/8" Dia. 20 CFM, \$7.95. Single 10 CFM, \$5.95.



DYNAMOTORS:

INPUT VOLTS	OUTPUT VOLTS	MA	STOCK NO.	USED	NEW
14	330	150	BD-87	6.95	8.95
14	250	50	DM-25	6.95	8.95
14	1000	350	BD-77	2.50	39.95
28	230	100	DA-1A	3.95	45.95
24	250	60	DM-32	2.95	6.95
24	375	160	DM-33	2.95	
28	210	125	DY-22	7.95	
24	220	80	DM-53	3.95	
28	1000	350	PE-72	8.95	
28	300	260	PE-94	.95	10.95
	150	010	A.B.C.M.		
		18			
14	172	138	DM-40	6.95	8.95
28	250	60	PE-86	2.75	8.95
12 or 24	500	50	USA/0515	4.95	
12 or 24	275	110	USA/0516	4.95	
13 or 26	400	135			
	300	025	PE-101C	3.95	4.95
12	150	100	DM-310X	4.95	7.95
6 or 12	500	160	PE-103	29.95	19.95
12	230	90	PE-132	6.95	8.95
18	450	60	SP-175	3.00	4.95

ADDRESS DEPT. E • All Prices Are F.O.B., Lima, Ohio • 25% Deposit on C.O.O. Orders

FAIR RADIO SALES • 132 SOUTH MAIN ST LIMA, OHIO

AIRCRAFT ELECTRONICS

ARC—1's, ART—13's, RTA 1B's, BC348's AND COMPONENT PARTS FOR ABOVE

WRITE OR CALL FOR BULLETIN

MERRICK ELECTRONICS

166-08 DOUGLAS AVE. JAMAICA, N. Y. RE 9-5960

FREE SURPLUS CATALOG

Just off the press—our brand new Catalog! Send for your FREE copy today! Mailed promptly on request!

MOTORS:

- 24 VDC REVERSIBLE**
- MOTOR — 3.7 RPM. 40 lb. Torque Motor Size: 5-1/2" x 4-1/32" x 3-5/16". Shaft size: 21/32" x 5/16". Also operates 24 VAC. Philco No. 441-1008 \$5.95
 - 27.5 VDC — 6000 RPM. 1.5 oz. in. Shaft Size: 1-1/2" x 1/4". Motor Size: 2-1/2" x 1-1/2" No. 5069-267 \$6.95
 - 27 VDC—110 HP—3500 RPM. Shaft Size: 5/8" x 1/4". Motor Size: 4" x 3-1/2". Air Assoc. No. ED-763. \$6.95
 - 80 VDC—150 HP—3000 RPM. Shaft Size: 3/4" x 3/4". Motor Size: 5" x 3". G.E. No.5 P/N381A10..... \$6.95
 - 28.5 VDC—1/25 HP—2200 RPM. Shaft Size: 1-1/2" x 1/2". Motor Size: 4-1/2" x 3-3/4". Electrolux No. 16876..... \$5.95
 - 2800 RPM Reversible Motor—Size: 5-3/4" x 3-1/2". Shaft Size: 1" x 1/4". Emerson No. 186-0412..... \$5.95
- GEAR HEAD** for above motor. Ball Bearing Geared Shaft, 10 to 1 reduction. Price..... \$5.95
COMBINATION: Motor & Reduction Gear..... \$10.00
21 VAC OPEN FRAME—20 RPM Double Shaft Back Gear Motor with Disengage Clutch. Shaft size: 1-1/2" x 3/16"..... Price: \$6.95
24 VAC OPEN FRAME—3 RPM Back Gear Motor. Shaft size: 3/4" x 3/16"..... Price: \$5.95
24 VDC REVERSIBLE—5000 RPM with Magnetic Brake. Flange Mount Spine Shaft—size: 3/4" x 3/16". Motor: 4" L. x 2-1/2" Dia. GE Motor only #5BA25A132A..... Price: \$8.95
24 VDC AIRWAY MOTOR—Model #Z-359. Approx. 5000 RPM. Motor size: 2-1/2" x 1-1/2". Shaft size: 1/2" x 1/4"..... Price: \$4.95
26 VOLT 60 CYCLE—60 RPM Synchronous Cramer Motor #1147. Shaft size: 1" x 1/2"..... \$1.95
110 VDC 1/70 HP, 1550 RPM. Motor size: 4" x 2-1/4". Shaft size: 1" x 3/16". Redmond #157..... \$4.95
6 VDC 1/20 HP, 4000 RPM. Motor size: 5" x 3". Shaft size: 3/4" x 1/4". Redmond #E-56..... Price: \$4.95
12 VDC 1/30 HP, 4500 RPM. Motor size: 3" x 2-1/2". Shaft size: 1" x 3/16". Delco #5047520..... \$4.95
A.C. INDUCTION MOTOR—115 Volts 60 cycle 1.0 RPM—Torque Oz. In. 75; Watts—3; with variable Multiple Disc Cover Wheel and Micro Switch mounted on Bracket Assy. Holtzer Cabot Motor Type RWC 2505..... \$14.95
GEARED HEAD MOTOR—Heavy Duty, 24 VDC 8 Amp. 2-1/2 lb. Torque; 100/200 RPM Shaft size: 5/16" x 1". Right Angle Drive..... \$8.95

TRANSFORMERS—110 V. 60 Cycle Pri.

5 VOLT CT-25A — 10,000 V. Ins. OPEN FRAME — 6" x 5" x 4-1/2". Sec. Two 12 V. 4 A. Winding—gives 12 V. 8 A. or 24 V. 4 A..... \$1.50
 Sec. 24 V. 1/2 A..... \$1.50
 Sec. 24 V. 1 A..... \$1.95
 Sec. 24 Volt 6 Amps..... \$5.95
 Sec. 6-24 or 30 Volts, 8 Amps..... \$5.95

INSULATING MATERIALS:

PHENOLIC LAMINATED SHEETS—36" x 36" x 1/4". Grade XX Type 1. Black. Price: \$10.00 per Sheet.
LAMINATED FIBERGLAS Sheets: 40" x 48" x 1/8" \$30.00 ea.
PLEXIGLASS SQUARES—6" x 7" x 1/4"—3 For \$1.00

COAXIAL CABLE CONNECTORS AND CABLES:

RG-8/U (SPECIAL) 51.5 ohm. Same size as RG-8/U. Prices: 1 to 100 ft. @ 8¢ per ft.—100 to 500 ft. @ 7 1/2¢ per ft.—500 to 1000 ft. @ 7¢ per ft.—1000 ft. Rolls (or more) @ 6 1/2¢ per ft.
RG-34/U—71 ohm, 145 ft. length..... \$15.00
PL-259—Plug ea. end & 32"—RG-54/U—58 ohm. 50¢
UG-21/U—Plug ea. end & 32"—RG-11/U—75 ohm 50¢
UG-22/U—with 4" Coaxial Cable..... 50¢

SAVE 65%

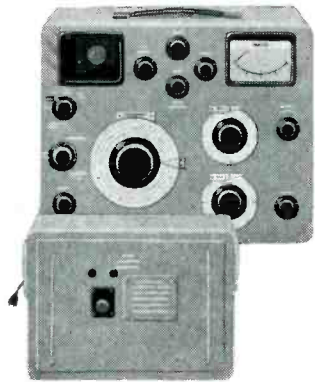

Marconi
SPECTRUM ANALYZER TF 890-1

Frequency: 9000 · 9650 mcs
Attenuation: 0-27 db. calibrated
Power: 110-120-220-240V 40-100 cps
A precision laboratory or portable instrument which may be used as a SPECTRUM ANALYZER, SIGNAL GENERATOR, WAVE METER, POWER METER, FREQUENCY METER, For measuring pulse width, cw spectrum width, or any X band test within this frequency. Set is supplied with power supply and complete kit of adapters, wave guide, attenuator and all accessories



TS-78/A1 PHANTOM ANTENNA

for AN/ARC-3 & SCR-274N

Newly Manufactured by

Associated Industries
IMMEDIATE DELIVERY!

Technical Manuals

We recently purchased, from the government, a large quantity of technical and operating manuals on RADIO, RADAR and AIRCRAFT equipment. Send for our listings.

SCR-291

Direction Finder

Frequency: 1.5 · 30 mcs.
Power: 115V · 60 cy. Single Ph.
Semi-portable radio direction finder using U-Adcock antenna system. Visual bearings are received on 5" cathode ray tube with illuminated azimuth scale. Designed for location of gun installations, radio stations and portable transmitters.

IMMEDIATE DELIVERY COMPLETE INSTALLATION
Write for Further Technical Data

Certified - Guaranteed

All equipment is sold with our certified, unconditional guarantee, checked and tested in our own shop. We are a recognized and approved supplier for Foreign and U. S. Govt. Agencies. We invite your inquiries for supply or technical data.

ASSOCIATED INDUSTRIES
CABLE ADDRESS *Aradis* LOS ANGELES
6855 TUJUNGA AVENUE
NORTH HOLLYWOOD, CALIF.

WESTON METERS

Model 301, RECTIFIER TYPE
0-150 Volts AC, 1000 ohms per volt AC, \$9.97 Ea.
Round bakelite case
NEW! BOXED 10% for \$89.97

OTHER WESTON MODEL 301

0-200 Microamps DC \$9.97
0-10 Volts DC (1000 ohms/v) 7.97
0-1 Ma (KV Scale) 7.97
0-50 Ma DC 7.97
0-1.5 Mills DC 7.97

MODEL 731

0-200 Microamps (Spec. Scale) 9.97
0-1 Ma (0-100 Scale) 8.97

MODEL 506

0-200 V 5.97
0-200 Microamps 7.97
0-1 KV with Mult. 7.97

WESTERN ELECTRIC METERS
3 1/2 inch round

0-50 MA 5.97
100-0-100 Microamps DC 8.97
0-1.5 Ma DC 5.97

WESTINGHOUSE METERS—Model NX35

0-500 Microamps (0-100 Scale) 6.97

GENERAL ELECTRIC

0-150 Volt AC—Model AO 22 7.97
0-3 Amp RF w/thermo—Model D044 7.97
0-5 Amp RF w/thermo—Model D044 7.97
Running Time, 99,999 hours 115V, 60 cy 10.97

UTC COMMERCIAL GRADE TRANSFORMERS

Type CG. Fully cased, Hermetically sealed, Primary 115 V 60 CY. Tapped from 105 Volts in 6 steps, Secondary 75-0-75V, 32.5 MA Contin-
uous duty rating. **BRAND NEW \$9.97 Ea.**
Type CG Choke to match, 12 Henry, 325 MA. **BRAND NEW \$4.97 Ea.**

G. E. RELAY CONTROL

(Ideal for Model Controls, Etc.)

Contains a sigma midget 8,000 ohm, relay (trips at less than 2 MA), high impedance choke, bimetal strip, neon pilot and many useful parts. The sensitive relay alone is worth much more than the total low price of **\$1.27 Each 10 for \$9.97**

Panel Meters

NEW GOVT SURPLUS STANDARD BRANDS 2" METERS

DB meter—10 to +20 \$3.47

3" METERS

0-200 Microamps \$6.97

0-400 Microamps 5.97

0-500 Microamps 4.57

0-200 Milliamp 4.57

0-1000 Milliamp 4.57

0-1.5 Volts AC 4.37

0-8 Volts AC 4.37

4" METERS

0-200 Microamps \$8.97

OIL CONDENSERS

4 MFD—600 VDC \$0.97

10 MFD—600 VDC 1.77

12 MFD—1800 VDC 1.77

6 MFD—1500 VDC 2.97

2 MFD—200 VDC 2.57

4 MFD—2000 VDC 3.97

2 MFD—2500 VDC 3.97

1 MFD—4000 VDC 5.97

2 MFD—200 VDC 3.97

5 MFD—500 VDC 6.97

3 mfd—750 VDC 1.77

01X 01 12KV DC 2.97

11 MFD 25 KVDC 49.97

5 mfd 60 VAC 2.97

NON-INDUCTIVE RESISTORS
Ohmite, 250 Ohm, 100 Watt. **57c**

Special, 5 for \$2.57

ACME PLATE TRANSFORMER

Pr. 220V 50/60 Cy, 3 Phase, Delta Connected. Secondary 3 phase, Y connected, 2622 Volts @ 7.5 KVA. **\$99.57**

RAYTHEON PLATE TRANSFORMER

Pr. 220V single phase, tapped, 60 cycle. Secondary, 6000, Volts to 8000 Volts @ 1 Amp. in **\$99.57**
400 Volt steps.

SOLA CONSTANT VOLT TRANSFORMERS

Input 95-125 V 60 Cy Output Regulated 115V
250 VA \$31.67
500 VA 48.67
1 KVA 79.97

TYPE G H.V. MICAS

G4 .00062 30KV \$39.57 G3 .0013 15KV, 29.97
G4 .0012 25KV, 44.57 G2 .0043 8KV, 14.97

CARTER SUPER DYNAMOTOR

12V Input, 480V Output @ 200 MA. CONTINENTAL DYNAMOTOR \$24.97
11V Input, 475V @ 210 MA Output. \$19.97

WIRE WOUND RESISTORS

Stock too long to list. We can supply most sizes, so order what you need.

10 Watts, From 1 Ohm to 70K Ohms Ea. \$.15
20 Watts, From 4 Ohms to 50K Ohms Ea. .20
25 Watts, From 1 Ohm to 100K Ohms Ea. .30
50 Watts, From 5 Ohms to 100K Ohms Ea. .40
100 Watts, From 50 Ohms to 100K Ohms Ea. .50
ADJUSTABLE SLIDER, WIRE WOUND
10 Watts from 1 Ohm to 10K \$.25
25 Watts from 20 Ohms to 2.5K35

EIMAC VACUUM CONDENSERS

6 MMF 32 KVDC (Vc 6-32) \$9.97
12 MMF 32 KVDC (Vc 12-32) 10.97
50 MMF 32 KVDC (Vc 50-32) 12.97
100 MMF 5 KVDC G. E. 4.97

Min. Order \$3.00—25% with Order

PEAK ELECTRONICS CO.

66 West Broadway, New York 7, N. Y.
Phone Worth 2-5439

Sensational Buy!

MODULATED BC-221-AK FREQUENCY METER

BRAND NEW! Limited quantity, first come, first served! Range 125 to 20,000 Kc, with crystal check points in all ranges. Complete with tubes, crystal, calibration charts. **\$210.00**
Your cost, BRAND NEW \$129.50
Used, Excellent Cond. with tubes & headset.....



HEADSETS

	Excellent USED	BRAND NEW
HS-23 high impedance	\$2.95	\$4.75
HS-33 low impedance	2.45	5.75
HS-30 low imp (featherwt)	1.49	2.45
H-16 1/2 high imp (2 units)		4.95
CD-307A cords, with PL55 plug and JK26 jack, 8' long		1.19

MICROPHONES

T-17 Shure Handmike 200-ohm carbon single button. Press-to-talk switch, 5' cord & plug. **BRAND NEW \$7.95**
Used, Excellent \$5.50



CARBON HANDMIKE, Sig Corps, 200 ohm single button. Press to talk switch, 4' cable, plug. **BRAND NEW 5.95**

	USED	BRAND NEW
T-45 Lip Mike, navy type	.49	\$1.85
T-30 Throat Mike		.85

DYNAMOTORS

Type	Input	Output	Excellent Used	BRAND New
DM-32A	28V 1.1A.	250V .05A.	\$4.90	\$7.50
DM-33A	28V 5 A.	575V .16A.	2.25	3.95
	28V 7 A.	540V .25A.		
DM-34D	12V 2.8A.	220V .080A.	14.50	
DM-37	25.5V 9.2A.	625V .225A.	14.75	
DM-40	14V 3.4A.	172V .130A.		7.95
DM-28	28V	224V .07A.	3.95	6.95
DM-21	14V	235V .09A.	6.85	16.50
PE-73	28V 20 A.	1000V .350A.	9.50	12.50
PE-86	28V 1.25A.	250V .060A.	2.95	5.50
PE-94A	28V 10 A.	300V .200A.	7.50	11.50
		150V .101A.		
PE-94B	28V 10 A.	300V .200A.	8.50	11.75
		150V .101A.		
PE-94C	28V 10 A.	300V .200A.	10.00	12.75
		150V .101A.		
PE-98	14V 21 A.	300V .200A.	22.50	37.50
		150V .101A.		
PE-101	13V 12.6A.	400V .135A.	3.75	4.85
	26V 6.3A.	9V AC. 1.12A.		
PE-103	6V	500V .160A.	27.50	44.50
	12V	500V .160A.		
PE-104	6V 1 A.	84V .09A.	12.50	14.50
(Vibrator)	12V 5 A.	51V .03A.		
DM-414 (with filter)	14V 2.8A.	1.4V 400A.		12.50
PS-225 (with filter)	28V 3.2A.	375V .150A.		10.50
EICOR Dynamotor D-401	27V 6.05A.	300V .200A.		9.95
		18V AC 2.2A.		
PE-135AX (with filter)	24V 12 A.	500V .200A.		34.50

GENERATOR

GN-39-F 14.6V 25 A. 1000V .350A. 39.50
(16" L, 8" dia. 50 lbs.)

INVERTERS

PE-206 Inverter—Leland
In: 28V DC—38A
Out: 500V 800 cyc. 80VA. 1 Ph. 9.75 12.50
PE-218 Inverter—Leland-Wincharger—GE.
In: 28V DC—92A
Out: 115V 380/500 Cyc. 1500VA. 1 Ph. 16.50 24.50

ARMY FIELD PHONES

Type EEB—Talk as far as 17 miles. Dependable 2-way communication at low cost. Ideal for home, farm, field. Up to six phones can be used on one line. Each phone complete with ringer. Originally cost govt. **\$65.00** each. Excellent Condition. **\$22.25**
Your cost.



WILLARD 6-VOLT MIDGET STORAGE BATTERY

3-amp hr. BRAND NEW, 3 5/8" x 1 13/16" x 2 3/8" Uses standard electrolyte **\$2.65**

WILLARD 2-Volt Storage Battery

20 AMP. HR. BRAND NEW **\$2.69**
1-QUART ELECTROLYTE FOR ABOVE. ENOUGH FOR TWO CELLS. BOTTLE **\$1.45**
7-PRONG 2-VOLT VIBRATOR, FOR PORTABLE AND FARM SETS (GE LB530) **\$1.49**

Please include 25% deposit with order—Balance C.O.D. MINIMUM ORDER \$3.00. All Shipments F.O.B. Our Warehouse N.Y.C.

CONTINENTAL RADIO COMPANY

Phone Cortlandt 7-4605
51 VESEY STREET • NEW YORK 7, N. Y.

SPECIAL PURPOSE TUBES

1B24	6.75	3DP1	2.50	RK-62	2.00	349A	7.50	721A	1.75	833A	28.50
1B27	11.00	3E29	10.75	RK-72	1.00	350A	4.00	723A/B	12.00	836	2.50
1B42	8.00	3EP1	4.00	RK-73	1.00	352A	15.00	724A	1.50	837	1.00
2AP1	5.75	3GP1	2.75	F-128A	75.00	354A	15.00	724B	1.75	838	3.00
2C39A	13.50	4B27	7.50	F-129B	150.00	355A	15.00	725A	4.00	846	125.00
2C40	5.75	4C27	10.00	VT-158	30.00	F-375A	12.50	726A	7.50	849	20.00
2C43	13.50	4E27	13.75	FG-190	9.50	393A	7.50	726B	40.00	851	48.00
2C44	1.00	4J34	75.00	C-202	12.50	394A	2.50	726C	45.00	860	2.00
2D21	1.00	4J35	125.00	204A	25.00	417A	7.50	728CY	35.00	861	13.50
2E22	1.75	5BP1	3.00	F-207	100.00	GL-434A	12.00	728DY	35.00	866A	1.00
2J21A	6.50	5BP4	3.00	WL-218	25.00	446A	1.00	728EY	35.00	869B	55.00
2J26	12.50	5CP1	3.75	250R	5.00	446B	3.00	728GY	35.00	872A	2.50
2J27	9.25	5D21	11.00	250TH	15.00	450TL	37.50	802	3.00	878	1.25
2J31	19.00	5FP7	1.00	250TL	13.00	WL-460	12.00	803	3.00	884	1.25
2J32	20.00	5FP14	15.00	251A	150.00	464A	7.00	805	3.00	885	1.50
2J33	20.00	5JP1	13.00	253A	6.00	527	15.00	807	1.25	892R	250.00
2J34	18.00	5JP4	13.00	267B	7.00	631-P1	4.75	808	1.50	902-P1	7.50
2J36	75.00	5JP11	35.00	271A	5.75	700A	13.50	809	2.50	913	10.00
2J38	12.50	5J30	23.50	274B	2.00	700D	13.50	810	9.75	923	1.00
2J56	75.00	5J32	60.00	276A	7.50	701A	5.25	811	2.50	931A	4.25
2J61	28.50	5R4GY	1.00	282A	7.50	702A	2.50	812	2.50	959	1.50
2K25	19.75	C6A	7.50	283A	3.75	705A	1.00	813	10.00	CK-1006	1.50
2K41	90.00	C6L	5.50	286A	6.50	706AY	25.00	814	2.50	1614	1.50
3AP1	5.00	6BL6	50.00	304TH	6.75	706FY	35.00	815	4.50	1624	1.25
3BP1	3.00	6BM6	60.00	304TL	6.75	706GY	35.00	816	1.25	2050	1.25
3B22	2.25	6C21	15.00	307A	3.00	707A	6.00	822	17.50	ZB-3200	125.00
3B24	3.75	6J4	4.75	310A	3.00	707B	8.75	826	1.00	8002R	85.00
3B24W	7.50	7BP7	3.00	311A	3.25	708A	2.50	828	9.00	8005	4.25
3B25	3.50	9LP7	3.00	313C	3.00	709A	2.50	829A	6.00	8012	1.75
3B26	2.75	12DP7	12.50	323B	9.75	715A	3.00	829B	8.00	8013	2.00
3B28	4.00	12GP7	13.50	328A	4.00	715B	4.00	830B	2.00	8020	1.00
3C23	6.75	RX-21	7.50	329A	7.50	715C	16.50	832	6.50	8025	4.00
3C24/24G	1.00	RK-23	2.00	348A	7.50	719A	15.00	832A	7.50	PD8365	50.00

- Prices do not include transportation
- Usual terms apply

western engineers

ELK GROVE, CALIFORNIA
GEORGE WHITING, OWNER

- Unconditional guarantee extended
- Subject to prior disposition

STOP HUNTING! WE'VE GOT IT!

Send us your requirements if we haven't got it listed here!

Just a partial list of our present stock:

- BC-348 • BC-342 • ART-13
- ARC-3 • APN-9 • LM
- BC-221 • BC-611
- VARIOUS TEST EQUIPMENT

NEW EXPORT DIVISION
FOR ALL FOREIGN ORDERS

Prompt attention to all inquiries—all languages

Atten: Schools, Labs, Hams!
WE PAY MORE

FOR RADIO PARTS & EQUIPMENT
Cash in on your surplus equipment—or we'll trade for something you really need. Write today!

Write for FREE Surplus Catalog.

HARJO SALES CO

4109 BURBANK BLVD.

P. O. Box 1187

Magnolia Park Station
BURBANK, CALIFORNIA

Cable: HARJO

3 OUTSTANDING TRANSFORMER VALUES!

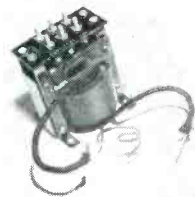
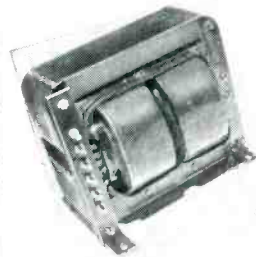

Acme Induction Heating or Transmitter Plate Supply

3100 Volts Each Side of Center at 500 M.A. Primary tapped for 98, 104, 110, 116, 123 Volts, 60 cycle A.C. Conservatively rated. 15 KV. impregnated mica insulation. Balanced secondary windings. Special high silicon low loss core. Size: 9" L. x 8" H. x 7 1/2" W. Shipping wt: 60 lbs. Priced extremely low at \$34.50.

Acme Rectifier Filament Transformer

2.5 Volts (C.T.) at 10 amps. 10 KV. insulation. Primary tapped as above. Excellent design and construction for continuous operation. Limited quantity. Only \$2.75 each.

Acme Filament Transformer

10 Volts (C.T.) at 10 amps. 5 KV. insulation. Primary tapped as above. Absolutely top quality. A highly useful type for many applications. Be sure to order spares at this low price: \$3.25 each.

NEW AND GUARANTEED

Prices shown apply to present limited stock only.

Order today.

SEeley 8-4143

WELLS SALES, INC.

833 W. Chicago Ave., Chicago 22, Ill.

TUBES:

Industrial
Receiving
Transmitting

Specialists in
JAN Tube Types

Standard Brands Only

0A2	.85	3HP14	6.50	700D	19.95
0A3	1.05	4B22	7.50	701A	6.50
0B2	.85	4B25	8.00	702A	1.75
0C3	.90	4J32	220.00	703A	4.50
0D1	3.50	4J36	140.00	704A	.85
1B26	2.20	4LCSB	3.50	705A	1.30
1B27	11.50	5BP1	3.35	706B	18.50
1P21	49.50	5BP4	3.35		
1P23	2.50	5D21	12.00		
1P28	9.00	5FP7	1.50		
1P40	1.55	5J29	11.50		
1P41	2.50	5LPS	17.00		
1P42	5.00	5R4GY	1.20		
2B32	2.25	5R4WGY	4.00		
2C40	6.00	WE 6AK5	1.25		
2C43	14.95	6AR6	2.70		
2C44	.98	6AS6	1.90		
2C51	3.75	6A57C	3.50		
2D21	1.20	6GJ	10.75		
2D21W	2.50	6H7	3.50		
2J21	6.50	6J4	5.75		
2J22	5.00	6K16W	1.50		
2J26	13.00	6K4	2.25		
2J31	20.00	6K4A	5.50		
2J37	12.00	6L6WGA	8.45		
2J40	32.00	7AK7	7.00		
2J50	20.00	7C30	85.00		
2J51	215.00	9C24	250.00		
2J54	62.50	9LPS	17.00		
2J54B	95.00	15R	.50		
2J61	30.00	28D7	1.40		
2J62	25.00	FG22	1.40		
2K22	20.00	FG33	23.00		
2K23	11.50	35T	3.50		
2K25	27.50	FG105	11.50		
2K28	25.00	FG172	29.95		
2K29	24.00	215A	7.50		
2K30	320.00	250T4	15.50		
2K33	175.00	250T1	16.50		
2K33A	195.00	274B	2.25		
2K34	140.00	304T4	7.75		
3B24	4.00	304T1	7.75		
3B24W	11.00	316A	.80		
3B25	3.50	TR317	17.00		
3B26	2.75	359A	4.50		
3B28	4.95	388A	1.50		
3B29	10.25	394A	3.00		
3BP1	3.70	GL414	120.00		
3CP1	2.00	GL434A	14.00		
3C21	5.00	GL46A	1.10		
3C24/24G	.95	GL46A	3.50		
3C45	11.50	471A	2.20		
3DP1	2.80	532	3.50		
3E29	11.50	KU627	17.00		
4FP7	1.75	700A	19.95		
5GP1	2.78	700B	19.95		
		700C	19.95		

Fully Guaranteed

715B	4.00	5670	3.25
722A	1.50	5676	1.15
723A/B	13.50	5682	2.00
728A	99.50	5687	3.75
728B	99.50	5691	9.50
728C	99.50	5692	9.50
728D	99.50	5693	7.50
728E	99.50	5702	2.95
728F	99.50	5702WA	4.50
800	1.50	5703	1.70
805	3.20	5703WA	3.50
829B	12.50	5718	6.00
830B	2.75	5719	6.50
832A	7.50	5720	23.00
837	.95	5725	3.25
838	3.25	5726	1.50
865	.95	5744	2.00
872A	3.50	5749	2.15
921	1.85	5750	2.50
922	1.60	5751	2.95
954	.35	5763	1.50
955	.45	5783	6.00
956	.45	5787	4.25
959	1.75	5814	1.85
966	1.50	5825	12.75
1812	2.00	5829	2.75
1814	1.95	5837	110.00
1816	1.85	5901	6.50
1819	.35	5844	2.00
1820	6.20	5881	2.50
1825	28.00	5912	6.50
1836	2.50	5902	11.00
1841	2.00	5910	.70
1845	35.00	5915	1.20
5550	39.50	5932	8.50
5551	60.00	5937	24.00
5557	8.50	5964	1.45
5588	14.00	5995	6.00
5599	21.50	6005	3.75
5600	1.20	6135	2.75
5632	12.15	6095	write
5634	4.50	6096	write
5636	7.50	6097	write
5637	3.00	6098	write
5638	3.00	6099	write
5639	12.00	6101	write
5640	12.50	6111	11.50
5641	8.00	6112	11.50
5642	1.20	6135	2.75
5643	8.00	6146	4.85
5644	12.00	6163	3.25
5645	7.50	6187	2.50
5646	7.50	6201	5.00
5647	5.50	8001	5.50
5651	3.00	8011	.75
5654	3.68	8013A	3.95
8686	8.20	8020	2.00
		8625	8.28

Receiving Tubes

6AG5	.65
6AQ5	.48
6SN7GT	.69
6V6GT	.50
12AT7	.78
12AU7	.60
12SL7	.50
12SQ7	.50
25L6	.58

All Other Types
in Stock. Write
for Quotes

706C	18.50
707A	5.00
707B	9.25
708A	3.50
709A	2.65
713A	.90

2 1/2" ROUND PANEL METERS

0-1 MA DC G.M. Lab Spec black scale	\$3.50
0-150	3.50
0-3 MA DC Hickock 56	3.50
0-5 MA DC Gruen G.W. 508	3.50
0-300 MA DC G.E. DW 55	4.95
0-50 Volts DC Gruen GW 508	4.95
0-300 Volts DC Sun 2 AP 380	4.95
0-500 Volts DC Hickock MR 26 W 500 DC	6.00
0-15 Volts AC G.E. 800 Cycles AW 41	1.25
0-150 Volts AC Hickock MR 26150ACV	4.95
0-300 VAC Triplett Metal Case 232	4.95
30-0-30 AMP DC G.E. DW 51 Metal Case Int. Sh.	3.00
0-50 Amp DC G.E. 50 MV less shunt	3.50

3 1/2" ROUND PANEL METERS

0-50 Micro Amp DC Electrotech	\$ 8.50
0-30 V. DC Weston 301 62 ohms/volt metal case	7.50
0-300 VDC G.E. DO 41 1000 ohms/volt	7.50
0-500 VDC G.E. DO 41 1000 ohms/volt	9.50
0-1 K.V. G.E. DO 41 1000 with IRC Res.	16.50
0-10 V. DC G.E. 100 ohms/volt DO 41	5.95
0-5 Amp. DC Simpson 25	6.00
0-50 Amp DC Weston Metal Case 301	7.50
0-100 Amp DC Hoyt 531 L Int. Sh. Surf Mtd.	2.00
0-300 Amp DC WH E1 with shunt black scale	8.50
0-50 MA DC Westinghouse NX-35	5.95
100-0-100 MA DC G.E. DO-41	4.95
0-150 MA DC G.E. DO-41	5.95
0-800 MA DC De Jur 310	3.00
0-1.5 V AC Hickock 47 M	3.50
0-15 V. AC Roller Smith TAS	3.50
0-130 V AC Westinghouse NA 35	5.50
0-2.5 ARF McClintock 35	4.00
0-5 A AC Triplett 0-100 scale, 331	4.50
0-100 AC Triplett with Current Transformer	9.50
WESTON 528 DOUBLE RANGE AC METER 0-3-.15. Amp with test leads and leather case	12.50

* Unless otherwise specified the above items all have white scales, round bakelite cases, and are brand new and in original cartons.

MARITIME SWITCHBOARD

Instrument & Accessories
336 CANAL STREET, NEW YORK 13, N. Y.
WOrth 4-8216 (7)

MILGRAY
ELECTRONICS, INC.

120 Liberty St.
New York 6, N. Y.
REctor 2-1297-8

**WE BUY AND SELL
GOVERNMENT SURPLUS**
electronic components, units, wire, etc.
Your Inquiries Invited
LAPIROW BROS.
1649 Hoffner St. Cincinnati 23, Ohio
KIrby 1285

FOR SALE
One used 10 KW FM
TRANSMITTER, RCA
model BTC-10.
FS-1017, Electronics
330 W. 42nd St., New York 36, N. Y.

WANTED

WANTED

SELSYNS and AMPLIDYNES

G. E. CONTROL TRANSFORMERS
Size 5, Models 2J5F1, 2J5D1, 2J5F1 or
equivalent. 115/55V 60~
G. E. AMPLIDYNES-MOTOR GENERATORS
Input 115/230V 60~ 1ph.
Output 250 VDC @ .6 Amps. or larger

Also need Type SDG Synchro Differential
Generators, 6G Generators, C78248 Syn-
chronous Transmitters, Electronic Tubes,
Inverters, Rate Generators, Autosyns, and
any other Specialized Rotating Equipment.

Advise quantity available, price and con-
dition. We are interested in any quantity—
small or large.

ELECTRO SALES CO., INC.

50-58 Eastern Ave., Boston 13, Mass.

URGENT
Will Buy BC348R Receiver @ \$75.00
BC348H—K and L Receivers \$70.00
Ship via EXPRESS C.O.D., subject to in-
spection to
H. FINNEGAN
49 Washington Ave., Little Ferry, N. J.

WANTED
ART-13, BC-312, BC-342, BC-348, APN-9,
BC-221, LM. Will take any. Transmit-
ting, Receiving or Test Equipment in
Trade for new Amateur or Commercial
Equipment.
ALLTRONICS, Box 19, Boston 1, Massachusetts
Tel. Richmond 2-0048 or 2-0916

WILL BUY
All ART13/type T47A \$200.00; ART13 type T47
\$150.00; BC348 unmodified \$65.00; BC348 modified
\$50.00; APN9 \$200.00; ARC3 complete \$350.00;
R77 Receiver \$200.00; ARC1 Radio \$200.00; BC312
\$60.00; BC342 \$60.00; ship via Express C.O.D.,
subject to inspection to
H. FINNEGAN
49 Washington Ave. Little Ferry, N. J.

**YOUR BEST SOURCE
FOR JAN TYPE TUBES**

OB2	.85	6C21	18.00	954	.55
OB3/VR90	.85	6F4	3.95	955	.55
OC3/VR105	.95	RK60	2.25	957	.55
OD3/VR150	.85	WY114B	3.50	958A	.85
1B24	6.75	120A	5.00		
1B29	2.40	121A	2.25		
C1B/3C31	4.50	F127A	17.50		
1P23	2.50	204A	37.50	1N21	1.40
1P32	3.95	211/VTAC	.85	1N21B	1.85
1P36	3.25	FG235A	75.00	1N23	2.25
1P40	1.50	304TL	7.95	1N23A	2.50
2C39A	12.50	307A	3.95	1N23B	2.75
2C40	7.75	CE309	4.75	1N26	7.75
2C42	7.50	310A	4.50	1N38	1.20

2D21 RCA	\$ 99	12AY7 GE	99¢
5BP1	3.50	6SH7	49¢

2C43	17.50	371B	1.75	CATHODE- RAY	
2C46	7.50	394A	2.50		
2D21W	2.25	700B	25.00	2AP1	5.50
2J31	27.50	715C	19.75	3BP1	3.65
2J32	27.50	717A	.75	3DP1	2.75
2J33	27.50	723AB	17.50	3GP1	2.75
2J48	24.00	726A	13.00	3KP1	9.75
2J54	47.50	801A	.35	5HP4	5.00
2J52	32.50	807	1.35	7BP7	3.95
2K22	42.50	810	10.50	9GP7	12.50
2K23	27.00	811	2.80		
2K25	29.50	813	9.25	Partial Listing Query us for other Types.	
2K33A	195.00	814	3.25	F.O.B. N.Y.C.	
2K41	130.00	832B	11.95	Rated (D&B) Firms	
2K45	99.50	832A	7.50	Open Account.	
2X2/879	.65	845	6.75	Attractive Discounts	
3A4	.82	860	2.25	To Quantity Buyers.	
3A5	.82	865	.95		
3B28	4.95	866A	1.30		
3C24	1.35	872A	3.25		
3C45	9.50	899RA	250.00		
3E29	10.95	918	2.25		
CSB	3.50	921	1.75		
5D21	11.95	923	1.25		
C6J	8.75	931A	3.95		

ALLIED ELECTRONIC SALES
SPECIALISTS IN
ELECTRONIC TUBES
8 Barclay
7-5839
74 Cortlandt St., New York 7, N. Y.

SPECIAL 2K33A \$185.00 ea.

EMELTONE ELECTRONICS CO. 71 W. Broadway - N. Y. 7, N. Y. Phone REctor 2-1696

SPECIAL VT 98 ENGLISH TYPE \$15.00 5687 \$4.00

Crystal Diodes

Standard Brands Only

Table of crystal diodes including models like 1N21A, 1N21B, 1N21C, 1N22, 1N23, etc.

SPECIAL PURPOSE TUBES

Table of special purpose tubes including models like 5J26, 5J32, 6AM5W, 6AK5, etc.

Receiving Tubes

Klystrons, Magnetrons

Table of receiving tubes and klystrons/magnetrons including models like 688, 884, 931A, 955, etc.

PRICES SUBJECT TO CHANGE ALL ITEMS SUBJECT TO PRIOR SALE WRITE, WIRE OR PHONE CASH PAID FOR YOUR SURPLUS TUBES—SEND LIST AND PRICES

POWER RHEOSTATS

Table of power rheostats with columns for Ohms, Shaft, Price, and Wattage (25, 50, 100).

ARCH ELECTRONICS CO.

DEPT. M 634 ARCH ST. PHILA. 6, PA. WALNUT 2-3553

ESSCO'S JAN. SPECIALS

Replacement parts available for radio compass BC-433 all material—Clean New Condition—Your inquiries on this listing of Reference No. for this unit and other units are invited.

Table of Essco's Jan. specials listing part numbers and prices.

For Fast Intelligent Friendly Service "CALL ON ESSCO" ELECTRONIC SPECIALTY SUPPLY CO. 58 Walker St., NYC 13, N.Y. WALKER 5-8187

Available Now SELECT SURPLUS

Complete basic components for SCR 183, 186, 187, 193, 238, 240, 242, 261, 263, 269, 273, 274, 280, 283, 284, 287, 300, 399, 506, 508, 510, 515, 517, 518, 520, 521, 522, 528, 530, 533, 540, 542, 578, 585, 610, 694, 718, 720, 729 SA-1, SG-, SO-, AP*8, AP*4, Radar Mark II Model 10

Complete units for aircraft installations ART-13, ARC-1, ARC-3, RTA-1B, TA-2J, TA-12, AVR-23, MN-31C

Accessories spares and replacement parts and tubes, plugs, connectors, etc. for all equipment listed. Telephone Materials Handsets TS-9, 10, 11, 13, 14, 15, 19 DE-8 completely reconditioned and checked out, special \$37.50 pr. EE-99, TP-3, RM-7, RM 14, RM-21, RM-20, BD-72 switchboard

Tremendous inventory of resistors, condensers, knobs, choices, transformers, switches, coils, wire, receiving, and special purpose tubes. Your quotation requests are respectively solicited—Red Arrow is always available to inspect, and buy, or swap for your electronic material. We offer lowest prices, proper presentation on all equipment and components, and immediate delivery from stock

RED ARROW ELECTRONIC SALES CO. 1217 Summit Ave., Union City, N. J. Union 3-7916 Direct phone from N. Y., Oxford 5-0984

TELEPHONE RELAYS



Large Stock of CLARE, TYPES C, D & E COOKE, AUTOMATIC—ELECTRIC ALL TYPES OF COILS and PILE-UPS

Table of telephone relays including Clare Type C Standard Size Sensitive Telephone Relays with coil and contact specifications.

Table of Clare Type G Half Size Sensitive Telephone Relays with coil and contact specifications.

Table of Other Type G Telephone Relays with coil and contact specifications.

Contact Symbols A=Norm. Open B=Norm. Closed C=S.P.D.T.

G.E. Relays #CR2791-B109P36 Coil—10,000 ohms Contacts 1A, 1B Operates on 8 MA... Price \$1.65 Signal Wheelock Relays #KS9685 Coil—2,000 ohms Contacts—1A, 1B, 1C Oper. at 9 Ma Price—\$2.75 ea.

Laach Relays Type 1025-SN-RF. Coil—24V. 425 ohms. Contacts—D.P.S.T. Norm. closed. lated at 10 Amps... Price—\$1.50 ea.

FIVE Prong CR-2791 G.E. Plug In Relays. 1) C-103C25 2200 ohms SPDT 4.5 MA... \$4.00 ea. 2) C-104B28 700 ohms SPDT 6 MA... \$3.00 ea.

Bulletin #700 Allen Bradley Contactors 110V AC 60 cy. D.P.S.T. N.O. 25 Amps... \$7.50 ea. Clare SK-5032 (Hermetically Sealed) Plug-In Relays. Coil—30 ohms 6 volts Contacts—DPDT. Price—\$4.00 ea.

Sigma Type 5F Sensitive Relays. Has two 70 ohm coils. Contacts—SPDT... Price—\$3.00 ea.

Type H Transmitting Mica Condensers 1) .003 MFD 2500V. DCW .45 ea. 2) .01 MFD 1200V. DCW .45 ea. 3) .001 MFD 1200V. DCW .35 ea.

Chase Electronic Supply Co. 105-07 225 St. Queens Village, N. Y. Hollis 4-3033



ARROW SALES INC.

FOLLOW ARROW FOR MILITARY ELECTRONICS

TRANSMITTER TA-2J-24

High powered crystal controlled, long-range transmitter. Frequency range: 300-600 Kc and 2.9-15 MC. Eight separate channels are provided. New. Send for complete literature. P.U.R.

VHF CONTROL TOWER

Complete Transmitter-Receiver, Frequency Meter, Power Supply. All mounted on standard racks. High frequency range: 100-156 Mc. 110/220 v. 60 CPS. Like new. Guaranteed. Write for complete literature. P.U.R.

Radar

APR-4 New	APT-3	RC-224
Complete	APT-4	RC-266
APR-5	Mark 16	1T34/APS13
APS-4 New	MD4/AP2	T-35/APT-5
Complete	MD5/APS3	TP-104/APT-5
APS-6 New	MD22/UPN2	MD38/APO13
Complete	RC-1841FF	ID 60/AFA-10
APT-1 APT-2	RC-214	

SOUND POWERED HANDSET R.C.A. MODEL MI-240

With mounting rack. New \$19.95 ea.

UHF SIGNAL GENERATOR

RCA 18710-A. Includes high frequency oscillator & attenuator, audio modulation oscillator, voltage regulated power supply, all in one case. Freq. range: 300-540 MC. Excel. cond. \$75.00

Test Equipment

Complete Line

DuMont 224-A Oscilloscope	TS127/U
1-77 Hickok Tube Checker	TS131
1-208 FM Signal Generator	TS-140/UP
RPC Model 644 Multimeter	TS-173/UR
Hewlett Packard 200-C	TS-174/UR
1-198	TS-23/APN
BC-638	TS-24A
BC-1255	TS-26/UPN
CW1-60ABJ	TS27/TSM
1E-36	TS-33
1-95	TS34/AP
1-96-A	TS-35/AP
1-122	TS36/AP
1-130A	TS-45A
1-139	ATM-3
1-145	TS59/APN
1-212	TS61/AP
1-222	TS89
TS-3A/AP	TS92
TS10A/APN	TS100/AP
TS12/AP	TS-102
TS-12 Spare	TS111/CP
Parts Kit	TS-118/AP
TS16/APN	TS126
TS19/APQ	1-100 ADF Test

TS182/UP
TS184A/AP
TS204/AP
TS251
TS323/UP
1-146
TS-268/U
Boonton Mod.
7B Sig. Gen.
Boonton Type
102FSig. Gen.
LAD Sig. Gen.
LAB-2
LAVOIE Freq
Meter: 300-
600 Mc.
TS-56A/AP
1-100 ADF Test

HEWLETT-PACKARD #205 Set

RECEIVERS—TRANSMITTERS

2-METER EQUIPMENT

R-28/ARC-5 Receiver
T-28/ARC-5 Transmitter
Excellent Cond. BOTH \$74.50

ARC-1	PE-125AX	RTA/1R
ARC-3	R-9/APN-4	SCR-422
R-4/ARR-2	BC-733-D	TA21-24
ID-6/APN-4	R-57/RN	R-89/ARUN
MP-10G	BC-738-A-AM-C	R41/ARR-1
BC-640	BC-639	RM-25
RM-26	SCR-284	SCR-536
SCR-540	MN-26 Complete Installation	
SCR-561 Equip.	R-44/ARR-5	
Motorola Model Patr-250	RA-10 DB	
AN/ARN-6	BC-447	EE 89 phone amplifier

GOVERNMENTS, AIRLINES AND INDUSTRIALS!

Send for FREE Catalogue No. 112 for complete list of Military, Industrial and Aviation Electronics. WE HAVE THE LARGEST INVENTORY OF SUCH EQUIPMENT IN THE UNITED STATES.

ARROW SALES INC.
 Mailing Address: P. O. BOX 3878-E, N. HOLLYWOOD, CALIF.
 Office-Warehouse: 7460 VARNA AVENUE, N. HOLLYWOOD, CALIF.
 Poplar 5-1810 • Stanley 7-6005 • Cable Address: ARROWSALES



POWER RHEOSTATS

ohms W	ea.	ohms W	ea.	ohms W	ea.
.1	150 54.89	37.5	50 2.10	500	150 4.63
.5	50 2.34	40	225 6.41	500	300 6.93
.5	150 4.89	50	25 1.86	575	150 4.63
1.1	50 2.34	50	50 2.10	700	225 6.41
1	50 2.34	50	25 1.86	750	25 1.86
2	25 1.86	75	25 1.86	750	150 4.90
2	100 3.86	75	50 2.10	800	100 3.60
2	300 6.93	75	75 3.25	800	25 1.86
3	100 3.86	75	300 6.93	1000	25 2.10
3	225 6.41	80	50 2.10	1000	50 2.22
3	25 1.86	100	25 1.86	1200	225 6.41
5	50 2.10	100	50 2.10	1200	300 6.93
5	100 3.86	100	100 3.86	1250	50 2.22
6	25 1.86	100	150 4.63	1250	150 4.30
6	50 2.10	125	25 1.86	1500	25 2.10
6	75 3.25	150	50 2.10	1500	50 2.22
7	25 1.86	175	25 1.86	1600	50 2.22
7.5	225 6.41	175	500 9.88	1800	50 2.22
7.5	225 6.41	185	25 1.86	1800	150 5.15
8	50 2.10	200	25 1.86	1800	25 2.10
8	500 9.88	200	50 2.10	2000	50 2.22
10	25 1.86	200	100 3.60	2250	150 5.15
10	50 2.10	200	150 4.63	2500	25 2.10
10	100 3.60	250	25 1.86	2500	50 2.22
12	25 1.86	250	50 2.10	2500	100 3.71
12	50 2.10	300	50 2.10	2500	150 5.15
12.5	500 9.88	300	75 3.25	3000	25 2.10
13	100 3.60	300	100 3.60	3000	100 3.71
15	25 1.86	350	25 1.86	5000	25 2.22
15	75 3.25	350	150 4.63	5000	50 2.34
15	100 3.60	370	25 1.86	5000	100 4.11
16	50 2.10	370	150 4.63	7500	50 2.34
20	25 1.86	400	25 1.86	7500	100 4.40
20	50 2.10	400	75 3.25	10000	50 2.50
25	25 1.86	500	25 1.86	10000	100 4.75
25	300 6.93	500	50 2.10	15000	52 2.75
25	500 9.88	500	75 3.25	20000	150 6.98
30	50 2.10	500	100 3.60		

Specify Type Shaft Required—(Knob Type) or (3/8" screwdriver slotted).

SPECIAL DISCOUNTS TO QUANTITY USERS

HIGH POWER TRANSMITTING MICAS

At 70% off list prices

OIL CONDENSER 15 MFD. 600 V.
 Famous Make #CAY 481758-10—Rect. Case Prod. Quant. Avail. Terrific Value—
\$2.79 ea. Case of 15 @ \$2.49 ea.
STEP-DOWN & FILAMENT TRANSFORMER
 Primary 115 V. 50/60 cy.—Sec. 24 V. @ 2 Amps. Made by Stancor. Complete with 8 Ft. Line Cord L/Plug. New.
\$1.98 ea. 10 for \$17.50
EDWARDS 24 V. ac/dc 3" ALARM BELL for above \$1.00 each.

OIL CONDENSERS

Largest Variety
Lowest Prices

Cap. Volt.	Price	Cap. Volt.	Price
.00025 25 KV	9.75	2.	.75
.004 10 KV	2.25	2.	660 AC 2.45
.0075 7 KV	2.95	2.	1500 1.98
.0075 10 KV	3.75	2.	1500 2.49
.02 7500	5.30	2.	2000 2.75
.05 10 KV	7.49	2.	2500 5.49
.1 2 KV	1.65	2.	3000 6.25
.1 2 KV	3.49	2.	4000 10.95
.1 3500	3.90	3.	2400 1.95
.1 6000	7.95	3.	600 2.00
.1 7500	11.25	3.9	330AC 2.50
.1 20 KV	39.50	4.	220AC 1.85
.25 1500	1.40	4.	400 1.75
.25 2000	1.80	4.	600 1.95
.25 2500	2.75	4.	700 2.25
.25 3000	3.49	4.	800AC 3.75
.25 3500	3.95	4.	1000 3.50
.25 4000	6.50	4.	1500 3.49
.25 5000	7.49	4.	2500 7.49
.3 600	.98	5.	50 1.25
.3 2000	1.85	5.	600 2.35
.5 600	1.15	5.	10KV P.U.R. 2.49
.5 1500	1.59	6.	400 2.85
.5 2000	1.85	6.	600 2.85
.5 2500	2.90	6.	1500 4.25
.5 3000	4.25	8.	440AC 3.90
.5 7500	8.95	8.	600 3.38
.75 1000	1.25	8.	1000 3.95
1. 250 AC	.75	8.	1500 5.10
1. 330 AC	.79	10.	600 3.75
1. 500	.65	10.	1000 4.25
1. 600	.68	10.	2500 14.95
1. 1000	1.85	12.	1000 4.59
1. 1500	1.59	12.	1000 4.59
1. 2000	2.35	15.	1000 Spec. 7.49
1. 2500	3.49	15.	5000 P.U.R. 4.75
1. 3000	4.95	30.	90AC 4.75
1. 5000	9.95	50.	330AC P.U.R. 2.75
1. 6000	12.95		
1.25 220AC	.80		
1.25 330AC	.80		
1.5 400 AC	.87		
2. 200	.49		
2. 220AC	.69		
2. 250 AC	.79		
2. 330 AC	.85		
2. 400	.85		
2. 500	.69		

ALSO: Bathtubs—Chattel and Round types.

ALL SIZES & TYPES—always in stock at LOWEST PRICES.
 Dimensions and Prices upon request cheerfully.

We are specialists in components. We have quantities for production runs. Let us quote on your requirements. Open cart to rated firms FOB N. Y.

A. MOGULL CO.
 17 Warren St., N. Y. 7, N. Y.
 Phone: WORTH 4-0865

ELECTRIC TRADING CO.

Offers a Well-Rounded Selection of Continuous Duty—110 V.—A.C.—60 Cycles

BLOWERS

Brand New • Top Quality • Fully Guaranteed

80 C.F.M.—3" DIAMETER ROTOR

General Electric Capacitor Motor—Sheet Steel Housing—3" Inlet, 2" Outlet. Base Mounted. **\$1250**
No. BL 80

100 C.F.M.—3" DIAMETER ROTOR

Powered by choice of Fasco or Heinze shaded pole, two pole, enclosed motors 3" inlet, 2" outlet. Sheet steel housing. No. BL100. **\$775**

BL100-6 Same Blower as BL100 above, 6V, DC, ball bearing motor. **\$875**

200 C.F.M.—4 1/2" DIAMETER ROTOR

Powered by Bodine split phase, 1725 rpm 40°C. Ball bearing motor. 4 1/2" inlet and 5 1/2" x 3" outlet. No. BL200B. **\$1950**

BL200-6 Same Blower as BL200B above—6V, DC, ball bearing motor. **\$1950**

230 C.F.M.—4 1/2" DIAMETER ROTOR

Powered by Fasco shaded pole two pole motor. 4" inlet, 2 1/2" x 2 1/2" outlet. No. BL230F. **\$1295**

600 C.F.M.—6" DIAMETER ROTOR

Powered by Westinghouse 1/4 H.P. 1725 rpm motor. 5 1/2" inlet and 7" x 3 1/2" outlet. Base mounted. No. BL600. **\$2850**

900 C.F.M. 7 1/2" DIAMETER ROTOR

American Blower Co. powered by Westinghouse 1/3 H.P. 1725 rpm motor. 7 1/2" inlet and 8" x 6" outlet. Base mounted. No. BL900ABC. **\$4500**

TWIN BLOWER—200 C.F.M.—3" DIA. ROTORS

Delco (General Motors Corp.) Shaded pole two pole enclosed motor. 3" inlets and 2" outlets. No. BL200D. **\$1675**

TWIN BLOWER—400 C.F.M.—4 1/2" DIA. ROTORS

Redmond shaded pole four pole motor. 4" inlets and 2 1/2" by 2 1/2" outlets. No. BL400R. **\$1750**

HIGH PRESSURE—STURTEVANT—WESTINGHOUSE

Range: 310 cfm @ 1/4" S.P. to 120 cfm @ 3" S.P. Powered by G.E. ball bearing 1/6 H.P. 3450 rpm motor. 3/4" inlet x 3/2" outlet. No. BL370. **\$5500**

400 CYCLE BLOWER—115V., single phase, 2" Rotor, 30 cfm. **\$975**

400 CYCLE BLOWER—115V., single phase, 1 1/2" Rotor, 10 cfm. **\$875**

Quantity Quotations and Additional Information Available on Request

ORDERS PROMPTLY FILLED WHILE QUANTITIES LAST.

ELECTRIC TRADING CO.

313-315 E Canal St., New York 13, N. Y.

Air Equipment Experience Since 1906

444

Want more information? Use post card on last page.

January, 1954 — ELECTRONICS

www.americanradiohistory.com

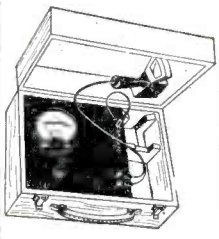

FLUXMETER
Used to calibrate field strength of magnets from 500 to 4000 gauss and indicate polarity. Probe has range of 1 1/4". Beautifully built in hardwood case with hinged cover. Instructions for operation on under side of cover. Size 12 1/4 x 9 x 6 in. Ideal for lab and school use. New. An exceptional value **\$24.50** at.....

FREQUENCY STANDARD

Complete self contained, dual 100/1000 kc crystal, multivibrator and harmonic amplifier. Calibrates with WWV and provides 1000, 100, and 10 kc check points from 100 to 45,000 kc. 115V. 60 cycles New with instructions. **\$23.95**



FREQUENCY METER 375 to 725 MCS



Model TS-127/U is a compact, self-contained, battery powered, precision (± 1 Mc) frequency meter which provides quick, accurate readings. Requires a standard 1.5V "A" and 45V "B" battery. Has 0.5 MIN. time switch. Contains sturdily constructed "H-Q" resonator with average "Q" of 3000 working directly into detector tube. Uses 957, 156 and 354 Tubes. Complete with new inst. book, probe and spare kit of tubes. Less **\$47.50** batteries

PANORAMIC ADAPTER AN/APA-10

Provides 4 Types of Presentation:

- (1) Panoramic (2) Aural
- (3) Oscillographic (4) Oscilloscopic

Designed for use with receiving equipment AN/ARR-7, AN/ARR-5, AN/A1R-4, SCR-587 or any receiver with I.F. of 455 kc. 5.2mc or 30 mc. 21 tubes including 3" scope **\$145.00** tube.....

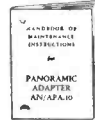

INSTRUCTION MANUAL. 80 pages of technical data covering the panoramic adapter, AN/APA-10 is available to those who wish to study its operation before purchasing it. **\$2.75**

HIGH VOLTAGE OIL CAPACITORS

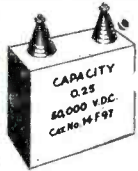

Capacity	Volts	Price
.001	50 KV	\$22.50
.025	50 KV	34.50
2 x .025	50 KV	34.50
.135	7.5KV	6.95
.2	50 KV	67.50
.25	15 KV	17.50

.25	20 KV	\$24.50
.25	50 KV	67.50
1.	15 KV	49.95
2.	5.5KV	13.75
2.	6 KV	14.50



SPECIAL! 1.0 MFD. 7500 VDC Oil filled capacitor
Cat. No. 26F681 **\$9.75**
Only



MICA CAPACITORS

High voltage Transmitting types, thousands in stock. Wide selection of sizes, types & ratings. All new and made by top manufacturers. Write for complete listings.

G.E. SERVO AMPLIFIER

Used in B29 planes for Central Station Fire Control Systems B2, B3 and B4. Used to drive Amplidyne 5AM31N9A and Control Motor 5BA50LJ2A listed below. New less tubes. **\$29.50**

AMPLIDYNE

G.E. 5AM31N9A. 530 Watts. 7500 RPM. Input: 27VDC. Output: 60VDC. Weight 3 1/2 lbs. **\$29.50**

CONTROL MOTOR

G.E. 5BA50LJ2A. Armature 27VDC at 8.3 Amps. Field 60VDC at 2.3A RPM 4000. H.P. 0.5 New **\$27.50**

REPAIR PARTS FOR

BC-348 RECEIVERS (H, K, L, R, Only)

Also BC 224 Models F, K. Coils for ant., r.f., det., osc., I.F., c.w., ocs., xtal filters, 4 gang cond., vol. con'ts., etc. Write for complete list and free diagram.

The equipment advertised above represents but a few of the hundreds of items carried in stock in our two large warehouses. This material includes antennas, capacitors, dynamometers, generators, radars, synchro, test equipment, and a wide variety of components. Your requests for quotations will receive our prompt attention.

WRITE WIRE PHONE

ELECTRONICRAFT
27 MILBURN ST. BRONXVILLE 8, N. Y.
PHONE: BRONXVILLE 2-0044

INDEX TO THE SEARCHLIGHT ADVERTISERS

JANUARY, 1954

This index is published as a convenience to the readers. Care is taken to make it accurate but ELECTRONICS assumes no responsibility for errors or omissions.

SEARCHLIGHT SECTION

(Classified Advertising)

H. E. Hilty, Mgr.

EMPLOYMENT406-417
EQUIPMENT418-447

ADVERTISERS INDEX

Allied Electronics Sales.....	442
Alltronics	442
Arch Electronics Co.....	443
Arrow Sales Inc.....	444
Associated Industries.....	440
Avionic Associates.....	430
Barry Electronics Corp.....	429
Blan	439
Carruthers Inc., Clarence.....	430
C & H Sales Co.....	425, 436
Chase Electronic Supply Co.....	443
Communications Equipment Co.....	426, 427
Compass Communications Co.....	420
Connector Corp. of America.....	434
Continental Radio Co.....	440
Electric Trading Co.....	444
Electro Sales Co., Inc.....	442
Electronicraft Inc.	445
Electronics Corporation of Nebraska.....	433
Electronic Specialty Supply Co.....	443
Emeltone Electronics Co.....	443
Emmons Radio Supply Co.....	437
Empire Electronics Co.....	430
Engineering Associates	434
Fair Radio Sales.....	439
Finnegan, H.	442
Harjo Sales Co.....	441
Houde Supply Co.....	436
Industrial Assembly Corp.....	437
Instrument Associates.....	418, 419
JSH Sales Co.....	434
Lapiro Bros.....	442
Leetronic Research Laboratories.....	424
Legri S. Co.....	434
Liberty Electronics Inc.....	422
Maritime Switchboard Co.....	442
Medical Salvage Co.....	432, 439
Merrick Electronics.....	439
Migray Electronics Inc.....	442
Mogul & Co., A.	444
Monmouth Radio Laboratories.....	430
Nibur Sales Corp.....	435
Peak Electronics Co.....	440
Photocon Sales.....	438
Radalab	438
Radio Development & Sales Co.....	443
Radio & Electronic Surplus.....	433
Radio Research Instrument Co.....	436
Radio Shack Co.....	438
Railway Communications Inc.....	433
Red Arrow Electronic Sales Co.....	443
Reliance Merchandizing Co.....	423
Rose Electronics Inc.....	432
R. W. Electronics.....	436
Servo-Tek-Products Co.....	431
Swedgal, M.....	432
"TAB"	446, 447
Tallen Co., Inc.....	432, 433
Telemarine Communications Co.....	436
Universal General Corp.....	428
V & H Electronic Industries Inc.....	435
Wells Sales Inc.....	441
Western Engineers.....	441
Weston Laboratories Inc.....	421
Wilgreen Industries.....	445
Wolfe Co., Edward.....	436

Wilgreen

INDUSTRIES

GUARANTEES*

SHIPMENT WITHIN

24 HOURS ON

"AN" CONNECTORS

Don't wait 'til your assembly line stops before you begin searching for vital 'AN' connectors. Let WILGREEN Industries break the production bottleneck at your plant! Just send your requirements for any connectors, in any amount to WILGREEN.

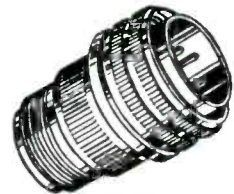

AN 3106 A

All Shell Sizes & Types

WILGREEN INDUSTRIES is making scheduled deliveries to many firms. Can we do the same for you?

"UG" Connectors in Stock

Wilgreen Industries

99 MURRAY ST. N. Y. 7, N. Y.
Worth 4-2490-1-2

SEARCHLIGHT SECTION

TAB "LP" STYLI SPECIALISTS AUDIO COMPONENTS
GE RPX041 Phono Cart. \$4.49
GE RPX050 Triple Play Cart. 1.38

AUDIO AMPLIFIERS READY TO GO
Model AMP5 Hi-Fi 5 Watt AC amplifier, plus built-in Pre Amp & V.R. pickup.

GRAMMES SPECIAL HI-FI AMPS
L22 Pre & Pwr Amp 8 Watt 20 to 20K. \$35.77
L23 Pre & Pwr Amp 10 Watt 20 to 20K \$35.90

LAB OR HI-FI POWER SUPPLY
Sola constant voltage power transformer mounted on chassis with chokes, chokes & filter capacitors.

RELAY SPECIAL
SPST Min 115VAC/3A. 95c; 3 for \$2.75
SPDT Min 115VAC/3A. \$1.49; 2 for \$2.49

"LENK" 180 WATT PERFECT BALANCE SOLDERING GUN
No other soldering gun offers all these features at this price.

SPEEDWAY ELECTRIC DRILLS with Jacobs Gear Chuck and Key Model 200J 1/4" Workhorse

CHROME VANADIUM SPEED DRILLS
1/8" Chrome Vanadium (C.V.) Speed Steel Top Quality for Machine or All Purpose Use

KITS AND COMPONENTS
Oil Condensers Assorted. 5 for \$1.25
Electrolytics Assorted. 5 for 1.25

METER BUYS
0-30 VDC/50mA. \$1.98; 2 for \$3.25
0-60 ADC "AN" Type Mtg. Lens Shunt. 2.95; 2 for 5.00

EXECUTIVE DRILL KIT
A must for the Engineer or Serviceman. Includes 200H 3/4" Heavy Duty Drill with Jacobs geared chuck & key (chrome finish).

866A KIT AND XFORMER
2 Tubes, 866a, 600V Input 115V/60 cyc output 2.5A, 10A/HT. SPECIAL \$4.98

TAB THAT'S A BUY ADJUST-A-VOLT "STACO" VARIABLE VOLTAGE TRANSFORMER

INDUSTRIALS: Order & Deduct 5% 12 or more 10% delivery from stock. RHEOSTAT SPECIALS

INFRARED SNOOPSCOPE SEE IN DARK TUBE
Image Converter Tube HiSensitivity amplified design 2 1/4" diameter screen - Resolution up to 350 lin/in.

DC POWER SUPPLY 0 to 12VDC/2 AMP variable DC supply - input 115V AC. Includes transformer, supply filament D.C. plating, battery charging, model railroad includes voltages or speed control and center of reversing sv. Ideal for two "HO" loco's. "TAB" Special to Your Door. Prepaid USA. \$10.95; 2 for \$20

FILAMENT TRANS. 6.3V/2A. 115V/0.7A. 2 for \$1.49; 10 for \$12.49

FILTER CHOKES 12Hy/30ma/3Kv/Vin. 2.25
10Hy/75ma. 1.25
10Hy/125ma/UTC/Cad. 1.98

TRANSFORMERS All 115 V 60 Cyc Input TV & CR Pwr Xmr up to 20" tubes. Hi 115V to 20 KV (w/quadriple etc.) ALL tubes. Pt. & Fil. 2nd 300 VDC/275Ma Full-wave. 6.4V/10A. 5.4V/8A. 2.5V/8A. 45V/10A. 5.4V/8A. 5.5V/8A. 45V/10A. 10V/1.5A WESTERN ELECT. \$5.49

MERCURY THERMO REGULATOR DUAL CRT, 100 P & 327. Extremely sensitive & accurate for most exacting requirements. Research, Fire Prev. Freeze. Pt. Control or Max. Min Temp Control. Brand New, w/data & o.kt. \$30.00

EICO TEST EQUIPMENT Stock & Type Kit Built Price
145K Sig Tracer \$19.95 \$28.95
221K VT VM 25.95 49.95

STORAGE BATTERIES 56 Volt WILLARD Mini-BRAND NEW 5 or 6 Designed Portable Equip. Models .98c; 4 for \$3

CRYSTAL DIODE HDQTRS. IN23B Sylvania \$1.89 New, Boxed & Jacketed Lots of 10

THAT'S A BUY THAT'S A BUY "TAB" THAT'S A BUY PH. RECTOR 2-6245 CABLE: "TABPARTS"

FEDERAL "ITT" SELENIUM BATTERY CHARGER RECTIFIER 10-60 Volts (CT) 100 Amp. Fan-Cooled

SELENIUM RECTIFIERS We specialize in Rectifiers and Power supplies for all applications. Immediate delivery.

RECTIFIER XFMRs PRIMARY 115V 60 cyc SECONDARY 0-9-12-15-24-36V

RECTIFIER CHOKES 4 Amp .01 Hy .5 Ohm \$7.95

MICA CONDENSERS Fig. MFD WVDC PRICE

CONDENSER SPECIALS 2 MFD 1000 VDC 25¢ 330 VAC "CD" MFRG LOTS OF 10

OIL CONDENSERS WAREHOUSE CLEARANCE SALE RECTANGULAR CASE

OIL CONDENSER SPECIAL 10 MFD 600 VDC \$1.75 ea.

STORAGE BATTERIES 56 Volt WILLARD Mini-BRAND NEW 5 or 6 Designed Portable Equip. Models .98c; 4 for \$3

CRYSTAL DIODE HDQTRS. IN23B Sylvania \$1.89 New, Boxed & Jacketed Lots of 10

SELENIUM RECTIFIERS We specialize in Rectifiers and Power supplies for all applications. Immediate delivery.

CONDENSER SPECIALS 2 MFD 1000 VDC 25¢ 330 VAC "CD" MFRG LOTS OF 10

STORAGE BATTERIES 56 Volt WILLARD Mini-BRAND NEW 5 or 6 Designed Portable Equip. Models .98c; 4 for \$3

CRYSTAL DIODE HDQTRS. IN23B Sylvania \$1.89 New, Boxed & Jacketed Lots of 10

THAT'S A BUY THAT'S A BUY "TAB" THAT'S A BUY PH. RECTOR 2-6245 CABLE: "TABPARTS"

TAB PHOTOFLASH LAMPS "Tab" Replaces Max. Each

100 WATT SEC PHOTOFLASH KIT Includes DX Flash Lamp Rated 150 Watt Sec Flash Lamp Holder & 8" Reflector & Cable, Power Transformer and Condensers.

SOCKET ASSEMBLIES 1/4" Jewel Bayonet Socket Light Dimmer (Shutter) Regulator \$7.95

PRECISION OILER OR CARBON TET DISPENSER Indispensable for the Laboratory or Service Shop.

CIRCUIT BREAKERS Heinmann Magn Bkrs. Amps. 3, 7, 9, 13, 15, 20, 30, 35, 40, 80, 100 EA. \$1.69; 10 for \$11.9

YOU PICK THEM 59c WHILE THEY LAST ELECTROLYTIC CONDENSERS AEROVOX "PCD" MALLORY SPRAGUE

MICROWAVE FLANGES AND WAVE GUIDE UG39 to UG40 "X" Band Adapter. Flange to Choke. Sperry Design. \$1.45; 6 for \$7.

FLEXIBLE WAVE GUIDE CG166/U (42") (E168003) Terminates UG52/U

OIL CONDENSER SPECIAL 10 MFD 600 VDC \$1.75 ea.

MICROWAVE Klystron Mts Assy (723AB) & Coupling to 2 Type "N" Co-Ax Fittings. As Shown. \$32.98

BARRETT'S THERMISTORS-VARIATORS Barreter Sperry Type 811/108 \$1.80; 12 for \$15.

Money Back Guarantee (Cos of Mds. Only) 5 Min. Order FOB N.Y.C. Add Shpg. Charges or 25% Dep. Prepaid Mds. USA only. Prices Subject to Change Without Notice.

"TAB" THAT'S A BUY

RESISTANCE DECADE BOX
 PRECISE AGAIN LEADS THE FIELD with its New Low-Frequency Resistor decade Box. Ideal for precision service work. Compact in size for Bench Drawers and Tool Boxes. Engineered with the best Quality Precision Accuracy and Dependability.
 5 Separate Switches, 11 Positions on Each; plus or minus better than 1% for Extreme Accuracy; Readings from 10 OHM to 1,111,110 OHM in 5 Decades. Deeply Etched Aluminum Panel; Rugged Construction; Complete with famous Precision Simplified Construction Manual. \$34.95 6 1/2" x 2 1/2"

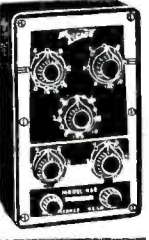

#468K (KIT) \$18.95
 #468W - factory wired \$24.95
 #478K - Capacity Decade kit \$18.95
 #478W - Capacity Decade, wired \$24.95

PRECISE ACCESSORIES

Model 999 Hi-Volts Probe, for use with VTVM #909 or 907. Essential for every TV serviceman, engineer and ham. Rugged construction features include: 3 individual media protection against voltage breakdown, changeable tip & resistors, swivel mount, mechanical shockproof construction.
"TAB" SPECIAL #999 \$6.98
 Model 912A RF Probe, input capacity less than 3mmf. Frequency range up to 200mc, input resistance, 200K ohm 1me, 160K ohm 10me, 25K ohm 100me. Calibrated at 70mc for accuracy, impedance & shunt capacity. The finest low price RF probe construction.
 #912A25 Probe VTVM 909 & 907 \$4.25
 #912M MM Probe Oscilloscope \$4.25
 Model 910 to capacity attenuator probe, permits scope measurements with 1/10 capacity loading effect. Frequency range through 100mc. Less than 7mm input capacity #960 \$5.95

MODEL 635 UNIVERSAL AF SINE-SQUARE & PULSE GENERATOR

Efficiently & effectively tests all AUDIO & VIDEO CIRCUITS. These Features:
 Sine Waves
 Square Waves
 Wien Bridge Oscillator
 Pulses
 Variable impedance output
 Verifiably constant output
 Voltage Regulated
 Cathode follower output
 Band 1 - 20-40 cycles
 Band 2 - 40-200 cycles
 Band 3 - 200-2000 cycles
 Band 4 - 2000-20,000 cycles
 Band 5 - 20,000-200,000 cycles
"TAB" Special #635K (Kit) \$33.50
#635W (Factory Wired) \$52.50



MODEL 630 RF-AF & TV MARKER GENERATOR
 Check these features: * Advanced circuitry * Variable modulation, cathode follower output * Crystal marker * Wien bridge * One * Constant * Constant output impedance * Vernier tuning * Complete shielding * Fundamentals through 110 Mc * Rugged design, quality components * 7 RF bands 800 Kc to 300 Mc * 4 aux bands 20 cy to 20 Kc.
"TAB" SPECIAL #630K (KIT) \$33.95
#630KA (KIT) Pre-Assembled RF Head \$38.95
#630W FACTORY WIRED \$53.95

SUPER VALUE INTRODUCTORY OFFER

SOLDERING IRON
LONG NOSE PLIERS
DIAGONAL CUTTING PLIERS
SCREW & NUT DRIVER SET
ROLL OF SOLDER
 Regularly sold for \$4.98
 With Precision or Elico Test Equipment **\$1.98**
"TAB" SPECIAL

EICO TEST INSTRUMENTS

Model 625 tube tester. Features include 4 1/2" easy to read meter; speedroll chart; lever switches for testing individual elements; checks all the latest Radio-TV and VR tubes; protective overload indicator; sturdy panel; rugged heavy gauge steel.
"TAB" SPECIAL #625K (KIT) \$34.95
#625 (FACTORY WIRED) \$49.95
 Model 1040 battery eliminator and charger kit. 5 to 9 volts; 10 amp continuous; 20 amp intermittent; heavy duty rectifier; full wave bridge; voltage and current output meter; fused primary; automatic reset secondary; rugged steel cabinet; a serviceman's "must" for auto radio repair.
"TAB" SPECIAL #1040K (KIT) \$25.95
#1040 (FACTORY WIRED) \$44.95
 Model 950A Resistance-Capacitance bridge and R-C-L comparator. Designed to meet the needs of the laboratory or serviceman. Measures and tests resistors 0.5 to 500 MEGOHM; condensers 10MMF to 5000MFD; voltage source 0-5000V for electrolytic leakage test; power locator; separate leakage test for mica and paper condensers. Rugged steel case.
"TAB" SPECIAL #950A-K (KIT) \$19.95
#950A (FACTORY WIRED) \$29.95
 Model 511 VOM accurate, compact and rugged; DC 5 Rngs to 2500V; AC (4) Rngs to 1000V; output (4) Rngs to 1000V; DC (3) Rngs to 100MFD; DC (2) Rngs to 10MFD; ohms (3) Rngs to 1 MEG; DB-8 to -45; etched panel, rugged case.
"TAB" SPECIAL #511K (KIT) \$14.95
#511K (FACTORY WIRED) \$17.95
 Model 145 Signal tracer; audibly traces RF, IF, Video and audio CRTs from antenna to speaker. Quickly localizes faulty stage and pinpoints defective parts and intermittents. High sensitivity and gain. Fast response over 200MC; VTVM jack for stage gain comparison; usable as intercom or PA system.
"TAB" SPECIAL #145K (KIT) \$19.95
#145 (FACTORY WIRED) \$25.95

PRECISION RESISTORS

CP1/2 AND CP1 1% ACCURACY MANUFACTURED TO "JAN" SPECIFICATIONS
 The chance of a lifetime. Take advantage of these tremendous savings. Normally sold for 50c to 80c each. We offer these new 1% Wilkor Carbon Film. High stability. Low Temp. Coef. Resistors at a fraction of mfg. price. 1/4 million in stock. From .50 ohm to 22 meg. Order any value you need.
 Type CP 1/2 1/2 Watt. 12 for \$1.25; 100 at \$9; 1000 at \$72
 Type CP 1 1 Watt. 12 for \$1.68; 100 at \$12; 1000 at \$96

Test equipment for college, school, Laboratory, Government & industrial; Supplied in easy to build Kit or factory Wired form. Designed for continuous use on Factory production line.

TUBE SPECIALISTS

0A2	50.88	6B06GT	1.20	CK536AX	.99
0B3	1.04	6BQ7	1.65	CK537AX	2.60
0B6	1.37	6C1	2.50	CK538DX	.98
0C3/VR90	.96	6C21	24.50	CK539DX	2.19
0C3/VR105	.92	6C6	.59	CK541DX	1.99
OD3/VR150	.90	6C6G	.60	CK542DX	.99
1B3016	.80	6D4	2.70	CK544DX	.99
1B22	1.82	6D6	.84	CK546DX	1.99
1B23	1.87	6F4	6.20		
1B24	3.38				
1B26	2.24	6F6	7.99	CK571AX/	2.49
1B27	11.98	6J3/SC21	9.89	CK575AX/	3.49
1B32/532A	2.48	6J5	6.86	6029	3.49
1B35	3.15	6J6	5.8	WL552	65.00
1B37	18.87	6K4A	3.68	WL576	34.98
1B38	29.45	6K6GT	4.54	703A	4.72
1B41	49.95	6K7	5.4	705A	1.88
1B42	17.48	6K8	1.08	707B	14.88
1B46	1.98	6L6	1.48	715A	4.96
1B63	45.00	6L6C	1.08	715B	7.94
1L4	.48	6L6CA	1.08	715C	17.98
1L5	1.35	6L6CAY	1.08	717A	2.88
1L5D5	.78	6L7	6.66	718BY	64.98
1L5N5	.78	6SC7	7.0	718CY	98.98
1P5	.78	6SF5	7.75	721A	7.30
1U4	.52	6S7	6.4	722A/287	1.94
1U5	.52	6SH7	5.8	723A/B	16.98
1V2	.70			724A	3.95
1X2A	.98			725A	2.74
2C36	27.00	6SK7GT	5.4	725A	9.98
2C39A	26.38	6SN7GT	6.8	726A	14.48
2C40	7.20	6S07GT	6.2	726B	64.88
2C43	13.99	6T6	9.60	727C	24.48
2C44	1.35	6S57	8.8	801A	4.48
2C51	1.88	6T8	9.6	805	5.48
2D21	1.48	6X4	1.29	821	3.22
2E43	1.49	6V6	1.39	807	1.54
2J31	27.00	6V6	1.39	808	2.62
2J32	27.00	6V6GT	5.8	809	3.58
2J33	27.00	6V6GT	5.8	810	3.00
2J37	12.70	6X5CT	5.2	812	2.70
2J38	69.88	6V6G	8.8	813	1.48
2J39	6.98	6V6	8.8	814	4.98
2J42	148.98	7C7	7.8	815	5.98
2J48	24.25	7E7	8.2	823	7.94
2E49	8.00	7F6	1.29	829B	12.48
2J50	99.98	7H7	7.72	832	7.72
2J55	84.98	7N7	.92	832A	9.92
2J56	149.00	7V7	1.06	833A	39.45
2J62	49.45	7V7	.68	836	3.48
2K22	23.48	8D21	298.50	837	1.42
2K23	11.48	12A15	.54	849	29.45
2K25	28.49	12A16	.54	860	4.48
2K26/23AB	1.48	12A17	.54	861	1.26
2K28	27.48	12A18	.72	866A	1.50
2K33	219.48	12A19	.69	872A	3.29
2K35	13.98	12A19	.69	872A	3.29
2K41	126.00			917	2.59
2K42	145.00	12A19W6	1.18	927/CE25	1.70
2K45	129.48	12A17	.98	CK1005	.68
2K48	99.48	12A17	1.68	1613	1.95
2K49	258.00	12A17	1.68	1614	1.95
2X2	4.2	12B1	.94	1625	.32
3B22	2.48	12B16	.59	1632	.98
3B23	2.48	12B16	.59	1633	.98
3B24	4.30	12B16	.59	1634	1.18
3B25	4.30	12B17	1.29		
3B26	3.70			1635	1.69
3B28	7.90	125A7GT	.68	1636	3.08
3C23	85.00	125C7	1.06	1642	3.08
3C23	8.67	125F7GT	.94	1644	.92
3C33/CI8	3.45	125G7	.80	2050W	1.48
3C33	9.58	125G7	.80	2050W	1.48
3C45	9.98	125J7GT	.54	5635	11.57
3D6/1299	8.15	125K7	.66	5637	11.57
3D7	8.15	125L7GT	.68	5638	11.57
3D22	13.95	125N7GT	.68	5641	7.52
3D23	4.90			5643	11.57
3E29	14.49	125R7	.66	5644	11.57
4C33	21.49	FG17	1.90	5645	11.57
4C35	18.98	FG3/AC24	1.58	5646	2.24
4E27	22.49	25B0ECT	.58	5654	1.72
4J22	129.51	25L6ECT	.58	5656	1.72
4J31	9.98	25L6ECT	.58	5657	298.48
4J52	199.99	252E2CT	.58	5663	1.06
EL5B19D	15.99	FG27A	8.4	5670	3.44
EL5B19E	8.99	FG27B	8.4	5670	3.44
5C22	38.95			CK5672	1.20
5D21	14.98	35T	4.88	CK5678	1.20
5I29	11.92	35V4	.58	5687	3.74
5R4G	1.20	35Z3	.68	5691	7.54
5R4GYW	1.75	48	1.98	5693	6.24
5T4	1.48	50A5	.76	5694	3.65
5U4G	1.48	50B5	.62	CK5702	2.90
5Z3	.99	RM61/XF61	2.65	CK5703	1.29
5Z4	1.48	FG18	1.98	WL5736	156.48
6A3	.90	HY65	4.98	5713	120.00
6A7	.85	71A	.74	5743	1.72
6A8GT	.90	78	.78	5769	298.00
6A8T	.80	80	.58	5812	2.99
6A9	.71	81	1.18	5814	2.00
6A9T	1.14	83	1.12	5820	148.00
6A96	1.22	83W	1.22	5840	7.98
6A97	1.18	83W	1.22	5841	7.98
6A98	1.18	100TH	9.88	5881	2.70
6A95W	2.79	FG104	24.58	8012	2.58
6A96	.90	FC105	14.98	8013	3.92
6A95	.98	VR130	4.50		
6A95T	2.90	FC166	48.49	1N21A	51.55
6A95	.52	FG172	29.00	1N21B	1.22
6A95W	2.78	211/VTAC	.86	1N22	1.98
6A96	.81	RX215	.78	1N23	1.35
6A97GT	1.29	RX233A	3.49	1N23A	2.22
6A98	2.98	250TH	18.97	1N26	4.98
6A95	2.22	250TH	17.75	1N25	4.98
6A57C	3.48	304TH	8.90	1N27	1.55
6A76	.54	371B	1.88	1N34	.64
6A95GT	1.10	389A	1.88	1N34A	1.90
6A96	.56	WL417A	8.48	1N35	1.65
6A95GT	.98	417A/5842	18.50	1N38A	1.29
6B4	1.18	446A	1.29	1N41	8.95
6B4C	1.18	446A	1.05	1N42	16.95
6B6C	.60	446B	49.57	1N45	1.45
6B6G	.99	450TH	49.57	1N46	.69
6B7	1.09	450TH	49.57	1N47	4.00
6B7C	1.23	450TH/HF200	15.95	1N48	.55
6B7D	.83	CK502AX	1.49	1N51	.45
6B7E	.83	CK503AX	1.79	1N54	1.00
6B7F	.98	CK512AX	1.45	1N54A	1.70
6B7G	1.58	CK531DX	3.68	1N58A	1.15
6B7H	.69	CK532DX	5.72	1N60	2.40
6B7K	1.58	WL532A	3.68	1N63/H63	6.49
6B7GT				1N63	.69
6B7	2.69	CK533AX	1.29		
		CK534AX	.99		

precise

"TAB" FACTORY DISTRIBUTORS PRECISE MODEL 610 AM-5M AND TV



The first low-priced RF Signal Generator to reach 10 MC on fundamentals, 330 MC on harmonics, with the accuracy and stability of high-priced equipment. PRECISE achieves this by using and capacity tuning of the coils, along with complete isolation of the Colpitts Oscillator by a Cathode Follower Buffer Output. The first to offer a complete factory pre-assembled and pre-tuned RF Amplifier; Bridge Type AF Oscillator; Colpitts RF Oscillator; Drum Dial; Coaxial Plugs; Individually Tuned Coils; Vernier Tuning; Separate RF Section; Complete Shielding, 400 Cycle and 60 Cycle Internal Modulation. 11 3/4" x 7 1/2" x 11 1/2" cabinet; wrinkle steel cabinet; deeply etched aluminum panel; amphenol type connectors; wt. 10 lbs. TUBE COMPLEMENT: 6C4, 6X4, 6X6, 6X8.

RF FREQUENCIES:
 Band 1 - 300KC to 1MC FUNDAMENTALS
 Band 2 - 1MC to 3MC FUNDAMENTALS
 Band 3 - 1MC to 30MC FUNDAMENTALS
 Band 4 - 30MC to 330MC 3rd Harmonic
 Band 5 - 30MC to 110MC FUNDAMENTALS
 Band 5A - 60MC to 240MC 2nd Harmonic
"TAB" SPECIAL #610K (KIT) \$23.95
#610KA (PRE-ASSEMBLED RF HEAD) \$26.95
#610W (FACTORY WIRED) \$39.95

8 1/2" INCH SCOPE LABORATORY DESIGN

* WIDE RANGE
 * PUSH PULL INPUT THRU OUTPUT
 * VOLTAGE REGULATED
 * HI-LOW-NORMAL SYNCH
 * INTENSIFIER ANODE
 * EXTRA FAST RETRACE
 * TV PICTURE CLARITY
 (8 1/2" x 11")
 * LAB TESTED ACCURACY
 * LOW IN PRICE
MODEL 308K \$129.50
 (Kit form)
MODEL 308W LAB WIRED
 TESTED AND CALIBRATED \$229.50

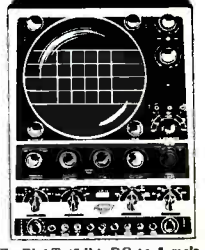

SPECIFICATIONS:
 PRECISE 8 1/2" & 7" SCOPES
 * VERTICAL FREQ RESPONSE: FLAT (5db) DC to 8 mc
 constant * VERTICAL SENS: GREATER THAN 10 mv constant
 * COMPENSATED Slew Rate Attenuators * 2 P.E. amplifiers from Input thru 1 & 2 * POSITIONING: NON-VARYING BRIDGE at input, VERT & HORIZ * BLANKING: Internal (reters trace blanked), external (reters trace not blanked), 60 or 120 cycle BLANKING thru Blanking amplifier circuit. * SYNC: External, INTERNAL-Positive, Negative, 60 or 120 cycle Sync * SV EYE RATE: Drive Line Deflection Lines available from 1 cycle to 30KC in five ranges (1-10 cycles uses external G circuit) Trigger potentiometer. * MAGNIFIER: Electronic magnifier and potentiometer for use with oscilloscope or VTVM trace blanking measurements. * CALIBRATION: Internal square wave calibrator and potentiometer for using oscilloscope or VTVM trace blanking measurements. * WRITE * FUNCTIONAL SCREEN: Edged illuminated scale and graticule may be turned on or off; Edged illuminated scale and graticule may be turned on or off; filtered screen. * OUTPUTS: 60 cycle phasing output; 60 cycle unphased output; Calibration output. * FOCUSING: Antistatic focus and intensity control. * DIRECT DEFLECTION: Antistatic focus and intensity control. * INTENSIFIER MODULATION: Modulation thru modulation amplifier. * SINUSOIDAL FREQ. Response (For any setting of controls). * AC/DC coupling. * SCOPE TUBE-NEW 8C1 in #308 & 7V1 in #308 (Green trace) Other scope tubes available. * WRITE * FUNCTIONAL DESIGN: Easy to OPERATE. CONNECT 5 way Binding Posts. * MATERIAL: Low loss components thruout; plus SAFETY MARGIN used POWER SUPPLY OVERDESIGNED for CONTINUOUS use. * DEEP ETCHED Aluminum Panel. * FINEST COMPONENTS Available (No Surplus). Heavy duty Steel cabinet & New reinforced GIRDER "T" circuit chassis for "EXPLODED VIEW" Instruction Tech Manual & All Components. GUARANTEED TO SATISFY THE ENGINEER.

MODEL 300K/7" OSCILLOSCOPE KIT \$94.95 MODEL 300W/7" FACTORY WIRED \$199.50

Fairchild Camera & Instrument Corp.	295
Fansteel Metallurgical Corp.	310
Federal Telecommunication Labs.	402
Federal Telephone & Radio Corp.	86
Federated Metals Div. American Smelting & Refining Corp.	299
Film Capacitors, Inc.	401
Filtron Co., Inc.	39
Five Star Company	405
Ford Instrument Company	247
Freed Transformer Co., Inc.	205
Frequency Standards	394
Furst Electronics	385

G & M Equipment Co., Inc.	380
G-M Laboratories, Inc.	343
G-V Controls, Inc.	236
Gabriel Electronic Div., Gabriel Co.	214
Gamewell Company	240
Gee-Lar Manufacturing Co.	369
General Ceramic & Steatite Corp.	259
General Electric Company	
Apparatus Dept.	28, 29, 78, 261
Electronic Dept.	47
Tube Dept.	57
General Precision Laboratory, Inc.	121
General Radio Company	17
General Transformer Co.	244
Goodmans Industries Limited	80
Graphite Metallizing Corp.	382
Green Instrument Co., Inc.	339
Gries Reproducer Corp.	390
Gudebrod Bros. Silk Co., Inc.	347

Hammarlund Manufacturing Co., Inc.	23
Haydon Company, A. W.	279
Haydon Manufacturing Co., Inc.	350
Heath Company	339
Heiland Research Corp.	349
Heinemann Electric Company	388
Heldor Manufacturing Corp.	59
Helipot Corporation, a division of Beckman Instruments, Inc.	199
Heminway & Bartlett Mfg. Co.	357
Hermaseal Company, Inc.	209
Hermetic Seal Products Co.	31
Hetherington, Inc.	228
Hewlett-Packard Company	25, 67
Hexacon Electric Co.	351
Hinde & Dauch	232
Hi-Q Division, Aerovox Corp.	286
Hopkins Engineering Co.	279, 347
Hudson Tool & Die Company, Inc.	94
Hughes Aircraft Company	267
Hughes Research & Development Laboratories	266
Hycor Sales Company of Calif.	359
Hydro-Aire, Inc.	69

I-T-E Circuit Breaker Co.	297
Ideal Industries Inc.	337
Illinois Condenser Co.	113
Indiana Steel Products Co.	98
Industrial Condenser Corp.	449
Industrial Hardware Mfg. Co., Inc.	361
Industrial Mica Corporation	355
Infra Electronic Corp.	363
Inst-X Sales Company	257
Institute of Radio Engineers, The	38
Instrument Corp. of America	271
Instrument Resistors Co.	404
International Crystal Mfg. Co.	77
International Instruments, Inc.	362
International Nickel Company, Inc.	88
International Resistance Co.	101, 105
Ippolito & Co., Inc., James	357

LOW DIELECTRIC ABSORPTION

45 times lower than paper capacitors
and
25 times lower than mica capacitors



For
Precision
Circuitry in:

Electronic Calculators
and Computers
Servomechanisms
Timing Devices
Countless Other Industrial
and Electronic Uses

Industrial Condenser Corporation's specialized experience and extensive laboratory facilities are available to give you the design and engineering experience you need for your particular capacitor applications. Don't fail to send for Catalog 1117. This catalog gives you important finger-tip capacitor data, including performance curves, characteristics and typical applications.

INDUSTRIAL
CONDENSER CORPORATION



Outstanding Operating Characteristics

Insulation resistance at +20° C. after three minutes charge: 900,000 megohm microfarads

Insulation resistance at +75° C.: 78,000 megohm microfarads

Insulation resistance at -75° C.: In excess of one million megohm microfarads

Change in capacitance from +25° C. to -80° C.: +0.76%

Self time constant of 10 mfd. capacitor: 4800 hours

Q at 50 kilocycles: 10,000

Power Factor at 1 kc: 0.00025

3249 North California Avenue

Chicago 18, Illinois

Answer to VHF, UHF and Microwave Requirements

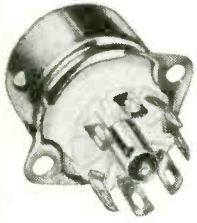

2-PIN MINIATURE TUBE SOCKETS



9-PIN MINIATURE TUBE SOCKETS

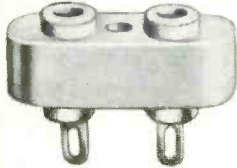

CRYSTAL SOCKETS



9-PIN CONNECTORS



STAND-OFF INSULATORS

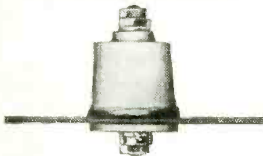

FEED-THROUGH INSULATORS AND TERMINALS

TEFLON* INSULATED CHEMELEC COMPONENTS

- **LOW LOSS FACTOR** — Less than 0.0005.
- **STABLE DIELECTRIC CONSTANT**—2.0 (60 cycles to 30,000 megacycles).
- **HIGH SURFACE RESISTIVITY**— 3.5×10^{13} ohms. Won't carbonize under arcing or DC plate.
- **WIDE SERVICE TEMPERATURE RANGE** — -110° F to $+500^{\circ}$ F.
- **ZERO WATER ABSORPTION**—ASTM Test.
- **DURABLE** — withstands thermal and mechanical shock and vibration in assembly and service.
- **CHEMICALLY STABLE**—Inert, non-gassing, immune to corrosive atmospheres, fungi, oils, solvents.

Write for Catalogs: Miniature Tube Sockets, No. SO-428; 9-pin Connectors, No. CN409-M; Crystal Sockets, No. CS-441; Stand-off Insulators, No. TE-401; Feed-Through Insulators and Terminals, No. CF-400.

UNITED STATES GASKET COMPANY

FLUOROCARBON PRODUCTS DIVISION
CAMDEN 1, NEW JERSEY

Representatives in Principal Cities Throughout the World



*du Pont's trademark for its tetrafluoroethylene resin.

Joy Manufacturing Company.....	114
Jelliff Manufacturing Corp., C. O.....	363
Jennings Radio Mfg. Co.....	284
Johnson Company, E. F.....	301
Jones Div., Howard B. Clinch Mfg. Co.....	361

Kahle Engineering Company.....	357
Kalbfell Laboratories, Inc.....	216
Karp Metal Products Co., Inc.....	37
Kartron.....	405
Kay Electric Company.....	231
Kearfott Company, Inc.....	322
Keller Tool Co.....	50, 51
Kellogg Switchboard & Supply Co.....	277
Kepeco Laboratories, Inc.....	30
Kester Solder Company.....	251
Ketay Manufacturing Corp.....	87
Keystone Electronics Company.....	343
Kings Electronics Co., Inc.....	373
Kinney Mfg. Div. of the New York Air Brake Company.....	275
Kirk & Blum Mfg. Co.....	242
Knights Company, James.....	230
Kollsman Instrument Corporation.....	256
Krohn-Hite Instrument Co.....	371

Laboratory for Electronics, Inc.....	125
Lambda Electronics Corporation.....	273, 367
Lampkin Laboratories, Inc.....	405
Lapp Insulator Company, Inc.....	248
Leach Relay Co.....	222
Lenkurt Electric Co.....	234
Lewis Engineering Co.....	352
Lewis Spring & Mfg. Co.....	218
Lindgren & Assoc., Erik A.....	398
Lion Fasteners, Inc.....	262

MB Manufacturing Co., Inc.....	106
Magna Driver Corp.....	362
Magnatran Incorporated.....	398
Magnetics, Inc.....	392, 393
Malayan Tin Bureau.....	110
Mallory & Co., Inc., P. R.....	42, 128, 195, 399
Manson Laboratories.....	368
Marconi Instrument, Ltd.....	102
McGraw-Hill Book Co.....	383
McShan Development Corp.....	329
Measurements Corporation.....	369, 401
Mepeco, Inc.....	124
Metal Textile Corp.....	358
Metals & Controls Corp., General Plate Div.....	118
Meyercoed Co., The.....	363
Mica Insulator Company.....	92
Microtran Co.....	375
Microwave Assoc. Inc.....	263
Midland Manufacturing Co., Inc.....	99
Miles Reproducer Co.....	405
Millen Mfg. Co., Inc., James.....	225
Millivac Instrument Corp.....	220
Milwaukee Transformer Co.....	341
Miniature Precision Bearings, Inc.....	201
Minneapolis-Honeywell Regulator Co., Industrial Div.....	76
Moloney Electric Company.....	211
Motordyne Inc.....	373
Muirhead & Co., Ltd.....	5
Mycalex Corporation of America.....	346

National Company, Inc.....	288
National Moldite Co.....	40
National Research Corporation.....	74
Natvar Corporation.....	109

New York Transformers Co., Inc.	258
Ney Company, J. M.	370
Nielsen Hardware Corp.	393

Olympic Metal Products Co., Inc.	326
Opad-Green Company	402
Oster Manufacturing Co., John	358

Panoramic Radio Products, Inc.	379
Par-Metal Products Corp.	387
Penn Engineering & Manufacturing Corp.	278
Phalo Plastics Corporation	340
Phelps Dodge Copper Products Corp., Inca Manufacturing Div.	126, 127
Pheoll Manufacturing Co.	276
Pickard & Burns, Inc.	331
Pix Manufacturing Co., Inc.	396
Polarad Electronics Corporation	43
Polytechnic Research & Development Company, Inc.	207
Potter Company, The	336
Precise Measurement Co.	405
Precision Apparatus Co., Inc.	452
Precision Paper Tube Co.	395
Printloid Inc.	359
Pye Limited	90
Pyrroferlic Co., Inc.	97

Quality Products Co.	405
----------------------	-----

R. F. Electronics Inc.	316
Radio Cores Inc.	304
Radio Corporation of America, Back Cover	
Radio Materials Corporation	237
Radio Receptor Company, Inc.	36
Radio Shack Corp.	367
Railway Communications, Inc.	321
Railway Express Agency, Air Express Div.	217
Raybestos-Manhattan, Inc.	245
Raytheon Manufacturing Company	19
R-B-M Division, Essex Wire Corp.	204
Reeves Hoffman Corporation	272
Relay Sales	265
Rembar Company, The	377
Representatives of Electronic Products Manufacturers, Inc., The	361
Resin Industries, Inc.	383
Rex Rheostat Co.	397, 405
Rollin Company, The	317
Rome Cable Corporation	221
Rutherford Electronics Co.	347

Sanborn Company	70
Sandia Corp.	330
Sarkes Tarzian, Inc., Rectifier Div.	44
Scientific Electric Div. of "S" Corrugated Quenched Gap Co.	390
Scintilla Magneto Div., Bendix Aviation Corporation	215
Sealtron Corp.	111
Secor Metals Corporation	394
Servo Corporation of America	382
Shallcross Manufacturing Co.	54, 55
Shure Brothers, Inc.	298



Most Complete Line of Sheets, Rods, Tape, Tubing, Bars, Cylinders, Fabricated Parts

Profit from our broad experience and completely modern specialized facilities for rapid, low-cost production of these fluorocarbon "wonder" plastics.

The finest dielectrics, especially for high frequency, high temperature service. Won't carbonize under arcing. Won't DC plate. Zero water absorption by ASTM test. Unaffected by extreme humidity. Chemically inert, non-gassing, immune to corrosive atmospheres, fungus, oil, solvents. Non-flammable, tough, resilient, withstand and absorb mechanical shock and vibration.

Whatever your requirements, whether for stock or for custom machined or molded parts, your inquiry will receive prompt attention. Write for Bulletins No. 300 and 500.

**duPont's trademark for its tetrafluoroethylene resin.*

†Trademark M. W. Kellogg Co.



UNITED STATES GASKET COMPANY

FLUOROCARBON PRODUCTS DIVISION
CAMDEN 1, NEW JERSEY

Representatives in Principal Cities Throughout the World

PRECISION

SERIES ES-500A

H SENSITIVITY—WIDE RANGE

OSCILLOSCOPE

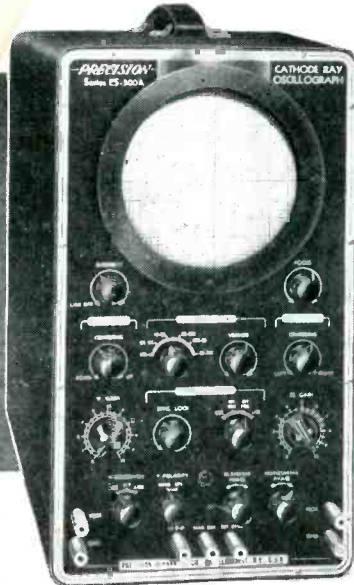

PUSH-PULL
'V' and 'H' AMPLIFIERS
 20mv. per inch 'V' Sensitivity
 1 Volt P-P Internal Calibrator

- ★ Regulated, Push-Pull Vertical Amplifier: .02v. per inch sensitivity, 10 cycles to 1 MC response. 2 Megs. and 22 mmf. input.
- ★ 1 Volt Peak to Peak, Regulated, Built-In Voltage Calibrator.
- ★ Compensated Vert. Input Step Attenuator.
- ★ 'V' Phase-Reversing Switch.
- ★ Push-Pull Horizontal Amplifier: .15v. per inch deflection sensitivity, 10 cycles to 1 MC response at full gain. 1/2 Meg. and 20 mmf. input.
- ★ Internal Linear Sweep: 10 cyc. to 30 KC.
- ★ Controlled, 4-Way Synch. Selection: Internal Pos., Internal Neg., External and Line.
- ★ 'Z' Axis Modulation Input.
- ★ Internal, Phasable 60 Cyc. Beam Blanking.
- ★ Sinusoidal Sweep Phasing Control.
- ★ All 4 Horizontal and Vertical Plate Connections Directly Accessible at Rear.
- ★ Four-Way Lab-Type Input Terminals.
- ★ Light Shield and Mask, removable and rotatable.
- ★ Fully Licensed under W.E. Co. patents.

SERIES ES-500A: In louvered, black ripple, heavy gauge steel case. 8 1/4" x 14 1/2" x 18".
 Net Price \$173.70

SERIES SP-5

Oscilloscope Test Probe Set

for
WAVEFORM ANALYSIS, TROUBLE-SHOOTING,
SIGNAL TRACING AND ALIGNMENT
 (with Series ES-500 and ES-500A)

Set includes shielded Master Cable and four different, detachable probe heads:

1. High Impedance—Low Capacity Probe
2. Signal-Tracing—Crystal Probe
3. Resistive—Isolating Probe
4. Shielded—Direct Probe

★ In vinyl-plastic carrying case.
 Net Price \$23.50

PRECISION APPARATUS COMPANY, INC.

92-27 HORACE HARDING BLVD., ELMHURST 13, N. Y.

Export Division: 458 Broadway, New York 13, U.S.A. • Cables—Mothanex
 In Canada: Alfas Radio Corp., Ltd., 550 King Street, W., Toronto 2B

Sierra Electronic Corporation.....	289
Sigma Instruments Inc.....	294
Signal Engineering & Mfg. Co.....	368
Sorensen & Company, Inc.....	2
Southern Electronics Co.....	389
Sperry Gyroscope Company.....	100, 101
Sprague Electric Company.....	9, 49
Stackpole Carbon Co.....	89
Standard Electrical Products Co.....	324
Standard Piezo Co.....	391
Star Porcelain Co.....	387
Stavid Engineering Inc.....	351
Steiner-Ives Co.....	108
Sterling Transformer Corp.....	84
Stevens-Arnold, Inc.....	319
Stevens Manufacturing Co., Inc.....	302
Stoddart Aircraft Radio Co., Inc.....	320, 344
Stone Paper Tube Company, Inc.....	46
Stupakoff Ceramic & Mfg. Co.....	283
Sturtevant Co., P. A.....	401
Sun Parts Distributors, Ltd.....	369
Superior Tube Co.....	33
Sylvania Electric Products, Inc.....	7, 280, 291, 392

Taylor Fibre Company.....	64
Tech Laboratories, Inc.....	300
Technical Service Corp.....	389
Technology Instrument Corp.....	311, 313
Teimer Company, Inc., Roland.....	359
Tektronix, Inc.....	318
Tel-Instrument Co., Inc.....	356
Telechrome, Inc.....	285
Telechron Dept., Gen. Elec. Co.....	241
Teletronics Laboratory, Inc.....	360
Telex, Inc.....	307
Tenney Engineering Inc.....	348
Tensolite Insulated Wire Co., Inc.....	360
Terpening Co., L. H.....	338
Titellex, Inc.....	235
Tobe Deutschmann Corp.....	268
Trad Television Corp.....	365
Transistor Products, Inc.....	249
Trans-Sonics, Inc.....	365
Transradio, Ltd.....	366
Triplett Electrical Instrument Co.....	120
Tung-Sol Electric, Inc.....	32A, 32B

Uelitte Co.....	52
Union Switch & Signal, Div. of West- inghouse Air Brake Co.....	229
United Electronics Corporation.....	119
United States Gasket Co.....	450, 451
United States Wire & Cable Corp.....	323
United Transformer Co.....	Second Cover
United Manufacturing & Service Co.....	378
U. S. Components, Inc.....	345

Vartlex Sales Co., Inc.....	255
Varian Associates.....	226
Veeder-Root, Inc.....	82
Vickers Electric Div., Vickers, Inc.....	224
Victoreen Instrument Co.....	282
Victory Engineering Corp.....	377

Waldes Kohinoor, Inc.....	107
Warren Wire Co.....	96
Waterman Products Co., Inc.....	254
Waters Mfg. Inc.....	378, 380
Wenco Mfg. Co.....	351
Westinghouse Electric Corp.....	27
Weston Electrical Instrument Corp.....	56
Wheeler Laboratories, Inc.....	372

White Dental Mfg. Co., S. S.....	208, 327, 397
Williams & Co., C. K.....	374
Winchester Electronics, Inc.....	242

Zophar Mills, Inc.....	351
------------------------	-----

PROFESSIONAL SERVICES.....	403
----------------------------	-----

SEARCHLIGHT SECTION

(Classified Advertising)

H. E. Hilty, Mgr.

EQUIPMENT ADVERTISERS.....	445
----------------------------	-----

EMPLOYMENT ADVERTISERS

Aircraft Radio Corp.....	412
Armour Research Foundation of Illinois Institute of Technology.....	410
Bendix Aviation Corp., Pacific Division.....	416
Bendix Aviation Corp., York Div.....	413
Bendix Aviation Corp., Research Laboratories.....	417
Bendix Radio, Div. of Bendix Aviation Corp.....	410
Boonton Radio Corporation.....	416
Cardwell Mfg Corp., A. D.....	417
CBS-COLUMBIA.....	414
Convair.....	408
Cook Electric Co.....	415
Delco Radio Division, General Motors Corp.....	416
Electronic Engineering Co. of California.....	417
Federal Telecommunication Labs.....	413
Freed Electronics & Controls Corp.....	414
General Instrument Corp.....	414
General Motors Corp., A.C. Spark Plug Div.....	410
Goodyear Aircraft Corp.....	407
Hoffman Laboratories Inc.....	406
Industrial Research Laboratories.....	414
Kollsman Instrument Corp.....	417
Lear, Inc.....	406
MacIen Corporation.....	406
Maxson, W. L.....	415
Melpar, Inc.....	412
Motorola Research Laboratory.....	412
National Cash Register Co., The.....	413
O'Shea Employment System.....	406
Radio Corporation of America.....	409
Southwestern Industrial Electronics Co.....	414
Stromberg-Carlson Co.....	414, 416
Vitro Corporation of America.....	415
Walker, W. C.....	416
Weightman & Assoc.....	406
Westinghouse Electric Corp.....	411
Wilcox Electric Inc.....	415

This index is published as a convenience to the readers. Every care is taken to make it accurate, but ELECTRONICS assumes no responsibility for errors or omissions.

THESE ARE THE

REASONS

WHY **DAVEN** IS THE LEADER IN THE AUDIO ATTENUATOR FIELD

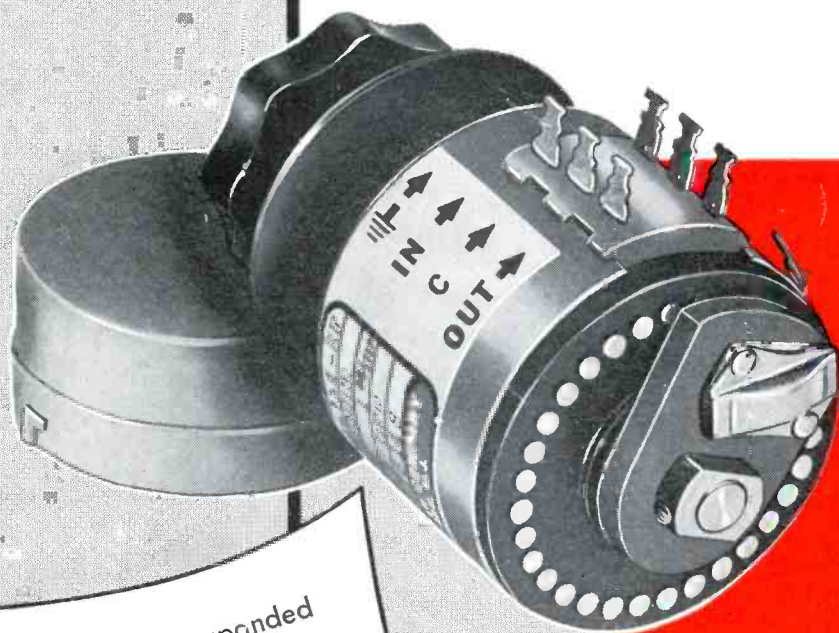

Greatly expanded production facilities enable Daven to make delivery from stock on a large number of standard attenuator types.

LA-130 Series,
Ladder Network
30 Steps, 1 3/4" Diameter



- 1 "KNEE-ACTION" ROTOR . . . gives positive contact and low contact resistance under all conditions.
- 2 BRASS CASE OF 2-PIECE CONSTRUCTION . . . gives excellent shielding and allows more compact equipment design.
- 3 "LOCK-TITE" DUST COVER . . . designed to withstand severe vibration and at the same time allow easy accessibility.
- 4 ENCLOSED ROLLER-TYPE DETENT MECHANISM . . . gives positive indexing, but does not increase depth of unit.
- 5 LOW-LOSS MOLDED TERMINAL BOARD . . . has high resistance to leakage.

Write for complete catalog data.

THE **DAVEN** CO.

WORLD'S LARGEST MANUFACTURER OF ATTENUATORS

191 Central Ave., Newark 4, N. J.



Why you can expect peak performance from regular RCA receiving tubes

Longer Life



Superior Performance



At no extra cost



● It's a matter of bonus values! At no greater cost to you, RCA receiving tubes give you the superior performance and reliability usually claimed for specialty-designed types of other manufacturers. That's because RCA receiving tubes are being improved constantly to keep pace with your present and future design requirements.

For Instance

The RCA-5U4-G features a new electrolytic coating on its channel filament which produces a uniform, hard emitter—leading to greatly increased life over the older version.

The RCA-6W4-GT incorporates a new RCA-developed carbonized plate-coating material having improved heat-dissipating properties. Result! The RCA-6W4-GT offers longer life and increased reliability.

The RCA-6AL5 utilizes double helical heaters to insure low hum. Cathodes are pinched to minimize cathode shift within the mount. Both features make possible greatly reduced microphonics. Carefully controlled contact potential assures high and uniform sensitivity.

RCA's continuing program of quality improvement means superior receiver performance, less factory-line rejects,

and fewer "in-warranty" failures. And remember, this *peak performance* from regular RCA receiving tubes costs you no more . . . actually costs you less in the long run.

For additional technical information write RCA, Commercial Engineering, Section A19Q, Harrison, N. J. For application assistance, simply call your nearest RCA Field Office:

(EAST) Humboldt 5-3900
415 S. 5th St., Harrison, N. J.

(MIDWEST) Whitehall 4-2900
589 E. Illinois St., Chicago, Ill.

(WEST) Madison 9-3671
420 S. San Pedro St., Los Angeles, Cal.



RADIO CORPORATION of AMERICA

ELECTRON TUBES

HARRISON, N. J.