

SEPTEMBER · 1953

PRICE 75 CENTS

electronics

A M C G R A W - H I L L P U B L I C A T I O N

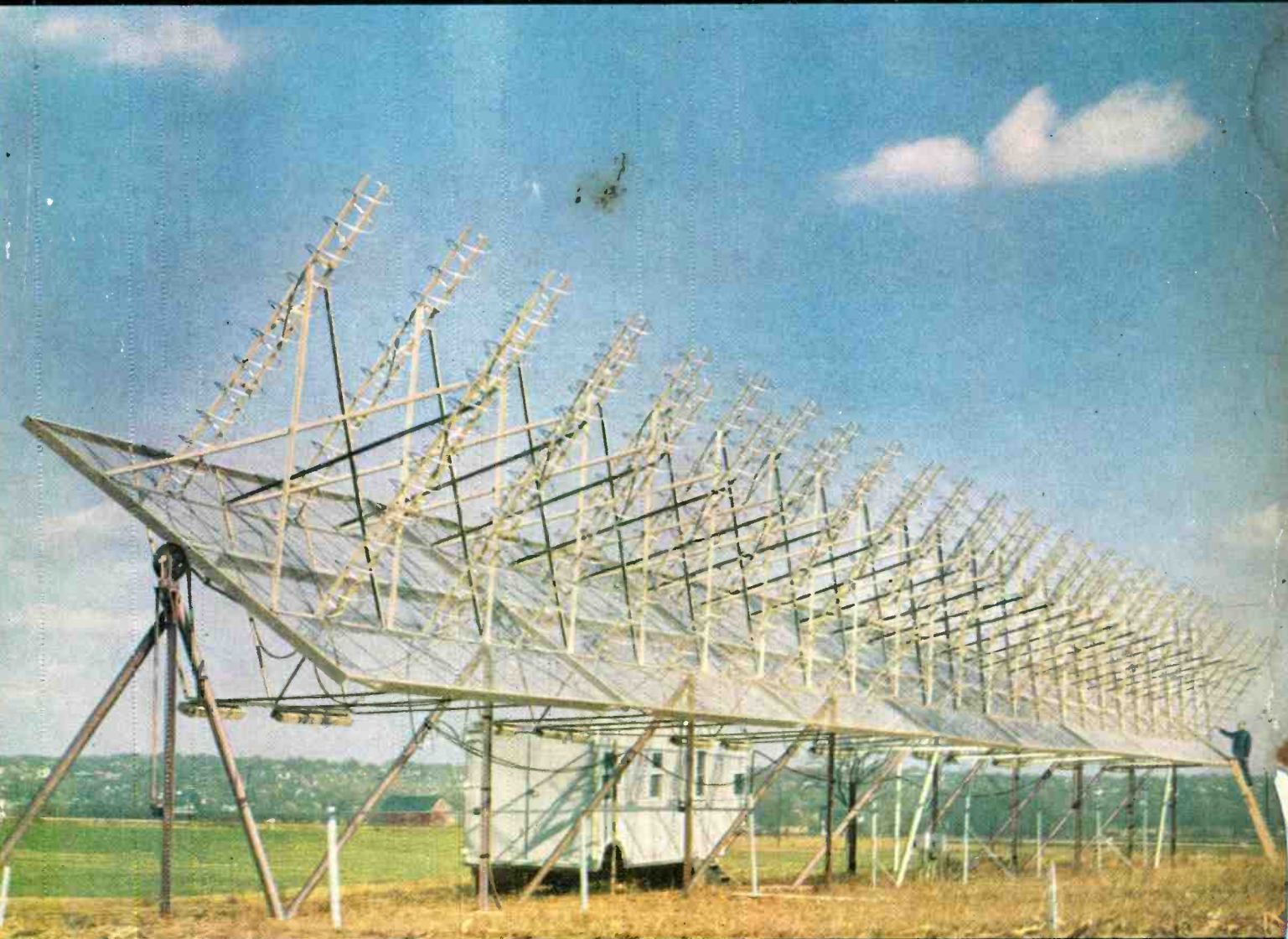

CELESTIAL RADIO TELESCOPE



MINIATURE COMPONENTS FROM STOCK...

SUBOUNCER UNITS

FOR HEARING AIDS...VEST POCKET RADIOS...MIDGET DEVICES

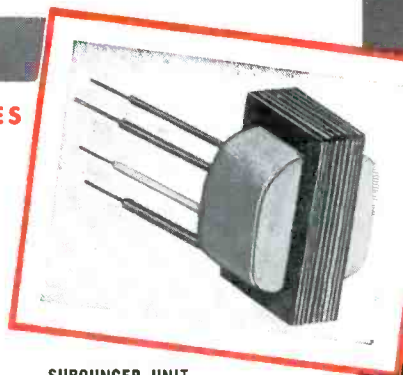

SUBOUNCER UNIT
Dimensions...9/16" x 5/8" x 7/8"
Weight......03 lb.

UTC Sub-ouncer units fulfill an essential requirement for miniaturized components having relatively high efficiency and wide frequency response. Through the use of special nickel iron core materials and winding methods, these miniature units have performance and dependability characteristics far superior to any other comparable items. They are ideal for hearing aids, miniature radios, and other types of miniature electronic equipment. The coils employ automatic layer windings of double Formex wire... in a molded Nylon bobbin. All insulation is of cellulose acetate. Four inch color coded flexible leads are employed, securely anchored mechanically. No mounting facilities are provided, since this would preclude maximum flexibility in location. Units are vacuum impregnated and double (water proof) sealed. The curves below indicate the excellent frequency response available. Alternate curves are shown to indicate operating characteristics in various typical applications.

Type	Application	Level	Pri. Imp.	D.C. in Pri.	Sec. Imp.	Pri. Res.	Sec. Res.	List Price
*S0-1	Input	+ 4 V U	200	0	250,000 62,500	16	2650	\$ 6.50
S0-2	Interstage/3:1	+ 4 V U	10,000	0	90,000	225	1850	6.50
*S0-3	Plate to Line	+ 20 V U	10,000 25,000	3 mil. 1.5 mil.	200 500	1300	30	6.50
S0-4	Output	+ 20 V U	30,000	1.0 mil	50	1800	4.3	6.50
S0-5	Reactor 50 HY at 1 mil	D.C. 3000 ohms D.C. Res						5.50
S0-6	Output	+ 20 V U	100,000	.5 mil.	60	3250	3.8	6.50

*Impedance ratio is fixed, 1250:1 for S0-1, 1:50 for S0-3 Any impedance between the values shown may be employed

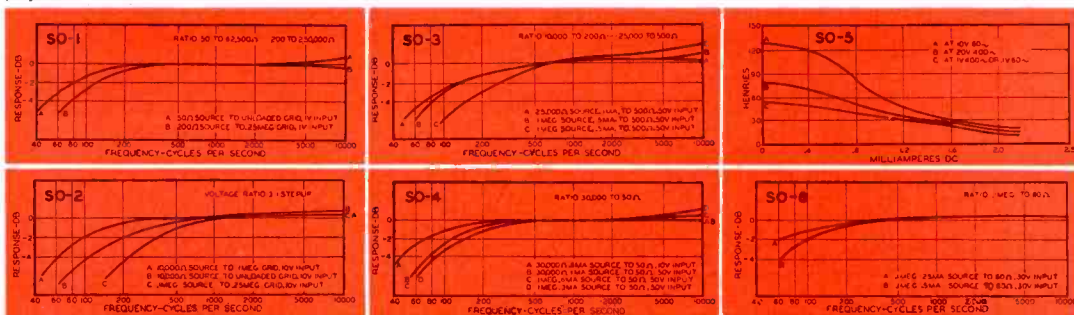

SUB-SUBOUNCER UNITS

FOR HEARING AIDS AND ULTRA-MINIATURE EQUIPMENT

UTC Sub-Sub-ouncer units have exceptionally high efficiency and frequency range in their ultra-miniature size. This has been effected through the use of specially selected Hiperm-Alloy core material and special winding methods. The constructional details are identical to those of the Sub-ouncer units described above. The curves below show actual characteristics under typical conditions of application.

Type	Application	Level	Pri. Imp.	D.C. in Pri.	Sec. Imp.	Pri. Res.	Sec. Res.	List Price
*SS0-1	Input	+ 4 V U	200	0	250,000 62,500	13.5	3700	\$ 6.50
SS0-2	Interstage/3:1	+ 4 V U	10,000	0	90,000	750	3250	6.50
*SS0-3	Plate to Line	+ 20 V U	10,000 25,000	3 mil. 1.5 mil.	200 500	2600	35	6.50
SS0-4	Output	+ 20 V U	30,000	1.0 mil.	50	2875	4.6	6.50
SS0-5	Reactor 50 HY at 1 mil.	D.C. 4400 ohms D.C. Res.						5.50
SS0-6	Output	+ 20 V U	100,000	.5 mil.	60	4700	3.3	6.50

*Impedance ratio is fixed, 1250:1 for SS0-1, 1:50 for SS0-3. Any impedance between the values shown may be employed.

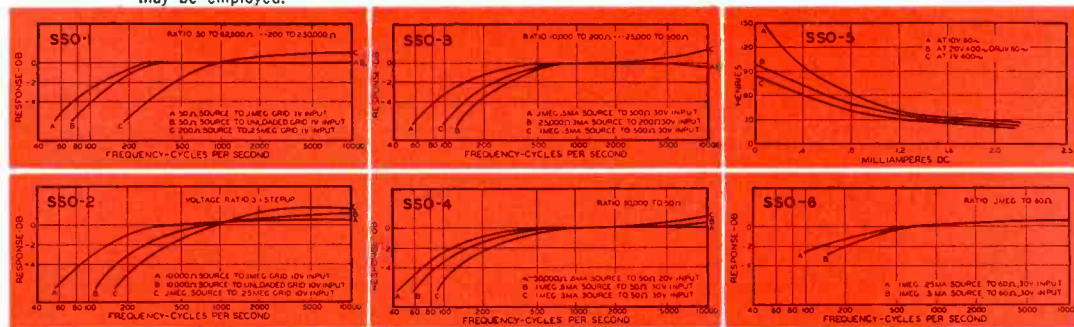

SUB-SUBOUNCER UNIT

Dimensions...7/16" x 3/4" x 5/8"
Weight......02 lb.

United Transformer Co.

150 VARICK STREET NEW YORK 13, N. Y.
EXPORT DIVISION: 13 EAST 40th STREET, NEW YORK 16, N. Y. CABLES: "ARLAB"

CELESTIAL RADIO TELESCOPE—Multiple helix array used at Ohio State University in radio astronomy studies. A description by designer John D. Kraus appears on page 148 **COVER**

FIGURES OF THE MONTH , includes Electronic Output Index	4
INDUSTRY REPORT , top-level news, trends and market interpretations	5
MODERN TRANSMITTER FOR A-M BROADCASTING , by Alexander A. McKenzie	130
COMPUTER SIMULATES MOVING RADAR TARGETS , by W. B. Birtley	137
COMPLEMENTARY SYMMETRY TRANSISTOR CIRCUITS , by Robert D. Lohman	140
ELECTRONIC GAGING AND SORTING APPLICATIONS , by Albert C. Sanford	144
NEW TECHNIQUES IN RADIO ASTRONOMY , by John D. Kraus and Edward Ksiazek	148
LINE SELECTOR CHECKS TELEVISION WAVEFORMS , by Edward M. Buyer	153
EQUIVALENT TRANSISTOR CIRCUITS AND EQUATIONS , by Abraham Coblentz and Harry L. Owens	156
THREE-TONE OSCILLATOR BROADCASTS TIME SIGNAL , by Sidney Feldman	162
VIBRATING-WIRE HIGH-Q RESONATOR , by Arthur W. Dickson and William P. Murden	164
WIDE-BAND DATA TRANSMITTER , by D. J. Gray, V. P. Gurske and W. E. Morrow	168
LOW-DISTORTION TRANSISTOR A-F OSCILLATOR , by Peter G. Sulzer	171
SOUND-REINFORCING SYSTEM FOR THEATER-TYPE STUDIO , by L. J. Kleinklaus	174
PHOTOTUBES OBSERVE TOTAL SOLAR ECLIPSE , by Francis J. Heyden	176
SIMPLIFIED VECTORSCOPE MEASURES PHASE , by William L. Firestone and Roy A. Richardson	180
WIDE-RANGE CALIBRATOR FOR VIBRATION PICKUPS , by Wilfred A. Yates and Martin Davidson	183
RECORDING FACILITIES FOR CONFERENCES , by G. E. Beggs, Jr.	186
BALANCE MEASUREMENTS ON BALUN TRANSFORMERS , by O. M. Woodward, Jr.	188
CATHODE-FOLLOWER DESIGN CHARTS (Reference Sheet), by N. O. Sokal	192

CROSTALK.....129	ELECTRONS AT WORK.....198	PRODUCTION TECHNIQUES.....262	NEW PRODUCTS.....316
PLANTS AND PEOPLE.....378	NEW BOOKS.....428	BACKTALK.....440	INDEX TO ADVERTISERS.....495

W. W. MacDONALD, Editor; **VIN ZELUFF**, Managing Editor; John Markus, A. A. McKenzie, James Fahnestock, Associate Editors; William P. O'Brien, John M. Carroll, William G. Arnold, David A. Findlay, Assistant Editors; Marilyn Wood, Editorial Assistant; Gladys T. Montgomery, Washington Editor; Harry Phillips, Art Director; Eleanor Luke, Art Assistant

KEITH HENNEY, Editorial Director

H. W. MATEER, Publisher; **WALLACE B. BLOOD**, Manager; R. S. Quint, Buyers' Guide Manager; N. F. Cullinan, Promotion & Research Assistant; H. E. Hilty, Classified Manager; D. H. Miller, James Girdwood, New York; Wm. S. Hodgkinson, New England; Warren W. Shew, Philadelphia; C. D. Gardner, Chicago; J. L. Phillips, Cleveland; T. H. Carmody, R. C. Alcorn, San Francisco; Carl W. Dysinger, Los Angeles; Robert H. Sidur, Atlanta



September, 1953

ELECTRONICS
Member ABC and ABP

Vol. 26, NO. 9



Published monthly with an additional issue in June by McGraw-Hill Publishing Company, Inc., James H. McGraw, (1860-1948), Founder. Publication Office, 99-129 North Broadway, Albany 1, N. Y.

Executive, Editorial and Advertising Offices: McGraw-Hill Building, 330 W. 42 St., New York 36, N. Y. Curtis W. McGraw, President; Willard Chevalier, Executive Vice-President; Joseph A. Gerardi, Vice-President and Treasurer; John J. Cooke, Secretary; Paul Montgomery, Senior Vice-President, Publication Division; Ralph B. Smith, Vice-President and Editorial Director; Nelson Bond, Vice-President and Director of Advertising; J. E. Blackburn, Jr., Vice-President and Director of Circulation.

Subscriptions: Address correspondence to Electronics—Subscription Service, 99-129 N. Broadway, Albany 1, N. Y., or 330 W. 42nd St., New York 36, N. Y. Allow one month for change of address. Subscriptions are solicited only from persons engaged in theory, research, design, production, maintenance and use of electronic and industrial control components, parts and end products. Position and company connection must be indicated on subscription orders.

Single copies 75¢ for United States and possessions, and Canada; \$1.50 for Latin America; \$2.00 for all other foreign countries. Buyers' Guide \$2.00. Subscription rates—United States and possessions, \$6.00 a year; \$9.00 for two years. Canada, \$10.00 a year; \$16.00 for two years. Other western hemisphere countries, \$15.00 a year; \$25.00 for two years. All other countries \$20.00 a year; \$30.00 for two years. Entered as second class matter August 29, 1936, at the Post Office at Albany, N. Y., under act of Mar. 3, 1879. Printed in U.S.A. Copyright 1953 by McGraw-Hill Publishing Co., Inc.—All Rights Reserved. BRANCH OFFICES: 520 North Michigan Avenue, Chicago 11, ILL.; 68 Post Street, San Francisco 4; McGraw-Hill House, London, E.C. 4; Washington, D. C. 4; Philadelphia 3; Cleveland 15; Detroit 26; St. Louis 8; Boston 16; 1321 Rhodes-Haverty Bldg., Atlanta 3, Ga.; 1111 Wilshire Blvd., Los Angeles 17; 738-9 Oliver Building, Pittsburgh 22. ELECTRONICS is indexed regularly in The Engineering Index.

TUBELESS MAGNETIC AMPLIFIER DC SUPPLIES

*for automotive
and aircraft industries*

Sorensen Nobatrons Model MA6/15 and Model MA2850 are tubeless—using magnetic amplifier principles. They have plenty of current capacity—100 amps at 6 volts or 75 amps at 12 volts in the MA6/15 and 50 amps at 28 volts in the MA2850. Please see the specs below.

The MA6/15 is designed primarily as an automotive production test instrument for use in checking window motors, heaters, clocks, radios, headlight dimmers, ignition systems, air conditioners, cigarette lighters. The MA2850 can be used for testing aircraft heaters, pitch changers, inverters, radar, fire control systems, etc. Built around tubeless circuits, both models are carefully engineered and built to give you years of trouble-free, dependable service. *Write for information now!*



*for the latest and
best in Isotronics*

specify



SPECIFICATIONS

Model MA2850

Input voltage range 190-230, 3 ϕ , 4 wire, 60~
Output 28 volts DC, adjustable between 23 and 36 volts.
Current 0 - 50 amperes
Ripple 3% max RMS
Regulation accuracy $\pm 1\%$ against line and load combined
Time constant 0.5 seconds under worst conditions
Dimensions 15 $\frac{1}{2}$ " wide x 25 $\frac{3}{8}$ " high x 13" deep
Meters are standard. Units are self contained.

Model MA6/15

Input voltage range 210-250 VAC, 1 ϕ , 60~
Output Adjustable 6 - 7.7 volts DC from 0 - 100 amperes
Adjustable 12 - 15.4 volts DC from 0 - 75 amperes
Ripple 1% max RMS
Regulation accuracy $\pm 1\%$ against line and load combined
Time constant 0.2 seconds under worst conditions
Dimensions 21" wide x 36" high x 15" deep
Meters are standard. Cabinets optional.

SORENSEN

SORENSEN AND COMPANY • 375 FAIRFIELD AVE., STAMFORD I, CONN.

THIS INTERESTING QUARTERLY WILL BE MAILED FREE TO ANY PART OF THE WORLD

AUSTRALIA

Messrs. Watson Victor Limited,
9-13, Bligh Street,
Sydney, N.S.W.

BELGIUM

Paul Groeninckx,
4-6, Avenue Hansen-Soulie,
Brussels.

CANADA

The J. W. Ellis Industries,
42, Lombard Street,
Toronto.

DENMARK

Ditz Schweitzer,
Norre Voldgade, 48,
Copenhagen, K.

FRANCE

Jacques Pères Fils,
4, Avenue de l'Opéra,
Paris 1.

HOLLAND

Geo. C. F. Kauderer,
Muiden.

INDIA

Adair, Dutt & Co. (India) Ltd.,
5, Dalhousie Square,
Calcutta.

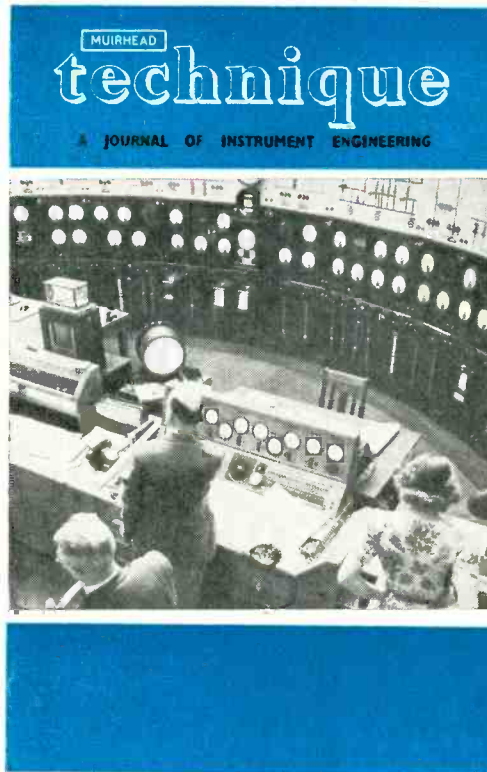

ITALY

Ing. Silvio Garrone,
Piazza Della Marina, 1,
Rome.

NEW ZEALAND

Richardson, McCabe & Co. Ltd.,
P.O. Box 792,
Wellington.

NORWAY

J. L. Nerlien A/S,
Nedre Slottsgt. 13,
Oslo.

SOUTH AFRICA

Johnson & Phillips South Africa
(Pty.) Limited,
P.O. Box 552,
Germiston.

SWEDEN

Ingenjorsfirma Hugo Tillquist,
Nybrotkajen 7, Postbox 7026,
Stockholm 7.

SWITZERLAND

Camille Bauer,
Dornacherstrasse 18,
Basel.

U.S.A.

Muirhead & Co. Ltd.,
Elmers End, Beckenham,
Kent, England.

TECHNIQUE IS ALSO PUBLISHED IN FRENCH. IF THIS EDITION
IS REQUIRED, MARK YOUR COUPON "EDITION FRANÇAISE"

FILL IN THIS COUPON AND MAIL TO US OR OUR AGENT

(SEE LIST ABOVE)

*Please mail me, free of charge,
the quarterly journal
of instrument engineering
"technique"
published by
Muirhead & Co., Limited.*

NAME _____
POSITION _____
COMPANY _____
ADDRESS _____

ELECTRONICS '90

MUIRHEAD & CO. LTD.
PRECISION ELECTRICAL INSTRUMENT MAKERS
BECKENHAM · KENT · ENGLAND

Telegrams and Cables: MUIRHEAD BECKENHAM.

PRECISION

MUIRHEAD

ELECTRICAL INSTRUMENTS

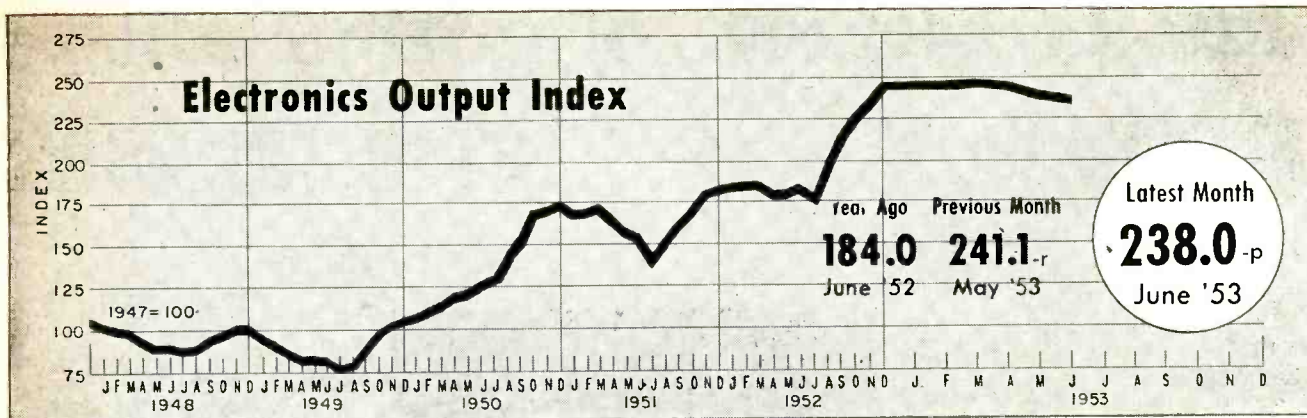

FIGURES OF THE MONTH

	Year Ago	Previous Month	Latest Month
RECEIVER PRODUCTION			
(Source: RETMA)	June '52	May '53	June '53
Television sets	361,152	481,936	524,479
Home sets	297,669	278,156	287,724
Clock Radios	124,489	129,391	131,144
Portable sets	205,186	204,065	239,189
Auto sets	246,909	497,379	505,774

	Year Ago	Previous Month	Latest Month
RECEIVER SALES			
(Source: RETMA)	June '52	May '53	June '53
Television sets, units	244,191	431,089
Radio sets (except auto)	716,407	449,116

	Year Ago	Previous Month	Latest Month
RECEIVING TUBE SALES			
(Source: RETMA)	June '52	May '53	June '53
Receiv. tubes, total units	24,365,462	37,253,308	42,505,685
Receiving tubes, new sets	15,770,335	27,261,346	26,478,801
Rec. tubes, replacement	5,187,557	7,422,621	12,965,382
Receiving tubes, gov't.	2,477,569	723,852	708,174
Receiving tubes, export	930,001	1,845,489	2,353,328
Picture tubes, to mfrs.	285,975	579,332	517,395

	Year Ago	Previous Month	Latest Month
SEMICONDUCTOR SALES			
(Source: RETMA)	June '52	May '53	June '53
Germanium Diodes	1,466,362	1,344,636

	Quarterly Figures		
	Year Ago	Previous Quarter	Latest Quarter
INDUSTRIAL TUBE SALES			
(Source: NEMA)	1st '52	4th '52	1st '53
Vacuum (non-receiving)	\$11,320,000	\$12,790,000	\$11,340,000
Gas or vapor	\$3,100,000	\$3,480,000	\$3,140,000
Phototubes	\$500,000	\$760,000	\$930,000
Magnetrons and velocity modulation tubes	\$8,460,000	\$10,510,000	\$10,070,000
Gaps and T/R boxes	\$2,450,000	\$2,090,000	\$2,050,000

	Year Ago	Previous Month	Latest Month
TV AUDIENCE			
(Source: NBC Research Dept.)	July '52	June '53	July '53
Sets in Use—total	17,983,200	24,292,600	24,519,000

	Year Ago	Previous Month	Latest Month
BROADCAST STATIONS			
(Source: FCC)	July '52	June '53	July '53
TV Stations on Air	109	198	224
TV Stns CPs—not on air	21	285	284
TV Stns—Applications	838	572	524
AM Stations on Air	2,356	2,458	2,466
AM Stns CPs—not on air	95	126	122
AM Stns—Applications	300	250	251
FM Stations on Air	627	580	578
FM Stns CPs—not on air	18	21	21
FM Stns—Applications	12	8	8

	Year Ago	Previous Month	Latest Month
COMMUNICATION AUTHORIZATIONS			
(Source: FCC)	June '52	May '53	June '53
Aeronautical	32,603	42,213	39,315
Marine	35,500	40,076	40,357
Police, fire, etc.	11,143	13,238	13,631
Industrial	13,680	16,850	17,378
Land Transportation	5,027	5,830	5,922
Amateur	113,092	111,011	111,289
Citizens Radio	1,401	2,124	3,829
Disaster	71	189	191
Experimental	488	439	414
Common carrier	985	1,193	1,214

	Year Ago	Previous Month	Latest Month
EMPLOYMENT AND PAYROLLS			
(Source: Bur. Labor Statistics)	May '52	Apr. '53	May '53
Prod. workers, comm. equip.	267,000	415,200-r	408,500
Av. wkly. earnings, comm.	\$64.80	\$66.02-r	\$65.04
Av. wkly. earnings, radio	\$60.83	\$63.68-r	\$62.56
Av. weekly hours, comm.	40.6	40.5 -r	39.9
Av. weekly hours, radio	40.1	39.8	39.1

	Year Ago	Previous Month	Latest Month
STOCK PRICE AVERAGES			
(Source: Standard and Poor's)	July '52	June '53	July '53
Radio—TV & Electronics	295.7	271.5	272.4
Radio Broadcasters	282.4	266.0	269.3

p—provisional; r—revised

FIGURES OF THE YEAR

	1952 Total
Television set production	6,096,279
Radio set production	10,934,872
Television set sales	6,144,990
Radio set sales (except auto)	6,878,547
Receiving tube sales	368,519,243
Cathode-ray tube sales	6,120,292

TOTALS FOR FIRST HALF			
	1952	1953	Percent Change
Television set production	2,318,235	3,834,236	+ 65.3
Radio set production	5,456,035	7,266,542	+ 33.1
Television set sales	2,775,900
Radio set sales (except auto)	3,017,196
Receiving tube sales	160,183,526	243,160,348	+ 51.7
Cathode-ray tube sales	1,845,309	4,150,683	+ 123.7

INDUSTRY REPORT

electronics—SEPTEMBER • 1953

FCC Gives the Nod to NTSC Color

Proposal to adopt industry specifications sets Sept. 8 as deadline for opponents

TAKING broadcasters and the electronics industry by surprise, the Federal Communications Commission has set forth a proposal for new color television rules. These proposed rules are based on new signal specifications for commercial color television adopted by the National Television System Committee on July 21, 1953.

► **Any Opposition**—An interested party who feels that the proposed rules should not be adopted has until Sept. 8 to file objections. Comments on the objections have an

additional fifteen-day leeway for filing. By Sept. 23, the Commission should have all the paperwork in its hands and will then decide whether or not to hold hearings. If there are no objections, no hearings will be necessary.

Industry leaders and the commissioners are optimistic. They point out that five industry bellwethers have already filed color-tv petitions specifying specs identical to those of NTSC (one company even jumped the gun, then amended its original petition to conform to NTSC's).

CBS, whose noncompatible system was first adopted October 10, 1950, is well on the new bandwagon with a recent authorization to put

NTSC color signals on the air from Sept. 10 to Dec. 10.

Expert prognosticators still feel their date of Jan. 1, 1954 for final FCC color rules is a good guess, but would be glad to be proved pessimistic.

TV Manufacturers Appraise Next Half

Despite truce in Korea many companies see clear sailing for the rest of '53

BY AND LARGE companies in the industry are not disturbed over the effects of the Korean truce on business, at least for the remaining months of 1953. They look to a continuation of the record sales chalked up during the first six months of the year.

► **Opinions**—Typical of views of many manufacturers in the field are those recently expressed by executives of five major companies.

Admiral's executive vice-president, J. B. Huarisa, sees a bright outlook for the second half of this year. Despite the truce in the Korean War, he said Admiral anticipates higher billing on production of a variety of electronic equipment for the armed forces.

Philco's executive vice-president, J. H. Carmine says that his company is looking ahead confidently to the last half of the year. "There is today no apparent reason why, with more people employed at higher wages than ever before, our industry should not continue to enjoy a high rate of activity."

"Cessation of hostilities in Korea and possible cut-backs in gov-

Sales Hit Record High For First Half of '53

Revised Electronics Output Index confirms good conditions reported by companies

ALMOST WITHOUT EXCEPTION, electronics firms reporting first-half sales and profit figures claimed all-time highs over previous years. Jumps of fifty to eighty percent over the same period during 1952 were not uncommon among larger companies in the industry, and several reported increases of more than 100 percent over last year.

► **New Output Index**—The heavy sales figures reported are consistent

with high output for first six months as indicated by the Electronics Output Index plot on page 4. This index is plotted to a new scale beginning this month to take advantage of increased plant coverage and revised Bureau of Labor Statistics figures on employment.

This plot reveals a steadier than usual situation in the electronic industry this year. Seasonal variations are evident for the years 1948 through last year, but so far this year fluctuations have been minor—including the slight dip for June which reflects the annual summer slump. Output is roughly double that of 1947.

ernment defense orders should not have a serious impact on the industrial economy. American industry is better prepared for any economic adjustments that may come than it has been in advance of a similar event in the past half-century. Our industrial climate is healthy; our financial position is strong, and our people are psychologically prepared for a long era of continued expansion and prosperity."

► **Plant Expansion** — Motorola looks for a satisfactory last half in television, according to president P. V. Galvin. He said that no significant change is seen in military production due to the Korean truce. He announced plans for the addition of 40-thousand square feet to the firm's Arizona laboratory for military research.

J. S. Knowlson, board chairman and president of Stewart-Warner said that, at present, it appears that business will continue good but increasingly competitive markets will keep profits from expanding. There is also great uncertainty as to size of military spending.

President H. W. Zimmer of Sylvania said that indications for the balance of the year appear to be even more favorable than they were a few months ago.

U. S. Funds Increased At Non-Profit Centers

INDICATION of the past trend in government financed scientific research and development at non-profit institutions is shown in a study of the subject by the National Science Foundation. In the year ending June 30, 1952, federal funds for scientific activities of all kinds amounted to \$2.2 billion. Of this amount, \$338 million was for scientific research and development at non-profit institutions, an increase of \$44 million over the amount allocated in 1951.

► **Reverse**—Opposite to the rise in total spending, Signal Corps funds for non-profit research dropped to \$4.7 million in 1952 compared to \$6.8 million in 1951, for a cut of \$2.1 million.

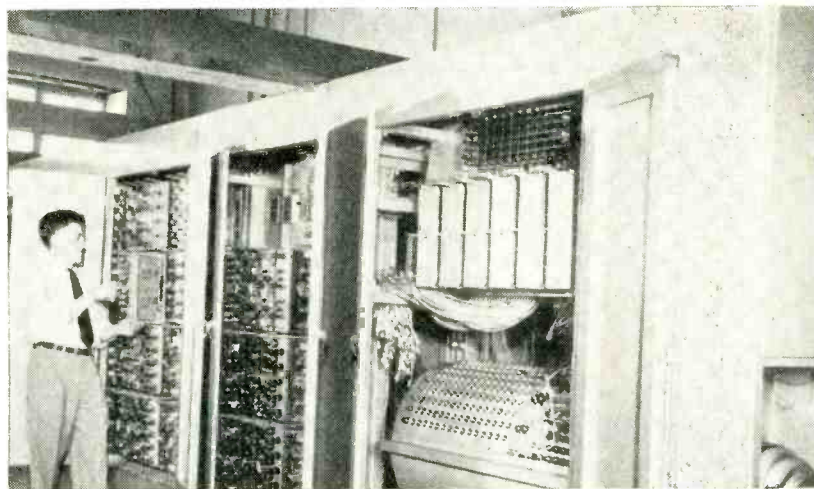

GIANT magnetic drum stores flight plans of 2,000 airplanes, as . . .

Computers Take On New Chores

Styled for specific jobs, digital machines find many commercial applications

ELECTRONIC digital computers with their insatiable appetite for numbers have long been heralded as thinking tools to relieve men's minds from the drudgery of routine calculation. Although the giant brains have performed auspicious service in research laboratories and government bureaus, mammoth general-purpose computers have not been found economically feasible in many applications and routine calculations must still, in general, be done by hand.

Recent digital machines, tailored for specific applications, may indicate a trend in computer design that will obviate many of the economic drawbacks to widespread use of electronic computers in industry and commerce.

► **Flight-Plan Storage Unit**—The problem of controlling the ever-increasing air traffic throughout the country may be solved by electronically storing and comparing the flight plans of up to 2,000 planes at a time. Developed for Civil Aeronautics Administration by engineering Research Associates Division of Remington Rand, the flight-plan storage unit includes a mag-

netic-drum memory that processes teleprinter characters at a rate of 23,000 per second and can store up to 312,000 characters. A desired flight plan can be located within 0.4 second and an automatic search of the drum's contents is performed once every 10 minutes.

Part of a system for air traffic control under development jointly by CAA and the Air Navigation Development Board, the storage unit is scheduled for demonstration this fall. The magnetic memory is also applicable to airline passenger reservation systems and other filing and checking systems requiring high-speed data handling.

► **Commercial Calculator** — Designed to meet accounting and computing requirements too heavy for the usual card-programmed calculators and yet not so demanding as to justify use of a giant brain, the IBM magnetic-drum calculator is aimed specifically at the businessman. In contrast with the flight-plan storage unit, the IBM machine has a drum only 4 in. in diameter and 12 in. long. The machine has up to 20,000 memory positions and can accept as many as 2,000 instructions. It occupies the same area as two office desks and a filing cabinet.

Likely applications for the magnetic-drum calculator include: com-

(Continued on page 8)

SILICON FOR SENSITIVITY...

GLASS FOR RELIABILITY

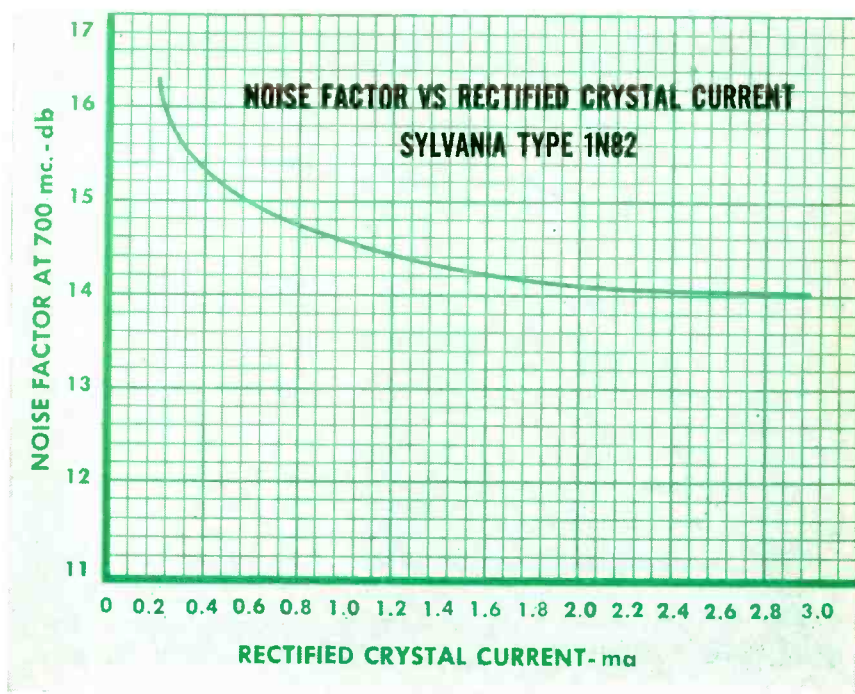
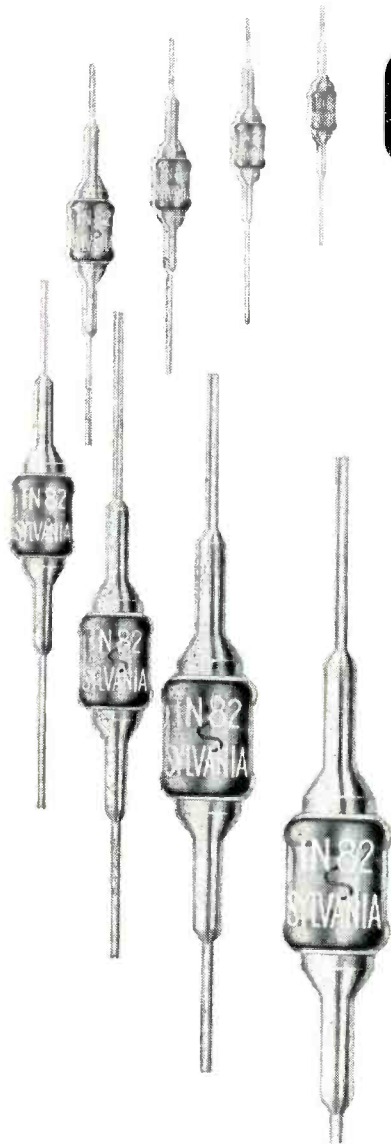

For low noise and high sensitivity in UHF tuners, choose Sylvania's 1N82 Crystal Diode. This diode was designed for peak performance as a UHF mixer.

The silicon crystal is well known for its high sensitivity and low noise, factors which have especially fitted it for use in radar receivers.

The combination of silicon and Sylvania's famous sealed-in-glass construction assures lowest tuner noise figures *plus* maximum dependability.

For full information concerning the complete line of Sylvania crystal diodes, mail the coupon now!



LIGHTING • RADIO • ELECTRONICS • TELEVISION
 In Canada: Sylvania Electric (Canada) Ltd., University Tower Bldg.
 St. Catherine St., Montreal, P. Q.

Sylvania Electric Products Inc.
 Dept. 3E-1009, 1740 Broadway
 New York 19, N. Y.
 Please send me latest data sheets concerning
 Sylvania Crystal Diodes.

Name _____
 Street _____
 City _____ Zone _____ State _____

puting insurance premiums, establishing production schedules and preparing utility bills. One of its features is a table look-up operation that facilitates automatic searching of rate tables.

RETMA Asks Excise Tax Relief For TV

EARLY ELIMINATION of the 10-percent excise tax on tv receivers was urged by Glen McDaniel, president of the Radio-Electronics-Television Manufacturers Association, in a statement submitted to the House Ways and Means Committee.

Stating that the industry is willing to contribute its fair share of revenue under a general manufacturers excise levy which would apply equally to all types of consumer products, he asked the committee to give special consideration to exempting color tv sets in conformance with the tradition of withholding taxes temporarily from new products and industries.

► **Movies** — Reminding the committee of the important contributions of the industry to national defense, Mr. McDaniel said that members of RETMA object to "being singled out as one of a relatively small number of industries to bear a sizable excise burden." He asked how the tax on tv can be defended while ornamental lamps, decorative furniture and the like go untaxed. He pointed out that Congress had passed legislation to free the motion picture industry from the excise and that this act would have given the major competitor of tv an unfair financial advantage. This tax bill has been vetoed by President Eisenhower.

► **Difficulties**—Apart from the inequities of the tv tax which was imposed as a temporary measure following the Korean outbreak, Mr. McDaniel cited its administrative difficulties. He said that the application of the tax to parts and components of radio and tv sets is both costly and confusing and creates problems that makes its collection more costly than the revenue obtained.

Radiation Instrument Business Changes

U. S. government was top customer in 1952; Private industry and AEC shares drop

IMPACT of atomics on the business of some electronic manufacturers was shown early this year when the Atomic Energy Commission reported its findings from a survey of the radiation instrument industry (ELECTRONICS, March, p 16) which showed that volume reached \$20 million last year. Now further information from the survey shows the past trend of the industry. Sales volume of \$7 million and \$6 million in 1951 and 1952 represent the years of greatest growth. Before that, sales increased at an annual rate of about \$2 million.

► **Market**—Sales to all customer groups have increased since 1948 on a dollar basis. But percentage-wise, the status of each market has changed quite radically. AEC and its principal contractors took over 58 percent of production in 1948 and government agencies, including the military, took 22.5 percent. By 1952 the standing of these two customers had almost completely reversed. The military and U. S.

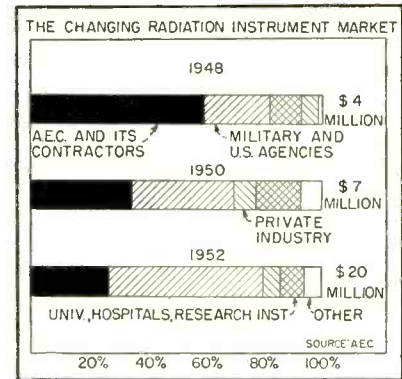

agencies took 52.5 percent of production while AEC and its contractors got only 27.4 percent of the total year's volume.

Although sales to private industry have also increased in dollar volume since 1948, the percentage of the total market that it represents had fallen from 11.0 to 6.0 percent by 1952.

► **Companies**—A total of 29 companies were in the radiation instrument business in 1952 and they employed around 2,400 people. In 1946, 200 were employed by five companies. Distribution of sales volume for the 29 companies in 1952 was as follows: 15 did up to \$200,000; 8 ranged to \$1 million; 6 did \$1 million to \$4 million. Thus, 7 companies accounted for about 50 percent of the total volume last year.

Electronics Ups Oil Discoveries

Scientific methods utilizing electronic equipment helped to make 1952 a top oil year

NEW OIL wells drilled in 1952 totalled 44,388, the highest number in the history of the oil industry. Electronics played a part in establishing this new record by helping to locate potential oil fields.

New field wildcats, which are holes drilled in unproven areas, were also highest last year. According to the American Association of Petroleum Geologists, last year's wildcat drillings totalled 6,698, over 500 more than were

drilled in 1951. This year's figures, though still incomplete, indicate that the upward trend will continue. During the first quarter of this year it is estimated that 240 more wildcat wells were drilled than during the same period in 1952.

► **Methods**—Of several techniques that oil men use to determine wildcat drilling areas, geophysical methods have increased in use. In 1952, a total of 1,332 wildcats were drilled using geophysical methods and equipment and 848 were drilled using both geophysical and geology methods, an increase of 340 for

(Continued on page 10)

**HERMETICALLY SEALED
METAL-ENCASED**

PRECISION CERAMIC CAPACITORS

with

HIGH STABILITY

for critical circuits

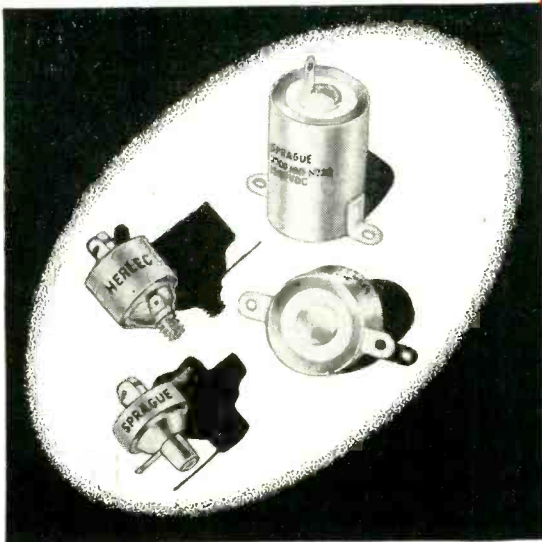

Sprague, on request, will provide you with complete application engineering service and assistance for optimum results in the use of precision ceramic capacitors.

IF YOUR problem is one of circuit stability in precision oscillators or of close capacitance tolerances in electronic instrumentation, have you investigated the advantages of Sprague-Herlec Precision Ceramic Capacitors?

These unique capacitors offer not only top capacitance and temperature stability but stability with applied voltage, uniform retrace characteristics, and high "Q". They are available in capacitance tolerances as close as $\pm 1\%$ and temperature coefficient tolerances as close as ± 10 ppm/ $^{\circ}\text{C}$ in regular production quantities.

Mechanically, they are small in size, sealed against atmospheric humidity, and resistant to vibration and shock. Standard operating temperature range is from -55°C to $+85^{\circ}\text{C}$.

Sprague-Herlec Precision Ceramics are available in all standard temperature coefficients from P100 to N750, and can also be manufactured to any exact intermediate coefficient required for balancing other circuit constants. When used in combination with Sprague Durameg[®] Accurate Wire-Wound Resistors, it is possible to achieve stability heretofore impracticable in mass-produced electronic equipment. Sprague can furnish you either these R-C network components or complete network subassemblies to meet your tolerance requirements.

For complete details on Sprague-Herlec Precision Ceramic Capacitors, write for Engineering Bulletins 603-B and 607-A to Sprague Electric Co., 35 Marshall Street, North Adams, Mass. or Herlec* Corporation, Grafton, Wisconsin.

*THE HERLEC CORP. IS A WHOLLY-OWNED SUBSIDIARY OF THE SPRAGUE ELECTRIC CO.

SPRAGUE

WORLD'S LARGEST CAPACITOR MANUFACTURER

EXPORT FOR THE AMERICAS: SPRAGUE ELECTRIC INTERNATIONAL LTD., NORTH ADAMS, MASS. CABLE: SPREXINT

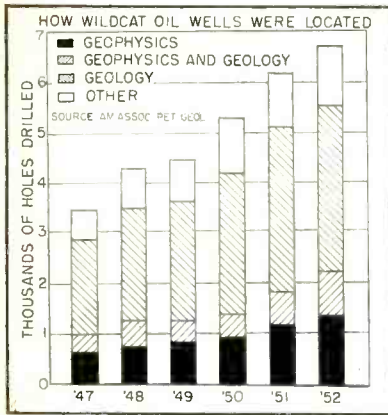

both methods over the 1951 total. Electronic equipment is used in both.

► **Dry Holes**—According to the American Petroleum Institute, only one out of nine wells drilled in a promising but unproven area turns

out to be an oil producer. The other 8 are costly dry holes. In 1952, oilmen drilled 12,242 exploratory holes to get 2,152 producers.

But technical methods which use electronics have helped to cut down the number of dry holes drilled. Last year, the 681 new-field wildcats drilled on technical advice (geology and/or geophysics) were successful, and 4,818 were dry. Thus, 12.4 percent of the wildcats drilled on technical advice were producers compared to 3.3 percent for those located without technical advice.

Locations for new wildcats based on technical recommendation were therefore 3.8 times more successful than those drilled without such advice, a strong selling point for electronic manufacturers that make equipment for this expanding field.

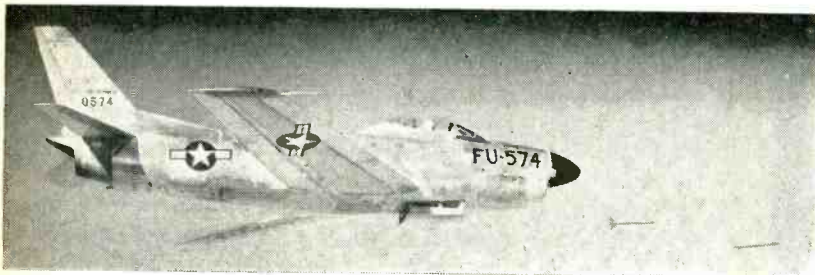

TOP EFFICIENCY in combat is assured because . . .

Tubes Take Over For F-86D Pilots

World's speed record holder uses 495 tubes and 6,400 other parts to accomplish job

CONTAINING more tubes than the average television station, the new F-86D North American Sabre jet is capable of doing just about anything electronically.

Tubes take over immediately after take-off in a typical interceptor problem. The plane automatically flies toward the target (the pilot does select his own speed) and when within range, radar signals tell the pilot when to push the buttons that release two dozen 2.75-inch rockets—electronically aimed, of course.

The pilot then makes minor ad-

justments that cause the tubes to return him to his base and, if weather prohibits visual contact flight, the tubes in his Lear autopilot approach coupler will bring the plane to within 50 feet of the runway in a perfect attitude for landing.

► **Electronic Engineer**—A set of automatic electronic engine controls regulate the fuel flow for best performance for all conditions of speed, altitude, engine rpm, temperature and engine airflow. The pilot simply maneuvers a single lever and sensing devices combine his settings with temperature and other conditions into appropriate signals for actual engine controls of the new Sabre jet.

Broadcast Station Robots Increase

FEELING the pinch of decreased a-m revenues, fearing the competition or cost of tv, and desirous of running generally unprofitable f-m ventures as cheaply as possible, broadcasters petitioned FCC for relief some months ago.

► **Remote Control**—One boon begged was permission to operate low-power transmitters from a distance. Struck by the dependability of electronic gear, particularly in the well-established entertainment field, the Commission relaxed its rules effective the middle of April.

At the time, scarcely a handful of licensees was using remote control under special experimental grants. Since then, about 150 applications have been filed for remote control of a-m transmitters, of which about 130 have been granted. In f-m, some 50 applications to date have garnered 40 grants. In all, there have been about 170 grants against 200 applications.

► **Equipment**—Methods of remote control depend upon the distance and the degree of control desired. For a transmitter on the roof, enough wires can be run down to the control point for each switch and meter to be duplicated. At a distance, two pairs of telephone wires are customarily employed, with pulses, tones or stepping switches to furnish control and monitoring information in sequence.

UHF Grantees Ask FCC To Okay Pay-To-See TV

PETITION calling on the Federal Communications Commission to set, at an early date, a rule-making procedure looking toward authorization of a limited service of subscription television, has been filed by a group of uhf cp holders in three states along the eastern seaboard. Co-signers of the petition

(Continued on page 14)

TO GAIN THE MOST IN

performance

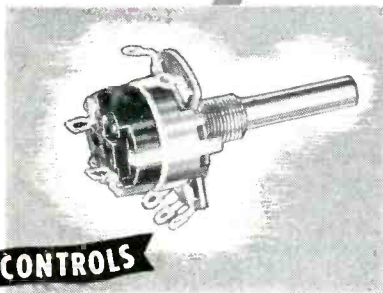

CONTROLS

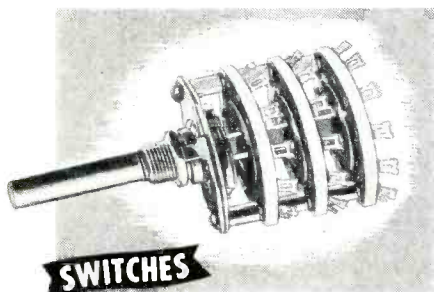

SWITCHES

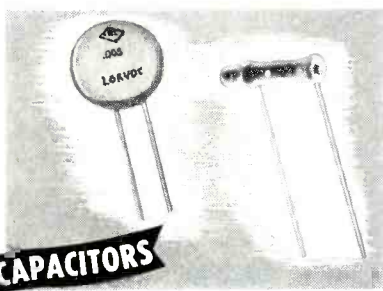

CAPACITORS

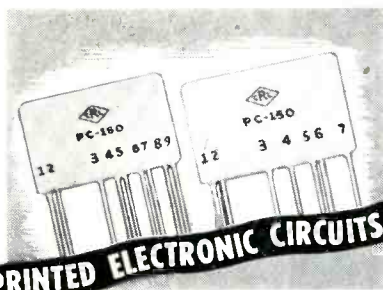

PRINTED ELECTRONIC CIRCUITS

...you're invited to concentrate your 5 major electronic component problems with the industry's most experienced and No. 1 electronic component source

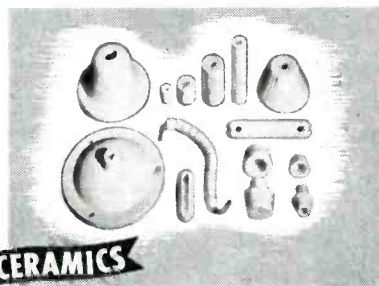

CERAMICS

see next 2 pages for details



1 VARIABLE RESISTORS

to meet your requirements

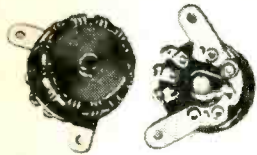

Model 1 Radiohm[®]
Miniature

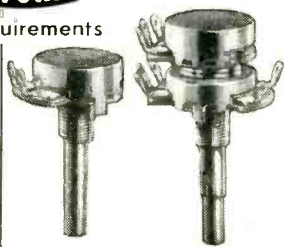

Model 2 Radiohm

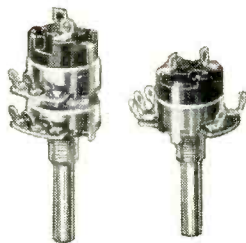

Model 2 Radiohm
(including JAN types)



Wirewound Radiohm
Three watts

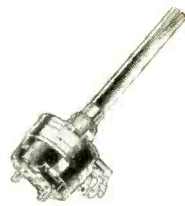

Model 2 EXPRESS[†]
for immediate
production needs



Series 20 Miniature
with a. c. line switch



Series 30
Dual Concentric
Switch and Control

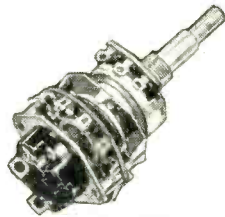

Series 30
Dual Concentric
Control and Switch

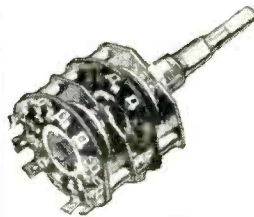

Series 30
Dual Concentric
Dual Switch

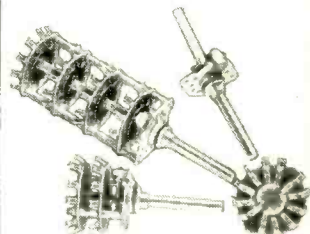

Standard Phenolic



Lever Switch

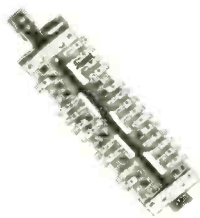

Slide Switch



Industrial Switch Kit

3 CAPACITORS

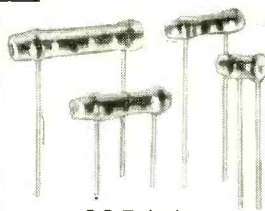

BC Tubular

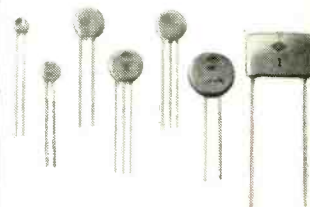

BC Discs

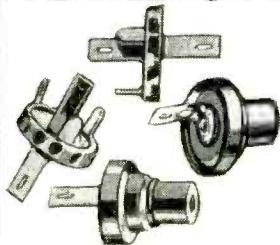

Button-Style



Feed-Thru HI-KAPS[®]

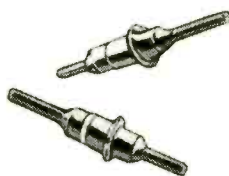

Miniature
Feed-Thru HI-KAPS[®]

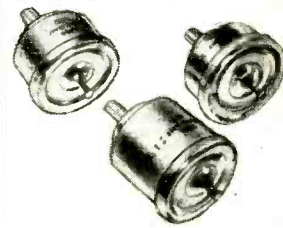

High Accuracy
Capacitors

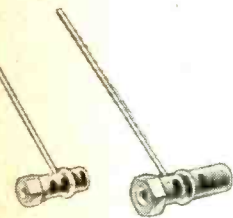

Stand-off

4 PRINTED ELECTRONIC CIRCUITS

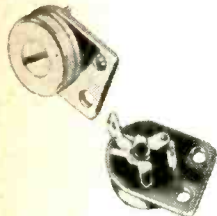

Ceramic Trimmers



Ceramic Min-Kaps[®]

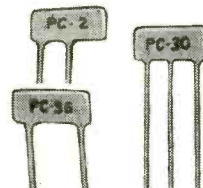

Miniature Resistor and
Resistor-Capacitor Units

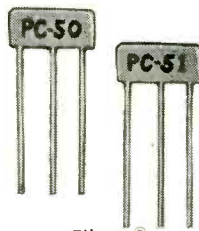

Filpec[®]
(balanced load
diode filter)

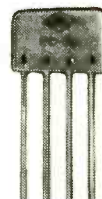

Standard Triode
Couplate[®]

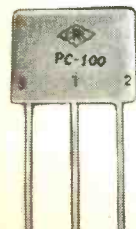

Vertical Integrator



Special Plates
to suit manufacturer's
requirements

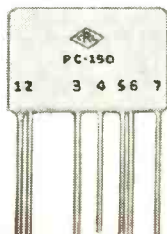

Audet[®]
Audio-detector plate

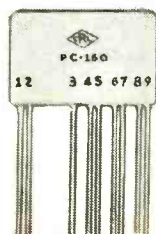

Pendet[†]
(Pentode detector
coupler)

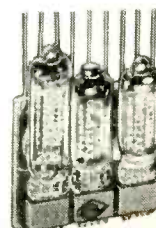

Model II Ampec[®]
Standard 3-stage
amplifier

2 SWITCHES

- 100's of variations possible

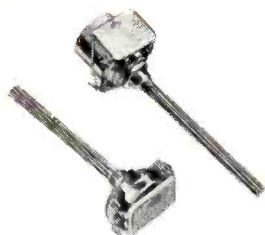

Compentrol (†)
Infinitely variable
loudness control

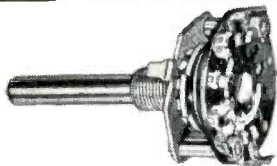

Series 20 Miniature
Phenolic insulation

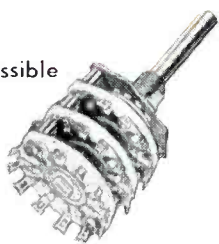

Series 20 Miniature
Ceramic insulation

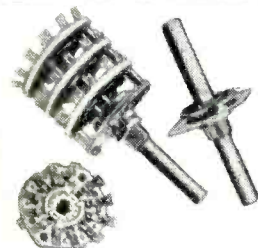

Standard Ceramic



Tone Switch



Spring Return Switch

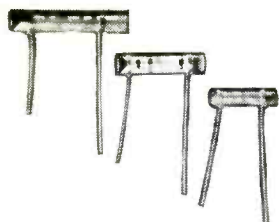

TC Tubular

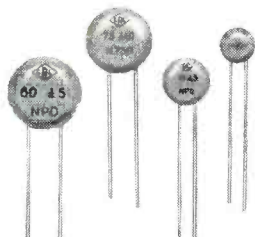

TC Discs



TV HI-VO-KAPS®

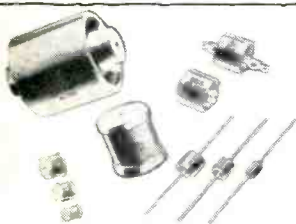

Transmitting
Capacitors



Tubular
Ceramic Trimmer

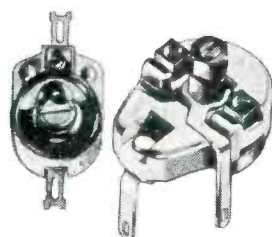

Ceramic Trimmers

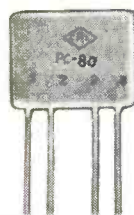

Midget Triode
Couplate (†)

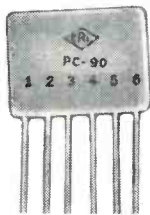

Pentode Couplates (†)

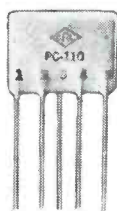

Filplate®
(by-pass & filter
application)

5 CERAMICS



Model III Ampec®
Miniature 3-stage
amplifier



Custom Ceramics
(Steatite, Centradite,
Zirconite.)



Metalized Ceramics

For Sale!

These and 100,001 other Centralab quality electronic components

WHETHER you buy electronic components in small lots or by the carload — no other single manufacturer can offer you such a *wide choice* in standard or special units. That's why Centralab is the industry's No. 1 electronic components source. Consider these facts:

- Centralab has pioneered more electronic "firsts" than any other manufacturer in the field.
- Introduced Printed Electronic Circuits — more than 30,000,000 in use, offering a new concept in reducing extra parts, time, errors and costs.
- Centralab ceramics are second to none — you can obtain grade L5 and L6 Steatite.
- You can count on the production facilities of *seven* conveniently located plants.
- Over 200 research and production engineers are constantly seeking to improve present CRL products.
- Unparalleled engineering assistance offered in the development of components for specific TV, FM, military and commercial electronic requirements.

You can rely on Centralab electronic components. Each is the result of more than 30 years' experience working in cooperation with manufacturers all over the world. For complete performance data on products shown — and engineering specifications — check information wanted and mail the coupon.

†Trademark

Centralab

A Division of Globe-Union Inc.
Milwaukee 1, Wisconsin
In Canada, Box 208, Ajax, Canada

Centralab, A Division of Globe-Union Inc.
914-L E. Keefe Ave., Milwaukee 1, Wis.

Please send me information on these Centralab products:

- Controls Switches Capacitors
 Printed Electronic Circuits Ceramics

Name.....Title.....

Company.....

Address.....

City.....Zone.....State.....

include WDHN-TV, New Brunswick, N. J.; WIP, Philadelphia; Stamford-Norwalk TV Corp., Stamford, Conn. and WELI, New Haven, Conn.

► **Plea** — The broadcasters state that uhf stations in vhf-served areas are confronted with “extremely serious economic problems . . . which seriously threaten the future development of the uhf band in the tv broadcast service.”

Stressing that the service they suggest should be supplemented to and not supplant existing “free” tv programming, the petitioners “envisage subscription tv service as an adjunct to the current system of tv broadcasting.”

They state that they will “support at a hearing an approach calling for a limited or regulated amount of subscription telecasting by any one station or in any one community, to preserve a proper balance between “free” tv and subscription tv.”

The petition concludes by pointing out that subscription tv operated a limited number of hours “would provide a sound economic basis upon which uhf broadcasters could rely for survival.”

New Markets in One-Way Signaling

Sleeper in the common carrier radio service is waking up and stretching across country

LIKE a mother-in-law’s lecture, one-way radio signaling has obvious disadvantages. But as presently used by businessmen, doctors and others, it has the advantages of simplicity, low cost and the ability to get many messages to many different subscribers in a short time. Its potential uses in police and similar services are tremendous.

► **Robot Announcer** — As employed by the pioneer company in New York City, one-way signaling uses a continuously operating transmitter that sends out a series of code numbers. The numbers are spoken by a robot machine into which they are fed by a telephone operator-secretary. Each subscriber is assigned a number. When a telephone call for Dr. Blank (245) is received, the operator-secretary takes the message and starts the robot announcing “245”.

Dr. Blank has a small radio receiver in his pocket. Every twenty minutes or half hour he listens for a few moments to see if he is being paged. When he hears his number, he goes to the nearest telephone and reports in, getting his message.

Over 600 subscribers in New York City pay \$12 a month for this service, which includes a receiver, maintenance and batteries. Systems in other cities may operate differently — some announce short messages.

► **National Potential**—Experts figure that for 1,000 subscribers in a system probably no more than 50 will require paging at any one time. This means that the listener will hear his call repeated at intervals not longer than a minute apart. Since there are two radio channels available, two competing companies can furnish fast service for more than 2,000 subscribers in any one area.

FCC has already granted licenses for more than 40 transmitters throughout the country and has applications for about twice as many more. One applicant seeks outlets in 24 different communities.

With continuing improvements (like selective calling) the one-way system at a fraction of two-way cost is heading for a real boom.

Automatic Pilot for Automobiles

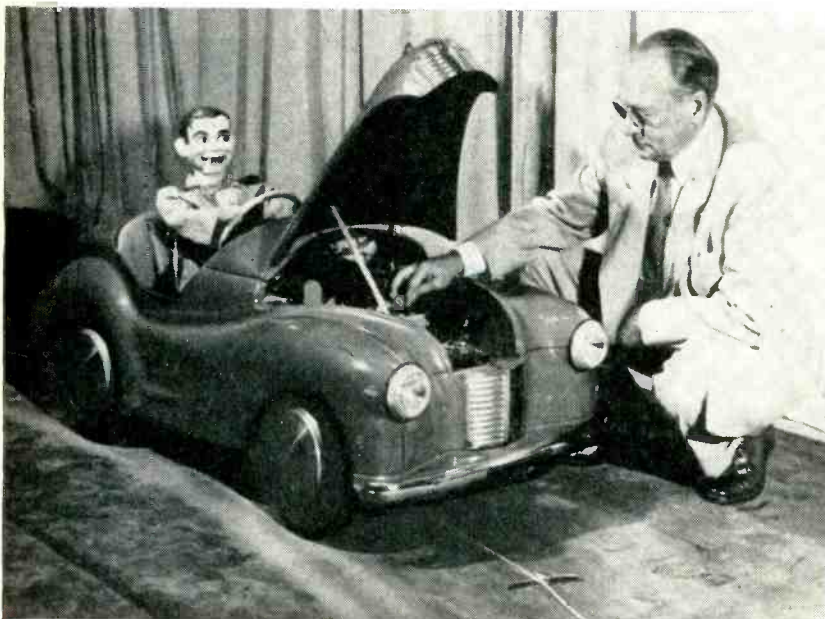

It steers itself over a prescribed route, stops when it approaches a metal obstacle, and turns out of its lane to pass a slower vehicle. The automatic automobiling system being adjusted by Dr. Zworykin of RCA is dependent on ultimate availability of transistors in tremendous quantities at a few cents apiece

Radio And TV Prices May Go Up

Wholesale tv price index has held firm but recent price increases portend a change

PRICES in the radio-tv industry have been very stable so far this year. As indicated by the wholesale price index, which refers to sales in quantities, not to prices of wholesalers or distributors, and represent the factory or first commercial transaction price for each

(Continued on page 16)

SHOCK - VIBRATION - NOISE ISOLATION NOTES

These **NEW** Product Bulletins give **YOU**
COMPLETE ENGINEERING DATA
on ALL-METL BARRYMOUNTS



Here's what's in them for YOU:

1. Transmissibility curves showing performance under test conditions of JAN-C-172A.
2. Curves showing reduction of transmitted acceleration and displacement.
3. Curves showing how changes in loading affect transmissibility at resonance and natural frequency for vertical motion.
4. Curves showing effect of high and low temperature on isolator performance.
5. Shock-characteristic data, including curves showing vibration isolation after 15g shock test.
6. Application data, including curves that show you how to choose isolators for unsymmetrical loads.
7. Dimensioned drawings of unit isolators, channel pairs, and mounting bases.
8. Detailed data on the construction, operating principle, and weights of mounts and bases.
9. A complete list of load ratings and catalog numbers for unit isolators, channel pairs, and bases.

These are the first really comprehensive bulletins on knitted-wire vibration isolators. To get your **FREE** copies, ask for Barry Product Bulletins 534 and 536. *And, if you have a special problem, count on getting the right answer from our Field Engineering Service.*

THE **BARRY** CORP.

707 PLEASANT ST., WATERTOWN 72, MASSACHUSETTS

SALES REPRESENTATIVES IN

Atlanta Baltimore Chicago Cleveland Dallas Dayton Detroit Los Angeles Minneapolis New York
Philadelphia Phoenix Rochester St. Louis San Francisco Seattle Toronto Washington

commodity, radio receiver prices are still below March levels and tv set prices have held firm for 4 months.

► **Rise**—Changes are in the wind and the stable price structure of March through June may be in for a revision. Philco announced in July upward price revisions of \$10 on 4 models due to increased manufacturing costs. Admiral also raised prices on some sets and at the same time increased dealer discounts blaming increasing production and material costs.

Not only set makers changed prices recently. The Carboly Department of GE has increased its permanent magnet prices an average of 10 percent and attributed the rise to increased labor costs in manufacturing.

► **Analysis**—According to John S. Meck, president of Scott Radio Laboratories, the cost of making tv sets has risen 21.8 percent since a year ago and the rise will be reflected in selling prices this fall. Base pay rates are up 3.5 percent and added expenses of improvement for fringe area reception and uhf increase that by at least 15 percent.

Parts prices have risen 8 percent and added costs of materials for improved stabilizing circuits have been about 10 percent, he said. Cabinet costs are up an average of 14.5 percent and engineering costs are about double. Merchandising costs also have risen because many of the new tv markets are small and remote.



PILOT being wired up will have his emotions and reactions recorded on the ground by way of uhf-radio telemetering system when . . .

Aviators Get More Remote Physicals

BECAUSE neither test pilots nor their expensive new craft are considered expendable, Navy medical men propose to tie tiny probes into radio telemetering systems so they can warn pilots of impending blackout.

► **Two-Bit Contacts**—Tiny silver electrodes fastened on the pilot's forehead, nape of his neck, shoulders and legs gather the small potentials from the body. Technicians have sometimes used a twenty-five-cent piece for an electrode.

Amplifiers and a uhf transmitter weighing about 40 pounds convert impulses to radio signals that are recorded on the ground. Tests carried out so far have allowed doctors to check out a pilot as far as 60 miles away. Because of the earth's curvature a pilot at 10,000 feet could be observed 150 miles away, according to theory. At 100,000 feet, the medics could watch from 400 miles.

► **Seven Checkpoints**—Using the telemetering system, scientists have obtained rate of breathing and volume, skin temperature of

the body and extremities, body temperature, electrocardiograms of the heart including pulse rate and electroencephalograph readings of brain waves to show whether a pilot is nearing unconsciousness. Doctors now are working on means of obtaining blood pressure and the oxygen saturation of the blood.

The latter awaits development of a small vacuum-type photocell.

Some day they hope to be able to radio to the test pilot, "You're passing out. Switch on your reserve oxygen tank!" to save a plane and its precious freight.

FCC Denies WNYC Radio Lighting

NEW YORK CITY'S high-flown idea to save \$500,000 a year by turning street lights on and off with a signal from municipal broadcast station WNYC (ELECTRONICS, p 18, April 1953) crashed on the FCC rocks. Legalists who predicted the Commission would frown upon use of a broadcast station to transmit

(Continued on page 18)

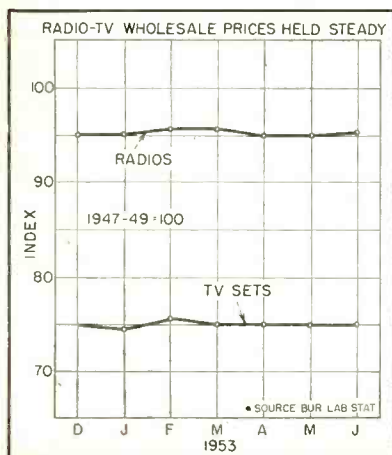



TYPE 1183-T

TV Station Monitor

- ★ Now In Use By Nearly Every TV Station
- ★ Standard Equipment with Transmitters of Such Leading Manufacturers as RCA, GE, DuMont
- ★ In Regular Production
- ★ Highest Stability
- ★ Less Than 0.1% Distortion For 25 kc Swing
- ★ Accurate, Visual and Aural Carrier-Frequency Indication
- ★ Reliable Modulation-Level Monitoring
- ★ Only Routine Maintenance
- ★ Convenient to Use

in T-V

Monitoring Equipment

The Type 1183-T T-V Station Monitor is in regular production—deliveries current to meet "on the air" schedules. Price: from \$2830 to \$2905 depending on frequency bands.

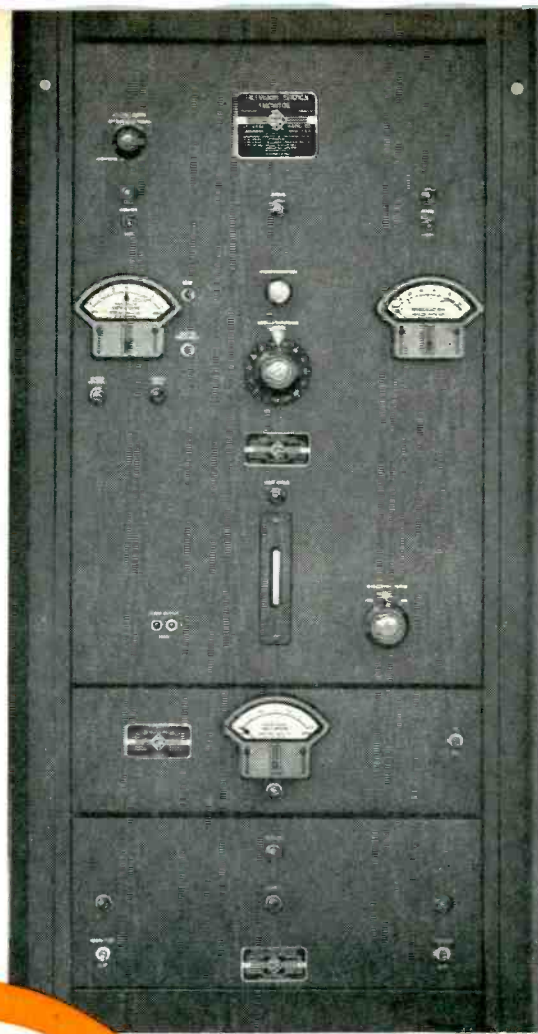

it's Dependability that Counts!

Since the beginning of broadcasting, G-R has pioneered in the design and manufacture of monitors of all types. Almost all of the 2424 Radio Broadcast Stations now on the air are equipped with G-R Monitors.

This experience has provided the necessary engineering and manufacturing background to anticipate all of the station needs for high quality, dependable, accurate and trouble-free T-V Monitors. Months of "post-freeze" operation in all of the leading v-h-f and u-h-f stations has proven the reliability, accuracy and convenience of the new G-R Monitor.



Large-scale illuminated meter continuously indicates frequency deviation of aural transmitter in terms of highly stable crystal oscillator. Zero correction for crystal oscillator easily accessible from panel, to compensate for long-time drift.



Visual transmitter frequency deviation is continuously indicated by this large scale meter, in terms of the same master crystal.

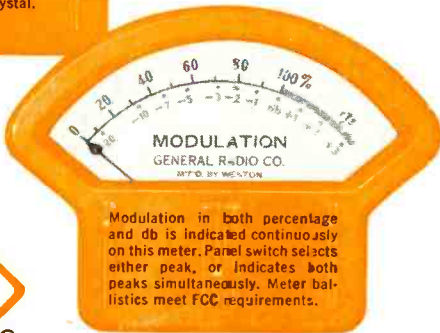

Modulation in both percentage and db is indicated continuously on this meter. Panel switch selects either peak, or indicates both peaks simultaneously. Meter ballistics meet FCC requirements.

- ★ Two large-scale, illuminated meters continuously indicate frequency deviation of aural and video transmitters in terms of a highly stable crystal oscillator. Modulation in both percentage and db is shown on another meter; panel switch selects either peak, or indicates both peaks simultaneously
- ★ High Stability Visual Monitor ≈ 500 cycles
Aural Monitor ≈ 1000 cycles

On all VHF channels, the above accuracy is guaranteed for at least thirty days — at the lower UHF frequencies (channel 14), the period is over sixteen days — on channel 83, the period is ten days or more

- ★ High-fidelity audio output for distortion and noise-level measurements, and for audio monitoring — residual noise level is down 70 db or better for 25 kc deviation
- ★ Overmodulation alarm for aural transmitter — lamp flashes when modulation exceeds predetermined level set by dial
- ★ Sensitivity for both Aural and Visual inputs. High Impedance Input (VHF) — 1 volt or better. Low Impedance (UHF) — 500 mw or less
- ★ Excellent signal-to-noise ratio through channel 83
- ★ Separate heater inputs allow direct connection of crystal oven to station standby power
- ★ Pilot lamp indicates adequate r-f input level
- ★ Terminals are provided for connecting remote center-frequency and modulation meters and over-modulation indicators
- ★ Counter-type discriminator has excellent linearity over ≈ 100 kc range — overall distortion is less than 0.1%, insuring accurate distortion measurements and center-frequency indications even under heavy modulation
- ★ New cabinet arranged for maximum heat dissipation and easy installation or removal for servicing



GENERAL RADIO Company

275 Massachusetts Avenue, Cambridge 39, Massachusetts, U. S. A.
80 West St., NEW YORK 6 920 S. Michigan Ave. CHICAGO 5 1000 B. Seward St. LOS ANGELES 38

Admittance Meters ★ Coaxial Elements ★ Decade Capacitors
Decade Inductors ★ Decade Resistors ★ Distortion Meters
Frequency Meters ★ Frequency Standards ★ Geiger Counters
Impedance Bridges ★ Modulation Meters ★ Oscillators
Variacs ★ Light Meters ★ Megohmmeters ★ Motor Controls
Noise Meters ★ Null Detectors ★ Precision Capacitors
Pulse Generators ★ Signal Generators ★ Vibration Meters ★ Stroboscopes ★ Wave Filters
J-H-F Measuring Equipment ★ V-T Voltmeters ★ Wave Analyzers ★ Polariscopes

nonbroadcast signals were con-founded when the denial was based instead squarely upon Conelrad.

► **Signal Interruption** — Basis of the New York proposal was that power of WNYC would be increased momentarily and the carrier interrupted for seven-tenths of a second to extinguish street lights. "No good," said FCC, "because the Conelrad (denying navigational information to enemy fliers) system contemplates using every broadcast

station to alert the public. Each station interrupts carrier twice, transmits a 1-kc tone and then either leaves the air or changes frequency."

► **Jammers**—Although New York City engineers had considered the problem only to dismiss it as improbable, the Commission felt that enemy agents would be sufficiently energetic to build a jammer or two and control street lights any way they wanted.

cutting off any non-business service functions, four divisions of the National Bureau of Standards working chiefly on military electronics research and development will be transferred to the Department of Defense.

The divisions will go under Defense management within the next month or two, but will remain temporarily at NBS Laboratories in Mid-Washington, D. C. and at Corona, California. Later, personnel and equipment will be transferred to Defense labs. The Corona Laboratories, housing Division 15 (missile development) may be assigned to the Navy for supervision.

Rail Electronics Bill Approved

A BILL giving the Interstate Commerce Commission the authority to order railroads to install electronic safety equipment has been passed by the Senate and is awaiting action by the House of Representatives.

In addition to ordering installation, the new bill would make it possible for the ICC to require railroads to establish rules and regulations for proper maintenance and use of the electronic equipment.

At the present time the ICC can order installation of block signal systems, automatic train stops and similar devices, but has no power to require installation or use of electronic devices and radio communications systems.

► **Need for Control**—Although the graph indicates that an increasing number of railroads have been installing radio equipment, the Senate commerce committee reported that there are still too many railroads not equipped with the latest and most effective safety devices.

"In terms of economic benefits alone, it seems to this committee that the railroads have a great deal to gain through early installation and proper maintenance of advanced electronic safety devices and systems. Why so many of our railroads have lagged behind in this field, when a large number of their colleagues have demonstrated the benefits involved, has proved an unsettling puzzle to this committee."

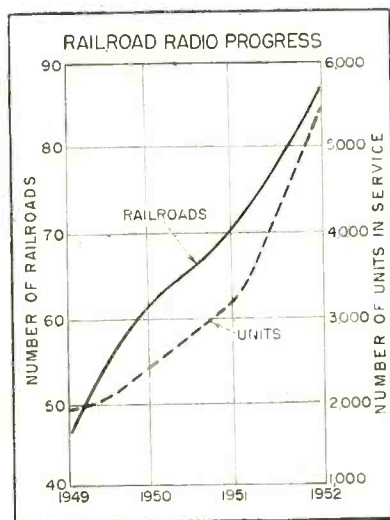

► **FCC Regulation**—In obtaining the right to order use of rail radio equipment, the ICC will not interfere with the FCC's control of radio licensing. A railroad ordered to install radio equipment would have to apply to the FCC in the usual manner, with the FCC retaining the power to reject any application that it does not consider to be in the public interest.

NBS Electronics Work Transferred To Defense

IN LINE with Secretary of Commerce Weeks' intentions of making Commerce Department bureaus function strictly for business and

► **Why**—Transfer of the four divisions, employing about 1,600 scientists and technicians, is seen as recognition of the fact that NBS was doing work it had not been set up to do. In the past few years more than half of its \$50 million annual budget was going into research and development work. The money was transferred from the Defense Department.

NBS will return with increased emphasis, according to Secretary Weeks, to functions for which it was originally created, keeper of the nation's Standards of Weights and Measures and related work on physical constants.

The transfer was agreed upon by Secretary Weeks and Defense Secretary Wilson after a recommendation made by a special committee appointed by Weeks and headed by M. J. Kelly, president of Bell Telephone Laboratories (ELECTRONICS, June, 1953, p 342).

Financial Roundup

PROFIT REPORTS for the first six months of 1953 by companies in the electronics field indicate that business has been twice as good this year as it was in 1952 for many firms and nearly all companies have experienced a healthy increase in profits. A compilation of the net incomes of 21 radio, tv and electrical equipment corporations by the National City Bank of New

(Continued on page 20)

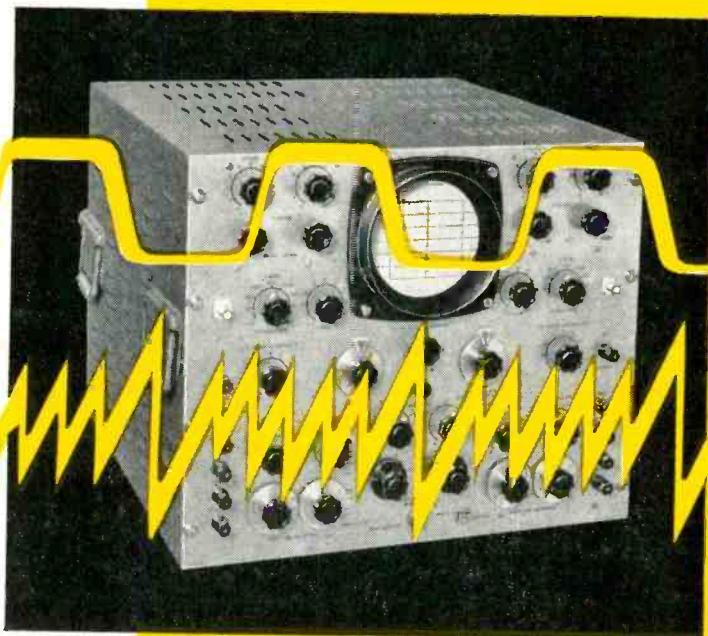

NEW *Dual Beam Scope* DC to 10 mc

From telemetering to radar . . . from stress analysis to brain studies . . . from ballistics to seismology. These are but a few of the fields for which this scope opens new horizons of exploration. It's the H-25, permitting you to compare and measure—easily and accurately—two simul-scope* signals on a single cathode ray tube, with a greater combination of features than has ever been commercially available.

Latest in the ETC line of multi-channel scopes, the H-25 now offers unusually high frequency response—DC to 10mc—with high sensitivity. High speed transients are displayed through two independent and continuously variable sweep generators. A delayed trigger permits the second sweep to give an expanded display of any part of the first. Advanced design adds direct coupling. And ALL at moderate cost!

If you are an electronic engineer, you'll find it worthwhile investigating this new scientific tool. Write, wire, or phone today for complete details.

*Simul-scope—Two or more simultaneous events which can be observed on a cathode ray tube. (Reg. Applied For.)



electronic tube corporation

1200 E. MERMAID LANE

PHILADELPHIA 18, PA.

SPECIFICATIONS

CATHODE RAY TUBE

Type: ETC Type 52REP1, 5" flat-face, dual gun. Other commercial phosphors available.

Accelerating Potential: 6000V.

Illuminated Graticule: With variable intensity.

VERTICAL AMPLIFIERS

Frequency Range: 0 to 10mc, approximately 0.3 V/in. to 100V/in. PP. 5 cycle to 10mc approximately .07V/in. to 100V/in. PP.

Rise Time: (10% to 90%) .05 μ sec.

Attenuator: Multiplier with steps of 1X, 10X, 100X, 1000X; continuously variable between steps.

Input Impedance: 1 megohm shunted by 40mmf.

Maximum Undistorted Deflection: 3 inches peak to peak.

Signal Delay: Provides .25 μ sec. delay. Permits observation of the waveform which triggers sweep.

HORIZONTAL AMPLIFIERS

Frequency Range: 0 to 500kc \pm 3db PP.

Synchronization: Internal, external, line, or delay.

Signal Delay: A sweep "B" delayed trigger is available from any part of sweep "A."

Time Base: Separate or common.

Sawtooth Signal Output: Available for both sweeps at terminals on front panel.

Positive Gate: Output available on front panel.

Z AXIS

Input Coupling: Capacitive to cathode of cathode ray tube.

Time Constant: 0.01 sec.

CALIBRATOR

Wave Shape: 60 cycle square wave.

Voltage: 0 to 0.5 volts. Peak continuously variable.

POWER SUPPLY

Power supply is separate, connected by 6 ft. armored cable.

ACCESSORIES

2 high impedance probes provided.

York for the first half of this year shows that net profits have increased 31 percent over the same period last year. For the second quarter only, net income for these companies increased 43 percent over 1952 second quarter results.

► **Net Profits**—Reports from 24 firms showed the following profit picture:

Company	Net Profit—6 Months	
	1953	1952
Admiral	\$4,762,152	\$2,523,355
AMF	2,151,000	1,739,000
AT&T (12m)	388,580,000	339,970,854
Consolidated		
Eng.	365,983	262,615
Cornell-Dubilier (9 m)	1,258,353	1,105,743
General Cable	2,971,347	2,469,954
GE	75,417,000	57,119,000
Hallcrafters (9 m)	153,333	826,282
Hoffman	697,320	598,692
W. L. Maxson (9 m)	646,194	329,936
Minn. M. & M.	9,056,111	7,486,720
Motorola	4,640,679	3,129,704
Nat. Union Radio	334,844	(loss) 34,963
Philco	6,900,000	4,289,000
RCA	18,185,228	11,299,930
Radioactive Prod. (12 m)	10,800 (loss)	(loss) 18,036
Raytheon (12 m)	3,859,000	2,047,000
Scott Radio	65,556	117,335
Stewart-Warner	2,143,064	1,809,578
Sylvania	5,169,092	3,398,776
Telecomputing	26,600	38,400
Trav-Ler Radio	468,607	37,708
Tung-Sol	1,015,355	889,843
Westinghouse	35,660,000	31,507,000

► **Loans** — General Precision Equipment concluded a \$15-million V loan revolving credit guaranteed by the USAF. It is designed to replace use of banks to finance defense business.

RCA completed a \$50-million credit with a group of institutional investors by selling \$10 million of 3½ percent promissory notes due May 1, 1977. Proceeds are for financing an expanded volume of defense business.

F-M System Keeps Work Crews in Touch

A SEVENTY-SEVEN unit, two-way f-m communication system now in operation in the Department of Public Works of Nassau County, N. Y., is proving useful in keeping field engineers, survey groups, and road repair crews in contact with each other and with the central office. Put into operation at the end of July, the system also proved

its worth for emergencies on the first day, when it was used to bring rescuers to five people stranded on a grounded cabin cruiser.

► **Equipment**—Installed and maintained by the New York Telephone Co., on an \$88,000 five-year contract, the system has two fixed stations and seventy-five mobile units. A 250-watt transmitter with seven remote control stations at the county office of the department, and a 50-watt unit at the sewage-disposal plant are the centers of operation. Two mobile units are in-

stalled in boats used for mosquito control work, and the other seventy-three units are in engineers cars and repair and emergency vehicles. All mobile units are rated 30 watts.

► **Sewage Power**—During failure of the local power supply, the 60-watt transmitter can be operated from a standby generator powered by gases that are a byproduct of the sewage disposal process.

The system will find value in directing emergency crews in the repair of storm damages, and is expected to be an important aid in speeding snow removal.

Recreation Dollars Go Mostly For TV

Radio-tv claimed the largest share of personal consumption expenditures for entertainment

SALES managers of tv manufacturers have long preached that to sell sets you must sell the customer on the benefits of entertainment and recreation that ownership brings. Success of this approach is seen in the breakdown of personal consumption expenditures for recreation made in the U. S. in the past four years as compiled by the Department of Commerce.

As shown in the chart, expenditures for tv sets have represented the largest investment by the U. S. public for recreation in every year since 1949. Last year, along with repairs, it accounted for 24 percent of the \$2.8 billion spent for recreation, leading expenditures for movies and professional sports attendance by \$1.2 billion.

Personal consumption expenditures are broken down into 12 groups ranging from food and tobacco to foreign travel and remittances. Total money spent in all groups last year was over \$218 billion. Recreation expenditures accounted for about 5 percent or \$11.7 billion of the total, the largest amount in the past four years.

► **Competition**—Movie makers and

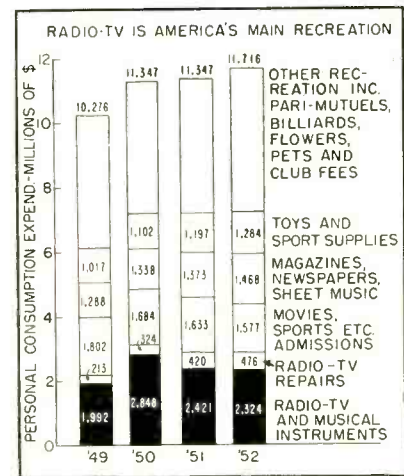

sports promoters have noted the effects of tv on their business right from the beginning. But both tv and movies have had a smaller share of personal expenditures for recreation since 1950. Movie and sports admission expenditures declined from \$1.6 billion in 1950 to \$1.5 billion in 1952. Television dropped from \$2.8 to \$2.3 billion in the two-year period. Decrease in set prices during that time may account for the lower dollar figure.

► **Reading**—Of the types of products on which personal consumption expenditures were made, mag-

(Continued on page 22)

Every single one of 'em relies on

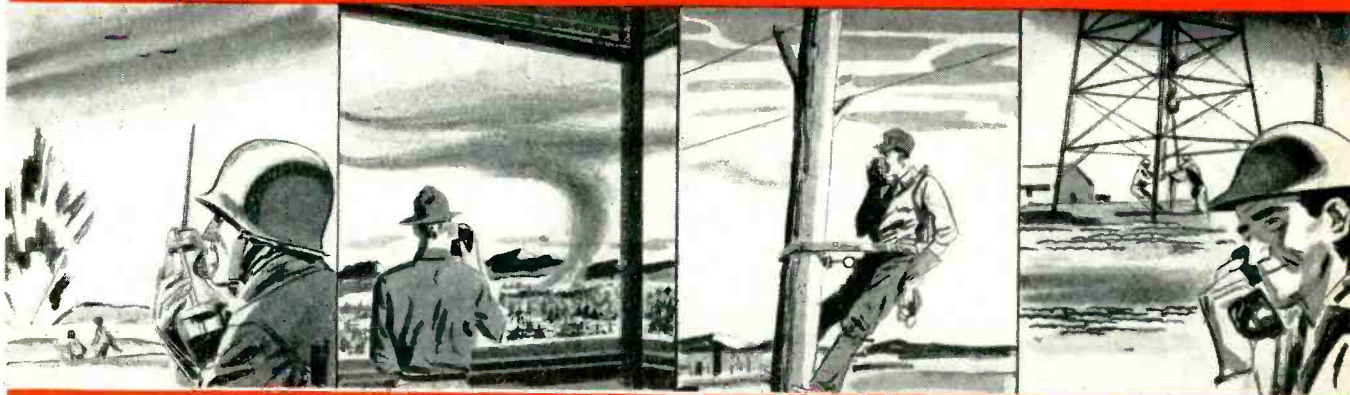

All the Portable Transmitter-Receiver Units, Military and Commercial, Employ RAYTHEON Filamentary Subminiature Tubes for

- low battery power
- constantly dependable performance
- extreme durability for rough service
- maximum compactness — flat for better packing
- uniform quality and availability

Raytheon has unsurpassed engineering and production resources for the making of Subminiatures — has made millions of them over the past fifteen years.

Raytheon Filamentary Subminiatures will be found in all the major manufacturers' portable units, among them:

BENDIX
 CLARK
 GENERAL ELECTRIC
 HALLICRAFTERS
 INDUSTRIAL RADIO

LINK
 MOTOROLA
 RADIO SPECIALTIES
 U. S. AIR FORCE AN/URC-4
 U. S. ARMY AN/PRC-6, 8, 9 and 10

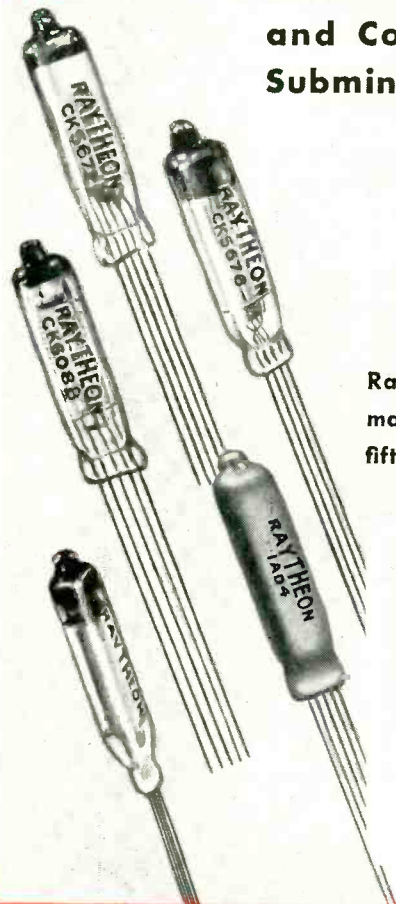

RAYTHEON MANUFACTURING COMPANY

Excellence in Electronics

Receiving Tube Division — for application information call

Newton, Mass. Bigelow 4-7500 • Chicago, Ill. NATIONAL 2-2770 • New York, N. Y. Whitehall 3-4980 • Los Angeles, Calif. Richmond 7-3524

RAYTHEON MAKES ALL THESE:

RELIABLE SUBMINIATURE AND MINIATURE TUBES • GERMANIUM DIODES AND TRANSISTORS • NUCLEONIC TUBES • MICROWAVE TUBES • RECEIVING AND PICTURE TUBES

azines and toys are the only two major categories (over \$1 billion) that have steadily increased since 1949. They seem to take up the slack left by the declines in tv and movie spending. Perhaps tv, with its horse operas and puppet shows for children, has been responsible for the increase in toy purchases.

Industry's Labor Force Keeps Growing

Number employed increases by 60,000 yearly, nears half million for 1953

COMMUNICATIONS equipment manufacturers employed about 465,000 people last year, 50,000 more than were part of the business in 1951. Since 1949, a total of 185,600 additional workers have joined companies in the field, according to the Department of Labor, for an increase of approximately 60,000 employees each year.

► **Breakdown**—Production workers last year accounted for 75.4 percent of the total number of people employed. But the number of production workers as a percentage of total industry employees has declined since 1949 when 78 percent of the workforce represented production workers. The remainder are engaged in executive, purchasing, finance, professional and technical, sales, and advertising functions.

So far this year, employment seems to follow past trends. The number of production workers has increased but not as fast as total personnel. If the past annual in-

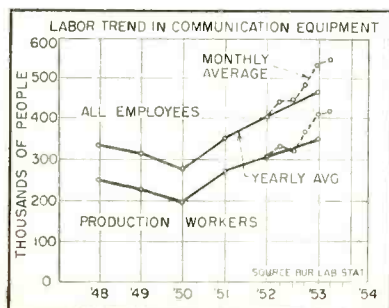

Which Twin-Screw Is the Phony?

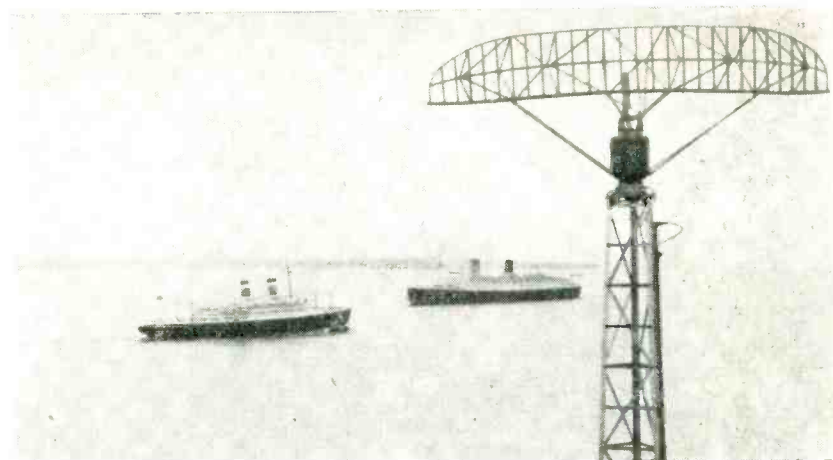

In darkness or fog, the port control operator sees these ships on his radar scope almost as clearly as by eye in bright day light. But which radar blip is he talking to on his radiotelephone? Precious seconds or minutes may be lost as he tracks the proper blip to correlate radar and radio. A special committee of Radio Technical Commission for Marine Services has just released requirements for an identification device, development models of which are undergoing tests at Long Beach, Calif. and on the Great Lakes. Picture was taken from New York Port Authority experimental station, now closed

crement of 60,000 additional workers continues this year, the industry's workforce for 1953 will total over a half million people.

► **Investment**—Additional workers do not only mean additional payroll costs. According to the National Association of Manufacturers, the national average investment per job is \$12,000. This may be high for the electronics industry where in many cases the only equipment used is a soldering iron. But even at half that cost, an annual increase of 60,000 workers could mean that the communications equipment industry must invest \$360 million a year.

Radio In Oil Industry Shows Sharp Upswing

Mobile vhf radio expands as microwave retrenches, radiolocation a new field

SECOND largest industrial user of radio communications facilities, the petroleum industry continued its rapid adoption of electronic

equipment during the past year ending June 30, 1953.

► **Mobile Radio**—Greatest expansion was in the field of vhf mobile radio. Oilmen have found radios in cars and trucks valuable throughout their whole range of operations. Radio links exploration parties, drilling crews, pipeline maintenance men and even finds uses in distribution and marketing.

Transmitters in the petroleum service now total 22,000 with authorizations granted to 600 users. This does not tell the whole story, however, since many transmitters used by the oil industry, especially mobile units, are licensed in other services such as the marine, aviation and highway truck services.

► **Radiolocation**—Off-shore geophysical exploration in the Gulf of Mexico has brought a new radio service into being. The industrial radiolocation service provides an extremely accurate form of electronic navigation essential for prospecting ships. The service shares the 1,750-1,800-kc band with the disaster communications

(Continued on page 24)

The Finest Signal Generator Of Its Kind

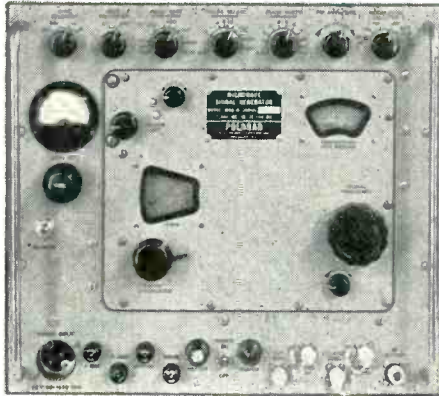

**POLARAD'S MODEL MSG-4
IS A MASTERFUL
COMBINATION OF
ACCURACY—SIMPLICITY—
LONGTIME RELIABILITY**

FEATURES:

One dial control
Temperature compensated
Klystron tube
Accurate stable power measurement
Oscillator cavity employs non-
contacting choke—Long life
Military ruggedness

SPECIFICATIONS:

Frequency Range—
7000 to 10,750 mc/sec
Frequency Accuracy—1%
Power Output—0.2 mw
Attenuator Range—120 db
Output Impedance—50 ohms
Internal Pulse Modulation
Pulse Width—
0.5 to 10 microseconds
Delay—3 to 300 microseconds
Rate—
40 to 4000 pulses per second
Synchronization—Internal or
external, sine wave or pulse
Internal FM
Frequency Deviation—
+ 6 mc/sec minimum
Rate—40 to 4000 cps
Synchronization—Internal or
external, sine wave or pulse
External Pulse Modulation
Polarity—Positive or Negative
Rate—40 to 4000 pps
Pulse Width—
0.5 to 2500 microseconds
Output Synchronizing Pulses
Polarity—Positive, Delayed
and Undelayed
Rate—40 to 4000 pps
Voltage—Greater than 25 volts
Rise Time—Less than 1 us
Tube Complement—
6B2-2; 5R4WGY-4; 6AK6-3;
6AS7G-1; 6AU6-5; 6X4W-2;
12AT7-13; 807-3; 5651-5; 5721-1.
Power Input—
105-125 volts, 50/1000 cps
Size—17" x 15" x 19 1/2"
Weight—90 lbs.

An unusually accurate and reliable laboratory tool, the Model MSG-4 is invaluable in the completion of complex microwave engineering tests.

In the factory, its simplicity of operation eliminates the need of microwave specialists at a time when highest quality must be maintained and economy is essential. Result: Exacting specifications are quickly verified and there are fewer rejects... faster shipments... more satisfied customers.

In the field, the military ruggedness of this versatile Signal Generator makes it possible to conduct vital tests under the most adverse conditions with laboratory accuracy.

For long lasting reliability, exceptional accuracy and simplicity of operation—the Polarad Model MSG-4 is unsurpassed for use in factory, field or laboratory. For further details contact your nearest Polarad representative or write us direct.



POLARAD ELECTRONICS CORPORATION

100 Metropolitan Avenue, Brooklyn 11, N.Y.

REPRESENTATIVES: Albuquerque • Atlanta • Boston • Chicago • Cleveland
Fort Worth • Kansas City • Los Angeles • New York
Ontario • Philadelphia • San Francisco • Seattle • Syracuse

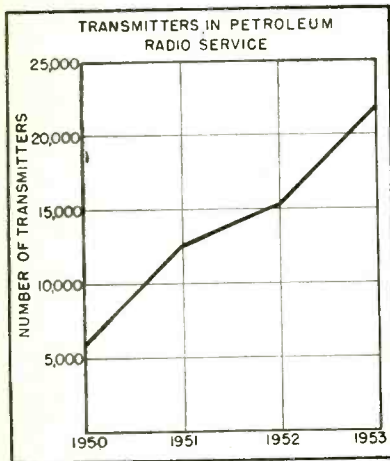

service. Other frequencies are available for this service in the uhf and shf bands.

► **Microwave**—The boom in point-to-point communications that made the pipeline industry the largest industrial user of microwave equipment tapered off during the past year. Users meanwhile occupied themselves with finding additional applications for their expensive systems.

Most of the microwave equipment in the pipeline industry is still used for telephone and teleprinter communications between pumping stations, meter stations and terminals. However, experiments have been carried on using microwave for facsimile, supervisory control, telemetering and remote control.

Commercial Trend Ups Ham Transmitter Sales

Home-designed equipment becomes more and more extinct as resale values drop

THIRTY years ago, radio amateurs were forced to build practically all their own equipment. Ten years ago, the amateur with a homemade receiver was either a fanatic or a bachelor. Today, the amateur with a 100-percent commercial station is commonplace, and the number of such stations is steadily increasing.

Manufacturers' analyses of potential markets for amateur transmitters indicate a steadily increasing number of sales—at least for the next two years. These estimates include sales of amateur-type equipment to non-amateur users, such as civil defense and industrial organizations throughout the world. Several foreign governments are using unaltered amateur equipment for important military and civil communications links.

► **What Happened?**—Largely responsible for the growing popularity of commercial equipment is the low trade-in value of home-designed gear, regardless of age and quality of workmanship and components. In contrast, many amateurs now trade in their old equipment as each new model comes out.

Utilities Group Installs Microwave Network

RESURGENT interest in private microwave communications is evidenced as the Middle South Utilities group begins construction of its 490-mile relay network. One of the largest nongovernment microwave networks in the power utilities field, the system will link electric power generating and distributing facilities in Arkansas, Louisiana and Mississippi (see *Power Companies Go Microwave, ELECTRONICS, Industry Report, p 8, Sept. 1952*).

The system will comprise 16 repeaters and 4 terminals. Total cost will exceed \$500,000. Contracts have been awarded to Motorola and Electronics, Inc.

Twenty-four channel equipment will be installed with initial channel utilization plans calling for private line, party line, teleprinter, telemetering, supervisory control and mobile radio control circuits. Supervisory control via microwave with powerline carrier interconnections will provide remote control of more than 40 unattended substations. The system is scheduled to

be in operation before the end of 1953.

► **Fire Communications** — An extensive microwave communications system to link outlying fire stations and fire-alarm headquarters is under study in Phoenix, Ariz. It is estimated that the microwave system will cost \$150,000 as compared with \$703,000 for a corresponding system of cables. The New York fire department is at present operating a one-hop microwave link as part of its communications system.

Jeep-Maker Building TV Station Equipment

Willys Motors, second Kaiser interest engaged in electronics, readies transmitter

ELECTRONICS division of Willys Motors has entered the tv equipment manufacturing business. Acquired by Kaiser Manufacturing last April, the company is the second firm in the Kaiser fold engaged in electronics. Just last year, Kaiser Corp. invested in Sanders Associates, makers of components in New Hampshire.

Willys proposes to supply a complete tv package to station holders in areas of 50,000 population or less where high-powered signals are not received. It will consist of a 1,000-watt transmitter operating from 450 to 900 mc, camera, projector, console, panel and other equipment. A prototype of the new transmitter is now in production and the company hopes to submit it to the FCC for approval late in September. If approved, the first transmitter delivery will go to WCEN in Mount Pleasant, Mich.

The company is also working with the National Association of Educational Broadcasters to develop a transmitter that meets requirements of educational tv systems.

► **Reason** — Raymond R. Rausch, executive vice-president and gen-

(Continued on page 26)



LET HERMASEAL HELP YOU WITH HEADER AND SEALED RELAY ASSEMBLY PROBLEMS!

Simple or complex, standard or special, Hermaseal makes them all, 2-electrode crystal holder bases, standard octal headers up to 18-terminal headers available in complete range of sizes, styles and patterns. Hermaseal can do the wiring and supply enclosures, with either dry air fill or vacuum-pumped and pressure-filled with dry nitrogen, for relays, transformers, choke coils, etc. Hermaseal hermetically sealed assemblies meet all specifications, are available in wide range of sizes and adaptations to meet specific requirements.



END CAPS FOR CONDENSERS FIVE STANDARD SIZES TO FIT MOST NEEDS!

When you need Tubular Button End Caps for condensers . . . end caps that must meet high quality standards . . . yet cost is a factor . . . and, you need them in a hurry . . . call on Hermaseal!

Hermaseal is a top specialist, a pioneer in hermetically sealed terminals, sealed headers and allied parts for the radio-electronics industry.



HERMASEAL GLASS SEAL TUBES HELP SPEED-UP ASSEMBLY!

You can save time, cut down on rejects because Hermaseal Seal Tubes have metallized ends for easy soldering to end caps. Hermaseal Seal tubes are available in a wide range of stock and special styles and sizes.



THE HERMASEAL COMPANY, INC.

ELKHART 10, INDIANA

eral manager of Willys said that surveys indicated it would be five years or more before some localities could obtain transmitting equipment unless additional manufacturing facilities were made available. He emphasized that the company has no intention of building radio transmission equipment.

Plans are to add 100 technicians to the electronics division.

Are Electronic Stock Prices Leveling Off?

END OF FIGHTING in Korea has caused electronic manufacturers and stockholders to watch the stock market closely. So far, observers have varied opinions of the direction electronic stock prices will take.

► **Prices**—Eleven stocks that make up the index shown below sold at prices from \$86 per share to \$6½ in 1952. In 1948, they ranged between \$35 and \$6½, showing, as the index does, that electronic stocks have increased considerably in price in the past five years. In July of 1953 prices for these stocks ranged from \$72 a share to \$11 per share.

► **Change** — Despite the glowing profit reports of companies in the electronics field for the first six months of 1953, some observers think that electronic stocks reached their high last December. Since then, prices have fallen more rapidly than the market in general.

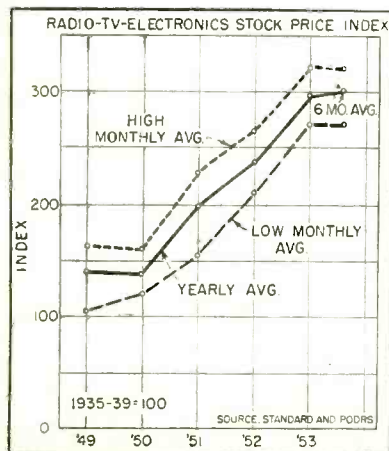

AUG. 29-SEPT. 6: West German Radio and Television Exhibition, Duesseldorf, Germany.

AUG. 31-SEPT. 1: National Science Foundation conference on Photoelectric Problems, Techniques and Instrumentation, Lowell Observatory, Flagstaff, Arizona.

SEPT. 1-3: International Sight and Sound Exposition, Palmer House, Chicago, Ill.

SEPT. 1-4: Pacific General Meeting, AIEE, Hotel Vancouver, Vancouver, B.C.

SEPT. 1-12: British 20th National Radio & Television Exhibition 1953, Earls Court, London, England.

SEPT. 14-16: Fourth Annual Convention and Manufacturer's Conference, NEDA, St. Louis, Mo.

SEPT. 21-25: Second Analytical Instrument Clinic, Chicago, Ill.

SEPT. 21-25: Eighth National Instrument Exhibit, Sherman Hotel, Chicago, Ill.

SEPT. 28-30: Ninth annual National Electronics Conference,

MEETINGS

Sherman Hotel, Chicago, Ill.
SEPT. 29-OCT. 1: AIEE Middle Eastern District Meeting, Daniel Boone Hotel, Charleston, W. Va.

OCT. 2-11: First Annual National Electronic Show, Santa Monica Pier, Santa Monica, Calif.

OCT. 5-8: Fall Technical Meeting sponsored by Canadian National Committee, URSI and IRE Antenna Group, Ottawa, Canada.

OCT. 13-15: National Conference On Tube Techniques sponsored by the Subpanel On Tube Techniques of the Department of Defense, Western Union Auditorium, New York, N. Y.

OCT. 20-22: Thirtieth Annual Session Of A.A.R. Communications Section, Hotel Plaza, San Antonio, Texas.

Nov. 9-12: Conference on Radio Meteorology, Austin, Texas.

Nov. 13, 14: Annual Electronics Conference, Hotel President Kansas City, Missouri.

Industry Shorts

► **Half-million** dollar electronic network analyzer that will enable utilities to determine the most practical and inexpensive way to expand their operations is being built for Syracuse University by GE.

► **Norwegian Broadcasting Corp.** has ordered tv equipment and hopes to start experimental service early next year. Regular programming is not expected for another two years.

► **May** production of tv receivers in the United Kingdom rose sharply to 90,000, compared to 81,000 in April and 91,000 in March. A provisional estimate for June output is 74,000. In 1952, tv production in March, April, May and June was 72,000; 65,000; 65,000 and 54,000.

► **Invention** of a radio capacitor made from sea sand from the Travancore coast of South India that contains 98 percent of pure titanium dioxide is claimed by re-

search scientists working in India's National Physical Laboratory in New Delhi.

► **Development** of a new magnetic decision element that may be superior to the transistor or vacuum tube in the 0-200 kc range, applicable to most weapon computers, was announced by Naval Ordnance Lab.

► **Official** Russian figures for the first half of 1953 indicate that sales of tv sets to individual consumers tripled compared to the same period in 1952.

► **Air** in new Grand Trunk coaches is heated and cooled through use of electronic thermostats that are eight times more sensitive than other types.

► **Nepszava** states that there were 887,000 radio subscribers in Hungary in 1952 compared to 383,000 in 1937. A total of 1,200,000 is expected by 1954.

In Westinghouse Picture Tubes

NEW PHOSPHOR GUN DESIGN

Create Brighter, Sharper Pictures

1 25% Brighter

An exclusive new Westinghouse screen phosphor now produces 25% more light output with the same beam current. Your sets can now give 25% brighter pictures with Westinghouse Reliatron Picture Tubes.



Chassis with ordinary new picture tube.



Chassis with new Westinghouse Picture Tube having 25% brighter phosphor. New phosphor is now found in all Westinghouse Reliatron Picture Tubes.

2 Improved Focus

Smaller spot size of new Westinghouse electron gun gives better picture definition, smaller snow particles in fringe areas, less blooming. Results in more sharply focused pictures in both primary and fringe areas.

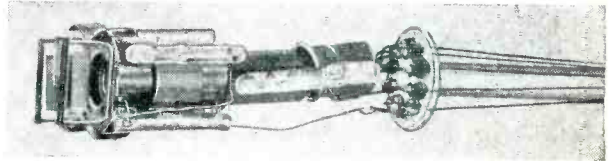

New Electrostatic Focus Gun. The first electrostatic focus gun which works well despite variation of operation voltage in receiver designs. Picture remains in focus despite variations in house voltage, despite variations in set components. Stabilizes focus through more precise shaping and control of electrostatic field.



Magnetic Focus Gun. Simple construction gives sharp focus, crisp picture, excellent reception in all areas.

Set Manufacturers:

- These improved design features
- 25% Brighter Phosphor
 - New Electrostatic Focus Gun
- are available in all popular picture tube types.

ET-95030

YOU CAN BE SURE...IF IT'S
Westinghouse

RELIATRON TUBES

TM

WESTINGHOUSE ELECTRIC CORPORATION, ELECTRONIC TUBE DIVISION, ELMIRA, N. Y.

for performance **ABOVE** and **BEYOND**
the usual standards . . .

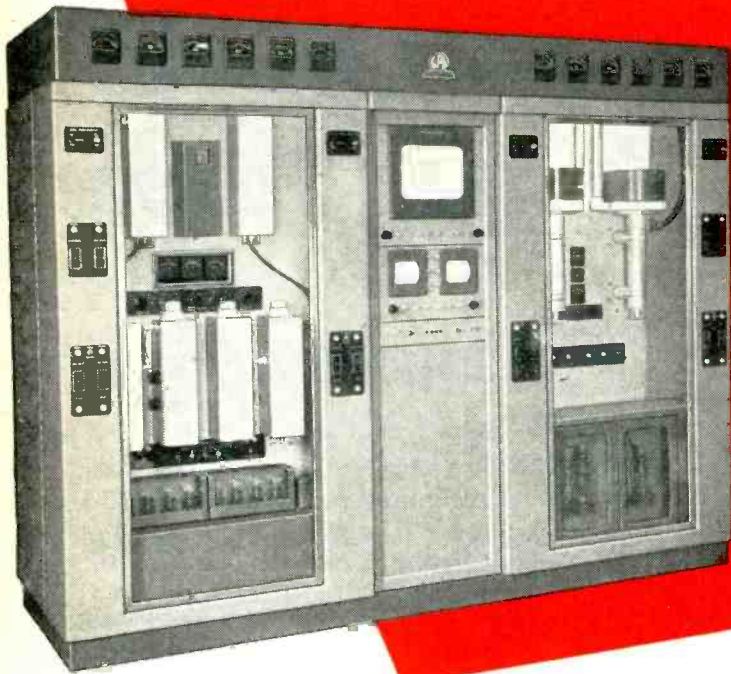

UHF-TV
TRANSMITTER

■ Precision-built by the makers of the world's most powerful transmitting equipment—for the Voice of America—the GPL-Continental TV Transmitter offers quality and construction superior to accepted standards of today.

Exclusive "Frequilock" feature provides aural-visual frequency control of $4.5 \text{ mc} \pm 500$ cycles or better, even as high as 890 mc. No more intercarrier buzz! In addition to the console unit there is ample rack space for picture and waveform monitors. Transmitter controls may also be operated from the rack. With simplified power and

control circuits, manual controls are minimized.

It is designed for compactness and maximum accessibility. In addition, it is housed in unit-construction, frameless type cabinet in which cabinet members serve not only as equipment mounting panels, but also as an efficient duct system through which cooling air is circulated.

This 1 KW transmitter is arranged for ready expansion to greater output, or the exciter only may be operated as a small community station with 250 watts output.

Write for full details on the GPL-Continental PA-714 1 KW Transmitter

"THE INDUSTRY'S LEADING LINE IN QUALITY, IN DESIGN"



Check these features of the *Continental* 1 KW UHF Transmitter

- Maximum accessibility
- Simplified power and control circuits.
- Completely air-cooled.
- Space-conserving cabinet design — Transview styling.
- May be operated without console — plenty of rack space (63") in centrally located panel on transmitter for picture and waveform monitors.
- Single output tube operation for each power amplifier.
- Built-in VSWR metering — continuous power measurement.
- Exciter is a 250-watt transmitter for all UHF channels.
- Complete flexibility for future power increase.
- Features Continental's new "Frequi-lock"—new development in frequency control provides aural-visual frequency control of $4.5 \text{ mc} \pm 500 \text{ cycles}$ or better, even as high as 890 mc. No more intercarrier Buzz.
- Delivery of immediate orders in December, 1953.

GPL MEETS EVERY STATION REQUIREMENT WITH EQUIPMENT OF SUPERIOR QUALITY AND UTILITY



CAMERA CHAINS — Extremely compact, readily portable, built for combined studio and field use. Choice of major networks for their top live programs. Exclusive remote control features provide pan, tilt, iris and lens change from 1000 feet away.



PA-100-A TV PROJECTOR — A truly professional 16 mm projector to meet the continuous-service, minimum maintenance requirements of economical film telecasting. Ruggedly built, it provides crisp, bright pictures as well as high fidelity sound. Sound frequency response flat to 7000 cycles. Sound flutter kept at less than 0.25%. Adjustable tone controls compensate for poor sound films.



VIDEO RECORDERS — A complete high-quality TV recording System which produces standard 16 mm 24 frames per second film. Images are reproduced in negative or positive on emulsion 7373 or 7302 or equivalent. Finest picture resolution, high quality recorded sound.

General Precision Laboratory

INCORPORATED
PLEASANTVILLE NEW YORK



Export Department:
13 East 40th St., New York City
Cable address: Arlab

Cable address: Prelab

TV Transmitters • TV Camera Chains • TV Film Chains • TV Field and Studio Equipment • Theatre TV Equipment

To Manufacturers of Electrical Apparatus, Appliances,



CHECK General

for

MAGNET

FORMVAR and PLAIN ENAMEL and



From the beginning of electrical equipment manufacture, General Cable plants have been a prime source of supply for all industry's requirements in magnet wire. Now, with batteries of new, ultra-modern, high-speed machines, General Cable is not only a mass producer but maintains quality control standards on a plane which has attracted wide attention.

The line of standard magnet wires includes shapes, types and sizes for every electrical device requirement and under every operating condition:

Formvar and other synthetic enamels, Plain Enamel, Nylon Enamel, with light, intermediate or heavy coatings.

Cotton, Paper, Silk, Nylon, Glass, and Special High Temperature Coverings with light, intermediate or heavy coatings (single and double wrappings, similar and dissimilar materials). Also bare and all types of enamel wire with all types of other coverings. Silicone and other types of bonding are also available.

Our engineers will be glad to assist you. Call on the nearest General Cable office for helpful service, detailed information and prompt delivery.

Other General Cable Products for Electrical Manufacturers include:

Apparatus, Transformer and Motor Leads — Paper, VC, or Plastic Insulated

Asbestos VC and all asbestos wires and cables

Automotive and Aircraft Wires and Cables

Battery and Starter Cables
General Purpose Wires
Ignition Wires and Cables

Electronic, Radio and TV Wires and Cables

Connection and Hook-up Wires
HF Coaxial Cables

Microphone Wires and Cables
TV Camera Cables

TV Lead-in Wire (UHF and HF)

Elevator Control Cables

Fixture Wire

Machine Tool Wiring

Oil Burner Cables

Reactor Cables

SAFETY m.i. WIRING SYSTEMS (Pyrotexax)[®]

SUPER SERVICE and low-cost welding cables.

SUPER SERVICE portable cords and cables

Underwriters cords of all types

Rubber and plastic insulated wires and cables — all types.

... and other types.

Tools . . .

1ST

Cable

WIRE

ALL OTHER INSULATIONS

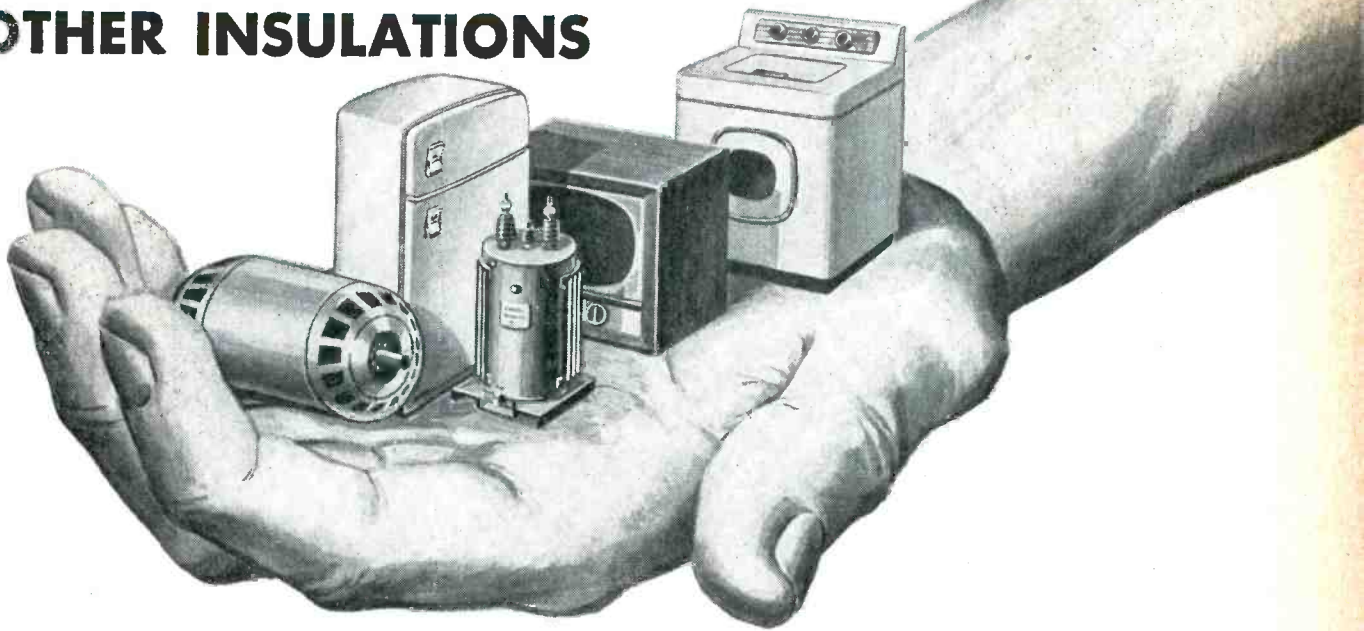

For Prompt, Dependable Information and Service Anywhere in the United States . . . General Cable maintains

21 Sales Offices

15 Resident Sales Representative Locations,

Over 600 Distributor Sales Locations

6 Regional Stock Distribution Points

6 Manufacturing Plants and Stocks

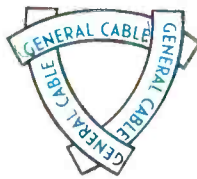
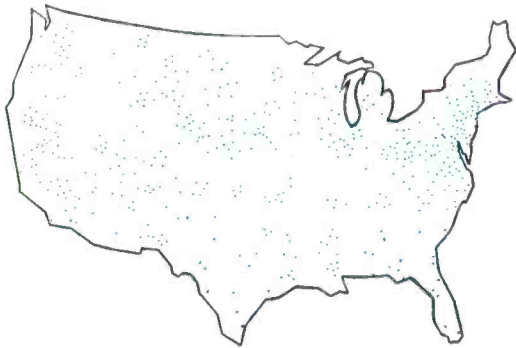

GENERAL CABLE

C O R P O R A T I O N

"More Power to You" 

Executive Offices: 420 Lexington Avenue, New York 17, N. Y. • Sales Offices in Principal Cities of the United States

DO YOU KNOW WHAT THIS IS ???

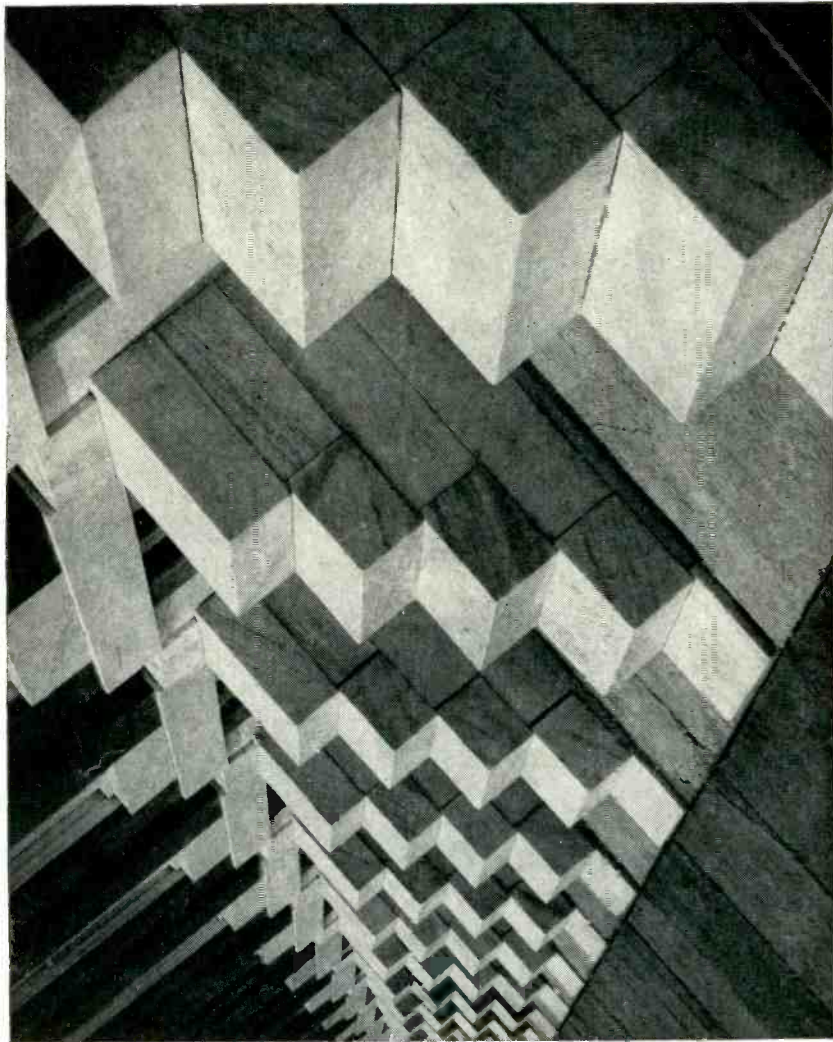

Photo from
"My Maryland"—
A. Aubrey Bodine

...AND WHAT IT MEANS TO YOUR FUTURE?

These are the traditional white marble steps* of Baltimore, photographed from an unusual angle. There are no unusual angles of employment with Westinghouse in Baltimore, since every opening is a step toward a well-planned future.

In your plans, be sure to include the Baltimore Divisions of Westinghouse. Here operations are deliberately keyed to a balance between civilian and military work, which means that continued peak production is a matter of policy, rather than chance.

Salaries are commensurate with training, experience and ability. In addition to a highly respected patent award plan, opportunities for advanced degrees and relocation expenses, Westinghouse offers all of the usual employee benefits, plus!

* Actually, most Baltimoreans now prefer to live in the spacious and attractive suburbs which surround the city.

Currently we have an opening for a:

TECHNICAL WRITER
ELECTRONIC CIRCUIT ENGINEER
TRANSFORMER DESIGN ENGINEER
AIRBORNE RADAR SYSTEMS ENGINEER
SERVO MECHANISM ENGINEER

... and other engineers who can complement our already fine organization.

To apply, send resume to—

R. M. SWISHER, Jr.

Employment Supervisor
DEPT. S-1

WESTINGHOUSE
ELECTRIC CORPORATION

109 West Lombard Street, Baltimore 1, Md.

If you are already employed at your highest skill in a defense industry, do not apply.

Edison

... First to make a successful
incandescent lamp

Thomas Alva Edison

1847-1931

One of the most prolific inventors of all time, this gifted American developed 1,033 patents during 50 years of continuous work. Among these was the "electric light," a carbonized cotton filament incandescent lamp, successful for the first time on Oct. 21, 1879. Edison died at 84, after receiving every honor a grateful world could bestow.

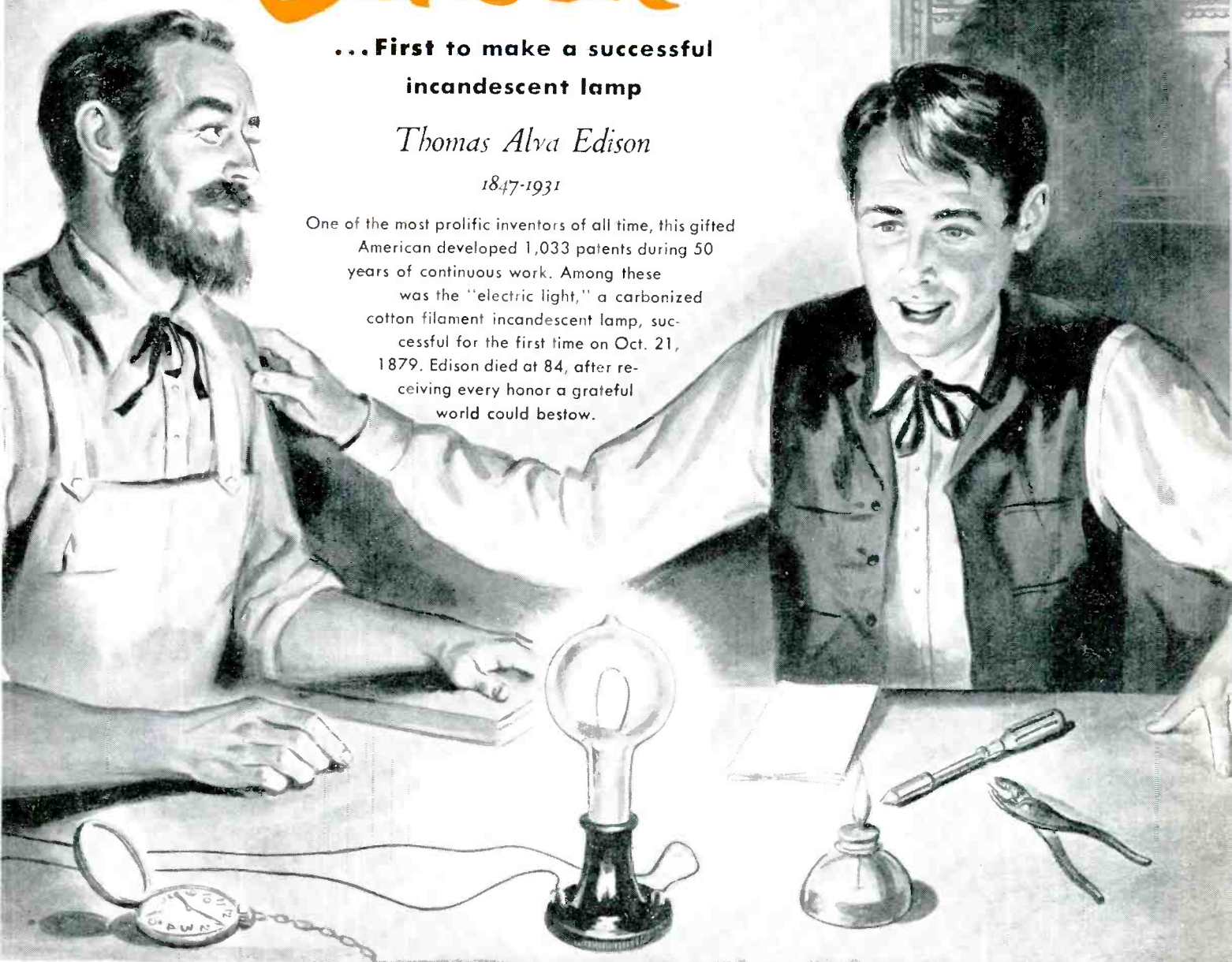

From an original drawing made for Ohmite

OHMITE®

... First in rheostats—today

Industry buys more Ohmite rheostats than any other make... and for good reason. Unmatched smoothness of operation and close, dependable control have made Ohmite rheostats the standard in their field. The special Ohmite design features insure unfailing dependability. Ten wattage sizes in a variety of types provide a wide range to suit your every need. You can specify Ohmite... with the confidence that comes in knowing you use the best.

Be Right with OHMITE

RHEOSTATS • RESISTORS • TAP SWITCHES



What Special Feature do you need in a RHEOSTAT?

OHMITE CAN SUPPLY IT!

In addition to standard rheostats, Ohmite offers rheostats with a wide variety of *special features*. All have the distinctive Ohmite design features: smoothly gliding metal-graphite brush; all-ceramic construction; insulated shaft and mounting; windings permanently locked in place by vitreous enamel.

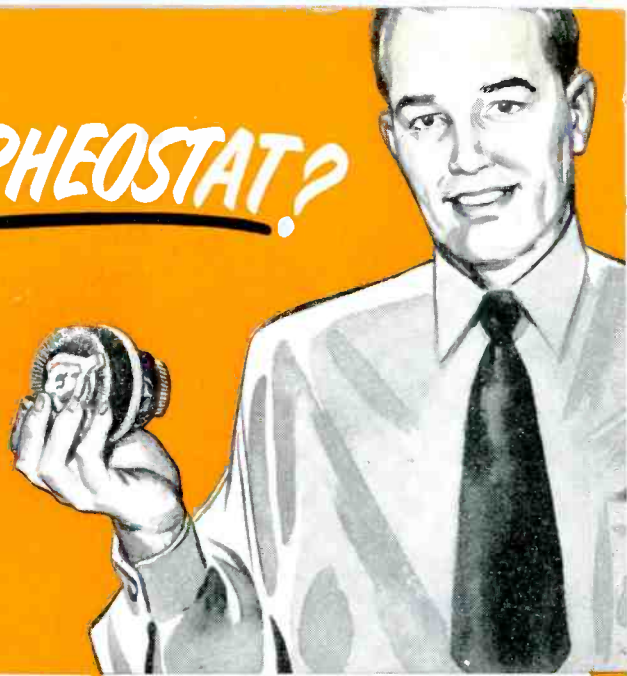

BUSHINGS FOR SPECIAL PANEL THICKNESS



Extra-long bushings and shafts allow mounting on panels up to 2 inches in thickness. Seven bushing lengths are available, from 1/4 to 2 1/8 inches.

360° WINDING

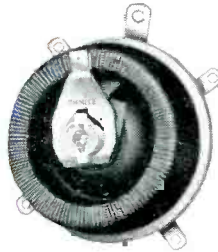

Two small models available with continuous circular core and endless winding. Unlimited rotation of shaft and contact arm. Taps supplied at any desired angle on windings.

DEAD LUG OFF POSITION

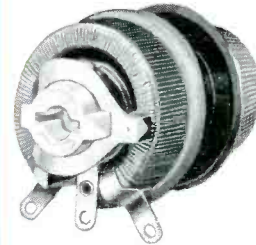

Opens the circuit at the high or low resistance position as the contact passes on to the lug, which is disconnected from the winding. Recommended for light duty.

SCREW DRIVER SLOT SHAFT



Where infrequent adjustments are needed, shaft ends can be slotted for operation with a screwdriver. Tampering with the shaft setting is thus minimized.

SEALED, ENCLOSED CAGES



Compact, corrosion-resisting metal enclosure, permanently sealed by a double seam, protects the unit completely. Available with rheostat Models H and J.

SNAP-ACTION OFF POSITION

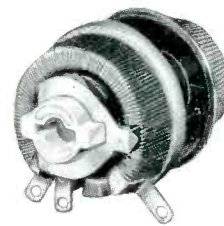

Opens the rheostat circuit at the high or low resistance position. The circuit is opened as the brush snaps into an insulated notch next to the lug, providing indexing.

TANDEM ASSEMBLIES

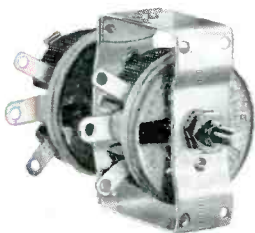

Ohmite rheostats can be mounted two or more in tandem, for simultaneous operation of several circuits. Universal joints provide smooth, positive mechanical action.

TOGGLE SWITCH

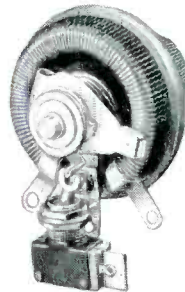

Toggle switch is operated with a positive snap by the movement of the contact arm. Opens the rheostat circuit or switches an independent circuit. Available for all models.

LESS THAN STANDARD ROTATION

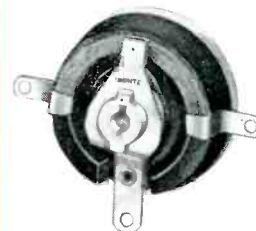

Rheostats can be supplied with winding space and angle of rotation less than standard. Rheostats can also be supplied with fixed or adjustable stops.

OHMITE MANUFACTURING COMPANY
4817 Flournoy Street, Chicago 44, Illinois



WRITE on Company Letterhead for Catalog and Engineering Manual No. 40.

Be Right with

OHMITE®

RHEOSTATS • RESISTORS • TAP SWITCHES

FOR SUPERIORITY

in performance . . . design . . . construction

SPECIFY • BUY • USE

STABILINE

TYPE **IE** INSTANTANEOUS
ELECTRONIC

Automatic VOLTAGE
REGULATORS

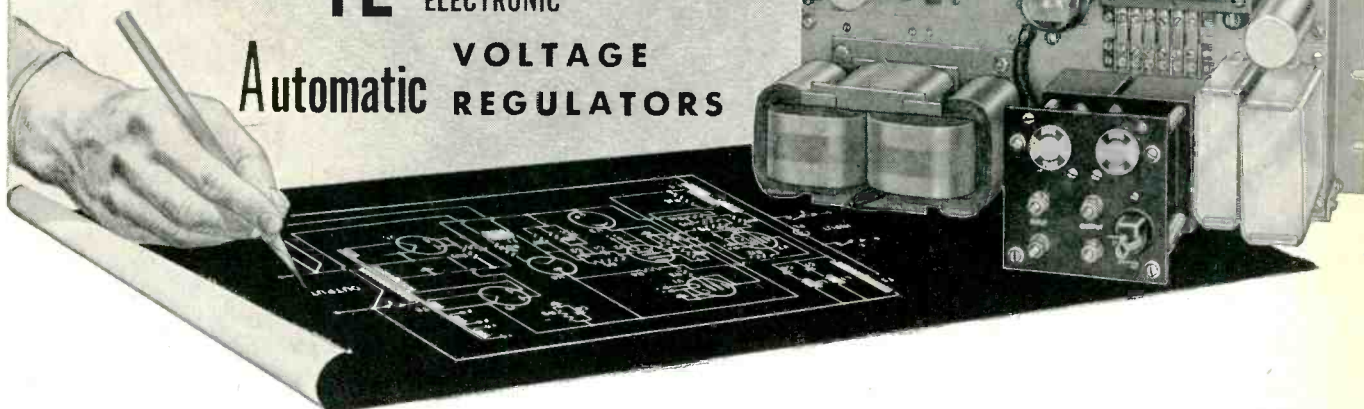

TO MAINTAIN CONSTANT OUTPUT VOLTAGE

REGARDLESS OF LINE OR LOAD CHANGES

Featuring:

INSTANTANEOUS CORRECTION — as compared with other forms of line voltage correction.

EXCELLENT STABILIZATION and REGULATION — the maximum change in output voltage will not exceed . . . ± 0.25 of 1% for any or all variations in operating conditions . . . ± 0.1 of 1% for input voltage changes . . . ± 0.15 of 1% for load current changes or load power factor changes from lagging 0.5 to leading 0.9.

MINIMUM WAVEFORM DISTORTION — except under the most adverse conditions, distortion is less than 2%.

WIDER INPUT RANGE — than most competitive types. 95-135 volts for a nominal of 115 volts and 195 to 255 volts for a nominal of 230 volts.

ADJUSTABLE OUTPUT VOLTAGE — a nominal 115 volt output is adjustable from 110 to 120 volts and from 220 to 240 volts on a 230 volt nominal output.

INSENSITIVITY TO FREQUENCY CHANGES — but to maintain optimum correction characteristics, tolerances should not exceed $\pm 10\%$ of the specified frequency.

Designed to meet the most exacting requirements for a-c line voltage stabilization, STABILINE Automatic Voltage Regulators type IE are precision built . . . subject to the most rigid manufacturing specifications but have the important characteristics of circuit simplicity and mechanical ruggedness.

Each STABILINE type IE is checked and rechecked to assure or better the published performance characteristics. A STABILINE Automatic Voltage Regulator built by The Superior Electric Company is superior in performance, design and construction.

THERE'S A STABILINE TYPE IE TO MEET YOUR NEEDS

Standard models are available in numerous ratings in capacities up to 5.0 KVA. Special types can be application engineered to meet practically any individual requirement.

FOR COMPLETE INFORMATION — use the attached coupon to send for your copy of Bulletin S351 including engineering and application data.



THE SUPERIOR ELECTRIC CO.
BRISTOL, CONNECTICUT



THE SUPERIOR ELECTRIC COMPANY
209 MAE AVENUE, BRISTOL, CONN.

Please send my copy of Bulletin S351.

NAME _____

POSITION _____

CO. NAME _____

CO. ADDRESS _____

CITY _____ ZONE _____ STATE _____

Manufacturers of

POWERSTAT VARIABLE TRANSFORMERS
STABILINE AUTOMATIC VOLTAGE REGULATORS
VOLTBOX A-C POWER SUPPLIES

POWERSTAT LIGHT DIMMING EQUIPMENT
VARICELL D-C POWER SUPPLIES
SUPERIOR 5-WAY BINDING POSTS

Selenium Rectifiers

**INTERNATIONAL
RECTIFIER
CORPORATION**

EL SEGUNDO
CALIFORNIA

**Largest
Range in the
Industry**

- T $\frac{1}{16}$ "
- U $\frac{1}{8}$ "
- V $\frac{1}{4}$ "
- Y $\frac{3}{8}$ "
- Z $\frac{1}{2}$ "
- X $\frac{3}{4}$ "
- W 1"
- B2
- A5
- B5
- A10
- B10
- A15
- B-10-M

- A-1" x 1"
- B-1.2" x 1.2"
- C-1.5" x 1.5"
- I-2" x 2"
- D-3" x 3"
- E-4 $\frac{3}{8}$ " x 4 $\frac{3}{8}$ "
- N-5" x 5"
- J-4 $\frac{1}{4}$ " x 6"
- F-5" x 6"
- H-6 $\frac{1}{4}$ " x 7 $\frac{1}{4}$ "

Selenium Diodes
Send for Bulletin SD-1

Germanium Diodes
Send for Bulletin GD-1

Hermetically Sealed
Selenium Rectifiers

Metal Enclosed
Selenium Rectifiers

Encapsulated
Selenium Rectifiers

Pigtail Terminals

Ferrule Terminals

Stud Terminals

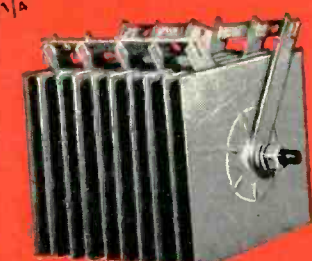

POWER RECTIFIERS
Single Stack Ratings:
125 ma to 2300 Amperes
Single Plate Ratings:
22 volts to 40 volts rms
Send for Bulletin C-349

CARTRIDGE TYPES
1.5 ma to 60 ma
20 volts to 10,000 volts
Send for Bulletin H-1

PHOTOELECTRIC CELLS
Send for Bulletin PC-649

INTERNATIONAL RECTIFIER CORPORATION

1521 E GRAND AVE. EL SEGUNDO, CALIFORNIA. PHONE: OREGON 8-3778
CHICAGO 205 W WACKER DRIVE. PHONE: FRANKLIN 2-3889
NEW YORK 501 MADISON AVENUE. PHONE: PLAZA 5-8665

TIME PROVED

Eimac 4W20,000A gives 25 kw peak sync power output through channel 13 with only 500 watts driving power

TYPICAL OPERATION

Class-B Linear Amplifier—Television Visual Service
(Per tube, 5 mc bandwidth, 216 mc.)

Load Impedance	650 ohms
D-C Plate Voltage	7000 volts
D-C Screen Voltage	1200 volts
D-C Control-Grid Voltage	—150 volts

	Peak	
	Sync Level	Black Level
D-C Plate Current	6	4.5 amps
D-C Screen Current	230	100 ma
D-C Grid Current	90	45 ma
Peak RF Grid Voltage	280	220 volts
Driving Power	500	300 watts
Plate Power Input	42	32 kw
Plate Dissipation	16	16.5 kw
Useful Plate Power Output	26	15.5 kw

FOR THREE YEARS THE EIMAC 4W20,000A has been proving itself an outstanding power tube in a variety of electronic applications. In VHF-TV operation it gives an easy 25 kw peak sync power output with only 500 watts driving power. This high power output with low driving power requirements is typical of Eimac radial-beam power tetrodes. Rugged 4W20,000A construction includes a ceramic envelope that minimizes losses and increases operational life. In pulse service, FM and TV operation the 4W20,000A is the only time proved tetrode in its power class.



Information about the 4W20,000A or any of Eimac's complete line of electron power tubes can be obtained by writing our Application Engineering department.

The Power for TV

EITEL-McCULLOUGH, INC., SAN BRUNO, CALIFORNIA



Nothing You Build Into Your Product *Can Count for More!*

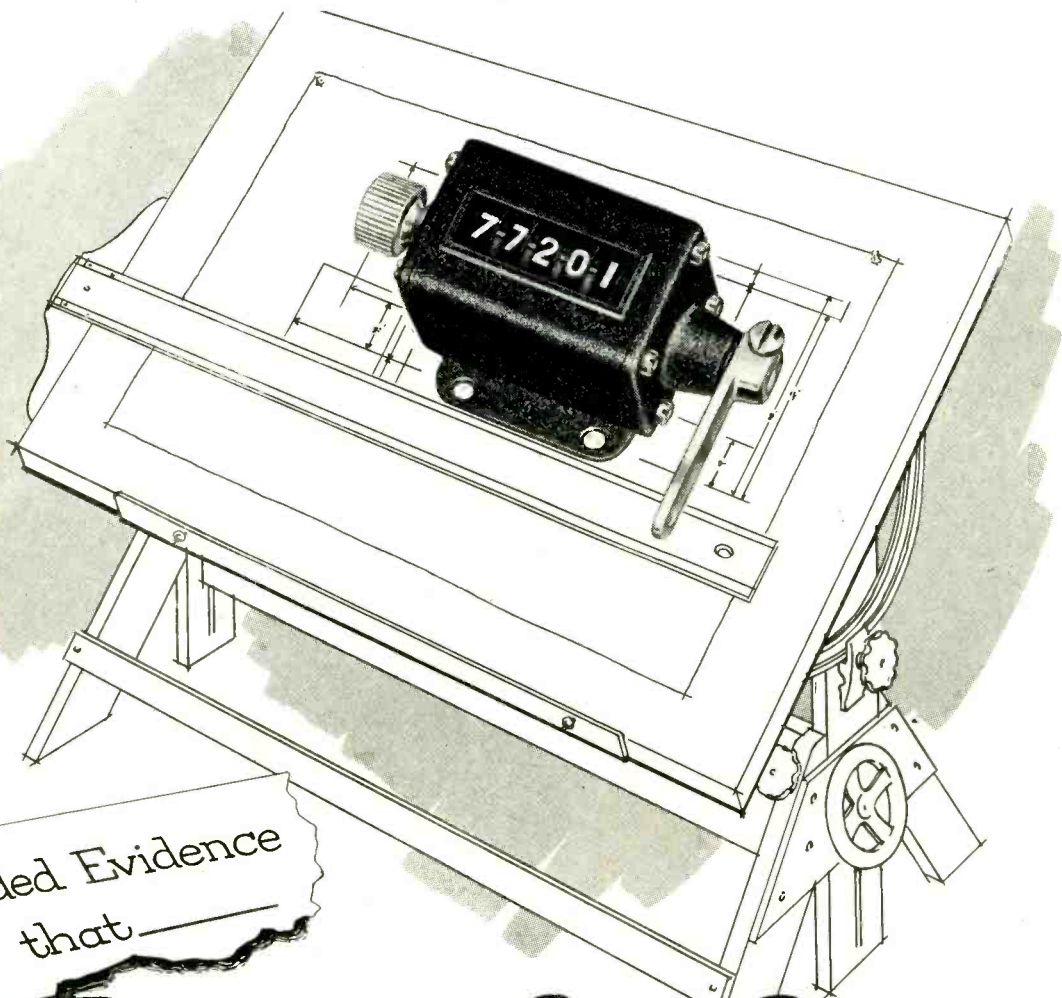

Added Evidence
that

Everyone Can Count on **VEEDER-ROOT**

This compact Reset Counter, shown actual size, is a standard built-in part of many makes of business machines, cameras, coin machines, compressors, die casting machines, hay balers, laundry equipment, plastic molding machines, punch presses, shoe machines . . . and what have you? It counts turns, strokes, pieces or other units of performance and output . . . supplying facts-in-figures that help toward closer

Control. Find out how your product can give your customers a *new usefulness*, with these or other Veeder-Root Counters for mechanical or electrical operation. Write:

VEEDER-ROOT INCORPORATED
HARTFORD 2, CONNECTICUT

Chicago 6, Ill. • New York 19, N. Y. • Greenville, S. C.
Montreal 2, Canada • Dundee, Scotland
Offices and Agents in Principal Cities



The Name that Counts

Almost as easy as this...

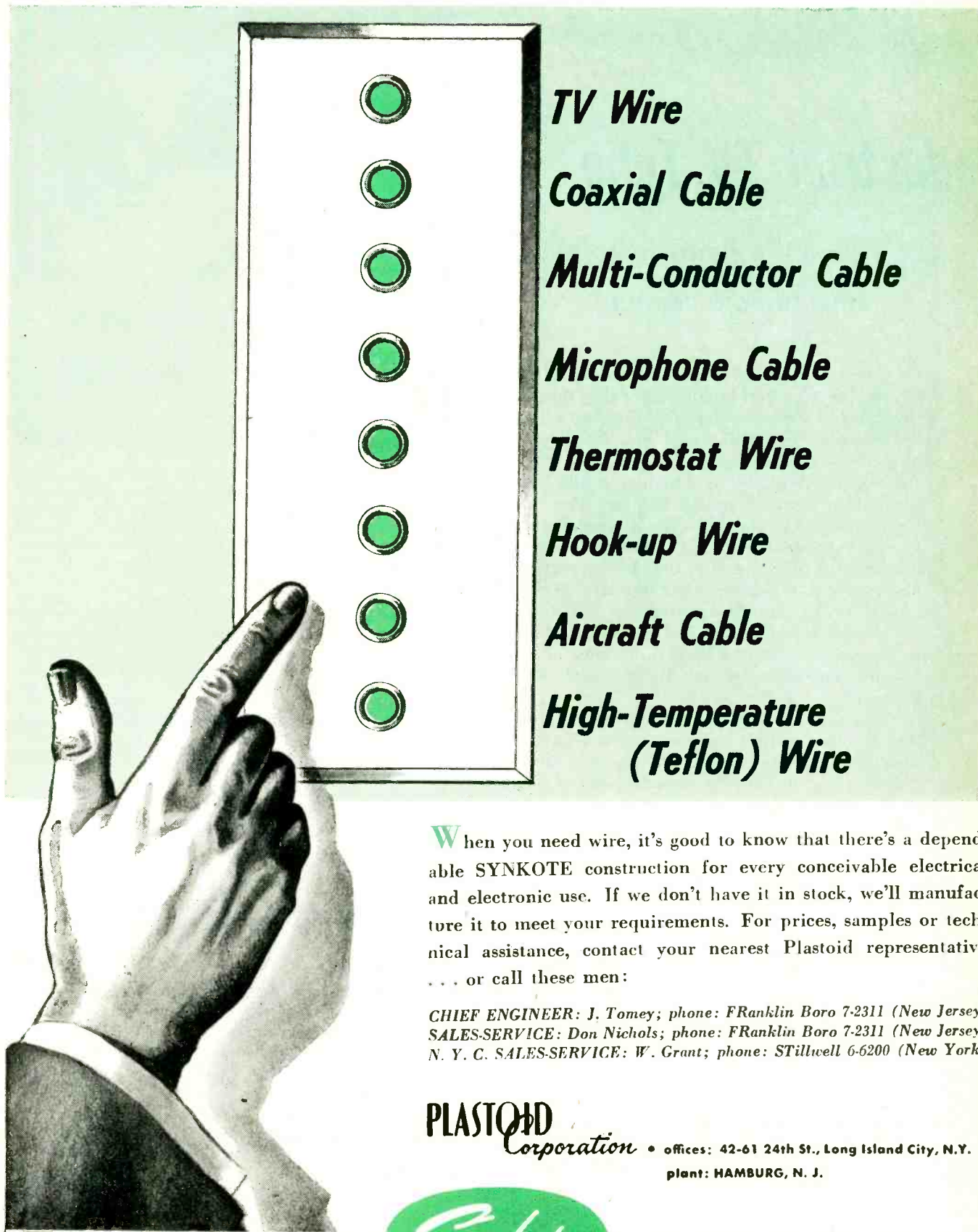

TV Wire

Coaxial Cable

Multi-Conductor Cable

Microphone Cable

Thermostat Wire

Hook-up Wire

Aircraft Cable

**High-Temperature
(Teflon) Wire**

When you need wire, it's good to know that there's a dependable SYNKOTE construction for every conceivable electrical and electronic use. If we don't have it in stock, we'll manufacture it to meet your requirements. For prices, samples or technical assistance, contact your nearest Plastoid representative . . . or call these men:

CHIEF ENGINEER: J. Tomey; phone: FRanklin Boro 7-2311 (New Jersey)
SALES-SERVICE: Don Nichols; phone: FRanklin Boro 7-2311 (New Jersey)
N. Y. C. SALES-SERVICE: W. Grant; phone: STillwell 6-6200 (New York)

PLASTOID

Corporation

• offices: 42-61 24th St., Long Island City, N.Y.
plant: HAMBURG, N. J.

MANUFACTURERS OF DEPENDABLE



INSULATED WIRE AND CABLE

Industrial TV Tube

... "goes the limit" in rough
and tumble service

Engineers at DIAMOND POWER SPECIALTY CORPORATION had two features in mind when they decided on this Image Dissector tube for industrial television.

They wanted simplicity of operation and they wanted dependability.

They got simplicity by designing a tube with no filament or electron gun. It has only three major components: (1) its cold cathode face (a film of Cesium Antimony having a photosensitivity maximum, in the blue region of the visible spectrum, at about 20-35 micro-amperes per lumen), (2) electron multiplier, (3) accelerator rings.

They got dependability and assurance of long life in the roughest service by making most of the internal components of an Inco Nickel Alloy — Inconel®.

Proof that Inconel was a wise choice is the fact that the first tubes they manufactured have given over four years of service, and are still in use.

Here's why most of the internal parts of the tube are made of Inconel...

- It's non-magnetic, even after being cold worked
- It has good drawing characteristics
- It has excellent spot welding characteristics
- It's less expensive when all costs are considered
- It can be easily kept free of foreign matter to avoid gas formation
- It can be easily cleaned and kept clean
- It remains strong and stiff when heated for degassification

All of these contribute materially to long tube life and dependability.

Perhaps Inconel, or another of the Inco Nickel Alloys, can lend its useful properties to an electronic design or fabrication problem of your own. We'd be glad to cooperate, or you may write for "Inco Nickel Alloys for Electronic Uses."

Consult your regular supplier of Inco Nickel Alloy forms for latest information regarding their availability. Remember, too — it always helps to anticipate your requirements well in advance.

THE INTERNATIONAL NICKEL COMPANY, INC.
67 Wall Street
New York 5, N. Y.

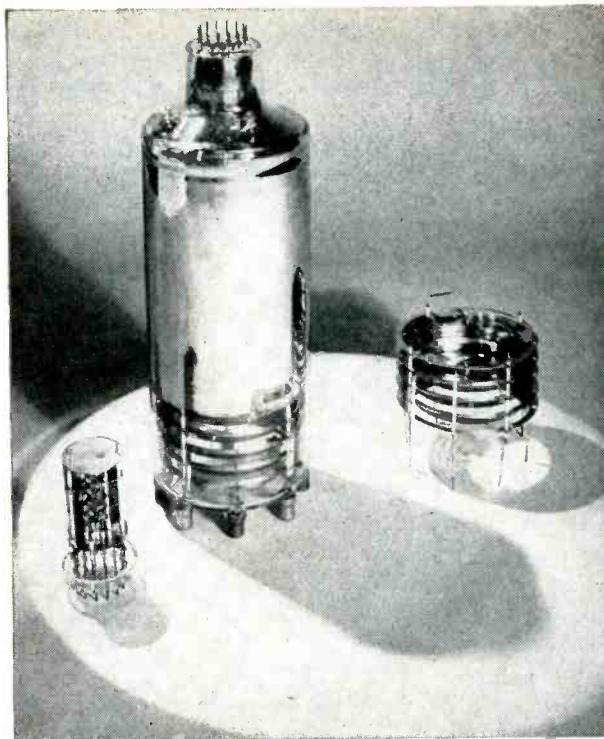

LIGHT falling on the face of Image Dissector tube of the "Utiliscope" closed circuit industrial television, liberates electrons from the special surface of the photocathode. These are multiplied through a series of eleven silver-magnesium cups on Inconel holders and increase the signal two to six million times. This signal is carried by co-axial cable to the monitor where it produces the television picture.

The success of the tube depends on a nearly perfect vacuum and absolute cleanliness and purity of parts within the tube. Formation of the multiplier cups (at left) and accelerating rings (at right) is precise work.

All of the tiny parts must be free of any contamination; they are immersed in a degreasing solvent, boiled in a detergent and annealed under a vacuum before being assembled with gloved hands. The electron multiplier alone has over 150 parts which are secured by spot welding. The designers found that Inconel was the only satisfactory metal for all but a few of the parts within the tube.



Inco Nickel Alloys

MONEL® • "R"® MONEL • "K"® MONEL • "KR"® MONEL
"S"® MONEL • INCONEL® • INCONEL "X"®
INCONEL "W"® • INCOLOY® • NIMONIC® ALLOYS
NICKEL • LOW CARBON NICKEL • DURANICKEL®

NATIONAL VULCANIZED FIBRE

...contributes to an improved product— copper-clad Peerless Capacitors for Bendix Radios

These copper-clad Peerless capacitors are used by the Bendix Radio Division, Bendix Aviation Corp., on the voice coil circuit and power input lead of their automobile radios. The capacitor is a combination of Peerless Insulation .004 inch thick copper-clad on both sides with .00135 inch copper foil. Punched clean, Ohmeter tests indicate no shorts between the copper foil surfaces. A minimum capacitance of 200 mmf is obtained.

This practical use of Peerless Insulation, a paper-thin grade of National Vulcanized Fibre, is typical of the countless contributions made by *the material of a million uses*—National Vulcanized Fibre—to business and industry.

National's Peerless Insulation was the *first* fish paper and has been accepted as standard ever since. It is smooth, strong and has excellent forming qualities. Write for detailed literature and engineering service information—

NATIONAL VULCANIZED FIBRE CO.

Wilmington

Offices in



Delaware

Principal Cities

Since 1873

National Laminated Plastics
nationally known—nationally accepted

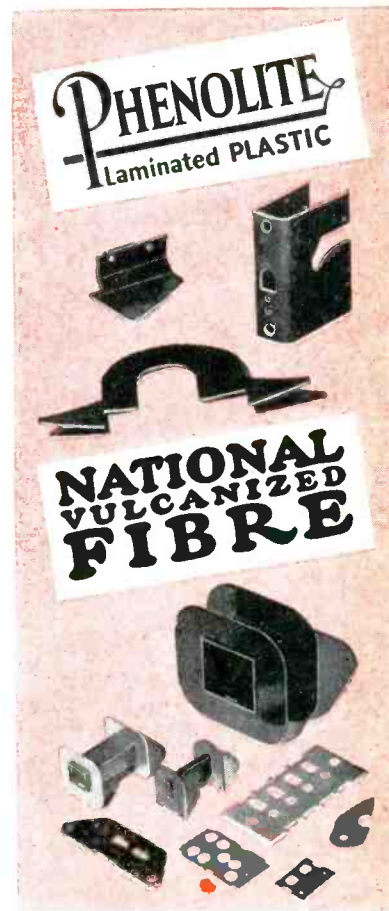

Peerless Insulation, possessing high dielectric strength plus excellent rigidity, is copper-clad on both sides to make these capacitors. The punched parts, selling for approximately 7/10 of one cent, replace commercial types of capacitors costing five or six cents.

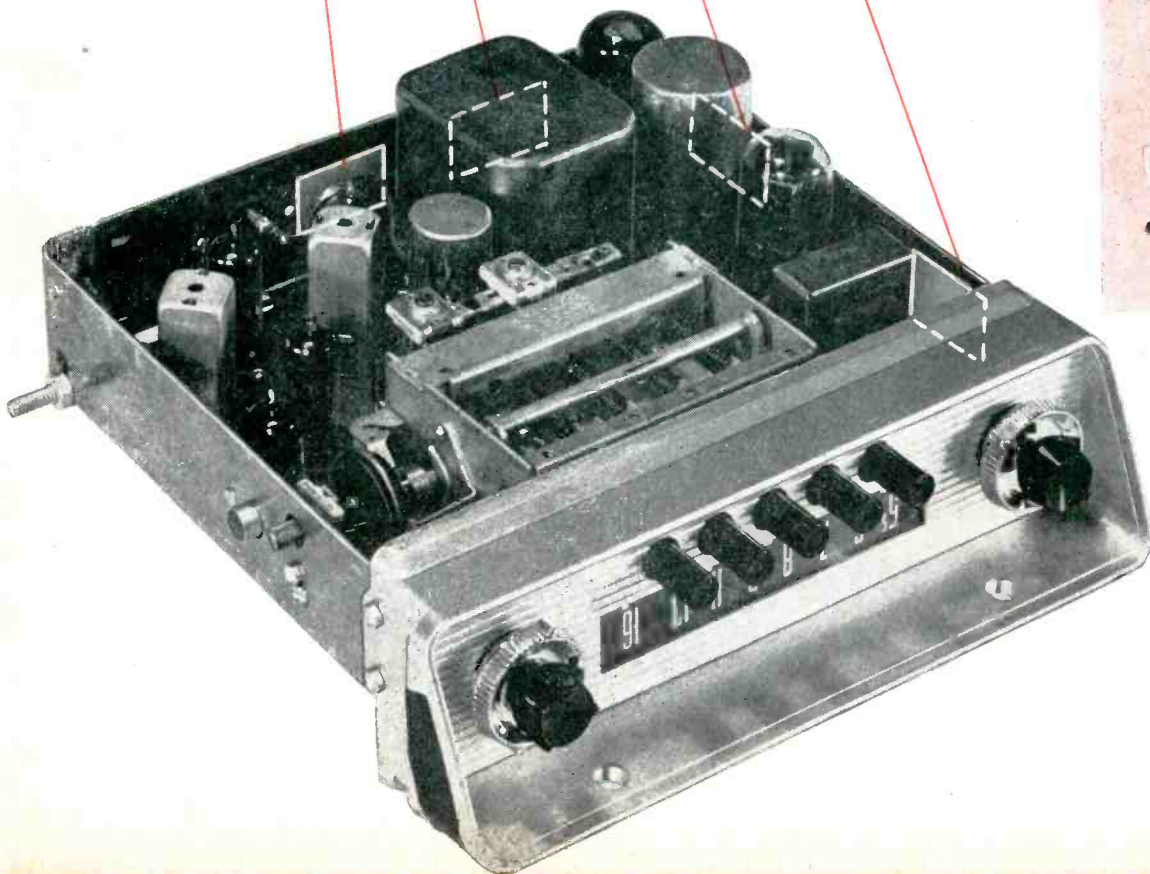

Rely on **PHELPS DODGE** for Magnet Wire and

**THE RIGHT WIRE
TRANSFORMER,**

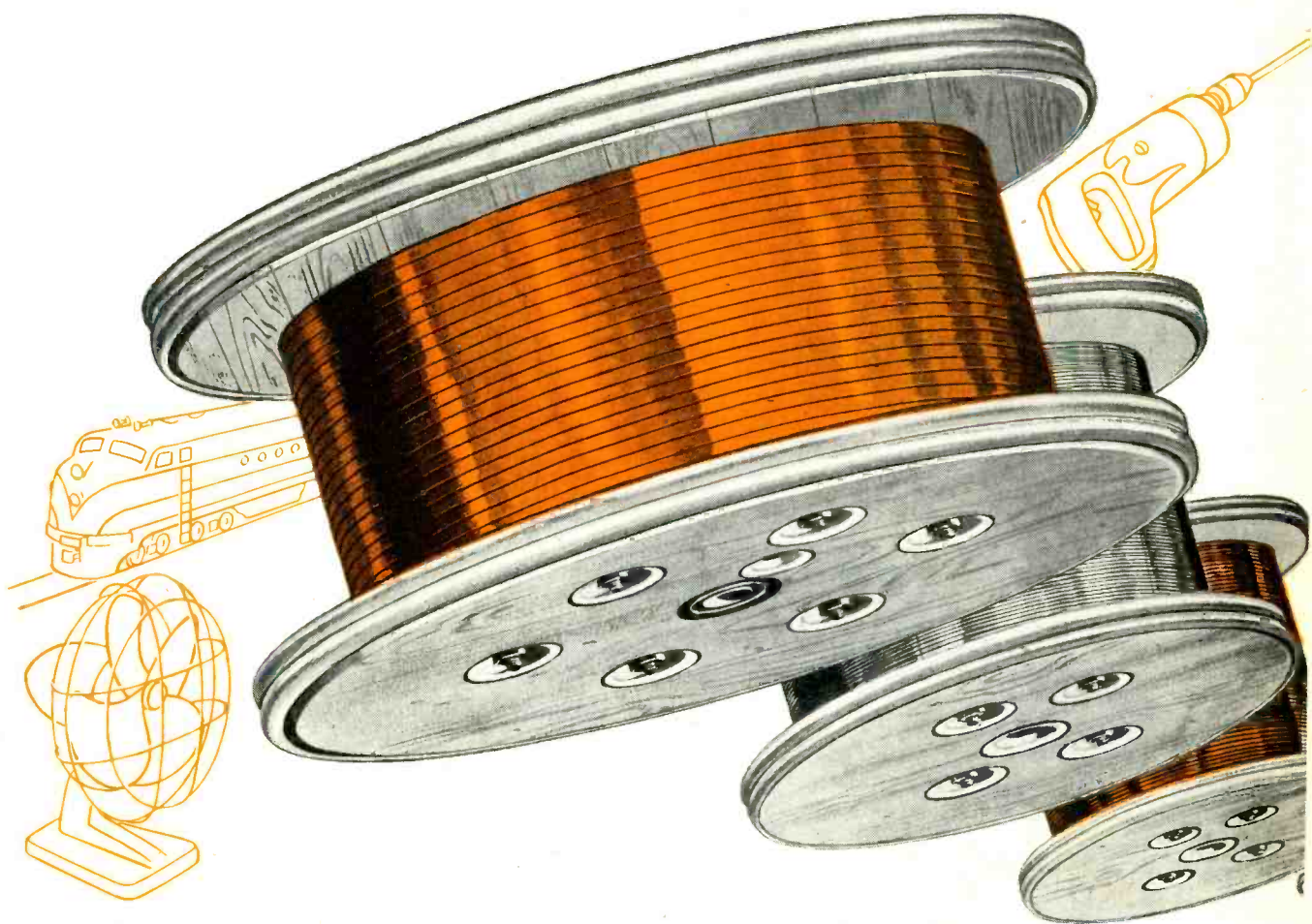

First for Lasting Quality—from Mine to Market!

Application "Know-How" —

FOR YOUR MOTOR OR COIL!

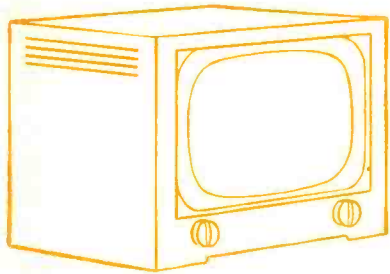
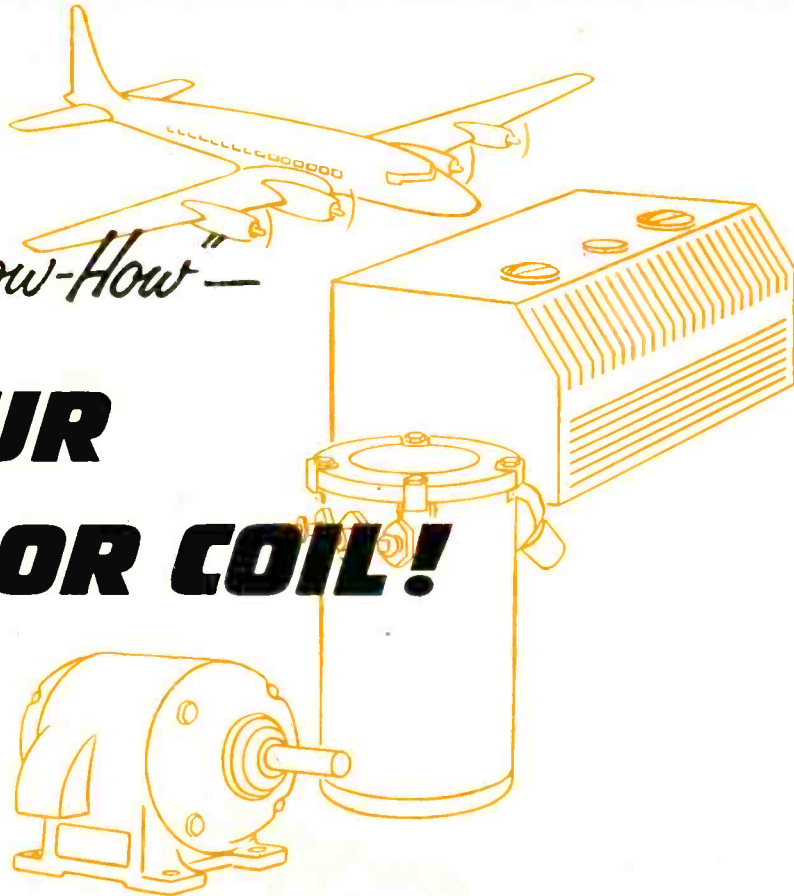

Vast and varied experience in every field of electrical and electronic manufacture.



Unexcelled research, manufacturing and quality control facilities—most complete and up-to-date line of magnet wire in the industry.



Practical help in selecting correct size, shape and insulation to meet exact design specifications.



**PHELPS DODGE COPPER PRODUCTS
CORPORATION**

INCA MANUFACTURING DIVISION

FORT WAYNE, INDIANA



PRODUCTS *wired for life with*

WARREN WIRE

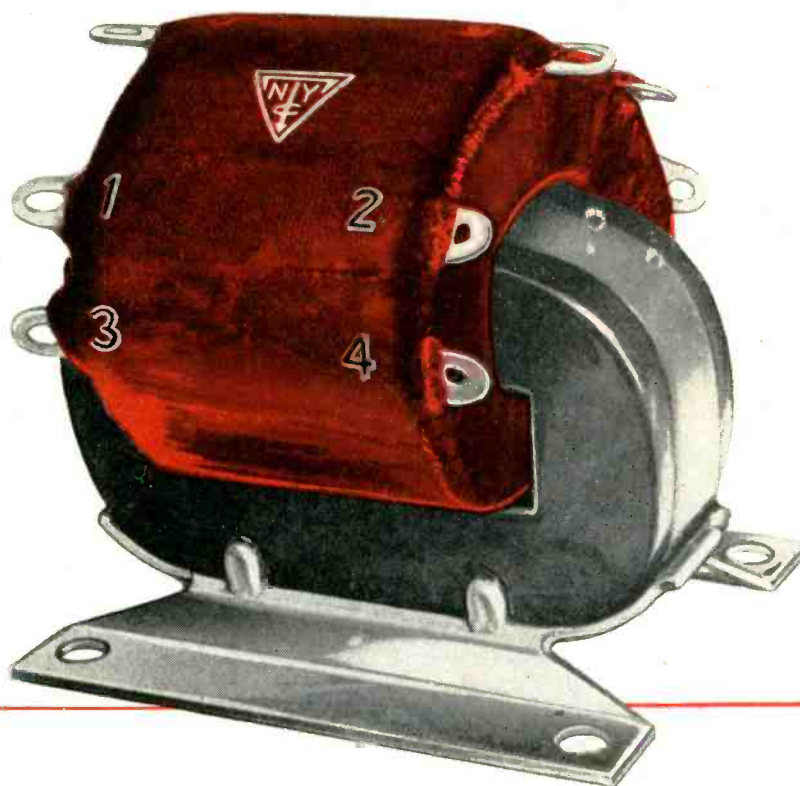

The NYT compact, lightweight, open type transformer, the HORNET, is designed and constructed by transformer specialists to give accurate and dependable service.

Three vital factors . . . sound engineering, skilled workmanship and quality wire . . . are combined to assure longer life and greater efficiency for this superior unit. Here, as in the manufacture of many other fine electric and electronic products, Warren Wire is used for its easy handling, efficiency and dependability. There's a Warren Wire Engineer near you frained to help you solve your wire problems right in your own plant. There is no obligation, of course.

Write for new Teflon Specification # 1001, dated February, 1953



WARREN WIRE COMPANY

Plant and Main Office: POWNAL, VERMONT

NEW YORK • SYRACUSE • NEW HAVEN • PHILADELPHIA • PITTSBURGH* • CLEVELAND*
DETROIT • CHICAGO** • ST. LOUIS** • ST. PAUL • LOS ANGELES* • SAN FRANCISCO

Manufacturers of Plain Enamel, Nylon, Formvar, Teflon and Served Magnet Wires . . . Teflon Hook-up and Lead Wire . . . Tinned and Bare Copper Wire.

*Office and Warehouse



VARIAN ADDS

40,000 SQ FT

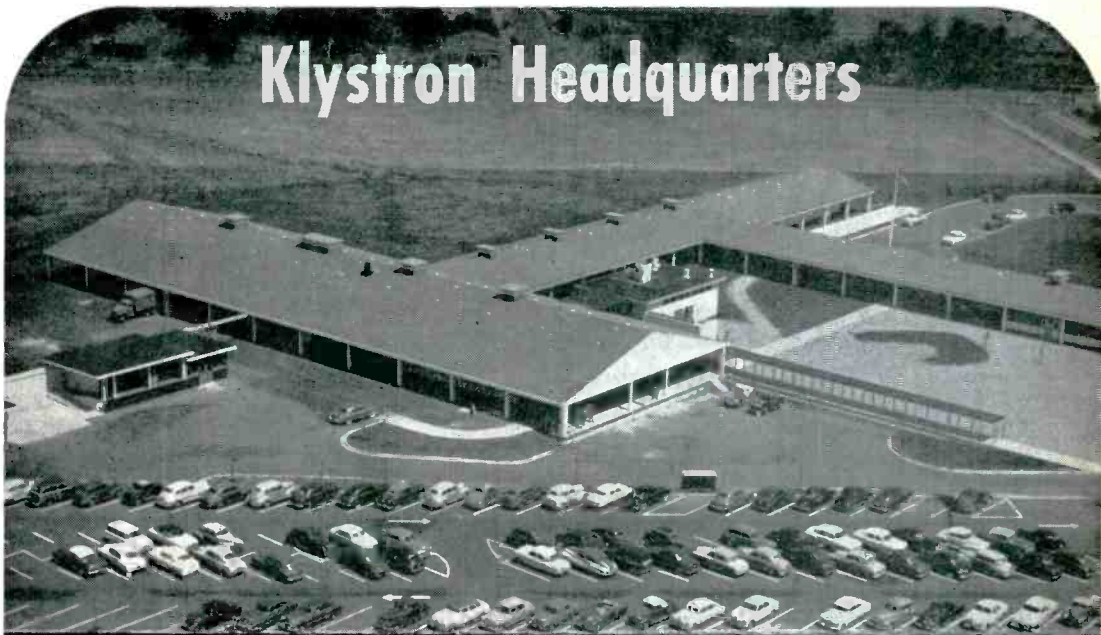

Klystron Headquarters

The New Varian Research and Administration Building

Continuing development and expansion of microwave-engineering applications for klystrons and other electron devices will be carried on in the newly-opened Palo Alto facilities of Varian Associates. This completes a greater than eight-fold growth for Varian in the five years since the formation of the company. Total extent of its several plants now exceeds 93,000 square feet. Size of the original staff has grown to 598. These people are all devoted to the goal of improving and expanding service to the electronic field—keeping Varian the first name in klystrons and related products. Since its discovery, Varian has pioneered in the new field of n.m.r. (nuclear magnetic resonance), has established the leading commercial laboratory for investigation and development of this penetrating technique; and has introduced instruments with broad new capabilities for exploring the characteristics of materials.

Field Engineering Representative: in 38 Cities throughout the World



VARIAN associates

PALO ALTO 1 • CALIFORNIA

First name in klystrons

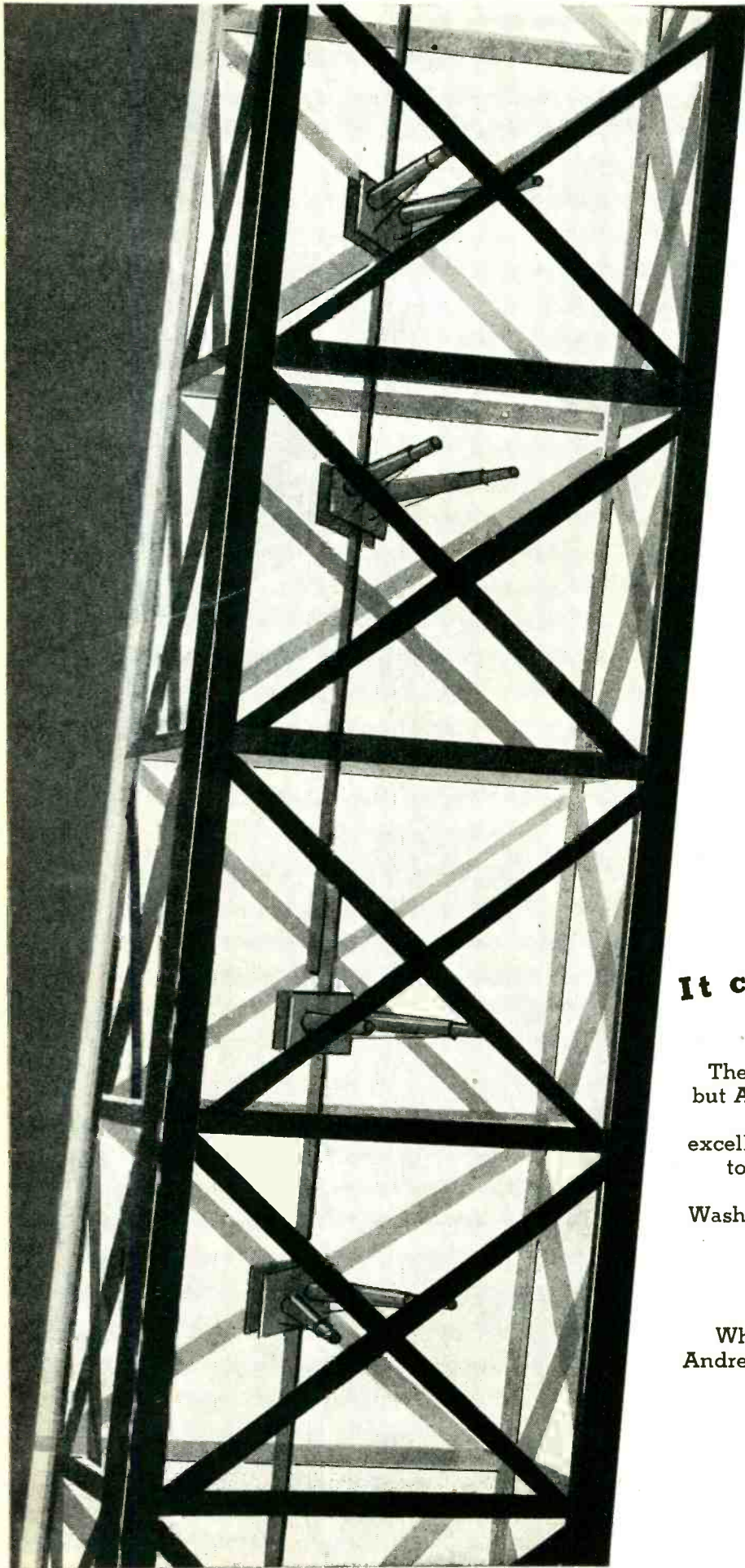

It couldn't be done?

The books said it couldn't be done—but Andrew engineers went ahead and designed an antenna that gives excellent coverage mounted *inside* the tower! This ingenious development enabled station WTOP in Washington, DC to use their television tower for FM too—and so save thousands of dollars.

Whatever your problem in antennas Andrew ingenuity will find the answer. Be sure to consult us.

Andrew
CORPORATION

363 EAST 75TH STREET, CHICAGO 19

when the circuit reads

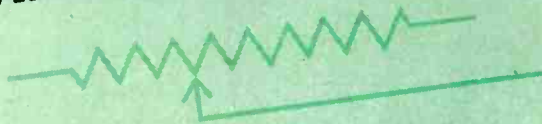

come to

WIRE-WOUND and CARBON CONTROL HEADQUARTERS

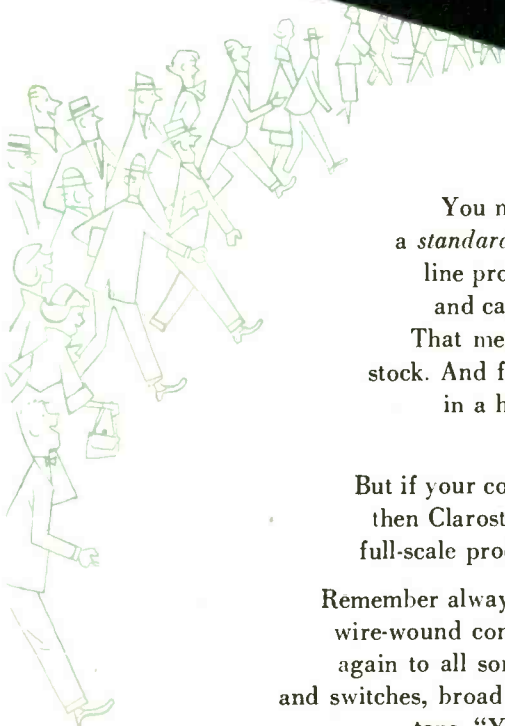
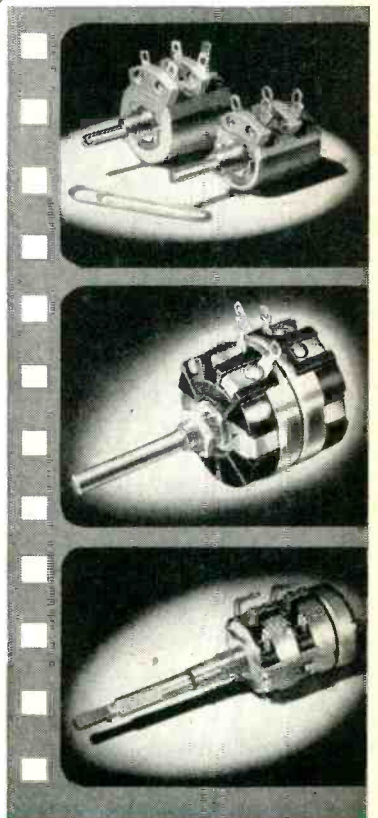
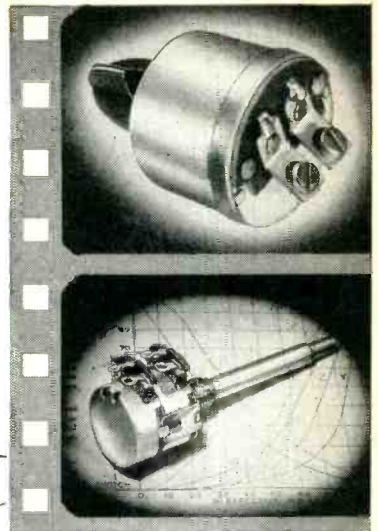

You name it — we supply it. Most likely it's a *standard* number, for Clarostat's outstanding line provides the widest range of wire-wound and carbon controls in meeting usual needs. That means immediate delivery from factory stock. And for single pieces or small lots, wanted in a hurry, your local Clarostat distributor carries a representative inventory.

But if your control requirements are extraordinary, then Clarostat can design, tool-up and swing into full-scale production on your *specials*, in jig time.

Remember always that, from miniaturized carbon and wire-wound controls, to standard-sized controls, and again to all sorts of single and tandem units, shafts and switches, broad and tight tolerances, any tapers and taps, "You Can Stand Pat with Clarostat" for your simple or difficult control needs.

Exceptional engineering, tool-designing and manufacturing facilities second to none, are standing by for you at Clarostat. Let us collaborate on your control requirements, here at "Controls Headquarters".

STAND PAT WITH

CLAROSTAT Controls & Resistors

CLAROSTAT MFG. CO., INC., DOVER, NEW HAMPSHIRE
In Canada: Canadian Marconi Co., Ltd., Toronto, Ontario

A N N O U N C I N G . . .

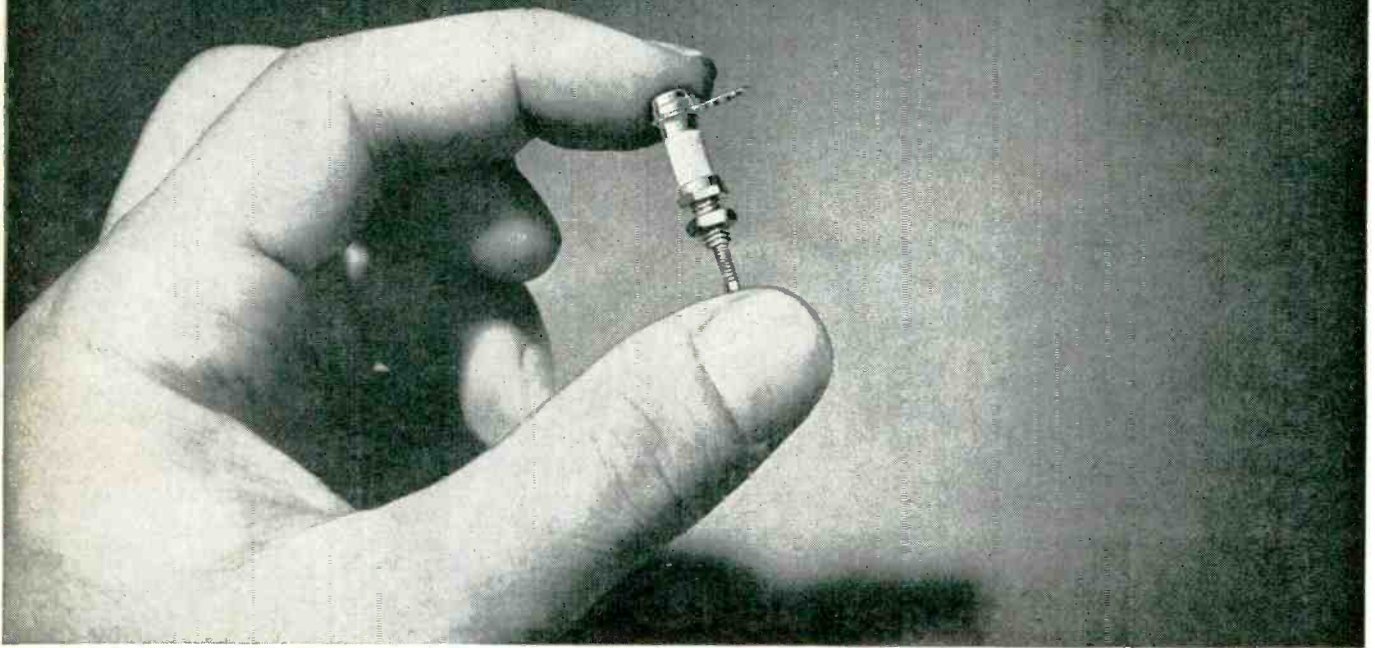

Shown approximately full size.

C.T.C.'s new CST-50 capacitor with greatly increased range, greater stability

Surpasses the range of capacitors many times larger in physical size.

The new CST-50 variable ceramic capacitor embodies a tunable* element of such unusual design it practically eliminates losses due to air dielectric. As a result a large minimum to maximum capacity range (1.5 to .2 MMFD) is realized — despite the small physical size of the capacitor. This tunable* element is a spring-type, S-shaped tuning sleeve* which maintains constant maximum pressure against the inside wall of the ceramic form.

Other Design Features

The CST-50 stands only $9/32$ " high when mounted, is less than $3/4$ " in diameter and has an 8-32 threaded

mounting stud. The mounting stud is split so that the tuning sleeve* can be securely locked without causing an unwanted change in capacity. The tuning sleeve* is at ground potential. The CST-50 is provided with a ring terminal which has two soldering spaces.

All C.T.C. materials, methods and processes meet applicable government specifications. For further information on C.T.C. components and C.T.C.'s consulting service (available without extra charge) write us direct, Cambridge Thermionic Corporation, 437 Concord Avenue, Cambridge 38, Mass. West Coast manufacturers contact: E. V. Roberts, 5068 West Washington Blvd. Los Angeles and 988 Market St., San Francisco, California.

C A M B R I D G E T H E R M I O N I C C O R P O R A T I O N

custom or standard . . . the guaranteed component

Write for Free Catalog #40 containing complete data on the entire CTC line.

Want more information? Use post card on last page.

September, 1953 — ELECTRONICS

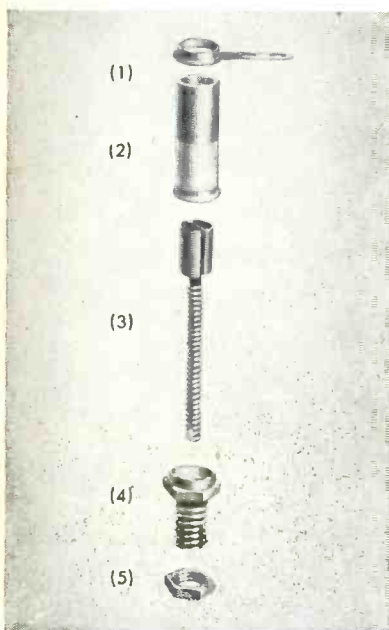

Exploded view of the CST-50 capacitor shows: (1) ring terminal with two soldering spaces; (2) metallized ceramic form; (3) spring-type S-shaped tuning sleeve* (4) split mounting stud; (5) locking nut.

*Patent Applied For

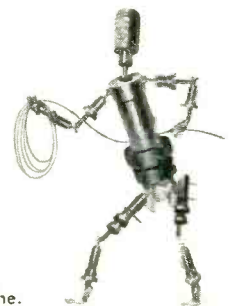

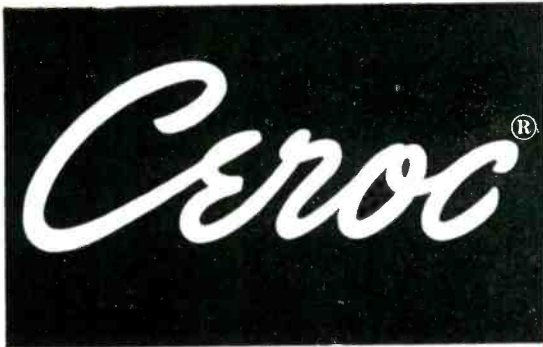

HIGH TEMPERATURE magnet wires

FOR

CLASS

H+

OPERATION

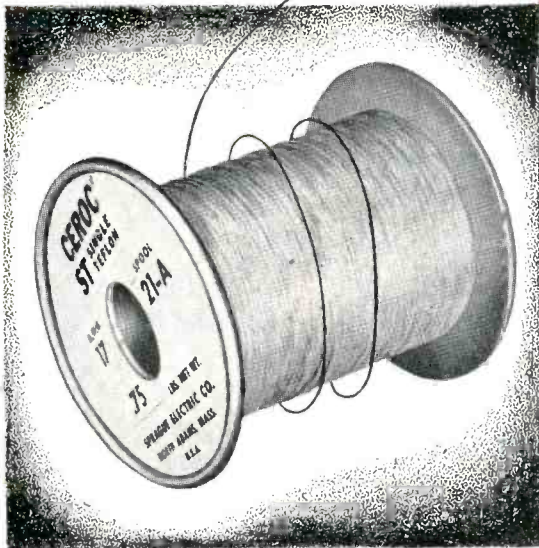

Sprague, on request, now will provide you with complete application engineering service and assistance for optimum results in the design and manufacture of components using Cerroc High-Temperature Magnet Wires.

If your problem is the design of reliable miniaturized electrical equipment, investigate the size and weight savings possible with Cerroc Magnet Wires.

Cerroc Magnet Wires operate at temperatures well above the 180°C limit for Class H insulation, because they have a base insulation of a thin, flexible ceramic material. No other wire uses this patented construction!

For operation at 250°C, Cerroc ST (Single Teflon) and Cerroc T (Double Teflon) have a tetrafluoroethylene overlay. Both have been used successfully up to 350°C in short-time military applications. Cerroc 200 for 200°C application has a silicone coating on the ceramic to facilitate winding.

Not only does the construction of Cerroc Magnet Wires permit very high current densities, but it also results in better cross-over characteristics in windings than those obtainable with all-plastic insulated wires.

For engineering data on Cerroc Magnet Wires, write on your business letterhead to the Sprague Electric Company, 35 Marshall Street, North Adams, Massachusetts.

ENLARGED CROSS-SECTIONS OF CERROC MAGNET WIRES

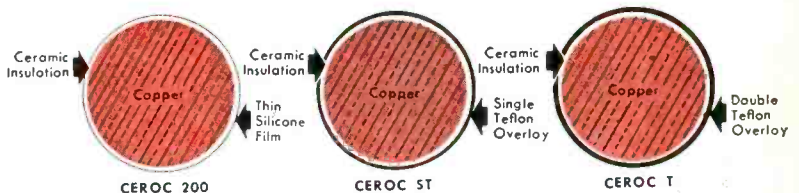

SPRAGUE

PIONEERS IN HIGH TEMPERATURE MAGNET WIRE

EXPORT FOR THE AMERICAS: SPRAGUE ELECTRIC INTERNATIONAL LTD., NORTH ADAMS, MASS. CABLE: SPREXINT











We haven't cut corners on
QUALITY CONTROL
 to speed deliveries for—

CHESTER
plasticord-plasticote
WIRES & CABLES

Extra shifts, not speed-ups are the way Chester catches up on production to meet your delivery dates. Chester Wires and Cables are never rushed through...every foot is quality controlled according to the highest standards known to the industry. This is the reason Chester Wires and Cables are of uniform quality, always dependable, whether you use a foot or a spool. For an extra measure of reliability, specify Chester, for your next electrical or electronic requirements.

WIRE AND CABLE DATA SHEETS

Contains complete information on Chester Quality Conductors. Call or write for yours, today!

	JAN-C-76 WIRES* SRIR, SRHV, SRRF, WL
 *Solid colors or spiral marking	105°C, 90°C, 80°C UL APPROVED; 120°C*
	FLEXIBLE CORD
	TV LEAD-IN WIRES
	COMMUNICATION WIRES & CABLES TO SPECIFICATIONS
	LACQUERED AND NYLON WIRES
	SHIELDED WIRES & CABLES
	INSTRUMENT WIRES
	COAXIAL CABLE
	SPECIAL WIRES & CABLES TO SPECIFICATIONS

"Chester" INVITES INQUIRIES concerning custom constructions including polyethylene, polyvinyl chloride, nylon, braided and lacquered wires, special insulating materials, glass, yarn or any known material. Recommendations will be made without obligation.



REGISTERED U.S. PAT. OFF.

CHESTER CABLE CORP.
 C H E S T E R • N E W Y O R K

Want more information? Use post card on last page.

September, 1953 — ELECTRONICS

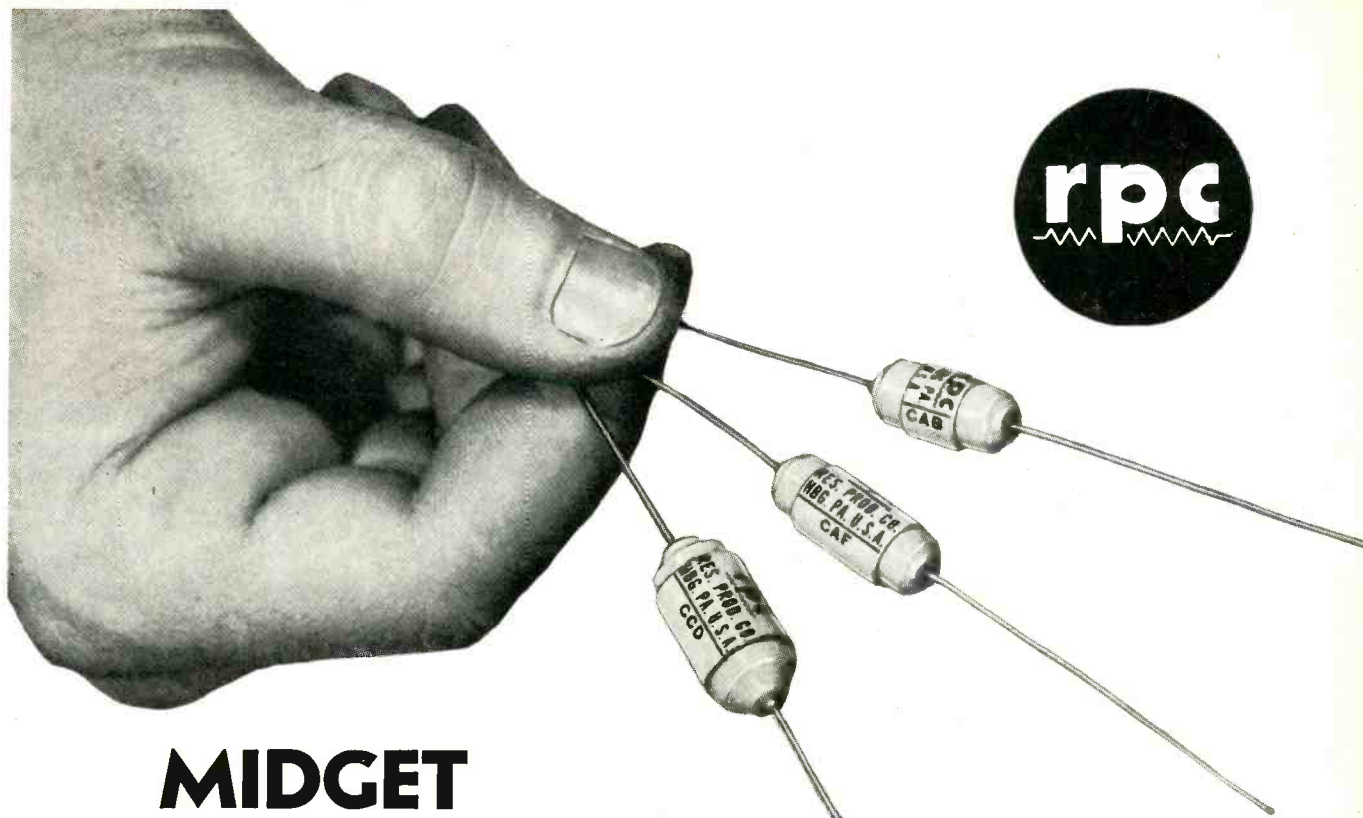

MIDGET Precision Wire Wound RESISTORS

TYPE	DIMENSIONS		Jan-R-93	MIL-R-93A	POWER RATING (WATTS)		RESISTANCE	
	Leng.	Diam.			Jan.	Comm'l.	Min. (ohms)	Max. (meg.)
CAB	9/16	9/32	—	—	—	1/4	2.0	0.15
CAF	13/16	9/32	RB51B	RB52B*	1/4	1/2	1.0	0.40
CCD	13/16	3/8	RB51B	RB52B*	1/4	1/2	0.5	1.0

*Proposed

Successfully used in Armed Forces' most critical applications

Scores of results have established the superiority and outstanding quality of RPC's new TYPE C PRECISION WIRE WOUND RESISTORS. These high quality units are designed to meet the stringent requirements of JAN-R-93.

Completely insulated precision resistors which may be soldered directly into circuits. Their small size and light weight make them self supporting. Ideal for aircraft applications where reduction in size and weight are vital.

Completely enclosed in rugged plastic of high insulation value. Windings are im-

pregnated in special compound and protected against dust, salt spray, humidity and mechanical damage.

Winding form is of low loss steatite having extremely high insulating quality with low coefficient of expansion. Impervious to moisture.

Type C resistors are wound with specially tested low temperature coefficient alloys. RPC's Type C resistors are being used by many of America's outstanding manufacturers. They are available in any amount with prompt delivery. Write for complete information.

RESISTANCE PRODUCTS CO.

714 RACE ST.

HARRISBURG, PENNA.

SPECIALIZING IN
THE MANUFACTURE
OF QUALITY RESISTORS
IN ANY AMOUNT

HIGH MEGOHM, HIGH VOLTAGE, HIGH FREQUENCY, WIRE WOUND PRECISION

STABILENE^{*}

GLASS TRACING CLOTH

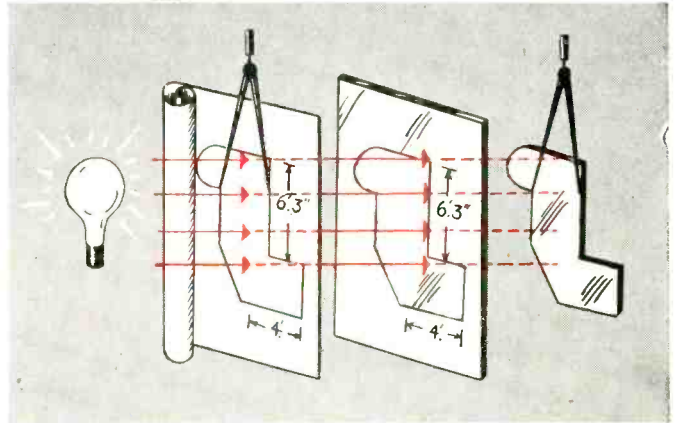
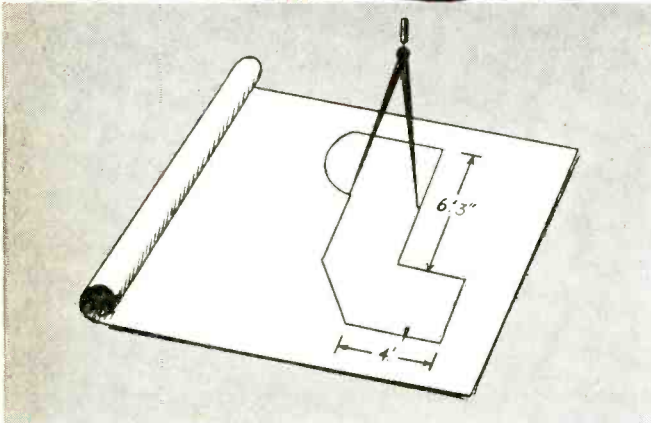

DIMENSIONALLY STABLE† TRACING CLOTH: Stabilene—first nationally introduced by K&E—is a new kind of tracing cloth—a woven glass cloth with a high degree of transparency. It is specially impregnated to provide an excellent drawing surface for pencil or ink.

Because Stabilene is both dimensionally stable and transparent, you can reproduce from Stabilene right on tool materials.

“DRAW IT ONCE”: Tool designs are drawn *only once*—full scale on Stabilene—then reproduced by contact printing on tool material which has been sensitized with a reproduction solution.

Preliminary dimensional drawings on tracing paper or cloth are eliminated altogether. The original drawings on dimensionally stable Stabilene are the *only* drawings required from drafting room through tool production.

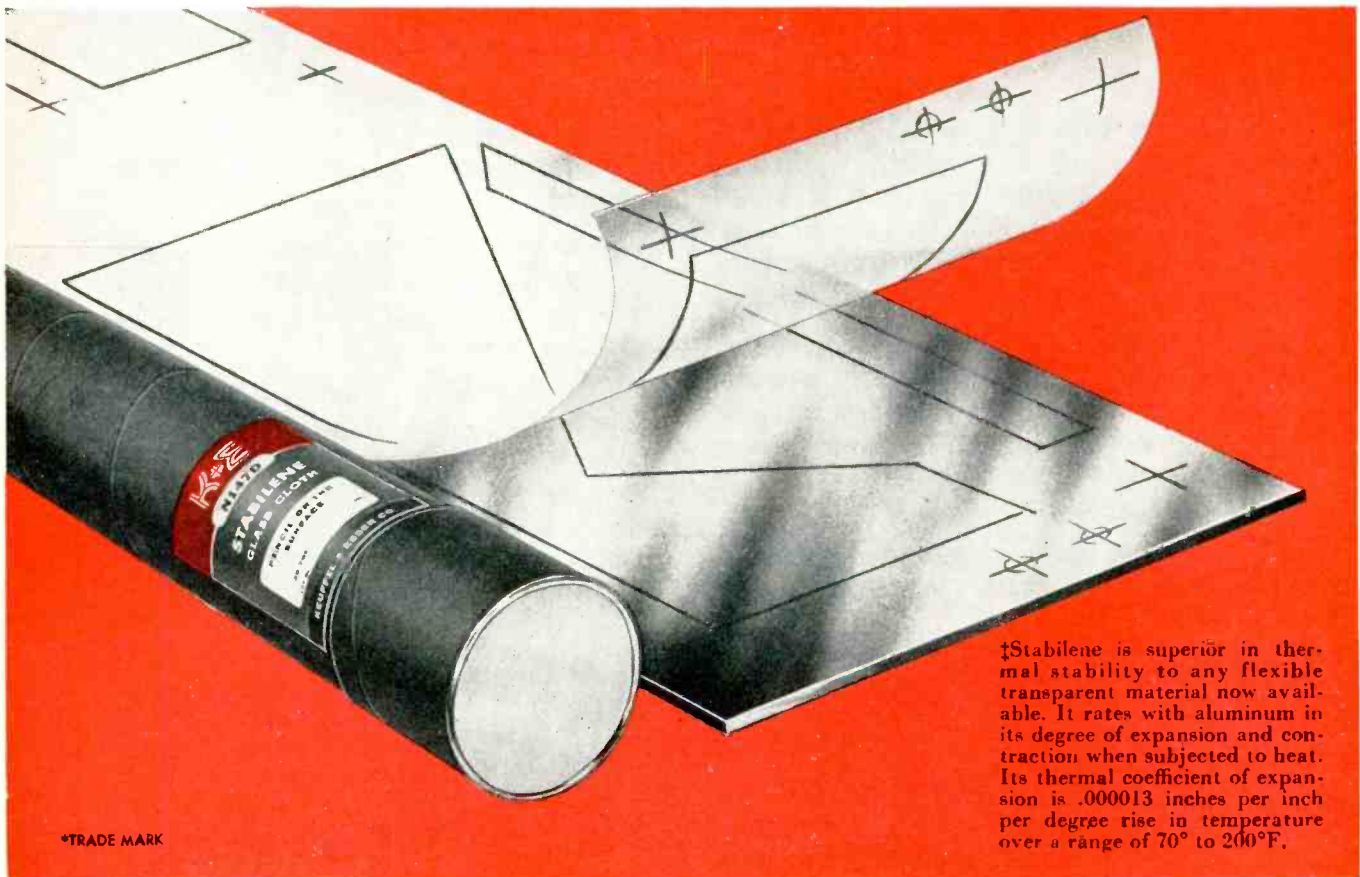

†Stabilene is superior in thermal stability to any flexible transparent material now available. It rates with aluminum in its degree of expansion and contraction when subjected to heat. Its thermal coefficient of expansion is .000013 inches per inch per degree rise in temperature over a range of 70° to 200°F.

*TRADE MARK

A SHORT CUT TO CUT COSTS!

The
Right Angle

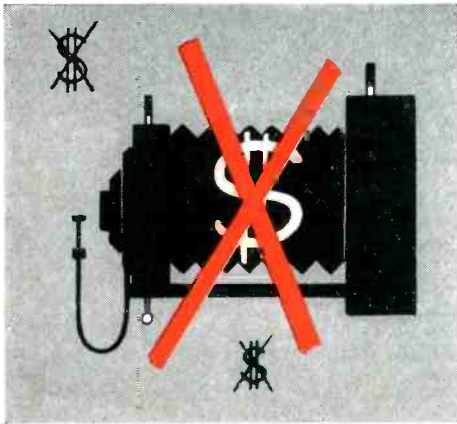

REVOLUTIONIZES PRODUCTION AND COSTS: Eliminates the need for shop layouts, camera photography, hand-scribing, and other methods calling for expensive equipment and highly trained personnel.

If a template is damaged or extra templates are needed new ones can be made from the original Stabilene drawing . . . quickly, easily, and inexpensively.

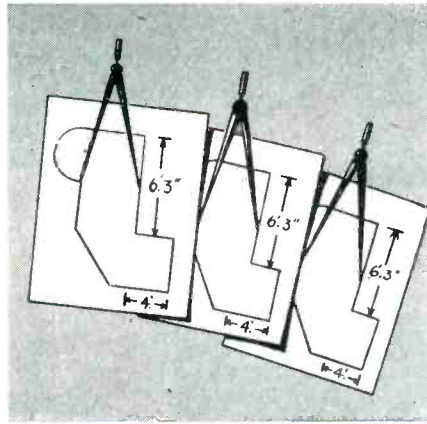

"DUPLICATE ORIGINALS" FROM STABILENE: Stabilene, itself sensitized for reproduction, can be used for dimensionally stable "duplicate originals." Such reproductions made on Stabilene are easily shipped to sub-contractors in lightweight rolls. "Duplicate originals" can also be used as the basis for design changes, new drawings, or composite drawings.

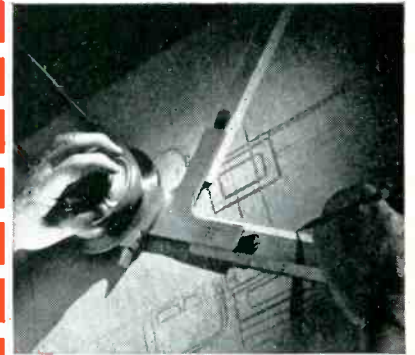

Save time, trouble and eyesight with a K&E PARAGON† Drafting Machine. You control your calibrated straight edge with a light touch of one hand, for parallel lines and lines at any angle.

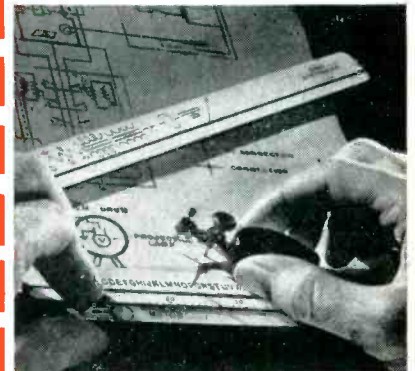

Make your lettering letter-perfect and save wear and tear on your nerves by using a LEROY‡ lettering outfit. Template grooves guide your pen so the finished result looks like printers' type, and the whole process is relaxing. There's a wide choice of sizes, styles and symbols.

†TRADE MARKS ®

Stabilene has cut costs for the aircraft industry, for instance, by eliminating many laborious steps once essential to the production of jigs, fixtures and dies, and other tools.

Stabilene is used by oil and utility companies, as well as by government departments for mapping and plane table work. Stabilene's dimensional stability is of vital importance in all these functions. For optical comparator work, the dimensional stability of Stabilene Glass Tracing Cloth makes it as accurate as the glass screen itself. Its transparency, too, is an essential feature for this work.

Stabilene has done much for others . . . think about what it might do for you . . . in cutting costs and speeding production.

We will gladly advise you about the application of Stabilene and help you get started. K&E can also make Stabilene reproductions for you. Write Keuffel & Esser Co., Hoboken, N. J. or ask your nearest K&E Branch or Distributor.



PARTNERS IN CREATING

KEUFFEL & ESSER CO.

EST. 1867

Drafting, Reproduction, Surveying Equipment and Materials. Slide Rules, Measuring Tapes

NEW YORK • HOBOKEN, N. J.

CHICAGO • ST. LOUIS • DETROIT

SAN FRANCISCO • LOS ANGELES • MONTREAL

SANBORN OSCILLOGRAPH RECORDING SYSTEMS HAVE MANY APPLICATIONS

Sanborn Recorders Help Speed Flight Design



SPERRY GYROSCOPE COMPANY

uses a two-channel Sanborn Recording System for basic research on their Zero Reader* Flight Director, a device which simplifies the manual control of aircraft. The Sanborn System shown above is recording the output of a flight simulator that solves Zero Reader equations.

* T. M. REG. U. S. PAT. OFF.

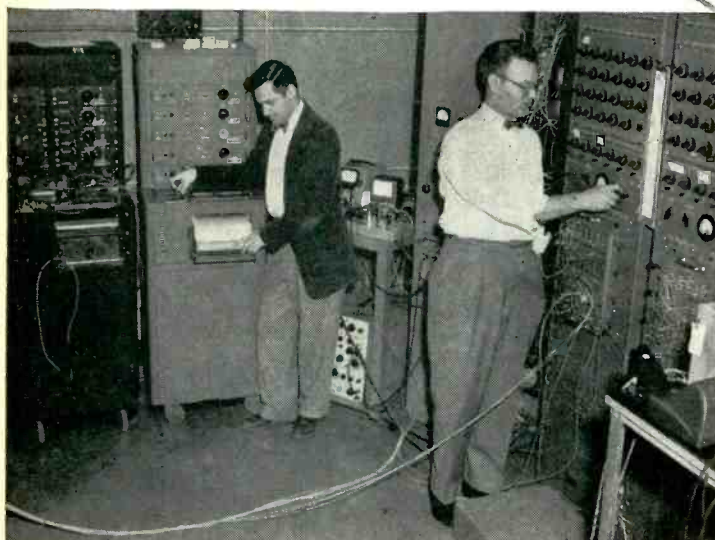

At McDONNELL AIRCRAFT CORPORATION the movements of a guided missile are simulated by high-precision analog computers which in turn send *eight* different resultant electric signals into two Sanborn four-channel Recording Systems (left) for the graphic recording of the hypothetical results of the guided missile problem.

How can Sanborn help you?

Sanborn one-, two-, and four-channel Recording Systems can provide an accurate and permanent graphic registration of almost any electrical phenomena whose frequency spectrum falls within the range of zero to 100 cycles per second. The availability and ready *interchangeability* of amplifiers and preamplifiers offer a wide range of use.

Records are traced by heated stylus on plastic coated strip-chart paper, and are in true rectangular coordinates. Other Sanborn advantages include: a high torque movement (200,000 dyne cms per cm deflection); built-in code and time markers; and a wide choice of paper speeds and channels.

Sanborn engineers will be pleased to make recommendations as to what type of equipment will best solve your recording problem. When writing, include the lower and upper limits and the frequency range of the phenomena to be recorded, and the type of transducer.



At DOUGLAS AIRCRAFT

COMPANY'S Flight Test Section, a Sanborn two-channel Recording System (shown removed from case for field operation) is used in conjunction with a telemeter radio link to record surface motion vibration in a flying aircraft while it is performing tests requiring continual monitoring. Recorded tracings provide the necessary permanent visual time history for comparison of the two events recorded and a study of their individual characteristics.

Ask for a copy of our "Applicability Folder" which presents a table of uses, complete performance data and specifications, brief descriptions of Sanborn Recording Systems and explanations of how their amplifiers may be readily interchanged.

SANBORN CO. INDUSTRIAL DIVISION
CAMBRIDGE 39, MASSACHUSETTS

NOW

N.U.

transistors and diodes

available in production quantities

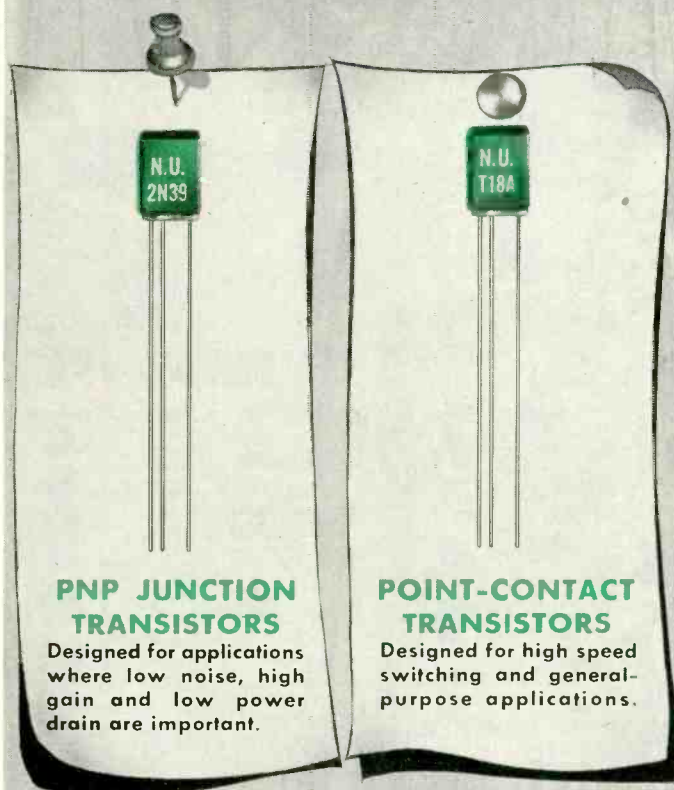

PNP JUNCTION TRANSISTORS
Designed for applications where low noise, high gain and low power drain are important.

POINT-CONTACT TRANSISTORS
Designed for high speed switching and general-purpose applications.

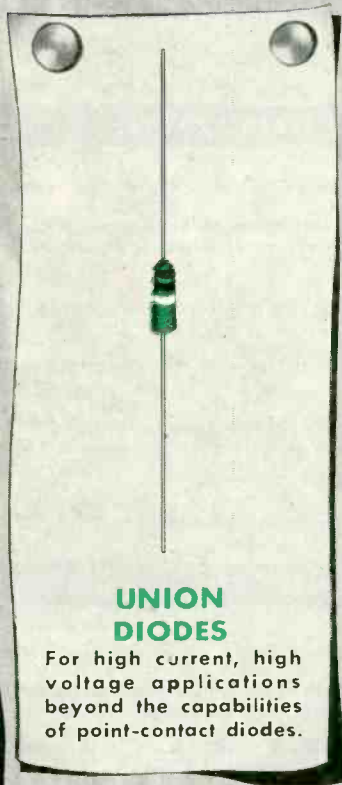

UNION DIODES
For high current, high voltage applications beyond the capabilities of point-contact diodes.

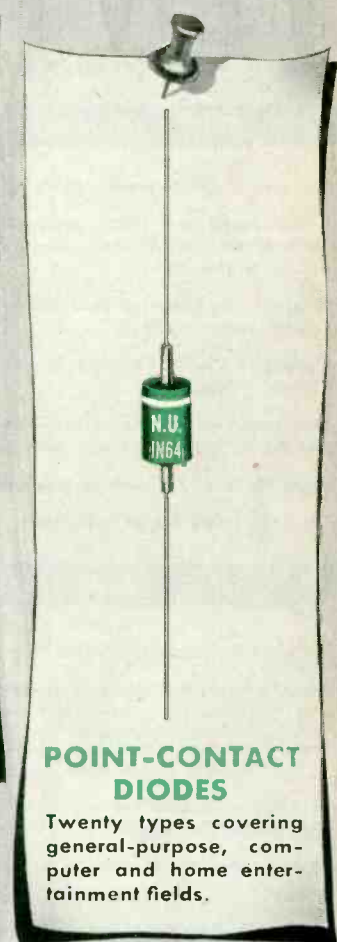

POINT-CONTACT DIODES
Twenty types covering general-purpose, computer and home entertainment fields.

From the electronics engineers who helped pioneer the research and development of transistors and diodes come N. U.'s commercially applicable products.

N. U. Transistors and Diodes are produced to rigid standards under exacting laboratory conditions and have uniform and lasting characteristics. You may be confident of their mechanical and electrical excellence and their performance under severe service conditions.

NATIONAL UNION RADIO CORP.

HATBORO, PENNSYLVANIA



MEPCO

PRECISION RESISTORS

MIL-R-93A NEW SEALED TYPES

Over 2 years of laboratory development and testing were required to achieve a sealed resistor design up to Mepco's standard of quality. No sacrifice of our standard time-proven features has been made in order to perfect this sealed resistor.

Completely hermetically sealed, these resistors provide perfect protection against immersion and high humidity.

All requirements of MIL-R-93A and JAN-R-93 are exceeded.

The operating temperature is -65°C to $+125^{\circ}\text{C}$. Temperature coefficients of $\pm .003\% / ^{\circ}\text{C}$ to $\pm .017\% / ^{\circ}\text{C}$ depending upon your requirements. (Refer to MIL-R-93A).

Other sizes available on special order.

MIL-R-93A JAN-R-93 STANDARD TYPES

Our standard time proven JAN, MIL and Commercial lug terminal resistor.

Manufactured and 100% tested in accordance with the applicable specifications, these resistors are used by every major electronic equipment manufacturer in the country.

Reversed and balanced PI-windings for low inductance, with use of only the finest resistance alloys.

Impregnated with approval fungus, moisture and salt waterproofing compounds.

JAN approved non-hydroscopic steatite bobbin, specially treated prior to winding in order to provide additional protection for fine enameled wire.

Protective fungi resistant acetate label.

Rigid hot solder coated brass terminals for easier soldering.

WIRE TERMINAL TYPES

Designed for direct connection into circuit without use of additional leads.

These resistors are of the same basic construction and materials as standard JAN and MIL types therefore providing equal dependability and long life.

Low Temperature Coefficient alloys provide $\pm .003\% / ^{\circ}\text{C}$ from -65°C to $+125^{\circ}\text{C}$ unless otherwise specified by your requirements.

Resistance tolerances range from $\pm 1\%$ down to $\pm .02\%$. Sets of matched resistors can be supplied $\pm .005\%$ or lower.

Special types not shown can be manufactured to your exact specifications.

JAN-R-29 METER MULTIPLIERS

Surpass all requirements of JAN-R-29

HERMETICALLY SEALED: Insures dependable operation under most severe moisture conditions.

STEATITE PROTECTIVE CASING: Glazed surface prevents high voltage leakage.

WINDINGS: "Certified" low temperature coefficient resistance alloys properly "aged" to provide long term stability.

REPLACEABLE INTERNAL SECTIONS: Eliminate complete loss of unit if damaged.

FERRULE TERMINALS: Heavy nickel plated brass. Corrosive resistant. Fit standard fuse clips.

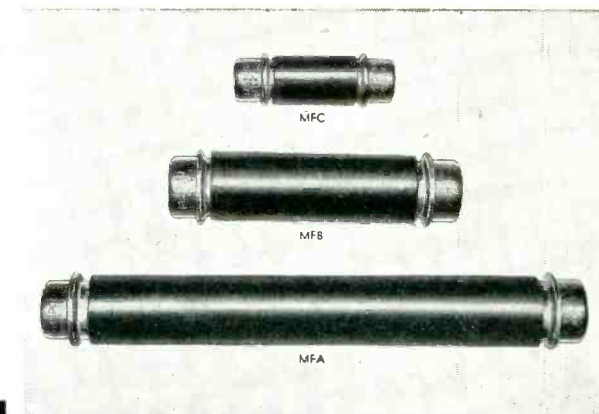
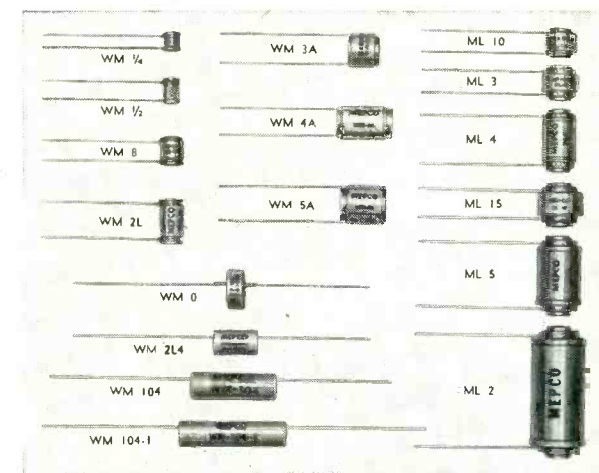
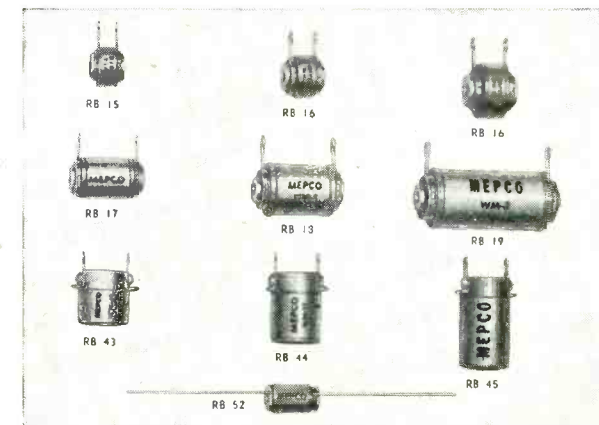
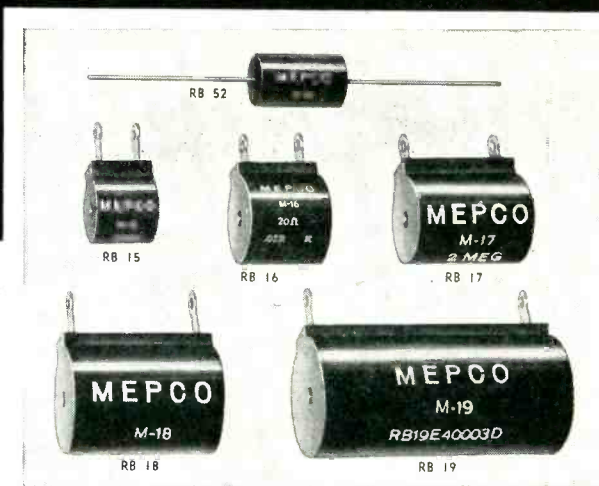

MEPCO, INC. MORRISTOWN, N. J.

You asked for it!



Now for the first time
Burnell & Co. offers a
complete catalog that provides
the answers to frequently asked
questions about Toroids, Coils
and Filters. BURNELL takes
another stride forward in serving
the Electronic Industry in the
exclusive manufacture of
communication network components.

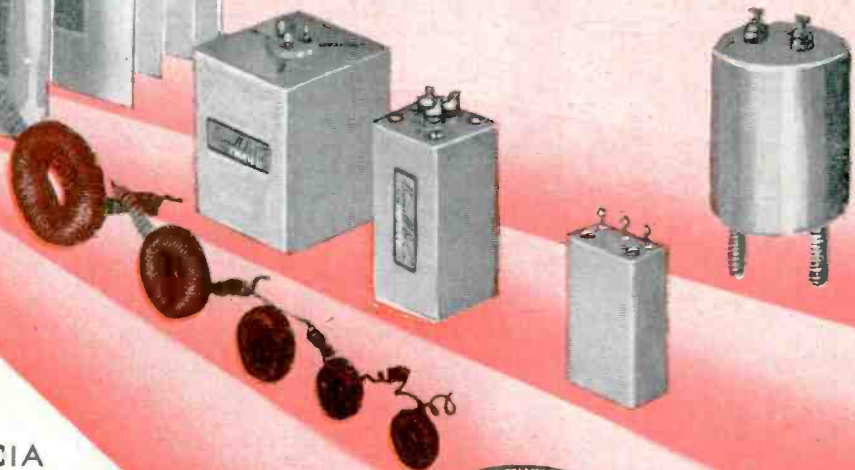

Write for catalog No. IC1A
to help solve your problems —

- FOR ALL MILITARY APPLICATIONS
- FACSIMILE
- TELEMETERING
- TELETYPE
- GUIDED MISSILES
- AIR CRAFT LANDING SYSTEMS
- CARRIER TELEGRAPH
- TELEPHONE
- CONTROL EQUIPMENT
- SONAR



POWER CONVERSION



BULLETIN NO. 118

D.C. OUTPUT VOLTS	D.C. OUTPUT WATTS	A.C. INPUT VOLTS 1Ø	CATALOG NO.	
			115	230
115	125	115	A10	
	125	230	A11	
	125	440	A12	
	250	115	A13	
	250	230	A14	
	250	440	A15	
	375	115	A16	
	375	230	A17	
	375	440	A18	
	500	115	A19	
	500	230	A20	
	500	440	A21	
230	750	115	A22	
	750	230	A23	
	750	440	A24	
	1000	115	A25	
	1000	230	A26	
	1000	440	A27	
	125	115	B10	
	125	230	B11	
	125	440	B12	
	250	115	B13	
	250	230	B14	
	250	440	B15	
	375	115	B16	
	375	230	B17	
	375	440	B18	
	500	115	B19	
	500	230	B20	
	500	440	B21	
750	115	B22		
750	230	B23		
750	440	B24		
1000	115	B25		
1000	230	B26		
1000	440	B27		

Typical Applications

- Motors
- Generator Fields
- Relays, Solenoids
- Magnetic Chucks
- Brakes, Clutches, Pulleys
- Business Machines
- Alarm Systems
- Impulse Clocks

Selenium Rectifier POWER SUPPLIES

GENERAL PURPOSE



BULLETIN NO. 147

D.C. OUTPUT VOLTS	D.C. OUTPUT AMPERES	CATALOG NO.	
		115 V.A.C. 60 ~ 1Ø	230 V.A.C. 60 ~ 1Ø
O-6	25.0	K38	—
	50.0	K47	K48
	100.0	K56	K57
O-12	12.5	K65	—
	25.0	K74	K75
O-28	50.0	K83	K84
	10.0	K92	—
	20.0	K101	K102
	40.0	K110	K111

Typical Applications

- Aircraft Motors
- Dynamotors, Inverters
- Relays, Solenoids
- Electroplating
- Actuators, Valves

Long Life

High Efficiency

No Warm-up Time

Zero Maintenance

MOTOR SPEED CONTROL



BULLETIN NO. 125

INPUT POWER REQUIREMENTS: 105-125 VOLTS 60 cycles A.C.			
MOTOR TYPE AND H.P. RATING	CONTROL RANGE IN PERCENT OF RATED SPEED	DYNAMIC BRAKING	CATALOG NO.
SHUNT UP TO 1/15 H.P.	0-100% OR 0-200%	NO	GM30
SERIES OR UNIVERSAL UP TO 1/15 H.P.	0-100%	NO	GM35
COMPOUND 1/4 AND 1/3 H.P.	0-100% OR 0-115%	YES	GM40
COMPOUND 1/2 AND 3/4 H.P.	0-100% OR 0-115%	YES	GM50

Typical Applications

- Coil Winders
- Lathe Feeds & Drives
- Drilling and Tapping
- Precision Grinders
- Conveyor Systems

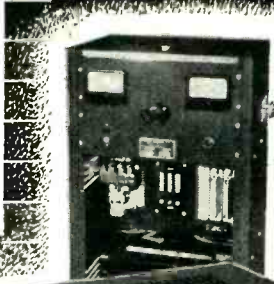

The applications listed on this page are typical of the many fields, in which OPAD-GREEN standard power supplies are effecting economies and assuring satisfaction. In many cases, equipments have been custom-built to fill particular requirements. Our engineers are always ready to provide the best solution for your D.C. power problem. Send us your specifications, or request our form PEQ to aid in establishing your needs.

71-2 WARREN STREET, NEW YORK 7, N. Y.

PROTECTOR TUBES

By

STONE

SLIT TUBES

The longitudinal slit permits easy assembly and provides a snug fitting tube for protecting threaded parts in intra-plant use and shipping.

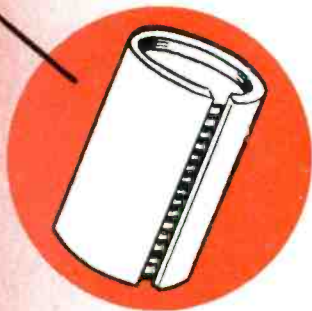

Increasingly large numbers of America's leading manufacturers are finding that the use of inexpensive Stone Protector Tubes saves them time and money.

Small diameter spiral wound paper tubing from 3/64" to 1" ID is our specialty although larger sizes are available. Every item is custom-made yet mass production prices prevail.

Stone Protector Tubes can be furnished in high strength kraft, fish paper, and plastic films in various wall thicknesses and lengths. They can be fabricated in many fashions and can be impregnated with a variety of waxes and resins.

Write us, or still better, get in touch with our nearest representative.

CONTAINERS

Small, round containers with end closures in several styles, used to package and protect glass drills, high speed reamers, diamond tools, thermometers, oil burner nozzles, and rectifiers.

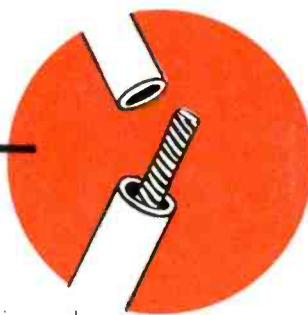
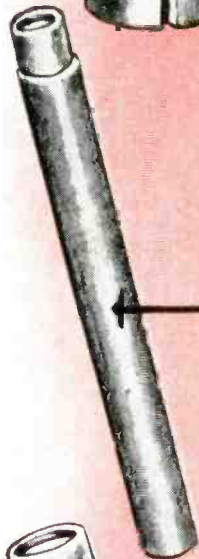

END CLOSURES

End can be closed by means of curled end with disc, cap, insert, or forming the tube end. Recommended for protecting motor shafts when dipping; brass valves and ignitor plugs in shipping; flasher sockets, pilot light lamps, electrical contacts when spraying.

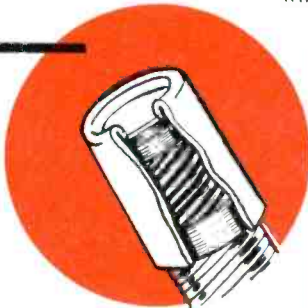
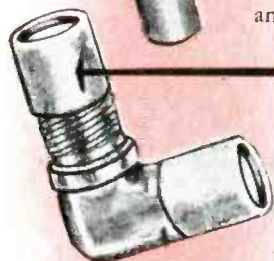

A general purpose protector used extensively to protect threaded and polished parts from damage in intra-plant conveying, assembling and storage. Used as shipping protectors on pipe fittings, spark plugs, and small hand taps.



• **STONE PAPER TUBE COMPANY**
Incorporated

• **STONIZED PRODUCTS COMPANY, INC.**

900-922 Franklin St. N.E. Washington 17, D.C.

SALES OFFICES

BRIDGEPORT 3-2575

O. E. Pfannkuch & Co.,
952 Main Street

CHICAGO Tuxedo 9-6920

Joseph L. Pits,
1643 N. Nagle Avenue

CLEVELAND Main 1-8410

C. E. White & Company,
Bulkley Building

LOS ANGELES . Pleasant 2-0791

E. H. Southwell Co.,
5957 So. Western Avenue

NEWARK Humboldt 5-9000

L. K. Detwiler, 443 Broad St.,
Room 205

PHILADELPHIA . Walnut 2-1182

I. R. Blair, 401 N. Broad St.,
Room 740

ST. LOUIS Parkview 3274

E. B. Henderson Co.,
8147 Delmar Blvd.

TORONTO Murry 1106

Electric Insulation & Fibre Co.,
Ltd., Mendota Road, Etobicoke

Operation Quality

EVERY magnet wire user should eavesdrop on the scene below.

Here Anaconda's team of magnet wire experts apply an exacting program of quality control.

This scene is enacted daily in the office of the mill superintendent. On his desk lie quality-control charts of every phase of wire manufacture. Before him gather foremen from each department—drawing, enameling, engineering, fabric cover-

THE MEN WHO MAKE YOUR MAGNET WIRE are held strictly accountable for its quality at meetings held daily in Anaconda's modern mills. This is why so many customers have eliminated incoming inspection of ANACONDA Wire.



ing . . . right down the line. Each must explain and remedy the slightest deviation from the most rigid standards that have been set up in the magnet wire industry today.

TYPICAL CUSTOMER REACTION

What does this mean to the coil-winder who uses ANACONDA Wire? At one of these quality-control sessions recently, Archie Carbine, enameling foreman, gave a typical example: "Yesterday a customer visiting our plant lingered for a moment in my department. He told me how the girls doing his winding ask for ANACONDA Wire first from their stockroom . . . and use it up first. They find it softer, easier to wind, more pliable, and tougher to break. The job each of us does here pays off in more than our own satisfaction. It saves the customer money."

ANOTHER IMPORTANT SAVING

Other customers agree. Here's how we know: many of them have depended on Anaconda for magnet wire for 25 years or more—and for 80-90% of their wire. Many have further expressed their confidence by eliminating incoming inspection of ANACONDA Wire. They have thereby reduced their cost of operation. Why not see for yourself? Ask your local Anaconda Representative to set a date for an inspection of these quality control steps by you or your engineers. This should convince you—more than words—exactly what Anaconda Quality Control means . . . why so many such visitors come away with a feeling that Anaconda makes a custom-built wire. And they are right! *Anaconda Wire & Cable Company, 25 Broadway, New York 4, N. Y.*

53279

ANACONDA[®]

TODAY'S HEADQUARTERS FOR MAGNET WIRE

**A COMPLETE LINE:
ANY TYPE, SIZE OR SHAPE**
—round, square, rectangular—

Your special needs will be given special attention.

Write for complete pocket-size catalog C69A and handy reference wall chart for shop use (gives dimensions of most popular wire sizes).

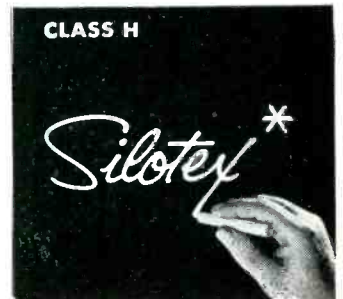
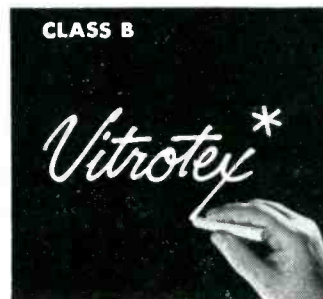
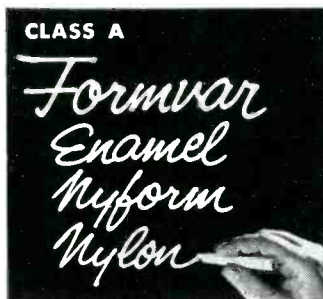

*Reg. U. S. Pat. Off.

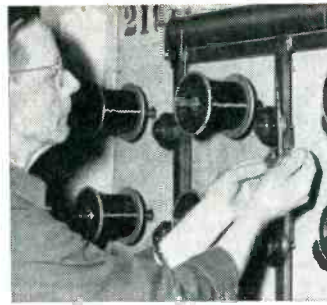

"MIKING" MAGNET WIRE. If the coating of this #29 plain enamel wire fails to come within close tolerances, the machine is shut down. Every 1½ hours the inspector records his findings. This record is then kept permanently.

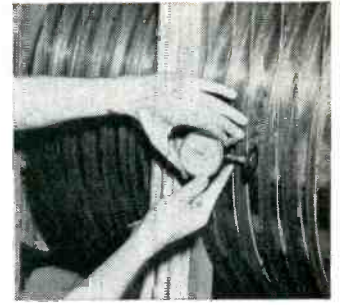

BONDING SPEED of covered wire is checked frequently with a tachometer. The inspector makes a note of this speed on form card beside the machine. Each wire size has a standard speed to assure the bond is properly baked.

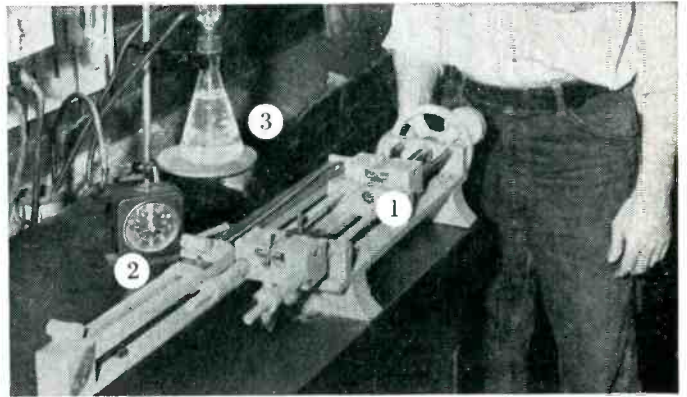

TRIPLE TEST of Formvar physical and chemical characteristics is made after wire comes from enameling machines. Shown in photograph above: 1. Elongation Test; 2. Snap Test; 3. Solubility Test.

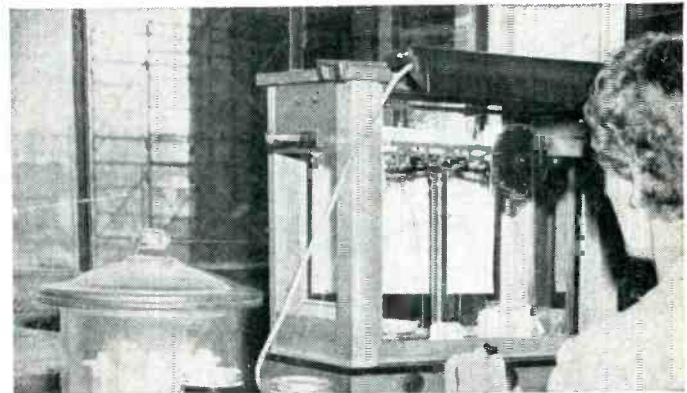

UNIFORM COATING FOR VITROTEX. In Anaconda's modern laboratory, technician carefully determines percentage of solids in glass bond. This is recorded as an important part of dimension control.

Announcing the **STANDARD** ELECTRONIC TACHOMETER



for **P · R · E · C · I · S · E · L · Y**
measuring speed and frequency



Takes Less Space (12" x 12" x 8")

Uses Less Power (100 Watts)

Has Fewer Tubes (Twenty-two)

EASIER TO READ . . . MORE RELIABLE . . . UNIT PLUG-IN CONSTRUCTION

SINCE 1884

STANDARD

The **STANDARD ELECTRIC TIME COMPANY**

97 LOGAN STREET • SPRINGFIELD 2, MASSACHUSETTS

Write for Bulletin #200

PRECISION TIMERS • CHRONO-TACHOMETERS • LABORATORY PANELS • PIPELINE NETWORK ANALYZERS

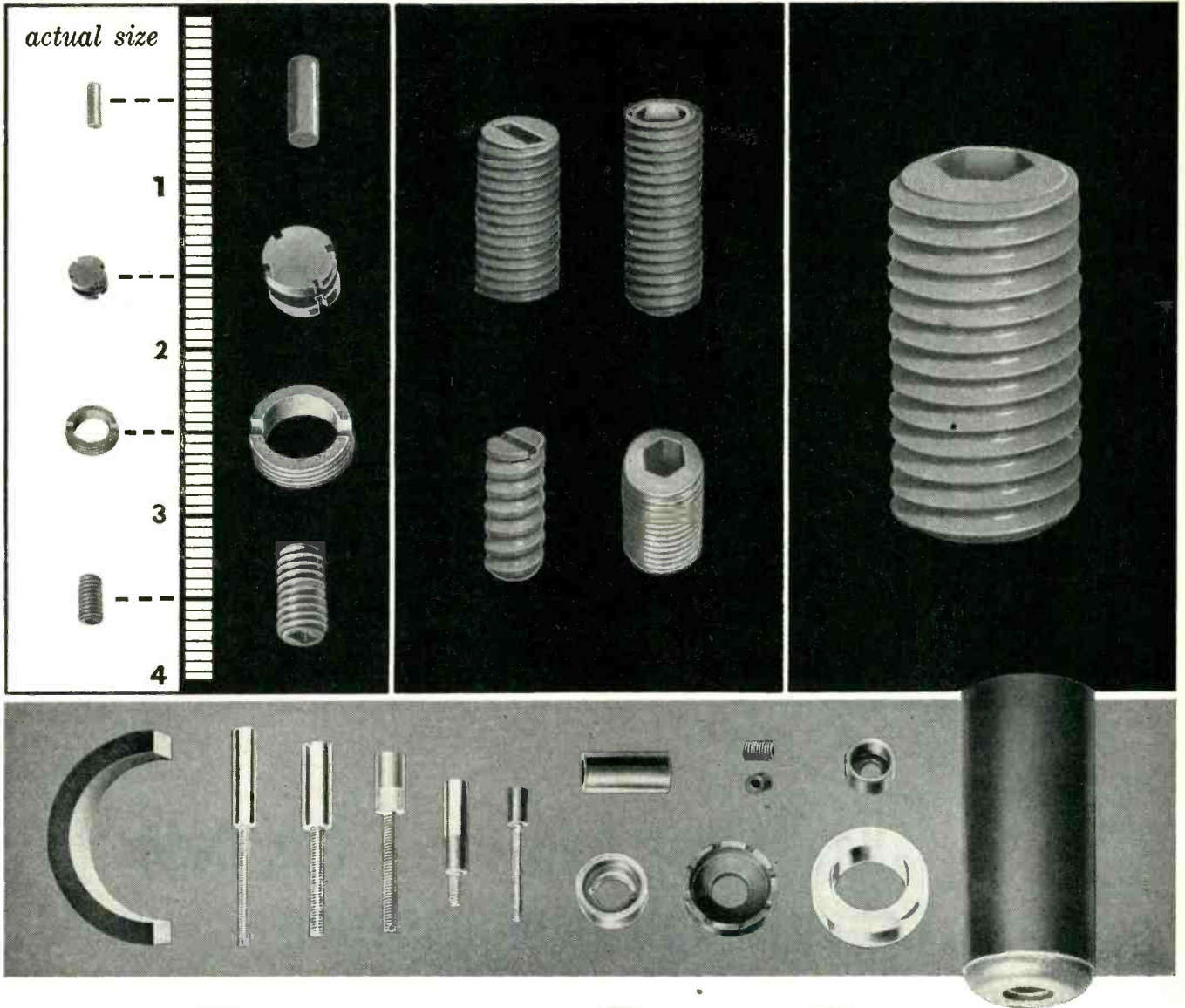

PYROFERRIC IRON CORES

- Scientifically manufactured under strictest quality controls to closest electrical and mechanical tolerances.
- Let us engineer your Core production requirements. Our engineering consultant service is available without charge.
- M.P.A. data sheets and tables give complete information including recommended sizes and tolerances, as well as a cross-reference index of manufacturers' material designation.



Write on your letterhead for latest catalog No. 23S.

PYROFERRIC
 PYROFERRIC BLDG. BRONX BOULEVARD
 at 216th St., N.Y.C. 67

Please send me M.P.A. data sheets and tables No. 305.

NAME _____ TITLE _____
 FIRM _____
 ADDRESS _____ CITY _____ STATE _____

**NILVAR
HERE**

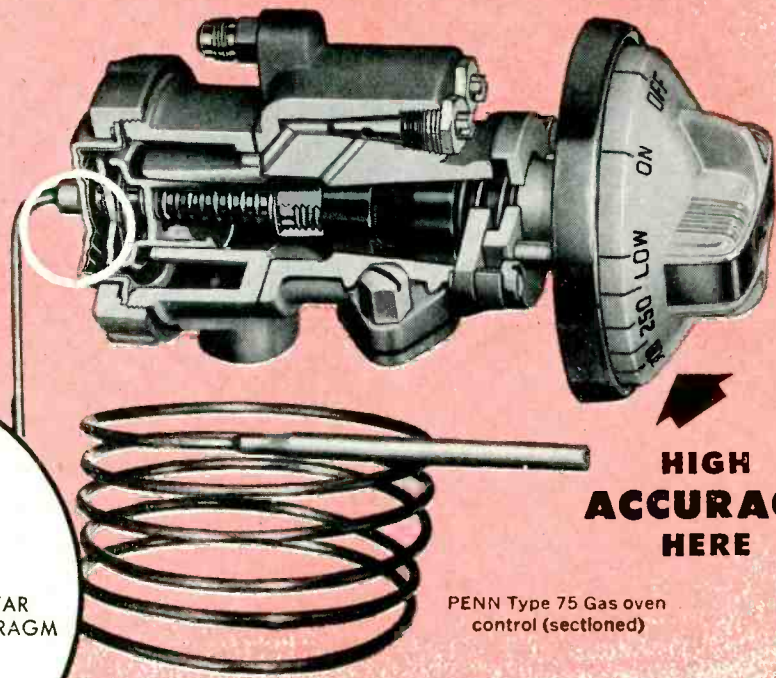
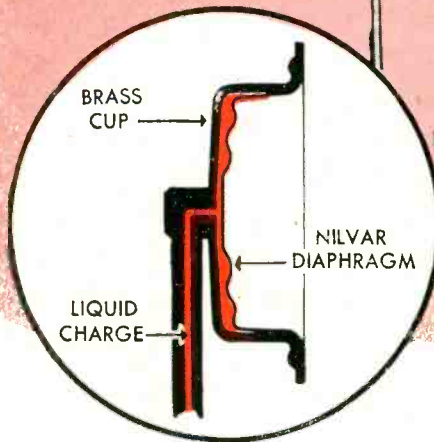

**HIGH
ACCURACY
HERE**

PENN Type 75 Gas oven control (sectioned)

Nilvar* Alloy Makes New PENN Gas Oven Controls Self Compensating

By providing a self-compensating flexible diaphragm assembly for its liquid expansion controls, PENN Controls, Inc. compensates for ambient heat and eliminates control time-lag. Result: controls *accurately* maintain the temperature dialed.

The PENN Self-compensated Diaphragm assembly utilizes a brass retaining cup and a flexible Nilvar diaphragm to form a hollow chamber. This connects to the temperature bulb through a capillary tube, the entire unit being filled with a liquid charge.

Because brass expands much more than Nilvar, ambient heat *simultaneously* increases the volume of the chamber, when it increases the volume of the liq-

uid charge. This self compensation reduces the effect of ambient heat on the diaphragm to zero and permits the diaphragm to respond *only* to bulb temperatures.

PENN specifies Nilvar for this application because it has a very low temperature coefficient of expansion — as low as $.000001/C^{\circ}$ — lowest of any alloy, and comparable to that of quartz. And its consistent uniformity helps maintain the high accuracy which PENN production standards require.

The remarkable dimensional stability of Nilvar may answer your engineering problems too. Why not talk it over with us. We'll be glad to make recommendations geared to your specific needs.

*T. M. Reg. U. S. Pat. Off.



Nilvar is produced only by

Driver-Harris Company

HARRISON, NEW JERSEY

BRANCHES: Chicago, Detroit, Cleveland, Los Angeles, San Francisco

In Canada: The B. GREENING WIRE COMPANY, Ltd., Hamilton, Ontario.

MAKERS OF THE MOST COMPLETE LINE OF ELECTRIC HEATING, RESISTANCE, AND ELECTRONIC ALLOYS IN THE WORLD

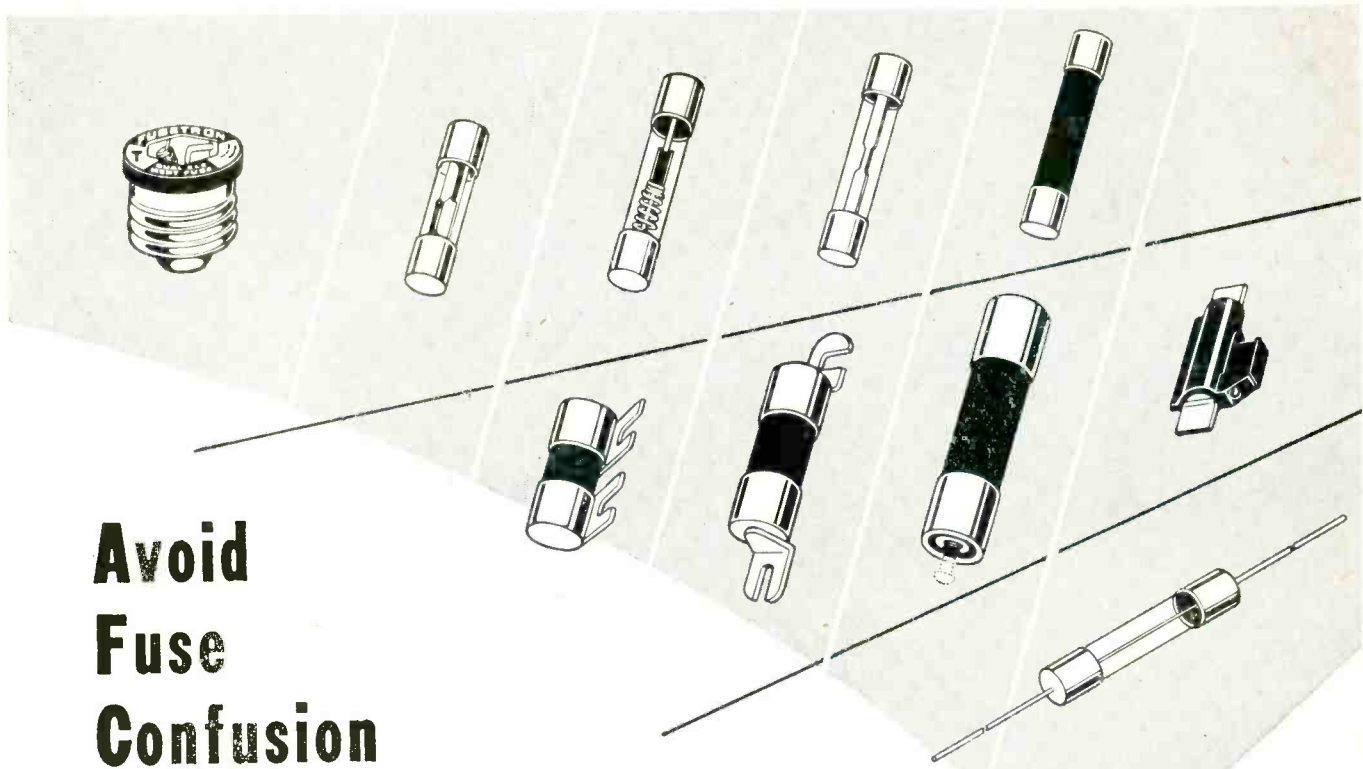

Avoid Fuse Confusion

Standardize on **BUSS** for *every*

protection need in TELEVISION • RADIO • RADAR • INSTRUMENTS • CONTROLS • AVIONICS

BUSS is the one dependable source for any fuse you need: standard type, dual-element (slow-blowing), renewable and one-time types...in sizes from 1/500 amp. up.

To make sure the highest standards of quality are maintained, every BUSS fuse is electronically tested. A sensitive testing device automatically rejects any fuse that is not correctly calibrated, or not right in all physical dimensions.

For Help in Finding the Right Fuse...

the BUSS Fuse Laboratories are at your service to assist you in selecting the fuse that will suit your needs best...if possible, a fuse that is available from local wholesalers' stocks.

PLUS a complete line of fuse clips, blocks and holders....

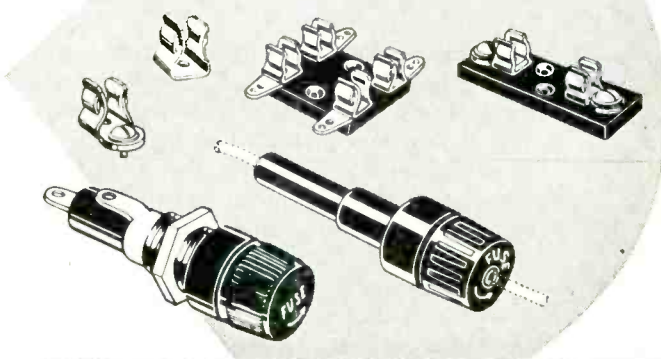

FOR MORE INFORMATION — *Mail this Coupon Today.*

BUSSMANN Mfg. Co. (Division of McGraw Electric Co.)
University at Jefferson, St. Louis 7, Mo.

Please send me bulletin SFB containing facts on BUSS small dimension fuses and fuse holders.

Name _____

Title _____

Company _____

Address _____

City & Zone _____ State _____ ELCR-953

BUSSMANN MFG. CO., Division McGraw Electric Company
University at Jefferson St. Louis 7, Mo.

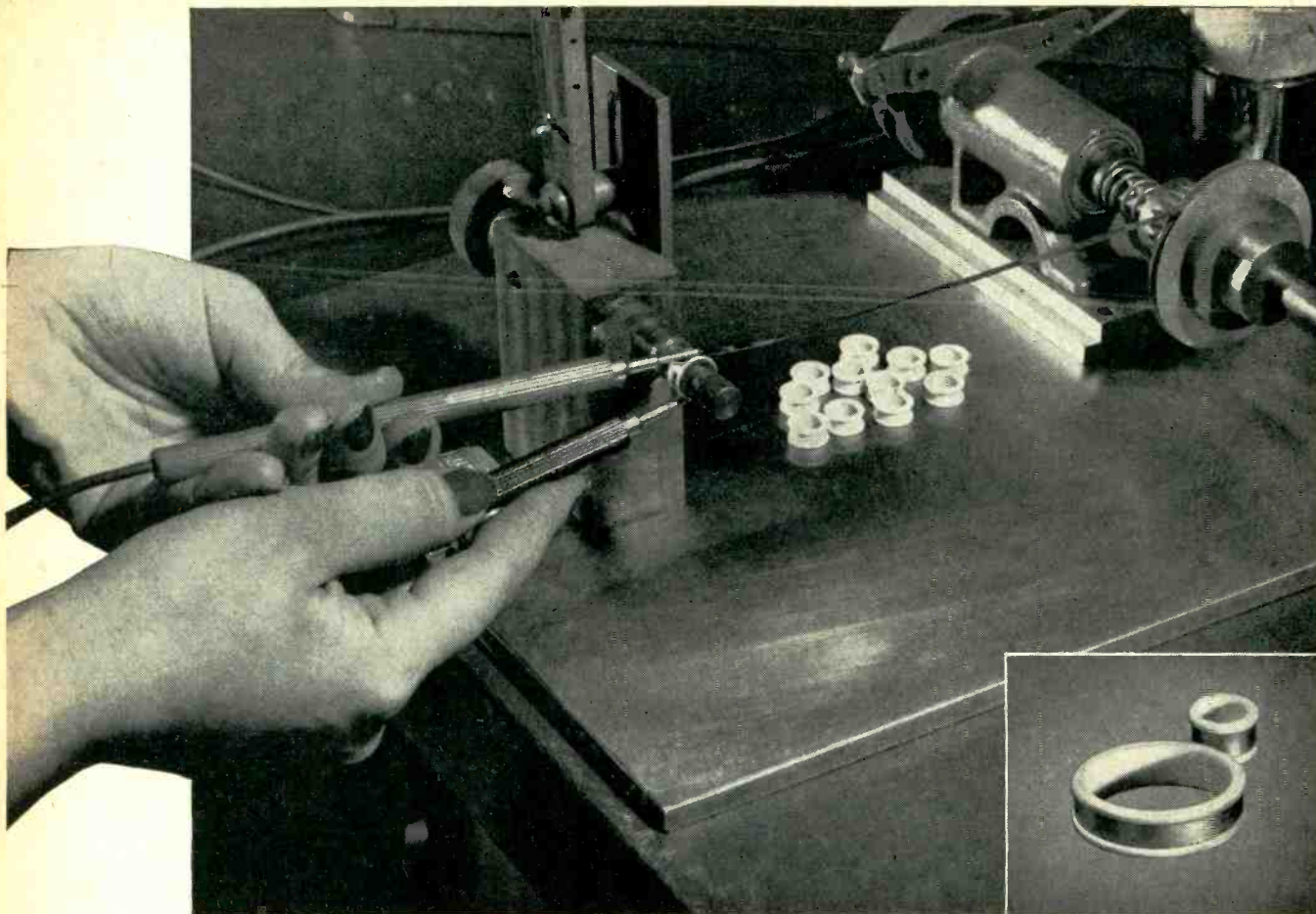

Hiperthin* Cores . . . newest approach to electronic circuit designs

New circuit designs, often making it possible to replace tubes in amplifiers, computers, modulators and similar electronic equipment, are being developed through the use of Westinghouse Hiperthin Cores.

An entirely new, thin magnetic material, capable of retaining its desirable qualities even when rolled as thin as $\frac{1}{8}$ mil, is the reason.

Compounded of grain-oriented silicon or nickel-iron alloys, it combines the fast response, high permeability and low coercive force needed in vhf circuits. Non-deteriorating, it eliminates the periodic replacement problem encountered with tubes, assuring sustained and accurate performance.

To manufacture the new core economically,

*Trade Mark

Westinghouse engineers devised new production methods. The illustration above shows a core being subjected to an electronically controlled spot weld, after being wound. New techniques have also been developed for effectively insulating the turns, and for annealing the metal on a ceramic form as a unit to insure permanent stability.

All your core requirements . . . whether they're for electrical or special electronic applications . . . can be met best by engineers who know and understand your problems. For further information write for reprint No. 4866, *Progress in Core Material for Small Transformers*. Westinghouse Electric Corporation, P. O. Box 868, Pittsburgh 30, Pennsylvania. J-70676

YOU CAN BE SURE...IF IT'S
Westinghouse



Potter & Brumfield excels in meeting SPECIAL RELAY PROBLEMS!



Unusual relay structures like these are developed by Potter & Brumfield to help design engineers meet special problems of circuitry and equipment requirements.

Push-button operated motor-driven antenna switching contactor, single-pole, double-throw, double-break, insulated for 20KV DC, 20 amperes r.f. Operating time: .25 sec.



Hermetically sealed relay built to withstand up to 11KV insulation test. Contact arrangement, 1 Form X. Pure silver contacts rated 5 amperes, 115 volts AC, non-inductive load.

Heavy duty power relay with double-pole, single-throw, normally open contact arrangement and double-pole, double-throw auxiliary contact arrangement. Entire assembly mounted on heavy duty plug.

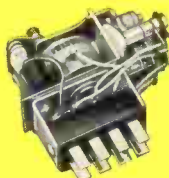

Hermetically sealed enclosures, with four type MH telephone relays.

SM relay with thermal switch and series resistor in "M" type enclosure.

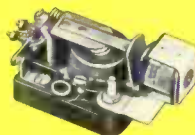

Single-pole, normally closed, double break latching relay with electrical reset for circuit overload.

Single-pole, single-throw, normally closed, double break, manual latch, automatic reset relay.

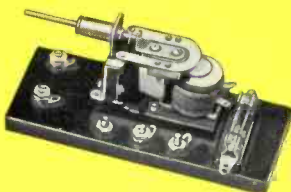

MJ relay with double contact arms and over-size contacts to handle heavy surge currents up to 150 amperes DC.

Single-pole, single-throw, normally closed, double-break, high efficiency sensitive relay.

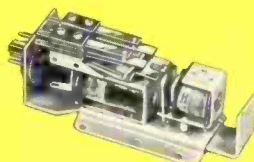

Latching type relay with special mounting bracket and octal plug.

Miniature telephone type MH relay in hermetically sealed enclosure with AN connector.



Dual coil differential relay with single-pole, double-throw contact combination.

P & B engineering offices are located in all principal cities to give you fast service on any relay problem. Check the "classified section" in your telephone directory, or write direct to:

Potter & Brumfield, Princeton, Indiana

See Other Side for P & B's Production Facilities

Potter & Brumfield's modern, complete facilities

give you **SERVICE** and **QUALITY**

in the **PRODUCTION**
of Custom
or Standard **RELAYS**

● Three large plants, including over 50,000 square feet of floor space, fully equipped with complete tooling, coil winding, plastic molding, heat treating, glass metalizing, welding, hermetic sealing and machine tools for every operation. Orderly, efficient plant layouts assure steady, precise assembly line production . . . single shift capacity 10,000 relays per day!



Mass Assembly

Skilled women assemblers trained in the intricacies of assembling and adjusting small relay parts, process thousands of units daily at high speed with maximum efficiency.



Coil Winding

Skilled operators wind millions of feet of various size wire daily into the many different coils required in standard and special relays.



Hermetic Sealing

P & B's hermetic sealing department uses the latest type dessicating equipment (left of picture) for purging and filling operations. Leak detection is accomplished with the mass spectrometer shown at far right.



Final Inspection

After innumerable preliminary inspections, completed relays are sent to final inspection where all structural and electrical characteristics are tested with precision instruments by highly skilled inspectors.

Write Potter & Brumfield **TODAY!**

... about your problems or requirements on relays or similar electro-mechanical assemblies. P & B's competent, well-trained personnel and modern plant facilities offer you the finest service in the relay industry. Samples, recommendations and quotations promptly forwarded on request. Write for new master catalog No. 122 describing and illustrating over 100 versions of P & B relays.

Potter & Brumfield

PRINCETON, INDIANA

Export: 13 E. 40th St., New York, N. Y.

SALES OFFICES IN PRINCIPAL U. S. AND CANADIAN CITIES

P & B STANDARD RELAYS AVAILABLE AT
YOUR LOCAL ELECTRONICS PARTS DISTRIBUTOR

We grew to help you

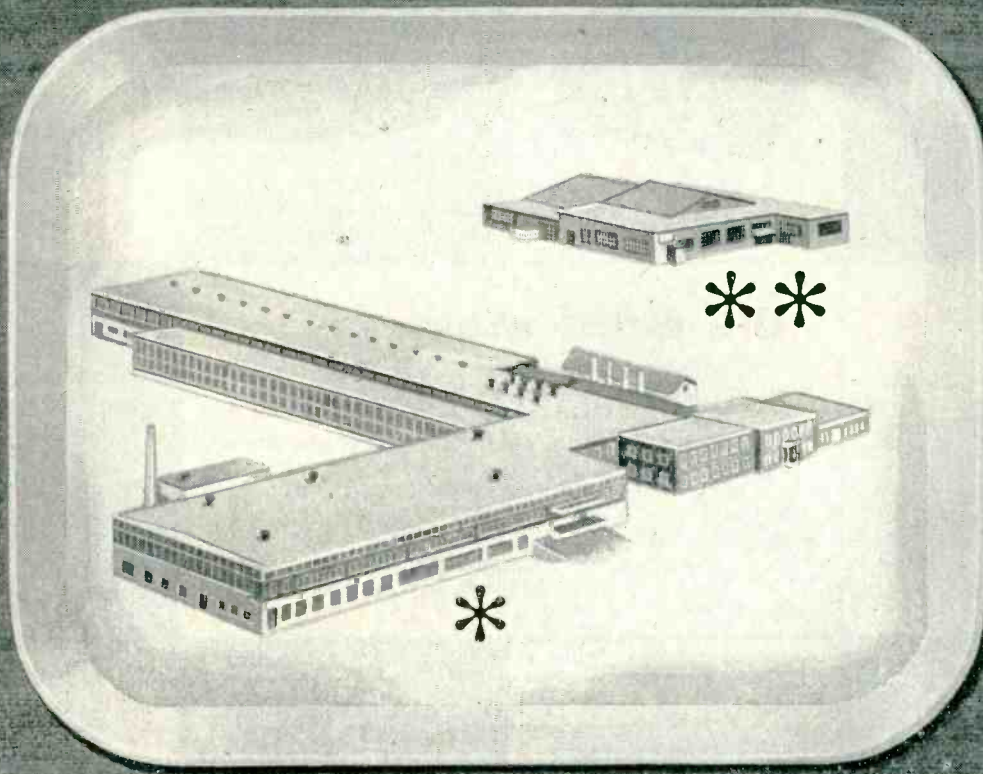

← **BIG, NEW 2-PLANT SIZE** →
50% more seamless nickel cathode capacity

Of this we are sure: you made us what we are today.

You demanded so many of our seamless nickel cathodes that we had to add capacity. We did.

We built another plant—this time at Wapakoneta, Ohio—increasing our seamless nickel cathode output by 50%.

Other familiar characteristics of Superior service remain—the desire to help you with your problems, the experience of skilled tube-fabricators, and quality-controlled manufacture.

Take advantage of Superior service and capacity now.

*Main Superior Tube plant at Norristown, Pa.

**NEW Superior Tube plant at Wapakoneta, Ohio

SEAMLESS NICKEL CATHODES				
Representative size and shape specifications in current production				
Type	Bead	O.D.	Wall Thickness	Length
ROUND	None	.015"	.002"	25.4 mm
ROUND	None	.121"	.0035"	8.0 mm
ROUND	Single	.045"	.002"	27 mm
ROUND	Double	.025"	.002"	28.5 mm
OVAL	Double	.025" x .048"	.003"	12 mm
OVAL	Single	.045" x .149"	.002"	31 mm
OVAL	Single	.025" x .048"	.003"	12 mm
ELLIPTICAL	Double	.025" x .048"	.003"	11 mm
RECTANGLE	Single	.030" x .0975"	.002"	11 mm
RECTANGLE	Double	.040" x .132"	.004"	33.4 mm

Many other types of nickel cathodes—made in Lockseam† from nickel strip, disc cathodes—and a wide variety of anodes, grid cups and other tubular fabricated parts are available from Superior. For information and Free Bulletin address Superior Tube Company, Electronics Division, 2500 Germantown Avenue, Norristown, Pa.



Seamless Nickel Cathode—Round, flanged one end. .115" O.D. x .105" I.D. 180" long.

Lockseam† Nickel Cathode Plate, .170" O.D. x .005" wall, 1" long.

Weld drawn‡ 305 Stainless Steel Anode Rolled and Bent 10°. .499" I.D. x .010" wall x 1.050" long.

Disc Cathode .121" O.D. .312" long.



† Manufactured under U.S. Patents
 ‡ Trademark Reg. U.S. Pat. Off.

All analyses .010" to 3/8" O.D.
 Certain analyses (.035" Max. wall) up to 1 3/4" C.D.

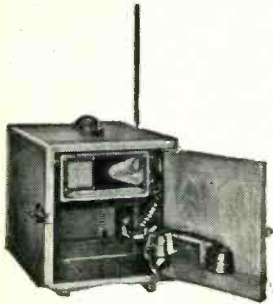
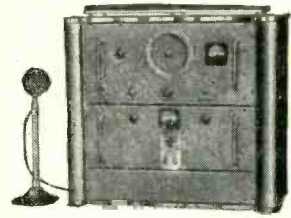

the right move . . .

In more than fifty countries Pye radio-telephones are indicating the right move. The next step, great or small, in divers undertakings.

In the engineering industry, immediate direct communications are vital. The deployment of resources to the fullest advantage demands contact. Contact swift and sure. Contact at speeds to match the action required.

Whenever men and machines are on the move Pye V.H.F. Radio-telephones will promote speed and efficiency.

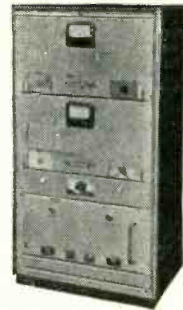

Telecommunications

CAMBRIDGE ENGLAND

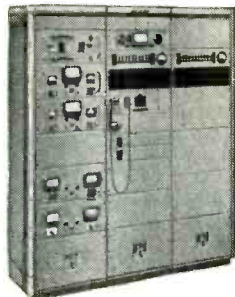

P Y E L I M I T E D • C A M B R I D G E • E N G L A N D

telling the story of 'dag' dispersions

Here is a
CRT Exterior Wall Coating
that's Fast-Drying,
Adherent, Opaque



'dag' Exterior Wall Coating is a dispersion of extremely fine graphite in lacquer.

It is easily applied by spraying, and dries for handling in 2 to 3 minutes. Maximum adhesion is obtained by drying at room temperature for 24 hours... with the same result from infra-red at 100°C. for ½ hour.

The coating obtained is as smooth as the glass itself and as black as coal. Its adhesion is so good that scratching it is almost an impossibility. Water won't loosen it either.

Acheson Colloids can also supply appropriate dispersions for coating interiors of tubes.

You can have more detailed data by asking for Bulletin No. 433-5 J.

Dispersions of molybdenum disulfide are available in various carriers. We are also equipped to do custom dispersing of solids in a wide variety of vehicles.



Acheson Colloids Company, Port Huron, Mich.

... also **ACHESON COLLOIDS LIMITED**, LONDON, ENGLAND

Units of Acheson Industries, Inc.



*try resin-bonded dry graphite films
for permanent lubrication*

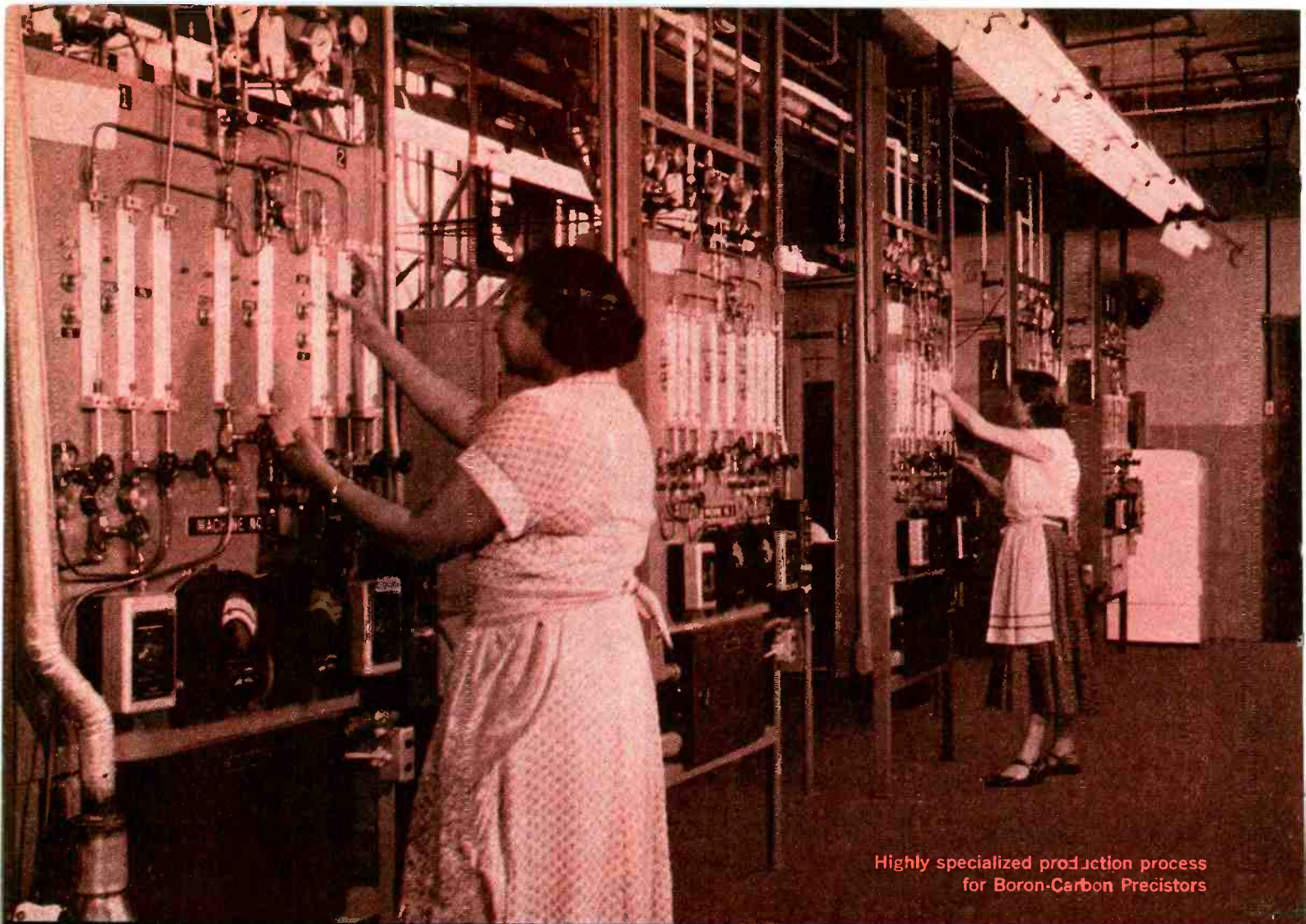

Highly specialized production process
for Boron-Carbon Precistors

ONLY FILM TYPE RESISTORS MEET HIGHER

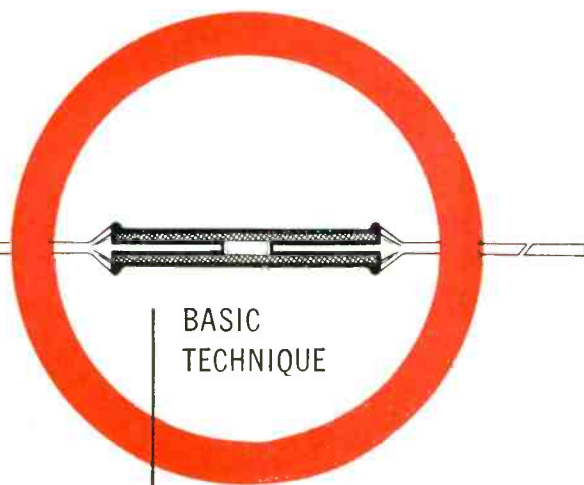

BASIC TECHNIQUE

A thin coating of pre-cured and stabilized resistance material is bonded to special glass or an inorganic core to form IRC's exclusive filament type element. This is in contrast to the carbon pill or slug principle of construction. Its uniformity and stability have proved superior since the earliest days of radio.

Advancing requirements of instrumentation, military electronics and television focus emphasis on greater stability for non-wire wound resistors. IRC believes its filament type construction offers the best answer to more exacting standards. For over 28 years the film type resistance element has proved its superior stability—even in today's newest IRC Boron-Carbon Precistor.

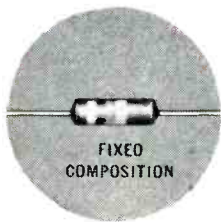

high popularity—high stability

More IRC Filament Type BT Resistors are used in radio and TV sets than any other brand. They meet and beat JAN-R-11 specifications, and have been tested and approved by most producers of government equipment. Exceptionally stable—in $\frac{1}{3}$, $\frac{1}{2}$, 1 and 2 watts. Send coupon for Data Bulletin.

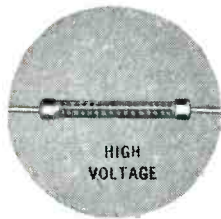

high voltage—high stability

IRC Type MV High Voltage Resistors offer outstanding stability even in very high resistance values. Filament resistance coating in helical turns on ceramic tube provides a long, effective conducting path. 2 to 90 watts. Check the coupon for detailed information.

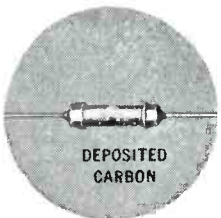

high economy—high stability

Type DC Deposited Carbon Resistors combine accuracy and economy with high stability. Excellent where carbon compositions are unsuitable and wire wound precisions too large or expensive. Available in $\frac{1}{2}$, 1 and 2 watts. Use coupon for further facts.

STABILITY STANDARDS

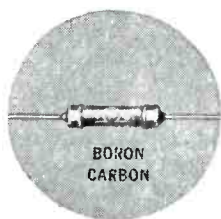

high accuracy—high stability

The ultimate in *stable* non-wire wound resistors, Type BOC Boron-Carbon Precistors conform to all requirements of MIL-R-10509A. Voltage coefficient less than 20 parts per million per volt. Extraordinary load life. $\frac{1}{2}$, 1 and 2 watts. Send for Bulletin.

Boron & Deposited Carbon Precistors • Power Resistors • Voltmeter Multipliers • Low Wattage Wire Wounds • Insulated Composition Resistors • Volume Controls •

Wherever the Circuit Says

Precision Wire Wounds • Ultra HF and Hi-Voltage Resistors • Low Value Capacitors • Selenium Rectifiers • Insulated Chokes • Hermetic Seal Terminals •



NEW
resistor



MOLDED
boron-carbon
precistor



Eliminates Possibility of End-Cap Trouble



Eliminates Danger of Mechanical Damage



Improved Electrical Characteristics

The new Type MBC $\frac{1}{2}$ watt, 1% resistor offers the inherent superiority of a Boron-Carbon resistor plus the advantage of a fully insulated unit. Send coupon for full details.

INTERNATIONAL RESISTANCE CO.

403 N. Broad St., Philadelphia 8, Pa.

In Canada: International Resistance Co., Ltd., Toronto, Licensee

Send me full data on: DC Deposited Carbon; BT Insulated Filament Type Resistors; MV High Voltage Resistors; BOC Boron-Carbon Precistors; MBC Molded Boron-Carbon Precistors

Name _____

Title _____

Company _____

Address _____

City _____ Zone _____ State _____

TRIPPLET 630 Volt-Ohm-Mil-Ammeter

"speaks" for itself in any company

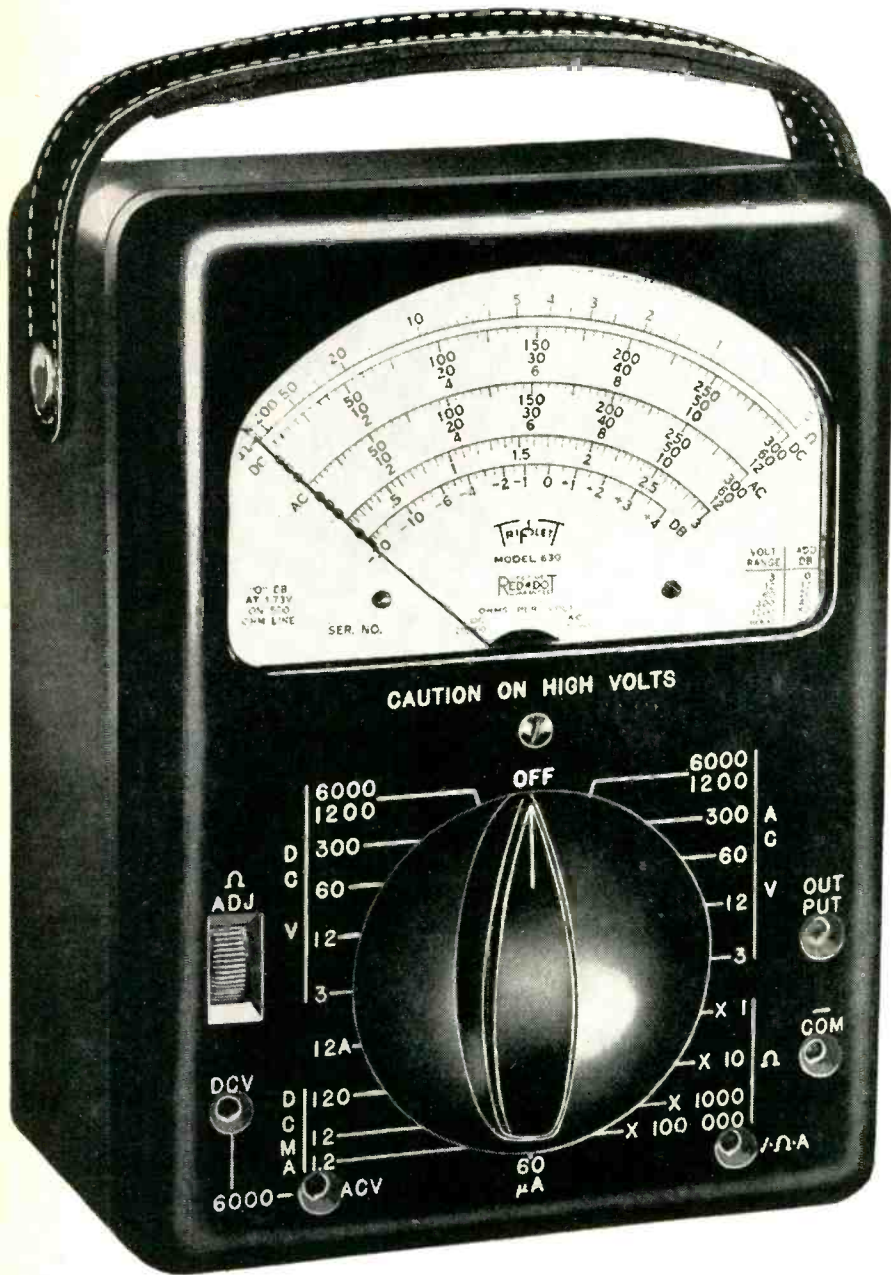

ing to desired circuit thru a single 2½" knob flush with the face panel. The molded switch itself embodies the most advanced engineering practices. Fully enclosed, the silvered contacts are kept permanently clean. Its rugged construction means stronger performance and longer life.

These two factors are but samples of the many ways in which on-the-job needs have been anticipated and provided for in a beautiful streamlined tester. It provides A.D-D.C. Volts, D.C. Micro-amperes, Milli-amperes, Amperes, Ohms, Megohms, Decibel and Out Put readings in a no-short design embodying interior construction with all direct connections; no harness cabling. Its fool-proof unit switch construction houses precision resistors in insulated recesses in direct connection with switch contacts.

Study the following Ranges and descriptions and compare them point by point with any similar instrument for conclusive proof that Triplet 630 "speaks" for itself in any company.

Ranges

D.C. Volts: 0-3-12-60-300-1200—at 20,000 Ohms/Volt (For Greater Accuracy on TV and other High Resistance Circuits.)

A.C. Volts: 0-3-12-60-300-1200-6000—at 5,000 Ohms/Volt

(For Greater Accuracy in Audio and other High Impedance A.C. Circuits.)

Decibels: -30, +4, +16, +30, +44, +56, +70. (For Direct Reading of Output Levels.)

D.C. Microamperes: 0-60—at 250 Millivolts.

D.C. Milliamperes: 0-1-2-12-120—at 250 Millivolts.

D.C. Amperes: 0-12—at 250 Millivolts.

*Ohms: 0-1,000-10,000—(4.4-44 at center scale).

*Megohms: 0-1-100—(4,400-440,000 center scale).

Output: Condenser in series with A.C. Volt ranges.

*Resistance ranges are compensated for greatest accuracy over wide battery voltage variations. Series Ohmmeter circuits for all ranges to eliminate possibility of battery drain when leaving switch in Ohms position.

TRIPPLET 630 Volt - Ohm - Mil - Ammeter has many significant advantages and features that make it stand distinctly apart from similar instruments in its price class. Actually in components, in engineering, in minutely accurate performance, Triplet 630 closely approaches laboratory standards.

Since the scales of any VOM comprise the means by which it makes its multiple services most valuable, the legibility and easy-read-ability are of prime importance. Triplet engineers have created in Triplet 630 the longest scales available in this size tester. (The upper arc by actual measurement is four and three-eighth inches.)

This long-scale factor accounts for the ease with which precise readings are easily made. Further legibility is gained by use of black and red scale markings. D.C. and D.B. are black and white. A.C. and Ohm markings are red on white. Ohms from one hundred million to one-tenth ohm mark the range of this amazing scale. On low ohms, center scale reading is 4.5 ohms.

The Single Switch

Further indication of the practical skill and engineering "know-how" behind Triplet 630 is the Single Switch. Its simplicity of operation assures no burn-outs thru momentary memory lapses. There is instant switch-

Get a Triplet 630 into your own hands at your distributor.
U.S.A. Dealer Net \$3950

TRIPPLET ELECTRICAL INSTRUMENT COMPANY
BLUFFTON, OHIO



SOME of our customers are equipped to do their own sub-assembly work; others find it more economical to have us do it.

Either way, we deliver the finest in sheet metal cabinets, chassis, housings and enclosures.

If we do your sub-assembly, all that's left for you to do is that which you and you alone must supervise—the wiring, assembly and testing of *your* equipment. The result: faster, cheaper, more efficient assembly.

Another Karp facility—sub-assembly:

the gathering place for extra enclosure-economies

And like our Assembly Department, the entire plant is dedicated to the principle of producing the finest sheet metal cabinets, chassis, housings and enclosures *at the lowest possible price*. How well we live up to the principle is easily proved: simply send us your blueprints. We'll promptly quote prices and delivery.

KARP METAL PRODUCTS CO.

Division of H & B American Machine Company

215 63RD STREET, BROOKLYN 20, N. Y.



- FACILITIES FOR ENGINEERED SHEET METAL FABRICATIONS:** in aluminum or steel • long run or short • spot, arc, gas or heliarc welding • any type finish.
- Modern plant—3 city blocks long
 - Thousands of dies available
 - Most modern of sheet metal fabricating equipment
 - U. S. Air Force Certified Welding Facilities
 - Air-conditioned spray room... complete baking facilities
 - Complete sub-assembly facilities

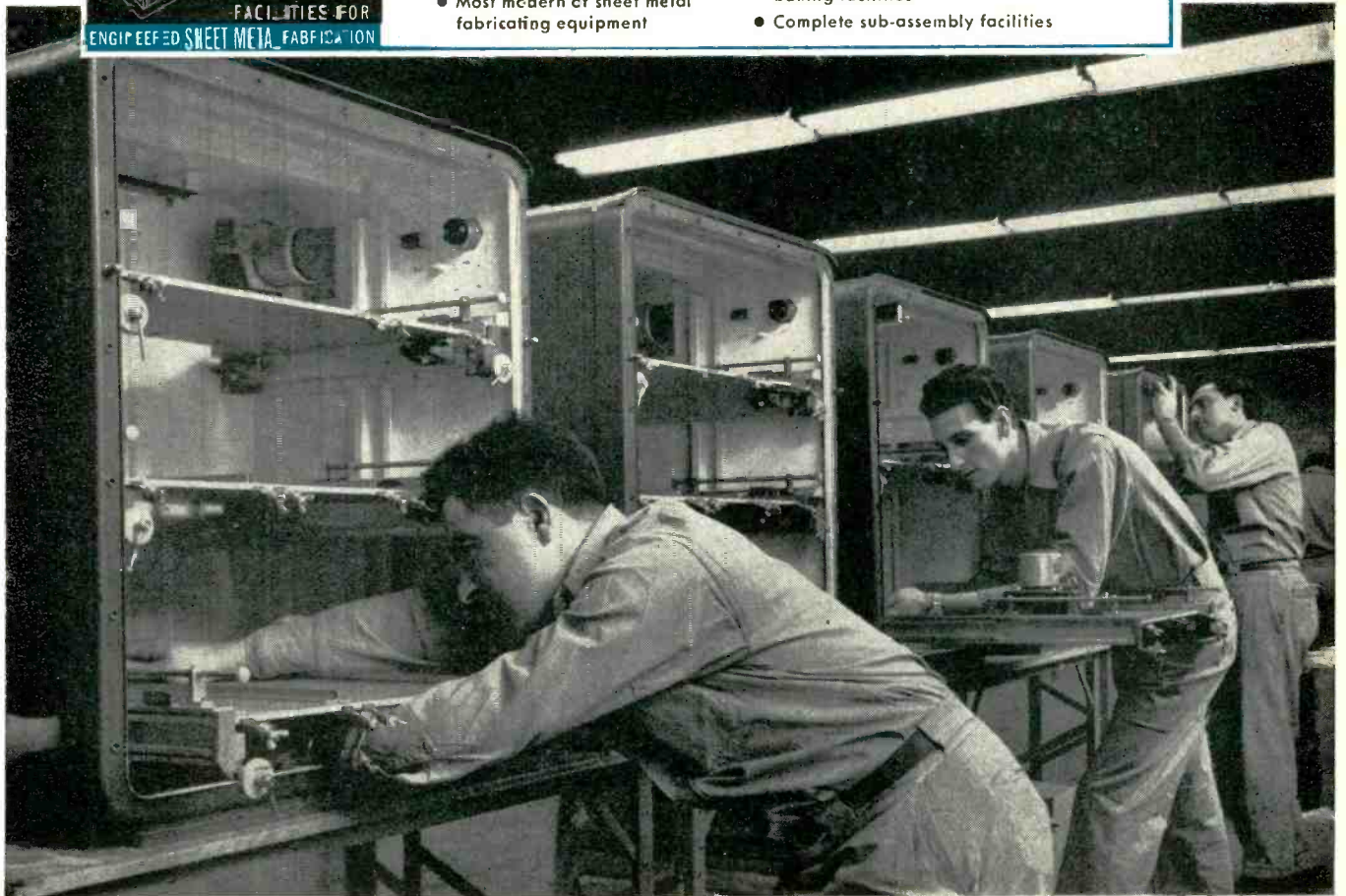

A NEW CTS FAMILY

Of Variable Resistors

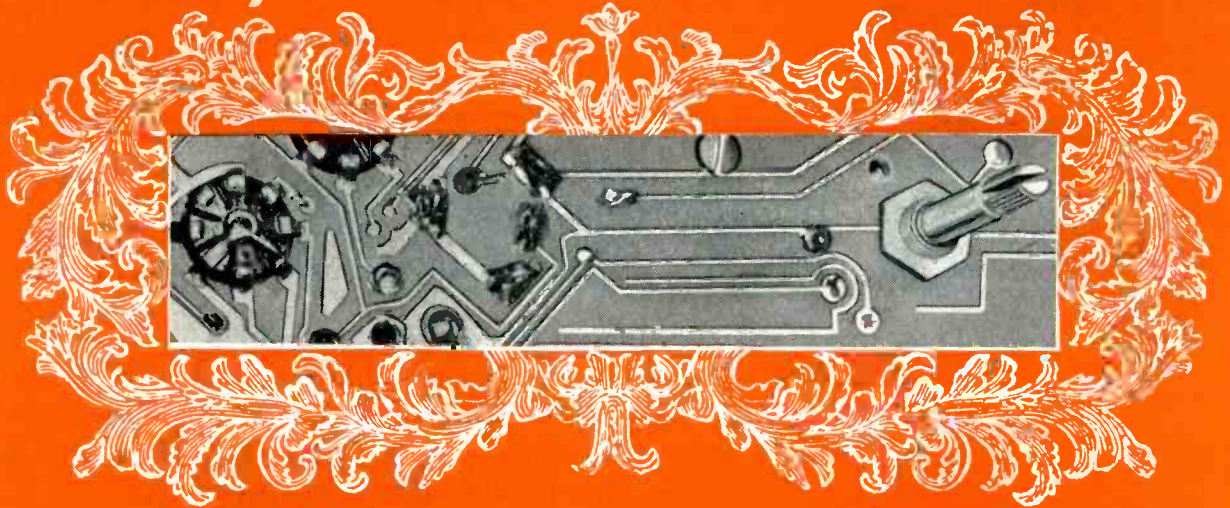

FOR PRINTED CIRCUIT APPLICATIONS

Note these unique design features:

- ① Protection against bending during handling is achieved by recessing each blade-type terminal in a notch in the bakelite base of the control.
- ② Valuable mounting space is conserved on the printed circuit panel by placing the terminals close in to the mounting bushing.
- ③ Adequate clearance for circuit paths is provided by ample spacing between terminals.
- ④ Available in *miniaturized* 3/4" diameter (U70) and in 1 1/16" diameter (U45, GC-U45, WF-U45).

For your printed circuit applications, CTS offers consultation without obligation.

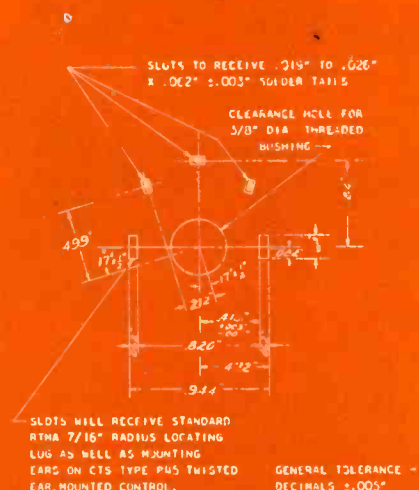
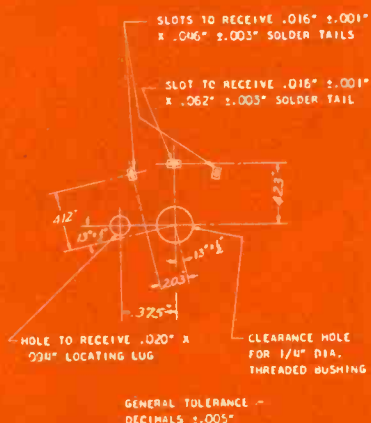

Ample spacing between printed circuit terminal openings for the miniature Type U70 series provides adequate clearance for circuit paths.

Ample spacing between printed circuit terminal openings for Types U45, GC-U45 and WF-U45 provides adequate clearance for circuit paths.

Type U70, 3/4" diameter *miniaturized* variable composition resistor with special printed circuit terminals. Wattage rating: .3 watt for resistances through 10,000 ohms, .2 watt with 350 volts maximum across end terminals for resistances over 10,000 ohms.

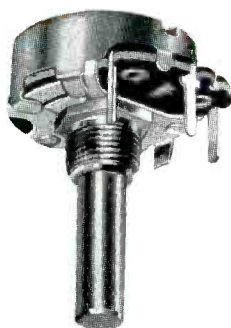

Type U45, 15/16" diameter, variable composition resistor with blade-type printed circuit terminals. Wattage rating: 1/2 watt for resistances through 10,000 ohms, 1/3 watt for resistances over 10,000 ohms through 100,000 ohms and 1/4 watt with 500 volts maximum across end terminals for resistances over 100,000 ohms.

Type GC-U45, 15/16" diameter, variable composition resistor with blade-type printed circuit terminals same as U45 except with attached SPST, 3 ampere, 125 volt "GC" type switch. Also available with type "WF", DPST, 3 ampere, 125 volt switch. (Variable resistor type WF-U45.)



CHICAGO TELEPHONE SUPPLY
Corporation

ELKHART • INDIANA

REPRESENTATIVES

Henry E. Sanders, McClatchy Bldg.
69th & Market St., Upper Darby, Penna.
Phone: Flanders 2-4420

W. S. Harmon Company, 1638 So. La Cienega Blvd.
Los Angeles 35, California • Phone: Bradshaw 2-3321

John A. Green Company, 6815 Oriole Drive
Dallas 9, Texas

IN CANADA

C. C. Meredith & Co., Ltd., Streetsville, Ontario

SOUTH AMERICA

Jose Luis Pontet
Buenos Aires, Argentina • Montevideo, Uruguay
Rio de Janeiro, Brazil • Sao Paulo, Brazil

OTHER EXPORT

Sylvan Ginsbury
8 West 40th Street, New York 18, N. Y.

Specialists in Precision Mass Production of Variable Resistors

This is the art
for next month's ads
on the new Allmetal
Plant in Garden City.
Any Comments?
C.W.

Maybe we should
emphasize the product in
the artwork - show various types
of stainless steel screws, nuts, bolts, etc.
P.F.

pretty picture, but a
comparison is needed -
show how new plant will increase
production. Better "in stock" set-up.
J.L.

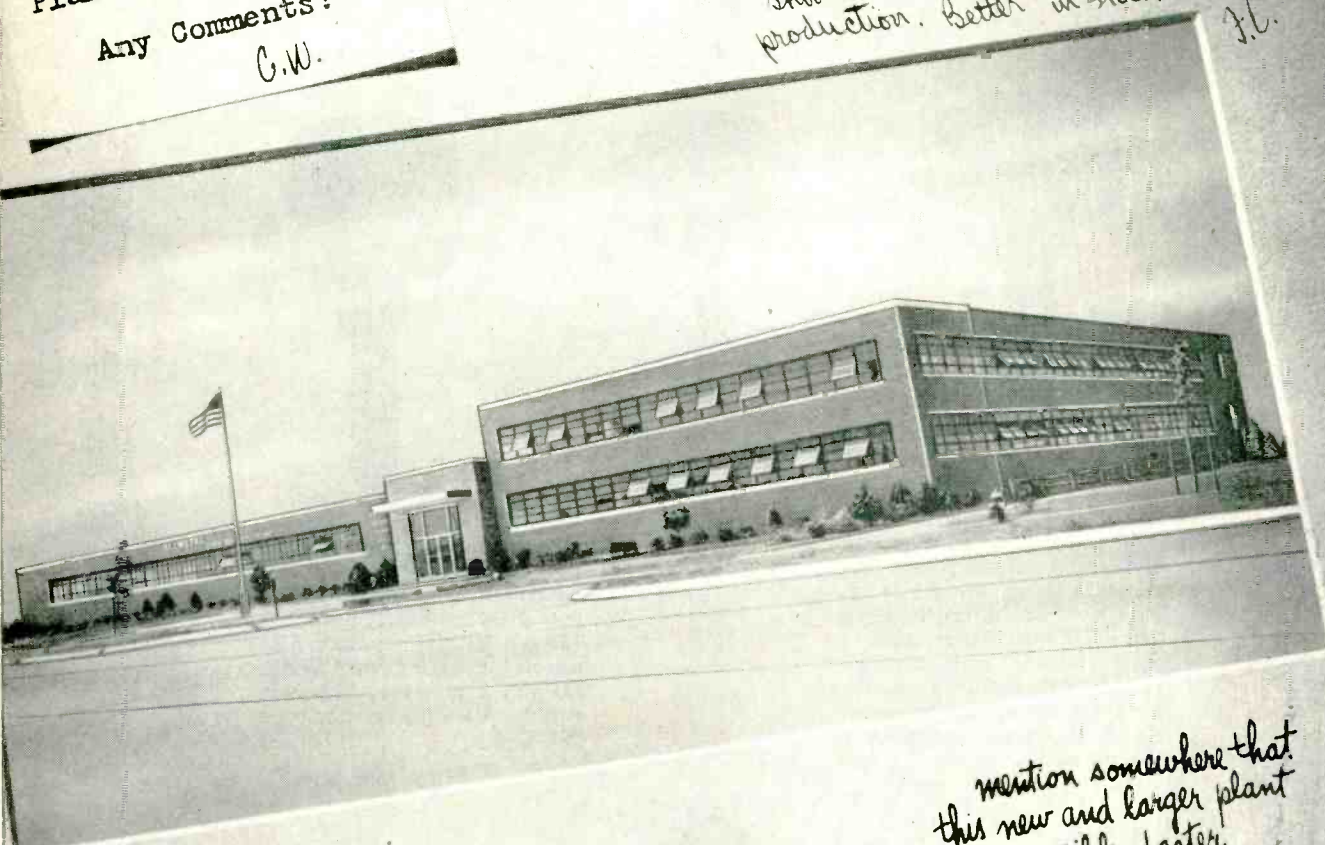

Don't let the newness of the plant obscure
the old story, still true: Allmetal gives
wide selection of standard
and "AN" fasteners,
quick delivery and
fast production
of "specials" too.
JC

mention somewhere that
this new and larger plant
makes possible faster
service on special orders.
J.M.

Write, on
your letterhead, for our new, 96-page catalog No. 53



ALLMETAL
SCREW PRODUCTS COMPANY, INC.
821 STEWART AVE., GARDEN CITY, L. I., N. Y.
TELEPHONE - GARDEN CITY 3-1200

use
this

Designers—The right tube... find it with G.E.'s

NEW SPOT-RATING SERVICE ON THYRATRONS!



YOUR electronic circuit may require a control tube with special performance. Even General Electric's 36 thyratrons—largest choice in the industry—may not include a type whose published ratings are identical with the tube you need.

Here G. E.'s Thyatron Spot-rating Service takes over. Published tube ratings, such as those listed on this page, apply to *only one set of pre-established conditions*. Under different circuit conditions, a G-E thyatron's voltage or current capacity may be greater. For exam-

ple, if your peak voltage is less than 1250 v, Type GL-3C23 in practice may be found able to handle in excess of 1.5 amp current.

General Electric always is glad to recommend such possibilities, after study. You can have a thyatron that custom-fits your circuit—at the same time, one that's industry-tested for performance. You will save by installing a type already in large production! . . . With the list below as your guide, write pinpointing your thyatron needs! *General Electric Company, Tube Department, Schenectady 5, N. Y.*

FOR EVERY APPLICATION, A CHOICE OF **PROVED** G-E THYRATRONS!

Primary application and type number	Average amp	Peak amp	Peak volts, inverse	Primary application and type number	Average amp	Peak amp	Peak volts, inverse
MOTOR CONTROL				GL-393-A	1.5	6	1250
GL-C1J	1	8	700	FG-27-A	2.5	10	1000
GL-3C23	1.5	6	1250	GL-5728/FG-67	2.5	15	1000
GL-5720/FG-33 (3 electrodes)	2.5	15	1000	GL-5830/FG-41	12.5	75	10000
GL-5560/FG-95 (4 electrodes)	2.5	15	1000	HIGH CURRENT AMPLIFICATION			
GL-5544	3.2	40	1500	GL-5663	0.02	0.06	500
FG-172	6.4	40	2000	GL-2D21	0.1	0.5	1300
FG-105	6.4	40	2500	GL-5727 (special heater-cathode construction)	0.1	0.5	1300
GL-6044	6.4	77	500	GL-502-A (metal)	0.1	1	1300
GL-5545	6.4	80	1500	GL-2050 (glass)	0.1	1	1300
GL-414	12.5	100	2000	GL-627	0.64	2.5	2500
GL-5855	12.5	150	1500	GL-678	1.6	6	15000
WELDING CONTROL				FG-154	2.5	10	500
GL-5560/FG-95	0.5	30	1000	GL-5559/FG-57	2.5	15	1000
GL-5632 (gas)	2.5	30	1250	GL-672-A	3.2	40	2500
GL-6011 (gas and mercury)	2.5	30	1250	MODULATOR SERVICE			
FG-172 (metal)	2.5	77	750	GL-6130	0.045	35	3000
FG-105 (glass)	2.5	77	750	GL-5948	1	1000	25000
	4	16	10000	SPECIAL APPLICATIONS			
REGULATED POWER SUPPLY				*GL-5662	(fuse tube)		200
FG-81-A (3 electrodes)	0.5	2	500	**GL-885 (2.5-v heater)	0.075	0.3	350
FG-98-A (4 electrodes)	0.5	2	500	**GL-884 (6.3-v heater)	0.075	0.3	350
FG-97	0.5	2	1000	*for electronic-blanket control **for oscilloscope sweep circuits			
GL-5557/FG-17	0.5	2	5000				



GENERAL ELECTRIC



Vibration Engineering that solves your problems

PROBLEM: To locate vibration and measure it

SOLUTION: This sensitive, velocity-type MB Vibration Pickup

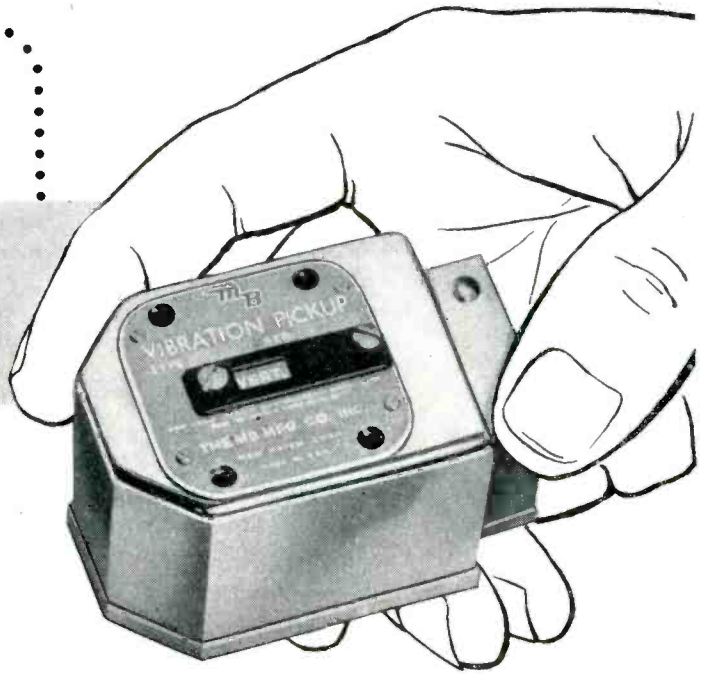

Illustrated here is the MB Type 122 Vibration Pickup developed for jet engine testing. It withstands 500° F.

To LICK VIBRATION you've got to *locate* it first. That's a job for which the MB Vibration Pickup was developed. It has the sensitivity needed to detect the faintest vibration—the stamina to withstand the strongest.

When fastened to the product, component or structure under test, this pickup faithfully converts vibratory motion into electrical output. Its signal can be seen and studied on the oscilloscope; or measured by meter such as the direct-reading MB Vibration Meter; or fed to vibration analyzer.

The pickup is usable from 5 to 2000 cps in horizontal or vertical operation. Magnetic damping assures calibration stability. Light-weight moving coil and low-friction pivot-

ing account for the pickup's wide range of serviceability.

Today, this unusual instrument is being found indispensable for accurate vibration detection. It's one more reason why MB is known as headquarters for the answers to vibration problems—including those in shake testing, measurements, vibration isolation and shock mounting. Full details on pickups in Bulletin No. Write us.



Double duty vibration exciter

Specification MIL-E-5272 and other vibration testing specifications can be met with the Model C-1 Shaker. It develops 50 pounds of force. An electromagnetic shaker, it features easy, continuous control of force and frequency. It also serves as a calibrator for vibration pickups.

The technique of calibration has been thoroughly presented in MB's booklet entitled "The Calibration of Vibration Pickups to 2000 cps." Send for Booklet C-11-5.



THE MB MANUFACTURING COMPANY, INC.
1060 STATE STREET, NEW HAVEN 11, CONN.

PRODUCTS AND EQUIPMENT TO CONTROL VIBRATION • TO MEASURE IT • TO REPRODUCE IT

INTERNAL



SUPPORTS AND INSULATORS
AlSiMag 393, 544, 548 Lava 1136, 1137
Anode • Cathode • Grid • Heater

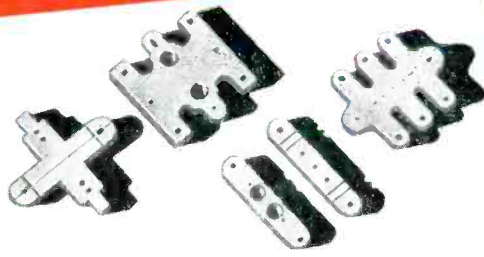

SPACERS
AlSiMag 393, 544, 548, 211-S
Lava 1136, 1137

EXTERNAL

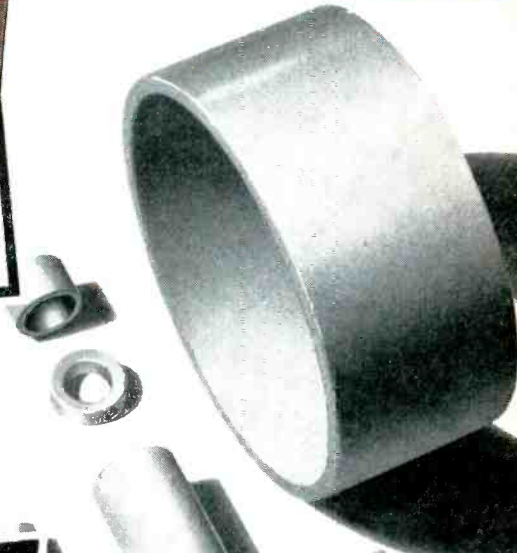

ENVELOPES
Precision ground internally and externally
AlSiMag 576, 243

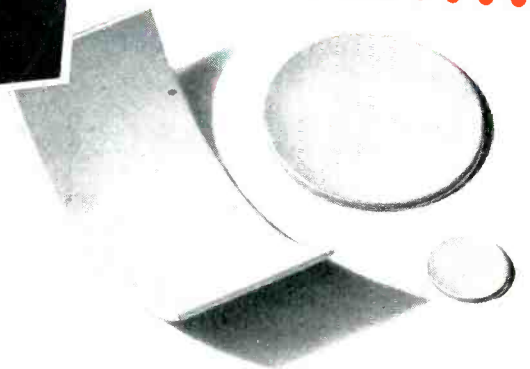

WINDOWS — Precision Ground
AlSiMag 576, 243

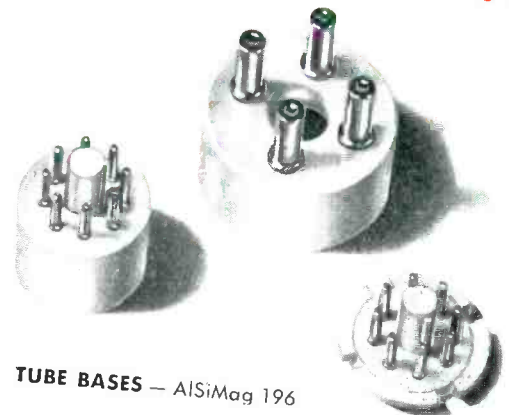

TUBE BASES — AlSiMag 196

For materials to match your
PERFORMANCE REQUIREMENTS

ALSiMAG[®]

provides the
widest choice of

INSULATING COMPONENTS FOR ELECTRON TUBES

Lava and compositions of Alumina, Steatite or Forsterite

Progress on tube design depends to a great extent on the materials available for their construction. In AlSiMag you have the widest choice of materials to match your requirements. New materials are constantly being developed to meet specific problems.

The wide choice of AlSiMag ceramics permits you to balance your mechanical and dielectric requirements for your specific use.

TEST SAMPLES from our files sent free on request. SAMPLES to your blue print made at reasonable cost. BULLETIN NO. 537 "Internal Insulators for Electronic Tubes" sent on request.

52ND YEAR OF CERAMIC LEADERSHIP

AMERICAN LAVA CORPORATION

A Subsidiary of Minnesota Mining and Manufacturing Company

CHATTANOOGA 5, TENNESSEE

OFFICES: METROPOLITAN AREA: 671 Broad St., Newark, N. J., Mitchell 2-8159 • SYRACUSE, N. Y.: 330 Arlington Ave., Phone 76-5068 • CLEVELAND: 5012 Euclid Ave., Room 2007, Express 1-6685
NEW ENGLAND: 1374 Mass. Ave., Cambridge, Mass., Kirkland 7-4498 • PHILADELPHIA: 1649 N. Broad St., Stevenson 4-2823 • ST. LOUIS: 1123 Washington Ave., Garfield 4959
CHICAGO: 228 N. LaSalle St., Central 6-1721 • SOUTHWEST: John A. Green Co., 6815 Oriole Dr., Dallas 9, Dixon 9918 • LOS ANGELES: 5603 N. Huntington Dr., Capital 1-9114



because...EDO knows aerodynamics

because...EDO knows marine design

because...EDO knows electronics

let **EDO** house your electronic equipment

Housing intricate electronic equipment for airborne or shipboard use to withstand shocks and forces which might cause malfunction often presents problems as difficult as the design of electronic systems themselves.

Tackling such problems for electronic manufacturers, ship and aircraft builders is a specialty of the Edo Corporation. Whether your equipment must operate properly on jet aircraft or on board ship under battle conditions, its reliability is improved if mounted in Edo-designed and built cabinets or housings.

If you have a housing problem, why not talk it over with our versatile engineering staff whose three-fold experience in the marine, aviation and electronics fields is unique *and at your disposal*.

to withstand...

SHOCK
MACH 1 SPEED
VIBRATION
CONCUSSION
SPRAY
ENVIRONMENTAL

TWO TYPICAL HOUSING PROBLEMS SOLVED BY EDO

1. AIRBORNE HOUSING. A volume producer of airborne radar nacelles, Edo was asked to design a pressurized external store housing capable of being flown in the trans-sonic speed range. From wind tunnel tests to completed tooling and production, Edo relieved the electronics manufacturer and the aircraft builder of these design problems.

2. SEABORNE INSTALLATIONS. To house its own electronic equipment developed and manufactured for the Navy, Edo engineers have perfected a series of *standard* electronic cabinets admirably suited to naval electronic equipment. Capable of housing all standard electronic units, the Edo cabinets are vibration-proof and spray-proof.



CORPORATION

College Point, L. I., N. Y.

SINCE
1925

Faster... For testing...

COMPACT, PORTABLE BENCH-TYPE TESTING UNIT FOR RAPID HIGH and LOW TEMPERATURES

Primarily developed for a branch of the armed forces, this high and low temperature testing unit has a temperature range from -80° F. to $+185^{\circ}$ F. Rapid temperature pull-down to -80° F. requires 30 minutes or less. Heat application is accomplished through reverse cycle refrigeration. Hazards of open heating elements are eliminated. Test chamber dimensions are 12" x 12" x 12" and the overall dimensions are 50" long, 26" high and 20" deep. Approximate weight is 450 pounds. The unit is compact and is entirely self contained. Controls are simplified and easy to operate. Equipped

with air-cooled compressors, the unit is quiet in operation. Cabinet is of stainless steel with all controls visible. A blower is provided for even distribution of temperatures and greater testing accuracy. The door illustrated is a latch type door providing for complete removal from the cabinet. Holes may be drilled for electrical contacts.

This is one of the many examples of WEBBER engineering skill and another of the many firsts built by WEBBER in the low temperature field.

Write for more complete information:

INDUSTRIAL FREEZER DIVISION
WEBBER MANUFACTURING COMPANY, INC., 2745 MADISON AVENUE, INDIANAPOLIS 3, INDIANA
(Formerly Webber Appliance Co., Inc.)

WEBBER

TRADE MARK

COMPLETE TEMPERATURE RANGE TESTING UNITS

LOW-TEMPERATURE INDUSTRIAL FREEZERS

THERE'S A WEBBER UNIT FOR EVERY NEED

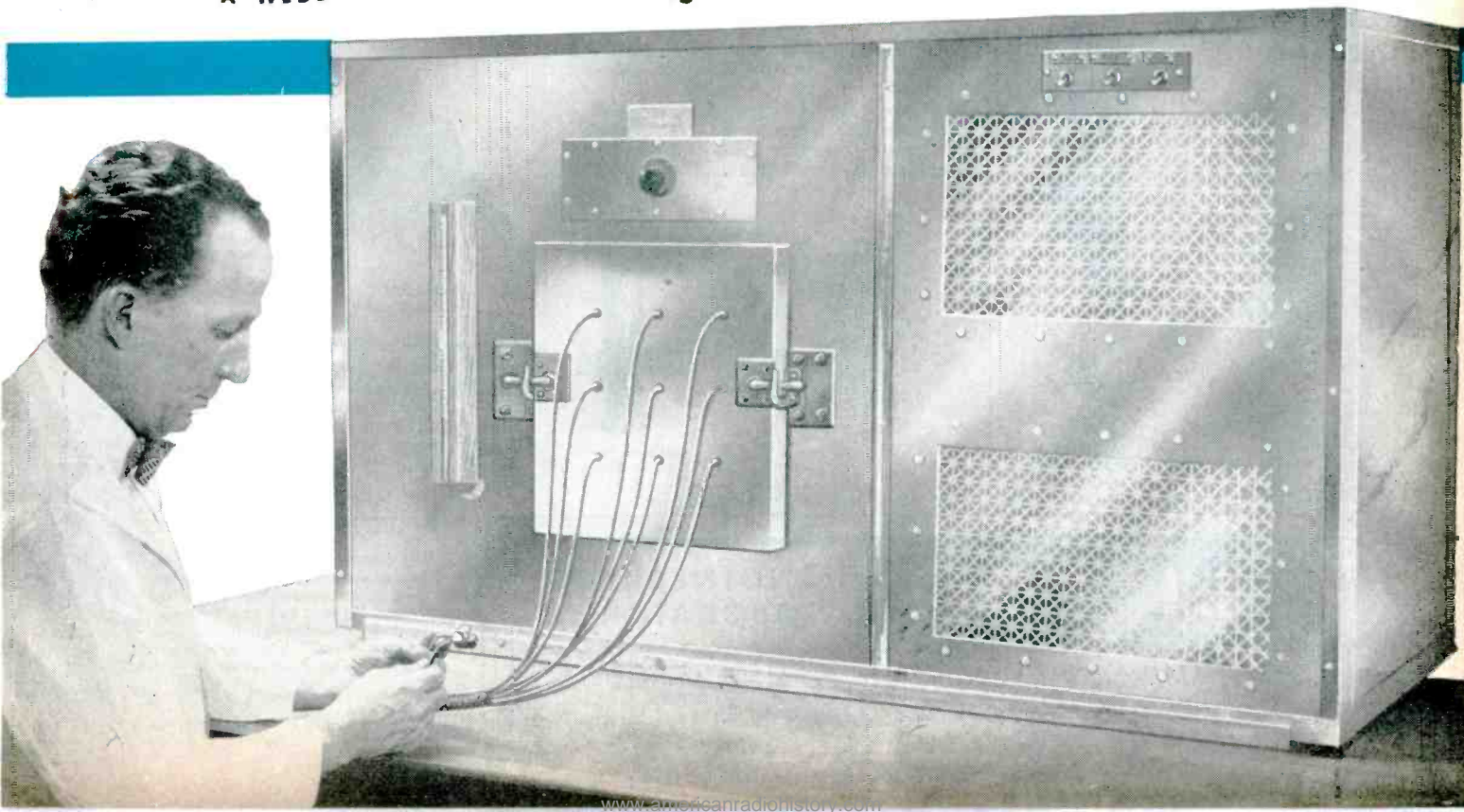

LITTON ENGINEERING NEWS

Now! A high quality, integrated tool line for vacuum tube manufacturing

Litton Engineering Laboratories now offers a complete, integrated line of tools for the fabrication, assembly, exhaust and testing of vacuum tubes. All are designed for maximum accuracy, durability and operating simplicity.

Model AQ Spindle Head provides fast, precise sizing and trimming of metal parts. For precision milling, Model G Milling Machine and Model Q Spindle Head are offered. Model AF Polishing Head is available for operations such as polishing kovar for kovar glass seals.



Model AF Polishing Head

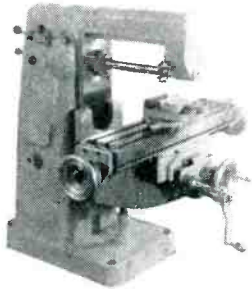

Model G Mill

Litton Bell Jars and vertical Hydrogen Furnaces insure trouble-free brazing with 100% yield. Precision spot-welding may be performed quickly and efficiently on Model A Spot-welder with one of two high-accuracy Litton Timers.



Model 5301 Bell Jar



Model 4400 Hydrogen Furnace

Model A Spot Welder

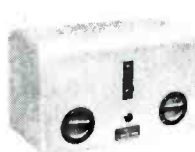
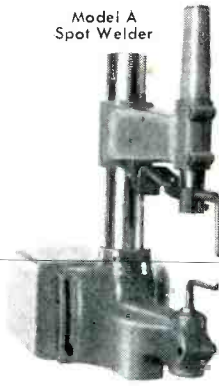

Model 5400 Timer

Litton Glassworking Lathes, standard of the vacuum tube and kinescope industries, are available in several models to handle work up to 36" diameter. Customized stem heads, 4-jaw chucks, burners and red-wood collets are available to adapt lathes exactly to your needs.

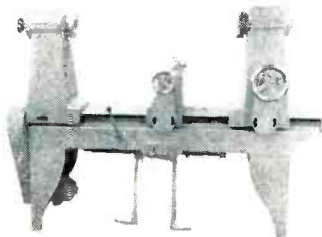

Model ME Glassworking Lathe

Litton Model PB Vacuum Pumps are proven units for high vacuum exhaust (5×10^{-8} mm Hg.) on the production line. Pumps are stainless steel, water cooled, and employ charcoal baffles and Litton Type "C" Molube oil.



No. 3 Oven



Model PB Vacuum Pump

Reliable pressure monitoring during continuous exhaust schedules is available with Model L-3032 Ion Gauge (Philips type*) and Model 4301 Ion Gauge Amplifier.



Model L-3032 Ion Gauge

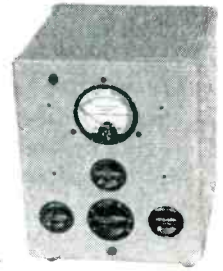

Model 4301 Ion Gauge Amplifier

For electrical tests, typical Litton equipment includes Model 3901 Differential Thermopile (temperature differential measurement), Model 4000 U-Line (SWR measurements 450 to 2750 mc), Model 5500 Phase Changer (for introducing vari-

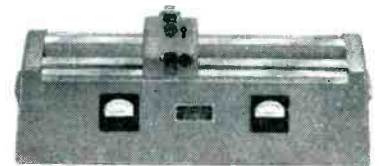

Model 4000 U-Line

able-phase standing waves at x-band frequencies), Model 4100 Water Load (for dissipating power) and Litton Heater Calibrators for calibrating loads.

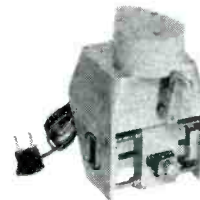

Model 5500 Phase Changer



Model 3901 Thermopile

The design and performance of all equipments has been proven throughout years of actual manufacturing service in Litton plants. If these equipments do not meet your requirements please advise of your specific needs. Write direct for complete information.

*Licensed under Philips Laboratories, Inc. Patent No. 2197079 Data subject to change without notice.

2781



LITTON

ENGINEERING LABORATORIES

1049 BRITAN AVENUE • SAN CARLOS 2, CALIFORNIA • U. S. A.

twenty times
tested!



TWICE SIZE →



EVERY Texas Instruments grown junction and point contact transistor must pass more than 20 tests—in addition to continual visual checks—before it is granted the TI trademark and shipped to the user.

Texas Instruments inspects *all* transistors *all along* the manufacturing process.

This 100% inspection insures that the completed product will adhere closely to published specifications (see distribution curves at lower right).

All TI transistors have moisture-proof glass-to-metal hermetic sealing. And they are *all* aged a minimum of 24 hours at rated output as a positive operating double-check.

If you want transistors of this insured high quality, they are now available from Texas Instruments Incorporated. Write for new junction transistor bulletin DL-S 310.

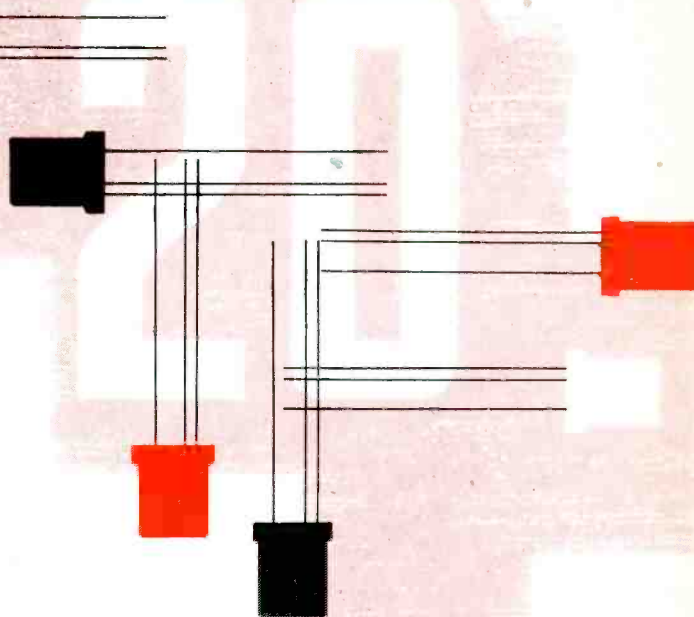

ELECTRICAL DATA

RATINGS, RECOMMENDED MAXIMUM:

	n-p-n Junction	
	Type 200	Type 201
Collector Voltage	30 volts	30 volts
Collector Current	5 ma.	5 ma.
Collector Dissipation (at 30°C)	50 mw.	50 mw.
Ambient Temperature	50°C	50°C

AVERAGE CHARACTERISTICS (at 30°C):

Collector Voltage	5 volts	5 volts
Emitter Current	-1 ma.	-1 ma.
Collector Resistance (minimum)	0.2 megohms	0.4 megohms
Base Resistance	150 ohms	150 ohms
Emitter Resistance	30 ohms	30 ohms
Current Amplification Factor (minimum)	0.90	0.95
Collector Cut-Off Current	10 μ a	10 μ a
Collector Capacitance	12 μ fd.	12 μ fd.
Noise Factor (average value)	22 db.	22 db.

STATISTICAL DISTRIBUTION CURVES

Based on 250 Type 200 Transistors

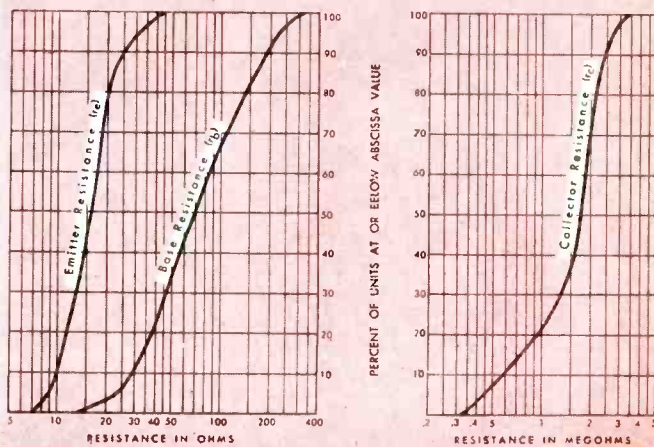

TEXAS INSTRUMENTS
INCORPORATED
6000 LEMMON AVENUE DALLAS 9, TEXAS



Bomac

HYDROGEN THYRATRONS*

Bomac Hydrogen Thyratrons are designed primarily for use as a switch tube in line type modulators for pulsing magnetrons in radar equipment.

Although the Hydrogen Thyatron is used extensively in radar modulators, it has also found many applications in laboratory, production and test equipment where precise triggering at high power levels is required.

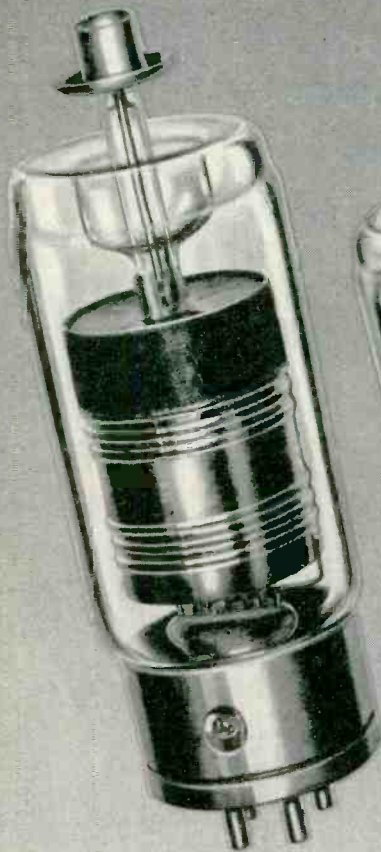

5C22



4C35



6130

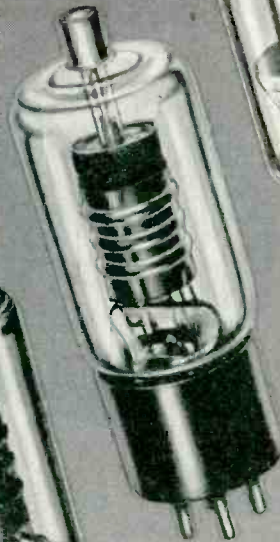

3C45

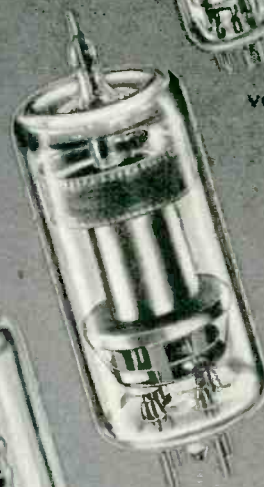

5959/E41



VC1228

For full data on ratings and operating characteristics, write for Thyatron Data Sheets.

Bomac produces a complete line of gas switching tubes. This includes TR, ATR, PRE TR and attenuator tubes for all frequency bands.

*Not shown are the E36A and HT415. Availability will be announced at a later date.

We invite your inquiries regarding

- ENGINEERING
- DEVELOPMENT
- PRODUCTION

Bomac Laboratories

INCORPORATED

BEVERLY, MASSACHUSETTS

Catalog on request. Write (on your company letterhead) Dept. C, BOMAC Laboratories Inc., Beverly, Mass.



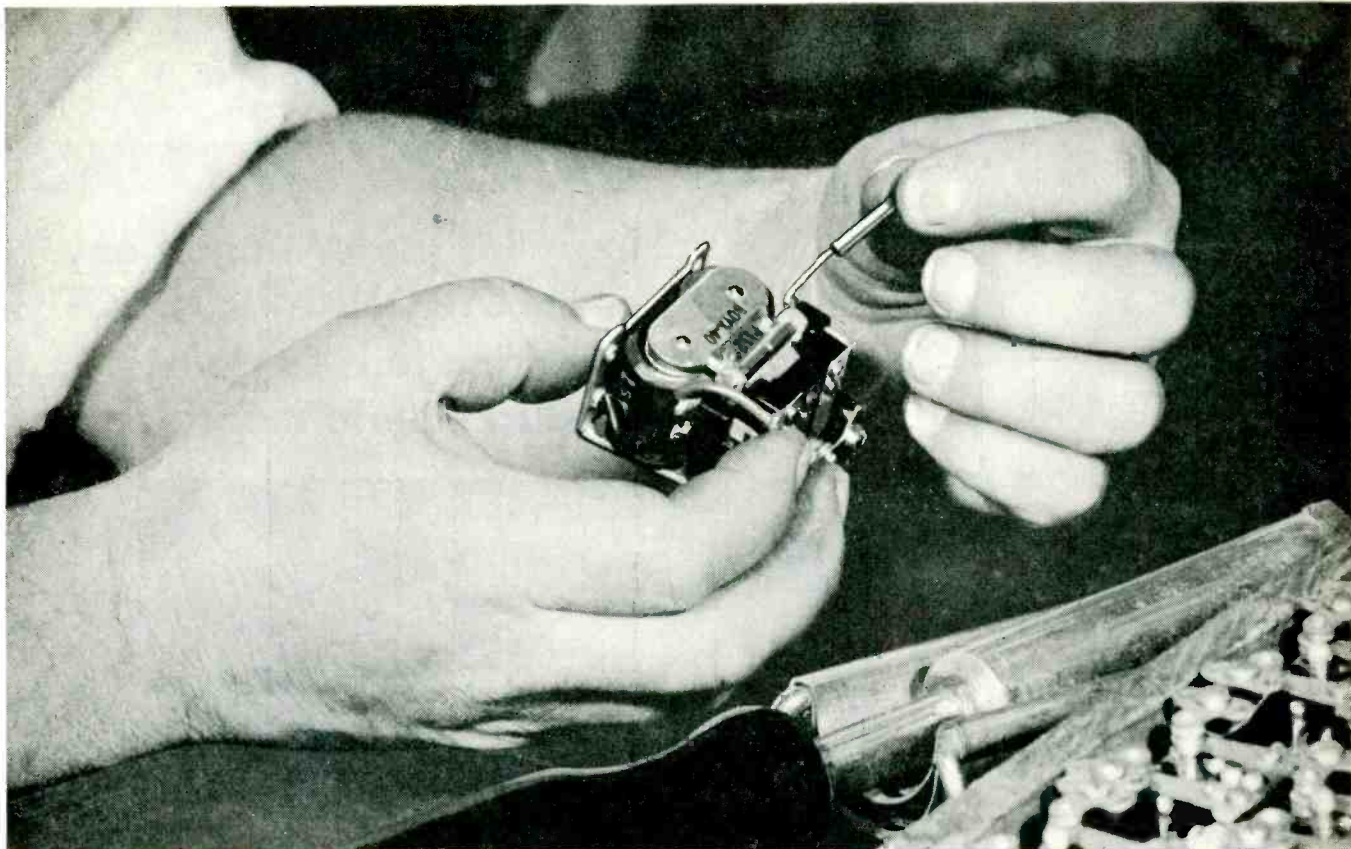

“Flexible at low temperatures” reports Allied Control Co. on **IRV-O-LITE** XTE-30

Ability to *retain* its initial flexibility over long periods of operation at low temperatures is one of the major reasons why Allied Control Company, Inc., New York, has selected Irvington's IRV-O-LITE XTE-30 extruded plastic tubing. Tubing is used for insulating the flexible pigtail connections to the moving contact arms on Allied's Type BOY relays.

Because of its smooth interior surface, XTE-30 tubing slips easily over the finely stranded wire leads without breakage of strands. In addition to its high dielectric strength, the tubing affords mechanical protection from abrasion and tearing.

Other features of XTE-30 include high tensile strength and resistance to acids, alkalis and most solvents.

Mail the coupon for technical specifications, dimensions and color range.

Look to
IRVINGTON
for Insulation Leadership
INSULATING VARNISHES
VARNISHED CAMBRIC
VARNISHED PAPER
VARNISHED FIBERGLAS
INSULATING TUBING
CLASS "H" INSULATION

Send this convenient coupon now

Irvington

VARNISH & INSULATOR COMPANY

15 Argyle Terrace Irvington 11, New Jersey

Plants: Irvington, N. J.; Monrovia, Calif.; Hamilton, Ontario, Canada

Irvington Varnish & Insulator Co.
15 Argyle Terrace, Irvington 11, New Jersey

Gentlemen:

Please send me technical data sheet on IRV-O-LITE XTE-30 Plastic Tubing.

Name..... Title.....

Company.....

Street.....

City..... Zone..... State.....

Specify **UNILECTRIC** TRADE-MARK **WIRING SYSTEMS**

for the Wiring of any
ELECTRIC or ELECTRONIC PRODUCT
because if the wiring fails so does
your product's performance

This Unilectric wiring harness protects the performance of a Military Auto Pilot

The military Auto Pilot for which this harness was engineered is now being called upon to perform under the most severe conditions. Performance of the wiring is protected by Unilectric's engineering, meticulous workmanship, and precision quality standards.



UNILECTRIC **WIRING SYSTEMS**
TRADE-MARK

Manufactured by
UNITED MANUFACTURING & SERVICE COMPANY
409 SOUTH 6th STREET • MILWAUKEE 4, WISCONSIN



Seal shown actual size

Look again!

See an individual sub-miniature hermetic seal with a barrel diameter of .100. We make others as small as .090. For the tiniest mounts in the world.

These glass-metal seals are particularly adaptable for rectifiers, hearing aids . . . for many other components that you may have thought couldn't be hermetically sealed because of their almost infinitesimal size.

Now, you know to what extremes of diminution HERMETIC can go to satisfy the requirements of industry and the Services. Above all, you should know that HERMETIC manufactures the largest line of hermetic seals available anywhere; the quality line that has attracted the greatest number of users because these are the only seals you can hot tin dip at 525° F. for easy assembly soldering, for a strain and fissure-free sealed part with

resistance of over 10,000 megohms. They will also withstand sub-zero conditions, swamp test, temperature cycling, high vacuum, high pressure, oils, compounds, chemicals, corrosion, salt water immersion and spray, and are available in RMA color code.

Seal illustrated is No. 1625-2; also available in .100 is No. 1625-1; and SK-2170-2 with barrel diameter of .090. New multi-header sub-miniatures may be had with a variety of terminations.

Write for information concerning your own problems and for a copy of our 32-page catalog.



Hermetic Seal Products Co.

31 South Sixth Street, Newark 7, New Jersey

F I R S T A N D F O R E M O S T I N M I N I A T U R I Z A T I O N

CHASE[®]

free-cutting brass rod



**means
longer life
for your tools**

Chase Free-Cutting Brass rod yields short chips as it is machined. The result is much easier cutting, longer tool life. Products produced are smoother, cleaner-surfaced, less expensive to buff or polish before lacquering, enameling or plating.

Fine quality Chase rod and drawn bar are available in a wide variety of free-cutting copper alloys. They are always uniform so that repeat orders have the same cutting characteristics.

For rod and bar, for finer products at lower unit cost, call the Chase warehouse nearest you.

Chase[®]

BRASS & COPPER

WATERBURY 20, CONNECTICUT • SUBSIDIARY OF KENNEDOTT COPPER CORPORATION

The Nation's Headquarters for Brass & Copper

Albany†	Cleveland	Kansas City, Mo.	New York	San Francisco
Atlanta	Dallas	Los Angeles	Philadelphia	Seattle
Baltimore	Denver†	Milwaukee	Pittsburgh	Waterbury
Boston	Detroit	Minneapolis	Providence	
Chicago	Houston	Newark	Rochester†	(†sales
Cincinnati	Indianapolis	New Orleans	St. Louis	office only)

Lamson LIFE WITHOUT FASTENERS

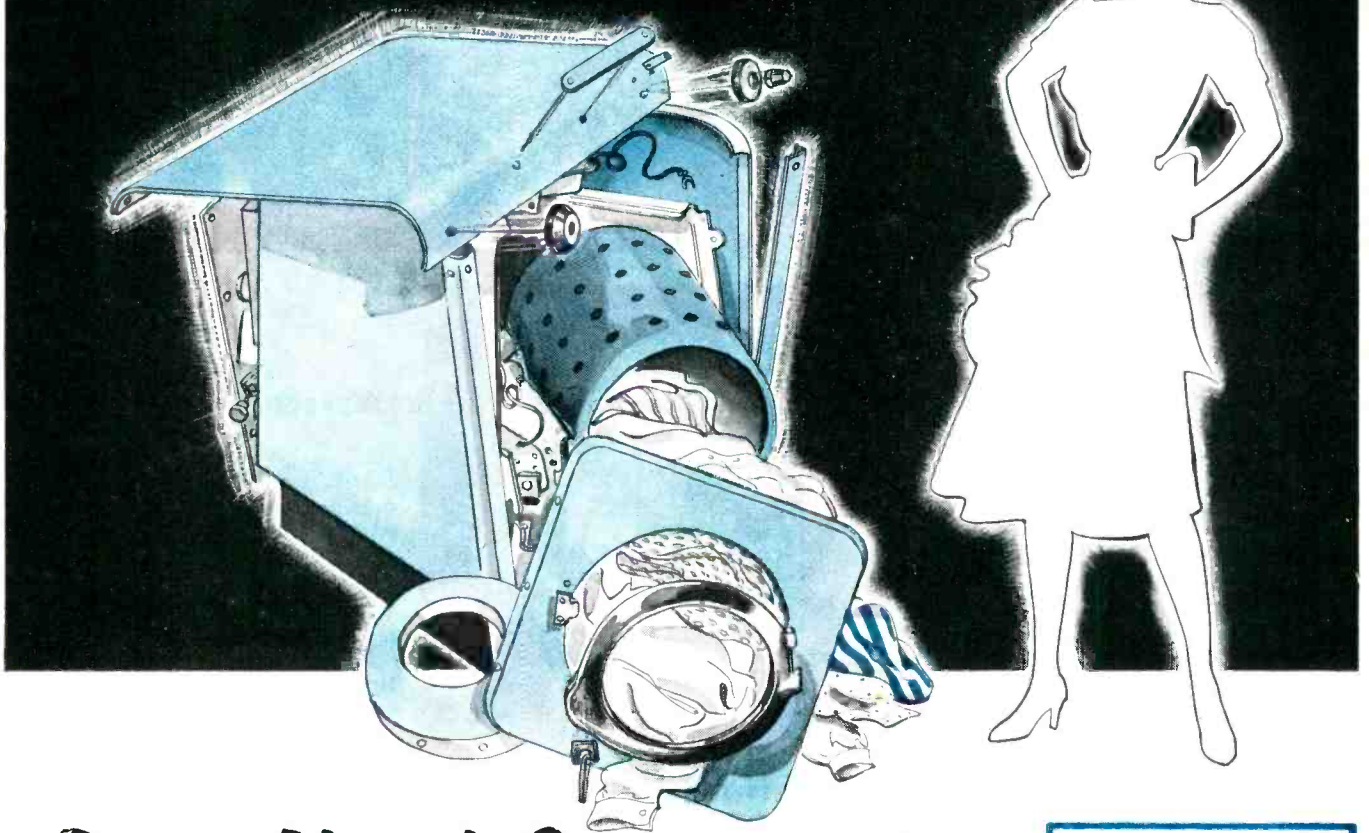

Done Already?

Watch out lady! By some black magic all bolts, nuts and screws have suddenly popped from your dryer!

Sure, it's pure fantasy, but it shows in no uncertain terms how important fasteners are to modern home appliances—and most other products, for that matter.

The moral for designers, production and purchasing men is obvious: *Fasteners are one of the most important components of any product.* And, as such, should be selected with care and purchased from a manufacturer with a reputation for top quality and service.

Lamson & Sessions welcomes your inquiry on any fastener problem, and offers you engineering help whenever you require it.

TAPPING SCREWS for quick, easy assembly



● Lamson tapping screws assure you of solid dependable construction... no holes to tap... no nuts to assemble. Available from stock: Head shapes—round, pan, truss, flat, oval and recessed hex. Threads—type "A", "B" and "C". Head types—slotted, clutch and Phillips.

Lamson & Sessions

The LAMSON & SESSIONS Co.
1971 West 85th St. • Cleveland 2, Ohio
Plants at Cleveland and Kent, Ohio • Birmingham • Chicago

FOR PROMPT DELIVERY AND HELPFUL SERVICE,
ORDER FROM YOUR LAMSON DISTRIBUTOR



MACHINE SCREWS AND NUTS

Precision made for fast, economical assembly.



PLUG NUTS

Ideal for blind or hard-to-reach places.



TAPPING SCREWS

Choice of round, pan, truss, flat oval, hexagon and Phillips heads.



CAP SCREWS

Bright and "1035" Hi-Tensile Heat-treated steel.



SQUARE AND HEX NUTS

Semi-finished, hot pressed, cold forged.



LOCK NUTS

Economical, vibration proof. Can be used repeatedly.



COTTER PINS

Steel, brass, aluminum and stainless steel.



"1035" SET SCREWS

Cup point type, hardened and heat-treated.

ONLY THE LFE 401 OSCILLOSCOPE

Offers all these Important Features

HIGH SENSITIVITY AND WIDE FREQUENCY RESPONSE OF Y-AXIS AMPLIFIER

The vertical amplifier of the 401 provides uniform frequency response and high sensitivity from D-C. Coupled with a sensitivity of 15 Mv./cm peak to peak at both D-C and A-C is a response characteristic which is 3 db. down at 10 Mc. and 12 db. at 20 Mc. Alignment of the amplifier is for best transient response, resulting in no overshoot for pulses of short duration and fast rise time. An example of the wide band response of the amplifier is shown in the accompanying photographs.

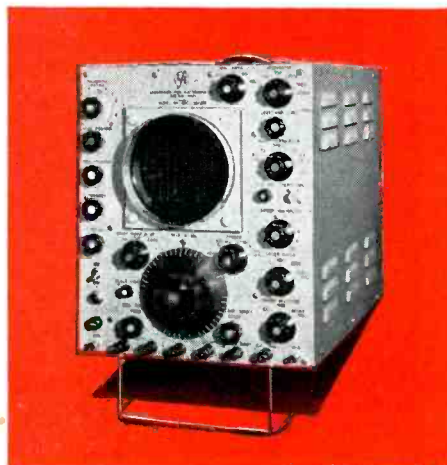
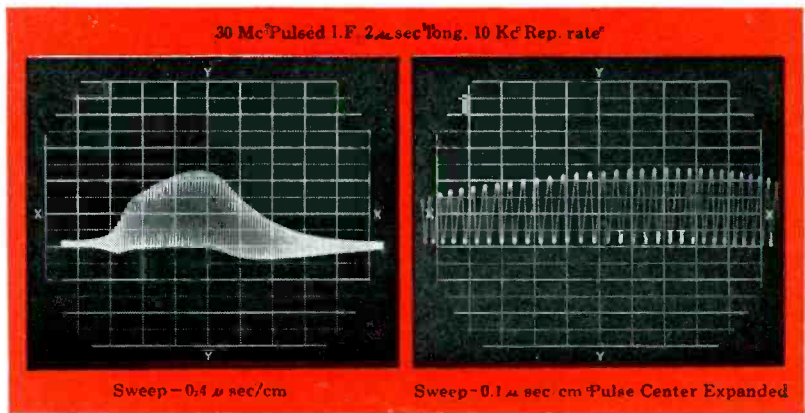

SPECIFICATIONS

Y-Axis

Deflection Sens. - 15 Mv./cm, p-p
 Frequency Response - DC to 10 Mc
 Transient Response - Rise Time (10%-90%) 0.035 μ sec
 Signal Delay - 0.25 μ sec
 Input line terminations - 52, 72 or 93 ohms, or no termination
 Input Imp. - Direct - 1 megohm, 30 μ m f
 Probe - 10 megohms, 10 μ m f

X-Axis

Sweep Range - 0.01 sec/cm to 0.1 μ sec/cm
 Delay Sweep Range - 5-5000 μ sec in three adjustable ranges.
 Triggers - Internal or External, + and -, trigger generator, or 60 cycles, undelayed or delayed triggers may be used.
 Built-in trigger generator with repetition rate from 500-5000 cps.

General

Low Capacity probe
 Functionally colored control knobs
 Folding stand for better viewing
 Adjustable scale lighting
 Facilities for mounting cameras

PRICE: \$895.00

LINEARITY OF VERTICAL DEFLECTION

The vertical amplifier provides up to 2.5 inches positive or negative uni-polar deflection without serious compression; at 3 inches, the compression is approximately 15%. The accompanying photographs illustrate transient response and linearity of deflection.

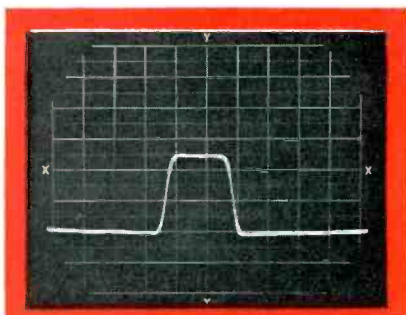

SWEEP DELAY The accurately calibrated delay of the 401 provides means for measuring pulse widths, time intervals between pulses, accurately calibrating sweeps and other useful applications wherein accurate time measurements are required.

The absolute value of delay is accurate to within 1% of the full scale calibration. The incremental accuracy is good to within 0.1% of full scale calibration.

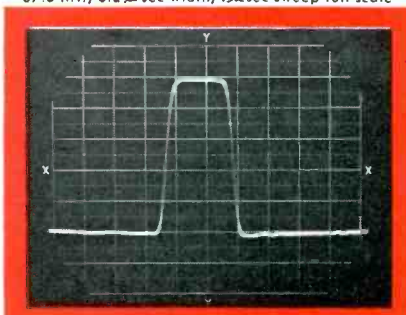

Additional Features:

TRIGGER GENERATOR with variable repetition rate from 500 to 5000 cps.
POSITIVE & NEGATIVE UNDELAYED TRIGGERS and a **POSITIVE DELAYED TRIGGER** are externally available.

An **INPUT TERMINATION SWITCH** for terminating transmission lines at the oscilloscope.
 A **FOLDING STAND** for convenient viewing.
FUNCTIONALLY COLORED KNOBS for easier location of controls.

Designed and built for electronic engineers, the 401, with its high gain and wide band characteristics, and its versatility, satisfies the ever-increasing requirements of the rapidly growing electronics industry for the ideal medium priced oscilloscope.

Write for Complete Information



LABORATORY for ELECTRONICS, INC.

75 PITTS STREET • BOSTON 14, MASS.

PRECISION ELECTRONIC EQUIPMENT • OSCILLOSCOPES • MAGNETOMETERS • COMPUTERS • MICROWAVE OSCILLATORS

Telecomputing announces...

THE TELEDUCER

Automatically Records Voltage

In Decimal Digits

With 0.1% Accuracy



It offers these important advantages:

Provides 0.1% accuracy (1,000 counts full scale).

Provides for minimum full-scale input of 20 millivolts (20 microvolts per count).

Requires only 0.8 second or less for balancing.

Uses a simple bridge-balancing circuit.

Reads low voltage without DC Amplification.

Does not hunt or oscillate.

Presents visual reading of voltage on neon indicator bank.

Permits tabulated digital output when used with Program Unit and Electric Typewriter. (Digital recording in punched IBM cards or teletype tape available when used with suitable program units.)

Computing Service

Your computing and data reduction problems, large or small, can be handled quickly, efficiently by Telecomputing's staff. Time and cost estimates will be presented if you will send information defining your problem.

TELEDUCER Technical Bulletin 104 and Technical Bulletins 106 and 107, giving specifications on the Program Unit and Electric typewriter, will be mailed you upon request. Coupon below is for your convenience.

TELECOMPUTING

CORPORATION
BURBANK, CALIFORNIA

Mr. Preston W. Simms, Dept. ES-9
Telecomputing Corporation, Burbank, California

Please send me Teleducer Bulletin 104.

Please send me Bulletins 106 and 107 on the Program Unit and Electric Typewriter.

Name _____

Company _____

Street Address _____

City and State _____

REALLY *New!*

COMPLETE *miniature* FREQUENCY STANDARD

A compact, complete, hermetically sealed frequency standard, presenting these features:—

1. JAN-ized construction throughout.
2. SPACE-SAVING, 1½" dia. x 4½" high.
3. WEIGHT, approximately 10 ounces.
4. AVAILABLE in 400 and 500 cycles.
5. ACCURACY—.002% (15° to 35°C).
6. SHOCK-MOUNTED on Silicone rubber.
7. POWER REQUIRED, 6 V. at 300 ma.
70 to 200 V. at 1 to 5 ma.

WRITE FOR DESCRIPTIVE LITERATURE,
SPECIFYING "TYPE 2007"

Also, manufacturers of frequency standards, multi-frequency standards, chart-recording chronographs, firing-cycle timers, the Watch-Master Watch Rate Recorder and other high-precision frequency and timing instruments, controlled by our tuning-fork oscillators.



ACTUAL
SIZE

Engineers!
Gear this frequency standard to your designs and help solve climatic, space and weight problems in JAN-ized-MIL equipment

American Time Products, Inc.

580 Fifth Avenue
New York 36, N. Y.

MANUFACTURING UNDER PATENTS OF THE WESTERN ELECTRIC COMPANY

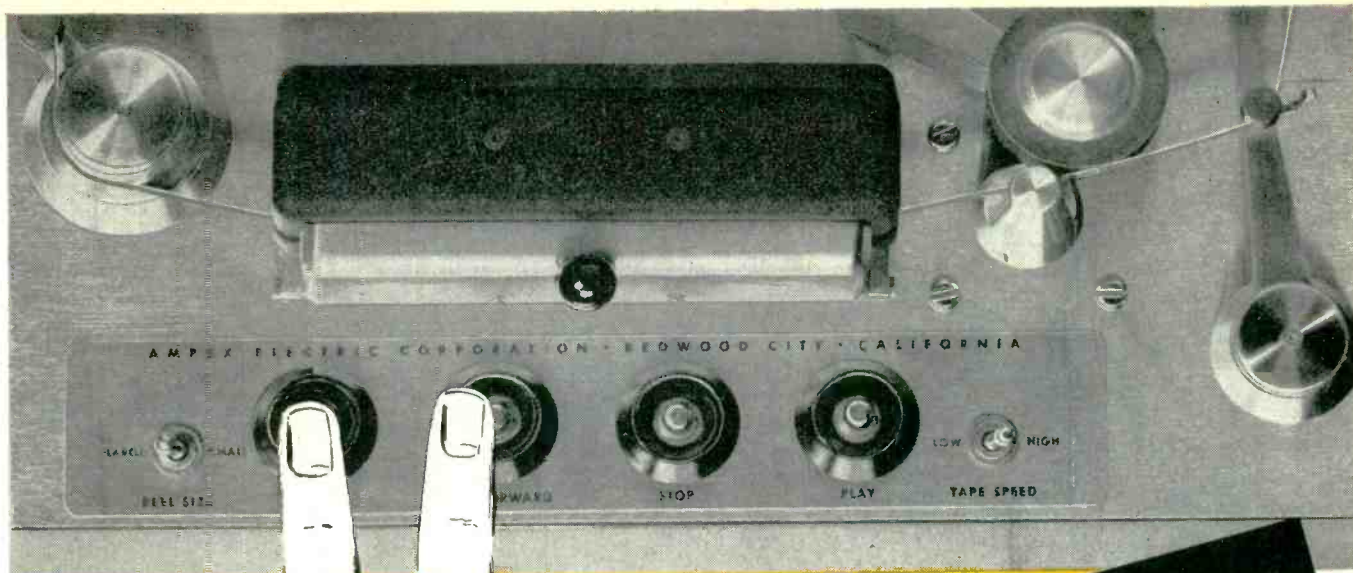

these pushbuttons are fast on cues...

They're the controls on the new AMPEX 350 Tape Recorder

Their quick, positive action will give station operators a new "sureness" with tape. Cueing is exact; editing is faster; fumbling is out. Remote control is available too. Responsiveness has always been a part of the *Ampex Standard of Excellence*—but now it is better than ever, making the AMPEX 350 truly the **NEWEST OF THE BEST**.

• **STARTING WITH A SPLIT SYLLABLE**

From pressing of the start button to stable tape motion takes 1/10th second. Tape can be backed off from starting cues as little as one to two inches. Precise starts become routine. Reliability is supreme.

• **STOPPING WITHIN TWO INCHES**

Even at 15 inches per second, the tape stops within less than two inches after the button is pressed. Band type brakes give positive stops; no drift or tape spillage can occur.

• **EASIER CUEING AND EDITING**

The Model 350 can be shuttled rapidly between fast forward and rewind without stopping. Cues for starting, editing or dubbing are speedily located. And for convenient editing, the capstan drives on the "pull side" of the heads.

• **ADJUSTMENT FOR REEL SIZES**

A new switch selects proper tape tension either for 10½-inch NARTB reels or for 5 or 7-inch plastic RMA reels. Proper tension means longer tape life, more accurate timing and truer performance.



AMPEX MODEL 350
The new slant puts all controls within easy reach of any operator, tall or short.

Recorders from \$975; Model 350 from \$1095; Reproducers from \$495. For further information write today to Dept.



**IF YOU PLAN FOR TOMORROW,
BUY AN AMPEX TODAY**

934 CHARTER STREET, REDWOOD CITY, CALIFORNIA
Distributors in principal cities; distribution in Canada by Canadian General Electric Company

NEW

K-LOK*

DISC CERAMICONS®

A Great Forward Development in

STABILITY

A Premium High Dielectric Constant Ceramic Capacitor

(PAT. APPLIED FOR)

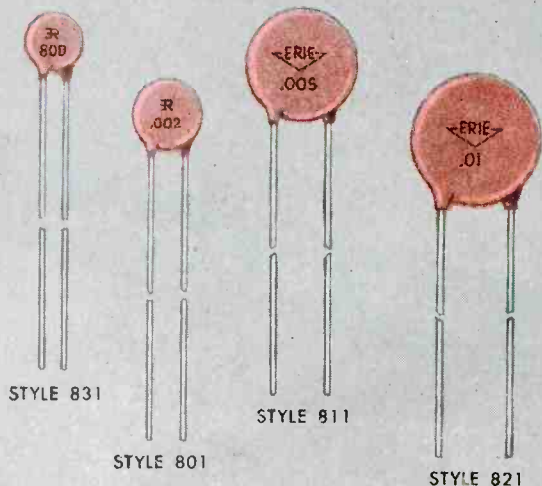

STYLE	CAPACITANCE RANGE—MMF
831	220-540
801	540-850
811	850-2500
821	2500-4500

Tolerances: $\pm 5\%$, $\pm 10\%$, $\pm 20\%$, GMV

ERIE takes pride in announcing this significant advance in ceramic capacitor design and application. K-LOK dielectric is the result of several years development activity having one planned objective—to produce premium performance characteristics in High-K ceramic capacitors.

In K-LOK we have achieved the enviable combination of high capacitance and really substantial stability under environmental extremes. The K-LOK is being produced and sold in addition to the standard line of ERIE Hi-K Ceramicons.

OTHER FEATURES TO BE NOTED ARE:

- Power Factor: 1% maximum
- Insulation Resistance: 10,000 megohms minimum
- Protective Insulation: Low loss phenolic dip for moisture seal and mechanical ruggedness
- ERIE K-LOK ceramic can be used on special order in supplying various high voltage disc capacitors and printed circuits

1 FLAT TEMPERATURE CHARACTERISTIC

Greatest capacitance change from 25°C value:

- + 5%, - 5% from - 55°C to + 105°C
- + 5%, - 10% from - 55°C to + 125°C

2 STABILITY WITH AGE

1% maximum capacitance decrease per decade of time.

3 LINEAR CIRCUIT OPERATION

Both voltage coefficient of capacitance and piezo-electric effect are low.

4 IMPROVED LIFE RATING:

- up to 1000 VDCW 85°C
- up to 500 VDCW 125°C

Samples available on request

*TRADE MARK



ERIE components are stocked by leading electronic distributors everywhere.

ERIE RESISTOR CORPORATION . . . ELECTRONICS DIVISION

Main Offices: ERIE, PA.

Sales Offices: Cliffside, N. J. • Philadelphia, Pa. • Buffalo, N. Y. • Chicago, Ill.
Detroit, Mich. • Cincinnati, Ohio • Los Angeles, Calif.

Factories: ERIE, PA. • LONDON, ENGLAND • TORONTO, CANADA

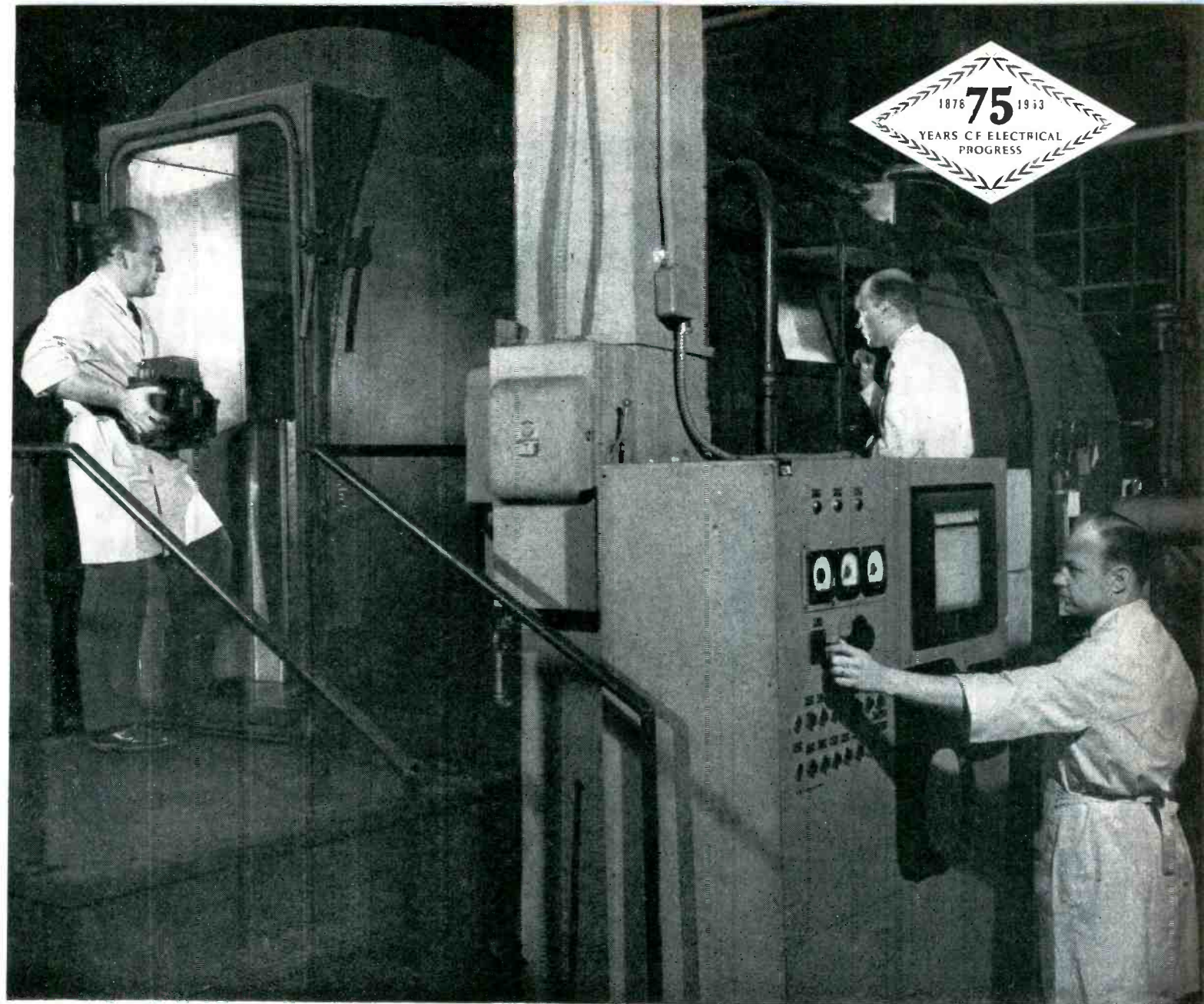

By testing motors "twenty miles up"— G.E. gives you more for your motor dollar

In this reinforced tank six feet long by eight feet wide G-E engineers watch motor performance at altitudes as high as 100,000 feet. Motor speed is checked by a stroboscope through a reinforced side window and a dynamometer inside the chamber acts as the motor load—as tank temperatures go as low as -80°C with controlled humidity.

In other similar tests your special problems of heat, cold, vibration, acceleration, etc., encountered in aircraft operation are detected and solved. Here, G-E engineers learn the facts about motor performance,

resulting in better fhp motors for you.

Whatever your aircraft motor problem, remember that G-E engineers are equipped and ready to solve it. General Electric's Specialty Motor Sub-Dept. can design and build precisely the motor you need to meet your most demanding requirements . . . solve your toughest problems.

For more information or engineering assistance, contact your nearby G-E Apparatus Sales Office, General Electric Company, Schenectady 5, N. Y.

704-17

You can put your confidence in—
GENERAL  ELECTRIC



BRIDGEPORT BRASS COMPANY

COPPER ALLOY BULLETIN



MILLS IN BRIDGEPORT, CONN. AND INDIANAPOLIS, IND. — IN CANADA: NORANDA COPPER AND BRASS LIMITED, MONTREAL

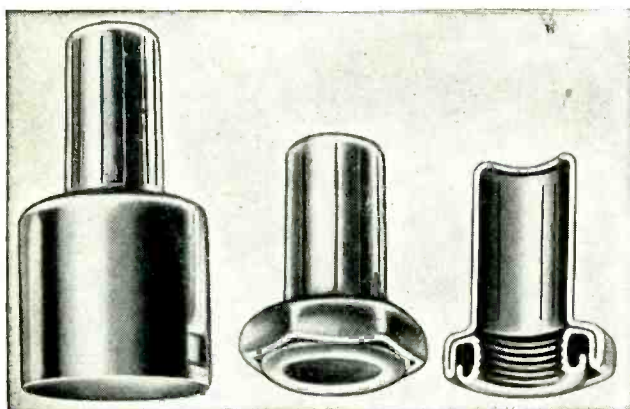

Making this special nut from strip metal economically and in large quantities, called for highly skilled tool designing and a thorough knowledge of metalworking. All products on this page through the courtesy of The Risdon Manufacturing Company, Naugatuck, Conn.

Imagination Unlimited Lowers Cost of Strip Metal Components

Rising costs of labor and materials should not necessarily lead to increased prices of fabricated items. Imagination unlimited, the utilization of existing automatic machines, and clever tool designing are often the answer to offsetting increased costs.

Cost savings can sometimes be accomplished by making a one-piece item from a two-piece assembly, or by changing from a casting or a screw machine item to one made from strip metal, tubing or wire. Or savings may be obtained through the elimination of costly secondary operations or the reduction of scrap losses.

Automatic multi-station slide and eyelet machines have wonderful possibilities for cost saving for quantity items of limited size. A coil of strip metal is fed into one end of the machine and the finished items come out at the opposite end after it has undergone a large number of exacting operations. Speed, close tolerances, low scrap losses and economy are associated with these methods.

Strip Metal Nut Replaces Screw Machine Piece

The item illustrated above was originally made from hexagon rod and involved a number of operations such as machining, considerable drilling and threading. In redesigning this compo-

nent from strip metal, 16 operations were involved, each of which had to be accurately planned so that a single annealing was required. After the draw, the metal was folded back against itself. It was then redrawn and folded back against itself after a clipping operation. Such a large amount of coldworking requires a thorough knowledge of the flow of metal in dies. Once perfected, the finished article is strong and considerably lighter.

Making One-Piece Components

In small gears, concentricity between the pitch diameter of the gear teeth and the inside diameter of the bore is important. Originally the gear shown below was designed to be made in two pieces — a bushing and a gear blank assembled in a staking operation. When made in one piece from strip metal, this part was improved because it was uniform and concentric.



This improved, one-piece sheet-metal gear was originally made by staking two parts.

The following electric terminal was formerly a two-piece item made by assembling a screw machine bushing and

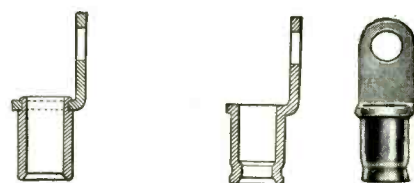

Complete one-piece terminal made from strip brass in a single automatic multiple plunger machine.

a stamping. On making this complete in one piece from strip metal, savings were made in labor cost and material, although it involved an intricate set of dies and the use of an automatic multi-plunger machine.

Eliminating Drilling, Milling

This piece was formerly turned from tubing. A secondary operation was necessary for milling the slot. When converted to strip metal, it was made complete on an automatic press. The four slots were developed by piercing the metal in the blank and the finished piece was formed by redrawing.



Produced from Coiled Tubing

Formerly this terminal was made from tubing which was cut to length, formed, swaged, and pierced, each in a separate operation. In the new method all of these operations were combined. Coiled tubing was fed into an automatic multi-sliding machine that produced the complete part.



Bridgeport Technical Service

High-speed, automatic operations call for material made to exacting specifications and uniformity. Not only must the metal be free from imperfections but special physical properties are needed to withstand the severe coldworking operations which are performed without any intermediate annealing. Bridgeport Brass Company is well qualified to supply copper-base alloys to meet the exacting requirements of metal goods fabricators. All processes are under strict laboratory control. Please contact your nearest Bridgeport sales office and we will gladly help you with your metal problems and requirements. (439)

Want more information? Use post card on last page.

September, 1953 — ELECTRONICS

Consistently Dependable

C-D MINIATURIZED CAPACITORS

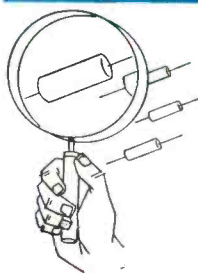
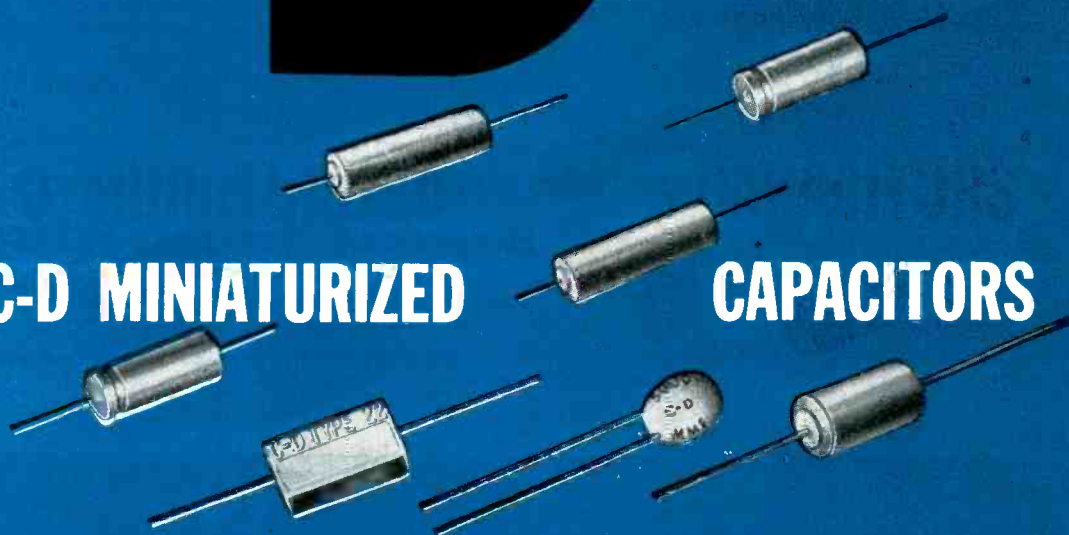

Tiny but tough! The smaller capacitors become, the greater the premium on trustworthiness. Cornell-Dubilier has a dependable miniaturized capacitor for practically every known application. Typical are the High Temperature Tubulars, Metallized Paper Tubulars, Midget Micacs, Disc and Tubular Ceramics. For the complete catalog write to: Dept. K-93, Cornell-Dubilier Electric Corp., General Offices, So. Plainfield, N. J.

CORNELL-DUBILIER

world's largest manufacturers of capacitors



ANTENNAS



ROTATORS



CAPACITORS



VIBRATORS



CONVERTERS

SOUTH PLAINFIELD, N. J. • NEW BEDFORD, WORCESTER AND CAMBRIDGE, MASS. • PROVIDENCE, R. I. • INDIANAPOLIS, IND. • FUQUAY SPRINGS, N. C. • SUBSIDIARY, THE RADIART CORP., CLEVELAND, O.

MITCHELL-RAND

electrical insulation headquarters

features

MIRAGLAS-A fiberglass tapes

for general purpose class A electrical insulation

**COMPARED WITH COTTON
OR RAYON
FOR GENERAL PURPOSE
CLASS A APPARATUS**

**MIRAGLAS-A FIBERGLAS TAPES
ARE MUCH MORE ECONOMICAL...**
being half as thick they cover more area...
having twice the tensile strength they provide
longer life and better performance... woven of
long staple fiberglass yarn they withstand high
temperatures and won't burn or rot... and
MIRAGLAS-A FIBERGLAS TAPES are specially treated
for machine or hand winding.

MITCHELL-RAND CAN MAKE IMMEDIATE DELIVERIES

Specify

**MIRAGLAS-A FIBERGLAS TAPES
FOR CLASS A INSULATION USE**

TYPE	CX	plain weave	THICKNESS .004"		
Available Widths	1/2"	3/4"	1"	1 1/4"	1 1/2"
Approx. Yds./Lb.	280	224	168	134	100
		total ends	type yarn	nominal breaking strength	
WARP	1/2"	26	150 1/0 waxed	65	
	3/4"	38	150 "	90	
	1"	50	150 "	125	
	1 1/4"	62	150 "	150	
	1 1/2"	74	150 "	180	
FILLING	24 ends per inch—150 1/0 waxed yarn				

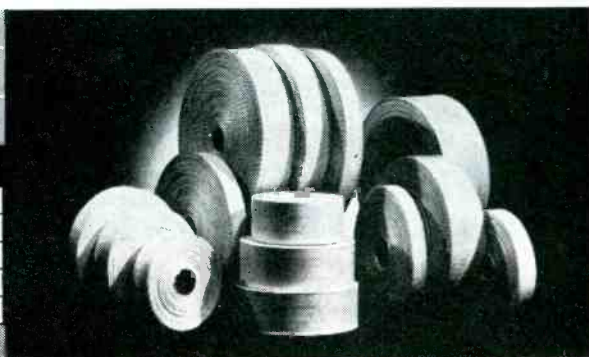

Write to MITCHELL-RAND for free samples and descriptive data.



MITCHELL-RAND

INSULATION COMPANY, INC.

51 MURRAY ST. • COrtlandt 7-9264 • NEW YORK 7, N.Y.

MIRAGLAS VARNISHED TAPES, CLOTHS AND SLEEVINGS • MIRAGLAS TAPES, BRAIDED SLEEVINGS AND TYING CORDS • MIRAGLAS SILICONE TREATED CLOTHS, TAPES AND TUBINGS • MICA TAPES, CLOTHS AND MICA-FIBERGLAS COMBINATIONS • FIBRE, PHENOL FIBRE AND MIRALITE POLYESTER RESIN SHEET INSULATING PAPERS—DURO, FISH, PRESSBOARD, ETC. • VARNISHED CAMBRIC TAPES, CLOTH AND SLOT INSULATIONS • COTTON TAPES AND SLEEVINGS • TWINES AND TIE TAPES • ASBESTOS TAPES, SLEEVINGS AND CLOTH, TRANSITE AND ASBESTOS EBONY • ARMATURE WEDGES AND BANDING WIRE • VARNISHED TUBINGS, HYGRADE, MIRAGLAS, HYGRADE VF, MIRAGLAS SILICONE • THERMOFLEX AND FLEXITE EXTRUDED PLASTIC TUBING • PERMACEL MASKING TAPES AND ELECTRICAL TAPES • BI-SEAL, BI-PRENE; FRICTION TAPES AND RUBBER SPLICE • COMPOUNDS—TRANSFORMER, CABLE FILLING, POTHEAD, ETC. • INSULATING VARNISHES OF ALL TYPES.

At last! STANDARD COMPONENTS to mount your circuitry in vertical planes that SAVE SPACE... SAVE PRODUCTION COST... ARE NATURALS FOR PLUG-IN CONSTRUCTION

It's as simple as this —

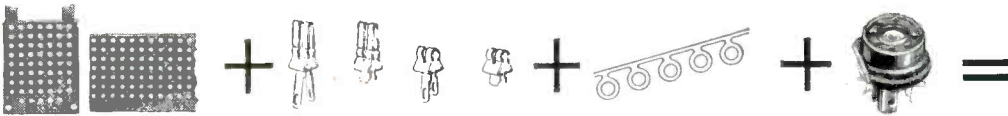

ALDEN PRE-PUNCHED TERMINAL MOUNTING CARDS pre-cut to proper size for Alden 7-pin, 9-pin, 11-pin and 20-pin Plug-in Packages. Or in 3' strips for chassis — cut it off as you require.

ALDEN MINIATURE STAKING TERMINALS mount in any pattern on Terminal Mounting Cards. Ratchet slots hold elements for soldering without pliering or wrap-around.

ALDEN JUMPER STRIP stakes right under Terminals providing common circuit without soldering.

ALDEN CARD MOUNTING TUBE SOCKETS for miniature 7-pin and 9-pin and octal tubes.

ALDEN TERMINAL CARD MOUNTING SYSTEM

Take the above basic components, lay them out on full scale Planning Sheets found in

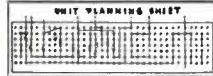

Alden Handbook. Following the Plan Sheet, Miniature Terminals and Tube Sockets stake into place on Card.

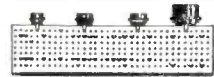

We can do it for you if you have volume production, so Cards come to you ready

to snap electronic elements and wiring into place for quick soldering.

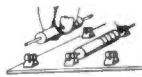

Both sides can

be used for wiring. Your design and production are simplified. Wiring is an open, easy-to-work sub-assembly, so units can come through production independently or be easily subcontracted.

— and how beautifully these circuitry planes become plug-ins

4 SIZES OF PLUG-IN PACKAGES



ALDEN PLUG-IN PACKAGE

Alden standard Bases, Lids, Handles, Cans, Sockets for 7, 9, 11 and 20-pin packages house Terminal Card Circuitry with tremendous flexibility for endless variety of open and shielded packages... making it easy and inexpensive to give your equipment reliability in service with instantly replaceable plug-ins for all sub-units.

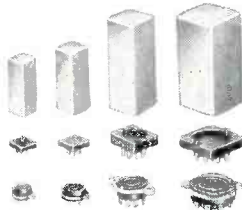

7-pin 9-pin 11-pin 20-pin
Package components and matching sockets.



ALDEN BASIC CHASSIS

Alden Universal Rack Adapter

4 SIZES OF ALDEN BASIC CHASSIS 2", 4", 8", 17"

Your circuitry on Terminal Card strips snaps right into Alden Basic Chassis. Vertical mounting and hinged front panel give beautiful accessibility and space saving. Chassis can be plugged interchangeably into Standard Racks, Alden Uni-Racks, Alden Portable Cases. Alden Rack Adapter mates Standard Rack to Chassis.

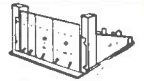

Plugged into Standard Racks

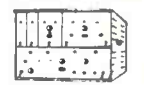

Plugged into Alden Uni-Racks



Plugged into Portable Cases

— and how easy to assign to each plug-in unit a tiny tell-tale to spot trouble instantly



See how compact front panel easily mounts six tiny Alden Sensing Elements — specifically designed to lick the problem of having only a small amount of space. Assembled by simplest methods.



ALDEN MINI-TEST POINT JACK
For checking critical voltages from front of panel.



ALDEN "PAN-i-LITE"
Miniature indicator light with unbreakable 1-piece light-lens unit replaceable from front.



ALDEN "FUSE-LITE"
Fuse blows — Lite glows. Simply unscrew 1-piece light-lens unit and blown fuse comes out with it.

— and to organize circuitry for 1 point of check, with 30-second replacement

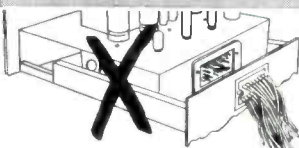

Alden's new concept in Rack-and-Panel Connectors, eliminates congested rats' nest of blind wiring and provides —

3. Critical voltages isolated by wide spacing.

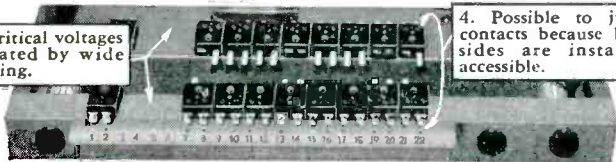

4. Possible to jump contacts because both sides are instantly accessible.

1. Connectors are spread out 2. All leads are instantly in an orderly row, giving a accessible, identified by number and color-coding.

All you need is this Kit —

3 Alden Serve-A-Unit Locks

2 Alden Lock Frame

4 Alden Back Connectors



1 Alden Slide Rails

It's as simple as this —

Arrange Alden Side Rails (1) and Alden Lock Frame (2) to suit your chassis. Alden Serve-A-Unit Locks (3) mount in your chassis to engage pre-punched holes in Alden Lock Frame (2) to pilot, draw in, lock or eject.

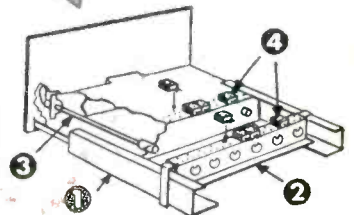

GET THE COMPLETE STORY — REQUEST "ALDEN HANDBOOK" — SENT FREE

ALDEN PRODUCTS CO. 127 N. Main St., Brockton 64, Mass.





For over **20** years . . .

**A
GOOD PLACE
TO GET
GOOD
RESISTORS**

**JAN-R-11
TYPES**

Styles RC10, RC20,
RC21, RC30, RC31,
RC41, and RC42.

Write for Bulletin J2

1/2-, 1-, and 2-watt fixed composition
types in all RTMA 5%, 10%, and 20%
preferred values.

. . . also automotive ignition suppression
and voltage regulation; fluorescent starting; protective
surge; and other special purpose types to your exact
specifications.



STACKPOLE

Electronic Components Division
STACKPOLE CARBON COMPANY
St. Marys, Penna.

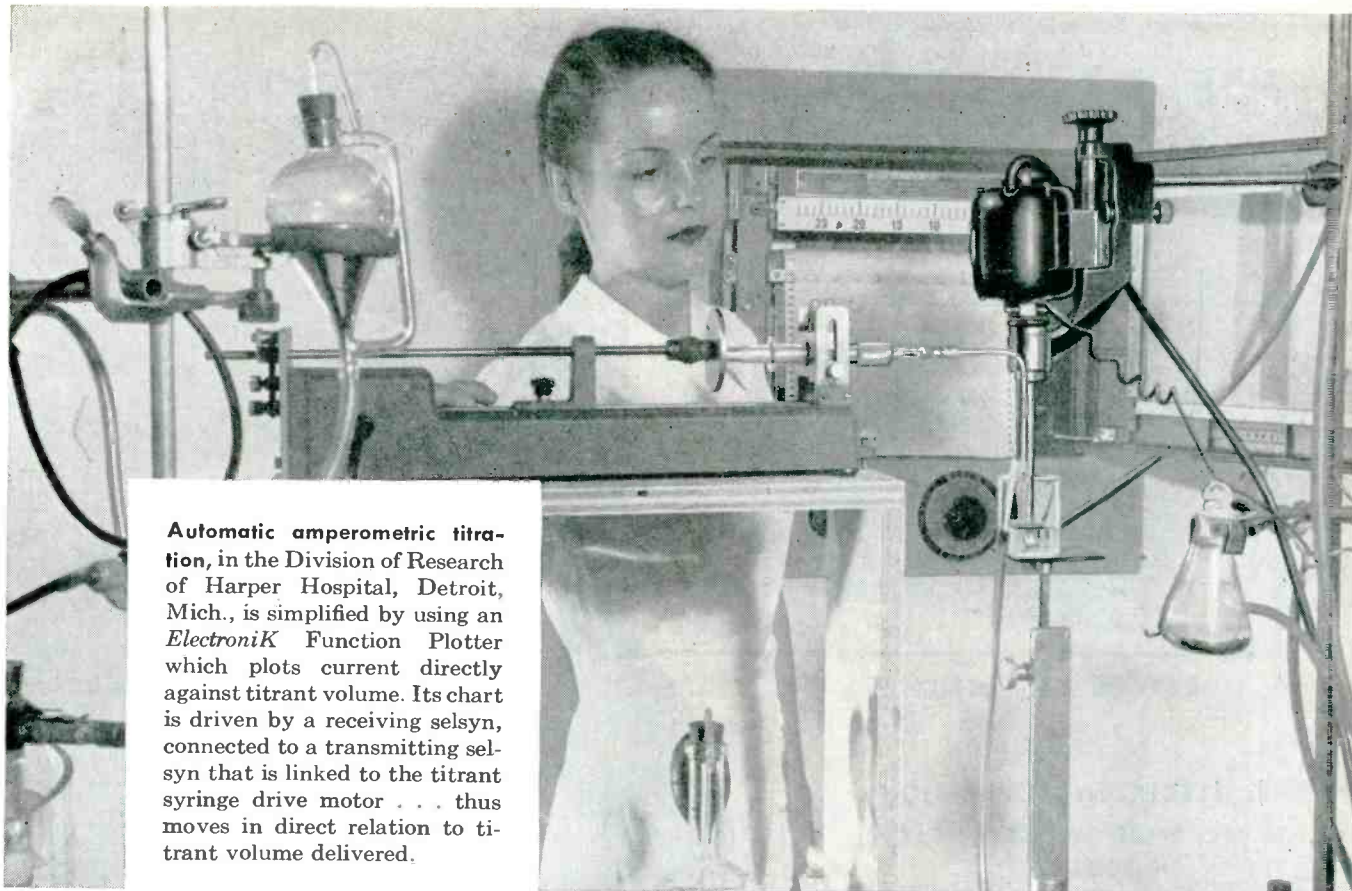

Automatic amperometric titration, in the Division of Research of Harper Hospital, Detroit, Mich., is simplified by using an *ElectroniK* Function Plotter which plots current directly against titrant volume. Its chart is driven by a receiving selsyn, connected to a transmitting selsyn that is linked to the titrant syringe drive motor . . . thus moves in direct relation to titrant volume delivered.

Speed your data recording with these *ElectroniK* instruments



For recording $y = f(x)$ —the Function Plotter. One of the best time-savers for any laboratory, this instrument automatically records a continuous curve such as stress vs. strain, speed vs. torque, temperature vs. pressure. It eliminates hours of hand logging and point-by-point plotting. It has two independent measuring systems; one moves the pen, the other moves the chart. Optional selsyn drive for the chart can also be supplied. Either can measure any variable that can be converted to a d-c signal. The chart moves 11 inches, at only 4 seconds for full travel. Pen movement is 11 inches; pen traverse time 2 seconds.



For recording two variables—the Duplex Recorder. This two-in-one instrument combines continuous records of any two independent variables on a single chart . . . where they can be conveniently compared without tedious cross-reference. Each of the two recording pens has its own independent "Continuous Balance" measuring system. Each pen can traverse the full 11 inches of chart width. Different calibrations can be supplied for each pen.

Your local Honeywell engineering representative will be glad to discuss ways that these instruments can save time in your research work. Call him today . . . he is as near as your phone.

MINNEAPOLIS-HONEYWELL REGULATOR CO.
Industrial Division
4428 Wayne Avenue
Philadelphia 44, Penna.

● **REFERENCE DATA:** Write for Data Sheet No. 10.0-5 on the Function Plotter . . . and Data Sheet No. 10.0-6 on the Duplex Recorder.



MINNEAPOLIS
Honeywell
BROWN INSTRUMENTS

First in Controls

FOR QUALITY TV RECEIVER PRODUCTION . . .

PRECISION ALIGNMENT OF VHF TV RECEIVERS PLUS
SPEED AND RELIABILITY ARE ASSURED WITH



The Model RF-P MARKA-SWEEP

COVERS RF AND IF

Featuring

- ALL ELECTRONIC OPERATION
 - 15 MC. WIDE SWEEP ON EACH VHF TV CHANNEL
- and . . .
- IF BAND CENTERED AT 43.5 MC.
 - SHARP CRYSTAL POSITIONED PICTURE AND SOUND CARRIER MARKERS
 - ACCURATE SWITCHED AND CONTINUOUS ATTENUATORS
 - UNUSUALLY FLAT AMPLITUDE RESPONSE
 - NEW DESIGN FOR RAPID AND EASY MAINTENANCE

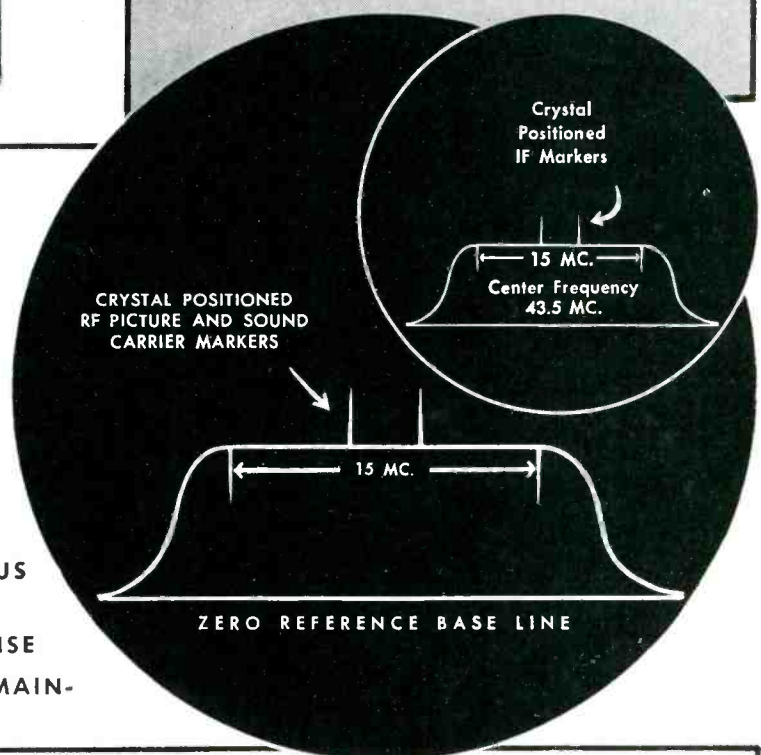

SPECIFICATIONS

FREQUENCY RANGE: All 12 channels in the VHF TV range. IF band centered at 43.5 mc.

FREQUENCY SWEEP: Sawtooth sweep 15 mc. wide on each channel.

MARKERS: Very sharp pulse type marks are crystal positioned. Picture and sound carrier markers provided on each RF channel. IF picture and sound carrier markers, or any two IF markers separated by 4.5 mc., provided on special order.

RF OUTPUT VOLTAGE: 300 ohm balanced—approximately 0.5 volt into load. 70 ohm unbalanced—approximately 0.25 volt into load.

RF OUTPUT CONTROL: Switched attenuator—20 db., 20 db., 10 db., 6 db., and 3 db. Continuous attenuator: approximately 6 db.

MARKER OUTPUT: Positive pulse, 10 volts peak, continuously variable, 0 to maximum.

PRICE: \$795.00 f.o.b. factory (two IF crystal positioned marks separated by 4.5 mc. added at specified frequencies—\$15.00). Catalog No. 630-B.

THE LIGNA-SWEEP—same as above except without markers and in smaller cabinet. Price \$495.00 f.o.b. factory.



KAY ELECTRIC COMPANY

14 Maple Avenue

Phone CALdwell 6-4000

Pine Brook, New Jersey



Nature's 60 million-year-old secret becomes

THE BIGGEST NEWS IN ELECTRICAL INSULATION!

Just as Nature preserved insects in amber for millions of years, you can now seal fragile electrical components in "Scotchcast" Embedment Resin for dependable insulation and protection against oil, moisture, chemicals and weather. It's available in two forms to meet your special requirements.

"Scotchcast" No. 1 is a *hot pouring* resin of the epoxy type. It's a solid at room temperature and is used with a solid hardener. Both the resin and the hardener are heated to 240°-250° for mixing and pouring.

"Scotchcast" No. 2 is a *cold pouring* epoxy-type resin that is supplied as a liquid. After liquid hardener is added, it cures and acquires protective and insulating properties similar to those of the hot pouring resin.

For complete data on these remarkably tough new resins, write Minnesota Mining & Mfg. Co., Dept. EE-93, St. Paul 6, Minnesota.

SCOTCHCAST

Electrical Embedment Resin



The term "Scotch" and the plaic design are registered trademarks for the more than 200 pressure-sensitive adhesive tapes made in U.S.A. by MINNESOTA MINING & MFG. CO., St. Paul 6, Minn.—also makers of "Scotch" Sound Recording Tape, "Undersal" Rubberized Coating, "Scotchlite" Reflective Sheet-ing, "Safety-Walk" Non-slip Surfacing, "3M" Abrasives, "3M" Adhesives. General Export: 122 E. 42nd St., New York 17, N.Y. In Canada: London, Ont., Can.

Why it pays to make **Rome** your source of special electronic cables



10 conductor shielded, Neoprene-jacketed electronic cable



Special 8 conductor, shielded, mobile transmitter cable



2 conductor, polyethylene-insulated, shielded, Neoprene-jacketed microphone cable



8 conductor, Rome Synthinol®-jacketed, TV camera cable



Special Rome Synthinol 901® hook-up wire—8 mil wall with nylon sheath



Special 136 conductor, Rome Synthinol-insulated, electronic cable

When you have an electronic wiring problem it pays to go to a specialist, such as Rome Cable. Wires and cables made by Rome, first, are designed by engineers with training and experience in electronic applications. Further, Rome Cable has the manufacturing knowledge and facilities to produce unusual constructions . . . with quality controlled step by step. By standardizing on Rome wires and cables you assure dependable performance for your product and add obvious quality . . . with a component engineered to your requirement.

Rome manufactures a wide range of hook-up wires, intercommunication cables, coaxial cables, electronic computer cables, R. F. transmission line, television camera cables as well as other special constructions.

Visit Us at the Silver Jubilee Show

INTERNATIONAL ASSOCIATION
OF ELECTRICAL INSPECTORS

September 21 to 26, Chicago, Illinois

Booth No. 1

COMMERCIAL TYPE HOOK-UP WIRES

Rome offers commercial type hook-up wires with three standard insulations.

Rome Hi-temp—a rubber insulation with exceptionally high resistance to heat and moisture. Underwriters' approved for 75° C.

Rome Synthinol—a polyvinyl chloride thermoplastic compound, highly resistant to acids, oils, alkalis, moisture and flame. Underwriters' approved for 80° C.

Rome Synthinol 901—offers all the advantages of Synthinol plus higher resistance to heat deformation, shrinkage and cracking, also improved solderability. Underwriters' approved for 105° C.

MILITARY HOOK-UP WIRES

Rome manufactures military type SRIR, SRHV and WL, complying with Joint Army-Navy Specification JAN-C-76, as well as shipboard types SRI and SRIB conforming to Specification MIL-C-915 A (SHIPS). Insulated with Rome Synthinol, these wires are made in a complete range of specification sizes.

ROME CABLE CORPORATION, Dept. EL-9, Rome, N. Y.

Please send me information on Electronic Wiring

Name

Company

Address

City Zone State

It Costs Less to Buy the Best



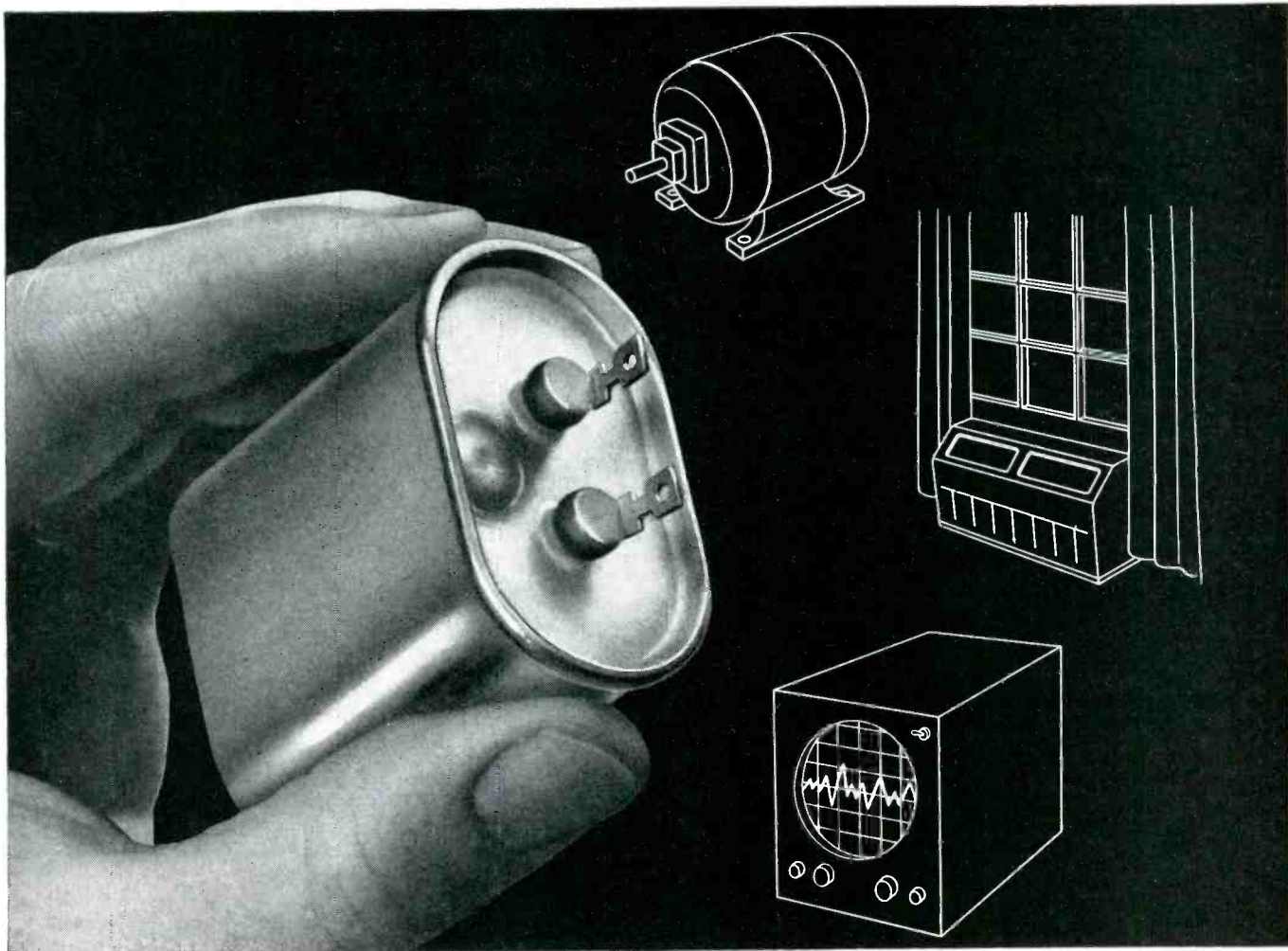

New oval-shaped General Electric capacitor saves space and weight in your electric equipment

If you're using fixed paper dielectric capacitors in case styles CP 53 and CP 70 it will pay you to consider General Electric drawn-oval units. These drawn-oval capacitors provide unsurpassed reliability combined with the important advantages of permitting smaller size, less weight and lower cost in the electric equipment you manufacture.

RATINGS range from 1 to 10 muf, 600 to 1500 volts dc, or 330 to 660 volts ac. Choice of mounting arrangements makes them ideally suited for air-conditioning units, electronic equipment, motors and controls or other applications where units capable of meeting all electrical and mechanical requirements of MIL-C-25A specs, except for case dimensions and markings, are desirable.

DOUBLE-ROLLED SEAM attaches cover to drawn-steel

case—producing a lighter, yet stronger capacitor. Actual savings in size and weight vary with case style and rating but can amount to as much as 30%. Depending upon case style and quantity ordered, prices average 10 to 20% lower than for rectangular capacitors.

MOUNTING VERSATILITY is provided by choice of three bracket styles for upright, inverted and side mounting to suit individual mounting requirements.

For more information on the new G-E drawn-oval capacitors, their ratings, dimensions and prices, contact your local G-E apparatus sales representative or write for Bulletin GEA-5777, General Electric Co., Section 442-10, Schenectady 5, N. Y.



You can put your confidence in—

GENERAL  ELECTRIC



Eliminates complex setups!

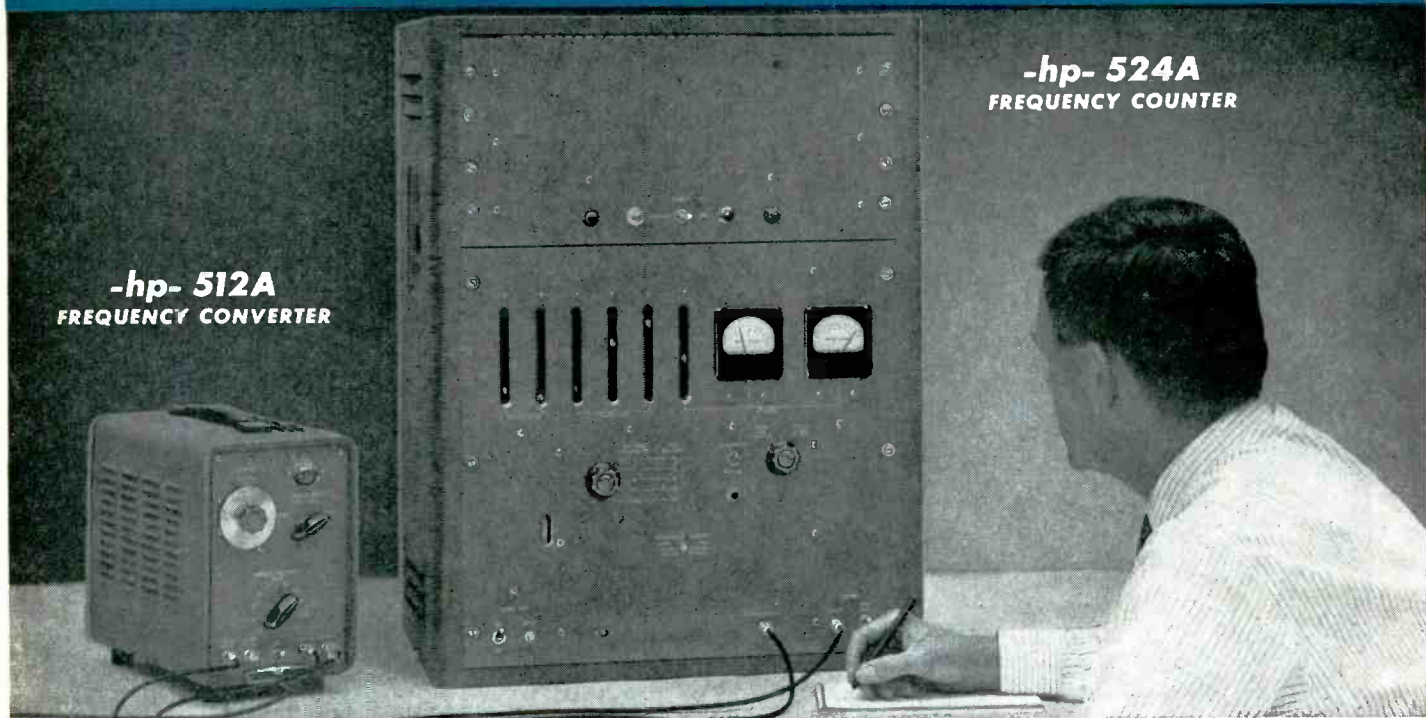

-hp- 524A
FREQUENCY COUNTER

-hp- 512A
FREQUENCY CONVERTER

Together, these two instruments offer you faster, easier, more accurate and broader range frequency measurements than any commercial equipment manufactured.

Now, in seconds, you automatically determine any frequency from 0.01 cps to 100 mc and *read the results directly*. Just connect the unknown, select the desired scale, and read! Ideal for use by non-technical personnel—no training is required. Split-second measuring speed makes the equipment particularly useful on the production line. Less investment in equipment, too—since the need for harmonic amplifiers, audio oscillators, multi-vibrators, search wave meters, transfer oscillators and oscilloscopes is eliminated.

FREQUENCY AND PERIOD MEASUREMENT

-hp- 524A Frequency Counter measures period as well as frequency. It has broad laboratory usefulness in frequency measurement including crystal checking, oscillator calibration and stability, pulse repetition rates, speed measurements and counting of random events occurring during a selected time interval.

-hp- 524A Counter performs all these functions without additional equipment through the range of 0.01 cps to 10 mc. *-hp- 512A* extends the Counter's range to 100 mc AND INCREASES SENSITIVITY 100 TIMES WITH NO LOSS IN ACCURACY!

-hp- 512A Converter offers you direct readings to 100 mc without interpolation or calculation. Operation consists

merely of tuning the Converter to the unknown and selecting the desired measurement range. The rest of the operation is automatic. The unknown is passed through a selective amplifier and mixed with a standard frequency (multiplied up from the 524A Counter's 100 kc standard). The resulting *difference* frequency is within normal range of the Counter, and is presented instantly on the Counter panel. The unknown is easily determined by adding to the Counter reading an even multiple of 10 mc as indicated on the Converter selector switch.

-hp- 524A FREQUENCY COUNTER

-hp- 524A operates on pulse-counting techniques. The unknown is applied through a wide-band squaring amplifier to a fast gate controlled by a time-base generator. When the gate is open, the unknown is applied directly to the counting circuits. When the gate is automatically closed; counting circuits remember and display the counted frequency in cps or the period in microseconds. Time base circuits are controlled by a crystal oscillator with instantaneous stability of 1/1,000,000 and accuracy of 2/1,000,000 per week.

COUNTER OPERATION

For high frequency work, *-hp- 524A* counts and displays unknown frequencies over exact time intervals of 0.001, 0.01, 0.1, 1 and 10 seconds. Counting and display periods are equal and automatically cycled. Counts are displayed repetitively, or "held" any desired length of time by depressing the "Manual" button.

Complete Coverage HEWLETT-PACKARD

Easily used by non-technical personnel

Instantaneous, direct Automatic FREQUENCY MEASUREMENT

.01 cps
to
100 mc

In low-frequency period measurement, the instrument measures the duration of one complete cycle in micro-seconds. A 10-cycle sample is taken to determine this period. Periods may be displayed repetitively or "held."

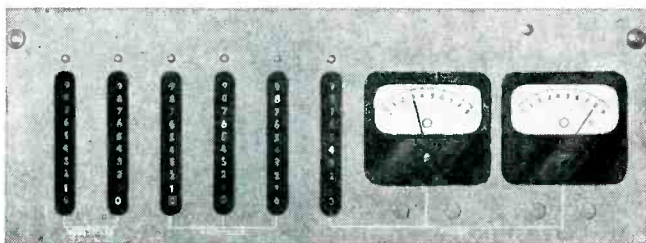

Fig. 1. Closeup of -hp- 524A panel shows how frequency count is displayed directly, instantly. Example counter is 10,168,438 cps.

SPECIFICATIONS

-hp- 524A Frequency Counter

- Counting Rate:** 10 mc per second maximum.
- Presentation:** 8 places, direct reading. First 6 places on neon lamp banks. Last 2 places on two meters.
- Count Period:** 0.001, 0.01, 0.1, 1, 10 secs.
- Low Frequency:** Permits low frequencies to operate at time base. Duration of one cycle is displayed in micro-seconds.
- Accuracy:** ± 1 count $\pm 2/1,000,000$ per week. (Higher accuracy external standard may be employed.)
- Period Measurement:** Within 0.03% up to 300 cps; within 1 μ sec between 300 cps and 10 kc.

- External 100 kc Standard Input:** For higher accuracy. Requires 1 v across 1 megohm shunted by 30 μ fd.
- Input Voltage:** 2 v peak minimum.
- Input Impedance:** Approx. 100,000 ohms, 30 μ fd shunt.
- Connectors:** Standard BNC type.
- Power Source:** 115 v ± 10 v, 50/60 cps, 400 watts.
- Size:** Approx. 28" high, 22 1/2" wide, 16" deep. Weight 123 pounds. Shipping Weight 260 pounds.
- Price:** \$2,000.00.

SPECIFICATIONS

-hp- 512A Frequency Converter

- Frequency Range:** As amplifier for -hp- 524A, 100 kc to 10 mc. As converter for -hp- 524A, 10 mc to 100 mc.
- Input Voltages:** 100 kc to 10 mc, 0.14 v minimum; 10 mc to 100 mc, 0.1 v minimum (on 50 ohm cable).
- Standard Mixing Frequency:** Multiplied up from 100 kc output of Model 524A. (Accuracy 1/1,000,000 short term.)
- Output Voltage:** 2 v minimum (sufficient to operate -hp- 524A over entire range).
- Connectors:** Standard BNC type.
- Power Source:** 115/230 v, 50/60 cps, 90 watts.
- Size:** (cabinet) 5 1/4" x 19" x 13" deep. Weight 20 lbs. Rack mount also available.
- Accessories Furnished:** Cables to interconnect with -hp- 524A.
- Price:** \$350.00.

Data subject to change without notice. Prices f.o.b. factory.

HEWLETT-PACKARD COMPANY

2709-A PAGE MILL ROAD • PALO ALTO, CALIFORNIA, U.S.A.

SALES REPRESENTATIVES IN ALL PRINCIPAL AREAS

Export: Frazar & Hansen, Ltd., San Francisco, Los Angeles, New York



INSTRUMENTS

Complete Coverage

BE COST-WISE

ECONOMIZE!

with

Heldor

—CANS & COVERS

built to meet MIL-T-27 & Commercial Specifications

—BUSHINGS

hermetic-seal, compression type

**ASSEMBLY
SERVICE—**

from assembly of bushings in covers to
actual hermetic sealing of your component.

WITH tough-selling, competitive days ahead it's more important than ever to LOWER COSTS, MAINTAIN QUALITY and MEET DELIVERIES . . . and that's when it pays to switch to Heldor for Cans and Covers built to meet MIL-T-27 or commercial specifications and hermetic-seal, compression-type Bushings and Terminals.

You'll cut your costs still further when you let Heldor do as much assembly as possible—bushings in the can covers, and if desired, your unit hermetically sealed in the can. That's how more and more electronic and nuclear component manufacturers meet today's stiff competition.

This opportunity can be yours, too. Just send Heldor your specifications (or prints) for an eye-opening quotation. *Do it TODAY!*

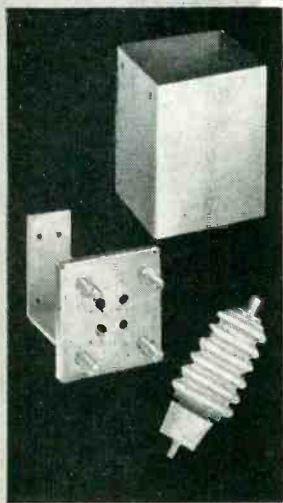

HELDOR MANUFACTURING CORPORATION



HELDOR BUSHING & TERMINAL CO., INC.

238 Lewis Street

Paterson, N. J.





You can't see **SYNTHANE** but it's in the picture

There are important factors about picture-making you never see in the print—the photographer, the lights, the darkroom, the chemicals. One of many materials essential to photography is Synthane—a laminated plastic.

Synthane is corrosion-resistant. . . Synthane spools carry film from early stages of emulsion coating through developing. Synthane is opaque to infrared rays which accounts for its use as slides for film packs. Synthane is an electrical insulator; you'll find it hidden in flash guns, lighting equipment and projectors. Synthane is wear-resistant and vibration-absorbing, fine for quiet gears in movie cameras.

The photographic industry is only one part of the American industrial picture, and the properties for which Synthane is valued in it are only a few of the many Synthane has. Others are good tensile, compressive, flexural, and impact strengths, dimensional stability, light weight, high dielectric strength, ease of machining. Synthane has all these properties—and more—in combination. And the combination may be valuable to you.

To get the complete picture of Synthane and its possible place in your product, write today for the 24-page Synthane Catalog. Synthane Corporation, 17 River Road, Oaks, Penna.



Here you see the three basic forms of Synthane laminated plastics—sheets, tubes and rods. All three are made by applying heat and high pressure to resin-coated laminations of paper, fabric, glass cloth or mat. Synthane is thermo-setting, has many much-sought properties in combination.

Synthane in Photography

A—16mm Reel

B,C,D—Film processing spools

E,F—Chemical-resistant screws for developing equipment

G—35mm film carrier



Synthane—one of industry's unseen essentials

SYNTHANE

LAMINATED PLASTICS

GENERAL PLATE ALCUPLATE[®]

(COPPER-CLAD ALUMINUM)

Reduces Costs
OVER SOLID COPPER
OR BRASS

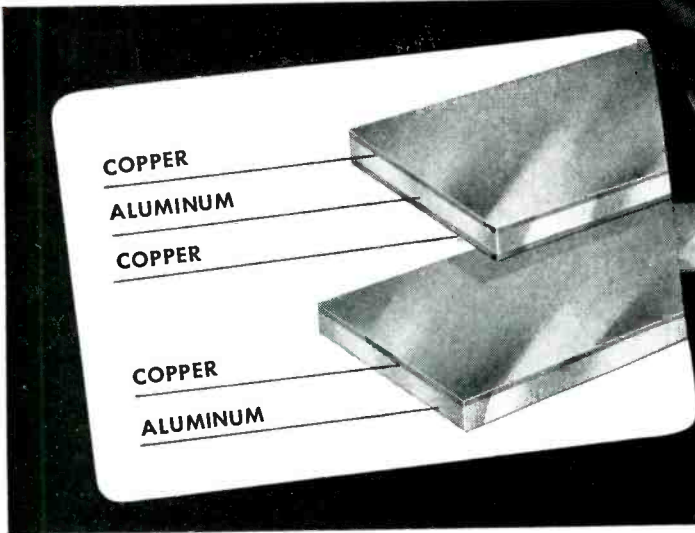

ALCUPLATE Provides High Electrical Conductivity, Soft-Soldering Surfaces, Good Heat Dissipation, Light Weight

Now, you can reduce your cost 15-30% or more over an equal area of solid copper or brass by using General Plate ALCUPLATE.

Made by permanently bonding a thin layer of copper to one or both sides of thicker aluminum, ALCUPLATE has practically the same physical and electrical properties as copper, plus the light weight of aluminum. The copper provides an ideal surface for soft-soldering operations, electroplating and other finishes.

ALCUPLATE is widely used in the electrical and electronic fields for terminals, clips, shims, small motor housings, electronic component cases, chassis, and brackets. It is also used for heat transfer assemblies, fin and tube type radiators, printed circuits, costume jewelry and similar applications.

ALCUPLATE can be fabricated by stamping, drawing or forming. Its malleability permits its use in the manufacture of many parts from work-hardened rather than annealed or dead soft materials.

ALCUPLATE is available in coils and flat cut lengths, copper clad on one or both sides of aluminum, 1/16" thick x 13" wide and under.

Technical Data Bulletin No. 702C gives full details. Write for a copy, today.

**You can profit by using
General Plate Composite Metals!**

**METALS & CONTROLS CORPORATION
GENERAL PLATE DIVISION**

39 FOREST STREET, ATTLEBORO, MASS.

A Few of the Many Products Made from General Plate ALCUPLATE



HEAT TRANSFER UNITS — ALCUPLATE provides ideal fin sections at reduced cost over solid copper fins. The copper surface permits the soft soldering of the fins to the tubes.



ELECTRONIC CHASSIS — Minimum weight combined with copper surface required for soft-soldering operations, electroplating, and low-resistance shield connections are advantages obtained by using ALCUPLATE.



COMPONENT CASES — ALCUPLATE is successfully drawn and formed into lightweight cases or cans and intricate parts.



BUS BARS — ALCUPLATE provides high conductivity, light weight, solderability . . . and is lower in cost than solid copper bus bars.



ELECTRICAL TERMINALS — Small terminals and large pressure-type connectors use single-clad ALCUPLATE . . . alleviates galvanic corrosion which otherwise results from aluminum and copper junctions.

DURAMEG[®]

ACCURATE WIREWOUND RESISTORS

ABOVE AND BEYOND MIL-R-93A SPECIFICATIONS

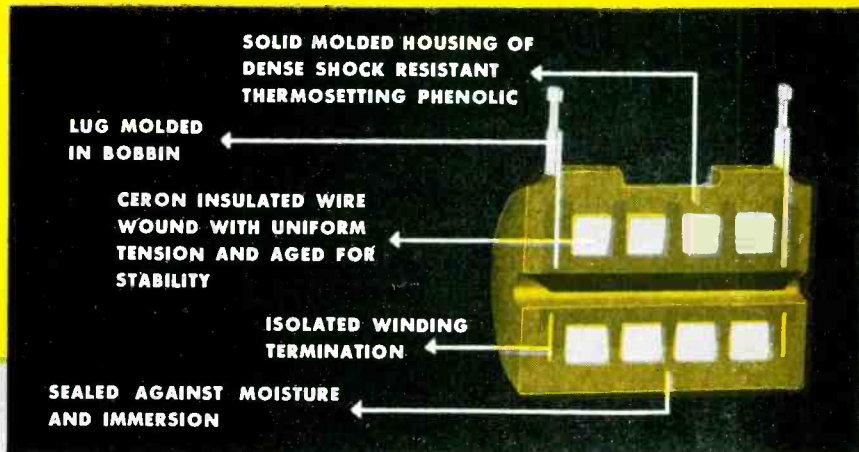

DURAMEG wattage ratings are based on full rated dissipation at 105° ambient. These ratings are from 4 to 5 times the 85°C MIL ratings for the best of conventional resistors.

DURAMEG Resistors pioneered and proved new performance records for reliable, high-accuracy wire-wound resistors. They're molded under high pressure and temperature in mineral-filled, dense phenolic—impervious to moisture—for positive protection against electrolysis failure. They'll even withstand the salt water immersion cycling for characteristic A in the former specification JAN-R-93. Installations require no secondary insulation for mounting. Yes, they're also tough and resistant to high mechanical damage.

The long-term stability of Durameg Resistors offers a new scope of performance to equipment

designers who must consider initial resistance tolerance of resistors as well as shifts in value with repeated thermal cycling and with age. With Durameg stability, you can design now for permanent peak performance!

Duramegs are the first accurate resistors that operate up to a hot spot temperature of 150°C as against the usual 105°C limit—made possible with Sprague's patented ceramic-insulated Ceron resistance wire. The unique combination of Ceron wire, Durameg molding technic and aging treatment, permits dissipation of full rated wattage at 105°C—the same temperature at which MIL ratings prescribe zero % dissipation!

DURAMEG Resistors are now available for commercial applications in dimensions identical to MIL styles. We will be glad to send you complete data upon request. * * * * *



**WRITE, WIRE OR PHONE FOR
ENGINEERING BULLETIN 120**

SPRAGUE ELECTRIC COMPANY
35 Marshall Street, North Adams, Mass.

SPRAGUE

PIONEERS IN ELECTRIC AND ELECTRONIC DEVELOPMENT

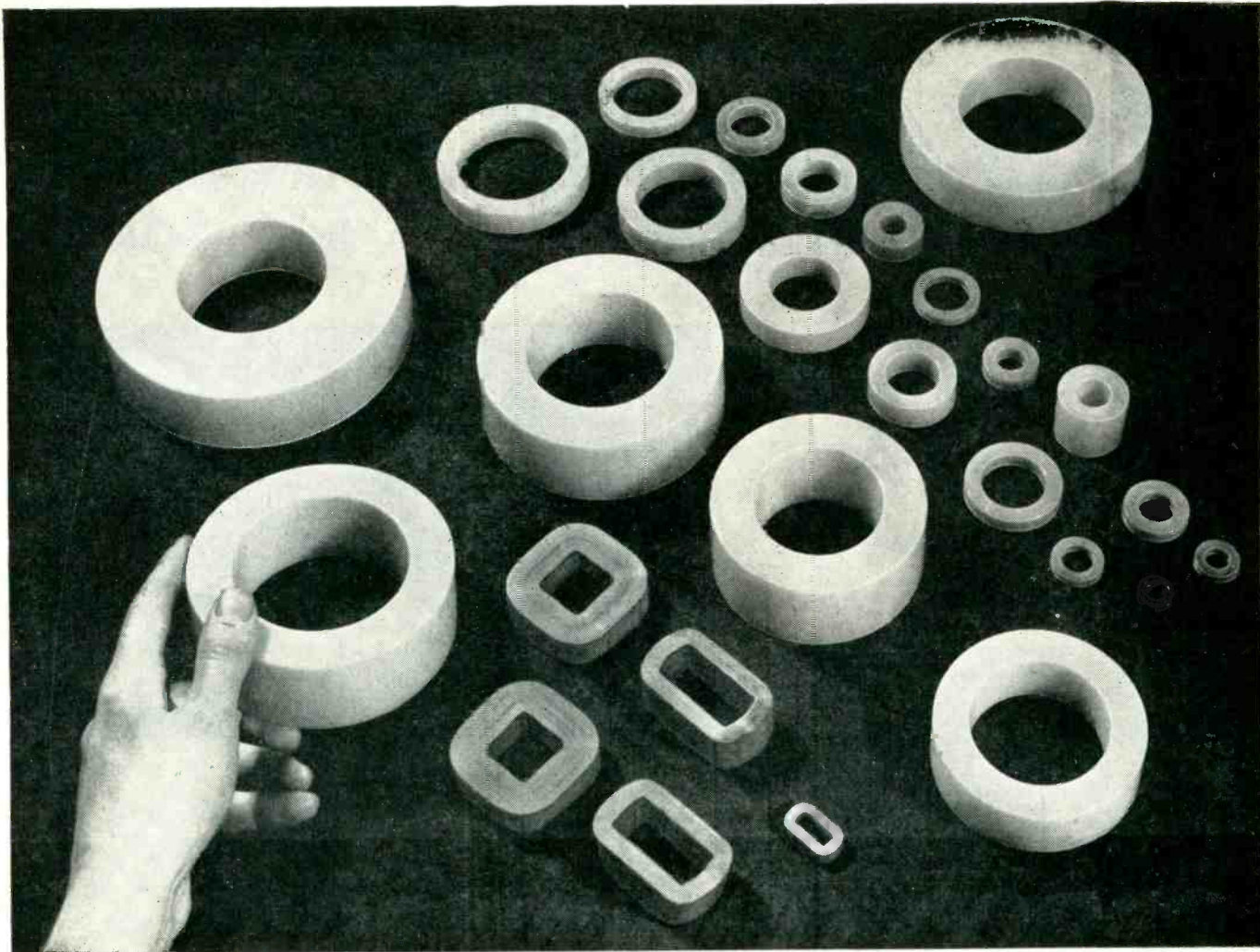

IN **TAPE-WOUND CORES** JUST NAME YOUR REQUIREMENTS!

RANGE OF MATERIALS

Depending upon the specific properties required by the application, Arnold Tape-Wound Cores are available made of DELTAMAX . . . 4-79 MO-PERMALLOY . . . SUPERMALLOY . . . MUMETAL . . . 4750 ELECTRICAL METAL . . . or SILECTRON (grain-oriented silicon steel).

RANGE OF SIZES

Practically any size Tape-Wound Core can be supplied, from a fraction of a gram to several hundred pounds in weight. Toroidal cores are made in twenty-two standard sizes with protective nylon cases. Special sizes of toroidal cores—and all cut cores, square or rectangular

cores—are manufactured to meet your individual requirements.

RANGE OF TYPES

In each of the magnetic materials named, Arnold Tape-Wound Cores are produced in the following standard tape thicknesses: .012", .008", .004", .002", .001", .0005", or .00025", as required.

Applications

Let us help with your problems of cores for Magnetic Amplifiers, Pulse Transformers, Current Transformers, Wide-Band Transformers, Non-Linear Retard Coils, Peaking Strips, Reactors, etc.

Address: ENG. DEPT. E

W&D 4613

THE ARNOLD ENGINEERING COMPANY

SUBSIDIARY OF ALLEGHENY LUDLUM STEEL CORPORATION

General Office & Plant: Marengo, Illinois

DISTRICT SALES OFFICES . . . Boston: 200 Berkeley St.

New York: 350 Fifth Ave.

Los Angeles: 3450 Wilshire Blvd.



for **THRIFTY SAVING** in power, weight and space

SPECIFY

Micro
BEARINGS

DESIGN YOUR PRODUCT WITH THE
THRIFTY-SAVING RETAINER
EXTRA-LIGHT

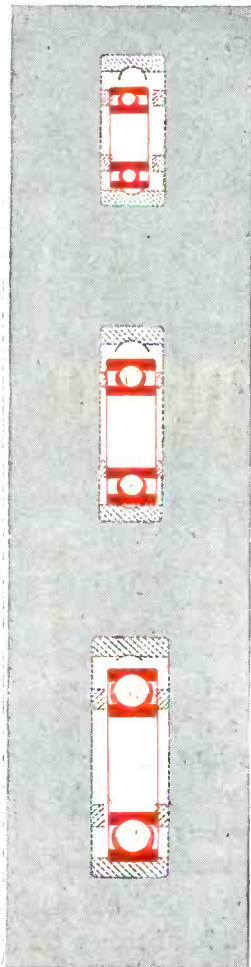

White Area Indicates
Loss when specifying
common sizes

bore **MICRO**
1/8" R144

Saving 80% in space and
weight over common R2
bearing shown in white

3/16" **MICRO**
R166

Saving 69% in space and
weight over common R3
bearing shown in white

1/4" **MICRO**
R188

Saving 69% in space and
weight over common R4
bearing shown in white

Illustration
Two Times Actual Size



MICRO
FR 188
5 Times
Actual
Size . . .

*Peeling off all excess metal we are now able
to furnish a smaller bearing in the various
shaft sizes. Thus we have produced a load-
carrying package of minimum weight and size.*

Arthur H. Daniels

Frequent losses occur in designs calling
for bearings with capacity far beyond re-
quirements

DESIGN LOADS FOR 1 MILLION REVOLUTIONS

M I C R O R144 — 52	Common R2 — 108
M I C R O R166 — 120	Common R3 — 194
M I C R O R188 — 224	Common R4 — 260

NEW HAMPSHIRE *SPECIFY Micro* **BALL BEARINGS, INC.**
32 MICRO CIRCLE PETERBOROUGH, N. H. **TELEPHONE 424**



Write for Catalog 53 for complete
data on the more than 130 available
MICRO Bearings, or consult
our Design Engineering Department.



We shot for the moon ... on a clear night

We set our sights on developing a new electron gun . . . one whose finer beam would establish an all-time high in resolution for electrostatic focus picture tubes.

We shot for a gun that would produce a smaller, sharper spot . . . a spot free from the effects of excessive "starring" which causes an outline blur similar to the haze around the moon on a cloudy night.

Smaller spot size, and cleaner, more uniform spot shape are the secrets of the Du Mont Hi-R Teletron. These are the features which have made possible a more vivid presentation of the television picture.

They are the reasons why, in just a few months, the Hi-R Teletron has become the performance standard of the television industry.

DU MONT®
*Teletrons**

Hi-R— A new high
in resolution — now being
incorporated in all DuMont
Electrostatic Focus Teletrons

*TRADE MARK

CATHODE-RAY TUBE DIVISION • ALLEN B. DU MONT LABORATORIES INC., CLIFTON, N. J.

Roses and Research...the story, in brief, of nature and science. At Littelfuse we continuously explore nature's contrasting laws, realizing that the delicate rose is still an adaptable perennial. You will find the same adaptability in the Littelfuse research department—in the perennial attention our engineers and technicians give to the problems you bring in. Consult us today.

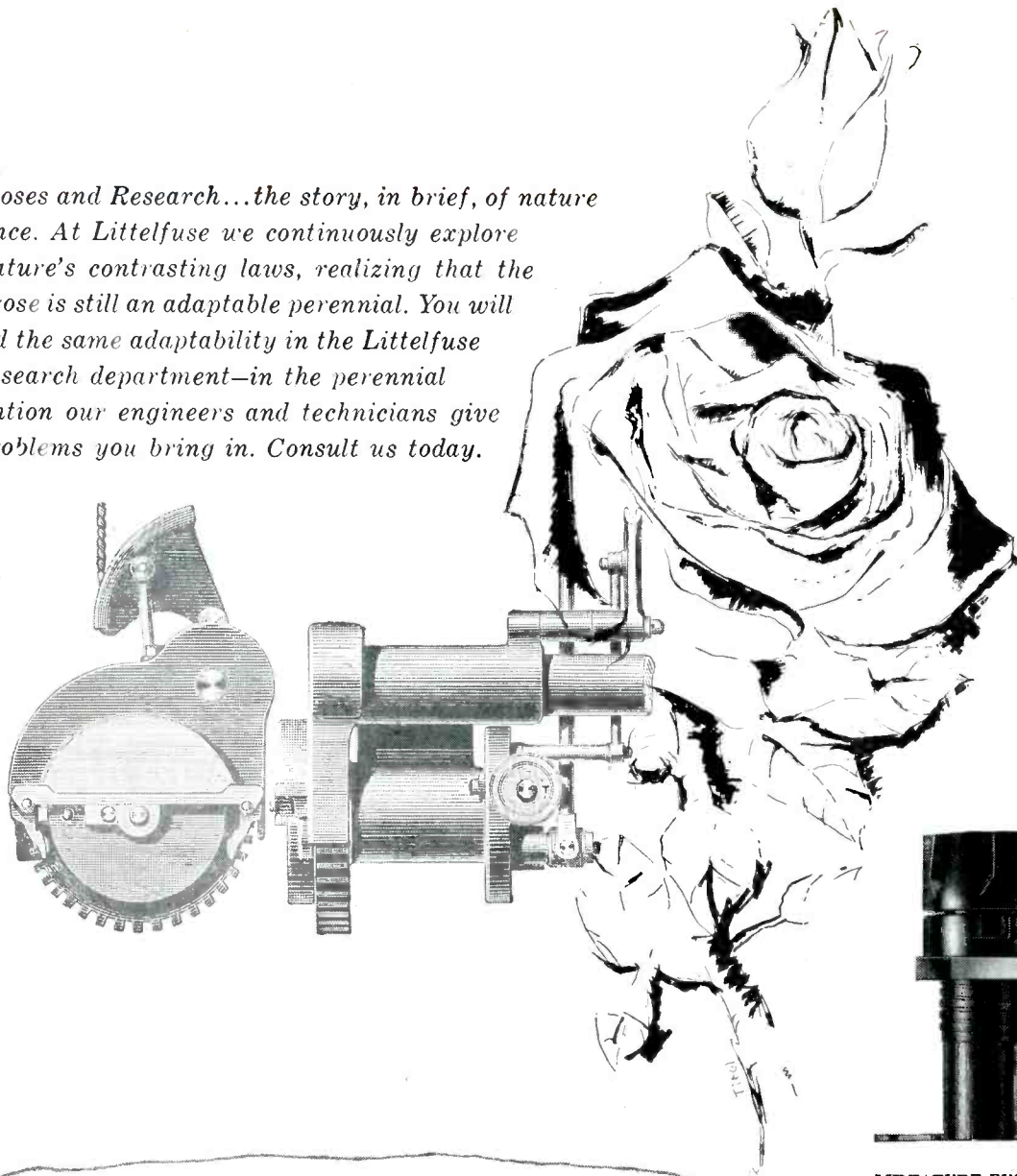

MINIATURE FUSE POST

LITTELFUSE L, n. c.

DES PLAINES ILLINOIS

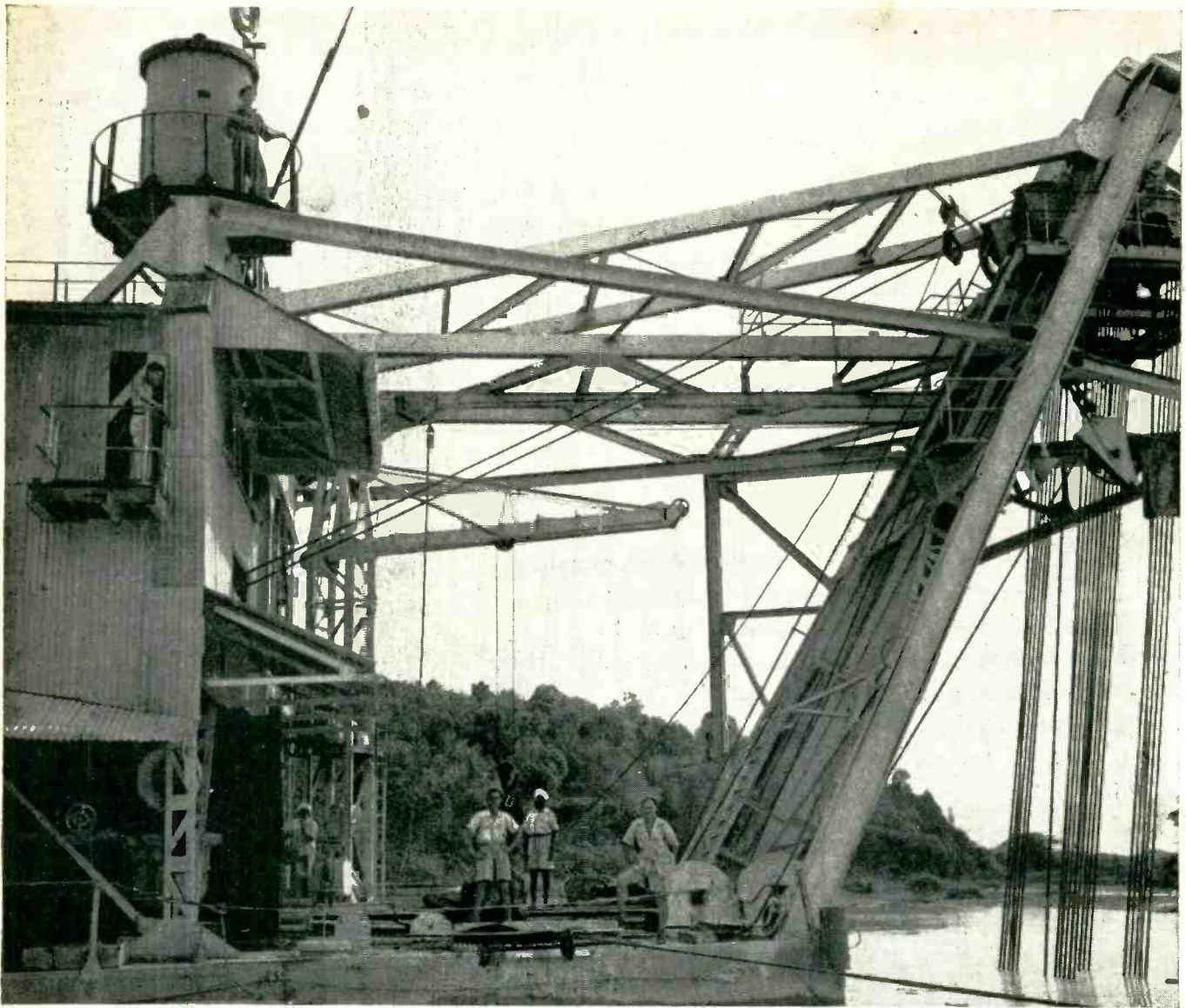

Here is the start of a Diesel locomotive

This complicated looking rig is part of a Malayan tin dredge.

Right here, in the heart of Southeast Asia, Diesel locomotives start off on the right track, for tin plays an important part in the manufacture of these modern giants. And over a third of the world's tin is mined in Malaya.

Tin is just as important to the engineer seeking ways to improve many a product.

Tin-zinc plating, for example, is an excellent and economical substitute for cadmium in many applications.

Phosphor bronze, another tin alloy, has uses ranging from iron lungs to foghorns.

In the field of chemistry, tin is increasingly important. Tin oxide is the best opacifier of enamel. Organotin compounds are the best stabilizers known for polyvinyl chloride plastics.

Thus tin is becoming continually more valuable as a modern industrial material.

With the end of U.S. Government controls, tin is again freely available in this country to any user, in any quantity, for any purpose. There are ample supplies of tin in sight for the foreseeable future, provided a reasonable price is paid.

So take a good, long look at tin in your own product research and development. Remember, no other metal

combines all the properties of tin. Tin is inert, nontoxic, friction and corrosion resistant. Tin is highly malleable, second only to gold. Above all, tin is economical to use. A little tin will do a lot of work.

This is the time to investigate thoroughly the ways it can work for you.

This Bureau is sponsored by the tin producers of Malaya to promote better understanding between America, world's largest consumer of tin, and Malaya, world's largest producer.

TIN NEWS, issued monthly, covers noteworthy current developments in the production, use and marketing of tin. Write for a free copy.



THE MALAYAN TIN BUREAU Dept. 384, 1028 Connecticut Ave., Washington 6, D.C.

TAYLOR Forming Materials are specially made for use in intricate shapes, compound curves and relatively deep draws. They are available with a wide variety of physical, mechanical and electrical characteristics.

Want to make something of them?



Make them into all kinds of panels, guards, barriers, ribs, masks, covers, ducts, containers, shields, shims or any other complicated formed part your product may require. While many grades of Taylor Vulcanized Fibre and Laminated Plastic can be formed to some degree, these four grades are ideally suited for most forming operations.

LAMINATED PLASTICS:

Grade C-7—for applications requiring toughness, resilience, mechanical strength and abrasion resistance.

Grade XX-7—for applications where mechanical strength is secondary to good electrical properties and low cost.

VULCANIZED FIBRE:

Trunk Fibre—for applications requiring good mechanical strength, toughness, abrasion resistance, surface finish and resistance to organic solvents.

Taylor Insulation—for applications requiring superior dielectric strength, toughness and abrasion resistance as well as good mechanical strength.

Make your products better and easier to assemble. Call your Taylor Engineer, he will be glad to work with you on your design problems and recommend the Taylor material that can be best formed to meet your particular requirements. Other grades of Taylor Vulcanized Fibre . . . as well as Phenol, Melamine and Silicone Laminated Plastics . . . may also fit into your design plans. Your Taylor Engineer will be glad to show you samples and discuss specifications.

Taylor Fibre Co., Norristown, Pennsylvania—La Verne, California

TAYLOR
Laminated Plastics
Vulcanized Fibre

SCINFLEX

**ASSURES YOU THE
LOWEST VOLTAGE DROP
IN THE INDUSTRY!**

When operating conditions demand an electrical connector that will stand up under the most rugged requirements, always choose Bendix Scinflex Electrical Connectors. The insert material, an exclusive Bendix development, is one of our contributions to the electrical connector industry. The dielectric strength remains well above requirements within the temperature range of -67°F to $+275^{\circ}\text{F}$. It makes possible a design increasing resistance to flashover and creepage. It withstands maximum conditions of current and voltage without breakdown. But that is only part of the story. It's also the reason why they are vibration-proof and moisture-proof. So, naturally, it pays to specify Bendix Scinflex Connectors and get this extra protection. Our sales department will be glad to furnish complete information on request.

- Moisture-Proof • Radio Quiet • Single Piece Inserts •
- Vibration-Proof • Light Weight • High Insulation Resistance
- High Resistance to Fuels and Oils • Fungus Resistant •
- Easy Assembly and Disassembly • Fewer Parts than any other Connector • No additional solder required.

The Finest
**ELECTRICAL
CONNECTOR**
MONEY CAN
BUY!



BENDIX SCINFLEX

**ELECTRICAL
CONNECTORS**



SCINTILLA MAGNETO DIVISION of
SIDNEY, NEW YORK



Export Sales: Bendix International Division, 72 Fifth Avenue, New York 11, N. Y.

FACTORY BRANCH OFFICES: 118 E. Providencia Ave., Burbank, Calif. • Stephenson Bldg., 6560 Cass Ave., Detroit 2, Michigan • Brouwer Bldg., 176 W. Wisconsin Avenue, Milwaukee, Wisconsin • 582 Market Street, San Francisco 4, California

Research tries the Unconventional

DALMO VICTOR
CORPORATION

PURCHASE REQUISITION
No. 48683

FOR *Research Lab*
DATE *9/17/52* PLANT NO. *6*

QUAN	UNIT	
<i>5</i>	<i>lb</i>	<i>peanut butter</i>
<i>5</i>	<i>lb</i>	<i>shortening</i>
<i>1 bag</i>	<i>(25 lbs)</i>	<i>fine sand</i>

FORM 10P-R

SIGNATURE *J.T. [unclear]*

at DALMO VICTOR

One typical DV Development

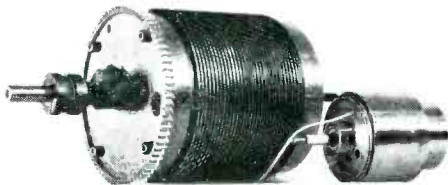

FLUID MAGNETIC CLUTCHES
Motion and its precision control are constant problems in radar antenna systems. For these requirements, one Dalmo Victor task group has evolved and engineered basic new types of fluid magnetic clutches, of which one example is illustrated.

Company purchasing personnel are sometimes amused by research department requisitions for all kinds of unexpected materials. Recently, a study of a wide variety of substances indicated that peanut butter, shortening and sand had ideal physical and electrical characteristics for a special antenna-loading problem at hand. So tests were made.

Dalmo Victor specialists never hesitate to explore unconventional channels of approach to engineering problems as well as the more customary ones. And, as a result, unusual ways are sometimes found for meeting difficult problems connected with development of complex, lightweight, electromechanical devices and the systems in which they operate.

DALMO VICTOR
SAN CARLOS · CALIFORNIA

DV

DOWN-TO-EARTH ELECTROMECHANICAL ENGINEERING



George M. Jolly, head of the Milium Division of Deering-Miliken & Co., tells how . . .

“We helped sew up \$500,000!”

“A Kansas City coat manufacturer had \$500,000 in sales sewed up—except for the linings! Buyers had flooded him with re-orders for 12,000 Milium-lined Fall coats. But the uncompleted coats were hanging in the loft.

“12,000 Milium linings had to catch up with 12,000 coats—and fast, too. We called in Air Express!

“As fast as the cloth was dyed and finished in New England, it was rushed to South Carolina and processed as Milium insulated linings, then speeded to Kansas City. Every deadline was met—and the deal was sewed up.

“Our customer’s 12,000 coats were turned into a fast \$500,000—thanks to the speed and reliability of Air Express!

“We face frequent customer deadlines. We can’t afford any air service but the *fastest* — there’s too much at stake. Yet in most of the weights and distances we ship, Air Express rates turn out to be lowest in the field!”

It pays to express yourself clearly. Say Air Express! Division of Railway Express Agency.



Air Express



GETS THERE FIRST via U.S. Scheduled Airlines

Want more information? Use post card on last page.

September, 1953 — ELECTRONICS

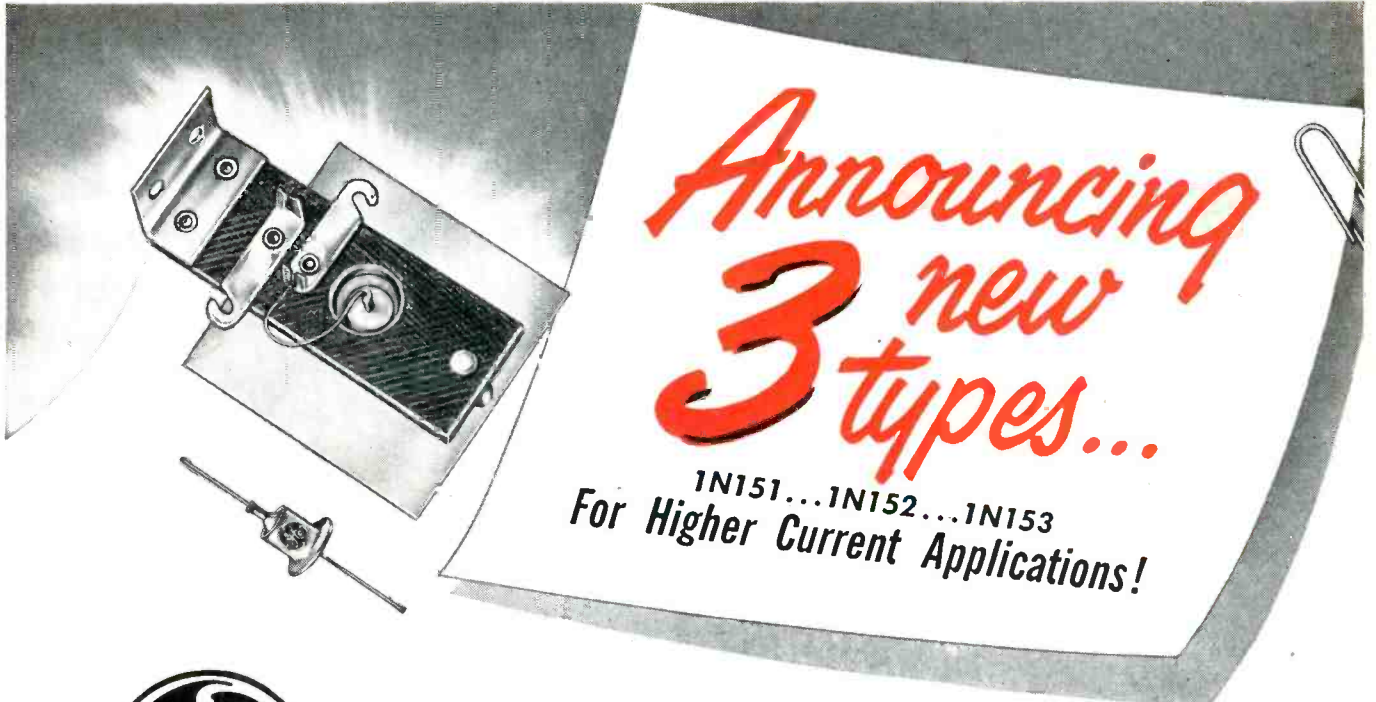

DIFFUSED JUNCTION GERMANIUM RECTIFIERS

ABSOLUTE MAXIMUM RATINGS—T-55°C—RESISTIVE LOAD							
DIFFUSED JUNCTION RECTIFIER	1N91	1N92	1N93	1N94	1N151	1N152	1N153
RMS INPUT VOLTAGE (Volts)	—	—	—	130	35	70	105
PEAK INVERSE VOLTAGE* (Volts)	100	200	300	380	100	200	300
PEAK FORWARD CURRENT (Amps.)	0.47	0.31	0.25	1.57	1.57	1.57	1.57
D.C. OUTPUT CURRENT* (Ma.)	150	100	75	500	500	500	500
D.C. OUTPUT CURRENT—CAPACITIVE LOAD (Ma.)	—	—	—	350	350	350	350
D.C. SURGE CURRENT (Amps.)	25	25	25	25	25	25	25
FULL LOAD VOLTAGE DROP (volts peak)	0.5	0.5	0.5	0.7	0.7	0.7	0.7
LEAKAGE CURRENT (Ma., @ rated P.I.V.)	2.7	1.9	1.2	0.8	2.4	1.9	1.2
CONTINUOUS REVERSE WORKING VOLTAGE (Volts D.C.)	30	65	100	185	30	65	100
OPERATING FREQUENCY (KC)	50	50	50	50	50	50	50
STORAGE TEMPERATURE (°C)	85	85	85	85	85	85	85

*Typical absolute maximum ratings. For other combinations refer to Fig. 1

- **VERY LOW LOSSES** when used for power supplies, battery chargers, filament supplies and switching circuits.
- **HERMETICALLY SEALED** against deteriorating elements. Glass-to-metal seals throughout.
- **MINIATURE SIZE** to facilitate use in all electronic equipments, yet heat losses are dissipated efficiently.
- **DESIGNED** to meet all military humidity tests and shock and vibration requirements.
- **MULTIPLE ARRANGEMENTS** can be made for full wave or bridge circuits up to tens of amperes. Send us your requirements—our engineers will furnish a complete recommendation.

Send for complete specifications: *General Electric Co., Section 493, Electronics Park, Syracuse, New York.*

News FROM OUR ADVANCED DEVELOPMENT LABORATORIES

Silicon junction diodes have been successfully operated above 400°F (more than 200°C). This is hotter than the melting point of the lead-tin solder ordinarily used to wire these signal diodes into circuits.



GENERAL ELECTRIC

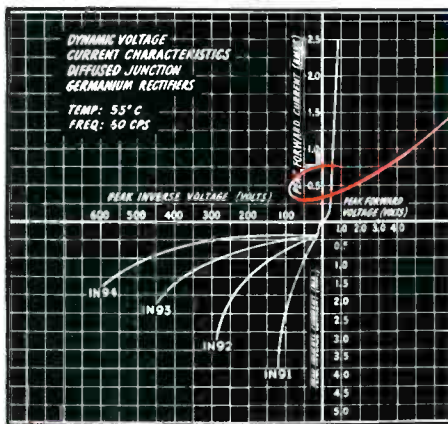

Note: THIS IS ONLY ONE OHM!

Fig. 1

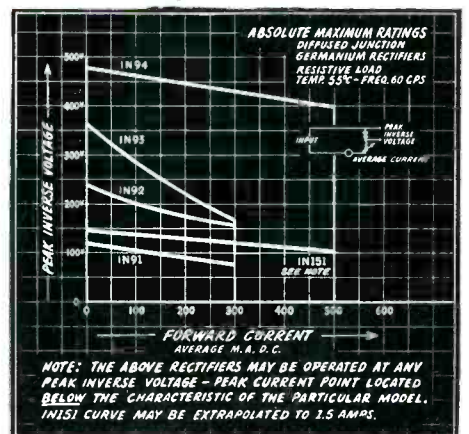

Wherever

reliable

sensitive control is required

SUGGESTED APPLICATION SCHEMATICS

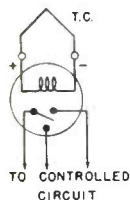

Temperature Control and Protection

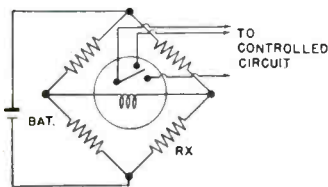

Resistance Selection

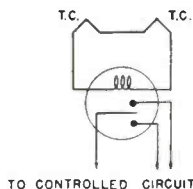

Temperature Differential Control

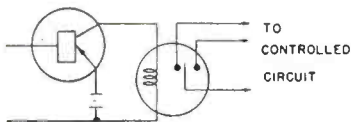

Transistor Selection

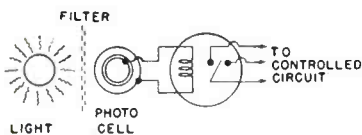

Low Level Light Detection and Control



WESTON Sensitrol Relays

- eliminate need for involved electronic circuits, and auxiliary power supplies.
- operate directly on values low as ½ microampere, or ¼ millivolt.
- handle substantial wattage at 110 volts on non-chattering magnetic contacts.
- available with single or double contacts, fixed or adjustable, manual or solenoid reset.

Designing, or redesigning, for greater simplicity, compactness or reliability, investigate these widely used, ultrasensitive relays. So sensitive that they operate direct on the output of thermocouples, resistance bulbs or photocells, they enable designers to cut manufacturing and maintenance costs by dispensing with involved circuits and many troublesome components. To help you adapt these rugged relays to your problems, engineering assistance is freely offered. Write . . . WESTON Electrical Instrument Corporation, 614 Frelinghuysen Avenue, Newark 5, New Jersey.

WESTON Instruments

The tape and parts pictured are typical of R/M Teflon manufacture



R/M Teflon*

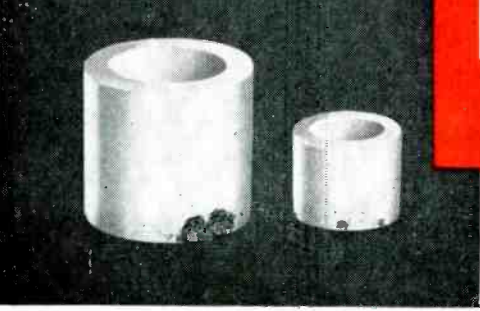
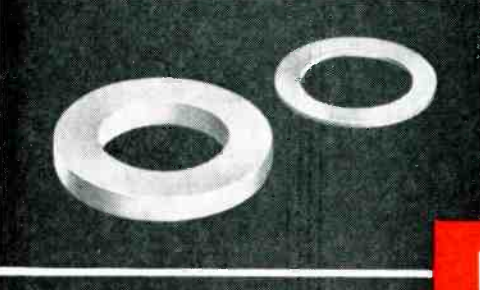
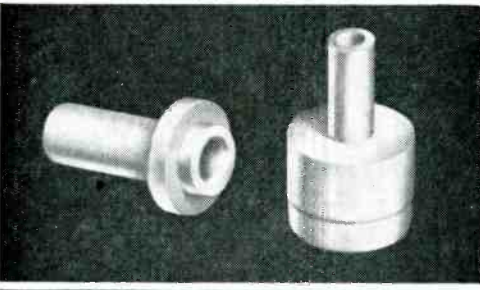
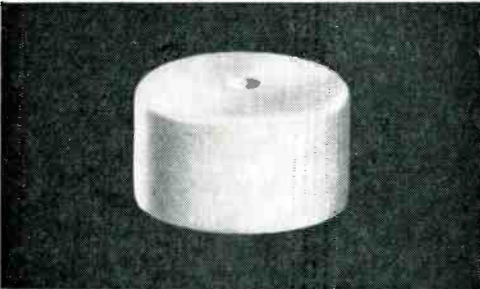
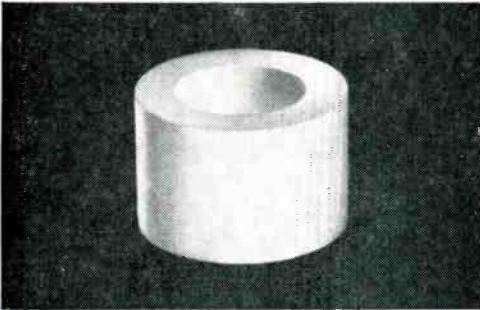

the plastic that makes engineering dreams become realities

It is difficult to write about Teflon without appearing to exaggerate. For in many different ways this almost magic plastic—the most important derivative of the new wonder chemical fluorocarbon—is making the seemingly impossible possible. Parts made of R/M Teflon have already brought many startling improvements to the electronics and electrical manufacturing fields. And everyone working with it senses that the surface has barely been scratched—that hundreds of applications remain to be revealed.

There undoubtedly are ways in which Teflon can be profitably put to use in your own plant. So we have this suggestion to make to you: consider the properties of Teflon listed below—then get in touch with us if you think that any of them might make a contribution to your operation. We will fabricate parts to your own specifications or supply you with Teflon in the form of rods, sheets, tubes or tape.

Properties

High resistance to acids and gases even at high temperatures • Moisture absorption zero • Unaffected by weather • Excellent heat stability up to 500°F. in continuous operation • As tape, leaves no carbon residue along discharge path • High impact resistance • Nonadhesive • Stretches easily • Tensile strength 1500-2500 psi

**Du Pont's trade-mark for its tetrafluoroethylene resin*

R/M

RAYBESTOS-MANHATTAN, INC.

ASBESTOS TEXTILE DIVISION

MANHEIM, PA.

FACTORIES: Manheim, Pa.; No. Charleston, S.C.; Passaic, N.J.; Neenah, Wis.; Crawfordsville, Ind.; Peterborough, Ontario, Canada

RAYBESTOS-MANHATTAN, INC., Manufacturers of Asbestos Textiles • Teflon Products • Packings • Brake Linings • Brake Blocks • Clutch Facings • Fan Belts • Radiator Hose • Rubber Covered Equipment Mechanical Rubber Products • Abrasive and Diamond Wheels • Sintered Metal Products • Bowling Balls

ELECTROMATIC relief valve depends on WARD LEONARD RELAYS

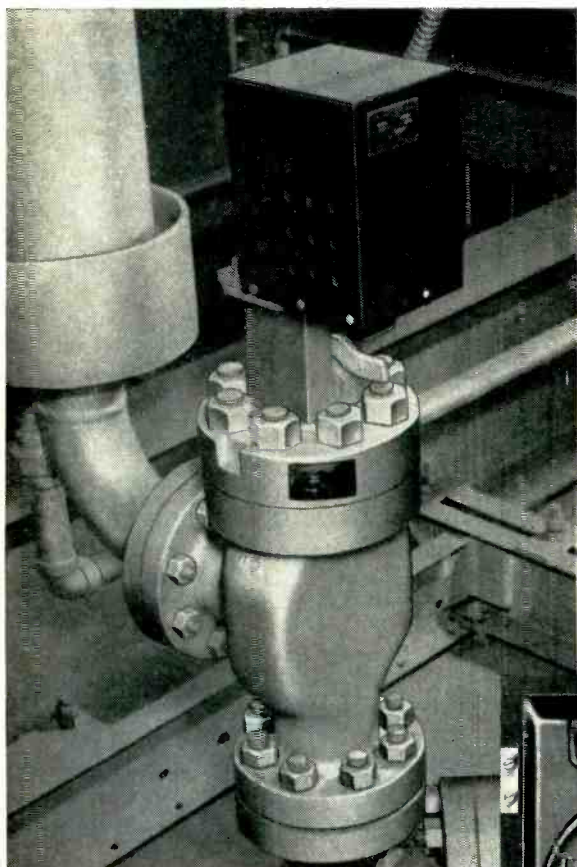

CONSOLIDATED ELECTROMATIC RELIEF VALVE ACTUATED BY WARD LEONARD RELAYS, keeps boiler pressures balanced within one percent of a predetermined level. This conserves power, maintains uniform line pressure and decreases maintenance of spring-loaded safety valves.

This relief valve, made by Manning, Maxwell & Moore, Stratford, Conn., is designed to increase the efficiency of steam generating systems by automatically keeping boiler pressures balanced within one percent of a predetermined value.

The relays used in the control unit which actuates this relief valve must give trouble-free performance with practically no attention. While they may be called into action frequently or only once or twice a year, it is extremely important that they function perfectly when needed. Such trigger-sharp sensitivity after long inoperative periods is a very exacting and unusual requirement for any relay. Ward Leonard relays handle this assignment dependably and accurately.

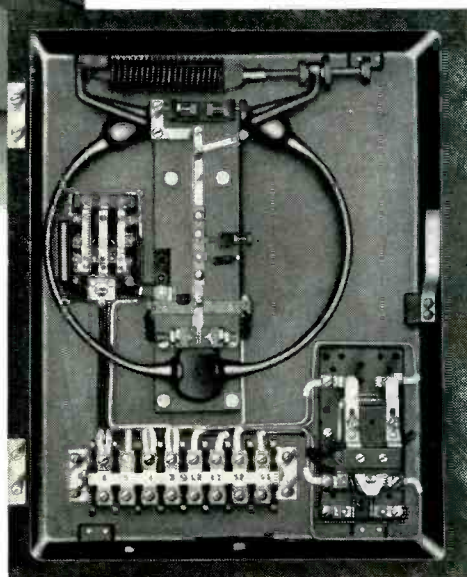

PERFECT PERFORMANCE, even after months of inoperation, is required of the electrical control unit. To meet this very severe and unusual operating condition, Ward Leonard 110 and 130 relays shown here give trouble-free performance with little or no maintenance. The midget 110 relay will open or close circuits up to ten amperes. The two-pole 130 relay can be economically adapted to a variety of applications by varying interchangeable parts in its assembly.



**WARD LEONARD
ELECTRIC COMPANY**

MOUNT VERNON, NEW YORK

Result-Engineered Controls Since 1892

**WARD LEONARD'S
attention to
every detail
in the
construction of
relay components
gives you
accurate,
dependable
performance**



CONTACT PRESSURE OF EVERY RELAY is measured on a gram gauge in Ward Leonard's Mount Vernon plant.

Take the Ward Leonard relay coils, for example. All magnetic relays have coils, but there can be a world of difference between them. Here's how Ward Leonard insures perfect performance in every relay coil as a routine production procedure:

Coils are layer wound using insulated magnet wire with insulating paper between each layer. They are vacuum impregnated with heat reactive varnish. Their ends are sealed with an end seal compound. Insulated tape used for anchoring provides auxiliary insulation. The outside wrap provides excellent mechanical protection. The final finish dip in insulating varnish provides a virtual hermetic seal for the coil.

These features of the relay coil are indicative of the detailed attention given to every component of Ward Leonard relays. And after the components are assembled, all finished relays are measured for resistance, close dimensional tolerances, pick-up, drop-out, dielectric strength and contact continuity.

Whether you make heavy industrial equipment like the Electromatic Relief Valve, or highly sensitive electronic apparatus, there's a Ward Leonard electrical control that will meet your needs.

For complete information, write for our Relay Catalog. Ward Leonard Electric Co., 31 South St., Mount Vernon, New York. 3.15



RHEOSTATS



RESISTORS



MOTOR CONTROLS



CHROMASTER



Ward Leonard's complete engineering text book, "Handbook of Power Resistors," \$3 per copy.

introducing the GOODMANS PERMANENT MAGNET SHAKERS

THESE shakers provide vibratory sinusoidal forces of frequency and amplitude by which specific vibratory conditions can accurately be simulated. They provide the means of assessing the effects of sudden acceleration on materials, structures and components; and are being extensively applied to FATIGUE TESTING, ELECTRICAL COMPONENT TESTING, FLEXURE TESTING OF PLASTICS, ETC. and SPECIALISED GUIDED WEAPON RESEARCH. For certain pre-knowledge of vibration and its effects consult GOODMAN'S.

MODEL 390A A medium duty model producing an alternating force of approximately 25 lbs.
 Thrust Force factor 4.7 lbs per amp.
 Max. Continuous Current Rating (R.M.S.) 2 amps, uncooled; 4 amps, with air cooling of approx 5 lbs per sq. in.
 Stroke 0.5 in total excursion.
 Impedance 8 ohms matching.
 Frequency Range Up to 10,000 c/s
 Weight of Moving System 0.16 lbs.
 Stray Fields Operating zone less than 100 gauss.
 Flux Density 11,000 gauss.
 Weight 26 lbs

MODEL 790 For Vibrating heavy components, and is capable of producing a force of ± 50 lbs.
 This unit has a force factor of approximately 9.2 lbs. per amp, and a total current capacity, with air cooling, of 4 amps. (R.M.S.)
 Stroke 0.5 in total excursion.
 Impedance 24 ohms matching (approx.)
 Frequency Range Up to 5,000 c/s.
 Weight of Moving System 0.5 lbs (approx.)
 Stray Fields Operating zone less than 100 gauss
 Flux Density 11,000 gauss
 Total Weight (inc. trunnion) 70 lbs

MODEL 8/600 For the vibration of heavy loads or complete assemblies. Has a total force of approximately ± 300 lbs.
 Stroke 1 in. total excursion.
 Impedance to suit driving equipment.
 Frequency Range Up to 3,000 c/s.
 Weight of Moving System 6 lb.
 Stray Fields (approx.) Operating zone less than 25 gauss.
 Flux Density 10,000 gauss
 Total Weight (inc. trunnion) 4 cwt. (approx.)
 This unit can be fitted with (a) built in air cooling blower (b) switch to give high or low impedance armature coil and (c) pick-up unit for monitoring wave form and amplitude.

DRIVING EQUIPMENT

A range of appropriate driving equipments is available and takes the form of High-Power Amplifiers, Stabilised Power Supply Units and precision R.C. Oscillators specifically designed to give continuous power output to drive the particular shaker concerned.

MODEL V47 for the vibration of very light electronic components, optical-cell research, hair-spring torque testing etc.
 Thrust Force factor 0.9 lbs. per amp.
 Max. Continuous Current Rating (R.M.S.) 1.5 amps; 2.0 amps up to 2 min. duration
 Stroke 0.2 in total excursion.
 Impedance Varies with frequency and load between 3 and 10 ohms.
 Frequency Range Up to 10,000 c/s
 Weight of Moving System 6.5 grams.
 Stray Fields Operating zone less than 25 gauss.
 Flux Density 11,000 gauss.
 Weight 2 lbs.

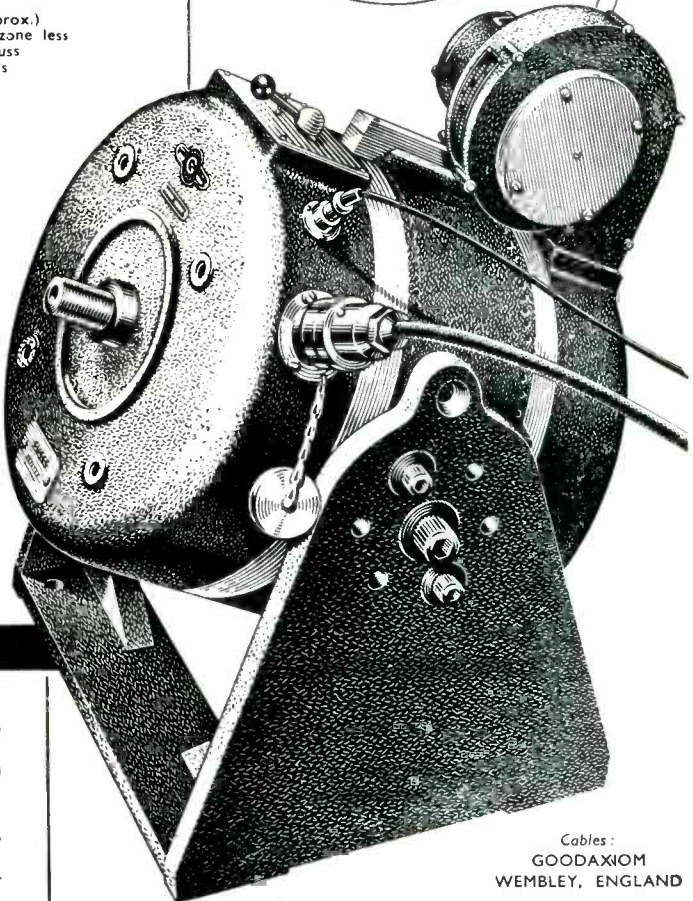
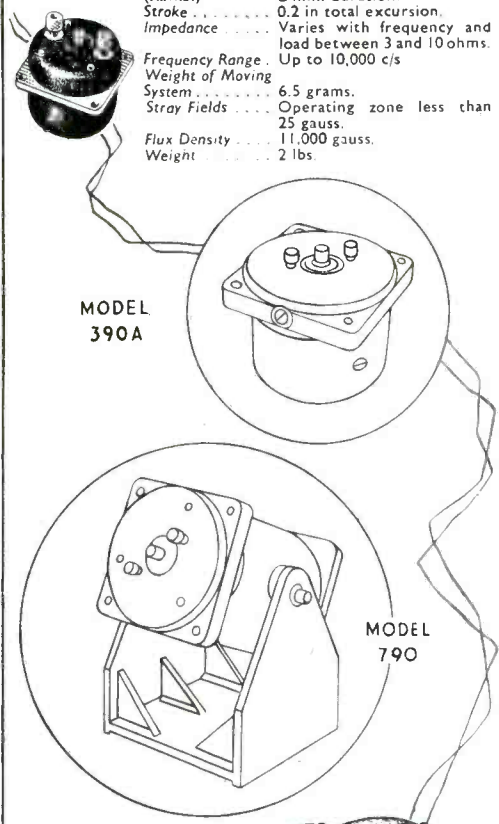

MAIL THIS COUPON

To GOODMAN'S INDUSTRIES LIMITED
 AXIOM WORKS, WEMBLEY, MIDDXX., ENGLAND

Please mail me your catalogue and technical data sheets in connection with your PERMANENT MAGNET Shakers.

NAME

COMPANY

CITY ZONE STATE E/U

Cables:
 GOODAXIOM
 WEMBLEY, ENGLAND

GOODMANS INDUSTRIES LTD
 AXIOM WORKS · WEMBLEY · MIDDXX · ENGLAND



NEW!

MAGNADUR

A NEW PERMANENT MAGNET MATERIAL...

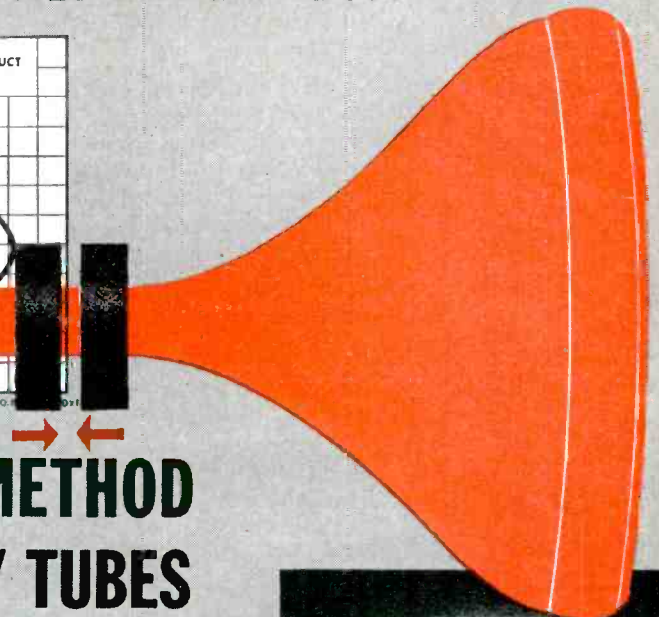
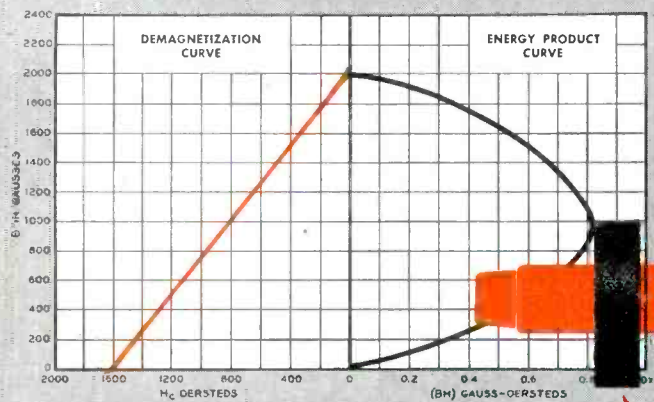

... AND HERE IS A NEW METHOD OF FOCUSING CATHODE RAY TUBES

Here is another Ferroxcube "first": a permanent magnet material with outstanding magnetic characteristics—and *no critical materials are involved in its manufacture*. Magnadur's extremely high coercive force and unusually high resistance to demagnetization permit entirely new magnet designs.

Magnadur will be produced in a variety of shapes. Production for the current year is concentrated on Magnadur toroids—developed specifically for TV focusing ring magnets.

Magnadur focus rings provide a real answer to TV focus problems. The double lens system, which is focussed by adjusting the relative position of two toroidal magnets, reduces stray fields to a minimum and provides a highly symmetrical field. Maximum sharpness and spot symmetry are assured.

Technical information will be sent upon request. Ferroxcube engineers are at your service for consultation. We'll be pleased to have you call or write.

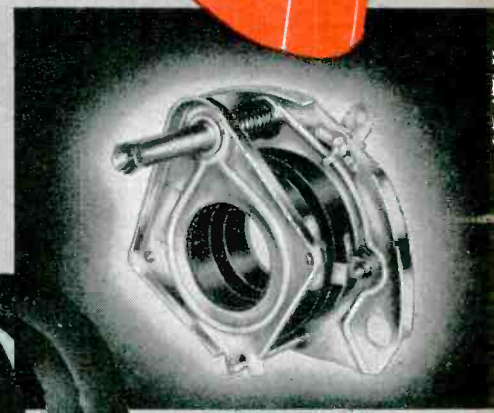

EXAMPLE OF A COMPACT TV FOCUSING DEVICE USING MAGNADUR RINGS

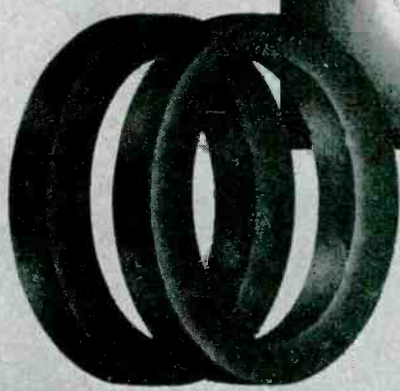

SEND FOR BULLETIN

FERROXCUBE CORPORATION OF AMERICA

A Joint Affiliate of Sprague Electric Co. and Philips Industries, Managed by Sprague
35 EAST BRIDGE STREET • SAUGERTIES, NEW YORK

SLANT your

requirements to

**INSTRUMENT CORP.
OF AMERICA**

for miniature

SLIP RING AND COMMUTATOR ASSEMBLIES

This Instrument Corporation of America plant contains the most modern and complete facilities available anywhere in the world for the exclusive production of Miniature Slip-Ring and Commutator Assemblies to precision standards. It is now in full scale production to meet your requirements in the fastest possible time at the lowest possible cost.

COMPLETE ENGINEERING AND PRODUCTION FACILITIES AVAILABLE

Our assemblies can be supplied at low cost. Quality is the highest in the industry. Dimensional accuracy and other characteristics are excellent and these units are highly recommended for instruments such as synchros, etc.

ONE PIECE ELECTRO-PLATED TYPES FOR EXTREME ACCURACY

Wherever extreme dimensional precision, accurate concentricity and high dielectric qualities are required, the electro-deposition method is recommended . . . the production of which is licensed under an exclusive arrangement with the Electro Tec Corporation.

TYPICAL SPECIFICATIONS:

Sizes: .035" to 24"
Cylindrical or Flat

Cross-sections: .005 to .060" or more

Finish: Polish to 4
Micro-Inches or Better

Breakdown: 1000 V or More
Hi-Pot Inter-Circuit

Ring Hardness: 75 to 90 Brinell

Rotation Speeds: To Over 12000 RPM

Surface Protection: Palladium and Rhodium or Gold Prevent Tarnish, Minimize Wear

Our engineering staff is at your service at all times for consultation

**INSTRUMENT
CORPORATION
OF AMERICA**

BLACKSBURG • VIRGINIA

UNDER EXCLUSIVE LICENSE
OF ELECTRO TEC CORPORATION

INSTRUMENT
CORPORATION
OF AMERICA

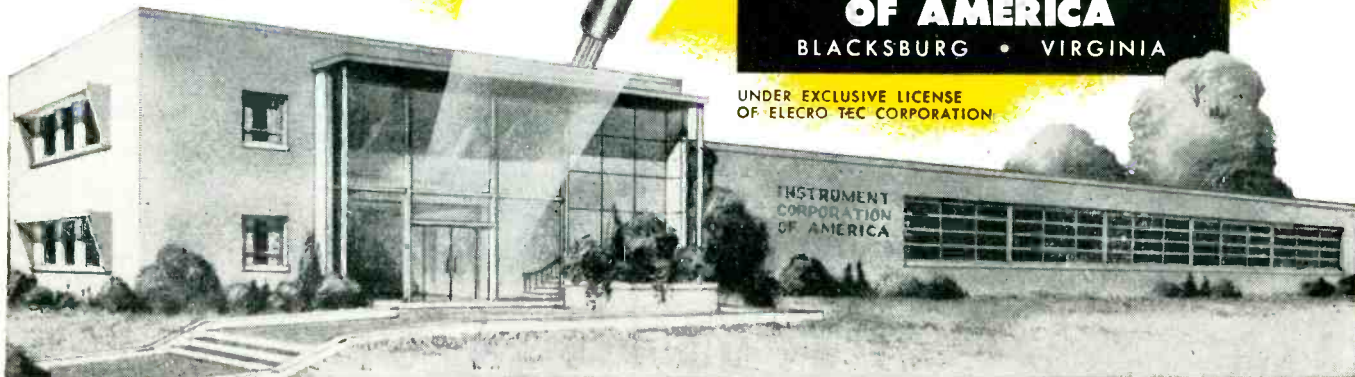

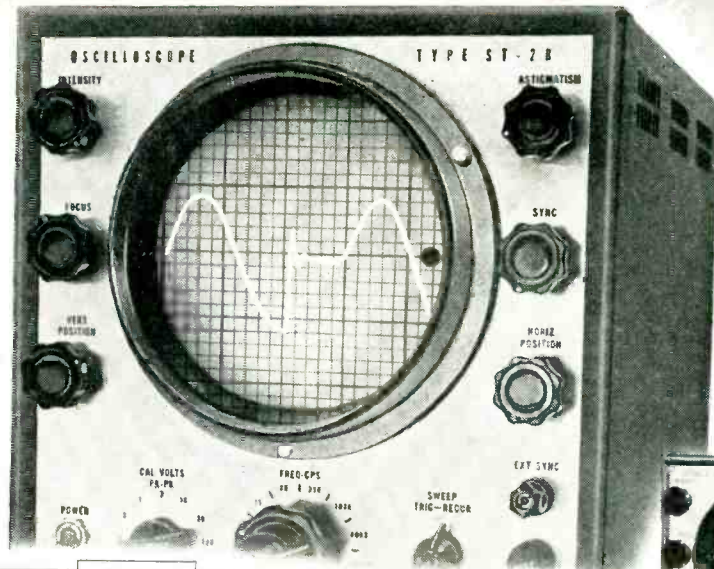

ELECTRONICS PARK—G-E HEADQUARTERS FOR ELECTRONICS RESEARCH

More Applications Per Dollar—

Identical, Highly Stable D-C Amplifiers! Better High Frequency Response than any other scope in its field!

FROM low level DC measurements requiring good stability to observing wave forms with significant components as high as 1 mc, the ST-2B gives outstanding service. Designed to permit a choice of short, medium or long persistence CR tubes, the unit incorporates identical direct coupled vertical and horizontal amplifiers. Filaments and screens on the first amplifier stages are regulated. Vertical selector switch allows choice of probe, calibration, AC or DC inputs.

SPECIFICATIONS—MODEL ST-2B

FREQUENCY RESPONSE

Vertical Amplifier

DC—0 to 400 kc, +0, -20%, not more than 50% down at 700 kc.
AC—10 cycles to 400 kc, +0, -20%, not more than 50% down at 700 kc.
Probe—2 cycles to 400 kc, +0, -20%, not more than 50% down at 700 kc.
Response independent of gain or attenuator setting.

Horizontal Amplifier

DC—0 to 400 kc, +0, -20%, not more than 50% at 700 kc.
AC—10 cycles to 400 kc, +0, -20%, not more than 50% down at 700 kc.
Response independent of gain or attenuator setting.

SENSITIVITY

Vertical	AC—10 mv. rms/inch
	DC—28 mv. dc/inch
Horizontal	AC—15 mv. rms/inch
	DC—42 mv. dc/inch
Probe	130 mv. rms/inch
Deflection Plates Direct	
Vertical	22 volts rms/inch
Horizontal	25 volts rms/inch

SWEEP

Range—Triggered or recurrent—2 cycles to 30 kc (may be extended downwards by adding external capacity across panel jacks).
Sync—±Internal, ±line and -Ext. (requires .3 volts peak to peak for external sync). Sync limiter on recurrent position.
Sweep Expansion—At least 4 times tube diameter.

PHASE SHIFT—Negligible phase shift between amplifiers from 0 to 300 kc.

BLANKING—Z-axis blanking requires 20 volts peak to blank.

CALIBRATION—Eight voltages available by selector switch:
.1, .3, 1, 3, 10, 30, 100 and 300 volts peak to peak ±15%.

DIRECT CONNECTIONS TO DEFLECTION PLATES—Available through capacitors—internal positioning circuits still function.

GERMANIUM DIODE CHECKER

For use in laboratories, quality control groups, service shops. Measures the static characteristics of diodes. FORWARD RANGES: Current—0.3, 1.2, 6 and 12 milliamperes full scale. Voltage—.3 and 1.2 volts full scale. INVERSE RANGES: Current—60, 120, 300 and 1200 microamperes full scale. Voltage—3, 12 and 120 volts full scale. POWER REQUIREMENTS: 105-125 volts, 50/60 cycle, approximately 10 watts.



Type ST-12A



General Electric Company, Section 493
Electronics Park, Syracuse, N. Y.

Please send me a copy of the following bulletins:

ST-2B (ECL-4) ST-12A (ECL-3)

NAME.....

COMPANY.....

ADDRESS.....

CITY..... STATE.....



GENERAL ELECTRIC

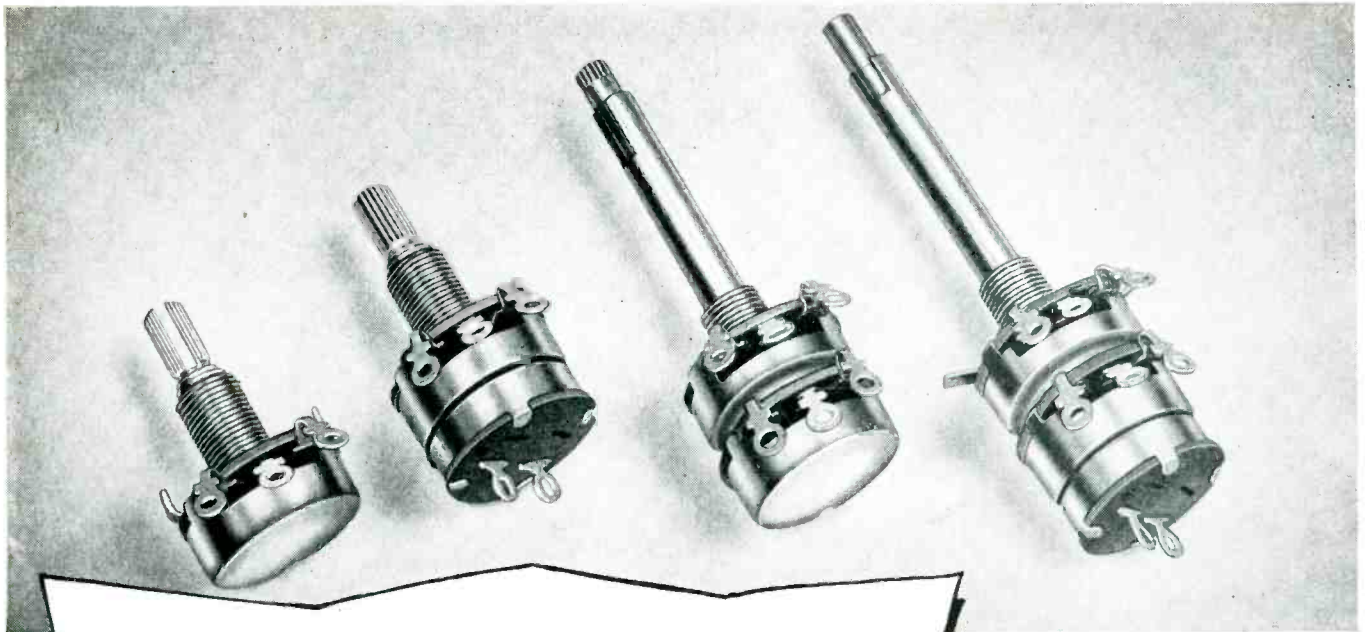

COMPLETELY NEW!

The new Mallory line is complete. Single, dual concentric and dual tandem constructions are available—with or without switch. Resistance values range from 250 ohms to 10 megohms.

A Complete Line of Mallory Carbon Controls ...Including a Dual Control with Switch Attached

You will get new standards of long life, quiet operation and stable, precise resistance values with these new Mallory Carbon Controls.

An entirely new type of carbon element, with unusually high density and surface smoothness, holds resistance drift to 10% and keeps noise level to a minimum. Service life is substantially increased.

In addition to superior electrical characteristics, these controls have a new welded construction, heavier fastenings, and firmly clinched termi-

nals that defy vibration and normal usage. Special silver contactors and heavy terminals assure long, trouble-free switch life.

Whether your models are in production or on the drawing board, get all the facts now on these new controls. A new Technical Bulletin with complete specifications is yours for the asking. Or, call your Mallory Sales Engineer. He will be glad to work with you... show you how these new controls can give better performance and keep your costs down.

NEW MALLORY AXIAL-LEAD, CERAMIC RESISTORS
that are **HIGH** in quality... **LOW** in cost

These new resistors are designed especially for television and radio applications where high quality and low cost are important. They are conservatively rated... will withstand overloads up to 100% of rated value. New Technical Bulletin on request.

*Expect more...
get more
from **MALLORY***

Parts distributors in all major cities stock Mallory standard components for your convenience

P. R. MALLORY & CO. Inc.
MALLORY

SERVING INDUSTRY WITH THESE PRODUCTS:

Electromechanical—Resistors • Switches • Television Tuners • Vibrators
Electrochemical—Capacitors • Rectifiers • Mercury Batteries
Metallurgical—Contacts • Special Metals and Ceramics • Welding Materials

P. R. MALLORY & CO. INC., INDIANAPOLIS 6, INDIANA

CROSS TALK

► **FRESH START . . .** Vacations are about over and, if you are anything like us, you greet the fall season with mixed feelings . . . personal regret and business relief.

The field of electronics is extremely active. Many new things are crying for attention by a full and presumably rested staff.

► **BANDWAGON . . .** Transistors will rate high as technical news during the coming winter, competing for page one position with color television. A number of design improvements, and practical applications, are known to be in the wind. So are some straight bids for publicity. Announcements will be difficult to evaluate.

► **PETITION . . .** Feverish activity that will soon take off some vacation-acquired fat is the development of commercial color-tv equipment.

The National Television Systems Committee petition for new transmission standards is in the hands of the FCC. CBS plans to feed experimental programs to network affiliates by mid-September, using the suggested standards. NBC is already well along the same road. RCA and other major manufacturers are now planning color-receiver production.

As the FCC studies the proposed new standards there will no doubt

be some dissenters. But NTSC has explored every possible aspect of the problem for more than two years, its ranks wide open to all interested engineers, so it is considered likely that the proposed standards will be the law of the land by the first of the year or soon thereafter.

► **NO UTOPIA . . .** Health of our industry may be judged from the fact that many well-heeled big companies are still eyeing electronics with more than casual interest. We don't blame them, but can't help feeling that some are curiously naïve.

This is, indeed, a growth industry. But it does have design pitfalls. It does have manufacturing problems. It does have sales competition.

► **AUTOMATION . . .** Attracting much attention is a new word describing an old art . . . *automation*. It generally means automatic control of manufacturing machinery.

Automatic control intrigues many manufacturers when there is a heavy demand for goods and labor cost is high. It is the ultimate step in mechanization. But it cannot be achieved by American industry overnight.

Automation will continue to grow at a pace largely determined by the flexibility of control devices. The one-of-a-kind character of the

market still presents major problems, many of which still have not been solved.

► **OPINION . . .** A columnist for another magazine within our field advises readers to keep their business affairs to themselves, says listeners may pass information along to competitors. We think this is, in general, bad advice reminiscent of the industrial dark ages. It is particularly hard to take from a member of the fourth estate whose very livelihood depends upon the dissemination of information.

Man progresses largely over roads started by others. Even if this were not so, engineers in particular have learned that it is possible to interchange information for mutual profit without forever relinquishing all competitive advantages. Anyone smart enough to develop a worthwhile new product, for example, is likely to have important refinements on the drawing board almost before it reaches the marketplace.

► **MORE SHOPTALK . . .** Checking with a thousand typical subscribers, we find five topics that appear to merit more editorial attention. They are: audio (and particularly tape recording), component-part design, dielectric heating, servo-mechanisms and carrier current.

We're beating the bushes for good papers on these subjects now.

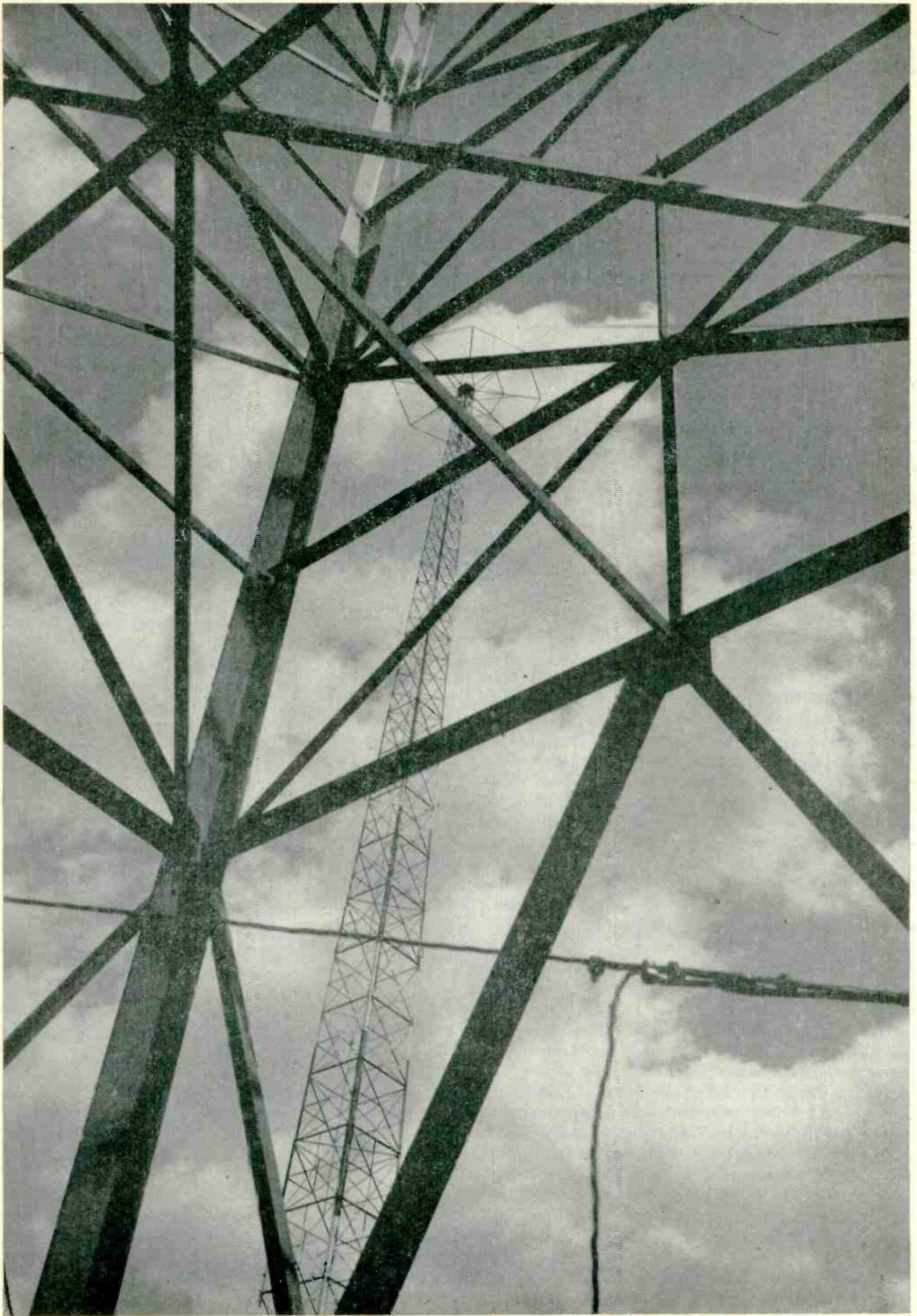

Modern Transmitter for A-M Broadcasting

Radio station WNEW, flooded out in late 1950, is rapidly nearing completion as a full-time 50,000-watt broadcast plant. Even the final testing of its night-time directional array must be carried on during commercial program hours. Its engineers use thirteen different techniques to avoid outages and loss of revenue

By **ALEXANDER A. MCKENZIE**

*Associate Editor
Electronics*

AS A CONTINUOUSLY operating radio-broadcasting station in the richest market area of the world WNEW, New York, has been engineered with sufficient safeguards to prevent loss of time, except momentarily, short of destruction of the plant itself.

Located in the New Jersey meadows, a vast swamp-land inundated by tidal water, the former transmitter plant was ruined in the disastrous flood that accompanied an east coast hurricane in late November, 1950. Off the air for a month, the station operated for more than a year and a half on a temporary platform before a new transmitter house, built upon higher ground, could be equipped and put to work. The importance of WNEW's engineering lies in the station's need for foolproof operation 24 hours a day, on 1,130 kc.

The choice of an air-only cooling system adequate for a 50-kw transmitter imposes special problems that can be most easily met in a new structure specifically designed for the purpose and containing no other central source of heating. The

multitude of special switching circuits, intercommunicators, alarms and shop facilities would be mere gadgeteering in a 250-watt day-time-only station.

At WNEW they insure the life blood of advertising revenue that, in turn, makes possible such a complex and expensive electronic plant. The new fireproof building, designed by Lockwood-Greene Engineers of New York, is of reinforced concrete designed to take the heavy floor loading imposed by the two transmitters with their associated equipment, and by the diesel engine. The exterior is of white brick, which materially reduces the heat load due to the sun, in the summer months.

Layout

A plan of the transmitter building is shown in Fig. 1. The floor slabs rest upon creosoted wooden piles driven some 75 feet into the swamp-land. Although cooling ducts for the main transmitter and output lines for the auxiliary are in the cellar, this area is used principally for storage of heavy equip-

ment as well as the various ducts.

The building is oriented in a generally east-west direction. The entrance is on the westerly side as indicated.

Across the front of the building from left to right are an office and the main transmitter room out of which is taken an enclosed space for the 10-kw auxiliary transmitter. The operating engineer's desk is located to the left of this area and the audio and monitor equipment is contained in racks across the center portion.

Along the west wall of the building is a complete kitchen. The facilities are necessary because the engineers come from some distance and are isolated at the station during mealtimes. At the rear of the west side of the building is the shop.

Along the east wall are the 10-kw transmitter, together with its power supplies and a blower room for the 10-kw transmitter. Outside air is taken through a filter and compressed, the air passing through a duct along the underside of the floor to the 10-kw room.

At the rear of the building on the west side is a large storage room for all kinds of equipment including large tubes. A tube dolly necessary for replacing the power-amplifier tubes is kept here. In the

 **How WNEW Insures 24-Hour Operation** Looking from the base of west tower through structure to top of twin east tower. Either tower can be used

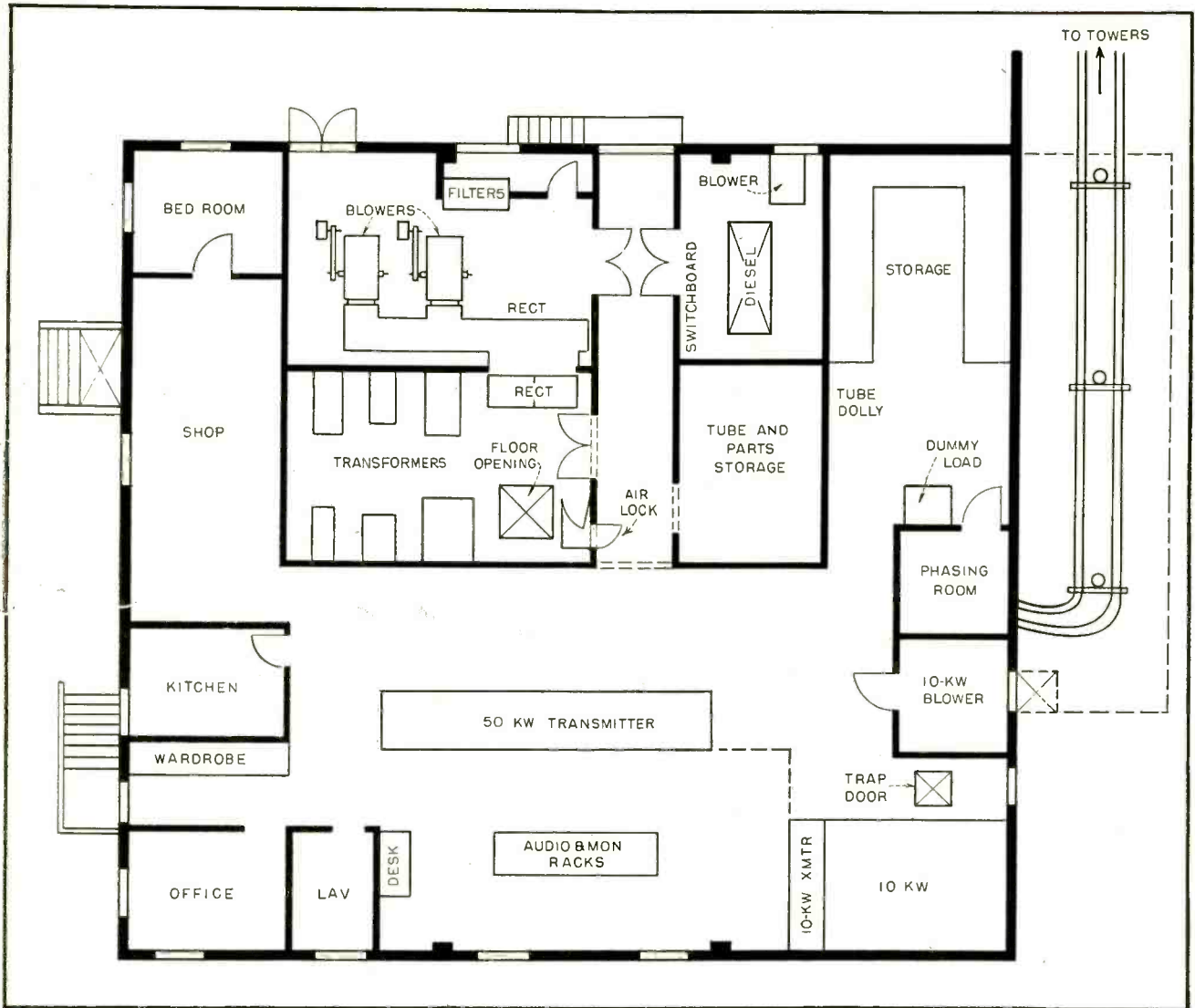

FIG. 1—Floor plan of WNEW transmitter plant in Kearny, N. J.

front of this room is located the water dummy load used for testing the transmitters at full power.

Cables

The phasing room is immediately behind the dummy load but extends out towards the front of the building. The lines between the phasing room and the towers are brought out into a yard east of the building and from there run about 500 ft to the towers.

Control cables are carried on the same poles that support the six-wire radio-frequency transmission lines. There are two of these line assemblies—one for each tower.

At the back of the building, behind the 50-kw transmitter, are the cooling systems for that transmitter and the emergency diesel plant. Air is taken in through a

double filter and blown past the dry-disk rectifiers used for obtaining high voltage for the power amplifier and the modulator. This air then goes down through a hole in the floor of the transformer room and up into the 50-kw transmitter cubicles, which are hermetically sealed. The warm air resulting after the transmitter tubes and equipment have been cooled is exhausted into the building during the winter, or outside during warm weather.

Power Plant

The diesel plant is protected by being indoors and well above the high water line. It can be started from the audio and monitoring equipment racks by a pushbutton control, or it can be started from its own switchboard. Upon failure of

commercial power, it starts automatically. A number of emergency lights turn on automatically when the diesel comes up to full power, but switchover is accomplished only

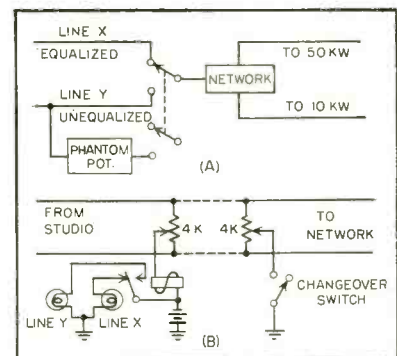

FIG. 2—Program over alternate routes is fed to both transmitters (A). Phantom circuit (B) automatically informs studio which line is in use

at the discretion of the transmitter operator.

The emergency wiring is so arranged that the 50-kw transmitter cannot be connected to the diesel-engine alternator. The latter is of 62 kva capacity, and will run the 10-kw transmitter, the entire audio and monitoring system, all r-f contactors and emergency lighting, with some reserve available.

As indicated, there is also a large storeroom for small tubes and parts. These are kept in drawers and are carefully marked so that an operator or a maintenance man needing a new part can quickly find it. All tubes are marked with a station serial number and adequate records are kept of these tubes and their disposition. Because of the 24-hour nature of the station's operation it is practically necessary to have at least one spare for every part in the transmitter.

An interesting feature of the spare-parts room is a map-like designation given to the drawers in which material is stored. Metal numbers are attached to the woodwork around the room proceeding from left to right and a number appears above each stack of drawers. In like manner the letters of the alphabet proceed from the ceiling downward toward the floor, across

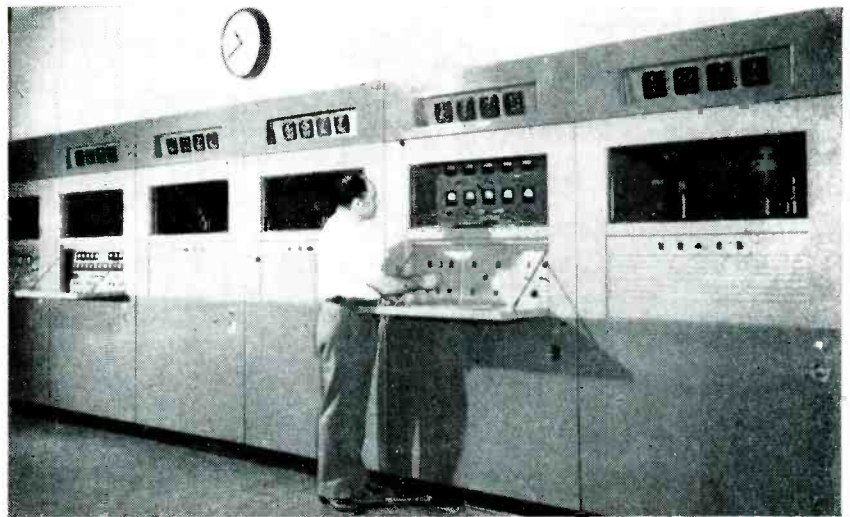

Transmitter supervisor, Karl Neuwirth, makes tuning adjustment to 50-kw final amplifier. Cubicles to right and left each contain an operating and spare tube that can be quickly switched into use. Forced air through equipment cubicles carries off heat that is exhausted outside in summer and heats building in winter

the horizontal line of drawers so that, for example, spare resistors can be found in location 3D.

Among the many techniques used to insure continuity of air time are several that might be applicable to other stations. They are described below and separately in picture captions.

Power Reduction

The type-50HG-2 50-kw transmitter as furnished by the manu-

facturer, Westinghouse Electric Corporation, has provision for reducing power by pushbuttons. For this installation, other features were incorporated by station engineers.

Power reduction requires three operating changes. Pushbutton-actuated contactors remove all voltages momentarily during the switching to avoid damage from arcing. Relays in the power-reduction system cause the following

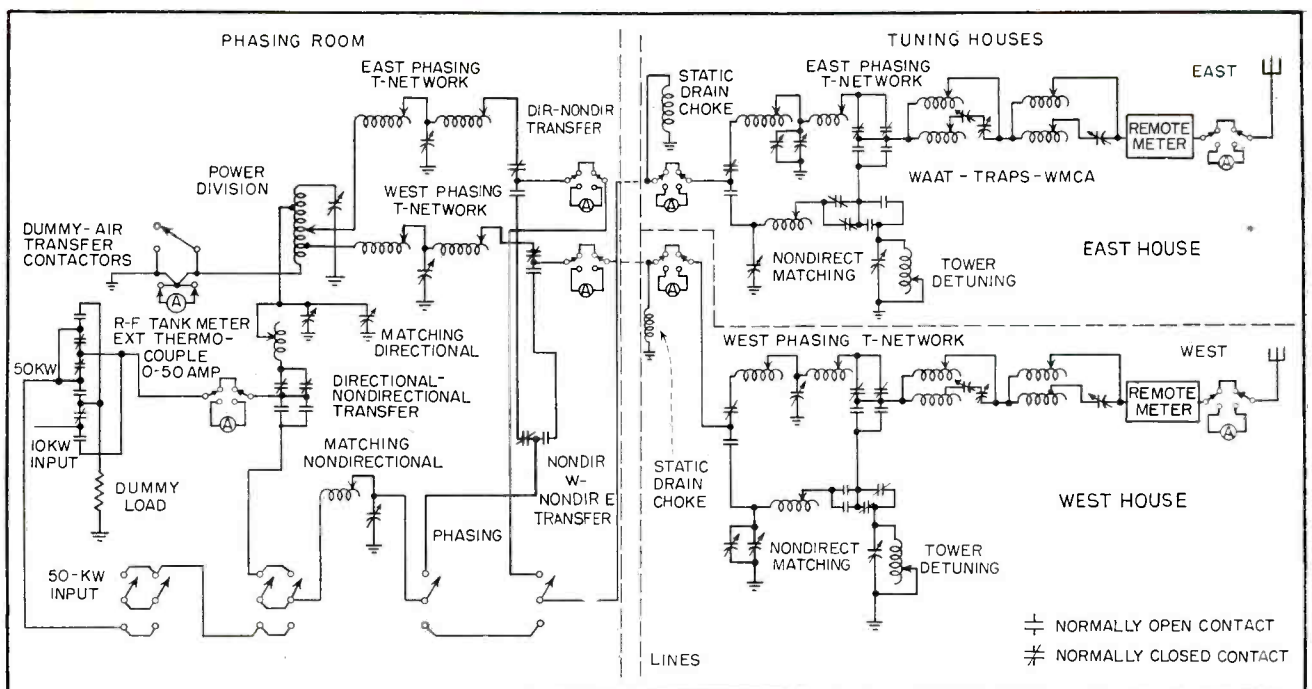
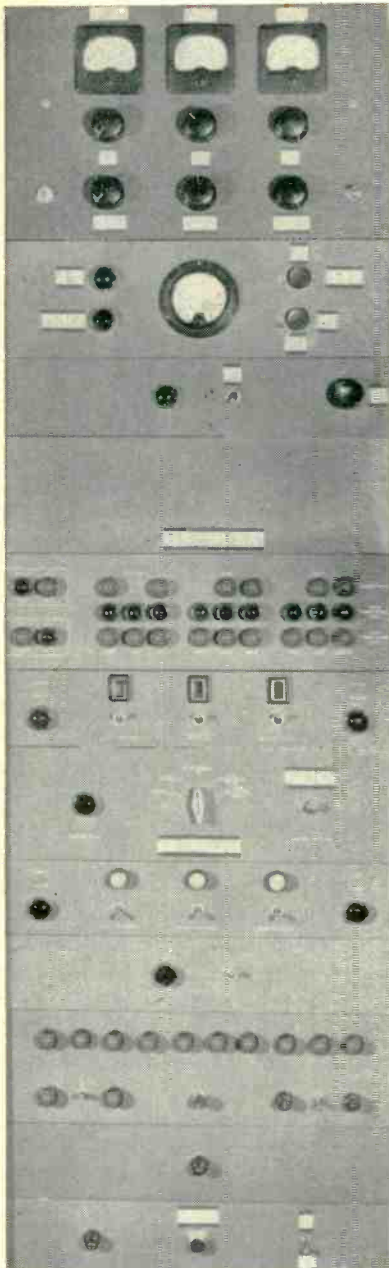

FIG. 3—Radio-frequency circuits in phasing room and antenna tuning houses provide flexibility in directional, nondirectional and emergency switching



Central control rack at far left of audio racks. Panels from top down include arc-protection equipment, power-transfer pushbuttons and antenna switching indicator lights. Latter show operator if proper switches have thrown for desired antenna connection. Other panels set up choice of transmitter and antenna, show visual alarm in case of failure and control dry-disk voltage rectifiers. Bottom panel is used for Conelrad keying

changes:

(1) Reduce plate voltage from the main rectifier by switching the transformer primary from delta to star connection.

(2) Modulator bias is reduced for each of the two modulator tubes.

(3) Audio program level into the modulator is corrected for the new



Operating engineers Saul Osias and Eric Potts prepare to replace final-amplifier tube weighing 250 pounds using motor-driven hoist on dolly. Auxillary 10-kw transmitter is in background. Racks at right hold measurement and control equipment shown in separate photograph at left

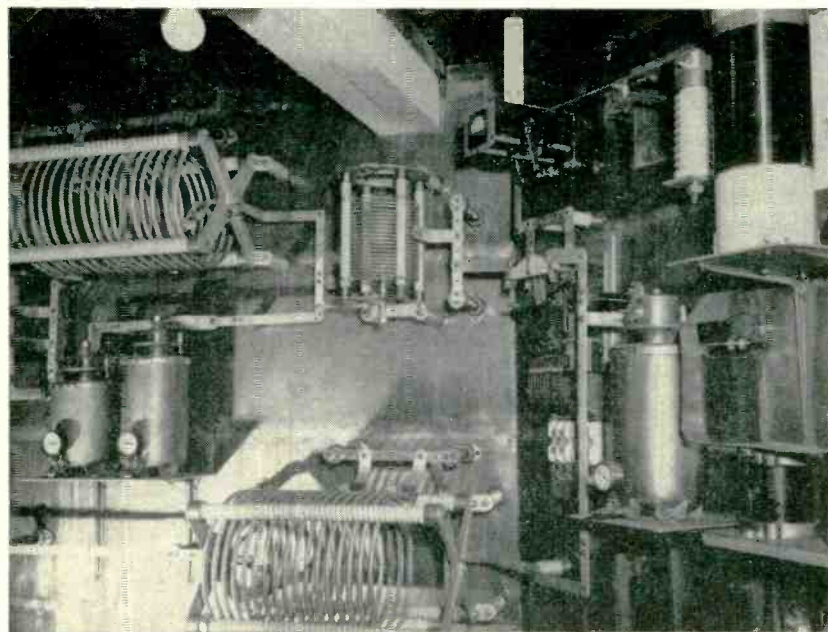

Interior view of one of two identical tuning houses at antenna bases. Upper coils and gas capacitors to left are used to match transmission line when operating directional at night. Lower coil and capacitor to right are used for 50-kw daytime operation. Coil in upper right is static drain choke

mode of modulator operation.

Power change, from high to low or vice versa, is instantaneous, and is accomplished by a single push-button for each function.

Audio Changeover

Incoming program from the New York studio is received over two lines furnished by the telephone

company. One line is equalized and passes through central-office repeaters. The other line comes directly from the studio by an alternate route. At the transmitter, the line in use goes through a network from which it is distributed to both the 50-kw and the 10-kw transmitters, as shown in Fig. 2.

The network can be connected to

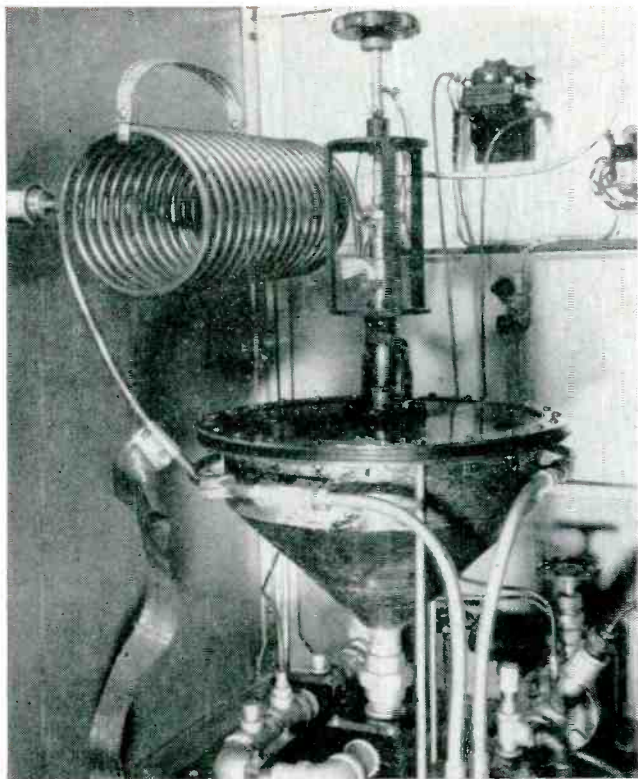

Water dummy load with capacity of 75 kw allows either transmitter to be tested at full power after maintenance schedule. Water dielectric between conical plates absorbs power. Reactance of water capacitor is balanced by that of coil at left. Heated water is run off and not recirculated

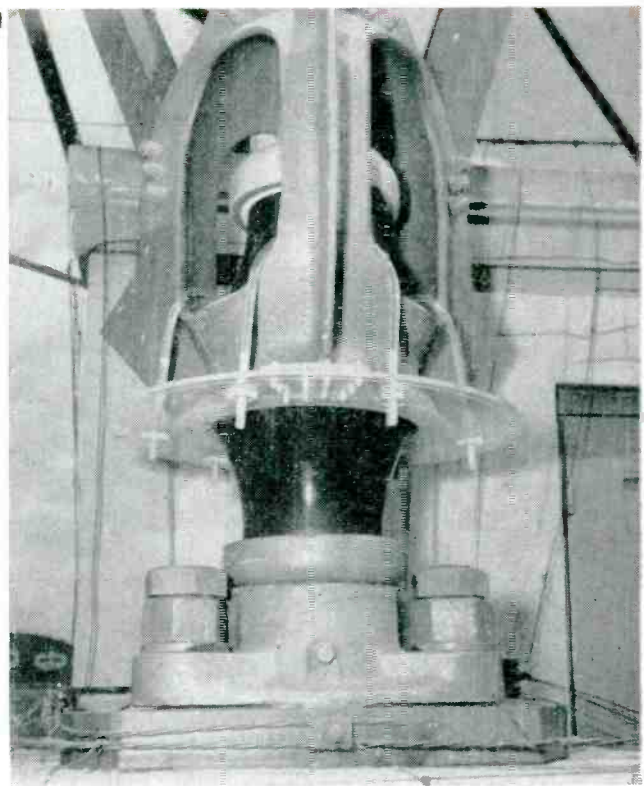

Lucite shield prevents rain water from flowing across surface of Lapp compression insulator at foot of each tower leg. Industrial smoke, salt spray and other impurities are washed down tower and, unless deflected, cause arcs taking transmitted off air. High r-f field precludes use of metal fixtures

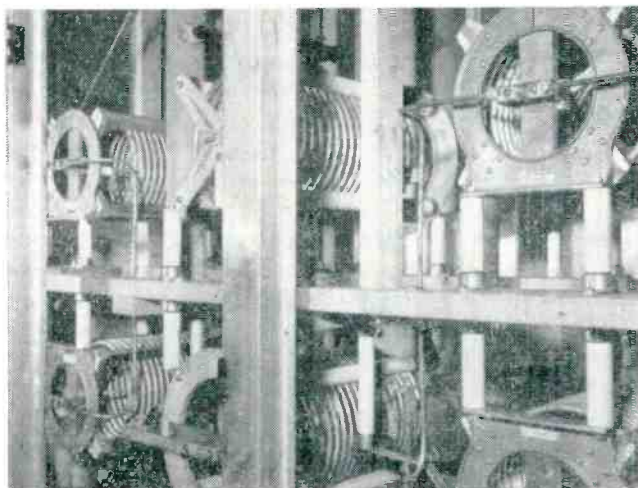

Phasing coils used to obtain desired directional pattern. Properly phased currents go from phasing room out over transmission lines to towers. Wooden grating that protects personnel has been removed for photograph

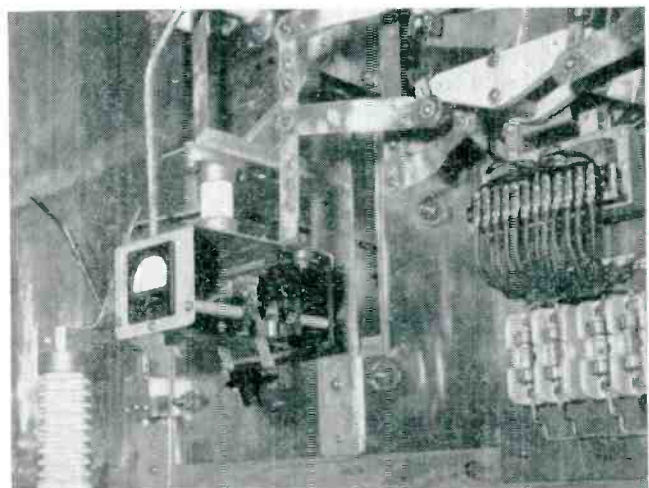

Opposite side of phasing room showing a remotely controlled switch that makes possible use of either or both towers. Control and monitoring wires are shown at right. Knife switch at left connects meter in series with line

either line and the changeover switch is equipped with an additional set of contacts to ground the arm of a phantoming potentiometer. As shown in Fig. 2B, this operation closes a relay at the studio to show the control engineer which program line is being used at the transmitter. Audio signals use the wire path while the two

wires are phantom to ground for the d-c signal circuit.

Duplicate audio channels are fed, one from each line, to guard against local audio-system failure.

Antenna Switching

As shown in Fig. 3, the r-f circuits connecting both the 50-kw and the 10-kw transmitters to the an-

tenna towers allow a maximum of flexibility that is useful in emergency or during maintenance periods.

Contactors are so arranged that the spare transmitter is connected to the water dummy load while the other is connected to the phasing room. Here, it is possible to send r-f power through the phasing net-

works for a two-tower directional pattern, or to choose either tower for a nondirectional broadcasting pattern.

In the tuning house at the base of each tower are other remotely operated contactors that connect incoming r-f lines for directional or nondirectional operation. The tower not used during nondirectional broadcasting is automatically detuned. As indicated, traps are provided for stations WAAT and WMCA, which are located adjacent to WNEW.

The knife switches shown at the lower left section of the drawing insure radio-frequency paths in the event of failure of the remote contactors in the phasing room.

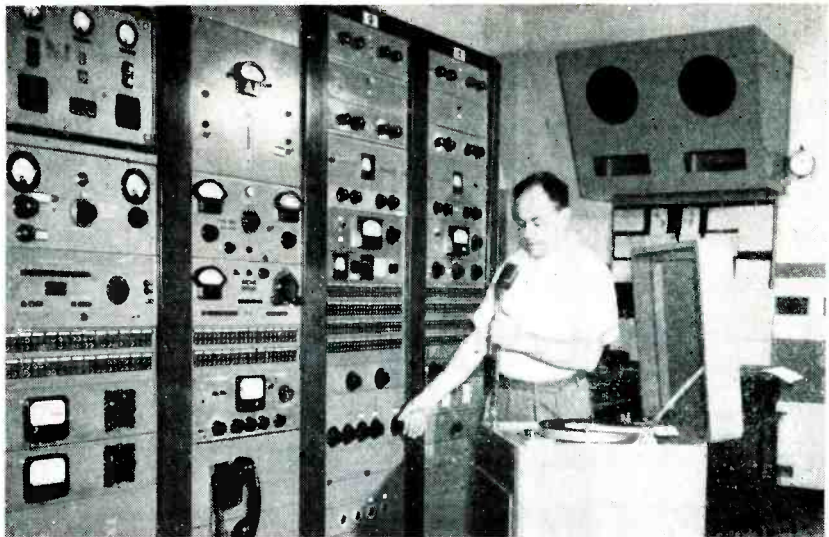

Frequency-measurement and control racks with audio equipment at right. Device in foreground is combination turntable, pickup, microphone and record-storage cabinet. Even if program lines between studio and transmitter are out, station can remain on air indefinitely with musical program

Arc-Protection Circuit

The arc-protection circuit shown in Fig. 4 has the advantage of taking either operating transmitter off the air before overload circuit breakers open. Its function is based upon pickup of radio-frequency energy from phasing room, east tower and west tower.

With transmitter power on, r-f appearing at these three locations is picked up by special loops and rectified. The resultant d-c sent over cables to a central panel operating relays K_5 , K_6 and K_7 . Adjustment can be made by the series

resistors and meters to provide various conditions of antenna operation. The relays in this diagram are shown in their normal on-air positions.

Failure of the direct current, owing to lack of r-f pickup due to a ground or arc at a tower will cause the associated relay to fall out. Assume that relay K_7 has opened owing to r-f failure at the west tower. The upper contact of K_7 will close, putting power through the primary of the alarm-bell trans-

former. Power is likewise applied through the closed contact of relay K_5 to operate K_1 , K_2 , K_3 and K_4 . These relays respectively open the cathode of the 50-kw transmitter r-f driver, short the audio program input, open the 10-kw transmitter plate contactor and light an indicator lamp at the audio relay rack.

As the transmitter goes off the air, d-c from the phasing-room rectifier fails allowing relay K_5 to drop out. When K_5 releases, it removes power from the bus feeding K_1 through K_4 , thus allowing the transmitter to go back on. During the time that r-f energy is not being picked up, the arms of relays K_5 , K_6 and K_7 fall back to ground the common lower bus connecting their back contacts. As soon as rectified d-c is picked up from either tower, closure of either K_5 or K_7 furnishes ground connection for relay K_5 . This relay then pulls up, by virtue of current from the phasing room, and locks up on its own contact. Assuming that the ground or arc has cleared, normal operation of the transmitter continues.

In preparing this article, the editors received cooperation and assistance from chief engineer Max J. Weiner and his staff, including William Schmidt, engineer, and Karl Neuwirth, transmitter supervisor. Bud Brant, station public-relations officer furnished corporate background material.

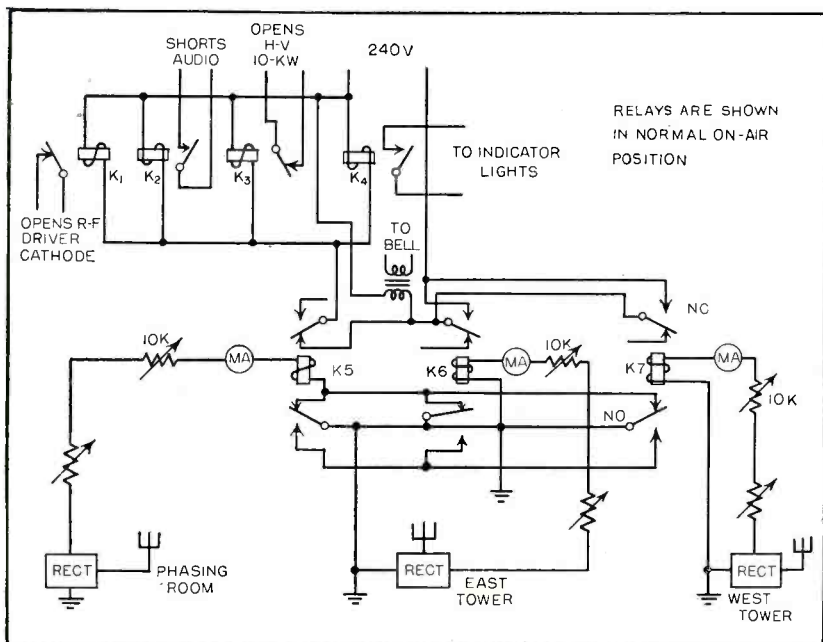
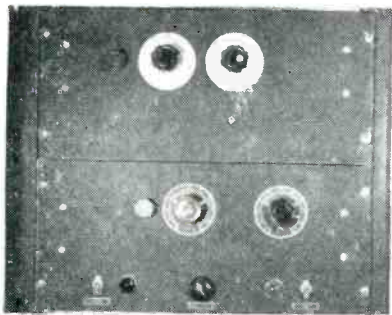
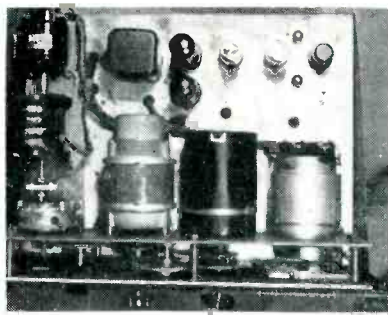

FIG. 4—Arc-protection circuit depends upon failure of r-f to operate relays that take transmitter off air



Upper panel of radar-target simulator contains azimuth-clutch control, azimuth indicator and heading control. Lower panel has range-clutch control, range indicator and velocity control



Upper chassis houses servo amplifier, azimuth-velocity motor and tachometer, differential synchro, resolver and indicator synchro. Panel arrangement is shown at left

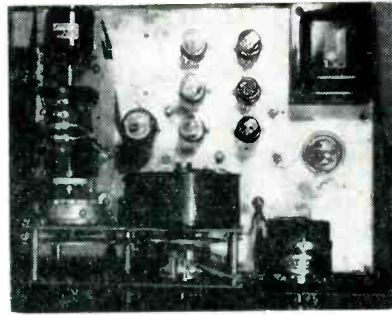

Lower chassis includes servo amplifier, power supply, phantastron circuit, range-velocity motor and tachometer, range potentiometer and velocity-control voltage adjustment

Computer Simulates Moving Radar Targets

Dual analog computers simulate interceptor and hostile aircraft on radar indicator used in training radar fighter controllers. Speed and course can be altered at will to permit evasive actions by invader and proper vectoring of interceptor

TRAINING OF RADARMEN and fighter controllers is augmented by two analog computers one of which simulates the unidentified aircraft or bogey and the other the interceptor. The simulated aircraft are displayed on the radar indicator in synchronism with either real or simulated antenna rotation.

Their movement is controlled by an instructor at a remote position. The instructor presets the computers so that initially the bogey is out of the range of the oscilloscope and the interceptor is at its home base. The instructor then sets the speed and course of the bogey so that it will move across the operator's oscilloscope. After detecting the bogey, the operator gives the proper interceptor speed and heading to the instructor. Speed and heading can be changed at any time during operation, permitting evasive action by the bogey and proper vectoring of the interceptor by communication between the operator at the oscillo-

By **W. B. BIRTLEY**

Haller, Raymond and Brown, Inc.
State College, Pa.

scope and the instructor at the interceptor computer.

Operational Theory

The polar coordinate system shown in Fig. 1 is that viewed on the ppi oscilloscope with the radar set at the origin. The aircraft appearing on the oscilloscope is at P with coordinates r , Θ defining its position. The aircraft has a heading α and velocity v , which is shown resolved along and at right angles to the radius vector r . From the diagram it can be seen that

$$\beta = \alpha - \Theta \quad (1)$$

and

$$\begin{aligned} v_r &= \dot{r} = v \cos \beta \\ v_\theta &= r \dot{\Theta} = v \sin \beta \end{aligned}$$

where \dot{r} and $\dot{\Theta}$ are the time derivatives of r and Θ .

The velocity control presents to the computer a voltage e . An electrical resolver furnishes one output $e \cos \beta$ proportional to \dot{r} and a

second output $e \sin \beta$ proportional to $r \dot{\Theta}$. By operating on these voltages with tachometer integrators the future position of the aircraft is determined. The target range at any time T will be

$$r_t = r_0 + \int_0^T \dot{r} dt \quad (2)$$

and the target azimuth angle at any time T will be

$$\Theta_t = \Theta_0 + \int_0^T \dot{\Theta} dt \quad (3)$$

The term $\dot{\Theta}$ in Eq. 3 is taken from the resolver output $r \dot{\Theta}$, which is then divided by r .

The tachometer integrators are geared to controls that present the coordinates r_T and Θ_T to the oscilloscopes.

No differentiation is made between ground range and slant range since the difference between the two is negligible for search radar over most of the area covered and is of appreciable importance only in a small region near the origin. This region usually cannot be observed

because of the presence of ground clutter.

Computer Operation

Figure 2 is a schematic diagram of the computer components. The instructor presets the computer by releasing clutch No. 1 and setting the range indicator to the desired initial range r_0 . The range indicator is on a shaft whose angular position is directly proportional to the range r_T . Also coupled to this shaft is potentiometer R_2 whose setting determines the delay time of the trigger pulse and hence the target range presented to the oscilloscope. The range servo system is illustrated in Fig. 3.

The instructor next releases clutch No. 2 and sets the knobs controlling aircraft heading and initial azimuth Θ_0 . The heading shaft is locked into position and the azimuth shaft assumes the position of the aircraft azimuth Θ_T as the aircraft proceeds in flight. The azimuth shaft setting Θ is com-

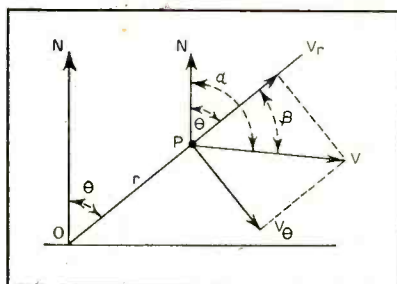

FIG. 1—Aircraft position, heading and velocity in polar coordinate system with radar set at origin

bined with the heading shaft setting α through a differential gear whose output shaft assumes the angle β as required by Eq. 1.

Coupled to the azimuth shaft is a differential synchro that receives an electrical rotation signal from either a real or simulated antenna synchro and shifts the phase angle by an amount Θ_T to represent indicator-synchro rotation slaved to the antenna synchro. The output shaft of the indicator synchro has a cam that opens a switch to allow video signals from the pulse de-

lay circuit to reach the oscilloscopes. The video signal can reach the oscilloscope only when the switch is open; that is, when the proper azimuth Θ_T of the aircraft, established by the computer, and the azimuth angle Θ_T of the ppi sweep coincide. The azimuth servo system is shown in Fig. 4.

The instructor next sets the speed indicator, which is on a Variac whose output voltage e is proportional to the speed of the aircraft. Voltage e is presented to a resolver whose shaft angle β determines the output of its two windings as $e \cos \beta$ and $e \sin \beta$ respectively. Since $e \cos \beta$ is proportional to dr/dt , integration can be performed and the comparison voltage e_s shown to tachometer No. 1 appears across R_3 , a calibration potentiometer. The output shaft of tachometer integrator No. 1 is coupled by clutch No. 1 to the range shaft and hence the range r_T is set according to Eq. 2.

Voltage $e \sin \beta$, however, is pro-

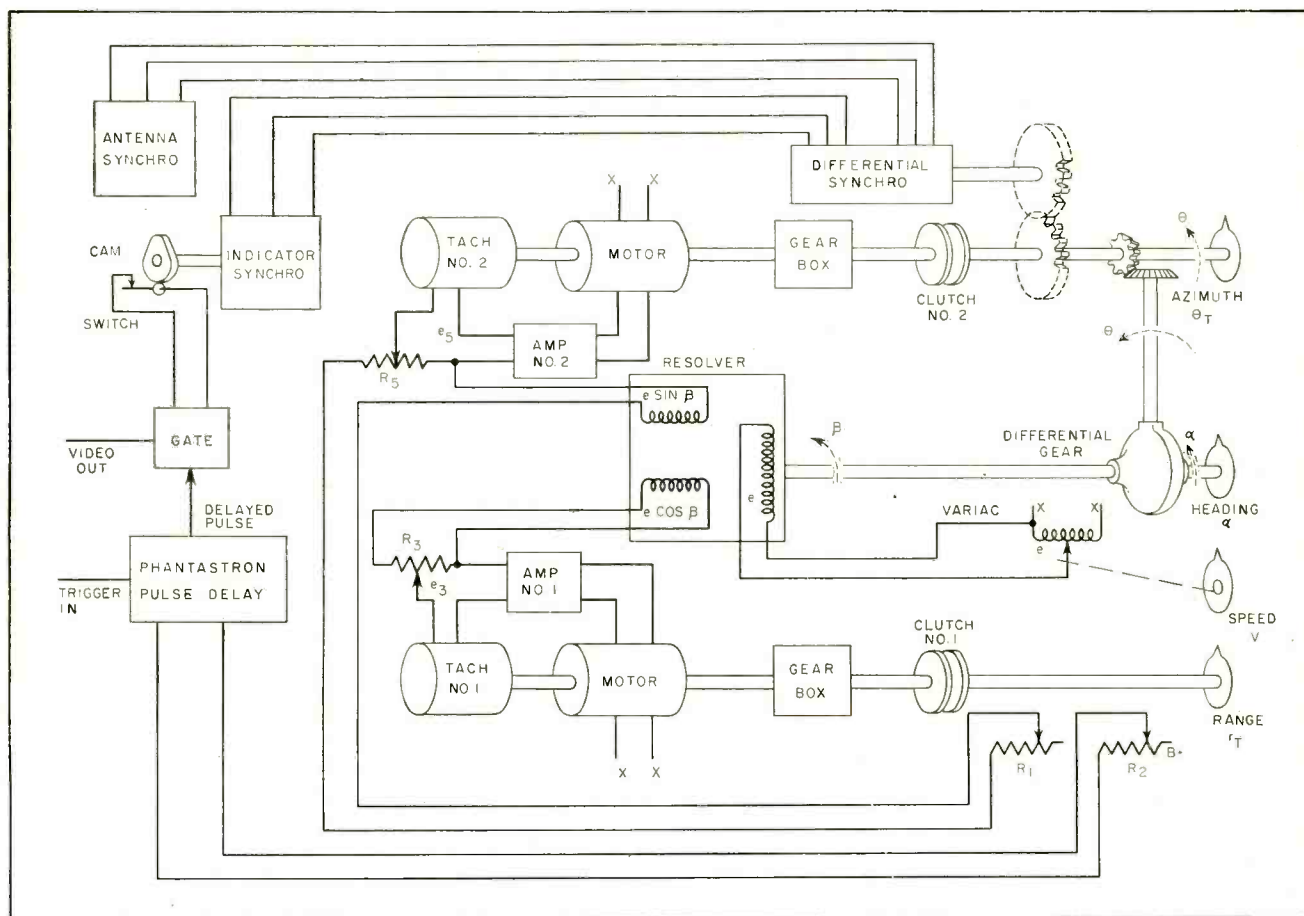

FIG. 2—Major components of moving-target computer

portional to $r\dot{\theta}$ and must be divided by r to produce a voltage proportional to $\dot{\theta}$. Therefore the output $e \sin \beta$ is fed to the series combination of R_1 and R_5 so that the current through the loop will be

$$i = \frac{e \sin \beta}{R_1 + R_5} \quad (4)$$

Now $R_1 \gg R_5$ and hence Eq. 4 can be approximated as

$$i \approx \frac{e \sin \beta}{R_1}$$

Since R_1 is coupled to the range shaft and its resistance is proportional to the range r , it will control the current through the loop and the voltage appearing across R_5 will be

$$e_s = iR_5 \approx \frac{e \sin \beta}{R_1} R_5, R_5 \approx \frac{r\dot{\theta}}{r}$$

$$R_5 = k\dot{\theta}$$

Voltage e_s proportional to $\dot{\theta}$ is then compared with the output of tachometer No. 2 in the loop comprising R_5 , R_4 and the amplifier input. The tachometer integrator then integrates $\dot{\theta}$ according to Eq. 3 and the output shaft of the integrator is coupled to the azimuth shaft by clutch No. 2. Resistor R_5 is variable to calibrate the tachometer output to the proper speed.

The indicator synchro follows the sweep rotation and opens a switch only at the point in its rotation corresponding exactly to the azimuth θ_r , permitting the delayed trigger pulse or simulated video to reach the oscilloscope. The angular position at which the rotating indicator synchro opens the switch is determined by the setting of the differential synchro that is coupled to the azimuth shaft.

Video Circuit

The pulse that triggers the oscilloscope sweep is fed into a phantastron circuit (Fig. 5) whose plate voltage is controlled by potentiometer R_2 . The phantastron circuit was chosen because of the good linear relationship between the plate voltage of the 6SA7 mixer and the time delay of the trigger pulse. Also, the phantastron is very stable with regard to small changes in power-supply voltage. The output of the phantastron is differentiated and fed through a gating tube to the video input of the oscilloscope.

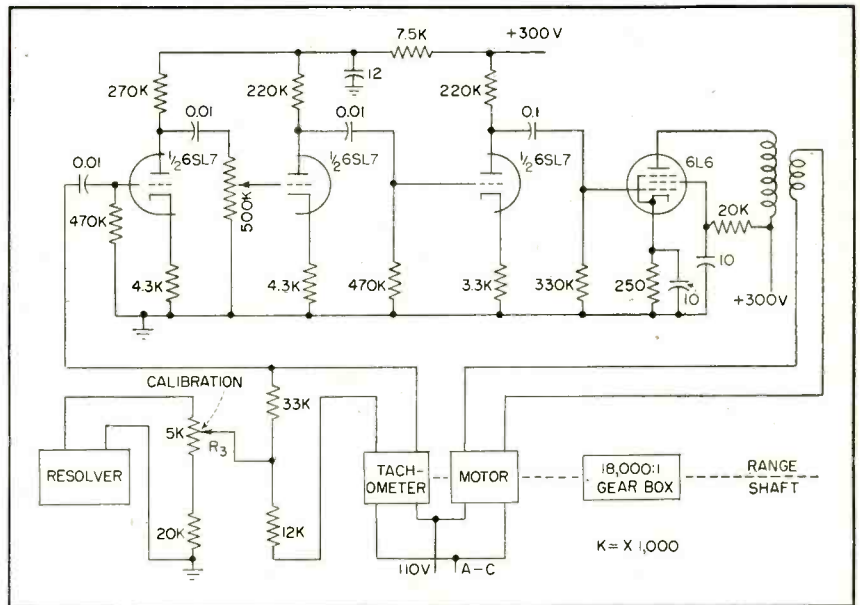

FIG. 3—Range servo system

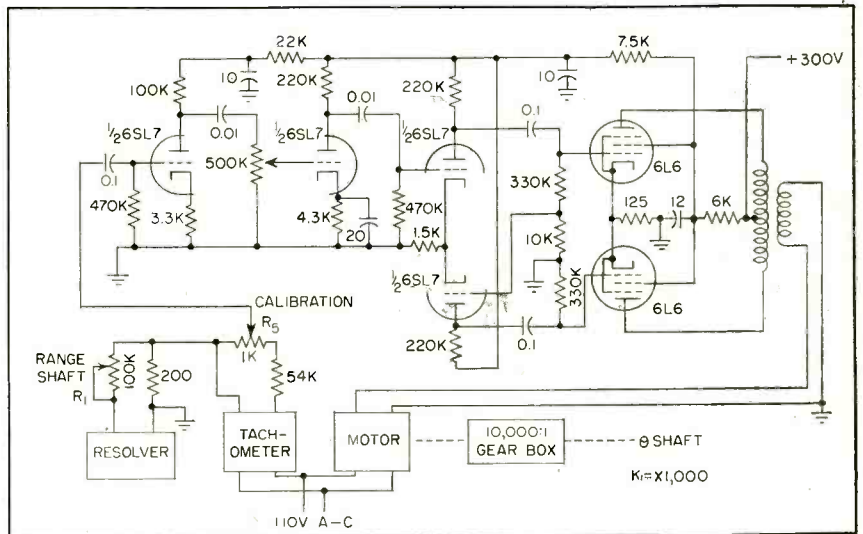

FIG. 4—Azimuth-angle servo system

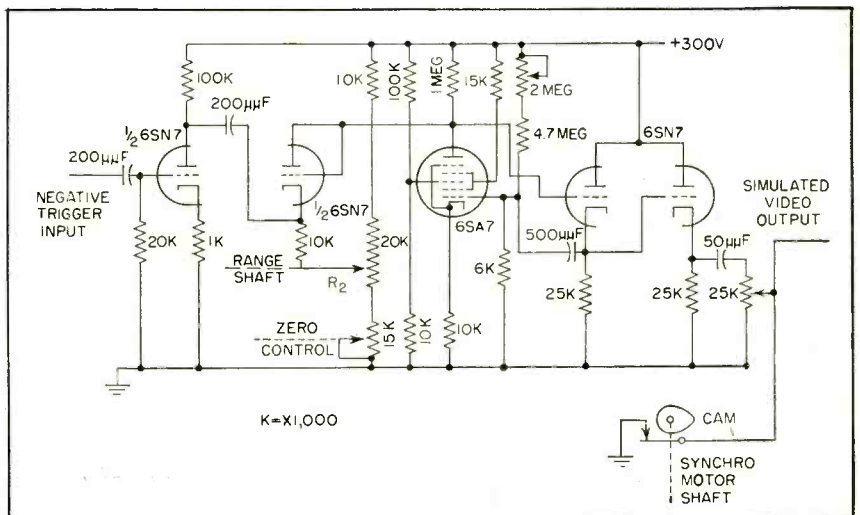
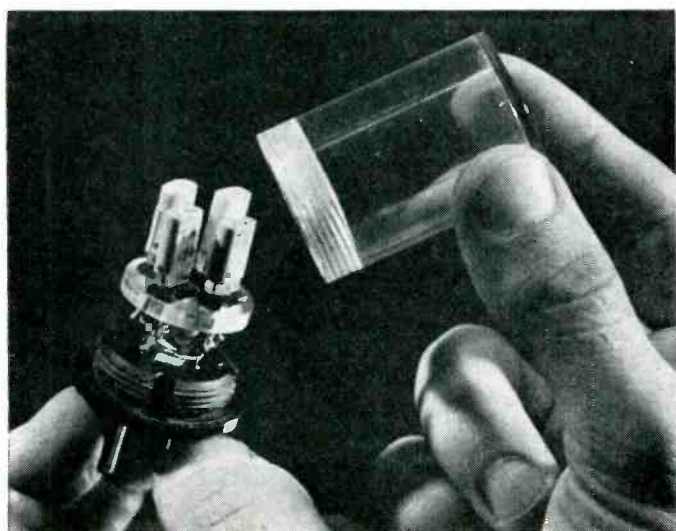

FIG. 5—Phantastron pulse-delay circuit

Complementary Symmetry

By **ROBERT D. LOHMAN**

*RCA Laboratories Division
Princeton, New Jersey*



AS REQUESTED

When this photograph first appeared in the "Industry Report" section of the January issue of *ELECTRONICS*, the editorial office was deluged with requests for more details.

In this article, Bob Lohman describes the circuit of the four-transistor audio amplifier shown and explains in detail the principle of complementary symmetry employed

TRANSISTOR circuitry has developed with remarkable rapidity during the last few years. A significant factor in this development has been the use of analog and duality concepts when converting from vacuum-tube to transistor configurations. However, there are some transistor circuits for which no vacuum tube dual exists. The complementary symmetry principle has yielded circuits of this type.

Circuits employing complementary symmetry make use of two properties exhibited by *pnj* and *njn* junction transistors.¹ These properties may be stated as follows:

(1) Under normal bias conditions, the current which flows in each electrode of a *pnj* transistor is the negative of the corresponding electrode current in an *njn* transistor.

(2) The polarity of an input signal necessary to increase conduction in a *pnj* transistor is the opposite of that necessary to increase conduction in an *njn* transistor.

It is convenient to call the first

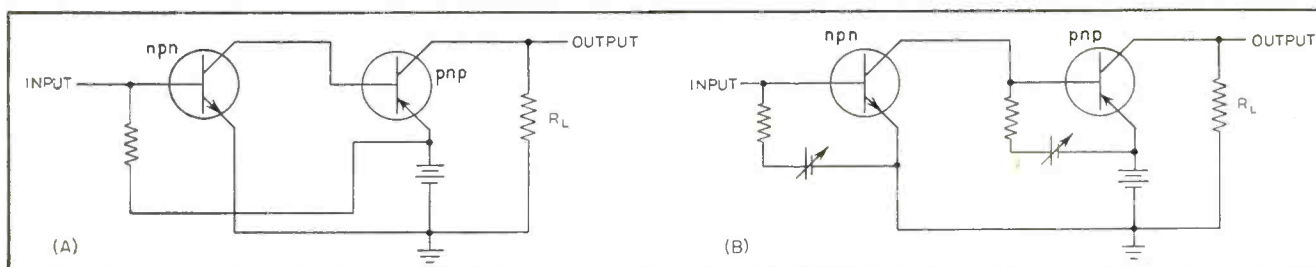

FIG. 1—Prototype circuits illustrate distinction between static and dynamic symmetry. Practical versions of these circuits appear in Fig. 3 and 4

Transistor Circuits

Combinations of *npn* and *pnp* junction transistors offer unique circuit possibilities including transformerless class-B amplification and direct coupling between cascaded stages using a single d-c power source. Useful circuits are described in detail

of these properties static symmetry and the second dynamic symmetry. The circuits to be described fall into three classes: those which use only static symmetry, those which use only dynamic symmetry, and those which use both simultaneously.

Since the small-signal equivalent circuits of the two types of transistors are identical, the advantages to be gained by using symmetrical circuits are found in biasing techniques and large-signal operation.

Circuits

The following circuits have been designated as either prototype or practical. It is desirable to inject a word of caution concerning the practical circuits. The schematic diagrams and performance characteristics are for particular amplifiers built in the laboratory to be used with experimental transistors. In some of these circuits, especially the class-B amplifier of Fig. 7, considerable selection of the transistors was necessary to obtain satisfactory performance. It should

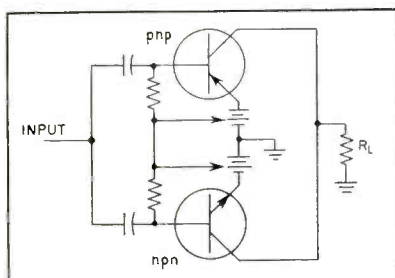

FIG. 2—Class-A power stage with dynamic and static symmetry

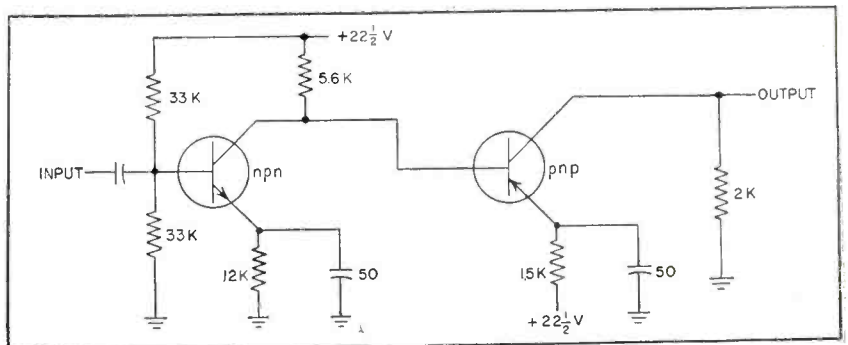

FIG. 3—Stabilized direct-coupled class-A amplifier provides voltage gain of 660, power gain of 53 db with an input resistance of 1,000 ohms

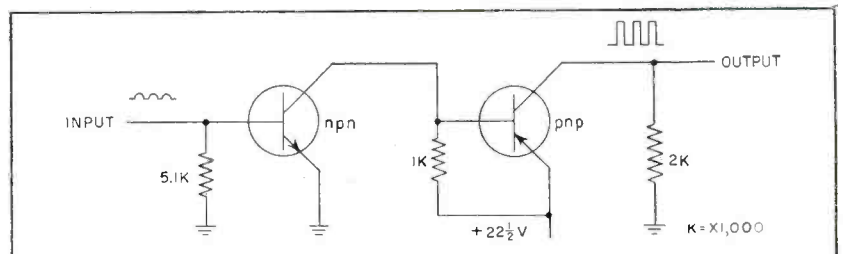

FIG. 4—Pulse amplifier converts 0.25-volt input half sine-wave to 20 volt pulse. Note use of single battery and direct coupling

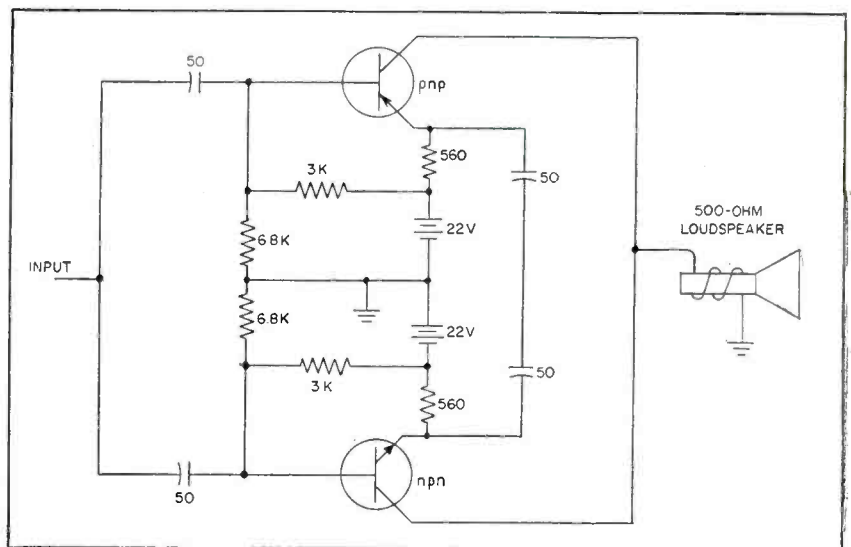

FIG. 5—Circuit provides 67-db voltage and 34.3-db power gains with input resistance of 300 ohms and power output of 100 mw

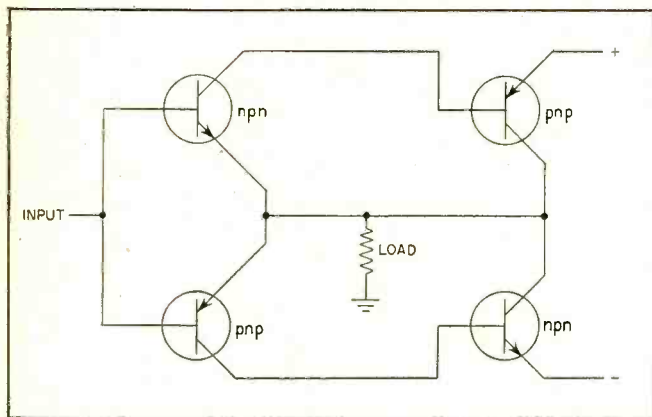

FIG. 6—Prototype of class-B power output circuit using four transistors and employing overall feedback

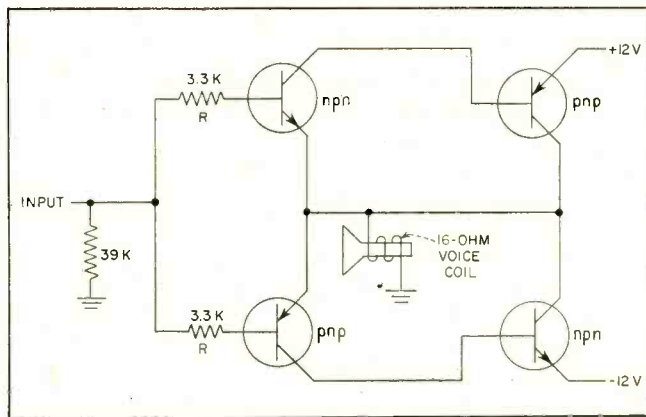

FIG. 7—Addition of input resistors to circuit of Fig. 6 improves performance as shown in Table 1. Power output is 500 mw

not be inferred that equivalent performance can always be expected from presently available commercial units.

Prototype Circuits

Figure 1 shows two prototype circuits which illustrate the distinction between static and dynamic symmetry. The first of these (A), which uses only static symmetry, may be considered a class-A amplifier. In this case, the single positive voltage source serves to supply collector voltage for both transistors. In addition, the polarity of the collector current of the *nnp* unit is correct to bias the *pnp* unit in the conduction range necessary for class-A operation.

The second circuit (Fig. 1B) shows how dynamic symmetry may be employed to advantage. It is assumed that the amplifier is to be used to amplify narrow, positive pulses. Under these conditions, it is desirable that the transistors conduct only for the duration of the pulse. Both units are therefore biased just at cutoff. The application of a positive pulse to the base of the *nnp* unit results in conduction in both units and in the development of a positive pulse across the load resistor.

Push-Pull

Figure 2 shows a prototype circuit which uses both static and dynamic symmetry. In this case, the circuit is to serve as a Class-A power output stage. To maximize the efficiency of power output amplifiers, it is necessary to pre-

vent zero-signal d-c current from flowing in the load. In conventional circuits this is done by employing impedance coupling, or, more usually, by using an output transformer. The static symmetry found in *nnp* and *pnp* transistors permits the same result to be accomplished with direct coupling. The zero-signal current which flows out the collector of the *pnp* unit flows in the collector of the *nnp* unit and there is therefore no d-c current in the load.

Because of the dynamic symmetry, push-pull operation is possible with a single-ended input signal. When a positive-going voltage is applied to both bases simultaneously, the current flowing in the *pnp* unit is decreased, while that in the *nnp* unit is increased. The resulting unbalanced current flows through the load. Thus the amplifier provides a single-ended push-pull output without benefit of either a phase inverter or an output transformer.

Useful Circuits

Practical embodiments of the three prototype circuits described above, as well as their measured performance characteristics, are shown in Fig. 3, 4 and 5. For the class-A amplifier (Fig. 3 and 5), the additional components are used to stabilize the operating point of the transistors³. For the pulse amplifier (Fig. 4), the bias batteries of the prototype circuit have been eliminated because it is possible to realize cutoff to the extent necessary simply by providing a rela-

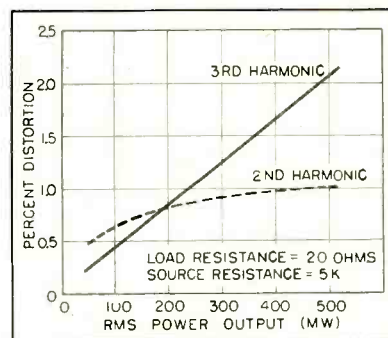

FIG. 8—Curve shows harmonic distortion in class-B amplifier

tively low resistance path between base and emitter.

Class B Circuit

Figure 6 shows the prototype of a class-B power-output circuit using four transistors and employing overall negative feedback. The stabilizing action of the feedback may be understood by assuming that an unbalance in the output current exists so as to make the load positive with respect to ground. The current leaving the collector of the *pnp* output unit is therefore larger than the current entering the collector of the *nnp* unit. If the base potential of the input transistors is held relatively fixed (at ground), the positive voltage across the load appears as bias on these transistors and causes the *pnp* unit to increase conduction and the *nnp* unit to decrease conduction. The current in the output *nnp* unit is thereby increased while that of the output *pnp* unit is decreased. The action continues until the unbalanced current is just sufficient to supply an error signal to the

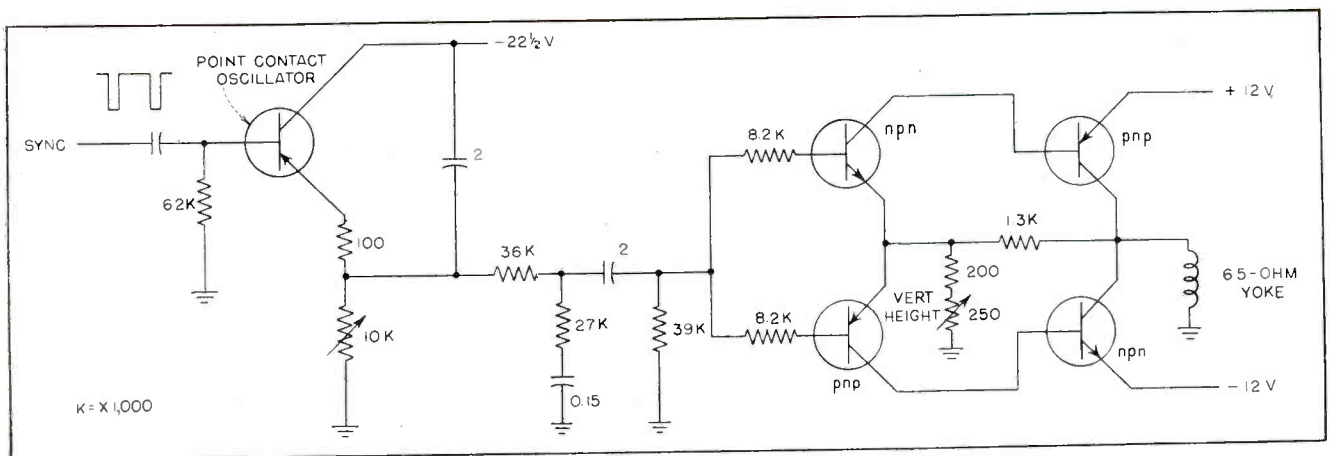

FIG. 9—Complete circuit of tv vertical deflection system employing transistor in complementary symmetry for class-B output connected directly to deflection yoke

feedback mechanism involved.

The fact that a small but definite error signal is required to equalize an original unbalance results in biasing one of the transistors to conduction (the input *mpn* unit in the above example) while the other one is cut off. The accompanying discontinuity sometimes results in cross-over distortion which, though small in terms of total harmonic content, may be objectionable because of the presence of certain high-order harmonics. By permitting the bases of the two input transistors to assume different potentials, the distortion may be decreased to negligible importance. Figure 7 shows a method for accomplishing this by adding two resistors to the input circuit.

The leakage current across the collector junctions flows through these resistors and generates a slight forward bias for each transistor. The emitters of both units can therefore emit minority carriers. The recombination of these carriers will decrease the original base current and thereby reduce the original bias, but the equilibrium condition is always such that base current reversal is avoided until the application of a signal. A smooth transition then takes place from one transistor to the other and the discontinuity is eliminated. Table I shows the results of measurements made on a particular amplifier with and without the resistors for a power output of 62 mw into a 16-ohm resistive load. The improvement effected is apparent.

At high power outputs distortion caused by other effects predominates and performance with and without the resistors is essentially the same.

Performance

In practice, in the temperature range from 70 F to 100 F, the zero-signal output currents vary from 5 to 30 ma. Since the peak currents at full output reach 350 ma, operation is still essentially class-B even at the higher value. The negative feedback serves to equalize the zero-signal current but cannot control its magnitude because only the unbalanced current provides an error signal. Dynamically, feedback reduces distortion, limits the voltage gain to unity, increases the input resistance, and decreases the output resistance. The power gain of the amplifier is thus the ratio of the input resistance to the load resistance.

With a load of 16 ohms, gains

in the order of 30 db have been obtained. Modifications of feedback have given gains up to 48 db, but it is easier to provide gain at low levels than in the power stage itself, and most of the circuits built have utilized 100-percent feedback. Figure 8 shows the distortion versus power output characteristic of one model of the amplifier when working into a 20-ohm resistive load. The frequency response is flat from 0 to 30 kc.

TV Circuits

Symmetrical amplifiers are well suited to television vertical deflection systems². In this application, it is possible to obtain push-pull operation without an output transformer or phase inverter and at the same time avoid any decentering current in the yoke. A modification of the basic class-B circuit described above, together with an oscillator to supply a sawtooth voltage waveform is shown in Fig. 9. This circuit provided a 160-ma peak-to-peak output with good linearity in a standard 65-ohm vertical yoke. At full output, the d-c current drain from each 12-volt battery was 28 ma. For ideal class-B operation, the ratio of peak current to average current is 4 to 1 because of the half cycle during which no conduction takes place.

REFERENCES

- (1) G. C. Sziklai, Symmetrical Properties of Transistors and Their Applications, *Proc. IRE*, p 717, June, 1953.
- (2) G. C. Sziklai, R. D. Lohman, and G. B. Herzog, A Study of Transistor Circuits for Television, *Proc. IRE*, p 708, June, 1953.
- (3) R. F. Shea, Transistor Power Amplifiers, *ELECTRONICS*, p 106, Sep., 1952.

Table I—Harmonic Distortion of Circuit in Fig. 7

Order of Harmonic	Percent Distortion	
	R = 3.3K	R = 0
2	2.5	1.3
3	0.8	1.5
4	0.2	0.5
5	—	0.9
6	—	0.3
7	—	0.5
8	—	0.2
9	—	0.3
10	—	0.2
11	—	0.2

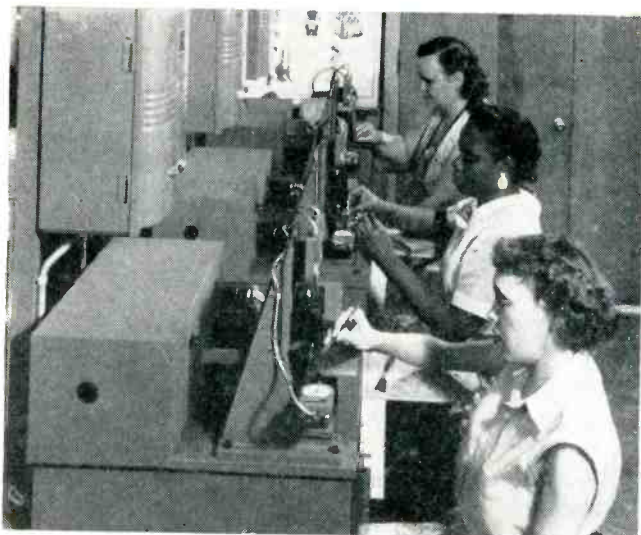

FIG. 1—Hand-feed gaging unit measures three dimensions of small odd-shaped parts in one operation

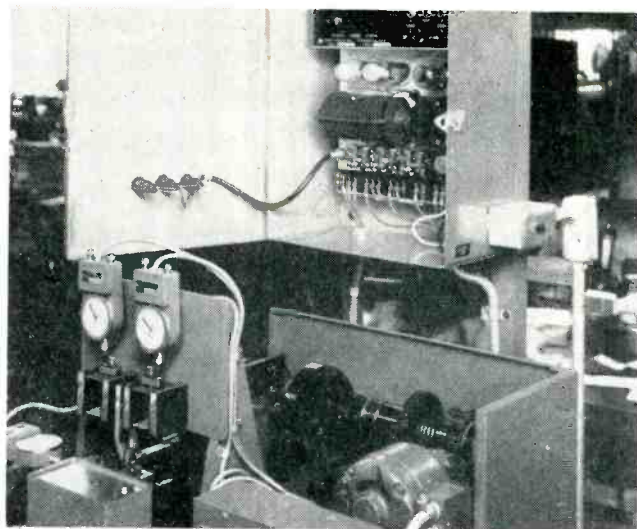

FIG. 2—Parts pass through sensing heads and are dropped into proper disposal chute set by measuring unit

STEPS TO AUTOMATION

Electronic Gaging and

Examples of high-speed automatic gaging and sorting using electronic equipment and special gages for operating at speeds up to 400 pieces per minute. Gages tied to machine controls give automatic production with no rejections

By **ALBERT C. SANFORD** *Engineering Dept., Federal Products Corp., Providence, R. I.*

TO TAKE best advantage of high measuring speeds made possible by the use of electronic gages the special requirements of the parts being gaged must be considered. For small parts of irregular shape, a hand-fed gage may be most practical. Regular parts such as ball bearings can be fed from a hopper, passing under the sensing head at the rate of 400 per minute.

This article will consider the use of electronic gaging in a variety of applications, including completely automatic units where the gage controls the operation of the production machine. The sensing heads used have been described in "Precise Parts Sorting on Production Lines" *ELECTRONICS*, July 1953, p142.

The gages shown in Fig. 1 and 2 are hand-loaded units designed to measure two diameters and one length in a single operation. The parts being measured are small, comparable in size to pinions used in small clocks. The irregular shapes make hand loading necessary.

When a part has been positioned for gaging, a motor-driven slide carries the part to the gaging station, stops momentarily while the measurement is taken, then continues its advance, dropping the measured part into correct disposal chute set by the power unit. These gages are capable of operating at rates of up to 60 pieces per minute, but difficulty in handling the work-pieces limits the effective gage rate

to about 40 to 50 pieces per minute.

Other types of material, such as mica, are almost impossible to hopper-feed economically. In cases such as this it is also advisable to use hand-loading methods. The semi-automatic mica sorting gage in Fig. 3 and 4 has enjoyed wide acceptance in the mica industry for this type of work. Sheet mica is placed between the normally open gage contacts. Inserting the mica interrupts the light to a phototube, initiating the gage cycle. A solenoid-operated cam closes the gage contacts, and a thickness measurement is made. The spindle contacts open and the mica drops into one of eight trapdoors preset by the classifier.

Sorting mica with a mechanical

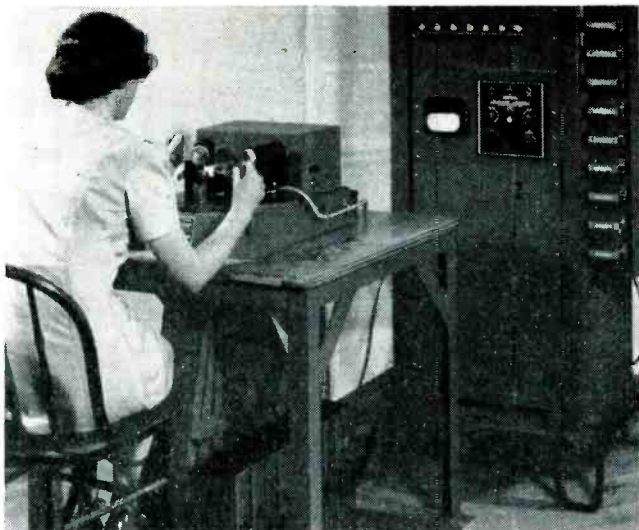

FIG. 3—Mica-sorting gage measures thickness of mica and operates trapdoor to proper disposal bin

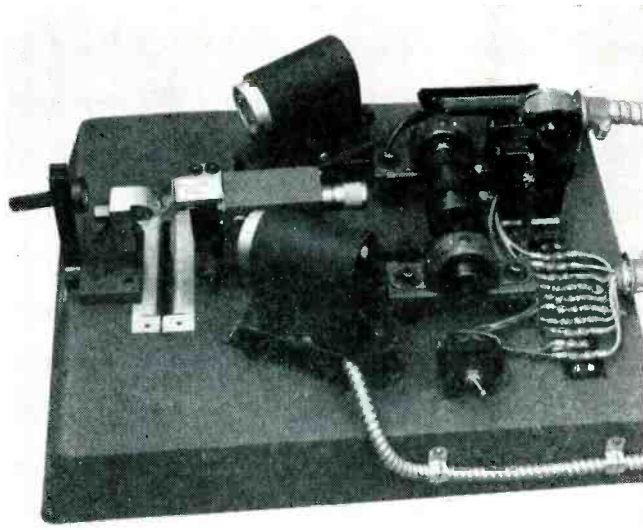

FIG. 4—Interruption of light beam operates motor to bring thickness-sensing contacts against mica sheet

Sorting Applications

dial indicator gage requires about three to four months operator experience to achieve a rate of about 50 to 60 pieces a minute. It is also attended by errors due to operator fatigue or inattention. With the automatic mica-sorting gage, the operator can achieve a rate of between 100 and 120 pieces per minute after less than one week's experience, with no possibility of mis-sorting due to operator inattention.

Magazine-Loaded Gages

Some types of parts are suited for magazine loading. Ball-point-ink tubes about $\frac{1}{8}$ inch in diameter and approximately $2\frac{1}{2}$ to 3 in. long are examples of this. Continuously rotating notched wheels on the gaging unit in Fig. 5 pick up ink tubes one at a time from the magazine and pass the pieces thru the measuring contacts. The length signal is obtained by a contact feeler. The feeler controls an accept-reject switch that sets the correct disposal. This type of gage can measure length or diameter of such pieces at a rate of about 60 pieces per minute.

Other parts, such as 20-mm pro-

jectiles, cannot be hopper-fed because of possible damage to the finished piece. A magazine-loaded gage to measure the various dimensions of 20-mm projectiles, such as tail diameter, crimping groove, rotating band, body, nose diameter and several lengths is shown in Fig. 6. The unmeasured work-pieces are hand-loaded into a magazine. The pieces are picked up by a notched wheel, carried around and deposited on an indexing chain. The parts are then carried through the successive measuring stations. At each station the size impulse for the particular workpiece is impressed upon a mechanical memory of the type shown in Fig. 7. The indexing chain and the memory wheel advance at proportional rates. When the workpiece arrives in front of its predestined disposal, the memory pin associated with that workpiece actuates a switch. The switch operates the solenoid kicker to push the workpiece into the correct disposal chute. This gage can measure the seven dimensions of a projectile at rates up to 5,000 pieces per hour.

Figure 8 illustrates a completely automatic hopper-fed gage for sort-

ing cylindrical loud-speaker magnets according to length and diameter. The parts to be measured are placed in a hopper where they are oriented and fed into the gage. A reciprocating pusher moves one piece at a time into gaging position. The succeeding workpiece displaces the first, which then drops down the preset disposal chute to the proper bin. A gage of this type produces up to 6,000 measured parts per hour and requires no attention except to keep the hopper loaded and disposal bins unloaded.

Bearing Gage

Figure 9 shows a similar hopper-fed gage designed for gaging needle bearings at a high rate of speed. The bearings have a simple symmetrical shape, making it possible to hopper-feed them at rates in excess of 400 pieces per minute. The gage measures the diameter of the pieces, sorting into six categories of 0.0001 in. variation, plus over and under. Similar rates are feasible for other parts provided the pieces can be fed that fast. Unmeasured workpieces are loaded into the hopper, oriented and fed

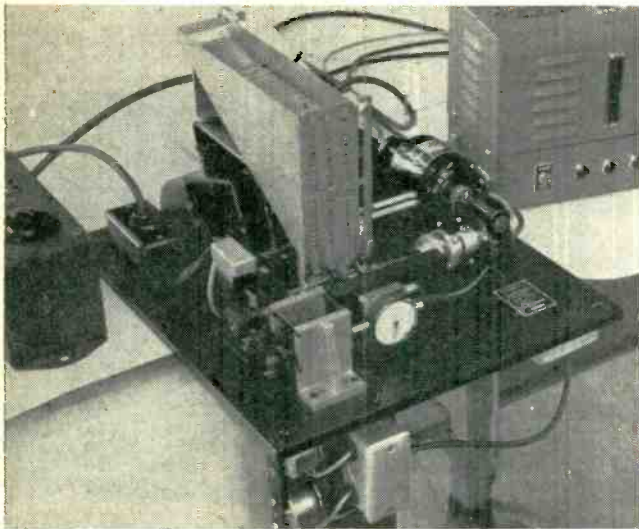

FIG. 5—Ball-point pen tubes in magazine-fed measuring unit are carried to measuring position by notched wheel

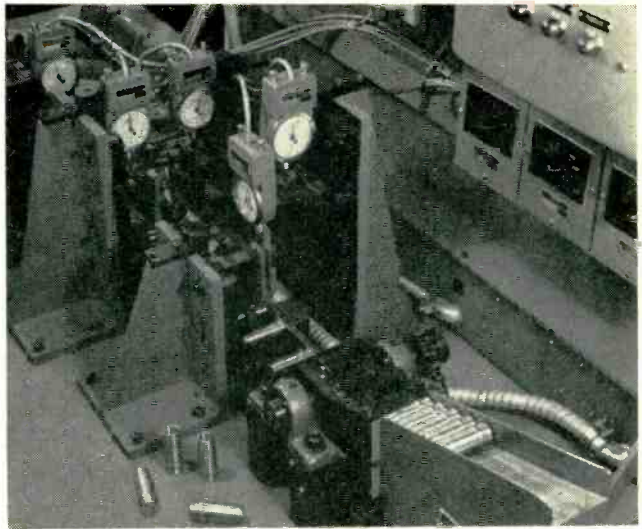

FIG. 6—Gage for 20-mm projectiles measures seven different dimensions and sorts parts at rates up to 5,000 per hour

STEPS TO AUTOMATION

end to end down the feed tube. At the bottom of this tube, parts are stacked side by side in the magazine. A notched feed wheel picks up one piece at a time and carries it through the gaging station. Size signal is impressed upon a mechanical memory rotating in synchronism with the feed wheel. When the measured piece is in position at the correct disposal, the memory opens the trap door.

Future of Automatic Gaging

The previous discussion has been concerned with taking parts which

have been produced at some process or other, bringing them over to an automatic inspection machine and sorting them out. While this is an improvement over hand methods, even this procedure can be improved. The first goal is to bring the gage to the machine and have the parts come from the manufacturing operation into the sorter and then be packaged.

On manufacturing processes suitable for such control, a gage mounted on the production machine could automatically adjust the machine so that all parts are manu-

factured within the required tolerance, eliminating further sorting.

An example of equipment designed to minimize work handling is a gage shown in Fig. 10 installed to measure workpieces as they come from a centerless grinder. Hard rubber tubes pass between the gaging rollers and are measured for diameter over their full length. A continuous size indication is provided by an electronic gage and signal lights. This gage installation incorporates washing facilities to remove grit from the parts before measuring. The gage is also provided with a small electrical time delay, permitting it to overlook minor variations along the length of the work.



FIG. 9—Rapidly rotating wheel carries needle bearing past measuring head at rate of 400 per minute

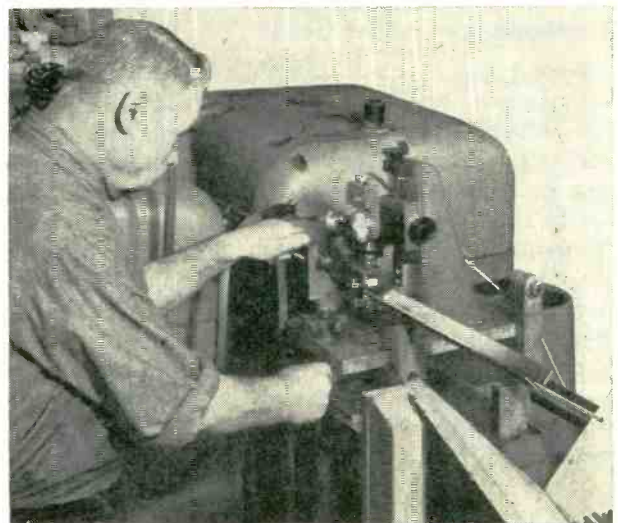

FIG. 10—Gage mounted on centerless grinder continuously monitors output of production machine

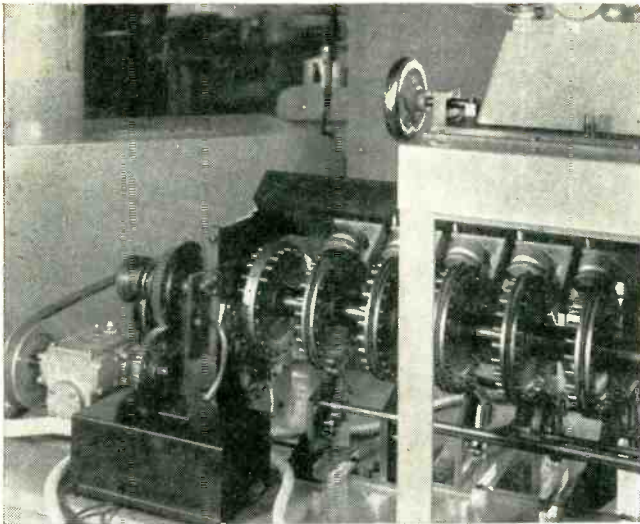

FIG. 7—Movable pins on memory unit carry dimensional information and set chutes for proper parts disposal

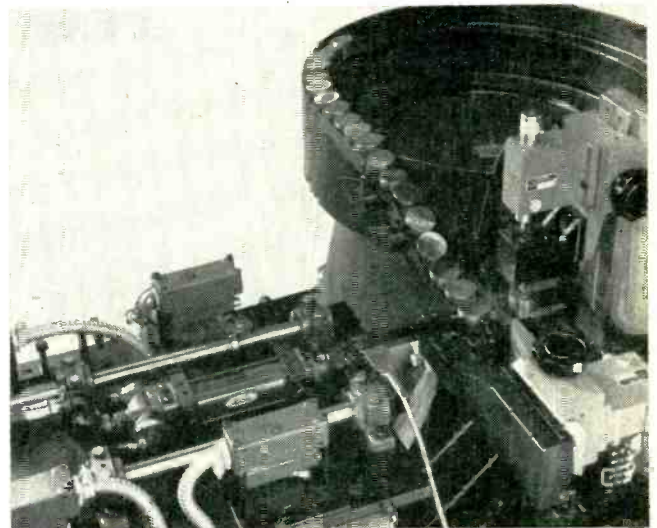

FIG. 8—Hopper-fed gaging unit sorts loudspeaker permanent magnets according to length and diameter

In the manufacture of instrument bearing jewels it is necessary to control the outside diameter of the pieces very carefully. The jewels are strung on a bow-like fixture mechanically held between the wheels of a grinder. After the jewels are ground for a predetermined length of time, the bow is moved from between the grinding wheels. At this time the gaging unit shown in Fig. 11 mechanically moves into position over the jewels, obtains a size signal by means of the electronic gage head and transmits that information to the grinder through a classifier. If the jewels are to size, the gaging unit stops the grinding machine and sounds a warning to the operator.

If the jewels are still oversize, the gage actuates the grinder for another grinding cycle.

A gage which automatically controls a machine so as to produce nothing but acceptable workpieces uses a continuous-grinding gage mounted to measure workpieces leaving a large parallel-disk grinder. The gage is mounted so that each workpiece passes through the gage contacts after passing between the grinding wheels. The gaging unit is tied into the machine controls so that the grinder is automatically adjusted as workpieces approach size limit. Adjustment is made to each grinding wheel alternately. Addition of the gage to the grinder helps to make a fully auto-

matic machine which will produce within-size parts.

Another example of a gage tied to machine controls is shown in Fig. 12. This gage continuously measures the outside diameter of the plastic coating on wire passing through gage rollers. In plastic extrusion, the coating thickness can be controlled by adjusting the takeup capstan speed. The gage is tied into the machine to automatically speed up or slow down the capstan, thereby making the necessary corrections to bring the wire back to size. Gage limits are usually set inside commercial tolerance limits, causing the gage to anticipate and keeping all the wire within commercial limits.

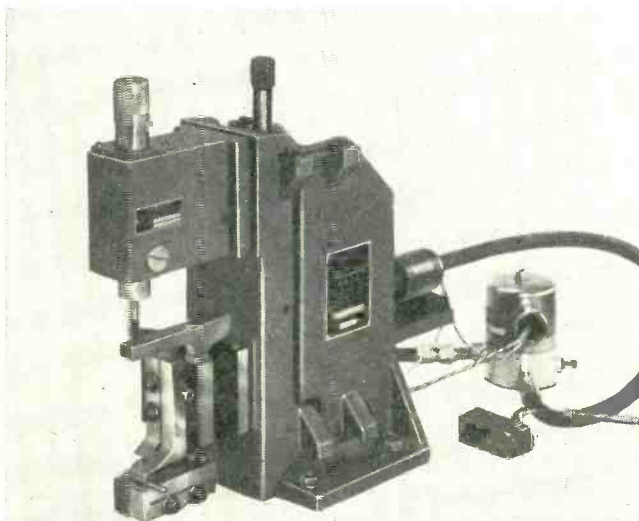

FIG. 11—Gage unit used to set grinder controls according to dimensions of bearing jewels being ground

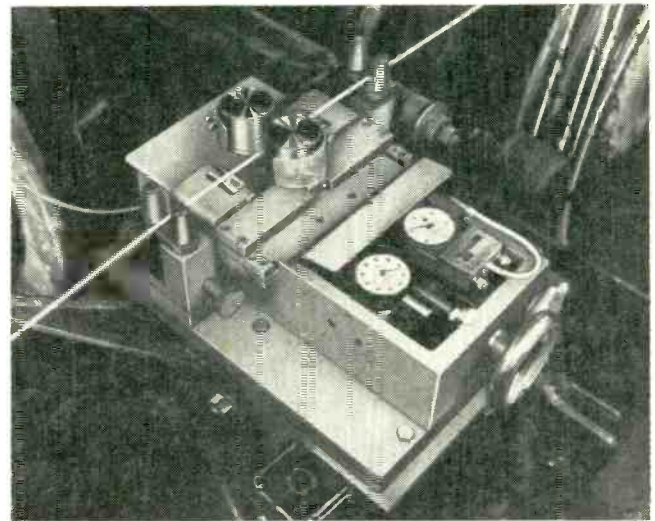
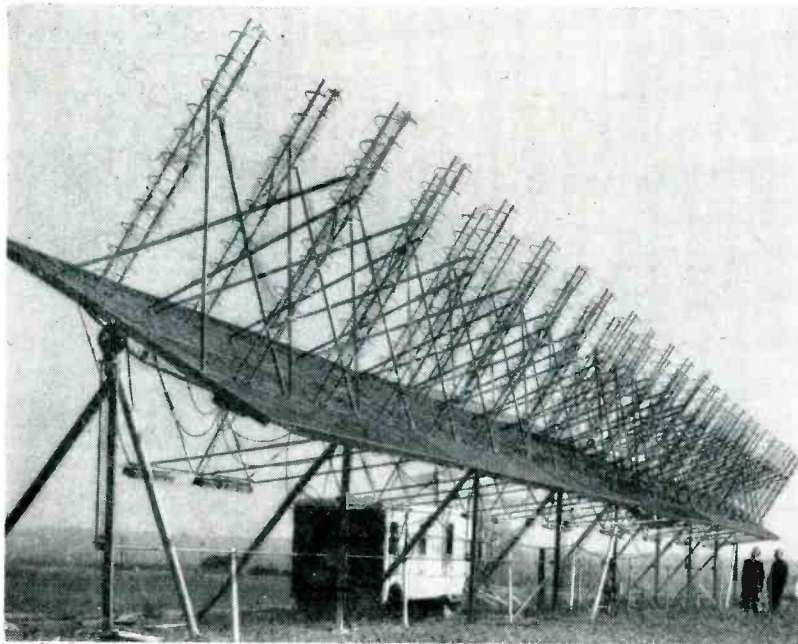
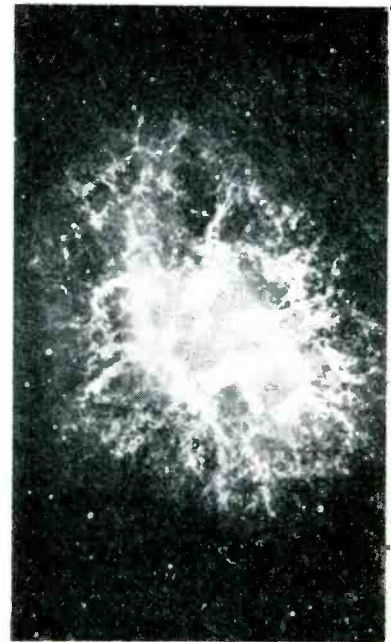

FIG. 12—Gage tied to takeup spool controls capstan speed to put a uniform plastic coating on the wire

New Techniques



THE FRONT COVER—Ohio State radio-telescope antenna, consisting of 48 helical beam antennas mounted on a steel ground screen 160 feet long. The antenna is balanced with counterweights and pivoted on its long (east-west) axis so that all parts of heavens observable from latitude of Columbus, Ohio can be scanned



Mt. Wilson photo of Crab Nebula, a supernova or exploded star. This was the first radio discrete source other than the sun that could be seen

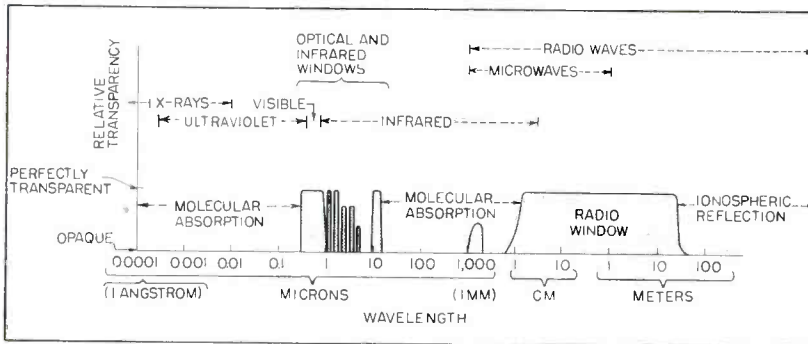

FIG. 1—Electromagnetic spectrum with logarithmic wavelength scale, showing regions for which the earth's atmosphere is transparent

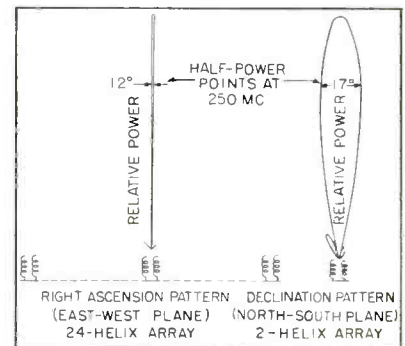

FIG. 2—Measured power patterns of OSU radio-telescope antenna

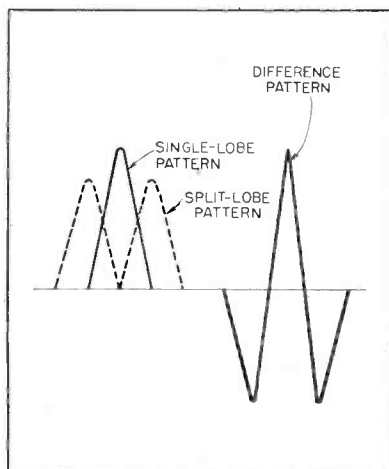

FIG. 3—Idealized single-lobe, split-lobe and difference-type antenna patterns used in radio exploitation of celestial objects thousands of light-years away

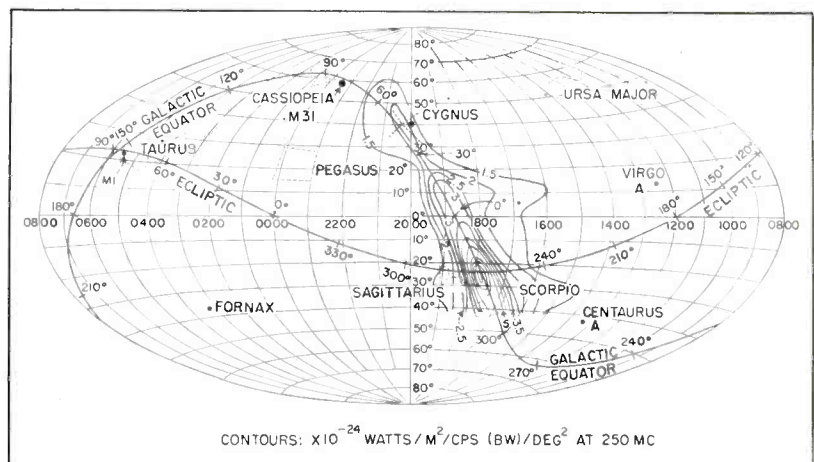

FIG. 4—Celestial sphere, showing intensity of background radio radiation of extraterrestrial origin as observed with OSU radio telescope at 250 mc. Maximum intensity occurs in the direction of the center of our galaxy. Solid circles show radio stars. Dashed lines indicate locations of a few visible constellations

in Radio Astronomy

Broadside array of 48 helical beam antennas mounted on pivoted ground screen gives beam width of 1.2 deg at 250 mc for scanning outer space to pick up radio signals emitted by exploding stars and other celestial objects

THE EARTH'S ATMOSPHERE is transparent to light, certain infrared bands,^{1,2} and to radio wavelengths between about 1 centimeter and 20 meters but is opaque to other wavelengths. These transparent bands are the windows in our atmosphere through which radiation can be received from outer space. Their locations in the electromagnetic spectrum are shown in Fig. 1.

Most of the information about the universe outside the earth has been obtained by optical observations. The presence of radio radiations from outer space was first noted about 20 years ago.³ From this discovery has grown the new science of radio astronomy, which involves the observation of celestial objects by the radio waves that they emit.^{4,5,6} From analogy to optics, the antenna with associated equipment for receiving these waves is often called a radio telescope.

Recent Advances

The origin of the waves detected with radio telescopes is for the most part a matter of conjecture. The received radiations may, however, be classified into two types: (1) radiation from discrete sources; (2) a general background radiation not resolvable into discrete sources.

Although the sun is a discrete source, no others had been detected until 1948.^{7,8} Since that time several hundred have been found. Some of the discrete sources are of small angular extent (a few minutes of arc or less) and are called point sources or radio stars, while others, termed extended sources, may be several degrees in

By **JOHN D. KRAUS**
and
EDWARD KSIAZEK

*Department of Electrical Engineering
Ohio State University,
Columbus, Ohio*

extent as measured from the earth.

Only a few discrete sources have been identified with visible objects and their nature is one of radio astronomy's most challenging problems. The first and most certain identification is that of a strong discrete source in the constellation Taurus with the Crab Nebula, which is the gaseous remnant of a supernova or exploded star. The explosion of this star was observed by Chinese astronomers in 1054 AD when it flared up to such brightness that it could be seen in broad daylight. This billowing mass of gas is still expanding at a tremendous rate and is apparently a strong source of radio waves.

The background radiation appears to have a continuous spectrum observable throughout most of the radio window. It has its maximum intensity in the direction of the center of our galaxy. In addition there is a single-frequency radiation at a 21-cm wavelength emitted by interstellar hydrogen.⁹

Although part of the background radiation at wavelengths other than 21 cm may be due to emission from interstellar matter, it is probable that much of it is the integrated effect of many discrete sources too weak or close together to be resolved by present techniques.

Not only has much knowledge of astronomical significance been obtained by radio astronomers but also considerable information of

immediate practical application. For example, the galactic radio surveys have established minimum noise levels for very high frequencies,¹⁰ while solar observations have yielded much data on the sun's effect on terrestrial communication. Furthermore, studies of the fluctuations in intensity of radio stars, similar to the twinkling of visible stars, have produced information about ionospheric disturbances.¹¹

OSU Radio Telescope

A new radio telescope was completed last October at the Ohio State University. The antenna is a broadside-array type consisting of 48 right-handed helical beam antennas¹² mounted on a steel ground screen 160 feet long by 12 feet wide. Each helix has 10 turns and is 15 inches in diameter by 10 feet in length. The helical beam antennas¹³ have the advantage of a wide bandwidth (200 to 300 mc) and negligible mutual coupling.

Each helix is matched to a 120-ohm coaxial cable (RG-63/U). Each group of six helices is connected through a short length of this cable to an exponentially tapered broad-band transformer which matches, in turn, to a 50-ohm coaxial cable. There are eight of these transformers, and equal lengths of 50-ohm cable (RG-17/U) run underground from each transformer to the receiving equipment situated in the van adjacent to the antenna. All eight cables can be connected in parallel at the receiver so that the pattern is a single lobe with its maximum in line with the helix axes. The beam width between half-power points at 250 mc is 1.2 degrees in right ascension

and 17 degrees in declination.

The measured patterns obtained with the sun as the source are shown in Fig. 2. The distance of the sun (93,000,000 miles) is more than sufficient to insure that a far-field or Fraunhofer pattern is obtained. However, the sun is not a point source; it subtends an angle of about $\frac{1}{2}$ degree, so that the measured main lobe (Fig. 2) is slightly broader and the minor lobes somewhat smaller than for a point source.

Since ephemeris tables are available giving the time of transit of the sun on any day, it is possible to determine the presence of any deviation of the antenna pattern from the perpendicular to the array axis by comparing the ephemeris and observed times of transit. If no tilt is present, all helices are in phase, as they should be for a simple broadside array. Actually, the presence of sunspots and ionosphere disturbances makes it necessary to average the observed transits for several days if an accuracy better than a few seconds (in time) is desired.

By inserting an additional $\frac{1}{2}$

wavelength of coaxial line in series with the cables to either half of the array a split-lobe pattern is obtained, as illustrated by the dashed pattern in Fig. 3. By observing a particular source on some days with a single-lobe pattern and on other days with a split-lobe pattern, it is possible to deduce the angular size of the source. Rapid switching from one type of pattern to the other is also employed, as described later.

Observations

As soon as twelve helices had been installed (August 1952), a survey of the background radiation was begun. Results are shown in Fig. 4. This map shows the celestial sphere on an Aitoff projection. The pole or north star (declination 90 deg) is at the top of the map, while the horizontal center line (declination 0 deg) is the projection of the earth's equator on the celestial sphere. The horizontal coordinate is the right ascension, expressed in hours, increasing from right to left since the meridian moves in this direction across the sky as the earth rotates.

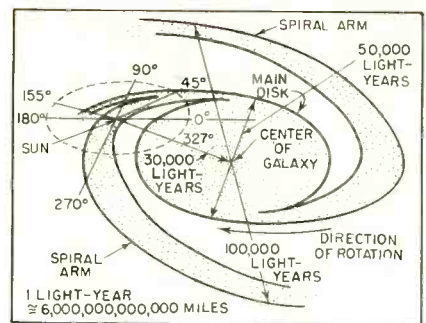

FIG. 5—Sketch of our island universe or galaxy, showing the sun's position in one of the spiral arms

The contours are equal-intensity lines indicating the strength of the received radiation, expressed in 10^{-21} watts per square meter per cps bandwidth per square degree of subtended solid angle. It is significant that the high-intensity contours lie close to the plane of our galaxy (galactic equator) shown by the heavy line. The low-intensity contours show a tendency to deviate quite far from the galactic equator, perhaps indicating concentrations of matter close to our solar system at high galactic latitudes.

The peninsula-like contours in the region of Cygnus may be taken as evidence of the fact that the solar system is situated in a spiral arm of our galaxy. Thus, when observing in the direction of Cygnus we are looking along a spiral arm and, hence, at a very considerable concentration of matter.

Our galaxy is an aggregation of millions of stars, with a central flat disc about 50,000 light years in diameter that turns like a great wheel in space. Long plumes or spiral arms trail out from the central disc to an overall diameter of about 100,000 light years. The sun with its planets is situated in a spiral arm, as suggested in Fig. 5. The size of the solar system is very small compared with the galaxy.

Values of galactic longitude in degrees are shown around the dashed circle in Fig. 5 and also along the galactic equator in Fig. 4. The center of the galaxy is at a longitude of 327 deg, while the spiral arm in Cygnus is at about 45 deg.

Since we are situated inside our own galaxy it is not possible to view it as in Fig. 5. However, it is

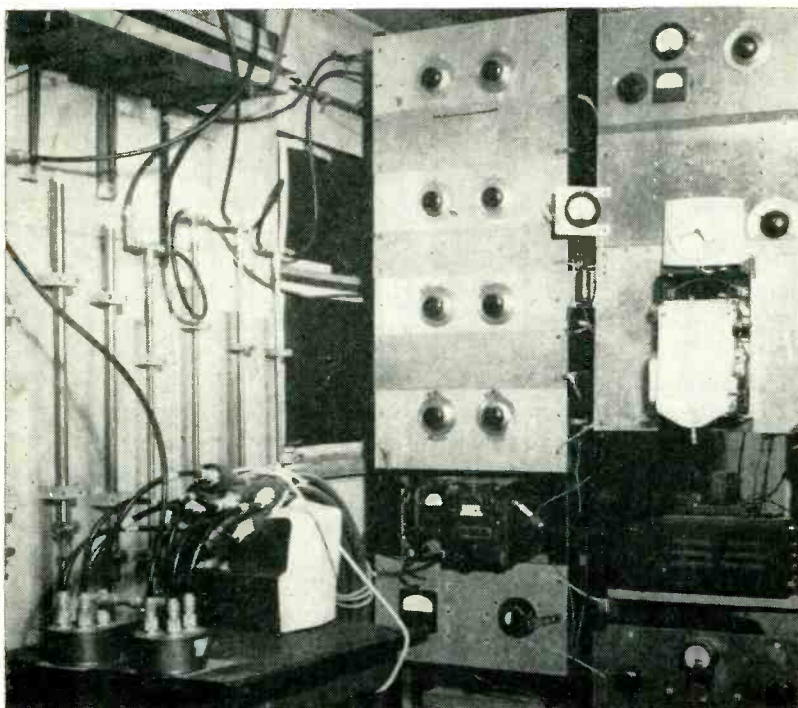

Receiving equipment of OSU radio telescope, mounted in van alongside the antenna. Cables from antenna terminate on table at left. Tuning stubs are on wall. Left-hand relay rack has preamplifier, superhet receiver, power supply and regulator. Right-hand rack has noise generator for testing and calibration, 30-cps a-c amplifier, recorder, d-c amplifier and power supplies

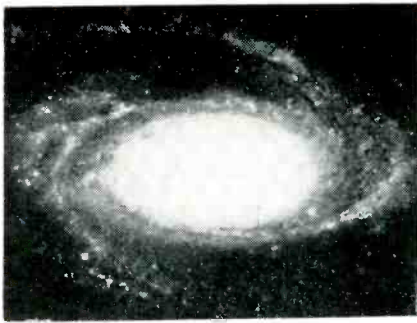

FIG. 6—Mt. Palomar photograph of a neighboring galaxy, M81 in Ursa Major, which our galaxy may resemble

possible to observe vast numbers of other galaxies at distances of millions of light years, some of which may bear a resemblance to our own. A photograph of a neighboring galaxy, known as M81 in Ursa Major, is shown in Fig. 6. Each white dot is a star. However, only the brightest ones are discernible, the rest merely contributing to the brightness of the unresolved central disc and haze of the spiral arms. Since our sun is not a very bright star it would not be discernible in a photograph taken of our galaxy at such a distance. Radio and optical observations are constantly adding new knowledge.^{14,15}

Most of the survey for Fig. 4 was made with 12 helices. The procedure used was to set the antenna at a fixed declination and as the earth rotated obtain a record for a strip of the sky a few degrees wide by 360 deg in right ascension in a 24-hour period. A record for a single declination (-38 deg) is presented in Fig. 7. This graph is a composite of records for 3 days. It was obtained with 48 helices and shows considerable detail or fine structure.

Many of the small humps on the graph of Fig. 7 are due to discrete sources. The ones designated by number (such as 17-3) were previously found by observers in Australia.¹⁶ The others, 15 in number, are sources newly discovered with the OSU radio telescope. The antenna pattern for a point source is shown in an insert in Fig. 7.

Receiving System

The receiving equipment diagrammed in Fig. 8 is situated in the van adjacent to the antenna.

The r-f input of the receiver is switched at intervals of several minutes from the antenna to a matched resistor at room temperature. This resistor may in practice be a reel of several hundred feet of lossy cable (RG-21/U). Switching to the matched resistor is desirable in order to provide a reference power level to which the antenna power may be compared. The power available from the resistor is given by $P = kTB$ watts, where k is Boltzmann's constant (1.38×10^{-23} joule per degree k), T is absolute temperature in deg Kelvin and B is bandwidth in cps.

Taking room temperature as 68 F and bandwidth as $\frac{1}{2}$ mc, the resistor power available to the re-

ceiver is 2×10^{-15} watt. This is a random noise power like that collected by the antenna.

If the antenna power is less than P , the antenna is directed at a region of space with a temperature below room temperature. However, if the antenna power exceeds P , as during the transit of the sun, the antenna is directed at a region or object with a temperature above room temperature. From this point of view the radio telescope may be regarded as a bolometer for determining the effective temperature of distant regions of space, coupled to the system through the radiation resistance of the antenna. The sawtooth record of Fig. 9 was obtained at a meridian transit of

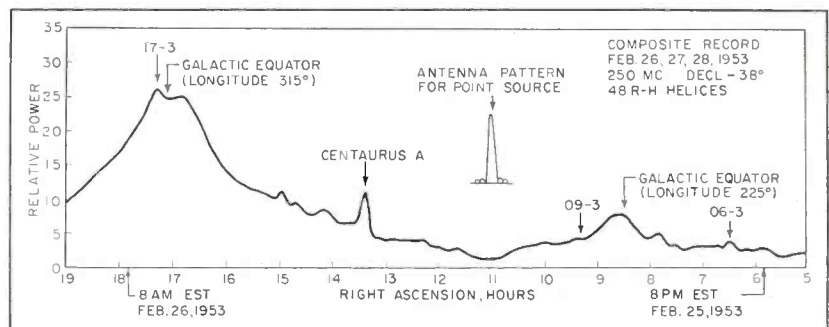

FIG. 7—Record showing discrete sources and background radiation along a strip of the sky at a declination of 38 deg south, as obtained at 250 mc with the OSU radio telescope. Nearly 20 discrete sources are discernible on this record

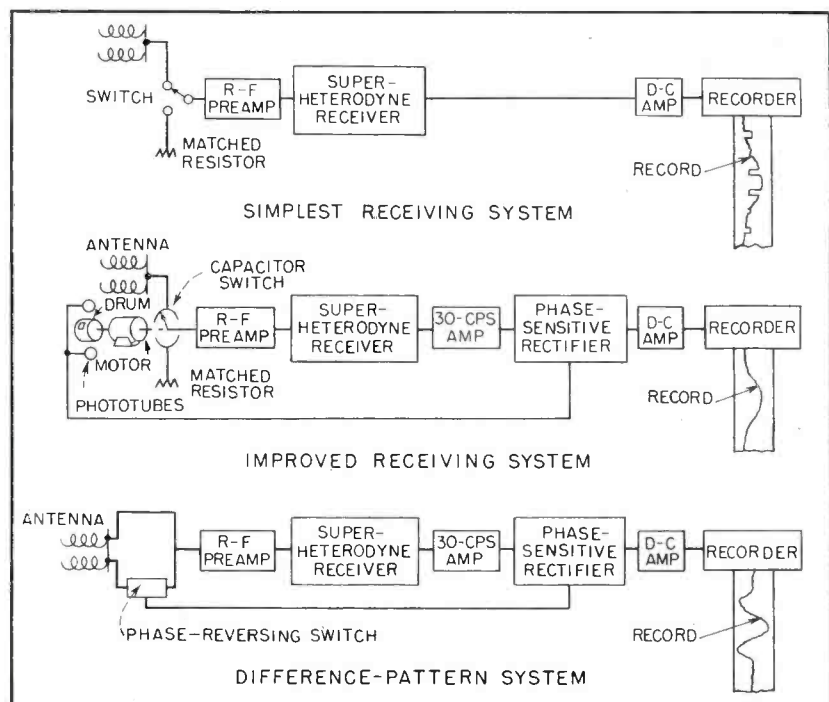

FIG. 8—Block diagrams of three receiving arrangements, showing types of records obtained

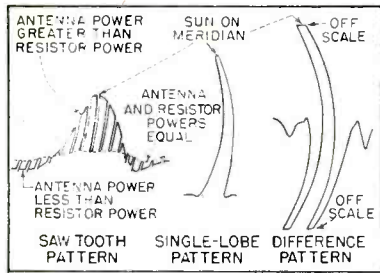

FIG. 9—Traces of actual records obtained using the three receiving systems

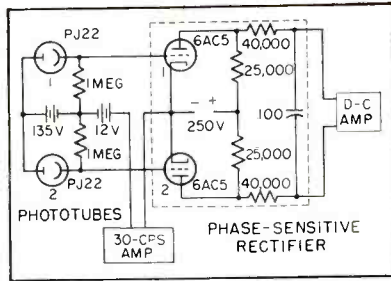

FIG. 10—Circuit of phase-sensitive rectifier and associated phototubes

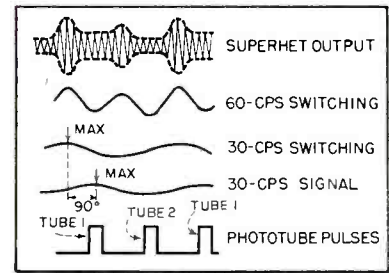

FIG. 11—Output of superheterodyne receiver and four component signals

the sun, using the receiving system just described.

Photoelectric Signal-Comparator

An improved receiving system, which permits much higher sensitivities, is shown at the center of Fig. 8. Here the antenna and matched resistor are compared 30 times per second¹⁷ by a motor-driven capacitor switch. The motor shaft also carries a slotted drum acting as a shutter between an internal light source and two diametrically opposed phototubes. In this system the 30-cps components of the superheterodyne output are amplified and rectified in a phase-sensitive unit, as shown in Fig. 10, actuated by the phototube pulses. The rectifier output is passed through a d-c amplifier and gives a trace on the recorder whose deflection is proportional to the difference between the resistor and antenna powers.

A sample record at a meridian transit of the sun using the improved system is shown at the center of Fig. 9. The graph of Fig. 7 was also obtained using this system.

A third arrangement that has been employed is shown at the bottom of Fig. 8. In this system an extra $\frac{1}{2}$ wavelength of coaxial line is switched in series with the cables to half of the antenna at a frequency of 30 cps. In this way the antenna pattern is switched from a single-lobe type to a split-lobe type (see Fig. 3) and back at a rapid rate, the antenna with split-lobe pattern being substituted for the matched resistor at room temperature.¹⁸ The resulting record is a difference pattern in which the split-lobe pattern is subtracted from the single-lobe type, as suggested in Fig. 3. An actual

record taken with this arrangement at a meridian transit of the sun is shown at the right in Fig. 9; the bent appearance of the records is due to use of a recorder in which the pen moves on the arc of a circle. The difference-pattern receiving system is of value in observing point sources since the background radiation, or radiation from extended sources substantially wider than the antenna beam width, is mostly balanced out, leaving a record of the point source only.

Circuit Details

The preamplifiers have butterfly-tuned grounded-grid triode stages with a bandwidth of about $\frac{1}{2}$ mc. The bandwidth of the i-f stages of the superheterodyne is also approximately this value. The superheterodyne output just ahead of the second detector has an envelope as suggested in Fig. 11 for either of the receiving arrangements employing 30-cps switching. After detection the three major components in the output are the 60-cps and 30-cps components due to the switching transient, and a 30-cps component due to the difference in signal from the antenna and resistor (see Fig. 11). Only the 30-cps components are amplified; by adjusting the phase of the phototube pulses so that they occur at signal maxima, the effect of the switching component is minimized.

As shown in Fig. 10, an R-C circuit of long time constant is connected to the output of the phase-sensitive rectifier. This circuit gives an output that is the average of many comparisons between the antenna and resistor powers or powers for the two antenna patterns.

It is significant that the antenna

power is usually much smaller than the power available from a matched resistor at room temperature and much less than the tuned-circuit noise in the first r-f stage. To detect such small powers requires that the receiver be highly stable. Accordingly, all supply voltages are regulated to better than 1 part in 10,000.

The OSU radio telescope project has been aided by grants from the Lovejoy Memorial Fund, the OSU Alumni Association Development Fund and the university's research foundation.

REFERENCES

- (1) J. H. Shaw, Infrared Studies of Atmospheric Constituents, *Eng. Expt. Station News, Ohio State Univ.*, p 22, June 1951.
- (2) W. M. Sinton, Far-Infrared Atmospheric Transmission, *Symposium on Molecular Structure and Spectroscopy, Ohio State Univ.*, p 38, June 1952.
- (3) K. G. Jansky, Electrical Disturbances Apparently of Extraterrestrial Origin, *Proc. IRE*, p 1,387, Oct. 1933.
- (4) Grote Reber, Cosmic Static, *Proc. IRE*, p 68, Feb. 1940; p 367, Aug. 1942; p 1,215, Oct. 1948.
- (5) C. R. Burrows, Radio Astronomy, *ELECTRONICS*, p 75, Feb. 1949.
- (6) Bernard Lovell and J. A. Clegg, "Radio Astronomy," John Wiley and Sons, Inc., New York, 1952.
- (7) J. G. Bolton and G. J. Stanley, Observations on the Variable Source of Cosmic Radio-Frequency Radiation in the Constellation Cygnus, *Aust. Jour. Sci. Res.*, p 58, March 1948.
- (8) M. Ryle and F. G. Smith, A New Intense Source of Radio-Frequency Radiation in the Constellation of Cassiopeia, *Nature*, p 462, Sept. 18, 1948.
- (9) H. I. Ewen and E. M. Purcell, Radiation from Hyperfine Levels of Interstellar Hydrogen, *Phys. Rev.*, p 881, 1951.
- (10) H. V. Cotton and J. R. Johler, Cosmic Radio Noise Intensities in the VHF Band, *Proc. IRE*, p 1,953, Sept. 1952.
- (11) C. G. Little and A. Maxwell, Fluctuations in Intensity of Radio Waves from Galactic Sources, *Phil. Mag.*, p 267, March 1951.
- (12) J. D. Kraus, Helical Beam Antennas, *ELECTRONICS*, p 109, April 1947.
- (13) J. D. Kraus, "Antennas," p 173, McGraw-Hill Book Co., Inc., New York, 1950.
- (14) J. H. Oort, Problems of Galactic Structure, *Astrophys. Jour.*, p 233, Sept. 1952.
- (15) W. W. Morgan, American Astronomers Report, *Sky and Telescope*, p 138, April 1952.
- (16) B. Y. Mills, Distribution of the Discrete Sources of Cosmic Radio Radiation, *Aust. Jour. Sci. Res.*, p 266, June 1952.
- (17) R. H. Dicke, Measurement of Thermal Radiation at Microwave Frequencies, *Rev. Sci. Inst.*, p 268, July 1946.
- (18) M. Ryle, A New Interferometer and its Application to the Observation of Weak Radio Stars, *Proc. Royal Soc., A*, p 351, 1952.

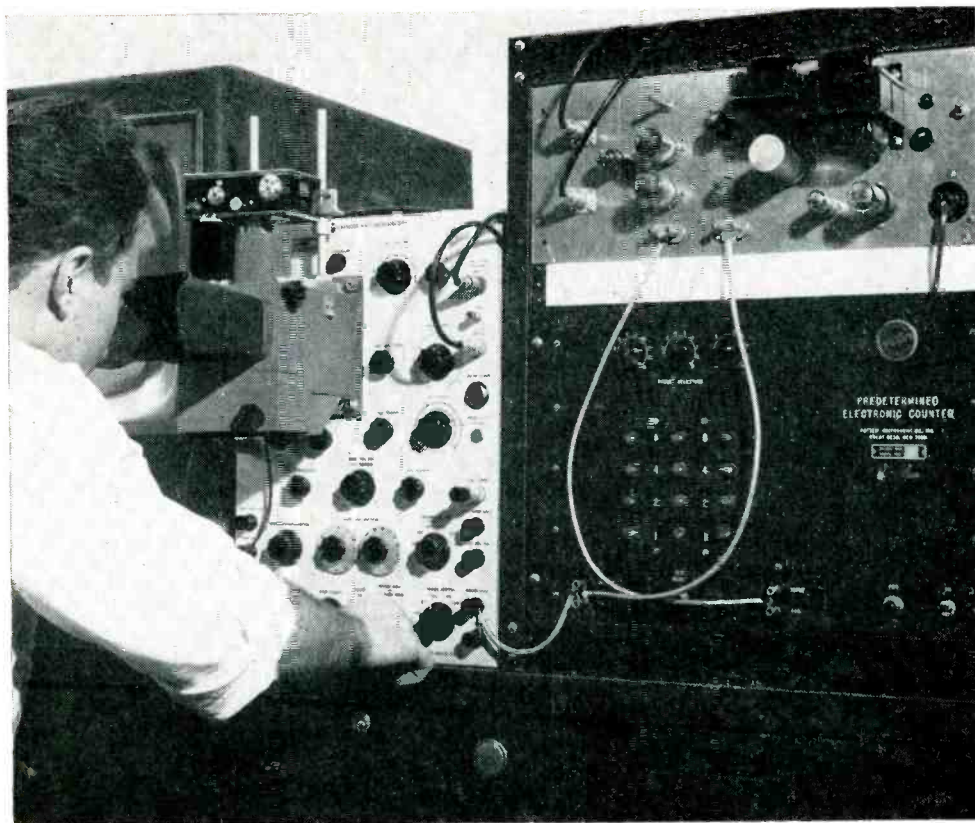

Waveform analyzing equipment comprises picture monitor, oscilloscope with recording camera, counter and line selector (upper right)

Line Selector Checks Television Waveforms

Oscillographic display of desired portion of waveform aids broadcasters in checking camera response, synchronizing signal and amplifier response. Digital counter provides stable adjustable delay for oscilloscope trigger at any integral number of scanning lines after the first vertical sync pulse of each frame

By **EDWARD M. BUYER**
*Chromatic Television Laboratories
New York, N. Y.*

STABLE WAVEFORM presentation is essential in analyzing a television system.

The television line selector permits study of the video waveform in any portion of the signal. The instrument is designed to operate

with a 525-line, 30-frame signal using standard driving pulses. Its range may be extended to off-the-air signals by any stable sync stripper that will deliver negative 4-volt sync signals into 75 ohms.

The video waveform is displayed

on a triggered crt-oscilloscope trace whose duration is variable from a few microseconds to 1,000 microseconds. To avoid superposition of unlike traces, only one sweep is permitted during each frame.

The line selector furnishes a

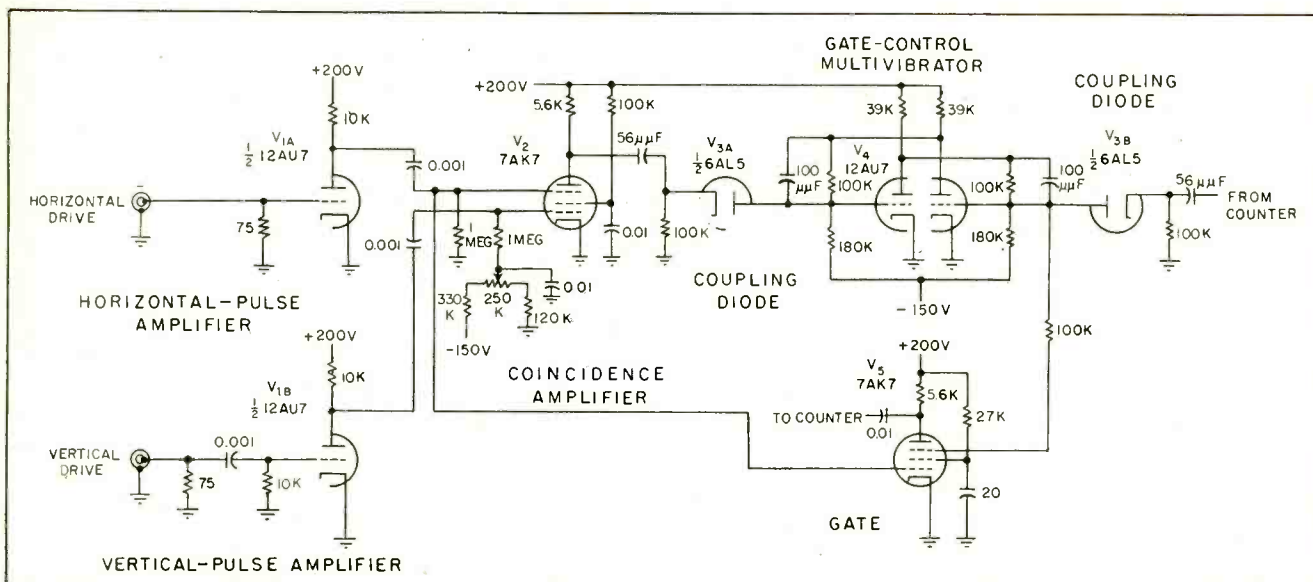

FIG. 1—Schematic of line selector. Coincidence circuit chooses first vertical pulse of each frame as reference. Digital counter provides time delay

trigger pulse to initiate the crt display. The pulse may be made to occur any integral number of scanning lines after the first vertical sync pulse in the frame. The duration of the display is governed by oscilloscope circuits. Any integral or fractional number of lines may be displayed.

A coincidence detector insures that the first vertical sync pulse is always used as the reference. This is done by selecting the vertical pulse whose leading edge coincides with a horizontal pulse. The long (usually 670 μ sec) vertical pulse is differentiated to less than one-half a scanning line to avoid coincidence between the second vertical pulse of a frame and the horizontal sync pulse following it.

Design

The delay unit of the line selector comprises a digital counter and associated circuits. The digital counter is used because it provides delay stability independent of delay time and almost as good as H-pulse stability. The delay time is measured in an integral number of scanning lines. The counter is capable of resetting in less than the duration of one line; examination of every line in the picture is possible. Delay stability is achieved without critical timing components, elaborate shielding or filtering.

The television line selector is shown schematically in Fig. 1. Negative driving pulses are amplified and inverted by V_{1A} and V_{1B} . The vertical pulse is differentiated by the 10-microsecond input-coupling circuit.

Circuit Details

Pentode V_2 is cut off by d-c restorer action of its suppressor grid in parallel with the control grid of V_5 and by fixed bias on its own control grid until coincident positive pulses cause plate current to flow. The resultant negative plate pulse triggers bistable multivibrator V_4 through coupling diode V_{3A} . The diode improves the stability of the system by isolating the trigger source from the multivibrator after the regenerative switching action is initiated.

The negative trigger at the left-hand grid of V_4 drives the other grid to zero potential. The suppressor grid of V_5 is connected through an isolating resistor to this grid of V_4 and is also driven to zero. This opens gate V_5 and the horizontal pulses at its control grid, clamped by d-c restorer action, are amplified and fed to the counter. When the count reaches a predetermined number, the counter emits an output pulse that triggers the oscilloscope sweep. This pulse is also coupled through diode V_{3B} and

triggers V_4 to shut gate V_5 . The flow of horizontal pulses ceases until the next vertical pulse opens the gate.

The line selector counter, oscilloscope, camera and picture monitor are shown in the photograph.

The oscilloscope generates a positive square wave of the same duration as the sweep. This square wave can be added to the video input of a monitor to brighten the area of the tv picture displayed on the oscilloscope.

Operation

To display the video waveform in a specific area of the picture, the video signal is applied to the oscilloscope and the counter controls adjusted until the brightened trace on the monitor overlays the area of interest.

To select a given line, assigning zero to the line coincident with the

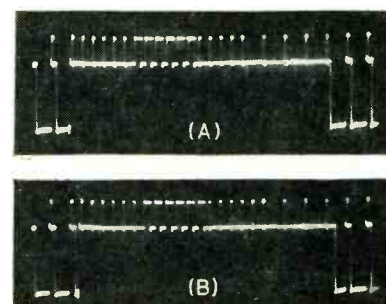

FIG. 2—Output of monochrome sync generator at start of first field (A) and second field (B)

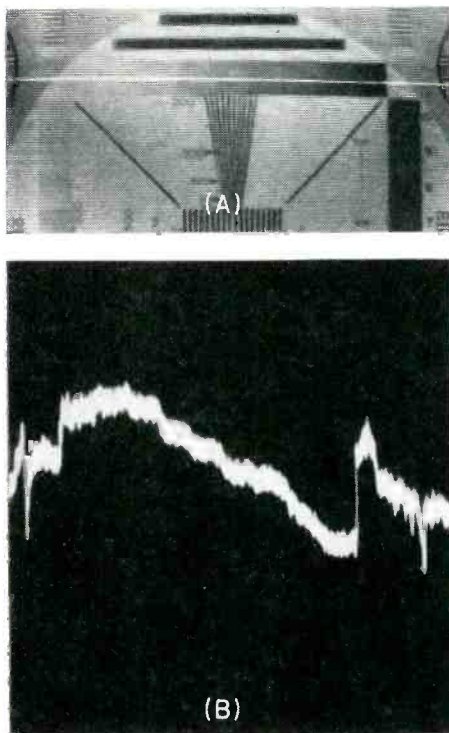

FIG. 3—Output of flying-spot scanner on line through grey scale of RTMA 600-line test pattern

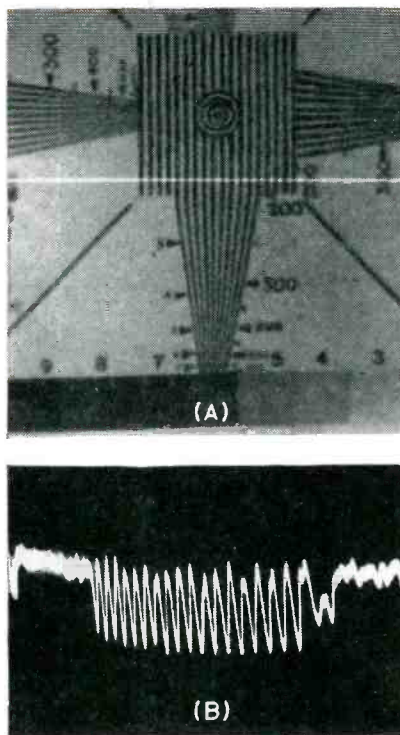

FIG. 4—Two-hundred-line waveform. Double dip following wedge is caused by scanning through numeral "zero"

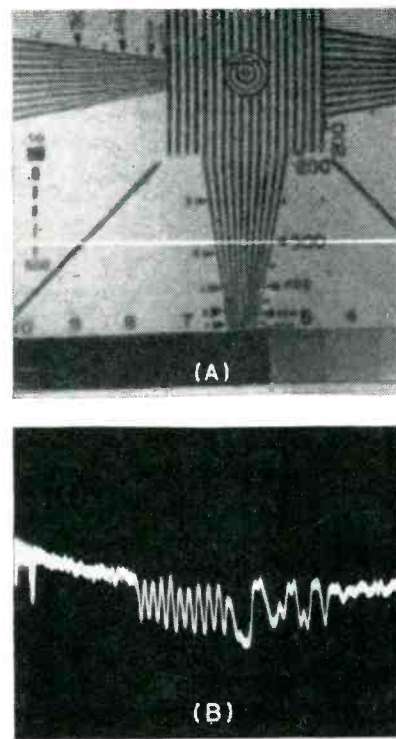

FIG. 5—Waveform at 300-line marker. Note dips following wedge due to marker and numeral "300"

vertical pulse, the desired number is set up on the counter selector switches. If it is desired to trigger the oscilloscope shortly before the vertical pulse of the second field, the counter is set to 262. The trigger occurs one-half line before the vertical pulse.

Start of Frame

At settings zero and 525, the vertical trigger and the counter output pulse are very close in time. The line selector operates satisfactorily even here.

When the counter is set to zero, it fires on the first input pulse. Since the counter output pulse follows the coincidence pulse by approximately 3 microseconds, the inherent delay of the counter, it is unable to trigger V_1 , which has a recovery time considerably longer than 3 times the pulse separation. Thus the gate remains open and a second horizontal pulse is fed to the counter. The resultant output pulse is again fed to V_1 . Since sufficient time has elapsed to allow recovery from the vertical trigger, switching occurs and the gate closes.

Therefore at a setting of zero, counter output pulses occur at the 0th and 1st pulse, and assuming that the oscilloscope is adjusted to give a sweep duration longer than one line, it will trigger on only the 0th pulse.

At the 525 setting, the second vertical pulse is applied to V_1 before the counter pulse arrives, but since the gate is already open, no switching occurs. Consequently, V_1 can be triggered at the counter pulse. At settings of 525 and over, the output trigger rate drops to 15 cps, or half the vertical trigger rate.

Applications

Figure 2A shows the output of a black-and-white sync generator with the counter set to zero and the sweep duration to 1,000 microseconds. Figure 2B shows the beginning of the second field. The counter is set at 260 and the half-line timing of the vertical pedestal is clearly observed. By setting the counter at 523 and 785, the beginning of the third and fourth fields respectively can be viewed. By varying the counter setting and the sweep duration, any desired char-

acteristic of any portion of the synchronizing waveform may be examined in detail.

Grey Scale

The output of a flying-spot scanner on a line through the grey scale of the RTMA 600-line test pattern is shown in Fig. 3B. The area under observation is shown as a bright line in 3A.

Figure 4B shows the scanner output at the 200-line portion of resolution wedge. The corresponding monitor picture is shown in 4A. The 300 line wedge is shown in Fig. 5A and B. The oscilloscope's sweep expander has been used to delay the sweep and spread out the wedge portion of the scanning line.

The author wishes to acknowledge the assistance of R. Dressler of Chromatic Television Laboratories, and L. Staschorer, formerly with Chromatic. Their suggestions and criticisms were invaluable during this development.

BIBLIOGRAPHY

RTMA, "Recommended Synchronizing Generator Waveforms", Jan. 1946, revised Oct. 1946.
J. Fisher, Television Picture Line Selector, *ELECTRONICS*, p. 140, March 1952.

TRANSISTORS: Theory and Application

Equivalent Transistor

Part VII

By ABRAHAM COBLENZ and HARRY L. OWENS

Signal Corps Engineering Laboratory
Fort Monmouth, New Jersey

IN PREVIOUS articles of this series the physics of the transistor was discussed to establish a theoretical foundation for a full understanding of transistor electronics. Subsequent articles will discuss circuit behavior of the transistor and show how the physical principles can be used to explain operation of existing circuits and assist in the design of new circuits.

Black Box

In electrical engineering, and more particularly in electronics, it is frequently convenient to analyze the performance of an unfamiliar circuit or electronic device in terms of equivalent fundamental circuit elements. The unfamiliar device is regarded as a black box with input and output terminals. The challenge is to determine what is in the black box, electrically speaking, without opening it.

Frequently, having access to the inside of the device does not provide the equivalent electrical circuit desired. This is especially true of transistors. The transistor is essentially a four-pole or four-terminal electrical device, the base acting as the common terminal for both input and output. The analysis of such four-pole black boxes is fairly standard but will be discussed in some detail to show its application to the transistor.

The process essentially consists of applying an input to either the left or right-hand pair of terminals and then measuring voltages and currents in the manner to be described below. Essentials of the

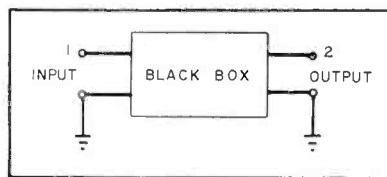

FIG. 1—Elementary generalized electrical network is readily applied to transistors

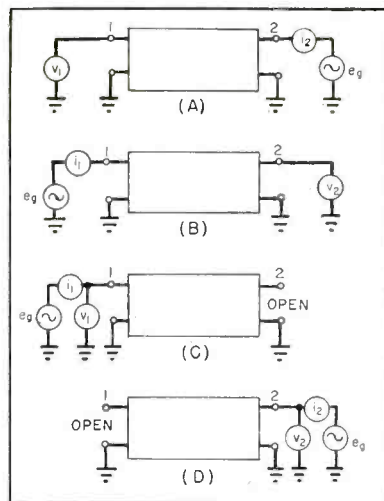

FIG. 2—Circuit hookups for measuring r_{12} (A); r_{21} (B); r_{11} (C) and r_{22} (D)

arrangement are shown in Fig. 1. In all cases the voltages are measured with a very-high-impedance voltmeter which may be considered for all practical purposes as an open circuit. Terminals 1 and 2 are identified by convention to correspond to the input and output terminals as shown.

The resistance obtained by measuring a voltage and current, is denoted by two numbers in its subscript, the first referring to voltage and the second to current. For instance, r_{12} is the resistance obtained by dividing the voltage be-

tween terminal 1 and ground by the current in circuit 2. See Fig. 2A. This implies that the test voltage e_0 is applied to terminal 2 since the current in circuit 1 is only that drawn by the voltmeter and can be ignored. Similarly, r_{21} is the resistance obtained by applying the test voltage e_0 to circuit 1, since the current is measured in 1, and measuring the open-circuit voltage in circuit 2; see Fig. 2B. The meanings of r_{11} and r_{22} are shown in Fig. 2C and 2D.

In the transistor work to follow, small letters refer to parameters which characterize the device itself or are intrinsic in the device; capital letters refer to externally added components. Thus, the internal resistance associated with the generator e_0 is designated by R_0 .

It should be remembered that ratios obtained by dividing observed voltages by observed currents in transistors are truly in the nature of impedances and not resistances. However, because in many instances, the reactive component of the impedance is negligible compared to the resistive component, and because using resistance notation simplifies introductory presentation of essential points, the resistance notation will be used.

Active Networks

The four basic tests generally used in comparing transistors are listed in Table I. To obtain a black-box equivalent it is necessary to find a combination of basic components that will give the same meter indications as a transistor in

Circuits and Equations

Relationships between transistor parameters, circuit elements and performance are derived using T equivalent and applying Kirchhoff's mesh equations. Input and output resistances are explained and expressions for voltage gains derived

these tests. Actually, there are many possible arrangements but the simplest is the T arrangement of resistors shown in Fig. 3. A voltage applied to terminal 1 will give a current reading in circuit 1 (the emitter circuit) corresponding to r_{11} of test 1, and similarly for all the other resistances (test 3).

The equivalent T fulfills the requirements with one important exception. In test 2 the signal is applied to the emitter, the emitter current recorded and the voltage from terminal 2 to ground measured. Since a very-high-impedance voltmeter is being used to measure the voltage between terminal 2 and ground, the drop across r_c can be ignored and v_2 is essentially the voltage from point *J* of Fig. 3, to ground. Then v_2 and i_1 measure the voltage and current respectively for r_b and the r_{21} of Eq. 2 is r_b .

In test 4 the voltage is applied to terminal 2 and the current in the collector circuit measured. The high-resistance voltmeter which records v_1 is, as before, actually recording the voltage from point *J* to ground so the voltage across r_b and the current through it are being measured. The quotient is the r_{12} of Eq. 4 and is again seen to be r_b . However, in practice r_{12} is very significantly different from r_{21} , whereas for the simple equivalent T of transistors it should be the same.

The discrepancy lies in the fact that the transistor is not simply a passive device and thus cannot be represented by a network of passive components. For a passive network r_{21} (sometimes called the forward transfer resistance for a

four pole network) is always equal to the r_{12} (usually referred to as the feedback resistance). Since, in the case of the transistor, the forward and feedback resistances are very definitely unequal (and this is always true) the transistor is not representable by such a network.

An active network is characterized by the fact that it contains a power source or generator capable of amplifying the input signal or contributing from within itself to the amplitude of the input. An excellent example is the vacuum tube for which the active aspect of its behavior is represented on its equivalent diagram by a generator of voltage output μe_g .

On this basis an equivalent circuit for the transistor must contain a generator or voltage source of some kind. This equivalent generator is indicated by $r_m i_e$ in the equivalent circuit of Fig. 4. The r_m is called the mutual resistance for the network.

Current indicated by i_e is the current through the emitter resistance r_e and is not necessarily the loop current in circuit 1. The following important relations may be derived from Eq. 1, 2, 3 and 4 (Table I) and Fig. 4.

$$r_{11} = r_e + r_b \quad (5)$$

$$r_{12} = r_b \quad (6)$$

$$r_{21} = r_m + r_b \quad (7)$$

$$r_{22} = r_c + r_b \quad (8)$$

Equation 7 is not immediately

Table I—Tests Used to Evaluate Basic Transistor Parameters

Test 1 — Apply signal to terminal 1 (emitter); read i_1 and v_1 (Fig. 2C) and obtain	$v_1/i_1 = r_{11}$ (1)
For both point-contact and junction transistors this value will usually be of the order of 500 ohms.	
Test 2 — Apply signal to terminal 1; read i_1 and v_2 (Fig. 2B) and obtain	$v_2/i_1 = r_{21}$ (2)
For point-contact transistors this may be of the order of 30,000 ohms and for junction types one megohm and higher.	
Test 3 — Apply signal to terminal 2 (collector); read i_2 and v_2 (Fig. 2D) and obtain	$v_2/i_2 = r_{22}$ (3)
For point-contact types this may be of the order of 20,000 ohms and for junction types 1 megohm or higher.	
Test 4 — Apply signal to terminal 2; read i_2 and v_1 (Fig. 2A) and obtain	$v_1/i_2 = r_{12}$ (4)
For point-contact and junction types this is usually of the order of 300 ohms	

apparent until the circuit equation involving these parameters is written.

Transistor Equivalent

Figure 5 shows the equivalent circuit of the transistor. Terminals available for connection are marked E , C and the base. For completeness a generator is shown in loop 1 whose output voltage is e_g and whose internal resistance is R_g , and a load is shown R_L .

Before proceeding to a more detailed analysis of this circuit, a number of important preliminary comments of a general nature should be made. Without the following precautionary notes the analysis of Fig. 5 may be confusing:

(1) The resistances indicated as r_e , r_b , r_c and r_m in the figure should for extreme accuracy, be shown as impedances. In the tests for the four-pole parameters a-c is used and the ratio of an a-c voltage to an a-c current is an impedance so that actually the tests outlined in Eq. 1 through 4 (Table I) do give impedances. However, these impedances are valid only at the test frequency. Usually this frequency is 270 cps.

(2) It should further be realized that the transistor is a biased device. Just as the vacuum tube is biased to a definite operating point by a battery or suitable cathode resistor for a given plate voltage, so the transistor must be biased to a suitable operating point by appropriate emitter and collector biasing potentials.

These are omitted for convenience in circuit analysis.

A shunt-feed bias arrangement such as shown by dashed lines in Fig. 5 may be assumed. In cases where the shunting effect of the d-c biasing arrangement is not negligible, a simple series-feed arrangement may be used and the effect of the series resistance introduced by the battery considered already lumped into the values of R_L and R_g shown.

(3) The i_e shown for the equivalent generator refers to the current flowing through the emitter resistance r_e . In Fig. 5, i and i_1 are identical but this is not always the case.

Table II—Rules for Current Direction and Polarities in Writing Mesh Equations

(A) Current direction is taken as the direction of the flow of electrons.
(B) The head of an arrow used to indicate direction of current flow is taken as positive when considering the voltage drop.
(C) When writing equations expressing Kirchhoff's Law that the sum of the voltage drops and rises around a closed loop is zero, all terms are written on one side of the equation. See for example Eq. 9.
(D) By convention, voltage drops are assigned a plus sign; a generator or source voltage, referred to as a voltage rise, is given a minus sign.
(E) The currents considered in Fig. 5 flow separately in their respective loops. In circuit elements where both flow, the principle of superposition is applied; that is, the currents add algebraically.
(F) The current i_e in the equivalent transistor generator $r_m i_e$ is defined as the current through the emitter resistance r_e when this current flows toward the junction J . For instance, in Fig. 5 the current through r_e is clearly i_1 and i_1 flows toward J . Thus $i_e = i_1$. Occasionally the direction of i_1 is assumed opposite to that shown in Fig. 5 in which case i_e would be the negative of i_1 .

In some circuits emitter current is not the same as the current through loop 1.

(4) A consistent convention must be adopted regarding the polarities of the generators in Fig. 5. The polarity convention to be used in these articles is that at a given instant of time the negative end of the equivalent generator $r_m i_e$ is toward the junction point J . In consonance with this, the negative terminal of the generator e_g goes to ground, as shown in the figure. This convention will assist materially in obtaining consistent results in the analysis of this and future circuits.

(5) In Figure 5 the base of the transistor is grounded and common to the input and output loops. Grounded emitter and grounded collector circuits will be discussed later, but discussion in this article will be limited to the grounded-base connection unless specifically indicated otherwise. In particular, Eq. 5 through 8 are valid only for the grounded-base connection.

(6) In writing the mesh or Kirchhoff-law equations for the analysis of Fig. 5, it is convenient to apply the rules listed in Table II to specify current direction and polarities insofar as they affect the signs of the terms in the equations.

In the actual analysis the r values for a given transistor are assumed to be known, R_g is also known and the load resistance R_L is

either known or assigned according to design requirements. A suitable voltage e_g is applied to the transistor. It would be convenient to know without actually hooking up each transistor under a variety of different conditions how the circuit will perform; that is, what will be the input resistance, the output resistance, the voltage gain and the power gain. To obtain this information it is necessary first to find currents i_1 and i_2 . The problem reduces itself to finding the loop currents and obtaining from the currents the information of interest.

Loop Equations

To obtain the currents knowing the other parameters in Fig. 5, the procedure is to write down for each loop an expression of the fact that the sum of the voltage rises and voltage drops in a closed loop is zero. Beginning at the ground point at the extreme left of loop 1 and proceeding clockwise in the direction of the arrow, the voltage drops and rises are as follows:

Since e_g is a generator or voltage rise and since the current flows through it from minus to plus, by rule D (Table II), e_g will be assigned a minus sign. Across R_g and r_e are two simple voltage drops which are given a positive sign also according to rule D . Both i_1 and i_2 flow through r_b and in the same direction and voltage drops due to i_1

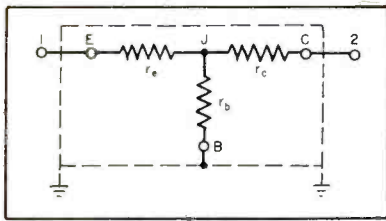

FIG. 3—Passive representation of transistor is only rough approximation of device

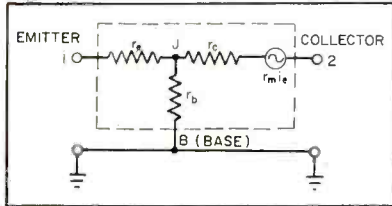

FIG. 4—More accurate active circuit representation of transistor includes generator $r_m i_e$ in collector loop

and i_2 are additive. Thus

$$i_1 (R_g + r_e + r_b) + i_2 r_b - e_g = 0 \quad (9)$$

In loop 2 starting at the ground point on the extreme right and proceeding around the loop in the direction of the current, the $i_2 R_L$ drop is given a positive sign. Since i_2 flows from plus to minus through $r_m i_e$, the equivalent transistor generator, a positive sign (rule D) is assigned to the generator voltage. By rule F (Table II) $i_e = i_1$ and the transistor generator can now be written $r_m i_1$ instead of $r_m i_e$. Across r_c the voltage drop is $r_c i_2$. Again the drop in r_b is $r_b (i_1 + i_2)$. The expression which shows that the sum of the voltage drops and voltage rises in loop 2 is zero is

$$i_1 (r_b + r_m) + i_2 (R_L + r_b + r_c) = 0 \quad (10)$$

Equations 9 and 10 completely define or describe the circuit of Fig. 5 for a-c voltages and currents. This analysis does not, however, give information regarding noise,

distributed capacitance, frequency response or any of the parameters such as lifetime and density of carriers which describe the transistor material itself. The equations will provide information regarding resistances, voltage and current gains, power gain and the stability of the circuit.

The solution of linear simultaneous Eq. 9 and 10 for the currents reveals the following

$$i_1 = \frac{e_g (R_L + r_b + r_c)}{[(R_g + r_b + r_c) (R_L + r_b + r_c) - r_b (r_b + r_m)]} \quad (11)$$

$$i_2 = \frac{-e_g (r_b + r_m)}{[(R_g + r_b + r_c) (R_L + r_b + r_c) - r_b (r_b + r_m)]} \quad (12)$$

These expressions give currents i_1 and i_2 in terms of the circuit parameters which, for a given transistor and circuit, are known. Henceforth it is possible to treat i_1 and i_2 as known quantities and express the circuit characteristics desired in terms of the currents as well as the circuit parameters.

Table III lists typical values for both transistor types.

Input Resistance

In Fig. 5 the arrows at A and B indicate the circuit condition seen by a generator such as e_g when the generator is connected from emitter to ground. The effect of the transistor and all the rest of the circuit to the right of points A and B might, if desired, be replaced by a single resistance whose effect (in so far as the generator is concerned) will be the same as the system now shown. This equivalent resistance seen by the generator or the input resistance is sometimes called the driving-point resistance.

Figure 6A indicates how R_i , the

internal resistance, replaces the effect of the circuit to the right of points A and B while current i_1 remains the same. Thus dividing e_g by i_1 gives the total resistance in the circuit of Fig. 6A. Subtracting R_g , the internal resistance of the generator, from this value gives the input resistance R_i . That is

$$R_i = \frac{e_g}{i_1} - R_g \quad (13)$$

Since i_1 is defined by Eq. 11, it is possible to obtain the input resistance as a function of the circuit parameters by the expression

$$R_i = r_b + r_e - \frac{r_b (r_b + r_m)}{R_L + r_b + r_c} \quad (14)$$

This equation expresses the input resistance of a grounded-base transistor in terms of the circuit parameters, and by studying this expression, a number of useful bits of information will become apparent. Note first the negative sign before the third term on the right-hand side. Since the circuit parameters of a transistor or its equivalent active T parameters are positive numbers, a combination of parameters may occur in Eq. 14 which will make R_i negative. This circumstance leads to particular application of transistors in electronic switching arrangements where the negative input resistance is intentional. Where it is unintentional, instability and parasitic oscillations occur. These points will be covered more fully in a subsequent article of this series.

Using the typical values given in Table III, the input resistance for a point-contact unit will be very nearly 120 ohms, and for a junction unit very nearly 90 ohms. This brings to light immediately the im-

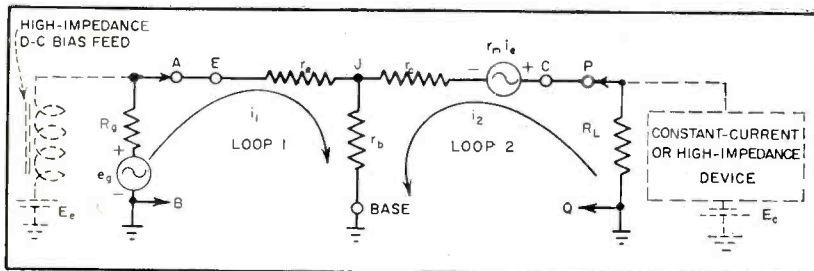

FIG. 5—Equivalent T of transistor, with suitable load and generator. Bias supplies (shown dashed) indicate that shunting effect of voltage source is considered negligible, or already lumped into R_g and R_L . Typical parameters are shown in Table III

Table III—Typical Transistor Parameters Used

	Point Contact	Junction
r_e	150 ohms	25 ohms
r_b	120 ohms	500 ohms
r_m	35 kilohms	0.96 meg
r_c	15 kilohms	1.0 meg
R_g	500 ohms	500 ohms
R_L	20 kilohms	100 kilohms
Alpha	2.3	0.96
e_g	0.01 volt	0.001 volt

portant fact that the transistor in the grounded-base connection is a low-input-impedance device.

Looking at Table III and Eq. 14 a useful simplification of Eq. 14 is obtained by reasoning as follows: in general, in electronics great precision in the specification of component parts is rarely necessary. It is possible to ignore r_b , whose value is 120 ohms for the point-contact unit compared to r_m which is 35,000 ohms. This is doubly true for the junction unit where $r_b = 500$ ohms and $r_m = 0.96$ megohms. Similarly, in the denominator of the third term right-hand side r_b is negligible compared to $(R_L + r_c)$ both for the point-contact and junction units and a simplified but practical form of Eq. 14 which will be used in subsequent analyses is

$$R_i = r_b + r_e - \frac{r_b r_m}{R_L + r_c} \quad (15)$$

Short-Circuit Stability

The grounded-base transistor is operated sometimes intentionally, and sometimes not, with the output shorted. With R_i of Fig. 5 virtually shorted ($R_L = 0$), Eq. 15 becomes

$$R_i = r_b + r_e - \frac{r_b r_m}{r_c} \quad (16)$$

In transistor practice a parameter somewhat analogous to the g_m of a vacuum tube is alpha. A formal definition for alpha will be given later but in equation form it is defined by

$$\alpha = \frac{r_b + r_m}{r_b + r_c} = \frac{r_{21}}{r_{22}} = - \frac{i_c}{i_e} \quad (17)$$

Again ignoring r_b since it is small compared to r_m and r_c both in point contact and junction transistors, alpha becomes

$$\alpha = \frac{r_m}{r_c} \quad (18)$$

Combining Eq. 18 and 16

$$R_i = r_b + r_e - r_b \alpha \quad (19)$$

As Table III shows alpha of point-contact transistors is about 2.3 on the average, and r_b is of the same order of magnitude as r_e . The input resistance may be negative for a point-contact transistor connected grounded-base if the output is shorted. Thus the point-contact transistor is in general short-circuit unstable. (Some point-contact

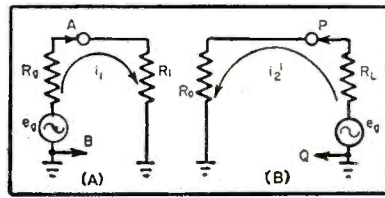

FIG. 6—Resistance R_i is equivalent to all of circuit (A) to right of points A and B; Resistance R_o replaces circuit to left of P and Q in (B)

transistors with very low values of r_b have been developed which are short-circuit stable.)

For the junction transistor where alpha is always less than unity, R_i (Eq. 19) is always positive. The possibility of short-circuit instability in the point-contact unit contrasts sharply therefore with the uniform stability of the junction unit under comparable conditions. This consideration of short-circuit stability will frequently decide unequivocally which type of transistor to use in a given application. A test for short-circuit stability will be discussed in a subsequent article on transistors for switching applications.

Output Resistance

To obtain the output resistance, which is the resistance presented at points P and Q of Fig. 5 to a load R_L , use is made of an artifice which will be useful in many other applications. As shown in Fig. 7 generator e_g has been placed in series with R_L and the generator resistance retained in the input circuit. It is now possible to determine what type of impedance a theoretical (zero internal resistance) generator e_g placed in the circuit as shown, would encounter. The resistance seen by the generator e_g , connected as in Fig. 7, less R_i , will be the output resistance. The circuit equations which describe Fig. 7 are identical with Eq. 9 and 10 except that now e_g will appear in loop 2. The equations are given below, i_1' and i_2' to denote the new currents

$$i_1' (R_g + r_e + r_b) + i_2' r_b = 0 \quad (20)$$

$$i_1' (r_b + r_m) + i_2' (R_L + r_b + r_c) - e_g = 0 \quad (21)$$

It is now necessary to solve these two equations for i_2' only, as can be seen from the equivalent circuit of Fig. 6B where the effect of all

that portion of the circuit of Fig. 5 to the left of point P and Q has been replaced by a single resistance R_o , which is the output resistance of the circuit. This yields

$$i_2' = \frac{+ e_g (R_g + r_e + r_b)}{[(R_g + r_b + r_e) (R_L + r_b + r_c) - r_b (r_b + r_m)]} \quad (22)$$

From Fig. 6B the output resistance R_o is the total resistance of the circuit less the load resistance R_L , or

$$R_o = \frac{e_g}{i_2'} - R_L \quad (23)$$

Using the value i_2' from Eq. 22

$$R_o = r_b + r_e - \frac{r_b (r_b + r_m)}{R_g + r_b + r_e} \quad (24)$$

Again ignoring r_b as negligible compared to r_m or r_e a simplified form of Eq. 24 is

$$R_o = r_e - \frac{r_b r_m}{R_g + r_b + r_e} \quad (25)$$

Using the values from Table III the output resistance of the grounded-base transistor is approximately 9,500 ohms for the point-contact and 530,000 for the junction types.

Thus the transistor in the grounded-base connection has a low input resistance, usually under 1,000 ohms, and an output resistance anywhere from a few thousand ohms to approximately a half megohm. Impedance-wise, the grounded-base transistor resembles a step-up transformer.

The negative sign in Eq. 24 suggests, as for the case of the input resistance, that a combination of parameters may be found for which R_o is negative. A negative output resistance will lead to instability or parasitic oscillations just as will a negative input resistance. From Eq. 24, very low values of input generator resistance R_g generally tend toward instability in transistor operation. The input and output resistance levels given for the ground-base connection do not apply to the grounded-emitter and grounded-collector connections.

Voltage Gain

In general, voltage gain is defined for any device as the ratio of output voltage to input voltage. In keeping with the rules regarding the polarity of voltage rises and voltage drops, formulated in the

first part of this article, it should be evident that if the input voltage which is a voltage rise is given a negative sign, the output voltage, which is a voltage drop across R_L , should be assigned a plus sign. In practice this is not so important so long as opposite signs are assigned to voltage drops and voltage rises. Observing that the effective voltage output is that available across the load resistance, the voltage gain is

$$VG = \frac{i_2 R_L}{e_o} \quad (26)$$

Knowing i_2 from Eq. 12, and substituting in Eq. 26.

$$VG = \frac{(r_b + r_m) R_L}{[(R_g + r_b + r_e)(R_L + r_b + r_e) - r_b(r_b + r_m)]} \quad (27)$$

Again ignoring r_b when added to r_e or r_m a simplified form of the expression for the voltage gain is obtained

$$VG = \frac{r_m R_L}{(R_g + r_b + r_e)(R_L + r_e) - r_b r_m} \quad (28)$$

Substituting from Table III numbers for the parameters it is easily verified that the voltage gain for a point-contact transistor is of the order of 30 and for a junction type, approximately 1,500.

Voltage gain depends directly on the value of R_L selected. In Table III the point-contact unit has actually been favored by selecting R_L greater than r_e while R_L is only 0.1 r_e for the junction. In practice, too high a value of load resistance is not practical due to stray capacitance. Having favored the point-contact unit in selecting the value of R_L , it should be evident that in general the junction transistor is capable of giving higher voltage gains than is the point-contact type.

Maximum Voltage Gain

It is often useful to know the maximum theoretically possible

voltage gain that may be obtained from a point-contact or junction transistor. To obtain these numbers, it is necessary to idealize the circuit arrangement by assuming an ideal generator, of zero internal resistance, and an ideal load, of infinite resistance. Without going into an extended proof, it is seen that if the internal generator resistance is zero, no voltage drop can occur across it; also, if the load resistance is infinite, all the available generator voltage will be developed across it.

Using Eq. 5 through 8 in Eq. 27

$$VG = \frac{r_{21} R_L}{(R_g + r_{11})(R_L + r_{22}) - r_{12} r_{21}} \quad (29)$$

Dividing numerator and denominator by R_L

$$VG = \frac{r_{21}}{(R_g + r_{11}) \left(1 + \frac{r_{22}}{R_L}\right) - \frac{r_{12} r_{21}}{R_L}} \quad (30)$$

Letting $R_g = 0$ and R_L approach infinity, the maximum theoretically possible voltage gain is

$$VG_{max} = \frac{r_{21}}{(0 + r_{11})(1 + 0) - 0} = \frac{r_{21}}{r_{11}} \quad (31)$$

Multiplying the numerator by $\frac{r_{22}}{r_{22}}$

$$VG_{max} = \frac{r_{21} \frac{r_{22}}{r_{22}}}{r_{11}} \quad (32)$$

and since from Eq. 17 alpha is

$$\frac{r_{21}}{r_{22}}$$

the maximum theoretical voltage gain becomes

$$VG_{max} = \alpha \frac{r_{22}}{r_{11}} \quad (33)$$

In considering the theory of operation of the point-contact transistor it was carefully pointed out that the voltage gain of the point-contact transistor is due both to a current gain and a resistance gain. In a previous analysis it has

been mentioned that alpha, which is defined by Eq. 17, is also the ratio of collector current to emitter current. Equation 33 shows that the maximum possible voltage gain from a transistor is the product of the current gain and the ratio of the collector-circuit resistance to the emitter-circuit resistance. From this equation the maximum theoretical voltage gain for the point-contact unit using the average values from Table III is

$$VG_{max} = 2.3 \times \frac{15,000}{270} = 128$$

For the junction-type transistor, using the values of Table III, the maximum theoretical voltage gain is 1,830. Thus the junction transistor is inherently capable of a much larger voltage gain than is the point-contact unit. The less-than-unity current gain of the junction type contrasted with the 2.3 for the point-contact is more than compensated for by the large ratio of collector to emitter resistance in the junction type. This fact leads to a preference for junction units as amplifiers at frequencies where junction transistor operation is feasible.

In summary, the following are the salient points of this article:

(1) Important information regarding the behavior of a transistor in a practical circuit is obtainable from a solution of the Kirchhoff equations describing the equivalent circuit of a transistor.

(2) A consistent set of rules must be used in applying the Kirchhoff Laws. These are given in Table II of this article.

(3) A great amount of information about the behavior of the circuit which represents a transistor is obtainable by finding: the input resistance, output resistance, voltage gain and power gain. (The power gain will be discussed in Part VIII of this series.)

(4) In the grounded-base connection the transistor has an input resistance usually less than 1,000 ohms and an output impedance from 5,000 to 500,000 ohms approximately.

(5) The junction transistor is inherently capable of a higher voltage gain than is the point-contact type transistor.

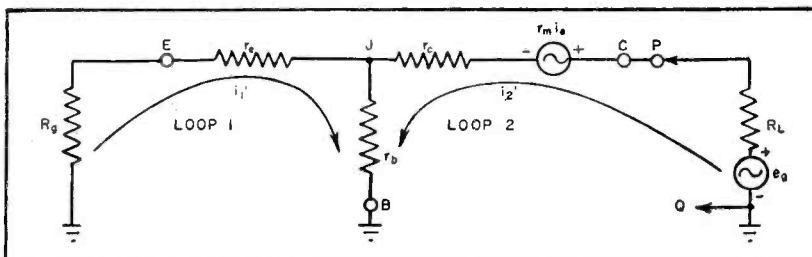

FIG. 7—To find R_o (see Fig. 6B) e_p potential is moved to loop 2. Currents flowing in loops differ from original conditions as explained in text

Three-Tone Oscillator

Separate Wien-bridge oscillators supply three components of A-minor chord used for hourly time signal. Frequency combination proves to be more pleasing and harmonious than single-frequency beep and provides unique station signature

PURPOSE of the time-signal oscillator is to provide a beep on the hour, when actuated by a synchronizing pulse from the Western Union clock circuit. A single-frequency oscillator had previously been employed, but a more pleasing and harmonious signal

was desired. Experiment revealed that the desired effect could be obtained by combining the outputs of three audio oscillators, whose frequencies were selected to correspond to a musical chord. This latter combination of frequencies was found to be more agreeable

than a single tone and has become a distinguishing feature of the station.

Note Combinations

Combinations of frequencies in the region of 1,000 cps were found to give the most pleasing sound.

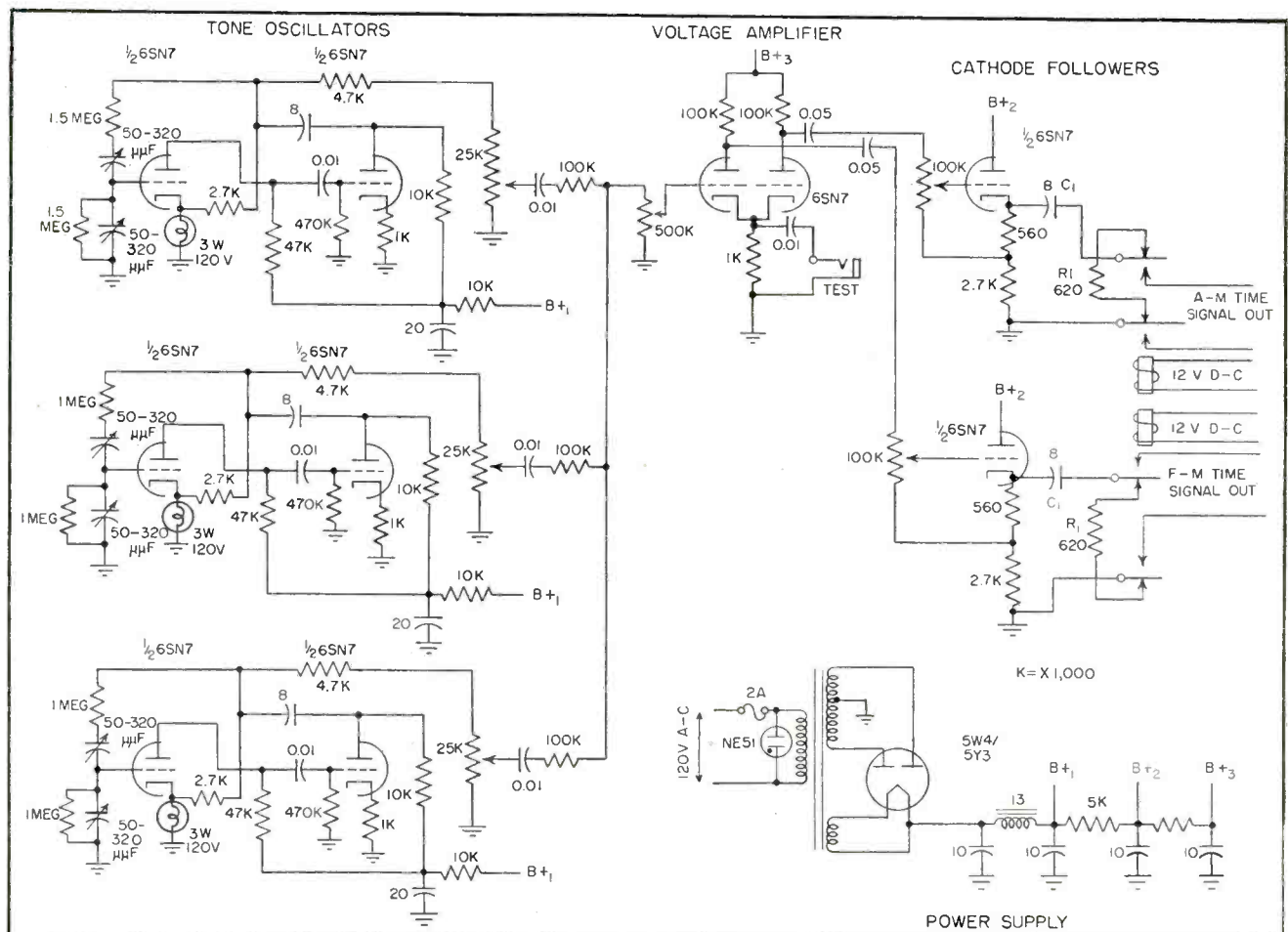

FIG. 1—Circuit schematic shows how three audio oscillators feed a-m and f-m transmitter inputs through cathode follower-voltage amplifier arrangement

Broadcasts Time Signal

By **SIDNEY FELDMAN**

WNYC
New York, N. Y.

The combination finally selected was based on an A-minor chord, using the frequencies A_5 (880 cps), C_6 (1,046.5 cps) and E_6 (1,318.5 cps)¹.

Audio Oscillators

The circuit schematic, Fig. 1, shows that each frequency is generated in a separate 6SN7, the two triode sections of which are connected as a Wien-bridge oscillator². The output of each oscillator then feeds into a separate 25,000-ohm potentiometer. The three potentiometers provide for mixing of the three tones in the desired relative proportions.

After the tones are mixed, the complex tone is amplified in a 6SN7 voltage amplifier. This stage in turn feeds the cathode-follower low-impedance line outputs. Two line outputs are provided: one to feed the a-m transmitter line, and the second to feed the f-m transmitter.

The two relays in the output circuit that feed the signal to the lines, operate on 12 volts d-c. The d-c actuating voltage is in turn controlled by the pulse from the synchronized clock circuit. When it is required to eliminate the beep, as must be done when a musical program runs over the hour, it is necessary only to interrupt the continuity of the relay circuit by opening the corresponding switch on the relay-control panel as shown in Fig. 2.

The relay-control panel is conveniently located near the master-control operating position. The power to the time-signal chassis is left on at all times to obviate any

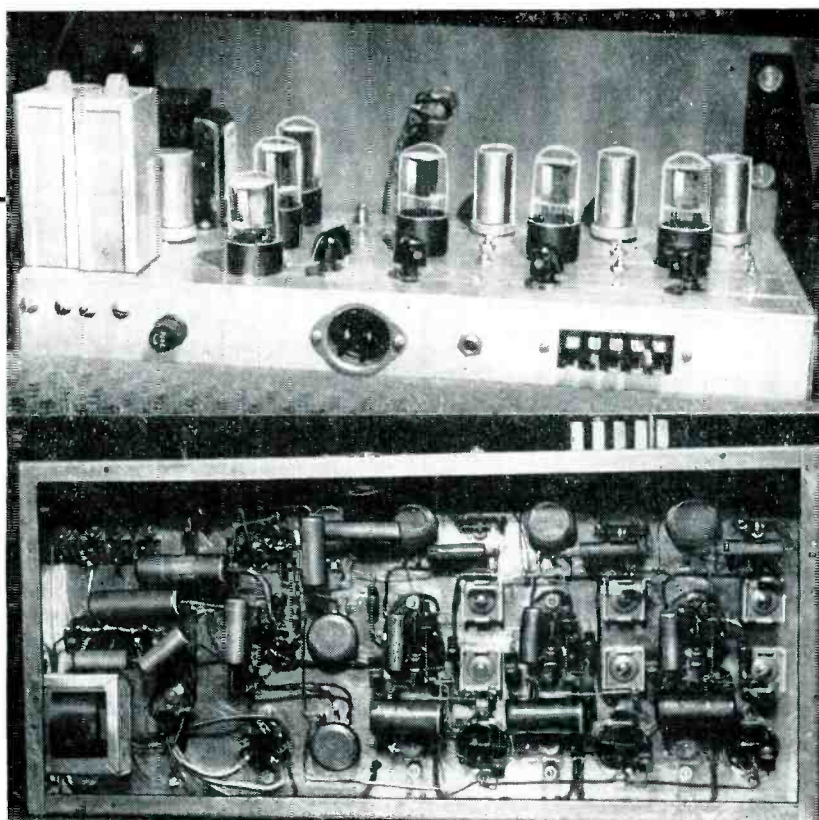

Rear panel and under-chassis views of time-signal oscillator

difficulty due to oscillator instability or drift.

Output Coupling

When the output stage is not feeding the line, it is necessary to load the output of the cathode follower with a 620-ohm resistor, R_1 . This load serves to keep constant the charge flowing through the cathode-follower output capacitor, C_1 , in either of the two positions of the output relay. If this load resistor is not provided, the sudden change in loading of the cathode

follower when the line relay is closed, produces a transient current surge through C_1 that in turn results in an audible "clunk" in the output circuit.

The harmonic distortion of each oscillator singly, as measured at the line-output terminals is approximately one percent at the normal line level of plus 8 dbm. This measurement was performed with a General Radio type-1932A noise and distortion set. Low distortion, combined with careful adjustment of the relative levels of each tone, results in a pleasant and clean sounding time signal.

Acknowledgement is made to James Merrell and Richard Oschmann, who performed most of the construction work on this project.

REFERENCES

- (1) H. F. Olson, "Musical Engineering", p. 29, McGraw-Hill Book Company, Inc., New York, 1952.
- (2) S. Seely, "Electron-Tube Circuits", p. 261, McGraw-Hill Book Company, Inc., New York, 1950.

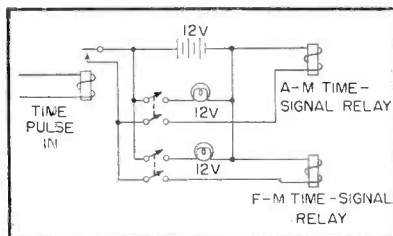

FIG. 2—Western Union time signal controls musical tone through relay system

Vibrating-Wire

Electrically driven vibrating wire fills the gap between 5 and 50 kc, where piezoelectric-crystal and tuning-fork resonators cannot be used, to obtain high-selectivity filtering or control of oscillator frequency. Tungsten wire in vacuum has Q of 1,840 at 2,210 cps

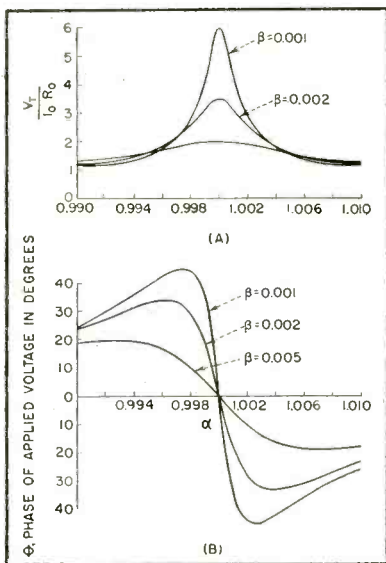

FIG. 1—Abscissa α is dimensionless frequency; β is damping ratio

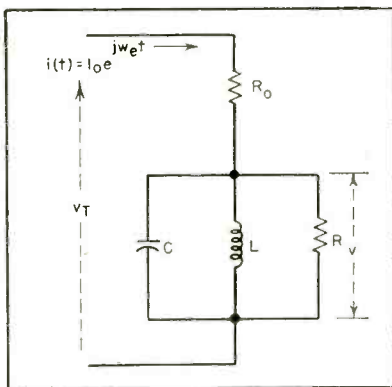

FIG. 2—Equivalent circuit of vibrating wire in magnetic field

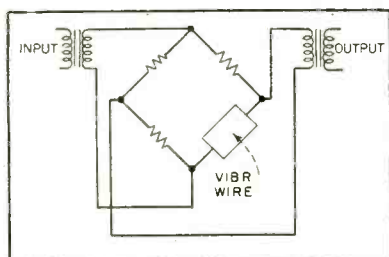

FIG. 3—Narrow-pass filter employs vibrating-wire

BETWEEN 5 and 50 kc, the upper and lower limits for the application of tuning-forks and crystal resonators, respectively, there is a range for which no high- Q resonant elements are generally available. It is the purpose of this paper to describe an element that fills this need. This element is the electrically driven vibrating wire.

A string or wire that is tensioned between fixed supports exhibits resonant characteristics. When such a wire is subjected to a transverse cyclic driving force, the displacement of the wire from its at-rest position rises sharply to a maximum at a specific driving frequency. The frequency at which this resonance occurs is determined by the mass-per-unit-length, the length of the wire and the applied tension.

The Q -value of such resonators can be very high since it depends primarily upon the air damping on the wire.

A particularly convenient way of driving the wire is to pass an alternating current of appropriate frequency through it while it is subjected to a strong transverse magnetic field. The reaction between the current and the magnetic field causes the wire to vibrate and to generate a counter-emf along its length. When the frequency of the driving current coincides with the resonant frequency of the wire, the counter-emf rises to a maximum. This change in emf causes the impedance presented to the current source to exhibit resonant characteristics.

A number of such vibrating-wire units have been constructed and used as controlling elements in

filter, discriminator and oscillator circuits. The basic structure used is illustrated. The wire, which is high-tensile-strength, nonmagnetic material, is stretched between two points. The magnet provides a strong field across the wire. Connecting leads are brought to terminals that are made part of a sealed protective case. Temperature compensation is inherent in the design and has proved adequate.

In those applications where a variation of the resonant frequency is desired, the basic construction takes a slightly different form. A calibrated tuning knob, actuating a spring-loaded lever system through a fine-pitch screw, changes the tension and thus the frequency of the wire. Units based on this principle have been constructed to cover a frequency range of 4 to 1.

Equations of Motion

To appraise the properties of a vibrating-wire element, it is necessary to obtain expressions for its motion in the magnetic field and for the motional impedance appearing across its terminals.

In examining the characteristics of a vibrating wire, the mode of the vibration must be specified. Depending upon the method of excitation, the wire may assume a number of spatial configurations. In most instances, a sinusoidal shape may be safely assumed. The number of nodes is expressed by the mode number, n . If x is the distance along the undisplaced wire and l is the wire length, we can write the expression for the transverse displacement of the wire as

$$y(x, t) = G(t) \sin(n\pi x/l) \quad (1)$$

The magnetic field along the wire

High-Q Resonator

By **ARTHUR W. DICKSON** and **WILLIAM P. MURDEN**

Southwest Research Institute
San Antonio, Texas

will normally have its maximum near the center and decrease toward the ends. For purposes of calculation, it is therefore feasible to assume a sinusoidal field distribution. The flux density will then be

$$B(x) = B_o \sin(n\pi x/l) \quad (2)$$

where B_o is the maximum flux density.

The driving current will normally be a sinusoidal function and is assumed to have a constant amplitude. If the displacement is small, the forces acting on an element of wire can be summed and the equation of wire motion written

$$F \frac{\delta^2 y}{\delta x^2} - \lambda \frac{\delta^2 y}{\delta t^2} - 2k\lambda \frac{\delta y}{\delta t} = -I_o B_o \sin(n\pi x/l) \exp j\omega_e t \quad (3)$$

where y is displacement of an element of the wire; x , distance of an element of the wire from one support; λ , unit mass of the wire; F , tension applied to the wire; k , damping factor; I_o , peak driving current; B_o , peak flux density; ω_e , angular frequency of the driving current; and l is wire length.

When the displacement of the wire is expressed by Eq. 1, the solution for the equation of motion is

$$y(x, t) = \frac{I_o B_o \sin(n\pi x/l)}{\lambda \sqrt{(n^2 \omega_o^2 - \omega_e^2)^2 + (2k\omega_e)^2}} \exp j(\omega_e t - \theta) \quad (4)$$

$$\theta = \arctan 2k\omega_e / (n^2 \omega_o^2 - \omega_e^2) \quad (5)$$

where

$$\omega_o = \frac{\pi}{l} \sqrt{\frac{F}{\lambda}} = \text{natural angular frequency}$$

$$n = \text{mode number}$$

By writing the expression for the voltage induced in an element in terms of the time derivative of displacement and integrating over the

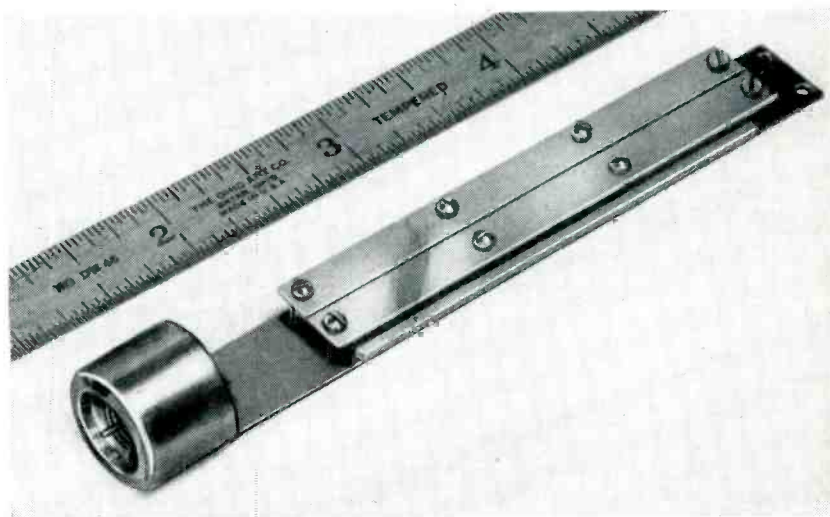

Fixed-frequency vibrating-wire element for 1,000 cps removed from protective case

length of the wire, the expression for the total induced voltage can be obtained.

$$v(t) = \frac{j\omega_e I_o B_o^2 l}{2\lambda \sqrt{(n^2 \omega_o^2 - \omega_e^2)^2 + (2k\omega_e)^2}} \exp j(\omega_e t - \theta) \quad (6)$$

Equations 4 and 6 show that both the displacement and induced voltage reach maxima for specific values of ω_e . These resonances do not occur at precisely the same frequency, however. The expressions for the mechanical and electrical resonant frequencies, as obtained by maximizing Eq. 4 and 6, are

$$\omega_{RM} = (n^2 \omega_o^2 - 2k^2)^{1/2} \quad (7)$$

$$\omega_{RE} = n\omega_o \quad (8)$$

These equations show that, although the mechanical resonant frequency is lowered by damping, the electrical resonant frequency is equal to the natural frequency of the wire, regardless of damping.

The voltage across the wire is low on both sides of resonance, and, as the frequency of exciting cur-

rent varies, the voltage changes in the manner characteristic of parallel systems having two energy-storage elements. If the phase and magnitude of the applied voltage, that is, the induced voltage plus the iR_o drop across the wire's d-c resistance, are plotted versus frequency, the conventional resonant curves are obtained. Figure 1 shows a set of dimensionless curves that may be obtained from the equation.

In the foregoing analysis, there has been no consideration of the internal elastic properties of the wire itself. As long as the curvature of the wire is small, that is, if the amplitude of vibration is small and the tension is high, wire stiffness can be neglected. For short wires subjected to low tension, however, stiffness often plays a considerable part in determining the resonant frequency.

When the equation of motion in-

cludes a force term to account for the stiffness, the motional impedance of the wire is unaltered, but the expressions for resonant frequency are changed considerably. The resonant frequencies, considering stiffness, are

$$\omega_{RM} = (q^2 n^2 \omega_o^2 - 2k^2)^{1/2} \quad (9)$$

$$\omega_{RE} = qn\omega_o \quad (10)$$

and

$$q = [1 + (EI/F) (n\pi/l)^2]^{1/2} \quad (11)$$

where q is the stiffness factor, E is Young's Modulus and I is the moment of inertia of the wire cross section. Equation 11 shows that q will become large when l and F are small. Short low-tension wires must, therefore, be considered in the light of these equations.

Electrical Characteristics

The use of a vibrating wire as a circuit element is suggested by its resonant characteristics and the ease with which its mechanical energy is converted into electrical energy. When the ends of the wire are considered as the terminals of a network, the wire behaves as a combination of purely electrical elements, and its characteristics can be represented by an electrical equivalent circuit. The configuration and the constants of the equivalent circuit must be determined from the equation of motion.

The solution of the equation of wire motion is obtained by assuming

$$y(x, t) = G(t) \sin n\pi x/l$$

When y in Eq. 3 is replaced with this expression, an ordinary differ-

ential equation is obtained.

$$\lambda \frac{d^2 G}{dt^2} + 2k\lambda \frac{dG}{dt} + (n\pi/l)^2 FG = I_o B_o \exp j\omega_o t \quad (12)$$

The solution of this equation yields $G(t)$ in the expression for displacement $y(x, t)$. The relation between the induced voltage (Eq. 6) and the displacement (Eq. 4) is such that the following expression can be written

$$dG/dt = 2\nu/B_o l \quad (13)$$

When the above value of dG/dt is substituted in Eq. 12, there results the equation

$$\frac{2}{B_o^2 l} \frac{d\nu}{dt} + \frac{4k\lambda}{B_o^2 l} \nu + \frac{2n^2 \pi^2 F}{B_o^2 l^3} \int \nu dt = I_o \exp j\omega_o t \quad (14)$$

This is recognized as the form of the equation that describes the circuit of Fig. 2. By equating the coefficients of the actual circuit equation with those of Eq. 14, the values of the circuit constants are found

$$C = 2\lambda/B_o l \quad (15)$$

$$R = B_o^2 l/4k\lambda \quad (16)$$

$$L = B_o^2 l^3/2n^2 \pi^2 F \quad (17)$$

The series resistance R_o must be included in the circuit so that the unit's binding posts will correspond electrically to the terminals of the wire.

A careful consideration of the equivalent circuit yields much information about the electromechanical characteristics of the wire. The previous assumption of parallel-resonant characteristics is substantiated by the mathematics. The circuit shows that a vibrating wire

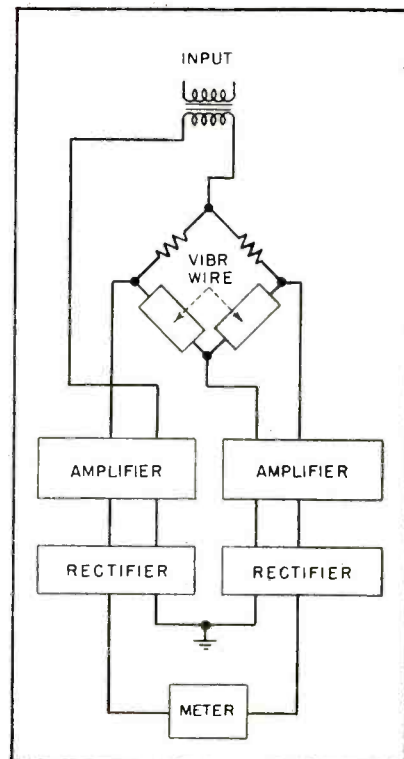

FIG. 4—Discriminator circuit employing two vibrating-wire elements

in a magnetic field is a good mechanical analog of a parallel RLC resonant circuit, the resonant frequency being

$$f_o = \frac{1}{2\pi \sqrt{LC}} = \frac{n}{2l} \sqrt{\frac{u}{\rho}} \quad (18)$$

where ρ is the wire density and u is its unit stress.

The unit stress in the wire is restricted to a relatively narrow range of values by the tensile strength of the wire material and nonlinearities that are experienced at low tension. The unit density ρ is fixed for any given material. Consequently, as can be seen from Eq. 18, the wire length is largely determined by the desired first-mode frequency range.

For example, a 100-cps tungsten-wire unit is about 10 inches long, while a 10-kc unit of the same wire material is only $\frac{3}{4}$ inch long. Here again the practical limitations of the units dictate the useful frequency range. The frequency of any unit can, of course, be increased by operation of the wire in a higher mode.

The impedance level of a vibrat-

TABLE I—Plated Tungsten Wire in an Evacuated Envelope

Constant	Symbol	Value
Wire length.....	l	2.0 inches
Wire diameter.....	d	1.0 mil
Resonant impedance.....	Z_{10}	178 ohms
Resonant frequency.....	f_o	2,210 cps
D-C wire resistance.....	R_o	6.0 ohms
Bandwidth.....	BW	1.2 cps
Damping ratio (fraction of critical).....		0.00019
Gap flux density.....	B_o	7,200 gauss
Equivalent capacitance.....	C	716 microfarads
Equivalent inductance.....	L	6.9 microhenrys
Q.....	Q	1,810

ing wire is indicated by R , the resonant motional impedance. Equation 16 shows that this impedance is directly related to the flux density and the wire length and inversely related to damping and the wire unit mass. Hence, high-impedance units can be built by using fine wires, high-flux density and little damping. High impedances are desirable since they are easier to match to tube plate resistances. Since low-frequency units require longer wires than high-frequency units, their impedances are generally higher and they are more easily incorporated in vacuum-tube circuits.

The complicating factor in the use of fine wires is that while the impedance is raised through a reduction in mass, the damping is considerably greater than for wires of larger diameters. The higher impedance is, therefore, obtained at the expense of a loss in Q .

The actual Q and bandwidth values that can be achieved for a given unit can be calculated from the equivalent circuit. By finding the half-power frequencies in the conventional manner, the bandwidth is found to be

$$BW = 1/RC (1 - 2[R_o/(R + R_o)]^2)^{1/2} \quad (19)$$

and

$$Q = n\omega_o/BW = n\omega_o RC / (1 - 2[R_o/(R + R_o)]^2)^{1/2} \quad (20)$$

Equation 19 shows that as the motional resonant impedance R increases, the bandwidth decreases. However, when the ratio R/R_o becomes large enough, the bandwidth approaches a constant value

$$BW = 1/RC = 2k \quad (21)$$

As R is increased, the value of Q behaves in the same manner. The constant Q value that is approached is

$$Q = n\omega_o RC = n\omega_o/2k \quad (22)$$

It is seen that any increase in k , the damping factor, will result in larger bandwidths and lower Q 's. The maximum attainable Q values are determined by the lowest wire-damping that can be obtained.

The approximate equations for Q and bandwidth (BW) can be derived directly from the magnitude curve of the wire impedance func-



Plug-in unit contains amplifier and 1,000-cps frequency standard shown in other photograph

tion by subtracting the value R , and considering only that part of the curve due to motional impedance. The useful Q of the unit thereby becomes independent of flux density and for any given frequency is solely dependent on the damping factor.

In quantitative terms the properties of resonant wires are most easily evaluated by considering a typical unit. Table I gives the values of the constants for such a unit. This table indicates the high Q 's that can be obtained with wire units. The Q value tabulated is in the lower range of crystals.

The low resonant impedance shown complicates the design of tube circuits incorporating wire elements. However, by suitable design the impedance may be boosted considerably and values of several thousands of ohms can be obtained.

Applications

As a frequency-controlling element the wire is connected in the feedback path of an oscillating cir-

cuit. The wire acts as a filter element to reduce the circuit loop gain at all but its resonant frequency. The oscillating frequency is then precisely equal to the resonant frequency of the wire. When a wire with a fixed tension is used the circuit becomes an accurate frequency standard. Successful units of this type can be built to operate between 1,000 cps and 50 kc.

In a similar manner, when tension-varying means are employed, variable-frequency circuits can be constructed. These units have the advantage of high accuracy of setting and resolution. The frequency ranges of such units are generally limited to one or two octaves.

Filter Bridge

A filter application of the vibrating wire is illustrated in Fig. 3, which shows a bridge-type, narrow-pass filter. Specific designs of this element can achieve bandwidths of as little as 1 cps at 2,000 cps. While the insertion loss is generally high, the increase of resonant impedance of the wire with proper design makes possible the decrease of loss to an acceptable value.

The bridge filter is not the only type which can be constructed. It is possible to synthesize circuits of other response characteristics and configurations. The restriction upon vibrating wire filter circuits is that the element is parallel resonant and can be used only in this capacity.

Vibrating wire discriminators find application whenever small frequency changes are to be measured. In narrow-range circuits, sensitivities of fractions of cycles per second can be achieved with extremely low-noise levels. When broad range discriminators are required, the Q of a wire unit is naturally too high to achieve the desired range and steps must be taken to decrease the Q . A typical discriminator unit is shown schematically in Fig. 4.

The authors wish to express their gratitude to John Ohman of Southwest Research Institute for his assistance in the preparation of this paper and to Interval Instruments, Inc., who have sponsored the work.

Wide-Band

By D. J. GRAY, V. P. GURSKE and W. E. MORROW

Staff Members
Lincoln Laboratory
Massachusetts Institute of Technology
Cambridge, Mass.

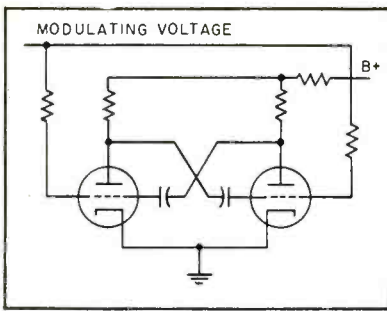

FIG. 1—Frequency-modulated multivibrator

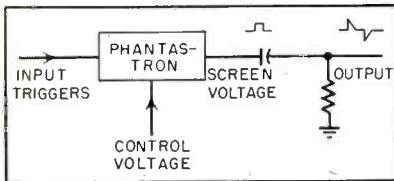

FIG. 2—Phantastron-delay circuit depends upon control voltage

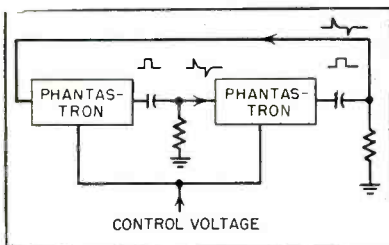

FIG. 3—Double-phantastron oscillator employs cascade triggering

OF THE POSSIBLE METHODS for recording signals having zero-frequency components on magnetic tape, one of the simplest from the standpoint of equipment is frequency modulation of an audible or ultrasonic carrier.

This system is widely used in telemetering,¹ where it is usual to provide several data channels on one recording channel. Since most telemetered data are confined to the region below 100 cps, it is possible to use carrier-frequency deviations in the order of one kilocycle and record several different carriers on a single tape track.

For this purpose, the free-running frequency-modulated multivibrator shown in Fig. 1 is in common use.² This device is sufficiently linear for the standard telemetering deviation of ± 7.5

percent of carrier frequency. If, however, the spectrum width of the data to be recorded is in the order of several kilocycles, the limitations of the multivibrator become apparent.

To obtain signal-to-noise ratio improvement with f-m, it is necessary to use modulation indices greater than one.

Modulation Index

For information bandwidth greater than 10 percent of the carrier frequency, the multivibrator is not sufficiently linear for most analytical purposes. If data from 0 to 5 kc are to be recorded with a minimum modulation index capability of 3, the carrier frequency must deviate ± 15 kc. The center frequency should be at least 30 kc in order to keep all significant components of the modulated wave above 5 kc. Thus the oscillator frequency must be linearly variable from 15 to 45 kc. It is difficult, if not impossible, to design conventional free-running multivibrators that can be frequency-modulated with good linearity over a range as great as this.

One oscillator that is capable of large carrier deviation with good linearity is the double phantastron. The phantastron-delay circuit has been described in the literature.³ The double phantastron, consisting of two phantastrons connected to trigger each other, is described in the M.I.T. Radiation Laboratory Series.⁴

The phantastron is a time-delay circuit that generates a pulse at some variable time after the cir-

cuit is triggered. The timing is done by a linear sawtooth voltage derived from a Miller-type sweep circuit. In the usual phantastron, the slope of the plate-voltage rundown is given very closely by the equation

$$de_p/dt = E_{cc}'/R_g C_g \quad (1)$$

where $E_{cc}' = E_{cc} - \bar{E}_g$ and \bar{E}_g is the average grid voltage during plate rundown.

$$T = E_{bb}' R_g C_g / E_{cc}' \quad (2)$$

The period T is proportional to plate-catcher voltage E_{bb}' and inversely proportional to the slope of the plate-voltage rundown. Therefore

$$F = E_{cc}' / 2 E_{bb}' R_g C_g \quad (3)$$

The frequency of the double phantastron therefore is equal to $1/2 T$ and is inversely proportional to the plate-catcher voltage and proportional to the slope of the plate-voltage rundown.

The usual form of phantastron control—namely, control of the plate-catcher voltage—is unsuitable here since this would give a frequency inversely proportional to the modulating voltage. In order to make the frequency proportional to modulating voltage, it is necessary to control the slope of plate-voltage rundown. In the circuit described, the modulating voltage is applied as the grid-return voltage, E_{cc} . In this way, a frequency proportional to the modulating voltage is obtained.

As illustrated in the block diagram of Fig. 2, the output consists of a negative-voltage spike occurring T seconds after the trigger. Time T is a function of control

The research described in this article was supported jointly by the Army, Navy and Air Force under contract with the Massachusetts Institute of Technology

Data Transmitter

Frequency-modulated oscillator uses double phantastron circuit for linear data-recording system that handles information in the range 0 to 5 kc with an accuracy of better than 1 percent. Modulation characteristic of the oscillator has been measured linear within ± 0.25 percent from 1 to 50 kc

voltage and is given by Eq. 2.

The phantastrons shown in Fig. 3 are connected in a manner such that the output of each triggers the other. The period is equal to the sum of the periods of the individual phantastrons. Therefore the frequency $\frac{1}{T}$ is a linear function of control voltage and is given by Eq. 3.

Circuit Analysis

The circuit details of the double phantastron are shown in Fig. 4. The phantastron tubes are marked V_1 . Trigger pulses are derived from the screen voltage rectangle shown in Fig. 5. At the end of plate-voltage rundown, the screen

conducts heavily and its voltage drops sharply. This negative step voltage is differentiated by C_2 and R_3 and triggers the other phantastron through the plate-catcher diode V_2 .

The plate-catcher voltage is such that the plate voltage will have been stabilized before the tube is triggered in the next cycle. The cathode followers V_3 provide a low-impedance charging path for the grid capacitors C_g . The timing circuit is composed of C_p and R_p . These components must have good temperature stability since any change in their values will change the frequency by the same percentage. Wire-wound resistors are

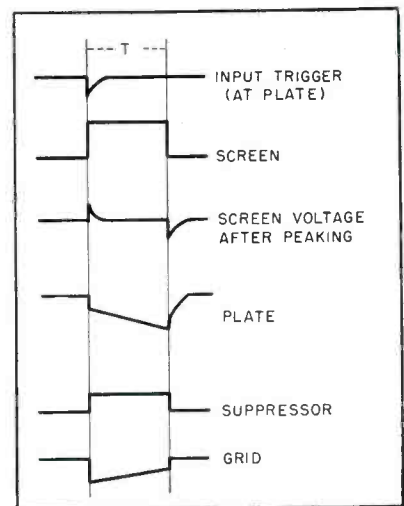

FIG. 5—Waveforms of voltages in the phantastron circuit

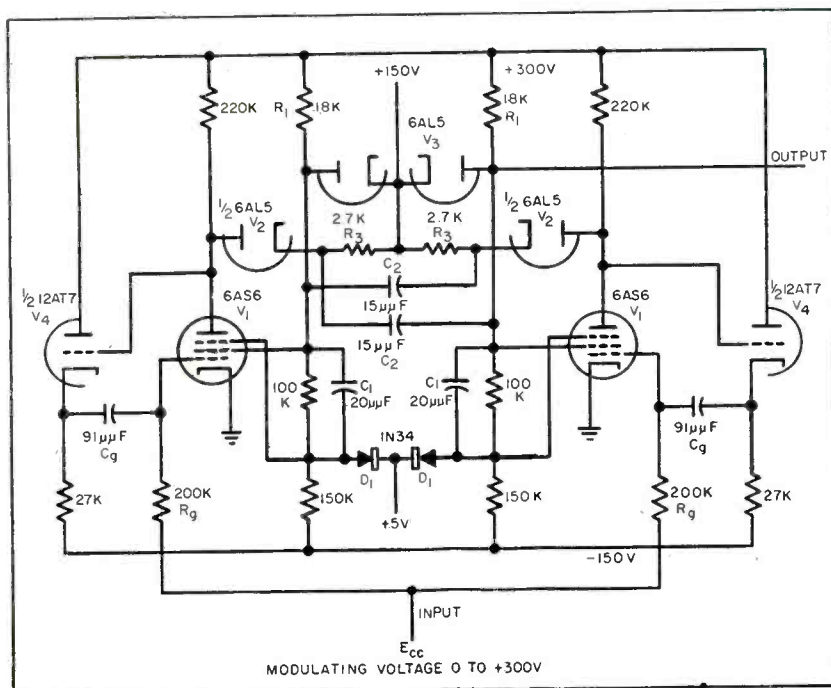

FIG. 4—Circuit of the complete double-phantastron frequency-modulated oscillator

satisfactory for R_p since inductance has the effect of speeding up the switching action. The modulating voltage is applied as the grid-return voltage, E_{cc} .

The crystal-diode suppressor catchers D_1 prevent the suppressor voltage from rising above about 5 volts. This insures that undesirable secondary emission from the suppressor grids will not occur. The screen catchers V_1 flatten the normally round-topped screen waveforms. This insures faster and more reliable triggering action.

Frequency Stability

The stability requirement on the plate-catcher supply voltage is determined by the frequency stability desired. Frequency is inversely proportional to plate-catcher voltage. The requirements on plate- and heater-supply voltages are not

so stringent. Ordinary regulated power supplies with unregulated heater voltage are adequate.

The commutating capacitors C_1 must be small enough so that the screen-suppressor voltage stabilizes in one-half the shortest operating period. The screen resistors R_1 should have small thermal coefficient of resistance.

Starting Trigger

It should be noted that this circuit is not necessarily self-starting. Since the triggers are injected through diodes, which are essentially high resistances at small voltages, it is possible for the circuit to be quiescent at zero frequency. Small noise voltages in the circuit will be sufficiently attenuated by the diodes to prevent self-starting. A number of methods is available for starting oscillation. The simplest is to remove momentarily the negative supply voltage, allowing the suppressor voltage to rise, the plates to conduct and oscillation to start when the negative voltage is returned. It may be done automatically by providing the negative voltage for suppressor return from the amplified and rectified output of the oscillator.

This method, however, is prejudicial to frequency stability since the suppressor and screen voltages are functions of output amplitude

and amplifier gain. A better automatic starter is a device such as a blocking oscillator arranged to inject a negative pulse into a plate of the oscillator when oscillation stops.

It is instructive to make a comparison between the double-phantastron oscillator and the free-running multivibrator. The timing mechanism of a multivibrator is well known.² The grid voltage of the off-tube rises from some large negative value toward some positive value along an exponential curve whose time constant is determined by circuit parameters. Switchover occurs when the grid voltage of the off-tube reaches a value that will allow the tube to start to conduct. The usual method of frequency control is variation of the grid-return voltage. Increasing the positive grid-return voltage will make the off-tube grid voltage rise faster and shorten the period, thereby raising the frequency.

Unfortunately, since the grid-voltage waveform is an exponential, the frequency will not be a linear function of grid-return voltage. Linearity of frequency with control voltage can be approached to any degree desired by using only a small part of the grid-voltage exponential. If high linearity is desired, however, high positive grid-return voltage is necessary; and when large frequency deviation is desired, the necessary grid-return voltage soon becomes a value in the order of thousands of volts. For this reason, the multivibrator is necessarily a device capable of good linearity only for deviations that are reasonably small percentages of carrier frequency.

Timing Voltage

The timing of the phantastron, on the other hand, is performed by a linear sawtooth voltage. The generation of this voltage is described in the literature concerning the Miller-type sweep generator.³ The assumptions made in deriving the equations describing phantastron operation are valid so long as the gain of the tube is much larger than unity and so long as the stray circuit capacitances are negligible. The modulation linearity of the double phantastron is therefore, in

theory, limited only by the magnitude of the stray capacitances.

In practice, it has been found that a carrier frequency of 50 kc approaches the upper limit of linear modulation. In the circuit described, the commutating capacitors prevented linear operation above this frequency. Smaller capacitors could not have been used since the stray capacitances then prevented reliable operation.

In the matter of short-time frequency stability, the phantastron oscillator is probably an order of magnitude better than the multivibrator. It has been shown experimentally⁴ that the jitter of a phantastron-delay circuit is much less than that of a multivibrator delay. In an oscillator, this jitter would appear as f-m noise.

When testing this circuit, battery supplies were used for heater, plate-catcher and grid-return voltages in order to insure frequency stability. Frequency was measured by Lissajous-figure comparison with the output of a General Radio primary frequency standard. The grid-return voltage was measured with a Rubicon potentiometer capable of reading to five-digit accuracy. Frequency of the oscillator is plotted as a function of control voltage in Fig. 6.

The departure of the abscissa of this curve from a straight line intersecting the curve at 5 kc and 40 kc, expressed in percentage of maximum grid-return voltage, is plotted as a function of frequency in Fig. 7. This error curve shows the departure of the oscillator input-output characteristic from linearity. For practical purposes, the modulation characteristic is linear from 1 kc to 50 kc. The rapid increase in error at high frequencies is caused by the effects of stray capacitance in the circuit.

REFERENCES

- (1) J. C. Coe, Telemetering Guided Missile Performance, *Proc IRE*, 36, p 1404, 1948.
- (2) P. E. Green, Magnetic Tape Recording for Very Low Frequency Phenomena, *Rev Sci Inst*, 21, p 893, 1950.
- (3) R. N. Close and M. T. Lehenbaum, Design of Phantastron Delay Circuits, *ELECTRONICS*, p 100, Apr. 1948.
- (4) B. Chance, and others, "Waveforms," 19, p 199, MIT Rad. Lab. Series, McGraw-Hill, New York, 1949.
- (5) Ref. 4, p 195.

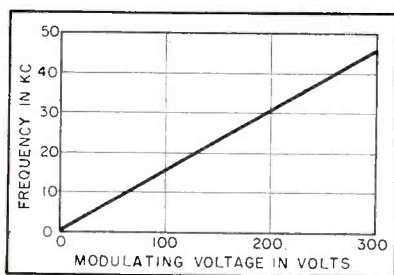

FIG. 6—Modulation characteristic of the phantastron

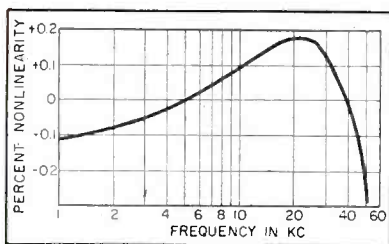
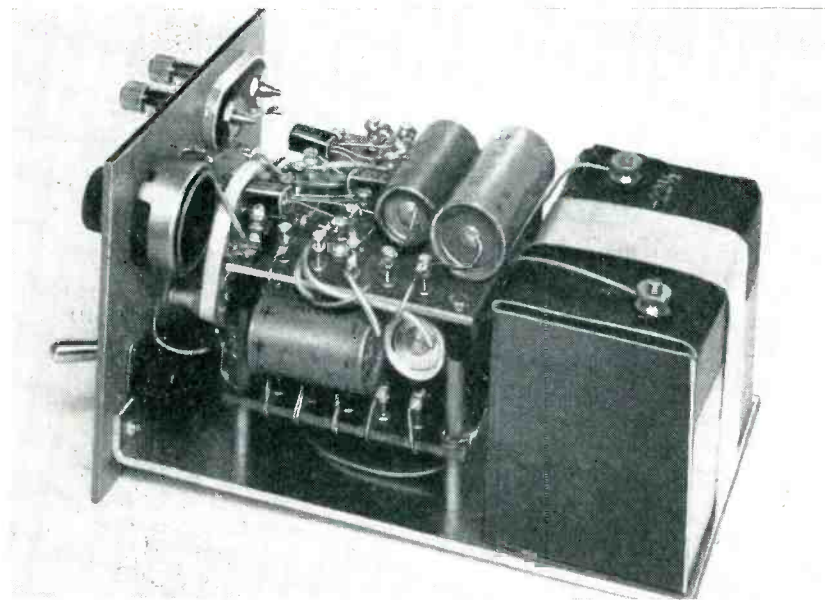
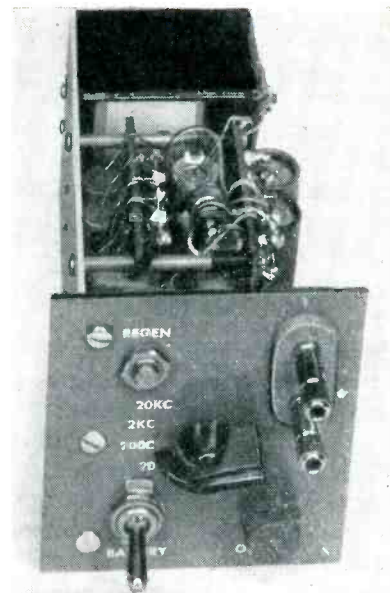

FIG. 7—Error curve showing percentage nonlinearity versus frequency



Side view of transistor oscillator shows efficient use of available space. Largest components are electrolytic capacitors and battery



Front panel controls are frequency, on-off, output amplitude and regeneration

Low-Distortion Transistor Audio Oscillator

Spot frequencies through audio range are provided by self-powered instrument using three *pn*p junction transistors. Total rms distortion and noise at center frequencies is less than 0.03 percent. A single 22½-volt battery is used

By **PETER G. SULZER**

*Consultant
Kensington, Maryland*

AN interesting property of the junction transistor is that its characteristic curves are straight and uniformly spaced over a wide operating range.

The junction transistor should therefore perform well as a low-distortion voltage amplifier. A useful application is in the audio-frequency oscillator to be described, which operates at four frequencies: 20, 200, 2,000 and 20,000 cps.

In the final instrument, the total rms distortion and noise is less than 0.03 percent at 200 and 2,000 cps, and is less than 0.05 percent and 0.13 percent at 20 and 20,000 cps respectively. The maxi-

mum available output is one volt.

The circuit is a modification of a vacuum-tube oscillator previously described.¹

Vacuum Tube Circuit

In developing the transistor oscillator it is convenient to start with the simplified vacuum-tube circuit of Fig. 1A. Here V_1 is a voltage amplifier and V_2 is a cathode follower.

Degenerative feedback is provided to the control grid of vacuum tube V_1 through the bridged-T network² which produces a voltage minimum and zero phase shift at the operating frequency. Positive

feedback is applied to the cathode of V_1 through the lamp whose positive resistance versus voltage characteristic controls the oscillation amplitude.

Bridge Action

It is convenient to regard the amplitude-stabilization mechanism as a bridge-balancing process in which the amplitude will build up until the attenuation through the lamp and R_2 is slightly less than the attenuation through the bridged-T network.

As a class-A amplifier the control grid of V_1 presents a high impedance to the output of the

bridged-T network, while the cathode follower has a low driving-point impedance for the network. Both conditions are highly desirable and help to produce small phase shifts in both feedback loops. Large feedback factors can then be used without danger of parasitic oscillation, and the oscillator will have good frequency stability and low distortion.

Transistor Circuit

Consider now, Fig. 1B, in which vacuum tubes V_1 and V_2 have been replaced with junction transistors JT_1 and JT_2 . The voltage amplifier JT_1 is shown in a grounded-emitter connection³ which produces a phase reversal from base to collector, as does V_1 from control grid to anode. The grounded-collector connection, which has characteristics similar to those of a cathode follower, is used for JT_2 .

It must be realized that such a direct replacement of vacuum tubes with correspondingly connected transistors may lead to trouble because of the low input impedance of the transistor. The matched input and output impedances of a typical *npn* junction transistor in the grounded-emitter connection are

500 ohms and 20,000 ohms respectively.

Connection of a 500-ohm non-linear resistance across the output of a bridged-T network containing resistances and reactances of several thousands of ohms would greatly modify the transfer characteristics of the network. Fortunately, however, feedback can be used to decrease the transistor loading.

Circuit Requirements

It is a requirement of the oscillator that the emitter be driven in phase with the base and, in fact, the voltage at the emitter slightly exceeds that at the base by an amount determined by the gain, bridge unbalance, and output required.

The impedance between base and ground is therefore multiplied by a large factor which depends upon the circuit constants. This value of impedance may be made either infinite or negative, as desired. In practice the impedance is made sufficiently large to avoid the degradation of the characteristics of the bridged-T network.

To obtain sufficient voltage gain from JT_1 , it is desirable to employ

a high load impedance. The grounded-collector connection of JT_2 permits this and also provides the desirable low value of output impedance.

The oscillator of Fig. 1B was constructed, and was considered satisfactory for use as a general-purpose test instrument. The total rms distortion was about $\frac{1}{2}$ percent at an output of one volt, which is not bad when it is realized that vacuum tubes would require ten times the anode-supply for comparable performance.

Improved Circuit

A portion of the signal current from JT_2 is wasted in the emitter load resistance. To avoid this a third transistor JT_3 was connected as the emitter load for JT_2 , as shown in Fig. 1C. The high dynamic collector resistance of JT_3 thereby permitted more efficient operation of JT_2 .

Push-Pull Operations

The presence of an appreciable amount of even-harmonic distortion however indicated the need for some form of push-pull output amplifier.

Push-pull operation accompanied

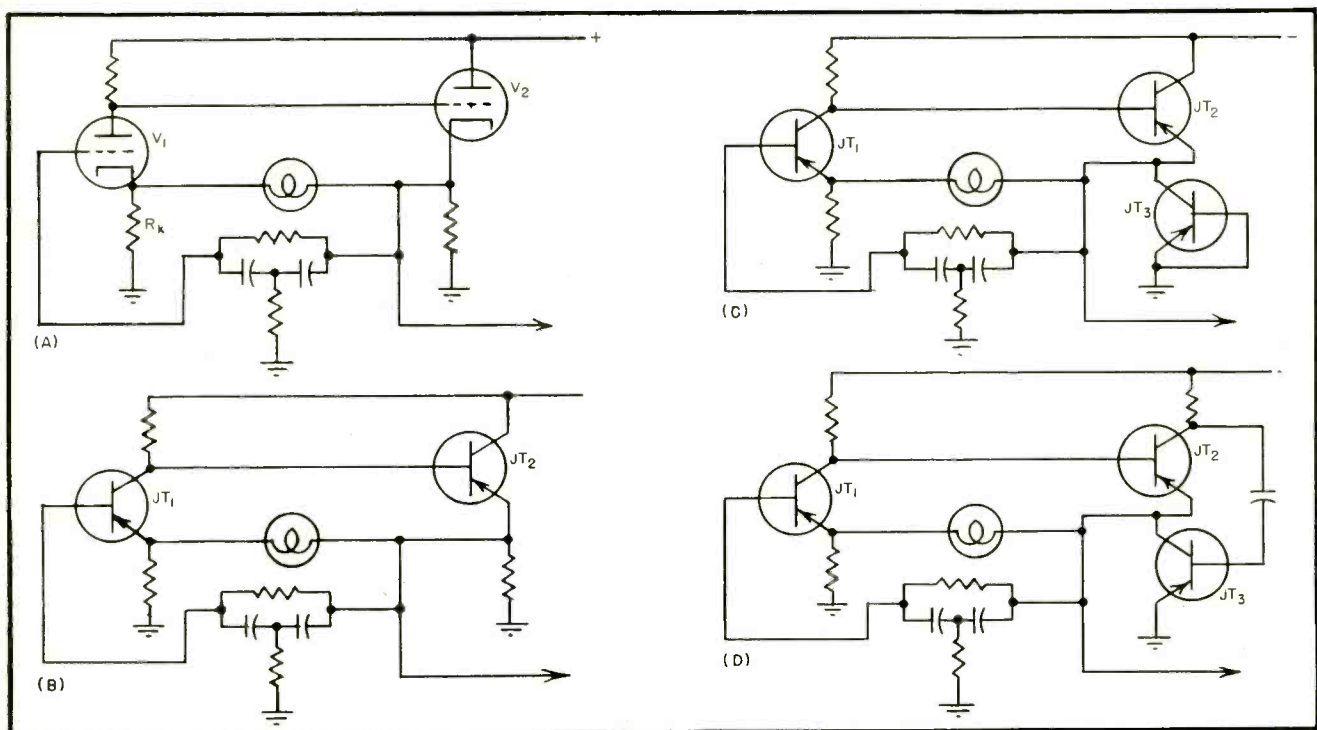

FIG. 1—Steps in development of transistor oscillator from vacuum-tube circuit

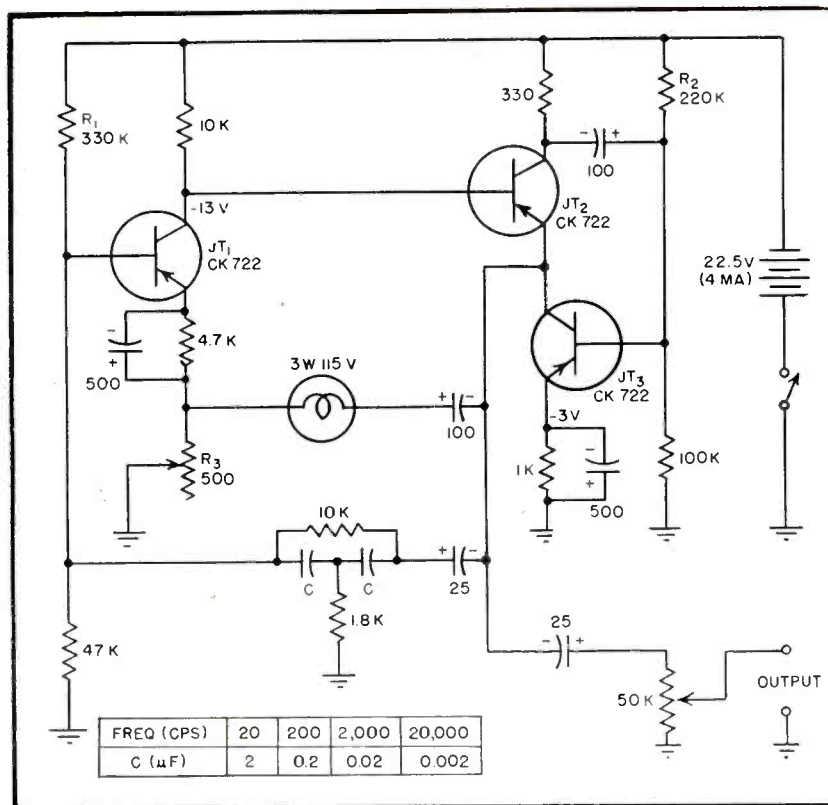

FIG. 2—Schematic of simple low-distortion transistor audio-frequency amplifier

by a tenfold reduction in total harmonic distortion can be obtained with the simple modification in Fig. 1D as shown. The base of JT_3 is driven from a load resistance in the collector circuit of JT_2 . The composite amplifier so obtained, which is similar to a vacuum-tube cathode follower described by Hammack⁴, has a voltage gain of very nearly unity.

It is capable of furnishing a high output current because the signal currents of both transistors flow through the load, but the transistors are effectively in push-pull because the collector current of one increases as the collector current of the other decreases. Additional useful characteristics are that the input impedance is increased in the same manner that the input impedance of JT_1 is increased, and the output impedance is decreased because of the additional negative feedback produced.

Final Version

The final circuit of the transistorized audio-frequency oscillator is shown schematically in Fig. 2. Am-

plitude control is obtained from the 3-watt 115-volt tungsten-filament lamp.

Capacitors C in the bridged-T network are switched to obtain the four operating frequencies. The output voltage is controlled by means of the 50,000-ohm potentiometer.

It will be noted that by-passed resistors are shown in series with the emitters of JT_1 and JT_3 . These were inserted to provide direct-current degeneration in the emitter circuits, which tends to stabilize the emitter currents⁶. This is particularly desirable in JT_1 because of the direct coupling between JT_1 and JT_2 . Such stabilization is necessary to assure the interchangeability of all transistors of a given type.

Although the condition of interchangeability was not obtained in the oscillator because of battery-power limitations, the moderate degree of stabilization produced is sufficient to protect the transistors from running away, and also decreases the effects of temperature drift.

Increase stabilization would have required higher emitter bias and lower values of base voltage-divider resistances, both of which would have increased the power consumption of the circuit.

Circuit Adjustment

In setting-up the oscillator the base and collector of JT_2 should be disconnected to permit the measurement of the collector voltage of JT_1 . If the collector is not operating approximately 13 volts below ground potential a modification of the value of R_1 is indicated. The base and collector of JT_2 can then be connected, and R_2 should be adjusted to its minimum value. Approximately 3 volts should be observed across the JT_3 emitter bias resistor. Here an adjustment of R_2 may be required.

Finally R_3 should be increased to produce a maximum output of one volt. The harmonic distortion should be as stated. If a high even-harmonic distortion is obtained a different value of collector-load resistance for JT_2 may be required.

Noise

Although transistor noise has been emphasized in the literature, the noise output of the oscillator was at least 80 db below one volt. The low noise output is a result of the very narrow operating bandwidth of the circuit.

It is thought that the performance of the oscillator is surprisingly good for such a simple circuit. This is accounted for in no small part by the excellent characteristics of the transistors employed which were, however, not selected especially for this particular application.

The writer thanks the McIntosh Laboratory, Inc., of Binghamton, N. Y., for permission to publish this paper.

REFERENCES

- (1) Peter G. Sulzer, Wide-Range R-C Oscillator, *ELECTRONICS*, p 88, Sept. 1950.
- (2) Peter G. Sulzer, A Note on a Bridged-T Network, *Proc. IRE*, p 819, Jul. 1951.
- (3) R. L. Wallace and W. J. Pietsenpol, Some Circuit Properties and Applications of $n-p-n$ Transistors, *Proc. IRE*, p 753, Jul. 1951.
- (4) Calvin T. Hammack, Cathode Follower, *ELECTRONICS*, p 206, Nov. 1950.
- (5) Richard F. Shea, Transistor Operation: Stabilization of Operating Points, *Proc. IRE*, p 435, Nov. 1952.

Sound-Reinforcing System

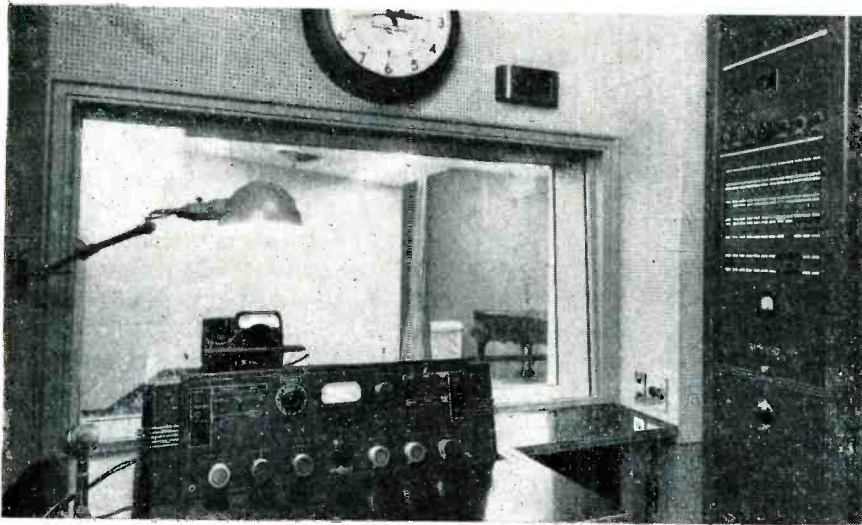

Control room of theatre-type studio. Isolation unit is mounted in bay at right. Other controls are grouped conventionally at the operator's position

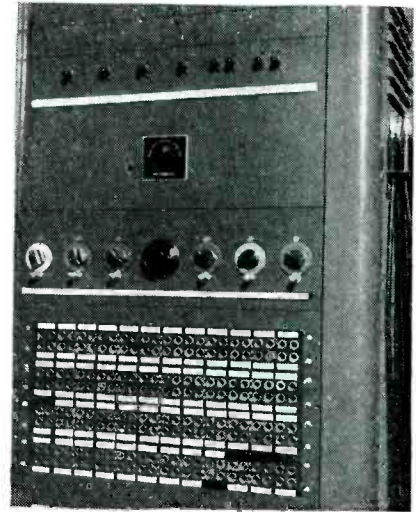

Front panel of isolation unit. Switches at top select input to sound system

Low-level from many loudspeakers in seating area of small theater-type studio avoids acoustical feedback. Broadcast console is modified to feed both program line and sound system. Line-bridging amplifiers divide input signal without crosstalk

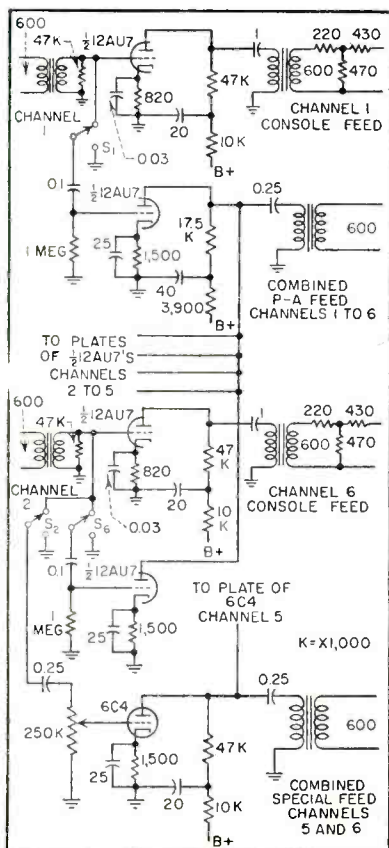

SOUND REINFORCEMENT in the seating area of a small theater-type studio can be achieved without the disadvantages generally inherent in high-level public-address systems. A low-level sound-reinforcement system using ten loudspeakers produces a general level of sound throughout the audience area without creating the usual problem of acoustical feedback. The loudspeakers are mounted in pairs on the ceiling. Placement is determined by drawing cone-projection lines, taking into account the ramping of the seating area.

Each loudspeaker pair has its own volume control and any combination can be cut in or out or its volume preadjusted. The entire system is governed by a master gain control mounted on the broadcast engineer's console. The individual controls avoid a problem

common in many public-address installations; namely, that when the output of a console is fed to the sound amplifier, all program material is reinforced. In the case of music for example, this may be highly undesirable. Likewise in audience participation programs where microphones are necessarily suspended over the seating area, the public-address sound level frequently results in degradation of the program.

Circuits

The broadcast console installed in the control room of the theater-studio has the usual six unbalanced microphone-attenuator networks. Each program circuit, however, is broken just after the channel-input switch to feed the sound reinforcement system. Thus a single microphone-gain control suffices for both the program line and sound system employed.

The isolation circuits shown in Fig. 1 were devised to obtain division of feed between the program

FIG. 1—Line-bridging amplifiers in isolation unit divide input between program line, sound system and special feed while avoiding crosstalk

For Theater-Type Studio

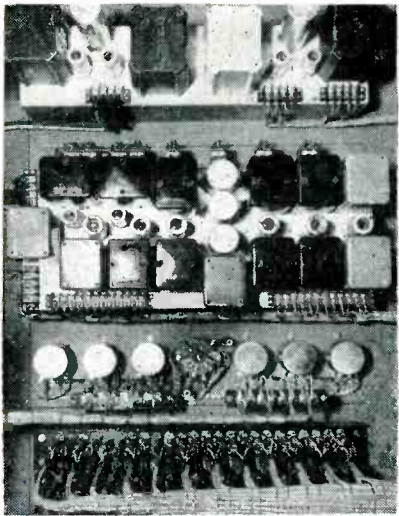

Rear of isolation unit. Line-bridging isolation amplifiers are at top

By **L. J. KLEINKLAUS**

Chief Engineer, WQXR
New York, N. Y.

line and the sound system for each individual input and, at the same time, to avoid interaction between circuits when more than one input channel is in use. Figure 2 is a single-line block schematic showing the location of the isolation panel with respect to console and other control-room circuits.

Each isolation circuit employs both halves of a 12AU7. One half completes the original circuit of the broadcast console while the other half is fed through a switch that determines whether that particular microphone output is to be reinforced and completes the circuit to the sound system. The same circuit configuration is repeated for each of the six input channels. An additional function is incorporated in channels 5 and 6. These channels do not have preamplifiers and are generally used to handle turntables or remote originations where preamplifiers are not required.

Each of these channels provides a special-feed output capable of sup-

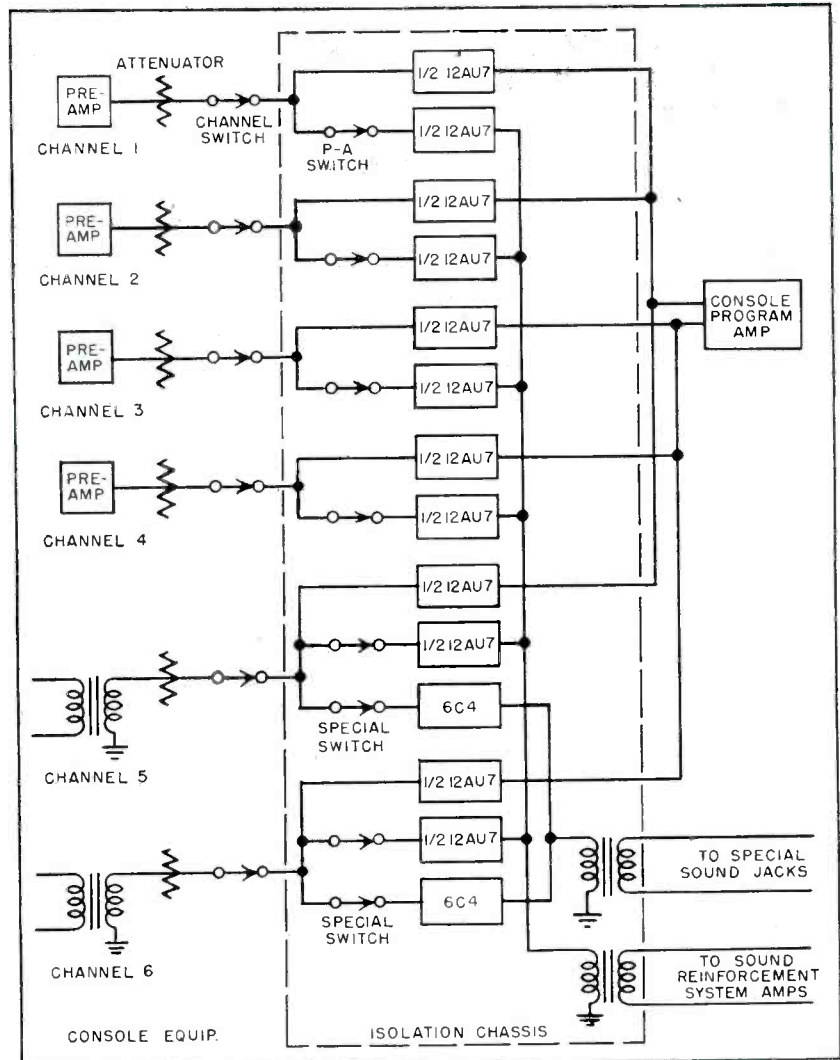

FIG. 2—Single-line block schematic shows location of isolation chassis with respect to console and other control-room circuits

plying headphones or loudspeaker circuits in special stage or studio locations. The special-feed circuit comprises an additional switch and a 6C4 triode. The circuit is particularly useful for two-way overseas panel discussions and for musical-quizz programs where recorded excerpts are used.

Performance

None of the isolation triodes provide any circuit gain but the isolation has been found to be extremely effective. No crosstalk has been noticed. Furthermore, use of the isolation panel in no way degrades frequency response or noise level or

introduces any distortion in the console. Working results of the sound-reinforcement system are such that spectators have remarked about the good acoustics of the theater.

The system is sufficiently flexible so that sound from the station bus can be supplied to the theater to entertain early arrivals. The loudspeaker network can also be used to furnish sound from an external source such as from sound tracks when the theater is used for film projection. The control room may also be used for programming divorced from any nonbroadcast proceedings in the theater-studio itself.

Phototubes Observe

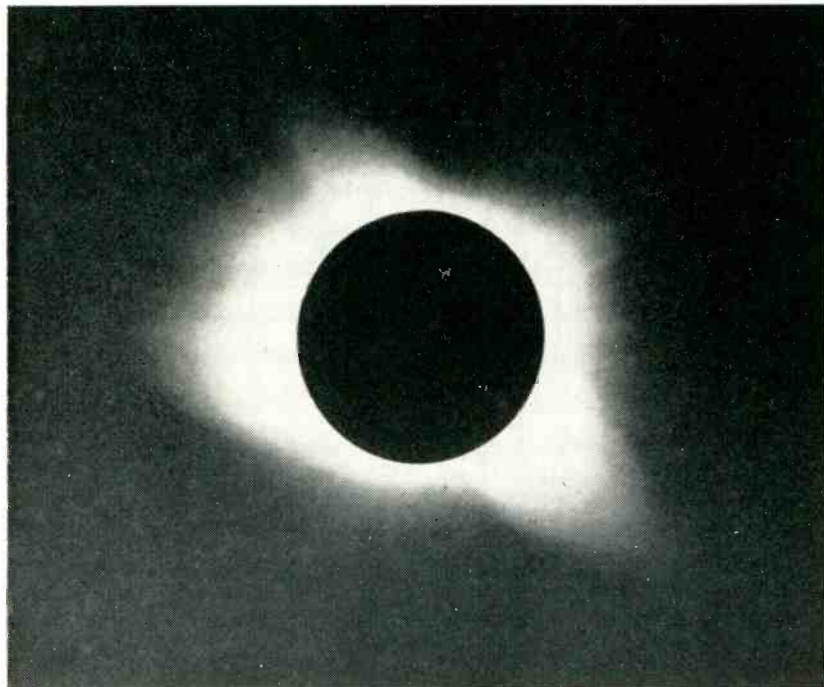

Total eclipse at Khartoum shows pearly-white solar corona containing atoms at temperatures of about a million degrees

By FRANCIS J. HEYDEN

*Georgetown College Observatory
Washington, D. C.*

to improve existing charts.

Since 1932, the eclipse expeditions sponsored by the National Geographic Society have averaged about fifty-percent success on the weather. After sitting out the eclipse of 1948 on a rain-drenched mountain in China, the author decided to try a method using a photoelectric tube with a high-speed recorder, rather than a camera.

An eclipse of the sun is simply the phenomenon in which the moon passes between the earth and the sun. The long conical shadow cast by the moon sends its point down to the surface of the earth. When the moon is in a part of its elliptically shaped orbit where the shadow is longer than the distance from the earth to the moon, the shadow brushes across the face of the earth along a path about eighty to ninety miles in width and about four or five thousand miles in length. This is a total eclipse for anyone within the path. When the moon is at the more remote end of its orbit the tip of the shadow just misses the surface of the earth as it passes by.

In this instance, the sun is not completely covered by the moon and it appears like a bright ring of light. This is called an annular eclipse. Whether total or annular, the eclipse cuts down the light of the sun very rapidly during the few minutes just preceding the instant when the moon is completely in front of the sun. To measure this drop in sunlight photographically the sky must be clear; but regardless of the weather, a phototube will record the falling or increasing light. By using a high-speed recorder to register both the light in-

ASTRONOMERS who go to remote parts of the world to observe a total eclipse of the sun may have several observational projects to achieve. One may use the few fleeting minutes during which the moon moves between the earth and the sun to observe and photograph the tenuous envelope of gases about the sun. This pearly-white solar corona containing atoms at temperatures of about a million degrees cannot ordinarily be seen because of the intense diffuse sunlight in the earth's atmosphere. Another astronomer grasps these few minutes to photograph the stars that appear close to the edge of the sun, so that he may measure whether or not the rays of light coming from the stars are bent or pulled in by the gravitational field of the sun. This observation will confirm the prediction of Einstein's theory that light rays are subject to the law of gravity in a special way. These are but two instances to show that an eclipse of the sun provides a marvelous laboratory experiment for an astrophysicist or for a cosmologist.

On the other hand, there are as-

tronomers who are interested in the mechanics of the motions of the bodies in the solar system. These involve the orbital motions of the moon and the earth and the rotation of the earth on its axis. A total eclipse might be compared to the instant when a great clock strikes the hour and announces the correct time to the world. This same instant marks the relative positions of the sun, moon and observer on the surface of the earth.

Improving Maps

The United States Air Force, through its Aeronautical Chart and Information Center, has been interested for some time in the accurate timing of the beginning and end of eclipses. From these contact times, which are observed to within a few hundredths of a second of time, distances between the observation sites can be calculated to first-order accuracy. In the space of a few hours it is possible to span oceans over which ordinary surveying methods are impossible and vast distances over land that would require years of triangulation work

Total Solar Eclipse

Technique using a pair of phototubes in a bridge circuit permits accurate timing of total solar eclipse in spite of rain or cloudy weather. Accurate time necessary for exact determination of latitude and longitude is relayed from WWV and recorded on light curve

tensity and an accurate time signal, the instant of minimum light, or midtotality, can be observed. Two small pieces of equipment were required to be designed and built especially for the observations.

One of these was a compact photoelectric photometer on a suitable mounting, which is coupled to a Brush BL-932 d-c amplifier. The first problem was the selection of a suitable phototube. It was beyond expectation that a phototube could be found that would have a more or less linear response over the range from near full sun to less than full moon. Since the chief aim of the observation was to obtain a relative measurement of minimum light near the beginning and ending of the total phase of the eclipse, there was no need to design a photoelectric photometer with linear response. At the same time it was all-important to have a tube that would respond symmetrically to diminishing and to increasing light over the same range in intensity.

The type-927 phototube was finally selected and built into the bridge circuit shown in Fig. 1. This tube has several advantages. Its response places the maximum sensitivity of the tube in a region of the spectrum around 8,000 angstroms, where readings for the outermost edge of the sun are assured, and the probability of a strong response from the solar corona less likely. The tube also has a response of 120 microamperes per lumen at zero cycles per second, which is the highest for all simple phototubes. The type 927 is commonly used in sound projectors for 16-millimeter film. It is small and requires a maximum of 90 volts for operation.

Being a gas-filled tube it has the serious fault of susceptibility to changes in temperature. To minimize this effect, two cells are used in a bridge circuit as shown in the diagram. One cell is exposed to the sun's light while the other is kept in total darkness.

But effectively, both cells are exposed to the same changes in temperature. After balancing the circuit by means of the variable resistance, the unit proved to be re-

markably free from fluctuations due to temperature. In a laboratory test, the photometer was exposed to a heat-ray lamp until the outside of the case became almost too hot to touch. The change in the output was only about one-thirtieth the full reading at the start of the test. This effect could easily have been caused by thermal changes in the battery, which is also contained in the photometer case.

Equatorial Mounting

The photometer needed a suitable mounting so that it could be pointed at the eclipsed sun and be kept guided on it at every instant by the observer. Aircraft navigators have been using an instrument called an astrocompass for several years. These instruments have been available on the war surplus market for less than ten dollars. In reality the astrocompass is a universal equatorial mounting suitable for holding a small telescope in any latitude. Once the axes have been set for azimuth and latitude, the declination and hour-angle circles can be used just like those on any large telescope.

A small worm-gear drive was adapted to the hour-angle circle of the compass. This made guiding very simple and accurate. The astrocompass is also supplied with lens and sighting target. This was placed on top of the photometer and turned so that the sun cast an image of itself on the target. By substituting a translucent plastic sheet for the target, the image of the full moon can be clearly seen on the target at night. With this arrangement guiding is no problem.

In cloudy weather, when no im-

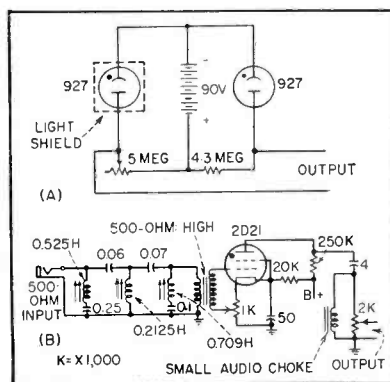

FIG. 1—Bridge circuit of the photoelectric photometer (A) and time-signal filter for pen recorder (B)

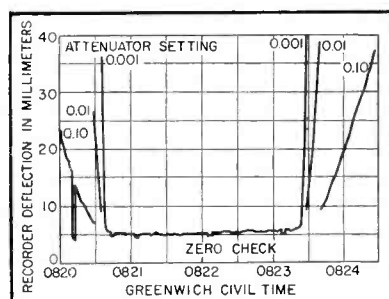

FIG. 2—Light curve recorded at Bangui, French Equatorial Africa. Sensitivity range was changed by amplifier decade attenuator. Zero check made by blocking off light from photometer tube



Air Force project officer and author inspect eclipse photometer at Khartoum. During eclipse, the instrument was set up in a tent and pointed through opening in top to prevent temperature change by winds blowing from desert during totality

stations in Tangiers and in Munich. The WWV signals were picked up first by Cincinnati, rebroadcast to Europe and Africa, picked up by Tangiers and Munich and rebroadcast again for the eclipse parties.

Tests of this time-signal network were made during the second week of December 1951. The rebroadcast signal from Tangiers was picked up at Georgetown Observatory simultaneously with the original signal from WWV. The observed time lag between the two signals included the relay equation of the transmitters and the travel time of the signal. Total lag amounted to +0.053 second. A theoretical value for the travel time with due allowance for skip distances was +0.048 second, leaving +0.005 second for the relay equation. This small correction leaves no doubt that this is the best method for making a single uniform time signal available to several widely separated observers of an eclipse.

The WWV time signal is more than simply a reference for correct standard time. Simultaneously it carries two pure musical notes, one at 440 cycles per second during a four-minute interval and another of 600 cycles per second alternately during the next interval. The second pulse which is broadcast along with the musical note lasts for only 0.005 second and has a frequency of 1,000 cycles. To record the second pulses and to suppress the musical pitches, a filter-circuit was built that would high-pass 1,000 cycles and reject 440 and 600 cycles. Tunable chokes were used for the high- and low-pass circuits as shown in Figure 1B. This filter circuit proved stable and effective. No signal below 800 cycles per second could get through it.

A type-2D21 thyatron was added to the output of the filter circuit. Some experimenting with the thyatron circuit was necessary. A four-microfarad electrolytic capacitor in the output slows up the recovery of the tube and makes it difficult for the observer to perceive when the grid bias is too high. The unit then triggers itself at intervals of about one second. A one-microfarad capacitor in this part of the circuit has

age of the sun is visible, diffusion of light by the clouds widens to several degrees the area over which the photometer can swing without any change in deflection.

Close guiding is not necessary under these conditions.

For a clear sky, careful guiding is essential. A short brass tube, blackened on the inside, restricts the view of the photocell to an area of the sky about 45 minutes of arc in diameter. As long as the eclipsed sun is kept within this area the tube is not affected seriously by diffuse light from other parts of the sky, or from observers who usually work with flashlights during a total eclipse.

The complete photometer with its batteries and universal equatorial mounting is fixed to an ordinary tripod. Perfect rigidity is not necessary. If the latitude of the observer, the hour angle and declination of the sun are known for a certain time, the instrument can be put into the right azimuth in a matter of minutes after it has been leveled.

Timing the instant when minimum light begins and ends requires the highest possible precision. To be worth while, the observation must be made within a probable

error of a few hundredths of a second. To do this one does not care to trust a portable chronometer for more than an hour or two, and each observer at widely separated sites must be able to receive an accurate radio time signal immediately before the observation and immediately after.

It was decided to place so much importance on the accurate time signal that no chronometer at all would be provided. Instead, the observers would have to record a radio time signal along with the light variations.

Time Standard

The U.S. Bureau of Standards transmits a continuous time signal that is accurate within a few thousandths of a second at all times. This signal is checked regularly during the day by the U.S. Naval Observatory. Our problem was to find a way to get this signal all the way across Africa and into Saudi-Arabia during the daytime. A preliminary survey showed that ordinarily WWV, the transmitter of the Bureau of Standards, is not heard in that part of the world during daylight hours.

The Voice of America was called on to rebroadcast WWV from its

proved much more satisfactory.

It was also evident that the thyatron requires only a weak input signal to trigger it. This proved a decided disadvantage in the original circuit because during the eclipse observations the radio operator had to monitor the radio time signal with earphones and at the same time count seconds aloud for the other observer who was operating the photometer.

Improved Trigger

After returning from the expedition the thyatron circuit was modified to eliminate this difficulty in the following way: a T-pad was inserted in the input to the filter and the variable biasing resistor for the grid of the thyatron was removed. This allows the radio operator to tune the time signal on his receiver as loud as he needs for comfort and efficiency, while he cuts the input to the filter circuit and thyatron as low as possible for smooth operation. If the signal fades he can increase the input signal for the trigger circuit by varying the T-pad.

The output current of the thyatron was too strong for the pen motor on the recorder. A voltage divider and choke circuit was introduced in the output so that the amplitude of the pen deflection could be controlled.

An unsuspected difficulty lay in ambush until the middle of January, when the expedition had reached Khartoum in the Sudan where it made its headquarters until a few days before the eclipse. There it was soon evident that the signals from the Voice of America stations are practically always jammed. Three or even four different types of jamming were observed during the period of preparation. The only remedy was to have the radio operators practice until they could handle the receivers like delicate instruments and record every time signal pulse that got through the jamming.

Since the recorder is driven by a synchronous motor, this feature proved invaluable in untangling the time-signal records after the observations had been taken. Despite the irregularities of the small gasoline generators that supplied the

power, the synchronous drive carried the paper record through the recorder at a uniform rate of speed. In some instances where ten or more second pulses had been lost on the record, the second interval remained uniform to within a millimeter on the recording tape, and the next good second mark was found and identified on the record.

This problem has also been minimized for the next expedition. The output circuit of the time-signal trigger has been modified to allow a chronometer contact to operate simultaneously with the incoming time signal. The chronometer contact throws the time-signal pen on the recorder in one direction and the radio signal throws it in the opposite direction. A two-second contact on the chronometer prevents any possibility of confusion if by chance both radio and chronometer signals are in synchronism. This simple change relieves the observer of all worry over the identification of good second marks and, above all, of the zero seconds for the beginning of a minute. It reduces the amount of labor involved in reading the tape records afterwards by at least a factor of one-tenth.

Observational Results

One of the curves showing the variations in light at the time of totality is presented in Fig. 2. It indicates clearly how rapidly the light of the sun is clipped by the edge of the moon within a few seconds before the total eclipse takes place. The curve during these few seconds appears like a straight line on the diagram, but this is only an illusion because the time coordinate has been reduced to simplify the diagram. Actually the curve is determined by many variables, and the final computations involved require the assistance of an electronic computer. The probable error of midtotality, which is determined by the symmetry of the curve, is an indication of the general accuracy of the result. At the sites where no clouds were present during the observations, this error is of the order of ± 0.01 second of time. The error becomes larger when the observations are made through clouds.

The times for midtotality at each site were calculated from the best known positions of the sun, moon and observer. The differences between these calculated times and those observed are a little more than half a second of time. This deviation indicates that there is need for a correction in the assumed position of the moon. The rotating earth with the moon revolving around it and both earth and moon revolving around the sun is a delicately timed mechanism. It is known that such a correction is necessary, and it varies from year to year. Several causes account for it including the shifting of weight on the earth due to the freezing and melting of ice-caps.

The slightest variation in the rotation of the earth changes the timing of the sun and the moon. The observed differences will also show the need for a correction in the latitude and longitude of the observers. These two quantities, the latitude and longitude, were determined with an instrument that relies on the accuracy of a spirit level and consequently the direction of gravity. Unfortunately gravity does not always point straight down at every point on the surface of the earth, and at these places, positions observed with such instruments are slightly in error. An eclipse observation does not depend upon gravity. Hence it can show where these errors are. The computations for finding all of these corrections are now being done and will take a few more months for completion to show results.

Corona Variation

This is the first attempt to use this method extensively for the observation of an eclipse of the sun. It has demonstrated its worth in several ways, for the variations in light from the outer edge of the sun, which were recorded on a tape moving at five inches per second, provide much interesting data not looked for in the original plan. The records of two of the six stations have been temporarily put aside because these sites experienced such heavy jamming during the observations that the radio operators feel that no time signals were received.

Simplified Vectorscope

Dynamic phase measurement is displayed on a cathode-ray oscilloscope. Designed for color-television, the instrument is useful in design of phase shift filters, delay lines, phase-modulation systems and high-speed radio direction finders

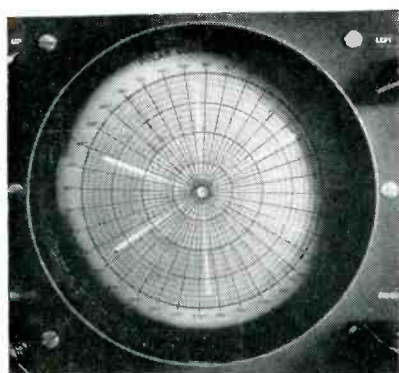

Display of six vectors sequentially switched at 60 cps

DESIGNED ORIGINALLY to observe steady-state phenomena or long signal bursts in connection with color-television development, the vectorscope indicates the phase between two alternating voltages by the angular displacement of a radial emanating from the center of a cathode-ray oscilloscope.

As a phase indicator, the vectorscope finds uses in monochrome television, high-speed direction finding and course indication; also in design of phase-modulation equipment, antennas, filters and delay lines; in synchronization of generators and oscillators; and in monitoring phase-modulation equipment and feed systems for multiple-antenna arrays.

Although designed to accept the original 3,898-mc color-burst frequency, the instrument may be tuned to accept the new NTSC color-burst frequency of 3.58 mc. Measurements at other frequencies require use of a dual-conversion

unit for which space has been provided on the chassis.

Since phase measurement with the vectorscope is entirely a visual process and because the system can respond to dynamic phase change, it can frequently yield information difficult if not impossible to elicit by other means. The photograph shows the instrument less power-supply components. It is mounted in a vertical chassis to keep crt leads short and facilitate fabrication. Figure 1 is a block diagram of the complete instrument.

Theory

The key circuit is the phase detector. This utilizes the principle that when two signals of the same frequency but of different phase are mixed in an electron tube, the

tube current will contain a component that is a function of the phase angle between the two signals.

Figure 2 represents a simplified phase detector from which analysis is made. The schematic diagram of the phase detector is shown in Fig. 3.

The voltages e_1 , and e_2 may be expressed

$$e_1 = e_1' = E_1 \sin(\omega t + \theta) \quad (1)$$

$$e_2 = E_2 \sin(\omega t)$$

Voltages available to the diodes are

$$e_{T1} = e_1 + e_2 \quad (2)$$

$$e_{T2} = -e_1' + e_2 = -e_1 + e_2$$

where T1 and T2 refer to the total voltage applied to the diodes D_1 and D_2 respectively.

The plate currents of the diodes can be expressed in series form as

$$i_1 = a_1 e_{T1} + a_2 e_{T1}^2 + \dots \quad (3)$$

$$i_2 = a_1' e_{T2} + a_2' e_{T2}^2 + \dots$$

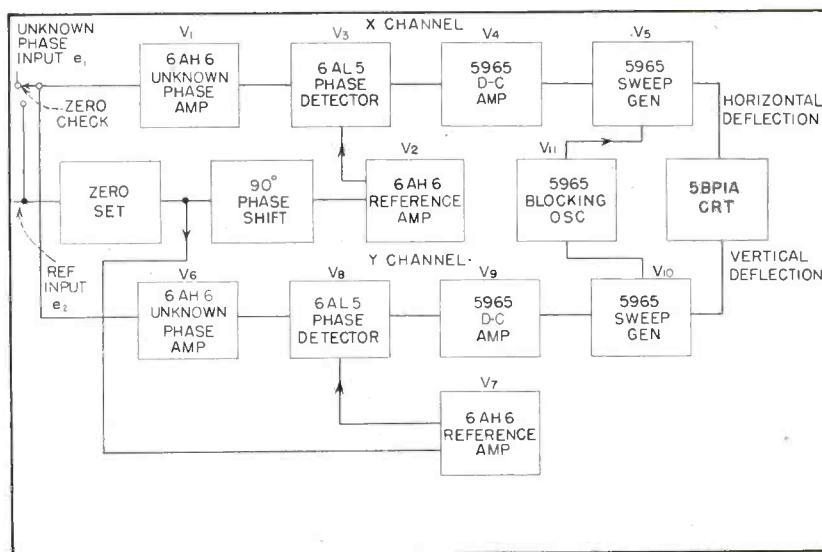

FIG. 1—Block diagram shows phase detector circuit that separates out phase-angle component of mixed signals

Measures Phase

By **WILLIAM L. FIRESTONE** and **ROY A. RICHARDSON**

Motorola Inc., Chicago, Ill.



where $a_1 = a_1'$ and $a_2 = a_2'$ if the tubes are assumed to have identical characteristics.

The output voltage is given by

$$V_o = R_L (i_1 - i_2) \quad (4)$$

which with the aid of Eq 1, 2 and 3 may be expressed

$$V_o = 2 R_L [a_2 E_1 E_2 \cos \theta + a_1 E_1 \sin (\omega t + \theta) - a_2 E_1 E_2 \cos (2 \omega t + \theta)] \quad (5)$$

A filter after R_L removes the r-f components permitting V_o to become

$$V_o = 2a_2 R_L E_1 E_2 \cos \theta \quad (6)$$

If the voltage e , were shifted 90 degrees and the same phase-detection process used, the result would be

$$V_o' = -2 a_2 R_L E_1 E_2 \sin \theta \quad (7)$$

If V_o and V_o' were applied to deflection plates of a cathode-ray tube, it is apparent that a spot would result and the position of this spot would be a function of the angle θ . If θ varied by 360 degrees, the spot would trace out a circle. This is the desired condition.

The same result could be obtained by using triodes or pentodes instead of diodes but the coefficient a_2 would naturally assume a different value.

Circuit

The signal of unknown phase e_1 is applied to two identical amplifiers V_1 and V_2 . The amplifiers isolate the X and Y channels, furnish the phase detectors with sufficient voltage to operate in the region where the diodes are essentially square law and provide for a large output from the phase detectors.

The reference signal e_2 is applied to two separate tubes after passing

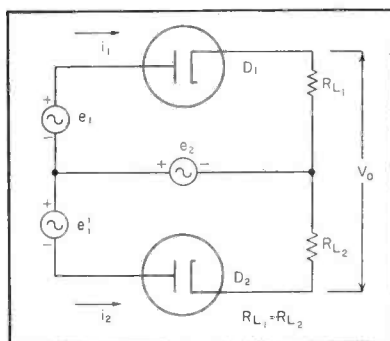

FIG. 2—Simplified schematic of phase detector

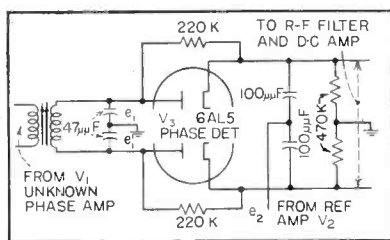

FIG. 3—Circuit of phase detector shows feed-in of reference voltage e_2

through the zero-set circuit. It is amplified by V_7 directly and by V_2 after being shifted 90 degrees through a low-pass filter.

The filter is made to give a 90-degree phase shift with nearly zero attenuation by choosing the cut-off frequency to be 1.41 times the operating frequency.

After being amplified, e_1 is applied to the phase detectors through the r-f transformers (see Fig. 3). Center-tapping the secondary of these transformers was avoided by using equal values of tuning capacitors connected in series. Injection of the reference voltage to the center of these capacitors resulted in extreme circuit

instability. To reduce the impedance of the secondaries to ground, the centers of these tuning capacitors were grounded and the reference voltage injected across the load resistors by 100- μ f capacitors. Circuit stability was greatly improved and filters were required to reduce the amount of r-f voltage on the grids of the d-c amplifiers.

The outputs of these phase detectors are the previously discussed d-c voltages V_o and V_o' and because the outputs of these detectors are insufficient to drive an oscilloscope, d-c amplifiers must be added.

The gains of the d-c amplifiers V_4 and V_5 were kept to a minimum to obtain static and dynamic stability. The 5965 dual triode was used for the amplifier because of the equality between the two triode sections. If the outputs of the d-c amplifiers were applied to the crt, the display would merely be a single spot tracing out a circle when phase varied. It is necessary to change the spot to a straight line so a vector presentation results.

Sweep generators V_6 and V_{10} accomplish this. However, before discussing the sweep generators V_6 and V_{10} it is desirable to consider the blocking oscillator V_{11} .

The oscillator is free running at 100 kc and provides a 0.3- μ sec positive pulse at the output winding of the transformer (Fig. 4). Both sections of a 5965 are used in parallel to provide a pulse amplitude of 80 volts.

This positive pulse is applied to the grids of the sweep generator tubes and causes an average nega-

tive voltage to be developed across the 200- μ f coupling capacitors because of grid current flow in the sweep-generator tubes. This negative voltage is of sufficient magnitude to cut off V_5 and V_{10} except during the time the pulse is applied from V_{11} .

Although not shown on the schematic diagram, there is in effect a 20- μ f capacitor across each of the sweep-generator tubes which consists of the sum of the crt deflection plate capacitance, the sweep-generator tube output capacitance and the stray circuit capacitance. During the time that V_5 and V_{10} are cut off, the combination capacitance will charge exponentially through the 330K resistors toward the plate voltage of the d-c amplifier. The voltage across each sweep-generator tube will rise exponentially for 10 microseconds and then drop rapidly when the pulse is again received from V_{11} . This represents the beginning of the next cycle of operation.

Thus each pair of deflection plates is furnished with a sawtooth voltage whose amplitude is a function of the output voltage of the phase detectors as amplified by the d-c amplifiers.

Because the trace is a function of the voltages present at each pair of deflection plates, the presentation on the crt face will be a line whose angular position is determined by the phase between the two input signals.

Horizontal and vertical-position controls are necessary because the crt manufacturer's tolerance specifies that the zero-deflection-voltage position of the crt spot may fall within a 15-mm square.

The zero-set circuit is used with the zero-check switch. Upon pressing this switch, the unknown signal is taken from the reference source. The vector on the crt is then adjusted to coincide with the zero angle of the polar-coordinate scale on the crt face. This accomplished by manipulation of the zero-set circuit.

Experimental Results

The design of phase modulators used in vhf mobile transmitters is a complex process requiring a great

deal of equipment. Such factors as amplitude distortion, nonsymmetrical phase deviation and deviation limits are dependent on tube and component characteristics and must be held under close control if a practical design having low distortion is to be realized.

By use of the vectorscope not only can the above mentioned distortion factors be evaluated quickly through visual indication, but phase deviation can be readily translated to output-frequency deviation.

For the measurement of phase modulation, the oscillator voltage is taken as the reference voltage while the signal of unknown phase is taken from the output of the phase modulator as shown in Fig. 5. Under conditions of modulation a fan-shaped pattern appears on the vectorscope.

Interpretation

To interpret this pattern in terms of the frequency deviation at the transmitter output frequency,

$$\Delta f = \pi M \phi_{\max} f_m / 180 \quad (8)$$

where Δf is the transmitter frequency deviation on one side of the unmodulated condition, M is the frequency multiplication within the transmitter, ϕ_{\max} is the angle

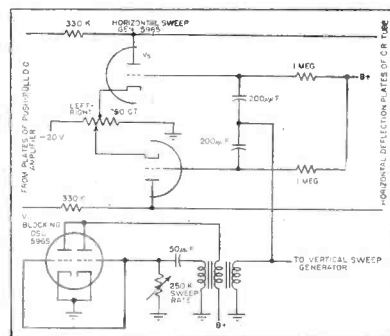

FIG. 4—Blocking oscillator V_{11} provides pulse to sweep generator V_5 , driving it to cutoff when input pulse is not present

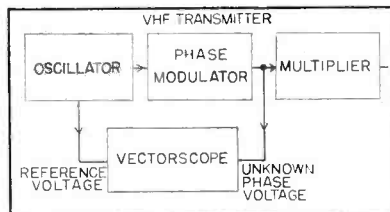

FIG. 5—Use of vectorscope to measure phase modulation

in degrees between the unmodulated position of the vectorscope display and the limit of the fan-shaped pattern with modulation present and f_m is the frequency of the modulating voltage.

The presence of nonsymmetrical deviation is indicated by a difference in the value of ϕ_{\max} on each side of the unmodulated position of the vector.

Other Applications

The vectorscope is useful for observing fixed phase shifts which occur in filters, r-f transmission lines and lumped-component delay network. The photograph shows a display of six vectors that were obtained by taking the unknown phase source from a device that sampled each of six separate delays at a 60-cycle rate.

With some additional equipment, the instrument can be used for direction finding.

The voltages available from two Adcock antennas at right angles are e_{12} and e_{34} while the voltage available from a vertical sense antenna may be expressed as e_s ,

$$\begin{aligned} e_{12} &= K'_A E_r \cos \theta \sin \omega_c t \\ e_{34} &= K'_A E_r \sin \theta \sin \omega_c t \\ e_s &= E_c' E_r \sin \omega_c t \end{aligned} \quad (9)$$

These voltages are all normally available with any direction-finding system. If e_{34} is shifted 90 degrees, it may be expressed as

$$e'_{34} = K'_A E_r \sin \theta \cos \omega_c t \quad (10)$$

This phase shift could be accomplished by different feeder lengths from the two antennas. If now e_{12} is added to e'_{34} in a linear mixer

$$\begin{aligned} e_a &= e_{12} + e'_{34} = K'_A E_r [\cos \theta \sin \omega_c t + \sin \theta \cos \omega_c t] \\ &= K'_A E_r \sin(\omega_c t + \theta) \end{aligned} \quad (11)$$

The two voltages e_s and e_a represent the exact voltages required by the vectorscope to yield a display of the direction-finding angle θ . Voltage e_s should be considered the reference and e_a the signal of unknown phase. If ω_c is not the proper angular velocity for the vectorscope, it may be converted to the desired frequency by a local oscillator-mixer system. No switching or rotating of antennas is required.

REFERENCES

(1) K. Schlesinger and L. W. Nero, A Phase Indicator for Color Television, ELECTRONICS, p 112, Oct. 1952.

By WILFRED A. YATES

and

MARTIN DAVIDSON

*Electronics Instrumentation Section
Electronics Division
National Bureau of Standards
Washington, D. C.*

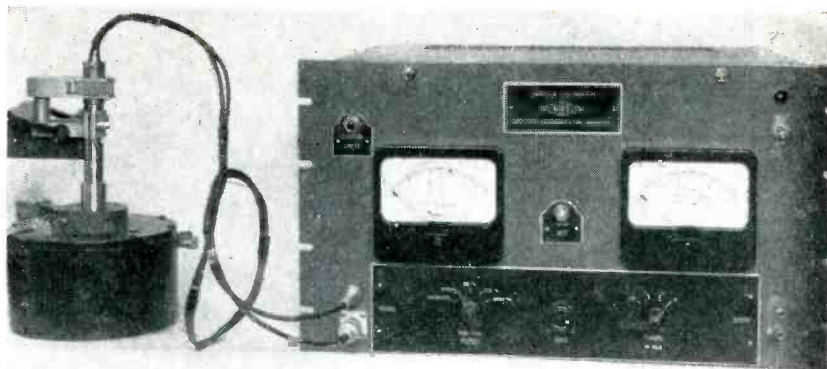

Pickup calibrator with probe attached to vibration generator. Accuracy of readings is within five percent of full-scale

Wide-Range Calibrator for Vibration Pickups

Nonloading displacement transducer used with vibration generator calibrates vibration pickups in range from 0.01 inch to 10 microinches. Extension of design can be used as controller in vibration generator servo-loop system

INCREASING use of vibration pickups has introduced a serious calibration problem. The importance of higher frequency components of vibration, especially where resonant properties of the pickups may complicate analysis, has emphasized the need for rapid, reliable calibration over wide ranges of amplitude and frequency.

The vibration calibrator provides direct meter indication of the peak amplitude of vibration produced by a vibration generator used for pickup calibration. Amplitude range extends from 0.01 inch into the microinch region with an accuracy of 5 percent of full-scale. Ranges of 0.01, 0.001 and 0.0001 inch are provided with a bandwidth of 10 to 20,000 cps. An additional range of 10 microinches has a flat response from 60 to 10,000 cps. In units of acceleration due to gravity, a range of approximately 2×10^{-4} to 4×10^6 g is encompassed. Oscilloscope connections are provided to permit study of the displacement wave-

form. Accuracy is maintained by direct standardization using a dial gage or other precision displacement measuring device. Stability of the instrument is such that standardization is required only infrequently.

Theory

The basis of measurement is illustrated in Fig. 1A. A stable non-contacting displacement-type transducer producing a voltage proportional to the probe-to-surface separation is the sensing element. Surface vibration with respect to the probe results in an alternating component of output voltage proportional to the amplitude of vibration. Passed through a 60-cycle chopper unit, the a-c component is read by a stable peak-to-peak vacuum-tube voltmeter.

The instrument is standardized by chopping the d-c voltage increment produced by a standard mechanically-measured 0.02-inch displacement change, into a square

wave. Fed into the vtvm on the 0.01-inch range, the square wave is equivalent to an 0.01-inch peak amplitude vibration. The voltmeter is then adjusted to read full-scale. Calibration of only one range is required since the more sensitive ranges are obtained by voltage dividers.

The vibration calibrator provides a direct comparison between indicated peak amplitudes and the 0.02-inch displacement. Choice of a standard displacement was dictated by the ease with which it can be reproduced.

Sensing Element

Transducer requirements may be specified in terms of stability, linearity, bandwidth and signal-to-noise ratio. Stable sensitivity is necessary to avoid frequent re-standardization. Transducer sensitivity should not vary with vibration frequency. Linearity refers to the constancy of sensitivity with respect to displacement from the

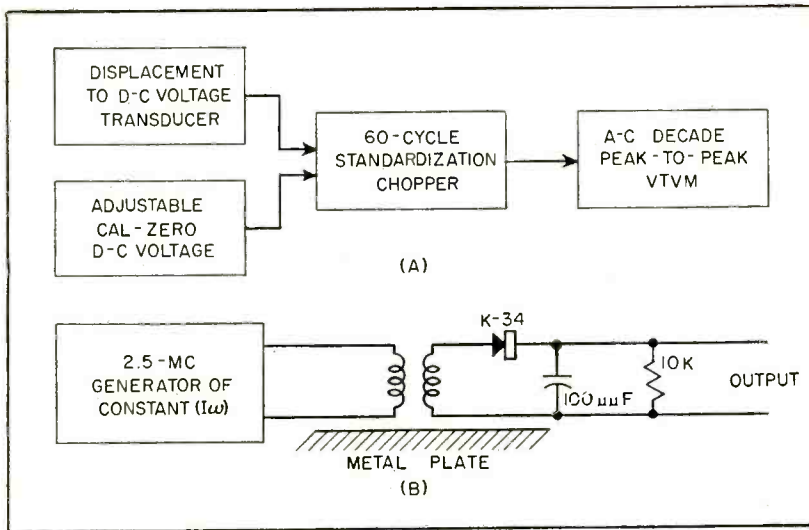

FIG. 1—Block diagram (A) of vibration calibrator. Chopper input is switched from transducer to calibrating voltage to set VTVM. Amplitude of vibration is measured by effect of plate distance on coil coupling in probe (B)

surface. Since this distance is not normally monitored mechanically, instrument accuracy should not be impaired by small variations in the initial setting. Finally, the signal-to-noise ratio of the transducer is significant because of the minute amplitudes measured.

The a-c vacuum-tube voltmeter must meet requirements of stability and bandwidth equivalent to those of the transducer. If the duty cycle of the 60-cycle chopper is not to be controlled accurately, the only a-c amplitude measurement of significance is on a peak-to-peak basis. Therefore, a peak-to-peak voltmeter, calibrated in terms of single peak amplitude, is used. Close attention to the decade stability of the amplifier section is required since only a single range is standardized.

Circuits

Operation of the displacement transducer is illustrated in Fig. 1B. This design is based on a mutual-inductance type developed by M. L. Greenough. The transducer consists of a carrier-excited air-core transformer and detector. Coupling between the primary and secondary windings, and therefore the amplitude of the detected secondary voltage, varies with the distance between the plane of the windings and the surface of a nonmagnetic metal plate as a result of eddy currents induced in the plate. With suitable coil configurations and over a limited

range of separation, the relationship between d-c output voltage and displacement is fairly linear as shown by the transfer curve, Fig. 2. Figure 3 illustrates the transducer sensitivity curve where the slope of the transfer curve is plotted against displacement. The operate point marked on this curve is selected on the basis that the average sensitivity for the 0.01-inch maximum amplitude of vibration and that of smaller amplitude ex-

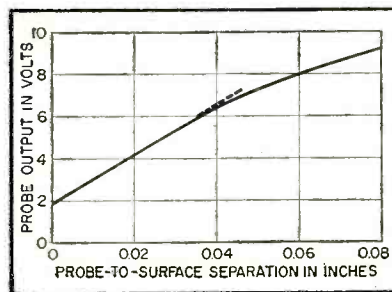

FIG. 2—Probe output in relation to distance from surface

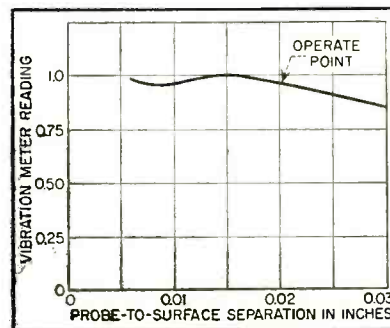

FIG. 3—Vibration meter reading and distance of probe from surface

cursions from this point are equal.

To obtain necessary sensitivity the primary winding of the transducer requires about 1.8 amperes rms at 2.5 mc. This current is obtained without excessive power consumption from the circulating current of a high-Q tank circuit (Fig. 4), composed of L_s and an 0.0016- μ f capacitor driven by the oscillator tube V_1 . The transducer coils are mounted in a protecting probe attached to the main chassis by a pair of cables.

Regulation

Stability requirements make it necessary to regulate the current \times frequency product in the probe primary. The regulation loop L_s , V_2 , V_3 , V_4 and the screen supply of V_1 has internal d-c positive feedback through a 75K resistor. The d-c open-loop gain is about 80. Loop oscillation is prevented by holding frequency response to half gain at 80 cps by negative feedback introduced through the 0.01- μ f capacitor.

While the regulation loop affords some improvement in the signal-to-noise ratio it is also necessary to shock-mount the subchassis containing those circuits and to choose the oscillator tube type with care. The lower limit of vibration-amplitude measurement in the present design is set by noise in the oscillator tube, which produces a reading of 0.4 microinch.

Because the transducer itself has no moving parts, there are no mechanical bandwidth problems to consider. Electrically, it has been calculated that no errors larger than 2 percent are produced in a vibration-frequency band from zero to several hundred kc, far beyond the bandwidth of the remaining circuits.

The initial spacing between surface and probe is normally set by a displacement meter with markings for that purpose. This meter measures the d-c component of the probe output and assures reproducible displacement settings. When vibration amplitudes are being read this meter is removed from the circuit to prevent vibration-induced meter coil motions from producing spurious signals at the vtm input.

For standardization, probe spacing is adjusted until the displace-

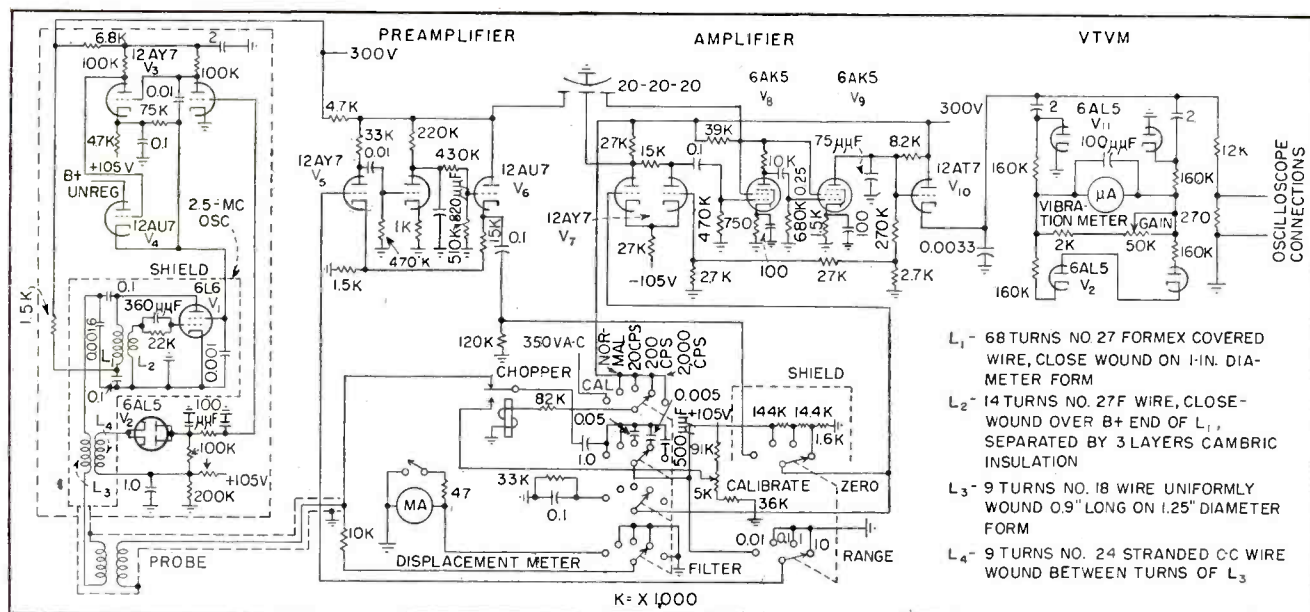

FIG. 4—Circuit of vibration-pickup calibrator. Transducer circuits are isolated by shock-mounted chassis to improve signal-to-noise ratio

ment meter reads zero. The calibrate-zero control is then adjusted to provide an equal buck-out voltage to the other contact of the chopper relay as evidenced by a zero vibration-meter reading. Thus when the probe is advanced toward the surface by the standard 0.02-inch displacement the voltage difference between the two contacts corresponds exactly to the standard displacement and permits adjustment of vtm gain to a standard square wave of equivalent vibration amplitude.

Amplifier

The main amplifier in the vtm is of conventional design. Overall bandwidth is restricted as shown in the solid curve of Fig. 5. The amplifier is stabilized to a gain of about 1,000 by 30 db of inverse feedback. The measuring ranges are obtained by precision dividers in the amplifier input. The most sensitive decade range is obtained by switching in preamplifier V_6 and V_7 , which has a stabilized gain of 10. Preamplifier bandwidth is further restricted as shown by the dotted line of Fig. 5 to decrease the noise bandwidth to obtain lower minimum vibration readings. The coupling element time constants of the amplifier pass the 60-cycle standardizing square wave but are not large enough to prevent low-frequency distortion. To compensate for this

and other small errors, a 33K resistor is inserted in the calibrate position to decrease the amplifier gain 5 percent during standardization.

The vibration meter is driven by the peak-to-peak detector, V_{11} . Initial thermal emission current of the detector is cancelled by diode V_{12} . Gain of the entire vtm system is adjusted over a two-to-one range by a variable meter shunt. The final detector is driven by the low-impedance source provided by cathode follower V_{10} . A 0.0033- μ f bypass capacitor prevents residual 2.5-mc carrier voltage from influencing the indication. Regulated voltage supplies of conventional design are also provided.

Test Results

Calibrator readings have been checked against those obtained with less convenient but more accurate methods. Comparison has been

made over a frequency range of 20 to 2,000 cps with amplitudes from 0.001 to 0.01 inch using a calibrated microscope with stroboscopic illumination. Within these limits, the measurements check within specified tolerance. Tests at higher frequencies were hampered by lack of suitable equipment.

Slight extension of the basic calibrator design would enable its use as a controller in a vibration generator servo-loop. This has not been done in the present case because of the wide diversity of vibration generators needed to cover so broad a frequency range.

Development of the vibration calibrator was sponsored by the Navy Department, Bureau of Ships. The assistance of the National Bureau of Standards Sound Laboratory and of the Wave-Mechanics Laboratory of the Naval Engineering Experimental Station in testing the instrument is gratefully acknowledged.

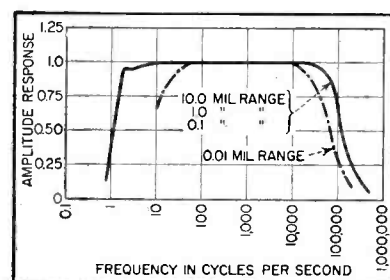

FIG. 5—Variation in response with frequency

BIBLIOGRAPHY

- M. L. Greenough, Technical Data on Electronic Micrometer, *ELECTRONICS*, 20, p 172, Nov. 1947.
- The Absolute Calibration of Vibration Pickups, *NBS Tech. News Bulletin*, 32, No. 1, Jan. 1948.
- Accelerometer Calibrators, *NBS Tech. News Bulletin*, 32, No. 12, Dec. 1948.
- J. P. Arndt, Direct Reading Microdisplacement Meter, *Jour. Acoust. Soc. Amer.* 21, No. 4, July 1944.
- M. Harrison et al, The Reciprocity Calibration of Piezoelectric Accelerometers, *Jour. Acoust. Soc. Amer.* 24, No. 4, July 1952.

Recording Facilities

CONFERENCE RECORDING in the past has suffered from attempts to utilize a single microphone and recording machine in rooms where the acoustics have been inadequate to allow intelligible recording of distant talkers. The equipment described is not a commercial unit, nor was it built with the idea of making a similar commercial system.

As in the past, the system utilizes dictating machines as the main recording units, for later transcribing convenience. Modern electronic dictating machines have good speech fidelity, plus many convenience and control features. The machine chosen is an **electronic** disk recorder utilizing constant groove speed to maintain fidelity and hence intelligibility of recording at all points on the disk. It can be remotely controlled, is inexpensive to operate, and incorporates an AVC circuit to improve the tolerance of the recorder to varying input signal levels.

The interconnection of the recording equipment with the microphone equipment in the conference area involved the design and construction of a control box using the circuit shown in Fig. 1. No changes are made in the dictating machine.

The essential components of the complete system are up to four microphones for pickup of discussions originating on the floor, a fifth microphone for the chairman of the meeting and a sixth microphone for the operator to insert comments and identifying remarks on the record. The latter can be a standard dictating microphone.

The chairman's mike is always alive and his remarks recorded, through the frequency correction and attenuation networks shown, on whichever of the two recorders is actuated. When a person from the floor desires to speak, he goes to the floor microphone nearest him. Just before activating this microphone, the operator momentarily inserts his own microphone in the circuit and identifies the speaker for the record.

The circuit is arranged so two or more of the microphones on the floor may be actuated at the same time for rapid discussion between two people; low-level mixing facilities is provided by the control box.

The circuit is arranged so two or more of the microphones on the floor may be actuated at the same time for rapid discussion between two people; low-level mixing facilities is provided by the control box.

By **G. E. BEGGS, JR.**

*Leeds & Northrup Co.
Philadelphia, Pa.*



Control box switches floor microphones

The circuit is used in conjunction with a public address system which reproduces discussion over the loudspeakers for the benefit of the other conferees. Only such comments as are derived from the microphones which are live at the particular time in the program are heard. The identifying comments from the control operator's microphone do not usually go out over the public address system.

When public address facilities are used, the low-level controls on the control box are preset to avoid acoustic feedback and the recording gain controlled with the separate gain control. Adequate gain is available to allow satisfactory recording even when p-a level is inadequate for proper loudspeaker operation.

Circuit Description

Low-impedance balanced-line microphones are used with a low-level mixer having four T-pads. After amplification, output networks reduce the level to a value appropriate for input to the recorders and boost the higher frequencies for better intelligibility. Recorders and earphone monitor channel are fed from the separate

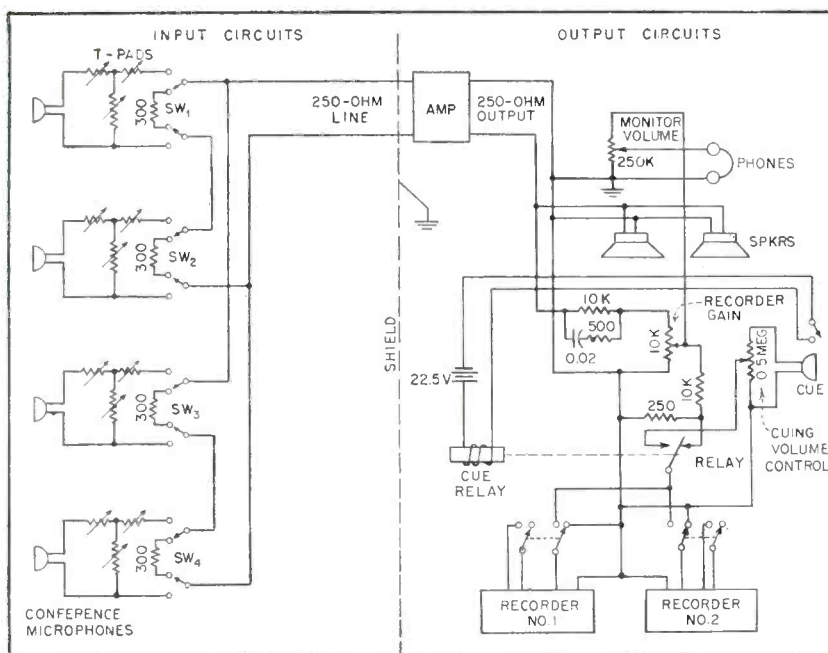

Schematic of control system for conference recording

for Conferences

Multiple microphones can be connected through a central control position to two electronic dictating machines for providing complete and accurate minutes of conferences. Use in conjunction with public address system is optional. Operator has break-in cueing microphone for recording names of speakers

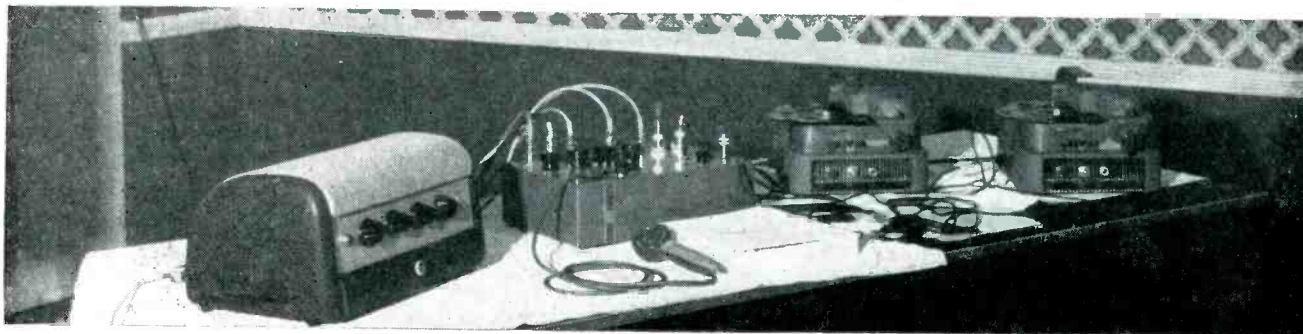

Operator's position at control box is located unobtrusively in conference room

recorder gain control. The output impedance of the dividing network is made low so that one or several Gray Audograph recorders can be operated simultaneously from the network.

Since disk rotation in the recorder is controlled by a d-c relay, the switch controlling the application of audio power to the recorder is also utilized to actuate the relay which starts the disk rotating. Thus, control of the two records is conveniently centralized at the control panel.

A socket identical to that in the recorder is built into the control box so that the recorder microphone can be plugged directly into it. The audio signal from this plug is fed into the normally-open contact of a relay through the cue gain control. The normally-closed contact of this relay feeds sound from the multiple microphone mixer into the recorder at all times, except when the relay is actuated through the plug by depression of the microphone handle switch. This switch energizes the relay coil from a 22½-volt battery built into the control box, transferring both recorders to the output of the cue mike momentarily to allow identification of talkers.

Where it is desired to use the equipment without public address facilities, an internal single-channel amplifier of straightforward design is incorporated in the control box. An input transformer is provided to match the 250-ohm output of the mixer to the grid of this amplifier. The output of the amplifier, either a cathode follower or transformer-coupled output, works into the network. In this case, it is necessary to reduce the overall attenuation of the output network since the internal preamplifier gain is considerably less than that in the complete public address amplifier.

Recording With P-A

A dual triode, such as a 12AY7, is used to provide a gain of the order of 60 db, utilizing both stages as amplifiers with transformer output to provide adequate recording and monitoring level. The output signal may also be used to feed a public address system, which can merely be a basic bridging amplifier which will operate from a level of the order of one volt. This amplifier would be connected directly across the output of the control box pre-amplifier when needed.

Since the conference is recorded continuously, it is unnecessary to use index strips when making a recording. The recorded records are identified by means of pencilled numbering of each side in the un-recorded center area. On play-back for transcription purposes, index strips are used, transcribing being done with a master machine instead of the usual secretarial machine.

Where any question arises as to what a certain passage meant, or whether a half-finished sentence should be omitted, the transcriber operator punches a correction hole in the index strip to facilitate later identification of the particular passage. In addition, punch marks are made with the end marker to indicate the beginning and end of each person's discussion and are so noted on the draft of the transcribed minutes; an example of a notation might be No. 10-12, which means that at the 12-minute point of record No. 10 there is a punch mark, at which point the beginning of Mr. X's speech starts. This permits easy identification of various passages on the records when the accuracy of the transcription is questioned by individuals attending the conference.

Balance Measurements

By O. M. WOODWARD, JR.

RCA Laboratories Division
Radio Corporation of America
Princeton, N. J.

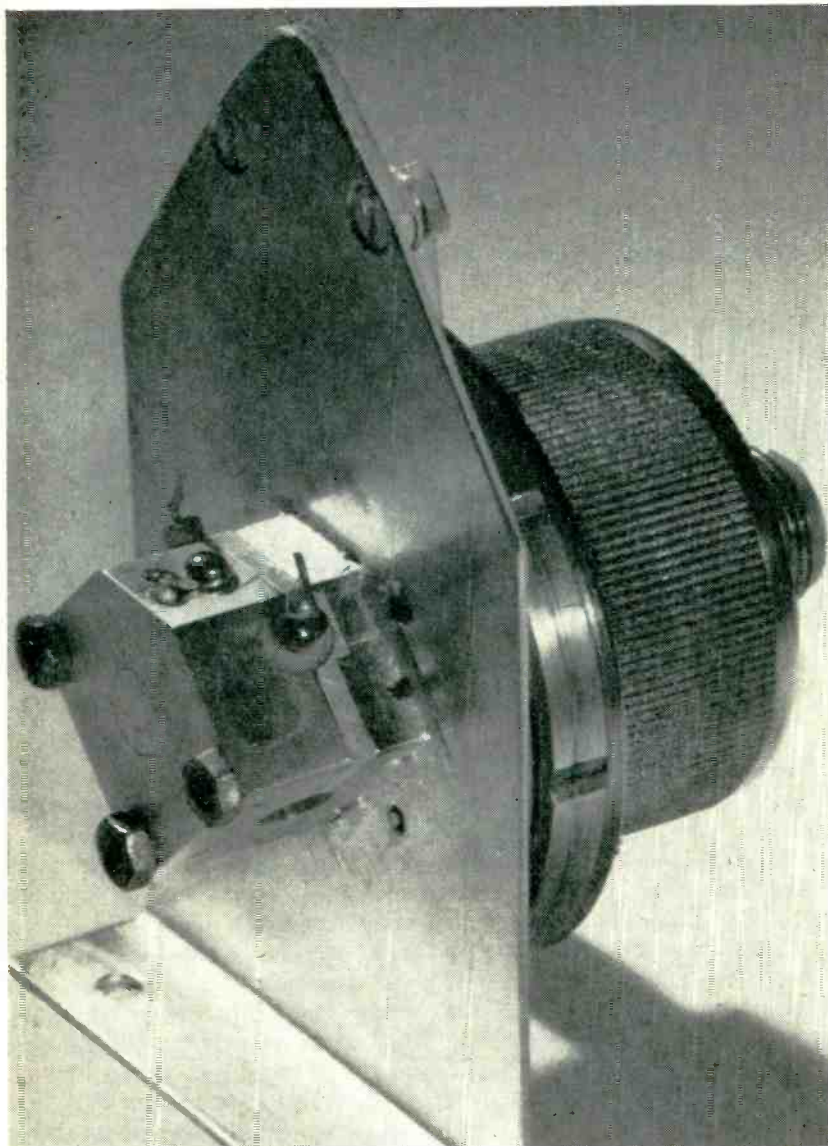

Balance comparator is used in determining efficiency of balun transformers

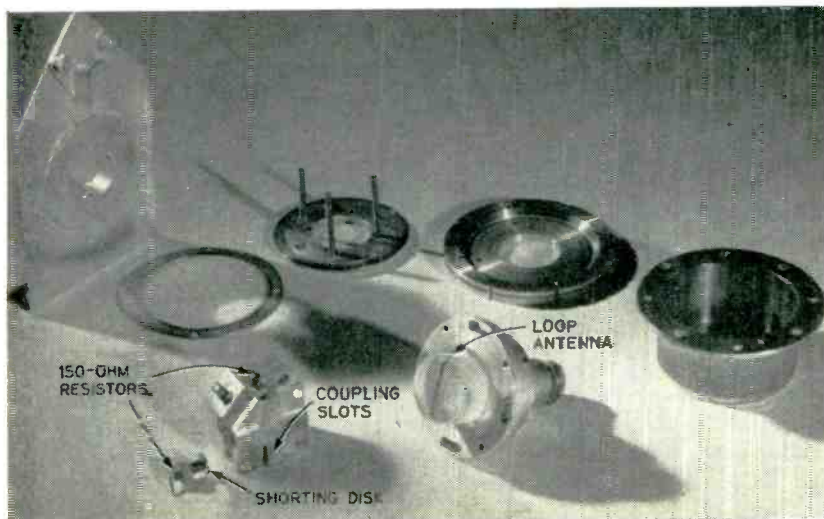

Disassembled parts of balance comparator

ANTEENNA SYSTEMS for reception of horizontally-polarized vhf and uhf signals are usually of the balanced, symmetrical type while modern receivers usually use un-symmetrical input circuits. An isolation transformer called a balun (*BALANCE-to-UNbalance*) is used to transfer efficiently balanced-mode energy from the antenna and to prevent unbalanced-mode currents from coupling to the receiver input. These unbalanced-mode (push-push) currents result in reduction both of gain and signal-to-noise ratio.

Balance efficiency may be taken as a figure of merit for baluns. It is the ratio of the balanced-mode (push-pull) components of load current to total load current and is expressed in percent.

A perfect balun has been shown to operate independently of source or load impedance.¹ Some baluns, however, have balance characteristics that are a function of frequency as well as load or source impedance. Since practical antenna installations vary widely, it is impossible to specify balance quality for all operating conditions. An arbitrary standard setup will be described for comparing the relative merits of different baluns. The device shown in the photograph is called a balance comparator and is used in determining balance efficiency.

Theory

Figure 1A shows a balun joining an unbalanced-mode generator to a balanced load, $2Z_0$. The balun is assumed to be made of linear, passive elements.

In the general case of imperfect balance, the unequal load currents, I_1 and I_2 , may be resolved into bal-

On Balun Transformers

Figure of merit is established to express relative balance quality obtained with balun transformers. Comparator for measuring balance efficiency is described and results of tests on typical uhf and vhf baluns are reported

anced or push-pull components, I_a , and unbalanced or push-push components, I_b , as shown in Fig. 1B. The unbalanced components return through ground to the generator. The vector relation of the load-current components is illustrated in Fig. 1C.

Balance efficiency is defined as

$$\text{Balance efficiency} = \frac{|I_a| \times 100}{(|I_a| + |I_b|)} \quad (1)$$

When only balanced currents flow, $I_b = 0$, and the balance efficiency is 100 percent.

For consistent comparison, the balun should be tested with a balanced load equal to the nominal design value.

Unbalanced Load

The balun may also be operated with energy flow in the opposite direction as shown in Fig. 2A where it joins a balanced-mode generator with an internal impedance $2Z_0$ to an unbalanced load, Z_L . This is the more common application in television practice in which the load is the television receiver input and the generator, the balanced antenna and transmission line.

Load currents I_1 and I_2 result from turning on each of the voltages, E_0 , separately. With both voltages on, the total load current is $(I_1 + I_2)$.

If one of the input voltages is reversed in phase (Fig. 2B) an unbalanced-mode generator is obtained and the load current becomes $(I_1 - I_2)$. If the balun input is balanced, this unbalanced mode is suppressed and I_1 equals I_2 .

From the vector diagram, Fig. 1C, it is seen that

$$I_b = I_1 - I_2/2 \quad (2)$$

$$I_a = I_1 + I_2/2 \quad (3)$$

and

$$\frac{I_b}{I_a} = \frac{I_1 - I_2}{I_1 + I_2} = \frac{1 - I_2/I_1}{1 + I_2/I_1} \quad (4)$$

Thus the ratio of the receiver current magnitudes for the two feed conditions shown in Fig. 2 is the same as the ratio of the unbalanced and balanced current magnitudes derived in the first case of Fig. 1.

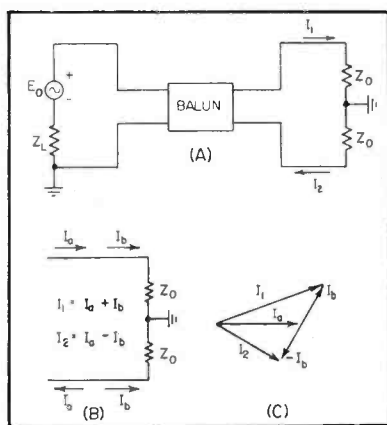

FIG. 1—Balun joining a balanced-mode generator to an unbalanced load

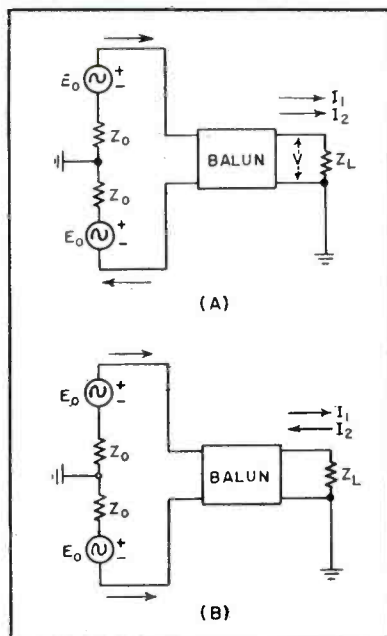

FIG. 2—Balun joining a balanced-mode generator to unbalanced load (A), and joining an unbalanced-mode generator to unbalanced load (B)

The relation between the balance efficiency and the impedances of the load and generator is considered next.

Applying Thevenin's theorem to the output circuit of Fig. 2A

$$I_1 = V_1/(Z_L + Z') \quad (5)$$

and

$$I_2 = V_2/(Z_L + Z') \quad (6)$$

where Z' is the measured impedance looking into the balun output with the input voltages, E_0 , turned off; and V_1 and V_2 are the open-circuit output voltages obtained by turning on the input voltages separately.

The ratio of I_1 to I_2 is unaffected by the value of the load impedance, Z_L . Hence, from Eq. 1 and 4, the balance efficiency is independent of the load impedance.

The load-current components are proportional to the balun input voltages produced by applying the two generators separately. However, since these voltages depend upon the generator internal impedance as well as the balun input impedances to ground, the ratio of I_1 to I_2 and hence the balance efficiency, is a function of the generator internal impedance, $2Z_0$.

The balun should therefore be tested with a generator having an internal impedance equal to the nominal value for which the balun was designed, 300 ohms in television practice.

Example

A typical example of balance efficiency plotted against frequency is shown in Fig. 3.

An advantage in expressing the quality of balance in this manner is seen in that the relative absolute magnitudes of the measurements for either type of balun application are apparent at any frequency.

One means of experimentally de-

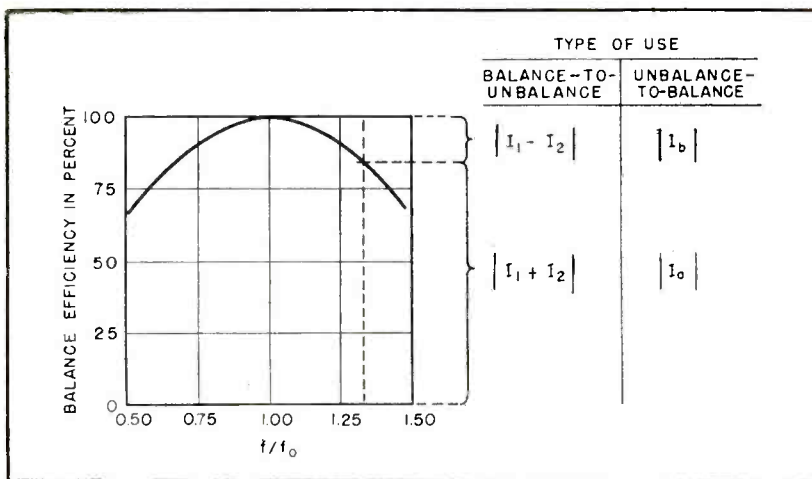

FIG. 3—Typical example of balance efficiency plotted against normalized frequency

termining the data required for calculating the balance efficiency is given by Tomiyasu.² The data may also be obtained by use of slotted lines. Connect balanced output loads of the balun to the inner conductors of two slotted coaxial measuring lines as shown in Fig. 4.

As the lines are identical and matched, the relative absolute magnitudes of the output voltages, V_1 and V_2 , are found by sampling each line with a probe and receiver.

The phase relationship is measured by the use of two adjustable probes joined by equal length lines to the receiver. The probe depth and position on each of the lines are adjusted for zero receiver indication. Since the phase shift is linear on the two matched lines, the relative phase difference between V_1 and V_2 may be calculated.

Balance Comparator

The layout of the balance comparator for measuring these quantities is shown diagrammatically in Fig. 5 and in the exploded view.

Two short coaxial lines are positioned at right angles with inner conductors consisting of small carbon resistors, Z . One end of each resistor is grounded to its outer conductor by a shorting disk, C . The free ends of the two resistors lead to the balanced terminals of the balun under test. The outer conductors of the coaxial lines and the balun ground terminal are joined together. The coaxial or unbalanced terminals of the balun connect to a signal source.

A receiver or other indicator con-

nnects to a single-turn loop that may be rotated on an axis perpendicular to the plane of the two coaxial lines. An equal number of saw cuts, D , in each of the coaxial lines provides electrostatic shielding but permits very loose magnetic coupling between the loop and resistors. The extension of the resistor axes and the axis of loop rotation intersect in a common point.

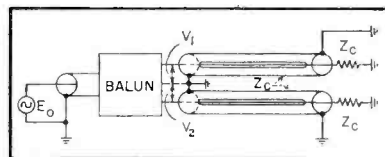

FIG. 4—Slotted-line method for measuring balance efficiency

With the loop in position B , bisecting the right angle formed by the two coaxial lines, the receiver indication will be proportional only to the unbalanced components, I_b . With the loop rotated 90 deg to position A , the receiver reading will be proportional only to the balanced-mode components, I_a .

Therefore the conditions previously described in which the balun joins an unbalanced generator to a balanced load are fulfilled. The values of the coaxial resistors Z are made equal to one-half of the nominal operating load of the balun under test.

Measurement

In operation, the loop is simply rotated to positions B and A and from the ratio of the corresponding receiver indications the balance efficiency may be calculated using Eq. 1. Identical results will be obtained if the receiver and generator are interchanged.

The relative magnitude of the currents I_1 and I_2 of Fig. 1A may also be found by rotating the loop to the 45-deg positions such that it is parallel to each of the resistors, Z , of Fig. 5 in turn. Hence the relative phases of the vectors of Fig. 1C may be calculated if desired.

In operation, considerable care must be exercised in maintaining

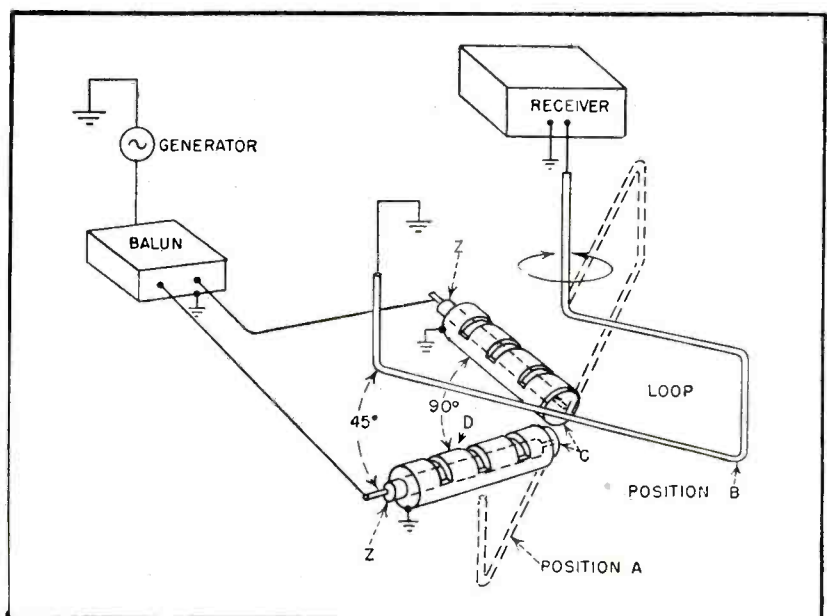

FIG. 5—Block diagram of balance comparator illustrating its use in determining balance efficiency

short symmetrical connection between the test balun and comparator terminals, especially in the uhf band.

As most of the baluns in television use are designed for nominal balanced impedances of 300 ohms, 150-ohm resistors are used in the balance comparator. However, the resistor-block assembly is designed so that other values may be easily substituted if necessary.

Tests

To check the accuracy of the device, measurements were taken on baluns having easily calculated balance-efficiency characteristics.

Figure 6A shows a balun is formed by a shorted coaxial sleeve, a quarterwave in length at the mid-band frequency of 700 mc, which isolates one end of the unbalanced coaxial line from ground potential. The equivalent electrical circuit is drawn in Fig. 6B. The calculated and measured data for the particular balun dimensions shown are plotted in Fig. 6C and show close

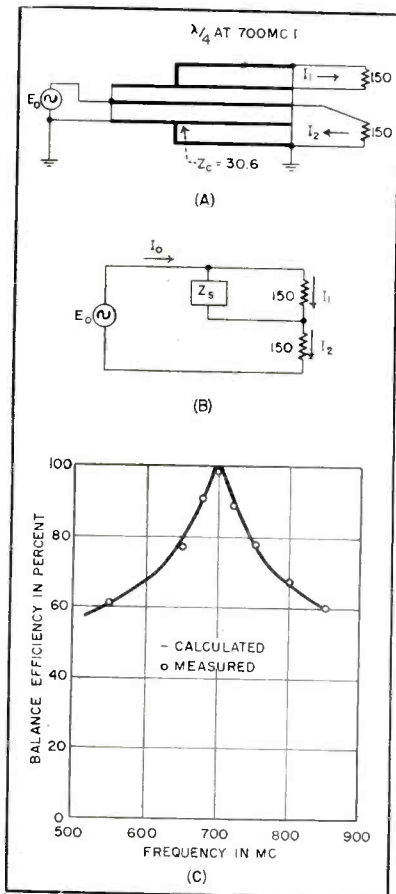

FIG. 6—Quarter-wave sleeve balun and results of balance-efficiency measurements

agreement. Greatest unbalance occurs when the sleeve reactance, Z_s , at the open end approaches zero. For this condition, $I_1 = 0$, or the components I_a and I_b are equal and opposite in one leg of the load. Hence, from Eq. 1, the minimum balance efficiency becomes 50 percent.

A commonly-used balun formed from a phase-reversing half-wave cable is shown in Fig. 7A and its equivalent electrical circuit in Fig. 7B. Calculated and measured data in the vhf range are given in Fig. 7C.

For the condition of a phasing cable an integral number of wavelengths long, I_1 and I_2 are equal in magnitude and flow in the same direction. Hence $I_a = 0$, and a minimum balance efficiency of 0 percent is obtained.

The greatest impedance bandwidth is obtained from this type of balun when the phasing cable is matched or equal to one-half the balanced load impedance. However, the greatest balance bandwidth is obtained when the ratio of load impedance to phasing-line impedance is made as large as possible.

The balance characteristics of both types of baluns are seen to be sharp in terms wide-band coverage.

Slotted Balun

A further check was provided by measurements taken on a balun (Fig. 8A) that is balanced independently of frequency change. This balun consists of two diametrically opposite slots cut in the outer conductor of the unbalanced coaxial line and the inner conductor shorted at the open end to one of the line sections produced by the slot. The slots are one-quarter wave in length at the midband frequency for the best impedance characteristic. A quarter-wave sleeve may enclose the slotted assembly as shown in Fig. 8A to provide shielding and a ground terminal near the balanced leads.

While this balun is well-balanced versus frequency, its impedance bandwidth is relatively narrow. For purposes of calculation, the impedance at the end of the coaxial line is one-fourth the shunt combination of the balanced load im-

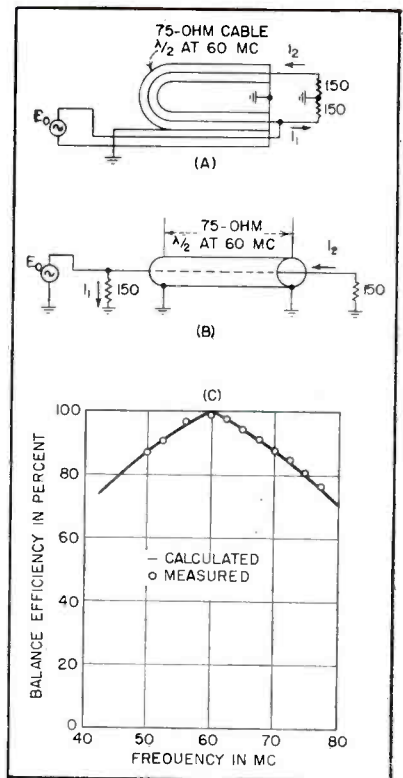

FIG. 7—Quarter-wave loop balun and results of balance-efficiency measurements

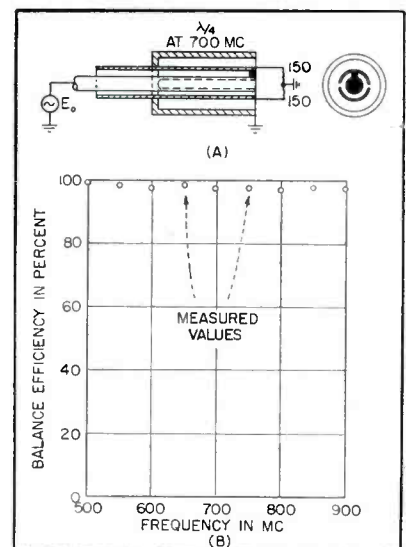

FIG. 8—Slotted balun and results of balance-efficiency measurements

pedance and the balanced reactance presented by the forked tube.

The measured balanced efficiency data on this balun is given in Fig. 8B.

REFERENCES

- (1) S. Frankell, Reactance Networks for Coupling Between Unbalanced and Balanced Circuits, *Proc IRE*, p 486, Sept. 1941.
- (2) K. Tomiyasu, Unbalanced Terminations on a Shielded-Pair Line, *Jour Appl Phys*, p 552, June 1950.

Cathode-Follower

Graphical procedure simplifies design and eliminates cut-and-try. Charts show output impedance vs input voltage for nine tube types commonly used in cathode-follower circuits and give required resistor value for operating point selected

CATHODE FOLLOWERS are widely used as sources of low output impedance but it is often troublesome to find the d-c operating point required to achieve a desired value of impedance.

The output impedance as seen by an external load is equivalent to the parallel combination of $1/g_m$, r_p and R_k . Since the tube parameters g_m and r_p are usually given in handbooks for only a few values of plate voltage and current, cathode-follower design often reduces to a tedious cut-and-try procedure.

The accompanying charts, however, enable the designer to choose circuit components directly to achieve the desired output impedance with either direct or a-c coupling to the

cathode-follower grid. They also furnish information needed to calculate gain and input impedance and plot input-output curves.

The charts show output impedance R_o plotted against d-c grid-to-ground voltage for various values of cathode resistance. Nine tube types commonly used in cathode-follower circuits are considered.

Assumptions

The expression for output impedance is derived from the

small-signal linear-equivalent circuit and is applicable for small excursions of input voltage about a given operating point such that R_o does not change appreciably during the cycle. This is the case for most cathode followers where the a-c component of the input waveform is a few volts or less.

When the input wave is large enough, the excursions of E_{in} make appreciable changes in R_o and account must be taken of the rates of rise and fall of the input and output waveforms. When the input rises and falls slowly enough, the large-signal cathode follower can be analyzed point-by-point using the charts. If the input falls faster than the cathode circuit can follow and if the waveform is large, the tube can be cut off. This case violates the linearizing assumption and will not be treated.

Chart Makeup

The charts show output impedance R_o plotted against d-c grid-to-ground voltage E_{in} for various values of cathode resistor R_k . The circuit is shown in Fig. 1A.

Curves also are plotted for various values of R_b/R_k , where R_b is the bias resistor in a self-biased a-c coupled circuit, Fig. 1B, and R_k is the total resistance from cathode to ground.

The dashed lines intersecting the solid R_k lines show successive values of E_{gk} , starting with zero at the right and progressing left toward cutoff.

The small bars perpendicular to the R_k curves mark points of maximum allowable plate dissi-

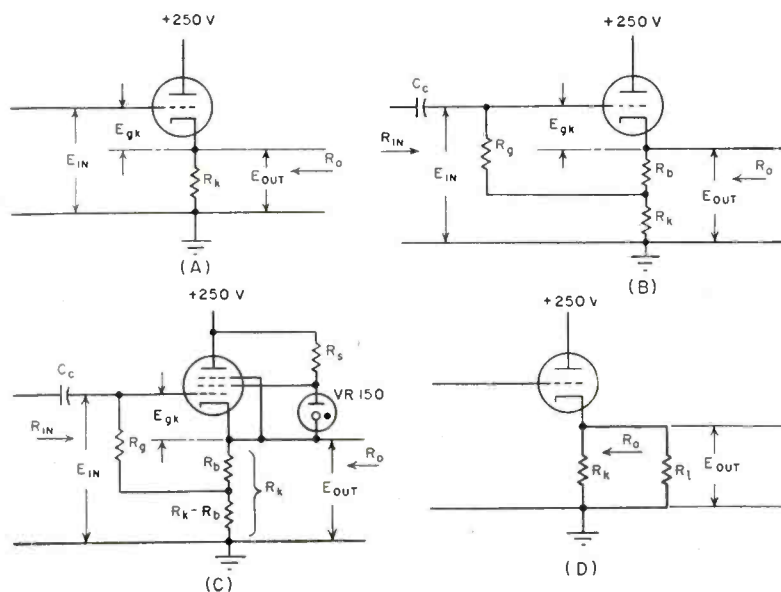

FIG. 1—Design procedure applies to direct-coupled cathode followers (A), a-c coupled, self-biasing circuits (B and C) and to cathode followers whose output is directly coupled to a resistive load (D)

Design Charts

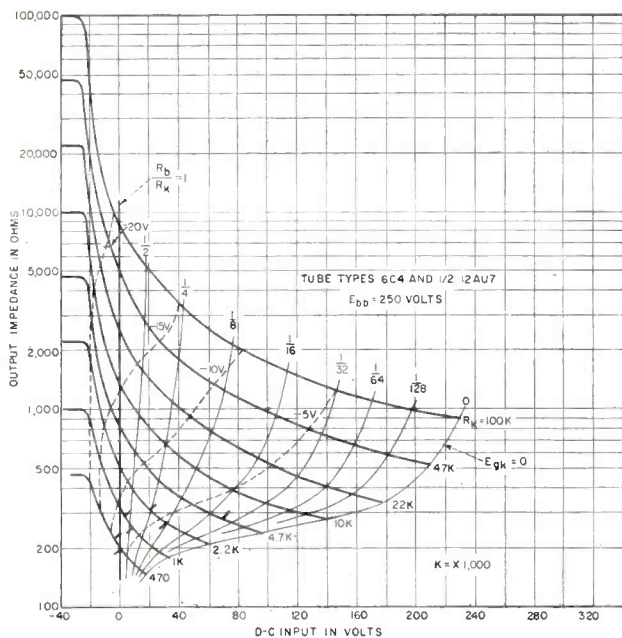

FIG. 2—Design curves for types 6C4 and 12AU7

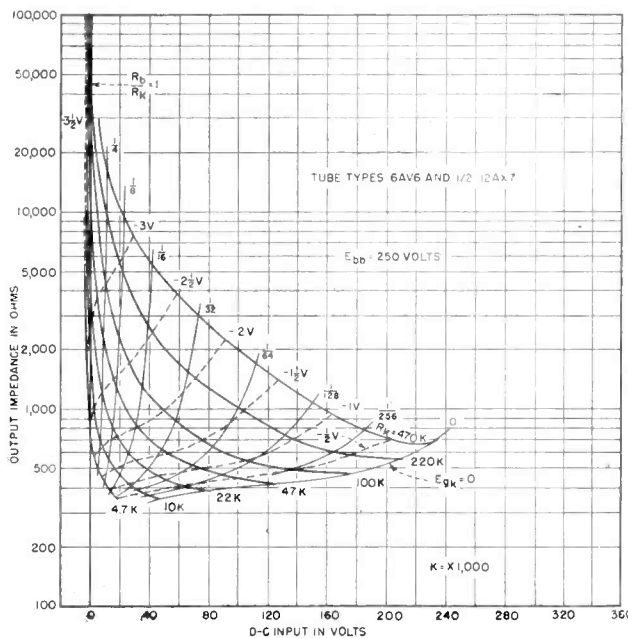

FIG. 3—Output impedance chart for 6AV6 and 1/2 12AX7

pation. Points to the right of a bar require greater than allowable average dissipation. This area can still be used in on-off service if the duty ratio keeps the average dissipation below the rated value.

Two sets of bars are shown in Fig. 2. The upper bars, which occur at lower input voltages, refer to 1/2-12AU7. The others refer to the 6C4. In Fig. 3 all of the conditions shown on the chart are below the maximum rated plate dissipation of the 1/2-12AX7; the bars refer to the 6AV6. In Fig. 4 the 6AB4 and 1/2-12AT7 are both rated for the same dissipation, so only one set of bars is shown. The upper bars in Fig. 5 and 6 occur at low input voltages and apply to the 6CL6; the lower bars apply to the 6AG7.

The charts are usable directly for circuits with plate-supply voltages within 20 percent of design value. For voltage-supply variations greater than this amount, the designer may have to refer to the tube characteristics for corrections to the

nominal operating point.

Design Relations

The output impedance is

$$R_o = \frac{1}{\frac{1}{r_p} + g_m + \frac{1}{R_k}} \quad (1)$$

Circuit gain is

$$A = \frac{d E_{out}}{d E_{in}} = \frac{d [E_{in} + E_{gk}]}{d E_{in}} = 1 + \frac{d E_{gk}}{d E_{in}} \quad (2)$$

For graphical use, this becomes

$$A = 1 - \left| \frac{\Delta E_{gk}}{\Delta E_{in}} \right| \quad (3)$$

To find the gain of the circuit, take a step in E_{gk} straddling the operating point, read off the corresponding change in E_{in} and apply in Eq. 3.

The input resistance is

$$R_{in} = \frac{R_g}{\left[1 - A \frac{(R_k - R_b)}{R_k} \right]} \quad (4)$$

The cathode current is

$$i_k = \frac{E_{out}}{R_k} = \frac{E_{in} + |E_{gk}|}{R_k} \quad (5)$$

Voltages E_{in} and E_{gk} can be read from the chart. For triodes,

i_k is the plate current; for pentodes it is the sum of plate and screen currents. In both cases it represents the total drain on the B+ supply.

The input-output curve, E_{out} vs E_{in} , is easily obtained, since $E_{out} = E_{in} + |E_{gk}|$. Voltage E_{gk} can be read in steps along any desired R_k curve, and the corresponding E_{in} read off the horizontal axis. The sum plotted against E_{in} gives the input-output curve.

Design Procedure

Example 1—For a direct-coupled cathode follower (Fig. 1A) using 1/2-12AU7 it is desired to find the proper cathode resistor for a nominal output impedance $R_o = 600$ ohms when E_{in} , the d-c signal level at the grid, is +80 volts.

Solution: In Fig. 2 the intersection of $E_{in} = 80$ volts with $R_o = 600$ ohms lies just below the $R_k = 22$ K curve, so R_k is slightly less than 22 K. By interpolation it is seen to be about 20 K.

Example 2—It is desired to distribute the audio output of a

(Continued on p 194)

Cathode-Follower Design Charts

continued from page 193

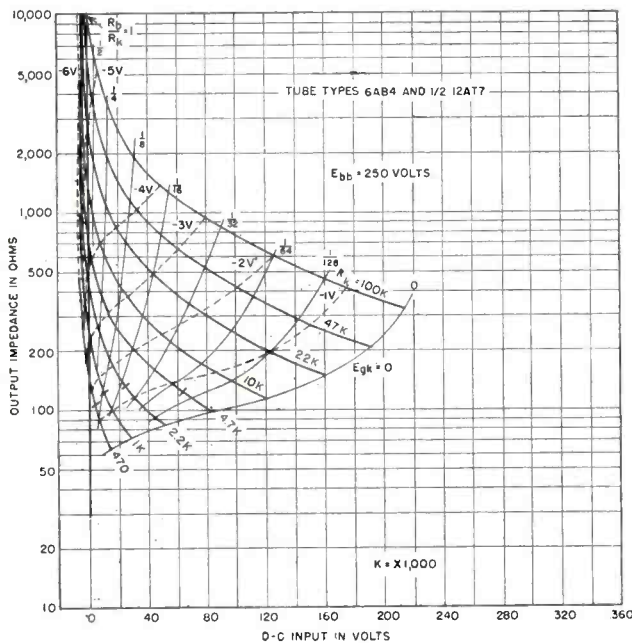

FIG. 4—Type 6AB4 and 1/2 12AT7 design charts

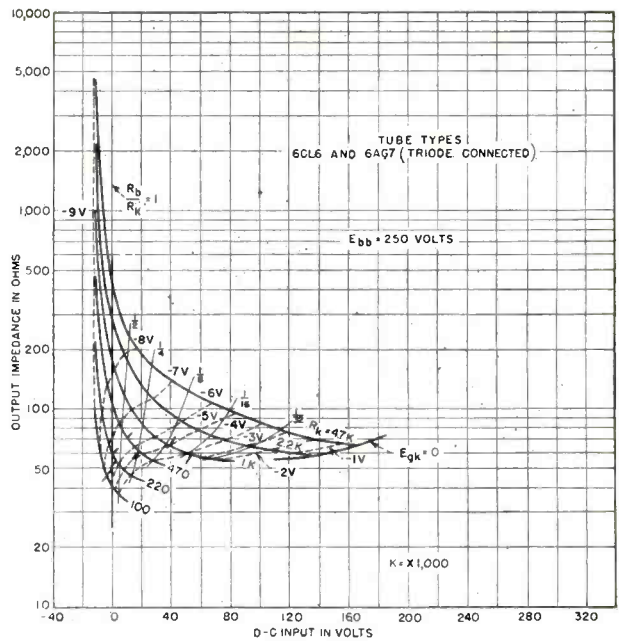

FIG. 5—Chart for 6CL6 and 6AG7 in triode connection

radio tuner to a number of amplifiers in different locations. The total amount of cable connecting the tuner to the amplifiers is 500 feet, and the capacitance of the signal wire to ground is 26.5 μf per ft. It is desired to have the upper and lower half-power frequencies, f_2 and f_1 , be 20,000 cps and 20 cps respectively. The tube to be used is a 6C4 connected as an a-c coupled, self-biased cathode follower (Fig. 1B).

Solution: For the upper half-power frequency to be 20,000 cps, an output impedance $R_o = 1/2\pi f_2 C$ is required, where C is the capacitance to ground of the signal wire, which is 26.5 μf per ft \times 500 feet = 1,330 μf . The output impedance required is $R_o = 1/2\pi \times 20,000 \times 1330 \times 10^{-12} = 600$ ohms.

When self-bias is used, the cathode resistance can be any convenient value, and the bias resistor will be chosen to provide the proper d-c conditions for the tube.

Choosing 22 K for the cathode resistance, the intersection of the $R_k = 22$ K curve in Fig. 2 with

$R_o = 600$ ohms lies between $R_b/R_k = \frac{1}{3}$ and $\frac{1}{6}$. By interpolation, it is seen to be at about $R_b/R_k = \frac{1}{4.3}$. Then $R_b = \frac{1}{4.3} R_k = \frac{1}{4.3} (22 \text{ K}) \approx 1.8 \text{ K}$, and the bottom resistor is $R_k - R_b = 22 \text{ K} - 1.8 \text{ K} \approx 20 \text{ K}$.

To find the gain under these conditions, take a five-volt step in E_{gk} straddling the operating point; E_{gk} goes from -15 volts to -10 volts, while E_{in} goes from 47 volts to 103 volts. Substituting into Eq. 3

$$A = 1 - \left| \frac{15 - 10}{47 - 103} \right|$$

$$= 1 - \frac{5}{56} = 0.91$$

The input resistance from Eq. 4 is

$$R_{in} = \frac{R_o}{1 - 0.91 \left(\frac{20 \text{ K}}{21.8 \text{ K}} \right)}$$

$$= 6.1 R_o$$

If the coupling network is to have a lower half-power frequency f_1 , the coupling capacitor C_c should equal $1/2\pi f_1 R_{in}$. For most tubes, R_o is not recommended to be greater than one megohm; lower values are preferred to reduce the bias-shifting

effect of grid current. If $R_o = 100 \text{ K}$, then $R_{in} = 6.1 R_o = 610 \text{ K}$ and if $f_1 = 20$ cps is required, $C_c = 1/2\pi \times 20 (610 \text{ K}) = 0.013 \mu\text{f}$. The closest nominal value is 0.01 μf and $R_o = 180 \text{ K}$ instead of the assumed 100 K gives the required R-C product with allowance for a -20-percent tolerance on the capacitance and a -10-percent tolerance on the resistance.

The cathode current, from Eq. 5, is $i_k = (87 + 6\frac{1}{2})/22 \text{ K} = 4.3$ ma.

Design Notes

If the cathode follower is to deliver small voltages across high-impedance loads, a low-power tube such as the 12AU7 or 12AX7 can be used. If the tube is to deliver large voltages across low-impedance loads, a power tube such as the 6AG7 or 6AS7 should be used. If the tube is to be direct-coupled to input voltages near zero or slightly negative, a high-cutoff-voltage (low- μ) tube such as the 12AU7 or 6AS7 is indicated.

When a cathode follower is to be operated at a high cathode

(continued on p 196)

Cinch

ELECTRONIC COMPONENTS

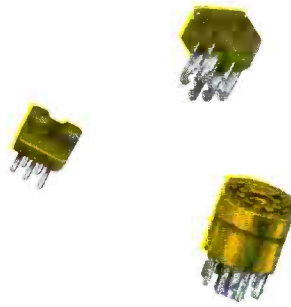

SOCKETS: Tube (Receiver, Transmitter and Special); Battery, all types • C-R Tube • Crystal • Electrolytic • Glass Type; 4 to 7 prong laminated • Infra-red Ray Tube • High Altitude Airborne Types • Kinescope; Magnal, Duodecal, Diheptal • Loktal-Miniature-Multiplug-Noval-Octal (Molded bakelite, steatite, teflon, Kel-F and laminated) • Plexicon • Printed Circuit • Special Sockets to Specs • Sub-Miniature; Hearing Aid Types • TV; 110V Circuit Breakaway • Vibrator • Pencil Tube Transistor • Diode

ANTENNA JACKS
BANANA PINS AND JACKS
BARRIER TERMINAL STRIPS
FANNING STRIPS
BATTERY PLUGS & SOCKETS
BINDING POSTS
DIODE SOCKET
CONNECTORS, MULTI CONTACT
FUSE STRIPS, BLOCKS & BOARDS
GRID CAPS
GRID CAP SHIELDS
HERMETICALLY SEALED TUBE SOCKETS

METAL STAMPINGS
MICRO-CONNECTORS
MOUNTING DEVICES
PHONO TIP JACKS
PRINTED CIRCUIT, CONNECTORS
SHIELDS, TUBE-MINIATURE & NOVAL & BASES SOLDERING LUGS—200 VARIATIONS
STRAP NUTS
TRANSISTOR SOCKET
TUBE HOLDERS—SPRING TYPE
VIBRATOR PLUGS AND SOCKETS

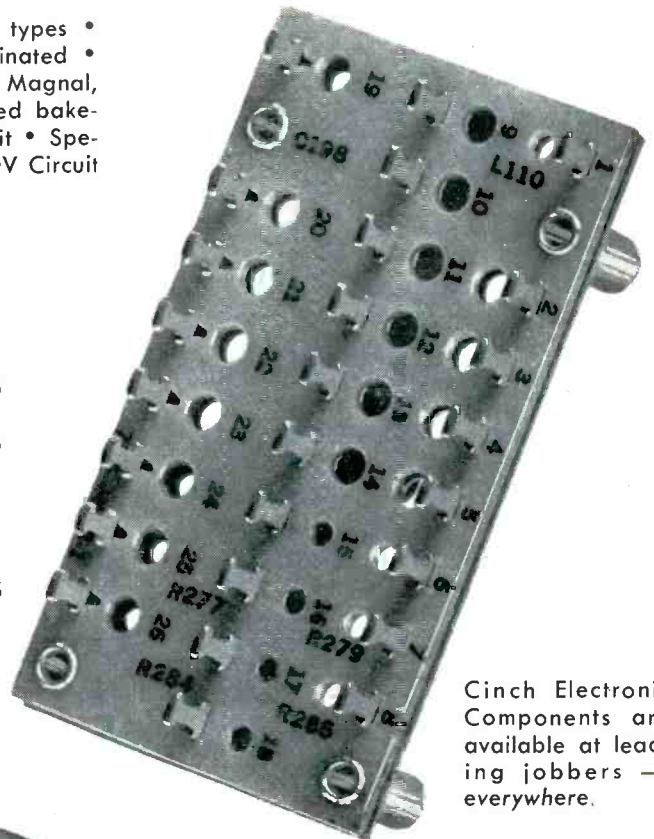

Cinch Electronic Components are available at leading jobbers — everywhere.

TERMINAL ASSEMBLIES: Blocks, boards in laminated and molded, assembled with lugs, pins, screw terminals, contacts, clips, turret lugs and other hardware to specifications.

This list includes products of the Howard B. Jones Division

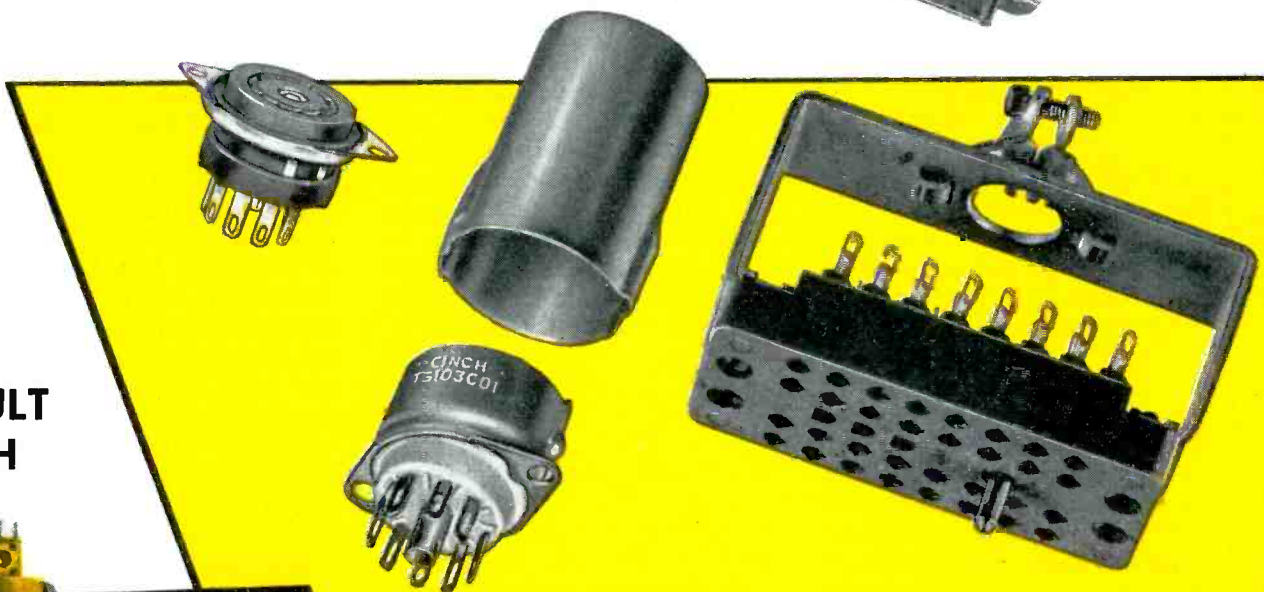

**CONSULT
CINCH**



Cinch
ELECTRONIC
COMPONENTS

CINCH MANUFACTURING CORPORATION

1026 South Homan Ave., Chicago 24, Illinois

Subsidiary of United-Carr Fastener Corporation, Cambridge, Mass.

Cathode-Follower Design Charts

continued from page 194

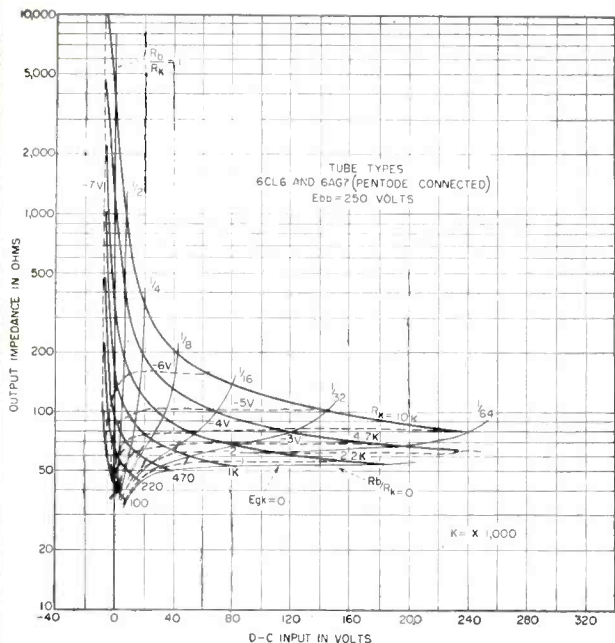

FIG. 6—Pentode connected 6CL6 and 6AG7

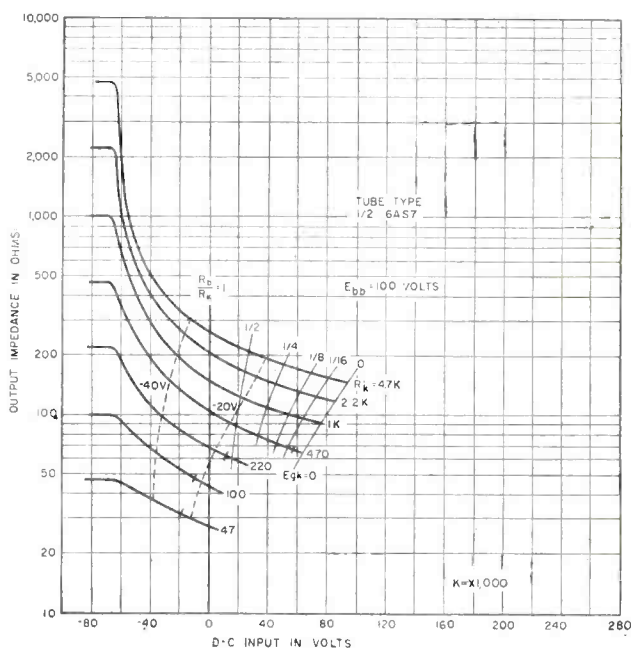

FIG. 7—Design chart for 1/2 6AS7 tube

voltage, care should be taken not to exceed the maximum allowable heater-to-cathode voltage rating of the tube. If a grounded heater supply causes the voltage to exceed the ratings, the heater supply can be connected either to cathode or to a point of positive voltage. If it is connected to the cathode, the capacitance to ground of the heater transformer and wiring will be in parallel with the load. The heater-cathode voltage rating for the 6C4, 6AV6, 6AB4, 12AT7, 6CL6 and 6AG7 is 90 volts. For the 12AU7 and 12AX7 it is 180 volts. For the 6AS7 it is 300 volts.

If a-c coupling is used, self-bias is usually preferable to fixed bias, since variations of the tube from the nominal characteristics tend to be counteracted.

Operation within a fraction of a volt of zero-bias may prove more erratic than with a volt or more of bias, since there may be fractional-volt variations in contact potential between grid and cathode and in initial velocity of electrons leaving the cathode. These effects tend to shift the bias point and will make

less difference when there is appreciable bias already on the tube.

Special Cases

For the 6AG7 shown pentode-connected in Fig. 1C, the VR-150 can be replaced by a bypass capacitor. Resistor R , may be adjusted to give 150 volts.

If the cathode follower output is direct-coupled to a resistive load, as in Fig. 1D, R_L changes the d-c conditions on the tube, affecting g_m and r_p , and thus changing the output impedance. This can be taken into account by considering the cathode load as R_k in parallel with R_L when looking up the bias conditions on the chart. The output impedance read off the chart will then be R_o in parallel with R_L . Resistor R_L can easily be taken out to find the true R_o .

$$\text{True } R_o = \frac{R_o \text{ chart}}{1 - \frac{R_o \text{ chart}}{R_L}}$$

The true R_o and true R_k are still related by the R_o/R_k ratio, and E_{in} read off the chart is also correct.

If the output impedance is re-

quired to be lower than can be obtained within the power dissipation rating of the best available tube, either connect in parallel N cathode followers each designed to have an output impedance NR , where R is the required output impedance, or reduce the plate-supply voltage so that the operating point can be shifted to one of higher d-c current without exceeding rated dissipation. The higher current produces higher g_m and lower impedance. For such changes in supply voltage, new charts must be constructed.

Allowance should be made for normal tolerances of the components, including the tube. Under given voltages, the g_m of the tube can vary on the order of ± 40 percent from the nominal. Self-biasing tends to minimize these variations, but if the output impedance must be held below some maximum value, the nominal design value should be sufficiently lower to allow for tolerance on g_m .

The author wishes to thank Vladimir Kenn of Raytheon Manufacturing Co. for supplying special data on tubes.

Stop Vibrator Power Supply Troubles Before They Start



The best time to do this is while your equipment is still on the drawing board. Each element . . . the vibrator, transformer and buffer capacitor . . . must be carefully selected for balanced electrical characteristics if your power supply unit is going to do the right job when it gets in service.

The best way to avoid vibrator power supply trouble is to call on the specialized knowledge and experience of Mallory engineers. Let us analyze the power requirements of your equipment and help you translate them into a power circuit that will give the performance you need.

Why call on Mallory? There are a lot of reasons . . . good ones. In the first place our experience in this field is backed by an unmatched fund of engineering knowledge that started over 20 years ago . . . when we produced the first commercial vibrator. Our experience includes supplying more vibrators for original equipment than all other makes combined.

That's not all. We are equipped to design and manufacture complete power supply units . . . to your exact requirements . . . to meet your production schedules. If you want to save engineering time and reduce production costs, write us today. It is a good way to stop your troubles before they begin.

Expect more . . . Get more from **MALLORY**

Parts distributors in all major cities stock Mallory standard components for your convenience

P. R. MALLORY & CO. Inc.
MALLORY

SERVING INDUSTRY WITH THESE PRODUCTS:

Electromechanical—Resistors • Switches • Television Tuners • Vibrators
Electrochemical—Capacitors • Rectifiers • Mercury Dry Batteries
Metallurgical—Contacts • Special Metals and Ceramics • Welding Materials

P. R. MALLORY & CO., INC., INDIANAPOLIS 6, INDIANA

ELECTRONS AT WORK

Including INDUSTRIAL CONTROL

Edited by ALEXANDER A. McKENZIE

Contour Tracer for Automatic Machinery	198	Predicting Response Curves of Pickups and Loudspeakers	204
Headphone Jack for Remote Cue Receivers	200	Spectrographic Monitor for Metallic Dust	210
High-Altitude Winds	200	Rotating Screen Color TV Tube	214
Germanium Infrared Modulator	200	Audio-Frequency Filters Using Negative Feedback	222
Radio Dispatch Speeds Steel Handling	200	Push-Pull Amplifiers for Increased Video Output	228
Slow Multivibrator Using Gas Tubes	202	Four-Quadrant Calibrator	236
Automatic Control of TV Picture Brightness	202	Pertinent Patents	240
50-MC Oscillator	204		

OTHER DEPARTMENTS

featured in this issue:

	Page
Production Techniques	262
New Products	316
Plants and People	378
New Books	428
Backtalk	440

Contour Tracer for Automatic Machinery

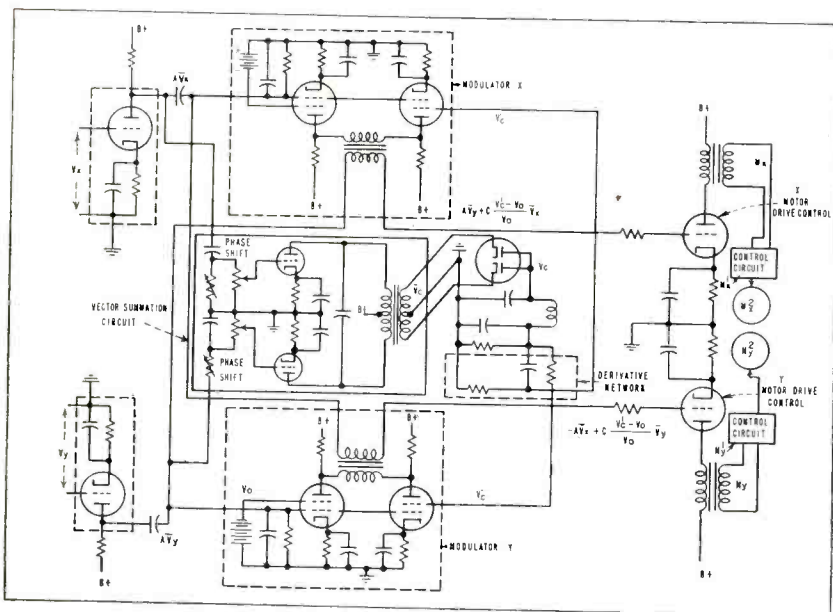

FIG. 1—Positioning and motion control system designed for automatic milling machine

AN INVENTION designed to be used in a position and motion control system such as may be found in automatic contour-tracing milling machines has recently been patented.

The electronic circuit of the positioning and motion control system is shown in Fig. 1. Input voltages V_x and V_y , are developed by the voltage generator shown in Fig. 2A when used in the manner shown in Fig. 2B. The voltage generator has a stylus that traces the contour to be duplicated. The displacement of the armature resulting from the flexure of the diaphragm upon pres-

sure of the stylus results in voltages V_x and V_y , being developed across the windings of the magnetic yoke shown in Fig. 2A.

The in-phase voltages V_x and V_y , representing displacement vectors, are applied to amplifiers and, in turn, to phase-shifting networks that rotate each voltage 90 deg in opposite directions in a vector summation circuit. If the stylus does not move, the resultant voltage V_0 will be zero. Voltages V_x and V_y are also applied to modulators X and Y which, in turn, drive the positioning motors M_x and M_y .

The voltage V_0 passes through

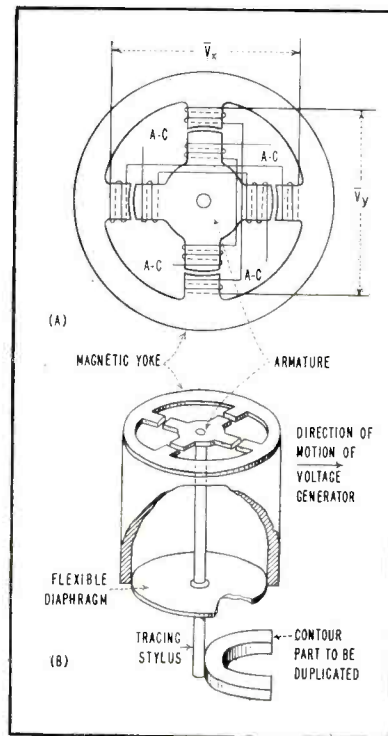
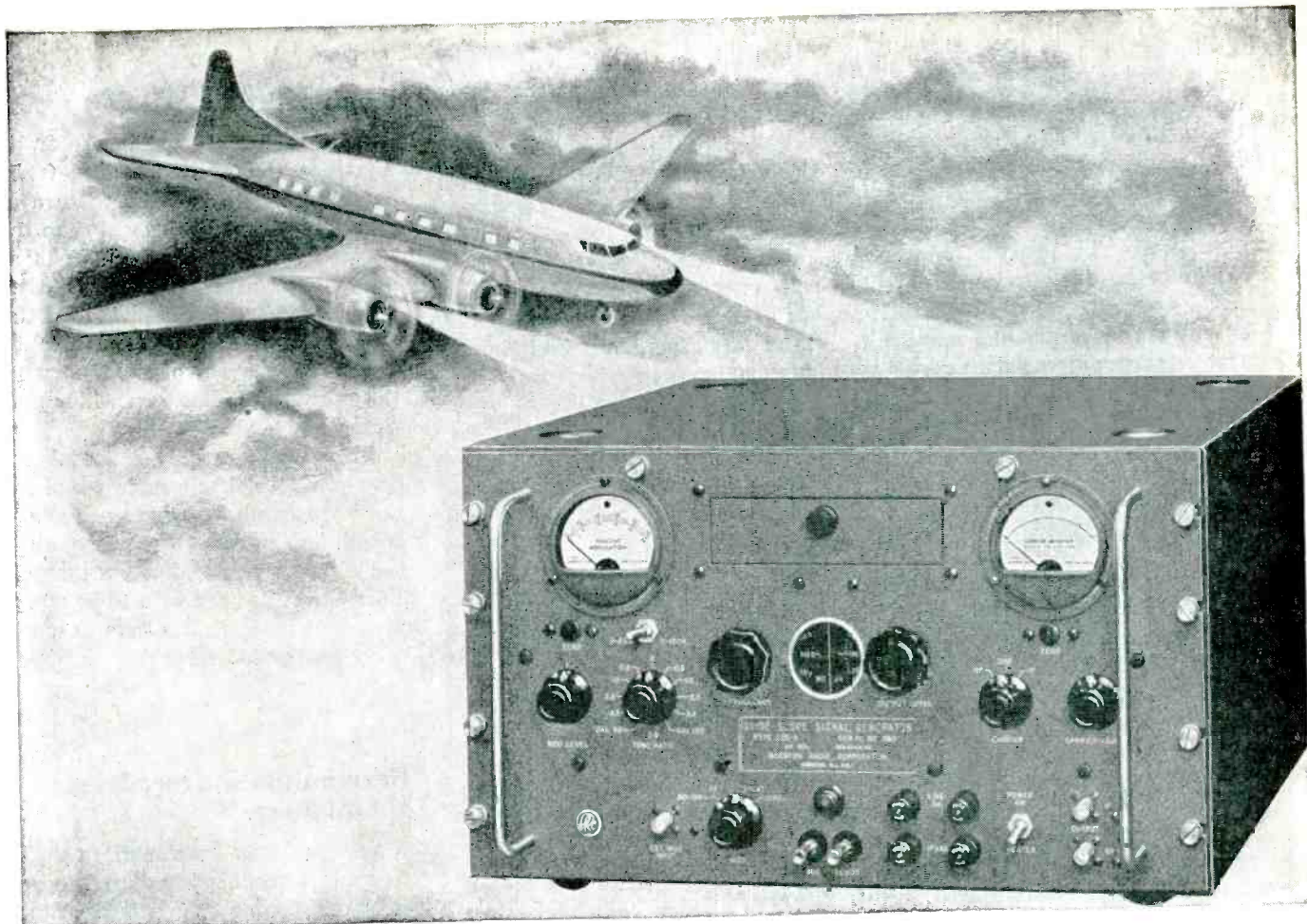

FIG. 2—Input voltages are developed by voltage generator (A) when used with stylus following contour (B)

the derivative network where a factor proportional to the time rate of change is added. The resulting voltage V^1 is compared in the modulators X and Y with a fixed reference voltage V_0 . When V^1 and V_0 are equal the modulator output is zero.

As the stylus pressure against the work template is applied, the stylus deflection is maintained con-



A *NEW* Crystal Controlled Glide Slope Signal Generator

The NEW Type 232-A Glide Slope Signal Generator provides, for the first time in a single self-contained instrument, complete testing and calibration facilities for Glide Slope Receiving Equipment as used in the CAA Instrument Landing System.

Crystal Controlled RF and IF Signal voltages, coupled through carefully designed piston attenuators, permit the accurate study, alignment, and calibration of the system under test; internal modulation is available for both the simulation of on and off-course signals and for general purpose work.

Extreme simplicity of operation is afforded through the use of functional front panel controls common to both RF and IF operation. Modulation and output level are indicated on large panel meters; RF frequency and output voltage are conveniently selected by reference to the legible dials grouped at the center of the instrument panel.

Features

- Overall distortion of demodulated carrier less than 2% through use of special filters and overall feedback.
- Specially designed average reading modulation indicator insensitive to distortion components.
- 90 and 150 cycle tone signals phased for minimum peak modulation.

Write for complete new Catalog "J"

TYPE 232-A

SPECIFICATIONS

FREQUENCY RANGE: (a) RF: 329.3—335.0 MC in increments of 0.3 MC
(b) IF: 18.9 MC (15—30 MC by change of crystal).

FREQUENCY ACCURACY: $\pm 0.0065\%$.

OUTPUT VOLTAGE RANGE: 1.0 to 200,000 microvolts continuously variable.

OUTPUT IMPEDANCE: 53 ohms.

MODULATION RANGE: 0 to 100% AM continuously variable.

MODULATING FREQUENCIES: (a) 1000 cps from conventional RC oscillator.

(b) 90/150 cps from alternator driven by 60 cps synchronous motor; DB tone ratio switch provides steps at ± 0.0 , ± 0.5 , ± 1.0 , ± 2.0 , ± 3.3 , and infinite db.

POWER SUPPLY: 105-125 volts; 60 ± 1 cps; 150 watts (electronically regulated).

PRICE: \$1500.00 F.O.B. Factory.



BOONTON RADIO
BOONTON · J · U · S · A · Corporation

stant with a constant pressure to maintain a constant speed between the cutting tool and the work piece. If the fixed reference voltage V_0 is changed the speed of the work is changed.

Although the inventor describes his invention in terms of its application to control of contour milling operations by controlling motion in two orthogonal co-ordinates, he

points out that the system is not limited to such use.

The mathematical relations of the voltages involved in the operation of the electronic circuit are shown in Fig. 1.

The inventor, C. L. Calosi has been granted Patent 2,627,055 and has assigned his invention to Raytheon Manufacturing Co., Newton, Mass.

Headphone Jack For Remote Cue Receivers

By JOHN B. LEDBETTER

Engineering Writer
Consolidated Vultee Aircraft Corp.
Pomona, Calif.

MANY broadcast stations use battery-portable or a-c/d-c receivers as air monitors on remote pickups. Because of the feedback problem, it is necessary to equip the receiver with a headphone outlet and a means of silencing the speaker. The simplest solution is to install a two-circuit jack which either grounds or opens the voice-coil lead, and connects the headphones across the plate of the output tube. This gives adequate volume level under all conditions and relieves the necessity of providing a separate means of controlling the volume. In most receivers, a 50K to 100K resistor in series with a 0.02 to 0.05 μf capacitor will produce a sufficient drop in output level for normal con-

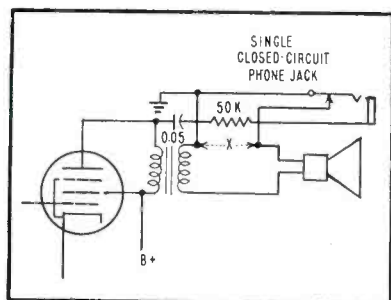

FIG. 1—Single closed-circuit phone jack is installed in secondary of output transformer

ditions of headphone use.

The circuit in Fig. 1 was used to modify a portable receiver when a 2-circuit jack was not available. A simple closed-circuit jack was made to function properly with the hookup shown. It is necessary only to insulate the jack frame from ground.

High-Altitude Winds

RADAR is being used in Australia to trace the ionized trail left by meteors and to plot the pattern of the upper winds. According to the *Australia Newsletter*, scientists at Adelaide University believe that when a pattern is completed for the whole earth, they will be able to check the accuracy of the theory on the relationship between winds and tides.

Information will be useful in predicting tidal movements and in radio research. Progress in research on winds at extreme altitudes has been possible because of clear skies that are said to be more prevalent in Australia than in most other parts of the world.

Germanium Infrared Modulator

A SYSTEM USING a germanium block to apply a modulating signal to an infrared beam was demonstrated at the exhibit of the Physical Society in London.

Germanium's transparency to infrared is dependent on the number of current carriers present in the material. Availability of carriers can be controlled by a contact arrangement similar to the emitter

Radio Dispatch Speeds Steel Handling

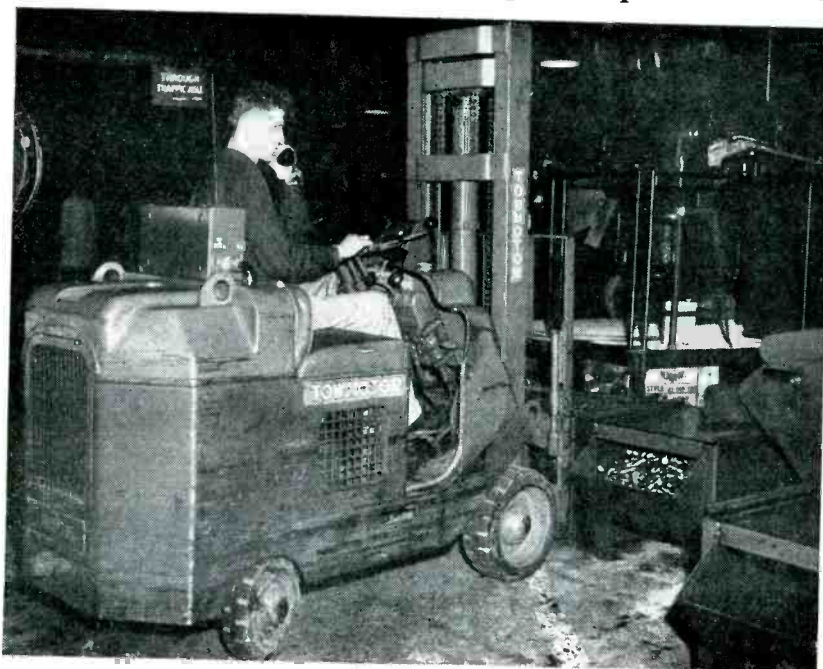

Dispatcher uses communications equipment operating from socket power. Sets on fork trucks are powered from battery, like a car radio

Five fork trucks now do the work of six in moving millions of steel parts for Standard Pressed Steel Co. through a 600,000 sq ft plant in Jenkintown, Pa. Radio-telephone equipment operating in the 152-174 mc band permits efficient load dispatching and enables the drivers to be reached instantly wherever they are. Even where steel stock is piled ceiling-high signals get through

Helipot

Single Turn

First in precision potentiometers



Here are three models of single turn, continuous rotation Helipots . . . each available from stock in a wide range of resistance values. All three feature the rugged dependability . . . the high degree of precision . . . the proven design characteristics . . . that you expect of every Helipot. Among their many features are the copper mandrel which effectively dissipates heat . . . the spot-welded connections (no pressure-type connections are used in any Helipot model) . . . the provision for easy, accurate phasing on the job . . . the wide choice of mounting styles, number of ganged sections, number of additional tap connections, etc. And like all Helipot models, they are available in variations to meet your exact specifications.

The versatility of these three series of single turn, continuous rotation Helipots makes them ideal for such uses as servo systems . . . analog computers . . . pH indication and control . . . level indication and control . . . telemetering circuits . . . color analysis and control . . . navigation aids . . . radar indicators . . . laboratory instruments, and many more. Your particular requirements will determine the model . . . the number of ganged sections . . . the number and placement of tap connections . . . the style of mounting . . . and other characteristics best suited to your needs.

Every Helipot series is available in variations to meet your exact specifications. Our engineering department will gladly give you every assistance . . . in adapting standard Helipots to your particular requirements . . . in building entirely new Helipots to meet your needs.

Below is a Quick-Reference-Guide to the J, L, and Y Series Helipots. For complete information, write for Data File 902.

	Model Y Series	Model J Series	Model L Series
Diam.	(a) 1 3/4"	2"	3"
Resist. Range	50-50,000 ohms (b)	50-50,000 ohms (b)	50-100,000 ohms (b)
Power Rating	2.5 watts	4 watts	5 watts
Active Elec. Rotation	356° ±1°	357° ±1°	358° ±1°
Coil Length	4.6"	5"	8"
Mounting	Y-Threaded Bushing. YS-Servo Flange, Sleeve Bearing. YSP-Servo Flange, Ball Bearing. YF-Two-hole Servo, Sleeve Bearing. YFP-Two-hole Servo, Ball Bearing.	Threaded Bushing (Spec). Servo Flange, Ball Bearing (Std.)	L-Threaded Bushing. LS-Servo Flange, Sleeve Bearing. LSP-Servo Flange, Ball Bearing.
Max. No. Ganged Sections (c)	14	8	8
Max. No. Tap Connections per Section (c)	17	21	33

- (a) Model Y Series Helipots are available in both linear and non-linear versions.
 (b) Higher or lower resistance values can be furnished on special order.
 (c) Sections can be ganged and tap connections added, during manufacture.

Helipot DIVISION

BECKMAN INSTRUMENTS, INC.
SOUTH PASADENA, CALIFORNIA

PLANTS IN SO. PASADENA, CALIF. AND MOUNTAINSIDE, N. J. REPRESENTATIVES IN PRINCIPAL CITIES

connection of a transistor.

In the exhibit, an ordinary lamp was used as an infrared source and the modulating signal was obtained from a phonograph. The resulting intensity-modulated beam was picked up by a lead-sulphide photocell, amplified and used to drive a loudspeaker.

Development work on the modulator was done by Alan F. Gibson of the Telecommunications Research Establishment.

Automatic Control of TV Picture Brightness

T. S. DIX, JR.

Engineering Section Manager
Television-Radio Division
Westinghouse Corp.
Metuchen, N. J.

ROOM LIGHT reflected from the face of a tv picture tube is added to both the light and dark elements of the image decreasing the apparent contrast ratio. For best viewing, the

ratio of light to dark values should remain unchanged for all practical lighting conditions.

The circuits shown in Fig. 1 may be used to maintain the desired contrast ratio by increasing or decreasing the gain of the video amplifier. A 1P41 phototube is mounted behind a translucent window in a position where it will receive light directed toward the picture tube screen. The phototube output is amplified and applied to the video amplifier screen grid voltage according to the amount of light in the room.

An increase in light intensity causes a corresponding increase in phototube current. The 1P41 cathode is connected to a negative potential of about 75 volts. Plate voltage is supplied through a 10-megohm load resistor. Using resistance values shown in the diagram, the grid of the cathode follower, V_{gk} , varies from approximately -10 volts in bright light to +5 volts in the absence of light.

Since a large grid-circuit resistance is desirable for the cathode follower, the stage is operated at a low plate voltage to reduce gas current and prevent damage to the tube. The plate is operated at about 75 volts.

The grid voltage of the second stage of the d-c amplifier, V_{gk} , varies from 0 to 25 volts depending on the setting of the sensitivity control, R_s , and the amount of illumination. With the control set at maximum, grid voltage is about 25 volts when the phototube is not actuated. The cathode is connected to the voltage divider at the junction of R_5 and R_6 to obtain the desired amount of bias. Spurious r-f voltages are bypassed to ground through C_1 and C_2 .

With S_1 open, normal voltage is applied to the video amplifier screen and the automatic-control circuits have no effect. When the switch is closed, the amplifier plate circuit becomes part of the video-amplifier screen supply circuit and the voltage applied to the screen is dependent on the current through the parallel combination of R_7 and R_8 . Capacitor C_3 bypasses the screen of

Slow Multivibrator Using Gas Tubes

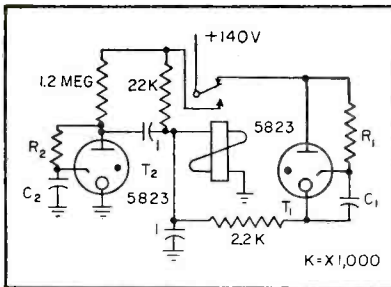

FIG. 1—Astable multivibrator circuit

By H. L. ARMSTRONG

Electrical Engineering Division
National Research Council
Ottawa, Canada

MULTIVIBRATORS or similar circuits are usually employed for timing periods from a few microseconds to a small fraction of a second. For times of several seconds thermal timers can be used, and for longer intervals, mechanical devices. None of these devices is well suited to measuring periods of a few seconds.

The circuit described here, a sort of analog to the multivibrator, works well in the range of a few seconds, and has other advantages as well. Like the ordinary multivibrator it can exist in astable, monostable and bistable form.

Figure 1 shows the astable circuit. Initially the relay is in the upper de-energized position. Capacitor C_1 charges until T_1 fires, allowing current to flow bringing the relay to the lower position, where it is held by current through the 22,000-ohm resistor. Now C_2 charges until T_2 fires. The voltage drop at the plate of T_2 is communicated to the relay coil through the capacitor joining them. This de-energizes the relay, allowing it to return to the

upper position where the cycle begins over again.

The relay used in tests had a 110-volt d-c coil of about 3,500-ohm resistance. It was a double-pole double-throw type, and the output consisted of the operation of the other contacts. Since current requirements are small, the 140-volt supply can be obtained from a small half-wave selenium rectifier.

To convert the circuit to monostable operation, it is merely necessary to change the igniter connection of T_1 to that shown in Fig. 2. Resistor R_5 may be one or two megohms, C_3 about one hundred μ f, and R_4 the proper value to give the desired bias on the igniter. This should be such that the sum of bias and trigger voltages is sufficient to fire the tube, usually from 80 to 100 volts. Optimum operating condition depends somewhat on various factors, and is best determined by actual test.

For bistable operation, the igniters of both tubes are connected as in Fig. 2, with a common trigger input connection.

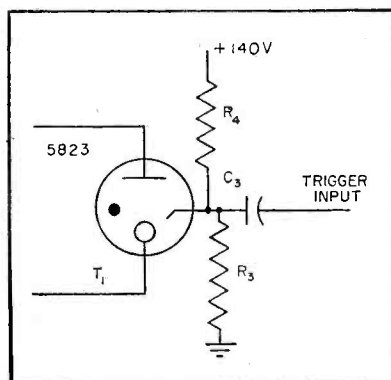
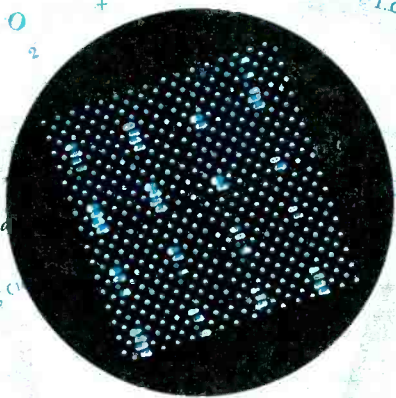

FIG. 2—Igniter connections for monostable and bistable circuits

pioneers in precision



International Business Machines Corporation

recently installed the first production model of the IBM high-speed electronic calculator, the "701." Most recent successor to the pioneer large-scale digital calculator first developed by IBM in 1944, the "701" solves in minutes a problem which would take one man, using a desk computer, seven years to complete.

Miniature Precision Bearings, Incorporated,

are the originators and pioneer developers of precision ball bearings in miniature sizes (1/10" to 5/16" o.d.). Exclusive MPB methods assure thousands of discriminating customers ultra quality bearings for vital equipment.

MPB ball bearings supply the unerring accuracy and proven dependability necessary in providing many devices with anti-friction qualities. MPB ball bearings function effectively with deft delicate responsiveness under extreme operating conditions. They are fully ground, lapped, honed, and/or burnished to ABEC 5 tolerances or better.

The possibilities offered by MPB ball bearings are being profitably explored by leading instrument makers of the future. We would welcome the opportunity to discuss the matter with you. Branch offices in New York and Boston and Engineering Representatives in Principal Cities are eager to serve you. Ask for detailed data sheets E-9.

Immediate delivery on most sizes and plant capacity to promptly meet your additional requirements.



have you ever wondered how precision ball bearings are made?

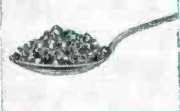

The new 15 minute 10 mm sound color movie "Mighty Minutaires" tells of the manufacture and use of these precision components. It is available to qualified groups. Write Engineering Dept., MPB, Inc. Keene, N.H. for dates.

Miniature precision Bearings

Incorporated



Keene, New Hampshire

"Pioneer Precisionists to the World's foremost Instrument Manufacturers"

save space weight friction

AMPHENOL

builds

to the

future

of

electronics

Quality components, new ideas—these are the contributions AMPHENOL has made to the electronics industry for over 20 years. During that time AMPHENOL's production of components has gradually increased until today AMPHENOL represents the largest single source for users of AN connectors, RF connectors, radio sockets and coaxial cables. And in the wonderful future that lies before the entire electronics industry, AMPHENOL is proud to claim a part. The record of past accomplishments, the ingenuity of the AMPHENOL engineering staff, plus the seemingly unlimited applications possible for new components insure that AMPHENOL will always provide the necessary parts for new electronic equipment. "Building to the future of electronics" is more than a slogan at AMPHENOL—it expresses our belief that before the electronics industry lies a golden age.

AMPHENOL has also steadily expanded their production facilities through the years: there are now five modern plants to better serve you with quality electronic components.



All products illustrated on the opposite page are listed in the General Catalog, B-2. If more complete product data is required, the inside cover page, B-2, will provide listings of the special catalogs and bulletins.

ELECTRONS AT WORK

(continued)

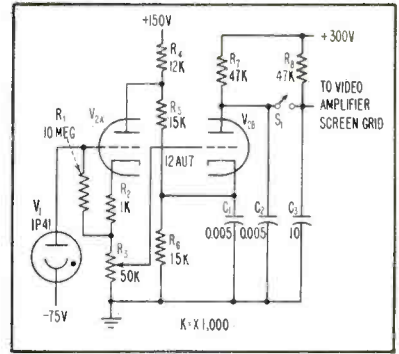
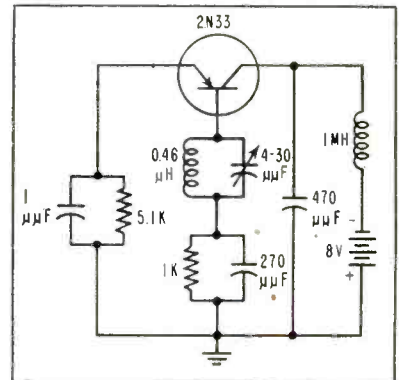

FIG. 1—Circuit of automatic picture brightness control

the video amplifier. When the contrast control is set for a normal picture, screen voltage varies from about 65 to 165 volts.

50-MC Oscillator



Oscillator circuit using a type 2N33 point-contact transistor in the 50-mc region. At 25 deg C, typical operation requires collector voltage of -8 v, and current of -3.3 ma d-c. Emitter current is 0.3 ma d-c. Useful power output is 1 mw. Circuit abstracted from RCA transistor tentative data sheet

Predicting Response Curves of Pickups and Loudspeakers

IN THE DESIGN of phonograph pickups consideration must be given both to the mechanical and electrical aspects of the system and their effects on each other. Relative movement between needle and head should correspond to groove modulation. However, owing to spurious vibrations set up in other parts of the mechanical system such is not always the case. This effect of vibration is greatest when a condition of resonance is reached. Electrical response curves of a

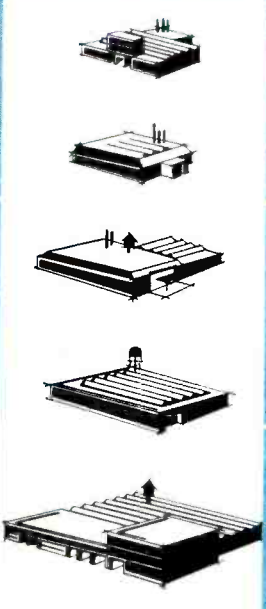

AMPHENOL

AMERICAN PHENOLIC CORPORATION • Chicago 50, Illinois

phonograph pickup show deviations that can be attributed to one or more types of mechanical vibration.

Some sources of resonant vibration are: pivotal resonance, in which the whole mass system resonates with the needle support compliance; lateral resonance, in which the tone arm vibrates laterally as a beam, with the distributed mass and the compliance forming the resonant elements; torsional resonance, in which the pickup head resonates with the torsional compliance of the tone arm about its

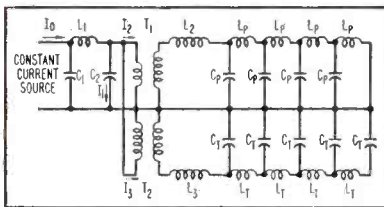

FIG. 1—Equivalent circuit of a pickup. Output is proportional to I_1

own axis; and needle resonance, in which the needle mass resonates with the record groove compliance.

Although analysis of this system could be carried out in purely mechanical terms it is helpful to translate the system into its electrical equivalent using the direct dynamic analogy. The electrical analogy has two important advantages, the electric circuit theory, which owing to the use of complex notation has reached a far more advanced state than the corresponding mechanical theory, may be utilized with little modification; the

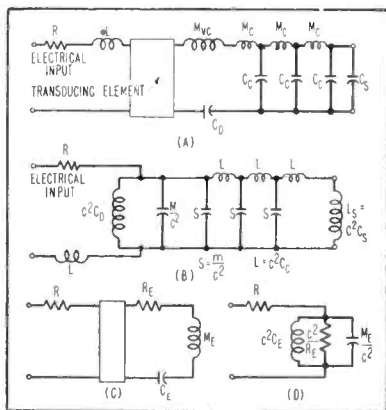

FIG. 2—Equivalent circuits for a loudspeaker. Diagrams (C) and (D) are simplifications for low frequencies

AN CONNECTORS

AMPHENOL is the leading manufacturer of approved AN connectors. These feature premium material, and careful inspection assures that each connector measures up to and beyond specifications.



RF CONNECTORS

AMPHENOL RF connectors provide never failing continuity and extremely low loss—are unsurpassed for mechanical design and electrical efficiency.

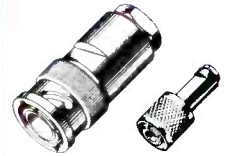

POWER CONNECTORS

AMPHENOL's lightweight and compact power connectors are built to stand rough handling. They are 100% shock-proof and can be relied upon for electrical connections in all appliances and machinery.



AUDIO CONNECTORS

AMPHENOL microphone connectors have been standard with leading microphone manufacturers for years. Providing unique interchanging coupling rings, they give mating connections at every junction.



RACK & PANEL CONNECTORS

AMPHENOL 26 series rack and panel connectors have the added strength needed for their efficient operation and safety features which include interlocking barriers to prevent accidental shorting.

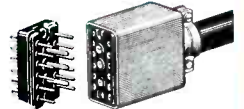

BLUE RIBBON CONNECTORS

AMPHENOL Blue Ribbon connectors represent a new solution to the problem of providing quick disconnection for electronic sub-assemblies, incorporate gold finished contacts and new sturdy dielectric.

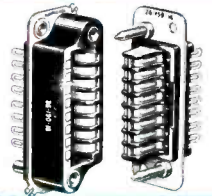

RG TYPE COAXIAL CABLES

AMPHENOL RG coaxial cables are made with low-loss polyethylene dielectrics. Precision extrusion guarantees strict end-to-end uniformity—constant inspection insures top quality.



MINIATURE CONNECTORS

AMPHENOL miniature connectors provide high-quality interconnection of miniature electronic equipment. They are made with the same skill and care that characterizes all AMPHENOL components.

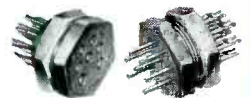

SOCKETS

AMPHENOL MIP sockets have unique construction features. The plate is molded directly into the bakelite body, cannot come loose or vibrate—speeds up production, reduces breakage.

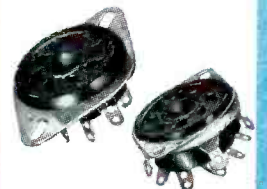

THERE IS AN **R-B-M** CONTROL To Fit Your Needs

ELECTRONS AT WORK

(continued)

A.C. MAGNETIC STARTERS

with Plasti-Clad
Magnet Coil

Write for
Bulletin 605

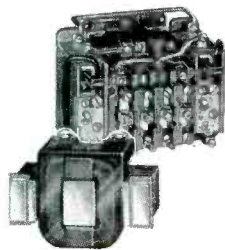

Full accessibility in a small package.

Contacts, coil and thermal element replacement with use of screwdriver only. Magnet coil—in molded phenolic case with riveted terminals—is completely embedded in a rock-hard resinous material, thus protecting against oil, dirt, moisture and normal mechanical damage.

HERMETICALLY SEALED RELAYS

Write for
Bulletin ASR

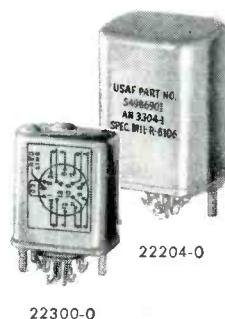

50% smaller — lighter.

R-B-M 22204-0 meets AN 3304-1 specifications. R-B-M engineers have developed the 22300-0 currently used in government electronic, airborne and ground equipment—as the electrical and mechanical equivalent of the AN 3304-1, yet 50% smaller in size with 1/2 the weight.

INDUSTRIAL CONTACTORS

with Plasti-Clad
Magnet Coil

Write for
Bulletin 600

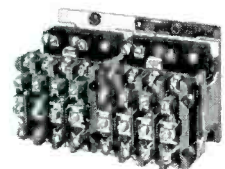

**2-8 poles Non-Reversing.
2-5 poles Reversing.
25 Amp — 600 AC Max.**

Contacts can be replaced without removing wiring. To change coil, remove magnet frame and coil assembly only. 10 and 15 amp. poles can be changed from normally open to normally closed by using screwdriver only.

GENERAL PURPOSE RELAYS

Write for
Bulletin 570

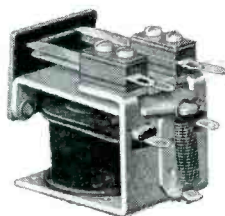

**Low cost. Small size.
Dependable performance.
Available in many contact
arrangements.**

Whatever your needs for inexpensive, dependable relays for commercial applications—investigate R-B-M General Purpose Relays.

Other R-B-M products include: motor overload protectors, motor starting relays and low voltage DC electrical devices.

Consult R-B-M On Your Control Problems — Write Department B-9

electric circuit may be set up and used as an analog computer.

In the electrical analogy mass is equivalent to inductance, compliance to capacitance, velocity to current and force to emf. Applying the analogy to a typical pickup the equivalent circuit shown in Fig. 1 results.

Mass of the needle is represented by L_1 , while C_1 and C_2 are the compliance of the record groove and needle support respectively. The symbol L_2 represents the moment of inertia of the head about the pivot and L_3 is its polar moment of inertia about the tone arm axis. Since the arm possesses mass and compliance it may be represented by a transmission line consisting of elements L_p and C_p . For lateral and pivotal vibrations, these elements represent distributed moment of inertia about the pivot and distributed rotational compliance, respectively. The line is short circuited at the end representing the pivot since at this terminal rotational velocity may occur without torque. The torsional constants of the arm may be similarly represented, forming another transmission line consisting of elements L_T and C_T . These are equivalent to polar moment of inertia and torsional compliance of the arm. In this case the line is open-circuited at the pivot since no torsional velocity can take place though torque may exist. Each of the transmission line circuits is fed by a transformer. Transformer T_1 has a step-up ratio equal to ratio of the torque at the needle support to that at the pivot point, and T_2 has a ratio equal to torque at the needle support to that at the pivot about the tone arm axis. The electrical output of the pickup is proportional to I_1 . Supplying the whole circuit is a constant current generator representing the record groove.

A number of resonances can take place that will affect the current flowing in C_2 , which represents the pickup output. At some low frequency the reactance effects of C_1 , L_3 , and C_p are negligible and a parallel-resonant circuit is formed by C_2 and L_p and the line inductance L_p . This corresponds to the pivotal resonance. At higher frequencies



**R-B-M DIVISION
ESSEX WIRE CORP.**

Logansport, Indiana

MANUAL AND MAGNETIC ELECTRIC CONTROLS
— FOR AUTOMOTIVE, INDUSTRIAL, COMMUNICATION AND ELECTRONIC USE

Coincidence Detector, Type 1201B, another of the basic elements in Burroughs' line of "Unitized" Pulse Control Equipment.

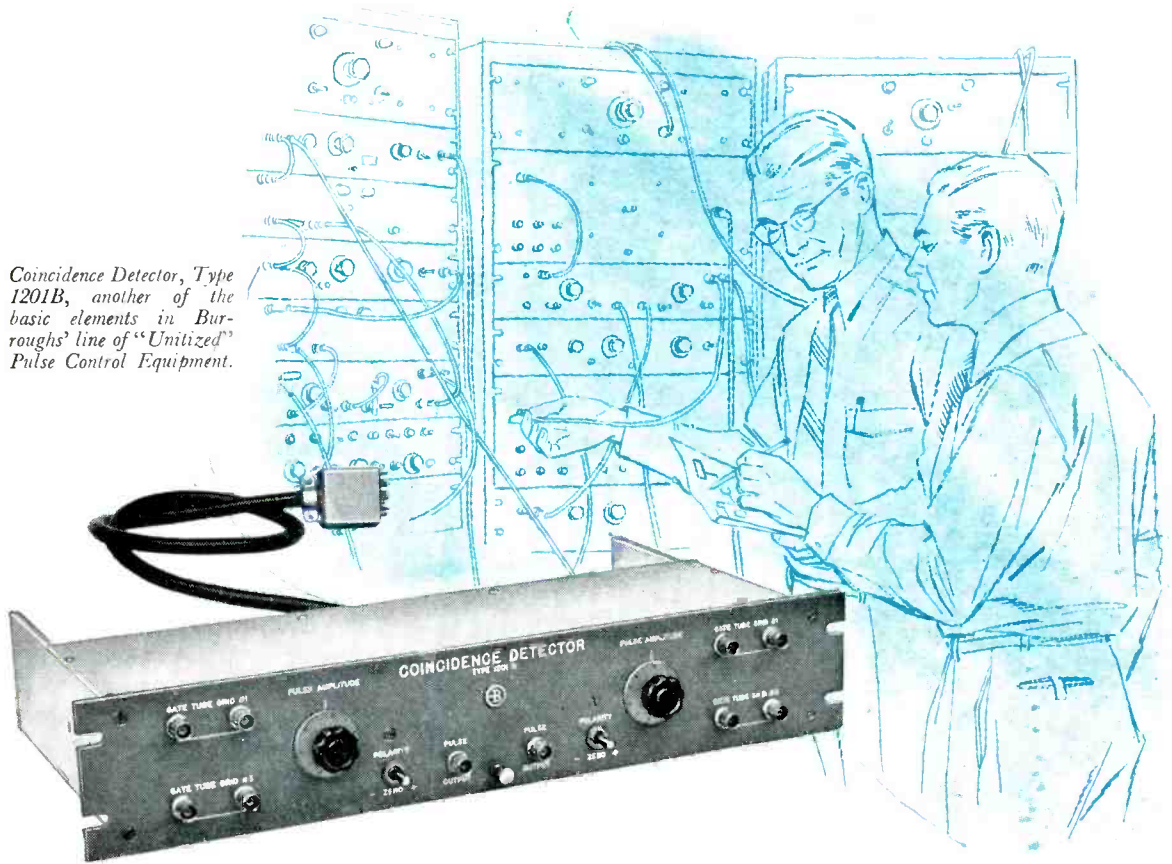

"Unitized" Pulse Control Equipment permits fast, easy readaptation of electronic test circuits

Speedy assembly of electronic testing equipment is one big advantage you gain when you use versatile Burroughs pulse control units . . . but there is another tremendous advantage that *only* "Unitized" equipment offers. Since each Burroughs unit performs just *one basic operation*—such as generating, counting, mixing, gating, or delay—it's easy to *reassemble* equipment for a *different* project when one set of electronic tests is completed. You simply make a block diagram of the new circuit needed and rearrange the cables to correspond to your diagram. This flexibility permits you to quickly perform tests which otherwise might require a very long time or not be undertaken at all.

SIMPLY "PLUG IN" BURROUGHS COINCIDENCE DETECTORS

Both of the coincidence detectors offered by Burroughs demonstrate the practical one-basic-function principle that makes Burroughs "Unitized" Pulse Control Equipment so suitable to your needs.

Burroughs Coincidence Detector, Type 1201B (shown here), is designed to detect coincidence between the output signal of a flip-flop and 0.1 microsecond pulses. Two inputs are provided for each unit. One accepts 0.1 microsecond pulses with

amplitudes of 12 volts or more. The other accepts the output of Burroughs Flip-Flop, Type 1101C or equivalent.

Burroughs "Unitized" pulse control assemblies have been in constant use for more than two years. Their proved dependability has led to their use by many leading electronic research organizations, including: Massachusetts Institute of Technology, Consolidated Engineering Corporation, The Catholic University of America and Magnetics Research Company.

For full information on Burroughs "Unitized" Pulse Control Equipment, write or call Department 12C, Electronic Instruments Division, Burroughs Corporation, 511 North Broad Street, Philadelphia 23, Pa.

- PULSE GENERATORS
- COINCIDENCE DETECTORS
- PULSE DELAYS
- FLIP-FLOPS
- PULSE GATERS
- CHANNEL SELECTORS
- MIXERS



THE BEST KNOWN NAME IN OFFICE MACHINES

Quick Deliveries FROM STOCK



SHALLCROSS

DECADE *Resistance* BOXES

36 STANDARD TYPES
FROM WHICH TO CHOOSE!

TYPE	DIALS	OHM STEPS	TOTAL RESISTANCE—OHMS	PRICE
542	1	0.01	0.1	\$29.00
543	1	0.1	1	22.00
544	1	1	10	22.00
545	1	10	100	22.00
546	1	100	1,000	22.00
547	1	1,000	10,000	24.00
548	1	10,000	100,000	26.00
549	1	100,000	1,000,000	36.00
550	1	1,000,000	10,000,000	66.00
840	2	0.1	11	34.50
841	2	1	110	40.00
842	2	10	1,100	40.00
843	2	100	11,000	40.00
844	2	1,000	110,000	45.00
817	3	0.01	11.1	60.00
818	3	0.1	111	51.00
820	3	1	1,110	56.00
821	3	10	11,100	60.00
822	3	100	111,000	63.00
823	3	1,000	1,110,000	77.00
824	3	10,000	11,100,000	120.00
817-A	4	0.01	111.1	75.00
819	4	0.1	1,111	71.00
825	4	1	11,110	77.00
826	4	10	111,100	79.00
827	4	100	1,111,000	92.00
828	4	1,000	11,110,000	139.00
817-B	5	0.01	1,111.1	94.00
8285	5	0.1	11,111	94.00
829	5	1	111,110	101.00
830	5	10	1,111,100	113.00
831	5	100	11,111,000	155.00
817-C	6	0.01	11,111.1	105.00
8315	6	0.1	111,111	109.00
832	6	1	1,111,110	121.00
833	6	10	11,111,100	169.00

ACCURACY OF INDIVIDUAL RESISTORS:

0.01 ohm 5%, 0.1 ohm 1%, 1.0 ohm 0.25%, All Others 0.1%

SHALLCROSS MANUFACTURING COMPANY
522 Pusey Avenue, Collingdale, Pa.

the transmission line becomes resonant and input impedance changes in both magnitude and sign over a small frequency range. Since the input is a constant current, the difference current through C_2 is an inverse function of the transmission-line current.

At some higher frequency corresponding to needle resonance the parallel circuit formed by L_1 and C_1 will resonate and a large current will flow in C_2 . As the frequency increases the reactance of C_2 decreases and that of L_2 and L_3 increases until the resonant lines have no effect on the current in C . The force exerted by the needle is proportional to potential difference at the input terminals.

By setting up the circuit and using it as an analog computer response curves can be plotted that indicate the response characteristics of the pickup represented by the system. Tests made on actual pickups indicate that the electrical analogy gives a response curve that closely resembles actual operating conditions.

In a loudspeaker system the same type of analogy can be made. The resulting circuit is shown in Fig. 2A where R and L are the resistance and inductance of the voice coil, and M_{vc} is its mass. Capacitance C_d is the compliance of the support spider. The distributed mass and compliance of the cone are represented by the transmission line and elements M_c and C_c . By mathematical analysis the transducing element of Fig. 2A can be transferred to an electrical equivalent resulting in the circuit shown in Fig. 2B.

The loudspeaker is normally connected to a signal source of low impedance. When the frequency of the source is varied over a wide range several resonance effects take place. At low frequencies the reactance effects of L are negligible and the circuit reduces to a simple parallel LC circuit. At higher frequencies the transmission line comes into resonance.

For best response to signals, any resonance in the loudspeaker system should be outside the audio-frequency range. This is not always



Uniformity

**—batch to batch uniformity
that makes inspection unnecessary**

We have used every type of GA & F Carbonyl Iron Powder thus far produced. The overall quality and batch-to-batch uniformity of your products have always been gratifying to us. Because of this product dependability, we feel that incoming inspection of your powders is unnecessary.

Richard D. Ponemon

President
Pyroferric Company, Inc.
621 East 216th Street
New York 67, N. Y.

GA & F Carbonyl Iron Powders are used to produce cores for transformer and inductor coils—to increase Q values, to vary coil inductances, to reduce the size of coils, to confine stray fields and to increase transformer coupling factors.

These powders are microscopic, almost perfect spheres of extremely pure iron. They are today produced in eight carefully controlled types, ranging in average particle-size from three to twenty microns in diameter. The Carbonyl Process assures the quality and uniformity of each type.

We urge you to ask your core maker, your coil winder, your industrial designer, how GA & F Carbonyl Iron Powders can increase the efficiency and performance of the equip-

ment or product you make, while reducing both the cost and the weight. We also invite inquiries for powders whose performance characteristics are different from those exhibited by any of our existing types.

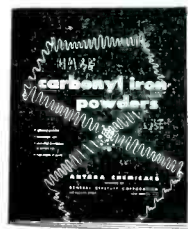

This 32-page book offers you the most comprehensive treat-

ment yet given to the characteristics and applications of GA & F Carbonyl Iron Powders. 80% of the story is told with photomicrographs, diagrams, performance charts and tables. For your copy—without obligation—kindly address Department 57.

GA & F CARBONYL IRON POWDERS



ANTARA CHEMICALS

Division of **GENERAL DYESTUFF CORPORATION**

435 HUDSON STREET • NEW YORK 14, NEW YORK



possible to achieve, but within this limitation the optimum condition is obtained when the equivalent circuit is critically damped.

Simplified equivalent circuits in Fig. 2C and 2D, show the damping effect for low frequencies. The resistance of the mechanical circuit R_E has been included since it does provide some damping of the resonant circuit. In practice the value of this resistance is too low to provide critical damping of the mechanical circuit. This means that the reflected resistance C^2R_E is too high to achieve this condition and that critical damping conditions can be reached by a suitable choice of $(R+R_o)$, where R_o is the generator output impedance.

In experimental tests to determine the accuracy of the equivalent circuit predictions, a photoelectric measuring device was used. A phototube and light source were arranged so that movement of the speaker cone would change the amount of light falling on the tube, in turn changing the voltage output of the cell. The voltage output of the cell can be used to plot the movement of the cone on an oscilloscope. Results have shown good agreement between the experimental and analytical work.

This article has been abstracted from a paper entitled "Objective Testing of Pickups and Loudspeakers" by K. R. McLachlan and R. Yorke, appearing in the September 1952 issue of the "Journal of the British Institution of Radio Engineers," p 485.

Spectrographic Monitor for Metallic Dust

BY IVOR B. N. EVANS

USING A RECORDING spectrograph system, a monitor for poisonous beryllium dust gives a continuous check on atmosphere contamination. The first commercial model, built for the Atomic Energy Commission by Winston Electronics Ltd. has an alarm system that can be used to sound a warning or operate automatic safety devices in plants working with beryllium.

Air is drawn into the monitor

ELECTRONS, INCORPORATED
127 SUSSEX AVENUE
NEWARK 3, N. J.

*Our Inert Gas Thyratrons control the lighting
in Klegl Bros' electronic dimmers at I.B.M.
World Headquarters*

Plain Pointers on Projection

ALTHOUGH we frequently speak of magnifying an object 100X with the Kodak Contour Projector, technically we do not magnify the object at all. Instead we magnify its image, as formed by a relay lens. This relay system, diagrammed in Fig. B, forms an image of the object at a ratio of 1 to 1. The magnifying optics in turn pick up this image and enlarge it from 10 to 100 times.

Since the end result is the same—an enlarged image of a part on the screen—this might seem a roundabout system to the uninitiated. On the contrary, there are logical mathematical reasons for it. One of the more restrictive factors in conventional optical systems is expressed by the formula, $M = id/od$; that is, magnification equals the ratio of the image distance to the object distance. In practice, where image distance is limited, this entails using lenses of short

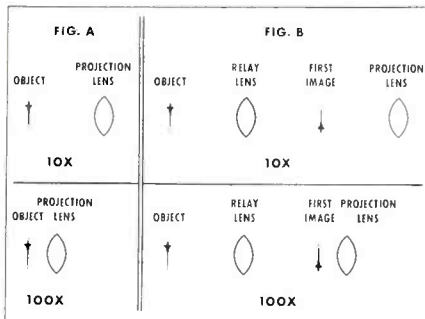

focal length for high magnifications. The lens is moved close to the work, decreasing object distance and unfortunately decreasing at the same time the size part which may be checked (Fig. A).

It was to overcome this limitation that our optical experts incorporated the relay system in the Kodak Contour Projector. Since this system merely images the part at unity, the focal length of the relay lens can be comparatively long—in this case eight inches. And the magnifying optics can be moved as close as desired to the image formed by the relay. As a result, users of our projector have a full eight inches in which parts may be staged, regardless of the magnification desired. This permits checking form tools, shafts, and other bulky parts.

If this were all that the relay accomplished, it would be justified design wise. However, it also makes it practical to incorporate in the projector a lens turret in which lenses of varying magnifying power may be mounted. With such a turret, magnification is changed by merely twisting a dial and the part remains in focus at the new magnification. This is a handy feature, and only one of a number of optical features of the Kodak Contour Projector to be discussed in this space.

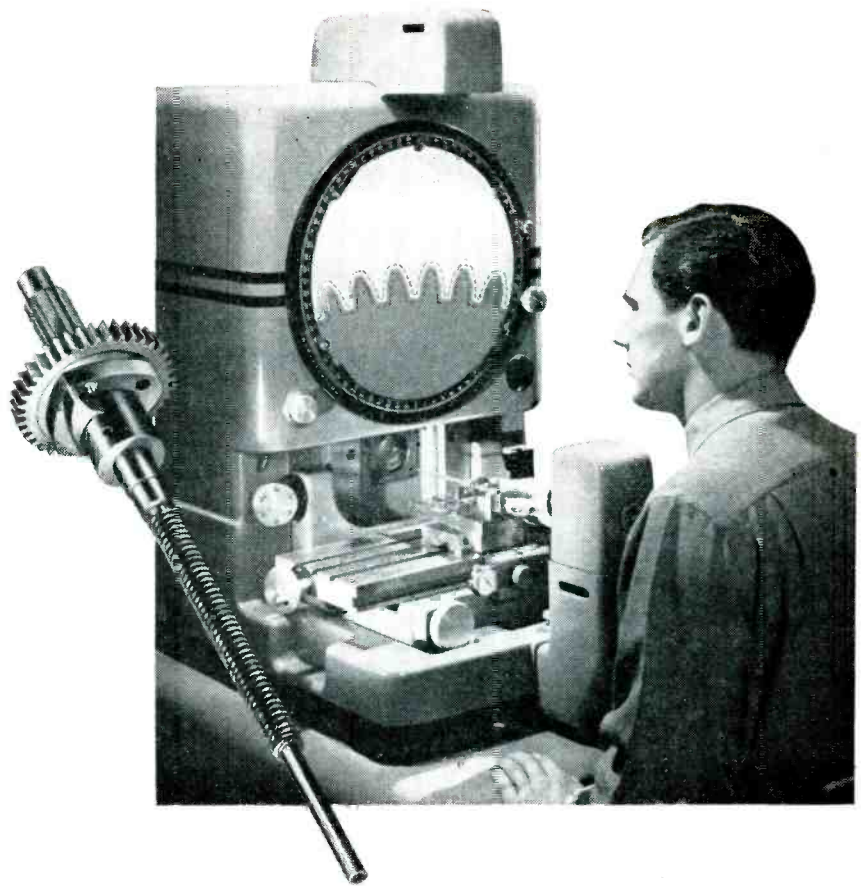

You can inspect long parts at all magnifications ...with the Kodak Contour Projector

THIS seven-inch-long cycle timing part must be inspected for tooth contour, location and spacing of two cams, shaft diameter, shoulder spacing, and form, size, and runout of the lead screw. All these dimensions may be quickly checked on the Kodak Contour Projector. That's because the Kodak Contour Projector provides an unvarying 8" clearance between lens and object at all magnifications. (The column at the left tells you why.)

The exceptional versatility of the Kodak Contour Projector permits this part to be completely inspected in six positions, at sev-

eral different magnifications, and using both surface illumination and silhouette projection. And the job requires little training, is done quickly and easily.

Whether for toolroom use or production assembly and inspection, you'll find a Kodak Contour Projector will get the work out in a hurry. With an appropriate chart-gage and fixture you can inspect all sorts of complex parts, large and small. There is a field representative in your area who will answer your questions. To get in touch with him, or for a copy of a new booklet, "Kodak Contour Projector," write to:

Special Products Sales Division
EASTMAN KODAK COMPANY
Rochester 4, N. Y.

the KODAK CONTOUR PROJECTOR



A new sound movie, Optical Gaging, shows how to simplify complex inspection problems. We'll tell you how to get it for a showing.

Kodak
TRADE-MARK

BALLANTINE

STILL THE FINEST IN ELECTRONIC VOLTMETERS



- Measures 1 millivolt to 100 volts over a frequency range from 10 to 150,000 cycles on a single logarithmic scale by means of a five decade range selector switch.
- Accuracy: 2% at any point on the scale over the ENTIRE RANGE.
- Input Impedance: $\frac{1}{2}$ megohm shunted by 30 mmfds.
- Generous use of negative feedback assures customary Ballantine stability.
- Output jack and output control permit voltmeter to be used as a flat high gain (70DB) amplifier.
- Available accessories permit range to be extended up to 10,000 volts and down to 20 microvolts.
- Available Precision Shunt Resistors convert voltmeter to microammeter covering range from 1 to 1000 microamperes.

For additional information on this Voltmeter and Ballantine Battery Operated Voltmeters, Wide-Band Voltmeters, Peak to Peak Voltmeters, Decade Amplifiers, Inverters, Multipliers and Precision Shunt Resistors, write for catalog.

BALLANTINE LABORATORIES, INC.

100 FANNY ROAD, BOONTON, NEW JERSEY

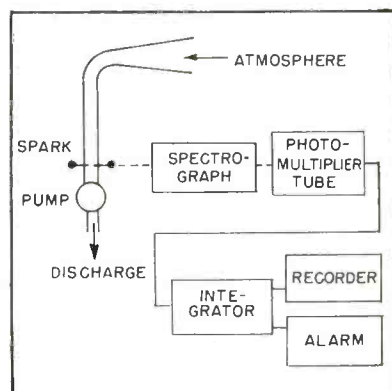

FIG. 1—Block diagram of spectrographic dust monitor. Spectrograph passes only lines of beryllium to phototube

through a horn, having an orifice about the same diameter as the human mouth, at a rate comparable to human breathing under manual labor conditions.

Passing through the electric spark between two copper electrodes, dust particles in the air emit light. This light passes through a slit to a concave mirror in the spectrograph unit. The mirror reflects the light onto a diffraction grating of 15,000 lines per inch. Ultraviolet light of one of the two beryllium spark lines is passed back, via the mirror, through a second slit to a photo-multiplier tube.

The current across the photo-multiplier closely follows the intensity of the beryllium line and, therefore, is an immediate indication of the amount of beryllium in the air being sampled. The tube's output is amplified to operate a chart recorder, giving a continuous record of the concentration of



Portable unit in use in beryllium machining plant constantly monitors contamination of atmosphere

From VERY SMALL...to LARGE CAPACITY

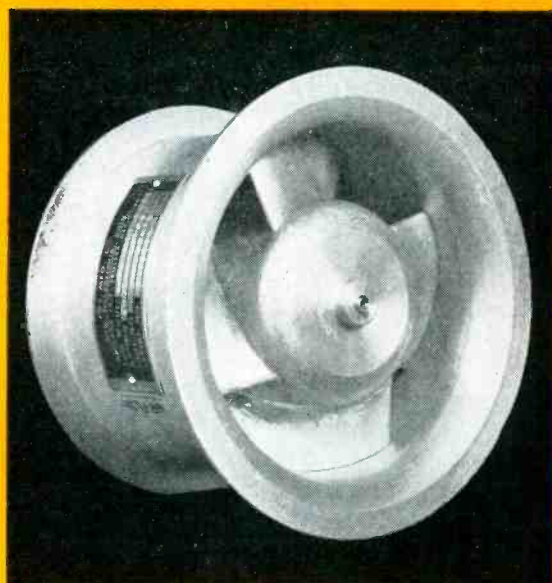
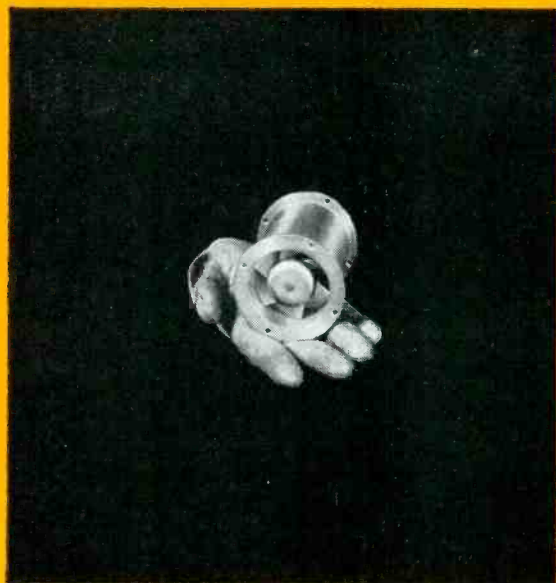

JOY AXIVANE® FANS

**are available to meet any
ELECTRONIC COOLING NEED**

Joy AXIVANE Electronic Cooling Fans are expressly designed to meet the needs of this exacting field of service. They are built in a complete range to suit any requirements, such as: spot cooling of ventilated units where local high-temperature conditions arise; heat removal from pressurized or hermetically-sealed units; or heat removal where space is so restricted that natural ventilation through the unit or over its surface is insufficient. Important operating advantages of these fans are their strength, high resistance to shock and vibration, and efficiency in low or high-pressure service. Aluminum and magnesium construction keeps weight at a minimum.

Available in sizes from 2" I.D. up, these Joy Fans are built to meet all present Air Force

and Naval electronic specifications. They can be furnished with totally enclosed or explosion-proof motors, if desired.

In general, keep these facts in mind: that the light, compact design, low power consumption and high overall efficiency of Joy AXIVANE Fans provide more satisfactory cooling for electronic equipment in either air-borne or surface units. ● If you have a problem in heat dissipation from electronic units, let us place at your disposal JOY's experience as the world's largest manufacturer of vaneaxial-type fans.

Consult a Joy Engineer

Over 100 Years of Engineering Leadership

WBD 1 4064

JOY MANUFACTURING COMPANY

GENERAL OFFICES: HENRY W. OLIVER BUILDING • PITTSBURGH 22, PA.

IN CANADA: JOY MANUFACTURING COMPANY (CANADA) LIMITED, GALT, ONTARIO



KLEINS

ELECTRONS AT WORK

(continued)

*the widest
selection
of quality
pliers*

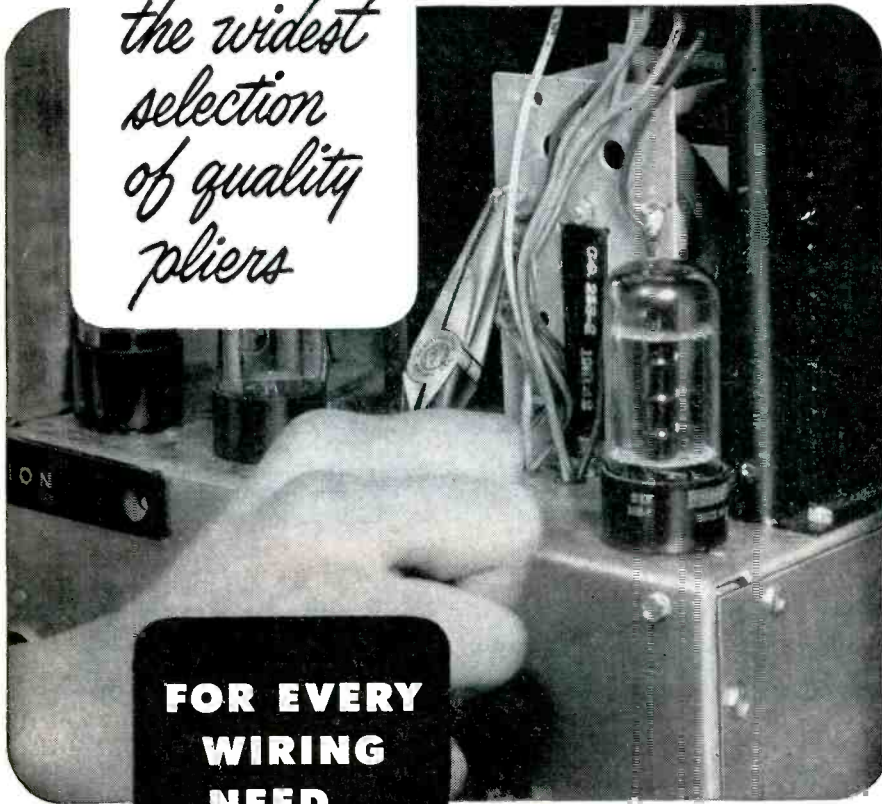

**FOR EVERY
WIRING
NEED...**

● Why put up with pliers that aren't *exactly* right — pliers that may be costing you valuable production minutes? In the complete Klein line there is a pair of pliers for *every* job in radio, TV or amplifier wiring. You'll find long nose pliers that assure a tight grip even in confined space, keen edged cutters, flat nose, duck bill—whatever you need, and in a wide variety of sizes.

Klein Pliers are better pliers, too, each pair individually tested for proper balance and hand-fit. Made by plier specialists with a reputation for quality "Since 1857."

ASK YOUR SUPPLIER

Foreign Distributor: International Standard Electric Corp., New York

This Klein Pocket Tool Guide gives full information on all types and sizes of Klein Pliers. A copy will be sent without obligation.



"Since 1857"



beryllium in the air.

To determine the average contamination level over periods from 20 minutes to an eight-hour working day an electronic integrator is used to sum up the amounts instantaneously indicated over a preset period. At the end of the desired period the integrator returns to zero and repeats the summation. The integrator output is fed to the recorder.

When, during a preset period, the maximum safe amount is reached, the trace cuts a warning line on the recorder chart. This brings into operation an alarm light, bell or automatic safety devices controlling ventilation.

Though specifically designed for use with beryllium, the monitor potentially can be used for a number of elements having spectral lines within the photomultiplier's range of sensitivity. Some interference may be caused by common dust elements such as calcium, magnesium, silicon, aluminum and iron.

A prototype model has been successfully tested as a silica monitor. The limit of detection was not as low as with beryllium, because of the low intensity of the silicon lines.

Rotating Screen Color TV Tube

I. REHMAN and E. SINGER

*Rehman-Singer Laboratory,
San Gabriel, Calif.*

and

C. S. SZEGHO

*The Ravland Corporation
Chicago, Ill.*

IN RECEIVERS for sequential color television pictures a color-filter wheel rotates in front of the cathode-ray tube. These filters absorb approximately 80 percent of the light developed by the black-and-white tube. To overcome this appreciable light loss, a color-image reproducer has been suggested in which a segmented luminescent screen is mounted within the tube, and in which each of the screen segments emits light corresponding to a selected primary color when subjected to cathode-ray excitation.^{1, 2}

Assuming that the efficiency of the fluorescent powder is the same



Mathias KLEIN & Sons
Established 1857 Chicago, Ill., U.S.A.

3900 BELMONT AVENUE, CHICAGO 19, ILLINOIS

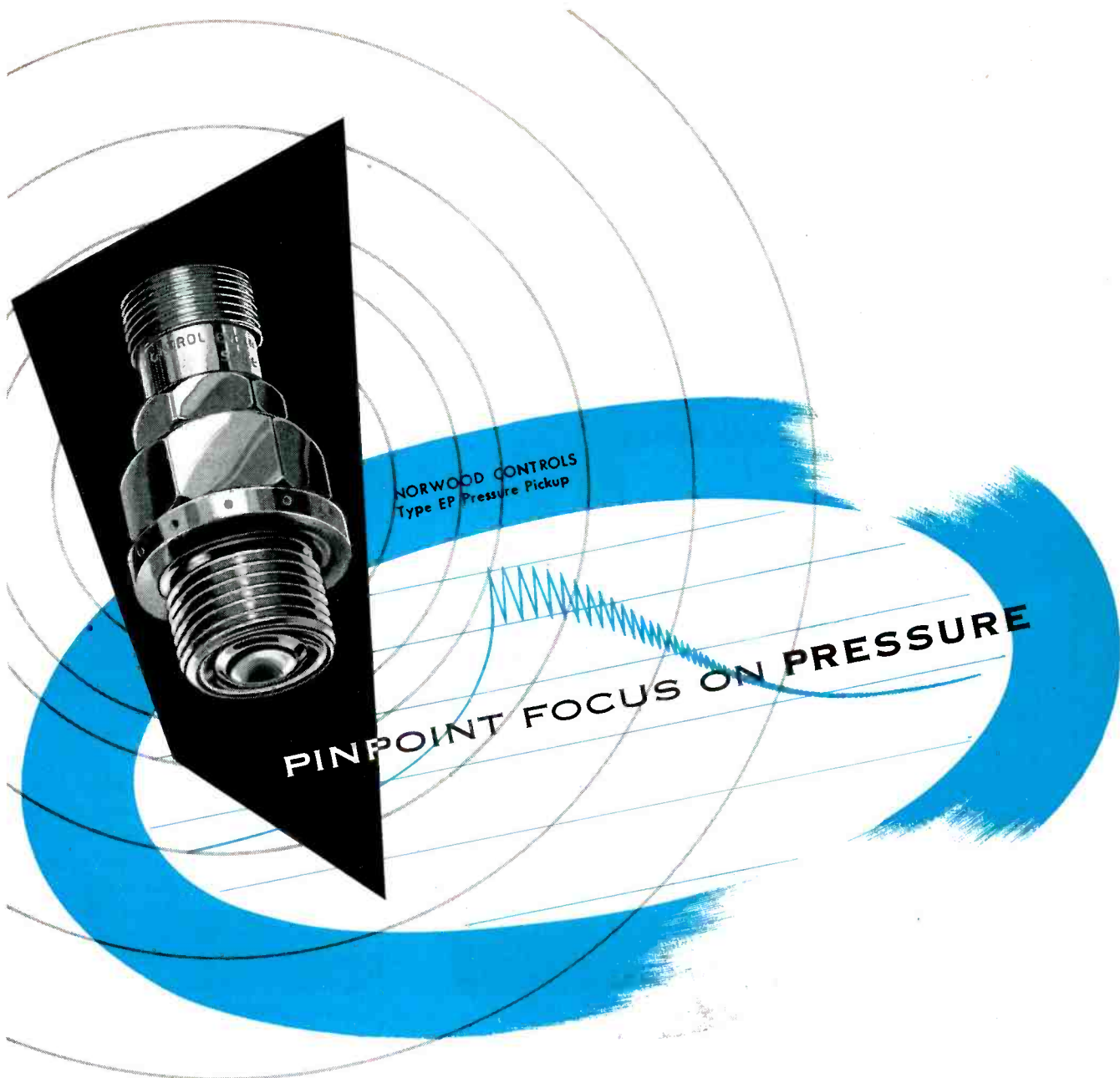

Versatility — for use in dynamic systems . . . tested and proven on gasoline and diesel engines . . . jet engines . . . rocket motors . . . blast measurements . . . high pressure, high temperature chemical reactions . . . hydraulic and pneumatic systems.

Full Scale Pressures — 500, 1,000, 2,000, 3,000, 5,000, 10,000 psi . . . response down to 0 psi absolute with 1% of full scale accuracy and temperature compensation.

High Frequency Response — flat to 20,000 cps . . . natural frequency up to 45,000 cps.

Flush Catenary Diaphragm — reduces changes in volume of pressure chamber to a minimum.

A word about NORWOOD CONTROLS — *This name stands for an expanding line of commercial instruments for the measurement of pressure, flow, temperature and weight. It represents a fresh concept of creative engineering which, combined with New England manufacturing skill, is establishing new frontiers in the field of instrumentation.*



CONTROL ENGINEERING CORPORATION

564 Providence Highway, Norwood, Massachusetts

Norwood Controls representatives are located in principal cities. Complete technical information will be supplied upon request.

Lapp

TUBE SUPPORTS

for forced-air-cooled
power tubes

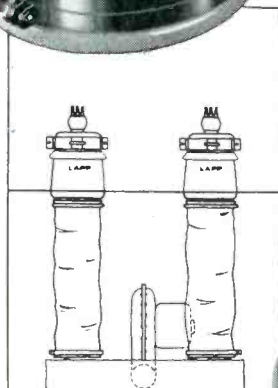

• No longer is it necessary for equipment manufacturers to design supports for forced-air-cooled tubes. After producing many such special designs, Lapp has engineered and built a complete series of insulating supports for air-cooled tubes. Use of these supports facilitates design of transmitter and other high-power circuits. Simple, compact, efficient and attractive in appearance, they make for economical production, easy interchangeability, and availability of replacement units. Write for Bulletin 301, with complete description and specification data. Lapp Insulator Co., Inc., Radio Specialties Division, 105 Sumner St., Le Roy, N. Y.

Lapp



FIG. 1—Rotating-screen tube for sequential color protection avoids use of large wheel twice raster height

as that of a black-and-white tube, the white portions of a color picture using a tube with a fluorescent wheel would equal the brightness of a corresponding monochrome tube.

The diameter of the rotating fluorescent screen must be more than twice the raster height, making a large direct-view tube with a built-in fluorescent wheel impractical.

A compact continuously-pumped projection tube with a revolving fluorescent wheel has been built. This tube employs a raster size of $1\frac{1}{2} \times 1\frac{1}{4}$ inches, and is shown in Figs. 1 and 2. Two stainless-steel shells house a revolving glass disk on which three pairs of phosphor segments fluorescing in the primary colors are deposited. One shell includes a window with a conventional projection-tube electron gun attached. Below the electron gun mounting, there is a port for the vacuum-pump connection. The other shell has a viewing window and also includes a central housing for the rotor, shaft and bearing that support and spin the $7\frac{1}{2}$ -inch diameter fluorescent disk. Three ad-



FIG. 2—Projection tube with rotating screen removed

Microwave TEST COMPONENTS

PRD offers a complete line of test equipment for precise measurements in the Microwave region. This equipment, the finest obtainable anywhere, includes Frequency Measuring Devices, Signal Sources and Receivers, Attenuators and Terminations, Impedance Measurement and Transformation Devices, Detection and Power Measurement Equipment, Bolometers and Accessories.

**When you test,
use the best—**

PRD

**QUALITY
DEPENDABILITY
ACCURACY**

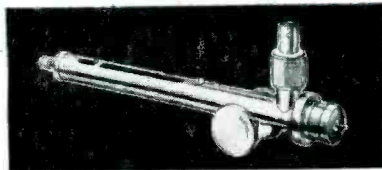

TYPE 250-A BROADBAND PROBE — Frequency range of 1 to 12.4 Kmc/s; two tuning knobs permit precise adjustment for maximum power transfer from the probe tip to the crystal or bolometer detector; third knob controls depth of probe tip insertion.

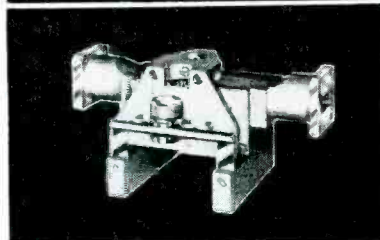

SLOTTED SECTIONS—The mechanical and electrical design of PRD slotted sections emphasizes these important features: Instrument accuracy assured indefinitely by virtue of three bearing carriage suspension to minimize wear; waveguide section machined from solid aluminum alloy stock, to avoid warpage no castings are used.

TYPE 275 VSWR AMPLIFIER — Featuring high gain; A.G.C. to maintain output constant for slow variation in r-f power source; low input noise level of 0.03 microvolts; wide VSWR ranges of 1:1.3, 1:3, 3:10, 10:30, and 30:100; greater accuracy because VSWR scale on meter is linear.

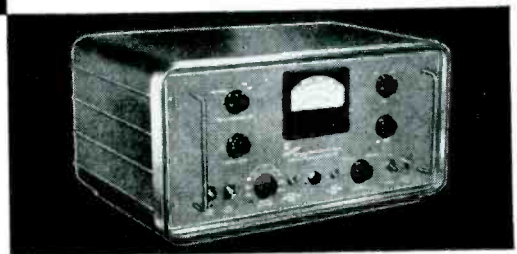

✓
WRITE FOR
NEW CATALOG
Address re-
quests for your
copy of the
new catalog to
Department
E-9 — no obli-
gation.



Polytechnic **RESEARCH
& DEVELOPMENT COMPANY • Inc**



55 JOHNSON STREET, BROOKLYN 1, NEW YORK
WESTERN SALES OFFICE:
741½ NO. SEWARD ST., HOLLYWOOD 38, CALIF.



**Broadband
Coaxial
Transmission Lines**

**Lowest Power Loss
No Electrical Discontinuity**

Designed for continuous service at any frequency to 2700 MCS, Prodelin Series 800 transmission line offers the highest microwave signal transmission efficiency with the lowest VSWR obtainable anywhere! And Prodelin Series 800 line can be cut at any point in the system, without regard for insulator spacing—it still retains its extremely high efficiency and low VSWR! Available in $\frac{7}{8}$ "", $1\frac{1}{8}$ "", $3\frac{1}{8}$ " and $6\frac{1}{8}$ " sizes and in 50 ohm impedance.

Prodelin Air-Tite couplings are electrically smooth and completely air tight. Simple mechanical assembly cuts field installation time by 50%! (Proved in actual field installations by experienced installers.)

Product Development Company manufactures parabolic antennas, omni-directional and bi-directional arrays, corner reflectors, coaxial cable and associated system components for various types of commercial and military service. Investigate Prodelin "Job-Packaging" today!

The World's Finest Transmission Lines

pdc

Prodelin Inc

305 Bergen Avenue
Kearny, New Jersey

Sales and Service Organization for **PRODUCT DEVELOPMENT COMPANY, INC.**

Manufacturers of Antennas, Transmission Lines and Associated System Facilities

ditional windows permit observation of the afterglow of the phosphors. The two shells are made vacuum-tight by means of a neoprene ring. The stator of a pulse-interlock synchronous motor is placed over the rotor housing and spins the rotor at 1,800 rpm^{3,4}. Precision ball-bearings similar to those used in rotating-anode x-ray tubes, are used inside the rotor housing.

The great tangential velocity of the rotating luminescent screen places limitations on the persistence of the phosphors that may be used. To maintain high resolution, the brightness of one picture element must decay to a small fraction of its activated luminance during the time in which the screen is displaced by the width of one element. Considering both the numerical values for the sequential system and the dimensions of the experimental tube, the decay time constant must be of the order of 2.7×10^{-6} sec if the brightness is to decay to 1 percent of that of a neighboring picture element.

The requirements for such a fast decay is common to the demands placed on phosphors for flying-spot cathode-ray tubes. The availability of suitable fast-decay color phosphors is limited.⁵ For green, zinc oxide activated with zinc was selected; for red, calcium phosphate activated with bismuth; and for blue, calcium magnesium silicate activated with titanium. The decay time constant of the first two phosphors is approximately one microsecond, but the last-named phosphor has a low-intensity tail; a calcium aluminum silicate would have been more suitable for the blue, but was not available. Unfortunately, the luminous efficiency of all of these phosphors is comparatively low,⁶ from 10 to 30 percent of that of ZnS-ZnCdS mixtures as used in monochrome tubes.

Crescent-shaped phosphor segments were applied to the glass by the silk-screening method and were aluminized on the electron gun side to enhance brightness. Owing to the large centrifugal force exerted during rotation, special care must be taken to insure adequate adhesion between the powder and the

NOW

A 200* AMP RELAY DESIGNED FOR

HIGH SHOCK VIBRATION

AND TEMPERATURE EXTREMES!



Series 8200 Relay

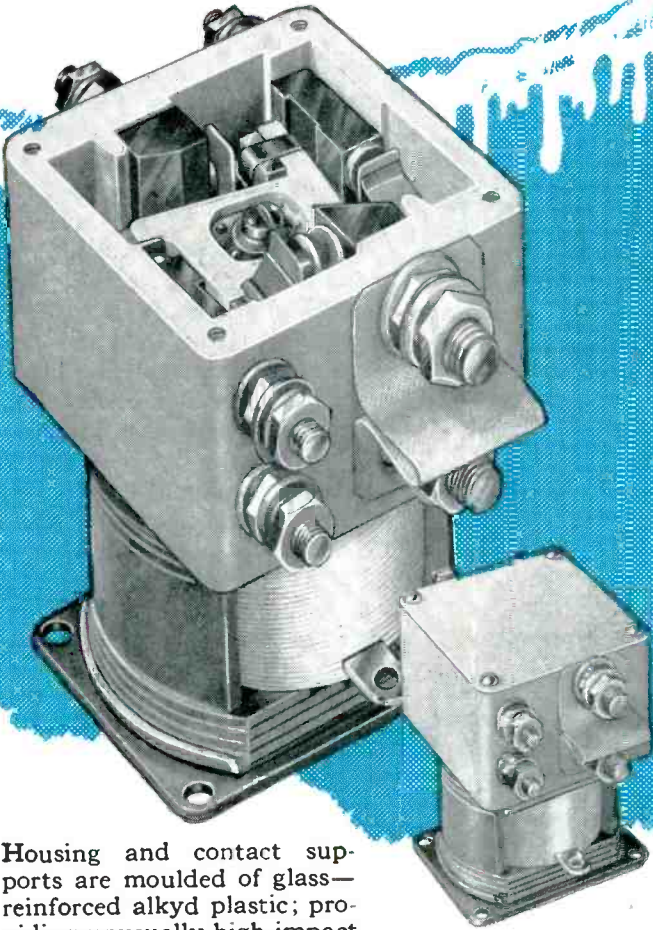

Housing and contact supports are moulded of glass-reinforced alkyd plastic; providing unusually high impact strength under all conditions.

Husky Series 8200 Relay Meets ALL Requirements of Spec. MIL-R-6106.

SMALL SIZE
2-9/16" high, 2-1/16"
wide, 3-1/8" long.
Weight, 15 ounces.

This unique Rotary type relay was developed particularly for the aircraft industry. It is designed to meet the need for a high current multipole relay for closing several circuits upon application of D.C. Voltage. The actuating principle is similar to that used so successfully for years in applications requiring high resistance to shock and vibration.

FEATURES

High Current: Designed to carry heavy in-rush currents up to 2500 amperes.

***Contact Arrangements:** (a) SPNO, 200 amps. (by paralleling 2 sets of contacts each rated at 100 amps.). Auxiliary contacts, 2 PNO, 25 amps.; (b) SPNO, 150 amps. Auxiliary 3 PNO, 25 amps.; (c) 2 PNO, 100 amps. Auxiliary contacts, 2 PNO, 25 amps.; (d) 4 PNO, 25 amps.

Shock: Tested performance greater than 70 G shock.

Vibration: Performs satisfactorily at 30 G vibration up to 500 cycles.

Altitude: Construction permits switching of full load currents up to 65,000 feet.

Temperature: Wide ambient temperature range, from minus 65 C to plus 125 C.

Operating Voltages: 6 to 115 volts D. C.

For complete specifications
write for File 8200



Price Electric

C O R P O R A T I O N

1500 CHURCH, FREDERICK, MARYLAND

NEW Type 2113, 12-Channel PICTURE SIGNAL GENERATOR

for Production Testing and Closed-Loop T.V.



The Type 2113, 12 Channel Picture Signal Generator has been specifically designed for production line testing of TV receivers. Used in conjunction with the equipment listed below, the manufacturer can produce his own "Indian Head" test pattern and is no longer dependent on local transmissions. This signal generator has also received wide acceptance for dealer demonstrations of TV receivers in areas where transmitting facilities are not yet available.

SPECIFICATIONS

OUTPUT SIGNALS AND ACCURACY: Picture and sound R. F. signals on all 12 standard TV channels. Picture carrier accuracy 0.01%; sound carrier better than ± 4.5 KC of "standard" on all channels.

PICTURE CARRIER OUTPUT: At least 50,000 microvolts into a 75 ohm terminated coaxial cable.

R. F. OUTPUT IMPEDANCE: Output is into a 75 ohm coaxial cable. Two probes are supplied for use with 75 ohm cable to match 75 or 300 ohm receiver antenna input circuits.

VIDEO INPUT IMPEDANCE: 75 ohms single ended.

VIDEO INPUT: Minimum 1 Volt Peak to Peak, black negative polarity.

PICTURE CARRIER MODULATION: Continuously variable 0 to 87%.

D. C. RESTORER: A D.C. restorer is provided to maintain constant average picture brightness when using program material for video modulation.

SOUND CARRIER DEVIATION: Continuously variable 0 to 40 KC.

SOUND MODULATION: Modulation from 400 cps internal oscillator or external signal such as music. Input either high impedance, unbalanced, or 600 ohms balanced. Either input can be selected by front panel switch.

These other TIC Instruments complete the "package"

TYPE 2120 PICTURE SIGNAL GENERATOR: A single channel TV transmitter for use where a high percentage of picture modulation is required for checking inter-carrier buzz.

TYPE 1311 VIDEO DISTRIBUTION AMPLIFIER: A 5 channel amplifier recommended where multiple 75 ohm, unity gain outlets are desired.

TYPE 2200 SYNC. SIGNAL GENERATOR: Provides all necessary RTMA sync. blanking and drive signals plus linearity blanking, in either polarity, for monoscope or studio camera operation.

TYPE 2300 MONOSCOPE: A "must" for checking linearity, resolution and smear in TV receivers and video distribution facilities. Recommended for use with Type 2200 Sync-Generator.

surface of the glass rotor.

This rotating screen tube lends itself to the measurement of phosphor afterglow. If the grid of the tube is pulsed in phase with a phosphor segment passing across the window, the afterglow appears as an arc of decreasing intensity, which can be photographed.

Because the available synchronous motor had a speed of 1,800 rpm, the vertical repetition frequencies for the color picture with which the tube was tested were chosen, for convenience, as 180 fields and 30 frames per second. Using the customary horizontal scanning frequency of 15,750 cycles, each frame was composed of 175 lines. The colors were pleasing in spite of the desaturated green, which is characteristic of zinc oxide activated with zinc. The screen brightness was low, as was expected from the comparatively low luminous efficiency of the color phosphors that had to be used because of the short persistence requirements. A typical white highlight brightness was 600 foot-lamberts at an anode voltage of 20 kv on the projection-tube gun and approximately 100 microamperes average current.

A 1½-foot projection screen illuminated through an $f/1.5$ lens would receive an illumination of approximately ½ foot-candle, which is scarcely enough. There are several possible sources of improvement. The luminescent-screen loading or the power input per unit area of the fluorescent screen cannot be increased above approximately 1 watt per sq. in. in the case of orthodox projection tubes because the screens heat up unduly. A tube with a rotating fluorescent screen, on the other hand, has a screen area which is effectively three times larger, allowing six times higher screen loadings. Inasmuch as the only other practical limiting factor is resolution, or blooming due to high beam current, it would be advantageous to increase the luminescent screen loading by increasing the anode voltage instead of the beam current. A further improvement could be made by utilizing the superior light-gathering power of a Schmidt optical system. Such an optical system requires a convex

Manufacturers of a Complete Line of TV Test Equipment
TIC Tel-Instrument Co. Inc.
 50 PATERSON AVENUE • EAST RUTHERFORD, N. J.

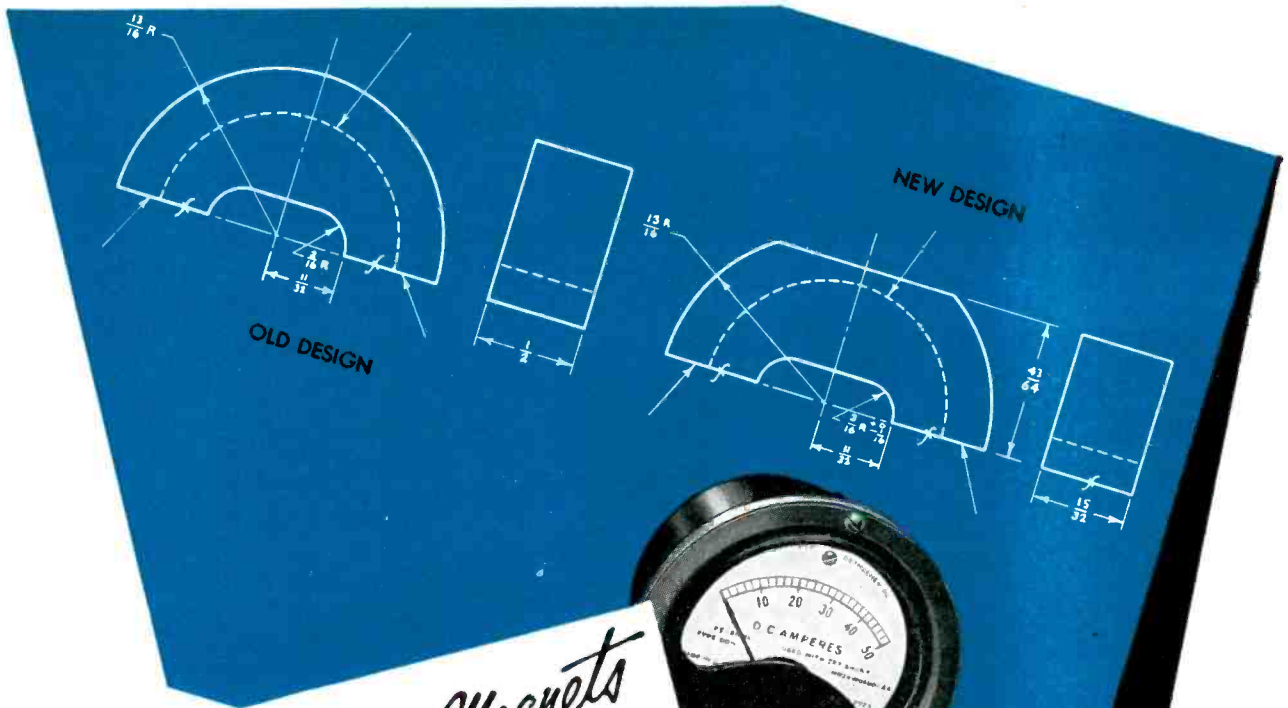

*Crucible Alnico Magnets
help ruggedize*

Roller-Smith Instruments

13% smaller—same magnetic strength

When the Roller-Smith Corporation decided to ruggedize their electrical instruments to meet Military Specifications, they discovered that they needed a smaller permanent magnet — one that would do the same job as the old one they were using.

They called on Crucible's technical service for assistance. In short order, Roller-Smith's objective was attained. For through improved design, Crucible developed an alnico magnet that was 13.5% smaller and lighter than the previous one . . . but with the same magnetic strength.

The Roller-Smith story is typical of the many cases solved with Crucible Alnico Magnets, because Crucible magnets have the highest gap flux per unit of weight of any on the market. Crucible has been the leading producer of Alnico Permanent Magnets since the industry started. When you have a magnet problem, call on Crucible.

CRUCIBLE

first name in special purpose steels

53 years of *Fine* steelmaking

PERMANENT ALNICO MAGNETS

CRUCIBLE STEEL COMPANY OF AMERICA, GENERAL SALES OFFICES, OLIVER BUILDING, PITTSBURGH, PA.
STAINLESS • REX HIGH SPEED • TOOL • ALLOY • MACHINERY • SPECIAL PURPOSE STEELS

American Optical Company chooses MICRO switches to control new heat-treating unit

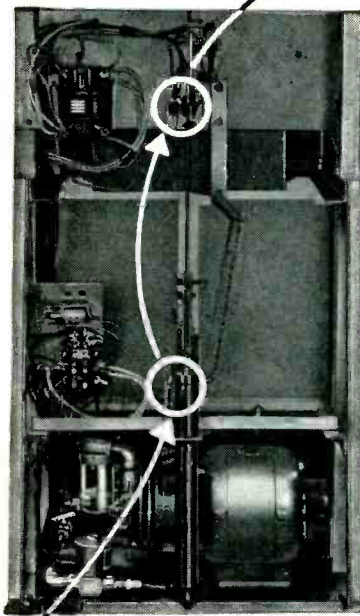

Two MICRO switches control timing of the heating and cooling cycles.



American Optical Company's MICRO switch-controlled AO M509 Heat Treating Unit.

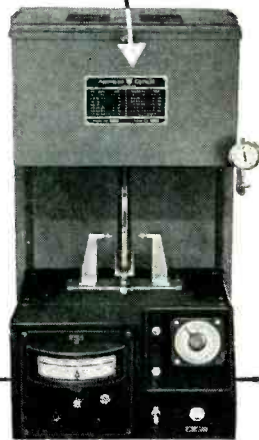

• A toughening process that will enable ophthalmic and safety lenses to withstand far greater impact than untreated lenses has been developed by the engineers of American Optical Company. It makes use of precision techniques which require the utmost in sensitive, accurate controls.

MICRO switches were selected to control the timing of the heating and cooling cycles because of:

- Long life characteristics
- Low operating force
- Sufficient electrical capacity to control the two solenoid valves and air pump motor.
- Dependability of performance.

Here again, MICRO switches have proved their worth as components of equipment where failure is intolerable. These heat-treating units must work day after day with minimum maintenance if production is to proceed smoothly in American Optical plants both in this country and abroad.

If you manufacture equipment which must not fail, let MICRO switch field engineers help you select from over 6000 types of switches the one switch best adapted to your products . . . the switch that will give you the utmost performance over a long life. Call or write the nearest MICRO branch office.

MICRO A DIVISION OF
MAKERS OF PRECISION SWITCHES MINNEAPOLIS-HONEYWELL REGULATOR COMPANY
FREEPORT, ILLINOIS



fluorescent screen.

The authors wish to thank the various members of the Rehman & Singer Laboratory who built the experimental tricolor projection tube, and the research laboratory of The Rauland Corporation for making the measurements.

REFERENCES

- (1) C. S. Szegho, U. S. Patent 2,422,937, Dec. 3, 1943.
- (2) Rehman & Singer, U. S. Patent Application 173,908.
- (3) I. Rehman, High Speed X-ray Motion Pictures, *Journal of the Biological Soc.*, 16, Sept. 1947.
- (4) Rehman & Singer, U. S. Patent Application 203,051.
- (5) A. Brill and H. A. Klasens, New Phosphors for Flying Spot Cathode Ray Tubes, presented at Spring Meeting of the Electrochemical Society at Philadelphia, May 1952.
- (6) A. Brill and H. A. Klasens, Intrinsic Efficiencies of Phosphors Under Cathode-Ray Excitation, presented at Spring Meeting of the Electrochemical Society at Philadelphia, May 1952.
- (7) C. S. Szegho, Color Cathode-Ray Tube with Three Phosphor Bands, *Journal of the SMPTE*, 55, p 367, Oct. 1950.

Audio-Frequency Filters Using Negative Feedback

BY T. JANISZ

Assistant Professor
Electrical Engineering
University of Detroit
Detroit, Mich.

CONSTRUCTION of an audio filter with constant input impedance designed to work into a required impedance is quite expensive, especially if it must have a reasonably good characteristic. Attenuation of about 60 db for undesired frequencies with sharp cutoffs usually require several inductors and capacitors of good quality.

The application of negative feedback varying with frequency, to tube circuits using low quality inductors and capacitors, can produce a band-pass or band-elimination filter whose characteristics can surpass the expensive one.

The circuit of the band-pass filter

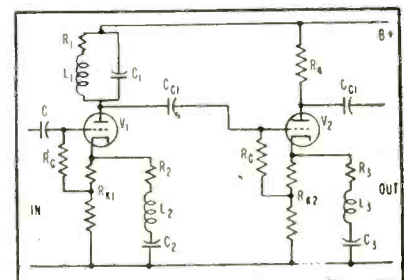
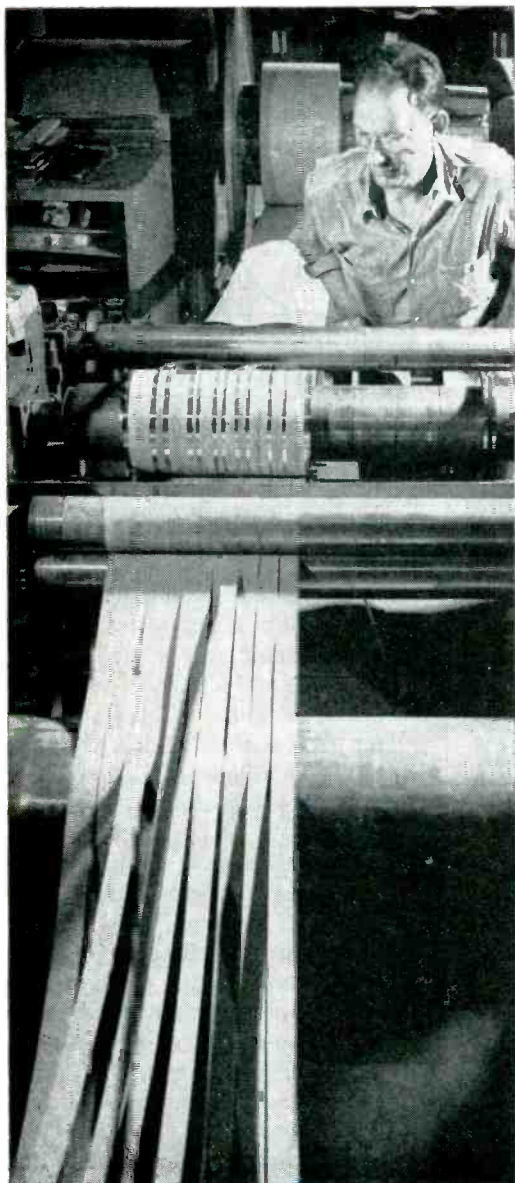

FIG. 1—Circuit of band-pass filter



MOLONEY

HiperCore

ELECTRONIC CORES

Start out Better, Wind up Best

Better electrical qualities in cores just don't happen . . . they are built in. Moloney HiperCore Electronic Cores start out right and stay that way. The finest cold rolled oriented silicon steel is fed through machines which accurately slit it into ribbons of a width to fit your specifications. These are carefully wound into cores of superior quality on Moloney patented mandrels. These machines maintain proper tension, stop when cores are wound to exact dimensions.

The result is a core with the famous Moloney "extra" . . . a core with better performance that weighs less, takes up less space. Moloney HiperCore Electronic Cores offer you lower losses and greater flux carrying capacities. And their standards are assured by rigid quality control all along the production line.

Moloney can ship HiperCore Electronic Cores quickly in any quantity you need in any of 300 standard sizes . . . or build them to your specifications. So if your product demands better performance, smaller size and less weight . . . specify the best electronic core, specify Moloney.

ME53-26



Write today for Bulletin SR-205 containing specifications, performance data and prices on 300 stock sizes.

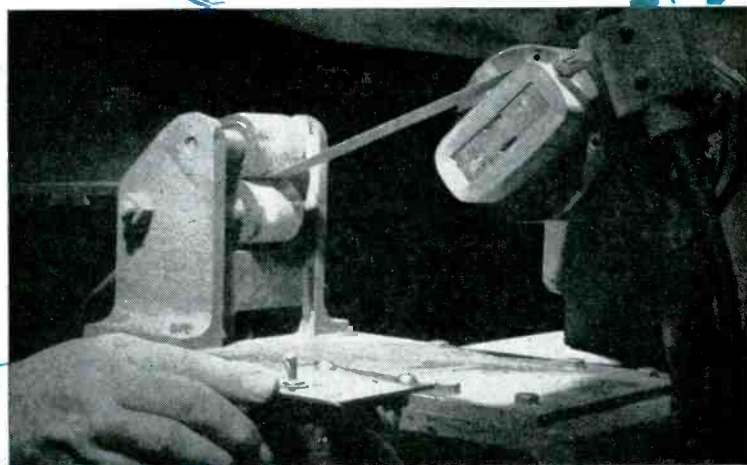

MOLONEY ELECTRIC COMPANY

Manufacturers of Power Transformers • Distribution Transformers • Load Ratio Control Transformers • Step Voltage Regulators • Unit Substations

SALES OFFICES IN ALL PRINCIPAL CITIES • FACTORIES AT ST. LOUIS, MO. AND TORONTO, ONT., CANADA

ELECTRONICS — September, 1953

Want more information? Use post card on last page.

223

Specialists in Magnetic Materials

Standard Designs—Special Shapes

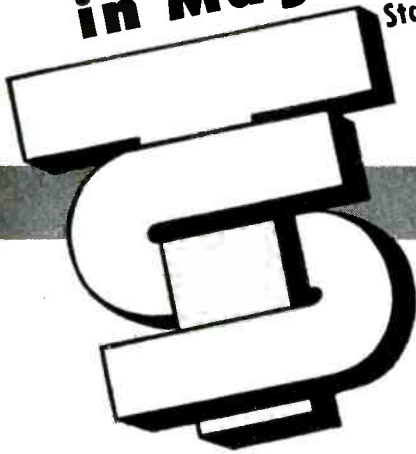

Permanent Magnets

Magnet Design—Bulletin 151. Written for the design engineer. Covers application, properties, design problems and testing of permanent magnets.

Standard Magnets—Catalog SM-1252. Complete data with dimensional drawings of standard magnets offered from stock for working models, small requirements, without special tooling.

Core Materials

Laminations—Bulletin L-752. Data on stamped silicon-iron laminations covering material applications, general specifications, typical value graphs. Also covers T & S OrthoSil oriented materials.

Wound Cores—Bulletin WC-353. New bulletin describing T & S Wound "C" and Toroidal Cores. Complete with specifications and value graphs.

Select the bulletin or catalog you need—write Thomas & Skinner today.



THOMAS & SKINNER Steel Products Company, Inc.



Bulletin
151



Catalog
SM-1252

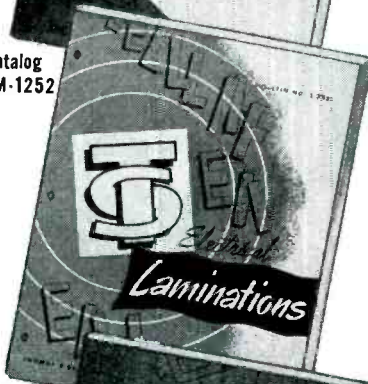

Bulletin
L-752



Bulletin
WC-353

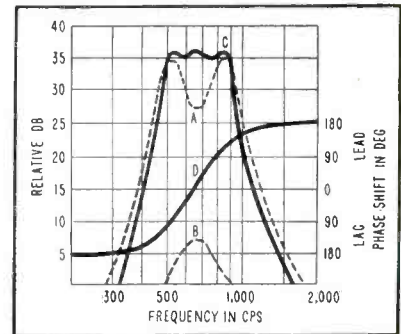
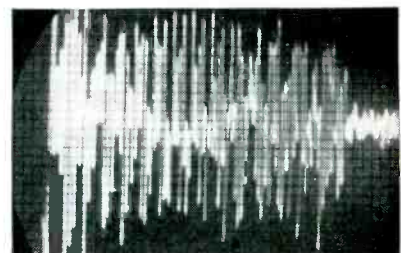

FIG. 2—Frequency response curves, A relative gain through V_1 , B relative gain through V_2 and C relative gain of entire filter circuit. Curve D shows phase shift between input and output voltages

consists of an amplifier containing three resonant circuits: a series-resonant circuit across the cathode of each tube and a parallel-resonant circuit in the plate of the first tube.

The performance of the filter in Fig. 1 is as follows. The amount of negative feedback developed across the cathode impedance of the first tube varies with frequency, in turn varying the amplification of the tube. If resistance R_{K1} is sufficiently large that its effect can be neglected against its parallel impedance Z_{K1} consisting of R_2 , L_2 , and C_2 , the amplification is inversely proportional to the amount of negative feedback. Therefore, the frequency response of the first tube circuit, assuming constant plate im-



(A)

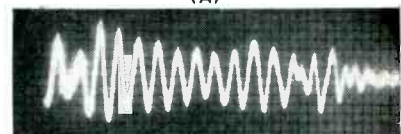

(B)



(C)

FIG. 3—Original complex wave (A) of the word "but" passed through 20 to 210 cycle filter (B) and 210 to 310 cycle filter (C)

it takes an Elephant
21 MONTHS...



Douglas delivers in 8 Weeks!!!*

Douglas Laboratories is a high-speed source for custom-built electronic equipment of almost every type:

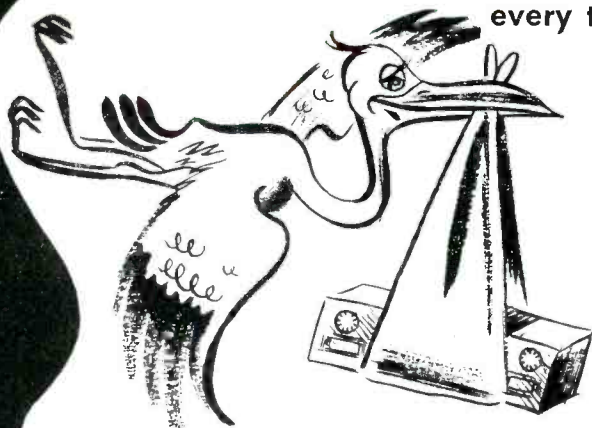

*AVERAGE DELIVERY CYCLE, from purchase order to final installation, 8 weeks.

POWER SUPPLIES: Regulated: up to 25KW. Unregulated: up to 250KW.

TUBE TESTING AND PROCESSING EQUIPMENT: Peak Emission sets up to 2,000 amperes, 25KV. Hydrogen Thyatron pulsers for all existing types. Characteristic Test Sets for all JAN tube types. Aging and life-test racks. Rectifier test sets. Interelectrode Capacitance bridges.

RADAR EQUIPMENT: Modulators. Magnetron signal sources. Pulsed-Cavity sources.

LABORATORY INSTRUMENTS: Extended-range synchrosopes. Sweep calibrators. Special Amplifiers. Pulse Transformer test sets. Pulse generators.

Prices are competitive, workmanship is excellent. Write, Wire, Phone — quotes in 48 hours if required.



DOUGLAS LABORATORIES, Inc.

373 Fourth Avenue, New York 16, New York. MUrray Hill 5-3563

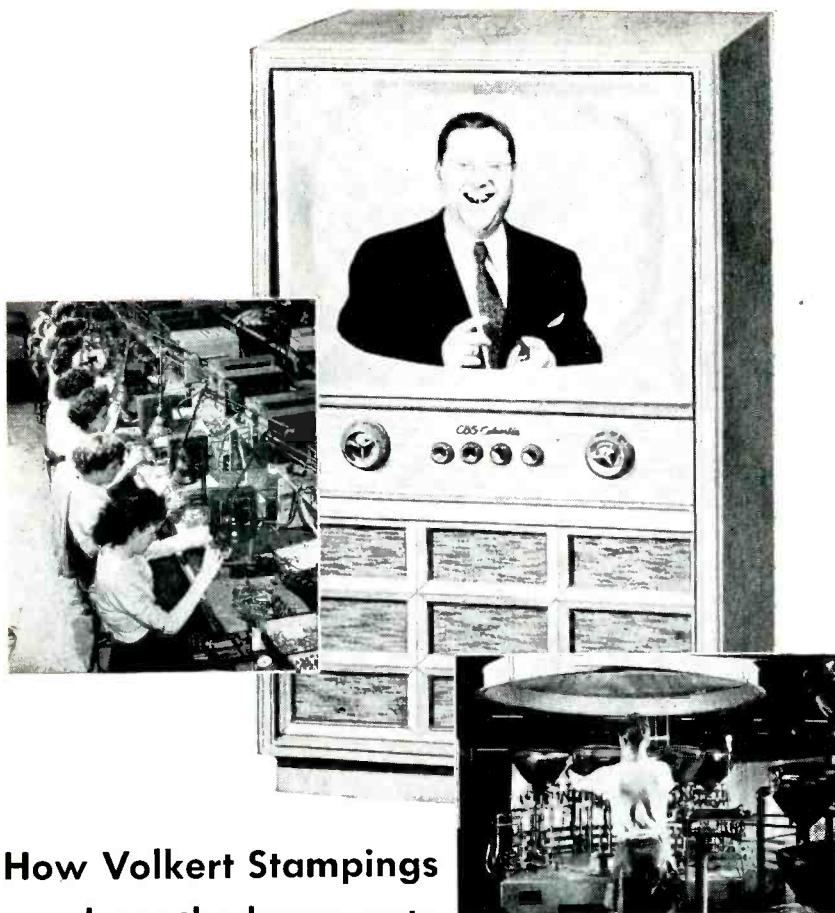

How Volkert Stampings shoot the beam onto CBS-Hytron's picture screen

CBS-Hytron wants Volkert quality, Volkert precision in the engineered stampings for the electron gun assembly for their television picture tube.

The electron gun that shoots the image onto the screen is the heart of the picture tube, and top performance is only possible with the kind of quality and accuracy Volkert stampings deliver. Volkert is not only a leading supplier of television stampings; Volkert is the pioneer designer and builder of the dies which produce these parts.

And Volkert is uniquely equipped to meet the exacting tolerances and large-quantity orders for gun parts used in

the thousands of CBS-Hytron picture tubes, produced each month for the great variety of popular television sets made by CBS-Columbia Inc. Latest-type production facilities and skilled inspection procedures permit Volkert to precision-manufacture more than 50,000 sets of gun parts weekly for many of the top picture tube makers.

Learn how others have cut stamping costs by taking advantage of Volkert's facilities and abilities. Write today for our illustrated case history booklet.

John Volkert Metal Stampings, Inc.
222-34 96th Ave., Queens Village 8, L. I., N. Y.

For design...tooling...production and assembly of precision stampings

it's **Volkert**

pedance is the inverse of the response of Z_{K1} , and will have maximum amplification at the series resonance of Z_{K1} . Actually, the plate impedance of the first tube, Z_{L1} , varies with frequency also, varying the amount of voltage developed across it with its maximum at parallel resonance. When the plate and cathode circuits are at resonance at the same frequency the circuit of the first tube will produce a pass filter for a singular frequency.

Mathematical analysis shows that in order to get sharp cutoffs the ratio of L_1/C_1 and L_2/C_2 must be much larger than the products $R_p R_1$ and $R_p R_2$, where R_p is the plate resistance.

If the resonant frequency of Z_{K1} occurs at a different frequency than that for maximum Z_{L1} , then the two peaks will spread. This spread is the width of a band-pass filter, and will have sharp cutoffs if the conditions imposed above are satisfied. Between the peaks a dip will appear in the response curve as shown in *A* of Fig. 2. To level the curve the second tube is resonant to the dip frequency as indicated by curve *B*. By proper design, or by experiment, the circuit of the second tube can be adjusted to obtain a flat-topped frequency response curve with the sharpness of the cutoffs further improved by negative feedback at the second tube. The resultant pass-band is shown by curve *C*.

The phase shift for different frequencies in the band-pass varies from 270 deg to 90 deg for the first and second tube circuits respectively. This amounts to an overall phase shift from 180 to -180 deg as shown in *D* of Fig. 2.

One of the main advantages of this filter is that its input impedance, equal to the input impedance of the first tube, is very high for all frequencies. It can be adjusted to any desired value and made practically constant for all frequencies by placing a suitable resistance across the input.

The characteristics of the filter can be improved further and adjusted to any desired value by applying similar circuits in cascade. Moreover, by the use of different



5881

6AX4
GT



**TUNG-SOL DESIGNED
AND DEVELOPED**

6U8



**ACCEPTED
BY THE ELECTRONICS INDUSTRY**

You may have detailed information on these and other types upon request.
TUNG-SOL makes All-Glass Sealed Beam Lamps, Miniature Lamps, Signal Flashers,
Picture Tubes, Radio, TV and Special Purpose Electron Tubes and Semiconductor Products.
Sales Offices: Atlanta, Chicago, Columbus, Culver City (Los Angeles), Dallas, Denver, Detroit, Newark, Seattle

TUNG-SOL ELECTRIC INC., Newark 4, New Jersey



6AU4
GT

5687



The THINNEST
LIGHTWEIGHT

HI-TEMPERATURE
INSULATION MADE

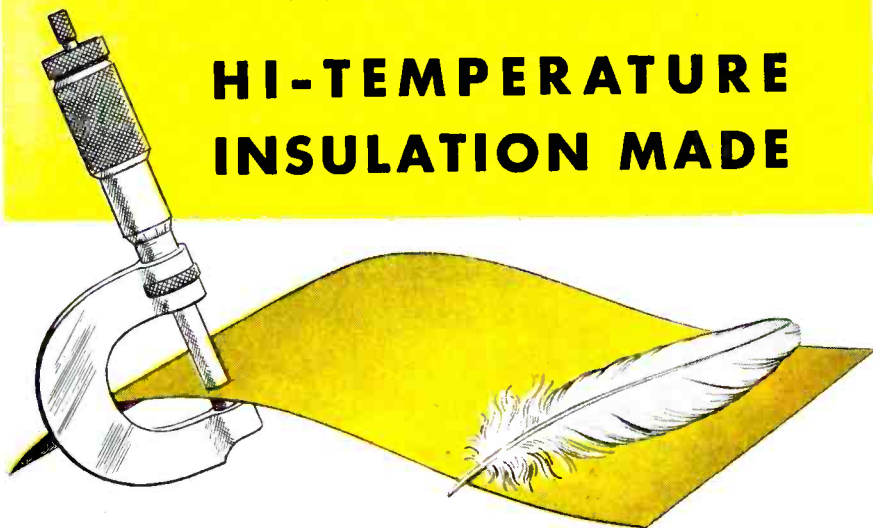

ELECTRO

SIL-THIN-GLAS .002 and .003
and
SIL-THIN-BESTOS .003 to .0035

offer design economies
at higher temperatures

Electro Extra Thin Hi-Temperature Insulation possesses exceptional dielectric and tensile strength. Its thinness, flexibility and lightweight permits compact construction . . . size and weight reduction of electronic and electrical equipment.

These Electro products meet all Class "H" requirements and are available in rolls, sheet or tape form.

For complete data or samples of these and other ELECTRO products contact Dept. E1

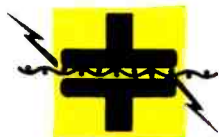

ELECTRO-TECHNICAL PRODUCTS

DIVISION OF SUN CHEMICAL CORPORATION
113 East Centre Street, Nutley 10, N. J.

capacitance and by keeping the inductance constant, the width of the band-pass can be varied through wide limits. Finally, the same components can be used for constructing band-elimination filters by reversing plate and cathode circuits.

As a test of the foregoing theory, a voice-frequency analyzer was constructed for the frequencies between 20 and 20,000 cps. Twelve band-pass filters were employed giving an overall frequency-response curve with a maximum variation of 2 db. With any of the 12 filters out, average discrimination of at least 20 db was obtained for all frequencies greater than 1.25 to 1.1 of the cutoff frequency. Actual performance of the filters can be seen in Fig. 3.

Push-Pull Amplifiers For Increased Video Output

BY ARNOLD NEWTON
Design Engineer
Forest Hills, N. Y.

THE TREND TOWARD larger screen areas and the concomitant use of higher accelerating potentials places increasingly heavy demands on the beam-deflection and video output circuits of television receivers.

Improved linearity and increased output capabilities make push-pull amplifiers attractive as video output stages. Triodes lend themselves readily for this application since neutralization is easily accomplished by conventional techniques

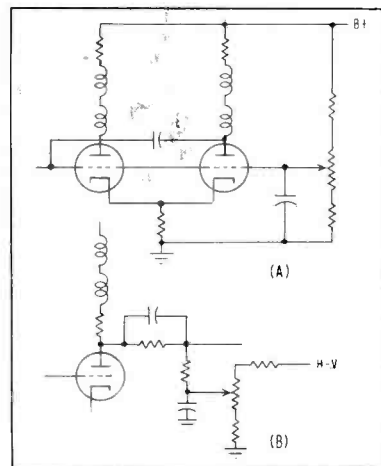

FIG. 1—Two means of brightness control. Variable bias (A) and use of auxiliary high-voltage supply (B)



CVC's inline . . .

now available

for TV tube aluminizing

Here is an inline system capable of aluminizing TV tubes with the same efficiency and high production rates as the famous inline exhaust systems pioneered by CVC.

Similar to the exhaust system, individual aluminizing units move around an oval track, one revolution completing the aluminizing cycle. Each cart is completely self-contained with mechanical and diffusion pumps, valves, power pickups, and controls for automatic operation. The operator need only load and unload tubes and replenish the aluminum on the filaments.

This new CVC system can handle any size TV tube currently produced. Interchangeable diffusion pump

jet assemblies permit easy adaptation of the system to the higher vacuums probably required for color TV tube aluminizing.

For smaller scale operations, CVC offers an integrated system of one to six individual pumping units with common roughing and holding pumps. Timing devices control cycling automatically and permit one operator to handle all systems.

CVC's vast experience in designing inline exhaust systems makes these units trouble-free and economical in operation. We will be pleased to give you the details on specifications, costs, and deliveries. *Consolidated Vacuum Corporation, Rochester 3, N. Y.* (a subsidiary of Consolidated Engineering Corporation, Pasadena, California).



Consolidated Vacuum Corporation

Rochester 3, N. Y.

designers and manufacturers of high vacuum equipment

SALES OFFICES: MENLO PARK, CALIF. • CHICAGO, ILL. • CAMDEN, N. J. • NEW YORK, N. Y.



What is your Delay or Regulating Problem?



For the most effective solution use the
SIMPLEST, MOST COMPACT
MOST ECONOMICAL
HERMETICALLY SEALED

AMPERITE

THERMOSTATIC DELAY RELAYS



STANDARD

Provide delays ranging from 2 to 120 seconds.

- Actuated by a heater, they operate on A.C., D.C., or Pulsating Current.
- *Hermetically sealed.* Not affected by altitude, moisture, or other climate changes.
- Circuits: SPST only—normally open or normally closed.

Amperite Thermostatic Delay Relays are compensated for ambient temperature changes from -55° to $+70^{\circ}$ C. Heaters consume approximately 2 W. and may be operated continuously. The units are most compact, rugged, explosion-proof, long-lived, and—very inexpensive!



MINIATURE

TYPES: Standard Radio Octal, and 9-Pin Miniature.

PROBLEM? Send for Bulletin No. TR-81

BALLAST-REGULATORS



T9 BULB

- Amperite Regulators are designed to keep the current in a circuit **automatically regulated** at a definite value (for example, 0.5 amp).
- For currents of 60 ma. to 5 amps. Operates on A.C., D.C., or Pulsating Current.
- Hermetically sealed, light, compact, and most inexpensive.

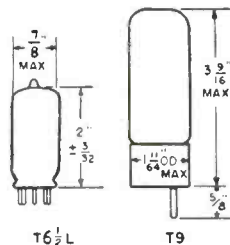
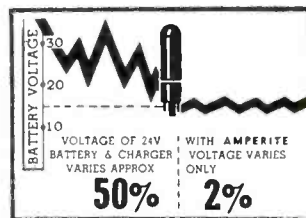

Maximum Wattage Dissipation: T6 $\frac{1}{2}$ L—5W. T9—10W.

Amperite Regulators are the simplest, most effective method for obtaining **automatic regulation** of current or voltage. *Hermetically sealed*, they are not affected by changes in altitude, ambient temperature (-55° to $+90^{\circ}$ C), or humidity. Rugged; no moving parts; changed as easily as a radio tube.

Write for 4-page Technical Bulletin No. AB-51



AMPERITE CO., Inc. 561 Broadway, New York 12, N. Y.

In Canada: Atlas Radio Corp., Ltd., 560 King St., W., Toronto 2B

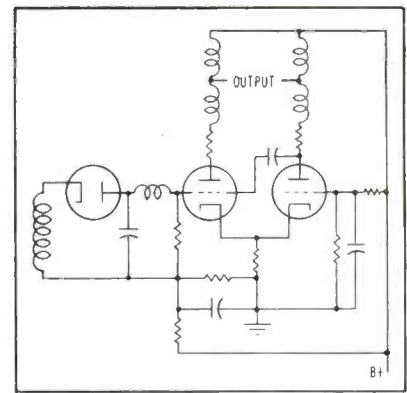

FIG. 2—Cathode-coupled push-pull output stage

described in the literature.

Maximum output voltage is limited by either the current handling capabilities of the tube or the available supply voltage, other conditions remaining fixed.

Pentodes, commonly used in this application, can be regarded as constant current generators in view of the relatively low value of load resistance required in most video circuits. Under these conditions the output voltage is directly related to the load resistance.

The following expression relates the peak-to-peak voltage E_p to the peak-to-peak current I_p , the rise-time t_r , the circuit capacitance C and the efficiency of the coupling network η

$$E_p = \eta I_p \frac{t_r}{\sqrt{2\pi C}}$$

The rise-time t_r is defined as $\sqrt{2\pi}$ times the standard deviation of the differentiated response of the network to a step function of current. For a two-terminal network, C is the total capacitance. Absence of overshoot is assumed.

The factor η indicates the degree of improvement relative to the R-C network for which $\eta = 1$.

Shunt-peaking yields $\eta = 1.52$ and the maximum attainable with a two-terminal network is

$$\eta = \frac{3}{\sqrt{2}}$$

Compensated four-terminal networks are capable of superior performance. The small percentage overshoot associated with the more desirable networks is generally quite tolerable and does not seriously detract from their usefulness. Values of η as high as 2.5

Distinguished Names
in Communications...

DU MONT



WELLS-GARDNER

... Put Their Confidence in

Midland CRYSTALS

These names are synonyms for quality. The products they identify are famous for dependable, precision performance in every detail. These manufacturers must be sure that suppliers of every component have similar high-level reputations to uphold.

The fact that the great names in communications rely on Midland Crystals is evidence enough that Midland Quality Control methods of crystal production insure completely reliable frequency control.

*Whatever your Crystal need, conventional or highly specialized,
When it has to be exactly right, contact*

**STEWART
SW
WARNER**

Emerson



Midland

MANUFACTURING COMPANY, INC.
3155 Fiberglas Road, Kansas City, Kansas

WORLD'S LARGEST PRODUCER OF QUARTZ CRYSTALS

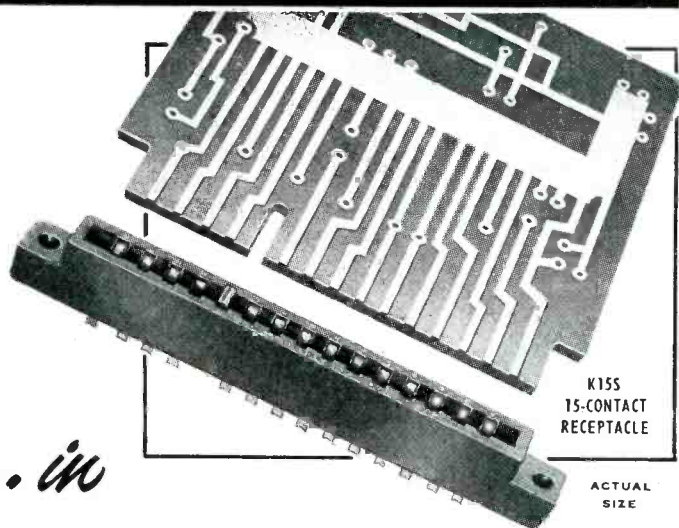

K155
15-CONTACT
RECEPTACLE

ACTUAL
SIZE

First... in

CONNECTOR RECEPTACLES FOR PRINTED CIRCUITS

First in...

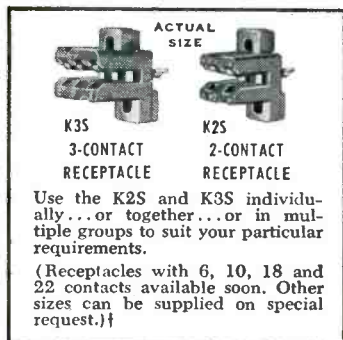

K3S
3-CONTACT
RECEPTACLE

K2S
2-CONTACT
RECEPTACLE

Use the K2S and K3S individually... or together... or in multiple groups to suit your particular requirements.

(Receptacles with 6, 10, 18 and 22 contacts available soon. Other sizes can be supplied on special request.)†

DESIGN...An original Winchester creation developed expressly for printed circuits.

SUPPLY...A complete line of receptacles for ALL printed circuit requirements.

QUALITY...Again, as always, electronic components of precision manufacture embodying the quality features that distinguish Winchester Electronics' Connectors from all others.

SPECIAL FEATURES

POLARIZING pin permits engagement in correct position only.

WIPING ACTION of contacts insures positive contact at all times.

MONOBLOC* CONSTRUCTION eliminates unnecessary creepage paths and reduces the number of moisture and dust pockets.

MOLDED MELAMINE bodies (in accordance with MIL-P-14) mineral filled... are fungus-proof and provide mechanical strength as well as high arc and dielectric resistance.

CONTACTS are spring temper phosphor bronze (QQ-B746a), gold plated over silver for low contact resistance, prevention of corrosion and ease of soldering.

Raised barriers between contacts increase surface creepage. Solder cups are .043" dia. for #20 A.W.G.

* Trade Mark

Patents Pending

WINCHESTER PRODUCTS AND WINCHESTER DESIGNS ARE AVAILABLE ONLY FROM WINCHESTER ELECTRONICS, INCORPORATED

WEST COAST
BRANCH:

†Our Sales Department invites your inquiries. Wire or write for catalog of other types or advise us of your special requirements.

1729 WILSHIRE BOULEVARD, SANTA MONICA, CALIFORNIA

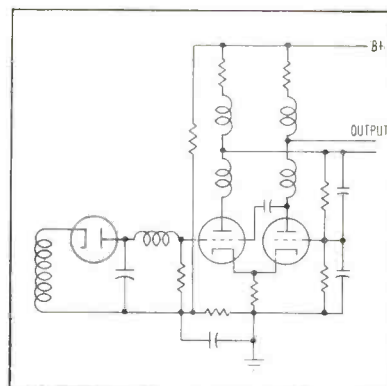

FIG. 3—Phase inverter and push-pull output stage

were reported for networks having small overshoots.

The capacitances of a four-terminal network are separated by intervening inductances and it is therefore necessary to distinguish between the filter input and output capacitances.

The tube output and a small amount of stray capacitance forms the input capacitance of the network. The remainder consisting of kinescope input and wiring capacitance is at the output of the network.

When the formula introduced above is applied to a four-terminal network, C refers to its output capacitance.

Best results are generally obtained when the ratio of terminal capacitances is 2-to-1.

Some advantage can be realized by using tubes in parallel, since I_p increases in direct relationship to the number of tubes whereas C increases less percentagewise. This is due to the fact that a major portion of C consists of kinescope input and incidental capacitance. However, a point of diminishing returns can be reached beyond which little is gained by increasing the number of tubes.

Even more unavoidable is limitation due to available supply voltage. In many instances, particularly where economical designs are involved, it is desirable to make use of video output voltages in excess of the supply potential. The use of tubes in parallel is clearly not the solution in this case.

Push-pull permits an extension of the limit imposed by the available supply voltage by a factor of

**WINCHESTER
ELECTRONICS**
INCORPORATED

GLENBROOK, CONN., U.S.A.

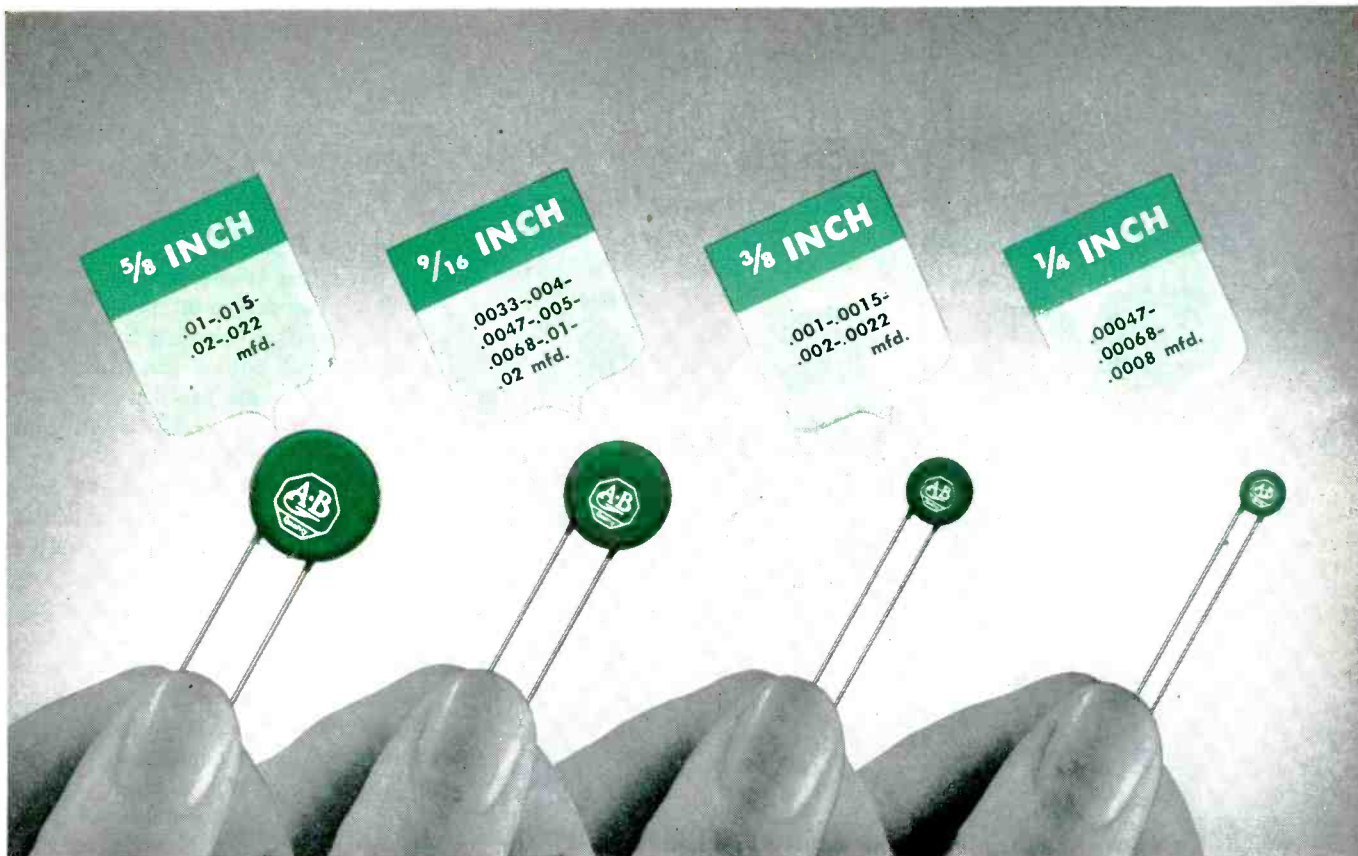

CERAMIC CAPACITORS

from **0.00047** to **0.022 mfd.**

••• in 4 sizes

Allen-Bradley ceramic capacitors are made in the four sizes and in the nominal values listed above. Minimum capacitance values are guaranteed over a temperature range from plus 10C to plus 65C. Since the ceramic discs of high K dielectric are compounded, molded, and sintered in the Allen-Bradley factory, the uniformity of the finished capacitors can be rigidly maintained under Allen-Bradley precision production controls. Uniform quality and performance are guaranteed. Allen-Bradley ceramic capacitors have been approved by the engineering departments of the largest electronic, electrical, and telephone laboratories.

When you specify Allen-Bradley ceramic capacitors for your circuits, you assure yourself of dependable performance, even under extreme conditions of temperature and moisture. The A-B trademark is your guarantee of quality capacitors. Samples will be furnished on request for qualification tests and type approval.

Allen-Bradley Co.
110 W. Greenfield Ave., Milwaukee 4, Wis.

Starting with the ceramic discs and continuing step by step through sintering, silvering, soldering, and wax impregnating . . . each operation is under Allen-Bradley precision control. Quality capacitors are the consistent result.

ALLEN - BRADLEY
RADIO & TELEVISION COMPONENTS

QUALITY

CANNON PLUGS

—the highest quality
—greatest variety
—widest use
—for the instrument industry



AN Designed to Air Force—Bureau of Aeronautics—requirements. Now widely used for all instruments requiring electrical circuits. Coupling nut connection and disconnection. Two plug types; 3 receptacles with variations and clamp accessories, in 15 shell sizes and more than 250 insert arrangements. A type for every need. Ask for "AN" Bulletin.



K & RK Designed for uses in aircraft, this versatile lightweight plug is widely used on a great variety of instruments and electronic equipment. Special acme coupling nut connection and disconnection. 8 contact sizes accommodate 16, 14, 10, 8, 6, 4, 2 and 0 AWG. Maximum 200a. 8 shell diameters. 204 insert variations. KH Series, hermetically sealed Type K, also available. Write for "K" Bulletin.



GS (AN) Designed for applications demanding hermetic sealing under high pressures in a temperature range from minus 300F to plus 600F. 2 basic shell designs. NEF threaded coupling nut. Steel shells and steel contacts. Mate with AN Series. See "AN" Bulletin or "GS" Bulletin.



XL For audio equipment and general electronic uses: 3 and 4 contact layouts, 10 and 15a; 17 shell designs; zinc and steel plug shells. Ask for "XL" Bulletin.



DPB-DPD For rack-and-panel installations, instrument panels and for any plug-in sub-assembly where both halves of the connector are rigidly mounted, or where one half is rigidly mounted and the other half cord mounted. 78 max. contacts, 200a maximum. Ask for "DP" Bulletin.

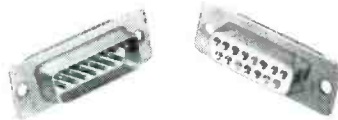

D SERIES SUB-MINIATURE PLUGS Designed to meet the miniaturization program. Used both as rack-and-panel disconnect and cord connectors for hand portable radio equipment, audio circuitry and related applications. Keystone shaped. 15 to 50 gold-plated contacts. DH hermetically sealed also available. See "D" Bulletin.



U SERIES SUB-MINIATURE PLUGS For hermetically sealed instruments, indicators, miniature switches, relays, transformers, amplifiers and other miniaturized sealed components. Steel shells & pin contacts; standard socket contacts in Silcan insulators. 1, 3, 6, 12 contact arrangements. 5a max. Bayonet lock coupling. See "U" Bulletin.

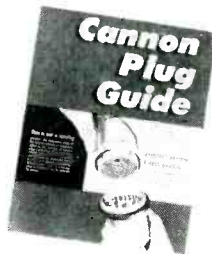

Send for a copy of the new Cannon Plug Guide.

CANNON ELECTRIC

Since 1915

CANNON ELECTRIC COMPANY, LOS ANGELES 31, CALIFORNIA

Factories in Los Angeles, Toronto, New Haven. • Representatives in principal cities. Address inquiries to Cannon Electric Company, Dept. I-110, Los Angeles 31, California.



2-to-1. With this scheme, the full amplitude of the output voltage is applied to the kinescope control electrodes (cathode and control grid) individually. The voltages are of opposite polarity, however, and the net effect is additive.

The push-pull system of video output requires coupling to both the grid and cathode of the kinescope. This raises some problems in connection with d-c restoration and brightness control.

The simplest means of d-c restoration, d-c coupling, presents the greatest difficulties. It is possible to effect brightness control by changing the bias conditions of one of the output tubes, Fig. 1A. Unfortunately, however, this would also lead to changes of gain, making the controls interrelated and neutralization imperfect.

The R-C divider network shown in Fig. 1B can be employed if a positive or negative potential, which is high relative to the plate voltage, is available. The sacrifice of output is a function of the voltage available for this purpose. The use of a negative voltage and the application of brightness control to the grid is somewhat preferable as higher impedances can be used with the consequent reduction of the loading effect on the high-voltage supply.

Partial d-c restoration can be obtained by d-c coupling to one of the control electrodes only. A more conventional but less economical method involves the use of a diode d-c restorer with one or both control electrodes.

The manner of coupling between the second detector and the video amplifier and the problem of phase inversion lend themselves to a number of solutions. In the circuit

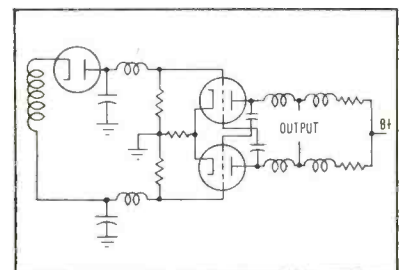

FIG. 4—Push-pull output with balanced input

You Can Depend on **COMMUNICATION ACCESSORIES** for

ADVANCED DESIGN

THROW AWAY the special washers and tubings used in your present mechanical mountings of toroids. C-A-C Advanced Design provides a molded-in brass bushing with center hole sizes to clear (type A) or tapped (type B) for a 6/32 screw.

PRESSURE ENCAPSULATION in low loss plastic provides a dense molding of extremely uniform dimension. We've cycled them from -73°C to 150°C —boiled them for hours in salt water—without any significant change.

TERMINALS are brass, silver-plated. Located for ease of connection. Any reasonable number of terminals may be provided. Units may be stacked and mounted with a single screw.

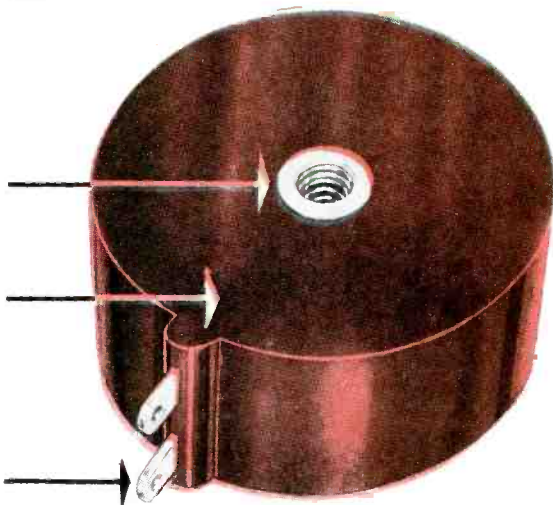

Compression MOLDDED PLASTIC TOROIDS

THE C-A-C MP (molded plastic) Toroid is the result of years of development and exhaustive tests to determine the most suitable materials and method of manufacture. The small, extra cost of the molded unit is more than justified by the superior protection of the unit from damage in assembly, and operation—and the elimination of complicated mounting arrangements. The assemblies are compact (see table for dimensions). Complete data available on request: samples will be furnished for your evaluation.

TOROIDAL INDUCTORS Data For Standard Types

Type	Normal Lmax.	Appr. Size O.D. x H	Useful Freq. Range	Qmax @ Freq.	lac- T.C. ma
* 206	3.0 Hy	.90x .40	Up to 15 KC	140 @ 9 KC	1 23
** 930	17.5 Hy	1.20x .60	Up to 15 KC	170 @ 7.5 KC	1 42
* 254	35 Hy	1.85x .85	Up to 15 KC	220 @ 5 KC	1 67
466	60 Hy	2.15x 1.00	Up to 15 KC	260 @ 5 KC	3 95
* 848	1.4 Hy	.90x .40	10- 50 KC	170 @ 20 KC	1 33
** 395	8.0 Hy	1.20x .60	10- 50 KC	220 @ 20 KC	1 61
* 381	17.0 Hy	1.55x .65	10- 50 KC	250 @ 17.5 KC	3 71
* 608	600 Mh	.90x .40	30- 75 KC	165 @ 60 KC	3 50
579	7.5 Hy	1.55x .65	30- 75 KC	185 @ 30 KC	2 110
* 041	320 Mh	.90x .40	50-200 KC	115 @ 120 KC	3 68
013	4.0 Hy	1.55x .65	50-200 KC	145 @ 70 KC	3 150

REMARKS

Qmax—Values taken at approx. .01 lac. Q decreases with increasing current to about .50 Qmax at 1.0 lac—higher inductance values have lower Qmax at lower frequency due to dielectric losses of winding distributed capacity. All values are for inductors wound with Heavy Formex wire.

T.C.—Temperature characteristics as follows:

- 1—approx. 100 ppm/°F
- 2— = .1% 55 to 90°F
- 3— = .1% 30 to 130°F

(most types with temp. characteristic 1 are available with characteristic 3 at no sacrifice in performance)

lac—r.m.s. current which raises 0.1 Hy inductor to max. (2% above initial) inductance — (1% increase occurs at approx 0.35 lac.

- * FINISHED SIZE — 1-1/16" O. D. x 1/2" THICK
- ** FINISHED SIZE — 1-5/16" O. D. x 11/16" THICK

Via C.A.C. Beechcraft, we are only hours away from you—we solicit the invitation to discuss your problems across your own desk.



COMMUNICATION ACCESSORIES *Company*

HICKMAN MILLS, MISSOURI

QUALITY is Foremost IN VICKERS RECTIFIERS



Vickers refines its own selenium for uniform, dependable performance

Automatic electro forming "pre-stresses" cells

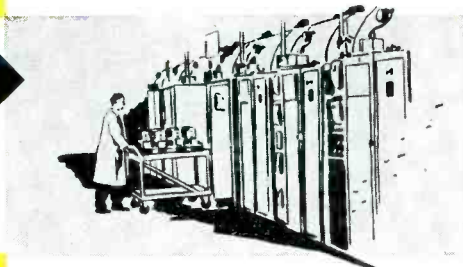

Performance matching of cells prevents overloading-overheating

Hydraulic assembly assures constant mechanical strength and dimension

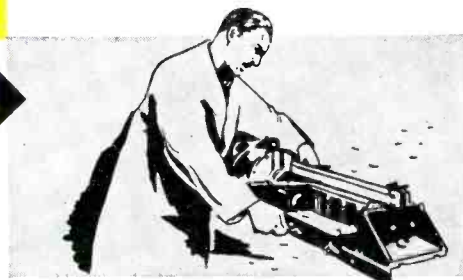

255 tests and inspections guarantee Vickers Quality



These reasons alone would be assurance of Vickers rectifier superiority. Add the many other refinements of design and construction . . . the experience and careful workmanship . . . and you will be sure that Vickers is the best answer to your rectifying needs, large or small.

Write for Bulletin 3000. Vickers engineering service is available without obligation.

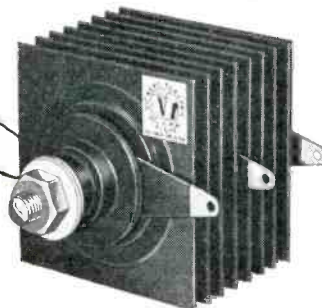

shown in Fig. 2 the detector load is directly connected to the grid of a cathode-coupled output stage. Both control grids of this stage have a positive potential with respect to ground in order to permit the use of a high cathode resistance, and yet maintain normal bias conditions.

The a-c cathode voltage equals half the grid-to-ground voltage and as a result the grid-to-cathode voltage applied to the second stage is equal, except for polarity, to the voltage seen by the first stage, which is equal to the difference between the grid-to-ground and cathode-to-ground voltages.

A capacitor whose capacitance is equal to the grid-to-plate capacitance is added from grid 1 to plate 2 for the purpose of neutralizing the effect of C_{gp} .

Higher gain may be obtained by using the circuit shown in Fig. 3. In this circuit the phase inverted signal for grid 2 is derived from plate 1 through an R-C divider. The attenuation offered by the divider network should of course be equal to the stage gain. With d-c coupling, it is still necessary to raise the cathode voltage and suffer a slight loss of available plate voltage.

A balanced-input push-pull amplifier is shown in Fig. 4. The detector circuit associated with it offers a balanced output. It makes use of a single diode and is most adaptable to a double-tuned i-f coupling circuit. The circuit is cross-neutralized and by virtue of its symmetry it offers a high degree of dynamic balance.

Tubes most suitable for push-pull video output stages include types 6J6, 12AT7, 12AV7, 12AU7 and 12BH7.

Four-Quadrant Calibrator

BY E. GAYNOR AND H. J. TATE
*Fairchild Guided Missiles Division
Fairchild Engine and Airplane Corp.
Wyandanch, N. Y.*

IN EXAMINING the relation between two voltage functions on a d-c oscilloscope, it is helpful to have a means for calibrating the deflection amplifiers. The calibrator described here was developed for use with a transistor-characteristic plotting circuit. To permit measurement

VICKERS ELECTRIC DIVISION

VICKERS Inc.

A UNIT OF THE SPERRY CORPORATION
1801 LOCUST STREET • SAINT LOUIS, MISSOURI

Where **stability** is important

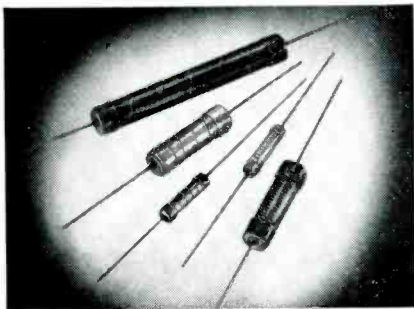

Corning Film-Type Resistors

With a film material that is entirely new for resistors, CORNING Film-Type Resistors afford a rugged unit with exceptional stability and capable of withstanding high ambient, high operating temperatures. (The film material is fired in at red heat to make integral contact with the heat-resistant glass base, forming a tough bond.)

CORNING Film-Type Resistors are available in two types: Type N with a resistance tolerance of 1% and capable of operating at ambient temperatures up to 140°C.; Type S with a normal resistance tolerance of 2% and capable of operating at ambient temperatures up to 200°C.

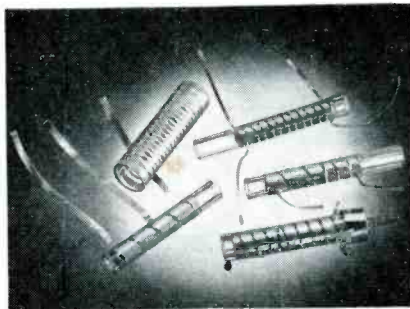

Corning Metallized Glass Inductances

The exceptionally high electrical stability and low temperature coefficient of CORNING Metallized Glass Inductances are the result of the integral contact of the fired-on metallizing with dimensionally stable glass coil forms. Drift is negligible, even under unusually variable ambient temperatures. High Q is inherent.

Whether you require uniform, variable or double pitch windings—fixed tuned, permeability tuned or permeability tuned inductance-trimmer combinations—we can meet your requirements exactly and to close tolerances.

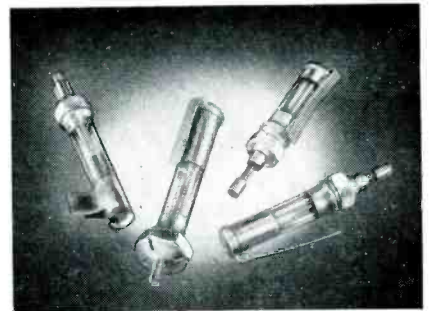

Corning Metallized Glass Midget Trimmer Capacitors

Since these components are produced by permanently bonding metal to tubes made of glass with practically zero temperature coefficients in the VHF range, capacity shift is negligible even with widely variable ambient temperatures.

CORNING Metallized Glass Midget Trimmer Capacitors are available in standard types from .3 to 12 u.u.f., or can be designed to meet your own particular needs. They are simple to solder, rugged and easy to tune critically. With direct traverse trimming, there is negligible capacity shift under vibration, and an absolutely smooth capacity curve.

► *Corning inductances, capacitors and resistors are mass produced on automatic machinery to close tolerances consistently duplicated from piece to piece. Our engineers will be glad to work with you on whatever design assistance you need. For complete information, use the coupon below.*

Corning Glass Works

New Products Division



Corning means research in Glass

CORNING GLASS WORKS, Dept. EL-9, Corning, N. Y.

Please send me information on:

- CORNING Metallized Glass Inductances, CORNING Film-Type Resistors
 CORNING Metallized Glass Trimmer Capacitors

Name..... Title.....

Company.....

Address.....

City..... Zone..... State.....



Photo Courtesy Globe Industries

Miniaturized Antenna Motor Filter

Reduces Control Motor Noise . . . Occupies Only 1/5 of Original Volume

PROBLEM—Engineers of a large Western aircraft manufacturer required components with greater reliability, yet smaller in size, for the suppression of noise from control motors in airborne radar. Any new design would have to meet Military Specifications MIL-I-6181.

SOLUTION—Sprague's Radio Noise Suppression Laboratories at Culver City, Calif., tackled the problem and came up with the filter shown above . . . tailored specifically for the permanent magnet motor involved. Dimensions: 1 1/8" x 1" x 13/16", 80% size reduction from the filter previously used by the aircraft manufacturer. And the reliability requirements were more than met!

RESULT—Let Robert Stein, Vice President in Charge of Engineering, Globe Industries, Inc., 125 Sunrise Ave., Dayton, O., tell you in his own words: "As the manufacturer of this permanent magnet control motor, we now furnish it complete with the Sprague tailor-made filter installed and have adopted this filter as standard on other applications, because of its small size, light weight, and excellent performance."

PRODUCTION SCHEDULES for such filters designed by Sprague's California labs are regularly met by Sprague's extensive pilot plant and mass-manufacturing facilities, the former for those sizzling rush orders, the latter for volume needs. For help with your radio noise filter applications, write, wire, or phone Sprague Electric Co., 11325 Washington Blvd., Culver City, Calif. (TEexas 0-7491) or North Adams, Mass. (North Adams 423).

Sprague on request will provide you with complete application engineering service for optimum results in the use of radio noise filters.

YOU CAN DEPEND ON
SPRAGUE

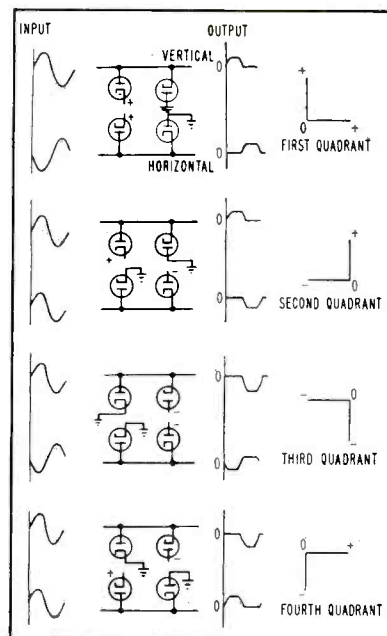

FIG. 1—Circuits and input phasings required to produce four-quadrant calibrations

of the various characteristics for point contact, *pnp* and *nnp* junction transistors, it was necessary to provide for calibration of four quadrants.

By using both in-phase and out-of-phase a-c voltages with positive and negative clipping it is possible with suitable switching to obtain four-quadrant calibration as shown in Fig. 1.

The complete circuit in Fig. 2 shows the switching arrangement. A voltage adjusting circuit in the output has a wire-wound linear-taper potentiometer calibrated to read voltage directly. Switches S_1 and S_2 are voltage dividers with ratios, 1, 1 and 100. The positive and negative reference voltages were taken from voltage regulating tubes in the plotting circuit power supply, but can be obtained directly

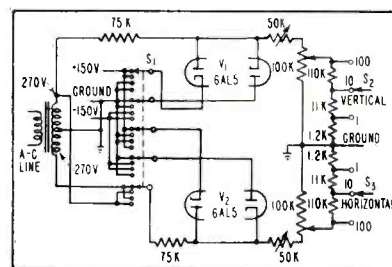
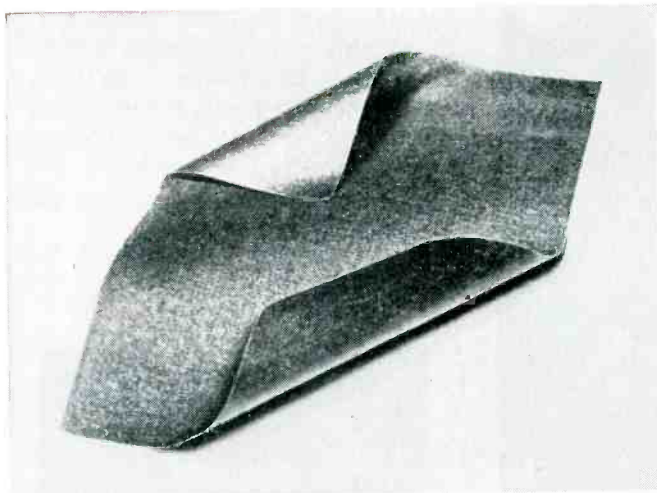
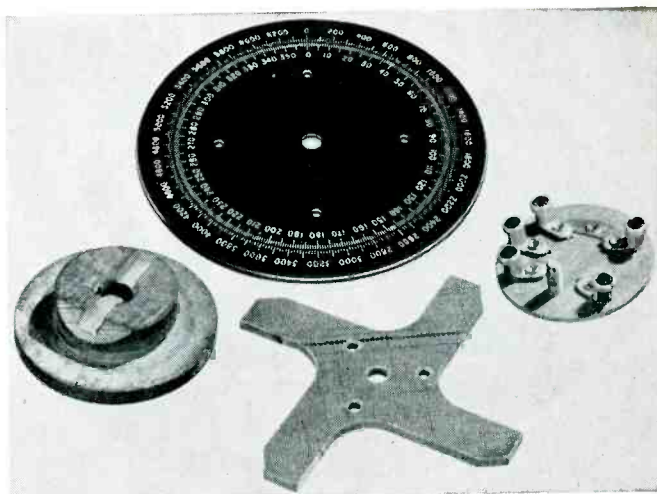

FIG. 2—Complete calibrator circuit uses four-position selector switch to select proper input phases

Do you have any of these problems?



1. Looking for a thin, flexible insulating material that will not break down under extremely high temperatures? ISOMICA* Flexible Plate, Class B and Class H, built-up from continuous mica sheets, gives superior electrical and thermal insulation for coil wrappings and similar applications.



2. Need a material with special mechanical, thermal and insulating properties? LAMICOID®—a laminated plastic made with various fillers—gives you the properties you need for antenna parts, coil forms, tube sockets, switch-gear and relay parts, panels, motor and transformer parts, and dozens of other uses.

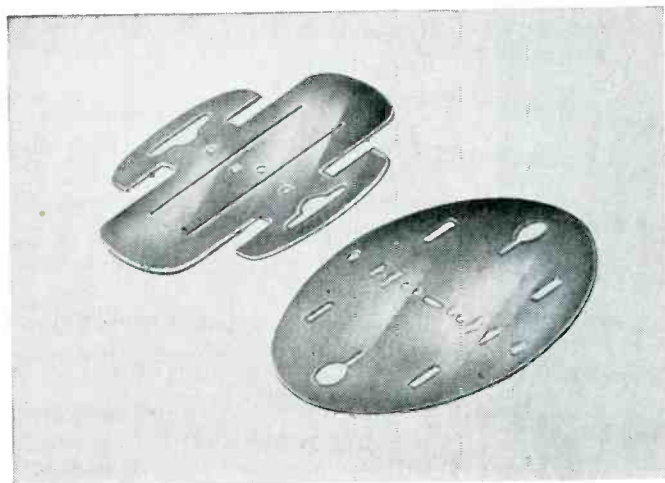

3. Need accurately punched mica stampings for filament, grid and plate supports? MICO produces mica stampings to extremely fine tolerances. Whenever you need precision-fabricated mica of the highest quality, call on MICO. We have 60 years of experience in this field.

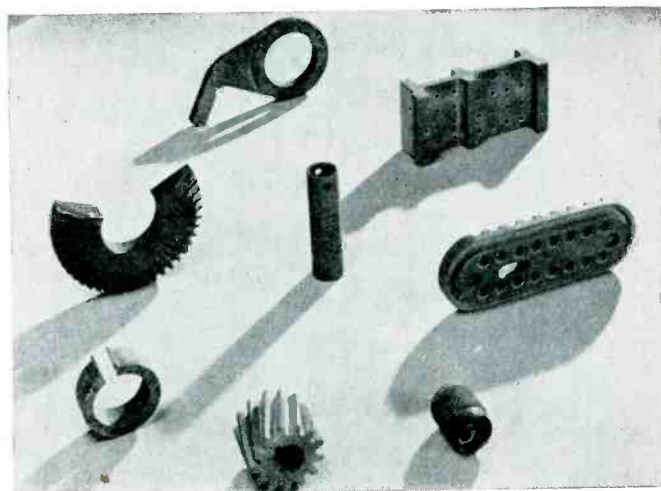

4. Looking for precision-made fabricated parts? Let us solve your problems with parts fabricated from LAMICOID®—a thermo-setting plastic—strong as metal, lighter than wood. We are fully equipped with the latest machinery and can provide you with the best possible service.

Whatever electrical insulation material you need—Class A to Class H—MICO makes it best. We manufacture it, cut it to size, or fabricate it to your specification. Send us your blueprints or problems today.

*Trade-mark

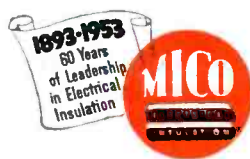

MICA *Insulator* **COMPANY**

Schenectady 1, New York

Offices in Principal Cities

LAMICOID® (Laminated Plastic) • MICANITE® (Built-up Mica) • EMPIRE® (Varnished Fabrics and Paper) • FABRICATED MICA • ISOMICA*

Better See
H&D!

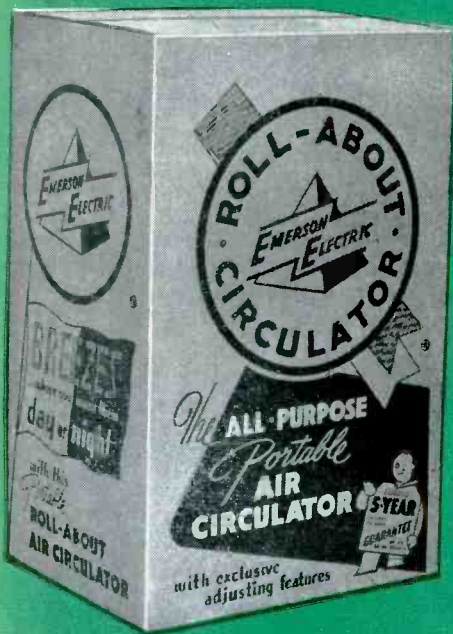

Handsome H & D shipping box protects, identifies and promotes nationally advertised fan. Customers really keep cool when product arrives intact. Give your product these same advantages. Request free booklet "Creative Package Engineering." Hinde & Dauch, Sandusky 10, Ohio.

CoroGated

our 65th year



HINDE & DAUCH

Authority on Packaging

17 MILLS AND FACTORIES • 40 SALES OFFICES

from the transformer with two rectifiers and regulator tubes.

Although this calibrator was developed in conjunction with transistor measurements, it can be utilized for any voltage calibrations that may be required on a d-c oscilloscope. A switch can be incorporated that will permit rapid comparison of the signal with the calibrating trace.

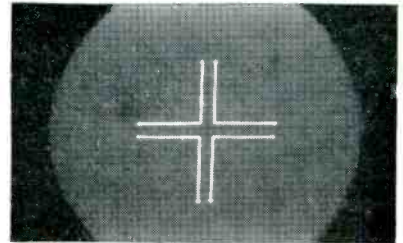

Four-quadrant traces on c-r tube. Picture is a quadruple exposure with zero displaced to show individual traces

Recording High-Speed Transients

Using a photographic apparatus developed by the Naval Research Laboratory, Washington, D. C. a record has been made of a spot of light passing across the face of a c-r tube at nearly 202,000 miles per second. To attain this velocity the deflection signal changes three million volts in a millionth of a second.

Since no matter is involved when the velocity of light is exceeded in this manner, the relativistic mass increase theory is not violated.

The new unit makes possible study of events occurring in one-millionth of a millionth of a second.

PERTINENT PATENTS

AN "ELECTRONIC CURVE TRACER", invented by J. W. Balde, J. C. Bregar and K. L. Chapman, was granted Patent 2,626,980. The patent is assigned to the Western Electric Company.

The purpose of this device is to provide a production test instrument for tracing the band-pass characteristics of wave-filters on an oscillograph screen. The instrument should have wide applicability for many other test purposes where characteristics curves are to be

Now... another 

JAN TYPE

1N34A

**with the PLUS factor of
polarity at a glance or touch**

Germanium
Diode for
military use

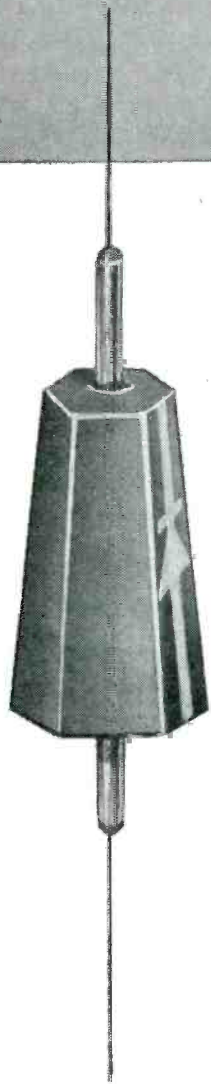

To the list of Radio Receptor diodes that can be designated JAN type comes another important model—1N34A. Built to the high standards of this designation, 1N34A as well as *all* Radio Receptor diodes gives you simplified polarity identification. The tapered case speeds up assembly, reduces possibility of error in connecting the diodes into the circuit, which all adds up to lowered production costs.

**These JAN type diodes
now available for
prompt delivery**

1N69
1N81

1N70
and now 1N34A

Many other types of diodes are available too, including a range of computer diodes made to meet special requirements. Radio Receptor also makes Germanium Transistors and SELETRON Selenium Rectifiers. Our engineers will gladly study your problems without obligation and submit their recommendations.

**Seletron
and Germanium
Division**

RADIO RECEPTOR COMPANY, INC.

 Since 1922 in Radio and Electronics 

SALES DEPT: 251 West 19th Street, New York 11, N. Y. • FACTORY: 84 North 9th Street, Brooklyn 11, N. Y.

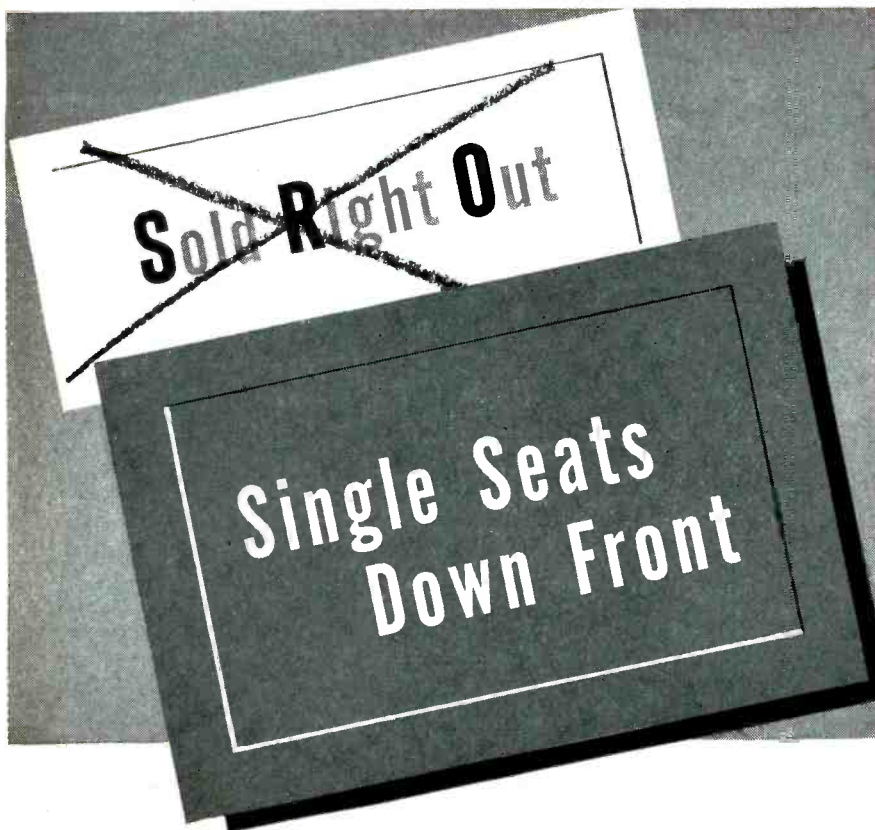

Our previous series of advertisements in this publication explained, in theatrical parlance, that our design and production facilities were pretty well "sold out" by the requirements of our present customers.

Now, we are happy to say (because we enjoy making new friends) that some of the heat has been taken off, and we are able to announce "Limited seating available"—as they say at the box office.

We shall be happy to talk with you about your present and/or future needs.



TRADE MARK

L. H. Terpening Company
 DESIGN • RESEARCH • PRODUCTION
 Microwave Transmission Lines and Associated Components
 16 W. 61st St. • New York 23, N. Y. • Circle 6-4760

traced rapidly and accurately.

A feature of the invention is the inclusion of an attenuation marker generator and a bandwidth marker generator. The attenuation markers are displayed in the Y-axis and the bandwidth markers are displayed by blanking portions of the trace along the X-axis.

Figure 1A is a block diagram of the curve tracer. A frequency-modulated signal is applied to the device under test. The generation of the f-m signal is accomplished by heterodyning a c-w oscillator with the output of a frequency modulated oscillator. The heterodyne signal, after limiting and pass-band filtering, is applied to the device under test. Another output from the f-m oscillator provides frequency markers by application of the f-m signal to a selected pair of quartz crystal filters. The crystal filters have a pair of resonant frequencies: one at the upper band limit and the other at the lower band limit. When the f-m signal is at the resonant frequency of either crystal, negative marker pulses are produced. These are applied to the intensity control grid of the scope to blank the display at points in the horizontal-sweep trace time corresponding to the frequency band limits desired. Different crystal pairs provide different bandwidth indications within the f-m sweep band. The cooperation between the sweep oscillator and the scope, with respect to the f-m signal, is in accordance with well

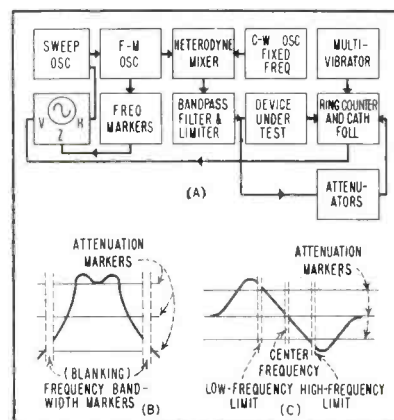

FIG. 1—Block diagram (A) of electronic curve tracer. Curves obtained when the tracer is used as a band-pass tester (B), and for discriminator circuit test (C)

NEW

GOOD-ALL

Capacitors



• GOOD-ALL production techniques make it possible for MIFILM capacitors to be available in sizes smaller than other miniaturized brands. Metal enclosed and hermetically sealed, MIFILM capacitors normally operate between -65°C and $+150^{\circ}\text{C}$. Insulation resistance 10^{15} ohms. Power factor less than .5%. Sizes from .173" dia. x $21/32$ " long (.001 mfd, 600 VDC) to .750" dia. x $1\frac{1}{8}$ " long (1 mfd, 600 VDC). Slightly larger sizes to 1000 VDC. Your inquiries regarding this revolutionary advance in miniature capacitors are invited. We invite sample orders for your evaluation.

*DUPONT'S TRADEMARK FOR ITS POLYESTER FILM.

★
MIFILM
subminiature
capacitors

★
With MYLAR*
plastic dielectric.
Metal enclosed.
Hermetically sealed.

★
Write for complete catalog
covering GOOD-ALL
MIFILM, MARBELITE and
MIRACLE X long life
capacitors.

GOOD-ALL

ELECTRIC MFG. CO.

114 W. FIRST ST. Phone 112-113 OGALLALA, NEBR.

ROBERT A. GOODALL, President

Cable Address, "GOODALLA"



**YES, THIS IS
HEADQUARTERS
FOR
MAGNET WIRE**

**WHAT IS YOUR
PROBLEM?**

Users and prospective buyers of Magnet Wire may expect from Wheeler a technical service that gets right to the heart of their problems . . . for radio, electronics, television or other applications. Since 1909, we've accumulated a wealth of practical experience that has been of considerable value to manufacturers in these fields.

From our initial operation of drawing electrolytic copper "rod" down to finished wire in sizes from AWG #22 to #50 . . . through our automatic Formvar and other insulating machines . . . high speed enameling production lines . . . or textile yarn wire covering machines . . . there's no let-up on testing and inspection to insure top quality of product.

Wheeler engineers and representatives are competent, friendly and willing cooperators.



**THESE DATA SHEETS
SHOULD SOLVE YOUR PROBLEM!**

Tell us about your Magnet Wire problem. Wheeler engineers will send you this file folder (which tells you about our plant and its facilities) and include data referring to your inquiry. No charge, of course.



WHEELER

MAKES THESE PRODUCTS A

Specialty

THE WHEELER INSULATED WIRE COMPANY, INC.

Division of The Sperry Corp. • 1101 EAST AURORA ST., WATERBURY 20, CONN.

5W1153

**MAGNET WIRE
COILS
COMMUNICATIONS
EQUIPMENT
TRANSFORMERS**

known practices for such equipment.

Fig. 1B is an illustration of the appearance of a typical scope trace when the curve tracer of this invention is employed to test band-pass characteristics of a filter.

Fig. 1C is an illustration of the scope trace observed when the invention is used for checking a discriminator circuit. Here, three quartz-crystal resonators are employed as described above, to provide the blanking pulses to correspond with upper and lower frequency limits along with the center frequency.

The attenuation marks are produced by a step-voltage waveform generator the output of which controls a group of vertical d-c deflection potentials, each for the duration of a horizontal sweep, so that a horizontal line is produced on the scope for each attenuation level.

The output wave of the device under test, and the several attenuation-marker sweep lines, are applied to the oscilloscope deflection and control grid on a time sharing basis through four isolation cathode followers which are gated by a ring-counter circuit, incorporating four double triodes, performing the function of an electronic switch.

The rapidity with which the several displays are written on the scope screen and the combination of visual persistence and phosphor persistence of the cathode-ray tube face present a composite display of the type illustrated in Fig. 1B or 1C.

Conductivity Measurement

A thyatron is employed by J. B. Collins, of Isleworth, England, as a "Static Conductivity Measuring Device" for the determination of conductivity of conductive rubber tires. This was awarded Patent 2,626,982. The patent is assigned to Firestone Tire and Rubber Co., Akron, Ohio.

The inventor points out that measurements of the resistance of conductive rubber tires as usually made, on devices such as a megger, requires more highly skilled production personnel.

The present invention was designed as a go-no go production



“Plug-in, plug-out” simplicity in Avien’s “TWO-UNIT” FUEL GAGE

This “repackaging” of Avien’s capacitance-type fuel gage is 50% lighter and needs no field adjusting.

Up until now, most fuel gaging systems needed four units: a tank unit, an indicator, a bridge-amplifier and a shockmount.

No field calibration was required for the Avien tank unit or indicator. Avien held them to such close tolerances, the adjustments for individual installations were actually “built-in.”

The bridge-amplifier (the “black box”) was a different story. This intermediate unit was supplied as a common part, for universal application. And that’s where field calibration had to be made.

There was only one answer, as far as Avien was concerned. The “black box” had to go.

Now, in the Avien Two-Unit system, the necessary components for the bridge and amplifier functions have been built into the indicator case. The “black box” is eliminated, and so are many parts which were necessary to make the “black box” universally applicable.

The Two-Unit Gage gets installation down to “plug-in, plug-out” simplicity. No more field calibration is necessary — and that means that all units designed for the same aircraft are interchangeable. Avien units are now all “shelf items.”

To install the Two-Unit Gage, you *don’t* need trained personnel, you *don’t* need specialized equipment, and you *don’t* need calibration instruction or data.

This new “package” brings savings all along the line. The basic system is reduced in weight by 50%. Installation time is cut. Less wiring and connectors are needed. Less maintenance is required. Trouble-shooting becomes easier. And fewer parts must be stocked for maintenance and repair.

As in the previous system, additional functions for fuel management can be integrated into the basic gage — and with less complexity than ever.

The Avien Two-Unit Gage is now available to meet your manufacturing schedules. The indicator is available in either large or small sizes, with all varieties of dial configurations.

Every month, Avien produces over ten thousand major instrument components for the aviation industry.

We believe that Avien’s Two-Unit Gage will contribute to the obsolescence of many earlier systems, including our own. For further information, write or call us.



AVIATION ENGINEERING DIVISION
AVIEN - KNICKERBOCKER, INC.
58-15 NORTHERN BOULEVARD, WOODSIDE, L. I., N. Y.



PRODUCTS

Speeding Electronic Progress

through crystal research

This new JK G-12 is designed for ultra stable frequency control in applications such as frequency standards, timing and counting circuits, broadcast equipment and frequency monitors. Electrodes are deposited directly on the large, precision-made quartz plate shockmounted in an evacuated glass envelope. Frequency range 500 kc to 1500 kc. Crystal may be desined for a minimum temperature coefficient of from 0°C to 50°C or for temperature controlled operation at 60°C with a JKO7E-115V Oven. Approximate height above chassis, 2 3/4". Maximum diameter of octal base, 1 3/4". Consult us on specific applications.

JK STABILIZED G-12 CRYSTAL
For the "Difficult" 500 kc to 1500 kc Range



Tomorrow's Crystals

The increasing demand for ultra-stable frequency control to meet today's new requirements has necessitated a new approach to crystal design. Evacuated glass envelopes—for maximum protection and freedom from contamination—are a part of the new design of JK Crystals for the Critical. Consult us on your requirements for crystals of this advanced design.

THE JAMES KNIGHTS COMPANY, SANDWICH, ILLINOIS

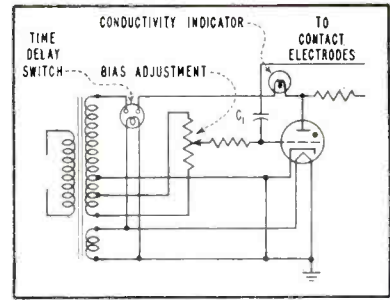

FIG. 2 — Circuit for production line measurement of conductivity of rubber tires

test setup for measuring resistance of conductive rubber tires. In operation, the circuit shown in Fig. 2 is adjusted so that the combined resistance of the tire of the proper conductivity and R_1 in series with C_1 apply potential sufficiently positive on the positive half cycle of the anode supply transformer to overcome the negative bias set by the bias-adjustment potentiometer. If all tires have at least the value of conductivity of a sample tire, the indicator will light as plate current is drawn by the thyatron. If the tire has less conductivity the indicator doesn't light.

Wave-Growing Tube

The invention of a "Plural-Beam Growing-Wave Tube" was awarded Patent 2,630,547, issued to W. J. Dodds and assigned to Radio Corporation of America.

Wave-growing tubes are a part of the traveling-wave tube art and provide amplification of microwave energy without the use of field-supporting or wave-guiding structures in the amplifying region of the tube, that is, in the drift space.

In the type of wave-growing amplifier of this invention, streams of moving electrons are provided to carry the microwave energy along the drift space instead of a passive element such as the helix or delay line.

Under the influence of input signals applied to a control element at least one electron stream is made to form waves which grow as they move through the drift space. The increase in wave energy is attained by lessening of an initial differential between kinetic energies of two groups of electron streams, and

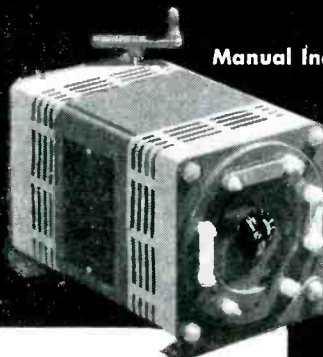
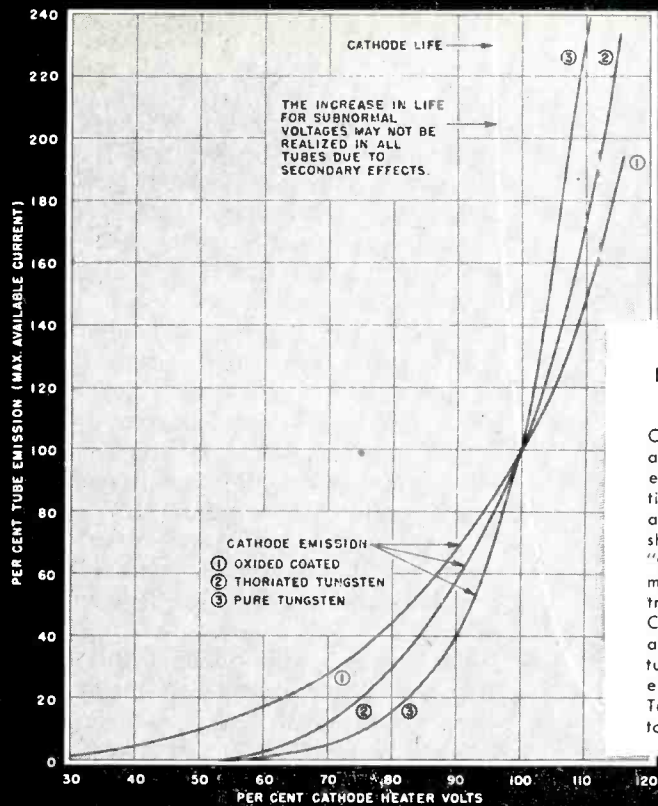

Manual Inductrol



ELECTRONIC TUBE-LIFE VS. VOLTAGE

Current-carrying ability of all electronic tubes is affected seriously by voltage deviation. The loss of emission at undervoltage results in shorter tube life. Curve 1 "Oxide Coated" applies to most of the thyratrons, pliotrons and receiving tubes. Curve 2 "Thoriated Tungsten" applies to small transmitter tubes and some battery-heated tubes. Curve 3 "Pure Tungsten" applies to oscillator tubes.

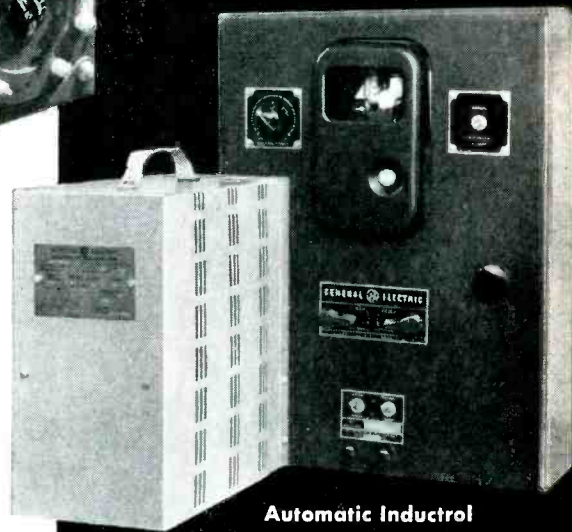

Automatic Inductrol

For maximum tube life and performance, include G-E Inductrols as "original equipment"

Automatic voltage regulation provides an effective and economical means of avoiding losses in power capacity

The life and efficiency of the electronic equipment you manufacture depends, to a large extent, on the performance of the electronic tubes. Tube life is adversely affected by over- or under-voltage conditions *that can easily be prevented.*

G-E dry-type induction voltage regulators, called Inductrols, offer you an effective and economical means of maintaining correct operating voltage. Two types are available for indoor service on circuits 600 volts and below, single-phase 3 to 240 kva; three-phase 9 to 520 kva.

1. **Automatic Inductrols** maintain a closely regulated output voltage from a varying supply voltage with a bandwidth of $\pm 1\%$. The standard range of regulation is plus and minus 10%.
2. **Hand-operated or manually controlled motor-operated Inductrols** provide a variable output voltage from a relatively constant supply voltage. They supply 100% raise and 100% lower regulation.

Typical applications for G-E Inductrols that have proved highly effective include: radar equipment, induction heating equipment, medical and industrial x-ray equipment, TV and radio transmitters.

For further information, contact your nearest G-E sales office, agent or distributor...or return the attached coupon.

HERE'S HELPFUL G-E DATA ON INDUCTROLS

For full details on dry-type induction voltage regulators, return this coupon . . . today!

Single-phase INDUCTROLS, indoor service
600 volts and below on circuits 3 to 240 kva—GEC-795A

Three-phase INDUCTROLS, indoor service
600 volts and below on circuits 9 to 520 kva—GEA-5824

Application bulletin,
Inductrols and electronic equipment—GEA-5936

General Electric Company
Section B 423-201, Schenectady 5, N. Y.

Name _____

Company _____

Address _____

City _____ Zone _____ State _____

You can put your confidence in—



LABORATORY PROVEN

FAIRCHILD

Transistor Analyzer

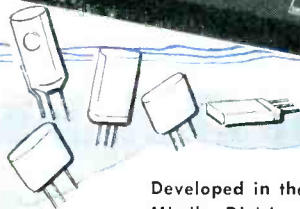

Developed in the Electronic Laboratories of the Fairchild Guided Missiles Division, the Fairchild Transistor Dynamic Analyzer incorporates in a single instrument all features necessary for testing transistor characteristics. During the past two years, this instrument has served as an essential tool in the Fairchild Laboratories for designing transistor circuits for use in missile guidance systems.

The Analyzer provides accurate and complete plots of static and dynamic characteristics of Transistors — point contact and junction. Its principles are basic, to meet future Transistor needs. Complete with all calibrating circuits built in — only external equipment, a standard DC oscilloscope.

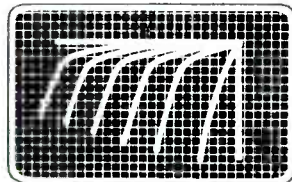
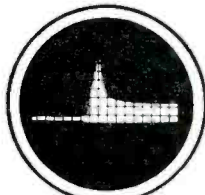

TYPICAL SCOPE PRESENTATIONS

Presents on the Scope: Alpha vs Emitter Current • Collector, Emitter and Transfer Characteristics • Collector Characteristics in Grounded Emitter Connection • Sweeping Technique Shows Up Anomalies • Complete families of curves obtainable in 10 incremental steps for each 5 ranges.



ENGINE AND AIRPLANE CORPORATION
FAIRCHILD

Guided Missiles Division

Wyandanch, L. I., N. Y.

Other Divisions: Aircraft Division, Hagerstown, Md. • Engine Division, Farmingdale, N. Y.

WRITE FOR DETAILED
TECHNICAL BULLETIN

a phenomenon of elastic collisions between fast and slow electrons.

Greatest gain is achieved when both electron streams are caused to form waves instead of one of them shooting through the drift space as a d-c stream.

The object of the present invention is to achieve improved performance of wave-growing microwave amplifiers by reducing noise and by providing adjustability of velocity and current for each beam without affect on the other.

In the prior art, the electron beams are produced from electron guns which provide concentric beams.

The wave-growing tube of this invention produces beams which travel parallel with each other, as can be seen in Fig. 3. An input signal is applied to a divided input circuit, where phase controlling means provide appropriate phase shifts to the input energy before being applied to the input cavities, each of which modulates the electron stream generated in separate electron guns. The drift spaces of each gun join into a common drift space wherein the beams run parallel until, in an area near the output resonant cavity, they begin to diverge as the electron streams approach the collector and pass the output resonant cavity. An axial magnetic field surrounding the tube may be generated by any of the well-known methods. The directions of the magnetic flux lines are shown by the MF_i and MF_o , the input and output flux respectively. The entire structure back to the electron guns is immersed in the magnetic field.

TV-Gamma Control

In color tv transmission, control of brightness level or gamma for each of the component colors of an image must be accomplished not in relation to the brightness levels of each individual color, because each color at any instant will differ from each other color in proportion to its relative amplitude, but in relation to the whole picture. For a process of controlling this brightness level, A. V. Bedford, of RCA, has been awarded Patent 2,627,547.

The circuit of Bedford's gamma

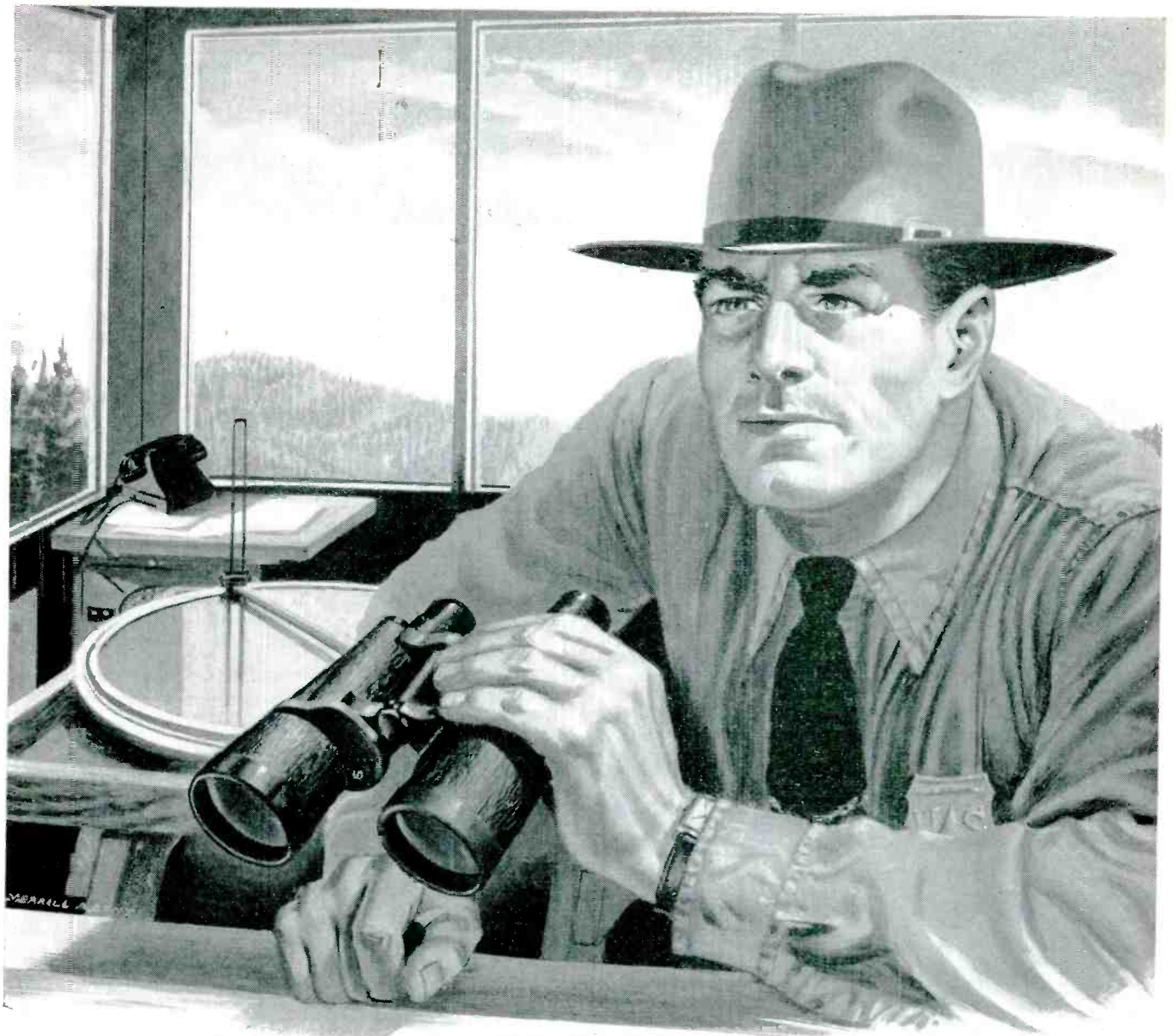

You know he's looking out for you

Yes, he's your watchman whenever you're in the woods . . . the forest ranger, with his eye constantly peeled for the small smolderings that can blaze so swiftly into big trouble.

And eyes just as keen watch constantly over every order for Bristol Brass sheet, rod and wire . . . checking, double-checking and then checking again, all along the line from casting to shipping. So if you're "in the woods" on any ques-

tion of Brass quality, supply, or fabrication, why not let Bristol look out for *you*, too?

. . . .

The BRISTOL BRASS CORPORATION, makers of Brass since 1850 in Bristol, Conn. Offices or warehouses in Boston, Chicago, Cleveland, Dayton, Detroit, Los Angeles, Milwaukee, New York, Philadelphia, Pittsburgh, Providence, Rochester.

"Bristol-Fashion" means **Brass at its Best**



Jennings
RADIO
VACUUM ELECTRONIC COMPONENTS



TYPE MMC-1
2000 MMFD. 10 or 15 KV.
225 AMPS. R.M.S.



TYPE MC-1.
1000 MMFD. 10 or 15 KV.
100 AMPS. R.M.S.

FOR INDUCTION and DIELECTRIC HEATING HIGHER CURRENT RATINGS LOWER INDUCTIVE LOSSES

Are offered by **JENNINGS NEW
COMPACTED VACUUM CAPACITORS.**

High current ratings because they are all-copper construction and have large contact surfaces for dissipating heat; low inductive losses because the vacuum dielectric permits a maximum amount of capacity at high voltages to be packed into an extremely small physical space. For example, an MMC-1, 2000 mmfd unit with a voltage rating of 10 KV and a current rating of 225 amperes has an over-all length of less than 5 inches. We believe this to be the shortest physical length yet devised for any type of capacitor

with the same capacity, voltage, and current ratings. With no dielectric to puncture, this vacuum capacitor is also self-healing after temporary overloads.

The oscillator shown above demonstrates how Jennings capacitors may be mounted in parallel in such a way that no parasitic suppressors are required. The large capacitors mounted between the conductor discs are MC-1, 1000 mmfd units used in the tank circuit. Above and below the conductor discs are mounted ten small JCS-1, 100 mmfd vacuum units used as grid and plate blocking capacitors.

Jennings also manufacture vacuum switches capable of repeatedly breaking the D.C. voltages and currents found in the oscillators of induction and dielectric heating units. The same switch may be used to provide extremely fast-acting overload protection for the D.C. power supply.

Write us for information regarding your own Capacitor problem.
Literature mailed on request.

**JENNINGS RADIO MANUFACTURING CORPORATION - 970 McLAUGHLIN AVE.
P. O. BOX 1278 - SAN JOSE 8, CALIFORNIA**

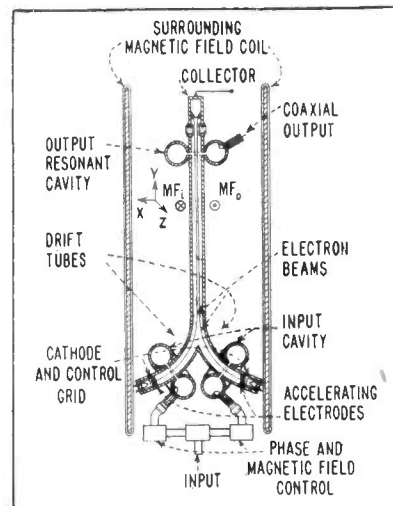

FIG. 3—Growing-wave tube uses electron stream to carry microwave energy through drift space

control is shown in Fig. 4. A group of three voltage multipliers are each fed with the appropriate color signals and a portion of each signal applied to a common amplifier. The composite signal is rectified and the resultant d-c applied simultaneously to all three voltage multipliers as a control potential. It is also applied as a mixer bias potential to an amplifier stage.

As a result, the change in gain of each of the selected color component signal trains will be controlled in accordance with the combined amplitudes, or sum, of all the selected component-color image representative signal trains. The reproduced image will then take on an accurate hue and color tonal quality

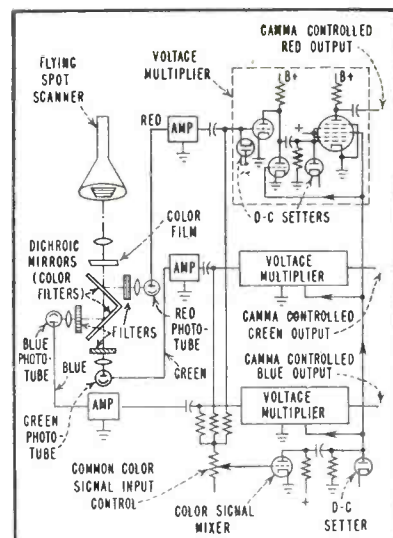
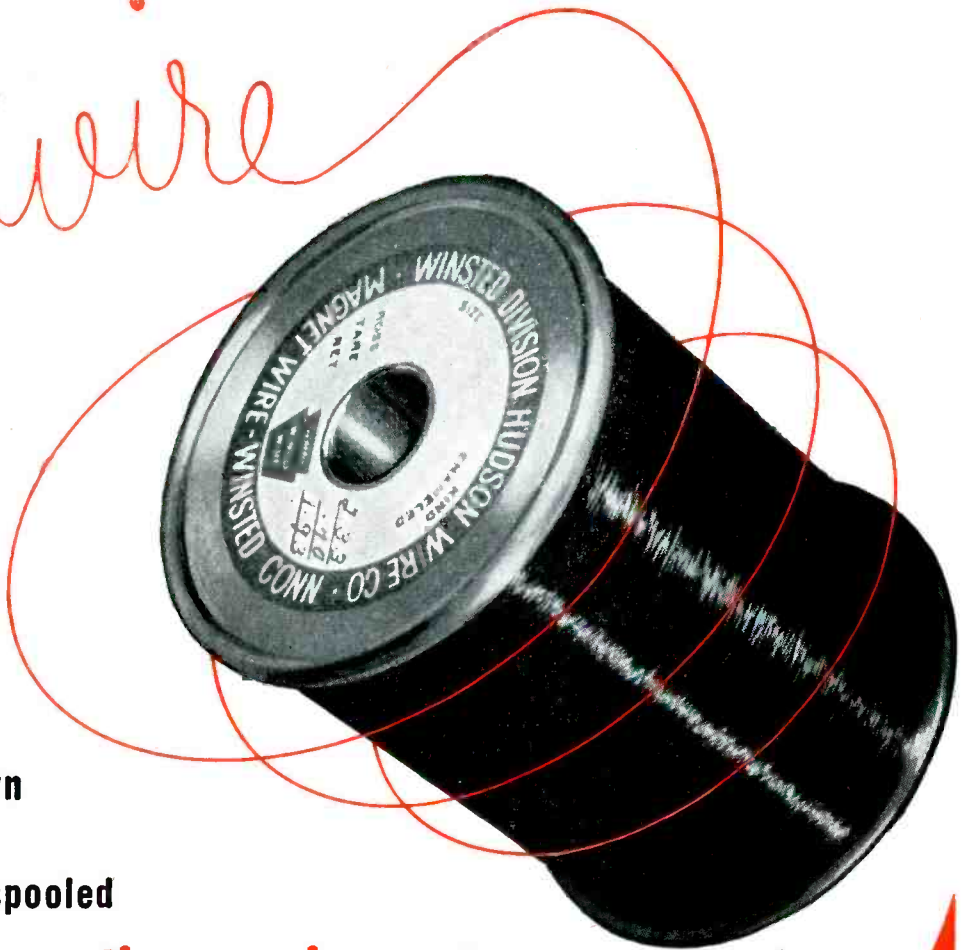

FIG. 4—Gamma control circuit for color television

fine wire

**made
finer!**



**custom drawn
custom insulated
custom spooled**

to your most exacting requirements

⊙ Backed by fifty years (1903-1953) of fine-wire specialization! During all this time we have supplied bare and insulated wires to many of the most critical wire users.

Your specifications and requirements for *insulated wires* in the East are processed by our Winsted Division; in the West, the Cassopolis Division has been established to facilitate rapid shipments. Insulators and others requiring *bare wires* should contact the Ossining Division for prompt and efficient service.

Our research and development staff is always available to aid our customers in their requirements.

BARE WIRES

(Ossining Division)

- | | |
|-----------------|--------------------|
| Copper | Tin |
| Brass | Cadmium |
| Bronze | Oxygen-free Copper |
| Phosphor-bronze | Silver |
| Nickel-silver | Fuse |
| Zinc | Silver-plated |
| Lead | Specialties |

TEXTILE-COVERED WIRES

(Winsted Division)

- | | |
|----------|------------|
| Nylon | Cotton |
| Celanese | Rayon |
| Silk | Fiberglass |
- Available on bare or enameled wire; single or double-coated.

INSULATED WIRES

(Winsted and Cassopolis Divisions)

- | MATERIALS | TYPES | COVERINGS |
|-------------|-------------|----------------------|
| Copper | Instrument | Plain and Heavy |
| Aluminum | Tubing | Enamel |
| Iron | Litz | Formvar |
| Copper-clad | Multiplied | EZsol (Liquid Nylon) |
| Steel | and Twisted | Cement-coated Enamel |

SPECIAL WIRES

(Ossining Division)

Silver-plated wires in coarse and fine sizes, for high-frequency conduction and high-temperature applications.

Electro-tinned, soft-annealed wire.

Other specialty wires to meet specifications.

HUDSON WIRE COMPANY



Bare Wires Insulated Wires

Winsted Division
Hudson Wire Company
Winsted, Conn.
Phone: Frontier 9-3341

Cassopolis Division
Hudson Wire Company
Cassopolis, Mich.
Phone: Cassopolis 56

Ossining Division
Hudson Wire Company
Ossining, N. Y.
Phone: Ossining 2-4710

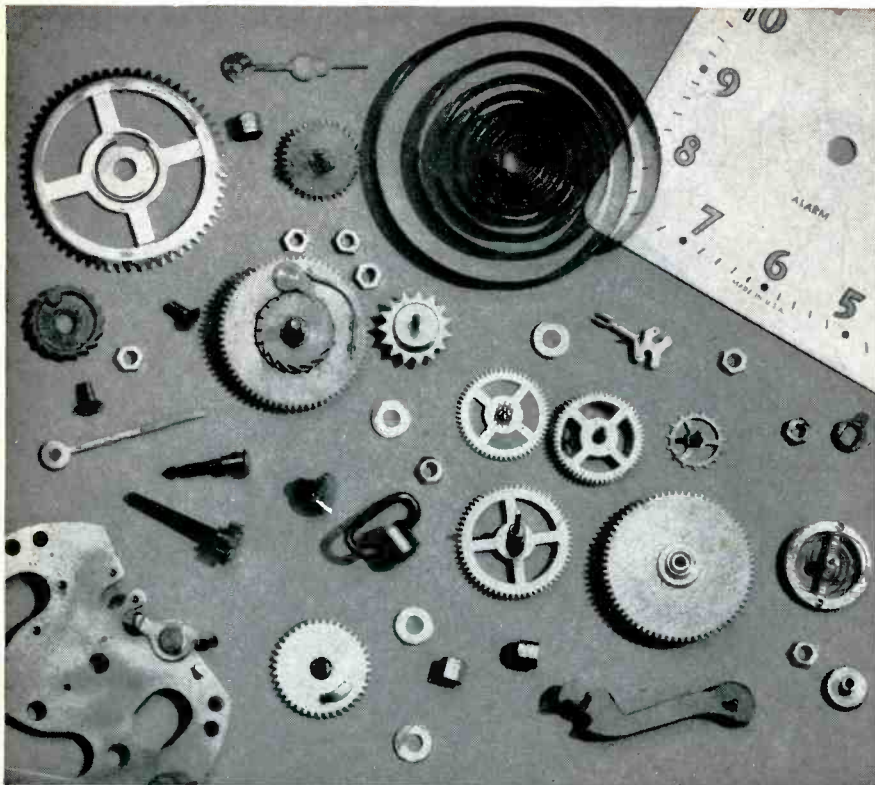

You'd never buy a clock this way

You don't ask to see the pieces of a clock. You *expect* it to perform as its makers say it will. You listen, you look, you buy. In short, confidence sells more clocks, automobiles, and *instruments* than investigation and analysis combined.

Do your instruments inspire this instant confidence? Do they *look* scientific, precise, accurate? Or do they have dials that are cluttered, hard-to-read, old-fashioned? . . . a sure sign that their operation is also cluttered and old-fashioned.

Don't underestimate this point. Having made millions of dials and nameplates for all kinds of instruments and timepieces, we know how dial design can effect saleability. So, take a hard look at your product line, and see if there's room for our experience.

We make self-luminous, fluorescent, phosphorescent, or *nonluminescent* dials — etched, lithographed, engraved, photographically reproduced, or screened — also edge-lighted panels — in other words *whatever* type you need . . . made with emphasis on accuracy and appearance. We also make special, high-accuracy scientific dials, in as small quantities as required. Literature on request. Simply address Dept.E-9, U. S. Radium Corp., 535 Pearl St., New York 7, N. Y.



MAKERS OF: Luminescent Materials: Radioactive, fluorescent, phosphorescent • Powders: Cathode-ray tube, television tube • Radium Locators: Pendants, lenses, buttons, screws, markers • Static Eliminators • Radioactive Foils — Alpha-Ray Ionization Sources • X-Ray Screens • Processed Isotopes • Neutron Sources • Radiation Sources and Standards.



DIALS • NAMEPLATES • EDGE-LIGHTED PANELS

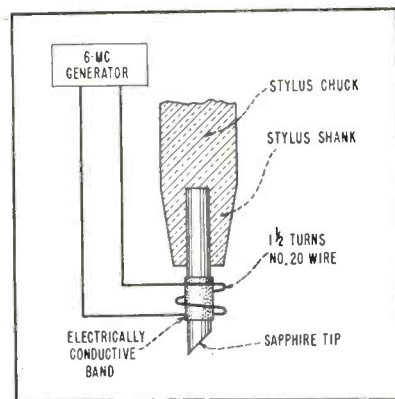

FIG. 5—Stylus used for cutting records is heated by r-f induction from 6-mc oscillator

which is necessary for a proper reproduction of color television images.

Heated Recording Styli

The recording industry is probably familiar with the techniques disclosed in Patent 2,627,416, issued to H. F. Schoemehl and H. D. Ward of RCA, for "Induction Heating of Recording Styli".

Heating of the recording stylus in the process of cutting sound-recording disks has been known to make grooves with smoother wall surfaces and, consequently, there is a lower noise level in the grooves playback. This is particularly desirable for microgroove recordings.

In a representative example of the system as disclosed in Fig. 5, a conductive coating is placed around the sapphire tip of a cutting stylus. An r-f generator at 6 mc has a work coil wound around the conductive stylus coating. When the r-f energy is applied, by induction, the coating becomes heated and heats the sapphire tip.

Two-Way Discharge Tube

In a patent 2,627,054 for an "Electric Discharge Tube" issued to G. H. Hough and D. S. Ridler of London, England, and assigned to International Standard Electric Corp., of New York, a novel two-way multiple discharge device is disclosed.

The patent refers to an earlier device of these inventors in which a series of discharge gaps are arranged in an array which permits discharge of each gap in succession in one direction. The present

NOW

KEL-F* WIRE IN STRIPES

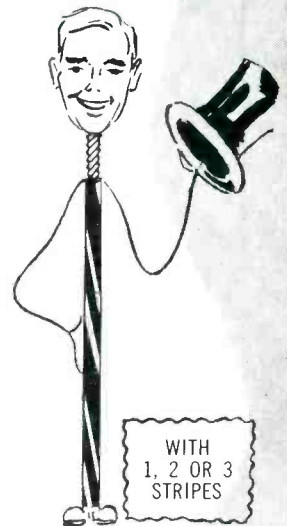
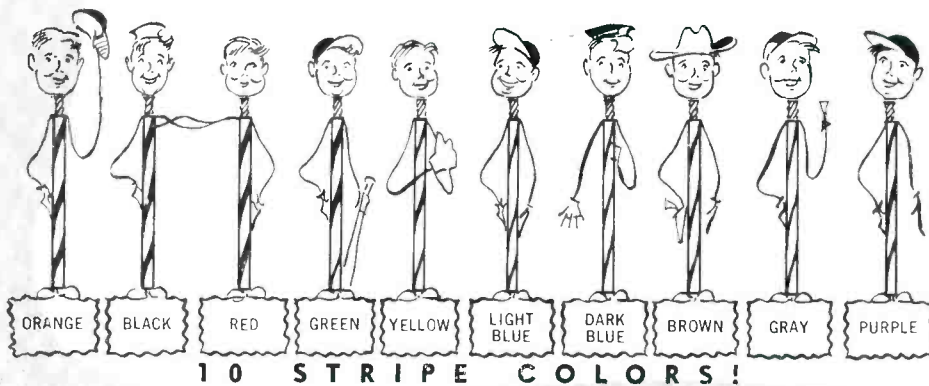

REX-KF[†] THE WONDER WIRE

(WITH KEL-F* INSULATION)

The Rex Corporation announces REX-KF Wire (Kel-F* insulated) with one, two, or three stripes in any combination of ten colors. Over 300 sharply distinguishing color codes are now easily available.

Striping removes the final obstacle to the broader use of wonderful trifluorochlorethylene insulation.

Write for full information on this remarkable advance in wire technology, and the story of REX-KF Wire, champion in every quality that makes wire good.

*T. M. of M. W. Kellogg Co.
 †T. M. of The Rex Corporation
 **Reg. U. S. Pat. Off.

THE REX CORPORATION

Insulated Wire Specialties, Microwall Wire, Cast Plastics, Rexolite U. H. F. Insulating Materials, Rextrude** 105 Electrical Tubing and Custom Plastic Extrusions.
WEST ACTON, MASSACHUSETTS

send for the
most widely used
Electronic Supply
Guide

free →

ALLIED'S 268-PAGE 1954 CATALOG

SEND FOR IT

the World's largest Stocks of

ELECTRONIC SUPPLIES FOR INDUSTRY

Simplify and speed the purchasing of *all* your electronic supplies and equipment. Send your orders to us at ALLIED—the reliable one-supply-source for all your electronic needs. Depend on us for quick shipment from the world's largest stocks of special-purpose electron tubes, test instruments, audio equipment, electronic parts (transformers, capacitors, controls, etc.) and accessories—everything for industrial and communications application, for research, development, maintenance and production. Let our expert Industrial supply service save you time, effort and money. Send today for your FREE copy of the 1954 ALLIED Catalog—the *complete*, up-to-date guide to the world's largest stocks of Electronic Supplies for Industrial and Broadcast use.

NEW HOME OF ALLIED RADIO



ultra-modern
facilities

TO SERVE YOU BEST

147,000 square feet of efficient floor space, utilizing latest conveyor and pneumatic equipment—devoted exclusively to the best service in Electronic Supply.

ALLIED RADIO

100 N. Western Ave., Dept. 11-J-3
Chicago 80, Illinois

one complete
dependable source
for everything
in electronics

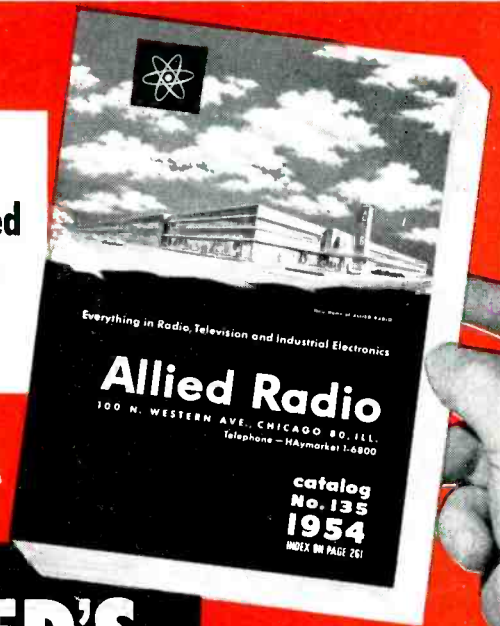

vention shows how the system may be operated in both directions.

The diagram, Fig. 6A, shows the schematic structural array of discharge gaps within the cold-cathode sequence discharge tube. The arrows are each cathode structures and show the favored direction of discharge. Cathode numbers followed by *a* are in one cathode row, those followed by *b* in a second, and so on. Cathodes in row *a* are in the center.

The operation of the invention is described as follows: Suppose that cathode 3a is discharging, the cathode favors discharge toward 6b or 9c due to its structure. When a negative pulse is applied to the forward direction input terminal, because the ionization transfer coupling to 6b or 9c is greater than to 7b or 8c, 9c will commence to discharge. The voltage drop through R_5 will be sufficient to extinguish discharge at 3a. Because cathode 4a is nearer the discharge of 9c than 3a, the cathode 4a will be primed. As a result, 4a will be fired in preference to 3a on removal of pulse from the forward input terminal. A subsequent pulse on the forward input, by the same process, will transfer the discharge from 4a through 11d to 5a. If, however, a pulse is applied to reverse the input terminal then the discharge is transferred from 4a to 3a again by transfer cathode 8c on removal of the pulse.

Resistors R_1 , R_2 , R_3 , R_4 are cathode current limiting resistors.

Figure 6B shows the physical

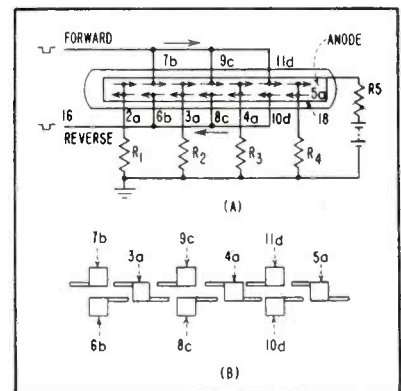
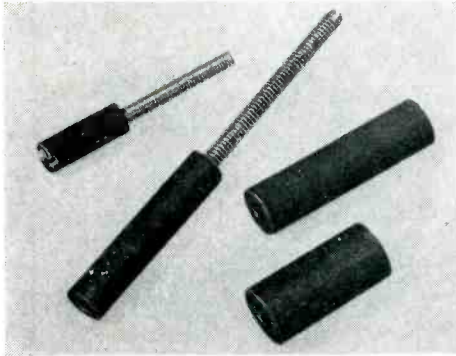
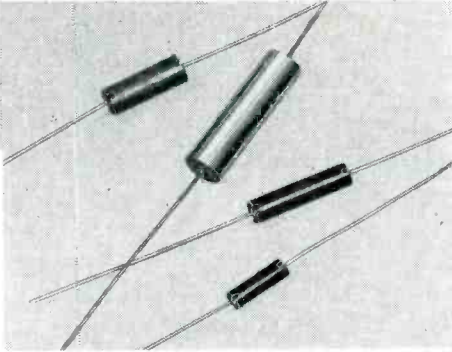

FIG. 6—Discharge tube (A) permits controlled discharge in two directions. Actual physical shape of discharge surfaces is shown in (B)

Now— **Moldite Dependability** in all 3!



FERRICORES



MOLDED COIL FORMS

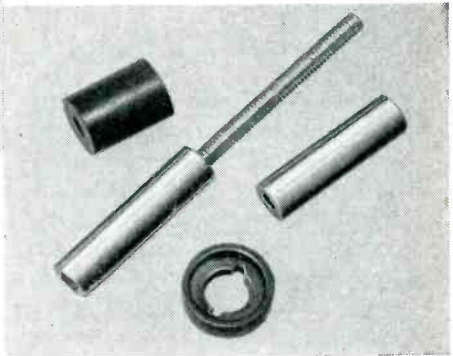

MAGNETIC IRON CORES

Moldite's famed precision production facilities are now devoted to 3 major types of electronic components —to give the industry a superlative core or coil form for every electronic application.

Through years of continued engineering and research Moldite has produced cores of guaranteed dependability, economy, quality and uniformity. Our customers' smooth running production lines tell the story best.

Specify a Moldite core specially designed and precision made for you, with absolute uniformity from first to last.

- FERRITE CORES
- MOLDED COIL FORMS (iron and phenolic)
- MAGNETIC IRON CORES
- FILTER CORES
- THREADED CORES
- SLEEVE CORES
- CUP CORES

Samples promptly submitted upon request for design, pre-production, and test purposes



... Send for our new
Catalog No. 110 —
THE MOST COMPLETE
LINE OF CORES
IN THE INDUSTRY!

NATIONAL

COMPANY
 1410 CHESTNUT AVE., HILLSIDE 5, N. J.

Robert T. Murray 614 Central Ave. East Orange, N.J.	Jerry Golten Co. 2750 W. North Ave. Chicago 22, Ill.	Martin P. Andrews Mott Road Fayetteville, N. Y.	Perlmuth-Coleman & Assoc. 1335 South Flower Los Angeles, Cal	Jose Luis Ponte Cardoba 1472 Buenos Aires
-----------------------------------------------------------	------------------------------------------------------------	-------------------------------------------------------	--------------------------------------------------------------------	-------------------------------------------------

ENGINEERS AND PHYSICISTS

Attending the

**NATIONAL
ELECTRONICS
CONFERENCE
AND EXHIBITION**

Chicago
Sept. 28, 29, 30, 1953

Inquiries are invited regarding openings on our Staff.

HUGHES research in the fields of Radar, Guided Missiles, Semiconductor Products, Digital Computers, Microwave Devices and Electron Tubes is creating new openings for those qualified in these fields.

IN RESEARCH AND DEVELOPMENT the problems are concerned with the physical design of electronic equipment involving Servo Mechanisms, Digital Computers, Pulse Circuitry, Antennas and Radomes, Miniaturization, Hydraulics-Gyros, Test Equipment, Subminiaturization, Stress Analysis, Instrumentation, Structures and Precision Production Problems.

ELECTRONIC MANUFACTURING includes the fields of Microwave Test

Equipment Design, Production Testing and Quality Control.

COMMERCIAL PRODUCTS activities have to do with Semiconductor Products Applications Engineering, Test Equipment Design, Semiconductor Components Engineering and Technical Writing.

FIELD ENGINEERING consists of Technical Advisory Service, Technical Writing, Field Modifications and Personnel Instruction.

*For the convenience of those attending the National Electronics Conference and Exhibition, members of our Technical Staff will be available for interviews at the Hotel Sherman.
For appointment telephone DEarborn 2-5700.*

Assurance is required that relocation of applicant will not cause disruption of an urgent military project.

HUGHES

RESEARCH AND DEVELOPMENT LABORATORIES
ELECTRONIC MANUFACTURING DIVISION
COMMERCIAL PRODUCTS DIVISION
FIELD ENGINEERING

Culver City
Los Angeles County
California

structure of the discharge surfaces of three storage cathodes.

The tails of storage cathodes 3a, 3b, 3c go both toward a forward transfer pair or a reverse transfer pair. The discharge takes place as described above.

Self-Pulsing Oscillator

A. A. Varela of Washington, D. C. has been granted Patent

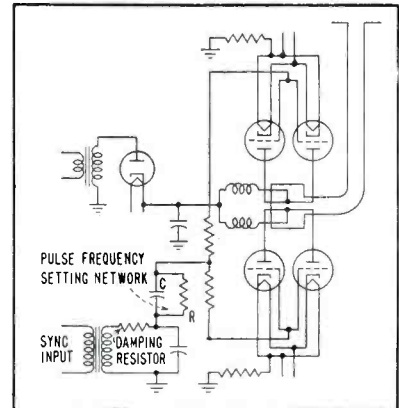

FIG. 7—Circuit of self-pulsing oscillator. Triggering of oscillation is on positive pulses only

2,627,029 for a "Self-Pulsing Oscillator".

The circuit of this invention is shown in Fig. 7. It is applicable to a high-power, high-frequency oscillator.

Upon application of a synchronizing signal to the sync input, the oscillator is triggered at a repetition rate set by the values of C and R.

The self-pulsing oscillator has an advantage over the prior methods employing grid-leak quenching techniques, in that the oscillator is only triggered on positive impulses.

The inventor claims his device makes possible precise pulse-frequency control of high-power, high-frequency oscillators without the necessity for external keying amplifiers or devices.

Voltage Regulator

Many voltage regulating systems have been described in the literature. The one described in Patent 2,617,973, recently issued to J. L. Wolff, Jr. and Donald F. Aldrich, and assigned to the U.S. Atomic Energy Commission, has a number

Why
Hughes Diodes
have set

**A
NEW
STANDARD
OF
RELIABILITY**

Reliability in a germanium diode is determined principally by permanent freedom from the two major causes of diode failure—moisture penetration of the diode envelope, and electrical instability under extreme operating conditions.

HUGHES GERMANIUM DIODES are designed to prevent such failures through two exclusive features:

1. **Fusion Sealing**—The glass-to-metal seal, proved in billions of vacuum tubes, is incorporated to full advantage in diode manufacture by the Hughes-developed process of fusion sealing at high temperature. The result is a rigid *one-piece* glass envelope making moisture penetration impossible.

2. **100% Testing**—One hundred per cent testing insures the satisfactory operation of **HUGHES DIODES** under adverse conditions of moisture, temperature, vibra-

tion and severe shock. Hughes testing procedures *invite* instabilities to occur prior to shipment and assure rejection of every defective diode. *Each HUGHES DIODE* is humidity-cycled, temperature-cycled, JAN shock-tested, and electrically tested under vibration.

Reliability of **HUGHES DIODES** has been proved in airborne military electronic equipment for navigation, fire control and guided missiles. The same high standard required for these uses is your insurance against costly shutdowns, high maintenance expense and time losses.

Specify **HUGHES DIODES** wherever reliability is essential.

HUGHES GERMANIUM DIODE ELECTRICAL SPECIFICATIONS AT 25° C.					
Description	RTMA Type	Test Peak Inverse Voltage* (volts)	Maximum Inverse Working Voltage (volts)	Minimum Forward Current @ +1 v (ma)	Maximum Inverse Current (ma)
High Peak	1N55B	190	150	5.0	0.500 @ -150 v
	1N68A	130	100	3.0	0.625 @ -100 v
High Back Resistance	1N67A	100	80	4.0	0.005 @ -5 v; 0.050 @ -50 v
	1N99	100	80	10.0	0.005 @ -5 v; 0.050 @ -50 v
	1N100	100	80	20.0	0.005 @ -5 v; 0.050 @ -50 v
	1N89	100	80	3.5	0.008 @ -5 v; 0.100 @ -50 v
High Back Resistance	1N97	100	80	10.0	0.008 @ -5 v; 0.100 @ -50 v
	1N98	100	80	20.0	0.008 @ -5 v; 0.100 @ -50 v
	1N116	75	60	5.0	0.100 @ -50 v
High Back Resistance	1N117	75	60	10.0	0.100 @ -50 v
	1N118	75	60	20.0	0.100 @ -50 v
	1N90	75	60	5.0	0.800 @ -50 v
General Purpose	1N95	75	60	10.0	0.800 @ -50 v
	1N96	75	60	20.0	0.800 @ -50 v
	1N126**	75	60	5.0	0.050 @ -10 v; 0.850 @ -50 v
JAN Types	1N127†	125	100	3.0	0.025 @ -10 v; 0.300 @ -50 v
	1N128‡	50	40	3.0	0.010 @ -10 v

*That voltage at which dynamic resistance is zero under specified conditions. Each Hughes Diode is subjected to a voltage rising linearly at 90 volts per second.
 **Formerly 1N69A. †Formerly 1N70A. ‡Formerly 1N81A.

© 1953, H. A. C.

In addition to RTMA types, HUGHES DIODES are also supplied 100 per cent factory-tested to special customer specifications.



Fusion sealed in glass for electrical stability

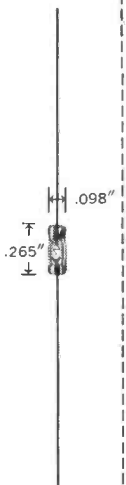

actual size

Semiconductor Sales Department
Hughes
 AIRCRAFT COMPANY
 CULVER CITY, CALIFORNIA
 Chicago New York City

Address inquiries to Dept. E

RELAYS

EXCLUSIVELY!

Over 5,348 relay types . . . each subject to many electrical and mechanical adaptations . . . produced by a highly skilled organization which, for over 25 years, has specialized in relays exclusively.

Here is relay experience!

"RELAY ENGINEERING" the famous 640-page handbook brings you full benefit of Struthers-Dunn's experience in producing thousands of relay types for hundreds of applications. A complete, fully-illustrated guide to all phases of relay selection, use, circuitry and maintenance. Price \$3.00.

STRUTHERS-DUNN

5,348 RELAY TYPES

Struthers-Dunn, Inc., 150 N. 13th St., Philadelphia 7, Pa.

BALTIMORE • BOSTON • BUFFALO • CHARLOTTE • CHICAGO • CINCINNATI
 CLEVELAND • DALLAS • DETROIT • KANSAS CITY • LOS ANGELES
 MINNEAPOLIS • MONTREAL • NEW ORLEANS • NEW YORK • PITTSBURGH
 ST. LOUIS • SAN FRANCISCO • SEATTLE • SYRACUSE • TORONTO

of desirable features.

Primarily, the regulating system is designed as a static device and operates without vacuum tubes. Currents of the order of 1 amp, rectified, may be drawn. The regulation compensates both for load variation and primary input variation.

The circuit of the regulating system is shown in Fig. 8. A magnetic amplifier is inserted in one leg of the primary winding of the power transformer of a rectifier power supply. The magnetic amplifier comprises a 3-legged closed core. Each of the outer legs has a winding commonly connected to the power-transformer primary and each connected to the line side through a rectifier. Each of the line rectifiers is oppositely poled so that only each half cycle of the power frequency passes through one leg only. The center leg of the magnetic-amplifier core has three windings. One is the d-c control winding in series with the d-c output of the rectifier, the other two, wound in current opposition to one another, are also connected to the d-c output, but through a fixed and variable impedance network that form a bridge circuit with the opposed control windings. When the bridge is balanced, the opposing control windings have no net effect on the magnetization of the core. As the d-c voltage output of the rectifier supply varies under load conditions, an unbalance occurs in the current flowing through the windings on the center leg. This varies the core magnetization and saturation level of the magnetic amplifier to control the primary voltage until the balanced condition

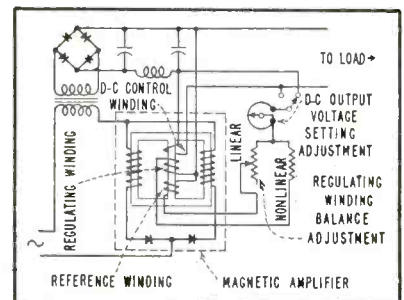

FIG. 8—Magnetic amplifier voltage regulator compensates for both load and primary input variations



There are lots of good arguments to back up the quality of

HUDSON

STANDARD CASES and COVERS SPECIAL SHAPES and FEATURES

Hudson precision drawn cases and covers are standard "in stock" parts delivered on short notice to meet your production schedules. In addition, the wide variety of shapes and sizes—plus dozens of optional features available—mean Hudson can economically solve practically any closure problem

quickly, and usually at lower unit cost. All cases and covers are precision drawn with tools and dies made by Hudson craftsmen. Check on the Hudson line of standard metal parts and quality metal stampings today. Send blueprints, sketches or specifications for quotations. . .no obligation.



ATTENTION ENGINEERS, DESIGNERS, PRODUCTION MEN!
Call or write for your copy of the new Hudson File Catalog including complete information on standard cases and covers. Please address inquiries on company letterhead, to Desk E-9.

PRECISION DRAWN CASES AND
COVERS AND QUALITY METAL
STAMPINGS FOR ELECTRONICS



**HUDSON TOOL and
DIE COMPANY • Inc**

118-122 SO. FOURTEENTH STREET, NEWARK 7, NEW JERSEY

GLASS - TERMINAL TUBULAR CAPACITORS

midget • metal-cased • hermetically-sealed

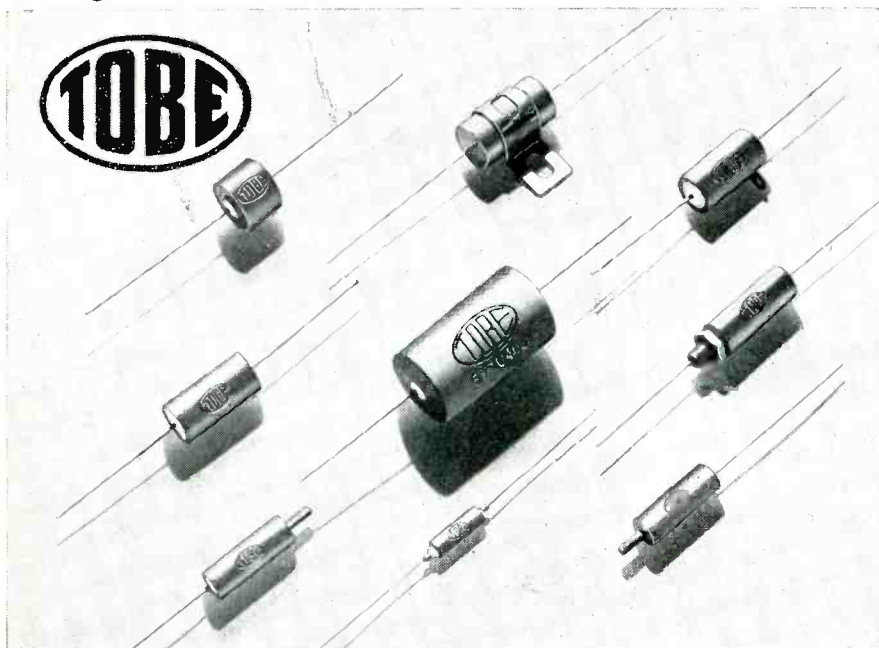

For miniaturized apparatus and where the self-healing characteristic is desirable, specify Tobe metallized-paper glass-terminal tubulars. Capacitance ratings from 0.01 to 10 mfd. Voltage ratings from 150 to 600 volts d-c. Mineral-wax or mineral-oil impregnation for temperatures - 55 to + 85C; silicone-fluid impregnation for - 55 to + 105C range.

For the "hot spots" where space is limited, specify Tobe silicone-fluid-impregnated glass-terminal tubulars. These units are built to work over a range of - 55 to + 125C. Capacitances 0.001 to 1.0 mfd. Working voltages 200 to 1000 volts d-c.

For cramped space in circuits whose surge characteristics prevent use of metallized-paper units, specify Tobe foil-paper capacitors with stabilized-Halowax impregnation. Capacitances 0.001 to 1.0 mfd. Voltage ratings 200 to 400 volts d-c. Temperature range - 40 to + 85C.

For general service specify Tobe glass-terminal tubulars with mineral-oil impregnation. Capacitances 0.001 to 1.0 mfd. Working voltages 200 to 1000 volts d-c. Temperature range - 55 to + 85C.

All types available with windings insulated from or grounded to case. Extended-foil windings for low-voltage high-frequency service; tabbed windings for minimum size. Standard capacitance tolerance $\pm 20\%$; can be furnished $\pm 5\%$.

Write for catalog giving complete list of sizes and ratings.



TOBE DEUTSCHMANN
CORPORATION
NORWOOD, MASSACHUSETTS

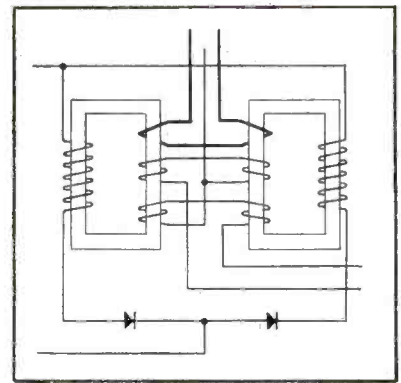

FIG. 9—Dual-ring magnetic amplifier provides closer regulation by providing higher gain

is again achieved.

Fig. 9 shows a variation of the magnetic amplifier employing a pair of core rings, each comprising a separate closed magnetic loop, but inductively coupled by winding the control, regulating and reference windings around an adjacent leg of each core ring. The inventors claim that the split dual-ring core magnetic amplifier has much higher gain than the 3-legged core magnetic amplifier and, consequently, much tighter control. Figures given in the patent specification point to regulation to within 0.1 percent from full-load to no-load and to maintain a voltage within 1 percent for a 20 percent change in input voltage.

Figure 10 illustrates the ampere-turns relationship (magnetizing force) with respect to voltage change in the resistance elements of the bridge when the d-c output voltage and linear impedance controls are set for the appropriate crossover which gives the desired regulation.

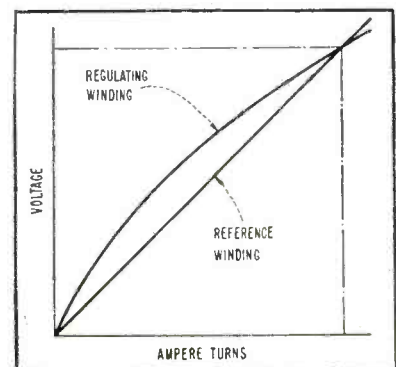

FIG. 10—Voltage-ampere turns characteristics for the magnetic amplifier windings

BEAM POWER

...from DC to 175 Mc!

RCA-6146 is uniquely versatile

MARINE TRANSMITTERS

AMATEUR TRANSMITTERS

MOBILE TRANSMITTERS

AUDIO & VIDEO MODULATORS

SERVO AMPLIFIERS



RCA-6146, actual size!

FROM dc amplifier to VHF services, the remarkable RCA-6146 beam power tube is setting a record for circuit versatility attained by few other tubes. Power sensitivity is high, regardless of plate voltage—or frequency. Small size offers wider latitude for compact equipment. Low cost contributes to genuine economy in circuit design—without sacrificing efficiency.

In class C rf service (ICAS) at 600 volts, a single RCA-6146 unmodulated can handle an input of 90 watts at frequencies as high as 60 Mc... and 60 watts at 175 Mc with a plate voltage of 400 volts. In class AB₁ (ICAS) two 6146's can deliver up to 120 watts

of audio... and in class AB₂, 130 watts. Triode-connected, two 6146's will deliver 19 watts of power!

RCA-6146 is designed for all general services calling for a 6.3-volt heater. Where tubes with 26.5-volt heaters are required, as in aircraft applications, RCA can supply Type 6159... similar in all other characteristics to the 6146.

For technical data, write RCA, Commercial Engineering, Section 42IR, Harrison, N. J. Or call your nearest RCA Field Office.

FIELD OFFICES:

(EAST) Humboldt 5-3900, 415 S. 5th St., Harrison, N. J.
(MIDWEST) Whitehall 4-2900, 589 E. Illinois St., Chicago, Ill.
(WEST) Madison 9-3671, 420 S. San Pedro St., Los Angeles, Cal.

IN PRODUCT IMPROVEMENT **RCA** NEVER STANDS STILL



RADIO CORPORATION of AMERICA

ELECTRON TUBES

HARRISON, N. J.

Production Techniques

Edited by JOHN MARKUS

Silver-Ink Printing on Resistors.....	262	Heating Beeswax With Soldering Iron.....	284
Approach to Automation—Resistor Sorter.....	264	Tightening Connectors.....	286
Testing and Soldering Magnetic Ampli- fier Coils.....	266	Ejection Chutes for Small Wire Parts.....	288
Four-Micrometer Stand Speeds Cathode Inspection.....	268	Automatic Final Testing.....	294
Drilling Through Tape Minimizes Scratching.....	270	Final Leakage Test on Soldering Guns.....	296
Spring Fasteners Speed Receiver Assembly.....	270	Self-Dressing Grinder.....	298
Grid-Mounting Slide.....	272	Paint Bar Speeds Color-Coding of Leads.....	300
Heated Stripper for Coaxial Cable.....	274	Welded Hook on Scissors Speeds Coil Tying.....	302
Whisker-Forming Fixture for Transistors.....	276	Coating Wires with Teflon.....	304
Induction Soldering of Capacitors.....	278	Inspecting Tubes with X-ray Equipment.....	306
Hair Drier Heats Diodes.....	280	Checking Phosphor Adherence.....	306
Dual-Head Punch Press Mounts Eyelet Sockets.....	282	Screw-Tightening Fixture.....	308
		Switch-Soldering Fixture.....	310
		Chassis Samples Shorten Training Time.....	312
		Electronic Counter Aids Adjustment of Relays.....	314

Silver-Ink Printing on Resistors

BOTH MANUAL and automatic inking techniques are used for printing brand names and resistance values on deposited carbon resistors in the San Juan, Puerto Rico plant of Radell Corp.

For the manual operation, rubber type for the desired lettering is mounted on sponge rubber with rubber cement, and this in turn is

clamped into a removable U-shaped type holder that drops into a recess cut into the wood inking fixture. The silver ink used for marking is placed on a piece of plate glass on the bench at the right of the operator, and is picked up from this with an ordinary ink roller. The roller is run across the upward projecting rubber type after each



All-manual setup for applying silver lettering to deposited carbon resistors. Drying board holds exactly 300 resistors

OTHER DEPARTMENTS

featured in this issue:

	Page
Electrons At Work.....	198
New Products.....	316
Plants and People.....	378
New Books.....	428
Backtalk.....	440



Construction details of fixture holding rubber type for lettering resistors. Type holder is in operator's left hand. Sliding strip with wedge, in right hand, is placed under type holder for adjusting type to correct height

printing operation.

After the type is inked, the operator places a coated resistor carefully in position on the fixture and rolls it across the type by placing her fingers on the end caps of the resistor. The resistor is then allowed to dry by inserting one of its leads in a drilled hole in a self-counting tray. This tray is simply a sheet of tempered pressed wood held about 2 inches above the bench by wood strips. The sheet has 300 drilled holes through which resistor leads can project downward without touching the bench.

Faster inking is achieved with a small hand-operated, automatically-inked offset printing press. The ink here is placed on a round metal disk

let 'er go, skip along,
stick with the "K" brand you know

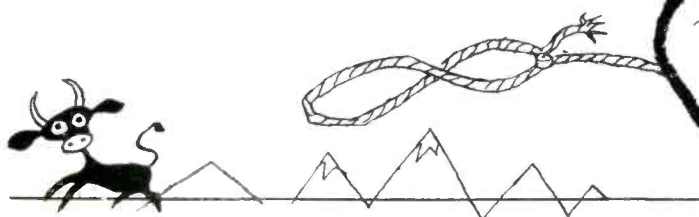

"Maverick" usually spells trouble, on the production line as well as out on the range. Being an unknown quantity or a "Johnny-come-lately," it leaves room for genuine doubt both as to performance and quality. And that's the reason so many experienced buyers — production experts to supervisors — insist on Kester . . . the one "brand" that is synonymous with the best solder and solder products.

Next time, choose one of these famous solder products: "44" Resin, "Resin-Five" and Plastic Rosin — all made only by KESTER . . . Key Name in Flux-Core Solder for More Than 50 Years.

KESTER

S O L D E R C O M P A N Y

4204 WRIGHTWOOD AVENUE, CHICAGO 39, ILLINOIS
NEWARK 5, NEW JERSEY • BRANTFORD, CANADA



at the top of the press. A pawl under this disk rotates it a small amount each time the press is operated, for automatic distribution of ink.

At each press operation, two



Offset printing press being used for lettering resistors

gelatin-coated rollers pick up the silver ink and roll it onto metal type locked into the vertical part of the press. Further lifting of the press bed to a vertical position moves out the rollers, and the gelatin on the press bed picks up the ink from the type. The bed is brought back down to the horizontal and the operator now rolls the resistor carefully over the gelatin much as in the manual technique. A paper mask cut from index-card stock exposes only the gelatin area containing the ink. The paper does not pick up the dry type of ink used in this process.

Use of the offset printing press gives a neater product, permits placing more information on a resistor and increases lettering speed about six times. With the

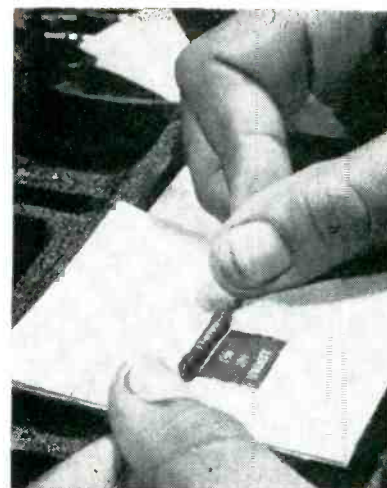

Closeup view of bed of press, just after resistor rolled across ink on gelatin

press, about 6,000 resistors can be lettered per day, in comparison with 1,000 by the manual method.

Approach to Automation . . . Resistor Sorter

DEPOSITED CARBON resistor bodies are automatically sorted into three different 10-percent tolerance ranges plus a reject group by a motor-driven turntable arrangement used with a comparator bridge in the San Juan, Puerto Rico plant of Radell Corp. This sorting is done after the ceramic bodies have been coated and fired, but before end terminal caps have

been applied to the resistor.

The operator loads the resistors into holes along the outer edge of the turntable as it rotates past her. A stationary disk about $\frac{1}{4}$ inch below the rotating table prevents the resistors from dropping through. The turntable moves each resistor in turn between three sets of wiping contacts that bear against the ends of the resistors above and

below the rotating table. These contacts are connected to the comparator bridge. If the resistance value falls within the 10-percent tolerance range for the first set of contacts, the comparator actuates a relay that is arranged to open the gate, allowing the resistor to drop through at that position and slide down a chute into the corresponding tote box. If the resistor is out-

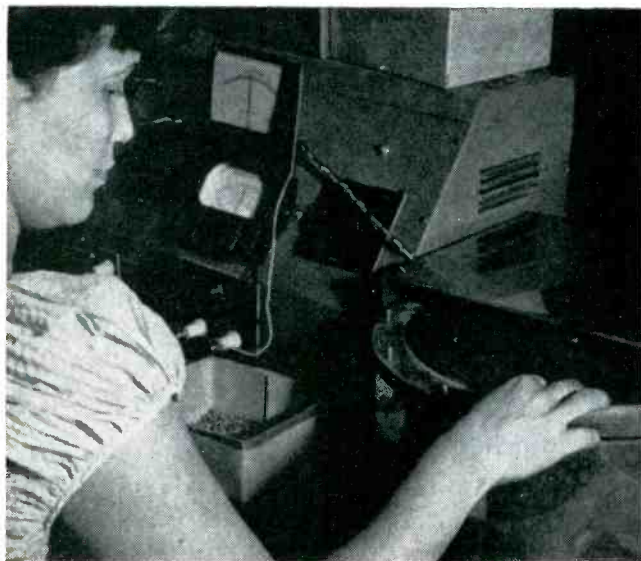

Method of loading automatic resistor-sorting turntable. Wiping contacts connected with comparator bridge are located under sheet metal housing covering rear half of turntable

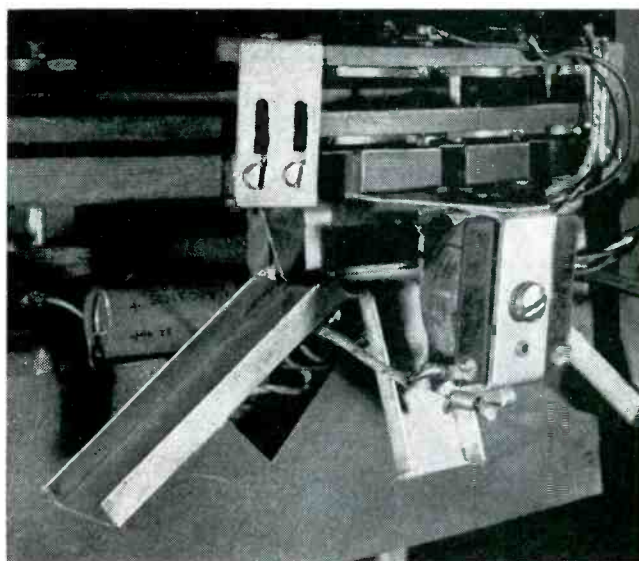

Measuring and sorting position at rear of turntable, showing use of ordinary relay with metal plate fastened to armature to serve as gate for three dropout holes

2 Waldes Truarc Rings Replace 2 End Plugs ...Eliminate 3 Operations... Save \$.066 Per Unit

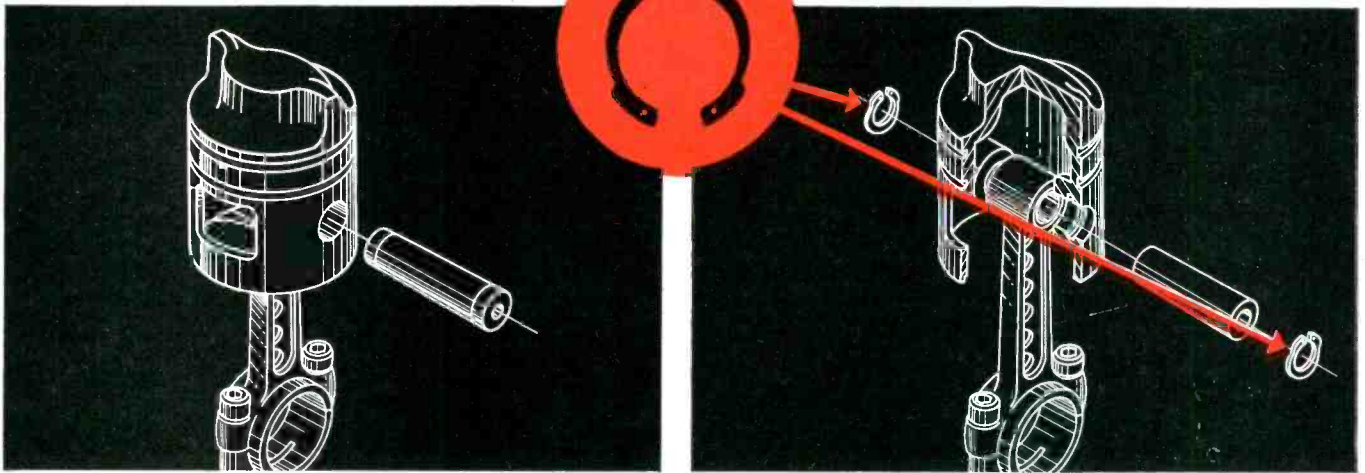

OLD WAY Two inserted-plug type wrist pin locks hold wrist pin in place. 3 operations involved: costly machining, pressing in place, post-assembly machining. Costly maintenance problem—resulting from end plugs hammering loose.

TRUARC WAY Two Truarc Inverted Retaining Rings (Series 5008) hold wrist pin in place. Truarc Rings snap into grooves easily cut in piston, provide positive lock . . . practically eliminate maintenance costs. Quick assembly, disassembly.

Titan Chain Saws, Inc., Seattle, Washington, uses 2 Waldes Truarc Rings to replace old-style inserted-plug type wrist pin locks in their Titan chain saws. Use of Waldes Truarc Retaining Rings eliminates 2 press fit end plugs. Machining of plugs, pressing in place, finish machining—no longer required. Truarc way holds rejections to a minimum. Unit efficiency is greatly increased.

Redesign with Truarc Rings and you, too, will cut costs. Wherever you use machined shoulders, bolts, snap

USE OF 2 WALDES TRUARC RINGS PERMITTED THESE SAVINGS PER UNIT:

OLD WAY	
Cost of 2 end plugs	} \$.169
Cost of pressing in and machining	
TRUARC WAY	
Cost of grooving piston	}103
Cost of 2 Truarc Rings	
Saving per Unit	\$.066

rings, cotter pins, there's a Waldes Truarc Retaining Ring designed to do a better job of holding parts together.

Waldes Truarc Rings are precision-engineered . . . quick and easy to assemble and disassemble. Always circular to give a never-failing grip. They can be used over and over again.

Find out what Waldes Truarc Retaining Rings can do for you. Send your blueprints to Waldes Truarc engineers for individual attention, without obligation.

For precision internal grooving and undercutting . . . Waldes Truarc Internal Grooving Tool.

SEND FOR NEW CATALOG

WALDES TRUARC

REG U S PAT OFF

RETAINING RINGS



Waldes Kohinoor, Inc., 47-16 Austel Place, L. I. C. 1, N. Y.
Please send me the new Waldes Truarc Retaining Ring catalog.

(Please print)

E 095

Name.....

Title.....

Company.....

Business Address.....

City.....Zone.....State.....

WALDES KOHINOOR, INC., LONG ISLAND CITY 1, NEW YORK
WALDES TRUARC RETAINING RINGS AND PLIERS ARE PROTECTED BY ONE OR MORE OF THE FOLLOWING
U. S. PATENTS: 2,382,947; 2,382,948; 2,416,852; 2,420,921; 2,428,341; 2,439,785; 2,441,846; 2,458,165;
2,483,380; 2,483,393; 2,487,802; 2,487,803; 2,491,306; 2,509,001 AND OTHER PATENTS PENDING.

TRANSFORMERS

PRODUCTION TECHNIQUES

(continued)

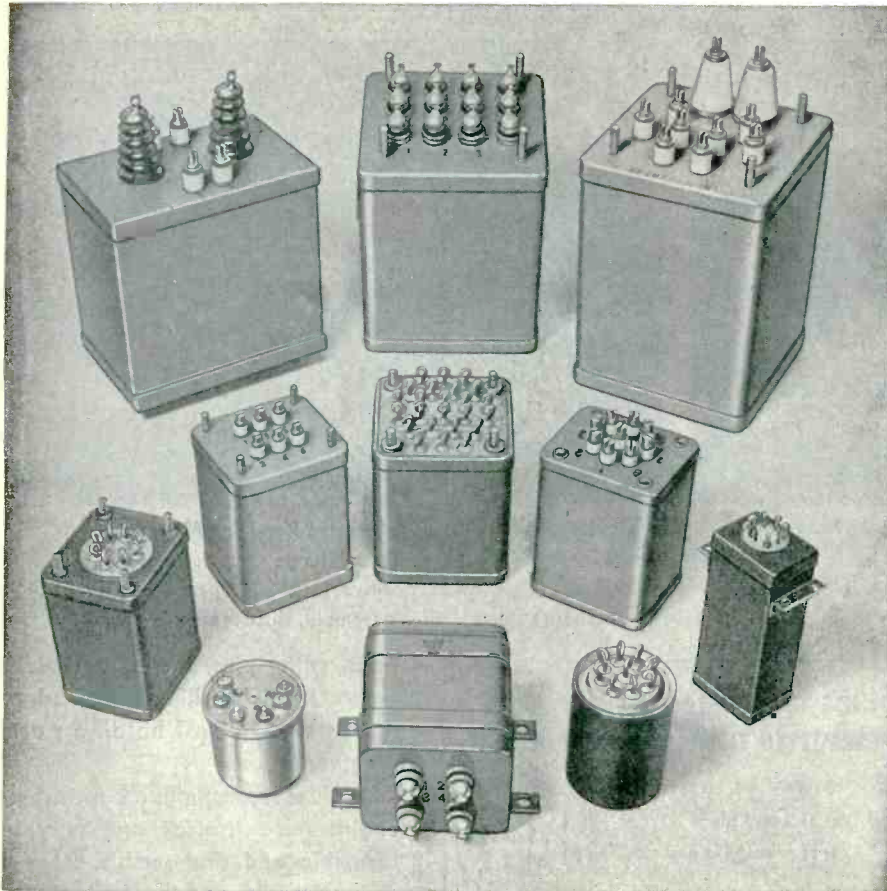

HERMETICALLY SEALED TO MIL-T-27 SPECIFICATIONS

NYT offers a wide variety of transformer types to meet military and civilian specifications, designed and manufactured by specialists in transformer development.

Latest NYT service for customers is a complete test laboratory equipped and approved for on-the-spot MIL-T-27 testing and faster approvals.

**NEW YORK
TRANSFORMER CO., INC.**
ALPHA, NEW JERSEY

side this tolerance range, the relay does not operate and the turntable carries it past to the second set of measuring contacts. Again, a correct value causes gate opening and dropout, and a wrong value goes on to the next measuring station. A resistor that gets past all three measuring contacts drops down through the permanently open reject hole just beyond the gate.

The relay arrangement is such that movement of its armature moves a strip of metal that unblocks all three dropout holes simultaneously. Turntable and hole spacings are such that only one resistor at a time can be in position for dropout, hence one relay-operated gate serves for all three sorting positions.

To take care of different resistor lengths, the contacts above the turntable are so mounted that they can be adjusted in height easily. A geared-down a-c motor drives the turntable at a speed of about 4 rpm to give a sorting rate of about one resistor per second.

Testing and Soldering Magnetic Amplifier Coils

SOLDERING of insulated leads to large layer-wound coils for magnetic amplifiers is expedited through use of a bench-mounted vertical post and clamp for holding the soldering iron horizontally at the optimum working position. A single clamp of the type used for supporting electrical conduit is bolted to the post and serves adequately for gripping the hexagonal barrel of the soldering iron. With this setup, the operator can apply solder



Soldering iron holder in use



HIGH
Quality

CLEVELITE*
for **BETTER COMPONENTS**

Clevelite ensures satisfactory performance wherever high dielectric strength, low moisture absorption, mechanical strength, low loss and good machinability are of prime importance.

Clevelite is made in SEVEN GRADES — Time Tested!

GRADE	APPLICATION
E	Improved post-cure fabrication and stapling.
EX	Special grade for TV yoke sleeves.
EE	Improved general purpose.
EEX	Superior electrical and moisture absorption properties.
EEE	Critical electrical and high voltage application.
XAX	Special grade for government phenolic specifications.
SLF	Special for very thin wall tubing having less than .010 wall.

When you specify and use CLEVELITE you obtain
High Quality and Fine Service.

*Send for our new Clevelite
Folder just off the press.*

WHY PAY MORE? For the best . . . Call CLEVELAND!

* Reg. U. S. Pat. Off.

The **CLEVELAND CONTAINER Co.**
6201 BARBERTON AVE. CLEVELAND 2, OHIO

PLANTS AND SALES OFFICES at Chicago, Detroit, Memphis, Plymouth, Wisc., Ogdensburg, N. Y., Jamesburg, N. J.
ABRASIVE DIVISION at Cleveland, Ohio
CANADIAN PLANT: The Cleveland Container, Canada, Ltd., Prescott, Ontario

REPRESENTATIVES

NEW YORK AREA R. T. MURRAY, 604 CENTRAL AVE., EAST ORANGE, N. J.
NEW ENGLAND R. S. PETTIGREW & CO., 62 LA SALLE RD., WEST HARTFORD, CONN.
CHICAGO AREA PLASTIC TUBING SALES, 5715 N. RAVENSWOOD AVE., CHICAGO
WEST COAST IRV. M. COCHRANE CO., 408 S. ALVARADO ST., LOS ANGELES



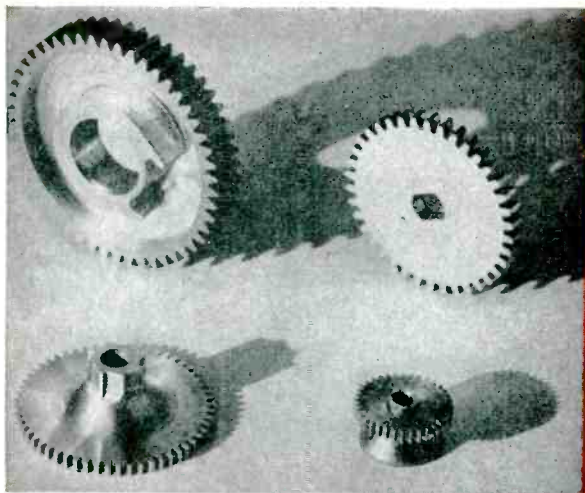

GEARS WITH SHAPES

Special Shapes and Features? . . . Tolerances within .0005" . . . Let our experience in supplying precision small and medium sized gears with such features solve these production problems for you . . . Ask for quotation on your job specifications. Circular on Request.

- SPUR
- WORM
- SPLINE
- HELICAL
- SPROCKET
- STRAIGHT BEVEL
- GROUND THREADS

THE *Finest*



IN GEARS

Beaver Gear Works Inc.

1021 PARMELE STREET, ROCKFORD, ILLINOIS

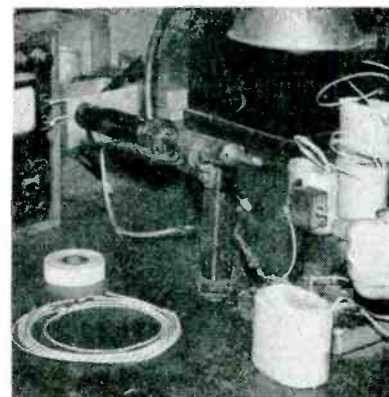

Checking continuity of finished coil by holding leads against contact screws which are connected semi-permanently to multimeter

with the right hand while bringing the twisted joint up to the iron with the left hand.

After leads have been attached and taped, they are held against two brass screws on a simple test stand. These screws are connected to a multimeter farther back on the bench for giving a quick continuity check of each coil as it is completed. This technique is used for small production runs of coils in the Paterson, N. J., plant of Bogue Electric Mfg. Co.

Four-Micrometer Stand Speeds Cathode Inspection

A WOOD BLOCK HAVING recesses for the frames of four micrometers permits making four different dimensional checks quickly one after another on coated cathodes and other parts for vacuum tubes. These can be four independent measurements or two go and no-go tests. The gages are locked in posi-



Four-micrometer setup used by Tung-Sol for dimensional checking of tweezer-held cathodes during sampling inspection for quality control

Fine
ALUMINUM
WIRE

- To meet the growing demand from producers of light-weight, high-frequency Galvanometer movements, we have expanded our facilities designed to process Wire of 2S Aluminum . . . This wire can be supplied in diameters ranging from approximately .001 inch through .005 inch . . . Anodized with an exceptionally thin and flexible dielectric coating.

Also available: wires of aluminum alloys enameled as small as .001 inch diameter, to meet rigid specifications of resistance, size and straightness.

SINCE
1901

Write for Latest List of Products

SIGMUND COHN CORP. 121 So. Columbus Avenue • Mount Vernon, N.Y.



did you know . . .

that Rauland made the first rectangular tube in 1945?
everybody knows . . . that engineering leadership means
sales leadership . . . and that means RAULAND

THE RAULAND CORPORATION, 4245 N. KNOX AVENUE, CHICAGO 41, ILLINOIS • MULBERRY 3-5000

RAULAND

did you know . . .



that Rauland was the first company to produce the
electrostatic low focus voltage tube?
everybody knows . . . that engineering leadership means
sales leadership . . . and that means RAULAND

THE RAULAND CORPORATION, 4245 N. KNOX AVENUE, CHICAGO 41, ILLINOIS • MULBERRY 3-5000



DID YOU KNOW

that Rauland was the first company to manufacture
aluminized tubes on a production basis?
everybody knows . . . that engineering leadership
means sales leadership . . . and that means RAULAND

THE RAULAND CORPORATION, 4245 N. KNOX AVENUE, CHICAGO 41 ILLINOIS • MULBERRY 3-5000



Burton Boone advertising

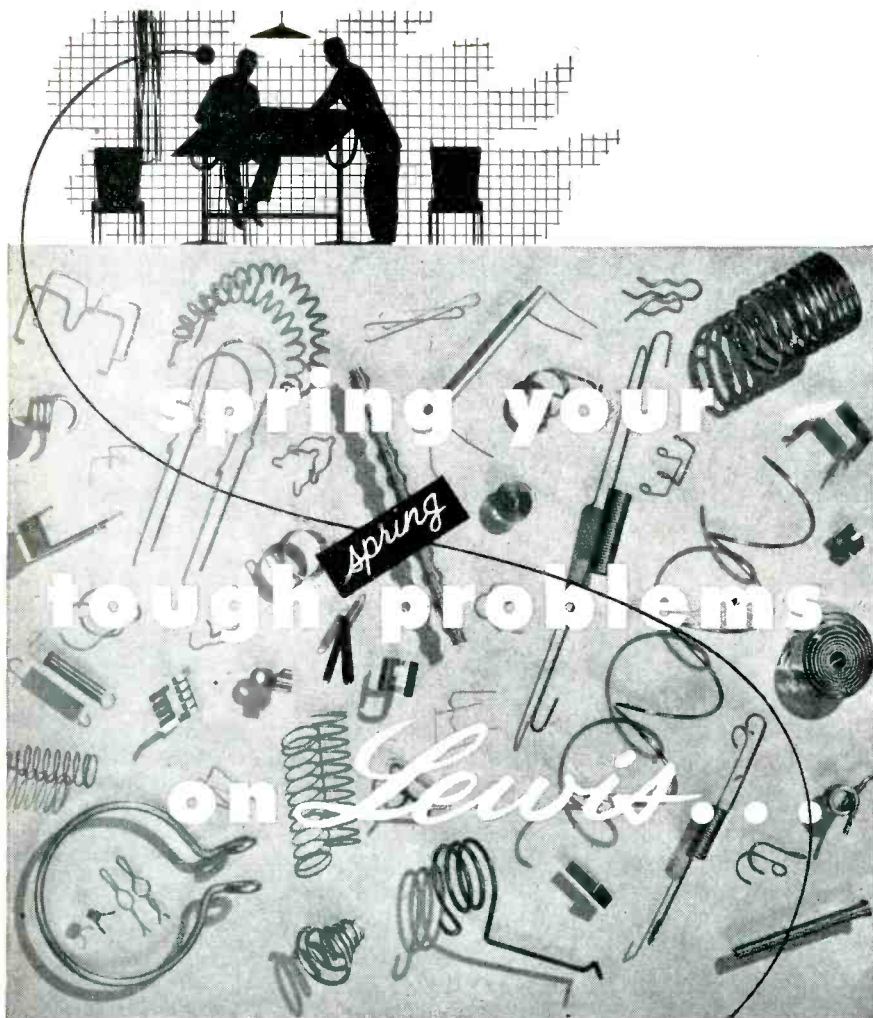

Lewis Spring has built an enviable reputation on ability for unusual service . . . whether it be in helping solve a tough application problem . . . or meeting emergency production schedules.

Extensive, modern facilities, experienced engineers and skilled production personnel produce springs, coils, wireforms and stampings tailored to the exact needs of a widely diversified group of large and small industrial plants.

We'd like to work with you on your spring, wireform and stamping problems. Send us drawings, specifications or samples. There is no obligation.

LEWIS SPRING & MANUFACTURING CO.
2656 W. NORTH AVENUE CHICAGO 47, ILLINOIS

Lewis  **PRECISION SPRINGS**

The Finest Light Springs and Wireforms of Every Type and Material

tion in the slots of the wood block with machine screws threaded into the sides of the block, hence any or all gages can be easily removed for other uses.

Drilling Through Tape Minimizes Scratching

CHIPS and slivers that might damage a templet during chassis drilling can be swept off easily if the holes are drilled through a mask of pressure-sensitive tape. This technique will protect mirror-finish surfaces when production runs are too small to justify punch-press setup.

Spring Fasteners Speed Receiver Assembly

SPECIAL angle brackets having built-in Tinnerman Speed Nuts resulted in a 63-percent production saving in fastening television chassis units to cabinets at Jackson Industries, Inc. in Chicago.

In the old way, four conventional angle brackets were riveted to the chassis after being drilled and tapped to receive machine screws. Hole alignment was always a problem when using machine screws to fasten the chassis, since the brackets were in blind positions.

In the new method, the bracket is similarly riveted to the chassis, but the tapping operation is now unnecessary. In addition, use of self-tapping screws in place of machine screws makes hole alignment easier and faster.

In another chassis-mounting

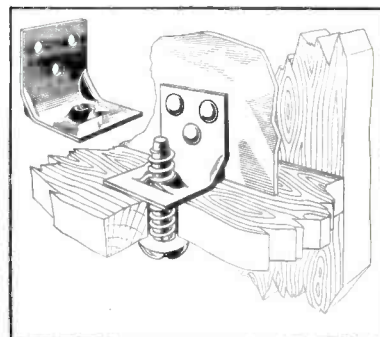

Details of special bracket used to speed fastening chassis to cabinet

marion

advancement
in instrument
design

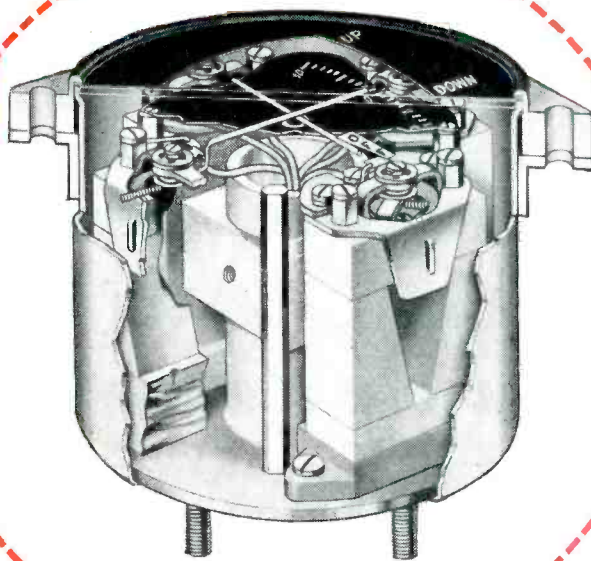

SETTING NEW DESIGN STANDARDS FOR AIRCRAFT INSTRUMENTS

Marion Electrical Instrument Company now makes available a line of aircraft instruments embodying proven Marion instrument features and incorporating new Marion developments. The result is single and multiple element aircraft types of greater durability and accuracy, incorporating a new single seal construction which isolates the glass-to-metal seal from mounting stresses and reduces thermal shock stresses. These instruments meet Army-Navy Aeronautical Design Standard AND 10401 requirements for 2 3/4" dial instruments. Applications of the new Marion AN Series include ammeters, voltmeters, radio navigational types (such as omni-range and ILS) and temperature indicators.



The single element Marion Model AN3 is completely ruggedized (per MIL-M-10304) including internal shock mount.

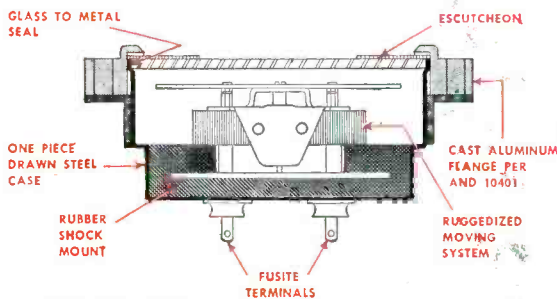

SERIES AN3

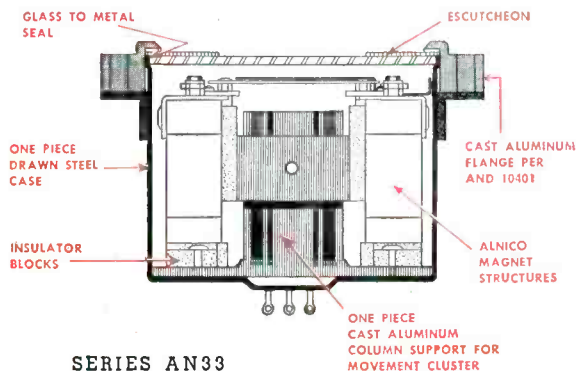

SERIES AN33

Marion AN33 Series provides for instruments incorporating two, three or four Marion ruggedized movements. A unique one piece base and column support provides greater rigidity and more precise alignment of the elements. All wiring passes directly through the center of this column to terminal connections. Accessories such as multiplier resistors and bridge networks where required are contained in an extension cap which is attached to the base of the instrument. The series consists of two element (Model AN32E), three element (Model AN33E), and four element (Model AN34E) types.

In both the Marion AN3 and AN33 Series the one piece drawn steel case is single-seal (glass-to-metal) hermetically sealed to the glass window, making the instruments impervious to the most severe of environmental hazards. A cast aluminum flange retains the escutcheon and provides for panel mounting (per AND 10401).

These Marion aircraft instruments represent another application of "Advancement In Instrument Design" to a critical instrument requirement. Marion Electrical Instrument Company, 401 Canal Street, Manchester, New Hampshire.



marion meters

Reg. U. S. Pat. Off

MANUFACTURERS OF RUGGEDIZED AND "REGULAR" METERS AND RELATED PRODUCTS

Copyright 1953 Marion Elec. Instr. Co.



look to

CHICAGO

for the "missing links" in
EXACT REPLACEMENT TRANSFORMERS FOR

LINK RADIO EQUIPMENT

For many years, CHICAGO has made most of the transformers and filter reactors for Link Radio equipment which is widely used in police communication and other mobile applications. CHICAGO Exact Replacement Transformers for this equipment are now available through your electronic parts distributor. The CHICAGO catalog numbers are identical to the Link parts numbers. See your distributor for these components.

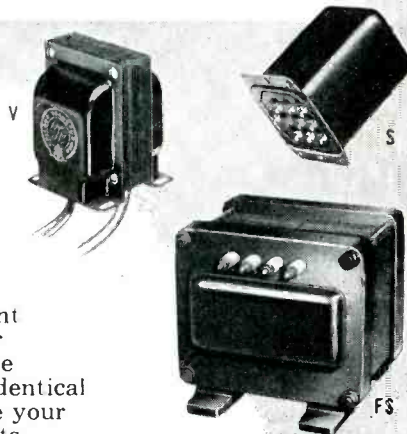

IN STOCK FOR IMMEDIATE DELIVERY

CHICAGO CAT. NO.	TYPE OF UNIT	REPLACES LINK RADIO PART NUMBERS:	MTG. TYPE	LIST PRICE
TR-1034	Vibrator Transformer (6 v.)	TR-1034 and 12534	V	\$ 9.50
TR-1035	Vibrator Transformer (12 v.)	TR-1035, 14269	V	9.50
TR-1040	Plate Transformer	TR-1040 and 11862	FS	97.50
TR-1050	Vibrator Transformer (6 v.)	TR-1050	V	9.90
TR-1054	Plate Transformer	TR-1054, 11944, 4891	V	18.50
TR-1056	Filter Choke	TR-1056, 0122U	V	10.85
TR-1063	Filament Transformer	TR-1063, 11992, 7211	V	10.50
TR-1065	Power Transformer	7650N, TR-1065	S	13.50
TR-1072	Power Transformer	TR-1072, 6248	V	9.50
TR-1073	Vibrator Transformer (6 v.)	TR-1073, 6250, TR-1080	V	9.25
TR-1077	Filter Choke	TR-1077, 7282N	BX	24.25
TR-1081	Output Transformer (Plate to Grid or Line)	TR-1081	S*	15.00
TR-1082	Filament Transformer	TR-1082	TX-1	31.25
TR-1083	Filament Transformer	TR-1083, 8218N	TX	20.50
TR-7074	Vibrator Transformer (12 v.)	TR-7074	V	11.50

*Pin-type terminals in place of solder lugs.

Free "New Equipment" Catalog

You'll want to have the full details on CHICAGO'S New Equipment Line, covering the complete range of "Sealed-in-Steel" transformers for every modern circuit application. Write for your Free copy of Catalog No. CT-153 today, or get it from your electronic parts distributor.



CHICAGO TRANSFORMER

DIVISION OF ESSEX WIRE CORPORATION
3501 ADDISON STREET, CHICAGO 18, ILL.



Export Sales Div.:
Scheel International, Inc.
4237 N. Lincoln Ave.
Chicago, Ill., U.S.A.
CABLE ADDRESS:
HARSHEEL

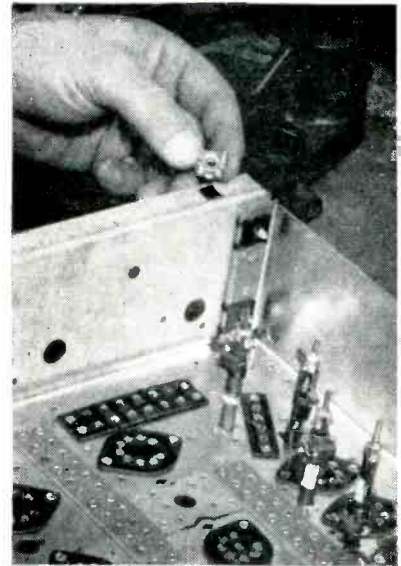

Special spring clip for holding captive nut is easily pushed into square punched hole in television chassis. All terminals here are tubular pins which project up through top of chassis for dip-soldering operation that solders over 400 connections simultaneously, in GE plant at Syracuse

technique, two sides of the chassis are bent at right angles to form the mounting brackets. Speed Grip nut retainers are then inserted in square holes previously punched in these flanges, again eliminating the chassis-tapping operation. The nuts move sufficiently in their spring mountings to permit easy alignment, while the square holes prevent the nuts from turning.

Grid-Mounting Slide

TO MINIMIZE HANDLING of precisely wound and shaped grids when assembling the electrodes of vacuum tubes, a special fixture was developed by Tung-Sol for supporting the cathode so the grid can be slid down over it.

The operator first positions the cathode and its mica spacer in holes and recesses provided for the purpose on the removable part of the fixture. This assembly is placed at the bottom of the slide on the fixture. The No. 1 control grid is now placed at the top of the slide and allowed to slide down over the cathode. The fixture is so designed that this is achieved without having

TINNERMAN
Speed Nut
Savings Stories

FASTEST THING IN FASTENINGS®

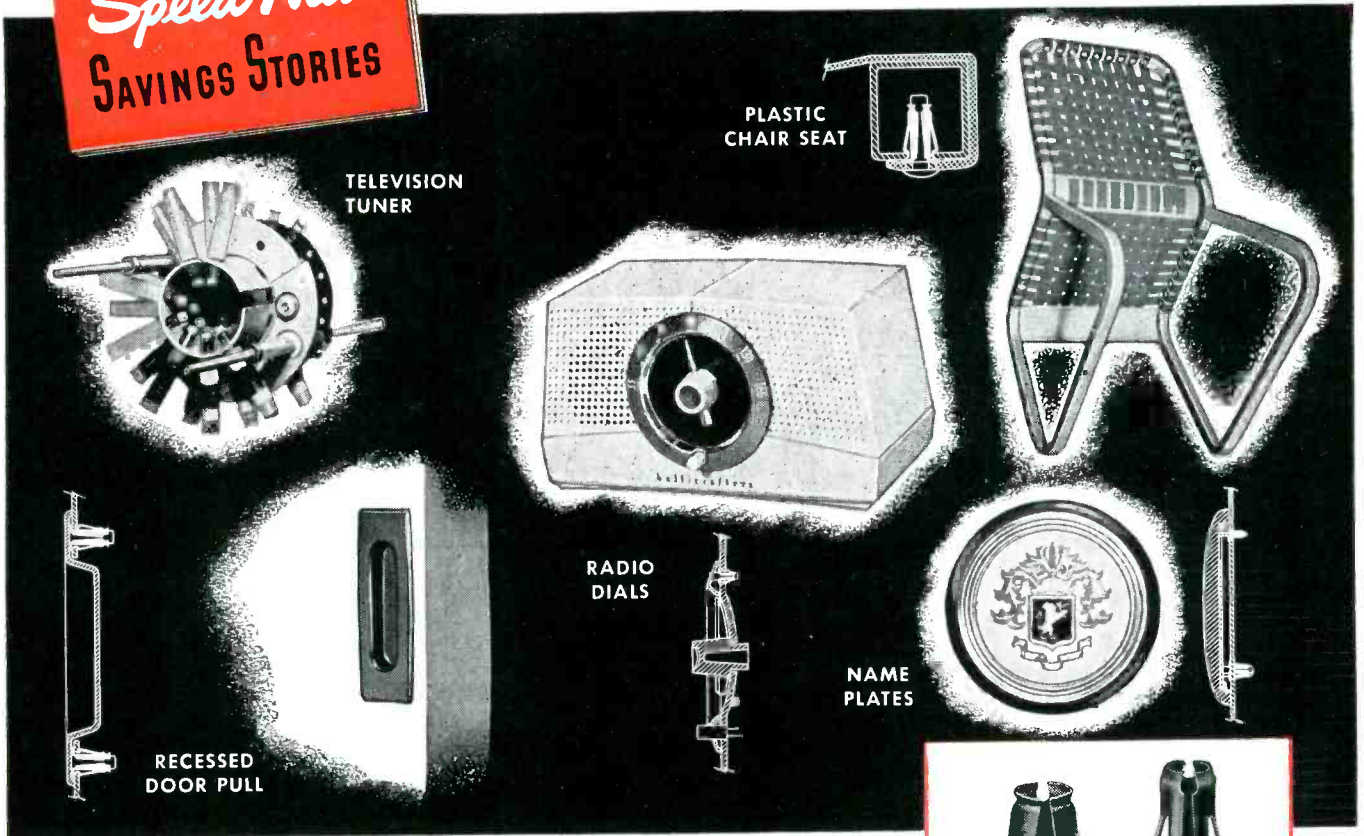

Tubular SPEED CLIPS® Reduce Assembly Costs
... Increase Production ... Improve Quality



Hundreds of manufacturers—dozens of industries—save thousands of dollars with Tinnerman Tubular type SPEED CLIPS. These high quality spring steel fasteners snap into place by hand, are self-retained in stud-receiving position. Applicable in punched or molded holes, equally effective on metal or plastic studs, ideally suited to “blind” attachments where only one side is accessible . . . just a few of the reasons these unique fasteners reduce production costs and materials handling.

Tubular type SPEED CLIPS have proven themselves in the electronics field. Production savings exceeding 50 percent and substantial increases in output have been achieved through their use. A wide variety of types and sizes are available to fill most fastening needs.

Your Tinnerman representative has complete information that may lead to improved fastening methods for you—see him soon.

Tinnerman Tubular Type
SPEED CLIPS

... heat treated spring steel fasteners available in a wide range of sizes with rust resistant finishes. Design variations include permanent-lock or removable-lock types. Integrally molded studs provide extra savings through reduced parts and parts handling.

Write direct for **SPEED NUT** “Savings Stories”, and your copy of Tubular Type **SPEED CLIP** Bul. #330. **TINNERMAN PRODUCTS, INC.**, Box 6688, Dept. 12, Cleveland 1, Ohio.

In Canada: Dominion Fasteners, Ltd., Hamilton, Ont. *In Great Britain:* Simmonds Aerocessories, Ltd., Treforest, Wales. *In France:* Aerocessoires Simmonds, S. A.—7 rue Henri Barbusse, Levallois (Seine).



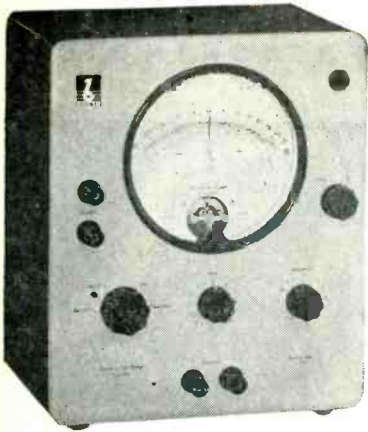

1-SECOND PRODUCTION TESTING OF RESISTANCE, CAPACITANCE OR INDUCTANCE

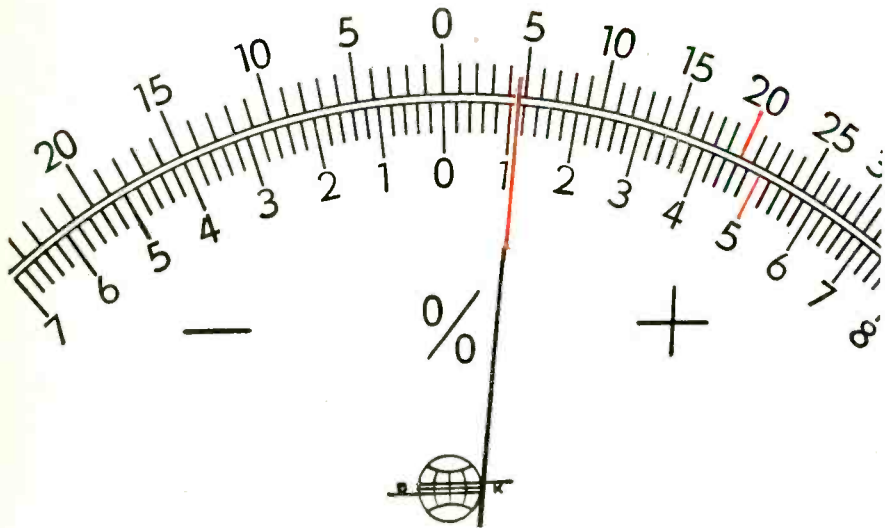

Actual size photo of center portion of dial.

Big, easy-to-read dial speeds inspection

Now you can have production testing on a high-speed basis with the Bruel & Kjaer Deviation Test Bridge (Model BL-1502). It is designed to test at rates up to 4000 units per hour. The dial, large and simple, is designed to permit fast reading without operator fatigue or inaccuracy.

This precision instrument reports the percentage deviation from a standard of your choice. The measurement can be the resistive, inductive or capacitive deviation characteristic. Write for bulletin. Brush Electronics Company, Dept. K-9, 3405 Perkins Avenue, Cleveland 14, Ohio. Outside of U. S. A. and Canada, address Bruel & Kjaer, Naerum, Denmark.

BRUSH ELECTRONICS

INDUSTRIAL AND RESEARCH INSTRUMENTS
PIEZO-ELECTRIC MATERIALS • ACOUSTIC DEVICES
MAGNETIC RECORDING EQUIPMENT
ULTRASONIC EQUIPMENT



COMPANY

formerly
The Brush Development Co.
Brush Electronics Company
is an operating unit of
Clevite Corporation.

any part of the grid touch the cathode. The grid support leads are now pushed into their holes in the fixture manually, after first swinging the lower part of the fixture to a vertical position.

The assembly is then swung back, the No. 2 grid is dropped into the slide, and it is similarly pushed into holes. The second grid rides on grooves in the slide, so that it clears the first grid without touching.

The remaining electrodes are then put on manually without the use of the slide, since they are sturdier and have greater clearance.

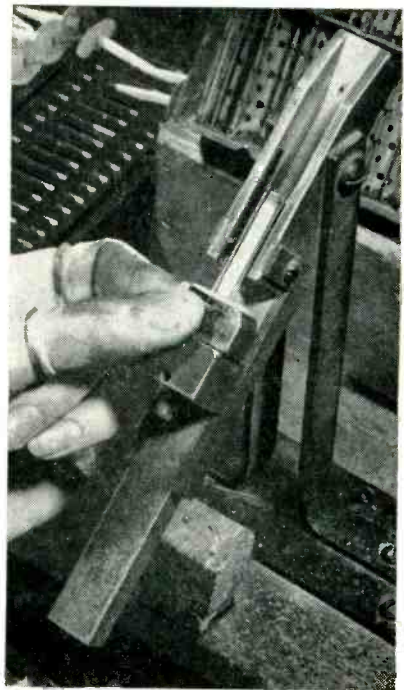

Method of using sliding fixture for assembly of vacuum tubes. Grid No. 1 has already been installed, and grid No. 2 is about half-way down to its final position. Lower part of fixture can be swung to vertical position temporarily for adjusting grid leads after assembly

Heated Stripper for Coaxial Cable

TO MINIMIZE the risk of nicking inner conductors of polyethylene-insulated coaxial cable when stripping insulation from an end preparatory to making a connection, the simple heated stripper shown in the accompanying diagram was developed by Navy Yard Mare Island.

An edged V is cut in one end of a

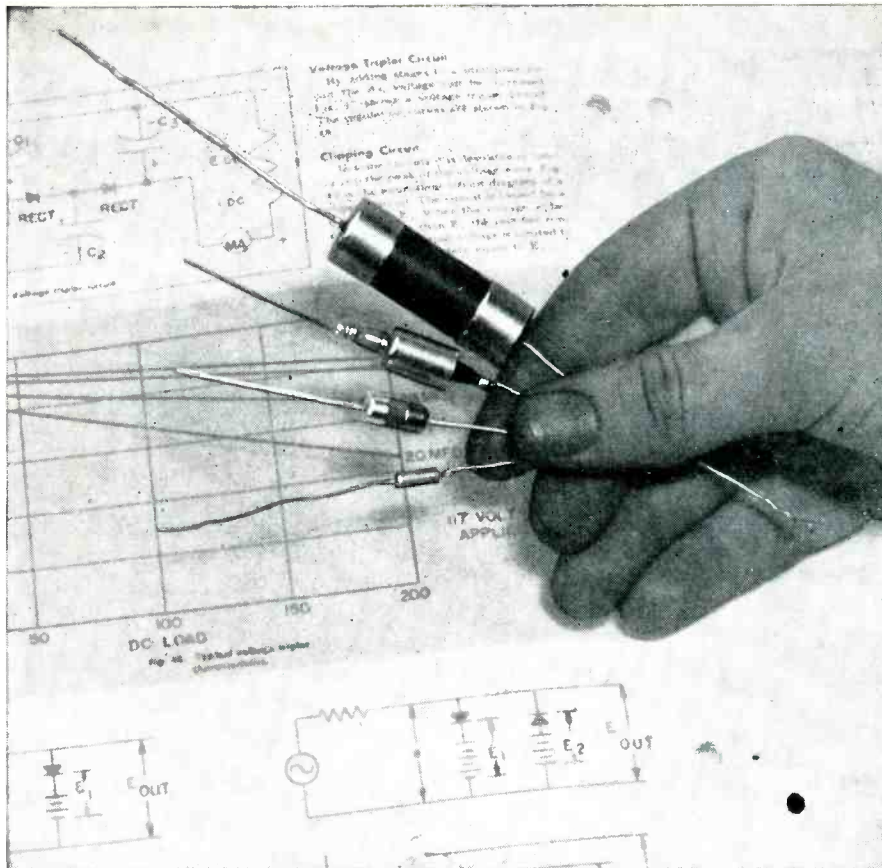

STACKS ARE AVAILABLE IN TEXTOLITE* TUBES OR HERMETICALLY SEALED CASINGS

G.E. Announces A New Line of Miniature Selenium Rectifiers

General Electric's new miniature selenium rectifiers are produced by the same carefully controlled process, and offer the same outstanding characteristics as larger G-E selenium rectifiers.

APPLICATIONS. In electronic applications, G-E miniature selenium rectifiers may be used in blocking, electronic computer, magnetic amplifier, communication, and signal circuits. They also can be used to operate small relays, solenoids, and precipitators.

ADVANTAGES. G-E miniature selenium stacks have long life, good regulation, and high reverse resistance. They will function over an ambient temperature range from minus 55 C through 100 C, and their totally enclosed construction provides excellent environmental protection.

Their small size and low heat rise permit compact mounting close to other components.

RATINGS. At an ambient temperature of 35 C, ratings for single stacks range from 0.5 ma d-c at 26 volts RMS, to 25 ma d-c at 5200 volts RMS. Higher ratings may be obtained by combining stacks. Two types of totally enclosed casings are used: Textolite* tubes for ordinary operating conditions, or hermetically sealed, metal-clad casings to meet government specifications for severe environmental conditions. Stacks can be furnished for either lead or bracket mounting.

FOR MORE INFORMATION consult your nearest G-E Apparatus Sales Office, or write Section 461-28, General Electric Co., Schenectady 5, N.Y.
*Registered Trade-mark of General Electric Co.

METALLIC RECTIFIER FACTS FOR ENGINEERS

High Temperature Operation

by C. E. Hamann

The rapidly expanding use of metallic rectifiers in the last few years has brought about a concerted effort within the industry to improve their quality and electrical characteristics through technological developments.

One of the outstanding accomplishments has been the great improvement in temperature characteristic of selenium rectifiers. Not only is it possible for selenium cells to be operated at higher temperatures, but in addition their range of operating temperatures has been increased. Selenium cells manufactured only a few years ago utilized a low melting-point metal alloy as a counter-electrode material. Recently, methods have been developed for applying alloys having melting points from 50 to 100 per cent higher than previous types. Thus higher operating temperatures are possible.

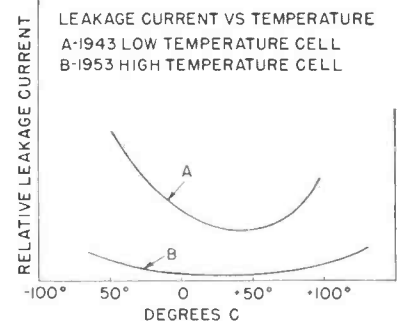

Concurrently, there has been considerable improvement in blocking characteristics. Thus, quality selenium rectifiers now give greater stability at both high and low extremes of temperature. These facts are highly important in meeting essential requirements for military applications and commercial uses.

Only continuing research and development programs make possible the improvements in the quality of metallic rectifiers necessary to meet the increasingly severe requirements of their applications.

C. E. Hamann
General Electric Company

You can put your confidence in —

GENERAL  ELECTRIC

NOW READ VOLTAGE RATIOS OF 100,000 to 1

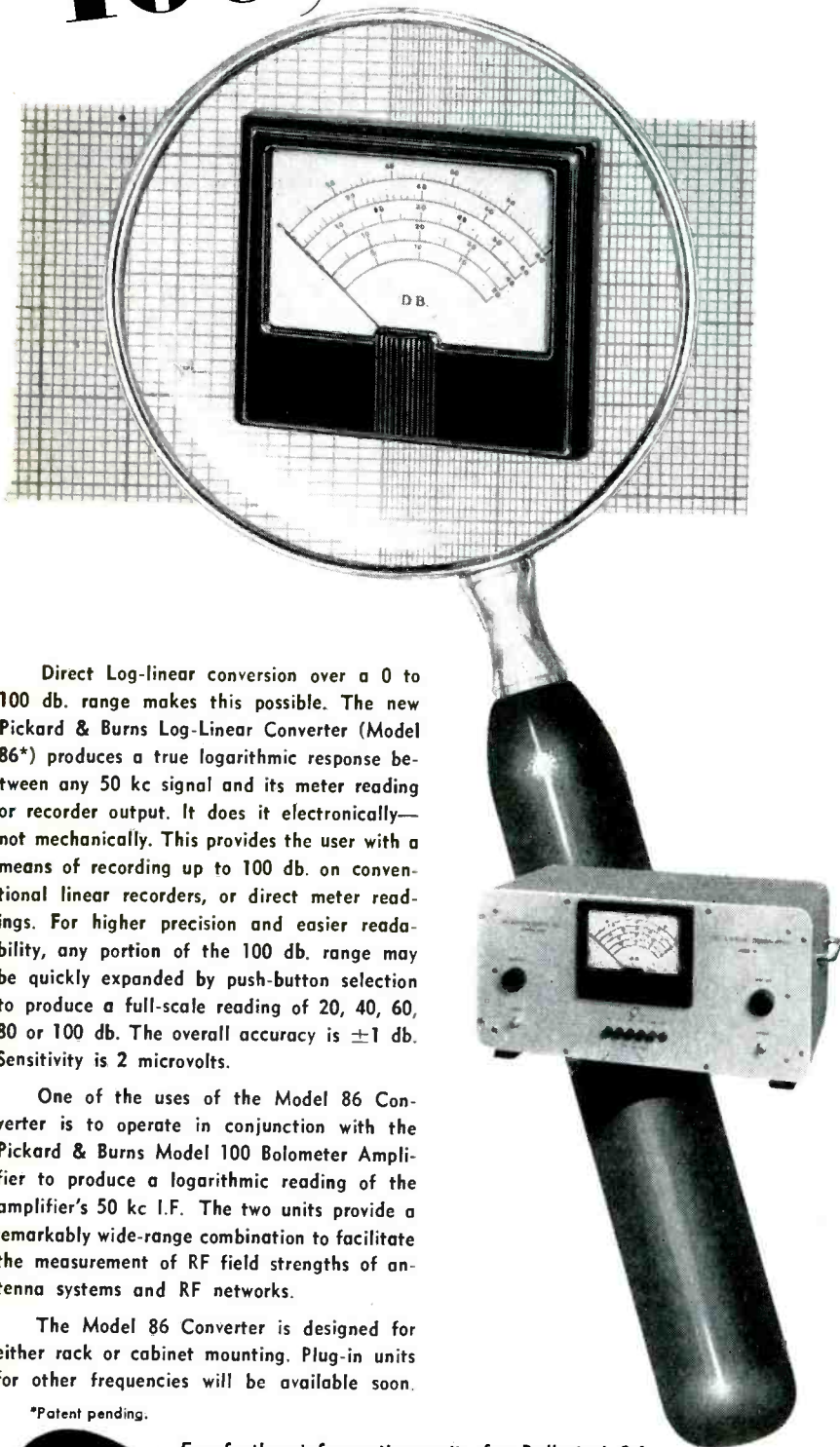

Direct Log-linear conversion over a 0 to 100 db. range makes this possible. The new Pickard & Burns Log-Linear Converter (Model 86*) produces a true logarithmic response between any 50 kc signal and its meter reading or recorder output. It does it electronically—not mechanically. This provides the user with a means of recording up to 100 db. on conventional linear recorders, or direct meter readings. For higher precision and easier readability, any portion of the 100 db. range may be quickly expanded by push-button selection to produce a full-scale reading of 20, 40, 60, 80 or 100 db. The overall accuracy is ± 1 db. Sensitivity is 2 microvolts.

One of the uses of the Model 86 Converter is to operate in conjunction with the Pickard & Burns Model 100 Bolometer Amplifier to produce a logarithmic reading of the amplifier's 50 kc I.F. The two units provide a remarkably wide-range combination to facilitate the measurement of RF field strengths of antenna systems and RF networks.

The Model 86 Converter is designed for either rack or cabinet mounting. Plug-in units for other frequencies will be available soon.

*Patent pending.

For further information write for Bulletin L-86



PICKARD & BURNS
INCORPORATED

24 Highland Avenue, Needham 94, Mass.

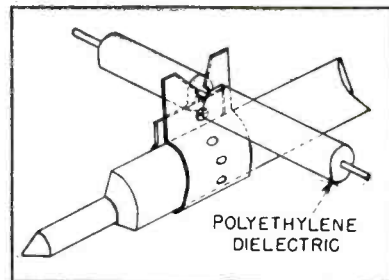

Method of mounting stripping blade on soldering iron

piece of copper strip, with a $\frac{1}{8}$ -inch wire slot in the bottom of the V. This strip is then wrapped around and bolted to the heating portion of an ordinary soldering iron. The cable insulation to be stripped is laid in the V and rotated. This stripping tool melts a clean, cauterized or vulcanized break that permits the end insulation to be removed easily with a slight pull. This method can be used on rubber insulation as well.

Whisker-Forming Fixture for Transistors

THIN PLATINUM-RUTHENIUM WIRE whiskers for point-contact transistors are formed to the correct angle and length with a simple manually operated fixture developed for pilot-plant production by Tung-Sol.

To load a length of wire into the

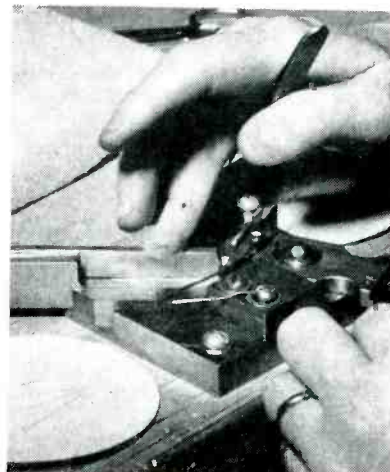

Operator pushes shearing bar with right hand to trim contact for transistor to correct length after bending. Bending slide is near fingers of left hand. Finished contacts can be seen on paper disc

GENERAL CERAMICS FERRAMIC* CORES *REG. TRADE MARK

Now available in standard types that simplify design and speed delivery!

STANDARD TOROID CORES



PART NO.	FIG. NO.	A	B	C
F-394	1	.080	.050	.025
F-259	2	.230	.120	.060
F-262	2	.375	.1875	.125
F-109-1	2	.870	.540	.093
F-109-2	2	.870	.540	.156
F-109-3	2	.870	.540	.250
F-226-1	2	1.125	.750	.125
F-226-2	2	1.125	.750	.500
F-268-1	2	1.250	.750	.187
F-268-2	2	1.250	.750	.375
F-268-3	2	1.250	.750	.250
F108	1	1.875	1.375	.250

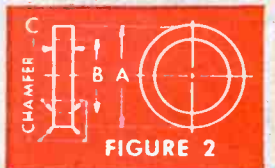
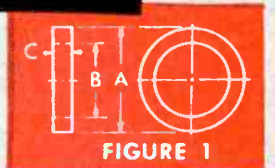

STANDARD CUP CORES

TYPE F-269



TYPE F-270



TYPE F-280 (ILLUSTRATED)
TYPE F-211 NO HOLE OR STEP
TYPE F-261 WITH HOLE, NO STEP



TYPE F-283 (ILLUSTRATED)
TYPE F-210 NO HOLE OR STEP
TYPE F-260 WITH HOLE, NO STEP

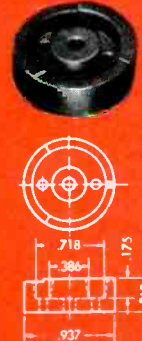

TYPE F-289



TABLE OF MAGNETIC PROPERTIES OF FERRAMICS

PROPERTIES	UNIT	A	B	C	D	E	G	H	H-1	I	J	N
Initial Perm. at 1 mc/sec	—	20	95	250	410	750	410	850	550	900	330	200
*Max. Permeability	—	100	180	1100	1030	1710	3300	4300	3800	3000	750	500
*Sat. Flux Density	GAUSS	1500	1900	3600	3100	3800	3200	3400	2700	2000	2900	3000
*Residual Magnetism	GAUSS	1000	830	2700	1320	1950	1050	1470	1500	700	1600	2300
*Coercive Force	DERSTED	5.0	3.0	2.1	1.0	.65	.25	.18	.35	.30	.80	.50
Temp. Coef. of Initial Perm.	%/°C	.15	.04	.40	.30	.25	1.3	.66	.80	.30	.22	.14
Curie Point	/°C	300	260	330	165	160	160	150	125	70	180	290
Vol. Resistivity	ohm-cm	1x	2x	2x	3x	4x	1.5x	1x	2x	2x	5x	6x
	—	10 ⁷	10 ⁵	10 ⁶	10 ⁷	10 ⁵	10 ⁸	10 ⁴	10 ⁴	10 ⁵	10 ⁷	10 ⁷
Loss Factor:												
At 1 mcs/sec	—	.0005	.0016	.00007	.00005	.00008	.00008	.00030	.0004	.0003	.000055	.000035
At 5 mcs/sec	—	.0007	.0011	.0008	.0012	.002	.00075	.00155	.001	.005	.0004	.00012

*Measurements made on D.C. Ballistic Galvanometer with Hmax = 25 Oersted. Above data based on nominal values.

The above standard items are available in all of the types of Ferramic material shown in the table of properties. Other shapes

and sizes of cores can be made of the above materials to your design. For further details or quotations call, write or wire today.



General CERAMICS and STEATITE CORP.
General Offices and Plant: KEASBEY, NEW JERSEY

MAKERS OF STEATITE, ALUMINA, ZIRCON, PORCELAIN, FERRAMICS, LIGHT DUTY REFRACTORIES, CHEMICAL STONWARE, IMPERVIOUS GRAPHITE & FERRAMIC MAGNETIC CORES

Another New Heiland Product

Heiland

Amplifier System



Model 119—Designed as a companion to the versatile "700 Series" Heiland Recording Oscillograph and Model 82-6 Bridge Balance unit.

for
Multi-Channel
Oscillograph
Recordings

Now, for the first time, a complete measuring system, including Oscillograph, Amplifier and DC balancing units, can be conveniently installed in a standard 19-inch relay rack with the accessory mounts available, or placed side by side on tables with equal ease and simplicity. Removable shock mount bases can also be supplied for installation in moving vehicles, aircraft, etc., where shocks and accelerations are encountered. Housed in a rugged, yet lightweight cast aluminum case finished in attractive silver-gray gloss enamel.

FEATURES:

- Rack, table or shock mounting
- Plug-in units, readily removable
- Compact
- Rugged
- One - surface operation
- Local or remote calibration
- High sensitivity
- Carrier Amplifier flat to 1000 cps.
- High power output
- Two or more systems may be synchronized
- Low gage - voltage required for maximum output
- Highly stable carrier generator
- High stability amplifiers

Specifications

Size: 11" x 16" x 18" (6 channels and power supply)
 Weight: Approximately 70 pounds (6 channels and power supply)
 Number of Channels: 6
 Power Output: ± 50 Ma. into 18 ohm load
 Sensitivity: .0005 volts input for full scale output
 Carrier Frequency: 5000 cps.
 Frequency Range: Carrier 1000 cps.. linear integrating 3000 cps.

See the first showing of the Heiland Model 119 Amplifier System at the I.S.A. Show—Chicago, September 21 through 25.

Write for our free catalog of Recording Oscillographs, Bridge Balance units & Galvanometers.



Heiland Research Corporation

130 East Fifth Avenue, Denver, Colorado

fixture, a spring-held block is pulled back by gripping its thumb notches. While the wire is held by this block, the operator pushes a slide that bends the end to the correct angle to serve as the contact. Next, a shearing bar is pushed downward to cut the bent contact end precisely to the correct length.

Induction Soldering of Capacitors

RAPID soldering of cans for hermetically-sealed capacitors is done by induction heating at the North Bergen, N. J. plant of Pyramid Electric Co.

Each unit in turn is placed on a sliding wood fixture, a solder pre-

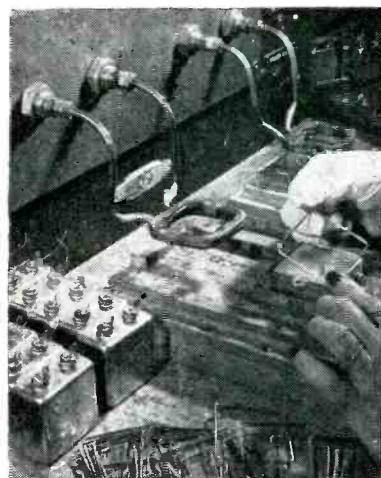

Placing solder preform over metalized bathtub capacitor loaded on slide



With a capacitor placed under each of the two work coils, power is applied by moving lever on panel with right hand, to melt the solder. Adjustable-height rods at ends of strip slide on bench top and serve to keep capacitors automatically at correct height for work coil

RMC

DISCAPS[®]

TYPE C

REPLACE TUBULAR CERAMIC and MICA CONDENSERS AT LOWER COST!

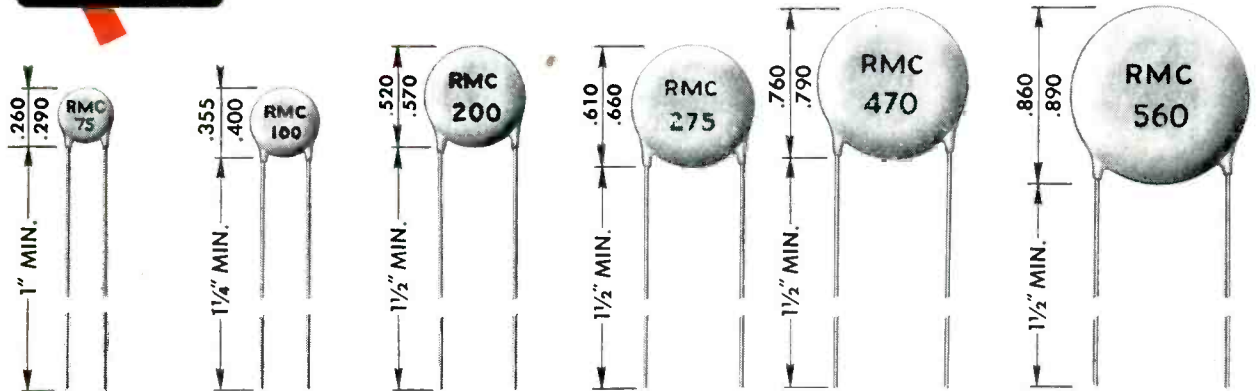

TC	1/4 Dia.	5/16 Dia.	1/2 Dia.	5/8 Dia.	3/4 Dia.	7/8 Dia.
P-100	1- 3 MMF	4- 9 MMF	10- 30 MMF			
NPO	2- 12	13- 27	28- 60	61- 75 MMF	76-100 MMF	101-150 MMF
N- 33	2- 15	16- 27	28- 60	61- 75	76-100	101-150
N- 80	2- 15	16- 27	28- 60	61- 75	76-120	121-150
N- 150	2- 15	16- 30	31- 60	61- 75	76-140	141-150
N- 220	3- 15	16- 30	31- 75	76-100	101-150	151-190
N- 330	3- 15	16- 30	31- 75	76-100	101-150	151-190
N- 470	3- 20	21- 40	41- 80	80-120	121-200	201-240
N- 750	5- 25	26- 56	57-150	151-200	201-280	281-350
N-1400	15- 50	51-100	101-200	200-250	251-330	331-560
N-2200	47- 75	76-120	121-200	201-275	276-470	471-560

RMC Type C temperature compensating DISCAPS are available in a wide range of capacities in temperature coefficients between P-100 and N-2200. Featuring smaller size, lower self inductance, and greater dielectric strength, Type C DISCAPS assure trouble-free performance on VHF or UHF applications. Rated at 1000 working volts, DISCAPS provide a high safety factor.

Today, practically all major television and electronic manufacturers use DISCAPS. They combine many electrical and mechanical advantages with a lower initial price permitting substantial production cost reductions.

If you have a design problem requiring a standard or special type of ceramic capacitor our engineers are at your service.

SPECIFICATIONS:

POWER FACTOR: Less than .1% at 1 megacycle

WORKING VOLTAGE: 1000 V.D.C.

TEST VOLTAGE (FLASH): 2000 V.D.C.

CODING: Capacity, tolerance and TC stamped on disc

INSULATION: Durez phenolic-vacuum waxed

INITIAL LEAKAGE RESISTANCE: Guaranteed higher than 7500 megohms

AFTER HUMIDITY LEAKAGE RESISTANCE: Guaranteed higher than 1000 megohms

LEADS: No. 22 tinned copper (.026 dia.)

TOLERANCES: $\pm 5\%$ $\pm 10\%$ $\pm 20\%$

These capacitors conform to the RTMA specification for Class 1 ceramic condensers.

The capacity of these condensers will not change under voltage.

SEND FOR SAMPLES AND TECHNICAL DATA

DISCAP
CERAMIC
CONDENSERS



RADIO MATERIALS CORPORATION

GENERAL OFFICE: 3325 N. California Ave., Chicago 18, Ill.

FACTORIES AT CHICAGO, ILL. AND ATTICA, IND.

DISTRIBUTORS: Contact Jobber Sales Co., 146 Broadway, Paterson 1, N. J.

YOU CAN ALWAYS RELY ON EDISON COMPONENTS

for Electronic
and
Communications Equipment
Because of:

HERMETICAL SEALING in rigid glass.

TAMPER-PROOF stability that defies time and abuse.

ACCURACY. Patented feature permits calibration *after* sealing.



THERMAL TIME DELAY RELAYS

Cathode and filament protection • Gyra Erection • Prevent surges and false starts in sensitive auxiliary equipment • Miscellaneous circuit switching

SPECIFICATIONS

Standard Octal Base

Delays ... 2 seconds to 5 minutes
Heater ... 5 watts nominal, continuous operation
Voltages: 6.3, 26.5 and 117
Contacts ... 6 amps maximum, 3 amps to 450 volts a.c. or d.c.
Vibration ... 1/16" amplitude at 55 cps. 50g shock.
Ambient ... -60 to +85°C Seated Height ... 3 1/4" max.

Miniature 7-Pin Base

Delays ... 5 seconds to 75 seconds
Heater ... 2.5 watts nominal, continuous operation
Voltages: 6.3 and 27.5
Contacts ... 2.5 amps max. 1 amp at 125 volts d.c.
Vibration ... 1/16" amplitude at 55 cps. 50g shock.
Ambient ... -60 to +85°C Seated Height ... 2 1/4" max.

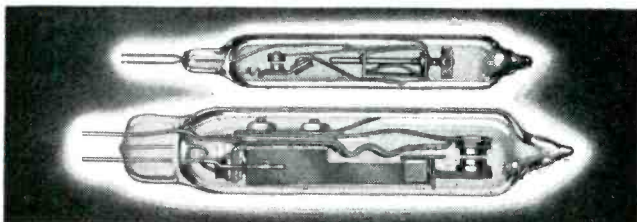

SEALED THERMOSTATS

Ambient protection for frequency standards • Precision heat control for electronic laboratory instruments • Overheat detection and fire alarm

SPECIFICATIONS

Heavy duty—type D8

Max. temp. ... 320°C
Max. watts ... 1000
Max. amps. ... 8.0 d.c.
Calibration tolerance ... ± 2.5°C
Length, 2 3/4"; dia., 9/16" (approx.)

Precision control—type S1

Max. temp. ... 190°C
Max. watts ... 150
Max. amps. ... 1.0
Control differential at 1/4 amp = 0.1°F
Length, 2 1/2"; dia., 3/8" (approx.)

Write for free bulletins and application data to:

Thomas A Edison
INCORPORATED

Instrument Division

DEPT. 54, WEST ORANGE, NEW JERSEY

YOU CAN ALWAYS RELY ON EDISON

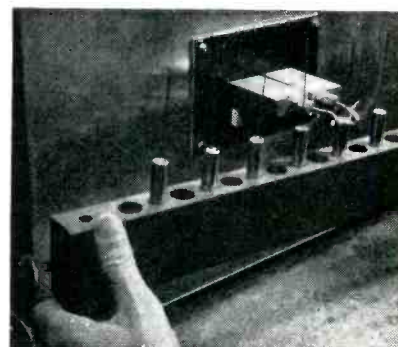

Tubular capacitors in heat-resistant jig are each held in loop of work coil for a few seconds until solder has fused, to give hermetic seals

form is placed over the seam, and the slide is moved to its forward position. This brings the capacitor under the work coil of the induction heater. A second jig is similarly loaded and positioned. A lever switch is then operated to apply r-f power to the two work coils for melting solder. The heating unit is a model S-6 made by Scientific Electric Co., Garfield, N. J

Another induction heater, made by Radio Frequency Corp. of Boston, Mass., is used in the same plant to solder-seal the ends of tubular metallized paper capacitors. The capacitors are placed in a jig made by drilling part-way through a cotton-bonded plastic strip. A smaller center hole drilled completely through accepts the capacitor lead. After the strip is loaded with capacitor units and ring-shaped solder preforms, the operator grasps the ends of the strip and holds each unit in turn in the U-shaped continuously-energized work coil until the solder melts.

The solder preforms used in both operations are made by winding a spiral of wire solder on a mandrel of appropriate size and shape. A lengthwise cut is then made to separate the spiral of solder into individual loops.

Hair Drier Heats Diodes

To MATCH pairs of diodes for frequency response at the higher extreme of the specified operating temperature range (55 deg C), an ordinary hair drier[®] is used to direct a stream of hot air at the diodes. A shelf for diodes being warmed

faster a new twist

to speed your production

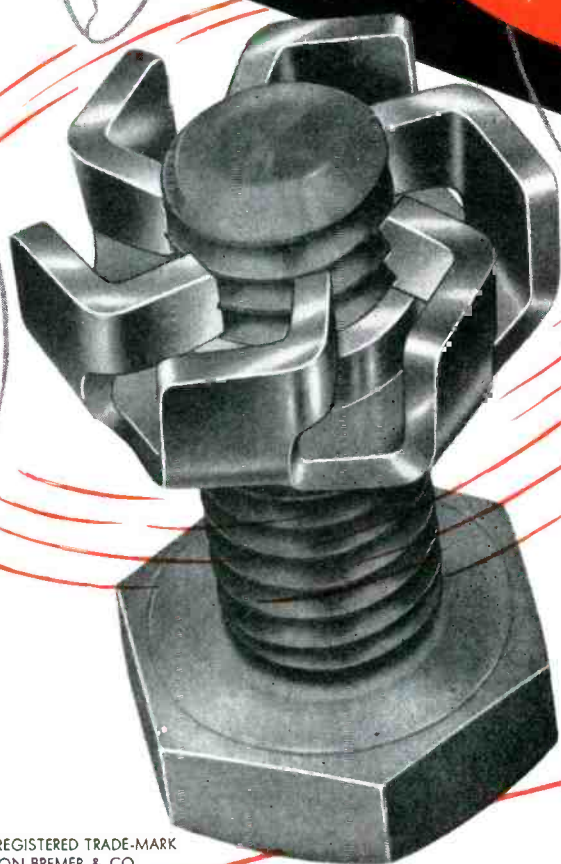

Spins down finger-free—locks securely with a twist of wrench or power tool. Re-useable over and over again. For truly vibration-proof performance and faster handling—specify Everlock nuts.

DEVELOPED AND PATENTED BY

**THOMPSON-BREMER
& COMPANY**

520 N. Dearborn Street, Chicago 10, Illinois

SUBSIDIARY OF AMERICAN MACHINE AND FOUNDRY CO., NEW YORK

"EVERLOCK" IS A REGISTERED TRADE-MARK OF THOMPSON-BREMER & CO.

• Write For Information or Contact Your nearest Distributor

Kenneth D. DeLaney
1942 Speice Avenue
Dayton, Ohio

J. M. Murphy
355 Middle Turnpike
Manchester, Connecticut

W. L. Barth, Jr.
5933 W. Addison
Chicago, Illinois

Thom Lundeen
505 Cleaveland Bldg.
Rock Island, Illinois

Richard C. Dudek
405 N. Maple Drive
Beverly Hills, California

J. J. McIntosh
2335 Edinburgh Ter., NE
Atlanta 6, Georgia

Oscar P. Martin
1466 Belle Avenue
Lakewood 7, Ohio

Russell T. Brosius
1617 Pennsylvania Blvd.
Philadelphia 3, Pa.

C. W. McNeil
704 M & M Bldg.
Houston, Texas

David A. Smith
1246 Hampton Ave.
St. Louis, Missouri

P. L. Robertson
Mfg. Co., Ltd.
Milton, Ontario, Canada

Donald G. Teeling
6060 N. Millersville Rd.
R.R.13, Box 128
Indianapolis 44, Ind.

J. Ramsey Reese, Inc.
71 Murray Street
New York, New York

Sam I. Keller
2457 Woodward Ave.
Detroit, Michigan

Leonard F. Berg
2639 University Ave.
St. Paul 4, Minnesota

A. J. Murphy
4457 E. Genesee St.
DeWitt, New York

Sam T. Gleaves
2206 Wadsworth Ave.
Louisville 5, Kentucky

• • • • •

PATTERN OF RELIABLE PERFORMANCE

Industry's demands for sturdy, dependable crystal components are many... and so are the Reeves-Hoffman Units to meet them.

Every Reeves-Hoffman Quartz Crystal Unit is built with the same exacting care to meet the most precise commercial and military specifications from 16 kc to 100 mc.

When you buy, be sure to specify...



REEVES-HOFFMAN..... The finest name in crystals



REEVES

HOFFMAN Corporation

a subsidiary of Claude Neon, Inc.

CARLISLE, PENNSYLVANIA

LICENSED UNDER PATENTS OF THE BELL SYSTEM

up is made by mounting a strip of insulating plastic on a small stand after drilling a series of holes large enough to take the pigtail leads of the diodes. Immediately in front of this shelf are the test clips in which the heated diode is placed for checking response at 4.3 mc.

As soon as the operator takes a diode off the shelf for measurement, she places another in the air stream to heat up. A cold test at -40 deg. C is similarly made in an insulated box which is kept filled with dry ice.

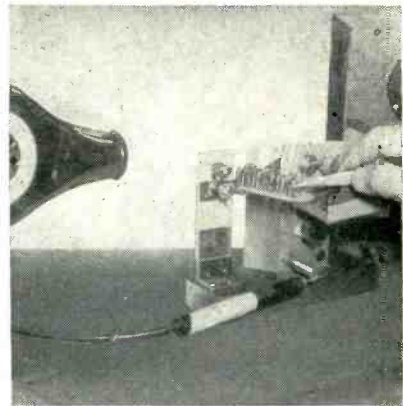

Placing germanium diode on shelf in air stream of hair drier, to heat up for a response test in Raytheon's Brighton Mass. plant

Dual-Head Punch Press Mounts Eyelet Sockets

THE TIME CYCLE for inserting a tube socket in its chassis hole and riveting it into position is cut almost in half through use of the new Sylvania integral-eyelet sockets and a dual-head riveting machine, in the auto radio manufacturing section of Sylvania's Buffalo manu-



Closeup of integral-eyelet socket that eliminates need for separate mounting rivets

VOLTAGE REGULATED POWER SUPPLIES

For Industrial and Research Use

by
KEPCO

Kepeco
Voltage Regulated
Power Supplies are
conservatively
rated. The regulation
specified for each unit
is available under all line
and load conditions
within the range of
the instrument.

Write for complete
specifications.

VOLTS	CURRENT	REGU- LATION	RIPPLE	6.3 V.† AC. CT.	MODEL
0-1500	0-200 Ma.	0.5%	20 Mv.		1520
0-1200	0-20 Ma.	0.1%	10 Mv.	10 Amp.	1220
0-1000	0-500 Ma.	0.5%	20 Mv.		1350
200-1000	0-500 Ma.	0.5%	20 Mv.		1250
0-1000	0-50 Ma.	0.1%	10 Mv.	10 Amp.	1020
0-600	0-3 Amp.	0.5%	10 Mv.		780
0-600	0-2.25 Amp.	0.5%	10 Mv.		770
0-600	0-1.5 Amp.	0.5%	10 Mv.		760
0-600	0-750 Ma.	0.5%	10 Mv.		750
0-600	0-300 Ma.	0.5%	5 Mv.	10 Amp.	615
0-150 Bias	0-5 Ma.	*	5 Mv.		
0-600	0-300 Ma.	0.5%	5 Mv.	10 Amp.	500R
#1 0-600	0-200 Ma.	0.5%	5 Mv.	10 Amp.	800
#2 0-600	0-200 Ma.	0.5%	5 Mv.	10 Amp.	
0-600	0-200 Ma.	0.5%	5 Mv.	10 Amp.	815
0-150 Bias	0-5 Ma.	*	5 Mv.		
#1 200-500	0-200 Ma.	0.5%	5 Mv.	6 Amp.	510
#2 200-500	0-200 Ma.	0.5%	5 Mv.	6 Amp.	
200-500	0-200 Ma.	0.5%	5 Mv.	6 Amp.	245
0-400	0-150 Ma.	0.5%	5 Mv.	10 Amp.	400
0-150	0-5 Ma.	*	5 Mv.		
100-400	0-150 Ma.	0.5%	5 Mv.	10 Amp.	141
100-400	0-150 Ma.	0.01%	1 Mv.	10 Amp.	2000
0-350	0-3 Amp.	0.5%	10 Mv.		730
0-350	0-2.25 Amp.	0.5%	10 Mv.		720
0-350	0-1.5 Amp.	0.5%	10 Mv.		710
0-350	0-750 Ma.	0.5%	10 Mv.		700
100-325	0-150 Ma.	0.5%	5 Mv.	10 Amp.	131
0-150 Bias	0-5 Ma.	*	5 Mv.		
0-300	0-150 Ma.	0.5%	5 Mv.	5 Amp.	315
0-150 Bias	0-5 Ma.	*	5 Mv.		
0-150	0-50 Ma.	0.5%	5 Mv.		150
3-30	0-30 Amp.	0.5%	0.1%		3030
1-13	0-10 Amp.	0.5%	10 Mv.		3200
0.3-3	0-100 Ma.	5 Mv.	1 Mv.		3100

DC POWER SUPPLY SPECIFICATIONS

REGULATION:

As shown in
table for both line
fluctuations from 105-
125 volts and load varia-
tion from minimum to maxi-
mum current.

*Regulation Bias Supplies: 10 milli-
volts for line 105-125 volts. 1/2%
for load at 150 volts.
†All AC Voltages are unregulated.

All units are metered except
Models 131, 315 and 3100.

All units are designed for
relay rack mounting
or bench use.

WORKMANSHIP

Workmanship is of a quality with the highest exist-
ing production standards and best instrument elec-
tronic practices consistent with the intended use of
the item as a continuous duty voltage regulated
power supply. Oil filled paper condensers and re-
sistor-board construction are included in the design.

MANUFACTURERS OF ELECTRONIC EQUIPMENT • RESEARCH • DEVELOPMENT



KEPCO

LABORATORIES

131-38 SANFORD AVENUE • FLUSHING 55, NEW YORK



for **YOUR** product

WHICH PILOT LIGHT DO YOU NEED?

THE BIG ONE

This Pilot Light Assembly was first made to accommodate the S-11 lamp and was intended for use in the cabs of great diesel locomotives.

THE LITTLE ONE

The miniaturization program on defense products required the development of this sub-miniature light. It is used on communication equipment and aircraft. Midget flanged base bulbs to fit are rated 1.3, 6, 12, and 28 volts.

Dialco HAS THE COMPLETE LINE of INDICATOR and PANEL LIGHTS

Samples to suit your own special conditions and requirements will be sent promptly and *without cost*. Just outline your needs. Let our engineering department assist in selecting the *right lamp* and the *best pilot light* for YOU.



Write for the Dialco HANDBOOK of PILOT LIGHTS

Foremost Manufacturer of Pilot Lights

DIALIGHT CORPORATION

60 STEWART AVENUE, BROOKLYN 37, N. Y.

HYACINTH 7-7600



ACTUAL SIZE
Cat. # 613529-211

or



ACTUAL SIZE
Cat. # 8-1930-621

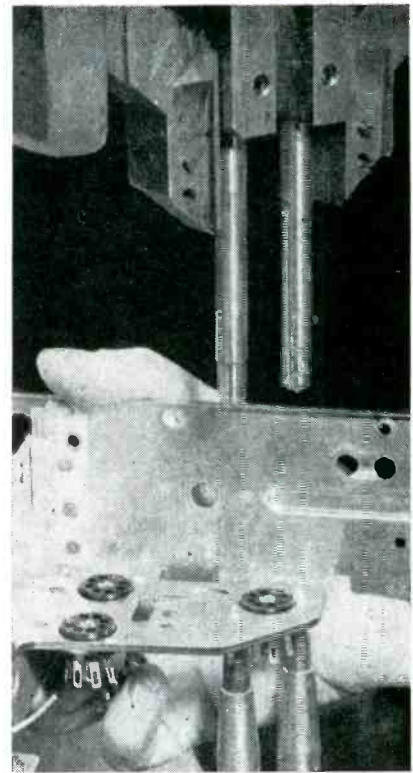
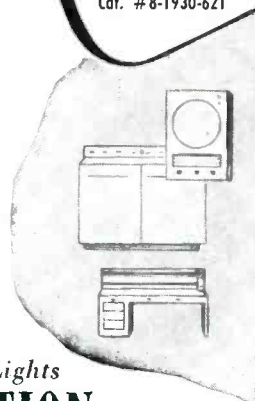

Socket and chassis in position ready for operation of riveting machine

facturing plant. The eyelets are made from the socket flange metal.

The operator simply places a socket on the pair of anvils, drops the chassis over the top of the socket so that the eyelets project up through punched chassis holes, then pushes the foot pedal of the press to complete the operation.

Heating Beeswax With Soldering Iron

BEEWAX IN AN empty bathtub paper capacitor housing is mounted on the holder for an electric soldering iron to keep the wax sufficiently warm and fluid all day long to use



Final adjustment of precision wire-wound resistors. Metal pan mounted on soldering iron holder keeps beeswax warm

Now available

the revolutionary
ELECTRO TEC
 process* for your
LARGE
SLIP RING
ASSEMBLIES



↗ An assembly with 14 concentric, hard silver rings electro deposited into machined plastic blank. Dovetail locks rings in place. Machined blank insures accuracy. Diameter approx. 11", thickness approx. 5/16".

↗ Cylindrical assembly with 25 rings. Three wide rings accommodate large contact area brushes for high current capacity. Length 14", O.D. approx. 5 3/8".

↗ An assembly with 30 rings of various widths to accommodate various current requirements. Unit is approx. 4.5/16" long, designed for flange mounting.

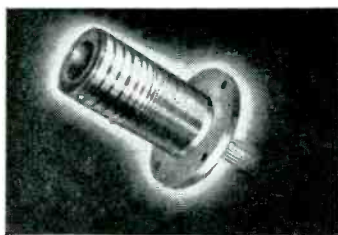

↗ Cylinder type assembly approx. 3 3/4" long with 24 hard silver rings. 1 3/8" O.D. with wall thickness less than 1/4".



*PATENTS
 PENDING

Our Engineering Department is available for consultation on any of your slip ring problems without obligation.



ELECTRO TEC CORPORATION
 SOUTH HACKENSACK • NEW JERSEY

featuring

- LOWER COST • CLOSER TOLERANCES
- ONE-PIECE CONSTRUCTION • JEWEL-LIKE FINISH • UNIFORM RING HARDNESS
- REDUCED WEIGHT



Now a Complete Service
 in all sizes of Slip Ring Assemblies

ELECTRO TEC is now tooled up, with new expanded facilities for production of large Slip Ring Assemblies to exact customer specification. Sizes range up to 24" in diameter, either cylindrical or disc type.

The exclusive ELECTRO TEC PROCESS*—the electro-deposition of hard silver rings into an accurately machined plastic blank—consistently yields a high degree of dimensional accuracy, excellent concentricity, and a jewel-like ring finish. This process also eliminates expensive tooling and mold charges, frequently lowers costs to 30% of other methods of manufacture. The silver rings are uniformly hard for long life—75-90 Brinell.

ELECTRO TEC one-piece construction precludes dimensional variation due to accumulated errors. The plastic base is fully cured before rings are plated into it, thus preventing separation of base material from the rings.

ELECTRO TEC LARGE SLIP RING Assemblies are widely used in Radar Equipment, Fire Control Systems, Test Tables and many other critical applications. Light weight combined with rugged durability recommends their use in airborne applications.

Every user knows the ELECTRO TEC reputation for quality and superiority in miniature and sub-miniature slip ring assemblies.

RUDOLF SCHAEFER

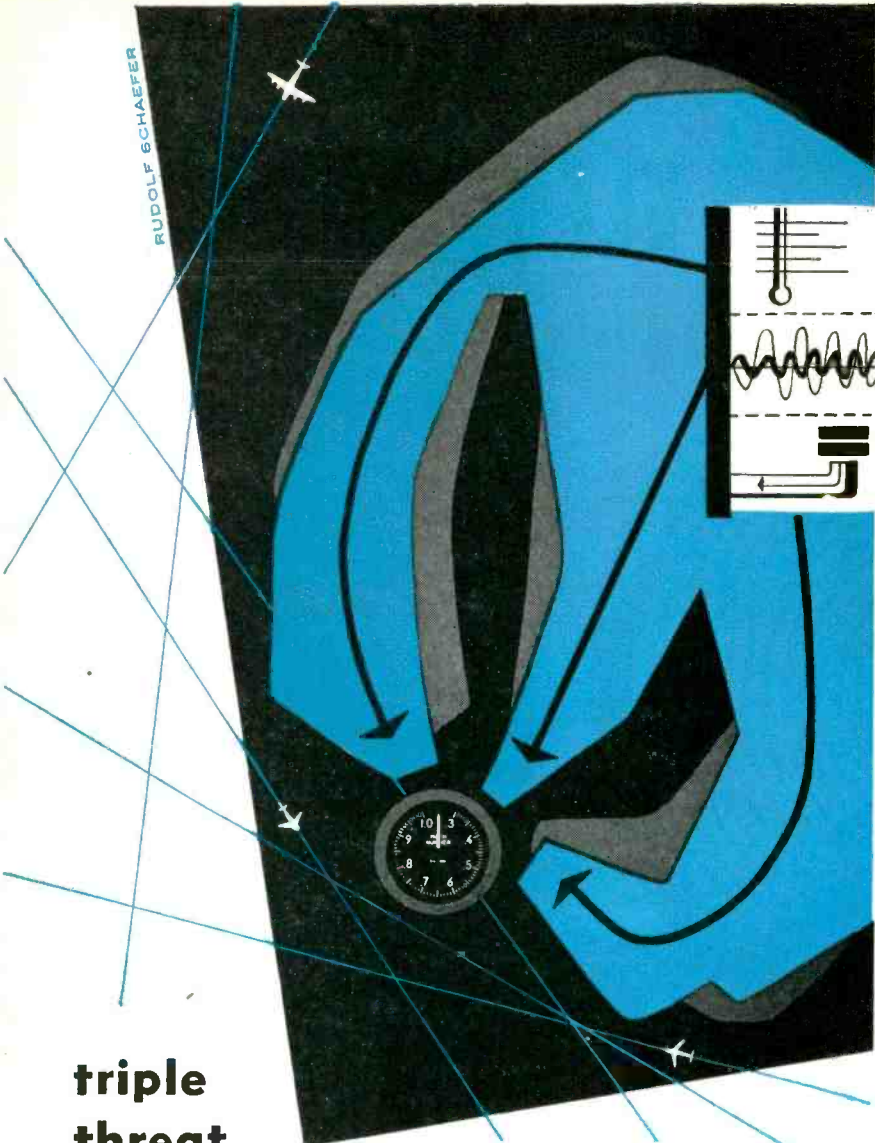

triple threat

Changing temperatures, vibrations, and accelerations affect the operation of all instruments. In spite of these variables, our products produce the right answers because they are properly designed.

- ✧ AIRCRAFT INSTRUMENTS AND CONTROLS
- ✧ OPTICAL PARTS AND DEVICES
- ✧ MINIATURE AC MOTORS
- ✧ RADIO COMMUNICATIONS AND NAVIGATION EQUIPMENT

Current production is largely destined for our defense forces; but our research facilities, our skills and talents, are available to scientists seeking solutions to instrumentation and control problems.



kollsman INSTRUMENT CORP.

ELMHURST, NEW YORK • GLENDALE, CALIFORNIA • SUBSIDIARY OF *Standard* COIL PRODUCTS CO., INC.

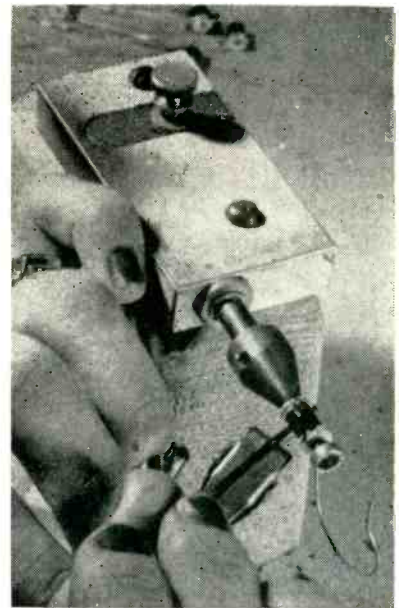

Method of using test clip and holding arbor to find point along resistance wire that gives desired resistor value to within as little as 0.05 percent tolerance

for anchoring fine resistance wire on ceramic forms. The wax is applied to the turns with an ordinary wood tooth pick. The holder used for the purpose is an American Beauty 660-watt temperature-regulating stand.

The wax is used after adjusting the length of wire in the resistor to bring it to within 0.05 or 0.1 percent of the specified value. This adjustment is done by mounting the ceramic bobbin on a simple arbor and moving a clip along the end of the wire while measuring the resistance with a galvanometer and Wheatstone bridge.

In this precision manufacturing operation at the plant of Hycor Co. in Vega Baja, Puerto Rico, management relies on simple arithmetical tests in selecting native workers. They quickly learn to manipulate the decade arms of the bridge to get an initial reading, and estimate the amount of clip movement needed along the length of the wire to bring the galvanometer to zero for the preset bridge value.

Tightening Connectors

AN AIR-OPERATED fixture with attached spanner wrench serves the double duty of holding a cable in position and providing a quick

Coming this November.....



NUCLEONICS BUYERS' GUIDE

THE OPPORTUNITY OF THE YEAR

If you are a manufacturer of products with applications in the nuclear energy field, you will certainly want to talk about them in the NUCLEONICS BUYERS' GUIDE. The reason? It's simply that those needing specialized product information

(physicists; electrical, electronic, chemical and mechanical engineers; metallurgists and project executives) have come to depend upon the NUCLEONICS BUYERS' GUIDE for the essential product data they must have.

AN EXPANDING INDUSTRY

The nuclear energy industry has already gone through the initial stage of development and is now ready to experience a phenomenal expansion program and take along with it those manufacturers with sufficient foresight to get their prod-

uct stories told in the right place and to the important buying influences. If your products have applications in this new industry, you will surely not miss displaying them in the November Issue.

RESERVE YOUR SPACE...

in the November NUCLEONICS BUYERS' GUIDE; your investment for getting to the more than 10,000 subscribers of NUCLEONICS plus other thousands of

pass-on readers. The rates are at the 1951 level. Pennies-per-reader for reaching the influential buying factors in this growth industry.

CLOSING DATES:

Last forms close: October 1; copy to be set: September 25.



Have you received your QUESTIONNAIRE for FREE listings in the forthcoming issue of the NUCLEONICS BUYERS' GUIDE?

Fill out the Questionnaire according to the regulations. The information we receive in this Questionnaire will provide you with FREE listings in the NUCLEONICS BUYERS' GUIDE. Do it now while there is still time. Make sure the company name and address are correct and that you have checked ALL products you manufacture! If you have not received the Questionnaire, clip the coupon at the right and mail it to us. You will receive yours by return post. Please return the completed Questionnaire by Sept. 15.

NUCLEONICS
330 WEST 42nd ST.
NEW YORK 36, N. Y.

Please send me the QUESTIONNAIRE for FREE listings in the 1953-1954 NUCLEONICS BUYERS' GUIDE.

NAME
COMPANY
ADDRESS



STANCOR ULTRA-MINIATURE TRANSFORMERS for TRANSISTOR CIRCUITS ...

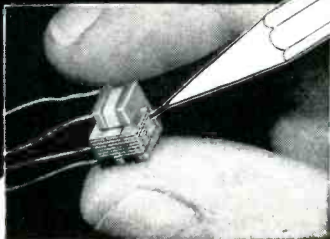

If you are having space problems with your transistor circuitry, consider these Stancor transformers as a means of solving your difficulties.

In addition to the units shown below, special transistor transformers, designed and built to your specifications by Stancor engineers, can be supplied in quantities of five or more.

These five Stancor ultra-miniature transformers, designed especially for transistor applications, are available through your local Stancor distributor. The smallest weighs 0.07 ounce and measures $\frac{1}{4}$ " x $\frac{3}{8}$ " x $\frac{3}{8}$ ". The largest weighs only 0.10 ounce and measures $\frac{3}{8}$ " x $\frac{3}{8}$ " x $\frac{3}{8}$ ".

Part No.	Application	Pri. Imp.	Sec. Imp.	Pri. DC Res.	Sec. DC Res.
UM-110	Interstage	20,000	1,000	1675	285
UM-111	Output or matching	1,000	50/60	120	9.0
UM-112	High imp. mic. input	200,000	1,000	4000	195
UM-113	Interstage	20,000	1,000	1350	205
UM-114	Output or matching	500	50/60	70	9.0

Write for Stancor Bulletin 462R listing complete data and performance curves on these units.



CHICAGO STANDARD TRANSFORMER CORPORATION
3578 ELSTON AVENUE • CHICAGO 18, ILLINOIS
EXPORT SALES: Roburn Agencies, Inc., 39 Warren Street, New York 7, N. Y.

means for tightening the cap onto the plug so as to obtain a water-tight seal for multiple-conductor cable.

In the assembly procedure recommended by Amphenol for power plugs, the cap is pushed down into position until it seats on the surface of the plug. The assembly is now placed in the special air fixture developed for the purpose, and air is applied with a foot-operated valve to hold the cap in position under pressure while it is being locked in place by tightening the spanner nut with the four-spoke wrench attached to the holding tool.

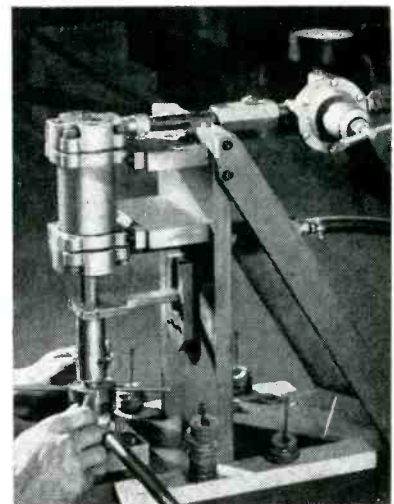

Air fixture developed to facilitate assembly of water-tight plugs on cables

Ejection Chutes for Small Wire Parts

HANDLING of the many shapes of lead wires used in vacuum tube manufacture is achieved with minimum rejects by Sylvania through use of special ejection chutes and devices for stacking the delicate finished components in small tote boxes.

For short, sturdy leads that can be stacked either way as long as they are parallel, a roughly fabricated metal chute is adequate. This flares out at its upper end to catch the leads as they drop out of the wire-cutting shears. The leads pass down the tube into a collecting box. From here, they are deflected against a guide plate and dropped down in a horizontal position into

Save Money, Maintenance and Man-hours!

GET YOUR **DC** FROM AC

with dependable, long-life

Federal

SELENIUM RECTIFIER

Power-Converting EQUIPMENTS

NO costly, bulky, moving equipment to buy ... no expendable parts to replace frequently ... virtually no maintenance! No wonder Federal's compact, rugged, always-dependable Selenium Rectifier Equipments are the growing answer to DC output requirements ... for industrial power, battery charging and hundreds of other DC applications.

Federal Equipments are ready to connect to your AC source ... ready to deliver uninterrupted DC power wherever you need it and whenever you need it!

Powered by Federal's completely inert selenium rectifiers, the life of Federal Equipments is practically *unlimited*. All are conservatively rated ... with a wide margin of safety to withstand momentary heavy overloads.



IF the DC output you need is not listed in Federal's line of standard power supply equipment, Federal will design and build to meet your specific requirements.

Tell us the rating you need ... write today to Dept. E-213A

"AMERICA'S FIRST AND LARGEST MANUFACTURER OF SELENIUM RECTIFIERS"

Federal

Federal Telephone and Radio Company

100 KINGSLAND ROAD, CLIFTON, N. J.

In Canada: Federal Electric Manufacturing Company, Ltd., Montreal, P. Q.
Export Distributors: International Standard Electric Corp., 60 Broad St., N. Y.

POWER SUPPLIES - Industrial, Military, Laboratory

Chucks, brakes, clutches, screens, separators, drums, pulleys, lifting magnets, relays, circuit-breakers, solenoids, DC motors - these are only a few of the wide variety of applications now being successfully served by Federal Power Supplies.

Federal's FTR-3152-AS

Typical of the many standard types ready for shipment

Rated:

115/230 volts, 4.4/2.2 amps.

AC Input: 220/440 volts

3-phase, 50/60 cycles



BATTERY CHARGERS - General Purpose

Battery Charging Equipments using Federal Selenium Rectifiers have received wide acclaim from all fields for their high efficiency, long life and minimum maintenance. Federal-engineered equipments are designed to give maximum battery life.

Federal's FTR-1339-AS

Typical of the many standard types ready for shipment

Rated: 3-12 cells, 15 amps.

AC Input: 115/230 volts

1-phase, 50/60 cycles



MAGNETIC AMPLIFIERS

Presently used in a wide range of successful applications for Industry and the Armed Forces, such as:

- Voltage Control
- Current Control
- Speed Control
- Position Control
- Temperature Control
- Photoelectric Control
- Counting
- Automatic Regulation

Federal Selenium Rectifiers, in partnership with the right magnetic components, provide Magnetic Amplifiers outstanding for:

Stability • Accuracy • Long Life
High Gain • Fast Response • Low-cost Operation

...an entirely new concept
of jewel mounting
for shock protection

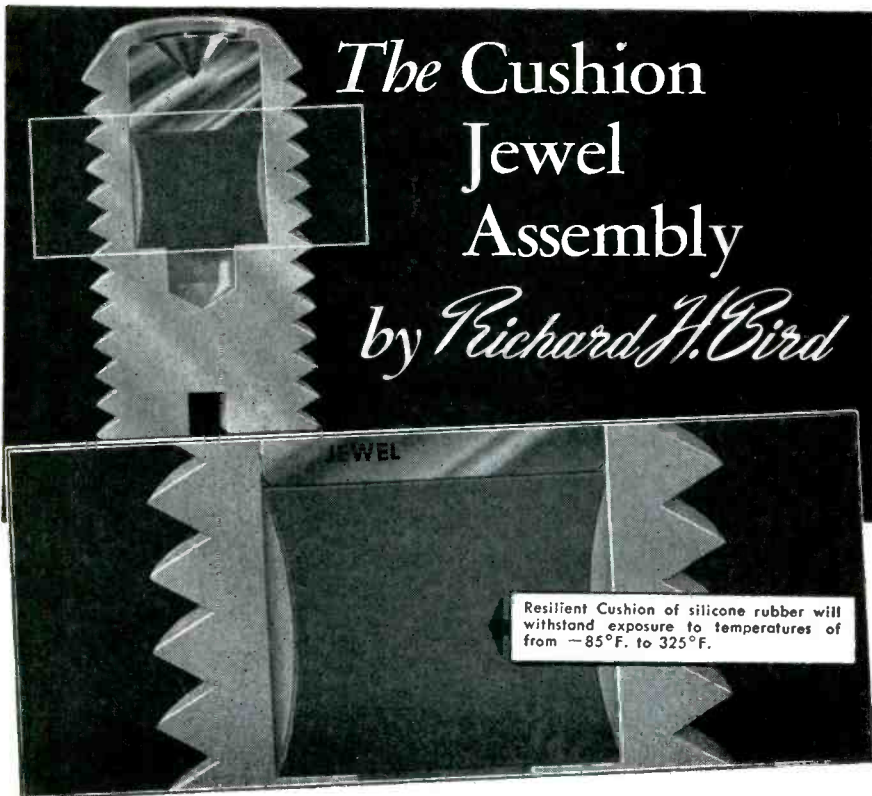

*The Cushion
Jewel
Assembly
by Richard H. Bird*

Here is your answer to protection for the critical jewel assembly in meters and instruments that must withstand severe shock and vibration conditions. Tests* show that BIRD Cushion Jewel Assemblies perform better and are less subject to damage than conventionally mounted jewels.

Actual assembly line tests show that damage to jewels through improper adjustments by inexperienced operators is practically eliminated when BIRD Cushion Jewel Assemblies are used. And Cushion Jewels are not expensive to use — you can include them in your production for pennies extra, with the added advantage of "protection" for your instruments under all conditions.

Bird Cushion Jewels for shock mounting

- Perform better, provide "protection"
- Variable cushioning to suit different operating conditions
- Produced in any mounting to specification
- Eliminates damage by inexperienced assemblers
- Controls movement of jewel — no loose assemblies
- Inexpensive shock-proofing for any instrument

* Tests, being conducted at the Squier Signal Laboratories, to compare cushioned and conven-

tional mounts, show that jewels that are cushion-mounted have a better resistance to vibration. Shock tests of instruments using cushion assemblies indicate better performance and less damage susceptibility than instruments using conventionally mounted jewels.

We want to show you how BIRD Cushion Jewel Assemblies can add shock protection to your instruments. A request on your letterhead will bring complete information — or, send us specifications and sizes of jewel bearings in your instruments for samples of Cushion Jewel Assemblies for test in your plant.

The engineering staff of the Bird Company is at your service for all small bearing problems.

Over 40 years of serving industry with Quality jewel bearings

Richard H. Bird & Co., Inc.

Sapphire and glass jewels · Precision glass grinding · Ferrite precision products · Sapphire stylii
1 Spruce Street, Waltham 54, Mass.

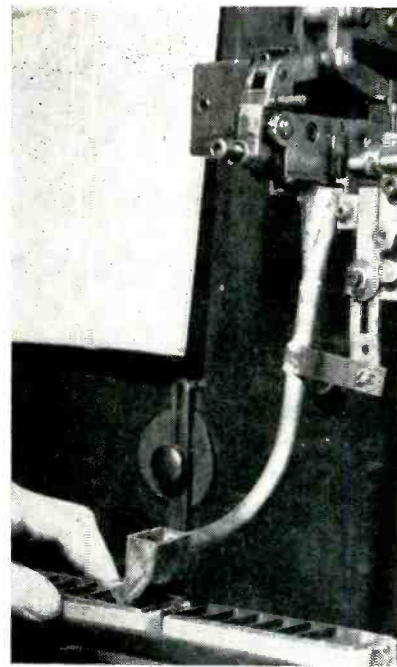

Ejection chute with matchbox-type dispenser at lower end for filling compartmented tote boxes with short lead wires for tubes

a compartment of the tote box. This action is much like that in which kitchen matches are dispensed from their large box. When a compartment is filled, the operator slides the tote box forward to bring the next empty compartment

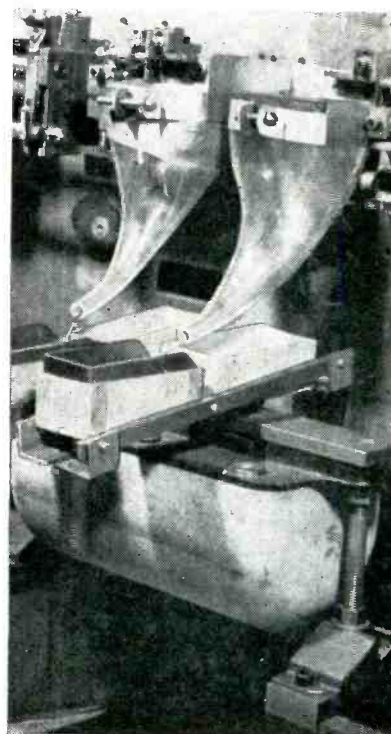

Tapered plastic ejection chutes for tube support wires

Definitely Different...

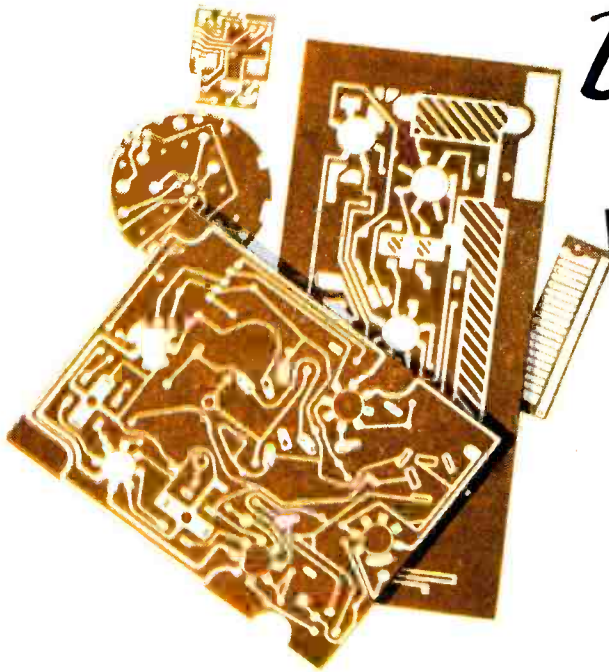

AEROVOX PRINTED WIRING

An improved method of Printed Wiring is now available. Aerovox offers a *definitely different* and improved technique. Cleaner, finer, more accurate detail; phenolic characteristics actually improved rather than impaired in processing; complete absence of corrosive agents; conductor of pure silver; conductor permanently bonded to base material without adhesives; excellent solderability. Obviously, Aerovox Printed Wiring

is unique.

Meanwhile, the advantages of printed wiring are well established, notably; (1) Lower assembly costs; (2) Dip soldering eliminates individual soldering; (3) No lead dress required; (4) All circuits precisely the same — no wiring mistakes to trouble-shoot; (5) Miniaturized assemblies — greater compactness and lessened weight; (6) Markings can be incorporated, eliminating assembly errors.

CHECK LIST OF FEATURES...

- ✓ Metallic silver conductor, mechanically formed.
- ✓ Phenolic base material not subjected to acid or chemical deterioration.
- ✓ Excellent bond — silver partially imbedded in phenolic base material — not dependent on adhesive.
- ✓ Readily solderable — either dip soldering or iron soldering.
- ✓ Negligible oxidation or tarnishing under normal conditions.
- ✓ No surface plating required for most switching circuits or normal protection.
- ✓ Temperature range of -65°C to $+125^{\circ}\text{C}$ will not affect bond.
- ✓ Identically reproducible, due to precision printing technique.
- ✓ Available in production — any quantities — meeting any reasonable delivery schedules.

Literature, with representative sample, on request. Let us quote on any wiring, switching or commutating problems; any quantities. Please write on your company letterhead to AEROVOX CORPORATION, Dept. P.W., New Bedford, Mass.

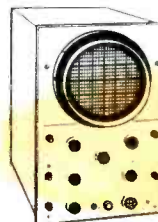
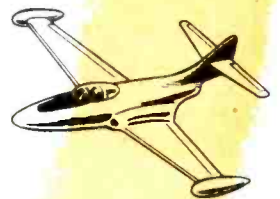
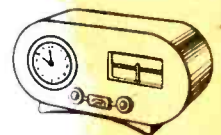

AEROVOX CORPORATION

NEW BEDFORD, MASS.

Hi-Q[®] DIVISION
CLEAN, N. Y.

ACME ELECTRONICS, INC.
PASADENA 4, CALIF.

Export: 41 E 42nd St., New York 17, N. Y. • Cable: AEROCAP, N. Y. • In Canada: AEROVOX CANADA LTD., Hamilton, Ont. JOBBER ADDRESS: 740 Belleville Ave., New Bedford, Mass.

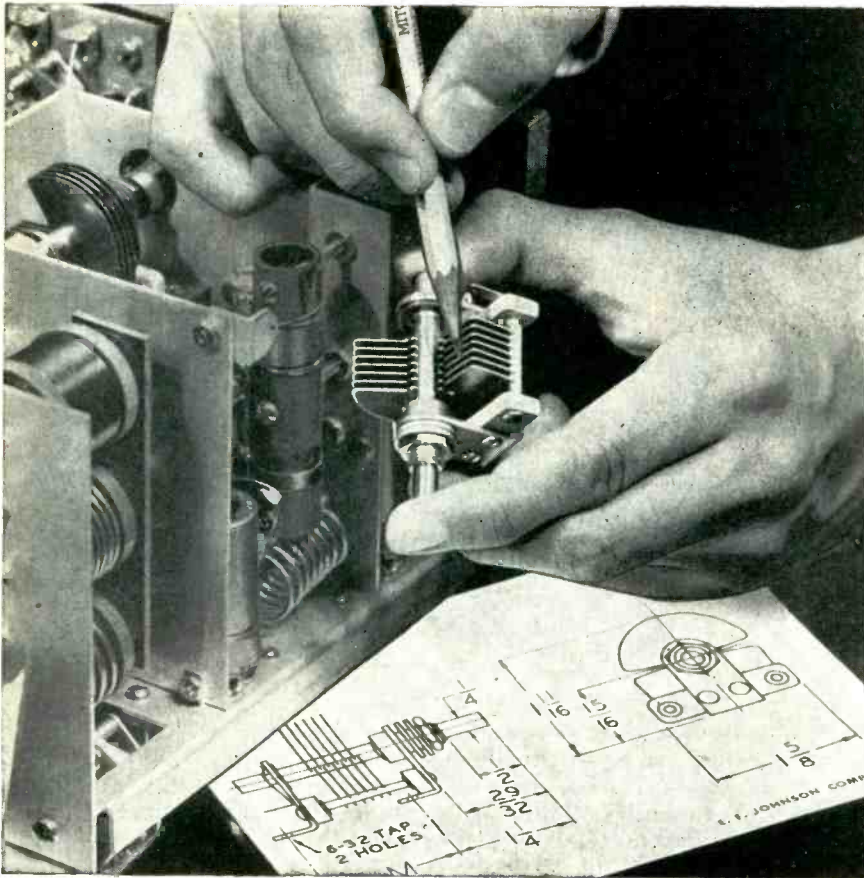

JOHNSON "R" CAPACITORS RUGGED and RELIABLE

Catalog Number	Type Number	"M" Dimension
149-1*	20R12	1-7/32"
149-2*	35R12	1-7/32"
149-3*	50R12	1-7/32"
149-4*	75R12	1-7/32"
149-5*	100R12	1-13/32"
149-6*	140R12	1-19/32"
149-8	200R12	2"
149-10	250R12	2-5/16"
149-11	325R12	2-23/32"

Nickel plated brass plates, .0226" — full soldered construction. Standard air gap, .024" — Steatite insulation, grade L4 or better. Silver plated beryllium copper rotor contact. Integral mounting feet and panel mounting bushing. All models of double bearing construction, with dual stator terminals and a .250" shaft with rear extension.

Specials can be furnished with .036", .050", .071", and .095" spacing, and with special plating, panel mountings, shaft extensions, or high torque bearings.

*Stock items. All other capacitors made to customers' order. Orders for "non-stock" or special capacitors should be of sufficiently large quantity to insure economical production runs.

For complete pricing and descriptive data on these and other types of JOHNSON capacitors, write for your copy of General Products Catalog 973.



E. F. JOHNSON COMPANY

CAPACITORS, INDUCTORS, SOCKETS, INSULATORS, PLUGS, JACKS, DIALS, AND PILOT LIGHTS

228 SECOND AVENUE SOUTHWEST

WASECA, MINNESOTA

into position for filling with wire. Tapered transparent plastic chutes handle longer tube support wires having flat ends. The finished parts drop against U-shaped metal striker plates inserted in small cardboard tote boxes, with all parts dropping the same way. A Syntron vibrator unit under the tote boxes distributes the leads across the width of the box, preventing pile-ups at the box centers and insuring maintenance of alignment even though leads are coming in at a rate of about 200 per minute.

In another setup at this firm's Warren, Pa. plant, delicate lead wires assembled by welding are in-



Clamping jaws of transport arm are here just about ready to drop assembled lead wire onto bent wires that guide it into open chute

dividually gripped by an arm with clamping jaws at one end and carried out to two bent wires. These wires guide the part gently down into a U-shaped chute, from which it slides into a semi-cylindrical metal tote box. This arrangement enables the operator to inspect the parts as they come out at a rate of about 180 assemblies per minute.

Compressed air provides motive power for another chute setup, used in welding short leads to rolled pins for tubes. The pins are oriented and separated by a Syntron rotary work feeder, then shot by air through a tube into welding position. The welded assemblies are picked off by an arm and carried to a knockoff wire over a vertical tube. The heavy pin end drops down first, so that the leads go down into a cylindrical cardboard

To clock-radio designers
who fall back to sleep



don't forget the **Signal Alarm**

...available only on Telechron Timers

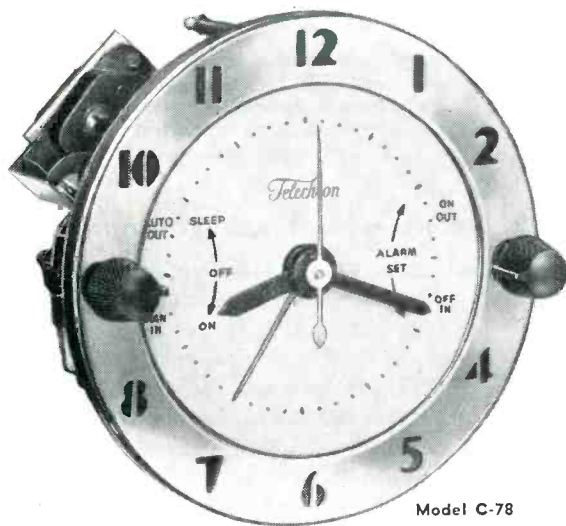

Model C-78

Sleep through the soft morning music of your clock-radio just once, and you'll see an important reason to specify Telechron Timers with signal alarm for your new models. And you'll see, too, how this exclusive feature can help your clock-radio become a sales success.

There are other exclusive advantages in Telechron Timers. The sealed lubricant reservoir gives better assurance of long timer life and quiet operation. There's extra simplicity of operation in the two knobs that do the work of three.

For any clock-radio price class, there's a Telechron Timer that will meet your needs. We custom style to meet your design requirements. Write for details. Telechron Department, General Electric Company, 49 Homer Ave., Ashland, Mass.



EXTRA SALES ADVANTAGE

Telechron Seal of Accuracy on the clock crystal and our trademark on the dial gives the buyer confidence in the accuracy of your clock-radio.





...when the **Milford Method** may save you thousands of dollars in costly fasteners and assembly!

ask about the **Milford Method**



This scientific approach to product and parts assembly is a fastener-engineering consulting service which analyzes your needs at the blueprint stage...before you invest in expensive tools and dies! It projects for you the right fastener. Look into the economies of the "MILFORD METHOD" now. Send your blueprints and samples for analysis and planning by the "MILFORD METHOD", or write for the "Milford Method" brochure today.

the MILFORD RIVET & MACHINE CO.
EST. 1919

MILFORD, the name to rivet in your memory for fasteners.

855 Bridgeport Ave., Milford, Conn.
806 Illinois Ave., Aurora, Ill.
1106 W. River St., Elyria, Ohio
26 Platt Street, Hatboro, Penn.
715 So. Palm Ave., Alhambra, Calif.

storage box in that position. A Syntron vibrator under the boxes joggles the leads so the boxes can be filled. Bent or otherwise imperfect assemblies fall outside the vertical tube and are carried by a V-shaped chute to a reject box at the left.

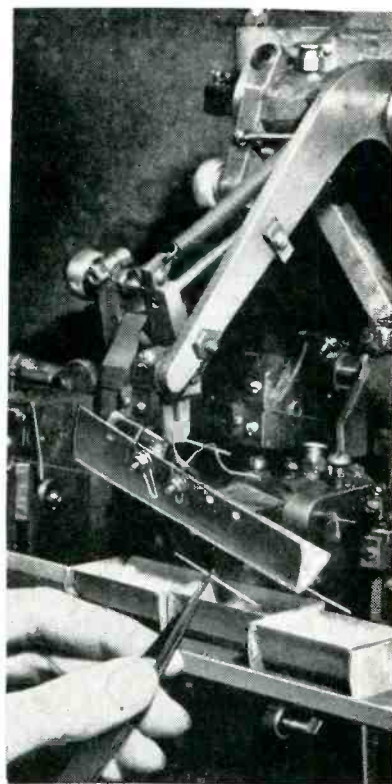

Rolled pins are shot by air from rotary work feeder at right into welding position. Finished assemblies drop through vertical chute into cylindrical boxes resting on vibrator

Automatic Final Testing

A TOTAL OF 115 different resistance checks are made automatically between circuit terminals and ground during final electrical testing of a 14-tube radar unit, through use of a model 1010 Rotobridge in the Coamo, Puerto Rico plant of Caribe Aircraft Radio Corp.

Finished units reach the test positions without tubes. The operator inserts a Rotobridge plug in each of the 14 tube sockets, then flips the switch of the test set. The tester compares the measured resistance between each socket terminal and ground with that of an acceptable finished unit that is connected as a standard to the other side of the Rotobridge.

When a circuit is found that is

Star Performers in Every Category

E-I SEALED TERMINALS

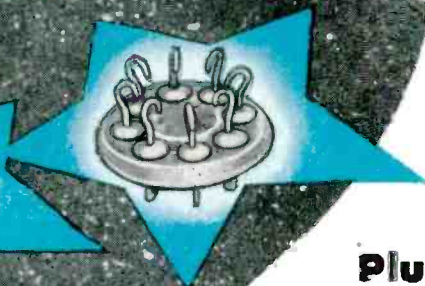

Specify **E-I**

**Compression Type Headers,
Plug-In Headers, GS Series Multiple
Headers, Custom Seals to Specification,
Tubular End Seals, Color Coded Terminals,
High Creepage Terminals**

Whatever your need, E-I can supply a Sealed Termination that exceeds requirements at a cost no higher than competitive types of lesser dependability. Over 12 years of specialization, with research, development and manufacture devoted exclusively to Hermetically Sealed Terminations insures this extra dependability in every single item shipped by E-I. For outstanding performance, faster delivery, lowest unit cost, call, write or wire your requirements to E-I today. Hundreds of Standard types, with optional features are available plus custom designs to your exact specification.

PATENT PENDING
ALL RIGHTS RESERVED

E-I... YOUR HEADQUARTERS for every type of Hermetically Sealed Termination. Write today for illustrated literature.



DIVISION OF AMPEREX
ELECTRONIC CORPORATION



ELECTRICAL INDUSTRIES

44 SUMMER AVENUE, NEWARK 4, NEW JERSEY
EXPORT AGENTS
PHILIPS EXPORT CORP., 100 EAST 42ND STREET, NEW YORK 17, N. Y.

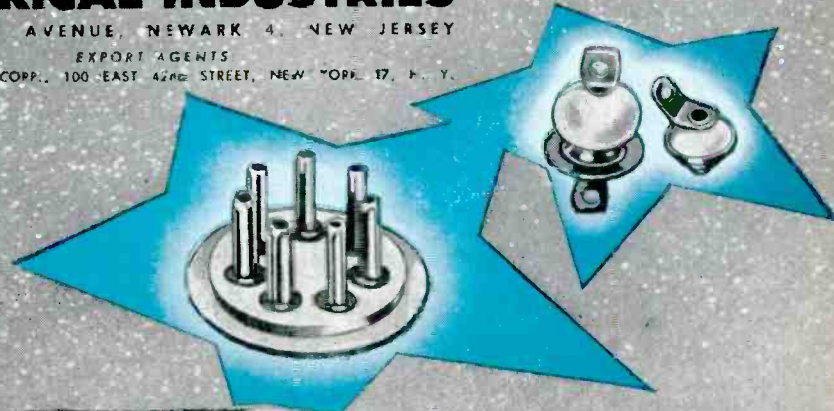

'DIAMOND H' RELAYS



...now even
mightier
midgets



Shown Actual Size

NEW CHARACTERISTICS engineered into famous "Diamond H" Series R Relays have now broadened their adaptability for such applications as guided missiles, jet aircraft, fire control and fire detection, radar, communication, high speed camera, geophysical and computer apparatus . . . wherever positive operation is demanded under critical conditions.

A 4PDT hermetically sealed, miniature aircraft relay basically, they are now also available DPDT with two independent coils, either or both of which will operate the units.

In their field still the smallest and lightest, (1.6 cu. in. 3.76 oz.) combining highest operating shock resistance (to 50 "G" and higher), widest temperature range (-65° to + 200° C.) and greatest ability to break high currents and high voltages, Series R Relays consistently operate over 400,000 cycles without failure at 5 A. and go 3,500 or more under 30 A. at 30 V., D.C., resistive. They carry voltages up to 300 D.C. at 4/10 A. for more than 400,000 cycles. With low contact

loading, life expectancy is 10 million cycles or better.

Operating time is 10 ms. or less; drop out time 3 ms. or less. Coil resistances up to 35,000 ohms are standard; to 50,000 ohms available for special units. Sensitivity approaches 100 mw. at 30 "G" operational shock resistance. Inter-electrode capacitance is less than 5 mmf. contacts to case—less than 2½ mmf. between contacts, even with plug-in type relay and socket. Vibration range is from 0 to 500 cycles per second and upward at 15 "G" without chatter.

All standard mounting arrangements, including ceramic socket, are available. Uniquely simple design permits compact grouping . . . and a firm bond between relay and chassis.

Designed to meet all requirements of USAF Spec. MIL-R-5757B, they far surpass many. Bulletin R-150, giving basic performance data under varying conditions, is yours on request. Our engineers are prepared to work with you to develop variations to meet your specific requirements. Tell us your needs.

THE HART MANUFACTURING COMPANY

202 Bartholomew Avenue • Hartford, Connecticut



Automatic test setup for making 115 final electrical tests on radar unit resting on piece of broadloom carpet on bench at right. Rotobridge test set in front of operator compares resistance readings with those of corresponding circuits in good sample unit on top of test set

outside of tolerance limits, the instrument stops and a red reject lamp comes on. By glancing at the dial number and looking it up on her chart, the operator can determine which circuit is defective. Oftentimes she can clear the trouble herself by tracing from the indicated tube-socket terminal. If the trouble calls for more elaborate repair, she notes it on the check chart and restarts the tester for completion of electrical testing on that unit.

Final Leakage Test on Soldering Guns

LEAKAGE AND CURRENT drain of finished soldering guns are quickly checked with a simple test set in Weller Mfg. Co.'s Bayamon, Puerto Rico plant.

First, the operator plugs a fin-



Making 1,700-volt leakage test on finished soldering gun by checking between gun and one side of line cord. Operator wears rubber glove as safety precaution

Transistors
 Ferrites
 Tantalum Capacitors
 Sub-Miniature Tubes
 Hermetic Seals
 Germanium Rectifiers
 Iron Cores
 Printed Circuits

Mercury Batteries
 Magnetic Amplifiers
 Crystal Diodes
 Silicones
 Sealed Relays
 Small-Size Instruments
 Teflon
 Fiber Glass
 Miniature Capacitors

Are you working with these?

then these
 belong in
 your planning

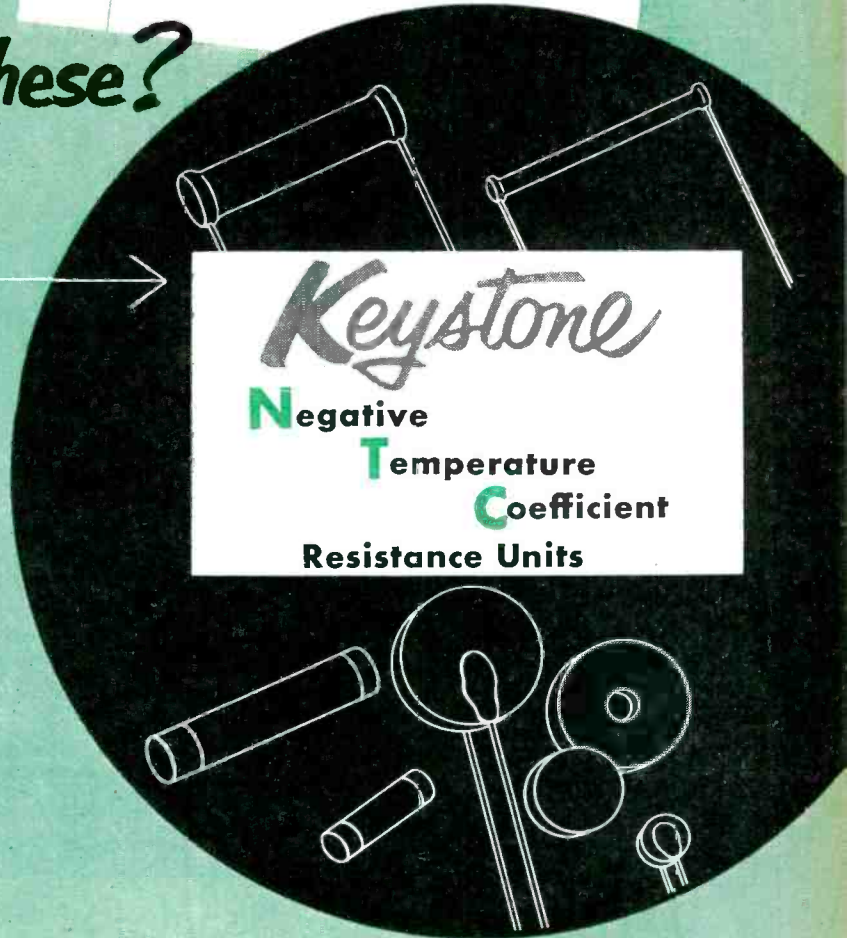

KEYSTONE NTC UNITS—modern as the newest electronic and electrical components and materials—are essential elements in today's product design and development.

Interrelating thermal and electrical behavior, and translating one into the other, NTC units are electrical semi-conductors in which resistance to the flow of current varies inversely with the temperature of the unit.

Keystone NTC Unit Properties

Consider the following desirable properties of NTC Resistance Units:

- Function over a wide temperature range, below and above room temperature.
- Usable in both AC and DC Circuits.
- Economical in first cost, requiring no maintenance.
- No moving parts—long useful life.
- Small in size and weight.
- Physically and electrically rugged.

Count on Keystone NTC Units when your design problems involve

temperature measurement and control . . . compensation or neutralization of the positive temperature coefficient of other electrical components . . . protection against initial current surge . . . time delay action

and your objectives are

- Improved performance
- Simplification and cost reduction
- Reliability and long life
- Reduction in size, weight and power consumption

Write for specific design information!

K *Keystone* CARBON COMPANY
 ST. MARYS, PA.

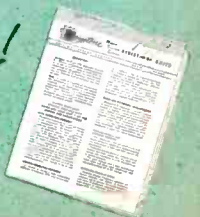

Ceramic Insulated for LOW LOSS... MINIMUM CREEPAGE NEW TYPE 2C TAP SWITCHES

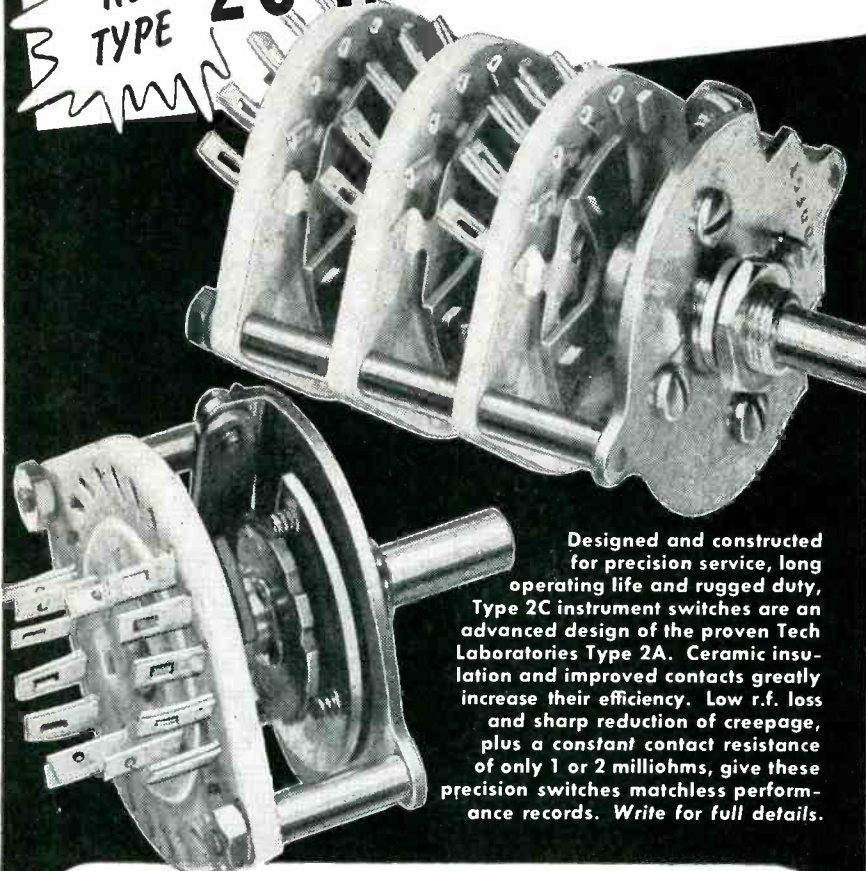

Designed and constructed for precision service, long operating life and rugged duty, Type 2C instrument switches are an advanced design of the proven Tech Laboratories Type 2A. Ceramic insulation and improved contacts greatly increase their efficiency. Low r.f. loss and sharp reduction of creepage, plus a constant contact resistance of only 1 or 2 milliohms, give these precision switches matchless performance records. Write for full details.

SPECIFICATIONS

Contact resistance: 1-2 milliohms
Contact material: Silver alloy
Contact design: Laminated wiper arm, self-cleaning, shorting or non-shorting
No. of contacts: 2 to 24 single pole, shorting or non-shorting
 2 to 11 double pole, shorting or non-shorting
 2 to 5 triple pole, shorting or non-shorting
Spacing: 15° or 20°, shorting or non-shorting
No. of poles per deck: 1 to 4

No. of decks: According to requirements
Life: 200,000 cycles, min.
Current carrying cap.: 3 amp.
Max. operating voltage: 120 V., a.c.
Mounting: Single hole, 3/8"-32 bushing, standard length for up to 1/4" panel, special lengths to order
Size: 1 3/4" dia.
Detent: Ball and spring
Weight: Approx. 1 oz. per deck



Manufacturers of Precision Electrical Resistance Instruments
 PALISADES PARK, NEW JERSEY

ished gun into a power outlet on the panel of the test set and operates the trigger switch, noting current drain on the ammeter for each of the two switch positions, and whether the spotlights operate.

Next, the operator holds the tip of the gun on a button-type terminal set into a recess in the panel, to apply 1,700 volts between the exposed metal and the primary winding as a check for leakage. A lamp mounted on the bench and connected to the test circuit glows to indicate excessive leakage or a short.

Self-Dressing Grinder

ADDITION OF A crush-roll dresser and holding fixture on the sliding table of a surface grinder insures maintenance of two angles on the shaped Norton alundum grinding wheel used in finishing plastic insulating strips for aircraft relays in the San Juan, Puerto Rico, plant of Phillips Control Corp. of P. R.

The operator loads two plastic pieces at a time onto positioning pins of the holding fixture, then operates the carriage-feed wheel to run the pieces under the grinding wheel, the surface of which is shaped to a very shallow V. This slants the pieces downward from the center to give the required angle for adjusting the relay contact blades that are later mounted

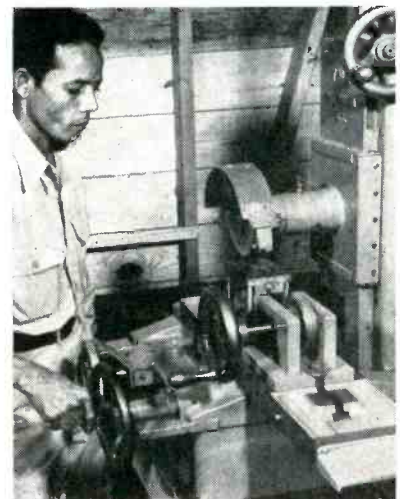

Operating carriage feed handwheel that moves the plastic terminal blocks under the grinding wheel



C-D-F INSULATING TAPES

Uniform strength and quality plus prompt deliveries!

C-D-F SILICONE TAPES for A.I.E.E. Class H Electrical Insulation. Available in Varnished Fiberglas cloth and Silicone Rubber-coated Fiberglas cloth. Resistant to high temperatures; high dielectric strength, low dielectric losses, excellent moisture resistance and high tensile strength. They resist mild alkalis, non-oxidizing acids, mineral oils, oxygenated solvents. Available in a range of sizes on continuous rolls. Write for Technical Bulletin #47.

C-D-F TAPES OF TEFLON* have the desired mechanical and electrical properties for heavy-duty motor, generator, and conductor insulation. Unaffected by temperature fluctuations, exposure to oils and greases, or weather conditions. Fiberglas supported and unsupported Teflon tapes are available in a range of sizes.

*du Pont trademarks.

C-D-F MICABOND TAPES have an inherently high and permanent resistance to heat with good dielectric properties. Micabond Tapes are used for insulating motor and generator armature and field coils, turbo-generator coils, and many similar applications where flexible high quality insulation of A.I.E.E. Classes B and H insulators are required. Available in a wide range of sizes with many different backings including: fiberglas, silk, cellophane, cotton, paper, and Mylar*.

If you have an insulating problem, probably a C-D-F product is the answer. C-D-F manufactures and fabricates electrical insulation, laminated and molded plastics. Sales offices are located in principal cities. Call your C-D-F sales engineer—he's a good man to know!

THE NAME TO REMEMBER . . .



SILICONE, TEFLON, MICABOND TAPES

Continental-Diamond Fibre Company

NEWARK 16, DELAWARE

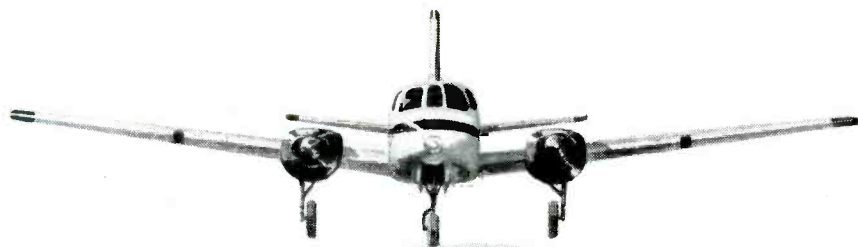

**There's a
TVOR system
for every field**

Available with
Rotating or stationary antenna
50 or 200 watts power
Single or dual units

Any competent radio technician can readily install one of these new TVOR systems on your landing field; private, industrial, or municipal. Rugged CAA type construction reduces maintenance problem to a minimum.

TVOR provides positive landing guidance to terminals during conditions of low visibility and is a superior airway navigation aid.

Write for further information and prices.

There are more complete Maryland Electronic TVOR's in operation, than all other makes combined.

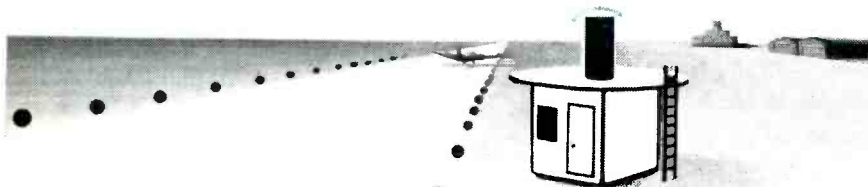

Maryland Electronic

MANUFACTURING CORPORATION

College Park, Maryland

on these strips. After grinding, a knob at the left of the holding fixture is operated to eject the finished parts.

At regular intervals the operator stops the grinder and runs the carriage further over, so that the grinding wheel is directly over the crush-roll dresser. He then rotates the dresser for a few revolutions by means of a hand wheel on the shaft of the dresser. This rotates the grinding wheel by friction and restores correct grinding contours by a crushing action. The vertical position of the grinding wheel is then readjusted to correct cutting height. The grinder used here is made by Thorton Mechanical Labs, New Britain, Conn.

In another grinding setup in the same plant, a black diamond costing about \$5 is mounted in a holding fixture in such a way that the grinding wheel runs over it on each pass, for continuous dressing. The diamond, being fixed in position with relation to the work, insures correct cutting height automatically even though the grinding wheel is brought nearer and nearer as it wears away.

**Paint Bar Speeds
Color-Coding of Leads**

LEADS of multiple-section electrolytic capacitors are painted in batches of 25 or more with a single



Painting leads of electrolytic capacitor plates at Pyramid Electric Co. The etched foil must be handled with gloves to prevent contamination



THIS BOTTLE TURNS SEVEN YEARS INTO SEVEN MONTHS

◀ *Test blocks of pole wood are fed to destructive fungi in bottles like this at Bell Laboratories. Wood rests on soil which controls moisture conditions and promotes fungus growth. Test speeds search for better preservatives.*

This year the Bell System is putting 800,000 new telephone poles into service. How effectively are they preserved against fungus attack and decay?

Once the only way to check a preservative was to plant treated wood specimens outdoors, then wait and see—for seven years at least. Now, with a new test devised in Bell Telephone Laboratories most of the answer can be obtained in seven months.

Cubes of wood are treated with preservatives, then enclosed in bottles with fungus of the most destructive kind, under temperature and humidity conditions that accelerate fungus activity. Success—or failure—of fungus attack on cubes soon reveals the best ways to preserve poles.

The new test has helped show how poles can be economically preserved for many years. It is another example of how Bell Telephone Laboratories works to keep down the cost of your telephone service.

A boring is taken from a pole section to see how far preservative has penetrated. For poles to last, it must penetrate deeply and be retained for a long time.



BELL TELEPHONE LABORATORIES

There are many opportunities for creative scientists and engineers at Bell Telephone Laboratories. For details see our advertisement on page 450.

by every test



ATR

AUTO RADIO VIBRATORS

Have Ceramic Stack Spacers

A COMPLETE LINE OF VIBRATORS

Designed for Use in Standard Vibrator-Operated Auto Radio Receivers. Built with Precision Construction, featuring Ceramic Stack Spacers for Longer Lasting Life. Backed by more than 22 years of experience in Vibrator Design, Development, and Manufacturing.

"A" Battery Eliminators, DC-AC Inverters, Auto Radio Vibrators

- ✓ NEW MODELS
- ✓ NEW DESIGNS
- ✓ NEW LITERATURE



See your jobber or write factory

AMERICAN TELEVISION & RADIO Co.

Quality Products Since 1931

SAINT PAUL 1, MINNESOTA—U. S. A.

stroke of the paintbrush, using a setup that makes several different colors of paint instantly available. The cans of paint are set into holes in a wood block at the beginning of each day. A paper covering is placed over the array, giving the effect of a paint bar. The paper is changed each day. When not in use, brushes can be laid on the paper or set back in the can, as preferred.

The color coding used here is required for identifying the leads when fitting standard terminal lugs over them. The lugs have square, triangular, circular or other geometric codings, and the lead colors are not seen by the ultimate user.

Welded Hook on Scissors Speeds Coil Tying

WHEN winding four coils simultaneously in a special lathe fixture at the Paterson, N. J. plant of Bogue Electric Mfg. Co., the individual coils must be tied before the fixture is unloaded. Notches in the metal dividers of the 5-piece winding bobbin permit pushing a loop of lacing cord under a coil. A small hook welded to the end of one blade of

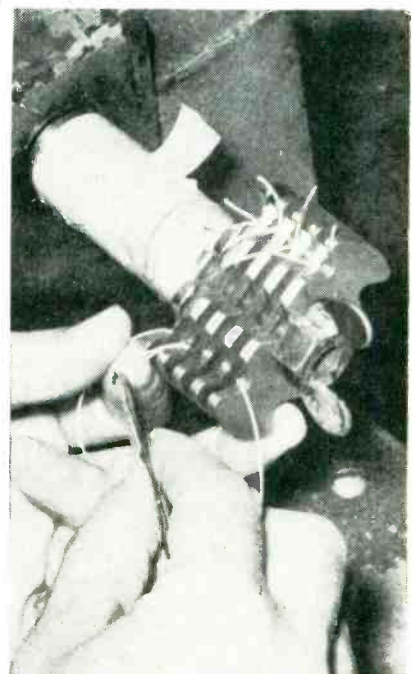

Method of using hook on end of scissors for pulling loop of cord around finished coil for miniature a-c motors and generators

Send for this *Free* **SAMPLE FOLDER...**

Contains
25
 different Test Samples of
 high-dielectric
**INSULATING
 TUBING and SLEEVING**



INCLUDES SAMPLES AND DESCRIPTIONS OF THE FOLLOWING...

VARGLAS SILICONE Class H insulating materials were pioneered by our Laboratory. Retain flexibility, electrical properties and mechanical strength in temperatures ranging from -85°F . to 500°F . Available in tubing, sleeving, lead wire, tying cord.

PERMAFIL-IMPREGNATED VARGLAS TUBING Fiberglass braid coated with General Electric's Permafil resin. Extremely tough, resistant to solvents and elevated temperatures, highly flexible. Can be bent or twisted with little or no loss of dielectric strength. Coils and standard 36" lengths.

VARGLAS SLEEVING AND TUBING Numerous types and grades—including synthetic-treated, varnished, lacquered, saturated, litewall and others.

VARGLAS NON-FRAY SLEEVING Fiberglass braid normalized to remove all organic impurities. It will withstand temperatures up to 1200°F . Recommended where dielectric properties are not paramount. Three types available.

VARFLO TUBING AND SLEEVING Vinyl-coated Fiberglas in full range of sizes, colors and grades. Extremely flexible with excellent heat aging qualities. Low priced.

VARFLEX COTTON TUBING AND SLEEVING Varnish or lacquer impregnated—for applications where MIL-I-3190 Class A materials are specified. All NEMA grades.

SYNTHOLVAR EXTRUDED TUBING Made in various standard formulations of vinyl polymers. Has high dielectric and tensile strength—will not support combustion nor absorb moisture. Type EG Approved under MIL-I-631A. Several others to meet special requirements.

NEW! VARGLAS SILICONE RUBBER SLEEVING AND TUBING—the culmination of 5 years of research—for applications requiring extraordinary flexibility. Details on request.



MAIL COUPON TODAY FOR SAMPLES!

VARFLEX CORPORATION,
 308 N. Jay St., Rome, N. Y.

Please send me free folder containing samples of your electrical sleeving and tubing.

I am particularly interested in insulation for:

NAME

COMPANY

STREET

CITY ZONE STATE

To Wind Coils of
"INVISIBLE WIRE"

(or other minute
 precision operations)

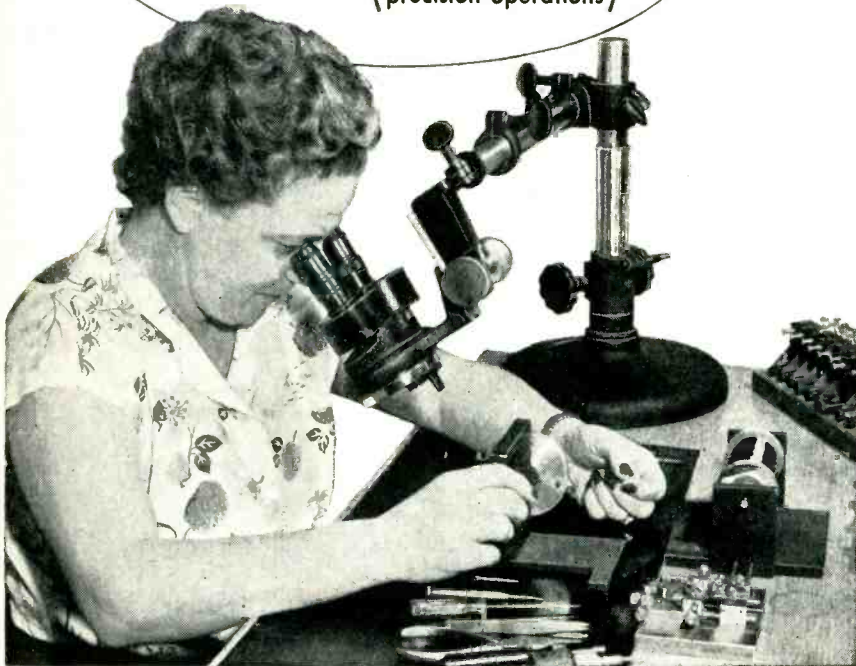

At the Hathaway Instrument Company, tiny galvanometer coils are wound with wire so fine that it is almost invisible to the unaided eye. Ingenious tooling and use of an AO Stereoscopic Microscope assure fast, precise workmanship.

These unique AO Microscopes provide two complete optical systems (one for each eye) to enhance the perception of depth and to provide three-dimensional reality plus an exceptionally wide field of view. Unlike ordinary microscopes, objects and movements are not inverted. Instead they appear in their natural directions. Because AO Stereoscopic Microscopes are unequalled for fabrication, assembly, inspection of minute precision parts, they are widely used in electronics, metal working, food and many other industries.

Let AO Stereoscopic Microscopes help you achieve high precision at low cost. Mail coupon below.

You NEED



Stereoscopic
 Microscopes

American Optical

 INSTRUMENT DIVISION
 BUFFALO 15, NEW YORK

American Optical Company
 Dept. J 178
 Instrument Division
 Buffalo 15, New York

Gentlemen:

Please send me further information on AO Stereoscopic Microscopes.

Signed
 Organization
 Address
 City..... Zone..... State.....

where it is cold-pressed onto the wires as they pass through. The entire coated assembly is then passed into a sintering oven or bath where the coatings are fused at about 750 F.

After the coatings are fused, the entire assembly is taken through rotary trimming knives, where the coated wires are separated and then reeled up.

Inspecting Tubes
 with X-ray Equipment

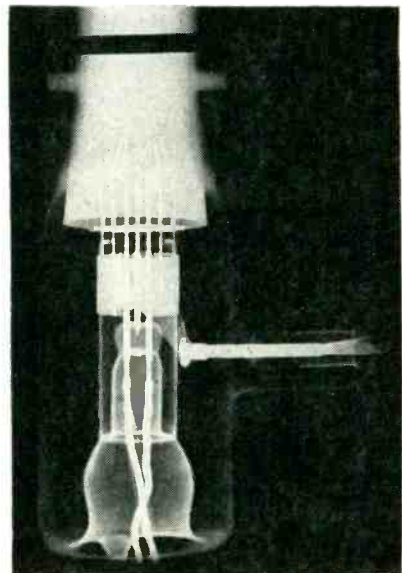

X-ray photograph of high-power industrial vacuum tube shows locations of leads and elements inside metal anode

ANALYSIS of rejects and sampling inspection of costly finished vacuum tubes are being expedited with the aid of GE X-ray equipment, used either with photographic negatives or with fluoroscopic screens. The resulting images often reveal defects that disappear when the tube is broken open for examination.

Checking Phosphor
 Adherence

A MODIFIED laboratory version of the ancient Chinese water torture is used in RCA's Marion, Indiana tube manufacturing plant to check the adherence of phosphor screens to the base plates of television picture tubes. Drops of mercury are arranged to fall from a height of 10 to 14 inches onto a dry phosphor

they're here! Telewave's MICROPADS

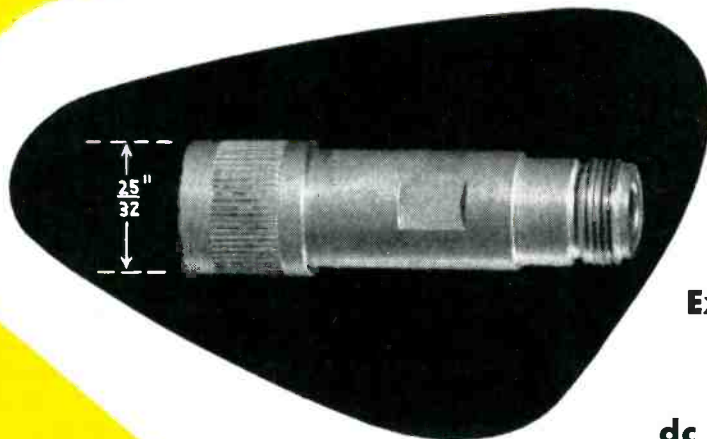

**Attenuator Pads
—Calibrated with
Exceptional Accuracy
—Miniaturized—
Frequency Range—
dc through microwave
(X Band) Low VSWR**

A masterpiece of accuracy, compactness and ruggedness—the versatile new MICROPAD is ideal as test equipment and is particularly suited for Broad Band applications where accurate measurement and space limitations are essential.

These unique attenuator pads employ Telewave's remarkable platinum film miniature microwave resistors. Exceptionally rugged . . . contain no fine wires or delicate elements . . . can withstand overloads of more than 100%.

For ultra high-precision microwave measurements—specify Telewave MICROPADS. Write for further details now.

PAD TYPE	db drop	L (INCHES)
3D	3	2 1/2
6D	6	2 1/2
10D	10	2 1/2
20D	20	3 3/8

SPECIFICATIONS

Impedance.....50 OHMS
 Accuracy.....—0.2 db calibrated at
 1, 10, 100 MC and 1, 2, 3,
 4, 5, 6, 7, 8, 9, 10 KMC
 VSWR Ratio.....Better than 2:1 throughout
 entire frequency range
 Finish.....Rhodium Flash over silver
 plate for optimum corro-
 sion resistance and
 electrical conductivity
 Power.....1/4 watt continuous duty
 at 25° C
 Mating Connector.....Mates with AN type
 UG-21B/U plug on one end
 and with AN type
 UG-23B/U jack at other

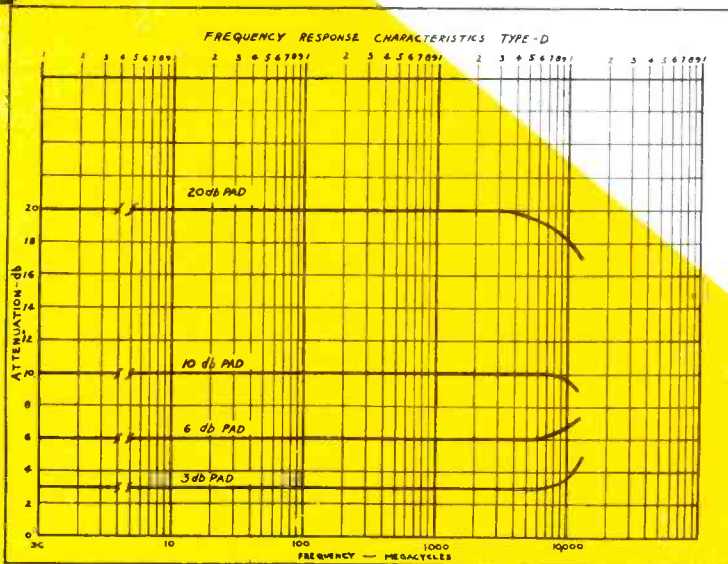

TELEWAVE LABORATORIES, INC.

100 Metropolitan Ave., Brooklyn 11, N. Y.

REPRESENTATIVES: Albuquerque • Atlanta • Boston • Chicago • Cleveland • Fort Worth • Kansas City •
 Los Angeles • New York • Ontario • Philadelphia • San Francisco • Seattle • Syracuse

NOW!

UHF AND MICROWAVE MEASUREMENTS MADE EASY WITH THE PRESTO MICROWAVE SECONDARY FREQUENCY STANDARD

50-11,000 MC OUTPUT



MODEL 100*

Price: \$265.00 f.o.b. factory

The PRESTO Model 100 Microwave Secondary Frequency Standard provides, for the first time, a versatile and relatively inexpensive instrument to generate accurate test signals over the extremely wide range of 50 to approximately 11,000 mc without any frequency tuning whatsoever. The Model 100 delivers to the 50 ohm input of a typical microwave receiver an uninterrupted, simultaneous series of CW

signals spaced every 100 and 200 mc over its complete frequency range, and a 50 mc marker output useful up to approximately 9,000 mc.

- No frequency tuning whatsoever.
- Markers every 50, 100, 200 mc.
- .005% accuracy over range.
- Lightweight and compact—8 1/2 lbs., 7 3/8" x 6" x 6 1/4".
- Military quality standard components used throughout.
- Low power consumption—60 watts.
- Operates from 115V—50-1750 cycle source.

USE IT

- To perform functions of expensive primary standards.
- To calibrate signal generators.
- To establish standard frequencies.
- To calibrate and align receivers.
- To radiate test signals for overall radar systems check.
- To provide markers for panoramic displays.

*Patent Applied For

PRESTO
RECORDING CORPORATION
PARAMUS, NEW JERSEY

SPECIALTY PRODUCTS DIVISION

screen placed at a 45-degree angle below.

The tests disclosed that under certain conditions, as many as 1,400 mercury drops were required to produce a hole 1/8 inch in diameter in a screen utilizing a potassium sulphate settling agent. In comparison, some 10 to 20 drops produced a similar hole in a screen using barium nitrate as the settling agent.

Screw-Tightening Fixture

A SPRING-LOADED metal fixture serves to hold the molded plastic armature contact bracket of an aircraft relay in position and at the same time align the contact blades accurately while they are being fastened to the bracket with slotted-head machine screws.

The operator first places six nuts in hexagonal molded recesses in the bottom of the bracket while holding it upside down. To keep the nuts in while inverting the bracket, she next places over the bottom of the bracket a metal bar having aligning pins. The bracket is now inverted and placed in the holding fixture, after first retracting its moving jaw. The base of the fixture is screwed to the workbench so that the jaw can be moved with one hand while inserting the bracket.

With the bracket in position, the

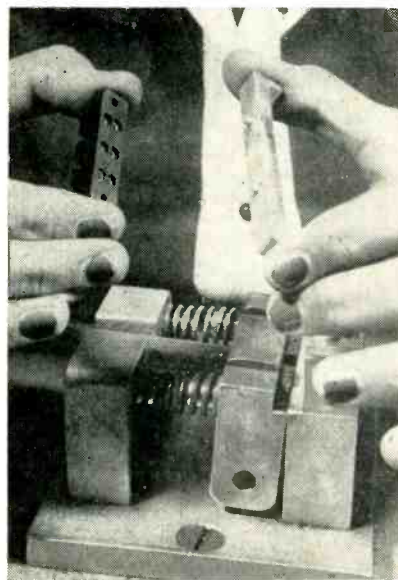

Placing metal bar against bottom of armature contact bracket to hold in previously inserted nuts

FREED

Instruments & Transformers

Famous
For

QUALITY • DEPENDABILITY • ACCURACY



No. 1030
Low Frequency
"Q" Indicator

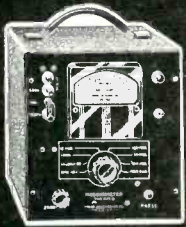

No. 1020B
Megohmmeter



Decade
Inductors



No. 1040
Vacuum Tube Voltmeter

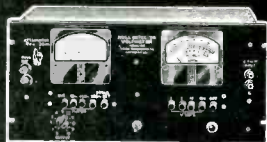

No. 1210
Null Detector &
Vacuum Tube Voltmeter



No. 1010
Comparison Bridge

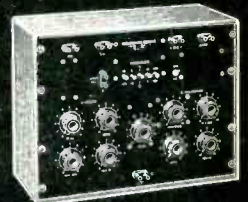

No. 1110A
Incremental Inductance
Bridge

FREED MILITARY PULSE TRANSFORMERS IN STOCK FOR IMMEDIATE DELIVERY

HERMETICALLY SEALED PULSE TRANSFORMERS for use in blocking oscillators, low level interstage coupling, and modulator outputs. Made in accordance with MIL-T-27 specifications. These pulse transformers are designed for maximum power, efficiency and optimum pulse performance. Balanced coil structures permit series or parallel connection of windings for turn ratios other than unity. Pulse characteristics, voltages and impedance levels will depend upon interconnections made.



DM-12



DM-18



DM-8



DM-01

CATALOG NUMBER	APPLICATION	PULSE VOLTAGE KILOVOLTS	PULSE DURATION MICRO-SECONDS	DUTY RATIO	TEST VOLTAGE KV., RMS	CHARACTERISTIC IMPEDANCE OHMS	CASE SIZE
MPT-1	Blocking oscillator or interstage coupling	0.25/0.25/0.25	0.2-1.0	.004	0.7	250	DM-12
MPT-2	Blocking oscillator or interstage coupling	0.25/0.25	0.2-1.0	.004	0.7	250	DM-12
MPT-3	Blocking oscillator or interstage coupling	0.5/0.5/0.5	0.2-1.5	.002	1.0	250	DM-18
MPT-4	Blocking oscillator or interstage coupling	0.5/0.5	0.2-1.5	.002	1.0	250	DM-18
MPT-5	Blocking oscillator or interstage coupling	0.5/0.5/0.5	0.5-2.0	.002	1.0	500	DM-12
MPT-6	Blocking oscillator or interstage coupling	0.5/0.5/0.5	0.5-2.0	.002	1.0	500	DM-12
MPT-7	Blocking oscillator, interstage coupling or low power output	0.7/0.7/0.7	0.5-1.5	.002	1.5	200	DM-18
MPT-8	Blocking oscillator, interstage coupling or low power output	0.7/0.7	0.5-1.5	.002	1.5	200	DM-18
MPT-9	Blocking oscillator, interstage coupling or low power output	1.0/1.0/1.0	0.7-3.5	.002	2.0	200	DM-18
MPT-10	Blocking oscillator, interstage coupling or low power output	1.0/1.0	0.7-3.5	.002	2.0	200	DM-18
MPT-11	Blocking oscillator, interstage coupling or low power output	1.0/1.0/1.0	1.0-5.0	.002	2.0	500	DM-01
MPT-12	Blocking oscillator, interstage coupling or low power output	0.15/0.15 0.3/0.3	0.2-1.0	.004	0.7	700	DM-8

SEND FOR COMPLETE CATALOG OF
FREED INSTRUMENTS AND TRANSFORMERS

FREED TRANSFORMER CO., INC.

1722 WEIRFIELD ST. (RIDGEWOOD) BROOKLYN 27, N.Y.

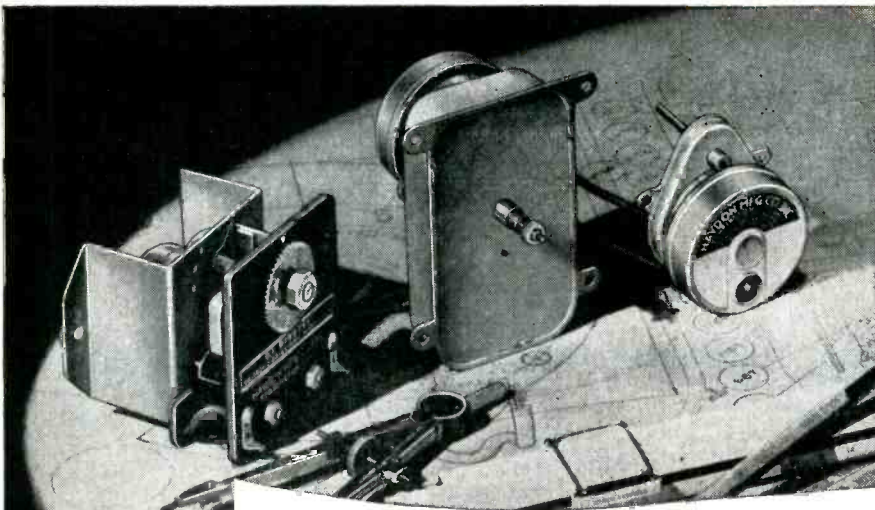

When called upon to
HARNESSTIME

Call in

HAYDON
AT TORRINGTON
HEADQUARTERS FOR
TIMING

**A.C. and D.C. TIMING MOTORS • TIMING DEVICES
TIME DELAY RELAYS • SPECIAL TIMING DEVICES
TIMING ENGINEERING SERVICES**



HAYDON* specializes in a varied line of standard timing components and custom engineered devices for volume application.

Our research and engineering staffs are constantly seeking to develop new and better ways to harness time for industrial, commercial and military applications.

In the field, HAYDON maintains a staff of engineers whose training, backed up by years of experience, enables them to help manufacturers insure, insofar as timing components can, the satisfactory performance of their products. The entire staff and rapidly expanding plant facilities of HAYDON are devoted solely to the production of timing motors, timing devices and clock movements.

AT YOUR SERVICE

The knowledge and skill of our field engineers and our research and engineering facilities are available to help you solve timing problems. Write us in detail or ask that we send a field engineer to talk things over.

*TRADEMARK REG. U.S. PAT. OFF.

HAYDON Mfg. Co., Inc.

Subsidiary of GENERAL TIME CORP.

2433 ELM STREET

TORRINGTON, CONNECTICUT



Method of using Yankee screwdriver to tighten contact screws while armature bracket is held rigidly in jig screwed to bench

three contact blades are set into three grooves in the fixture, and two screws are started in each blade by hand. With all six screws positioned, the operator uses a Yankee screwdriver to turn the screws into the nuts and tighten them. After the relay has been further adjusted to meet the electrical specifications, a dab of GE glyptol is applied to each screw to cover any marks made in the plating by the screwdriver. This technique is employed in the plant of Phillips Control Corp. in San Juan, Puerto Rico.

Switch-Soldering Fixture

A SIMPLE AND inexpensive hardwood holding fixture is used in the Coamo, Puerto Rico plant of Caribe Aircraft Radio Corp. for a variety of subassembly operations. A single conveniently located wing nut serves both for repositioning and for locking or releasing the subassembly.

The base of the fixture is a piece of five-ply plywood about 6 by 9 inches in size. To this is bolted the jigsawed and drilled hardwood up-

TOP QUALITY
TOP BRAND



- ⚡ RESEARCH
- ⚡ ENGINEERING
- ⚡ CRAFTSMANSHIP
- ⚡ PRECISION
- ⚡ PRODUCTION
- ⚡ DELIVERY
- ⚡ QUALITY

The top frequency control choice in all electronic applications:

MILITARY... MARINE... AIRBORNE
MOBILE... AMATEUR... INSTRUMENTATION
ULTRASONICS... STANDARD



BLILEY ELECTRIC COMPANY
UNION STATION BUILDING • ERIE, PA.

SOLID BRASS ELECTRONIC HARDWARE AND FITTINGS

for
Industrial
and Marine
Applications



Precision machined from solid brass
... plated to your requirements.

Spherical seat (ball and cone type). RF fittings including ferrules, adapters, couplings, nuts; receptacles, etc. Made in accordance with BuShips drawing RE-49A-501A for use with flexible metal hose, conduit, tubing, etc.

Rapid delivery on standard or special sizes. Let's discuss your needs! Write or phone, today.

HARDWARE DIVISION

HOPKINS
Engineering Co.

FACTORY: 2082 Lincoln Ave.
Altadena, Calif. Sycamore 8-1185
Offices in WASHINGTON, D. C.
and DETROIT

Want more information? Use post card on last page.

PRODUCTION TECHNIQUES (continued)

right. This has holes at three different heights, in which the bolt for the two-piece wood work-gripping blocks can be inserted. These blocks are drilled to grip the shaft of a selector switch tightly. The work can be rotated around the shaft, with the switch indexing detents serving to hold the assembly at any desired angle. The wing nut arrangement permits changing the angle of the subassembly in a vertical plane.

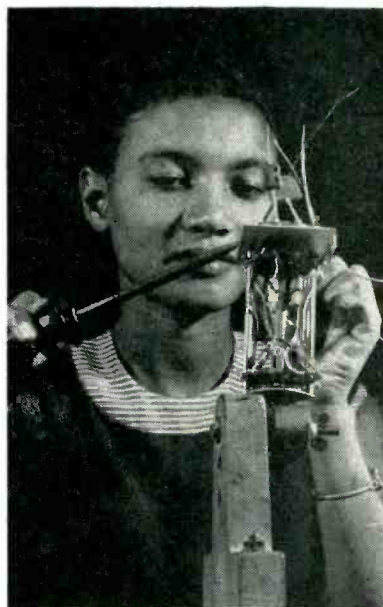

Method of using hardwood holding fixture to facilitate assembling and soldering selector switch unit for military radar equipment

Chassis Samples Shorten Training Time

TO SHORTEN the time needed for getting a production line up to speed on a new television receiver model, Olympic Radio & Television places a chassis sample in front of the operator at each of the 60 work positions on the line. Each chassis has been partly wired so that it looks exactly the way it should at its particular position on the line after the operator at that position has completed her assigned work. The parts and leads to be installed are clearly tagged with white masking tape.

Another advantage of this technique is that absenteeism has less effect on production. By glancing at the sample chassis, the relief operator can see exactly what must be

HUMPHREY LINEAR POTENTIOMETER



ABSOLUTE PRECISION LINEARITY

Gives noise-free, sharp out-put when subjected to vibration, dither and other environmental conditions. Rugged, light-weight, with exclusive internal design.

Dual element
construction

Resistance Values to
13,000 ohms/inch, higher
in special units.

1/2" diam. for strokes up to 3"
3/4" diam. for strokes over 3"

SPECIAL CONSTRUCTION AVAILABLE
FOR HIGH TEMPERATURE APPLICATIONS

NEW HUMPHREY ACCELEROMETER

Readily adapted to wide selection of g ranges.

Accuracy: From plus or minus 1% at zero, to plus or minus 2% at maximum acceleration.

A RUGGED, COMPACT ACCELEROMETER with integral Potentiometer take-off, giving amazing accuracy under adverse conditions, due to the rugged construction. No "cross-talk".

FULLY TESTED AND QUALIFIED FOR
MILITARY APPLICATIONS

Pacific SCIENTIFIC CO.

1430 Grande Vista Ave., Los Angeles 23, Calif.
25 Stillman Street, San Francisco 7, California
1915 1st Avenue South, Seattle 4, Washington
806 East Abram Street, Arlington, Texas

EASTERN REPRESENTATIVE: AERO ENGINEERING INC.
Mineola L.I., N.Y. • Indianapolis • Baltimore • Montreal

Want more information? Use post card on last page.

September, 1953 — ELECTRONICS

The New DuMont CATHODE-RAY OSCILLOGRAPH TYPE 301-A



Carry
your
laboratory
to the
field!

Performance and versatility you would expect only in a larger, heavier laboratory-bench instrument — ruggedness and dependability geared to the requirements of field use — portability that will revolutionize your field servicing techniques — these, and many other features combine to make up the new Du Mont Type 301-A cathode-ray oscilloscope.

The new Du Mont 301-A has been designed for field test and maintenance of airborne equipment, computers, microwave relays, and all other field or laboratory applications requiring a *quantitative, wide-band* oscilloscope.

PRICE \$935* *Also available with "ruggedized" tubes
@ \$985

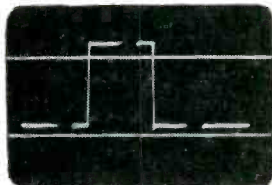

Quantitative analysis of pulse with amplitude calibration lines showing pulse to be 1.1 volts. Internally generated blanking markers indicate 10 μ sec pulse width.

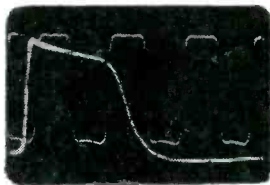

Trigger output pulse. Internally generated amplitude calibration standard indicates 110 p-p volts.

SPECIFICATIONS

CATHODE-RAY TUBE — Tight-tolerance Du Mont Type 3WP1; overall acceleration, 1400 volts.

VERTICAL DEFLECTION — Deflection Factor: 0.28 p-p volts/inch. Sinusoidal Frequency Response: down not more than 20% at 10 cps and 4 mc. Rise Time: 0.08 μ sec max. Undistorted Deflection: 2 inches minimum. Signal Delay: built-in delay of 0.35 μ sec.

LINEAR TIME BASE — Sweep Range: driven sweeps only, continuously variable in duration from 200,000 μ sec to 10 μ sec. Maximum Sweep Speed: 0.55 inches/ μ sec.

TRIGGER GENERATOR — (available at front panel) Range: 45-5500 cps. Rise Time: less than 0.5 μ sec. Duration: 1-2 μ sec approx.

VOLTAGE CALIBRATION — Attenuator is calibrated to 0.3, 1, 3, 10, 30, and 100 volts/inch. Precision $\pm 2\%$. Calibrator output available at front panel.

TIME CALIBRATION — Blanking markers at 10,000, 1000, 100, 10, and 1 μ sec intervals. Accuracy $\pm 5\%$. Available at front panel.

PRIMARY POWER — 115 volts, 50-1000 cps, 110 watts. Standby heater 15 watts.

PHYSICAL CHARACTERISTICS — Two protective handles on front panel, carrying handle on top of cabinet; supporting foot for instrument folds under cabinet. Size: Height, 9 $\frac{1}{8}$ " ; width, 6 $\frac{1}{2}$ " ; depth, 16 $\frac{3}{8}$ " ; weight, 20 lbs. complete, 17 $\frac{1}{2}$ lbs. without cover and accessories.

ACCESSORIES SUPPLIED — Calibrated scale, filter; CABLES, 4' and 6', terminated in BNC connectors; input termination, 75 ohm, plug-in adapter; PROBES, Cathode Follower, Passive, Detector. Adapters (2), BNC to binding post. (Probes, cables and terminations fit in protective cover.)

Write to Technical Sales Department
for 301-A Bulletin.

DU MONT *for Oscillography*

Instrument Division, Allen B. Du Mont Laboratories, Inc., 760 Bloomfield Ave., Clifton, N. J.

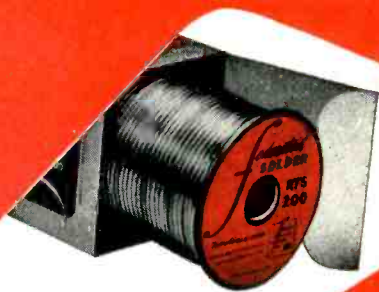

You Can Speed Production-Line Soldering with New, Active, Non-Corrosive RTS 200

Federated Metals' new RTS 200 rosin core solder has proved in production operations to be 5 ways better than ordinary rosin solders:

30% GREATER SPREAD—by test the spread of RTS 200 is 30% greater than that of conventional rosin core solders.

4 TIMES FASTER OXIDE PENETRATION—oxide films and corrosion products on the parts you are soldering need not slow down operations. RTS 200 pierces these retarding agents 4 times faster than ordinary solders.

NON-CORROSIVE—despite the exceptional activity of the RTS 200 flux at soldering temperatures, there is *no harmful corrosive residue* when tested under the high humidity conditions of military specification MIL-S-6872.

NON-TOXIC—the chemicals used in RTS 200 flux are commonly used in industry and have no toxicity factor whatsoever.

STABLE FLUX—experience of over one year with the type flux used in RTS 200 shows that it is just as active after standing as when used immediately. If you store RTS 200 for extended periods, you need not worry about its stability, as you do with ordinary solders.

Try this new, industry-tested active solder *today*. Available in a variety of wire sizes, compositions and quantities. For information see your distributor or write any one of Federated's 14 plants or 22 sales offices across the nation. There is one near you.

Federated Metals Division

AMERICAN SMELTING AND REFINING COMPANY
120 BROADWAY, NEW YORK 5, N. Y.

In Canada: Federated Metals Canada, Ltd., Toronto, Montreal



Aluminum and Magnesium, Babbitts, Brass and Bronzes, Anodes, Die Casting Metals, Lead and Lead Products, Solders, Type Metals

done at that position.

At the end of a production run, the last units to go down the line are the samples themselves. There is thus no waste of parts through using the technique, and no need to make individual drawings or instruction sheets for each work position.

Experienced key workers are used to prepare the samples before the line is in operation. This work serves as a check on balancing of the line and often reveals possible improvements in production planning.

Electronic Counter Aids Adjustment of Relays

THE TIME elapsed from deenergizing of a relay to the closing of the back contacts is adjusted to within 20 thousandths of a second of the critically precise value of 0.110 second with the aid of a Berkeley Model 410 electronic counter, as a regular production operation in the Union City, N. J. plant of Keystone Products Co. Corrections are made by adjusting the position of an arm.

Release of the solenoid voltage is utilized to open an electronic gate. This allows pulses from a 1,000-cps generator to go to the counter. Counting continues until the relay armature has released far enough for the back contacts to touch and restore the bias on the counter. This stops the count. The operator then reads the count in thousands of a second and makes adjustments if it is out of tolerance.



Method of adjusting relay after measuring release time with electronic counter and signal generator

How to Get Microwave Components You Can Trust

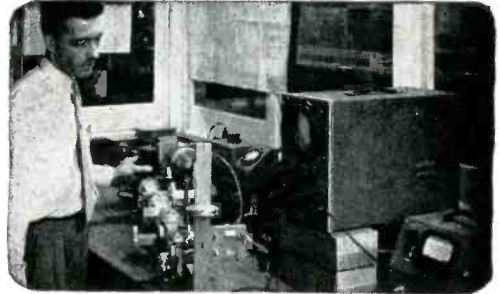

Philco Xb Band Rigid Components receiving swept-frequency discrimination tests.

Microwave components are not costly in relation to the whole job. But they can make or break the performance of a sizable investment once they are installed. It is, therefore, imperative to see that your microwave components are built and checked precisely to your drawings or specifications by a manufacturer who has the knowledge, experience, and facilities to meet these requirements.

When you specify Titeflex Waveguides and components you can be confident of top craftsmanship in manufacture. You can be sure Titeflex will meet your specs or drawings *before* shipment. Only testing facilities as complete as Titeflex maintains could give you this assurance.

Titeflex inspection often saves you the time and cost of duplicate inspection. It is the final step in the production of custom-engineered, precision-manufactured microwave components.

Titeflex engineering and production facilities are available to help you solve your Microwave problems from original design to final production.

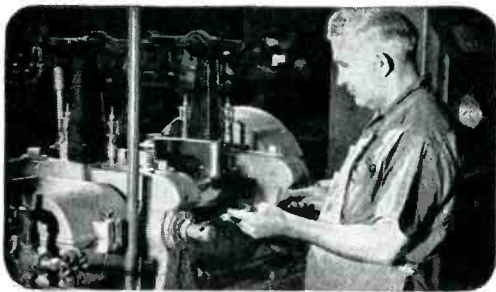
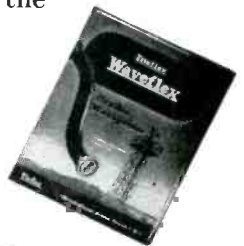

Milling the rubber-like compound which is subsequently molded over Titeflex flexible waveguides to protect them.

Have you this catalog of Titeflex microwave components? Use coupon in sending for your free copy.

Let Our Family of Products Help Yours



✓ Check products you are interested in.



SEAMED AND SEAMLESS METAL HOSE



PRECISION BELLOWS



IGNITION HARNESS



IGNITION SHIELDING



ELECTRICAL CONNECTORS



RIGID AND FLEXIBLE WAVE GUIDES

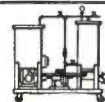

FILTERS



FUSES

TITEFLEX, INC.
524 Frelinghuysen Ave.
Newark 5, N.J.

Please send me without cost information about the products checked at the left.

NAME _____
TITLE _____
FIRM _____
ADDRESS _____
CITY _____ ZONE _____ STATE _____



NEW PRODUCTS

Edited by WILLIAM P. O'BRIEN

Control, Testing and Measuring Equipment Described and Illustrated . . . Recent Tubes and Components Are Covered . . .
Forty-Five Trade Bulletins Reviewed

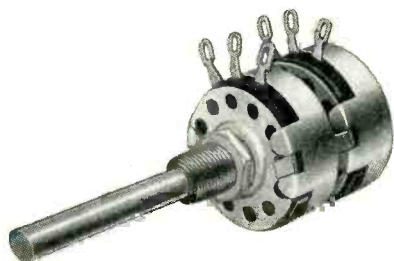

POTENTIOMETERS are mounted in tandem

OHMITE MFG. Co., 4835 Flournoy St., Chicago, Ill., is now offering the Dual type AB molded composition potentiometers, consisting of two units mounted in tandem and controlled by the rotation of one shaft. These 2-watt units are designed for industrial, laboratory, and radio, tv and electronic service applications. The resistance element is a thick, solid molded ring, heat treated under pressure—not a sprayed film or paint-type resistor. Seven resistance values are available, ranging from 10,000 ohms to 1.0 megohm.

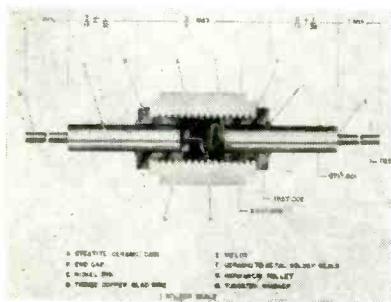

GERMANIUM DIODES are vacuum-tight sealed

BOMAC LABORATORIES, INC., Salem Road, Beverly, Mass., has developed a new line of germanium diodes featuring vacuum-tight, moisture-resistant seals, as well as extreme mechanical stability. Use of a ceramic case insures stable elec-

trical characteristics and complete isolation from adjacent circuitry. Design of the diodes consists essentially of a small, low-loss ceramic case into which two end caps are threaded. Metallization of the case surfaces allows vacuum-tight ceramic-metal seals to be made. The specially treated germanium pellet and tungsten whisker are precisely adjusted for optimum performance by use of force fitting, knurled, nickel pins. Use of nickel terminal pins and flexible, tinned leads permits the unit to be either clipped into spring holders or soldered directly for circuit applications.



OSCILLOGRAPH records automatically

GENERAL ELECTRIC Co., Schenectady 5, N. Y., has announced a new 7-element automatic oscillograph for recording power-system disturbances and photographically recording preselected magnitudes, wave shapes and phase relations. Type PM-13 oscillograph has seven permanent magnetic, fluid-damped galvanometers with a separate shunt and resistor unit for adapt-

OTHER DEPARTMENTS

featured in this issue:

	Page
Electrons At Work	198
Production Techniques	262
Plants and People	378
New Books	428
Backtalk	440

ing them to current or voltage measurements. Relays and controls are provided for starting the instrument automatically by overcurrent in $\frac{1}{4}$ cycle, and stopping it after a predetermined interval or after the fault has cleared. Bulletin GEC-396 gives complete information on the unit.

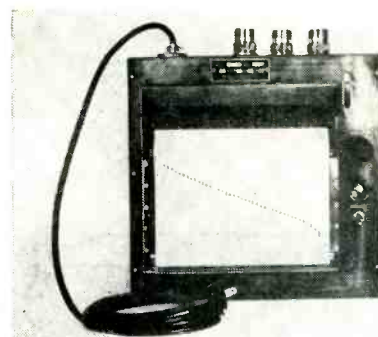

RECORDER has many marking styli

HOGAN LABORATORIES, INC., 155 Perry St., New York 14, N. Y., is offering the RX-30 series of multi-stylus recorders that can record simultaneously on a large number of fixed styli across a chart $9\frac{1}{2}$ in. in width. The recording medium used is Faxpaper, a current-sensitive electrolytic recording paper. Because of its wide-range half-tone characteristics, this paper makes possible the gathering of additional information in each marking channel by means of variable-density recording techniques. The recorder is supplied with a single, fixed chart-advance speed, but this speed can be chosen from several differ-

24 INCH ALUMINIZED SYLVANIA PICTURE TUBES

AVAILABLE NOW

When the television industry has demanded picture tubes of finest performance, it has turned again and again to Sylvania . . . the recognized leader in quality picture tube production.

Now Sylvania once more meets the industry's demands . . . this time for a large-screen aluminized tube. New mass production techniques and 50,000 square feet of specialized, new facilities, at Sylvania's great Seneca Falls, New York plant, assure unbeatable quality and immediate availability of the much-wanted type 24CP4A.

Thus once again the television industry finds Sylvania's know-how in quality mass production provides a new television picture tube by which all future standards may be set. For further information on the 24CP4A, see your Sylvania representative, or write to Sylvania Electric Products Inc., Dept. 3R-3008, 1740 Broadway, New York 19, N. Y.

SYLVANIA



**LIGHTING • RADIO
ELECTRONICS
TELEVISION**

In Canada: Sylvania Electric
(Canada) Ltd., University Tower Building,
St. Catherine St., Montreal, P. Q.

ent speeds available to best suit the use to which it may be put. The number of styli may also be varied to meet requirements. A 400-ft roll of Faxpaper will feed the recorder for 20 minutes of operating time.



TRANSISTOR TESTER for factory and laboratory

ELECTRONIC RESEARCH ASSOCIATES, INC., Box 29, Caldwell, N. J. Model TT-11 transistor tester provides a means of testing transistors, diodes or other semiconductor devices on a direct-reading "go no-go" basis. The unit tests *npn*, *mpn* junction and point-contact transistors and is not obsoleted by new transistor types. Both static and dynamic tests are performed and results are independent of voltage and temperature variations. These features together with its simplicity of operation make the device particularly suitable for both lab development work and factory production. The tester utilizes a bridge method for comparing the characteristics of the unknown with known reference transistors.

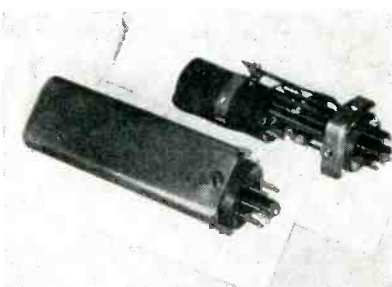

HEATER RECTIFIER reduces hum in amplifiers

VECTOR ELECTRONIC Co., 3352 San Fernando Road, Los Angeles 65,

Calif. The small rectifier-filter circuit shown here was developed especially for reducing hum by supplying d-c heater current to the first stage of low-level amplifiers. It is provided with an octal plug for convenient mounting and occupies a space above the chassis only $1\frac{1}{2} \times 1\frac{1}{2} \times 4$ in. Since its rated input voltage is 6.3 to 7.5 v a-c, the device can be connected directly to the available a-c filament supply. It provides up to 0.3 ampere d-c, the d-c output voltage being about 85 percent of the a-c input voltage at 0.3-ampere load, 95 percent at 0.15-ampere load. Filtering is adequate to reduce the a-c component in the load over 20 db.

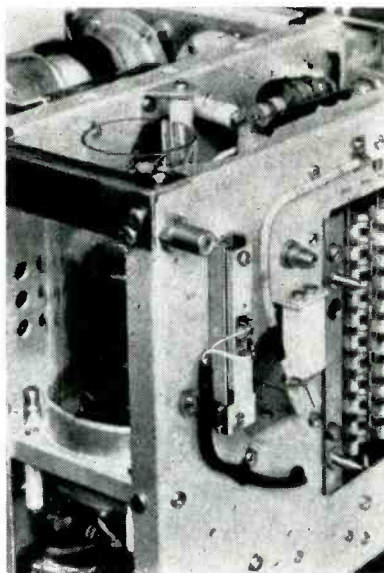

RADIATION SWITCH provides tube protection

FEDERAL TELEPHONE AND RADIO CORP., Clifton, N. J., has available a new overload radiation switch that provides complete protection against tube failure due to anode overheating. Designed especially to protect radiation-cooled transmitting tubes from damage caused by excessive plate dissipation, it will operate with any tube whose radiant energy density at the bulb surface is greater than 1 w per square in. Rugged and easy to install, the device is resistant to shock and vibration, has positive snap action, and can be readily adjusted to the desired operating level. It is also capable of controlling sizeable

currents. The unit is actuated entirely by (direct) radiant energy and is essentially unaffected by ambient temperature changes over a range of -20 to $+100\text{C}$.



SUPERHET RECEIVER for 540 kc to 31 mc range

HAMMARLUND MFG. Co., INC., 460 W. 34th St., New York 1, N. Y., has introduced the HQ-140-X general purpose superheterodyne communications receiver. The unit has a continuously tunable frequency coverage of from 540 kc to 31 mc (555 to 9.7 meters) in 6 convenient bands, and includes a self-contained power supply. Band-spread tuning is available on the 4 higher frequency ranges, with direct calibration for the 80, 40, 20, 15 and 10-meter amateur bands. Full use of the receiver's high sensitivity is available for reception of even the weakest stations because of inherently high signal-to-noise ratio and the Hammarlund noise limiter.

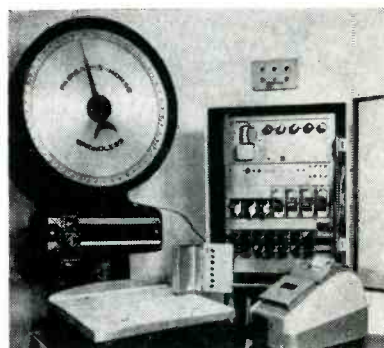

TOTALIZING SCALE relays data to IBM units

INDUSTRIAL ELECTRONIC ENGINEERS, 3973 Lankershim Blvd., North Hollywood, Calif. A recently developed electronic conversion unit, the ETS-7, records net weight readings directly from any dial

for the
FINEST
 in recorded
 sound



America's leading phonograph record manufacturers use
audiotape* for the original sound
 and audiodiscs* for the master recording

NO ONE listens to recorded sound with a more critical ear than the professional recordists who make America's finest phonograph records. Here there can be no compromise with quality.

That's why it's significant that so many of them repeatedly specify Audiotape and Audiodiscs to meet their most exacting requirements. For example, it was found that 29 of the 30 best selling records of 1952 were made from Audiodisc masters. And over 43% were first recorded on Audiotape before being transferred to the master discs.

Remember - you get this same superlative sound by using Audiotape and Audiodiscs in *your* recording work.

© The exclusive trade-mark of Columbia Long Playing Records - Reg. U.S. Pat. Off.

* Trade Mark. Audiodiscs are manufactured in the U.S.A. under exclusive license from PYRAL, S.A.R.L., Paris



AUDIO DEVICES, Inc.

444 MADISON AVE., NEW YORK 22, N. Y.
 Export Dept.: 13 East 40th St., New York 16, N. Y.
 Cables "ARLAB"



audiodiscs
 audiotape
 audiofilm
 audiopoints

I AM THE SALES MANAGER OF SIGMA INSTRUMENTS, INC.



I HAVE NOTHING TO DO WITH SIGMA ADVERTISING.
BUT I'M THE BOY WHO HAS TO TAKE IT.

DAILY I HEAR



WE ARE AN INSTITUTION
INSTEAD OF A COMPANY
(AM I EMPLOYED
OR COMMITTED?)



OUR PRESIDENT AND OUR ADVERTISING AGENCY ARE BUSY COUNTING
CRICKETS' CHIRPS I WANT TO SELL OUR PRODUCTS.



DIRECTOR AND OUR ADVERTISING AGENCY
COUNT AND PLUCK CROWS FEATHERS.
I STILL WANT TO SELL OUR PRODUCTS.



SINCE I HAVE NOTHING TO LOSE BY SPEAKING (except my job),
HERE IS WHAT THE SIGMA SALES DEPARTMENT HAS TO SAY,
PREVIOUS ADVERTISING IMPLICATIONS NOTWITHSTANDING

WE **DO** SELL SENSITIVE RELAYS WE **DO** LIKE OUR CUSTOMERS
WE **DO** LIKE MILITARY BUSINESS, TOO
WE **WERE** REASONABLY HUMAN **BFFLCCFAB****

ABOVE YOU SEE AN IMPRESSION OF MY MIND.
THERE IS NO NEED TO TURN THIS PICTURE UPSIDE DOWN TO
FIND THE SALES MANAGER. I AM UPSIDE DOWN
ALREADY THANKS TO MY ASSOCIATES. YOU ALONE CAN
STRAIGHTEN ME OUT BY CASTING YOUR VOTE BELOW.



**THE
QUESTION
IS** →

**MAIL THIS
COUPON TODAY**
THE LIFE YOU SAVE
MAY BE MY OWN

*NOTE: for your convenience
I have already registered
your opinion

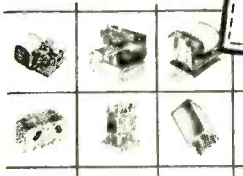

THE SIX BASIC
SIGMA RELAYS
Not foreign products, but not illustrated since
February 31, 1951. (adv.)

SIGMA INSTRUMENTS, INC.
COMPLAINT DEPARTMENT
937 b STATLER BLDG., BOSTON 16, MASS.

I Do I Do Not like Sigma advertising
I want technical data, pictures of products, etc. No Yes
The Sales Manager should be fired. No Yes
The president should be fired. No Yes
The technical research director should be fired. No Yes
The advertising agency should be fired. No Yes

Name _____
Job _____
Company _____
Address _____

NOW TELL US WHAT YOU REALLY
THINK OF SIGMA ADVERTISING. 

Upon receipt of your reply we will send you a
life-size foot print of the sales manager suitable
for framing.



** BEFORE FISH, FISHING LURE, CRICKETS, CROWS, FLIES, AND BUGS

scale and enters the information into IBM units or other business machines. The ETS-7 controls conveyor, monorail, or hopper delivery across scales; records weight readings as fast as one unit per second. Weights are itemized, subtotaled and totaled as desired; printed automatically on tape or business form. Typical uses of the unit are in controlling batching preparations, preparing freight invoices, and recording net weight in production runs.

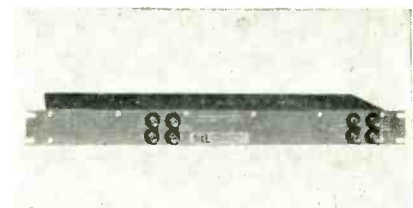

TRANSFORMER PANEL
available in three models

SPENCER-KENNEDY LABORATORIES, INC., 186 Massachusetts Ave., Cambridge 39, Mass. Series 303 transformer panels are designed to be used with the series 300 variable electronic filters when a 600-ohm impedance is required. They can also be used when it is necessary to go from a 10,000-ohm impedance to a 600-ohm impedance. The transformers on each panel are arranged to provide either grounded, floating or balanced connections. The series 300 come in three models: the 303A provides one 600-ohm output; the 303B, two 600-ohm outputs; and the 303C, two 600-ohm inputs and two 600-ohm outputs.



PRECISION COUNTER
for production or lab

HEWLETT-PACKARD Co., 395 Page Mill Rd., Palo Alto, Calif. Model

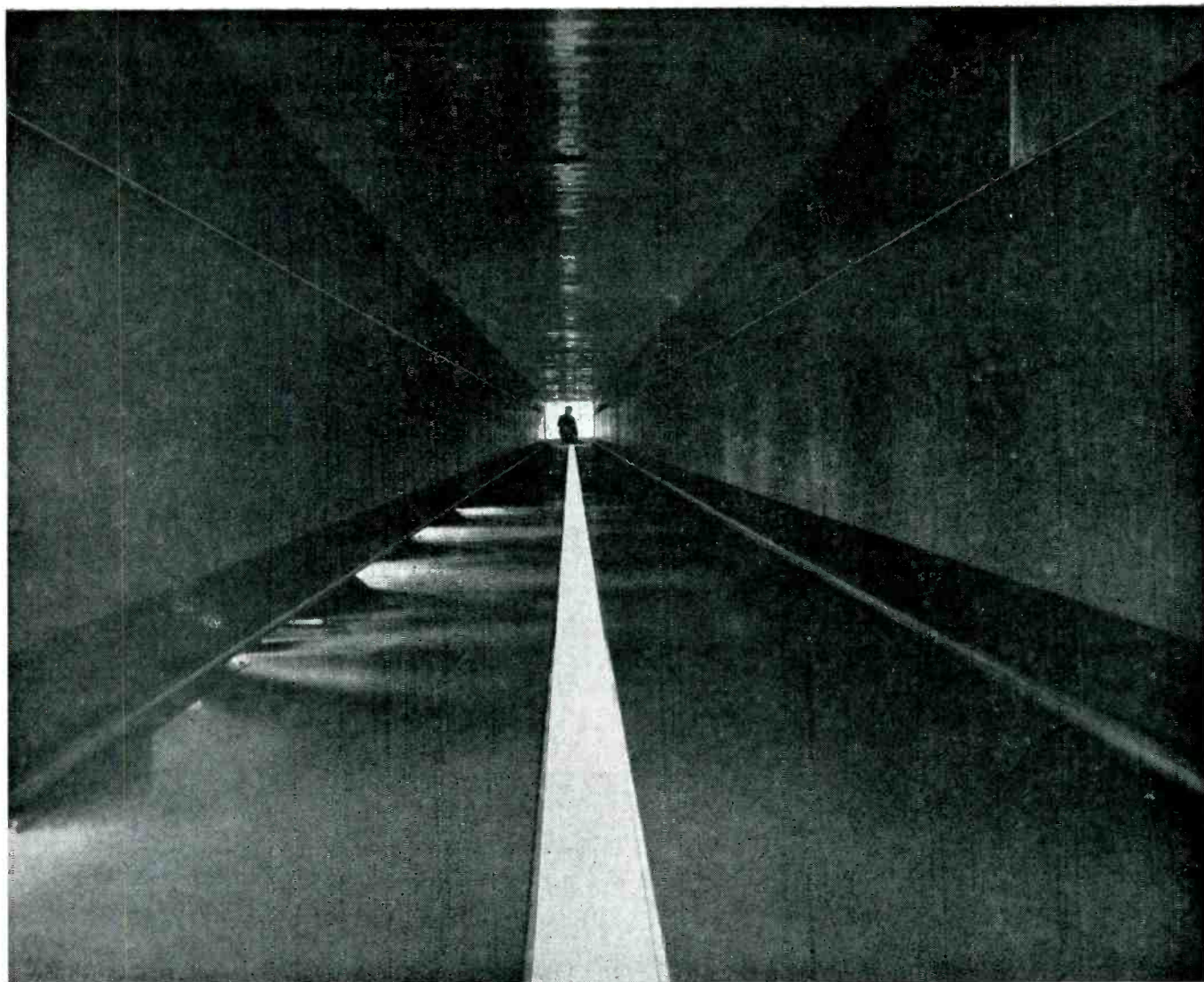

You are looking into the **COOLING END**
of a television tube exhaust oven.

We all know about controlled heating
but **STEINER-IVES OVENS** have
CONTROLLED COOLING as well.

STEINER-IVES CO.
SPRINGFIELD ROAD • UNION, N. J.





*Contract
Manufacturing
Facilities*



**WRITE FOR
NEW
BULLETIN**

This 40 page comprehensive booklet shows typical examples of Kirk & Blum fabrication, complete facilities of plant and equipment for jobs ranging from one unit to thousands.

Whatever your requirements in sheet, plate and alloy fabrication, Kirk & Blum can produce for you . . . economically and quickly.

Complete facilities to $\frac{1}{2}$ " capacity for square and rotary shearing, braking, forming, rolling, punching, riveting, welding, grinding, drilling and finishing sheets and light plates and structurals.

For complete details, write for literature on fabrication facilities and experience or send prints to:

THE KIRK AND BLUM MANUFACTURING COMPANY
3211 FORRER STREET • CINCINNATI 9, OHIO

KIRK AND BLUM METAL FABRICATION

522B all-purpose precision counter provides frequency, period and time-interval measurements over a broad range. The instrument measures time from 10 μ sec to 27.8 hr. Counting is available over periods of 1/1,000, 1/100, 1/10, 1 and 10 seconds or multiples. Time of display can be varied to any duration, counts are automatically reset and action is repetitive. Results are shown in cps, kc, seconds or milliseconds. The 522B may be used to measure or count production quantities, nuclear radiations, rps and rpm, power-line frequencies to high accuracies, weight, pressure, temperature and acceleration at remote points, very low frequencies, oscillator calibration and pulse repetition rates.

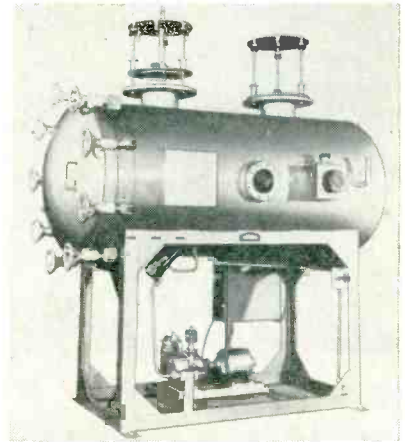

EXPLOSION CHAMBER has new safety features

BOWSER TECHNICAL REFRIGERATION, Terryville, Conn., has announced an improved type of explosion chamber designed to fill the testing needs of manufacturers of all types of airborne electrical or electronic equipment. It incorporates many new safety features as well as advanced operating facilities. Among the new safety features are: automatic fuel metering, which eliminates the hazards of manual metering, and a specially designed tank constructed in accordance with ASTM standards. Advancements in operational design include a special ignition circuit whereby firing of the gaseous atmosphere is possible at any altitude up to 70,000 ft. A sturdy climb and dive valve is tied into the vacuum-pump system

130° C.

WITH IMPROVED BH "649"

Laboratory tested for retention of flexibility
and original rated electrical protection after

130 C° — 1500 hours

150 C° — 500 hours

160 C° — 24 hours

232 C° — 3 hours

BH "649" is a braided Fiberglas sleeving coated with an improved vinyl-chloride formulation. Available in all standard sizes and colors, in grades A-1 (7000 V.), B-1 (4000 V.) and C-1 (1500 V.). Send for data sheets and samples from current production.

**BENTLEY, HARRIS
FIRST IN**

use of Fiberglas
heat-treated Fiberglas
true high temperature
flexibility
vinyl-coated Fiberglas
silicone rubber coating
colors in silicone rubber
true Class B (130°C.)
protection

Another Bentley, Harris First!

Bentley, Harris Manufacturing Co.
Conshohocken, Pa.
Address Dept. E-9

BH *Fiberglas* SLEEVINGS

*BH Non-Fraying Fiberglas Sleevings are made by an exclusive Bentley, Harris process (U. S. Pat. No. 2393530). "Fiberglas" is Reg. TM of Owens-Corning Fiberglas Corp.

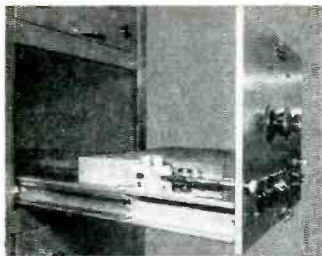

1. FULL EXTENSION — Continuous ball bearing action permits smooth, non-jar chassis removal. Locks in fully extended position, must be unlocked to return.

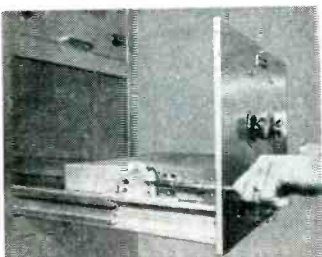

2. PIVOT RELEASE — Withdrawing release rods disengages them from quadrant mechanism, enables perfectly balanced unit to be tilted by simply raising.

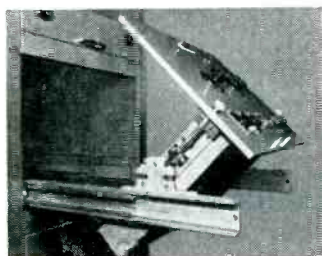

3. 45° PIVOT — Unit locks in 45 degree or 90 degree position. Special pivoted positions can be obtained to fit individual requirements.

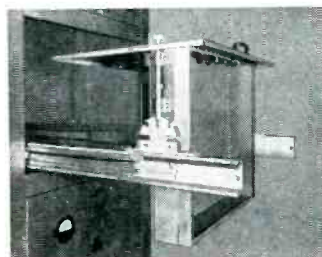

4. FULL TILT — Maintenance and repairs easily made. Access to component is gained in a few seconds. Special slides can provide plus or minus 90° tilt.

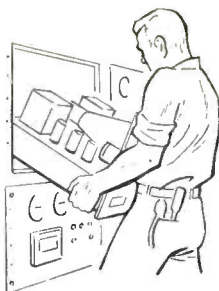

*Why put up
with this costly,
time-wasting step
any longer?...*

Design accessibility into your equipment

When repairs and maintenance of electronic equipment are needed, wasted time costs money! Alert manufacturers have totally eliminated the laborious step of "getting at" vital components by installing Grant Industrial Slides. Is your equipment mechanically up to its high electronic standards? If not, Grant offers you: Stock Slides. A great variety of types, suitable for most needs available for immediate delivery. Custom Slides. Our engineering staff will assist you at your plant and develop slides that fit your requirements perfectly.

Grant Industrial Slides



*Write for our complete Industrial Slide Catalog.
Grant Pulley and Hardware Corporation
31-73 Whitestone Parkway, Flushing, New York*

so that desired altitudes can be quickly simulated, and viewing windows permit observation of equipment undergoing test.



CURVE TRACER for both transistor types

MAGNETIC AMPLIFIERS INC., 632 Tinton Ave., New York 55, N. Y., announces production of a new automatic transistor curve tracer. It is recommended for designing transistor circuits, comparing matching and selecting, detecting anomalies, studying the effects of temperatures, age, normal usage, overloading and detecting failures and their causes. The unit tests *npn*, *pnp*, junction and point-contact transistors and features flexibility of design to accommodate new types as produced.

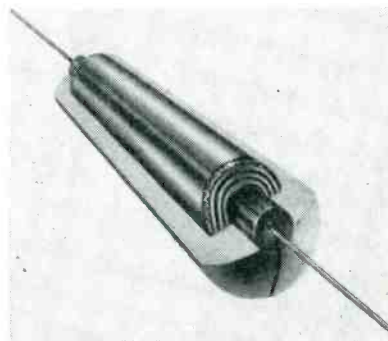

SEALED CAPACITORS in molded plastic cases

ASTRON CORP., 255 Grant Ave., East Newark, N. J., is producing the Blue-Point capacitor, a new concept in the design, construction and performance of molded-plastic paper capacitors. These capacitors are permanently sealed against heat and moisture by means of a special solid glasslike thermosetting bond that becomes an integral

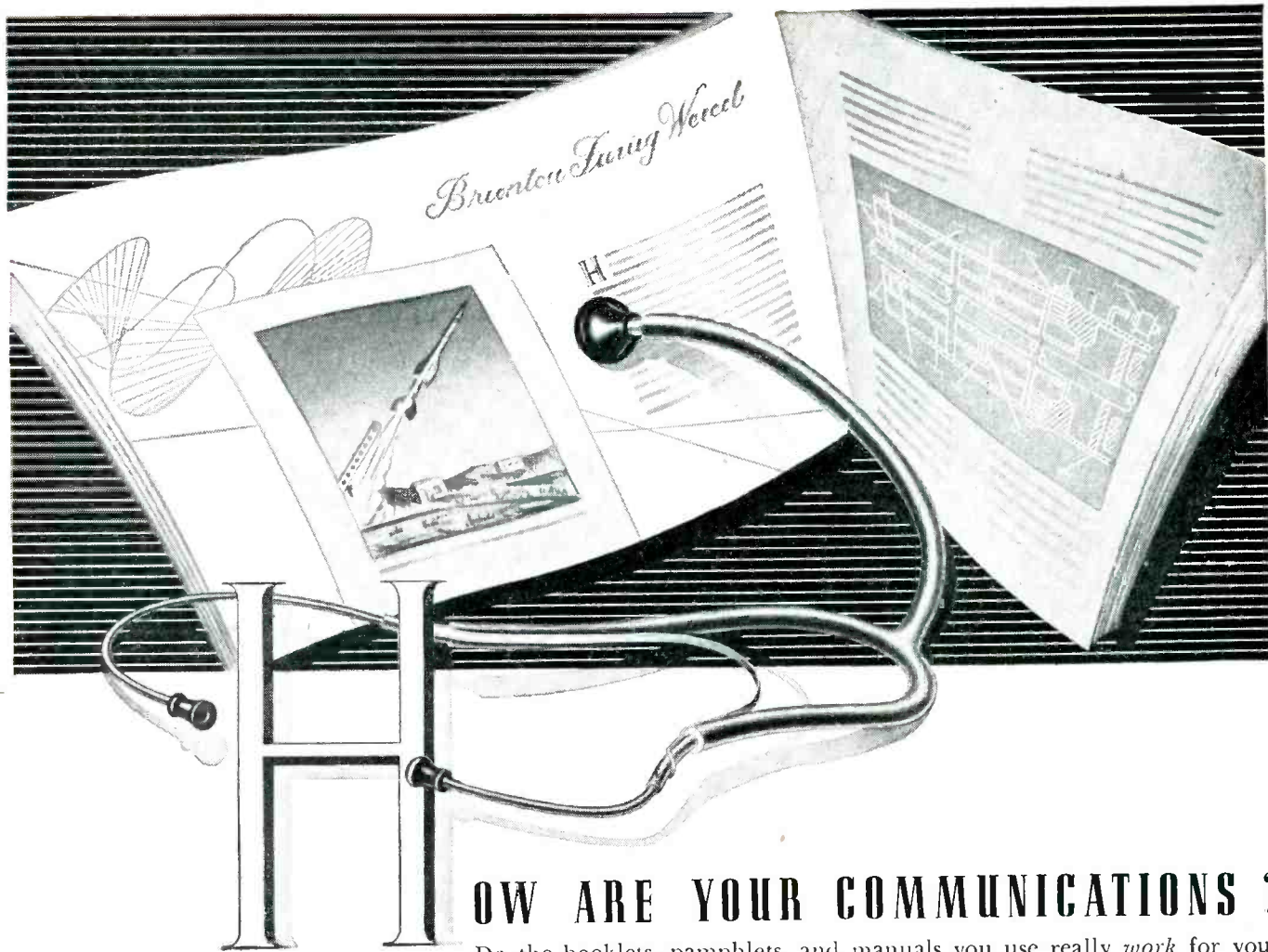

HOW ARE YOUR COMMUNICATIONS ?

Do the booklets, pamphlets, and manuals you use really *work* for you? Are these vital publications, that tell the story of your products and your company, as effective, readable, well designed and illustrated as they can be? Today more than ever, your entire operation is judged by each annual report, employee manual, and public relations piece that you produce. Have you examined your communications lately? If you have any doubt as to the impact of your instructional and promotional literature, remember . . .

COMMUNICATION IS OUR BUSINESS

For a good many decades McGraw-Hill has stood for complete coverage in the business literature field. Now the McGraw-Hill **TECHNICAL WRITING SERVICE** offers a new approach to your publication problems — an *integrated* writing, editing, illustrating, and printing service for the *custom* production of: INSTRUCTION MANUALS, PRODUCT BULLETINS, TRAINING AIDS, INDUSTRIAL RELATIONS LITERATURE, ANNUAL REPORTS, COMPANY HISTORIES, PROCEDURAL GUIDES and other collateral literature. More than 150 editorial and graphic experts are at your disposal, ready to prepare high-quality material to your own or government specifications. Save time, save money . . . and make your communications work! Let *our* staff be your staff for technical and business publications.

McGraw-Hill Book Co. TECHNICAL WRITING SERVICE

Write or phone Technical Writing Service, McGraw-Hill Book Co., Inc.
330 West 42nd Street, New York 36, N. Y. • LONgacre 4-3000

This service is available through ad agencies.

HERE'S WHY

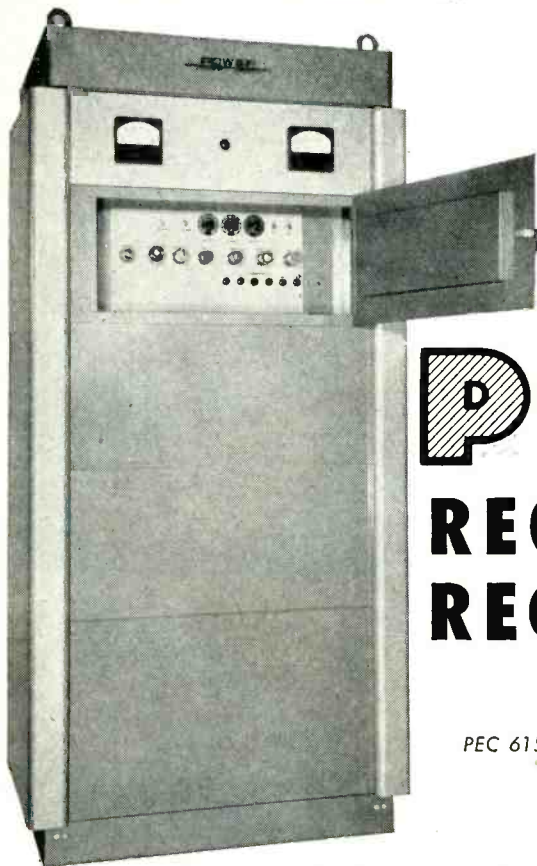

MAJOR
COMPUTER
INSTALLATIONS
ARE
POWERED BY

PECO REGULATED RECTIFIERS

PEC 615 Series.

Accuracy and reliability are the main reasons! PEC 615 models have already passed "on the job" tests—assuring trouble-free power supplies for various sections of many of the larger electronic computer installations. In addition, it was found that only a small amount of maintenance was needed. Space-saving, functional design accounts for much of this economy.

For complete specifications, write for Bulletin No. 109 today.

SPECIAL FEATURES

- Each power supply is insulated from ground so that either polarity may be grounded as required.
- Each power supply is equipped with a "high-low" protective system.
- All tubes used are operated at conservative ratings to provide long-life, with a minimum of maintenance.
- At the time of starting, the voltage is automatically applied and slowly raised to the operating condition to protect the tubes and condensers.
- Fuses are provided in each thyratron tube plate lead for maximum protection.

PECO *Custom Built* REGULATED RECTIFIERS

To meet the requirements of closely regulated and filtered rectifier type power supplies, where the total amount of power is too great to be assembled into a single cabinet, Power Equipment Company is prepared to build equipments arranged for mounting on racks, and designed to generally conform with the customer's existing or proposed apparatus. For complete specifications, write for Bulletin No. 108.

POWER EQUIPMENT *Company*

Battery Chargers ☆ Battery Eliminators
☆ D.C. Power Supply Units ☆ Regulated
Exciters ☆ and other Special Communica-
tions Equipment

5740 NEVADA, EAST / DETROIT 34, MICHIGAN

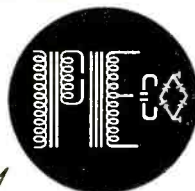

NEW PRODUCTS

(continued)

part of the case. The Blue-Point bond also locks in the leads so that they cannot be pulled out. Neither lead, bond nor case is affected by flame or soldering-iron heat, regardless of how close they are applied. The capacitors are mineral-oil impregnated for continuous operation at 85C and extremely stable operation over a wide temperature range. The capacitors are produced in all popular ratings and sizes.

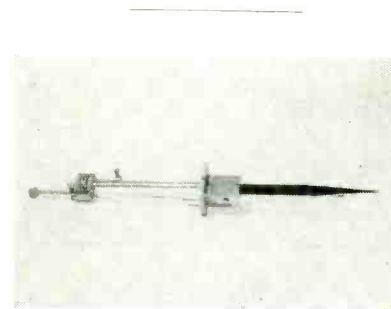

WAVEGUIDE LOADS are movable-tunable

TECHNICRAFT LABORATORIES, INC., Thomaston-Waterbury Road, Thomaston, Conn., has introduced new devices that provide essentially perfect low-level waveguide loads. Readily adjustable to a vswr not exceeding 1.001, precision of adjustment is limited by the sensitivity of the measuring equipment with which they are used. Currently available are model L75A for use with WR-159 and model 164A for use with RG-52/U (WR-90) waveguides. Also available are WR-159 waveguide termination, model T75A, incorporating the L75A load; and model T64A, WR-90 termination, incorporating the 164A load.



FLEXIBLE CABLE for uhf and vhf reception

U. S. WIRE & CABLE CORP., Progress & Monroe Sts., Union, N. J. The Hol-O-Kor flexible cable was designed to fulfill the need for a low-loss lead-in 300-ohm line for uhf reception. It has special construction features so that changes in weather and atmospheric condi-

For problems here

you'll find the answers here

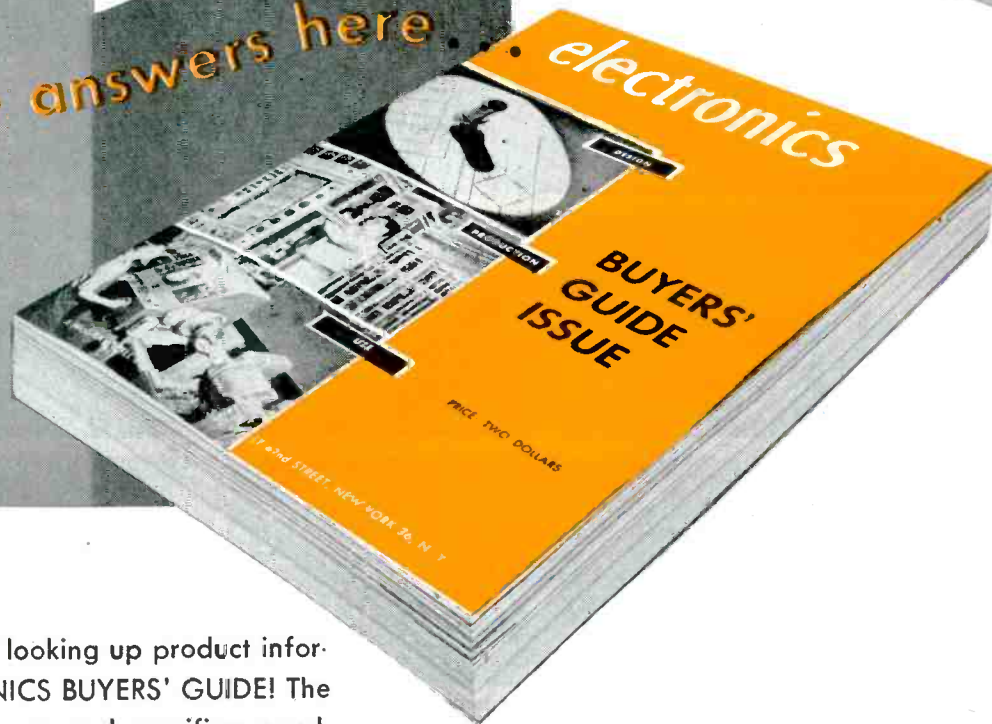

It's become a habit . . . looking up product information in the ELECTRONICS BUYERS' GUIDE! The fact is, designers, engineers and specifiers reach for the GUIDE as they reach for their slide rule. They just naturally keep the GUIDE close by them as they work at their breadboards. Designing electronic equipment necessitates fitting in the correct component that is required in the circuitry. What they need is a ready source of information . . . product information that is essential in their work. That's why they always reach for the GUIDE.

You, too, can solve your product problems and save countless hours of trial-and-error searching by getting in the habit of looking it up in the GUIDE. It's the most convenient, finger-tip method of locating product information.

Get into the habit of LOOKING IT UP IN "THE GUIDE"

The most reliable source of product information in the field . . . the most complete, most accurate reference book. 1520 product listings — complete in every category — amply cross indexed . . . the entire electronic industry is in the habit of looking in the GUIDE for immediate answers to its product problems.

 **electronics BUYERS' GUIDE** 

330 WEST 42ND STREET • A MCGRAW-HILL PUBLICATION • NEW YORK 36, NEW YORK

PROMPT DELIVERY...

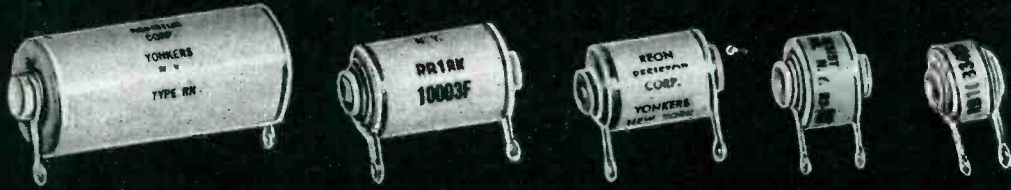

of Precision Wire Wound Resistors

in sample or production quantities!

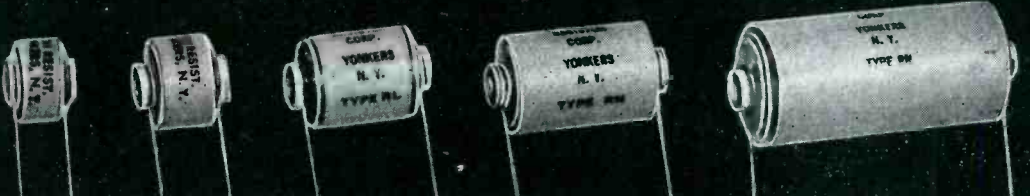

**MIL-R-93A
SERIES**
Lug Terminals
Wattage Ratings:
¼ to 1 watt
Tolerance: 1% to .02%
Resistance Range:
.1 ohm to 4 meg.
Exceed all MIL-R-93A
specifications

**COMMERCIAL
SERIES**
Lug Terminals or
Radial Leads
Tolerance: 1% to .02%
Wattage Ratings:
½ to 5 watts
Resistance Range:
.1 to 15 meg.
Same construction as
MIL-R-93A series

**MINIATURE
SERIES**
Radial or Axial Leads
Wattage Ratings:
.15 to 1.5 watts
Resistance Range:
.1 ohms to 1.6 meg.
Physical Size: 3/8" dia.—
¼" to 1¼" long

**SUB MINIATURE
SERIES**
Radial or Axial Leads
Wattage Ratings:
.1 to .5 watts
Physical Size: ¼" dia.—
¼" to 1½" long
For use where space
is important

**CENTRAL AXIAL
LEAD TYPES**
Wattage Ratings:
¼ to 1 watt
Physical Size: ¼" to 7/16"
dia.—5/8" to 1½" long
Small, rugged, self-
supporting, designed for
ease in assembly

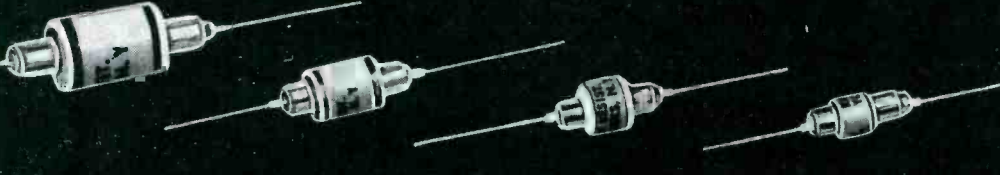
Sub-Sub Miniature Series—The smallest precision wire wound resistors. For use in tight spaces. Only 3/32" long by 3/16" diameter.

Hi-Temp Series—For applications requiring resistors capable of withstanding severe thermal shock and extreme temperatures. Operate from -65°C. to 200°C. Available in all types shown.

Hi-Watt Series—Available in all series shown. Wound with special low temperature coefficient wire to provide power dissipation ratings up to 10 watts.

Encapsulated Series—Hermetically sealed resistors completely immune to immersion and humidity. Designed to exceed all MIL-R-93A requirements.

Our Engineering Staff welcomes the opportunity to help you with YOUR problems! For further details write for Bulletin E-61

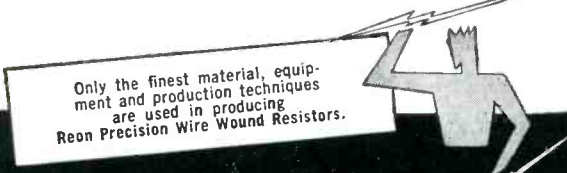

Only the finest material, equipment and production techniques are used in producing Reon Precision Wire Wound Resistors.

Where quality and dependability count...

Specify Reon Precision Wire-Wound Resistors!

REON RESISTOR CORP.
117 STANLEY AVENUE • YONKERS, N. Y.
YO 5-9850

MANUFACTURER'S REPRESENTATIVES:

New York, N.Y.
Boston, Mass.
Syracuse, N.Y.

Philadelphia

Cleveland, Ohio
Chicago, Ill.
St. Paul, Minn.
Merriam, Kan.
Dallas, Tex.
Albuquerque, N.M.
Los Angeles, Cal.

H. L. Hoffman & Co., 110 E. 23rd St., Tel. Gr 3-3022
Dick Castle, H. L. Hoffman & Co., 18 Tremont St., Tel. Ca 7-1905
Mason Berg, H. L. Hoffman & Co., 500 Lafayette Bldg.,
Tel. Sy 3-4645
Phil Goldstein, H. L. Hoffman & Co., 1123 Western Saving Fund
Bldg., Tel. Pe 5-9966
Frank W. Rauer, 4144 Marvin Avenue
Ritter Sales Co., 612 North Michigan Ave., Tel. Su 7-7759
Edward Hoffman, 1641 Scheffer Ave., Tel. Emerson 3371
Koenig Sales, 6359 Antloch Ave., Tel. Hedrick 3166
John B. Guenther, 7322 Marquette Ave., Tel. Emerson 6286
Neil Powell, Kittleson Co., 106A South Cornell, Tel. 2-9581
Harold A. Kittleson Co., 7614 Melrose Ave., Tel. Whitney 1167

tions do not affect either its impedance or its electrical efficiency. Moisture and salt which are prevalent along the coastal areas of our country cannot harm or hamper this transmission line, as these elements are absorbed on the outer covering of this cable. Signal strength remains at a maximum, whether used for uhf or vhf.

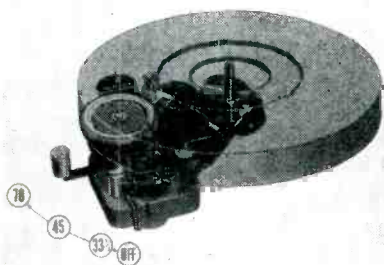

PHONOMOTOR is three-speed unit

THE GENERAL INDUSTRIES Co., Elyria, Ohio, has introduced model SS manually-operated three-speed phonomotor. The unit, with 2-pole motor, incorporates the vertical idler shifting principle. An idler wheel drives the turntable directly from appropriate step on motor shaft. Moving the shift lever to OFF position automatically disengages the idler wheel from the motor shaft during nonoperating periods. Features include a ribbed mounting plate, oilless bearing and dynamically-balanced rotor. The unit is furnished with an 8-in. turntable, the shaft of which revolves with it and is grooved for turntable clip.



COMPUTING DEVICE is graphical-numerical

THE GERBER SCIENTIFIC INSTRUMENT Co., 162 State Street, Hart-

REON

PRECISION wire wound RESISTORS

... surpass MIL-R-93A specs!

from every angle... the TOUGHEST CONDITIONS require REON RESISTORS

Production line ruggedness with hair-line accuracy!
You can be sure once it's mounted... it stands up for good!

One of the largest sample departments in the country!
Prompt delivery of samples to your needs in approx. two weeks. Production quantities in four weeks.

High standards of quality!
Whether for Commercial or for Government equipment, Reon Resistors are manufactured to the same rigid specifications.

WRITE... for complete specifications on the Reon Resistor MIL-R-93A series and for information on other standard commercial and special types. Request our application sheet.



MIL-R-93A Series

- RB15, RB16, RB17, RB18, RB19
- Wattage Ratings:
MIL: 1/4 to 1 watt
COM: 1/4 to 2 watts
- Tolerance:
MIL: 1% to .1%
COM: 1% to .02%
- Resistance Range:
MIL: 1 ohm to 4 meg.
COM: 1 ohm to 10 meg.

REON PRECISION WIRE WOUND RESISTORS are dependable under the most adverse conditions.

- HEAT
- COLD
- OVER-LOADING
- HUMIDITY
- AGING

REON RESISTOR CORP.
117 STANLEY AVENUE, YONKERS, N. Y.

Some REON types

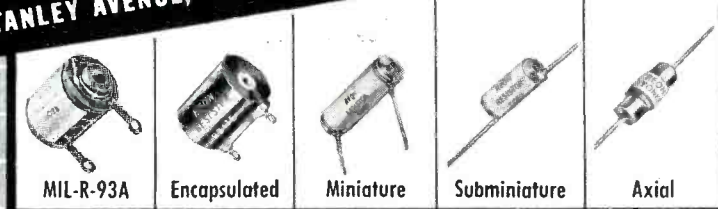

**Fast, accurate determination of match;
load impedance, power—10 kc to 3 mc**

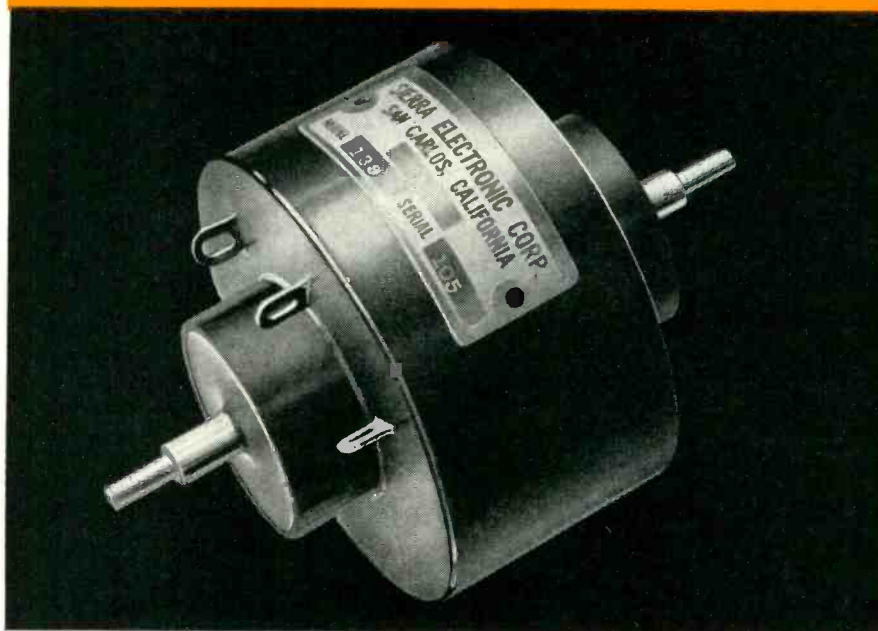

Model 139 Directional Coupler

These new Sierra Couplers provide fast, accurate and continuous readings of transmission line characteristics over a wide frequency, power and impedance range. Designed for operation up to 15 kw, they consist of a wide band, toroidal ferrite core transformer connected internally to a 10 μ fd coaxial capacitor. The instruments are very simple to install, operate in any position, and are usable with coaxial or open-wire line, or with a lumped linear passive network.

Transformers in Model 139 are rated 25 \pm 2 millihenrys; capacitor is rated 4.25 kv rms; frequency range is 10 kc to 3 mc. The couplers are moderately priced and available for immediate shipment.

Nominal coupling factor of Model 139 is 50 db and directivity is 62 db. However, the coupling and directivity are easily adjustable over a wide range, depending on auxiliary circuitry.

REQUEST BULLETIN 101 FOR FORMULAS AND DETAILED INFORMATION.

Sierra Electronic Corporation

San Carlos 2, California, U. S. A.

Sales representatives in major cities

Manufacturers of Carrier Frequency Voltmeters, Wave Analyzers, Line Fault Analyzers, Directional Couplers, Wide-Band RF Transformers, Custom Radio Transmitters, UHF Detectors.



2770

ford 3, Conn., has developed the GraphAnalogue, which handles data involving linear functions as well as arbitrary nonlinear functions directly, thus eliminating much of the time and drudgery normally spent in processing data. The instrument is about 14 in. long, 5 in. wide and $\frac{1}{2}$ in. thick. It is most useful in data reduction where oscillogram recordings can be read directly in the final dimensions irrespective of the shape of the calibration curve. The unit has 18 scales including logarithmic, probability, trigonometric, power, linear and reciprocal. Most important is the graph paper insert, the purpose of which is to read, plot and interpolate graphs, curves and scales involving nonlinearity. Accompanying each GraphAnalogue is an instruction manual, explaining and illustrating many basic applications, including the following: counting cycles, obtaining frequencies, normalizing curves, reading graphs difficult to read, scale factors on oscillograms, reading oscillograms, scaling accurately very small lengths, comparing sine functions, plotting square scales and interpolating logarithmically between curves.



ANTENNA FILTER is the interaction type

CHANNEL MASTER CORP., Ellenville, N. Y., has developed the Ultra Tie, model No. 9034, an interaction filter that combines separate antennas into a single vhf-uhf antenna system. It performs two valuable functions: (1) At the mast, it joins all types of individual vhf and uhf antennas together for use with a

**SIERRA
VHF-UHF
COUPLERS**

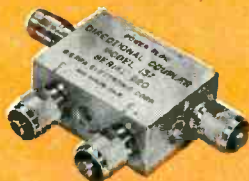

Model 137 (Illustrated) For 51.5 ohm coaxial line. Frequency range 30 to 1,500 mc, coupling factor 70 to 35 db. Directivity throughout range greater than 46 db. Rugged construction; Type N fittings.

Model 138 Similar to Model 137 except offers a coupling factor ranging from 59 to 24 db.

(Sierra also offers Models 137A and 138A, identical with above except primary line impedance 50.0 ohms.)

Model 148 Crystal Detector Sensitive read-out for VHF-UHF couplers. 50 ohms impedance, built-in low pass filter.

Data subject to change without notice.

MAGNETIC AMPLIFIERS

"Moto Mag"
REGISTERED TRADEMARK
OF KEYSTONE PRODUCTS CO.

Keystone has an answer for your servomechanism problems with their line of "Moto-Mags". With our packaged Magnetic Amplifiers you will find that "Moto-Mags" are capable of saving valuable design time and costs.

The units being manufactured at this time are for 400 cycle power. Why not investigate the possibility of using "Moto-Mags" in your systems today. Full literature will be sent upon request.

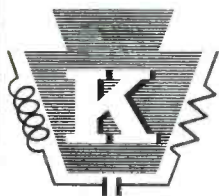
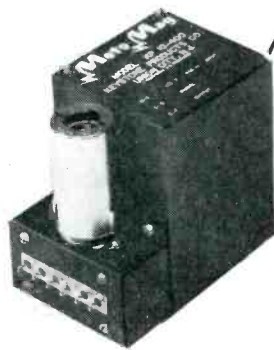

KEYSTONE PRODUCTS COMPANY

904-6 TWENTY-THIRD ST. • UNION CITY 9, NEW JERSEY • UNION 6-5400

DEPEND ON

Bendix

Red Bank

RELIABLE ELECTRON TUBES

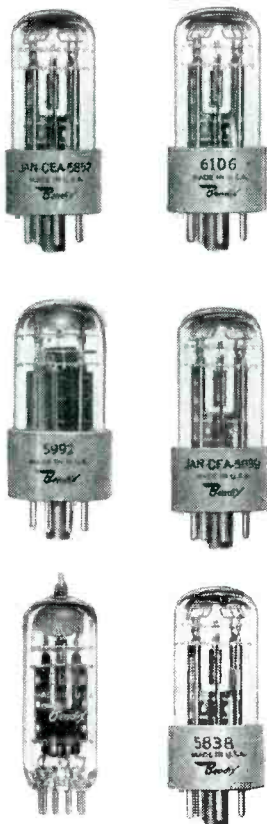

With electronic controls taking over more and more operational functions in aircraft, it's becoming increasingly important that the electron tubes used be dependable under conditions of high altitude, continuous vibration, varying voltages and frequent shock. Because of their advanced design and construction . . . born of never-ceasing research and special production skills . . . Bendix Red Bank Reliable Electron Tubes have the dependability necessary to meet these severe operating conditions. You can depend on our long, specialized experience to give you the right answer . . . for all types of regular as well as special-purpose tube applications. Call on us for full details.

*Manufacturers of Special-Purpose Electron Tubes,
Inverters, Dynamotors and Fractional D. C. Motors*

TYPE AND MODEL INDEX				TYPICAL OPERATING CONDITIONS		
Bendix No.	RTMA No.	JAN No.	General Type	Heater Voltage	Plate Voltage Per Plate	M.A. Load
TE-2		5839	OCTAL FULL WAVE RECTIFIER	26.5	350	70
TE-3	5838		OCTAL FULL WAVE RECTIFIER	12.6	350	70
TE-5		5852	OCTAL FULL WAVE RECTIFIER	6.3	350	70
TE-10	5993		MINIATURE FULL WAVE RECTIFIER	6.3	350	70
TE-22	6106		OCTAL FULL WAVE RECTIFIER	5.0	350	100

BEAM POWER AMPLIFIER TUBE	
SPECIFICATIONS	
BENDIX NO.	TE-8
RTMA NO.	5992
HEATER VOLTAGE	6.3 V
PLATE VOLTAGE	250 V
SCREEN VOLTAGE	250 V
GRID VOLTAGE	12.5 V
G. M.	4000
PLATE CURRENT	45 MA
POWER OUTPUT	3.5W

Bendix

Red Bank

DIVISION OF



EATONTOWN, N. J.

Export Sales: Bendix International Division, 205 East 42nd St., New York 17, N. Y.

NEW PRODUCTS

(continued)

single transmission line; and (2) at the set or converter, it separates vhf and uhf signals where separate vhf and uhf terminals are provided. The Ultra Tie features free-space terminals, making it impossible for dirt, ice or rainwater to accumulate between the terminal feed points, and short out the picture.



TINY RELAY is hermetically sealed

POLYTRON ENGINEERING INC., 32 W. Biddle St., Baltimore 1, Md. The PE5A relay is designed for applications where size and sensitivity are major factors, and where extreme shock and vibration are prevalent. The unit, although only 1 3/8 in. long and 3/4 in. in diameter, will withstand 100G shock and vibration. Built to meet standard military specifications, the relay is sealed in a metal can and uses a standard 7-pin miniature plug-in base. It has an operating range of 24 to 28 v d-c and uses palladium-silver contacts that are rated up to 2 amperes inductive load. Available coil resistances range from 400 to 1,000 ohms.



LINEAR CONVERTER gives log reading in db

PICKARD & BURNS, INC., 240 Highland Ave., Needham, Mass., an-

All
business
is
specialized



... and nothing specializes on your business like your business paper

Here's a profit-wise peddler; he picks his corner, not for crowds but for customers. His business is *specialized*. Like yours.

One thing about specializing is the time it saves. Take your business reading. Where else could you find, fast, the vast flood of specific facts, the up-to-the-minute information about new products, materials and methods to keep you posted on your particular field? Much of what you want isn't published *anywhere* else except in this business paper of yours. Its business is to specialize in *your* business . . . to gather, sort out, report and interpret the facts you need.

What's more . . . look at the ads. It may be news to you, but advertisers are spending over \$300,000,000 this

year to report on their products and services in specialized *business* papers. Your share of that investment is here, in the pages of this paper of yours. Nowhere else can you find such a complete and factful source of everything you need. **Time saver?** It can be a job saver, a profit saver, a life saver! Read it thoroughly — cover to cover . . . and put it to work!

This business paper in your hand has a plus for you, because it's a member of the Associated Business Publications. It's a paid circulation paper that must earn its readership by its quality . . . And it's one of a leadership group of business papers that work together to add new values, new usefulness, new ways to make the time you give to your business paper still more profitable time.

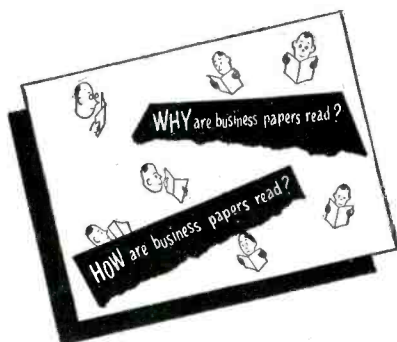

A copy of this quick-reading, 8-page booklet is yours for the asking. It contains many facts on the benefits derived from your business paper and tips on how to read more profitably. Write for the "WHY and HOW booklet." Room 2710.

McGRAW-HILL PUBLISHING COMPANY
330 West 42nd St., New York 36, N. Y.



One of a series of advertisements prepared by THE ASSOCIATED BUSINESS PUBLICATIONS



Over 455 PRECISION PUSH-BUTTON SWITCH TYPES

Looking for precision-built push-button or snap-action switches in the 15 to 50 ampere range with operating pressures of approximately 4 pounds?

Chances are, Hetherington has just what you want—in standard types—backed by a record of proved performance in critical aviation or military applications. Just about any circuit, activating arrangement or mounting style is available and each standard type is readily adaptable to numerous and inexpensive variations.

Write for catalog—or send details of your requirement for recommendation by Hetherington switch specialists.

HETHERINGTON, INC., SHARON HILL, PA.

West Coast Division: 8568 W. Washington Blvd., Culver City, Calif.

**PROMPT
DELIVERIES . . .
LARGE QUANTITIES
OR SMALL**

HETHERINGTON

SWITCHES WITH BUILT-IN INDICATOR LAMPS
MINIATURE SWITCHES
TOGGLE SWITCHES • ROTARY SWITCHES
SWITCHES TO MILITARY SPECIFICATIONS

announces the model 86 log linear converter. It produces a true logarithmic relationship between any 50-kc output or i-f and the model 86 meter reading. This provides the user with the means of recording up to 100 db on conventional linear recorders. Any portion of this 100-db range may be quickly expanded by push-button selection to give a full-scale reading of 20, 40, 60, 80 or 100 db. Because of the logarithmic relationship it is possible to read and record voltage changes of 100,000 to 1 without decading.

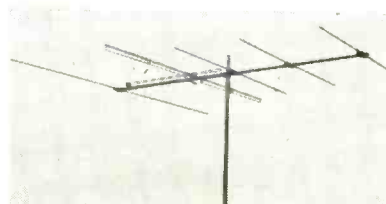

TWIN-TUNED YAGI has high gain

CHANNEL MASTER CORP., Ellenville, N. Y. Model 525 twin-tuned Yagi antenna is peaked for both channels 2 and 5. The antenna, featuring a transformer-type dipole, has a gain of 6½ db on channel 2 and almost 8 db on channel 5, for a single bay. Stacking provides substantially higher gain. Directivity and rear rejection are excellent. The 2-channel antenna operates with just a single transmission line and there is no switching necessary. It is recommended for areas that are within range of channels 2 and 5 and makes an economical 1-antenna installation that will do the job of two single-channel Yagis.



FIVE-IN. C-R TUBE for multitrace display

ELECTRONIC TUBE CORP., 1200 E. Mermaid Lane, Philadelphia 18,

Pa., has announced a 5-in., square-face that is equivalent to the screen area of a 7-in. round-face c-r tube. The type 7YP1 five-gun tube, developed especially for military applications, is ideal wherever a square tube is desirable for multi-trace display. Another feature is the extra sensitive 3D4 deflection plate system, with the guns arranged to present undeflected spot positions displaced $\frac{3}{4}$ in. from one another and in a straight line. All deflection-plate connections are brought out through the tube neck to minimize interelectrode capacitance.

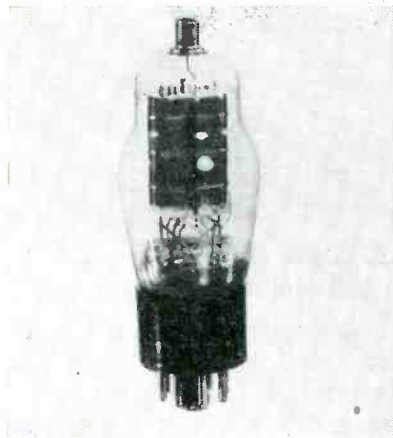

NEW TETRODE is a beam power amplifier

SYLVANIA ELECTRIC PRODUCTS INC., 1740 Broadway, New York 19, N. Y., has released a new tetrode beam power amplifier. Type 6BQ6G was designed for service as a horizontal deflection amplifier in tv receiver sweep circuits. The new amplifier is contained in a ST-12 bulb, thus providing a better safety margin for dissipation. As a horizontal deflection amplifier, a d-c plate supply voltage of 600 v and a peak positive plate voltage of 6,000 v are allowable.

VTVM has high input resistance

ELLIOTT LABORATORIES, 50-34 201st St., Bayside, Long Island, N. Y., has released the model 940 vtvm. Peak-to-peak or rms voltages with a frequency response of 25 to 10,000 cycles are obtainable. Input resistance of 16.5 megohms will not cause

NOW for the first time in *Over 10 Years* **BOGUE** **400 CYCLE GENERATORS**

AVAILABLE FROM STOCK!



Due to the extremely high production at our newly enlarged plant, we are able to offer for immediate shipment from stock "World Famous" Bogue Hi-Cycle Generators in the following sizes:

5, 10, 20 and 50 KVA
Single Phase & Three Phase Output
220/440 Volt Input

Deliver 400 cycles regardless of
load and input variations

LOW HARMONICS CLOSE VOLTAGE REGULATION

Our engineering department will be glad to supply full specifications on stock units as well as on special units to meet all Hi-Cycle requirements.

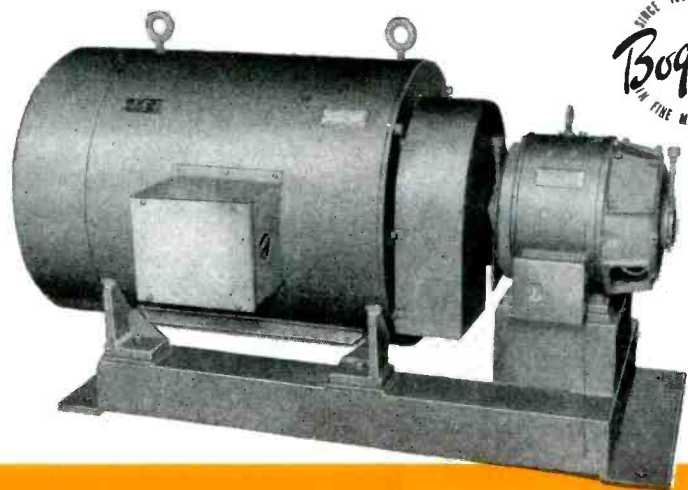

BOGUE ELECTRIC

The Authority on High Cycle Power

52 IOWA AVENUE • PATERSON 3, NEW JERSEY



CAPTIVE NUTS

National Captive Nuts of stainless steel may be pressed into aluminum and certain types of brass sheet metal to provide integral flush-mounted tapped holes in a wide variety of sizes. Four basic types have been designed for metal thicknesses of $\frac{1}{16}$ " , $\frac{3}{32}$ " , $\frac{1}{8}$ " , $\frac{3}{16}$ " and $\frac{1}{4}$ " .

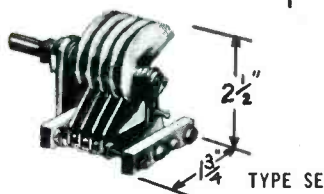
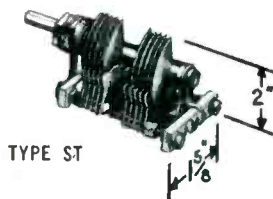
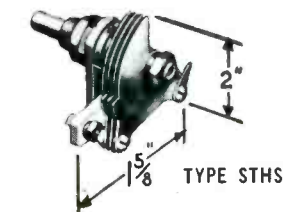
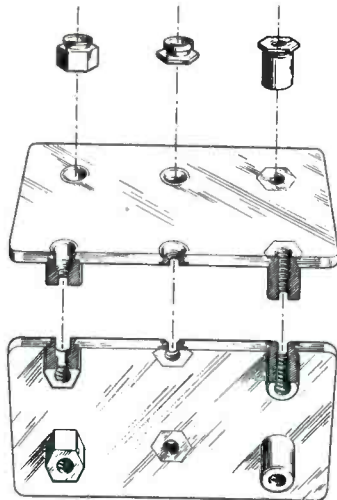

VARIABLE CONDENSERS

National makes a complete line of quality variable condensers covering a wide range of capacities and uses. A few types are shown.

Type ST (180° rotation) has straight line wave-length plates. Type SS has straight-line capacity plates. Both types are available in single bearing, double bearing and split stator double bearing models.

Type SE (270° rotation) has straight-line frequency plates.

National's engineering staff is available to manufacturers for designing condensers to special requirements.

Write for drawings and specifications.

Write for drawings



the circuit under test to be overloaded. Model 940 utilizes a dual triode balanced-bridge circuit. Its a-c and d-c voltages are read on 6 ranges: 3, 15, 30, 150, 300 and 1,500 v. There is a center position for discriminator alignment. Resistance is measured in 5 ranges: from 0 to 1,000, 10,000, 1 megohm, 10 megohms and 1,000 megohms. Included are 5 db ranges from -24 to -1.5, -8 to -15, +12 to +35, +21.5 to +44.5 and +32 to +55 db.

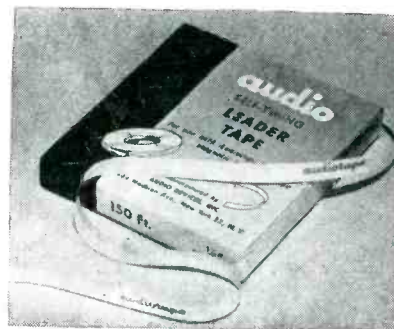

LEADER TAPE is self-timing

AUDIO DEVICES, INC., 444 Madison Ave., New York 22, N. Y., has perfected an improved leader and timing tape made of strong, durable white plastic material. It can easily be marked with pencil or ink and will outlast paper tapes many times over. Used with standard $\frac{1}{4}$ -in. magnetic recording tape, it serves as a threading leader, protective outer wrap for tape on reel, and as a spacer for identification and spotting of recorded selections within the reel. Spaced markings, $7\frac{1}{2}$ in. apart, provide a simple method of timing at all standard tape speeds. The tape is available in 150-ft rolls, individually packaged in a self-dispensing container.

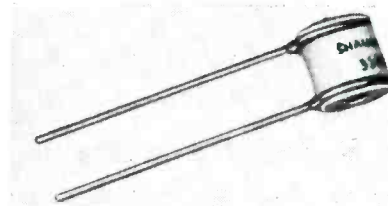

TINY RESISTOR is precision wirewound

SHALLCROSS MFG. CO., Collingdale, Pa., has developed the type 16 resistor measuring only $\frac{1}{8}$ in. long by

17/64 in. in diameter. Designed to save space in subminiature industrial and military equipment, the 0.1-w precision wirewound resistor can be mounted either by its radial wire leads or by an axial No. 2 clearance hold through the resistor's steatite bobbin. The resistor can be noninductively wound in all values up to a maximum of 150,000 ohms. Standard tolerance is 1 percent with closer tolerances available. When processed with the company's BX impregnation, the resistor will withstand prolonged exposure to high humidity. For less severe applications, lacquer coating is available.

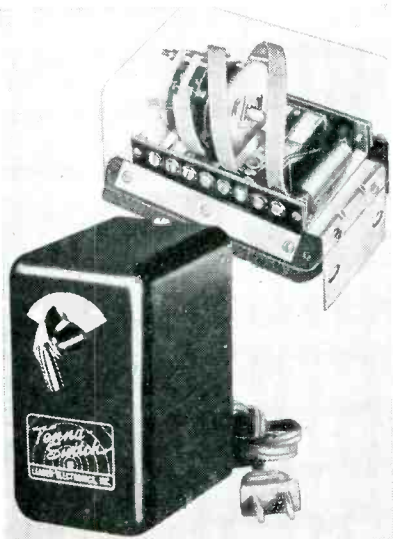

ANTENNA SWITCH
coordinates multi-arrays

LEADER ELECTRONICS, 5713 Euclid Ave., Cleveland 3, Ohio, recently developed the Tenna-Switch for coordinating multiple antenna arrays. It is an electrical instrument that makes it possible to switch from one antenna to any other from within the home by merely switching the lever on the control box. Because it is a remote control electrical switch there is no signal loss that is inherent in network arrangements. Only one antenna lead-in is necessary, eliminating lead-in interference. The unit is designed to work with any combination of antenna installations, such as multiple antenna arrays on a single mast, antennas on separate masts, with various channel yagis, and for combination uhf and vhf antenna installations. Two or more sets in

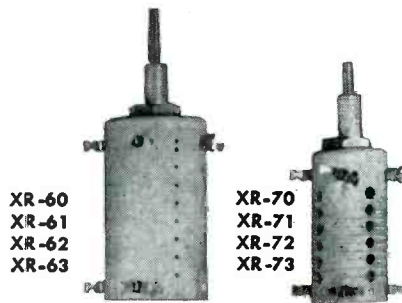
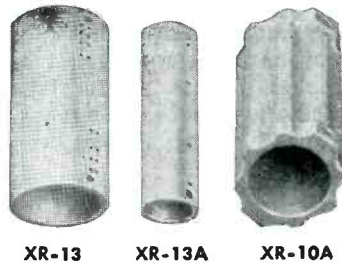

CERAMIC COIL FORMS

National high-grade ceramic coil forms have been designed for a wide variety of communication and industrial applications. Types XR-13, XR-13A and XR-10A are primarily for use in transmitters, diathermy equipment, etc. The XR-60 and XR-70 series are permeability-tuned coil forms, conforming to JAN specifications, with either brass or iron slugs. Write for drawings and specifications.

COMPLETE LINE OF SOCKETS

There is a National socket for every popular tube type and every circuit application. All feature low-loss electrical characteristics, firm tube support and easy, secure mounting. They are recommended wherever the highest quality is required.

Write for drawings and specifications.

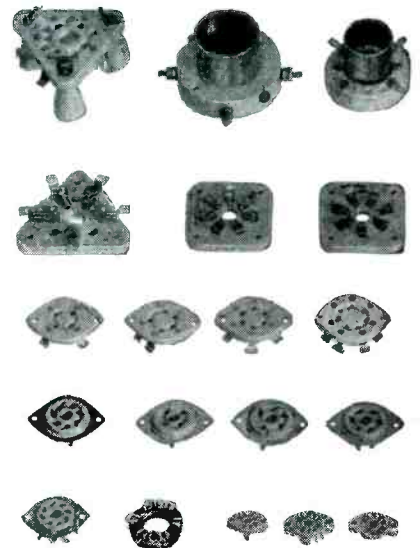

Write for drawings



High Impedance Millivolt Measurements Above 5 MC

Below the input voltage level of 25 mV germanium diodes and other crystal rectifiers are nearly square law detectors. When combined with a high impedance vacuum tube millivoltmeter for DC, having 1 mV full scale deflection at 6 megohms input impedance, these crystal rectifiers can be used as "pseudo-thermocouples" for high impedance millivolt measurements at input wattage levels substantially lower (microwatts) than those of ordinary heater type thermocouples (milliwatts). This is particularly useful for mV measurements above 5 MC since little in the way of instruments has been available in those higher frequency ranges, so far.



*It Measures
Where Others Fail*

Millivac MV-18B RF-mV-Meter

- Measures RF signals down to a single mV and DC down to 50 microvolts.
- Wide Frequency Range (1 MC to 200 MC flat within 10% directly calibrated. Useful up to 2,500 MC with calibration chart).
- Minimum Circuit Loading (new "MINIMUM CAPACITY PROBES" have 1.0, 1.5 and 2.8 MMF rated input capacities).
- Wide Voltage Range (RF 10mV to 1,000 V, directly calibrated, 1 mV to 10 mV by chart—DC 50 microvolts to 10 mV, directly calibrated).
- Square Law Dial For Vacuum Thermocouples and High Impedance "Pseudo-Thermocouples" Measurements.

MILLIVAC INSTRUMENT CORPORATION
P.O. BOX 997, Schenectady, N. Y.

NEW PRODUCTS

(continued)

a home may be operated with a single antenna with no signal loss.

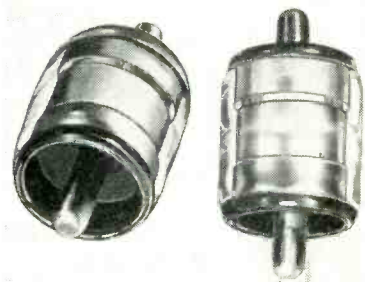

VACUUM CAPACITORS for aircraft equipment

DOLINKO & WILKENS, INC., 1901 Summit Ave., Union City, N. J., has introduced a new line of miniature fixed vacuum capacitors especially suited for aircraft electronic equipment. Small size and compact construction of the units coupled with practically loss-free characteristics assure efficient high-frequency operation. High voltages and currents as well as temporary overloads are easily accommodated; internal breakdown voltage is constant and not affected by altitude, dust, humidity, temperature and other factors. They are available in capacitances to 50 μf and voltages to 15 kv.

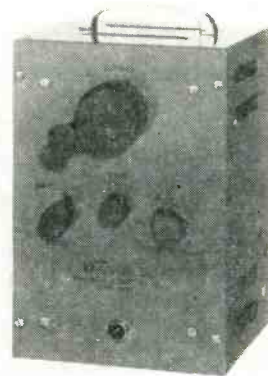

MARKER GENERATOR is a compact unit

VECTRON, INC., 404 Main St., Waltham, Mass., is now offering their new MG10S microwave marker generator to permit the addition of 4, 2 or 0.5-mc markers to the display of any S-band spectrum analyzer. This compact, self-contained unit (9 in. x 6 in. x 5½ in., weighing less than 10 lb) uses standard re-

ceiver-type tubes and the special harmonic circuit permits continuous coverage of the entire S-band, 1,550 to 5,200 mc, and through C-band to at least 6,200 mc. The multiple-turn, coarse-tuning control is supplemented by a fine-tuning vernier. Standard units provide a choice of 0.5, 2 and 4-mc multiple sideband markers, factory adjusted to an accuracy of ± 1 percent of the marker frequency.

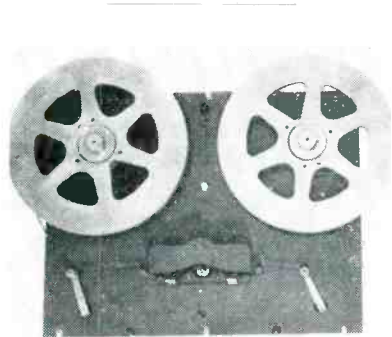

**TAPE REPRODUCER
for background music**

PRESTO Co., Paramus, N. J. Model PB-17 tape reproducer will automatically play 8 hours of taped material, at which time it will either stop or replay the same reel. The dual-track unit will accommodate reels up to 14 in. in diameter and operates at a tape speed of $3\frac{3}{4}$ in. per sec. An automatic mechanism reverses the tape at the end of the reel and the machine plays back the adjoining track to complete an 8-hour uninterrupted cycle. Frequency response ranges from 50 to 8,000 cps. The unit embodies the new unitized construction allowing quick maintenance. The PB-17 meets a definite need for industrial background music, wired music systems, entertainment locations and the like.

**UHF-VHF LINE
has low-loss insulation**

ANACONDA WIRE & CABLE Co., Hastings-on-Hudson, N. Y. The ATV-270 FOAM line features a

DC-AC CHOPPERS
New 1953 Models for Military Use —
0-500 CPS

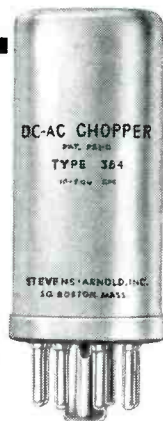

Tops in Performance — Tops in Dependability

Stevens-Arnold choppers are electro-mechanical precision vibrators that are used as modulators or demodulators. Designed specifically for airborne applications, and 1000 hours operation.

- Gold contacts used exclusively. Gold is the only material that assures superior chopper-performance in the critical 0-1½ volt DC range.
- Multiple testing guarantees uniformity. Before shipment, each unit must pass *two* complete operating tests at 3 different temperatures — -55°C., +25°C. and +85°C.
- Not only are all military specifications met, but liberal safety factors have been provided to meet emergency conditions of voltage and frequency. Example: — frequency tolerance 0-500 cps, coil voltage tolerance +30% -20%.



Also Available 60-CYCLE TYPES

A complete line of single and double-pole types.



SEND COUPON TODAY FOR COMPLETE INFORMATION

**STEVENS-
ARNOLD
INCORPORATED**

22 Elkins Street,
South Boston 27, Mass.

SA-6

STEVENS-ARNOLD, Inc.
22 Elkins St., South Boston 27, Mass.

Please send me the following catalog (s)

- Catalog 208 B — (0-500 cps)
- Catalog 246 D — (60 cps)

NAME _____

COMPANY _____

STREET _____

CITY _____ ZONE _____ STATE _____

STANDARD

Radio Interference and Field Intensity

MEASURING EQUIPMENT

Complete Frequency Coverage—14kc to 1000 mc!



NM-10A

VLF

14kc to 250kc

Commercial Equivalent of AN/URM-6B.

Very low frequencies.

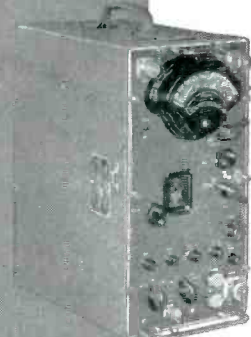

NM-20B

HF

150kc to 25mc

Commercial Equivalent of AN/PRM-1A. Self-contained batteries. A.C. supply optional. Includes standard broadcast band, radio range, WWV, and communications frequencies. Has B.F.O.



NMA-5A

VHF

15mc to 400mc

Commercial Equivalent of TS-587/U.

Frequency range includes FM and TV Bands.

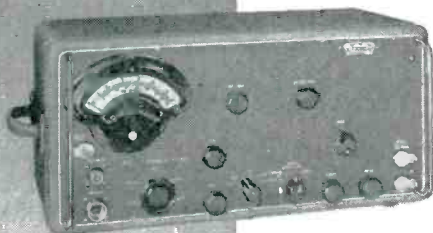

NM-50A

UHF

375mc to 1000mc

Commercial Equivalent of AN/URM-17.

Frequency range includes Citizens Band and UHF color TV Band.

These instruments comply with test equipment requirements of such radio interference specifications as MIL-I-6181, MIL-I-16910, PRO-MIL-STD-225, ASA C63.2, 16E4, AN-I-24a, AN-I-42, AN-I-27a, MIL-I-6722 and others.

STODDART AIRCRAFT RADIO Co., Inc.

5644-A Santa Monica Boulevard, Hollywood 38, California Hollywood 4-9294

NEW PRODUCTS

(continued)

one-piece, cellular construction that makes it virtually impossible for the user to be troubled by internal moisture condensation—a problem sometimes encountered in uhf lines of semi-solid construction. The new line consists of two high-strength conductors firmly enclosed and accurately spaced within a new compound, foamed polyethylene. The construction gives the line superior low loss qualities, a major requisite for h-f applications. It is the easiest uhf-vhf line to terminate, needing only a skilled hand and a penknife to prepare the line for connection to the antenna. Characteristic impedance is 270 ohms. Attenuation (dry) at 100 mc is 1.5 db per 100 ft.; at 500 mc, 3.6 db per 100 ft.; at 900 mc, 5.0 db per 100 ft. Dimensions are approximately 0.30 × 0.45 in.



MULTI-HELIX ARRAY for point-to-point use

MARK PRODUCTS Co., 3547 Montrose Ave., Chicago 18, Ill., has extended its line of helical beam antennas to include multiple helix arrays for point-to-point applications in the 450, 900 and 2,000-mc regions. The model H-2960R shown is a two-helix array for the 890-960-mc region. Molded integrally into a cellular-core-fiberglas homogeneous structure the two helices arrayed on a common ground plate provide beamwidths of 32 deg in the single-helix plane and 17 deg in the two-helix plane. The measured gain is 18.8 db above isotropic. All helical

units are designed to withstand 100 mph wind velocity with ½-in. radial ice load.

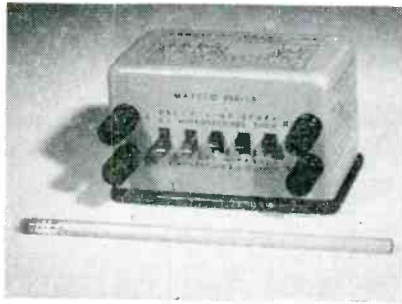

DELAY LINE
is a laboratory type unit

MAY ENGINEERING Co., 6055 Lankershim Blvd., N. Hollywood, Calif. The laboratory-type precision delay line illustrated is variable in additive increments of 0.02 μsec each and is used for electronic circuit work such as color tv, instrumentation pulse-forming networks and computer circuits. The instrument is the lumped-constant type with a total maximum delay of 1.0 μsec measured at ½ amplitude, with a rise time of 0.05 μsec (measured at 10 percent and 90 percent amplitude). The characteristic impedance is 50 ohms and maximum peak voltage is 500. The unit features low attenuation. Overall dimensions are 2½ x 3 x 4½ in.

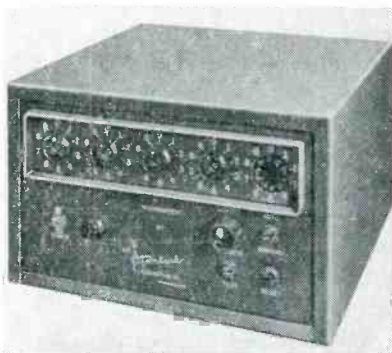

TACHOMETER
is highly accurate

THE STANDARD ELECTRIC TIME Co., Springfield 2, Mass., has announced a new electronic tachometer for measurement of speed, frequency or events per unit of time. It features the use of a new cold cathode glow transfer tube to give a clear,

Precision ATTENUATION to 3000 mc!

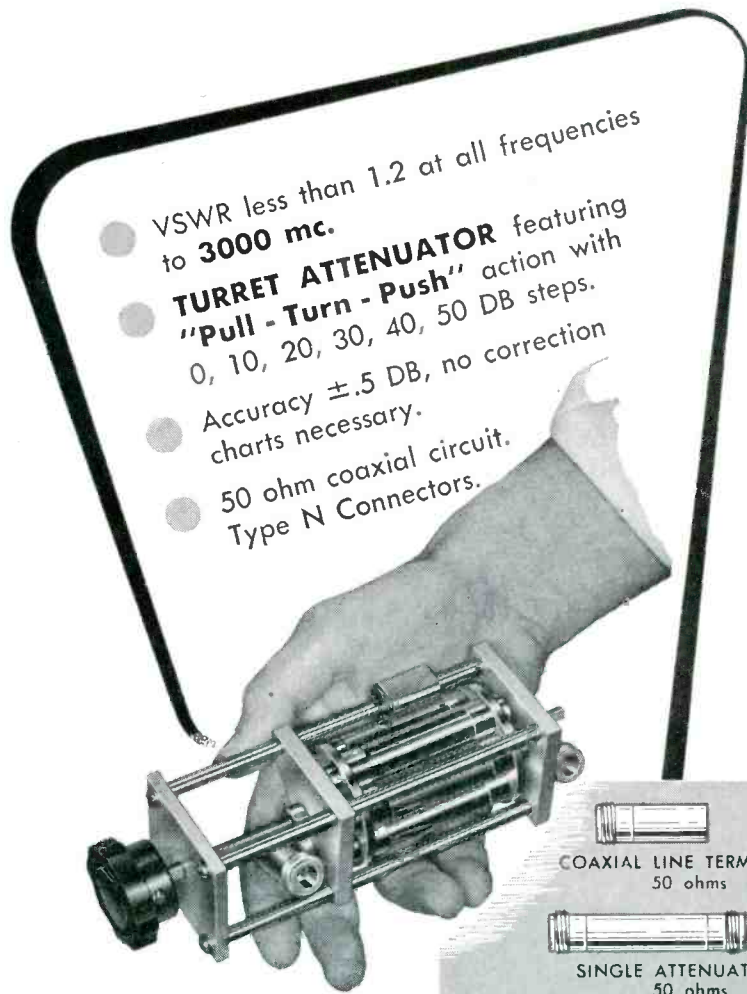

- VSWR less than 1.2 at all frequencies to 3000 mc.
- **TURRET ATTENUATOR** featuring "Pull - Turn - Push" action with 0, 10, 20, 30, 40, 50 DB steps.
- Accuracy ±.5 DB, no correction charts necessary.
- 50 ohm coaxial circuit. Type N Connectors.

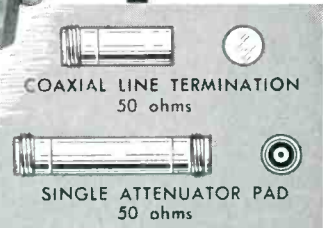

COAXIAL LINE TERMINATION
50 ohms

SINGLE ATTENUATOR PAD
50 ohms

Inquiries are invited concerning single pads and turrets having other characteristics

VSWR ± 1.2 to 3000 mc.
One watt c.w. power dissipation

STODDART AIRCRAFT RADIO CO., INC.
6644-A SANTA MONICA BLVD., HOLLYWOOD 38, CALIFORNIA
HOLLYWOOD 4-9294

FILTERS

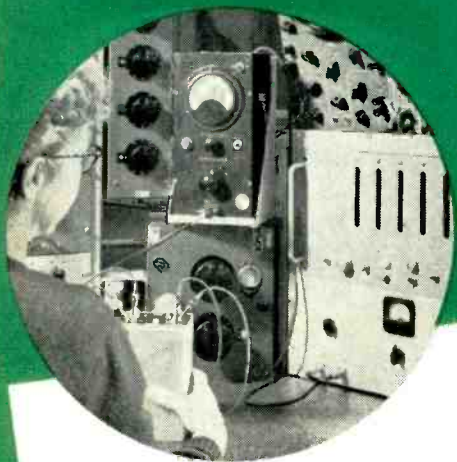

to assure
your product's performance
Lenkurt tests them
mesh by mesh

When you guarantee your product's performance—you are guaranteeing the components it contains. That's why the confidence you can have in LENKURT FILTERS is so important. Lenkurt uses laboratory care even in mass production quantities.

Typical of Lenkurt's extra care is the well engineered procedure for testing both filter meshes and final assemblies. Each mesh of a Lenkurt filter is tested for frequency response, effective a.c. resistance and other significant requirements. The frequency sources used are accurate within ± 1 cycle. Lenkurt's testing techniques are direct reading to cut testing time and eliminate sources of human error. Their efficiency makes possible the uniform adherence to any feasible specification you request.

Lenkurt's efficient testing techniques were the subject of an article in Electronics Magazine, April 1953. Reprint copies are furnished on request. Write today for further information.

Lenkurt

LENKURT ELECTRIC SALES CO.
SAN CARLOS 1, CALIFORNIA

sharp, compact read-out. Accuracy of count is ± 1 ; accuracy of time base, 1 part per million; and power requirements, 100 w. The unit measures 12 in. x 8 in. x 12 in. For easy servicing if required, the instrument has 11 plug-in sub-chassis, 22 vacuum tubes, and 7 plug-in cold cathode counter tubes. Bulletin 200-T is available for the asking.



TV PICTURECASTER for channels 2 through 13

BOXOFFICE TELEVISION, 255 W. 84th St., New York 24, N. Y., has developed the tv Picturecaster, a closed-circuit transmitter for tv pictures and sound. It accepts video and audio from any source—receiver, camera chain, coaxial line or generator—and transmits them into any type of transmission line on any vhf channel, 2 through 13. The transmitter frequency is crystal-controlled, with the sound and video carriers automatically maintained $4\frac{1}{2}$ mc apart for best results with intercarrier receivers. A-M picture and f-m sound are receivable on all standard tv sets.

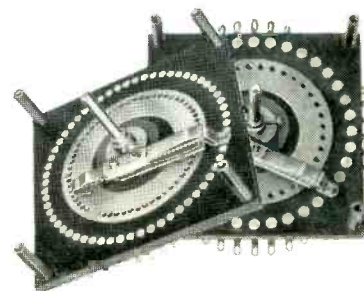

ROTARY SWITCHES are heavy duty-type

SHALLCROSS MFG. Co., Collingdale, Pa., has announced two single deck,

single-pole rotary switches designed for complicated range or circuit switching of experimental apparatus or heavy duty test equipment. Both the 60-position (type 10061-S) and the 36-position (type 10054-S) models have a unique detent mechanism that also provides the nonshorting action. The rotor arm is actually lifted as it moves from one contact to the next thus allowing the maximum number of usable contacts in the smallest space. Large solid silver contacts mounted on a laminated phenolic deck result in an average contact resistance of less than 0.006 ohm. Current carrying capacity of the type 10054-S is 40 amperes, with breakdown voltage of 2,500 v. The 60-position type will carry 30 amperes and has a breakdown of 1,500 v.



TRANSISTOR TESTER has 2-percent accuracy

TRANSISTOR PRODUCTS, INC., Snow and Union Sts., Boston, Mass. Model T-61 transistor test set is used to test the small signal behavior of all point-contact and junction transistors. Its function is to measure 4 independent parameters of the 4-terminal equivalent circuit of the transistor. Overall accuracy is 2 percent. The unit contains separate metering circuits for all applied d-c currents and voltages, a precision single frequency audio oscillator, and a precision vtvm for direct reading of the parameters under test. It is powered by 8 separate self-contained regulated power supplies, making possible operation without adjustment over

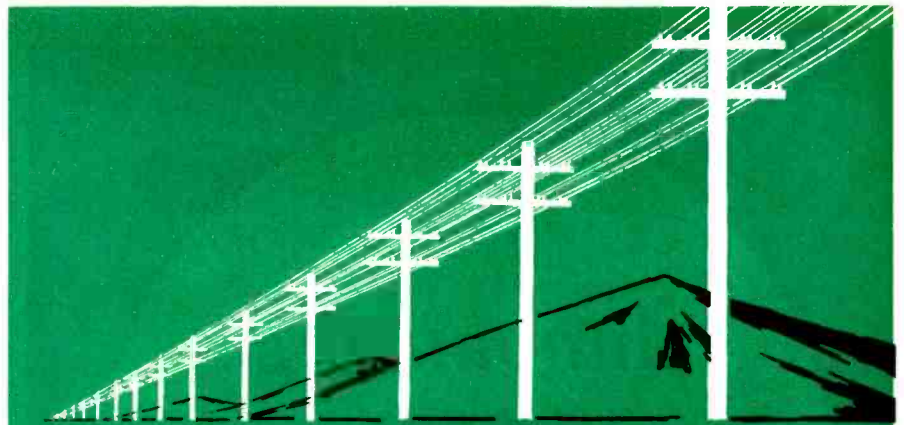

ELECTRONIC HIGHWAYS FOR A GROWING NATION

LENKURT "STACKABLE" CARRIER EQUIPMENT PERMITS
ORDERLY EXPANSION OF TELEPHONE SYSTEMS

A telephone carrier system that helps keep pace with the growth of America's communities and towns is one achievement of Lenkurt Electric, the nation's largest independent manufacturer of telephone carrier equipment. Just as one lane roads must grow to two lane and multi-lane highways, so telephone systems must grow to meet their traffic demands. Lenkurt was first to provide a practical and economical means for the expansion of telephone systems on a channel-at-a-time basis.

Lenkurt "stackable" carrier is an orderly "building-block" system that permits phone services to expand whatever amount is necessary — without buying more equipment than is needed or paying excessive premium for channel-at-a-time expansion. When two voice channels are needed in place of one, Lenkurt "stackable" carrier provides the one added channel — not three or twelve necessary with previous carrier systems. Then later if a second and third carrier channel are needed, these can be added one at a time.

Unlike previous systems suitable primarily for very long circuits, Lenkurt's "stackable" carrier is economical on the shorter toll circuits which comprise the bulk of all telephone networks.

Now used on thousands of telephone lines throughout the world, "stackable" carrier systems are one example of Lenkurt's contributions to the communications industry.

LENKURT ELECTRIC CO.
SAN CARLOS 1, CALIFORNIA

Announcing
FOR 2000 mc.
GABRIEL OFFSET
FEED ANTENNAS

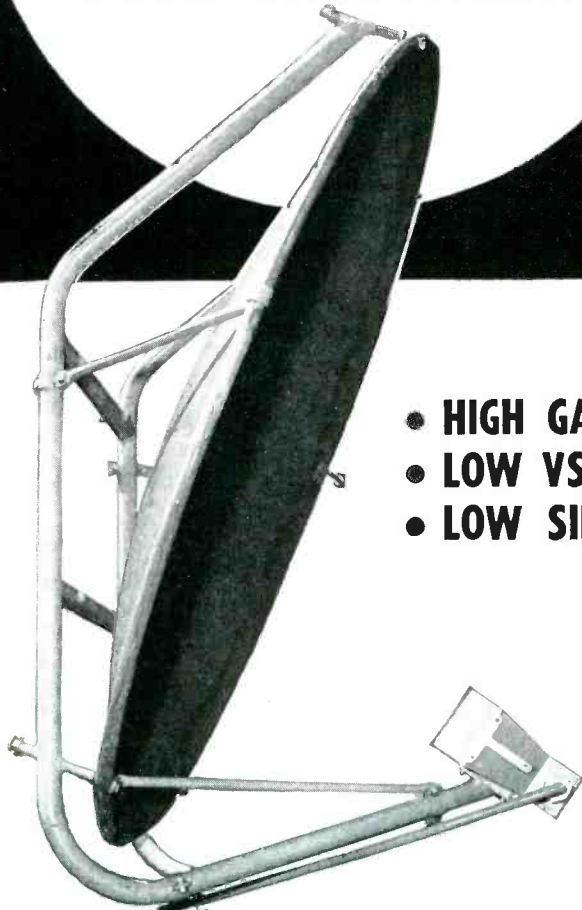

- HIGH GAIN
- LOW VSWR
- LOW SIDE LOBES

MODEL 2K6T: *A 6 foot microwave antenna. — Gives outstanding performance from 1700 to 2110 mc. — New offset feed design increases efficiency of assembly thereby achieving high gain of better than 30 db. Write for further information.*



THE GABRIEL COMPANY
 Endicott Street, Norwood, Massachusetts
WORKSHOP ASSOCIATES DIVISION

all normal line voltage variations. The cabinet measures 28 in. x 21½ in. x 15 in.

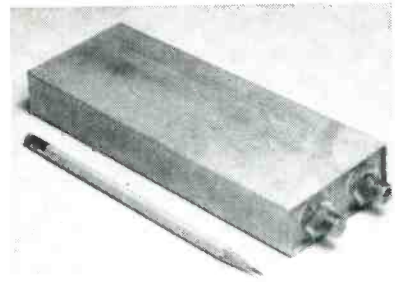

RECHARGEABLE CELL
 delivers power surges

COGENEL, INC., 230 Park Ave., New York 17, N. Y. The battery cell shown is one of many possible sizes and has a capacity of 35 ampere-hours, delivering 1.2 volts. A peak current of 1,200 amperes can be drawn for a short period without damage to the cell.

The unit is hermetically sealed, eliminating spilled electrolyte. Active material within is electrolytically bonded to a solid sintered plate. Materials used are nickel and cadmium in a potassium hydroxide electrolyte.

Designed for military aircraft, the new batteries can be used to operate solenoids, starting Diesel auxiliary equipment or as standby power source.

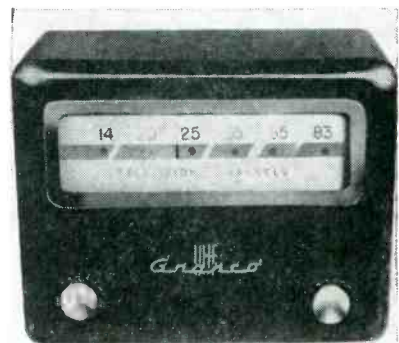

TV CONVERTER
 for all-channel operation

GRANCO PRODUCTS, INC., 36-17 20th Ave., Long Island City 5, N. Y., is producing the Star, a low cost uhf all-channel tv converter. The unit incorporates coaxial tuned cavity

elements to insure very low noise, high gain and excellent frequency stability. It is simple to install and requires no i-f adjustments. A selector switch turns the tv set on and off and provides instant changeover between uhf and vhf. The Star is supplied with a 6AF4 oscillator tube, a 6CB6 i-f amplifier tube and a crystal mixer. It is shipped ready to install and operate at 110-120 v, 60 cycle a-c.

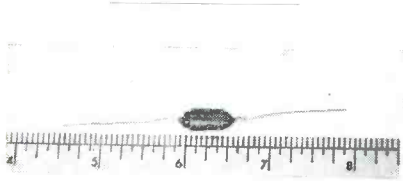

TINY R-F CHOKE incorporates ferrite core

THE GRAYBURNE CORP., 4-6 Radford Place, Yonkers, N. Y., has developed the P-Wee r-f choke. The unit incorporates a high permeability ferrite core resulting in excellent operating characteristics and very small size. It is especially recommended for use in computer circuits and other applications where component size is a critical factor. Electrical characteristics are as follows: d-c resistance is 120 ohms; inductance is 25 mh \pm 5 percent; distributed capacitance is 8 μ f; Q at 100 kc is 115; Q at 450 kc is 80; and current carrying capacity is 100 ma.

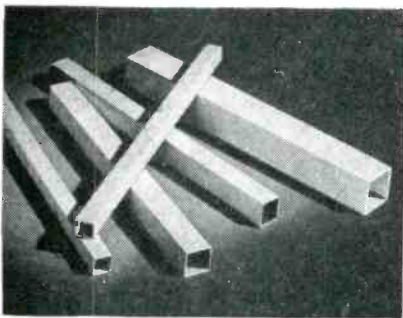

PAPER TUBES for coil winding

PARAMOUNT PAPER TUBE CORP., 614 Lafayette St., Fort Wayne 2, Ind. The Paraformed paper tubes make it possible to provide spiral-wound

REPUBLIC is like the ELECTRONICS INDUSTRY

Like the electronics industry, Republic is young and growing. Seven years ago Republic started in a small way. Like electronics men, Republic thought in a big way from the start, thinks in a big way today.

Compact size with unlimited thinking enables Republic to give each job exacting, personal attention and to impose Republic quality on all orders, large or small. Republic specializes in just one thing — rolling plain aluminum foil. Each roll of Republic Aluminum Foil is custom made for your machines, for your specific applications. Each roll has clean, straight-cut edges, accurate gage. Each roll is manufactured to eliminate work stoppages and rejects. Use of Republic Aluminum Foil means greater production at lower cost.

Republic capacitor foil is made in widths of $\frac{1}{4}$ " and wider, and in gages from .00017" to .005". When specifying aluminum foil, it's worth remembering that Republic constantly watches the little things that mean bigger production for you.

REPUBLIC FOIL & METAL MILLS INCORPORATED

DANBURY CONNECTICUT

Branch Sales Offices: 209 W. Jackson Blvd., Chicago 6, Ill.
666 Mission St., San Francisco 5, Cal.



precision connectors by Continental

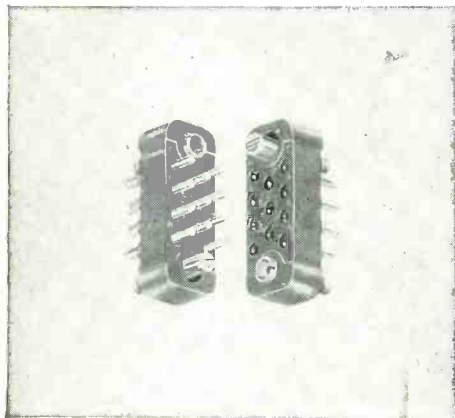

ACTUAL SIZE

Sub-Miniature Connectors Series SM-20

afford extreme size reduction without sacrificing pin diameter . . . available in 11, 14, 20, and 34 contacts for #20 AWG wire . . . 5 amp. continuous current rating . . . Submit your special subminiature connector requirements to our engineering department.

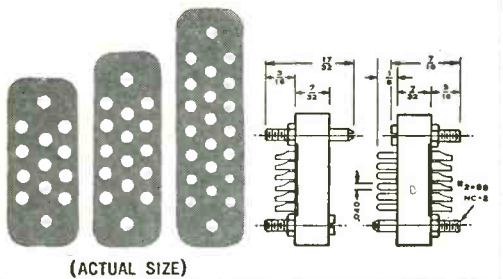

(ACTUAL SIZE)

Continental Connectors

ELECTRONIC SALES DIVISION

DeJUR-AMSCO CORPORATION

Write Dept. ESM-9, DeJUR AMSCO CORPORATION, 45-01 Northern Blvd., Long Island City 1, N. Y.

square and rectangular tubes with perfectly flat side walls, sharp square inside corners, and very small radius on the four outside corners. These paper tubes eliminate the possibility of any sharp outside edges cutting the wire during multiple or single winding of coils. They also eliminate squeezing operation of finished coil and possibility of shorts due to fractured enamel insulation. They permit coil manufacturers to hold extremely close tolerances and still have good rigidity and physical strength. Any need for wedges to tighten the winding on the laminated core is practically eliminated. The tubes are available in square and rectangular types from $\frac{1}{2}$ in. to 30 in. long, from 0.450 in. to 25 in. inside perimeter.



POTENTIOMETERS for high temperature use

G. M. GIANNINI & Co., INC., 117 E. Colorado St., Pasadena 1, Calif., have available the model 8620 Rectipot. Standard models will operate in a temperature range of -55 to $+71^{\circ}\text{C}$, and a new high temperature model will operate in a range of -55 to $+149^{\circ}\text{C}$. They can be had with either one or two electrically independent resistance units, both operated from the same shaft. Linear strokes of from 0.5 in. to 5.25 in. are available and the shaft is free to rotate through 360 deg. The potentiometers feature linearities of ± 0.5 percent or better and long life of over 1,000,000 cycles. They are manufactured with total resistances ranging from 400 ohms per in. to 15,000 ohms per in. of stroke. Additional stroke

ranges and resistances are available on special order.

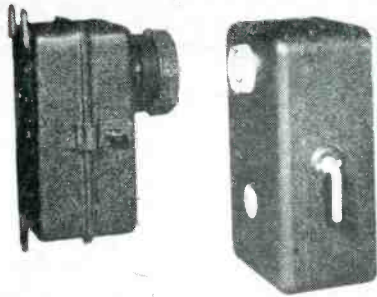

INTRUSION ALARM has 50-ft operating range

PHOTOSWITCH INC., 77 Broadway, Cambridge 42, Mass. Photoelectric intrusion alarm set P1A consists of type A20C-2 control and type L60B light source. An invisible infrared beam is projected from the light source, spanning any distance up to 50 ft. This is aligned to strike the eye of the control. Momentary interruption of the beam actuates the control relay, which is wired to operate and sustain an external alarm device. The alarm can be silenced only by restoring the electrical circuit to original conditions by use of a manual or automatic reset switch. Supply is 115 v, 50 or 60 cycles. Relay is spdt (isolated contacts). Contact rating is 10 amperes, 115 v a-c.

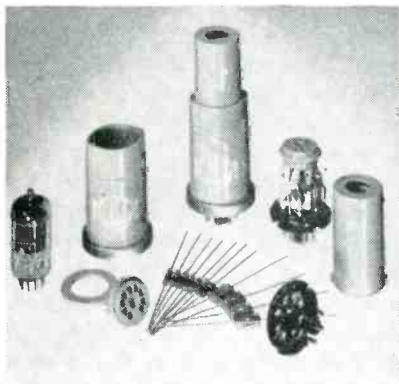

PLUG-IN CIRCUITS offer ease of design

ELECTRONIC ENGINEERING CO. OF CALIFORNIA, 180 South Alvarado St., Los Angeles 4, Calif., announces a new series of packaged plug-in

precision electronic instruments by **DeJUR**

1½" SQUARE WATERTIGHT Panel Meter

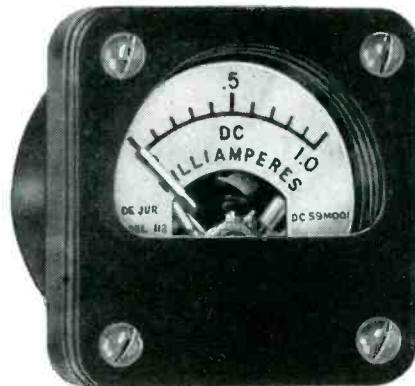

ACTUAL SIZE

- From 1 to 100,000—DeJUR's 1½" meter sets the world's standard for quality, performance!
- Available with 2 terminal designs
 1. Solder terminal
 2. 4-40 screw terminal
- Multi-color or luminescent scales and pointers
- Proven external pivot D'Arsonval movement
- From prototype to production on short notice

For further information write DeJUR-Amsco Corporation, Dept. EM-9, 45-01 Northern Boulevard, Long Island City 1, New York



YOU'RE SURE WITH **DeJUR**

POTENTIOMETERS • CONNECTORS • METERS
DeJUR-AMSCO CORPORATION
45-01 NORTHERN BLVD., L.I.C. 1, N. Y.



Measure PHASE Difference Directly 0°-360° . . .

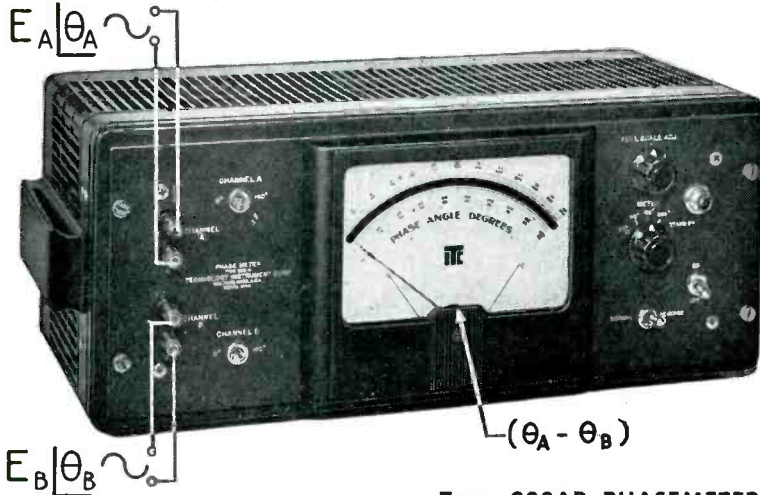

Type 320AB PHASEMETER

- . . . In 4 full scale ranges, 0°-36°, 0°-90°, 0°-180°, 0°-360°, without ambiguity
- . . . Independent of voltage amplitude from 1 to 170 volts peak
- . . . Independent of voltage wave form
- . . . Independent of frequency from 2cps. to 100kc. (accuracy: 20cps-20kc, 1% of full scale +3°; error increases slightly above 20kc.)
- Large, easily read, mirrored scale panel meter
- Ease of operation — ideal for production testing or laboratory use
- Eliminates tedious and inaccurate oscilloscope techniques
- Terminals for recorder . . . instantaneous response of output voltage to phase changes
- Incremental accuracy better than 1% of full scale
- Proven performance and quality workmanship

In audio facilities, ultrasonics, servomechanisms, geophysics, vibration, acoustics, aerial navigation, electric power transformation or signalling, . . . in mechanical applications such as printing register, torque measurement, dynamic balancing, textile and packaging machinery and other uses where an accurate measure of the relative position of moving parts is required . . . the type 320AB Phase Meter has achieved widespread approval as a unique and versatile measuring instrument.

For further information on measuring phase, send for specification bulletin and TIC Laboratory Reports

ENGINEERING REPRESENTATIVES

Chicago, Ill. — Uptown 8-1141
 Cleveland, Ohio — PROspect 1-6171
 Waltham, Mass. — WALtham 5-6900
 Rochester, N. Y. — MonroE-3143
 Dayton, Ohio — MichigAn 8721

Arnrior, Ont., Can. — Arnrior 400
 Hollywood, Cal. — HOLlywood 9-6305
 Dallas, Texas — DIXon 9918
 Roseland, New Jersey — Caldwell 6-4545
 Wyncote, Pa. — Ogontz 8805
 Silver Spring, Md. — Sligo 7-550

TECHNOLOGY INSTRUMENT CORP.

535 Main Street, Acton, Massachusetts, Tel. ACTon 3-7711

circuits that offer ease of electronic circuit design, simplified development techniques and rapid production of highly-specialized pulse-type equipment. First developed for and used by the armed services, they are now offered to the electronic and allied industries in 26 catalog types and 40 secondary versions. The standard circuits include amplifiers, flip-flops, multivibrators, squaring circuits, pulse gates, crystal oscillators, pulse amplifiers and many others. By using these packaged plug-in circuits, both drafting and wiring time can be reduced. Template drawn equivalent symbols cut the drafting time while simplified techniques require only the wiring of power and interconnection circuits.

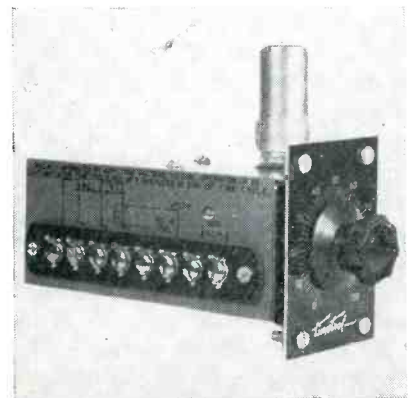

ELECTRONIC TIMER recycles instantaneously

TIMETROL Co., 2919 Gladstone Ave., Rockford, Ill. Model 801 electronic timer is used to provide either timed ON periods or timed delay in the range between 0.05 and 20 seconds. In groups of two or more it can be used for repeat cycling, programming or other intricate applications. It features high repeat accuracy regardless of line voltage variations, tube aging or temperature change. The timer includes two fast acting relays; one, a start relay controlled from an external contact switch which initiates the time cycle, and another energized by the timer after the timed interval. The relay contacts and coil circuits are isolated and therefore may be connected to a different power supply from that used to

NEW PRODUCTS

(continued)

energize the timer. A four-page illustrated booklet gives complete technical data.



CABLE TESTER
has 15 kv d-c output

JAMES G. BIDDLE Co., 1316 Arch St., Philadelphia 7, Pa., has introduced a new impulse cable fault locator. The model 4 transmitter was designed primarily for use on lead-covered cable installed in ducts, but is also used on aerial and buried cable. It has a maximum output of 15 kv d-c and a discharge capacitance of 2 μ f. This 150-lb unit requires a source of supply of about 600 va at 115 v a-c and may be used as a source of d-c voltage for proof testing of cable and other insulation, a valuable feature both at installation and after alterations or repairs. Maximum proof testing capacity is 15 ma at about 0.7 megohm and about 50 ma at short circuit.



POTENTIOMETER
has ultra-low torque

ELECTRO-MEC LABORATORY, 19 Murray St., New York 7, N. Y., has developed the type 1418 potentiometer.

TIC-TALKS

FEATURE

Something new in Precision Potentiometers . . .

... the standardization of a Non-Linear Precision Potentiometer, the type RVP3-S59 Sine-Cosine potentiometer, one of the many types standard with the Technology Instrument Corporation, performs two operations in a single potentiometer assembly . . . two wipers spaced 90 degrees apart yield both sine and cosine outputs.

1. Total resistance: 20,000 ohms plus or minus 5 per cent between terminals 1 and 3.
2. Accuracy: Plus or minus .5 per cent of the peak to peak amplitude.
3. Maximum voltage: Conservatively rated as **150 volts** between terminal 1 and 3.
4. Life: Guaranteed for at least 500,000 complete cycles in either direction at 30 rpm.
5. Potentiometer base: Precision machined aluminum (originated by TIC) finished with corrosion resistant black Alumilite.
6. All fixed connections are soldered.
7. Wipers: Paliney spring wiper with double contact, for positive electrical connection, long wear and light torque.
8. Resistance Element: Karma wire with temperature coefficient of .00002 parts per degree centigrade.
9. Slip Rings: Inlaid coin silver slip rings. Paliney contacts on dual brushes for positive connection and low contact resistance.
10. Full humidity protection with type 76-5 fungus resistant varnish.
11. Units may be ganged, using TIC's patented "Constrict-O-Grip" clamp rings which permit precise phasing with amazing ease.

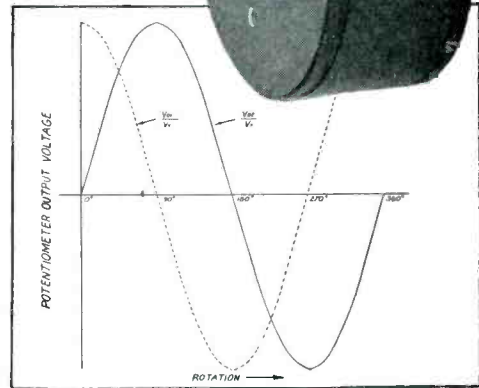
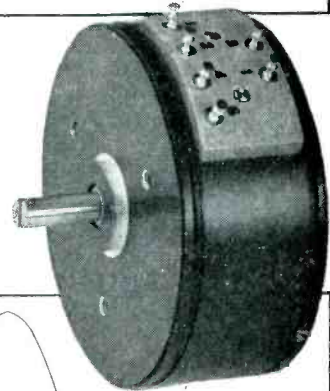
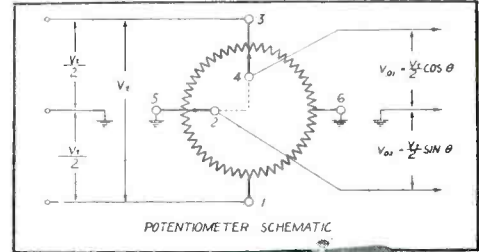

TIC standard potentiometers have the same built-in precision and craftsmanship normally found only in custom-built products. Research, engineering and design facilities for special constructions and non-linear or linear functions are an integral part of TIC services. Submit your potentiometer problem, whether the need is for standard or custom design.

Engineering Representatives

- | | |
|------------------------------------|---------------------------------------|
| Cleveland, Ohio — PProspect 1-6171 | Arnprior, Ont., Can. — Arnprior 400 |
| Chicago, Ill. — Uptown 8-1141 | New York, N. Y. — Murray Hill 8-5858 |
| Rochester, N. Y. — Monroe 3143 | Cambridge, Mass. — Eliot 4-1751 |
| Canaan, Conn. — Canaan 649 | Hollywood, Cal. — Hollywood 9-6305 |
| Dayton, Ohio — Michigan 8721 | Dallas, Texas — Dlxon 9918 |
| Baltimore, Md. — Plaza 7694 | Binghamton, N. Y. — Binghamton 3-1511 |

Technology Instrument Corp.

535 Main Street, Acton, Massachusetts, Tel. ACTon 3-7711

Kay-Lab ELECTRONIC INSTRUMENTS

set new standards of accuracy and performance
to solve your research and production problems

Join the leading research laboratories, manufacturers, government agencies, and universities which depend on Kay-Lab for the finest instruments and for complete, competent engineering and research service.

Use Kay-Lab's wide experience in the special design and manufacture of precision electronic instruments to help solve your particular problems.

Competent, well-informed Kay-Lab representatives are in your area. Write or wire for their addresses.

Precision Electronic Instruments
Power Supplies • Attenuators
Amplifiers • Electronic Computer
Components



For Precision DC REFERENCE Use Kay-Lab's New METER CALIBRATOR

Here is a precision DC reference source which produces absolutely calibrated DC voltage independent of input line voltage and output load variations. Calibrated from one to 300 volts in one-volt steps. Standard model provides absolute calibration to .1%, custom model to .01%.

Write Dept. B for free technical bulletins about Kay-Lab METER CALIBRATOR, DECADE AMPLIFIER, MICRO-MIKER, and ABSOLUTE DC POWER SUPPLIES.



KALBFELL LABORATORIES, INC.

1090 Morena Boulevard — San Diego 10, California
Post Office-Box 1878 Telephone: Woodcrest 6359

These days are busy ones for the electronics industry... days when you will especially appreciate the time-saving, time-tested services of "THE REPRESENTATIVES" of Electronic Products Manufacturers, Inc. Here is an organization whose membership numbers the most highly qualified men in the field. It is fully equipped to assist you and your employees in understanding the accepted electronics industry trade practices, and to promote better relations in the industry through ethical sales representation either locally, regionally or nationally.

Since 1935, the REPM has served electronic products manufacturers ably and efficiently.

National Headquarters Office
"THE REPRESENTATIVES"
of Electronic Products Manufacturers, Inc.
600 S. Michigan Avenue, Chicago 5, Illinois
Harrison 7-2402

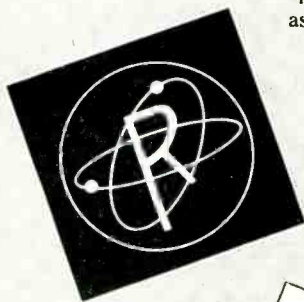

MEMO
to
*Electronic Products
Manufacturers*

Burton browne advertising

eter with a shaft torque as low as 0.025 oz in. It is applicable to devices where an exceedingly small mechanical force must be converted into an equivalent electrical voltage. The servo type mounting and ball bearing shaft, ABEC class 5, provide easy installation and adjustment and insure maximum physical and electrical stability under extremes of shock, temperature and vibration. Potentiometers are available with resistance values between 100 and 350,000 ohms, rated at 3 watts, electrical rotation up to 360 deg, a multiplicity of taps and brushes, linearity to 0.1 percent and resolution down to 0.03 percent. The toroidally wound resistor element is $3\frac{1}{2}$ in. long.

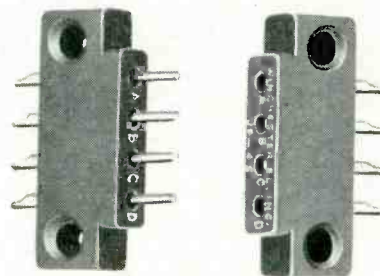

TINY CONNECTOR has four contacts

WINCHESTER ELECTRONICS, INC., Glenbrook, Conn. A new miniature four-contact connector, the JF-4, designed for right angle mounting is lightweight and suitable for limited space applications in portable and aircraft equipment. Overall dimensions are 1 in. maximum height and $1\frac{1}{8}$ in. engaged length. Total weight of plug and receptacle is 0.04 oz. The molded phenolic body is mineral filled and provides high arc and dielectric resistance as well as mechanical strength. Monobloc construction eliminates unnecessary creepage paths and reduces the number of moisture and dust pockets. Brass pin contacts and spring temper phosphor bronze socket contacts are precision machined and gold plated over silver for low contact resistance, prevention of corrosion and

ease of soldering. Contacts have 0.043 in. diameter solder cups for No. 20 AWG. Breakdown voltage between contacts at sea level conditions is 3,500 v d-c; at 60,000 ft altitude, 1,000 v d-c.

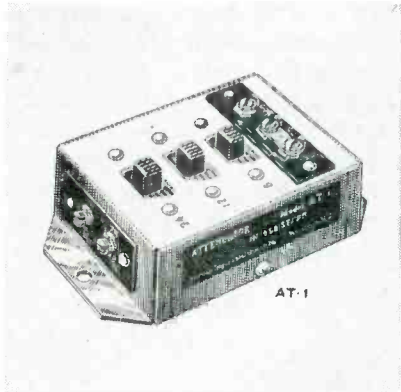

TV ATTENUATOR
requires no power

BLONDER-TONGUE LABORATORIES, INC., 526-536 North Ave., Westfield, N. J., has introduced the model AT-1, a unit that provides precise attenuation ranging from 0 to 42 db, in 6-db steps, over the entire vhf band. It instantly provides proper attenuation levels for equalizing signal strengths in multi-antenna installations, for reducing tv signals to prevent overloading, and to simulate fringe-area reception. Three switches allow variable attenuation of 6, 12, 18, 24, 30, 36 or 42 db. The compact unit requires no power and may be used for testing, or permanent installation at any point in a tv line. The 75-ohm terminal strip, and the 75 and 300 ohm terminal strip are interchangeable as the input or output.

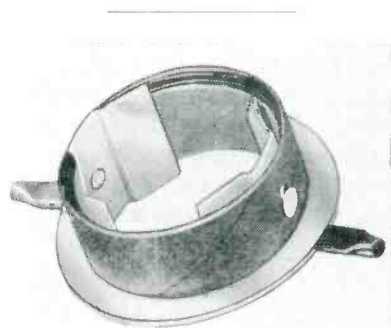

CENTERING DEVICE
features plastic frame

HEPPNER MFG. Co., Round Lake, Ill. An improved centering device,

SMALL PARTS can play a **BIG PART** in...

Lower Production Costs!



Leading manufacturers in the electronics, machinery, appliance and toy fields have been saving substantially by using precision Multi-Swage parts instead of those previously made by turning, drilling, stamping or forming.

LET BEAD CHAIN MAKE YOUR

Tiny Parts to your Specifications at far less cost!

HERE ARE ONLY A FEW TYPICAL TINY PARTS MADE BY BEAD CHAIN'S Economical, Dependable **MULTI-SWAGE METHOD**

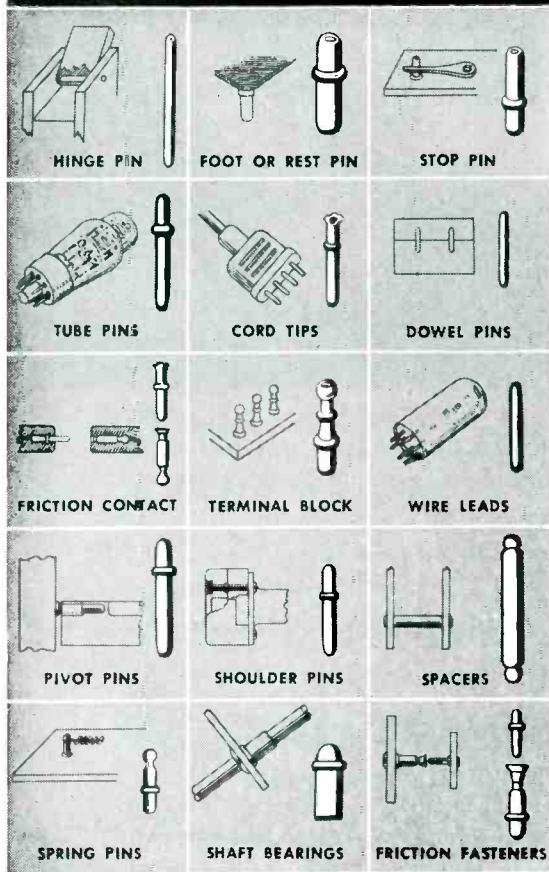

The advanced manufacturing method developed and used exclusively by Bead Chain swages practically any type of small tubular part from flat stock into precision forms with positive, tight seams... and does it *Automatically*. If you can use high-volume production... we can deliver it at a much faster rate... and at far less cost! Scrap is eliminated! Deliveries to you are dependably prompt!

We can supply you with parts that are beaded, grooved, shouldered and made with almost any metal. Diameters up to 1/4", lengths to 1 1/2"

This catalog can save you a lot of production time and money! Write for it



GET PROOF-POSITIVE COST COMPARISONS!

Send us a blueprint or sample and quantity requirements. We will quickly show you the big economies we can deliver.

BEAD CHAIN [®]
Original and World's
Largest Producer of Bead Chain



THE BEAD CHAIN MFG. CO.
BRIDGEPORT 5, CONNECTICUT

Please send me your Catalog of Multi-Swage Parts

NAME

TITLE

COMPANY

ADDRESS

KEY NO 88

THE BEAD CHAIN MANUFACTURING CO., BRIDGEPORT 5, CONN.

SHARP PERMANENT MARKING

WITH HI-DUTY
MARKING TOOLS



For legible permanent marking of metal components use  engraved lettering tools. Precision engraved dies and inserts for indenting or embossing identification on your parts will

1. Improve appearance.
2. Advertise throughout life of part.
3. Facilitate reordering.

Write for free catalog on Production Marking Equipment.

GEO. T. SCHMIDT, INC.

MARKING MACHINES • MARKING TOOLS
1804 Belle Plaine Ave., Chicago 13, Ill.

COMPLETE MACHINE FACILITIES TO PRODUCE

- Hand Stamps
- Engraved Inserts for Dies
- Shank Style Stamping Dies
- Embossing Dies
- Code Stamps
- Steel Type
- Numbering Heads
- Marking Machines
- Nameplate Marking Equipment

model BCC603, features a plastic frame instead of the kraft tubing frame formerly used. The advantage of the new construction is that the tenite plastic is permanent under all conditions. Model BCC-603 is designed for use with electrostatic tv tubes of all sizes. A distortion-free beam is assured by uniformity of field. The unit will not cause defocusing. Mounting is directly on the tube adjacent to the deflection yoke. The device is held securely in place by phosphor bronze tension springs. Beam centering is done by rotating individual magnets.

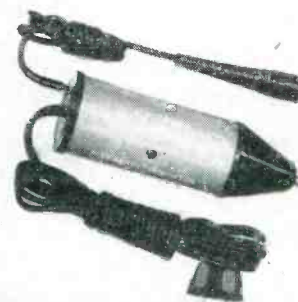

CAPACITOR TESTER is also leakage indicator

LEE ELECTRONIC LABS, INC., 233 Dudley St., Boston 19, Mass., has developed the model CT-1 electronic capacitor tester and leakage indicator. It features a built-in electronic power supply providing both a-c and d-c test voltages and contains miniature selenium rectifier and dual capacitor R-C filter network in a special circuit with a highly sensitive neon lamp leakage indicator. It permits quick, accurate, direct testing of capacitors for leakage with actual d-c voltage applied and readily indicates intermittently open capacitors with a-c applied. It is also ideal for high-resistance continuity testing of all circuits and parts, indicating leakage, resistance or insulation breakdown to over 200 megohms.

INDICATOR shows elapsed time

MARION ELECTRICAL INSTRUMENT Co., Manchester, N. H. The HM2ET elapsed time indicator was

PROOF of PERFORMANCE

Shure slender Gradient Microphones solve difficult acoustic problem

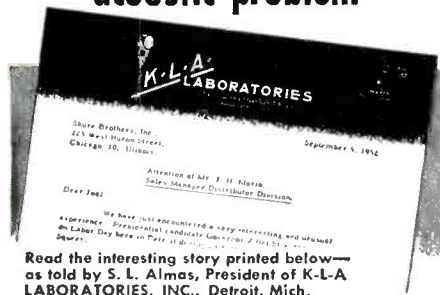

"We have just encountered a very interesting and unusual experience. Presidential candidate Governor Adlai Stevenson spoke on Labor Day here in Detroit during an open air meeting in Cadillac Square.

"The speech was televised coast to coast and T.V. engineers did not want a battery of microphones obscuring the speaker's face. We did not want ordinary broadcast microphones used that would cause feedback before sufficient signal was obtained to drive the public address system to the desired output.

"After due consideration, it was mutually agreed to use only two microphones for network T.V. - Radio - 5 Newsreels, two Tape Recorders, and Public Address System. We suggested two Shure Model #315 microphones, and these were used with excellent results. We received compliments galore.

"Congratulations for having designed a microphone to satisfy the demands of such varied fields of sound reproduction."



"315"
GENERAL PURPOSE
LIST PRICE \$7950

Former Governor Stevenson of Illinois, pictured as he addressed Detroit audience on Labor Day, during the 1952 presidential campaign.

SHURE

"300"
BROADCAST
LIST PRICE \$13500

Shure Patents Pending

SHURE BROTHERS, INC.
MICROPHONES AND ACOUSTIC DEVICES
225 W. Huron St. Chicago 10, Ill. Cable: SHUREMICRO
Want more information? Use post card on last page.
ELECTRONICS — September, 1953

NEW PRODUCTS (continued)

designed for installation where panel space is limited. It meets standard 2½ in. JAN dimensional specifications for panel mounting. Yet, the indicator is easy to read, having a standard size counter. It is hermetically sealed. The motor will start readily and operate continuously at temperatures ranging from -55C to 85C. It is available registering in 1/10 hr steps to 9,999.9; or hour steps to 99,999. It has a self-starting synchronous motor either 110-125 or 220-250 v for 50 or 60-cycle a-c operation.

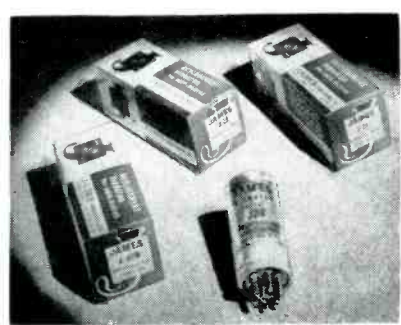

VIBRATORS are series drive type

JAMES VIBRAPOWER Co., 4036 North Rockwell St., Chicago 18, Ill., has introduced a new line of series drive vibrators specifically designed for the long, dependable service required in communications equipment. The series drive gives steady low voltage starting throughout an extended life of the component. The design, furthermore, separates starting and driving functions from main vibrator contacts, insuring greater dependability and additional hours of satisfactory service.

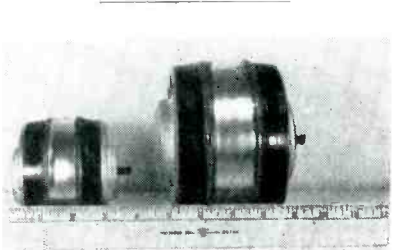

VACUUM CAPACITORS for industrial heating

JENNINGS RADIO MFG. CORP., 970 McLaughlin Ave., San Jose, Calif., has designed two new vacuum capacitors specifically for high cur-

STABILITY! ACCURACY! PRECISION!

Carefully crafted for matchless performance, Silicohm and Dalohm resistors are designed and made to survive the most severe environmental, shock and vibration conditions.

Silicohm

Miniature Wire Wound POWER RESISTORS

Complete welded construction from terminal to terminal. Temperature coefficient 0.00002/deg. C. Ranges from 0.1 Ohm to 55,000 Ohms, depending on Type. Tolerance 0.05%, 0.1%, 0.25%, 0.5%, 1%, 3%, 5%.

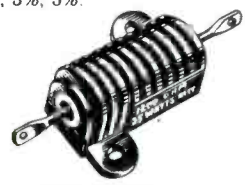

RH TYPE — Available in 25, 50 and 250 watt sizes. Silicone sealed in die-cast, black anodized radiator finned housing for maximum heat dissipation.

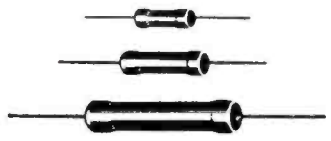

RS TYPE — Available in 2 watt, 5 watt, and 10 watt sizes. Silicone sealed offering maximum resistance to abrasion, high thermal conductivity and high dielectric strength.

DALOHM DEPOSITED CARBON RESISTORS



Dalohm precision deposited carbon resistors offer the best in accuracy, stability, dependable performance and economy. Available in ½ watt, 1 watt and 2 watt sizes.

Write, Wire or Phone George Risk,
1300 28th Ave., Columbus, Nebr.
for price and delivery.
Phone 2139.

DALE PRODUCTS, INC.

In Canada: Teletronics Corp., Ltd.
Toronto and Montreal

Want more information? Use post card on last page. 353

- FOR . . .
- PULSE INVERSION
 - D-C ISOLATION
 - IMPEDANCE MATCHING
 - MAGNETIC CORE CIRCUITS
 - BLOCKING OSCILLATOR TRANSFORMER

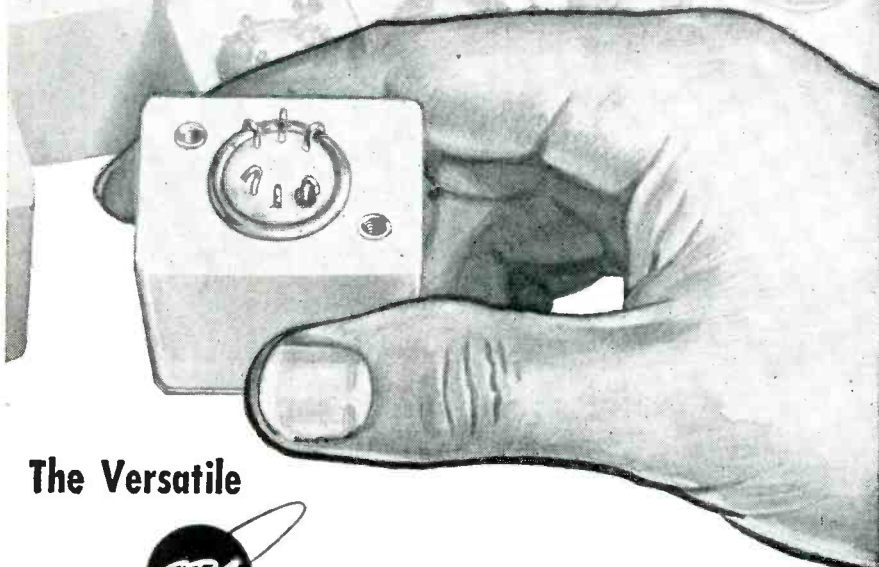

The Versatile



Type 130A1 PULSE TRANSFORMER for Low-Power applications

SUPERIOR ELECTRICAL CHARACTERISTICS—The ERA 130A1 pulse transformer provides appropriate impedance levels for operation in low-power circuits. Short rise time and small droop minimize critical circuit design problems.

VERSATILITY—ERA three-winding pulse transformers can be used in several different ways. For example, the Type 130A1 can be used as low-impedance 1:1, high impedance 1:1, conventional 2:1, 2:1 with two outputs or as 3:1.

CONVENIENT MOUNTING—Through-panel mounting utilizes same mounting hole pattern as a conventional nine-pin miniature tube socket. This compact transformer design permits mounting on a tube strip in approximately the same space required for a standard miniature tube.

INSULATING CASE—The plastic case permits mounting the transformer in close proximity to other components and terminals without danger of short-circuits caused by metal-cased or uncased transformers.

*Immediate delivery on
sample quantities*

**WRITE FOR
DESCRIPTIVE BULLETIN**

Engineering Research Associates
Division of **Remington Rand**
INC.

1902 West Minnehaha Avenue, Dept. E-15, St. Paul W4, Minnesota

DIGITAL COMPUTERS . . . DATA-HANDLING SYSTEMS . . . MAGNETIC STORAGE SYSTEMS . . .
INSTRUMENTS . . . ANALOG MAGNETIC RECORDING SYSTEMS . . . COMPUTING SERVICE

rent r-f applications such as are encountered in induction and dielectric heating circuits. The MC-1, 1,000 μf unit with a voltage rating of 10 or 15 kv peak and a current rating of 100 amperes has an overall length of only $3\frac{1}{4}$ in. The MMC-1, a 2,000- μf unit with the same voltage rating and a current rating of 225 amperes has an overall length of less than 5 in. These short physical lengths reduce inductive losses to an absolute minimum. This reduction in size and increase in current carrying capacity is made possible by mounting the capacitor plates directly against the anodes. This gives greater heat dissipation, more capacity in less space, and the least possible capacitance drift with variation in temperature.

MAGNETIC MODULATOR for d-c to a-c conversion

GENERAL MAGNETICS INC., 135 Bloomfield Ave., Bloomfield, New Jersey now have available a completed line of magnetic modulators. Units are available in 60 and 400 cycle designs. Designed to convert low level dual-polarity d-c signals to a-c signals of corresponding amplitude and phase sense, complete specifications and response curves are available from the manufacturer, on input modulator types as well as on thermocouple and strain gage converters. Typical harmonic distortion has been reduced to less than 10 percent above 0.1 v output.

Literature

Gold Bonded Diodes. Transatron Electronic Corp., 403 Main St., Melrose 76, Mass., has available bulletin TEL1300 giving a fully illustrated description of a line of 12 gold bonded germanium diodes. Chief features listed for the line include superior forward conductance, conservative back voltage rating, improved mechanical stability, ease of soldering, staked leads, improved shock stability, uniform

**Priced
Right!**

WIRE FORMS

& Metal Stampings

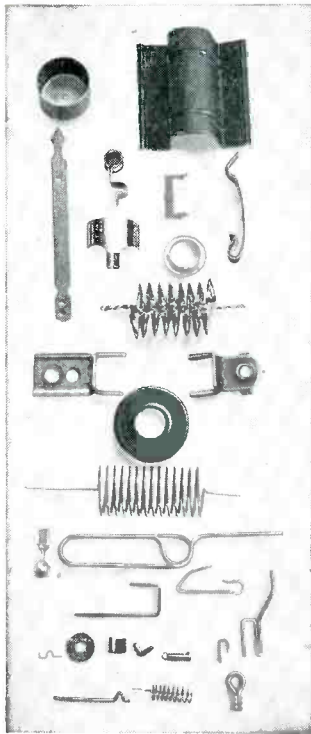

High-speed, quality production with custom-made precision. Wire formed to any shape for every need.

**IMMEDIATE CAPACITY FOR
DEFENSE SUB-CONTRACTS
STRAIGHTENING & CUTTING**
Perfect straight lengths to 12 ft.

.0015 to .125 diameter
WIRE FORMS

.0015 to .125 diameter
SMALL METAL STAMPINGS
.0025 to .035 thickness
.062 to 3 inches wide

Specializing in Production of Parts for
Electronic, Cathode Ray Tubes & Transistors

Write for illustrated folder.
Send Blueprints or Samples
for Estimate.



**ART WIRE and STAMPING
COMPANY**
1 BOYDEN PLACE
NEWARK 2, N. J.



... instantly ready for setting up
single or ganged, linear or
non-linear potentiometer
assemblies.



Experimental laboratories
and design engineers! . . .

... Servotrol's Pot-kit provides you with a versatile assortment of "Unitized" Type RVC2 potentiometers, mounting plates and clamp rings. With this set of transducers mechanical shaft rotation can be converted to almost any linear or non-linear electrical relationship.

**Versatility of the Pot-kit
eliminates delays!**

Any of the fourteen linear potentiometers may be converted to non-linear functions by connecting shunt resistors of proper value across the three equally spaced taps on the winding. The Pot-kit enables you to translate your ideas to conclusions without delay.

**NEW, UNIQUE SERVOCALCULATOR
included in the kit**

Calculating values of shunt resistors and effective potentiometer resistance accomplished in a matter of seconds with direct readings from the disc scales. Eliminates time-consuming computations.



360° Sine Function

A sine function potentiometer with a complete 360° function angle of rotation is provided to broaden the range of experimentation with the Pot-kit.

The extreme versatility of Servotrol's Pot-kit B simplifies breadboarding and speeds decision as to the needed potentiometer or assembly for your prototype systems.

ENGINEERING REPRESENTATIVES

Cleveland, Ohio — Prospect 1-6171
Chicago, Ill. — Uptown 8-1141
Rochester, N. Y. — Monroe 3143
Canaan, Conn. — Canaan 649
Dayton, Ohio — Michigan 8721
Baltimore, Md. — Plaza 7694
Arnprior, Ontario, Can. — Arnprior 400
New York, N. Y. — Murray Hill 8-5858
Cambridge, Mass. — Eliot 4-1751
Hollywood, Cal. — Hollywood 9-6305
Dallas, Texas — Dixon 9918

Immediate deliveries:

For further details —
Write, wire or phone for Bulletin #E-8



**SERVOTROL
COMPANY**

114 W. ILLINOIS ST., CHICAGO 10, ILLINOIS

• TEL. SUPERIOR 7-3082
EASTERN OFFICE: FRAMINGHAM CENTRE, MASS.
• TEL. FRAMINGHAM 4421

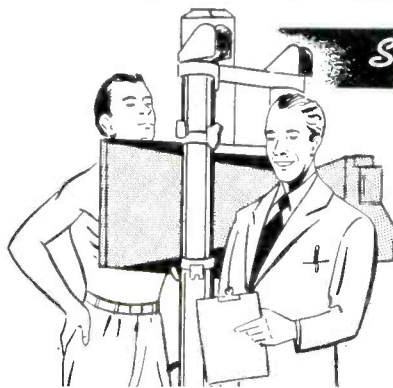

Speeding X-Ray Photography

with EETCO-DESIGNED MOTORS

Manufacturing X-Ray equipment calls for precision and dependability in every part.

That's why, when the nation's three leading manufacturers of X-Ray machines chose the motor that moves the delicate negative holders, they selected motors designed and built by EETCO.

These tiny motors of 1/500 h.p. (intermittent service) provide the reliable, steady source of power that revolves the negative changing mechanism. After a photo is made, the exposed negative with its lens and shutter, are automatically moved aside and a new unit moved into the ready position. Handling this task demands an even, slow application of power to avoid damage to the delicate mechanism. This is typical of the many unusual applications to which EETCO-designed motors have been put.

If your particular problem calls for special design, or merely for standard motors that can handle the toughest service, you'll find that EETCO is the source on which to depend. Out of the many unusual requirements filled by EETCO engineers has come experience unsurpassed in industry and always at your disposal.

Equally important, the EETCO plant is well-equipped and staffed to turn out motors for you on a mass-production, low-cost basis when necessary.

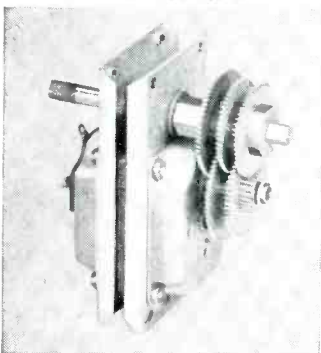

Write today for complete details
and catalog information



ELECTRO ENGINEERING PRODUCTS CO.
609 W. LAKE STREET, CHICAGO 6, ILLINOIS

• P-M DC MOTORS & GENERATORS • CAPACITOR TYPE MOTORS • UNIVERSAL MOTORS
• DC MOTORS & GENERATORS • SHADED POLE MOTORS (2-4-6 Pole) • P-M AC GENERATORS

characteristics and high humidity resistance. Maximum ratings and typical applications are given in tabular form.

Environmental Test Chambers. American Research Corp., Bristol, Conn., has published a 4-page folder showing its line of environmental test chambers. Standard features, specifications and dimensions for seven different types are given. As indicated on page 4 of the brochure, custom built facilities or special accessories can be supplied to meet customer requirements.

Tuning Fork Resonator. Philamon Laboratories Inc., 5717 Third Ave., Brooklyn 20, N. Y. Circular No. 102 fully describes the model J miniaturized tuning fork resonator. It contains data on construction, frequencies, accuracies, operation and installation. A price list is included.

Selenium Rectifier Stacks. General Electric Co., Schenectady 5, N. Y., has announced a new bulletin on miniature selenium rectifier stacks for electronic circuit applications. The illustrated, 4-page publication, GEA-5935, contains data on the applications, construction features and electrical characteristics of the small selenium rectifiers. Included are tables of ratings and dimensions, plus graphs on the effect of temperature and life expectancy of the various types of stacks.

Flexible Delay Lines. Richard D. Brew and Co., Inc., 106 Concord Ave., Belmont 78, Mass., has available a catalog sheet that describes electrical delay lines that are passive circuit networks of the distributed constant type, designed to delay electrical signals a specifically desired amount of time. In the delay lines described, a fine pitch solenoid winding on a flexible plastic core is covered with a thin layer of high dielectric constant tape. A fine mesh litz braid over the tape constitutes the ground plane of the network. Outer layers of insulation complete the delay line. Included in the catalog sheet are chief fea-

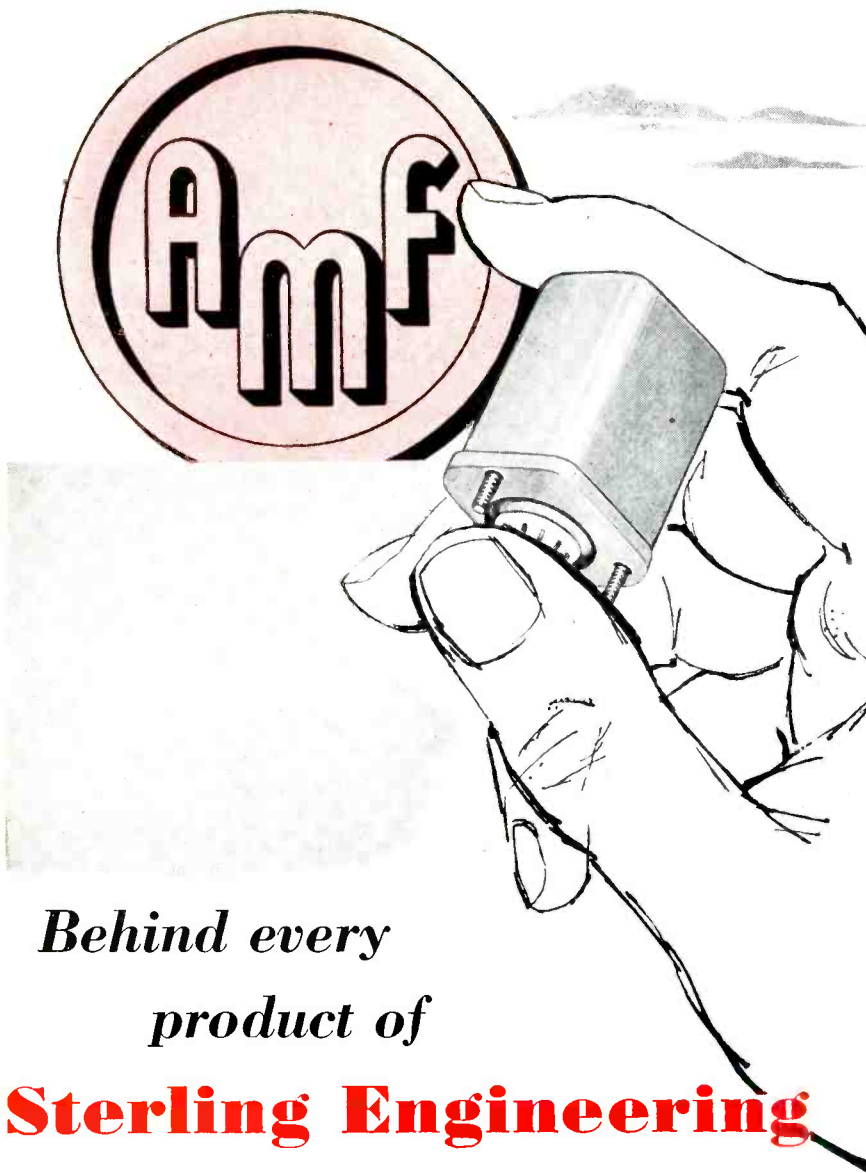

Behind every
product of
Sterling Engineering

Sterling Engineering—long a manufacturer of the very highest quality relays and associated electrical devices—now employs the complete know-how of American Machine & Foundry Company, one of the nation's leading producers of complex electronic equipment.

AMF's unparalleled skill and experience—evidenced in many automatic and electronic marvels such as radar scanning equipment, automatic gun mechanisms, air force training devices, and Pinspotter (the automatic pin boy)—joins Sterling's own design and production knowledge to give greater-than-ever assurance that AMF Sterling Relays can meet your *strictest* requirements.

To be sure of satisfaction, be sure you check with Sterling. Send today for our free Catalogue. Write Sterling Engineering, Laconia, N. H.



Sterling Relays

STERLING ENGINEERING COMPANY, INC., LACONIA, N. H.

Facts you should know about HEYCO STRAIN RELIEFS!

the Nylon Bushings that Anchor cord to housing

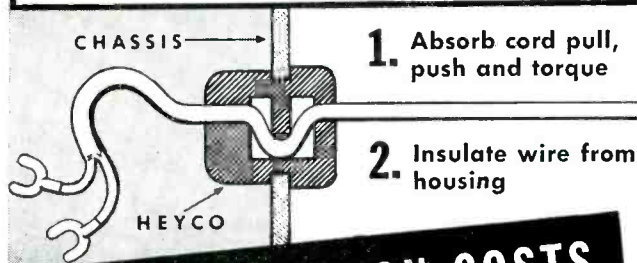

1. Absorb cord pull, push and torque
2. Insulate wire from housing

**CUT PRODUCTION COSTS
IMPROVE PRODUCT QUALITY**

APPROVED  

SAMPLES? Send wire size and chassis information—
Try HEYCOS at no cost to you—today!
MADE IN ALL SIZES FOR CLOCK WIRE TO S-10/3 CABLE

HEYMAN MANUFACTURING COMPANY
KENILWORTH 2, NEW JERSEY

HEYCO ELIMINATES STRAIN ON TERMINALS!

THE HEYMAN ORGANIZATION WITH 25 YEARS STAMPING EXPERIENCE HAS MODERN PRESS CAPACITY FOR OVER 2,000,000 FINISHED STAMPINGS PER DAY.

ASK FOR BULLETIN 33

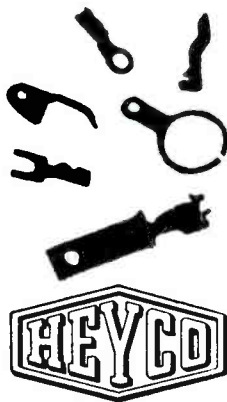

**DON'T WORRY
ABOUT SUDDEN
TEMPERATURE
CHANGES**

USE
Standard Piezo
CRYSTALS



Years of laboratory experimentation and field testing have enabled Standard Piezo to produce crystals that perform dependably . . . accurately under the most extreme operating conditions to be found anywhere. Send for our completely illustrated catalog, or outline your own particular crystal problem. Our engineering department will be glad to assist you.

*Standard
Piezo
Co.*
CARLISLE, PENNSYLVANIA

New 800-2600 mcs FREQUENCY METERS Lightweight — Portable Units

SPECIFICATIONS

- 1. ACCURACY**
Better than .05% from 20°F to 120°F
- 2. SENSITIVITY**
Usable indication with 1 milliwatt input
Adjustable for higher levels
- 3. INDICATOR**
50 Microammeter
- 4. INPUT**
50 Ohm Type N Connector
- 5. EXTERNAL DC OUTPUT**
Pin Jacks
- 6. EXCURSION OF MICROMETER**
One-half inch
- 7. MICROMETER SCALE**
at 1000 Mc —
1 Division equals 290 KC
at 1400 Mc —
1 Division equals 350 KC
at 2000 Mc —
1 Division equals 450 KC
at 2600 Mc —
1 Division equals 555 KC
- 8. EXTERNAL SIZE**
6½ x 9¾ x 7"
- 9. WEIGHT**
Four pounds

**... For Field and
Laboratory Use!**

Models
FS-C-171-A 800-1200 MCS.
FS-C-172-A 1200-1600 MCS.
FS-C-173-A 1600-2250 MCS.
FS-C-174-A 1700-2600 MCS.

Units consist of cavity body, micrometer control, crystal, suitable connectors and calibration chart. Write for specifications and prices.

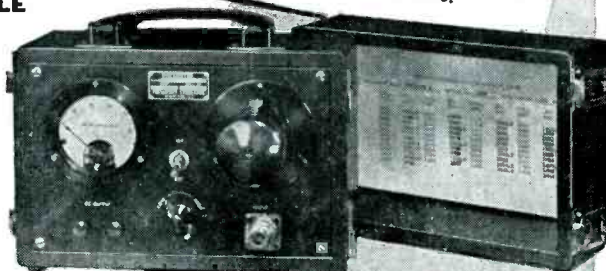

frequency standards

(Cavity units are also available for custom housing)

P. O. Box 504,
Asbury Park, New Jersey

STAINLESS WELD FASTENERS

- **ADD CORROSION RESISTANCE** to the many advantages you enjoy with PEM Weld Fasteners. Now they are also available in Stainless Steel.
- **NO BURNOUTS** in thin sheets. Engineered projections prevent them.
- **NO RETAPPING.** Shank prevents threads from weld splatter.
- **NO PILOTS** or costly special electrodes.
- **NO INDEXING.** Ideal for narrow flanges. Self locating.
- **WRITE** for Literature and Samples to
Penn Engineering & Manufacturing Corp., Doylestown, Pa.

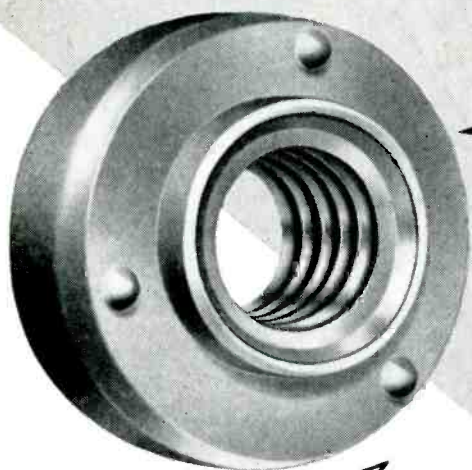

specify

PEM

The **WELD FASTENER**
that cuts **COSTS** and
speeds **ASSEMBLY**



tures, technical data and ordering information.

TV Parts & Picture Tubes. Allen B. DuMont Laboratories, Inc., 1500 Main Ave., Clifton, N. J. A 32-page guide of original television parts and picture tubes for replacement in DuMont television receivers has been published. The guide, cross-indexed three ways for easy reference by the serviceman, also includes electrical values of the components.

Signal Generators for UHF Use. Simpson Electric Co., 5200 W. Kinzie St., Chicago 44, Ill. How the company's signal generators can be effectively adapted for uhf applications is the subject of a new booklet, "How to Use the Simpson 479-480 for UHF Alignment." The booklet tells how the adaptation of the company's signal generators will provide signals of the type, accuracy, and strength necessary to assist the serviceman in identifying the nature of troubles in uhf circuits, and in correcting these troubles and aligning the receiver for satisfactory reception.

Portable Strain Indicator. Baldwin-Lima-Hamilton Corp., Philadelphia 42, Pa. Bulletin 4103 describes a newly improved SR-4 portable strain indicator, the type MA, with self-contained a-c power pack mounted inside the instrument case. The brochure illustrates the unit and gives operation instructions and physical characteristics.

Test Chambers. Bowser Technical Refrigeration, Terryville, Conn. A 4-page bulletin illustrates and describes a line of temperature, altitude and relative humidity test chambers. Standard units described combine a temperature range from +185F to -100F with relative humidity simulation from 20 percent to 95 percent, and altitude simulation from atmospheric pressure to 80,000 ft. Complete specifications are given.

Woven Glass Fabrics. E. I. DuPont Co., 350 Fifth Ave., New York, N. Y. Latest word on woven glass

4 mmf/ft

AIR-SPACED ARTICULATED

CO-AX CABLES

offer a unique combination of

- ✓ FRACTIONAL CAPACITANCE
- ✓ HIGH IMPEDANCE
- ✓ MINIMUM ATTENUATION

ALONG WITH

- ✓ EXCEPTIONAL FLEXIBILITY
- ✓ LIGHT WEIGHT

38 STOCK TYPES

FOR ANY OF YOUR STANDARD OR SPECIAL APPLICATIONS

A few of the very low capacitance types are:

Type No.	Capacitance $\mu\text{F}/\text{ft.}$	Impedance ohms	O.D.
C.44	4.1	252	1.03"
C.4	4.6	229	1.03"
C.33	4.8	220	0.64"
C.3	5.4	197	0.64"
C.22	5.5	184	0.44"
C.2	6.3	171	0.44"
C.11	6.3	173	0.36"
C.1	7.3	150	0.36"

WE ARE SPECIALLY ORGANIZED TO HANDLE DIRECT ORDERS OR ENQUIRIES FROM OVERSEAS

SPOT DELIVERIES FOR U.S.

BILLED IN DOLLARS—SETTLEMENT BY YOUR CHECK CABLE OR AIRMAIL TODAY

TRANSRADIO
LTD.
CONTRACTORS TO
H.M. GOVERNMENT

138A GROMWELL RD., LONDON, S.W.7
ENGLAND

CABLES: TRANSRAD LONDON

ELECTRONICS — September, 1953

encapsulated

PULSE TRANSFORMERS

wound to your requirements

SMALL IN SIZE

Weight— $\frac{1}{3}$ oz.

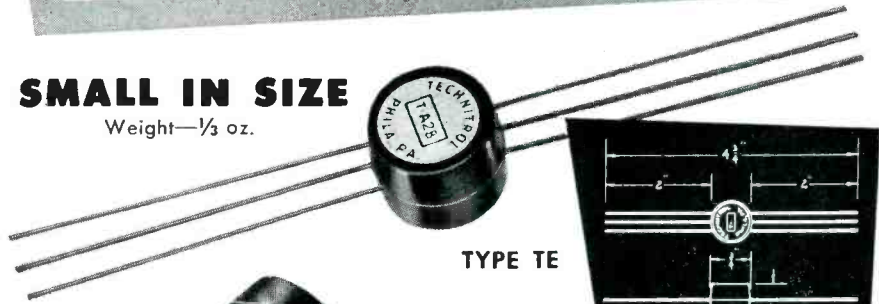

TYPE TE

Write for Bulletin 166 E for additional information and specifications.

TYPE TP

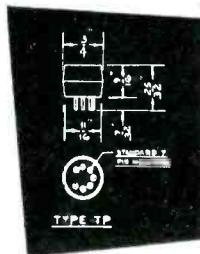

SMALL IN PRICE

As low as \$5.00 each in quantity lots. One to three—\$7.50 each.



TECHNITROL

ENGINEERING COMPANY

2751 N. 4th St., Philadelphia 33, Pa.

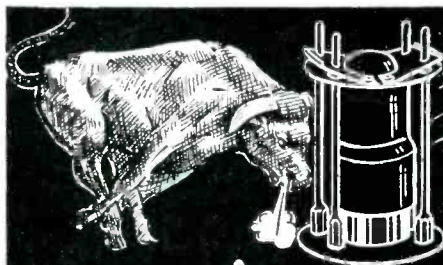

SHOCK PROOF

VACUUM TUBE RETAINERS

These retainers are used to secure Vacuum Tubes and to resist side motion of Vacuum Tubes used in radio equipment which is subject to shock and vibrations. These retainers meet the requirement of all JAN specifications. The insulated portion is made of a melamine base Fibre Glass Phenol which provides 300 volts insulation to ground and withstands a temperature of 350 F. The insulated plate can readily be fastened or released by hand.

Available for envelope types T7, T8, MT8, T9, T12, ST12, T12ZDL, ST14, S14, ST16, T5 $\frac{1}{2}$, T6 $\frac{1}{2}$, MT-IC, ST19, T14, ST128CT-9.

Manufacturers of
Electronic Components

JAMES IPPOLITO & CO., INC.
401 CONCORD AVENUE, BRONX 54, N. Y.

Want more information? Use post card on last page.

359

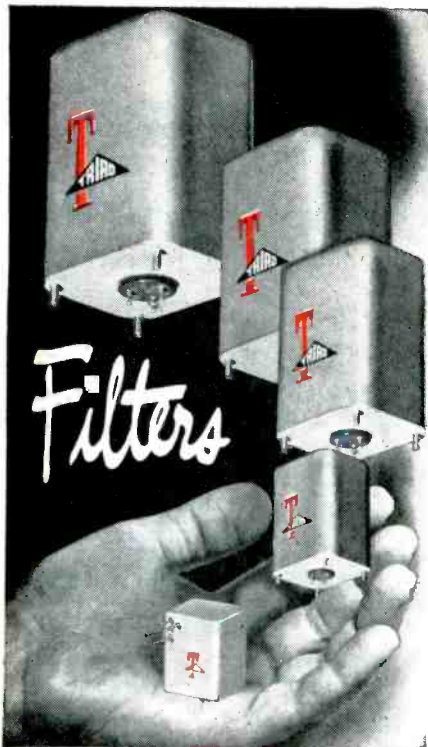

by **TRIAD**

Designed by Triad to meet exacting military requirements for airborne telemetering equipment, the tiny electric wave filter shown above actually contains eleven precision components: 2 toroidal inductors, 5 JAN-C-5 capacitors, and 4 precision wire-wound resistors. The resulting attenuation slope is over 50 decibels per octave.

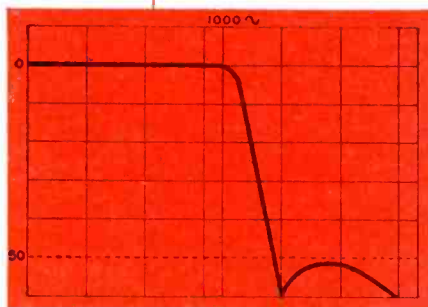

The same brilliant design and controlled manufacturing that goes into Triad's distinguished line of hermetically sealed military transformers is available to you for licking the toughest wave filter problems. Call Triad first!

For specifications and prices on Triad's general line of transformers, write for Catalog TR-53G



4055 Redwood Ave. • Venice, Calif.

Want more information? Use post card on last page.

360

NEW PRODUCTS

(continued)

fabrics impregnated and coated with Teflon tetrafluoroethylene resin is available in a new technical bulletin. Not only are the outstanding electrical and mechanical properties of these fabrics, tapes and laminates set forth in tabular form, but uses in other fields are also touched upon.

Panelboards. Bulldog Electric Products Co., Detroit 32, Mich., has published a new illustrated bulletin dealing with its compact Vacu-Break panelboards. Bulletin VP-450 has 12 pages containing complete descriptive material, dimensional data, horsepower ratings and other pertinent information. The bulletin explains the operation of the arc-snuffing Vacu-Break switch units and the compact 2½-in. sliding contact unit.

Teflon Products. Ethylene Chemical Corp., Summit, N. J. A new 8-page catalog describes and illustrates an extensive line of Teflon products. It includes Teflon product lists and price lists, and offers stress relieved as well as high tensile molded rods, tubes and sheets; extruded rod; extruded tubing, electronized rod; custom moldings, machined parts and shaved tape. Techniques for machining Teflon are described and engineering services are offered. Teflon applications and properties are listed with charts, tables and diagrams.

Chemo-Carbon Resistors. Arnhold Ceramics, Inc., One E. 57th St., New York 22, N. Y. Bulletin No. 1 gives a complete description of the development of Stemag Chemo-Carbon precision resistors. Included are styles, dimensions, tables showing characteristics and resistance-tolerance, and a listing of the Chemo-Carbon resistor types now available.

Beryllium Products. The Beryllium Corp., Reading, Pa. Beryllium products, including the pure metal, oxide and alloys, are described in the product directory, a recently published 20-page booklet. The booklet covers in concise form the various commercial products offered by the corporation,

Engineering

WRITERS

ENGINEERS, E. E. or PHYSICS GRADUATES, for preparation of technical manuals...

HUGHES RESEARCH AND DEVELOPMENT LABORATORIES' expanding program for production of radar, electronic digital computers, guided missiles and other military advanced electronic systems and devices requires the following:

- 1 ELECTRICAL ENGINEERING AND PHYSICS GRADUATES to prepare operating, servicing and overhauling instructions for complex electronic equipment. Those with previous maintenance experience on military equipment preferred. Writers will participate in a three-month program in our technical training school to become familiar with the latest Hughes equipment prior to writing assignments.
- 2 ENGINEERS EXPERIENCED in the writing and preparation of maintenance manuals for electronic equipment or guided missiles. These specialists will work step-by-step with the people designing, developing and manufacturing the products involved. Experience in the writing of engineering reports is of value.

HOW TO APPLY

Write full details of your qualifications to

HUGHES

Research and Development Laboratories

SCIENTIFIC AND ENGINEERING STAFF

Culver City, Los Angeles County California

Assurance is required that relocation of the applicant will not cause disruption of an urgent military project.

Ultraviolet Laboratory Equipment

UTILITY MODEL QUARTZ LAMP

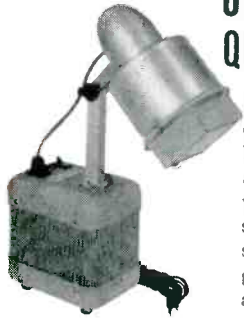

A high pressure, quartz mercury arc lamp. It is ideally applicable for use with the microscope, polarimeter, spectrometer, and general laboratory applications.

INSPECTOLITE



A source of "black light" for making rapid qualitative analyses by visual observation.

OPTOSIL



Fused quartz suitable for many optical uses. Hanovia's special manufacturing process greatly reduces the size and number of air bubbles as compared to general commercial grades. Higher optical grades available.

1787

Write for technical data on these or other ultraviolet laboratory equipment.

HANOVIA

CHEMICAL & MFG. CO.
(Special Products Division)

100 CHESTNUT STREET, NEWARK 5, N. J. — Dept. E-953

Oster
MFG. CO. INC. 1953

AVIATION PRODUCTS
for air-borne quality and dependability



SAFER FLIGHT

EXTRA FIGHT

Here is an engineering and production skill you can use to help you achieve safer flight, extra fight. For 25 years, OSTER has specialized in electro-mechanical products. A staff of trained field engineers is at your service. Call on us to help you select the product best suited to your job.

INSTRUMENT CONTROL MOTORS

1. Synchro Generator
2. Synchro Control Transformer
3. Synchro Transmitters
4. Synchro Differentials
5. Synchro Receivers
6. Synchro Resolvers
7. Two Speed Synchros
8. Reference Generators
9. Low Inertia Servo Motors
10. Servo Torque Units
11. Tachometer Generators

DRIVE MOTORS & BLOWER MOTORS

1. Permanent Magnet
2. DC
3. 60 Cycle AC
4. 400 Cycle, 1 Phase
5. 400 Cycle, 2 Phase
6. 400 Cycle, 3 Phase
7. 50 — 1600 Cycle, Variable Frequency

AIRCRAFT ACTUATORS

1. Rotary
2. Linear

JOHN OSTER
MANUFACTURING COMPANY
AVIATION DIVISION
RACINE, WISCONSIN

© 1953



AUDIO GEN. KIT
\$29.50



R. F. SIGNAL GEN. KIT
\$19.50

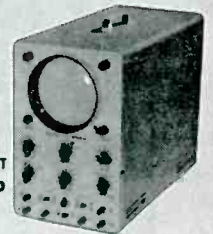

5" SCOPE KIT
\$43.50



T.V. ALIGN. GEN. KIT
\$39.50

BUILD YOUR OWN *Heathkit* TEST EQUIPMENT

Heathkits are completely engineered instruments supplied unassembled. Every kit goes together smoothly and easily. All drilling, punching, and painting has already been done for you. All parts are furnished and are of highest quality.

Detailed construction manual shows clearly where each wire and part goes and tells exactly how to build the kit. Write for free catalog.



SIGNAL TRACER KIT
\$22.50



VACUUM TUBE VOLT METER KIT
\$24.50



BATTERY ELIMINATOR KIT
\$24.50

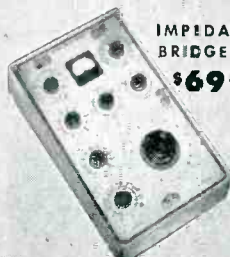

IMPEDANCE BRIDGE KIT
\$69.50

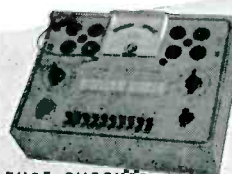

TUBE CHECKER KIT
\$29.50

HEATH COMPANY
BENTON HARBOR 14,
MICHIGAN

EXPORT AGENT
ROCKE INTERNATIONAL CORP.
13 East 40th Street
NEW YORK CITY (16)



GRID DIP METER KIT
\$19.50



CONDENSER CHECKER KIT
\$19.50

FOR FASTER, MORE ACCURATE MEASUREMENT OF...

YOU CAN READ THE ANSWER DIRECTLY ACCURATELY AND EASILY

without computation or interpolation on this Potter Megacycle Frequency-Time Counter. For maximum versatility, complete reliability, and proved performance, this unique instrument is outstanding. One compact unit provides the means for these basic tests.

DIRECT FREQUENCY from 0 to one megacycle.

PERIOD for one or ten cycles of the unknown.

TIME INTERVAL from 30 microseconds to 1,000,000 seconds.

FREQUENCY RATIO for two unknown frequencies.

TOTAL COUNT from 1 to 10^6 .

RPM with an accuracy of ± 1 rpm at any speed.

TIMING in increments of 10 or 100 usec; 1, 10, or 100 millisecs; or 1 sec.

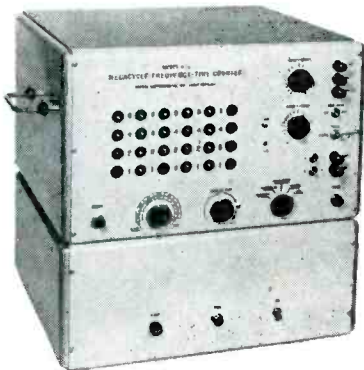

OPTIONAL FEATURES

such as additional decades, mechanical registers, preamplifiers, and 1 mc crystal for interval resolutions to one usec, further increase the utility of the Model 850.

Only Potter Instruments offer a choice of the famous Potter 1-2-4-8 four lamp readout for maximum reliability and readability or the 0-9 ten lamp readout for direct digital indication. Adjustable display time for either indication provides automatic or manual reset after the reading period.

As accessory equipment the Potter Instrument Company can also supply high speed printers and digital magnetic tape handlers for recording the digital information.

If you are now using awkward, time-consuming methods of measurement, you can save time and money by putting this universal measuring instrument into your program now. Like every Potter product, the Model 850 is the industry standard, and is always specified wherever results are important. For complete information and our recommendations on your specific laboratory or production problem, write to Department 9-C, the Potter Instrument Co., Inc., Great Neck, New York.

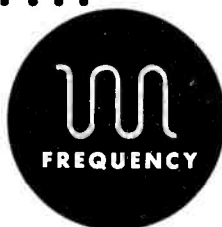

and

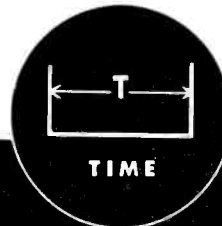

The Only Universal

Megacycle
Frequency
Time
Counter

Potter

Use it, too, as an accurate secondary frequency standard with outputs of 100, 10 and 1 kc; 100, 10, 1 and .1 cps.

including beryllium master alloys, beryllium copper wrought products, beryllium casting ingots and other products such as castings, nonsparking tools, forgings, beryllium oxide, beryllium metal and ferro-beryllium.

Plastic Recording Reels. Minnesota Mining and Mfg. Co., 900 Fauquier St., St. Paul 6, Minn. Recent improvements in the design of plastic reels for magnetic recording are discussed in "Sound Talk" bulletin No. 23. The technical bulletin points out how timing error, reel warpage, uneven tape winding, fast threading and tape spillage are affected by reel design, and how these problems have been solved through design changes.

Grooving Tool. Waldes Kohinoor, Inc., 47-16 Austel Place, Long Island City 1, N. Y., has completed a 20-page descriptive catalog covering its Truarc grooving tool. It includes facts, figures, charts and illustrations to demonstrate how the equipment can be employed to best advantage. Among the subjects covered in detail are: cutting ranges, accessory parts, use of the tool and 17 case histories. The manual explains how to select the right model tool for particular operations and supplies data on adjustment and maintenance and replacement parts.

Line and Slide Switches. Stackpole Carbon Co., St. Marys, Pa. Bulletin RC-9B describes a comprehensive selection of inexpensive line and slide switches for radios, tv sets, appliances, instruments and similar equipment. Included are complete specifications, dimensions and helpful application data for seven new line switches recently developed for use with variable composition resistors. In addition, similar data are given for a wide variety of slide switches including several new heavy-duty types for fractional horsepower motors.

Electronic Weighing. Baldwin-Lima-Hamilton Corp., Philadelphia 42, Pa. Typical applications



POTTER INSTRUMENT CO., INC.

115 CUTTER MILL ROAD

GREAT NECK, N. Y.

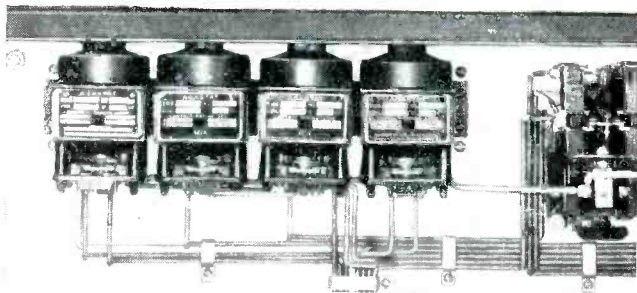

Cleaver-Brooks chooses Agastat time delay relays for Boiler Control Circuit Timing

4 AGASTATS handle these applications:

- 1 . . . allows 30 seconds for warmup of tubes in electronic control relay
- 2 . . . delays fuel delivery to burner for 15 seconds to permit boiler purge
- 3 . . . controls a 15-second ignition period
- 4 . . . delays full capacity delivery of fuel oil to burner for 3 (or 5) seconds, facilitating smooth lighting

AGASTAT time delay relays are solenoid actuated and pneumatically timed. They are light, compact, *dust-proof* and can be furnished to operate mounted in any position.

Write for Bulletin—
Dept. A3-94

AGA

Division of Elastic Stop Nut Corporation of America
1027 Newark Avenue, Elizabeth 3, New Jersey

To Readers Outside North America

The Field Maintenance Department of Tektronix, Inc. has replacement parts available for immediate shipment to users throughout the world. On replacement parts shipments, Tektronix assumes the cost of surface transportation anywhere, and the cost of emergency air shipments in North America. Although it is economically unsound to assume overseas AIR transportation costs, in the case of urgency Tektronix will assume half these costs. As a convenience we will prepay overseas air shipments and invoice the customer for his half of the cost. This service applies to "in-warranty" and "out-of-warranty" replacements, and is possible because the Tektronix Field Maintenance Department is operated as a non-profit customer service.



Laboratory Oscilloscope

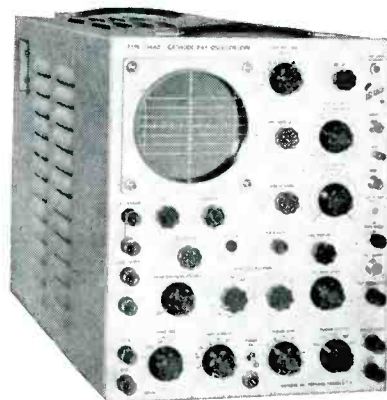

The Tektronix Type 514A-D Cathode-Ray Oscilloscope has the versatility necessary for general purpose laboratory use. Its direct-coupled 10 mc vertical amplifier provides excellent transient response. Six centimeters of undistorted vertical deflection can be displayed on the new precision flat-faced 5" cathode-ray tube. A new 5x sweep magnifier adds to the utility of the wide, continuously variable time base range. Direct-coupled unblanking assures a steady intensity level with sweep speed or duty cycle changes. The amplitude and duty cycle of the new square-wave voltage calibrator are both continuously variable.

Condensed Specifications

Vertical Amplifier	Time Base Range
Risetime—0.04 μ sec	0.1 μ sec/cm to
Bandwidth—dc to 10 mc	0.01 sec/cm,
ac—2 cycles to 10 mc	continuously variable,
	accurate within 5%
Sensitivity	
dc—0.3 v/cm to 100 v/cm	Single, triggered, or
ac—0.03 v/cm to 100 v/cm	recurrent sweeps
Calibrator	5x sweep magnifier
0 to 50 v square wave,	3 kv accelerating potential
accurate within 3%,	All dc voltages
duty cycle variable	electronically regulated
2% to 98%	

Supply Voltage—105 to 125 v or 210 to 250 v,
50 to 60 cycles.

Type 514A-D \$950 f.o.b. Portland, Oregon



Tektronix, Inc.

P.O. Box 831A, Portland 7, Oregon
Cable: TEKTRONIX

VHF COMMUNICATIONS RECEIVER

S220A

SPACE ECONOMY!

SAVE MORE THAN 40% RACK SPACE!
A standard 66" rack will hold only 7 ordinary VHF receivers. 12 SCHUTTIG S220A receivers will fit in this same rack! The SCHUTTIG receiver requires only 5 1/4 inches of vertical rack space as contrasted with 8 3/4 inches for other VHF receivers. The S220A is competitive in price, too!

UNSURPASSED PERFORMANCE

SELECTIVITY: Bandwidth is ± 20 Kc 6 db down; ± 100 Kc 60 db down.
SENSITIVITY: 1 MICROVOLT modulated 30% provides 1 watt with 10 db S/N ratio!
OUTPUT: 3 WATTS; feeds either built-in speaker or 600 ohm line.

SCHUTTIG and CO.
INCORPORATED

9th and Kearny St., N.E.
Washington 17, D. C.

MOUNT 6 OPEN RELAYS IN THIS SPACE

DECOHM TYPE D-3

miniaturized telephone type

"Molded Coil" Relay

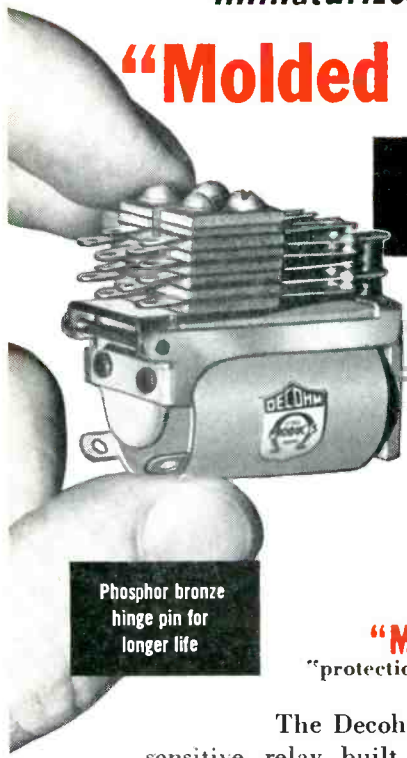

- Nickel silver springs used
- Twin or single contacts rated from 1 to 5 amps
- Coil resistance 1 to 10,000 ohms
- Dimensions: 11/16 x 1-3/8 x 1-7/16 inches

Phosphor bronze hinge pin for longer life

"Molded Coil" construction provides "protection plus" in a competitively priced relay!

The Decohm D-3 relay is a small, compact, highly sensitive relay built to meet exacting military standards. Its size, range and sensitivity make it an ideal relay for all types of communications, aeronautical and industrial applications. The coil of the D-3 is sealed in a homogeneous mass which makes it impervious to most adverse ambient operating conditions. The molded coil dissipates heat readily and promotes longer relay life.

SPECIFICATIONS

- CONTACT COMBINATIONS:** Forms A-B-C-D-E-F-G-H 12 springs maximum
- CONTACT MATERIAL:** 2 amp. twin palladium contacts are standard
- OPERATING VOLTAGE:** 1 to 150 volts DC
- OPERATING TIME:** .002 sec. min. to .035 sec. max. .004 seconds standard
- COIL PROTECTION:** Coil completely imbedded in molded plastic. Withstands roughest moisture and humidity requirements and temperatures from -70 C to +140 C. Will operate one normally open contact on 1/8 watt, or 4 double throw contacts on less than 1 watt and still meet a 10G vibration test.

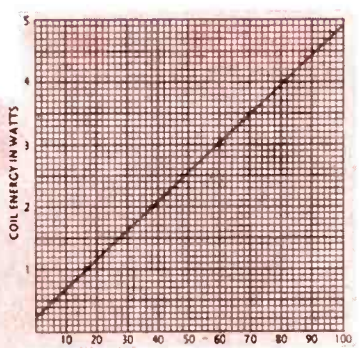

OPERATING CHARACTERISTICS — The graph curve shows coil temperature rise above ambient with zero to 4 watts applied to the D-3 relay coil.

Write for catalog of Decohm products. State your requirements for relay needs. Decohm engineers available to work on all critical problems.



DAVIS ELECTRIC COMPANY

Cape Girardeau, Missouri

Manufacturers of

"Molded Coil" and Hermetically Sealed Relays, TV Yokes, Electrical Assemblies

of the SR-4 crane scales and indicating or recording instruments for weighing loads electronically are described in bulletin 4105, a new 8-page illustrated brochure. The new bulletin shows how these scales, utilizing the principles of the well-known SR-4 bonded resistance wire strain gage, are installed and used.

Vibration Isolator. The Barry Corp., 700 Pleasant St., Watertown 72, Mass. Product bulletin 532 presents complete technical and performance data on the new type 915 Barrymount. The unit described is designed as an isolator of vibration and structure-borne noise from high-speed machinery such as motor generator sets, compressors, grinders, fans and blowers. The bulletin describes typical application practice for these isolators, and gives complete data on load ranges, physical dimensions, isolation efficiency at various frequencies, and variation of natural frequency over the range of rated loads.

Ferromagnetic Cores. Stackpole Carbon Co., St. Marys, Pa. A new bulletin gives engineering information, application data, and dimensions for the most popular standard types of Ceramag (R) ferromagnetic cores. The types described range from tiny cup cores and cylindrical cores with threaded inserts to "U" cores for transformers and split ring quadrants for deflection yoke applications. A valuable feature of the bulletin is a 16-page insert containing physical and electrical characteristic graphs of various Ceramag grades. The laboratory test procedures used in determining these characteristics are also described. New editions of this insert will be issued as additional technical information becomes available or whenever new Ceramag grades are developed.

Electrical Fittings. Buchanan Electrical Products Corp., Hillside, N. J. Catalog 53 is a 16-page bulletin describing a complete line of solderless wire connectors and specialized electrical fittings. It contains profusely illustrated

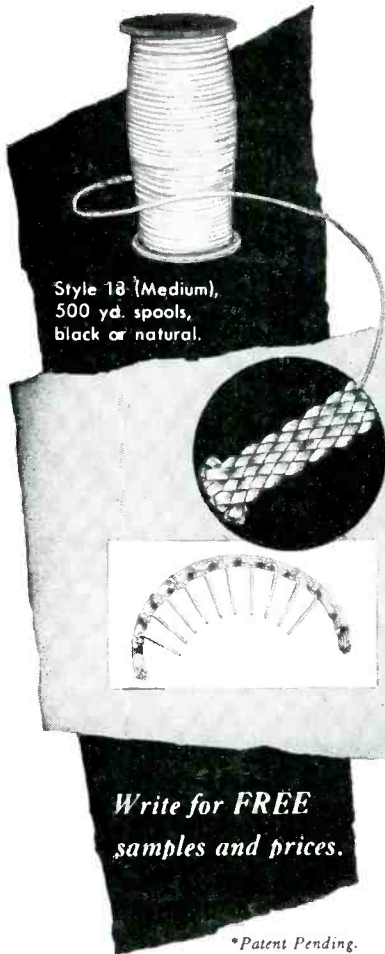

for lacings that stay put!

GUDELACE

BRAIDED NYLON LACING TAPE*

A New and Revolutionary Type of Lacing.

- Saves time, saves money, greatly reduces the number of rejects
- Won't "bite through" insulation
- Won't cut wiremen's fingers or cause dermatitis
- Ties easier, ties tighter and cuts down on slipping of knots

Let GUDELACE answer your lacing problems.

Write for **FREE** samples and prices.

*Patent Pending.

GUDEBROD BROS. SILK CO., INC.
Electronics Division, Dept A

Main Office: 12 South 12th Street, Philadelphia 7, Pa.
225 West 34th Street, New York 1, N.Y.



HEAT RESISTANT WIRES FOR EVERY APPLICATION . . .

Just a Reminder!

Now is the time to install Lewis heating cable on those outside pipe lines that caused you trouble last winter. Nickel Chrome conductor with special insulation designed for 500°F operation.

Write for details

Send your electronic control, communications or appliance wiring specifications for a recommended solution by our engineers.

FOR A TRIAL ORDER OR A CARLOAD consult



THE LEWIS ENGINEERING CO.
Wire Division
NAUGATUCK CONNECTICUT

HEATING UNITS
HEATING ELEMENT
RESISTANCE
LINE CORD
THERMOCOUPLE WIRE
ASBESTOS LEAD
& FIXTURE WIRE
INSULATED
RESISTANCE WIRE
FIBERGLAS
INSULATED WIRE
WIRE TO ANY
SPECIFICATIONS

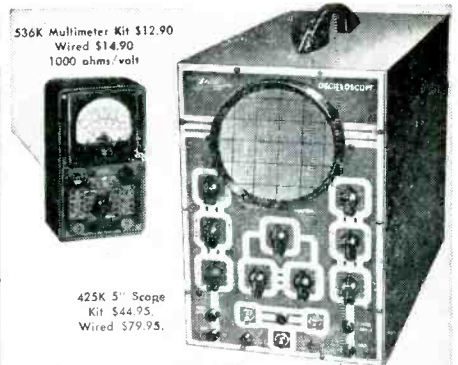

536K Multimeter Kit \$12.90
Wired \$14.90
1000 ohms/volt

425K 5" Scope
Kit \$44.95
Wired \$79.95.

YOU BUILD

EICO

KITS
IN ONE
EVENING-

but they
last a lifetime...
and you
save 50%

24 INSTRUMENTS -
the Industry's most complete
line of MATCHED
TEST INSTRUMENTS

1/4 - million EICO Instruments are now in use the world over! That's the proof of EICO's leadership in Value.

For latest precision engineering, finest components, smart professional appearance, lifetime performance and rock-bottom economy — see and compare the EICO line at your jobber's today before you buy any higher-priced equipment! You'll agree with over 100,000 others that only EICO Kits and Instruments give you the industry's greatest values at lowest cost.

Write NOW for
FREE latest Catalog
E-9

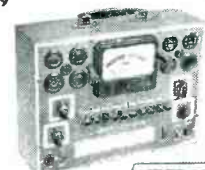

625K Tube Tester
Kit \$34.95.
Wired \$49.95.



221K VTVM Kit \$25.95.
Wired \$49.95.



565K Multimeter Kit \$24.95.
Wired \$29.95.
24,000 ohms/volt.



NEW 377K
Sine & Square Wave Audio Gen.
Kit \$37.95 Wired \$49.95



360K Sweep Gen.
Kit \$34.95. Wired \$49.95.

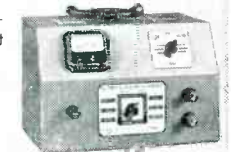

104DK Battery Elim.
Kit \$25.95. Wired \$34.95.

Laboratory
Precision
at Lowest Cost

Prices 5% higher on West Coast.



©1952 INSTRUMENTS & KITS
ELECTRONIC INSTRUMENT CO., Inc.
84 Withers Street, Brooklyn 11, N. Y.

**SPECIALISTS IN
THE DESIGN AND
MANUFACTURE OF**







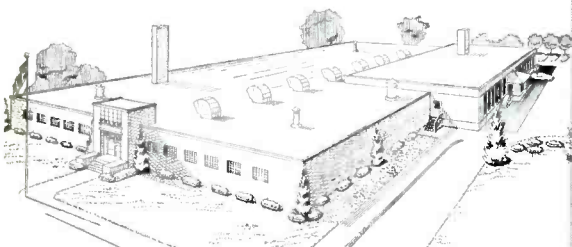

- Electro-Acoustic Devices
- Custom Printed and "Packaged" Circuitry
- Plastic Molding
- Coil Winding
- Transformers
- Electronic Component Assemblies

**COMPONENT
RELIABILITY
and
MINIATURIZATION**

**TELEX, INC.
ELECTRO-ACOUSTIC
DIVISION
CAN MEET YOUR MOST
EXACTING DESIGN AND
PRODUCTION REQUIREMENTS**

The Electro-Acoustic Division of Telex, Inc., offers you an expertly staffed, modern laboratory, engineering know-how and the finest in production facilities. The variety of special skills at your disposal in Telex personnel and plant facilities means quick and cost-saving solutions for your design and production problems.

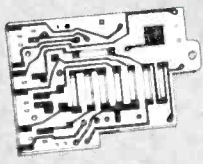

	MIDGET TRANSFORMER
	MOLDED BOBBINS
	MIDGET RECEIVERS
	MOLDED INSERTS
	SPECIALTY MOLDING
	COIL ASSEMBLIES
	PRINTED CIRCUITS
	MOLDED KNOBS & CAPS
	MOLDED PLUGS
WRITE, WIRE OR PHONE: J. R. Anderson Electro-Acoustic Division TELEX, INC. Telex Park, St. Paul, Minn. Phone - Nestor 7211	

information on pres-Sure connectors for solderless wire splicing and terminating, Bushend insulated bushings for electrical metallic conduit, snap-action plugs for temporary or permanent plugging of knockout holes in wiring device boxes and other applications; also heavy duty molded terminal blocks in various styles, types and sizes. The catalog includes complete specifications, dimensional data, application instructions and ordering information.

Transformers and Components. Halldorson Transformer Co., 4500 Ravenswood Ave., Chicago 40, Ill., is issuing a 1953 catalog containing the most comprehensive line of transformers in the firm's 40 year history. The component data give more detailed listings than ever, yet well classified for quick references. Special features include an expanded tv section with many exclusive items, an up-to-date output transformer chart, and mounting dimensions for all components.

Electronic Tubes. Amperex Electronic Corp., 230 Duffy Ave., Hicksville, L. I., N. Y., has available a 20-page catalog covering a wide line of communication, industrial, rectification, radiation detection, electromedical, amateur and special purpose tubes. It was compiled for those in the engineering field who seek the proper tubes to suit their applications. It is also intended to serve as a quick reference guide and a dependable source of supply for initial equipment as well as for replacement purposes.

Metal Hose Catalog. Titeflex, Inc., 524 Frelinghuysen Ave., Newark 5, N. J. Catalog No. 200 furnishes charts on frictional losses versus flow rates in flexible hose, and also tells photographically how seamed metal hose is made. Included is a specification page to help the prospective customer order metal hose, and should prove helpful to purchasing agents, designers and others responsible for hose selection. Particular attention is given to the

WAVEGUIDE

Components

**TO SPECIFICATIONS
SINCE 1943**

Tees	Bends
Mixers	Ratracces
Duplexers	Cavities
Rotating Joints	Pads
Filters	Phasers
Attenuators	Flanges
Electronic Assemblies	
Special Purpose Components	

For the complete story on Premier's fully integrated engineering, production and testing facilities, write Dept. E today for our new brochure.

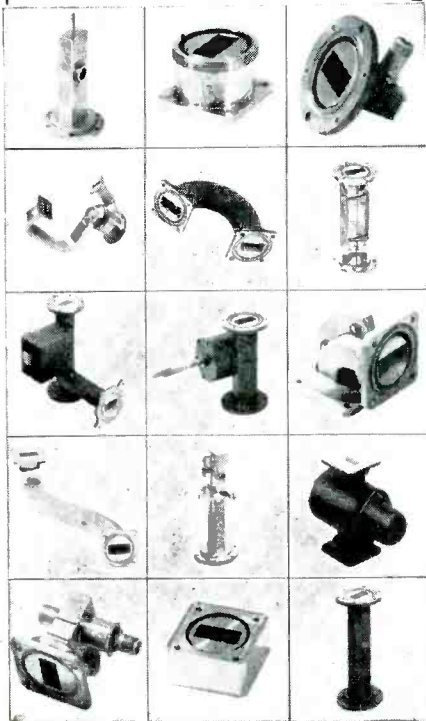

**PREMIER
INSTRUMENT CORP.**

52 West Houston Street
New York 12, N. Y.

ZOPHAR

WAXES

COMPOUNDS

Zophar Waxes, resins and compounds to impregnate, dip, seal, embed, or pot electronic and electrical equipment or components of all types; radio, television, etc.

Cold flows from 100°F. to 285°F.

Special waxes non-cracking at -76°F.

Compounds meeting Government specifications plain or fungus resistant.

Let us help you with your engineering problems.



ZOPHAR MILLS, INC.
112-130 26th Street,
Brooklyn 32, N. Y.

Just right for your job!



high-precision thermistors
by **BENDIX-FRIEZ**

As temperature measuring elements and liquid level sensors, these temperature responsive resistors are the best you can buy. In standard or special types, their high-precision manufacture makes them precisely right for your job when it comes to resistance values, size, temperature coefficient, mountings and quality. Ask us about applications.

STANDARD TYPES FOR IMMEDIATE DELIVERY

Size (inches)	@ +30°C.	@ 0°C.	@ -30°C.
.140 x .75	45.0 ohms	86 ohms	194 ohms
.040 x 1.5	12,250 ohms	26,200 ohms	65,340 ohms
.018 x 1.5	35,000 ohms	82,290 ohms	229,600 ohms

Write for details.

FRIEZ INSTRUMENT DIVISION of . . .
1454 Taylor Avenue, BALTIMORE 4, MARYLAND
Export Sales: Bendix International Division
72 Fifth Avenue, New York 11, N. Y.

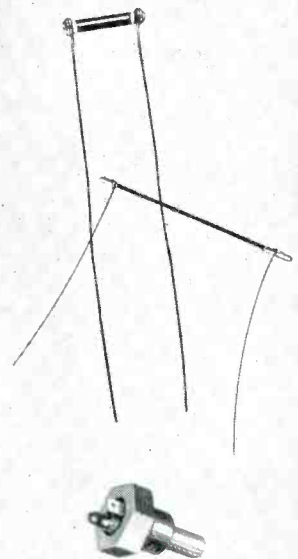

Used in this typical application for sensing the temperature of hydraulic oil.





CAROL
RG 59/U
COAXIAL CABLE

Strict control over every phase of manufacture assures you of highest performance from Carol RG 59/U Coaxial Cables. The dielectric is Carol Polyethylene, extruded by precision methods under accurate temperature control... to guarantee perfect "end to end" uniformity, solidity, and flexibility.

The cable is jacketed in Carol Vinyl—especially compounded in our laboratories for maximum oil resistance, abrasion resistance, and ability to withstand exposure to acids, alkalis, moisture and flame.

A selection of RG types is available. We also manufacture special coaxial cable to your own specifications.

For details on our complete line of cable for electronic equipment, write or call Carol today.

CAROL
CABLE DIVISION
of The
CRESCENT COMPANY
INC.

Pawtucket, Rhode Island

Want more information? Use post card on last page.

description of conduit for ignition shielding and to high and low-frequency conductors.

Extruded Thermoplastics. Plax Corp., West Hartford, Conn., has issued a 4-page brochure on its extruded thermoplastics. Entitled "The Plax Extrusion Story," the booklet contains a table of properties comparing polyethylene, methacrylate, polystyrene and fluorocarbons. An illustrated section shows the forms in which the extruded plastics are available, dimensions, surface, color, and primary uses and applications.

Capacitor Indicator. Lindell Electric Control Corp., 57 Lispenard St., New York 13, N. Y. A single-sheet bulletin deals with the model 150 capacitor indicator. Included are a description, illustrations, a listing of range selections, operating instructions and price.

Microphotometers. Leeds & Northrup Co., 4934 Stenton Ave., Philadelphia 44, Pa., has published a revised 12-page catalog giving complete information about the Knorr-Albers recording microphotometer and the Vincent-Sawyer spotting microphotometer. It fully describes and illustrates how the units are recording or indicating line density measurements of spectrographic plates or films in both research and industrial laboratories. Included are photographs illustrating the many operational features of both instruments. For easy reference, all specifications for both the instruments and accessories are conveniently arranged in tables. Ask for catalog EM9-90(2).

All-Channel Antenna. Tennialab, Quincy, Ill. A single-sheet catalog bulletin covers the Omnitenna stacked collinear array for all-channel tv reception. Included are an illustration and chief features, as well as information on frequency range, construction, assembly, forward gain, front-to-back data and price.

C-R Tube Phosphors. Sylvania Electric Products Inc., 1100 Main

Specify

ADVANCE RELAYS

for
 precise
 circuitry

There are many reasons why industry specifies ADVANCE RELAYS: They meet or surpass Military and Civilian requirements—many types have AN approval—many are hermetically sealed—all are lightweight—small—rugged—compact—and all are precision-built for efficient, trouble-free, long life performance.

If you have relay problems involving contact loads, coil resistances, close differential, timing features, input sources, critical environment or any particular requirements involving unusual or accurate circuit behavior, ADVANCE can supply the relay.

A complete line of relays for radar, radio, electronic and electrical equipment applications.

Write for new, descriptive Catalog containing detailed information about ADVANCE Relays and facilities.



ADVANCE ELECTRIC AND RELAY COMPANY

2435 NO. NAOMI ST., BURBANK, CALIF.



Sales Representatives in Principal Cities of U. S. and Canada

Want more information? Use post card on last page.

ELECTRONICS FOR COMMUNICATION ENGINEERS

Saves research time and effort on electronic problems in communications. Its 252 articles from *Electronics* contain a wealth of design equations, charts, nomographs, tables, etc. Covers amplifiers — antennas — audio — cathode-ray tubes — components — electronic music — filters — measurements — microwaves — oscillators — power supplies — propagation — pulses — receivers — transmission lines — transmitters. Edited by John Markus and Vin Zeluff, Assoc. Editors, *Electronics*. 624 pp., hundreds of illus., \$10.00



TELEVISION ENGINEERING

Second Edition

Covers the whole television process—from studio to receiver—clearly, and in detail. Treats TV technology, operating principles of TV systems, use of equipment. Provides practical working diagrams, complete with values of parts, tube types, etc. Explains color TV, intercarrier sound reception, distributed amplification, and many other phases. By Donald G. Fink, Editor, *Electronics*. Second Edition. 721 pp., 512 illus., \$8.75

ELECTRON-TUBE CIRCUITS

Timely book discusses different classes of circuits which have widespread application in radar, television, pulse communication, and general electronic control. Shows how to combine circuits of various types to achieve one or a number of operations. Treats power rectifiers, filters, regulators, amplitude modulation, oscillators, etc. By S. Seely, Prof. of Elect. Eng., Syracuse U. 529 pp., 641 illus., \$6.50



PRINCIPALS OF RADAR

Third Edition

Deals with the fundamental concepts and techniques of pulse radar. Presents the engineering principles of the pulse circuits and the high-frequency devices common to nearly all radar systems. Describes the general features of radar systems and system components; discusses pulse circuits and their application to radar modulators, indicators, and receivers. Covers radio-frequency aspects of radar, including basic concepts pertaining to transmission lines, wave-guides, cavity resonators, and antennas, and the techniques of their use in radar systems. By the Massachusetts Institute of Technology Radar School Staff. Revised by J. F. Reintjes, MIT, and Godfrey T. Coate, formerly of MIT. Third Edition, 887 pp., 565 illus., \$7.75

SEE THESE BOOKS 10 DAYS FREE

McGraw-Hill Book Co., 330 W. 42 St., NYC (36)

Send me book(s) checked below for 10 days' examination on approval. In 10 days I will remit for book(s) I keep, plus few cents delivery, and return unwanted book(s) postpaid. (We pay for delivery if you remit with this coupon—same return privilege.)

- Markus & Zeluff—ELECTRONICS FOR COMM. ENGRS.—\$10.00
 Fink—TELEVISION ENGR.—\$8.75
 Seely—ELECTRON-TUBE CIRCUITS—\$6.50
 Reintjes & Coate—PRINC. OF RADAR—\$7.75

(Print) Name

Address

City Zone State

Company

Position L-9

This offer applies to U. S. only

interested in

H-E* ?.....

Investigate

NOTHELFER "NWL" SPECIAL TRANSFORMERS

For ELECTRONICS, RESEARCH and SPECIAL INDUSTRIAL FIELDS

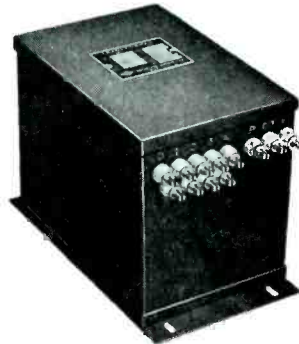

*HIGH EFFICIENCY

Over 28 years' experience in the manufacture of special transformers to meet individual requirements. Built in quality proved by years of actual use.

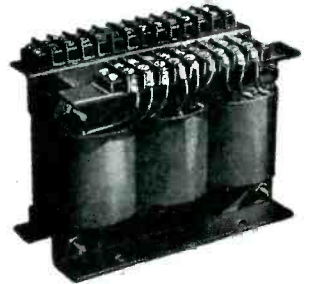

From 10 VA to 300 KVA Dry-Type only. Both Open and Encased. 1, 2, and 3 Phase. 15 to 400 cycles.

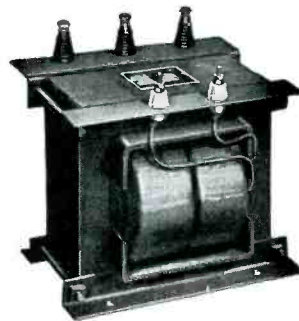

NOTHELFER WINDING LABORATORIES



9 ALBEMARLE AVE., TRENTON 3, N. J.

Burlington

RUGGEDIZED HERMETICALLY SEALED INSTRUMENTS

LABORATORY APPROVED Under MILITARY SPECIFICATION MIL-M-10304

- Will withstand Hi-Impact Shock Tests, extensive vibration and tumbling requirements, extreme thermal shock, humidity and temperature tests.
- Magnetically shielded.
- Glass to metal type seal with molded vulcanized rubber terminal connections capable of carrying 30 amps for self-contained units.
- Black satin onodized aluminum bezel.
- D'Arsonval permanent magnet type movement—for all D. C. Ranges.
- Available in 2-1/2" and 3-1/2" round case types.
- Guaranteed one year against defective workmanship and materials.

BURLINGTON INSTRUMENTS ALSO AVAILABLE IN HERMETICALLY SEALED OR BAKELITE CASES IN 1-1/2" THROUGH 4-1/2" SIZES.



BURLINGTON INSTRUMENT COMPANY
DEPT. F-93, BURLINGTON, IOWA

GTC Transformers

demanded for

Unusual Applications

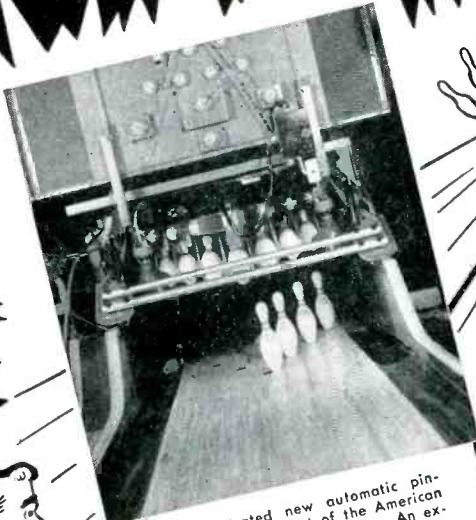

The illustrated new automatic pin-spotter is a product of the American Machine & Foundry Company. An exceptionally high degree of precision is necessary for proper performance.



"GTC" Transformers are used in the **AUTOMATIC PIN-SPOTTER** because of their accepted ability to meet the most rigid specifications. If your application is most unusual or standard, we suggest you consider "GTC" — proven transformers where maximum performance is essential.

We welcome your inquiries.

GENERAL TRANSFORMER COMPANY

servicing industry since 1928

18240 Harwood Avenue, Homewood, Illinois
(Suburb of Chicago)



St., Buffalo 9, N. Y. Volume 1 No. 7 of the company's Engineering Information Service gives a complete listing of all c-r tube phosphors registered with JETEC. The information is placed in tabular form and includes color, persistence and service. Also included are graphs of spectral energy distribution and persistence.

Terminal Blocks. Kulka Electric Mfg. Co., Inc., 633 South Fulton Ave., Mt. Vernon, N. Y., has published a 20-page booklet dealing with its standard line of terminal blocks, special Navy terminal blocks, aircraft and electronic switches. The devices described eliminate splicing, increase insulation, stop leaks and shorts, and generally simplify wiring work. Included are technical specifications, illustrations and dimensional drawings.

Gas-Free Metals. Vacuum Metals Corp., a subsidiary of National Research Corp., Cambridge, Mass., has available technical data sheets on: (1) Cuprovac-E, a gas-free high-purity copper with properties suited for vacuum tube manufacture; and (2) Ferrovac-52100, a gas-free alloy bearing steel, free of inclusions, with greatly improved fatigue properties. The company also offers reprints of a recently published technical article giving details of performance tests and data on Ferrovac-52100.

Pressure and Vacuum Gages. Minneapolis-Honeywell Regulator Co., Wayne and Windrim Aves, Philadelphia 44, Pa. A new 32-page catalog 7001 describes many types of pressure and vacuum gages used to measure vacuums as great as 10^{-11} mm of mercury and pressures as high as 150,000 psi. It covers indicators, recorders, pneumatic and electric controllers and pneumatic transmission. Information is presented in tabular form for ready reference.

Selenium Rectifier. Westinghouse Electric Corp., Box 2099, Pittsburgh 30, Pa. The type K Mag-amp selenium rectifier is described

XCELITE Hand Tools
 REFERRED BY THE EXPERTS

**THE TAMING OF THE
 SCREW!**

NO MORE
 Dropping
 Groping
 Gripping

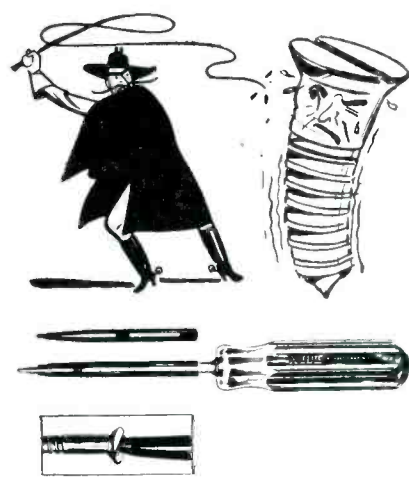

NEW XCELITE SCREWHOLDER

If Your Screwdriver Fits, So Will This!

ANOTHER XCELITE FIRST! It fits any round bladed screwdriver in its range.

Rugged, "wedge-grip" screwholder attachment . . . so slimly, trimly made, it slips into tight corners others can't touch! Slides out of way when not in use. Available in 3/16" and other major sizes.

You too can tame that SCREW . . . with the help of XCELITE! See your dealer today.

XCELITE, INCORPORATED
 (formerly Park Metalware Co., Inc.)
 Dept. C Orchard Park, N. Y.

For Originality
LOOK TO XCELITE

SECON

**DEVELOPMENT and PRODUCTION
 METALLURGISTS**

Fine wire and ribbon in base, rare, and precious metals, and alloys for new and highly engineered applications. In small units and sizes, and to close tolerances.

SECON

Further details on request.

SECON METALS CORPORATION
 228 East 45th Street, N. Y. 17, N. Y., MU 7-1594

HUNICONH

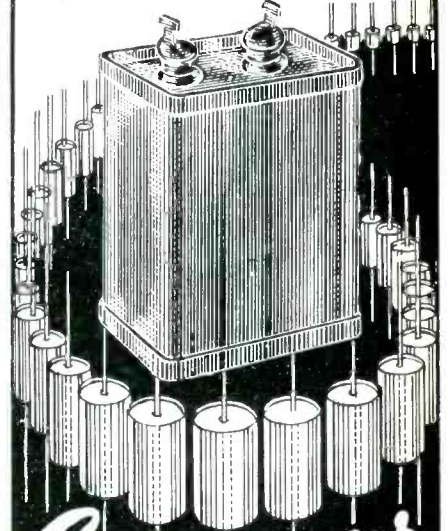

*Capacitors
 Reliability +*

Unicon capacitors are specified when reliable performance is the primary requisite. We view with satisfaction the confidence placed in our products by leading Electronic firms, as evidenced by repeated re-orders after initial contracts placed with our firm. Your capacitor problems always receive the maximum attention of our research, development, and production departments, thus assuring you a finished product having **RELIABILITY PLUS.**



Unicon Type D capacitors employ a newly developed plastic resin film as a dielectric.

The power factor, dielectric absorption, and temperature co-efficient of these condensers are much better than those of oil paper capacitors. They compare favorably in size with metallized paper capacitors of equal ratings and give far superior performance. Operation to 125°C is permissible. When high insulation resistance, without simultaneous low "soakage" and/or low power factor, is required, Type D capacitors make an excellent low-price substitute for Polystyrene or Teflon capacitors.

Unicon always gives your capacitor problems the Optimum Solution.

Capacitors made to your specifications
Write for Catalog F

film capacitors, inc.

337 East 139th Street New York 54, N. Y.
 Telephone CYpress 2-5180

PRECISION-ENGINEERED
HOUSINGS
DESIGNED FOR
ELECTRONICS

MORE THAN 3000 SIZES,
IN A COMPLETE RANGE
OF METALS—STEEL,
BRASS, ALUMINUM,
Mu-METAL.

OLYMPIC HOUSINGS are designed for easy assembly. Minimum variations in dimensions at any stage. Built-in flexibility assures modification and fabrication to meet blueprint specifications.

- Delivery from stock—no shipping delays

- Tooling costs eliminated

OLYMPIC HOUSINGS are engineered to incorporate three major elements of construction—*Uniformity, Strength, Compactness.*

On your next project—let OLYMPIC craftsmen give you facts, figures and specifications. Send for new illustrated folder E4 today.

STANDARDIZE WITH OLYMPIC
OLYMPIC

METAL PRODUCTS COMPANY, INC.
ALPHA, NEW JERSEY

in an 8-page booklet, TD-52-650. First sections of the booklet give a definition of selenium rectifier terms and electrical characteristics. A number of graphs are included showing reverse current leakage limits and forward current-voltage drop under various conditions. Tables, formulas and examples are provided to aid in the selection of the physical dimensions for any particular cell size and cell combination.

Microwave Equipment. Nassau Research & Development Associates, Inc., 66 Main St., Mineola, N. Y. A new line of microwave instruments and components is described in a 4-page bulletin that is now available. The listings include frequency meters, mixers, impedance meters, attenuators and other microwave items.

Solder Flux. Kester Solder Co., 4201 Wrightwood Ave., Chicago 39, Ill. "Kester Soldering Fluxes" is the title of a new 12-page brochure. Containing detailed information on a wide variety of flux formulas, the booklet is designed to aid the industrial solder user in his selection of fluxes for both production use and experimental purposes. Please use company letterhead in writing for a copy of the brochure.

Varistors. International Resistance Co., 401 N. Broad St., Philadelphia 8, Pa. Catalog bulletin SR-3 deals with a line of Varistors (nonlinear resistors). It gives comprehensive data on voltage current characteristics, current ratings, temperature characteristics, typical applications, dimensions and other specifications. The 6-page bulletin features detailed charts and graphs.

Strip Chart Recorders. Minneapolis-Honeywell Regulator Co., Philadelphia 44, Pa. An illustrated description of ElectroniK strip chart recorders of the single-record pen-type is found in specification sheet 164. The units discussed measure and record practically any variable that can be translated into electrical units. Included are speci-

U. G. CONNECTORS

*Our Coaxial Cable
Connectors Meet All
Government Specifications*

★ ALL ORDERS DELIVERED PROMPTLY ★

*Manufacturers of
Highest Quality Connectors*

ALLIED INDUSTRIES, INC.

1023 S. 21st STREET
LOUISVILLE 10, KY.

Phone Arlington 4640

PRECISION TRANSFORMERS

... for Exacting
MILITARY AND INDUSTRIAL REQUIREMENTS

Atlas offers a thoroughly reliable source of custom built transformers. We design — to your performance requirements — transformers incorporating the latest manufacturing techniques. Atlas precision controlled processes and inspection assure reliable performance.

Atlas facilities are arranged for fast delivery of small or large scale production. Testing facilities include a wide range of instruments, insuring exhaustive testing of even the most exacting circuits. We manufacture to MIL-T-27 or ANE-19 government specifications. Available are all standard transformers: power, pulse, audio, interstage, output, modulation, phase changing etc., as well as all types of chokes, reactors, bobbins and layer wound coils.

We specialize in:

MAGNETIC AMPLIFIERS and associated circuit development for industrial sensing and control applications.

INSTRUMENT TYPE REFERENCE TRANSFORMERS and bridge transformers featuring: phase errors as low as 1/20°, ratio errors to 1/100 of 1%.

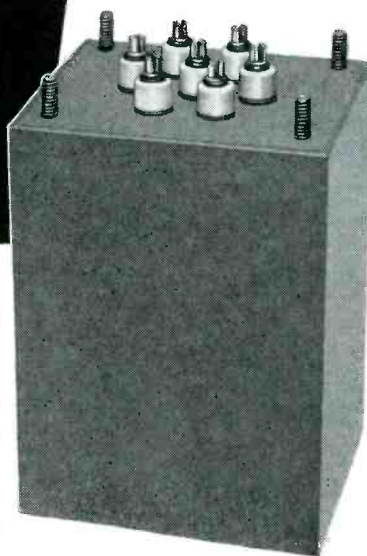

Construction Types:

- Hermetically sealed cans
- Fosterite
- Scotch cast
- Open type

ATLAS

ATLAS ENGINEERING CO., Inc.

3 EDGEWOOD ST., ROXBURY, MASS.

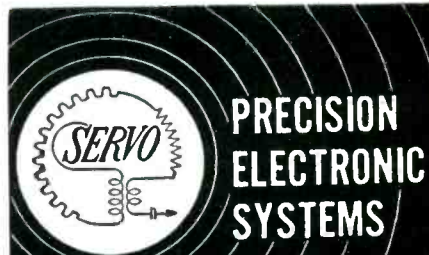

RADIO

- Direction Finders
Electronic Goniometer
- Signal Generators
Crystal Control
1 kc to 150 mc.
- Spectrum Generator
Marker Pulses
.5 to 50mc.

CONTROLS

- Servoscope
- Servoboard
- System Synthesis
- Reluctance Amplifiers
- 60 Servo Amplifier
- Plug-in Component Assemblies

RADIATION

- Servotherm Bolometers
- Bolometer Preamplifiers
- Thermistor Power Supply
- Servotherm Pyrometers

Write today for
complete information

SERVO

CORPORATION
OF AMERICA
NEW HYDE PARK, N. Y.



First in

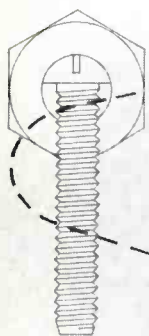

stainless steel

fastenings



● behind this symbol is an on-hand inventory of *more than 9,000 items and sizes* of stainless steel fastenings. Ready for immediate shipment, this stock is the largest and most complete in the industry. In addition, a production capacity for large or small quantities of special orders is at your service! A good reason — when you think of stainless steel fastenings — to think **FIRST** of Anti-Corrosive! *Send for Catalog 53F today!*

ANTI-CORROSIVE METAL PRODUCTS CO., INC.
Castleton-on-Hudson, New York

fications, data on individual models, options and ordering instructions.

Test and Measuring Equipment. Radio City Products Co., Inc., 152 W. 25th St., New York 1, N. Y., has issued a colorful and fully illustrated 4-page catalog featuring its new line of test and measuring equipment. Complete specifications and data are included on the company's entire test line, with particular emphasis given to the model 750 Do-All pattern, marker and signal generator for uhf and vhf; and the model 324 Do-All tube and battery tester.

Linear Actuators. Barber-Colman Co., Rockford, Ill. Bulletin F 4381-1 gives complete information on the company's linear actuators for aircraft application. It emphasizes the design features and gives application information, plus specification data on these new, compact and lightweight units that are used in remote positioning of aircraft engine controls, trim tabs, oil cooler shutters, valves and similar functions where linear motion is required.

Electroplated Gold. Technic Inc., 39 Snow St., Providence 1, R. I., has published a 4-page technical data bulletin giving a concise summary of all available knowledge of the properties and characteristics of gold. Physical, thermal, chemical and electrical properties are covered. Included is a listing of the material's applications for waveguides, tubes, variable resistors, terminals and vibrating and flexing components.

TV Receiver Data. Allen B. DuMont Laboratories, Inc., 1000 Main Ave., Clifton, N. J. A spiral-bound service information book containing schematic diagrams of all the company's tv receivers is now available. In addition to the full set of schematic diagrams, the book contains complete parts lists, alignment data and miscellaneous service data.

High-Vacuum Rectifier. Lewis and Kaufman, Ltd., 50 El Rancho Ave., Los Gatos, Calif. A recent tube data sheet covers the Los

Now...thoroughly revised,
greatly enlarged . . .

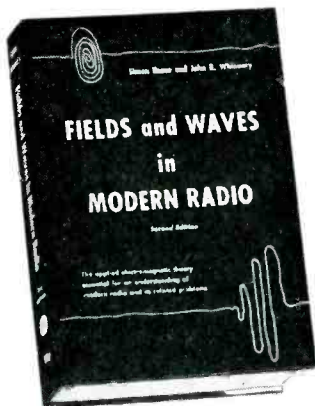

FIELDS AND WAVES IN MODERN RADIO

Second Edition

By SIMON RAMO,
Hughes Aircraft Company
and JOHN R. WHINNERY,
University of California

All the electromagnetic theory you need for a practical understanding of fields and waves in present day radio . . . presented in a simple yet thorough manner unequalled by any other book.

This clear, comprehensive coverage has won the first edition an enviable reputation among engineers throughout the country. The new edition retains all the outstanding features of the first, but is completely revised and enlarged to bring you right up to tomorrow in radio theory and practice.

Whether you are highly experienced in this field, or a relative newcomer, you will find *Ramo and Whinnery* a "must." It is soundly written to provide a thorough grounding in principles as well as valuable help in solving countless practical problems.

CHAPTER HEADINGS

Oscillation and Wave Fundamentals
The Equations of Stationary Electric and Magnetic Fields
Solutions to Static Field Problems
Maxwell's Equations and High-Frequency Potential Concepts
Circuit Concepts and Their Derivation from the Field Equations
Skin Effect and Circuit Impedance Elements
Propagation and Reflection of Electromagnetic Waves
Guided Electromagnetic Waves
Characteristics of Common Wave Guides and Transmission Lines
Resonant Cavities
Microwave Networks
Radiation

1953 576 pages illus. \$8.75

Write today for a copy on
10 days' free approval

JOHN WILEY & SONS, Inc.
440 4th Ave., New York 16, N. Y.

Precision DC Power Supply for Electronic Equipment

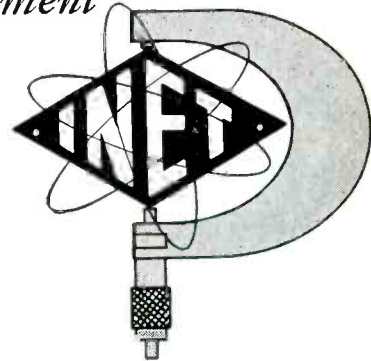
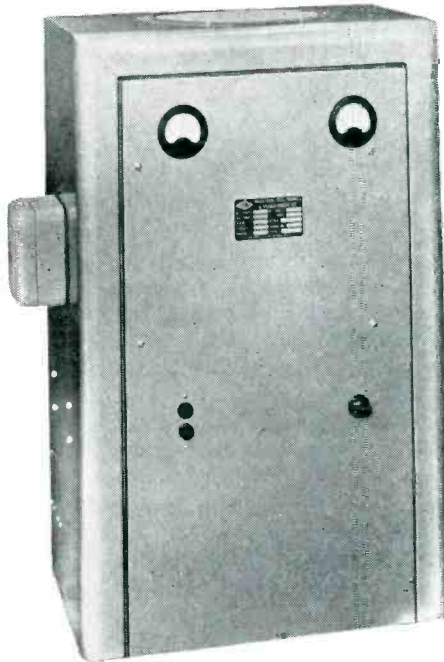

◆ Efficient, closely regulated selenium rectifiers for all types of computers, business machines and other electronic equipment.

Low initial cost . . . low maintenance, units have no moving parts or vacuum tubes.

Compact, completely self-contained, protected . . . magnetic amplifier controls . . . fully regulated DC power supply.

Optional steel cabinets for floor-standing, wall or caster-mounted.

Output ratings from 5 to 500 VDC at 5 to 200 Amps continuous.



Complete engineering specifications available upon request.

8655 South Main Street, Los Angeles 3, California

HYCOR Precision Wire-wound

Resistors

LET'S FACE FACTS!

Most manufacturers of precision wire-wound resistors offer products having similar physical appearances and electrical characteristics. Our claim to individuality is based upon **RELIABILITY OF PRODUCT**. The formula to obtain **RELIABILITY** is: *Skilled, painstaking attention to EVERY detail in EVERY step of fabrication!*

Our steady customers tell us that the formula works!

Our newly expanded production facilities now enable us to offer rapid delivery.

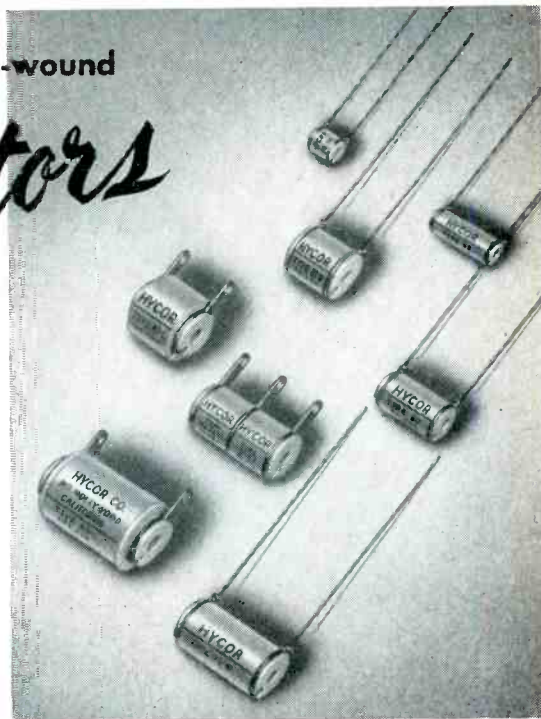

11423 VANOWEN ST., NORTH HOLLYWOOD, CALIFORNIA

HYCOR
Company, Inc.

SUNset 3-3860

Manufacturers of Precision Resistors, Toroid Inductors and Electric Wave Filters

REPRESENTATIVES:

Jack Beebe, 5707 W. Lake Street, Chicago, Illinois
George E. Harris & Co., Box 3005, Municipal Airport, Wichita, Kansas
Marvin E. Nulsen, 5376 E. Washington St., Indianapolis 19, Indiana
Burlingame Associates, 103 Lafayette Street, New York City
Canada: John R. Tilton, 1166-A Lake Shore Road, Long Branch, Ontario

For further information
contact your nearest
Hycor representative or
write for Bulletin R

Common Denominator of all LINK Electronic Equipment... INFINITE PRECISION

As aircraft behavior at sub-sonic and super-sonic speeds becomes more and more complex, the need for thorough on-the-ground flight training becomes ever more vital to the success of the Air Training Program. At the same time the simulation of these complex flight conditions demands infinite precision.

Link Electronic Equipment simulates *with infinite precision* every power and aerodynamic factor that influences take-off, flight and landing . . . speed, direction, rate of climb, effect of fuel consumption on trim, flight position, deviation and a host of others.

This infinite precision is built into all Link Electronic Equipment. Link Jet Trainers operate with the dependable certainty of the simplest mechanism. Yet they duplicate *exactly* the "in air" conditions of today's most advanced aircraft.

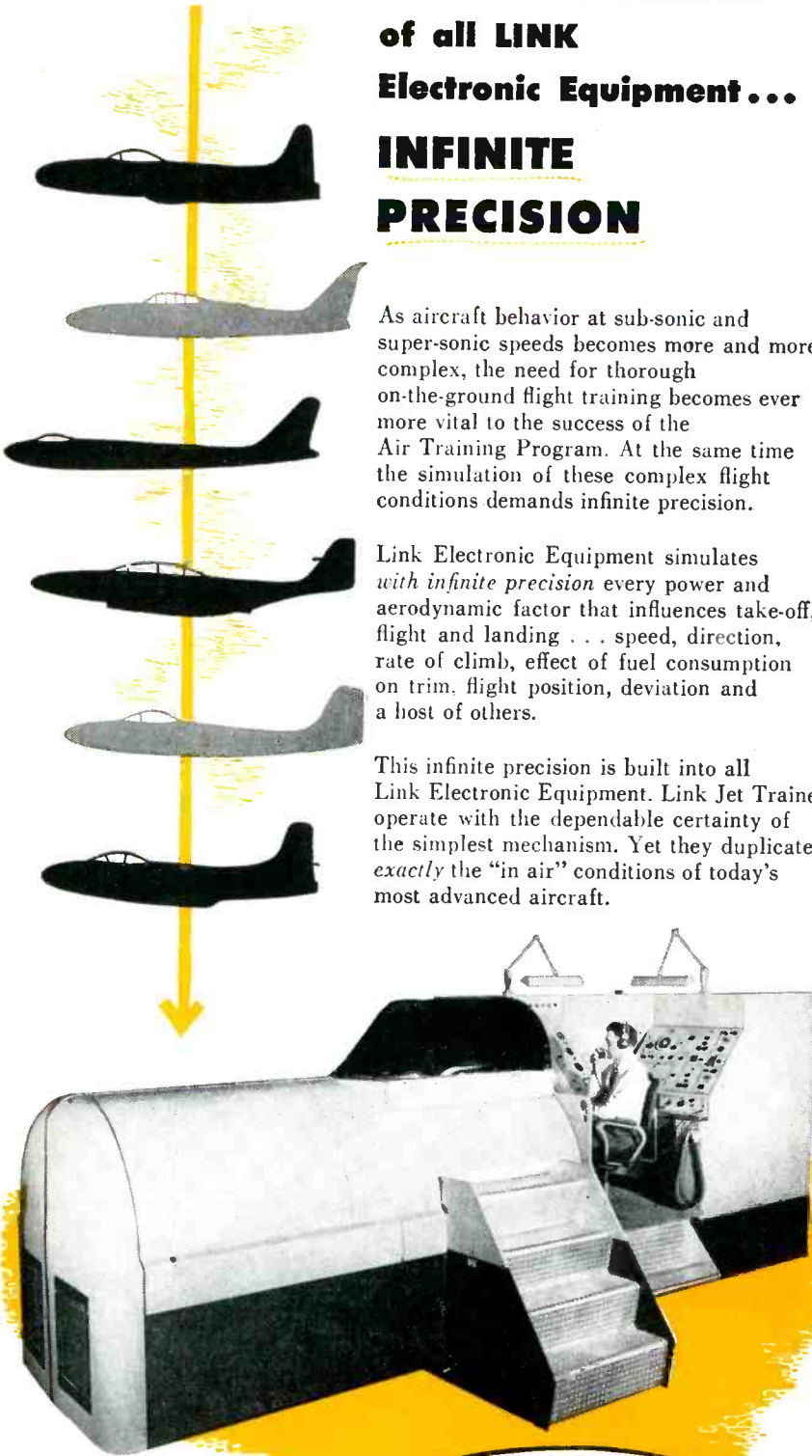

*the connecting
link between
ground and sky*



LINK invites employment applications from engineers and draftsmen.

Gatos brand 705A, a thoriated-tungsten type high-vacuum rectifier. The publication illustrates the tube, provides a dimensioned outline drawing, and includes operating figures and plate characteristics for full-filament and half-filament connection.

Glass-Bonded Mica. Mycalex Corp. of America, Clifton, N. J., has issued a comprehensive 23-page, illustrated reference and operation manual on the machining of glass-bonded mica. The booklet describes how to machine Mycalex glass-bonded mica so as to retain full advantage of its unique engineering properties, radiation resistance, ability to withstand temperatures up to 950F, high dielectric, and permanent electrical and mechanical stability. The pocket-sized publication is divided into four parts: the general picture, do's and don'ts, troubles you will not have, and how to perform specific machining operations. A complete index makes it easy to find each section.

Measuring Equipment. General Electric Co., Schenectady 5, N. Y. A revised edition of the 64-page measuring equipment catalog contains information on more than 115 testing and measuring devices for laboratory and production line use. Publication GEC-1016A gives information on products ranging from simple current indicators to completely automatic oscillographs; from surface roughness scales to mass spectrometers; from d-c amplifiers to radiation monitors. A brief description of each product and its field of application, condensed tables of important characteristics and prices indicate whether or not the measuring device is suited for a specific job.

Circular Chart Recorders. Minneapolis-Honeywell Regulator Co., Philadelphia 44, Pa. Specification sheet 160 describes and illustrates the Electronik circular chart recorder, series 152X, that measures and records practically any variable that can be translated into electrical units. The bulletin gives technical specifications and ordering information.



Mobile Mountings

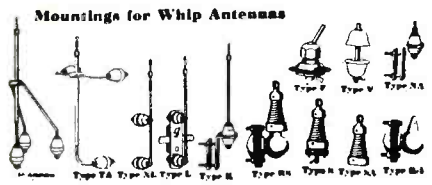

To Meet Every Need For Civil Defense, Utility or Amateur Use

Premax presents a wide variety of low-cost yet sturdy Mountings for mobile and marine use. There are types to meet practically every situation, including a new spring mount and spring adapter which will take every shock. Write for Bulletin and prices.

PREMAX PRODUCTS
DIVISION CHISHOLM-RYDER CO., INC.

5301 HIGHLAND AVE., NIAGARA FALLS, N. Y.

Complementary Instruments for...

Servo Test

100-A Dynamic Analyzer

for the laboratory evaluation problem.

- Transient & frequency response of Servo loops & components.
- Hi-power AC or DC step for component transient test.
- Data frequencies .0002 to 50 cps. Carrier frequencies 60 to 2500 cps.



101-A Servo Tester

for field maintenance, production & environmental test.

- Compares transient response to that specified by the manufacturer.
- Standard conditions of test.
- Checks DC, 60 or 400 cps. loops.
- Simple & rapid test procedure.



ICCO INDUSTRIAL CONTROL COMPANY

Wyandanch Long Island, New York
MIDLAND 3-7548

Over 85% of the torque wrenches used in industry are

STURTEVANT TORQUE WRENCHES

Read by Sight, Sound or Feel.

- Permanently Accurate
- Practically Indestructible
- Faster—Easier to use
- Automatic Release
- All Capacities

in inch ounces... inch pounds... foot pounds
(All Sizes from 0-6000 ft. lbs.)

STURTEVANT TORQUE MANUAL

Every manufacturer, design and production man should have this valuable data. Sent upon request.

PA STURTEVANT CO
ADDISON (QUALITY) ILLINOIS

JAN Original High Voltage INSULATED COUPLINGS

MEETS 'MIL SPECS'

Mineral filled Melamine — Pat. Pend.

Stainless Steel

Withstands Greater Than 15KV

Plain or Locking types

- ✓ Capacitance, shaft to tip: 1.7 mmfd.
- ✓ Temperature range: -75° to +175°C.
- ✓ Withstands rugged use. High torque load: 10" lb. Max.
- ✓ Completely vibration and shock-proof. Single unit construction — molded Melamine to Metal.
- ✓ Non-corrosive, moisture and fungus proof.
- ✓ Used in approved Air Force and Navy Equipment; Meets MIL series armed forces specs.
- ✓ Fits standard slotted potentiometers without machining.
- ✓ Wide range of shaft lengths.

STOCK DELIVERIES!

Illustrated Literature & Data Sheets on Request • Write Dept "L"

5" CRT Bezels for flat or curved faced tubes. Available with camera mounts

Cathode Ray Tube Shields

Offset Extension Shaft Coupler Trimmer Covers Tube Shields, etc.

JAN HARDWARE MANUFACTURING CO., INC.
25-30 163rd Street • Flushing 58, N. Y. • INdependence 1-1200

PLANTS AND PEOPLE

Edited by WILLIAM G. ARNOLD

Illinois Tech Grads Get Higher Pay

AVERAGE starting salary for the June engineering graduate of Illinois Institute of Technology reached an all-time high of \$362 a month, according to a survey conducted by Earl C. Kubicek, IIT placement director.

Mr. Kubicek announced that the beginning salary of the June graduate jumped \$20 over the February class average of \$342. He attributed this sharp one-semester increase to the extreme shortage of engineers and the large percentage of IIT graduates who have previous work experience by the time they receive their degrees.

The Illinois Tech graduates with the highest starting salaries were the architects, who averaged \$399 a month. Following in order of average monthly salary were mechanical engineers, \$377; electrical engineers, \$371; industrial engineers,

\$370; mathematics majors, \$368; civil engineers, \$367; physics graduates, \$360; chemistry majors, \$356; chemical engineers, \$352; fire protection and safety engineers, \$342; business and economics graduates, \$327; metallurgical engineers, \$317.

Every June graduate who filed through the IIT placement office got a job. Even those facing military service were snapped up by industry. Most companies were willing to hire service-eligible engineers in the hope that, even if they were called up after a few months, the experience gained with the firm and the seniority they accrued while in service would induce them to return to their former employer. The average student had seven interviews and in many cases he had his choice of that many jobs.

According to the school's records,

average monthly engineer salaries have risen steadily. While this year's graduates averaged \$362, a year ago the figure was \$335. Five years ago it was \$265; 10 years ago, \$169; 15 years ago, \$100.

OTHER DEPARTMENTS

featured in this issue:

	Page
Electrons At Work	198
Production Techniques	262
New Products	316
New Books	428
Backtalk	440

Electronics Conference Set To Open

THE ninth annual National Electronics Conference will convene September 28, 29 and 30, 1953 at the Hotel Sherman, Chicago.

The technical program offers 99 papers covering a broad field of electronic research, development and industrial application and is supplemented by over 140 exhibits by manufacturers in the electronics field.

The conference is sponsored by the AIEE, Illinois Institute of Technology, IRE, Northwestern University, University of Illinois, with Purdue University, University of Wisconsin, RETMA and SMPTE participating.

The president of this year's conference is J. D. Ryder of the University of Illinois.

Engineering Department Of RETMA Expands

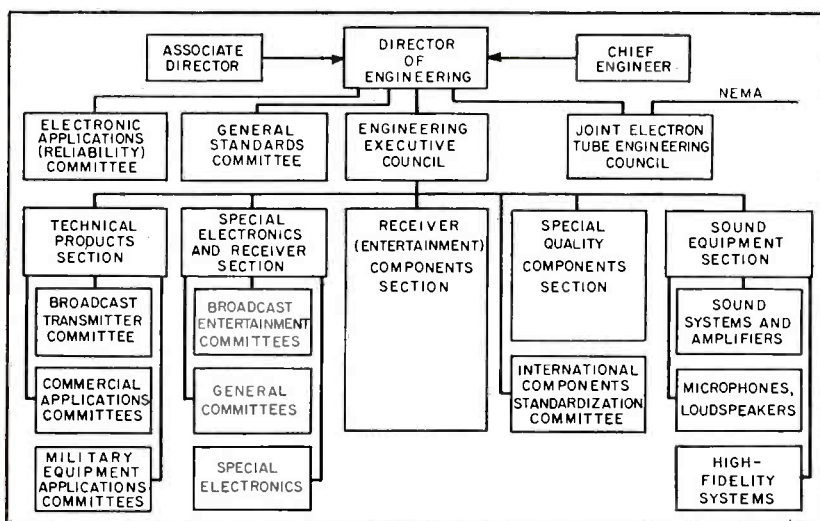

Broad scope of activities already covered by the engineering department of RETMA is shown in the organization chart of the department. An executive council was formed during the past year to serve as an overall planning board for the more than 150 engineering committees on its roster. The department has further expanded its activities by opening a Los Angeles office headed by Joseph J. Peterson, formerly Lee Electric sales manager, and appointing Jean A. Caffiaux, formerly of Sylvania, as assistant to Ralph R. Batcher, RETMA chief engineer

ASA Organizes New Electronic Group

THE American Standards Association announced the recent organization of a new committee in the field of electronic components, sectional committee C83, in the Communications Division of the ASA Electrical Standards Board.

Leon Podolsky, technical assistant to the president of the Sprague Electric Co., has been appointed chairman of the committee, which will be concerned with standards, specifications, methods of testing and rating of



WHATEVER THE SPECIFICATION
... LOOK TO *Ketay*
FOR SYNCHROS & SERVO MOTORS

KETAY, the world's largest producer of government approved synchros, offers high precision rotary and instrument components for most every need. Industry, as well as suppliers to the Armed Forces, will find Ketay ready to solve their problems with a complete line of synchros, servos, magnetic amplifiers, computers and control systems.

If you are searching for a specific size or type... if availability is a problem... if engineering counsel is needed... Ketay can help. Why not join us for an exploratory discussion of your particular problem. Write today to Dept. C

WHATEVER THE NEED CHOOSE KETAY!

Available as listed

1. SYNCHRO, Size 16, O.D. 1.537", 115 V, 400 Cycles
(Transmitter, Receiver, Control Transformer)
2. INDUCTION MOTOR, O.D. 1.750", 3 phase 2 Pole, 115 V, 60 Cycles
3. SYNCHRO, Size 18, O.D. 1.750", 115 V, 400 and 60 Cycles
(Transmitter, Receiver, Differential, Control Transformer)
4. SERVO MOTOR, O.D. .937", 26V, 400 Cycles
5. SYNCHRO, O.D. 1.437", 14.4 V and 26 V, 400 Cycles
(Transmitter, Receiver, Resolver, Differential, Control Transformer)
6. SERVO MOTOR Mk 7, O.D. 1.437", 115 V, 400 Cycles
7. SYNCHRO, Type 1F or 1HC, O.D. 2.250" 115 V, 60 Cycles
(Receiver, Transmitter)
8. SYNCHRO, Size 31, O.D. 3.10", 115 V 400 and 60 Cycles
(Transmitter, Receiver, Differential, Control Transformer)
9. SYNCHRO, Size 23, O.D. 2.250", 26 V and 115 V 400 & 60 Cycles
(Transmitter, Receiver, Resolver, Differential, Control Transformer)
10. SYNCHRO, O.D. .937", 26 V, 400 Cycles
(Transmitter, Receiver, Resolver, Differential, Control Transformer)
11. LINEAR TYPE CONTROL TRANSFORMER, O.D. 1.625", 26 V, 400 Cycles
12. SYNCHRO, Size 11, O.D. 1.062", 26 V and 115 V, 400 Cycles
(Transmitter, Receiver, Resolver, Differential, Control Transformer)
13. SERVO MOTOR, O.D. 1.062", 115 V, 400 Cycles
14. SYNCHRO, Size 15, O.D. 1.437", 26 V and 115 V, 400 Cycles
(Transmitter, Receiver, Resolver, Differential, Control Transformer)
15. SYNCHRO, Size 19, O.D. 1.90", 115 V, 400 Cycles
(Transmitter, Receiver, Control Transformer)



MANUFACTURING CORP.

555 Broadway, New York 12, N. Y.

PACIFIC DIVISION
 12833 Simms Ave., Hawthorne, California

DESIGN

DEVELOPMENT

MANUFACTURE of precision instruments,

components, and systems.



Leon Podolsky

components used in electronic circuits. The RETMA will take the administrative leadership in the new committee's standards work.

Mr. Podolsky is chairman of RETMA's International Standards Committee. He represented this country at meetings of the International Electrotechnical Commission in Opatija, Yugoslavia in June and July of this year.

Associations and companies which will have representation on the new ASA committee are: AIEE, Armed Services Electro Standards Agency, IRE, NEMA, the ASA Telephone Group, Aircraft Industries Association, the ASA Electric Light and Power Group, Western Union Telegraph Co., U. S. Atomic Energy Commission, American Association of Railroads and the National Bureau of Standards.

Sylvania Establishes Defense Laboratory

THE establishment of an electronic defense laboratory by Sylvania was announced by president H. Ward Zimmer.

Mr. Zimmer said the new laboratory, now located in temporary quarters in Mountain View, Calif., will undertake studies, laboratory experiments and field tests of electronic equipment under a contract with the Army Signal Corps.

Present plans call for erection of a new lab building of approximately 60,000 sq ft in Mountain View in the near future.

When in full operation the new

lab will employ approximately 250 persons, most of whom will be scientists.

Henry Lehne has been appointed director of the electronic defense laboratory. Mr. Lehne joined the Sylvania organization in January of this year to head the new project. Previously he was with Republic Aviation Corp. in charge of military sales, and since 1950 was a vice-president and sales manager.

New Air Research Heads Appointed

MAJ. GEN. Donald L. Putt's appointment by direction of the President as commander of the Air Research and Development Command was announced by the U. S. Air Force.

After assuming his new post, General Putt announced the appointment of Maj. Gen. James McCormack, Jr., as vice commander of Air Research and Development Command.

General Putt succeeds Lt. Gen. Earle E. Partridge, who assumed new duties as Deputy Chief of Staff for Operations, Headquarters, U. S. Air Force.

General McCormack who was formerly assistant vice commander of the command, assumes the former duties of General Putt.

Employee Trust Buys A. D. Little

THE employees' trust of Arthur D. Little acquired controlling interest in the company, one of the largest industrial research organizations of its kind.

The change in ownership, Earl P. Stevenson, president, announced, was brought about by an offer from the employees' retirement trust to purchase the shares of common stock of individual holders. Among these were the shares held in trust for the benefit of MIT. Mr. Stevenson said that there will be no change in the company management or methods of operation.

"Although majority control of a company by its employee-retirement trust is an almost unique form of ownership," Mr. Stevenson added, "we feel it is particularly appropriate to our situation. Arthur D. Little is a personal-service organization composed largely of professional personnel. Since our success as an organization depends in part upon the creativity of our staff, it is fitting that the staff should have a stake in the company's corporate success. We provided such a stake sometime ago by establishing an employees' profit sharing retirement trust, of which all employees are members. Each

New DuMont Television Studios Previewed



Rodney D. Chipp (extreme right, leaning over), director of engineering for the DuMont Television Network, points out the network's new switcher to a group of radio and television executives touring DuMont's New York Tele-Centre

KOVAR* Glass Sealing Alloy

Western Electric
15 YEARS



SPERRY
12 YEARS



VARIAN
associates
4 YEARS



17 YEARS

Eimac
TUBES
12 YEARS

The Most
DEPENDABLE
Proved by
Experience

Bomac
5 YEARS



MACHLETT
14 YEARS

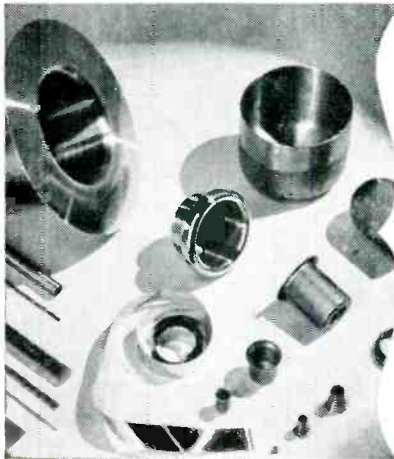

Supplied by **Stupakoff**

in the form of: SHEET, ROD, WIRE, FOIL, TUBING, EYELETS,
LEADS and FABRICATED SHAPES

The ideal alloy for glass sealing, Kovar matches the expansivity of certain hard glasses over the entire working temperature range. It resists mercury attack, has ample mechanical strength and seals readily with simple oxidation procedure. It is available as sheet,

strip, foil, rod, tube, wire—or fabricated into cups, eyelets, leads and other shapes. The prominent users of KOVAR and the length of time they have employed this metal are convincing proof of satisfaction.

*Westinghouse Trade Mark No. 337,962

STUPAKOFF Products for Electrical and Electronic Applications

ASSEMBLIES—Metallized ceramic induction coils and shafts; metallized plates for fixed rigid assemblies; ceramic trimmer condensers.

CERAMICS—Precision-made ceramic products for electrical and electronic applications, all voltages, frequencies and temperatures.

RESISTOR CERAMICS—Used for temperature indicating or measuring equipment, for infrared light source and for heating elements. Complete with terminals, in the form of rods, tubes, discs, bars, rings, etc.

CERAMIC DIELECTRICS—For by-pass, lead-through, blocking, stand-off and trimmer applications. Temperature compensating Ceramic Dielectrics and high K materials. Tubes, discs and special shapes, plain or silvered.

PRINTED CIRCUITS—Amplifiers, couplings, filters, integrators.



STUPALITH—Will withstand extreme thermal shock. May be made to have zero, low-positive or negative expansivities. Safely used at temperatures up to 2400° F.

SEALS, KOVAR-GLASS—Terminals, Lead-ins; Stand-offs—for hermetically sealing and mechanical construction in radio, television, electronic and electrical apparatus. Single or multiple terminal units, in a wide variety of sizes and ratings.

KOVAR METAL—The ideal alloy for sealing to hard glass. Used for making hermetic attachments. Available as rod, wire, sheet, foil—or as cups, eyelets and other shapes.

STUPAKOFF CERAMIC & MFG. CO., Latrobe, Pennsylvania

WHY DOES G-V

Produce More Miniature

Thermal Time Delay Relays

Than All Other
Manufacturers
Combined?

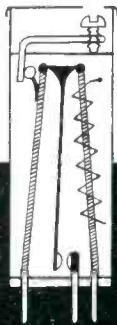
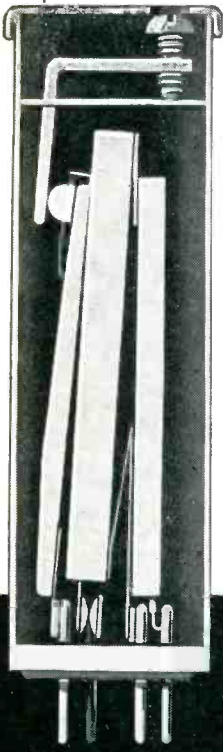

**Because G-V RELAYS
have been ...**

Adopted as a production component by scores of principal producers of electronic equipment.

Delivered for use on over 150 Government contracts.

In successful field use for two years.

G-V ENGINEERING OFFERS A NEW APPROACH TO THERMAL RELAY DESIGN

- Stainless steel mechanism welded into a single integral structure and supported at both ends for unequalled resistance to vibration and shock
- Heater built inside expanding member for maximum efficiency and protection
- Rolling contact action for positive operation
- Easy adjustability where desired
- Precise operation never before available in thermal relays
- Time ranges: 3 seconds to 5 minutes
- Hermetically sealed in metal shell
- Heater voltages up to 230 volts
- Fully temperature compensated
- Suitable for military and industrial use
- Unequalled for ruggedness and precision

U. S. and Foreign Patents Pending



Only G-V offers complete technical data and helpful engineering cooperation on **THERMAL TIME DELAY RELAYS.**

Rapidly expanding production facilities assure prompt deliveries.

Write for bulletin and help with your particular problems.

G-V CONTROLS INC. 24 Hollywood Plaza
East Orange, New Jersey

year, Arthur D. Little contributes a fixed proportion of its earnings irrevocably to this trust, which holds and invests these funds for the benefit of employees who make their careers in this company. By choosing to invest their funds in the company itself, the trustees are creating an even closer bond between the staff and the company."

The trustees of the employees' retirement trust are M. B. Dalton, president of the Boston Manufacturers Mutual Fire Insurance Co.; H. S. Ford, treasurer emeritus of MIT; Royal Little, chairman of Textron and E. P. Stevenson, president of Arthur D. Little.

Under the will of Mr. Little who died in 1935, the earnings of his stock interest in the company have been used to support educational activities at MIT. This stock, which has been held by trustees, with MIT taking no part in the management of Little is now being sold by MIT for \$1.3 million, which is several times its value at the time of the original transfer. In announcing the purchase, the trustees said, "The purchase of MIT's stock by the trust will carry out the two major objectives of the company's founder, Arthur Dehon Little. It constitutes a substantial financial contribution to the institute and it assures the continuance of the professional service activities of the organization under the high standards he originally established."

Dr. James R. Killian, Jr., president of MIT stated, "The fact that we are no longer owners of Little's common stock will not in any way affect the fine relationship MIT has long had with the company. We look forward to many years of close association with our neighbor and shall always be grateful to Dr. Arthur D. Little for his generous help to MIT."

General Bradley Joins Bulova Research

GENERAL OMAR N. BRADLEY announced that he will join the Bulova Research and Development Laboratories (wholly-owned subsidiary of the Bulova Watch Co.) as chairman of the board when he goes on the inactive list after completing

now... RESINITE

brings you the **HIGHEST RESISTIVITY** of any RESINATED PRODUCT

Resinite Coil Forms are laboratory tested and field proven. Their operating characteristics—volume resistivity . . . power factor . . . thermal properties . . . low moisture absorption . . . and resistance to voltage breakdown—represent a new achievement in basic components for electronic application.

Resinite Coil Forms are available with inside or outside threads, slotted, punched or embossed. Axial pressure in excess of 25 lbs. is accomplished through a special three row threaded design. Torque can be controlled to + or - 1 in. oz.

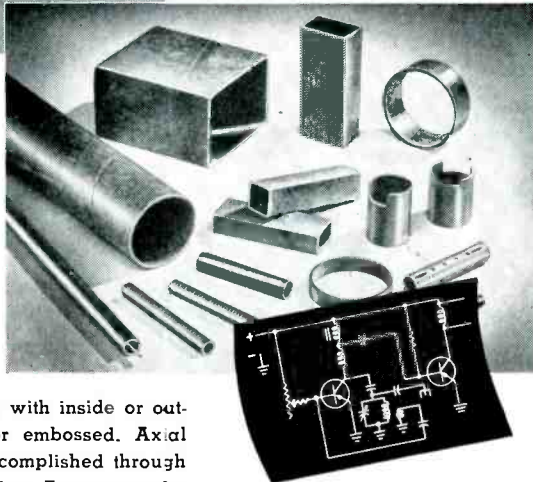

RESINITE 8104: for coil forms requiring very high dielectric properties under extreme humidity.

RESINITE "AC": for applications requiring very high dielectric strength. ELECTROLYTIC CORROSION IS IMPOSSIBLE.

RESINITE 104: for stapling, severe forming, fabricating.

Send today for full details and technical information.

RESINITE CORPORATION
DIVISION OF PRECISION PAPER TUBE

2035E W. Charleston St., Chicago 47, Ill.
79 Chapel St., Hartford, Conn.

Pulse Generator and Calibrator

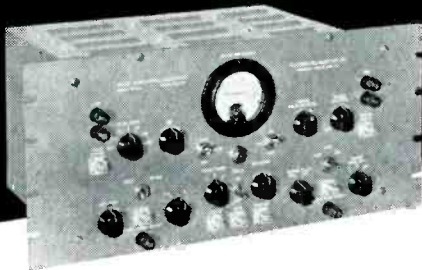

MODEL PC-100R

- Paired pulses 5 to 5000 microseconds interval, 50 cycles to 5 Kc. recurrence rate with meter indication
- Width 1 microsecond, rise and decay times 0.1 microsecond, amplitudes 0-75 volts open circuit, 220 ohm internal impedance
- Polarities and amplitudes independently controlled, separate or mixed outputs
- Sync internal or from external positive 10 volt trigger
- Positive 50 volt sync output trigger coincident with fixed pulse, 220 ohm internal impedance
- Time markers 1, 10 or 100 microseconds; negative pulses 0 to 10 volts, 220 ohms internal impedance
- Amplitude calibration 60 cycle square wave, 0.1 to 100 volts in steps
- Model PC-100 cabinet mounted, PC-100R relay rack panel mounted

Incorporates design of
HAZELTINE ELECTRONICS CORP.
Model 1456 Senior Pulser

TELETRONICS LABORATORY INC.
WESTBURY, L. I., N. Y.

MANUFACTURERS OF ELECTRONIC INSTRUMENTS AND PRODUCTION TEST EQUIPMENT

14 Types of Germanium Transistors

STABLE • UNIFORM • DURABLE
Hermetically Sealed

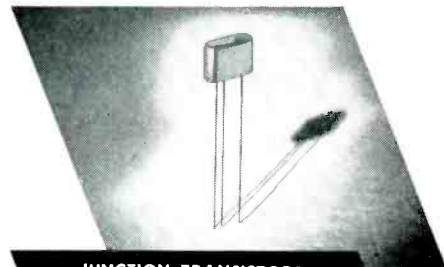

JUNCTION TRANSISTORS

Four types of these junction transistors are now available for audio or low speed switching applications where dependability, long life and minimum space requirements are important.

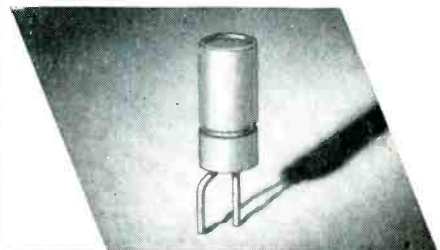

POINT CONTACT TRANSISTORS

Nine types of these point contact transistors are now available for applications as switches, amplifiers or oscillators. Special types made to meet your special requirements.



PN and NPN PHOTO TRANSISTORS

Type X-4 germanium PN junction photo transistor is designed for use as a light detector. Type X-25 is an NPN junction photoamplifier transistor with sufficient power output to operate a relay.

For data sheets and complete information on our transistors, diodes and transistor test set, write Dept. E9.



TRANSISTOR PRODUCTS, INC.
SNOW AND UNION STREETS, BOSTON 35, MASSACHUSETTS
AN OPERATING UNIT OF
CLEVITE CORPORATION

Now a NEW

"Pencil Point" SOLDERING TOOL
FOR SMALL OR MINIATURE WORK

IDEAL Thermo-Tip

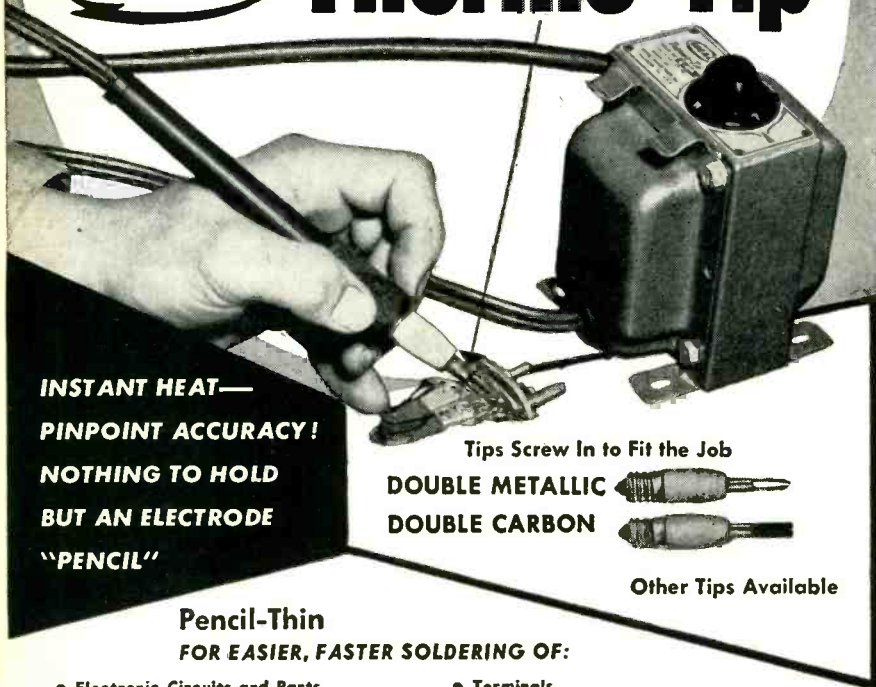

**INSTANT HEAT—
PINPOINT ACCURACY!
NOTHING TO HOLD
BUT AN ELECTRODE
"PENCIL"**

Tips Screw In to Fit the Job
DOUBLE METALLIC 
DOUBLE CARBON 

Other Tips Available

**Pencil-Thin
FOR EASIER, FASTER SOLDERING OF:**

- Electronic Circuits and Parts
- Aircraft Connectors
- Pin Type Plugs
- Wire-to-Wire
- Terminals
- Radio and TV Chassis
- Instruments
- Printed Circuits

Here is an all-new production tool expressly designed to make small and miniature soldering simpler and surer than ever before. It is so fast that some joints can now be soldered in less than 1 second! . . . so much lighter and easier to handle than soldering irons or guns that a woman can use it all day long without fatigue! Check this unique combination of features against your job requirements:

GETS INTO SMALL, TIGHT SPOTS because of smaller electrode pencil.

NO HEAT DAMAGE—instant resistance heating makes sound joints before resistors, condensers, printed circuits, terminal fibre, etc., can be damaged. Pinpoints the heat!

NO "COLD FLOW JOINTS"—resistance principle *requires* that metal be heated before the solder will flow. Tap switch adjust heat as needed.

SAFE—soldering pencil uses harmless (6v) voltage and high amperage from separate step-down transformer.

LESS FIRE HAZARD—electrodes are hot only when in use.

LESS REPLACEMENT COST—only low cost electrodes to buy.

TIPS FOR EVERY SMALL JOB
—2 sizes of double carbon, single carbon with ground clamp, double metallic. May also BE USED AS SOLDERING IRON
—two sizes of chisel tip irons.

MAIL FOR FURTHER DATA

SOLD THROUGH LEADING DISTRIBUTORS

IDEAL INDUSTRIES, Inc. 
1055 Park Avenue, Sycamore, Illinois
Please send catalog data on NEW IDEAL THERMO-TIP.

NAME.....
COMPANY.....
CITY.....ZONE.....STATE.....
ADDRESS.....



General Omar N. Bradley

his second two-year term as chairman of the Joint Chiefs of Staff.

In connection with the announcement, General Bradley stated that both education and scientific research and development seemed to offer him the greatest opportunity to continue to contribute to the defense of the country and that he had chosen research and development. He noted that in recent years, with the rapid developments and changes in electronics, guided missiles and atomic energy, it has become increasingly evident that America's defense is largely dependent on the inventive genius of our scientists and engineers, and the best application of their genius to our military problems.

He stated further, "For many years I have been aware of the continuing need for closer coordination and cooperation between our laboratories and the Armed Forces. Prior to World War II, I was in charge of the weapons section of the Infantry School where I developed a keen appreciation of the importance of linking research with practical military needs. Subsequently in North Africa, Sicily, France and Germany, and lately in Korea, I have seen dramatic results from this teamwork, advanced weapons which provide maximum effectiveness and vital protection for our American men in action."

"Therefore, my decision went to research and industry. I have chosen to work with a precision industry, the Bulova Research and Development Laboratories, a wholly owned subsidiary of the Bulova Watch Co. It has already contributed significantly to the develop-

Phaotron

SENSITIVE MINIATURE RELAYS

PERFECTLY COUNTER-BALANCED

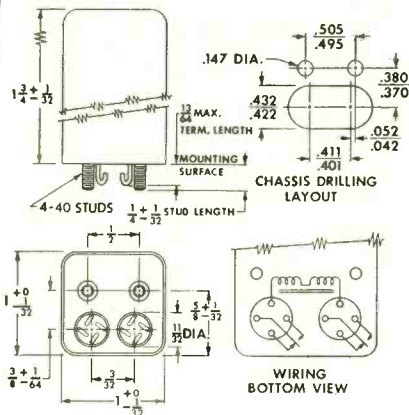

Contact arrangements up to and including DP DT 3 Amp at 28 volts D.C., or 100 Milliamperes at 150 volts D.C. resistive load.

Hermetically Sealed.

Required coil power as low as 20 milliwatts.

Coil resistance up to 15,000 ohms.

Weight, maximum 3.5 oz.

DUE TO ITS PERFECTLY COUNTER-BALANCED FEATURES THIS RELAY WILL WITHSTAND HIGH ACCELERATION, VIBRATION, SHOCK AND TUMBLING

Mass Production Requirements Invited

Detailed information on request.

ENVIRONMENT FREE ELECTRICAL EQUIPMENT by



PHAOSTRON COMPANY • 151 PASADENA AVE. • SOUTH PASADENA, CALIF.



PRECISION RF STEP ATTENUATOR*

Model AT-120 0 to 1000 MC

Small, rugged ladder attenuator achieves attenuation accuracy and low vswr from dc to uhf. Suitable for all signal and sweep generators in this frequency range.

Care in design assures maximum flexibility in mounting, drive, and types of input and output connections.

Easily adaptable for inclusion in different types of test equipment and in laboratory and production test applications.

SPECIFICATIONS

MAXIMUM STEPS

Ten (eleven contact positions)

ATTENUATION RANGE

Up to 120 db total
Attenuation per step optional

OUTPUT IMPEDANCE

50 or 75 ohms nominal

INPUT IMPEDANCE

100 or 150 ohms nominal
50 or 75 ohms optional

INPUT AND OUTPUT VSWR

1.1 to 1000 mc at 50 ohms

ACCURACY

$\pm .3$ db per 20 db step from its dc value up to 1000 mc.

*PAT. PENDING



TELEVISION CORPORATION

Dept. E-9
1001 FIRST AVENUE
ASBURY PARK, N. J.

BECO DEKADIAL for accurate resistance, capacitance, inductance. Readings to four significant figures.

RANGE SELECTOR:
seven positions

CIRCUIT SELECTOR:
six positions

Universal BINDING POSTS
connect to all bridge arms

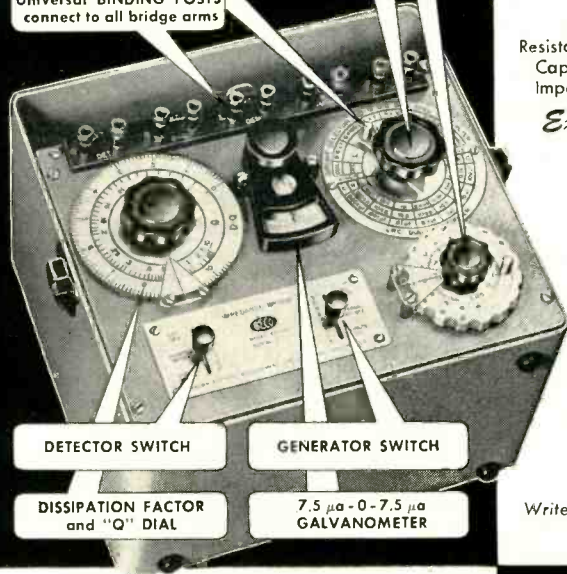

DETECTOR SWITCH

GENERATOR SWITCH

DISSIPATION FACTOR
and "Q" DIAL

7.5 μ a - 0 - 7.5 μ a
GALVANOMETER



IMPEDANCE BRIDGE

Wide Range

Resistance: 1 milliohm to 11 megohms
Capacitance: 1 mmf to 1100 mfs.
Impedance: 1 mh to 1100 henrys

Exceptional Accuracy

Resistance: $\pm 0.1\%$
Capacitance: $\pm 0.25\%$
Inductance: $\pm 1.0\%$

SHOWN
MODEL 250-C1
\$340

9"x11"x11" over-all. Convenient operation from battery, or from AC power lines with Beco accessory amplifier.

Write to factory for literature and analysis of your needs.

BROWN ELECTRO-MEASUREMENT CORP.

4312 S. E. Stark St.
PORTLAND 15, OREGON

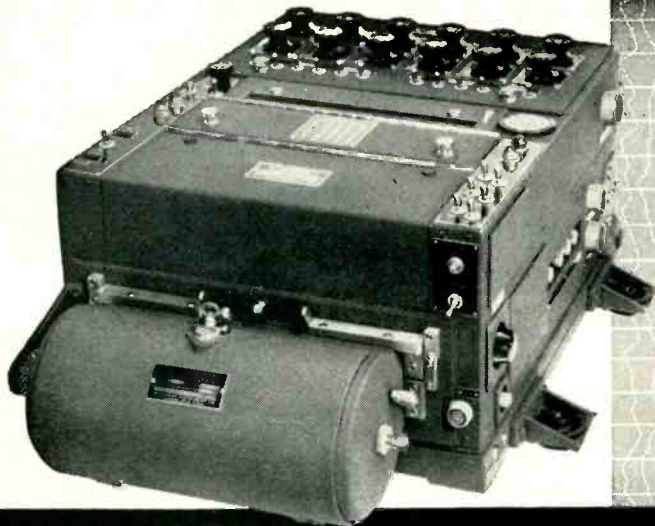

the **NEW** S-8 Oscillograph

Here, in a versatile instrument of advanced design, are all the things you need for complete oscillographic recording. The Hathaway Type S-8 Oscillograph, which has long been the standard of oscillographic recording, has been improved to meet the rapidly expanding demands of modern research. Whether your measurement problems are simple or complex, the **NEW** Type S-8 Oscillograph has the inherent capabilities necessary to measure vibration, pressure, acceleration, and strain with new ease and accuracy.

The newest features include:

QUICK-CHANGE TRANSMISSION fully enclosed with gears running in oil to provide instantaneous selection of 16 record speeds over the range of 120:1

CHART TRAVEL INDICATOR provides continuous indication of chart motion. Operator knows instantly by flashing lamp if anything should happen to interfere with chart motion

FULL-RESILIENT MOUNTING FOR MOTOR AND TRANSMISSION isolates all possible vibration and makes possible the use of modern super-sensitive galvanometers

NEW GALVANOMETER STAGE accommodates all Hathaway galvanometer for recording milliamperes, microamperes, or watts

NEW RECORD-LENGTH CONTROL AND NUMBERING SYSTEM designed for long, trouble-free service under all kinds of ambient conditions

All the other valuable features are retained, such as **PRECISION TUNING-FORK-CONTROLLED TIMING SYSTEM** produces either 1/10-second or 1/100-second time lines across sheet

WIDE RANGE OF GALVANOMETER TYPES AND CHARACTERISTICS provide for almost any recording requirements. Natural frequencies to 10,000 cps. Sensitivities to 50,000 mm per ma, single and polyphase watts

DAYLIGHT LOADING AND UNLOADING RECORDS TO 200 FT. IN LENGTH, width to 10 inches

SIMULTANEOUS VIEWING AND RECORDING

AUTOMATIC BRILLIANCY CONTROL

12 TO 92 ELEMENTS

Whatever your needs may be, investigate the **NEW** Type S-8 Oscillograph and its 170 types of galvanometers — the most versatile equipment in existence for general-purpose applications.

WRITE FOR BULLETIN 2B1-K FOR DETAILS

Hathaway
INSTRUMENT COMPANY
 1315 SO. CLARKSON STREET • DENVER 10, COLORADO

ment of new weapons, and is capable, in my opinion, of playing an important role in the future."

"The research laboratories were founded after the outbreak of the Korean War, and under the guidance of Mr. Arde Bulova have drawn together some outstanding scientists and engineers in the precision field. I first became acquainted with and interested in the Bulova approach to our national problems when they founded the Joseph Bulova School of Watchmaking for handicapped veterans. In one of the most difficult trades, they gave a lot of our wounded men the opportunity to establish themselves again as fully self-supporting citizens, and it was with great pride that I participated five years later in a reunion of their first graduates, still going strong."

"As chairman of the board of directors of the Laboratories company, I shall be responsible for over-all policy guidance and shall be free from day-to-day operations. Because of my familiarity with many of our defense requirements, it is my hope and belief that I can aid in establishing programs at Bulova which will make a major contribution to national defense."

Mr. Bulova, chairman of the board of Bulova Watch Co., said, "We look to General Bradley to give broad policy guidance to this young enterprise. In his post with Bulova, he will be free to devote his energies to problems of the future, without the burden of day-to-day operating responsibilities. We confidently anticipate that this new association will result in significant contributions to American defense, and ultimately will make possible new peace time products and processes to improve the living standards of all the people."

Greene Received Bane Aeronautical Award

THE Thurman H. Bane Award, given annually by the Institute of Aeronautical Sciences for an outstanding achievement in aeronautical development, has been awarded for 1953 to Benjamin F. Greene, Jr., of the Air Force Cambridge Research Center. Mr. Greene is cited "for the development of an

S.S. White MOLDED RESISTORS



The All-Weather Resistors

TYPE 65X
(Actual Size)

The resistors that give you . . .

- Inherent low noise level
- Good stability in all climates

STANDARD RANGE

1,000 OHMS TO 9 MEGOHMS

These resistors are used extensively in commercial equipment, including radio, telephone, telegraph, sound pictures, television, etc. They are also used in a variety of U. S. Navy equipment.

HIGH VALUE RANGE

10 TO 10,000,000 MEGOHMS

This unusual range of high value resistors has been developed to meet the needs of scientific and industrial control, measuring and laboratory devices—and of high voltage applications.

SEND FOR BULLETIN 4906

It gives details of Standard and High Value Resistors, including construction, characteristics, dimensions, etc. Also described are S.S. White 80X Resistors, designed for extremely high voltage equipment. Copy with Price List sent on request.



THE S.S. White INDUSTRIAL DIVISION
DENTAL MFG. CO.



Dept. R, 10 East 40th St.
NEW YORK 16, N. Y.

WESTERN DISTRICT OFFICE: Times Building, Long Beach, Calif.

NOW **DX**

90° DEFLECTION YOKE

. . . an Accepted Standard of Major Manufacturers!



Yes, as leading TV manufacturers know . . . the DX 90° Deflection Yoke for 27" receivers gives the ultimate in performance and compactness. Enclosed in an Underwriters' Approved Tenite case, this yoke assures a sharp, full-screen focus without use of pincushion magnets. Ingeniously designed for mass production on special equipment, it provides the attractive price and top quality major manufacturers demand. We invite your inquiry.

DEFLECTION YOKES . . . TOROID COILS . . . CRYSTALS
I. F. TRANSFORMERS . . . R. F. COILS . . . DISCRIMINATORS
SPEAKERS . . . TV TUNERS . . . ION TRAPS . . . TRANSFORMERS

DX RADIO PRODUCTS CO.

GENERAL OFFICES: 2300 W. ARMITAGE AVE., CHICAGO 47, ILL.



WHEN
DESIGN ENGINEERS
TALK SHOP TODAY
THEY TALK

miniaturization



. . . because miniaturization meets today's demands for increased performance from smaller, lighter equipment. It saves vital space and weight on aircraft, guided missile and many similar applications . . . and it is bringing new portability and usability to countless types of commercial and industrial equipment.

If your miniaturization problem involves instrumentation, we can help. International Instruments is devoted exclusively to the design, development and production of miniature instruments and has created many important "firsts". We offer a complete line of 1" and 1½" Meters featuring accuracy and dependability comparable to conventional sized meters . . . plus far greater resistance to shock and vibration. Special scales and ranges can be provided to meet practically any electrical measuring requirement. Use the coupon below to send for data sheets covering our standard instruments — or ask our Engineering Department to help with your special needs.



MODEL 153



MODEL 150



MODEL 100



international instruments
INCORPORATED

P.O. BOX 2954, NEW HAVEN 15, CONN.

- Please send data sheets covering your standard instruments.
 Arrange to have your representative call.

NAME _____
POSITION _____
COMPANY _____
CO. ADDRESS _____
CITY _____
ZONE _____ STATE _____

PRESENTING

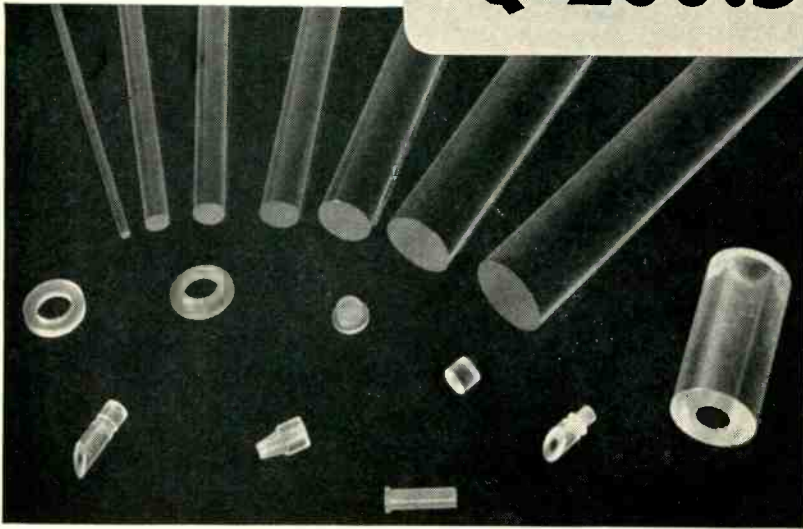
**POLYPENCO[®]
Q-200.5**

- **excellent UHF insulation**
- **good machining qualities**
- **dimensionally stable to 400°F**
- **available in standard shapes**

POLYPENCO Q-200.5 is ideal for coaxial spacers, connector beads, stand-off insulators, coil forms, UHF antennae insulators, etc. Its low dissipation factor (less than .0002 at 30 megacycles) remains practically constant over the entire frequency range. It is transparent, light, and resists most chemicals.

POLYPENCO Q-200.5 now joins the family of high quality industrial non-metallic materials supplied by The Polymer Corporation of Penna. It meets the requirements of specification MIL-P-77A (Type E2). Polymer quality controls assure uniform high quality in piece after piece and lot after lot. You can get POLYPENCO Q-200.5 in centerless ground rod up to 1" diameter in 6-8 feet lengths for your own fabrication or we will fabricate it for you.

P

Write for technical bulletin giving data and properties of POLYPENCO Q-200.5.

POLYPENCO Q-200.5

nylon and teflon* / **stock shapes, finished parts**

also available to your specifications

The POLYMER CORPORATION of Penna. • Reading, Penna.
Warehouse stocks:
Chicago, Ill. • Newton, Mass. • Brantford, Conn. • Los Angeles, Calif.

*Trademark for Du Pont tetrafluoroethylene resin

electronic system for airport traffic control which greatly increases the landing rate of aircraft under high density traffic or poor visibility conditions."

The electronic system developed by Mr. Greene utilizes radar to track the aircraft and automatically schedules the landing sequence of aircraft approaching an airport. The equipment is so designed that it first calculates the time at which a given aircraft would arrive and then determines if another aircraft has been previously scheduled for that time. If the runway is found to be free, the aircraft comes directly in. If, on the other hand, a landing has been scheduled, the system then finds the next available open time and computes a detour path that will introduce the proper delay. The computed heading instructions are relayed by radio to the pilot.

With the system, landings can be scheduled at 30-second intervals providing, of course, that other factors, such as clearing aircraft from the runway, will so allow.

**Automation Firm
Opens Offices**

R. Hunt Brown

AUTOMATION CONSULTANTS, a new firm of consulting engineers, has opened offices in New York City. The firm has been organized to advise U.S. businessmen of the opportunities open to them in electronic devices such as computers, controls and other technological developments which, if properly utilized, can enable the office as well

STERLING

A DEPENDABLE SOURCE FOR TRANSFORMERS MIL-T-27 & COMMERCIAL

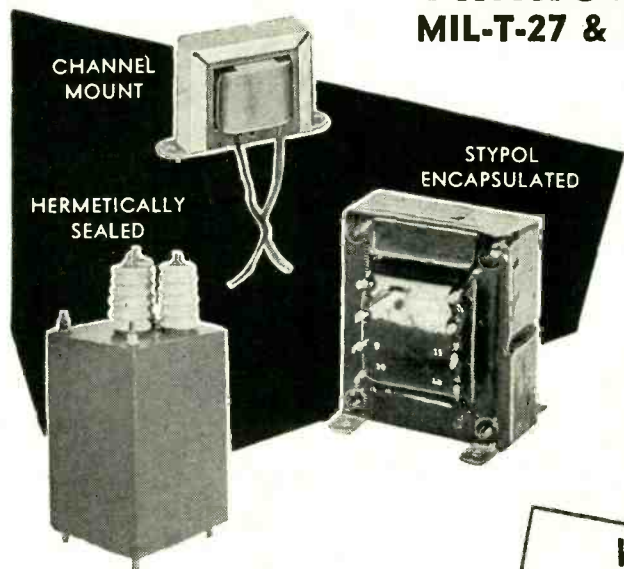

- Pulse
- Audio
- Power
- Filter Choke
- Filament
- RF Coils

Custom Built to
your Specifications



297 North 7th St., Brooklyn 11, N. Y.

**WE SOLICIT
SAMPLES AND SHORT
RUN PRODUCTION**

MODEL 212A TELEVISION AMPLIFIER

Suitable for apartment house, hotel, and community television antenna systems, the -SKL- Model 212A TV Chain Amplifier will amplify up to twelve television channels simultaneously, thus assuring reception of all present and future television channels. The -SKL- Model 212A TV Chain Amplifier is simple to install and operate; because of its broad bandwidth, it requires no tuning or adjustment in the field.

Spencer-Kennedy Laboratories manufactures a complete line of master antenna system equipment.

For further information about the model 212A TV chain amplifier write for Bulletin 212-4.



FEATURES:

- Twelve Channel Amplification
- High Reliability
- Simplicity of Operation
- Excellent Picture Quality
- Low Maintenance Cost

SKL SPENCER-KENNEDY LABORATORIES, INC.
186 MASSACHUSETTS AVE., CAMBRIDGE 39, MASS.

if you are
concerned with
**POWER
SUPPLIES**

you should have
the new and
comprehensive

LAMBDA
catalog

of electronically
regulated
laboratory
power supplies.

Manufactured by
one of America's
pioneer specialists,
this field-proven
precision equipment
is priced
surprisingly low.



SEND FOR NEW CATALOG

Lambda Electronics Corp.
103-02 Northern Blvd., Corona 68, N. Y.
Please send me the new Lambda Power
Supplies Catalog as soon as it comes off
the press.

Name _____ (Please print)
Title _____
Company _____
Street _____
City _____ Zone _____ State _____ E-953

Audio frequency output power meter TF893



Exceptional impedance range

With forty-eight impedance steps from 2.5 ohms to 20,000 ohms for balanced inputs—and a similar number for unbalanced at one-quarter the impedance—the instrument is ideal for optimum load matching. Two important design features play a great part in this meter's excellent performance over so wide a range of impedance. First, the use of a resistance network to select the significant figures of the input impedance value. Second, decade multiplication of impedance by a transformer with a wound-strip core of anisotropic alloy.

RANGE—POWER: 20 microwatts to 10 watts in five ranges.
IMPEDANCE: 0.625 ohms to 20,000 ohms. **FREQUENCY**: Practically flat response over range exceeding 500:1.



MARCONI INSTRUMENTS

VACUUM TUBE VOLTMETERS • FREQUENCY STANDARDS • OUTPUT METERS • WAVE METERS • WAVE ANALYSERS • Q METERS • BEAT FREQUENCY OSCILLATORS

23-25 BEAVER STREET • NEW YORK 4

CANADA: CANADIAN MARCONI CO., MARCONI BUILDING, 2442 TRENTON AVENUE, MONTREAL
ENGLAND: Head Office: MARCONI INSTRUMENTS LIMITED, ST. ALBANS, HERTFORDSHIRE
Managing Agents in Export: MARCONI'S WIRELESS TELEGRAPH COMPANY LIMITED, MARCONI HOUSE, STRAND, LONDON, W.C.2

as the factory to operate on a push-button basis.

President of the new company is R. Hunt Brown, a graduate electrical engineer of Yale, who brings to his post the experience of 26 years' service with IT&T of which he was as assistant vice-president. As a project engineer, he has been responsible for many commercial installations of automatic equipment in the U. S. in recent years.

Mr. Brown states that "Automation Consultants hope to bridge the gap between the businessman and the electronic manufacturer, wherever custom-made systems are required."

Sprague Makes Four Executive Appointments



Wilbur A. Lazier

ROBERT C. SPRAGUE, chairman of the board of the Sprague Electric Co., announced that Wilbur A. Lazier will serve as vice-president and technical director in charge of the firm's research and engineering, and that Neal W. Welch becomes vice-president in charge of sales. Preston Robinson, former head of the research and engineering department and a member of the Sprague board of directors, will continue to serve the organization as a consulting engineer.

Mr. Sprague also announced the election of Paul J. Crittenden and Hollis R. Wagstaff as assistant treasurers of the company. Under guidance of treasurer George B. Flood, Mr. Wagstaff will handle financial activities while Mr.

... TO A
**SENIOR
ENGINEER**

Interested In a
**Challenge As Great
As All Tomorrow**

If . . .

you're the man we hope you are, you now have a good position. Perhaps you have not thought of a change but will consider the right opportunity.

You have at least five years of experience in electronics or an allied field. You desire to do more than just carry assignments to satisfactory conclusions. You have a burning desire to blaze new trails on the horizon, and feel yourself ready to do it.

You would appreciate an opportunity and the "go ahead" to pioneer . . . at your own pace. You've matured in engineering . . . you know where you've been . . . you now want to know where you're going . . . and what you personally can achieve through your creative engineering talent.

If you fill these qualifications, we have an opportunity that will fascinate you. You will work with one of the foremost engineering teams in the world, and enjoy rare freedom and encouragement. The last word in equipment would be at your fingertips. No richer benefits are offered anywhere . . . regardless of the standards by which you measure.

Are YOU the man we hope you are? If so, write us with full trust.

Send your resume to:

JOHN C. WELD
Supervisor of Employment
254 Rano Street, Buffalo 7, New York

DONALD BRADLEY
Personnel Supervisor
70 Forsyth Street
Boston, Mass.



**SYLVANIA
ELECTRIC PRODUCTS INC.**

RADIO AND TELEVISION DIVISION
254 RANO STREET
BUFFALO 7, NEW YORK

NEY'S SMALL PARTS PLAY A

BIG PART IN
PRECISION INSTRUMENTS

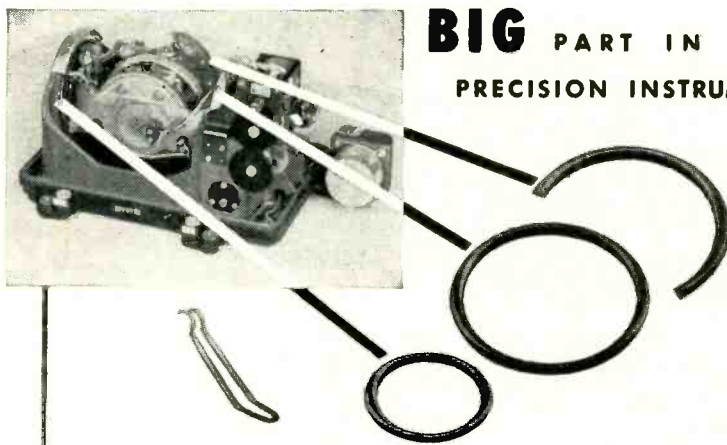

This Cageable Vertical Gyro, for use in stabilization and control systems of aircraft, guided missiles and radar scanners, manufactured by the Aeronautical Division of the Minneapolis-Honeywell Regulator Co., contains three doughnut potentiometers wound with NEY-ORO G high strength, precious metal resistance wire, contacted with wiper brushes of Paliney #7* (illustrated at far left).

Many other manufacturers of precision instruments specify Ney precious metal component parts for use as slip rings, brushes, wipers, commutator segments, etc. Ney Precious Metal Alloys have specific qualities which mean greater accuracy, longer life and resistance to most corrosive industrial atmospheres.

Call or write the Ney Engineering Department for assistance with your instrument problems.

*Registered trade mark

THE J. M. NEY COMPANY • 179 Elm Street, Hartford 1, Conn.
Specialists in Precious Metal Metallurgy Since 1812

3NY53B

PATENTED

Socket-Turrets for most tube types will carry a wide variety of circuit elements.



Plug-Ins of many sizes with sockets and plugs as desired provide great flexibility in circuitry.

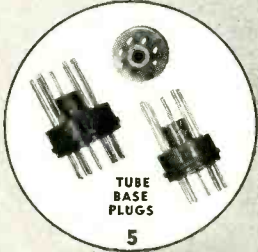
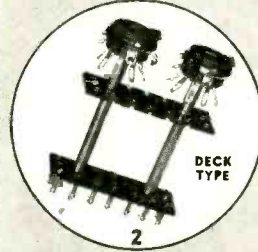
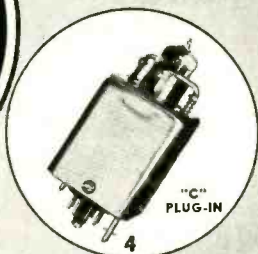
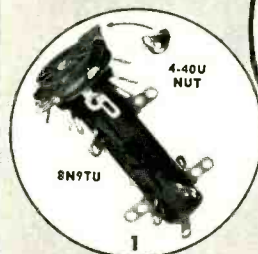

UNIQUE

Unitize those tricky circuits for quick change or repair, compactness, ease of wiring. New snap-on 4-40 U nuts for socket saddles enable easy mounting (1). New pre-punched, eye-letted strip construction provides many variations (2). New Socket Test Adapters for most tubes enable quick tests on tube side (3). New miniature tube base plugs (5). Write for new catalog.

REPRESENTATIVES

B. B. Taylor Company
241 Sunrise Hwy., Rockville Centre, N.Y.
R. J. Magnuson
4258 W. Irving Park Rd., Chicago 41, Ill.
David H. Ross Company
534 El Camino Real, San Carlos, Calif.

Vector Electronic Co.

3352 SAN FERNANDO RD., LOS ANGELES 65

USE "Double Feature"

INSULATING TUBING AND SLEEVING

TURBOTUF

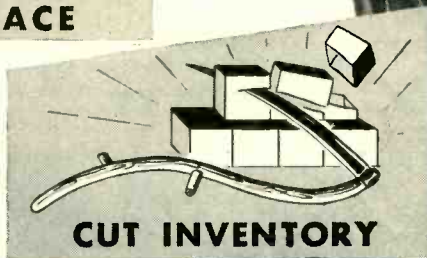
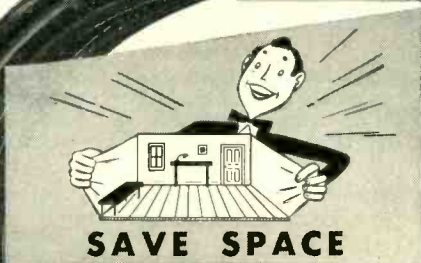

Easily the most economical insulating tubing and sleeving for commercial use . . . equally and ideally suitable for the insulation demands of Classes A & B. Separate A & B inventories unnecessary—space and dollars saved when you use TURBOTUF.

Easily the finest insulating tubing and sleeving—Meets exacting specifications for durable resistance to icy or sweltering temperatures . . . made of superior materials to give long wear—won't crack, bend, chip, or peel under rigorous abrasion . . . excellent pliability—can be knotted, bent, tugged at, stamped on—springs back in perfect condition . . . easier to handle because of its uniformity . . . won't fray . . . not affected by oils, alcohols, alkalis and weak acids—high dielectric strength and long life.

PROTECT YOUR EQUIPMENT — SAVE MONEY — GET "DOUBLE FEATURE" TURBOTUF

Insulating Material

TURBO

Specialists Since 1920

The William BRAND and Co., Inc.

Dept. E-9

Willimantic, Conn., U.S.A., Tel. HARRISON 3-1661

TURBOTUF Insulating Tubing and Sleeving • TURBO Insulated Wires • Wire Markers • Extruded Tubing • Varnished Saturated Sleeving and Tubing • Cambric Cloths, Tapes, Papers • Mica

SALES REPRESENTATIVES IN PRINCIPAL CITIES

PLANTS AND PEOPLE

(continued)



Neal W. Welch

Crittenden will continue to be responsible for credit and insurance matters.

Dr. Lazier has served with the duPont experimental station, as first director of the Southern Research Institute and, more recently, as director of chemical research and development and member of the board for Chas. Pfizer & Co., Brooklyn pharmaceutical manufacturer. Dr. Lazier has been granted over 100 U. S. patents for his inventions.

Neal W. Welch has been with Sprague since 1932. Following many years as sales administrator, he was appointed director of sales last January.

Paul J. Crittenden, who joined the company in 1949, was formerly associated with the Northern Trust Co. of Chicago as assistant secretary and, later, with the MacMillan Publications Co. as treasurer and comptroller.

Mr. Wagstaff was formerly president and director of the Seaboard Packing Co.

Railroads Grant Lower Tube Rates

AS A RESULT of an application by Glenn Catlin, counsel for National Electronic Distributors Association, and traffic representatives of several Chicago tube manufacturers the Western Classification Committee has announced a reduction in rates applicable to defective and burned out tubes, being returned to tube manufacturers or to salvage or inspection points designated by such manufacturers.

The effect of the committee's ac-

Precisely
fabricated
to the most

*Critical
Tolerances*
for electronic devices



Miniature and Subminiature
Radio Tubes-Television Tubes
Hearing Aid Tubes

Our technical skill will improve the performance of condensers, neon electrodes, soldering irons, electrical appliances, gauge glasses, diaphragms, stoves, mica washers, and for all other mica applications.

We guarantee that the quality of our mica will reduce your shrinkage costs!

Send for our "HANDBOOK
on FABRICATED
NATURAL
MICA"



Quality—



Since 1929

**INDUSTRIAL
MICA CORPORATION**

225 So. Van Brunt St.
Englewood, New Jersey

THE DISTINCTIVE NEW

ER-225
SERIES

RACKS by PAR-METAL

18" Deep, 22" Wide

offer you the greatest dollar-for-dollar value in the industry today!

Because only in the ER-225 will you find these unique features:

- ✓ Standard 43¼", 67¾", and 83½" heights.
- ✓ New ribbed design corner trims, with new quick FRONT detachable fastenings.
- ✓ The door is stamped from one piece of steel and reinforced—with formed, clean, smooth, double thick edges.
- ✓ "Multitracks" available with closed or open intermediate sides for rack-to-rack wiring.
- ✓ Streamlined modern design; beautiful finish.

Planning an electronic product? Consult Par-Metal for

**RACKS • CABINETS
CHASSIS • PANELS**

Remember, Par-Metal equipment is made by electronic specialists, not just a sheet metal shop.

Made by
Electronic
Specialists!

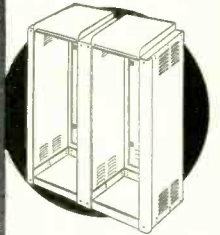
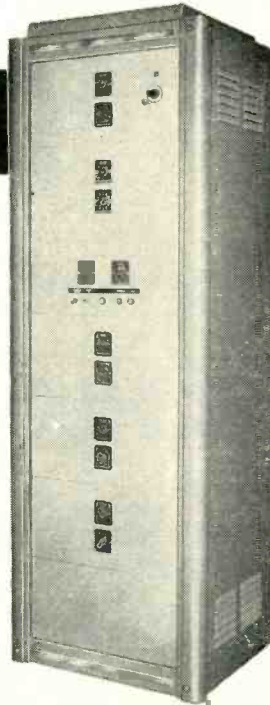

"MULTIRACKS"

These Racks may be assembled in multiple units as shown above.

SHELVES available. Also ROLLER TRUCKS available for single racks or "Multitracks".

NO INCREASE IN COST!

The ER-225 is priced to compete with racks not having the equivalent features. Beyond doubt—it's the industry's greatest value.

The ER-225 Rack as used by the American Communications Corp., N. Y. C. 13.

PAR-METAL

PRODUCTS CORPORATION

32-62 — 49th ST., LONG ISLAND CITY 3, N. Y.

Tel.: Astoria 8-3905

Export Dept.: Rocke International Corp.

13 East 40 Street, New York 16, N. Y.

WRITE FOR CATALOG!

**STOCK KNOBS
IN ANY QUANTITY**

...AND NEVER A TOOL CHARGE!



GEE-LAR—The House of Knobs—has hundreds of styles and patterns in stock at all times. Whatever your needs... whether for production, lab or experiment... you can get them faster and at lower cost from GEE-LAR.



WRITE TODAY
for Gee-Lar Catalog

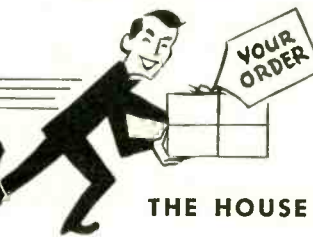

THE HOUSE OF KNOBS

GEE-LAR MANUFACTURING COMPANY

1332 10TH AVENUE • ROCKFORD, ILLINOIS



Increased Combat Effectiveness and Operational Safety

In our front line aircraft, throughout the world, the philosophy of "packaged electronic functions" developed by Servomechanisms, Inc. to a high degree of refinement, insures:

- maximum reliability
- ease of maintenance
- complete interchangeability

SERVOMECHANISMS
INC.

PACKAGED FUNCTIONAL COMPONENTS

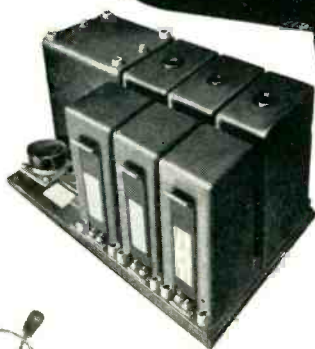

A typical Servomechanisms, Inc. analog computer and companion transducer featuring plug-in components and pre-wired chassis — each electronic "building block" easily removable. . . simple to check and service.

For further information on specific applications write to Dept. CLO-5.

WESTBURY DIVISION
EL SEGUNDO DIVISION

POST AND STEWART AVES., WESTBURY, N. Y.
316 WASHINGTON ST., EL SEGUNDO, CALIF



tion is that such tubes will take a rate of 1½ time first class, instead of the old rate, which still applies to shipments of new tubes, of 1½ times first class. As an example of the reduction, Mr. Catlin pointed out that the old LCL rate, Chicago to Syracuse, is \$4.05 per cwt., and the carload rate \$2.30 per cwt. "When the new rate is published," he said, "the LCL rate will be \$3.38 per cwt., a reduction of \$0.67, and the carload rate will be \$1.89, a reduction of \$0.41." Both the old and new rates are also subject to the general 15 percent increase recently put into effect, Mr. Catlin pointed out.

Amateur Search Begins



The amateur radio operator judged to have performed the "outstanding public service of 1953" will receive this Edison Radio Amateur Award next February from the GE Tube Department. Inspecting trophy at recent amateur convention of the American Radio Relay League at Houston, Tex., are, l-r: George E. Sterling, FCC commissioner and one of the award judges; G. A. Bradford, GE Tube Dept. advertising manager; Goodwin L. Dosland, president of the American Radio Relay League, also an award judge

Zenith Plans New Factory

HUGH ROBERTSON, executive vice-president of Zenith Radio Corp. announced plans for the construction of a new manufacturing plant by the Wincharger Corp. of Sioux City, Ia, Zenith subsidiary.

The new plant will have floor space of 300,000 sq ft with increased facilities for production of motors and capacity for one million radio and upwards of 100,000 tv sets per year. It will employ about 2,500 people, approximately twice

CUT PRICE ?



In your design, be wary of bargain-priced coils! Remember: Inferior coil construction can ruin your end-product . . . but Coto-designed and Coto-produced coils build customer good will. Without obligation consult Coto-Coil Company, 65 Pavilion Avenue, Providence 5, R. I. New York Office: 10 E. 43rd Street, New York 17.

Coto PRECISION WOUND **Coils**

there's a
BIRTCHEK CLAMP
for *almost*
every purpose!

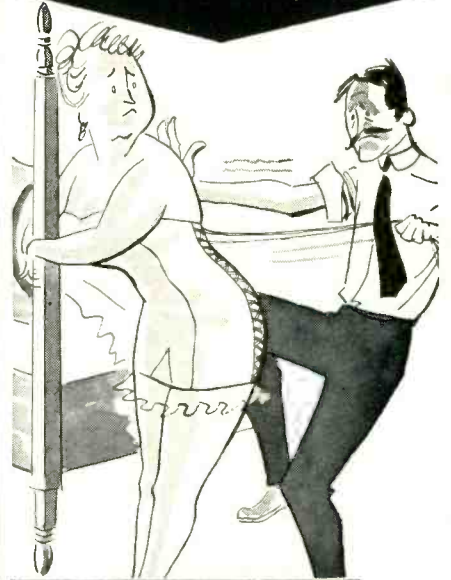

NEW SUB-MINIATURE TUBE CLAMPS

The Birtcher KOOL KLAMPS were developed for use under conditions of extreme heat and severe vibration and shock. Made from a heat treatable silver alloy of high thermal conductivity, reducing bulb temperatures by as much as 40° C, KOOL KLAMPS are improving the reliability of miniaturized electronic equipment.

The Birtcher Corporation, world's largest producer of electro-surgical devices, maintains a separate division for the manufacture and sale of tube and component clamps.

The BIRTCHEK CORPORATION

4371 Valley Blvd.
Los Angeles 32, California



Please send catalog and samples by *return mail*.

Company _____ E-9-3
Attention of: _____
Address _____
City _____ State _____

Voltage Limiter problems?



NOW IN PRODUCTION

Three types of limiters—each made in strict accordance with customer's and "MIL" specifications. All limiters are manufactured under controlled laboratory conditions; over 50 intermediate inspections.

WE ALSO PRODUCE

Electrical and electronic assemblies, special relays, solenoids, hermetically sealed assemblies, rectifiers, terminal and junction boxes and boards, automatic controls. All work performed in complete compliance with customer's standards.

OUR CONTRACT SERVICE OFFERS REASONABLE PRICES — PROMPT DELIVERY — A FAULTLESS PRODUCT.

FOR A QUOTATION send us your prints, specifications and delivery requirements. Our reply will be prompt.

Manufacturers of Wassco GLO-MELT Resistance Soldering Equipment

WASSERLEIN MANUFACTURING CO., INC.

126 W. Cass St. • Joliet, Illinois

New Booklet on Gamewell Precision Potentiometers

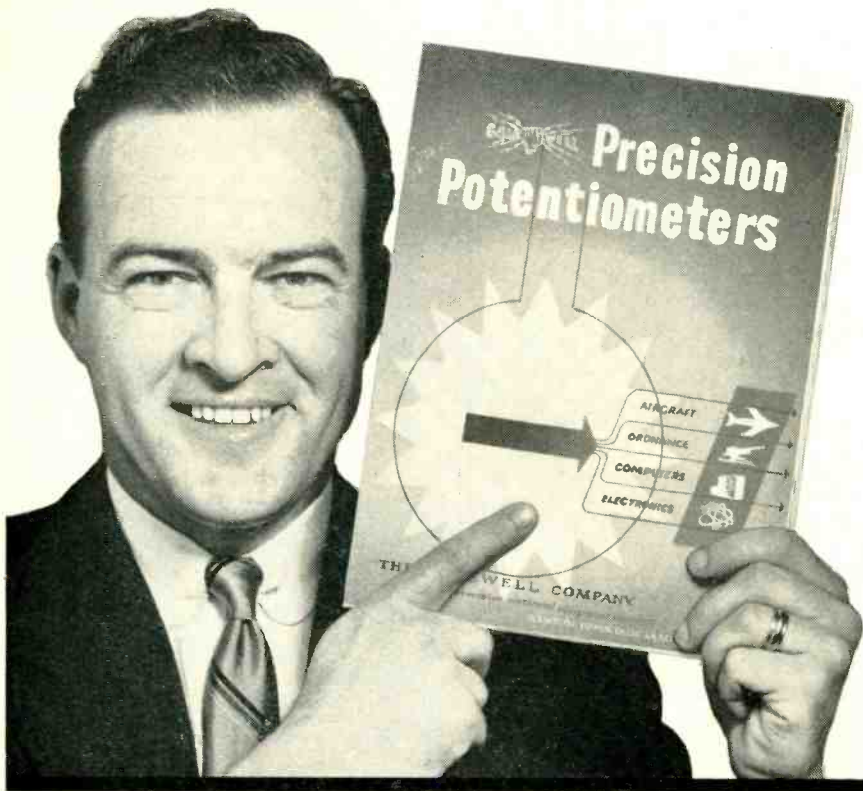

CONTENTS

- Methods of Manufacture
- Windings Available
- Linear Potentiometers description condensed specifications
- Non-Linear Potentiometers description condensed specifications
- Special Applications
- Glossary of Terms Used
- Information Required with Orders

For your copy of this new Gamewell Precision Potentiometer booklet, just send us a note on your company letterhead. Your copy will be mailed immediately, at no obligation to you.

THE GAMEWELL COMPANY • Newton Upper Falls 64, Massachusetts

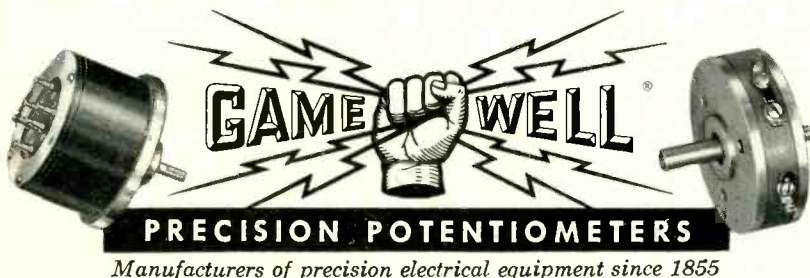

as many as the present plant.

The exact site of the new factory has not been determined by Wincharger executives who are presently working with Sioux City officials to select a suitable location. However, it will be located on high ground to be safe from flood waters that caused considerable damage to the Wincharger plant last year. Present plant has about 140,000 sq ft of space.

UHF Station Goes Out of Business

RADIO Roanoke regrettably announced that it has ceased operation of tv station WROV-TV in Roanoke, Va., on channel 27.

This action was taken in order to insure that its application for vhf channel 7 in Roanoke would be accepted by the FCC.

William Shakespeare Joins Glenco Corp.

WILLIAM MACINTYRE SHAKESPEARE, ceramist, formerly of MIT, has joined the Glenco Corp. of Metuchen, N. J. as ceramic engineer in charge of a group for development of new ceramic compositions and new casting techniques.



William M. Shakespeare

Sylvania Ups Output Of Aluminized TV Tubes

SYLVANIA ELECTRIC PRODUCTS announced that its television picture tube division, with headquarters in Seneca Falls, N. Y. is actively engaged in perfecting methods and increasing facilities for the mass

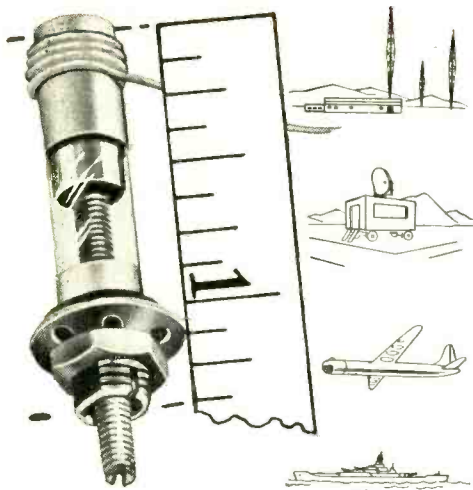

leading manufacturers use

JFD PISTON TYPE VARIABLE TRIMMER CAPACITORS

in both civil and military equipment

- No. VC 1 G (0.7 to 6.0 mmf.) Glass Dielectric
- No. VC 5 (1.0 to 10.0 mmf.) Quartz Dielectric
- No. VC 11 (1.0 to 10.0 mmf.) Quartz Dielectric
- No. VC 11 G (1.0 to 12.0 mmf.) Glass Dielectric
- No. VC 20 (0.5 to 1.9 mmf.) Glass Dielectric

NO OTHER LIKE IT!

- Approximately ZERO TEMPERATURE COEFFICIENT FOR QUARTZ AND INVAR construction.
- Approximately ± 50 PPM per degree C. for Glass and INVAR construction.
- One-piece SPRING LOADED PISTON and screw prevent backlash.
- SILVER BAND fused to exterior of precision drawn quartz or glass tube serves as optimum stationary electrode.
- "Q" of 1,000 at 1 mc.
- DIELECTRIC STRENGTH equals 1,000 volts DC at sea level pressure and 500 volts at 3.4 inches of mercury.
- 10,000 megohms INSULATION RESISTANCE MINIMUM.
- OPERATING TEMPERATURES, -55 C. to $+125$ C. with glass dielectric. -55 C. to $+200$ C. with quartz dielectric.
- Over 100 megohms MOISTURE RESISTANCE after 24 hours exposure to 95% humidity of room temperature.
- PISTON DIMENSIONAL ACCURACY is held to close tolerance maintaining minimum air gap between piston and cylinder wall.

Write for Form No. 199

JFD MFG. CO.

BROOKLYN 4, N. Y.
BENSONHURST 6-9200



world's largest manufacturer
of tv antennas & accessories



STOP RF LEAKAGE ON THE DRAWING BOARD

... WHEN YOU DESIGN METEX ELECTRONIC WEATHERSTRIPPING INTO YOUR EQUIPMENT YOU GET ITS POSITIVE SHIELDING EFFECTIVENESS — AT MAXIMUM OVERALL ECONOMY

Plan now to take full advantage of *Metex Electronic Weatherstripping's* unusual effectiveness in shielding all types of electronic equipment. Because it is made of knitted wire mesh, *Metex Electronic Weatherstripping* is both conductive and resilient. It assures positive metal-to-metal contact between all mating surfaces. And being resilient it accommodates itself positively to surface inequalities.

In reality, *Metex Electronic Weatherstripping* can do more for you than just shield RF leakage. It can cut the cost of machining mating surfaces to close tolerances. It can eliminate the need for extra fasteners and many other costly means of making joints RF tight.

Applications in which *Metex Electronic Weatherstripping* has already proved its effectiveness include pulse modulator shields, wave-guide choke-flange gaskets, local oscillators on TV sets, dielectric heaters, etc.

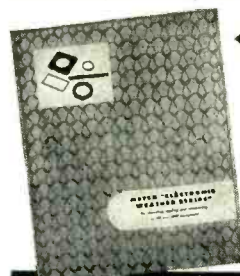

For detailed information on METEX ELECTRONIC PRODUCTS, write for FREE copy of "Metex Electronic Weatherstrips" or outline your SPECIFIC shielding problem — it will receive our immediate attention.

SPACE SAVERS FOR
MODERN CIRCUITRY —
MONEY SAVERS FOR
PRODUCTION ECONOMICS —



IN-RES-CO TYPE IR WIRE WOUND RESISTORS

The practical, low cost solution for circuit designers striving for the sub-miniature. Type IR units offer precision resistance values capable of retaining stability through long periods of continuous or intermittent service. Type-IR resistors are available at prices based on mass production methods of manufacture. Wound to a tolerance of $\pm 1\%$, they are permanently accurate. Conservative ratings allow ample safety margin in all classes of service. Special Bakelite forms eliminate shrinking, swelling and temperature effects. IN-RES-CO moisture and fungus proof coating offers absolute protection against climatic extremes. Specify IR Type resistors for all applications where precision performance and limited space are important determining factors.

INSTRUMENT RESISTORS CO.

COMMERCE AVENUE



UNION NEW JERSEY

APPLICATION-DESIGNED RESISTORS FOR ELECTRONICS AND INSTRUMENTATION

WRITE FOR NEW RESISTOR HANDBOOK — Contains complete data and recommended applications for resistors for every purpose.



METAL TEXTILE CORPORATION



ROSELLE, NEW JERSEY

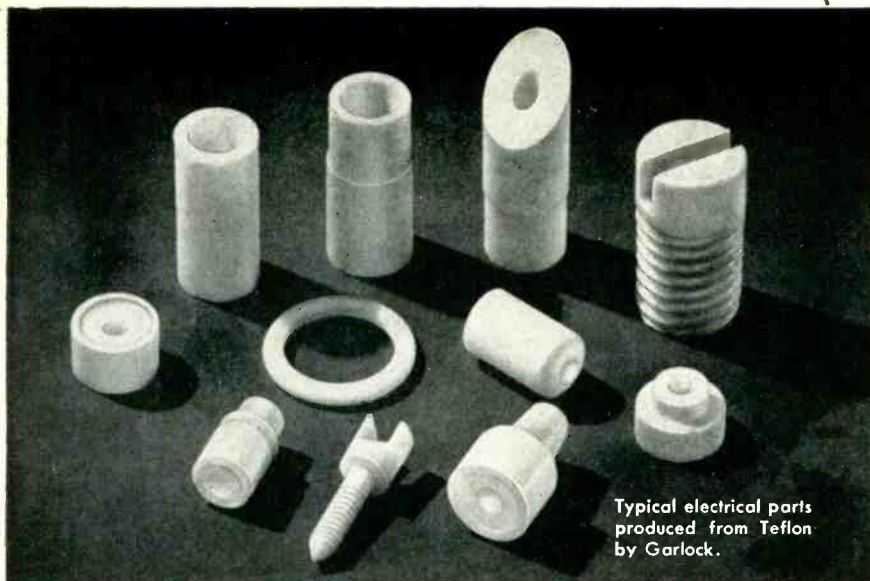

For Precision Electrical Parts

Made of *Teflon*^{*}, *Kel-F*[‡],
Nylon, or Polythene . . .

SEND YOUR INQUIRIES TO GARLOCK

The Garlock Packing Company, manufacturers of mechanical packings since 1887, places at your disposal a completely-equipped, modern plastics plant under expert technical supervision. Our complete facilities enable us to mold, extrude, machine or otherwise fabricate (from powder) electrical parts to the same high quality standards to which Garlock has rigidly adhered for over 65 years.

Garlock, therefore, invites your inquiries on:

1. **Finished Electrical Parts**—molded or machined—of Teflon, Kel-F, Nylon or Polythene.
2. **Teflon Tape**—Electrical grade—pretested for dielectric fault (maximum 85 per 100 feet of 0.005" tape).

SHEETS, TUBES, SLEEVES AND OTHER SHAPES AVAILABLE IN TEFLON OR KEL-F

For fabricators of finished parts, Garlock can furnish Teflon and Kel-F in sheets, tubes, sleeves and a wide variety of other shapes. Teflon sheets can be supplied in sizes as large as 48" square; Kel-F sheets and discs as large as 48" diameter.

Mail Your Inquiries to Dept. 34, Palmyra, N. Y., or contact one of our branch offices shown below and a Garlock representative will call.

THE GARLOCK PACKING COMPANY, PALMYRA, NEW YORK

Branch Offices: Baltimore, Birmingham, Boston, Buffalo, Chicago, Cincinnati, Cleveland, Denver, Detroit, Houston, Los Angeles, New Orleans, New York City, Philadelphia, Pittsburgh, Portland (Ore.), Salt Lake City, San Francisco, St. Louis, Seattle, Spokane, Tulsa.

In Canada: The Garlock Packing Co. of Canada Ltd., Toronto, Ont.
Branch Offices: Calgary, Hamilton, Montreal, Vancouver, Winnipeg

*du Pont's trademark for its tetrafluoroethylene resin

‡Registered trademark for M. W. Kellogg Company's trifluorochloroethylene polymers

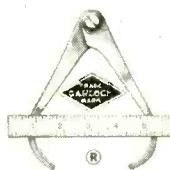

GARLOCK

MANUFACTURERS OF
MECHANICAL PACKINGS
SINCE 1887

production of aluminized picture tubes.

W. H. Lamb, general manager of the division, indicated that because of increasing interest among receiver manufacturers, the company has accelerated aluminizing plans to the maximum. The interest in aluminizing is focused on large size tubes (24 and 27-inch), despite the fact that manufacturing consistently high-quality aluminized tubes is a much more complicated process than making the non-aluminized versions.

Mr. Lamb said that Sylvania is in limited production and is currently sampling receiver manufacturers, but that total demand for aluminized tubes is expected to exceed the industry supply for some time. He indicated that the limited supplies now available would be increased rapidly during coming months, and said that the company is inviting inquiries from receiver manufacturers interested in aluminized tube in 24 or 27-inch sizes—or even in 21-inch sizes.

Avco Consolidates Distribution

VICTOR EMANUEL, chairman and president of Avco Manufacturing Corp. announced that the distribution of appliances and television and radio sets of the Crosley Division and laundry and kitchen appliances of the Bendix Home Appliances Division, will be consolidated under the supervision of a single distributor organization.

To implement this new sales policy, the Crosley and the Bendix Home Appliances Divisions will be consolidated under one management with headquarters at Cincinnati, Ohio.

James D. Shouse, one of Avco's senior vice-presidents, who presently heads all Crosley operations in both manufacturing and broadcasting and is a director and member of the executive committee of Avco, will be general manager of the combined operations.

William A. Blees, vice-president of Avco and general sales manager of Crosley for the past four years, will join the top executive staff of Avco in New York, concentrating

FOR UHF-TV TEST

FOR UHF-TV SWEEP GENERATOR
MODEL 130 450 to 900 MC

Model 130 has a maximum sweep width of at least 30 megacycles, continuously variable. Output is from 10 microvolts to more than 1 volt. The signal is blanked on the return sweep, providing a reference base line. Markers available.



PRICE \$265-

FOR UHF-TV GRID DIP OSCILLATOR
MODEL 200 400 to 900 MC



PRICE \$140-

This multi-purpose instrument has a place in every electronics laboratory and factory. The power supply and oscillator are in one compact unit. Reading is direct. A fine performer, the model 200 has remarkably smooth meter indication.

Write to Dept. A

New London Instrument Company
NEW LONDON, CONNECTICUT



TRANSFORMERS

"Fill Your Need to a"

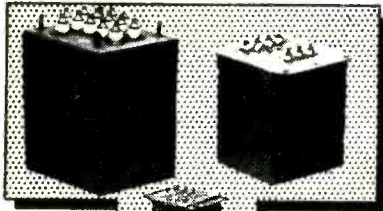

For INDUSTRIAL and ELECTRONIC EQUIPMENT

Let us quote on your Specifications, no obligation

SAMPLE SHORT and LONG RUNS

Delivery as Promised!

DESIGNED TO COMMERCIAL AND MILITARY SPECIFICATIONS (MIL-T-27 and AN-E-19)

EPCO Products Inc.

2500 Atlantic Ave.
Brooklyn 7, New York



SERVES your SERVO-SYSTEMS better

FORD INSTRUMENT
Single Spider Gear
Precision Differential

Available in 3/16, 1/4, 5/16 inch shaft diameters

Send for FREE Booklet with Full Information

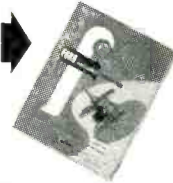

A zero spiral angle insures smooth motion with equal friction and thrust in either direction of rotation. Here's the low friction differential that's perfect for high sensitivity servo loops. Lost motion on pitch line does not exceed 5 minutes of arc (in the 1/4" and 5/16" models)—less than 7 minutes in the 3/16" model—exceptional accuracy. Additional design characteristics give exceedingly long life expectancy to this differential of fine FORD precision.

10A



FORD INSTRUMENT COMPANY

DIVISION OF THE SPERRY CORPORATION
31-10 Thomson Avenue, Long Island City 1, N. Y.

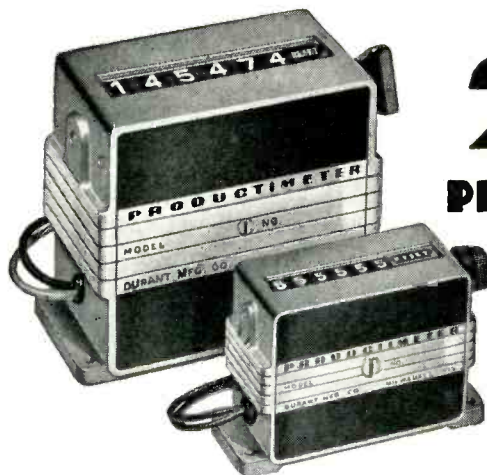

2 ELECTRIC PRODUCTIMETERS

"CS" and "Y"
ELECTRIC PRODUCTIMETERS
The answer to all electric counting requirements

Two Companion Counters . . . Two Sizes . . .
Hi-Speed . . . Accurate . . . Long Life . . . Totally Enclosed

Speeds of 1000 counts per minute. Both counters give maximum readability. Design fits all mounting conditions . . . panel mounting or base mounting. Hardened steel working parts for long life and dependability.

New type case for compactness,

rigidity, and protection against dust and moisture conditions. Operate accurately over wide current fluctuations.

DURANT MANUFACTURING CO.
1912 N. Buffum St. 112 Orange St.
Milwaukee 1, Wis. Providence 3, R. I.
Representatives in Principal Cities

Write for "New Electrics" Bulletin

PRODUCTIMETERS

SINCE 1879

Count Everything

**miniature
precision components
for high-performance**

Servo Systems

Developed and produced by Kearfott, these units exemplify accomplishments of creative engineering teamed with production skill providing performance values of accuracy, speed of response and reliability unique for their size. Advanced design techniques are typified by the unitized stator and housing construction, permitting line-bored relationship of stator and rotor. This makes practical the extremely close concentricity tolerances apparent in improved efficiency of the Servo Motors and the very high accuracy of the companion Synchro. A very rugged structure, stable under extremes of environmental exposure is also provided.

Conforms to Navy BuOrd Size 11
(Maximum Diameter 1-1/16")

TECHNICAL INFORMATION

Synchro—Available as Control Transformer, Transmitter, Resolver, Differential, for 26 or 115 volt 400 cycle operation. Maximum error tolerance is 7 minutes of arc. The hardened pinion shaft may be used as a spline. Terminals for convenient installation and replacement are provided. Other synchros for 60 cycle operation may be obtained. (Basic Type R500).

Servo Motor—The Servo Motor (Basic Type R119) features a very high torque-to-inertia ratio. Motor input is 3.5 watts per phase at 115 volt 400 cycle. Available with high-impedance control winding for operation directly in plate circuit of an Amplifier. Integral precision gear train can be provided. Many other models available including Servo Motors for 60 cycle duty. (Basic Type R303).

Servo Motor-Generator—The motor described above is available with an integral high performance damping generator, providing an output signal of 1/2 volt per 1000 RPM over a 5500 RPM speed range. (Basic Type 420400).

Technical Bulletins on standard Kearfott products are available and will be sent on request. Your inquiries are invited for the development and production of special units for unusual applications. Write today for Bulletin #53 describing our products and facilities.

**KEARFOTT COMPONENTS
INCLUDE:**

Gyros, Servo Motors, Synchros, Servo and Magnetic Amplifiers, Tachometer Generators, Hermetic Rotary Seals, Aircraft Navigational Systems, and other high accuracy mechanical, electrical and electronic components.

Kearfott

SINCE 1917

CREATIVE ENGINEERING
PRODUCTION ACHIEVEMENT

KEARFOTT COMPANY, INC., 1150 McBride Ave., Little Falls, N. J.
West Coast Office: 253 N. Vinedo Ave., Pasadena, Calif.
A General Precision Equipment Corporation Subsidiary

Synchro Control
Transformer
(Actual Size)



Geared
Servo Motor
(Actual Size)



Servo Motor-
Tachometer
Generator
(Actual Size)

on distribution and merchandising problems for the corporation. He will assist Mr. Shouse in consolidating the sales operations of the two divisions before assuming his New York responsibilities.

Hector J. Dowd, vice-president and director of Avco, who has been general manager of Bendix Home Appliances Division in South Bend, will return to the executive staff in the New York office.

Parker H. Ericksen was appointed director of sales for Crosley and Bendix Home Appliances Divisions of Avco and was elected a vice-president of Avco.

Mr. Emanuel, in commenting on the consolidation, said "We feel sure that the operating efficiencies and economies resulting from this move will be reflected in our business as well as that of the distributors and dealers. We have made this move in view of the new conditions under which we will be selling in highly competitive markets. We want to concentrate and streamline our activities with these two premier lines, working closely with a limited number of distributors and dealers to increase the sales and profits for all of us."

Consolidation of the Crosley and Bendix Home Appliances management follows the integration of Crosley and Bendix Home Appliances subsidiaries in Canada as a part of the new Avco of Canada. The Canadian firm also includes Moffats, appliance manufacturer with plants in Ontario.

Herlec Moves To New Plant

THE HERLEC CORP., mid-western ceramic capacitor manufacturing subsidiary of Sprague Electric, has completed the move of all its oper-

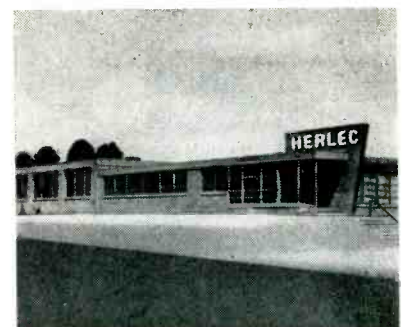

New Herlec Plant



Measurements
Corporation
MODEL
111-B

CRYSTAL CALIBRATOR

For The Frequency Calibration
Of Equipment In The Range Of
100 Kc. to 1000 Mc.

Frequency Accuracy: $\pm 0.001\%$

The Model 111-B provides a test signal of crystal-controlled frequency and has a self-contained detector of 2 microwatts sensitivity.

For calibration and frequency checking of signal generators, transmitters, receivers, grid-dip meters, etc.

**MEASUREMENTS
CORPORATION**

BOONTON



NEW JERSEY

BE SAFE WITH
Q-max
A-27
LOW-LOSS LACQUER & CEMENT

- Q-Max is widely accepted as the standard for R-F circuit components because it is chemically engineered for this sole purpose.
- Q-Max provides a clear, practically loss-free covering, penetrates deeply, seals out moisture, imparts rigidity and promotes electrical stability.
- Q-Max is easy to apply, dries quickly and adheres to practically all materials. It is useful over a wide temperature range and serves as a mild flux on tinned surfaces.
- Q-Max is an ideal impregnant for "high" Q coils. Coil "Q" remains nearly constant from wet application to dry finish. In 1.5 and 55 gallon containers.

*Communication
Products Company, Inc.*
MARLBORO, NEW JERSEY
(MONMOUTH COUNTY)
Telephone: FReshold 8-1880 

LFE SOLID DELAY LINES STORE INFORMATION

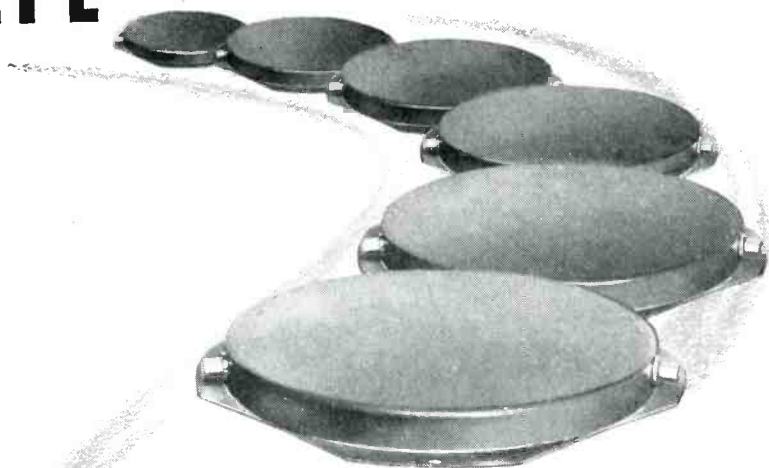

Offer important advantages in obtaining precise delay intervals for pulse or modulated signals:

Wide ranges of delay
Low attenuation
Low spurious response
Wide bandwidth

Smooth pass band
Wide temperature range
Minimum size and weight
Rugged construction

Available for video integration, computers, time markers, moving target indication, etc.

For complete information, write: *Specialties Division*



LABORATORY for ELECTRONICS, INC.

75-4 PITTS STREET • BOSTON 14, MASS.

PRECISION ELECTRONIC EQUIPMENT • OSCILLOSCOPES • MAGNETOMETERS • COMPUTERS • MICROWAVE OSCILLATORS • SOLID DELAY LINES

**NOW! CHANGE SOLDERING
IRON ELEMENTS IN A JIFFY!**

with **HEXA CON** TRADE MARK

*Patent Applied For

Readily Removable Terminal* does the trick!

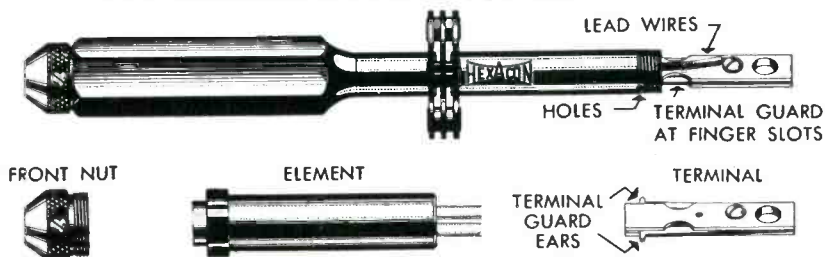

ALSO NEW!
**BRASS-SHEATHED
ELEMENTS**
Easier to replace—
Better Protection

Write for catalog showing 40 industrial soldering irons of every type and size; there is no obligation.

Quick-change terminal can be removed in a second or two, permitting replacement of element in a fraction of the usual time. By simply depressing terminal guard at the finger slots, the terminal comes out in a jiffy — no longer necessary to fish element lead wires around terminal.

HEXA CON — Industry's No. 1 Soldering Iron

HEXA CON ELECTRIC COMPANY
130 W. CLAY AVE., ROSELLE PARK, NEW JERSEY

ations to its new plant at Grafton, Wisc., it was announced by Harry Rubinstein, president. The new factory is located about 25 miles from the former Herlec location in downtown Milwaukee.

General Instrument Names Three Executives



Ralph R. Stubbe

APPOINTMENT of Ralph R. Stubbe as assistant chief engineer, Edwin A. Freed as manager of operation of its Elizabeth, N. J. plant and Robert L. Klabin as manager of its Sickles Division in Conn. were announced by General Instrument Corp.

In announcing Mr. Stubbe's appointment, Monte Cohen, president, said that Mr. Stubbe, whose 15 years in the electronics industry has been spent with such firms as Westinghouse, Hazeltine, NBC and Hoffman Radio, will play a key role in GI's expanding production of uhf tuners, converters and other components.

Mr. Stubbe was with Hoffman Radio of Los Angeles as design engineer for tv receivers when he accepted his post at General Instrument.

Mr. Freed who joined General Instrument in 1951 as sales manager, after nine years with RCA where he was manager of sales of component parts, will continue to direct sales in his new position and will be in complete charge of all operations at the home plant. He pioneered as early as 1922 in enterprises that became the Freed-Eiseman Radio Corp.

Mr. Klabin, controller of the com-

Don't Overlook Buttons



for VHF and UHF applications

Silvered mica button capacitors meet all requirements as components for better VHF and UHF performance. Exceptionally small and light in weight, they are a valuable aid to miniaturization. Extremely low series inductance makes them ideal for application in high frequency circuits.

Sangamo Button Capacitors are encased in silver plated corrosion resistant brass and are stable over an operating temperature range from minus 50° C to plus 85° C. The silver plated case performs the dual purpose of shielding and serving as the low potential terminal.

Sangamo Buttons can be furnished with temperature coefficients and drift characteristics up to and including "E" of JAN-C-5. They are available in a wide variety of styles and in multi-section assemblies to facilitate installation in miniaturized equipment.

Engineering Bulletin TS-110 gives detailed information. Write for your copy today.

SC53-11



Those who know... choose Sangamo

SANGAMO ELECTRIC CO. MARION, ILLINOIS

EUROPEAN
RADIO TUBES
Obtainable from Stock

INTERNATIONAL ELECTRONICS CORPORATION
137, Hudson Street, N.Y. 13, N.Y.

Sole distributors in the U.S.A. for:
Mullard Overseas Ltd

MRV 13

Linde
Trade-Mark
M. S. C.
(Mass Spectrometer Checked)
RARE GASES
HELIUM · NEON
ARGON · KRYPTON · XENON

LINDE Rare Gases are mass spectrometer checked to assure you gases of known purity and uniformly high quality. Available in commercial-size cylinders and glass bulbs.

LINDE, the world's largest producer of gases derived from the atmosphere, can meet your individual needs of purity...volume...mixture...containers...

LINDE AIR PRODUCTS COMPANY
A DIVISION OF UNION CARBIDE AND CARBON CORPORATION
30 East 42nd Street New York 17, N. Y.
In Canada:
Dominion Oxygen Company, Limited, Toronto

The term "Linde" is a registered trade-mark of Union Carbide and Carbon Corporation

ELECTRONICS — September, 1953

A NEW SOLUTION TO OLD PROBLEMS

AEROCOM'S NEW
ARTIFICIAL ANTENNA,
SIMULATING ACTUAL OPERATING
CONDITIONS. SAVES TIME
ON TRANSMITTER AND RECEIVER TUNING

It is no longer necessary to final tune transmitters or receivers aboard aircraft. With the new Artificial Antenna (Model DA200) you can precisely simulate, electrically, any normal aircraft antenna. All this without leaving the test bench. This equipment will accept any transmitter power up to 200 watts -- coaxial fitting provides direct 52 ohm metered load. Sturdily constructed for hard usage, can be mounted in standard rack cabinet or used on bench top.

A letter or wire from you will bring descriptive literature

AER - O - COM

3090 DOUGLAS ROAD

MIAMI 33, FLA.

Reg. U.S.

Pat. Off.

quality "precision" LEADS
of
TUNGSTEN
MOLYBDENUM
NICKEL
NICKEL-CLAD
COPPER
and ALLOYS

quality hand-wound COILS
of Tungsten and Molybdenum

quality MACHINED TUBE COMPONENTS
to customers' specifications

Your products can only be as good as the parts you put into them!

SEND US YOUR BLUEPRINTS or SPECIFICATIONS FOR QUOTATIONS!

ELECTRONIC PARTS MANUFACTURING CO., Inc.
508 25th St., Union City, N. J.

Electronic Parts Manufacturing Co., Inc.
508 25th St., Union City, N. J.
Send me copy of your brochure.
Name.....
Address.....

Want more information? Use post card on last page.

403

the **Waterman** **WIDE BAND POCKETSCOPE**®



MODEL
S-14-B

Size:
12" x 6" x 7"
14 Pounds

ANOTHER EXAMPLE OF *Waterman* PIONEERING...

The **WIDE BAND POCKETSCOPE**, model S-14-B, hits a new high in frequency response for light, compact, truly portable oscilloscopes. The response extends all the way from DC to 700 KC within -2 db without peaking. Thus providing a pulse rise time of 1.8 microseconds. Furthermore, sensitivity has not been unduly compromised in order to accomplish such fidelity. The vertical sensitivity is 50 millivolts rms/inch. The sweep is operated in either a repetitive or trigger mode and covers a range from 0.5 cycles to 50 KC with synchronization polarity optional. Other essential vertical and horizontal amplifier characteristics

include non-frequency discriminating attenuators and gain controls as well as individual calibration voltages. Additional provisions for direct access to all the deflection plates, the second anode, and the amplifier outputs help to make the S-14-B a standout instrument of flexibility and utility. All this plus portability! The incredibly small size and light weight of the S-14-B now permits "on-the-spot" use of the oscilloscope in all industrial, medical, and communications fields. Its rugged construction assures "laboratory performance" regardless of environment.

WATERMAN PRODUCTS CO., INC.

PHILADELPHIA 25, PA.

CABLE ADDRESS: POKETSCOPE

WATERMAN PRODUCTS INCLUDE

S-4-A SAR	PULSESCOPE ®
S-5-A LAB	PULSESCOPE
S-11-A INDUSTRIAL	POCKETSCOPE
S-12-B JANized	RAKSCOPE ®
S-14-A HIGH GAIN	POCKETSCOPE
S-15-A TWIN TUBE	POCKETSCOPE

Also **RAYONIC**® Cathode Ray Tubes and Other Associated Equipment

MEMO...
Write for details today!

WATERMAN PRODUCTS



Edwin A. Freed

pany, has been given indefinite leave from the home offices to manage the Sickles Division. He has served General Instrument since 1935. In his new post, he will report to B. F. Valliere, vice-president in charge of operations of the Sickles Division. C F Sullivan, assistant controller, will be acting controller during Mr. Klabin's absence.

Nelson Heads RCA Transistor Sales

ROY E. NELSON was promoted to the newly-created post of manager of semi-conductor equipment sales for RCA Victor's Tube Department.

Formerly with the department's government equipment sales as a sales engineer handling the development and sales of new products, he will now be responsible for sales of RCA transistors to equipment manufacturers, according to L. S. Thees, general sales manager of the department.

Mr. Nelson will also be responsible for the dissemination of latest transistor engineering data to equipment customers and for assisting them in the solution of technical problems. The semi-conductor equipment sales activity will be under the supervision of M. J. Carroll, equipment sales manager.

Mr. Nelson joined RCA Victor as a radio engineer in 1933, at the company's Harrison plant. He was transferred later to New York to theatre television equipment. Mr. Nelson served with the Air Force during World War II and was discharged as a Colonel.

He rejoined RCA Victor in 1946

★ model 1200

★ continuous duty

REVERSIBLE DC MOTORS

18 to 30 volts with
or without brake . . .

- Ambient temperature: — 55° C to + 105° C.
- Size: 1.25 in. diameter, 2.18 in. long.
- Weighs 5.3 ounces . . . without brake.

We can manufacture these motors to meet your specifications. This particular motor is used on an actuator for aircraft use.

*Let's discuss your need!
Write or wire us, TODAY*

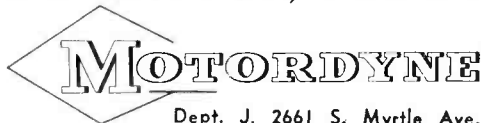

Dept. J, 2661 S. Myrtle Ave.
MONROVIA, CALIFORNIA

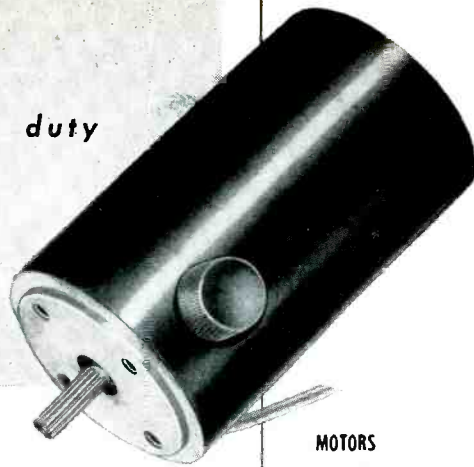

MOTORS
GENERATORS
RELAYS
TRANSFORMERS
SPEED CONTROL
GOVERNORS
MAGNETIC
SERVO AMPLIFIERS
MAGNETIC
CONTROLS & CIRCUITS



INC.

This book will save you

30 Minutes a day

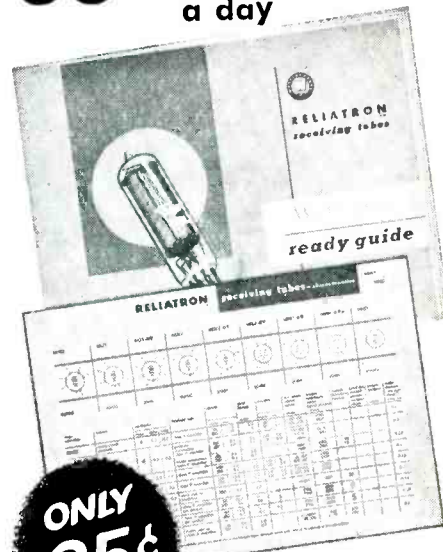

**ONLY
35¢**

- COMPLETELY NEW
 - FIRST EDITION
- JUST OFF THE PRESS

FIND TUBE RATINGS, CONNECTIONS IN SECONDS

This big new Westinghouse *Ready-Guide* is a completely new kind of handbook of receiving tube data. Designed to save time for busy servicemen and engineers. Eliminates "squinting" at tiny data listings.

BIG — BOLD — CLEAR

Just 9 tube types are listed on each 8½" x 11" page. Not 30 or 40 tiny type listings as in most condensed data books. Best of all, large clear base diagrams are located on the same page as ratings. Bothersome cross referencing, footnotes cut to the bone.

COMPLETE, ACCURATE, UP-TO-DATE

This new Westinghouse *Ready-Guide* lists complete data on receiving tubes which account for more than 98% of tube usage. 48 pages. 385 pictures and diagrams. 342 types listed.

SPECIAL: 3 for \$1.00

This *Ready-Guide* is being sold at less than cost as an introductory offer only. Price is only 35¢—3 for \$1.00. Order from your nearest RELIATRON Tube Distributor or mail coupon below.

ET-9503B **RELIATRON TUBES** TM

Westinghouse

Westinghouse Electric Corporation
Electronic Tube Division, Dept. A-209
Box 284, Elmira, N. Y.

..... Enclosed is \$1.00 for 3 copies of
Ready-Guide
..... Enclosed is 35¢ for 1 copy

NAME.....

ADDRESS.....

CITY..... STATE.....

Please Print

for maximum economy . . .

5KW VACUUM TUBE BOMBARDER OR INDUCTION HEATING UNIT

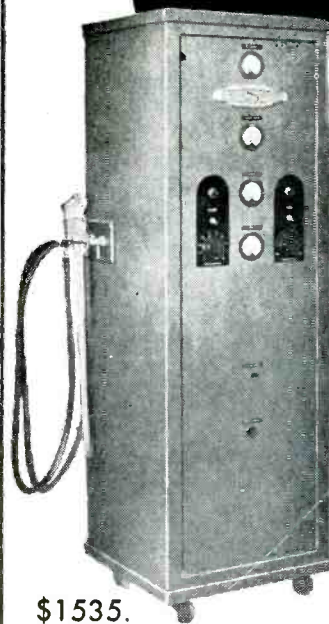

\$1535.

Simple . . . Easy to Operate . . . Economical
Standardization of Unit Makes This New Low
Price Possible.

Maximum economies can be obtained only by use of
correct frequency and power combinations when applying
the techniques of induction heating to manufacturing
processes.

It is significant that only Scientific Electric in the present
market, can offer you a selection of frequencies depending
on power required, in wide power range. 2-3½-5-6-7½-10-12½-15-18-25-40-60 KW (all units
above 60 KW are considered custom built). This means
that electronic heating equipment produced by Scientific
Electric is tailored to your needs . . . fitted perfectly to
the task entrusted to it, enabling you to keep your
initial investment in equipment to a minimum while
affording you all the proven advantages of electronic
heating.

Write now for complete information or send samples of
work to be processed. Specify time cycle for your
particular job. We will quote on proper size unit for
your requirements.

DESIGNERS AND MANUFACTURERS OF HIGH FREQUENCY AND HIGH VOLTAGE EQUIPMENT SINCE 1921

Scientific Electric

105-119 MONROE ST  GARFIELD, N. J.

Standard push button ATTENUATOR



for true **V.H.F.** measurements

This outstanding "Standard" V.H.F. Attenuator now in its second year of production remains the first and only accurate instrument of its kind and continues to meet a heavy demand from leading organisations and authorities the world over.

Four models now available

Characteristic Impedance	75 ohms	50 ohms
0.9 db in 1 db steps	Type 74600-A	Type 74600-E
0.90 db in 10 db steps	Type 74600-B	Type 74600-F

All types will handle inputs up to 0.25 watts.

Accuracy of D.C. adjustment

0.9 db Models: The insertion loss error will not exceed ± 0.05 db for any setting.

0.90 db Models: The insertion loss error for the 90 db setting will not exceed ± 0.3 db. For other settings this limit falls linearly to a value of ± 0.06 db at the 10 db setting.

High frequency performance

0.9 db Models: At 50 Mc/s the insertion loss error for the 9 db setting will not exceed ± 0.15 db. For other settings this limit falls linearly to a value of ± 0.05 db for the 1 db setting.

0.90 db Models: At 50 Mc/s the insertion loss error will not exceed ± 0.1 db per step. N.B. All insertion loss errors are relative to zero db setting.

Ready for Building into your own equipment. Calibration charts for frequencies up to 100 Mc/s for the 0.9 db models or 65 Mc/s for the 0.90 db models can be supplied on request.

Standard Telephones and Cables Limited

(An I.T. & T. Associate)

TRANSMISSION DIVISION, NORTH WOOLWICH, LONDON, E16

as assistant to the director of the license department of the International Division, and joined the RCA Tube Department in 1950 as an equipment sales field engineer.

E'lise Harmon Heads Aerovox Printed Circuits



E'lise Harmon

MISS E'LISE HARMON heads the printed circuit activities of Aerovox Corp. in New Bedford, Mass.

Previous to joining Aerovox, Miss Harmon was chemist and engineer at the Bureau of Standards and also with the Naval Research Bureau in Washington. Before that, she was with the Ordnance Division of the War Department in St. Louis. During the war she developed a high-altitude brush. She has done consulting work for Pan American Air Lines, Davies Fruit Company and Standard Oil of Illinois.

With the Aerovox version of the printed circuit technique, pure silver is mechanically bonded to a plastic support. Chemical etching is not used.

The company also announced the appointment of Miss Carolyn Chortlton as a Physical Chemist in the research department in New Bedford, Mass.

Edison Acquires Measurements

THOMAS A. EDISON, INC. has purchased the entire outstanding stock of Measurements Corp., Boonton, N. J., according to an announce-

MAGNATRAN

PRODUCTS ARE BETTER★

For HEAVY DUTY HIGH VOLTAGE

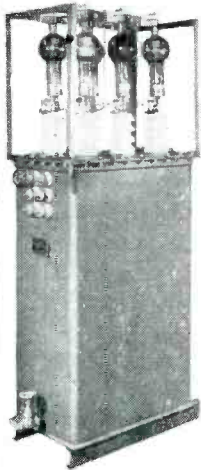

34 KW 17,000 V.D.C.

**YES . . . WE BUILD BETTER EQUIPMENT
BASED ON MANY YEARS OF EXPERIENCE**

★While this word has been overworked in many instances, we will be pleased to demonstrate the extras built into our transformers to make them better.

← NEW UNITIZED RECTIFIERS

For high voltage D.C. sources . . . lower initial cost . . . minimum upkeep . . . convenient — ready to connect to AC. line and D.C. load . . . compact — requires minimum floor space.



Askarel Immersed
Filter Reactor
50,000 Volt Test

AIR . . . OIL . . . ASKAREL

Plate Transformers . Filament Transformers . Filter Reactors . Modulation Transformers . Distribution Transformers . Pulse Transformers . Testing Transformers . Precipitation Transformers . General Purpose Transformers . Hi-Voltage Transformers.

WRITE FOR DETAILED INFORMATION

MEETS STANDARDS OF AIEE-NEMA

A NAME SYNONYMOUS WITH EXPERIENCE

MAGNATRAN INCORPORATED

TRANSFORMERS AND ELECTRICAL EQUIPMENT
WALTER GARLICK, JR., PRESIDENT
246 SCHUYLER AVE., KEARNY, NEW JERSEY



**2 OUT OF 3
Engineers Depend On
BURGESS
BATTERIES**

**FOR INDUSTRIAL
ELECTRONIC APPLICATIONS**

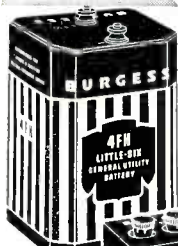
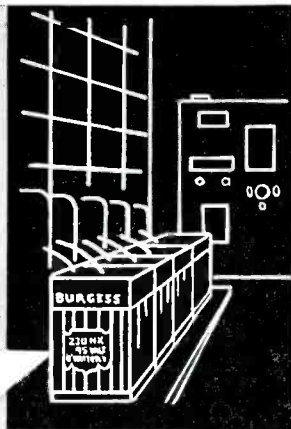

No. 4FH



No. Z30NX

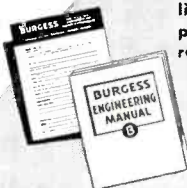

Independent surveys show 2 out of 3 engineers prefer BURGESS BATTERIES over other industrial dry batteries. There's an important reason for this popularity! BURGESS BATTERIES are backed by more years of engineering "know-how" than any other dry batteries. More and more engineers are switching to Burgess, exclusively, because they know what to expect from every BURGESS BATTERY they buy . . . top performance and long life. Whatever the application, Burgess is completely equipped to meet your exact, dry battery requirements.

Burgess provides its customers with a FREE engineering manual listing the complete line of BURGESS BATTERIES and specifications. Also a check sheet to enter new battery specifications. Write to Burgess for the name of your local distributor or, if you have a special application, write for the FREE check sheet.

BURGESS BATTERIES
BURGESS BATTERY COMPANY
FREEPORT, ILLINOIS

Let **WILLIAMS**
help you apply

ferric oxides

to the manufacture
of your

FERRITES

You'll be well repaid by getting the facts on a special group of Pure Ferric Oxides, developed by Williams especially for use in the manufacture of ferrites.

Williams Ferric Oxides analyze better than 99% Fe₂O₃. They contain a minimum of impurities. They are available in a broad range of particle sizes and shapes. Among them, we're certain you'll find one that's "just right" for your requirements. The proper application of Ferric Oxides to the manufacture of Ferrites is our specialty.

Tell us your requirements . . . we'll gladly send samples for test. Chances are good that our Ferric Oxide "Know How" can save you considerable time and money. Address Dept. 25, C. K. Williams & Co., Easton, Pa.

WILLIAMS
COLORS & PIGMENTS

C. K. WILLIAMS & CO.
Easton, Pa. • East St. Louis, Ill.
Emeryville, Cal.

P.S. We also produce IRN Magnetic Iron powders for the Electronic Core Industry, the Magnetic Tape Recording Industry and others. Write for complete technical information.

For Parts that must be
TAKEN OFF—PUT BACK—BUTTONED TIGHT

LION FASTENERS

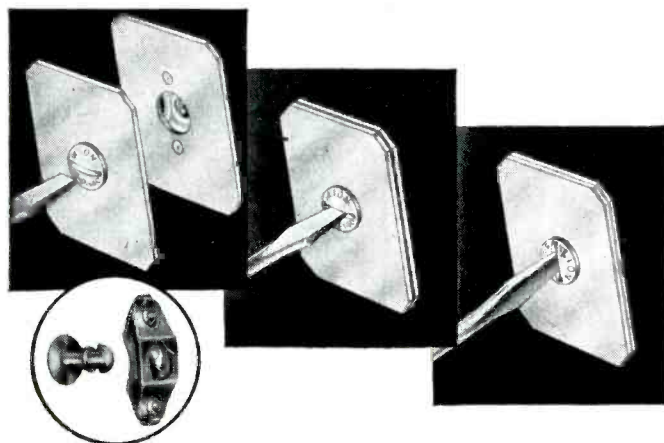

LOCKS TIGHT WITH A QUARTER TURN
Always at correct tension

Lion Fasteners are *right* for buttoning parts that must be removed repeatedly for inspection, maintenance, or other reasons.

Vibration and shock can't loosen a Lion Fastener. Even an inexperienced service man can't replace it wrong. A quarter turn opens it. Another quarter turn locks it. The tension is *designed into it*.

Lion Fastener Spring Assembly is quickly spot welded or riveted in place. The stud cannot be lost. It is grommeted tight to the sheet. They will button sheets .040 plus or .020 minus over or under standard rating. The misalignment is as much as .156. The one-piece forged stud is tested to 1425 lbs. Write today for demonstration kit and application data.

TYPICAL APPLICATIONS: INSPECTION PLATES • COWLING
 ELECTRICAL PANELS • CABINETS • DUCTWORK

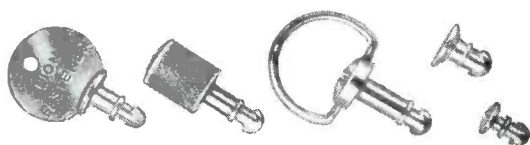

Free DEMONSTRATION KIT contains sample Lion Fasteners to help you visualize their adaptability to your product. Write on your company letterhead. No obligation.



L I O N
FASTENERS, INC.
 500 MAIN ST., HONEOYE FALLS, N. Y.
In Canada:
 A. T. R. Armstrong Co., 50 St. Clair Ave. West, Toronto

ment by Henry G. Riter, 3rd, Edison president.

Under the purchase plan, Measurements Corp., manufacturer of "Standard" high frequency electronic test equipment, becomes a wholly-owned subsidiary of Thomas A. Edison and will continue its operations under its present name and management.

Acquisition of Measurements' stock was made in exchange for 16,000 shares of Edison Class B common stock and an undisclosed sum of cash.

"Measurements Corp. puts Edison into an entirely new market, which is at the same time akin to its Instrument Division business," Mr. Riter said. "The purchase was made in keeping with Edison's policy of expansion in the fields of electrical and electronic equipment and instrumentation."

"The new purchase comes shortly after the liquidation of the lead-acid automobile battery business of Edison, which had proved unprofitable for a number of years. All businesses we now have meet our specifications of growth and profit potentials."

Measurements Corp. has a modern plant, built in 1948 at Boonton, N. J. and a smaller plant devoted entirely to government contract work at Succasunna, N. J. Principal customers are manufacturers of radio, tv and industrial electronic apparatus, university and commercial research laboratories and government agencies.

Other moves being contemplated by Edison at this time include stepped up production of Edison Voicewriting equipment and possible expansion of the company's Nickel-Iron Alkaline Storage Battery Division.

**General Precision
 Names Willis**

APPOINTMENT of H. Hugh Willis as director of advanced instrumentation for General Precision Equipment Corp. was announced by Hermann G. Place, company president.

For the past six years, Mr. Willis was technical director for Vitro Corp., where he guided the company's activities in the nuclear

DEPENDABLE *Miniature*
RADIO FILTERS

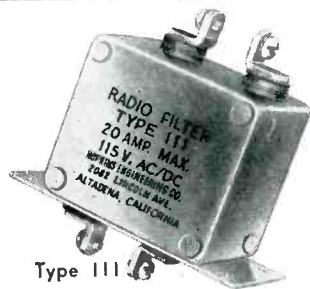

Type III

- Saves space!
- 115 V ac/dc, 20 amp.
- Excellent attenuation
- Feed through installation
- Flange mounting bracket
- Corrosion & fungus resistant

If you have radio interference problems, write or wire us, TODAY!

HOPKINS
Engineering Co.

FACTORY: 2082 Lincoln Ave.,
Altadena, Calif. SYcamore 8-1185
Offices in WASHINGTON, D. C.
and DETROIT

New Development
for ELECTRONIC EQUIPMENT



MEETS
ARMY, NAVY,
and
CIVILIAN
"SPECS"

**FUNGUS-PROOF
NYLON**

**LACING CORD and
FLAT BRAIDED TAPE**

Mold and micro-organisms need no longer impair the efficiency of the lacing cords and tapes used in your electronic equipment. For Heminway & Bartlett's Nylon Lacing Cords and Tapes are *fungus proof!* They have high abrasion resistance and low moisture absorption. Their finish has the desirable malleability of wax and is non-toxic to humans. Samples gladly sent on request.

The Heminway & Bartlett Mfg. Co., 500 Fifth Avenue, New York 36, N. Y.
Sales Offices: Chicago, Boston, Philadelphia, St. Louis, Cincinnati, San Francisco, Charlotte, Gloversville. Foreign Agent: Turner, Halsey Co., Inc., 40 Worth St., New York, N. Y. Cable Address: THECOTEX

HEMINWAY & BARTLETT

PHAZOR NULL METER
Pat. Pend. MODEL 100A



\$229.50 F.O.B. New York, N. Y.

A phase sensitive null detector wherein noise and harmonic voltages are effectively eliminated.

- For use in conjunction with bridge and potentiometer circuits.
- Simplified and precise zeroing of synchro devices.
- Allows separate adjustment of phase and magnitude in null circuits.
- Eliminates the necessity for filters.

SPECIFICATIONS

Input Impedance
High Gain—2 megohms shunted by 30 mmfd.
Low Gain—2.5 megohms shunted by 15 mmfd.
Sensitivity—6 millivolts off-scale deflection
Frequency Range—30-10,000 cps (higher ranges available)
Selectivity 40 db. down on all noise & harmonics
Reference Input Power—10 milliwatts
Maximum Input Voltage—125 volts RMS
Peak Input Voltage—400 volts
Power Supply—105-125 volts, 60 cps, 25 watts
Dimensions—Hgt. 9 in., Width 15 in., Depth 8 in.
Weight—25 pounds

INDUSTRIAL TEST EQUIPMENT CO.
55 EAST 11th ST., N. Y. 3 - Tel: GR. 3-4684

Specification Coils

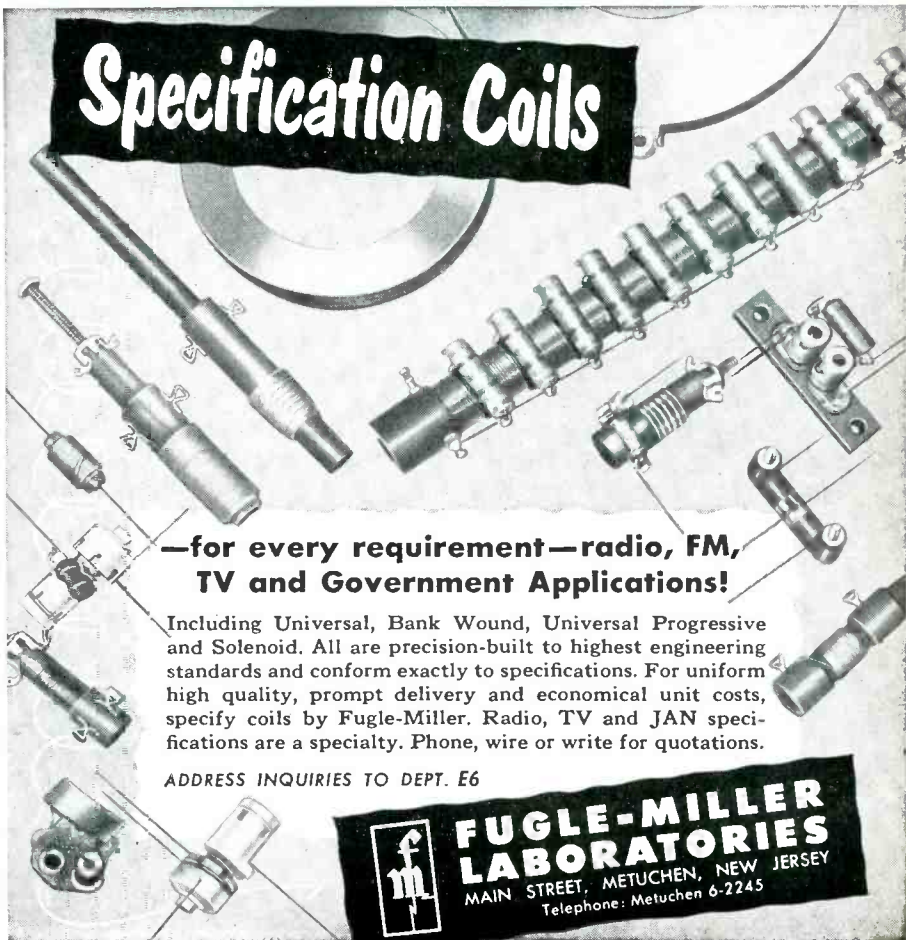

—for every requirement—radio, FM, TV and Government Applications!

Including Universal, Bank Wound, Universal Progressive and Solenoid. All are precision-built to highest engineering standards and conform exactly to specifications. For uniform high quality, prompt delivery and economical unit costs, specify coils by Fugle-Miller. Radio, TV and JAN specifications are a specialty. Phone, wire or write for quotations.

ADDRESS INQUIRIES TO DEPT. E6

**FUGLE-MILLER
LABORATORIES**
MAIN STREET, METUCHEN, NEW JERSEY
Telephone: Metuchen 6-2245

VECO

ANALYSIS CELLS

PLANTS AND PEOPLE

(continued)

A new type of analysis cell that utilizes extremely sensitive glass coated VECO THERMISTORS for analyzing and reference elements.

Unaffected by corrosive gasses, liquids, and residues, which quickly throw old style open-wire elements out of calibration, these VECO CELLS are adaptable to a wide variety of uses, and combine simplicity of operation with a degree of efficiency heretofore unobtainable.

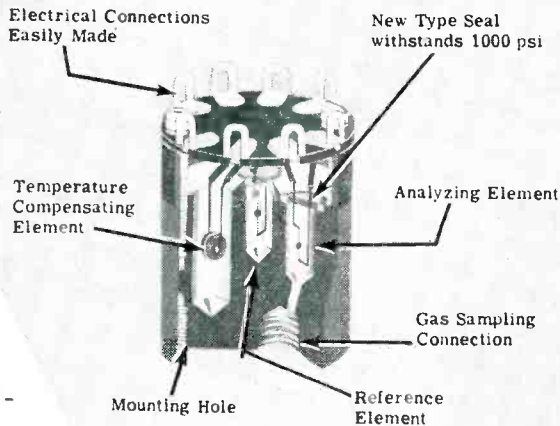

VECO ANALYSIS CELLS provide new efficiency for • instrumentation • gas analysis • combustion study — for • chemical research • hospital and college laboratories • food storage protection — cells designed and manufactured to your specific requirements.

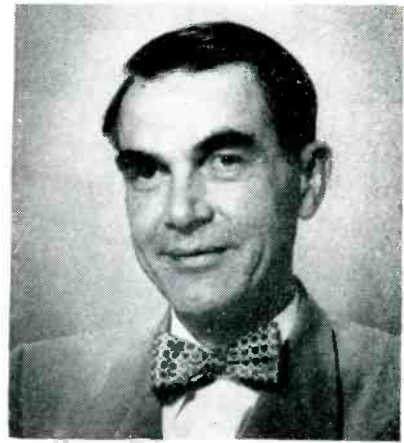

H. Hugh Willis

energy program and other highly technical and secret work for the Armed Services. Prior to that, he was vice-president for engineering and product development of Ever-sharp, Inc. During World War II, Mr. Willis was vice-president of engineering of Sperry Gyroscope Co. and a member of the radar section of the National Defense Research Committee.

Mr. Place declared that the appointment of Mr. Willis was made "to co-ordinate within the corporation's several subsidiaries the important work of instrumentation, particularly in connection with atomic energy."

THERMISTORS

A request on your business letterhead will bring the VECO DATA BOOK describing Thermistors, their characteristics and applications.

VECO THERMISTORS are made and stocked in a wide range of resistance values - or can be produced in quantity to your exacting specifications.

Approved and accepted by Government Agencies.

Victory's staff of engineers and physicists are ready to recommend the proper VECO Thermistor for • vacuum manometry • oscillator stabilization • temperature measurement • flow measurement • temperature compensation • surge protection • radar power measurement • volume limiting • gas analysis - temperature control • time delay • voltage regulation, as well as for any other new or unusual measurement or control application. Write today!

- BEAD
- WASHER
- DISC
- ROD
- TYPES

Victory
ENGINEERING CORPORATION

Springfield Road, Union, N. J.

Tel. UNIONville 2-7150

Manufacturers of:
Varistors
Combustion Analyzers
Temperature Sensing Devices
Electronic and Thermal
Control Instruments

CBS Names Three Project Engineers

BERNARD M. DOVER, FRANK J. FROEHLICH and ROGER SOMERVILLE have been appointed project engineers at CBS-Columbia, it was announced by L. W. Kay, vice-president of engineering.

Mr. Dover who will work on tv receivers was previously head of the tuner engineering department of Emerson Radio. He also served as a project engineer on tv receivers at Loral Electronics and as a tv receiver development engineer for Viewtone Radio.

Mr. Froehlich who will work on military equipment was previously a project engineer for Sperry Gyroscope working on special electronic equipment for the Air Force. As a chief radio technician in the Navy and as an engineer with Hazeltine Electronics, he worked on radar equipment.

Mr. Somerville who has been named a mechanical project engi-

PIPELINE TO PRECISION



Model WWVR

Designed specifically to conveniently receive and make maximum use of all the Standard Frequency Transmissions of WWV without any special setup.

Send for complete specifications

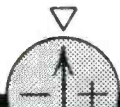

SPECIFIC PRODUCTS
5864 HOLLYWOOD BOULEVARD
LOS ANGELES 28, CALIFORNIA

Runzel CORD, WIRE & CABLE
PRECISION MADE WIRE
FOR *Quality Products*

The consistent quality standard of Runzel wire, cord and cable offers manufacturers complete assurance of performance. Runzel products undergo such thorough inspections in the process of their manufacture that flaws are reduced to an absolute minimum.

Your wire needs in hook-up, lead-in, shielded wire speaker cords and all types of insulated wire are available from this centrally located source. We maintain a complete engineering service. Your wiring problems are solicited. For their scientific solution, the Runzel Laboratory provides research assistance.



RUNZEL CORD AND WIRE CO.
4727 WEST MONTROSE AVE. CHICAGO, ILLINOIS



1st
1952

1st
1953

Produced for Sterkline Furniture Corp. — Fawn and Bear crib decoration in third dimensional technique.

Produced for Ed Lilly and Co. — oil paint re-creation of Florence Nightingale distributed in observance of hospital week.

Awards Made for Outstanding Merit and Distinction in Production of Decalcomania Lithography

For the second straight year the decal industry has been invited to compete in the Lithographers National Association Awards . . . and for the second straight year we proudly acknowledge the winning of FIRST PLACE by The Meyercord Co.

It is important to you to know that The Meyercord Co. has been honored by expert judges recruited from top levels of the graphic arts. When

you bring your decal transfer problem to Meyercord you are *sure* you will receive the counsel of carefully trained and experienced people . . . backed by the finest and most complete laboratory and production facilities available. Count on Meyercord for the *right* decal for *every* commercial surface and finish.

Your inquiry is invited—drop us a line and tell us about your problem.

THE MEYERCORD CO.

World's Largest Decalcomania Manufacturers

DEPT. J-303, 5323 WEST LAKE STREET
CHICAGO 44, ILLINOIS

FOR
MILITARY

Acme Electric

OR
AVIATION APPLICATIONS



All the experience of 35 years of transformer building is now available to west coast buyers of electronic and MIL-T-27 transformers thru our west coast engineering laboratories. Adequate facilities for designing quality transformers are available on your requirements.

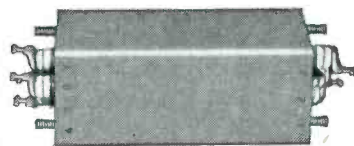

ACME ELECTRIC CORPORATION

MAIN PLANT: 319 Water Street • Cuba, N. Y.

West Coast Engineering Laboratories: 1375 W. Jefferson Blvd. • Los Angeles, Calif.

In Canada: ACME ELECTRIC CORP. LTD. • 50 North Line Rd. • Toronto, Ont.

Acme Electric
TRANSFORMERS

Many products... One Standard



**Instrument Quality*

There is one characteristic common to all Giannini instruments—they are built to rigid, instrument-quality standards. They are instruments with an earned reputation of offering the utmost in mechanical and electrical fineness—resulting from outstanding craftsmanship and rigorous calibration, testing and inspection procedures. Your job requirements can be met or exceeded by Giannini IQ instruments.

For catalog and engineering data on these and other fine instruments write:



ACCELEROMETERS
Linear Transmitting



ANGULAR TRANSMITTERS
Pitch, Yaw, Pitot Static

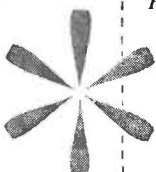

GYROS
*Free • Rate
Vertical • Directional*



POTENTIOMETERS
*Low Torque • Many
types and resistance
values*



PRESSURE SWITCHES
*Absolute • Differential
Gage*



PRESSURE TRANSMITTERS
*Absolute • Differential
Gage • (Resistance type)*



STEPPING POSITIONERS
*Intermittent Rotary
Power*



TEMPERATURE DEVICES
*For high or low
temperature*

**INSTRUMENTS
CONTROLS**

Giannini

G. M. GIANNINI & CO., INC., PASADENA, CALIFORNIA, EAST ORANGE, NEW JERSEY

neer on government assignments was previously assigned to military equipment design for Fairchild Recording, Reeves Instrument, Emerson Radio and other firms. He has been associated with the design and development of Navy Air Force fire control, radar and guided missiles.

Standard Coil Names Berne Fisher

THE APPOINTMENT of Berne Fisher as director of engineering for Standard Coil Products Co. was announced by Glen E. Swanson, company president. Mr. Berne, who holds a number of mechanical and electrical patents relating largely to tv equipment, had been associated with General Instrument Corp. for the past 18 years, most recently as chief engineer and production manager.



Berne Fisher

GE Continues Warehouse Growth

COMPLETION of a \$325,000 addition to the GE electronic tube warehouse and Eastern Regional Tube Department headquarters at Clifton, N. J., is scheduled for mid-September, Grady L. Roark, manager of marketing for the department announced.

"A greatly increased demand in the Eastern region for GE picture tubes, both as original equipment and as replacements, is the basic reason for the expansion," Mr. Roark said.

The new construction will add 46,000 sq ft to the existing 50,000

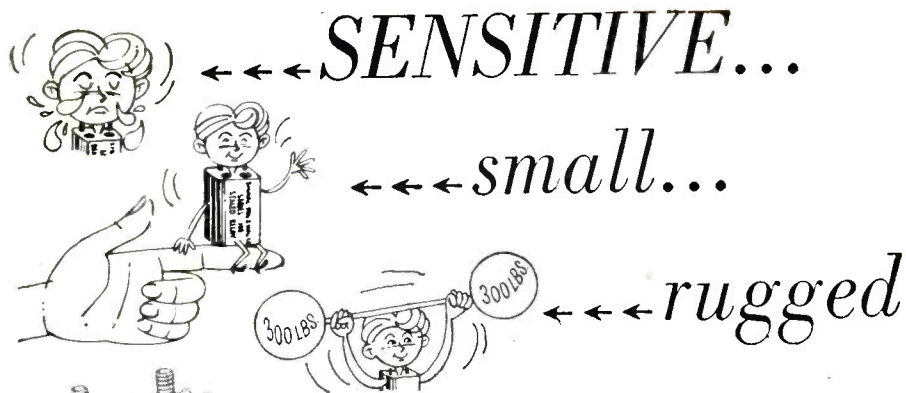

←←← **SENSITIVE...**

←←← *small...*

←←← *rugged*

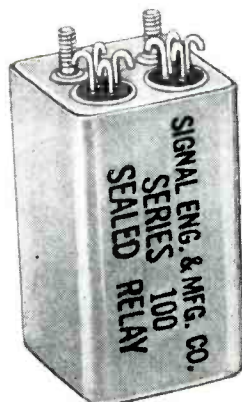

THE NEW SERIES 100 RELAY
(Hermetically Sealed)

One of the greatest challenges in the field of electronics is the designing of components small enough and rugged enough for today's and tomorrow's "miracle" machines and equipment.

The engineers of the Signal Engineering & Mfg. Co., always alert to this challenge, now offer the new Series 100 Miniature Relay which is among the smallest and most sensitive of the double-pole type. It maintains high precision under varying conditions and is ideally suited to such equipment as military guided missile controls which must withstand extremes of shock, vibration, and temperature.

DIMENSIONS

1"x1"x1 3/4"

Engineering Representatives in Principal Cities.

Write now for Bulletin SR-6



PRECISION INDEXING

up to **2400 PER HOUR**

MODEL 2243 INDEX MECHANISM

MODEL 2144A INDEXING MACHINE CHASSIS

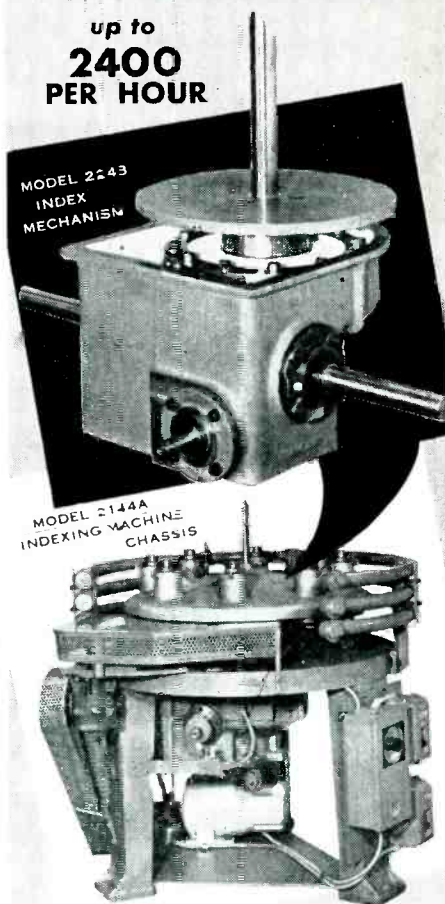

For the first time KAHLE makes available separately the index mechanism (Model 2248) with or without chassis (Model 2144A) which is capable of indexing at 2400 per hour! This is the heart of many famous machines whose ruggedness, precision and minimum maintenance requirements have made KAHLE a leader and name well known throughout the world in electronics and the glass industry.*

KAHLE's more than 40 years of experience have perfected these units—used in the electronics and glass industries in such applications as annealing, fire polishing, sealing, etc.—which are offered for installation on your own tables or incorporated in your own machines. Index mechanisms are available with 8, 16, 24, 30, 32 and 48 positions.

Particulars about special features of the indexing chassis... Dual-Motor Drive, Timer-Index Control, Automatic Head Stop, Universal Head Receptacles, etc... will be given gladly. Write KAHLE today for complete information.



WATCH FOR ANNOUNCEMENT OF A COMPLETELY NEW PRODUCT

SCOPE DOLLY Model 1

- Convenient Height and Viewing Angle
- Adjustable to Hold Portable Scopes
- Ball Bearing Swivel Rubber Tired Casters
- Lightweight Aluminum Construction
- Recommended by Laboratories Wherever Used

\$35.00 F.O.B. Louisville, Ky.

Formerly manufactured by UNIQUE DEVICES
Now manufactured and sold by

TECHNICAL SERVICE CORPORATION

1404 W. Market Street

Louisville 5, Kentucky

PIX

WIRE FORMING SPECIALISTS

Precision Parts to meet your Production and Engineering needs. From .002" dia. to .125" dia. Radio tube parts—Stampings—Drawings Modern facilities, high-production equipment.

Metal Crystal Holder Parts

Send sketch or print for quotation.

PIX MANUFACTURING CO., Inc.

24A Bedford St. Newark 3, N. J.



TANTALUM CAPACITORS ARE BASIC in current electronic trend.....

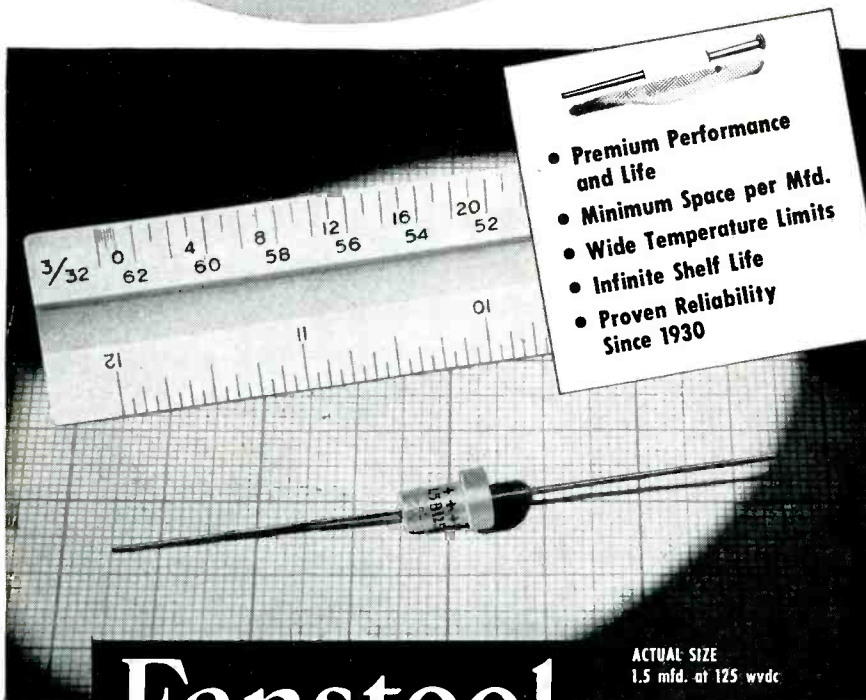

Fansteel TANTALUM CAPACITORS

Now, through the use of tantalum, new high standards of electrolytic capacitor performance are available. The tantalum oxide film is the most stable dielectric, chemically and electrically, yet discovered. As a result, Tantalum Capacitors offer advantages not found in any other electrolytic type—long life, space saving, wide temperature range, excellent frequency characteristics, no shelf aging.

Tantalum Capacitors are made by Fansteel and other leading capacitor manufacturers. Ask for current information bulletins on Fansteel Tantalum Capacitors.

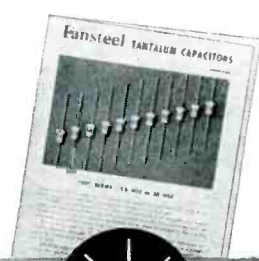

FANSTEEL METALLURGICAL CORPORATION
NORTH CHICAGO, ILLINOIS, U. S. A.
Tantalum Capacitors... Dependable Since 1930



32401C

sq ft of floor space in the warehouse. The completed total of 96,000 sq ft will give the Clifton building a "neck-and-neck" position as the world's largest electronic tube warehouse, along with the new GE Chicago tube warehouse recently opened.

Expansion of the Clifton warehouse will enable it to stock more than 30,000 tv picture tubes. The warehouse inventory also includes two million tv and radio receiving tubes and a complete line of industrial and transmitting tubes.

Besides the Clifton and Chicago warehouses, the GE Tube Department is constructing a new 25,000 sq ft tube warehouse in Los Angeles.

IT&T Merges U. S. Subsidiaries

STOCKHOLDERS of IT&T voted to merge the corporation's principal U.S. manufacturing and research subsidiaries with the parent company. The companies affected, which now become IT&T divisions, are: Capehart-Farnsworth Corp., The Coolerator Co., Federal Telecommunications Laboratories, Federal Telephone and Radio Corp. and Kellogg Switchboard and Supply Co.

Fraser Elected Head Of Astatic Corp.

GEORGE B. FRASER was elected president of the Astatic Corp. of Conneaut, Ohio, by the board of



George B. Fraser



SWEEPMASTER

Sweep Frequency Generators
give you these
outstanding advantages . . .

- Frequency Marker with an accuracy independent of Sweep Width. Inserted after external detection, it eliminates erroneous interpretation—eliminates possibility of undesirable transient distortion or limiting actions. The Marker is adjustable in amplitude and, after adjustment, remains independent of other controls.

- An attenuator whose performance is free of Frequency, assuring you that the Output

Envelope is the same as that indicated by the Internal Monitor.

- A simple switching operation to permit examination of either Envelope of the Swept Frequency Signal.

- Durable, compact, lightweight Output and Detector Probes, either of which can be detached easily and replaced by cables having standard connectors.

SPECIFICATIONS

MODEL	CENTER FREQUENCY	RF OUTPUT 50 ohm * TERMINATION	SWEEPWIDTH CONTINUOUS ADJUSTMENT	FREQUENCY MARKER
SM I	100 KC to 14 MC	1 volt RMS	150 KC to 14 MC	100 KC to 14 MC
SM II	500 KC to 50 MC	0.2 volt RMS	150 KC to 20 MC	500 KC to 50 MC
SM III	500 KC to 75 MC	0.1 volt RMS	150 KC to 20 MC	500 KC to 75 MC

FLATNESS: Less than 1 DB variation over maximum sweepwidth range.

FREQUENCY MARKER: Engraved calibration accurate to $\pm 2\%$.

HORIZONTAL DEFLECTION: A 60 cps sine wave for application to horizontal input of oscilloscope is supplied.

BLANKING: The RF signal may be operated con-

tinuously or blanked out for $\frac{1}{2}$ of each 60 cycle period.

EXTERNAL DETECTOR: Blocking capacitor of 400 volt breakdown capacity.

*75 ohm available when specified

MANUFACTURERS ENGINEERING & EQUIPMENT CORP.

15 Mill Road • Hatboro, Pa.

Cunningham
ESTABLISHED 1938

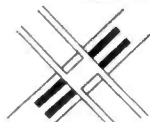

CROSSBAR

For details of
this truly
superior switch,
write

For broadcast studio master control and monitor switching of audio and video circuits . . . intercoms . . . telegraph . . . computers . . . many other applications.

Extreme flexibility. Fast and quiet switching with low crosstalk level. Any group of setups may be held intact while setting up others.

Provision for spot or remote control.

Model 10X10

Connects any of ten circuits in horizontal plane to any of ten vertical.



JAMES CUNNINGHAM, SON & CO., Inc. DEPT. E-9 ROCHESTER 8, NEW YORK

**Biggest
AUDIO
and
HI-FI
Event of
the Year!**

AUDIORAMA 1953

Presented by **THE AUDIO FAIR**

The annual event in the Audio field of utmost interest to Government and Military Agencies, Broadcast Engineers, Recordists, Sound-On-Film Men, Hobbyists, High Fidelity Enthusiasts, and Distributors and Dealers of Audio and High Fidelity equipment. The AUDIO FAIR is the largest and most concentrated exhibition of Audio Equipment held under one roof! Every up-to-the-minute development will be represented, seen and heard.

SPONSORED



*The General Public
Is Invited to Attend*

NO ADMISSION CHARGE

AUDIORAMA is presented by THE AUDIO FAIR
HARRY N. REIZES, Managing Director, 67 W. 44 St., N. Y.

TIME:
Oct. 14, 15, 16, 17

PLACE:
Hotel New Yorker
New York City
Registration On
5th, 6th
and 7th Floors

FERRANTI

TRANSFORMERS

HERMETICALLY SEALED

- Designed to MIL-T-27 specifications

- MIL-T-27 standard steel cases

- Rugged sealed terminals

- Core and coil securely anchored to mounting studs

- High vacuum impregnated

- Fully tested and guaranteed

These quality standard types are readily available and cover a wide range of specifications, set forth in detail in a new catalog.



Quotations submitted promptly on the above and all other types of transformers and reactors

FERRANTI

FERRANTI ELECTRIC, INC.

30 Rockefeller Plaza New York 20, N. Y.

HAMMARLUND CAPACITORS

with brass plates and soldered assemblies
Perform better... last longer!

Long, trouble-free service and continuous fine performance is assured when Hammarlund variable capacitors are used in your product. They can be wired in with the certainty that they will continue to function for the life of the equipment.

Here are descriptions of three capacitors that are built with the same sturdiness and quality that have made Hammarlund parts and equipment famous for more than 40 years. You can be sure your product design will meet the toughest specifications when it includes Hammarlund Capacitors.

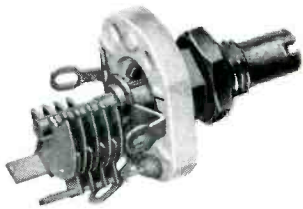

"MAC" CAPACITORS. The new miniature "MAC" was engineered to provide the low minimum capacity essential for use as a trimmer in the VHF range. Its silicone-treated base is only $\frac{3}{4} \times \frac{5}{8}$ inches. The rotor and stator are soldered assemblies of brass, silver-plated for low losses. Models are available with capacities ranging from 1.4 mmf to 19.6 mmf.

"MC" CAPACITORS. The "MC" is a versatile, single section tuning capacitor designed to give the user a choice of mountings, connections and capacity characteristics. The threaded brass front bearing and tapped aluminum end brackets permit panel or base mounting. A rotor stop permits 180° clockwise rotation for increasing capacity. "MC's" are available with capacities ranging from 5.5 mmf to 320 mmf.

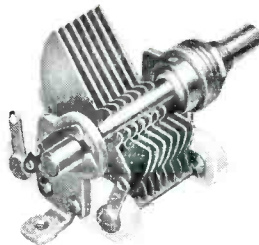

"VU" CAPACITORS. For those interested in VHF or UHF equipment, the "VU" offers a uniquely designed capacitor using completely original concepts. With it, conventional "lumped constant" circuits, rather than tuned cavity techniques, can be efficiently used up to 500 megacycles. Models are available with capacities ranging from 3.35 mmf to 45 mmf.

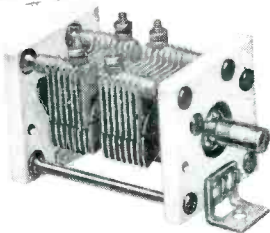

If you don't have your new Hammarlund Capacitor Catalog describing and illustrating these and many other standard parts in detail, write to The Hammarlund Mfg. Co., Inc., 460 W. 34th St., New York 1, N. Y., for one today. Ask for Bulletin T2.



HAMMARLUND

460 West 34th St. • New York 1, N. Y.

directors, following the annual shareholders meeting.

Mr. Fraser was formerly vice-president and general manager. He has been treasurer since he joined the company in 1936 and retains this title along with the top Astatic post.

Previous advancements include assistant general manager in 1944 and vice-president and general manager in 1950.

He is the third Astatic president since the company was established in the early thirties. Floyd W. Woodworth, one of the founders, was president until his retirement in 1950.

Andrew Promotes Executives

THE ANDREW CORP. recently announced the appointment of John S. Brown as director of engineering. He is a 10-year man with Andrew and is now responsible for all phases of its engineering and development program.

The company also announced the appointment of Lawrence R. Krahe as head of the advance development group. He is responsible for the administration of this group at the company's 420 acre antenna development center located at Orland Park, Ill.

Robert P. Lamons, formerly Eastern regional sales engineer for the company, has been appointed sales manager with headquarters in Chicago, Illinois.

Robert C. Bickel who managed the Andrew West Coast sales affiliate has been named to succeed Mr.



John S. Brown

"INDUSTRIAL" for ELECTRONIC COMPONENTS

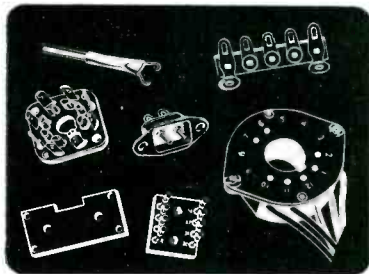

Precision engineered electronic components and connecting devices for all your needs.

- ANODE CONNECTORS
- INTERLOCK PLUGS
- LAMINATED TUBE SOCKETS
- TERMINAL STRIPS
- WIRED ASSEMBLIES
- BAKELITE STAMPINGS
- TERMINAL BOARD ASSEMBLIES

—NEW ITEMS—

- TUNER STRIPS, SOCKETS and BRACKETS for UHF

Our extensive design and production facilities are available for developing your special requirements and applications. Representatives in principal cities throughout U. S. A. Call or write for samples and information. ORegon 7-1881.



INDUSTRIAL HARDWARE Mfg. Co., Inc.
109 PRINCE STREET • NEW YORK 12, N. Y.

HICKOK

Model 640

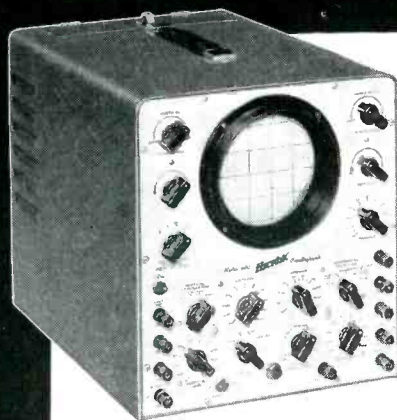

Laboratory Engineering
5" OSCILLOSCOPE

- DC amplifiers to 4.5 mc with 17 millivolt sensitivity.
- Calibrating voltages, triggered sweep, Z-axis modulation, light shield provided.
- Write for technical details . . .

THE HICKOK ELECTRICAL INSTRUMENT CO.

10527 Dupont Ave. • Cleveland 8, Ohio

NEW Model 220 WIDE BAND D.C. AMPLIFIER

INPUT IMPEDANCE: 1 Megohm shunted approx. 20 mmF for each single-ended or differential input; 2 Megohms shunted approx. 10 mmF for push-pull signals

FREQUENCY RESPONSE: d.c. to 100,000 cycles within 1 db. 6 db down at 200,000 cycles

MAXIMUM GAIN: 100 ± 10% for balanced or unbalanced inputs or outputs

INPUT ATTENUATORS: 100, 10 or 1 and "off" positions, independently in each channel

DC INPUT CONNECTIONS: Two posts for push-pull or differential, one post connected to ground; for single-ended signals, other input is disabled by setting attenuator to "off" position

AC INPUT CONNECTIONS: Arranged like DC connections; signal terminals connected to DC terminals through coupling condensers

OUTPUT IMPEDANCE: Approx. 250 Ohms single-ended, approx. 120 Ohms push-pull. Minimum load resistance; 250 Ohms

UNDISTORTED OUTPUT: 20 volts or 5 Milliampers (peak) max.

NOISE AND HUM: Below 40 microvolts referred to input

MOUNTING: Metal cabinet, 8" wide by 8" high by 13" deep

POWER CONSUMPTION: 120 watts from 115 volt 50-60 cycle, single-phase a.c. power line.



A precision instrument designed for use as a preamplifier in conjunction with cathode-ray oscilloscopes, vacuum tube voltmeters and other instruments.



Write today for descriptive literature on the Furst Model 220 D.C. Amplifier and other precision laboratory instruments.

FURST ELECTRONICS

3322 W. Lawrence Ave., Chicago 25, Illinois

If You Use...or Can Use
MOULDED OR FABRICATED

RUBBER

In Any Shape or Form

BUMPERS — BUSHINGS

CORKS — GROMMETS

VACUUM CUPS — GASKETS

SHEET — SLAB — SPRING

CYLINDER — WASHERS

SHEET — TUBING

EXTRUSIONS

LARGEST STOCK OF
SPONGE IN U.S.A.



3 decades of experience plus unexcelled laboratory and engineering service is at your command.

ATLANTIC's new comprehensive catalog is now available. Write for your copy today. No obligation.

ATLANTIC INDIA RUBBER WORKS, INC.

571 West Polk Street • Chicago 7, Illinois • HArrison 7-8290

NEW STEVENS THERMOSTAT

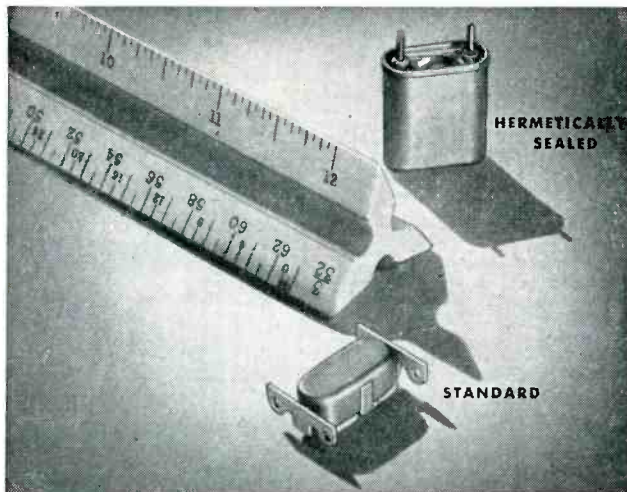

- close temperature control
- clean make and break
- fast response

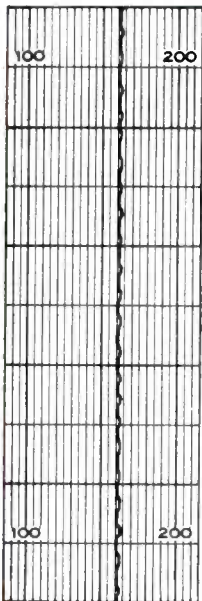

Compactly designed for use in communications equipment, electronic devices and apparatus demanding a high degree of temperature stability, Stevens Type C* thermostats feature an electrically independent bi-metal that responds *only to heat from controlled device.*

Typical temperature curve at left shows how this construction completely eliminates artificial cycling or life-shortening "jitters." Current flows readily through stainless steel or alloy contact spring . . . does not pass through high resistance bi-metal. Contacts open only when bi-metal overcomes spring pressure and friction of bi-metal strip against contact spring surface—for a clean, positive break.

Components are permanently riveted to dimensionally stable Alsimag base to further insure against erratic operation. Heavy-duty silver contacts assure long life.

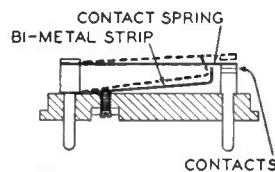

Standard and hermetically sealed Stevens Type C thermostats are carefully pre-calibrated in pots simulating actual service conditions; spot life-tests assure quality control. Specify Stevens Type C thermostats for closer temperature control—*longer life.*

A-2299

* PATENT APPLIED FOR

STEVENS manufacturing company, inc.
MANSFIELD, OHIO



Lawrence R. Krahe

Lamons as regional sales engineer. J. F. Moynihan takes Mr. Bickel's California post.

Peterson Joins AMF Engineering

ARTHUR V. PETERSON, formerly with the Atomic Energy Commission, has joined the staff of the vice-president in charge of engineering of American Machine & Foundry Co., it was announced by Morehead Patterson, AMF board chairman and president.

Mr. Peterson, who spent more than 10 years in the U. S. atomic energy program, will concentrate on the expansion of AMF's activities in the atomic energy field. AMF has designed and developed specialized electronic and mechan-



Arthur V. Peterson

ical equipment for the Savannah River Project and other atomic energy activities.

For the past six months, Mr. Peterson has served as a consultant with the Weapons Systems Evaluation Group of the Department of Defense. He became associated with the AEC as a civilian in 1947 when it replaced the Manhattan Engineer District, the U. S. Army agency responsible for the atomic energy program up to that time.

RCA Engineering Names Herbst

PHILIP J. HERBST has been named to head the communications engineering section of RCA Victor's Engineering Products Department and to direct engineering design and development of RCA two-way mobile radio communications and microwave equipment, it was announced by M. C. Batsel, chief engineer of the department.

Since 1951, Mr. Herbst has been technical administrator for standard products engineering at the Camden plant. His most recent assignment has been in connection with equipment for the transmission of television signals and multiplex communication of microwave relays.

Mr. Herbst joined the research department of the Victor Talking Machine Co. in 1927. Except for several years as a research engineer with GE and Farnsworth, he has been active in RCA Victor experimental broadcast work. From 1942 to 1946 he served in RCA's Princeton Laboratories.

Knight Named Federal Transmitter Head

APPOINTMENT of Gordon C. Knight as manager of the Lodi, N. J. Television Transmitter Division of Federal Telecommunication Laboratories was announced by the company. He succeeds Martin Silver, who resigned to enter the television broadcasting field.

Mr. Knight, assistant to the president of IT&T since August, 1952, will be responsible for the development and production of the division's complete television line.

Active in management and indus-

VICTOREEN'S VOLTAGE REGULATOR TUBES

Cover the Range from 50 Volts to 20,000 Volts.

A single voltage regulator tube may readily replace a complex and expensive regulating circuit. Investigate the advantages of a reliable, long-life Victoreen tube • for voltage regulation of power supplies • as voltage reference for control of higher currents • for voltage limiting to prevent circuit overloading • in voltage adjustment for fine control of precision power supplies. A single VR tube is space saving, too.

HIGH VOLTAGE REGULATORS 5000 to 20,000 Volts		Maximum current 1000 μ a Regulation 1.5% per 250 μ a
HIGH VOLTAGE REGULATORS 3000 to 5000 Volts		Maximum Current 250 μ a Regulation 5-55 μ a is 1.5%
HIGH VOLTAGE REGULATORS 400 to 2500 Volts		Maximum Current 100 μ a Regulation 5-55 μ a is 1.5%
GLOW TUBES 57 Volts		Maximum Current 800 μ a Regulation 200-800 μ a is 3.0%
ADJUSTABLE REGULATORS 645 to 705 Volts		Maximum Current 55 μ a Regulation 5-55 μ a is 3%

DISTRIBUTORS

- Allied Radio Corp., Chicago, Illinois
- W. D. Brill Co., Oakland, California
- Gifford-Brown, Des Moines, Iowa
- Harrison Equipment Co., Houston, Texas
- Industrial & Electronics Supply, Dallas, Texas
- Radio Shack Corp., Boston, Massachusetts
- Southeastern Radio Supply Co., Raleigh, No. Carolina
- Terminal Radio Corp., New York City, New York
- W. & W. Distributing Co., Memphis, Tennessee

WEST COAST REPRESENTATIVE

- Carlton Engineering Co.
- Los Angeles-San Francisco, California

EXPORT DISTRIBUTOR

- Terminal Radio Corp., New York City, New York
- Cable TERMRADIO

WRITE FOR FACTUAL DATA SHEETS ON THESE AS WELL AS YOUR OTHER COMPONENT REQUIREMENTS



The Victoreen Instrument Co.

3800 PERKINS AVE. • CLEVELAND 14, OHIO

NEW

the pioneer
is the leader



PANORAMIC MODEL G-3

For Research,
Development
and
Production
Test
Applications

Frequency Coverage:
2KC to 300KC

Center Frequency:
Variable and calibrated between 2KC and 200KC

Sweepwidth:
Variable and calibrated from 200KC down to OKC. Selected sweepwidth remains constant as center frequency is varied.

Amplitude Scale:
Linear or two decade log.
Amplitude range 50db overall.

Sweep Rate:
6.7 c.p.s.

Voltage Output:
2.5 volts, flat to ± 1.5 db

Internal Source Impedance:
600 ohms

Output Attenuation:
Toggle switch operated, 75 db with steps of 40 db, 20 db, 10 db and 5 db.

DIRECT READING ULTRASONIC RESPONSE INDICATOR

Used as an adjunct to the Model SB-7 Panoramic Ultrasonic Analyzer the G-3 permits simple rapid visual inspection of amplitude versus frequency characteristics of networks and devices between 2KC and 300KC.

The combination, a complete package, serves as a frequency sweep source and synchronous selective detector which insures indications of fundamental responses only.

Direct readings of frequency, amplitude, sweepwidth and center frequency are available from the calibrated dials and screen of the SB-7 Panoramic Ultrasonic Analyzer.

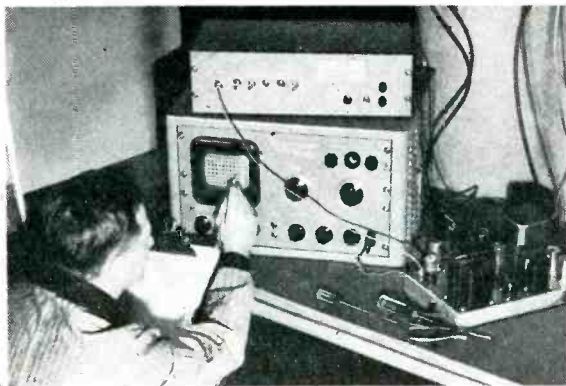

Our complete line of equipment will be demonstrated at the Electronics Conference Booth #116.

Write for complete information, price and delivery

10 SOUTH SECOND AVENUE,
MOUNT VERNON, NEW YORK

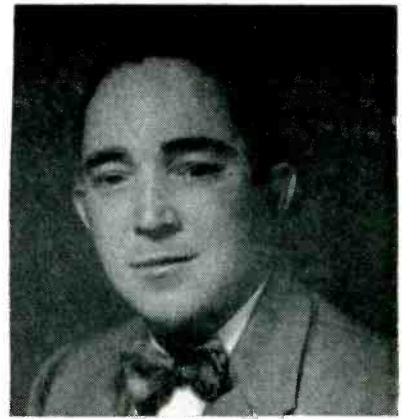

Gordon C. Knight

trial relations since 1941, Mr. Knight was formerly associated with IT&T's subsidiary, Capehart-Farnsworth Corp., serving successively as assistant to the president, division manager of research and development, and operations manager of the commercial products division.

Daystrom Makes New Moves

THE APPOINTMENT of Robert Erickson, vice-president of Daystrom Instrument Division to vice-president and assistant to the president of the parent company, Daystrom, Inc., was made by the board of directors.

In his new position, Mr. Erickson reports directly to Thomas Roy Jones, president. He will be responsible for working with the executives of the subsidiary companies in exploring products and fields for company expansions.

Plans were also announced for a new department of research and development by the chief engineer of the Daystrom Instrument Division, Nelson H. Mageoch. The initial project for the new department is the development of an amplifier for gun fire control equipment, which will use transistors and magnetic amplifiers instead of vacuum tubes.

The company recently received the Navy's stamp of approval on Daystrom's first Mark 56 gunfire control system. In addition to the acceptance of the first unit, Chief of the Navy's Bureau of Ordnance, Rear Admiral M. F. Schoffel, cited Daystrom Instrument for meeting its schedule on time. The Navy pointed out that the completion



Mark your own symbols, numbers, lettering, on your small parts, tools, identification and name plates . . . easily, simply, quickly . . . tracing from a master with the GREEN ENGRAVER.

Widely used in electronic and plastic fields, in machine tool shops and wherever permanent marking is needed. The GREEN ENGRAVER engraves equally well on metals, plastic, wood, hard rubber and glass.

✓ Fact-filled folder on request . . . showing how economies in costs, labor and time are achieved with the GREEN ENGRAVER.

✓ Routs ✓ Models ✓ Profiles ✓ Engraves Etching attachment and other special equipment for industrial uses are available.

Green Instrument Co.
INCORPORATED

363 PUTNAM AVE., CAMBRIDGE, MASS.
Visit us: National Instrument Exhibit, Booth 262

PULSE GENERATOR by MANSON

HIGH-FREQUENCY PULSE GENERATOR Model 570

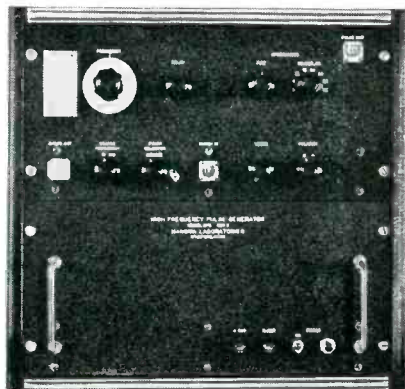

Pulse Rep. Rate: 200 to 200,000 cycles/sec. in three decade ranges, from an internal oscillator. May also be triggered from an external source.

Output Pulse: Height 0 to 150 V; width 0.5 to 30 μ s. Phaseable $\pm 2.5 \mu$ s with respect to the synch output pulse.

Polarity: Positive or Negative.

Impedance: Constant at 600 ohms.

Attenuation Control: Coarse (6-db steps), and Fine (0 to 8-db).

Maximum Duty Cycle: 50%.

The Model 570 High-Frequency Pulse Generator is designed to provide a source of variable-frequency pulses or square waves suitable for driving high-speed counters, checking wide-band amplifiers, modulating Klystrons, and testing or triggering other electronic circuits. It is an all-hard-tube unit, providing for long, trouble-free operation. The two 6AR6 output tubes can deliver 40 Watts of average power, and all power supplies are regulated. A blower insures low ambient temperatures for all components. Chest handles are provided for easy portability, and all components are readily accessible if service should be necessary. The equipment is conservatively designed to the highest commercial standards.

Write for Details and Prices
or tell us your requirements.

MANSON LABORATORIES

Industrial Control Devices —
Electronic and
Electro-Mechanical Instruments

207 Greenwich Avenue • Stamford, Conn.

for the ELECTRONIC INDUSTRIES

Quality

Ribbons STRIPS

**MOLYBDENUM
TUNGSTEN
TANTALUM
FORMED PIECES**

*Your Special
Metals Rolled
to Thin Sizes &
Close Tolerances*

YOUR INQUIRIES WILL
RECEIVE PROMPT ATTENTION

H. CROSS CO.

15 BEEKMAN ST., N. Y. 38, N. Y.
WOrth 2-2044 and COrtlandt 7-0470

Cosmic

**ELECTROLYTIC
and
PAPER TUBULAR
CONDENSERS**

CONDENSER
SPECIALISTS
SINCE 1923

FOR
A.C. D.C. SETS
PHONOGAPHS
etc.

COSMIC RADIO CORPORATION
853 Whittier St., Bronx, N. Y.
Phone LUdlow 9-3360

WAVEGUIDE BENDS . . . STANDARD or SPECIAL

E and H BENDS, ELECTROFORMED BEND
AVAILABLE UPON REQUEST • V S W R LESS
THAN 1.05 • SILVER and RHODIUM PLATED.

Waveguide Size	Radii in Inches			
	1/2	3/4	1	1 1/2
1/2 x 3/4	✓	✓	✓	✓
7/8 x 3/4	✓	✓	✓	✓
1 x 3/4	✓	✓	✓	✓
1 1/2 x 3/4	✓	✓	✓	✓
2 x 1	✓	✓	✓	✓

Send for additional data
and prices on this and
other Narda Series and
Models

The NARDA Line
INCLUDES:
Frequency Meters, Attenuators, Detectors, Mixers, Laboratory Test Equipment, Hi-Power Impedance Meters, Custom built Electronic and Micro-wave Equipment.

NARDA NASSAU RESEARCH & DEVELOPMENT ASSOCIATES INCORPORATED
66 MAIN STREET MINEOLA, NEW YORK
Subsidiary of PEERLESS INSTRUMENT CO., INC. GARDEN CITY 3-3570

MILWAUKEE TRANSFORMERS



**A TYPE FOR EVERY NEED
A PERFORMANCE TO EXCEED
EVERY DEMAND!**

Hermetically Sealed Components That Perform Superbly and Lastingly in Airborne and Ground Applications.



**WRITE
FOR FREE
BROCHURE**

AUDIO, POWER, PULSE TRANSFORMERS REACTORS — FILTER NETWORKS

Custom Engineered to rigid MIL T-27
government and commercial requirements.

MILWAUKEE TRANSFORMER CO.

5231 NORTH HOPKINS STREET
MILWAUKEE 9, WISCONSIN



marks one of the greatest transfers of engineering information in the history of Navy contracts. Previously, the system had been manufactured by GE. Daystrom began the contract in 1951 with 26,000 blue prints furnished by GE and starting from scratch, completed the first unit last June.

Tannoy Plans Canadian Company

IN A MOVE to expand its methods of distribution in North America, Tannoy, Ltd. plans to form a company to operate in Canada. The English company, which specializes in the field of acoustic engineering, has completed installations in the Houses of Parliament of England and Canada, in the United Nations Headquarters and for the recent Coronation of Queen, Elizabeth II. It is expected that the new Canadian company will be in operation shortly.

Ganzenhuber Joins Hughey & Phillips

JOHN H. GANZENHUBER has been elected vice-president and general manager of Hughey & Phillips, tower lighting division, with headquarters at the company's Burbank, Calif. plant. He recently resigned as manager of the government contracts division of Hoffman Laboratories.

He has been associated with Standard Electronics Corp. as vice-president and with Western Electric Co. as manager of broadcast



John H. Ganzenhuber

sales and assistant manager of government sales.

Mr. Ganzenhuber, in addition to assuming management of engineering and production of the tower lighting division, will supervise new product development. According to M. S. Phillips, president, the company will undertake to expand into allied fields, as well as further develop its present line of tower lighting specialties and electronic controls.

Raytheon Names Three Assistant Vice-Presidents

C. R. HAMMOND AND O. P. SUSMEYAN, have been named assistant vice-presidents of Raytheon's Receiving Tube Division, and W. M. Thompson has been appointed an assistant vice-president of the Power Tube Division.

Mr. Hammond was with the Ken-Rad Tube Co. from 1933 to 1945, when he joined Raytheon. Since that time he has served with the receiving tube division in various sales capacities and since 1950 as equipment sales manager.

Mr. Susmeyan was associated with the Champion Lamp Co. from 1928 to 1940. He then joined RCA Victor Tube Department leaving in 1942 to join Raytheon's receiving tube division. In 1950 he was named plant manager. In his new position he will also manage receiving tube manufacturing.

Mr. Thompson who has been with Raytheon for nearly 24 years started out as an office sale engineer and for many years directed purchasing of the Receiving and Power Tube divisions. One of the first organizers of the Power Tube Division, he is now responsible for all of the division's manufacturing operations.

Teletronics Makes Expansion Moves

TELETRONICS LABORATORY has recently completed construction of a new engineering building located adjacent to the manufacturing plant in Westbury, L. I., N. Y. The new building provides facilities for offices, laboratories and drafting department.

Charles W. Barbour, Jr. has re-

NEW! ENGRAVED

Vinylite INSPECTION STAMPS

are better than
rubber 3 ways

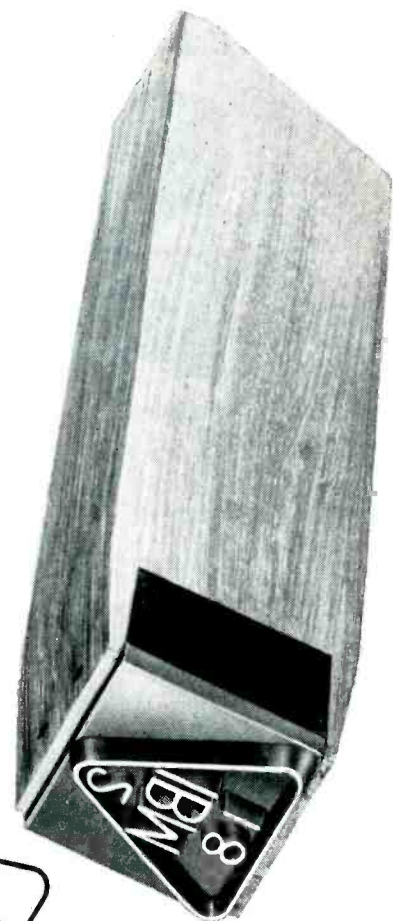

ENGRAVED Vinylite IS ACID-PROOF

Acid etching inks, used for permanent stamping on metal and all non-porous surfaces will eat away at rubber. Vinylite resists this action—gives longer life by far!

ENGRAVED Vinylite STAMPING GIVES RAZOR-SHARP IMPRESSIONS EVERY TIME

Opaque inks will clog shallow rubber stamp faces rapidly. Our deep-molded engraved VINYLITE stamp faces have more than three times the depth of ordinary rubber stamps. Markings always remain super sharp . . . an important advantage since this mark is a permanent record of your inspector's approval.



ENGRAVED Vinylite HAS CUSHION-LIKE RESILIENCE

Our VINYLITE molding process includes a timed curing that imparts to this versatile plastic all the elasticity of rubber. Resilient VINYLITE resists abrasive action, conforms to irregular surfaces . . . and lasts much longer!

Engraved Vinylite stamp faces are adaptable to any marking device. They can be used to stamp on every surface, metal, wood, fabric, paper, plastic, etc.

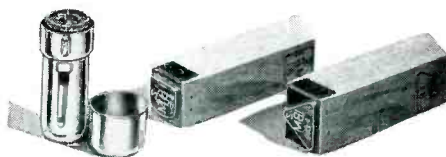

THE DURO-POCKET STAMP

THE PIN & PEG

Some of the many industries now using ENGRAVED Vinylite STAMPS

- AVIATION
- ELECTRICAL
- ELECTRONICS
- PLASTICS
- POTTERY & CHINA
- PACKAGING

KRENGEL MANUFACTURING CO., INC. Tel. CO 7-5714 Dept. 1
227 Fulton St., New York 7, N. Y.

Please check the following:

FREE Vinylite Sample & Price List

Please have salesman call for appointment

NAME

COMPANY

STREET

CITY

ZONE

STATE

D.E.A. Transistor CHARACTERISTIC PLOTTER

inc.



For oscilloscopic presentation of transistor

THREE FAMILIES OF CURVES DISPLAYED—

r_{22} r_{12} h_{12}

For Point contact PNP junction NPN junction Transistor

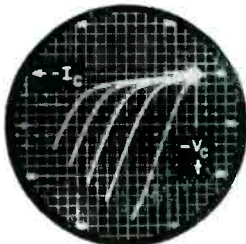

r_{22}

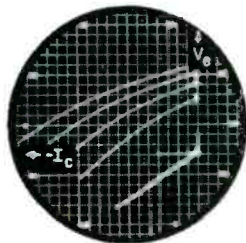

r_{12}

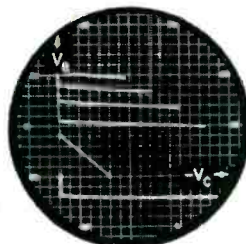

h_{12}

characteristic curves.

FEATURES

- Entirely electronic operation.
- No blanking — trace and retrace of each curve shown.
- Choice of common-base or common-emitter connection.
- Collector swept with triangular voltage waveform.
- Two sweep rates provided: 250 cps. (4 millise. per curve) and 25 cps. (40 millise. per curve).
- Choice of collector voltage polarity.
- Choice of input current-staircase polarity.
- One to 8 curves per family.
- Internally generated signal for calibrating oscilloscope display.
- Plug-in transistor sockets.

ADVANTAGES

1. 250 cps. collector sweep provides flicker-free displays for point-contact transistors, and for junction transistors in the common-base connection.
2. 25 cps. collector sweep permits tracing curves of junction transistors in the common-emitter connection.
3. Availability of two sweep speeds allows double check on curve splitting and anomalies.
4. Triangular collector voltage maintains traces of uniform intensity for easy viewing or photographic recording.
5. h_{12} display permits the determination of r_b for junction transistors.

SPECIFICATIONS

Transistor types accommodated: Point-contact, PNP junction, and NPN junction.

Displays: r_{22} (V_c vs. I_c ; I_{in} constant)

r_{12} (V_{in} vs. I_c ; I_{in} constant)

h_{12} (V_{in} vs. V_c ; I_{in} constant)

Test Connections: Common-base, common-emitter.

Input Current: Staircase waveform. Number of steps adjustable from 1 to 8. Selection of current step increments as follows: 1, 5, 10, 50, 100, 500 and 1000 microamperes. Choice of polarity.

Collector Voltage: Triangular waveform, continuously variable from 0-50 volts peak. Selection of repetition rate: 250 cps. or 25 cps. Choice of polarity.

Auxiliary Equipment Required: A good quality oscilloscope, preferable direct coupled, with at least 100 kcps. bandwidth and a minimum sensitivity of 50 millivolts rms. per inch in both amplifiers.

Mounting: Supplied in cabinet or ready for rack-mounting in standard 19" rack.

Finish: Gray baked enamel.

Power Requirements: 115 volts AC; 50-60 cycles; 200 watts.

Write for free Bulletin

D.E.A.
inc.

Dunn Engineering Associates inc.
11 Windsor Street, Cambridge, Massachusetts

PLANTS AND PEOPLE

(continued)

cently been appointed assistant chief engineer of the company. Mr. Barbour, who joined Teletronics in April, 1952, was formerly in charge of the radar development section, electronics department of the Glenn L. Martin Co. During World War II he was radar project engineer for the Submarine Signal Co.

Pacific Mercury Plans New Facility

PACIFIC MERCURY TELEVISION MANUFACTURING CORP. plans to start construction on a new 121,000 sq ft manufacturing, engineering and office facility, to be ready for occupancy the end of the year. It will be the first step in a four-year program scheduled to provide the company with 350,000 sq ft of plant on a 40-acre site.

Eventually all Pacific Mercury operations will be consolidated on the new site, including the research center recently moved from Santa Barbara, Calif. to the company's present Van Nuys plant.

Jensen Elected Head Of Trade Group

KARL W. JENSEN, vice-president of Jensen Industries of Chicago was elected chairman of the Association of Electronic Parts & Equipment Manufacturers, trade association of 120 midwest firms. He succeeds F. F. Florsheim of Columbia Wire and Supply Co.

Theodore Rossman, general manager of Pentron Corp., Chicago, was elected vice-chairman, the position formerly held by Mr. Jensen.

Helen Staniland Quam, distribu-



Karl W. Jensen



is this your timing problem?

Sorry! A. W. Haydon Company
Can't Help Your Timing Here.

Only a "pro" and practice can straighten you out!

But

We are the "pro's" for precision timing. Come to us with these timing problems. You'll find that we have solved more complex A.C. and D.C. timing problems than just about anybody else. Maybe we have already solved yours. It costs you nothing to find out. Write for catalog.

The A. W. HAYDON COMPANY
235 NORTH ELM STREET
WATERBURY 20, CONNECTICUT
Design and Manufacture of Electro-Mechanical Timing Devices

KELLOGG

MIDGET
Condenser
Microphone

Check These Features

- Uniform Dependable Response
- Exceptional Calibration Stability
- Laboratory and Industry-Proved Performance

For precision sound measurements! For high quality recording! Proved by sixteen years of reliable use by Industry. Fully satisfies the most exacting requirements of Laboratories for reliability, stability and accuracy. Send for full information today—NOW!

KELLOGG

Magnetic Impulse
Counter

- The long life normal to relay equipment!
- Occupies space of only two telephone relays!
- Operates over same wide range of pulse ratio and frequency as a chain of counting relays!

Simple! Saves Space! Saves Money! . . . Wide application to many fields—from industrial control to any system where trains of impulses, such as generated by a telephone dial, are counted. Your letter-head will bring full particulars. Write now!

Whenever you have requirements for telephone terminating equipment for Microwave Systems, check with Kellogg—Ring-down and dial Selective Calling Equipment—Signalling Oscillators—Hybrid Terminations—Strap Attenuators—Line and Patching Jacks—Jack Fields.

KELLOGG

A Division of
International Telephone and Telegraph Corporation

KELLOGG SWITCHBOARD AND SUPPLY COMPANY
Dept. 26-1
Sales Offices: 79 W. Monroe St., Chicago 3, Illinois

"PERFECT..."

That's What Production Engineers Say about **DANCO COILS**

And, it's no accident, of course. The Danco rigid policy of attentive testing and inspecting every coil in all vital stages of production guarantees perfect performance. Send us samples or specifications with quantity requirements for our recommendation. No obligation!

- Form Wound
- Paper Section
- Acetate Bobbin
- Molded Coils
- Bakelite Bobbin
- Cotton Interweave
- Coils for High Temperature Application.

Also, Transformers Made To Order

THE DANCO ELECTRIC CO.
MAIN ST., WINSTED, CONN.

FIXED PAD ATTENUATORS

by **MICROLAB**

FREQUENCY RANGE .D.C.-3000 Mc.
ATTENUATION 2-60 db.
VSWR, D.C.-1500 Mc 1.10 max.
VSWR, 1500-3000 Mc 1.15 max.
IMPEDANCE 50 or 75 ohms.
POWER INPUT One watt max.
PRICE \$20.00-\$30.00
Write for complete catalog
Phone: South Orange 2-7422

MICROLAB 301 SOUTH RIDGEWOOD ROAD
SOUTH ORANGE, NEW JERSEY
COAXIAL COMPONENTS and TEST EQUIPMENT

the most economical way to FOCUS a TV tube

the original Focomag



CUTS RECEIVER COSTS BY ELIMINATING CENTERING AND FOCUSING RHEOSTATS. Also lowers cost of power transformer. Perfectly focuses 27", 21" and all smaller tubes having magnetic deflection. Highly efficient ring magnet uses only 1 oz. Alnico P. M.



NO HARMFUL EXTERNAL FIELD. Ring magnet is completely enclosed by the external shunt (an original Heppner design). This prevents the leakage field from having any magnetic effect on other components. Uniform field produced by ring magnet.

FLEXIBLE NYLON ADJUSTING SHAFT ELIMINATES BREAKAGE.

Picture-positioning lever. You specify mounting arrangement.

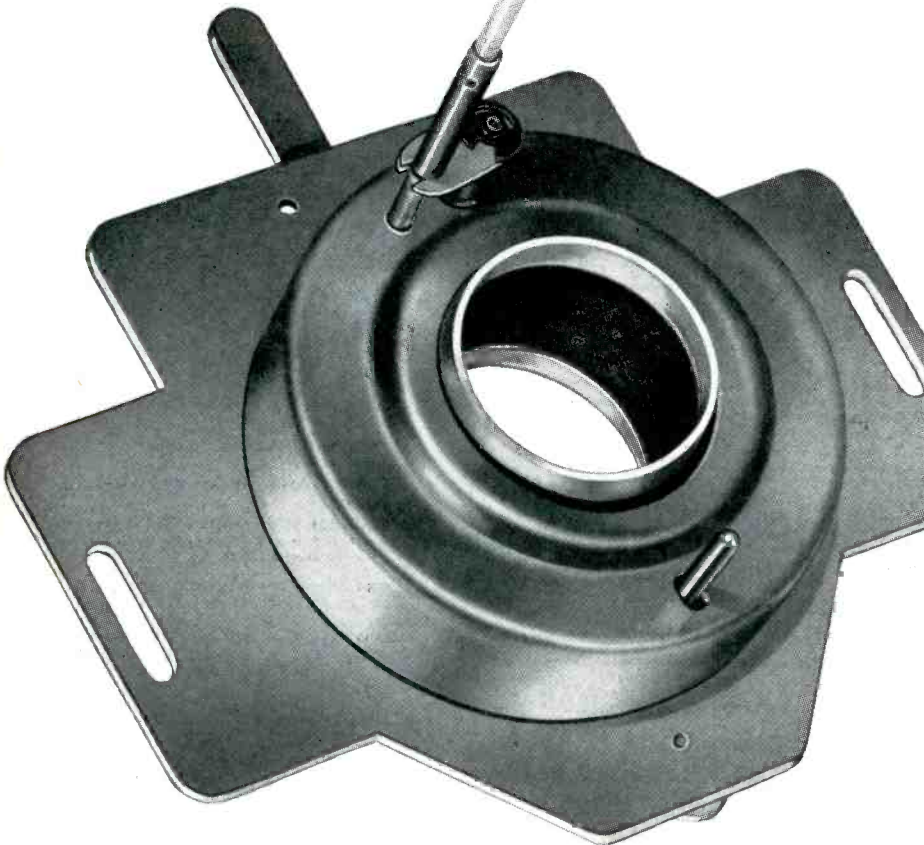

Write today for information on lowering your set costs with this FOCOMAG.

HEPPNER

MANUFACTURING COMPANY

Round Lake, Illinois (50 Miles Northwest of Chicago)
Phone: 6-2161

SPECIALISTS IN ELECTRO-MAGNETIC DEVICES

Representatives: **John J. Kopple**
60 E. 42nd St., New York 17, N. Y.
James C. Muggleworth
506 Richey Ave., W. Collingswood, N. J.
Ralph Haffey
R. R. 1, U. S. 27, Coldwater Rd.,
Ft. Wayne 3, Indiana
Irv. M. Cochrane Co.
408 So. Alvarado St., Los Angeles, Calif.

PLANTS AND PEOPLE

(continued)

tor sales manager of Quam-Nichols Co., was reelected treasurer of the association for her sixteenth annual term, and K. C. Prince was re-named executive secretary.

Mr. Jensen was also named EP&EM representative on the board of directors of the Radio Parts & Electronic Equipment Shows through which the association co-sponsors the annual Electronic Parts Show with four other trade groups. Jensen succeeds C. A. Hansen of Jensen on the board.

Brady Named Head Of Ferroxcube Research

APPOINTMENT of L. J. Brady as director of research of the Ferroxcube Corp. of America of Saugerties, N. Y. has been announced by W. W. Stifler, Jr., general manager. Dr. Brady will head up an expanded research and development program on both Ferroxcube ferrite materials and Magnadure non-metallic permanent magnetic materials.

He was formerly assistant manager of the process development department of the General Aniline and Film Corp. He was previously head of the technical service for the Air Reduction Co. and in charge of their research analytical and physics laboratories.

Cook Names Killian Publications Director

J. ROBERT DOWNING, director of the Cook Research Laboratories, Chicago, announced the appointment



Leo G. Killian

of Leo G. Killian as director of technical publications.

Since coming to Cook Labs in 1947, Mr. Killian has been in charge of the preparation of technical reports, overall project liaison and contract co-ordination. Immediately preceding his work with Cook, he was head planning engineer for Raytheon's Chicago Broadcast Equipment Division. He spent over ten years in engineering design, research and development with Hazeltine, Kellogg, Bell and Howell and Scott Radio.

In his new position, Mr. Killian will be in charge of all technical reports, engineering proposals, technical manuals, technical standards and publications relating directly to Cook Lab's products and research work.

**Ceramics Forms
New Department**



Irving J. Abend

GENERAL CERAMICS AND STEATITE CORP. of Keasbey, N. J., announced the formation of a new applications engineering department. The section will work out the new engineering problems arising from the rapidly broadening scope of uses of Ferramics, the soft magnetic core materials made by the company.

The department will be headed by Irving J. Abend who has had 17 years experience in the field. He was formerly chief engineer of the Freed Radio Corp. and has been associated with the electronics division of Air Associates, International Detrola Corp. and the David Bogen Co.

One Call for All...

NEW BRANCH
Just Opened!
NEWARK, N. J.
35 William St.

- Same Day Service
- Free Truck Delivery in 25 Mile Area
- Free Parking
- Hi-Fi Studios

Hudson
RADIO & TELEVISION CORP.

AUTHORIZED Distributors of All Standard Electronic Equipment and Components for Industrial and Laboratory Use... High Fidelity Sound Equipment

presenting

The Sensational New
low cost **RCA TV EYE**



**Remote Controlled
Closed Circuit
TV CAMERA**

AMAZINGLY compact camera, and ingenious control unit... hooked into any three channels of standard TV receiver, and plugged into AC outlet, these two precision-engineered equipments serve as closed-circuit television chain providing excellent results at remarkably little expense!

Compact, portable, easy to operate... RCA TV Eye introduces 20th Century technique of visual communication

- for greater efficiency
- for faster instruction
- for improved safety
- for better control
- for extra business

With RCA TV Eye it is literally possible to see without being present... to see where it was formerly too dangerous... or too inaccessible... or too time-consuming... or too exhausting... or just impossible!

**hundreds
of uses**

- IN SCHOOLS large group viewing of laboratory experiments or microscope slides.
- IN HOSPITALS to observe patients in special situations requiring continuous attendance.
- IN BANKS to compare signatures with original in bank's record room.
- IN PLANTS and factories. For protection of property... for remote observation of equipment.
- IN INSTITUTIONS for more effective and efficient surveillance.
- IN DEPARTMENT STORES to increase store traffic... to promote particular products.

makes closed circuit tv an everyday tool!

RCA TV EYE Camera, Control Box, Vidicon and 2" Lens	Net \$995.00
Accessories:	
Lens 1", F2.5	\$23.30
Lens 2", F3.5	\$21.50
Tripod	\$47.00

SPECIFICATIONS: Control chassis 14 lbs. Camera less lens 4.2 lbs. Cable 25 ft. 3 lbs. Camera 10 x 5 x 3 3/4". Control box 11 x 8 x 6" 90 watts power consumption.

AUTHORIZED FACTORY DISTRIBUTORS

Hudson

RADIO & TELEVISION CORP.

ELECTRONIC & SOUND EQUIPMENT

Adjoining Radio City
48 West 48th St., N. Y. 36

Phone: Circle 6-4060

Downtown New York
212 Fulton St., N. Y. 7

NEWARK, N. J.
35 William Street
Phone: Market 4-5151



Send for FREE CATALOG

Write for Giant New 1954 Hudson Complete Catalog, the "Buying Guide of the Electronics Industries".



Hudson Radio & TV Corp.,
48 W. 48th St., N. Y. 36 Dept. N-9

We are interested in items checked below:

- Send Giant New 1954 Hudson Complete Catalog
- Send Literature on RCA TV Eye
- Arrange for Demonstration of RCA TV Eye on our premises

Name

Firm

Address

City Zone State

Designed for

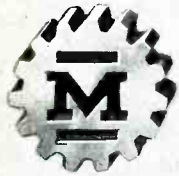

Application



**The No. 80070 Series
of
Cathode Ray Tube Bezels**

The MILLEN "Designed for Application" line of plastic and cast aluminum panel bezels includes units for the 1", 2", 3" and 5" tubes. The 5" size is also available with a special neoprene cushion for the new flat faced tubes as well as the standard cushion. The finish on all types, either metal or plastic is a handsome flat black. The 2", 3" and 5" sizes include a green plexiglass filter. Mumetal and nicoloi shields are also available for all types of cathode ray tubes for use with any of these bezels.

**JAMES MILLEN
MFG. CO., INC.**

MAIN OFFICE AND FACTORY
**MALDEN
MASSACHUSETTS**



NEW BOOKS

Electron Optics

BY O. KLEMPERER. *Cambridge University Press, New York, 1953, 459 pages, \$9.50.*

TO ALL intents and purposes this new edition, of a slight volume of barely one hundred pages published in 1938, constitutes an entirely new book. In it, the author has utilized his extensive experience in the application of electron optics in industry and university research to assemble material gleaned from some 500 literature references, as well as his own research, into a compendium covering practically every phase of the electron optics of stationary electric and magnetic fields.

Chapter Lineup

The book begins with brief chapters on basic principles of optics and electron optics, on the determination of the cardinal points of electron lenses, and on methods of field plotting and ray tracing in electric fields. More detailed descriptions of various types of electrostatic lenses and their properties follow. In the discussion of magnetic lenses the problems of field determinations and ray tracing are once more taken up. Aberrations are divided into geometrical aberrations (including the effects of component asymmetries) and electronic aberrations, covering chromatic aberration as well as relativistic, space charge and diffraction effects. The effect of space charge on the spreading of a beam as well as on virtual cathode formation is discussed in a separate chapter. Various types of electron emission systems employed in electron guns are treated in considerable detail.

This discussion of axially symmetric systems is followed by two chapters dealing with systems producing a line focus and deflecting fields. The first covers both true two-dimensional fields and "lipped lenses", whose electrodes are symmetrically distorted to produce a line focus instead of a point focus. The deflecting fields include cathode ray and particle spectrograph de-

HOW

Barnstead

PURE WATER

HELPS

RCA

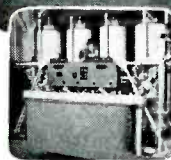
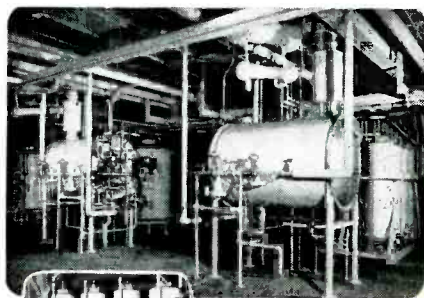

RCA requires Pure Water... copper-free to an extreme degree and free from organic impurities for trouble-free TV picture tubes. That is why RCA makes use of Barnstead 200 gph double-effect Stills in combination with Barnstead 1000 gph Demineralizers.

**LIKE RCA...
THOUSANDS OF
PLANTS THE WORLD
OVER MAKE USE OF
BARNSTEAD EQUIP-
MENT FOR OBTAINING
PURE WATER**

If you use water, in any of countless manufacturing and processing operations, you will find that Barnstead equipment producing either demineralized or distilled water, or both, will insure better products, consistent results, fewer rejects; and will cut your costs in many ways. Join the thousands of companies the world over who look to Barnstead for the solution to their Pure Water problems. Write today stating your problem. Our engineers will make recommendations without obligation... recommendations that will cut costs and increase production.

The Right Equipment for Your Pure Water Needs

B
75
Years of Progress
in
Pure Water

We Make Both... Stills and Demineralizers

1878 1953

Barnstead
STILL & STERILIZER CO.

84 Lanesville Terrace, Boston 31, Mass.

Want more information? Use post card on last page.
September, 1953 — ELECTRONICS

COMCO

Communications Systems
with *Customized* quality

Proven thru the daily operation of thousands of COMCO transmitters and receivers giving reliable service under all operating conditions.

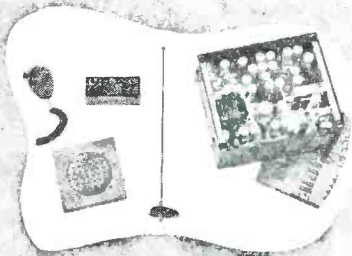

VHF-FM MOBILE PACKAGE A COMPLETE LINE OF TWO-WAY RADIO EQUIPMENT

- VHF-FM mobile and base stations
- Remote control equipment & relay stations
- VHF-FM two-way aircraft equipment
- Aeronautical ground station equipment
- VHF-AM mobile unit for airport vehicles
- VHF antennas and other accessories

For details contact your nearest COMCO dealer



Manufacturers of Radio and Electronic Equipment
COMMUNICATIONS COMPANY, INC.
CORAL GABLES 31, FLORIDA

FOR PUBLIC ADDRESS, RADIO, and kindred fields, **JONES** 400 SERIES **PLUGS & SOCKETS**

of proven quality!



P-406-CT



S-406-AB

Socket contacts phosphor bronze cadmium plated. Plug contacts hard brass cadmium plated. Insulation molded bakelite. Plugs and sockets polarized. 2, 4, 6, 8, 10, 12 contacts. Steel caps with baked black crackle enamel. Catalog No. 18 gives full information on complete line of Jones Electrical Connecting Devices — Plugs, Sockets and Terminal strips. Write



HOWARD B. JONES DIVISION
CINCH MANUFACTURING CORPORATION
CHICAGO 24, ILLINOIS
SUBSIDIARY OF UNITED-CARR FASTENER CORP.

ELECTRONICS — September, 1953

For SPECIFIED PERFORMANCE Specify JELLIFF RESISTANCE WIRE

COMPLETE CONTROL OF MANUFACTURE . . .

A WIDE RANGE OF EXPERIENCE . . .

A WIDE RANGE OF ALLOYS . . .

make JELLIFF the ideal source of
Resistance Wire to assure your Product's

Performance According to Specs.

*Precision resistors—rheostats—
relays—thermocouples—ohmmeters
—bridges—high-temperature fur-
naces can all benefit from the
PLUS-PERFORMANCE of
JELLIFF RESISTANCE WIRE*



Detailed Enquiries Welcomed. Address Dept. 25

ANOTHER BETTER TOOL...

for the ELECTRONIC ENGINEER and the RESEARCH SCIENTIST

A versatile instrument
for research involving
high repetition rates

MODEL B-2 PULSE GENERATOR

PULSE WIDTH: variable in 4 ranges from .2 μ s to 1,000 μ s
PULSE RISE TIME: .02 μ s
PULSE AMPLITUDE: \pm 80 volts open circuit
INTERNAL IMPEDANCE: 93 ohms
INTERNAL DELAYS: variable in 5 ranges from 0 to 10,000 μ s with respect to synchronizing pulse
INTERNAL REPETITION RATES: variable in 4 ranges from 10 cycles at 100 KC
SYNCHRONIZING PULSES: 5—Independently available at separate output jacks

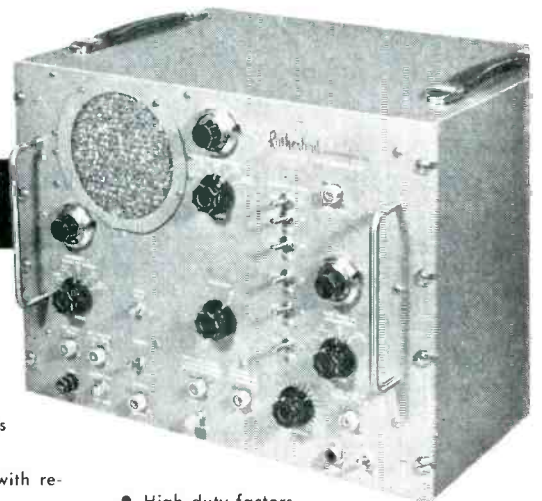

- High duty factors
- Can be triggered externally and for single pulse operation
- Calibrating potentiometers are provided for each range

Write for complete data: our Bulletin E-B-2

Rutherford **ELECTRONICS CO.** 3707 S. ROBERTSON BLVD.
CULVER CITY, CALIFORNIA

Want more information? Use post card on last page.

429

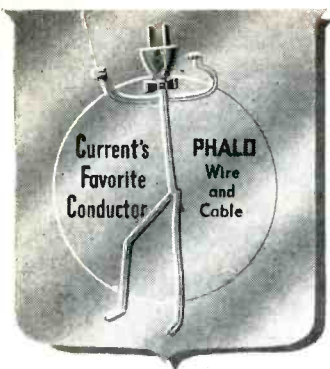

A
Standard
of
Quality



**CUSTOM-
MADE
CORD SETS BY
PHALO**

Just a short time back the custom-made cord set shown here did not exist! It was custom created and produced for a very special application by *PHALO*!

PHALO has an industry-wide reputation for designing and producing the unusual in cords and cord sets . . . and in so doing, solving the "unsolvable" problems!

See the *PHALOCORD* section of the new *PHALO CATALOG* for details. ASK FOR CATALOG.

ASK ALSO FOR THE NAME OF YOUR NEAREST *PHALO* SALES REPRESENTATIVE IN THE FOLLOWING CITIES:

New York, N. Y.
Rochester, N. Y.
Philadelphia, Pa.
Greensboro, N. C.
Wichita, Kansas
Natick, Mass.

Cleveland, Ohio
Houston, Texas
Phoenix, Ariz.
Chicago, Ill
Detroit, Mich.
Los Angeles, Cal.

San Francisco, Cal.

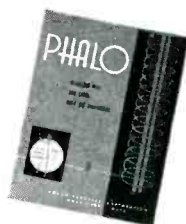

PHALO PLASTICS CORPORATION

CORNER OF COMMERCIAL ST. • WORCESTER • MASS.

Insulated Wire and Cables — Cord Set Assemblies

flecting fields. A last chapter, on applications of electron optics in industry and research, gives very brief descriptions of its uses in cathode ray tubes, television, photomultipliers, image tubes, electron microscopes, electron spectrometers and electron accelerators. The section on electron spectrometers is supplemented by an analysis of the derivation of velocity distributions from experimental measurements. Conversion factors and tables of relevant numerical constants are given in the appendix. One of the most valuable features of the book is the extensive bibliography at the end, to which all literature references in the text refer. There is no subject index.

Conclusions

In the main, the book is reportorial rather than systematic. Very largely, formulas and results are quoted without derivation. Presumably, the ground could not have been covered in the allotted space without this. At the same time, this procedure makes it more difficult to convey an overall understanding of the subject as well as to trace errors which can never be wholly avoided. In a few instances the reporting is obscure or inaccurate.

In the opinion of the reviewer, the book will be appreciated most by workers in the field of electron optics, as a guide to the extensive literature. The distribution of emphasis on the subject matter differs from that found in most books on electron optics. Indeed, a careful perusal is almost certain to reward the reader with information which is both novel and interesting. —E. G. Ramberg, *RCA Laboratories, Princeton, N. J.*

Vacuum-Tube Oscillators

By WILLIAM A. EDISON, *Stanford University. John Wiley and Sons, Inc., New York, 1953. 176 pages, \$7.50.*

THE COMING of age of the profession of electronics has been signaled, in recent years, by the appearance of books which dare to be frankly specialized, and no apologies offered. Before the war, publishers would have thought twice before printing a book that treated elec-

tronic circuits piecemeal. Today, with electronic practitioners numbering in the tens of thousands, we can welcome books like Professor Edson's "Vacuum Tube Oscillators" into the growing company of exhaustive treatises aimed not at electronic circuits in general, but at a particular class of circuit.

Oscillators are, of course, a rather broad class, and the author treats the subject broadly. Harmonic (tuned-circuit and resonator) oscillators, operating in linear and non-linear modes; relaxation oscillators; oscillators based on negative impedance (two-terminal) and on feedback (four-terminal); oscillators bearing famous names from Abraham and Armstrong to van der Pol and Wien; piezoelectric; magnetostrictive; free-running and synchronized; every type of oscillator this reviewer has ever heard of in twenty years (and many he hasn't) are to be found in this comprehensive book.

Author's Goal

The primary purpose of the book, which has been ten years in the writing, is to bring together under uniform terminology and units (MKS) the scattered literature of the subject, in a textbook suitable for senior and graduate students. The author has listed, and is evidently familiar with, no fewer than 352 references to books and periodicals, arranged in alphabetical order of authors' names and keyed into the text at every possible opportunity.

Organization of Book

The book is arranged in 18 chapters. A lucid introduction sets the stage, classifying oscillators by analogy to the amplifier with feedback and the clock. Then follow, in six chapters, treatments of transient behavior of linear circuits, negative resistance, non-linear oscillations, feedback and stability, resonators and linear oscillators. Two chapters covering 70 pages then take up practical harmonic oscillators, free-running and crystal controlled, respectively. Chapter 10 treats intermittent phenomena, useful in the super-regenerator, but a nuisance to be controlled in other applications. Op-

EXTRA-RIGID CONSTRUCTION IN MINIATURE MOTORS

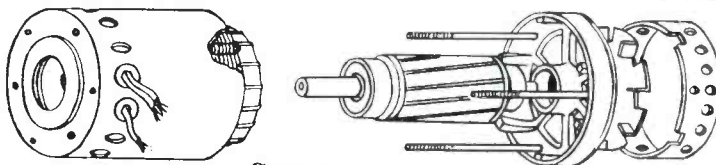

**Stainless steel thru-bolts
Rigid die-cast aluminum housing
Riveted stator**

These construction features, incorporated in all Air Marine sub-fractional horsepower motors, result in extra-rigid design that assures positive bearing alignment and uniform air gap. Even after repeated impact shock and vibration tests, motor performance remains unchanged. Motors are protected against humidity and fungus growth — can be mounted in any position — are equipped with ball bearings using suitable lubricants for high and low ambient temperatures — meet all AN specifications.

A NEW ENGINEERING DEVELOPMENT

The 50-800 cycle Type A15BF-15 Motor



Latest result of Air Marine design skill is the Type A15BF-15 motor, the first ever manufactured for operation over the entire frequency range from 50 to 800 cycles.

Motor is designed for operation on 115 volt variable frequency supply — has single winding, four leads, reversible.

Totally enclosed — available with or without fan or blower. Type A15BF-15 is designed for single phase operation — available for 2 and 3 phase operation also.

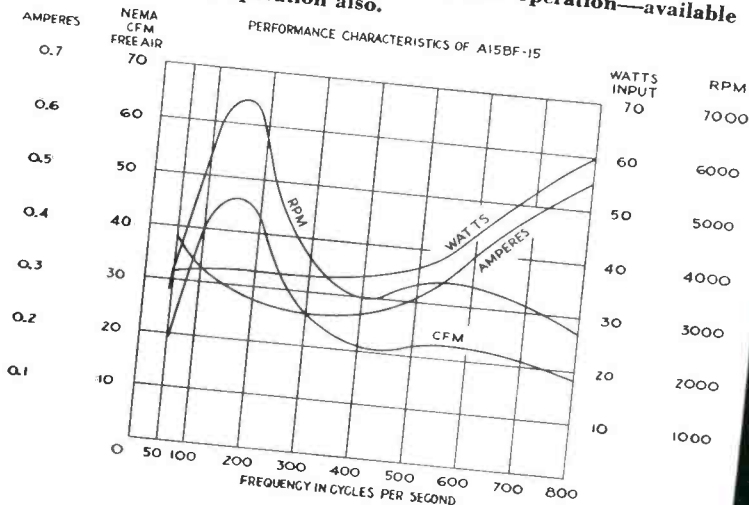

AIR MARINE

MOTORS INC.

3939 MERRICK ROAD, SEAFORD, L. I., N. Y.
SUset 5-7309

Send for Sub-Fractional Horsepower Motor and Application Folder and Engineering Assistance Form Number E100.

Want more information? Use post card on last page.

TERMALINE COAXIAL LOAD RESISTORS

50 ohms DC to 4000 mc—5 watts to 2500 watts

The constant resistance (Low VSWR) of the TERMALINE resistor make it the ideal dummy load and standard resistor at UHF and VHF. Design is such that normal reactance is put to work producing a pure resistance over an extremely wide frequency range. Acting as a "bottomless pit" for RF energy, thousands of TERMALINE units are in daily use with high frequency transmitters.

Model	Cont. Power Rating	Input Connector
80F	5 watts	UG-23B/U
80M	5 watts	UG-21B/U
80A	20 watts	UG-23B/U
81	50 watts	UG-23B/U
81B	80 watts	UG-23B/U
82	500 watts	} Adaptor to fit UG-21B/U supplied
82A	500 watts	
82C	2500 watts	

Other adaptors or cable assemblies for any standard coaxial line available.

ALL TERMALINE units, except Model 82C, are self-cooled. Substantial quantity discounts.

LITERATURE UPON REQUEST

eration at high-power levels follows. Then come three chapters on relaxation oscillations, means of locking and synchronizing, frequency multiplication and division. The effects of noise (tube and circuit), which are often neglected in discussions of oscillators, occupy a short chapter. Chapters on modulation of oscillators, automatic frequency control and multiple resonance effects conclude the work.

The treatment is mathematical but not unnecessarily complex. Full use is made of diagrammatic analysis, such as the Nyquist method.

Opinion of Reviewer

At first glance, this may appear to be an expert's book written by an expert for the delectation of his peers. But this is not a fair evaluation. It is rather a comprehensive and uniform compilation of virtually all the known facts. True, it makes few concessions to the tyro. It provides no pat answers to such (urgent) questions as "what is the best circuit for the local oscillator in a television receiver, consistent with minimizing oscillator radiation?" Readers seeking guidance on such specific applications will be disappointed. But designers who have a specific oscillator circuit to deal with, and who wish to examine its behavior down to the roots, will do well to consult Edson as a start. If the answers are not there (it's a fair wager they will be), then there are always the 352 references to consult. As for students—those who take a graduate course based on this text can count on confounding their supervisors.—DONALD G. FINK, *Philco Corporation, Philadelphia, Pa.*

Advanced Mathematics in Physics and Engineering

By ARTHUR BRONWELL, *Northwestern University. McGraw-Hill Book Company, Inc., New York, 1953, 475 pages, \$6.00.*

IN REVIEWING another mathematical book (May 1953 *ELECTRONICS*, p 397-399) the reviewer characterized this Bronwell text as one of the several best books available for providing "the better undergraduate student, the graduate student, or the pro-



BIRD ELECTRONIC CORP.
1800 EAST 38TH ST., CLEVELAND 14, OHIO
TERMALINE Coaxial Line Instruments

NEELY ENTERPRISES
Hollywood • San Francisco
Albuquerque
EARL LIPSCOMB ASSOCIATES
Dallas • Houston

ELECTRONIC GLASS WORKING EQUIPMENT

For Radio, Television Tubes, Incandescent Lamps, Glass Lathes for Television Tubes

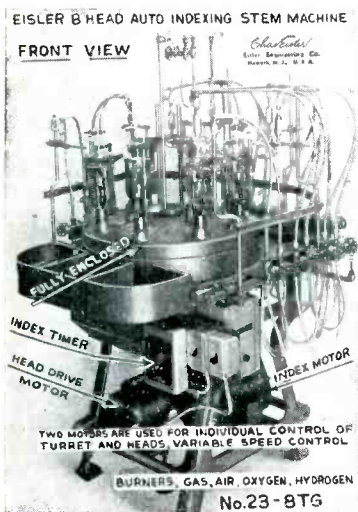

TURNTABLES

We make over 100 types of turntables; tilting models and positioners.

More Eisler Stem and Sealing Machines are in use in the Electronics Industry than all other makes combined. There is a reason: they are simple, well-built, compact, last long, have good production, and are constantly being improved to give more production.



EISLER B POSITION AUTO INDEX SEALING MACH. GENEVA DRIVE FRONT VIEW

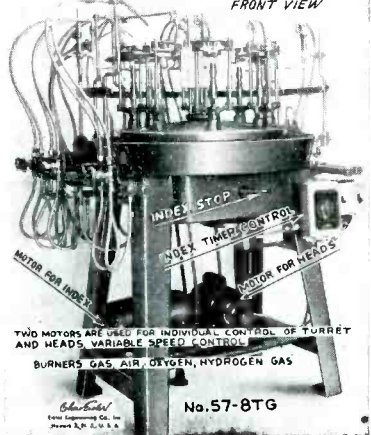

We make Transformers, Spot and Wire Butt Welders, Wire Cutting Machines and 500 other items, indispensable in your production. Eisler Engineers are constantly developing New Equipment. If you prefer your own designs, let us build them for you. Write to Charles Eisler who has served The Industry over 33 years.

Dr. Charles Eisler, President

EISLER ENGINEERING CO., INC.

751 South 13th St., Newark 3, N. J
Near Avon Avenue

fessional worker in the various domains of technology and applied science with a grasp of that content of mathematical analysis beyond the elementary calculus which is more or less essential to ready understanding and facile use of modern day theory."

Underlying Philosophy

In no small measure, the considerable merits of this text stem from the several principles adopted by the author in gestating it. These principles are most accurately stated through quotation from the author's excellently-written preface. Thus:

a. Comprehensiveness combined with a moderate degree of rigor: "It endeavors to present a reasonably comprehensive exposition of the branches of advanced mathematics which constitute the principal analytical methods used throughout physics and engineering. It is hoped that this will enable the student to gain broader horizons of knowledge and to acquire a higher degree of mathematical proficiency. To this end, clarity and understanding have been the foremost considerations, although a moderate balance of mathematical rigor has been sought."

b. Delineation of the common bases of physical phenomena: "It is the author's belief that the basic laws in many of the more important areas of physics and engineering can be expressed in very general form by a few fundamental mathematical formulations. These general formulations provide a broad perspective of the physical sciences and form the springboard for the development of vast areas of applications."

In this text an attempt has been made to develop the fundamental formulations in those fields which are the common ground of the physicist and the engineer. It is then shown how these simplify for special cases to the equations which usually form the starting point in the solution of problems in physics and engineering. Solutions of typical problems are included in order to provide concrete examples of the mathematical methods."

c. Stress of unity of mathematical



One stands out!

**Who's the best performer
of the miniature choppers?**

the "MIDGET"

Airpax chopper, by long odds!

THE RIGHT WEIGHT . . . weighs only 1.2 ounces!
THE RIGHT LENGTH . . . measures only 1.625" long!
**THE RIGHT DIAMETER755" and will fit a 7-pin
miniature shield base!**

THE RIGHT DESIGN FOR MAXIMUM PERFORMANCE!

Small size and big performance have won wide acclaim for the C747 MIDGET chopper. Available with SPDT contacts, a 6.3 volt drive for 400 cycle operation, usually a 380 to 420 cycle frequency range. Phase angle nominal 65°, dwell time of 135°.

AIRPAX
DESIGNERS PRODUCTS ENGINEERS
COMPANY
MIDDLE RIVER, BALTIMORE 20, MD.

Celco

Manufacturers of: TRANSFORMERS VARIABLE REACTORS MAGNETIC AMPLIFIERS

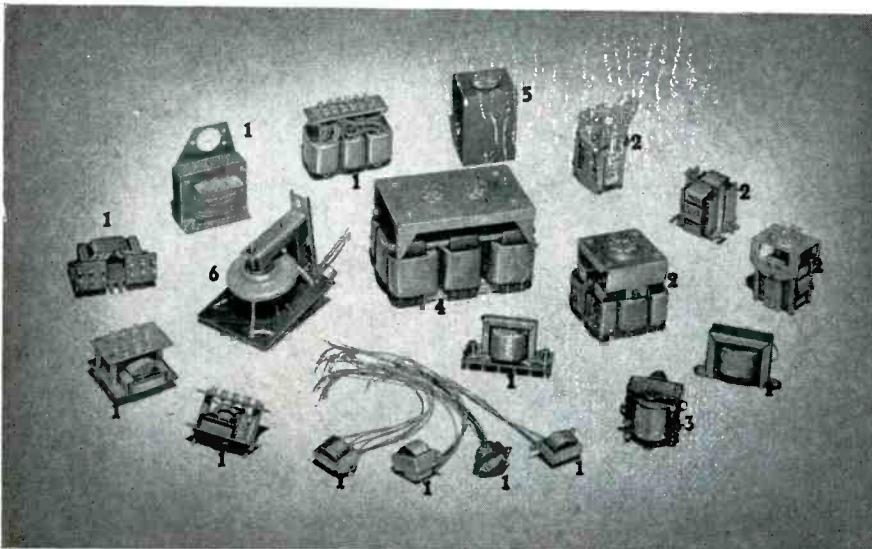

1. **OUTPUT, MATCHING, COUPLING, AND POWER SIGNAL 400 CYCLE TRANSFORMERS:** used where reliability and miniature size is required, such as control amplifying systems. Supplied with any special lead wires or terminations.
2. **DUAL MAGNETIC AMPLIFIERS:** all types used in latest 400 cycle aircraft control amplifiers for Servo Systems.
3. **VARIABLE REACTOR:** used today in tuned resonant circuits for vacuum tube voltage regulating systems. Suitable for experimental laboratory work where a HI-Q and wide range of inductance is required.
4. **TRIPLE MAGNETIC AMPLIFIER:** used in aircraft automatic pilots, by both the Army Air Force and Navy.
5. **HERMETICALLY SEALED TRANSFORMERS:** designed to conform to military specifications for hermetically sealed transformers, magnetic amplifiers and reactors.
6. **FLY BACK: HORIZONTAL OUTPUT AND HIGH VOLTAGE TELEVISION TRANSFORMER:** manufactured for extra quality performance at very low costs.

COMMERCIAL USE

Omni-Range; Dme; Line Course Computers; Automatic Pilots; Navigation; Transmitters and Receivers; Oil Burner Ignition; Fly Back; Vertical Output; Linearity Controls.

MILITARY USE

Servo Amplifiers; Adjustable Reactors; Transistor Magnetic Amplifier; Class H Transformers; Drone Control; Guided Missile; Voltage Control; Marine Control; Sonar; Celco Research.

Celco Gives Prompt Service—send us your requirements for our immediate attention.

Celco

Constantine Engineering Laboratories Co.

ISLAND AVENUE MAHWAH, NEW JERSEY

NEW BOOKS

(continued)

content: "Finally, anyone who has studied mathematical methods in physics and engineering cannot help being impressed by the strong underlying unity in the methods of mathematical analysis in many fields of physics and engineering. A course in advanced mathematics offers a unique opportunity to explore this fundamental unity in the mathematical methods. In this text an attempt has been made to develop the mathematical analysis of various fields along similar lines so as to emphasize this unity."

d. Prime focus on the dynamic state: "Throughout the text, emphasis has been placed upon applications in dynamics, rather than in statics. This is a recognition of the fact that most of the interesting and useful problems in physics and engineering are basically dynamic problems. Also, experience has shown that a student who has mastered the analysis of problems in dynamics usually experiences little difficulty in solving comparable problems involving statics, whereas the converse is not often true."

Chapter Headings

The major content of the text is best epitomized through statement of the headings of the seventeen chapters: namely, Infinite Series; Complex Numbers and Hyperbolic Functions; Fourier Series and Fourier Integral; Ordinary Differential Equations; Series Solutions of Differential Equations—Bessel and Legendre Equations; Partial Differentiation; Elastic Vibrations and Elastic Oscillations—Systems with Lumped Parameters; Vibration in Systems with Distributed Elements; Lgrange's Equations; Vector Analysis; Solutions of the Wave Equation; Heat Flow; Dynamics of Fluids; Electromagnetic Theory; Functions of a Complex Variable; Complex Roots of Polynomials and Dynamic Stability; Laplace Transformations. For the most part, each of these chapters closes with selected references and a well chosen set of problems. A partial set of answers to the latter and a detailed index of particulars terminate the text.

Bronwell's book is excellently planned, well knit in context, and

A NEW FAST 10mc SCALER (0.1 MICROSECOND RESOLUTION)

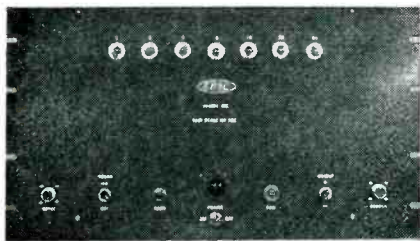

MODEL 410 SCALER

FEATURES:

1. **Resolving Time:** 0.1 μ sec.
2. **Maximum Continuous Rate:** 10^7 counts per second or 10 mc; no lower limit
3. **Interpolation:** Simple neon light indicators usually available only in slower Scalers
4. **Scale Factor:** Binary scale of 128 for maximum reliability

APPLICATIONS:

1. **Fast Nuclear Counting:** When used in conjunction with conventional slow Scalers (app. 10^5 counts per second); it extends their range to 10^7 counts per second
2. **High Frequency Measurements:** Extends range of 100kc frequency counters up to 10 mc.
3. **Time Interval Measurements:** Allows time interval measurements to an accuracy of 0.1 μ sec.

ELECTRICAL AND PHYSICAL INSTRUMENT CORPORATION

DESIGN, DEVELOPMENT AND MANUFACTURE
ELECTRONIC AND ELECTRICAL DEVICES

Sales and Business Office
25 West 43rd Street
New York 36, N. Y.
Telephone: Longacre 4-2265

Engineering Division
42-19 27th Street
Long Island City 1, N. Y.
Telephone: Stillwell 4-6389

SEALING
DIPPING
POTTING
IMPREGNATING



INSULATING
FUNGUSPROOFING
MOISTUREPROOFING
HEAT CONDUCTING

WAXES BIWAX COMPOUNDS

Developed and produced for manufacturers of electronic components and other electrical units.

Specifications and samples available on request.

Information relative to your problem or application will enable us to make suggestions and recommendations.

BIWAX CORPORATION 3445 HOWARD STREET
SKOKIE, ILLINOIS

ADJUSTABLE POLYSTYRENE PRECISION CAPACITOR

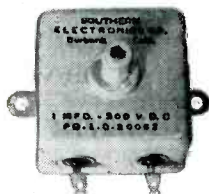

PAT. APPLIED FOR
NOW BEING USED BY LEADING ANALOG COMPUTER MFRS., including Reeves Inst. Corp.;
Goodyear Aircraft; Beckman Inst.; Jet Prop. Lab.; Electronic Associates.

SOUTHERN ELECTRONICS COMPANY

239 W. Orange Grove Ave.

Burbank, Calif.

CAPACITANCE AVAILABLE — 1 TO 10 UFD.
VOLTAGE AVAILABLE — 100 TO 400 VDC.
INSULATION RESISTANCE — 10^8 MEG./MFD.
TEMP. COEFF., 100 P.P.M. PER $^{\circ}$ C (-20° F TO 140° F)

NOMINAL TOLERANCE — 1% — CAN BE ADJUSTED
TO LESS THAN .1%

Ideal as **SECONDARY STANDARD** or
for **TEST EQUIPMENT**

TERMINAL BLOCKS NAVY TYPE



Shaw terminal blocks, produced to Navy specifications are now available from stock.

Supplied with complementary hardware if desired.

Shaw's reputation as an experienced custom molder assures you the highest quality precision-made terminal blocks.

Write to
Shaw today
for complete
specifications
and prices.



SHAW
INSULATOR
COMPANY

151 COIT ST., IRVINGTON 11, N. J.
SINCE 1892

SAVE WITH S.S. WHITE REMOTE CONTROL FLEXIBLE SHAFTS

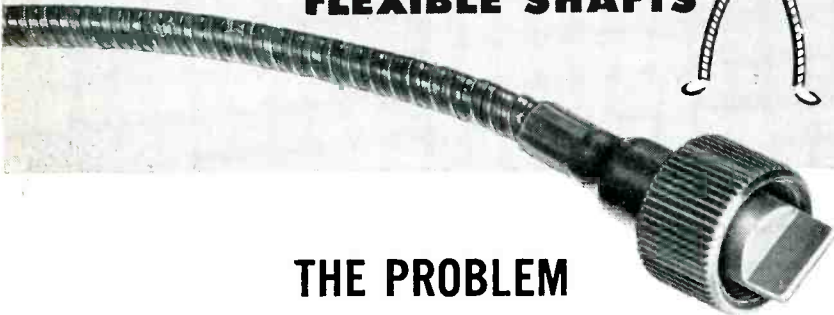

THE PROBLEM

ALIGNMENT, VIBRATION AND NOISE

A manufacturer of automobile radios had to provide a means of coupling the tuning and volume control knobs of the receiver with their respective circuit elements. In order to keep down manufacturing costs, the ideal control shaft would have to eliminate any problems of alignment, it had to dampen vibration and prevent noise caused by vibration from being communicated to the sensitive parts of the receiver circuit. For these reasons, the manufacturer chose —

THE LOW-COST SOLUTION

AN S.S. WHITE REMOTE CONTROL FLEXIBLE SHAFT

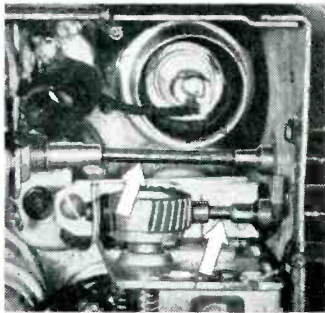

The flexible shafts **reduced assembly time and labor, eliminated alignment problems and provided 100% vibration-free performance.** In addition, it is apparent from the illustration that these coupling shafts give wide latitude in the placing of parts and make possible the most effective arrangement. It's savings

like these that make it well worth your while to investigate the economies of using S.S. White flexible shafts on your own remote control applications.

Valuable Flexible Shaft Information

This 256-page flexible shaft handbook will be sent free if you request it on your business letterhead. It contains full facts and data on flexible shaft selection and application.



THE S.S. White INDUSTRIAL DIVISION
DENTAL MFG. CO.



Dept. E, 10 East 40th St.
NEW YORK 16, N. Y.

Western District Office • Times Building, Long Beach, California

nicely done in detail. It comprises, with few exceptions, the prime content of those areas of mathematical knowledge which two decades of undergraduate and graduate teaching paralleled with some fifteen years of research experience have evidenced to the reviewer as among the most basic and useful to study by a student of engineering or applied physics who plans a career in research, development, or teaching. Yet again, the clarity of exposition, the nice balance between demonstrated rigor and stated reference thereto, and the self-containment of all pertinent detail render it an excellent text for self-study: say, by the practicing young professional who finds need of a better mathematical equipment than that he gained in the usual undergraduate curriculum, to keep abreast of the rapid development of analysis and theory in his field through a reading of the current periodical literature.

Level of Book

The plane of writing is well suited to the senior student, first-year graduate student, or well-equipped young practitioner. The exposition is superb: thus, conciseness of statement, completeness of detail and a generosity of well-chosen examples illustrative of the general theory are blended to yield an easily-read, fully-documented and self-instructing whole. The problem exercises are numerous, aptly-chosen and well-ranged from easy to fairly difficult. Advance of answers to only a part of these exercises enables assignment to the student of problems either with or without known answers, thus simultaneously provides for use by both types of teachers (those who do, and those who do not wish the student to have answers to assigned exercises) and by the self-study student who wishes to check on the accuracy of his analysis. The line drawings are excellently done; the equations are well displayed; the contrast between boldface and ordinary type is superlative. The almost total absence of misprints, the fine presswork, the sturdy and pleasing cover, and the other pertinent physical features indi-

cate the careful attention of the publishers to ease of use and reading by the student.

Errors and Discrepancies

Finally, it is to be noted that the text appears to be essentially free of gross errors in theory. Naturally, in a book which covers such a wide range of fairly complicated analysis a few discrepancies are certain to appear. Those stemming from typography are rather obvious and no doubt will be corrected in subsequent printings. However, the following generalities may well be directed to the attention of the reader:

(a) On page 313, in remarking the possible components of the current density J , the author mentions the displacement current density $J_d = \partial D / \partial t$ and the conduction current density $J_c = \delta E$ and sums these in (10) on page 314. It is desirable to mention also the convection current density $J_{cv} = \rho v$ which is the essential component (at least at the lower frequencies) in the interelectrode spaces of electronic tubes, and subsequently completely express J in (10) as the sum of the three.

(b) The definition on page 362 of "the branch from $2\pi n < \theta < 2\pi(n+1)$ " excludes the points on the branch cuts from lying in any sheet, hence anywhere in the Riemann surface! Obviously, this should be amended to "from $2\pi n \leq \theta < 2\pi(n+1)$ " or "from $2\pi n < \theta \leq 2\pi(n+1)$ " as one chooses. The former is the usual choice. Correspondingly, the rest of the text should be amended per this point.

(c) The heading of Section 16.2 on page 389 is somewhat mistitled; perhaps simply "Stability Criteria" would have been a better choice. For Theorem 2 is a continued fraction criterion that was formulated long after the work of both Routh and Hurwitz; and contrary to the statement on page 393, "known as the Routh-Hurwitz criterion", Theorem 3 is simply the well-known Hurwitz criterion (as set out in Reference 8 of page 413) while Routh's criterion is nowhere treated in the text. (The cited Reference 7 contains a good account on pages 210-231 of edition 6, reissue 1930.)

In general, however, the text is

MILO HAS THE SCOPE to handle all your industrial electronic component requirements

QUICK SERVICE
COMPONENT KNOWLEDGE

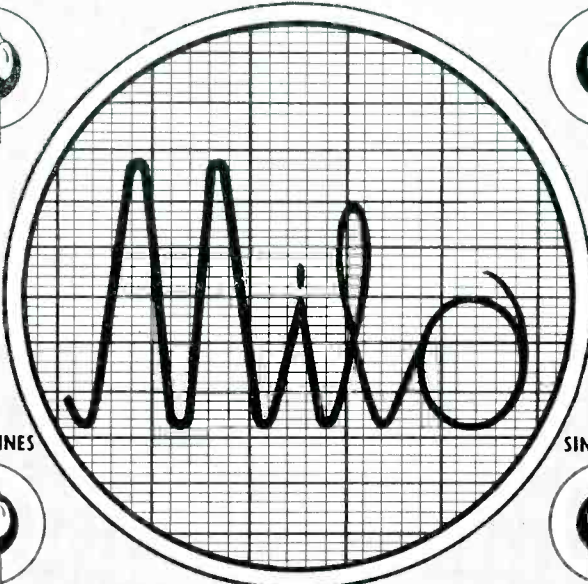

COMPLETE LINES

ALL COMPONENTS TEST INSTRUMENTS

IN STOCK

SINGLE SOURCE

TUBES, PARTS, METERS, WIRE, CHASSIS, PANELS, RACKS

EXPEDITED

LEADING BRANDS

VALUES 1 mmf to 5000 mfd
ALL TYPES

VOLTAGES 3 V. to 100 KV.
TOLERANCES JAN F TO JAN Y

COMPREHENSIVE CAPACITOR STOCK

TELEPHONE BE 3-2980
TELETYPE
NY 1-1839

LEADING BRANDS

VALUES 1 Ohm to 22 Megohms
Higher, in non-standard

WATTAGES 1/4 W to 1000 W
TOLERANCES .1% to 20%

RESISTOR "HEADQUARTERS"

JAN-TYPE COMPONENTS
LABORATORY USE
GENERAL USE

WRITE 200 Greenwich St. WIRE MILO WUX-NY

ALL TYPES

LEADING BRANDS

REGULAR SPECIAL PURPOSE

CRYSTAL DIODES

TUBE SELECTION

MILO RADIO & ELECTRONICS CORP. 200 GREENWICH ST., NEW YORK 7, N. Y.

Announcing NEW RCA "TV EYE"

- LOW-COST, CLOSED CIRCUIT TV CAMERA USES YOUR OWN TV RECEIVER
- AMAZINGLY SIMPLE AND EFFECTIVE UNIT MAKES CLOSED CIRCUIT TV AN EVERYDAY TOOL

Thousands of uses in every industry . . . and in banks, offices, stores, hospitals, institutions, homes, etc.

COMPLETE BASIC UNIT

(excise tax included where applicable; plus only incidental cost of hook-up cables, depending upon length.)

\$995.00

Available only from your RCA Distributor. Call or write MILO for descriptive pamphlet E-9.

MILO RADIO & ELECTRONICS CORP. 200 Greenwich St., New York 7, N. Y. BEekman 3-2980

Try Remler for Service-Tested
"Hard-to-Get" Components

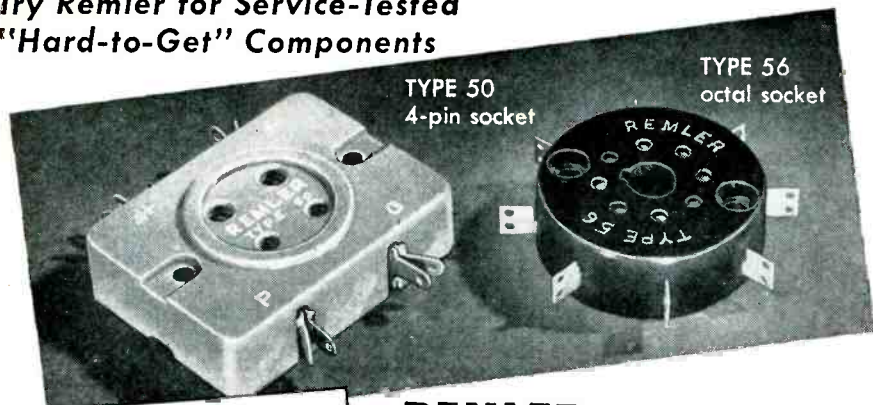

TYPE 50
4-pin socket

TYPE 56
octal socket

*Custom
Components*

Metal-plastic components designed and manufactured to order. Write for quotations specifying electrical and mechanical characteristics. Describe application. No obligation.

**REMLER
TUBE SOCKETS**

● STANDARD FOR 30 YEARS...
THE BEST IN THE INDUSTRY

Heavy duty phenolic sockets with high current wiping action contacts . . . for industrial, transmitter and test applications. Rugged. Years of tube insertions and withdrawals do not impair contact effectiveness. Black phenolic, low loss phenolic or alkylid.

Remler Company Ltd. 2101 Bryant St. San Francisco 10, Calif.

Since 1918 **Remler**
PIONEERS IN ELECTRONICS AND PLASTICS



**D. C.
POWER
SUPPLIES**

Rapid self-contained selenium rectifier power supplies required no warm up, no maintenance; have long life, even in continuous full-load service; are easy to operate, and are low in cost. For instance:

Model	DC Output		AC Input		Dimensions			Price
	Amp.	Volts	Volts	Cy.	High	Wide	Deep	
15A	15	0-6	110	60	8"	14"	8"	\$79.50
25A	25	0-6	110	60	9"	15"	9"	101.75
25D	25	0-24	110	60	12 1/8"	20"	13"	189.50
50B	50	0-10	110	60	12 1/8"	20"	13"	165.00

Other standard models are available with DC outputs from 1 to 220 volts; from 50 watts to 100 kw; and with regulation, ripple, and efficiency to meet your specifications. Ask for Catalog S. Phone: TAlmadge 8-2200

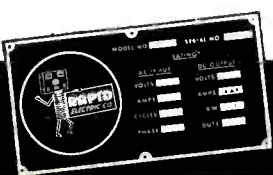

THE NAMEPLATE THAT MEANS "More Power to You!"

RAPID ELECTRIC CO.
2881 MIDDLETOWN ROAD, NEW YORK 61
distributors in major cities

remarkably free of error and be-speaks the author's breadth of knowledge and careful attention to accuracy.

In addition to the references cited in the text, the student who plans to master the content of the text, the practitioner who purchases it for self-study, or the teacher who adopts this book for classroom usage will find much valuable, complementary material in the following additional references, most of which have appeared since completion of the work under review. First, and especially, is to be noted that masterful work, not too well known to engineers, by H. Jeffreys and B. S. Jeffreys, "[Mathematical] Methods of Mathematical Physics," Cambridge University Press, edition 2, 1950. Next to be remarked is the unique text by B. Van der Pol and H. Bremmer, "Operational Calculus Based on the Two-Sided Laplace Integral," Cambridge University Press, 1950. Finally to be cited are several recent excellent books, which in most instances provide perhaps the best available technically-slanted modern account of those very powerful phases of analysis, indicated in their titles, which are becoming increasingly important analytical tools in modern electrical theory: I. S. Sokolnikoff, "Tensor Analysis: Theory and Applications," (1951); W. E. Milne, "Numerical Solution of Differential Equations" (1953); D. Hartree, "Numerical Analysis" (1952); Z. Nehari, "Conformal Mapping" (1952); I. A. Sneddon, "Fourier Transforms" (1951); and R. Weinstock, "Calculus of Variations: With Applications to Physics and Engineering" (1952).

Finale

In conclusion, it is to be conjectured that inasmuch as this book ranks among the very best of the numerous books of its kind, and because it entails a domain of analysis whose importance in both technical education and practice increases yearly, it ought enjoy both a goodly number of classroom adoptions and an appreciable non-classroom sale.—Thomas J. Higgins. Professor of Electrical Engineering, University of Wisconsin.

Introducing SSB

TRANSMITTER-ADAPTER

Adapts AM transmitters to single-sideband operation

- Provides extra channel
- Improves signal-to-noise and signal-to-jamming
- Reduces fading problems
- Uses most efficient SSB system
- Allows the use of Class-C amplifiers & multipliers
- Low initial & operating cost
- Complete with built-in test equipment

—Also available—

Phased tone converter for generation of 6 FSK channels

KAHN RESEARCH LABORATORIES

Elizabeth Bldg., 22 Pine St.
Freeport, L.I., New York
Freeport 9-8800

MISSILE Engineers and Technicians



For Field Test Positions in NEW MEXICO "The Land of Enchantment" ON

Guidance Flight Testing
Servomechanisms
Telemetry Test Equipment
Airborne Electronics Equipment
IDEAL WORKING CONDITIONS

WRITE: FIELD TEST DIRECTOR
P. O. BOX 391
HOLLOMAN AIR DEVELOPMENT CENTER
NEW MEXICO

BELL Aircraft
CORPORATION

Save time... ENGRAVE your own NAME PLATES DIALS • PANELS

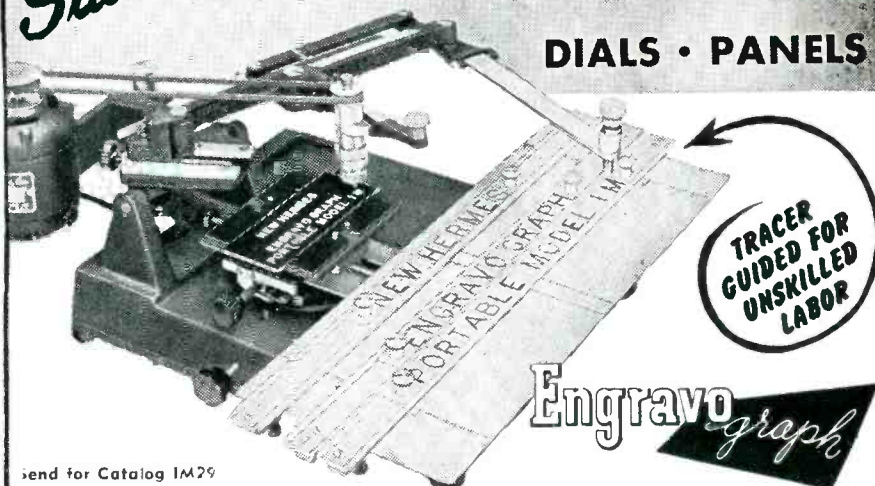

TRACER
GUIDED FOR
UNSKILLED
LABOR

Engravo
graph

Send for Catalog IM29

The fastest, easiest method for engraving individual nameplates, dials and panels.

- Automatic depth regulator
- Engraves 15 sizes from One Master alphabet
- Equipped with self-centering device

NEW HERMES, Inc. 13-19 University Place, N.Y. 3, N.Y.
In Canada: 359 St. James St., Montreal • Sales representatives in principal cities
World's Largest Manufacturer of Portable Engraving Machines

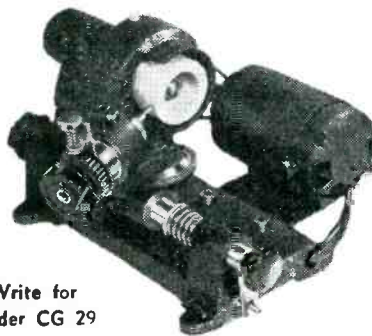

* Write for
Folder CG 29

For all owners of pantograph
and routing machines . . .
**NEW HERMES
CUTTER GRINDER**
The only belt-driven
grinder at low cost.

- Smooth, vibration-free operation.
- Ball bearing grinding spindle.
- Tool head indexed for single lip and 2, 3, 4-sided cutters.

NEW HERMES, Inc. 13-19 University Place, N.Y. 3, N.Y.

Ferrites

Purified synthetic products of reagent quality. Controlled particle size and shape contribute to effective control of packing and shrinkage. Our know-how can help you accomplish best results.

Manufactured by highly modern processes under rigid laboratory control. This ad clipped to your letterhead will bring a working sample.

made with
**HIGH PURITY
MAPICO**
RED FERRIC OXIDES
are TOP performers

COLUMBIAN CARBON COMPANY
MAPICO COLOR DIVISION
MANUFACTURER
BINNEY & SMITH CO., Distributor
41 EAST 42nd STREET, NEW YORK, N. Y.

for high permeability applications

now — the first time
available . . .

PERFORMANCE GUARANTEED

TAPE WOUND CORES

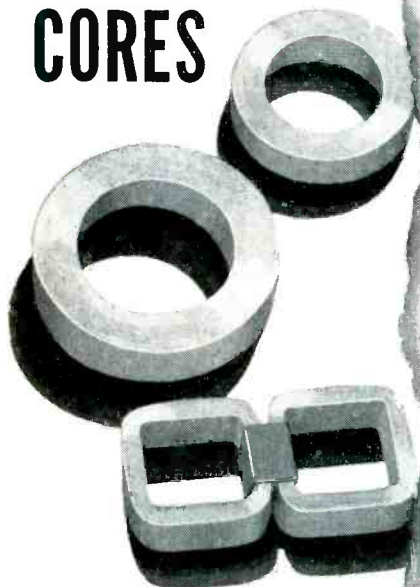

ONLY MAGNETICS, INC.

offers Performance-Guaranteed Tape Wound Cores. Guaranteed performance to specifications means truly economical production of high permeability magnetic devices in your plant . . . and controlled buying by your purchasing department. If you haven't investigated Performance-Guaranteed Tape Wound Cores, why not let us send you the complete story?

FACTORY CORE MATCHING

For applications in which closely matched characteristics are required, save time and money by using the Magnetics, Inc. factory core matching service.

free engineering design
service for high permeability
magnetic applications

Magnetics, Inc. engineering is second to none in the field of high permeability magnetics. Services are free to customers.

Write for full information

MAGNETICS, inc.

Specializing in High Permeability Magnetics

Dept. E-2 BUTLER, PA.

Want more information? Use post card on last page.

440

BACKTALK

Shunt & Power

DEAR SIRs:

On page 250 of the May 1953 issue of *ELECTRONICS* there appears an article on the "Power Required by a Shunt Impedance", which is intended to be a résumé of Zepler's paper, "A Network Theorem". The topic of the article is stated to be the calculation of "the amount of additional power (which) the generator in this circuit will have to supply" when one proceeds "to shunt an impedance across some portion of a linear circuit". It is, furthermore, stated that "some of this extra power will be consumed in Z (the added shunt impedance) and the rest of it will be dissipated in the remainder of the circuit".

There does not seem to exist any reason, in view of these statements, why the reader should not interpret "power" in accordance with firmly established usage as the scalar product of voltage and associated current; in other words, the quantity indicated by a wattmeter. He is, therefore, likely to be somewhat nonplussed to find an illustrative example discussed on page 252 which takes several fairly complex calculations to arrive at the "additional power" when a reactance is added to a purely reactive circuit. His bafflement is likely to mount at the end of the derivation, when he comes face to face with the statement that in the final circuit of Fig. 1C "the power is fictitious since there is no resistance".

Unencumbered by sophistication and equipped only with an elementary knowledge of circuit analysis, one concludes simply and directly that the power dissipated or consumed in a reactive circuit is zero, and that it is still zero after another reactance has been added. One may go one step further and even conclude that any reactance whatsoever, or any combination of reactances, may be used for Z_s in Fig. 1C on page 252, since the power consumption would be the same, that is, zero.

Zepler's Network Theorem actually deals with the determination of a circuit which is equivalent in

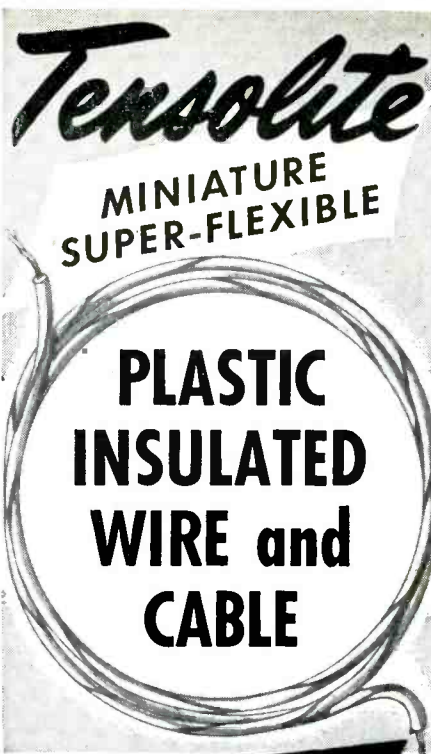

Tensolite
MINIATURE
SUPER-FLEXIBLE

PLASTIC INSULATED WIRE and CABLE

TENSOLON HOOK-UP WIRE

Teflon insulated for continuous use up to 250°C, "Tensolon" is available in 14 solid colors and features a free-stripping, thin wall covering with high dielectric strength.

TENSOLEX JAN-C-76 HOOK-UP WIRE

Types WL, SRIR, and SRHV available in small wire sizes in all standard colors including spiral stripping. Nylon jackets can also be supplied for greater resistance to abrasion.

SUB-MINIATURE WIRE AND CABLE

Thin wall vinyl insulation over flexible stranded conductors (AWG sizes down to #40) meets many requirements for small space factor. Available in all standard colors with or without wire braid shields.

SUPER-FLEXIBLE CABLES

Tensolite super-flexible cables, featuring the patented tensulation process, solve many problems calling for limpsness and long flex life. Phonograph pick-up cables, hearing aid cordage, and telephone tinsels are regularly being supplied.

TENSOLITE WIRE KITS

For laboratory and prototype requirements, the following convenient desk size wire kits are now available from stock: Teflon Kit, SRIR Kit, Sub-miniature "1482" Kit, Flexible Cable Assortment.

SPECIAL CONSTRUCTIONS

Tensolite's engineering and development facilities are also available for collaboration in the solution of many special cable problems. Simple or complex, Tensolite will welcome an opportunity to estimate on your requirements.

WRITE FOR OUR COMPLETE CATALOG

TENSOLITE INSULATED WIRE COMPANY • INC

TARRYTOWN • NEW YORK

Want more information? Use post card on last page.

September, 1953 — *ELECTRONICS*

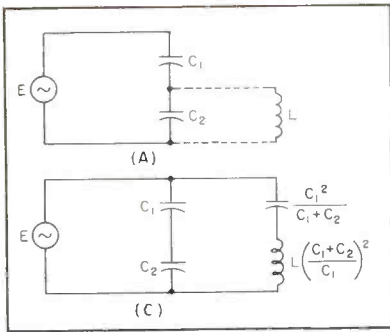

FIG. 1—Reproduction of circuits appearing on p 252 of May 1953 issue

input impedance to a given circuit, as a careful reading of the original paper discloses. Consequently, equality of power consumption is only incidental. If the only criterion for the establishment of Zepler's equivalent circuit were equality of power consumption, this circuit would hardly be unique since merely the conductive component of the input admittance would have to be duplicated, leaving the susceptance arbitrary. Specifically, the equation on page 252 (ELECTRONICS, May 1953)

$$\frac{E^2}{Z_x} = \frac{E'^2}{Z + Z_i}$$

does not express a power equality, as stated there. The reason is that (volts)² divided by an impedance does not represent power, unless the impedance is a pure resistance. Apparently, Zepler's warning "Then the power in this . . . circuit is

$$\frac{E'^2}{Z_i + Z}$$

where the term power is used for want of a better word" (my italics) is inadequate to put the unwary on guard that he is investing "power" with a private meaning.

After the real meaning of Zepler's Network Theorem has been recognized, it is appropriate to examine its usefulness. Since a comprehensive discussion of this subject has already been presented elsewhere², let us look merely into the significance of the illustrative example for brevity's sake, being aware this time that the circuit of Fig. 1C is meant primarily to have the same input impedance as the circuit in Fig. 1A. Why, one may ask, go to the trouble of deriving the circuit of Fig. 1C? It is not easier to handle nor in any other

NEW AIRCRAFT SERVO COMPONENT



The Type 71-5 Baroresistor is a pressure actuated potentiometer designed for operational use in aircraft. It features:

HERMETICALLY SEALED MECHANISM

The potentiometer winding and operating parts are hermetically sealed in a vacuum. Pressure is applied inside the bellows only. Therefore, the Type 71-5 Baroresistor is not affected by dust, fungi, or moisture.

RUGGEDIZED CONSTRUCTION

A special high force mechanism was developed for the Trans-Sonics Baroresistor to avoid the necessity for employing micro force potentiometer elements. Shock of 30g in any direction will not cause electrical discontinuity.

MACHINE CALIBRATION

Each instrument is calibrated by machine and its performance is automatically recorded as a graph of resistance versus pressure. Every turn of the winding is inspected. All electrical characteristics are automatically checked in an eleven stage inspection cycle.

TECHNICAL REPRESENTATIVES

- | | |
|--------------------------------------------------------|---------------------------------------------------|
| Los Angeles, Calif.
Telephone:
Cumberland 3-4183 | Dayton, O.
Telephone:
Hemlock 1254 |
| San Francisco, Calif.
Telephone:
Lyell 3-2189 | Seattle, Wash.
Telephone:
Main 7005 |
| St. Louis, Mo.
Telephone:
Sweetbriar 2175 | Houston, Tex.
Telephone:
Manroe 5-5624 |
| Detroit, Mich.
Telephone:
Broadway 3-2900 | Cleveland, O.
Telephone:
Yellowstone 2-7849 |

Condensed Data

- Range: 0-15 psi, absolute
- Resistance: 7500 ohms
- Maximum voltage: 75 volts
- Resolution: 1/3%
- Accuracy: 2% of full scale

Typical Applications

- Servos—Vary servo loop gain as a function of altitude.
- Computers—Voltage divider, P total/P static.
- Fire Control—Air density measurements.
- Telemetry—Pressure transducer.
- Recording—Pressure transducer.

Write for
Bulletin No.
71-5 for
further details

Price:
\$225.00
Short delivery

TRANS SONICS, INC.

5 Forest Street, Bedford, Mass.

**For the
FIRST
TIME**

LOW COST SCREEN ROOMS

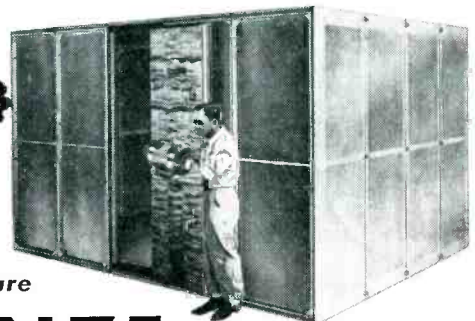

A Sturdy Double-Shielded Enclosure

in BRONZE

PATENT PENDING

Guaranteed attenuation 126—128 DB in Bronze . . . 142—146 DB in Copper. Used by world's largest industrial and electronic equipment manufacturers and U. S. Government engineers. Meets military specifications. Available with double or single frame models. Complete line of portable standard sizes . . . or special sizes. MAIL COUPON for illustrated circular with construction diagrams and performance charts.

. . . COPPER BRONZE . . .

ACCURATE

Lindgren

SHIELDING ENCLOSURE

4515-17 N. RAVENSWOOD AVE.
CHICAGO 40

Sales and Engineering
Representatives throughout
the United States

BOOTH—73

Hotel Sherman
National Electronic Conference
September 28-29-30

ERIK A. LINDGREN & ASSOC. (MFRS.)

4515-17 N. Ravenswood, Chicago 40

Please send illustrated circular, construction diagrams, and performance charts on the NEW Lindgren Screen Rooms.

NAME _____
ADDRESS _____
CITY _____ STATE _____

way superior to the original circuit! In Fig. 1A, the input impedance is:

$$Z_{in} = \frac{1}{j\omega C_1} + \frac{j\omega L}{1 - \omega^2 LC_2}$$

After the open-circuit voltage transfer ratio and the source impedance of the Thevenin-generator have been calculated and Z_o has been determined, the input impedance of the equivalent circuit of Fig. 1C is calculated as:

$$Z_{in} = \frac{j\omega L \left(\frac{C_1 + C_2}{C_1} \right)^2 + \frac{C_1 + C_2}{j\omega C_1^2} \left[\frac{C_1 + C_2}{j\omega C_1 C_2} \right]}{j\omega L \left(\frac{C_1 + C_2}{C_1} \right)^2 + \frac{C_1 + C_2}{j\omega C_1^2} + \frac{C_1 + C_2}{j\omega C_2 C_2}} \cdot \frac{1}{\left[-\omega^2 L(C_1 + C_2)^2 + (C_1 + C_2) \right] j\omega C_1}$$

$$= \frac{-\omega^2 LC_2(C_1 + C_2) + C_2 + C_1}{-\omega^2 L(C_1 + C_2) + 1}$$

$$= \frac{1}{j\omega C_1} + \frac{j\omega L}{1 - \omega^2 LC_2}$$

The comparison with the first calculation, carried out in the way the input impedance would ordinarily be obtained, does not speak well for the usefulness of the Network Theorem.

Questionable as its usefulness may be, it should be pointed out in all fairness that the report in *ELECTRONICS* artificially restricts the scope of Zepler's Network Theorem to shunt impedances. Actually, the impedance between any two points not linked by mutual inductance to the rest of the circuit can be removed and replaced by an impedance Z_x , which is calculated in accordance with Zepler's Network Theorem and connected across the input-voltage terminals, without modifying the input impedance. As a simple illustration of this statement, the Network Theorem may be applied with re-

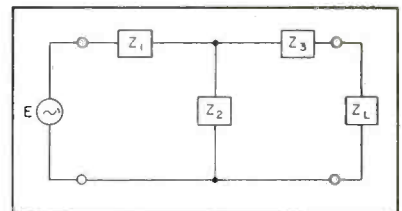

FIG. 2—Example of use of Network Theorem on low-impedance of a T-section

BOESCH Tape WINDING MACHINES *

Designed especially for the winding of cellophane and tapes of like characteristics. This machine provides a fast and practical means of taping toroidal cores and coils. Tape widths starting at 1/8" thru 3/8". Coil range up to 2 1/2" O. D.

We invite your inquiry and will tape samples to your specification.

*Available to licensees of the Western Electric Co., Inc.

Designers and Builders of coil winding machinery, special machinery and equipment. Write for brochure.

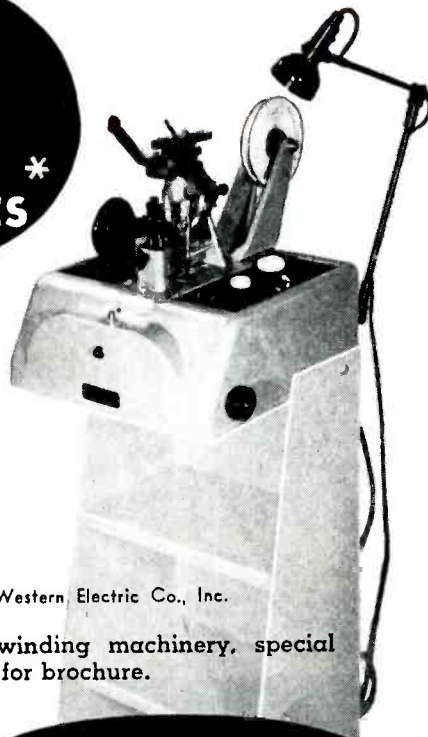

WORLD'S MOST VERSATILE
WINDING MACHINES

BOESCH

MANUFACTURING CO., INC.
DANBURY, CONN.

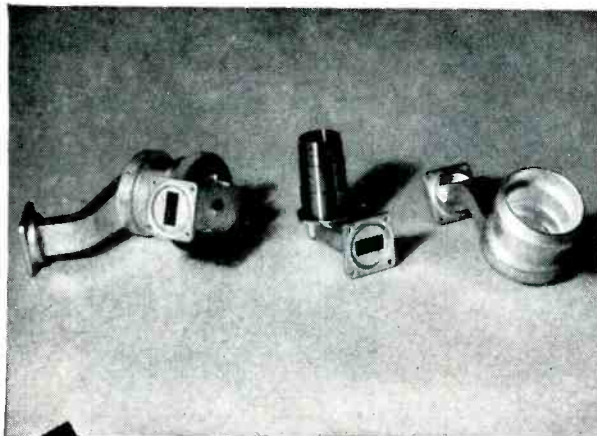

N.R.K. MFG. & ENGINEERING CO.
4601 WEST ADDISON STREET • CHICAGO 41, ILL.
SPRING 7-2970

Microwave
Assemblies,
Radar Components,
and Precision
Instruments . . .
manufactured to
your Blueprints
and Specifications.

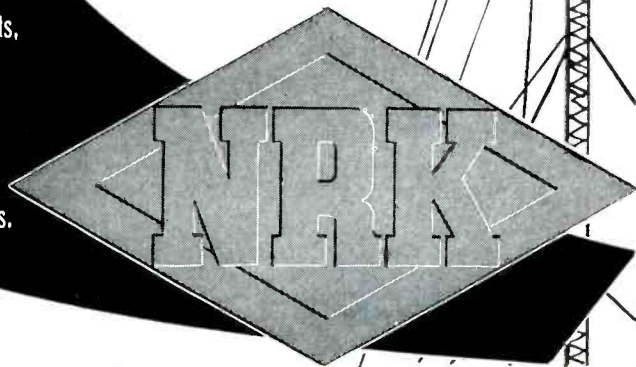

OFFERING

- sub-miniature, rotary,
- electrical equipment for
- specialized applications...

- Mission-Western Engineers, Inc., offer a wide range of basic motor designs adaptable to highly specialized applications.



400 cps 115 VAC
1 ϕ Gearmotor. 80
incb ounces at 22
RPM. Dimensions:
1.50" dia. x 2.81"
long.

400 cps 115 VAC
1 ϕ Gearmotor. 10
incb ounces at 10
RPM. Dimensions:
1.06" dia. x 2"
long.

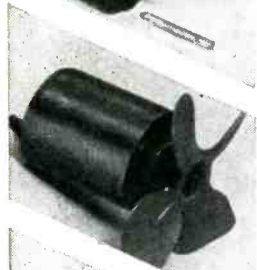

320/1000 cps 115
VAC 1 ϕ motor and
3" fan assembly.
8500 RPM at 400
cps. With 2" fan.
10,000 RPM at
400 cps. Motor
Dimensions: 1.45"
dia. x 1.75" long.



400 cps, 115 VAC
1 ϕ motor and L-R
#2 Centrifugal
Blower, 22 CFM
free air. With 60
cps motor, 10 CFM
With 28 VDC
motor, 35 CFM.



Permanent Magnet
DC motor & L-R
#1 1/2 Centrifugal
Blower. 20 CFM
free air. Motor
dimensions: 1 1/4"
dia. x 2" long.

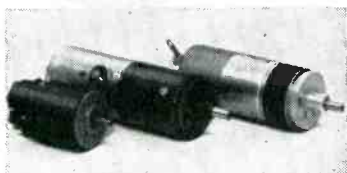

Permanent Magnet DC Motors & Gearmotors. Output Speeds to 1 RPM. Frame diameter 1 3/16" or 1/4". Also available (1 1/4" dia. frame only) in Split Series DC when design forbids use of Permanent Magnet type.

If you have a problem involving design or application of AC or DC type motors, why not write us for engineering assistance and recommendations on a Mission-Western designed motor?

Many other types and frame sizes, in both AC and DC, available.

Mission-Western is associated with Western Gear Works—since 1888 a leader in the mechanical power transmission field.

5326

MISSION-WESTERN

ENGINEERS, INC.

132-134 West Colorado St., Pasadena 1, Calif.

Want more information? Use post card on last page.

ELECTRONICS — September, 1953

BACKTALK

(continued)

spect to the load impedance of a T-section, that is, an impedance in series with one arm of the network. With respect to Fig. 2

$$\frac{E}{E'} = 1 + \frac{Z_1}{Z_2}$$

$$Z_i = Z_3 + \frac{Z_1 Z_2}{Z_1 + Z_2}$$

$$Z_x = \left(1 + \frac{Z_1}{Z_2}\right)^2 \left[Z_L + Z_3 + \frac{Z_1 Z_2}{Z_1 + Z_2} \right]$$

$$= (Z_L + Z_3) \cdot a^2 + Z_1 \cdot a$$

where $c = 1 + \frac{Z_1}{Z_2}$

The equivalent input-impedance circuit is shown in Fig. 3. Its input impedance is

$$Z_{in} = \frac{(Z_1 + Z_2)(Z_L a^2 + Z_3 a^2 + Z_1 a)}{Z_1 + Z_2 + Z_L a^2 + Z_3 a^2 + Z_1 a}$$

$$= \frac{Z_2(Z_L a^2 + Z_3 a^2 + Z_1 a)}{Z_2 + Z_1 a + Z_3 a + Z_1}$$

$$= \frac{Z_2(Z_L a + Z_3 a + Z_1)}{Z_2 + Z_L + Z_3}$$

$$= \frac{(Z_L + Z_3)(Z_1 + Z_2) + Z_1 Z_2}{Z_L + Z_2 + Z_3}$$

where the relationship $Z_1 + Z_2 = Z_x a$ has been used repeatedly in order to simplify the calculations. The input impedance calculated directly from the original circuit of Fig. 2 is

$$Z_{in} = \frac{(Z_L + Z_3) Z_2}{Z_L + Z_2 + Z_3} + Z_1$$

$$= \frac{(Z_L + Z_3)(Z_1 + Z_2) + Z_1 Z_2}{Z_L + Z_2 + Z_3}$$

It has been verified that the Network Theorem does apply to series impedances as well, but this should not be construed as a recommendation to calculate the input impedance of a loaded T-section by Zepler's Network Theorem. Impedance Z_L itself could be interpreted as a complex network, consisting of many branches, without

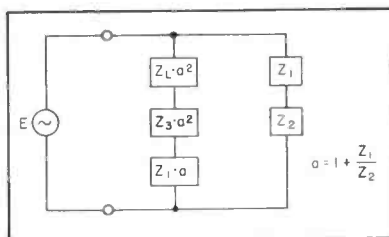

FIG. 3—Equivalent input-impedance circuit

ELECTRONIC LENSES?

Pennsylvania Optical, one of the oldest optical houses in the nation, is now successfully applying spectacle making mass production methods to the lens problems of the Electronics Industry.

We're proud of the lenses we are now making for some of the largest manufacturers of electronic equipment. Picture tube face plate lenses. Lenses for Magnetrons, Iconoscopes. Atomic Radiation Windows. Filter Lenses of all kinds. A host of allied "problem children." We take a lot of pride in our control of flat surfaces, of prism tolerances, and diameters.

We are inviting additional specialized lens work in the electronics field, leading to volume orders. We're equipped for everything from basic research to making our own tools to meet its demands. Will you let us know your lens problems?

PENNSYLVANIA OPTICAL COMPANY

234 So. Eighth St., Reading, Pa.
Telephone: Reading 4-8397

Need to be sure 
of **CONTINUOUS,**
ADEQUATE-VOLTAGE
POWER?
USE THIS ASCO
COMBINATION

Automatic Transfer Switch
with Close Differential Relay

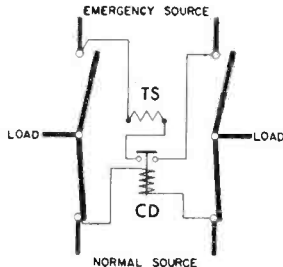

**When installing your
emergency power supply**

 Be sure of continuous power by installing an ASCO Automatic Transfer Switch to transfer the load to emergency should normal power fail.

 Be sure of adequate-voltage power by equipping your ASCO Automatic Transfer Switch with ASCO Close Differential Relays, to provide for transfer and re-transfer of the load on a small voltage differential.

POINT 1  The best electronic equipment is useless without power; you need an emergency supply to prevent costly shut-downs. But even with this emergency source, unless automatic load transfer is provided, your equipment will be inoperative until the emergency power switch is located and manually thrown. During this "waiting period" your equipment is useless and time and money are wasted.

ASCO can eliminate this delay by supplying an Automatic Transfer Switch that will transfer in two to five cycles on small units and five to nine cycles on large!

Once the normal source is again in proper operating condition, the ASCO Transfer Switch will automatically restore the load to the normal source.

POINT 2  Where adequate-voltage power is important, ASCO Transfer Switch equipped with ASCO Close Differential Relays can provide transfer on a 5% differential in power supply voltage (less, if required).

Close differential relays are also available as unit devices for any application.



Our ideas on the automatic transfer of loads are discussed in a special free pamphlet. May we send you a copy?

Automatic Switch Co.

385-L LAKESIDE AVENUE ORANGE, NEW JERSEY
Want more information? Use post card on last page.

BACKTALK

(continued)

invalidating the preceding derivation. A more generalized proof, for both passive and active networks, can be found in reference 2.

LEO STORCH
Hughes Aircraft Co.
Culver City, California

REFERENCES

- (1) E. E. Zepler, A Network Theorem, *Wireless Engineer*, 29, No. 341, page 44, Feb. 1952.
- (2) Leo Storch, Note on A Network Theorem, *Wireless Engineer*, 30, No. 4, page 77, Apr. 1953.

Man and Machine

Dear Sirs:

In *ELECTRONICS* for June 1953 (p 368) appeared an article by Norbert Wiener, entitled "A Machine Wiser Than Its Maker."

I take the liberty to quote the following sentence from this article: "The apparent theodicy hinted by the glory and the aptness of the infinite complexity of nature is, according to Darwinism, merely what is left of a random process of growth and change when its softer and less durable manifestations have been worn away by the sands of time and the weakness of their own futility." (p 370)

From a philosophical point of view I have strong objections against the word "random" in this sentence. To make clear what I mean I propose the following sentence as an antidote: "The apparent purposefulness hinted by the magnificent complexity of the modern motorcar is, according to neo-positivism, merely what is left of a random process of growth and change when its softer and less durable manifestations (for example: the Ford T-model) have been worn away by the sands of time and the weakness of their own futility."

I am afraid that you will consider this proposition as pure nonsense. On behalf of what is Wiener's sentence a manifestation of wisdom? It looks as if his article is a modern defense of that old baseless delusion: determinism, advocated by astrology in the Middle Ages.

Dr. I. J. van Slooten
Philips Research Laboratories
Eindhoven
The Netherlands

DOUBLE BARREL
Advertising

Advertising men agree—to do a complete advertising job you need the double effect of both Display Advertising and Direct Mail.

Display Advertising keeps your name before the public and builds prestige.

Direct Mail supplements your Display Advertising. It pin-points your message right to the executive you want to reach—the person who buys or influences the purchases.

More and more companies are constantly increasing their use of Direct Mail because it does a job that no other form of advertising will do.

McGraw-Hill has a special Direct Mail Service that permits the use of McGraw-Hill lists for mailings. Our names give complete coverage in all the industries served by McGraw-Hill publications—gives your message the undivided personal attention of the top-notch executives in the industrial firms. They put you in direct touch with the men who make policy decisions.

In view of present day difficulties in maintaining your own mailing lists, our efficient personalized service is particularly important in securing the comprehensive market coverage you need and want.

Ask for more detailed information today. You'll be surprised at the low over-all cost and the tested effectiveness of these hand-picked selections.

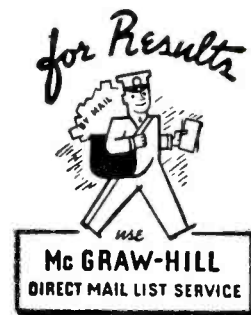

Dept. A

McGRAW-HILL
PUBLISHING CO., INC.

330 West 42nd Street
NEW YORK 18, N. Y.

Want more information? Use post card on last page.

September, 1953 — ELECTRONICS

ELECTRICAL
COILS

Bobbin, spool, form, layer, interleaved, interwoven types. Made of any material, any finish, for any application.

Send blue-prints and specifications for prompt quotation.



THE FIVE STAR COMPANY
 West Main Street
 Plantsville, Conn.

SUB-CONTRACTING
MILITARY and COMMERCIAL
 receivers—test equipment
 transmitters—controls
 sub-assemblies

TELETRONICS LABORATORY, INC.
 Westbury, L. I., N. Y. Westbury 7-1028



FLUXES
 SODERING
 BRAZING & WELDING
 L. B. ALLEN CO., INC. Chicago 31, Ill.
 6751 BRYN MAWR AVE.

Shorted Turn Indicator
 Sensitive, rugged, non-shocking
 for unmounted coils; \$150. f.o.b.
 HUNTINGTON BEACH, CALIF.



KARTRON

WALKIE-RECORDALL 8 lb. miniature BATTERY RECORDER-PLAYBACK
 Continuous, permanent, indexed recording, up to 4 hrs., only 3¢ hr. Instantaneous, permanent playback. Picks up sound up to 60 ft. Records conferences, lectures, dictation, 2-way phone & sales talks; while walking, riding or flying. Records in close briefcase with "hidden mike". Write for Detailed Literature.

MILES REPRODUCER CO., INC.
 812 BROADWAY Dept. E-9 NEW YORK 3, N. Y.

Have you problems in
Metal to Glass Seals?

NAME IT . . . WE'LL MAKE IT!
 TERMINALS
 HEADERS
 END SEALS . . . SPECIAL ITEMS

QUALITY PRODUCTS CO.
 387 Charles St., Providence, R. I.

We invite inquiries on



WRITE FOR CATALOG

REX RHEOSTAT CO.
 BALDWIN, L. I., N. Y.

CONTACTS
 FOR THE FIELD OF ELECTRONICS

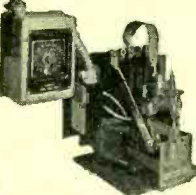

EISLER MANUFACTURES COMPLETE EQUIPMENT
 WELDERS FOR SPOT & WIRE BUTT
 RADIO, TV TUBE EQUIPMENT & REPAIR UNITS
 INCANDESCENT, FLUORESCENT MFG EQUIPMENT
 NEON SIGN MAKERS EQUIPMENT, GLASS LATHES
 ELECTRONIC EQUIPMENT, VACUUM PUMPS, Etc.
 Wet Glass SLICING & CUTTING MACHINES for Lab Use
 TRANSFORMERS, SPECIAL & STANDARD TYPES

EISLER ENGINEERING CO., INC.
 751 So. 13th St. Newark 3, N. J.



LARGE OPEN CAPACITY
West Germany

• Well known West German manufacturers with large capacity, specialized in the production of US signal equipment (radio and navigation) want orders from US firms for the production of complete sets, parts, etc. or cooperation under license procedure.

Write Box B 12634
CARL GABLER GmbH,
 Boersenstrasse 2-4,
 Frankfurt/Main—Germany

CRYSTALS FOR ALL PURPOSES

LOW FREQ.—FT 241A for 55B, lattice filter, 1/2" spc, 54th or 72nd harm channels listed by fund. Fractions omitted.	SCR 522 1/2" sp	BC-610 2 Banana Plugs 1/2" spc.
370 396 422 487 512	400 459	5520
372 387 423 488 513	440 481	5910
374 398 424 490 514	441 462	6370
375 401 425 491 515	442 463	6450
376 402 426 492 516	444 464	6470
377 403 427 493 518	445 465	6497.9
379 404 429 494 519	446 466	6522.9
380 405 430 495 520	447 468	6547.9
381 406 431 496 522	448 469	6610
383 407 433 497 523	450 470	7380
384 408 434 498 525	451 472	7390
385 409 435 501 526	452 473	7480
386 411 436 502 527	453 475	7580
387 412 437 503 528	454 476	7610
388 413 438 504 530	455 477	7910
390 414 481 505 531	456 479	EA
391 415 482 506 533	457 480	EA
392 416 484 507 534	458	EA
393 418 485 508 536		EA
394 419 486 509 537	99c each	200 or
395 420 511 538	10 for	1N FT
	\$9.00	241 A
		HOLDER
		1/2" SPC.
		\$1.95 EA

FT 243 — 1/2" PIN SPC.

4190 6175 7806	1015 5740 5840	6273 6450 6600 7440 7650
5030 6206 7840	3735 5760 5850	6306 6473 6606 7506 7673
5485 6773 7873	5305 5773 5873	6325 6506 6640 7540 7706
6040 6873 7906	5677 5800 5906	6340 6540 6673 7573 7973
6073 7740 7940	5706 5806 5840	6373 6573 6706 7606 8240
6140 7773	5725 5825 5973	6406 6575 6740 7640 8273

49c EA—10 for \$4.50 99c EA—10 for \$9.00

• Add 20¢ for each 10 xtals or less for postage and handling



Sun
PARTS DISTRIBUTORS, LTD.
 520 TENTH ST., N.W. - WASHINGTON, D.C.

WIDE RANGE DECADE RESISTOR



Especially designed for use in development and production laboratories where standardized RTMA resistor values are to be determined easily and quickly.

For descriptive literature write or wire

Rochester Electronics Co., Inc.
 DEPT S-4 Box 227 PENFIELD, NEW YORK

A PRIVATE TECHNICAL PLATING SERVICE
 offering PALLADIUM RHODIUM in flash, intermediate and heavy electrodeposits. Information regarding electroplated thicknesses upon request.

DANIEL D. ZIELIK
 Fairfield, Connecticut
 Brown's Lane

SUBCONTRACTING
MILITARY AND COMMERCIAL
 Design, development and manufacture of Servomechanisms, Controls, Toroids, Saturable Reactors, Magneto Amplifiers.

FIDELITY INSTRUMENT CORPORATION
 1320 W. MARKET STREET
 YORR, PENNA.
 TEL. 7675

FM MODULATION METER
 Measures maximum modulation deviation on mobile-system FM transmitters, all frequencies, 25 to 200 MC. Price \$240.00.

LAMPKIN LABORATORIES, INC.
 BRADENTON, FLORIDA

HIGH VOLTAGE POWER SUPPLIES



Available in ranges from 2,500 to 25,000 volts D.C. with or without built-in meters. Regulated or unregulated types available. Delivery good on all standard models.

Send for free catalogue—Dept. EI*

PRECISE MEASUREMENTS CO.
 942 KINGS HIGHWAY, BROOKLYN 23, N. Y.
 Phone ES 5-9435

MILITARY-SUB-CONTRACTING-COMM.
 Electronic—Mechanical Devices
 Full Metal, Machine Shop Facilities
 From Raw Metal to Finished Device
 No Order Too Small

UNIVERSAL MANUFACTURING CO.
 196 Bowery
 Rector 2-1997 New York 12, N. Y.

PROFESSIONAL SERVICES

ANNIS ELECTRIC RESEARCH LABORATORY, INC.

CONSULTING — RESEARCH — DEVELOPMENT
AND DESIGN OF RADIO AND ELECTRONIC
EQUIPMENT
Antennas, Wave Propagation, Information Storage,
Computers, Impedance Matching, and Variable
Speed A-C Motors.
P. O. Box 581 1401 1/2 S. Neil St.
Champaign, Ill. Tel. 6-1780

CROSBY LABORATORIES, INC.

Murray G. Crosby & Staff
Radio - Electronic
Research Development & Manufacturing
Communications, FM & TV
Robbins Lane, Hicksville, N. Y.
Hicksville 3-3191

EDGERTON, GERMESHAUSEN & GRIER, INC.

Consulting Engineers
Research, Development and Manufacture
of Electronic and Stroboscopic Equipment
Specialists in High-Speed Photography
160 Brookline Avenue Boston 15, Mass.

Eldico of New York, Inc.

Pioneers of Television Interference Elimination from
Transmitters, Induction Heaters, Diathermy and
etc.
Donald J. S. Merten & Engineering Staff
44-31 Douglaston Pkwy Douglaston, N. Y.
Bayside 9-8686

ERCO RADIO LABORATORIES, INC.

Radio Communications Equipment
Engineering - Design - Development - Production
Pioneers in Frequency Shift, Telegraph
Garden City • Long Island • New York

HARRIS GALLAY

Consultant
Electronic Project Development for Industry
Day, Week and Duration of Project Services
Our Laboratory Facilities Optional
Plymouth 9-4237 60 Perry St., Belleville 9, N. J.

GORDON ASSOCIATES, INC.

Government Contract Liaison and Consulting
Specializing in Signal Corps Electronic Require-
ments, Technical Manuals, Tabular List of Parts,
Drawings.
L. Gordon, Pres. P. Treston, Ch. Engr.
157 Broad Street Telephone
Red Bank, New Jersey Red Bank 6-2743

HANSON-GORRILL-BRIAN INC.

Products & Mfg. Development
ELECTRICAL - ELECTRONIC
HYDRAULIC - MECHANICAL
One Continental Hill Glen Cove, N. Y.
Glen Cove 4-7300

HIGHLAND ENGINEERING CO.

William R. Spittal & Staff
DESIGN, DEVELOPMENT AND MANUFACTURE
OF TRANSFORMERS, CHOKES, ETC.
FOR THE
ELECTRONIC, INDUSTRIAL & ALLIED FIELDS
Main & Urban, Westbury, L.I., N.Y.
WE-7-2983

THE REAL VALUE

*of placing your unusual problem
in the hands of a competent con-
sultant is that it eliminates the
elements of chance and uncer-
tainty from the problem and pro-
vides real facts upon which to base
decisions.*

HOGAN LABORATORIES, INC.

John V. L. Hogan, Pres.
Applied Research, Development, Engineering
Est. 1929. Electronics, Optics, Mechanisms, Fac-
simile Communication, Digital Computers (Circle).
Electro-sensitive recording media, Instrumentation.
155 Perry Street, New York 14. CHelsea 2-7855

THE KULJIAN CORPORATION

Consultants • Engineers • Constructors
Electronic Control
Specialists
Utility • Industrial • Chemical
1200 N. Broad St., Phila 21, Pa.

MAGNETIC INDUSTRIES, INC.

Development & Manufacture
Servo Magnetic Amplifiers and
Special Relays
2640 Huldy Houston 6, Texas

Measurements Corporation

Research & Manufacturing Engineers
Harry W. Houck Jerry B. Minter
John M. van Beuren
Specialists in the Design and
Development of Electronic Test Instruments
Boonton, New Jersey

Eugene Mittelmann, E.E. Ph.D.

Consulting Engineer & Physicist
High Frequency Heating—Industrial Electronics
Applied Physics and Mathematics
549 W. Washington Blvd. Chicago 6, Ill.
State 2-8021

NEW ROCHELLE TOOL CORP.

FOR CERTIFICATION OF INDUCTION
AND DIELECTRIC HEATING EQUIPMENT
IN ACCORDANCE WITH F.C.C. RULINGS
320 Main St., New Rochelle, New York
Phone NE 2-5555
Mobile Test Unit Available Entire U. S.

NIAGARA ELECTRON LABORATORIES

CONSULTATION - DESIGN - CONSTRUCTION
MFG. THE THERMOCAP RELAY
Specializing in solution of problems of electronic
and electro-physical instrumentation for the re-
search of analytical laboratory. Industrial plant
problems also invited.
Andover, New York Cable Address: NIATRONLAB

MAURICE I. PARISIER & CO.

Communications Expert
International Engineering Consulting
RADIO BROADCASTING & COMMUNICATIONS
Planning & Installation Supervision
Communication Equipment for Armed Forces
1475 Broadway New York 36, N.Y. LOngacre 4-5434
Offices: Paris-Buenos Aires — Sao Paulo-Bourbay

PICKARD AND BURNS, INC.

Consulting Electronics Engineers
Analysis and Evaluation
of Radio Systems
Research, Development and Production
of Special Electronic Equipment
240 Highland Ave. Needham 94, Mass.

ALBERT PREISMAN

Consulting Engineer
Television, Pulse Techniques, Video
Amplifiers, Phasing Networks,
Industrial Appliances
Affiliated with
MANAGEMENT-TRAINING ASSOCIATES
3308-14th St., N. W. Washington 10, D. C.

JOSEPH RACKER COMPANY

Radar Consultants & Editors
Technical Manuals
Research and Development
140 Nassau Street, New York 38, N. Y.
Worth 4-1463

ROTRON RESEARCH CORPORATION

Research and Development
Fluid Dynamics and Heat Transfer.
Exclusively Electronic Applications
Cooling Problems, Heat Exchangers, Fans,
Turbines and Pump Designs
Woodstock, N. Y. Phone 2408

SKINNER, HARLAN AND IRELAND, INC.

Consulting Engineers
Specializing in Magnetic Materials and
Their Application
1122 E. 23rd St. Indianapolis 7, Indiana

THE TECHNICAL MATERIEL CORPORATION

Communications Consultants
Systems Engineering
General Offices and Laboratory
121 Spencer Place, Mamaroneck, N. Y.

WHEELER LABORATORIES, INC.

Radio and Electronics
Consulting—Research—Development
R-F Circuits—Lines—Antennas
Microwave Components—Test Equipment
Harold A. Wheeler and Engineering Staff
Great Neck, N. Y. Great Neck 2-7806

YARDNEY LABORATORIES, INC.

Research - Design - Development
Electro-Chemical Generators of Energy
105 Chambers Street Worth 2-3534, 35, 36
New York 7, N. Y.

UNDISPLAYED RATE

\$1.80 a line, minimum 3 lines. To figure advance payment count 5 average words as a line. POSITION WANTED & INDIVIDUAL SELLING OPPORTUNITY WANTED undisplayed advertising rate is one-half of above rate, payable in advance.
BOX NUMBERS count 1 line additional.

Send NEW ADVERTISEMENTS to N. Y. Office, 330 W. 42 St., N. Y. 36, for the October issue closing Sept. 3. The publisher cannot accept advertising in the Searchlight Section, which lists the names of the manufacturers of resistors, capacitors, rehostats, and potentiometers or other names designed to describe such products.

INFORMATION

DISCOUNT 10% if full payment is made in advance for four consecutive insertions of undisplayed ads (not including proposals).

EQUIPMENT WANTED OR FOR SALE Advertisements acceptable only in Displayed Style.

DISPLAYED—RATE PER INCH

The advertising rate is \$16.10 per inch for all advertising appearing on other than a contract basis. Contract rates quoted on request.

AN ADVERTISING INCH is measured $\frac{7}{8}$ inch vertically on one column, 3 columns—30 inches—to a page. ELECT.

STAFF EDITOR

Must be graduate engineer (electronics). Industry experience essential. Aptitude for technical reporting desirable. Mail resume, requirements to

W. W. MacDonald, Editor
ELECTRONICS
330 W. 42nd St.,
New York 36, N. Y.

REPLIES (Box No.): Address to office nearest you
NEW YORK: 530 W. 42nd St. (36)
CHICAGO: 530 N. Michigan Ave. (11)
SAN FRANCISCO: 63 Post St. (4)

POSITIONS VACANT

ELECTRONICS ENGINEERS and Physicists interested in Research and Development on trigger circuits and high speed sweeps. Opportunity to do original work on transducer applications to specialized problems in shocks and detonations. P-8766, Electronics.

PATENT ATTORNEY wanted by New York patent law firm to work in or near New York City. P-8775, Electronics.

ELECTRONIC ENGINEER—degree with interest covering technical, organizational, and supervisory phases of receiving tube measurements. New plant located in Finger Lakes region, one mile from town, offers work that is a challenge with excellent opportunities to prove yourself. Salary commensurate with ability and experience. All employee benefits included. Write and include resume to: Employment Supervisor, Westinghouse Electric Corp., Bath, New York.

POSITIONS WANTED

GOVERNMENT CONTRACTING—E. E. graduate with 11 years electronics design experience, 5 years as officer associated with electronics R & D in AF and 7 years in present position having responsibility for Gov't contractual work with large eastern electronics mfr, seeks new position in Gov't contract field. Fully qualified in all phases of contract negotiations and administration. \$12,000. per year salary desired. PW-8769, Electronics.

ELECTRONIC FIELD Engineer, five years experience in Communications, Radar and systems engineering desires work in Puerto Rico and the Caribbean area. Age 31. Married. PW-8767, Electronics.

WANTED

ANYTHING within reason that is wanted in the field served by Electronics can be quickly located through bringing it to the attention of thousands of men whose interest is assured because this is the business paper they read.

EXECUTIVE DEV. ENGINEER
\$15,000—NO FEE

Supervise a development section for the country's most progressive manufacturer of electrical and electronic equipment.

Ask for Ray Edwards

O'SHEA EMPLOYMENT SYSTEM

64 E. Jackson, Chgo., Ill. Tel. WAbash 2-1884

**ELECTRONIC DEVELOPMENT
IS MOVING WEST***

ENGINEERS—Take this opportunity to join the staff of a Western electronics pioneer & leader.

Creative ability finds expression with us!

- RESEARCH
- DEVELOPMENT
- PRODUCTION

Broad project variety in special receivers, transmitters & other devices. Advanced design techniques.

* Figures show 20% U. S. activity in So. California

Relocation expenses—excellent working conditions—Central location. Scheduled reviews & advances. Fine insurance plan. Move should not disturb urgent military projects.

Send complete resume with income history & requirements to engineering employment mgr.

Hoffman LABORATORIES, Inc.

3761 SO. HILL ST.

LOS ANGELES 7, CALIF.

(A Subsidiary of Hoffman Radio Corp.)

ELECTRONIC ENGINEERS**SENIORS:**

To act as a group leaders on design, development and production of radio, radar, television transmitters, receivers and test equipment.

SPECIALISTS:

(2) Microwave circuitry and UHF plumbing, preferably with microwave test equipment design experience.

Must have minimum five years practical experience, including knowledge of Government specifications, airborne, ground and/or naval equipments. Excellent opportunity for advancement. Write, giving outline of education, experience, background and salary expected, to

Engineering Personnel Department

FREED ELECTRONICS AND CONTROLS CORPORATION

200 Hudson Street, New York 13, N.Y.

Manufacturers of

Radio and Television
Receivers
Industrial Controls

Freed-Eisemann

Electronic Equipment
Nucleonics
Instruments

RADIO ENGINEERS

Transmitter and Receiver Engineers needed for overseas work in communications. Salaries \$5,200 and up according to experience.

PAGE ENGINEERS

(Page, Creutz, Garrison and Waldschmitt)
600 Bond Building, Washington, D. C.

ELECTRONIC ENGINEERS

FOR DESIGN & DEVELOPMENT WORK IN
RADAR

COMPUTERS

DIGITAL TECHNIQUES

with a young progressive company,
send resumé of experience and
education, with salary requirements,

to
 Electronic Engineering Company

of California

120 SOUTH ALVARADO STREET LOS ANGELES 4, CALIFORNIA
DUNKER 2-7323

ENGINEERS**ELECTRONIC
SERVO****DESIGNERS****ELECTRO—
MECHANICAL**

**"AC" OFFERS
A Challenge to Men
of Resourcefulness**

FIELD ENGINEERS

• For recent college graduates, here are positions with a challenge —

ASSIGNMENT — you will assist in the installation, operation, and maintenance of our equipment at aircraft plants and Air Force bases. The work will include liaison between AC and the customer, training of customer personnel, analysis of problems, and recommendations for improvements. Many of these outstanding openings are one-year overseas assignments.

YOUR BACKGROUND — your educational background can be in any of the fields of AE, EE, ME, Physics, or equivalent. To be successful in these positions you should have a definite interest in people as individuals and be willing to relocate to field assignments. Single men given preference.

TRAINING — our theoretical and applied in-plant training (here in Milwaukee) will prepare you for these assignments.

In addition to your salary, you will receive a field allowance — and a substantial bonus if selected for overseas assignment . . . if you're looking for an opportunity with a "present" and a future write us for further facts.

We need men of high caliber, experienced in the field of airborne automatic electro-mechanical control equipment. You will be engaged in the manufacture and development of highly complex equipment of the most advanced type in a steadily expanding division of our company—a division with 20 years of successful operation in the precision instrument field. We offer many advantages to those who join our organization—**SALARY** increases are based on merit and initiative . . . two weeks **VACATION** with pay . . . **HOSPITALIZATION BENEFITS** . . . **LIVING and RECREATIONAL FACILITIES** are among the best anywhere along Lake Michigan . . . **POSITIONS ARE PERMANENT** due to long-range manufacturing and development programs . . . in short—here at our "AC" Milwaukee plant you get small company advancement opportunities with large company employe benefits . . . **EXPENSES** incident to interviews are all absorbed by us.

For less experienced engineering graduates, we have a Junior Engineer Training Program which makes it possible for you to become acquainted with all phases of our company . . . you can also take advantage of educational opportunities for advanced degrees at Marquette University and the University of Wisconsin.

We answer ALL inquiries . . . write or apply

AC SPARK PLUG DIVISION

GENERAL MOTORS CORPORATION
1925 E. KENILWORTH PLACE • MILWAUKEE 2, WISCONSIN

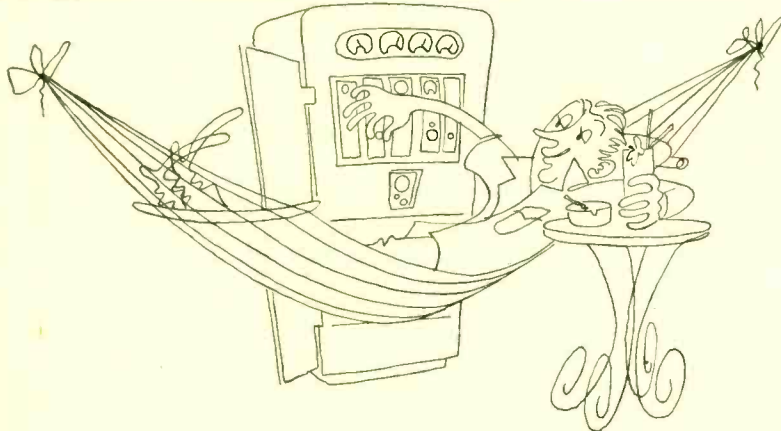
**Pleasant Working Conditions**

So we're exaggerating a little! If you want to get technical about it (and you probably do) your life at our company won't be quite this cushy. We can promise this though—even the sky's not the limit for future opportunity. You work with a congenial group of engineers. People will listen to your ideas. The boss's door is always open.

Who you are—You're an Electronic or Mechanical Engineer. You're experienced in air communication and navigation circuitry and development. You have worked with low or high frequency circuits, instrumentation, component utilization or associated problems.

What you do now—Simple! Just contact:

Arthur E. Harrison, Vice President, Engineering

wilcox Electric Company, Inc.

Fourteenth & Chestnut, Kansas City 27, Mo.

HOUSTON, TEXAS

Precision equipment manufacturer needs qualified experienced engineer for audio and sub-audio transformer design and development. Experience with high permeability alloys desirable. Knowledge of magnetic circuitry must be sufficient for development work on magnetic amplifiers. Salary commensurate with ability.

**SOUTHWESTERN
INDUSTRIAL ELECTRONICS CO.**

P. O. BOX 13058, HOUSTON 19, TEXAS

ELECTRONICS ENGINEERS

This established electronics manufacturer located in the heart of western New York requires men with design experience. Permanent positions available for senior and junior men with EE or ME degrees or equivalent experience. Fine cultural community in which to live with good schools, homes, and progressive associates. Please write to:

**CHIEF ELECTRONICS ENGINEER
STROMBERG-CARLSON COMPANY
ROCHESTER 3, NEW YORK**

DESIGN RESEARCH DEVELOPMENT

key words to your employment opportunities at **GOODYEAR AIRCRAFT . . .**
 pioneer and leader in lighter-than-air craft . . . an established and growing
 company building an outstanding technical reputation

DESIGN ENGINEERING opportunities exist in the fields of airships, air-
 planes, and components, airframes, power-plant installations, controls,
 hydraulics, electronics systems, fuel cells, canopies, and wheels and brakes

DEVELOPMENT of missiles, jet aircraft, and helicopters, electric and elec-
 tronic system, servomechanisms, fiber resin laminates, and many other
 projects present an urgent need for capable engineers

WELDING ENGINEERS, civil engineers, mechanical engineers with ability
 in metals fabrication, and industrial engineers experienced in time study
 are needed. Job opportunities also exist for technical editors and illustrators

POSITIONS are open at several levels, and inquiries are also invited from
 recent graduates. Salaries are based on education, ability, and experience

PAID VACATIONS, free group life insurance, a good hospitalization plan,
 paid sick leave, company-sponsored pension plan, planned recreation, and
 free parking are among the facilities at the plant

A **FRIENDLY CITY**, Akron, Ohio, is located in the center of the midwestern
 industrial region

IF YOU ARE INTERESTED in a secure future, write, giving details, or request
 an application from

C. G. Jones, Salary Personnel Department

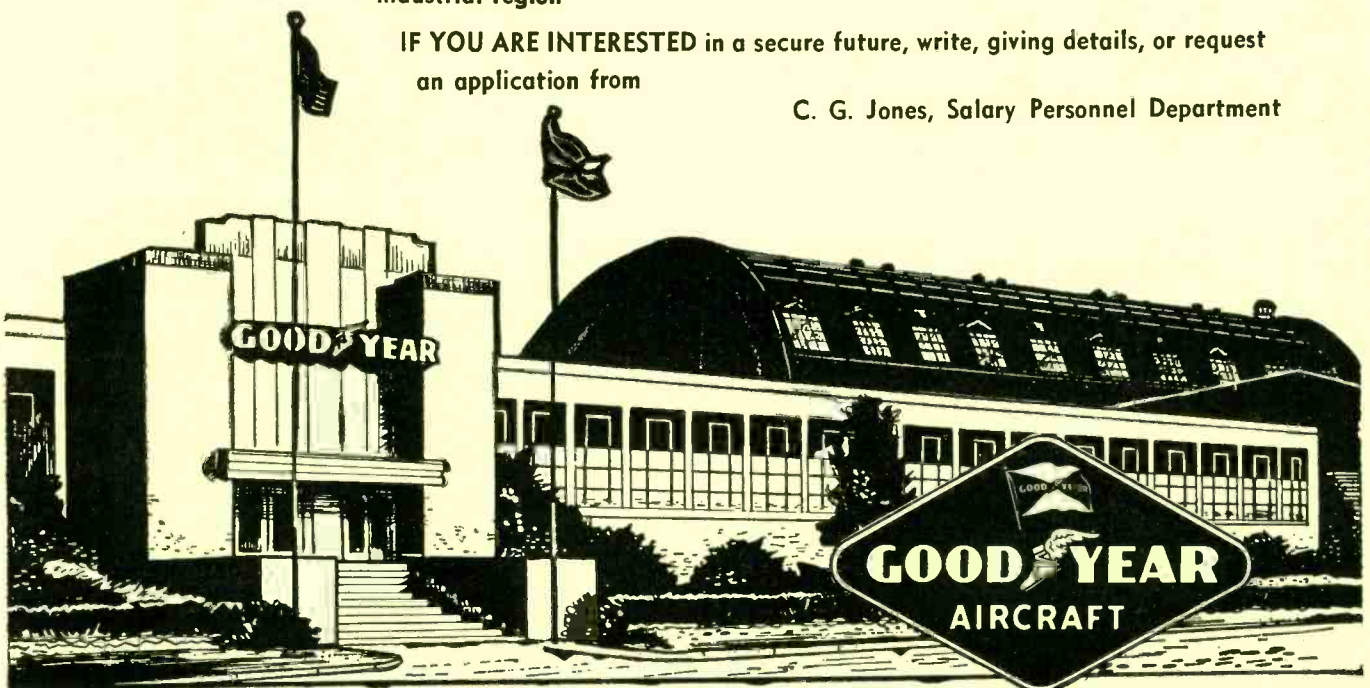

GOODYEAR AIRCRAFT CORPORATION, 1210 Massillon Road, Akron 15, Ohio

ENGINEERS

Unusual Opportunities for Men with Long-Range Plans

• We are one of the leading Electronics firms in the Chicago area and require Design and Development Engineers with from 3 to 5 years' experience. Positions also available at Project Engineer, Engineer and Junior Engineer levels.

We will consider men with the necessary experience and ability who are ready to take on the responsibilities of these openings. The men selected will be given intermediate and advanced level assignments in our well-equipped Television, Radio, and Government Equipment Laboratories.

We are located in the northwest section of Chicago where living and working facilities are sec-

ond to none. We are within easy access of all shopping centers with convenient city transportation. Close by are many suburbs where one can live and commute back and forth in a short time—adjacent to all great centers of learning.

Our company has a long-range program of design and development in which you may participate . . . all positions are permanent.

- Our requirements concern experience in all phases of the development of monochrome and color TV receivers • color generating equipment
- UHF systems • radio receivers (broadcast or military) • radar systems • and laboratory test equipment

We suggest you write Mr. Walter Wecker, Personnel Division, giving educational qualifications and related experience. Interviews will be arranged at your convenience.

Admiral Corporation

3800 W. Cortland St.
Chicago 47, Illinois

Bell Telephone Laboratories

has career openings for experienced

*electrical engineers
mechanical engineers
physicists*

For work on Guided Missiles, Radar, Fire Control and Underwater Systems in New Jersey (20 miles from New York City).

The company that has pioneered many of the major developments in the fields of communications and electronics now offers you an opportunity to join its staff. Here you will gain invaluable experience and great satisfaction through the challenging diversified nature of the work. To qualify, you must be a college graduate (preferably not over 40 years of age) with related experience of the following types:

Systems Engineering

Analysis
Coordination
Evaluation
Planning
Studies

Systems Development

Fundamental Development
Circuit Design
Mechanical Design
Equipment Development
Field Testing

Write, giving full details of education and experience to:

BELL TELEPHONE LABORATORIES Inc.

Employment Director, Box 2, New York 14, N. Y.



ENGINEERS SYSTEMS RADAR SERVO COMPUTER

BACKGROUND:

Responsible positions open for top level development and project engineers with practical and research experience in:

Advanced Electronic Circuits and Systems

Microwave Radar

Microwave Receivers and Transmitters

Also Engineering Design and Analysis relating to fields such as:—

Analogue and Digital Computers

Servomechanisms

Communications

Navigation

Fire Control



Requirements emphasize advanced analytical and/or management experience on highly complex electronic and electro-mechanical systems.

Kindly send resume and salary requirements to

The W.L. MAXSON CORP.
460 W. 34th ST., NEW YORK 1, N.Y.

ENGINEERS:

**DOES YOUR
PRESENT JOB
GIVE YOU**

ALL THESE

RCA

CAREER

ADVANTAGES?

**POSITIONS NOW OPEN FOR
SENIOR DEVELOPMENT
AND DESIGN ENGINEERS:**

- ✓ ELECTRONIC . . .
- ✓ COMMUNICATIONS . . .
- ✓ MECHANICAL . . .
- ✓ COMPUTER . . .
- ✓ ELECTRON TUBE . . .

**PERSONAL INTERVIEWS ARRANGED
IN YOUR CITY.** A copy of our booklet
"Challenge and Opportunity," describing the role of the
engineer in RCA, will be mailed upon request. Please
send a complete resume of your education and
experience to:

MR. ROBERT E. McQUISTON, Manager
Specialized Employment Division, Dept. 200 I
Radio Corporation of America
30 Rockefeller Plaza
New York 20, N.Y.

CHECK SHEET

Yes	No	
<input type="checkbox"/>	<input type="checkbox"/>	PROFESSIONAL RECOGNITION AND PRESTIGE?
<input type="checkbox"/>	<input type="checkbox"/>	ADVANCEMENT IN STATUS?
<input type="checkbox"/>	<input type="checkbox"/>	SECURITY AND STABILITY?
<input type="checkbox"/>	<input type="checkbox"/>	CHALLENGE AND OPPORTUNITY?
<input type="checkbox"/>	<input type="checkbox"/>	HIGH SALARY SCALE AND OPPORTUNITIES FOR PROMOTION?
<input type="checkbox"/>	<input type="checkbox"/>	EXCELLENT SUBURBAN HOUSING AT REASONABLE COST?
<input type="checkbox"/>	<input type="checkbox"/>	FACILITIES FOR PROFESSIONAL ADVANCEMENT?
<input type="checkbox"/>	<input type="checkbox"/>	UNEXCELLED TECHNICAL AND LABORATORY FACILITIES?
<input type="checkbox"/>	<input type="checkbox"/>	ASSOCIATION WITH TOP SCIENTISTS?
<input type="checkbox"/>	<input type="checkbox"/>	TUITION REFUND PLAN FOR ADVANCED STUDY?
<input type="checkbox"/>	<input type="checkbox"/>	MILITARY OR COMMERCIAL OPPORTUNITY?
<input type="checkbox"/>	<input type="checkbox"/>	MODERATE COST OF LIVING?
<input type="checkbox"/>	<input type="checkbox"/>	MODERN RETIREMENT PLAN?
<input type="checkbox"/>	<input type="checkbox"/>	COMPANY-PAID LIFE INSURANCE?
<input type="checkbox"/>	<input type="checkbox"/>	COMPANY-PAID LIBERAL HOSPITAL, SURGICAL AND DISABILITY PLAN (FAMILY BENEFITS)?
<input type="checkbox"/>	<input type="checkbox"/>	LIBERAL VACATION PLAN?
<input type="checkbox"/>	<input type="checkbox"/>	LIBERAL HOLIDAY SCHEDULE?
<input type="checkbox"/>	<input type="checkbox"/>	PROFESSIONAL STATUS AND UTILIZATION OF YOUR EDUCATION AND EXPERIENCE?



RADIO CORPORATION of AMERICA

Exceptional Opportunities for...

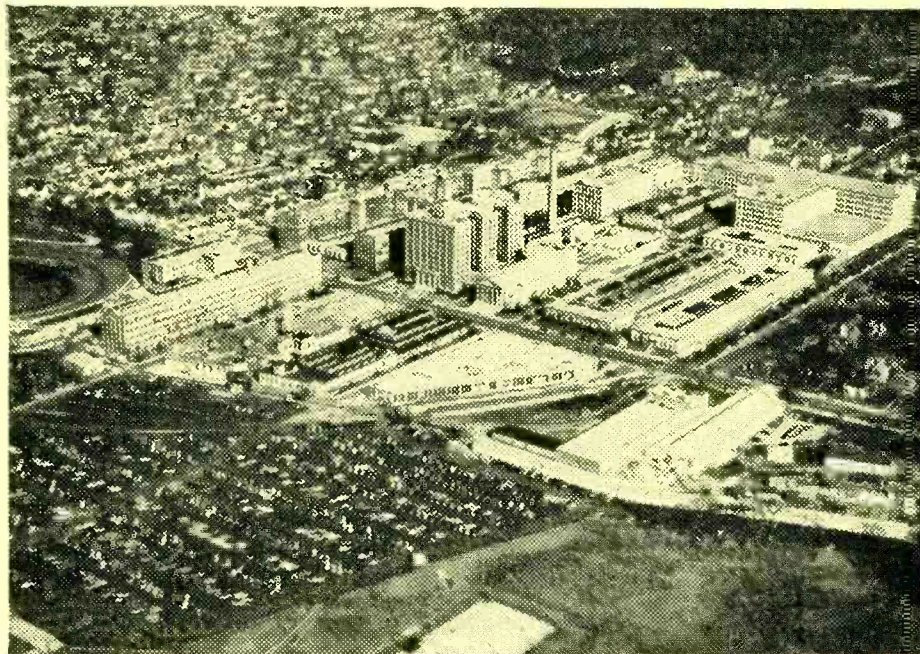

electrical engineers
mechanical engineers
mechanical designers

in the field of electronic computers and associated equipment for use in business machines.

Write, giving education and experience to Employment Manager.

Reply to Department A.

THE NATIONAL CASH REGISTER COMPANY, Dayton 9, Ohio

**PROGRESS WITH A LEADER
OFFERING
ADVANCED ENGINEERING POSITIONS
IN
NEW AIR CONDITIONED PLANT**

Country Surroundings
—Big City Advantages
Add Up To An
Unlimited Future With

SYLVANIA'S ELECTRONICS DIVISION

A leader in the development and production of microwave components, Sylvania's expanding Electronics Division offers a few top microwave engineers an assured future.

Here, in New England's Greater Boston area, you will be next door to some of the country's most renowned technical centers of learning and research, yet you and your family will enjoy the serenity of country living.

ENGINEERING SPECIALIST
This is a top engineering staff position for a man who has the flair, ability and knowledge of a specialist who will be cognizant of and assist as an expert in all divisional microwave programs and problems of our four plants. The position offers top-rank professional activity covering invention, research, development, production and application in the microwave field. Products involved include semi-conductor devices, TR and ATR tubes, magnetrons, klystrons, and travelling wave tubes. Requirements for this position include advanced

engineering or physics degree, or equivalent, and at least 5 years of solid experience in the microwave field.

MICROWAVE SPECIALIST
For advanced microwave investigations, particularly related to silicon crystal development, applications and improved evaluation and testing. Requires sound background in electromagnetic theory, waveguide circuitry, microwave mixer operation. An engineering or physics degree and 1 to 5 years of microwave experience are desirable.

Please send complete resume to:

Mr. Robert L. Koller
Sylvania Electric Products Inc., Electronics Division
Woburn, Mass.

SYLVANIA

**WANTED
ENGINEER WITH
EXPERIENCE IN
VHF OR UHF**

Interesting creative work with the most resourceful and progressive firm in the field of television equipment.

This position is permanent. It will offer every opportunity for unlimited advancement and for developing a successful career. The plant is now housed in a newly-acquired larger building, only 22 miles from downtown New York City. The surroundings and atmosphere are stimulating and congenial.

Attractive Salary
Write stating qualifications.

BLONDER-TONGUE LABORATORIES
526-536 NORTH AVENUE
WESTFIELD, NEW JERSEY

FIELD AND RESEARCH ENGINEERS

- Radio Communications
- Navigation Equipment
- Microwave
- Terminal Equipment
- Teletype
- Radar
- Computer
- Test Equipment

Responsible positions with a well established progressive organization. Applicants must have diversified training and experience. Personal interviews will be arranged for applicants meeting employment requirements. Reply by letter giving age, education, experience and other qualifications to:

George W. Sarbacher, Jr.

**NATIONAL
SCIENTIFIC LABORATORIES,
Inc.**

2010 Massachusetts Avenue, N. W.
Washington 6, D. C.

ENGINEERS AND PHYSICISTS BS-MS-Ph.D:

Responsible positions in mechanical, electrical or electronic engineering, physics or engineering physics for advanced development and design of special equipment and instruments. Prefer men with minimum of two years' experience in experimental research design and development of equipment, instruments, intricate mechanisms, electronic apparatus, optical equipment, servomechanisms, control devices and allied subjects. Positions are of immediate and permanent importance to our operations. Southwestern location in medium sized community. Excellent employee benefits. Reply by letter giving age, experience and other qualifications. All applications carefully considered and kept strictly confidential.

Ind. Rel. Manager
Research & Development Dept.

**PHILLIPS
PETROLEUM COMPANY**
Bartlesville • Oklahoma

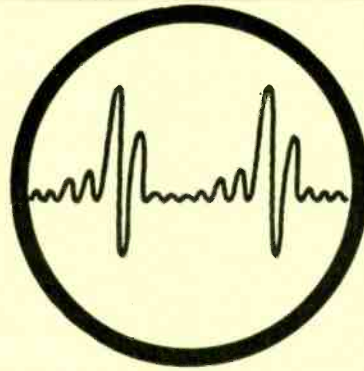

SPECIAL OPPORTUNITIES FOR SENIOR ENGINEERS

Convair in beautiful, sunny San Diego invites you to join an "engineers" engineering department. Interesting, challenging, essential long-range projects in commercial aircraft, military aircraft, missiles, engineering research and electronics development. Positions open in these specialized fields:

Electrical Design	Servo-mechanisms
Mechanical Design	Aerodynamics
Structural Design	Thermodynamics
Structures	Operation Analysis
Weights	System Analysis

Generous travel allowances to those accepted.
For free brochure, write Mr. H. T. Brooks,
Engineering Dept. 900

CONVAIR

IN BEAUTIFUL
SAN DIEGO

3302 PACIFIC HIWAY
SAN DIEGO 12, CALIFORNIA

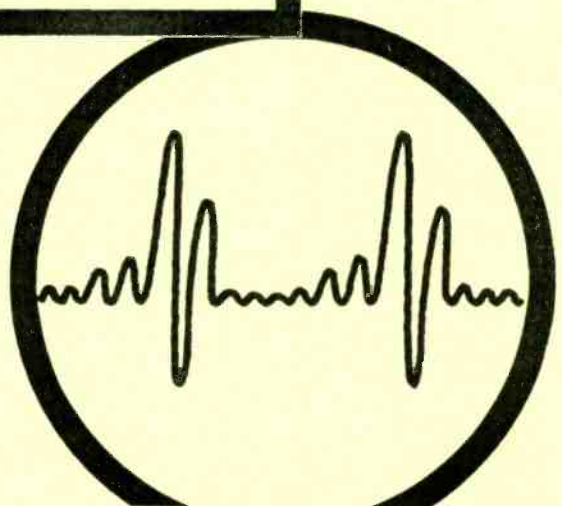
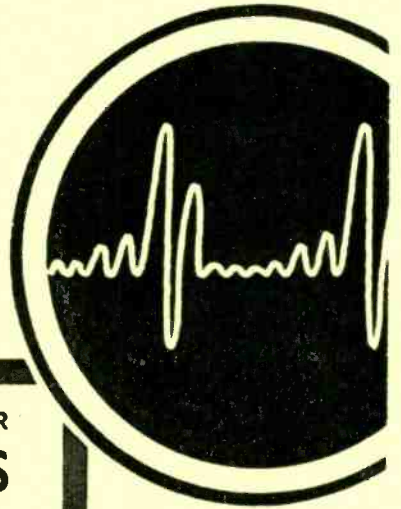



- TV RECEIVER DESIGN ENG.
- ELECTRONICS ENG.
- FIELD ENGINEERS
- TEST & INSPECTION ENG.
- COMPONENTS ENG.

You're needed to work on: Radar, G.C.A., Mobile Radio, Auto Radio, Airborne Communication & Navigation Equipment, Television, Antennas, Microwave Equipment, Servo Mechanisms and Guided Missiles.

You will benefit from high wages, a modern, air-conditioned plant, paid vacations and holidays, group insurance and a good chance for advancement.

Housing immediately available in the beautiful suburban and county areas that surround the Bendix Radio plant.



Write,
Wire or Phone
MR. E. O. COLE
Dept. J

Bendix Radio

DIVISION OF BENDIX AVIATION CORPORATION

Baltimore-4, Md. Phone: VALley 3-2200

*Makers of the World's Finest
Electronic Equipment*

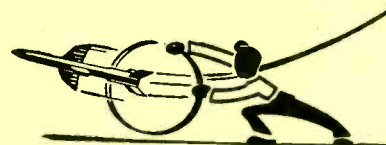

... *An invitation to*

Experienced

ELECTRONIC ENGINEERS and PSYCHICISTS

We have several positions of technical leadership available in our growing Guided Missile Division. Applicants must have over four years experience and/or advanced degrees in either missile guidance systems, radar, servomechanisms, fire control computers, or U. H. F. techniques.

Our plant is located in beautiful suburban St. Louis, where you can enjoy the comforts of "county" living with easy access to "big city" shopping, entertaining, medical and educational facilities. Moving allowance for qualified applicants. Our Housing Representative will assist you in relocating.

Address replies to:

Technical Placement Supervisor
Box 516, St. Louis 3, Mo.

MCDONNELL
Aircraft Corporation
ST. LOUIS 3, MO.

ELECTRONIC ENGINEERS

EE or ME degree, minimum 3 years' experience in research and development work involving microwave circuits and antennas, circuit development, servomechanisms, analogue computers or related equipment.

FIELD REPRESENTATIVES

A few openings for graduate engineers only with backgrounds similar to above. Continental U.S.A.

What You Can Expect at General Precision Laboratory

A progressive group of young, successful men, firmly established as designers and manufacturers of electronic equipment . . . a medium-sized staff in which you receive individual recognition . . . a policy of promotion-from-within that helps qualified men move ahead swiftly . . . a modern laboratory located in a pleasant suburban community ideal for family living.

Expenses will be paid for qualified applicants who come for interviews. Please submit complete resume to: Mr. H. F. Ware

GENERAL PRECISION LABORATORY

INCORPORATED

A Subsidiary of GENERAL PRECISION EQUIPMENT CORPORATION
63 BEDFORD ROAD, PLEASANTVILLE, NEW YORK

Electrical Engineers and Physicists

- Radar Simulation
- Advanced Circuitry
- Analog Computers
- Ballistics
- Mapping
- Telemetering

Senior and Junior Engineers

Monotony Unknown . . .

Here is your opportunity to join with an organization where your skill will be utilized in association with an entire project, not just a segment of a job. We are small but growing . . . we offer you the opportunity to grow and advance with us. Gain individual recognition by working closely with technical management. Associate with other top-notch engineers . . . live and work in suburban surroundings, just 8 miles from metropolitan Baltimore. If you are interested in an organization where monotony is unknown . . . write:

Industrial Research Laboratories

Hilltop and Frederick Roads
Baltimore 28, Maryland

*"An Unexcelled Opportunity
For Professional Growth"*

ELECTRONIC ENGINEERS & PHYSICISTS

IN RESEARCH AND DEVELOPMENT

GUIDED MISSILES • RADAR • SOLID STATE PHYSICS •
VACUUM TUBES • ELECTRONIC NAVIGATION •
TELEVISION • MICROWAVES • ANTENNAS •
RADIO • COMPUTERS • TRANSISTORS •

DIRECT INQUIRIES TO:
THE EMPLOYMENT DEPT.

CAPEHART-FARNSWORTH

CORPORATION
FORT WAYNE, INDIANA

**AN IT&T
ASSOCIATE**

UHF-VHF SENIOR ENGINEERS

WE ARE LOOKING FOR
ENGINEERS FOR OUR
ELECTRONIC RESEARCH AND
DEVELOPMENT DIVISION

THESE ARE THE REQUIREMENTS:

3 to 5 years genuine design and development experience, specializing in VHF and UHF measurements, and component and tuner engineering projects.

Good theoreticians, but with solid practical experience and excellent records of achievement. Prefer graduate Electrical Engineers.

THESE ARE THE ADVANTAGES:

A ground floor connection in the new research and development division of one of the oldest and most highly regarded manufacturers of radio and television components.

The opportunity to work in a fully equipped, completely modern research laboratory on permanent long range commercial projects.

To work directly with prominent electronic research director, who will encourage and give full consideration to your ideas.

To locate in one of the many desirable suburban residential communities adjacent to Philadelphia and within easy driving distance of the seashore.

ADDRESS REPLIES TO:

RADIO CONDENSER COMPANY

Davis & Copewood Sts.
Camden 3 N. J.

ELECTRONIC INSTRUMENT COMPANY

Requires

DEVELOPMENT ENGINEERING MANAGER

Well established small Company, primarily active in commercial field, has opening for Electronic Engineer or Physicist to direct activities of its Development Engineering Department. Successful applicant will report directly to President, assume responsibility for program of instrument development and will be expected to contribute to formulation of future Company program.

Applicants should, in general, fulfill the following requirements:

1. 10 to 15 years' experience; substantial portion in Electronics. Administrative experience desirable.
2. Good theoretical grasp, but capable of rapidly developing practical methods of implementing theory.
3. Imagination and enthusiasm a primary requirement.
4. Ability to work efficiently in small, well integrated Company.

Please apply in writing, giving full resume of education and experience to:

The President
BOONTON RADIO CORPORATION
BOONTON, NEW JERSEY

RESEARCH ENGINEERS AND PHYSICISTS

Southwest Research Institute, 8500 Culebra Road, San Antonio, Texas, has several staff positions requiring engineers and physicists with B.S. or advanced degrees and 2-10 years experience. Versatility and excellent grounding in fundamentals preferred for research applied to broad industrial development problems. Please write to Mr. S. J. Keane, Physics Department.

MICROWAVE ENGINEER

For production design and development of waveguide systems, klystron oscillators, attenuators, and echo boxes. Send resume to Personnel Manager.

VECTRON, INC.
400 Main Street Waltham, Mass.

to
men
who
want
the
best

ENGINEERS, EE

1. Development of radio and radar components and systems.
2. Design of components for the magnetic deflection of Cathode Ray Tubes.
3. For component and system development work in airborne navigational equipment.

DESIGNERS

1. For work in the design of electro-mechanical navigational computers.

Kollsman provides excellent facilities for the design and development of America's finest aircraft instruments. In our modern laboratories you'll find a congenial atmosphere in which you can do your best work. You'll be encouraged to advance as our progressive organization continues to grow.

At Kollsman you'll receive liberal benefits including paid life, hospitalization, surgical, accident and health insurance. Not to be overlooked is the convenient location in a quiet residential section only 20 minutes from the heart of New York City. Why not find out what Kollsman has to offer you?



KOLLSMAN INSTRUMENT CORP.
80-08 45th Ave., Elmhurst, L. I., New York

RECEIVER ENGINEERS MECHANICAL ENGINEERS DRAFTSMEN

Career Opportunities
With Old Established
Central Connecticut Firm
Interesting Projects
Top Salaries
Suburban Living

We Need Men Experienced
in Servo Mechanisms
UHF, VHF, Microwave,
Receivers, Transmitters
Variable Capacitors

Replies Held In Strict Confidence
Write Or Phone Collect
Personnel Mgr.—Sherwood 7-2741

THE
ALLEN D. CARDWELL MFG. CORP.
Plainville, Connecticut

INSTRUMENT MEN

Age 35-45

Required by major oil company for career opportunities in South America.

Duties include supervision and job responsibilities in installation and maintenance of electronic indicating and recording instruments measuring temperature, pressure, volume and velocity variables as related to crude production, transportation and processing of petroleum products. Minimum requirements: Degree in Electrical Engineering or equivalent in experience, three years industrial instrument experience preferably petroleum or chemical industry. Salary plus bonus: \$7,500-\$11,000, depending on experience. Also liberal benefits and home vacations with traveling expenses. Replies confidential.

Box 1540
Dept. H
General Post Office
New York 1, New York

Engineers & Physicists

- Mechanical Engineers
- Servo Engineers
- Electrical Engineers
- Chemists
- Physicists

The diversified research and development programs now in progress at
melpar, inc.
The Research Laboratory
of Westinghouse Air Brake Co. and its subsidiaries
offer excellent opportunities for professional achievement to qualified men.



Write to Personnel Director,
MELPAR, INC. Dept. E-3
452 Swann Avenue
Alexandria, Virginia
or 10 Potter St., Cambridge, Mass.

Our representative,
Mr. E. M. Lane,
will interview at
the Sherman Hotel
in CHICAGO during
the National
Electronics Conference,
Sept. 28-30.

*Your inquiry
will have
special value . . .*

if you mention this magazine, when writing advertisers. Naturally, the publisher will appreciate it . . . but, more important, it will identify you as one of the men the advertiser wants to reach with this message . . . and help to make possible enlarged future service to you as a reader.

BENDIX AIRCRAFT TYPE GENERATOR

Bendix-Eclipse Aviation; Type 1235... Counter-clockwise rotation. Speed 2500-4500 RPM; 23.5 VDC @ 15 A. A. Two-Bush ball bearing generator suitable for any application where 28 volt output is required. Field and armature taps for adjustment of voltage from 12 to 28 volts. NEW \$15.00



G. E. GENERATORS

General Electric Type 5-ASB-31JJ3; 400 cycles out at 115 volts; 7.2 amps; 8,000 rpm.; size 6" long x 6" dia. \$99.50 ea.

SINE-COSINE GENERATORS (Resolvers)

Diehl Type FJE43-9 (Single Phase Rotor). Two stator windings 90° apart, provides two outputs equal to the sine and cosine of the angular rotor displacement. Input voltage 115 volts, 400 cycle. \$30.00 ea.
Diehl Type FPE-13-1 same as FJE-43-9 except it supplies maximum stator voltage of 220 volts with 115 volts applied to rotor. \$25.00 ea.

Arma Resolver Type 213014; equal in size to size 5 synchro; 55-60 cycle; single phase primary, 2 phase secondary. \$79.50

VOLTAGE GENERATORS (RATE)

ALNICO MIDGET D.C. VOLTAGE GENERATOR Type B-35-D \$17.50
ALNICO MIDGET D.C. VOLTAGE GENERATOR Type B-44-D \$17.50
A.C. GENERATOR: 67 V., 20 Cyc., 2-Phase, .015 Amps. Type PM-1, 1200 R.P.M. \$15.00

SYNCHROUS SELSYNS

110 volt, 60 cycle, brass cased, approx. 4" dia. x 6" long. Mfg. by Diehl and Bendix.



Quantities Available.

REPEATERS \$20.00 ea.
TRANSMITTERS \$20.00 ea.

AUTOSYN MOTOR TYPE 1

115 VAC; 60 cycle; 1-phase; DR. # CB 4279 Foot Mounted; Mfg. Bendix Aviation Corp. \$22.50 ea.

SELSYN GENERATOR

General Electric MOD. 2J15M1; 115-57.5 Volts 400 Cycle \$22.50 ea.

SYNCHROS

AUTOSYN MTR. KOLLSMAN Type #403; 32 VAC; 60 cycle; single phase. \$22.50
AUTOSYN MTR. BENDIX Type #851; 32 VAC; 60 cycle; single phase. \$22.50
SYNCHRO TRANSMITTER, KEARFOTT Type R-212-1A-A Rotor; 26 Volts; single phase; Stator; 11.8 Volts; 3-phase; 400 cycle. \$25.00
MICROSYN UNIT, Type IC-006-A \$35.00
IF Special Repeater (115V-400 Cy.) \$15.00 ea.
2J1F 3 Generator (115-400 cyc.) \$10.00 ea.
5CT Control Transformer: 90-50 Volt, 60 Cy. \$50.00 ea.
5F Motor (115/90 Volt—60 cyc.) \$50.00
5G Generator (115/90 v.—60 cy.) \$50.00 ea.
5/DG Differential Generator (90-94 volts—400 cyc.) \$30.00 ea.
TRANSMITTER, BENDIX C-78248; 115 Volt, 60 Cycle. \$25.00 ea.
Differential—C-78249; 115 V.; 60 Cy. \$5.00
5N MOTOR (115 Volts/60 Cycle) \$22.50
REPEATER, BENDIX C-78410; 115 Volt, 60 Cycle \$37.50 ea.
REPEATER, AC synchronous 115 V., 60 cycle, C-78863 \$15.00 ea.
REPEATER, DIEHL MFG. No. FJE 22-2; 115 Volt; 400 Cy.; Secondary 90 V. \$27.50
7G Synchro Generator (115/90 volt; 60 cycle) \$75.00
6G Synchro Generator (115/90 volt; 60 cycle) \$60.00
6DG Synchro Differential Generator (90/90 volt; 60 cycle) \$60.00
2-JF5-J Selsyn Control Transformer: 105-55 Volts; 60 Cycle \$50.00
5JD5H1 Selsyn Generator: 115-105 Volts; 60 cycle \$50.00
2J1F1 GENERATOR: 115—57.5 Volt; 400 cycle \$12.50 ea.
2J1H1 DIFFERENTIAL GENERATOR: 57.5—57.5 Volt; 400 cycle \$12.50 ea.
2J1G1 CONTROL TRANSFORMER: 57.5—57.5 Volt; 400 cycle. \$7.50 ea.

PIONEER TORQUE UNITS

TYPE 12601-3-A: Contain CK5 Motor coupled to output shaft through 125:1 gear reduction train. Output shaft coupled to autosyn, follow-up (AY43). Ratio of output shaft to follow-up Autosyn is 15:1. \$70.00 ea.
TYPE 12602-1-A: Same as 12606-1-A except it has a 30:1 ratio between output shaft and follow-up Autosyn \$70.00 ea.
TYPE 12602-1-A: Same as 12606-1-A except it has base mounting type cover for motor and gear train \$70.00 ea.

INVERTERS

10563 LELAND ELECTRIC

Output: 115 VAC; 400 cycle; 3-phase; 115 VA; 75 PF. Input: 28.5 VDC; 12 amp. \$69.50 ea.

PIONEER 12117

OUTPUT: 26 volts; 400 cycles; 6 volt amperes, 1-Phase INPUT: 24 VDC; 1 amp. \$25.00 ea.

ALTERNATOR, CARTER

Mfg. Carter Motor Co.; 26.5 VDC; 10.5 amps; 6500 rpm; INPUT: 7 VAC; 9.7 amp; 650 cycles, and 295 VDC 200 amps. \$49.50 ea.

PE 218 LELAND ELECTRIC

Output: 115 VAC; Single Phase; PF 90; 380/500 cycle 1500 VA. Input: 25-28 VDC; 92 amps; 8000 RPM; Exc. Volts 27.5.

BRAND NEW \$39.95 ea.

PE 109 LELAND ELECTRIC

Output: 115 VAC, 400 cyc.; single phase; 1.53 amp.; 8000 RPM; Input: 13.5 VDC; 29 amp. \$69.50

MG-075 ONAN

Navy Type PU/11 Output: 115 VAC; 480 cyc.; single phase; 5.3 amp and 26 VDC @ 3.8 amp. Input: 115/230 VAC; 60 cyc.; single phase \$225.00

MG 153 HOLTZER-CABOT

Input: 24 V, DC, 52 amps; Output: 115 volts—400 cycles, 3-phase, 750 VA. and 26 Volt—400 cycle, 250 VA. Voltage and frequency regulated \$95.00 ea.

PIONEER 12130-3-B

Output: 125.5 VAC; 1.15 amps. 400 cycle single phase, 141 VA. Input: 20-30 VDC, 18-12 amps. Voltage and frequency regulated \$89.50 ea.

12116-2-A PIONEER

Output: 115 VAC; 400 cyc.; single phase; 45 amp. Input: 24 VDC 5 amp. \$90.00 ea.

10285 LELAND ELECTRIC

Output: 115 Volts AC, 750 V.A., 3 phase, 400 cycle, .90 PF, and 26 volts, 50 amps, single phase, 400 cycle, 40 PF. Input: 27.5 VDC, 60 amps. cont. duty, 6000 RPM. Voltage and Frequency regulated. \$195.00

10486 LELAND ELECTRIC

Output: 115 VAC; 400 Cycle; 3-phase; 175 VA; .80 PF. Input: 27.5 DC; 12.5 amp; Cont. Duty \$90.00 ea.

PIONEER 10042-1-A

DC INPUT 14 Volts; OUTPUT: 110 Volts; 400 Cycle 1-Phase; 50 Watt. \$90.00

94-32270-A LELAND ELECTRIC

Output: 115 Volts; 190 VA; Single Phase; 400 Cycle; .90 PF, and 26 Volts; 60 VA; 400 Cycle; 40 PF. Input: 27.5 Volts DC; 18 amps; cont. duty, voltage and freq. regulated \$95.00

PIONEER AUTOSYNS

AY-1..... 26 Volt—400 Cycle..... \$6.95
AY-5..... 26 Volt—400 Cycle..... \$7.95
AY27D..... \$12.50
AY6—26 Volt—400 cyc..... \$4.95 ea.
AY30D—26 Volt—400 cyc..... \$35.00 ea.
AY14D..... \$10.00
AY34..... \$20.00
AY20—26 Volt—400 cyc..... \$12.50 ea.

PORTABLE GAMMA SURVEY METER

Model 247B: For detecting and measuring higher intensities of Gamma radiations while obtaining discrimination against other radiations. Range switch permits selection on scales of zero to 50, zero to 500, zero to 5000, and zero to 50,000 milliroentgens/hour (MR/HR). Entirely self-contained, the unit consists of a watertight aluminum case with sealed detector assembly, hermetically sealed meter, vacuum tubes and circuit components with power supply of 1.45V dry battery and 1-300V dry battery. Dimensions are 10-¹/₂" wide; 12-59/64" high; weight 12-³/₄ lbs. incl. batteries. Mfg. Victoreen Instrument Co. Original A.E.C. cost over \$300. Buy it at a tremendous savings \$99.50 Brand New



Immediate Delivery

ALL EQUIPMENT FULLY GUARANTEED

All prices net FOB Pasadena, Calif.

C and H Sales Company

BOX 356-X EAST PASADENA STATION

PASADENA 8, CALIFORNIA

ALNICO FIELD MOTORS

(Approx. size overall... 3³/₄" x 1¹/₄" diameter)

DELCO TYPE #5069600; 27.5 volts DC; 250 RPM \$13.95
PM Motor, Delco Type #5069371; 27.5 volts; DC Alnico Field; 10,000 r.p.m.; dimensions 1" x 1" x 2" long; shaft extension ¹/₄" diameter 0.125" \$15.00

PIONEER GYRO FLUX GATE AMPLIFIER Type 12076-1-A, complete with tubes \$27.50 ea.

AC CONTROL MOTOR

A. C. SYNCHRONOUS MOTOR Type RBC 2505; Volts 115; Cycles 60; RPM 50; Mfg. HOLTZER CABOT ELECT. Approx. size: 2¹/₂" x 2¹/₂" x 2¹/₂" \$15.00 ea.

400 CYCLE MOTORS

PIONEER: TYPE CK5 2 Phase; 400 cycles \$25.00 ea.

EASTERN AIR DEVICES TYPE J49A: 115 V; 0.1A; 7000 r.p.m. Single phase 400 cycle \$17.50 ea.

AIRESEARCH: 115V; 400 CPS; Single phase 6500 RPM; 1.4 amp; Torque 4.6 in. oz.; HP .03 \$10.00 ea.

EASTERN AIR DEVICES TYPE JM6B: 200 VAC; 1 amp; 3 phase; 400 cycles, 6000 RPM \$12.50 ea.

EASTERN AIR DEVICES, TYPE J31B: 115 V. 400-1200 Cycle. Single Phase \$12.50 ea.

AIRESEARCH: AC Induction, 200 V; 3 Phase, 400 Cycle, 2 H.P.; 11,000 RPM; 8 amps. \$79.50 ea.

AIRESEARCH: AC Induction, 200 V; 3 Phase, 400 Cycle, 12 H.P. 6500 RPM; 1.5 amps. \$25.00

Electric Motor: PNT—1400—A1—1A Serial No. 207, 208 V., 400 cycles, 3 phase Kearfott Co., Inc. \$17.50 ea.

SERVO MOTOR 10047-2-A; 2 Phase; 400 Cycle, with 40-1 Reduction Gear

SMALL DC MOTORS

DELCO #5072000; 27.5 VDC; 11.75 rpm \$15.00

DELCO #5068750; constant speed; 27 VDC; 160 RPM; built-in reduction gears and governor \$17.50 ea.

J. OSTER: series reversible motor; 1/50th H.P.; 10,000 RPM; 27¹/₂ VDC; 2 amps; SPERRY #806069; approx. size 1¹/₂" x 3³/₄" \$7.50 ea.

(Approx. size... 4" long x 1¹/₄" dial.)

General Electric Type 5A10AJ37; 27 volts, DC; 5 amps, 8 oz. inches torque; 250 RPM, shunt wound; 4 leads; reversible. \$15.00 ea.

General Electric, Mod. 5BA10FJ33; 12 oz. inches torque, 12 V DC, 50 RPM, 1.02 amp. \$15.00 ea.

General Electric-Type 5BA10AJ53C; 27 volts, DC; 5 amps, 8 oz. inches torque; 145 RPM; shunt wound; 4 leads; reversible \$15.00 ea.

GENERAL ELECTRIC DC MOTOR Mod. 5BA10AJ64, 160 r.p.m.; 65 amp; 12 oz.-in. torque; 27V DC \$19.95 ea.
2¹/₄ H.P. MOTOR—Mfg. LEECE-NEVILLE Co; Type 1454-MO; 24VDC; 4000 RPM; 100 amp. \$35.00

115 VOLT GENERATORS

Brand new Eclipse generators: 115 VAC; 9.4 amp; 1000 watts; single phase; 800 cycles, 2400-4200 rpm. DC output is 30 volts at 25 amp. Unit has spline drive shaft and is self-excited \$29.95



MICROPOSITIONER

Barber Colman AYLZ 2133-I Polarized D.C. Relay: Double Coil Differential sensitive, Alnico P. M. Polarized field. 24V contacts; .5 amps; 28 V. Used for remote positioning, synchronizing, control, etc. \$12.50 ea.

BLOWER

Eastern Air Devices, Type J31B; 115 volt; 400-1200 cycle; single phase; variable frequency; continuous duty; L & R #2 blower; approx. 22 cu. ft./min. \$15.00

BLOWER ASSEMBLY

115 Volt, 400 Cycle, Westinghouse Type FL 17CFM, complete with capacitor. \$12.50 ea. New

SENSITIVE ALTIMETERS

Pioneer Sensitive altimeters, 0-35,000 ft. range... calibrated in 100's of feet. Barometric setting adjustment. No hook-up required. \$12.95 ea.



WRITE FOR OUR
FREE BULLETIN
MORE GOOD ITEMS

GUARANTEED
BRAND NEW

ELECTRONIC RESEARCH

Receiving Tubes	Type No.	Price	Type No.	Price	Type No.	Price	Type No.	Price	Type No.	Price	Type No.	Price	Type No.	Price	
2A3	1.28	6AV6	.55	6N7GT	.89	7C7	.79	12X3	.89	50Y6GT	.92	1B49	50.33	2K39	139.00
2A5	.79	6B4G	1.25	6P5GT	.86	7E5	.79	12Z3	.89	53	.95	1H20	.88	2K45	129.50
2B7	.79	6B5	1.29	6R7	.79	7E7	.58	14A4	.97	55	.95	1P21	35.00	2K55	135.00
2E5	.94	6B7	.95	6R7	.79	7E7	.58	14A7	.74	155B	.32	1P23	4.10	3AP1	8.95
2X2	.50	6B8	.75	6S4	.72	7F7	.99	14B6	.74	56	.69	1P24	1.27	3AP4	10.25
2X2A	1.85	6B8G	.75	6S7	1.06	7F8	1.35	14B8	.89	57	.69	1P29	2.19	3B2/	
3A4	.65	6BA6	.65	6S7G	.99	7G7	.89	14C5	1.10	58	.69	1Q23	122.50	EL-1C	2.60
3A5	.95	6BA7	1.20	6SA7	.71	7H7	.79	14C6	.93	59	1.24	1S21	9.50	3B24	5.20
3A8GT	1.50	6B7	1.10	6SB7Y	1.04	7J7	1.10	14E7	1.09	71A	.79	1Z2	3.75	3B24W	7.50
3B7	.57	6BC7	1.10	6SC7	.93	7L7	.97	14F7	.89	75	.85	2A4G	1.22	3B25	4.50
3C6	1.15	6BD6	1.60	6SD7GT	.94	7N7	.97	14H7	.89	76	.69	2AF1	8.95	3B26	3.75
3D6	.57	6BE6	.65	6SE5	.83	7Q7	.79	14J7	.89	77	.69	2B4	2.10	3B27	4.20
3E5	.77	6BF6	.83	6SF5GT	.80	7R7	.94	14N7	.89	78	.79	2B22	2.20	3BP1	5.75
3E5GT	.83	6BF5	.65	6S7	.75	7S7	1.11	14R7	.89	79	.89	2C21	.65	3C22	89.50
3S4	.77	6BG6	1.89	6SG7	.75	7T7	1.11	14S7	.89	80	.89	2C22	.45	3C23	9.65
3V4	.79	6BH6	.95	6SH7	.75	7Y4	.73	14X7	.89	81	1.19	2C26	.39	3C24	1.85
3V4GT	.77	6BJ6	.95	6SH7GT	.75	7Z4	.79	19T8	.99	82	1.11	2C28A	.49	3C27	6.95
3V4GT	.77	6BK7	1.60	6S17GT	.69	10	.39	19T8	.99	83	1.11	2C33	4.95	3C31	1.85
3V4GT	.77	6BL7GT	1.45	6S17GT	.85	12A	.65	22	1.16	84V6Z4	.75	2C34	.49	EL-CIB	3.95
3V4GT	.77	6BL7GT	1.45	6S17GT	.85	12A	.65	22	1.16	84V6Z4	.75	2C39	22.00	3C37	32.50
3V4GT	.77	6BL7GT	1.45	6S17GT	.85	12A	.65	22	1.16	84V6Z4	.75	2C39A	29.00	3C45	12.95
3V4GT	.77	6BL7GT	1.45	6S17GT	.85	12A	.65	22	1.16	84V6Z4	.75	2C40	12.00	3CP1	2.25
3V4GT	.77	6BL7GT	1.45	6S17GT	.85	12A	.65	22	1.16	84V6Z4	.75	2C42	23.75	3D21	2.98
3V4GT	.77	6BL7GT	1.45	6S17GT	.85	12A	.65	22	1.16	84V6Z4	.75	2C43	17.75	3DP1	4.85
3V4GT	.77	6BL7GT	1.45	6S17GT	.85	12A	.65	22	1.16	84V6Z4	.75	2C44	1.20	3DPIA	6.75
3V4GT	.77	6BL7GT	1.45	6S17GT	.85	12A	.65	22	1.16	84V6Z4	.75	2C46	21.50	3E29	13.75
3V4GT	.77	6BL7GT	1.45	6S17GT	.85	12A	.65	22	1.16	84V6Z4	.75	2C51	5.75	3EP1	4.75
3V4GT	.77	6BL7GT	1.45	6S17GT	.85	12A	.65	22	1.16	84V6Z4	.75	2C52	13.75	3FP7	2.90
3V4GT	.77	6BL7GT	1.45	6S17GT	.85	12A	.65	22	1.16	84V6Z4	.75	2D21	11.75	3FP7A	6.95
3V4GT	.77	6BL7GT	1.45	6S17GT	.85	12A	.65	22	1.16	84V6Z4	.75	2E22	1.85	3G2	3.95
3V4GT	.77	6BL7GT	1.45	6S17GT	.85	12A	.65	22	1.16	84V6Z4	.75	2E24	4.10	3HP7	3.95
3V4GT	.77	6BL7GT	1.45	6S17GT	.85	12A	.65	22	1.16	84V6Z4	.75	2E26	3.79	3J31	145.00
3V4GT	.77	6BL7GT	1.45	6S17GT	.85	12A	.65	22	1.16	84V6Z4	.75	2J21	8.75	4-125A	29.50
3V4GT	.77	6BL7GT	1.45	6S17GT	.85	12A	.65	22	1.16	84V6Z4	.75	2J22	8.95	4-250A	
3V4GT	.77	6BL7GT	1.45	6S17GT	.85	12A	.65	22	1.16	84V6Z4	.75	2J27	24.75	5D22	35.00
3V4GT	.77	6BL7GT	1.45	6S17GT	.85	12A	.65	22	1.16	84V6Z4	.75	2J31	27.00	4A1	4.40
3V4GT	.77	6BL7GT	1.45	6S17GT	.85	12A	.65	22	1.16	84V6Z4	.75	2J32	22.95	4AP10	1.40
3V4GT	.77	6BL7GT	1.45	6S17GT	.85	12A	.65	22	1.16	84V6Z4	.75	2J33	36.50	4B22/	
3V4GT	.77	6BL7GT	1.45	6S17GT	.85	12A	.65	22	1.16	84V6Z4	.75	2J35	39.50	EL-5B	8.95
3V4GT	.77	6BL7GT	1.45	6S17GT	.85	12A	.65	22	1.16	84V6Z4	.75	2J36	27.00	4B24	5.75
3V4GT	.77	6BL7GT	1.45	6S17GT	.85	12A	.65	22	1.16	84V6Z4	.75	2J37	27.00	4B25	
3V4GT	.77	6BL7GT	1.45	6S17GT	.85	12A	.65	22	1.16	84V6Z4	.75	2J38	17.50	4-6CF	8.95
3V4GT	.77	6BL7GT	1.45	6S17GT	.85	12A	.65	22	1.16	84V6Z4	.75	2J39	36.50	4B32	10.50
3V4GT	.77	6BL7GT	1.45	6S17GT	.85	12A	.65	22	1.16	84V6Z4	.75	2J40	34.50	4C35	27.00
3V4GT	.77	6BL7GT	1.45	6S17GT	.85	12A	.65	22	1.16	84V6Z4	.75	2J41	49.50	4E27	21.50
3V4GT	.77	6BL7GT	1.45	6S17GT	.85	12A	.65	22	1.16	84V6Z4	.75	2J42	65.00	4J36	150.00
3V4GT	.77	6BL7GT	1.45	6S17GT	.85	12A	.65	22	1.16	84V6Z4	.75	2J43	39.50	4J38	120.00
3V4GT	.77	6BL7GT	1.45	6S17GT	.85	12A	.65	22	1.16	84V6Z4	.75	2J44	67.50	4J52	275.00
3V4GT	.77	6BL7GT	1.45	6S17GT	.85	12A	.65	22	1.16	84V6Z4	.75	2J45	148.50	4X150A	36.00
3V4GT	.77	6BL7GT	1.45	6S17GT	.85	12A	.65	22	1.16	84V6Z4	.75	2J46	45.25	4X150A	118.50
3V4GT	.77	6BL7GT	1.45	6S17GT	.85	12A	.65	22	1.16	84V6Z4	.75	2J47	165.00	4X1000A	129.36
3V4GT	.77	6BL7GT	1.45	6S17GT	.85	12A	.65	22	1.16	84V6Z4	.75	2J48	37.50	5AP1	5.95
3V4GT	.77	6BL7GT	1.45	6S17GT	.85	12A	.65	22	1.16	84V6Z4	.75	2K25	28.50	5AP4	4.75
3V4GT	.77	6BL7GT	1.45	6S17GT	.85	12A	.65	22	1.16	84V6Z4	.75	2K26	78.50	5AP4	4.75
3V4GT	.77	6BL7GT	1.45	6S17GT	.85	12A	.65	22	1.16	84V6Z4	.75	2K27	29.50	5B1	5.50
3V4GT	.77	6BL7GT	1.45	6S17GT	.85	12A	.65	22	1.16	84V6Z4	.75	2K28	27.50	5B1	5.50
3V4GT	.77	6BL7GT	1.45	6S17GT	.85	12A	.65	22	1.16	84V6Z4	.75	2K29	265.00	5BP1	5.50
3V4GT	.77	6BL7GT	1.45	6S17GT	.85	12A	.65	22	1.16	84V6Z4	.75	2K30	280.00	5BP4	5.50
3V4GT	.77	6BL7GT	1.45	6S17GT	.85	12A	.65	22	1.16	84V6Z4	.75	2K31			
3V4GT	.77	6BL7GT	1.45	6S17GT	.85	12A	.65	22	1.16	84V6Z4	.75	2K32			
3V4GT	.77	6BL7GT	1.45	6S17GT	.85	12A	.65	22	1.16	84V6Z4	.75	2K33			
3V4GT	.77	6BL7GT	1.45	6S17GT	.85	12A	.65	22	1.16	84V6Z4	.75	2K34			
3V4GT	.77	6BL7GT	1.45	6S17GT	.85	12A	.65	22	1.16	84V6Z4	.75	2K35			
3V4GT	.77	6BL7GT	1.45	6S17GT	.85	12A	.65	22	1.16	84V6Z4	.75	2K36			
3V4GT	.77	6BL7GT	1.45	6S17GT	.85	12A	.65	22	1.16	84V6Z4	.75	2K37			
3V4GT	.77	6BL7GT	1.45	6S17GT	.85	12A	.65	22	1.16	84V6Z4	.75	2K38			
3V4GT	.77	6BL7GT	1.45	6S17GT	.85	12A	.65	22	1.16	84V6Z4	.75	2K39			
3V4GT	.77	6BL7GT	1.45	6S17GT	.85	12A	.65	22	1.16	84V6Z4	.75	2K40			
3V4GT	.77	6BL7GT	1.45	6S17GT	.85	12A	.65	22	1.16	84V6Z4	.75	2K41			
3V4GT	.77	6BL7GT	1.45	6S17GT	.85	12A	.65	22	1.16	84V6Z4	.75	2K42			
3V4GT	.77	6BL7GT	1.45	6S17GT	.85	12A	.65	22	1.16	84V6Z4	.75	2K43			
3V4GT	.77	6BL7GT	1.45	6S17GT	.85	12A	.65	22	1.16	84V6Z4	.75	2K44			
3V4GT	.77	6BL7GT	1.45	6S17GT	.85	12A	.65	22	1.16	84V6Z4	.75	2K45			
3V4GT	.77	6BL7GT	1.45	6S17GT	.85	12A	.65	22	1.16	84V6Z4	.75	2K46			
3V4GT	.77	6BL7GT	1.45	6S17GT	.85	12A	.65	22	1.16	84V6Z4	.75	2K47			
3V4GT	.77	6BL7GT	1.45	6S17GT	.85	12A	.65	22	1.16	84V6Z4	.75	2K48			
3V4GT	.77	6BL7GT	1.45	6S17GT	.85	12A	.65	22	1.16	84V6Z4	.75	2K49			
3V4GT	.77	6BL7GT	1.45	6S17GT	.85	12A	.65	22	1.16	84V6Z4	.75	2K50			
3V4GT	.77	6BL7GT													

SPECTRUM ANALYZER

TS 148/UP

Most versatile instrument in the Microwave field for frequencies from 8470 mc/s to 9630 mc/s all directly calibrated.

It will measure within the above frequencies spectra of radar transmitters, receivers, echo boxes, local oscillators, resonant cavities, T R boxes, magnetrons, klystrons and test sets.

This instrument is manufactured to the highest standards of the industry and is used by the largest radar and aircraft manufacturers as well as the services of the United States.

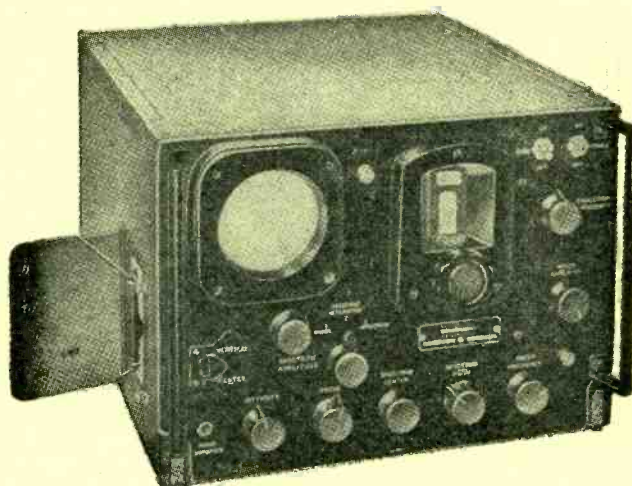

Specifications

Power Supply 50-1200 Cps; 105-125 Volts; 125 Watts
 Frequency-meter Range Calibrated directly from 8470 mc/s to 9630 mc/s
 Sweep Frequencies Continuously Variable from 10 to 30 Cps
 Attenuation (Spectrum Amplitude) Uncalibrated, Variable from 3 to 70 db.
 Operating Temperature Range —40°C. to +55°C.
 Frequency swing of analyzer r-f oscillator (sawtooth FM) 40 to 40 mc/s
 Overall i-f bandwidth at half power points 50 kc/s
 Sensitivity to CW — Spectrum Amplified Pos. — 80 db. below 1 watt for 1 inch
 of deflection on Oscilloscope Screen.
 — Spectrum Position — 55 db. below 1 watt for 1 inch of
 deflection of Oscilloscope Screen.
 Maximum dispersion of spectra 1.5 mc/s per inch
 Maximum error + 5 megacycles

We will gladly furnish all details regarding specifications prices and delivery.

Other test equipment, used checked out, surplus.

TSK1/SE K Band Spectrum Analyzer
 TS3A/AP Frequency and power meter S Band
 RF4A/AP Phantom Target S Band
 TS12/AP VSWR Test Set for X Band
 TS13/AP X Band Signal Generator
 TS14/AP Signal Generator
 TS15/AP Flux Meter
 TS19/APQ 5 Calibrator
 TS33/AP X Band Power and Frequency Meter
 TS34/AP Western El Synchroscope
 TS35/AP X Band Signal Generator
 TS36/AP X Band Power Meter

TS45 X Band Signal Generator
 TS47/APR 40-400 MC Signal Generator
 TS69/AP Frequency Meter 400-1000 MC
 TS100 Scope
 TS102A/AP Range Calibrator
 TS108 Power Load
 TS110/AP S Band Echo Box
 TS125/AP S Band Power Meter
 TS126/AP Synchroscope
 TS147 X Band Signal Generator
 TS270 S Band Echo Box
 TS174/AP Signal Generator

TS226 Power Meter
 TS239A Synchroscope

SURPLUS EQUIPMENT

APA10 Oscilloscope and panoramic receiver
 APA38 Panoramic Receiver
 APS 3 and APS 4 Radar
 APR4 Receiver
 APR5A Microwave Receiver
 APT2 Radar Jamming Transmitter
 APT5 Radar Jamming Transmitter

MINIMUM ORDER
 25 Dollars

YOU CAN REACH US ON TWX 3135

Cables:
 TELSERSUP

SPECIAL

Wide Band S Band Signal Generator
 2700/3400MC using 2K41 or PD 8365
 Klystron, Internal Cavity Attenuator,
 Precision individually calibrated Fre-
 quency measuring Cavity. CW or Pulse
 modulated, externally or internally.

Large quantities of quartz crystals mounted
 and unmounted.

Crystal Holders: FT243, FT171B others.

Quartz Crystal Comparators.

North American Philips Fluoroscopes Type 80.

Large quantity of Polystyrene beaded coaxial
 Cable.



LIBERTY ELECTRONICS, INC.

135 LIBERTY STREET NEW YORK 6, N. Y.
 PHONE WORTH 4-8262

Hard-to-get X-BAND SIGNAL GENERATOR Now Available

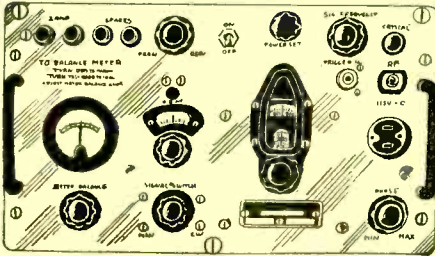

Model 385A
(Equivalent to TS-147 C/UP
TEST SET)

ESPEY Model 385A (Equivalent to Test Set TS 147 C/UP) is a Portable Microwave Signal-Generator designed for testing and adjusting beacon equipment and radar systems which operate within the frequency range of 8500 MC to 9600 MC.
COMPACT — SELF-CONTAINED — WEIGHS ONLY 40 LBS. COMPLETE WITH ACCESSORIES AND COMBINATION CASE.

GENERAL SPECIFICATIONS:
FREQUENCY RANGE: 8500 MC to 9600 MC. Selection is accomplished by a tuneable klystron which is set to an accurate absorption wavemeter.
FREQUENCY ACCURACY: ± 2 MC.
OUTPUT POWER RANGE: - 42 dbm to -83 dbm.
INPUT POWER RANGE: + 7 dbm to + 30 dbm.
ATTENUATOR ACCURACY: ± 1 db with calibration chart provided.
INPUT AND OUTPUT COUPLING: Type N female fittings (UG 23B/U).
MODULATION AVAILABLE ON OUTPUT: FM signal internally generated.
MODULATION OF INPUT SIGNAL ACCEPTED: CW or any other wave shape including pulse. Minimum pulse width accepted is .5 microseconds. Meter will read average power of input signal.

FM MODULATION: Carrier can be modulated through klystron mode at any frequency in range. (Minimum mode is 30 MCS). The sweep rate is continuously adjustable from 0 to 6 MCS. per microsecond.

EXTERNAL SYNC. PULSE REQUIRED: Amplitude of video input 10-50 volts positive polarity pulse .5 to 20 microseconds wide. Unit may also be synchronized from RF input pulse provided peak RF input power is at least 5 watts.

POWER SOURCE: 115 ± 10 volts A.C. 50 to 1600 cycles, single phase.

POWER CONSUMPTION: 125 watts.

SIZE: Width 11 inches.

Length 18 3/4 inches.

Height 12 1/4 inches.

WEIGHT: 40 lbs. including accessories.

ACCESSORIES AND SPARES PROVIDED:

- ACCESSORIES:** 1 R.F. Cord assembly. Consists of 8 ft. of RG-9A/U cable fitted with two UG-21B/U connectors. Calibrated to an accuracy of ± 0.3 db.
 1 Trigger cord assembly. Consists of six ft. of RG-11/U cable fitted with two type 49195 connectors.
 1 Power cord assembly. Consists of six ft. of rubber covered two-conductor cord with male plug and female receptacle.
 1 Pick-up antenna.
 1 coaxial cable fitting (right angle).

SPARES, OPERATING:

- 1 thermistor mount.
- 5 fuses, 2 amp.
- 9 wave guide flange joint gaskets.
- 3 panel lamps, 3.0 volt.
- 2 IN 23 B rectifier crystals.

THE ACCESSORIES AND SPARE PARTS ARE CONTAINED IN THE REMOVABLE PROTECTIVE COVER.

NEW YORK'S RADIO TUBE EXCHANGE

TYPE	PRICE	TYPE	PRICE	TYPE	PRICE	TYPE	PRICE	TYPE	PRICE	TYPE	PRICE	TYPE	PRICE
OA2.....	\$1.40	2122.....	17.95	4E27.....	17.50	450TL.....	45.00	958A.....	.69	958A.....	.69	958A.....	.69
OA3.....	1.10	2126.....	27.75	4I25.....	199.00	464A.....	5.95	810.....	11.00	991.....	.35	810.....	11.00
OB2.....	1.35	2127.....	29.95	4I26.....	199.00	471A.....	2.75	811A.....	3.95	F1148.....	.35	811A.....	3.95
OC3.....	1.25	2131.....	29.95	4I27.....	199.00	4810.....	24.00	813.....	9.95	1280.....	1.25	813.....	9.95
OD3.....	1.25	2132.....	69.95	4J31.....	199.00	203A.....	8.95	814.....	3.95	1611.....	1.95	203A.....	8.95
C1B.....	3.95	2135.....	195.00	4J32.....	195.00	211.....	9.95	815.....	3.50	1613.....	1.38	211.....	9.95
1B21A.....	2.75	2138.....	17.95	4J33.....	195.00	217C.....	18.00	816.....	12.95	1616.....	2.95	217C.....	18.00
1B22.....	3.95	2139.....	12.50	4J37.....	199.00	242C.....	10.00	829.....	16.95	1619.....	.69	242C.....	10.00
1B23.....	9.95	2140.....	35.00	4J38.....	189.00	244A.....	12.95	829A.....	13.95	1622.....	2.75	244A.....	12.95
1B24.....	17.95	2142.....	200.00	4J39.....	199.00	249C.....	4.95	829B.....	15.95	1624.....	2.00	249C.....	4.95
1B26.....	2.95	2149.....	109.00	4J41.....	199.00	250TH.....	22.50	830B.....	2.50	1625.....	.45	250TH.....	22.50
1B27.....	12.50	2150.....	195.99	4J41.....	199.00	250TL.....	19.95	832.....	7.95	1851.....	1.85	250TL.....	19.95
1B32.....	4.10	2161.....	45.00	4J41.....	199.00	274A.....	3.00	832A.....	9.95	2051.....	1.80	4J41.....	199.00
1B38.....	33.00	2162.....	45.00	5BP1.....	6.25	204B.....	3.00	833A.....	49.95	8012.....	1.425	5BP1.....	6.25
1B42.....	19.95	2K 25.....	29.50	5BP4.....	6.95	304TH.....	10.00	834.....	7.95	8013.....	2.95	5BP4.....	6.95
1B51.....	9.95	2K 28.....	37.50	5D21.....	21.00	304TL.....	10.00	836.....	4.95	8013A.....	5.95	5D21.....	21.00
1B56.....	49.95	2K 29.....	37.50	5J1P.....	27.50	307A.....	4.95	837.....	2.95	8019.....	1.75	5J1P.....	27.50
1B60.....	69.95	2K 39.....	150.00	5J2P.....	27.50	310A.....	5.95	838.....	6.95	8025.....	3.50	5J2P.....	27.50
1N21.....	1.35	2K 41.....	150.00	5J2P.....	27.50	311A.....	6.95	845.....	5.95	8025.....	3.50	5J2P.....	27.50
1N21A.....	1.75	2K 45.....	149.50	WE6AKS.....	2.50	312A.....	3.95	849.....	52.50	8025.....	3.50	WE6AKS.....	2.50
1N21B.....	4.25	2V3G.....	2.10	C6A.....	12.50	323A.....	15.00	851.....	80.50	PDR365.....	89.00	C6A.....	12.50
1N22.....	1.75	3BP1.....	7.50	C6J.....	10.95	327A.....	3.95	860.....	4.95	9001.....	1.75	C6J.....	10.95
1N23.....	2.00	3124.....	5.50	7BP7.....	7.95	328A.....	6.95	861.....	29.50	9002.....	.95	7BP7.....	7.95
1N23A.....	2.75	3124W.....	7.50	7DP4.....	10.00	350A.....	6.95	866A.....	1.75	9003.....	1.75	7DP4.....	10.00
1N23B.....	4.25	EL3C.....	5.95	12AP4.....	55.00	350B.....	5.95	869B.....	57.50	9004.....	1.75	12AP4.....	55.00
1N34A.....	.96	3C22.....	120.00	15E.....	1.95	357A.....	20.00	869BX.....	35.00	9005.....	2.90	15E.....	1.95
1N43.....	2.50	3C24.....	1.95	15R.....	.95	368AS.....	6.95	872A.....	3.95	9006.....	.35	15R.....	.95
3B22.....	1.95	3C31.....	3.95	NE16.....	.66	371B.....	2.95	878.....	1.95			NE16.....	.66
2B25.....	3.75	3DP1A.....	10.95	FG17.....	6.95	385A.....	4.95	884.....	1.95			FG17.....	6.95
2C34.....	.35	3DP182.....	12.00	KY21A.....	8.75	388A.....	2.95	885.....	1.75			KY21A.....	8.75
2C40.....	10.00	3E29.....	15.50	FG33.....	12.95	394A.....	7.95	889P.....	199.50			FG33.....	12.95
2C43.....	20.00	4A 21.....	2.75	35T.....	4.95	MX408U.....	.75	914.....	1.00			35T.....	4.95
2C44.....	.90	3GP1.....	5.50	45 Special.....	.35	417A.....	17.95	931A.....	75.00			45 Special.....	.35
2D21.....	1.75	4A 21.....	2.75	RK 39.....	2.95	434A.....	19.95	954.....	.35			RK 39.....	2.95
2E22.....	2.75	4B 26.....	6.95	HF50.....	1.75	446A.....	1.95	955.....	.55			HF50.....	1.75
2E30.....	2.75	4C 27.....	25.00	VTS2.....	.25	446B.....	5.40	956.....	.89			VTS2.....	.25
2J21A.....	17.95	4C 28.....	35.00	RK 72.....	1.10	450TH.....	45.00	957.....	.29			RK 72.....	1.10

Thousands of other tubes

CRYSTALS

... in FT 241-A Holders—1/2" Pin SPC. Marked 54th OR 72nd Harmonic MC Freq. Listed below by fundamental frequency with fractions omitted.

370	390	405	422	438	454	470	487	504	520
372	391	406	423	440	455	472	488	505	522
374	392	407	424	441	456	473	490	506	523
375	393	408	425	442	457	474	491	507	524
376	394	409	426	443	458	475	492	508	525
377	395	411	427	444	459	476	493	509	526
379	396	412	429	445	461	477	494	511	530
380	397	413	430	446	462	479	495	512	531
381	398	414	431	447	463	480	496	513	532
382	399	415	433	448	464	481	497	514	533
384	400	416	434	450	465	483	498	515	534
385	401	418	435	451	466	484	501	516	536
386	402	419	436	452	468	485	502	518	537
387	403	420	437	453	469	486	503	519	538
388	404								

10 for \$8.00 Postpaid

\$1.00 EACH

MINIMUM ORDER 25 Dollars

YOU CAN REACH US ON TWX NY1-3235

Cables: TELSERSUP



LIBERTY ELECTRONICS, INC.

135 LIBERTY STREET NEW YORK 6, N. Y.
PHONE WORTH 4-8262

HIGH FREQUENCY M-G SETS AND AMPLIDYNES FROM AMERICA'S LARGEST ELECTRICAL CONVERSION HOUSE

400 CYCLE MG UNITS

G.E. HIGH CYCLE POWER UNIT. (PU-9/TPS-2) Alternator Type ASB, 115V, 3 ϕ , 325 kva, 8000 RPM belt-driven by Lawson engine Model TLC351, 1.8 hp. New, in portable carrying case. \$189.99

KATO 400 CYCLE MOTOR GENERATOR SET: Motor operative at 220/440-3-60 V belted to self-excited alternator 500 VA, 120/208V Volts, 3 ϕ , 400 cyc. 2000 RPM, NEW \$465.50
With rebuilt reluctance type synch. motor. \$489.50

KATO 400 CYCLE MOTOR GENERATOR SET: Motor operative at 220/440-3-60 V belted to self-excited alternator 500 VA 115V, 1 ϕ , 400 cyc. 2000 RPM, NEW \$475.00
With rebuilt reluctance type synch. motor. \$499.50

SPECIAL MG. SET, Motor: 2.5 HP, 220/440-3-60. Self-exc. Alternator with output of 1.25 KVA, 115 V, single ph. 400 cyc. PRICE. \$325.00

LOUIS-ALLIS 1 KVA M.G. UNIT: Motor input 220/440 volts, 3 ϕ , 60 cyc., 3460 R.P.M., direct conn. to alternator type POGH, 115 volts, 1 ϕ , 400 cyc., 1 K.V.A. New. Price. \$353.00

LOUIS-ALLIS 3 UNIT MG SET. Consists of 5 HP motor operative at 220/440-3-60 directly coupled to alternator with output of 115 volts, 1 ph., 400 cyc. and with exciter unit all mounted on steel base. 1.8 K.V.A. Price. \$565.00

LELAND MG. SET. Consists of 5 HP Motor operative at 220-3-60 direct connected to self exc. alternator with output of 3 KVA, 120/208 V, 3 ph. 400 cyc. PRICE \$960.00

BOGUE LABORATORY 400 CYCLE SUPPLY: Motor 10 HP, 220/440-3-60 direct-coupled to self-excited alternator. Following outputs are obtainable:

- A. 5 KVA, 115 V, 3 ϕ , 400 Cy.
- B. 5 KVA, 120/208 V, 3 ϕ , 400 Cy.
- C. 3 KVA, 115 V, 1 ϕ , 400 Cy.

Harmonic content less than 1%. NEW \$1850.00

BRITISH 5 KVA 400 CYC. M.G.: Consists of 10 HP motor of 220/440-3-60 V belted to alternator with output of 5 KVA, 115 volts, 1 ϕ , 400 cyc. PRICE \$1095.00

AMERICAN 400 CYCLE SETS. A precision built motor generator set ideal for laboratory test work. Consists of 10 H.P. motor directly connected to alternator with output of 5 KVA, 120/208 Volts, three phase, 400 cycles. With electronic exciter—voltage regulator. Freq. variation $\pm 5\%$; Voltage variation $\pm 1\%$; Total harmonic cont. 1.2%. PRICE \$1850.00

CARSON PERMO-MAGNET 400 CYCLE M.G.: Motor 7.5 H.P., 220/440-3-60, dir. conn. to alternator 120 volts, 1 ϕ , 400 cyc., 41.6 amps. (no brushes). PRICE \$699.95

BTH 400 CYCLE M-G SETS. Consists of an alternator of 6 KVA with output of 115 volts, 1 ϕ , 400 CPS. V belted drive to 10 HP. motor operative at 220/440-3-60. Excitation provided by dry disk rectifier. Complete with field rheostat. SPECIAL PRICE \$998.00

US-ONAN VARIABLE FREQUENCY SUPPLY

Driven by 5 HP, 220/440 Volt, 3 Ph., 60 Cy. US Synchro gear Variable motor. Special attachment permits remote pushbutton control of speed from 1430 to 10,000 RPM. Direct-Connected Alternator is made by Onan and is rated at 1.5 KVA, 115 Volts, single phase, 8 PF. The Frequency may be varied from 400 cycles to 2400 cycles. The generator is designated by Model #MG207E, and the excitation is provided by a separate motor generator furnished with the below price. NEW \$2450.00

LOUIS-ALLIS FREQUENCY CHANGER SETS. Pri: 220 H.P., 220/440-3-60; Sec. 15/10.8 K.W. 3300/2200 RPM/306/220 Volts 35/35 Amps. 2 ph. 500/360 C.P.S. Brand new. PRICE \$1250.00

We can supply these units for 400 cycle output and with transformers to supply 3 phase, wye output. Write for further information.

KATO MG SET. Motor: 12.5 HP, 220/440-3-60. Output: 7.5 KVA, 230 Volts, 1 ϕ , 350 cyc. with direct conn. exciter. Brand New. PRICE \$1395.00
We have been fortunate in procuring several large size motor-generator units which we are able to offer at a very attractive price. These sets consist of a 75 H.P. motor dir. conn. to an alternator mfg. by Kato. The obtainable outputs are as follows:

- A. 45 KVA, 115 V, 3 ϕ , 400 cyc.
- B. 45 KVA, 120/208 V, 3 ϕ , 400 cyc.
- C. 30 KVA, 115 V, 1 ϕ , 400 cyc.

Harmonic content approximately 1%. We can furnish MG unit with voltage regulation and meter panels. Write for full information.

FAIRBANKS MORSE FREQUENCY CHANGER: Motor, synchronous, 77.5 HP, 220/440-3-60-1800 driving alternator type TAZB, 62.5 KVA, 50 KW, 440 Volts, 1 ϕ , 360 cyc., with exciting M.G. PRICE \$2650.00

WE ARE ABLE TO QUOTE ON 400 CYCLE MOTOR GENERATOR UNITS FROM 500 WATTS TO 100 KW. SEND YOUR REQUIREMENTS AND WE WILL BE HAPPY TO FORWARD OUR QUOTATION.

INVERTERS

G. E. INVERTER UNITS, Model 5ATI21JJ2B; Input: 24 VDC, 55 amp, 8000 RPM. Output: 115 Volts, 3 phase, 400 CPS, 750 VA, and secondary output of 26 Volts, single phase, 400 CPS, 250 VA. With automatic voltage and frequency regulation, built in. Rebuilt and warranted equal to new. SPECIAL PRICE \$97.50

GENERAL ELECTRIC 400 CYCLE UNITS. Operate at 28 VDC 100 Amp. Output: 115 VAC 1 ϕ , 400 CPS, 1500 V.A. With filter system built-in. PRICE. \$39.50

WINCHARGER PU-7/AP; Input 28 VDC, 160 Amps. Output: 115 VAC, Single ph. 2500 V.A., 400 C.P.S. Frequency and voltage regulation built-in. PRICE \$97.00

WINCHARGER PU-16/AP INVERTER. Type MG-750. Input: 28 volts, 60 amp. Output: 115 volts, 6.5 amp., 400 cyc., 1 ph. Brand new. PRICE \$69.50

HOLTZER-CABOT MG218. Compact 2 bearing units for low current 400 cycle output. Operative at 115 VDC, 2.3 amp. Output: 110 Volts, 1.0 amp. 1 ph. 400 CPS. Brand new. PRICE \$79.50

MG 153 HOLTZER-CABOT

Input: 24 V, DC, 52 amps; Output: 115 volts—400 cycles, 3-phase, 750 VA, and 26 Volt—400 cycle, 250 VA. Voltage and frequency regulated. \$95.00 ea.

LELAND INVERTER; Input 25-28 VDC, 52 amps. Output 250 VA, 25-28 VAC, 3 ϕ , 400 cyc, 40% P.F., also delivers 750 VA, 115 VAC, 400 cyc., 90% P.F. Price \$8950.00

LELAND INVERTER; Input 28 VDC, 12.5 amps. Output 115 Volts, 3 ϕ , 400 cyc., 80% P.F. Price \$53.50

500 CYCLE MG UNITS

BRITISH MADE 500 CYCLE MG SETS. Motor: 230 Volts, 3 PH—50 Cycles. Alternator: 5 K.W. 180 Volts, 27.8 Amp. 500 Cycles. Excitation—110 VDC. When used at 60 Cycle current, Output is 600 cycles, 220 Volts. PRICE \$535.00
Also available with 230 VDC motor. Rheostat included for frequency control.

GE DUAL OUTPUT MG SETS. Consist of Motor rated 3 H.P., 220/440 V, 3 ϕ , 60 Cy. directly coupled to 2 generators. Output .5 K.W. 220 Volts, 2.27 Amp. 525 Cycles. Also .5 K.W. 110 Volts, D.C. 4.55 Amp. 3 separate units mounted on common bed plate. PRICE \$150.00

G.E. MG SET MODEL SLY56A85A. Motor: 1.1 HP, 220 VDC, 4 amp. Generator: 600 watts, 125 VAC, 4.8 amp., 500 cyc., 1 ph. PRICE \$89.50

800 CYCLE MG UNITS

H.F. MOTOR GENERATOR. G. E. Model 5LYI26A4. Motor: 115 VDC direct connected to Generator 24-32 VDC, 78 amps., and to alternator 120 VAC, 720 cyc., 1 ph. KW-24. \$289.00

INVERTER UNIT PE206A. Input: 27.5 VDC, 28 amp. Output: 80 Volts, single ph. 800 CPS, 500 VA. PRICE \$42.50

CONTINENTAL DC/AC SET. Motor: 1.5 HP, 230 VDC, 3440 RPM. Output: 120 VAC, 6.6 amps., 8 KW, 800 cyc., 1 ph., also output of 14 VDC, 4 amps., Model CG21637. Compact 2-bear. units. Completely rebuilt. PRICE \$114.50
Same set operative at 110/220-1-60. PRICE \$135.00

ONAN 800 CYCLE MG UNIT. Employing 5 H.P. Motor operative at 220/440 Volts, 3 ϕ , 60 Cy. V belted to self-exc. generator with output of 1.5 KVA, 115 Volts, single ph. 800 CPS, and secondary output of 500 Watts, 28.5 VDC, 17.5 amperes. PRICE. \$375.00

HIGH FREQUENCY UNITS

NORMAND ELEC. CO. (BRITISH MFG.) MG UNIT. Motor: 220 VDC, 8.8 amp. 2 HP, 4200 RPM, directly connected to H. F. alternator with output of cyc. 1200 watts. Exc. 24 VDC. PRICE \$149.00

ELECTRIC SPECIALTY FREQUENCY CHANGERS. Type BFB52/BFB5354 Input: 230 Volts, 3 Ph. 60 cy. 3600 RPM. Output: 250 Volts, 20 Amps, single ph. 180 Cyc. 5000 VA, 3000 Watts. Brand New. Compact ball bearing units for operation of HI-cycle equipment. SPECIAL PRICE \$160.00

BENDIX POWER MG SET. Consists of G.E. 2 HP. Rep-Ind Motor, 115 volts, single phase, 60 cyc. directly connected to Bendix alternator with output of 120 volts, 700 cyc., 600 watts and DC output of 14.5 volts, DC, 22 amp. Brand new. PRICE \$225.00

HIGH FREQ. UNIT. Motor: 24 VDC 50 amp. Alternator: 17 VAC, 1300-1600 cyc sep. exc. at 24 VDC, 1.25 BHP, 4000 RPM. Made in Canada by Electric Tamper & Equ. PRICE \$82.50

Alternators only to same specifications as above, sep. exc. at 24 VDC. PRICE \$44.50

WESTINGHOUSE 180 CYCLE ALTERNATORS. 750 V.A. Output: 110 Volts, 3 Phase, 180 C.P.S. 3000 R.P.M. Separately excited at 110 VDC. Price. \$65.00
Also available with built-in exciter. Price. \$94.00

BURKE ALTERNATOR, 62.5 KVA. 220 Volts, 3 Ph. 180 Cycles, 1800 RPM, separately exc. at 125 VDC, 80% P.F. Type ACR-7. Complete with auxiliary exciter MG set and field rheostat. Ball bearings. Will deliver 400 cycles at 4000 RPM. Rebuilt. PRICE \$1375.00

IDEAL FREQUENCY CHANGER SET. Motor operative at 220-3-60 with direct connected induction type alternator with output of 12.5 KVA, 220 V, 3 ph. 180 Cyc. PRICE \$445.00

BURKE FREQUENCY CHANGER. Operative at 440-3-60 with output of 12.5 KVA, 230 Volts, 3 ph. 180 cycles. Two bearing machine with direct connected exciter. PRICE \$575.00

ESCO HIGH FREQUENCY MACHINE. Input: 110 Volts, 8 Amp. 2900 RPM. Output: 125 Volts, 8 Amp, 1 KVA, single ph. 580 cycles. PRICE \$119.75

GENERAL ELECTRIC HIGH FREQUENCY MG. Consists of motor and dual output generator mounted on steel base. Motor operates at 220/440-3-60 direct connected to alternator with output of 115 Volts, 1 Ph. 1050 Cycles, 1 KVA and 115 Volts, DC, 2 KW. With field rheostat. PRICE \$525.00

GENERAL ELECTRIC 180 CYCLE GENERATORS. We have several 50 KVA units with output of 225 Volts, 3 phase, 180 cycles, 80% PF. with direct connected exciter. Rebuilt and fully guaranteed. PRICE \$690.00

GE 400 CYCLE GENERATOR. General Electric Type 5ASB31J3; 400 cycles output at 115 volts; 7.2 amps; 8,000 rpm.; size 6" long x 6" dia. New. \$99.50 ea.

GEN. ELECTRIC AMPLIDYNES

Model 5AM65FB2A; Input: 115 VAC, 3 ϕ , 60 cyc. 5 amp. Output: 500 watts, 250 Volts, 2 Amp. \$144.00

Model 5AM31NJ18A; Input: 27 VDC, 44 amp. 8300 cyc. 1 amp. Output: 115 Volts, D.C. 3.25 amp. 3450 RPM. \$188.00

Model 5AM31NJ18A; Input: 27 VDC, 44 amp. 8300 RPM. Output: 60 VDC, 8.8 amp. 530 watts. \$24.95

Model 5AM78AB19; Input: 32 VDC, 60 amp. 2 H.P. 2200 RPM; Output: 250 Volts, D.C. 3 amperes; 750 Watts. \$190.00

Model 5AM45DB26; Input: 440 V, 3 ϕ , 60 cyc. Output: 125 V.D.C. 1.0 Amp. \$55.00

Model 5AM49AB7A; Input: 440 Volts, 3 ϕ , 60 Cyc. Output: 375 Watts, 250 V.D.C. 1.5 Amp. Price \$100.00

Model 5AM45DB32A; Input: 440 Volts, 3 ϕ , 60 cyc. Output: 250 VDC, .8 A., 3450 RPM. Price. \$52.50

Model 5AM78AB10; Input: 32 VDC, 60 A. Output: 250 VDC, 3 A. Price. \$190.00

Model 5AM78AB40; Input: 440 V, 3 ϕ , 60 cyc. Output: 250 VDC, 6 A. Price. \$285.00

Model 5AM78AB56A; Input: 115 VDC, 11 A. Output: 250 V, 3 A., 1725 RPM. Price. \$185.00

Model 5AM78AB128; Input: 220 V, 3 ϕ , 60 cyc. Output: 125 V, 8 A., 3450 RPM. Price. \$225.00

Model 5AM31NJ9A; Input: 27 VDC, 44 amp. 8300 RPM. Output: 60 VDC, 8.8 amp. 530 watts. Price \$24.95

G.E. Amplidyne Generator Model AM701. 25 KW, 125 amps., 200 volts, 1785 RPM. special duty cycle, 150 volts, 220 amps. PRICE \$975.00

G.E. AMPLIDYNE GENERATOR Model 5AM628A. 160 volts, 33 amps., 1700 RPM PRICE \$790.00

WILLIAM J HORLICK COMPANY

Est. in 1922
266 SUMMER ST.
BOSTON 10 MASS.

IF IT'S FROM ONE FREQUENCY TO ANOTHER, FROM DC TO AC OR AC TO DC, IF IT'S FROM ONE VOLTAGE TO ANOTHER, THEN CALL ON US.

SUPERIOR VALUES FROM AMERICA'S LARGEST ELECTRICAL CONVERSION HOUSE

VOLTAGE STABILIZERS

Sola; Cat. 30785, pri. 95-125 V; sec. 6.3 V, 2.7 A, 17 VA. Price\$3.85

Western Electric; Model D122855, pri. 92-115 V, 400 cycles, transtat type. Price.....\$12.75

Raytheon, Cat. V2540, pri. 180-260 V, sec. 220/230 V, 250 W. Price.....\$25.00

Sola; Cat. 30531, pri. 190250 V, sec. 230 V, 477 VA. Price\$85.00

Raytheon, Type CRP-301489, pri. 440-220/115, 57-62 cyc; Sec. 115 V, 0.5 KVA. Price.....\$72.75

Raytheon; Cat. VR550 pri. 180-266 V, Sec. 220/230 V, 500 watts. Price.....\$75.00

Raytheon; Cat. Type CRP-301407, pri. 92-138 V, 67-63 cyc, sec. 115 V., 0.82 KVA. Price\$117.50

Raytheon; Cat. 560, pri. 180/260 V, sec. 220/230 V., 1000 VA. Price\$110.00

Sola; Cat. 30768, pri. 95-195 V., 125-250 V., sec. 115 V., 2000 VA. Price.....\$175.00

G.E.; Cat. 69G102, pri. 95-130 V, sec. 115/120/125, 5 KVA. Price\$355.00

TRANSFORMERS

GENERAL ELECTRIC MULTI-TAP TRANSFORMER. Cat. #7406272, 4 KVA. Pri: 230, Sec: 115. 7 taps in 5 volt steps on output. Auto type. New. Price\$55.00

WESTINGHOUSE STEP-DOWN TRANSFORMERS. Pri: 550 V. Sec: 220/440, 60 cyc.

Type	KVA	Price
1406808	.500	\$18.85
1406809	.750	23.75
1406810	1.0	29.85
1406796	2.0	41.25

WESTINGHOUSE PRECIPITRON TRANSFORMER. Style 1246505. Pri: 115 V, 25 cyc. Sec: 7500 V, 4 MA, with tap at 5500 V. Filament windings 2.5 V. Can be operated at 60 cyc. to obtain 18 KV., 0.5 MA. Price\$14.95

GENERAL ELECTRIC HV TRANSFORMER. Style 326596-G1, 3 KVA. Pri: 115/230 V. Sec: 3000/5200 V. Pyranol filled. Price\$54.00

WESTINGHOUSE AUTOTRANSFORMER, 2 KVA, 220/110 V, 50/60 cyc. Complete with cord and output plugs. Price\$48.00

WESTERN ELECTRIC TRANSTAT. Pri: 110/220/440/550. Sec: 115V, 1 phase, 60 cyc, 1 KVA. Voltage variable between 0-150. Complete with built-in voltmeter and fuses. Price\$98.00

GENERAL ELECTRIC AUTOTRANSFORMER. Cat. #64G678, .5 KVA, 230/115 V. Price\$16.50

MOTOR GENERATORS

GENERAL ELECTRIC TBS MG. Motor: 230 VDC, 1 HP, 3600 RPM. Generator: 300 VDC, 60 W, 875 VDC, 306 W. Price\$85.00
Also available with 120 VDC Motor.

JANETTE ROTARY CONVERTERS. Input: 12 VDC. Output: 110/1/60, 212 VA. Radio filtered.
Price \$72.00

BURKE DC-AC MG UNIT. Motor: 9.4 HP, 115 VDC, 1800 RPM. Alternator: 10 KVA, .5 PF, 120/1/60, drip-proof. New. Price\$690.00

ALLIS-CHALMERS DC-AC MG. Motor: 115 VDC, 3600 RPM. Generator: 120 V, 1 phase, 60 cyc, 5 KVA, .8 PF. Frequency, voltage regulation built in. New. Price\$512.00

ESCO MG. Motor: 32 VDC, 1800 RPM. Gen: 115/1/60, 200 VA. Frequency reg. New. Price.....\$94.00
With 24 VDC motor. Price.....\$48.00

CENTURY LOW VOLTAGE SUPPLY. Generator output: 27 VDC, 9.3 amps. Comp. winding. 1750 RPM.

With 110 Volt DC Motor.....\$ 85.00
With 220 Volt DC Motor..... 85.00
With 220 Volt, 3 ϕ , 60~..... 97.00
With 110/220 Volt, 1 ϕ 120.00

MASTER LV MG SET. Motor: 110/220-1-60, 1725 RPM. Gen: I-12 VDC, 41.6 amps. Gen: II-12 VDC, 41.6 amps. MG is ball-bearing, comp. wound, complete with switch to permit series or parallel connection of generators. Price.....\$280.00

BOGUE LV MG SET. Motor: 10 HP, 220/440-3-60. Gen: 15 VDC, 500 amps. Price.....\$575.00

MASTER LV MG SET. Motor: 15 HP, 220/440-3/60, 2730 RPM, Nema frame. Generator I: 24 V, 208 amps., 5 KW. Generator II: 12 V, 416 amps., 5 KW. New. Price\$1,230.00

ONAN LV MG SET. Motor: 220/400-3-60, 13.2/0.6 amps. Gen: 12-15 VDC, 150 Amps. Price.....\$320.00

ELECTRIC PRODUCTS LOW FREQ. SUPPLY. Motor: 220/440-3-60. Gen: 220-3-30, .8 PF, 900 RPM. Price\$712.00
This MG unit will supply 2 KW of 1 phase current. New.

DELCO-DIEHL LV MG. Motor: 7.5 HP, 220/440 V, 1750 RPM, 18.4/9.2 amps. Gen: 40 V, 125 amps., 5 KW, drip proof. Will deliver 27 or 32 VDC, 125 amps. New. Price\$595.00

MISCELLANEOUS

GENERAL ELECTRIC AC RELAYS. Single pole, single throw, 15 amps., 110 V, 50/60 cyc. Cat. #CR2811. In neat handy box. New. Price.....\$8.99

BARDCO DYNAMOTORS. Input: 115 VDC, 1.5 HP, 1750 RPM. Output: 230 VDC, 3.2 amps. Price \$98.00

400 CYCLE METER PANELS. Contain two 400 cyc. meters. These include 0-150 VAC, Type AD7 and 0-600 amps. AC, Type AD7. Meters are 7" square. New. Price\$125.00
Current transformer (400 cyc.) to operate ammeter on panel. Price.....\$40.00

G. E. ROTARY CONVERTERS

Dynamotor Model 5D46A18 78 Volts. DC input to deliver 110 Volts. AC, single phase, 60 cycles, 1.5 amp. SPECIAL PRICE (Rebuilt).....\$9.95

Robins and Myers Motor Generator Units. Operate at 110 Volts, AC, single phase, 60 cyc. and deliver 32/40 Volts, DC. Can be used with field rheostat to supply 24/28 VDC for the operation of aero equipment from lighting line. Rated at 40 watts but will deliver 200 watts for intermittent operation. Gear head built into one end rotates external shaft at 225 RPM. An exceptional value at \$18.75 each. With field rheostat \$20.00. Also available for operation at 115 VDC at \$12.50 and with rheostat at \$13.75 each. Both unit shave 1/4 HP Motor. Stock up on these sets while they are available. Special price on quantity. Rebuilt.

KATO ROTARY CONVERTERS

Type 1205A Model 26KA54 Input, 110 VDC, 1800 RPM. Output: 115 VAC 1 phase, 60 cy. 1 KVA. Compact and ruggedly built for cont. duty oper. Filtered. Shock mounted. New.....\$90.00

Continental Motor Generator Sets, Type DS-445X, operate at 230 Volts DC, 1800 RPM, stab. sh. output 25 KVA, .5 P.F., 240 volts, ϕ . 60 cyc, weight app. 1600 lbs., rebuilt, price.....\$600.00

SELSYN MOTORS GE MODEL 5MJ365AK1, RPM 1200/400, primary stator 440/3/60, 3 KVA, 16 A, secondary rotor 93.5 V, 54.5A, 32.8 FT.L.S.
Price \$225.00

DC Manual Controllers, mfg. by Marconi Co. of England. Enc. type. For starting duty of 24 VDC Motors, rated at .7 HP. A really hard-to-get unit at a give-away price. SPECIAL.....\$4.60

General Electric, DC motor, Type SD, 1/20 HP, B.B., 110 Volts, .7 amps. sh. wdg., price.....\$3.35

G. E. DC Motor, type BY, 1/17 HP, 2100 RPM, sh. wdg., RB., price.....\$3.00

MARATHON MOTOR GENERATORS

Input at 32 VDC Output 110VAC, 1 phase, 60 cy. 500 VA. Marine Type with voltage regulator and frequency controller. Rebuilt LN.....\$75.00

GENERAL ELECTRIC 8 KW High Voltage Generators; Rebuilt like new, double commutator type each rated at 4000 Volts, DC, 2.5 amperes; can be connected in series to give 8000 Volts, DC at 2.5 amperes or 4000 volts, 5 amperes in parallel. Separately excited. Units weigh about 800 pounds. Offered at a fraction of their original cost.....\$175.00

GE LOW VOLTAGE MG SETS. Motor: 1 HP, 220/440-3-60 direct conn. to Gen. 500 Watts, 18-28 VDC. \$140.00

VOLTAGE REGULATOR GE. MOTOR CONTROL. Cat. #837625, Type A1RS, .568 KVA, 60 cycles, primary volts 115, low amps. 16.2, indoor service, voltage controlled by motor 110/1/60, 1/40 HP. Price \$39.50

PIONEER DYNAMOTOR, Type PS250. Input: 12 VDC, 4.9 amp. Output: 350 VDC, .100 amp., brand new. Price\$14.00

BRITISH DC/AC MG UNITS. Operate at 100/110 VDC, 4 amps., 3000 RPM. Output: 230 VAC, .87 amp., 50 cyc. Wt: 132 lbs. Brand new. Price \$42.50

G.E. Motor Starting Reactors Type 11K2840G2: Rated at 440 V, 3 Ph. 60 Cy. 16.8 Amp. Only a 3 Pole Double Throw Switch is necessary with this unit to make a 15-20 HP compensator starter. Useful for any purpose requiring three phase choke. Special Price \$25.00

Admiralty Motor Generator Set, British mfg., input 200/236 VDC, 1500 RPM, output 10 KW at 100% P.F., 230 volts, 43.5 amps., 1 ϕ 50 cy., price \$295.00

LATE ARRIVAL

General Electric Frequency Changer, Motor: 30 HP, Triacid, 550/3/60, 3600 RPM. Direct connected to Frequency Converter, Model 5MM445B11, with secondary of 30 KW, 440 volts, 3 phase, 240 cycles. Price.....\$1550.00

EMERSON LOW VOLTAGE MOTORS, 1/25 HP, 5000 RPM, shunt wound, 27.5 volts, 3 amps., new. Price\$4.50

FEDERAL VARIABLE RESISTORS, 1250 ohms, 50 watts, 1" lgth. Price\$.25

CROCKER-WHEELER LV MG SET. Motor: 25 HP, 220/440-3-60, 870 RPM. Generator I: 12 volts, 1000 amps., 12 KW. Generator II: 12 volts, 200 amps., 2.4 KW. Price\$1,475.00

BOGUE ELECTRIC AC-DC MG SET. Motor: 7.5 HP, 220-440-3-60. Direct coupled to 2 Bogue generators with output of 12 VDC at 160 amps, 1.9 KW from each generator. Output can be connected as 12 Volts at 320 amps. or as 24 volts, 160 amps. Price\$455.00

Write for our new
100-page catalogue
on your company letterhead

WILLIAM I HORLICK COMPANY

Est. in 1922

266 SUMMER ST.
BOSTON 10 MASS.

IF IT'S FROM ONE FREQUENCY TO ANOTHER; FROM DC TO AC OR AC TO DC,
IF IT'S FROM ONE VOLTAGE TO ANOTHER, THEN CALL ON US.

A LEADING SUPPLIER OF ELECTRONIC & AIRCRAFT EQUIPMENT

A. C.
SYNCHRONOUS
MOTORS

110 Vt. 60 Cycle

HAYDON TYPE 1600, 1/240 RPM
 HAYDON TYPE 1600, 1/60 RPM
 HAYDON TYPE 1600, 4/5 RPM
 HAYDON TYPE 1600, 1 RPM
 HAYDON TYPE 1600, 1 1/5 RPM
 TELECHRON TYPE B3, 2 RPM
 TELECHRON TYPE BC, 60 RPM
 HOLTZER CABOT, TYPE RBC 2505, 2 RPM,
 60 oz. 1 in. torque.

SERVO MOTORS

PIONEER TYPE CK1, 2 ϕ 400 CYCLE
 PIONEER TYPE 10047-2-A, 2 ϕ , 400 CYCLE,
 with 40:1 reduction gear.

D. C. MOTORS

BODINE NFHG-12, 27 VTS., governor controlled,
 constant speed 3600 RPM, 1/30 HP.
 DELCO TYPE 5068750, 27 VTS., 160 RPM,
 built in brake.
 DUMORE, TYPE EIY2PB, 24 VTS., 5 AMP.,
 .05 HP., 200 RPM.
 GENERAL ELECTRIC, TYPE 5BA10AJ18D,
 27 VTS., 110 RPM, 1 oz. 1 ft. torque.
 GENERAL ELECTRIC, TYPE 5BA10AJ37C,
 27 VTS., 250 RPM, 8 oz. 1 in. torque
 BARBER COLMAN ACTUATOR TYPE AYLC
 5091, 27 VTS., .7 amp., 1 RPM, 500 in.
 lbs. torque.
 WHITE ROGER ACTUATOR TYPE 6905, 12
 VT., 1.3 amp., 1 1/2 RPM, 75 in. lbs.
 torque.

AMPLIDYNE AND MOTOR

AMPLIDYNE, GEN. ELEC. 5AM31NJ18A in-
 put 27 vts., at 44 amp. output 60 vts. at
 8.8 amp., 530 watts.
 MOTOR, GEN. ELEC. 5BA50LJ22, armature
 60 vts. at 8.3 amp., field 27 vts. at 2.9
 amp. 1/2 HP., 4000 RPM.

PIONEER AUTOSYNS
400 CYCLE

TYPE AY1, AY5, AY14G, AY14D, AY20,
 AY27D, AY38D, AY54D.
 PIONEER AUTOSYN POSITION.
 INDICATORS & TRANSMITTERS.
 TYPE 5907-17, single, Ind. dial graduated
 0 to 360°, 26 vts., 400 cycle.
 TYPE 6007-39, dual Ind., dial graduated
 0 to 360°, 26 vts., 400 cycle.
 TYPE 4550-2-A, Transmitter, 2:1 gear ratio
 26 vts., 400 cycle.

INVERTERS

WINCHARGER CORP. PU 16/AP, MG750,
 input 24 vts. 60 amps. outputs 115 vts.,
 400 cycle, 6.5 amp., 1 phase.
 HOLTZER CABOT, TYPE 149F, input 24 vts.
 at 36 amps., output 26 vts. at 250 V.A.
 and 115 vts. at 500 V.A., both 400 cycle,
 1 phase.
 PIONEER TYPE 12117, input 12 vts., output
 26 vts. at 6 V.A., 400 cycle.
 PIONEER TYPE 12117, input 24 vts., output
 26 vts. at 6 V.A., 400 cycle.
 WINCHARGER CORP., PU/7, MG2500 input
 24 vts. at 160 amp., output 115 vts. at
 21.6 amp., 400 cycle, 1 phase.
 GENERAL ELECTRIC, TYPE 5D21NJ3A, in-
 put 24 vts. at 35 amps., output 115 vts.
 at 485 V.A., 400 cycle, 1 phase.
 LELAND, PE 218, input 24 vts. at 90 amps.
 output 115 vts. at 1.5 K.V.A., 400 cycle,
 1 phase.
 LELAND, TYPE D.A. input 28 vts., at 12
 amp. output 115 vts. at 115 V.A., 400
 cycle, 3 phase.

ENGINE HOUR METER

JOHN W. HOBBS, MODEL MI-277 records
 time up to 1000 hours, and repeats,
 operates from 20 to 30 volts.

VOLTAGE REGULATOR

LELAND ELEC. CO. TYPE B, CARBON PILE.
 Input 21 to 30 volts D.C. regulated out-
 put 18.25 vts. at 5 amp.
 WESTERN ELEC. TYPE BC937B, input 110
 to 120 volts, 400 cycle. Output variation
 0 to 7.2 ohms at 5 to 2.75 amps.
 WESTERN ELEC. TRANSTAT, input 115
 vts., 400 cycle output adjustable from
 92 to 115 vts., rating .5 K.V.A.
 AMERICAN TRANS. CO., Transtat input
 115 vts., 400 cycle output 75 to 120 vts.
 or 0 to 45 volts, rating .72 K.V.A.

SYNCHROS

1 F SPECIAL REPEATER 115 vts. 400 cycle.
 2J1F1 GENERATOR, 115 vts. 400 cycle.
 2J1F3 GENERATOR, 115 vts. 400 cycle.
 2J1G1 CONTROL TRANSFORMER 57.5 vts.
 400 cycle.
 2J1H1 DIFFERENTIAL GEN. 57.5/57.5 vts.
 400 cycle.
 5G GENERATOR, 115 vts. 60 cycle.
 5DG DIFFERENTIAL GEN. 90/90 vts. 60
 cycle.
 5HCT CONTROL TRAN. 90/55 vts. 60
 cycle.
 5CT CONTROL TRAN. 90/55 vts. 60 cycle.
 5SDG DIFFERENTIAL GEN. 90/90 vts. 400
 cycle.

ALL PRICES
 F. O. B.
 GREAT NECK
 N. Y.

**IMMEDIATE
 DELIVERY -- FULLY
 GUARANTEED**

TACHOMETER GENERATOR
& INDICATOR

GENERAL ELECTRIC, GEN, TYPE AN5531-1,
 Pad mounting 3 phase variable frequency
 output.
 GENERAL ELECTRIC, GEN. TYPE AN5531-2,
 Screw mounting 3 phase variable fre-
 quency output.
 GENERAL ELECTRIC, IND. 8DJ13AAA,
 works in conjunction with above genera-
 tors, range 0 to 3500 RPM.

D. C. ALNICO FIELD MOTOR

DIEHL TYPE FD6-23, 27 vts. 10,000 RPM.

GENERAL ELECTRIC
D. C. SELSYNS

8TJ9-PAB TRANSMITTER 24 VTS.
 8TJ11- INDICATOR, dial 0 to 360°, 24
 vts.

RECTIFIER POWER SUPPLY

HAMMETT ELECTRIC MFG. CO. MODEL
 SPS-130. Input voltage 208 or 230 volts,
 60 cycle, 3 phase, 21 amps. Output 28
 volts at 130 amps. continuous duty, 8
 point tap switch, voltmeter ammeter,
 thermo reset all on front panel.

MISCELLANEOUS

PIONEER MAGNETIC AMPLIFIER ASSEM-
 BLY Saturable reactor type, designed to
 supply variable voltage to a servo motor
 such as CK1, CK2, CK5 or 10047.
 SPERRY A5 CONTROL UNIT, part No.
 644836.
 SPERRY A5 AZIMUTH FOLLOW-UP AM-
 PLIFIER, part No. 656030.
 SPERRY A5 DIRECTIONAL GYRO, part No.
 656029, 115 vt. 400 cycle, 3 phase.
 SPERRY A5 PILOT DIRECTION INDICA-
 TOR, part No. 645262 contains AY 20.
 ALLEN CALCULATOR, TYPE C1, TURN &
 BANK IND., part No. 21500, 28 vts.
 D. C.
 TYPE C1, AUTO-PILOT FORMATION STICK,
 part No. G1080A3.
 PIONEER GYRO FLUX GATE AMPLIFIER,
 Type 12076-1-A, 115 vt. 400 cycle.

**INSTRUMENT
 ASSOCIATES**

363 GREAT NECK ROAD, GREAT NECK, N. Y.
 Telephone GReat Neck 4-1147

Write for Catalog NE100

U. S. Export License-2140

Western Union address:
 WUX Great Neck, N. Y.

Buy TOP Radio-Electronic Values!

HEAVY DUTY SWITCHES



H&H 4-P.D.T. Toggle Switch. 5 AMP. @ 250 Volt. 10 Amp. @ 125 Volt. Single $\frac{3}{4}$ " hole mount. Ball handle.
 Stock No. 6203A Price Each **\$1.95**

CUTLER HAMMER TYPE 8905K628

4 Pole D.T. Neutral Center Toggle Switch. Luminous Tip—Bat Handle. 2 Hole Mg.
 Stock No. 6291A Price Each **\$1.95**

RECTIFIERS

A precision balanced copper oxide double bridge rectifier. Housed in a sealed metal container 1" x 1- $\frac{3}{4}$ " x 1" high. Tapped mtg holes in bottom. Discs have vaporized gold contact surfaces. Made by Bradley Labs. to W. E. spec. D 220005. Nominal input volts 10.5 V.A.C. 5 M.A.
 Stock No. 6283A Price Each **\$1.50**

2 VOLT BATTERY

Signal Corps Type UB-54A 2 Volt 27 Ampere Hour Storage Battery. Ioon-Spillable Transparent Acid Proof Plastic Case has Built-in Ball Type Hydrometer. 3" x 4" x 5" High.
 Stock No. 5458A Price Each **\$2.50**

HIGH VOLTAGE TRANSFORMER

21,000 volt 100MA. Half Wave oil filled. Maloney Electric Co.
 Stock No. 5728A Price Each **\$300.00**

PLATE TRANSFORMER

Thordarson Tru-Fidelity Plate Transformer. Primary 208-210-220-230-240 Volts 60 Cycle. Secondary 310 V.C.T. @ .86 Amps. 10,000 Volt insulation. Brand new—limited quantity.
 Stock No. 6399 Price Each **\$60.00**

FILTER REACTORS

4 Henry @ 1.75 Amps. Thordarson Tru-Fidelity. 15,000 Volt Test. 10 Ohms D.C.
 Stock No. 6400A Price Each **\$35.00**

Swinging Choke. Thordarson Tru-Fidelity. 10-20 Henry @ 500 to 50 M.A. 7500 Volt Test. 35 Ohms D.C.
 Stock No. 6401A Price Each **\$20.00**

SCOPE TRANSFORMER

2500 Volt @ 1.6 M.A. Secondary. 115 Volt 60 Cycle Primary. Insulated for 7500 Volts. Open strap mounting 3%" centers. Mfg. by Thordarson.
 Stock No. 6387A Price Each **\$1.25**

FILAMENT TRANSFORMER

20 VOLTS TAPPED AT 14 VOLTS @ 20 AMPS. PRIMARY TAPPED IN 5 VOLT STEPS FROM 210 TO 210 VOLTS. 50-60 CYCLE STANCOH SS10696. 4" x 3" x 5" HIGH.
 Stock No. 6292A Price Each **\$4.95**

MIL-T-27

FILAMENT TRANSFORMER

PRIMARY: 107.5; 112.5; 117.5; 122.5; 215; 225; 235 and 245 Volts 50/60 cycle SECONDARY: 6.3 Volts @ 5.3 AMPS and 6.3 Volts @ 3 AMPS. Ceramic bushings with solder lug terminals. Rated for continuous duty under Mil-T-27. Class "A" Grade I specs. Hermetically sealed case, 2 $\frac{3}{4}$ " x 3 $\frac{1}{2}$ " x 3 $\frac{1}{8}$ " high.
 Stock No. 6284A Price Each **\$3.50**

6.3 VOLT FILAMENT TRANSFORMERS

Primary 115 Volt 60 Cycle 1600 Insulation Three 6.4 Volt Secondaries

6.3 Volts @ 4.9 Amps.
 6.3 Volts @ 4.5 Amps.
 6.3 Volts @ 1.1 Amps.
 Stock No. 5254A

Horizontal Half Shell Mounting. 2 $\frac{1}{4}$ " x 2 13/16" Mounting Centers. 2 13/16" x 3 $\frac{3}{8}$ " Core Size. 2 $\frac{1}{2}$ " above Chassis. Soder Lug Terminals—All Terminals Marked.



TYPE "J" POTENTIOMETERS

500 Ohm—2 Watt Type J Pot. $\frac{3}{8}$ " Long Shaft. $\frac{1}{4}$ " long Bushing. Complete with Knob.
 Stock No. A6123 Price Each **49¢**

100 ohm Type I with $\frac{3}{8}$ " bushing and locking nut. Screw-driver slot.
 Stock No. 6270A Price Each **\$.49**

LAB. POTENTIOMETERS

MODEL 260. 6 Watt 20,000 OHM Laboratory. Potentiometer. Resistance tolerance plus or minus 5%. Five finger bronze wiper. Bakelite shaft $\frac{3}{8}$ " Diam. x 1 $\frac{1}{4}$ " Long.
 Stock No. 6277A Price Each **\$1.50**

MALLORY M200R

200 ohm 4 watt Rheostat
 Stock No. 6137A Price Each **30¢**

SENSITIVE RELAYS



MIDGET TYPE RELAYS
 Automatic Electric Type R-45, 6500 ohm Coils. Normally open contacts except as noted.

Stock No.	Contents	M. A.	Price Each
102252	S.P.S.T.	2.0	\$1.25
102249	2-P.S.T.	4.5	1.50
102264	3-P.S.T.	6.0	2.00

* 1 Norm. open-1 Norm. closed.

Same type and style as above, but has 24 V.A.C. coil. Intermittent duty. Will operate on 6 V.D.C. continuous duty. Contacts: S.P.S.T.-N.O. and S.P.D.T.
 Stock No. 102248A Price Each **\$1.25**

304TL's EIMAC JAN 304TL's
 INDIVIDUALLY BOXED \$10.95

RESISTORS PRODUCTION QUANTITIES

in stock of late carbon and wire wound resistors. $\frac{1}{2}$ —10 watt sizes, savings 10—25%. Send us your requirements.

.01 MFD.—600 VOLT MICA CONDENSERS

Large quantities available in both CM-35 and CM-40 case sizes.
 TOLERANCE PRICE PER

5%	1000
10%	\$150.00
20%	125.00
	100.00

SIGNAL CORPS & NAVY TRANSFORMERS

Over 200,000 transformers, chokes etc. For Signal Corps and Navy Equipment. Send us your requirements, or ask for our catalog listing by Signal Corps Numbers. DON'T DELAY!

MICA CONDENSERS



Type 9 and A2 5000 Volt Test Mica Condensers

Stock No.	Cap. Mfd.	Price Each
6274A	.002	\$.60
6275A	.01	\$1.00

SWEEP CAPACITOR

5-10 MMFD. Sweep Generator Capacitor. Has cylindrical silver plated rotor, concentric to silver plated stator plates. Rotor has high speed ball bearings. Completely enclosed in moulded bakelite housing. Ideal for motor driven sweep generators.
 Stock No. 6276A Price Each **\$2.00**

BUTTERFLY CONDENSERS

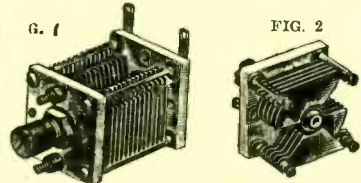

9-62 mmfd per section. 6-34 mmfd sections in series. Double ceramic end plates and bearings. $\frac{1}{4}$ " diam. shaft, 5/10" long. .065 Plate spacing end plates 1- $\frac{3}{8}$ " square.

Stock No.	FIG.	Price Each
No. 5076-A	FIG. 1	90¢
No. 5077-A	FIG. 2	60¢

4-22 mmfd per section. 3-12 mmfd sections in series. Single ceramic end plate 1- $\frac{3}{8}$ " square. $\frac{1}{4}$ " diam. x $\frac{1}{4}$ " long shaft.

THORDARSON AUDIO PASS FILTERS

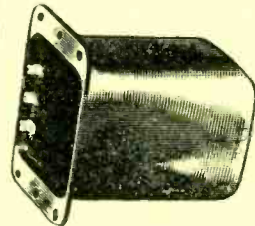

Band pass 800 to 1200 cycles input 10000 ohms — Output 25000 Ohms Level 10DB

Stock No. T48500 Price \$5.50 ea.

THORDARSON BAND PASS FILTERS

600 ohms to 600 ohms 1700 cycles to 3300 cycles Attenuation 25 DB at 1450 cycles or 50 DB at 4880 cycles. Size: 6" x 6 $\frac{1}{2}$ " x 5"

Stock No. 5897A Price Each **\$8.00**

LOW PASS FILTER

500 Ohm to 500 Ohm. 200 to 2000 Cycles. Sig. Corps No. 321891—1.2. P/O R/19A—TRC-1.
 Stock No. 6413A Price Each **\$3.00**

TERMS:

Open Accounts to rated or Acceptable reference accounts. Others pre-payment of 25% deposit with order, balance C.O.D. Price F.O.B. Chicago and subject to change without notice. Merchandise subject to prior sale.

ORDER TODAY!!

Radio Surplus Corp.

732 South Sherman Street
 Chicago 5, Illinois
 Phone: HARRISON 7-5923

INVERTERS

Onan M-G-215H, Navy type PU/13, Input 115/230, 60 cy., 1 Ph. Output: 115, 480 cy., 1 Ph., 1.2Kw and 26V DC at 4 amps. New.....\$295.00
 Onan M-G-075, Navy type PU/11 Input: 115/230, 60 cy., 1 Ph. Output: 115, 480 cy., 1 Ph., 5.3 amps. and 26 VDC @ 3.8 Amps. New.....\$225.00
 Leland Elec. Co. PE206A, Input: 28DC at 38 Amps. Output: 80V, 800 cy., 1 Ph., 485VA. New.....\$22.50
 G.E. J8169172, Input: 28DC. Output: 115, 400 cy., 1 Ph., 1.5KVA. New.....\$32.50
 G.E. SA51315511A, Model 218J, Input: 28DC. Output: 115, 400 cy., 1 Ph., 1.5 KVA. Regulated. New.....\$89.50
 Holtzer-Cabot M.G. 164, Input: 440, 3 Ph., 60 cy., Output: 70V, 146 cy., 3 Ph., 0.140KVA. New \$67.50
 Elcor, 74DC to 110AC, 60 cy., 1 Ph. at 2.4 Amps. New.....\$39.50

DYNAMOTORS

Navy type CA10-211444, Input: 105 to 130DC. Output: either 26DC at 20 amps, or 13DC at 40 amps. Radio filtered and complete with line switch. New.....\$89.50
 Type PE94CM, For SCR-522. Brand new in overseas cases. Has wide band input and output filters. \$19.50

AMPLIDYNES

G.E. 5AM211J7, Input: 27VDC. Output: 60VDC. 150 Watts, 4800 RPM. Type MG-27-B. New \$34.50
 Edison 5AM31M10A, Input: 27VDC, 44 Amps. 8900RPM. Output: 60VDC at 8.8 Amps. 530 Watts. New.....\$12.50
 G.E. 5AM31N19A, 530 Watts, 7500 RPM. Input: 27VDC. Output: 60VDC. Weight 34 1/2 lbs. \$29.50

SMALL D.C. MOTORS

G.E. 5BA50L12A, Armature 27VDC at 8.3 Amps. Field 60VDC at 2.3A RPM 4000. H.P. .05. New.....\$27.50
 Oster E-7.5, 27.5DC. 1/20HP, 3800RPM. Shunt Wound. New.....\$9.50
 Dumore Co. type ELBG, 24VDC, 40-1 gear ratio. For type B-4 Intervalometer. New.....\$6.75
 G.E. 5BBW47AB12, 3/4 H.P. Perm. Mag.—1 amp. 250V. 1725 RPM. New.....\$22.50

400 CY. BLOWERS

Westinghouse, Type FL, 115V, 400 cy., 6,700 RPM. Airflow 17C.F.M. New.....\$6.75

SYNCHROS

Ford Inst. Co. Synchro Differential Generator, Mod. 3 Type 5SDG. 90/90V. 400 cy., Ord. Dr. 173020. New.....\$22.50
 Armor, Synchro Differential Generator, Type 6DF, New.....\$60.00
 Hohart Mfg. Co. Synchro Differential Synchro Type XIX 115V. 60 cy. New.....\$9.50

STEP BY STEP MOTOR

Bendix—Type CAL 14810 (BK1 Mod 0). 70 Volts DC Input.....\$16.50

HIGH VOLTAGE OIL CAPACITORS

.001 MFD 50,000V DC	\$37.50
.01 MFD 5,000V DC	2.95
.02 MFD 8,000V DC	9.50
.025 MFD 50,000V DC	49.00
.025/.025 MFD 50,000V DC	59.50
1 MFD 500V DC	.95
1 MFD 3,000V DC	2.95
.135 MFD 7,500V DC	6.95
.15 MFD 12,000V DC	7.50
2 MFD 50,000V DC	69.50
.25 MFD 15,000V DC	22.50
.25 MFD 20,000V DC	26.50
.25 MFD 50,000V DC	79.50
1 MFD 7,500V DC	12.50
1 MFD 15,000V DC	43.50
2 MFD 6,000V DC	14.50

TRANSMITTING MICA CAPACITORS



LARGE QUANTITIES IN STOCK
WRITE FOR LIST

CRYSTAL DIODE

Sylvania 1N21B, Individually boxed and packed in leaded foil.....\$3.00

REPAIR PARTS FOR

BC-348 RECEIVERS (H, K, L, R, Only)
 Also BC 224 Models F, K. Coils for ant., r.f., det., osc., I.F., c.w. osc., xtal filters, 4 gang cond., vol. conts., etc. Write for complete list.

RELAYS

Struthers-Dunn 1BXN129, 115 A.C.	\$2.60
Advance type 455C, SPDT, 115 A.C.	\$1.95
Leach type 1154A, SPDT, 115 A.C.	\$2.35
Leach type 1054, BSN 20-28V D.C.	\$2.35
Clare Plug-in base No. 30PMX 115 A.C.	\$2.45
G.E. Plug-in base Sensitive K271853	\$3.25
Western Electric D-163781 Plug-in	\$4.95
Guardian Time Delay type 15-9-SPDT	\$2.95

TERMS: Rated Concerns Net 30, FOB Bronxville, New York. All Merchandise Guaranteed. Prices Subject to Change

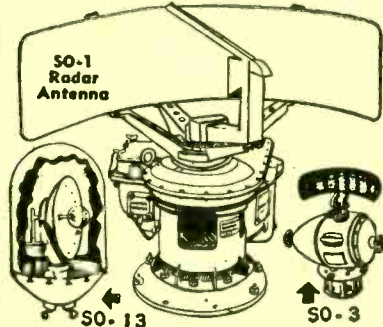

RADAR ANTENNAS

Type SO-1 (10CM) assembly with reflector, waveguide nozzle, drive motor, etc. New.....\$279.50
 Type SO-3 (3 CM.) Surface Search type with reflector, drive motor, etc., but less plumbing. New in original cases.....\$189.50
 Type SO-13, (10CM.) Complete assembly with 24" dish, dipole, drive motor, gearing, etc. New \$149.50
 Also in stock — spare reflectors, nozzles, probes, right angle bends for SO-1 antennas.

MISC. RADAR EQUIPMENT

MODEL SQ, Portable radar set, 10CM. Operates on 90-130 volt, 60 cy., 1 Ph. "A", "B", and "PPI" presentation. Complete with tech manual and full set of operating spare parts.
 MODEL SG-1, Consists of complete equipment including Radar Transmitter-Receiver CRP-43AAK-3, Range and Train Indicator CRP-55ARC-3, Control Amplifier CRP-50AAT-1, Motor Dynamo-Amplifier (Amplidyne) CG-21AAV and Antenna CRP-66AHJ-1.
 MODEL ASG-1 Radar unit consisting of transmitter and converter assembly CPR-43ABC, Antenna Assembly CRP-ACZ, Mounting Base CPR-10ABE, etc.
 Spare Parts available for Model SQ and SG-1 Radar Modulator Units for SO-11 (CUZ-50AGD)
 Pulse Timer units for SD-5
 Transmitter-Receiver units SO-13
 Spare Parts for SO-1
 Spare Parts for SQ
 Marker Oscillator Crystals in holders 98.35KC
 Bearing Control Units CRP-23AEK
 Synchro Amplifiers—Bendix
 90° Waveguide Bends 10CM Bronze
 Signal Monitors CRP-60AAN
 Repeater Amplifiers CBM-50AFO
 Oscillator Tube Cavities for SO-1, 13 etc., RF303
 10CM Horns, 1 1/2" x 3" waveguide, standard contact. flange input, circularly polarized horn output
 Duplex Tees #223005-17
 Auxiliary Rectifier CABM-20237 (SO-2 Radar)
 SO-1 (66AGE) Antenna R.F. Nozzle Assembly
 SCR 545A Major Units

MODEL AN/APA-10 PANORAMIC ADAPTER

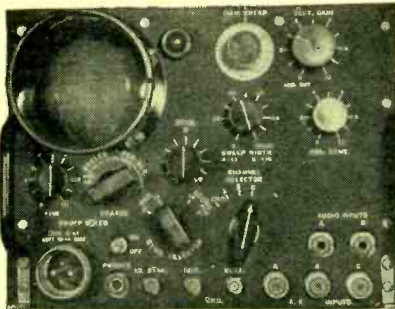

Provides 4 Types of Presentation:
 (1) Panoramic (2) Aural
 (3) Oscillographic (4) Oscilloscopic

Designed for use with receiving equipment AN/ARR-7, AN/ARR-5, AN/APR-4, SCR-587 or any receiver with I.F. of 455 kc, 5.2mc or 30mc. With 21 tubes including 3" scope tube. Converted for operation on 115 V. 60 cycle source.
Price.....\$245.00
 Gov't Cost \$1800.00.
 AN/APA-10 80 Page Tech Manual.....\$2.75

SCR-522 EQUIPMENT

Complete BC-624C receivers and BC-625AM Transmitters including mounting racks, plugs, connectors, P.E. 94C dynamotor. Brand new equipment with instruction manuals.

HIGH POT TRANSFORMERS

High Voltage Trans. Westinghouse Pri: 115, 60 cy. Sec: 15,000 C.T., 60 MA. Good for Hi-Pot test set up. C. T. ungrounded.....\$29.50

PULSE TRANSFORMERS

PULSE WECO KS-9563 Supplies voltage peaks of 3500 from 807 tube. Tested at 2000 Pulses/sec and 5000 peak. Wdg. 1-2=18 ohms. Wdg. 1-3=72 ohms. L of Wdg 1-3=822H at 100 cps.....\$3.95
 PULSE WECO KS-161310, 50 KC to 4MC, 1 1/2" Dia. x 1 1/2" high. 120 to 2350 ohms. New.....\$3.95
 High Reactance Trans. G.E. type Y. 3502A.—60 cy. Voltage 11200-135. Inductance H.V. Winding 135 Henries. Output: Peak Voltage 22.8KV. Cat. 8318065G1. New.....\$39.50

RAYTHEON VOLTAGE REGULATORS

Adj. Input taps 95-130V., 60 cy. 1 Ph. Output: 115V. 60 Watts, 1/2 of 1% Reg. Wt. 20 lbs. 6 1/2" H x 3 3/4" L x 4 3/4" W. Overload protected. Sturdily constructed. Tropicalized. New.....\$16.50



AUTO TRANSFORMER

G.E. 400 cy. Cat. No. 80G184
 K.V.A. .945S—520P Volts 400/345/230/115 New.....\$4.50

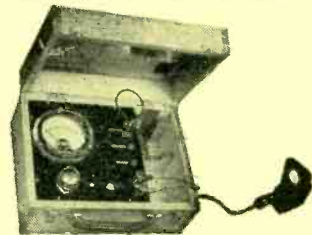

FLUXMETER

Used to calibrate flux strength of magnets from 500 to 4000 gauss and indicate polarity. Probe has gap of 1 1/4". Beautifully built in hardwood case with hinged cover. Instructions for operation on under side of cover. Size 12 3/4 x 9 x 6 in. Ideal for lab and school use. New. An exceptional value at.....\$29.50

MULTI-CONDUCTOR CABLE

CO-215, Stock 3E2215, Bulk 9 conductor No. 20 A.W.G. Stranded tinned copper plastic insulated, color coded, tinned copper braided shield. Flamenol jacketed. Made by G.E. Available 1000, 1500, 2000 ft. reels. Price.....\$15 Ft.

AMPLIFIERS

GE Servo type 2CV1C1 400 cycle
 Constant Output Line RC-730C
 Synchro Amplifiers for Radar
 Intercommunication type BC-605

ANTENNAS

AS-33 APT-2, AT-38A/APT, AS-62/AP'S-13
 AS-125/APR for APR-5A
 TDY RADAR JAMMER HORNS
 PARABOLOIDS, MAGNESIUM DISHES 17 1/2" dia.
 SCL-623-A (part of RC-153-B Antenna)
 CU 64/APT Antenna matching unit 50 ohm unbal. to 100 bal.

POTENTIOMETERS

W.E. KS-15138 Linear Sawtooth
 W.E. KS8732 for SCR547 Radar
 W.E. KS-8801 Motor Driven

HIGH QUALITY CRYSTAL UNITS

Western Electric—type CR-1A/AR in holders 1/2" pin spacing. Ideal for net frequency operation. Available in quantities, 5910-6350-6370-6470-6510-6610-6670-6690-7270-7350-7380-7390 - 7480 - 7580-9720. All fundamentals in KC. Good multipliers to higher frequencies.....\$1.25 each

SWEEP GENERATOR CAPACITOR

High speed ball bearings. Split stainless steel. Silver plated coaxial type 5/16 mmfd. Brand new.

Price \$2.25



ELECTRONICRAFT INC.

27 MILBURN ST. BRONXVILLE 8, N. Y.

PHONE: BRONXVILLE 2-0044

Reliance Specials

SOUND POWERED HANDSET



Brand New
TS-10 Type—Includes 5 ft. cord
USES NO BATTERIES OR EX-
TERNAL POWER SOURCE
PAIR—\$18.95

SOUND POWERED HEAD & CHEST SET

Brand New
Navy Type M Head and Chest Set. Brand New For Work
Requiring Free Use of Hands. Heavy Duty—Consists of
Headset with 2 Phones and Chest Mike. Includes 20 Ft.
Rubber Cord EACH \$14.88

TELEPHONE FIELD WIRE

W-110-B
1/2 MILE COIL . . . \$7.95
1 MILL REEL . . . \$14.95



HAYDON TIMING MOTOR
1 R.P.M. 115 V., 60 Cycle . . . \$1.95

TIMING MOTOR



8 RPM 115 V 60 cyc
E. Ingraham Co. **\$1.79**

Timer—Industrial Timer Corp. 15 min. on 15 min. off
continuous 115 V. A.C. Fully cased Plugs into outlet
socket \$5.50

TIME DELAY RELAY



Raytheon CPX 24166
1 Min. Delay. 115 V., 60 Cycle
2 1/2 second recycling time spring return.
Microswitch contact, 10A. Holds ON as
long as power is supplied. Fully Cased.
ONLY \$6.50

JONES BARRIERS STRIPS

2-140V	\$0.17	3-141W	\$0.27	8-141 1/2 W	\$0.64
3-140 3/4 W	.21	4-141	.24	9-141	.48
6-140	.28	5-141	.29	9-141 1/2 W	.71
10-140W	.59	5-141 3/4 W	.41	3-142	.24
10-140 3/4 W	.59	7-141 1/2 W	.56	2-150	.43
3-141 1/4 W	.27	8-141	.44	3-150	.60

Brand New Meters—Guaranteed

0-10 ma. D.C. 3 1/2". \$3.95 0-80 Amp. D.C. 2 1/2". \$2.50
0-1 Ma. D.C. 3 1/2" Delux. (Scale Reads 0-4 KV). \$5.75

SELENIUM RECTIFIERS

Full Wave 200 MA 115V. \$1.70
Half Wave 100 MA 115V.91

3 AG FUSES

Amp.	per 100	Amp.	per 100	Amp.	per 100
1/8	\$4.00	3/4	\$4.00	8	\$3.00
3/8	4.00	4	3.00	15	3.00
1/2	4.00	5	3.00		

3 AG FUSE HOLDERS (Finger) 25¢

Type	EB 3/4 W	10%	6¢ ea.	\$4.00 per C
Type	GB 1W	5%	12¢ ea.	8.00 per C
Type	GB 1W	5%	9¢ ea.	7.00 per C
Type	HB 2W	5%	12¢ ea.	9.00 per C
Type	HB 2W	10%	24¢ ea.	18.00 per C

AVAILABLE IN ALL STANDARD RMA VALUES

POSTAGE STAMP MICAS

5 mmf to 910 mmf.	5¢
.001 to .0013 mfd.	8¢
.002 to .0056 mfd.	15¢
.0062 to .0091 mfd.	20¢
.01 mfd.	28¢

SILVER MICAS

mmf	mmf	mmf	mmf	mmf	mfd	mfd	mfd
10	50	100	170	360	510	.001	.0024
18	51	110	180	370	525	.0011	.0025
22	56	115	208	390	560	.0013	.0027
23	60	120	225	400	570	.0015	.0028
24	62	125	240	410	680	.0016	.003
25	66	130	250	430	700	.0018	.0033
27	68	135	255	470	800	.0022	.0039
30	75	150	260	488	900	.0023	.004
40	82	155	270	500			

Price Schedule

10 mmf to 700 mfd.	10c
.0011 mfd to .002 mfd.	20c
.0022 mfd to .0082 mfd.	50c
.01 mfd.	95c

PULSE TRANSFORMERS

UTAH—9262	9278	9289	9318	9340	9350
WESTERN ELECTRIC—D166173			D161310		
KS9696, KS9800, KS9862, KS13161					
GENERAL ELECTRIC—80-G-5					
JEFFERSON ELECTRIC—C-12A-1318					
DINION COIL—TR1048	TR1049				
also 352-7250-2A;	352-7251-2A;			T-1229621-60	

AN CONNECTORS

See Our Ad February, 1953 Electronics
PHONE! WIRE! WRITE! YOUR NEEDS

GET ON OUR MAILING LIST

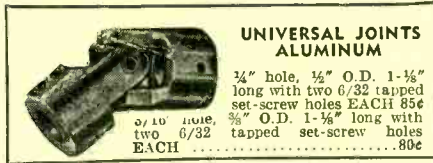

UNIVERSAL JOINTS ALUMINUM

3/4" hole, 1/2" O.D. 1-1/2" long with two 6/32 tapped set-screw holes. EACH \$5.95
3/4" O.D. 1-3/4" long with two 6/32 tapped set-screw holes. EACH .80¢

OIL FILLED CONDENSERS

MFD	V.D.C.	Price	MFD	V.D.C.	Price
5.2	50	\$0.89	0.5	3,000	\$2.40
6	400	.85	2	3,000	4.50
3 x 3	400	1.00	2	4,000	7.95
4	500	.85	0.01	5,000	.95
1	600	.55	1	5,000	4.88
0.5-0.5	600	.40	0.03-0.03	6,000	1.50
2	600	.75	1	6,000	9.95
4	600	1.75	0.02-0.02	7,000	1.55
8	600	1.85	0.1	7,000	1.75
10	600	3.25	0.1-0.1	7,000	5.95
4 x 3	600	2.50	0.1	7,500	2.25
8-8	600	1.95	0.075-0.075	8,000	6.50
1	800	.60	0.15-0.15	8,000	6.95
1	1,000	.69	0.25	20,000	19.95
2	1,000	.95			
3	1,000	1.70			
3	1,500	.65			
0.02	2,000	.65			
0.1-0.1	2,000	1.30			
0.1-0.5	2,000	.95			
0.5	2,000	1.65			
3	2,000	3.75			
8	2,000	7.95			
0.25	3,000	2.25			



1 mfd
6,000
V.D.C.
G.E. **\$9.95**

OIL FILLED AC CONDENSERS

MFD	V.A.C.	Price	MFD	V.A.C.	Price
7.5	220	\$2.00	15	440	\$6.25
20	220	4.95	1	660	2.95
1	236	1.60	0.9	660	4.35
4	236	1.60	3	660	4.45
8	236	1.95	4	660	4.95
3	330	1.45	5	660	5.45
4	330	2.25	6	660	5.95
20	330	6.75	8	660	7.50
25	330	7.50	0.2	750	.69
4-4	375	2.15			

COAXIAL CABLE CONNECTORS

A full line of Jan approved connectors in stock



83-1AC	\$0.42	PL-274	\$1.10	UG-88/U	\$0.90
83-1AP	.30	PL-275	2.10	UG-89/U	1.10
83-1BC	.30	SO-239	4.00	UG-102/U	.80
83-1F	1.10	UG-13/U	1.70	UG-103/U	.68
83-1H	.12	UG-18/U	1.05	UG-104/U	1.40
83-1HP	.22	UG-20/U	1.60	UG-105/U	1.50
83-1J	.73	UG-21/U	.85	UG-106/U	.15
83-1R	.40	UG-21/U	1.00	UG-107/U	2.75
83-1RTY	.65	UG-21C/U	1.05	UG-146/U	2.00
83-1SP	.45	UG-21D/U	1.45	UG-167/U	3.75
83-1SPN	.50	UG-22/U	1.30	UG-175/U	.12
83-1T	1.30	UG-22A/U	1.60	UG-176/U	.12
83-2AP	1.95	UG-22B/U	1.20	UG-185/U	.95
83-2J	2.10	UG-23/U	1.20	UG-196/U	1.65
83-2R	1.65	UG-23C/U	1.50	UG-203/U	1.65
83-22AP	1.40	UG-23/U	1.10	UG-224/U	1.15
83-22F	2.10	UG-24/U	1.30	UG-255/U	1.95
83-22J	1.40	UG-27/U	1.25	UG-260/U	1.95
83-22R	.68	UG-27A/U	2.25	UG-261/U	1.10
83-22SP	1.80	UG-27B/U	2.95	UG-262/U	1.10
83-22T	1.95	UG-28A/U	2.95	UG-273/U	1.45
83-168	.12	UG-29R/U	1.75	UG-274/U	2.30
83-185	.12	UG-30/U	2.30	UG-290/U	.90
CW-123A/U	.45	UG-57R/U	1.85	UG-291/U	.95
M-358	1.30	UG-58/U	.70	UG-306/U	2.65
M-359	.30	UG-59/U	.90	UG-414/U	1.95
M-359A	.65	UG-59A/U	1.90	UG-499/U	1.25
PL-258	.75	UG-83/U	1.75	UG-625/U	1.35
PL-259	.45	UG-85/U	1.65		
PL-259A	.50	UG-87/U	1.40		

NEW COAXIAL CABLES Jan approved

Price per 1000 ft.	Price per 1000 ft.
RG 5/U* \$140.00	RG 22/U* \$150.00
RG 6/U 180.00	RG 22A/U 285.00
RG 7/U* 85.00	RG 24/U 675.00
RG 8/U 100.00	RG 26/U 475.00
RG 9/U* 250.00	RG 29/U* 50.00
RG 9A/U 275.00	RG 34/U* 300.00
RG 10/U 240.00	RG 35/U 900.00
RG 11/U* 100.00	RG 41/U* 295.00
RG 11A/U* 150.00	RG 54A/U 97.00
RG 12/U 240.00	RG 55/U* 110.00
RG 13/U* 215.00	RG 57/U* 325.00
RG 17/U 650.00	RG 58/U 60.00
RG 18/U 900.00	RG 59A/U* 70.00
RG 19/U 125.00	RG 59/U 55.00
RG 20/U 1450.00	RG 62/U* 75.00
RG 21/U* 20.00	RG 77/U* 100.00

Add 25% for orders less than 500 feet.
* No minimum order—other 250 minimum.

NEW RG-8/U Unmarked 100 Ft. Coil. Special \$5.95

SELSYN MOTORS

Army Ordnance Type C-78248 115V. 60 Cy. Transmitter.
Approx. 3-3/4" dia. x 3-3/4" L. Like new. EACH \$27.50

SELSYN MOTORS

50 V. 50 Cy. High Torque. Connect in Series For Use on
110 V. 60 Cy. Approx. 3-3/4" dia. x 5-3/4" L. Like
New ONLY \$12.95 PAIR

DIFFERENTIAL Used \$4.95

115 V., 60 Cycle New \$9.95
#C78249



3 3/4" dia. x 5 3/4" long
Used between two C78248's as a dampener. Can be
converted to 3600 RPM Motor in 10 minutes. Con-
version sheet supplied. (Converted) \$5.50
Mounting Brackets—Bakelite for selsyns, and dif-
ferentials shown above 35¢ pair

PRECISION RESISTORS

1/2 watt one percent tolerance WW3 or Equal 35¢ ea.	1 watt one percent tolerance WW4 or Equal 45¢ ea.
250 7.4 16.37 105 8 400 445.1 25K	100K 128K 150K 240K 320K 500K 600K
334 9.1 20 123.8 414.3 5000 30K	120K 130K
502 10.48 25 125 705 6500 32.89K	1 watt WW3 or Equal 65¢ ea.
557 10.84 30 130 723 7000 33K	84K-2% 522K-1% 645K-1% 700K-1% 1 meg-5%
627 11.1 46 147.5 750 8000 35.89K	
760 11.25 50 160 855 8000 36K	
1 10.1 12.32 55.1 220.4 2200 8800 37K	
1.53 13 162.54 235 2250 14.82K 47K	
2 13.02 75 260 2500 15K 50K	
2.04 13.15 79.81 270 2850 15.75K 59K	
2.5 13.52 87 298.3 3427 16.7K 59.15K	
3.5 13.89 97.8 301.8 4000 17K 59.15K	
5.26 14.98 100 366.6 4300 20K 125K	

1 watt one percent tolerance WW4 or Equal 45¢ ea.
1.861 3.39 20 270 2000 7000 8000 55K
1.01 5.1 28 270 2000 8000 55K
2.55 5.21 38 1250 3300 9000 80K
2.58 12 50 1750 6000 20K

1 watt one percent tolerance WW4 or Equal 60¢ ea.
100K 128K 150K

RELAYS!

RELAYS!

RELAYS!

SEE OUR PREVIOUS ELECTRONICS ADS FOR LISTINGS OR WRITE FOR CIRCULARS

324 CANAL ST., N.Y.C., 13, N.Y. Walker 5-9642
Universal general corp.

VISITING NEW YORK?

WE INVITE YOU TO DROP IN

We have the largest variety of electronic merchandise ever exhibited on street level. Over 80,000 different items in stock. Visit our large store display at 324 CANAL STREET—Just West of Broadway.

SIGMA RELAYS

- 4F: 1 ma; SPDT; 8000 ohm; #R287 5.95
41FS7: 2 ma; SPDT; 10,000 ohm; #R914 2.95
41FZS7: 115VAC; SPDT; Will Operate Continuously on 220VAC; #R909 2.95
41F: 6VDC; SPDT; 62 ohm; Will Operate on 1 1/2 VDC; #R924 1.75
41F: 12 VDC; SPDT; 340 ohm; Will Operate on 6 VDC; #R925 1.95
4AH: 4 ma pull-in. 2.5 ma hold; SPDT; 2000 ohm; Air Tight Seal, RTMA 5-prong Plug Base; #R444 4.25
4RJ-47G: 3VDC; SPDT; 47 ohm; Hermetically Sealed; Solder Head Terminals; #R448 5.95
5RJ100S: 1.5VDC; SPDT; 100 ohm; Hermetically Sealed; Solder Head Terminals; #R1001 6.95
5RJ5000G: 1.4 ma pull in, 0.4 ma hold; SPDT; 5000 ohm; #R281 6.95

WESTERN ELECTRIC MERCURY RELAY 275C

Pressure Sealed; 2 Coils; 700 & 3300 ohm. Makes at 6.6 ma. Breaks at 5.2 ma with coils in series. SPDT; High Current Capacity; High Speed; RTMA Octal Plug Base; #R464 \$17.50



110V 60 Cyc TIMING MOTORS

- INGRAHAM 8 RPM Fully Enclosed... \$1.95
TELECHRON 3.6 RPM... 2.50
GILBERT With Gear Train for 6 RPD... 1.95
GILBERT 60 RPM (1 RPM)... 1.75
HAYDON 1600A; 1 RPM... 2.25
HAYDON: 1/12 RPM, 24V AC... 1.95

ROTARY RATCHET RELAYS

Ledex D.C. Impulse operated mechanisms rotate in 30° steps. Ratchet mechanism has 1/4" shaft with flats for standard switch wafers.

- #33 Mechanism only, 36-48V, 200 ohm. #R597... 1.50

- #75-3576 Mechanism & Ratchet & 4" long shaft, 6-8V, 1/2 ohm, #R599... 3.75

- #25 Mechanism Only, 12-18V. 4.5 ohm. #R824... 1.50

- #26 Mechanism Only, 6-8V. 2 ohm. #R825... 1.50

- Miniature Mechanism Only, 12-24V, 35 ohm. #R826... 1.50

- Miniature Mechanism Only, 6-12V, 10 ohm. #R827... 1.50

TELEPHONE TYPE RELAYS

These relays have been standardized so that coils and frames of most manufacturers can be interchanged without affecting adjustments. A wide variety of applicable combinations are thus possible from a comparatively small number of relays.

Listed below are frames and coils from our stock. They may be purchased separately. However, a complete relay consists of coil and frame. In ordering complete relays specify which coil with which frame, i.e.: F101 with K117.

Representative completed relays are also listed with voltage and current ratings. Values are indicative of sensitivity that may be expected from similar combinations.

- CLARE, 6500 ohm, 8 ma DC, 3 makes (3As) #R27C \$4.25
CLARE K101, 6500 ohm, SPDT, 2 ma DC. Fast Action #175 \$4.25

FRAMES

(For Cost of Relay Add Price of Frame to Price of Coil)

Stock No.	Contacts	Price each	Stock No.	Contacts	Price each
F101	1A	1.25	F111	1B, 2A	1.75
F102	2A	1.50	F114	1B, 3A	2.00
F103	3A	1.75	F133	1B, 1C	1.75
F104	4A	2.00	F108	1B, 1A, 1C	2.00
F127	8A	3.00	F131	1B, 9A, 1C	4.00
F128	12A	4.00	F107	2B, 1A	1.75
F106	1A, 1B	1.50	F135	2B, 1C	2.00
F107	1A, 2B	1.75	F112	2B, 2A, 2C	3.00
F108	1A, 1B, 1C	2.00	F136	2B, 3A, 1C	2.75
F109	1A, 1C	1.75	F121	5B, 1C	2.75
F110	1A, 2C	2.25	F122	1C	1.50
F111	2A, 1B	1.75	F123	2C	2.00
F137	2A, 1C	2.00	F109	1C, 1A	1.75
F112	2A, 2B, 2C	3.00	F137	1C, 2A	2.00
F129	2A, 2B, 6C	5.00	F117	1C, 6A	2.75
F114	3A, 1B	2.00	F133	1C, 1B	1.75
F136	3A, 2B, 1C	2.75	F135	1C, 2B	2.00
F115	3A, 2C	2.75	F108	1C, 1A, 1B	2.00
F117	5A, 1C	2.75	F136	1C, 3A, 2B	2.75
F120	1B	1.25	F121	1C, 5B	2.75
F132	2B	1.50	F110	2C, 1A	2.25
F134	3B	1.75	F115	2C, 3A	2.75
F106	1B, 1A	1.50	F112	2C, 2A, 2B	3.00

SPECIAL CONTACT ARRANGEMENTS

We can supply any contact arrangement up to 20 contact leads (10 form A or 10 form B; or combinations; or 3 form C) for a nominal extra charge. To compute cost of custom made frame add: 1.00 for blank frame plus .50 for each form C, plus .25 for each form A or B and 2.00 as the nominal extra charge. Thus a frame with 2A, 3B, 1C would cost 1.00 + .50 + .75 + .50 + 2.00 = 4.75.

SHOCKMOUNTS

Large Quantities of Lord, Barry, U. S. Rubber and Other Makes of Shockmounts in Stock. Most Sizes Available. Prices Below Manufacturer's Cost. Send Us Your Requirements.

APC TRIMMERS

We Have Production Quantities of 13, 15, 25, 35, 50, 75, 100 and 140 Mmf Air Trimmers Available at Low Prices.

Mu-Metal Laminations

Es, Fs, Is, Ls. Ten Sizes. Quantities Available. Sample Kit, 6 lbs, Sufficient Quantity of Each Size for One Unit—Post-Paid in U. S. A. \$19.75

HYPERSIL LAMINATIONS

Full loops. Several sizes available in quantity. Sample Kit 4 1/4 lbs. One complete loop each size. Postpaid in U.S.A. 19.75

TERMS:—All Prices F.O.B. Our Plant. Rated Firms Net 10 Days. All Others Remittance with Order. Orders Under \$10 Remittance With Order. Plus approximate Shipping Charges (average will be returned).

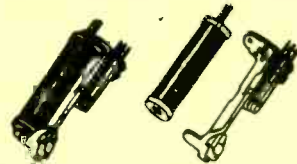

- A18258 BENDIX (Cook 102) 8-12 VDC, Copper Slug. Slow Release. SPDT, 200 ohm. Part of SCR 522. #385 \$2.49
R5229A1 AUTOMATIC 6VDC, 3PST n.o. (3As), 75 ohms. Slow Release. #412 \$2.50
R5021A1 AUTOMATIC 1500 ohm, 20 ma DC, SPST n.c. (1B). #413 \$2.95

COILS

(For Cost of Relay Add Price of Coil to Price of Frame)

Stock No.	Ohms	Price each	Stock No.	Ohms	Price each
K101	0.75	1.25	K108	900	1.75
K131	5.0	1.25	K109	1000	1.75
K102	12	1.25	K136	1200	2.00
K156	50	1.25	K111	1300	1.75
K132	175	1.25	K137	1425	2.25
K153	300	1.50	K138	1500	2.25
K154	400	1.50	K139	1600	2.25
K104	450	1.50	K112	2000	2.25
K105	500	1.50	K140	2300	2.50
K133	600	1.50	K155	2500	2.50
K134	700	1.50	K113	3000	2.50
K107	750	1.50	K116	6500	2.75
K135	800	1.75	K118	40,000	3.25

SLOW-ACTION COILS

SLOW-MAKE			SLOW-RELEASE		
Stock No.	Ohms	Price each	Stock No.	Ohms	Price each
K122	33	1.50	K149	3.9	1.50
K146	125/1300	2.50	K123	75	1.50
K147	500/1500	2.50	K124	200	1.50
K148	1300	2.00	K150	800	2.00
K146	1300/125	2.50	K151	1000	2.00
K147	1500/50	2.50	K152	1300	2.25
			K127	2500	2.50

A-C COILS

Stock No.	Voltage	Price each
K119	6VAC	1.75
K121	110VAC	2.50

DUAL COILS

Stock No.	Ohms	Price each	Stock No.	Ohms	Price each
K141	50/2000	2.25	K145	1000/1000	2.25
K142	125/1300	2.25	K106	1100/500	2.00
K143	200/1000	2.00	K142	1300/125	2.25
K106	500/1100	2.00	K144	1800/500	2.50
K144	500/1800	2.50	K141	2000/50	2.25
K143	1000/200	2.00			

A = Normally Open; B = Normally Closed; C = Double Throw.

ACCESSORIES FOR TELEPHON TYPE RELAYS

- Clare CR1 Molded Bakelite Cover #CR1... .90
Clare BR2 Long Relay Bracket #BR2... .20
Clare BR4 Short Relay Bracket #BR4... .15

KOVAR GLASS TO METAL SEALS HIGH-VOLTAGE FEED THRU



Many types and sizes. Send us your blueprint or sample for our quote. Our prices are a fraction of original factory cost.

- SAMPLE KIT 96 Seals (3 ea. 12 types) 5⁰⁰ postpaid in USA
LAB KIT 300 Seals (20 types) 15⁰⁰ postpaid in USA

DIRECTRON SELENIUM RECTIFIERS

Buy Direct From M'factor

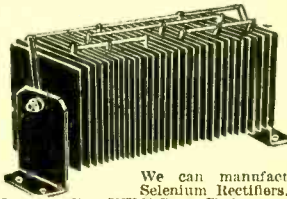

We can manufacture other Selenium Rectifiers, Selenium Rectifiers Supplies, XFMR'S., & Chokes.

NEW SELENIUM RECTIFIER TRANSFORMERS

PRI: 115 V., 60 cycles in.	4 Amps.....	\$8.75
SEC: 9, 12, 18, 24, and 36	12 Amps.....	16.75
Volts	24 Amps.....	35.75
Continuous Ratings	30 Amps.....	45.00
	50 Amps.....	59.75

NEW SELENIUM RECTIFIER CHOKES

4 Amps.—.07 Hy.—.6 ohm	\$7.95
12 Amps.—.01 Hy.—1 ohm	\$14.95
24 Amps.—.004 Hy.—.025 ohm	\$29.95

• Vacuum Capacitors 50 MMF.—20 KV... \$9.50

PANORAMIC ADAPTOR Only \$69.50

- 5" Scope, In Good, Used Condition
- 115 Volts—60 Cycle Input
- Sweeps 100-0-100 KCS

FILTER CAPACITORS

Capacity	W. Voltage	Ea.
500 MFD.	50 V.	.98
1000 MFD.	12 V.	.40

• W.E. Chokes—New Herm. Sealed.—KS-9476
—8 hy. @ 300 MA. 75 ohms \$5.00
KS-13063—1 to 7 hys.—200 to 700 MA. 42 ohms average \$7.75

• Vibrapacks—12 Volts Input—Mallory 350 V. @ 125 MA. Out—New \$9.95

WESTERN ELECTRIC NEW COMPONENTS

Several Tons of W.E. Rack Panels, Input and Output XFMR'S., Repeat Coils, Power XFMR'S., Chokes, Lamp Sockets, Filters, Jacks, Etc., in Stock—**ASK FOR LIST OR "WRITE"**

Full Wave Rect & Trans. 115V/60cy inputs
up to 14VDC at 12 amps..... \$23.98
up to 28VDC at 12 amps..... 31.98
up to 28VDC at 48 amps..... 129.00

FULLY GUARANTEED

TUBE SPECIALS

STANDARD BRANDS ONLY

0A2 .90 2J27	10.95 5W4	.80 6Y6G	.88 16RP4	78	.80 700A	19.00 866A (JAN)	1.20 5617	2.50
0A3/VR75 1.05 2J32	25.00 5X4G	.75 6X5GT	.47 (CBS)	27.00	.66 700B	25.00 866A	1.55 5634	4.50
0B2 .80 2J34	25.00 6-4	.35 7A7	.75 16TP4	83	FG-81A	3.49 700D	44.00 869B	65.00 5636
0B3/VR90 .95 2J39	7.95 6-4B	.45 7A8	.65 7B7	27.00	.85 708A	4.75 872A	3.75 5637	3.00
0C3/VR105 .95 2J40	27.50 6AB7	.95 7B7	.75 (CBS)	27.00	1.15 CK710	.95 884	1.55 5638	3.00
0D3/VR150 .95 2J55	60.00 6AC7	.80 7B8	.75 17BP4A	25.00	84-6Z4	.65 715A	5.00 885	1.65 5642
OZ4/OZ4A .55 2J61	39.95 6AF4	1.39 7C4	.29 (CBS)	25.00	98R	9.50 717A	.88 902	5.00 5651
1A04 1.20 2J62	39.95 6AG5	.70 7C5	.69 17CP4	24.50	HF-100	6.00 721A	4.50 SD917A	3.00 5654
1A04 1.20 2J62	39.95 6AG5	1.25 7C6	.69 (CBS)	24.50	100TH	5.95 723A	8.50 918	2.20 5656
1A3 .70 2K23	11.50 6AK6	.95 7C30	85.00 17HP4	27.00	101F (WE)	2.50 723A/B	17.00 922	1.60 5661
1A5GT .70 2K25	6A15	1.30 7E5	.39 (CBS)	27.00	VU-111	.88 724A	4.50 922	2.50 5663
1A7GT .77 7Z5AB	23.95 6AK5	.77			114-B	40 725A	4.70 931A	4.75 5670
1A7GT .77 7Z5AB	23.95 6AK5	.77			11726	.98 726B	60.00 SN949	3.50 5672
1A7GT .77 7Z5AB	23.95 6AK5	.77			F-123A	6.50 726-C	78.00 954	.35 5675
1A7GT .77 7Z5AB	23.95 6AK5	.77			211/VT4C	.88 730A	22.00 955	.42 5676
1A7GT .77 7Z5AB	23.95 6AK5	.77			250TH	16.50 802	3.30 955	.45 5678
1A7GT .77 7Z5AB	23.95 6AK5	.77			300B (WE)	7.95 811A	3.55 SN980D	3.00 5726
1A7GT .77 7Z5AB	23.95 6AK5	.77			HF-300	19.95 812	2.95 931/NE16	.50 5732
1A7GT .77 7Z5AB	23.95 6AK5	.77			304TH	7.75 812A	3.60 FM1000	15.5744
1A7GT .77 7Z5AB	23.95 6AK5	.77			304-TE	7.75 813	11.75 CK1005	.75 5749
1A7GT .77 7Z5AB	23.95 6AK5	.77			307A	4.00 814	3.95 CK1027	2.75 5751
1A7GT .77 7Z5AB	23.95 6AK5	.77			310A (WE)	3.95 815	5.00 1612	2.00 5800 (Vict)
1A7GT .77 7Z5AB	23.95 6AK5	.77			311-A (WE)	6.50 816	1.20 1613	.85 5814
1A7GT .77 7Z5AB	23.95 6AK5	.77			312A (WE)	5.00 828	1.25 1616	.88 5829
1A7GT .77 7Z5AB	23.95 6AK5	.77			359A (WE)	4.00 828	10.50 1622(6L6M)	1.95 5837
1A7GT .77 7Z5AB	23.95 6AK5	.77			374A (WE)	3.50 829A	7.95 1625	.35 SD1104
1A7GT .77 7Z5AB	23.95 6AK5	.77			387A (WE)	2.50 829B	7.40 1626	.18 5838
1A7GT .77 7Z5AB	23.95 6AK5	.77			60 25BQ6GT	1.00	12.50 1629	.25 5840
1A7GT .77 7Z5AB	23.95 6AK5	.77			75 25L6GT	.62	7.75 1632	.70 5844
1A7GT .77 7Z5AB	23.95 6AK5	.77			407A (WE)	4.50 832A	9.95 1655	1.79 5886
1A7GT .77 7Z5AB	23.95 6AK5	.77			408A (WE)	2.50 834	9.50 1665	1.85 5901
1A7GT .77 7Z5AB	23.95 6AK5	.77					5910	.75
1A7GT .77 7Z5AB	23.95 6AK5	.77					5995	write
1A7GT .77 7Z5AB	23.95 6AK5	.77					6095	write
1A7GT .77 7Z5AB	23.95 6AK5	.77					6096	write
1A7GT .77 7Z5AB	23.95 6AK5	.77					6097	write
1A7GT .77 7Z5AB	23.95 6AK5	.77					6099	4.20
1A7GT .77 7Z5AB	23.95 6AK5	.77					6101	3.00
1A7GT .77 7Z5AB	23.95 6AK5	.77					6161	110.00
1A7GT .77 7Z5AB	23.95 6AK5	.77					6216 (Hyt)	3.20
1A7GT .77 7Z5AB	23.95 6AK5	.77					7193	.35
1A7GT .77 7Z5AB	23.95 6AK5	.77					8003	11.00
1A7GT .77 7Z5AB	23.95 6AK5	.77					8005	4.95
1A7GT .77 7Z5AB	23.95 6AK5	.77					8008	6.20
1A7GT .77 7Z5AB	23.95 6AK5	.77					8011	.49
1A7GT .77 7Z5AB	23.95 6AK5	.77					8013A	3.95
1A7GT .77 7Z5AB	23.95 6AK5	.77					8020	1.98
1A7GT .77 7Z5AB	23.95 6AK5	.77					9001	1.15
1A7GT .77 7Z5AB	23.95 6AK5	.77					9002	.85
1A7GT .77 7Z5AB	23.95 6AK5	.77					9003	1.15
1A7GT .77 7Z5AB	23.95 6AK5	.77					9004	.30
1A7GT .77 7Z5AB	23.95 6AK5	.77					9005	1.90
1A7GT .77 7Z5AB	23.95 6AK5	.77					9006	.25
1A7GT .77 7Z5AB	23.95 6AK5	.77					9007	1.95
1A7GT .77 7Z5AB	23.95 6AK5	.77					9008	1.15
1A7GT .77 7Z5AB	23.95 6AK5	.77					9009	1.15
1A7GT .77 7Z5AB	23.95 6AK5	.77					9010	1.15
1A7GT .77 7Z5AB	23.95 6AK5	.77					9011	1.15
1A7GT .77 7Z5AB	23.95 6AK5	.77					9012	.85
1A7GT .77 7Z5AB	23.95 6AK5	.77					9013	1.15
1A7GT .77 7Z5AB	23.95 6AK5	.77					9014	.30
1A7GT .77 7Z5AB	23.95 6AK5	.77					9015	1.90
1A7GT .77 7Z5AB	23.95 6AK5	.77					9016	.25
1A7GT .77 7Z5AB	23.95 6AK5	.77					9017	1.95
1A7GT .77 7Z5AB	23.95 6AK5	.77					9018	1.15
1A7GT .77 7Z5AB	23.95 6AK5	.77					9019	1.15
1A7GT .77 7Z5AB	23.95 6AK5	.77					9020	1.15
1A7GT .77 7Z5AB	23.95 6AK5	.77					9021	1.15
1A7GT .77 7Z5AB	23.95 6AK5	.77					9022	.85
1A7GT .77 7Z5AB	23.95 6AK5	.77					9023	1.15
1A7GT .77 7Z5AB	23.95 6AK5	.77					9024	.30
1A7GT .77 7Z5AB	23.95 6AK5	.77					9025	1.90
1A7GT .77 7Z5AB	23.95 6AK5	.77					9026	.25
1A7GT .77 7Z5AB	23.95 6AK5	.77					9027	1.95
1A7GT .77 7Z5AB	23.95 6AK5	.77					9028	1.15
1A7GT .77 7Z5AB	23.95 6AK5	.77					9029	1.15
1A7GT .77 7Z5AB	23.95 6AK5	.77					9030	1.15
1A7GT .77 7Z5AB	23.95 6AK5	.77					9031	1.15
1A7GT .77 7Z5AB	23.95 6AK5	.77					9032	1.15
1A7GT .77 7Z5AB	23.95 6AK5	.77					9033	1.15
1A7GT .77 7Z5AB	23.95 6AK5	.77					9034	1.15
1A7GT .77 7Z5AB	23.95 6AK5	.77					9035	1.15
1A7GT .77 7Z5AB	23.95 6AK5	.77					9036	1.15
1A7GT .77 7Z5AB	23.95 6AK5	.77					9037	1.15
1A7GT .77 7Z5AB	23.95 6AK5	.77					9038	1.15
1A7GT .77 7Z5AB	23.95 6AK5	.77					9039	1.15
1A7GT .77 7Z5AB	23.95 6AK5	.77					9040	1.15
1A7GT .77 7Z5AB	23.95 6AK5	.77					9041	1.15
1A7GT .77 7Z5AB	23.95 6AK5	.77					9042	1.15
1A7GT .77 7Z5AB	23.95 6AK5	.77					9043	1.15
1A7GT .77 7Z5AB	23.95 6AK5	.77					9044	1.15
1A7GT .77 7Z5AB	23.95 6AK5	.77					9045	1.15
1A7GT .77 7Z5AB	23.95 6AK5	.77					9046	1.15
1A7GT .77 7Z5AB	23.95 6AK5	.77					9047	1.15
1A7GT .77 7Z5AB	23.95 6AK5	.77					9048	1.15
1A7GT .77 7Z5AB	23.95 6AK5	.77					9049	1.15
1A7GT .77 7Z5AB	23.95 6AK5	.77					9050	1.15
1A7GT .77 7Z5AB	23.95 6AK5	.77					9051	1.15
1A7GT .77 7Z5AB	23.95 6AK5	.77					9052	1.15
1A7GT .77 7Z5AB	23.95 6AK5	.77					9053	1.15
1A7GT .77 7Z5AB	23.95 6AK5	.77					9054	1.15
1A7GT .77 7Z5AB	23.95 6AK5	.77					9055	1.15
1A7GT .77 7Z5AB	23.95 6AK5	.77					9056	1.15
1A7GT .77 7Z5AB	23.95 6AK5	.77					9057	1.15
1A7GT .77 7Z5AB	23.95 6AK5	.77					9058	1.15
1A7GT .77 7Z5AB	23.95 6AK5	.77					9059	1.15
1A7GT .77 7Z5AB	23.95 6AK5	.77					9060	1.15
1A7GT .77 7Z5AB	23.95 6AK5	.77					9061	1.15
1A7GT .77 7Z5AB	23.95 6AK5	.77					9062	1.15
1A7GT .77 7Z5AB	23.95 6AK5	.77					9063	1.15
1A7GT .77 7Z5AB	23.95 6AK5	.77					9064	1.15
1A7GT .77 7Z5AB	23.95 6							

COMMUNICATIONS EQUIPMENT CO.

MAGNETRONS

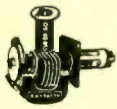

Type	Price	Type	Price
2J21	58.75	2J39	\$24.50
2J22	7.50	2J49	\$9.50
2J27	19.95	2J61	34.50
2J31	24.50	2J62	34.50
2J32	28.50	2J31	85.00
2J37	12.50	725-A	Write
2J38	16.50	730-A	24.50

QK 60, 61, 62—\$85 ea.

SELSYNS

115 VAC 60 CYCLES 1 PHASE

1—Transmitter #C-78248 } Per Set
 1—Differential #C-78249 } **\$24.50**
 Transmitter Units Only.....\$17.50 ea.

SO-13 Motor-Alternator

Input: 22-30VDC @ 75-60 Amp.
 Output: 115V/400 Cy., 1 phase
 1000 VA Brand New **\$150.00**

PULSE TRANSFORMERS

G.E. K-2449: Line to magnetron: Pri: 50 ohms Z, 9.5 KV @ 80 Amp. Sec: 450 ohm Z, 28 KV @ 28 Amp. Peak pow. 800 kw. (Pulse width: 1 usec @ 635 pps.) Twin bifilar secondary permits use of external filament transformer.....\$62.50
 UTAH X-151T-1: Dual Transformer, 2 Wdgs. per section 1:1 Ratio per sec 13 MH inductance 30 ohms DCR.....\$7.50
 UTAH X-150T-1: Two sections, 1 Wdg. per section, 1:1 Ratio, 3 MH, 6 ohms DCR per Wdg.....\$7.50
 TR1049: Ratio: 2:1 Pri, 220 MH, 50 Ohms, sec. 0.7511. DCR 100 Ohms.....\$6.75
 K-901695-501: Ratio 1:1, Pri. Imp. 40 Ohm. Sec. Imp. 40 Ohms. Passes pulse 0.6 usec with 0.05 usec rise.....\$39.50
 G.E. K-2745 Pulse Output Pri. 5v. sec. 41v.....\$7.50
 Ray UX 7896—Pulse Inversion 40v + 40v.....\$7.50
 Ray UX 8442—Pulse Inversion 40v + 40v.....\$7.50
 PHILCO 352-7250, 352-7251, 352-7287.....\$5 ea.
 RAYTHEON: UX8693, UX5986.....\$5 ea.
 W.E.: D-166310, D-166638, KS 9800, KS9948.....\$5 ea.
 UTAH #9262, with Cracked Beads, but will operate at full rated capacity.....\$5.00
 UX 8693 (SCS #279627-51); 3 Wdgs. 22 turns ±18 wire. DCR is: 362/372/4 ohms. Total voltage 2500 vdc.....\$3.00
 D-166173: Input: 50 ohms Z. Output: 900 ohms Z 2450. Freq. range 10 kc-2mc. P/O AN/APQ-13.....\$12.50
 K-2450: Pulse-inversion auto-transformer: primary 13 kv, 4 usec. Output: 14 kv @ 100 kw peak.....\$34.50
 K-2748-A: Line to magnetron. Has magnetron well and provision for external fil. trans.....\$37.50

PULSE NETWORKS

15A-1-400-50: 15 KV, "A" CKT. 1 microsec. 400 PPS, 50 ohms imp.....\$37.50
 G.E. #3E (3-84-810) (8-2-24-405) 501PT; 8KV "E" CKT Dual Unit; Unit 1, 3 sections, 0.84 Microsec. 810 PPS, 50 ohms imp.; Unit 2, 8 Sections, 2.24 microsec. 405 PPS, 50 ohms imp.....\$6.50
 7-5E3-1-200-67P, 7.5 KV "E" Circuit, 1 microsec 200 PPS, 67 ohms impedance 3 sections.....\$7.50
 7-5E4-16-60, 67P, 7.5 KV "E" Circuit, 4 sections 16 microsec. 60 PPS, 67 ohms impedance.....\$15.00
 7-5E3-3-200-67P, 7.5 KV, "E" Circuit, 3 microsec. 200 PPS, 67 ohms imp, 3 sections.....\$12.50
 #755: 10KV, 2.2usec., 375 PPS, 50 ohms imp.....\$27.50
 #754: 10KV, 0.85usec., 750 PPS, 50 ohms imp.....\$27.50
 KS8865 CHARGING CHOKE: 115-150H @ .02A, 32-40H @ .08A, 30,700V Corona Test, 21KV Test.....\$37.50
 G.E. 25E5-1-350-50 PPT, "E" CKT, 1 Microsec. Pulse @ 350 PPS, 50 OHMS Impedance.....\$69.50
 KS9623 CHARGING CHOKE: 16H @ 75 MA, 380 Ohms DCR, 9000 Vac test.....\$14.95
 G.E. 6E3-5-2000 50 PPT; 6 KV., "E" Circuit 0.5 usec /2000 PPS/50 ohms/2 sections.....\$7.50

10 CM R.F. HEAD

Complete R.F. Head and Modulator delivers 50 KW Peak R.F. at 3000 MC. Pulsar delivers 12KV pulse at 12 Amp. into magnetron of .5, 1, or 2 microsec. Duration at duty cycle of .001. Unit requires 115V, 400-2400 Cycles, 1 phase @ 3.5A Also 24-28 VDC @ 2A. External sync. Pulse of 120V Req'd. Brand New, Complete with schematic and all tubes.....\$375.00

MAIL ORDERS PROMPTLY FILLED. ALL PRICES F.O.B. NEW YORK CITY. SEND M.O. OR CHECK. ONLY SHIPPING SENT C.O.D. RATED CONCERNS SEND P. O. ALL MDSE SUBJECT TO PRIOR SALE AND PRICES SUBJECT TO CHANGE WITHOUT NOTICE. PARCELS IN EXCESS OF 20 POUNDS WILL BE SHIPPED VIA CHEAPEST TRUCK OR RAILX.

MICROWAVE PLUMBING

"S Band," RG48/U Waveguide

POWER SPLITTER for use with type 726 or any 10 CM Shepherd Klystron. Energy is fed from Klystron antenna through dual pick-up system to 2 type "N" connectors.....\$22.50 EACH
 DIRECTIONAL COUPLER, Broadband type "N" Coupling, 20 db. with std. flanges, Navy #CABV 47AAN-2.....\$37.50
 LHTR. LIGHTHOUSE ASSEMBLY. Part of RT39 APG 5 & APG 15. Receiver and Trans. Cavities w/assoc Tr. Cavity and Type N CPLG, To Recvr. Uses 2C40, 2C43, 1B27. Tunable APX 2400-2700 MCS, Silver Plated.....\$49.50
 BEACON LIGHTHOUSE cavity 10 cm. Mfg. Bernard Hlce, each.....\$47.50
 MAGNETRON TO WAVEGUIDE Coupler with 721-A Daplexer Cavity, gold plated.....\$45.00
 RT-39 APG-5 10 cm. lighthouse RF head c/o Xmtr.-Recvr-TR, cavity compl. recvr. & 30 MC IF strip using 60K5 (2C40, 2C43, 1B27 lineup) w/Tubes, 721A TR BOX complete with tube and tuning plungers.....\$12.50
 McNALLY KLYSTRON CAVITIES for 707B or 2K28.....\$4.00
 WAVEGUIDE TO 3/4" RIGID COAX "DOORKNOR" ADAPTER CHOKE FLANGE, SILVER PLATED BROAD BAND.....\$32.50
 ASI4A AP-10 CM Pick up Dipole with "N" Cables.....\$4.50
 OAJ ECHO BOX, 10 CM TUNABLE.....\$22.50
 HOMERELL-TO-TYPE "N" Male Adapters, W.E. #D167284.....\$2.75
 I. F. AMP. STRIP: 30 MC. 30 d.b. gain, 4 MC Bandwidth, uses 6AC7's—with video detector. A.P.C. less tubes.....\$24.50
 POLYROD ANTENNA, AS31/APN-7 in Lucite Ball. Type "N" feed.....\$22.50
 ANTENNA, AT49A/APR: Broadband Conical, 300-3300 MC Type "N" Feed.....\$12.50
 "E" or "H" PLANE BENDS, 90 deg. less flanges.....\$7.50

7/8" RIGID COAX—3/8" I. C.

ROTARY JOINT, Stub-supported, UG 46/UG 45 fittings.....\$27.50
 10 CM STABILIZER Cavity, tunable, standard UG46 UG 45 fittings.....\$45.00
 RG 44/U RIGID COAX, stub support, 5 ft. sections, with UG46/UG45 connectors.....\$12.50
 RIGHT ANGLE BEND, with flexible coax output pick-up loop.....\$8.00
 RT ANGLES for above.....\$2.50
 SHORT RIGHT ANGLE BEND, with pressurizing nipple.....\$3.00
 RIGID COAX to flex coax connector.....\$3.50
 RT ANGLE BEND 15" L. OA.....\$3.50
 FLEXIBLE SECTION, 15 L. Male to female.....\$4.25
 7/8" RIGID COAX, BULK HEAD FEED-THRU.....\$14.00
 Mixer Assy. "Pencil" Type for "S" Radars. Complete with crystal and 2-type "N" output connectors.....\$12.50

1 1/4" x 5/8" WAVEGUIDE

CG 98B/APQ 13 1/2" Flex. Sect. 1 1/4" x 5/8" O.D. \$10.00
 X Band Wave GD, 1 1/4" x 5/8" O.D. 1/16" wall aluminum.....per ft. 75¢
 Slug Tuner Attenuator V.E. guide, gold plated.....\$6.50
 BI-Directional Coupler, Type "N" Takeoff 25 db coupling.....\$22.50
 BI-Directional Coupler, UG-52, Takeoff 25 db. coupling.....\$22.50
 Waveguide-to-Type "N" Adapter, Broadband.....\$22.50

APS-2 SPARE PLUMBING

Z-601C: Elevation Joint.....\$9.50
 Z-601B: Transmission Line from EL. Jt. to antenna feed.....\$4.00
 Z-601A: Antenna and Dipole feed Assy.....\$12.50
 Z-601E: Azimuth Rotating Joint.....\$15.00
 Z-911: Long Lit. Angle Bend, 90 Deg.....\$4.50
 Z-910: Short RT. Angle Bend with pressure fitting.....\$3.50

RADAR TEST SETS

TS 268/UP Crystal Test Set, for checking type IN21, IN21A, IN22, IN23, etc. Extremely compact, reliable, rugged. Operates from one flashlight cell. In portable wood case. New.....\$42.50
 TS 270A/UP: Echo-Box for checking overall performance of radar equipment operating in Sg Band. Brand new, complete with pick-up horn, spare crystals, cords, etc. P.O.R.*.....\$49.50

SPERRY MICROLINE SX-12 Power Supply and Modulator for operating 2K39, 2K41, 417A, etc. Operates from 115V, 60 Cy. Used, Excellent supplied with 2—417A Klystrons. P.O.R.*.....\$49.50

TS 159 TPX: Combined wavemeter, freq. meter, signal generator, voltmeter and power meter. Freq 150-190 MC. Voltmeter: 0-500VDC. Power Meter: 0-800 Watts Peak. Uses 10 MC crystal for checking calibration. Power 115V, 400 Cycles. New, Complete with calibration chart.....\$49.50

TS-36 POWER METER. Operates 8500 - 9500 MC Thermistor bridge feeds 0-200 microamp meter and video output jack. Calibration chart plots power-vs-meter reading, Waveguide input 1-1/2" x 3/8" size. Bridge uses 4-1-1/2 V size C Dry cells. Power Range: 0.1-1000 MW. NEW \$175 * P.O.R. Price on Request.

X Band—

RG 52/U WAVEGUIDE

VSWR Measuring Section, Consisting of 6" straight section, with 2 pick-up, Type "N" Output Joints. Mounted 1/2 Wave apart.....\$8.50
 UG 40A/U Broadband Choke Flanges.....\$1.65
 1" x 1/2" waveguide in 5' lengths, UG 39 flanges to UG46 cover.....per length \$7.50
 Rotating-joints supplied either with or without deck mounting. With UG40 flanges.....each, \$17.50
 Bulkhead Feed-Thru Assembly.....\$15.00
 Pressure Gauge Section 15 lb. gauge and press nipple.....\$10.00
 Pressure Gauge, 15 lbs.....\$17.50
 Directional Coupler, UG-40/U Take off 20 db.....\$17.50
 TR-ATR Duplexer section for above.....\$8.50
 Waveguide Section 12" long choke to cover 45 deg. twist & 2 1/2" radius, 90 deg. bend.....\$4.50
 Waveguide Section 2 1/2 ft. long silver plated with choke flange.....\$5.75
 Rotary joint choke to choke with deck mounting.....\$17.50
 3 cm. mitered elbow "E" plane.....\$12.00
 90 degree elbows, "E" or "H" plane 2 1/2" radius.....\$12.50
 45 degree twist.....\$8.00
 Microwave Receiver, 3 CM. Sensitivity: 10-13 μ Watts. Complete with L.O. and AFC Mixer and Waveguide Input Circuits, 8 LP. Stages give approximately 120 DV gain at a bandwidth of 1.7 MC. Video Bandwidth; 2 MC. Uses latest type AFC circuit. Complete with all tubes, including 723A/B Local Oscillator.....\$175.00
 ADAPTER, waveguide to type "N", UG 81/U, p/o TS 12, TS-13, Etc.....\$27.50
 ADAPTER, UG-163/U round cover to special brl. Flange for TS-45, etc.....\$2.50 each

APS-15

SPARE WAVEGUIDE PARTS

CU-73/APS-15A, SCS #2Z3265-73 right angle bend, E plane, 6 1/2" x 10", with directional coupler on 6 1/2" arm, type "N" takeoff 20 db coupling.....\$12.50 each
 Z-607 Dwg. Symbol. Approx. 150 degree bend with 90 deg. twist. One end pick-up loop with press. fitting.....\$6.50
 Z-614: Philco 756-1142, CG124/APS-15A, Wave-selector; approx. 16" L. with 15 deg. bend at center (E-plane) 20 db coupling.....\$12.50
 Philco 348-1425, 180 deg. bend. with pressure fitting.....\$4.50
 Z-609, Philco 348-1629, 13 1/2" run, with bend & 90 deg. twist (on 3 1/2" section).....\$6.75
 Z-606: 8" run with 30 deg. bend (E-plane) one end.....\$4.50
 Philco 318-1427 E plane bend 11" x 6 1/2".....\$6.50
 CG1/APS-3 Philco 358-5212, S-curve 16" L with round contact flanges.....\$5.75

WAVEGUIDE FLANGES

UG 39/U	\$1.10	UG 51/U	\$1.65
UG 40/U	\$1.25	UG 52/U	\$3.40
UG 40A/U	1.65	UG 52A/U	\$3.40

K Band

RG 53/U WAVEGUIDE

APS-34 Rotating joint.....\$49.50
 Right Angle Bend E or H Plane, specify combination of couplings desired.....\$12.00
 45° Bend E or H Plane, choke to cover.....\$12.00
 Mitered Elbow, cover to cover.....\$4.00
 TR-ATR-Section Choke to cover.....\$4.00
 Flexible Section 1" choke to choke.....\$5.00
 "S" Curve Choke to cover.....\$4.50
 APS-34 K-Band Pillbox Antenna.....\$22.50
 Slotted Section, with Carriage & Probe.....\$45.00

MICROWAVE MIXER

CV-12/APR-6: Waveguide/mixer unit, 4000-6000 mc. Designed for use with microwave receiver. Has pick up loop for coupling to lighthouse cavity local oscillator. RF input is to 1" x 2" waveguide (contact flange). Output (thru IN21 xt.) is from standard 50-ohm coax connector. Brand new, complete with crystal. As shown.....\$35



50KW Diesel Generator

Delco Generator Mod. #1-3659
 50 KW 120 Volt DC 500 Amperes
 1500 RPM Stab Shunt
 wound 60° C Rise
 Navy Spec. #17-C-7
 CUMMINS DIESEL
 SBMH 63 Model HGD
 Eng. #45751

New **\$3500**

COMMUNICATIONS EQUIPMENT CO.

400 CYCLE TRANSFORMER

Stock	Rating	Price
352-7102	6.3V/2.5A	\$1.45
M-7472426	1450V/1.0MA, 2.5V/.75A, 6.4V/3.9A, 5V/2A, 6.5V/3A, P/O ID-39/2PK-13	4.95
352-7039	640VCT @ 380MA, 6.3V/.9A, 6.3V/6A 5V/6A	5.49
702724	9800/8600 @ 32MA	8.95
K59584	5000V/290MA, 5V/10A	22.50
K59607	734VCT/177A, 1710VCT/177A	6.79
352-7273	700VCT/350MA, 6.3V/0.9A, 6.3V/2.5A 6.3V/.06A, 5V/CA	6.95
352-7070	2X2.5V/2.5A (2KV TEST) 6.3V/2.25A, 1200/100/750V, @ .005A	7.45
352-7196	1140/1.25MA, 2.5V/1.75A, 2.5V/1.75A -5KV Test	3.95
352-7176	320VCT/50MA, 4.5V/3A, 6.3VCT/20A 2.5V/1.75A, 6.3V/2A -5KV Test	4.75
RA6400-1	13V 9A	2.49
901692	2.77V @ 4.25A	3.45
901699-501	900V75MA, 100V/.04A	4.29
901698-501	900VCT/.067A, 5V/3A	3.79
UX8555C	800VCT/65MA, 5VCT/3A	3.69
RA6405-1	700VCT/806MA5V/3A, 6V/1.75A	4.25
T-4852	2500V/MA, 300, VCT, 135MA	5.95
352-7098	1100V/50MA TAPPED 625V 2.5V/5A 6.3V/2.7A, 63.V/.66A, 6.3VCT/21A	4.25
KS 9336	27V/4.3A, 6.3/2.3A, 1.25V/.02A	2.95
M-7474319	650VCT/50MA, 6.3VCT/2A, 5VCT/2A	3.75
KS 8984	400VCT/35MA, 6.4V/2.5A, 6.4V/.15A	3.85
52C080	1150-0-1150V	2.75
32332	6VCT/00006 KVA	1.75
68G631	6.3V/9.1A, 6.3VCT/6.5A, 2.5V/3.5A, 2.5V/3.5A	4.85
80G198	592VCT/18MA, 6.3V/8.1A, 5V/2A	5.35
302433A	6.4/7.5A, 6.4V/3.8A, 6.4/2.5A	4.79
KS 9445	ALL CT	
KS 9685	600VCT/36MA	2.65
70C30G1	2100V/.027A	4.95
M-7474318	2-2.5V Wdgs. at 2.5A, Each Lo-Cap., 2KV Test	5.95
352-7069	2V/1.75A, 5V/3A, 6.5V/6A, 6.5V/1.2A, P/O BC800	
352-7099	360VCT/20MA, 1500V/1MA, 2.5V/1.75A, 6.3V/2.5A, 6.3V/.6A, P/O BC-929	6.45
D163253	525V/.002A, 2.5V/5A	4.85
M-7471957	2.5V/20A, 12KV Test	4.85
352-7179	250V/100MA, 6.5V/12ACT 5V/2A	3.45

POWER TRANSFORMERS

Comb. Transformers—115V/50-60 cps Input	Price
CTJ5-2 600VCT/2A, 5V/6A	\$5.95
CT-15A 550VCT .085A 6.3V/.6A, 6.3V/1.8A	2.85
CT-164 4200V, .002A/12KV Test, 5VCT/3A/12KV Test, 6.3V/.06A/5400V Test	12.95
CT-341 1050 10 MA., 6.25V @ 5 MA, 26V @ 4.5A 2x2.5V/3A, 6.3V @ 3A	9.95
CR 825 360VCT .340A 6.3VCT/3.6, 6.3VCT/3A	3.9
CT-626 1500V .160A 2.5/12, 30/100	9.95
CT-071 110V .200A 33/200, 5V/10, 2.5/10	4.95
CT-367 580VCT .050 A 5VCT/3A	2.25
CT-403 350VCT .026A 5V/3A	2.75
CT-931 585VCT .086 A 5V/3A, 6.3V/6A	2.75
CT-456 390VCT 30 MA 6.3V/1.3A, 5V/3A	3.45
CT-931 585VCT 86 MA 5V/3A, 6 V/6A	4.95
CT-442 525VCT 75 MA 5V/2A, 1 CT/2A, 50V/200 MA	3.85
CT-720 550-0-550V/250 MA, 6.3V/1.8A	8.95
CT-43A 600-0-600V/.08A, 2.5VCT/6A, 6.3VCT/1A	6.49
CT7-501 650VCT/200MA, 6.3V/8A, 6.3V/5A	6.49
CT-444 230-0-230V/.085A, 5V/3A, 6V/2.5A	3.49
Filament Transformers—115V/50-60 cps Input	Price
Item Rating Each	
FT-157 4V/16A, 2.5V/1.75A	\$2.95
FT-101 6V/.25A	.79
FT-924 5.25V/21A, 2x7.75V/6.5A	14.95
FT-824 2x2.6V/2.5A, 16V/1A, 7.2V/TA, 6.4V/10A, 6.4V/2A	8.95
FT-463 6.3VCT/1A, 5VCT/3A, 5VCT/3A	5.49
FT-55-2 7.2V/21.5A, 6.5V/6.85A, 5V/6A, 5V/3A	8.95
FT-986 16V @ 4.5A or 12V @ 4.5A	2.79
FT-38A 6.3/2.5A, 2x2.5V/7A	2.79
FT-A27 2.5V/2.5A, 7V/TA, TAP 2.5V/2.5A, 16 KV Test	18.95
FT-608 6.3V/3A/750V Test	1.79
FT-873 4.5A/V/.5A, 7V/TA	2.19
FT-899 2x5V A 5A, 29KV Test	24.50
Special Fil. Transformers—60 cps	Price
Item Pri. Volts Secondaries	
STF-370 220/440 3x2.5V/15A, 3KV Test	6.95
STF-11A 220V 2x40V/.05A, 2x5V/6A	4.49
STF-608 220V 24V/.06A, 5V/3A, 6.3V/1A, 6.3V/1A	3.45
STF-968 230V 2.5V/6.5A	3.50
STF-631 230V 2x5V/27A, 2x5V/9A	17.59
Special Plate Transformers—60 cps	Price
Item Pri. Volts Secondaries	
STP-613 230V 230/.05A, 230V/.05A	\$1.79
STP-409 220/440V 136VCT/3.5A	5.69
STP-815 240/440, 3ph 1330V/.67A, 6KV Test	27.50
STP-823 137V 222VCT/.3A	2.35
STP-088 50V 2x750V/.001A	1.79
STP-945 210/220/230 550-0-550V/.3A	5.95

10 KW TRANSMITTER PARTS

1) Plate XFMR: Amertran 33134, Pri: 198/220/240V, 60 cy., 1 ph. Sec: 3650V, 16.7 KVA, 30 KV insulation, Oil Immersed.
 1) Reactor, Modulation, Amertran 33153, 50 H @ 3.0 amps. DCR=80 ohms. Freq.—.03 cy. to 10 K.C. Level: 63 DB. 40 KV Test. Impedance: 3000 ohms. A great value. **\$695.00**
 Both units (Trans & Choke) for

P-4 SYNCHROSCOPE

For observing Magnetron or Radar Modulator Pulses, Waveforms, Transients, etc. Designed by the Radiation Laboratory, this versatile scope has the following specifications:
 Writing Speed: .04/0.1688/0.5/2 inches/USEC
 Local Oscillator: 500/1000/2000/4000 PPS
 Trigger Gen. Output: 135V positive
 Tube Line-up: 1—5LP1/ 2—2X2/ 1—5Z3/ 1—6SK7/ 2—6SL7/ 6—6SN7/ 1—7V7
 P-4 Synchroscope, used, A-1 cond.... **\$125.00**

T-1 BOMBIGHT PARTS

Main Servo Unit, Complete Mfr's. Pl. #1594486
 Double Angle Servo Unit Assy. Pl. #1592448
 Servo Motor Assy. Pl. 1590816
 Write for prices

PLATE TRANSFORMERS

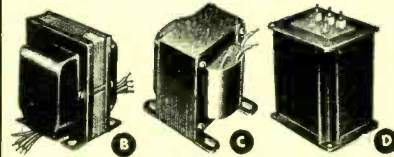

(All primaries are 110 v. 60 cps, single phase)
 DC ratings are approximate values obtained at output of a 2-section choke input filter using MV rect. tubes.

Stock	Volts A.C. R.M.S.	Volts D.C.	Current (Mills.)	Fig.	Price
PT101	550-550	400	150	B	\$6.43
PT157	660-660	500	250	B	6.42
	550-550	400			
PT158	1080-1080	1000	125	B	10.00
	500-500	400	150		
PT159	900-900	750	225		9.70
	800-800	600			
PT167	1200-1400	1200	300	C	24.10
	1175-1175				
PT168	2100-2100	1750	300	C	30.58
	1800-1800	1500			
PT062	2900-2900	2500	300	D	47.04
	2385-2385	2000			

* Simultaneous rating.

FILTER CHOKES

(Smoothing)

Type	Ind. Hys.	Cur. MA.	DCR Ohms	Test Volts	Fig.	Price
181	10	200	140	3000	B	\$4.70
182	10	250	125	3000	B	6.47
183	8	300	80	3000	B	6.76
Swinging Input chokes						
187	4-16	150	210	3000	B	3.82
189	4-16	250	125	3000	B	6.47
190	3-14	300	80	3000	B	6.76

TELEVISION TEST GEAR

KAY MEGASWEEP, T.V. Align. Gen. \$215.00
 KAY MEGAPIPPER T.V. Mark. Gen. 85.00
 KAY MEGAMARKER S.R. Chan 2-13 Marker Gen. 95.00

All Equipment is used, but excellent. Guaranteed to be in A-1 shape.

SELENIUM RECTIFIERS*

Current (Continuous)	18/14 Volts	36/28 Volts	54/42 Volts	130/100 Volts
1 Amp.	\$1.25	\$2.10	\$3.60	\$7.50
2 Amps.	2.20	3.60	6.50	10.50
2½ Amps.				13.00
4 Amps.	3.75		8.75	
5 Amps.	4.95	7.95	12.95	27.00
6 Amps.	5.50	9.00	14.00	33.00
10 Amps.	6.75	12.00	20.00	40.00
12 Amps.	8.50	16.00	25.50	50.00
20 Amps.	13.25	24.00	36.00	90.00
24 Amps.	16.00	31.00	39.50	98.00
30 Amps.	18.50	36.00		
36 Amps.	25.50	45.00		

* Full Wave Bridge

DYNAMOTORS

ALL BRAND NEW—ORIGINAL PACKING

TYPE	VOLTS INPUT	AMPS OUTPUT	VOLTS	AMPS	PRICE
PE 86	28	1.25	250	.060	\$4.25
OM 416	14	6.2	330	.170	6.75
DM 33A	28	7	540	.250	3.95
BD AR 93	28	3.25	375	.150	7.50
23350	27	1.75	285	.075	3.95
B-19 PACK	12	9.4	275	.110	8.95
			500	.050	
DA-3A*	28	10	300	.260	6.95
			150	.010	
			14.5		
5053	28	14	250	.060	3.95
PE 73 CM**	28	13	1000	.350	**
337	14	8	425	.160	7.95

* Replacement for PE 94.

** Price sent on request.

INVERTERS

PE-218-H: Input: 25/28 vdc. 92 amp. Output: 115 v. 350/500 cy 1500 volt-ampers. New. \$44.50
 PE-206: Input: 28 vdc. 38 amps. Output: 80 v 800 cy. 500 volt-amps. Dim: 13"x5½"x10½".
 New. \$22.50
 NAVY COR-21095: Input 22-80 VDC/75-60A.
 Output: 115V/400 CY. 1 KVA/8.7A. 13PM: 4800.
 With coupling provision for motor. Brand New.
 Original packing. \$150.00

MOBILES! C. D. MEN! CAP!!

IDEAL DYNAMOTOR — CONVERTS EASILY TO SUPPLY UNIT DELIVERING

12 Volt Input — 6 Volt Input
 610 V @ 150 MA OR 300 V @ 90 MA
 325 V @ 125 MA OR 160 V @ 110 MA
 Brand New with Conversion Data. \$3.75

VIBROPACK, Mallory Type G-556. Input 12 VDC. Output: 225/250/275/300 VDC @ 100 MA. Brand New with 2 spare vibrators. \$12.50

VIBRATOR, -TR 1210. For use in industrial inverters delivering 115 Vdc @ 100 Watts from 12 VDC. \$1.69

GN 35 HAND GENERATORS

BRAND NEW, IN ORIGINAL CARTONS, WILL DELIVER 8 V @ 2.5A AND 325-365 V @ 100 MA OR 10 V 1.25A AND 380-420 V @ 70 MA. LESS HAND CRANKS. A GREAT VALUE \$17.50

This Month's Special

- ARC-3 PARTS
 - T-206 Output XFMR. #55320. \$2.75
 - T-101 Mike XFMR. #55548. 1.50
 - T-102 Driver XFMR. #55545. 1.75
 - T-103 Audio XFMR. #55546. 1.75
 - T-104 Modulation XFMR. #55547. 3.25
 - T-105 Side Tone XFMR. #55544. 1.85
- Driver Transformer, for ART-13, T-202. 1.29
- Side-Tone Transformer, for ART-13, T-203. 1.19
- Modulation Transformer, ES-691025 for BC 456. 1.19
- AN-104 Antennas for SCR 522.95
- BC 929 Indicators, p/o APN-2. 32.50
- BC 451 Trans. Control Box, p/o SCR 274N. 1.85
- C-30/ARC-5 Control Box. 1.65
- FT-225-A Mounting Racks. 1.65
- FT-227-A Shock Mount Racks. 1.65
- J-22/ARC-5 Junction Boxes. 1.75
- J-17/ARC-5 Junction Boxes. 2.75
- MDT/ARC-5 Modulators, all Tubes. 5.95
- MC 211 Right Angle Drives.21
- BC 433G Compass Rcvrs., Used. Excellent. 32.50
- ART-13 Barometric Limit Switches. 8.75
- BC 306 Antenna Loading Unit for BC 375. 3.00
- RL-7 Interphone Amplifiers, Used, Excellent, Less Tubes. 3.75
- SA-4/APA-1 Motor Driven (28 VDC) Yagi Antenna Switch. 24.50
- MT-36-C Ant. Loading Unit for TA-21 XMTR. 35.00
- A-62 Phantom Antennas, for use with Mobile XMTRS, 20-38.9 MC 40 Watts. 3.95
- RT-19/ARC-2 Trans-Receiver, 24 VDC, covers Amateur 2-Meter Band. Complete with Tubes and Crystals. 39.50
- Radar Trainer, Type 15-C. Consists of 4 separate XMTRS. Operating 380-500 MC, I—Pulse Gen. I—Power Supply, all Cables, 2 Inst. Books. 215.00
- Rubber Inserts, M-300 for HS-30 Headsets. 3.25/M
- BC 496A Dual Control Boxes (Receiver) for SCR 274N. 1.35
- T-30 Throat Microphones.69
- National XS-3 Double-Down Insulators, fits 2½" Hole. All Hardware Included.63
- IN-84 Double Cone Insulators. 12 for \$1.00
- ARC-5 UGS
 - #5842. 35¢
 - #5777. 35¢
 - #PL 154. 70¢
 - #PL 154A. 70¢
 - #7027. 45¢
 - #7025. 45¢
 - #PL 152. 65¢
 - #6418. 35¢
- C-114 Loading Coils.85
- Overload Breaker: 500 MA @ 1000VDC Manual Reset. Heinemann AM 1610. 5.00
- Voice Coil & Diaphragm Assy. (Spares) for Beachmaster Speaker Assy. Will handle 50 W. Audio. 45¢

MAIL ORDERS PROMPTLY FILLED. ALL PRICES F.O.B. NEW YORK CITY. SEND M.O. OR CHECK. ONLY SHIPPING SENT C.O.D. RATED CONCERNS SEND P. O. ALL MDSE. SUBJECT TO PRIOR SALE AND PRICES SUBJECT TO CHANGE WITHOUT NOTICE. PARCELS IN EXCESS OF 20 POUNDS WILL BE SHIPPED VIA CHEAPEST TRUCK OR RAIL.

131 Liberty St., New York 7, N. Y. Dept. E-9 Chas. Rosen Phone: Dlgby 9-4124

SEARCHLIGHT SECTION

WANTED
ARC-1, 3, ART-13, BC-342, 348, APS-10, 15, TS-13, 35, 146, 147, 148, 174, 175, 263 ETC. All SCR, BC, AN, TS. ALL TUBES.

RADALAB
 1964 Webster Ave., Bronx 57, N. Y.
 TEL: WE 3-3232-3

TERMS—Minimum order \$25.00 all prices FOB New York City. 25% deposit with order, balance COD. Rated firms open account. Prices subject to change without notice.

ALL TUBES STANDARD BRAND, NEW, GUARANTEED

OA2 \$.89	3DP1/S2 5.95	304TL 7.90	814 2.95	931A 5.25	5676 3.30	9001 1.40	OA3/VR75 97
OB295	3E29 11.75	307A 5.25	815 3.75	958A 1.75	5687 3.95	9003 1.50	OB3/VR90 89
1B24 8.25	3J21 WRITE	703A 3.95	829B 11.75	959 2.95	5691 7.65	FG17 3.50	OC3/VR105 95
1P21 29.75	5LP1 14.75	705A 1.85	832 7.25	1603 5.15	5692 6.50	FG32 11.75	OD3/VR150 98
2C40 9.25		707A 7.95	832A 8.25	1624 1.40	5693 6.50		WL676 49.50
2C42 8.50		707B 15.95	833A 39.50	5516 5.25	5702 1.89		WL677 45.00
2C43 12.95	2 J 41 RCA	715B 9.25	845 5.40	5643 7.25	5703 2.40		IN21 1.40
2G51 5.90	Write For Price	715C 19.75	866A 1.40	5651 2.65	5704 6.50		IN21B 2.75
2D21 1.25		721A 2.80	891B 69.75	5654 1.95	5718 8.65		IN21C 20.00
2D21W 1.25		723A/B 18.75	872A 3.25	5670 4.00	5719 1.69		IN23 1.10
2K25 30.00	6C21 19.75	725A 7.40	884 1.80	5672 1.40	5726 2.75		IN23B 3.25
2K28 31.50	6J4 5.90	726A 14.50			5814 16.50		IN26 7.45
2K50 WRITE	100TH 8.95	803 3.75			5876 6005		IN3462
3C45 14.95	21196	805 4.25			8005 8020		IN34A85
3D24 4.90	250TH 16.50	807 2.95			8020 8025		IN38 1.25
3D21A 4.69	250TL 16.50	811 10.50					IN38A 1.10
3DP1 3.50	304TH 7.90	813 10.50					

Complete stock of receiving tubes available. Send us your requirements.

7C 22 TUBES
 Brand New W.E.
 Tuneable 400-800 MC, 450KW output.
 15KV plate, AV filament P.O.R.

FG57 4.35	FG97 17.50
FG97 6.40	FG105 22.50
FG105 1.10	FG172 17.50
FG172 4.75	

TEST EQUIPMENT

- TSK1/SE K Band Spectrum Analyzer
- TS3A/AP Frequency and power meter S Band 225.00
- RF4A/AP Phantom Target S Band
- TS10/APN Altimeter Test Set 35.00
- TS12/AP VSWR Test Set for X Band
- TS/13-AP X Band Signal Generator 1000.00
- TS14/AP Signal Generator
- TS15/AP Flux Meter
- TS19/APQ 5 Calibrator
- TS-23/APN Altimeter Test Set
- TS33/AP X Band Power and Frequency Meter
- TS/34AP Western El. Synchroscope 240.00
- TS35/AP X Band Signal Generator
- TS36/AP X Band Power Meter
- TS-45/APM-3 X Band Signal Generator 300.00
- TS/47/APR 40-400MC Signal Generator
- TS-56/AP L Band Slotted Line
- TS-59/APN Altimeter Test Set
- TS-61/AP S Band Echo Box
- TS-62/AP X Band Echo Box
- TS69/AP Frequency Meter 400-1000MC
- TS-76/APM-3 Wave Guide Kit for TS-45
- TS-89/AP Voltage Divider
- TS100 Scope
- TS102A/AP Range Calibrator
- TS108 Power Load
- TS110/AP S Band Echo Box
- TS125/AP S Band Power Meter
- TS126/AP Synchroscope
- TS146/UP X-Band Test Set
- TS147 X Band Signal Generator
- TS-148 X Band Spectrum Analyzer
- TS-173/UP Frequency Meter 550.00
- TS174/AP Freq. Meter
- TS175 Freq. Meter
- TS-250/APN Test Set for Altimeter
- TS251 Range Calibrator APN9
- TS270 S-Band Echo Box
- 256B&R Synchroscope—Mfg DuMont
- TSX-45E 3 CM Spectrum Analyzer

AN/APN-3 SHORAN
 A high precision navigation and bombing equipment for use in aircraft or ships. Used with AN/CPN-2 ground beacons. Complete sets available: indicator, computer, comparator etc. Mfg: RCA. Write

MILITARY ELECTRONICS

- SCR-284 Portable Field Radio, Frequency Range 3-5 Mc. 6 or 12v D.C. . \$280.00
- SCR-522 Transceiver 10 156 Mc. 4 CH. xtal control 24v \$129.00
- SCR-536 HANDIE TALKIE \$200.00 pr.
- SCR-555 Direction Finder 18-35 mc. Complete installations. 12v D.C. Input POR
- SCR-619 ARMY FIELD RADIO 27-38.9 mc. Xtal Control 6-12v D.C. Input. POR
- SCR-718A, B, C, High Alt. Altimeter 0-50,000 ft. 2 ranges 110v 400-2600 cyc. \$575.00
- AN/ARC-1 Transceiver 100-156 mc xtal controlled 10CH. 24v 20 and 50 CH. available \$750.00
- AN/ARC-3 Transceiver 100-156 mc. xtal controlled 8 CH. 24v . . . \$1350.00
- AN/ARC-4 Transceiver 140-144 Mc. Xtal control 4 CH. 12-24v . . . \$65.00
- APT-4 RADAR JAMMER TRANSMITTER 165-780 mc. 110v. 400cyc. P.O.R.
- APT-5 RADAR JAMMER TRANSMITTER 30 watt output, uses 3C22 tube. \$159.50
- AN/APR-1 Receiver 38-1000 mc. in 3 Tuning units. 110v 60-2600 cyc. \$895.00

AN/TPQ-2 K-BAND GROUND RADAR
 Very late model set. Used to plot trajectory of artillery and mortar shells and to enable counter battery fire with extreme accuracy. This Radar is so accurate and sensitive it will pick up movements of personnel on the battlefield. It can also be used to measure height of cloud cover for weather forecasting. Mfg: WESTERN ELECTRIC. Write

- AN/APR-4 Receiver 38-4000 mc. 5 Tuning units. 110v 60 cyc. POR
- AN/APR-5 Receiver 1000-3100 mc. 10 mc. IF. bandwidth. 30MC IF 110v 60 cyc Input \$475.00
- AN/APR-6 Receiver 6000-10,000 Mc. uses 30 mc. IF 110v 40 cyc. Input. \$475.00
- AN/APA-11 Pulse Analyzer used to measure pulse char. of any signal fed to it POR
- BC-639 100-156 MC VHF Receiver with PWR Supply 110v 60 cyc. P.O.R
- AN/APN-9 LORAN RECEIVER Airborne Navigation Equipment P.O.R.
- BC-348 Receiver 28v Freq. Range. 1.7-18 mc \$150.00
- BC-348R or Q Receiver 28v late model. \$190.00

RADAR

TS-250 ALTIMETER TEST SET
 Can be used with APN-1, SCR-718 or most any airborne altimeter. Operates 24 v. D.C. Brand new Mfg'r. P.O.R.

- BC-312 Receiver 1-7-18 mc. 12v D.C. \$159.50
- BC-342 Receiver 1.7-18 mc. 110v A.C. \$159.50
- AN/APS-2 S Band Radar Airborne Range 5-100 miles 5" P.P.I. 3" A Scope
- AN/APS-3 X Band Radar Search and Homing 5" Screen. Provides Class B indication \$950.00
- AN/APS-4 X Band Search Homing Radar. Presentation 3" B Scope. \$950.00
- AN/APS-6 X Band Search and Gun Firing RADAR. Range 3-100 miles. \$2500.00

X, K, S-BAND WAVEGUIDE COMPONENTS
 Slotted lines, Term., adapters, mounts, etc. in stock. SEND YOUR REQUIREMENTS

10 CM STANDARD FREQUENCY BEACON CAVITIES
 Mfg. Bernard Rice. Price \$18.50 each

- AN/APS-10 LIGHTWEIGHT SEARCH AND NAVIGATION RADAR. Freq. 9375 mc. Range approx. 90 miles. 110v 400 cyc. 5" P.P.I. POR
- AN/APS-15A and B High Resolution X BAND Navigation and Blind Bombing Radar. Presentation on 5" PPI and 3" A" Scope. Output 40 KW. 115v 400 cyc. POR
- AN/APN-2 Complete Sets available checked out, also SCR-729 available. POR
- UPN-2 S Band Radar Beacon. Has range 35 miles, used to send coded signals to Radars. 110v 60 cyc Input. \$350.00
- UPN-4 Portable 3 cm Radar Beacon. Used to send coded signals to Radar 12v D.C. Input POR
- SO-8 MARINE RADAR S-BAND. . . \$2000
- SO-13 MARINE RADAR S-BAND \$2250

SCR 291A
 Long range automatic direction finder. Used to take bearings on aircraft, ships, etc. Freq. range 1.5-30MC. input 110v 60 cycle. Complete sets available including receiver, indicator, antennae, cables, etc. Write

ALL EQUIPMENT RECONDITIONED CHECKED OUT AND GUARANTEED

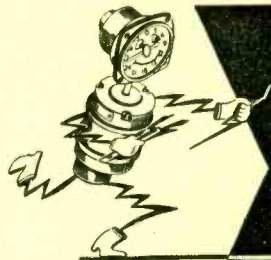

IMMEDIATE SHIPMENT

from Servo-Tek

SYNCHROS • DC MOTORS • AC MOTORS • INVERTERS
SERVO MOTORS • ACTUATORS • GEAR MOTORS • GENERATORS

Guaranteed to Meet
Original Manufacturers' Specifications

PIONEER AUTOSYNS

6007 Dual Indicator	\$ 24.50
AY-1 Receiver	9.50
AY-54D Receiver	12.50
AY-20 Receiver	14.50
AY-14 Transmitter	12.50
CL-3 Magneson Transmitter	17.50
AY-150 Precision Transmitter	24.50
I-82A 5" Indicator	27.50
I-81A 3" Indicator	34.50
Position Indicating System	19.50
1006 Magneson Indicator AN-5730	24.50
AY-101D Precision Transmitter-Receiver	27.50
AY-131D Differential	27.50
AY-201-3B Transmitter-Control Transformer	32.50
AY-231-3-B Differential	32.50

A-C SERIES MOTORS

Electrolux 60 Cy. Reversible with Brake	24.50
Electrolux 60 Cy. Governor Controlled	24.50
G-E 5BN38HA-18 Split Field 60 Cy.	12.75
G-E 5BN38HA-8 or 19 4 Leads 60 Cy.	9.75

D-C SELSYNS

Type EA-10210A5 or B6 D-C Selsyn	8.75
G-E 8TJ9PAX or PDL	3.75
G-E 8TJ9PAV or PXB	4.75

60 CYCLE SERVO MOTORS

Dielhi FPE-25-11 5 Watts	27.50
Dielhi FPE-25-3 2.5 Watts	19.50
DuOrd No. 207927 15 Watt	59.50
Arma Type SA 10 Watt	49.50
Dielhi FP-25-2.5 Watts	19.50

400 CYCLE SERVO MOTORS

Kearfott Type R-108-2A	39.50
Pioneer Type 1007-2A Drz Cup	14.50
Pioneer Type CK-2 Induction	29.50
Pioneer PBD39853 with Rate Generator	39.50
Pioneer Type CK-17 Gear Reduced	29.50
Kollsman Type 776-01 Drag Cup	27.50
Kollsman Type 776-06 Drag Cup	34.50

SERVO AMPLIFIERS

Pioneer Type 12077	39.50
Pioneer Type PED-41580	14.50

400 CYCLE MOTORS AND BLOWER

E.A.D. Type J-72B Induction Motor	19.50
E.A.D. J-72B Blower Assembly	24.50
AiResearch Type 27770 and 27780 Brake	14.50
Dielhi FBF-24 Induction Motor	18.75
Westinghouse Type FL Blower	12.50
E.A.D. Type J-31 Induction Motor	19.50

SYNCHRONOUS AND TIMING MOTORS

E.A.D. Type J-33 Synchronous	16.50
Synchron Type 690 1 rpm Timing	2.75
Barber-Coleman Type PYA4240	12.50
(Gear Reduced Synchronous—40 in.-lb.)	

AIRCRAFT AMPLIDYNES—MOTORS—CONTROLS

G-E Type 5AM31N18A Amplidyne	39.50
G-E Type 5AM31N19A Amplidyne	39.50
G-E Type 5BA50LJ29 Turret Motor	19.50
G-E Type 5BA50LJ67 Turret Motor	29.50
G-E Type 5BA50LJ66 Turret Motor	29.50
G-E Type 5BA50LJ29 Turret Motor	39.50
G-E Type 5BA50GJ1 Turret Motor	29.50
G-E Type 5BA50LJ2A Turret Motor	19.50
G-E Type 20V1C1 Control Amplifier	39.50

208 VOLT—3 PHASE MOTORS AND ACTUATORS

AiResearch Type 29178 Linear Actuator	119.50
Hoover Type C-280 or C-290 Rotary Actuator	79.50
AiResearch Type 29180 Rotary Actuator	139.50
G-E Type 5K25J111 Rotary Actuator	69.50
U.S. Motors Double-shaft Brake Motor	79.50
Western Design Type A-3421 Brake Motor	89.50
Delco Type EX-88432 Linear Actuator	169.50
Rittor Type D2163 Rotary Actuator	119.50
G-E Type 5K31G11 Brake Motor	129.50
Chicago Pneumatic Type I-A Linear Actuator	69.50
Rittor Type D-2162 Rotary Actuator	169.50
Type S-1231612 D-C Gyro Motor	6.75

AIRCRAFT GYROS

G-E Bank and Climb Control—12 V. D.C.	79.50
Sperry Type 650035 Attitude Gyro	49.50
AAF Type C-1 Electric Turn and Bank	24.50

TACHOMETER OR RATE GENERATORS

Elinco Type B-68 A-C Rate Generator	34.50
Elinco Type F-16 A-C Rate Generator	27.50
Pioneer Type PBD Servo Motor and A-C Rate Generator	39.50
Elinco Type PM-1 PM Generator	29.50
Elinco Type PM-2 PM Generator	29.50
Elinco Type B-35D PM Generator	29.50
Elinco Type B-44 PM Generator	29.50

RESOLVERS

Dielhi FJE-43.9 400 Cycle	39.50
Dielhi FPE-43-1 400 Cycle	39.50
Dielhi Limited Rotation—60 Cycle	49.50

PIONEER TORQUE UNITS

Type 12606-1-A	89.50
Type 12602-1-A	89.50
Type 12604-3-A	89.50

400 CYCLE LINEAR ACTUATOR

AiResearch Linear Actuator	24.50
Chicago Pneumatic Type PN-21 or 24	24.50

SELSYNS AND SYNCHROS

Henschel Type N	39.50
Kollsman Type 403-02	29.50
Bendix Type 851	24.50
G-E Type 2J1G1 Control Transformer	9.75
G-E Type 2J1F1 Generator	12.75
G-E Type 2J1H1 Differential	14.75
G-E Type 2J1F3 Generator	9.75
Sperry Type 89812 Repeater	14.50
Sperry Type 75835 Control Transformer	9.50
Type II-5 Repeater	39.50
Bendix and Henschel Type A	49.50
Bendix and Henschel Type M	49.50
Dielhi Type FJE-65-14	19.50
G-E Type 2J1A2 Generator	49.50
Dielhi Type XXI Repeater	24.50
W-E Type KS-5950-L2 400 Cycle	19.50
Type I-82F Radio Compass Indicator	9.50
Kollsman Type 775-01 400 Cycle	19.50
Type VII (C-78248) Generator	39.50
Type IX (C-78410) Repeater	49.50
Type XVIII (C-78556) Generator	29.50
Type XV (C-78365) Control Transformer	49.50
Type IV (C-78414) Generator	64.50
Type V (C-78415) Repeater	69.50
Type VIII (C-78411) Generator	19.50
Type XIX (C-78249) Differential	12.50

NAVY ORDNANCE SYNCHROS

All Types In Stock

SYNCHRO CAPACITORS

Type IC Mark 12	2.75
Type 3C Mark 1	6.75
Type 6C Mark 2	9.75
Type 4C G-E-25F679	4.75

THREE PHASE 400 CYCLE INVERTERS

Leland Type 10563	79.50
Leland Type 10285	119.50
Holtzer-Cabot MG-153-F	139.50
Holtzer-Cabot MG-153	119.50

SINGLE PHASE 400 CYCLE INVERTERS AND GENERATORS

Pioneer Type 12108 26 Volts	24.50
G-E 5D21N13A 485 va.	49.50
Pioneer 12116-2-A 50 va.	79.50
Pioneer 12123-1-A 100 va.	119.50
Pioneer 12130 140 va.	39.50
Pioneer 12117-6-A	39.50
G-E, Russell, Leland PE-218	49.50
Holtzer-Cabot MG-221	99.50
Holtzer-Cabot MG-218	99.50
Pioneer 12120-4-A	119.50
Holtzer-Cabot Type MG-149F	129.50
Holtzer-Cabot Type MG-149H	19.50
G-E 5AS131N13 1500 va.	99.50
Windcharger PU-7/AP 2500 va.	89.50
Windcharger PU-16 750 va.	129.50
Leland Type 10339 250 va.	14.50
Westinghouse Type C-1 45 va.	19.50
Pioneer Type 800 1200 va.	69.50
G-E Type 5AS121L12 800 Cycle	69.50

D-C SERIES MOTORS

General Industries 62800 1/12 hp.	9.75
Oster Type A-21-E 12R Split Field	12.50
Westinghouse Type 1171391 1/8 hp.	9.75
Oster Type A-21-D-7A .005 hp.	8.75
Type S1231612 Gyro Motor	6.75
Dielhi FDE-83-1 or 2 1/6 hp.	9.75
Oster C-2P-1L 1/100 hp.	12.50
Revere Split-field Midget	6.75
Stewart Warner Heater Motor	3.75
Air Associates EE-1590M 1/4 hp.	17.50
Oster C-28P-1A 1/100 hp.	9.75
General Industries 61400 1/8 hp.	14.75

D-C SHUNT MOTORS

Dielhi FD52-2 (Sperry 803010)	4.75
Elinco Type B-64	16.50
Oster Type B-9-2	9.50
Oster Type B-9-1	9.50
Electric Specialty JAI 1/4 hp.	19.50
Electric Specialty HCA31.5 3/4 hp.	29.50
Oster DESTU-2-1R Dual Speed	12.75
Delco Type 5069267 1/100 hp.	6.75
Delco Type 1592818	19.50
Oster Type E-7-5 1/20 hp.	19.50
Westinghouse Type ADS 1/90 hp.	6.75
Russell Electric 211221 3/16 hp.	16.50
Sperry No. 807368 Reversible	12.50
G-E 5BA25HJ27A 1/100 hp.	12.50
G-E 5BC26AC134 1/20 hp.	12.50
Electric Specialty HCA-21 Brake	39.50
Electric Specialty HCA-21 Brake	39.50
National Mineral 24 volt 1 hp.	19.50
Oster Type A-16A-2B Double Shaft	9.75
G-E 5BA25MJ408 1/8 hp.	12.75
Eicor ML-2310-52 Double-shaft	12.50
Holtzer-Cabot RHD 2220 1/2 hp.	12.50
Hughes Aircraft 492799	6.75
White Electric KS-5603-L02 1/100 hp.	6.75
Dumore EI-Y2PB 1/20 hp. gearhead	9.75

D-C LINEAR ACTUATORS

AiResearch Type 25800-24	24.50
AiResearch Type 25800-13	24.50
Footo Bros. 5" Travel	24.50

D-C GEAR-REDUCED MOTORS AND ACTUATORS

Oster Type A-16B-26R	9.75
Barber-Coleman AYL05091 Actuator	19.50
Oster Type B-9-1 Dual Output Speeds	8.75
Lear Type 156 Rotary Actuator	14.50
Bodine Type NSE-11R Split Field	12.50
Bodine Type NSH-11R 4 Lead	22.50
Norden SBAE Servo Assembly	39.50
G-E 5BA25AJ-31 or 32	39.50
G-E 5BA10AJ370—250 rpm.	19.50
Jack & Heiler 950R Starter	12.50
G-E 5BA25MJ409 1/8 hp.	12.75
White Rogers 6905 Rotary Actuator	19.50
Air Associates EE-1210	29.50
White Rogers 6912 Rotary Actuator	19.50
White Rogers 6913 Rotary Actuator	19.50
C-1 Autopilot Servo	59.50

D-C GOVERNOR CONTROLLED MOTORS

Delco Type 5067125 PM Motor	24.50
Delco Type A-7155 1/30 hp.	19.50
Bodine NSHG-12 1/30 hp.	16.50

D-C PERMANENT MAGNET MOTORS

Delco Type 5069230 145 rpm.	29.50
Delco Type 5069600 250 rpm.	29.50
Delco Type 5072520 190 rpm.	17.50
Dielhi FD6-23 10,000 rpm.	12.75
Delco 5071895 250 rpm.	16.75
Dielhi FD6-31—Double Shaft	6.75
Oster Open Frame	29.50
Delco 5069611 10,000 rpm.	14.75
Delco 5068571 10,000 rpm.	14.75

D-C BLOWER ASSEMBLIES

Delco Type A-C 1592818	12.50
Oster Type MX-215/APG 20 cfm.	18.75
Oster Type C-2P-1L 7,000 rpm.	16.75
Lear Type E-139-8 5500 rpm.	14.50

MISCELLANEOUS

Radio Controlled Servo Units	125.00
E.A.D. J-49B 60 Cycle Motor	9.75
G-E Phase Changing Transformer	3.75
Type FQ Electro Pneumatic Ram	12.50
Type S-1283228 2 phase motor	6.75
Pressure Warning Switch	3.75
1 hp. Adjusto-speed	89.50
White Rogers 6203 Temperature Controller	29.50
Sperry 661824 Saturable Reactor	6.75
Eclipse PEX-29752 Conversion Transmitter	275.00
Drafting Machine	16.50
E.A.D. Type J-50 Blower 10 cfm.	39.50
PM Motor and Rate Generator	39.50
Type RH 400 Cycle Transtat	9.75

WRITE FOR LISTING

Prices F.O.B. Hawthorne

Telephone: Hawthorne 7-3100

Servo-Tek
PRODUCTS CO.
INCORPORATED

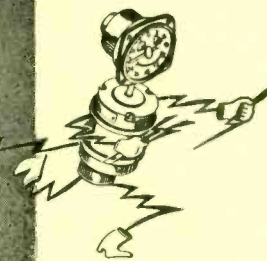

1086 GOFFLE ROAD
HAWTHORNE, NEW JERSEY
Cable Address: SERVOTEK

Wilgreen Industries

99 MURRAY STREET NEW YORK 7, N. Y. WOrth 4-2490-1-2

DISCOUNTS
40-60
80%
8 to 48 Hour
Delivery on
'AN' & 'UG'
Connectors!

"UG" CONNECTORS "UG"

TYPE	TYPE	TYPE	TYPE	TYPE	TYPE	TYPE	TYPE
UG9/U	UG27B/U	UG83/U	UG108/U	UG182A/U	UG243/U	UG286/U	UG493/U
UG10/U	UG28/U	UG85/U	UG108A/U	UG185/U	UG244/U	UG294/U	UG494/U
UG11/U	UG28A/U	UG87/U	UG109/U	UG188/U	UG245/U	UG290/U	UG495/U
UG12/U	UG28B/U	UG87/U	UG109A/U	MX195/U	UG246/U	UG291/U	UG496/U
UG13/U	UG29/U	UG88/U	UG110/U	UG197/U	UG249/U	UG294/U	UG499/U
UG14/U	UG29A/U	UG88B/U	UG114/U	UG201/U	UG250/U	UG299/U	UG503/U
UG15/U	UG29B/U	UG89/U	UG115/U	UG202/U	UG251/U	UG306/U	MX504
UG16/U	UG30/U	UG90/U	UG119U/P	UG203/U	UG252/U	UG309/U	UG505/U
UG17/U	UG32/U	UG91/U	CW123A/U	UG204A/U	UG253/U	UG333/U	UG506/U
UG18/U	UG33/U	UG91A/U	UG131/U	UG206/U	UG254A/U	UG334/U	UG507/U
UG18A/U	UG34/U	UG92/U	UG146/U	UG207/U	UG255/U	UG335/U	UG526/U
UG18B/U	UG35A/U	UG92A/U	UG148A/U	UG208/U	UG256/U	UG347/U	UG530/U
UG19/U	UG36/U	UG93/U	UG149A/U	UG212A/U	UG257/U	UG348/U	UG531/U
UG19A/U	UG37/U	UG93A/U	UG154/U	UG213A/U	PL258	UG349/U	UG532/U
UG19B/U	UG37A/U	UG94/U	UG155/U	UG215/U	PL259	UG352/U	UG533/U
UG20/U	UG38A/U	UG94A/U	UG155/U	UG216/U	PL259A	M358	UG535/U
UG20A/U	UG39/U	UG95/U	UG156/U	UG217/U	UG259/U	M359A	UG536/U
UG20B/U	UG40/U	UG95A/U	UG157/U	UG218/U	UG260/U	MT412	UG541/U
UG21/U	UG45/U	UG96/U	UG158/U	UG219/U	UG260A/U	UG414/U	MX544/U
UG21A/U	UG46/U	UG96A/U	CW155/U	UG220/U	UG261/U	UG419/U	UG557/U
UG21B/U	UG49/U	UG97/U	UG159A/U	UG222/U	UG262/U	UG420/U	MX564/U
UG21C/U	UG50/U	UG97A/U	UG160A/U	UG223/U	UG265/U	UG422/U	UG567/U
UG21D/U	UG51/U	UG98/U	UG160B/U	UG224/U	UG268/U	UG423/U	UG568/U
UG22-U	UG57B/U	UG98A/U	UG166/U	UG231/U	UG270/U	UG478/U	UG571/U
UG22A/U	UG58/U	UG100/U	UG167/U	UG233/U	UG271/U	UG479/U	UG572/U
UG22B/U	UG58A/U	UG100A/U	UG167A/U	UG234/U	UG272/U	UG482/U	UG573/U
UG22C/U	UG59/U	UG101/U	UG173/U	UG235/U	UG273/U	UG483/U	UG625/U
UG23/U	UG59A/U	UG101A/U	UG174/U	UG236/U	UG274/U	UG484/U	UG627/U
UG23A/U	UG60/U	UG102/U	UG175/U	UG237/U	PL274	UG486/U	UG628/U
UG23B/U	UG60A/U	UG106/U	UG176/U	SO239	UG275/U	UG487/U	UG634/U
UG23C/U	UG61/U	UG107A/U	UG180A/U	UG241/U	UG276/U	UG491/U	UG628/U
UG27A/U	UG61A/U	UG107B/U	UG181A/U	UG242/U	UG279/U	UG492/U	MX913/U

"AN" CONNECTORS "AN"

851P	16-9P	18-22P	20-16S	22-10S	22-37S	24-28S	32-3S	36-8P	40-12P
854S	16-9S	18-22S	20-17P	22-11P	22-1P	24-835P	32-4P	36-8S	40-12S
105-2P	16-10P	18-23P	20-17S	22-11S	24-1S	24-835S	32-4S	36-9P	40-13P
105-2S	16-10S	18-23S	20-18P	22-12P	24-2P	28-1P	32-5P	36-9S	40-13S
105L-3P	16-11P	18-24P	20-18S	22-12S	24-2S	28-1S	32-5S	36-10P	40-14P
105L-3S	16-11S	18-24S	20-19P	22-13P	24-3P	28-2P	32-6P	36-10S	40-14S
105L-4P	16-12P	18-25P	20-19S	22-13S	24-3S	28-2S	32-6S	36-11P	44-1P
105L-4S	16-12S	18-25S	20-20P	22-14P	24-4P	28-3P	32-7P	36-11A	44-1A
125-1P	16-13P	18-26P	20-20S	22-14S	24-4S	28-3S	32-7S	36-12P	44-2P
125-1S	16-13S	18-26S	20-21P	22-15P	24-5P	28-4P	32-8P	36-12S	44-2S
125-2P	18-1P	18-27P	20-21S	22-15S	24-5S	28-4S	32-8S	36-13P	44-3P
125-2S	18-1S	18-27S	20-22P	22-16P	24-6P	28-5P	32-9S	36-13S	44-3S
125-3P	18-2P	18-28P	20-22S	22-16S	24-6S	28-5S	32-9S	36-14P	44-4P
125-3S	18-2S	18-28S	20-23P	22-17P	24-7P	28-6P	32-10P	36-14S	44-4S
125-4P	18-3P	18-29P	20-23S	22-17S	24-7S	28-6S	32-10S	36-15P	44-5P
125-4S	18-3S	18-29S	20-24P	22-18P	24-9P	28-7P	32-12S	36-15S	44-5S
12-5P	18-4P	18-30P	20-24S	22-18S	24-9S	28-7S	32-12S	36-16P	44-6P
12-5S	18-4S	18-30S	20-25P	22-19P	24-10P	28-8P	32-13P	36-16S	44-6S
125-6P	18-5P	18-31P	20-25S	22-19S	24-10S	28-8S	32-13S	36-17P	48-1P
125-6S	18-5S	18-31S	20-26P	22-20P	24-11P	28-9P	32-14S	36-17S	48-1S
145-1P	18-6P	20-1P	20-26S	22-20S	24-11S	28-9S	32-14S	36-18P	48-2P
145-1S	18-6S	20-1S	20-27P	22-21P	24-12P	28-10P	32-15S	36-18S	48-2S
145-2P	18-7P	20-2P	20-27S	22-21S	24-12S	28-10S	32-15S	36-19P	48-3P
145-2S	18-7S	20-2S	20-28P	22-22P	24-14P	28-11P	32-16P	36-19S	48-3S
14-3S	18-8S	20-3P	20-28S	22-22S	24-14S	28-11S	32-16S	36-20P	48-4P
145-4P	18-9P	20-4P	20-29P	22-23P	24-15P	28-12P	32-17P	36-20S	48-4S
145-4S	18-9S	20-4S	20-29S	22-23S	24-15S	28-12S	32-17S	36-21P	48-5P
145-5P	18-10P	20-5P	20-30P	22-24P	24-16P	28-13P	32-18P	36-1S	48-5S
145-5S	18-10S	20-5S	20-30S	22-24S	24-16S	28-13S	32-18S	36-835P	3057-3
145-6P	18-11P	20-6P	20-31P	22-25P	24-17P	28-14P	32-19P	36-853S	3057-4
145-6S	18-11S	20-6S	20-31S	22-25S	24-17S	28-14S	32-19S	40-11P	3057-6
145-7P	18-12P	20-7P	20-32P	22-27P	24-18P	28-15P	32-20P	40-1S	3057-8
145-7S	18-12S	20-7S	20-32S	22-27S	24-18S	28-15S	32-20S	40-2P	3057-10
145-9P	18-13P	20-8P	20-33P	22-28P	24-19P	28-16P	32-101P	40-2S	3057-10-S
145-9S	18-13S	20-8S	20-33S	22-28S	24-19S	28-16S	32-101S	40-3P	3057-12
165-5-1P	18-14P	20-9P	22-1P	22-29P	24-20P	28-17P	32-102P	40-3S	3057-12-6
165-5-1S	18-14S	20-9S	22-1S	22-29S	24-20S	28-17S	32-102S	40-4P	3057-16
16-2P	18-15P	20-10P	22-2P	22-30P	24-21P	28-18P	36-1P	40-4S	3057-20
16-2S	18-15S	20-10S	22-3P	22-30S	24-21S	28-18S	36-1S	40-5P	3057-24
165-3P	18-16P	20-11P	22-4P	22-31P	24-22P	28-19P	36-2P	40-5S	3057-28
165-3S	18-16S	20-11S	22-5P	22-31S	24-22S	28-19S	36-2S	40-6P	3057-32
165-4P	18-17P	20-12P	22-6P	22-32P	24-23P	28-20P	36-3P	40-6S	3057-40
165-4S	18-17S	20-12S	22-7P	22-32S	24-23S	28-20S	36-3S	40-7P	
165-5P	18-18P	20-13P	22-8P	22-33P	24-24P	28-21P	36-4P	40-7S	
165-5S	18-18S	20-13S	22-9P	22-33S	24-24S	28-21S	36-4S	40-8P	
165-6P	18-19P	20-14P	22-6P	22-34P	24-25P	28-22P	36-5P	40-8S	
165-6S	18-19S	20-14S	22-6S	22-34S	24-25S	28-22S	36-5S	40-9P	
16-7P	18-20P	20-15P	22-7P	22-35P	24-26P	28-23P	36-6P	40-9S	
16-7S	18-20S	20-15S	22-8P	22-35S	24-26S	28-23S	36-6S	40-10P	
165-8P	18-21P	20-16P	22-9P	22-36P	24-27P	28-24P	36-7P	40-10S	
165-8S	18-21S	20-16S	22-9S	22-36S	24-27S	28-24S	36-7S	40-11P	
			22-10P	22-37P	24-28P			40-11S	

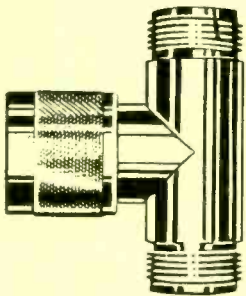

UG 107 B/U

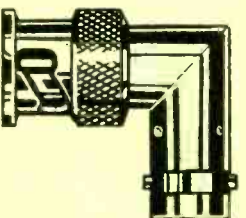

UG 306/U

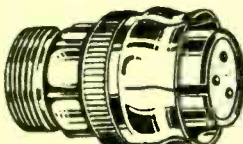

AN 3107 A/B

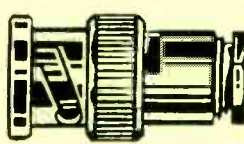

UG 88/U

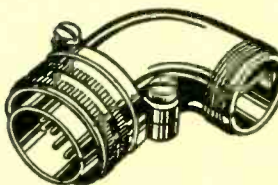

AN 3108 A/B

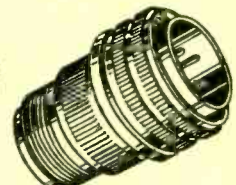

AN 3106 A/B

Weston HIGH QUALITY TEST EQUIPMENT

**WL-117 WAVEMETER**

A precision wavemeter having a range from 2400 mc to 3400 mc with an accuracy of better than 0.1% over the entire range. The resonant cavity has a Q of not less than 1000 and normally from 1000 to 2000. The unit, supplied with a pickup dipole interconnecting cable and adapters, may also be used for relative field strength measurements.

PRICE: \$390.00**WL-62 ECHO BOX**

A portable ringing cavity for microwave research; the unit has a frequency range from 9320 to 9420 mc, with a Q of 50,000 to 80,000. The echo box is used for relative power measurements, spectrum analysis, frequency checks, tests for unstable operation and a host of other applications in the laboratory.

PRICE: \$530.00**WL-108 TERMINATION**

This 1" x 1/2" waveguide hi-power load is capable of dissipating a peak power of 200 kilowatts and an average power of 150 watts. The VSWR is less than 1.10 over the entire frequency range of 9300 to 9450 mc. All accessories including carrying case and coupling adapters are supplied with the unit.

PRICE: \$90.00**WL-13 SIGNAL GENERATOR**

A versatile x-band signal generator providing a source of pulsed or CW power and having provisions for square-wave and sawtooth modulation. Accurate monitoring of the RF output is accomplished with a thermistor bridge and a calibrated attenuator. The power supply is electronically regulated to insure stable operation of the 723A/B Klystron oscillator.

PRICE: \$1275.00**WL-89 VOLTAGE DIVIDER**

An indispensable aid in high power radar and transmitter measurements this unit has provisions for 100:1 and 10:1 voltage division. It can be used with an oscilloscope to measure video pulses between 200 and 20,000 volts in high-impedance circuits. The ratio accuracy is within +15% and transmission is within 2 db from 150 cycles to 5 megacycles.

PRICE: \$45.00**WL-102 PULSE GENERATOR**

Equivalent to the TS-102/AP Range Calibrator, this crystal controlled pulse generator produces a square-topped, 50 volt synchronizing pulse of .8 microseconds at a prf of 400, 800, 1600 or 2000 cps, and a triangular marker pulse of 0.4 microseconds duration at a prf corresponding to a pulse-echo distance of 1500 ft. The phase between the marker and sync. pulses is continuously variable from -180 to +180 degrees.

PRICE: \$550.00**WL-125 POWER METER**

This instrument is a compact, battery operated thermistor bridge designed to measure power in the range of 2400 to 3335 mc., and having a full-scale sensitivity of 2 milliwatts. Among other applications, it can be used to measure antenna patterns, check standing wave ratio and determine average or peak powers. A complete set of accessories, including a 10 db and 16 db attenuator pad for measuring higher power levels, are supplied with the unit.

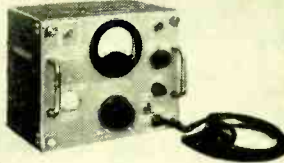
PRICE: \$390.00**SG-8/U NOISE GENERATOR**

This popular model, employing a 5722 temperature limited diode as the R.F. noise source, can be used as an absolute means of receiver noise measurements as well as for fundamental studies. The normal input impedance is 270 ohms but a 50 ohm adaptor is supplied with the unit as a standard accessory.

PRICE: \$290.00**WL-90 DUMMY LOAD**

Provides a 50 ohm termination in the form of a 50 to 1 ratio voltage divider for making overall performance tests on radar units such as the AN/APQ-7, 13, 13A, 23 and a host of other equipments in this frequency and power range. The 49 and 1 ohm resistor elements are carbon coated ceramic rods in helium filled glass tubes and are capable of dissipating up to 500 watts at a peak voltage of 5000 volts.

**BC-221 FREQUENCY METER**

This universally used and time-tested instrument is a precision meter designed to measure or radiate R.F. impulses between 125 and 20,000 KC. The overall accuracy of the unit is 0.034% over the entire operating range. It is portable and completely self contained or, if desired, it can be obtained with a power supply for 115 volt operation.

PRICE:
Without Modulation \$125.00
With Modulation 165.00
115v. Power Supply 35.00

**TS-100 OSCILLOSCOPE**

This instrument can be used with a linear sweep as a general purpose test oscilloscope or it can be used with a circular sweep as a precision range calibrator. It has a PRF rate of 300 to 1500 per second. Trigger input - 15 volts at 100 volts per microsecond rise. Trigger output - 120 volts (+ 20 volts) it can be used for detecting "jitter" in trigger divider circuits and modulator trigger pulse, and also for determining and adjusting division rate.

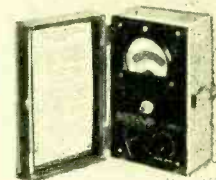
PRICE: \$550.00**WL-268B/U CRYSTAL RECTIFIER TEST SET**

A combination ohmmeter-ammeter designed to measure the electrical characteristics of microwave crystal rectifiers such as the 1N21 and 1N23 series. The instrument is completely self contained and requires only a single 1 1/2 or 2-volts cell for operating power.

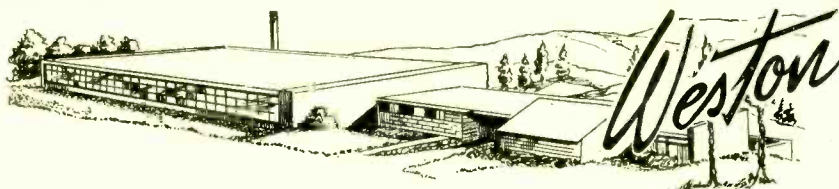
PRICE: \$53.75

LABORATORIES, INC.
HARVARD, MASS.
Tel: HARVARD 250-AYER 300-TWX HARV 193
Cable: WESLAB

SAVE ON TUBES BRAND NEW TUBES GUARANTEED TUBES

OA2..... 50.95	2J49..... 85.00	4J30..... 199.50	C6L/5528..... 2.50	VT-127A..... 2.75	KU627..... 17.50	801A..... .39	CK1006..... 1.95
OA3/VR75..... 1.10	2J66..... 149.00	4J31..... 99.50	6ALSW..... 1.75	FG172..... 29.50	KU676..... 39.50	803..... 3.75	M1009P7..... write
OB2..... 1.35	2J68..... 39.50	4J34..... 149.50	6AN5..... 2.95	HF200..... 14.50	WL677..... 39.50	805..... 3.25	1613..... .89
OB3/VR90..... 1.09	2J62..... 35.00	4J41..... 99.50	6AN6..... 2.90	204A..... 49.50	700/B/C/D..... 16.50	807..... 1.59	1616..... .90
OC3/VR105..... 1.00	2K22..... 32.50	4J52..... 200.00	6AS6..... 2.30	211/VTAC..... .95	702A..... 2.75	808..... 2.95	1619..... .39
OD3/VR150..... .90	2K25..... 28.50	4-65A..... 15.00	6AS7G..... 4.50	217C..... 4.95	703A..... 4.75	809..... 2.95	1625..... .39
1B22..... 2.00	2K26..... 69.50	4-125A..... 22.50	6BF7..... 2.50	221A..... 1.95	705A..... 1.50	811A..... 2.90	1626..... .39
1B23..... 8.95	2K28..... 32.00	4X150A..... 22.50	6BL6..... 69.50	RX233A..... 3.50	706A..... 39.50	813..... 19.95	1629..... .39
1B24..... 9.50	2K29..... 23.95					814..... 2.75	1642..... .69
1B26..... 2.30	2K34..... 150.00					815..... 3.95	1644..... .89
1B27..... 12.50	2K41..... 125.00					816..... 1.95	2050..... 1.40
1B32/532A..... 2.98	2K45..... 110.00					828..... 9.95	2051..... 1.10
1B38..... 29.50	2K48..... 99.50					829..... 8.95	5516..... 5.50
1B42..... 17.50	3B23..... 4.05					829B..... 9.95	5586..... 175.00
1B51..... 9.50	3B24..... 4.75	4X500A..... 75.00	6BM6..... 69.50	250R..... 8.95	706BY..... 39.50	830B..... 2.75	5611..... 115.00
1N21B..... 2.50	3B26..... 3.50	CSB..... 7.50	6C21..... 24.50	250TH..... 16.50	706CV..... 29.50	832..... 8.32	5635..... 8.95
1N22..... 1.25	3B28..... 6.50	SAP1..... 4.50	6F4..... 4.50	250TL..... 15.00	706FY..... 39.50	832A..... 9.50	5637..... 4.00
1N23B..... 3.49	3B29..... 12.50	SBP1..... 4.50	6J4..... 5.25	FG253A..... 89.50	706GY..... 39.50	833A..... 39.50	5643..... write
1N34A..... .79	3B29..... 2.50	SBP4..... 4.50	6K4..... 3.50	FG258A..... 149.50	707A..... 7.95	836..... 3.45	5646..... 8.95
1N35..... 1.50	3C22..... 72.50	SCP1..... 7.50	6L17/GTY..... 2.69	274B..... 3.25	707B..... 13.50	837..... 1.45	5651..... 2.75
1N38..... 1.50	3C23..... 9.95	SCP1A..... 14.50	6X5WGT..... 1.80	304TH..... 7.95	708A..... 3.95	838..... 1.98	5654..... 2.00
1N47..... 4.50	3C24/24G..... 1.50	SCP12..... 42.00	7C23..... 69.50	307A/RK75..... 4.25	713A..... .95	849..... 24.50	5656..... 14.95
1N54..... .89	3C27..... 3.75	SD21..... 18.50	12AY7..... 2.00	310A..... 4.95	715A..... .95	851..... 49.50	5657..... 299.00
1N55..... 2.75	3C33..... 9.95	SFP7..... 1.95	12DP7..... 16.95	307A..... 12.95	715B..... 8.95	852..... 17.50	5670..... 4.30
1N58A..... 1.25	3C45..... 12.50	SFP14..... 16.50	12GP7..... 25.00	310B..... 1.25	715C..... 18.00	854..... write	5672..... 1.29
1N60..... .60			12HP7..... 13.50	319A..... 4.50			5676..... 1.29
1N63/K63..... 2.39			15R..... .89	327A..... 4.50			5687..... 3.75
1N69..... .89			FG 17/5557..... 3.95	331A..... 10.95			5694..... 2.60
1N70..... 2.40			RX 21..... 8.50	349A..... 8.50			5702..... 2.95
VS-2..... 9.50			FG 32..... 12.95	350B..... 3.95			5703..... 1.30
2A515..... 4.25			35TG..... 5.95	368AS..... 6.00			5704..... 2.50
2C21/1642..... .69			RK47..... 4.95	371B..... .75			5718..... 6.95
2C39..... 17.50			EF50..... .75	374B..... 4.95			5719..... 8.95
2C39A..... 22.00			52HAP7..... write	388A..... 1.49			5750..... 3.10
2C40..... 7.25			FG57/5559..... 15.00	393A..... 9.95			5787..... 6.00
2C42..... 19.95			RK60/1641..... 2.25	394A..... 3.95			5814..... 2.75
2C43..... 14.95			RK65/5D23..... 29.50	417A..... 8.50			5844..... 4.50
2C44..... .60			HY69..... 4.50	434A..... 15.00			5876..... 14.95
2C46..... 19.95			RK72..... 1.70	446A..... 1.19			5904..... 17.50
2C51..... 4.50	3D22..... 10.95	SHP1..... 4.50	RK73..... 1.20	446B..... 3.50	717A..... .90	860..... 4.50	5905..... 17.50
2C52..... 4.95	3E29..... 11.95	SHP1..... 4.50	75T..... 6.95	507H..... 44.50	719A..... 24.50	861..... 19.95	5963..... 1.20
2D21..... 1.25	3FP7..... 1.95	SJP1..... 22.50	75TL..... 8.95	450TL..... 44.50	720AY..... 249.50	865..... .98	6005..... 4.50
2D21W..... 2.49	3GP1..... 3.95	SJP2..... 19.95	83V..... 1.10	451..... 3.95	720BY..... 249.50	872A..... 2.75	6026..... 2.25
2E22..... 2.75	3HP7..... 3.95	SJP4..... 22.50	FG95/5560..... 22.50	464A..... 10.95	721A..... 2.95	874..... 1.10	6111..... 9.96
2E24..... 3.50	3K30..... 250.00	SJP5..... 27.50	VF98..... 19.95	469..... 13.95	723A..... 9.95	884..... 1.95	8005..... 6.95
2E26..... 3.25	3K30..... 250.00	SJ23..... 39.50	98R..... 5.95	471..... 2.25	723B..... 9.95	888R-A..... 1.40	8012..... 1.95
2J21A..... 7.95	4B24..... 6.95	SJ26..... write	100TH..... 9.50	527..... 11.50	723A/B..... 16.95	889R-A..... 175.00	8020..... 1.25
2J22..... 6.95	4C27/CV92..... 17.50	SJ29..... 11.95	FG-104/5561..... 29.50	WL530..... 16.95	724B..... 2.75	905..... 3.25	8025..... 4.75
2J26..... 14.95	4C28..... 35.00	SJ30..... 39.60	FG-105..... 19.00	531..... 5.75	725A..... 7.50	923..... 1.25	8025A..... 4.75
2J27..... 14.95	4C35..... 22.00	SJ33..... 25.00	VU-111..... .95	CK536AX..... .95	726B..... 45.00	931A..... 5.50	9001..... 1.25
2J31..... 27.50	4J22..... 129.50	SNP1..... 5.95	HF120..... 9.95	559..... 1.19	726C..... 69.50	954..... .33	9002..... .98
2J32..... 29.50	4J23..... 129.50	SR4GY..... 1.25	F-123A..... 7.75	575A..... 13.95	730A..... 25.00	955..... .49	9003..... 1.50
2J33..... 27.50	4J26..... 129.50	ST4..... 1.50				956..... .49	9004..... .69
2J34..... 25.00	4J27..... 129.50					957..... .49	9005..... 1.50
2J36..... 89.00	4J28..... 129.50					958A..... .69	9006..... .49
2J42..... 149.50	4J28..... 129.50					959..... 2.45	
2J48..... 24.50	4J29..... 149.50					CK1005..... .69	

YOUR SURPLUS WANTED
We Pay Highest Prices!



SPECIAL! Vacuum Capacitors
 50 mmtd. 15,000 v. . . \$7.50
 12 mmtd. 32,000 v. . . \$10.00
 50 mmtd. 32,000 v. . . \$12.50
 100 mmtd. 20,000 v. . . \$14.50

RECEIVING TUBES?
 WE HAVE ALL TYPES
 IN STOCK
 Standard Brands ONLY!

All Prices F.O.B. Los Angeles, subject to change without notice. Minimum order \$3.00

Jsh ELECTRONICS
 Dept. E-28
 7552 Melrose Ave.
 Los Angeles 46,
 California

Thousands of other types in stock. Send us your requirements.

IN STOCK

For Immediate Delivery . . . Brand New

JAN-C-25 CAPACITORS

CP 53 - CP 54 - CP 55
 CP 61 - CP 63 - CP 65
 CP 67 - CP 69

Every "D" - "E" & "F" characteristic item listed in JAN-C-25

CP-70 CAPACITORS

"D" - "E" & "F" Characteristics
 "B" and "E" Terminals
 600 - 1000 - 1500 Volts

Also
 "E" TERMINAL CAPACITORS
 HIGHER VOLTAGES

Jan-C-91 CAPACITORS

Types CN-35 and CN-43

Commercial Type Capacitors

BATHTUB TYPES:
 (Commercial equivalents CP61 through CP70)

SMALL AND LARGE RECTANGULAR CONTAINER TYPES:
 Commercial equivalents (CP53, CP54, CP55)

MOLDED PAPER:
 Rectangular (Commercial equiv. CN35 & CN43)
 Tubular

METAL TUBULAR—GLASS END SEAL

METALLIZED PAPER:
 Cardboard tubular
 Metal tubular—glass end seal
 Hermetically sealed metal container types (CP53 through CP70 Containers)

MOUNTING BRACKETS:
 CP06 & CP07—spade lug and footed

NOISE SUPPRESSION CAPACITORS AND FILTERS

O'DEL ELECTRONICS CORPORATION

291-293 West Broadway • New York 13, N. Y. • CA nal 6-4700

**WHEN YOU ORDER
WELLS
COMPONENTS...**



**HERE'S WHAT
YOU GET**

- 1 IMMEDIATE DELIVERY FROM STOCK
(in any quantity)
- 2 FINEST QUALITY OF FAMOUS BRANDS
- 3 GENERALLY LOWER PRICES
- 4 RETURN PRIVILEGE FOR FULL
CREDIT IF NOT SUITED TO YOUR
REQUIREMENTS

The valuable service Wells provides to the industry is being used by many of our greatest manufacturers as a matter of course.

Our vast stock (the world's largest) may contain just the components you need to fill urgent orders — at a substantial savings in time and cost.

ADEL CLAMPS • ANTENNAS, Insulators, Mast Sections • BINDING POSTS • BLOWERS • CABLE ASSEMBLIES • CHOKES • COILS • CONDENSERS Oil Filled, Bath tub, Hearing Aid, Transmitting Mic, Silver Mic, Ceramic, Variable, Trimmer • CRYSTALS • FILTERS • FUSES & MOUNTINGS • GENERATORS • GROUND RODS • HEADSETS • I.F. COILS • JACKS • JACK BOXES • KEYS, Telegraph KNOBS • LAMPS • LORD MOUNTS • LUGS MOTORS & BRUSHES • PLUGS • RECTIFIERS Selenium, Copper Oxide, Meter, Diode • RESISTORS—All Types • SELSYNS • SOCKETS • SWITCHES Aircraft, Micro, Switchettes, Toggle • TIMERS • TUBING—Flexible • TUNING SHAFTS • TRANSFORMERS All Types • VIBRATORS • WALKIE TALKIES

DYNAMOTORS

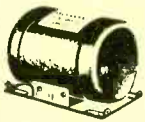

**OVER 100,000
NEW DYNAMOTORS
IN STOCK!**

DM 32A — DM 53A — PE 86 — PE 101C
DM 33A — D 101 — PE 94, etc.
Large quantities of brushes for all
types of dynamotors and motors.

Write us for quotations. Advise us
your requirements.

A complete Signal Corps stock number listing of items in our stock. Write for listing No. 5G-200. (For government agencies and contractors only.)

Manufacturers and distributors—write for new Condenser Catalog C-10 now available.

Write, Wire, Phone Your Requirements
all phones: **SEeley 8-4143**

**WELLS
SALES, INC.**

833 W. CHICAGO AVE., DEPT. SL, CHICAGO 22, ILL.

ELECTRONICS — September, 1953

RESISTORS

A M E R I C A ' S **B** E S T

Immediate deliveries from our stock in New York:

10% toler.:	1-99 ea.	100-999 ea.	1000 or more
½ watt	\$.05 ea	\$2.75 p/C	\$22.50 p/M
1 watt	\$.075 ea	\$4.75 p/C	\$37.50 p/M
2 watt	\$.10 ea	\$7.75 p/C	\$57.50 p/M

5% tolerance: add 100% to the above prices.
Prices are for EACH value separate.

Indicate TWO choices of make, or we will
ship as per our choice.

LEGRI S COMPANY

158 WEST 99 STREET, NEW YORK 25, N. Y.

Phone: UNiversity 5-4110

STOP
LOOK
LISTEN .

Re: Subcontracting work. One of the finest small plants in the South has open capacity for additional subcontracting work. Electronic, mechanical, optical, photographic field. The brochure describing facilities and qualifications of this plant will be mailed on request. Quotations are made within a few days. Represented by

LEGRI S COMPANY

158 WEST 99 STREET, NEW YORK 25, N. Y.

Phone: UNiversity 5-4110

SPECIAL PURPOSE TUBES

C1A.....	\$6.25	3C24.....	1.00	12GP7.....	11.50	307A.....	3.25	706FY.....	30.00	833A.....	30.00
1B22.....	1.75	3C31.....	2.50	RX-21.....	5.50	310A.....	3.50	706GY.....	30.00	836.....	2.50
1B23.....	6.75	3DP1.....	3.00	RK-72.....	1.00	311A.....	4.75	707A.....	4.00	837.....	1.00
1B24.....	7.75	3DP1A.....	5.00	RK-73.....	1.00	313C.....	2.25	707B.....	9.50	838.....	2.50
1B35.....	8.00	3E29.....	10.50	75T.....	5.00	316A.....	1.00	708A.....	2.75	846.....	65.00
1C21.....	2.00	3EP1.....	3.50	FG-95.....	16.50	323A.....	11.25	709A.....	2.75	849.....	22.50
2AP1.....	6.75	3FP7.....	1.00	100TH.....	6.00	328A.....	4.25	714AY.....	5.25	860.....	2.75
2C40.....	5.75	3GP1.....	3.00	F-128A.....	65.00	329A.....	6.00	715A.....	3.00	861.....	10.00
2C43.....	8.75	3JP12.....	15.00	VT-158.....	50.00	348A.....	4.50	715B.....	4.50	866A.....	1.00
2C44.....	1.00	3KP1.....	9.75	FG-172.....	18.75	353A.....	3.25	715C.....	13.75	869B.....	65.00
2D21.....	1.00	4C27.....	12.75	FG-190.....	9.00	354A.....	15.00	719A.....	18.25	878.....	1.50
2E22.....	1.75	4J34.....	112.50	204A.....	37.50	355A.....	10.50	721A.....	2.00	884.....	1.25
2J22.....	5.25	4J35.....	150.00	F-207.....	180.00	368AS.....	5.25	723A/B.....	13.50	892R.....	257.25
2J27.....	11.25	5BP1.....	3.50	212E.....	32.00	375A.....	10.50	724A.....	2.00	902-PI.....	4.75
2J31.....	20.25	5BP4.....	3.50	WL-218.....	35.00	394A.....	3.00	724B.....	2.00	918.....	1.25
2J32.....	22.50	5CP1.....	3.50	221A.....	1.25	417A.....	6.00	725A.....	4.75	923.....	1.00
2J33.....	20.25	5D21.....	13.75	F-232CH.....	180.00	GL-434A.....	9.75	726A.....	8.75	927.....	1.00
2J34.....	18.75	5FP7.....	1.50	250R.....	6.00	446A.....	1.00	726B.....	35.00	931A.....	3.75
2J38.....	9.00	5FP14.....	12.25	250T.....	7.50	446B.....	2.25	728CY.....	25.00	CK-1006.....	2.75
2J50.....	15.75	5JP1.....	16.75	250TH.....	13.50	450TL.....	35.00	728DY.....	25.00	1622.....	1.50
2J55.....	63.75	5JP4.....	16.75	250TL.....	8.50	GL-451.....	3.00	728EY.....	25.00	1624.....	1.25
2J56.....	122.50	5JP11.....	16.75	253A.....	11.75	464A.....	6.00	728GY.....	25.00	2050.....	1.00
2J61.....	30.00	5J23.....	30.00	267B.....	8.75	527.....	8.75	803.....	2.50	ZB-3200.....	150.00
2K25.....	20.50	5J29.....	9.00	271A.....	7.25	WL-530.....	12.75	807.....	1.25	8012.....	1.50
2X2A.....	1.25	5J30.....	29.50	272A.....	5.25	575A.....	7.50	808.....	1.50	8013.....	2.00
3AP1.....	4.75	5R4GY.....	1.00	274B.....	2.25	700A.....	12.50	811.....	2.25	8014A.....	41.25
3BP1.....	3.75	6C21.....	16.75	276A.....	7.50	700D.....	12.50	814.....	2.50	8025.....	3.50
3B24.....	4.25	6CF.....	12.75	282A.....	10.25	701A.....	4.50	829A.....	7.50		
3B24W.....	6.75	C6L.....	9.00	286A.....	6.00	702A.....	2.00	829B.....	9.00		
3B26.....	2.75	7BP7.....	4.00	304B.....	5.75	703A.....	3.50	832.....	6.00		
3C22.....	54.50	9LP7.....	2.25	304TH.....	6.00	705A.....	1.00	832A.....	7.50		
3C23.....	8.75	12DP7.....	8.75	304TL.....	5.00	706AY.....	30.00				

- Receiving tube quotations upon request
- Usual terms apply

western engineers

ELK GROVE, CALIFORNIA

GEORGE WHITING, OWNER

- Unconditional guarantee extended
- Subject to prior disposition

LERU LABORATORIES, INC.

Wayne, N. J.
Paterson, N. J.

Black Oak Ridge Rd.
Mailing Add. RD4

Tel. Terhune 5-2765,6

Production, Modification and Development of Radar Equipment.

A-1, Mark-10, Mark-16, Mark-20, SL-1, SG-1, APS-4, APS-6, APS-15, APQ-13, CPN-8, TPS-1.

Our personnel and facilities guarantees performance to exacting specifications.



Antenna Assembly and Alignment.

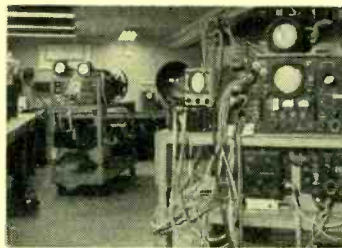

Complete System Acceptance Testing.

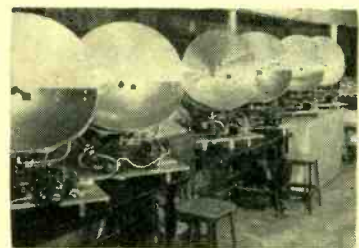

Airborne Search Antennas.



Control and Junction Box Assembly and Inspection.



Radar Receiver Alignment and Test.



Pressurization and HI-Voltage Breakdown Test.

Your inquiries are invited on any phase of our activities

CONDENSERS

NEW OIL CONDENSER SPECIALS GUARANTEED

6 mfd—150 V . . . \$.35
Three term. dual 3 mfd. oil cond. complete with brackets, measuring 4 1/4" x 1 1/4" x 1 1/4". Ideal for audio crossover networks.

2 x 1 mfd—230 VAC . . . \$.49
2 S.T. Bath tub

7 mfd—600 V . . . \$ 1.45
By leading mfg. 2 1/2" x 3 3/4" x 1 1/4"

.2 mfd—1000 V . . . \$.19
Standard size 2 ST bath tub

1 mfd—600 V . . . \$.63
Channel BT mtg. Lots of 100, 10% disc.

OVER 16,000 SOLD

10 mfd—600 V . . . \$.98
Three term. hot mtg. 2 channel type. Dims. 3 1/2" x 2 1/2" x 2". Two 5 mfd. sections rated 400 V at 72 deg "C". 1800 V test. Meets commercial specs. for 600 V operation up to 40 degs "C". Ideal for filter or power factor application. Repeat sales prove this rugged high quality condenser to be of outstanding value. Carton of 24, weight .85 lb. 42 lbs. Large qty. available . \$ 8.99

16 mfd—600 V . . . \$ 1.75
Dual 8 mfd. hermetically sealed and packed. Tube type PT-SC-11 measuring 3 1/2" x 2 1/2" x 2 1/2". Stud mtg centers 2". Plugs into standard four prong socket. Quantity discount.

5 mfd—1000 V . . . \$ 1.99

7 mfd—800 V . . . \$ 1.99
Insulated & guaranteed for 1000 V operation. Ind. boxed & herm. sealed. Top brand.

.5 mfd—400 V . . . \$.20
Avox #416MCT. 100 10%, 500 25%

AIRCRAFT TOG. SWS.

Aircraft type-20A @ 24 VDC-10A @ 125 VAC-C-H
 CM# Circuit Spec. Circuit
 #201 K4 B-7A SPBT On-Mom. Off
 #211 K5 B-6B SPBT On-Mom. Off
 #208 K4 B-7A SPBT On-Of-Mom. On
 #210 K5 B-11 SPBT On-Of-Mom. On
 #200 K8 AN3022-1B SPDT On-Of-On
 Flush Mounted-Luminous Tip—Bat. Handle—
 Price—\$.22 ea.; \$20/100; \$170/1000
 To get 1000 qua. disc. you may combine types

OTHER AIRCRAFT TYPES

CM# Circuit Cur. @ 125vac Price
 #871 K4 SPBT 15A Push but.—
 Type A2—On-Mom. Off \$ 5.9 P.T.
 #905 SP-4Pos.36A @ 24VDC On-Of-Mom.
 K-514 On-Mom. On .79 L.T.
 #905 K-628 SPST 5A B-6A-1 1/4 Bat. 32 L.T.
 #905 K-722 3PST 10A Of-Mom. Off .79 L.T.
 #911 K-524 DPST 16A Push But. Of-Mom. On .59 P.T.
 #202 K-7 SPST 10A 2 Gang B-5A .52 L.T.
 10% Dis. in quantity of 100 or more per Type.

TOGGLES SWITCHES

CM# Circuit Price AH & H Circuit Price
 #800K4 SPDT \$.80 GA. 125V DPST \$.42
 #824K4 DPDT .76 6A. 125V DPDT .56

RELAYS & CONTRACTORS

Type	Volt	Ohms	Current	Action	Price
1027	12	Leach	87	8 DPDT	1.25
1028	12	Leach	100	4 DPDT	1.25
1220-DE	24	Leach	98	20 SPST.	1.25
1222-BF	24	Leach	160	Double Break	1.25
1227-2BA	24	Leach	140	25 SPST.	1.25
1254M	24	Leach	160	10 2-SPST.	1.25
7055	12	Leach	100	50 SPST N.O.	3.50
2791-B100-C3	24	GE	150	8 DPDT	.95
2791-B100-G3	24	GE	230	3PST N.O.	.95
9340-H7A	24	Sq. D	132	250 SPST N.O.	2.75
9340-H7B	24	Sq. D	150	8 SPST N.O.	2.95
6046-H1A-C1	24	CH	70	50 DPDT	9.95
6046-H1B-C1	24	CH	70	50 DPDT	11.95
6046-H2B-C2	24	CH	70	50 DPDT	11.95
B-8 Time Delay	24	Quard	500	8 SPDT	.95
106-612	115	WL	8	DPST	1.50
9340-975	24	Sq. D	500	4 Pole	8.95

DIESEL GEN.

25 KW 3 phase 60 cy. Hill diesel, G.E. Gen. Complete with control panel & starting batteries. Ready for immediate operation. Guaranteed, P.U.R.

TYPE "J" POTS \$.89

OHMS SHAFT	OHMS SHAFT
50 1/8 S	20000 1/4 & 1/8 L
100 1/8 S	25000 3/8 & 1/8 S
150 1/8 S	30000 1/2 & 1/8 S
300 3/8 S	40000 1/2 & 1/8 S
1000 1/8 S & 1/8 S	50000 1/2 & 1/8 S
1500 1/8 S	100000 1/2
2000 1/8 S & 3/8 S	150000 2/8
2500 1/8 S	200000 1/8 L, w/1
3000 1/8 S	250000 1/8 L, w/1
5000 1/4	300000 1/8 L, w/1
5000 1/8 S & 3/8	300000 1/8 L, w/1
10000 3/8 & 1/7	(2 term.)
10000 5/8	5 Mec. 1/8 L
15000 1/8 S	1 Mec. 1/8 S & 1/8

CHOKES & FIL. TRANS.

3 Hen. 1.30 amp.	\$ 9.50
5 Hen. 2 amp.	P.U.R.
5 Hen. 1.5 ma.	.89
8 Hen. 150 ma.	@ \$ 1.50
20 Hen. 300 ma.	10.50
5-25 Hen. 200 ma.	3.25
50 Hen. 125 ma.	2.35
Prim. 115V., Sec. 6.3V @ 6A.	2.25

Mfd	Volts	Price	Mfd	Volts	Price
001-006	10KV	4.75	1	26KV P.U.R.	59.79
01	10KV	4.75	3	600V TLAD	.85
012	25KV	22.50	3	1000V	.85
02	10KV	5.25	3	1000V TLA	1.29
02	20KV	17.90	3	1500V	1.79
025-025	50KV	\$8.00	3	2000V	2.80
03	10KV	15.25	3	2500V	3.95
05	2KV	2.49	3	3000V	5.80
05	7500V	2.95	3	4000V	7.95
08	12.5KV	15.85	3	5000V	14.95
08	1500V	.59	3	6000V	19.55
1	2000V	.49	3	12.5KV P.U.R.	.0001
1	3000V	.59	3	1500V	1.25
1	4000V	.69	3	1500V P.U.R.	.0015
1	5000V	.79	3	2000V	2.80
1	7500V	1.39	3	3000V	4.95
1	10KV	3.50	3	4000V P.U.R.	.0002
1	15KV	9.50	3	5000V	7.95
1	12KV	14.95	3	6000V	11.95
1	15KV	16.95	3	7500V P.U.R.	.0015
1	20KV	22.50	3	1000V	1.25
1	30KV	38.00	3	1500V	1.95
1	40KV	53.50	3	2000V	2.80
1	50KV	79.00	3	3000V	4.95
1	60KV	104.50	3	4000V	7.95
1	75KV	159.50	3	5000V	11.95
1	10KV	14.95	3	6000V	14.95
1	15KV	20.50	3	7500V	20.50
1	20KV	27.00	3	1000V	1.25
1	30KV	38.00	3	1500V	1.95
1	40KV	53.50	3	2000V	2.80
1	50KV	79.00	3	3000V	4.95
1	60KV	104.50	3	4000V	7.95
1	75KV	159.50	3	5000V	11.95
1	10KV	14.95	3	6000V	14.95
1	15KV	20.50	3	7500V	20.50
1	20KV	27.00	3	1000V	1.25
1	30KV	38.00	3	1500V	1.95
1	40KV	53.50	3	2000V	2.80
1	50KV	79.00	3	3000V	4.95
1	60KV	104.50	3	4000V	7.95
1	75KV	159.50	3	5000V	11.95
1	10KV	14.95	3	6000V	14.95
1	15KV	20.50	3	7500V	20.50
1	20KV	27.00	3	1000V	1.25
1	30KV	38.00	3	1500V	1.95
1	40KV	53.50	3	2000V	2.80
1	50KV	79.00	3	3000V	4.95
1	60KV	104.50	3	4000V	7.95
1	75KV	159.50	3	5000V	11.95
1	10KV	14.95	3	6000V	14.95
1	15KV	20.50	3	7500V	20.50
1	20KV	27.00	3	1000V	1.25
1	30KV	38.00	3	1500V	1.95
1	40KV	53.50	3	2000V	2.80
1	50KV	79.00	3	3000V	4.95
1	60KV	104.50	3	4000V	7.95
1	75KV	159.50	3	5000V	11.95

BATH TUB COND.

Mfd	Volts	Price	Mfd	Volts	Price
01-01	800	\$ 2.25	3x.25	800	.65
02-02	800	2.25	1000	.48	
04-04	800	2.25	3	400	.35
05	800	2.25	3	400	.37
05-05	800	2.25	5	800	.47
08-08	800	2.25	5	800	.52
1	800	2.25	10	1000	.69
1	1000	2.45	1	200	.25
1	1200	2.65	1	300	.35
1	1400	2.85	1	400	.45
1	1600	3.05	1	500	.55
1	1800	3.25	1	600	.65
1	2000	3.45	1	800	.85
1	2200	3.65	1	1000	1.05
1	2400	3.85	1	1200	1.25
1	2600	4.05	1	1400	1.45
1	2800	4.25	1	1600	1.65
1	3000	4.45	1	1800	1.85
1	3200	4.65	1	2000	2.05
1	3400	4.85	1	2200	2.25
1	3600	5.05	1	2400	2.45
1	3800	5.25	1	2600	2.65
1	4000	5.45	1	2800	2.85
1	4200	5.65	1	3000	3.05
1	4400	5.85	1	3200	3.25
1	4600	6.05	1	3400	3.45
1	4800	6.25	1	3600	3.65
1	5000	6.45	1	3800	3.85
1	5200	6.65	1	4000	4.05
1	5400	6.85	1	4200	4.25
1	5600	7.05	1	4400	4.45
1	5800	7.25	1	4600	4.65
1	6000	7.45	1	4800	4.85
1	6200	7.65	1	5000	5.05
1	6400	7.85	1	5200	5.25
1	6600	8.05	1	5400	5.45
1	6800	8.25	1	5600	5.65
1	7000	8.45	1	5800	5.85
1	7200	8.65	1	6000	6.05
1	7400	8.85	1	6200	6.25
1	7600	9.05	1	6400	6.45
1	7800	9.25	1	6600	6.65
1	8000	9.45	1	6800	6.85
1	8200	9.65	1	7000	7.05
1	8400	9.85	1	7200	7.25
1	8600	10.05	1	7400	7.45
1	8800	10.25	1	7600	7.65
1	9000	10.45	1	7800	7.85
1	9200	10.65	1	8000	8.05
1	9400	10.85	1	8200	8.25
1	9600	11.05	1	8400	8.45
1	9800	11.25	1	8600	8.65
1	10000	11.45	1	8800	8.85
1	10200	11.65	1	9000	9.05
1	10400	11.85	1	9200	9.25
1	10600	12.05	1	9400	9.45
1	10800	12.25	1	9600	9.65
1	11000	12.45	1	9800	9.85
1	11200	12.65	1	10000	10.05
1	11400	12.85	1	10200	10.25
1	11600	13.05	1	10400	10.45
1	11800	13.25	1	10600	10.65
1	12000	13.45	1	10800	10.85
1	12200	13.65	1	11000	11.05
1	12400	13.85	1	11200	11.25
1	12600	14.05	1	11400	11.45
1	12800	14.25	1	11600	11.65
1	13000	14.45	1	11800	11.85
1	13200	14.65	1	12000	12.05
1	13400	14.85	1	12200	12.25
1	13600	15.05	1	12400	12.45
1	13800	15.25	1	12600	12.65
1	14000	15.45	1	12800	12.85
1	14200	15.65	1	13000	13.05
1	14400	15.85	1	13200	

SEARCHLIGHT SECTION

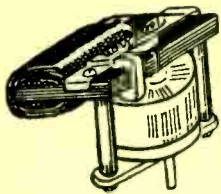

Genuine TELECHRON Motors

- 2 RPM. \$2.90
- 3 RPM. 3.90
- 4 RPM. 3.90
- 3.6 RPM. ... 3.15
- 1 RPM. 3.95
- 60 RPM. ... 4.30
- 3 R.P. Hr. ... 2.85
- 1 R.P. 12 Hr 4.25

1800 RPM SYNCHRONOUS Motor: 115 volts AC, 18 watts 1 1/4 lbs.; 2"x3"x2"..... **\$4.50**

Hand Cranked A.C. Generators { 2 bar. \$4.50
Removed from Ancient Telephones { 3 bar. \$5.50
5 bar. \$6.50

Polarized Bell or Buzzer Works on Magneto or 115 volt A.C. **\$1.50**

Complete 2 Station Magneto Ringer Telephones. Incl. Batteries—wire. **\$17.50**

ZENITH Motorized Remote control made for T.V. but ideal for opening doors—windows—Turntables—Gadgets—Tuning Radios. Complete with Transformer 18 ft. cable and reversing button. **\$8.95**
A few more left.....

NE-2 1/25 Watt NEON Pilot lamp \$7.50

NE-16 3/4 Watt NEON lamp D.C. \$3.00

NE-21 3/4 Watt NEON lamp S.C. \$2.50

NE-48 1/4 Watt NEON lamp D.C. \$2.50

NE-30 1 Watt NEON lamp Med. \$2.00

AR-1 2 Watt ARGON lamp Med. \$3.00

NE-40 3 Watt NEON lamp Med. \$3.50

#313 28 volt .2 Amp. Pilot lamp \$2.80

#1820 28 volt .1 Amp. Pilot lamp \$2.00

#49 2 volt .06 Amp. Pilot lamp \$1.00

1 3/4 volt Transformer made for #28 tube filament. Will light 30 of the above #49 lamps. **\$1.50**

#C1256 6 volt Automobile lamp D.C. but no pins to hold it in socket. 20 for. **\$1.00**

#1800 Special—100 for. **\$3.50**

#112 1.35 volt .08 Amp. Pilot lamp \$1.00

1.1 volt Flashlight lamp single pen-lite Battery. 20 for. **\$1.00**

HAYDON SYNCHRONOUS TIMING MOTOR

110 v. 60 cycle 30 RPM. **\$2.60**

110 v. 60 cycle 1/10 RPM. **\$2.35**

110 v. 60 cycle 1 RPM. **\$2.85**

220 v. 60 cycle 2 RPM. **\$1.65**

New Sound Powered HAND SET TELEPHONES 50' Flex. Rubber covered cable FREE. Pair **\$19.00**

ALL PRICES F.O.B. N. Y.

EST. 1923

BLAN

EST. 1923

64A Dey St.

New York 7, N. Y.

Perhaps the smallest reversible GEARED-MOTOR in the world

Delco-PM-Permanent Magnet Alnico Field Motor #5071895 some with 1 1/16" rear, some with smooth 1/4" shaft. 250 RPM, 27 volts, 100 ma. Speed depending on the voltage. Designed to be used in bombsights, automatic pilots, etc. Cost at the factory \$28.10. Delivery 4 months. **\$17.50**
OUR PRICE Immediate Delivery!!

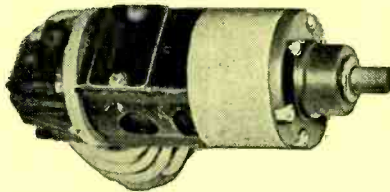

Packaging for parcel post costs money; it costs no more to pack two motors in the same box, so you can take advantage of our

SPECIAL 1/2 Price OFFER

1st motor. ... \$17.50, 2nd motor. ... \$8.75

2 MOTORS AT FRACTION OF FACTORY COST. **\$26.25**

Also have #5067127

Clamps to hold motor: \$1.50 ea.

Subject to prior sale



GRAIN OF WHEAT LAMPS

#322 3 V. .19 amp

#328 6 V. .2 amp

100 for \$25.00 10 for \$3.00



MARKTIME 5 HOUR SWITCH

A 10 amp. timing device. Pointer moves back to zero after time elapses. Ideal for shutting off radios and TV sets when you go to bed. Limited supply at this special PRICE. **\$4.90**

Also available in 15 min., 30 min., 1 hr. at \$5.90

10 Seconds to 24 Minutes Timer

A hand wound electric TIMING SWITCH. Pointer moves back to ZERO and shuts off RADIO—TV—Electric Mixer—Photographic Devices—Time Delay etc. Furnished with Calibration Chart and Pointer Knob. Biggest bargain \$1.25 we ever had.....



1" Round Elapsed Time Meter **\$1.25**

General Electric \$15.50

Westinghouse Square \$16.00



REDMOND Powerful 5" Blower or Ventilator 115 volts AC 60 cycles 18 watts. For Kitchen—Laboratory. Heat or Cold or Chemicals. **\$7.50**

A Miracle Switch that will not leave you in the Dark. Delayed Action Light Switch **\$1.95**

POWER RHEOSTATS



ohms	W	Ea.	ohms	W	Ea.	ohms	W	Ea.
.1	150	4.89	50	50	2.10	500	100	3.60
.5	25	1.98	60	25	1.86	500	150	4.63
.5	50	2.34	75	25	1.86	500	300	6.93
.5	150	4.89	75	50	2.10	750	25	1.86
1	50	2.34	75	75	3.25	750	150	4.90
1	50	2.34	80	50	2.10	1000	25	2.10
2	100	3.86	100	25	1.86	1000	50	2.22
2	300	6.93	100	50	2.10	1200	225	6.41
3	100	3.86	100	100	3.60	1200	300	6.93
3	225	6.41	125	25	1.86	1250	50	2.22
5	25	1.86	150	50	2.10	1250	150	4.90
5	50	2.10	175	25	1.86	1500	25	2.10
5	100	3.86	185	25	1.86	1500	50	2.22
5	150	4.63	200	25	1.86	1600	50	2.22
6	25	1.86	200	100	3.60	1800	150	5.15
6	50	2.10	200	150	4.63	2000	25	2.10
6	75	3.25	225	50	2.10	2000	50	2.22
7	25	1.86	250	25	1.86	2250	150	5.15
7.5	75	3.25	250	50	2.10	2500	100	3.71
7.5	225	6.41	300	50	2.10	2500	100	3.71
8	50	2.10	300	75	3.25	2500	150	5.15
10	25	1.86	300	100	3.60	3000	25	2.10
10	50	2.10	350	25	1.86	3000	100	3.71
10	100	3.86	350	100	3.60	5000	25	2.22
12	25	1.86	350	150	4.63	5000	50	2.22
12	50	2.10	370	25	1.86	7500	50	2.22
15	25	1.86	378	150	4.63	7500	100	4.40
15	75	3.25	400	25	1.86	10000	50	2.50
15	100	3.86	400	75	3.25	10000	100	4.75
20	50	2.10	500	25	1.86	15000	25	2.10
25	25	1.86	500	50	2.10	20000	150	6.93
50	25	1.86	500	75	3.25			

Specify Type Shaft Required—1/4" S5 or Knob Type (Special Prices to Quantity Users)

HIGH POWER TR. MICA

G-1 TYP	.000c	10Kv	.006	10KV
.0001	6KV	.00065	10KV	.015
.00015	6KV	.001	10KV	.25
.0002	6KV	.002	10KV	1.6KV
.0004	6KV	.03	2KV	.00025
.0008	6KV	.045	2KV	.0006
.01	6KV	.001	2KV	.0025
.032	4KV	.00015	20KV	.0039
.04	1KV	.00025	20KV	.0075
.051	1.5KV	.0004	20KV	.01
.08	1.5KV	.00045	15KV	.01083
.09	1.5KV	.00047	20KV	.03
		.0005	20KV	.056
.0001	10KV	.00095	5KV	.000155
.00015	10KV	.001	20KV	.0004
.0002	10KV	.0012	20KV	.000533
.0003	10KV	.00124	15KV	.001
.000375	10KV	.0015	20KV	.007
.004	5KV	.0051	10KV	.007

OTHERS (Many Others)

TRANSMITTING MICAS TYPE "4" and "9"

mfd.	kw	type	ea.	mfd.	kw	type	ea.
.001	600	4	.36	.0015	600	4	.36
.001	600	4	.36	.00162	600	4	.42
.00005	600	4	.29	.002	600	4	.39
.00005	2500	9	.57	.002	1200	4	.72
.0001	600	4	.29	.0025	600	4	.39
.0001	2500	9	.57	.003	600	4	.43
.00015	600	4	.36	.004	600	4	.45
.0002	600	4	.29	.005	1200	9	.39
.00025	600	4	.29	.0047	600	4	.47
.0005	600	4	.29	.005	2500	9	1.86
.0005	2500	4	.75	.006	600	4	.54
.0005	2500	9	.77	.01	600	4	.65
.0006	2500	9	.85	.01	1200	9	1.41
.0007	600	4	.36	.02	600	4	.92
.00075	600	4	.36	.02	1250	9	2.12
.0008	600	4	.36	.025	600	4	1.08
.0009	600	4	.36	.03	300	4	.99
.001	600	4	.36	.03	600	4	1.34
.001	1200	4	.54	.043	600	4	1.75
.001	1200	9	.57	.05	300	4	1.19

Many other sizes in stock



TYPE "J" POTENTIOMETERS

TYPE "J" TYPE "JL" TYPE "JJ"

\$1.25 \$1.50 \$2.95

ohms	ohms	ohms	ohms
150*	400†	80K†	500-500†
200†	500†	100K†	600-600†
200*	650†	125K*	1500-1500*
300†	900†	150K*	2000-2000†
400†	10K*	165K†	2000-50K*
500†	12K†	250K†	2200-25K†
600†	15K*	300K*	5000-35K†
650†	20K*	400K*	25K-10K†sw
750†	25K*	1Meg*	2000-20K†
1000*	30K*	1Meg†	25K-10K†
1400†	50K*	2Meg†	7K-1Meg†
1500†	60K*	3Meg*	5K-5K†
2000†	75K†		400K-400K*
			25K-400K†
			1Meg-500K†
			50K-50K†

Type "JJ" \$4.95

20K-200K-20K† 750K-750K-750K†
45K-27K-2.5K 1/2 sh 800K-800K-800K†
700K-700K-700K† 1Meg-1Meg-1Meg†

(*) 1/8" screwdriver slotted shaft. (†) Knob type shaft. (**) Both types.

Many other Hard-To-Get items available for immediate delivery from our large inventory. Send us your requirements and let us quote.

New MICA listing now ready.

A. MOGULL CO.

17 Warren St., N. Y. 7, N. Y.

Phone: WORTH 4-0865-6431

AN/APR-4 LABORATORY RECEIVERS

Complete with all five Tuning Units, covering the range 38 to 4,000 Mc.; wideband discone and other antennas, wavetraps, mobile accessories, 100 page technical manual, etc. Versatile, accurate, compact—the aristocrat of lab receivers in this range. Write for data sheet and quotations.

We have a large variety of other hard-to-get equipment, including microwave, aircraft, communications, radar; and laboratory electronics of all kinds. Quality standards maintained. Get our quotations!

We will buy any Electronic Material at top prices. SCHOOLS—unload your dusty surplus for cash or credit.

ENGINEERING ASSOCIATES

434 PATTERSON ROAD

DAYTON 9, OHIO

WE BUY AND SELL GOVERNMENT SURPLUS

electronic components, units, wire, etc.

Your Inquiries Invited

LAPIROW BROS.

1649 Hoffner St. Cincinnati 23, Ohio
Klrby 1285

SEE OUR AD

PG 484

- Parts & Equipment
- Amplifiers & Power Supplies (stand-ard and to-order)

COMPONENTS SUPPLY CO.



THE MARK OF WHOLESALE ECONOMY

STOCK-UP! BUY AT THESE 1947 PRICES

SPECIAL OFFER
Oil Filled Condenser
 .25 MFD, 6000 VDC
 25F659

3 7/8" High, 3 3/4" Wide
 1/4" Thick, Brand New

Lots of One Hundred **\$2.90**
 EACH



TELECHRON SYNCHRO-NOUS MOTOR

Type C-5, 115 volts, 60 cycles, 1 RPM, 6 watts, 3/16" shaft, 3/4" long. Overall size 3-3/8" high, 2 7/8" thick. Usually \$14.50. Your Cost \$4.90

CONDENSERS—Standard Brands

10 MFD	600 VDC	CP-70 STYLE	\$2.50	.005 MFD	TYPE 9 MICA	\$7.79
2 MFD	750 VDC	S1318745	1.25	.01 MFD	2500 WVDC	.75
2 MFD	1000 VDC	D-4430	1.45		2500 WVDC	
1.5 MFD	1500 VDC	CP70B1FG205K	1.45		TYPE E MICA	
6 MFD	1500 VDC	8832A	1.25		8000 WVDC	\$5.50
3 MFD	1500 VDC	CRV48731	3.45	.01 MFD	8000 WVDC	4.90
1 MFD	2000 VDC	TJ15080	3.90	.0001 MFD	TYPE F MICA	
2 MFD	2500 VDC	TRS2001	1.60	.02 MFD	3000 WVDC	\$1.25
0.2 MFD	50K VDC	2509	2.90		2000 WVDC	1.05
		14F126	39.50		BATHTUBS	
.01 MFD	600 WVDC	TYPE 4 MICA	\$0.19	.5 MFD	400 VDC	SIDE \$1.60
.004 MFD	1200 WVDC	TYPE G MICA	0.31	.25 MFD	600 VDC	SIDE .60
.0025 MFD	25 KV	25 KV	\$60.00	.5 MFD	600 VDC	SIDE .75
.00025 MFD	20 KV	20 KV	39.50	.2 MFD	600 VDC	TOP .40



REDMOND BLOWER MOTOR:

Type L 3 1/4" fan 5 1/4" length
 115 volts 60 cycles 140 CPM
 1600 RPM\$9.50

STANDARD BRANDS TUBES FULLY GUARANTEED

2B22	\$ 2.95	316A	\$ 1.75	838	\$2.95
2J22	25.00	371B	1.15	955	.49
2J32	39.00	559	1.90	1299A	.89
3C24	1.40	703A	3.95	1619	.49
3GP1	5.75	705A	1.95	1625	.49
6SH7	.59	707A	18.00	1626	.49
211	.90	713A	1.25	1629	.39
HY114B	.49	717A	1.10	7193	.19
304TH	9.95	724B	2.50	9006	.49

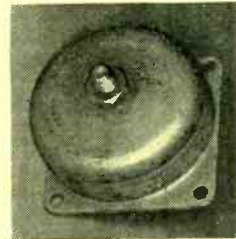

RUGGED SHOCK MOUNT

Barry Type C-2045, 250 pounds rated capacity, mounting centers 2 1/2" x 2 1/2".
 Only \$9.99 each

Electronics, INC. 92 Broad Street, Babson Park 57, Mass. — Wellesley 5-5210-1

QUARTZ CRYSTALS

Standard makes such as crystal Research, Bliley, etc. made to a tolerance of .03% or better and are available in the following frequencies and types: Type FT-243 (Pin Spacing 0.485, Pin dia. 0.093") Price \$1.15 each. In lots of 25 (can be ordered in various frequencies) Price \$23.75
 NOTE:—In the frequencies listed below, those shown singly are in quantities of 50 or more, while others showing two frequencies with the word "to" in between indicates a variety of frequencies, between these limits. In small quantities, for example:—"3761 to 2770" indicates availability in 3762, 3763—3770 KC.

FREQUENCY (IN KILOCYCLES)

1930	5500	5900	7525 to 7576	7725 to 7728.75	7840	8000	8550
2125	5630	5955	7560	7733.3	7850	8001 to 8100	8575
2320	5633.3	6000 to 6075	7580	7740	7860	8100 to 8200	8580 to 8591.7
2390	5650 to 5667.7	6100 to 6173.3	7608.3	7741.7	7870	8225 to 8291.7	8600 to 8691.7
2400	5655.5	6202.6 to 6250	7616	7750	7875	8250	8700 to 8741.7
2430	5677.7	6300 to 6375	7620	7751.25	7880	8260	8716.7
2940	5700	6400 to 6475	7625	7758.3	7890	8300	8786.25
3105	5706.7	6500 to 6575	7641.7	7773.75	7900	8333.3	8808.75
3110	5722.2	6600 to 6675	7650	7775	7906.6	8366.7	8876.25
3664 to 3690	5725	6700 to 6725	7660	7783.7	7925	8380	8921.25
3751 to 3799	5740	6825 to 6875	7673.3	7791.7	7930	8385	9135.0
3825	5744.4	6830	7675	7800	7940	8306.6 to 8375	9500
4280	5750	6900 to 6975	7691.7	7806.6	7950	8400	9411 to 9500
4375.25	5760	6978.75	7700	7810	7960	8425	9501 to 9583
4644 to 4650	5773.3	7239 to 7240	7708.3	7820	7975	8450	12,650 to 12,996
4840 to 4890	5790	7425 to 7475	7710	7825	7980	8408.3 to 8491.7	13,004 to 13,896
4900 to 4960	5800 to 5893	7458.75	7716.7	7830	7983.3	8525	16,585.55

Type FT241 or CRIA/AR (Pin Spacing 1/2", Pin dia 1/8") Price each .79 25 for \$17.50

4390	5450	5840	6300 to 6370	6730	7270	7725 to 7790	8412 to 8490
4880	5604.1	5910 to 5970	6370	6870	7440	7800 to 7890	8500 to 8567
5030 to 5090	5740	6010 to 6090	6403 to 6490	6890	7460	7900 to 7990	8630
5100 to 5180	5780	6104 to 6181	6520 to 6590	6910	7500 to 7560	8236 to 8298.4	8645
5200 to 5295	5817.5	6203 to 6290	6630 to 6690	7140	7600 to 7675	8300 to 8351	11,677

Type DC 34 & 35 (Pin Spacing 13/16" Pin dia 3/16")

2326	2422	2540	3077.5	3190	3480	4305	4380
2360	2446	2851	3095	3270	3705	4325	4405
2390	2478	2863	3155	3462.5	4300	4345	

Type 241A W.E. (Pin spacing 0.485", Pin dia 0.093") Price \$1.15 ea. \$23.75 for 25

70.0	72.0	73.2	76.0	78.0	91.2	92.8	95.4	96.6	98.2
70.6	72.4	73.4	76.4	78.8	91.6	93.0	94.0	96.8	98.6
70.8	72.8	74.8	76.8	79.6	92.0	93.2	94.2	97.6	
71.6	73.0	75.4	77.6	80.8	92.4	93.6	94.6	98.0	

BE1205—We can supply Crystals ground to a tolerance of .01% to a frequency close in value to those crystals itemized in BE1201, BE1202, or BE1203. Price \$1.95 each

EDLIE ELECTRONICS, INC. 154 Greenwich Street
 New York 6, N. Y.
 Telephone DIgby 9-3143

FOR THE BEST IN QUALITY AND ECONOMY TRY STANDARD RADIO

SIGNAL CORPS CAPACITORS

NOT SPECIALS

A partial listing—many others also available for immediate delivery from our stock

Just examples of our customary low prices

Equipment Number	Sig. Corps No.
FMTR-50 BW	3DB6-33
EE 80 & EE 91	3D171
PE 104 A	3DE-250
BD 110 A	3DB2.958
BC 189 & 189A	3D 248
BC 191	3DB1.1A
FT 244A-RACK	3DB2.816
FT-300 FED. TRANS.	3DB4-75
SCR 300	3DB4.192
BC 412A	3DA200-1
BC 435A	3DA250-11
SCR 527A	3DA-120
BC-610	3DB3.8
BC-610	3DB8-161

For SCR-284

3D9150.16
3D9200-33.2
3D9500-23.2
3DB2.6020
3DB4-58

**For ART-13
Listed by CAP. No.**

C-105
C-106
C-107
C-118
C-119
C-120
C-122
C-124
C-126
C-128
C-129
C-130
C-201
C-202
C-207
C-208
C-2211
C-2212

For BC312 & BC342

3D195
3D277
3D281
3D284
3D289
3D290
3D291
3D371

PULSE TRANSFORMERS

Utah-9280	\$7.50
Utah-9350	7.50
West. 134BWF2	8.50
West. 166AW	7.50
Rayth. UX7307	4.75
Many Others	

W. E. Thermistors & Varistors

D 166382	\$2.95
D 166228	.98
D 167176	1.25
D 167613	.98
D 168392	1.15
D 168687	.98
D 162720	.75

Miscellaneous

.0001-20KV G3 Mica	\$19.95 ea.
.001-25KV 46 Mica	42.50 ea.
.001-1200WV 1445 Mica	20.00/c
1.0-500WV OIL	45.00/c
.0011-5KV 6 Mica	1.85 ea.
100 Watt 100 ohm Rheo.	1.59 ea.
B5A Switch	20.00/c

WE CARRY ONE OF THE LARGEST STOCKS IN THE COUNTRY OF OIL CONDENSERS, MICA CONDENSERS, HIGH WATTAGE RHEOSTATS, AIRCRAFT SWITCHES, OTHER SWITCHES, FUSES, FUSEHOLDERS AND TUBE SOCKETS.

GET OUR DOWN TO EARTH PRICES.

All Merchandise New and Guaranteed.

STANDARD COMPETES WITH THE LOWEST IN SELLING AND WITH THE HIGHEST IN BUYING. TRY US AND SEE. A SQUARE DEAL AT ALL TIMES. WE DEFY ANYONE TO PROVE OTHERWISE.

BI-MONTHLY BULLETINS. SEND US YOUR NAME SO WE CAN SEND YOU YOUR COPY. WE HAVE OVER 1,000 SATISFIED CUSTOMERS.

STANDARD RADIO—ELECTRICAL PRODUCTS

51 W. 3RD ST., N. Y. 12, N. Y. ORegon 4-4383

CONNECTORS IS OUR BUSINESS

WORLD'S MOST COMPLETE STOCK

Types In stock: AF, A, AP, ARC, BN, BNC, C, CLY, CN, CUF, D, DPB, DPD, E, F, FK, FM, FT, FW, GK, HN, IOH, IK, JJ, JK, LC, LF, LK, LN, M, MC, N, NK, P, PJ, PL, PM, PYE, RF, RFK, RGK, RNK, RTC, RWK, S, SF, SK, SKL, SO, U, UG, UHF, WK, XL, ZA.

HAROLD H. POWELL CO.
2104 Market St. LOcust 7-5285
Philadelphia 3, Pa.

X-RAY

All types for industrial and experimental application. Tubes, cables and components.

MEDICAL SALVAGE CO., INC.
217 E. 23rd St., New York 10, N. Y.
Murray Hill 4-4267

CARRIER EQUIPMENT

Western Electric CF-1A 4-channel carrier telephone terminals.
EE-101-A 2-channel 1000/20 cycle carrier ringers.
CFD-B 4-channel carrier pilot regulated telephone terminals complete with four channels 1000/20 cycle ringing.
CFD-B 4-channel pilot regulated telephone repeaters.
C-42-A V. F. telegraph in from 2- to 12-channel terminals.
FMC 1 or 2 channels carrier telephone terminals, automatic regulation, duplex signaling each channel. Carrier frequencies above 35 KC. Ideal for adding channels above type "C".
Complete engineering and installation services offered.

RAILWAY COMMUNICATIONS, INC.
Raytown, Missouri
Telephone: FLEMing 2121

HIGH VACUUM EQUIPT.

FORE PUMPS—DIFFUSION PUMPS
VACUUM COATERS—MISC. EQUIPT.
Some new. REASONABLE. Write for list
ZENITH OPTICAL LABORATORY
1940 Great Neck Rd. Copiague, L. I., N. Y.

SELENIUM RECTIFIERS

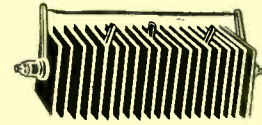

FULL WAVE BRIDGE TYPES

D.C. AMPS.	0-26 VAC 0-20 VDC	0-52 VAC 0-40 VDC	0-130 VAC 0-100 VDC	0-156 VAC 0-120 VDC
.5	\$2.75	\$5.10	\$9.85	\$11.40
1.0	3.65	6.85	15.50	18.15
1.5	3.90	7.35	16.20	18.90
2.0	5.55	10.10	20.50	23.95
4.0	7.45	13.95	29.65	36.00
6.0	8.00	14.65	30.40	37.00
8.0	9.65	18.20	42.00	49.60
12.0	10.25	19.05	43.85	51.80
15.0	17.40	32.80
22.5	18.20	34.30

RECTIFIER TRANSFORMERS

All Primaries Tapped
110-125 Vac 60 Cycles



SEC. VOLTS	AMPS	PRICE
18 VAC	10	\$9.95
tapped at 9V.	35	35.00
	70	60.00
36 VAC	2	\$5.95
	5	7.80
	10	12.95
	20	28.50
	35	45.00

HI-AMP CHOKES

5 AMPS	.03 HY	.2 OHM	\$7.95
10 AMPS	.015 HY	.06 OHM	13.95
20 AMPS	.007 HY	.03 OHM	28.50

FILTER CAPACITORS



W.V. D.C.	Cap. Mfd	Price	W.V. D.C.	Cap. Mfd	Price
12	3000	\$1.50	50	500	.95
15	1000	.75	50	1000	1.95
15	2000	1.25	50	2000	3.50
15	4000	2.50	150	200	1.75
18	1000	.90	200	500	3.25
18	2000	1.45	200	1200	6.50
25	1000	1.50			
35	2000	2.00			
35	3000	2.25			

MOTOR SPECIAL

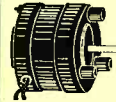

Diehl Cat #FB2101-6 115 Vac
60 Cycles 0.4 Amps 1800 RPM
4-Pole Shaded Type. Shaft
1/4" x 1" Long. Ball Bearing.
Cast Frame. Shpg. Wt. 6 Lbs.
Brand New.....\$4.50



OIL CAPACITOR

2 x .15 MFD 8000 V.D.C. Use
both section in parallel for .3 MFD
or in series for .075 MFD. Cat
#26F381.....99c
Lots of six in orig. carton.....\$5.00

MISCELLANEOUS

Grain-O-Wheat bulbs, type 319A, 3 volts Doz.\$1.00
Selenium Rect., Bridge, 36VAC-28VDC 2 Amp. 4.95
Circuit Brkr., 10 Amp, thermal, push-to-reset. 40
Guardian Relay, 250 Amp, Type BR. 2.50
Thordarson Choke 10 Hys. 55 Ma. Fully Casd. 65
Fuse, 1/40 Amp. 8AG Doz. .50
Oil Capacitor, 8 MFD 660VAC KGM6080 3.00
Phase Inverter, FTI MC-413-A w/tubes 3.00
Oil Capacitor, .5 MFD 400VDC, Rect. Case 10
Shaft Coupling, ceramic, 1/4" x 1/4" 15



FILTER CHOKE

50 Hys. 40 ma. 1780v. RMS Test. Ray-
theon Type U7402. Dimen. 3 1/2" x 3 1/2"
x 3 1/2". Shpg. weight 6 lbs.\$1.50

Minimum order \$5.00. All prices are FOB a flip
ping point. Send check or MO. We will ship
transportation charges collect. Rated concerns
send P.O., Terms Net 10 days.

GATES ELECTRIC

63 WEST BROADWAY
New York, N. Y. Phone WO 2-7587

TRANSMITTERS

Radio Telephone—Radio Telegraphy
All Frequencies
Single Units or Complete Systems
R.C.A.—ET-4336—350 watts—H.F.
Bendix—70 watts—4 channel—L.F.—H.F.
Bendix—50 watts—4 channel with rcvr
L.F.—M.F.
Collins—40 watts—Xtal—M.O. with rcvr.
M.F.—H.F.
R.C.A.—10 watts—Xtal—with rcvr. M.F.
G.E.—10 watts—Xtal—light weight, Air-
craft.
Federal T&T—400 watts—4 channel—
H.F.
W.E.—350 watts—2 channel—carrier shift

RECEIVERS

RCA—AR88D
Hammarlund—Super Pro.
Bendix—RA-10-DA
Collins—TCS
Hallicrafters—S-36
Wilcox—CW-3
Stromberg-Carlson—RBM U.S. Navy
Scott—SLR-F
R.C.A.—140 KC to 21000 KC. self con-
tained

*Equipment spare parts and accessories
for most equipment—New from stock*

WALKIE TALKIE and HANDIE TALKIE SPARE PARTS

for

BC-1000 (SCR-300)	BC-611 (SCR-536)
5 Gang Variables, I.F. Transformers, XTALS, 6815 K. C., 4300 K.C. Sockets, R.F. & OSC Coils	I.F. Transformers, R.F. and P.A. Coils, All Crystals, Caps, Cases, Bases, Tops, Antennas, Fittings, Insulators, Contact Plates, Switches, Resistors, Condensers and Manuals
Input - Output Transformers, Jacks, Fittings, CS-128 Cases, Plugs, Cables, Antennas (AN-130, AN-131), Handsets, Switches, Resistors, Condensers and Manuals.	

*Large Quantities
All New*

GUARANTEE:
Our equipment carries with it an un-
qualified guarantee of satisfaction to
the user.
Inquiries for material other than those
briefly listed here are welcome. We
offer and sell only material owned
by us.
Export packing facilities on the prem-
ises to expedite fast quotations over-
seas.

SEARCH RECEIVER—ARD-2

Frequency range 80 to 3000 Mcs.
Measures RF signals from 80 to 3000 Mcs
and pulse rates from 50 to 8000 cycles.
The ARD-2 can be used as a Direction Find-
er to locate signals, or as a frequency
meter, by VISUAL and AURAL indicators,
provide Originally designed and used by
USN aircraft. Ideally suited for military,
laboratory and general purpose use.
Equipment consists of the following:
ANTENNA DETECTOR-CMD-66AFH—Has
variable length antennas, diode detector
and silver plated tuning stub with cali-
brated scale.
AMPLIFIER CMD-50ADC—has three stage
pulse amplifier, a trigger circuit, a pulse
rate counter circuit and audio amplifier,
visual signal indicator, rectifier power
supply which is operative on 115 Volts
AC 60 to 2400 cycles current, regulated.
TEST OSCILLATOR-CMD-60ABG—has cavity
frequency of 400 cycles with selection of
four pulse repetition rates.
ALL CABLES AND FITTINGS, ACCESSORIES
AND SHOCK MOUNTED RACK for im-
mediate installation, plus two Technical
Manuals.
SPARE PARTS—Steel chest includes spares
for components and two extra sets of
spare tubes. Guaranteed NEW
All the above in original export packed
cases. Wt.: 113-lbs
Price each . . . \$375⁰⁰

MICROPHONE, WESTERN ELECTRIC
(#1120-DA), high quality, F-1 single but-
ton. Press-to-talk upright telephone stand
type new, individually boxed with cord
and W.E. Swbd plug similar to PL-68.
Perfect for airport, police commercial
radiotelephone installations. New, Each
\$8.50

COMMUNICATION DEVICES CO.

TWX—NY1—223
Cable—Commudev, N. Y.
Tel. ADirondack 4-6174

2331 TWELFTH AVENUE

NEW YORK 27, N. Y.

LOOKING FOR HARD-TO-FIND PARTS & EQUIPMENT?

*Just a partial list of our
present stock:*

- BC-348 • BC-342 • ART-13
- ARC-3 • APN-9 • LM
- BC-221 • BC-611

• VARIOUS TEST EQUIPMENT
NEW EXPORT DIVISION
FOR ALL FOREIGN ORDERS

Prompt attention to all
inquiries—all languages

Atten: Schools, Labs, Hams!

WE PAY MORE
FOR RADIO PARTS & EQUIPMENT
Cash in on your surplus equipment—
or we'll trade for something you really
need. Write today!

Write for FREE Surplus Catalog.

HARJO SALES CO

4109 BURBANK BLVD.
P. O. Box 1187
Magnolia Park Station
BURBANK, CALIFORNIA
Cable: HARJO

SPECIAL OFFERING

The following high quality equipment is offered at greatly reduced prices.
The equipment never has been used.

WESTERN ELECTRIC 124B AMPLIFIERS (Audio)

The 124B Amplifier is designed primarily
for use as a monitor amplifier in the program
plant or as a part of a one-way speech or
music transmission system. It may also be
employed, in special applications, as a line
amplifier in short regional program networks
or as a temporary or emergency line amplifier
on the major networks.

This amplifier is equipped with a gain
control adjustable in 19 steps of 2 db attenua-
tion per step from the maximum gain. There
are five different input arrangements pro-
vided, the one to be chosen depending upon
the type of service in which the amplifier will
be employed and the maximum input levels
which may be encountered.

Normal Power Output: 14 watts—Total Harmonic Content 1% RMS.
Maximum Power Output: 20 watts—Total Harmonic Content 4.5% RMS.

Mfrs. net price (approx.) . . . \$170.00 ea.
Our price 85.00 ea.

WESTON MODEL 802 VOLUME LEVEL INDICATORS (VU METERS)

Scale "A".
Mfrs. net price (approx.) . . . \$ 37.50 ea.
Our price 20.00 ea.

WESTON MODEL 301 VU METERS

Scale "A".
Mfrs. net price (approx.) . . . \$ 30.00 ea.
Our price 12.50 ea.

WESTERN ELECTRIC F1AW-3 TELEPHONE HANDSET

Mfrs. net price (approx.) . . . \$ 6.60 ea.
Our price 4.50 ea.

WESTERN ELECTRIC G2 HANDSET MOUNTING

Mfrs. net price (approx.) . . . \$ 3.85 ea.
Our price 5.00 ea.

WESTERN ELECTRIC J86205B SELENIUM RECTIFIER

115V AC 60 O Input
17—22V DC, 8.5 Watts Output
Mfrs. net price (approx.) . . . \$100.00 ea.
Our price 45.00 ea.

METROPOLITAN Telephone Supply Corp.

Telephone MAin 4-3769
254 NAVY STREET, BROOKLYN 1, NEW YORK



I'M OFFERING YOU-

SPOT DELIVERY & CASH SAVINGS

JAN-Spec. and other specials, plus standard components of industrial, television and radio apparatus. Some end equipment, too, including telephone switchboards, transmitters, portable filter centers, power supplies and dynamotors, etc. Compare our prices on these items:

1,154 PE-94 DYNAMOTOR POWER SUPPLIES. In: 28 V. D-C; out: 300 V. at 260 ma., 14.5 V., at 4.9 A., and 150 V. at 10 ma., D-C. P/o SCR-522 \$5.00 ea.

8,000 TYPE 120KT RESISTORS, 120 watts, 10,000 ohms. Individual overseas wrapped. . . . \$.69 ea.

31 RM-23 CONTROL UNITS. Part of RC-76 equipment. Signal Corps Stock #2C679-23. . . . \$24.00 ea.

26 RM-25 CONTROL UNITS. Part of SCR-561, -572 and -642 eqpt. Sig. C. 2C679-25. . . . \$44.00 ea.

QUANTITY DISCOUNTS

General Electric BC-375-E 100-watt Radio Transmitters. Quantity available. Range to 500 miles. (Illustrated circular has full data.)



PRICED FAR BELOW COST TO MANUFACTURE!

8,000 NF1-I NOISE FILTERS. Mfr., P. R. Mallory. Rating up to 100 amperes; oil condensers. \$.59 ea./C. F.O.B. warehouse. Subject to prior sale. Minimum order \$50.00.

KITS FOR EXPORT

Complete parts and tubes for overseas manufacture of Audio Amplifiers and 5-tube Superheterodyne Radio Receivers.

LOWEST PRICES!

FACTORY EXCESS-STANDARD BRANDS T-V focus and deflection coils, tubes, wire, phono, turntables and motors, transformers, sockets, etc., available in production quantities.

FUSES-Littelfuse and Bussman. . . . \$15.00/m/pt

CERAMICONS-Nearly all values, in hollow, solid and disc types. . . . \$20.00/m/pt

ELECTROLYTICS-Metal can and paper tubulars. Tens of thousands. Standard brands. Priced low.

MICA AND PAPER BYPASS CONDENSERS. Most capacities.

VARIABLE CONDENSERS-TRF and Superhet. TRIMMERS and PADDERS-"Mica compression" and "air variable" types. Large quantities.

RESISTORS-1/2- and 1/3-W., uninsulated carbon. Most values. SPECIAL, \$5.00/M. Min. sale, 1,000. Insulated Resistors also in stock.

"CSC" 5-watt Audio Amplifiers, available in current production, meet general-purpose needs.

"CSC" low-voltage and heavy current Selenium-rectifier Power Supplies are an economical source of current for testing and servicing 12- and 24 V. D-C equipment (Aircraft dynamotors, etc.).

Catalog sheets upon request on your letterhead.

WE MANUFACTURE TO YOUR SAMPLE AND SPECIFICATIONS

7 FLOORS OF STOCK

COMPONENTS SUPPLY CO.



161S Washington St., New York 6, N. Y. BEekman 3-8717

TUBES:

Industrial Receiving Transmitting

Specialists in JAN Tube Types

Standard Brands Only

OA2 \$.90	6J4 8.00	1612 2.70
OA3 1.20	6J6W 1.75	1614 1.95
OA4G 1.00	6K4 2.25	1616 2.50
OB2 1.00	6K4A 3.50	1620 6.20
OC3 1.00	6L6WGA 8.50	1641 2.00
1B27 12.50	7AK7 7.00	5544 20.00
1B42 8.50	9C24 300.00	5545 35.00
1P21 50.00	15R 2.00	5550 39.50
1P40 1.95	FG32 14.00	
1P41 2.80	FG33 23.00	
1P42 5.70	8B7 1.40	
2C40 8.00	35T 3.00	
2C43 18.00	FG105 19.50	
2C51 3.75	FG172 29.95	
2D21 1.25	GL414 120.00	
2D21W 2.35	434A 19.00	
2E26 3.25	652 80.00	
2K25 26.75	805 5.25	
3B24W 9.00	807 1.50	
3B25 5.00	813 13.50	
3B29 9.00	814 5.50	
3E29 10.00	815 5.00	
4-125A 17.50	829B 9.95	
5R4GY 1.40	832A 12.50	
5R4WG 4.00	833A 49.00	
5Y3WGA 4.70	920 3.50	
6AC7W 3.25	921 2.00	
6AK5WE 1.25	922 1.85	
6AR6 3.25	931A 5.60	
6AS6 2.20	95540	
6ASTG 4.00	95690	
6C24 40.00	966 1.50	
6F4 6.25	SC968B 8.00	

Receiving Tubes
6AQ5 . . . \$.48
6V650
12A773
12AU760
12SL765
All Other Types in Stock. Write for Quotes

Fully Guaranteed

5643 12.00	5844 9.00
5644 12.00	5901 6.50
5645 7.75	5902 11.00
5646 7.75	591075
5647 5.50	5915 1.20
5651 9.30	5932 8.50
5654 1.65	5937 8.00
5656 12.25	5963 1.40
566380	5964 1.50
5670 3.25	5995 6.00
5676 1.15	6005 3.75
5686 3.00	6072 5.50
5687 2.75	6080 5.95
5691 9.50	6082 5.25
5692 9.75	6095 3.75
5693 7.75	6096 2.75
5702 3.00	6097 1.50
5702WA 4.50	6099 5.00
5703 1.20	6101 5.00
5703WA 3.50	6111 11.50
5704 2.80	6112 11.50
5718 6.00	6135 2.75
5719 12.00	6146 4.85
5720 23.00	6163 3.25
5725 4.25	6137 2.50
5726 1.50	6201 5.50
5744 2.25	8020 3.50
5749 2.15	1N21 1.20
5750 2.50	1N23A 2.25
5751 2.95	1N21B 2.25
5763 1.40	1N23B 3.25
5783 6.00	1N34A70
5787 4.25	1N44 1.21
5800 6.50	1N45 1.39
5814 2.25	1N4855
5825 12.95	1N5471
5829 2.75	1N63 4.50
5840 8.95	1N6990
	1N70 3.00



MILGRAY ELECTRONICS, INC.

120 Liberty St. New York 6, N. Y. Rector 2-1297-8

WE HAVE THE LARGEST STOCK OF MILITARY EQUIPMENT IN THE WORLD. ALL EQUIPMENT RECONDITIONED AND CHECKED OUT TO ORIGINAL SPECIFICATIONS IN OUR OWN COMPLETELY EQUIPPED SHOP

RADAR-COMMUNICATIONS-TEST EQUIPMENT

APS-2 S-band search radar	ARQ-5 automatic panoramic rec. 18-80 MC	TS-13/AP X-band sig. gen. pwr. & freq. mtr.
APS-3 X-band search & homing radar	ARN-7 automatic radio direction finder	TS-14/AP S-band sig. gen. & pwr. mtr.
APS-4 X-band search & homing radar	SCR-555 direction finder 18-86 MCS	TS-15/AP fluxmeter
APS-6 X-band search & gun laying radar	SCR-284 portable field radio station	TS-16/AP altimeter test set
APS-10 X-band search & navigation radar	AN/TRA-2 remote control equipment	TS-23/APN SCR-718 test set
APS-15 X-band navigation & blind bombing radar	AN/ARC-1 radio tele. trans/rec. 120 channel	TS-24/ARR-1 test set
SQ-13 S-band marine radar	SCR-522 V. H.F. trans/rec. 100-156 MCS	TS-32/AP TRC-1 test oscillator
SQ-10 GM portable radar	SCR-269G automatic R.D.F.	TS-33/AP power test meter
TFS-1 portable search radar	AN/ARN-7 automatic R.D.F.	TS-34/AP portable synchroscope
TFS-3 long range early warning ground radar	SCR-291 radio direction finder	TS-35/AP X-band sig. gen. pwr. & freq. mtr.
VC-VE-VF-VG remote PPI radar indicators	AN/TRC-1 V.H.F. radio tele. relay station	TS-36/AP X-band pwr. mtr. batt. oper.
UPN-12 S-band paratroop radar beacon	RC-261 radio remote control with R.M. 53, 52	TS-45/AP X-band sig. gen. pwr. freq. mtr.
SCR-602 early warning portable radar	BC-639 rec. 100-156 MC with RA42 power supply	TS-56/AP L-band slotted line
APN-19 airborne S-band radar beacon	BC-902 port. marker beacon xmitter 75 MCS	TS-59/APM altimeter test set
APQ-5 low alt. bombing attachment	RC-103 instru. landing system	TS-61/AP S-band echo box
APA-10 Panoramic adaptor	SCR-718C high altitude radio altimeter	TS-62/AP X-band echo box
APA-11 pulse analyzer used with APR equip.	SCR-536 handi-talkies 3-6 MC batt. recorder	TS-67/AP ARN5 I.L.S. test set
APA-17 automatic bearing indicator used with APR equip.	AN/CRC-7 V.H.F. handi-talkies 112 MC	TS-69/AP cavity type freq. mtr. 400-1000 MC
APA-23 automatic sig. strength & time recorder	BC-191 transmitter	TS-89/AP voltage divider
APA-38 panoramic adapter 30 MC input used with APR equip.	BC-325 airport high pwr. xmitter	TS-98/AP pulse voltage divider
APR-1 radar search rec. 38-1000 MC	BC-640 xmitter 100-156 MC 80 watt	TS-102/AP precision range calibrator
APR-2 radar search rec. 85-1000 MC	DAK automatic direction finder marine	TS-111/AP S-band w. meter
APR-4 radar search rec. 38-4000 MC	RAK-7 rec. w/p.a. 15-500 KC 110 v. 60 eye	TS-114/AP AP82 radar test set
APR-5 radar search rec. 1000-3100 MC	TCS marine equipment 1.5-12 MCS	TS-125/AP S-band precision pwr. mtr.
APR-6 radar search rec. 6000-10000 MC	BC-348 rec. 1700 KC-18 MC & 200-400 KC	TS-127-U freq. mtr. 300-750 MC
APT-4 radar jammer 165-780 MC	BC-342 rec. 1700 KC-18 MC 115 v. 60 eye	TS-148/UP 3 CM spectrum analyzer
APT-5 radar jammer sec. C225 ocs.	TS-3/AP S-band pwr. & freq. mtr.	TS-151/UP S-band sig. gen. pwr. freq. mtr.
APN-9 airborne loran	TS-10/AP altimeter test set	TS-170/ARNS I.L.S. field test set
CPN-8 10 CM high pwr. ground radar beacon	TS-12/AP X-band VSWR test set	TS-226/AP pwr. mtr. 300-1000 MC to 1 KW peak
APN-1 altimeter		TS-268/UP crystal diode test set
CR3-3 dual freq. victory girl		TS-100 radio compans test set
PPN-1 Rebecca transponder used with APN2		I-208 tank radio test set

FAMOUS MAKE PANEL METERS
2" sq., any range milliammeter d.c. voltmeter r.f. ammeter. Large selection available. \$295 EA. WHILE THEY LAST!!

SPECIAL GIVE AWAY OFFER EIMAC TYPE 100TH TUBES 3 for \$150 NEW GUARANTEED

ONE MILLION TUBES TUBES In Stock At Low Prices Receiving, Transmitting, Special Purpose, Cathode Ray, Klystrons, Magnetrans, Crystal Diodes, New, Standard Brands, Guaranteed

EXPORTERS • GOVERNMENT AGENCIES • LABORATORIES • SCHOOLS!! Consult us. Come to the source. Warehouses of our own stock. We will buy, sell or swap in any quantity. Space limits complete listings. Write for our catalog.

RADIO HAM SHACK, INC.

Cable: "Hamshack N. Y." New York 13, N. Y.

370 Greenwich St.

Canal 6-8446-7-8-9



**24 HOUR
DELIVERY
FROM STOCK!**

RELAYS

Our stock of more than a million relays — in over a thousand different types — is the world's largest. Don't delay your production for want of large or small quantities of relays of any type.

Telephone, wire or write for quotations.

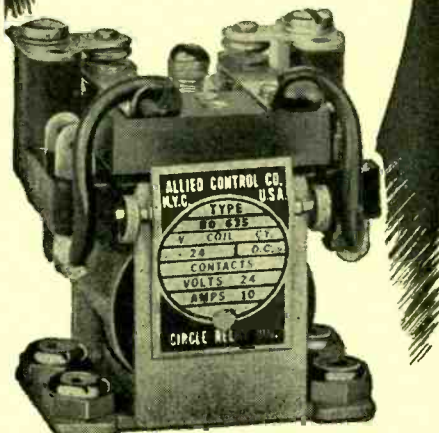

NEW AND MORE
COMPREHENSIVE
**1953
RELAY SALES
CATALOG**
NOW READY

Be sure to send for your copy



Telephone
SEeley 8-4146

**833 W. CHICAGO AVE.
DEPT. 4, CHICAGO 22, ILL.**

BLOWERS

115 Volt 60 cycle BLOWER (pictured) - approx. 100 CFM Dis. 2 1/4" Intake; 2" outlet. Quiet running Motor size: 2 1/4" x 3 1/4". NEW — not Gov't surplus.
\$8.95
Order No. 1C939
DUAL BLOWER—Same as RN-520 above, except has blower assembly in each side of motor. Order No. 1C930 \$13.95
COMPACT TYPE—108 CFM motor built inside squirrel case, 4 1/2" Intake; 3 3/4" x 3" Dis. Complete size: 4 1/4" W. x 8 3/8" H x 8 1/4" D. Order No. 2C067 \$14.50
FLANGE TYPE—140 CFM, 3 1/2" Intake; 2 1/2" Dis. Complete size: 8 1/2" W x 7 1/4" H x 6 3/4" D. Order No. 1C907 \$13.95
FLANGE TWIN—275 CFM, 4 1/2" Intake; 3 3/4" x 3" Dis. Complete size: 11 3/4" W x 9 3/8" H x 8 1/16" D. No. 2C069 \$21.95



MOTORS:

24 VOLT DC 1/10 H P
2800 RPM Reversible Motor. Size: 5 1/4" x 3 1/2". Shaft Size: 1" x 1/4". Emerson #188-0412 — Price: \$5.95
GEAR HEAD for above motor. Ball Bearing Geared Shaft, 10 to 1 reduction. Price: \$5.95
COMBINATION: Motor and Reduction Gear \$10.00
24 VAC OPEN FRAME—20 RPM Double Shaft Back Gear Motor with Disengage Clutch. Shaft size: 1 1/4" x 3/16". Price: \$6.95
24 VAC OPEN FRAME—3 RPM Back Gear Motor. Shaft size: 5/8" x 3/16". Price: \$5.95
24 VDC REVERSIBLE—5000 RPM with Magnetic Brake. Flange Mount Spine Shaft—size: 5/8" x 3/16". Motor: 4" L. x 2 1/4" Dia. GE Motor only #5BA25AJ32A Price: \$8.95
24 VDC AIRWAY MOTOR—Model #Z-350. Approx. 5000 RPM. Motor size: 2 1/2" x 1 1/2". Shaft size: 1/2" x 1/4". Price: \$4.95
26 VOLT 60 CYCLE—40 RPM Synchronous Cramé Motor #1147. Shaft size: 1" x 1/2". Price: \$1.95
110 VDC 1/70 HP, 1550 RPM. Motor size: 4" x 2 1/2". Shaft size: 1" x 3/16". Redmond #157. \$4.95
6 VDC 1/20 HP, 4000 RPM. Motor size: 5" x 3". Shaft size: 3/4" x 1/4". Redmond #E-58. Price: \$4.95
12 VDC 1/30 HP, 4500 RPM. Motor size: 3" x 2 1/4". Shaft size: 1" x 3/16". Delco #5047520 \$4.95

COAXIAL CABLES:

RG-8/U (SPECIAL) 51.5 ohms. Same size as RG-8/U. Prices: 1 to 100 ft. @ 8¢ per ft., 100 to 500 ft. @ 7 1/2¢ per ft., 500 to 1000 ft. @ 7¢ per ft., 1000 ft. rolls @ 6 1/2¢ per ft.
RG-34/U—71 ohms, 145 ft. length. \$15.00

PE-103 DYNAMOTOR

With Filter Base and Cables, 6 or 12 VDC input; output 500 VDC 160 MA.NEW: \$39.95—USED: \$29.95

TRANSFORMERS—100V. 60 Cycle Pri.

5 VOLT CT-25A—10,000 V. Ins. OPEN FRAME—6" x 5" x 4" \$7.95
Sec. Two 12 V. 4 A. Windings—gives 12 V. 8 A or 24 V. 4 A. \$5.95
Sec. 24 Volt 1/2 Amp. \$1.50
Sec. 24 Volt 1 Amp. \$1.95
Sec. 24 Volt 6 Amp. \$5.95
Sec. 6-24 or 30 Volts 8 Amp. \$5.95



ATTENTION:

LOOK OVER SOME OF THE ITEMS

WE HAVE IN STOCK—MANY MORE NOT LISTED!

SEND US YOUR REQUIREMENTS. IMMEDIATE ANSWERS!

ANTENNAS:	DYNAMOTORS:	RADAR ● RECEIVERS ● TRANSMITTERS:	MISCELLANEOUS:
AN-104B	DM-21	APS-3	RL-42B
A-104A	DM-25	RT-5/APS-4	MC-235
AN-109	DM-32	T-28/APT	HS-30
AN-117	DM-36	T-39/APQ-9	M-396
AN-130	DM-40	AM-14/APT	M-359
AN-131	DM-41	AM-18/APT	BC-434A
AN-147	DM-42	AM-33/APT	BC-1366
AN-95	DM-43	BC-645	BC-450
MS-49 to 56	DM-45	BC-966	MC-476
AB-38-GR	PE-86	BC-454	FT-470
RC-173	PE-94	BC-455	WT-7A
AT1/APN-2	PE-103	BC-456	F-10A
AT2/APN-2	BD-77	RA-10DA	ME-57
AT37/APT	BD-87	DY-22	BC-347
AT38/APT	BD-93	DA1-A	BC-709
AT42/APT	DA1-A	MP-28BA	BD-72
AT49/APR-4	MP-10G	SCR-284	BD-116
AS27/ARN-5	PE-206		EE-65
AS61/ARN-5			K-13
AS62/APR-2			N-6A

ADDRESS DEPT E • All Prices Are F.O.B., Lima, Ohio • 25 Deposit on C.O.D. Orders

FAIR RADIO SALES • 132 SOUTH MAIN ST. LIMA, OHIO

PULSE TRANSFORMER

Tube base plug in type

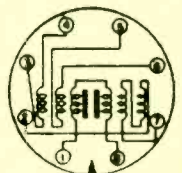

Here are precision made, high quality compact pulse transformers wound on hypsersil cores. They are built in octal bakelite tube bases and can be adapted to many uses. They are completely impregnated and sealed.

SUGGESTED USES

- ★ Blocking Oscillator, Multivibrator and Scope Circuits.
- ★ Wherever Accurate Timing and Triggering are necessary.
- ★ Unexcelled in circuit applications for generating low power and low voltage pulses.
- ★ Can be used in circuits utilizing repetition rates from 0 to well over 1 MC and pulse widths ranging from .05 Microsecond up.

Price \$4.50 each Immediate Delivery

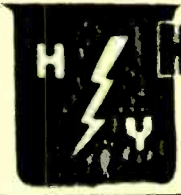
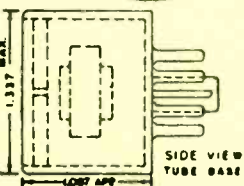
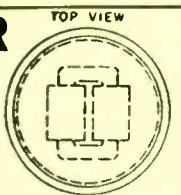

HATRY and YOUNG

THE Elect IN ELECTRONICS

811 Boylston St., Boston 16, Mass. CO 7-4700

TYPE EB, GB, HB RESISTORS?

TYPE JU, JLU POTENTIOMETERS?

WE'RE LOADED WITH THEM!

**Absolutely the LOWEST prices!
Immediate Delivery!
Write or call Resisco NOW!**

Resisco Corporation
SERVING THE WORLD OF ELECTRONICS
366 BROADWAY, NEW YORK, 19, N.Y.
REctor 2-0284



MARITIME INTERNATIONAL COMPANY

11 STATE STREET NEW YORK 4, N. Y.
Cable Address: Foxcroft Telephone: Digby 4-3192

Your Reliable Source of Supply For SPECIAL PURPOSE & TRANSMITTING TUBES

This Month's Special:

2J39 Raytheon Magnatron \$4.95 ea.

GLASS TUBING

PYREX - NONEX - URANIUM
BULBS & CYLINDERS
WRITE FOR FREE MONTHLY LIST
HOUE SUPPLY COMPANY
PHONE KEYPORT 7-1286
M. R. #1 Box 86X Keyport, N. J.

MILITARY ELECTRONIC SPARE PARTS & COMPONENTS

In stock for—
ART-13, ARN-7, BC-348, SCR-269
SCR-522, SCR-274-N, MN-26.
Write for Circular now, no charge.
NORMAN ELECTRONIC SALES
1930 S. State St. Chicago 16, Ill.
Phone DAnube 6-4476

**25,000 VOLT
1 MFD
CAPACITORS
\$50.00**

western engineers
ELK GROVE, CALIFORNIA

If there is
Anything you want . . .
that other readers of
this paper can supply
OR—
Something you don't want
that other readers can
use, advertise it in the
SEARCHLIGHT SECTION

OUTSTANDING VALUES IN JAN TYPE TUBES

Your best source of supply for special purpose and receiving type tubes

OB3/VR90	.95	10T1 Ballast	.50	865	.85
OC3/VR105	.95	10Y/VT25A	.39	872A	3.25
OD3/VR150	.85	RK34	.45	876	.70
1B22	2.00	R460/1641	1.75	818	1.50
1B24	8.95	72	.99	825	1.75
1B26	2.25	VU111	1.00	823	1.25
1P21	4.00	120A W.E.	5.00	833A	4.25
2A4G	1.20	121A W.E.	5.00	833A	4.25
2C21	.35	F123A	7.00	855	.35
2C26	.25	F127A	17.50	857	.35
2C38A	12.50	211/VT4C	.49	858A	.65
2C40	7.25	233D	2.00	1003	.75
2C42	7.50	250TH	20.00	1005	.50
2C46	7.50	304TL	7.75	1008	3.00
2C51	5.25	E1MAC	3.25	1007	.85
2D21W	2.25	307A	3.25	1633	.80
2E24	3.75	309A	5.00	1636	.85
2E30	1.65	310A W.E.	5.00	1639	.25
2J22	2.75	311A	6.00	1624	1.25
2J31	22.50	313C	9.00	1625	.30
2J33	22.50	327A	3.95	1626	.30
2J34	22.50	E1MAC	3.25	1629	1.00
2J48	37.50	394A	3.00	1644	.50
2J54	47.50	437A	7.00	2051	.95
2K22	35.00	471A	2.00	5970	1.25
2K23	27.50	507AX	1.25	5726	1.75
2K41	125.00	555	1.75	7193	.40
2X2/879	4.50	W1-681/685	32.50	8031	.85
3AP1	7.50	707A	3.00	8033A	4.00
3B26	3.50	715A	4.50	8020	1.25
3B28	7.50	715B	7.50	8001	1.10
3BP1	4.00	715C	15.50	9000	1.25
3C24/24G	1.75	717A	.80	9003	1.35
3C45	3.50	721A	1.75	9004	.25
3DP1	3.50	723AB	17.50	9006	.25
3DP1A	5.50	801A/VT62	.29	CRYSTAL DIODES	
3E29	9.50	813	6.25		
3GP1	3.50	814	2.25	1N21	1.00
5NP1	4.00	829B	9.50	1N23A	2.50
6CC1	16.00	837	1.20	1N23B	2.75
7BP7	5.00	843	.50	1N26	7.50
9GP7	7.50	860	3.75		

Above is only partial listing. WRITE FOR OUR SPECIAL PRICES ON other types. ATTRACTIVE PRICES ON RECEIVING TYPE TUBES. RATED firms SEND P.O. F.O.B. N.Y.C.

ALLIED ELECTRONIC SALES

74 Cortlandt Street New York 7, N. Y.
BARCLAY 7-5839—5840

Prompt ANSWERS

to business problems . . .

MISCELLANEOUS business problems are daily being solved quickly and easily by the use of the Searchlight (classified advertising) Section of this and other McGraw-Hill publications.

When you want additional employees, want to buy or sell used or surplus new equipment, want additional products to manufacture, seek additional capital, or have other business wants — advertise them in the Searchlight Section for quick, profitable results

- American Machinist
- Aviation Week
- Business Week
- Bus Transportation
- Chemical Engineering
- Chemical Week
- Coal Age
- Construction Methods & Equipment
- Electrical Construction & Maintenance
- Electrical Merchandising
- Electrical World
- Electronics
- Eng. & Mining Journal
- E. & M. J. Markets
- Engineering News-Record
- Factory Mgt. & Maintenance
- Fleet Owner
- Food Engineering
- Nucleonics
- Power
- Product Engineering
- Textile World
- Welding Engineer

Classified Advertising Division
McGraw-Hill Publishing Co.
330 W. 42nd St., New York City 36, N. Y.

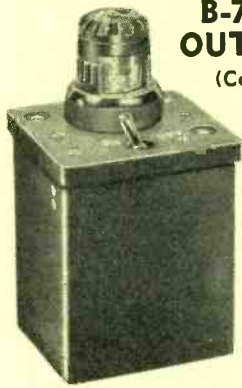

B-7 PULL OUT LIGHT
(Cockpit Lamp)
\$2.25 each
For Aircraft, Boats, Cars and Workshops. Gives White or Red Light. Unit pulls out 6 feet from self-rewind reel. Any Voltage. Mounts Anywhere. Small Bakelite case 3 x 3 1/4 x 4 1/4.

SPECIAL OFFER

RHEOSTAT — 50 Watts 125 ohm W/Knob 1.15 ea.

CAPACITOR SPECIALS

Cat. #22F-391 1 MFD. 600 V DC. .75 ea. Bathtubs ST CP-53 Case
Cat. #23F-154 1 MFD. 500 V DC. .45 ea. Channels Oil Filled
Cat. #TJU-10010 1 MFD. 1,000 V DC Ceramic-Screw Term. .60 ea.
Cat. #21F-442 5 MFD. 330 V AC or 600 V DC .1.25 ea.
Cat. #26F-382 10 MFD. 600 V DC. 2.85 ea. W/Brackets—Ceramic-Screw Term.

MOTOR SPECIALS

DIEHL PILOT MOTOR #802077 24 V DC 10,000 RPM .85 ea.
BODINE #NSHG-12 27 V DC Governor Controlled Constant Speed 3600 RPM 1/30th HP .695 ea.
HUGHES — BOOSTER MOTOR 24 V DC Reversible .350 ea.
SELSYNS 2J1G1 .750 ea.
2J1F3 .750 ea.

RELAYS — SWITCHES — SWITCHETTES — BLOWERS — ALL TYPES — IN STOCK

All Merchandise Guaranteed New. Check With Us On Your Present and Future Requirements

Excess Inventories Purchased

NEW YORK ELECTRONICS

218 FULTON STREET NEW YORK 7, N. Y. RECTOR 2-4137

TELEPHONE EQUIPMENT & PARTS

New TS9 handsets for EE8 telephones... \$7.00 Ea.
New WECO F/W handsets with 3 cond. Cord \$6.95 Ea.
EE8 field telephones reconditioned & tested \$19.50 Ea.
New ATR inverter 110V. D.C. to 115V. A.C. \$40.00 Ea.
New Raytheon Rectifiers. Input 115 V. A.C. Output 24 V. D.C. at 1.0 Amp. \$50.00 Ea.
New PL 68 plugs—\$1.00 Ea. PL58—\$0.50 Ea. PL7104—\$0.75 Ea.
New CD494 cords less plugs for TS13 etc. \$1.50 Ea.
New WECO ringers for 302 telephones. \$2.50 Ea.
20-Line WECO Jack strips. \$7.00 Ea.
10-Line lamp jacks \$4.00 Ea.
Reconditioned upright desk telephones for Extensions etc. \$1.40 Ea.
New Receiver & Transmitter elements like & interchangeable with WECO. \$1.00 Ea.
New WECO 400 throat mikes. \$8.90 Ea.
New CC 335 cords 3 cond. \$0.40 Ea.
New RM29A remote control units with bag export packed. \$16.00 Ea.
New EE65G wire chief test sets. \$35.00 Ea.
Dials WECO 4H, \$2.50 Ea. Conn. Tel. dials, \$1.75 Ea.
Sound power receiver & Transmitter elements \$2.00 Ea.
Linemen safety straps. \$5.00 Ea.
Batteries BA-40 Taps. 1.5V.-&90V. \$3.00 Ea. BA 70 Taps-4 1/2 V.-60V. 90V. \$5.00 Ea. BA 205U tap 30V. \$3.00 Ea. BA 39 Taps 7.5V. & 150V. \$5.00 Ea.
BC 1267A radio Rec. & Trans. W/tubes & Power supply RA105A \$75.00 Ea.
WECO 40 tyne carrier complete 12 channels with power supply.
Terms: Check with order F.O.B. Brooklyn 5, N. Y.

EASTERN TELEPHONE COMPANY
323 VANDERBILT AVENUE
BROOKLYN 5, N. Y. MA 2-3753

RADIO SHACK Corp. 167 Washington Street
Dept. 9E Boston 8, Massachusetts



HAYDON and BARCOL MOTORS

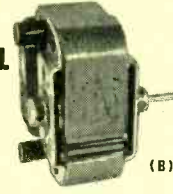

(A) only \$1.49

(A) Type 1600A. 115/1/60: 1/4 RPM. Order No. RE-2087A
(A) Type 1600A. 115/1/60: 2/5 RPM. Order No. RE-2088
(B) Type DYAB. 115/1/60: 2300 RPM. 250th HP. Order No. RE-1262A

12 HOUR CLOCK TIMER

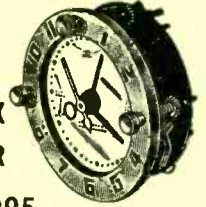

only \$3.95 Reg. \$5.50

Famous maker. Turns devices ON at preset times, adj. from 0 to 12 hours. Fits 3.6" hole. Three control knobs on front, controlling appliances, preset time of turn on, and time knob. Brand new, original boxes. Like unit in clock radios. W/mtg bezel, and mtg hardware. Order No. RE-5105.

4 1/2" ROUND METER

SPECIAL \$2.75 ea.



3 for \$6.95

Reg. \$8.70 ea. Burlington. Reads 0 to 100 amps. DC. Comes less shunt. Basic movement makes unit into 0 to 5 mil meter. Brand new. Original cartons. Order No. RE-5057.

SALE!
1 mfd @ 15,000 OIL CONDENSER \$38.75

Order No. RE-370

FREE! 8-PAGE FLYER OF OFF-PRICE VALUES WRITE TODAY!

OC3/VR-105 \$.99	EL-C5B \$ 5.50	QK-59 \$65.00	724A \$ 2.55
QD3/VR-150 .85	EL-C6A 5.50	QK-60 65.00	724B 2.95
1A3 .78	4J36 145.00	QK-61 65.00	725A 8.50
1A5GT .62	4J37 145.00	71A .69	726A 13.50
1B22 1.95	58P1 4.69	RK-72/CRP-72 1.00	801 .85
1B24 9.10	5D21 18.50	FG-90 4.50	803 3.95
1B27 13.50	5FP7 1.65	100TH 10.50	804 10.50
1B32/532A 2.19	6AC7 .89	VR-105 .99	805 3.95
1N21 1.00	6AJ5 .99	VT-127 2.10	807 1.65
1N22 1.19	6AJ6 1.00	VR-150 .85	810 10.95
1N23 1.19	6B6C .75	211/VT-4C 1.25	811 2.85
1N27 1.65	6C6 74	227A 4.50	813 8.95
1P23 2.75	6C8G .74	274B 2.95	814 2.79
1R4 .59	6H6 .59	EL-302.5 1.50	815 3.40
1T4 .59	6K7 .63	304TH 13.95	816 1.25
2A3 .95	6SC7 .97	304TL 19.50	826 1.25
2AP1 7.50	6SH7GT .79	GL-316A 2.50	830B 2.65
2B22 2.25	6SH7 .79	350A 4.50	832 7.95
2C33/RX233 2.75	7C4/1203A .75	359A 1.50	832A 9.50
2C40 14.50	7E5/1201 .89	371B 2.95	838 3.50
2E22 2.25	7E6 .55	388A 2.50	866A 1.00
2J21 7.95	10Y 1.30	394A 3.50	872A 3.65
2J21A 8.50	12A6 8.5	WL-417A 19.50	884 1.25
2J22 9.50	12C8 .79	GL-434A 19.50	902P1 5.50
2J27 14.95	12SGT .52	GL-446A 2.50	954 .45
2J34 29.95	12SF7 .59	464A 6.75	957 .75
2J50 69.50	12SJ7GT .55	CK-501X .69	CK-1089 .45
2J55 84.50	14H7 .69	532A/1832 2.25	1616 1.25
2X2 .69	14J7 .69	GL-605 49.95	1619 .75
2X2A 1.50	15R .75	WL-653B 69.00	1624 1.45
3A4 .79	CE-22 .95	ZP-653 50.00	1625 1.00
3B7/1291 .62	RK-25 3.69	705A 2.95	1629 .79
3C23 9.50	23D4 .65	706A, B 19.50	1655/65C7 .97
3C24/24G 1.95	FG-27A 6.50	706AY 27.50	1846 95.00
3DP1 3.50	30SP .48	707A 9.95	2005 .95
3D6/1299 .62	45SP .45	721A 2.45	8051 5.85
3EP1 4.50	53A 2.50	723AB 22.50	8020 2.50
3FP7 2.95			9001 1.10
3GP1 3.95			9002 1.00
3JP12 7.95			9003 1.49
4B22/EL5B 5.50			9004 .85
4B25/EL6CF 5.50			9006 .50

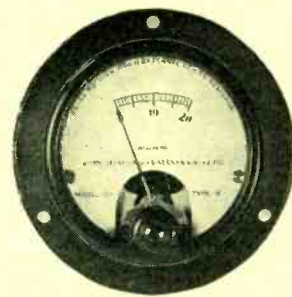

BRAND NEW—FULLY GUARANTEED MICROAMMETER

Weston 301 • Original Weston Boxes
0-20 Microamps DC

3 1/2" ROUND FLUSH MOUNT BAKELITE MFD. FOR TEST SET TS62...No. Ks 9490

\$9.95 ea.
Spot Delivery—"AN" Inspected & Approved
FOBNY

MANUFACTURERS QUANTITY AVAILABLE

NEW SURPLUS COMPONENTS FOR LABS., SCHOOLS, INDUSTRY

CROSS POINT INDICATORS—
P/O ZA equip.—New...\$4.95
WESTON 506—2 1/2" Rd—0-200 Microamps. New...\$7.95
HI-VOLTAGE CONDENSER—
.001 MFD—75,000V No. 75026X. New...\$49.50
WESTON 642—4" Rd Flush Mount —1%—5 AmpAC...\$12.95
RHEOSTAT—60 ohm—25 watt—screwdriver adjust—Famous makes—new 5000 available...@ 25c ea.
WESTON 280—Portable standard —1%—mirror scale—0-1 AmpDC each...\$14.95
MICRO SWITCH—Type HI-ALT B-1—Diecast metal housing—SPST...lots of 25 50¢ ea.
MICRO SWITCH—Type WZE—7R097—Diecast metal housing—SPST...lots of 25 75¢ ea.

Rated Accounts 10 Days • others 25% with order balance COD

GREENWICH SALES CO. 59 Cortlandt St. New York 7, N. Y. Dlgy 9-3813

TUBE COST DATA
you've always wanted!



Most comprehensive and accurate purchasing and cost-analysis tool in tube history! Product of over 2 years' research. Covers every tube type and crystal manufactured in U.S.—from tiniest crystal to largest transmitting tube—including...

Amperex • Bomac • Chatham • Cetron Du Mont • Eimac • Federal • General Electric Hytron • Industro • Lewis & Kaufman Machlett • National • National Union North American Philips • Philco • Raytheon RCA • Sperry • Sylvania • Taylor • Tung-Sol • United • Western Electric • Westinghouse

Tells list prices and your current costs for over 4,000 tube types! Kept up-to-date by State Labs' famous Weekly Market Guides mailed free to all owners of the Tube Buyers' Guide. In loose-leaf form, alphabetically and numerically indexed for quick, easy reference.

PRaised BY INDUSTRY LEADERS

Says W. L. Urquhart, President, W. L. Urquhart, Inc. one of America's leading electronic tube exporters:

"Without doubt your new 1953 U.S. Electronic Tube Buyers' Guide contains the most extensive tube cost information ever to hit the tube markets of this country. It's invaluable to me—I wouldn't be without it for a day."



for YOUR copy-USE the COUPON!

Note: This Tube Buyers' Guide is necessarily restricted to Purchasing Agents, Manufacturers, Industrials, Government Agencies, Distributors, Exporters. Please fill out the coupon in full and attach to your letterhead.

STATE LABS, INC. Dept. E-9
649 Broadway, New York 12, N. Y.

Send me your FREE 1953 U.S. Electronic Tube Buyers' Guide.

NAME _____
TITLE _____
COMPANY NAME _____
ADDRESS _____
CITY _____ STATE _____
NATURE OF COMPANY BUSINESS _____

State Labs, Inc., 649 Broadway, N. Y. 12, N. Y.
ORegon 7-8400

MARINE TRANSMITTERS

TCS radiotelephone 1.5 to 12 Mc for marine or mobile use. Operates from 12VDC. Complete with all accessories. Excellent condition. \$450.00
TBA 1 KW Professionally converted for 110/220 60 cy operation and modulated. Write for complete description. \$3500.00
SO-1 & SO-8 Radar Fully reconditioned, like new overseas packed. \$2750.00

HIGH VOLTAGE CONDENSERS

Cat. No.	MFD	WVDC	
G.E. 26F444	8	2 KV	9.95
G.E. 23F47	2	4 KV	9.95
G.E. 25F309G2	1	6 KV	7.50
G.E. 25F774	-1 X .1	7 KV	8.00
G.E. 25F450	1	7.5 KV	7.50
G.E. 25F360	1	12 KV	9.50
C.D.	.65	12.5 KV	17.50
Intertron	.75	15 KV	19.95
G.E. 14F91	1.0	15 KV	39.50
Intertron	.5	25 KV	49.50
Intertron	1.0	25 KV	69.50
East A673	1.0	30 KV	89.50
G.E. 14F71	.25	32.5 KV	60.00

HIGH CURRENT MICA CONDENSERS

Ceramic cased, Sangamo type G1 or similar

Mfd	WVDC	Amp @ 1 mc	
.04	1 KV	25	7.50
.08	1.5 KV	35	12.50
.09	1.5 KV	40	15.00
.02	3 KV	21 (600 Kc)	15.00
.00035	6 KV	7	14.50
.00075	6 KV	5	14.50
.0005	6 KV	5	14.00

Type G-2 or similar

.0012	5 KV	8	17.50
.003	7 KV	15	19.00
.0002	10 KV	3	19.50
.00025	10 KV	3	19.50
.0003	10 KV	5	19.50
.0005	10 KV	6	19.50
.00057	10 KV	8	19.50
.00065	10 KV	6	19.50

Type G-3 or Similar

.05	3 KV	50	45.00
.005	5.5 KV	25	45.00
.00015	20 KV	5	36.00
.0012	20 KV	15	36.00

TRANSFORMERS

All primaries 115V 400cy

UX8486A 5V/5A/13,500VRMS	53.50
UX8306A 6V/3.7A/1700VRMS	2.50
UX8302C 6.3V/4.7A: 5V/3A: 6.3V/6A 1780VRMS	3.95
UX8485A 6500V/.055A	11.50
UX8301C 600V%/175A	5.50
UX7812B 1000V/.0025A/3KVVRMS ¹ 6V/45A/1780 VRMS	6.95
UX779E 800V.085A/390V/100A: 5V/3A: 5V/3A/1780VRMS	4.50
UX8352A 55V/.01A: 110V%/0.01A: 6.3V/1.0A 2.5V%/7.0A/1275VRMS	5.50
UX7732A 4580V/002A: 2.5V/5A/11000 VRMS	5.50
WX4298E Pulse transformer, pri 4KV 1Mu sec Sec 15KV @ 16A	47.50
WX4298B Pulse Transformer, 40V-40V (pulse Inversion)	9.50
UX8442 Trigger Transformer, 40V-40V (pulse Inversion)	7.50
UX7307 Blocking Transformer	10.00

PULSE NETWORKS

15A-1-400-50: 15KV "A" Circuit 1 Mu Sec, 400 PPS, 50 ohms Impedance	\$27.50
25A-850-50: 25KV "A" Circuit 1 Mu Sec 850 PPS, 50 ohms Impedance	60.00

PIONEER TORQUE UNITS

12604-3-A Contains CK5 motor & AY43D autosyn Gear ratio, motor to shaft 125:1, Gear ratio shaft to follow-up Autosyn 35:1	\$70.00
12606-1-A Same as above except Gear ratio shaft to follow-up autosyn 30:1	70.00
12602-2-A Same as 12603-1-A except has base mounting cover for motor & gears	70.00
12077-1-A Pioneer Amplifier	35.00

Pioneer autosyns

AY-1 26V 400cy	\$6.95
AY-2 28V 400cy	8.95
AY-6 28V 400cy	3.95
AY-30D 26V 400cy Generates signal to amplifier 12077-1-A	25.00
AY-43D or DW cancels signal from amplifier 12077-1-A	25.00

DYNAMOTORS

TYPE	INPUT	OUTPUT	RPM	
DM-35	12V	220V	80	\$12.50
DM-35	12V	625V	225	24.50
DM-36	24V	220V	80	12.50
DM-37	24V	625V	225	17.50
DM-64	12V	275V	150	11.50
DM-65	12V	400V	140	22.50
EDV	12V	1000V	350	25.00
TCS Rcvr	12V	225V	100	12.50
TCS Xmtr	12V	440V	200	22.50

All prices FOB Oakland, Calif., subject to change without notice. Terms 25% cash with order, Balance COD.

EMMONS RADIO SUPPLY CO.

405 10th St., Oakland, Calif.
Phone TWinoaks 3-7411

Tube Specials, New. Boxed

3BP1A	3.00	1826 @	20
9CP7	8.00	8011 @	89
15R	.49	812 @	3.00
114B	16.00	931 @	12.50
2J40	3.95	1B26 @	5.00
98R			1.75

Large Inventory On Plugs & Connectors Kits Available For

SCR274N — ARC5	} PL—PLP—or PLQ Prices On Request All Types Available
SCR269 — R5ARN7	
SCR522 — 542	
BC375 — BC191	
ART-13 — ARC-3	

Dynamotor Bargains Used Operating

DY10	10.00	PE94	2.00
DM53	3.50	DA1A	3.00
DM28	4.00	PE103	22.50
DM33	2.00	BD-()83	2.50
PE86	1.00	PE218	8.50

Telephone Supplies Handsets Used Good

EE 8's Checked out.	\$18.75	TS-9	\$4.50
BD 72 Switchboard.	39.50	TC-10	7.50
BD 57 Switchboard.	25.00	TS-13	5.50
PE 73 Switchboard.	2.50	TS-19	3.50

Control Boxes Jack Boxes

BC-451—New	1.25	BC 1366	.25
BC-602—Good	1.75	BC 629	1.00
BC-434—Good	3.50	BC 639	1.00
C4—ARN 7 Good	15.00	BC 631	1.00

Equipment Values—

Prices On Request. (Immed. Del.)

ARC 1-10-20-50 Channels	APN 9—Complete
ARC 3—Complete	MN 31—Complete
TS-35—Test Equipment	SCB 522—Complete
AP'S 3 Complete	BC-375—Complete
BC 191 New	BC348—Checked out

Complete Inventory of Parts For AN/ARC3 and SCR718C

RED ARROW ELECTRONIC SALES CO.

1217 SUMMIT AVENUE

Tel—UN-3-7916 Union City, New Jersey

RELAY SPECIALISTS

AUTHORIZED FACTORY DISTRIBUTORS
STRATHERS-OUNN POTTER & BRUMFIELD

STORAGE BATTERY



6 Volt Miniature

NT6—3 1/2 x 1 3/4 x 2" \$2.95

Six Pole DT Allied Relay	\$6.95
Sigma 4F 8000 Ohm Coil	6.81
Sigma 5R Dual 100 Ohm Coil	4.95
4 Pole Double Throw	3.95
3 Pole Double Throw	2.95

RADIO DEVELOPMENT & SALES CO.
323 ATLANTIC AVE.—ULSTER 5-0488—BKLYN, I. N. Y.

SELSYN SYNCHROS

5 CT—5 SCT—5 DG	\$45.00
5 F & 5 G	\$49.00

TIMING MOTORS

TELECHRON SYNCHRONOUS—TYPE B-3

220 Volt 60 Cycle 1 RPM	
24 Volt AC 6 RPM	115 Volt 60 Cycle 1 RPM
220 Volt 60 Cycle 1 RPM	\$3.50 ea.
HAYDON SYNCHRO MOTORS 110 VAC	
3.6 Watt—1/2 RPM	\$2.75
2.2 Watt—1/120 RPM	\$2.45

BODINE MOTOR TYPE KC1-22

115 VAC 18.6 RPM Torque 32.0 NEW	\$12.50
115 VAC 10 RPM Torque 32.0 NEW	\$12.50
115 VAC 9.3 RPM Torque 65 NEW	\$12.50
Bodine Motor 115 V 1/75 HP, 1800 RPM Type NYC-12 NEW	\$16.50

EQUIPMENT

Signal Generator I-138A	\$165.00
SCR 522 (BC 624-A-BC 625A) Like New w/all Tubes Each	\$75.00
Bendix Aircraft Radio Transmitting Equipment.	
Model ART, NEW	

TRANSFORMERS

Power & Filament, Freed—Style D
500 V CT 120 MA
Sec. 6, 3V 5 Amp & 5V 3 Amp. \$2.68 each

UG CONNECTORS

UG 9/U	\$1.25
UG 352/U	\$6.50
UG 234/U	\$15.00

METER

Westinghouse Voltmeter, NA-35, Style BX-48450-1, 0-150 V.A.C., 3" Round 5 or more \$5.95 Each

LEONARD GREENE

342 Watertown St. Newton, Mass. DE-2-9300

EMELTONE ELECTRONICS CO.

71 West Broadway - New York 7, N. Y.

Phone
REctor 2-1696

Crystal Diodes
Standard Brands Only

SPECIAL PURPOSE TUBES

Receiving Tubes
Klystrons, Magnetrons

1N21A 1.75 1N21B 2.00 1N21C 20.00 1N22 1.70 1N23 1.95 1N23A 2.25 1N23B 2.55 1N25 5.25 1N26 8.00 1N27 8.00 1N28 4.25 1N31 1.50 1N34 .71 1N34A .71 1N35 1.50 1N38 1.10 1N40 11.50 1N41 12.00 1N43 1.75 1N44 1.50 1N48 .60 1N51 .50 1N52 1.37 1N54 .60 1N58 1.25 1N60 .51 2AP1 10.00 3AP1 10.00 3AP1A 12.00 3BP1 6.00 3CP1-51 2.00 3CP1 5.50 5BP1 5.00 5CP1 6.00 5FP7 2.50 5GP1 5.00 5LP1 20.00 7BP7 8.00 OA2 1.00 OA3-VR75 .110 OB2 .50 OB3-VR90 .95 OB3-VR150 .50 1B21A 2.50	1B22 2.50 1B23 7.00 1B24 12.00 1B26 3.50 1B27 13.00 1B29 2.75 1B32 3.25 1B35 3.00 1B42 9.00 1B43A 60.00 1B45 8.00 1P21 28.00 1P28 10.00 1P29 1.80 2C26A .60 2C34 .60 2C39 20.00 2C39A 21.00 2C40 10.00 2C43 17.50 2C44 1.50 2C46 30.00 2C51 5.00 2C53 13.00 2E22 2.50 2E24 3.00 2E27 3.50 2E36 3.50 2J21A 1.50 2J22 1.50 2J26 15.00 2J27 20.00 2J31 30.00 2J32 26.00 2J33 25.00 2J34 25.20 2J36 130.00 2J38 24.00 2J39 15.00 2J40 35.00 2J42 125.00 2J48 45.00 2J49 65.00	2J51 250.00 2J55 80.00 2M22 30.00 2M23 20.00 2M25 25.00 2M26 100.00 2M28 35.00 2M29 35.00 2M39 100.00 2M41 150.00 2M45 125.00 2X2 60.00 3A5 1.10 3B22 3.50 3B24 5.50 3B24W 8.50 3B25 6.50 3B26 6.00 3B27 4.50 3B29 4.50 3C21 3.00 3C24 1.50 3C33 21.00 3C45 18.00 3E29 12.00 4X100A 40.00 4X125A 25.50 4X250A 30.00 4X500A 38.80 4X1000A 100.00 4B24 5.75 4B25 8.50 4B26 10.00 4B27 6.00 4B28 35.00 4B29 35.00 4B30 21.50 4B31 18.00 4B32 23.50 4B33 30.00 4B34 47.50 4B35 16.50 4B36 150.00 4B37 80.00 4B38 1.50 4B39 2.00 6AK5W 2.00	6AK5 1.80 6AN5 2.50 6AN6 3.25 6AR6 2.75 6AS6 2.25 6AS7C 4.00 6C1 9.00 6C21 22.00 6C24 55.00 6C28 8.00 6E21 2.50 6E24 2.50 6E28 2.50 6E31 4.00 6E34 8.00 6E37 5.00 6E40 2.50 6E42 11.50 6E44 25.00 6E46 1.25 6E48 30.00 6E51 7.00 6E54 7.00 6E58 24.00 6E61 26.00 6E64 16.00 6E68 5.80 6E71 5.50 6E74 1.90 6E78 3.50 6E81 3.95 6E84 7.00 6E88 55.00 6E91 19.00 6E94 3.25 6E98 9.00 6E99 29.00 6E99A 1.20 6E99B 6.00 6E99C 3.50 6E99D 1.65 6E99E 60.00 6E99F 1.40 6E99G 1.55 6E99H 1.75 6E99I 5.00 6E99J .45 6E99K .67	730A 35.00 731A 4.50 801 2.10 802 4.00 803 4.00 804 16.00 805 3.00 807 1.65 807W 11.50 808 2.25 809 1.50 810 11.50 811 2.95 812 3.75 813 3.50 814 11.50 815 4.50 816 1.50 817 1.50 818 1.50 819 7.00 820 12.75 821 4.50 822 7.00 823 7.50 824 24.00 825 26.00 826 16.00 827 5.80 828 1.90 829 3.50 830 7.00 831 24.00 832 7.50 833 9.50 834 41.00 835 13.00 836 1.45 837 3.95 838 1.25 839 11.00 840 7.00 841 3.95 842 55.00 843 19.00 844 3.25 845 26.00 846 1.40 847 8.00 848 1.65 849 60.00 850 3.50 851 1.55 852 1.75 853 5.00 854 .45 855 .67	956 755 957 .35 958 .95 959A 1.00 961 2.00 962 4.00 963 1.50 964 1.50 965 6.00 966 2.25 967 1.50 968 1.50 969 1.50 970 3.00 971 3.00 972 3.00 973 3.00 974 3.00 975 3.00 976 3.00 977 3.00 978 3.00 979 3.00 980 3.00 981 3.00 982 3.00 983 3.00 984 3.00 985 3.00 986 3.00 987 3.00 988 3.00 989 3.00 990 3.00 991 3.00 992 3.00 993 3.00 994 3.00 995 3.00 996 3.00 997 3.00 998 3.00 999 3.00 1000 3.00	5702 4.45 5703 1.90 5704 2.75 5718 8.50 5719 11.00 5720 18.75 5722 6.25 5723 3.90 5724 2.00 5725 16.00 5726 3.25 5727 1.50 5728 1.50 5729 1.50 5730 1.50 5731 1.50 5732 1.50 5733 1.50 5734 1.50 5735 1.50 5736 1.50 5737 1.50 5738 1.50 5739 1.50 5740 1.50 5741 1.50 5742 1.50 5743 1.50 5744 1.50 5745 1.50 5746 1.50 5747 1.50 5748 1.50 5749 1.50 5750 1.50 5751 1.50 5752 1.50 5753 1.50 5754 1.50 5755 1.50 5756 1.50 5757 1.50 5758 1.50 5759 1.50 5760 1.50 5761 1.50 5762 1.50 5763 1.50 5764 1.50 5765 1.50 5766 1.50 5767 1.50 5768 1.50 5769 1.50 5770 1.50 5771 1.50 5772 1.50 5773 1.50 5774 1.50 5775 1.50 5776 1.50 5777 1.50 5778 1.50 5779 1.50 5780 1.50 5781 1.50 5782 1.50 5783 1.50 5784 1.50 5785 1.50 5786 1.50 5787 1.50 5788 1.50 5789 1.50 5790 1.50 5791 1.50 5792 1.50 5793 1.50 5794 1.50 5795 1.50 5796 1.50 5797 1.50 5798 1.50 5799 1.50 5800 1.50
--------------------------------------------------------------------------------------------------------------------------------------------------------------------------------------------------------------------------------------------------------------------------------------------------------------------------------------------------------------------------------------------------------------------------------------------------------------------------------------------------------------------------------------------------------------------------------------------------------------	---------------------------------------------------------------------------------------------------------------------------------------------------------------------------------------------------------------------------------------------------------------------------------------------------------------------------------------------------------------------------------------------------------------------------------------------------------------------------------------------------------------------------------------------------------------------------------------------------------	----------------------------------------------------------------------------------------------------------------------------------------------------------------------------------------------------------------------------------------------------------------------------------------------------------------------------------------------------------------------------------------------------------------------------------------------------------------------------------------------------------------------------------------------------------------------------------------------------------------------------------------------------------------------------------	-------------------------------------------------------------------------------------------------------------------------------------------------------------------------------------------------------------------------------------------------------------------------------------------------------------------------------------------------------------------------------------------------------------------------------------------------------------------------------------------------------------------------------------------------------------------------------------------------------------------------------------------------------------------	----------------------------------------------------------------------------------------------------------------------------------------------------------------------------------------------------------------------------------------------------------------------------------------------------------------------------------------------------------------------------------------------------------------------------------------------------------------------------------------------------------------------------------------------------------------------------------------------------------------------------------------------------------------------------------------------------------------------------	---------------------------------------------------------------------------------------------------------------------------------------------------------------------------------------------------------------------------------------------------------------------------------------------------------------------------------------------------------------------------------------------------------------------------------------------------------------------------------------------------------------------------------------------	--------------------------------------------------------------------------------------------------------------------------------------------------------------------------------------------------------------------------------------------------------------------------------------------------------------------------------------------------------------------------------------------------------------------------------------------------------------------------------------------------------------------------------------------------------------------------------------------------------------------------------------------------------------------------------------------------------------------------------------------------------------------------------------------------------------------------------------------------------------------------------------------------------------------------------------------------------------------------------------------------------------------------------------------------------------------------------------------------------------------------------------------------

PRICES SUBJECT TO CHANGE

ALL ITEMS SUBJECT TO PRIOR SALE

WRITE, WIRE OR PHONE

TELEPHONE RELAYS



Large Stock of
CLARE, TYPES C D & E
COOKE, AUTOMATIC-ELECTRIC
ALL TYPES OF COILS and PILE-UPS
Send Us Your Specs. for Our Quote

CLARE TYPE C STANDARD SIZE SENSITIVE TELEPHONE RELAYS

Coil	Contacts	Will Close at	Price
1) 6500 ohms 1A	4 MA	2 MA	\$2.25 ea.
2) 6500 ohms 1B	4 MA	2 MA	3.00 ea.
3) 6500 ohms 1B-1C	3.5 MA	2 MA	2.75 ea.
4) 6500 ohms 2A	4 MA	4 MA	3.00 ea.
5) 6500 ohms 4A	4 MA	4 MA	3.00 ea.
6) 6500 ohms 3A-1B	4 MA	4 MA	3.00 ea.
7) 6500 ohms 5A	5 MA	5 MA	3.25 ea.

CLARE TYPE G HALF SIZE SENSITIVE TELEPHONE RELAYS

Coil	Contacts	Will Close at	Price
1) 6500 ohms 2A	5 MA	5 MA	\$2.50 ea.
2) 5800 ohms 3A	4 MA	2.50 ea.	2.50 ea.
3) 5800 ohms 2B-1C	5 MA	2.50 ea.	2.50 ea.
4) 4850 ohms 1C	4 MA	2.50 ea.	2.50 ea.
5) 3600 ohms 1C	6 MA	2.00 ea.	2.00 ea.
6) 4850 ohms 1A	5 MA	2.00 ea.	2.00 ea.
7) 3300 ohms (None)	ACTUATOR	1.50 ea.	1.50 ea.

All above Relays may be used for continuous duty operation on 110V. D.C.

OTHER TYPE G TELEPHONE RELAYS

1) 1300 ohms 1A-1C	24 or 48V.	\$2.50 ea.
2) 400ohms 1A	12 or 24V.	1.65 ea.

CONTACT SYMBOLS
A=Norm. Open B=Norm. Closed C=S.P.D.T.

G.E. Relays #CR2791-R109P36 Coil—10,000 ohms Contacts 1A, 1B Operates on 8 MA... Price \$1.65
Signal Wheelock Relays #KS9665 Coil—2,000 ohms Contacts-1A, 1B, 1C Oper. at 9 Ma Price—\$2.75 ea.
Leach Relays Type 1025-SN-BF. Coil—24V. 425 ohms. Contacts—D.P.S.T. Norm. closed. Rated at 10 Amps. Price—\$1.50 ea.
FIVE Prong CR-2791 G.E. Plug In Relays.
1) C-103C25 2200 ohms SPDT 4.5 MA... \$4.00 ea.
2) C-104B28 700 ohms SPDT 6 MA... \$3.00 ea.

CLARE TYPE A Tel. Relay. Coil—55 Volts AC 60 cy. Contacts—3PDT (3 form C) Price—\$3.50 ea.

Clare SK-5032 (Hermetically Sealed) Plug-in Relays. Coil—30 ohms 6 volts Contacts—DPDT. Price—\$4.00 ea.

SIGMA TYPE 5F SENSITIVE RELAYS. Has two 70 ohm coils. Contacts—SPDT. Price—\$3.00 ea.

TYPE H TRANSMITTING MICA CONDENSERS

1) .003 MFD	2500v.	DCW	\$.45 ea.
2) .01 MFD	1200v.	DCW	.45 ea.
3) .001 MFD	1200v.	DCW	.35 ea.

Chase Electronic Supply Co.
222 Fulton St.
New York 7, N. Y.
Digby 4-3088
HOLLIS 4-3033

K-RK-ARC-UG-PL-AN

CONNECTORS

In Stock for Immediate Delivery

Connector Corporation

OF AMERICA

137 Hamilton St., New Haven 11, Conn. Phone: Spruce 7-2513
New York Phone: LEXington 2-6254

IN STOCK FOR IMMEDIATE DELIVERY

SIGMA 4F 8000 OHM RELAYS

All New, Contract Termination Material—Production Quantities Available

Special Low Price—3 for \$10.25—10 for \$32.50—100 for \$300.00

Super-Sensitive BK-35 Type Relays, 10,000 ohm at 1/2 ma, SPDT \$4.95

HERE IS ANOTHER GOOD NUMBER

Type DYR-6011, Dual .1 mfd 600 VDC, 3 Side Terminals Bathtub Capacitor 100,000 Clean New Units Available—Priced at 17 1/2¢ for Quick Sale
Note: at this price you can use them as is, tie both sections together (or approx. .25 mfd capacity or use as single .1 mfd unit).

FOR FAST, INTELLIGENT, FRIENDLY SERVICE ON ELECTRONIC ITEMS "CALL ON ESSCO"

ELECTRONIC SPECIALTY SUPPLY CO.

58 WALKER STREET NEW YORK CITY 13, N. Y. TEL. WALKER 5-8187

T47A/ART-13 TRANSMITTERS
BC-610-E TRANSMITTERS
BC-312, BC-342, BC-348 RECVRs.
BC-212 & LM FREQUENCY METERS

ALLTRONICS
BOX 19, BOSTON 1, MASSACHUSETTS
Richmond 2-0916, LYnn 8-3100

SEE OUR AD PG 484

• Parts & Equipment
• Amplifiers & Power Supplies (stand-ard and to-order)
COMPONENTS SUPPLY CO.



RADIO TUBES at New Low Prices

Type	Our Price	Type	Our Price	Type	Our Price	Type	Our Price	Type	Our Price
OZ4A	\$.59	6AG5	.62	6K6GT	.54	12SR7	.69	805	3.00
1R5	.57	6AL5	.49	6K8G	.80	12SQ7	.56	808	1.75
1S4	.69	6AQ5	.50	6SG7	.60	35Z4GT	.59	830B	2.40
1T4	.61	6AX4GT	.90	6SK7 Met.	.58	35Z5GT	.40	864	.20
1A5GT	.62	6B8G	.70	6SH7	.60	50L6GT	.50	866A	1.10
1B3GT	.93	6B8	.75	6SK7GT	.55	42	.60	9002	.80
1U5	.60	6BE6	.52	6SN7GT	.60	2E22	1.90	9004	.38
2X2	.56	6BQ6GT	1.00	6SS7	.80	5CP1	5.00	9006	.35
5T4	1.59	6C6	.59	6X5GT	.50	5BP1	4.00	2050	1.50
5U4G	.50	6H6 Met.	.54	7Q7	.60	100TH	6.00		
6AB7	.80	6J5 Met.	.50	12AU7	.65	357A	7.00		
6AC7	.80	6J5GT	.40	12SK7 Met.	.50	803	2.50		

Purchasing Agents NOTE: all tubes are New, Standard Brands, Packed in original cartons. Immediate delivery. Terms 25% with order, balance C.O.D. Minimum order: Transmitting tubes \$25.00, Receiving tubes—50 per type, or multiples of 50. Discounts on large orders. State quantity. Call or write today for detailed price list.

We are world-wide suppliers to Air lines, Government Agencies and the Radio industries

METROPOLITAN OVERSEAS SUPPLY CORPORATION

1133 Broadway

New York 10, N. Y.

Chelsea 3-1105

IMMEDIATE DELIVERY

NEW — AN/APR4 — USED

RECEIVERS

With following TUNING UNITS in stock—TN16-17-18-54

Write for prices

APS3 components	TS184/APS13
BC1306	TS251
PE237	EE8 Telephones
BC433G	BC314
MG153	BC342
BC1033	SCR714 (BC1137)
APS13	Dynamotor DM28
SCR269F & G	DY9
APR2	BC376
SCR625	RA52
SCR 508 crystal	CRT3
350 ft. RG 54U cable	MP10
TS10	LP21LM
TS16	BC1277
TS59	BC1287
TS69	IE19A
TS 100/AP	MN26C-LB-Y
TS127	RA10DA-DB
TS159/TPX	MR9B
	AN/CPN3

We buy any electronic material at top prices!

Write for our new 1953 Catalog!

Shipments FOB warehouse. 20% Deposit on orders. Minimum order \$5.00. Illinois residents, add regular sales tax to remittance. Prices subject to change without notice.

R W ELECTRONICS

Dept. EL, 1712-14 S. Michigan Ave.
Chicago 16, Ill.
PHONE: HARRISON 7-9374

COILS

RF-IF Sub-assemblies
Production & Special Test Equipment
AN/APR-4 Receivers & Parts
JERRELL ELECTRONIC, INC.
1970 Neva Dr. Dayton 4, Ohio
ORegan 1351

FOR SALE

RESISTANCE BATTERY CHARGER
240 VOLTS — DC
12 VOLT OUTPUT. AUTOMATIC
FS 8874 Electronics
330 W. 42 St. New York 36, N. Y.

WANTED

(Additional Wanted Advertising on the opposite page)

!! WANTED !!

IN ORDER TO SUPPLY GOVERNMENT AND INDUSTRIAL REQUIREMENTS, WE ARE PAYING TOP DOLLAR FOR ALL TYPES OF RADIO AND ELECTRONIC SURPLUS. WE SPECIALIZE IN TEST EQUIPMENT AND COMPLETE RADIOS, SUCH AS:

APA, APN, APQ, APR, APS, APT, ARB, ARC, ARN, ART, ATA, BC, DY, I, IE, LM, MG, PE, PU, SCR, TCS, TN, TS, and many others.

WE ESPECIALLY NEED: APA10, APN9, APR4, APS4, ARC1, ARC3, ART13, ATC, BC221, BC342, BC348, BC611, BC721, DY12, DY17, I100, LM10 to LM18, MG149F, MG149H, PU14, R5/ARN7, R5A/ARN7, SCR718C, TCS, TN16, TN17, TN18, TN19, TN54, TS3, TS13/AP, TS33, TS35, TS45, TS75, TS76, TS102, TS147/UP, TS148/UP, TS173, TS174, TS175, TS250, TS251, TS323, (ICT, IF, IG, SCT, SDG, 5F, 5G, 6DG, 6G 115V. 60 c.p.s. Selsyns), and all types of Hewlett Packard, General Radio Co., Measurements Corp., Boonton Radio, Ferris, Leeds & Northrup, and other test equipment.

Please state accurate description, condition, and your lowest price. Explain modification, if any. We pay freight charges.

PURCHASING AGENTS, ENGINEERS, EXPORTERS, INDUSTRIAL BUYERS, DEALERS, AND INDIVIDUALS, Please send us your requirements.

NEW CATALOG NOW AVAILABLE.

PHOTOCON SALES

417 N. Foothill Blvd. SYcamore 2-4131
Pasadena 8, California RYan 1-6751

WILL BUY

All ART-13/type T-47A \$200.00; ART-13/type T-47, \$150.00; BC-348 unmodified \$65.00, BC-348 modified \$50.00; APN-9 \$200.00; ARC-3 complete \$600.00; R77 Receivers \$300.00; ARC-1 \$300.00; BC-312 \$80.00; BC-342 \$60.00.
Ship via Express C.O.D., subject to inspection to:

H. FINNEGAN
49 Washington Ave. Little Ferry, N. J.

WANTED

ART-13, ATC DY-17, APR-4, APR-5, APN-4, APN-9, ARC-1, ARC-3, RTA-1B, BC-312, BC-342, BC-348, GRC, TDQ, TS & I Test Equipment, Manuals. Will trade for new ham Equipment.

ARROW APPLIANCE CO.
Box 19 Boston, 1, Mass.
Richmond 2-0916; Lynn 8-3100

WANTED

High Voltage OIL CONDENSERS
4 mfd. 10,000 volts or higher ratings and voltages.

THE OVERBROOK COMPANY
Overbrook, Massachusetts

REQUIRED

One new or used in good condition
SA or SA-2 Radar antenna array.
Please send quotation to Department of Telecommunications and Air Traffic Control, Kanaalweg 3, The Hague, Netherlands.

WE BUY

All kinds of surplus electronic equipment and components.

ELECTRONICRAFT, Inc.

27 Milburn St. Bronxville 8, N.Y.
BRonxville 2-0044

IN DETROIT IT'S AARON

FOR SALE

BRITISH A.I.A. MARK IV RADAR—160 to 220 MC—48 sets composed of the following:
 48—Modulators Type 16 Ref. No. 10DB/404
 48—Receivers Type R-3075 Ref. No. 10DB/403
 48—Transmitters Type R-3074 Ref. No. 10DB/402
 48—Switches Type 50 Ref. No. 10FB/232
 48—Antennas Type I Ref. No. 10BB/735
 48—Panel Control, Type IV, 12/24 V
 48—Engine Driven Alternators, Type R Ref. No. 5U/1271, 500 W., excitation 24 VDC 1300 to 2500 cycles.
 Plus—junction boxes, mounts, connectors, hoses w/oils
 Also the following test equipment for same:
 3—Signal Generators, Type 27 Ref. No. 10SB/52
 3—Wave-Meters, Type W-1296 Ref. No. 10T/79
 4—Test Sets, Type 33 Ref. No. 105/B/63
 795—British Tubes (Spares)

FOR SALE

XA-2 (ARQ-7) R.F. HEAD out of Pamaratic Sweep Receiver—2 bands: 16-77 MC—8 pcs.

FOR SALE

AT5-A/APS-4 AIRBORNE RADAR—20 units

FOR SALE

WESTINGHOUSE MOTOR-GENERATOR — A.C. Motor Type FS—1 hp. 3450 rpm, 60 cycle, 3 phase, cont. duty—D.C. Generator—Type FK, .5 KW, 3450 rpm, 250 VDC, 2 amps output—20 units

FOR SALE

TYPE G-1 SIGNAL ASSEMBLY OXYGEN PRESSURE—(Aircraft) made by G.E.—4,000 pcs.

AARON ELECTRONIC SALES

6025 MT. ELLIOTT

Walnut-1-9188

Detroit 11, Mich.

FOR SALE

CS-121-A D.F. UNIT—2 to 20 MC in 5 bands—20 units housed in a wooden chest CH-114-A each unit consists of:
 BC-991-A Oscilloscope
 BC-976-A Radio Receiver
 PN-21-A Control Panel, has 12 VDC to 110 VAC inverter

FOR SALE

FRIEZ-WIND VELOCITY INDICATING SYSTEM—Magneto Generator Type—Transmitter Cat. No. 1200-A 22 pcs.

FOR SALE

I—CABINET RACK FM-52—contains:
 BD-112 Panel—2 variacs and timer
 Meter Rack—2 DCma, 1 ACV
 BC-956 Oscilloscope BC-952 Receiver
 BC-954 Oscilloscope PE-192 Power Unit

FOR SALE

VOICE FREQUENCY HYBRID—TA-31 (XC-1)/U—Signal Corps., U. S. Army Cont. No. W-28-003-SC-1550—CCGSA-45—18 pcs.

FOR SALE

EDISON TEMPERATURE INDICATOR—24—28-VDC—120°C—No. P109—C127—A—FSSC—No. 88—1—2815—Plus 120°C—Wheatstone Bridge Inst.—Sensitive Resistive Type Element—160 pcs.

FOR SALE

10—PERFORMANCE TEST FIXTURES — Stock # (R) 86-DE-287—for use in testing Delco Remy regulators and Eclipse Supercharger regulators

ALL MERCHANDISE SUBJECT TO PRIOR SALE

Write-Wire-Phone—Mr. Gene Morasco, Sr.

WANTED

Amplidynes and Selsyns

GE Models 5AM45DB15, 5AM73AB58, 5AM-73AB9, 5AM73AB62, or equivalent types. Input 110/220V 60 Cycles; Output 250V DC at .6A.

Synchro Transmitters

C78248 and C69405-2, Type I-1. Advise price, condition and quantity available. Also need other types of synchros, auto-syns, Control Motors and Electronic Components.

Electro Sales Co. Inc.
 50 Eastern Ave. Boston 13, Mass.

POWER TUBES REBUILT

UNIVERSAL VACUUM TUBE CORP.
 137 Alexander Ave., Yonkers 2, N. Y.

ULTRA SENSITIVE
 RELAYS—SIGMA 4F \$4.50
 KURMAN BK-35 4.25
 11,000 ohm coil 0.4 Ma., SPDT adj.

DYNAMOTORS—New
 6 V. input, 180V/225 Ma. 9.50
 6 V. input, 350V/150 Ma. 9.50

JAN—C—25 CAPACITORS

available, CP53, 54, 55, 70
 Large Stock of Electronic Materials
 Send For Catalog

Gyro Electronics Co. WOrth 6-0859
 325 Canal Street, New York, N. Y.

4 PDT RELAY

26.5 VDC midget
 425 ohm \$2.95

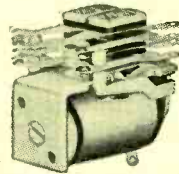

Above frame also in—
 280 ohm @ \$2.45. 12 vdc 70 ohm @ \$2.25. DPDT 6 vdc. 18 ohm \$1.95. SPST N.O. \$1.25. DPDT 6 vdc. 18 ohm \$1.95. SPST N.O. double break 10A cont. 5.3 vdc 15 ohm \$1.95

RELAY 3 PDT 24 vdc 250 ohm Clare Type K \$ 2.75
 CONNECTOR 15 pin Amphenol #26-151... .69
 S BAND CONVERTER Navy CG-46ABW... 89.50
 ISOLATION XFORMER 35 watts 115v. & 6.3 2.45
 SYNCHRO MOTOR 1 FS 115/90 v 400 cycles 14.95
 MOTOR 400-1800 eye 115v EAD J31C... 9.95
 SILVER TMR ERLE TS2a 1.5-7, 4-30, 7-45 36
 LINK MOBILE XMTBS #25UFM 30-40 MC. 59.50
 TRANSISTOR or 5 pin submini socket... .15
 BIRCHER CLAMPS 926A, 926B, 926C... .25
 J Pot 1 meg w/switch audio taper... 1.39
 CHOKE 2H 70 ma. 100 ohm wgt 5.5 oz... .29
 TOGGLE switch spst C.H. #8280... .23

CONDENSERS in stock: bathtubs from .02 400v to 2 mfd—600v, upright oils (CP65 pyranols, YAB, etc) from 3x.1-600v to 1 mfd 600v. Large oils from .1-7500v to 1 mfd-2,000v. Also mica, silver mica, compression trimmers, ceramics, air variables. Detailed listing available.

PL-144, SO-124, PL-68, AN-3106-10s-2s, 83-1H, 300-500 cycles, 1100 watt/variable freq. electronic generator 220v 60 cy. input. CML #1400
 2% .002 Silver Mica—3AG fuses—Switches—J Pots

All Material New, Clean, Guaranteed
 Partial list only. Write for Bulletin E

EMPIRE ELECTRONICS CO.

409 Ave. L, Brooklyn 30, N. Y. Cloverdale 2-2411

LAMP MAKING MACHINERY

Used Equipment at worth while savings. Exhausts, Sealing In, Basing, Pumps, Flaring, Aging, Etching, Mounting Pliers, Flashing, Spotters, Lacquers, many others.

What are your Requirements?

PURCHASING AGENTS EXCHANGE

208 W. 23rd. St. N. Y. Watkins 4-2612.



FOLLOW ARROW FOR MILITARY ELECTRONICS

VHF CONTROL TOWER
 COMPLETE TRANSMITTER-RECEIVER. FREQUENCY METER, POWER SUPPLY, ALL MOUNTED ON STANDARD RACKS. 6 FT. HIGH. FREQUENCY RANGE: 100-156 MC. 110/220 V. 60 CPS. LIKE NEW. GUARANTEED. WRITE FOR COMPLETE LITERATURE.....P.U.R.



TRANSMITTER TA-2J-24

High powered crystal controlled, long-range transmitter. Frequency range: 300-600 Kc and 2.9-15 MC. Eight separate channels are provided. New. Send for complete literature.....P.U.R.

Radar

APR-4 New, Complete	APT-3 Mark 16	RC-224 RC-266
APR-5 New, Complete	MD4/AP2	RT34/APS13
APR-6 New, Complete	MD5/APS3	T-85/APT-5
APT-1 APT-2	MD22/UPN2	PP-104/APT-5
	MD38/APQ13	RC-184/FF
	RC-214	

FOLLOW ARROW TO GET HIGHEST PRICES FOR YOUR NEW AND USED RADIO GEAR! What have you to sell? WRITE TODAY!



TS-159/TPX

Can be used as frequency meter. 150-200 MC. Separate 30 MC. output. Unit is crystal controlled. 2" meter has two scales: 0-50 and 0-500 VDC. Operates from 110 V. 400 cyc. Easily converted to 110 V. 60 cyc. Complete, new, with schematic. \$69.50 Only

Test Equipment

Complete Line

DuMont 224-A Oscilloscope	TS127/U
1-77 Hickok Tube Checker	TS131
1-208 FM Signal Generator	TS-148/UP
RPC Model 644 Multimeter	TS-170/ARN
Hewlett Packard 200-C	TS-175/UR
1-198 APN	TS-174/UR
BC-638	TS-24A
BC-1255	TS-28/UPN
CWI-60A/B	TS27/TSM
1E-36	TS-33
1-95	TS34/AP
1-96-A	TS-35/AP
1-122	TS36/AP
1-130A	TS-45A
1-139	APM-3
1-145	TS-59/APN
1-212	TS61/AP
1-222	TS89
TS-3A/AP	TS92
TS10A/APN	TS100/AP
TS12/AP	TS-102
TS-12 Spare Parts Kit	TS111/CP
TS16/APN	TS-118/AP
TS19/APQ	TS126

HEWLETT-PACKARD #205

RECEIVERS—TRANSMITTERS

ARC-1	PE-125AX	RTA/1B
ARC-3	R-9/APN-4	SCR-422
R-4/ARR-2	BC-733-D	TA21-24
ID-6/APN-4	R-57/ARN	R-89/ARN
MP-10G	BC-788-A-AM-C	R-1/ARR-1
BC-640	HC-639	RM-25
RM-26	SCR-284	SCR-536
SCR-530	MN-26 Complete Installation	

SCR-561 Equip. Motorola Model Fstr-250 EE 89 phone amplifier

GOVERNMENTS, AIRLINES AND INDUSTRIALS! Send for FREE Catalogue No. 112 for complete list of Military, Industrial and Aviation Electronics. WE HAVE THE LARGEST INVENTORY OF SUCH EQUIPMENT IN THE UNITED STATES.

ARROW SALES INC.

Mailing Address: P. O. BOX 3878-E, N. HOLLYWOOD, CALIF.
 Office-Warehouse: 7460 VARNA AVENUE, N. HOLLYWOOD, CALIF.
 Poplar 5-1810 • Stanley 7-6005 • Cable Address: ARROWSALES

THE Electro INDEX

INDEX

SEARCHLIGHT

SEPTEMBER, 1953

This index is published as a convenience to the readers. Care is taken to make it accurate but ELECTRONICS assumes no responsibility for errors or omissions.

Electro INDEX to Electronic Component VALUES

PULSE NETWORKS & TRANSFORMERS

GE #E3-5-2000-P2T	\$14.50
Sprague #7.5E3-3-200-67P	12.50
Sprague #7.5E4-16-60-67P	14.50
Sprague #8E5-1-1000-50P	22.50
Sprague #10E3-0.5-2000-50P	34.50
Sprague #15A1-400-50P	27.50
Sprague #15E4-0.3-400-50P	24.50
Fast #15E5-1.3-700-50P2T	29.50
Sprague #25E5-1.0-500-50P3T	65.00
GE #M7467813P1, 2.5 Microsec, 2000PPS, 2.7KV	9.50
Raytheon WX5782A, 1.2 Microsec, 3.5 KV	14.50
WE #D163329 Network Assy.	29.50
Raytheon U12920 Pulse Trans.	14.50
GE #80G13 Pulse Trans.	8.50

HIGH VOLTAGE CAPACITORS

Cat. No.	Mfd.	WVDC	Price
21XP30	120	3KV	\$99.50
22F985	4	4KV	22.50
22F221	4	4KV	22.50
PFD40244	7	4KV	34.50
22F225	1	5KV	14.50
14F3	4	5KV	32.50
14F2	7	5KV	49.50
19F210	0.1	6KV	17.50
A7548	2x.25	6KV	17.50
TK00020	2	6KV	27.50
26F513	2x.68	7.5KV	27.50
7520	2x1.0	7.5KV	27.50
14F338	4.5	7.5KV	79.50
CC21B	2x0.5	9KV	19.50
3DA20-136	.02	10KV	7.50
10020	0.1	10KV	9.95
Inerteen	1.0	10KV	25.00
14F13	5	10KV	124.50
26F58	0.1	12KV	9.95
TK120065	65	12.5KV	19.50
15020	.25	15KV	19.50
14F17	1	15KV	45.00
14F63	1	15KV	45.00
31F8	1.5	15KV	62.50
20020	.25	20KV	27.50
14F64	.25	20KV	27.50
37485	.25	20KV	27.50
26F585	.06	25KV	17.50
X5W200	.25	20KV	27.50
20005	1.0	20KV	52.50
14F22	0.1	20KV	45.00
14F139	.01	22KV	15.50
Inerteen	.5	25KV	57.50
25020	.5	25KV	57.50
14F24	.5	25KV	57.50
14F33	.75	25KV	72.50
Inerteen	1.0	25KV	85.00
A6734	1.0	25KV	85.00
S1258441	1.5	25KV	124.50
14F112	.001	50KV	24.50
14F98	2x.025	50KV	37.50
14F127	.025	50KV	37.50
14F126	.2	50KV	70.00
14F97	.25	50KV	70.00

VARIABLE TRANSFORMERS

Line Volts	Output V.-Amps	KVA	Price
115	0-135	3.0	\$11.25
115	0-135	7.5	16.50
*115	0-135	7.5	0.86
115	0-135	15.0	20.50
*115	0-135	15.0	41.50
115	0-135	30.0	51.00
115	0-135	45.0	5.0
115	0-115	45.0	6.1
115	0-75.5	45.0	5.2
*115/230	0-230	25.0	5.7
*115/230	0-270	31.0	7.0

* w/case, line cord plug, input receptacle
used, reconditioned like new units

ELECTRONIC TUBES

0A2	.95	1B36	16.75	1N35	1.75
0A3	1.04	1B38	39.35	1N36	4.25
0A4G	1.05	1B41	45.00	1N47	5.25
0B2	1.25	1B42	17.50	1N58A	1.15
0B3	1.10	1B50	32.50	1N60	.60
0C3	1.10	1B51	12.00	1P21	29.50
0D3	.95	1B54	37.50	2AP1	6.50
0Z3	.95	1D21	3.95	2AP1A	10.50
VG1A	8.75	1N21	1.25	2B22	3.25
ELC1B	8.75	1N21A	1.55	2C21	.95
1B21A	2.95	1N21B	2.50	2C22	.49
1B22	3.10	1N22	1.85	2C26A	.59
1B23	8.75	1N23	1.35	2C33	3.45
1B24	9.00	1N23A	2.35	2C36	27.50
1B26	8.75	1N23B	2.95	2C39	26.00
1B27	13.00	1N24	1.55	2C39A	26.00
1B29	2.75	1N26	8.25	2C40	9.50
1B32	2.25	1N34	.60	2C43	18.00
1B35	11.50	1N34A	.90	2C44	1.45

ELECTRONIC TUBES

2C80	4.50	RK65	1.75	813	13.50
2C81	6.75	CE67	22.50	814	3.25
2C82	6.75	CE072	.85	815	4.95
2C83	11.50	RK73	.75	816	1.50
2D21	1.50	RK75	4.25	826	1.25
2E22	2.50	FC81A	9.25	828	12.50
2E30	2.00	89Y	.95	829	9.00
2E31	2.10	FC87	26.00	829A	11.00
2E32	1.60	FC95	27.50	830	13.00
2E36	2.25	FC98A	27.00	830B	3.25
2E41	3.35	HF100	15.00	832	8.50
2E42	2.65	WL100	59.35	832A	9.55
2G21	2.20	100T5	2.95	833A	37.50
2G22	2.20	FC104	24.95	834	13.50
2J21A	7.20	FC105	74.38	835	4.65
2J22	9.00	VU118	.10	837	1.65
2J23	25.00	114B	2.35	838	4.95
2J26	23.00	RK120A	14.50	841	.65
2J30	69.50	F123A	26.50	842	1.25
2J32	37.50	F124A	26.50	845	13.50
2J34	32.00	VT127	9.95	849	89.95
2J35A	37.50	F128A	45.00	851	75.00
2J39	24.50	FC172	29.95	852	27.50
2M22	45.00	GL203A	11.00	860	203.00
2M25	45.00	203D	3.25	861	29.95
2M26	80.00	207	230.00	865	2.35
2M29	29.95	217	1.45	866A	1.60
2M33	195.00	CE213	3.75	872A	2.50
2M34	195.00	217C	10.95	874	2.00
2M41	135.00	RK233A	3.95	874	1.50
2K45	135.00	249B	7.95	886	2.70
2R35	1.95	250TH	23.00	905	3.95
2X2	7.75	264C	3.45	923	15.50
2X2A	1.85	267B	7.50	926	2.45
3B21	17.00	VT127	9.95	929	1.95
3B22	27.50	FG271	57.50	929	1.40
3B24	5.50	274B	3.75	930	1.65
3B24W	9.50	FG280	7.00	932	4.75
3B26	6.75	282A	14.50	932	4.25
3B27	6.50	304TH	13.50	954	.49
3B28	14.95	304TL	11.95	959	.68
3BP4	7.50	307A	4.95	956	.68
3CP1	4.75	308A	55.00	957	.69
3C24	1.95	310A	6.50	993	3.39
3C27	7.50	311A	3.75	CM1005	.95
3C28	6.50	312A	3.75	CM1017	1.75
3C35	12.50	316GA	3.00	CM1019	1.75
3C45	18.50	319A	23.25	CM1090	3.50
3D23	2.50	320A	4.75	R1133C	7.50
3E29	11.00	331A	3.50	E1348	.95
3F24	3.50	334A	2.65	1203A	1.25
3FP7A	14.00	349A	1.35	1203A	4.50
3GP1	6.95	350A	8.00	1206	.85
3K24	19.50	368AS	7.75	1614	2.35
KC4	50.00	371B	1.39	1614	4.90
KC4-3	39.95	388A	4.75	1616	1.25
4B26	11.00	394A	4.50	1620	6.50
4B28	6.25	417A	17.50	1622	2.25
4C35	32.50	446A	16.75	1625	4.90
4E27	22.50	446D	16.75	1626	.49
4F27A	15.50	471A	12.95	1632	.49
4J31	135.00	450TL	55.00	1630	.85
4J32	195.00	464A	8.95	1632	.85
4J33	195.00	471A	12.95	1633	1.10
4J52	225.00	GL502A	1.80	1634	.45
CS8	4.25	530	16.95	1641	2.65
CP1	4.50	549	34.50	1663	3.10
5D21	17.50	559	1.75	1846	3.10
5F27	2.75	577	1.75	1851	3.95
5FP7A	12.50	WL616	45.00	1960/5836	3.95
5FP14	27.50	617	11.00	2050	1.85
5P1	27.50	KU628	12.50	2448	1.15
5LP1	27.50	6F31	65.00	4120	3.25
5LP2	35.00	FG632A	50.00	S5501	12.00
5R24	1.50	649	6.95	R4330	15.00
5RP1A	27.50	651/656	69.50	R4410	15.00
5RP2A	37.50	6F60	37.95	5527	10.00
5R4V	1.75	653	9.95	681	7.00
5RW4V	3.25	672A	34.50	5557	18.50
5UP11	22.50	GL675	7.05	5559	2.35
6A15	1.30	706AV	59.50	5654	4.00
6AN5	3.15	706DV	58.50	5659	4.35
6A66	3.05	707C	59.50	5661	3.75
6A56	2.95	707A	18.25	5661	2.00
6A57	4.50	707B	19.25	5663	4.20
6B67	1.30	708A	4.75	5664	8.45
6B68	75.00	709A	3.85	5670	6.95
6C61	7.95	713	1.98	5691	8.45
6C21	6.95	715	1.90	5692	8.45
6J4	6.95	715	5.00	5693	6.95
6K4	4.50	715A	5.75	5732	3.95
6P7	1.50	724B	1.50	5743	4.75
9LP7	37.50	715C	24.50	5751	3.75
10Y	6.5	717A	1.75	5783	1.65
12P7	17.50	718V	79.50	5807	5.25
12P7	17.50	719A	42.50	5807	5.25
12P7	17.50	720CV	65.00	5814	3.95
15A3	7.0	724B	22.50	5814	3.95
15E	1.85	723AB	22.50	5871	3.35
15R	1.05	724A	2.75	5937	4.90
15T	9.00	726C	75.00	7193	4.95
RK20A	3.95	725A	9.50	UX6089	1.75
24G	1.85	726A	14.50	UX6653	1.25
25T	9.00	726C	75.00	7193	4.95
FG-27A	23.00	SN729	3.25	2C22	

**TO THE
ADVERTISERS**

SEPTEMBER, 1953

SEARCHLIGHT SECTION
(Classified Advertising)
H. E. Hilty, Mgr.

Kollsman Instrument Corp.	456
Lapirow Bros	480
Lectronic Research Laboratories	458, 459
Legri S Co.	477
Leru Labs Inc.	478
Liberty Electronics, Inc.	460, 461
MacDonald, W. W.	447
Maritime International Co.	486
Maritime Switchboard Co.	479
Maxson Corp., W. L.	450
McDonnell Aircraft Corp.	454
Medical Salvage Co., Inc.	482
Melpar, Inc.	456
Metropolitan Overseas Supply Corp.	490
Metropolitan Telephone Supply Co.	483
Milgray Electronics, Inc.	484
Mogull Co., Inc., Alexander	480
Monmouth Radio Laboratories	479
National Cash Register Co., The	452
National Scientific Laboratories, Inc.	453
New York Electronics	487
Norman Electronics Sales	486
O'Del Electronics Corp.	476
O'Shea Employment System	447
Overbrook Co., The	490
Page Engineers	447
Phillips Petroleum Co.	453
Photocon Sales	490
Powell Co., Harold	482
Purchasing Agents Exchange Inc.	491
Radalab	472
Radio Condenser Co.	455
Radio Corporation of America	451
Radio Development & Sales Co.	488
Radio & Electronic Surplus	479
Radio Ham Shack, Inc.	484
Radio Shack Corp.	487
Radio Surplus Corp.	465
Railway Communications Inc.	482
Red Arrow Sales Co.	467
Relay Sales	485
Reliance Merchandising Co.	467
Resisco Corp.	486
R. W. Electronics	490
Servo-Tek Products Co.	473
Southwest Research Institute	455
Southwestern Industrial Electronics Co.	448
Standard Radio-Electrical Products	482
State Labs Inc.	488
Stromberg-Carlson Co.	448
Sylvania Electric Products Inc.	452
"TAB"	494
Universal General Corp.	468
Universal Vacuum Tube Corp.	491
Vectron, Inc.	455
Wells Sales Inc.	477
Western Engineers	478, 486
Weston Laboratories Inc.	475
Wilcox Electric Inc.	448
Wilgreen Industries	474
Zenith Optical Lab.	482

THE Electro INDEX

SELSYNS—SYNCHROS

Immediate Delivery—Fully Guaranteed

1CT Control Transformer, 90/55V 60	564.50
1G Generator, 115/90V 60	64.50
1F Motor, 115/90V 60	64.50
1HCT Control Transformer, 90/55V 60	84.50
1DG Differential Generator 90/90V 60	64.50
1HG Generator, 115/90V 60	84.50
1HDG Differential Generator, 90/90V 60	84.50
2J1M1 Control Transformer, 105/63V 60	59.50
1N Motor, 115/90V 60	49.50
1SF Motor, 115/90V 400	17.50
1F Special Motor, 115/90V 400	15.00
2J1D1 Generator, 115/90V 400	12.50
2J1F1 Generator, 115/57.5V 400	9.50
2J1F3 Generator, 57.5/57.5V 400	9.50
2J1G1 Control Transformer 57.5/57.5V 400	9.50
2J1H1 Differential Generator 57.5/57.5V 400	12.50
2J1H2 Generator 115V 400	17.50
2J1J1 Motor, 115/90V 400	15.00
3F Motor, 115/90V 60	84.50
3HCT Control Transformer, 90/55V 60	84.50
2JDSR1 Motor, 115/90V 400	27.50
5SF Motor, 115/90V 400	32.50
5SG Generator, 115/90V 400	32.50
5SDG Differential Generator 90/90V 400	32.50
K5S950 Generator, 115/90V 400	15.00
K5S950L2 Generator, 115/90V 400	15.00
2JA39BB2 Motor, G.E., 110/55V 60	55.00
2J5F31 Control Transformer 105/55V 60	60.00
2JDS2 Motor, 115/105V 60	60.00
2J5H1 Generator, 115/105V 60	50.00
2J5HA1 Generator, 115/105V 60	60.00
2J5A4 Generator, 115/105V 60	60.00
2J5J1 Differential Generator 90/90V 60	60.00
2JDS2 Motor 115/90V 60	60.00
2J5LA1 Generator 115/105V 60	60.00
2J5F31 Generator 110/55V 60	35.00
2JDS2A16 Motor, 110/40V, 60	55.00
5A Generator, 115 Volts 60 Cycles	22.50
5B Generator, 115 Volts 60 Cycles	22.50
5CT Control Transformer 90/55V 60	50.00
5HCT Control Transformer 90/55V 60	69.95
5D Differential Motor, 115/90V 60	50.00
5DG Differential Generator 90/90V 60	50.00
5F Motor, 115/90V 60	50.00
5G Generator, 115/90V 60	22.50
5M Motor, 115 Volts 60 Cycles	22.50
5N Motor, 115 Volts 60 Cycles	64.50
2J6F1 Generator 115/90V 60	64.50
2J6F2 Generator 115/90 Volts 60	64.50
6SG Generator, 105/90 Volts 60	60.00
6CT Control Transformer 90/55V 60	60.00
6DG Differential Generator 90/90V 60	60.00
6G Generator, 115/90V 60	57.50
7G Generator, 115/90V 60	69.95
C44985-5 Type II-3, Repeater, 115V 60	22.50
C56701 Type II-4 Repeater, 115V 60	22.50
C56776-1 Repeater AC Syn. 115V 60	22.50
C69406 Diehl FJ84-8 Transmitter 115V 60	22.50
C69406-1 Type II-2 Repeater, 115V 60	22.50
C77610 Type III Repeater 115V 60	22.50
C78248 Transmitter AC Syn. 115V 60	22.50
C78249 Differential AC Syn. 115V 60	9.50
C78254 Type XII Differential 115V 60	22.50
C78411 Transmitter AC Syn. 50V 60	14.50
C78444 Transmitter AC Syn. 115V 60	49.50
C78359 Diehl 84-4, Receiver 115V 60	22.50
C78360 Diehl 84-5, Transmitter 115V 60	22.50
C78386 Type XV Transformer 115V 60	22.50
C78791 Transmitter AC Syn. 115V 60	22.50
C79331 Type I-4 Transmitter 115V 60	22.50
C81369 Type II-8 Repeater, 115V 60	22.50
PATT-6547 Admiralty Transmitter 115V 60	17.50
PATT-6548 Admiralty Transmitter 115V 60	17.50

DIEHL AC CONTROL MOTORS

FP25-2, 22V 2ph 60 ~.85A 1600RPM	\$22.50
FP25-3, 20V 2ph 60 ~.5A 3200RPM	22.50
FPE25-8, 75/75V 60 ~.11/.11A 2ph 2 watts, 2 pole	24.50
FPE25-9, 100/100V 400 ~.44/.44A 2ph 7 watts, 2 pole	27.50
FPE25-11, 75/75V 60 ~.11/.11A 2ph 4 watts, 2 pole	29.50
FPE25-12, 115/115V 60 ~.16/.16A 2ph 5 watts, 2 pole, 3200 RPM	34.50
FPE25-14, 20/20V 60 ~.5/.5A 2 ph 2 pole	22.50
FPE25-16, 20/20V 60 ~.85/.85A 2 ph 2 pole, 1600 RPM	24.50

SINE-COSINE GENERATORS (Resolvers)

Diehl Type FJE43-9 (Single Phase Rotor). Two stator windings 90° apart, provides two outputs equal to the sine and cosine of the angular rotor displacement. Input voltage 115 volts, 400 cycle. \$30.00 ea. except it supplies maximum stator voltage of 220 volts with 115 volts applied to rotor. \$25.00 ea. Diehl Type FJE43-10 \$30.00

PM MINIATURE MOTORS

DELCO 5068571, 27VDC, 10000RPM	\$18.50
DELCO 5068750, 27VDC, 160RPM (used)	12.50
DELCO 5069230, 27VDC, 145RPM (used)	12.50
DELCO 5069600, 27VDC, 250RPM (used)	12.50
GE #5BA10A3J37B, 27VDC, 250RPM 8oz/in torque (used)	12.50
GE #BA10A40, 24VDC 140RPM 10oz/in torque	16.00
HOLTZER-CABOT #B3-RBD0808, 24VDC 5000RPM	15.00
Diehl P. M. Motor #FD6-21, Part #KS15098L01, 27.5VDC 10,000RPM (large quan. available)	14.50

FRACTIONAL HP MOTORS

EAD J31, 115VAC 400cy 1/50HP 5000RPM	\$9.95
EAD J31, 115VAC 400cy 1/100 HP 25A 7200RPM	9.95
DELCO A7155, 27VDC 2.4A 1/30HP 3600RPM	9.95
OSTER #D-4-2 24VDC 1/60HP 1800 RPM	9.95
1/4HP 3800RPM	22.50
ELEC. SPEC. TYPE 1A1, 24VDC, 15A 1/4HP 3800RPM	22.50
DELCO A7156, 27.5VDC 1/50HP 3000 RPM	8.95
OSTER #E-6-1, 115VDC .39A 1/50HP 1725RPM	9.95
ELEC. IND. #203, 115VAC 60cy 0.45A 1/75HP 1800RPM	12.50
JAY ELEC. #145, 230VDC Armature-30V Fields 1/4HP 3450RPM	23.75
DIEHL/DELCO C78291/C7889, 115V 60cy 3ph 1/40HP 2850RPM	4.95
OSTER #ES-2-1 SERVO, split differential fields, stalled torque, 11 oz/in w/.5A arm. cur. & 70MA one field 5000RPM	9.95
OSTER VRS-1B, 6VDC, 1.8A 5000 RPM	8.95
PACKARD, 6VDC, 1/100HP 5000 RPM	6.95
REDMOND, 6VDC, 1/50HP 5000 RPM	8.95
PIONEER K55603, 24-28VDC, 0.6A, 1/100HP 500RPM	5.50
ALLIANCE 2207, 27.5VDC 1/100HP 7500RPM	8.95
LEAR #C004, 24VDC, 1.5A 8W 7500 RPM	6.95
EICOR ML2310-52, 24VDC 0.32A 1800RPM	5.00
UNIVERSAL #523, 115VDC 12A 5000 RPM	5.95
WESTINGHOUSE #171391B, 27VDC 6.5A 1/8HP 5800RPM	14.95
HOLTZER-CABOT RBD-220 2 VDC 18A 1/3HP 6000RPM	22.50

BLOWERS

W.E. KS15098L01, PM Mtr w/T Impeller, 27.5VDC 10,000RPM	\$14.50
ALLIANCE 28VDC 35CFM	8.95
FASCO MOD 69C, 115VAC 60cy 50 CFM	9.95
REDMOND 24VDC 1.35A 4750RPM 100CFM	12.50
REDMOND 115VAC 60cy 85CFM	12.95
WESTINGHOUSE TYPE FL 115V 400cy 6700RPM 50CFM	8.95
EAD, 115V 400cy 110CFM	14.95
WESTINGHOUSE 115VDC 1/75HP 250CFM	20.50
AMERICAN 230V 60cy 1/3HP 2000 CFM	49.50

Electro INDEX to Electronic Component VALUES

ELECTRO Sales Company Inc.



50 EASTERN AVE., BOSTON 13, MASS. CAPITOL 7-3456



he's working
for you

THIS FELLOW IS TRAINED IN YOUR BUSINESS. His main duty is to travel the country — and world — penetrating the plants, laboratories and management councils . . . reporting back to you every significant innovation in technology, selling tactics, management strategy. He functions as your all-seeing, all-hearing, all-reporting business communications system.

THE MAN WE MEAN IS A COMPOSITE of the editorial staff of this magazine. For, obviously, no one individual could ever accomplish such a vast business news job. It's the result of many qualified men of diversified and specialized talents.

AND, THERE'S ANOTHER SIDE TO THIS "COMPOSITE MAN," another complete news service which complements the editorial section of this magazine — the advertising pages. It's been said that in a business publication the editorial pages tell "how they do it" — "they" being all the industry's front line of innovators and improvers — and the advertising pages tell "with what." Each issue unfolds an industrial exposition before you — giving a ready panorama of up-to-date tools, materials, equipment.

SUCH A "MAN" IS ON YOUR PAYROLL. Be sure to "listen" regularly and carefully to the practical business information he gathers.



McGraw-Hill PUBLICATIONS

Electro Engineering Products Co	355
Electro Tec Corporation	285
Electro-Technical Products, Div. of Sun Chemical Corp.	228
Electronic Instrument Co., Inc.	365
Electronic Parts Manufacturing Co., Inc.	103
Electronic Tube Corporation	19
Electrons, Inc.	210
Engineering Research Associates, Div. of Remington Rand	354
Epco Products, Inc.	399
Erie Resistor Corporation	92

Fairchild Engine & Airplane Corporation	248
Fansteel Metallurgical Corp.	414
Federal Telephone & Radio Corporation	289
Federated Metals Div. American Smelting & Refining Co.	314
Ferranti Electric, Inc.	415
Ferroxcube Corporation of America	125
Fidelity Instrument Corp.	445
Film Capacitors, Inc.	371
Five Star Company	445
Ford Instrument Company	399
Freed Transformer Co., Inc.	309
Frequency Standards	357
Fugle-Miller Laboratories	409
Furst Electronics	417

G-V Controls, Inc.	382
Gabler, Carl	445
Gamewell Company	396
Garlock Packing Company	398
Gee-Lar Manufacturing Co.	393
General Cable Corporation	30, 31
General Ceramic & Steatite Corp.	277
General Electric Company Apparatus Dept.	93, 103, 247, 275
Electronic Dept.	75, 119, 127
General Precision Laboratory, Inc.	28, 29
General Radio Company	17
General Transformer Co.	370
Giannini & Co., Inc., G. M.	412
Good-all Electric Mfg. Co.	243
Goodmans Industries Limited	124
Grant Pulley & Hardware Corp.	324
Green Instrument Co., Inc.	421
Gries Reproducer Corp.	498
Gudebrod Bros. Silk Co., Inc.	365

Hammarlund Manufacturing Co., Inc.	416
Hanovia Chemical & Mfg. Co.	361
Hart Manufacturing Co.	296
Hathaway Instrument Co.	386
Haydon Co., A. W.	425
Haydon Manufacturing Co., Inc.	310
Heath Company	361
Heiland Research Corporation	278
Heldor Manufacturing Corp.	106
Helipot Corporation, The	201
Heminway & Bartlett Mfg. Co.	409
Heppner Manufacturing Company	426
Hermaseal Company, Inc.	25
Hermetic Seal Products Co.	85
Hetherington, Inc.	334
Hewlett-Packard Company	104, 105

Hexacon Electric Co.	401
Heyman Manufacturing Company	357
Hickok Electrical Instrument Co.	417
Hinde & Dauch	240
Hopkins Engineering Co.	312, 409
Hudson Radio & Television Corp.	427
Hudson Tool & Die Company, Inc.	259
Hudson Wire Co.	251
Hughes Aircraft Company	257
Hughes Research & Development Laboratories	256, 360
Hycor Company, Inc.	375

Ideal Industries Inc.	384
Industrial Control Co.	377
Industrial Hardware Mfg. Co., Inc.	417
Industrial Mica Corporation	393
Industrial Test Equipment Co.	409
Inet, Inc.	375
Instrument Corp. of America	126
Instrument Resistors Co.	397
International Instruments, Inc.	387
International Nickel Company, Inc.	38
International Rectifier Corp.	34
International Resistance Co.	68, 69
Ippolito & Co., Inc., James	359
Irvington Varnish & Insulator Co.	83
Jan Hardware Mfg. Co., Inc.	377
Jelliff Manufacturing Corp., C. O.	429
Jennings Radio Mfg. Co.	250
JFD Mfg. Co.	397
Johnson Company, E. F.	292
Jones Div., Howard B. Clinch Mfg. Co.	429
Joy Manufacturing Company	213

Kahn Research Laboratories	439
Kahle Engineering Company	413
Kalbfell Laboratories, Inc.	350
Karp Metal Products Co., Inc.	71
Kartron	445
Kay Electric Company	100
Kearfott Company, Inc.	400
Kellogg Switchboard & Supply Co.	425
Kepco Laboratories, Inc.	283
Kester Solder Company	263
Ketay Manufacturing Corp.	379
Keuffel & Esser Co.	50, 51
Keystone Carbon Company	297
Keystone Products Company	331
Kirk & Blum Mfg. Co.	322
Klein & Sons, Mathias	214
Knights Company, James	246
Kollsman Instrument Corporation	286
Krengel Manufacturing Co., Inc.	423

Laboratory for Electronics, Inc.	88, 401
Lambda Electronics Corporation	389
Lampkin Laboratories, Inc.	445
Lamson & Sessions Co.	87
Lapp Insulator Company, Inc.	216
Lenkurt Electric Sales Co.	342, 343
Lewis Engineering Co.	365
Lewis Spring & Mfg. Co.	270
Linde Air Products Co., A Div. of Union Carbide & Carbon Corp.	403
Lindgren & Assoc., Erik A.	441

ENGINEERED FLUOROCARBONS

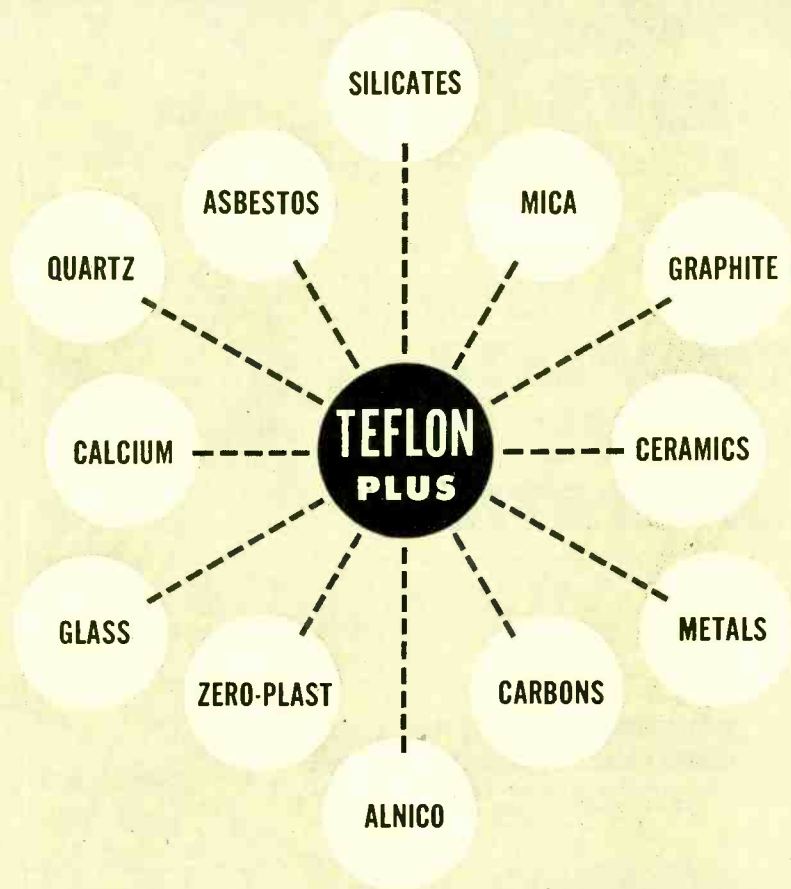

Offer Engineers a Whole New Family of Materials

Starting with TEFLON*, United States Gasket Company engineers have developed a series of "Filled" Fluorocarbon materials, greatly broadening the scope of usefulness of this wonder-plastic. For example, United States Gasket Company "Application Engineering" has already helped solve such material problems as long-wearing chemical resistant bearings and pump impellers; valve and pump packings, expansion joints and chambers, gaskets; the metal plating of Teflon; the hermetic sealing of electronic components; soldering and cementing to Teflon; etc., etc.

If you have a special materials problem, that one of these Teflon "alloys" might solve, tell us about it. Our engineering department will work with yours to determine the Chemelec Mixture best suited to your requirements.

UNITED STATES GASKET COMPANY



FLUOROCARBON PRODUCTS DIVISION
FABRICATORS OF "TEFLON" "KEL-F" AND OTHER FLUOROCARBON PLASTICS
CAMDEN 1, NEW JERSEY

*duPont's trademark for its tetrafluoroethylene resin.

**MULTIPLE ASSEMBLIES
FOR SMALL PARTS BELONG TO
HORSE-AND-BUGGY DAYS**

**GRIES
DIE CASTINGS
GIVE YOU TINY
PARTS LIKE THESE
COMPLETE
IN ONE
OPERATION**

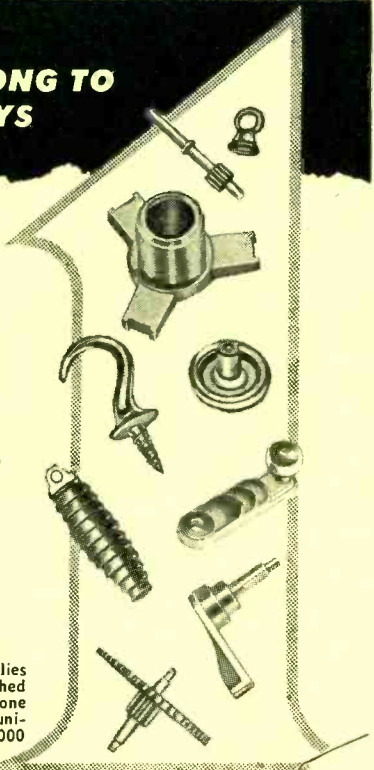

Compare GRC small die castings with assemblies produced by other methods. GRC completely finished parts save you time, labor, money. Cast in one high-speed operation, they open broad opportunities for your new designs. Fast delivery on 100,000 pieces to many millions.

Write today for bulletin and samples.
Send prints for quotations.

GRIES REPRODUCER CORP.

Manufacturers of Small Castings Exclusively
151 Beechwood Ave., New Rochelle, N. Y.
New Rochelle 3-8600

America's
Foremost
Producers
of Tiny
Die
Castings

Smallness Unlimited
Max. Wt.: 1/2 oz.
Max. Lgth.: 1 3/4 in.



Measurements Corporation
MODEL 78

**STANDARD SIGNAL
GENERATORS**

FREQUENCY RANGE: Choice of two bands; frequency ratio of each band 1.8 to 1 within range of 10 Mc. to 250 Mc. Special single band instruments also available up to 420 Mc.

OUTPUT VOLTAGE: Continuously variable from 1 to 100,000 microvolts.

MODULATION: AM, fixed at 30%.

POWER SUPPLY: 117 v., 50/60 cycles.

**MEASUREMENTS
CORPORATION**

BOONTON NEW JERSEY

**ALFAX UNIVERSAL
RECORDING PAPER**

For the first time there is available an indelible recording paper — ALFAX — that is NOT subject to humidity, temperature or capillary action problems usually associated with pen and ink or papers marked by arcing or heat.

**ELECTRICITY IS THE INK
THAT MARKS ALFAX**

Alfax paper can be marked by current as low as one volt and is instantaneous, permanent and stable. Highly sensitive Alfax is capable of fourteen steps by simply varying the current through the paper.

Alfax is the only paper that is capable of high speed recording, stable before or after recording, is non-transferable, has low current consumption at high speeds, can record at high humidity over all temperature ranges, is smudge proof and non-toxic, widths from 1/4" to 72".

Alfax opens a whole new field of monitoring and recording of phenomena which never before have been done easily and cheaply.

THIS MONTH'S EXAMPLE

To find material defects in gun barrels a Govt. arsenal applied a helix recorder with Alfax paper that graphically recorded the inside of the barrel, instantly showing the exact information needed. No other recording medium was suited to this job.

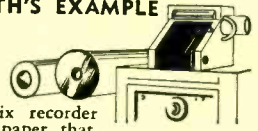

Request Booklet—describe your problem

Alfax Paper & Engineering Co.

Alden Research Center, Westboro, Mass.
ENGINEERING SERVICE TO
RECORDER MANUFACTURERS

Link Aviation, Inc.	376
Lion Fasteners, Inc.	408
Littelfuse, Inc.	113
Litton Engineering Laboratories	80

MB Manufacturing Co., Inc.	76
Magnatran Incorporated	407
Magnetics, Inc.	440
Malayan Tin Bureau	114
Mallory & Co., Inc., P. R.	128, 197
Manson Laboratories	421
Manufacturers Engineering & Equipment Corp.	415
Marconi Instrument, Ltd.	390
Marion Electrical Instrument Co.	271
Maryland Electronic Mfg. Corp.	300
McGraw-Hill Book Co.	369
McGraw-Hill Book Co. Technical Writing Service	325
Measurements Corporation	401, 498
Mepeo, Inc.	54
Metal Textile Corp.	397
Metals & Controls Corp., General Plate Div.	108
Meyerord Co.	411
Mica Insulator Company	239
Micro, A Division of Minneapolis-Honeywell Regulator Co.	222
Microlab	425
Midland Manufacturing Co., Inc.	231
Miles Reproducer Co.	445
Milford Rivet & Machine Co.	291
Millen Mfg. Co., Inc., James	428
Millivac Instrument Corp.	338
Milo Radio & Electronics Corp.	437
Milwaukee Transformer Co.	422
Miniature Precision Bearings Inc.	203
Minneapolis-Honeywell Regulator Co., Industrial Div.	99
Minnesota Mining & Mfg. Co.	101
Mission-Western Engineers, Inc.	443
Mitchell-Rand Insulation Co., Inc.	96
Moloney Electric Company	223
Motordyne Inc.	405
Muirhead & Co., Ltd.	3
Mullard Overseas, Ltd.	403

N. R. K. Mfg. & Engineering Co.	442
Nassau Research & Development Associates, Inc.	421
National Company, Inc.	336, 337
National Moldite Co.	255
National Union Radio Corp.	53
National Vulcanized Fibre Co.	39
New Hampshire Ball Bearings, Inc.	111
New Hermes, Inc.	439
New London Instrument Co.	399
New York Transformer Co., Inc.	266
NEY Company, J. M.	391
Nothelfer Winding Laboratories	369
Nucleonics	287

Ohmite Mfg. Co.	32A, 321E
Olympic Metal Products Co., Inc.	372
Opad-Green Company	56
Oster Manufacturing Co. John	361

Pacific Scientific Co.	312
Panoramic Radio Products, Inc.	420
Par-Metal Products Corp.	393
Penn Engineering & Manufacturing Corp.	358
Pennsylvania Optical Company	443
Phalo Plastics Corporation	430
Phaotron Company	385
Phelps Dodge Copper Products Corp., Inca Manufacturing Div.	40, 41
Pickard & Burns, Inc.	276
Pix Manufacturing Co., Inc.	413
Plastoid Corporation	37
Polarad Electronics Corporation	23
Polymer Corporation of Pennsylvania	388
Polytechnic Research & Development Company, Inc.	217
Potter & Brumfield	64A, 64B
Potter Instrument Company, Inc.	362
Power Equipment Company	326
Precise Measurement Co.	445
Precision Apparatus Co., Inc.	500
Precision Paper Tube Co.	499
Premax Products	377
Premier Instrument Corp.	367
Presto Recording Corp.	308
Price Electric Corp.	219
Prodelin, Inc.	218
Pye Limited	66
Pyroferic Co., Inc.	61

Quality Products Co. 445

Radio Corporation of America 261,

Back Cover

Radio Materials Corporation	279
Radio Receptor Company, Inc.	241
Railway Express Agency, Air Express Div.	118
Rapid Electric Co.	438
Rauland Corporation	269
Raybestos-Manhattan, Inc.	121
Raytheon Manufacturing Company	21
R-B-M Division, Essex Wire Corp.	206
Reeves Hoffman Corporation	282
Remler Company, Ltd.	438
Reon Resistor Corp.	328, 329
Representatives of Electronic Products Manufacturers, Inc. The	350
Republic Foil & Metal Mills, Inc.	345
Resinite Corp. Div. of Precision Paper Tube Co.	383
Resistance Products Co.	49
Rex Corporation	253
Rex Rheostat Co.	445
Rochester Electronics Co., Inc.	445
Rome Cable Corporation	102
Ranzel Cord & Wire Co.	411
Rutherford Electronics Co.	429

Sanborn Company	52
Sangamo Electric Company	402
Schmidt, Inc., Geo. T.	352
Schuttig & Co. Incorporated	363
Scientific Electric Div. of "S" Corrugated Quenched Gap Co.	405
Scintilla Magneto Div., Bendix Aviation Corporation	116
Secon Metals Corporation	371
Servo Corporation of America	373
Servomechanisms, Inc.	394



Wind Your Coils on the BEST PRECISION

COIL BOBBINS

Exacting quality control and finest materials add up to make PRECISION BOBBINS the best cores for R.F., I.F. coils, solenoids, switches, and other electronic applications.

Count PRECISION BOBBIN advantages:

- Greater Insulation
- Better Heat Dissipation
- Higher Moisture Resistance
- High Strength, Light Weight
- More Winding Space
- Low Unit Cost

PRECISION COIL BOBBINS can be designed to your particular specifications—any size, shape, quantity—dielectric kraft, fish paper, cellulose acetate, combinations or phenol impregnated materials. Flanges plain or fitted with leads, slots, holes for terminal wires—recessed or embossed to fit any mounting.

Send specifications for free sample and ask for Bobbin Catalog.

Also Mfrs. of PRECISION Paper Tubes

PRECISION PAPER TUBE CO.

2041 W. Charleston St.

Chicago 47, Ill.

Plant No. 2: 79 Chapel St., Hartford, Conn.

BIRNBACH Electronic COMPONENTS

Cut production costs—speed operations, by specifying BIRNBACH—your reliable Source of Supply for all requirements in Radio, Television, and Electronic Components, Accessories, Wire and Cables.

COMPLETE WAREHOUSE STOCKS

FOR PROMPT DELIVERY

- Govt. Spec. Hookup Wire
JAN-C-76 SRIR-SRHY Plastic
WL-Extruded Nylon Jacket
Aircraft Wire—Nylon Jacket
105° C. UL Approved
JAN-C-76 WL-Glass Braid
- Multiconductor Rubber Covered Cables, shielded
- Tinned and Bare Wire
- Magnet Wire
- Heavy Formvar Wire
- Vinyl Extruded and Radio Grade Tubing
- Shielded Wires
- Insulated Hardware
- Plugs, Jacks, Sockets
- Test Leads, Switches
- Insulators, Steatite and Ceramic
- Terminal Strips

Quality Products
for the Electronics Industries since 1923

BIRNBACH RADIO CO., Inc.
145 HUDSON STREET
NEW YORK 13, N. Y.

WRITE FOR
CATALOG 53-E

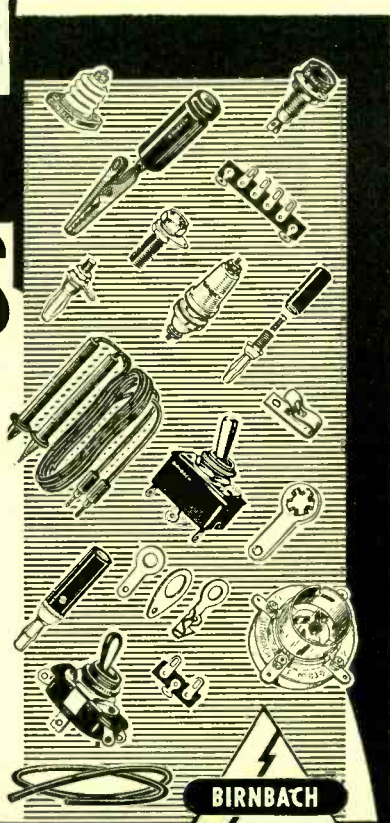

PRECISION

SERIES ES-500A
HIGH SENSITIVITY—WIDE RANGE
5" OSCILLOSCOPE

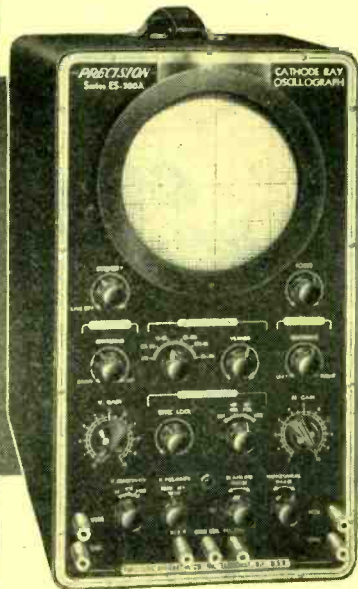

**PUSH-PULL
'V' and 'H' AMPLIFIERS**
20mv. per inch 'V' Sensitivity
1 Volt P-P Internal Calibrator

- ★ Regulated, Push-Pull Vertical Amplifier: .02v. per inch sensitivity. 10 cycles to 1 MC response. 2 Megs. and 22 mmf. input.
- ★ 1 Volt Peak to Peak, Regulated, Built-In Voltage Calibrator.
- ★ Compensated Vert. Input Step Attenuator.
- ★ 'V' Phase-Reversing Switch.
- ★ Push-Pull Horizontal Amplifier: .15v. per inch deflection sensitivity. 10 cycles to 1 MC response at full gain. ½ Meg. and 20 mmf. input.
- ★ Internal Linear Sweep: 10 cyc. to 30 KC.
- ★ Controlled, 4-Way Synchron. Selection: Internal Pos., Internal Neg., External and Line.
- ★ 'Z' Axis Modulation Input.
- ★ Internal, Phasable 60 Cyc. Beam Blanking.
- ★ Sinusoidal Sweep Phasing Control.
- ★ All 4 Horizontal and Vertical Plate Connections Directly Accessible at Rear.
- ★ Four-Way Lab-Type Input Terminals.
- ★ Light Shield and Mask, removable and rotatable.
- ★ Fully Licensed under W.E. Co. patents.

SERIES ES-500A: In louvered, black ripple, heavy gauge steel case. 8¼" x 14½" x 18".
Net Price \$173.70

SERIES SP-5 Oscilloscope Test Probe Set

for
WAVEFORM ANALYSIS, TROUBLE-SHOOTING,
SIGNAL TRACING AND ALIGNMENT
(with Series ES-500 and ES-500A)

- Set includes shielded Master Cable and four different, detachable probe heads:
1. High Impedance—Low Capacity Probe
 2. Signal-Tracing—Crystal Probe
 3. Resistive—Isolating Probe
 4. Shielded—Direct Probe
- ★ In vinyl-plastic carrying case.
Net Price \$23.50

PRECISION APPARATUS COMPANY, INC.

92-27 HORACE HARDING BLVD., ELMHURST 13, N. Y.
Export Division: 458 Broadway, New York 13, U.S.A. • Cables—Morhanex
In Canada: Atlas Radio Corp., Ltd., 560 King Street, W., Toronto 2B

Want more information? Use post card on last page.

Servotrol Company	355	Varflex Sales Co. Inc.	303
Shallcross Manufacturing Co.	208	Varian Associates	43
Shaw Insulator Co.	435	Vector Electronic Co.	391
Shure Brothers, Inc.	353	Veeder-Root, Inc.	36
Sierra Electronic Corporation	330	Vickers Electric Div., Vickers, Inc.	236
Sigma Instrument Inc.	320	Victoreen Instrument Co.	419
Signal Engineering & Mfg. Co.	413	Victory Engineering Corp.	410
Simmons Fastener Corporation	305	Volkert Metal Stampings, Inc., John	226
Sorensen & Company, Inc.	2		
Southern Electronics Co.	435		
Specific Products	411		
Spencer-Kennedy Laboratories, Inc.	389		
Sprague Electric Company	9, 47, 109, 238		
Stackpole Carbon Co.	98	Waldes Kohlnoor, Inc.	265
Standard Electric Time Company	60	Ward Leonard Electric Co.	122, 123
Standard Piezo Co.	357	Warren Wire Co.	42
Standard Telephones & Cables, Ltd.	406	Wasserlein Mfg. Co., Inc.	395
Steiner-Ives Co.	321	Waterman Products Co., Inc.	404
Sterling Engineering Company, Inc.	356	Webber Mfg. Co., Inc.	79
Sterling Transformer Corp.	389	Westinghouse Electric Corp.	27, 32, 64, 405
Stevens-Arnold Incorporated	339	Weston Electrical Instrument Corp.	120
Stevens Manufacturing Co., Inc.	418	Wheeler Insulated Wire Co., Inc.	244
Stoddart Aircraft Radio Co., Inc.	340, 341	White Dental Mfg. Co., S. S.	387, 436
Stone Paper Tube Company, Inc.	57	Wiley & Sons, Inc., John	375
Struthers-Dunn, Inc.	258	Williams & Co., C. K.	407
Stupakoff Ceramic & Mfg. Co.	381	Winchester Electronics, Inc.	232
Sturtevant Co., P. A.	377	Workshop Associates, Div. of Gabriel Company	344
Sun Parts Distributors, Ltd.	445		
Superior Electric Co.	33		
Superior Tube Co.	65		
Sylvania Electric Products, Inc.	7, 317, 391		
Synthane Corporation	107		

Taylor Fibre Company	115		
Tech Laboratories, Inc.	298		
Technical Service Corp.	413	Ziellk, Daniel D.	445
Technitrol Engineering Co.	359	Zophar Mills, Inc.	367
Technology Instrument Corp.	348, 349		
Tektronix, Inc.	363		
Tel-Instrument Co., Inc.	290		
Telechron Dept. General Electric Co.	293		
Telecomputing Corp.	89		
Teletronics Laboratory, Inc.	383, 445		
Telewave Laboratories, Inc.	307		
Telex, Inc.	366		
Tensolite Insulated Wire Co. Inc.	440		
Terpening Co., L. H.	242		
Texas Instruments, Inc.	81		
Thomas & Skinner Steel Products Co., Inc.	294		
Thompson-Bremer & Co., Sub. of American Machine & Foundry Co.	281		
Tinnerman Products, Inc.	273		
Titeflex, Inc.	315		
Tobe Deutschmann Corp.	260		
Trad Television Corp.	385		
Transistor Products, Inc.	383		
Trans-Sonics, Inc.	441		
Transradio, Ltd.	359		
Triad Transformer Corp.	360		
Triplett Electrical Instrument Co.	70		
Tung-Sol Electric, Inc.	227		

PROFESSIONAL SERVICES..... 446

SEARCHLIGHT SECTION

(Classified Advertising)

H. E. HILTY, Mgr.

SEARCHLIGHT ADVERTISERS INDEX 492-493

This index is published as a convenience to the readers. Every care is taken to make it accurate, but ELECTRONICS assumes no responsibility for errors or omissions.

**Vacuum Tube Voltmeter
Audio Oscillator
Equalization Filters**

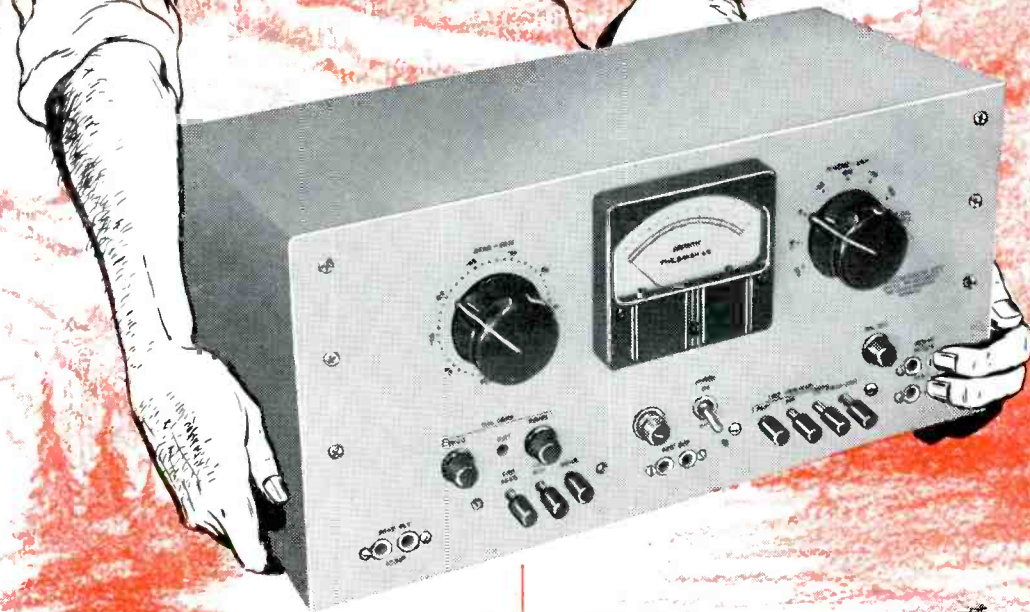

Three-in-one – Easily Portable

**DAVEN
TRANSMISSION
MEASURING SET
TYPE 12-A**

**For Measuring the
Characteristics
of Microwave
Relay Systems**



This unit provides the necessary information on transmission characteristics for the installation of terminal equipment, for the maintenance of terminal equipment, and for the field service of transmission lines and terminal equipment for microwave relay systems.

In one portable unit for efficient field use are combined the functions which normally would be performed by a separate Vacuum Tube Voltmeter, Audio Oscillator and Equalization Filters.

This unit has filters for providing response curves for accurate indication of 144, F1A or flat transmission lines. The 12-A also has provision for measurement of harmonic distortion and has its own self-contained low distortion 1000 cycle oscillator with variable amplitude.

The amplifier of the 12-A provides range levels from plus 20 to minus 80 DBM in calibrated steps of 10 Db. The associated meter is calibrated in 0.5 Db steps. The dynamic characteristics of the indicating meter are such that its response approximates the speed of appreciation of sounds by the ear.

This unit has line blocking capacitors for use across central battery and dial telephone lines.

Write for additional specific information and for catalog material.

THE **DAVEN** CO.

191 Central Avenue
Newark 4, New Jersey

WORLD'S LARGEST MANUFACTURERS OF ATTENUATORS

Now RCA-207E1 TANDEM 40-Mc IF AMPLIFIER

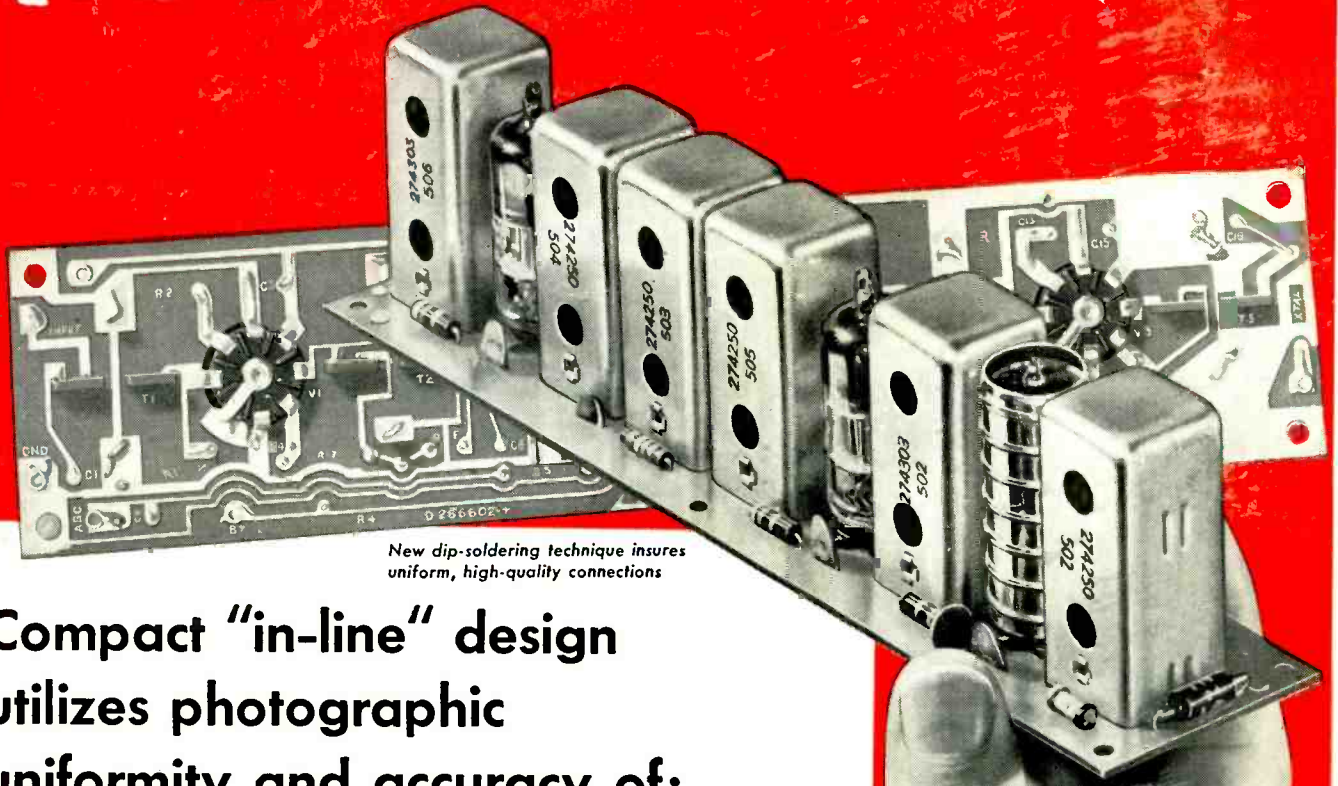

New dip-soldering technique insures uniform, high-quality connections

Compact "in-line" design utilizes photographic uniformity and accuracy of:

- ✓ PRINTED TRANSFORMERS
- ✓ PRINTED COILS
- ✓ PRINTED TRAPS
- ✓ PRINTED WIRING

Features:

- 41-25-Mc sound if
- 45-75-Mc picture if
- 40-uv sensitivity
- 4-Mc bandwidth
- 3 if stages, plus crystal detector
- No lead dress problems
- Requires chassis space of only 8 25/32" x 1 13/16"
- Excellent skirt selectivity

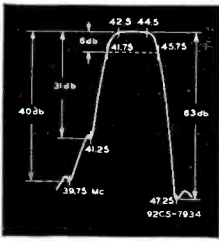

Overall response curve

Advantages:

- Pre-aligned and tested as a complete unit to save installation time
- Packaged intercarrier-sound if amplifier
- All tuning adjustments are above chassis
- All parts accurately positioned



RADIO CORPORATION of AMERICA
ELECTRONIC COMPONENTS HARRISON, N. J.



RCA-209K1

Also available:

Tunable RCA Printed-Circuit IF Transformers, Coils, and Traps

Ask for bulletin on RCA-209K1 through RCA-214K1

For full design advantages and technical data, write RCA, Commercial Engineering, Section 421R Or just call your nearest RCA field office:

(EAST) Humboldt 5-3900

415 S. 5th St., Harrison, N. J.

(MIDWEST) Whitehall 4-2900

589 E. Illinois St., Chicago, Ill.

(WEST) Madison 9-3671

420 S. San Pedro St., Los Angeles, California