

# electronics

JULY • 1953

PRICE 75 CENTS

A MCGRAW-HILL PUBLICATION

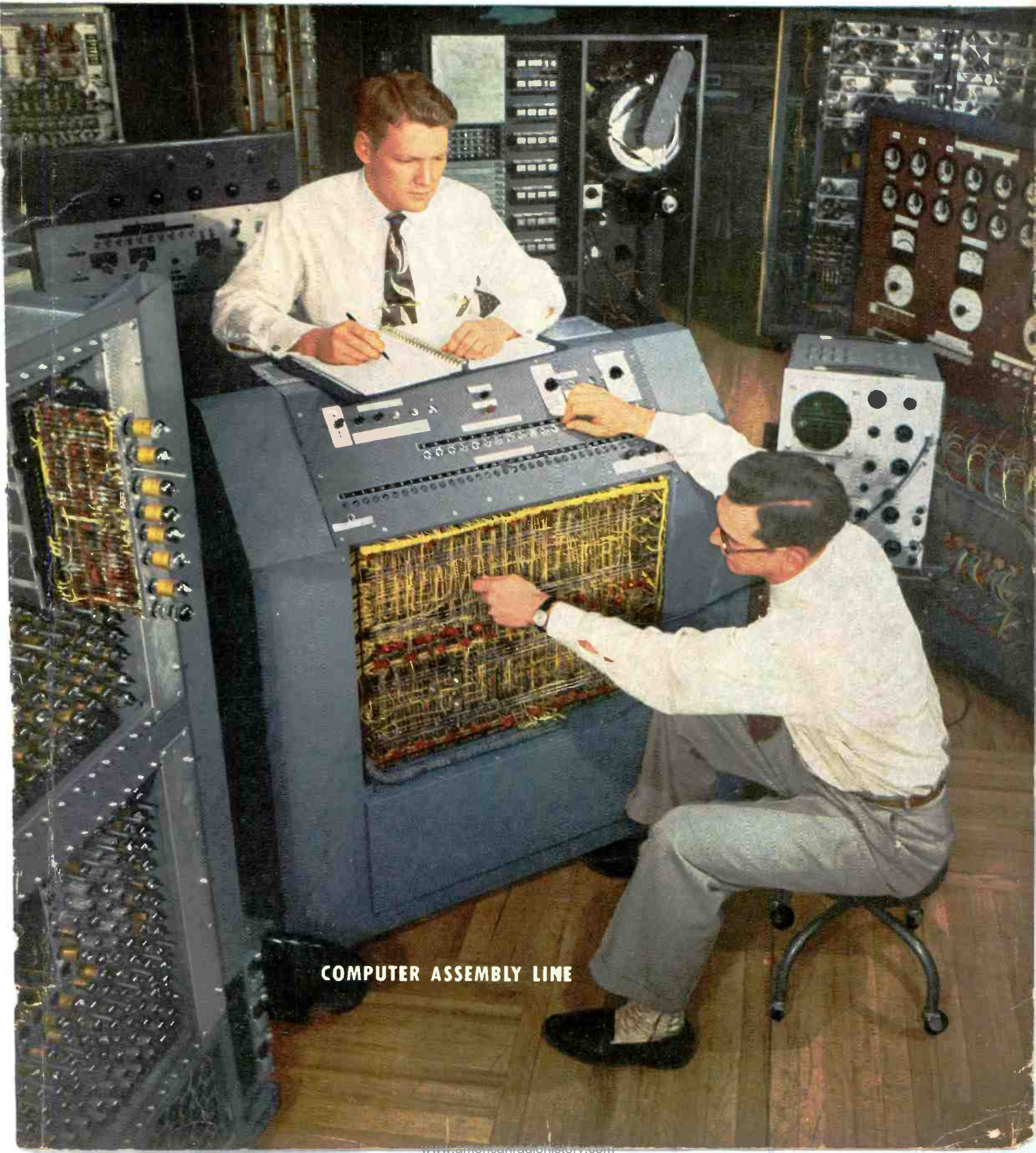

COMPUTER ASSEMBLY LINE



# for Stock Hermetically Sealed Components

For over fifteen years UTC has been the largest supplier of transformer components for military applications, to customer specifications. Listed below are a number of types, to latest military specifications, which are now catalogued as UTC stock items.



**RCOF CASE**

Length .....1 25/64  
 Width .....61/64  
 Height .....1 13/32  
 Mounting .....1 1/8  
 Screws .....4-40 FIL.  
 Cutout .....7/8 Dia.  
 Unit Weight .....1.5 oz.



**RC-50 CASE**

Length .....1 5/8  
 Width .....1 5/8  
 Height .....2 5/16  
 Mounting .....1 5/16  
 Screws .....#6-32  
 Cutout .....1 1/2 Dia.  
 Unit Weight .....8 oz.



**SM CASE**

Length .....11/16  
 Width .....1/2  
 Height .....29/32  
 Screw .....4-40 FIL.  
 Unit Weight .....8 oz.

## MINIATURE AUDIO UNITS...RCOF CASE

Type No.	Application	MIL Type	Pri. Imp. Ohms	Sec. Imp. Ohms	DC in Pri., MA	Response ± 2db. (Cyc.)	Max. level dbm	List Price	
H-1	Mike, pickup, line to grid	TF1A10YY	50,200 CT, 500 CT*	50,000	0	50-10,000	+ 5	\$16.50	
H-2	Mike to grid	TF1A11YY	82	135,000	50	250-8,000	+21	16.00	
H-3	Single plate to single grid	TF1A15YY	15,000	60,000	0	50-10,000	+ 6	13.50	
H-4	Single plate to single grid, DC in Pri.	TF1A15YY	15,000	60,000	4	200-10,000	+14	13.50	
H-5	Single plate to P.P. grids	TF1A15YY	15,000	95,000 CT	0	50-10,000	+ 5	15.50	
H-6	Single plate to P.P. grids, DC in Pri.	TF1A15YY	15,000	95,000 split	4	200-10,000	+11	16.00	
H-7	Single or P.P. plates to line	TF1A13YY	20,000 CT	150/600	4	200-10,000	+21	16.50	
H-8	Mixing and matching	TF1A16YY	150/600	600 CT	0	50-10,000	+ 8	15.50	
H-9	82/41:1 input to grid	TF1A10YY	150/600	1 meg.	0	200-3,000 (4db.)	+10	16.50	
H-10	10:1 single plate to single grid	TF1A15YY	10,000	1 meg.	0	200-3,000 (4db.)	+10	15.00	
H-11	Reactor	TF1A20YY	300 Henries-0 DC, 50 Henries-3 Ma. DC, 6,000 Ohms.						12.00

## COMPACT AUDIO UNITS...RC-50 CASE

Type No.	Application	MIL Type	Pri. Imp. Ohms	Sec. Imp. Ohms	DC in Pri., MA	Response ± 2db. (Cyc.)	Max. level dbm	List Price	
H-20	Single plate to 2 grids, can also be used for P.P. plates	TF1A15YY	15,000 split	80,000 split	0	30-20,000	+12	\$20.00	
H-21	Single plate to P.P. grids, DC in Pri.	TF1A15YY	15,000	80,000 split	8	100-20,000	+23	23.00	
H-22	Single plate to multiple line	TF1A13YY	15,000	50/200, 125/500**	8	50-20,000	+23	21.00	
H-23	P.P. plates to multiple line	TF1A13YY	30,000 split	50/200, 125/500**	8	30-20,000 BAL.	+19	20.00	
H-24	Reactor	TF1A20YY	450 Hys.-0 DC, 250 Hys.-5 Ma. DC, 6000 ohms ... 65 Hys.-10 Ma. DC, 1500 ohms.						15.00

## SUBMINIATURE AUDIO UNITS...SM CASE

Type No.	Application	MIL Type	Pri. Imp. Ohms	Sec. Imp. Ohms	DC in Pri., MA	Response ± 2db. (Cyc.)	Max. level dbm	List Price	
H-30	Input to grid	TF1A10YY	50***	62,500	0	150-10,000	+13	\$13.00	
H-31	Single plate to single grid, 3:1	TF1A15YY	10,000	90,000	0	300-10,000	+13	13.00	
H-32	Single plate to line	TF1A13YY	10,000****	200	3	300-10,000	+13	13.00	
H-33	Single plate to low impedance	TF1A13YY	30,000	50	1	300-10,000	+15	13.00	
H-34	Single plate to low impedance	TF1A13YY	100,000	60	.5	300-10,000	+ 6	13.00	
H-35	Reactor	TF1A20YY	100 Henries-0 DC, 50 Henries-1 Ma. DC, 4,400 ohms.						11.00

The impedance ratings are listed in standard manner. Obviously, a transformer with a 15,000 ohm primary impedance can operate from a tube representing a source impedance of 7700 ohms, etc. In addition, transformers can be used for applications differing considerably from those shown, keeping in mind that impedance ratio is constant. Lower source impedance will improve response and level ratings... higher source impedance will reduce frequency range and level rating.

\* 200 ohm termination can be used for 150 ohms or 250 ohms, 500 ohm termination can be used for 600 ohms.  
 \*\* 200 ohm termination can be used for 150 ohms or 250 ohms, 125/500 ohm termination can be used for 150/600 ohms.  
 \*\*\* can be used with higher source impedances, with corresponding reduction in frequency range. With 200 ohm source, secondary impedance becomes 250,000 ohms... loaded response is -4 db. at 300 cycles.  
 \*\*\*\* can be used for 500 ohm load... 25,000 ohm primary impedance... 1.5 Ma. DC.

*United Transformer Corp.*  
 150 VARICK STREET • NEW YORK 13, N. Y.  
 EXPORT DIVISION: 13 EAST 40th STREET, NEW YORK 16, N. Y. CABLES: "ARLAB"

# electronics

JULY • 1953

A MCGRAW-HILL  
PUBLICATION

**COMPUTER ASSEMBLY LINE**—Engineers check out IBM electronic data processing machine at Poughkeepsie, N. Y., plant. Built at the rate of one per month, the EDPM-701 is among the first large-scale digital computers to be mass produced (see p 200)..... **COVER**

<b>FIGURES OF THE MONTH, including Electronics Output Index</b> .....	4
<b>INDUSTRY REPORT, top-level news and market interpretations</b> .....	5
<b>HOW ELECTRONICS CONTROLS GUIDED MISSILES, by John M. Carroll</b> .....	130
<b>FLYING-SPOT MICROSCOPE, by F. Roberts, J. Z. Young and D. Causley</b> .....	137
<b>COAXIAL SWITCH FOR RAPID TRANSMITTER CHANGING, by John T. Wilner</b> .....	140
<b>PRECISE PARTS SORTING ON PRODUCTION LINES, by Albert C. Sanford</b> .....	142
<b>HOW TO DESIGN SMALL BOAT ANTENNAS, by Elbert Robberson</b> .....	146
<b>IMPROVING RESPONSE OF MAGNETIC PLAYBACK HEADS, by Arthur H. Mankin</b> .....	150
<b>UHF-TV RADIATORS USING SLOT ARRAYS, by Robert J. Stegen</b> .....	152
<b>LINEAR-TO-LOGARITHMIC VOLTAGE CONVERTER, by R. C. Howard, C. J. Savant and R. S. Neiswander</b> .....	156
<b>POINT-CONTACT TRANSISTOR OPERATION, by Abraham Coblentz and Harry L. Owens</b> .....	158
<b>PORTABLE PREAMPLIFIER FOR VIBRATION ANALYSIS, by R. K. Vinycomb and L. D. Crawley</b> .....	164
<b>CONTINUOUS-INDICATING LORAN NAVIGATOR, by Roger B. Williams, Jr.</b> .....	166
<b>SIMPLIFIED HORIZONTAL DEFLECTION GENERATOR, by Arnold Newton</b> .....	170
<b>METHODS AND EQUIPMENT FOR TRANSISTOR TESTING, by B. J. O'Neill and Arthur Gutterman</b> .....	172
<b>REGULATED POWER-SUPPLY BLOCKS, by John H. Bigbee</b> .....	176
<b>COUNTER-CIRCUIT MULTIPLEX RECEIVER, by A. R. Vallarino, H. A. Snow and C. Greenwald</b> .....	178
<b>CODE PRACTICE KEYS, by James R. McDermott</b> .....	182
<b>REMOTE TUNING RECEIVER HAS NO MOVING PARTS, by Samuel Stiber</b> .....	186
<b>MAGNETIC AMPLIFIER TRANSIENT ANALYZER, by W. A. Geyser</b> .....	189
<b>PARALLEL-RESISTOR CHART (Reference Sheet), by Mitchell Aron</b> .....	192
<b>CROSSTALK</b> ..... 129 <b>ELECTRONS AT WORK</b> ..... 196 <b>PRODUCTION TECHNIQUES</b> ..... 262 <b>NEW PRODUCTS</b> ..... 292	
<b>PLANTS AND PEOPLE</b> ..... 334 <b>NEW BOOKS</b> ..... 363 <b>BACKTALK</b> ..... 386 <b>INDEX TO ADVERTISERS</b> ..... 429	

**W. W. MacDONALD, Editor; VIN ZELUFF, Managing Editor; John Markus, A. A. McKenzie, James Fahnestock, Associate Editors; William P. O'Brien, John M. Carroll, William G. Arnold, William E. Pettit, David A. Findlay, Assistant Editors; Ann Mastropolo, Marilyn Wood, Editorial Assistants; Gladys T. Montgomery, Washington Editor; Harry Phillips, Art Director; Eleanor Luke, Art Assistant**

**KEITH HENNEY, Editorial Director**

**H. W. MATEER, Publisher; WALLACE B. BLOOD, Manager; R. S. Quint, Buyers' Guide Manager; N. F. Cullinan, Promotion & Research Assistant; H. E. Hilty, Classified Manager; D. H. Miller, James Girdwood, New York; Wm S. Hodgkinson, New England; Warren W. Shew, Philadelphia; C. D. Wardner, Chicago; J. L. Phillips, Cleveland; T. H. Carmody, R. C. Alcorn, San Francisco; Carl W. Dysinger, Los Angeles; Robert H. Sidur, Atlanta**



July, 1953

**ELECTRONICS**  
Member ABC and ABP

Vol. 26, No. 7



Published monthly with an additional issue in June by McGraw-Hill Publishing Company, Inc., James H. McGraw (1860-1948), Founder. Publication Office, 99-129 North Broadway, Albany 1, N. Y.

**Executive, Editorial and Advertising Offices:** McGraw-Hill Building, 330 W. 42 St., New York 36, N. Y. **Curtis W. McGraw, President; Willard Chevalier, Executive Vice-President; Joseph A. Gerardi, Vice-President and Treasurer; John J. Cooke, Secretary; Paul Montgomery, Senior Vice-President, Publication Division; Ralph B. Smith, Vice-President and Editorial Director; Nelson Bond, Vice-President and Director of Advertising; J. E. Blackburn, Jr., Vice-President and Director of Circulation.**

**Subscriptions:** Address correspondence to **Electronics—Subscription Service, 99-129 N. Broadway, Albany 1, N. Y., or 330 W. 42nd St., New York 36, N. Y.** Allow one month for change of address. Subscriptions are solicited only from persons engaged in theory, research, design, production, maintenance and use of electronic and industrial control components, parts and end products. Position and company connection must be indicated on subscription orders.

Single copies 75¢ for United States and possessions, and Canada; \$1.50 for Latin America; \$2.00 for all other foreign countries. Buyers' Guide \$2.00. Subscription rates for two years. All other countries \$20.00 a year; \$30.00 for two years. Canada, \$10.00 a year; \$16.00 for two years. Other western hemisphere countries, \$15.00 a year; \$25.00 Mar. 3, 1979. Printed in U.S.A. Copyright 1953 by McGraw-Hill Publishing Co., Inc.—All Rights Reserved. **BRANCH OFFICES:** 520 North Michigan Avenue, Chicago 11, Ill.; 68 Post Street, San Francisco 4; McGraw-Hill House, London, E.C. 4; Washington, D. C. 4; Philadelphia 3; Cleveland 15; Detroit 26; St. Louis 8; Boston 16; 1321 Rhodes-Haverty Bldg., Atlanta 3, Ga.; 1111 Wilshire Blvd., Los Angeles 17; 738-9 Oliver Building, Pittsburgh 22. **ELECTRONICS** is indexed regularly in **The Engineering Index.**

SANBORN OSCILLOGRAPH RECORDING SYSTEMS HAVE MANY APPLICATIONS

# Sanborn Recorders Help Speed Flight Design

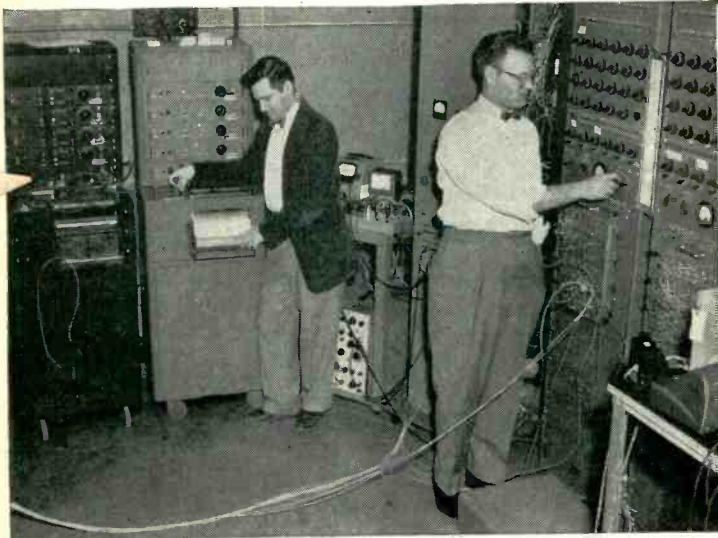

At **MCDONNELL AIRCRAFT CORPORATION** the movements of a guided missile are simulated by high-precision analog computers which in turn send *eight* different resultant electric signals into two Sanborn four-channel Recording Systems (left) for the graphic recording of the hypothetical results of the guided missile problem.

## SPERRY GYROSCOPE COMPANY

uses a two-channel Sanborn Recording System for basic research on their Zero Reader\* Flight Director, a device which simplifies the manual control of aircraft. The Sanborn System shown above is recording the output of a flight simulator that solves Zero Reader equations.

\* T. M. REG. U. S. PAT. OFF.

## How can Sanborn help you?

Sanborn one-, two-, and four-channel Recording Systems can provide an accurate and permanent graphic registration of almost any electrical phenomena whose frequency spectrum falls within the range of zero to 100 cycles per second. The availability and ready *interchangeability* of amplifiers and preamplifiers offer a wide range of use.

Records are traced by heated stylus on plastic coated strip-chart paper, and are in true rectangular coordinates. Other Sanborn advantages include: a high torque movement (200,000 dyne cms per cm deflection); built-in code and time markers; and a wide choice of paper speeds and channels.

Sanborn engineers will be pleased to make recommendations as to what type of equipment will best solve your recording problem. When writing, include the lower and upper limits and the frequency range of the phenomena to be recorded, and the type of transducer.



## At DOUGLAS AIRCRAFT COMPANY'S

Flight Test Section, a Sanborn two-channel Recording System (shown removed from case for field operation) is used in conjunction with a telemeter radio link to record surface motion vibration in a flying aircraft while it is performing tests requiring continual monitoring. Recorded tracings provide the necessary permanent visual time history for comparison of the two events recorded and a study of their individual characteristics.

Ask for a copy of our "Applicability Folder" which presents a table of uses, complete performance data and specifications, brief descriptions of Sanborn Recording Systems and explanations of how their amplifiers may be readily interchanged.

**SANBORN CO.** INDUSTRIAL DIVISION  
CAMBRIDGE 39, MASSACHUSETTS

# THIS INTERESTING QUARTERLY WILL BE MAILED FREE TO ANY PART OF THE WORLD

## AUSTRALIA

Messrs. Watson Victor Limited,  
9-13, Bligh Street,  
Sydney, N.S.W.

## BELGIUM

Paul Groeninckx,  
4-6, Avenue Hansen-Soulie,  
Brussels.

## CANADA

The J. W. Ellis Industries,  
42, Lombard Street,  
Toronto.

## DENMARK

Ditz Schweitzer,  
Norre Voldgade, 48,  
Copenhagen, K.

## FRANCE

Jacques Pères Fils,  
4, Avenue de l'Opéra,  
Paris 1.

## HOLLAND

Geo. C. F. Kauderer,  
Muiden.

## INDIA

Adair, Dutt & Co. (India) Ltd.,  
5, Dalhousie Square,  
Calcutta.

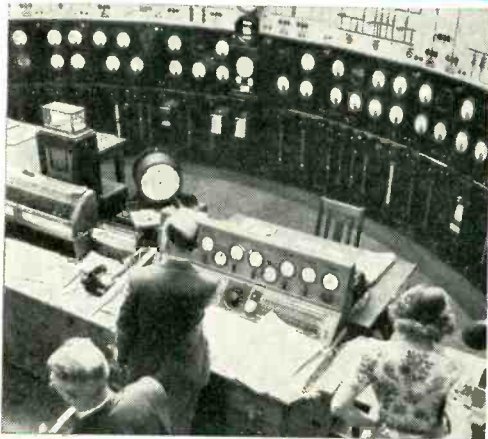

## ITALY

Ing. Silvio Garrone,  
Piazza Della Marina, 1,  
Rome.

## NEW ZEALAND

Richardson, McCabe & Co. Ltd.,  
P.O. Box 792,  
Wellington.

## NORWAY

J. L. Nerlien A/S,  
Nedre Slottsgt. 13,  
Oslo.

## SOUTH AFRICA

Johnson & Phillips South Africa  
(Pty.) Limited,  
P.O. Box 552,  
Germiston.

## SWEDEN

Ingenjorsfirma Hugo Tillquist,  
Nybrokajen 7, Postbox 7026,  
Stockholm 7.

## SWITZERLAND

Camille Bauer,  
Dornacherstrasse 18,  
Basel.

## U.S.A.

Muirhead & Co. Ltd.,  
Elmers End, Beckenham,  
Kent, England.

TECHNIQUE IS ALSO PUBLISHED IN FRENCH. IF THIS EDITION  
IS REQUIRED, MARK YOUR COUPON "EDITION FRANÇAISE"

**FILL IN THIS COUPON AND MAIL TO US OR OUR AGENT**  
(SEE LIST ABOVE)

*Please mail me, free of charge,  
the quarterly journal  
of instrument engineering  
"technique"  
published by  
Muirhead & Co., Limited.*

NAME \_\_\_\_\_  
POSITION \_\_\_\_\_  
COMPANY \_\_\_\_\_  
ADDRESS \_\_\_\_\_  
\_\_\_\_\_  
\_\_\_\_\_

ELECTRONICS 90

**MUIRHEAD & CO. LTD.**  
PRECISION ELECTRICAL INSTRUMENT MAKERS  
BECKENHAM · KENT · ENGLAND

Telegrams and Cables: MUIRHEAD BECKENHAM.

PRECISION  
**MUIRHEAD**  
ELECTRICAL INSTRUMENTS

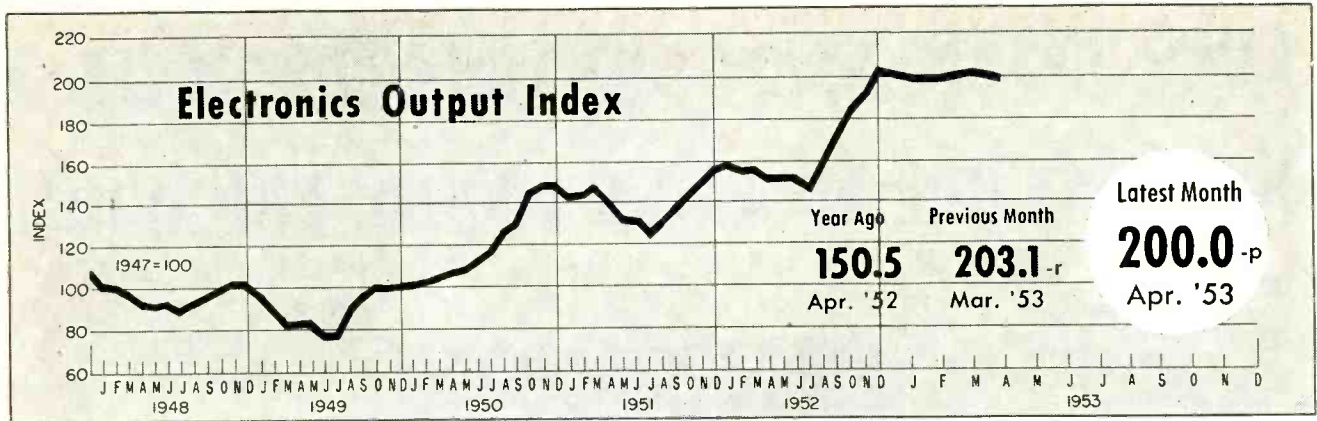

## FIGURES OF THE MONTH

	Year Ago	Previous Month	Latest Month		Year Ago	Previous Month	Latest Month
<b>RECEIVER PRODUCTION</b>				<b>TV AUDIENCE</b>			
(Source: RTMA)				(Source: NBC Research Dept.)			
Television sets	322,878	810,112	567,878	Sets in Use—total	17,290,800	23,256,000	23,930,000
Home sets	286,164	442,101	286,974	<b>BROADCAST STATIONS</b>			
Clock Radios	176,003	275,079	187,394	(Source: RTMA)			
Portable sets	110,529	177,656	201,476	TV Stations on Air	108	179	189
Auto sets	275,250	654,367	483,092	TV Stns CPs—not on air	0	264	266
<b>RECEIVER SALES</b>				TV Stns—Applications			
(Source: RTMA)				AM Stations on Air			
Television sets, units	603,704	319,721	412,802	AM Stns CPs—not on air	66	135	130
Radio sets (except auto)	516,618	412,802	412,802	AM Stns—Applications	323	249	244
<b>RECEIVING TUBE SALES</b>				FM Stations on Air			
(Source: RTMA)				FM Stns CPs—not on air			
Receiv. tubes, total units	26,247,258	44,691,200	41,342,599	FM Stns—Applications	10	9	9
Receiving tubes, new sets	15,334,092	31,367,831	30,441,417	<b>COMMUNICATION AUTHORIZATIONS</b>			
Rec. tubes, replacement	6,095,641	9,949,321	8,236,990	(Source: FCC)			
Receiving tubes, gov't.	3,257,119	1,449,857	1,167,234	Aeronautical	32,147	38,022	38,887
Receiving tubes, export	1,560,406	1,924,191	1,496,958	Marine	35,116	39,425	39,745
Picture tubes, to mfrs.	270,781	808,053-r	721,283	Police, fire, etc.	10,787	12,682	12,956
<b>SEMICONDUCTOR SALES</b>				Industrial			
(Source: RTMA)				Land Transportation			
Germanium Diodes	1,172,475	2,450,015	2,450,015	Amateur	108,648	112,666	110,884
<b>INDUSTRIAL EQUIPMENT ORDERS</b>				Citizens Radio			
(Source: NEMA)				Disaster			
	1st '52	4th '52	1st '53	Experimental	349	415	432
Dielectric Heating	\$240,000	\$440,000	\$340,000	Common carrier	942	1,094	1,144
Induction Heating	\$2,530,000	\$2,420,000	\$2,910,000	<b>EMPLOYMENT AND PAYROLLS</b>			
Welding Control	\$1,390,000	\$1,390,000	\$1,430,000	(Source: Bur. Labor Statistics)			
Other Electronic Control	\$970,000	\$970,000	\$700,000	Prod. workers, comm. equip.	331,200	419,400-r	418,700
<b>INDUSTRIAL TUBE SALES</b>				Av. wkly. earnings, comm.			
(Source: NEMA)				Av. wkly. earnings, radio			
Vacuum (non-receiving)	\$11,320,000	\$12,790,000	\$11,340,000	Av. weekly hours, comm.	41.0	40.6-r	41.0
Gas or vapor	\$3,100,000	\$3,480,000	\$3,140,000	Av. weekly hours, radio	40.5-r	40.2-r	40.4
Phototubes	\$500,000	\$760,000	\$930,000	<b>STOCK PRICE AVERAGES</b>			
Magnetrons and velocity modulation tubes	\$8,460,000	\$10,510,000	\$10,070,000	(Source: Standard and Poor's)			
Gaps and T/R boxes	\$2,450,000	\$2,090,000	\$2,050,000	Radio—TV & Electronics	281.8	298.9	295.3
				Radio Broadcasters	273.9	290.7	287.3

## FIGURES OF THE YEAR

	1952 Total	1952	1953	Percent Change
Television set production	6,096,279	1,647,709	2,827,821	+ 71.62
Radio set production	10,934,872	3,215,746	4,993,720	+ 55.29
Television set sales	6,144,990	1,592,452	2,100,620	+ 31.91
Radio set sales (except auto)	6,878,547	1,709,805	1,851,673	+ 8.88
Receiving tube sales	368,519,243	112,181,580	163,401,355	+ 45.66
Cathode-ray tube sales	6,120,292	1,311,610	3,053,956	+ 132.77

# INDUSTRY REPORT

electronics—JULY • 1953

## Printed Amplifier Strip Goes Into TV Production

### Entire video i-f amplifier is assembled on etched-foil strip and dip-soldered

ANOTHER approach to automation in television receiver production, just unveiled by the RCA Tube Department, is a complete prealigned 40-mc i-f amplifier strip produced by a combination of printed wiring and dip-soldering techniques. Chief advantages are improved performance, greater uniformity of production, greater reliability and lower cost. Semi-automatic equipment is being installed to produce these amplifier units in large volume and already at least two manufacturers have scheduled it for inclusion in their new fall lines.

► **Secret**—Ingenious design of components makes it possible to anchor as well as connect all i-f transformers, tube sockets, capacitors and resistors simultaneously in one simple dip-soldering operation. After conventional etching of the

conductor pattern on one side of a plastic sheet, holes are punched for the parts and for the eyelets which are riveted on later to serve as terminals for attaching input, output and power leads.

Next, operators insert preformed, precut leads of resistors and capacitors in 0.04-inch holes, snap three tube sockets into their self-aligning holes with quick thumb pressure, then insert the mounting tabs and lead projections of six printed coils and transformers in the six sets of rectangular holes punched for this purpose. This completes assembly work. The panel is now gripped by its side edges with a holding tool and dipped first in liquid resin, then in a vat of molten 60-40 solder. A final wax dip makes the unit ready for final test and prealignment.

► **Significance**—In commercial receivers, evolution of etched circuitry traces slowly through radio sets, vhf tv tuners, interference-sup-

pressing filters, individual components, and now a major tv sub-assembly. With groundwork well advanced on low-cost printed components, the logical next steps would be printing of the other major sub-assemblies for a tv set.

Some proponents of etched wiring feel that subassemblies give better control over production than is possible with one-shot assembly of an entire printed tv chassis.

## Company Earnings Dropped Slightly

Sales, net assets rose but sales margins, asset returns dropped in electronics

FINAL FIGURES on the financial status of 78 radio-tv-electrical equipment corporations compiled by the National City Bank of New

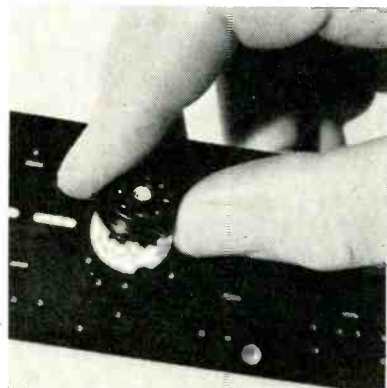

Inserting socket into punched hole from back of etched-wiring panel. Quick pressure with thumb locks socket in place

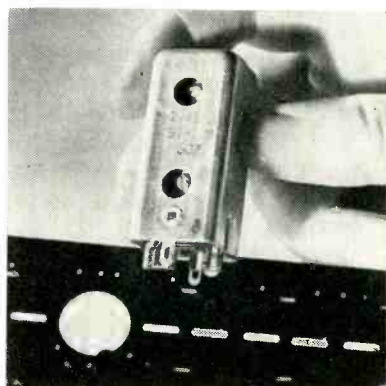

Inserting i-f transformer in set of four rectangular slots, two for printed leads and two for mounting tabs that are attached to the shield can

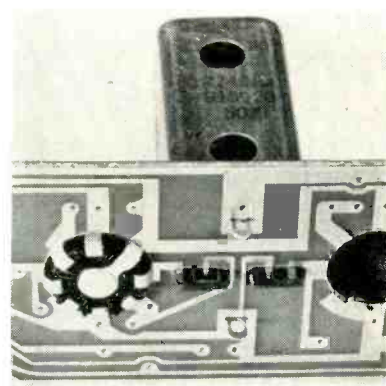

Appearance of printed side of panel after socket and transformer have been inserted. Small holes are for resistor and capacitor leads

York show a downward trend in net profit in 1952.

► **Margin On Sales**—Although dollar sales for these companies surpassed those of 1951 by as much as 16 to 20 percent, in most cases the continuing advances in operating costs and taxes squeezed net profit so that for these companies it showed a one-percent decline. The average margin of net profit was cut from 5.2 cents to 4.6 cents per sales dollar, the lowest margin of the last five years. Most industry classifications also experienced smaller profit margins in 1952.

For individual companies the percent of profit for each dollar of sales varied widely in the industry, from as little as 1.9 cents per dollar of sales to 5.8 cents. General Electric and Westinghouse were among the leaders in high margins on sales.

► **Return On Assets**—Net profits as a percent of the net worth, or the rate of return on net assets for these companies, also reached a low point in 1952, according to the survey.

It shows the return declined from 16.0 cents in 1951 to 14.8 cents for each dollar reported in book net assets in 1952.

One reason for the drop is the continuing increase in the industry's net worth. For radio-tv electrical equipment firms in the survey, total book net assets carried on the balance sheets in 1948, as the tv boom began, totaled \$1.7 billion.

By 1951 net assets had increased

to \$2.4 billion and at the end of last year had reached \$2.8 billion.

► **Value Lag**—Tremendous growth in net assets experienced by the industry in the past 5 years is shown by the survey. Financial observers feel that this growth has been understated and that the percent return on assets has tended to be high. They point out that plant and equipment is usually carried on company balance sheets at original cost less depreciation. This is below replacement cost and there is a substantial lag in the process of adjusting book values to current values. Thus, at present replacement costs, the net worth of the radio-tv electrical equipment firms surveyed may approach \$4 billion with a resulting lower percentage of return.

## Industry Engulfs 1953 Graduates

### New crop hard at work after industry's biggest student-courting campaign

SOME 6,500 graduates with degrees in electrical engineering and physics had that king-for-a-day feeling this spring as they were courted by representatives from hundreds of electronic firms seeking fresh blood. Many a student found himself wooed by upwards of twenty-different firms, offering starting salaries seldom below \$350 a month plus a wide variety of extra benefits.

As examples of specific salaries, one large firm landed its quota of 250 new men by starting design and development engineers at \$355 a month for a four-year graduate, \$370 for a five-year graduate or one having a year of related military electronic experience, \$377 for a master's degree, and \$392 for a master's plus military experience. Industrial engineers started at \$325 but had a faster promotion schedule.

► **Figures**—Estimating from latest Engineering Manpower Commis-

## Business Briefs

**Cutbacks** — Consumer goods makers, suspecting they were overshooting their market, are cutting back. Federal Reserve Board's figures show 30-percent drop in tv production between February and April, 9-percent drop in household goods.

**Credit**—Consumers went in hock for \$500 million in April, as much in May. Credit in one year has risen \$5 billion to total above \$26 billion. Consumer debt now is 13.5 percent of total wages and salaries, 9 percent of total consumer income.

**Market**—Wall Street's prices hit low for 1953. Experts blamed vaguely the international situation, tight money market.

**Trade** — Administration has worked a compromise which will allow Reciprocal Trade Agreements Act to be extended one year. Second bill, offered by Rep. Simpson (R-Pa), contains touchy tariff questions.

**Tax Cut**—Trying to restore more efficient and larger production, Britain has cut sales taxes on radio, tv and appliances as much as 66 percent. Personal and corporate income taxes are down 5 to 17 percent, the largest relief on the smallest incomes. On January 1, 1954, 30 percent of the excess profits tax will go.

sion statistics, the EE crop this year was 5,300 with first degrees, 825 with master's and 100 with doctorates. The majority of these took jobs in electronic plants.

Next largest electronic hirings were from the 7,000 graduating mechanical engineers, to meet in-

(Continued on page 8)

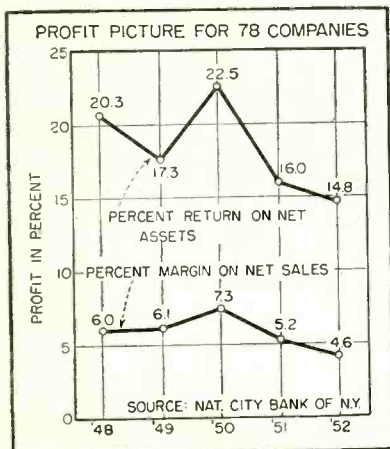



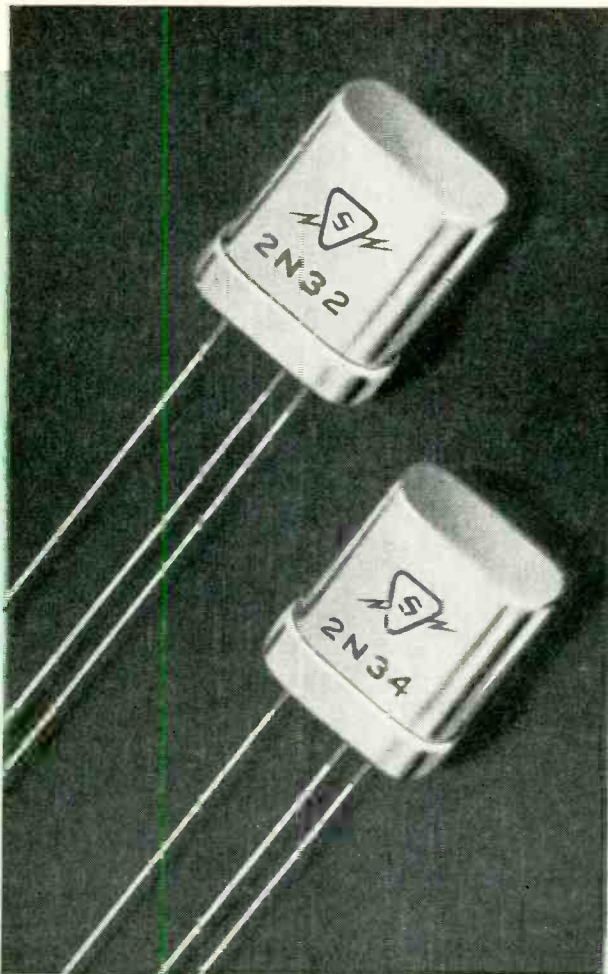

# SYLVANIA HERMETICALLY SEALED TRANSISTORS

**S**TARTING with the new hermetically-sealed Sylvania 2N32 and 2N34, you can now use transistors with the assurance of quality and performance that has made Sylvania the leading producer of germanium and silicon diodes. Embodying the hermetically-sealed design that has made Sylvania glass diodes the most widely used on the market today, Sylvania transistors offer this same feature for improved transistor performance.

The Sylvania 2N32 is a point-contact transistor, designed especially for switching operations. The Sylvania 2N34 is a junction type transistor for low-frequency, low-power amplifier applications. For further data and characteristics, mail the coupon NOW!

# SYLVANIA



**LIGHTING • RADIO • ELECTRONICS • TELEVISION**

In Canada: Sylvania Electric (Canada) Ltd., University Tower Bldg.  
St. Catherine Street, Montreal, P. Q.

Sylvania Electric Products Inc.  
Dept. 3E-1007, 1740 Broadway  
New York 19, N. Y.

*Please send me full information concerning Sylvania Transistors.*

Name \_\_\_\_\_

Company \_\_\_\_\_

Street \_\_\_\_\_

City \_\_\_\_\_ Zone \_\_\_\_\_ State \_\_\_\_\_

dustry need for integration of electronic and mechanical performance specifications.

A high percentage of the 300 who received degrees in engineering physics were hired by electronic firms. Many of the 2,100 with degrees in general, administrative and management engineering also went to electronic plants.

Allowing for those who took jobs in power-plant electric motor and other non-electronic plants, as well as those who earned higher degrees in night school while already employed, the electronic industry acquired about 4,500 new graduates. This checks closely with the prediction made in Industry Report, p8, June 1952. A recent Columbia University survey noted that those who started at lower salaries tended to get bigger raises, and after a year or two were earning as much as those who started at higher salaries.

### Parts Labor Picture

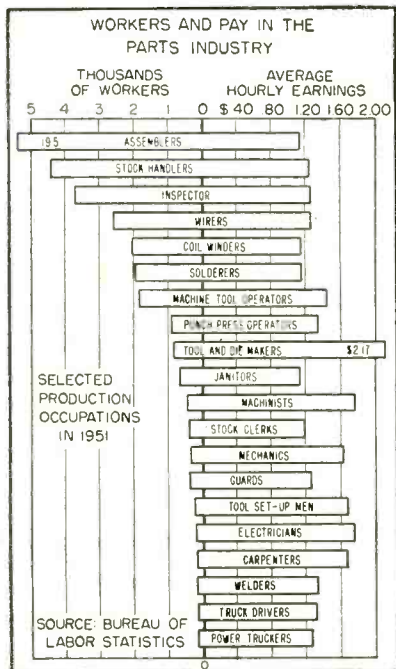

Assemblers made up the bulk of the parts industry's work force in 1951 and earned \$1.14, the lowest hourly pay. Highest earnings went to tool and die makers who made \$2.17 an hour, nearly \$.40 more than electricians and machinists who ranked second on the pay scale. A total of 695 janitors cleaned up \$1.15 an hour



PARIS crowds watch ancient rites on hooded outdoor tv receivers, as...

## Global Hookup Carries Coronation

NINETEEN television cameras occupied vantage spots both in the abbey and along the route of the procession as 2,750,000 set owners in Great Britain, France, Belgium, Holland and Germany received the Coronation program directly.

The BBC's five high-powered tv transmitters were augmented by three lower power units especially for the event, which was carried via microwave to twelve transmitters on the continent.

► Radio—Hundreds of millions of listeners overseas depended upon a-m radio. More than 100 commentators described the rites in 42 different languages. In Great Britain, all 37 BBC broadcast transmitters carried the ceremony while 48 short-wave transmitters beamed it overseas to six continents. Total cost of the a-m program was about \$126,000.

The pageant was recorded on 45 miles of magnetic tape and 60,000 feet of motion-picture film was used for television recording.

► Color—Public broadcast of color tv in England was highlighted.

Chromatic Television Laboratories in association with Pye, Ltd. installed six receivers using 22-inch Lawrence color tubes, three in hospitals, one in the INS press

room, one in the Foreign Office and one in the Pye, Ltd. office. Using 3 Pye tv cameras adapted for 405-line field-sequential color operation, events taking place outside Westminster Abbey were transmitted over the air on 575 mc.

## Inventory Trend Is Up In Electronics Field

Value has risen steadily since 1949; reflects the industry's growth and markets

EVER SINCE the "big dump" in 1951, radio-tv industry has held a wary eye on inventories. This year, again, manufacturers, distributors and dealers are watching shelved goods closely and wondering about the seasonal selling lag setting in.

Big problem in getting an up-to-date overall picture is the time lag in the figures. Department of Commerce totals are usually several months behind but the latest report says that total business inventories rose 3.5 billion since last August to a new record of \$76 billion in April, 1953.

► Trend—The radio-tv industry has followed the same trend as

(Continued on page 10)

**BLACK  
BEAUTY®**

**dry-assembly  
phenolic-molded**

# TV TUBULARS

**The Standard By Which Others Are Judged**

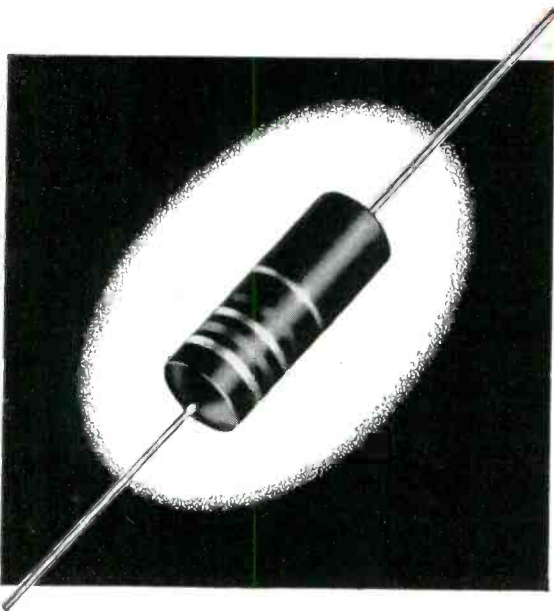

**L**OOK at the critical points in any TV set. That's where you'll find Sprague "Black Beauty" Molded Tubular Capacitors. Over 250 million have been made since 1947 and demands are still increasing... thanks to their unprecedented failure-free record.

Sprague's unique patented design and "dry assembly" processing make these the first tubulars made just like more expensive metal-encased oil capacitors. Every "Black Beauty" from 200 to 12,500 volts is molded *dry* in non-flammable phenolic. After molding it is impregnated thru an eyelet under high vacuum; the lead is then inserted and the capacitor solder sealed.

Every major TV manufacturer uses "Black Beauties" in critical circuits. He can depend on *extra high insulation resistance; minimum capacitance change with temperature variations; and absence of drift with repeated heating and cooling.*

A letterhead request will bring you sizes, ratings, and performance data. Write for Engineering Bulletins 210C and 214A to the Sprague Electric Company, 35 Marshall Street, North Adams, Massachusetts.

# SPRAGUE

**WORLD'S LARGEST CAPACITOR MANUFACTURER**

EXPORT FOR THE AMERICAS: SPRAGUE ELECTRIC INTERNATIONAL LTD., NORTH ADAMS, MASS. CABLE: SPREXINT

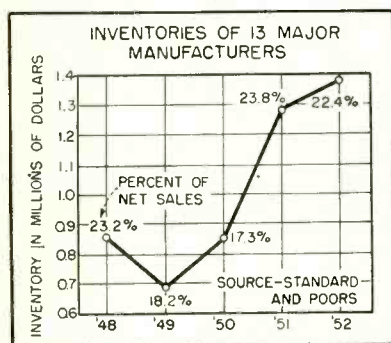

business in general, despite the tight reins most firms keep on inventories. As shown in the chart, the inventories of 13 major electronic manufacturers reached a peak of \$13.8 million last year. Inventories for individual companies ranged from \$43.3 thousand to \$6.2 million. All but three firms increased inventories over 1951.

As a percentage of net sales, inventories were lower last year because sales have risen. The general trend as indicated by the 13

manufacturers shows that at the end of 1952, inventories were 1.4 percent lower than in 1951.

► **Breakdown**—Further substantiation of the trend in inventories in the past few years, is the fact that totals for the entire communications equipment industry have increased. According to the Census Bureau, the industry's inventories were \$384.4 million in 1947, \$522.8 million in 1950 and \$776.8 million in 1951. Of these amounts in each year, about 80 percent was in materials and supplies and work in process and the remainder was finished products. The percentages have remained fairly constant although many companies have had to store more material to take care of defense orders. Some observers feel that defense business along with the growth in civilian sales accounts for the industry's rising inventory trend.

trocadiographs, electroencephalographs and colorimeters are gaining in sales. At the AMA meeting great interest was shown in use of magnetic tape for recording heart-beat signals over long periods at low cost, then rerecording conventionally only the medically significant portions as electrocardiograms.

► **TV And Facsimile**—At least four medical schools now have closed-circuit tv equipment in use, three with color tv and one with black and white. A few other institutions have equipment on order.

Telegnosis, the term applied to diagnosis at a distance through use of facsimile equipment for transmitting x-ray pictures, is also gaining. With it, the staff of a distant rural hospital can obtain the services of an expert roentgenologist or medical specialist anywhere in the country within a few minutes. A production model of the facsimile machine has been built by Time Facsimile Corp. and production of it will begin when field tests are completed.

## Medical Electronics Nears Billion

**Manufacturers are cashing in on increasing use of electronics in medicine**

GROWING importance of the medical field as an electronic market was emphasized at the recent meetings and exhibits of the American Medical Association in New York City. The value of electronic equipment in use by the medical profession is nearing \$1 billion.

► **Market**—Size of the medical market for varied electronic products is apparent from the following statistics: According to AMA, there are approximately 195,000 physicians in active practice and every year about 7,000 new graduates. There are more than 6,000 hospitals in the U.S., plus an increasing number of clinics and industrial dispensaries.

► **Products**—Big three of the products sold to the medical field, in order of sales importance, are x-ray, diathermy and diagnostic

devices. Other important products are electronic surgical instruments and radioisotope instruments for medical use. One medical version of the betatron, costing about \$250,000 each installed, is now being used for cancer therapy. Orders for six more have been placed.

Volume of the medical x-ray business is indicated by the fact that over 15,000 medical x-ray tubes were sold in 1952. The total for 1951 was near 21,000. It is estimated that more than 50 percent of the general practitioners in the U.S. are owners of x-ray equipment. With prices ranging between \$2,000 and \$18,000, total value of equipment in use represents more than \$0.5 billion in sales for the ten manufacturers in the field.

There are over 80,000 diathermy machines in use, representing an estimated value of about \$60 million.

Electronic diagnostic devices account for the third largest sales volume in the medical field. Elec-

## FCC Makes Share-Time Grants To TV Stations

**Pairs of tv CP applicants get grants to share time on single channels**

FRIENDLY tv station competitors gain with share-time operations now permitted by FCC. In such a grant, each applicant requests his own facility to operate on a share-time basis.

The division of time is settled by the competitors. It is usually a day or night operation, with alternating of the choice time. The Commission does not encourage or discourage this type of operation—it is a question of giving the best service to a community in as short a time as possible.

► **Grants**—Share-time tv grants have been made to the following stations: WVET-TV and WHEC-

(Continued on page 14)

STEATITE

ZIRCONITE

CORDIERITE

TITANATE



**What do these names mean to you?**

*These Centralab Engineered Ceramics solve electronic and industrial production problems . . . hold promise of wonders to come!*

FOR MORE INFORMATION ON HOW THESE CENTRALAB ENGINEERED CERAMICS

CAN OFFER YOU BIG SAVINGS,

SEE NEXT TWO PAGES

# If your product requires you can make it better with

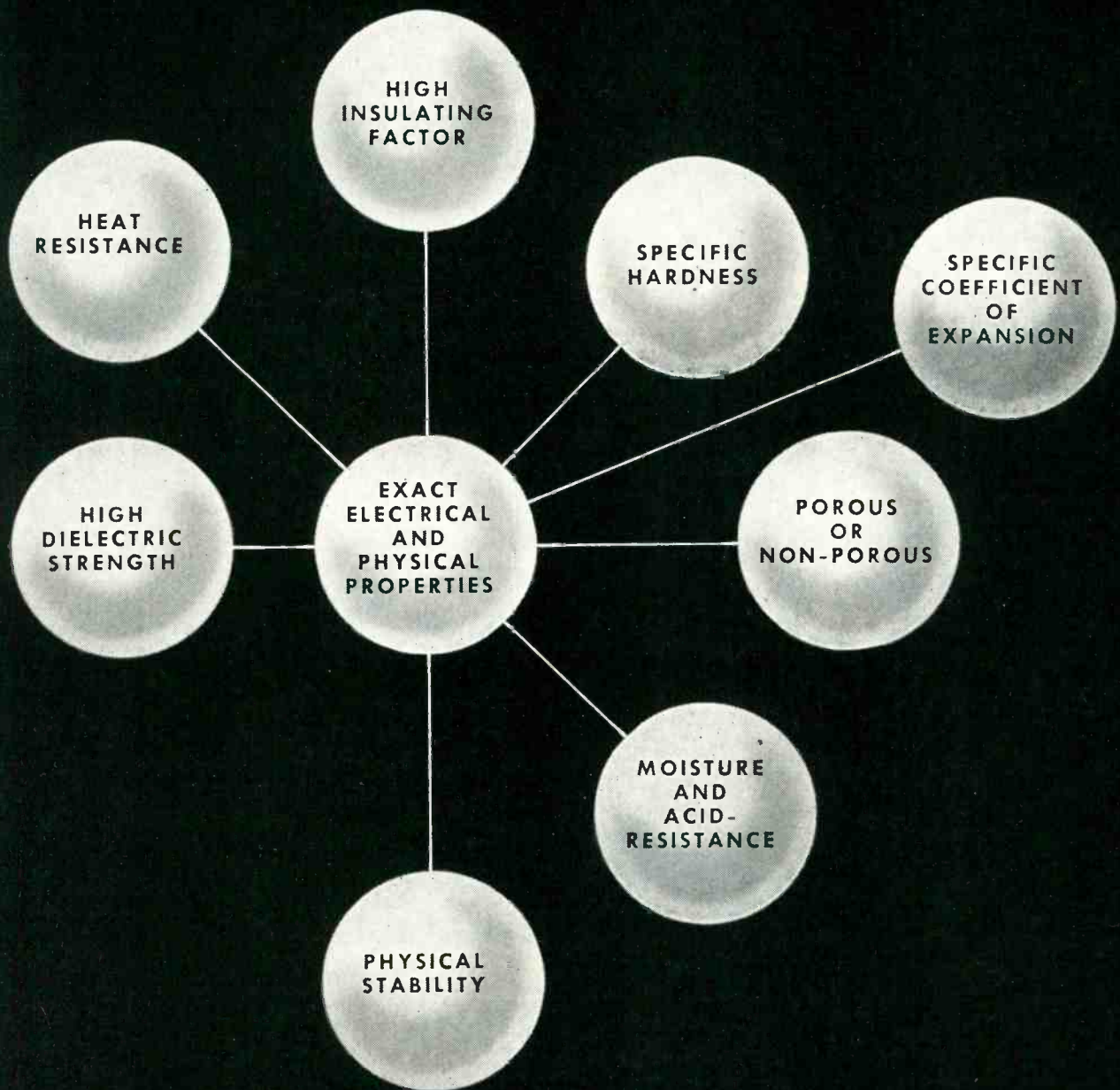

**T**HERE'S a Centralab Ceramic material to match your individual requirements — electrically . . . physically . . . structurally. These materials are unique. We can extrude, mold or press them. What's more, Centralab Ceramics can be worked the same as metal—drilled, turned, ground or tapped. In addition, they can be metalized. Every Centralab Ceramic has some of the properties shown above, and they meet all

JAN-I-8 and JAN-I-10 specifications, without exception.

Centralab is the leader in ceramic development — making fine ceramics since 1928. Metalized ceramic material for close tolerance application was a CRL first. We have a complete staff of engineers, physicists and chemists ready to help you develop better product design through the use of Engineered Ceramics. Write for full technical details.

# any of these properties, CRL Engineered Ceramics!

Here are examples of special Centralab Ceramics produced for structural, electrical and electronic use

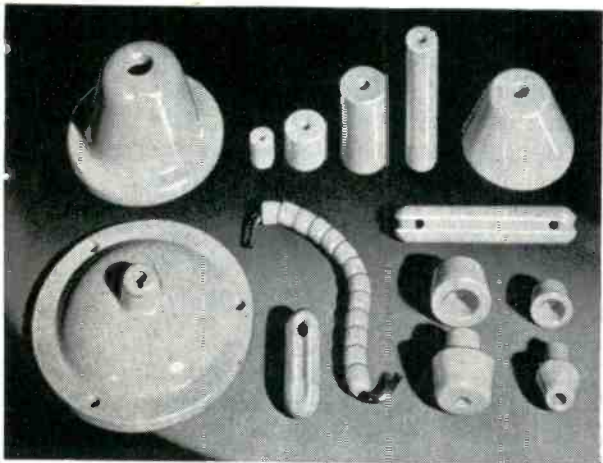

Note the Standoffs illustrated, upper center. Made to government specifications, they are available commercially at a price lower than most standard units. Note the many types of specialty items.

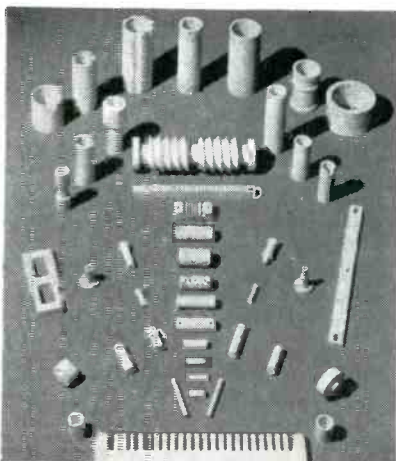

Specialty items include forms for coils and various electronic components, such as variometer rotor and stator bars, heater coils, etc. Commercial units are available in Grade L-5 and L-6 Steatite if required.

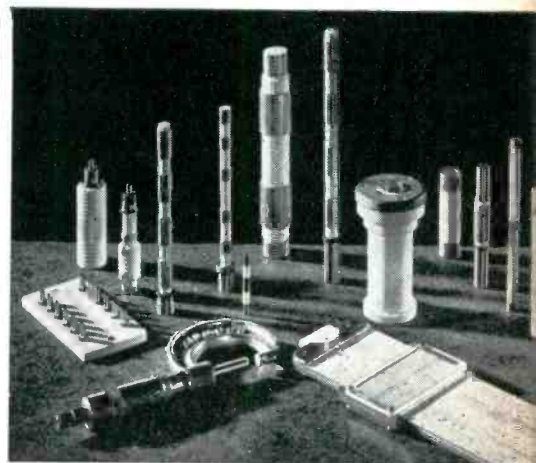

Many different ferrous and non-ferrous metals can be applied to ceramic bodies, combining the desirable properties of the metal plus the dielectric strength and other unique properties of ceramics.

**FULL Centralab design and production facilities are available to meet your exact need**



Centralab engineers constantly improve CRL Ceramics searching for new materials . . . developing more economical production methods. Consult Centralab on your problems.



Production operations—including mixing, molding, drilling, tapping and stamping are mechanized. This assures uniform quality, fast operation, low costs.



There's a quality inspection for Centralab Ceramics after each major operation. Modern methods are used to insure maintenance of unusually high "Average Quality Level."

## Centralab

A Division of Globe-Union Inc. • Milwaukee 1, Wis.  
In Canada, Box 208, Ajax, Ontario

CENTRALAB, A Division of Globe-Union Inc.  
914-G East Keefe Avenue, Milwaukee 1, Wisconsin

Please send me full technical information  
on Centralab Engineered Ceramics.

Name.....

Address.....

Company..... Title.....

TV, Rochester, N. Y. on channel 10; KSBW-TV, Salinas, Calif. and WMBY-TV, Monterey, Calif. on channel 8; WMIN-TV, St. Paul, Minn. and WTCN-TV in Minneapolis on channel 11; Maricopa Broadcasting and Koy Broadcasting in Phoenix, Arizona on channel 10.

First share-time authorized by the FCC was a grant for separate construction permits to KSBW-TV in Salinas, Calif. and WMBY-TV in Monterey, Calif. joint operation on channel 8.

These applicants originally competed for channel 8 but amended

their applications to propose using the channel on a share-time basis as provided in FCC rules which permit sharing channels on a voluntary basis.

► **How It Works**—KSBW-TV and WMBY-TV intend to use the same transmission facilities, sharing the cost, and operating with the same power. Their transmitter will be on Baldy Peak about 9 miles from Salinas. They will share time equally—each broadcasting 42½ hours a week. Separate studios will be maintained in Salinas and Monterey, about 14 miles apart.

to 45 pounds. The plant also takes advantage of automatic equipment such as a Cameron slitter which cuts the rolls into narrow strips at a speed of 1,850 feet per hour.

► **Capacitor Preparation**—Plant B attaches anode tabs to the foil manually which takes the most time. One plant saves time in cutting anode foil to length by shearing 5 rolls at once. Multiple cutting of anode and cathode tabs also saves time.

► **Impregnation**—Plants B and C use specially designed centrifuges for impregnations. Plant D, with the shortest time, uses an impregnation paste followed by a heat treatment. Management attributes plant A's comparatively high man-hour requirements to the use of older methods of centrifuge or vacuum impregnation.

► **Aging**—Plant A takes almost 12 times as long as plant D for aging. Plant A's management states that efficient aging depends upon the methods used in earlier operations and attributes slower performance in aging to methods of foil impregnation and preparation as well as to aging techniques.

► **Conclusion**—The report found that direct labor time for plant A was high because, among other factors, it included material-handling functions not included by other plants. Production workers in the plant carry materials in small paper boxes, thus adding to the unit man-hours of the operators.

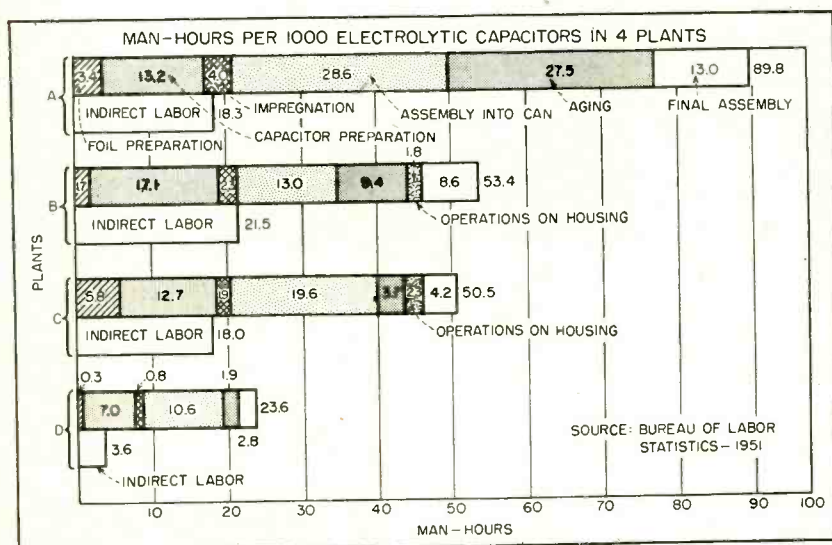

CASE studies of four capacitor manufacturers result from . . .

## U. S. Survey of Capacitor Production

Comparison of techniques in four selected plants show wide variations

IN AMERICAN plants manufacturing dry electrolytic capacitors, key factors contributing to productivity levels are mass production by assembly-line techniques, use of specially designed or adapted machinery, close quality control and inspection, and alertness in adapting innovations in production methods to the electrochemical process necessary for capacitor manufacture. These are the findings of the Bureau of Labor

Statistics in a report prepared for the Mutual Security Agency.

These factors enabled one plant in the study to produce 1,000 electrolytic capacitors of a certain specification in 23.6 man-hours. Other plants making capacitors (of somewhat different specifications) required two to three times as many man-hours. A breakdown of operations in the four plants surveyed is shown.

► **Foil Preparation**—Low man-hours for plant D in this operation were accomplished, in part, by processing large rolls of foil which are 17½ inches wide and weigh 40

## Diathermy Business

### Set For June 30 Boom

Deadline for compliance with radiation regulations to create big market

UNLESS another reprieve is granted by FCC to diathermy users, a market of at least 30,000 diathermy equipment sales representing a dollar volume of over \$20 million

(Continued on page 16)



# SHOCK AND VIBRATION NEWS

"Gives the customer  
**THE  
ULTIMATE  
IN  
VIBRATION  
PROTECTION**  
for his instrument"

Photo courtesy INDUSTRIAL NUCLEONICS CORP.

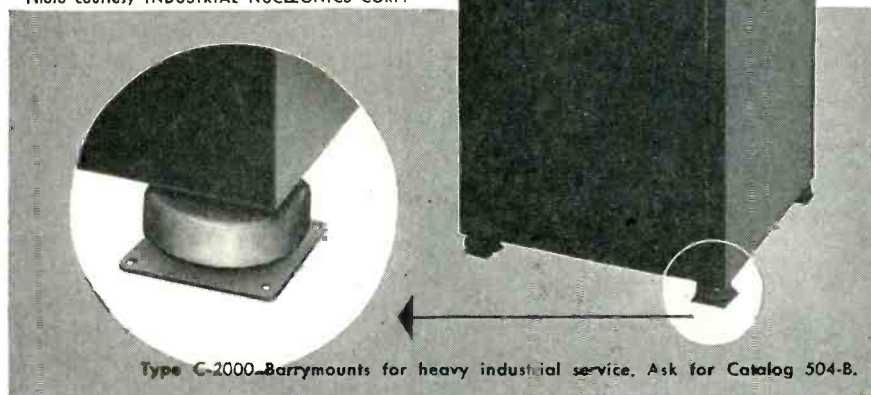

Type C-2000 Barrymounts for heavy industrial service. Ask for Catalog 504-B.

The AccuRay Beta Gage — a sturdy industrial instrument for continuous production gaging of plastics, textiles, paper, rubber, and metals — is specifically designed to resist vibration. So why does Industrial Nucleonics Corporation use Barrymounts?

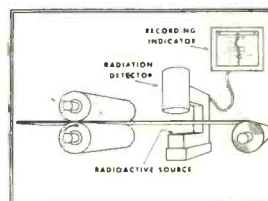

"We use Barry shock mounts solely as a vibration isolator to protect the instrument from externally caused vibrations. We would not consider marketing the instrument without the added safeguard of the mounts. We feel that the use of mounts is indicative of the thoroughness of design of our instrument, and that it gives the customer the ultimate in protection for his instrument."

Is protection against shock and vibration vital to the performance and the life of your equipment — or is this protection a "plus" dictated by thoroughness of design? In any case, Barrymounts give you the assurance that you have the ultimate in vibration protection. Ask the nearest Barry representative for his recommendations.

THE **BARRY** CORP.

707 PLEASANT ST., WATERTOWN 72, MASSACHUSETTS

SALES REPRESENTATIVES IN

Atlanta Baltimore Chicago Cleveland Dallas Dayton Detroit Los Angeles Minneapolis New York  
Philadelphia Phoenix Rochester St. Louis San Francisco Seattle Toronto Washington

will be available.

► **Market**—Approximately 80,000 diathermy machines are in use in the U. S. Manufacturers estimate that about 30,000 to 35,000 of these meet FCC radiation requirements. The rest should be replaced or rebuilt to meet regulations. However, manufacturers doubt that full compliance by all diathermy owners would be possible. They expect about 15,000 or 20,000 machines to continue in use. The remaining 30,000 represent the replacement market.

► **Product**—Two kinds of equipment on the market meet the new

FCC requirements. One uses microwave frequencies to do the job while the other uses crystal control. It is estimated that over 50 percent of the 30,000 sales of diathermy equipment made in the past four years have been of the microwave type.

► **Future**—In 1952 when the FCC made the one-year extension for compliance with the radiation regulation, it warned that any further requests for extension would be handled on an individual basis, with consideration given to efforts made in each case to replace non-conforming equipment during the period of the extension.

circuits that give flight controls the "feel" that can throw even the most confident pilot into a cold sweat when troubles are introduced by an instructor.

► **Cost Comparison**—A comparable simulator has shown a saving of over \$1.5 million a year—more than the cost of the simulator. This figure is based on an operating cost of \$68 per hour for the simulator compared to \$350 for the plane—including depreciation for both. These figures do not include the \$1,000 plus per hour earning potential of planes released from training.

In the electronic portions of the new simulator, heavy reliance is placed on specially-wound potentiometers operating in conjunction with tight servo systems. Most of the tubes used are in servo amplifiers. Design is conservative to provide minimum down time; during the first 1,046 hours of operation, one simulator was inoperative for only 60 minutes—less than 0.5 percent.

A simulator for the giant 10-engine B-36 bomber is nearing completion at Curtiss-Wright Electronics Division.

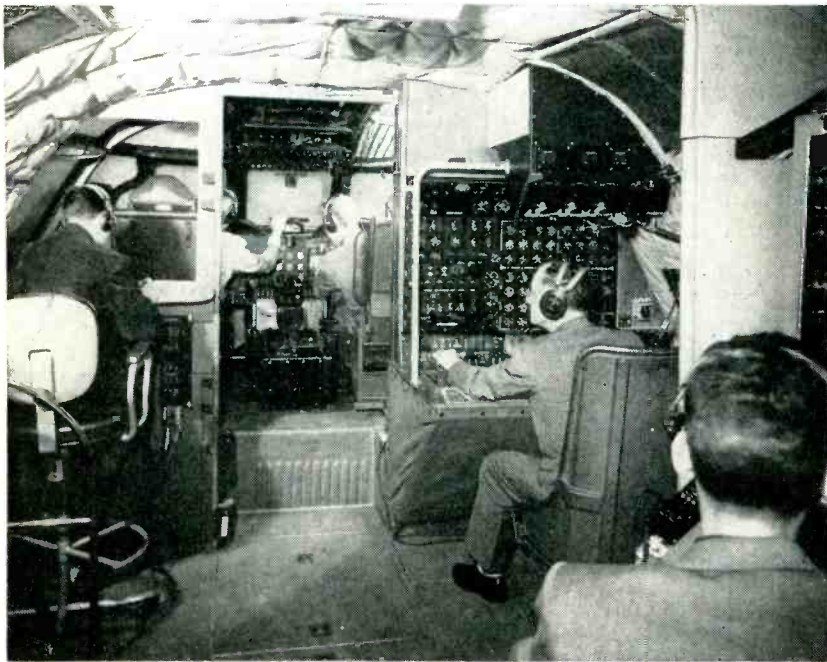

MOCK-UP trains air crew without leaving ground. Although initial cost is high...

## Simulators Cut Pilot Training Cost

**Airlines and Services save nearly 70 percent and turn out better pilots**

HIGH initial cost is of secondary importance where electronic flight simulators are concerned. The Air Force has recently taken delivery on the first of four Curtiss-Wright Dehmel simulators for the 200-pas-

senger Globemaster. Each simulator costs over \$1 million.

Like predecessors duplicating other aircraft types, the new C-124 simulator is identical in every detail to the business end of the Douglas-built plane. Over 500 tubes and a maze of wires (including some harness runs of almost six-inch diameter) complete the realism with sound effects and electronic

## Depreciation Reserves Continue To Climb

**Sums set aside by electronic firms increased; manufacturers are wary of future**

AMOUNTS reserved by the electronic industry for depreciation have steadily increased in the past five years. For ten major manufacturers, such reserves have almost doubled from \$60.2 million in 1948 to \$105.8 million last year. Amounts set aside by individual firms in 1952 ranged from \$190,000 to \$59.7 million. All but two companies surveyed increased depreciation totals over the year before.

As a percentage of net sales, funds for the industry have held relatively constant. As shown in the graph, the percentage for ten

(Continued on page 18)

# MULTI-PURPOSE POWER AMPLIFIER

## with Wide Frequency Range

- ★ Supplies as much as 15 watts
- ★ Negligible overshoot  
when amplifying pulses  
with 0.1  $\mu$  sec rise times
- ★ Noise level better than  
60 db below 15 watts
- ★ Balanced or grounded  
150 or 600 ohm output
- ★ Built in voltmeter  
indicates terminal voltages

The Type 1233-A Power Amplifier is a versatile instrument of wide frequency range and substantial output. It finds use in the electrical laboratory, production test-station and for a wide variety of applications in industry.

This amplifier is widely used in the testing and development of audio-frequency equipment, and in driving supersonic transducers. At standard broadcast frequencies, it has sufficient amplification for exciting antennas in measurements of gain characteristics. The 20-cycle to 3 Mc range was specifically designed for amplifying oscilloscope deflection voltages.

Where a reliable instrument is needed for undistorted amplification over a wide frequency range, the Type 1233-A Power Amplifier is highly recommended.

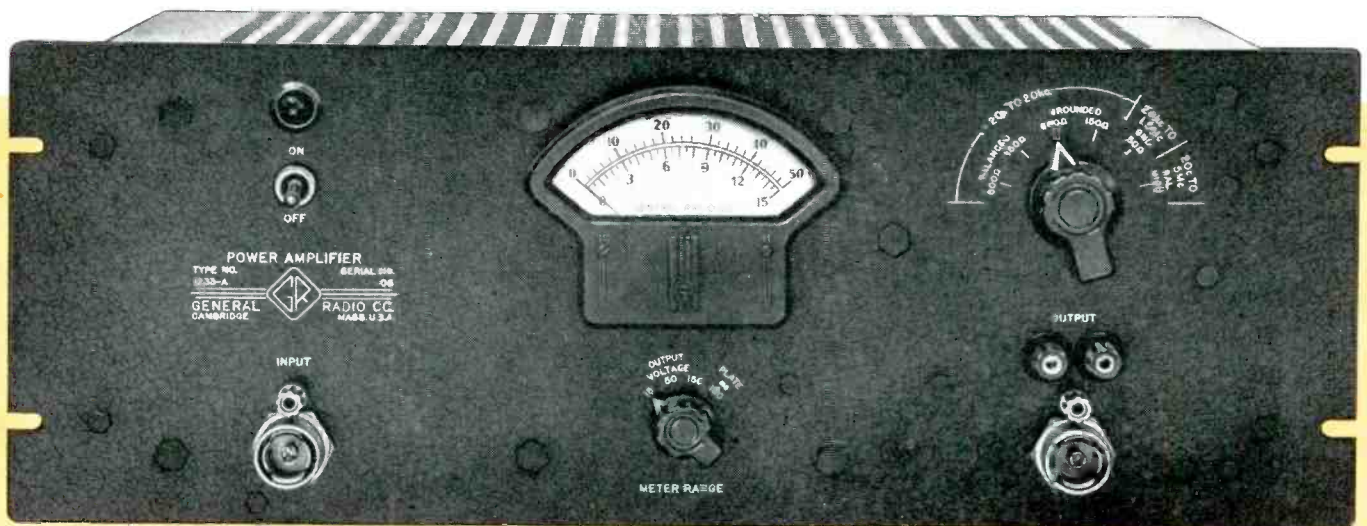

### ★ Three Frequency Ranges

20 cycles to 20 kc	150 or 600 ohms, balanced or grounded	15 watts from 50 c to 15 kc 8 watts at 20 c and 20 kc
20 kc to 1.5 Mc	50 ohms grounded	15 watts from 20 kc to 0.5 Mc 8 watts at 1.5 Mc
20 cycles to 3 Mc	high impedance output for connection to oscilloscope deflection plates	150 volts peak to peak

Input Voltage — Less than 0.2 volts for full output  
Input Impedance — 100,000 ohms in parallel with  
37  $\mu$ f grounded

Distortion — less than 3% at rated output on all ranges  
Dimensions — 19 $\frac{3}{8}$  x 14 $\frac{1}{4}$  x 7 $\frac{1}{2}$  inches, overall  
Price — \$525

## GENERAL RADIO Company

275 Massachusetts Avenue, Cambridge 39, Massachusetts, U. S. A.  
90 West St. NEW YORK 6 920 S. Michigan Ave. CHICAGO 5 1000 N. Seward St. LOS ANGELES 31

Admittance Meters ☆ Coaxial Elements ☆ Decade Capacitors  
Decade Inductors ☆ Decade Resistors ☆ Distortion Meters  
Frequency Meters ☆ Frequency Standards ☆ Geiger Counters  
Impedance Bridges ☆ Modulation Meters ☆ Oscillators  
Variacs ☆ Light Meters ☆ Megohmmeters ☆ Motor Controls  
Noise Meters ☆ Null Detectors ☆ Precision Capacitors  
Pulse Generators ☆ Signal Generators ☆ Vibration Meters ☆ Stroboscopes ☆ Wave Filters  
U-H-F Measuring Equipment ☆ V-T Voltmeters ☆ Wave Analyzers ☆ Polariscopes

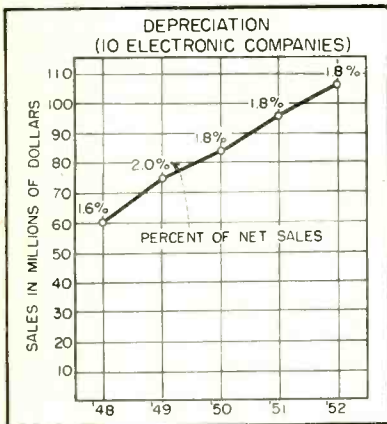

major companies in the field has remained at 1.8 percent since 1949.

► **Significance**—Depreciation reserves are an index to expansion plans. According to the sixth annual McGraw-Hill survey of Business Plans for New Plants and Equipment, 85 percent of manufac-

turing companies covered, including electronic firms, plan to invest all their depreciation funds to keep equipment up to date and to provide capacity for new products and new markets.

► **Future**—The industry's depreciation reserves and thus its expansion has been aided substantially by the government's fast-tax amortization policy. Under it, companies in the field have been able to amortize an average of 60 percent of the investment in new defense facilities over a period of 5 years instead of the normal 25 years.

The goal of \$396 million in fast tax aid for the industry set by the U.S. is expected to be completed by 1954. Already over 75 percent of the money has been certified.

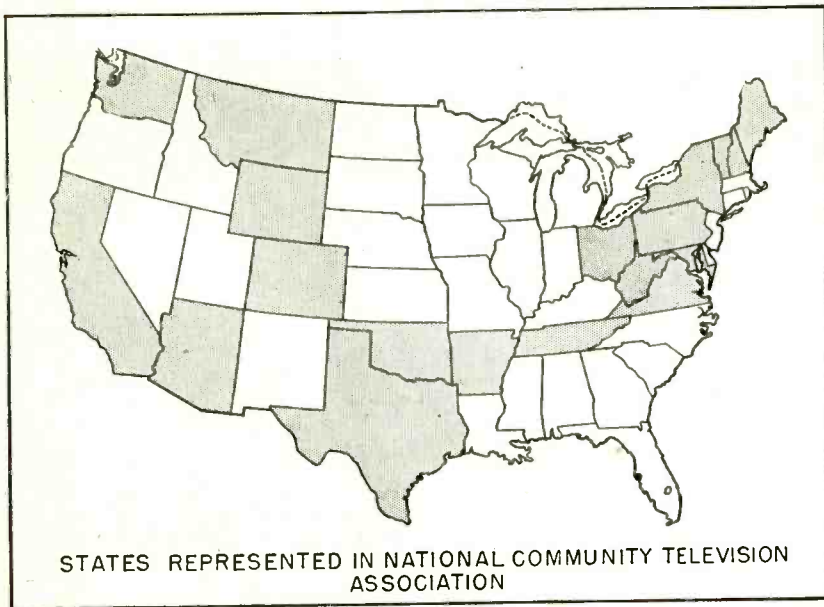

DELEGATES from 19 states attend NCTA conclave, as . . .

## Community Television Expands

DESPITE post-freeze television-station construction, the National Community Television Association reports a membership increase of nearly 100 percent during its second year of life. Sixty-three of the country's 200-odd community antennamen are now NCTA members.

Nearly 100,000 television sets

serving 350,000 viewers are now receiving television programs via video party lines.

► **Trends**—International Telemeter, developers of coin-box subscription television, plan to inaugurate experimental pay-as-you-see service in October over their own

community tv system in Palm Springs, Calif. Other subscription tv promoters are wistfully eyeing wired-television viewers as a ready-made box office.

Community tv operators are also seriously considering local program insertion. Equipment would range from small industrial-tv cameras working into video carrier-current transmitters to small-scale studio set ups.

A manufacturer has also announced a converter for community reception of uhf television signals.

► **UHF or Cable**—Reaction of small-city tv broadcasters to community television has been mixed. One uhf broadcaster has offered to buy a uhf antenna for any community system willing to pick up and distribute his signal. Other cases have been reported where a CP-holder threatened to turn back his construction permit if a tv cable company were granted a franchise in his city.

► **Problems**—During the past year, radiation has plagued community tv. Most complaints have originated with owners of antenna installations who find that signals radiated from the cable create an objectionable ghost on their tv screens. No legal action has reportedly been taken against operators but the FCC has inquired of equipment manufacturers as to design of their tv equipment.

## RTMA Asks U.S. To Set Quartz Crystal Base

POINTING out that the quartz crystal industry is essentially a wartime industry and that its production capacity now has been increased beyond requirements, RTMA asked the Department of Defense and top military officials to set up a production base for the industry which would prepare it to meet both current and full mobilization requirements.

In a letter to defense officials, Mr. George E. Wright, chairman of the Crystal Section of RTMA, said that normal commercial demand for

(Continued on page 20)

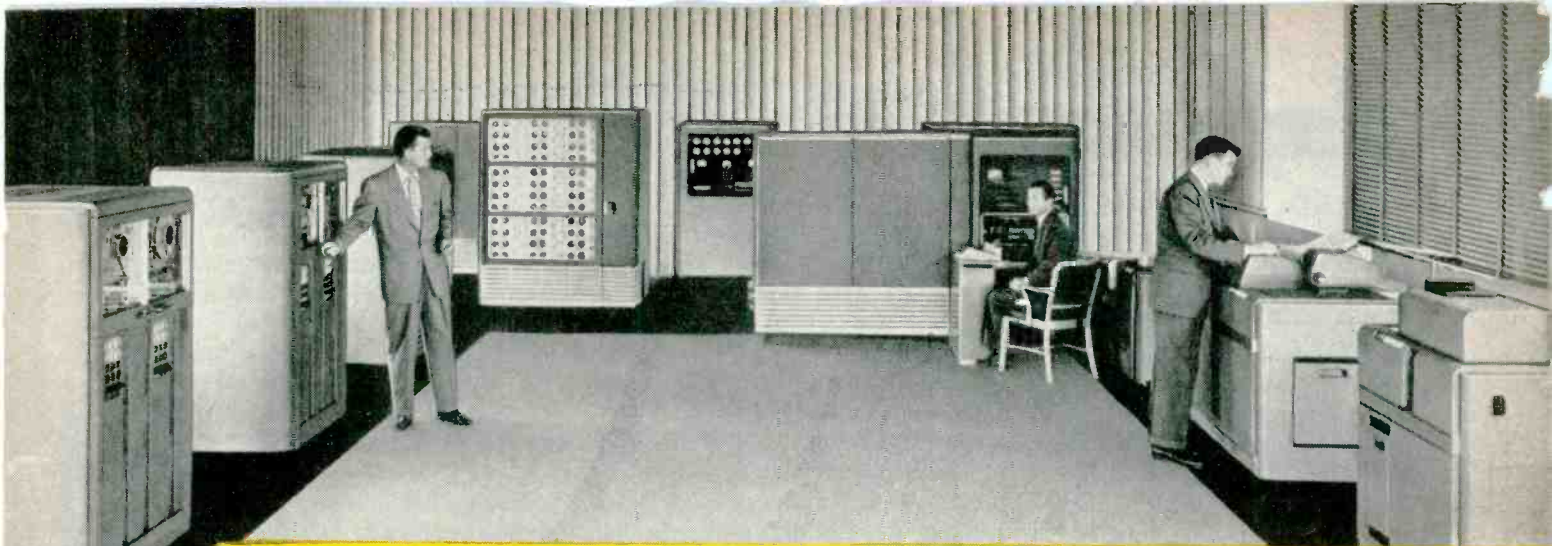

## FOR HIGH-SPEED COMPUTERS ... G.E.'s NEW TWIN TRIODE!

IBM's new Data Processing Machines have 2,700 GL-5965's in their tube complement. This computer will add and subtract 16,666 times a second, or divide and multiply 2,192 times. It answers an urgent call by defense and industry for faster solution of mathematical problems and better data storage... Here is an outstanding example of new computer design which the GL-5965 made possible!



### GL-5965 9-PIN MINIATURE

New twin triode for computer applications, as cathode follower and diode driver.

#### With

- high-perveance design.
- high plate dissipation; 2.2 w per plate, 4 w per tube.
- low heater power requirement.
- balanced cutoff characteristics.
- special cathode designed for "on-off" dependability.
- long tube operating life under cutoff conditions.

## Designers:

**IBM's use of G-E computer tubes shows  
97% still on the job after service equalling 5 years!**

**LONG LIFE** . . . IBM experience with GL-5844's, G.E.'s first computer tube, shows less than 3 percent cumulative failures after 10,000 hours! In other words, 97 out of every 100 tubes are still in use after "on-off" service that roughly equals 5 years' business use at 40 hours a week.

**DEPENDABILITY** . . . Records kept on a fifth of the million-and-more GL-5844's in IBM Type 604 Electronic Calculating Punches, show a failure rate of .0023 per 1,000 hours. This means that in

a period of approximately six months, only 460 out of 200,000 General Electric tubes have had to be replaced!

Add to the new GL-5965's twin-triode flexibility . . . high perveance . . . low heater power . . . these General Electric computer-tube qualities of long life and freedom from trouble, and you have the tube *you* need for your advanced circuit. Ask for full information! *General Electric Company, Tube Department, Schenectady 5, New York.*

GENERAL  ELECTRIC

quartz crystals is about one-tenth of the military requirements experienced in 1951 and 1952, is therefore dependent upon military contracts.

"Lack of careful planning in placement of such contracts, during a period of reduced appropriations, could easily weaken and destroy the nucleus of the industry that will be needed to form a mobilization base," he said.

The RTMA section urged the government to make plans to overcome the instability created by the sharp fluctuation between wartime and peacetime requirements for quartz crystals. RTMA crystal manufacturers suggested that an advisory group, composed of industry and government representatives, be appointed to assist in coordinating the plans for crystal production to meet current and wartime procurement schedules.

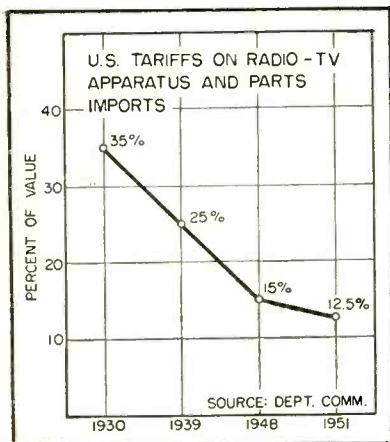

RECORD of tariff reductions on U. S. electronic imports shows that . . .

## U. S. Radio-TV Import Tariffs Are Low

**Imposts on most electronic imports have been reduced more than 50 percent**

LEVIES on radio-tv apparatus and parts have steadily declined from 35 percent in 1930 to the present 12.5 percent that went into effect in June, 1951. A reduction in 1939 was made under the United King-

dom Trade Agreement. In 1948 and 1951, the tariffs were reduced under GATT (General Agreement On Tariffs And Trade).

► **Breakdown**—Not all electronic equipment comes under the same tariff rates. Radio and television apparatus and parts cover the bulk of electronic imports and have the tariffs shown in the graph. Other equipments have different rates but in all cases they have been reduced since the Tariff Act of 1930 when all had a tariff of 35 percent. Photocells and electronic tubes other than radio now have a tariff of 15 percent and x-ray tubes, with a levy of 10 percent, have the lowest tariff of any electronic equipment.

► **Ad Valorem**—All electronic tariff rates are figured according to the value (ad valorem) placed on the equipment by U. S. Customs. The percentage is always taken on the highest valuation. It can be based on the foreign value, the U. S. value, the cost of production or the American selling price, whichever is highest. The classification given the equipment also determines the tariff rate and can be used to obtain the highest revenue.

► **Comparison**—Our tariffs on electronic equipment are lower than those of most other nations. In Mexico, for example, import tariffs in 1951 on radio receivers with cabinets were 24.1 percent; on radio receivers without cabinets, 16.1 percent; on spare parts for radio apparatus, 2.1 percent. In addition, all of these imports were restricted. But the rates show why some U. S. radio firms have elected to set up assembly plants in Mexico rather than ship the complete product across the border.

► **Reduction**—It is reported that President Eisenhower has agreed to enlarge the U. S. Tariff Commission from 6 to 7 members to get passage of his request for a one-year extension of the Reciprocal Trade Agreement Act.

This is seen by some manufacturers as a victory for protectionist factions that may make further tariff reductions difficult to obtain.

## Financial Roundup

PROFIT statements and security transactions in the past month were made by companies in the electronics field. Profits for the first three months of the year for the companies reporting continued to be higher than in 1952.

Company	Net Profit	
	1953 First Quarter	First Quarter 1952
American Cable & Radio	\$238,799	\$200,765
AT&T	101,310,260	86,831,361
Anaconda Wire Beckman Inst. (9 mos.)	1,921,922	1,607,273
British Cable (Annual)	617,870	448,000
Claude Neon (Annual)	16,858,332	12,839,876
Cornell-Dubilier (6 mos)	2,559,285	1,938,850
Consolidated Inst. (Annual)	895,000	736,000
Daystrom (Annual)	501,511	437,591
T. A. Edison	1,405,000	771,000
Emerson (6 mos.)	110,823	100,531
General Inst. (Annual)	1,768,694	548,228
Gray Mfg. (Annual)	1,275,863	993,557*
Philco	408,965	406,049
Standard Coil	3,401,000	2,341,000
Westinghouse	1,737,045	905,116
	16,858,000	15,485,000

\* Loss

► **Stock Transactions**—Electronic Associates offered to common stock holders the right to buy an additional 10,000 shares of \$1 par common stock at \$15 per share on a 1 for 10 basis. Proceeds are to be used for additional working capital.

Weston Instruments offered capital stock holders the right to subscribe to 107,055 additional shares at \$18 per share on a 1 for 3 basis. Proceeds will be used to reduce loans.

Computer Manufacturing offered 150,000 shares of common stock (par 10 cents) at \$1 per share. Proceeds will be used for repaying advances and for working capital.

Erie Resistor registered with SEC covering 62,500 shares of convertible preferred stock, \$20 par, to be offered at \$20 per share. Of net proceeds, approximately \$850,000 will be used for the Erie, Pa. plants and to equip a new plant at Holly Springs, Mass. The balance will be added to working capital.

Applied Science Corp. registered with SEC covering 750,000 of 6-percent sinking fund ten year debenture notes, due April 30, 1963. They will be offered for sale along with 75,000 shares of the common stock (par 1 cent) of

(Continued on page 22)

From  
**SUBMINIATURE**  
to **HEAVY DUTY**

From  
**MILLIWATTS**  
to **KILOWATTS**

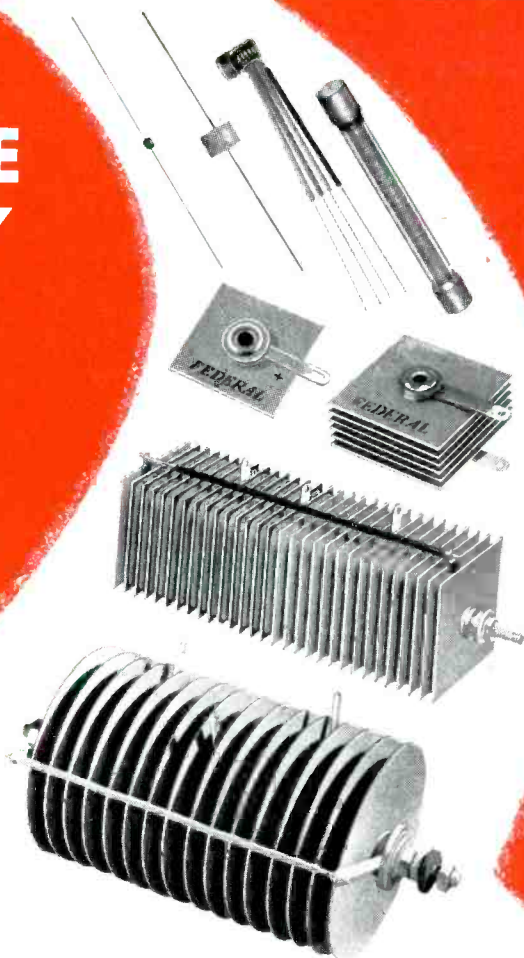
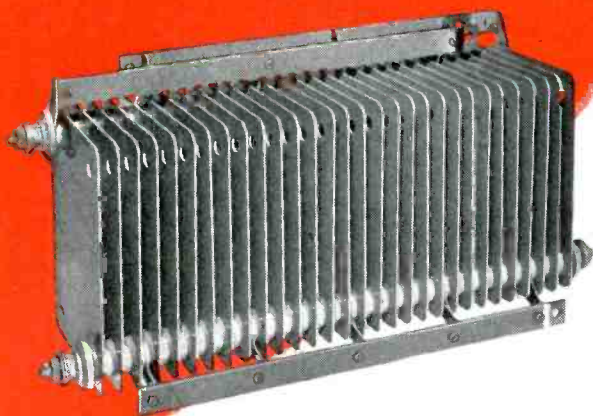

Whatever the DC requirement

there's a **Federal**

**SELENIUM RECTIFIER**

to do the job!

Now  
Federal Offers  
**ENCAPSULATION**  
OF SELENIUM RECTIFIER STACKS  
—plus other components



Another Federal "First" . . . a unique development in component-sealing that expands the application range of rectifiers and opens to industry a new concept in Military Equipment Design.



Applications range from tiny rectifiers to sub-assemblies and complete power supplies.

FOURTEEN years ago Federal introduced the selenium rectifier to America's electronic engineers and product designers.

Today, *tens of millions* of these versatile AC-to-DC power conversion units are at work in almost unlimited fields of application . . . from subminiatures with milliwatts of output to heavy duty stacks for the biggest DC-operated equipments.

Here's *proof* of the *high quality* built into Federal's compact, economical, long-life, fully inert selenium rectifiers . . . here's *proof* of their *efficiency* and *dependability* in consumer, industrial and military power conversion jobs!

Write Federal today for information on *your* rectifier requirements . . . whatever the size, type or rating. Give your design the benefit of the research, engineering and manufacturing skill that *pioneered* the selenium rectifier . . . and now *keeps* "Federal" the standard of industry! Address Dept. F-413B

America's oldest and largest manufacturer of selenium rectifiers

**Federal Telephone and Radio Corporation**



SELENIUM-INTELIN DIVISION

100 KINGSLAND ROAD, CLIFTON, NEW JERSEY

In Canada: Federal Electric Manufacturing Company, Ltd., Montreal, P. Q.  
Export Distributors: International Standard Electric Corp., 67 Broad St., N. Y.

Bradco, Inc. Proceeds will be used to acquire all the capital stock of Communication Measurement Lab. and of the Applied Science Corp. of Princeton. The remainder will be used for other purposes.

► **Stock Filings**—Skiatron Electronics filed with SEC covering 10,000 shares of common stock

(par 10 cents) to be offered at market (about \$2 per share). Proceeds are to be used to carry on public demonstrations of subscriber television.

Triad Transformer filed with SEC covering 10,060 shares of common stock (par \$5) to be offered at \$10 per share. Proceeds will be used for working capital.

## Lightplane Output Ups Electronics Business

Increasing use of private aircraft by business widens avionic equipment market

MAKERS of lightplane or utility aircraft, as they are now known in the aircraft industry, produced approximately 3,200 aircraft during 1952. For the first time since World War II the industry's falling production rate has reversed. In 1951, approximately 2,477 utility aircraft were built. With cuts in military plane production possible in the future, this sign of revival has not only been good news to aircraft manufacturers but to producers of electronic communications and air navigation equipment as well.

Main reason for the resurgence of the utility aircraft industry is growing use of company-owned aircraft by private industry. According to Aircraft Industries Association, 30 percent of the nation's fleet of active civil aircraft serve business or professions, and 32 percent of the total number of hours flown by these aircraft was for business and industry use. More multi-engined aircraft are now operated by private business organizations for executive transportation than are operated by the scheduled airlines.

► **Potential**—According to a survey by one of the leading manufacturers of utility aircraft, the average expenditure for electronic aids in their planes is \$600, ranging from \$300 for radio only to \$1,700 for complete equipment (ELECTRONICS, p 20, May, 1952). Thus in this segment of the aircraft industry alone, electronic manufacturers had a potential dollar volume of sales of nearly \$2 million. With increasing use by industry, in agriculture and as family transportation, potential sales may well double in 1953.

► **Manufacturers**—In recent months, manufacturers have stressed private aircraft applica-

(Continued on page 24)

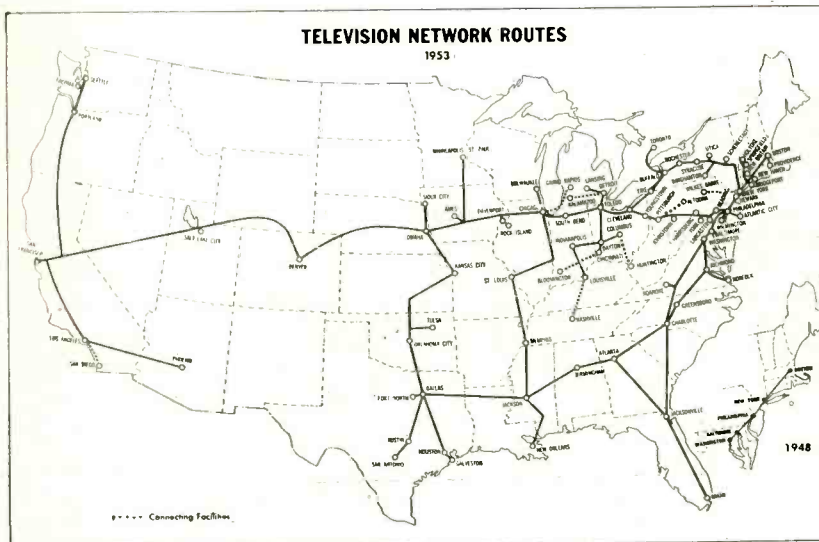

GROWTH of facilities since 1948 shows . . .

## Television Network Routes Expand

Number of channel miles to be available at end of year may total 47,000

PLANS to add 13,000 channel miles to existing tv routes by the end of 1953, almost doubling the average number of miles added in any of the past five years have been made by AT&T. Work has already started on a link between Seattle and Yakima, Washington and the company has FCC approval for additional links. By the end of this year, there may be a total of 47,000 channel miles in use.

► **Growth**—Five years ago, the Bell Telephone System opened for commercial use some 916 channel miles for tv to provide network service to 12 stations in 5 cities. Only Boston, New York, Philadel-

phia, Washington and Baltimore were linked for network service. By the end of that year more than 2,500 channel miles were added to transmit network programs to 30 stations in 13 cities. Over each of the next four years, an average of 7,000 channel miles were added to Bell System tv facilities. Now the facilities extend some 34,000 channel miles, enabling more than 130 stations in 87 cities to receive live network tv programs. In addition, Bell's facilities have been used on 117 occasions to connect theaters for tv service.

There are over 170 tv stations on the air broadcasting to an estimated potential audience of 95 million. These stations, more than 62 of which have been constructed since July, 1952, are located in some 120 cities.



telling the story of 'dag' dispersions

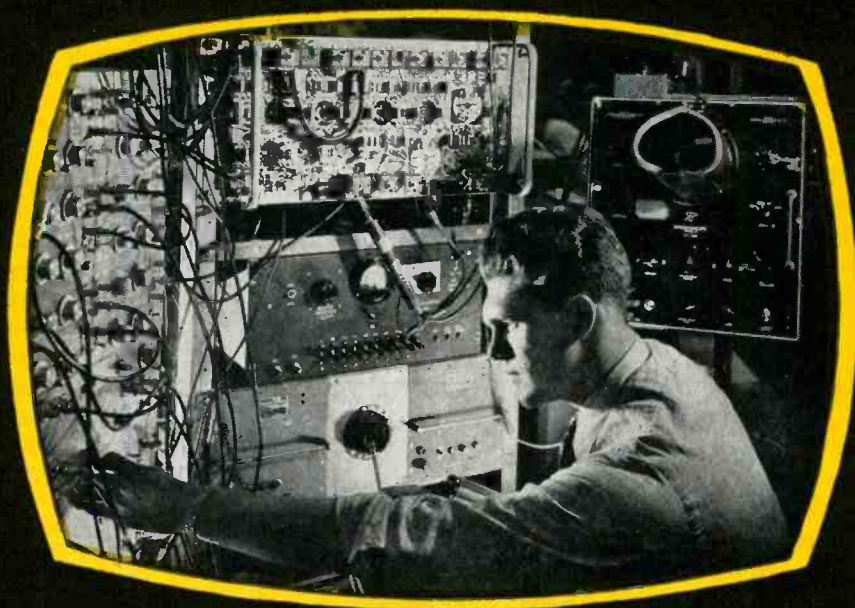

Can This Unique Material Help You?  
Check These Properties . . .



**'dag' Colloidal Graphite**

Chemically inactive, non-fusible, gray-to-black solid.  
Electrically conductive, diamagnetic, electrophoretic.  
Low in photoelectric sensitivity, resistant to electron bombardment.  
Forms tenacious *dry film* which is opaque, conducts heat, adsorbs gas, and has low coefficient of friction.

**In Vacuum Tubes**—'Aquadag', a dispersion of colloidal graphite in water, applied to grids and plates minimizes secondary emission, "back" emission, and photoelectric effects.

**In CRTs**—A dispersion of colloidal graphite in distilled water applied to inside walls retards secondary emission, adsorbs gases, and serves as an electrical conductor. And another dispersion, in lacquer, will opaque exterior walls.

**In Light-Sensitive Cells**—Colloidal graphite does not react with selenium to form selenides; therefore, it is used as an electrode material in photo tubes.

**In Other Applications**—As a conductive coating on piezo-electric crystals, on high-voltage coils, on suspension-type insulators...generally *wherever* a conductive lubricant is required.

Write *today* for more detailed information. Ask for Bulletin No. 433-5G.

*Dispersions of molybdenum disulfide are available in various carriers. We are also equipped to do custom dispersing of solids in a wide variety of vehicles.*



**Acheson Colloids Company, Port Huron, Mich.**

... also **ACHESON COLLOIDS LIMITED, LONDON, ENGLAND**

Units of Acheson Industries, Inc.

try 'dag' resin-bonded dry films for permanent lubrication

tions of electronic equipment to take advantage of the growing market. For example, Bendix Aviation recently introduced Distance Measuring Equipment (DME), developed by Hazeltine, and expected that the volume sales would come from the executive aircraft field. As military plane production declines, more electronic manufacturers will introduce avionic equipment for the growing utility aircraft market.

## Offshore Oil Men Spot Drills Electronically

MUCH-NEEDED OIL trapped under the Gulf of Mexico can be discovered by essentially the same methods used on dry land. When seismic, or other soundings are made underwater the drilling crew must know within a matter of feet where to set up their rigs. Many oil domes are far offshore and can't be spotted by optical or crude radio-direction-finding methods.

► **Government Cooperation**—So vital is the oil need that FCC has been lenient in allowing special use of frequencies that permit electronic surveying of the trackless Gulf.

One prospecting company needs to know the distance between two

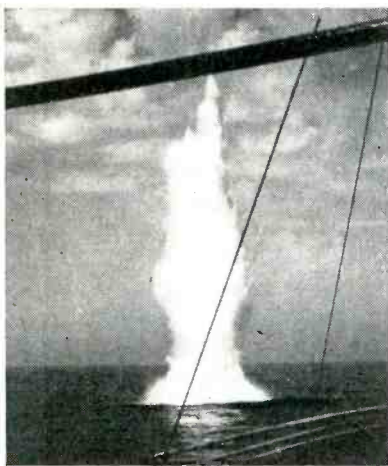

Underwater explosion used in the seismic method of locating oil deposits in the Gulf of Mexico is recorded aboard ship (in foreground) and, moments later, at another ship. Distance and direction between ships is measured by Raydist

boats with an accuracy of better than five feet to interpret geophysical data taken simultaneously. A hyperbolic grid system operated by Raydist Navigation Corp. is furnishing such a location service. Other leased service is offered both by this company and Offshore Raydist, Inc. from three networks reaching from New Orleans to Texas. As many as ten separate crews in the Gulf can use the networks as now installed.

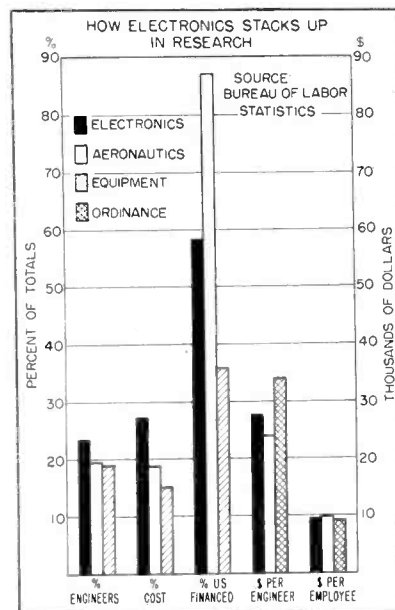

TOP three research specialties stand out as . . .

## Defense Department Reviews Research

**Electronics activity claims more engineers and costs more than any other research**

PRELIMINARY report of a survey of U. S. industrial research and development capacity in mid-1952, conducted by the Research and Development Board of the Defense Department, classifies companies into 16 research specialties including electronics.

► **Engineers**—Nearly 94,000 research engineers and scientists were employed by the companies reporting in January, 1952. Elec-

tronics research claimed 23.2 percent of total researchers, the highest percentage of all research specialties. Aeronautics and equipment and supplies followed with 19.6 and 19.0 percent respectively.

► **Research Cost**—National outlay for scientific research and development totaled more than \$3.5 billion in 1952, over four times the yearly expenditures at the beginning of World War II. The total cost of research for all surveyed companies for 1951 was nearly \$2 billion and electronics took 27.3 percent of this money.

► **Governments Share**—Close to half of all industrial research was financed by Federal Government agencies, mainly the Department of Defense and the Atomic Energy Commission. Percentages for the top three specialties were: aeronautics, 87 percent; electronics 58.5 percent; equipment and supplies, 35.9 percent. Thus, although electronics research, as shown in the chart, employed more engineers and bore the greatest share of total research costs, U. S. spending with the industry was almost 30 percent less than that spent in aeronautics research.

► **Cost per employee**—Average cost per research engineer or scientist in companies in the 16 research specialties ranged from \$14,500 for basic and medical science up to \$33,900 for ordnance. Electronics ranked second to the top with an average cost per engineer or scientist of \$27,600.

Taking all research employees together, including supporting personnel, the allocation of research cost per employee in electronics was \$9,800.

## TV Is Better Than It Seems

NUMBER of inquiries and complaints about television to Better Business Bureaus in 1952 ranked in sixth place. Television's total was 84,202, representing only 5 percent of the

(Continued on page 26)

# Faster... For testing...

## COMPACT, PORTABLE BENCH-TYPE TESTING UNIT FOR RAPID HIGH and LOW TEMPERATURES

Primarily developed for a branch of the armed forces, this high and low temperature testing unit has a temperature range from -80° F. to +185° F. Rapid temperature pull-down to -80° F. requires 30 minutes or less. Heat application is accomplished through reverse cycle refrigeration. Hazards of open heating elements are eliminated. Test chamber dimensions are 12" x 12" x 12" and the overall dimensions are 50" long, 26" high and 20" deep. Approximate weight is 450 pounds. The unit is compact and is entirely self contained. Controls are simplified and easy to operate. Equipped

with air-cooled compressors, the unit is quiet in operation. Cabinet is of stainless steel with all controls visible. A blower is provided for even distribution of temperatures and greater testing accuracy. The door illustrated is a latch type door providing for complete removal from the cabinet. Holes may be drilled for electrical contacts.

This is one of the many examples of WEBBER engineering skill and another of the many firsts built by WEBBER in the low temperature field.

*Write for more complete information:*

INDUSTRIAL FREEZER DIVISION  
WEBBER MANUFACTURING COMPANY, INC., 2745 MADISON AVENUE, INDIANAPOLIS 3, INDIANA  
(Formerly Webber Appliance Co., Inc.)

# WEBBER

TRADE MARK

COMPLETE TEMPERATURE RANGE  
TESTING UNITS

LOW-TEMPERATURE  
INDUSTRIAL FREEZERS

THERE'S A WEBBER UNIT FOR EVERY NEED

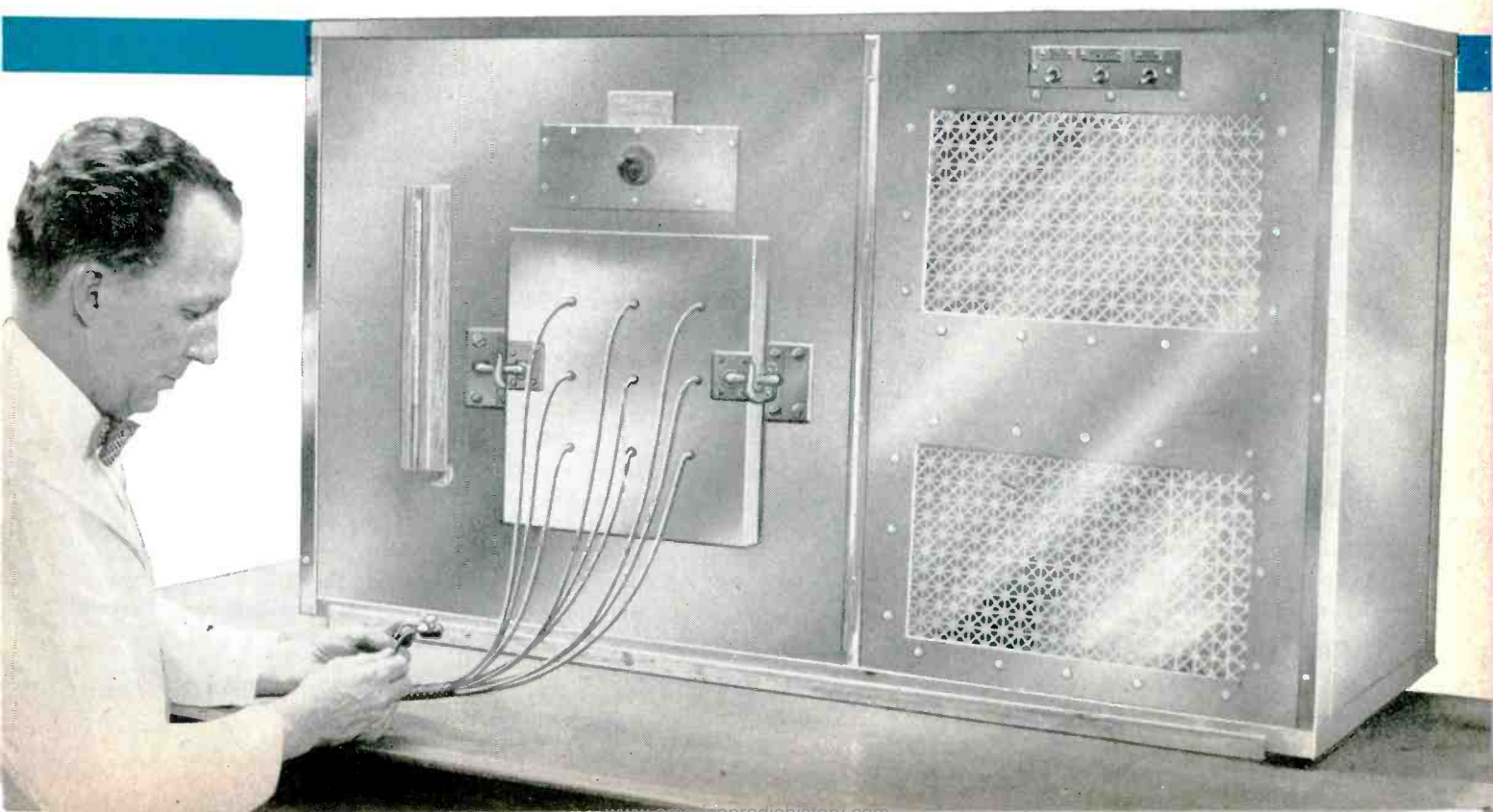

1.6 million grand total, as compared to 118,450 for solicitations, 93,991 for home appliances, 93,559 for insurance, 93,056 for construction and 85,038 for automotive.

About 75 percent of all requests were inquiries for information about the reliability of companies, products, services, individuals and day-to-day business transactions. The remaining 25 percent were in the nature of complaints.



**RADIO** relay supplemented damaged telephone cables, as . . .

## NATO Microwaves Aided Flooded Holland

**Sixty-mile emergency link restored telephone service vital to relief operations**

LAST February, when flood-waters inundated large areas of the Netherlands, relief and flood-control operations were imperiled as the elements raised havoc with the Dutch telephone system.

Responding to a request for assistance, the Allied Air Forces Central Europe rushed two RCA type-20A microwave terminals and one repeater to the scene. (See: *Microwaves Sharpen Europe's Air Defenses*, Industry Report, *ELECTRONICS*, p 10, Oct. 1952.)

► **Vital Link**—The equipment sup-

**MEETINGS**

JUNE 29-JULY 3: ASTM Annual Meeting, Atlantic City, N. J.  
 AUG. 19-21: WESCON (Western Electronic Show & Convention), IRE (7th Region) and WCEMA (West Coast Electronic Manufacturers' Association cosponsors, Municipal Auditorium, San Francisco, Calif.)  
 AUG. 29-SEPT. 6: West German Radio and Television Exhibition, Duesseldorf, Germany.  
 SEPT. 1-3: International Sight and Sound Exposition, Palmer House, Chicago, Ill.  
 SEPT. 1-12: British 20th National Radio & Television Exhibition 1953, Earls Court, London, England.  
 SEPT. 14-16: Fourth Annual Convention and Manufacturer's Conference, NEDA, St. Louis, Mo.  
 SEPT. 21-25: Second Analytical Instrument Clinic, Chicago, Ill.  
 SEPT. 21-25: Eighth National Instrument Exhibit, Sherman Hotel, Chicago, Ill.  
 SEPT. 28-30: Ninth annual National Electronics Conference, Sherman Hotel, Chicago, Ill.  
 Nov. 9-12: Conference on Radio Meteorology, Austin, Texas.  
 Nov. 13, 14: Annual Electronics Conference, Hotel President, Kansas City, Missouri.

plemented a badly damaged cable between Rotterdam and Middelharnis, two main distribution points in the Dutch telephone system. Middelharnis is one of the hardest-hit spots in Holland. Power for the microwave equipment was supplied by portable units brought from NATO headquarters near Fontainebleau.

Despite delay in obtaining accurate maps and technical difficulties encountered in tying into the local switchboard, within nine days 13 of the 24 available voice channels were placed in use.

## Industry Shorts

► **OMIBAC** comprises first letters of GE's Ordinal Memory Inspecting Binary Automatic Computer.

► **Cost** to equip a tv station so that it could transmit network programs in compatible color was estimated at \$15,000 by NBC vice-president Sylvester Weaver.

► **First** units in an aircraft radar warning system for the perimeter of Western Europe have been made and delivered by Microlambia of Italy under the U.S. Offshore Procurement program. They are built under a licensing and technical as-

sistance agreement with Raytheon.

► **Sixty-five** percent of those replying to a Purdue University opinion panel post card survey indicated that they would pay one dollar for the privilege of seeing a championship fight on their home tv receivers by subscription tv.

► **Broadcast** receiving licenses totaled 12.9 million in Great Britain and Northern Ireland at the end of April, 1953 including 2.2 million for tv and 186,338 for autoradios. Television licenses increased by 60,891 during the month.

► **Dutch** tv transmissions, still in their initial stages, will end on October 1, 1953 unless the Dutch Government decides to subsidize them, according to the Dutch TV Foundation.

► **Commerce** Department assured RTMA that it will make appropriate provision for the electronics industry if industry divisions are established in the department subsequent to any termination of NPA activities.

► **Large** deposit of nickel ore recently discovered in Cuba by Freeport Sulphur is believed to constitute one of the most important proven sources of nickel anywhere in the world.

# NO GLARE

## and less distortion, with Westinghouse 21AP4, 21MP4 Metal-Cone Tubes

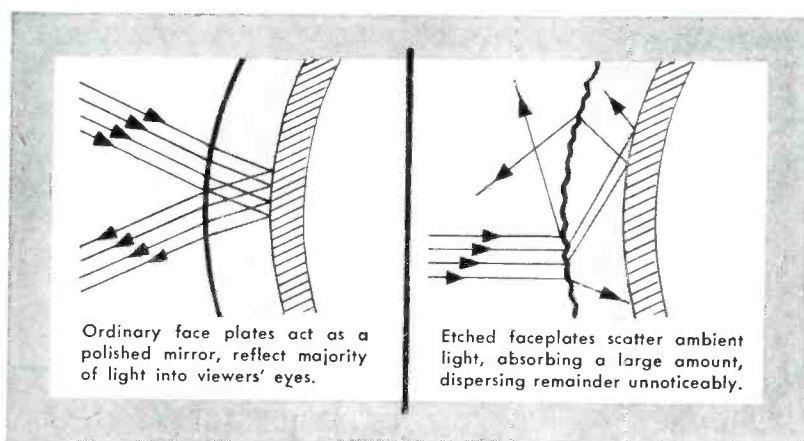

300X photomicrograph of smooth face shows smooth reflecting surface; tiny scratches are invisible to naked eye.

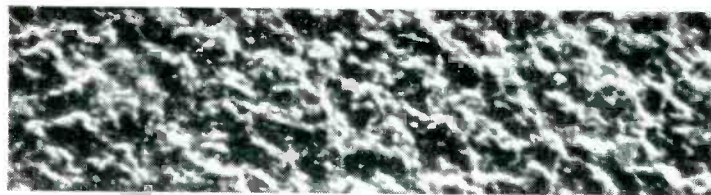

300X photomicrograph of etched face shows surface which disperses ambient light, does not affect picture quality.

"No glare, no room reflection, less distortion, clear picture over full tube area!" Your sets can have these hard-selling, practical advantages if you use Westinghouse 21-inch metal-cone tubes in your designs.

Their etched spherical face plates completely eliminate the annoying problem of room reflections. And best of all—this factual, appealing sales feature can be demonstrated in any retail show room by the purchaser himself.

Westinghouse metal-cone tubes have less distortion due to uniform face plate thickness: Corner focus is better, brightness is uniform. These stronger tubes save money due to less weight, easier handling. Both the 21AP4 and the 21MP4 are available now in production quantities. For technical or application information, write, wire, or phone

Commercial Engineering Department  
A-207, Westinghouse Electric Corporation,  
P. O. Box 284, Elmira, New York.

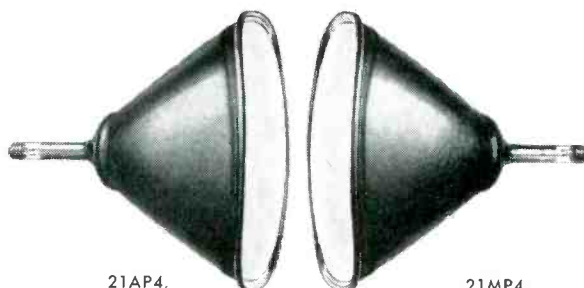

ET-95022

YOU CAN BE SURE... IF IT'S  
**Westinghouse**

**RELIATRON TUBES**  
TM

WESTINGHOUSE ELECTRIC CORPORATION, ELECTRONIC TUBE DIVISION, ELMIRA, N. Y.

# Lamson LIFE WITHOUT FASTENERS



## Blue Monday!

A washer's a "washout" without fasteners. But luckily for the housewives of America this catastrophe can never happen.

For Lamson & Sessions has long worked hand in glove with the appliance people to develop dependable engineered fasteners for home appliances.

If you, too, want to be *sure* of the "just right" fasteners for your product, check with Lamson during the planning stage. Our engineers will be happy to help you with your selection and possibly suggest fasteners that will save time and money on the assembly operation.

Remember, no matter what your fastener requirements, it's always *pleasant* and *profitable* to do business with Lamson & Sessions.

### TAPPING SCREWS For Fast Sheet-Metal Fastening



Self-tapping screws require no nuts, no tapped holes. Therefore, they are important time-savers on all sheet metal assembly work. A choice of type "A", "B" and "C" threads. Heads available with slotted or Phillips driver recesses.



### The LAMSON & SESSIONS Co.

1971 West 85th St. • Cleveland 2, Ohio

Plants at Cleveland and Kent, Ohio • Birmingham • Chicago

FOR PROMPT DELIVERY AND HELPFUL SERVICE,  
ORDER FROM YOUR LAMSON DISTRIBUTOR



#### MACHINE SCREWS AND NUTS

Precision made for fast, economical assembly.



#### PLUG NUTS

Ideal for blind or hard-to-reach places.



#### TAPPING SCREWS

Choice of round, pan, truss, flat oval, hexagon and Phillips heads.



#### CAP SCREWS

Bright and "1035" Hi-Tensile Heat-treated steel.



#### SQUARE AND HEX NUTS

Semi-finished, hot pressed, cold forged.



#### LOCK NUTS

Economical, vibration proof. Can be used repeatedly.



#### COTTER PINS

Steel, brass, aluminum and stainless steel.



#### "1035" SET SCREWS

Cup point type, hardened and heat-treated.

# The most versatile test data recorder you've ever seen!

## Check these features:

### SPAN:

adjustable from 1 to 50 millivolts. Arbitrary dial markings, readily converted to millivolt range by means of calibration supplied with recorder.

### ZERO SUPPRESSION:

coarse and fine dials permit movement of zero by  $\pm 100\%$  of max. span.

### DAMPING:

adjustable to obtain optimum balancing action for almost any span or source impedance.

### SENSITIVITY:

automatically adjusts measuring circuit response as span is changed.

### SPEED:

full scale pen travel as fast as one second.

### WIDE CHART:

11-inch calibrated width gives high resolution.

### STANDARDIZING:

manual.

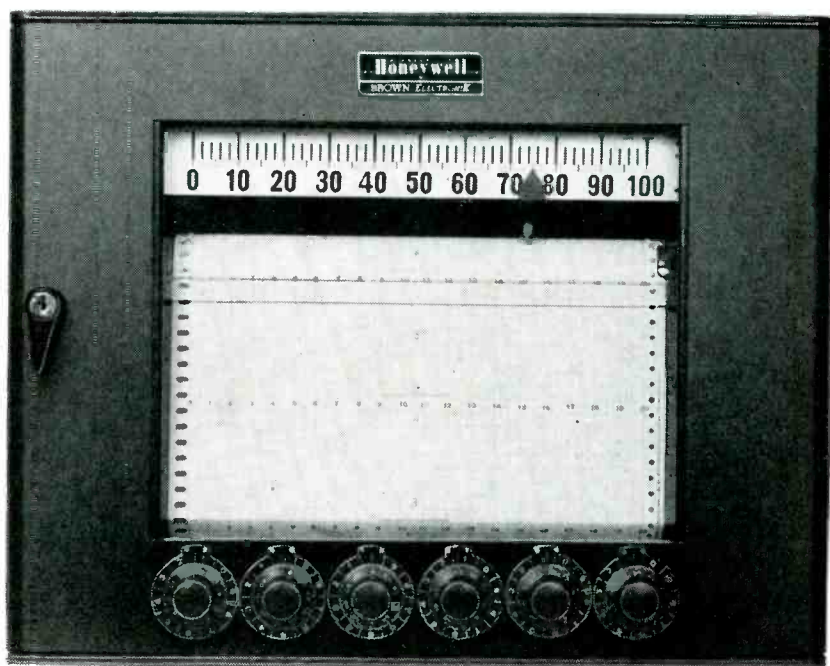

If you need to record results of a variety of tests, this new *ElectroniK* instrument is just what you've been looking for. A simple turn of its dials converts it to practically any range your tests require.

Especially useful with strain gauges, accelerometers, tachometers, differential thermocouples—or any other voltage-producing transducer—it is like having a hundred instruments in one. You can vary its full scale span over a wide range, to spread out test curves in exceptionally readable form. You can move its zero point up and down at will, until the portion of the test curve in which you're most interested is spread across the recorder chart. And you can change its sensitivity and damping to give the recording characteristics that best fit your test. Span and zero adjustments are completely independent.

Our local engineering representative will be glad to discuss how this new instrument can bring new convenience to your test work. Call him today . . . he is as near as your phone.

MINNEAPOLIS-HONEYWELL REGULATOR Co., *Industrial Division*, 4428 Wayne Ave., Philadelphia 44, Pa.

### ● REFERENCE DATA:

Write for Data Sheet No. 10.0-10 "Adjustable Span *ElectroniK* Recorder."



MINNEAPOLIS  
**Honeywell**  
BROWN INSTRUMENTS

*First in Controls*

# General

*teamed up*

**"More Power to You"**

#### NATIONAL SALES OFFICES

Atlanta, Ga.  
Buffalo, N. Y.  
Cambridge, Mass.  
Chicago, Ill.  
Cincinnati, O.

Cleveland, O.  
Dallas, Tex.  
Detroit, Mich.  
Houston, Tex.  
Indianapolis, Ind.  
Kansas City, Mo.

Los Angeles, Cal.  
Milwaukee, Wis.  
Minneapolis, Minn.  
New York, N. Y.  
Newark, N. J.  
Philadelphia, Pa.

Pittsburgh, Pa.  
St. Louis, Mo.  
San Francisco, Cal.  
Seattle, Wash.  
Washington, D. C.



# Cable

**FOR QUICKER SERVICE  
anywhere in the United  
States... General Cable  
maintains**

-  **22 Sales Offices**
-  **14 Resident Sales  
Representative Locations**
-  **Over 600 Distributor  
Sales Locations**
-  **6 Regional Stock  
Distribution Points**
-  **6 Manufacturing  
Plants and Stocks**

*to render service!*



General Cable is an institution that stands for nation-wide service points, strategically located . . . Field Offices to render on-the-spot service . . . Teamed with important supply houses to put General Cable products on a local delivery basis from local distributing points.

Whatever your electrical wire and cable need, whenever you need it, make "General Cable" a part of your product description.

*One Source of Complete Supply  
One Completeness of Service  
One Standard of Quality*

**GENERAL CABLE**

C O R P O R A T I O N

Executive Offices: 420 Lexington Avenue, New York 17, N. Y. Sales Offices in Principal Cities in the United States.



—C. R. Herrick, Director of Traffic, Packard Motor Car Co.

## “We can’t afford traffic jams at Packard!”

“An automobile plant is geared around its assembly lines. And they can be stopped for lack of a bolt!

“We simply cannot afford to let a traffic jam get started at Packard!

“When we face unforeseen delays on the part of our suppliers, we make extensive use of Air Express. Such shipments may range from 5 lbs. to more than a thousand.

“Recently, for instance, we needed a heavy shipment delivered overnight from the East Coast to meet a production crisis. The vendor was located in a

non-airport city. We called Air Express — and the load was rolling into the plant gates at Detroit the next morning!

“Dependability like that is priceless. Yet in a good many weights and distances you actually save money by specifying the fastest service — Air Express.

“We handle several thousand pounds a month via Air Express, every shipment of which is important and must be on time. We give Air Express credit for valuable assistance in maintaining production of 1953 Packards and Packard Clippers from our assembly lines.”

It pays to express yourself clearly. Say Air Express! Division of Railway Express Agency.



**AIR EXPRESS**

**GETS THERE FIRST**

via U. S. Scheduled Airlines

# Röntgen

... First to discover the X-ray

*Wilhelm Konrad Röntgen*

1845-1923

Röntgen, a German physicist and educator, in 1895 discovered that a Crookes tube produced invisible rays that could penetrate opaque materials. He named these "X-rays." He also developed the basic methods of X-ray photography, and was awarded the Nobel Prize in 1901.

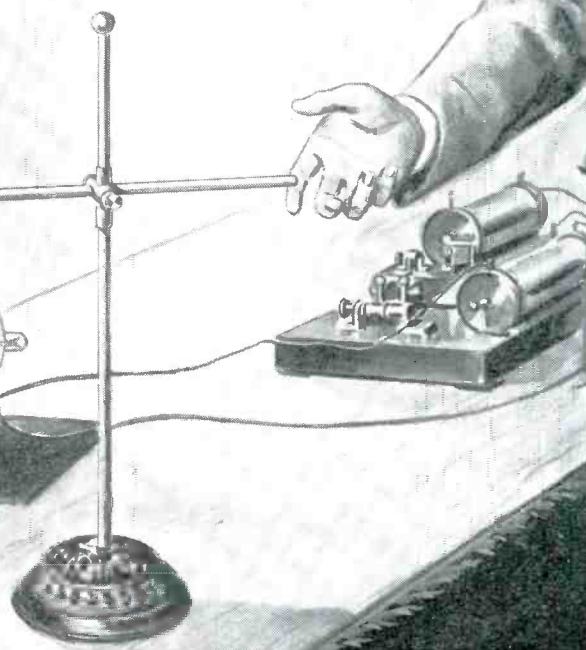

From an original drawing made for Ohmite

## OHMITE®

... First in rheostats—today

You can *always* tell Ohmite rheostats by their unmatched smoothness of operation, dependability, and long, trouble-free life. Ohmite rheostats *perform* better because they're *built* better . . . designed with patented features that make them the most popular rheostat on the market . . . preferred by manufacturers everywhere. No wonder more Ohmite rheostats are sold than any other make!



*Be Right with* OHMITE

RHEOSTATS • RESISTORS • TAP SWITCHES

# OHMITE<sup>®</sup>

FOR

*Dependability*

## RHEOSTATS

All-ceramic and metal, close control rheostats for unsurpassed dependability and smoothness of operation. Ten stock sizes, 25 to 1,000 watts.

## TAP SWITCHES

Five compact models, 10 to 100 amperes, AC, up to 12 taps. All-ceramic and metal construction. Silver-to-silver contacts, with self-cleaning rotor.

## RESISTORS

A wide range of dependable, fixed, adjustable, tapped, and non-inductive, power wire-wound resistors. Also a wide range of precision resistors.

## R. F. CHOKES

Single layer R. F. plate chokes and power line chokes, on steatite or plastic cores. Protected by a special moisture-resistant coating.

*Be Right with* **OHMITE**  
**OHMITE MANUFACTURING COMPANY**  
4816 FLOURNOY STREET, CHICAGO 44, ILLINOIS



WRITE on company letterhead for Catalog and Engineering Manual No. 40

Telecomputing announces...

# THE TELEDUCER

## Automatically Records Voltage

## In Decimal Digits

## With 0.1% Accuracy

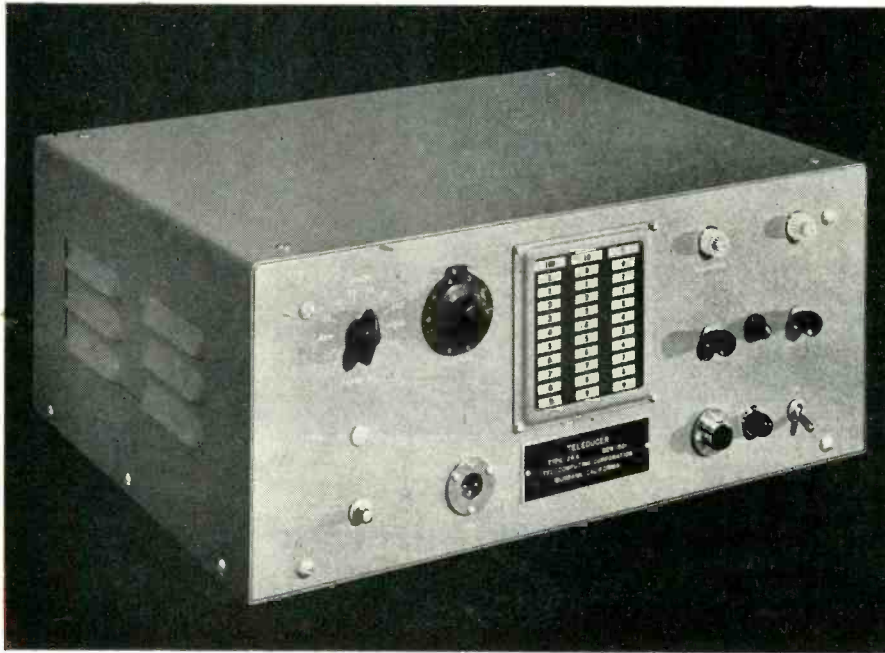

*It offers these important advantages:*

Provides 0.1% accuracy (1,000 counts full scale).

Provides for minimum full-scale input of 20 millivolts (20 microvolts per count).

Requires only 0.8 second or less for balancing.

Uses a simple bridge-balancing circuit.

Reads low voltage without DC Amplification.

Does not hunt or oscillate.

Presents visual reading of voltage on neon indicator bank.

Permits tabulated digital output when used with Program Unit and Electric Typewriter. (Digital recording in punched IBM cards or teletype tape available when used with suitable program units.)

### Computing Service

Your computing and data reduction problems, large or small, can be handled quickly, efficiently by Telecomputing's staff. Time and cost estimates will be presented if you will send information defining your problem.

TELEDUCER Technical Bulletin 104 and Technical Bulletins 106 and 107, giving specifications on the Program Unit and Electric typewriter, will be mailed you upon request. Coupon below is for your convenience.

# TELECOMPUTING

**CORPORATION**  
BURBANK, CALIFORNIA

Mr. Preston W. Simms, Dept. ES-7  
Telecomputing Corporation, Burbank, California

Please send me Teleducer Bulletin 104.

Please send me Bulletins 106 and 107 on the Program Unit and Electric Typewriter.

Name \_\_\_\_\_

Company \_\_\_\_\_

Street Address \_\_\_\_\_

City and State \_\_\_\_\_

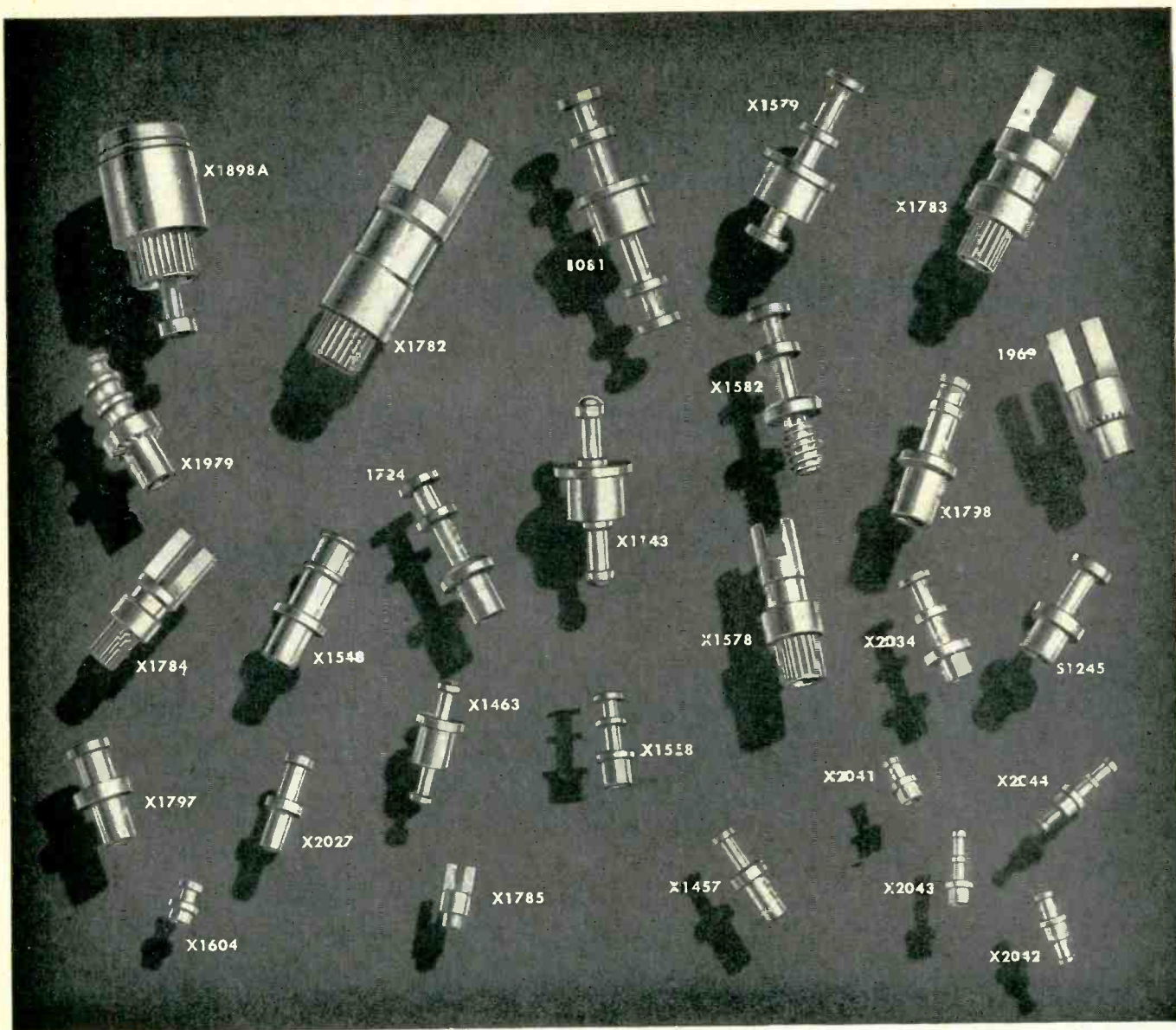

Shown Approximately Twice Size.

## Everything you need in standard terminal lugs ... or made to your own specifications!

C.T.C. has exactly the types and sizes of terminal lugs you want ... or will quickly make them to your specifications in any production quantity. Very likely you'll find what you're looking for in the broad C.T.C. line of standard terminals. There are 28 different types, each available in varied shank lengths.

C.T.C. standard terminals are of silver plated brass, coated with water dip lacquer to keep them chemically clean for soldering.

In addition, combination screw and solder terminals are available in 3 sizes, and a complete line of phenolic or ceramic terminals can be furnished.

All materials, processes and finishes meet applicable government specifica-

tions. Finishes include hot tinned, electro-tin, cadmium plate or gold plate on special order. In the event standard terminals don't meet your needs, C.T.C. offers a special consulting service to solve your solder terminal problems without extra cost or obligation.

For all specifications and prices, write to Cambridge Thermionic Corporation, 437 Concord Avenue, Cambridge 38, Mass. West Coast Manufacturers contact: E. V. Roberts, 5068 West Washington Blvd., Los Angeles 16 and 988 Market Street, San Francisco, California.

### CAMBRIDGE THERMIONIC CORPORATION

*custom or standard... the guaranteed components*

See our listing in *Electronics Buyers' Guide*





# FILAMENTARY SUBMINIATURE TUBES

average **58,000** HOURS

of dependable performance for each failure

Combined life test data for all Raytheon Filamentary Subminiature types, representing 47,000,000 tube-hours with 27,000 tubes, show 58,000 hours of satisfactory operation for each failure.

As an indication of results that may be obtained with some individual types, one user has reported 220,000 tube-hours per failure, based on tests of nearly thirteen hundred Raytheon Type CK6088 Tubes.

What's more, Raytheon Filamentary Subminiatures have what it takes to withstand extreme shock, severe vibration, extraordinary acceleration.

Low microphonic output and low power input are equally valued characteristics of these tubes.

For their supreme reliability and long life Raytheon Subminiature Tubes have become standard the world over — *more of them in use than all other makes combined.*



Here are data for a few representative types. Information on all types of Raytheon Filamentary Subminiatures is available on request.

Type	Description	Filament Volts	Filament Ma.	Plate Volts	Screen Volts	Grid Volts	Plate Ma.	Screen Ma.	Mutual Cond. Umhos	Voltage Gain	Plate Resis. Meg.
1A4	RF Pentode	1.25	100	45	45	Rg = 2 meg.	2.8	0.8	2000		0.5
1A6	Output Pentode	1.25	40	41.4	41.4	-3.6	2.4	0.6	1000		0.18
1A7	RF Pentode	1.25	40	45	45	Rg = 5 meg.		0.2	750		1.5
1A9	Diode Pentode	1.25	40	45	45	Rg = 5 meg.	1.0	0.3	425		0.3
1A10	RF Pentode	1.25	20	45	45	Rg = 5 meg.	0.75	0.2	750		1.5
1A11	Diode Pentode	1.25	20	45	45	Rg = 5 meg.	0.5	0.2	280		0.4
1V6	{ Mixer-Pentode Osc.-Triode	1.25	40	45 45	45	Rg = 5 meg. Rg = 1 meg.	0.4 0.4	0.15	200** 550		1.0
CK512AX	Pentode	0.625	20	22.5	22.5	-0.625	0.125		160		1.25
CK5672	Output Pentode	1.25	50	67.5	67.5	-6.5	3.25	1.1	650		
CR5676	UHF Triode	1.25	120	135		-5.0	4.0		1600		
CK 78	RF Pentode	1.25	50			Rg = 5 meg.	0.8		820		1.2
CK6029	UHF Triode	1.25	200	90		-4.0	0.5		2000		
CK6088	Output Pentode	1.25	20	45	45	-1.25	0.65	0.15	625		0.7

†Power Output — mw

\*\*Conversion Conductance



## RAYTHEON MANUFACTURING COMPANY

Receiving Tube Division — for application information call

Newton, Mass. Bigelow 4-7500 • Chicago, Ill. National 2-2770 • New York, N. Y. Whitehall 3-4930 • Los Angeles, Calif. Richmond 7-3524

RAYTHEON MAKES ALL THESE:

RELIABLE SUBMINIATURE AND MINIATURE TUBES • GERMANIUM DIODES AND TRANSISTORS • NUCLEONIC TUBES • MICROWAVE TUBES • RECEIVING AND PICTURE TUBES

# IF MAGNET WIRE IS

PHELPS DODGE has the



MOST COMPLETE AND  
UP-TO-DATE LINE OF MAGNET  
WIRE IN THE INDUSTRY



EVERY TYPE OF INSULATION  
TO MEET DESIGN REQUIREMENTS

*Black Enamel • Formvar • Sodereze® • Bondeze® • Nylon  
Glass • Paper • Cotton • Multiple Combinations*



AVAILABLE IN ALL  
SIZES AND SHAPES—ROUND,  
SQUARE, RECTANGULAR . . .

*Over 400 different types!*

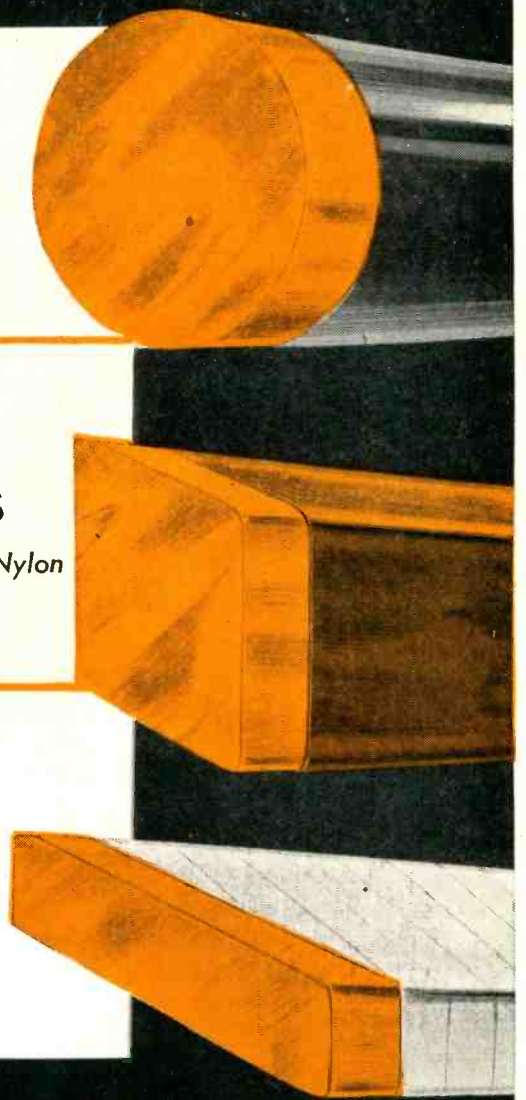

"It takes the best

**PHELPS DODGE *COPPER* PRODUCTS  
CORPORATION**



# YOUR PROBLEM

*Quickest, Easiest Answer!*

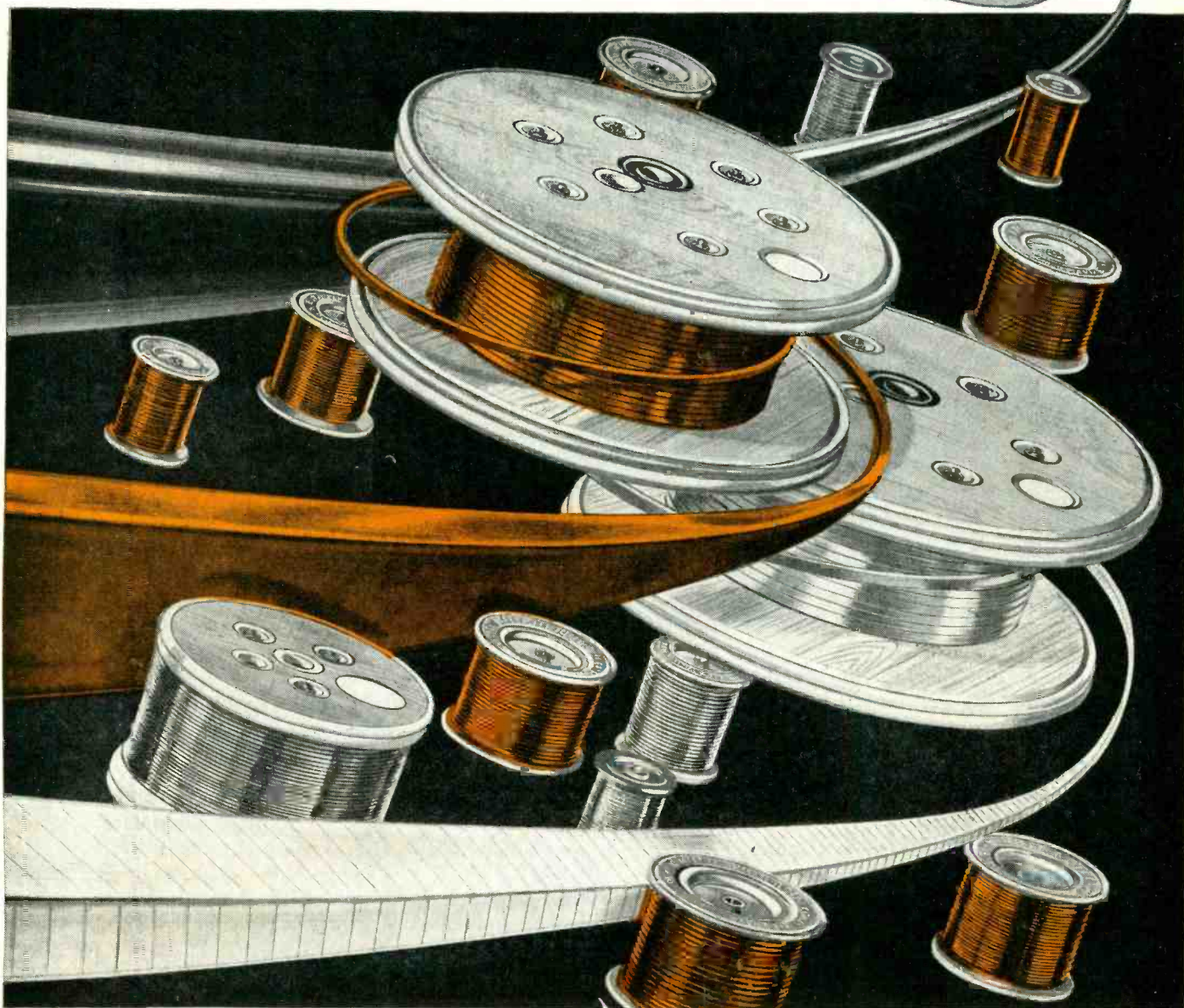

to make the best!"



**INCA MANUFACTURING DIVISION**

FORT WAYNE, INDIANA

# How to measure the depth of D. Jones' locker

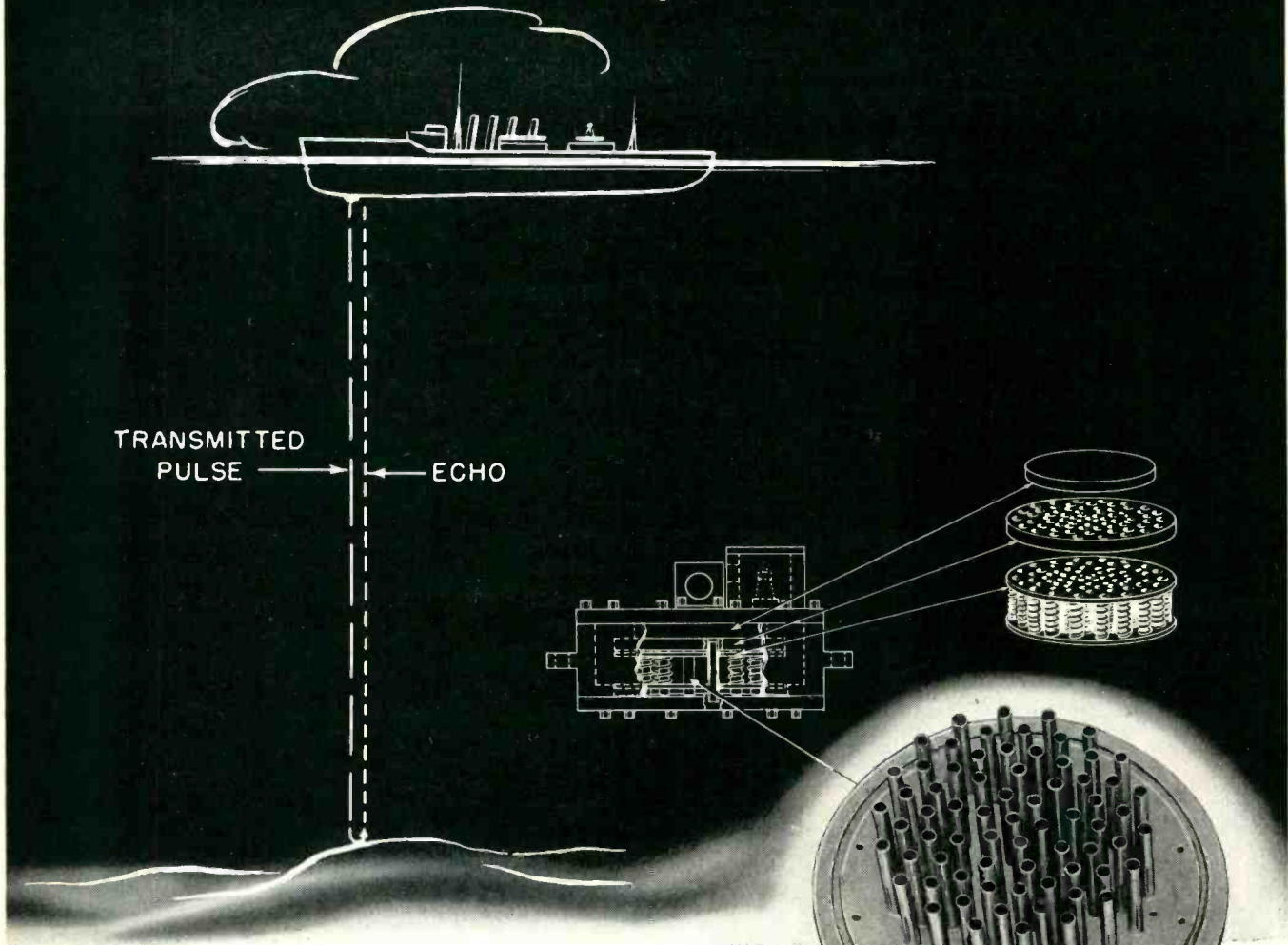

Best insurance against running aground is sonar . . . echo sounding equipment.

RCA Victor Division of Radio Corporation of America uses the phenomenon of magnetostriction to send and receive supersonic pulses and so determine the distance to a submerged object on the ocean's floor.

Magnetostriction—the familiar “Joule Effect” of your textbook days—is the ability of a ferromagnetic metal to change dimensions when magnetized. The metal of RCA echo sounding equipment is Superior Grade “A” nickel tubing.

70 pieces of Superior seamless nickel tubing, cold drawn to  $\frac{3}{8}$ " O.D. x .020" wall thickness and cut to  $\frac{1}{4}$  of the wave length of the alternating current signal, are soldered to a plate. Each length is enclosed by a coil.

Energizing the coil with alternating current, the tube expands and contracts, creating a piston effect on plate and diaphragm, sending out a supersonic wave. Likewise, reception of the echo wave by the diaphragm again causes the nickel tubes to pulsate and induce a current in the coil.

RCA Victor looks to Superior for accuracy and uniformity of analysis, precision drawing and cutting in large quantities. For cathodes, anodes, or tubing specialties, and tubing technology—ask Superior. Superior Tube Company, 2500 Germantown Avenue, Norristown, Pa.

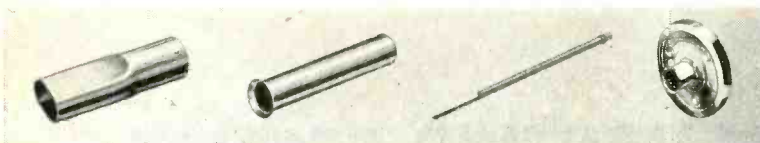

Seamless Nickel Anode. Flattened one end. .500" O.D. x .025" Wall x 1.625" long.

Seamless Nickel Cathode. Round, flanged one end, .070"/.072" I.D. x .0025" Wall. .295" long.

Lockseam\* Nickel Cathode. Round, tabbed, single bead, .045" O.D. x .0021" Wall. 27 mm long.

Disc Cathode .121" O.D. .312" long.

**Superior**  
THE BIG NAME IN SMALL TUBING

All analyses .010" to  $\frac{1}{8}$ " O.D.  
Certain analyses in Light Walls up to  $2\frac{1}{4}$ " O.D.

Many types of nickel cathodes—made in Lockseam\* from nickel strip, disc cathodes, and a wide variety of anodes, grip cups and other tubular fabricated parts are available from Superior. For information and Free Bulletin, address Superior Tube Company, Electronics Division, 2500 Germantown Avenue, Norristown, Pa.

\*Manufactured under U.S. Patents.

# LFE **SOLID** DELAY LINES STOP TIME!

**WIDE RANGES OF DELAY**  
**LOW ATTENUATION**  
**LOW SPURIOUS RESPONSE**  
**WIDE BANDWIDTH**  
**SMOOTH PASS BAND**  
**WIDE TEMPERATURE RANGE**  
**MINIMUM SIZE AND WEIGHT**  
**RUGGED CONSTRUCTION**

Now available for applications such as video integration, computers, time markers, moving target indication.

LFE solid ultrasonic delay lines utilize fused quartz as the delay medium and offer many advantages in obtaining precise delay intervals for pulse or modulated signals:

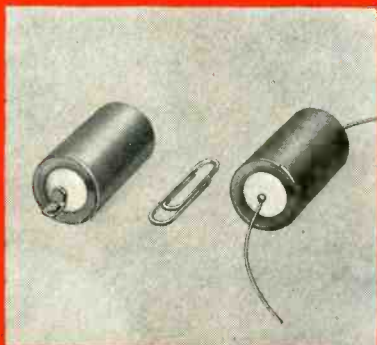

PRECISION RANGE MARKER DELAY LINE

### TYPICAL DELAY LINE SPECIFICATIONS FOR PRECISION 1,000 YDS. RANGE MARKER

Delay Time	3.050 ± 0.003 microseconds at 50° C. 3.05 μsec ± 0.02 over a temperature range 0° C. to 100° C.
Attenuation of first pulse	28 db. into 1,000 ohms
Center Frequency	30 Mc.
Bandwidth	7 Mc.
Capacity	15 to 20 mmfds.
Pulse decay	1 to 1½ db. average

This item available from stock



TYPICAL SOLID DELAY LINE

### RANGE OF SOLID DELAY LINE SPECIFICATIONS

Delay Time	1-3,000 microseconds can be provided with a high degree of accuracy.
Frequency Range	5-100 Mc.
Spurious Response	Up to 60 db. below desired signal.



For further information, write: SPECIALTIES DIVISION

**LABORATORY for ELECTRONICS, INC.**

75-3 PITTS STREET • BOSTON 14, MASS.

PRECISION ELECTRONIC EQUIPMENT • OSCILLOSCOPES • MAGNETOMETERS • COMPUTERS • MICROWAVE OSCILLATORS • SOLID DELAY LINES

# COMPLETE CIVILIAN LINE

Exceptionally good delivery cycle on civilian orders due to tremendous mass production facilities.

TYPE C45-70

NEW HIGH QUALITY MINIATURIZED "DIME-SIZE" CIVILIAN CONTROL—Performance Fully Equals Larger Types.

TYPE 76, 3/4" diameter variable composition resistor. Wattage ratings: .3 watt for resistances through 10,000 ohms, .2 watt with 350 volts maximum across end terminals for resistances over 10,000 ohms. Also available in concentric shaft tandem construction C45-70 as shown above.



TYPE C2-45



TYPE C2-35

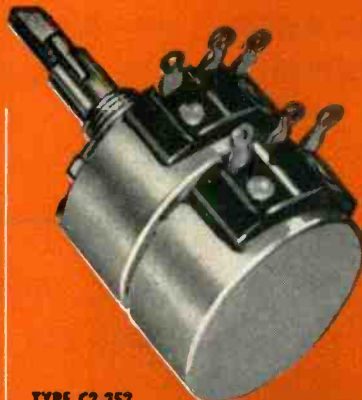

TYPE C2-252



TYPE C2-25



TYPE GC-45, 15/16" diameter variable composition resistor. Wattage rating: 1/2 watt for resistances through 10,000 ohms, 1/3 watt for resistances over 10,000 ohms through 100,000 ohms, 1/4 watt with 500 volts maximum across end terminals for resistances over 100,000 ohms. Available with or without illustrated attached switch and in concentric shaft tandem construction C2-45 as shown above.



TYPE GC-35, 1 1/8" diameter variable composition resistor. Wattage ratings: 3/4 watt for resistances through 10,000 ohms, 2/3 watt for resistances over 10,000 ohms through 25,000 ohms, 1/2 watt with 500 volts maximum across end terminals for resistances over 25,000 ohms. Available with or without illustrated attached switch and in concentric shaft tandem construction C2-35 as shown above.



TYPE GC-252, 2 watt, 1 17/64" diameter variable wirewound resistor. Available with or without illustrated attached switch and in concentric shaft tandem construction C2-252 as shown above.



TYPE GC-25, 4 watt, 1 17/32" diameter variable wirewound resistor. Available with or without illustrated attached switch and in concentric shaft tandem construction C2-25 as shown above.

Typical concentric shaft tandem with panel and rear sections operating separately from concentric shafts (TYPE C45-70 ILLUSTRATED). Similar construction available for all military resistors.

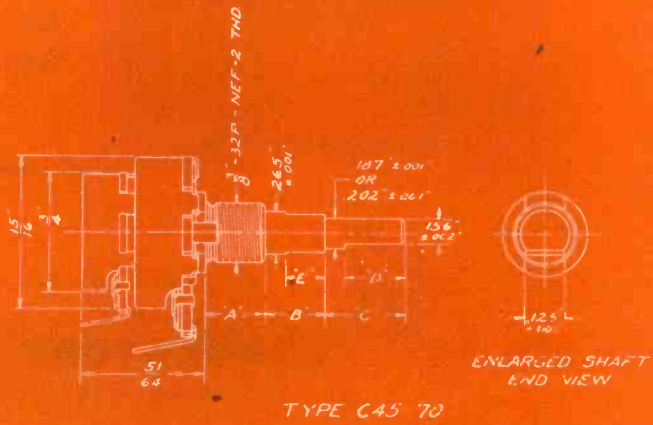

## REPRESENTATIVES

Henry E. Sanders  
McClatchy Bldg.  
69th & Market St.  
Upper Darby, Penna.  
Phone: Flanders 2-4420

W. S. Harmon Company  
1638 So. La Granga Blvd.  
Los Angeles 34, California  
Phone: Broadway 7-3121

W. A. Green Company  
6815 Oracle Drive  
Dallas 9, Texas

## IN CANADA

C. C. Meredith & Co.  
Streetsville, Ontario

## SOUTH AMERICA

Jose Luis Pantel  
Buenos Aires, Argentina  
Montevideo, Uruguay  
Rio de Janeiro, Brazil  
Sao Paulo, Brazil

## OTHER EXPORT

Sylvan Greshery  
8 West 40th Street  
New York 18, N. Y.

Specialists in

# COMPLETE MILITARY LINE

Immediate delivery from stock on 189 types including JAN-R-94 and JAN-R-19 types of variable resistors.

## NEW 38-PAGE ILLUSTRATED CATALOG—

Describes Electrical and Mechanical characteristics, Special Features and Constructions of a complete line of variable resistors for military and civilian use. Includes dimensional drawings of each resistor. Write today for your copy.

**TYPE 4S, (JAN-R-94, Type RV2)**  
1/4 watt, 15/16" diameter variable composition resistor. Also available with other special military features not covered by JAN-R-94 including concentric shaft tandem construction. Attached switch can be supplied.



**TYPE 3S, (JAN-R-94, Type RV3)**  
1/2 watt, 1 1/8" diameter variable composition resistor. Also available with other special military features not covered by JAN-R-94 including concentric shaft tandem construction. Attached switch can be supplied.



**TYPE 2S2, (JAN-R-19, Type RA20)**  
2 watt, 1 17/64" diameter variable wirewound resistor. Also available with other special military features not covered by JAN-R-19 including concentric shaft tandem construction. Attached switch can be supplied.



**TYPE 2S, (JAN-R-19, Type RA30)**  
(May also be used as Type RA25)  
4 watt, 1 17/32" diameter variable wirewound resistor. Also available with other special military features not covered by JAN-R-19 including concentric shaft tandem construction. Attached switch can be supplied.



**TYPE 6S, (Miniaturized)**  
1/2 watt 70°C, 3/4" diameter miniaturized variable composition resistor.



**TYPE 90**  
1 watt 70°C, 15/16" diameter variable composition resistor. Attached switch can be supplied. Also available in concentric shaft tandem construction.



**TYPE 9S, (JAN-R-94, Type RV4)**  
2 watt 70°C, 1 1/8" diameter variable composition resistor. Also available with other special military features not covered by JAN-R-94 including concentric shaft tandem construction. Attached switch can be supplied.



## UNPRECEDENTED PERFORMANCE CHARACTERISTICS

Specialty designed for military communications equipment subject to extreme temperature and humidity ranges. -55°C to +150°C...aridity to saturation.



CHICAGO TELEPHONE SUPPLY Corporation

ELKHART • INDIANA

Burton Browne Advertising

Precision Mass Production of Variable Resistors

**eliminate doubt...**

**place the responsibility  
for your  
electrical insulation**

**with...**



**and obtain the  
electrical insulation best suited  
for the job.**

MIRAGLAS VARNISHED TAPES, CLOTHS AND SLEEVINGS • MIRAGLAS TAPES, BRAIDED SLEEVINGS AND TYING CORDS • MIRAGLAS SILICONE TREATED CLOTHS, TAPES AND TUBINGS • MICA TAPES, CLOTHS AND MICA-FIBERGLAS COMBINATIONS • FIBRE, PHENOL FIBRE AND MIRALITE POLYESTER RESIN SHEET INSULATING PAPERS—DURO, FISH, PRESSBOARD, ETC. • VARNISHED CAMBRIC TAPES, CLOTH AND SLOT INSULATIONS • COTTON TAPES AND SLEEVINGS • TWINES AND TIE TAPES • ASBESTOS TAPES, SLEEVINGS AND CLOTH, TRANSITE AND ASBESTOS EBONY • ARMATURE WEDGES AND BANDING WIRE • VARNISHED TUBINGS, HYGRADE, MIRAGLAS, HYGRADE VF, MIRAGLAS SILICONE • THERMOFLEX AND FLEXITE EXTRUDED PLASTIC TUBING • PERMACEL MASKING TAPES AND ELECTRICAL TAPES • BI-SEAL, BI-PRENE, FRICTION TAPES AND RUBBER SPLICE • COMPOUNDS—TRANSFORMER, CABLE FILLING, POTHEAD, ETC. • INSULATING VARNISHES OF ALL TYPES.

**mitchell-rand**

**INSULATION COMPANY, INCORPORATED**

**51 MURRAY ST. • COrtlandt 7-9264 • NEW YORK 7, N.Y.**

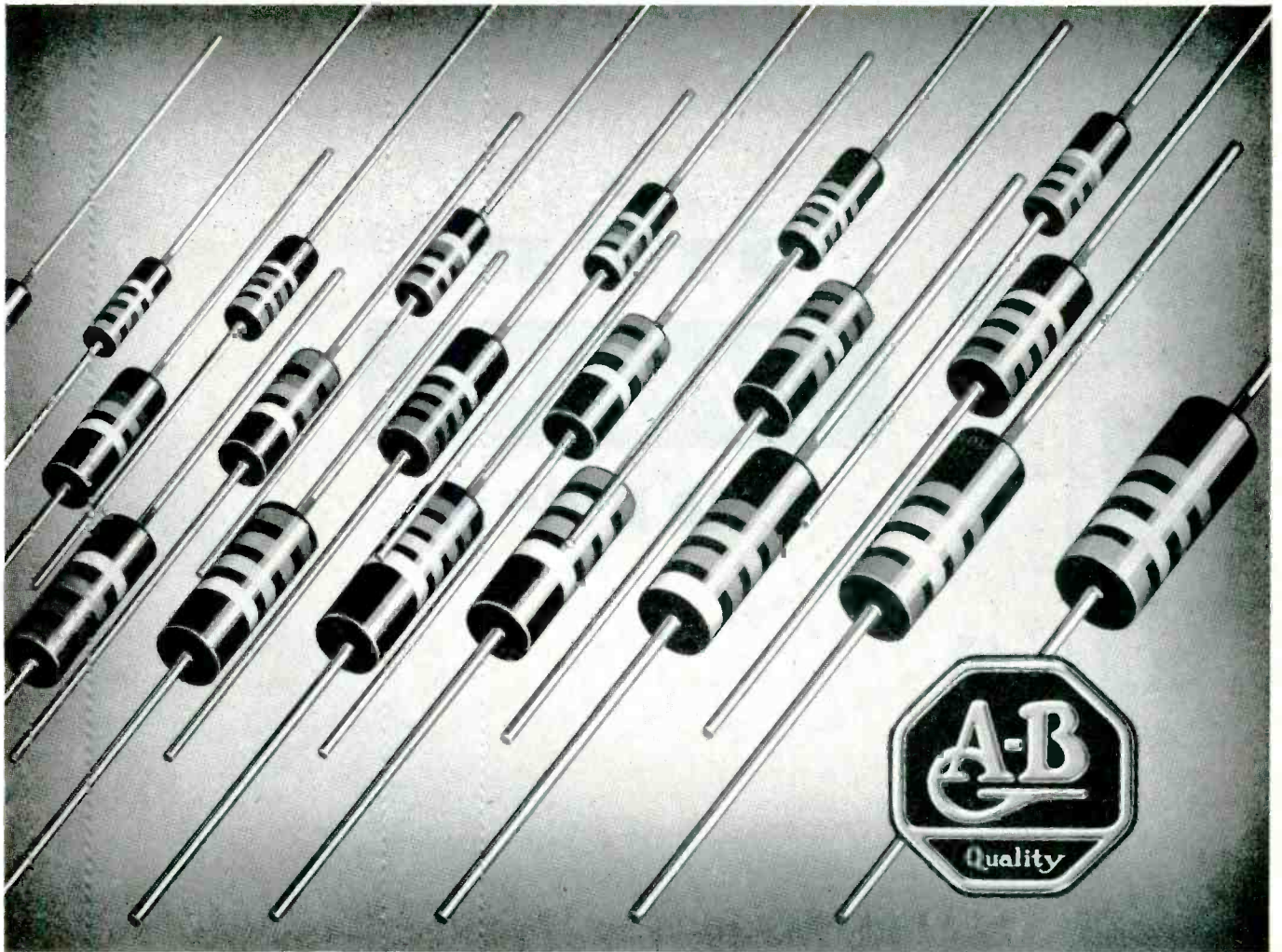

## BRADLEYUNITS—*by the Million*

... Quality Resistors for Dependable Performance



### IMBEDDED LEADS are differentially tempered

The tinned leads of Bradleyunits are differentially tempered. This graduated softness of the leads near the body of the Bradleyunit prevents sharp bends and avoids damage to the resistor.

Millions upon millions of Bradleyunits have been built into radio and electronic equipment over the past two decades.

Their reputation for high quality is due to the fact that they are rated at 70C ambient temperature . . . not 40C. Under continuous full load for 1000 hrs, the resistance change is less than 10%. They require no wax impregnation to pass salt water immersion tests.

Bradleyunits are available in standard R. T. M. A. values in  $\frac{1}{2}$  and 2 watt sizes from 10 ohms to 22 megohms; 1 watt from 2.7 ohms to 22 megohms. They withstand extremes of temperature, pressure, and humidity.

May we send you an Allen-Bradley Test Data Bulletin?

Allen-Bradley Co., 110 W. Greenfield Ave., Milwaukee 4, Wis.

**ALLEN-BRADLEY**  
**FIXED & ADJUSTABLE RADIO RESISTORS**  
 Sold exclusively to manufacturers **QUALITY** of radio and electronic equipment

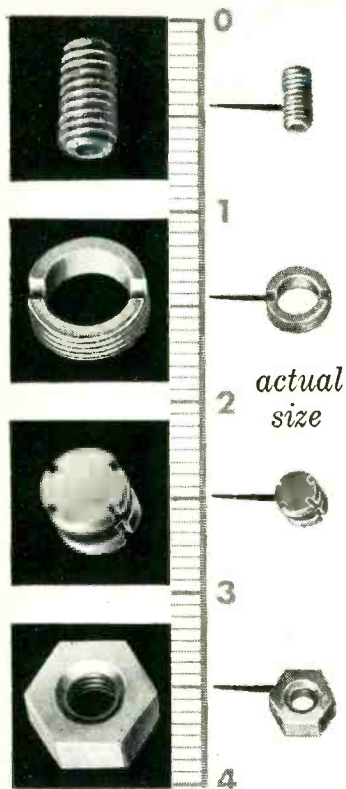

**iron**  
*pyroferric*  
**cores**

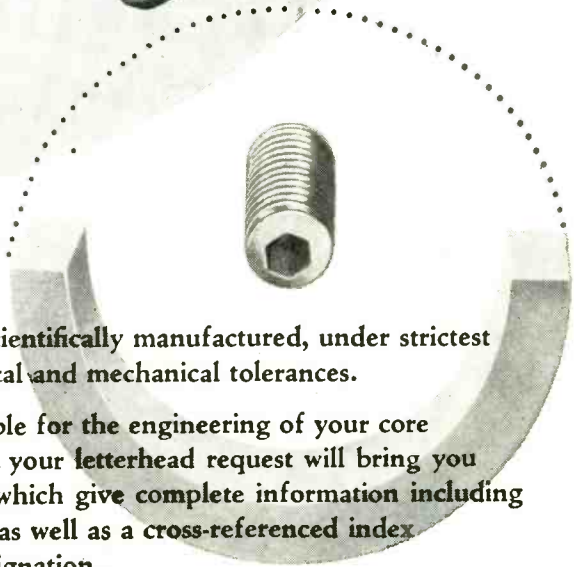
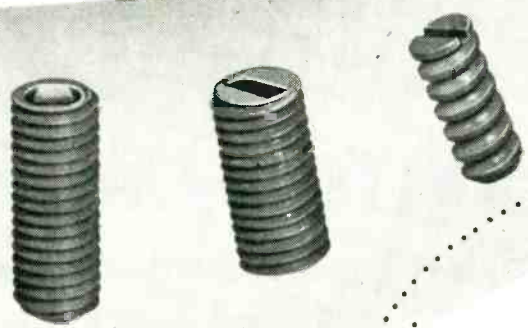

PYROFERRIC IRON CORES are scientifically manufactured, under strictest quality controls to close electrical and mechanical tolerances.

PYROFERRIC services are available for the engineering of your core production requirements . . . your letterhead request will bring you M.P.A. Data Sheets and tables which give complete information including recommended sizes and tolerances, as well as a cross-referenced index of manufacturers' material designation.



**PYROFERRIC**

PYROFERRIC BLDG.

BRONX BOULEVARD  
 at 216th St., N.Y.C. 67



# MECHANICAL FILTERS FOR INDUSTRY

Collins Mechanical Filter with hermetically sealed shield removed. Compare size with matchbook.

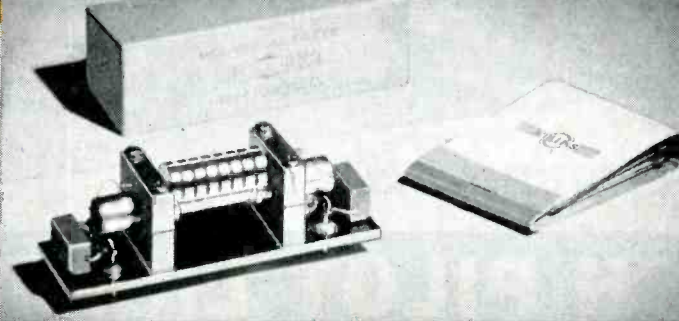

Engineers' drawing of 455 kc Mechanical Filter interior.

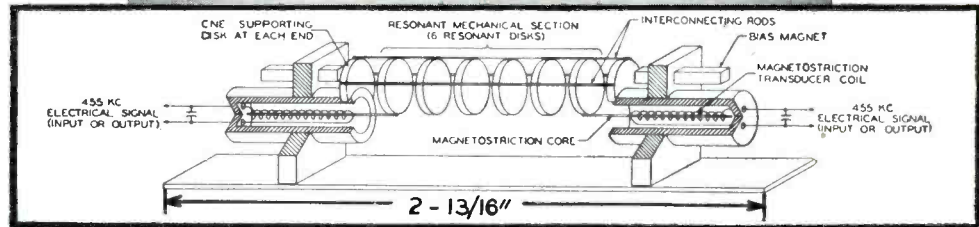

## SELECTIVITY CURVES FOR THREE TYPICAL MECHANICAL FILTERS

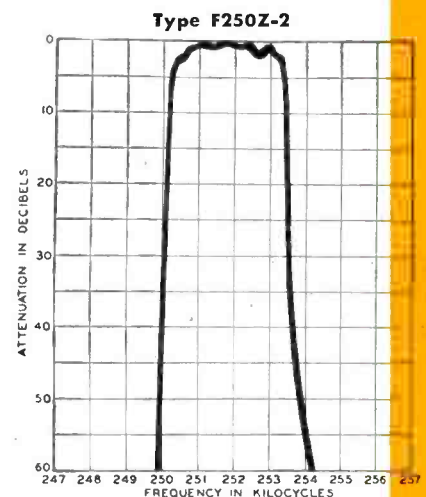
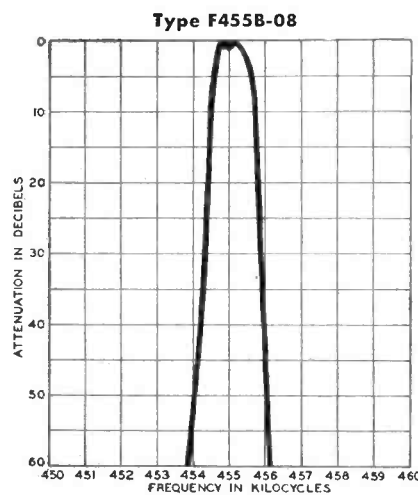
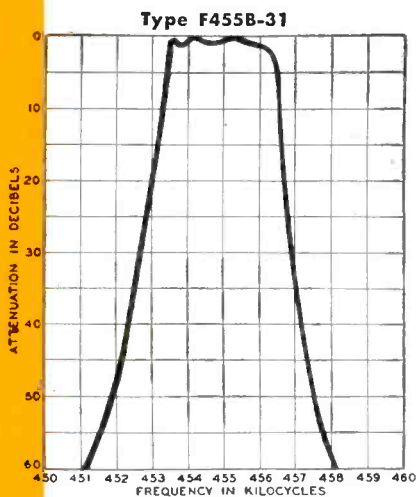

THE COLLINS Mechanical Filter was first revealed to the Radio Industry during the 1952 IRE Convention. Since that time the original Mechanical Filter Type F455B-31 has become available in production quantities. Other Collins Mechanical Filters, designed to operate at various bandwidths in the intermediate frequencies, are also available in engineering sample quantities. All of the Mechanical Filters listed here offer a close approach to the ideal rectangular selectivity curve. Consult the chart of available Mechanical Filters (right) for the solution to your selectivity problem.

A request on your letterhead will bring full technical specifications, price and delivery information.

Type No.	Center Frequency	Bandwidth	Terminal Arrangement
F250A-60	250 kc	6.0 kc	Solder
F250Z-1	248.7 kc	3.0 kc	Solder
F250Z-2	251.3 kc	3.0 kc	Solder
F455A-08	455 kc	800 cycle	Solder
F455A-31	455 kc	3.1 kc	Solder
F455A-60	455 kc	6.0 kc	Solder
F455B-08	455 kc	800 cycle	Plug-In
F455B-31	455 kc	3.1 kc	Plug-In
F455B-60	455 kc	6.0 kc	Plug-In
F500A-14	500 kc	1.4 kc	Solder
F500A-31	500 kc	3.1 kc	Solder
F500B-31	500 kc	3.1 kc	Plug-In
F500B-14	500 kc	1.4 kc	Plug-In

FOR ELECTRONIC DEVELOPMENTS, LOOK TO . .

**COLLINS RADIO COMPANY, Cedar Rapids, Iowa**



11 W. 42nd St., NEW YORK 36

1930 Hi-Line Drive, DALLAS 2

2700 W. Olive Ave., BURBANK

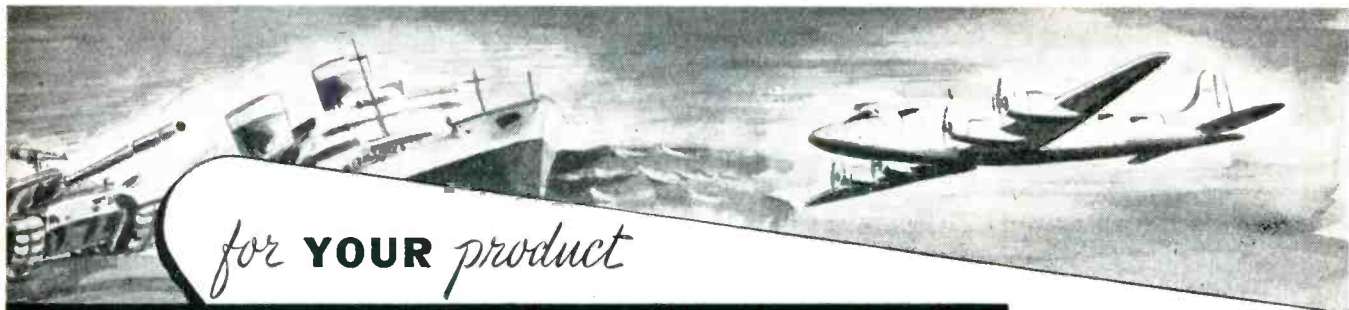

for **YOUR** product

# WHICH PILOT LIGHT DO YOU NEED?



## THE BIG ONE

This Pilot Light Assembly was first made to accommodate the *S-11 lamp* and was intended for use in the cabs of great diesel locomotives.

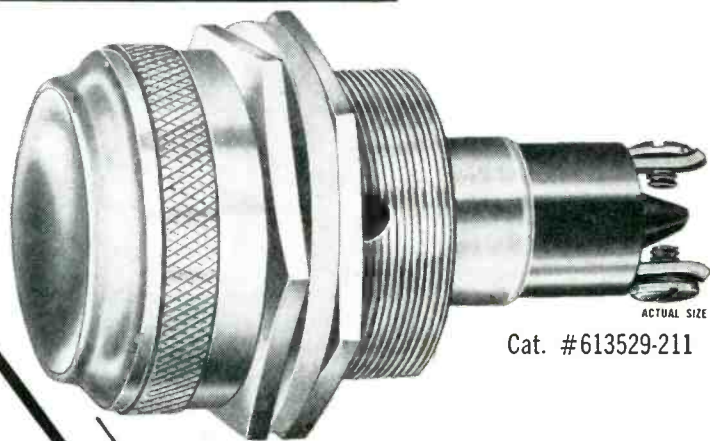

ACTUAL SIZE  
Cat. #613529-211

Dialco HAS THE COMPLETE LINE OF INDICATOR and PANEL LIGHTS

This **BIG** one

or

this **LITTLE** one

## THE LITTLE ONE

The miniaturization program on defense products required the development of this *sub-miniature* light. It is used on communication equipment and aircraft. Midget flanged base bulbs to fit are rated 1.3, 6, 12, and 28 volts.



ACTUAL SIZE  
Cat. #8-1930-621

*Samples*

to suit your own special conditions and requirements will be sent promptly and *without cost*. Just outline your needs. Let our engineering department assist in selecting the *right lamp* and the *best pilot light* for YOU.



Write for the Dialco HANDBOOK of PILOT LIGHTS

Foremost Manufacturer of Pilot Lights

# DIALIGHT CORPORATION

60 STEWART AVE., BROOKLYN 37, N. Y.

HYACINTH 7-7600

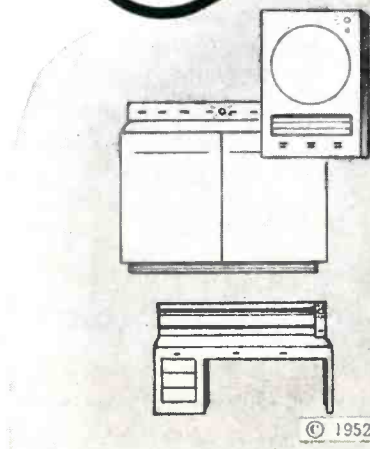

© 1952

# Leece- Neville

## PRODUCTS *wired for life*

with

# WARREN WIRE

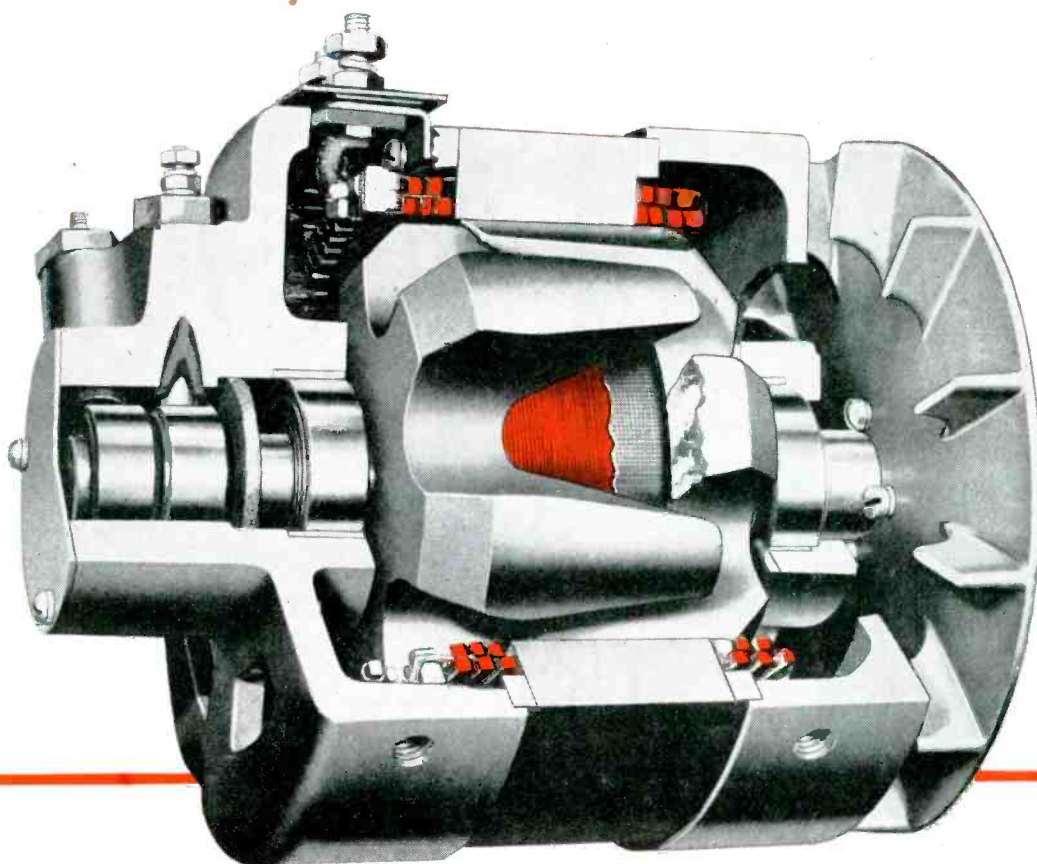

Leece-Neville A.C.-D.C. Alternator Systems have been known to run over half a million miles . . . and perform at top efficiency the entire period. Such unusually long performance . . . effecting great savings . . . can come only from the skillful application of advanced engineering, precise manufacturing and the use of the finest materials. Here, as in the manufacture of many other fine electric and electronic products, Warren Wire is used for its easy handling, efficiency and dependability. There's a Warren Wire Engineer near you trained to help you solve your wire problems right in your own plant. There is no obligation, of course.

Write for new Teflon Specification # 1001, dated February, 1953

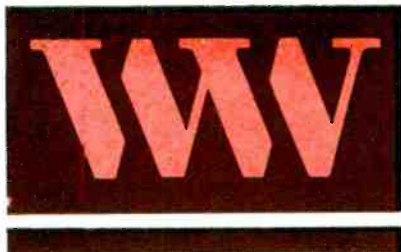

### WARREN WIRE COMPANY

Plant and Main Office: POWNAL, VERMONT

NEW YORK • SYRACUSE • NEW HAVEN • PHILADELPHIA • CLEVELAND  
DETROIT • CHICAGO • ST. LOUIS • ST. PAUL • LOS ANGELES • SAN FRANCISCO

Manufacturers of Plain Enamel, Nylon, Formvar, Teflon and Served Magnet Wires . . . Teflon Hook-up and Lead Wire . . . Tinned and Bare Copper Wire.

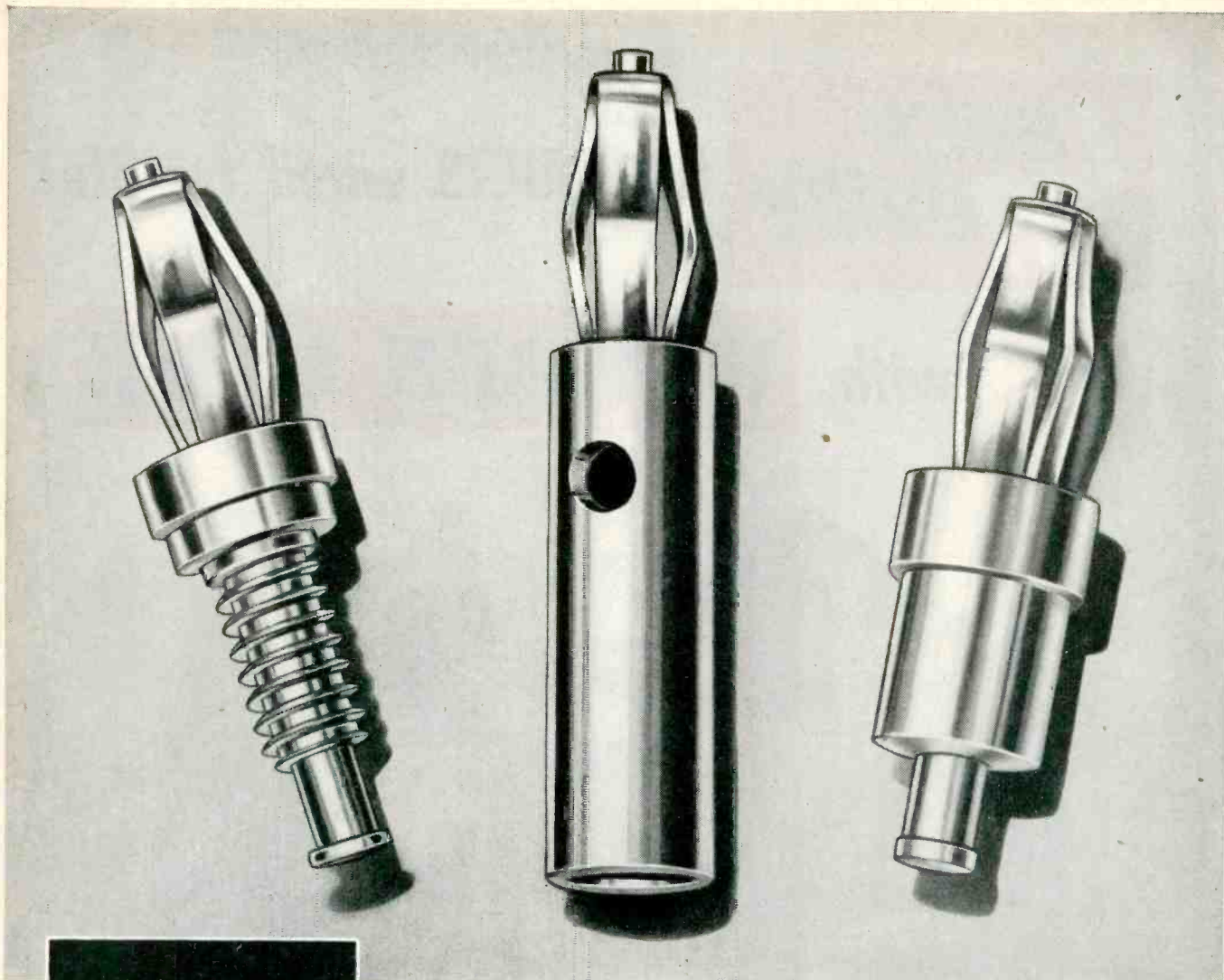

6 times enlargement

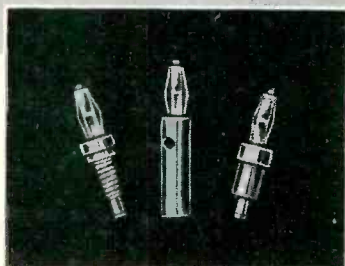

Actual size

# Ucinite Miniature Banana Pins

Ucinite miniature banana pins have springs both soldered and staked to the bodies for solid construction to withstand rough usage.

Springs are designed to fit .093 sockets. Pins are available in a variety of types for assembly by staking . . . with nuts and washers . . . with soldered tails . . . with multiple plug-in features. They are available in cadmium, silver or gold plate.

For flexibility and ruggedness use Ucinite Banana Pins!



**The**  
**UCINITE CO.**  
*Newtonville 60, Mass.*  
Division of United-Carr Fastener Corp.

*Specialists in*  
**ELECTRICAL ASSEMBLIES,**  
**RADIO AND AUTOMOTIVE**

# Special purpose fasteners by

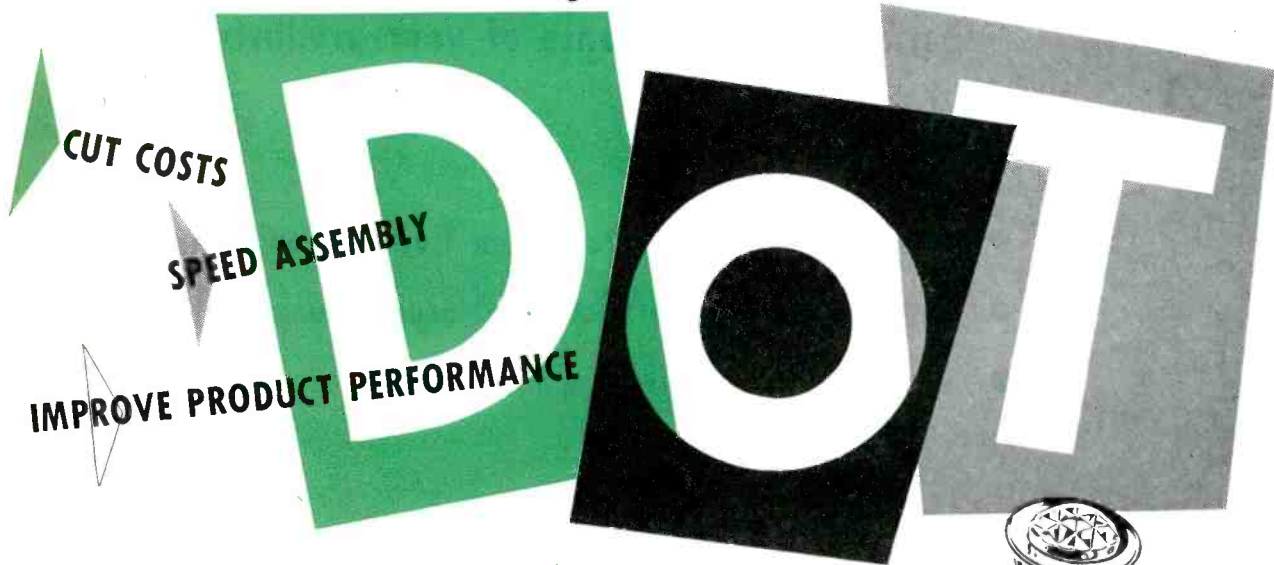

Give DOT the job of keeping your fastening methods up to scratch. A survey of your assembly operations may reveal costly fastener deficiencies that could be remedied simply by using special-purpose DOT fasteners specifically designed for their jobs.

With wide experience in the design and volume production of special fasteners for use in automobiles, aircraft, electronic apparatus, appliances, furniture . . . United-Carr's engineering staff is ideally equipped to serve you.

It is important, however, to call in United-Carr *before* your new designs are frozen for production. It is in the *planning* stage that you can make most effective use of our specialized services.

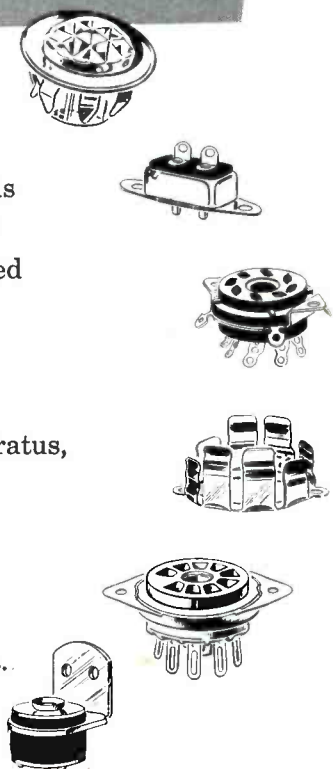

**UNITED - CARR FASTENER CORP.**

Cambridge 42, Massachusetts

MAKERS OF **DOT** FASTENERS

RIGOROUS QUALITY CONTROL PRODUCES

*Uniform*

# INDIANA PERMANENT

Helps you meet rigid engineering specifications and better the performance of your products

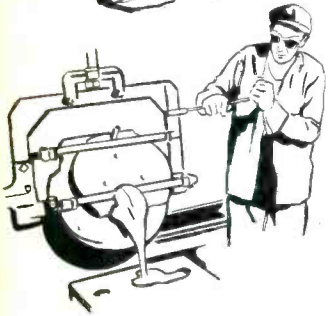

*plus*

- Maintaining steady production flow in your plant
- Reducing rejects on your final product assemblies
- Securing added sales appeal for your product

**ALL MATERIALS • ALL SIZES • ALL SHAPES**  
INDIANA—World's largest producer of permanent magnets—

CAST: Alnico, Indalloy, Cunico, Cobalt.

SINTERED: Alnico, Indalloy, Vectolite.

DUCTILE: Cunico, Cunife, Silmanal.

FORMED: Chrome, Cobalt, Tungsten.

**FOR ALL APPLICATIONS**

- Typical ones: Radar Magnetrons • Loudspeakers
- Phonographs • Meters • Instruments • Controls
- Motors • Generators • Magnets • TV Focus Coils
- Coin Selectors.

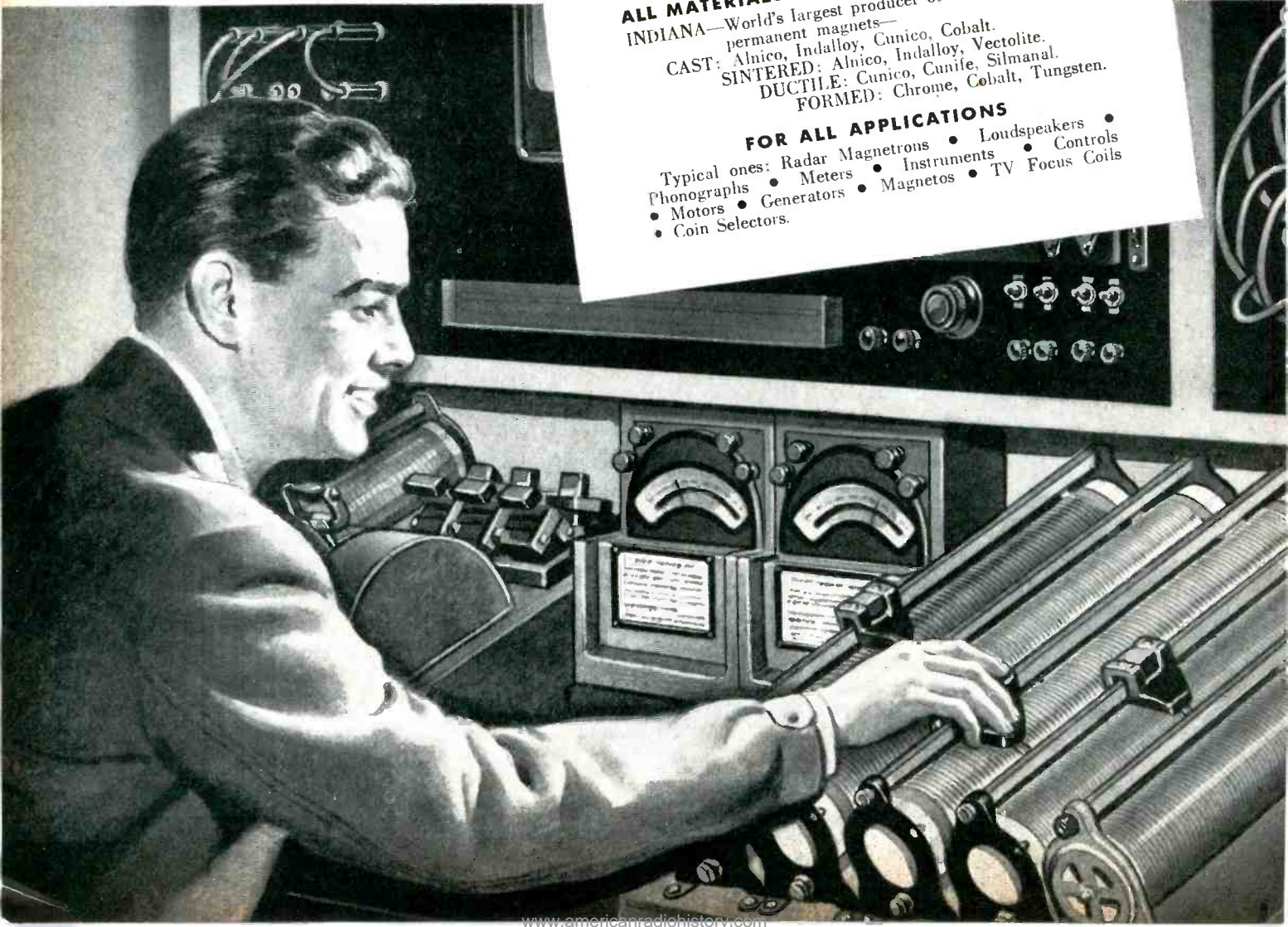

# High Quality MAGNETS



Chemical Analysis—Here alloys are checked for composition and magnetic qualities. ●

The desire to design and manufacture a quality product is a living, vital creed at INDIANA. Here physicists, metallurgists, mathematicians, trained technicians, and master craftsmen work as a team to produce quality permanent magnets that supply a constant, uniform magnetic field, indefinitely. At thirteen critical points (six are shown on this page), Indiana Permanent Magnets undergo rigorous examination and tests to be positive that they conform to the required design specifications. This continuous supervision during all stages of production assures you of magnets of sound structure having precise magnetic characteristics and exact physical dimensions. To meet your mass production demands, INDIANA gives you the advantages of the largest facilities in the world for the manufacture of permanent magnets and complete magnet subassemblies. Take advantage of INDIANA's wealth of experience, research leadership, and specialized engineering "know-how" for help in your design problems.

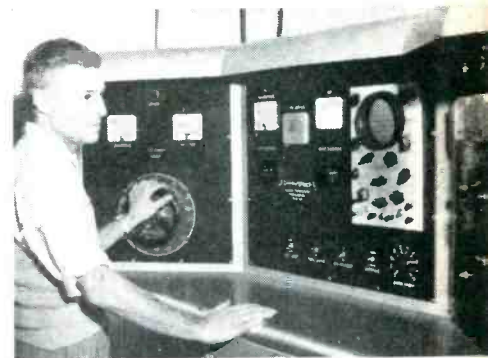

Control Panel for Spectrograph—The spectrograph is used for precise detection and measurement of various alloys in a test sample.

Write for this Permanent Magnet Design Handbook No. 4-A7

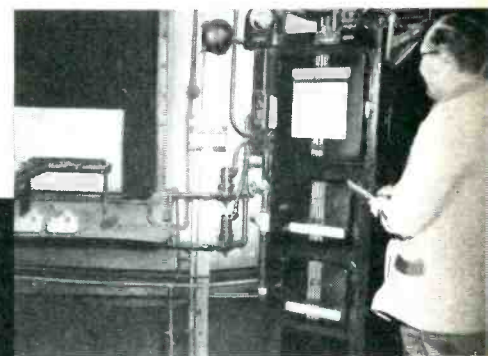

Electric and gas-fired furnaces—special heat treatment assures proper magnetic qualities.

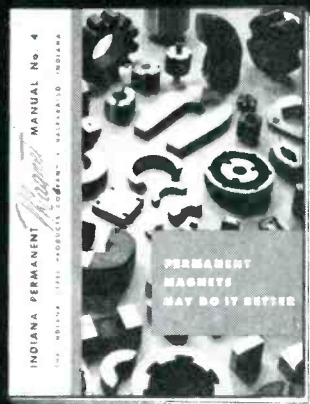
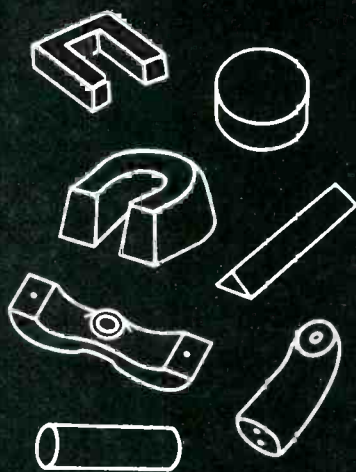
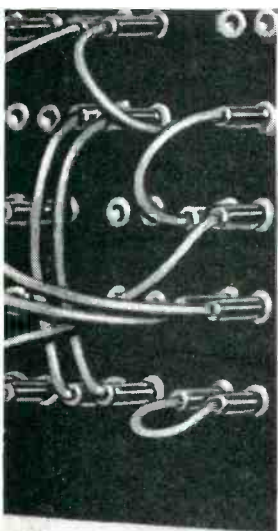

The Indiana Steel Products Co.  
VALPARAISO, INDIANA

**WORLD'S LARGEST**  
MANUFACTURER OF PERMANENT MAGNETS

SALES OFFICES FROM COAST TO COAST — BOSTON • CHICAGO  
CLEVELAND • NEW YORK • PHILADELPHIA • ROCHESTER • LOS ANGELES

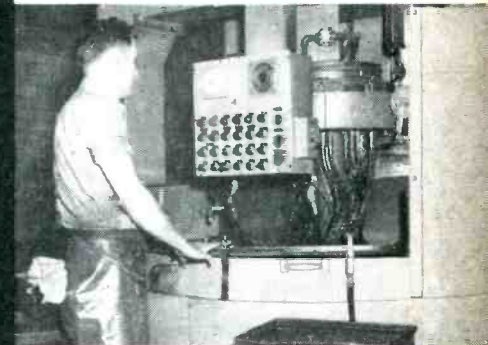

Grinding—high production grinders permit close dimensional tolerances.

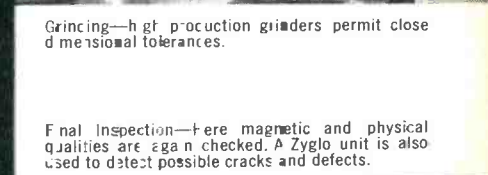

Final Inspection—Here magnetic and physical qualities are again checked. A Zyglo unit is also used to detect possible cracks and defects.



# NEW VITROHM Rheostat

with 6 exclusive features

provides smoother operation, finer control, longer life



**1** Pressed steel base plate assures a sturdy, light-weight rheostat base. The black japanned finish is corrosion resistant.

**2** Balanced contact arm reduces creep from vibration or shock. The arm is keyed directly to one end of the drive shaft.

**3** Solid brass rectangular contacts provide more steps of control for any given plate diameter.

**4** Reflexed collector ring supplies a self-cleaning surface. It is permanently held in position by Vitrohm enamel.

**5** Vitrohm enamel permanently seals and insulates the resistance element, stationary contacts and collector ring.

**6** Contact shoe and bearing are self-lubricated to provide exceptionally smooth control and low operating torque.

This new line of Vitrohm Pressed Steel Rheostats incorporates 21 advanced design features, including the 6 shown here. They are designed for a wide variety of industrial applications to give smoother operation, lower operating torque, longer life, and more control steps. From raw

materials to finished product, close control over workmanship and continual inspection of every component is maintained. These are the most dependable and economical rheostats ever made by Ward Leonard — the leader in rheostat manufacture for over fifty years.



**WARD LEONARD  
ELECTRIC COMPANY**

MOUNT VERNON, NEW YORK

*Result-Engineered Controls Since 1892*



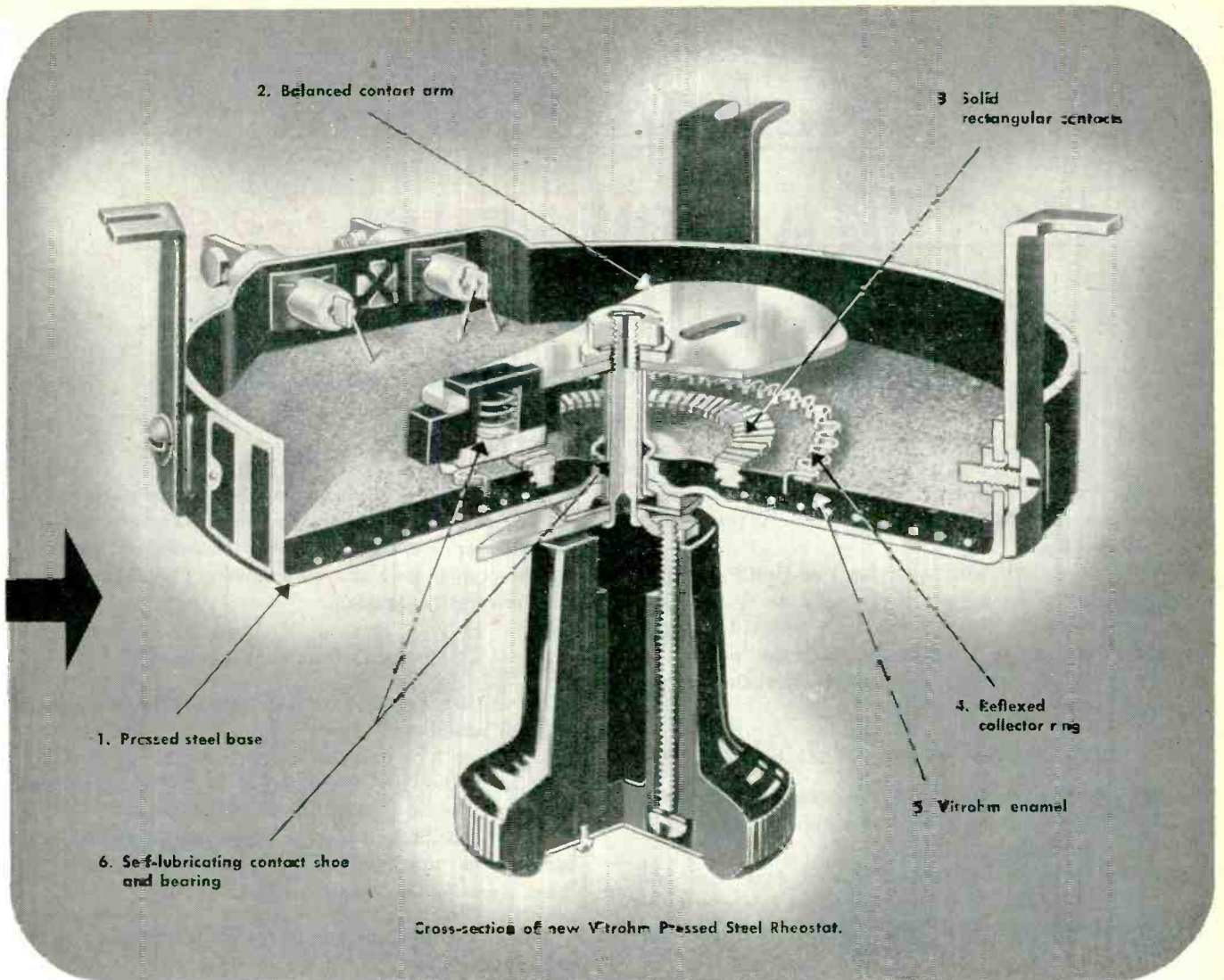

Cross-section of new Vtrohm Pressed Steel Rheostat.

## RHEOSTATS FOR EVERY APPLICATION

Ward Leonard manufactures the most complete line of power rheostats ever offered for industrial control applications. It includes standard and special designs for all current ratings up to 400 amperes. A complete description of the entire line with mountings, manual and motor drive accessories, a variety of enclosures, and optional features will be found in the *new* Ward Leonard Bulletin 60a. It will pay you to send today for your free copy. Write to Ward Leonard Electric Co., 31 South Street, Mount Vernon, N. Y.



3-17



RESISTORS

RELAYS

MOTOR CONTROLS

CHROMASTER

DIMMERS

# Avien Introduces its "Two-Unit" Fuel Gage

This "repackaging" of Avien's capacitance-type fuel gage is 50% lighter and needs no field adjusting

Ever since Avien developed its capacitance-type fuel gage, our engineers have stuck to the task of reducing the system to its simplest form.

Now they've done it, with the Avien Two-Unit Fuel Gage.

Basically, it is the same sharply accurate system that Avien has designed and which has been installed on thousands of modern planes. The big news is in the "package"—for the necessary components have been reduced to a sensing unit and an indicating unit.

## Avien has buried the "black box"

Up until now, most fuel gaging systems needed four units; a tank unit, an indicator, a bridge-amplifier, and a shock-mount to guard it against vibration.

No field calibration was required for the Avien tank unit or indicator. Avien held them to such close tolerances, the adjustments for individual installations were actually "built in."

The bridge-amplifier (the "black box") was a different story. This intermediate unit was supplied as a common part, for universal application. And that's where field calibration *had* to be made.

The rigid specs for the bridge-amplifier component have previously held back improvements in the system as to weight, size, cost, performance and flexibility. There was only one answer, as far as Avien was concerned. The "black box" had to go.

In the Avien Two-Unit system, the necessary components for the bridge and amplifier functions have been built into the indicator case. The "black box" is eliminated, and so are certain components which were necessary to make the "black box" universally applicable.

## No more field adjustments

The Two-Unit Fuel Gage gets installation down to "plug-in, plug-out" simplicity.

The Avien tank unit and indicator are pre-calibrated for the aircraft they are designed for. Since the intermediate unit is not needed, neither is field calibration.

Since no calibration is required, all units designed for the same aircraft are interchangeable. Avien units are now all "shelf items."

The Two-Unit Gage eliminates three drawbacks of field calibration:

1. *No trained personnel needed.* To err is human, but human fallibility is built out of the Two-Unit Gage.
2. *No specialized test equipment needed.* No precision condensers, bridges or calibration boxes required.
3. *No calibration instruction or data needed.* Have you ever run this "paper chase"? By the time you've tracked the information down, it's often obsolete. No more of that!

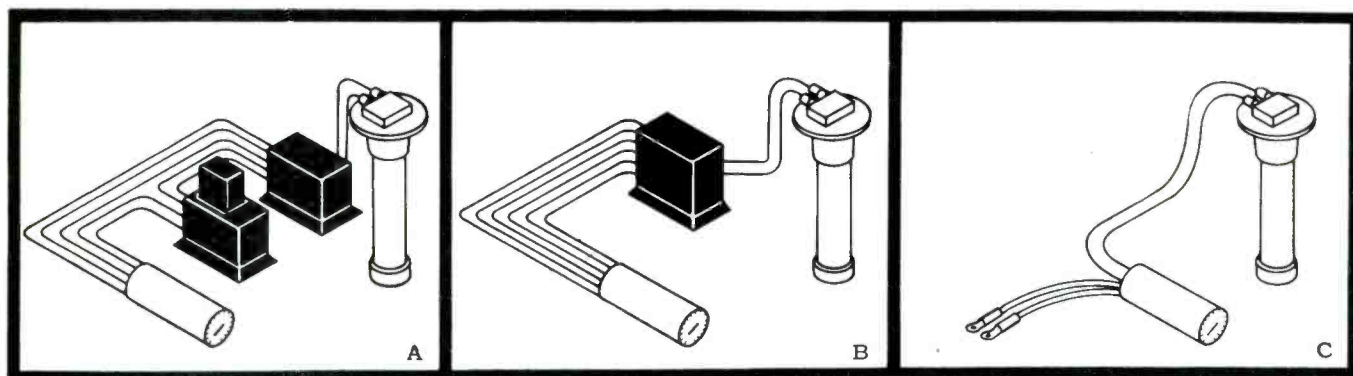

**Fuel gaging progress:** Early gaging system (A) had four units. The 1952 system (B) incorporated bridge and amplifier into a single unit, reduced weight almost 15%. Avien's Two-Unit Fuel Gage, now being introduced (C) repackages the system with further miniaturization of components, this time reducing weight by 50%.

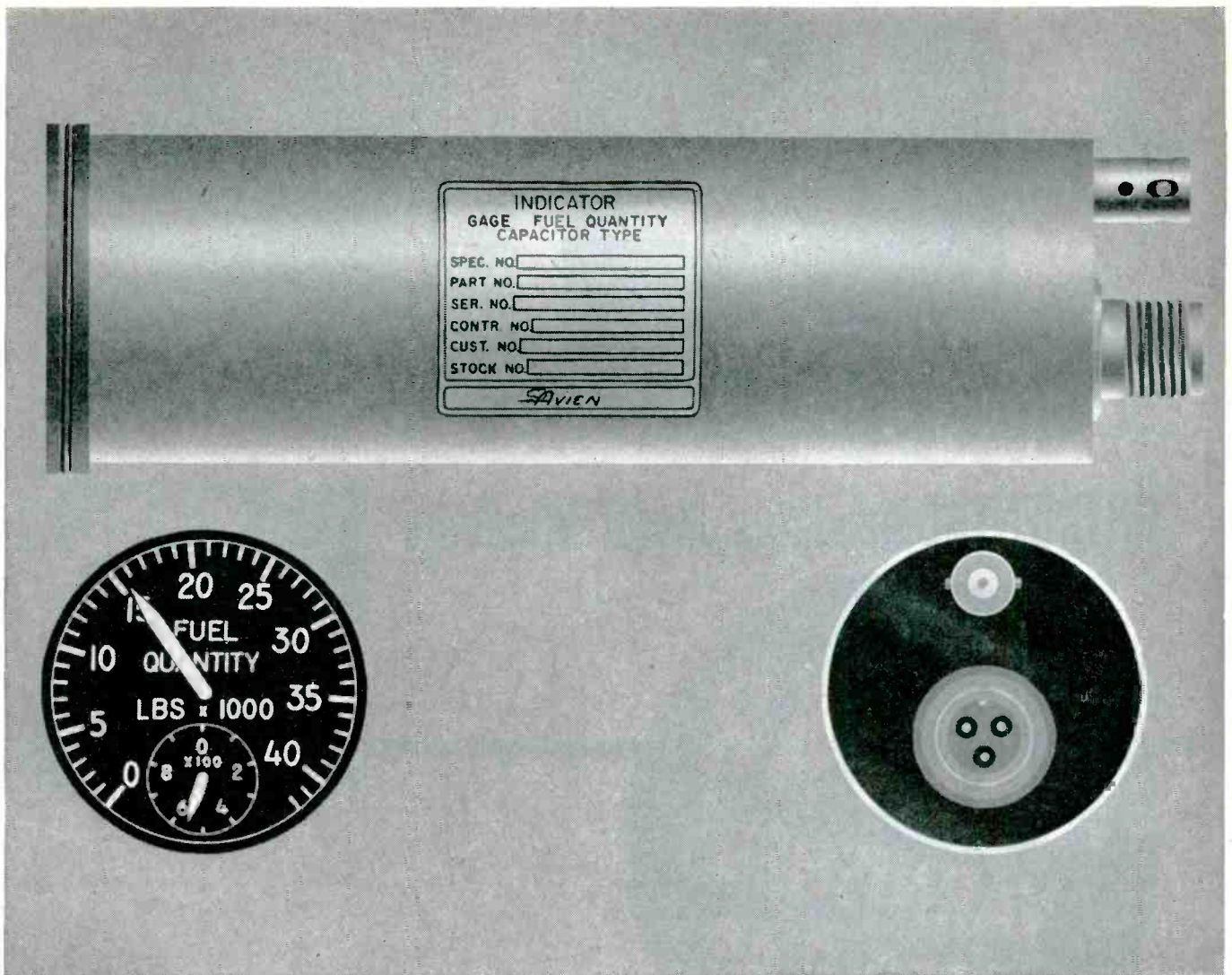

Full scale drawing of Avien's Two-Unit Fuel Gage: Front, side and back views of the small-size indicator-amplifier unit. "Plug-in, plug-out" simplicity is the keynote.

### Savings all along the line

Simplification means less weight. In the Two-Unit Fuel Gage, the basic system is reduced in weight by 50%.

There are cost savings, too. Less time is spent in installing the Two-Unit Gage. Less wiring and connectors are needed. Less maintenance is required, because there are fewer components to maintain. Trouble-shooting becomes easier, because there are fewer units to cause trouble. And fewer parts must be stocked for replacement and repairs.

### Fuel gaging AND fuel management

Avien's Two-Unit system retains an important feature of the former gage. Additional functions for fuel management can be integrated into the basic gage.

This means that simulators, level switches, balancing controls, totalizing equipment, etc., can be hooked up to the basic system — and with even less difficulty.

Another interesting aspect is that the Two-Unit Gage is designed to take advantage of recent improvements in mechanical and electronic design — the new lightweight coaxial cable, the new miniature A N connectors, and Avien's new lightweight tank units.

### Now scheduled for production

The Avien Two-Unit Fuel Gage is now available to meet your manufacturing schedules.

The indicator is available in either large or small sizes, with all varieties of dial configurations.

Every month, Avien produces over ten thousand major instrument components for the aviation industry.

We believe that Avien's Two-Unit Gage will contribute to the obsolescence of many earlier systems, including our own.

For further information write or call us.



**AVIATION ENGINEERING DIVISION**

AVIEN-KNICKERBOCKER, INC.

58-15 NORTHERN BLVD., WOODSIDE, L. I., N. Y.

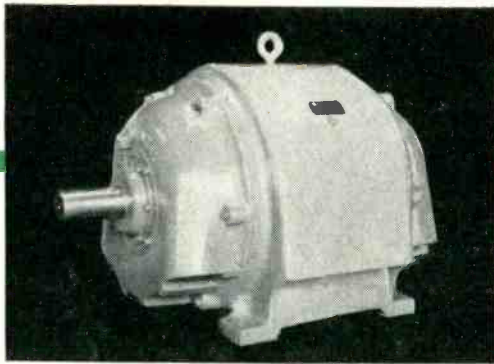

Drip-proof motor of the type used in severe service applications, where motors are exposed to the weather or are subjected to frequent overloads.

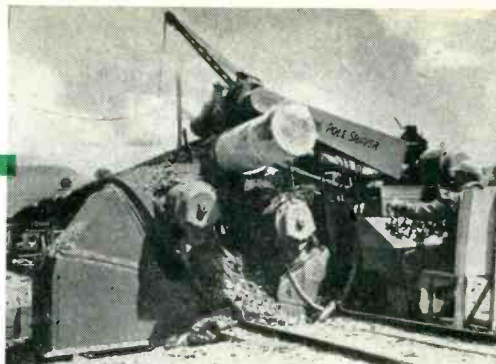

A good example of outdoor service is this pole shaver, driven by 5 Continental 440 V. drip-proof type poly-phase motors: 2-15 hp., 1800 rpm.; 2-3/1/2 hp., 1200/600 rpm.; and 1-5 hp., 1800 rpm.

## CONTINENTAL Insulates Motor Windings

*with*

**NATVAR  
VARNISHED  
FIBERGLAS**

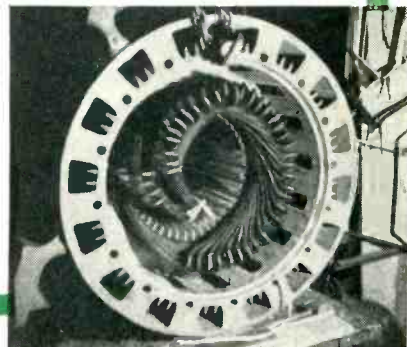

Stator of Continental 6600 V explosion-proof type, showing windings in place. They are insulated with Natvar Varnished Fiberglas to give extra protection against moisture, dirt, and heat.

Continental Electric Co., Newark, N. J., manufactures polyphase motors from 1 — 700 hp. and in several types including drip-proof, splash-proof, and explosion-proof. They also make generators, dynamotors, converters and motor-generator sets.

Thousands of Continentals are giving uninterrupted service in refineries and other field uses with little or no protection from the weather. To insure this performance, insulating materials are carefully chosen for their ability to stand up under severe operating conditions. Natvar Varnished Fiberglas is used because of its superior resistance to both moisture and heat.

If you need flexible insulating materials with good physical and electrical properties, and exceptional uniformity, it will pay you to get in touch with your Natvar distributor, or with us direct.



### Natvar Products

- Varnished cambric—straight cut and bias
- Varnished cable tape
- Varnished canvas
- Varnished duck
- Varnished silk
- Varnished special rayon
- Varnished Fiberglas cloth
- Varnished papers
- Slot insulation
- Aboglas®, asbestos-Fiberglas composite
- Varnished tubing and sleeving
- Varnished identification markers
- Lacquered tubing and sleeving
- Extruded plastic tubing and tape
- Styroflex® flexible polystyrene tape
- Extruded plastic identification markers

Ask for Catalog No. 22

# NATVAR CORPORATION

FORMERLY THE NATIONAL VARNISHED PRODUCTS CORPORATION

TELEPHONE

RAHWAY 7-8800

CABLE ADDRESS

NATVAR: RAHWAY, N. J.

201 RANDOLPH AVENUE • WOODBRIDGE, NEW JERSEY

# MAKE THE RIGHT CONNECTIONS

WITH

# SUPERIOR 5-WAY BINDING POSTS

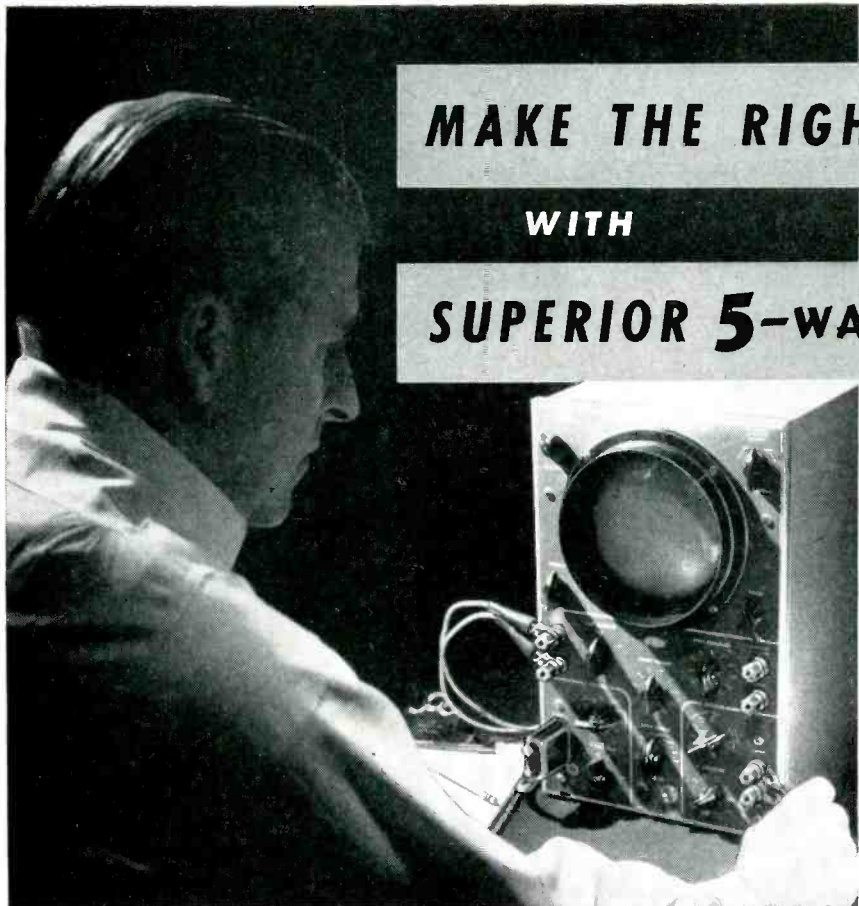

AVAILABLE IN  
BLACK AND RED

ACTUAL  
SIZE

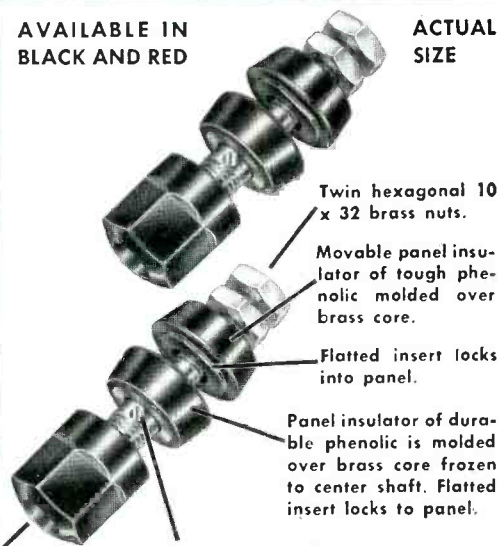

Twin hexagonal 10 x 32 brass nuts.

Movable panel insulator of tough phenolic molded over brass core.

Flatted insert locks into panel.

Panel insulator of durable phenolic is molded over brass core frozen to center shaft. Flatted insert locks to panel.

Phenolic hex-shaped thumb nut with insert is captive with stud.

Hole in center shaft at right angles to insulator flatted surface for permanent clamping accommodates wire up to size No. 12.

## 5 CONNECTIONS

- 1 Plug-in for standard  $\frac{3}{4}$ " banana plug
- 2 Clip-lead to shaft
- 3 Wire looped around shaft and clamped
- 4 Wire (up to No. 12) permanently clamped through center hole
- 5 Clamped spade lug

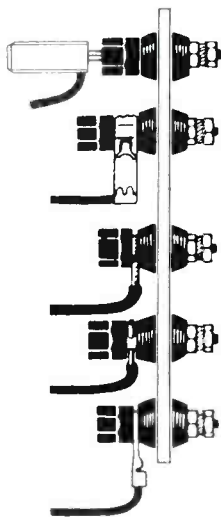

WRITE ON YOUR COMPANY LETTERHEAD FOR A FREE SAMPLE

## FIRST CHOICE FOR ELECTRIC AND ELECTRONIC EQUIPMENT

SUPERIOR 5-WAY Binding Posts provide added flexibility and greater dependability to electric and electronic equipment. Better electrically . . . more rugged mechanically . . . made of only the finest materials . . . 5-WAY Binding Posts afford safe, positive connections. Mounting in any panel from  $\frac{1}{16}$ " to  $\frac{1}{4}$ " is easily accomplished by a single keyed or unkeyed hole. Complete insulation from the panel is provided. Current capacity is 30 amperes with a working voltage of 1,000 volts. Two colors, RED and BLACK, are available for easy circuit or polarity identification.

USE THIS COUPON TO SEND FOR FREE DESCRIPTIVE LITERATURE

**THE SUPERIOR ELECTRIC COMPANY**  
207 Mae Avenue, Bristol, Connecticut  
Please send a copy of the Superior Electric  
5-WAY Binding Post Bulletin BP652.



NAME \_\_\_\_\_

POSITION \_\_\_\_\_

COMPANY \_\_\_\_\_

CO. ADDRESS \_\_\_\_\_

CITY \_\_\_\_\_ ZONE \_\_\_\_\_ STATE \_\_\_\_\_

**THE SUPERIOR ELECTRIC CO.**  
BRISTOL, CONNECTICUT



- POWERSTAT VARIABLE TRANSFORMERS
- STABILINE AUTOMATIC VOLTAGE REGULATORS
- VOLTBOX A-C POWER SUPPLIES
- POWERSTAT LIGHT DIMMING EQUIPMENT
- VARICELL D-C POWER SUPPLIES



***New!***

***An economical  
woven glass\* tape  
for Class A coils!***

**Better performance**

**No premium cost**

**\*Made with Fiberglas yarns**

**AT A COST NO HIGHER THAN THAT OF COTTON, THIS IMPORTANT NEW GLASS TAPE BRINGS YOU ALL THE PLUS FEATURES OF GLASS ITSELF!**

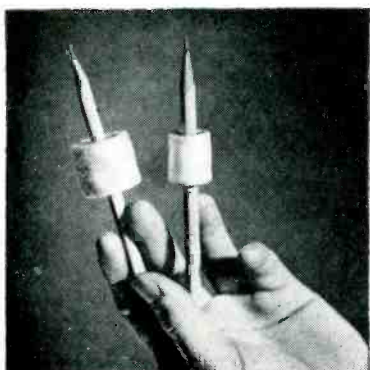

**it's thinner . . .**

only 4 mils thick, yet designed to replace 7-mil cotton tapes.

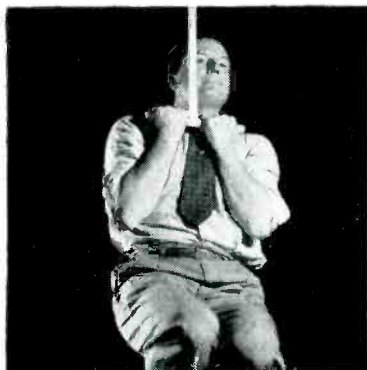

**it's stronger . . .**

with tensile strength of 125 lbs. per inch width, easily twice that of cotton.

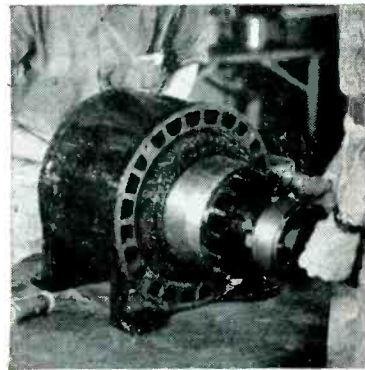

**it's longer-lasting . . .**

because glass won't rot and resists moisture, oils and most acids.

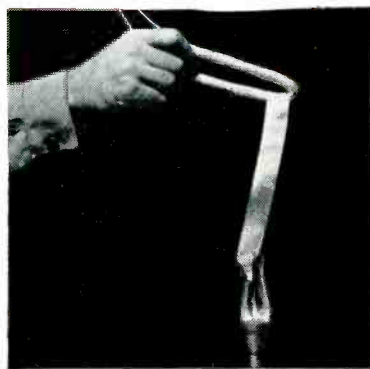

**it's overload insurance . . .**

because glass won't burn, withstands higher temperatures.

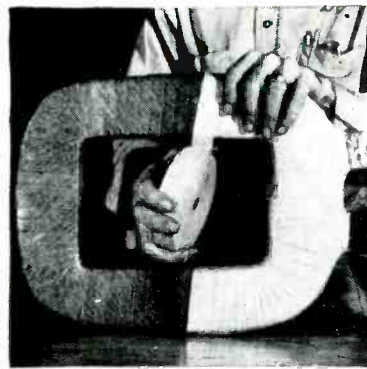

**it's easy to use . . .**

specially treated for quick, easy hand or machine use.

If you haven't already checked into the possibilities of this tape, be sure to call your supplier today — or write direct to Owens-Corning Fiberglas Corp., Dept. 860, 16 East 56th Street, New York 22, N. Y.

\*Fiberglas is the trade mark (Reg. U. S. Pat. Off.) of Owens-Corning Fiberglas Corporation for a variety of products made of or with fibers of glass.



**"if it's Fiberglas, it's Owens-Corning!"**

# MEPCO'S NEW SEALED Precision Resistors STOP Humidity Failures



Over 2 years of laboratory development and testing were required to achieve a sealed resistor design up to Mepeco's standard of quality. No sacrifice of our standard time-proven features have been made in order to perfect this sealed resistor.

**SPECIFICATIONS:** Meets all requirements of MIL-R-93A and JAN-R-93.

**SEALING:** Completely encapsulated and bonded.

**OPERATING TEMPERATURE:**  $-65^{\circ}\text{C.}$  to  $+125^{\circ}\text{C.}$

**WINDINGS:** Reversed and balanced PI-windings for low inductance with use of only the finest "certified" resistance alloys.

**EXCLUSIVE INTERNAL FEATURES:** Internal section's cross-over wire insulated from winding by 2000 v. insulation (patented). Special metal molded connecting feature, which bonds end of winding and terminal in a non-corrosive and mechanically secure manner — no solder or flux used.

**TERMINALS:** Rigid hot solder coated brass terminals for easier and more secure soldering.

TYPE	NOMINAL WATTAGE RATING	RESISTANCE		NO. SECTIONS	SUPERSEDES JAN-R-93 TYPE
		MIN.	MAX.		
RB15 (M15)	.25 .50	0.1 ohm	.185 meg.	2	RB10
		0.1 ohm	.6 meg.		
RB16 (M16)	.35 1.00	0.1 ohm	.3 meg.	2	RB11
		0.1 ohm	1.5 meg.		
RB17 (M17)	.50 1.00	0.1 ohm	.3 meg.	4	RB12
		0.1 ohm	2.0 meg.		
RB18 (M18)	.50 1.00	0.1 ohm	.75 meg.	4	RB13
		0.1 ohm	4.0 meg.		
RB19 (M19)	1.00 2.00	0.1 ohm	4.0 meg.	8	RB14
		0.1 ohm	15.0 meg.		
RB52 (M52)	.25 .50	0.1 ohm	.1 meg.	2	RB51
		0.1 ohm	.5 meg.		

MIL - R - 93A

### WATTAGE & RESISTANCE TOLERANCE

TOLERANCE SYMBOL	RESISTANCE TOLERANCE	PERCENT OF NOMINAL WATTAGE
B	0.10 %	50 %
C	0.25 %	50 %
D	0.50 %	75 %
F	1.00 %	100 %

MIL - R - 93A

### TEMPERATURE COEFFICIENT

(REFERRED TO  $25^{\circ}\text{C.}$ )

SYMBOL	EXPRESSED IN PERCENT PER DEGREE C.	
	NEGATIVE, MAX.	POSITIVE, MAX.
E	0.0022	0.0022
J	0.0040	0.0155
K	0.0050	0.0255

### SPECIAL REQUIREMENTS

Variations of the above ratings, tolerances, temperature coefficient, etc. can be supplied to special order.

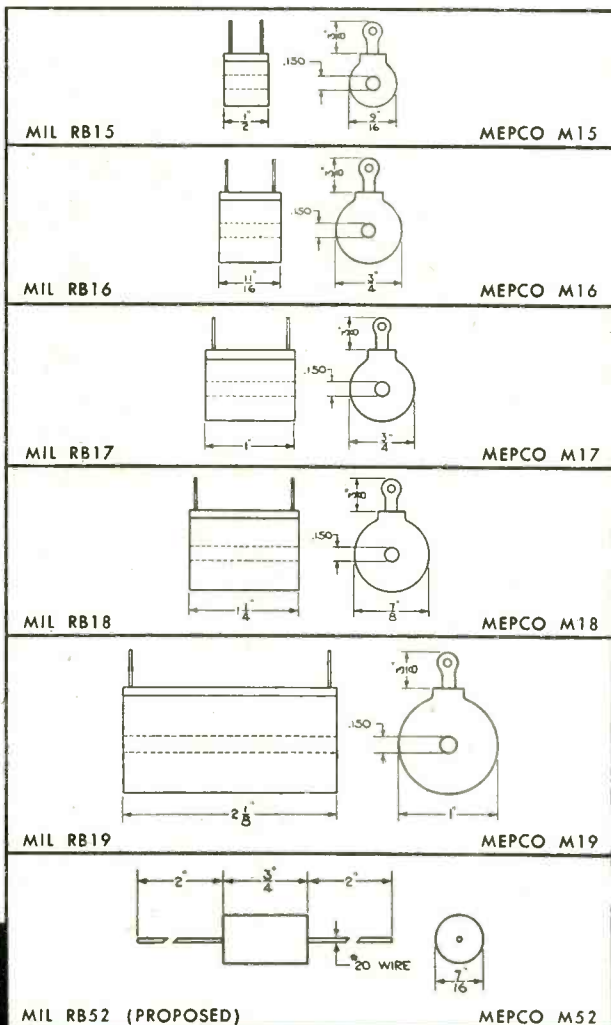

# MEPCO, INC.

MORRISTOWN, NEW JERSEY



Put your finger on

**EXTRA DEPENDABILITY**

by specifying...

CHESTER means dependability *plus* in wires and cables for every electronic and electrical application. The compounds used in all CHESTER Wire and Cable constructions are made in the CHESTER plant. Thus, complete control over selection of raw materials and manufacturing techniques, provides full control of quality ... your assurance of uniformity in every foot of conductor bearing the CHESTER label!

**CHESTER**  
*plasticord-plasticote*  
**WIRES & CABLES**

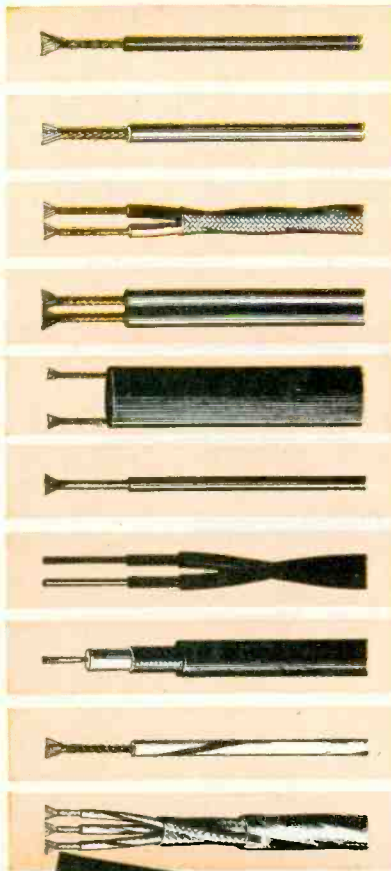

JAN-C-76 WIRES\* SR1R, SRHV, SRRF, WL

105°C, 90°C, 80°C, UL APPROVED, 120°C\*

SHIELDED WIRES & CABLES

FLEXIBLE CORD

TV LEAD-IN WIRES

INSTRUMENT WIRES

COMMUNICATION WIRES & CABLES TO SPECIFICATION

COAXIAL CABLE

LACQUERED AND NYLON COVERED WIRES

SPECIAL WIRES & CABLES TO SPECIFICATIONS

\*Solid colors or spiral marking

**CUSTOM CONSTRUCTIONS**  
to specification using Polyethylene, Polyvinyl chloride, Nylon, Braided and Lacquered Wires, Special Insulating Materials, Glass, Yarn, etc. Inquiries invited.

ASK "Chesty" FOR the New Chester Literature. Complete data on wires and cables for electrical and electronic wiring. Request yours, today!



REGISTERED U.S. PAT. OFF.

**CHESTER CABLE CORP.**

C H E S T E R • N E W Y O R K

# From freehand to stencil ... this better way of lettering

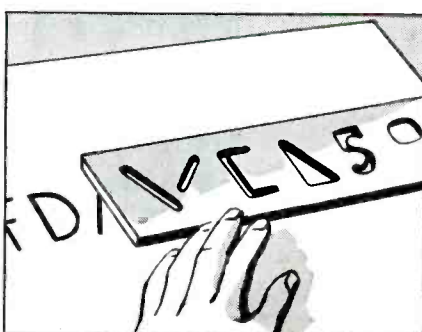

If the results of freehand lettering were always something to be proud of, there would be little or no need of special lettering aids. But as draftsmen know, freehand lettering is often irregular in appearance, and seldom can two men in a department letter exactly alike. Even as simple a device as a height guide helps considerably. Yet it fails in the important function of controlling the shape and regularity of the letters.

An obvious way of controlling shape as well as size is to use a stencil guide. To avoid the broken lines characteristic of stencils, guides were first devised consisting of cut-out portions of letters which could be combined to compose complete letters. However, they covered the work in progress, obscuring it from view, and the appearance of the finished lettering still depended largely on the skill of the operator.

To afford greater control, a stencil guide was developed on which all but a few letters were complete in outline. Shifting the guides with a shuttling motion permitted the breaks in the lines to be filled in. Like all stencils, these too covered up the lettering, and they also had to be supported slightly above the drawing surface so they could be shifted without smearing the work.

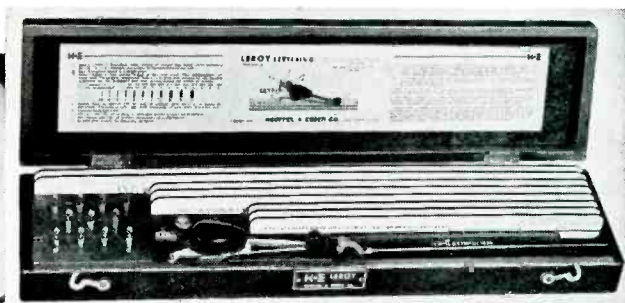
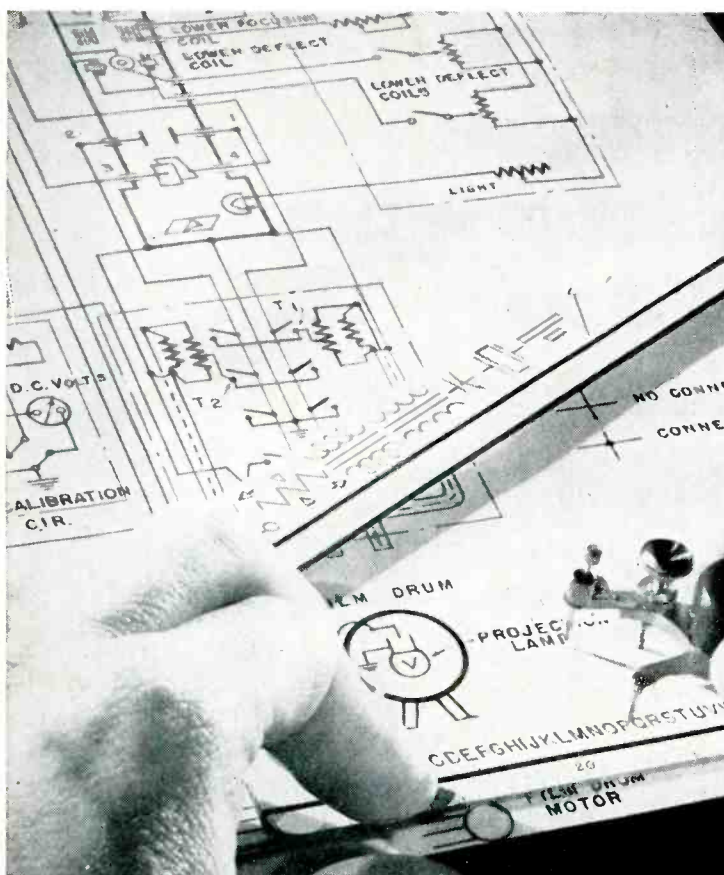

to LEROY<sup>®</sup>  
was bound to come!

The  
Right Angle

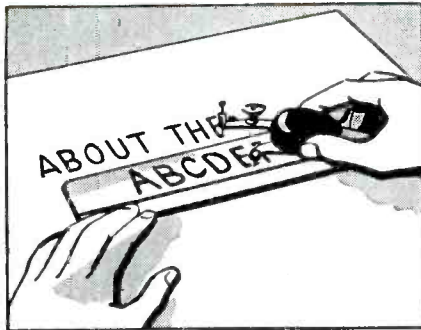
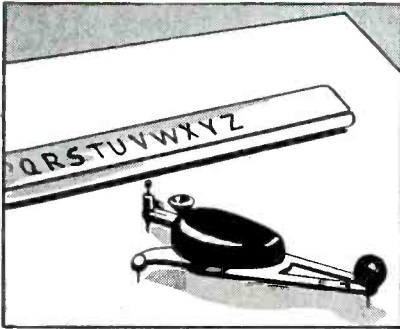

Instead of stencils, the LEROY Lettering Set has templates with grooved characters which guide the pen virtually by "remote control". In place of a hand-held pen, there is a movable scriber. It combines a lettering pen, a pin that fits in and follows the grooved characters, and a sliding pivot, and it holds them in triangular relationship. Because a straight groove in the template restricts the motion of the pivot, the movement of the pen is governed entirely by the movement of the tracer pin.

With the LEROY scriber, the lettering is done above the template where it is always visible and safe from smearing, instead of through a stencil. Each letter, numeral or symbol is formed completely with unbroken lines, without moving the template. Its size and shape are entirely controlled by the template grooves, so that rapid, uniform lettering is easy. By a simple adjustment of the scriber, either vertical or slant lettering is possible from the same template.

With a LEROY Lettering Set, you can draw capitals, lower case letters and numerals from a single template. You can form perfect letters on the first trial, and can develop speed with a few minutes' practice. No guide lines, no "roughing in", no erasing. You can be sure of uniformity throughout the drafting room, in pencil or ink.

There are LEROY templates and pens for every size and thickness of lettering normally required, as well as templates with engineering and scientific symbols and with special alphabets. K&E can also produce special templates for phrases, symbols or trade marks of your own design.

Ask your K&E Distributor or Branch to tell you about other LEROY features, or write to us for complete booklet on LEROY.

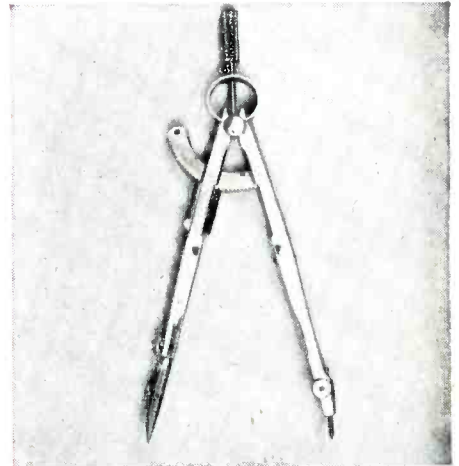

You will find "Quick Set" the handiest large bow combination you've ever used. It has a trigger-quick action for coarse settings plus micrometer adjustment for precise settings. Complete with interchangeable pen and pencil inserts for circles up to 12½" diameter in pencil and 12" diameter in ink.

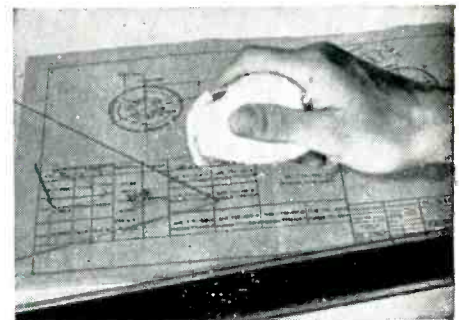

Cut down on the clean-up with an ABC\* Dry Clean Pad. Tiny gum eraser particles sift through the mesh of the pad. Sprinkle them in a light film over the drawing surface before starting work and you'll have no graphite smears. Use it the same way for final clean up. Contains no grit or abrasive.

\*Trade Mark

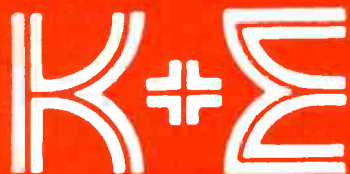

PARTNERS IN CREATING

KEUFFEL & ESSER CO.

EST. 1867

Drafting, Reproduction, Surveying Equipment  
and Materials, Slide Rules, Measuring Tapes

NEW YORK • HOBOKEN, N. J.  
CHICAGO • ST. LOUIS • DETROIT  
SAN FRANCISCO • LOS ANGELES • MONTREAL

# TUNG-SOL



- 1 Exceptionally high permeance and tremendous reserve emission.
- 2 Out-performs all other tubes of its class.
- 3 Performance potential equivalent to two-and-a-half times that of a 6SN7GT tube.
- 4 On the Army-Navy Preferred List.

This high-performance general-purpose tube may be used as a power amplifier, as a cw, or pulsed oscillator, and as a cathode follower. It is equally useful in balanced circuits, as a modulator or a servo amplifier and in the countless other applications for which twin triodes are so suitable. It is painstakingly produced under laboratory conditions. Each part is individually inspected and tested and every step of assembly is rigidly held to highest standard. The result is exceptional uniformity and reliability.

## RATINGS

Interpreted according to RMA standard M8-210

Heater Voltage ( $\pm 10\%$ )	12.6	6.3	VOLTS
Maximum Heater-Cathode Voltage	90		VOLTS
Maximum Plate Voltage	300		VOLTS
Maximum Inverse Plate Voltage	1000		VOLTS
Maximum Plate Dissipation (each unit)	4.2		WATTS
Maximum Total Plate Dissipation (both units)	7.5		WATTS
Maximum Bulb Temperature (at any part of envelope)	220°		C
Maximum DC Grid Current (each unit)	6		MA.
Maximum External Grid Circuit Resistance (each unit)	1		MEG

## CHARACTERISTICS

Class A<sub>1</sub> Amplifier—Each Unit

Heater Voltage	12.6	6.3	VOLTS
Heater Current	450	900	MA.
Plate Voltage	120	180	250 VOLTS
Grid Voltage	-2	-7	-12.5 VOLTS
Plate Current	36	23	16 MA.
Plate Resistance	1650	2750	4000 OHMS
Transconductance	11000	6400	4100 $\mu$ MHOS
Amplification Factor	18	17.5	16.5
Grid Voltage (approx.) For $I_b=100 \mu$ A	-10	-15	-21 VOLTS

For more complete information about the 5687, write for these bulletins.

# TUNG-SOL ELECTRON TUBES

The Tung-Sol engineering which has produced the 5687 is constantly at work on a multitude of special electron tube developments for industry. Many exceptionally efficient general and special purpose tubes have resulted. Information about these and other types are available on request to Tung-Sol Commercial Engineering Department.



## TUNG-SOL ELECTRIC INC., NEWARK 4, NEW JERSEY

SALES OFFICES: ATLANTA, CHICAGO, CULVER CITY (Los Angeles), DALLAS, DENVER, DETROIT, NEWARK, SEATTLE

TUNG-SOL makes All-Glass Sealed Beam Lamps, Miniature Lamps, Signal Flashers, Picture Tubes, Radio, TV and Special Purpose Electron Tubes and Semiconductor Products.

JULY, 1953

**YOU'LL FIND THE  
RIGHT FUSE, FASTER  
in the Complete Line  
of Electronically  
Tested**

# BUSS FUSES

**for Television • Radio •  
Radar • Instruments • Controls •  
Avionics . . . .**

You'll save time and trouble when all your fuse needs are supplied by one, dependable source. The complete BUSS line makes it easy for you to select the fuse to do the job right.

The makers of BUSS fuses insist on perfection. Every fuse is electronically tested in a sensitive device that rejects any fuse not properly calibrated, properly constructed and right in all physical dimensions.

Take advantage of the profit-saving efficiency that you can gain by standardizing on the complete line of BUSS fuses.

*Plus*  
A COMPLETE LINE OF FUSE CLIPS,  
BLOCKS AND HOLDERS



IF YOU WOULD LIKE ASSISTANCE on your protection problems, BUSS fuse engineers are always at your service. They will be glad to help you select the fuse that will do the job best... if possible, a fuse that is available from local wholesalers' stocks.

**BUSSMANN Mfg. CO.,** Division of McGraw Electric Co.  
University at Jefferson, St. Louis 7, Missouri

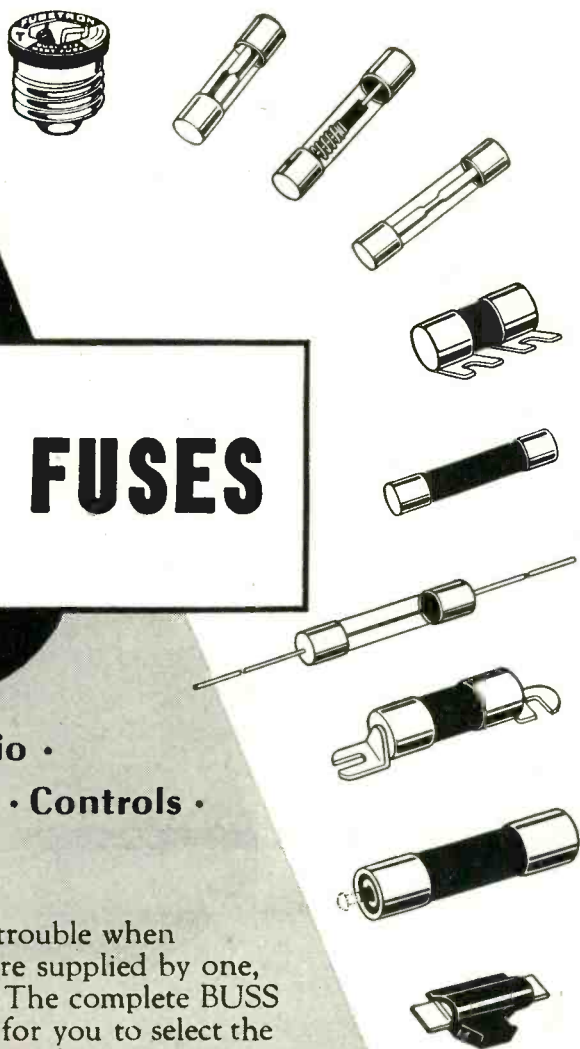

## MAIL THIS COUPON TODAY...

BUSSMANN Mfg. Co. (Division of McGraw Electric Co.)  
University at Jefferson, St. Louis 7, Mo.

Please send me bulletin SFB containing facts on  
BUSS small dimension fuses and fuse holders.

Name \_\_\_\_\_

Title \_\_\_\_\_

Company \_\_\_\_\_

Address \_\_\_\_\_

City & Zone \_\_\_\_\_ State \_\_\_\_\_ TRC-753

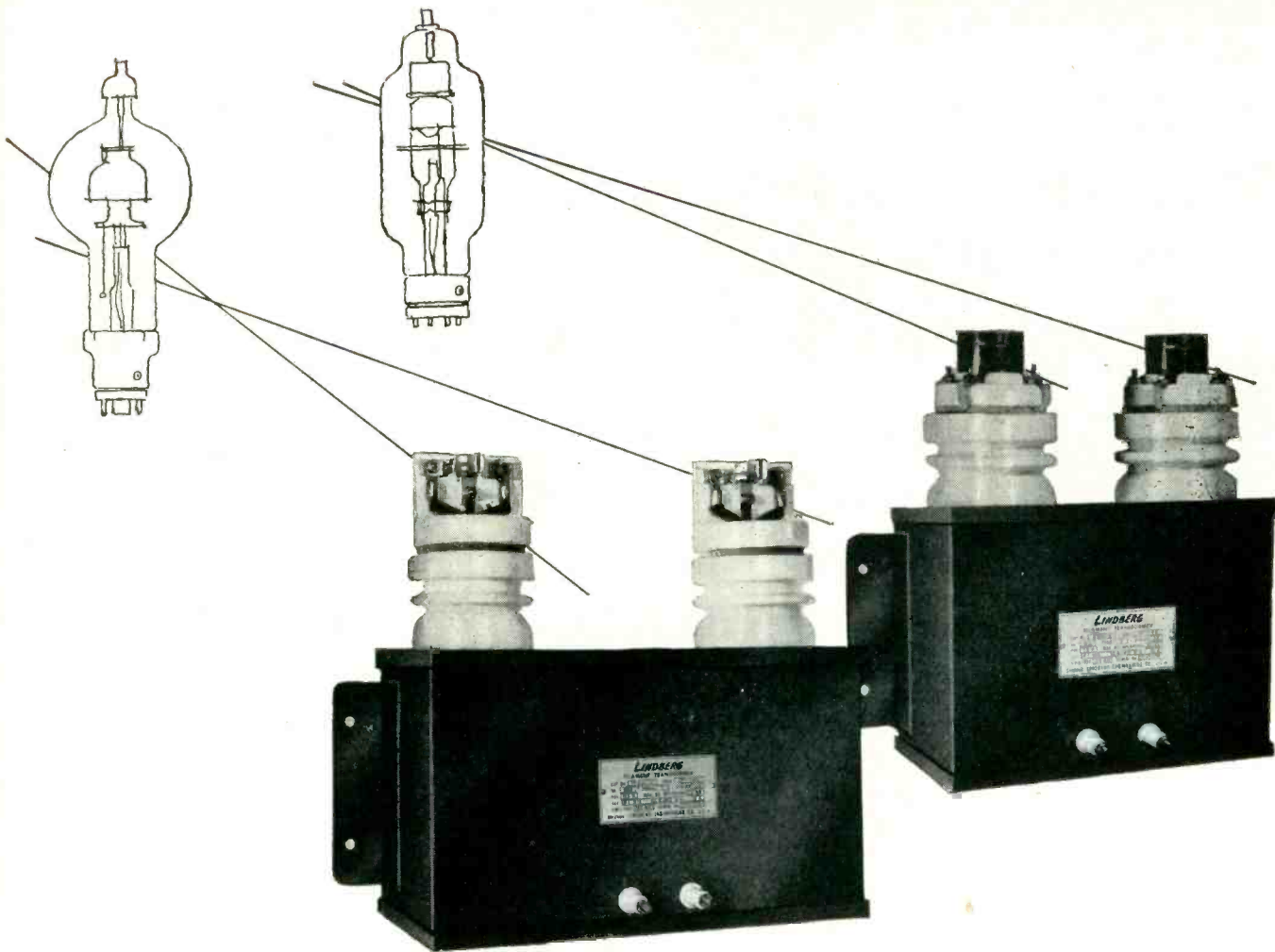

## ANNOUNCING .. New **LINDBERG** Dual Filament Transformers!

Two-in-one! .. they supply filament power for two rectifier tubes simultaneously.  
Furnished complete with sockets .. no wiring necessary. Contained in one case .. conserves space.

Lindberg Dual Filament Transformers have been developed specifically for industrial electronic applications. Each transformer supplies filament power for *two* tubes .. tubes of the type used in large induction heating units, dielectric heating units, radio and TV transmitting equipment, light X-ray equipment, and high voltage testing equipment.

Contained in a single enclosure, Lindberg Dual Filament Transformers do the work of two

separate conventional-type filament transformers .. and they save space, improve appearance, simplify mounting, wiring and handling.

**SPECIFICATIONS** .. Lindberg Dual Filament Transformers are available in two sizes .. 100 V.A. and 200 V.A., 115 volt primary, dual 5 volt filament supply. Each secondary circuit center tapped at 2.5 volts. The 100 V.A. size is equipped with tube sockets for use with 575A type tube .. the 200 V.A. with sockets for tube type 869B.

**IMMEDIATE DELIVERY** .. Lindberg Dual Filament Transformers are stock items. Orders shipped same day received.

# **LINDBERG** TRANSFORMERS

Transformer Division, Lindberg Engineering Co., 2489 West Hubbard, Chicago 12, Illinois

# FOR THE FIRST TIME

## A COMPLETE PRESSURE PICTURE

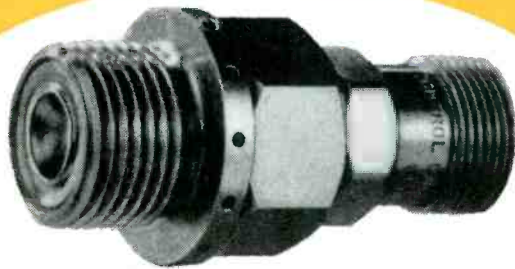

NORWOOD CONTROLS Type EP Pressure Pickup

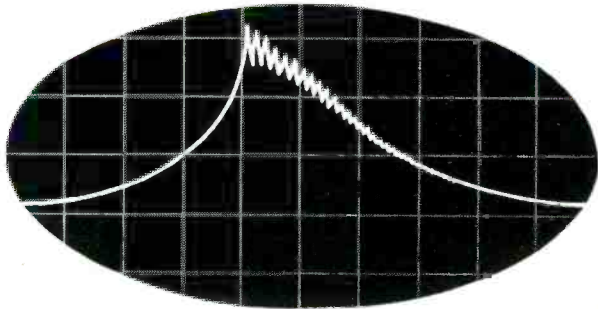

**Versatility** — for use in static and dynamic systems . . . tested and proven on gasoline and diesel engines . . . jet engines . . . rocket motors . . . blast measurements . . . high pressure, high temperature chemical reactions . . . hydraulic and pneumatic systems.

**Accuracy** — output linear with input to  $\pm 1\%$  over full static and dynamic range.

**Full Scale Pressures** — 500, 1,000, 2,000, 3,000, 5,000 and 10,000 p.s.i. . . . response down to 0 p.s.i. absolute.

**High Frequency Response** — flat to 20,000 c.p.s. . . . natural frequency up to 45,000 c.p.s.

**Excellent Compensation** — transducer is not appreciably affected by rapidly fluctuating gas temperatures up to 2500°F. and is insensitive to extraneous vibration.

**Flush Catenary Diaphragm** — reduces changes in volume of pressure chamber to a minimum.



**CONTROL ENGINEERING CORPORATION**  
564 Providence Highway, Norwood, Massachusetts

Norwood Controls representatives located in principal cities.  
Complete technical information on request.

To clock-radio designers  
who fall back to sleep



## don't forget the **Signal Alarm**

...available only on Telechron Timers



Model C-78

Sleep through the soft morning music of your clock-radio just once, and you'll see an important reason to specify Telechron Timers with signal alarm for your new models. And you'll see, too, how this exclusive feature can help your clock-radio become a sales success.

There are other exclusive advantages in Telechron Timers. The sealed lubricant reservoir gives better assurance of long timer life and quiet operation. There's extra simplicity of operation in the two knobs that do the work of three.

For any clock-radio price class, there's a Telechron Timer that will meet your needs. We custom style to meet your design requirements. Write for details. Telechron Department, General Electric Company, 47 Homer Ave., Ashland, Mass.



### EXTRA SALES ADVANTAGE

Telechron Seal of Accuracy on the clock crystal or our trademark on the dial gives the buyer confidence in the accuracy of your clock-radio.





# WALDES TRUARC RINGS REPLACE COTTER PINS... SAVE 44% IN LABOR AND ASSEMBLY COSTS

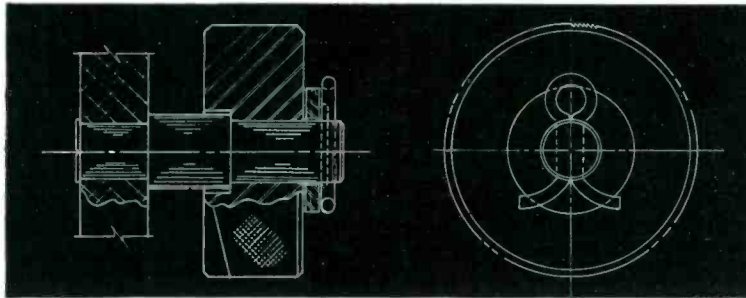

**COTTER PIN WAY:** Flint wheel shaft in lighter assembly requires cotter pin, washer. Difficulty in drilling perfect hole causes rejects. Assembly is slow, costly.

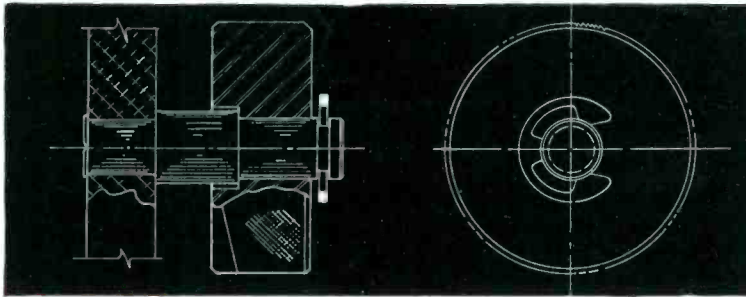

**TRUARC WAY:** Waldes Truarc "E" ring fits into groove in shaft; locks assembly securely for life. Groove is quickly, easily cut... assembly is simple, speedy.



Brown & Bigelow, St. Paul, Minn., saved \$6.95 per thousand units by incorporating Truarc Rings in the design for the REDI-FLAME compressed gas desk lighter! In spite of greater initial cost of Truarc Rings as against cotter pins, they were able to cut machining and assembly costs drastically—for an overall savings of 44%!

Redesign with Waldes Truarc Rings and you too will cut costs. Wherever you have a fastening problem... wher-

ever you use machined shoulders, bolts, snap rings, cotter pins, there's a Truarc Ring designed to do a better job of holding parts together.

Waldes Truarc Rings are precision-engineered... quick and easy to assemble and disassemble. They can be used over and over again.

Find out what Truarc Rings can do for you. Send your blueprints to Waldes Truarc engineers for individual attention, without obligation.

COMPARATIVE COSTS			
Cotter Pin Way		Truarc Way	
Material	\$ Per M	Material	\$ Per M
Shaft	.48	Shaft	.35
Cotter pin	.46	Truarc ring	8.68
Washer	1.50		
	2.44		9.03
Labor		Labor	
Shaft	10.22	Shaft	2.27
Washer	.72		
Assembly	9.28	Assembly	4.41
	20.22		6.68
<b>TOTAL</b>	<b>\$22.66</b>	<b>TOTAL</b>	<b>\$15.71</b>
<b>TOTAL SAVINGS WITH TRUARC RINGS:</b>			
<b>\$6.95 or 44%</b>			

For precision internal grooving and undercutting... Waldes Grooving Tool.

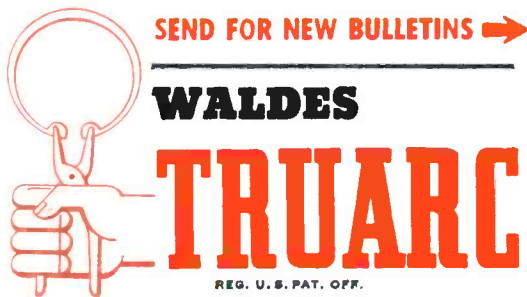

SEND FOR NEW BULLETINS →

**WALDES TRUARC**  
RETAINING RINGS

WALDES KOHINOOR, INC., LONG ISLAND CITY 1, NEW YORK

WALDES TRUARC RETAINING RINGS AND PLIERS ARE PROTECTED BY ONE OR MORE OF THE FOLLOWING U.S. PATENTS: 2,302,947; 2,302,948; 2,410,052; 2,420,921; 2,426,341; 2,429,789; 2,441,040; 2,455,103; 2,463,360; 2,483,303; 2,487,002; 2,487,003; 2,491,306; 2,506,061 AND OTHER PATENTS PENDING.



Waldes Kohinoor, Inc., 47-16 Austel Place, L. I. C. 1, N. Y. Please send engineering specifications and data on Waldes Truarc Retaining Ring types checked below.

- Bulletin #5 Self-locking ring types
- Bulletin #6 Ring types for taking up end-play
- Bulletin #7 Ring types for radial assembly
- Bulletin #8 Basic type rings
- Send me information about the Waldes Grooving Tool.

Name \_\_\_\_\_  
 Title \_\_\_\_\_  
 Company \_\_\_\_\_  
 Business Address \_\_\_\_\_  
 City \_\_\_\_\_ Zone \_\_\_\_\_ State \_\_\_\_\_ 5678

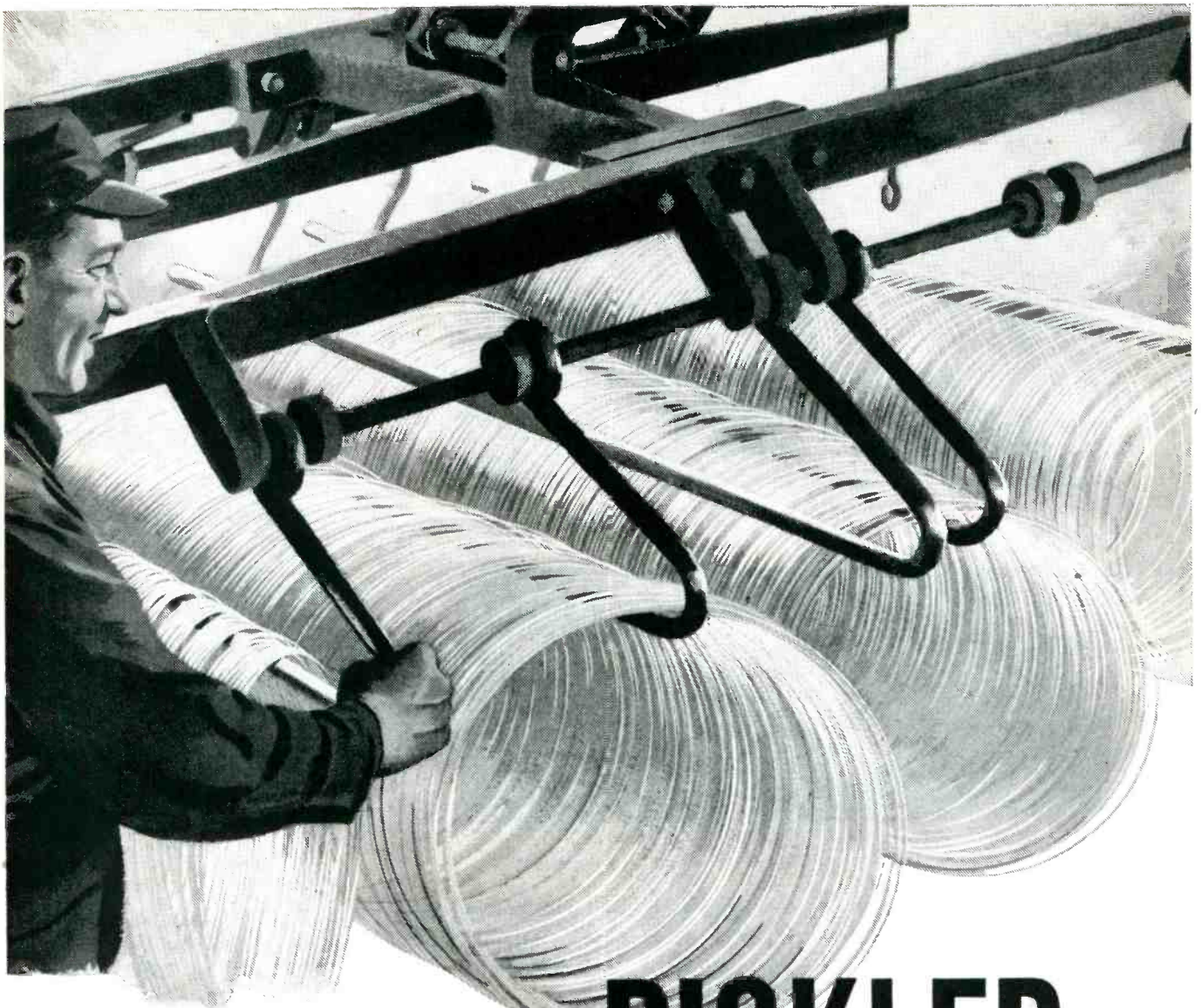

# PICKLED

**to bring you CHASE® wire with a clean, bright finish**

Be sure you're getting clean, even tempered brass or copper alloy wire, free from physical defects. Ask for Chase wire by name.

We check constantly on the dimensions, color, surface condition and temper of Chase wire to make sure the wire you get is entirely uniform. Only a flash pickle is required to make Chase

wire clean and oxide-free because carefully controlled annealing assures a high lustre, excellent surface texture and uniform color.

*Cut your production costs with Chase wire. Write for free booklet giving shapes, sizes, alloys and tempers available.*



# Chase



**BRASS & COPPER**

WATERBURY 20, CONNECTICUT • SUBSIDIARY OF KENECOTT COPPER CORPORATION

*The Nation's Headquarters for Brass & Copper*

Albany†	Cleveland	Kansas City, Mo.	New York	San Francisco
Atlanta	Dallas	Los Angeles	Philadelphia	Seattle
Baltimore	Denver†	Milwaukee	Pittsburgh	Waterbury
Boston	Detroit	Minneapolis	Providence	
Chicago	Houston	Newark	Rochester†	(† sales office only)
Cincinnati	Indianapolis	New Orleans	St. Louis	

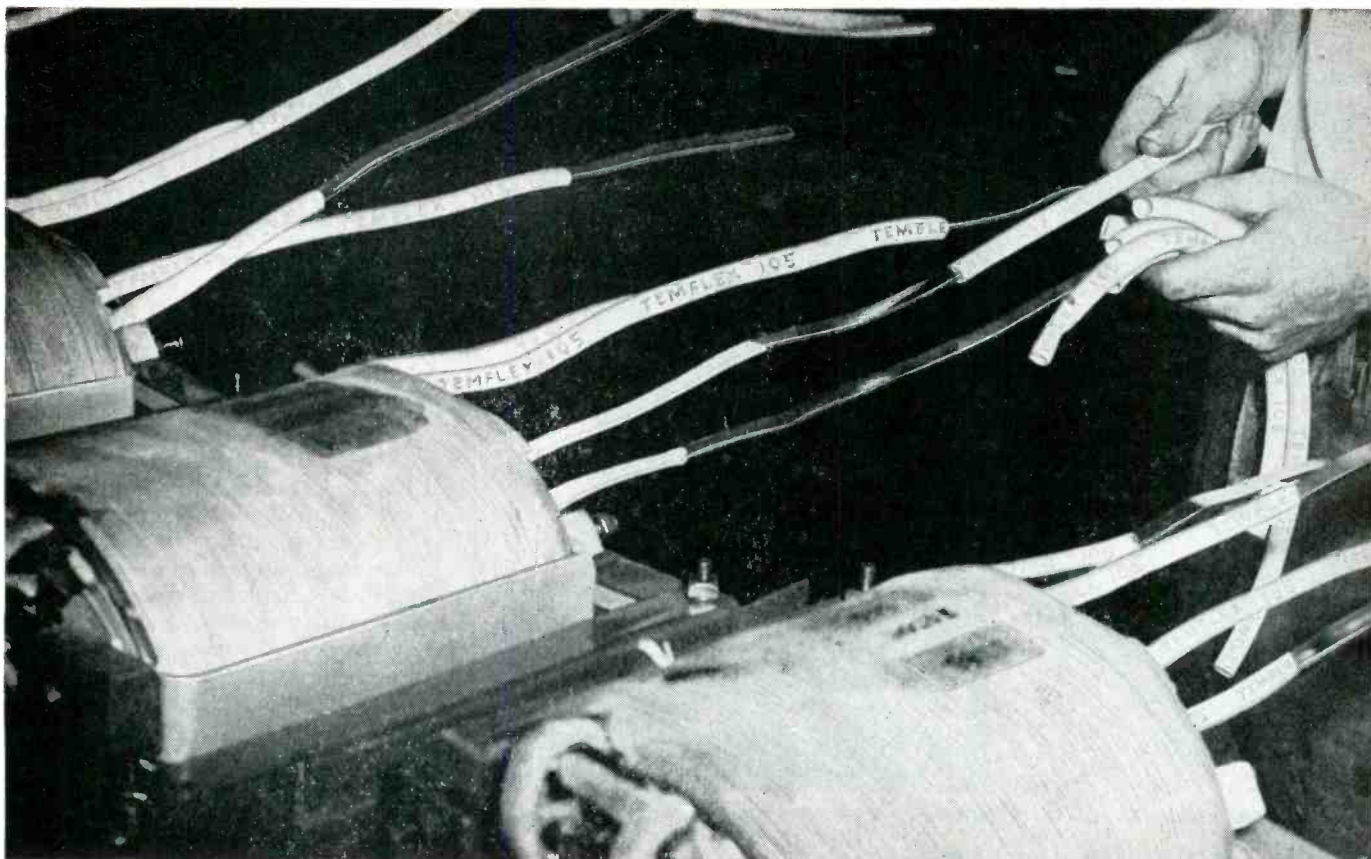

## Wagner Electric reports "Long Life" when transformer leads are insulated with **TEMFLEX 105**

Lengths of Irvington's Temflex 105 Plastic Insulating Tubing are quickly and easily slipped over transformer leads at Wagner Electric Corporation. And once they're in place, they're there to *stay* through the toughest service.

This product of Irvington's Fibron division is approved by Underwriters' Laboratories for *continuous* operation at 105° C.—and for 90° C. operation *in oil*.

Temflex 105 Tubing *retains* its original high dielectric strength of 1100 vpm, its flexibility and excellent elongation characteristics even after continuous high-temperature operation, varnishing, baking or immersion in chemicals.

Produced in all standard colors, readily identified by the continuously printed name on the smooth tubing surface. Identify it by name when you buy!

A Technical Data Sheet is yours for the asking—just mail the coupon.

Look to  
**IRVINGTON**  
 for Insulation Leadership  
 INSULATING VARNISHES  
 VARNISHED CAMBRIC  
 VARNISHED PAPER  
 VARNISHED FIBERGLAS  
 INSULATING TUBING  
 CLASS "H" INSULATION

Send this convenient coupon now

# Irvington

VARNISH & INSULATOR COMPANY

11 Argyle Terrace, Irvington 11, New Jersey

Plants: Irvington, N. J.; Monrovia, Calif.; Hamilton, Ontario, Canada

Irvington Varnish & Insulator Co.  
 11 Argyle Terrace, Irvington 11, N. J.

Gentlemen:

Please send me Technical Data Sheet on  
 Temflex 105 Tubing.

Name.....Title.....

Company.....

Street.....

City.....Zone.....State.....

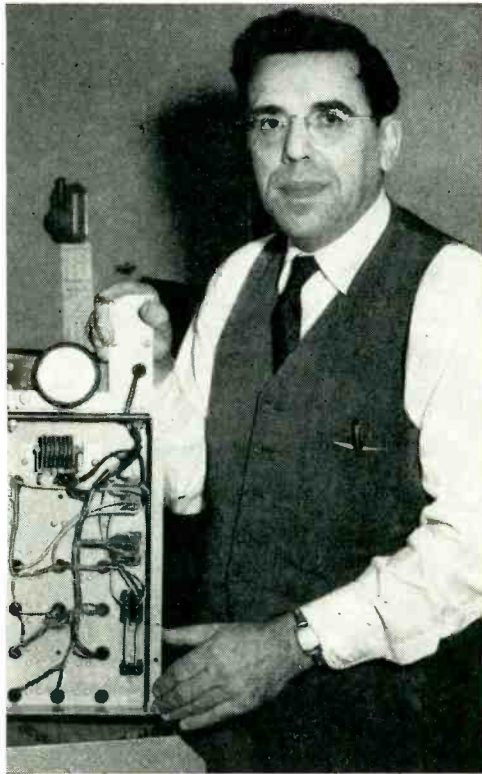

G-E SELENIUM RECTIFIER POWERS CONTROL CIRCUIT OF WRAP-O-MATIC MACHINE

# Reliable D-C Power Assured by G-E Selenium Rectifiers

More and more manufacturers of automatic equipment are using General Electric selenium rectifier stacks. They are taking advantage of the reliability and long life of these rectifiers by using them as power supplies for d-c operated relays and contactors in control circuits.

**TYPICAL** of this type of application is the Wrap-O-Matic, a paper feeding and cutting machine manufactured by the Rosenthal Manufacturing Co. of Chicago, Ill. The Wrap-O-Matic measures paper or cellophane from a roll and automatically cuts it off at one of four pre-selected lengths, depending upon which button the operator presses. Substantial savings in time and reduced paper wastage are reported by users of the equipment.

The Wrap-O-Matic's control system operates at 24 volts d-c, supplied by a small transformer and a G-E selenium rectifier stack. It controls the operation of two G-E

motors which feed the paper and drive the cutting knife. D-c coils are employed because of the frequency of operation, and the need for instantaneous, smooth make-and-break.

**ADVANTAGES.** G-E selenium rectifiers incorporated in your product will assure your customers dependable control and smooth operation. G-E selenium rectifiers have exceptionally low forward voltage drop and high reverse resistance. These two qualities, both readily measurable, assure low heat loss, and long life.

**MORE INFORMATION** on G-E selenium rectifiers is available from your nearest G-E Apparatus Sales Office, or by writing. Bulletin GEA-5935 describes Miniature Selenium Rectifiers, and GET-2350 gives general application information. Address: Section 461-30, General Electric Co., Schenectady 5, N. Y.

*You can put your confidence in—*

**GENERAL  ELECTRIC**

## METALLIC RECTIFIER FACTS FOR ENGINEERS

### A Look Into The Future

By C. E. Hamann

Metallic rectifiers are often described as static devices. While this term aptly describes the rectifier itself, it certainly does not apply to the fast growing metallic rectifier industry. Scarcely a day passes without the announcement of some new rectifier development or successful application.

New developments in the selenium rectifiers such as improved electrical characteristics, high temperature operation, and longer life, are given widespread publicity. Little mention, however, is made of its older brother, copper-oxide.

Considerable engineering effort has been applied toward improving the electrical characteristics of copper-oxide rectifiers.

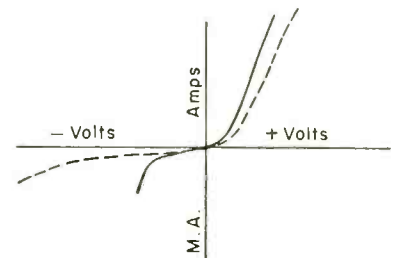

**RELATIVE CHARACTERISTICS**  
Solid line—Conventional copper-oxide  
Dotted line—High voltage copper-oxide

As a result of constant research, copper-oxide cells of higher voltage rating—perhaps two or three times that of the older type—appear to be a certainty in the near future.

Copper-oxide rectifiers have certain, inherent characteristics not found in other metallic rectifiers. Copper-oxide rectifiers can stand on the shelf for 25 years and still exhibit full blocking ability in the first half-cycle of applied voltage.

In blocking applications in d-c circuits where fast response is desirable, engineers will do well to consider the possibilities of using copper-oxide rectifiers.

For more information on G-E copper-oxide rectifiers, write for Bulletin GEA-5699A.

*C. E. Hamann*

General Electric Company



**They've Got to be SURE!**

**That's Why  
Indianapolis Sweepstakes  
Champions Choose**

EVERLOCK washers have been used on the top three cars in every Indianapolis Sweepstakes since 1936! This grueling, rugged grind demands the utmost in protection against vibration and strain. It's significant that, without exception, these winners put their trust in EVERLOCK washers. EVERLOCK's alternating chisel edges really bite into the surface—powerful spring steel tension holds them secure. Available in four standard types or made specially to your specifications. Next time you order screw-washer assemblies—*be sure*—specify EVERLOCK washers.



**1-2-3 AGAIN!**

*This year again Everlock swept the field at the great Indianapolis Classic. The first, second and third place cars were all equipped with Everlock Washers.*

*Everlock's alternating chisel-edge design assures tight, vibration-proof assemblies for your product, too. On your next order, specify Everlock—the washer that has the edge.*

**WRITE FOR LATEST CATALOG AND PRICES**

EVERLOCK is a REGISTERED TRADE-MARK OF THOMPSON-BREMER & CO.

**THOMPSON-BREMER & COMPANY • 520 N. DEARBORN STREET, CHICAGO 10, ILLINOIS**  
 SUBSIDIARY OF AMERICAN MACHINE AND FOUNDRY COMPANY • NEW YORK, N. Y.

# Spectrum

## ANALYZER TS-148/UP

**NEW AND IMPROVED DESIGN**

**OUTSTANDING PERFORMANCE**

**MORE RUGGED CONSTRUCTION**

### Specifications . . .

- Attenuation (Spectrum Amplitude): 3 — 70 db uncal.
- Frequency range: 8430 Mcs — 9660 Mcs.
- Frequency sweep: 10 — 30 cps continuous.
- Frequency swing (FM sawtooth) of analyzer r-f oscillator: 40 — 50 Mcs.
- Maximum error:  $\pm 4$  Mcs.
- Maximum dispersion of spectrum: 1.5 Mcs per inch.
- Overall i-f bandwidth at half power point: 50 Kcs.
- Sensitivity to CW:
  - a. Spectrum amplified position: 80 db below 1 W per inch deflection on oscilloscope screen.
  - b. Spectrum position: 55 db below 1 W per inch deflection on oscilloscope screen.
- Weight: 86 pounds (complete in armored case with all accessories).

#### Partial list of satisfied users of the G & M TS-148/UP include:

Bell Aircraft Corp. (Lab.)  
 California Institute of Technology (Lab.)  
 Consolidated Vultee Aircraft Corp. (Lab.)  
 Douglas Aircraft, Inc. (Lab.)  
 Fairchild Engine & Airplane Corp. (Guided Missiles Div.)  
 French Naval Base (Toulon)  
 Gilfillan Bros. (Electronics)  
 Royal Canadian Air Force (Lab.)  
 Westinghouse Electric Corp. (Lab.)

### We also manufacture . . .

- I-96-A VHF Bench Test Equipment.
  - IE-17-A SCR-536 Test Equipment.
  - IE-19-A VHF Portable Test Equipment.
  - MB-2 Marker Beacon Test Equipment, Portable.
  - TS-E6 Slide Back Voltmeter for E-3, E-4, E-5, etc. Firing Systems).
  - TS-E7 Moving Target Simulator (for E-3, E-4, E-5, etc. Firing Systems).
  - TS-170-C ILS Portable Test Equipment.
  - TS-173-C ILS Portable Test Equipment.
  - TS-239/UP Wide Band Oscilloscope.
  - UPM-1 Radar Test Set.
- Special items to order, such as:
- 1 KW Transmitters and Jamming Equipment.
  - 5 KW Transmitters and Jamming Equipment.
  - Direction Finders.
  - Communication Receivers, etc.



TS-148/UP



ACCESSORIES & CASE



SHIPPING AND CARRYING CASE

Armored foot locks  
with foam rubber cushions inserted.

**WRITE OR WIRE FOR PRICES  
AND DELIVERY SCHEDULES**

"Where Hi-Quality is Fundamental"

**G & M EQUIPMENT CO., INC.**

7309-7327 VARNA AVENUE  
NORTH HOLLYWOOD, CALIFORNIA



Phones -

POplar 5-4185  
Stanley 7-1624  
Stanley 7-2212  
Stanley 7-1086

**TELETYPE: N.H. 7063**

**WESTERN UNION: ZDV**

**CABLE: GMEINC**

# Picture YOUR PRESENT CHASSIS with these advantages —

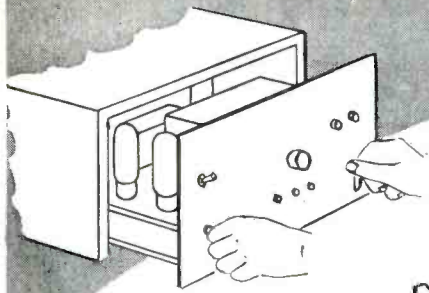

**INSTANT REMOVAL FROM FRONT**  
for servicing or plugging in replacement spare.

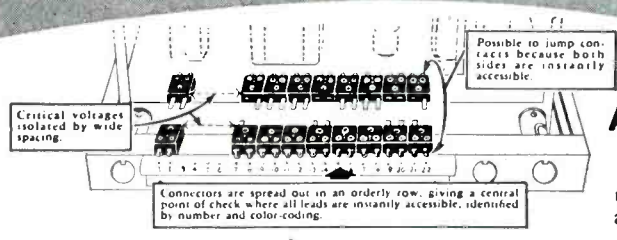

**100% ACCESSIBILITY AT BACK**  
to check all incoming and outgoing leads.

Arrange Alden Side Rails (1) and Alden Lock Frame (2) to suit your chassis. Alden Serve-A-Unit Locks (3) mount in your chassis to engage pre-punched holes in Alden Lock Frame (2) to pilot, draw in, lock or eject.

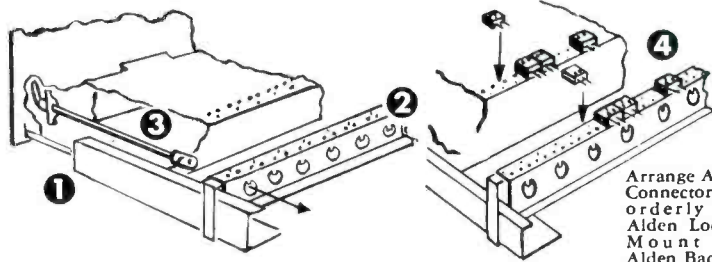

Arrange Alden Back Connectors (4) in orderly row on Alden Lock Frame. Mount mating Alden Back Connectors on your chassis.

**IT'S AS SIMPLE AS THIS**

## All you need is this simple Alden Serve-A-Unit Kit —

- 1 ALDEN SIDE RAILS**  
ANY LENGTH
- 2 ALDEN LOCK FRAME**  
ANY LENGTH
- 3 ALDEN SERVE-A-UNIT LOCKS**  
Adjustable to any length
- 4 ALDEN BACK CONNECTORS**  
Keep leads spread out in orderly accessible rows



**ALDEN UNIVERSAL BRACKET**  
Joins Lock Frame to Side Rails

If you want it, here's a RACK ADAPTER —

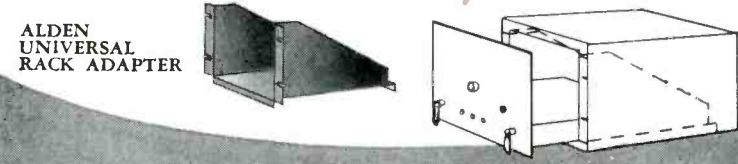

You can arrange Side Rails and Lock Frame so your chassis plugs into this Rack Adapter.

**ALDEN COMPONENTS FOR PLUG-IN UNIT CONSTRUCTION**

## Why not design new circuitry in compact vertical planes It's as simple as this —

**USE ALDEN'S TERMINAL CARD MOUNTING SYSTEM**

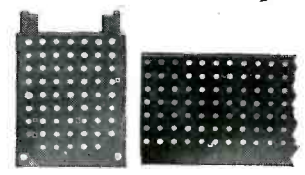

**ALDEN PREPUNCHED TERMINAL MOUNTING CARDS** cut to proper sizes for 7-pin, 9-pin, 11-pin and 20-pin packages. Or in 3' strips for chassis — cut it off as you require.



**ALDEN MINIATURE STAKING TERMINALS** Lay out in any pattern on Terminal Mounting Cards; ratchet slots hold elements for soldering without pliering or wrap-around.



**ALDEN JUMPER STRIP** stakes right under Terminals providing common circuit without soldering.



**ALDEN CARD-MTG. TUBE SOCKETS** for min. 7-pin, 9-pin and octal tubes.



Typical circuitry for 20" package

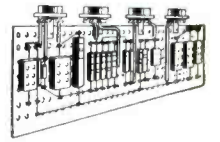

Typical circuitry for chassis

## —and how beautifully these vertical units fit into plug-ins. It's as simple as this —

**USE ALDEN PLUG-IN PACKAGES AND BASIC CHASSIS COMPONENTS**

### 4 SIZES OF PLUG-IN PACKAGES

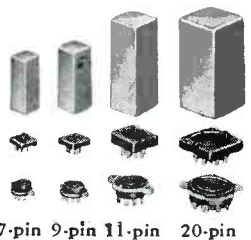

7-pin 9-pin 11-pin 20-pin  
Package components and matching sockets.

HUNDREDS of COMBINATIONS with these COMPONENTS



**COLOR-CODED HANDLE** directs package to color-coded socket.

### 4 SIZES OF PLUG-IN CHASSIS

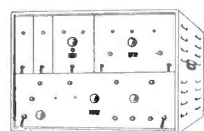
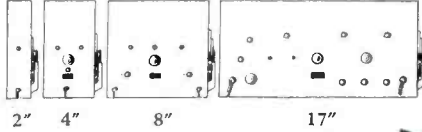

**ALDEN UNI-RACK**

Mount vertical planes of circuitry in Alden Basic Chassis, with Alden Back Connectors and Alden Serve-A-Unit Lock as above.

**ALDEN BASIC CHASSIS**

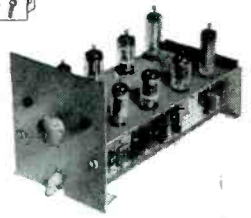

## —and assign to each unit a tiny tell-tale to spot trouble instantly. It's as simple as this —

**USE ALDEN SENSING ELEMENTS**



**ALDEN MINI-TEST POINT JACK**  
For checking critical voltages from front of panel.



**ALDEN "PAN-i-LITE"**  
Miniature indicator light with unbreakable 1-piece light-lens unit replaceable from front.



**ALDEN "FUSE-LITE"**  
Fuse blows — Lite glows. Simple unscrew 1-piece light-lens unit and blown fuse comes out with it.

GET THE COMPLETE STORY — REQUEST "ALDEN HANDBOOK" — SENT FREE

**ALDEN PRODUCTS COMPANY 127 North Main Street, Brockton, Mass.**



# NEW HIGH VACUUM ROTARY PUMP

... Ends Water Vapor Trouble

... Maintains Fast Pump Down Time

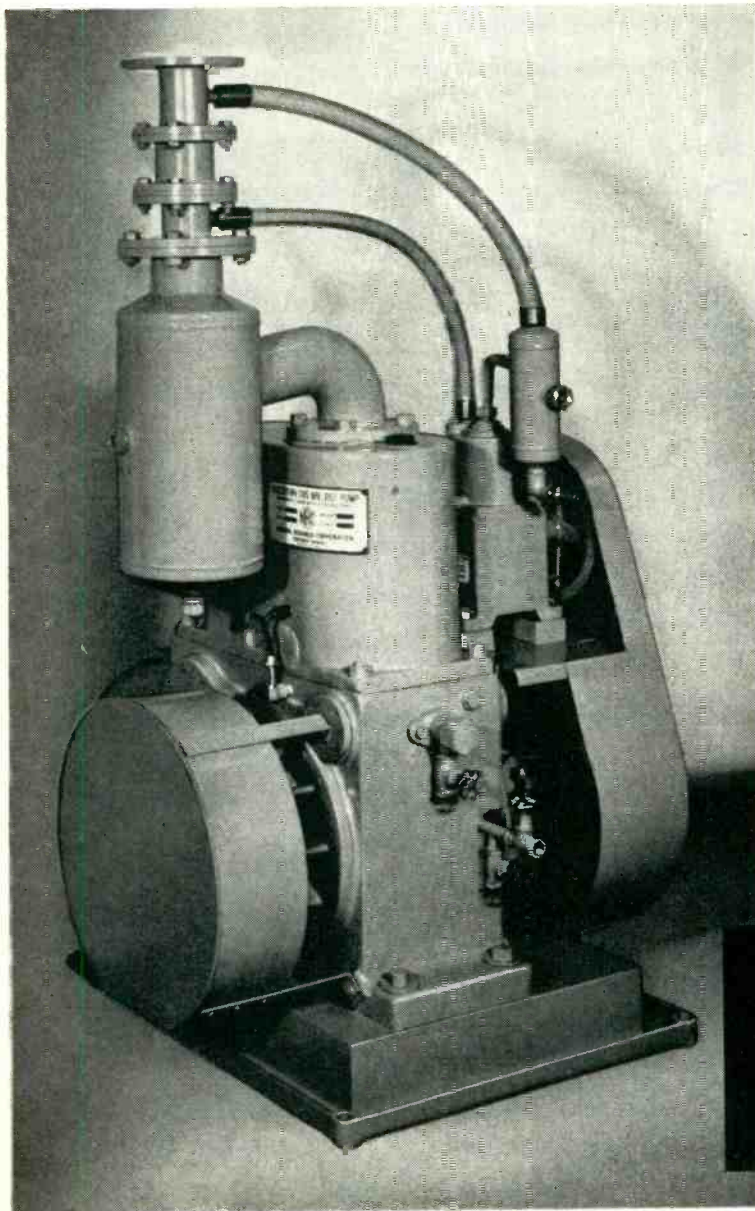

- Eliminates oil reclaiming units
- Provides greater capacity under 1 mm Hg
- Requires up to 80% less oil charge
- Capacities from 1¼ cfm to 400 cfm
- Pressures down to 10<sup>-4</sup> mm Hg

For the first time, a high vacuum rotary pump that can pump condensable vapors is available to U. S. A. industry.

In the new NRC Rotary Gas Ballast Pump water vapor is *prevented* from condensing and contaminating the oil... so, unlike other type pumps, fast pump down time is *maintained*.

There is a full line of NRC pumps — vane, piston-type and 2-stage.

Send today for the new bulletin that gives a full explanation of the Gas Ballast principle and complete data on the construction and operation of the NRC Rotary Gas Ballast Pump



National Research  
Corporation  
EQUIPMENT DIVISION

70-A Memorial Drive, Cambridge, Massachusetts

NRC Rotary Gas Ballast Pump. Model NRC100M. 2-stage pump unit.





# Germanium Transistors and Diodes

## FOR EVERY PURPOSE!

### PNP JUNCTION TRANSISTORS

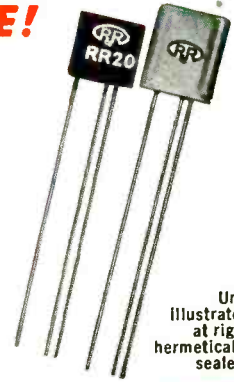

Unit illustrated at right hermetically sealed.

PNP JUNCTION TRANSISTORS			
(Typical Characteristics at 25° C—Grounded Emitter)			
TYPE NO.	RR14‡	RR20‡	RR21‡
Collector Voltage—volts	-1.5	-1.5	-15.0
Collector Current—ma	-0.5	-0.5	-3.0
I <sub>co</sub> —Microamp.*	10	10	30
Current Amplification	25	40	25
Power Gain—db	30	40	—
Noise Factor—db (1 Kc)	22	22	—
Power out—mw (10% Dist.)†	—	—	20.0

\* I<sub>e</sub> = 0, V<sub>c</sub> = -1.5 volts.  
 † With 1000 ohm driving impedance and 5000 ohm load.  
 ‡ RR14H, RR20H and RR21H are hermetically sealed types.

Tiny, stable high gain units, most economical of power, may be soldered in place or socketed in a recommended RTMA transistor socket. They are suitable for audio amplifiers, servo amplifiers and transformer coupled carrier amplifiers. Available in plastic or hermetically sealed in metal and glass.

### POINT CONTACT TRANSISTORS

Available in a variety of stable controlled types suitable for both fast and medium speed switching circuits and high frequency amplifiers. Advanced mechanical design for economical production . . . Heat conducting metal case; standard basing, choice of solder-in or plug-in.



POINT CONTACT TRANSISTORS		
Typical Characteristics at 25° C		
SWITCHING TRANSISTORS		
TYPE NO.	R1698	R1734
Off Collector Current max. ma (I <sub>e</sub> = 0)	-2.2 (@ V <sub>c</sub> = 40V)	-0.7 (@ V <sub>c</sub> = -7V)
On Collector Voltage max. volts (I <sub>e</sub> = 3.0)	-4.0 (@ I <sub>c</sub> = 5.5 ma)	-1.2 (@ I <sub>c</sub> = -4.0 ma)
Collector Dissipation max. m w	120	120
Nominal cut-off Frequency m c	1.5	10.0
GENERAL PURPOSE TRANSISTOR		
TYPE NO.	R1729	
Collector Voltage—volts	-30	
Emitter Current—ma	1.0	
Input Resistance (R <sub>11</sub> )—ohms	190	
Output Resistance (R <sub>22</sub> )—ohms	6000	
Current Amplification Factor	2.5	
Nominal Cut-off Frequency—mc	5.0	

Our engineers will be glad to offer suggestions regarding your Germanium Transistor and Diode applications without obligation . . . Write to Section E.

### JUNCTION POWER DIODES

WITH THESE DISTINGUISHING CHARACTERISTICS:

- Very low forward drop
- Low reverse leakage
- Tiny
- Hermetically sealed in metal and glass.

Useful in power supplies, magnetic amplifiers and telephone systems, etc., they have the characteristics of large plate-type power rectifiers and size and weight of a small circuit component.

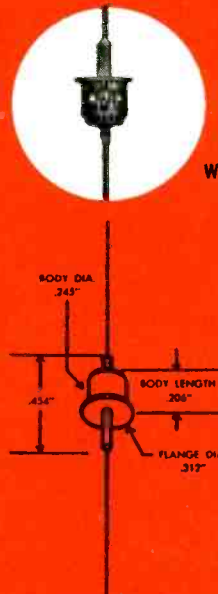

SHOWN APPROXIMATELY ACTUAL SIZE

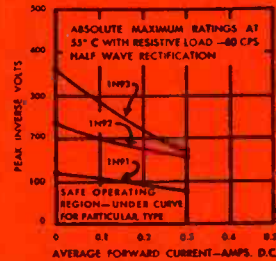

JUNCTION POWER DIODES			
Maximum Ratings at 55° C—Resistive Load			
TYPE NO.	1N91	1N92	1N93
Peak Inverse Voltage (volts)	100	200	300
Peak Forward Current (ma)	470	310	230
D.C. Output Current (ma)	150	100	75
Voltage Drop at Full Load (volts)	0.5	0.5	0.5
Surge Current (amps)	25	25	25
Reverse Working Voltage (continuous volts)	30	65	100
Max. Freq. of Operation (kc)	50	50	50

Coming . . .

### JUNCTION POWER TRANSISTORS

For Audio power up to 2 watts



### PHOTO TRANSISTORS

To operate power relay with one junction transistor as DC amplifier,

## SELETRON & GERMANIUM DIVISION

# RADIO RECEPTOR COMPANY, INC.

Since 1922 in Radio and Electronics

SALES DEPT: 251 W. 19th St., New York 11, N. Y. • FACTORY: 84 N. 9th St., Brooklyn 11, N. Y.

# Specify UNILECTRIC TRADE-MARK WIRING SYSTEMS

for the Wiring of any  
**ELECTRIC or ELECTRONIC PRODUCT**  
*because* if the wiring fails so does  
your product's performance

## *This Unilectric wiring harness protects the performance of a Military Auto Pilot*

The military Auto Pilot for which this harness was engineered is now being called upon to perform under the most severe conditions. Performance of the wiring is protected by Unilectric's engineering, meticulous workmanship, and precision quality standards.



 **UNILECTRIC WIRING SYSTEMS**  
TRADE-MARK

Manufactured by  
**UNITED MANUFACTURING & SERVICE COMPANY**  
409 SOUTH 6th STREET • MILWAUKEE 4, WISCONSIN

**for Real Uniformity,  
specify  
STACKPOLE  
Ceramag®  
ferrite cores!**



Most ferrite core users have learned by costly experience, that it's one thing to obtain satisfactory samples—but quite another thing to have these sample cores reproduced in production quantities. *But not at Stackpole!*

Stackpole Ceramag ferrite cores are outstandingly uniform in every physical and electrical respect. The production unit is exactly like the sample. Each production unit is exactly like the other.

In short, Stackpole has perfected control of the complicated problems involved in handling ferrite materials. The result spells cores of outstanding uniformity in their electrical characteristics, highly accurate physical tolerances and with the ability to withstand exceptionally high temperatures without permeability change for many specific uses.

**Write for Stackpole  
Ceramag Bulletin**

FIXED AND VARIABLE  
RESISTORS—LINE &  
SLIDE SWITCHES  
CERAMAG® ferrite CORES  
IRON CORES  
(Side-molded, sleeve, cup, choke coil,  
threaded and conventional types)

MOLDED COIL FORMS—  
"GIMMICK" CAPACITORS, etc.



**STACKPOLE**

**Have you investigated  
these potential NEW  
Ceramag core uses?**

**HIGHER TEMPERATURE OPERATION  
IN NITROGEN ATMOSPHERES**

New equipment designed and sealed in nitrogen, due to high ambient temperatures imposed by miniaturization, poses a real temperature problem for permeability tuning cores as well as for I-F transformer and R-F cores. This is solved handily by Stackpole Ceramag cores thanks to the fact that they stand higher temperatures and show less drift than high-permeability iron cores.

**SUPERSONIC-FREQUENCY  
APPLICATIONS**

Ceramag cores assure high permeability with low losses in the supersonic-frequency range.

**CENTER CORES FOR  
POWDERED IRON POT CORES**

Used as center cores in powdered iron pot cores operating at less than 1 megacycle, Ceramag increases L by approximately 100% and increases Q on the order of 50%.

**INCREMENTAL PERMEABILITY  
APPLICATIONS**

Because Ceramag is more easily saturated than conventional core materials, it is ideally suited for pulse generation, magnetic amplifying and incremental permeability tuning.

**HASH AND INTERFERENCE  
SUPPRESSION**

Recent experience indicates that the unique characteristics of Stackpole Ceramag help materially in minimizing "hash" and interference when the cores are used in the filter systems of electrical equipment and tools. Inquiries are invited.

Electronic Components Division

**STACKPOLE CARBON COMPANY • St. Marys, Pa.**

# ENGINEERING BRAINS TEAM WITH ELECTRONIC BRAINS

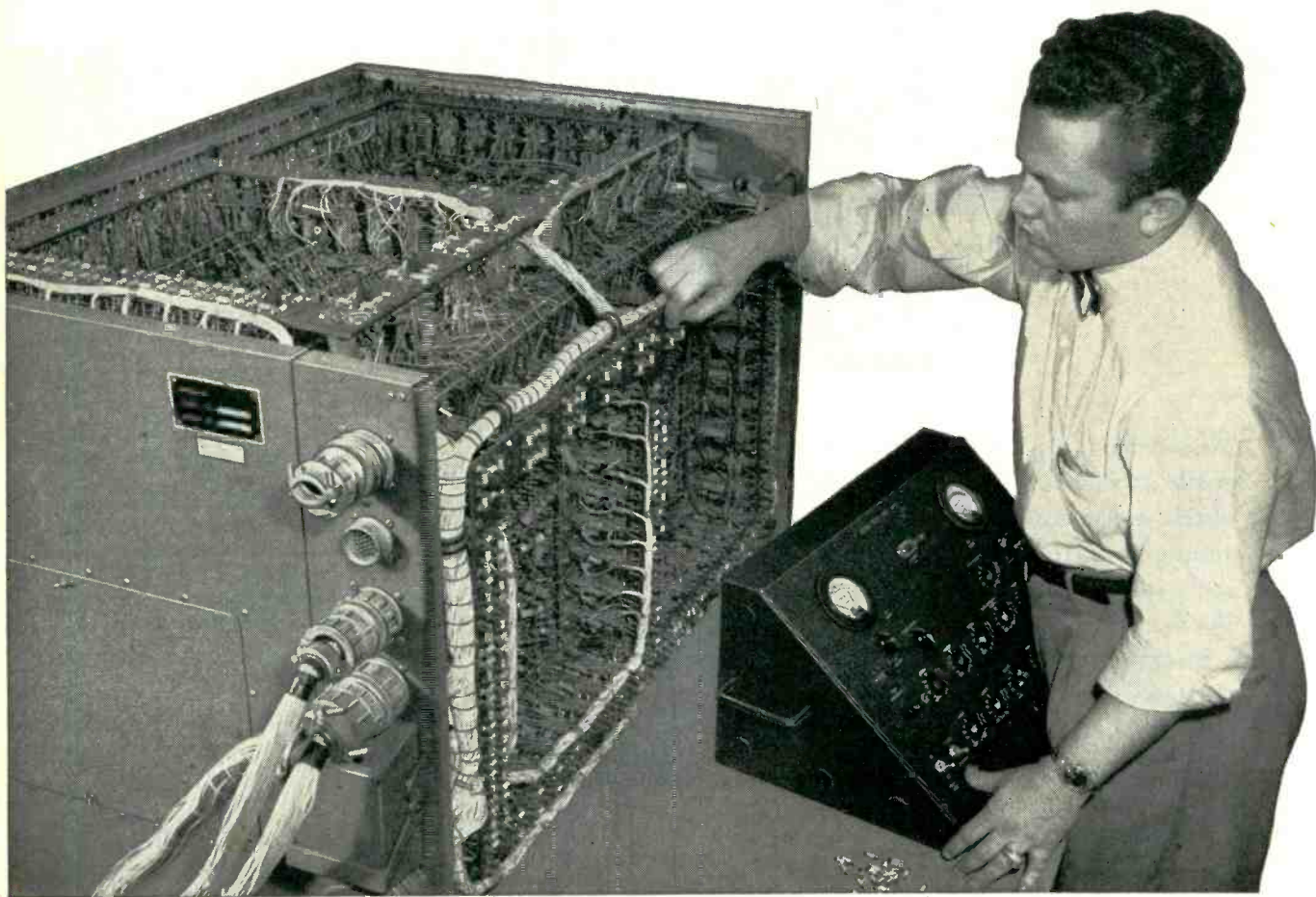

## AT NORTH AMERICAN AVIATION

The combination of North American's imaginative scientists and engineers working with lightning-fast electronic "thinking" machines is an unbeatable one . . . for together they've set advanced standards for guided missile research, development, and design.

Computers like the one being checked above are used to predetermine the flight pattern of a given missile design by simulating its flight conditions, and to solve related problems. North American Aviation engineers also develop and use other electro-mechanical computers which become the brains of automatic guidance systems for missiles and for fire and flight control equipment.

Development of guidance systems for long-range missiles is just one example of the challenging elec-

tronic and electro-mechanical work being pioneered in North American's Missile and Control Equipment Operations. If you like theory, you will find an exciting career at North American in specialties such as operations analysis, advanced dynamics, kinematics, noise, error and information theory, systems engineering, statistical quality control, servo analysis, and other advanced fields.

If research, development, or design is your specialty, you'll find attractive opportunities in automatic guidance systems, fire and flight control systems, radar and airborne communications systems and other system developments.

Write today for complete information, giving us your education and experience.

## ***NORTH AMERICAN AVIATION, INC.***

*Engineering Personnel Section, Missile and Control Equipment Operations*

12214 Lakewood Boulevard, Dept. 93-E, Downey, California

**NORTH AMERICAN HAS BUILT MORE AIRPLANES THAN ANY OTHER COMPANY IN THE WORLD**

Let Hermetic  
Show You How  
to Achieve a

HERMETIC offers the following enclosures selected from a wide variety of available designs:



STANDARD  
TRANSISTOR  
HOUSING

Pat. 2577576

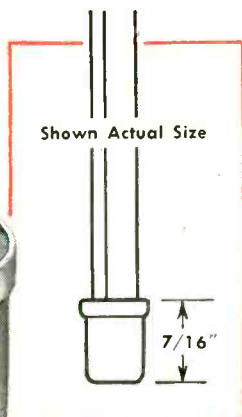

DIODE  
HOUSING

# True Hermetic Seal for Transistor and Diode Housings

It is axiomatic that the only true hermetic seal is a glass-metal seal. This has been demonstrated in vacuum tube design and operation.

In the development of transistor and diode housings, HERMETIC has employed the same principles as those proven in the manufacture of vacuum tubes and has eliminated the necessity of using the high sealing temperatures so detrimental to the performance of semi-conductors.

HERMETIC's long years of experience in the design and production of hermetic seals have enabled its staff of specialist-engineers to create glass-metal housings to meet the most demanding requirements of the semi-conductor industry. HERMETIC's Transistor and Diode Housings have received wide acceptance and usage in the field.

HERMETIC's glass-metal seals of compression or standard design are known to be vacuum tight, moisture proof and contaminant proof by mass spectrometer tests and by virtue of years of successful operation.

Because the production pace of the semi-conductor industry is a swift one, HERMETIC has geared itself to produce and deliver in accordance with its customers' schedules.

Contact HERMETIC today!



**H**ERMETIC SEAL PRODUCTS CO., 31 South Sixth St., Newark 7, N. J.

THE EXPERIENCED SOURCE for TRANSISTOR and DIODE HOUSINGS

---

## PROBLEM:

**To get a Thermostat Element with the stability to operate for 100 years without calibration**

## SOLUTION:

**General Plate TRUFLEX® Thermostat Metal provided this stability**

---

The Museum of Science and Industry laid its "living" cornerstone September 3, 1952, thus starting a one hundred year experiment.

Within the 1-ton limestone block is a specially fabricated monel box containing a score of physically or biologically "alive" items from bacteria to metals . . . including a thermostatic clock which will record the years.

This clock is constructed to register once as the temperature falls to 20°F and will not count again until the temperature has risen to 85° and again fallen to 20°. It will register once each winter and count the number of years that have passed since the laying of the cornerstone.

Essential to the reliability of the clock was a thermostat element which would keep its stability without further calibration for 100 years.

The scientist concerned with the project presented the problem to General Plate whose engineers provided the solution with a specially designed Truflex thermostat metal element.

You, too, can obtain constant and accurate performance in your products because General Plate fabricates to your exact specifications, complete Truflex thermostat metal units ready for installation. You get reliable performance because every order comes to you an exact duplicate of the original . . . consistently uniform in tolerances, temperature reaction and performance, thus preventing rejects and costly adjustments in assembly.

General Plate TRUFLEX thermostat metal assemblies are made to meet your specific requirements for temperature range, electrical resistance, corrosion resistance, etc. If you prefer to make your own assemblies, General Plate will produce Truflex thermostat metal sheet or strip to your material specifications. Write for information or engineering assistance.

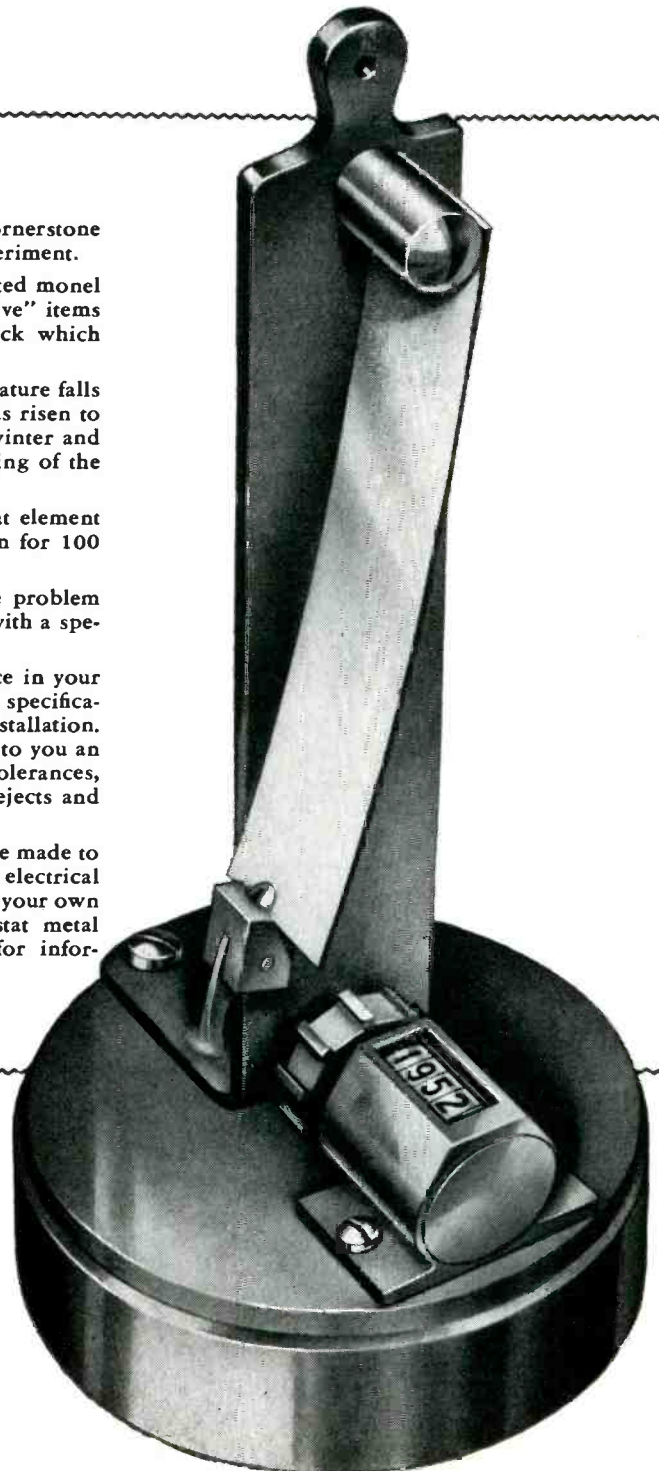

**You can profit by using  
General Plate Composite Metals!**

**METALS & CONTROLS CORPORATION  
GENERAL PLATE DIVISION  
37 FOREST STREET, ATTLEBORO, MASS.**



# ELECTRONIC TEST INSTRUMENTS

## TEST VOLTAGE PROBLEMS 1/100 cps to 10 mc?

Hewlett-Packard has 17 different oscillator models. Some are highly specialized, others are all-purpose instruments. Almost certainly, there's a model to meet your exact requirements. All are precision instruments of highest quality. All embody the famous RC circuit pioneered by *-hp-*. Check the table below for the oscillator that can help you most. Then write us for complete operating and application details.

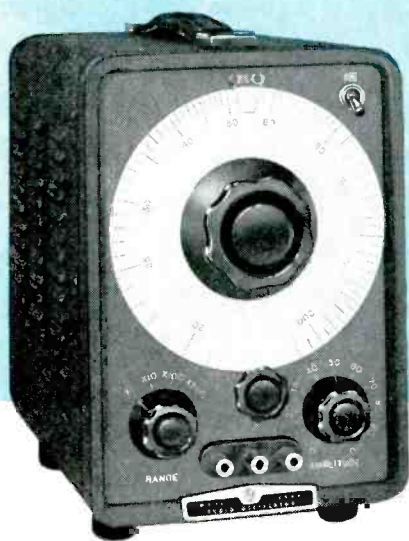

### -hp- 200CD AUDIO OSCILLATOR

World standard for electronic or electrical measurements, now redesigned with wider range, lighter weight, smaller size. Use for any lab, field or production problem in sub-audio, audio, telephony, carrier, supersonic, telemetering or rf measurement fields. Highest stability, low distortion, constant output, no zero set while operating. With carrying strap for bench or portable use; or for rack mounting.

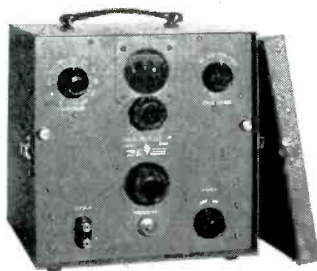

### -hp- 204A Battery-Operated Oscillator

Precision instrument for measurements 2 cps to 20 kc where ac power is not available. Compact, light weight, weather-proofed—extra rugged construction for field duty. Frequencies set and read directly on large dial. Particularly useful for telephone or remote broadcast line checks, strain gauge applications, telemetering and geophysical measurements. Provides completely hum-free signal. Operates from flashlight and 45-volt batteries. Output stable and constant throughout range.



### -hp- 650A Resistance-Tuned Oscillator

Highly stable, wide band (10 cps to 10 mc) oscillator particularly useful for testing television amplifiers, receiver alignment, bridge or carrier circuits, wide band systems; determining tuned circuit response. Operates independently of line or tube changes, requires no zero setting. Output flat within 1 db throughout range, monitored with VTVM. 60 db attenuator adjusts in 10 db steps.



### -hp- 202A Low Frequency Function Generator

Compact, convenient, all-purpose source of transient-free voltages between 1/100 cps and 1 kc. Provides distortion-free signals for vibration studies, servo applications, medical and geophysical work and other subsonic problems. Generates sine, square or triangular waves. Output 10 v RMS, balanced or single ended, 1% distortion, constant within 0.2 db.

Instrument	Primary Uses	Frequency range	Output	Price
-hp- 200AB	Audio tests	20 cps to 40 kc	1 watt/24.5v	\$120.00
-hp- 200CD	Audio and ultrasonic tests	5 cps to 600 kc	160 mw/20v open circuit	150.00
-hp- 200H	Carrier current, telephone tests	60 cps to 600 kc	10 mw/1v	350.00
-hp- 200I	Interpolation, frequency measurements	6 cps to 6 kc	100 mw/10v	225.00
-hp- 201B	High quality audio tests	20 cps to 20 kc	3w/42.5v	250.00
-hp- 202A	Low frequency measurements	.01 cps to 1 kc	20 mw/10v	450.00
-hp- 202B	Low frequency measurements	1/2 cps to 50 kc	100 mw/10v	350.00
-hp- 202D	Low frequency measurements	2 cps to 70 kc	100 mw/10v	275.00
-hp- 204A	Portable, battery operated	2 cps to 20 kc	2.5 mw/5v	175.00
-hp- 205A	High power audio tests	20 cps to 20 kc	5 watts	390.00
-hp- 205AG	High power tests, gain measurements	20 cps to 20 kc	5 watts	425.00
-hp- 205AH	High power supersonic tests	1 kc to 100 kc	5 watts	550.00
-hp- 206A	High quality, high accuracy audio tests	20 cps to 20 kc	+15 dbm	550.00
-hp- 230A	Carrier test oscillator	35 cps to 35 kc	+14 dbm/600 ohms	275.00
-hp- 233A	Carrier test oscillator	50 cps to 500 kc	3w/600 ohms	475.00
-hp- 234A	Carrier test oscillator	160 cps to 160 kc	+14 dbm/600 ohms	300.00
-hp- 650A	Wide range video tests	10 cps to 10 mc	15 mw/3v	475.00

*Data subject to change without notice. Prices f.o.b. factory*

## HEWLETT-PACKARD COMPANY

2711A PAGE MILL ROAD • PALO ALTO, CALIFORNIA, U.S.A.

SALES REPRESENTATIVES IN PRINCIPAL CITIES

Export: Frazar & Hansen, Ltd., New York City, San Francisco, Los Angeles



# Instruments for Complete Coverage

# They needed "arms" that never got tired

...so they came to Inco  
for Technical Aid

**Coded Track Circuit Control** — It's an ingenious signal control system for railroads. Electrical engineers of UNION SWITCH & SIGNAL — division of WESTINGHOUSE AIR BRAKE CO. — developed it.

This complicated electrical system guards trains on thousands of miles of rail across the country — sending out coded pulses that warn the engineer of conditions up ahead on the tracks. One code says "All clear" ... another "Slow down" ... absence of code, "Stop!"

Now a circuit like this required lots of experimenting and research to design.

And one of the problems was the metal for the arms of the pendulum-type armature in the code transmitters alongside the tracks.

The arms had to vibrate as much as 180 times a minute—up to 94 million flexings a year—without tiring. So, the metal of which they were made had to have exceptional resistance to fatigue as well as to extreme changes in weather—to corrosion as well as to impact.

The designers have tested many alloys but none has had all the necessary characteristics, except one — Duranickel — which they chose with the aid of Inco's Technical men.

In this tough, conductive, corrosion-resisting spring alloy they found the perfect solution to their problem. In all the many systems now installed, there has never been a single instance of failure.

**If you're being "side-tracked"**—Like trains, designs can sometimes be "side-tracked."

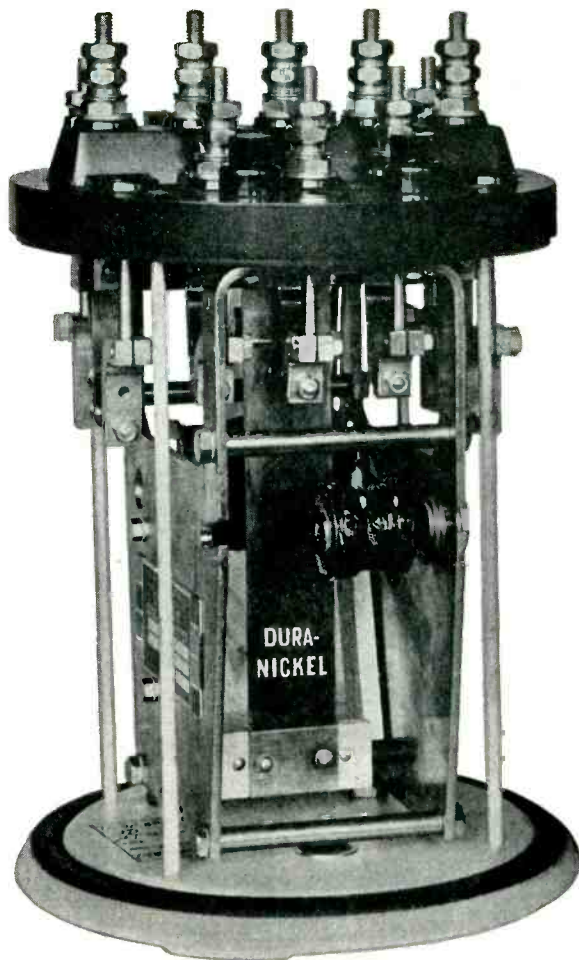

The arms of this pendulum-type armature are made of fatigue- and corrosion-resisting Duranickel. It transmits as many as 94 million pulses a year, and there has never been any failure due to this alloy.

They can be held up for many reasons — a tough metal selection problem, for example.

If you have such a problem, talk it over with an Inco Nickel Alloy engineer. Chances are he has the solution at hand. If not, he'll do his best to get it for you. And if you have a spring selection problem, Duranickel may be the answer. So write B. B. Winter at Inco, today, and ask for your free copy of technical bulletin T-32 on "Duranickel."

**THE INTERNATIONAL NICKEL COMPANY, INC.**  
67 Wall Street New York 5, N. Y.

## Inco Nickel Alloys

MONEL® • "R"® MONEL • "K"® MONEL  
"KR"® MONEL • "S"® MONEL • NICKEL  
LOW CARBON NICKEL • DURANICKEL® • INCONEL®  
INCONEL "X"® • INCOLOY® • NIMONICS®





**Six facts every  
engineer and scientist  
should know about the new**

# CRC 102-A

**Electronic Digital  
General-Purpose Computer**

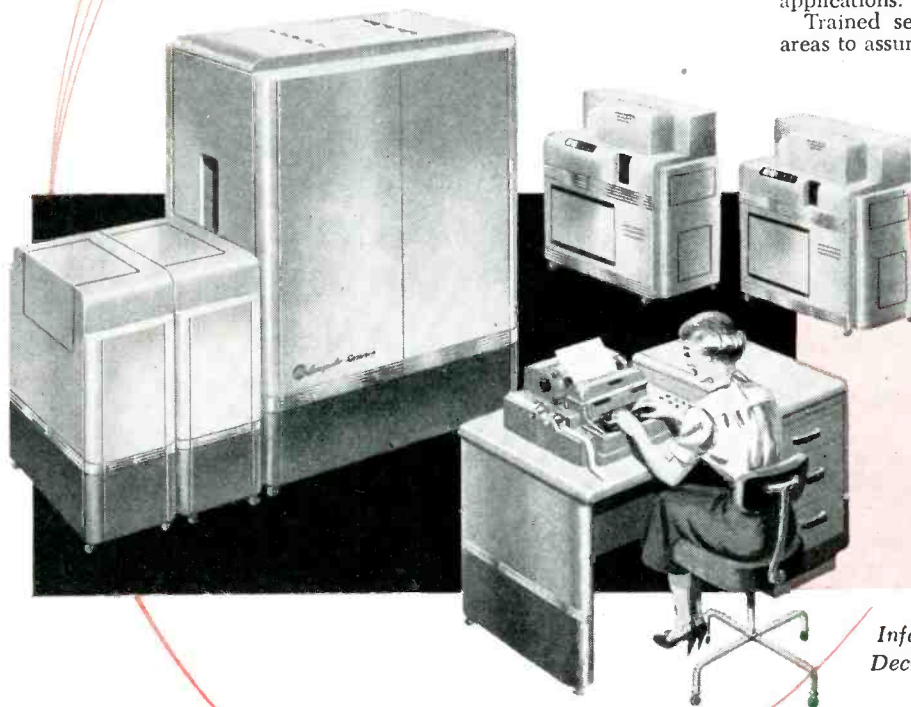

**1. LOW INITIAL COST**—The CRC 102-A is one of the lowest priced, large scale, digital electronic computers now available commercially. It may be purchased, rented, or leased with an option to buy. Performance guarantees are given as part of every lease contract.

**2. FAST AVAILABILITY**—Applying production-line techniques to the construction of the CRC 102-A has resulted in the shortest delivery time of any fully electronic, digital, general-purpose computer. Production schedules call for completion of one CRC 102-A every eight working days.

**3. WIDE CHOICE OF INPUT-OUTPUT DEVICES**—Data in either octal or decimal form may be entered into the CRC 102-A manually from a typewriter, automatically or semi-automatically from punched paper tape, and automatically from IBM cards or from computer-controlled magnetic-tape units.

The computer will print output data automatically on its typewriter in octal, decimal, or alphabetic form, perforate paper tape in octal or decimal form for reproducing hard copy or for re-entering data into the computer at some later time, punch octal or decimal data on IBM cards for use with punched card equipment, or record data on magnetic tape for later use.

**4. HIGH RELIABILITY**—The unique circuit design and relatively small number of vacuum tubes and other critical components in the CRC 102-A result in less down time due to machine failure. Complete plug-in circuitry and easily adjusted mechanical components speed up preventive maintenance checks. Each machine undergoes extensive shakedown tests and is operated under actual customer conditions in CRC's Computing Center before delivery to further assure high reliability.

**5. EASY PROGRAMMING**—Addition of "programmer's" commands, a test switch for program debugging, faster speeds, greater flexibility, and the wide selection of input-output equipment has greatly simplified programming procedures and increased the computer's capabilities.

**6. ADDITIONAL SERVICES ARE NOW AVAILABLE**—Programming sub-routines, application studies, and training courses on computer operation, are now available from CRC's Applications Division.

Facilities of the new Computing Center enable potential computer users to evaluate the CRC 102-A for their specific applications.

Trained service personnel are now available in most areas to assure proper maintenance of all CRC computers.

*For complete, detailed information on the new CRC 102-A write to the Director of Applications.*

## TYPICAL APPLICATIONS

- Wave Propagation Studies
- Network Analysis • Antennae Design
- Transient Analysis
- Electrical Power Distribution
- Servo Problems
- Solution of Partial Differential Equations
- Net Relaxation Problems

*Information is also available on the CRC 105 Decimal Digital Differential Analyzer and the CRC 107 Data Processing Computer.*

FIRST IN ELECTRONIC COMPUTATION

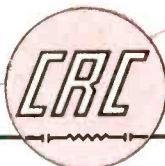

**Computer Research  
CORPORATION**

3348 WEST EL SEGUNDO BLVD., HAWTHORNE, CALIFORNIA

# A MAINE LOCATION Is A PROFITABLE LOCATION For The Electronics Industry

## MAINE GEARED TO THE ELECTRONICS INDUSTRY

- Experienced, Loyal Labor
- Exceptionally Fine Labor-Management Relations
- Favorable Tax Structure
- No State Income Tax
- Access to Major Markets
- Excellent Transportation
- Healthful, Productive, Climate
- Abundant, Economical, Power
- Unlimited Natural Resources
- Good Schools and Colleges
- And Maine is a grand place to live, to work, to play.*

**FREE** — Big, beautifully illustrated 36 page brochure giving facts and figures on Industrial Maine will be sent without cost or obligation to executives. Ask for it on your company stationery.

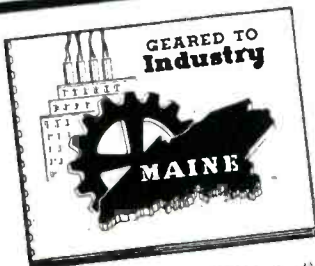

Whether you're moving, expanding or planning to establish a new concern, it will pay you to investigate the advantages of a plant in this fast growing industrial State.

Maine's industrial climate is exceptionally favorable for the Electronics industry.

- There's an ample supply of able, loyal home owning workers.
- The nation's finest Research facilities are close by.
- Labor-management relations are "tops". Strikes and dissension are virtually non-existent.
- There's no State Income Tax and real and personal property taxes, assessed at the local level, are fair and equitable.
- In Maine you'll have also the advantages of a small community location, and a modern efficient plant built to your specifications on a long term, low cost basis.
- You and your family will really enjoy living in Maine.

## Ask About The MAINE COMMUNITY PLAN

Our trained industrial engineers are at your service without cost or obligation, and your inquiry will be held in the strictest confidence. Write, wire or phone today — Now!

In the  
ELECTRONICS  
INDUSTRY  
the Trend's to  
MAINE

MAINE DEVELOPMENT COMMISSION State House, Augusta 9, Maine

It's the exclusive  
**AEROLENE** impregnant  
 that makes the difference . . .



Aerolite tubulars—hermetically-sealed metal-case units, with or without insulating jackets. Featuring vitrified terminal seal.



Space-saver metal-case Aerolites are available in rectangular-can and in bathtub housings, in widest range of terminals and mountings.

# AEROVOX

## HIGH-TEMPERATURE

### metallized-paper

## CAPACITORS\*

Don't overlook that *plus* factor—Aerolene. This unique, Aerovox-exclusive, solid-setting impregnant accounts for the higher temperature ratings of Aerolene units. For in addition to the usual advantages inherent in metallized-paper capacitors, there are further gains when the sections are solidly, ruggedly, permanently imbedded in solid Aerolene impregnant for maximum protection against heat and cold, moisture, vibration and roughest handling. Also hermetically-sealed to protect against leaks.

Aerolite (metallized-paper) capacitors with Aerolene impregnant, offer longer service life, lower radio-frequency impedance, and extended electrode construction with soldered connections at all electrical contacts. The accompanying graphs tell their own story of superior performance.

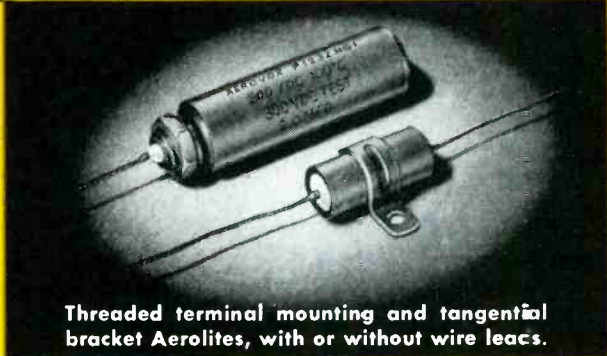

Threaded terminal mounting and tangential bracket Aerolites, with or without wire leads.

\***FUNCTION-FITTED!** Because Aerovox pioneered the metallized-paper development in this country, our engineers can provide outstanding application-engineering service. Let us collaborate with you on your circuits, associated components, operating conditions. Literature on request.

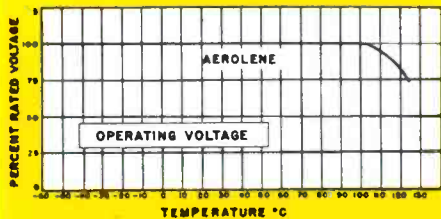

Temperature Range: Operating at working voltage equal to rated voltage over temperature range of minus 55° C to plus 100° C; and at working voltage equal to 75% of rated voltage up to 125° C.

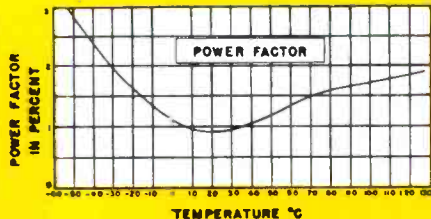

Power Factor: 1.5% or lower at 25° C, when measured at or referred to a frequency of 1000 cycles per second on capacitors up to and including 1.0 mfd., and when measured at or referred to frequency of 60 cycles, on capacitors greater than 1.0 mfd.

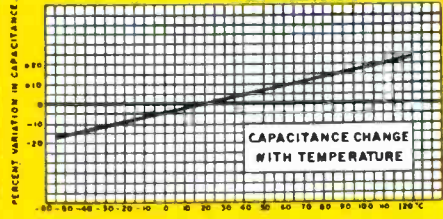

Nominal Capacitance up to and including 1.0 mfd. is measured at or referred to at frequency of 1000 cycles per second at 25° C. Capacitors above 1.0 mfd., measured at or referred to frequency of 60 cycles per second at 25° C.



# AEROVOX CORPORATION

NEW BEDFORD, MASS.

HI-Q<sup>®</sup> DIVISION  
 OLEAN, N. Y.

ACME ELECTRONICS, INC.  
 PASADENA 4, CALIF.

WILKOR DIVISION  
 CLEVELAND, OHIO

Export: 41 E 42nd St., New York 17, N. Y. • Cable: AEROCAP, N. Y. • In Canada: AEROVOX CANADA LTD., Hamilton, Ont. JOBBER ADDRESS: 740 Belleville Ave., New Bedford, Mass.

# Largest Vibration Exciter

## Ever Built

- ▶ *New MB shaker delivers 10,000 pounds force output!*
- ▶ *Widens scope of vibration testing to MIL-E-5272 and other specifications!*

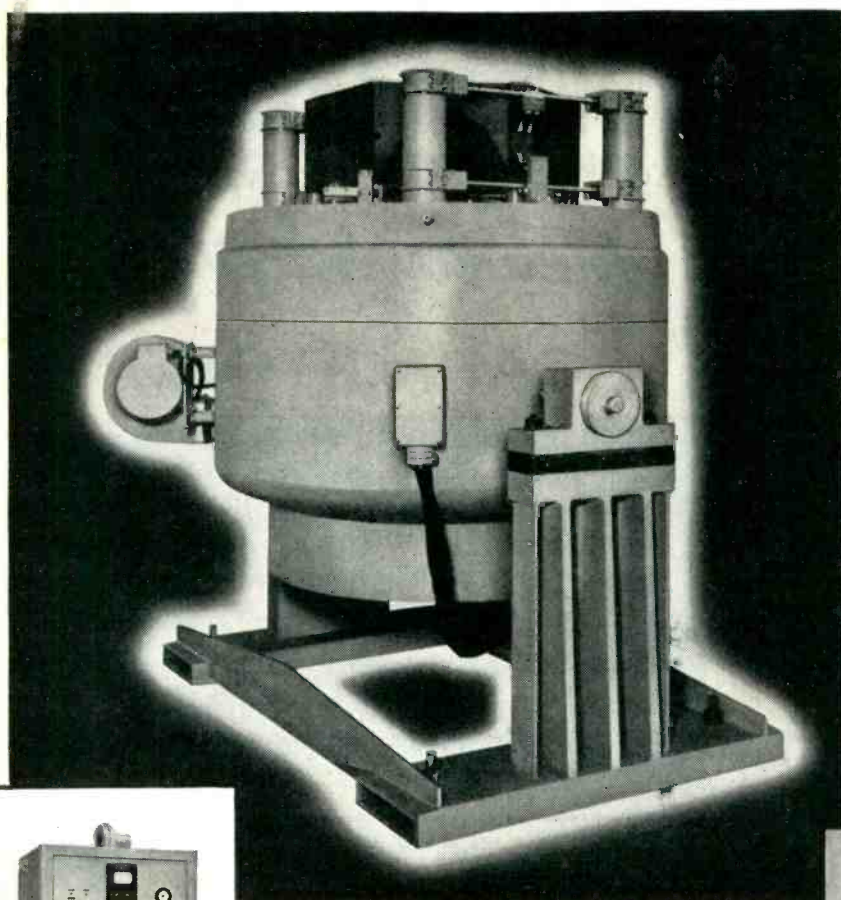

**H**ERE'S the latest—and the largest—vibration exciter ever built for shake testing. Developed by MB vibration specialists, this unit incorporates all the advances made in the last seven years for assuring dependable operation, pure table motion, and absence of resonances. These include specially designed table flexures, forced air cooling, built in protection against overtravel of the table and against misoperation of the equipment.

This extra heavy duty, conservatively rated, electromagnetic shaker has the capacity and endurance to permit continuous testing at rated output. It will handle anything from electrical components to air-frame structures.

Remember—available MB Vibration Exciters now range from 5 pounds output size all the way up to this new giant. Make MB your headquarters for help on vibration testing and other problems.



**MODEL C-100 VIBRATION EXCITER** has 1/2" total table travel. Flexure design supports heavy table loads without sacrificing stroke. Trunnion support permits operation in all positions from horizontal to vertical, and has built-in vibration isolation. Operating range: 5 to 500 cps.

◀ **CONTROL PANEL (Model T-100)** assures proper operation of equipment with interlocked controls. Accurate, easy, continuous control of force and frequency permits quick adjustments, or "scanning" over entire operating range. MB Vibration Meter provided; also running time meter.

▶ **ROTATING POWER SUPPLY** rated to deliver full power without need for power factor correction. Blowers cool each unit separately. Alternators feed driver coil of shaker, with minimum harmonic distortion.

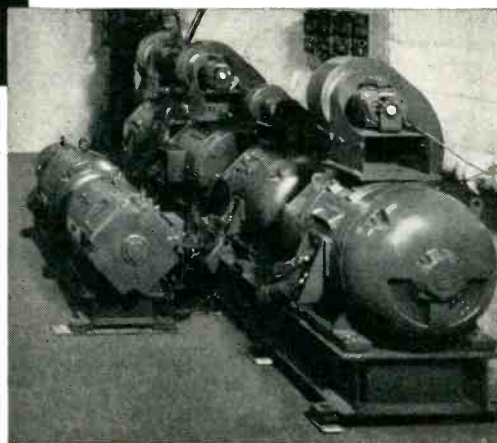

**THE MB MANUFACTURING COMPANY, INC.**  
1060 STATE STREET, NEW HAVEN 11, CONN.



**BULLETIN TELLS MORE**  
Contains specifications, operating information and helpful hints on usages of the complete line of MB Exciters. Write for Bulletin 1-VE-5.

PRODUCTS AND EQUIPMENT TO CONTROL VIBRATION • TO MEASURE IT • TO GENERATE IT

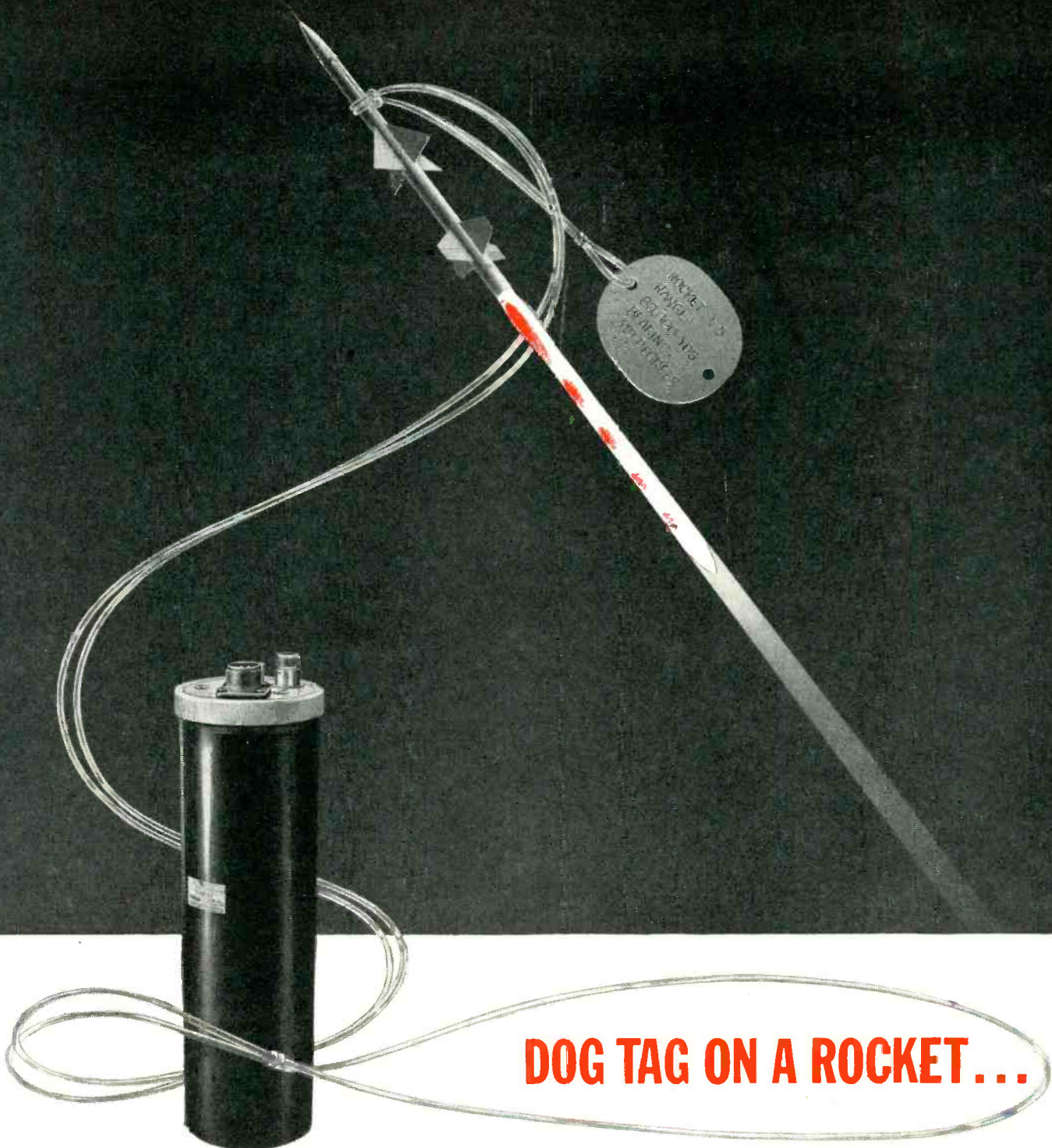

## DOG TAG ON A ROCKET...

Rockets are elusive weapons which are frequently lost in the radar scope. These fast flying missiles present a minimum target which is hard to track.

But now a Bendix-Pacific Radar Beacon is installed in the missile to provide a reinforced echo that is easily observed—like an identifying dog tag. These Beacons, which weigh only 5½ pounds incorporate both a receiver and a transmitter, providing a powerful signal which is retransmitted in 2 microseconds. In addition to use in missiles, the Bendix-Pacific Beacons simplify air traffic control prob-

lems, reduce the time of locating targets for airborne radar checkout and, in effect, increase the size of target drones to simulate larger aircraft.

The importance of Bendix-Pacific electronic developments in airborne radar, radio control, telemetering and missile guidance have brought about rapid expansion of this company's engineering and manufacturing facilities. Three plants and a highly specialized group of electronic engineers are available to develop and produce advanced applications to meet your requirements. Your inquiry is invited.

### ATTENTION ENGINEERS...

Bendix-Pacific has a few openings for thoroughly qualified engineers in sonar, radar, servomechanisms and telemetering. For those seeking a challenging future under ideal Southern California living conditions, Bendix-Pacific offers worthwhile opportunity. Your inquiry will be considered in strict confidence.



AIRCRAFT HYDRAULIC CONTROLS • AIRBORNE RADAR • SONAR • INDUSTRIAL HYDRAULIC CONTROLS • TELEMETERING • ELECTRO-MECHANICAL EQUIPMENT

One of the typical groups of Speedomax Recorders used on recording panels at Bell Aircraft Corporation's Test Center. Patch board in the center of the panel provides flexibility in charting rocket development data.

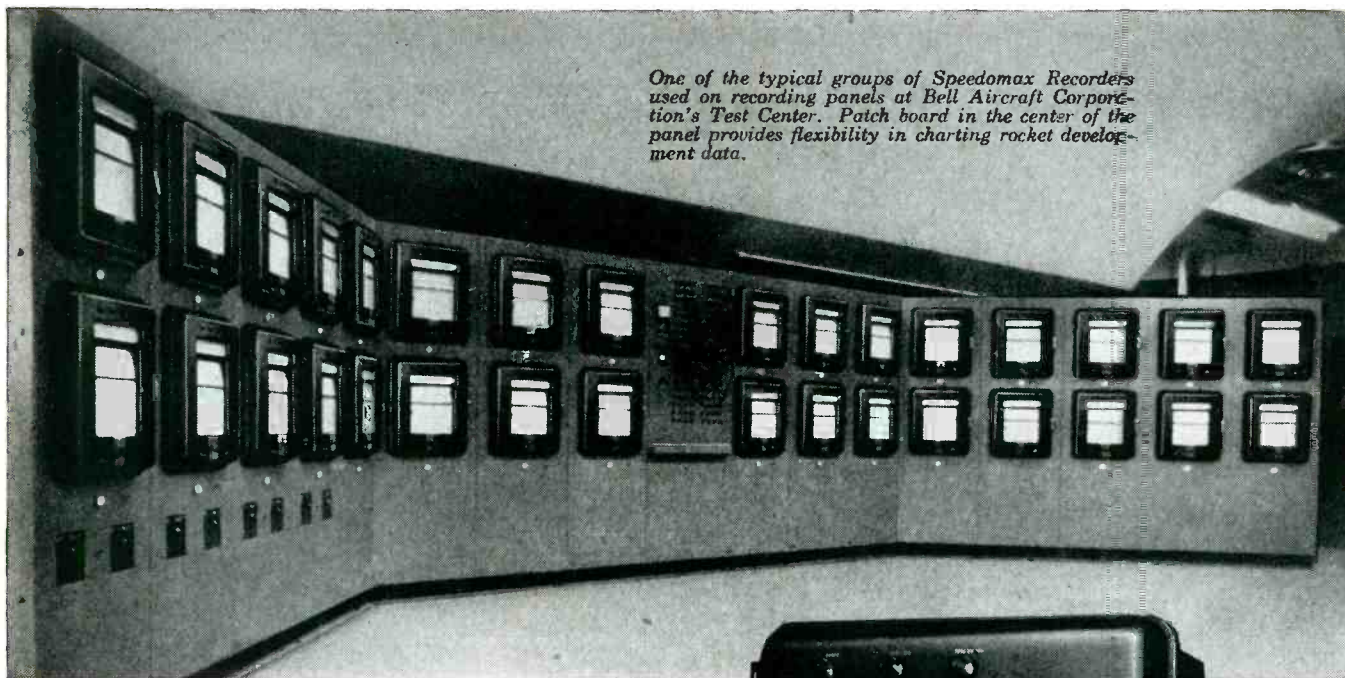

Just set the knobs at top of instrument for the desired range and zero, and this AZAR recorder is adjusted to your exact specs . . . spreads any millivolt value from one to twenty across the full chart width, for measuring Force, Weight, Temperature, Speed, Voltage or any condition which yields an electrical recorder signal.

**COMPLEX  
ROCKET-TESTING  
ROUTINES**

*Simplified*

by Speedomax® adjustable-zero adjustable-range Recorders

● Rocket engine development at Bell Aircraft Corp., of Buffalo, N. Y. involves several unique instrument requirements. The nature of rocket combustion problems demands highly versatile instruments . . . instruments that can be dial-set to meet a wide variety of new test conditions. Furthermore, the instruments must also simultaneously record a combination of motor parameters. The highly flexible Speedomax adjustable zero adjustable range (AZAR\*) Recorder provides Bell with just the right instrument combination for speedy, accurate test results.

Data for use in the engineering, designing and testing of rocket motors are obtained from pressure, temperature, force and flow measurements. Electronic transducers provide a d-c voltage proportional to the quantity measured; this signal is relayed to the AZAR Recorders through the patching network located in the center of the panel.

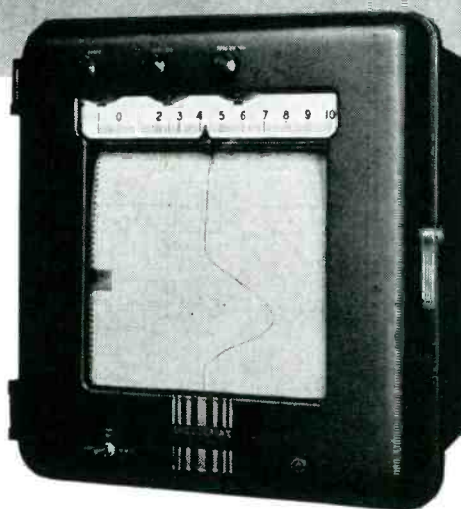

Various types of primary elements are used because of the extreme ranges encountered. All recorders are read in millivolts and converted to the measured quantity during data reduction. Adjustment of the range and zero makes it possible to read any pre-selected portion of the instrument scale.

Duplicate information is relayed to remotely located consoles for the convenience of engineers at the test stands. This is accomplished by electrical signals fed from the retransmitting slidewires of the recorders. Jog pen (used at Bell for time correlation between machines) and other accessory features to meet individual requirements can be incorporated in the versatile AZAR Recorder.

A general description of this instrument is available, and will be especially useful if you can describe to us the nature of your recording problem. Contact our nearest office or write 4979 Stenton Ave., Philadelphia 44, Penna.

\* L&N Trademark



Jrl. Ad. EM9(4)

# IF YOU USE ENCLOSURES, CHASSIS AND RACKS LIKE THESE...



**KARP** SHEET METAL FABRICATIONS  
WILL MEET YOUR HIGHEST  
STANDARDS OF QUALITY

**KARP** FABRICATIONS WILL CUT  
YOUR ASSEMBLY COSTS

**KARP** FABRICATIONS  
ARE COMPETITIVELY PRICED...  
FOR LONG RUNS OR SHORT

**W**ith a Karp-built enclosure, chassis or rack, every dimension is correct; every hole accurately located. Your production costs are cut, for your components are easily assembled. No more slow-downs due to poorly built cabinets. And Karp Metal will supply you with these custom-built fabrications at competitive prices. Let us help you with your sheet metal problem. Send us your blueprints—we'll promptly quote prices and delivery.

## **KARP METAL PRODUCTS CO.**

*Division of H & B American Machine Company*  
215 63RD STREET, BROOKLYN 20, N. Y.

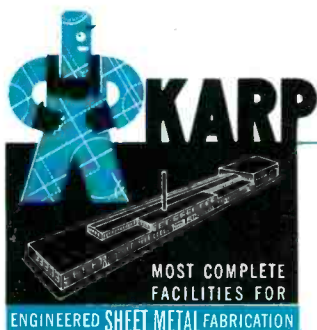

### **FACILITIES**

**FOR ENGINEERED SHEET METAL FABRICATIONS:** in aluminum or steel  
long run or short • spot, arc, gas or heliarc welding • any type finish.

- Modern plant—3 city blocks long
- Thousands of dies available
- Most modern of sheet metal fabricating equipment
- U. S. Air Force Certified Welding Facilities
- Air-conditioned spray room... complete baking facilities
- Complete sub-assembly facilities

### DIODE FILTERS

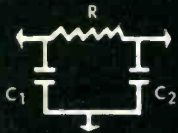

1403-01 1403-02  
1403-03

### TRIODE PLATE COUPLERS

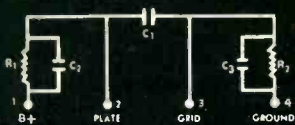

1404-01 1406-01  
1404-02 1406-02

### VERTICAL INTEGRATOR

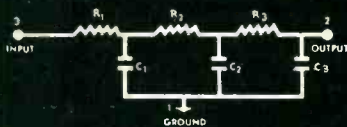

1405-01

### PENTODE PLATE COUPLERS

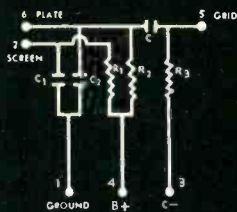

1407-01 1407-02  
1407-03

### AUDIO OUTPUT CIRCUITS

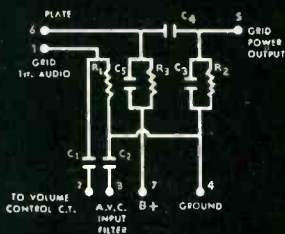

1408-01 1408-02

# ERIE

## electronic printed circuits

**PERFECTED BY MORE THAN  
A DECADE OF DEVELOPMENT**

### ... OFFER THESE ADVANTAGES

Fewer soldered connections mean less installation time.

Fewer connections mean fewer wiring errors.

Circuit stability is improved through simplification.

Costs for procurement and stock maintenance are considerably reduced.

Space is saved by substituting a single installation for several installations.

Reduced space requirements permit reduced size and weight of complete product.

Other material costs are reduced by smaller size, lighter weight.

**E**RIE Electronic Printed Circuits achieve miniaturization by bonding the complete or partial circuit to a ceramic base plate, thus combining the work of several capacitors in one installation unit.

Erie began the development of Printed Circuits in 1940, and today they are widely used by manufacturers of electronic products to effect a reduction in size, weight, and cost; and to improve performance. ERIE Electronic Printed Circuits have helped to solve design and production problems in radio and television receivers, hearing aids, military equipment, and many other products employing electronic control. Write for catalog and samples.

*ERIE components are stocked at leading  
electronic distributors everywhere.*

**ERIE**  
RESISTOR CORP.

**ERIE RESISTOR CORPORATION** . . . ELECTRONICS DIVISION

Main Offices: **ERIE, PA.**

Sales Offices: Cliffside, N. J. • Philadelphia, Pa. • Buffalo, N. Y. • Chicago, Ill.  
Detroit, Mich. • Cincinnati, Ohio • Los Angeles, Calif.

Factories: **ERIE, PA. • LONDON, ENGLAND • TORONTO, CANADA**



# HALLETT



# HALLETT

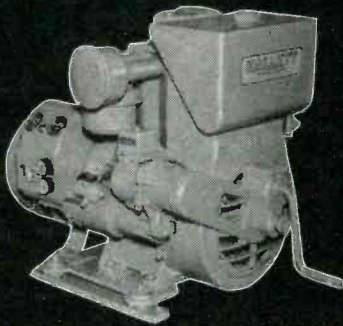

# HALLETT

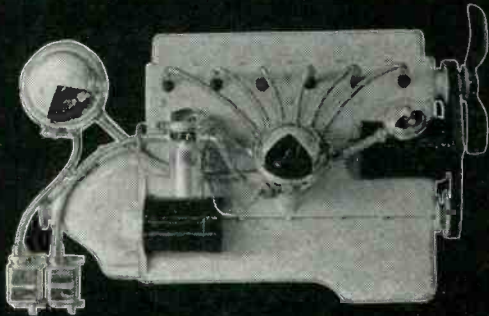

## HALLETT MANUFACTURING COMPANY

Main Plant: 1601 West Florence Avenue, Inglewood, California, Oregon 8-4751; District Sales Offices: Washington, D.C., 13th and E Streets, District 7-0217; Detroit, Mich., Book Tower Bldg., Woodward 1-9553; New York, N.Y., Grand Central Bldg., Murrayhill 3-4752; Chicago, Ill., 600 South Michigan Blvd., Wabash 2-1343.

### QUICK DISCONNECT COUPLINGS FOR COAXIAL CABLE USE

Investigate the advantages of compact, lightweight Hallett Quick Disconnect Couplings for coaxial cables, TV and radio installations, computers, etc. Manufactured to meet rigid military specifications and all vibration and thermal shock tests. Write for catalog and prices.

### DIESEL ELECTRIC GENERATOR SETS

Hallett dependable full Diesel power from 2½ KW to 10 KW in both water and air cooled models for standby power, portable, mobile and stationary units — also available, bare engines with power take-offs for all power applications from 5 HP to 18 HP. Write for catalog concerning your power requirements.

### RADIO INTERFERENCE REDUCTION AND CONTROL EQUIPMENT

Stock kits for most engines and tailor-made for special applications. Hallett radio interference reduction and control equipment is the standard of the industry — positively shields out all noise indefinitely. Manufactured in accordance with Government specifications. Technical data upon request.

Gentlemen: Please send me more information concerning:

- Hallett Diesels
- Quick Disconnect Couplings for Coaxial Cable Use
- Radio Interference Reduction and Control Equipment

Name \_\_\_\_\_

Firm Name \_\_\_\_\_

Address \_\_\_\_\_

City \_\_\_\_\_ Zone \_\_\_\_\_ State \_\_\_\_\_

For *Critical* Applications  
**Triplett 630-A Has No Counterpart**

*Accuracy*  
 to 1½%

*Readability*  
 with a Mirror-Scale

*Adaptability*  
 with ½% resistors

Try This Volt-Ohm-Mil-Ammeter  
 at your distributor's



TRIPLETT ELECTRICAL INSTRUMENT CO., BLUFFTON—

OHIO

# DURAMEG<sup>®</sup>

## ACCURATE WIREWOUND RESISTORS

### ABOVE AND BEYOND MIL-R-93A SPECIFICATIONS



**DURAMEG wattage ratings are based on full rated dissipation at 105° ambient. These ratings are from 4 to 5 times the 85°C MIL ratings for the best of conventional resistors.**

DURAMEG Resistors pioneered and proved new performance records for reliable, high-accuracy wire-wound resistors. They're molded under high pressure and temperature in mineral-filled, dense phenolic—impervious to moisture—for positive protection against electrolysis failure. They'll even withstand the salt water immersion cycling for characteristic A in the former specification JAN-R-93. Installations require no secondary insulation for mounting. Yes, they're also tough and resistant to high mechanical damage.

The long-term stability of Durameg Resistors offers a new scope of performance to equipment

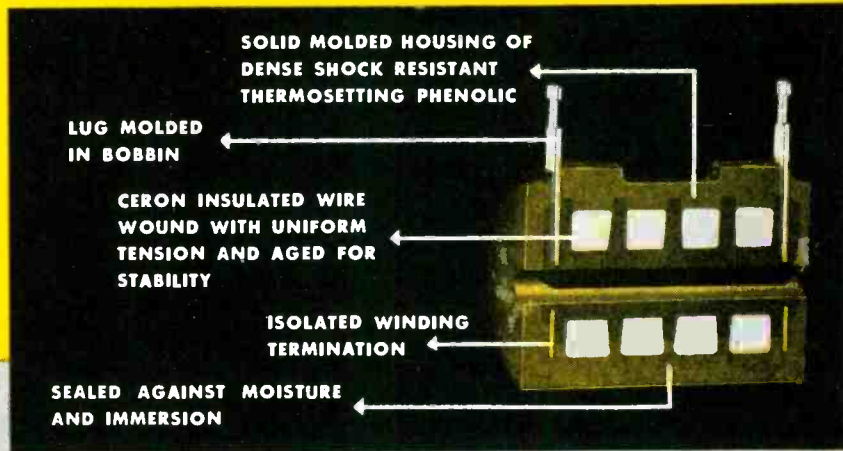

designers who must consider initial resistance tolerance of resistors as well as shifts in value with repeated thermal cycling and with age. With Durameg stability, you can design now for permanent peak performance!

Duramegs are the first accurate resistors that operate up to a hot spot temperature of 150°C as against the usual 105°C limit—made possible with Sprague's patented ceramic-insulated Ceron resistance wire. The unique combination of Ceron wire, Durameg molding technic and aging treatment, permits dissipation of full rated wattage at 105°C—the same temperature at which MIL ratings prescribe zero % dissipation!

DURAMEG Resistors are now available for commercial applications in dimensions identical to MIL styles. We will be glad to send you complete data upon request. ★ ★ ★ ★ ★



**WRITE, WIRE OR PHONE FOR  
ENGINEERING BULLETIN 120**

●  
SPRAGUE ELECTRIC COMPANY  
35 Marshall Street, North Adams, Mass.

# SPRAGUE

PIONEERS IN ELECTRIC AND ELECTRONIC DEVELOPMENT

EXPORT FOR THE AMERICAS: SPRAGUE ELECTRIC INTERNATIONAL LTD., NORTH ADAMS, MASS. CABLE: SPREXINT

# Do you have any of these problems?

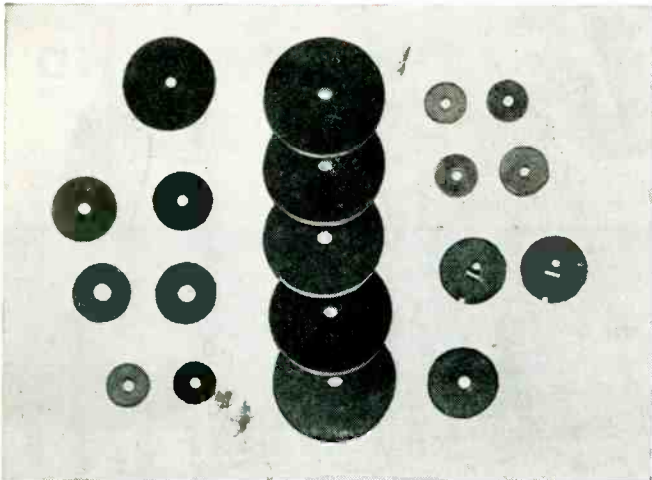

**1. Need a combination of gasket sealing and mechanical and electrical properties?** Various grades of LAMICOID®—laminated plastic made with organic and inorganic binders—are combined with natural or synthetic rubber to obtain the excellent insulating and mechanical properties of LAMICOID and the sealing properties of rubber.

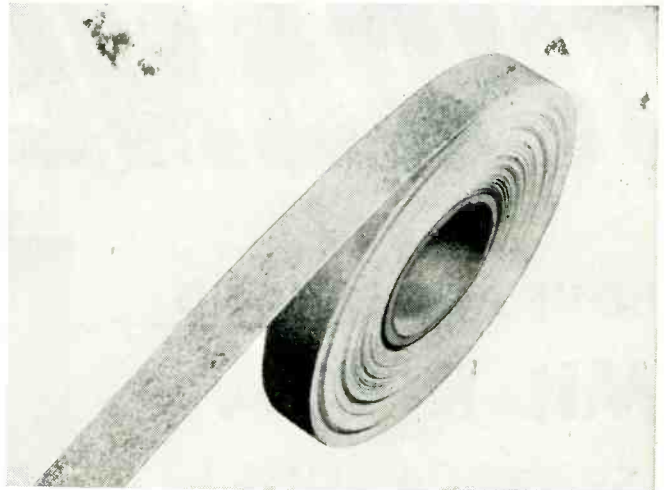

**2. Need a mica tape that can be run on taping machines at high speed?** ISOMICA® tapes are made from long rolls of thin continuous mica sheet... are more uniform in mechanical and dielectric strength... have no high spots or voids. For electrical insulation of class B or class H motors, generators and transformers.

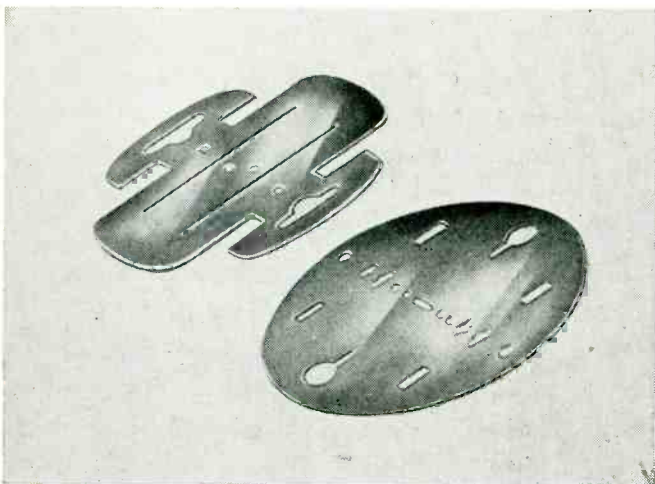

**3. Need accurately punched mica stampings for filament, grid and plate supports?** MICO produces mica stampings to extremely fine tolerances. Whenever you need precision-fabricated mica parts of the highest quality, call on MICO. We have 60 years of experience in this field.

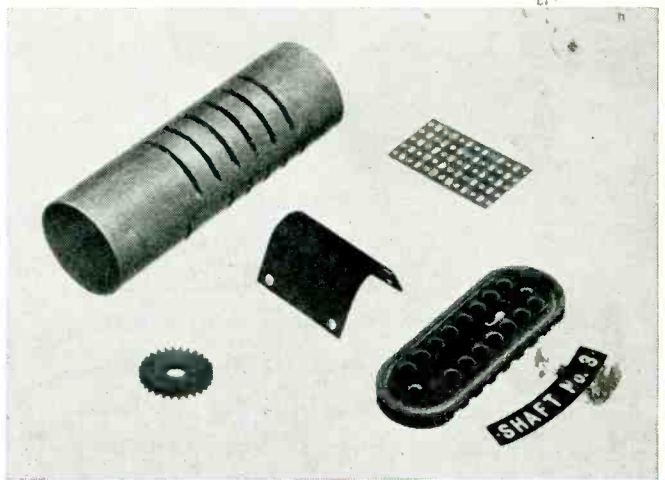

**4. Need special mechanical and electrical properties for brackets, terminal blocks, access panels, etc.?** LAMICOID® is half as heavy as aluminum and, weight for weight, stronger than steel. Offers high impact strength, high dielectric strength, excellent abrasion and moisture resistance.

Whatever electrical insulating materials you need, MICO makes them best. We manufacture all standard types and many special materials, and fabricate parts to your specifications. Send us your blueprints or problems today.

*\*Trademark*



**MICA** *Insulator* **COMPANY**

Schenectady 1, New York

Offices in Principal Cities

LAMICOID® (Laminated Plastic) • MICANITE® (Built-up Mica) • EMPIRE® (Varnished Fabrics and Paper) • FABRICATED MICA • ISOMICA®

# Who put those teeth in the F3D?



among others,

**DALMO VICTOR**  
SAN CARLOS · CALIFORNIA

**DV**

## One typical DV Development



### ANTENNA PATTERN CHECKING

One of the problems of speeding radar-antenna production output has been solved at Dalmo Victor through the development of special automatic space-pattern recording equipment, illustrated. This apparatus reduced final check-out time on each antenna system from the two hours required by the former hand-plotting method to 15 minutes.

Ability to seek out aircraft in flight and score direct hits without visual contact is given to the Douglas F3D Skyknight through radar equipped with search and tracking antennas designed, developed and manufactured by the unique specialist staff of Dalmo Victor Company.

Perhaps you have a problem in the design-through-production engineering of a complex, lightweight, electromechanical device. If so, Dalmo Victor can help.

**DOWN-TO-EARTH ENGINEERING FOR THE WILD BLUE YONDER**

Up where the

# ATOMIC BOMB LETS GO

Split Seconds Seem Like Eternity

...the nuclear device itself must be armed and fired. These and hundreds of similar details must be taken care of without fail in proper order and at predetermined times in order that the desired information be obtained. This control is provided by a device known as a "sequence timer" located in the control room. The device sends out electric signals which acti

THIS EXCERPT from the "Guide for Observers' Tour of the Control Point and Forward Area, Nevada Proving Grounds" highlights the importance of equipment capable of accurately measuring elapsed time down to unbelievably short intervals.

The first section of the panel shown below is used only for air bursts. The second and third sections contain the frequency control equipment for the motor-generator set which supplies power to the timing equipment, with voltage recorders connected to various points in the target area — thus assuring accurate timing — and recorders for wind velocity and direction. In order to activate test equipment at the exact time, very precise control of the frequency for the timer is required ... The precision timers on the fourth and seventh sections are by STANDARD.

*Complex instrument panel in Control room of Control Point, Yucca Pass, Nevada Proving Grounds*

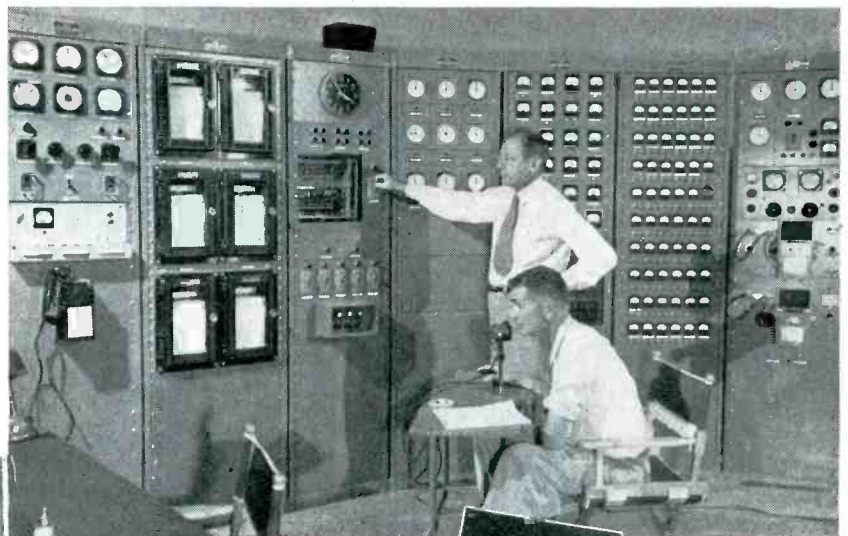

**The STANDARD ELECTRIC TIME COMPANY**



97 LOGAN STREET • SPRINGFIELD 2, MASSACHUSETTS

Since 1884

PRECISION TIMERS • CHRONO-TACHOMETERS • LABORATORY PANELS • PIPELINE NETWORK ANALYZERS

# A New Approach in Economical Side-Band Filters

**TOMORROW'S FILTERS TODAY** .. is .. **A STEP FORWARD** ..

IN COMMUNICATION NETWORK COMPONENTS

*Burnell* SINGLE SIDE-BAND FILTERS



Single side band reception of space carrier telegraph and telephone transmissions, despite the improvement in reception attributable to its use, is still considered to be in its embryonic stage. Elimination of the quality of the modulation products, and the attainment of mono-band reception of the intelligence transmitted, has always been the apotheosis of communication engineers. Probably the greatest single factor that has precluded the rapid advancement of single side band systems, has been the excessive cost of the carrier and side band filters. Filters presently produced consist of a complex array of crystals and L. C. networks, which represents not only an expensive design but one not readily obtainable.

BURNELL & COMPANY'S new approach to this problem, not employing crystals, is based on the use of a system having a 25KC carrier and the exclusive embodiment of toroidal coils in a highly engineered circuit of temperature stabilized and temperature compensated components to produce the sharp-sided curve required in this system.

*Burnell & Company*  
YONKERS 2, NEW YORK  
CABLE ADDRESS: "BURNELL"

**TOMORROW'S FILTERS TODAY** .. is .. **A STEP FORWARD** ..

IN COMMUNICATION NETWORK COMPONENTS

*Burnell* SINGLE SIDE-BAND FILTERS



The use of the 25KC carrier is a major advance in the design of side band filters. Primarily, it establishes a better ratio between the carrier frequency and the cut off frequency which, together with the aid of ingenious circuitry and materialized molybdenum permalloy toroidal cores, obviates the necessity for quartz crystals. The end result is a tremendous saving in size and weight, producing filters which are a fraction of the size of the former crystal filters. Typical dimensions are 1 3/4" x 6" x 2 1/2" and weight 1 1/2 lbs.

In offering these advantages BURNELL & COMPANY has taken not one but five steps forward by offering single side band filters which are:

- 1) LESS EXPENSIVE
- 2) MUCH SMALLER
- 3) MUCH LIGHTER
- 4) MORE RUGGED
- 5) MORE AVAILABLE

*Burnell & Company*  
YONKERS 2, NEW YORK  
CABLE ADDRESS: "BURNELL"

**and OPENS NEW DOORS** .. in ..

IN COMMUNICATION NETWORK COMPONENTS

*Burnell* SINGLE SIDE-BAND FILTERS



The potential demand for single side band equipment has up to now been restrained behind the "locked doors of frustration", so to speak, but we feel that we are helping to unlock those doors and release an even greater demand for side band equipment small enough and inexpensive enough to reawaken the interest of communication equipment manufacturers in this field for

both civilian and military application. In the latter field single side band systems were virtually prohibitive because of the inaccessibility of crystal filters for field use. The BURNELL system now eliminates all the objectionable features.

*Burnell & Company*  
YONKERS 2, NEW YORK  
CABLE ADDRESS: "BURNELL"

**HIGH SPEED COMMUNICATIONS**

IN COMMUNICATION NETWORK COMPONENTS

*Burnell* SINGLE SIDE-BAND FILTERS

In addition to the carrier, lower side band and upper side band filters illustrated here, there is available a low pass filter for the demodulation circuit. There is also available for wider band operation side band filters having a 6KC pass band, with the same dimensions and weight.

By adding this group of filters to our existing series of multiplex filters we can, with pride, state that BURNELL & COMPANY has gone a long way toward assisting the communications industry to develop high speed communications resulting from more efficient operation and greater freedom from interference.

If you are an engineer in "communications", you will be interested in our brochure describing the BURNELL single side band filters in greater detail.

*Burnell & Company*  
YONKERS 2, NEW YORK  
CABLE ADDRESS: "BURNELL"

from a  
SINGLE  
SOURCE

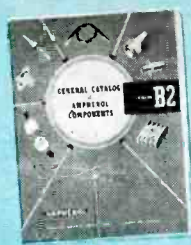

**Amphenol builds to the future of Electronics...**

AN Connectors    RF Connectors  
Cables    Cable Assemblies    Sockets

The electronics industry finds AMPHENOL their prime supplier of all of the above components and for very good reasons. Engineers specify AMPHENOL because of the tested *quality* of each AMPHENOL part. Expert manufacture and close production control guarantee this quality—assure the perfection that is a must in electronic components. Purchasing agents delight in the fact that AMPHENOL represents a *single source* for the majority of their needs. They know that the AMPHENOL line represents the most complete listing of connectors, cables and sockets in the world: over 9,000 cataloged items in steady production from AMPHENOL's five plants! And if a special part is needed, AMPHENOL engineers will work in close cooperation with industry to either develop a totally new component or modify an existing one. AMPHENOL's years of experience in electronics are always at the disposal of industry.

*The complete AMPHENOL line is represented in the following catalogs:*

**A-2 AN CONNECTORS** For power, signal and control circuits in aircraft and electronics equipment.

**B-2 GENERAL CATALOG OF AMPHENOL COMPONENTS.** A condensed listing of all AMPHENOL products.

**C-3 METHODS MANUAL** A presentation of assembly procedures of electrical connectors and components.

**D-2 RADIO FREQUENCY CABLES AND CONNECTORS** A complete listing including valuable engineering data of AMPHENOL RF Components.

AMERICAN PHENOLIC CORPORATION  
chicago 50, illinois

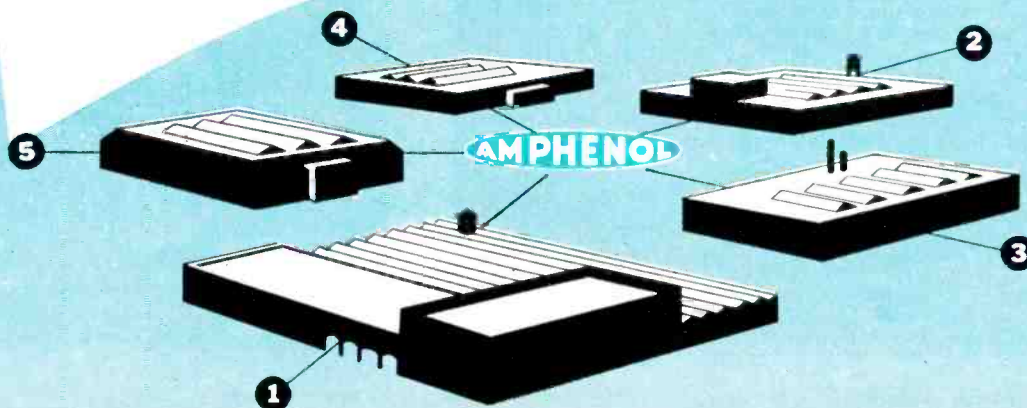



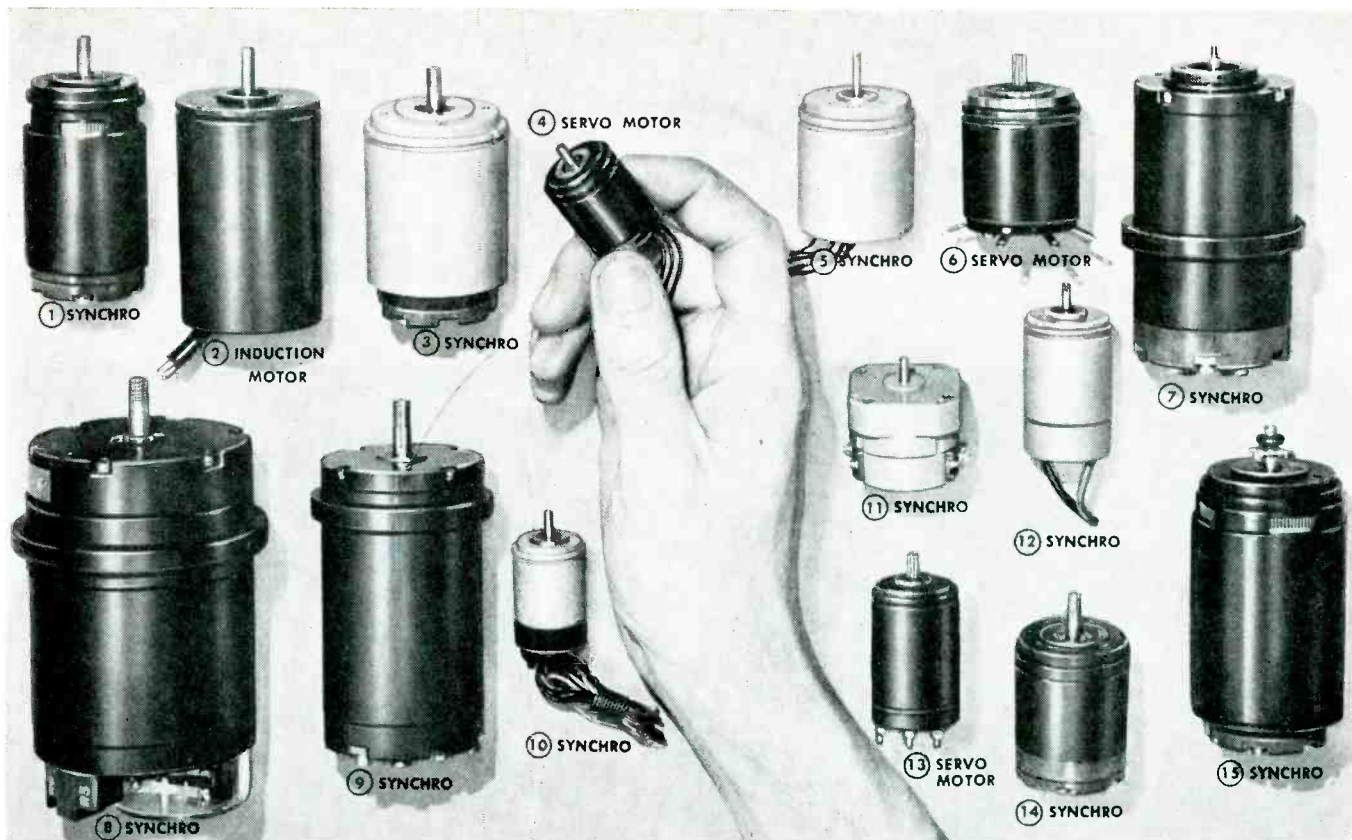

# *Ketay* gives you a complete variety of sizes and types of Synchros and Servo Motors

**WHATEVER THE NEED  
CHOOSE KETAY!**  
*Available as listed*

1. SYNCHRO, Size 16, O.D. 1.537", 115 V, 400 Cycles  
(Transmitter, Receiver, Control Transformer)
2. INDUCTION MOTOR, O.D. 1.750", 3 phase 2 Pole, 115 V, 60 Cycles
3. SYNCHRO, Size 18, O.D. 1.750", 115 V, 400 and 60 Cycles  
(Transmitter, Receiver, Differential, Control Transformer)
4. SERVO MOTOR, O.D. .937", 26V, 400 Cycles
5. SYNCHRO, O.D. 1.437", 11.1 V and 26 V, 400 Cycles  
(Transmitter, Receiver, Resolver, Differential, Control Transformer)
6. SERVO MOTOR Mk 7, O.D. 1.437", 115 V, 400 Cycles
7. SYNCHRO, Type 1F or 1HG, O.D. 2.250" 115 V, 60 Cycles  
(Receiver, Transmitter)
8. SYNCHRO, Size 31, O.D. 3.10", 115 V 400 and 60 Cycles  
(Transmitter, Receiver, Differential, Control Transformer)
9. SYNCHRO, Size 23, O.D. 2.250", 26 V and 115 V 400 & 60 Cycles  
(Transmitter, Receiver, Resolver, Differential, Control Transformer)
10. SYNCHRO, O.D. .937", 26 V, 400 Cycles  
(Transmitter, Receiver, Resolver, Differential, Control Transformer)
11. LINEAR TYPE CONTROL TRANSFORMER, O.D. 1.625", 26 V, 400 Cycles
12. SYNCHRO, Size 11, O.D. 1.062", 26 V and 115 V, 400 Cycles  
(Transmitter, Receiver, Resolver, Differential, Control Transformer)
13. SERVO MOTOR, O.D. 1.062", 115 V, 400 Cycles
14. SYNCHRO, Size 15, O.D. 1.437", 26 V and 115 V, 400 Cycles  
(Transmitter, Receiver, Resolver, Differential, Control Transformer)
15. SYNCHRO, Size 19, O.D. 1.90", 115 V, 400 Cycles  
(Transmitter, Receiver, Control Transformer)

**KETAY** offers high precision rotary and instrument components for most every need in the Armed Forces and Industry. As the world's largest producer of government approved synchros, Ketay stands ready to solve your problems with a complete line of synchros, servos, magnetic amplifiers, computers and control systems.

If you are searching for a specific size or type... if availability is a problem... if engineering counsel is needed... Ketay can help. Why not join us for an exploratory discussion of your particular problem. Write today to Dept. C

**Ketay** **MANUFACTURING CORP.**  
555 Broadway, New York 12, N. Y.  
PACIFIC DIVISION  
12833 Simms Ave., Hawthorne, California

**DESIGN**

**DEVELOPMENT**

**MANUFACTURE** ... of precision instruments, components, and systems.

- KINETIX INSTRUMENT DIVISION
- RESEARCH & DEVELOPMENT DIVISION

*for* **BRASS** *Bridgeport Service*  
CO.



**OFFICES AND  
WAREHOUSES IN  
PRINCIPAL CITIES**



## **BRIDGEPORT WAREHOUSE SERVICE**

The Bridgeport warehouses are designed to supply from stock limited quantities of sheet, rod, wire or tubing. It is the policy of the company to maintain adequate warehouse stocks at all times so that small orders can be filled without delay.

The fabricator is in a position to obtain promptly metal to fill orders for experimental work or to start production runs, while waiting for mill shipments.

Bridgeport warehouses make every effort to carry the variety of alloys, sizes and gages which fulfill the requirements of the locality they serve.

To take care of the maximum range of widths of strip metal, slitting service is available—not only to serve warehouse stocks, but also to make customers' stocks of non-ferrous strip metal more flexible.

Bridgeport's Warehouse Stocklist carries weight tables and a technical digest giving the properties of the most popular copper-base alloys. If you do not have a copy, ask your nearest Bridgeport office.

*Mills in Bridgeport, Conn. and Indianapolis, Ind.*

*In Canada: Noranda Copper and Brass Limited, Montreal*

## **BRIDGEPORT BRASS COMPANY**



**30 GRAND STREET, BRIDGEPORT 2, CONNECTICUT**

# SORENSEN

# *electronically*

**REGULATES  
AND CONTROLS**



Model 2000S

**FREQUENCY**

**AC  
LINE**

**HIGH VOLTAGE  
DC  
LOW CURRENT**

**LOW VOLTAGE  
DC  
HIGH CURRENT**

**SORENSEN ISOTRONIC AC LINE REGULATORS  
ARE YOUR BEST CHOICE FOR PERFORMANCE PLUS ECONOMY**

The man who **uses** instruments likes Sorensen AC Line Regulators because of regulation accuracy, clean waveform, insensitivity to frequency fluctuation, load range.

trouble-free performance for months on end.

The man who **pays for** instruments likes Sorensen AC Line Regulators because of reasonable price and the fact that there are no extras for installation and special wiring.

The man who **maintains** instruments likes Sorensen AC Line Regulators because of circuit simplicity, conservatively rated tubes (only 3 in all), built-in ability to deliver

The man who **designs** instruments likes Sorensen AC Line Regulators because they are ideal for incorporation as reliable components.

**OTHER  
SORENSEN  
ISOTRONIC PRODUCTS  
INCLUDE:**

**NOBATRONS**  
(low-voltage, high-current DC Supplies)

**B-NOBATRONS**  
(high-voltage, low-current DC Supplies)

**NOBATRON-RANGERS**  
(full-range-variable DC Supplies)

**FREQUENCY CHANGERS**

**SATURABLE CORE REACTORS**

**VARIABLE AUTO-  
TRANSFORMERS**

**ELECTRICAL SPECIFICATIONS**

Models available (numbers indicate VA capacities) 150S 250S 500S (-2S also) 1000S (-2S also) 2000S 3000S (-2S also) 5000S (-2S also) 10000S (-2S also) 15000-2S	<b>Input</b>	95-130 VAC, 1 $\phi$ , 50-60 $\sim$ ; 190-260 VAC in "-2S" models
	<b>Output</b>	115 VAC $\pm$ 5%; 230 VAC in "-2S" models
	<b>Regulation accuracy</b>	$\pm$ 0.1% against line or load
	<b>Distortion</b>	2% - 3% maximum
	<b>P. F. range</b>	Down to 0.7
	<b>Load range</b>	0 to full load
	<b>Miscellaneous</b>	Models 150S, 250S, 500S, 1000S, 5000S, 10000S, and 15000-2S are self-contained. Cabinets available for others.
1001	Regulation accuracy 0.01%, load range 0 - 1000 VA, output 115 VAC $\pm$ 5%, other characteristics similar to those given above.	

\* ISOTRONIC=Regulation and control of voltage, current, power, and frequency by electronic means.

For Complete Information Write

**SORENSEN & COMPANY, INC.**

375 Fairfield Avenue

Stamford 1, Conn.



# SORENSEN

**SPECIFY**

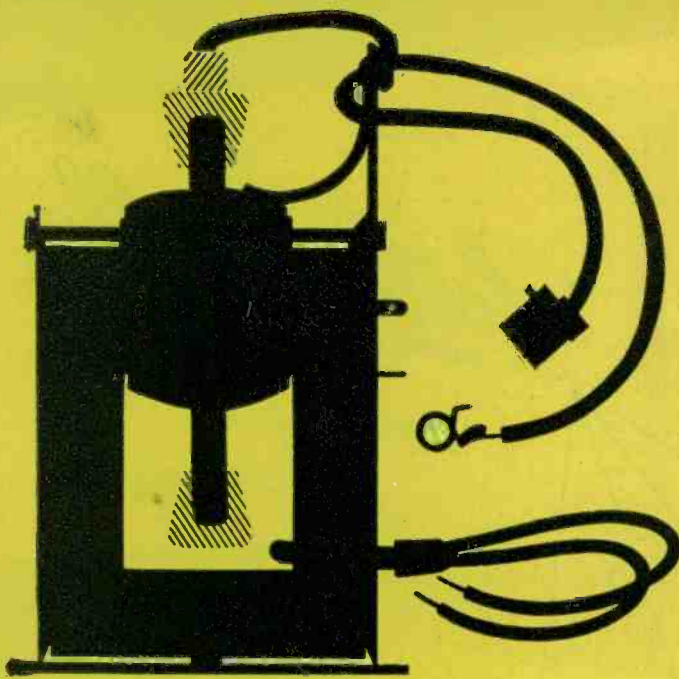

**high voltage ARC INHIBITOR by Guthman**

When TV manufacturers discovered that higher voltages of the new 27 and 21-inch television receivers rendered existing wax corona ring sweep transformers inadequate, they brought the problem to Guthman.

In a cooperative program with these TV engineers, a flyback transformer with a cast resin corona ring was developed—the perfect answer to this difficulty.

Your problems in the development of coils and transformers are welcome at *Edwin I. Guthman & Company, Inc.*, 15 South Throop St., Chicago 7, Telephone: CH 3-1600, also Attica, Indiana.

**THEY HAD A PROBLEM...**





**Here's a basic new material**

## *Corning fused silica*

Made by a radically new process, Corning Fused Silica offers electronic engineers a material with exciting possibilities.

The raw materials used to produce Corning Fused Silica are non-crystalline and of controlled high purity. As a result, it has the outstanding properties shown at right.

In addition, this new material is not darkened by radiation, has superior ultra-violet transmission properties, and is extremely pure chemically.

Because of its structural homogeneity, as evidenced by low attenuation of ultrasonic waves in the megacycle frequencies, Corning Fused Silica is an ideal material for ultrasonic delay lines for radar and computer applications. In addition, it weighs less than other materials used for this application, and is unaffected by vibration.

Its purity has suggested use as a crucible for melting germanium and other semi-conductors.

### ELECTRICAL PROPERTIES

	60 cycles/sec.	1 megacycle/sec.
S. I. C. (room temp.)	3.9	3.8
S. I. C. (200°C)	3.9	3.8
Power factor (room temp.)	<.0001	<.0001
Power factor (200°C)	<.0005	<.0002
Loss factor (room temp.)	<.0004	<.0004
Loss factor (200°C)	<.002	<.0008
Volume Resistivity:	Greater than $10^{17}$ ohm-centimeters.	
Surface Resistivity:	Same as for conventional clear fused quartz.	

### ULTRASONIC PROPERTIES

Velocity of Sound:	
Shear wave .....	$3.75 \times 10^3$ cm/sec.
Compression wave .....	$5.96 \times 10^3$ cm/sec.
Attenuation: Indications are that the value is less than .05 db/ft./megacycle. (Equivalent to optical grades of fused quartz)	
Stress After Annealing .....	Less than 50 psi.

If this new material suggests an application to you, we would welcome the opportunity to discuss it. Or mail coupon below for detailed information.

## **Corning Glass Works**

New Products Division



*Corning means research in Glass*

### **CORNING GLASS WORKS, Dept. EL-7, Corning, New York**

Please send me information on Corning Fused Silica

Name ..... Title .....

Company .....

Address .....

City ..... Zone ..... State .....

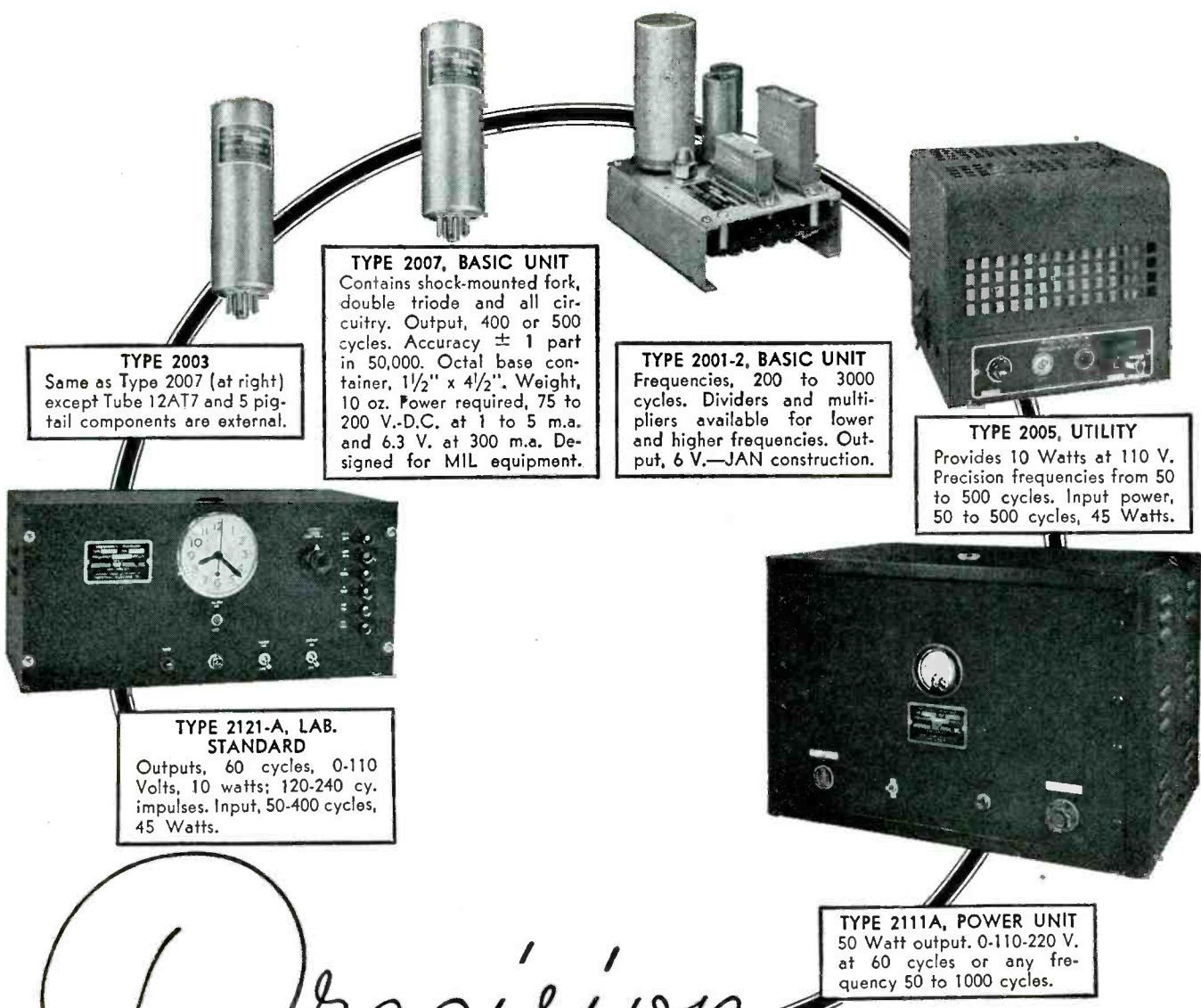

**TYPE 2003**  
Same as Type 2007 (at right) except Tube 12AT7 and 5 pig-tail components are external.

**TYPE 2007, BASIC UNIT**  
Contains shock-mounted fork, double triode and all circuitry. Output, 400 or 500 cycles. Accuracy  $\pm 1$  part in 50,000. Octal base container,  $1\frac{1}{2}'' \times 4\frac{1}{2}''$ . Weight, 10 oz. Power required, 75 to 200 V.-D.C. at 1 to 5 m.a. and 6.3 V. at 300 m.a. Designed for MIL equipment.

**TYPE 2001-2, BASIC UNIT**  
Frequencies, 200 to 3000 cycles. Dividers and multipliers available for lower and higher frequencies. Output, 6 V.—JAN construction.

**TYPE 2005, UTILITY**  
Provides 10 Watts at 110 V. Precision frequencies from 50 to 500 cycles. Input power, 50 to 500 cycles, 45 Watts.

**TYPE 2121-A, LAB. STANDARD**  
Outputs, 60 cycles, 0-110 Volts, 10 watts; 120-240 cy. impulses. Input, 50-400 cycles, 45 Watts.

**TYPE 2111A, POWER UNIT**  
50 Watt output. 0-110-220 V. at 60 cycles or any frequency 50 to 1000 cycles.

# Precision FREQUENCIES

GUARANTEED ACCURACY  
1 PART IN 100,000 (.001%)  
except where otherwise noted

The basis of these frequency standards is an electronically actuated high-precision fork, temperature-compensated and hermetically sealed against barometric changes. The partial list of uses at the right not only suggests the broad range of applications but also proven dependability where there can be no compromise with accuracy. Please request details by Type No. Our engineers are available for advice or cooperation on related problems.

- WIDELY USED  
IN SUCH FIELDS AS**
- Aviation, Navigation
  - Ordnance, Ballistics
  - High Speed Photography
  - Viscosity Measurement
  - Fluid Flow
  - Nuclear Physics, Telemetering
  - Chemical Reaction
  - Radiation Counting
  - Computers
  - Facsimile
  - Fire Control
  - School and Indl. Research Labs.
  - Accurate Speed Control

**American Time Products, Inc.**  
580 Fifth Avenue New York 36, N. Y.

OPERATING UNDER PATENTS OF WESTERN ELECTRIC COMPANY

Stone's Coil Bobbins are strong, light-weight forms, made to accurate tolerances for winding coils used in:

- TIMER MOTORS
- RELAYS
- SIGNAL SYSTEMS
- TV SPEAKERS
- ELECTRICAL NOVELTIES
- SOLENOIDS
- ELECTRICAL TOYS



Stone's Electrical Insulating tubes are used as core or shaft insulating, rivet and screw insulators, spacer bushings, or liner and protector sleeves, in the manufacture of:

- FRAC. H. P. MOTORS
- RELAYS
- SOLENOID SWITCHES
- TRANSFORMERS
- FLUORESCENT LAMP STARTERS
- COMMUTATORS
- ELECTRIC BLANKETS
- ELECTRIC CORD SETS
- INDICATOR LIGHTS
- VOLTAGE REGULATORS
- ELEC. MEASURING EQUIPMENT
- INCANDESCENT LAMPS
- ELECTRIC TRAIN SETS



**SALES OFFICES**

- BRIDGEPORT.....3-2575  
O. E. Pfannkuch & Co.,  
952 Main Street
- CHICAGO.....Tuxedo 9-6920  
Joseph L. Pits,  
1643 N. Nagle Avenue
- CLEVELAND.....Main 1-8410  
C. E. White & Company,  
Bulkley Building
- LOS ANGELES..Pleasant 2-0791  
E. H. Southwell Co.,  
5957 So. Western Avenue
- NEWARK.....Humboldt 5-9000  
L. K. Detwiler, 443 Broad St.,  
Room 205
- PHILADELPHIA...Walnut 2-1182  
I. R. Blair, 401 N. Broad St.,  
Room 740
- ST. LOUIS.....Parkview 3274  
E. B. Henderson Co.,  
8147 Delmar Blvd.
- TORONTO.....Murry 1106  
Electric Insulation & Fibre Co.,  
Ltd., Mendota Road, Etobicoke

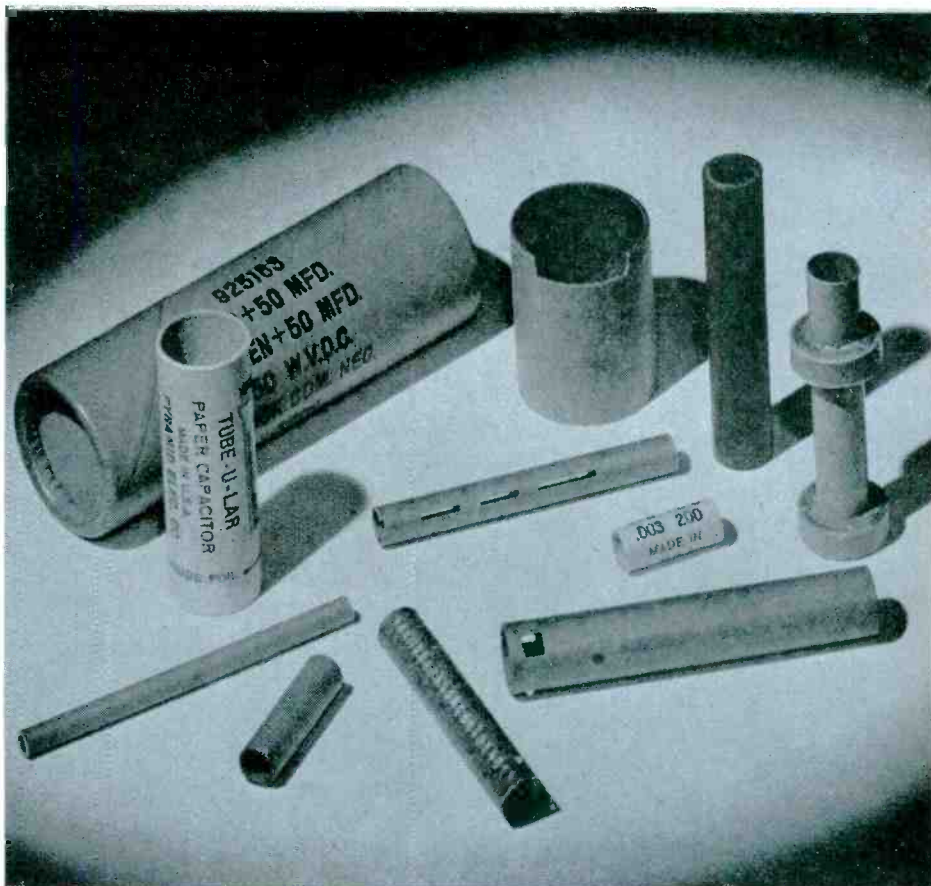

Stonized spiral phenolic coil forms, lug collars, bushings, and printed covers are used as component parts

of many products of the electronics and electrical industries, among them being:

- R.F., I.F., AND OSCILLATOR, AND OTHER COILS FOR RADIO AND TV • PERMEABILITY TUNERS • TUBULAR CONDENSERS  
TRANSFORMER COILS • ELECTRIC MOTORS • SELENIUM RECTIFIERS • RELAYS • TIME CONTROL ASSEMBLIES

## Why Don't You Write Us?

**WE** HAVE a lot to offer you, particularly if you manufacture any of the items or related products listed on this page.

Stone, alone in the paper tube field, can place at your service the experience gained from an industrial heritage of 126 years. Down through the years, we have been able to improve our accuracy of manufacturing and our mass production techniques to such a point that we can assure you quality products at low cost. Many hundreds of the country's leading manufacturer's know this to be true.

Small diameter spiral wound insulating tubing from 3/64" to 1" ID is our specialty although the larger sizes are available. All Stone tubes are custom-made despite the fact

they are mass produced and can be furnished in hi-dielectric kraft, fish paper, and plastic films in various wall thicknesses and lengths. They can also be formed, notched, punched, printed, dipped or impregnated with a variety of waxes and resins.

Why don't you write us or better still, get in touch with our nearest representative? Stone makes many thousands of different items and we are sure that we can either adapt one of the products to your own requirements . . . or develop one specifically for you. You will be certain to find an organization ready and able to offer you unsurpassed service . . . the kind that has made Stone one of the world's largest small diameter paper tube manufacturers.

## STONE PAPER TUBE COMPANY

INCORPORATED

900-922 Franklin Street, N. E., Washington 17, D. C.



## You know he'll always steer you right

Strip this man of everything but his eyesight, and he *still* could steer you through. For he has "learned his book" well, both in print and in experience. But when the book doesn't cover a tough new situation, then he throws the book away and acts on his own.

That's exactly the way you can expect the "ship's company" here at Bristol to act, when they act in *your* interest. They know how to steer through your shipments of Brass sheet, rod and wire, and how to get them there *right*,

and *on time*. That's how the clipper ships from Bristol, England, became famed around the world. . . . And *that's what "Bristol-Fashion" means.*

The BRISTOL BRASS CORPORATION, makers of Brass since 1850 in Bristol, Conn. Offices or warehouses in Boston, Chicago, Cleveland, Dayton, Detroit, Los Angeles, Milwaukee, New York, Philadelphia, Pittsburgh, Providence, Rochester.

*"Bristol-Fashion" means* **Brass at its Best**



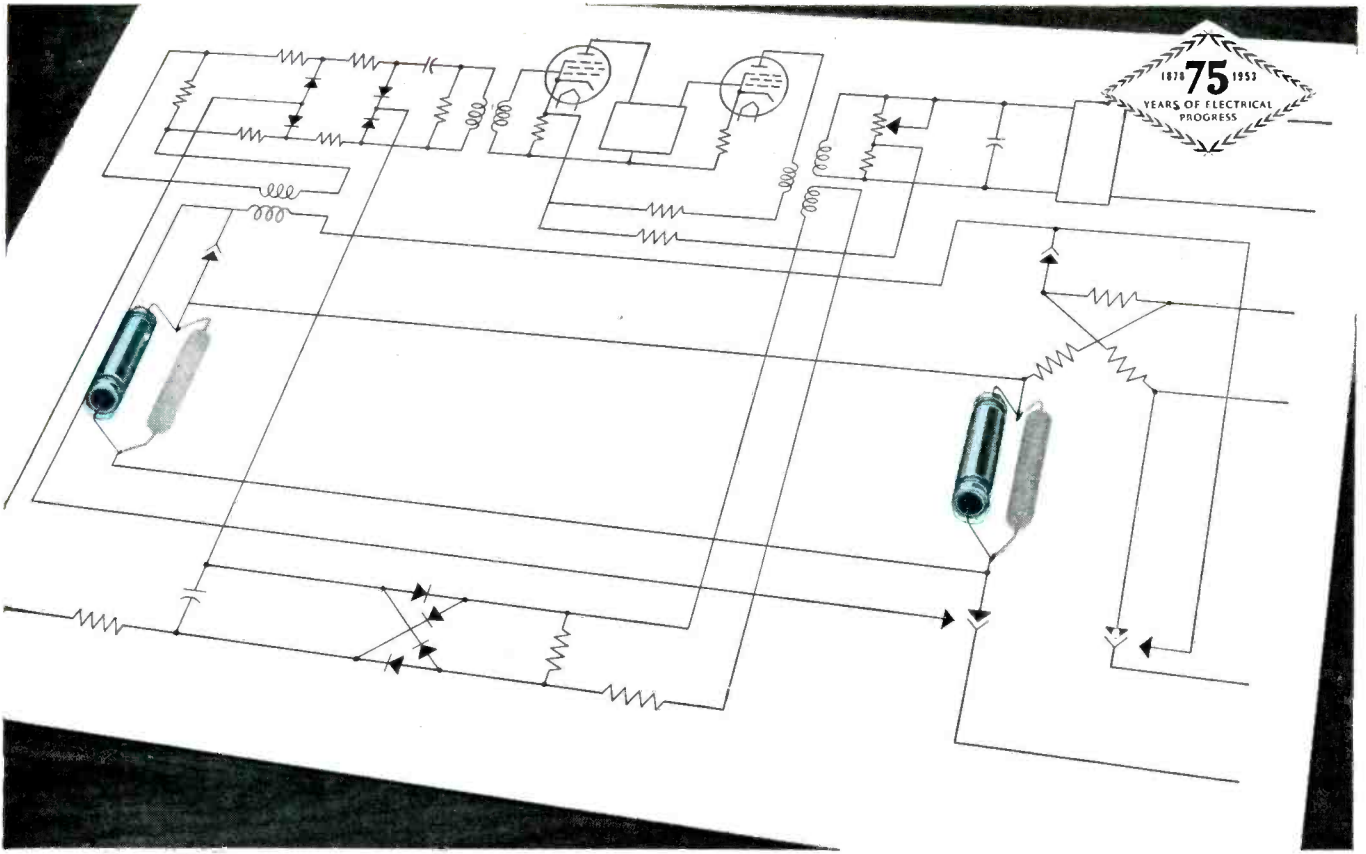

# Small G-E Tantalytic Capacitors do big job in new Bell System carrier circuit

The new Bell System N Carrier System is a 12-channel, double-sideband system for single cable application . . . providing low loss, stable, high velocity service for toll and exchange circuits in the range from 15 to 200 miles . . . at a minimum manufactured, installed and maintenance cost. This system requires the use of miniaturized components which will yield large reductions in size and weight yet still give maximum service.

**G-E Tantalytic capacitors are a "natural"** for the system to handle the job of series d-c blocking, r-c timing and d-c power noise filtering. Recently developed, these polar and non-polar electrolytic capacitors are recommended for virtually all low-voltage d-c applications (ratings from 175 muf at 5 vdc to 12 muf at 150 vdc) where small size, large capacitance, long operat-

ing life and long shelf life are major considerations. And since they offer greater capacitance per unit volume than aluminum electrolytics and paper capacitors, they are ideally suited for miniaturized equipment. In some short-time applications, i.e. guided missiles, it is now possible to operate these capacitors in a temperature range from -55 to +110C with proper voltage and life derating.

If your application calls for a small size capacitor with superior performance, it will pay you to investigate the new G-E Tantalytic capacitor. For further information on Tantalytic and other General Electric specialty capacitors for a-c and d-c applications, see your local G-E representative or write for "Tantalytic Capacitors" Bulletin GEC-808 to General Electric Co., Section 442-5, Schenectady 5, New York.

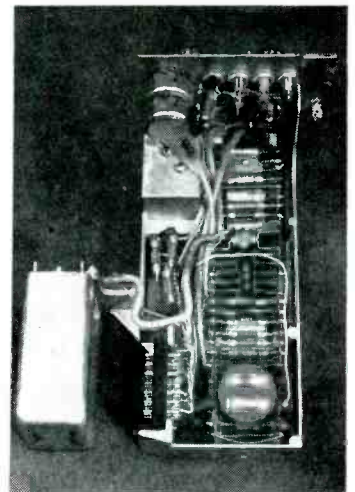

**G-E TANTALYTIC** capacitors installed in telephone carrier amplifier.

*You can put your confidence in—*



**No Water too  
SHALLOW**

**No Water too  
DEEP**

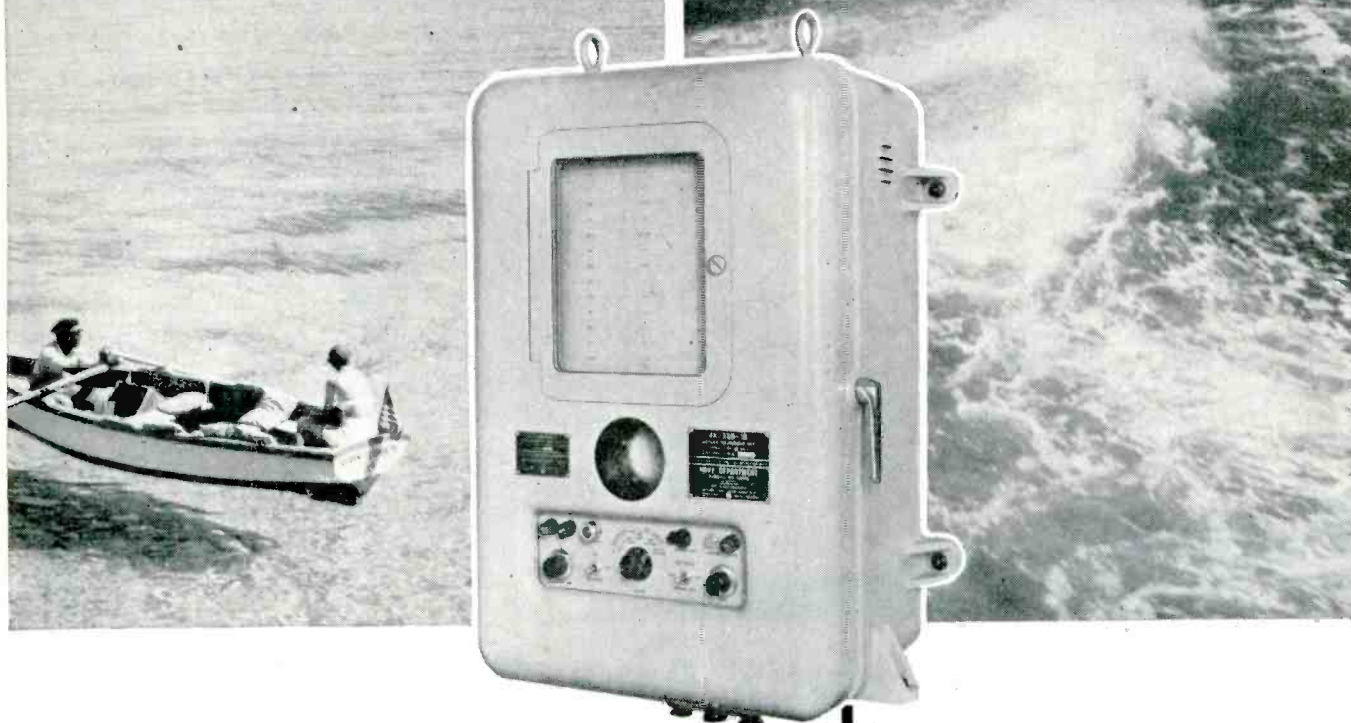

## for ACCURATE Measurement by the EDO DEEP DEPTH SOUNDER

In shallow waters or open ocean, the Edo deep depth sounder has been hailed for its remarkable range, accuracy and dependability. Developed for the U. S. Navy, and now in wide use on Navy ships, the Edo 185 is the first depth sounder that can measure any known ocean depth while under way.

Already proven on hundreds of ships and by years of service on survey vessels, the Edo 185 is now available commercially. It represents the ultimate in fine depth sounding equipment, far exceeding other depth finders in performance and usefulness.

RESEARCH AND PRODUCTION GO  
HAND-IN-HAND AT EDO

Development of electronic equipment such as the Edo 185 Deep Depth Sounder, with performance never before achieved, is part of Edo's continuing program of research in the application of electronics to advanced underwater detection systems of many different types and purposes.

Hand-in-hand with Edo's extensive research experience, go facilities and skilled personnel to manufacture in quantity intricate electronic equipments whose accuracy and dependability have become so well-known.

Behind the design and manufacture of Edo products, stands over a quarter of a century of experience in the design and manufacture of precision equipment. A vast background in the marine and aviation fields assures a highly practical approach to both the design and manufacture of all Edo products. That's why the famed Edo flying fish emblem is recognized more and more as the symbol of quality.



**Edo**

**CORPORATION**

College Point, L. I., N. Y.

SINCE  
1925

**SPECIALISTS IN UNDER-WATER DETECTION EQUIPMENT**

# THE Simplicity Features

## INSTRUMENT MEN PREFER

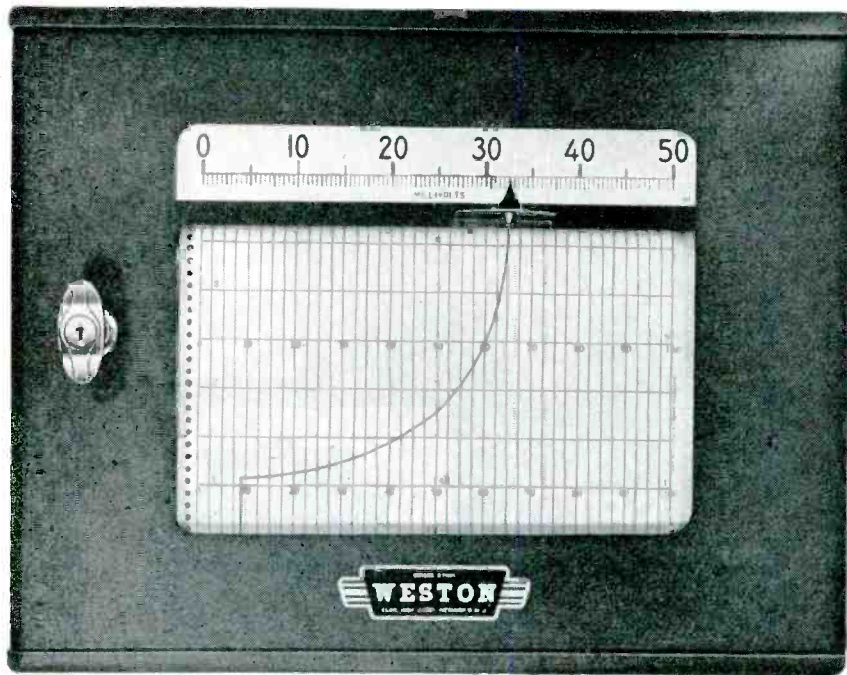

### Simplified **WESTON** Recording Potentiometer

Here is the recorder that has been widely acclaimed by instrument men because its new design concept has contributed new simplicity and new economies in instrument operation and maintenance. More compact, too; and its rugged construction gives it new resistance to vibration and shock, assuring sustained high accuracy over longer periods. Can be used to measure and record temperature, d-c current, d-c voltage, resistance, a-c voltage, a-c current, speed, speed ratio, power, frequency, hydrogen ion (pH), light intensity or any other quantity that can be converted into electrical values. The whole story is available in booklet form. Write for your copy today. WESTON Electrical Instrument Corporation, 614 Frelinghuysen Avenue, Newark 5, New Jersey. *Representatives in all principal cities. In Canada . . . Powerlite Devices, Ltd., Montreal, Toronto.*

**WESTON**

# WESTON *Instruments*

INDICATE — RECORD — CONTROL



**TO CHANGE CHARTS**, you simply swing chart frame open a full 180°, insert chart and swing it over timing drum and across front of frame and fasten. No loose pieces to handle!

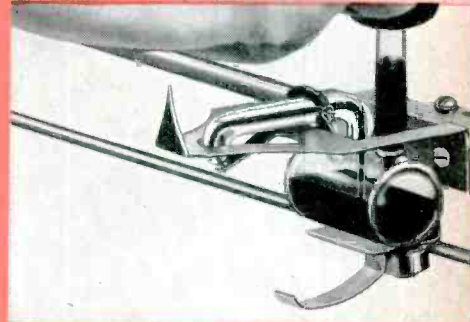

**TO REFILL PEN**, simply open chart frame completely exposing pen for quick, easy filling. Recorder continues operation and charts remain in time sequence during filling.



**TO CHANGE CHART SPEEDS**, a simple screw-driver adjustment gives you a choice of 3 different speeds. These speeds are doubled or quadrupled by changing one worm and gear assembly.

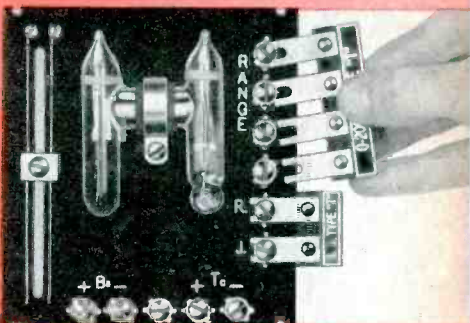

**TO CHANGE RANGES**, you simply substitute the desired range standard. The reference junction compensation is changed in like manner. No soldered connections to break!

**TO REMOVE THE AMPLIFIER**, you simply take out two screws and pull two plugs. With no soldered connections servicing is quick and simple. ▼

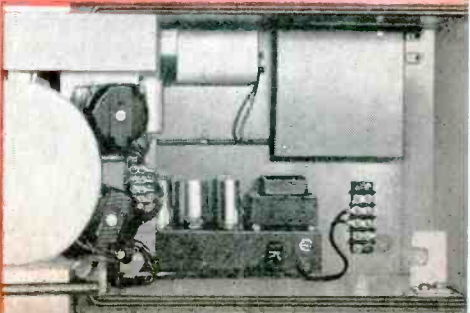

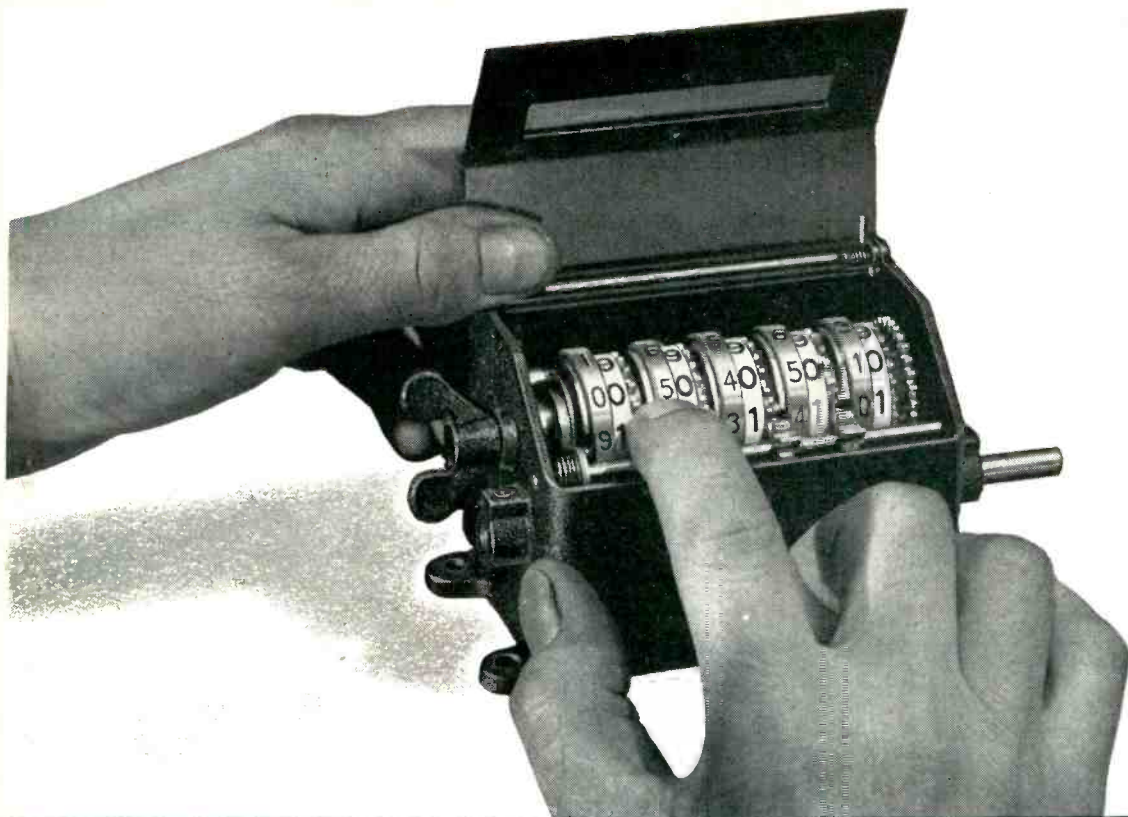

You get what you set...

Added Evidence  
that \_\_\_\_\_

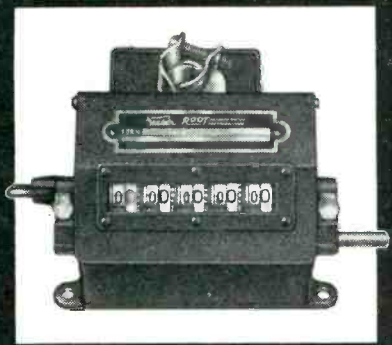

# Everyone Can Count on VEEDER-ROOT

Set the predetermining wheels for any run you want. Then, when the counting wheels reach the pre-set number, an electrical contactor makes or breaks the circuit to light a light, ring a bell, or trigger a stop-motion. Yes, this V-R Predetermining Counter is an efficient variable control for many types of stop-motion. Short runs and over-runs are prevented on a wide range of

machinery, from coil winders to textile looms. Now, figure out how you can use this Cost-Controlling Counter. Then write:

**VEEDER-ROOT INCORPORATED**

"The Name That Counts"

**HARTFORD 2, CONNECTICUT**

Chicago 6, Ill. • New York 19, N. Y. • Greenville, S. C.

Montreal 2, Canada • Dundee, Scotland

Offices and Agents in Principal Cities



*"Counts Everything on Earth"*

# TAPE DUPLICATION GOES INTO "MASS PRODUCTION"

## with the NEW AMPEX Tape Duplicator

Whether you need thousands—or just a few at a time, high fidelity duplicate tapes can now be produced at a cost comparable to disc recordings. The extraordinary fidelity inherent in a good master tape is retained in the duplicates to as high a degree as a sensitive ear can discern. The AMPEX Tape Duplicator is easy to set up, simple to operate and produces up to 80 hours of duplicate performance in 15 minutes operating time.

### *Duplicate tapes open new opportunities*

**RADIO BROADCASTING**—"Tape networks" and programming services become practical supplements or alternatives to line networks.

**BACKGROUND MUSIC**—Tape becomes the best medium for background music in that it provides higher fidelity, longer playing and lower attendance costs.

**RECORD MANUFACTURE**—With mass duplication of tapes now feasible, all performances currently sold on Lp records can also be offered on tape.

**EDUCATION**—Systemwide duplication and distribution of educational tapes, music and outstanding school performances becomes practical.

**COMMERCIAL DUPLICATING SERVICES**—With this efficient equipment now available, excellent business opportunities exist in setting up tape duplication services.

### *Features of the AMPEX Tape Duplicator*

- One to ten simultaneous duplicates (slave recorders can be purchased one at a time as needed)
- Time saving speedup during duplication (as much as 32 to 1)
- \*15,000 cycle response on 7½ in./sec. duplicates
- \*45 to 50 db signal-to-noise ratio
- Duplicate tapes of any standard speed from any master
- Single or double track duplicates in one pass
- Any standard reel sizes up to 14-inch
- Centralized pushbutton controls

\*From master tapes of suitable quality.

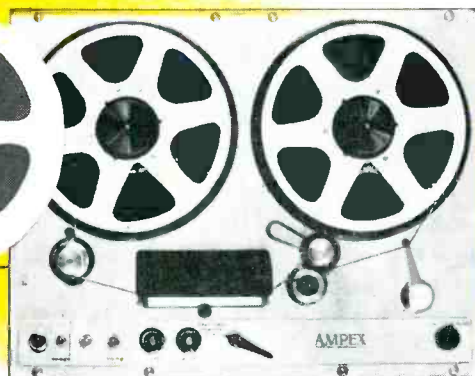

## AMPEX

MAGNETIC RECORDERS

Write Today

for further information; Dept. E-1204A

AMPEX ELECTRIC CORPORATION • 934 Charter Street • REDWOOD CITY, CALIFORNIA  
Distributors in principal cities

# ALLIED CONTROL'S

# ME

✓ SIZE CUT 66%

✓ WEIGHT CUT 48%

✓ RELIABILITY DOUBLED

✓ WRIGHT FIELD APPROVED

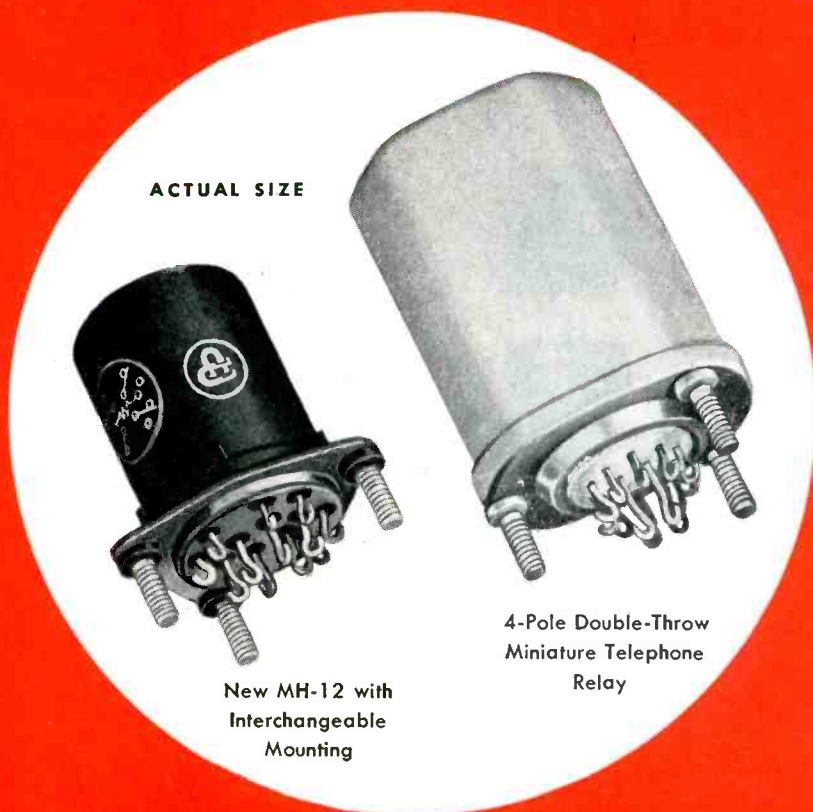

ACTUAL SIZE

New MH-12 with  
Interchangeable  
Mounting

4-Pole Double-Throw  
Miniature Telephone  
Relay

Designed to withstand a shock of 50G, these new Allied Control double-throw miniature relays were developed to meet the rigid requirements of U.S.A.F. Specifications MIL-R-5757A.

Known as the Allied MH series, this new line of relays consists of the 6-pole MH-18, the 4-pole MH-12, and the 2-pole MH-6. Contacts are rated at 2 amps resistive or 1 amp inductive at 28 volts D. C.

The high performance of these relays has been achieved

in an extremely compact, unitized construction and parallels the most recent advances in airborne equipment design. The "actual size" photographs shown above highlight the 66% savings in overall size, the 48% savings in weight and the 30% reduction in chassis area.

For detailed specifications and drawings of these new relays, contact your local Allied Control Representative or write us for Bulletin 1002.

# W

## 50 G MINIATURE RELAY

APPROVED MIL-R-5757A

### SIX DIFFERENT MOUNTINGS

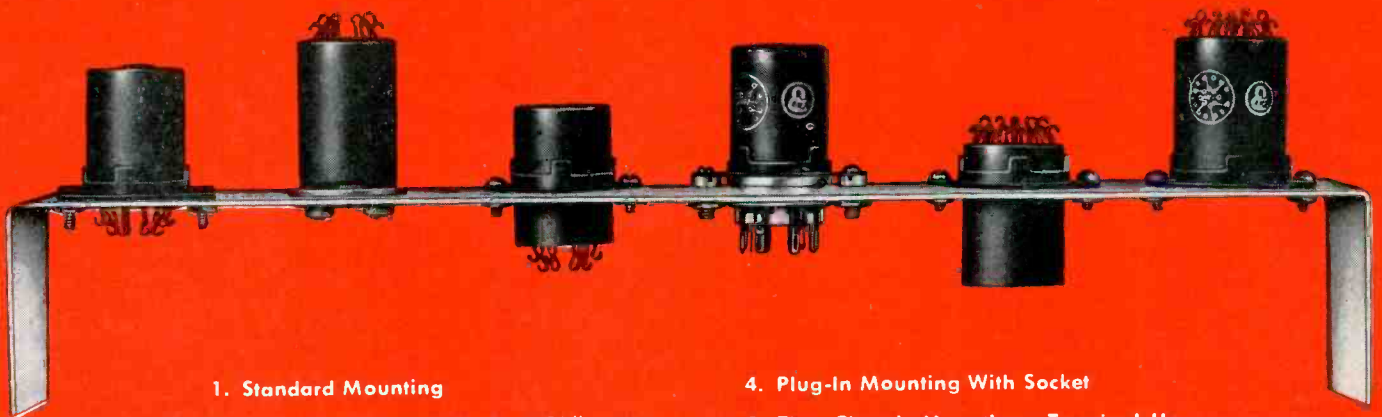

1. Standard Mounting
2. Flush Mounting—2 Studs at  $\frac{5}{8}$ " Centers
3. Thru-Chassis Mounting—Terminals Down
4. Plug-In Mounting With Socket
5. Thru-Chassis Mounting—Terminal Up
6. Flush Ring Mounting



6-POLE  
MH-T8



4-POLE  
MH-12



2-POLE  
MH-6

### FEATURES

- Wide Ambient Temperature Range:** 55°C to 85°C standard—65°C to 125°C MHB-type
- Vibration Resistant:** 15G's vibration to 500 cycles • **Operating Shock:** no contact chatter to over 50G's
- High Altitude:** seal-tested to 70,000 feet
- Dependable Operation:** life expectancy of over 1 million operations at rated load
- High Speed:** operate-to-make time under 8 ms.  
release-to-make time under 4 ms.  
release-to-break time under 2 ms.

**ALLIED CONTROL COMPANY, INC.**  
2 EAST END AVENUE, NEW YORK 21, N. Y.



# Let **JOY** handle Your **FAN ENGINEERING** on **ELECTRONIC COOLING PROBLEMS**

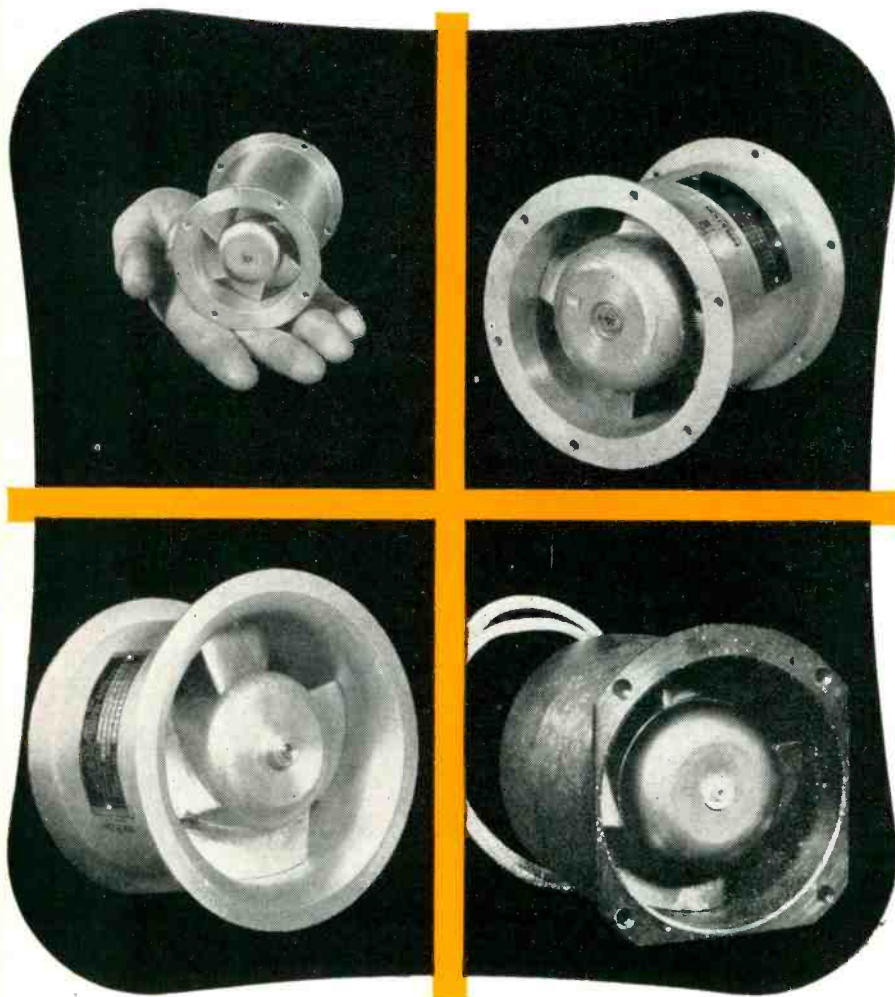

\*Reg. U. S. Pat. Office

W&D 1-4010

JOY AXIVANE\* Fans offer you advantages in electronic equipment cooling which have been thoroughly proved in service. The higher pressure-output of these vaneaxial blowers generally permits more compact arrangement of the equipment. Additional advantages are: light weight, high strength, high shock and vibration resistance, and high efficiency in low or high pressure service.

For minimum weight, JOY electronic cooling fans are made of aluminum, magnesium, or combinations of these metals. They are designed to meet all present Air Force and Naval electronic specifications, and are available in fan sizes from 2" I.D. up. Totally-enclosed or explosion-proof motors can be furnished where required.

● If you have a problem in heat dissipation from electronic units, no matter what the service conditions may be, let us place at your disposal JOY'S experience as the world's largest manufacturers of vaneaxial-type fans.

*Consult a Joy  
Engineer*

Over 100 Years  
of Engineering Leadership



## JOY MANUFACTURING COMPANY

GENERAL OFFICES: HENRY W. OLIVER BUILDING • PITTSBURGH 22, PA.

IN CANADA: JOY MANUFACTURING COMPANY (CANADA) LIMITED, GALT, ONTARIO



# Top Performance for All TV

**AT UHF** Eimac klystrons provide top power with light weight, convenient external circuitry, economy and spectrum coverage with least amount of tubes.

**AT VHF** the 4W20,000A and 3X2500A3 typify the outstanding dependability of Eimac's complete line of power amplifier tubes.

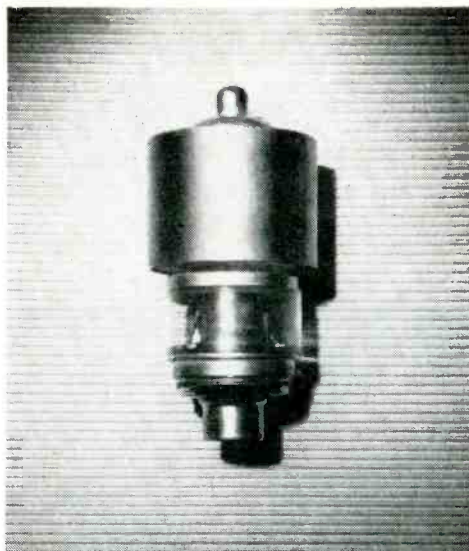

**3X2500A3**—A pair of these air-cooled power triodes easily gives a peak sync power output of 5 kw through channel 13. Unique grid and filament terminals allow installation and removal without aid of tools.

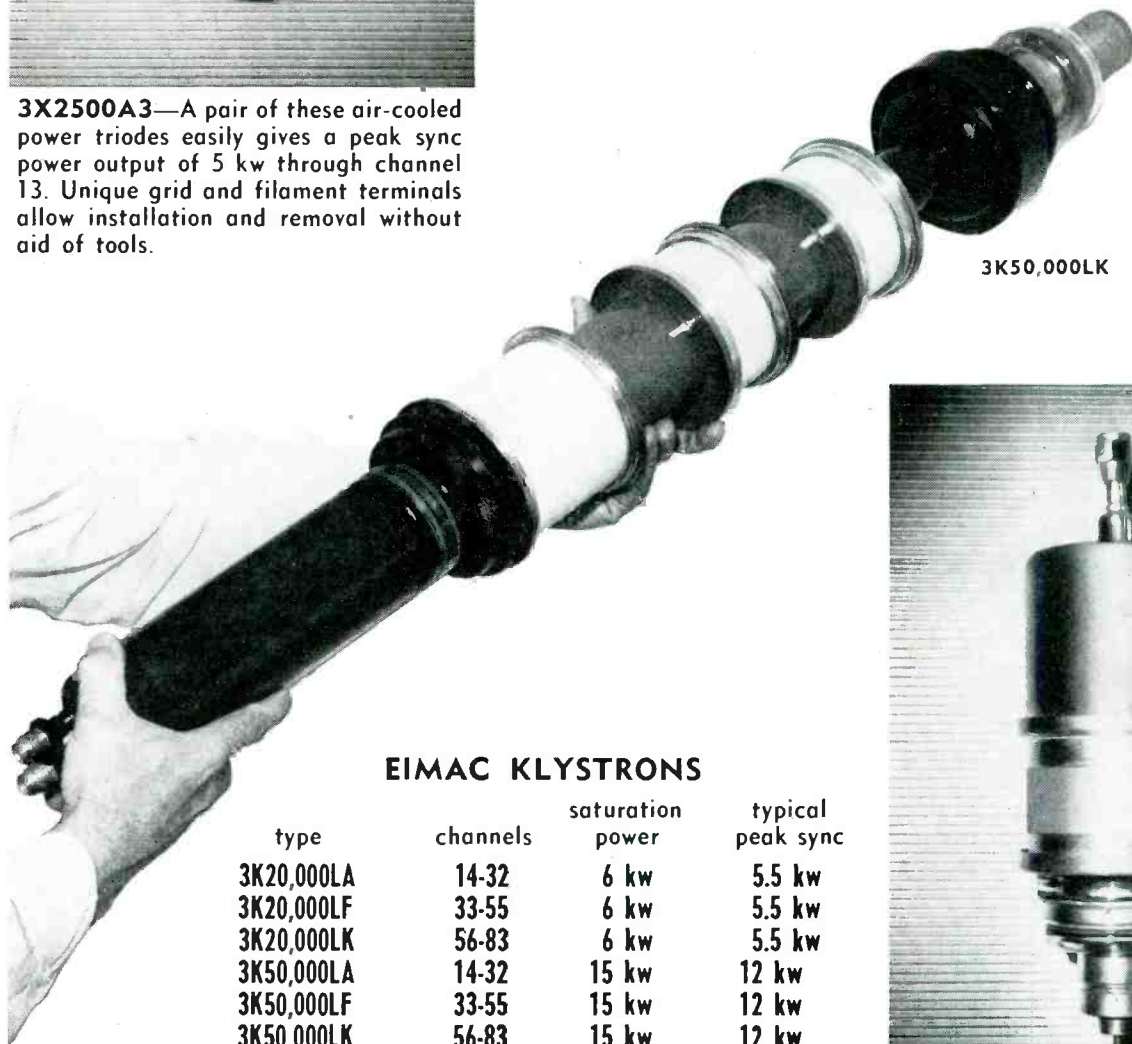

**3K50,000LK**

## EIMAC KLYSTRONS

type	channels	saturation power	typical peak sync
3K20,000LA	14-32	6 kw	5.5 kw
3K20,000LF	33-55	6 kw	5.5 kw
3K20,000LK	56-83	6 kw	5.5 kw
3K50,000LA	14-32	15 kw	12 kw
3K50,000LF	33-55	15 kw	12 kw
3K50,000LK	56-83	15 kw	12 kw

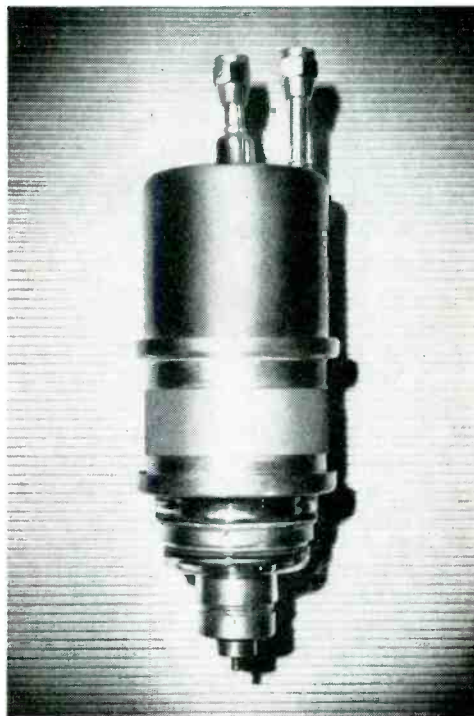

**4W20,000A**—A radial-beam power tetrode noted for high power gain and operating economy. Peak sync power output through channel 13 is 25 kw.



**EITEL - McCULLOUGH, INC.**  
**SAN BRUNO, CALIFORNIA**  
 Export Agents: Frazer & Hansen, 301 Clay St., San Francisco, California

# Accurate Field Testing of X-Band Radars

WITH MICROLINE\* TEST SET  
AND RANGE CALIBRATOR

Included in Sperry's complete line of Microline instruments are the 38A Test Set (TS 147B/UP) and the AN/UPM-11 Range Calibrator for the accurate testing of X-band radars. These equipments, of rugged design for field usage, can also be employed in laboratory and production testing.

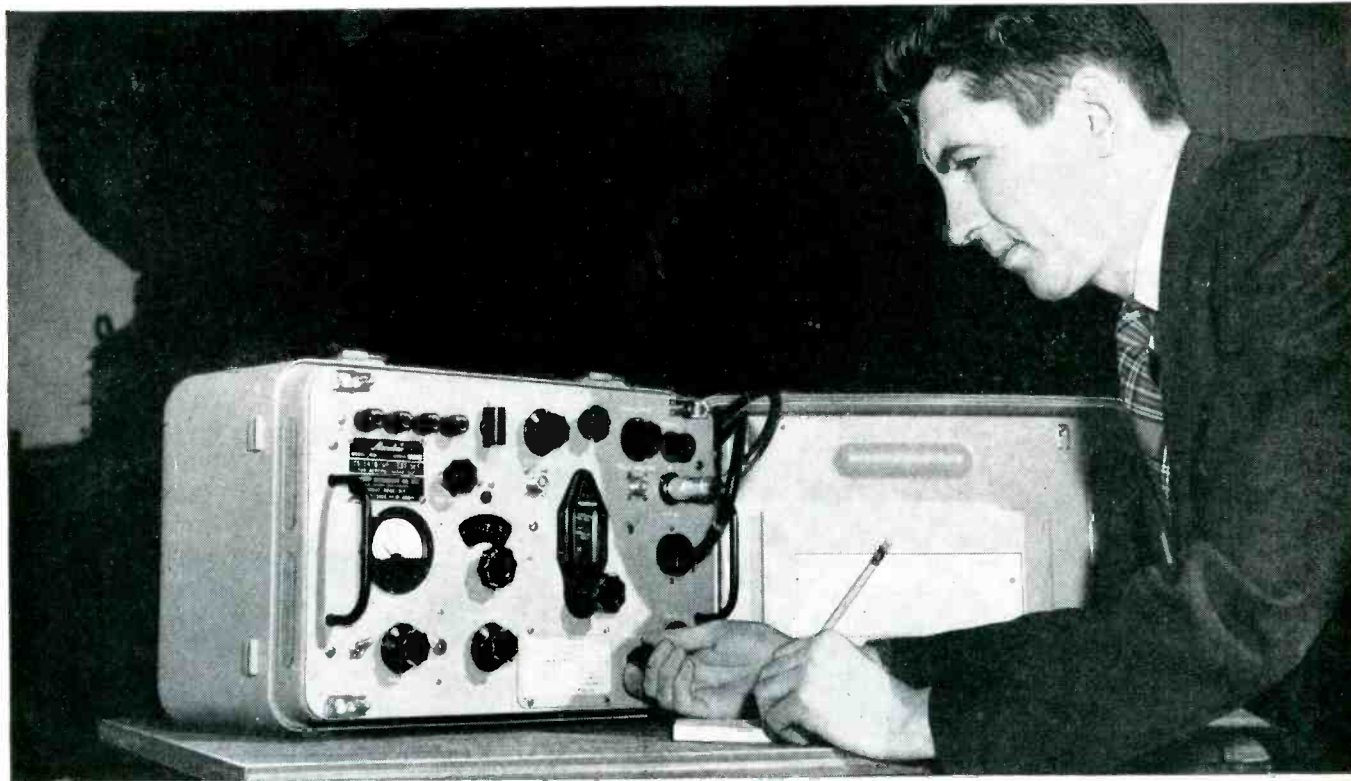

## MODEL 38A Test Set (TS 147B/UP)

This portable test set is suitable for measurements on all radar, beacon or missile systems in the 8500-9600 mc. range. It supplies microwave signals of known frequency and power, either continuous wave, frequency modulated or externally modulated. It also measures the power and frequency of external signals in the above frequency range. Model 38A contains a direct reading frequency meter, wattmeter and signal generator which allow the measurement of power and frequency of radar transmitters as well as receiver sensitivity, bandwidth, recovery time and AFC action. Tuning of the frequency meter is accomplished with both a direct and a 5 to 1 reduced drive mechanism for ease of determining narrow pulsed signals as short as 0.2 microseconds.

### SPECIFICATIONS:

*R-F Power Output:* Adjustable from -7 to -85 dbm (decibels relative to one milliwatt).

*R-F Power Input:* From +7 to +30 dbm.

*Accuracy:*  $\pm 1.5$  db. A calibration chart is supplied.

*Frequency Meter Accuracy:*  $\pm 2.5$  mc. absolute at 25°C and 60% RH. Calibration point 9310  $\pm 1.0$  mc.

Our nearest district office will be happy to supply further information on these and other Microline instruments.

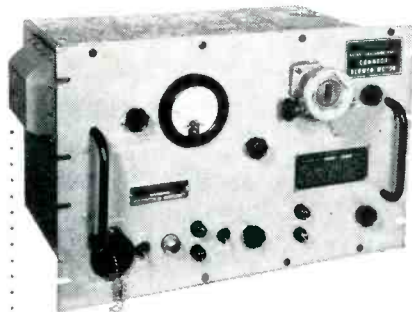

## MODEL AN/UPM-11 RANGE CALIBRATOR

This instrument is used to test X-band fire-control radars which operate in the 8500-9600 mc. frequency band. It receives microwave signals from a radar and responds with accurately spaced pulses thereby providing a

means of calibrating the radar range. It can also be used to boresight the antenna axis of any X-band radar system.

### SPECIFICATIONS:

*Range Markers:* 200 to 50,000 yds. depending on delay line

*Accuracy:*  $\pm 5$  yards

*Repeatability of readings (same radar system):*  $\pm 1$  yard

*Tuning:* Manual or AFC

\* T. M. REG. U. S. PAT. OFF.

**SPERRY** *GYROSCOPE COMPANY*  
DIVISION OF THE SPERRY CORPORATION

GREAT NECK, NEW YORK • CLEVELAND • NEW ORLEANS • BROOKLYN • LOS ANGELES • SAN FRANCISCO • SEATTLE  
IN CANADA • SPERRY GYROSCOPE COMPANY OF CANADA, LIMITED, MONTREAL, QUEBEC

# CAN A TUBE BE A CHOKE?

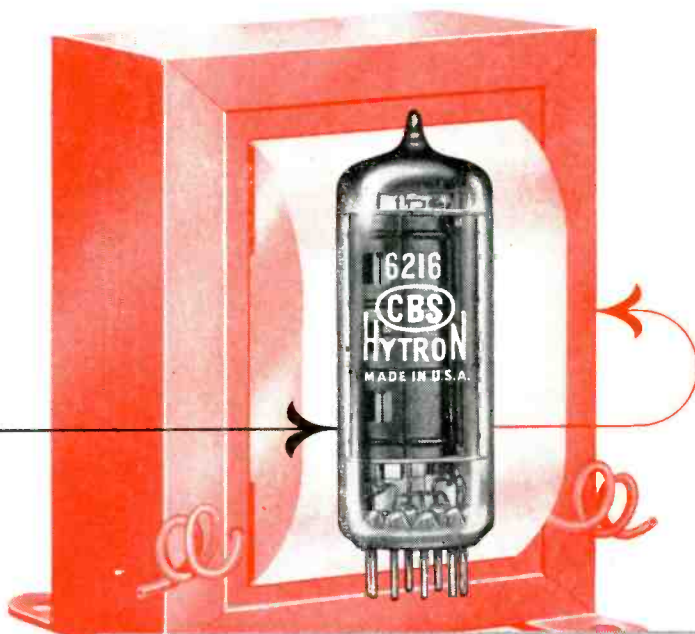

Yes, the CBS-Hytron 6216 . . . a 9-pin miniature, beam pentode . . . does the trick. The 6216 filter-reactor tube replaces a bulky, heavy, 12-henry choke rated at 100 ma., 350 ohms.

Light . . . compact . . . vibration-resistant . . . "ruggedized" (for impacts up to 625G), the 6216 is a natural for military airborne and vehicular equipment. Electrical design offers low d-c resistance (tube drop) and high a-c impedance (plate resistance). The two prime requisites of a good filter reactor.

Check the 6216's many features. Note the simple filter-reactor circuit. Compare performance of 6216 with that of an iron-core choke. Note also the many other possible applications for this versatile CBS-Hytron original. Write for complete data. Or order the CBS-Hytron 6216 today.

## CBS-HYTRON 6216 FEATURES

1. "Ruggedized," vibration-resistant construction
2. Inhibited interface formation ("sleeping sickness")
3. Over-all characteristics optimized for maximum efficiency
4. Very high permeance
5. Extreme power sensitivity
6. Conservative ratings for reliable performance

## COMPARISON OF FILTERING ACTION 6216 vs. Choke — 12 Henries, 150 Ma.

Operating conditions for 6216: Grid bias, see curve; screen voltage, derived from 400v through 60,000 ohms; filament voltage, 6.3v; unfiltered voltage applied to filter, 400v.

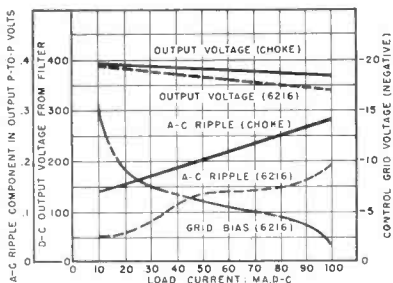

## OTHER APPLICATIONS FOR CBS-HYTRON 6216

Special features of CBS-Hytron 6216 offer many advantages as: (1) Wide-band video amplifier. (2) Husky, vhf class C amplifier or frequency multiplier. (3) Class A or B amplifier. (4) Pass tube in electronic voltage-regulated power supply. (5) Passive switching tube, with low cut-off voltage requirement.

**FREE DATA.** Write for complete 6216 data and curves today.

## TYPICAL FILTER-REACTOR CIRCUIT USING 6216

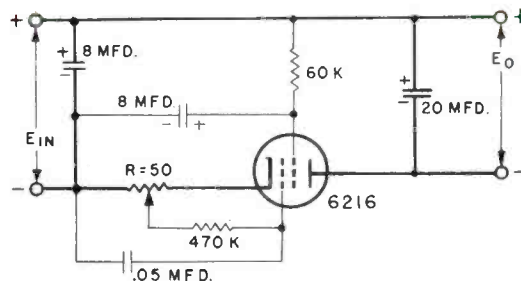

**How the circuit works:** High a-c impedance of 6216 . . . operated above knee of  $I_b$  vs  $E_b$  curve . . . is in series with load. Limits ripple current. Small voltage across lower portion of R is applied to grid through 0.05 mfd condenser. 6216 amplifies this voltage . . . which develops ripple voltage across load impedance in phase opposition to ripple voltage of load. Inverse feedback suppresses ripple still further. With two 6216's in parallel, d-c resistance is halved; load current for given IR drop and power sensitivity is doubled.

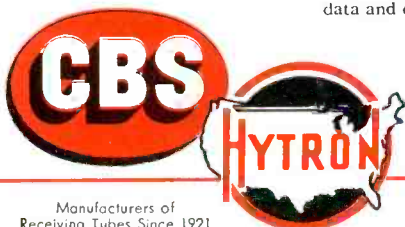

Manufacturers of Receiving Tubes Since 1921

CBS-HYTRON Main Office: Danvers, Massachusetts

A Division of Columbia Broadcasting System, Inc.

RECEIVING . . . TRANSMITTING . . . SPECIAL-PURPOSE AND TV PICTURE TUBES • GERMANIUM DIODES AND TRANSISTORS

# SIMPLE or COMPLEX...

**Special Rome Synthinol® 901**  
HOOK-UP WIRE—8 MIL WALL  
with nylon jacket overall

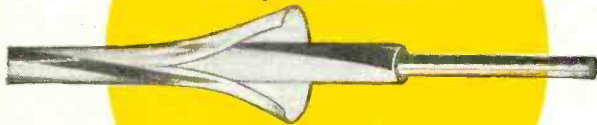

Underwriters' approved for  
105° with no assigned voltage

**Special 136**  
CONDUCTOR

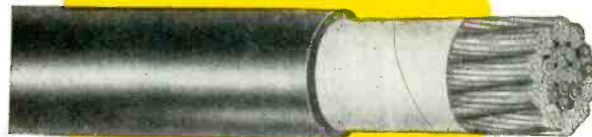

**ROME SYNTHINOL**  
INSULATED CABLE

## Look to "Rome"

for your special cable requirements

### COMMERCIAL TYPE HOOK-UP WIRES



Rome manufactures commercial type hook-up wires with three standard insulations.

**ROME HI-TEMP**—a rubber insulation with exceptionally high resistance to heat and moisture., Underwriters' approved for 75° C.

**ROME SYNTHINOL**—a polyvinyl chloride thermoplastic compound, highly resistant to acids, oils, alkalis, moisture and flame. Underwriters' approved for 80° C.

**ROME SYNTHINOL 901**—offers all the advantages of Rome Synthinol plus higher resistance to heat deformation, baking embrittlement, shrinkage and cracking; also improved solderability. Underwriters' approved for 105° C.

Available in sizes 24 AWG to 16 AWG for 300 and 600 volt ratings (Rome Synthinol sizes 18 AWG to 14 AWG for 1000 volts), plain or with outer covering.

### MILITARY TYPE HOOK-UP WIRES

Rome Cable is a manufacturer of military types SRIR, SRHV and WL, complying with Joint Army-Navy Specification JAN-C-76, as well as shipboard types SRI and SRIB conforming to Specification MIL-C-915A(SHIPS). Insulated with Rome Synthinol, these wires are manufactured in a complete range of specification sizes.

Designing and manufacturing special wires and cables to meet the most exacting requirements of electronic and other electrical equipment manufacturers is a specialty with Rome Cable. Perhaps your specifications call for a complex product like the 136 conductor cable, illustrated above, for electronic computers. Or you may require something as simple as the single conductor, space-saving hook-up wire, with an 8 mil wall. Regardless, Rome has the technical skill, engineering experience and plant facilities to offer the exact cable for your particular need.

Rome also produces a wide range of commercial type hook-up wires, television camera cables, intercommunication cables and radio frequency transmission line. All can be manufactured for exceptionally low dielectric losses at all frequencies, high heat resistance and conductivity. For special cables, it pays to go to cable specialists. Make Rome your source for special cables. For complete information, send the coupon below.

*It Costs Less to Buy the Best*

**ROME CABLE CORPORATION**  
Dept. EL-7, Rome, N. Y.  
Please send me information on Electronic Wiring

Name.....

Company.....

Address.....

City..... Zone..... State.....

**ROME CABLE**

*Corporation*

ROME • NEW YORK

and

TORRANCE • CALIFORNIA



# YOUR PROBLEMS

# ARE

# C-A-C

# PROBLEMS

Hardly a day passes but what we receive interesting research problems on the application of toroids.

CAC engineers welcome the opportunity to consider your specific requirements in frequency selective networks — For your convenience use our specification list (below) which covers most filter requirements:

### FILTER SPECIFICATIONS

1. Pass Band
  - a) Frequency limits: \_\_\_\_\_ to \_\_\_\_\_
  - b) Max. insertion loss at min. point: \_\_\_\_\_ db
  - c) Required flatness:  $\pm$  \_\_\_\_\_ db
2. Attenuation Band
  - a) Frequency limits & relative attenuation required:
    - 1) \_\_\_\_\_ to \_\_\_\_\_; \_\_\_\_\_ db
    - 2) \_\_\_\_\_ to \_\_\_\_\_; \_\_\_\_\_ db
    - etc
3. Terminations \*
  - a) Input
    - 1) impedance in pass band: \_\_\_\_\_ ohms
    - 2) impedance beyond pass band:  increase  decrease  
 not important
    - 3)  balanced,  unbalanced
  - b) Output
    - 1) impedance in pass band: \_\_\_\_\_ ohms
    - 2) impedance beyond pass band:  increase  decrease  
 not important
    - 3)  balanced,  unbalanced
4. Operating Conditions
  - a) Power level \_\_\_\_\_ DBM
  - b) Temperature range \_\_\_\_\_ ° to \_\_\_\_\_ ° F or C
  - c) Vibration requirements \_\_\_\_\_
5. Case Requirements
  - a) Max. dimension: \_\_\_\_\_ in. x \_\_\_\_\_ in. x \_\_\_\_\_ in.
  - b) Mounting by No. \_\_\_\_\_ (thread) x \_\_\_\_\_ in.  studs  
 tapped inserts.
  - c) Location of terminals and mounting provisions:  
on \_\_\_\_\_ in. x \_\_\_\_\_ in. surface.
  - d) Hermetic Seal:  yes  no.
  - e) Finish Color;  dark gray  light gray  black  Special (Specify)
6. Other Requirements
  - a) Military specifications applicable:  MIL-T-27  \_\_\_\_\_  
 none
  - b) Special Requirements: \_\_\_\_\_

\*NOTE: If low frequency limit of pass band is d.c., input and output impedances are usually equal and must both be either balanced or unbalanced.

### TOROIDAL INDUCTORS Data For Standard Types

Type	Normal Lmax.	Apr. O.D. x H	Useful Freq. Range	Qmax @ Freq.	lac.	T.C. ma
206	3.0 Hy	.90x .40	Up to 15 KC	140 @ 9	KC	1 23
930	17.5 Hy	1.20x .60	Up to 15 KC	170 @ 7.5	KC	1 42
254	35 Hy	1.85x .85	Up to 15 KC	220 @ 5	KC	1 67
466	60 Hy	2.15x 1.00	Up to 15 KC	260 @ 5	KC	3 95
848	1.4 Hy	.90x .40	10-50 KC	170 @ 20	KC	1 33
395	8.0 Hy	1.20x .60	10-50 KC	220 @ 20	KC	1 61
381	17.0 Hy	1.55x .65	10-50 KC	250 @ 17.5	KC	3 71
608	600 Mh	.90x .40	30-75 KC	165 @ 60	KC	3 50
579	7.5 Hy	1.55x .65	30-75 KC	180 @ 30	KC	2 110
041	320 Mh	.90x .40	50-200 KC	115 @ 120	KC	3 68
013	4.0 Hy	1.55x .65	50-200 KC	145 @ 70	KC	3 150

### REMARKS

Qmax—Values taken at approx. .01 lac. Q decreases with increasing current to about .50 Qmax at 1.0 lac—higher inductance values have lower Qmax at lower frequency due to dielectric losses of winding distributed capacity. All values are for inductors wound with Heavy Formex wire.

T.C.—Temperature characteristics as follows:

1—approx. 100 ppm/°F

2— $\pm$  .1% 55 to 90°F

3— $\pm$  .1% 30 to 130°F

(most types with temp. characteristic 1 are available with characteristic 3 at no sacrifice in performance)

lac—r.m.s. current which raises 0.1 Hy inductor to max. (2% above initial) inductance — (1% increase occurs at approx 0.35 lac.



Custom miniaturization of filters is achieved through use of miniaturized components and advanced design techniques.



Uncased coils adjusted to your specifications.



Moistureproof Plastic Coated Toroids available in all types.

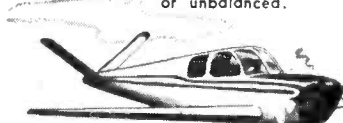

Via C.A.C. Beechcraft, we are only hours away from you—we solicit the invitation to discuss your problems across your own desk.

## COMMUNICATION ACCESSORIES

Company

HICKMAN MILLS, MISSOURI

TINNERMAN®  
**Speed Nut**  
 SAVINGS STORIES

FASTEST THING IN FASTENINGS®

*Champion*

Name Plates  
 cars, stoves, refrigerators

Attaching clock movement  
 to plastic case over  
 D-shaped stud

Solenoid Caps

Oven Filaments  
 to oven liners

**NEW Tinnerman Push-On SPEED NUTS®**  
 ... for wide range of applications

**- PRICE SAVINGS AVERAGE 25%!**

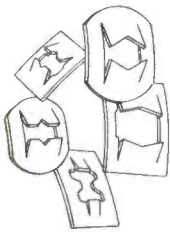

● Tinnerman, originators of Push-On type SPEED NUTS, offers this new C12000 Series at substantial savings! Large volume, high speed production, plus years of engineering and manufacturing experience make this economy possible! These new lightning-fast Push-Ons are available in a complete range of popular sizes, with rust-resistant finish, for round, D-shaped or rectangular studs. A unique feature, exclusive with Tinnerman Push-Ons, is their use over D-shaped studs where removability is desired. Call or see your Tinnerman representative for full, cost-saving information about these new, low-priced Push-On type SPEED NUT brand fasteners.

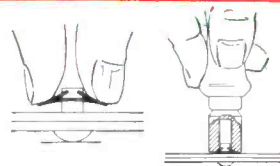

**NEW C12000 Push-On SPEED NUTS**

... are one-piece, self-locking, spring steel fasteners. Start by hand... zip down over integral studs, rivets, tubing, nails, any unthreaded parts; bite lock on smoothest, hardest surface!



Send today for copy of "Greater Savings Than Ever with C12000's"; also FREE Production Samples! Write: TINNERMAN PRODUCTS, INC., Dept. 12, Box 6688, Cleveland 1, Ohio. In Canada: Dominion Fasteners Ltd., Hamilton, Ontario. In Great Britain: Simmonds Aerocessories, Ltd., Treforest, Wales. In France: Aerocessaires Simmonds, S. A. - 7 rue Henri Barbusse, Levallois (Seine).



TINNERMAN

**Speed Nuts®**



MORE THAN 8000 SHAPES AND SIZES

# X-BAND KLYSTRONS in QUANTITY

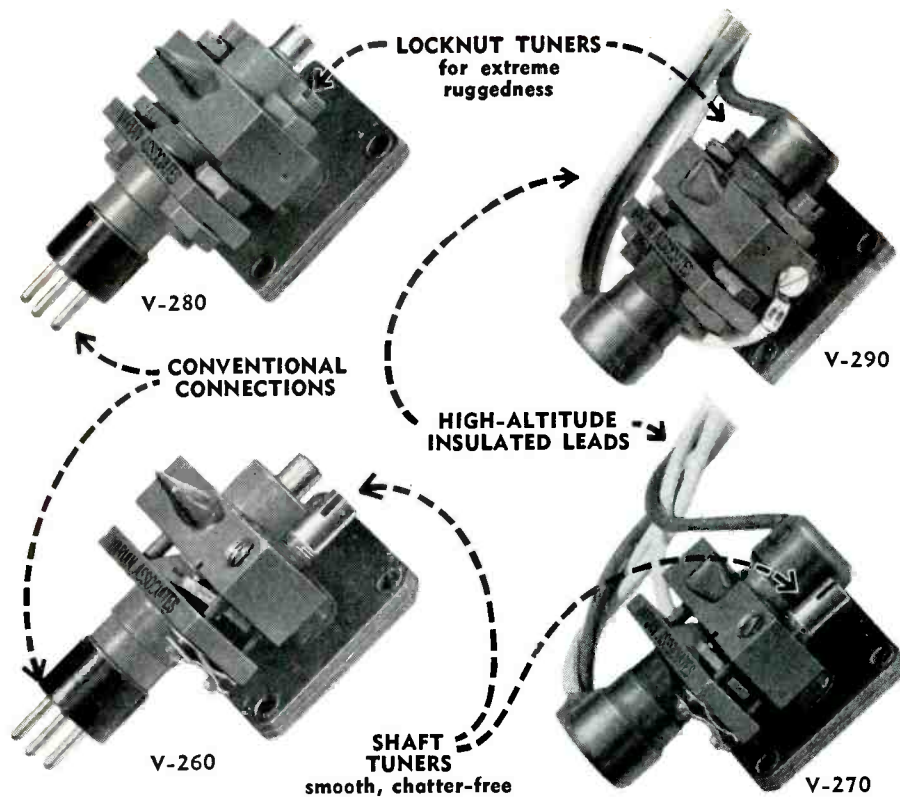

### GENERAL DATA

	V-260, V-270	V-280, V-290	X-13
Frequency Range, kmc	8.5-10.0	8.5-10.5	8.2-12.4
Heater Voltage, v	6.3	6.3	6.3
Heater Current, amp	1.2	1.2	1.2
Tuner	slotted shaft	locknut	micrometer

### MAXIMUM RATINGS

	V-260, V-270	V-280, V-290	X-13
Resonator Voltage, v	350	385	500
Resonator Current, ma	42	74	65
Reflector Voltage, v	0 to-1000	0 to-1000	0 to-1000

### TYPICAL OPERATION

	200	300	200	300	300	500
Resonator Voltage, v	200	300	200	300	300	500
Frequency, kmc	9.3	9.3	9.3	9.3	10	10
Resonator Current, ma	17	28	23	42	28	58
Power Output, mw	20	70	15	48	90	560
Electronic Tuning Range, mc	30	48	50	82	46	43
Temperature Coefficient, kc/°C	60	60	60	60	100	100
Reflector Voltage, v	-120	-160	-80	-100	-230	-600
Load VSWR, less than	1.1	1.1	1.1	1.1	1.1	1.1
Warm-up Time, sec to Oscillation	15	15	15	15	15	15

**OUTSTANDING FEATURES** of the series include rapid warm-up to on-frequency operation in 30 seconds, non-microphonic characteristics, low-voltage operation, lightness (6 oz.), compactness (volume less than a 2-in. cube), negligible barometric-frequency coefficient, smooth, chatter-free rotary-shaft tuners (V-260, V-270), integral-lead terminations (V-270, V-290) brought out through molded silicone-rubber structures to permit unpressurized operation to extreme altitudes and temperatures without arc-over, matched load operation without external matching sections, and waveguide outputs. All tubes are tested under high amplitude vibration conditions.



**FOR LABORATORY** measurement work at x-band—the familiar Varian X-13 general-purpose signal source (the prototype for this series of tubes) is now available for early shipment in production quantities.



**VARIAN associates**

FIELD REPRESENTATIVES IN 21 CITIES

rugged local oscillators for radar and beacon services

... full production

... quantity prices

... firm basis for new equipment design

\* Trademark

For full data, write Section ABAX, Varian Associates, Palo Alto, Calif.

# MOLONEY *HiperCore* ELECTRONIC CORES

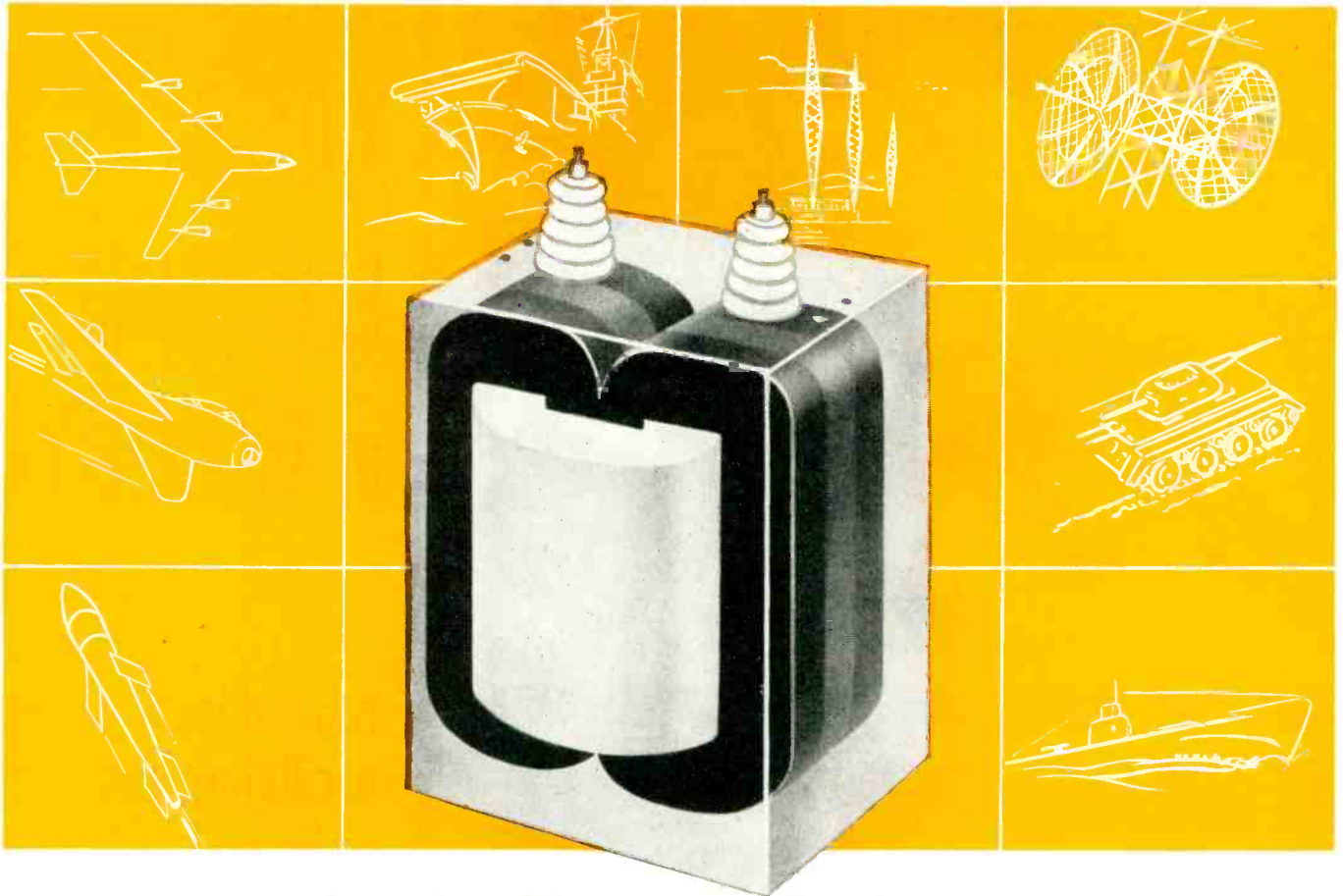

## ... for Any Electronic Application

Moloney HiperCore Electronic Cores assure better transformer performance because of their advanced wound core design. These wound cores have greater flux carrying capacity and lower losses than other types of cores of comparable sizes. In addition to better performance, a smaller, lighter core is obtained. In electronic applications, where size and weight are critical, Moloney HiperCore Electronic Cores are particularly desirable. Because they are wound cores, savings in assembly time can be favorably reflected in accelerated production. Rigid production control assures cores that test well within industry standards. More than 1000 standard sizes are available and special sizes can be made for specific applications, if desired.

Write today for bulletin SR-205 containing specifications, performance data and prices on over 300 stock sizes.

ME 53-17

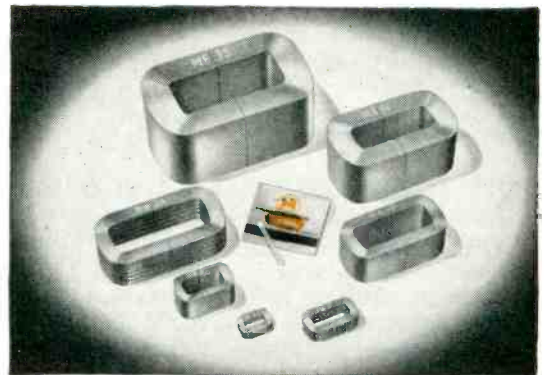

Moloney HiperCore Electronic Cores are wound with grain oriented silicon steel of 1, 2, 4 or 12 mil thicknesses.

## MOLONEY ELECTRIC COMPANY

*Manufacturers of Power Transformers • Distribution Transformers • Load Ratio Control Transformers Step Voltage Regulators • Unit Substations*



**BETTER PERFORMANCE  
GREATER RELIABILITY  
LESS MAINTENANCE**

SALES OFFICES IN ALL PRINCIPAL CITIES • FACTORIES AT ST. LOUIS, MO. AND TORONTO, ONT., CANADA



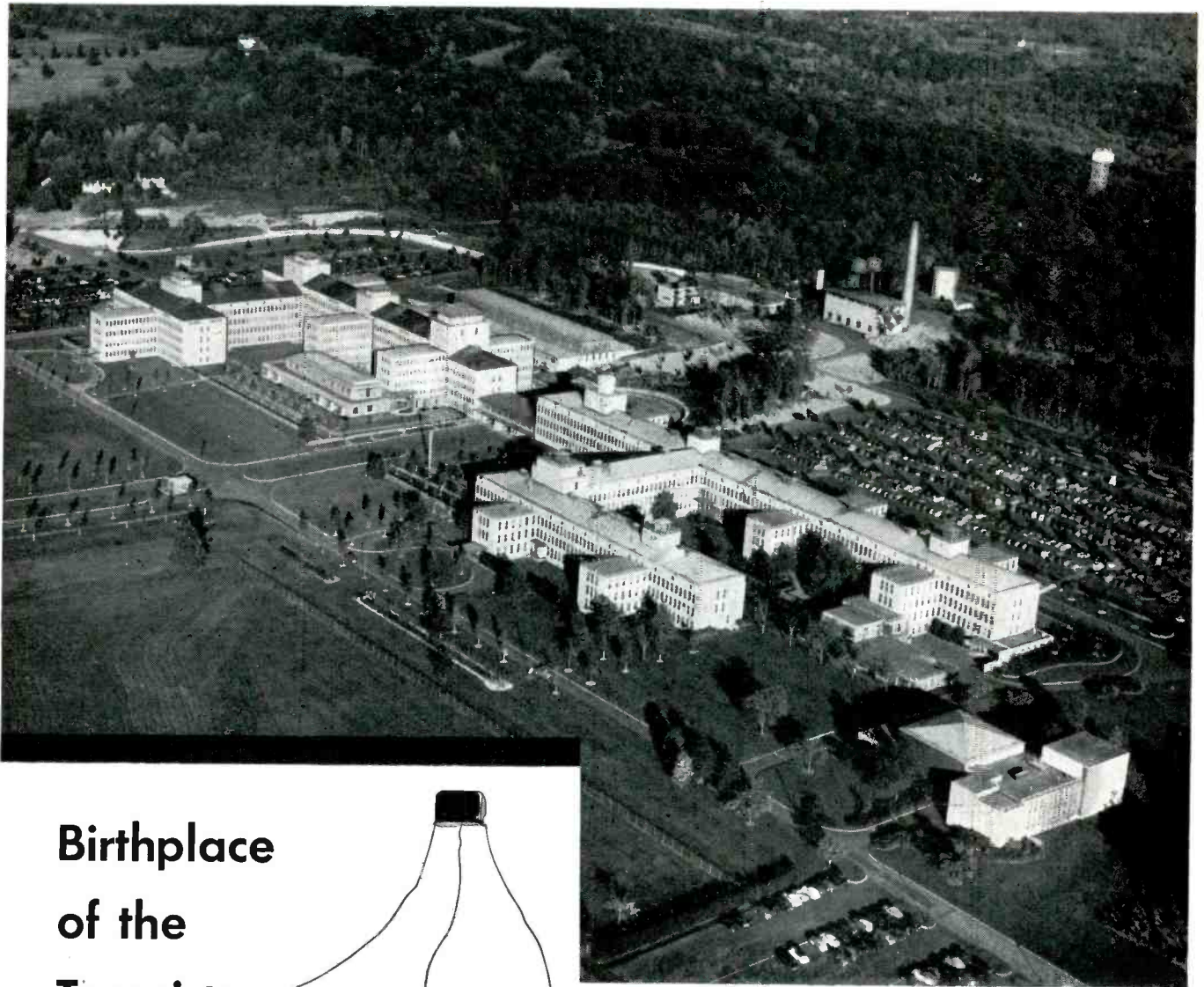

## Birthplace of the Transistor

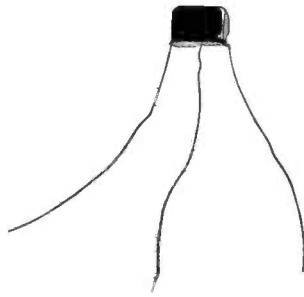

Bell Telephone Laboratories at Murray Hill, N. J. Other laboratories are in New York City and at Whippany and Holmdel, N. J.

The *Transistor*, that revolutionary new electronics device, is a product of *telephone* research. It was conceived, invented and developed at Bell Telephone Laboratories by men in search of ways to improve telephone service. It was announced just five years ago.

The *Transistor* can do most of the things that vacuum tubes can do—and others, too—but it is not a vacuum tube. It works on entirely new physical principles. Rugged, simple and tiny, the Transistor uses incredibly small amounts of power—and then only when actually operating.

*Transistors* promise smaller and cheaper electronic equipment and the spread of electronics where other equipment has not been able to do the job as economically. They are already at work in the Bell System, generating the signals that carry dialed numbers between cities, and selecting the best route for calls through complex switching systems. Engineers see many other possibilities: for example, as voice amplifiers in telephone sets to aid the hard of hearing, and as switches.

Recognizing the tremendous possibilities of the *Transistor* in every phase of the electronics industry, the Bell System has made the invention available to 40 other companies. Thus, again, basic research to improve telephony contributes importantly to many other fields of technology as well.

### TRANSISTOR SUMMARY

Basically, a *Transistor* is a tiny wafer of germanium with three electrodes, over-all about the size of a coffee bean.

It can amplify signals 100,000 times on much less power than a pocket flashlight requires. This opens the door to its use in smaller telephone exchanges where vacuum tube equipment would be too costly to operate.

Unlike a vacuum tube, the *Transistor* has no vacuum and no filament to keep hot. It operates instantly, without "warm-up" delay. The Transistor can also be used as an electric eye and to count electrical pulses.



## BELL TELEPHONE LABORATORIES

There are many opportunities for creative scientists and engineers at Bell Telephone Laboratories. For details see our advertisement on page 401

Want more information? Use post card on last page.

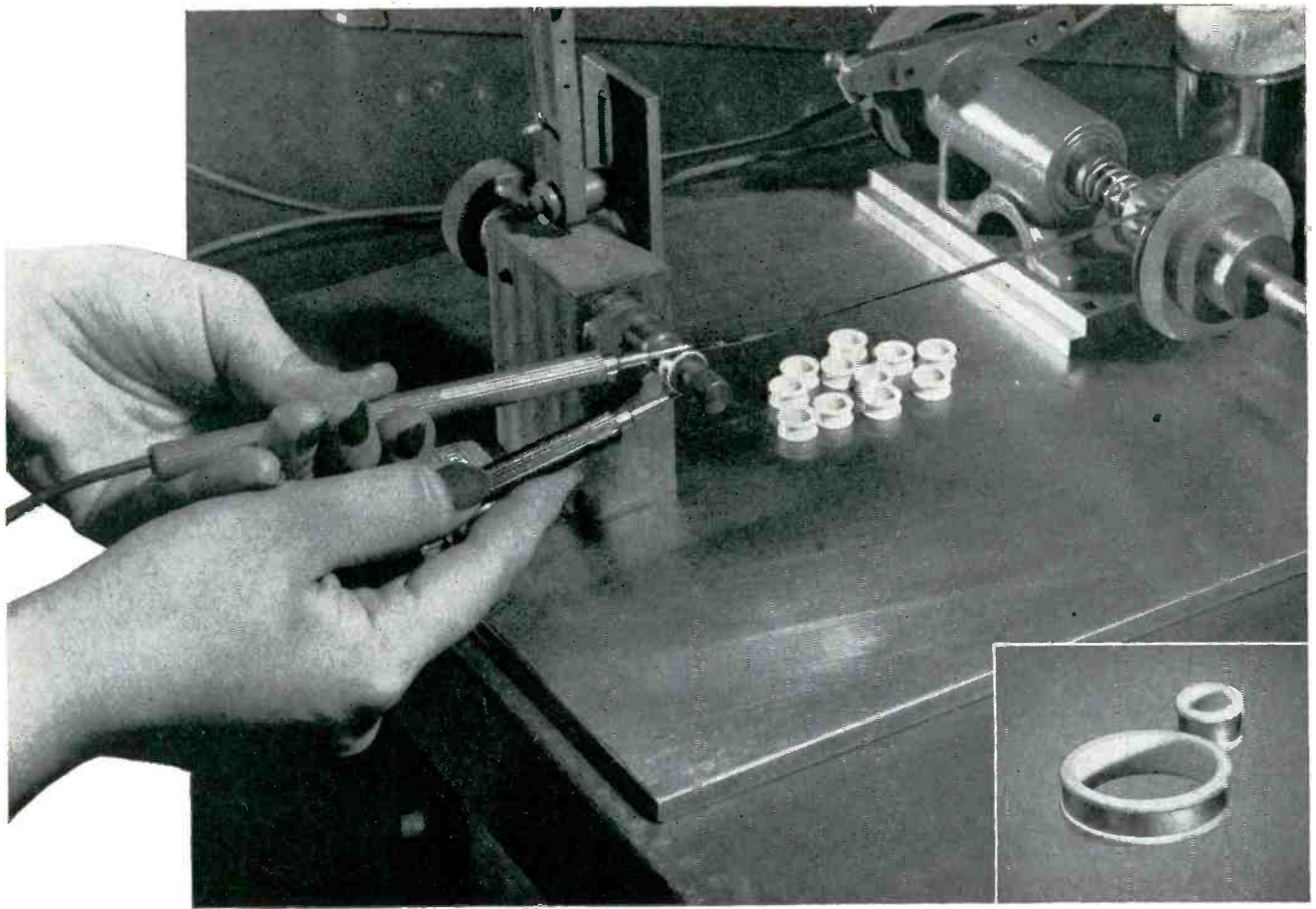

## Hiperthin\* Cores . . . newest approach to electronic circuit designs

New circuit designs, often making it possible to replace tubes in amplifiers, computers, modulators and similar electronic equipment, are being developed through the use of Westinghouse Hiperthin Cores.

An entirely new, thin magnetic material, capable of retaining its desirable qualities even when rolled as thin as  $\frac{1}{8}$  mil, is the reason.

Compounded of grain-oriented silicon or nickel-iron alloys, it combines the fast response, high permeability and low coercive force needed in vhf circuits. Non-deteriorating, it eliminates the periodic replacement problem encountered with tubes, assuring sustained and accurate performance.

To manufacture the new core economically,  
\*Trade Mark

Westinghouse engineers devised new production methods. The illustration above shows a core being subjected to an electronically controlled spot weld, after being wound. New techniques have also been developed for effectively insulating the turns, and for annealing the metal on a ceramic form as a unit to insure permanent stability.

All your core requirements . . . whether they're for electrical or special electronic applications . . . can be met best by engineers who know and understand your problems. For further information write for reprint No. 4866, *Progress in Core Material for Small Transformers*. Westinghouse Electric Corporation, P. O. Box 868, Pittsburgh 30, Pennsylvania. J-70676

YOU CAN BE SURE...IF IT'S  
**Westinghouse**



# IDEAS

*in the making*

*Araldite® Bonding, Casting and Coating Resins developed by Ciba Research are simplifying manufacturing methods, improving product efficiency, and opening new fields of product development. You will want to know more about them.*

(G. C. Wilson & Company)

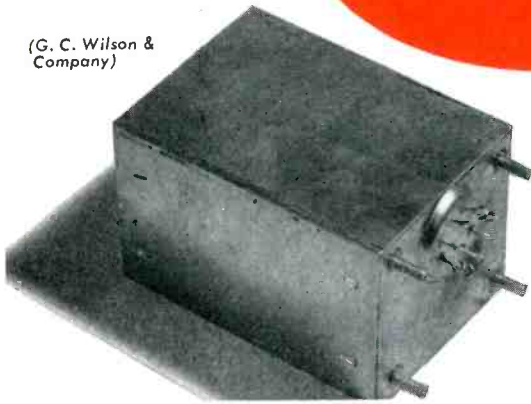

## ELECTRONIC ASSEMBLY OF AIR-TO-GROUND ROCKET MADE MOISTURE-PROOF AND STRENGTHENED WITH EPOXY COATING RESIN

The time-saving simplicity of coating operations combined with the rugged protection afforded by ARALDITE coating resins make applications such as this routine on either a specialized assembly or mass production basis.

(Aircraft Transformers, Inc.)

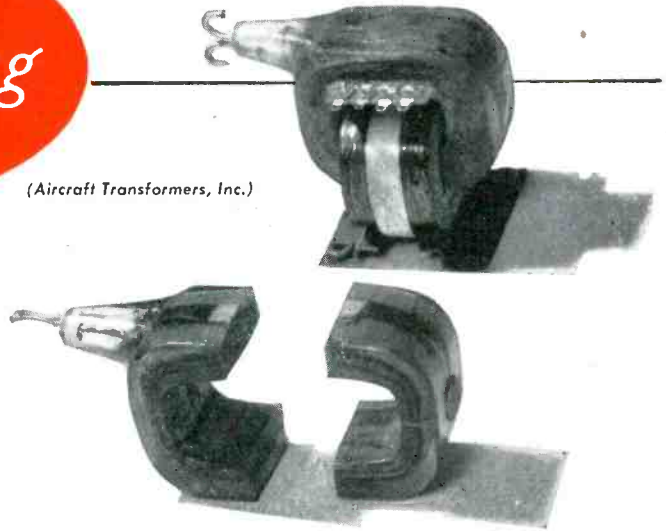

## EPOXY RESIN ENCAPSULATES TRANSFORMER COILS

The excellent dielectric properties of ARALDITE epoxy casting resins coupled with high affinity for metals have made them "the resin of choice" among leading electrical and electronic designers and manufacturers for potting and impregnating transformers, capacitors, coils, motor windings and similar apparatus requiring long-lasting efficiency in operation.

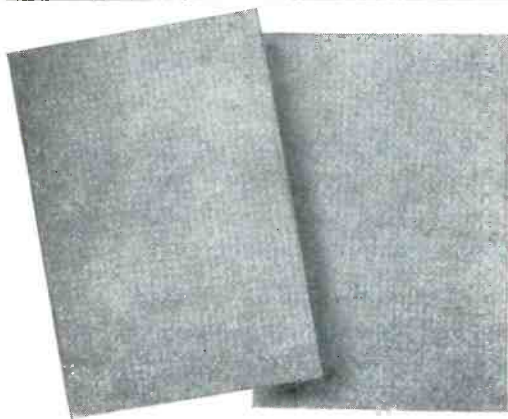

(Cordo Chemical Company)

## EPOXY RESIN PRE-IMPREGNATES GLASS CLOTH

The application of ARALDITE "CN" epoxy impregnating resins by fabricators of glass laminates suggests a wide field of related uses where the low shrinkage, excellent dielectric strength, exceptional resistance to chemical attack and durable adhesive properties provide unprecedented advantages for product "in use" efficiency. ARALDITE impregnating resins are produced in types suitable for either heat-curing or self-curing. ARALDITE is available as pre-impregnated cloth or as cured laminates.

SEND THIS COUPON . . . or write us on your company letterhead . . . for complete technical data on the physical properties and recommended procedures for the successful use of Araldite Resins for your own fabricating needs.

# CIBA

## Plastics

**BONDING ★ CASTING  
COATING RESINS**

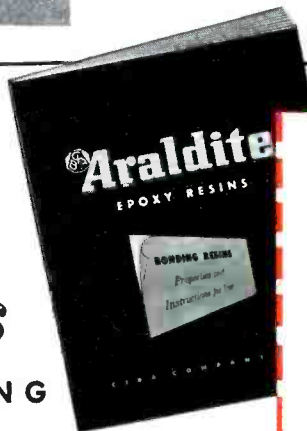

**CIBA COMPANY, INC.,** PLASTICS DIVISION  
627 Greenwich St., New York 14, N. Y.  
(In Canada: Ciba Co. Ltd., Ciba Bldg., Montreal)

Please send me Ciba Plastics Technical Bulletins for  
BONDING  CASTING  COATING

Name \_\_\_\_\_

Company \_\_\_\_\_ Title \_\_\_\_\_

Address \_\_\_\_\_

E-7

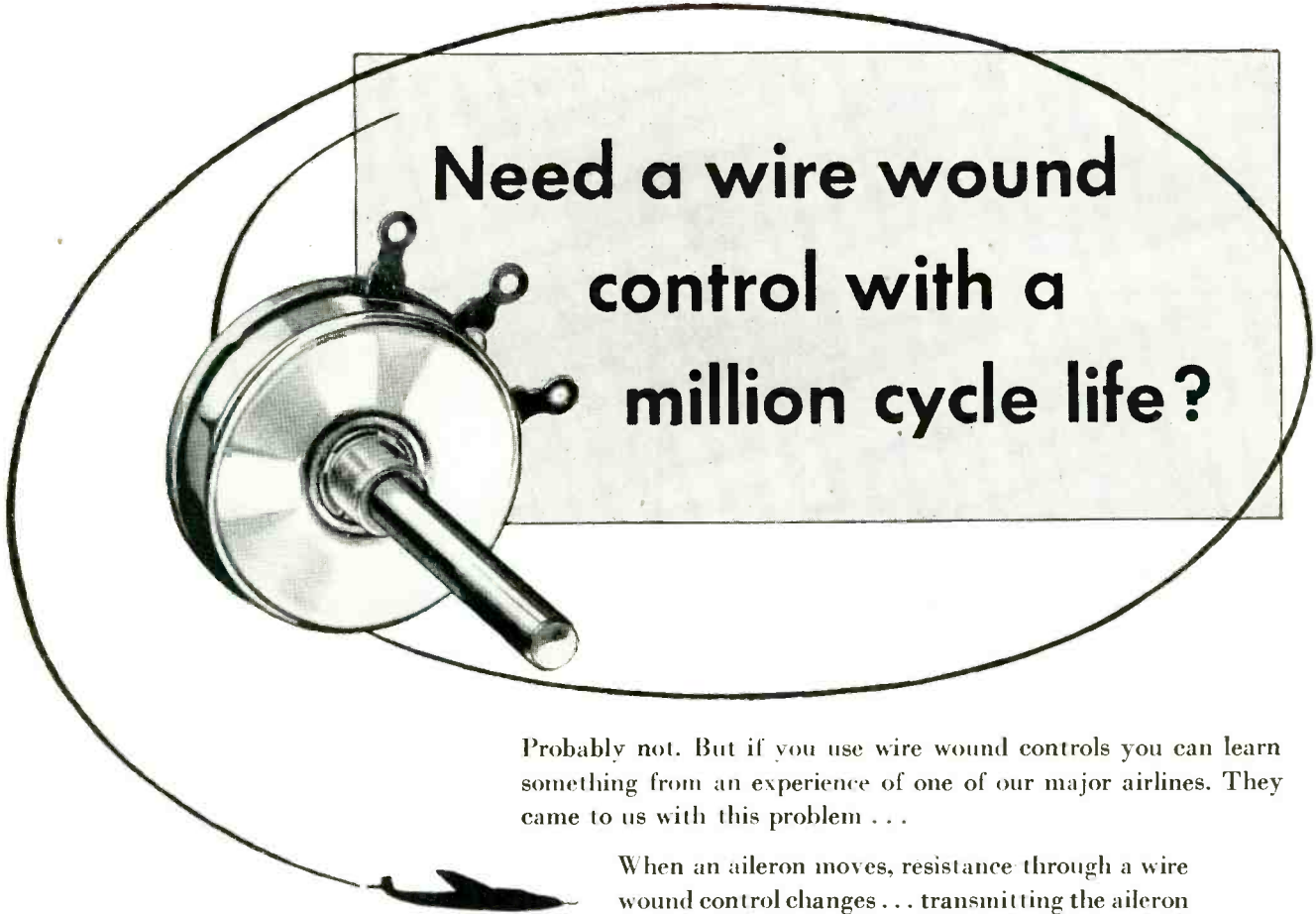

## Need a wire wound control with a million cycle life?

Probably not. But if you use wire wound controls you can learn something from an experience of one of our major airlines. They came to us with this problem . . .

When an aileron moves, resistance through a wire wound control changes . . . transmitting the aileron position to the automatic pilot which instantly and automatically corrects the aileron position. As a result, the aileron control is moving almost constantly within a very narrow range. It was the highly concentrated wear in this area that was causing the trouble.

The answer to the problem was a standard Mallory wire wound control except for special contact materials that provided the needed life. The result was a million cycles of dependable operation with substantial economies in maintenance schedules.

You may never need a control that will last for a million cycles, but you can bet that Mallory will have the answer to your control problems . . . standard or special. For complete information, write for your copy of our new Technical Information Bulletin 76-3 covering both military and commercial types.

*Expect more . . .*

Get more from **MALLORY**

Parts distributors in all major cities stock Mallory standard components for your convenience

P. R. MALLORY & CO. Inc.  
**MALLORY**

#### SERVING INDUSTRY WITH THESE PRODUCTS:

**Electromechanical**—Resistors • Switches • Television Tuners • Vibrators  
**Electrochemical**—Capacitors • Rectifiers • Mercury Dry Batteries  
**Metallurgical**—Contacts • Special Metals and Ceramics • Welding Materials

P. R. MALLORY & CO., INC., INDIANAPOLIS 6, INDIANA

## CROSS

## TALK

► **TARGET** . . . NTSC panel chairmen are working toward a September 1 deadline for the preparation of final reports on compatible color television. It seems certain that a request for a hearing will be filed in Washington well before the first of the year and it is likely that the FCC will accede to the request by then or soon thereafter.

Setting of a hearing date often takes three months or more after the filing of a request, due to the weight of preparatory paperwork and other necessary routine. In this instance it is believed that the Commission may waive some preliminary requirements; it is being kept well informed concerning the Committee's work and is closely following field tests now in progress.

► **TESTS** . . . When panel chairmen testify before the FCC in behalf of compatible color television they will be well prepared to answer questions regarding the NTSC system. Tests now in progress in half a dozen cities are exhaustive, covering even such fine points as possible radiation by color oscillators in the amateur bands.

Membership on the Committee is no sinecure. Just a few weeks ago, for example, we spent two days helping to set up specifications and equipment for just one test, and then stayed up all night running off data. Others have done much much more.

► **CONTROLS** . . . Experimental compatible-color-tv receivers are indeed more difficult to adjust during installation than the latest commercial monochrome models. It seems to us, however, that the adjustments are not much more difficult than they were on early monochrome sets and that they hold just about as well. Reduction in the number of back-of-set controls and minimizing of interaction between controls should come quickly as the art progresses.

Front-panel tuning is surprisingly simple and stable. There may be more fiddling around by the user of the first commercial models but we remember an early experience with a monochrome set. It resisted informed manipulation but performed beautifully the instant a neighbor's small boy ostensibly threw everything out of whack. This experience is nicely covered by the quotation "And a little child shall lead them."

► **MONSTERS** . . . Last month (p 129) it was speculatively noted that this may be the first commercially significant year for circuit mechanization. Since then a number of machines designed for automatic production of electronic devices or subassemblies have been seen, most of them in back rooms.

One of the reasons why such machines are just now coming to light is that manufacturers are getting over their hesitancy to

invest heavily in relatively inflexible equipment; the design of such things as radio receivers is relatively stable. Another is the development of machines that are, in fact, more flexible than their early prototypes. Still another is a growing tendency to gamble on the retention of necessary production-line help during the transition from women to machines.

The latter problem can be sticky. In one plant production workers refer surreptitiously to a back-room machine as "The Monster."

► **TREND** . . . The trend toward 12-volt systems appears to be at least momentarily halted at a mere handful of American automobiles. That handful is pretty important saleswise, however, so several manufacturers of mobile radio equipment and accessories are reluctantly designing so-called "universal" equipment to operate on either 6 or 12. It is, apparently, expensive to convert existing 6-volt gear to 12-volt operation in many cases.

► **SHOPTALK** . . . The response to **ELECTRONICS'** cleaner and more continuous editorial makeup has been substantial and favorable. Many useful suggestions for further improvement have been received. In general, readers, like Oliver Twist, say: "Thanks, give us more." This we will do, as proposals prove out from a practical publishing standpoint.

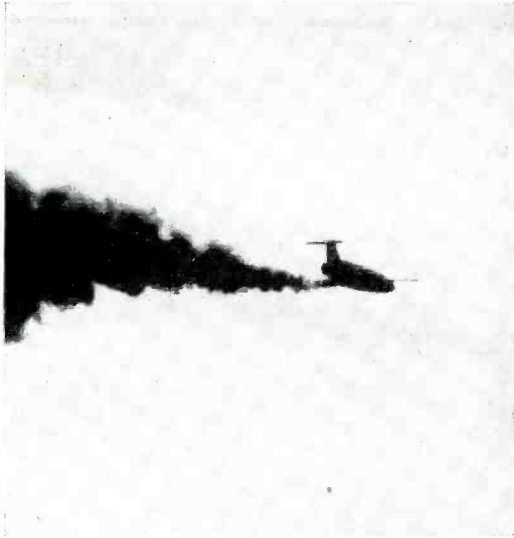

GROUND-TO-GROUND—Air Force Matador wings over Atlantic near Cocoa, Fla.

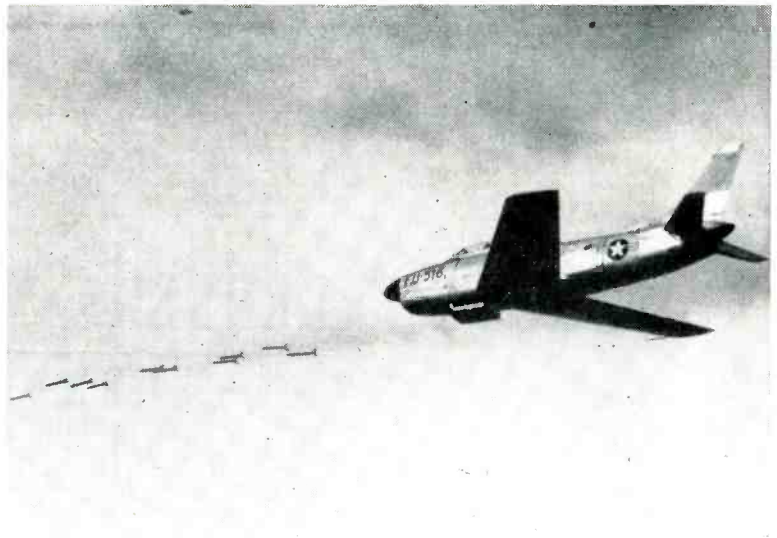

AIR-TO-AIR—Mighty Mouse rockets fired from North American Sabre are electronically aimed

# How Electronics Controls

Air-defense and surface-bombardment weapons nearing production stage anticipate era of pushbutton warfare. Electronics plays major role in their control and guidance. Details of V-2 control system illustrate how servo loop corrects trajectory and flying position

By **JOHN M. CARROLL**

*Assistant Editor*  
ELECTRONICS



**R**OCKETING into the skies, missiles like Nike may represent America's last line of defense against hostile bombers laden with atomic bombs. Radar, tracking the invader, would feed course and speed data to ground-based computers that sense guidance information and transmit it to the missile. Developed jointly by Douglas Aircraft and Western Electric, Nike reportedly can track down and destroy supersonic bombers flying at great altitudes.

This and other missile types now nearing production embody the results of an eight-year research program that cost better than \$4 billion and employed the talents of countless thousands of engineers

and scientists. The work was divided almost evenly between aerodynamists and electronic specialists. Few electronic firms and research laboratories have not been touched in some way by the program.

## *Cloak and Dagger*

The origins of our guided-missile program go back to the holocaust that marked the last days of Hitler's Third Reich. Fleeing their laboratories at Peenemuende on the sandy, wind-swept Baltic seacoast to escape the advancing Red Army, guided-missile experts of the Luftwaffe and army ordnance had scarcely set up shop in the Bavarian-Alps village of Kochel when

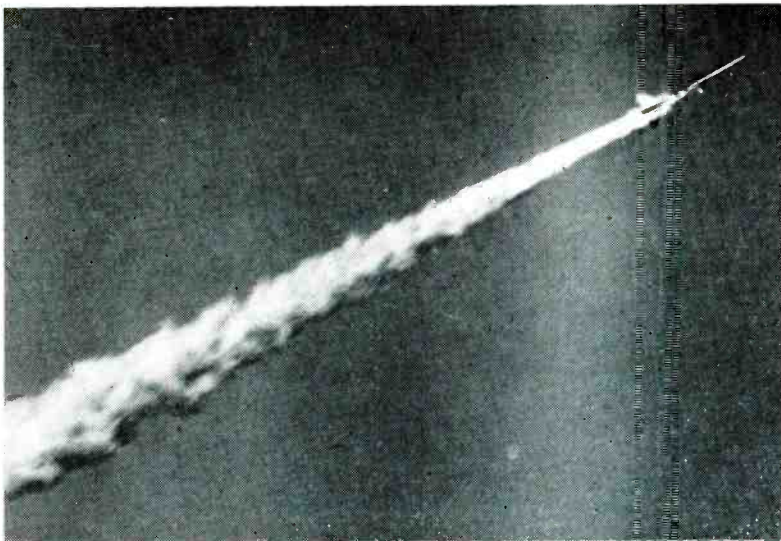

**GROUND-TO-AIR**—Boeing GAPA furnished valuable knowledge about rocket air-defense technique



**AIR-TO-GROUND**—Navy fighter launches Tiny Tim rocket at Inyokern, Calif., test center

# GUIDED MISSILES

news of the collapse of German resistance reached them.

A hasty decision was made to surrender to American forces. Meanwhile, technical intelligence teams following in the wake of the Allied advance uncovered stores of V-2 rockets and parts in the vast underground factories at Nordhausen. Army missile men credit the 120 German scientists and 100 rockets evacuated to the U.S. with saving more than \$50 million and five years research time in our program. During the past six years, the Army has test-fired nearly seventy V-2's at White Sands Proving Grounds.

## German Missiles

The first V-2 rocket struck London in the fall of 1944. Subsequently 1,152 V-2's were fired against England and 1,314 against the Dutch port of Antwerp after its capture by the Allies. The V-2 was 47 ft long. Loaded, it weighed over 14 tons, including 9.7 tons of liquid propellant. The rocket carried its 2,000-lb warhead 250 miles. Allied intelligence teams delving into German naval research notes unearthed plans to launch V-2's from submarine-towed cais-

sons that could surface near coastal targets.

Forerunner of the V-2, the V-1 was a pulse jet guided by an autopilot with compass and altimeter correction. Thirty feet long, it had a 200-mile range and loafed along at 360 mph.

Tactically more potent than either V-1 or V-2 were radio-controlled glide bombs used with devastating effect against Allied shipping in the Mediterranean. A tone control system enabled the bombardier

in a mother plane to correct the bomb's course after launching.

Less publicized were the radio-controlled antiaircraft rockets Rheintochter and Wasserfall. Wasserfall was guided by an automatic aiming device working in conjunction with Wurzburg radar fire-control equipment. It attained a 1,700-mph speed.

Immune to Allied electronic countermeasures was the Spieler, a Luftwaffe air-to-air missile. Spieler received its control signals from the



**SPIELER**—Developed by German Luftwaffe, this air-to-air missile received control signals over wire, making it immune to electronic countermeasures. Proximity fuze increased missile's deadliness

## BOMBARDMENT MISSILES

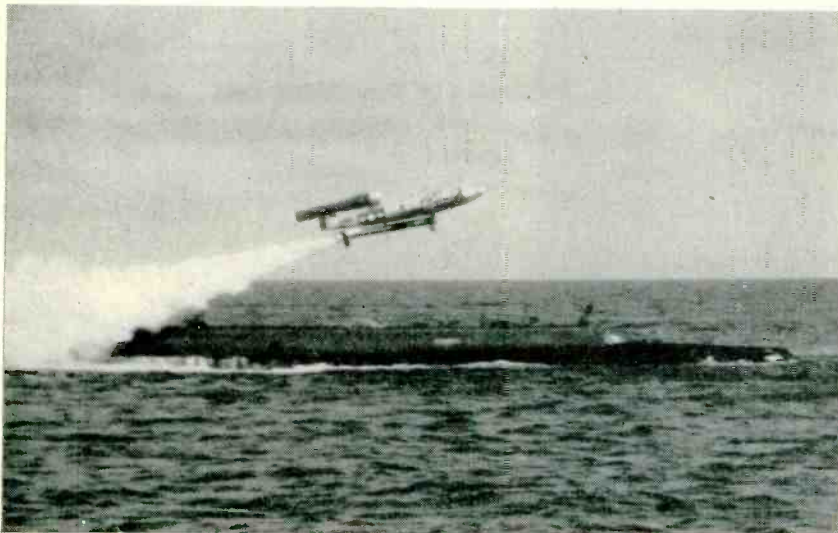

**LOON**—Navy version of German V-1, this pilotless pulsejet has been successfully fired from submarines. Missile is carried in waterproof hanger aft of conning tower while underwater



**REGULUS**—Chance-Vought missile designed for Naval shore bombardment and amphibious warfare

## INTERCEPTORS

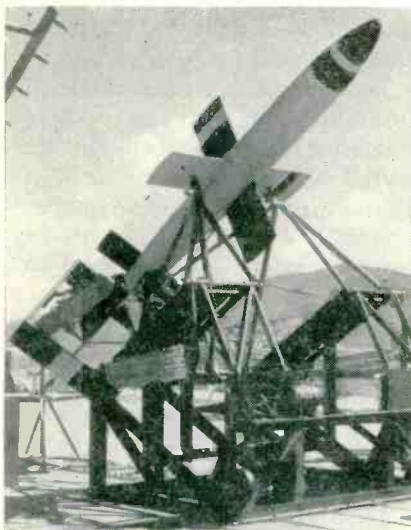

**LARK**—Navy ground-to-air interceptor built by Fairchild. Newer Navy interceptors include Terrier, a Johns Hopkins-Convair missile and the Sperry Sparrow

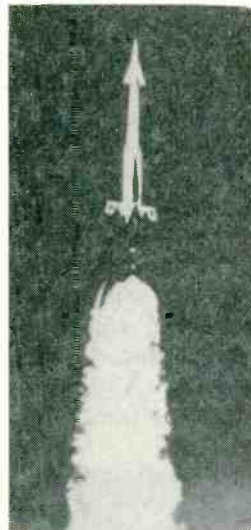

**NIKE**—Army ground-to-air interceptor developed jointly by Douglas and Western Electric

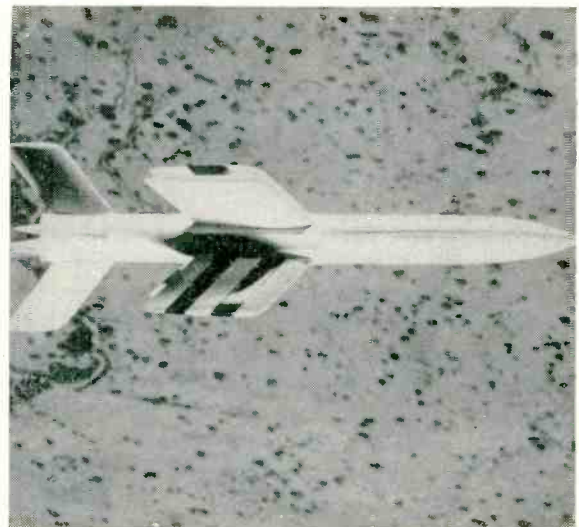

**FIREBIRD**—Launched from a mother plane, this early Ryan-built Air Force missile was bracketed on target by mother plane's radar. Other USAF pilotless fighters are Boeing Bowmarc and Hughes Falcon

mother plane neither by radar nor radio but over a thin wire that it spun-out spider-like during flight.

### **Glide Bombs and Drones**

Guided missiles include glide bombs and pilotless aircraft as well as rockets. Prior to 1945 American missiles fell almost exclusively into

the first two classes. The Bat, a glide bomb guided to its target by self-contained radar, sank many tons of Japanese shipping. Other guided bombs such as Azon, Razon and Tarzon were used in the ETO.

First pilotless aircraft were target drones. Jet drones like the Ryan Q-2 Firebee are still useful in

training antiaircraft gunners and radarmen. Pilotless planes were used tactically during World War II when war-weary B-17 bombers laden with high explosive were crashed into their targets by command signals from a mother plane. The Navy recently used drone-controlled F6F Hellcats against objec-





**MATADOR**—Designated B-61, this Martin-built Air Force tubojet aircraft is designed for long-range bombardment

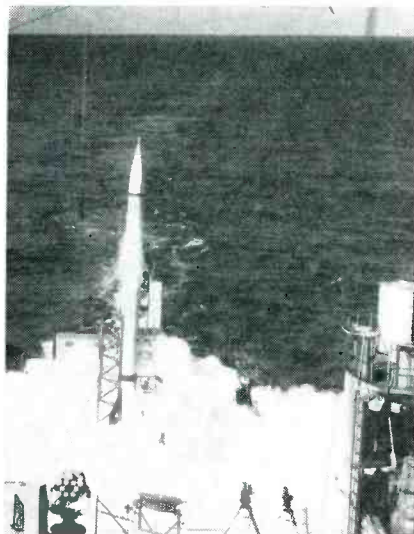

**VIKING**—Launching from seaplane tender Norton Sound. Viking is built by Glen L. Martin

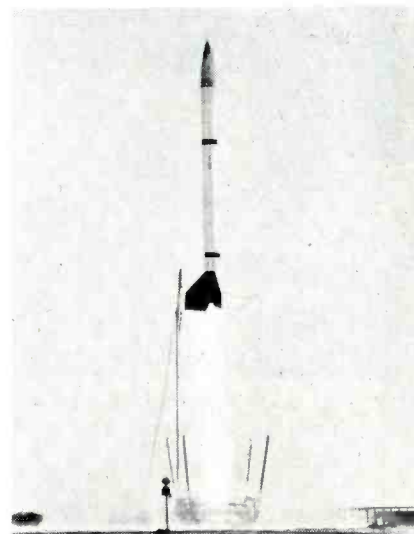

**CORPORAL E**—Developed for Army by CalTech, this ground-to-ground missile will be built by Firestone

tives in Korea. A built-in television camera was used to provide the pilot with a display of the drone's instrument panel.

Lockheed QF-80 pilotless jet bombers gathered valuable data on radiological hazards within the atomic cloud during nuclear tests at Yucca Flats, Nevada. The QF-80 uses the Sperry E-4 autopilot to correct unwanted deviations while responding to command signals. It can take off and land automatically.

The Loon, Navy version of the German V-1, has been successfully launched from submarines.

Also interested in pilotless aircraft, the Air Force has announced that it is forming squadrons of Martin B-61 Matadors.

### American Rockets

Army, Air Force and Navy Bureaus of Aeronautics (BuAer) and Ordnance (BuOrd) share responsibility for running 30-odd missile development programs and 51 major development facilities.

The Army recently announced production of two missiles, Nike for air defense and Corporal E, a missile much like the V-2, for ground-to-ground bombardment. A contract has also gone out to Chrysler to produce Redstone, a long-range, ground-to-ground missile developed by ex-German scientists at Red-

stone Arsenal. Army guided-missile battalions have already had field training with Nike.

The Navy appears to favor the Convair Terrier as its ground-to-air interceptor missile.

Viking-9, offshoot of an early research vehicle, is the Navy opposite number to the Corporal E. Viking rounds have been launched from the seaplane tender Norton Sound.

A newly-unveiled Navy missile, Regulus, is designed for launching from submarines, surface vessels and shore bases. A BuAer missile

developed by Chance Vought, Regulus requires only slight modification of the launching vessel. Tactically,

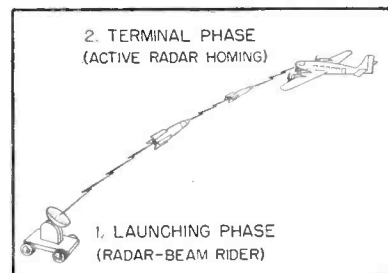

**FIG. 2**—Guidance system for a hypothetical air-defense missile

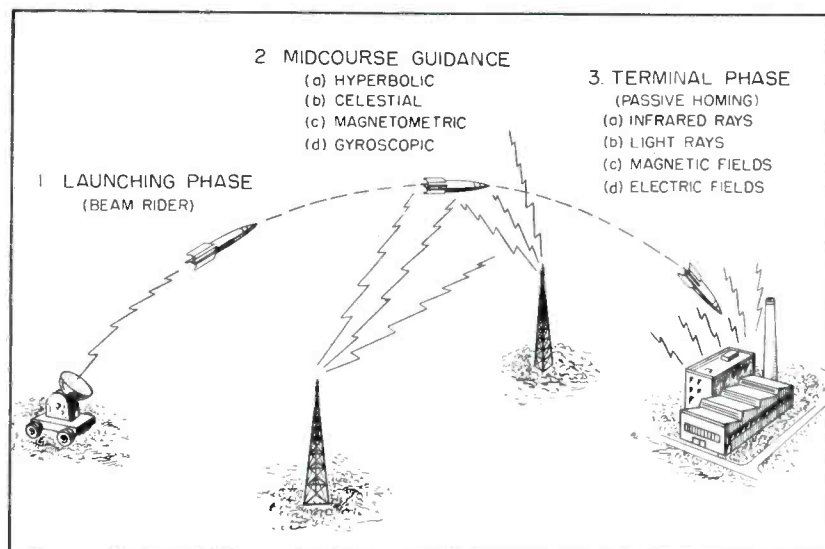

**FIG. 1**—Guidance system for a hypothetical long-range ground-bombardment missile

# LAUNCHING A MISSILE



Engineers check instrumentation during missile's last "hanger flight"



German "Meillerwagen" has hydraulic lift to position a missile on firing table

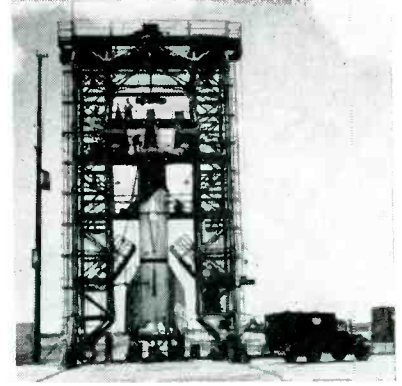

Gantry crane secures missile for fueling and final instrument check

Regulus could be used against coastal targets and in amphibious warfare.

## Missile Guidance

In rockets, drones and glide bombs electronic guidance and control play essential roles. Control and guidance are often used interchangeably to denote the entire process of intelligence and maneuver that enables a missile to hit its target. In guidance, however, primary emphasis is on flight path and information for determining proper course. In control, emphasis is on course changes during flight. Basic guidance system for a hypothetical long-range ground-bombardment missile is shown in Fig. 1.

There are broadly three types of guidance: guidance in the launching phase, midcourse guidance and terminal guidance. A common system used in the launching phase is beam-rider guidance. A beam, such as radar, forms a line in space along which the missile is directed. Equipment built into the missile enables it to sense deviation from centerline. Amplifiers, servomechanisms and movable aerodynamic surfaces restore the missile to centerline. Basic guidance scheme for a hypothetical air-defense missile is given in Fig. 2.

Midcourse guidance is essentially a problem in navigation. Proposed systems include celestial, hyperbolic, gyroscopic and magnetometric navigation as well as preset guidance.

Celestial navigation provides that a missile, suitably instrumented, follow a predetermined course with primary reference to the relative position of the missile and selected celestial bodies. Determination of the vertical to the earth's surface may also be necessary.

In hyperbolic, advantage is taken of lines of position obtained by measuring the distance of the navigating equipment from two or more transmitters of known location. Loran, Decca and Gee are hyperbolic systems. Navigation systems may also make use of the earth's magnetic field or gyroscopic effects.

## Homing

Successful terminal guidance ends with the missile crashing into its target. The problem is one of

homing. Active homing recalls the Bat glide bomb that carried its own radar to illuminate the target. Received echos gave directional course correction through gyro stabilizers and servomechanisms moving wing surfaces. An off-center reflector enabled the radar signal to bracket the target.

In semiactive homing the missile homes on a target illuminated by a third source. For example, an air-to-air missile may be guided by reflections from a target bracketed by the mother plane's radar.

A missile may also home on the natural radiations of the target. These may be light or infrared rays, electric or magnetic fields. Passive homing suggests use in long-range bombardment missiles that may home on signals from

Table I—Flight History of a V-2 Rocket

Time	Operation
X	Time switch starts, missile rises with 1-g acceleration
X-1 sec	Doppler transmitter on
3 sec	Guiding-beam receiver on
4 sec	Inclination program begins
40 sec	Dynamic pressure valve closes, warhead fuze is armed
42 sec	Missile at 6.2 miles, speed Mach 2
47 sec	Combustion-cutoff receiver unblocked
47-67 sec	Doppler transmitter on
52 sec	Inclination program ends, altitude 10 miles, speed Mach 3
60 sec	Altitude 14.6 miles, speed Mach 4
63 sec	Altitude 15.5 miles, speed Mach 4½. Combustion cutoff, if controlled by integrating accelerometer, occurs when desired velocity is attained. This is usually 3,365 mph
88-90 sec	Doppler transmitter on
90 sec	Time switch completes cycle
175 sec	Missile attains peak of trajectory, about 50 miles
320 sec	Missile strikes target



Missile stands free on firing table minutes before take off

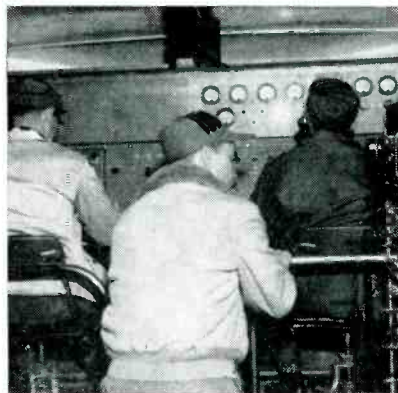

"It is now X minus 15,14 . . ." range officer counts final seconds



"The missile is away" . . . V-2 rises in a cloud of smoke and dust

enemy radio transmitters or heat rays from war plants and power stations.

### Electronic Control

Circuit details of modern missile-control systems are classified. However, the control system of the German V-2 rocket embodies some basic principles of missile control.

Range for V-2 is determined by cutting off the fuel supply at the proper instant. This is accomplished either by a preset timing switch or by radio signals from the ground station. Trajectory and flying position are determined by control surfaces, not spin. Direction control is derived from a preset steering device but this is occasionally assisted by a radio beam that determines direction in the yaw

plane. The missile also contains a 46-mc radio beacon; using the Doppler principle, the ground crew tracks the rocket by these signals. Every tenth missile is equipped also with a telemetering transmitter to provide ground monitoring of its performance during flight. Instruments and control equipment weight 858 pounds. Power is supplied primarily by 27-volt batteries; d-c/a-c motor-generator sets furnish 40 volts at 500 cps.

Sequence of time-dependent action is controlled by a time switch. The time switch is started by the take-off switch, a plug that flies out as the missile leaves the firing table. The take-off switch also disengages the ground power supply used to power missile circuits prior to take-off to avoid premature discharge of

batteries. The electrical fuze network in the warhead has a capacitor filter to smooth out transients introduced by the switching relays.

### Direction Control

The control surfaces comprise four tabs and four vanes in the burning jet. The vanes and tabs are numbered to correspond to the rocket's fins. The axes of the missile in flight and the control surfaces are shown in Fig. 3.

Gyro D (Fig. 4A) controls rotation about the D-axis (pitch) through operation of vanes 2 and 4. Gyro EA (Fig. 4B) controls rotation about the E-axis (yaw) and the A-axis (spin) through operation of vanes 1 and 3 (Fig. 3). The radio beam also controls these vanes.

Displacing vanes 1 and 3 in the

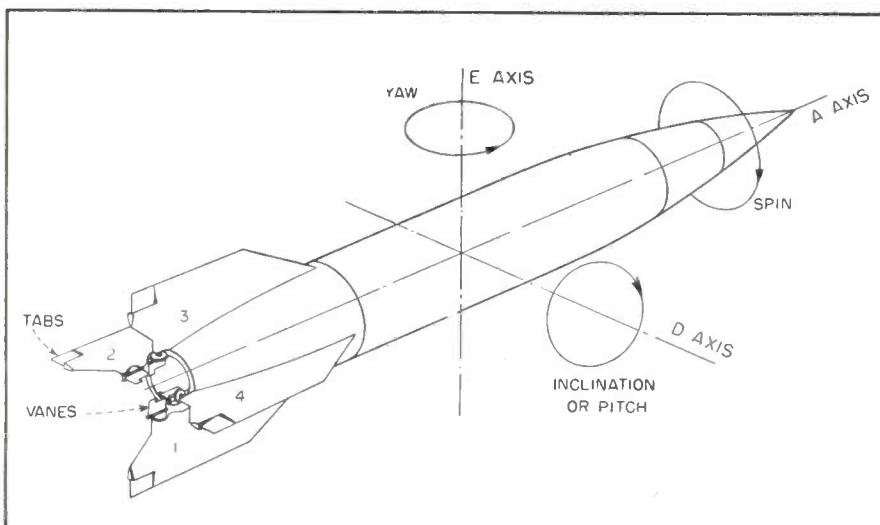

FIG. 3—Sketch of German V-2, showing aerodynamic control surfaces and principal axes

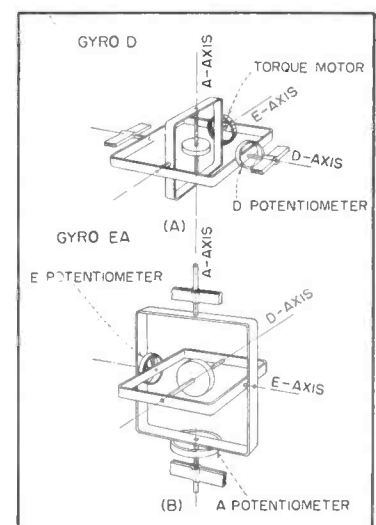

FIG. 4—Directional gyros sense course deviations

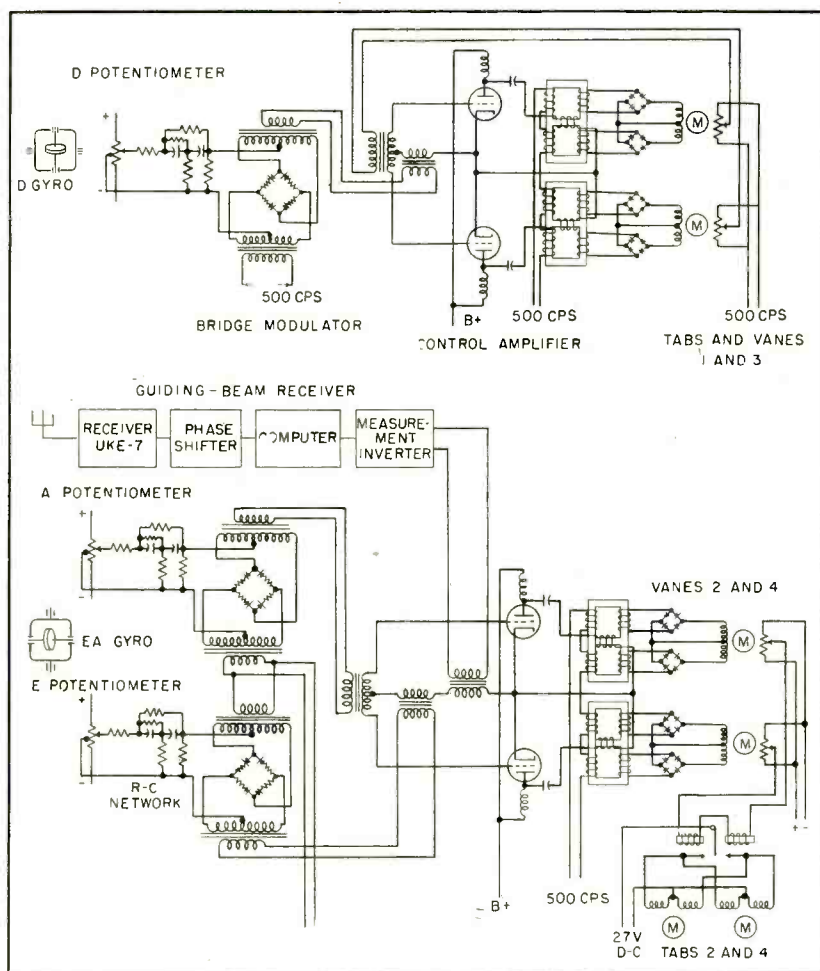

FIG. 5—Servo loop moves control surfaces to correct course deviation. Guiding-beam receiver also can control direction in yaw plane. Resistance-capacitance network reduces missile's hunting about flight path

same direction causes rotation about the E-axis, displacing vanes 1 and 3 in opposite directions causes rotation about the A-axis. Displacing vanes 2 and 4 in the same direction causes rotation about the D-axis.

Tabs are provided as well as vanes; vanes give control at take-off but tabs furnish additional control, particularly over spin, that vanes alone could not give. The tabs turn 12 deg; vanes turn 24 deg. Tabs 1 and 3 are linked to vanes 1 and 3.

Tabs 2 and 4 have separate drive mechanisms that displace them in opposite directions. Tab drive is actuated only when vanes 1 and 3 respond to a large spin signal, greater than 3 deg. The tab drive motors move slowly but once the tabs are displaced, they remain displaced unless a second large spin signal is received. The tabs act to compensate for structural irregularities that tend to produce spin.

This adds desired loading to tabs 1 and 3.

The inclination program (Table I) rotates the missile about the D-axis and is produced by a 3,000-rpm d-c torque motor that causes the D gyro to precess about the D-axis. After combustion cutoff, all vanes and tabs return to null position and the missile behaves as a projectile.

Figures 4A and 4B show how course deviations, sensed by the gyros, are converted to error signals by potentiometers. Figure 5 is the circuit that converts these signals into rudder movement. However, if signal voltages from the D-E and A potentiometers were applied directly as control to rudder motors, a vane, moved right to control left deviation, would still be right when the missile passed null. Since this would create oscillation, the vanes are returned to null position before the missile restores to course centerline. The error signal

is passed through a double differentiating R-C network before being applied to the control amplifiers. This creates an advance of rudder current ahead of missile oscillation, which can be described as causing a leading phase shift.

### Combustion Cutoff

Combustion cutoff can be accomplished either by radio signals from the ground or by an integrating accelerometer in the missile. The accelerometer is a gyro whose rotation speed is proportional to the acceleration so that the number of rotations is proportional to the velocity attained. There are two switch cams located on a large gear wheel driven through a gear drive from the accelerometer. The first switch reduces thrust from 25 to 8 tons. The second switch cuts off thrust. The two-stage cutoff is used so that variations in duration of cutoff do not change range.

The close-up photograph of the V-2 on the firing table shows part of its antenna system. The lower part of the fin is plastic and is used to support rod-antenna mountings. The plastic fin tip also has a copper or cadmium-plated frame connected to the tail section. This frame acts as a loop antenna. Loops 2 and 4 are ganged to receive the radio-control signals for combustion cutoff. Rod antennas 2 and 4 receive the guiding-beam signals. Loops and rods 1 and 3 are telemetering antennas. The doors of sections 2 and 4 in the body of the missile are mounted on insulating wood frames and function as a dipole antenna for the Doppler transmitter.

### BIBLIOGRAPHY

- Radio Guidance of Ships and Planes, *ELECTRONICS*, p 248, Aug. 1930.
- "The Missile A-4, Series B." German Technical Report, Berlin, 1945.
- Guided Missiles, Glomb, Gorgon and Gargoyle, *ELECTRONICS*, p 268, Jan. 1946.
- S. L. Ackerman and G. Rappaport, Radio Control Systems for Guided Missiles, *ELECTRONICS*, p 86, Dec. 1946.
- Bat, Homing Guided Missile, *ELECTRONICS*, p 186, Dec. 1946.
- V. L. Heeren, C. H. Hoepfner, J. R. Kauke, S. W. Lichtman and P. R. Shifflett, Telemetering From V-2 Rockets, *ELECTRONICS*, p 100, March 1947 and p 124 Apr. 1947.
- Kooy and Uytendogaard, "Ballistics of the Future," McGraw-Hill Book Co., New York, 1948.
- RDB Comm. on Guided Missiles, "Dictionary of Guided-Missile Terms," Public Affairs Press, Washington, 1949.
- Guided Missile, *ELECTRONICS*, p 120, Jan. 1950.
- S. L. Ackerman and J. B. Wynn Jr., Guided Missile Test Center Telemetering System, *ELECTRONICS*, p 106, May 1952.
- D. A. Anderton, Missile Program Still Lags Dangerously, *Aviation Week*, March 2, 1953.

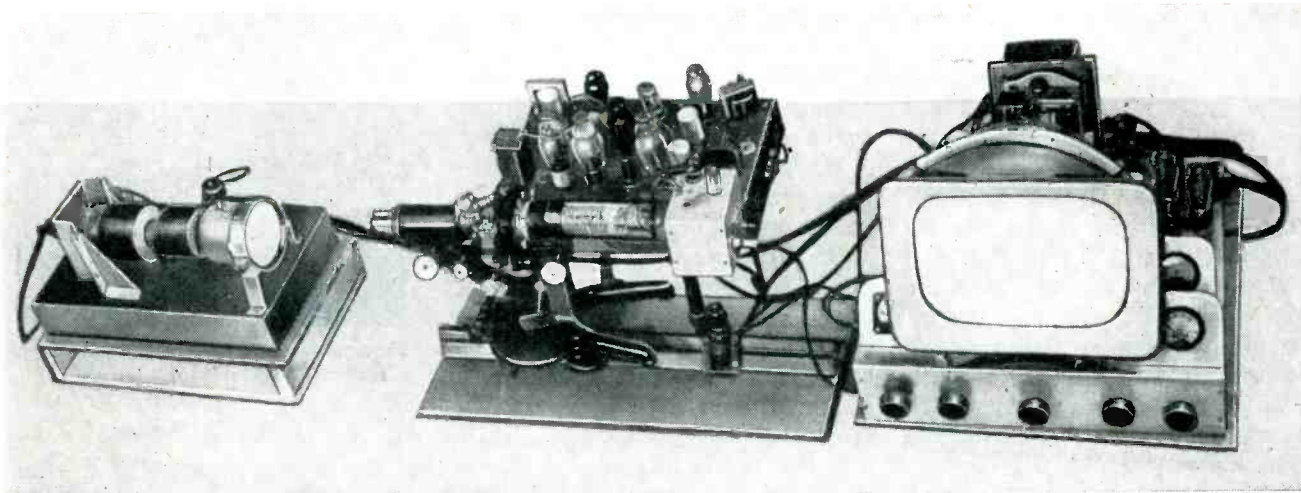

Complete setup of flying-spot microscope consists of scanner (left), optical microscope, phototube (center), time base generator (rear) and viewing monitor. Any number of repeaters may be added, and additional electronic magnification employed

# Flying-Spot Microscope

Television-type scanner illuminates specimen in compound microscope to obtain pictures superior in size, brightness, contrast and resolution to those of normal microscope. Discrete particles are automatically counted and sized

By F. ROBERTS, J. Z. YOUNG and D. CAUSLEY

*Department of Anatomy  
University College London  
London, England*

**T**HE FLYING-SPOT MICROSCOPE, as its name implies, is a combination of a microscope and the well-know flying-spot video generator<sup>1</sup>. To convert such a video generator into a flying-spot microscope a standard compound microscope is used in place of the transparency (Fig. 1).

A greatly reduced image of the flying spot on the scanner tube, is projected onto the microscope specimen mounted on the microscope slide. As this imaged spot is approximately of diameter

$$d = \frac{1.22 \lambda}{N.A.} \quad (\text{in } \mu)$$

where  $\lambda$  = wavelength of light from scanner in  $\mu = 10^{-4}$  centimeter and  $N.A.$  = numerical aperture of microscope objective (varies from

low-power value of 0.15 to the high-power oil-immersion value of 1.4). For the green-emitting scanner tube  $\lambda = 0.5 \mu$  and therefore  $d = 0.5 \mu$ . This approaches the diameter of the smallest particle that can be resolved in the conventional microscope, and is very small compared with the usual size of microscopic objects.

The microscope specimen is scanned by this spot and by means of the multiplier phototube the two-dimensional density distribution of the microscope specimen is converted into the familiar voltage-time relationship of a typical video signal. The signal from the phototube is amplified by the video amplifier, phase and amplitude corrected for lens aberrations, and used to

intensity modulate the display picture tube, giving a bright projection picture of the microscopic specimen. At the same time this output is fed to the appropriate section of the high-speed counting equipment.

### Automatic Counting

In chemical engineering, clinical medicine and general microscopic research work it is often desired to count particles such as powders, blood cells, photographic grains and so on. The flying-spot microscope allows this to be done automatically.<sup>2</sup>

A birefringent crystal is mounted at a convenient point between the raster and the specimen, and a polarizing cube is mounted below the condensing lens. An additional

phototube is mounted at right angles to the original phototube. An anticoincidence circuit is connected between the phototube outputs and the counter. The counter-start and-stop mechanisms are connected to the microscope frame-blanking amplifier via differentiating circuits.

Thus the flying spot from the objective is split into two spots by the birefringent crystal and the specimen is now scanned by two spots instead of one. The spots are adjusted one line-width apart in the vertical direction and polarized at 90 degrees to one another. The transmitted light from these spots is collected by the condensing lens and passed to the phototubes via the polarizing cube, which transmits the light from one polarized spot to one phototube and reflects the light from the other polarized spot to the other phototube. Each phototube therefore receives light from one spot only.

This process is illustrated in Fig. 2. In Fig. 2A two spots are approaching a microscopic particle scanning from above, one spot being one line-width above the other. First, one spot will hit the particle and be obscured as in

Fig. 2B. The result is that a signal will be generated by its associated phototube. This pulse then passes through the anticoincidence circuit to the counter, which registers once.

When this spot returns to the same particle on the next line it will be one line lower, and its companion spot will have taken its former place, one line-width above (Fig. 2C). The result is that both spots are now obscured by the particle and both phototubes generate pulses. These pulses are prevented from operating the counter circuit by the anticoincidence circuit; therefore no count is made until the time when the bottom spot is

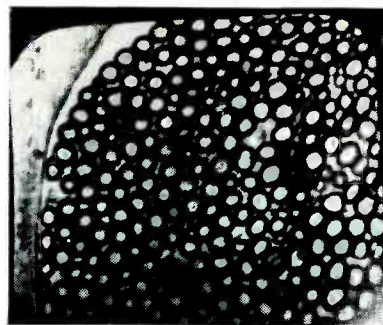

Photograph of screen showing a cross section of a nerve trunk at 300 X

off the particle, the top spot being obscured (Fig. 2D). A signal is now passed to the inhibiting section of the anticoincidence circuit, and no signal is passed to the counter; the latter will therefore read a count equal to the number of particles.

### Biological Applications

Because of the narrow spectral sensitivity of the eye, blue or green light is generally used for illumination with the conventional microscope. However, if the wavelength of the exciting energy is reduced, important gains in resolution and contrast can be obtained.

Resolution being proportional to  $1/\lambda$ , any reduction in  $\lambda$  will show up

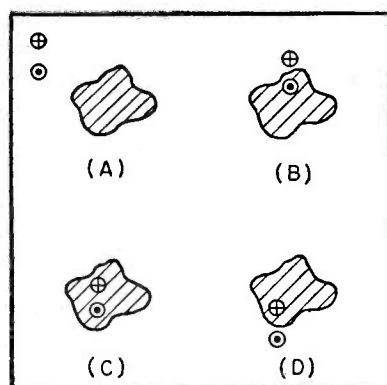

FIG. 2—Drawings show how dual-spot system permits automatic counting

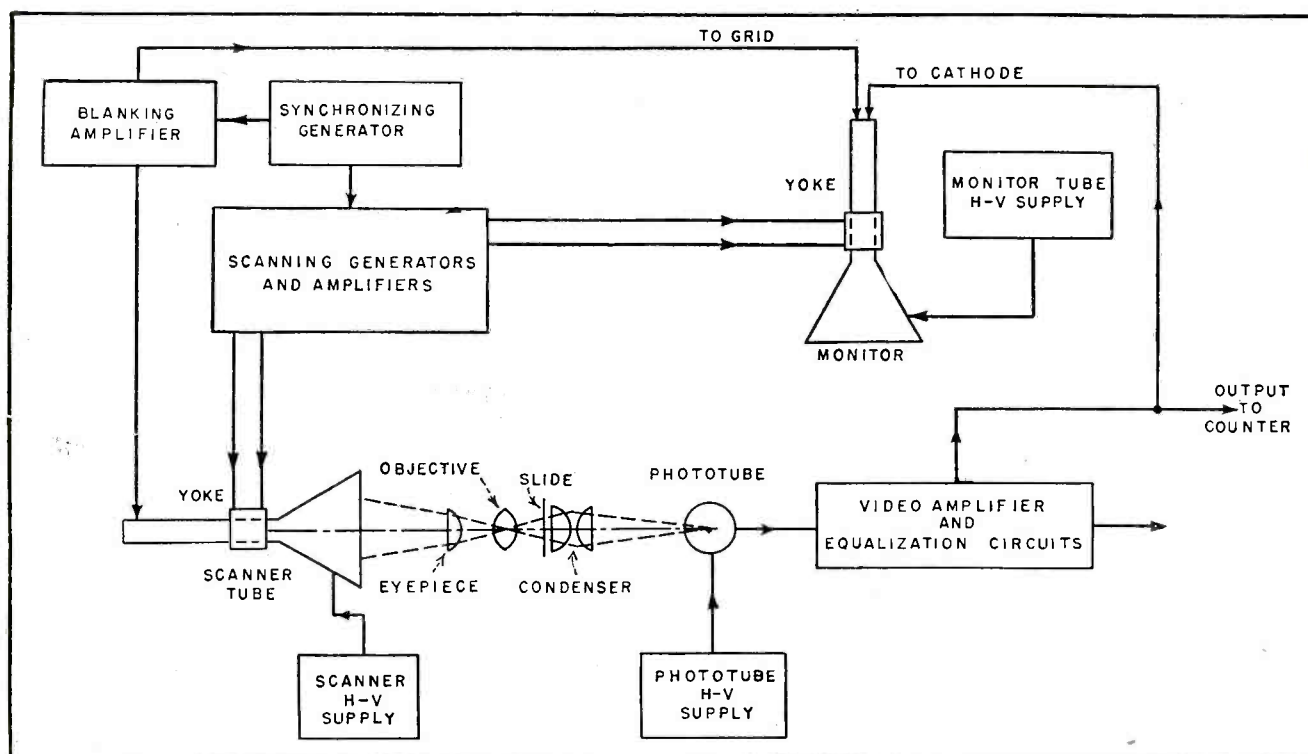
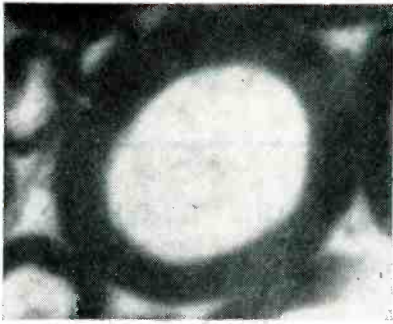
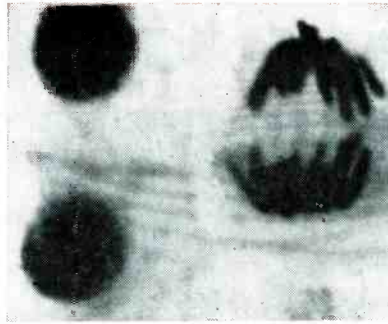

FIG. 1—Block diagram shows use of television scanning system with compound microscope



Enlarged version of portion of nerve trunk (3,000 X) shows individual fiber



Cell of a "root rip" dividing (5,000 X) illustrates application to living cells

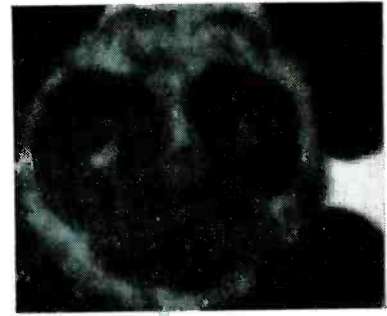

White cell from bone marrow enlarged 10,000 times by flying-spot microscope

immediately in increased resolving power, providing the lens in use is corrected for the new excitation band. Shortening of the wavelength of the excitation leads directly to the ultraviolet region of the spectrum. This region is most important biologically for some constituents of the living cell show selective absorption over the range 2,500 to 3,000 Angstrom units.

Thus it is no longer necessary to kill cells by staining in order to obtain the contrast necessary for observation. By using color-television technique, it should be possible to color-translate from the deep ultraviolet to the visible spectrum in such a manner that each ultraviolet spectral absorbing characteristic of the living cell is represented by a particular color. The final result would be to obtain a picture of the living cell in color, each shade representing a particular constituent.

Apart from convenience, this method of dealing with the ultraviolet region of the spectrum should show considerable improvements over any photographic method. Ultraviolet radiation is toxic and it is therefore necessary to keep down the dosage. The superior efficiency of the flying-spot technique in the ultraviolet region ensures a much smaller dosage than would be required if either the film or television camera were used.

### Other Applications

The examination of the retina of the eye using an ophthalmoscope presents many difficulties. These are greatly multiplied if defects of the retina have to be demonstrated to an audience. A low-power version of the flying-spot microscope can be

used to give large-screen pictures of the retina, making observation and demonstration easy. In a simple equipment the lens of the eye itself can be used as the microscope.

In atomic energy research, it is often necessary to view material which is highly radioactive. This has been done by attaching an optical train to the microscope. However, a great deal of light is lost, and the mechanical difficulties are rapidly multiplied as the optical train is increased in length. By the use of the flying-spot microscope, dangerous materials can be examined in comfort at any distance and no limits are set on the power of objective that can be used.

A standard type of long-term memory for machines is the card index. It is bulky and the access time long. By the use of a flying-spot microscope the information stored on microfilm can be passed through an optical gate, the objective lens of the microscope. The flying spot then picks off the information, and the resulting output of the phototube passes to short-term memory equipment or electrical decoders.

The storage capacity and access times of such a memory should be many times better than the standard long-term memory systems.

### Tubes Used

While in reference 1 the use of standard kinescopes as scanner tubes is advocated, such tubes are quite useless in flying-spot microscopy because of long afterglow and large spot size. Inexpensive scanner tubes specially chosen for appropriate spectral emission (yellow, green, ultraviolet), spot size and resulting high signal to noise

ratio are, however, available.

The phototubes used are specially chosen for high cathode sensitivity and low noise.

While for all the usual microscopic specimens the usual television-type kinescope gives excellent results, certain high-resolution, low-contrast materials, such as live bacteria and certain diatoms, require the magnesium fluoride radar tube display. The time bases are still the standard television speed and as a result the signal to noise is increased by the square root of the numbers of rasters stored in the magnesium fluoride phosphor decay time.

A new equipment, which while retaining television scanning speeds for field finding, allows a four second frame, one thousand line time bases to be switched in, has been developed.

This new machine permits the use of electronic beam switching in place of the calcite and polarizing cube and leads to much cheaper counting equipment. Slow-speed scanning also reduces the dosage to the cell which is particularly important when using ultraviolet.

### Acknowledgments

Thanks are due G. O. Norrie for much of the design, to E.M.I. Research Laboratories, Ltd., and Cinema-Television, Ltd, England, for the provision of scanner tubes, and to Philips Research Laboratories, Eindhoven, Holland for work on a deep ultraviolet scanner tube.

### REFERENCES

- (1) J. R. Popkin-Clurman, Inexpensive Picture Generator, p 102, *ELECTRONICS*, Aug. 1950.
- (2) F. Roberts and J. Z. Young, The Flying Spot Microscope, *Jour. Inst. Elec. Eng., England*. Apr. 1952.

# Coaxial Switch for Rapid

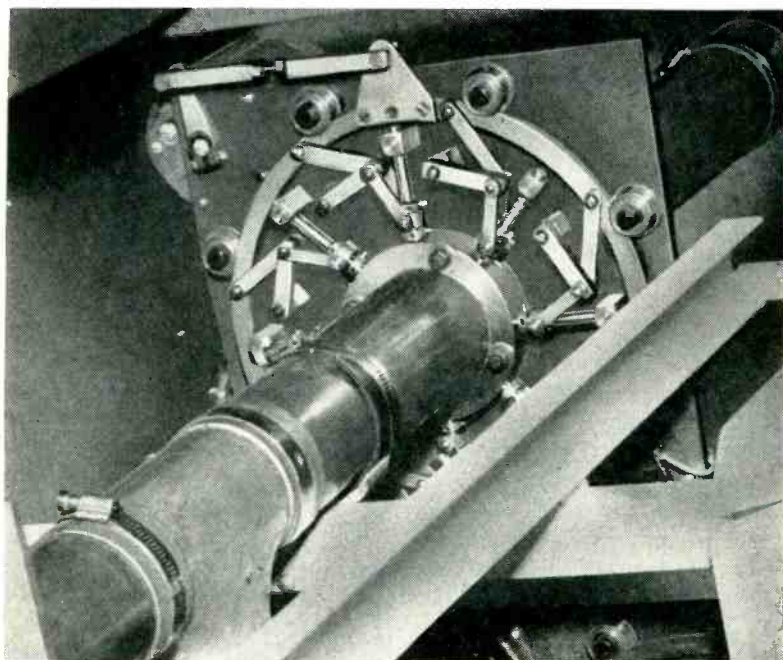

Circular lever is driven by motor behind plate at upper left, moving rods into contact with the inner conductor

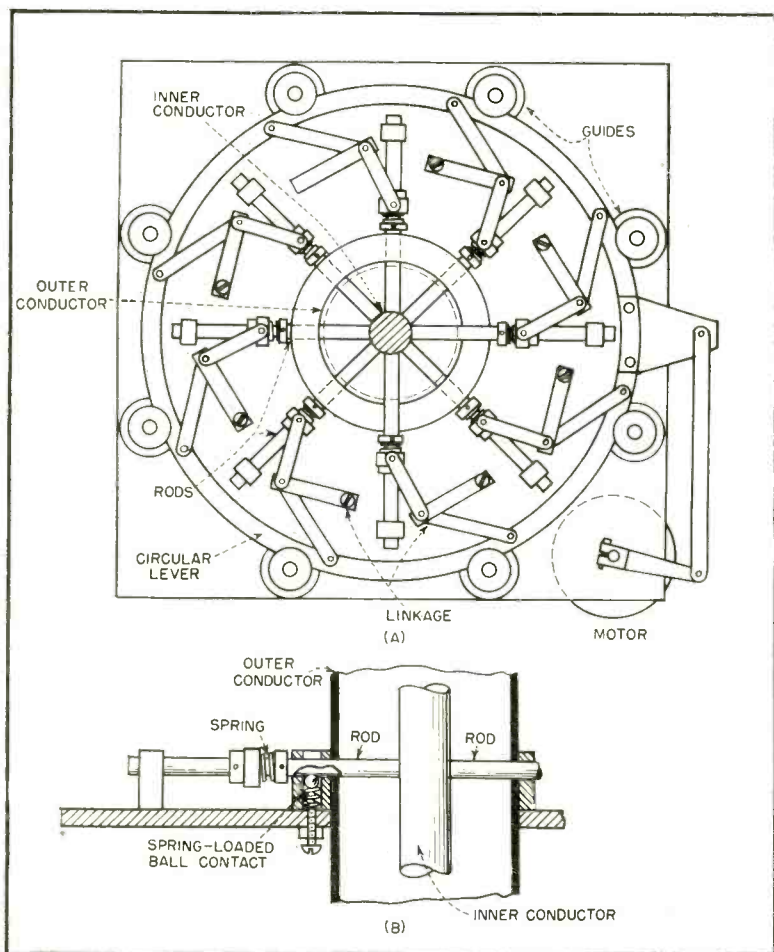

FIG. 1—Coaxial switch (A) uses circular lever to operate eight contacting rods simultaneously. Vertical cross-section (B) shows use of spring-loaded ball as rod electrical contact

By **JOHN T. WILNER**

*Director of Engineering  
WBAL-TV  
Baltimore, Md.*

**A** SWITCHING SYSTEM has been described<sup>1</sup> which enables an operator to replace the main transmitter with the emergency transmitter in the event of failure of the first unit. The switch described was designed for use on a low-frequency television channel.

This article describes another switch which can be used on all vhf channels, and probably some of the lower uhf channels, to switch auxiliary transmitters, cut a power amplifier in or out of service, or switch a dummy load to a transmitter for test purposes.

The system is quick acting and introduces no distortion to the television signal.

## Operation

The construction of the switch is shown in Fig. 1A.

Eight chromium-plated steel rods pass through the outer conductor of the transmission line to make contact with the inner conductor. The surfaces of the rods which come against the inner conductor have the same radius as the conductor to insure good contact. With the switch in the open position all eight rods are withdrawn until their ends are flush with the inside of the outer conductors so that in the open position, no discontinuity of the transmission line will exist.

The switch is opened and closed through mechanical links connecting each rod to a common circular lever. This lever is moved by a motor-operated connecting rod. Pressure for closing the rod is applied through a spring so that all eight rods make pressure contact with the inner connector.

At the frequency of channel 11 a quarter wave in such a transmis-



# Transmitter Changing

Fast-acting system usable on all vhf channels permits switching from main to standby transmitter within four seconds. Standing-wave ratio can be held to better than 1.05-to-1 on channel 11 for 15-mc bandwidth

sion line in free space becomes 14.8 inches. Since the installation of the switch required that the side reactances around the carrier be cancelled out by a stub, it is essential that contact be made between the inner and outer conductor at exactly the same place regardless of the wear or mechanical tolerances of the mechanism during operations.

For this reason a circular millway was cut into the side of each rod as shown in Fig. 1B. A steel ball under spring pressure engaging this millway insures that the rod will always make sliding contact at the same surfaces. This steel-ball contactor also provides the shortest electrical path between the inner and outer connectors, thus maintaining the same characteristics throughout its life.

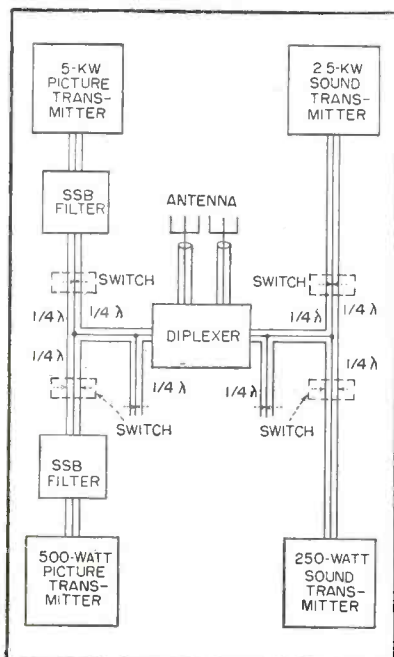

FIG. 2—Placement of switches and shorting stubs in transmission lines

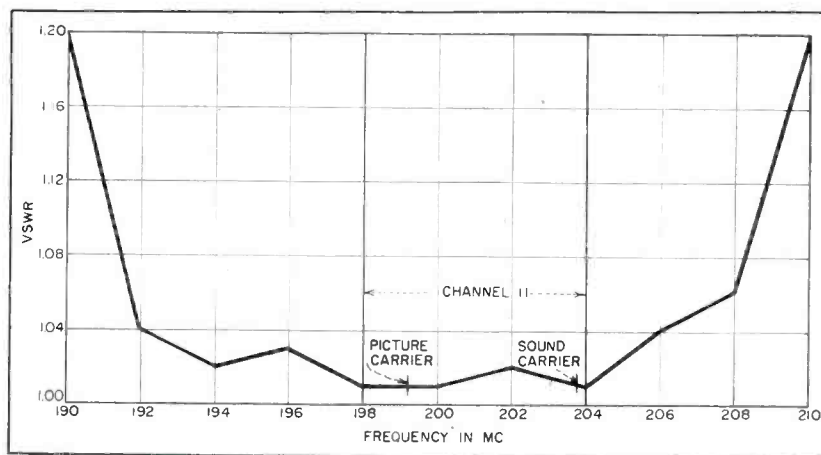

FIG. 3—The vswr of system with dummy load

The switch was installed in the transmission lines as shown in Fig. 2. Two switches are required for each of the audio and the video transmitters. In each case the outputs of both transmitters come to a junction T-fitting from which power is fed to the antenna system.

The switches are placed a quarter wavelength on either side of the junction with the ball pressure against the rods on the side away from the junction. A quarter-wave short-circuiting stub is placed one-quarter wavelength from this same junction towards the antenna. Since similar reactances one-quarter wave apart cancel each other, a low standing-wave ratio is obtained over a large portion of the television spectrum. Figure 3 shows the standing-wave ratio of input to the transmission line that the main transmitter would normally see with the antenna disconnected and a dummy load inserted in its place. A standing-wave ratio of better than 1.05-to-1 is obtained for about a 15-mc bandwidth.

After the switches had been in

operation several months a check was made on standing-wave ratio and quality of the transmitter picture. No discernible change was noticed.

## Controls

A control panel next to the main transmitter operating panel is arranged so that throwing one switch will remove plate voltage from the defective transmitter, operate the r-f switches and apply plate voltage to the standby transmitter. Each of these operations can also be made individually from separate switches on the same panel. The time for the complete operation in the automatic position is 4 seconds, this being determined entirely by the speed of the operating motor.

Acknowledgment is made to members of the engineering department, especially Harrison Brooks, assistant chief engineer, who aided in the development of this project.

## REFERENCE

- (1) L. A. Looney and F. C. Everett, Reducing Outage at WNBT and WNBC-FM, ELECTRONICS, p 110, Jan. 1952.

# Precise Parts Sorting

Operating principles and electronic circuits of three basic types of precision dimension-measuring gages—the electrical switch-type, electromechanical moving-core type and the electronic moving-coil type—in which the sensing spindle moves the contacts, core or coils respectively

**A**N AUTOMATIC GAGE is a machine designed to inspect parts on a production-line basis without the aid of many operators. It generally consists of a hopper, a metering or feeding device, a measuring device and provision for disposal of the measured product. This article considers the electronic and electrical devices which do the measuring and actuate the disposal units.

## Contact-Type Gages

The simplest of these measuring devices is the electrical contact or switch type which generally incorporates a spindle similar to that of a dial indicator. Changes in size of the workpiece move the spindle which in turn actuates switches. Operation of the switches, one of which is usually provided for the high limit and one for the low limit, sets up electrical circuits which can be used to control disposal traps and auxiliary equipment.

Several makes of this type of unit are available, all of them similar in basic operation. Figure 1 shows the combination electric switch-indicator unit called the Electricator, which is usually used in conjunction with the power unit shown in Fig. 2. Each of the limit switch contacts is tied in with the grid circuit of a separate thyatron tube which is basically an electronic relay. When the switch contact is closed, it causes the thyatron to fire.

Due to the nature of the thyatron on d-c operation, the circuit is nonreversible. If a borderline piece is being measured and the contacts

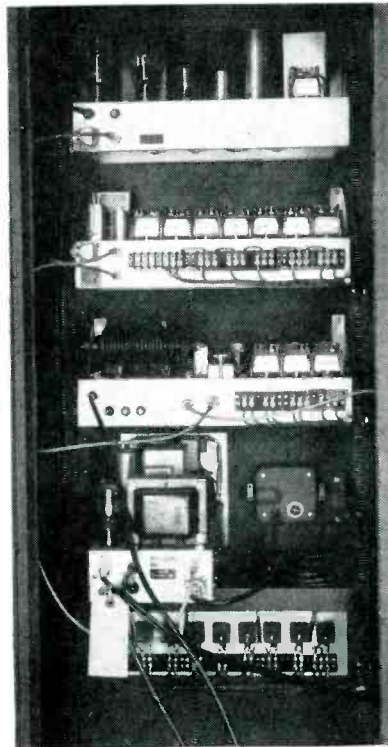

Rack contains (top to bottom) power supply, classifier, solenoid supply and gage amplifier

close momentarily, the thyatron tube will go into operation and, regardless of how much the limit switch contacts chatter, a steady signal is received. This is essential for automatic gaging. If the circuit is not instantly self-holding or nonreversing, traps and other elements will chatter and may produce an apparent error in measuring.

The switch-type unit has several advantages. It is the least expensive basic measuring device available commercially which will

set up an electrical impulse in accordance with the size of the part. The repeat characteristics of this type of unit are good, especially considering that it is a fairly inexpensive piece of equipment. The repeat characteristics of this particular unit are on the order of twenty-five millionths of an inch or better. While this means that it can be used for fairly close tolerances, using the customary 10-percent gage maker's tolerance, the unit is generally used where limits are greater than plus or minus 0.00025-inch. There have been cases where it has been used for 0.0001-inch limits, but here gage maker's tolerance is being exceeded.

The main disadvantage of this unit is that it is a mechanical device. As such, it is possible to have a little bounce at the electrical limits if the spindle is moved too rapidly, when pieces are passed under it at high rates of speed. This may cause some apparent inaccuracy at one of the limits. In general, this type of unit is used for jobs where less than 100 pieces per minute have to be checked.

## Electromagnetic Gages

In the electromagnetic gage the spindle moves an iron core between two coils as in Fig. 3. This type of gage is generally energized with 60-cycle current. The electromagnetic type of gage can be made extremely sensitive and with very high magnification. It is not uncommon to find such gages with scales graduated in millionths of an inch.

# On Production Lines

By **ALBERT C. SANFORD**

*Engineering Department  
Federal Products Corp.  
Providence, R. I.*

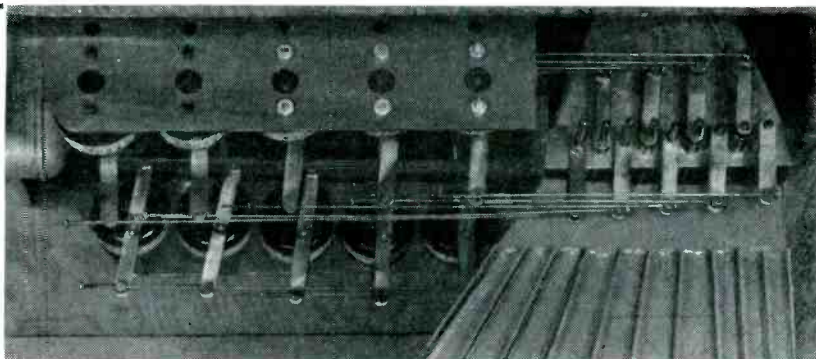

Disposal chute has number of solenoid-operated trap doors, normally open, which direct pieces to proper slides

The electromagnetic gage head contains two coils which are fixed to the gage head casting. These coils have independent magnetic fields with a movable common armature operating approximately midway between them. The armature is pivot-mounted at one end and floats freely at the other end. It is flexibly coupled at the spindle, so any movement of the spindle is transferred to the armature.

The electromagnetic gage circuit, in Fig. 4, is actually a bridge circuit using coils in the bridge legs. Movement of the gage spindle moves the armature relative to the two fixed coils and unbalances the magnetic field. This produces a comparatively large change of current for extremely small movements of the spindle. The microammeter measures the amount of the unbalance and is generally calibrated to show spindle movement to small fractions of an inch.

The magnification of this type of gage is adjustable. By increasing the gap between the two coils and reducing the size of the armature, magnification is decreased. Magnification can be increased by decreasing the air gap.

Despite the electrical actuation of such gages, certain time lags are inevitable. Suppose that an automatic gage is to be built for measuring a small cylindrical piece which is to pass underneath either a cylindrically radiused contact or one with a very small flat. Since a cylindrical piece is being introduced under a cylindrical anvil, the maxi-

mum dimension or the time for which the spindle will be in its uppermost position is short.

With the electromagnetic gage operating on 60 cycles, it requires perhaps two cycles or roughly one-thirtieth second and probably a little bit more, to provide a safety factor. This may sound fast but time is required to get the piece from the feed chute into the metering device, push it through the gage and then down the disposal chute. Considering that the time the workpiece must spend under the measuring contact limits the maximum speed of the pusher or metering device, one-thirtieth second is none too fast. It limits the maximum speed of the part past the contact and therefore limits gage design to a maximum speed of possibly 60 to

70 pieces a minute.

In the electronic-mechanical type of gage, the movable coil is attached to the spindle and two fixed coils are fastened to the gage head casting, as in Fig. 5. Movement of the spindle in accordance with size differences of the parts changes the relative position of the spindle coil to the fixed coils.

## High Frequency

While this is not too much unlike the 60-cycle gage, there is an important difference. The current passing through the coils is operating at 100,000 cycles or more per second. For the sake of illustration, assume the same gaging conditions as previously described, wherein a small cylindrical piece is passing under the spindle. If two or three electrical cycles are allowed for the circuit to reach equilibrium,  $1/30,000$  second has been used for the measurement. While the theoretical speed is never achieved in actual practice, this is roughly 1,000 times as fast as the gage using 60-cycle current. Actual tests with this type of device have shown that the speed is quite high.

The amplifier circuit used with the electronic gage is shown in Fig. 6. The voltage regulator tube in the power supply permits the circuit to withstand a line voltage variation of  $\pm 10$  percent with less than 1 percent meter variation.

The 100,000-cps frequency of the 6K6 oscillator tube is maintained within close limits by a 6SN7 control tube. Part of the high-fre-

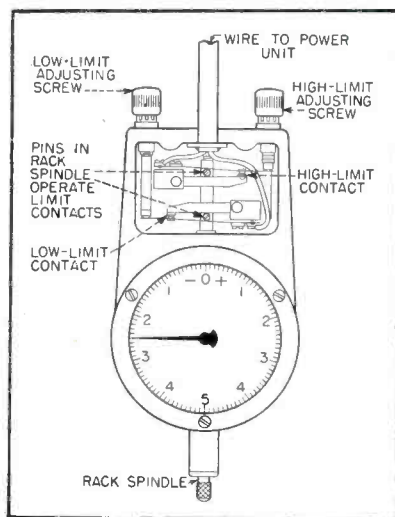

FIG. 1—Combination electric switch and indicator gage

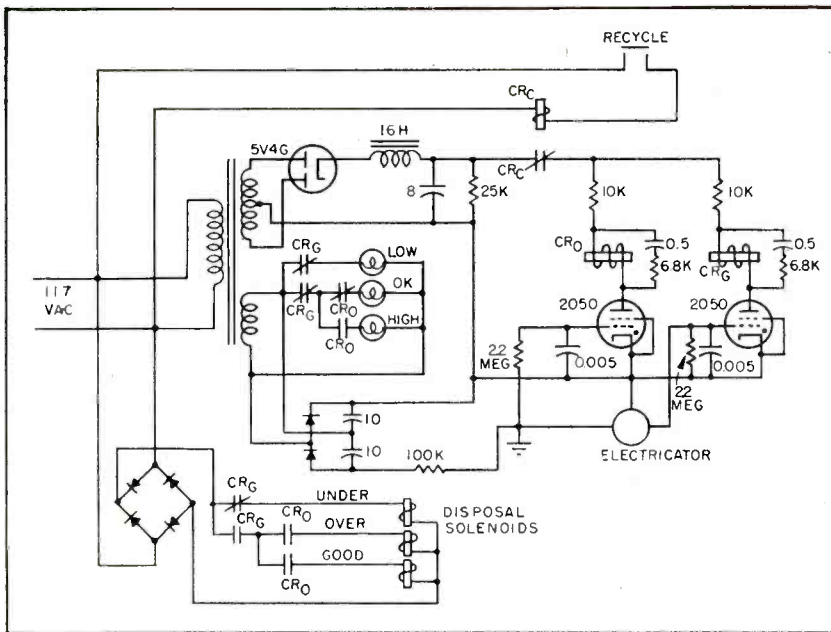

FIG. 2—Thyatron connected to each limit switch contact acts as electronic relays

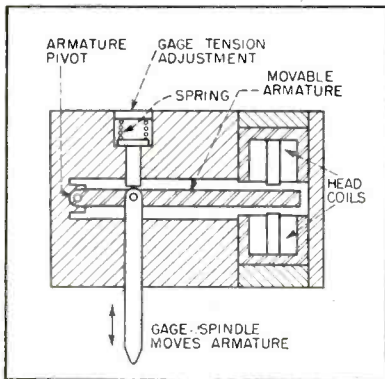

FIG. 3—Electromagnetic gage head has two fixed coils and a movable armature attached to the gaging spindle

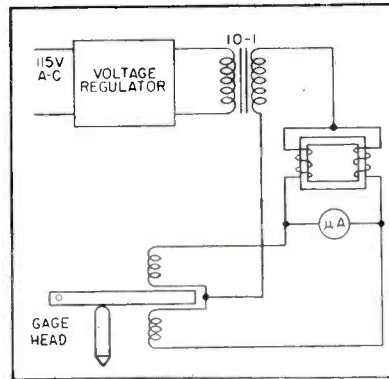

FIG. 4—Coils act as legs in balanced bridge circuit. Microammeter measures the unbalance

quency a-c is applied to the gage head coils and part to the zero adjustment.

The zero adjustment contains a coil almost identical electrically with the head coil assembly. In the gage head, the high-frequency signal energizes the stationary coils, with no direct connection to the spindle coil. However, displacement of the spindle coil from the region around the electrical neutral position induces a varying voltage at 100,000 cps in the spindle coil. This voltage is almost directly proportional to contact point displacement. This induced voltage passes to a four-stage amplifier consisting of three 6SJ7 and one 6K6.

The 6SN7 phase detector is in the circuit to allow measurement with

the spindle moving up, or with the spindle moving down and overlooking the opposite spindle motion. The rectifier portion of the 6SN7 converts the amplified 100,000-cps signal into d-c at a potential of between 0 and 50 volts essentially in direct proportion to the spindle position. This voltage operates the meter and is available to operate the classifiers or segregators which are essential to automatic gaging.

### Sorting

When a measured workpiece is removed from beneath the spindle of a comparator, the size signal is lost. Some means must be provided to hold the signal, even after the parts are removed, until the part has had a chance to pass through

the disposal as the signal directs.

Some means must also be provided to decide into what size category the workpiece belongs. This is also properly a function of the classifier.

The classifier consists of a series of d-c operated, nonreversing thyatrons, one for each size category, as in Fig. 7. Each of these is triggered to fire at slightly higher voltage than its predecessor. As the gage signal voltage (0-50 volts) rises in accordance with the size of the part, one thyatron after another fires. Equilibrium is reached when the gage voltage has reached its peak, operating certain thyatrons, but is not high enough to fire the next one in the series. The last thyatron to fire operates its associated relay, holding that condition until cleared by the operation of a switch.

The disposal system consists basically of a chute in which there are a number of solenoid-operated trap doors. These doors are normally in their relaxed position so that a work-piece can drop straight through. When one of the classifier relays operates, it energizes its associated trap door solenoid. This causes the trap door to move, blocking the free fall of the measured workpiece and directing it into a particular disposal pan or box.

The basic means of measuring with the electronic gage head and a classifier remains the same for all gages using the gage head and classifier. The primary variations are in the sensitivity of the particular electronic gage and the number of

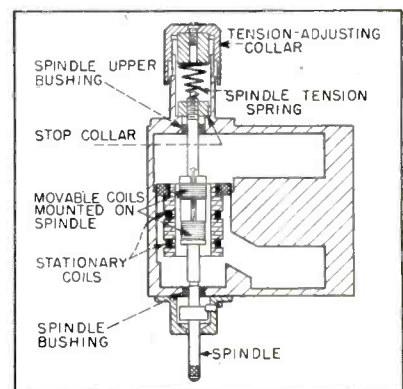

FIG. 5—Electromechanical type gage has movable coils on spindle and two fixed coils

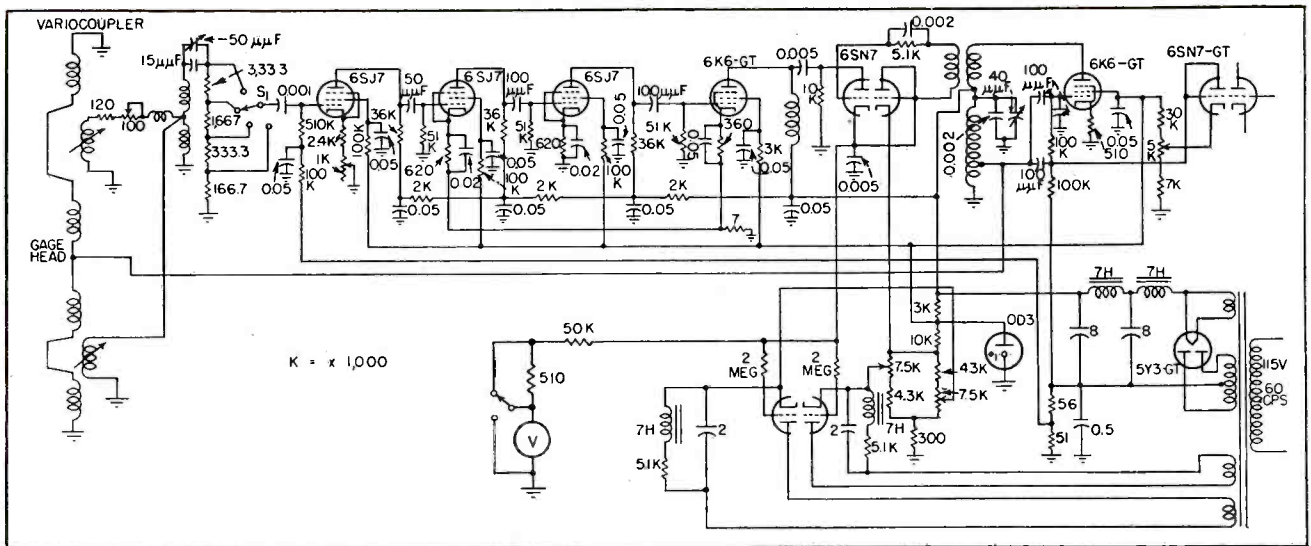

FIG. 6—Circuit of electromechanical gage. Oscillator generates 100-kc signal. Voltage generated by coil unbalance is amplified and rectified to give indication on meter

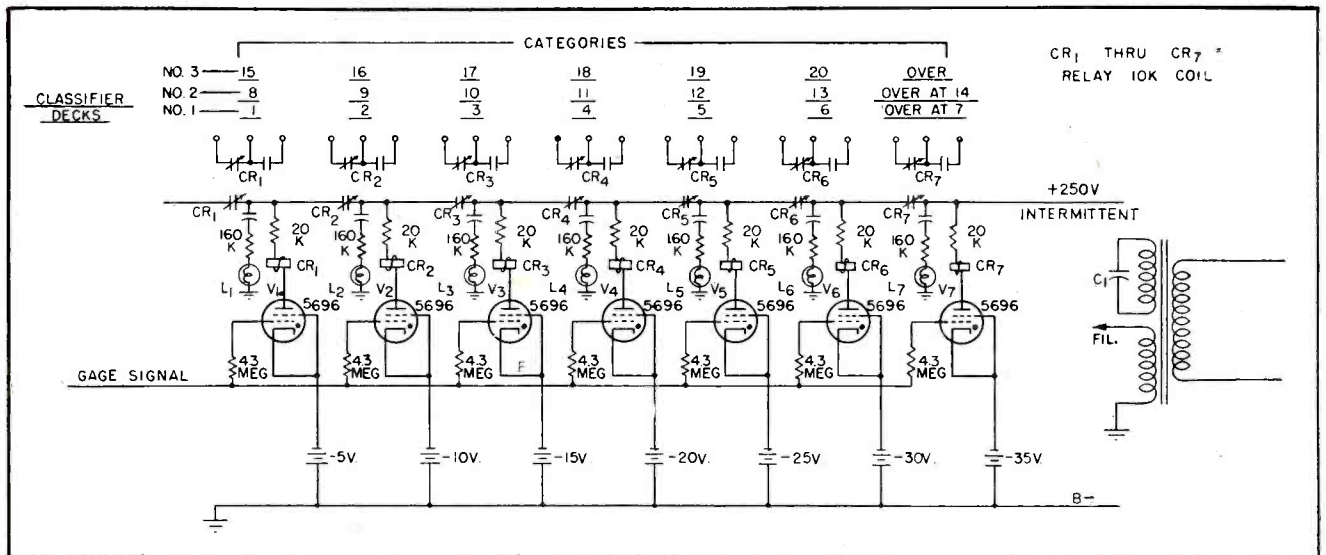

FIG. 7—Classifier is series of d-c operated nonreversing thyratrons which hold part size signal until cleared

classifications needed which, in turn, determine the size of a classifier.

### Applications

In the manufacture of contoured zipper wire, the drawing machine occasionally pulls the wire unevenly, causing sections to be smaller than the rest of the wire. When the wire is finished, it is put into automatic zipper-making machines. When one of the undersize or necked-down sections goes through, the machine makes a zipper which will not stay closed.

An electronic gage was put on this job. It was found that small

necked-down sections which went by in about 1/500 second could be picked out. It is possible in that extremely short time to pick up the size signal and operate auxiliary equipment.

The high speed possible is not yet entirely practical for automatic gaging because of limitations on speed of material handling. Electronic equipment has already been built that will gage and sort 400 pieces per minute. Tests show that an entire measuring unit, classifier and electrical sorting device can be made to operate at rates better than 500 pieces per minute. For most operations it is not possible to feed

at this rate, so up to now the full effectiveness of the gage has not been used. However, this high speed of response gives the gage a high margin of safety.

The electronic-mechanical gage also has the advantage of being able to provide extremely high magnification with scales graduated in millionths. This type of unit must touch the work and is therefore not at all suitable where thickness of soft material must be measured. In continuous measuring it cannot be used where the material has a widely varying pass line or where it is extremely hot, as in a hot-strip mill.

# How to Design



Typical dock showing radiotelephone-equipped boats. Every vertical projection (except for obvious telephone pole and bark-encrusted pilings) represents a different hopeful solution to the short antenna problem

By **ELBERT ROBBERSON**

*Port Washington, Long Island  
New York*

frequencies allocated to this service extend from 2.110 to 2.738 mc, so ground-wave propagation is predominant. Transmitter power is limited to 5 to 100 watts by the engine battery or auxiliary power available, so maximum efficiency is important.

Small boat antennas, unlike those in other services, cannot be rated according to gain. Because of their small size, they must be rated as to loss, as expressed by a comparison of radiation resistance to loss factors.

Radiation resistance at the mid-band frequency of 2.5 mc is plotted in Fig. 1, along with the basic equivalent circuit of the small boat antenna. As indicated the antenna represents a resonant circuit with an inductive component in the transmitter balancing the capacitive characteristic of the antenna, and with the radiation resistance and the various loss resistances in series.

The power delivered by the transmitter is dissipated in the different resistances in proportion to their numerical value. Usually, most of the available power is wasted. In fact, any small boat antenna system which does not throw away over half of the transmitter power has come to be thought of as a high-gain antenna.

A simplified circuit diagram of the output circuit of a representative marine radiotelephone is shown in Fig. 2. This diagram shows only the basic transmitter output circuit, minus provisions for channel switching, antenna and power changeover, and power-output indication.

The r-f amplifier plate tank cir-

**E**NGINEERS are seldom called upon to provide two-way radio communications under conditions more unfavorable than aboard the small motor yacht or work boat. On these craft, usually 20 to 50-feet in length, they are frequently expected to connect a 10-watt transmitter to an antenna not over 0.05 wavelength long, with a high-resistance ground and a weak battery—then to telephone 100 miles through summer static!

The degree to which efficient operation can be approached depends largely on the antenna system used.

Since many features of marine antennas (both good and bad) are

applicable to other communications services, such as the aeronautical, the military and mobile, an analysis should be useful not only to marine technicians, but also to engineers called upon to provide communications under comparably poor conditions anywhere.

## Requirements

The primary purpose of marine radiotelephone is lifesaving, the summoning of the Coast Guard or other boats in an emergency. A transmitting range of 50 to 100 miles is desirable for vessels in coastal waters, while those operating offshore need a range at least equal to their cruising radius. The

# Small Boat Antennas

No single improvement in antenna system design can contribute more to radiation efficiency than increasing antenna capacitance to reduce size of loading coil. Practical problems involved in maritime mobile antennas are discussed

cuit is made up of fixed capacitor  $C_1$ , a portion of  $L_3$  and all of  $L_2$ . The coil  $L_2$  is of small diameter to make antenna coupling variable in small increments as successive turns are tapped. Load impedances from about 1 to 100 ohms can be accommodated. Antenna circuit resonance is obtained by adjusting antenna loading coil,  $L_1$ , so its inductive reactance equals and cancels the capacitive reactance of the short antenna, leaving the circuit one of pure resistance.

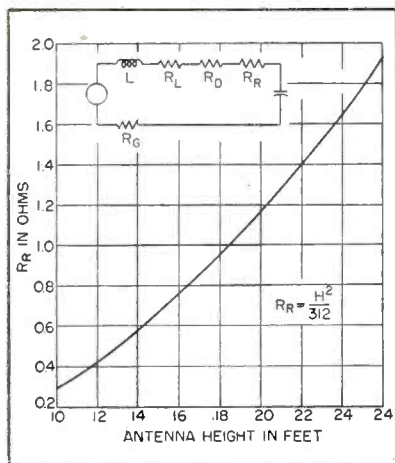

FIG. 1—Curve shows radiation resistance at 2.5 mc versus height of antenna in feet. Insert shows simplified equivalent circuit of marine antenna system

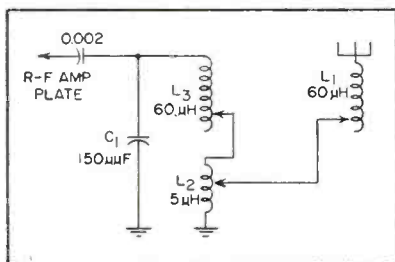

FIG. 2—Simplified schematic of typical radiotelephone output circuit

This is accomplished physically as shown in the photograph of a typical marine radiotelephone. Note the treatment of the r-f output circuit, with its multiplicity of clips and associated leads, connecting back and forth through the chassis to switches, relays and output indicators. Note also the dead-end coil turns, the extreme closeness of the panel, power supply, chassis, and cabinet to the coils.

The consequent coil loss is so pronounced in most marine radiotelephones that a noticeable difference in antenna current occurs at different frequencies in the range of the set, as more or less coil is used.

A typical 12-ft antenna has, at the midband frequency 2.5 mc, a radiation resistance of 0.4 ohm and an effective capacitance of 40  $\mu\text{f}$  requiring a loading-coil inductance of 100  $\mu\text{h}$ . In order that the coil resistance loss be brought down to the same value as the radiation resistance (so that only half the power would be lost in the coil), a loading-coil Q of 3,920 would be required.

With the loading-coil Q in the neighborhood of 300, which is good for a commercial coil, the effective resistance is still 5.25 ohms. Obviously, then, system design that improves loading-coil Q is helpful, but no spectacular improvement can be expected in this direction. Antennas requiring the very least possible amount of loading coil for resonance are the logical solution.

## Dielectric Loss

On a boat, the dielectric loss  $R_d$  is variable, fluctuating with weather and wind, as more or less rainwater or spray comes aboard.

After a boat has been in the water only a short while, its whole structure, including the decks, bulkheads and masts, becomes a sort of non-homogeneous variable resistor. With a pocket ohmmeter, heavy conductivity can be found between supposedly insulated fixtures, and even between the screws holding the boat together, or between ground and a probe plugged into the planking that forms the hull of the boat.

## Insulators

The insulators most commonly used are Bakelite or the glazed porcelain types employed in broadcasting and commercial services, and with most of them, somewhere underneath, or where the molding flash has been ground off, there is an unglazed surface that acts as an open door not only to solid water, but to moisture from the other materials contacted, and to atmospheric moisture. It is quite common for  $R_d$  to be in the neighborhood of one megohm, even on a dry, sunny day.

At first glance, this does not seem to be important but with antennas as short as those used on small boats, shunt resistances that may be tolerable in other fields will completely disable a marine radiotelephone transmitter.

Applied to very short antennas, a shunt resistance has the equivalent effect of a series resistance of the value  $R_{series} = X^2/R_{shunt}$  where X is the reactance of the antenna. With the antenna of the previous example, the series equivalent for a leakage resistance of one megohm would be about 2.5 ohms—very much more than the radiation re-

sistance of 0.4 ohm given before.

Even if there were no other loss, 86 percent of the transmitter output would be squandered in heating this resistance. Just one dash of spray will plunge the shunt resistance to 20,000 ohms or less, which is translatable into an equivalent series resistance of 123 ohms. Even if the slight amount of power left for the 0.4-ohm antenna to work on were of any use, there would still be no operation possible, because this extreme change of load resistance is far beyond the compensatory range of the transmitter.

In cases of absolute nonoperation of transmitters, resistances as low as 10,000 ohms have been measured through an insulator between the terminal and the raw underside. Baking such insulators in an oven or over a flame will temporarily restore operation in an emergency—but it would be much better to use absolutely nonhygroscopic material in the first place.

Even nonhygroscopic insulators become lossy when coated by moisture, dirt, or salt spray, so as few insulators as are mechanically essential should be used, and their design should provide a long leakage path.

### Ground Loss

There is one important loss remaining in the antenna circuit—the ground resistance  $R_G$ . This resistance has been found to range from 0.25 ohm and less to 25 ohms and more.

On two different boats having identical 25-watt transmitters, both delivering rated power to identical antennas, one may have an antenna ammeter reading of 3 amperes, while the other may have a reading of only 1 ampere. This is indicative of a total effective antenna resistance of less than 2.78 ohms in the first boat, and 25 ohms in the second.

The difference between the two installations is all in the ground system—the first transmitter is solidly grounded to a steel hull, while the second, in a wooden boat, is grounded only to the distant engine. This latter case is representative, unfortunately, of at least half the small boat installations now existing.

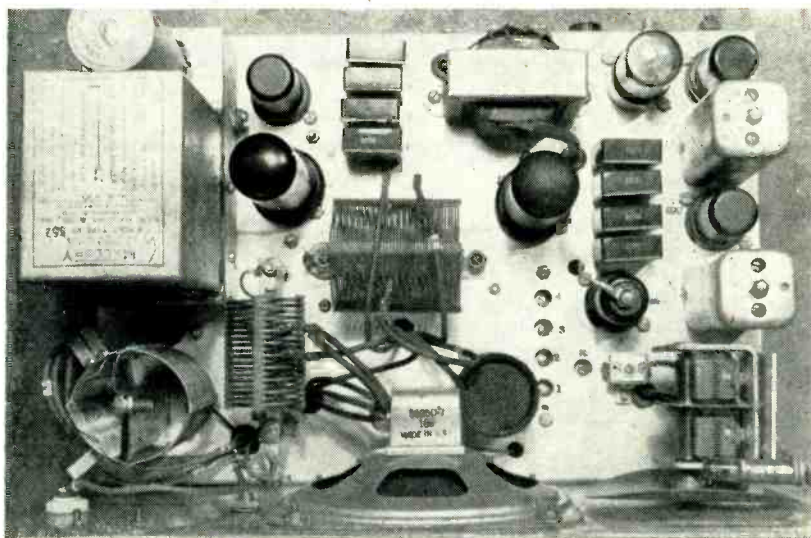

The r-f nest of a typical 10-watt marine radiotelephone. Transmitter components occupy left half of chassis. Note compromise design for electrical and mechanical convenience

Grounding can be improved on a small boat by the installation on the bottom of the vessel of as large a ground plate as the shape and size of the hull permit, and the bonding to ground of all neutral metal on board, such as piping, engines, rudders, tanks, life-lines and the radiotelephone transmitter itself by as short and heavy a conductor as can be installed.

A summary of typical losses may easily be made by starting from the fact that the usual antenna current for a small boat transmitter developing 25 watts of power is around 1.5 amperes. The total effective antenna resistance is therefore about 11.1 ohms.

At the midband frequency of 2.5 mc, the apportionment of generated power in this case would resemble the following:

Radiation resistance, for antenna height of 18 ft.....	0.96 ohms
Coil resistance, for resonating 50- $\mu$ f antenna, 80 $\mu$ h, Q of 250.....	5.02 ohms
Insulator leakage, 1 megohm, having equivalent series resistance of .....	1.58 ohms
Ground resistance...	3.54 ohms

Total ..... 11.10 ohms

Thus, with the boat fairly dry, only 8.6 percent of the generated power is used for making signals.

In most transmitters, less coil is used than indicated in the above breakdown because of the distributed capacitance of incidental circuitry, but this leads to another shunt loss, on the other hand, so the total loss remains about the same.

### Optimum Design

The first essentials of a good marine installation are good insulation and a good ground. That leaves only the loading coil loss as a variable.

The best antenna is the one requiring the least loading coil for resonance. The first efforts toward a reduction were along the lines that if a quarter wavelength at the desired frequency were 94 feet, wrapping that length of wire on a much shorter pole would result in a

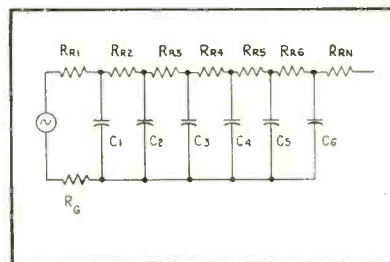

FIG. 3—Distributed R and C equivalent circuit of Marconi antenna shows advisability of placing antenna resonating coil near base of antenna. It is desirable to get maximum current flow through the radiation resistance



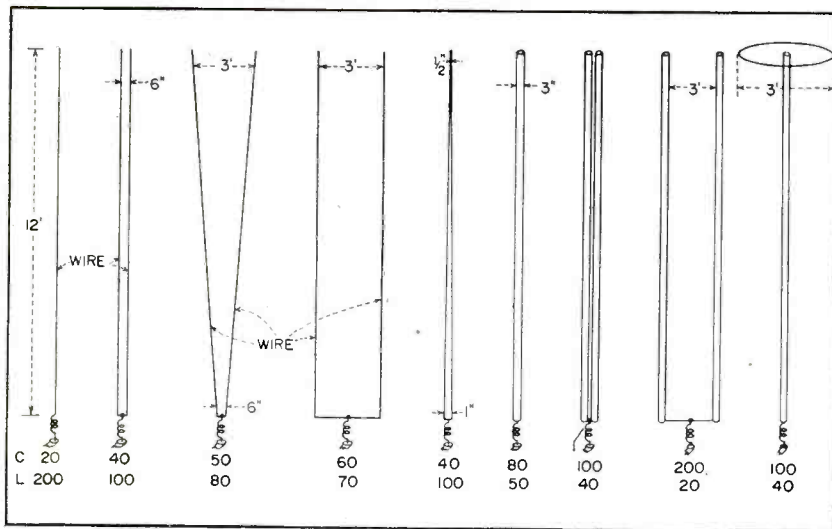

FIG. 4—Typical methods for increasing capacitance of vertical antennas to reduce size of loading coil required. Losses in average 20- $\mu$ h coil are significantly less than losses in 200- $\mu$ h coil

quarter-wave antenna of much less than usual height. So entrenched is this fallacy that whole fleets of small boats carry such antennas. The proponents of these designs engage in a perpetual controversy over the proper spacing of the turns in the wire spiral, and the lumping of some of it in close-wound coils in the middle, at the top or at some other esoterically derived spot. Such wrapping may result in improvement but not due to the inductance of the winding, nor the quarter-wave-length of wire used. The effective resistance of such spirals runs from 5 to 15 ohms dry, and 25 to 50 or more ohms after one dash of rainwater. Any improvement over a straight wire realized by the use of such coils in an antenna is due more to the increased capacitance of the system than to anything else.

More improvement can actually be obtained in many such antennas by short-circuiting the whole coil or spiral turn by turn. The performance then approaches that of a metal cylinder of the same diameter. The wood always contributes an added loss due to its inherently poor dielectric characteristics.

Another popular type of antenna is the short metal radiator, with a loading coil in the circuit somewhere aloft and with a metal shield over the coil for weather protection. This does help to achieve resonance with less of the transmitter loading coil in the circuit, but usually not

for the reason thought.

The radiation resistance of one such antenna at the midband frequency is 0.3 ohm. The inductance of the bare loading coil is 26  $\mu$ h, with an effective resistance of 1.9 ohms. Installation of the shield around the coil reduces the coil inductance to only 16  $\mu$ h, (due to the shield acting as a short-circuited secondary winding) and the effective coil resistance increases to 2.13 ohms (due to secondary loss).

In spite of the coil losses, the antenna performs better with the shield in place, but not because the shield prevents coil wetting. The shield adds to the effective capacitance of the antenna. In fact, this benefit is obtained with the loading coil short circuited or removed.

Figure 3 shows more accurately the equivalent circuit of the very short antenna. As this diagram shows, the farther out from the transmitter the loading coil is situated, the less capacitance to ground exists at the coil's far end. When the coil is located at the very end of the antenna, there is practically no capacitance connected to its far end and a coil of enormous size would be required, since it would have to be self-resonant.

In spite of this, some small boat antennas are made with a coil toward the top or even on the very tip of the antenna, working into a capacitance hat in the form of a wagon-wheel or birdcage.

Placement of coils aloft does have the advantage that less antenna current passes through them, hence their resistance loss is somewhat reduced. A point is reached as a coil is moved toward the end of an antenna, where it is actually better to short-circuit the loading coil, and thereby allow it to act as a capacitance-adding device, rather than to try to make it act like a coil.

Useful gain can usually be obtained by installing a high-Q loading coil just outside the transmitter, or at the base of the antenna. The optimum size of this coil is that which will eliminate the need for any of the transmitter loading coil except a small portion for channel switching. Putting the coil at the base of the antenna has the added value of lowering the lead-in r-f voltage and reducing insulation leakage.

If an effort is also made to increase the capacitance of the antenna, the inductor loss can be even further reduced.

A shape of antenna that concentrates capacitance toward the top also raises the radiation resistance, and would be highly acceptable, if not prohibitive from the standpoint of weight or drag. Most simulated birdcages or wagon wheels do not qualify in this last respect although they do add capacitance. The same weight and drag values reworked into a more pleasing shape can be made to provide comparable loading improvement. Several examples of ways to increase effective antenna capacitance are shown in Fig. 4. As illustrated, increasing the number and size of conductors, or fanning and separating individual conductors can add substantially to the effective capacitance of an antenna. In situations where height is limited no other improvement can provide as much improvement in mobile performance.

#### REFERENCES

- (1) Byrnes, 2-Way Lifeboat Radio, *Communications*, p 17, Sept. 1943.
- (2) Kopetzky, Low Frequency Radiations from Short Mobile Antennae, *Communications*, p 66, Nov. 1943.
- (3) Bennett, Design of Broad Band Aircraft Antenna Systems, *Communications*, p 46, March 1945.
- (4) Smith, Performance of Short Antennas, p 1,026, *Proc. IRE*, Oct. 1947.
- (5) Smeby, Short Antenna Characteristics, *Proc. IRE*, p 1,185, Oct. 1949.

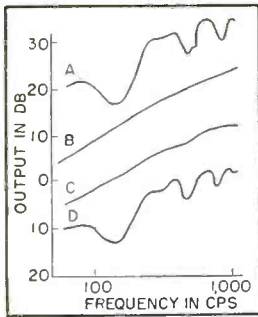

FIG. 1—Irregular response is due to playback head

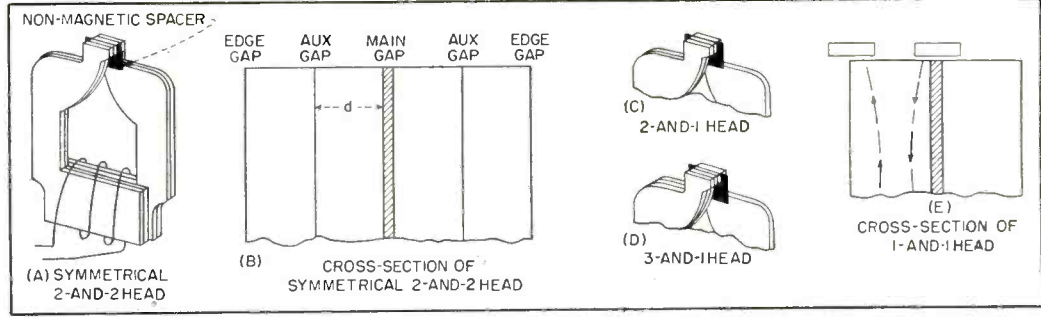

FIG. 2—Examples of various possible arrangements of laminations and nonmagnetic spacers in a playback head, where edge and auxiliary gaps are sources of interfering flux

# Improving Response of

**T**HE FREQUENCY RESPONSE of a magnetic tape recording and playback head shows certain departures from smoothness, particularly at the lower frequencies. Practical improvement in the heads may be achieved by an understanding of the reasons for presence of irregularities.

The frequency response of a head is obtained by recording the frequency spectrum at constant current (the record current and bias current being determined in accordance with RTMA Specification REC-134), and then playing the tape back and measuring the output voltage. The output voltage ascends with frequency at about 6 db per octave until the combined effects of high-frequency core losses, the thickness effect in the magnetic tape and the effect of the gap spacer<sup>1</sup> cause the output to reach a maximum and then descend. At 3.75 inches per second, this maximum occurs at approximately 1,000 cps. Where over-all flatness of the frequency response is desired, equalization may be applied to the recording current and/or the playback network.

## Source of Irregularities

The irregularities are a function of the playback head only. This is shown in Fig. 1, where two heads are used—a smooth-response head and a head whose response has been

purposely made as irregular as possible. In Fig. 1A, the irregular head is used both for recording and for playing back its own signal, and gives an irregular result. In Fig. 1B, recorded by a smooth head and played back on itself, the response is smooth. In Fig. 1C, the response is recorded by the irregular head and played back on the smooth head; again the response is smooth, although there are slight irregularities. Figure 1D shows that the response when recorded on the smooth head and played back on the irregular head is irregular.

In the playback process, it is helpful to think of gaps as sources of flux, which take magnetic flux from the tape and supply it to the coil. In addition to the main gap, there may be two other types of sources of flux in tape heads. These sources, which interfere with the output of the main gap and cause the irregularities, are the edges of the pole pieces (edge gaps)<sup>2</sup> and the spaces between laminations.

In tape heads in which the laminations are at right angles to the direction of tape travel, the spaces between these laminations act as sources of flux. These will be called auxiliary gaps. Since these sources of flux are displaced from the main gap, there will be a phase difference between their output and the output of the main gap. Their output will add to the main gap output at some frequencies, subtract at others, or interfere with the output and produce an irregular response.

Figure 2A shows one type of tape recording and playback head. The two magnetic pole pieces (0.010 inch thick) are separated from each other by a metallic non-magnetic spacer, which is commonly 0.0005 inch thick. This forms the main gap. In addition to the main gap, the symmetrical head contains two auxiliary gaps (the spaces between the laminations) and two edge gaps as in Fig. 2B. Modifications can have only one auxiliary gap as in Fig. 2C or can have the relative position of the gaps changed as in Fig. 2D.

## Two-Lamination Head

Consider the case where there are symmetrical edge gaps alone, displaced from the main gap by a distance  $b$ , as shown in Fig. 2E. Let the tape traveling over the head have impressed upon it a magnetic signal of wavelength  $\lambda$ , and be traveling across the head with velocity  $v = x/t$ , where  $x$  is the displacement. The output from the main gap then is

$$e = A \cos \frac{2\pi x}{\lambda} \quad (1)$$

where  $A$  is a variable which includes in it the 6-db-per-octave rise at low frequencies due to the velocity characteristic of the magnetic circuit and the decline in output at the high frequencies (short wavelengths) due to the gap effect.

The output from the edge to the right is

$$e_2 = -C \cos \frac{2\pi(x+b)}{\lambda} \quad (2)$$

\* Now with Electro Engineering Products Co., Inc., Chicago, Ill.

Effect of lamination air gaps on frequency response of magnetic tape playback heads. Edges of pole pieces and spaces between laminations act as sources of interfering flux. Unsymmetrical arrangement of laminations gives smoothest response curve

By **ARTHUR H. MANKIN**

Shure Brothers, Inc., Chicago, Ill.\*

# Magnetic Playback Heads

since the source is located at the point  $(x + b)$ . The minus sign is in front of the term because there is an inherent 180-degree phase reversal at the edges. An elemental magnet placed at the edge causes flux to flow through the coil in a different direction than a similarly poled magnet placed at the main gap.

Similarly, the output from the edge to the left is

$$e_s = -C \cos \frac{2\pi(x-b)}{\lambda} \quad (3)$$

Adding Eq. 1, 2 and 3 gives the total output as

$$e_{out} = \cos \frac{2\pi x}{\lambda} \left( A - 2B \cos \frac{2\pi b}{\lambda} \right) \quad (4)$$

This last equation is the useful result since it gives the frequency response in terms of the ratio of pole width  $b$  to wavelength  $\lambda$  on the tape. This result is shown as curve A in Fig. 3, which is the actual frequency response of a head with pole pieces 0.020 inch in width (in the direction of tape travel) plotted at a tape speed of 3.75 inches per second.

The calculated first minimum for the above set of constants occurs at 167 cps which is in good agreement with the observed value. At 15 inches per second, with  $\frac{1}{2}$ -inch pole faces, the first minimum occurs at 60 cps. One method of minimizing this effect is to place the main gap unsymmetrically between the edges; then the separate re-

sponses of the edges do not add to each other in phase. Also, by causing the tape to leave the pole pieces gradually, the magnitude of the effect may be decreased.

## Four-Lamination Head

Curve B in Fig. 3 gives the frequency response of a head in which there are two 0.010-inch laminations on either side of the main gap. These laminations are arranged at right angles to the direction of travel. Using an exactly similar method as for the two-lamination case, with  $d$  as the lamination width, the output voltage is

$$e_{out} = \cos \frac{2\pi x}{\lambda} \left( A + 2B \cos \frac{2\pi d}{\lambda} - 2C \cos \frac{4\pi d}{\lambda} \right) \quad (5)$$

This gives one term due to the edges plus a term due to the auxiliary gaps. The response from Eq. 5 for a smooth-response head in which the pole pieces are in-

definitely long is shown by curve C in Fig. 3; here  $A$  was arbitrarily given the value 1,  $B \frac{1}{2}$  and  $C \frac{1}{3}$ . The curve corresponds quite closely to the actual response in curve B.

## Three-lamination Head

With two 0.010-inch laminations on one side of the gap and one 0.010-inch lamination on the other, the smoother response of curve D is obtained. The theoretical response for this condition is

$$e_{out} = \cos \frac{2\pi x}{\lambda} \left( A + (B - C) \cos \frac{2\pi d}{\lambda} - C \cos \frac{4\pi d}{\lambda} \right) \quad (6)$$

It is possible to calculate the response of any configuration of laminations, varying both in number and width, by this method. As another example, the configuration with three laminations on one side of the main gap and only one on the other gives, both theoretically and practically, almost as smooth a response as the 2 and 1 structure used commercially.

Helpful and stimulating conversations on the subject with other members of the Tape Recording Section of Shure Brothers, Inc., including Lee Gunter, Jr. and Thomas W. Phinney are hereby acknowledged.

## REFERENCES

- (1) R. L. Wallace, Jr., Reproduction of Magnetically Recorded Signals, *Bell System Technical Journal*, p 1,145, Oct. 1951.
- (2) D. L. Clark and L. L. Merrill, Field Measurements on Magnetic Recording Heads, *Proc. IRE*, 35, p 1,575, Dec. 1947.

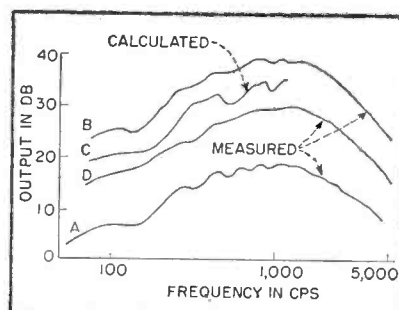

FIG. 3—Frequency response curves for various arrangements of laminations

# UHF-TV Radiators

Directional transmitting systems for uhf-tv broadcast applications make radiating slot preferable to modifications of conventional structures. Scale models indicate ease in obtaining special patterns with simplified feed and support inherent in new designs

By **ROBERT J. STEGEN**

*Hughes Aircraft Co.  
Culver City, Calif.*

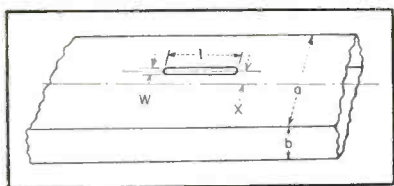

FIG. 1—Longitudinal slot in rectangular waveguide showing parameters discussed in design formulas

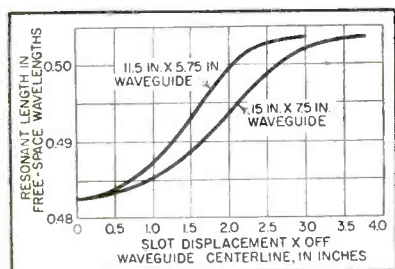

FIG. 2—Resonant length of longitudinal slot in uhf waveguide as a function of displacement

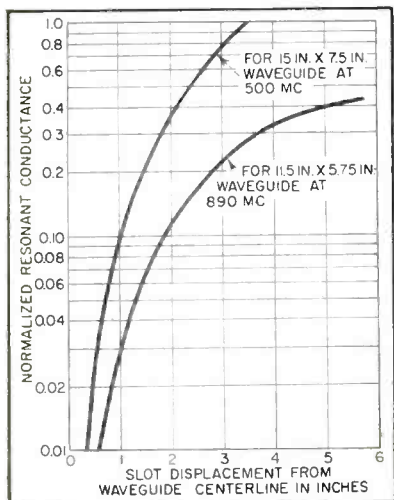

FIG. 3—Resonant conductances of longitudinal shunt slots at 500 and 890 mc

**P**RIME REQUIREMENTS for television antennas have been high gain, uniform azimuth pattern, minimum feed complexities and structures capable of withstanding all types of weather. In the future it may become desirable to modify the azimuth pattern from omnidirectional and also to shape the vertical pattern. Reduction of feed complexities is also of prime importance. Antennas used at present consist of bays stacked one above the other, each bay requiring a separate feed point.

These systems are complicated and would be even more so if scaling to ultra-high frequencies were attempted. To reduce the number of feed points the traveling-wave principle has been suggested<sup>1</sup>. This antenna uses a helix wound around a central cylinder for support. The helix is designed to operate in the mode that results in a main beam of radiation normal to its axis. The polarization is horizontal and the pattern is omnidirectional in azimuth, the elevation beam being narrow and a function of the length of the helix. Although only one feed point is needed, the construction of this antenna is complex.

## Slot Antenna

Since uhf-tv frequencies fall in the lower end of the microwave region, it appears reasonable to use microwave techniques in antenna design. A logical system would comprise a vertical array of longitudinal shunt or inclined series slots on a waveguide. Both these types will give the, same general

pattern with horizontal polarization. The series slot array has a small amount of cross-polarization.

## Secondary Beams

The shunt slot array has secondary beams about 20 db below the main beam that may be undesirable if low side-lobe level is desired. A very low side-lobe level is usually not required.

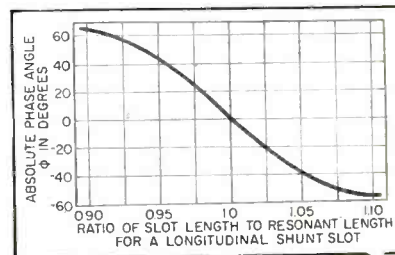

FIG. 4—Absolute phase  $\phi$  of slot radiation vs ratio of length to resonant length for slot width 1/20 wavelength

There are several distinct advantages to using a slot array antenna: linear arrays of discrete elements whose excitation is carefully controlled in general have considerably better aperture efficiency than continuous distributions in which the theoretical distribution is only approximated; cost of manufacturing a slot array is nominal because of its simplicity. Shaped elevation patterns are easily obtainable by varying the aperture distributions and directional azimuth patterns also may be readily obtained. Power

# Using Slot Arrays

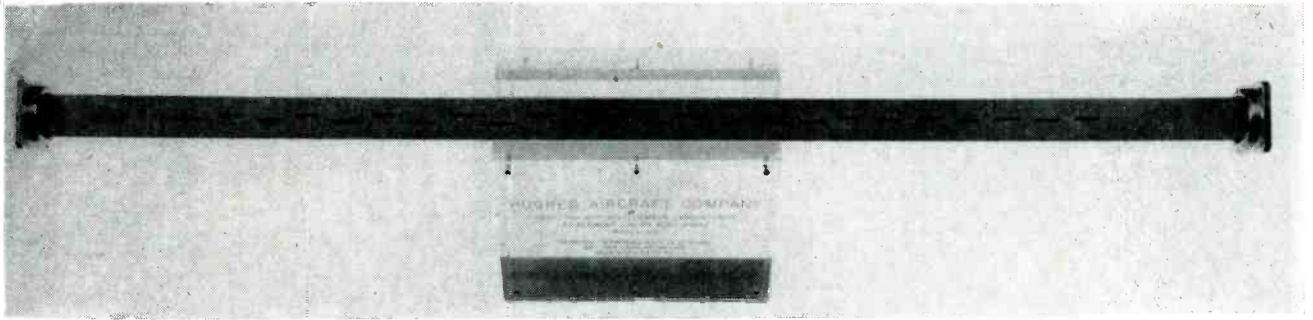

FIG. 5—Longitudinal shunt slot array of 24 elements designed for 9,375 mc with beam width of 3.9 deg

loss in the transmission line is very low. The slot array on its waveguide is self-supporting and need only be secured at the base.

## Radiating Slot

Although it is recognized that both inclined slots or displaced longitudinal slots in the broad face of waveguide are essentially acceptable as radiators, the greatest effort has been directed toward determining the characteristics of the displaced longitudinal slot. This type of slot is shown in Fig. 1 and may be represented as a pure shunt element across the transmission-line representation of the waveguide. Sufficient experimental measurements have been made on longitudinal shunt slots<sup>2</sup> to indicate that an extrapolation from the X-band measured data may be made to the uhf-tv frequencies with few, if any, slot measurements.

For instance, the length of a slot as a function of its displacement from the center line of standard  $18 \times 7\frac{1}{2}$  in. and  $11\frac{1}{2} \times 5\frac{1}{2}$  in. wave-

guide is expected to be as shown in Fig. 2. The conductance of a resonant slot at 500 mc and at 890 mc in the appropriate standard waveguide is shown in Fig. 3. This curve satisfies the expression

$$G = 2.09 \frac{a}{b} \frac{\lambda_g}{\lambda} \cos^2 \left( \frac{\pi}{2} \frac{\lambda}{\lambda_g} \right) \sin^2 \frac{(\pi x)}{a} \quad (1)$$

where  $a$  = the wide dimension of the waveguide,  $b$  = the narrow dimension of the waveguide,  $x$  = the displacement of the slot off the waveguide center-line,  $\lambda$  = the free-space wavelength, and

$$\lambda_g = \lambda / \sqrt{1 - \left( \frac{\lambda}{2a} \right)^2} \quad (2)$$

= the guide wavelength.

Figure 4 shows the phase of the radiation of a nonresonant longitudinal shunt slot. The phase  $\phi$  of the radiation is defined by

$$\tan \phi = B/G \quad (3)$$

where  $B$  is the shunt susceptance of the slot and  $G$  is the shunt con-

ductance represented by the slot.

The width of the slots is not critical and may be up to a tenth wavelength wide. This means that at 500 mc the slots will be about 12 in. long by as much as 1 in. wide. To keep insects and birds out of the waveguide and also for weatherizing, it may be advisable to glue thin fiberglass covers directly over the slots.

## Elevation Pattern

The elevation pattern will in general be a narrow beam normal to the array. If gain is the main criterion, the aperture distribution will be uniform. The resulting half-power beamwidth may be accurately calculated from the expression

$$\theta_E = 50.9/(l/\lambda) \text{ degrees}$$

where  $l/\lambda$  is the length of the antenna in wavelengths. The array will be expected to have a 10-db width,  $\theta (1/10)$ , of about  $\theta (1/10) = 1\frac{2}{3} \theta_E$  and a 20-db width,  $\theta (1/100) = 2 \theta_E$ .

The gain of a uniform array de-

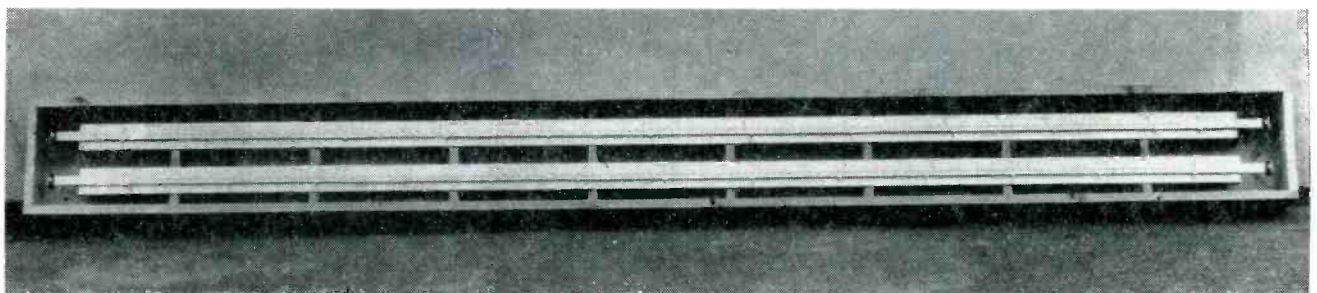

FIG. 6—Array of 144 elements for 10,125 mc. Beam width is 0.71 deg

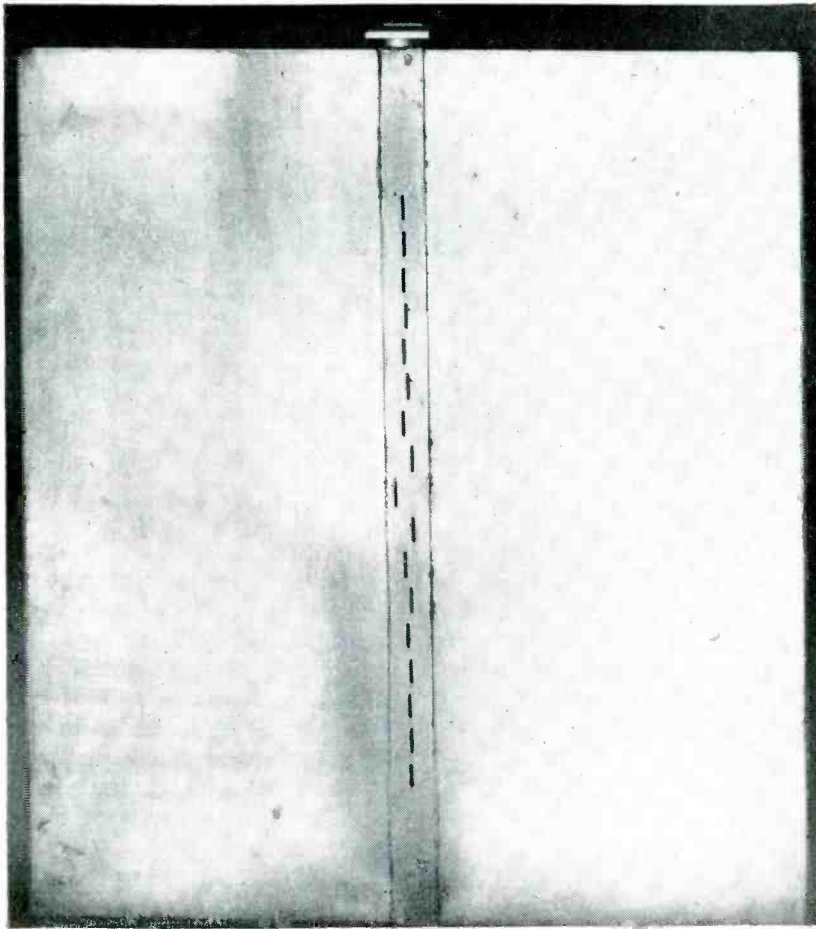

FIG. 7—Longitudinal shunt slot array of 17 elements. Design frequency is 9,910 mc. Idealized aperture shown in Fig. 8 in text is 6 to 60 deg

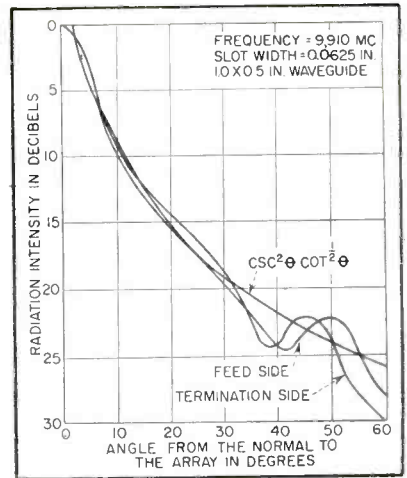

FIG. 8—Radiation pattern of 17-element array shown in Fig. 7

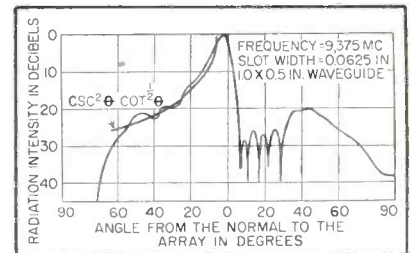

FIG. 9—Radiation pattern of 15-element array of nonresonant longitudinal shunt slots

depends on the azimuth pattern. For an omnidirectional azimuth pattern the power gain is approximately  $G = 2l/\lambda$ . An array that has an azimuth beam width,  $\theta_a$ , less than 180 deg will have a power gain given approximately by the expression  $G = 32,500/\theta_a \theta_e$  where  $\theta_a$  and  $\theta_e$  are the azimuth and elevation half-power beam widths in degrees.

### Slot Array

The slot array consists of  $N$  slots cut into the broad face of the waveguide. These slots are displaced from the center-line of the waveguide, adjacent slots alternating about the center-line. The slots are, in general, spaced exactly a half guide-wavelength apart. This is then called a resonant array. The main beam is normal to the array.

The array is terminated a quarter wavelength beyond the last slot with a shorting place. The input ad-

mittance is usually designed to be unity. For a resonant array the conductance of the slots is directly proportional to the power radiated. Therefore a uniform array of  $N$  slots will consist of identical slots whose conductance is  $1/N$ .

Shaped beams or low side-lobe

level beams are readily achieved. The design of these arrays has been discussed elsewhere<sup>2</sup>. A simple rule for the pattern bandwidth of a resonant array is  $\pm 50/N$  percent. This indicates that unless the array is very long there will be no appreciable pattern deterioration over the band of one tv channel. The admittance bandwidth will be a function of the bandwidth of the slots and the admittance design of the array. This will usually be adequate. If necessary, overloading<sup>3</sup> may be used. Overloading is a broadbanding design technique whereby the input admittance is made a large real value and then matched with an iris.

The power-handling capacity of the waveguide is in the tens of megawatts and the power-handling capacity of a one-inch-wide slot will be over one megawatt.

Three linear arrays successfully designed and built by the author

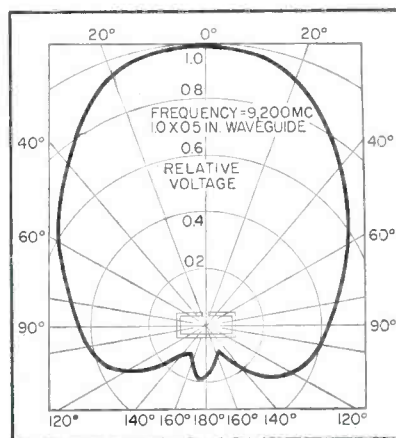

FIG. 10—Azimuth pattern of vertical array with no ground plane

are shown in Fig. 5, 6 and 7. The 24-element array was designed for a uniform side-lobe level 30 db below the main beam and measured 28 db at the design frequency. The side-lobe level was better than 26 db over a 15 percent band. The 144-element arrays were designed for a uniform side-lobe level of 40 db down and measured 29 db. This discrepancy is completely attributable to machining tolerances. The 17-element array was designed to have a symmetrical pattern approximately proportional in power to  $\csc^2 \theta \cot^{1/2} \theta$ . The two halves of the pattern about the normal to the array are shown in Fig. 8. The input impedances and beamwidths of these arrays were as designed.

If the antenna is to be constructed high over a city, such as on a mountain top or high building, a beam that has its greatest gain horizontally, a broad beam below and a sharp dropoff above the horizontal would be ideal. This type of pattern, although more difficult to calculate, is possible with a slot array. The pattern of such an antenna which has been constructed is shown in Fig. 9.

### Azimuth Pattern

Present antenna designs for television stations have in general called for omnidirectional patterns in the horizontal plane. This is a result of stations being in metropolitan areas. Some uhf channels are allocated to smaller cities and in many cases it will be desirable to have directional azimuth patterns. Slot arrays are almost ideally suited to this application. The variety of patterns and beamwidths available with a slot array are indicated in the patterns of Fig. 10 through 13.

A vertical slot array in a rec-

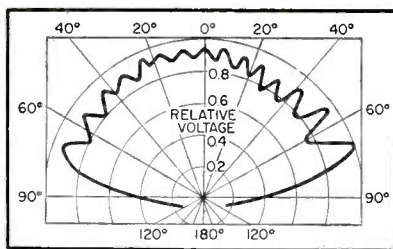

FIG. 11—Azimuth pattern of vertical array of longitudinal slots in 15-wavelength ground plane at 9,200 mc

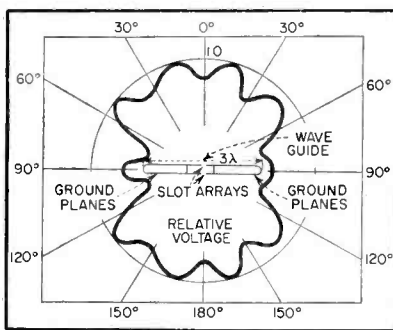

FIG. 12—Azimuth pattern of vertical double array of slots in a three-wavelength ground plane

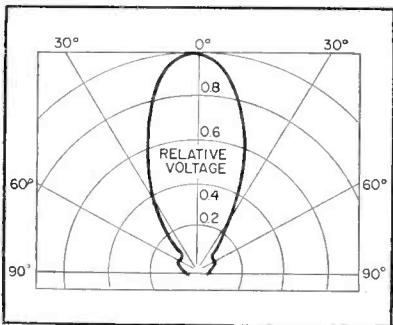

FIG. 13—Azimuth pattern of vertical array of longitudinal slots with horn

tangular waveguide would have the azimuth pattern shown in Fig. 10. The half-power beamwidth is 90 degrees. Figure 11 shows the azimuth pattern of a vertical slot array in a 15-wavelength ground plane. The half-power beamwidth is 165 degrees. The metalized side of a building could be used for the

ground plane if this pattern were desired.

The omnidirectional pattern of Fig. 12 is achieved by placing two arrays of slots on opposite sides of the waveguide and placing the ground plane about the waveguide.

The pattern of Fig. 13 was obtained from the linear array and horn shown in Fig. 14. The azimuth half-power beamwidth of this horn-slot combination is 35 degrees. Almost any desired beamwidth may be obtained with appropriate horn dimensions. The horn aperture is given approximately by the expression  $A = 60\lambda/\theta_A$  where  $\theta_A$  is the desired azimuth half-power beamwidth in degrees.

The admittance of the slots is only slightly affected by the presence of the ground planes. The horn has a somewhat more appreciable effect on the slot admittance. The radiation pattern will be essentially undisturbed by these horns but the input admittance to the arrays will be changed and will need correcting. If the horns are placed closer to the slots, if baffles are placed about the slots, or if heavy weatherizing covers are placed over the slots, the admittance characteristics of the slots may be changed quite drastically.

The author wishes to acknowledge the contributions to this material made by many members of Hughes Research and Development Laboratories and especially by members of the Microwave Laboratory.

### REFERENCES

- (1) L. O. Krause, Sidefire Helix UHF-TV Transmitting Antenna, *ELECTRONICS*, p 107, Aug. 1951.
- (2) Robert J. Stegen, Slot Radiators and Arrays at X-Band, *Trans. IRE Prof. Gr. on Antennas and Propagation*, p 62, Feb. 1952.
- (3) S. Silver, "Microwave Antenna Theory and Design", 12, p 324, MIT Radiation Lab. Series, McGraw-Hill Book Co., Inc., New York 1949.
- (4) Same as ref 3, p 365.

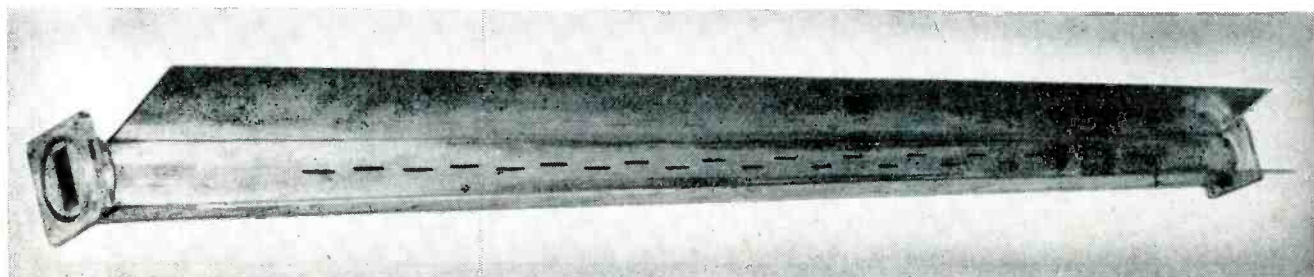

FIG. 14—Twenty-four element array with horn

# Linear-to-Logarithmic

**I**N ALMOST EVERY electronic field, need occasionally arises for linear-to-logarithmic conversion of data. Probably its most extensive use has been in one-dimensional instrument indicators and recorders. Here, for advantageous scale compression, linear inputs are converted to logarithmic values such as decibels. This use can be extended to two-dimensional semilog and log-log oscilloscope presentations.

In electronic-analog computing, the logarithmic converter in conjunction with an antilogarithmic converter conveniently performs multiplication and division by addition and subtraction of voltages and

By **R. C. HOWARD, G. J. SAVANT and R. S. NEISWANDER**

*California Institute of Technology  
Pasadena, California*

as readily produces integer and non-integer exponent functions.

## Evaluation Criteria

A linear-to-logarithmic converter is an electronic device which, when presented with an input  $x$  representing some number scaled into d-c voltage, produces an output  $y = \log_a x$  where  $y$  is also a number scaled into voltage, and  $a$  is the base

of the logarithm. Over 20 years ago a vacuum-tube circuit using a triode-connected UX-222 tetrode was developed to accomplish this.

Since then many converters have appeared: devices employing germanium diodes, selenium rectifiers, exponential time decays, vacuum-tube diodes, triodes, tetrodes and pentodes<sup>1-6</sup>. Analog-computer, arbitrary-function generators, such as photoelectric cathode-ray-tube devices, can also be used as logarithmic converters.

To evaluate this diverse group the following criteria were established: high-level, moderate-range voltage input; high conversion gain; stable and accurate conversion; reproducible characteristics; and practicable design.

Since the triode converter appeared most promising, development work focused on this item. The most common circuit utilizes the logarithmic relationship between grid current and plate

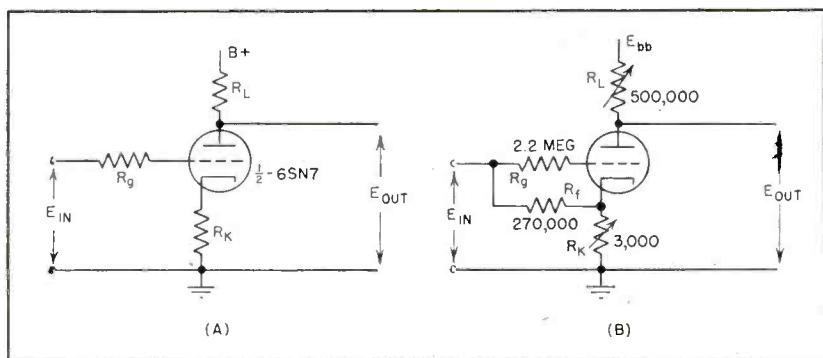

FIG. 1—Conventional triode circuit (A) can be modified to provide high-gain conversion of linear to logarithmic data

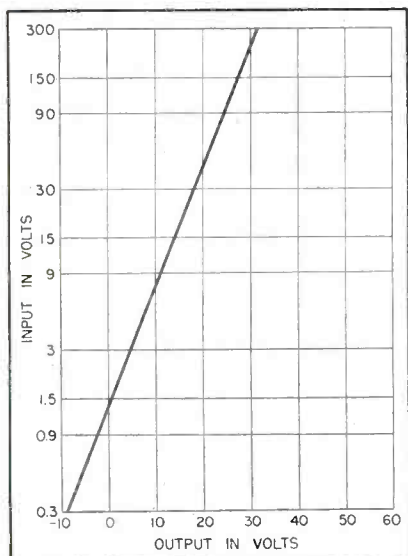

FIG. 2—Conversion characteristic is linear over three log cycles

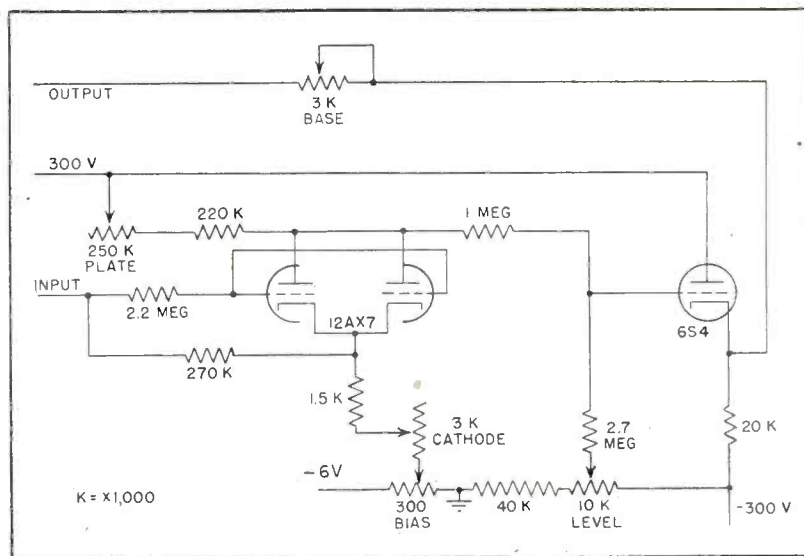

FIG. 3—Complete converter has cathode-follower output to provide isolation and aid in cancellation of offset voltage



# Voltage Converter

Conventional triode circuit modified for use with analog computers provides high-gain conversion of linear to logarithmic data over 0.3 to 300-volt range. Converter characteristics are readily reproducible; tubes need not be preselected

current in some triodes operating at low plate voltages. If a large grid resistor is added for voltage-to-voltage conversion, the basic circuit becomes that of Fig. 1A.

Resistors  $R_L$  and  $R_K$  and the plate voltage are adjusted to produce an output  $E_o = -\log_a(E_i) + E_{offset}$ . With this basic circuit, Nadel<sup>1</sup> succeeded in obtaining a remarkably accurate conversion with a logarithm base of about 3 over a range of 1 to 300 volts.

## Modified Triode Circuit

A high-gain conversion characteristic was discovered in the high-plate-voltage region of a few triodes. Typical values for this converter are shown in Fig. 1B. The corresponding response curve is presented in Fig. 2. The input-to-cathode resistor was added to improve the low-input-voltage response; the resistor does not affect higher-level conversion. Tubes do not have to be preselected to maintain similar characteristics. Good stability, 75 millivolts per hour, was attained by 500-hour tube aging.

The output of the converter is of the form  $E_o = -\log_a E_i + E_{offset}$ . Both  $E_{offset}$ , which arises from the large positive plate voltage, and the logarithm base,  $a$ , vary for different tubes. For reproducibility,  $E_{offset}$

can be canceled in each converter, and the logarithm base,  $a$ , can be made to coincide with some standard.

The removal of  $E_{offset}$  was directly accomplished by adding a cathode follower to the triode and subtracting  $E_{offset}$  at the follower's grid. This addition introduced the further advantage of isolating the triode converter from the actual output.

Adjustment of the logarithm base requires a simple adjustment of gain after logarithmic conversion.

This restricted-range gain control is inserted at the cathode-follower's output. The final circuit is shown in Fig. 3.

Although developed for a computer requiring a low logarithm base and zero d-c level, the same circuit has many possibilities. Table I shows the variety of logarithm bases and output voltages available with different tubes.

## REFERENCES

- (1) Arthur C. Hardy, A Recording Photoelectric Color Analyzer, *Jour. of Opt. Soc. of Amer.*, 18, No. 2, p 96, Feb. 1929.
- (2) Stuart Ballantine, Variable-Mu Tet-rodes in Logarithmic Recording, *ELECTRONICS*, 2, p 472, Jan. 1931.
- (3) Frederick V. Hunt, A Vacuum-Tube Voltmeter with Logarithmic Response, *Rev. Sci. Instr.* 4, p 672, Dec. 1933.
- (4) John P. Taylor, A D-C Amplifier for Logarithmic Recording, *ELECTRONICS*, 10, p 24, March 1937.
- (5) Ralph E. Meagher and Edward P. Bentley, Vacuum-Tube Circuit to Measure the Logarithm of a Direct Current, *Rev. of Sci. Instr.*, 10, p 336, Nov. 1939.
- (6) I. A. Greenwood, Jr., J. V. Holdan, Jr. and D. Macrae, Jr., "Electronic Instruments, MIT Rad Lab series, Vol. 21, p 125, McGraw-Hill Book Co., New York, 1948.
- (7) Tests at North American Aero-physics Lab., 1950.

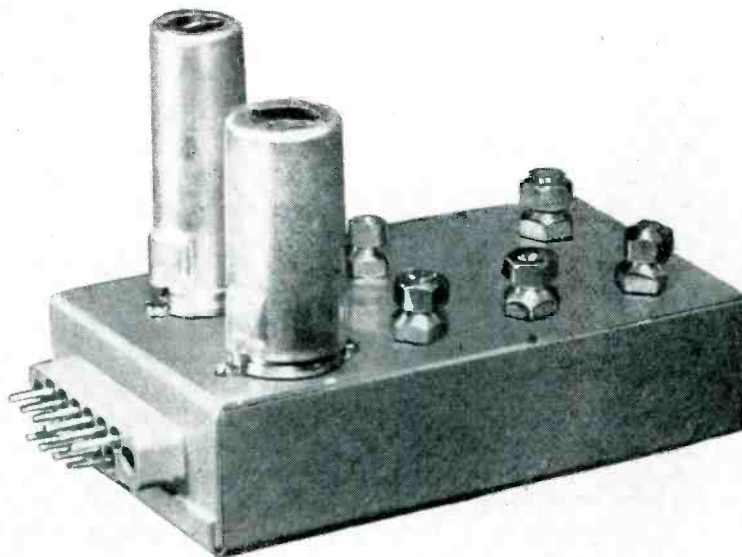

Linear-to-logarithmic converter is mounted on plug-in chassis

Table I—Various Logarithm Bases and Output Voltages Available With Different Tube Types

Case	Tube	$E_{bb}$	$E_f$	$R_L$	$R_K$	$R_f$	$R_g$	$E_k$	Base	$E_o$
1	1/2 12AY7	300	5.8	450K	12.4K	470K	2.5Meg	-3.0	1.30	60
2	1/2 12AY7	300	5.8	320	14.0	470	2.5	-8.5	1.38	33
3	1/2 12AU7	280	5.8	100	14.0	5,000	2.5	-13.6	1.78	25
4	1/2 12AU7	280	5.8	27	150.0	5,000	2.5	-3.4	1.78	72
5	1/2 12AT7	290	5.8	36	5.6	1,000	2.5	-24.0	1.18	113
6	1/2 12AX7	290	5.8	18	5.3	150	2.5	-19.0	1.14	231
7	1/2 12AX7	290	5.8	160	6.3	400	2.5	-5.9	1.13	110
8	2/2 12AX7	300	6.0	350	3.0	270	2.2	-3.0	1.26	30

# TRANSISTORS: Theory and Application

## Point-Contact

Part V

By ABRAHAM GOBLENZ and HARRY L. OWENS

Signal Corps Engineering Laboratories  
Forth Monmouth, New Jersey

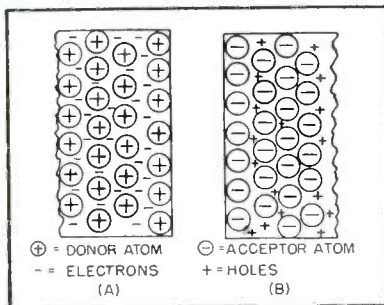

FIG. 1—Donor material (A) and acceptor material (B) show arrays of charged atoms just below surface of germanium

PREVIOUS articles of this series have developed the theoretical concepts associated with *p* and *n*-type semiconductor materials. These principles will be applied to a detailed analysis of the theory of operation of the point-contact transistor.

### Temperature Dependence

Much information is obtainable from the covalent bond picture of germanium and silicon. From this picture it is apparent on a qualitative basis that the transistor using germanium or silicon is a temperature-dependent device. An increase in temperature will be accompanied by disruption of some of the covalent bonds thereby freeing electrons to act as carriers.

By definition, the presence of these additional carriers will increase the conductivity. Many of the parameters which characterize a transistor are dependent on conductivity, and these parameters will vary with temperature. If the temperature is increased sufficiently, enough covalent bonds are broken

so that additional increases in temperature will have a negligible effect on the number of available carriers. Under such circumstances, the conductivity approaches an upper limit, called the intrinsic conductivity. The word "intrinsic" implies that the conductivity of the semiconductor is essentially dependent upon the properties of the material itself rather than upon the impurities that control its conductivity at lower temperatures.

The intrinsic temperature for germanium normally suitable for transistors is of the order of 100 C. Near the intrinsic temperature, control of the carriers is very difficult because of their very large number and high thermal energy. Since this control is essential to efficient transistor action, it is evident that the intrinsic temperature sets an upper limit for satisfactory transistor operation. In practice, other considerations further limit the maximum operating temperature so that it may be substantially less than the intrinsic temperature.

In Part IV of this series it was shown that impurity atoms occupy lattice sites and by their displacement of germanium atoms give rise to excess electrons or holes. In the conduction process the carriers are the holes or the electrons—the

ionized atoms at the lattice sites do not contribute to the conduction.

Conduction in a semiconductor is essentially electronic rather than ionic. In an ionic conduction process, conduction is by atoms that have gained or lost one or more electrons (ions).

At a given instant of time if it were possible to look just below the surface of a semiconductor such as germanium, there would be seen an array of countless germanium and impurity atoms vibrating about their mean lattice positions due to thermal agitation with mobile holes or electrons moving among the atoms. In the case of a donor material, the impurity atoms have a net positive charge and it is convenient for analytical purposes to picture the situation as in Fig. 1A. Here is shown an array of donors, hereafter indicated as a plus sign enclosed in a circle, near the surface of the *n*-type material. For the *p*-type material, Fig. 1B, an array of acceptors with their negative charge is shown. This picture will serve as a useful tool in the analysis of transistor action.

### P-N Junction

Figure 2A shows a piece of *p*-type material adjacent to a piece of *n*-type material, such an arrange-

### PREVIOUS ARTICLES IN THIS SERIES

Transistors: Theory and Application, Part I, p 98, March 1953.  
Energy Levels in Transistor Electronics, Part II, p 138, Apr. 1953.  
Physical Properties of Electrons in Solids, Part III, p 162, May 1953.  
Transistor Action in Semiconductors, Part IV, p 164, June 1953

# Transistor Operation

Detailed discussion of point-contact transistor action is presented, including physical construction, hole and electron movement, potential hills, surface states and relationship of these phenomena to external connections and applied voltages

ment producing a  $p-n$  junction. It is not possible to make a satisfactory junction by simply taking a piece of  $n$ -type and a piece of  $p$ -type germanium and putting them together, regardless of the pressure used to hold them together or how carefully the interfaces are cleaned and polished. Experience has shown that, because an action occurring at a microscopic level among particles of atomic dimensions is involved, it is extremely difficult to get orders of purity and cleanliness or smoothness at the surfaces that are required to obtain a satisfactory  $p-n$  junction. It is therefore not considered feasible to make a  $p-n$  junction mechanically. A process for making  $p-n$  junctions will be described later.

These  $p-n$  junctions have been used successfully in circuit applications commonly associated with the familiar germanium diode.

This structural arrangement is a convenient device for establishing a general rule for the polarities of applied potentials both for transistors and diodes.

## Potential Hills

It might appear at first that under the action of ordinary diffusion, the excess of holes (Fig. 2A) would diffuse into the  $n$  region and excess of electrons would diffuse into the  $p$  region so that, in time, the  $p-n$  junction as such would cease to exist. Of course this does not happen at ordinary temperatures. A very simple analysis, but one which has some very far reaching implications, will show why.

In trying to diffuse into the  $n$  region, a hole in the  $p$  region en-

counters a barrier layer of positively-charged atoms (donors) just across the junction plane. The positive electric field created by the donors opposes the transgression of holes.

Figure 2B shows what the potential variation or distribution looks like to the hole trying to get across the junction. As it approaches the junction, the lines of electric flux extending out impede its motion, and if the hole does reach the junction, it must have had initially a large energy to overcome the opposition of the donor electric field. The increase of energy which a hole must thus possess in order to move against the electric field, is shown in Fig. 2B as a small potential hill. This name is commonly applied to the effect at the junction that prevents the holes from diffusing across it.

At room temperature, for example, the holes will, in general, not have sufficient energy from thermal agitation to climb the potential hill and therefore a significant number of holes do not diffuse from the  $p$  to the  $n$  region. Electrons in the  $p$  region however will, due to the electric field of the donors, diffuse easily into the  $n$  region sliding down a potential hill. However, the electrons are only minority carriers in the  $p$  region, and their migration to the  $n$  region will never annihilate the  $p-n$  junction because there is already an excess of electrons in the  $n$  region.

In Fig. 2C is shown the corresponding condition for electrons in the  $n$  region which would, ordinarily, diffuse into the  $p$  region under normal kinetic vibration or

motion. Analogously for the case of the holes, electrons that approach the junction come under the influence of the negative electric field

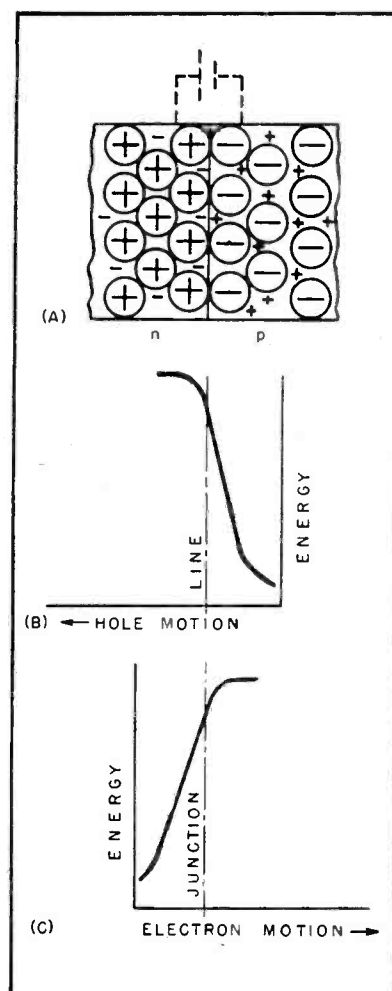

FIG. 2—Donor and acceptor materials arranged as a junction are shown in A. Any hole trying to diffuse from acceptor material to donor must climb potential hill due to array of donors near surface of  $n$  germanium (B). An electron trying to diffuse from  $n$  region to  $p$  region must climb potential hill indicated in C

due to the array of acceptors and encounter the potential hill that turns back most of them.

The effect due to the array of acceptors and donors is representable as in Fig. 2A by a small battery shown dotted in the figure. For the position shown it will introduce the same potential hills as do the arrays of acceptors and donors. This picture, however, is extremely important because it provides instantly the answer to the polarity problem.

If a battery is connected as in Fig. 3A, it aids the equivalent battery of Fig. 2A and increases the height of the potential hill. With this arrangement the number of carriers that can climb the potential hill is very small and most of the conduction is actually due to minority carriers since this polarity of bias enhances the flow of electrons from the *p* region to the *n* and of holes from the *n* region to the *p* region. The number of minority carriers is so small that the total current is small and this polarity of bias gives rise to the reverse-current or high-resistance condition.

In Fig. 3B, however, the external battery is connected so as to oppose or flatten out the potential hill or the equivalent battery of Fig. 2A. The flow of holes from the *p* to the *n* region and the flow of electrons from the *n* to the *p* region is enhanced. This is the low-resistance or forward-current polarity of bias.

### Barrier Potential

The order of magnitude of the potential difference across the junction in the absence of an external battery is in tenths of a volt and it may thus appear that a very small battery connected as in Fig. 3B would be sufficient to completely annihilate the potential hill. This is not so. A semiconductor that has approximately a hundred thousand times the resistance of a conductor such as copper is involved. An important potential drop occurs in the *p* and *n* regions without reference to the barrier at all and, of course, as the current increases this drop increases.

The more the barrier is broken down by using the polarity of Fig. 3B the more readily do the carriers move across it. In that sense the

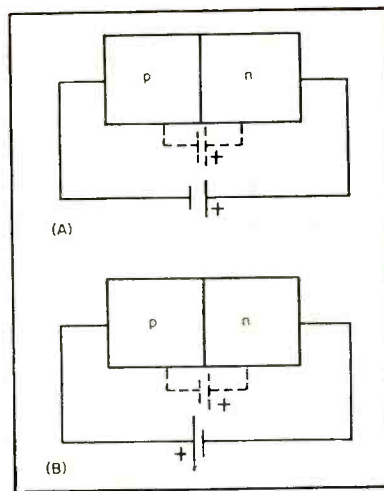

FIG. 3—In A, the potential hill, represented by dashed-line battery, is reinforced or raised by connection of external battery. This is identified as reverse-current (high-resistance) connection. In B, the potential hill, represented by dashed line battery, is overcome or lowered by external battery. This is forward-current (low-resistance) connection

resistance of the barrier is decreased. As the current increases the net drop available across the barrier itself for counteracting this contact potential at the barrier decreases, and it is clear that the two actions are opposite in direction. Nevertheless, it is possible to make the potential hill quite small by the use of potentials of the order of one volt. If the battery potential is made too high in the reverse direction voltage breakdown occurs, see Fig. 3A. In the case of the forward connection of Fig. 3B, the application of too high a voltage will permanently damage the junction due to the heating effects of excessively high currents.

### State of Theory

Before proceeding to the discussion of the theory of the point-contact transistor it is necessary to make some precautionary remarks. The vacuum tube has been known for over 50 years and vacuum-tube theory is on relatively firm ground. In vacuum tube theory, the reader is accustomed to seeing only the well-worked-out and thoroughly established theories in print, each such theory having had ample time to be checked and cross-checked by many workers in the field. This is in general not true of transistor theory because the entire field is

barely five years old.

Authorities in the field today do not unanimously agree upon a theoretical explanation of point-contact transistor operation. To the reader familiar with the calculus this will not appear particularly surprising. The mathematical analysis of physical phenomena occurring at a point such as the pointed tip of the fine wire used for the cat whisker is extremely difficult and involved. Theories that adequately explain all the known phenomena involved in point-contact operation have not been completed. Many of the equations developed are so complex and difficult to verify experimentally that physically significant solutions are not yet available.

There is, therefore, no complete mathematically supported theory of point-contact rectification or transistor action that may be used to interpret observed phenomena or predict future behavior. The theoretical explanation of the action of a point-contact transistor that will be given must be considered to be merely one of the many possible theories. The reader should look upon the explanation proffered with a certain amount of critical reserve. The explanation to be given is, in the opinion of the authors, the best currently available but because the art is so young it is well to bear in mind that it may be considerably modified in years to come.

### Theory of Operation

In Fig. 4 is shown the essential arrangement for point-contact transistor operation. The base (or pellet) is a piece of *n*-type germanium of about 4 to 5 ohm-cm resistivity, approximately 20 mils thick, and about 50 mils in length and width. The cat whiskers are wires of some metal such as phosphor bronze approximately 5 mils in diameter, spaced approximately 2 mils apart with some simple provision such as a bend in the wire, to keep a few grams pressure on the surface of the germanium.

The cat whisker shown on the left is called the emitter for reasons which will appear shortly. The other cat whisker is the collector. The base connection on the underside of the germanium pellet consists of an ohmic soldered connection.

The reader may be concerned with possible deleterious effects of the heating involved in the soldering operation. Actually harmful effects on the electrical properties of the germanium are not observed until temperatures considerably higher than those encountered in the soldering operation are reached. Further, to degrade appreciably the characteristics of the germanium, elevated temperatures must be maintained for times much in excess of those encountered in the soldering process.

It is known that electrons that find their way to the surface of the semiconductor become held or bound in certain conditions or states that are different from the quantum states of the electrons inside the bulk of the material. When the electrons enter into these surface states (surface quantum states) they appear to be bound and do not readily return into the bulk of the material. The result is that a surface layer of such electrons in these surface states is built up on the material. For an *n*-type material, and mention has already been made that point-contact transistors are usually made with *n*-type material, this surface layer of electrons, as shown in Fig. 5, combines with the array of donors just below the surface to form a small potential hill, as shown by the dotted battery. This arrangement produces an effect analogous to the *p-n* junction discussed in connection with Fig. 2.

### Rules for Polarity

Two rules may be established for the polarities of connections of transistors, which will apply to all the transistors, point-contact and junction. The reasons for these rules will become apparent during this article and the next.

(1) The emitter is always biased in the forward or low-resistance direction.

(2) The collector is always biased in the reverse or high-resistance direction.

On the basis of these two rules, and if we accept the surface-states electron theory discussed above, it is apparent that the emitter bias or battery  $E_e$  of Fig. 4 will be connected to oppose the potential hill at the surface as shown, and the

collector battery  $E_c$  will be connected to aid the surface potential hill. It is thus seen that without knowing the theory of operation of the transistor the reader by the simple mnemonic outlined, will know exactly how to bias a point-contact transistor, or, as we shall see later, a junction transistor.

Looking at Fig. 4, the surface electrons near the emitter have been removed because of the polarity of the connection, but those a little further away are still present. This is intended to illustrate the concept of bound electrons. If a metal plate, such as in a capacitor, is given a charge the charge will, in general, distribute itself evenly over the surface. If a battery terminal of suitable polarity is connected to the plate, all the charge on the plate can be drained off at once merely by connecting the battery at one point because the charges on a conductor plate are, in general, not bound. This is not true of an insulator or semiconductor. When the cat whisker at the emitter is applied as shown, only the electrons on the surface in the immediate vicinity are whisked away by the battery; the remaining surface electrons remain in their bound states as indicated.

### Cat Whiskers

One might wonder why it is necessary to use a cat whisker? Why can't a simple metal-plate connection be used? To answer this question it is necessary first to investigate the general characteristics of a point in electrical work.

An electric field such as may exist between the plates of a capacitor is usually considered to be made up of lines or rays called flux lines. The number of such flux lines depends on the potential, not on the area. Thus, for a given potential, electric flux lines are extremely crowded at a point and the electric flux intensity which by definition is flux lines per unit area is very high.

In a lightning rod, for instance, since the cloud must be discharged into the rod as soon as possible before the cloud accumulates enough charge to cause a lightning flash, the rod is made pointed. By crowding the electric flux lines from the cloud into a point, a sufficient field

intensity is developed to cause a current to flow down the electric rod and thus partially discharge the cloud.

Large potentials may not be applied to a transistor because of the possibility of very large currents, which will cause heating or, for the case of reverse connections, voltage breakdown. To break the covalent bonds in the germanium, a high-intensity electric field is needed at the emitter. The only way to get this high-intensity field is to use a point. For this reason the emitter contact is a point contact.

### Hole Injection

When the emitter bias  $E_e$  is applied, even though this bias is of the order of 1 volt, a high-intensity electric field is created at the point and imparts sufficient energy to the electrons in the valence bonds nearby to raise them into the conduction band and to break these valence bonds. These electrons under the influence of the applied potential immediately flow out of the material and into the emitter. The breaking of the valence bonds creates holes in the immediate vicinity of the emitter as shown in Fig. 4. While the term is somewhat a misnomer, this process of creation of holes is called injection because the effect is the same as if holes had been injected by the emitter. As soon as the holes are created they drift toward the collector under the influence of the electric field between emitter and collector.

Since we are dealing with an *n*-type material, with free or excess electrons, many of the holes on their way to the collector will recombine with the electrons and cease to exist. As these recombinations are taking place all the time, the number of holes that will combine with electrons increases with the transit time. Since a large number of holes is necessary for maximum effectiveness in transistor action, it is desirable to place the emitter and collector close together. Point-contact transistors of current design have emitter to collector spacings up to approximately 5 mils. If spaced too far apart, the gain and frequency response are adversely effected.

In the region of the collector the

potential hill at the surface limits the current flow and in the absence of holes the current will be of the order of one or two milliamperes. Holes that reach the immediate vicinity of the collector are attracted by the negative charge there and in moving to the collector point tend partially to cancel out or nullify the potential hill at the surface. In this way more electrons are permitted to climb the potential hill and the current at the collector is increased.

This increase in collector current as a result of hole injection is transistor action, and it is observed that small changes in the hole injection such as may be due to a modulation of the emitter bias by an a-c potential result in amplification of the emitter current containing the modulation intelligence.

### Resistance Gain

In transistor action the low-resistance connection is used in the emitter circuit and the high-resistance connection in the collector circuit, referring to the biasing potentials applied. The following rules apply:

(1) The internal resistance of the transistor between emitter and base, usually designated by  $r_{11}$ , is always a relatively low resistance. The internal resistance of the transistor between collector and base, usually designated by  $r_{22}$ , is always a relatively high resistance.

(2) Transistor action is accompanied by a resistance gain in that the ratio of  $r_{22}$  to  $r_{11}$  is greater than 1.

The low-resistance connection of the battery  $E_e$  in Fig. 4 satisfies the emitter circuit requirement of rule 1 but in the collector circuit the action of the holes nullifies the effect of the surface charge and thereby lowers the internal resistance between collector and base. Because point-contact transistor action is always accompanied by this effect of the holes in decreasing the internal resistance of the germanium, it is seen that the collector-to-base resistance requirement of rule 1 cannot be met. If  $r_{22}$  is small, satisfactory voltage and power gains cannot be achieved. However, there is an additional factor involved.

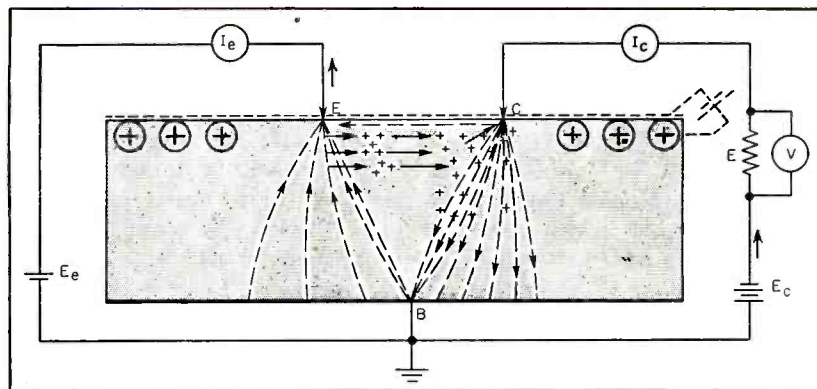

FIG. 4—Drawing illustrating point-contact transistor action shows role of surface states and array of donors with equivalent potential hill denoted by dashed-line battery

Looking at Fig. 4 it is seen that some holes do not follow a straight-line path from emitter to collector but, by the process of diffusion and random motion, travel in a more or less circuitous or indirect path to the collector. These holes form a positive space charge or cloud within the germanium in the region of the conducting path and thereby evoke or attract additional electrons from nearby sites, lowering the resistance of the path.

The significant point here is that the advent of the holes causes a decrease in the collector-to-base resistance due both to the effect of the holes in annihilating the surface charge and due to the positive space-charge effect. The result is that the resistance of the collector circuit is significantly decreased and a current flows that may be two to three times the emitter current. However, this clearly does not explain a resistance gain.

The condition of low resistance and high current is shown in section  $AB$  of Fig. 6. In the region from  $A$  to  $B$  the current is seen to be proportional to the voltage in accordance with Ohm's law; an increase in voltage is accompanied by a proportionate increase in current. If the applied collector bias is increased beyond point  $B$  the available supply of electrons soon becomes inadequate to sustain an Ohm's-law current. The supply of electrons is controlled by:

(1) The normal number of majority carriers at room temperature. This is a function of the impurity content.

(2) The neutralizing action of the holes on the surface electrons.

(3) The positive space charge due to the diffused holes.

Above point  $B$  of the figure, for instance, increases of applied potential  $V_c$  are not followed by proportionate increases of the current due to this exhaustion of the available carriers or electrons, and the curve rises steeply as shown in Fig. 6. The slope of the curve in the figure is  $r_{22}$ , the collector-to-base resistance.

The transistor is normally operated at approximately point  $C$  of the figure where the collector-to-base resistance is high. Summarizing, in the collector circuit the reason for the high resistance is not alone the reverse-current connection of the bias, but also the exhaustion of the available current carriers beyond the Ohm's law limit.

### Typical Values

Let  $i_e r_{11}$  represent the internal voltage drop from emitter to base and  $i_c r_{22}$  the internal voltage drop from collector to base. Since  $i_c$  is greater than  $i_e$  due to the effect of the holes, and  $r_{22}$  is greater than  $r_{11}$  due to the carrier-exhaustion effect mentioned, the possible voltage gain of the transistor is the product of current gain and resistance gain. It is important to note that voltage and power gain in the point-contact transistor are due both to the current gain and resistance gain.

The ratio of  $i_c$  to  $i_e$  is usually denoted by the Greek letter  $\alpha$  (alpha), and for typical point-contact transistors now on the market is of the order of 2.5. Typical values for  $r_{11}$  and  $r_{22}$  are approximately 300 and 18,000 ohms respectively, representing a resistance gain of about 60.

Thus it may be seen that typical voltage gains are of the order of 150 and typical power gains are of the order of 400.

In their migration from the emitter to the collector the holes move in an *n*-type material, and recombinations of holes and electrons are the rule rather than the exception. In fact, the discussion regarding recombination should explain why a very important effort in solid state physics is directed toward improving and controlling the lifetime of these carriers. Single crystals of germanium that are to be used in the manufacture of transistors are compared and evaluated for their lifetimes as a production control. Lifetime of carriers in single-crystal germanium is an important design parameter. Typical values vary from a few microseconds to two or three thousand microseconds.

### Frequency Response

The velocity of holes and electrons in semiconductors is not the same as the velocity of electrons in conductors. The reader accustomed to thinking of electron velocities in orders of hundreds of thousands of centimeters per second may be surprised to learn that in semiconductors velocities are of the order of a few thousand centimeters per second. Typical values for germanium are: for electrons, about 3,600 cm per second, for each volt per cm of potential difference or as is sometimes said, of potential gradient; for holes, about 1,700 cm per second per volt per cm of gradient.

Some very important effects in the transistor ensue as a result of this relatively slow movement of holes and electrons in semiconductors. For instance, in a wire information in the form of modulated waves piling up when fed into one end is not a matter of concern. The extremely high velocity of the electrons in the wire that carry the intelligence makes it almost certain that, for any reasonable frequency, the information fed in will move out of the way before the next bit is fed in. In semiconductors, however, because the velocity is so low, this piling up presents a serious limitation. At relatively low frequencies serious modulation distortion re-

sults because of the piling up of intelligence connected with the long transit time of electrons and holes.

Another consequence of the large transit time in transistors is evident in the decrease of the current gain, alpha, with frequency. When the period of one cycle is equal to the transit time, the positive half of a sinusoid may still be within the emitter-collector region when the negative half of the same cycle enters. Under these conditions, the effect on the flow of holes due to the positive and negative halves of the cycle cancel, and current gain is zero. This is for the extreme case when frequency is the reciprocal of the transit time. For lower frequencies, the effects are in proportion and the observed fact is that the current gain decreases with frequency.

The decrease of alpha with frequency is also due to the fact that all the flow lines of the holes from emitter to collector are by no means straight lines. In fact, these flow paths resemble more closely the flux lines observed in pictures of the

magnetic field between two poles. Since the transit time for these circuitous paths is greater than for the straight paths, neutralizations of the effects of the holes occur, particularly at the higher frequencies (lower periods).

While figures of frequency cutoff as high as 300 mc have been reported in the literature, these must be regarded as development laboratory values rather than representative limits obtainable from transistors now on the market. For most point-contact transistors currently being produced upper frequency limits are in the neighborhood of 10 mc, typical values around 3 mc. Some remarkable progress is being made along these lines at present and the reader can confidently expect commercially available units with importantly extended frequency limits to appear on the market in the near future.

This frequency limitation does point out, however, the desirability of having the emitter and collector as close together as possible because the frequency response increases rapidly as the spacing is decreased. Mechanical and electrical counter-indications set a lower limit on this spacing.

### Resume

(1) The point-contact transistor is capable of current gain due to the action of holes in enhancing the collector current for a given amplitude of emitter current.

(2) Voltage and power gain of the point-contact transistor are due to a combination of current and resistance gain.

(3) The theory of operation of point-contact devices in general is, as yet, not completely understood and it is essential to keep abreast of the literature in order to observe the progress in this field.

(4) The concept of potential hills is essential for the discussion of transistor action and is useful as a convenient mnemonic by which the polarity of applied biases may be remembered.

(5) The frequency response of point-contact transistors is a function of the transit time and the distribution of the flow lines of the carriers from emitter to collector.

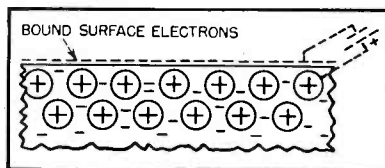

FIG. 5—A layer of electrons may be considered to exist in bound states at the surface of a semiconductor. This layer, in conjunction with the array of donors just below the surface, produces in effect the potential hill represented by the dashed-line battery

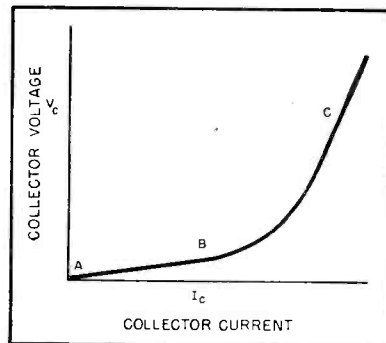

FIG. 6—Typical collector characteristic curve indicating variation of collector current with applied bias voltage. After point B insufficient carriers are present to support a proportional current for the applied electric field and the apparent resistance increases rapidly

# Portable Preamplifier for

In field work involving low-frequency vibration analyses, this self-powered preamplifier, used with an electrodynamic pickup and a vibration analyzer or portable oscilloscope, provides good gain and accuracy

**V**IBRATION analyses in the field are often carried out by means of a vibration pickup and analyzer or oscilloscope. Some form of preamplifier is required between the pickup and the analyzing instrument.

Tests show a preamplifier having an overall gain of only 12 times (22 db) is generally sufficient. The amplifier must have a substantially flat response from 5 to 1,000 cps and be capable of integration accurate to 1 percent throughout this range, while maintaining the quoted gain at the lowest frequency.

## Description

Rather than adopt a high-stability design, it was decided to make the circuit as simple as possible and to provide an easy means of checking the gain of the amplifier under working conditions. A meter on the front panel may be switched to read the amplifier calibrating voltage when an a-c power line is connected to an input plug on the front panel. The meter may also be switched to give a check on the battery voltages under load.

The B battery is a compact layer type while the filaments are heated from two flashlight cells in parallel. All the batteries are clipped to the chassis and thus housed within the amplifier case. The front panel also carries the input and output connectors, on-off switch, gain switch, circuit switch and a screwdriver adjustment for the calibrating voltage. The amplifier complete with batteries is housed in a case 6 by 7 by 8 inches and weighs 6½ lb.

The amplifier, Fig. 1, comprises two miniature tubes coupled by a

resistance-capacitance network. Integrating stages may be switched into circuit between these stages. Type 1S4 tubes are used in both positions.

## Circuit

The input is taken through a stepped attenuator to the grid of the first tube. This is a voltage-amplifying pentode operating at zero bias. The second grid is fed from a voltage divider across the B battery, which produces less distortion of the signal than the more usual series-resistor method of feed. The gain of the amplifier is thus somewhat dependent on B battery voltage, but this is immaterial as the overall gain can be readily checked. The measured gain of the first stage is 22 times and its output is fed through a coupling capacitor to the two-megohm grid resistor of the following stage.

To make available the maximum

possible gain, two alternative integrating capacitors are provided. In conjunction with the one-megohm integrating resistor, these give time-constants of 1/20 and ¼ second respectively. The integrating circuits introduce an attenuation of 7.8 times at 25 and 5 cps, these being the lower limits of frequency for each circuit if integration accurate to within 1 percent is desired.

The third position of the circuit switch brings a fixed resistor in place of either of the integrating capacitors. The coupling circuit then has a flat frequency response resulting in a uniform attenuation of 7.8 times throughout the range of the amplifier. This ensures that the output of the amplifier is of the same order whether switched to the "integrate" or to the "straight" condition.

The second 1S4 tube is strapped as a triode to simplify the matching

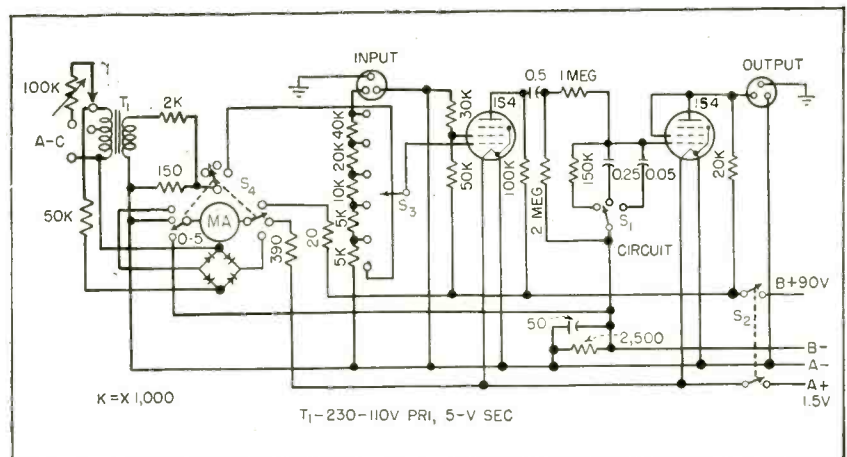

FIG. 1—Preamp circuit comprises two miniature type 1S4's; 5- and 25-cps integrating circuits available by setting switch. Input is taken through stepped attenuator to grid of first tube, which operates at zero bias



# Vibration Analysis

By R. K. VINYCOMB and L. D. CRAWLEY

Davey, Paxman and Co. Ltd.  
Colchester, Essex, England

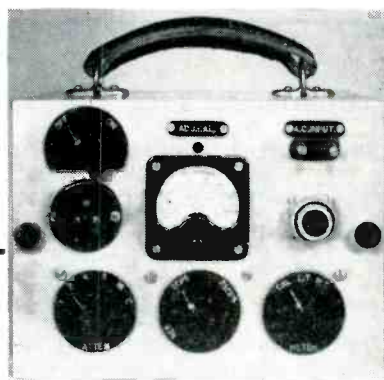

Preamplifier can be calibrated from any a-c source

of external loads. Since instruments such as portable vibration analyzers have input impedances as low as 20,000 ohms, it is important that loads as low as this will not affect the linearity of the preamplifier.

Ideally, the output tube might have been a cathode follower, but as this provides no gain, it was necessary to choose between a triode or a pentode with a low value of plate load. The triode was chosen as being the simpler. This tube obtains bias from a by-passed resistor in the B- line. The measured gain of the stage is 5 times. The output is taken directly from the plate since most oscillographs include a blocking capacitor at the input.

In the sixth position of the input attenuator switch the grid of the first tube is connected, via the meter selector switch, to a fixed attenuator across the secondary of a small transformer. The primary of the

transformer is fed from an a-c power line through a variable resistor which has a screwdriver adjustment.

When the meter selector switch is set to "calibrate" the meter is connected through a bridge rectifier so that it reads the transformer primary voltage. This voltage may be set to a predetermined value, marked on the meter dial, by means of the variable resistor, irrespective of wide variations in a-c line voltage. A known calibrating voltage is thus injected into the first tube which enables the gain of the preamplifier and any succeeding equipment to be checked, wherever an a-c line is available (by noting the reading on the analyzer output meter, measuring the height of the oscilloscope trace and so on).

The remaining two positions of the meter selector switch connect the meter, through suitable resistors, to the A and B batteries.

An indicating mark on the meter dial suffices for both batteries and shows when they have reached the end of their useful lives.

## Performance

The measured performance is shown in Fig. 2. The response of the amplifier straight is substantially flat from 5 to 1,000 cps and the two integrating stages give the required slope of 6 db per octave (necessary to achieve correct integration) over the ranges from 5 to 75 cps and 25 to 1,000 cps respectively.

The overall gain (straight) is 14, with 5-cps integrate it is 70/ $f$ , and with 25-cps integrate it is 350/ $f$  where  $f$  is frequency in cps.

The effect of reducing the A-battery voltage from 1.5 to 1.25 volts is negligible.

Overall gain of the preamplifier is approximately proportional to B-battery voltage. The figures given above were taken with a new 90-volt battery. Shown dotted on Fig. 2 is the response when the B battery had dropped to 78.5 volts. This resulted in a loss of gain of approximately 1 db.

All the above measurements were made with the amplifier feeding into a load consisting of a 20,000-ohm resistor in series with a 2- $\mu$ f capacitor. Maximum peak output before appreciable distortion was apparent was 10 volts.

During the many months in which the original amplifier has been in operation, no modifications or repairs have been needed.

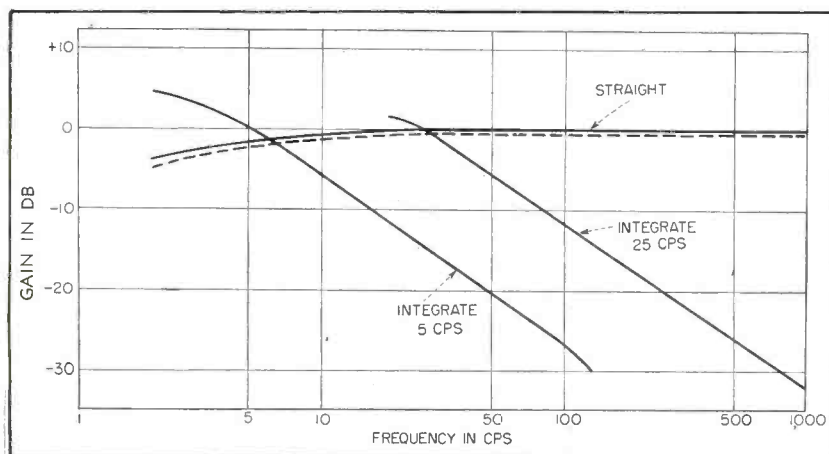

FIG. 2—Response curves for straight amplification with fresh 90-volt battery and 78.5-volt weak battery (dotted curve), and responses with integrate-25-cps and integrate-5-cps circuits switched in

# Continuous-Indicating

Instantaneous fixes for fast-moving aircraft are obtained with a 12-tube servo-relay attachment for standard navigation equipment. Remote guidance of vessels, such as survival craft, dependent upon continuous positional information can follow an extension of this development

**F**AST-FLYING AIRCRAFT increasingly require immediate and accurate determination of position that can best be given by continuous indication. Automatic or remote control of vessels, such as survival craft, is possible only with continuous position indication. Equipment for this purpose has recently become available as an adjunct to the existing loran navigational service.

Loran,<sup>1, 2</sup> is based upon time-difference hyperbolas generated by pulsed emissions from transmitters at the ends of a base line. Each pair of transmitters produces a hyperbolic line of position for the vessel or aircraft equipped with a suitable receiver-indicator. A fix is obtained at the intersection of the lines generated by two pairs of transmitters.

In practice, received pulses are manually adjusted to the same amplitude and superimposed on a cathode-ray screen. The time de-

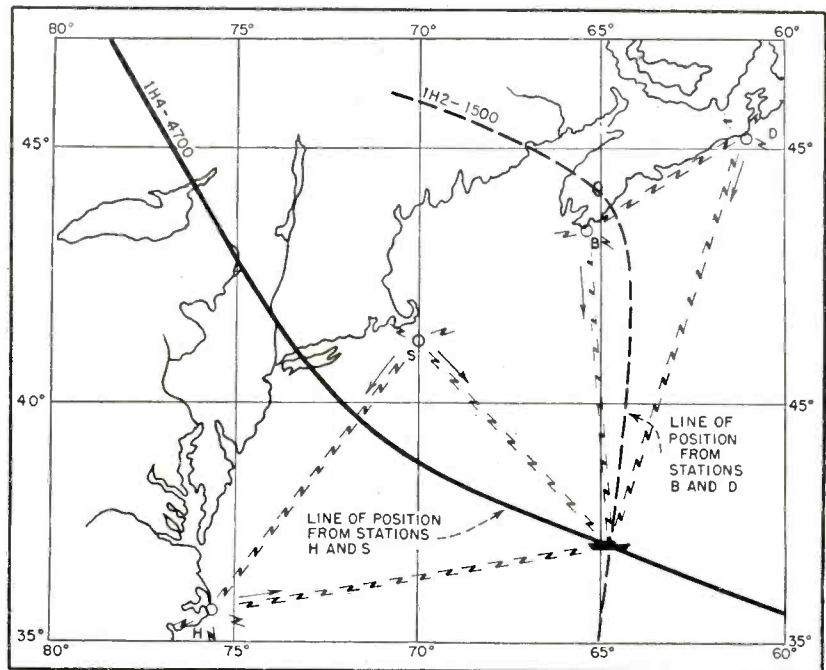

A loran fix is the point of intersection of two lines of position derived from difference of arrival of two pulse signals for each line

lay in the arrival of the slave pulse after the master is determined from the delay introduced into movable pedestal circuits that are adjusted for superposition of the pulses. Special charts with an overlay of loran delay lines show the navigator his location.

The loran oscilloscope presentation is shown in Fig. 1. Numbered dials actuating the movable pedestal (B) circuit directly indicate delay between time of arrival of the A (master) and B (slave) pulses for the instant of the observation.

For continuous, automatic indications aboard a moving craft, a 12-tube unit is added to the standard Sperry Mark-2 indicator to synchronize the indicator with the received signals, maintain correct pulse amplitude as shown on the

cathode-ray screen and maintain pulse superposition in height and time.

Figure 2 shows a block diagram of the automatic-gain-control and the automatic-amplitude-balance-control circuits. Both these circuits derive their control signals by measurement of amplitude from a region on the leading edge of the loran video pulses. To allow operation with noise and to select the correct portion of the video pulse for amplitude control, short-time samples of the amplitudes of the A and B pulses are made. The correct portions of the video pulses are sampled only when the A-pulse position is controlled by the afc circuit and the B pedestal so placed under the B pulse that the time difference reading is nearly cor-

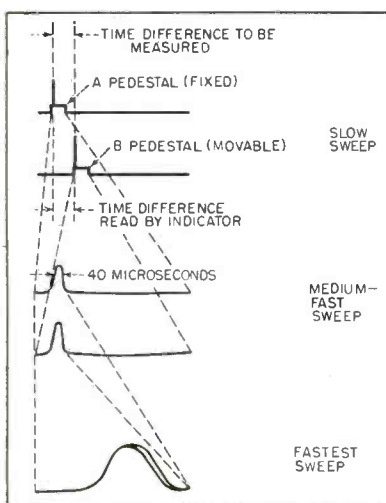

FIG. 1—Typical loran cathode-ray oscilloscope presentation shown with three different sweep speeds

# Loran Navigator

By **ROGER B. WILLIAMS, Jr.**

*Sperry Gyroscope Co.  
Great Neck, N. Y.*

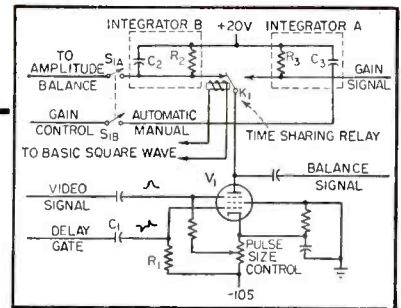

FIG. 3—Pulse-amplitude sampling circuit uses relay

rect. Amplitude samples derived under this matched-pulse condition are integrated in circuits having time constants about 40 to 50 times the pulse-recurrence interval.

The resulting amplitude measurement is thus unaffected by noise bursts and short-time pulse-amplitude fluctuations. Voltage samples of both A and B pulses are measured by a single coincidence circuit and are then separated into A and B integrators by a time-sharing relay or chopper.

The output of each integrator is a d-c voltage proportional to A or B video-pulse amplitude. The A-pulse voltage is amplified and introduced to control the receiver gain as in a normal automatic-gain-control system. The difference between A and B-pulse control voltages is used to control the gain of the r-f amplifier in the receiver differentially. In this manner the video pulses are

maintained balanced in amplitude regardless of the difference in pulse amplitudes received at the antenna.

### Pulse Amplitude Detector

The pulse-amplitude detecting circuit is shown in Fig. 3. Output from the delayed gate generator is differentiated by  $R_1$  and  $C_1$  to form a positive pulse about 10 microseconds wide delayed about 75 microseconds from the start of the A and the B pedestals. This signal is applied to the no. 1 grid of dual-control pentode  $V_1$ . This grid is normally biased below plate-current cutoff for the tube. The positive pulse brings grid 1 above cutoff so that plate current flows during this interval.

The magnitude of this plate-current pulse depends, to a large extent, on the bias existing on grid 3 during the conduction time. If the video pulse is introduced to

grid 3 and the sample pulse occurs at the same time, the plate current of  $V_1$  will be a measure of the video-pulse amplitude. Capacitor  $C_2$  with plate load resistor  $R_2$ , and capacitor  $C_3$ , with resistor  $R_3$ , average these current pulses to produce d-c voltages proportional to the A and B video-pulse amplitudes.

The manual gain and amplitude-balance controls allow the original pulse match to be made. Charging  $C_2$  and  $C_3$  to a potential determined by this network prevents sudden changes in receiver gain or changes in amplitude balance when switch  $S_1$  is opened by the operator for automatic operation.

Time-sharing relay  $K_1$  is a fast-acting switch or chopper driven in synchronism with the basic square wave. This square wave is positive during the first half of each loran pulse-recurrence interval and negative during the second half. Since the A pulse always arrives at the receiver during the first half interval and the B pulse during the second half, time sharing of the video-amplitude detection circuit is possible.

Since chopper  $K_1$  contacts the A storage circuits during the A half cycle and the B storage circuits during the B half cycle, the voltage on the arm of the chopper is a square wave equal in magnitude to the difference in A and B video-pulse amplitudes and of a phase according to the sign of the difference. This control voltage is amplified and introduced as a differential bias signal to the receiver r-f amplifier. The amplifier is thus caused to have high gain during one half cycle and low gain during the second half cycle. The phase of the control signal is such as to equalize

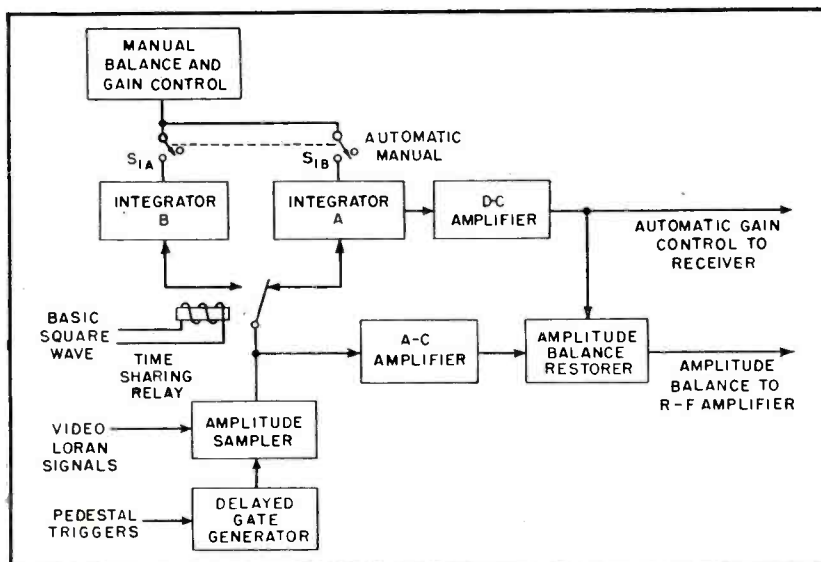

FIG. 2—Automatic-gain-control and automatic-amplitude-balance circuits

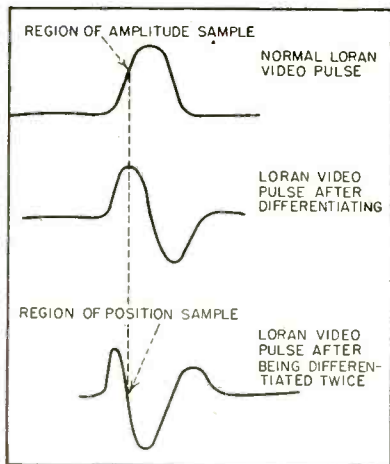

FIG. 4—Waveforms of Loran video pulse showing amplitude and position sampling regions

the amplitudes of A and B Loran pulses in the receiver, and therefore, the video pulses as seen on the cathode-ray tube.

#### AFC and ATD

Common to both the afc and automatic-time-difference (atd) circuits is a pulse-time-position detector. This detector circuit is a dual-control pentode similar to the pulse-amplitude detector circuit in operation. Video signals at grid 3 of this detector have been differentiated twice by passing through successive high-pass networks. The resulting pulse waveform shown in Fig. 4 has a zero-voltage crossover at the time of maximum slope of the leading edge of the undifferentiated pulse. The region of this slope near the zero crossover has very nearly a linear time-voltage relation.

A short sample of the amplitude of the waveform in this region is then a measure of pulse position with respect to the sample period as well as a measure of the pulse amplitude. If the waveforms being sampled are of the same shape and amplitude, the difference in voltages sampled is a direct measure of the difference in A and B-pulse positions with respect to the A and B-sample periods.

Integration of a number of voltage samples of the A pulse then provides a d-c control voltage proportional to the A-pulse displacement from the A-sample period. This voltage may be used to control the frequency of the timing oscillator as shown in Fig. 5.

Frequency of the timing oscillator is adjusted with a reactance tube so the sample period occurs at the zero-voltage point of the differentiated video pulse. Samples of the B video pulse are integrated forming a d-c voltage proportional to the B video pulse position with respect to the B-sample period. Outputs of the A and B integrators are amplified and used to control a small d-c motor. The motor operates when there is a difference between A and B video pulse positions with respect to the sample periods. The motor is geared to the time-difference control shaft to move the B pedestal and thus maintain the pulses constantly matched.

Figure 6 shows the pulse-position sampler circuit, which is similar in operation to the pulse-amplitude sampling circuit. The output of the delayed-gate generator is differentiated to form a positive pulse about 10  $\mu$ sec long. This pulse is applied to grid 1 of dual-control pentode  $V_2$ , biased below cutoff. The differentiated video signal is applied to grid 3 of  $V_2$ . The amplitudes of plate-current pulses that occur when the gate voltage on grid 1 is positive are determined by the potential on grid 3 during the conducting interval.

Since the shaped video pulse is a time-voltage function, the amplitude of the plate-current pulses is proportional to the time displacement between the zero crossover of the differentiated video pulse and the sample period. The B current pulses are integrated in  $R_4$  and  $C_4$  and the A pulses in  $R_5$  and  $C_5$  depending on the position of relay  $K_1$ . This relay is switched in synchronism with the basic square-wave voltage in a manner similar to relay  $K_1$  in the pulse-amplitude sampler. Resistors  $R_6$  and  $R_7$  introduce a rate signal into the output control voltage in order to improve system transient performance. The voltage drop across  $R_6$  or  $R_7$  is proportional to the current through it and is therefore a maximum when the voltage on  $C_4$  or  $C_5$  is changing most rapidly. Thus, the output control signals are the sums of the position signal and the rate of change of the position signal. Capacitors  $C_6$  and  $C_7$  limit the frequency response of the rate network.

#### Oscillator Control

The resulting d-c control voltage representing the sum of the rate of change of A-pulse position and the A-pulse position, controls the fre-

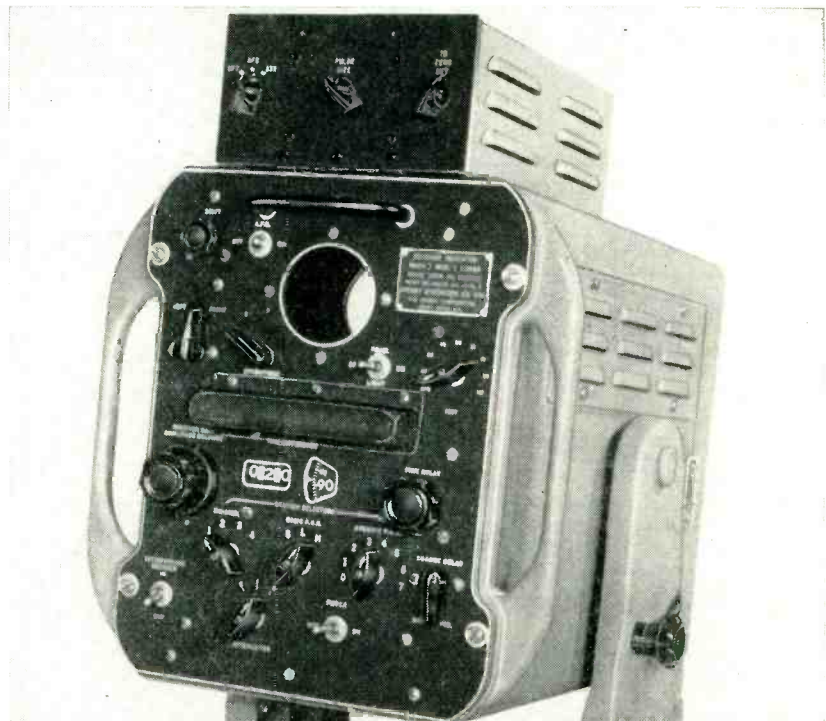

Twelve-tube servo-relay unit mounts atop standard Loran receiver indicator

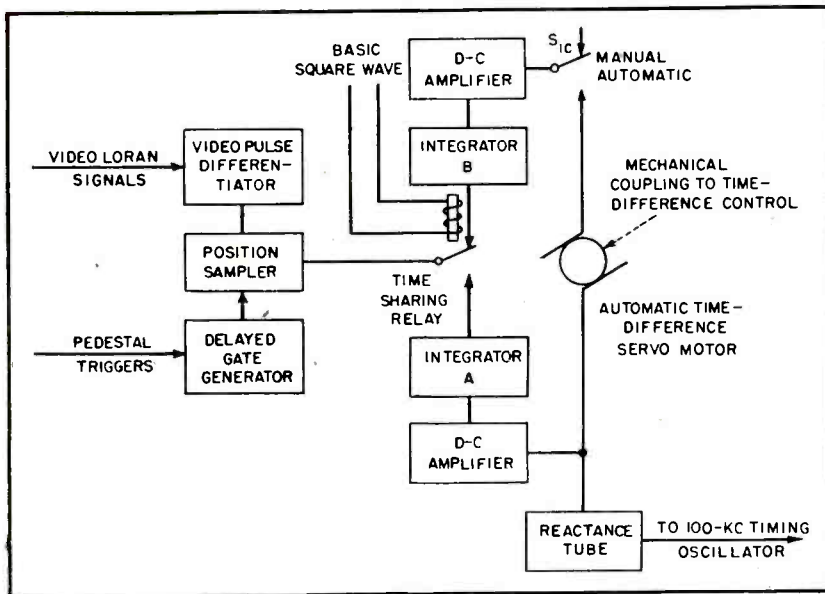

FIG. 5—Automatic-frequency-control and automatic-time-difference circuits

frequency of the 100-kc timing oscillator through a reactance tube. The phase of the control signal is such that the 100-kc timing oscillator is locked in phase with the repetition rate of the received master A pulses.

The A-pulse position voltage is also amplified by a d-c amplifier and directly coupled to a cathode follower. The B-pulse rate and position voltage is similarly amplified.

A small d-c motor is connected between the outputs of the cathode followers. This motor has a linear speed-voltage curve, and therefore, runs at a speed proportional to the difference in A and B-pulse positions with respect to their sample periods and in a direction according to the sign of the difference.

The motor is geared to the time-difference control shaft and phased so any time difference between the B pulse with respect to the B-sample period and the A pulse with respect to its sample period is reduced to zero. The time-difference error signal is derived from both the A and the B-pulse positions rather than from the position of the B pulse with respect to the B-sample period alone. By this technique errors in A-pulse position caused by drifts in the automatic-frequency-control system do not affect the automatic time-difference pulse-matching accuracy.

When the timing oscillator frequency is manually set to coincide

exactly with the repetition rate of the received pulses, no afc error voltage is required. The A-sample period then occurs when the differentiated video pulse crosses the zero-voltage line. Under this condition both the A and B pulses are sampled at the zero-voltage point so that the automatic-time-difference circuit is unaffected by unbalance in amplitude between the video pulses. If the gain of the afc circuit is sufficiently high the condition of near-zero voltage sampling exists even when the timing-oscillator frequency is slightly in error. Thus, the atd circuits can be made nearly independent of amplitude unbalance between the A and B video pulses.

### Pulse Matching

As the vessel or aircraft moves, causing the difference in pulse arrival time and the pulse amplitudes to vary, the automatic control systems described maintain the pulses

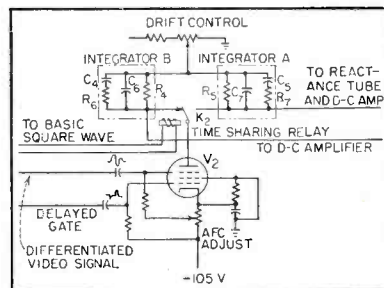

FIG. 6—Pulse-position sampling circuit

matched in amplitude and in time difference on the face of the cathode-ray indicator. The operator thus has a continuous indication of one line of position of the vessel. If two continuous indicating loran systems are synchronized on separate pairs of loran stations, the operator has continuous data as to the vessel's exact position at any time.

Since long time constants are used in both time-difference and pulse-amplitude control channels system bandwidth as measured after the second detector is very narrow and operation at low signal-to-noise ratios is possible. In practice, reliable signal matches have been maintained at 1-to-1 signal-to-noise ratios.

The automatic-gain-control system maintains the A video-pulse height appearing on the cathode-ray tube constant within 6 db over an input signal range into the receiver of at least 100 db, representing antenna input signals from 10 microvolts to 1 volt peak amplitude. The automatic-amplitude-balance system maintains the amplitude balance between video pulses constant within 3 db for unbalance between signals at the antenna input of 60 db, or for a signal-amplitude ratio of 1,000 to 1.

The application of electromechanical servo-type choppers as time-sharing relays is somewhat unique. The loran system, because of the division of A and B pulse occurrence into separate half cycles of the pulse repetition period, is particularly well suited for time sharing. In this instance the time-sharing relays permit the use of a single coincidence circuit for measuring the amplitude of both A and B pulses and another single coincidence circuit for measuring the position of the A and B video pulses. Because of this common usage, and since the difference in pulse position voltages rather than the B-pulse position voltage alone is employed as the error signal, nonlinearities and unbalances in the coincidence circuit do not affect the output error signal.

### REFERENCES

- (1) D. G. Fink, The Loran System—Part I, *ELECTRONICS*, p 94, Nov. 1945.
- (2) D. G. Fink, Loran Receiver-Indicator, *ELECTRONICS*, p 110, Dec. 1945.

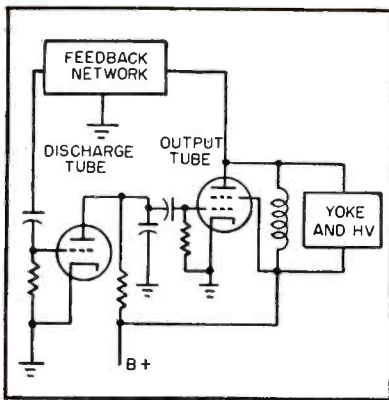

FIG. 1—Oscillatory deflection generator

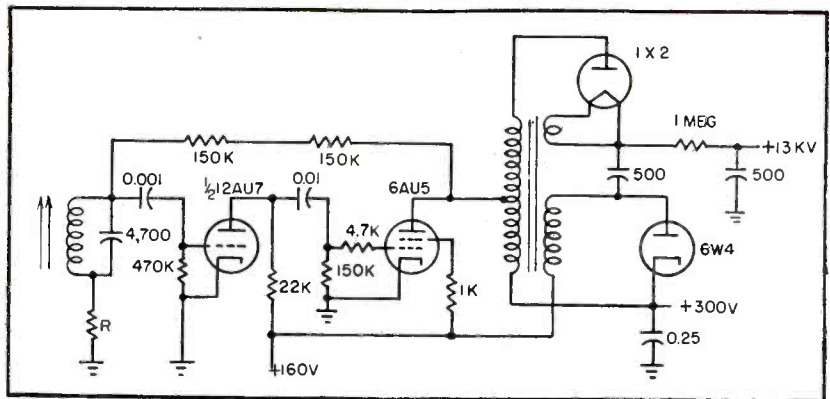

FIG. 2—Horizontal deflection generator circuit

# Simplified Horizontal

Cost and complexity of television receiver may be reduced through use of simplified horizontal deflection oscillator-amplifier which uses fewer and less costly parts, as compared to conventional circuits. Automatic frequency control may be applied to give performance comparable to more elaborate systems

IT IS GENERALLY recognized that the horizontal deflection circuit is responsible for a significant percentage of power consumption and cost of a tv. Much effort has been directed towards the development of more efficient and economical circuits and components.

In the general circuit of the self-oscillatory deflection system (Fig. 1), the voltage fed back to the grid of the discharge tube is of sufficient amplitude to cause grid-current flow. The bias developed cuts off the discharge tube for the scanning period.

Synchronization and other salient properties of the oscillator depend on the nature of the feedback system. The use of a resistor in place of the resonant element would impart to the circuit properties characteristic of a blocking oscillator.

Falling into the category of soft oscillators, the circuit would be readily amenable to impulse synchronization. It would be unsatisfactory however, because of its high susceptibility to noise interference.

By **ARNOLD NEWTON**

*Consultant  
Forest Hills, New York*

A high-Q tuned circuit in the grid circuit of the discharge tube places the circuit in the category of hard oscillators. The superior noise immunity is accompanied, however, by poor impulse synchronization properties manifest as excessive drift in presence of varying phase conditions between the synchronizing signal and the free-running frequency of the oscillator.

### Hybrid Circuit

A circuit combining these properties is shown in Fig. 2. The voltage wave-shape at the grid of the discharge tube is sinusoidal with a pulse superimposed on the positive crest. The sine-wave amplitude exceeds that of the pulse by a considerable factor. Since the frequency is mainly determined by the tuned circuit, the favorable noise-immunity characteristics of a sine-

wave oscillator are substantially preserved.

The discharge pulse is developed across the peaking resistor *R* (about 4,000 ohms) which can also serve as a convenient point for sync injection. The required sync polarity is positive at this point. The plate circuit of the discharge tube may contain the conventional R-C charging network, but in the particular circuit employed a high degree of peaking was found desirable and the charging capacitor was omitted. A linear growth of yoke current is the result of the inductive nature of the plate load of the output stage when it is in conduction. Negative pulses at the grid of the output stage cut off the tube for the period of retrace.

### Automatic Frequency Control

Although a higher degree of noise-immunity is realized when the voltage applied to the grid of the discharge tube is developed across a high-Q tuned circuit, some form of afc is indicated in view of the

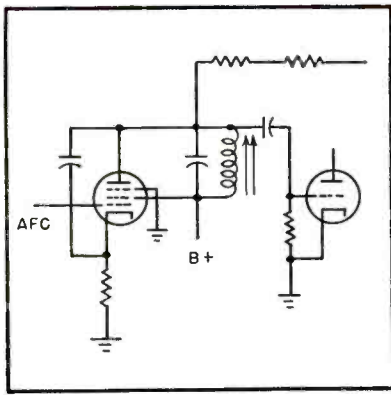

FIG. 3—Reactance tube afc control

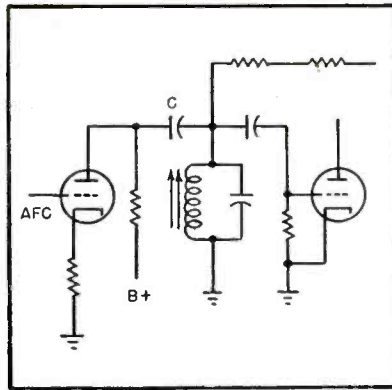

FIG. 4—Using  $r_p$  as a control parameter

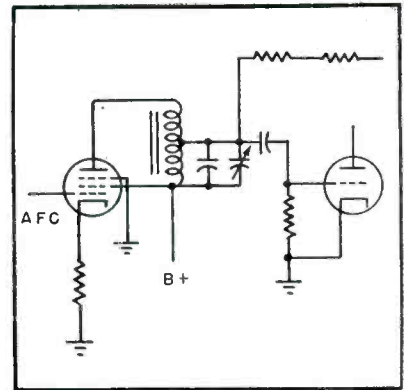

FIG. 5—Using nonlinear ferrite

# Deflection Generator

poor phase stability of impulse synchronization. In addition afc itself contributes to noise immunity due to the fact that only a very narrow band of frequencies is allowed to affect the oscillator.

The simplest means of afc perhaps is to rely on the frequency-bias relationship of the particular oscillator. The correcting voltage should be applied to the appropriate grid and in the proper phase.

## Sensitivity

Higher sensitivity to the correcting voltage can be realized through the use of either an inductive or capacitive reactance tube (Fig. 3). Since the reactance tube is in shunt with the tuned circuit, a high value of  $r_p$  is needed to maintain a high circuit Q. For a given loading effect of the tuned circuit due to the reactance-tube phase-shift network, the sensitivity to error voltage is directly related to the  $g_m$  of the reactance tube.

In Fig. 4 the bias applied to the triode control tube determines its plate resistance and thereby determines the effective reactance of the circuit which consists of a capacitor in series with the plate resistance of the tube. The sensitivity of this circuit is a function of the tube characteristics and the value of the capacitance in the control circuit. Sensitivity can generally be improved by increasing the capaci-

tance but the Q is degraded as a result.

## Core Control

The afc circuit shown in Fig. 5 makes use of the nonlinear characteristics of ferrite. The correcting voltage controls the magnetizing field of a ferrite-core coil which in turn determines the permeability of the core and the tuned circuit inductance. A high control-winding inductance increases the sensitivity of the system. However, since the stepped-up a-c signal appears across the control winding, the degree of step-up is limited by the available supply voltage and tube ratings, keeping in mind that it is desirable to maintain a substantially fixed value of control current over the a-c swing. The required speed of response is also a factor which limits

somewhat the inductance of the control winding.

In the interest of Q, sensitivity and speed of response the control tube should have a high  $r_p$  and  $g_m$ . A sufficient volume of core material should also be used to maintain linearity over the a-c swing.

Many limitations can be obviated by suppressing the a-c voltage in the control winding. This suppression can be accomplished by using two reactors in which the control windings are bucking with regard to the a-c voltage. A single core can be used and cross-coupling eliminated if the axis of the respective windings are made normal to each other. A toroidal structure is very suitable for this purpose.

A more economical design may be based on the use of separate magnetic circuits as shown in Fig. 6. A core having a high d-c but a low a-c permeability, such as annealed pure iron, guides the control flux. The gap of this core contains the saturable a-c magnetic circuit. To minimize a-c losses due to the d-c core, the a-c stray fields should be reduced to a minimum. This can be accomplished by using a cup-core or otherwise providing a low-reluctance a-c return.

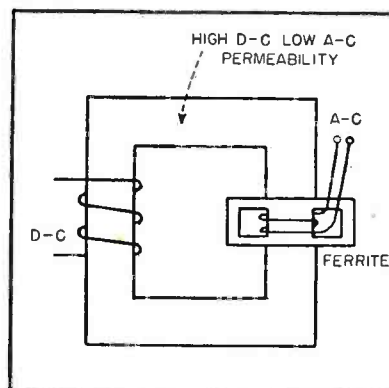

FIG. 6—Split magnetic circuit control

## BIBLIOGRAPHY

N. Schlesinger, Locked Oscillators for Television Synchronization, *ELECTRONICS*, Jan. 1949.

U. S. Patent No. 2,479,081.

# Methods and Equipment

By **B. J. O'NEILL** and **ARTHUR GUTTERMAN**

Chief Engineer *Magnetic Amplifiers Inc.* Project Engineer  
New York, N. Y.



Simplified transistor tester traces characteristics on screen of cathode-ray tube

**T**RANSISTORS can be completely described by four impedances: input, output, forward transfer and reverse transfer. These impedances are a function of the operating conditions and are usually represented graphically by four curves. The input characteristics are a plot of  $V_e$  versus  $I_e$  with  $I_c$  as a parameter, the output:  $V_c$  versus  $I_c$  with  $I_e$  as a parameter, the forward transfer:  $V_c$  versus  $I_e$  with  $I_c$  as a parameter and the reverse transfer:  $V_e$  versus  $I_c$  with  $I_e$  as a parameter. The corresponding impedances are then simply the slopes of the curves.

While all four curves are convenient, two are usually sufficient since the other two can be obtained from these except in the case where the two chosen display only three of the four variables. The most useful curves are the output characteristics, which are used in the same manner that the tube-circuit designer uses the plate family of curves. The other curves are of lesser importance for most applications. They provide information concerning the input circuit and can also be used to find anomalies, although the output characteristics curve will usually indicate them.

All the above curves refer to the grounded-base connection. Since junction transistors are often used with the emitter grounded applying the signal to the base, the output characteristics so taken are

very useful to the design engineer.

In addition to the terminal impedances, the current gain alpha is also of importance. Alpha is defined as

$$\alpha = \left. \frac{\Delta I_c}{\Delta I_e} \right|_{V_c = \text{Constant}}$$

and can be measured directly or obtained graphically from the output curves. In the grounded-emitter connection, the current gain beta is defined and measured in a similar manner, substituting  $I_b$  for  $I_e$ .

## Curve Taking

Any desired curve can be taken statically using point-by-point methods. This, however, is not only extremely tedious, but is of limited value because of thermal changes in the transistor. During the time a single measurement is being made, the transistor is getting warm; the next measurement will be made at a different temperature. Thus, the resulting curve is not a plot of three variables but contains a fourth undesirable parameter, temperature. Unless the readings are very precisely timed and spaced at exact intervals, it will be impossible to duplicate a family of curves.

This thermal effect is also present if the curves are taken dynamically at very slow sweep rates. At very low frequencies up to several cycles per second, the transistor exhibits a definite thermal effect. Superimposed on the normal transistor output is another output that is not a function of the signal, but is due to the slow heating and cooling of the transistor. Therefore for dynamic curve taking, the sweep rates should be high enough to avoid thermal changes.

An equally troublesome condition is present if the sweep rate is too

high. A characteristic curve should represent the operation of the transistor over the normal operating-frequency range and with negligible secondary effects. At high frequencies, shunt capacitance, hole storage and transit time all contribute to the results and the curve is not a true picture of transistor operation in the usual frequency range.

The easiest curves to take dynamically are the output and reverse transfer characteristics. A sweep voltage is applied to the collector and the proper bias to the emitter. The collector voltage for the output curve and the emitter voltage for the reverse transfer curve and the collector current are displayed on the vertical and horizontal axes respectively of a cathode-ray oscilloscope.

By changing the bias in discrete steps a complete family of curves is obtained. If desired, the emitter can be grounded and the bias applied to the base to obtain grounded-emitter characteristics.

## Other Curves

To obtain the input and forward transfer curves considerable difficulties are involved. In both curves collector current is a parameter. In the case of the input curve, the emitter is swept and collector current is increased in steps to obtain the family of curves. Since the collector is fed from a constant-current source, the collector voltage can rise to excessively dangerous values. This can be prevented by a clamping diode, but the usefulness of the curves so obtained is limited. A further difficulty appears in the case of junction transistors where some units have collector impedances as high as



# for Transistor Testing

Practical curve tracer displays characteristics of *npn*, *pnp* and point-contact transistors in grounded-base and grounded-emitter circuits. Instrument permits speedy grading and selection of transistors for manufacturers and users

100 megohms. The constant-current source should have a substantially higher impedance such as 2,000 to 5,000 megohms. This is extremely difficult to achieve.

Transistor curves are not only used to aid the circuit designer. In manufacturing it is desirable that defective units be picked out. One common anomaly sometimes present in semiconductor devices is hysteresis. The current produced by the sweep voltage does not return along its outgoing path. Therefore, it is important when taking transistor curves that the retrace is not blanked.

The curve tracer to be described provides all the information needed for both the transistor fabricator and the circuit designer. Output or transfer families of curves are automatically displayed on a crt. Excessive collector voltages and elaborate current supplies are avoided. The sweep rate is 60 cycles, conveniently obtained from the power line and safely removed from either the low or high-frequency trouble limits. Using a half-cycle sine wave for sweeping results in identical forward and retrace sweeps. A telephone-type stepping relay, driven by the 60-cycle line, steps the bias after each sweep and assures an equal time interval between each curve of a family to avoid thermal effects. A block diagram of the unit is shown in Fig. 1.

## Automatic Bias Circuit

The automatic bias circuit is shown in Fig. 2. A stepping relay selects one of eight different resistors and one open position to vary bias current of either polarity in nine equal steps including zero current. A step increment switch selects six different step increments

from 20 to 1,000  $\mu$ a. This switch is of the constant impedance type and therefore introduces no error. A potentiometer provides smooth control for any step increment between 0 and 1,000  $\mu$ a if six fixed steps should prove inadequate. Also, the potentiometer provides a smooth manual change of bias current from 0 to 8 milliamperes for careful

study of a transistor over the entire operating range. A meter monitors the bias current for all manual operations but is shorted out when the stepping relay is run automatically to display the entire family of curves simultaneously.

The stepping relay is driven by the 60-cycle line through a half-wave rectifier to provide 60 steps

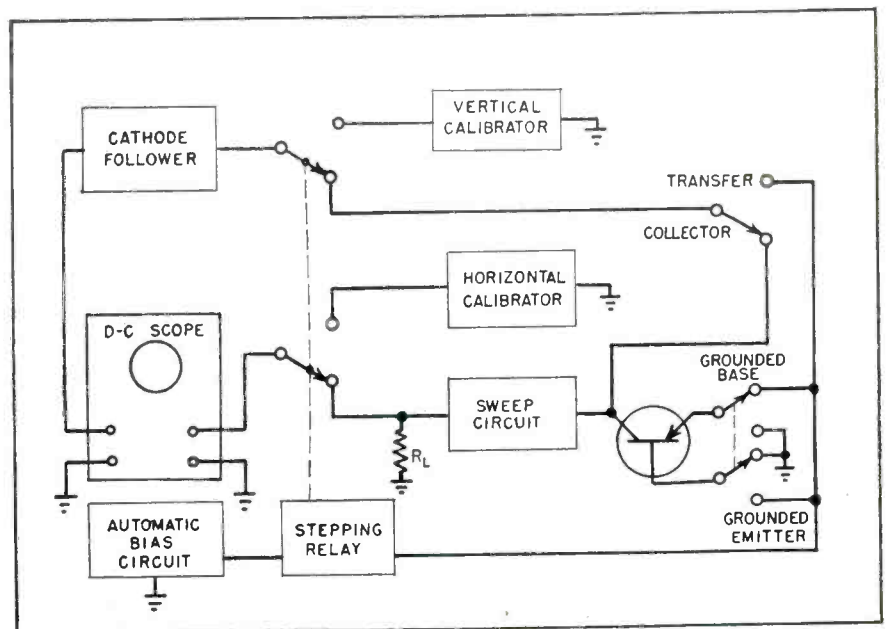

FIG. 1—Block diagram showing switching circuits of transistor-curve tracer. Forming circuit is not shown

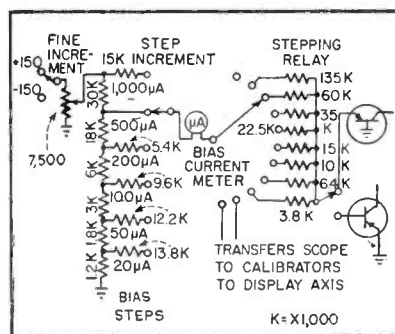

FIG. 2—Automatic bias-stepping circuit employs telephone-type stepping relay

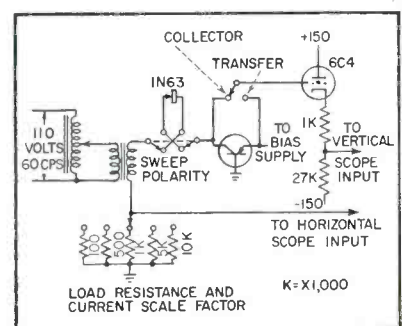
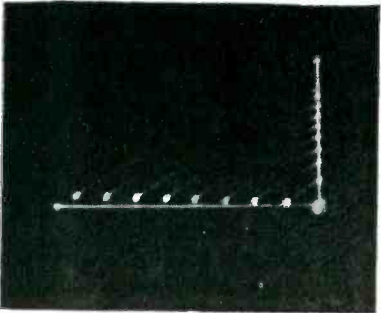
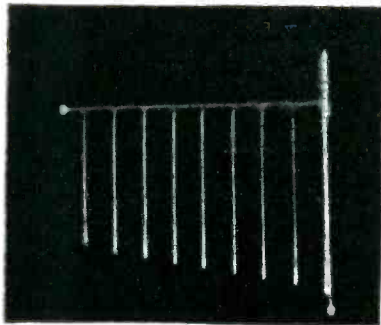
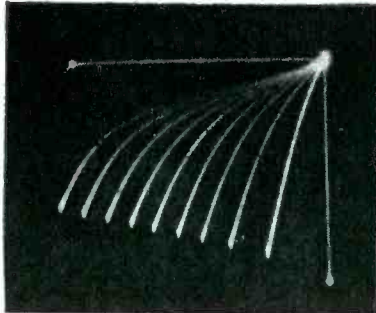
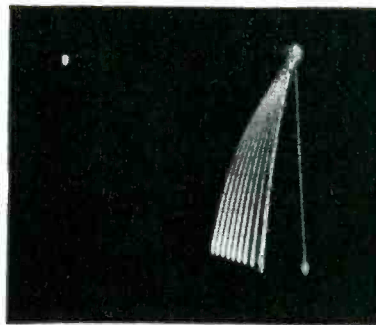

FIG. 3—Sweep circuit provides reversible half-sine-wave sweep voltages



Curves showing excessive base resistance in pnp junction transistor. Collector curves start above origin. Vertical scale is 10 volts at top (collector 5 volts below transfer)



Forming is illustrated by collector curves showing point-contact transistor with very low alpha (top) and same transistor after successive forming pulses (bottom). Note increase in alpha

brated potentiometer. Thus, the half-cycle sine wave is clamped at a fixed voltage and can be used to calibrate the scope. Two calibrators are used, one for the vertical axis and one for the horizontal axis. A quadrant switch connects the diodes in such a manner that any one of the four quadrants can be selected.

The voltage calibrator is connected through the stepping relay so that after a single family of curves is plotted, the calibrating axes are automatically displayed. The lengths of the axes determining the calibration, are continuously displayed when the stepping relay is running. Thus the origin, the zero-current and the zero-voltage lines are always present on the crt and d-c drift will not affect the results.

### Alpha Measurements

The current gain, alpha, in the grounded-base connection (beta, in the grounded-emitter connection) is of interest to the transistor fabricator and the circuit designer. It is comparable both to the amplification factor and transconductance of vacuum tubes and might be considered a figure of merit for transistors. It is an indication not only of the external power gain but also of the internal physical current mechanism.

The simplest method of obtaining alpha or beta is to measure it directly on the collector curves along a constant-voltage line. By varying the step increment alpha can be measured over as small a range as desired and if the crt is carefully calibrated alpha can be measured to an accuracy of 3 percent. Also, when the entire family of collector curves is plotted the behavior of alpha as a step function of emitter current

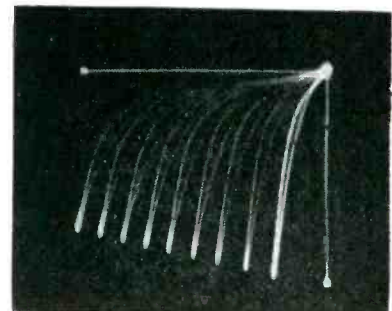

Collector curves show hysteresis in point-contact transistor

per second. Thus each sweep of the collector occurs just once per bias step resulting in a uniformly illuminated oscilloscope display. If the switch is allowed to run asynchronously, irregularity of exposure will result when the crt display is photographed.

The stepping relay is connected through a three-position switch and a latching relay so it can be turned off, run automatically, or moved one step at a time if it is desired to examine one curve of a family in detail.

### Sweep Circuit

A 60-cycle voltage from the power line, adjusted by means of a continuously variable transformer is applied to the collector as the sweep voltage. A crystal diode, connected through a reversing switch permits sweeping either polarity. The sweep current, measured as the voltage drop across one of five different load resistances, is applied to the horizontal scope input. Because it is desired to ground either the base or the emitter, the sweep current as displayed on the scope will be positive from right to left. To preserve the conventional directions of the four quadrants, it is necessary to reverse the horizon-

tal deflection plate connections. Since the sweep voltage is a half cycle of a sine wave, both the forward sweep and the retrace are identical functions and are displayed on the crt.

The sweep voltage applied to the vertical scope input is measured directly from collector to ground for the collector curves and from input to ground for the transfer curves. When plotting the collector curves of a junction transistor, however, the dynamic collector impedance can be very high, sometimes as much as 100 megohms. If the vertical scope input is placed directly across the collector, the maximum dynamic impedance that could be plotted would be the scope input impedance. To avoid this and permit a true indication of collector impedance a cathode-follower isolating stage is used between the vertical input and the collector. A simplified schematic of the entire sweep circuit is shown in Fig. 3.

### Voltage Calibrator

The voltage-calibrator circuit, shown in Fig. 4 consists of a 60-cps voltage, obtained from the secondary of the power transformer, fed through a resistor and a series diode to a clamping diode and a cali-

can be examined on the scope.

The technique found most useful, however, is to sweep the emitter current over the operating range and plot alpha vs. emitter current on a crt. The complete behavior of alpha can then be observed, all anomalies can be detected and the accuracy can be held to about 3 percent with careful calibration or to any value desired with suppressed-zero techniques. The behavior of alpha as a function of emitter current, especially for small values of current, is of great interest in all phases of transistor development and application. The rate of initial rise of alpha is an indication of the switching speed for point-contact transistors and is a much more fundamental measurement than  $N$  on negative resistance curves. ( $N$  curves are a plot of emitter voltage vs. current with resistance added to the base to display the negative input resistance region.) The  $N$  curves will indicate whether a transistor can be used for switching applications but a swept alpha curve will give a quantitative measurement as well.

### Forming

A convenient accessory that can be used with the transistor-curve tracer is a forming attachment. The forming circuit is shown in Fig. 5 and is essentially a capacitor that can be charged to any desired voltage and then discharged into the collector. The capacitor can be discharged either in the forward or reverse direction and after each discharge the transistor can be examined on the curve tracer. One of the accompanying oscillograms shows a common failure found in the point contact-transistor, namely, low alpha, and the result after successive forming. The transistors are formed during manufacture but reforming by the user has resulted in rejuvenating a large number of not only those that have failed in use but also those that are defective when received. Reforming is apparently similar to the forming employed in manufacture and creates a  $p$ - $m$  junction under the collector electrode. This junction is usually larger after reforming than when the transistor is originally formed. In reforming a point-contact

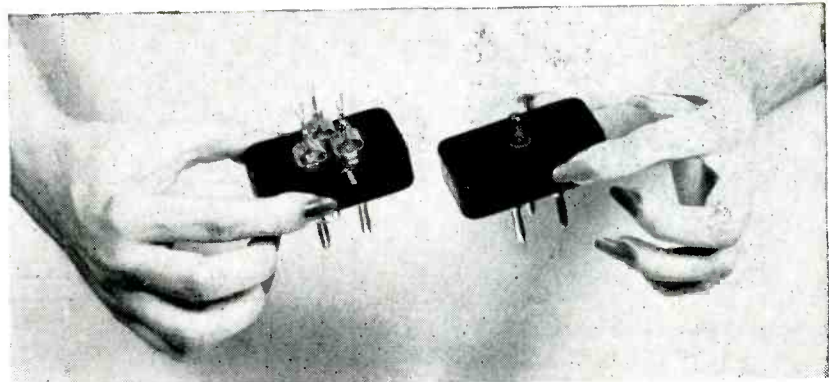

Jigs adapt curve tracer to all types of transistors

transistor, the collector curves are first observed. Then the capacitor (Fig. 5) is charged to a low voltage, which is best determined by experiment. A much lower voltage is used if the capacitor is to be discharged in the forward direction rather than in the reverse direction. In general, reverse forming results in a lower  $I_{e0}$ , but some transistors can be formed only in the forward direction.

After each discharge of the capacitor the collector curves are examined on the crt. If successive pulses produce no further change the voltage should slowly be raised for each pulse. When the curves have fanned out the desired amount,

the forming is completed. Reformed transistors seem to have the same life and behavior properties as transistors when they are originally formed. Crystal diodes can also be reformed and their properties can sometimes be improved.

### Operation

Operation of the instrument is quite simple. After selecting a load resistance, which also determines the current scale factor, the calibrator and scope are adjusted to the desired ranges. The bias step is chosen and the function switch set to the characteristics, type of transistor and connection desired. The stepping relay is turned on and the sweep voltage adjusted. The entire family of curves will then appear on the crt. If desired, the stepping relay can be stepped manually, one step at a time, with the meter indicating the bias current. Or, for a careful study of anomalies, the fine-increment control can be used to sweep out smoothly the bias current over the entire range. Extreme flexibility is provided for any type of operation with a minimum of adjustment.

Acknowledgement is made to Raytheon Manufacturing Company and CBS-Hytron for their cooperation.

### BIBLIOGRAPHY

- (1) The Transistor, Bell Telephone Laboratories, Contract #DA 36-039 sc 5589 (Task 3).
- (2) D. A. Alsberg, Transistor Metrology, IRE National Convention paper, March 1953.
- (3) H. G. Follingstad, A Transistor Alpha Sweeper, IRE National Convention paper, March 1953.
- (4) D. J. Crawford and H. F. Heath, Jr., Germanium Diode Testing Program, IRE National Convention paper, March 1952.
- (5) W. Shockley, "Electrons and Holes in Semiconductors," D. Van Nostrand Co., New York, N. Y., 1950.

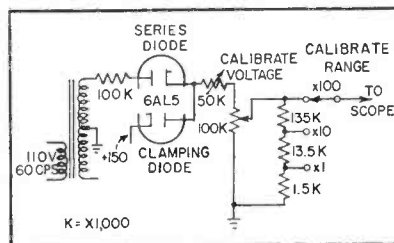

FIG. 4—Voltage calibrator places measured coordinates on scope screen with trace

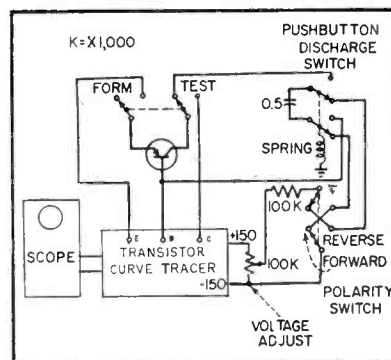
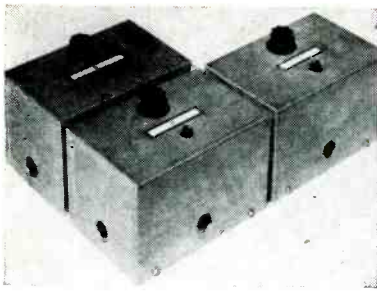
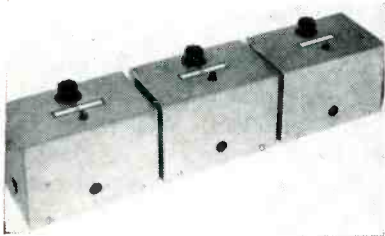

FIG. 5—Forming circuit may be used to rejuvenate many inoperative point-contact units



Series-parallel interconnection of power units



Series connection of units for maximum voltage

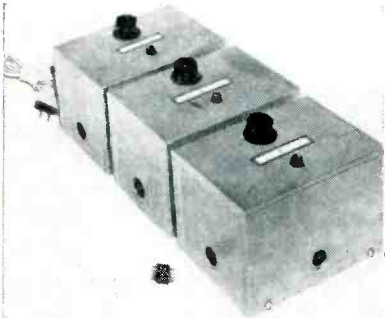

Parallel connection of units for maximum current

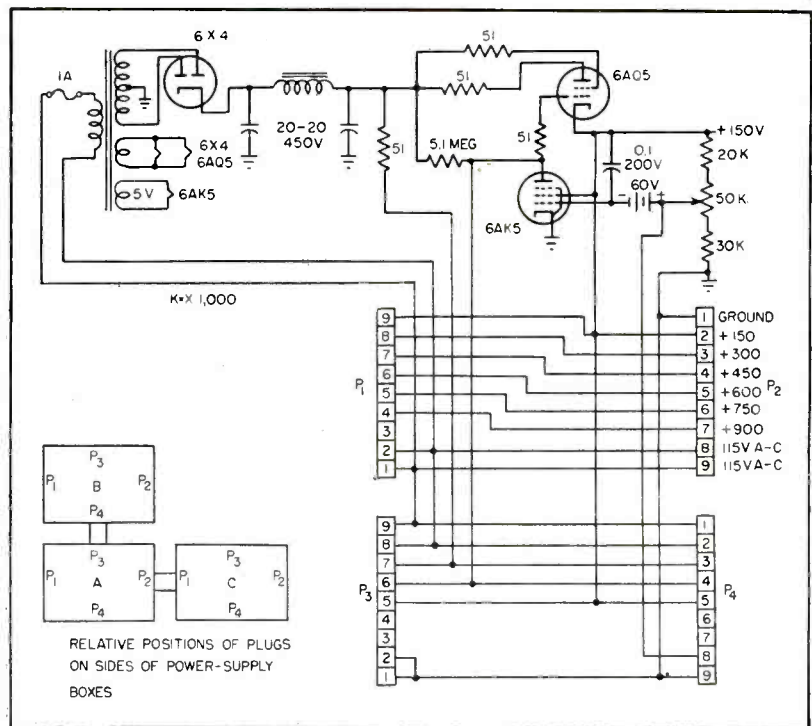

The basic regulated power-supply unit is conventional, but the jack connections allow parallel (unit B) and/or series (unit C) connection to unit A

# Regulated

By JOHN H. BIGBEE

Hughes Aircraft Co.  
Culver City, Calif.

**T**HE PROBLEM of supplying necessary direct-current power for electronic circuits has been approached and solved in many ways. Years ago, when B batteries were in vogue, a large enough quantity of fresh batteries would do the job. It was possible either to parallel or series-connect the batteries and tap off various voltages. The internal impedances were tolerable for most of the useful battery life. However, the deterioration of the cells, together with their bulk, was a nuisance that transformers, rectifiers, and filters eventually eliminated.

With attempts to improve regulation and reduce the internal impedance of these supplies, many automatic electronic regulators were designed. In addition to solv-

ing the problems mentioned, another important advantage was gained—the facility of setting the output voltage smoothly to a desired value. An inexpensive method of reducing slow d-c drift is still needed.

Today a large variety of well-regulated power supply circuits covers a wide range of voltages and currents. Most of these units, however, are designed to satisfy a specific range of power. The supplies designed especially for laboratory use, where broader variations are needed, are inconveniently bulky and expensive.

The supplies pictured are intended to serve as a general solution to the power-supply problem. They can be constructed in such a way as to minimize the space oc-

cupied. Each unit is identical in design, providing the economy of standardization.

The basic components were selected with the idea of designing around those manufactured in largest quantity, in order to optimize the quality-versus-cost curves. Of course, size, voltage and current considerations are also important.

The units are each a complete, self-contained, regulated power supply capable of supplying 70 milliamperes and adjustable from 70 to 150 volts. The output ripple voltage is less than one millivolt rms. Care has been taken to hold all insulation ratings above 1,500 volts. The units are designed to connect together through plugs to permit expansion of the

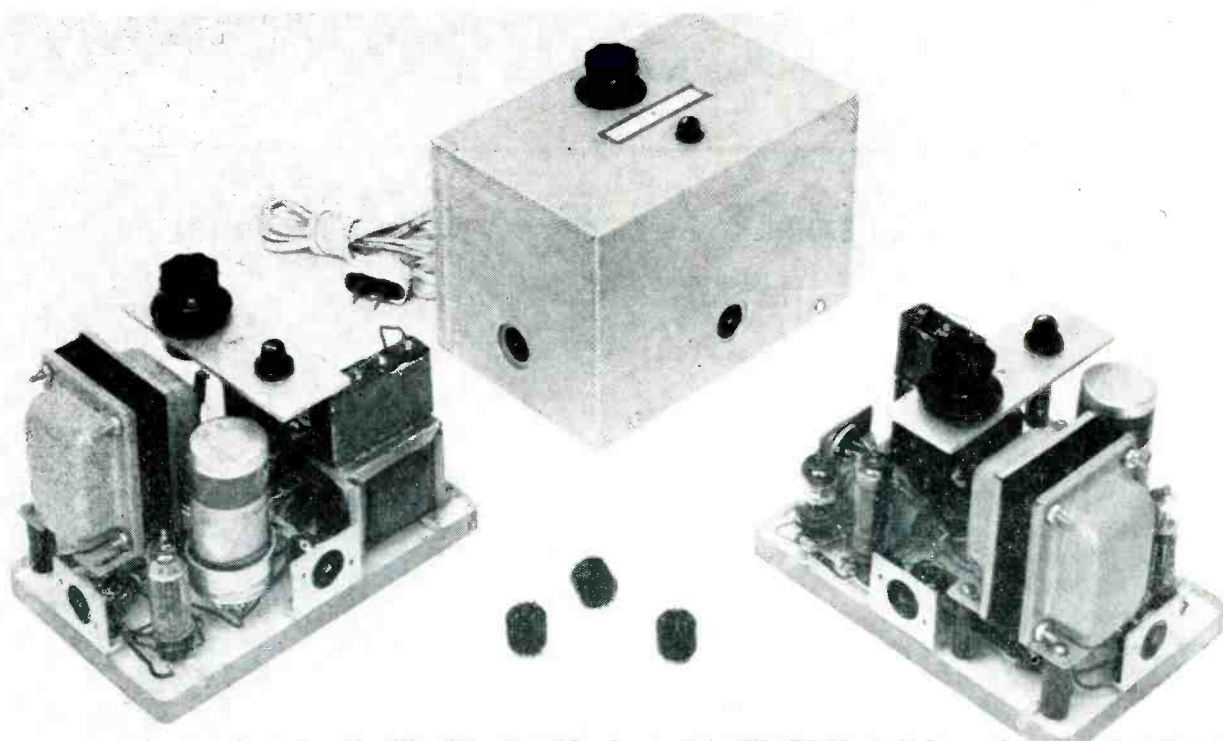

Three identical units with and without protective grille showing external voltage control, fuse holder and interconnection plugs and jacks

# Power-Supply Blocks

Compact regulated units provide 70 milliamperes each with smooth voltage control from 70 to 150 volts. Unique plug arrangement allows series, parallel or series-parallel connection like block B batteries for greater voltage, increased current or both

power source for either higher voltage output, higher current output, or both.

## *Interconnecting Units*

For higher voltage output the units connect together along their longer axis as illustrated. Here the units are in series (since the ripple voltages might conceivably add, care was taken to hold ripple to a minimum). Internal impedance has been held low to avoid instability in the regulators.

For greater current output the units may be connected together along their shorter axis. This connects the series regulator tube outputs in parallel. The regulator control tube in the forward unit then acts as control for all the units. The control tubes in the remaining

units are automatically biased beyond cutoff when the units are plugged together. Units may be plugged together in both directions to provide whatever combinations of voltage and current are desired.

Intermediate voltages are available from all the plugs as the circuit indicates, and most applications permit adjustment of the voltages to such values as needed without the use of dropping resistors or dividers. The decoupling networks needed in many high-gain circuits can usually be eliminated by the same procedure.

Power for the units is supplied through the a-c cord and plug shown in the photograph. When units are connected together they receive power at 115 v, 60 cycles through the unit to which they con-

nect, thus permitting the supplies to be controlled by a single on-off switch. The interconnecting plugs are made of copper-clad steel pins anchored in a bakelite insulating block.

These plugs insert into standard nine-pin miniature sockets providing ventilation spaces between supply units when connected together, and eliminating exposed pins that might be dangerous in operation.

These little units give the flexibility of batteries without their annoying bulk and short life. In addition they have the advantages of regulated d-c power, a wide range of voltages and currents, and it is possible to standardize completely upon one simple laboratory power supply.

# Counter-Circuit

By A. R. VALLARINO, H. A. SNOW and C. GREENWALD

Federal Telecommunication Laboratories, Inc.  
An I. T. & T. Associate  
Nutley, New Jersey

**A** SIMPLIFIED f-m subcarrier system is illustrated in Fig. 1. The input to this system may be a broadband multiplex signal within the range of 250 cps to 150 kc.

This signal is first applied to an f-m subcarrier transmitter in which the applied signal frequency modulates a 1-mc subcarrier. The modulated subcarrier is then passed to a radio transmitter and modulates the r-f transmitted frequency. At the receiver end the r-f signal is demodulated and provides a 1-mc subcarrier containing the original multiplex modulation. An f-m subcarrier receiver then demodulates this subcarrier and provides the original multiplex signal at its output terminals. This last subcarrier receiver is the one with which this paper is concerned.

Early low-distortion receiver designs were rather complex and contained many tuned circuits including a balanced mixer, balanced discriminator and i-f circuits, all of which required fairly accurate alignment. These receivers were difficult to manufacture and to maintain in the field. This led to an investigation of receivers employing the counter principle.

A counter-type receiver shown in the photograph is simple in construction and has no critical parts to align. It introduces a distortion of only 0.2 percent over the modulating frequency band of 250 cps to 150 kc when operating with a 1-mc f-m subcarrier having a deviation of  $\pm 250$  kc.

## Counter Receiver

The receiver block diagram is illustrated in Fig. 2. The circuit centers mainly around two parts;

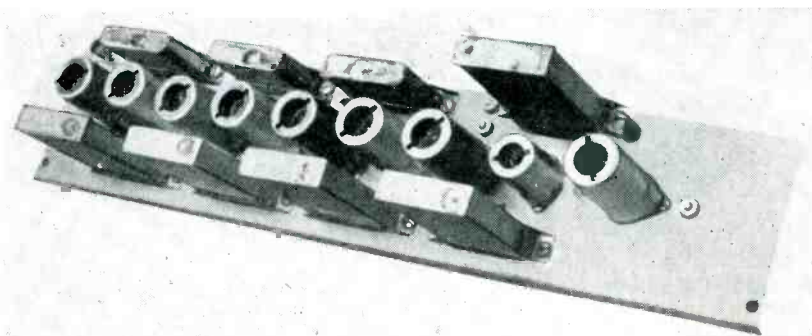

Counter receiver for frequency-division-multiplex systems has no adjustments, thus being ideally suited for field use

the limiters, represented by the first block in Fig. 2 and the counter, represented by the second block. The remaining filter and video amplifier are conventional.

The limiters amplify and convert the input signal to square-wave pulses of constant amplitude. These pulses are applied to a counter discriminator. The baseband portion of the counter output is then selected by the low-pass filter which cuts off sharply at 200 kc and rejects all higher frequency components. The baseband signal is then amplified to a suitable level by the video amplifier.

The 1-mc square-wave constant-amplitude output of the limiters is applied through a cathode follower to a counter circuit as shown in Fig.

3. The cathode follower supplies voltage to the counter from a low-impedance source, thus maintaining a low resistance in the counter circuit.

Capacitor *C* is charged primarily through the diode and discharged through load resistor *R*. Across this output resistance pulses are developed having a constant average amplitude for a constant frequency. The average output amplitude varies directly with the number of pulses per second. Thus, this average output amplitude varies linearly with frequency resulting in an essentially linear discriminator action.

## Limiters

The major problem in a counter receiver is the design of a limiter that will convert the f-m input signal to square waves of very small rise time and provide equal output amplitudes for each cycle over the entire deviated band, regardless of input level. Thus, in this application, for a  $\pm 250$ -kc deviation and a 1-mc carrier, a rise time of less than 0.05  $\mu$ sec and a constant peak-to-peak amplitude over the band of

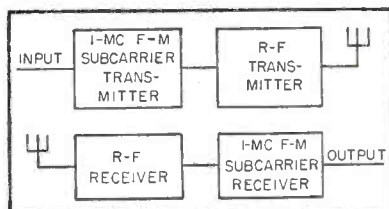

FIG. 1—Simplified block diagram illustrates typical f-m subcarrier system

# Multiplex Receiver

Low-distortion f-m counter receiver operates at 1 mc with modulating frequencies exceeding 150 kc, has no tuning adjustments, and most parts values are noncritical. Analysis shows output voltage to be linear function of input frequency

750 to 1,250 kc should be provided by the limiters.

The effect of amplitude modulation of the incoming signal is aggravated by nonsymmetrical clipping of the input wave. There are two primary effects, one of which introduces additional phase modulation into the incoming signal and the other causes amplitude detection in the limiter stages. The phase modulation introduced by nonsymmetrical clipping becomes part of the transmitted signal and cannot be removed in following circuits, while the signal resulting from the amplitude detection falls within the bandwidth of the limiters and can be transmitted through to the final output.

To avoid the distortion that can be introduced into the counter output signal by both of these effects, it is important to maintain symmetrical clipping by the limiters.

## Limiter Circuits

The limiters used in this receiver, as shown in Fig. 4, are a well-known type sometimes called cathode-coupled clippers. Each limiter consists essentially of a double triode, the first section being a cathode follower, coupled through a common cathode impedance to the second triode section. The limiter output is produced across a load resistor in the plate of the second triode. The grid bias voltage is supplied by a voltage divider connected from the plus B supply to ground. Since the B supply is regulated, the bias voltage is quite constant and is not affected by amplitude variations of the signal.

Six such stages are cascaded to provide adequate limiting and gain

to operate at a nominal input level of 100 millivolts. While all six stages are not limiting at this level, several limiting stages are required to reduce amplitude variation to a negligible amount and to reduce the rise time of the square wave pulses to a value less than 0.05  $\mu$ sec.

## Limiter Characteristics

The tubes best suited for this limiter should have a sharp cutoff, high transconductance, high amplification factor and high current

capability between the two tubes of the stage.

Curves are shown for positive bias voltages at the second grid from 0 to plus 50 volts in 10-volt steps. Bias and input voltages are measured from ground to grid, not cathode to grid. At all times, except on overload, the grids are negative with respect to the cathode so that no grid current flows. The vertical line along the plus 50-volt ordinate indicates a value of input voltage such that the resulting grid to cathode voltage on triode

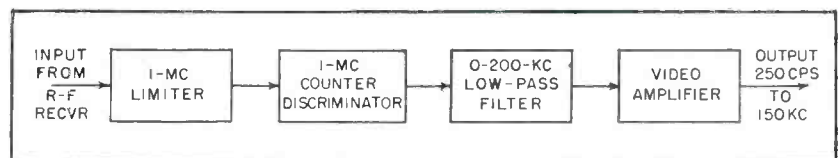

FIG. 2—Subcarrier counter receiver block diagram. Low-pass filter and video amplifier are conventional

capability. The 12AT7 was selected from available receiving types as best meeting these requirements.

Static characteristic curves of a limiter stage were calculated from the grid voltage-plate current characteristic of these tubes. These curves are shown in Fig. 5 for the circuit conditions shown. The input voltage to the stage is shown on the abscissa and current flow through  $R_o$  is indicated at the left side.

Each solid curve shows the output plate current of the stage for a fixed bias on the second grid, as the input voltage to the first grid is varied from minus 10 to plus 60 volts. The dotted curves show the total current through both tubes and are only of interest as an aid in understanding the current divi-

sion. 1 is minus 0.5 volt at which point grid current begins to flow. This is considered the overload point of the stage.

To illustrate the action of this limiter, the heavy curve representing values for a plus 20-volt bias on the second grid, may be followed across Fig. 5 from left to right.

At the left end and up to 16 volts input, the first tube is cut off so that the output current, flowing in the second tube, is constant at a value set by the second tube bias. Above 16 volts input, current begins to flow in the first tube which increases the positive cathode voltage and thus reduces the output current in the second tube. At 20 volts the output current from the second tube has dropped to ap-

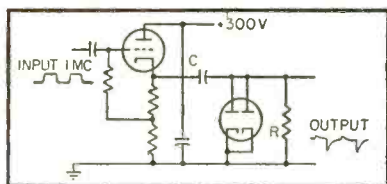

FIG. 3—Counter discriminator circuit has no critical parts values nor tuning adjustments

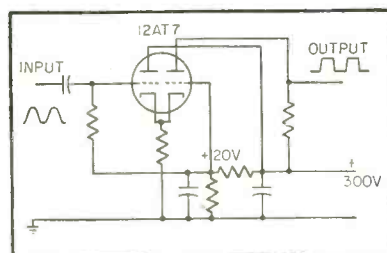

FIG. 4—Cascaded limiters, permit use of simple discriminator circuit

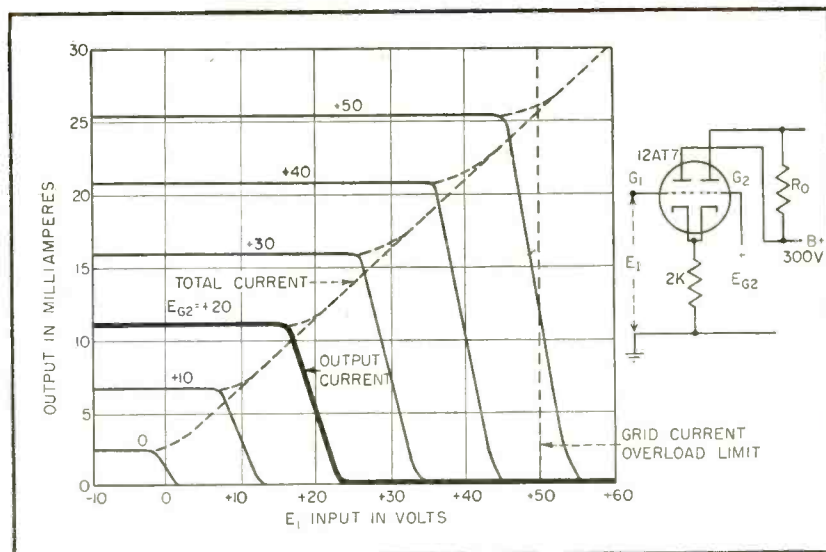

FIG. 5—Symmetrical limiting is insured by biasing tube to center of output current curve

proximately one-half its initial value, due to increasing current in the first tube. At plus 24 volts input, the cathode voltage has been raised by the first tube current to a value that cuts off current in the second tube entirely so that increasing the input voltage beyond this point has no further effect on the output current.

It is apparent that when a fixed bias of plus 20 volts is applied to the first grid, an a-c input signal

operates around the center point of the sloping portion of the output current curve. If the signal is less than 3 volts peak, no limiting occurs and the stage acts as an amplifier along the sloping portion of the curve. If the a-c input voltage exceeds 4 volts peak, symmetrical clipping of the peaks occurs. For this curve, a-c voltages of the order of 30 volts peak may be applied before overload occurs, this 30 volts being the difference between the

plus 20-volt bias and the 50-volt overload point of the curve.

An example of typical operation using an operating bias of plus twenty volts applied to both grids results in a quiescent output tube plate current of 5.8 ma, and an output current swing of 11 ma. The peak input voltage that can be applied before reaching the overload point is 30 volts. With an output load  $R_o$  of 2,000 ohms, for example, a peak-to-peak output voltage of

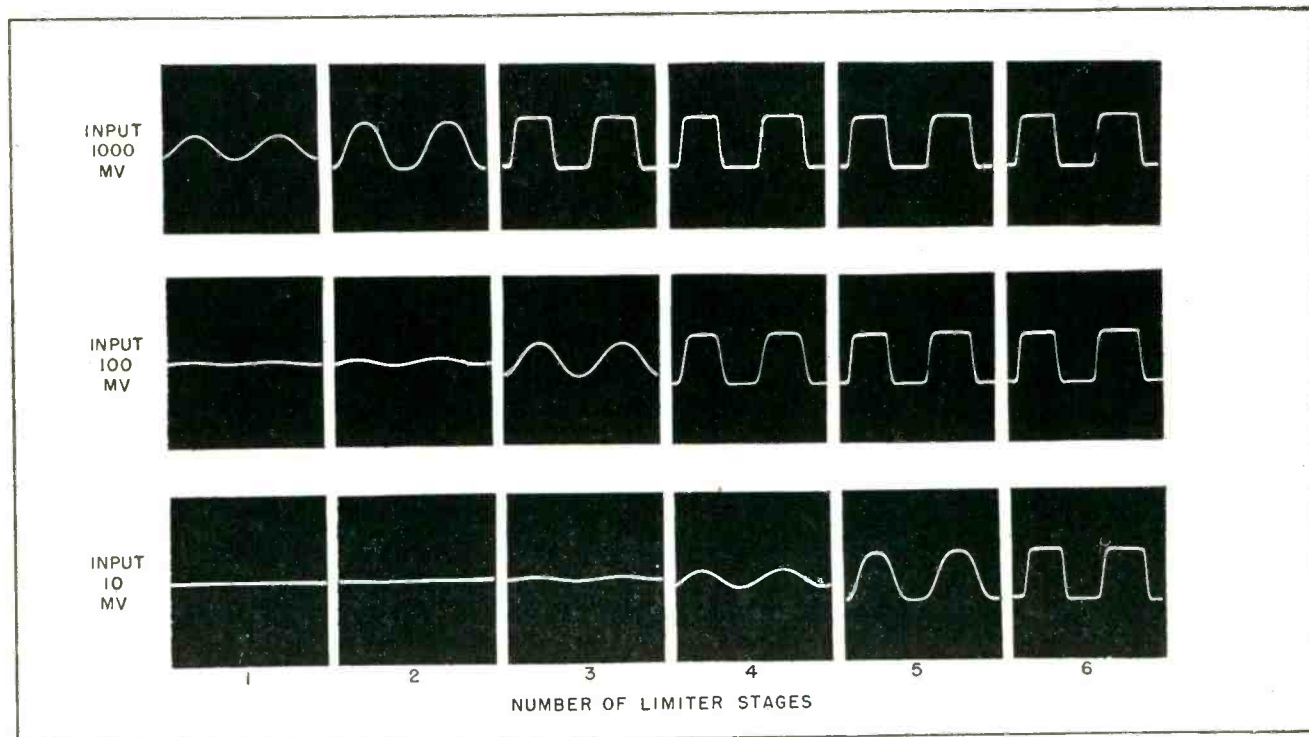

FIG. 6—Oscillograms show effect of cascaded limiters. Strong signals (top row) are first affected, while first limiters serve as amplifiers for weaker signal (bottom row). Strong and weak signals appear identical after six limiting stages



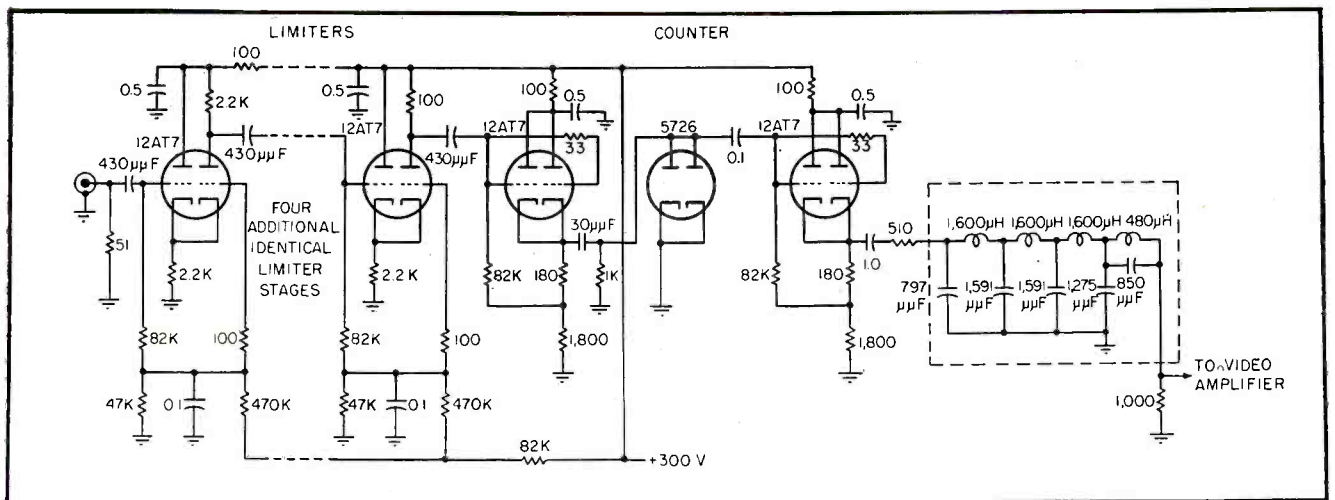

FIG. 7—Counter receiver circuit. Only critical parts values are those used in low-pass separation filter

about 22 volts is available to drive the following limiter.

Other operating regions may be selected by applying equal positive bias voltages to both grids of a limiter stage; higher bias voltages giving a larger output current but a more restricted range of input voltage before overload occurs while lower bias voltages give lower outputs with a greater range of input signal before overload. Exceeding the overload limit results in loss of symmetry in the output due to grid current in the first triode section. Consequently, the optimum operating curve depends on the magnitude of the input voltage swing.

It is of importance to note that the output curves are essentially symmetrical around any operating point when equal values of positive bias voltage are applied to both grids.

### Limiter Performance

Figure 6 shows the wave shapes at the output of each of the six cascaded limiters for three input voltages. Each of the 18 curves is an oscilloscope photograph taken with a specially-designed video amplifier capable of passing square waves of 0.03-µsec rise time.

In the upper group of pictures, a 1,000-mv, 1-mc sinusoidal signal was applied to the input of the limiters. The first limiter acts as an amplifier only, as shown by its output waveform. A slight flattening of the output of the second limiter indicates that limiting is

just beginning. However, the third limiter is limiting well and the fourth, fifth and sixth limiters exhibit substantially the same output waveform.

Reducing the input level 20 db or to 100 millivolts shows, in the second group of curves, that the first three limiters are essentially amplifiers while the limiting is accomplished in the last three stages.

Reduction of the input levels another 20 db, or to 10 mv, results in practically all of the limiting being achieved in the last two limiter stages with substantially the same waveform at the output of the sixth limiter, as shown with the other input levels.

The rise time of this output wave depends basically on the  $RC$  time constant in the plate of the last limiter stage over this 40-db change in input level. A dynamic test of distortion over this input range indicates practically no change in distortion figures of 54 db with modulating frequencies up to 150 kc. Figure 7 shows the complete receiver schematic.

### Output Formula

The counter discriminator shown in Fig. 3 is driven from a cathode follower source. It consists basically of an  $R-C$  circuit plus a diode. It provides an output voltage:

$$E_o = - \left[ \frac{E_i RC}{T} \left( \epsilon^{-\frac{T}{R_1 C}} - 1 \right) - \frac{E_i R_A C}{T} \left( \epsilon^{-\frac{T}{R_2 C}} - 1 \right) \right]$$

where  $E_o$  = average output voltage across load resistor  $R$ ;  $E_i$  =  $(E_{max} - E_{min})$  of voltage from cathode to ground;  $R$  = load resistor;  $R_A$  = load resistance when diode is conducting, that is, equal to  $R$  in parallel with the conducting resistance of the diode;  $R_{11}$  = total counter series resistance when diode is not conducting. This includes resistance of cathode follower source;  $R_{12}$  = total counter series resistance when the diode is conducting,  $R_{12} < R_{11}$ ;  $C$  = counter circuit series capacitance;  $T = 1/f$  = period of input signal where  $f$  is frequency.

If  $R_1 C \ll T$ , then  $\epsilon^{-\frac{T}{R_1 C}}$  and  $\epsilon^{-\frac{T}{R_2 C}}$  approach zero and

$$E_o = \frac{E_i RC}{T} - \frac{E_i R_A C}{T}$$

Since  $T = \frac{1}{f}$

$$E_o = E_i RC f - E_i R_A C f = E_i C f (R - R_A)$$

This in effect says that if the  $R_1 C$  time constant is sufficiently small to allow  $C$  to charge up to the maximum input voltage in one-half cycle of the input frequency, and to discharge to the minimum input voltage in the other half-cycle, and if  $(E_{max} - E_{min})$  of the input voltage is constant over the entire band occupied by a frequency-modulated signal, then the output voltage  $E_o$  is a linear function of input frequency.

# Code Practice Keyer

Punched or translucent tape fed through phototube keying head sends perfect 20-words-per-minute Morse code letters at any integral overall speed from 4 to 20 wpm. Electromagnetic clutch controlled from phototubes and variable relaxation oscillator permits use of single tape

By **JAMES R. McDERMOTT**

*Electronics Project Manager  
McGraw-Hill Technical Writing Service  
New York, N. Y.*

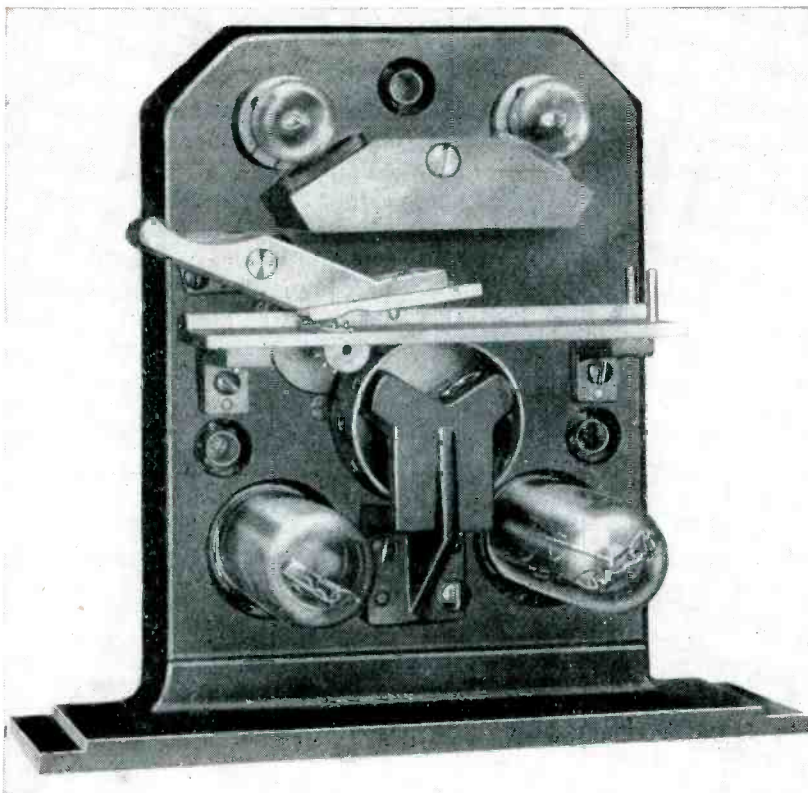

Phototube keying head with exciter lamps, lens system, tape retaining plate, rotating shutter and phototubes below. Continuous tape movement is from right to left across retaining plate, driven by star wheel to left of rotating shutter

**S**TUDIES of problems involving student instruction in the audible reception of radiotelegraph code have indicated that a distinct psychological advantage to the learner is obtained by use of a new technique of code training. This technique is based on the fact that it is desirable for the beginner to hear the code characters (such as letters, numbers and punctuation) transmitted at a speed comparable to that he will encounter in later experience (20 words per minute).

A unique electronic and electro-mechanical device designed to provide this technique of code training is used by the U. S. Navy. Manufactured by H. O. Boehme, Inc., the device, called a primary training keyer, is used to transmit practice code at any one of 17 selected integral rates from 4 to 20 wpm. During 20 wpm transmissions, automatic code tape flows continuously through a phototube keying head, and code messages are transmitted with the element (dot or dash) and space-time relationship in accord with the standard system of automatic code transmission.

During transmissions of 4 to 19 wpm, electronic timing circuits, through the action of a relaxation oscillator that operates an electromagnetic clutch, interrupt the mechanical travel of tape through the keying head. The timing circuits control tape travel to transmit each character at the 20-wpm rate, yet

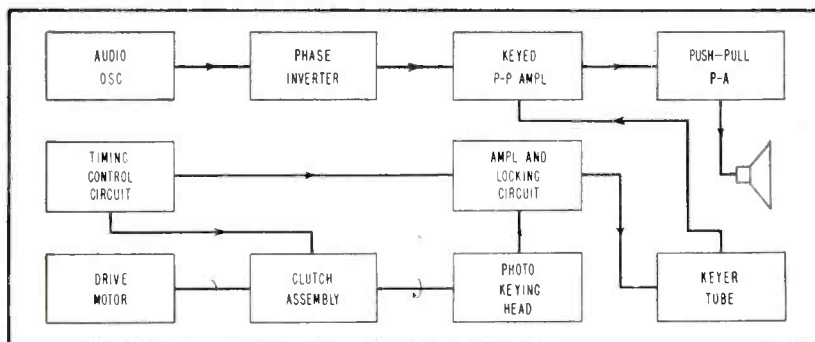

FIG. 1—Circuit functions separated into most important blocks. Voice channel in equipment is not shown here

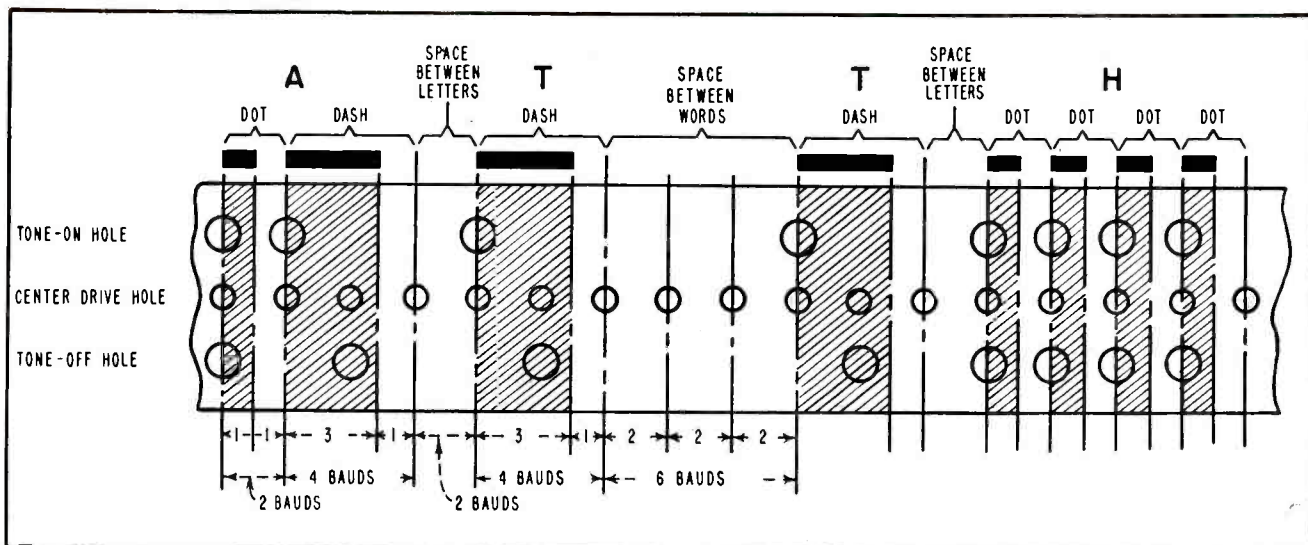

FIG. 2—Spacing standards used in the code keyer for characters and between words. Shaded sections indicate tone-on and unshaded sections tone-off time

insert additional space time between characters. At 19 wpm the added space time is a minimum and progressively increases to a maximum at 4 wpm.

The training keyer consists of an amplifier chassis and a keyer chassis mounted in a sheet-metal cabinet. Interconnection of the more important circuits is shown in Fig. 1.

The amplifier chassis contains a tone-signal oscillator, an amplifier, and a keying circuit that turns the tone signal on and off to form the dots and dashes of practice messages.

Audible dots and dashes are heard in a loudspeaker mounted on the front panel of the amplifier chassis, or in remote speakers and headsets. Provisions are also included for use of an instructor's hand key and microphone for checking practice messages.

The keyer chassis contains timing and phototube amplifier circuits that are energized by light shining through perforations in the automatic code tape as it passes through the keying head. The keying-head motor that drives the tape is mounted on the keyer chassis. The phototube keying head through which the tape is drawn is a detachable unit that plugs into the front panel of that chassis.

Either opaque paper tape furnished with the equipment or standard translucent tape, in which mes-

sages have been punched by use of a standard Wheatstone perforator, as shown in Fig. 2, may be used.

In operation, teeth of a starwheel in the keying head engage the center holes of the tape and draw the tape from right to left across a tape retaining plate. The tape is held in place against the plate by a retaining lever.

#### Mark-Space Phototubes

As the perforated tape passes through the keying head, pulses of light from the exciter lamps pass through the holes and alternately strike the tone-on (mark) and tone-off (space) phototubes. The phototubes conduct and produce alternate pulses of current. These pulses trigger the phototube amplifier to produce a tone-on and then a tone-off condition.

The rotating shutter, through which light from the exciter lamps must pass to reach the phototubes, as shown in Fig. 3, is designed with apertures that permit only sharp pulses of light to initiate or cut off the tone signal. In this manner, clean-cut keying is obtained.

The double-aperture plate is a thin piece of metal containing two small rectangular slits that are parallel but offset from each other as shown. The plate is located in the center of the tape retainer plate directly beneath the focused beams of light from the exciter lamps.

The tone-on and tone-off holes

are punched even with each other in the tape (Fig. 2). If light from the exciter lamps were permitted to shine through both holes and reach both phototubes at the same time, the equipment would be inoperative. Staggering the slits makes it possible to initiate the mark signal before the space pulse cuts the tone off. The effect is the same as if the holes in the tape were offset.

Keyer-drive is from a 60-cycle synchronous motor that has built-in gearing to reduce output shaft speed to 80 rpm. The motor shaft is flexibly coupled to an electromagnetic clutch assembly. When the relay coil of the clutch assembly is energized, the moving clutch engages the driving clutch and the output shaft of the motor rotates the star wheel and shutter of the keying head.

When the relay coil, operated by the timing circuit, is de-energized the moving clutch is pulled back against the teeth of the stop clutch. Rotation of the keying head parts, and consequently tape travel through the head, is stopped.

The audible tone is supplied by a modified Wein-bridge oscillator shown in Fig. 4. The frequency is variable over a minimum range of 450 to 3,000 cycles and is varied by rotation of  $R_{1A}$  and  $R_{1B}$ .

In the selector switch positions of code, hand key, or standby, the audio-tone generator operates con-

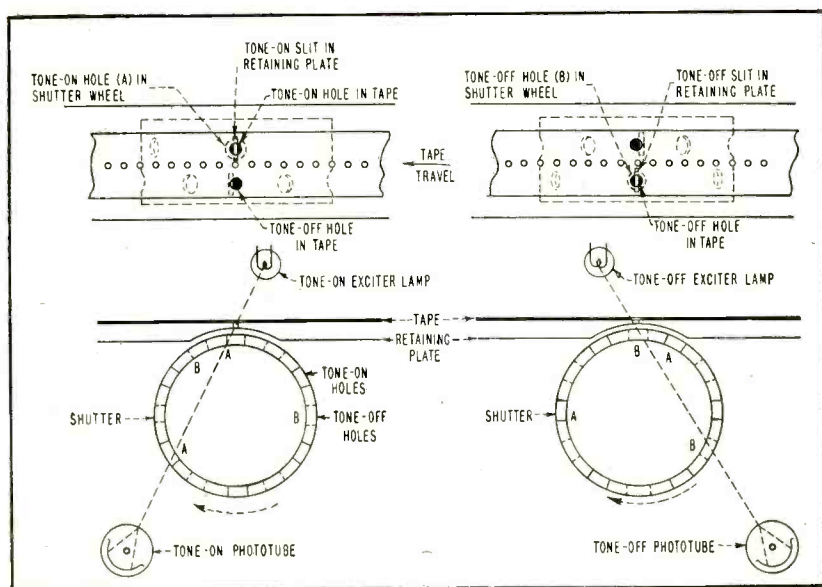

FIG. 3—Tone-control shutters are offset to simplify standard tape punching. Hole and shutter relationship is shown at (A) for tone-on and at (B) for tone-off conditions

tinuously. In code and hand key positions the output of the generator is applied to the input of the phase inverter. In voice operation the audio generator is rendered inoperative by a negative blocking bias applied to the grid of  $V_{1B}$  and is also disconnected from the input of the phase inverter  $V_{3A}$ .

The microphone preamplifier stage amplifies the output of the crystal microphone used with the equipment to a level sufficient to drive the phase inverter. In voice operation the output of the preamplifier is applied to the phase inverter. In code, hand key and standby operation the preamplifier is disconnected from other circuits.

Tube  $V_{3A}$  is a conventional phase inverter. The voice or tone-signal output of the inverter is applied to the grids of the keyed push-pull amplifier  $V_{4A}$  and  $V_{4B}$ . During voice operation the keyed push-pull amplifier is continuously operative. During code or hand key operation the tone signal is applied to the grid of the keyed stage.

The cathodes of the keyed stage are held at approximately 80 volts by connection to a bleeder across the B+ supply. The plate voltage of  $V_1$  is raised above this value, or reduced below it by operation of the keyer tube. The keyer tube is either conducting or cut off. When  $V_{3B}$  is on, plate current flow through  $R_{10}$  reduces the voltage at the plate

of  $V_{3B}$  and at the keyed stage to about 50 volts, blocking it.

When the keyer tube is off, the voltage at the keyed stage plates rises to approximately 200 volts and the stage operates normally. In this manner the constant tone signal applied to the grids is broken into dots and dashes that appear at the plates and are fed to a conventional push-pull output stage.

When selector switch  $S_3$  is in the voice position, -12 volts is applied to the grid of  $V_{3B}$ , cutting off plate-current flow and leaving the keyed stage on.

When the keyer is operated at the nominal sending rate of 20 wpm, the tape passes through the keying head at the continuous rate of 0.8 inch per second. The length of the dots and dashes is determined by the rapidity with which alternate on and off pulses of light pass through the tape holes and energize the phototubes.

Operation of the phototube amplifier and locking circuit is effective only when the selector switch is in the code position during automatic code transmission from tape.

The vacuum tubes of the amplifier and locking circuit do not operate as conventional amplifiers, but as switches that are either on (conducting) or off (nonconducting). The triode tubes are connected in bridge-type circuits such that a tube that is off, or blocked, applies a

positive voltage to the grid of the following tube, turning it on. This second tube, which is on, then applies a negative voltage greater than cutoff to the grid of the third tube, cutting it off, and so on.

A pulse of light from the exciter lamp strikes tone-on phototube  $V_7$ , which conducts. This applies a positive voltage to the grid of  $V_{8B}$  turning it on, and turning  $V_{9A}$  off. When  $V_{9A}$  is off, it turns  $V_{10A}$  on. This action turns keyer tube  $V_{3B}$  off, the keyed push-pull stage becomes operative and the tone is heard. At the same time, when tube  $V_{9A}$  is off, it turns locking tube  $V_{8B}$  on. Conduction through  $V_{8B}$  holds  $V_{9A}$  off,  $V_{10A}$  and  $V_{10B}$  on, and the keyer tube  $V_{3B}$  off. Thus, the locking circuit holds the tone on, even though phototube  $V_7$  and triode  $V_{8B}$  conduct only for the instant of the initial pulse.

The tone-off switching and locking cycle may be traced in similar manner. During automatic code operation the outputs of  $V_{10A}$  and  $V_{10B}$ , which are parallel, are applied to keyer tube  $V_{3B}$  and the timing control circuit.

### Code Speed Control

The timing-control circuit regulates tape movement through the keying head at transmission speeds of 4 to 19 wpm. The timing circuit is inoperative at 20 wpm because the clutch relay coil is continuously energized by grounding the grid of the clutch relay control tube  $V_{13}$ . The moving clutch is then held against the teeth of the driving clutch and the star wheel rotates, drawing the tape through the keying head at the constant rate of 0.8 inch per second.

When the words-per-minute switch is set on any number from 4 to 19, the timing control circuit performs the following functions.

When a light pulse turns the tone on, the amplifier applies a negative voltage to the timing-control circuit. This voltage energizes the clutch relay coil and drives the tape during tone-on time. When the tone-off pulse turns the tone off, the negative voltage keeps the clutch coil energized for the period of time required to drive the tape the one baud of space associated with the element transmitted. Between the

characters and spacing units of two bauds, the tape stops. Length of this dead time is regulated by resistors such as  $R_{11}$  in the words-per-minute timing control circuit to provide the required wpm rate.

After the dead time has passed, the timing control circuit energizes the clutch coil long enough to cause the tape to travel one spacing unit of two bauds. If the space unit is followed by another the tape stops for another period of dead time. When the space is followed by a dot or dash, the tone-on pulse of the element prevents the relay coil from being de-energized and the tape travels into transmission of the next character without stopping.

### Tape-Drive Circuits

A negative voltage during tone-on time from the phototube amplifier is taken from the center arm of  $R_{12}$  and this voltage is applied to the cathode of one section of  $V_{11}$ . Since the plate of this section is connected to ground through  $R_{13}$ , the plate becomes positive with respect to the negative cathode. Current flows from cathode to plate and down to ground through  $R_{13}$ , developing a negative voltage on the grid of  $V_{12A}$ . This voltage is greater than cutoff and consequently the tube is blocked.

When switch tube  $V_{12A}$  is off, the

grid of  $V_{13}$  becomes positive and the tube conducts. The clutch relay coil is energized and the tape moves through the keying head.

A tone-off pulse striking its phototube causes the amplifier voltage from  $R_{12}$  to go sharply positive. The cathode of  $V_{11}$  becomes positive with respect to its plate, and the tube ceases to conduct. Although the tone is now off, the tape travel continues because the negative voltage applied across  $R_{13}$  has charged  $C_1$ . This voltage, applied to the grid of  $V_{12A}$  holds that tube at cutoff until the charge leaks off. When it conducts,  $V_{13}$  is cut off to de-energize the clutch coil, and halt tape travel.

Switch tube  $V_{12A}$  has a fixed cutoff value. Consequently the greater the negative voltage applied across  $R_{13}$  during tone-on time, the longer time will be required for that voltage to fall to the conduction point after the tone goes off. Adjustment of  $R_{12}$  varies this applied voltage; the potentiometer is set to apply a voltage sufficient to hold the relay coil energized until the tape has traveled the distance of one baud after the element tone-on time.

When the baud of tape travel has passed, the clutch coil is then de-energized and tape travel stops for a period of dead time unless the tone-on pulse of a following dot or dash keeps the coil energized.

When the tape stops, it will not travel again until the clutch is energized, or until  $V_{12A}$  is cut off by a negative voltage pulse generated by a relaxation oscillator on the timing control circuit. Such a negative voltage can be applied to the other cathode of  $V_{11}$ , producing current flow from cathode to plate, through  $R_{13}$  to ground, and cutting off the grid of  $V_{12A}$ .

Voltage from the relaxation oscillator is a sharp sawtooth pulse. The proper period of voltage decay time is adjusted by rotation of time delay control  $R_{18}$ . This adjustment changes the  $RC$  time constant of  $R_{18}/C_1$ , and the time required for the sharp voltage pulse from the relaxation oscillator to leak off to ground. When this voltage reaches the cutoff value of  $V_{12A}$ , that tube conducts and de-energizes the clutch coil, thus stopping the tape after one unit of space travel.

When the tape stops for dead time between words, a single pulse from the relaxation oscillator moves the tape forward one spacing unit of two bauds. At this point  $V_{12A}$  conducts again and the tape travel stops, inserting a second period of dead time. At the end of the third spacing unit between words, the tone-on pulse energizes the clutch and the tape travels on into transmission of the next character.

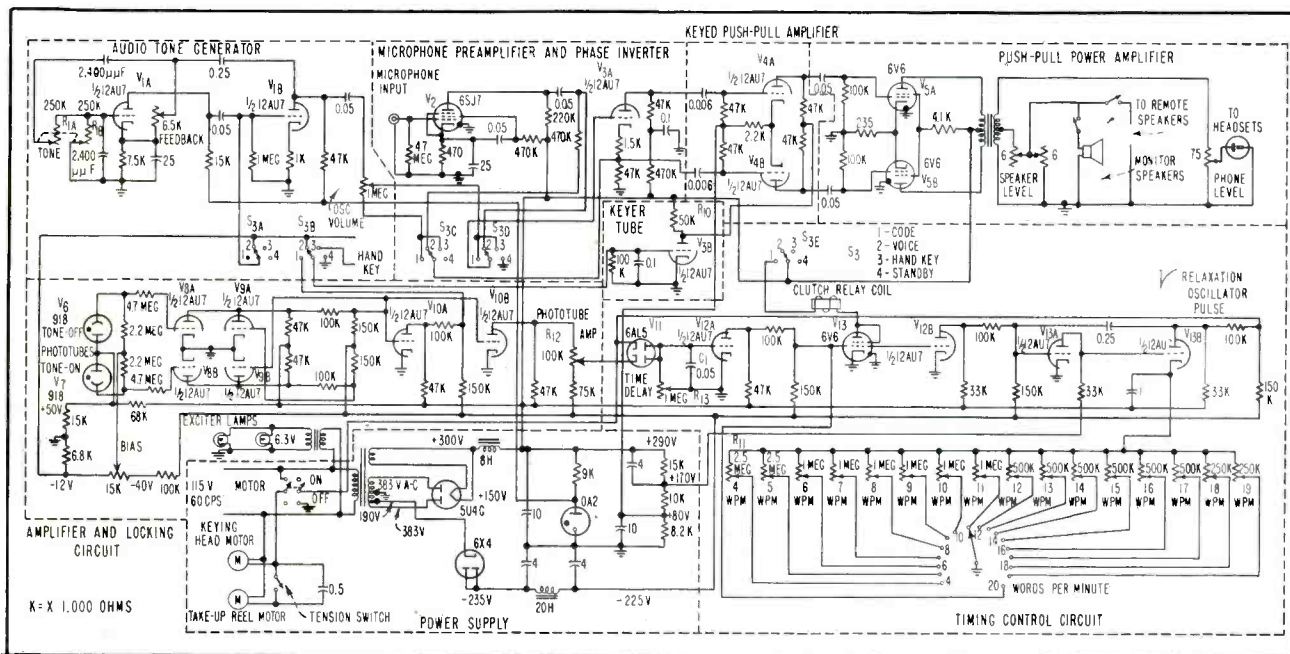

FIG. 4—Complete circuit diagram of the practice tone keyer is described in text

# Remote-Tuning Receiver

Inductance of ferrite core coils is changed remotely to tune receiver from 500 kc to 3 mc by increasing control current from 8 ma to 233 ma. Control power required is less than 2 watts. Other possible applications are suggested

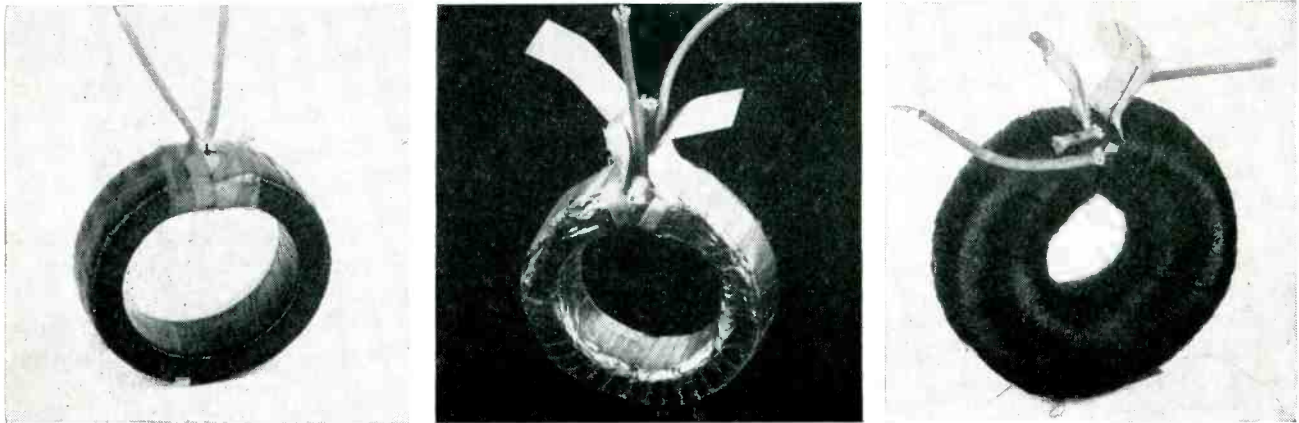

FIG. 1—Photos show steps in coil preparation. Two separate cores with opposing r-f windings are taped together with insulating tape and then surrounded as a unit with the d-c control winding

**A**T SPORADIC INTERVALS during the fifty-year development of the communications art attempts have been made to construct controllable, variable inductors without moving parts, for use in resonant circuits to cover as much of the frequency spectrum as possible at reasonable expenditure of control power.

Only in recent years have core materials become available that make such variable inductances feasible. The accompanying photograph shows the r-f portion of a radio receiver using d-c controlled inductances. The receiver covers a frequency range of 500 kc to 3 mc, with incremental-permeability-tuned resonant circuits at the antenna input, first r-f, second r-f, cathode follower and crystal detector stages.

## Design Requirements

Use of variable inductances in such applications places rather stringent requirements on the types of core materials and circuitry used.

## By SAMUEL STIBER

*Signal Corps Engineering Laboratories  
Fort Monmouth, New Jersey*

The Q of the controllable inductor must be fairly high to obtain good selectivity and low noise. The control circuit should not provide a feedback path for the r-f nor introduce noise in the r-f circuit. The r-f signal should not exert a control function within the amplitude range to be expected, as this would cause detuning of the respective circuits or might manifest itself as a reduction of Q with signal amplitude and a consequent reduction in selectivity in the presence of strong signals.

The deviation in inductance with control field must be repeatable. The magnetic core must be free of magnetostriction or other resonance effects that would make behavior of individual tuning elements unpredictable. The coefficient of temperature must be reasonably low or controllable. Power required to effect the inductance change must be low.

Structure should be simple and easy to manufacture and the material should not require complex test procedure. Saturation flux density of the core material should be low so that minimum power is required to obtain a change from maximum to minimum permeability. Initial permeability should be high.

## Toroid Selection

The toroid form provides a higher effective permeability, lower stray field and less coupling of the r-f to the control winding than any other known arrangement. Two toroids are stacked side by side as shown at left in Fig. 1. Each half of the r-f coil is wound around each toroid in opposing sense so that a voltage induced in each by a modulated control field would produce no emf at the r-f coil terminals. Coupling between coils is negligible. A protective bandage is applied combining the two toroids into one

This article is based on a paper delivered at the 1952 National Electronics Conference. The conference paper appears in the *NEC Proceedings*.

# Has No Moving Parts

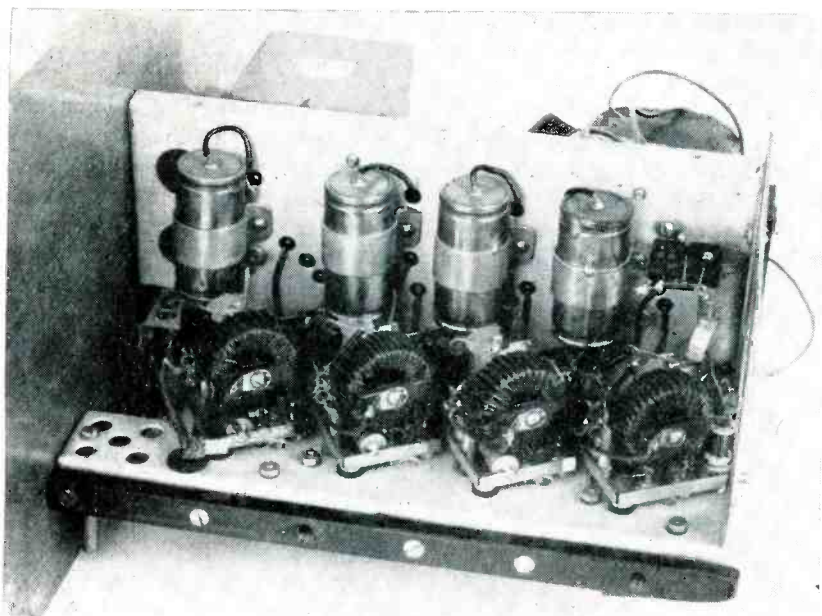

Radio-frequency portion of r-f receiver using d-c controlled inductances to tune from 500 kc to 3 mc

package as shown in the center of Fig. 1. Figure 1 also shows (right) electrostatic shield wound around the combined cover and in turn insulated by a multiturn control winding placed over the radio-frequency coil.

## Normalizing

Prior to test and selection, the cores are normalized (reduced to the same history) by heating in an oven above the Curie point, applying a strong a-c field which is then slowly reduced to zero, or by saturating with a strong periodic pulse.

The cores are then compared on a low-impedance bridge against a master selected at the center of the band. Experience has shown that plus or minus 3 percent limits enable tracking to within  $\pm \frac{1}{2}$  db.

## Frequency Variation

The most promising materials proved to be Ferramic D in the frequency range 30 to 50 mc and Ferraxcube IV in the frequency range 500 kc to 30 mc.

The incremental permeability of a ferrite material decreases without reversal if the flux density is increased from zero to complete saturation of the core. This is independent of the polarity of the flux. The variation of frequency of an oscillator utilizing the variable inductance is shown in Fig. 2. The relative frequency change  $f/f_0$  with a change in control or biasing field  $H$  is shown for Ferramic I, G and C. These measurements were made in the frequency range 0.1 to 1 mc. No attempt was made to show the maximum possible range of frequency but rather the relative frequency change for a given power input to the  $H$  winding. A large frequency ratio  $f/f_0$  for a small control power is of course desirable. The open area of each loop is a measure of the hysteresis loss in the core and ideally should be as small as possible.

The small r-f signal current in a relatively few turns of the r-f coil represents a negligible change in permeability but in the case of the

low-frequency inductance the plate current of the tube represents a significant factor. For example, if the driver coil has 250 turns and the minimum current is 20 ma, the total is 5 ampere turns. The r-f coil has 80 turns and the plate current is 10 ma (0.8 ampere turn). However, the r-f coil is split into two halves, connected in opposite sense and while the one half would aid the driver, the other half would oppose, thus keeping the total permeability approximately constant.

Figure 3 shows measurements taken at elevated temperatures for the frequency band 3 to 10 mc and 20 to 40 mc for Ferramic A and B. These graphs show a room temperature curve versus yoke flux as well as a high and a low-temperature curve.

Inspection of these results indicates that for any magnetic bias the frequency change due to the bias increases with temperature.

## Applications

The use of such electronically-tuned r-f components has been suggested for sweep oscillators, frequency-modulated oscillators, automatic-frequency-control systems, magnetic amplifiers, remote tuning of receivers and transmit-

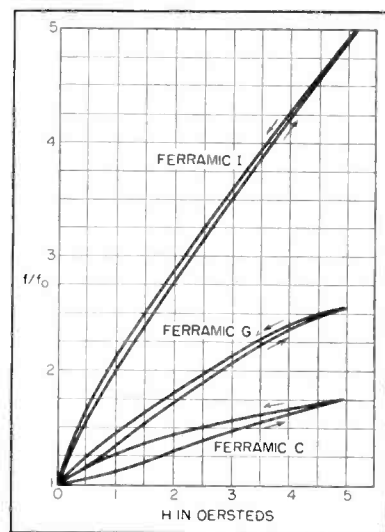

FIG. 2—Variation of normalized oscillator frequency with control field

ters, switching circuits and variable tuned filters. Figure 4 shows the circuit of the front end of a trf receiver that covers the frequency range 500 kc to 3 mc. This receiver has a sensitivity of approximately 2 microvolts for a 2 to 1 signal-to-noise ratio. Its bandwidth is 11 kc at 500 kc and 22 kc at 3 mc.

Means for tracking include one small adjustable series inductance with powdered-iron slug, permitting approximately a 3-percent change in inductance at the high-frequency end of the band. In addition, variable shunt trimmers are utilized to track the low-frequency end of the band. By these two means, continuous tracking is obtained over the frequency range. The tracking problem is seemingly greater than in tracking ganged capacitors, due to the absence of simple means of adjustment, such as slotted end plates on rotors. However investigation into means of tracking shows that two inductances of identical initial permeability and processing will track up to high saturation values.

The requirement for driving the group of variable inductances is that all should resonate at the same frequency with the same control current. Since the driver coils are connected in series, r-f chokes and by-pass capacitors are necessary to provide decoupling.

The operation of a variable in-

ductance has been investigated in reference to its use as a local oscillator in a superheterodyne receiver with Ferramic B as the core material. A Colpitts oscillator using a 6C4 provided an output voltage substantially constant over the frequency range 2 to 6 mc.

Control current required for tuning the tuned-radio-frequency receiver shown is 8 ma at 500 kc and rises to 233 ma at 3 mc. Total control power required to tune through the frequency range 500 kc to 3 mc (6 to 1) is less than two watts.

The receiver may readily be

hermetically sealed as there are no moving parts. The use of transistors to replace tubes should facilitate this feature. Tuning can be accomplished remotely at any desired speed.

### Conclusions

The study and development of ferrite materials sponsored by the Signal Corps Engineering Laboratories has resulted in a variable inductance having a volume of less than one cubic inch, weight slightly over one ounce, which can be shifted in frequency by a 2-watt source as follows: 7 to 1 in the frequency range 500 kc to 3 mc, 4 to 1 in the frequency range 3 to 12 mc, 2.1 to 1 in the frequency range 11 to 25 mc, and 2 to 1 in the frequency range 25 to 50 mc.

The problem of tracking such elements has been made simple. Useful Q's of the order of 25 to 70 are obtainable from 500 kc to 50 mc. Average temperature coefficient of the tuning elements is below 0.1 percent per degree C. No noticeable noise is produced.

Acknowledgement is herewith given to General Ceramics and Steatite Corporation, Keasby, N. J., C.G.S. Laboratories, Stamford, Conn., and to the University of Michigan. Much of the information presented in this article has resulted through work accomplished by these three sources.

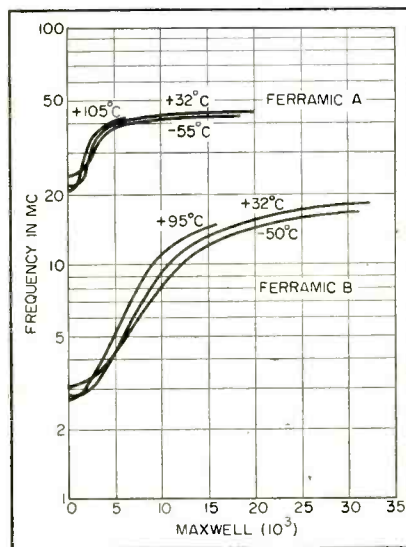

FIG. 3—Curves show dependence of ferrites on temperature

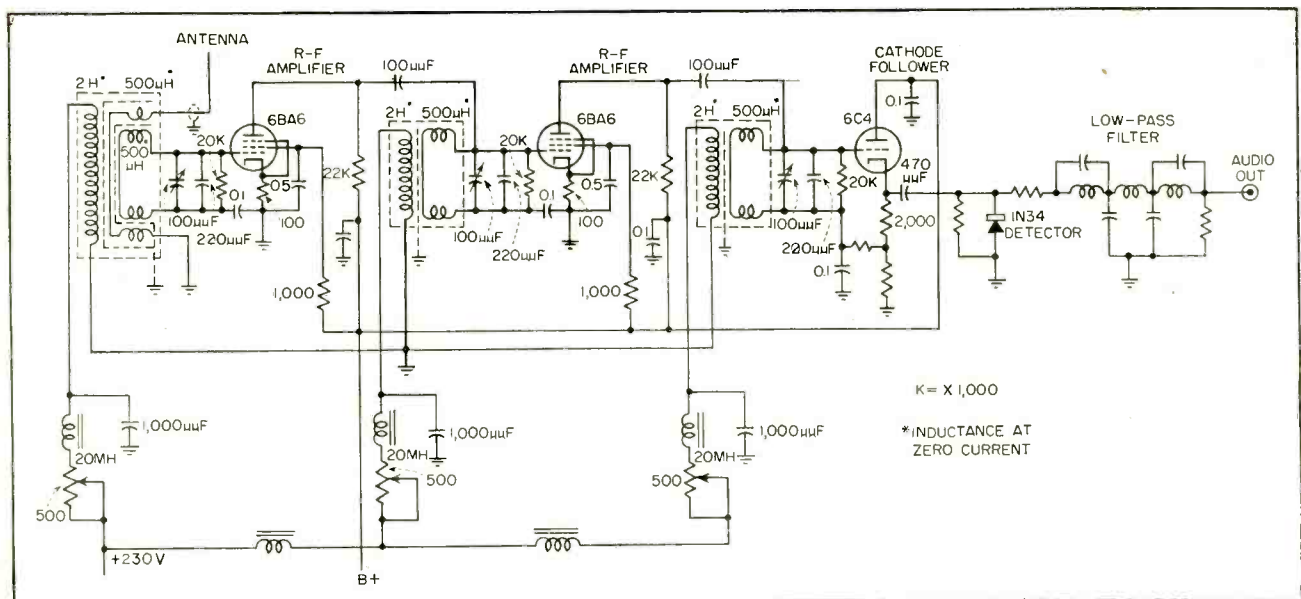

FIG. 4—Complete schematic of remote-tuning receiver using r-f saturable reactors as tuning elements



# Magnetic Amplifier Transient Analyzer

Dual-beam oscilloscope displays input and output signals of magnetic amplifier simultaneously and continuously on common time base for studying effect on speed of response of various circuit parameter changes. Permits rapid determination of optimum design as shown in oscillograms made during studies of typical circuits

By **W. A. GEYGER**

*Magnetics Division  
U. S. Naval Ordnance Laboratory  
Silver Spring, Maryland*

**M**AGNETIC amplification is accompanied by a certain time-lag between the application of the input signal and the attainment of the full output load current.

This sluggishness of response due to magnetic inertia is not an important drawback in some applications where the additional lags arising from external parts of the electrical control system (due, for example, to the thermal inertia of a thermocouple) are appreciably greater than those inherent in the magnetic amplifier itself. But in other applications, especially those in the field of high-performance servomechanisms and some other types of automatic control and instrument work, a very short response time is of paramount importance.

## Investigations

Considerable effort has been expended in theoretical and experimental investigations concerning the transient performance of various types of magnetic amplifier circuits.

The object of these investigations is to study the major factors that control the transient response of saturable reactor devices with resistive or inductive loads in their output circuits.

It has been shown that application of rectangular hysteresis-loop core materials<sup>1, 2</sup> in combination with a suitable core construction results in a very close approximation between the usual theoretical assumptions and actual experimental conditions. Therefore, the transient performance of such magnetic amplifiers can be described by simple linear equations with suffi-

cient accuracy to be used in the design of these amplifiers.

In considering the accuracy of theoretical methods of determining the response time of conventional types of magnetic amplifiers having a response time of about 6 to 30 cycles it must be remembered that in most practical design problems concerning such low-speed amplifiers an approximate value is all that is required. However, in regard to the transient performance of special magnetic amplifier circuits<sup>3-8</sup> having preferably a very short response time of about one cycle only, experimental methods have assumed increasing importance in the development of such high-speed amplifiers.

## Conventional Techniques

The cathode-ray oscillograph is ideally suited for observing the waveforms of electric and magnetic quantities varying with time. The techniques generally used in analyzing the transient response of magnetic amplifiers consist of the following procedure:

The voltage drop produced by the output (load) current across an ohmic resistor is applied to one channel of a dual-beam oscilloscope so that the actual deflection of the beam is proportional to the instan-

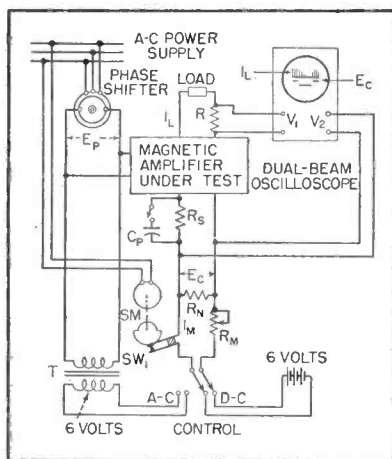
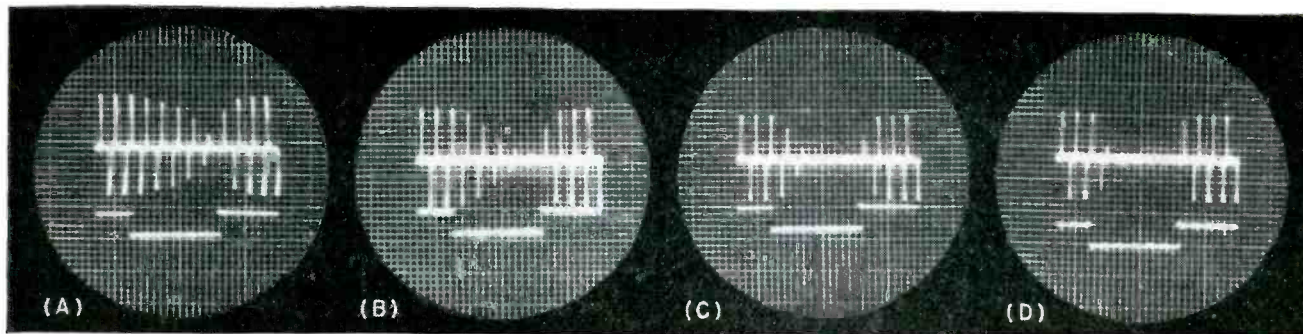

FIG. 1—Diagram of the transient response analyzer exhibiting the complete transient phenomena of the magnetic amplifier permanently as a standing picture on the short-persistence screen of a dual-beam cathode-ray oscilloscope



Oscillograms show transient performance of a conventional type push-pull self-saturating magnetic amplifier with four series-connected d-c control winding units and a-c load resistor with the following control circuit operating conditions: (A) Series resistance in the control circuit  $R_S = 500$  ohms, shunt capacitor  $C_P = 0$ ; (B)  $R_S = 1,000$  ohms,  $C_P = 0$ ; (C)  $R_S = 2,000$  ohms,  $C_P = 0$ ; and (D)  $R_S = 2,000$  ohms,  $C_P = 3.5$  microfarads

taneous value of load current.

The input (control) voltage is applied to the second channel of the oscilloscope so that deflection of the second beam is proportional to the instantaneous value of control voltage.

Sweep starting time is then triggered to the start of a photographic exposure in such a way that the transient phenomena associated with making and breaking of the switch contacts that apply or interrupt the control voltage will be recorded during a period of a single sweep of the beam in the desired position on the film or photographic paper of the camera.

This procedure makes it possible to secure adequate conditions in photographic recording of the non-repetitive transient phenomena of the magnetic amplifier to be investigated, provided that the cathode-ray tube is operated at sufficiently high accelerating potentials. The fact that the waveforms of input voltage

and output current are displayed simultaneously on the screen on a common time base enables a precision and convenience of correlation unobtainable with two individual oscillographs, especially when an illuminated calibrated scale with 0.1-inch cross-section lines is used.

A sufficiently clear photographic reproduction of such an illuminated scale in connection with nonrepetitive transients may be difficult because the necessarily limited time of exposure is very short (for example, 0.2 second corresponding to 12 cycles of a 60-cycle power supply; or even 30 milliseconds corresponding to 12 cycles of a 400-cycle power supply).

#### Improved Method

For analyzing the transient response of magnetic servo amplifiers having a very short response time of about one cycle, a cathode-ray dual beam type analyzer was developed. It displays the waveforms

of input voltage  $E_c$  and output current  $I_L$  simultaneously on a common time base in such a way that these waveforms are permanently exhibited on a long-persistence screen.

The complete transient phenomena of the magnetic amplifier to be investigated can be continuously observed, and the effect of any change in circuit operating conditions can easily be studied and conveniently recorded photographically. Since, in this case, the time of exposure may be extended to about 2 or 3 seconds, a very clear reproduction of an illuminated scale with 0.1-inch cross-section lines is secured. It is also possible to apply a projection-type cathode-ray oscilloscope.

The diagram of the transient response analyzer is shown in Fig. 1. According to conventional techniques, the voltage drop  $I_L R$ , produced by the output (load) current  $I_L$  across an ohmic resistor  $R$ , is applied to the one channel ( $V_1$ ) of a dual-beam oscilloscope, while the

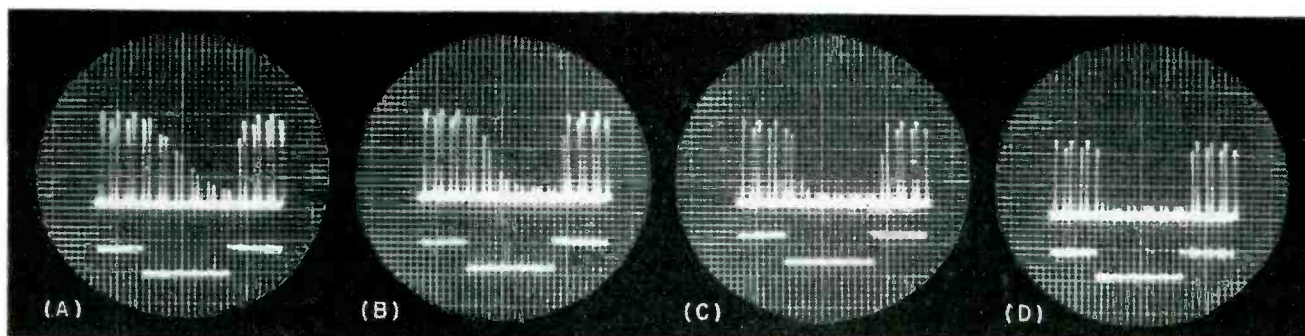

Oscillograms show transient performance of a conventional type push-pull self-saturating magnetic amplifier with four series-connected d-c control winding units and full-wave d-c load resistor with the following control circuit operating conditions: (A) Series resistance in the control circuit  $R_S = 500$  ohms, shunt capacitor  $C_P = 0$ ; (B)  $R_S = 1,000$  ohms,  $C_P = 0$ ; (C)  $R_S = 2,000$  ohms,  $C_P = 0$ ; and (D)  $R_S = 2,000$  ohms;  $C_P = 3.5$  microfarads

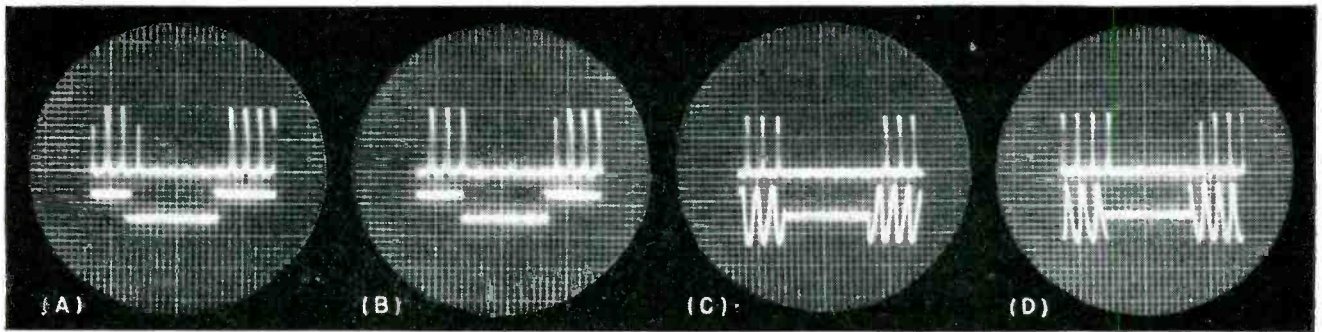

Oscillograms showing the transient phenomena of a high-speed magnetic servo amplifier of the half-wave type having inherent one-cycle response with d-c (A, B) and a-c control (C, D). These oscillograms illustrate the effect of changing actual time interval between instant of opening (or closing)  $SW_1$  (see Fig. 1) and the instant when the 60-cycle power supply voltage  $E_p$  of the magnetic amplifier goes through zero

input (control) voltage  $E_c$  is applied to the second channel ( $V_2$ ). The magnetic amplifier to be investigated and a small step-down transformer  $T$  are supplied from a phase shifter, whereas a synchronous motor  $SM$  operating  $SW_1$  is directly supplied from the three-phase power supply.

This automatic switch is synchronously operated in such a way that it makes during a period of 6 cycles and breaks during the succeeding period of 6 cycles, alternately. Therefore, with a 60-cycle power supply, the cam that operates  $SW_1$  rotates at a synchronous speed of 300 rpm corresponding to 12 cycles per revolution.

The control voltage  $E_c = I_M R_N$  supplied from a battery (d-c control) or from the step-down transformer  $T$  (a-c control), can be adjusted by means of a variable series resistor  $R_M$ , according to the actual requirements.

Figure 1 also illustrates the possibility of varying the operating conditions of the control circuit loop by means of a forcing resistor  $R_s$  and a shunt capacitor  $C_p$ . In this way, the effect of lead networks on the transient performance of magnetic amplifiers may be investigated.

When the sweeps of the dual-beam oscilloscope are synchronized so that 12 cycles of the (a-c or d-c) output current  $I_L$  appear on the screen, then the operation of  $SW_1$  will also be synchronized and a sequence of 6-cycle making and 6-cycle breaking will exhibit the complete transient phenomena of the magnetic amplifier permanently as a standing picture on the long-

persistence cathode-ray tube screen.

Introduction of the phase shifter offers the possibility of varying the actual time interval between the instant of opening (or closing)  $SW_1$  and the instant when the power supply voltage  $E_p$  of the magnetic amplifier goes through zero. Of course, the phase shifter may be eliminated if the angular position of the cam on its shaft can be continuously changed by mechanical means, in a similar way to conventional Joubert-disk type contact arrangements.

#### Variations

The arrangement of Fig. 1 may be modified in various ways. The aforementioned sequence of 6-cycle making and 6-cycle breaking has proved to be particularly useful for investigating magnetic amplifiers having a response time of about one to six cycles. It is possible, however, to operate the cam of the switch at 900 rpm and to synchronize the sweeps of the dual-beam oscilloscope so that 4 cycles of the (a-c or d-c) output current  $I_L$  appear on the screen.

This procedure has proved useful in analyzing the transient performance of high-speed magnetic servo amplifiers having inherent one-cycle response, particularly in regard to variations of the actual time interval between the instant of opening (or closing)  $SW_1$  and the instant where the power supply voltage  $E_p$  goes through zero.

When operating with a power supply frequency of 400 cycles per second, the method can be applied equally well, provided a 400-cycle synchronous motor is used for driv-

ing the cam of  $SW_1$  in the control circuit. However, with higher power supply frequencies (up to about 20,000 cycles per second),  $SW_1$  may be replaced by any suitable type of electrical modulator. A dry-disk rectifier bridge circuit, separately excited from a subharmonic generator producing a synchronous auxiliary current with rectangular wave-shape may be used in such cases. Of course, electronic types of modulators may be equally well suited for this purpose.

The accompanying oscillograms illustrate the practical application of the transient response analyzer shown in Fig. 1.

These oscillograms demonstrate the capabilities of this visual test device in research and development work on actual magnetic amplifier circuits. In each case, the lower trace shows input voltage and the upper trace shows output current.

#### REFERENCES

- (1) G. W. Elmen and E. A. Gaugler, Special Magnetic Alloys and Applications, *Elec. Eng.*, p 843, 67, Sept. 1948.
- (2) W. A. Geyger, Magnetic Amplifiers with Orthogonal Tape Cores, *Proc. NEC*, p 59, 6, 1950.
- (3) F. G. Logan, "Electric Controlling Apparatus," U. S. patent 2,259,647.
- (4) R. A. Ramey, "On the Mechanics of Magnetic Amplifier Operation," AIEE No. 51-217, May 1951. "On the Control of Magnetic Amplifiers," AIEE No. 51-389, Sept. 1951.
- (5) A. E. Schmid, Application of a 60 Cycle Magnetic Amplifier to a Position Indicating Servomechanism, *Proc. NEC*, 7, 1951.
- (6) C. W. Lufcy, A. E. Schmid and P. W. Barnhart, "An Improved Magnetic Servo Amplifier," AIEE Paper No. 52-235, May 1952.
- (7) W. A. Geyger, A New Type of Magnetic Servo Amplifier, AIEE Paper No. 52-237, May 1952.
- (8) W. A. Geyger, Magnetic Amplifiers of the Balance Detector Type—Their Basic Principles, Characteristics, and Applications, *Proc. AIEE*, Section T 0-93, 70, 1951.

# Parallel-Resistor Chart

Permits quick choice of the best combination of two available RTMA preferred-value resistors in either 10-percent or 20-percent tolerance ranges to give a desired higher power rating at a particular resistance value

ONE problem that often comes up in laboratories is making full use of the most readily available standard components. Virtually all labs have a constant supply of  $\frac{1}{2}$ , 1 and 2 watt composition resistors in the standard 10-percent and 20-percent tolerance ranges. A typical problem might be combining two of these to get a 3-watt resistor of the required value. If making conventional calculations combined with trials, three or four trials are usually needed to find the resistor required. The chart in Fig. 1 reduces all of the calculation to a simple glance. The simplicity of the chart results from the solution of two simultaneous equations.

$$y = \frac{R_2}{A} x \quad (1)$$

$$y = \frac{R_1}{A} x + R_1 \quad (2)$$

Solving these two simultaneous equations, their point of intersection is at

$$x = \frac{R_1 A}{R_2 + R_1} \quad (3)$$

$$y = \frac{R_1 R_2}{R_1 + R_2} \quad (4)$$

The  $y$  ordinate is the solution for the parallel combination of two resistors or the series combination of two capacitors.

The choice of parallel resistors is, however, dependent upon the power dissipation in each resistor. This information can be derived by multiplying both sides of Eq. 3 by  $R_2$ , then substituting

## By MITCHELL ARON

Assistant Chief Engineer  
Commercial Products Division  
Radio Receptor Company Inc.  
Brooklyn, N. Y.

combined parallel resistance  $R$  for  $R_1 R_2 / (R_1 + R_2)$  to get

$$R_2 x = RA \quad (5)$$

Multiplying both sides by  $E^2$  and rearranging gives

$$\frac{E_2}{R} x = \frac{E^2}{R^2} A \quad (6)$$

Now assume that the power being dissipated in the parallel combination is 1 watt, and let  $A$  be also arbitrarily made equal to 1. Equation 6 then becomes  $x = E^2/R_2$ . Since  $E^2/R_2$  is the power dissipated in  $R_2$ , the abscissa is proportional to the power dissipated in  $R_2$ . Thus, for every watt dissipated in the parallel combination  $R$ ,  $x$  watts will be dissipated in  $R_2$ . The power dissipated in  $R_1$  is of course the difference between the total and that dissipated in  $R_2$ .

A plot of a series of the lines just discussed is given in Fig. 1. For convenience the heavy lines are drawn to the 20-percent series of preferred values and the combination of light and heavy lines form the 10-percent series of preferred values.

### Example

Let it be required to find the nearest parallel combination of two resistors in the 20-percent series of preferred values to give a combined resistance of 4,000 ohms. The parallel combination must be able to dissipate 3 watts.

*Solution:* 4,000 ohms can be rewritten as  $4.0 \times 10^3$  ohms. Follow the 4.0 horizontal line across, noting that the nearest intersection of two heavy lines is 6.8 and 10.0 and the intersection falls at  $x = 0.41$ . Thus the parallel combination of 6.8 K in parallel with 10 K is the nearest combination of 20-percent resistors to 4 K, and gives an exact resistance of 4.05 K. Since  $10 \text{ K} = R_2$  (read on the righthand side of chart), the power rating of  $R_2$  must be  $= 0.41 \times 3.0 = 1.23$  watts and the dissipation of  $R_1$  is  $3 - 1.23 = 1.77$  watts. Thus the resistors that will fulfill the needs of the problem are 6.8 K, 20-percent, 2-watt in parallel with 10 K, 20-percent, 2-watt.

Although it is not required for most calculations of the type just explained, further information can be gleaned from the chart. For example, although the resistances in the preceding problem are not equal, due to standardization, resistances of equal 2-watt power rating are called for. The maximum power that can be dissipated by the parallel combination is determined by the power at which the smaller of the two resistances will dissipate 2 watts. Thus the maximum power for the combination, using the data from the chart, is

$$\frac{2}{1 - 0.41} = \frac{2}{0.59} = 3.4 \text{ watts.}$$

Because of the similarity in the arithmetic, the chart will work equally well for series combinations of capacitors.

(Continued on p 194)

# CINCH, the Standard SOCKET

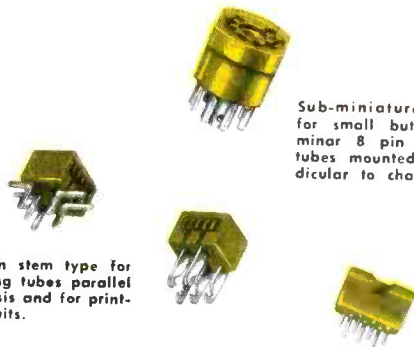

Sub-miniature socket for small button sub-minor 8 pin base T3 tubes mounted perpendicular to chassis.

Five pin stem type for mounting tubes parallel to chassis and for printed circuits.

Seven pin stem type for tubes vertically mounted.

## EXCLUSIVELY AT CINCH; QUANTITY PRODUCTION OF

**LOW LOSS MICA COMPONENTS.** An adequate and unequalled facility for quantity production and prompt delivery . . . and the constant demonstration of ability to hold tolerances on Mica moldings, meeting the most exacting requirements in small metal plastic assemblies for components of higher quality materials held to closer tolerances . . . has advanced CINCH to the foremost as a producer of low loss Mica components.

CINCH with ample physical properties, space and production facilities is producing many variations of standard electronic components for military use.



Cinch Electronic components are available at leading jobbers — everywhere.

This list indicates the wide scope and myriad of variations and re-designing possible with Cinch background of socket production experience.

**Tube (Receiver, Transmitter and Special): Battery, all types**

**C-R Tube**

**Crystal**

**Electrolytic**

**Glass Type; 4 to 7 prong laminated**

**Infra-red Ray Tube**

**High Altitude Airborne Types**

**Kinescope; Magnal, Duodecal, Diheptal**

**Loktal-Miniature-Multiplug-Noval-Octal (Molded bakelite, steatite, teflon, Kel-F and laminated)**

**Plexicon**

**Printed Circuit**

**Special Sockets to Specs**

**Sub-Miniature; Hearing Aid Types**

**TV; 110V Circuit Breakaway**

**Vibrator**

**Pencil Tube Transistor**

**Diode**

The Cinch organization is flexible, readily adapted to any electronic component requirement . . . in military or commercial emergency.



CINCH MOLDED MINIATURE



CINCH NOVAL NINE PRONG



CINCH-ERIE PLEXICON

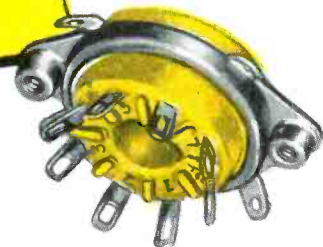

**CONSULT CINCH**

**CINCH MANUFACTURING CORPORATION**

1026 South Homan Ave., Chicago 24, Illinois

Subsidiary of United-Carr Fastener Corporation, Cambridge, Mass.

**Cinch**  
ELECTRONIC  
COMPONENTS

Parallel-Resistor Chart—continued from page 192

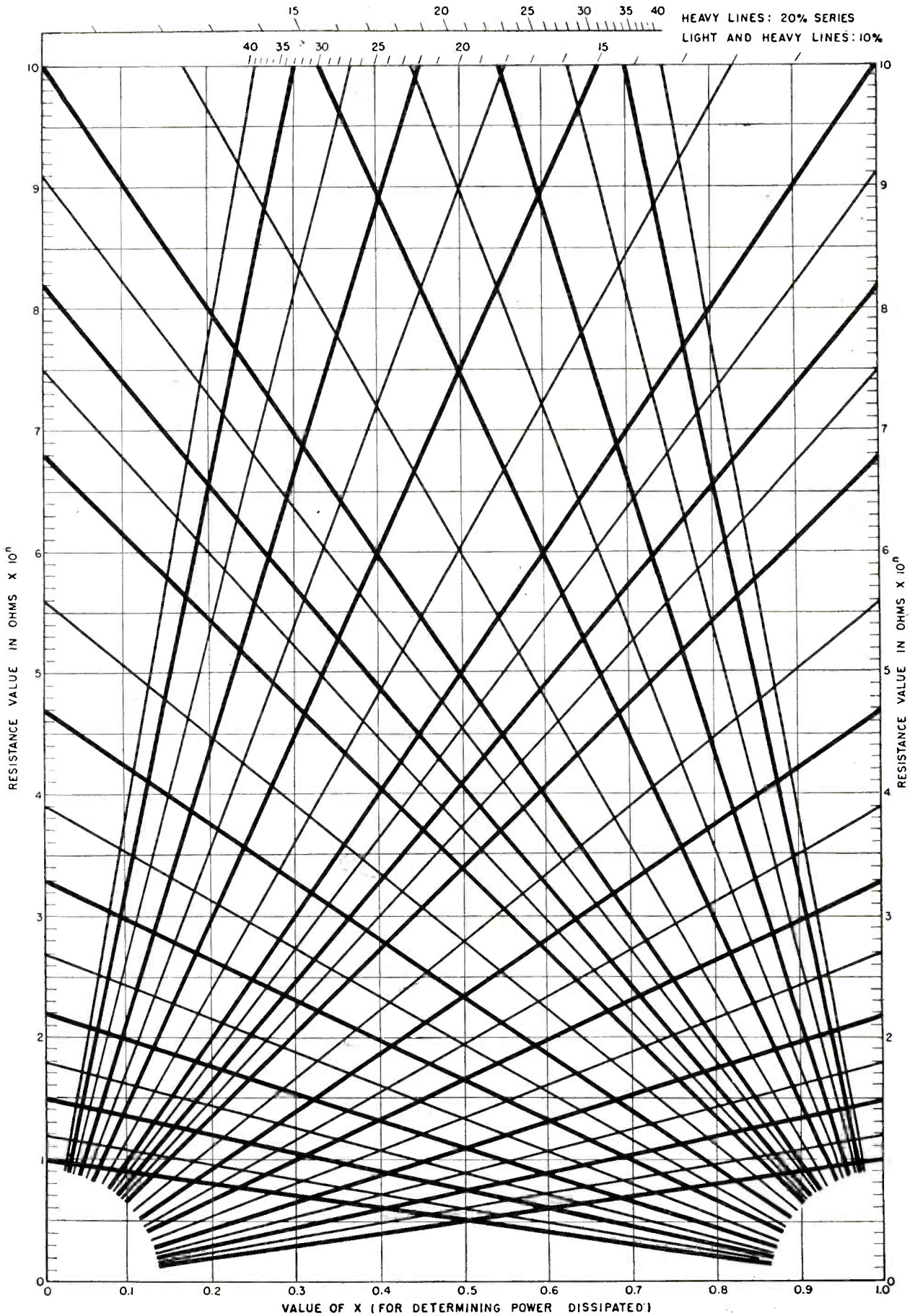
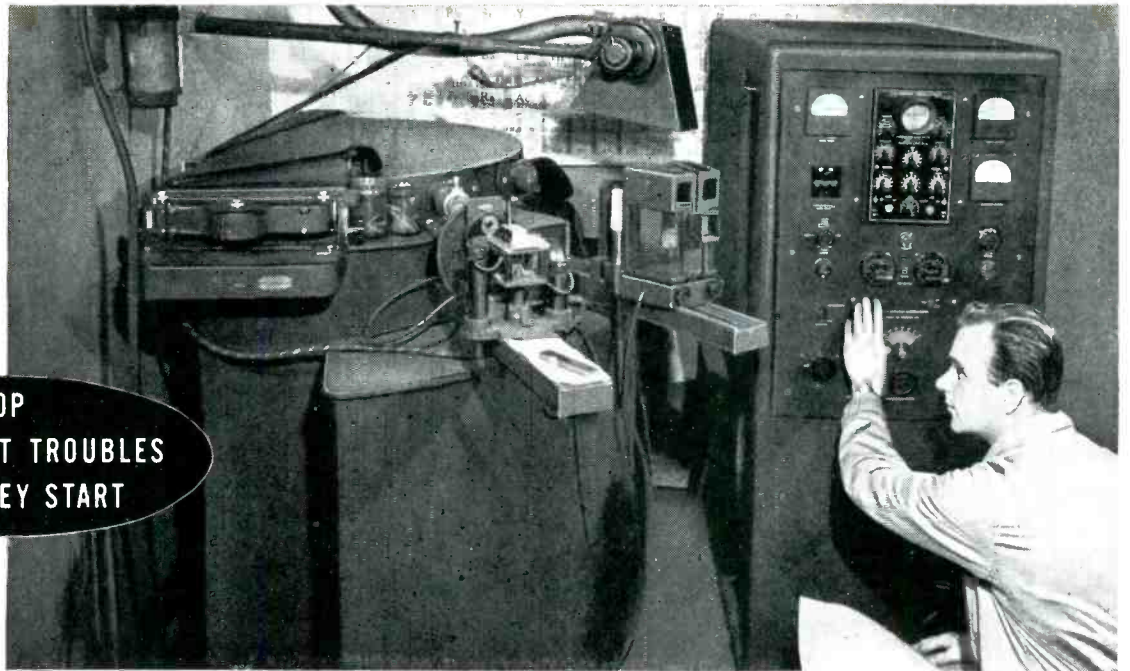

FIG. 1—Trace along horizontal line for desired parallel resistance, note nearest intersection of lines coming from lower left and right corners, and read RTMA preferred values of required individual resistors on side and top scales for these lines



STOP  
YOUR CONTACT TROUBLES  
BEFORE THEY START

*Spectrograph equipment in the Mallory Contact Engineering Laboratory for analyzing the composition of metals and alloys used in electrical contacts.*

## To A Concentration of .0001%

Mallory quality control includes spectrographic analysis of contact metals and alloys.

At Mallory, performance and long life for the contacts in your products start in the laboratory where a spectrograph and densitometer give fast accurate answers to the composition of metals and alloys.

This equipment is used regularly in production quality control as well as in new material development and trouble shooting. It is a positive means of identifying any contamination or impurity that might reduce contact efficiency.

Mallory is equipped with complete laboratory, engineering and production facilities to handle any contact requirement — from simple button or rivet contacts to complex contact assemblies.

Mallory engineers have had years of experience in the design and production of over 5000 different types of contacts and contact assemblies. We are ready for your call.

*Expect more . . . Get more from* **MALLORY**

In Canada, made and sold by Johnson Matthey and Mallory, Ltd., 110 Industry Street, Toronto 15, Ontario

Electrical Contacts and Contact Assemblies

**P. R. MALLORY & CO. Inc.**  
**MALLORY**

**SERVING INDUSTRY WITH THESE PRODUCTS:**

**Electromechanical** — Resistors • Switches • Television Tuners • Vibrators  
**Electrochemical** — Capacitors • Rectifiers • Mercury Batteries  
**Metallurgical** — Contacts • Special Metals and Ceramics • Welding Materials

**P. R. MALLORY & CO. INC., INDIANAPOLIS 6, INDIANA**

# ELECTRONS AT WORK

Including INDUSTRIAL CONTROL

Edited by ALEXANDER A. MCKENZIE

Low-Cost 3-D TV.....196	Noise Test for Magnetic Recording Media .....216
Peak-to-Peak Voltmeter Probe.....198	Low Temperatures in Electronics.....222
F-M Transistor Oscillator.....198	Piezoelectric Activity of Barium Titanate.230
Kilowatt Broadcast Ventilator.....198	Two R-C Oscillator Circuits.....234
Light Source for Phototubes.....202	A-C Voltage Regulation with Ordinary Transformers .....238
Ferroelectric Memory Circuits for Computers .....204	High Power Klystron Amplifier.....244
Ultrasonic Delay Lines.....210	
Pertinent Patents.....248	

## Low-Cost 3-D TV

INTENDED as an inexpensive means of bringing three-dimensional pictures to tv audiences, a system demonstrated on a closed circuit by American Television Inc. uses a rotating-shutter viewer synchronized with the tv cameras by the 60-cycle power-line frequency.

Two tv cameras are coupled together through a mirror system giving views separated by a distance approximating that between eyes. A square-wave generator alternately cuts off one camera then the other, producing 15 images per

second from each camera. The images are transmitted in the usual fashion, requiring no change in transmitting standards.

At the receiving end the television receiver need not be altered. The viewing unit has a synchronous motor to rotate a straight flat piece of metal with a cutout in each alternate corner. As the metal strip rotates, it opens the right eye, then the left one in step with the electronic switch at the camera. Since most television stations are local and in the same power network as

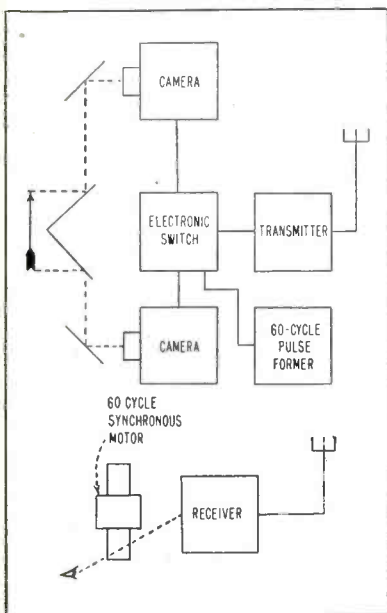
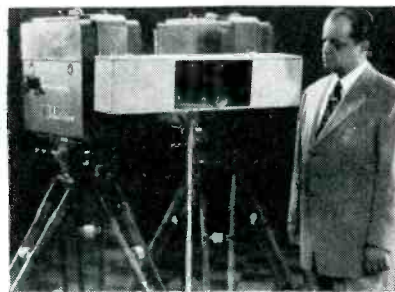

FIG. 1—Three-dimensional tv system synchronized by power-line frequency



Mirror-box takes separate images to two coupled cameras

the receiver the ordinary 60-cycle power system will provide synchronization.

Another possible method eliminating the mechanical viewer, uses a checkerboard system of Polaroid having a right and left alternate series of checkers and then using

## OTHER DEPARTMENTS

featured in this issue:

	Page
Production Techniques .....	262
New Products .....	292
Plants and People .....	334
New Books .....	364
Backtalk .....	386

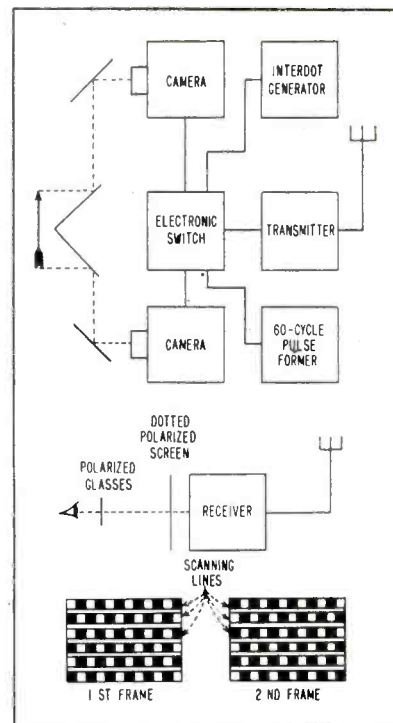
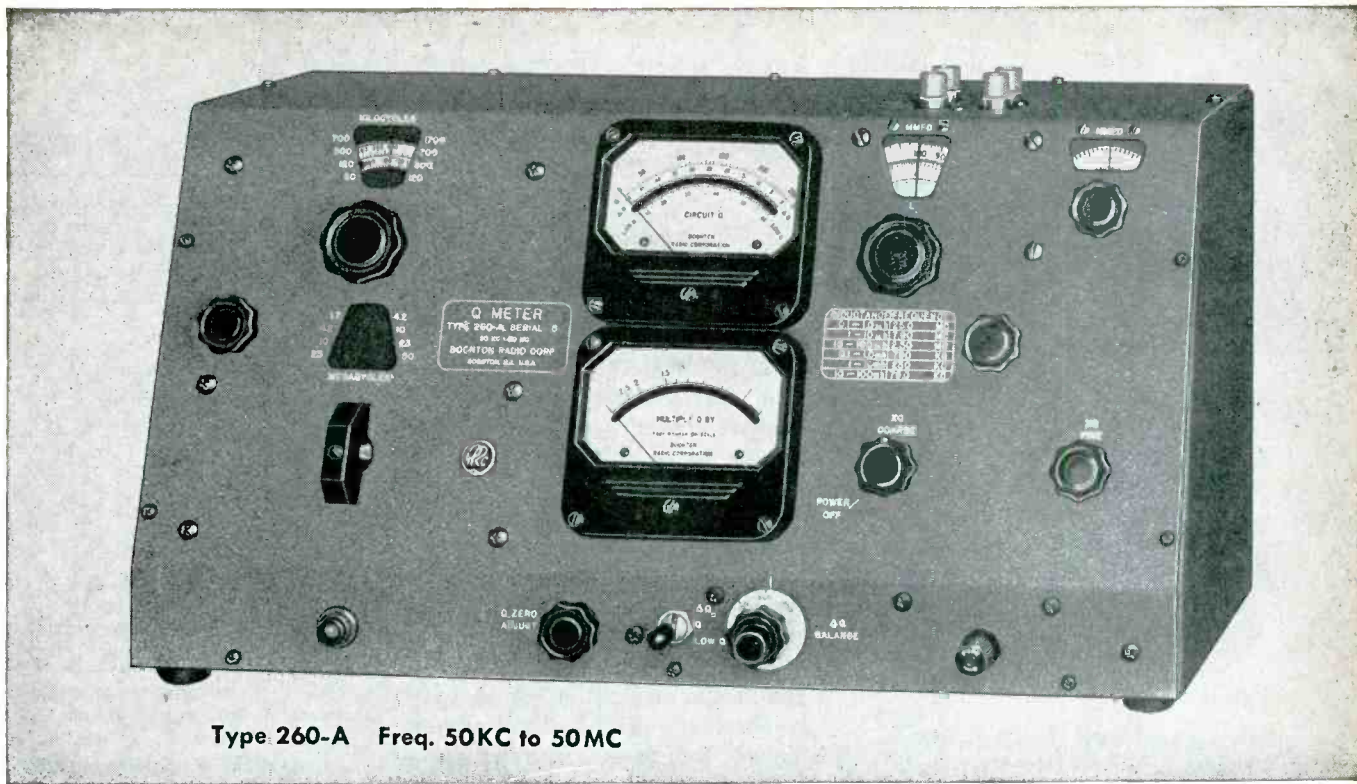

FIG. 2—Alternate method using interdot system to produce separate images

interdots at the transmitter to correspond with every other image. Polaroid spectacles having the lenses polarized at right angles to each other would be worn. No moving parts need be used in such a system.

The system using a mechanical viewer can also be used as a 2-color tv system. Each camera can be filtered to pick up a separate color and each eye can observe the colors alternately through similar





Type 260-A Freq. 50KC to 50MC

# 18 years of improvements are combined in this NEW Q Meter

## NEW FEATURES

- Lo Q Scale permits Q readings down to a value of 10.
- $\Delta$  Q Scale reads the difference in Q of two circuits or components up to a value of 125.
- Thermocouple for indicating current inserted into measuring circuit redesigned for high burnout point well above operating current.
- Oscillator maximum output level adjusted to minimize possibility of thermocouple failure.
- Voltage insertion resistor decreased to 0.02 ohms to minimize effect on measuring circuit. New type low reactance metalized coaxial resistor used.
- All indications on large meters with parallax correction and accuracy of  $\pm 1\%$  full scale.
- Range switch controls mask and arrow which indicate correct scale on frequency dial.
- Oscillator rigidly supported by casting which supports turret ball bearings and circuit using long life subminiature triode.

Visit our booths #2-521 and #2-522 at the I.R.E. Show

**BOONTON RADIO**

BOONTON · N · J · U · S · A ·

Corporation



The Q Meter Type 260-A replaces our Type 160-A, one of Boonton Radio's Q Meters which has been standard equipment in laboratories and on production lines for eighteen years. Many improvements have been made during this time, but several of our ideas for a better instrument were too extensive to put into a model already in production. These ideas were carefully tested for use in a new model. The Q Meter Type 260-A includes all past improvements and the extensive changes that we have accumulated.

### SPECIFICATIONS:

**FREQUENCY COVERAGE:** 50 KC to 50 MC Continuously variable in eight ranges.

**FREQUENCY ACCURACY:** Approximately  $\pm 1\%$ .

**RANGE OF Q MEASUREMENTS:** 10 to 625.

**RANGE OF DIFFERENCE Q MEASUREMENTS:** 0 to 125.

**INTERNAL RESONATING CAPACITANCE RANGE:**

Main Tuning Dial: 30 to 450 mmf (direct reading) calibrated in 1.0 mmf increments from 30 to 100 mmf: 5.0 mmf increments from 100 to 450 mmf.

Vernier:  $-3.0$  to  $+3.0$  mmf (direct reading) calibrated in 0.1 mmf increments.

**ACCURACY OF RESONATING CAPACITOR:**

Main Tuning Dial: Approximately  $\pm 1\%$  or 1.0 mmf, whichever is the greater.

Vernier:  $\pm 0.1$  mmf.

**POWER SUPPLY:** 90-130 volts—60 cps (internally regulated).

**POWER CONSUMPTION:** 65 Watts.

Model available for other Power Supply voltages and frequencies.

Type 103-A Accessory Inductors Available for entire frequency range.

PRICE: \$725.00 F. O. B. FACTORY

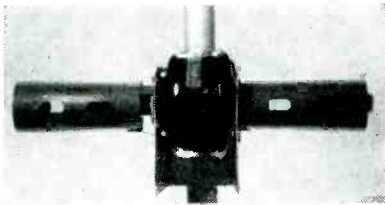

Synchronous motor drives two viewers mounted on shaft

filters on the viewer.

The advantage of the system lies in the low cost of the equipment. At the receiver the only requirement is a viewer that can sell for about \$5.00. The tv station uses its present equipment plus one electronic switch.

### Peak-to-Peak Voltmeter Probe

WHEN AN OSCILLOSCOPE is not available, the amplitude of complex waveforms can be measured with a vtvm using a crystal probe. The full-wave doubler circuit of Fig. 1 employs two type 1N58 germanium diodes.

Crystal  $D_1$  conducts whenever its cathode is negative. This causes  $0.5 \mu\text{f}$  capacitor  $C_1$  to charge in a negative polarity across 10-megohm

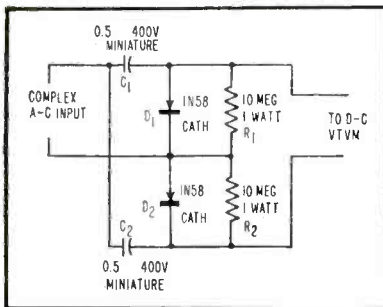

FIG. 1—Crystal-diode voltmeter probe

resistor  $R_1$ , producing a negative direct voltage at the terminals. The other crystal,  $D_2$  connected in opposite polarity produces a positive voltage across  $R_2$ .

Since these voltages add in series across the resistors, the vtvm reads peak-to-peak values on the d-c scale.

This information is abstracted with permission from *Sylvania News*, Mar. 1953.

## F-M Transistor Oscillator

By H. H. WIEDER  
AND NATHAN CASS

National Bureau of Standards,  
Washington, D. C.

IT IS GENERALLY KNOWN that certain ferroelectrics, such as the titanate ceramics, exhibit a marked change in capacitance with variations in the applied potential as shown in Fig. 1. A recent paper<sup>1</sup> presented a method of coupling a barium-strontium-titanate capacitor into the resonant circuit of an oscillator in such manner that large frequency deviations with little amplitude modulation could easily be obtained. This method was employed for frequency modulating vacuum tube oscillators in the uhf and vhf ranges by relatively simple means. The essential feature of this system is the provision for an impedance transformation of the titanate capacitor as shown in Fig. 2. The reflected impedance of this non-

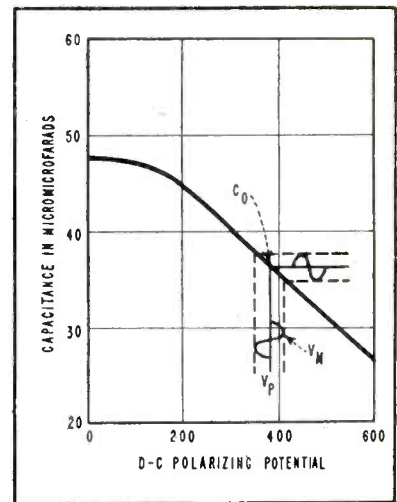
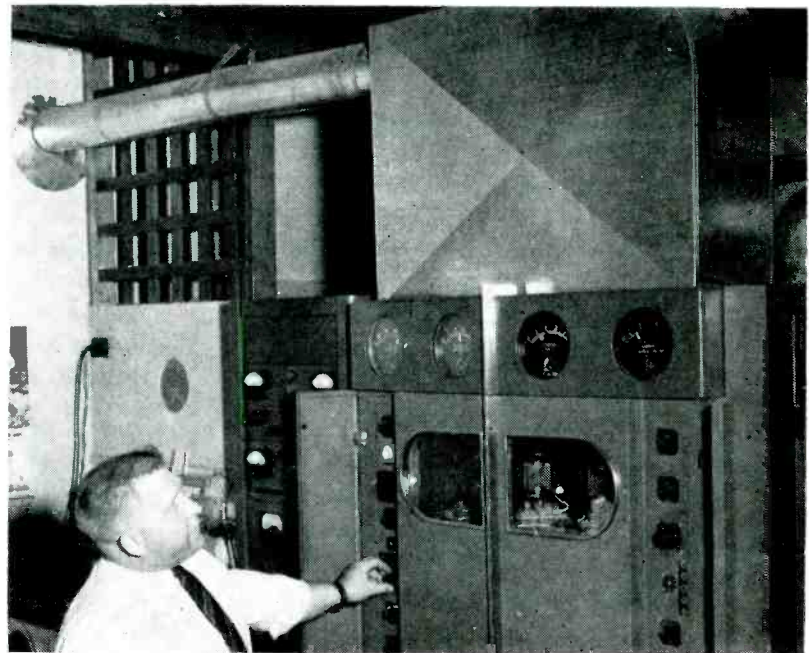

FIG. 1—Capacitance versus polarizing potential for barium-strontium-titanate capacitor when  $V_M$  is a-c modulating potential and  $V_P$  is d-c polarization potential

linear capacitor is used to vary the resonant frequency of the oscillator tank circuit.

Two advantages are obtained in this manner: The effective Q of the

## KILOWATT BROADCAST VENTILATOR



Engineers at WAEB in Allentown, Pa. reduced the ambient temperature within their 1-kw broadcast transmitter from 10 to 15 degrees when they made three changes in the cooling system. Chief Engineer W. R. Gottshall (above) hit upon the idea of installing a duct and exhaust fan connecting the escape vent atop the transmitter to the outside. A supplementary 100-cfm blower circulates room air around power transformers. Additional vent holes were drilled in the cabinet. These holes and existing vent openings are covered with double thicknesses of cheese cloth

Now available  
in **TWO** versions

# The AJ Series Helipot

...**TINY** 10-turn Helipots  
with **BIG** performance

12 times the resolution of conventional units!

In all airborne and many other modern electronics applications for precision potentiometers, miniaturization, light weight and circuit simplification are key objectives. And you get these features—and more—in Helipot's new AJ Models... compact potentiometers the diameter of a penny, yet with 12 times the resolution of conventional potentiometers of the same diameter. Announced only a few months ago, the original AJ has proven so popular that it is now made in two versions to meet the requirements of its many users—the original AJ mounting with a threaded bushing... and the new AJS mounting for servo applications. Also, the AJS is available in two bearing arrangements—AJS with sleeve bearings, and the AJSP with ball bearings.

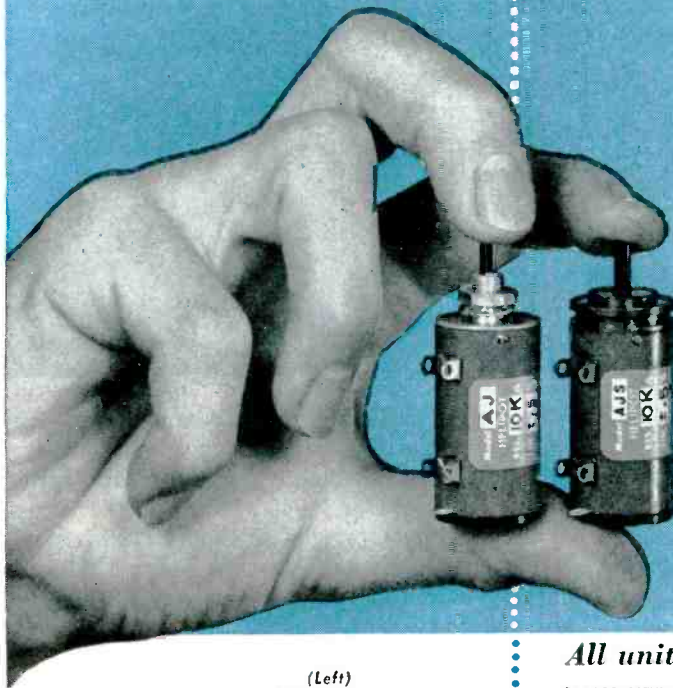

(Left)  
Model AJ  
Bushing Mounting

(Right)  
Model AJS  
Servo Mounting

## All units have these important features . . .

**SMALL SIZE—LIGHT WEIGHT:** All AJ Models are only 3/4" in diameter (small as a penny) 1 3/8" long—weigh 1.0 oz. They require a minimum of valuable panel space!

**HIGH PRECISION—CIRCUIT SIMPLICITY:** On many applications an AJ Series will replace two conventional potentiometers, providing both wide range and fine adjustment in one

unit. The 18" slide wire gives a resolution of 1/3000 in a 100 ohm unit—1/6500 in a 50,000 ohm unit!

**RELIABILITY:** The AJ models are rugged and simple—built to close tolerances with careful quality control. Their performance and reliability reflect the usual high standards of Helipot quality.

## Advanced Construction

For light weight, unusual compactness, high accuracy and resolution, coupled with utmost reliability, investigate the AJ series . . .

- ▶ All types have bearings at each end of the shaft to assure precise alignment and linearity at all times.
- ▶ Either single or double shaft extensions can be provided to meet individual needs . . . also, ball or sleeve bearings, special shaft lengths, flats, screwdriver slots, etc.
- ▶ By means of a unique Helipot welding technique, tap connections can be made to only ONE turn of the resistance winding, and can be provided at virtually any desired point on the resistance element.
- ▶ New improved terminals are rigidly anchored in place to prevent twisting and coil failures due to fatigue. These anchor-locked terminals are used both at the taps and at the coil ends.

## Meet Rigid Helipot Standards

Helipot—world's largest manufacturer of precision potentiometers—has built an enviable reputation for its high design and construction standards, and the AJ models meet these standards in every way.

The resistance elements are made of precision-drawn alloys, accurately wound by special machines on a heat-dissipating copper core.

Each coil is individually tested, then permanently anchored in grooves precision-machined into the case. Slider contacts are of long-lived Paliney alloy for low contact resistance and low thermal e.m.f. . . . and all terminals are silver plated and insulated from ground to pass 1,000 volt breakdown test.

In spite of light weight and compact design, all AJ models are built throughout for long life and rugged service. Potentiometer life varies with each application, of course, depending upon rotation speed, temperature, atmospheric dust, etc. But laboratory tests show that under proper conditions, all of the AJ series have a life expectancy in excess of one million cycles each!

Get full details from your nearest Helipot representative—or write for Data File # 702.

# THE Helipot CORPORATION

A subsidiary of Beckman Instruments, Inc.

SOUTH PASADENA, CALIFORNIA

Field Offices: Boston, Rochester, New York, Philadelphia, Cleveland, Detroit, Chicago, St. Louis, Los Angeles, Seattle, Dallas, High Point, N. C. and Fort Myers, Florida, in Canada: J. S. Root, Toronto. Export Agents: Frathorn Co., New York 36, New York.

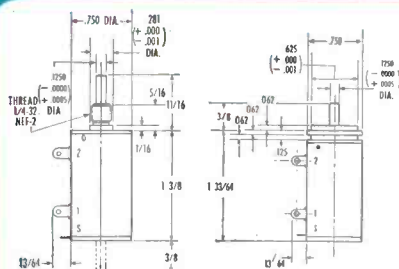

AJ

AJS

## CONDENSED SPECIFICATIONS

Number of turns	10
Power rating	2 watts
Coil length	18"
Mechanical rotation	3600° + 12° - 0°
Electrical rotation	3600° + 12° - 0°
Resistance ranges	100 ohms to 50,000 ohms
Resistance tolerance	± 5.0%
Linearity tolerances:	
All values	± 0.5% (standard)
5000 ohms and above	± 0.1%
Below 5000 ohms	± 0.25%
Starting torque	0.75 oz. in.
Net weight	1.0 oz.

## THE FRONT COVER

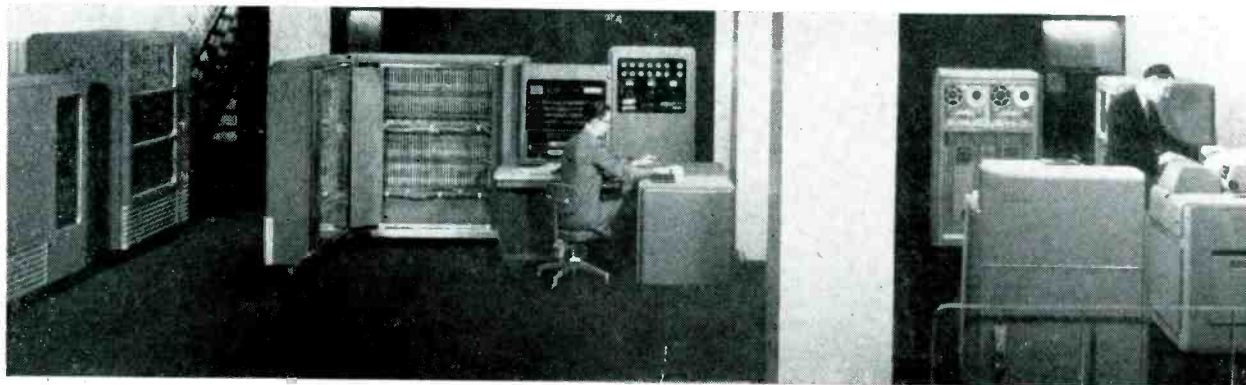

**D**ESIGNED to speed engineering and scientific computation, the IBM electronic data-processor Model 701 comprises eleven interconnected units. Data on punched cards can be fed to the machine at the rate of 600 equivalent decimal digits per second. Its punched card output is 400 digits per second. Over 16,000 addition or subtraction operations per second can be performed and multiplication is possible at rates exceeding 2,000 operations per second.

The equipment works in a binary notation. Standard word length is 36 binary digits. The master-oscillator pulse-repetition-frequency is one megacycle.

Three information-storage systems are employed: Two electrostatic-memory frames each using 72 specially-designed 3-inch cathode-ray tubes provide storage capacity for 2,048 words. The magnetic-drum memory comprises two drums, each having 72 information tracks and accommodating 8,192 words. Two magnetic-tape units can store 200,000 words and are particularly useful for filing program information.

The machine employs 4,000 vacuum tubes and 12,000 germanium diodes. The unit shown in the photograph is installed at IBM headquarters in New York.

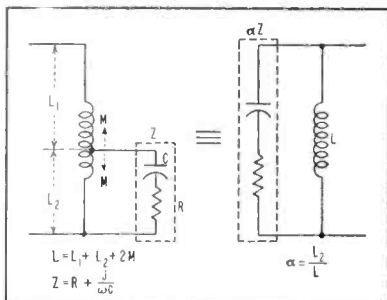

FIG. 2—Inductively coupled resonant circuit and its equivalent.  $Z$  is  $\text{BaTiO}_3$  modulating capacitor

resonant circuit can be made much higher than the low  $Q$  of the titanate capacitor. The  $IR$  drop across the ceramic is reduced to a minimum, eliminating capacitor damage caused by internal dielectric heating.

This method of modulation can be extended to transistor oscillators. An r-f oscillator employing a standard commercial junction transistor and a novel method of providing a polarization potential to the ceramic capacitors by means of a Zamboni pile are described below.

Figure 3 is a schematic of the frequency-modulated pnp junction

transistor oscillator. The generalized equations determining the relationships of emitter, collector, and base impedances for a c-w oscillator using point-contact transistors were described by Oser, Enders, and Moore<sup>2</sup>, and are equally applicable for the junction transistor.

The collector impedance is zero and the base impedance is maximum at the frequency of oscillation. A stable sinusoidal wave is obtained at 2.5 megacycles. The oscillator delivers about one milliwatt using a 30-volt miniature B battery at one milliampere. The barium titanate modulating capacitor  $M$  is coupled to the inductance  $L$  by a transformation ratio selected at will. Varying the potential impressed upon the titanate alters its effective capacitance and, consequently, the resonant frequency. It can be seen by referring to Fig. 1, that a polarization potential is necessary to bring the capacitance variations within the linear range of the  $\Delta c/\Delta v$  curve.

The Zamboni pile  $z$  is used as a polarization source in this circuit. High voltage piles of the Zamboni

type were described by Howard<sup>3</sup>; they are characterized by a high internal resistance and exceedingly long life. They have been used with some success in applications requiring high potentials with low current drains (less than  $10^{-9}$  ampere).

Measurements on the a-c impedance at audio and ultrasonic frequencies of two sample piles manufactured at the National Bureau of Standards indicated an essentially resistive value of impedance in the order of a thousand ohms. The function of  $C_1$  in the diagram is to

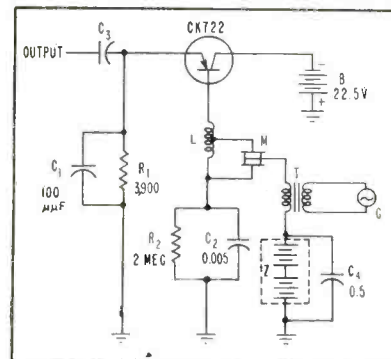

FIG. 3—Schematic of f-m transistor oscillator

# *pioneers in precision*



## **G. M. Giannini and Co. Inc.,**

a pioneer in remote control and indicating instrument development, is the foremost manufacturer of toroidally wound low torque potentiometers. Microtorque and Rotostepper unit combinations have been used in many unusually difficult control instrument applications.

## **Miniature Precision Bearings**

incorporated, pioneered and developed the first miniature radial ball bearings. From a group of five original ball bearings, **MPB** has designed and developed a completely integrated line of more than 130 types and sizes many of which now form the basis for international standardization. This extensive variety of **MPB** ball bearings makes possible the application of anti-friction and freedom from attention qualities in thousands of miniaturization projects.

**MPB** ball bearings are fully ground, lapped, and/or honed to ultra precision finishes (ABEC 5 or better). They are torque tested, ultrasonically cleaned, supplied in specific tolerances and classified within the tolerances for prompt assembly and maximum service. **MPB** ball bearings are normally supplied in 10 design series, from 1/10" to 5/16" o.d., of selected chrome bearing steel. Most are also supplied in stainless steel, some in beryllium copper, and all are assembled with best quality balls.

More than a million **MPB** ball bearings have played a vital part in the efficient operation of aviation instruments, railway and marine indicating and recording devices, cameras, medical appliances and other equally fine mechanisms. The wealth of engineering knowledge gained through participation in an extraordinarily broad field of application is available to you.

*Our facilities have been expanded so that we can now schedule prompt delivery of most sizes. Our completely new and enlarged catalog is now being distributed, and will be gladly mailed if you request Bulletin E7.*

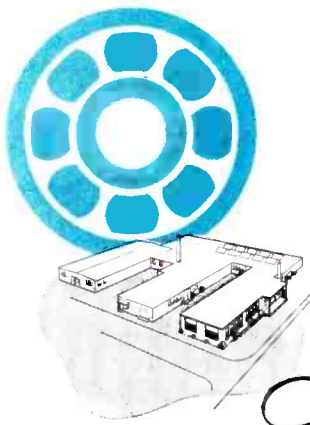

## **Miniature precision Bearings**

Incorporated



Keene, New Hampshire

*"Pioneer Precisionists to the World's foremost Instrument Manufacturers"*

*save  
space  
weight  
friction*

# 50% SMALLER LIGHTER

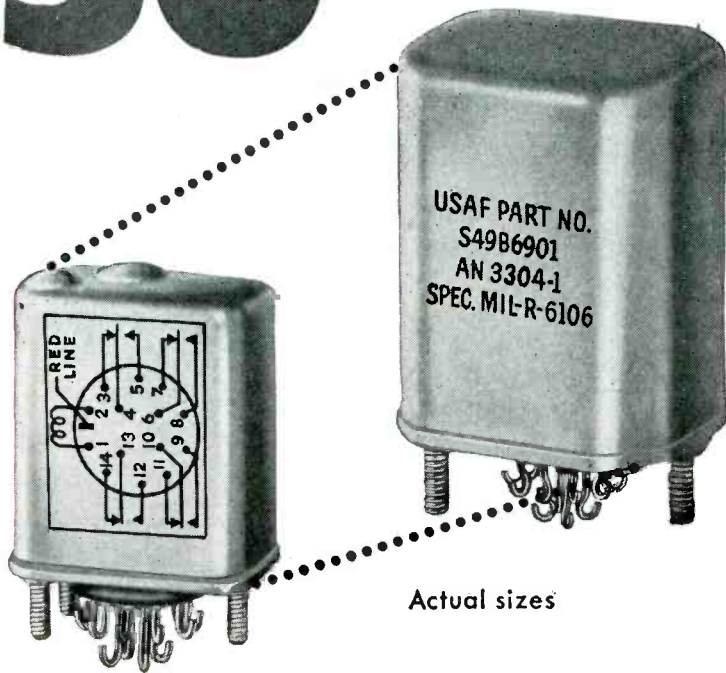

## R-B-M 22300 SERIES

### Hermetically Sealed Relays

The R-B-M 22300 hermetically sealed telephone type relay is the electrical and mechanical equivalent of AN 3304-1, except for smaller size and mounting dimensions.

An improved armature design, plus high temperature molded nylon coil bobbin, provides greatly improved magnetic efficiency and enables R-B-M to reduce the overall size of the relay. The R-B-M 22300 design still retains palladium cross-bar contacts identical to those used in the larger size.

Maximum contacts—6 Form A and 4 Form C—3 ampere 28 Volts. D. C. coil construction only. Maximum coil resistance 5000 ohms. Minimum power .75 watts. Also available in AN 3304 can for dynamotor or low capacitance application.

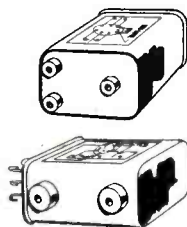

Optional Mounting Arrangements

Write Dept. B-7 for ASR Bulletin



**R-B-M DIVISION  
ESSEX WIRE CORP.**  
Logansport, Indiana

MANUAL AND MAGNETIC ELECTRIC CONTROLS  
— FOR AUTOMOTIVE, INDUSTRIAL, COMMUNICATION AND ELECTRONIC USE

provide bypassing of the pile at audio frequencies. This capacitor must have a high leakage resistance in order to keep the d-c load on the pile at a minimum

Modulation transformer *T* furnishes an a-c modulating signal that varies the titanate capacitance *M* about a quiescent value *C*. (Fig. 1), determined by the d-c polarization potential. The nonlinear capacitor *M* is composed of two series-connected 100- $\mu$ f capacitors; these are effectively in parallel with respect to the polarization and modulating potentials.

A frequency-modulated oscillator using the Bell Laboratories 1698 point-contact switching transistor at a carrier frequency of 3.5 megacycles gave results equal to those obtained for the junction transistor system described.

Although the frequency-modulated oscillator described is for the low r-f range, this oscillator can be designed for the higher-frequency ranges subject only to the limitation of the transistor frequency response.

Transistors, nonlinear capacitors and Zamboni piles have a limited range of temperatures in which their behavior is satisfactory. A simple afc system added to the transistor f-m oscillator could materially increase its range of stability without affecting the essential simplicity of the modulation system.

The authors are indebted to D. W. Finger of the Battery Research Section, National Bureau of Standards, for providing the Zamboni piles described in this article.

#### REFERENCES

- (1) M. Apstein and H. H. Wieder, A Wide Range F-M System using Non-Linear Capacitors; *ELECTRONICS*, to be published.
- (2) E. A. Oser, R. O. Enders, and R. P. Moore, Transistor Oscillators; *RCA Review*, XIII, No. 3, Sept. 1952.
- (3) Paul L. Howard, A High Voltage Pile of the Zamboni Type. *Journ. Electrochem. Soc.* 99, No. 8; Aug. 1952.

#### Light Source for Phototubes

TRITIUM-ACTIVATED self-luminescent materials for use as light sources have levels of luminosity up to 25 microlamberts. Beta rays emitted by tritium are completely absorbed by a sheet of paper and the ma-

One thing in common ...



**Hoffman**

**Admiral**  
**Magnavox**

**GREAT NAMES IN COMMUNICATIONS ...**

**RELY ON**  *Midland* **CRYSTALS**

These companies—and many others in leadership position in the field—depend on Midland crystals for completely reliable frequency control in their products.

**THAT FACT IN ITSELF** is testimonial enough to the kind of performance Midland Quality Control has built into millions of crystals for every communications use.

*Whatever your Crystal need, conventional or highly specialized  
When it has to be exactly right, contact*



*Midland*

**MANUFACTURING COMPANY, INC.**  
3155 Fiberglas Road, Kansas City, Kansas

**WORLD'S LARGEST PRODUCER OF QUARTZ CRYSTALS**

# Winchester Electronics

"L-LT" indicates  
knob-actuated locking.  
Knob (LT) may be on  
either plug or recep-  
tacle.

Plug  
QRE12P-LT

Receptacle  
QRE12S-L

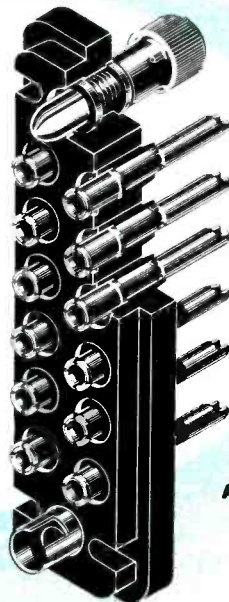

ACTUAL  
SIZE

## QRE CONNECTORS

for HIGH CURRENT  
HIGH ARC RESISTANCE  
HIGH DIELECTRIC  
RUGGEDNESS  
COMPACTNESS  
QUICK DISCONNECT

High acceptance is also a feature of Winchester Electronics' Connectors resulting from the exceptional service they give in critical applications. These patented\* Connectors have the following **SPECIAL FEATURES**:

**POLARIZING:** Heavy guide pilot and socket insure self-alignment of contacts as well as polarization.

**SELF-ALIGNING:** Individually floating contacts assure self-alignment.

**QUICK-DISCONNECTING:** Individually spring loaded contacts enable ease of separation. Forcing, which results in damage, is eliminated and special levers are not required.

**PRECISION MACHINED CONTACTS:** Pins from brass bar (QQ-B611) and sockets from spring temper phosphor bronze bar (QQB-746a). They

are gold plated over silver for consistent low contact resistance, reduction of corrosion and ease of soldering.

**MOLDED MELAMINE BODIES:** (MIL-P-14) Mineral-filled and fungus-proof. Provide mechanical strength as well as high arc and dielectric resistance.

**MONOBLOC† CONSTRUCTION:** Eliminates unnecessary creepage paths, moisture and dust pockets, and provides stronger molded parts.

HOODS, CONNECTOR CLAMPS AND MOUNTING BRACKETS AVAILABLE.

**WINCHESTER PRODUCTS AND WINCHESTER DESIGNS ARE AVAILABLE ONLY FROM WINCHESTER ELECTRONICS, INCORPORATED.**

QRE Connectors are available with 6, 12, 18, 24, 34 and 208 contacts.  
\*Patent Number 2,466,370 †Trade Mark

Wire or write our Sales Department about your special requirements.

West Coast Branch: 1729 WILSHIRE BOULEVARD  
SANTA MONICA, CALIFORNIA

## WINCHESTER ELECTRONICS INCORPORATED

GLENBROOK, CONN., U.S.A.

material has no penetrating x-rays or gamma radiation.

A tritiated organic phosphor, such as trans-stilbene has peak emission at 3,800 Å with some emission in the visible spectrum. By mixing a tritiated solid with an efficient phosphor, such as zinc sulfide, spectral emission characteristics can be chosen with peaks from about 4,000 to 7,000 Å.

A light source can be obtained with maximum emission peak at 4,550 Å to approximate the 4,800-Å peak response of the 5819 multiplier phototube.

From general theoretical considerations, it can be expected that the luminosity of tritiated light sources would follow the rate of decay of tritium, which corresponds to a loss in light output of about 5 percent per year.

Light sources suitable for standardization of phototubes are available from Tracerlab, in Boston, Mass., but approval for purchase is required from the U.S. Atomic Energy Commission.

## Ferroelectric Memory Circuits for Computers

FERROELECTRIC PROPERTIES of barium titanate have made this material useful as a storage element in computers and switching systems. Ferroelectric materials are dielectrics in which electric dipoles occur spontaneously and align themselves parallel by mutual interaction. Because of this, the dielectric induction versus applied electric field intensity for ferroelectric materials show hysteresis loops similar to the curves of flux density versus field intensity for ferromagnetic materials.

The basic memory circuit consists of a minute capacitor containing a ferroelectric material as

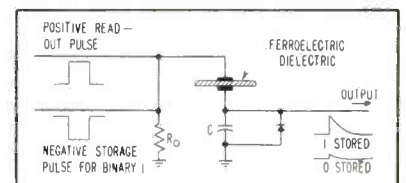
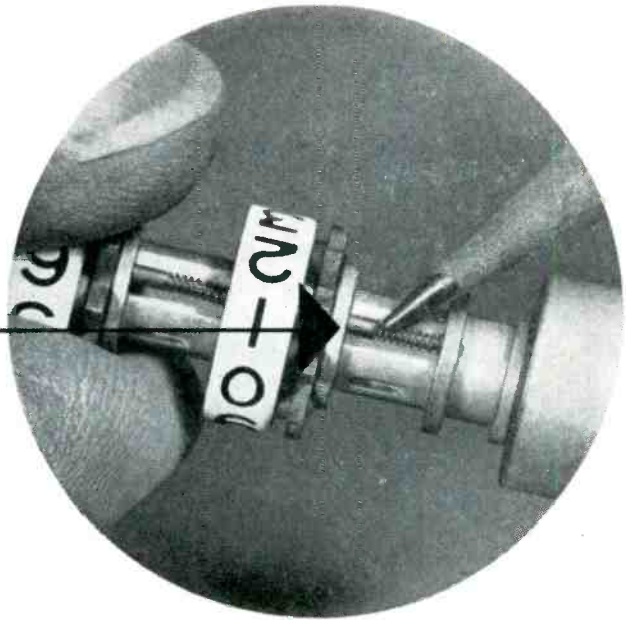

FIG. 1—Circuit of the basic ferroelectric memory unit



**Eyestrain here**  
**used to be**  
**a big cost factor**  
**for MONROE**



These little plunger pins locate the dials on the Monroe LA Desk Calculator. Each has a 90° cone point that fits into a detent of 110° included angle.

Previously, binocular microscopes were used to check cone angle, length, roundness, and diameter of these pins. But, the inspectors had to spend considerable time just resting their eyes—and running up the cost of the reliability that Monroe customers expect.

Now the microscopes are gone and checking these pins on the Kodak Contour Projector, Model 3, is more like watching television. Moreover, with the unique Surface Illuminator of the Kodak Contour Projector, inspectors are

able to check surface finish on the cone tip of the plunger at 50X, to make sure of free movement and positive stopping of the calculator dials.

Many other parts involved in the foolproof operation of Monroe calculating machines are being inspected in large volume on a battery of Kodak Contour Projectors, Model 3. They average about 13 critical dimensions for each part, shapes are mostly rather complex. By carefully engineered mechanical gages, Monroe had brought the inspection time per piece down to an average of about 50 seconds. Optical gaging on the Kodak Contour Projector has brought this average down to 12 seconds.

If you'd like to find out if such economies could be effected in your production program, write and ask us for more information. Eastman Kodak Company, Special Products Sales Division, Rochester 4, N. Y.

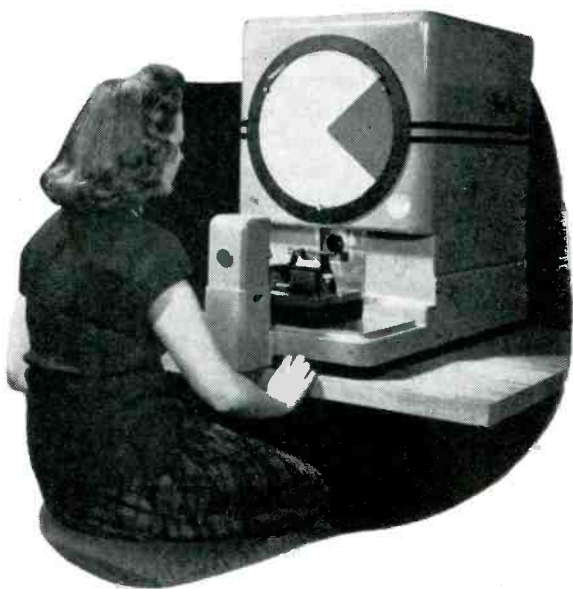

**the KODAK CONTOUR PROJECTOR**



A new sound movie shows how to simplify complex inspection problems. We'll tell you how to get it for a showing.

**Kodak**  
TRADE-MARK

✓ Largest assortment of sizes and mounting styles to match equipment requirements

## MECHANICALLY

✓ Widest range of types to match exacting circuit requirements

## ELECTRICALLY



# RELAYS

**5,348  
TYPES**

## STRUTHERS-DUNN

STRUTHERS-DUNN, INC., 150 N. 13th ST., PHILADELPHIA 7, PA.

BALTIMORE • BOSTON • BUFFALO • CHARLOTTE • CHICAGO • CINCINNATI  
CLEVELAND • DALLAS • DETROIT • KANSAS CITY • LOS ANGELES  
MINNEAPOLIS • MONTREAL • NEW ORLEANS • NEW YORK • PITTSBURGH  
ST. LOUIS • SAN FRANCISCO • SEATTLE • SYRACUSE • TORONTO

a dielectric in series with an output capacitor that is shunted by a rectifier or resistor as shown in Fig. 1. The rectifier is used only when it is desirable to prevent storage pulses from appearing across the output of the memory circuit. The ferroelectric material is initially polarized in one direction by a voltage pulse, called the read-out pulse, applied across it and the series output capacitor. This pulse clears out any previous memory condition in the ferroelectric material and restores it to a normal state in preparation for storage.

A binary 0 may be said to be stored when no storage pulse is applied. A binary 1 is stored by applying a voltage pulse opposite in polarity to the read-out pulse.

The stored information is read out by the read-out pulse applied across the ferroelectric and output capacitor. Voltage across the output capacitor will be high if the ferroelectric presents a high capacitance and low if the capacitance is low.

The capacitance of the ferroelectric is determined by the state of the dielectric. When in its normal state (binary 0 stored) the capacitance will be low, and when polarized in the opposite direction to the read-out pulse (binary 1 stored) the ferroelectric presents a relatively high capacitance to the pulse. Thus, the information stored is indicated by the amplitude of the output pulse.

The dynamic hysteresis loop involved in the operation of the circuit described is shown in Fig. 2, with the polarization of the crystal as the ordinate and applied voltage as the abscissa. The applied voltage is equal to the field strength times the crystal thickness. The normal state of polarization is at point A (binary 0). If a positive read-out pulse is applied the loop is traversed from A to C returning to A when the pulse is removed. The slope of the loop along this part indicates a low capacitance. When a binary 1 is stored in the material by a negative pulse the loop is traversed from A to D and back to B when the pulse is removed. If a positive read-out pulse is now applied the state of the material will move from

# MAGNETIC AMPLIFIERS

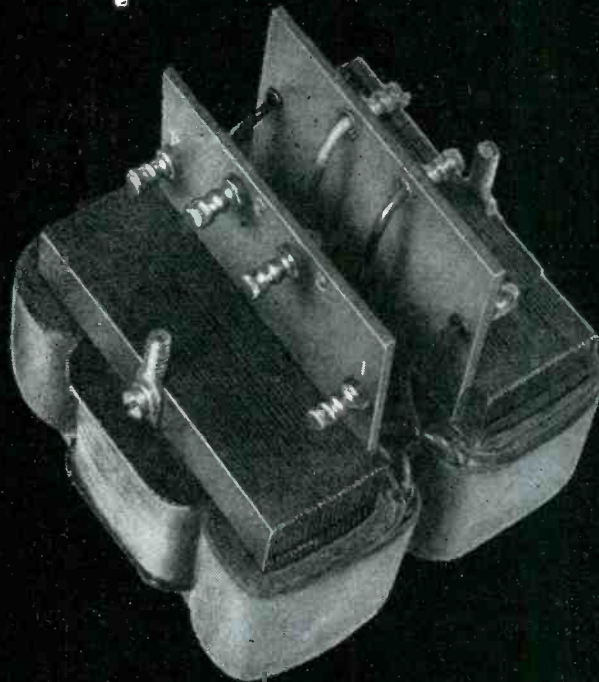

*Typical Keystone Magnetic Amplifier, open unit. Also supplied hermetically sealed.*

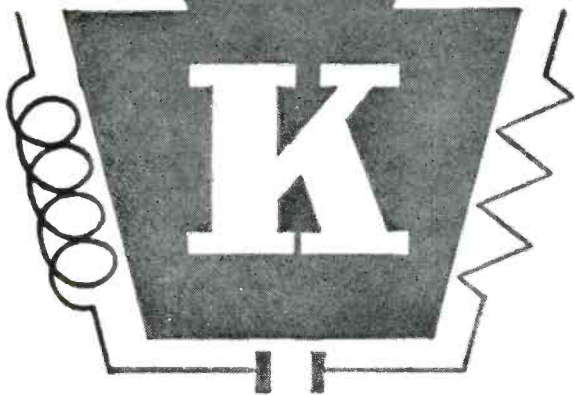

Keystone is noted for its specialization in magnetic amplifiers. No standard "line" . . . rather we build magnetic amplifiers of all sizes, your design or ours. We'll ship them right on schedule, open or hermetically sealed. If magnetic amplifiers for Servo systems are your problem, we'll give your inquiry prompt, intelligent attention.

**KEYSTONE PRODUCTS COMPANY**  
UNION CITY 2, N. J. • UNION 6-5400



# TWO VERSATILE Electronic Voltmeters

## A Sensitive VOLTMETER and NULL DETECTOR

### AS A VOLTMETER

Frequency Range.....10cps—2mc  
Voltage Range.....100 $\mu$ v—100v  
Input Impedance.....2meg shunted by 15 $\mu$ f  
Accuracy.....3% 10cps—1mc  
5% elsewhere

- Voltages as low as 40 microvolts can be measured.

### AS A NULL DETECTOR

Frequency Range.....5cps—4mc  
Threshold Sensitivity.....<10 $\mu$ v  
Max Scale Sensitivity.....10 $\mu$ v/scale  
division down to 40 $\mu$ v

- Can be used also as wide-band preamplifier with max gain of 60DB and 500  $\sim$  output impedance.

Model 310A  
\$235.



## A Sensitive VOLTMETER and DECADE AMPLIFIER

(Battery Operated)

### AS A VOLTMETER

Frequency Range.....2cps—150kc  
Voltage Range.....100 $\mu$ v—100v  
Input Impedance.....2meg shunted by 15 $\mu$ f  
Accuracy.....3% 5cps—100kc  
5% elsewhere

- Ideal for measuring voltages in circuits above ground potential.
- Switch provided for high meter damping.

### AS A DECADE AMPLIFIER

Frequency Range.....2cps—150kc  
Voltage Gains.....1000, 100, 10, 1  
Output Impedance.....approx 3000  $\sim$   
Equivalent Input Noise.....<10 $\mu$ v

Model 302B  
\$225.



### Both Instruments Feature

- Single logarithmic voltage scale with decade range switching.
- Same accuracy of reading at ALL points on the scale.

## WORLD'S LEADING ELECTRONIC VOLTMETERS

Write for FREE DB calculator and for complete information on these and other Ballantine instruments.

# BALLANTINE LABORATORIES, INC.

100 FANNY ROAD, BOONTON, NEW JERSEY

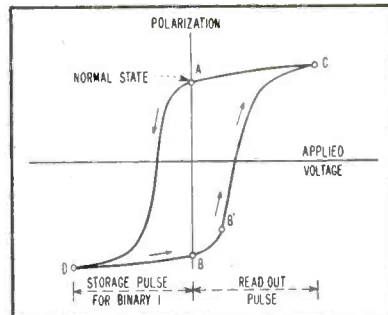

FIG. 2—Dynamic ferroelectric hysteresis loop

B to B' during the initial rise of the pulse.

This point occurs where the product of the voltage across the ferroelectric times its capacitance becomes equal to the voltage across the output capacitor times its capacitance. The capacitance at B' is quite high as shown by the steep slope of the hysteresis loop and most of the voltage of the read-out pulse appears across the fixed output capacitor. As the output capacitor discharges through the back resistance of the diode, the voltage across the ferroelectric increases until the saturation point C is reached. When the read-out pulse is removed the loop is traversed from point C back to A and the ferroelectric is left in its normal state.

Since the information stored in the ferroelectric material depends upon internal polarization and not on surface charge, the memory will last for several days even when the electrodes are short circuited.

It has been found that several independent sets of electrodes can be placed on the same crystal without appreciable interference between adjacent cells. This characteristic may allow the construction of memory storage units capable of storing as many as 2,500 binary digits on a crystal one inch square and 0.005 inch thick.

In a storage unit such as that shown in Fig. 3, 400 digits could be stored. Each face has a row of parallel electrodes set at a 90-degree angle to those on the other side. Each crosspoint of a top and bottom electrode forms a memory cell. To store a memory pulse in any cell in the array, one half of the required polarizing voltage is applied to the top electrode and an equal but opposite polarity voltage is applied to

## It's easy to convert tube exhaust systems with these pump and port units

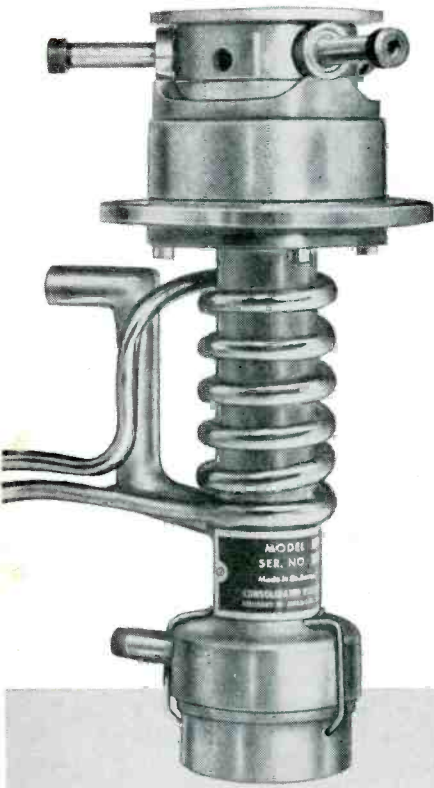

### For most rotary exhaust machines—

*CVC's* Oil Diffusion Pump model MB-10 and port type TP-02 offer the maximum compactness and performance:

- Together they measure only 8¾" high; operate through any sweep and sliding valve combinations.
- The pump speed is 10 liters/second; ultimate pressure in the port is 10<sup>-3</sup> mm Hg or lower; high limiting forepressure is 0.5 mm Hg.
- The two-position *mechanically* operated port and valve with its rugged mounting flange is easily attached to standard rotary machines.
- There's a readily removable jet assembly; jet parts separate to facilitate cleaning.
- The heater operates directly from any 115 volt power supply.

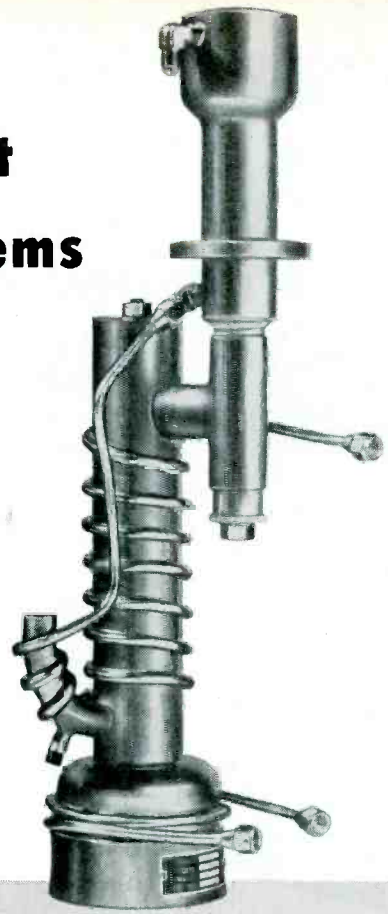

### For large size TV picture tube exhaust—

*CVC's* Fractionating Oil Diffusion Pump type MCF-60 with the quick closing port produces pressures of 10<sup>-5</sup> mm Hg and lower before getter flash in the large size picture tubes. Illustrated above is *CVC's* model MCF-60-013 (19½" high) having a rated speed of 60 liters/second and provided with:

- Water-cooled port for protection of rubber sealing gasket during bakeout.
- Quick opening compression type tubulation seal.
- Easily removable jet assembly.
- Properly located glass trap and clean-out port.

It's pumps like these that make *CVC* inline and rotary exhaust systems so efficient and economical to operate.

Whether you require just the pumps or a completely engineered exhaust unit, we welcome the opportunity of talking with you. *Consolidated Vacuum Corporation, Rochester 3, New York* (A subsidiary of Consolidated Engineering Corporation, Pasadena, Calif.)

**Consolidated Vacuum Corporation**  
Rochester 3, N. Y.

designers and manufacturers of high vacuum equipment  
SALES OFFICES: MENLO PARK, CALIF. • CHICAGO, ILL. • CAMDEN, N. J. • NEW YORK, N. Y.

formerly



Vacuum Equipment Dept.

TOP PERFORMANCE COSTS LESS  
with  
**JOHNSON**  
Type "C" and "D" Capacitors!

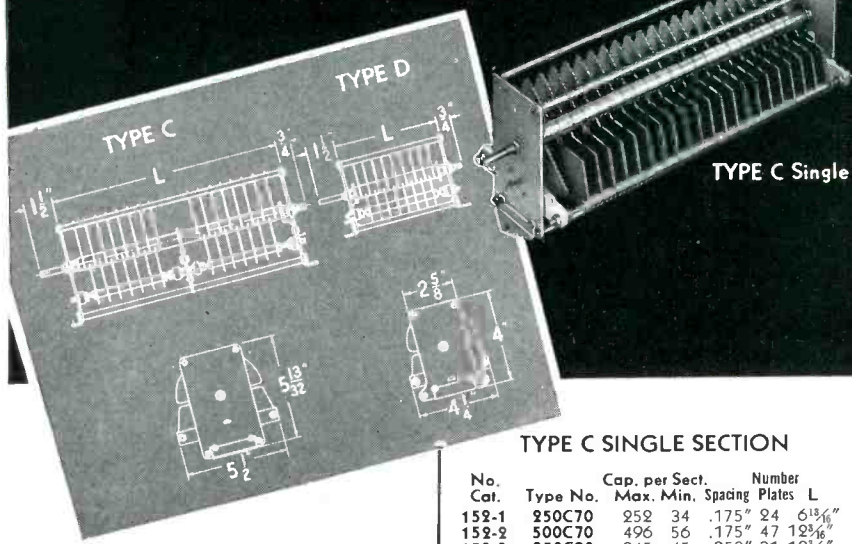

Tough, and of rugged construction, JOHNSON Type "C" and "D" capacitors are reliable, yet simply manufactured. Designed for use in medium power RF equipment, their functional engineering permits rapid, accurate assembly; resulting in lower construction costs and a lower sales price. The finest materials available today are used in the fabrication of JOHNSON Type "C" and "D" capacitors, and have been thoroughly tested and found ideally suited for their application.

**CONSTRUCTION**

Heavy aluminum end frames, .051" plates and 5/16" tie rods assure extreme rigidity. Rotor contacts are laminated phosphor bronze. Dual models have center rotor contact for electrical symmetry. Low-loss Steatite insulators are located outside the most intense RF fields and used solely to support stator assemblies. Shafts are 1/4" diameter, cadmium plated with 3/4" rear extensions.

Mounting brackets furnished for normal or inverted mounting. End frames drilled and tapped for panel mounting, special brackets or mounting of accessory components.

**SPECIAL TYPES**

Variations from standards such as special capacitances, ball bearings, dynamically balanced rotors, stainless steel shafts and right angle drive duals can be furnished in production quantities.

**TYPE C SINGLE SECTION**

No. Cat.	Type No.	Cap. per Sect. Max. Min.	Spacing	Number Plates	L
152-1	250C70	252 34	.175"	24	6 13/16"
152-2	500C70	496 56	.175"	47	12 3/4"
152-3	250C90	245 45	.250"	31	12 3/4"
152-4	350C90	337 63	.250"	43	14 27/32"
152-5	50C110	51 19	.350"	8	4 25/32"
152-6	100C110	103 30	.350"	17	8 19/32"
152-7	250C110	251 66	.350"	41	18 5/8"
152-8	50C130	51 24	.500"	10	7 11/16"
152-9	100C130	102 42	.500"	21	13 11/32"

**TYPE C DUAL SECTION**

152-501	200CD45	204 21	.125"	15	8 19/32"
152-502	300CD45	290 26	.125"	21	10 5/8"
152-503	200CD70	198 27	.175"	19	12 3/16"
152-504	300CD70	305 37	.175"	29	16 25/32"
152-505	150CD90	147 30	.250"	19	14 25/32"
152-507	50CD110	50 18	.350"	8	10 5/8"
152-509	100CD110	103 32	.350"	17	16 25/32"
152-510	50CD130	51 24	.500"	10	14 27/32"

**TYPE D SINGLE SECTION**

153-2	100D35	99 14	.080"	8	2 23/32"
153-4	250D35	252 24	.080"	20	4 25/32"
153-6	500D35	496 36	.080"	39	6 25/32"
153-7	100D45	104 19	.125"	12	4 25/32"
153-8	150D45	146 23	.125"	17	4 25/32"
153-9	50D70	51 17	.175"	7	2 25/32"
153-10	70D70	72 18	.175"	11	4 25/32"
153-11	100D70	98 23	.175"	15	4 25/32"
153-12	150D70	151 31	.175"	23	6 13/16"
153-13	250D70	244 45	.175"	37	10 5/16"
153-14	350D70	351 62	.175"	53	13 11/32"
153-15	50D90	53 20	.250"	10	4 25/32"
153-16	70D90	73 25	.250"	14	5 13/16"
153-17	100D90	99 30	.250"	19	7 11/16"
153-18	150D90	149 43	.250"	29	10 5/16"

**TYPE D DUAL SECTION**

153-501	100DD35	95 13	.080"	8	4 25/32"
153-502	150DD35	147 15	.080"	12	5 13/16"
153-503	200DD35	202 19	.080"	16	7 11/16"
153-504	300DD35	291 24	.080"	23	9 15/32"
153-505	500DD35	496 38	.080"	39	13 11/32"
153-506	150DD45	155 24	.125"	18	9 15/32"
153-507	200DD45	198 27	.125"	23	12 3/16"
153-508	50DD70	52 15	.175"	8	5 13/16"
153-509	70DD70	72 17	.175"	11	7 11/16"
153-510	100DD70	97 22	.175"	15	9 15/32"
153-511	150DD70	151 31	.175"	23	13 11/32"
153-513	50DD90	52 19	.250"	10	9 15/32"
153-514	100DD90	97 30	.250"	19	14 27/32"

For complete information on other types of JOHNSON variable capacitors, write for your copy of General Products Catalog 973

**E. F. JOHNSON COMPANY**  
CAPACITORS, INDUCTORS, SOCKETS, INSULATORS, PLUGS, JACKS, DIALS, AND PILOT LIGHTS  
228 SECOND AVENUE SOUTHWEST • WASECA, MINNESOTA

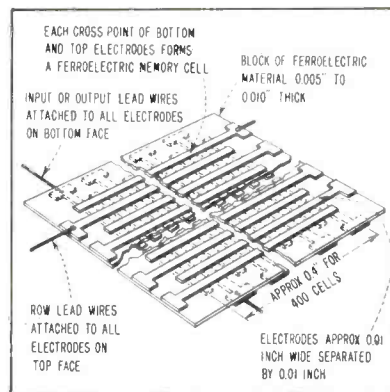

FIG. 3—Construction of a memory unit capable of holding 400 binary digits. Ferroelectric material suitable for this purpose has recently become available.

the bottom electrode. The cell in which the digit is stored will be at the cross point of the two electrodes. The full polarizing voltage will appear across a cell at the crosspoint while only half the required voltage will be applied across the other cells.

This type of circuit requires a ferroelectric material that will not change from its original state when positive or negative pulses one half of the polarizing voltage is applied. Such a material has recently become available and preliminary tests indicate that it might be possible to use it for constructing this type of array.

This article has been abstracted from a paper entitled "Ferro-electric Materials as Storage Elements for Digital Computers and Switching Systems" by J. R. Anderson, appearing in the Jan. 1953 issue of *Communications and Electronics*.

**Ultrasonic Delay Lines**

ULTRASONIC DELAY LINES were first developed during World War II as storage and timing elements for radar systems and computers. Recently they have been made commercially available as standard items with reproducible performance. The ranges in performance given below are extreme and all possible combinations may not be compatible.

The most practical type of delay line consists of a solid medium, preferably a glass or fused quartz, on which two quartz crystal trans-



for **POWER RESISTOR** needs  
COME TO . . .

# Greenohm\* HEADQUARTERS



Power Resistor Decade Box — any resistance from 1 ohm to 999,999 ohms—in working circuit.



"Standees" or above-chassis-mounted power resistors in ceramic casings, with Greenohm cement filling.

The toughest power resistors made! That's why you find Greenohms in radio-electronic and electrical assemblies noted for dependable performance and longest life.

These green-colored power resistors are available in *standard* and *special* types. Protected by the exclusive cold-setting inorganic cement, these units withstand severe overloads and extreme temperature changes without altering their resistance values or appearance. Resistance windings remain unimpaired in the manufacturing process.

Your needs most likely can be met by the extensive selection of fixed and adjustable Greenohms. But if your needs are extraordinary, then Clarostat is prepared to design your special power resistors and to deliver any quantities to meet any assembly schedules.

Engineering Bulletin on Greenohms, sent on request. Let us have your power resistor requirements for engineering collaboration, quotations, delivery schedules.

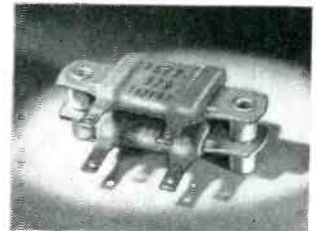

Stacked Greenohms for banking several power resistor sections.



Typical of special Greenohms — a screw-base resistor with handy knob for fast replacement, in changing resistance values.

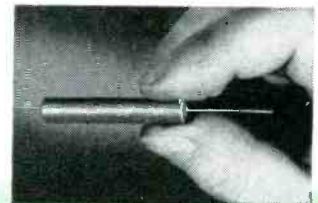

Greenohm Junior or miniature resistor in ceramic casing filled with Greenohm cement.

STAND PAT WITH

## CLAROSTAT Controls & Resistors

CLAROSTAT MFG. CO., INC., DOVER, NEW HAMPSHIRE

In Canada: Canadian Marconi Co., Ltd., Toronto, Ontario

\*Trade-marks

# THE RELIABLE ELECTRONIC MEMORY



## MAGNETIC DRUM STORAGE SYSTEMS for Rapid-Access Data Storage

The Magnetic Storage Drum has proved to be the most versatile rapid-access electronic memory yet developed. ERA pioneered the development of these systems. Today, you can select from the family of ERA Magnetic Storage Drums, a model with characteristics best suited to your requirements—without the necessity of costly special development. ERA Magnetic Drum Memory Systems provide *all* of these features:

- **LARGE STORAGE CAPACITY** allows a recorded density as high as 2200 binary digits per square inch.
- **HIGH SPEED** of associated equipment permits storage or reading of data at rates up to 125,000 digit-groups per second.
- **CONTINUED RE-USE** of recording surface—recording heads are not in contact with drum surface and no wear occurs.
- **NON-VOLATILE STORAGE** means stored information is unaffected in the event of power failure.



Send us your requirement. Write on your business letterhead to: Engineering Research Associates Division of Remington Rand Inc., 1902 West Minnehaha Avenue, St. Paul W4, Minnesota.

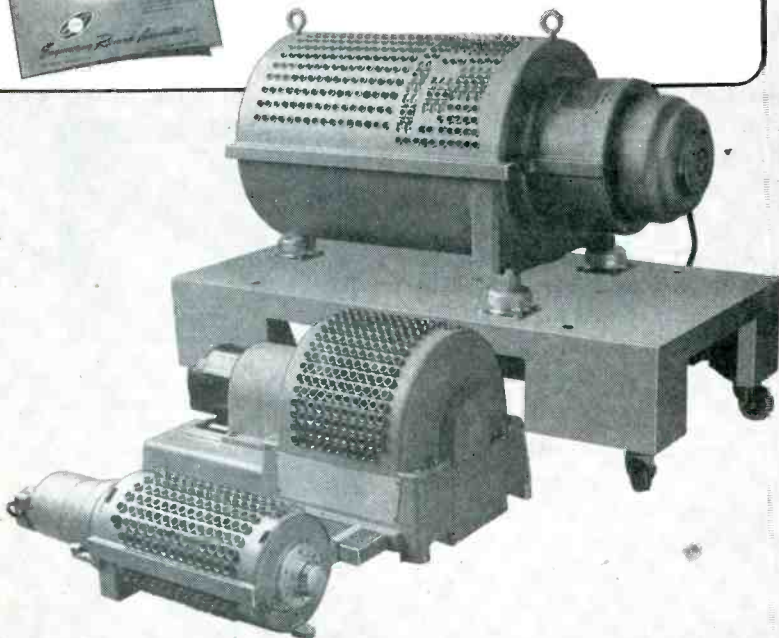

*Engineering Research Associates*

Division of  
**Remington Rand**  
INC.

1902 West Minnehaha Avenue, Dept. E-13, St. Paul W4, Minnesota

DIGITAL COMPUTERS . . . DATA-HANDLING SYSTEMS . . . MAGNETIC STORAGE SYSTEMS . . .  
INSTRUMENTS . . . ANALOG MAGNETIC RECORDING SYSTEMS . . . COMPUTING SERVICE

ducers are mounted to convert the electrical signal into sound and back again. The electrical behavior can be represented closely by a four-terminal network with certain pass bands harmonically related. Operation is obtained between 5 and 60 mc. Bandwidths of 50 to 70 percent of the crystal fundamental are obtained even up to 40 mc where a 24-mc bandwidth to the 3-db points has been measured.

The long delay time is a unique characteristic of the ultrasonic line and is determined by the path length of the sound between the two crystals and the velocity of sound. Delays of 6 to 10 microseconds per inch render possible a great saving in space over other methods. The pass band is unusually wide and the phase characteristics remain unchanged with length of delay, so that such a line is the most practical device for storing short pulses from two microseconds to several thousand.

For short delays less than 100 microseconds, the path may be kept straight. The longer delays require folding the path within the medium into a reflection pattern, which may be of a convenient size. Depending on the overall requirements, a 1,000- $\mu$ sec line can be packaged in a container less than  $1 \times 6 \times 6$  in. and weighing less than one pound.

Operation of any passive element, such as a delay line, in an electronic network results in an insertion loss, which in this case, because of the wide bandwidth and the low conversion action of the transducers, may be considered high. When the optimum condition for power transfer occurs of having the crystal capacitance equal the stray capacitances of the tubes, typical losses may range theoretically from 28 to 36 db. An inductance is usually placed in parallel with the load resistors to tune out the crystal reactance.

To the conversion loss should be added losses due to ultrasonic absorption in the medium. At 15 mc these losses range from 0.1 to 0.3 db per  $\mu$ sec in ordinary glasses and about 0.005 db per  $\mu$ sec in fused quartz. The absorption increases linearly with frequency in solids but distortion of the pass band or pulse shape does not occur. Geo-



# GPL NOW... 20 Output Lines in Packaged DISTRIBUTION AMPLIFIER

GPL introduces a new design concept in distribution amplifiers with this compact package of 5 interchangeable units. In less than 12 inches of rack space, 20 outputs are provided... in one-fifth previous area.

Each amplifier has 4 outputs, which may be modified for 5 different combinations of video and sync distribution. Any amplifier may be removed while the others are in operation.

For TV studios or laboratories where video, sync and blanking signals require multiple distribution, this GPL design provides flexibility in multiple output combinations. Feed levels are 1.4 volts for video; 4 volts for sync distribution.

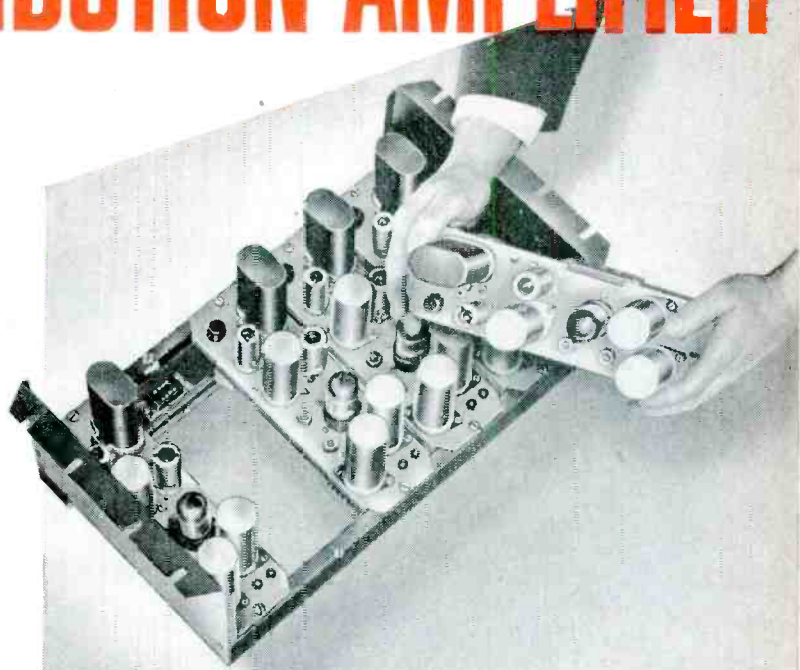

## DESIGN FEATURES

20 outputs in rack area  
10½ x 17½ inches.

Extreme flexibility of output voltage  
and impedance combinations.

All test points easily available.

Frequency response flat within  
2 db to 10 mc.

Gain variable from 0.6 to 2.0.

## GPL SYNC GENERATORS

### CIRCUIT RELIABILITY... IN LESS SPACE

New GPL unit now available has 2 synchronizing generators with change-over panel mounted in one space-saving rack. Maximum circuit reliability without operator adjustment. Binary counters and delay lines, stable master oscillator. Built-in power supply. Ask for specifications.

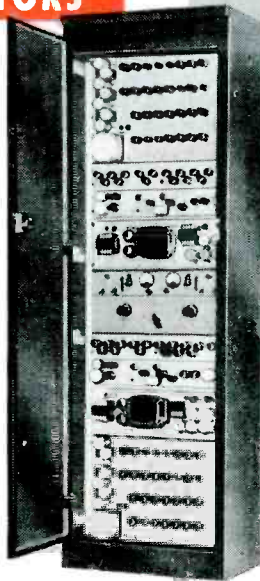

FOR COMPLETE SPECIFICATIONS  
WRITE, WIRE OR PHONE

## General Precision Laboratory

INCORPORATED

PLEASANTVILLE NEW YORK

# GPL

Cable address: PreLab

Export Department:  
13 East 40th St., New York City  
Cable address: ArLab

TV Camera Chains • TV Film Chains • TV Field and Studio Equipment • Theatre TV Equipment

# Ceramic Insulated for LOW LOSS... MINIMUM CREEPAGE NEW TYPE 2C TAP SWITCHES

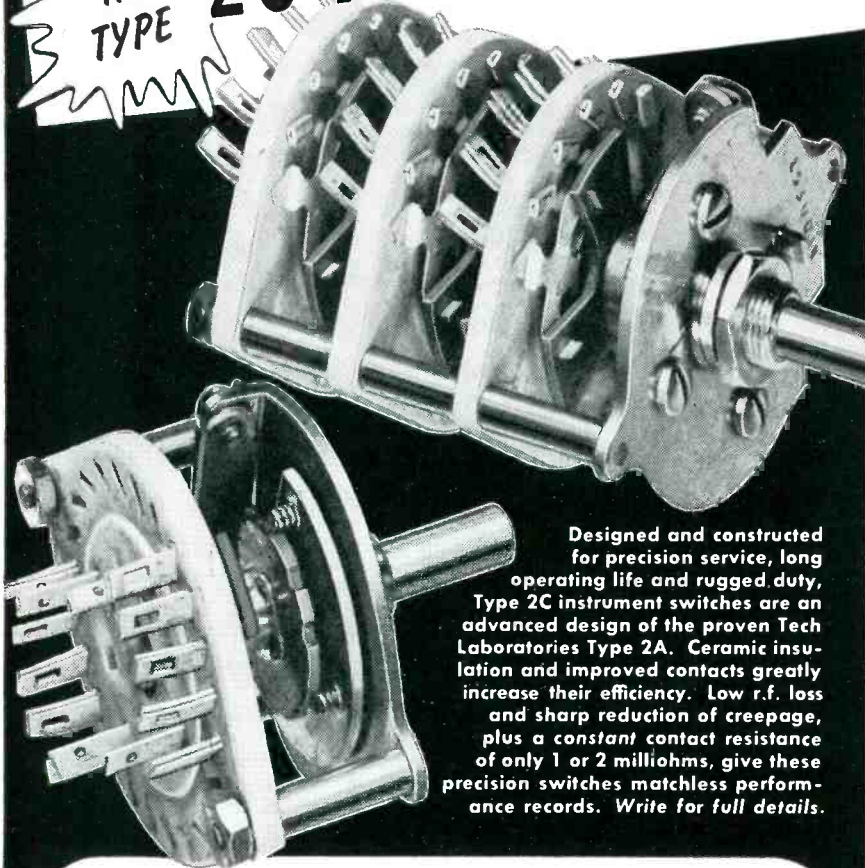

Designed and constructed for precision service, long operating life and rugged duty, Type 2C instrument switches are an advanced design of the proven Tech Laboratories Type 2A. Ceramic insulation and improved contacts greatly increase their efficiency. Low r.f. loss and sharp reduction of creepage, plus a constant contact resistance of only 1 or 2 milliohms, give these precision switches matchless performance records. Write for full details.

## SPECIFICATIONS

**Contact resistance:** 1-2 milliohms

**Contact material:** Silver alloy

**Contact design:** Laminated wiper arm, self-cleaning, shorting or non-shorting

**No. of contacts:** 2 to 24 single pole, shorting or non-shorting  
2 to 11 double pole, shorting or non-shorting  
2 to 5 triple pole, shorting or non-shorting

**Spacing:** 15° or 20°, shorting or non-shorting

**No. of poles per deck:** 1 to 4

**No. of decks:** According to requirements

**Life:** 200,000 cycles, min.

**Current carrying cap.:** 3 amp.

**Max. operating voltage:** 120 V., a.c.

**Mounting:** Single hole, 3/8"-32 bushing, standard length for up to 1/4" panel, special lengths to order

**Size:** 1 3/4" dia.

**Detent:** Ball and spring

**Weight:** Approx. 1 oz. per deck



Manufacturers of Precision Electrical Resistance Instruments  
PALISADES PARK, NEW JERSEY

metric losses due to diffraction effects in the path may be difficult to evaluate but are negligible in short lines. Finally, there are losses of 6 db per crystal when the line is fully terminated to cut down multiple reflections.

Practical delay lines can be made that will have from 30 to 45 db insertion loss into 1,000 ohms and with capacitances from 20 to 80  $\mu$ f.

Fixed capacitance of crystals is usually much greater than the optimum value for power transfer because the radiation from one crystal to the other is then better collimated and less difficulty is experienced with reflections from the side walls as unwanted secondary signals. Larger crystals result in a lower than theoretical insertion loss because the power radiated and received is greater.

The electrical bandwidth will be lowered because of the increased crystal capacitance unless the input and output resistors are lowered. However, the gain-bandwidth of the system is relatively constant in much the same way as this characteristic holds for vacuum tubes.

A factor often limiting the operation of the delay line is the appearance of secondary signals at times other than the desired delay. The more compact the design and the lower the carrier frequency, the stronger these signals will be. For computer work, reduction of all secondaries including multiples of the main delay to a level of 15 to 20 db is usually sufficient, while for radar systems over 40 to 50 db difference between the main delay and all others may be needed.

For accurate pulse reproduction, the pass band must be flat and uniform. Ripples may be held in such cases to less than 0.5 db departure from a smooth curve.

When the delay lines are used as timing devices, such as range markers in radar systems, many signals may be desired so that the crystals are unterminated and the medium chosen is of low loss.

For special applications when more than one line is used in the same system, the units can be matched to better than 0.01 percent. In the shorter units, low-tempera-

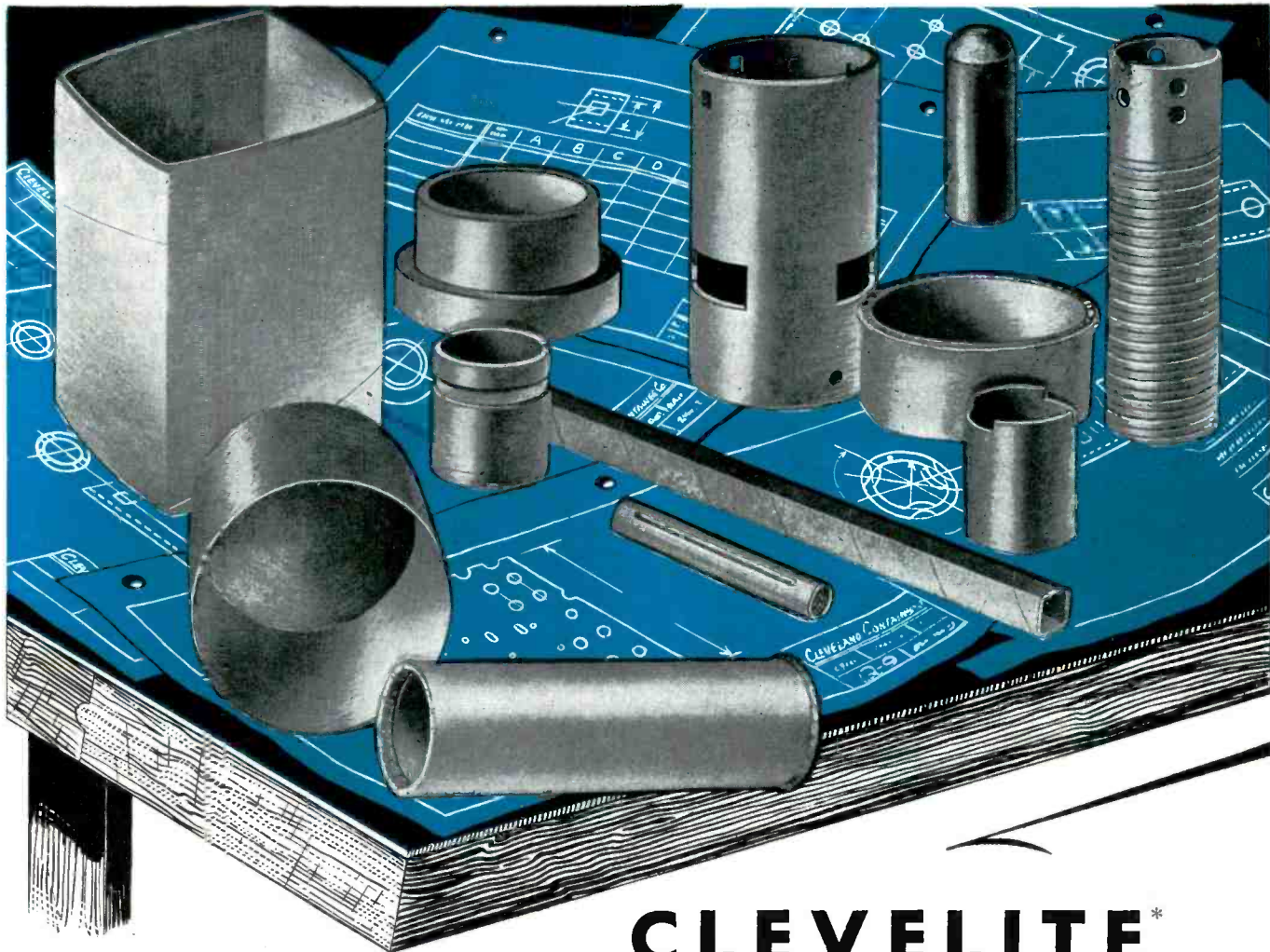

## A GRADE FOR EVERY NEED!

Diameters—wall thicknesses and lengths to meet regular or special adaptations.

IN RADIO AND TELEVISION their use is almost universal. They have high insulation resistance and low moisture absorption. Their low dielectric loss is suitable for ultra high frequency applications.

CLEVELITE is produced in seven grades.

GRADE	APPLICATION
E	Improved pasture fabrication and stapling.
EX	Special grade for TV yoke sleeves.
EE	Improved general purpose.
EEX	Superior electrical and moisture absorption properties.
EEE	Critical electrical and high voltage application.
XAX	Special grade for government phenolic specifications.
SLF	Special for very thin wall tubing having less than .010 wall.

**Why Pay More?  
For the Best...  
Call CLEVELAND!**

## CLEVELITE\* LAMINATED PHENOLIC TUBING

is more than ever before—the first choice in the electronic and electrical industries.

It combines proven performance with low cost and excellent service!

Wherever high dielectric strength, low moisture absorption, mechanical strength, low loss and good machineability are of prime importance... the combined electrical and physical properties of

### CLEVELITE are essential

**IMMEDIATELY AVAILABLE!**

**Tell us your needs.**

\*Reg. U. S. Pat. Off.

*The* **CLEVELAND CONTAINER Co.**  
 6201 BARBERTON AVE. CLEVELAND 2, OHIO

PLANTS AND SALES OFFICES at Plymouth, Wisc., Chicago, Detroit, Ogdensburg, N. Y., Jamestown, N. A.  
 ABRASIVE DIVISION at Cleveland, Ohio  
 CANADIAN PLANT: The Cleveland Container, Canada, Ltd., Prescott, Ontario

#### REPRESENTATIVES

NEW YORK AREA R. T. MURRAY, 604 CENTRAL AVE., EAST ORANGE, N. J.  
 NEW ENGLAND R. S. PETTIGREW & CO., 62 LA SALLE RD., WEST HARTFORD, CONN.  
 CHICAGO AREA PLASTIC TUBING SALES, 5215 N. RAVENSWOOD AVE., CHICAGO



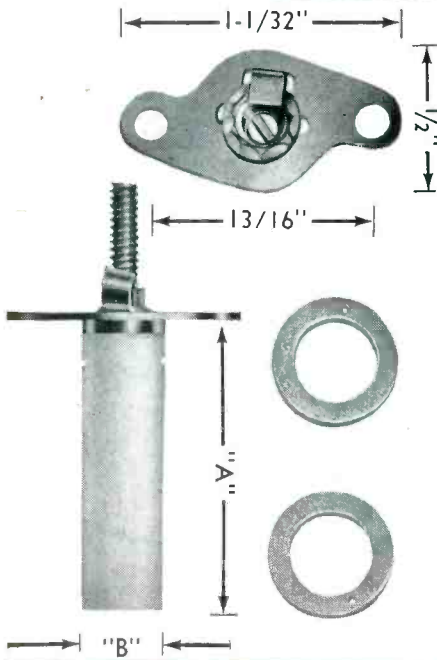

### NEW PERMEABILITY TUNED CERAMIC COIL FORMS

Small ceramic coil forms designed primarily for high frequency applications and conforming to government specifications. Coil form is Grade L4 ceramic (JAN I-10); base is silver-plated brass; core is brass or iron. Supplied with two nylon rings to separate coils if more than one is wound on same form. Small holes in rings can be used to secure leads.

TYPE	CORE	"A" DIM.	"B" DIM.
XR 80	BRASS	1 $\frac{1}{4}$ "	1 $\frac{1}{4}$ "
XR 81	IRON	1 $\frac{1}{4}$ "	1 $\frac{1}{4}$ "
XR 82	BRASS	1 $\frac{3}{4}$ "	1 $\frac{1}{4}$ "
XR 83	IRON	1 $\frac{3}{4}$ "	1 $\frac{1}{4}$ "
XR 90	BRASS	1 $\frac{1}{4}$ "	$\frac{3}{8}$ "
XR 91	IRON	1 $\frac{1}{4}$ "	$\frac{3}{8}$ "
XR 92	BRASS	1 $\frac{3}{4}$ "	$\frac{3}{8}$ "
XR 93	IRON	1 $\frac{3}{4}$ "	$\frac{3}{8}$ "

### PRECISION-WOUND R.F. CHOKES

National makes a complete line of quality R.F. chokes to meet every electronic need. In addition, National's engineering staff and production facilities are capable of winding chokes to any set of specifications for commercial or military applications. Close tolerances guaranteed. Write for complete information or send specifications.



Write for drawings



ture coefficient materials are available. For delays longer than 100  $\mu$ sec where fused quartz is the best available material, the temperature coefficient of delay will be  $108 \times 10^{-6}$  per deg C. The insertion loss and secondary level will decrease with increasing temperature.

Material for this survey has been furnished by D. L. Arenberg, Arenberg Ultrasonic Laboratory, Jamaica Plain, Mass.

### BIBLIOGRAPHY

- MIT Radiation Laboratory Series, 1, McGraw-Hill.  
 D. L. Arenberg, *Journ. Acous. Soc. Am.* Jan. 1948.  
 A. G. Emslie, H. B. Huntington, H. Shapiro, and A. E. Benfield, *Journ. Franklin Inst.* 245, Feb. 1948.  
 Staff of Eng. Research Assoc., Inc., *High Speed Computing Devices*, McGraw-Hill, 1950.

### Noise Test for Magnetic Recording Media

BY ROGER C. CURTIS  
*Project Engineer*  
*Dictaphone Corp.*  
*Bridgeport, Conn.*

A SIMPLE DIRECT METHOD of evaluating magnetic recording media for noise has been developed by the Dictaphone Corporation. A minimum of special equipment is required and the test is suitable for quality control as well as for preliminary checks of new media to determine the value of further testing. In its simplest form, the method consists of reproducing from an unrecorded erased medium through an unequalized amplifier to an indicating meter with d-c bias applied to the head. Correlation between the meter readings and subjective listening tests made on regular recording and reproducing equipment has been found to be

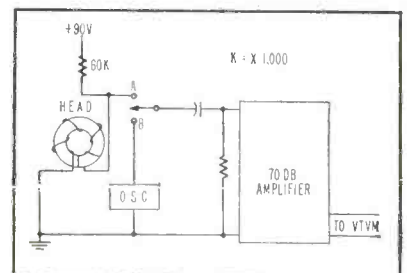
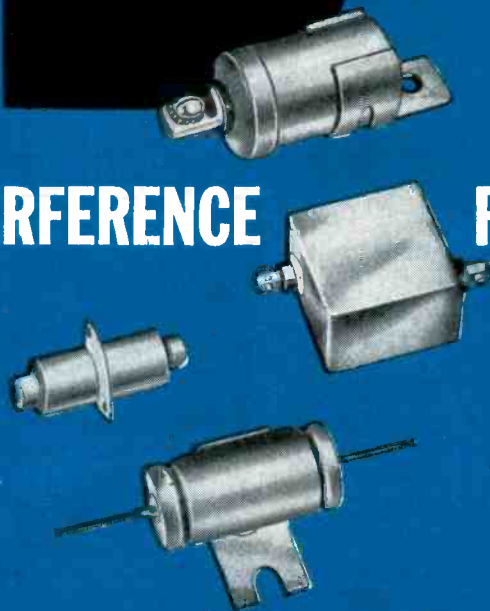

FIG. 1—Circuit of noise tester for recording media. VTVM can be replaced by analyzer to learn frequency distribution of noise

# C D

onsistently  
ependable

## INTERFERENCE FILTERS



**There's a C-D for every known interference problem!** Did you know that C-D makes and sells more interference filters than any one else? Chances are the solution to your filter problem is already waiting for you in our files. If we don't have the answer, we'll find it for you. Write for catalog to: Dpt. K-73. General Offices, Cornell-Dubilier Electric Corporation, South Plainfield, New Jersey.

## CORNELL-DUBILIER

*world's largest manufacturers of filters*

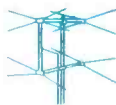

ANTENNAS

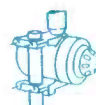

ROTATORS



CAPACITORS



VIBRATORS



CONVERTERS

SOUTH PLAINFIELD, N. J. • NEW BEDFORD, WORCESTER AND CAMBRIDGE, MASS. • PROVIDENCE, R. I. • INDIANAPOLIS, IND. • FUQUAY SPRINGS, N. C. • SUBSIDIARY, THE RADIART CORP., CLEVELAND, O.

# Quick Facts on -COLE- TEST INSTRUMENTS



## PRECISION DECADE RESISTANCE BOXES (Model 1900)

Ranges from 11 to 1,111,100 ohms... Each decade assembly is shielded from the adjacent assemblies by partitions cast directly into the metallic case and decades are mounted upon a metallic panel which completes the shielding... Extreme accuracy permits their use as laboratory reference standards... Individual resistors are used for each step in each decade... Wire alloy eliminates errors due to thermal emf generation.



## DC INDUSTRIAL ANALYZER (Model 2700B)

Completely self-contained... Reads currents from 0 to 750 amperes, from 0 to 750 volts, and resistance from 0 to 20,000 ohms of direct current... Suitable for electric current from fractional to 600 h.p. ratings... Only connections required are to load and power circuits... Reduces errors in connections. Operator can follow load variations without disconnecting instrument.

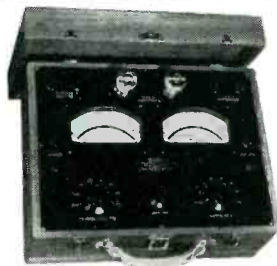

## OPTICAL POINTER TYPE INSTRUMENT (Model 18A22)

Accurately readable at a distance, and from any angle... Saves steps where one operator has multiple jobs to perform... Highly valuable in jet propulsion and atomic energy research where instrument must be set up near operation... Pointer light eliminates parallax error... Available in a wide variety of readings.

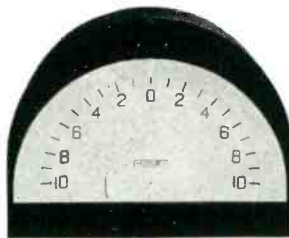

# -COLE-

*Instrument Company*

1320 SO. GRAND AVENUE  
LOS ANGELES 15, CALIF.

COLE has many other types of testing instruments available... pyrometers... aircraft system testers... electrostatic voltmeters... insulation testers... and many more.

Send for more information on these COLE test instruments with the coupon below.

Be sure to see our exhibit, Booth 903, at the Western Electronics Show and Convention, Civic Auditorium, San Francisco, August 19-21.

Yes, I want more information on **-COLE-** Test Instruments

NAME \_\_\_\_\_ TITLE \_\_\_\_\_

COMPANY \_\_\_\_\_

STREET ADDRESS, OR BOX NUMBER \_\_\_\_\_

CITY \_\_\_\_\_ ZONE \_\_\_\_\_ STATE \_\_\_\_\_

good so that meter indication may be used as a basis for acceptance of media.

### Noise Sources

Noise in magnetic recording arises from inhomogeneity in the recording medium, variations in cross-section of the sound track, variations in contact between the recording medium and the recording and reproducing heads. Modulation noise, or noise behind the signal, is a function of the degree of inhomogeneity of the medium and the magnitude of average induction in the medium. Variations in cross-section of the sound track produce noise because of the variations in the remanent flux for a constant

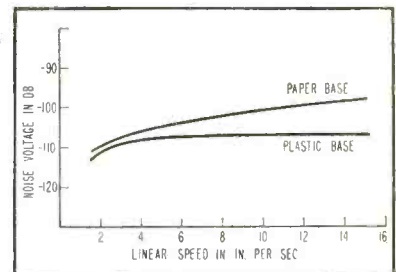
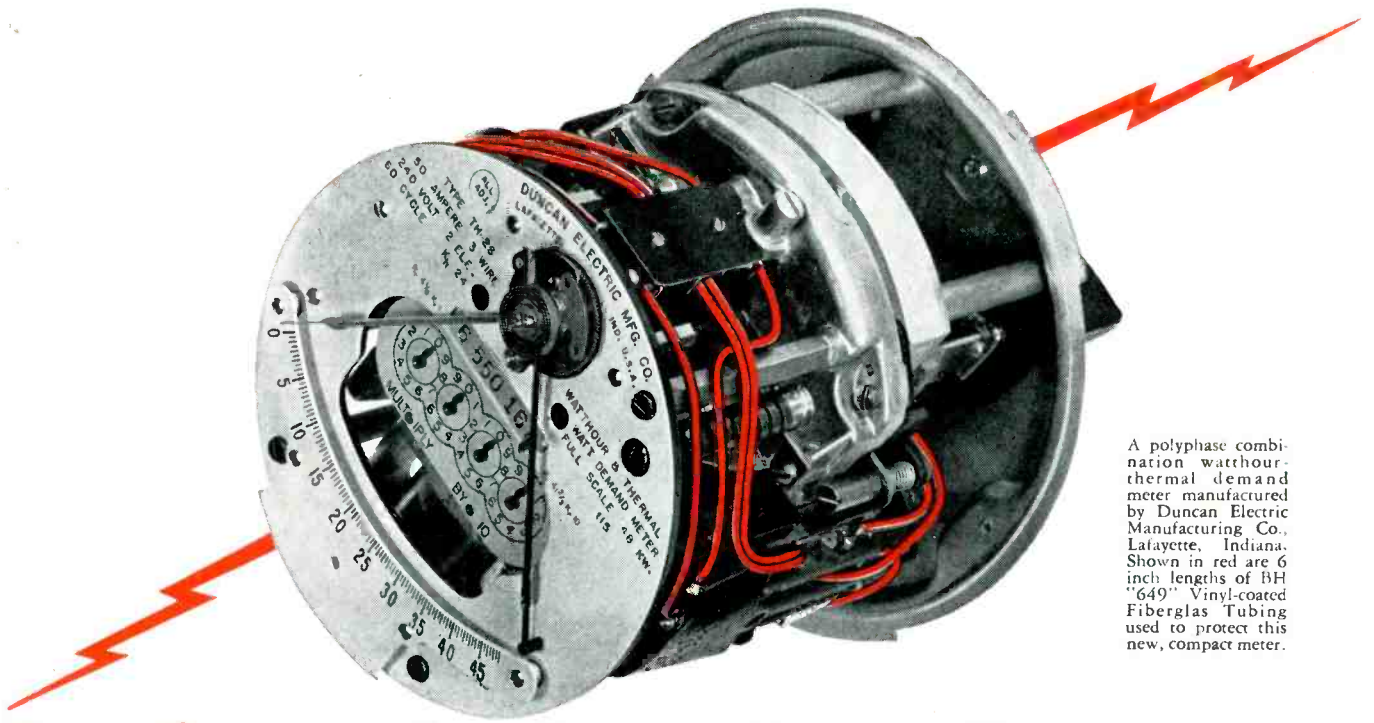

FIG. 2—Graph of noise voltage in relation to speed. Zero db is 0.775 v

value of magnetizing field. Variations in contact between the head and the medium such as caused by surface irregularities produce variations in the reluctance of the magnetic circuit of the head, which appear as variations in the remanent induction when recording and as variations in output voltage in reproducing.

The circuit used for the noise tests is shown in Fig. 1. Bias current is supplied from a well-filtered d-c source through a series resistor. The value of the resistor is high in comparison to the impedance of the head (450 ohms) since it effectively shunts the output of the head. The variations in voltage across the head are fed to the input of a 70-db amplifier through a coupling capacitor. The circuit impedance that loads the head is the parallel impedance of the series bias-feed resistor and the input impedance of the amplifier.

Amplifier gain is standardized by



A polyphase combination watt-hour-thermal demand meter manufactured by Duncan Electric Manufacturing Co., Lafayette, Indiana. Shown in red are 6 inch lengths of BH "649" Vinyl-coated Fiberglas Tubing used to protect this new, compact meter.

# 1 1/2 lengths of BH "649"—safe—even when lightning strikes

Used by utility companies for metering customer's watt demand load and kilowatt-hour consumption, the new Duncan polyphase thermal demand meters, insulated with BH "649" Fiberglas Tubing, are the first to be built into a standard circular glass meter cover. Extremely compact, good insulation is an absolute necessity.

operating temperatures from  $-40^{\circ}\text{F}$ . to  $160^{\circ}\text{F}$ . It must take a bend and maintain a level of 5,000 volts RMS. BH "649" has easily passed these tests. It helps us maintain our high standards and has materially reduced rejects."

Here's what Duncan says — "We selected BH "649" after testing several types of insulating tubing. Our meters must stand up against lightning and other transient conditions on utility lines. BH "649" does — allows for a longer periodic maintenance schedule.

Whatever your concern — excessive current — vibration — temperature extremes — flexibility — moisture, oil and fungus resistance — or what — let us help you. Send required voltages and temperatures encountered. We'll make recommendations and send you production testing samples from the big, trustworthy family of BH Tubings and Sleeveings for electrical insulation.

"Meter insulation must resist assembly soldering temperatures of  $450^{\circ}\text{F}$ . and not melt or char. It must resist ambient

Address Dept. E-7  
Bentley, Harris Manufacturing Co.  
Conshohocken, Pa.

**BH  
FIRST IN**  
use of Fiberglas  
heat-treated Fiberglas  
true high temperature  
flexibility  
vinyl-coated Fiberglas  
silicone rubber coating  
colors in silicone rubber  
true Class B ( $130^{\circ}\text{C}$ .)  
protection

# BH Fiberglas\* SLEEVIINGS

\*BH Non-Fraying Fiberglas Sleeveings are made by an exclusive Bentley, Harris process (U. S. Pat. No. 2393530). "Fiberglas" is Reg. TM of Owens-Corning Fiberglas Corp.

# TRANSFORMERS

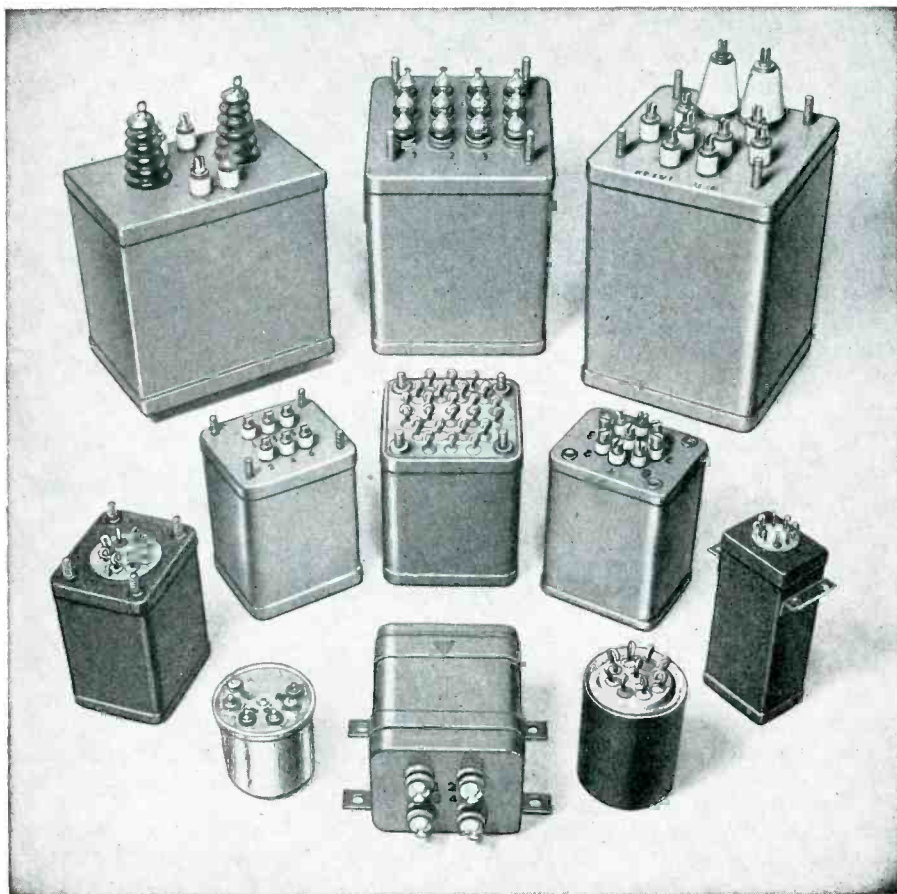

## HERMETICALLY SEALED TO MIL-T-27 SPECIFICATIONS

NYT offers a wide variety of transformer types to meet military and civilian specifications, designed and manufactured by specialists in transformer development.

Latest NYT service for customers is a complete test laboratory equipped and approved for on-the-spot MIL-T-27 testing and faster approvals.

**NEW YORK  
TRANSFORMER CO., INC.**  
ALPHA, NEW JERSEY

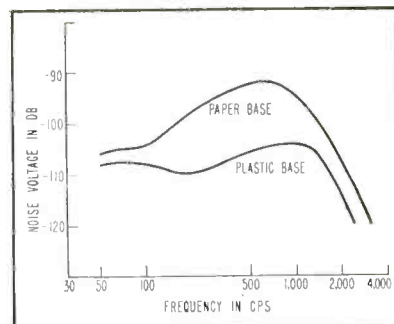

FIG. 3—Frequency distribution of noise in two types of recording tape, one with paper base and the other plastic

a calibrating signal of known level. The switch in Fig. 1 is moved to *B* to connect the circuit to the oscillator for calibration of the amplifier.

Moving the switch to *A* connects the circuit for noise measurement. For total noise measurements, a vacuum-tube voltmeter is used. With high, low or band-pass filters inserted, the noise contribution in various parts of the spectrum may be read. With a harmonic wave analyzer, the distribution of noise through the audible spectrum may be investigated.

### Test Results

Figures 2 and 3 show the results of measurements on two media differing only in the base materials, plastic and paper. The curves were made with a head with pole pieces 0.014 inch thick and a 0.001 inch gap. The bias current was 1.5 ma d-c, which is sufficient to saturate the medium. Variation in total noise for the two media with variation in linear speed of the medium is shown in Fig. 2. The lower noise from the plastic base material is apparent.

Cutoff frequency of the head by gap effect varies with linear speed so that the upper-frequency limit of noise is reduced as the speed is reduced. The reduction of effective bandwidth causes the noise output to decrease at the lower speeds. At 4 in. per second with 0.001 inch gap, the theoretical cutoff is at 4 kc. Figure 3 shows curves of the same two media taken at 4 in. per second showing the high-frequency cutoff. The curves also show the pronounced noise output around 700 cps on the paper base tape caused



# WORKING WITH VIDEO?

Crystal-positioned  
pulse type  
frequency marks

Excellent amplitude  
linearity —  
less than .1 db/mc.

Zero level  
reference  
baseline

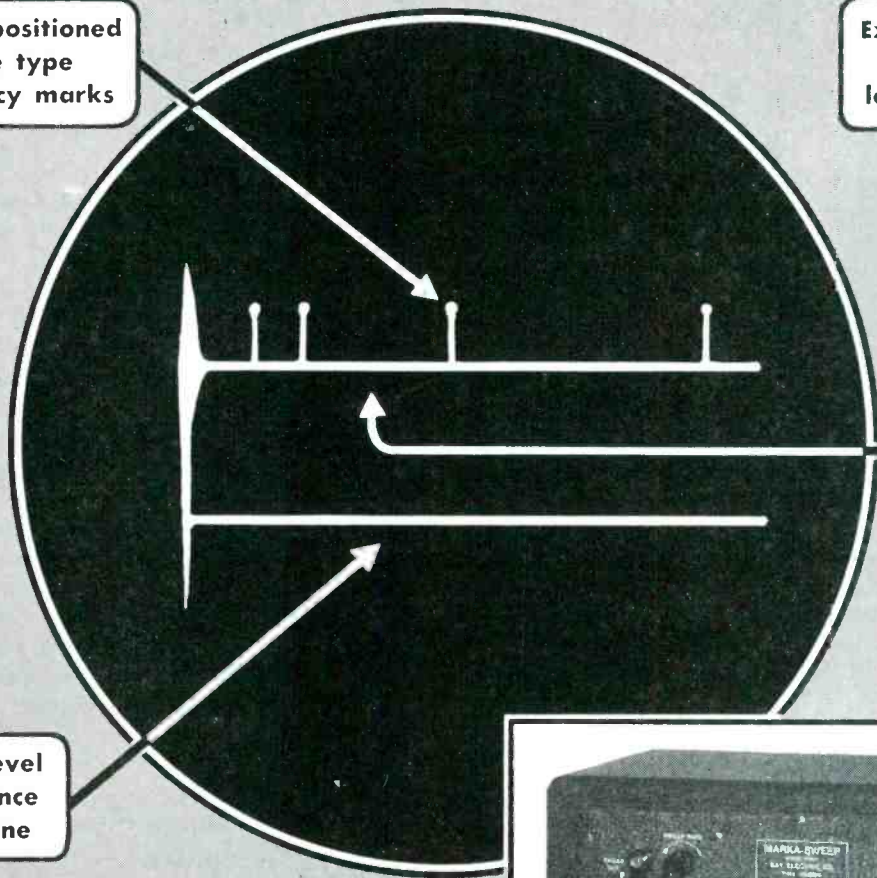

## *A New* SWEEPING OSCILLATOR DESIGNED FOR YOUR VIDEO NEEDS!

The new Marka-Sweep Model Video extends to video circuit design and testing the speed, accuracy and convenience that has attended the use of sweep generators at higher frequencies. The oscilloscope pattern shown above is an exact reproduction of the detected output of the Model Video.

### FEATURES:

**Sweep Method:** All Electronic

**Sweep Ranges:** 50 kc to 5 mc.  
50 kc to 10 mc.  
50 kc to 20 mc.

**Frequency marks of the pip type:** Crystal positioned at 1, 2, 5, 10, 15, 20 mcs. Other frequencies to special order.

Variable frequency pip mark formed by injecting CW from auxiliary signal generator (Kay Accessory Oscillator now available.)

Separate attenuators on markers and video.

**Price:** \$495 f.o.b. Factory. 10% higher outside U.S.A. and Canada.

Write for Complete Specifications and 1953 Catalog



## KAY ELECTRIC COMPANY

14 Maple Avenue

Phone CAldwell 6-4000

Pine Brook, New Jersey



# NOW

## a direct-reading 0-42 megacycle FREQUENCY METER

the Berkeley Model 5570

### description

Model 5570 is a single, compact instrument for rapid, precise measurement of frequencies from 0 cps to 42 mc. Basic sections are (1) a high-speed events-per-unit-time meter (EPUT), and (2) a heterodyne unit. Frequencies of 2 mc and below are applied directly to the EPUT and are read on the last six decade panels. From 2 to 42 mc, frequencies are applied to heterodyne unit and selector knob turned until output meter indicates the proper harmonic has been selected. External adjustment of crystal control unit to WWV is provided, to obtain an accuracy of 1 part in  $10^7$ ,  $\pm 1$  count.

### applications

Rapid, accurate transmitter monitoring, crystal checking, general laboratory and production line frequency determination. Addition of a Berkeley Digital Recorder will provide an automatic printed record of the last 6 digits; ideal for plotting frequency drift or indicating stability.

### specifications

<b>RANGE:</b>	0 cycle to 42 megacycles
<b>ACCURACY:</b>	$\pm 1$ count, $\pm$ crystal accuracy (short term: 1 part in $10^7$ )
<b>POWER REQUIREMENTS:</b>	117 volts, $\pm 10\%$ , 60 cps, 260 watts
<b>INPUT REQUIREMENTS:</b>	Approximately 1 volt rms. (50 ohm impedance)
<b>DISPLAY TIME:</b>	1 to 5 seconds continuously variable
<b>TIME BASE:</b>	0.00002, 0.0002, 0.002, 0.02, 0.2 and 2 seconds
<b>DIMENSIONS:</b>	Approximately 32" high x 21" wide x 16" deep
<b>PANELS:</b>	Two 8 $\frac{3}{4}$ " x 19"; one 12 $\frac{1}{4}$ " x 19"
<b>ACCESSORIES:</b>	Available soon to extend range to 160 mc.
<b>PRICE:</b>	\$1990.00, F.O.B. Richmond, California

Prices and Specifications subject to change without notice.

Please request Bulletin 107

## Berkeley Scientific

division of BECKMAN INSTRUMENTS INC.  
2200 WRIGHT AVENUE • RICHMOND, CALIFORNIA

"DIRECT READING DIGITAL PRESENTATION OF INFORMATION"

by the surface irregularities of the paper. The noise output spectrum of the smoother plastic base tape is quite uniform throughout the spectrum up to cutoff indicating the random nature of the magnetic variations.

Reproducing with d-c bias sufficient to saturate any medium that is to be tested gives a measure of the maximum value of total noise that could be produced under normal recording and reproducing conditions. The frequency distribution of the noise is readily determined by the use of wave analyzers or filters. The character of the noise may be judged by direct listening. Surface variations of the coating or of the base material are generally observed as low-frequency noise, while inhomogeneity of the medium is usually random. Data is thus rapidly available from a single, continuous run that gives a good comparative noise figure under easily reproducible conditions.

### Low Temperatures in Electronics

THE GENERAL EFFECT of low temperature is the production of ordered states of matter. If, at ordinary temperatures, something occurs with an energy smaller than several hundredths of an electron volt, it is swamped by the random agitation of the world about it, caused by thermal motion. Thus at normal temperatures a lower limit is set on the energy range of phenomena that may be reached.

With a means of isolation from the energy of the outside thermal motion, the entire range of low-energy phenomena may be reached. Liquid helium is used as this means of isolation in current studies affecting communications and control processes, which are accomplished principally at low energy levels.

Outstanding among the phenomena unique to very low temperatures is the conversion of certain metals and compounds into perfect electrical conductors. This phenomenon of superconductivity is of sufficient importance to the practical engineer that it should be considered in some detail. The fact that



in 1908

# Nichrome\*

made electric heat possible!

since then...  
**The Standard of Quality  
 for Electrical Alloys**

When Driver-Harris introduced Nichrome® in 1908, *dependable* electric heat became possible for the first time. And with each passing year, Nichrome looms larger as the *ideal* alloy for producing electric heat in domestic and industrial equipment.

Its consistent dependability and unique performance have earned it a world-wide reputation—and made it *the* standard of quality for electrical alloys. That's why today, the great majority of heating elements of all types—in applications ranging from electrical home appliances to large industrial furnaces—are made of this excellent alloy.

Naturally, we take particular pride in our trademark: Nichrome—granted solely and wholly to us by the United States Patent Office forty-five years ago. Representing a series of superb heating and resistance alloys, developed and produced *only* by Driver-Harris, this trademark symbolizes *long life* and *trouble-free* operation to manufacturers everywhere.

Sole producer of Nichrome®, Advance®, Karma® and over 80 other alloys for the electrical, electronic and heat-treating industries.

\*T.M. Registered in United States Patent Office by Driver-Harris Company August, 1908

## Driver-Harris Company

HARRISON, NEW JERSEY

BRANCHES: Chicago, Detroit, Cleveland, Los Angeles, San Francisco

Manufactured and sold in Canada by The B. GREENING WIRE COMPANY, LTD., Hamilton, Ontario, Canada

Factories: U. S. A., CANADA, ENGLAND, IRELAND, FRANCE, ITALY, SPAIN Representatives in 38 COUNTRIES



**MAKERS OF THE MOST COMPLETE LINE OF ELECTRIC HEATING, RESISTANCE AND ELECTRONIC ALLOYS IN THE WORLD**

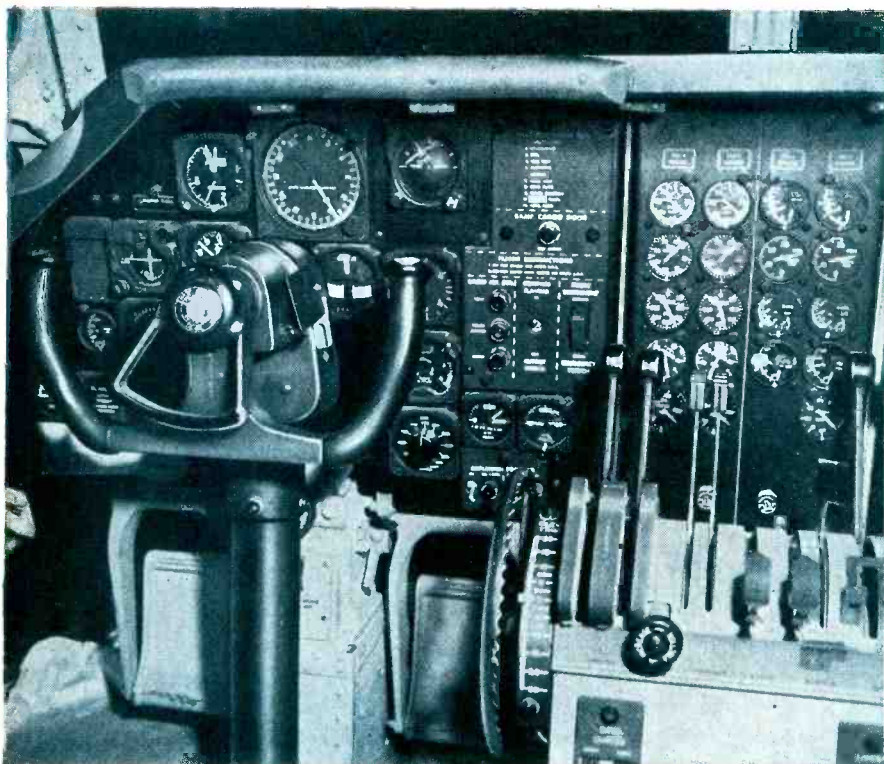

One false reading and disaster may strike. Here there's . . .

## no room for error

According to an Air Force survey, the most common "pilot-errors" are: misreading the instrument pointers, reversals in interpretation of readings, inability to see the instrument properly, and mistaking one instrument for another. A poorly lighted panel, or a dial that's difficult to read, and the finest scientific instrument can be as misleading as a dime-store watch. In short, where accuracy is essential you need MORE than precision. You need see-ability, and *readability*.

That's the advantage of U. S. Radium edge-lighted panels. Besides being the best looking panels available, they are also the most functional. Their clean, modern lines are a reflection of the "human engineering" in their design. They are lighted scientifically and *uniformly*. For accurate, at-a-glance readings they have few, if any equals.

**Whatever your requirements** — for dials, edge-lighted panels, or nameplates — whether luminous or non-luminous — and in whatever materials or finishes you desire — you name it, we make it. Get the finest — U. S. Radium. Write or phone for complete information. Dept. E-7, U. S. Radium Corp., 535 Pearl Street, New York 7, N. Y.



**MAKERS OF:** Luminescent Materials: Radioactive, fluorescent, phosphorescent • Powders: Cathode-ray tube, television tube • Radium Locators: Pendants, lenses, buttons, screws, markers • Static Eliminators • Radioactive Foils — Alpha-Ray Ionization Sources • X-Ray Screens • Processed Isotopes • Neutron Sources • Radiation Sources and Standards.



**DIALS • NAMEPLATES • EDGE-LIGHTED PANELS**

electrical resistance is proportional to temperature is to be expected from theory. On this principle then, the resistance of pure metals should gradually decrease to zero at absolute zero; and this is what happens with the best of normal-temperature conductors such as copper and silver in their pure state.

For other metals, including some that are poor conductors at ordinary temperatures, their resistance vanishes completely at some critical temperature above absolute zero. The electrical resistance of practically all metals has been investigated down to about 1 deg K or lower, and in all, about twenty metals so far have been found to be superconductive. For the most part these lie in a well-defined region in the periodic table and include among others mercury, tin, lead, aluminum and zinc.

It is interesting that the inter-metallic compounds of bismuth and nickel and of gold and bismuth become perfect electrical conductors although the components themselves are not superconductors. This is also true of the semimetallic compounds, cupric sulfide, the molybdenum carbides, and the tungsten carbides. In many cases an alloy becomes superconductive at a temperature lower than the transition temperature of either of the individual metals. The highest temperature at which superconductivity has been found is 15 deg K with columbium nitride.

Although superconductivity is not fully understood theoretically, it has already found application in bolometers, for detection of radiant energy. The two desirable qualities in bolometers are speed and sensitivity. At room temperature, thermal fluctuations, or Brownian movement of the electrons, places a limit on bolometer sensitivity. This limit can be effectively removed by lowering the temperature, thereby reducing the Brownian movement.

Briefly, the sensitive element is a superconducting strip of metal maintained in the transition range between normal and superconductivity where a slight change of temperature will cause an enormous change in electrical resistance. For example, the resistance of tin was



COMMUNICATIONS SUPERVISORS:

get **\$25,000**  
coverage for **\$700!**

Here are the plain facts that speak for themselves of \$24,300 savings.

To increase the "talk-back" range of one-hundred cars from 20 miles to 25 miles—corresponding to an increase of 50% in area coverage—one-hundred 15 watt transmitters must be replaced with 60 watt transmitters . . . at an approximate cost of \$25,000.

You can get the same coverage by installing an Andrew 3000-type antenna for only about \$700.

One postcard can save you over \$24,000. Before you buy, write us for a complete analysis of costs and antenna types to meet your needs.

*Andrew*  
CORPORATION

363 East 75th Street · Chicago 19

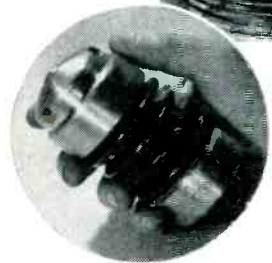
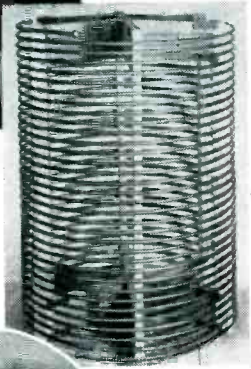
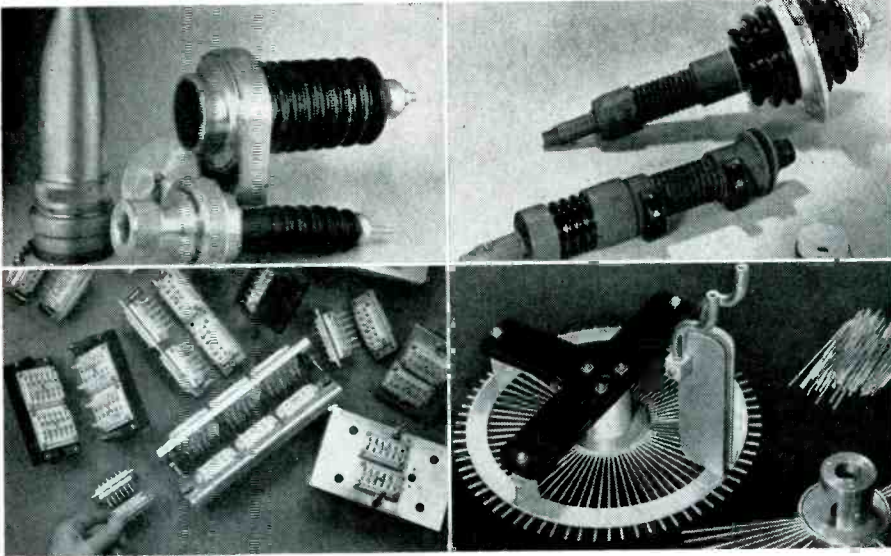

**OUR BUSINESS  
IS  
ELECTRICAL  
PORCELAIN  
... its application  
... design  
... manufacture  
... and assembly**

"Radio Specialties" identifies a large and busy department at Lapp. Through it, we have designed and built, in large volume, hundreds of parts for hundreds of specialized electronic requirements. Our skill is in our knowledge of the capabilities, and limitations, of ceramic insulation . . . in engineering ingenuity to meet specified requirements . . . and in efficient production. If you have requirement for insulating parts and associated sub-assemblies, we may be able to show you how they can be made most economically, to perform most efficiently. Write Lapp Insulator Co., Inc., Radio Specialties Division, 103 Sumner St., Le Roy, N. Y.

**Lapp**

found to decrease gradually with temperature down to 3.7 K; at this point the resistance dropped so sharply that 50 percent was lost in the next 0.0001 degree. Further, low-temperature operation guarantees rapid response by virtue of the low heat capacity and also a low ultimate limit of detectability because of the low level of noise due to statistical fluctuations.

Many bolometers using columbium nitride as the sensitive element have been studied. An improvement in speed by a factor of a hundred over bolometers operating at room temperatures has been realized in practice, and it has been found possible with such bolometers to detect changes in temperature as small as 0.0000001 deg C.

Neglecting atmospheric absorption, which can vary over wide limits, the superconducting bolometer is sufficiently sensitive to detect the heat of a candle at a distance of 25 miles.

When used with an oscillating scanning mirror, the bolometer can pick up images of objects by their own thermal radiation and present crude pictures of the objects on a television screen. If installed inside a warehouse, the bolometer would be able to detect an intruder in complete darkness, transmit the picture by wire for an almost unlimited distance and present the picture on a television screen at a central station. Similarly any temperature difference, even as little as a few degrees, developed by spontaneous combustion or any sort of abnormal heating could be detected and shown on a tv screen at some distant point. Experiments have also been carried out in the scanning of the external walls of a building, where imperfect thermal insulation caused temperature differences that showed up immediately in the picture of the building being shown on the screen.

A superconducting bolometer was also found to be a detector of radio signals, necessarily superior to other types of radio receivers operating at room temperature in its signal-to-noise ratio. More practical interest is being attached to the fact that the superconductive bolometer can be used as an alpha

# RMC DISCAPS®

APPROVED AND USED BY LEADING MANUFACTURERS

## "Heavy Duty" By-Pass DISCAPS

### TYPE B

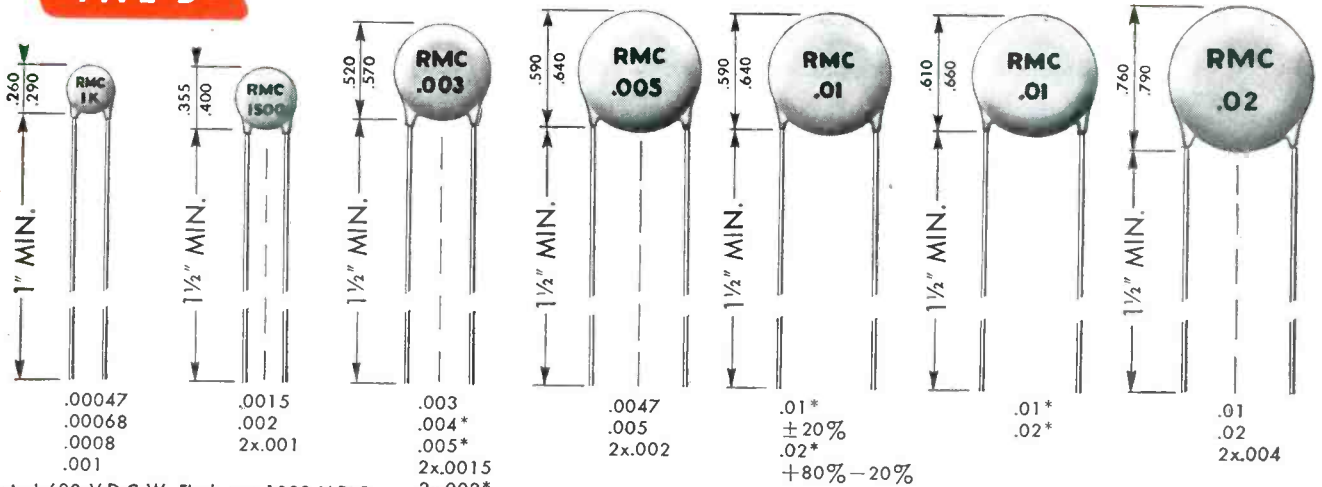

\*Rated 600 V.D.C.W. Flash test 1200 V.D.C.

### SPECIFICATIONS

#### TYPE B BY-PASS SERIES—GUARANTEED MINIMUM VALUE

POWER FACTOR: 1.5% Max. @ 1 KC (initial)  
 POWER FACTOR: 2.5% Max. @ 1 KC (after humidity)  
 WORKING VOLTAGE: 1000 V.D.C.  
 TEST VOLTAGE (FLASH): 2000 V.D.C.  
 LEADS: No. 22 tinned copper (.026 dia.)

INSULATION: Durez phenolic—vacuum waxed  
 INITIAL LEAKAGE RESISTANCE: Guaranteed higher than 7500 megohms  
 AFTER HUMIDITY LEAKAGE RESISTANCE: Guaranteed higher than 1000 megohms

## HIGH VOLTAGE DISCAPS—Designed for Deflection Yokes

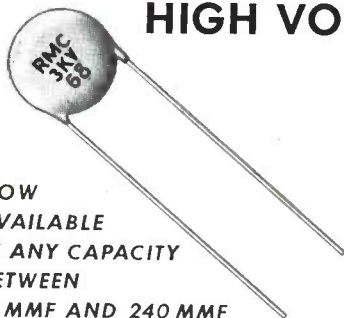

NOW AVAILABLE IN ANY CAPACITY BETWEEN 15 MMF AND 240 MMF

### SPECIFICATIONS

POWER FACTOR: .1% Max. @ 1 M C (initial)  
 POWER FACTOR: 2.5% Max. @ 1 M C, after humidity  
 WORKING VOLTAGE: 2000, 3000, 4000, 5000 V.D.C.  
 TEST VOLTAGE: 4000, 6000, 8000, 10,000 V.D.C.

LEADS: No. 22 tinned copper (.026 dia.)  
 INSULATION: Durez phenolic—vacuum waxed  
 INITIAL RESISTANCE: Guaranteed higher than 7500 megohms  
 AFTER HUMIDITY LEAKAGE RESISTANCE: Guaranteed higher than 1000 megohms  
 AVAILABLE TOLERANCE: ±5% ±10% ±20%

SEND FOR SAMPLES AND TECHNICAL DATA

DISCAP CERAMIC CONDENSERS



**RADIO MATERIALS CORPORATION**

GENERAL OFFICE: 3325 N. California Ave., Chicago 18, Ill.

FACTORIES AT CHICAGO, ILL. AND ATTICA, IND.

DISTRIBUTORS: Contact Jobber Sales Co., 146 Broadway, Paterson 1, N. J.



# Sheet Metal Fabrication

BY  
**KIRK AND BLUM**



## Contract Manufacturing Facilities



Whatever your requirements in sheet, plate and alloy fabrication, Kirk & Blum can produce for you ... economically and quickly.

Complete facilities to  $\frac{1}{2}$ " capacity for square and rotary shearing, braking, forming, rolling, punching, riveting, welding, grinding, drilling, and finishing sheets and light plates and structural. For complete details, write for literature on fabrication facilities and experience or send prints to:

**THE KIRK & BLUM MANUFACTURING CO.**  
3211 Forrer Street Cincinnati 9, Ohio

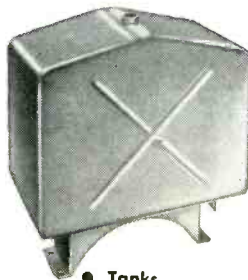

- Tanks
- Spare Parts Boxes
- Panel Boards
- Machine Bases, Pedestals and Frames
- Hoppers
- Electrical Enclosures
- Guards
- Rolled Steel Rings
- Racks • Pans
- Stampings
- Louvre Panels
- Cabinets

particle detector, which not only counts the particles but gives an indication of their energy.

Superconductors become excellent magnetic shields. With such a shield, magnetic noise in the atmosphere may be completely excluded from a region.

Superconductivity also offers a means of constructing magnetometers of high sensitivity and low noise. High-Q resonators are available in the form of cavities fabricated from superconducting material. Values of Q in range of millions have been reached. Because the metals have vanishing expansion coefficients at low temperatures and become exceedingly stiff and rigid, the mechanical stability of these resonators is great.

Another subject of potential interest to electronics workers is the temperature dependence of electrical noise. The ordinary noise found in metallic resistors, referred to as Johnson or thermal noise is known to decrease in direct proportion to the temperature and to increase with the value of the resistance used. Thus when thermal noise in a resistor is of great importance, a considerable increase in the signal-to-noise ratio can be expected by making it of metal and lowering the temperature.

Photoconductors, substances that react to light by changing their electrical conductivity, are limited in sensitivity by thermal noise which may be removed with liquid helium.

The field of semiconductors may also benefit from low-temperature measurements or processes. Admixtures of alloying materials markedly affect the conductivity of germanium. The effect is different at very low temperatures from that at room temperatures. Some material as yet undiscovered, may show semiconducting properties at liquid helium temperature and be useful as a low-noise transistor.

Insulators become so nearly perfect at these low temperatures that they may hold a charge for unusually long periods. This may be useful, for example, in a storage tube for computers.

The magnetic properties of matter are greatly changed or at least exaggerated, at low tempera-

### Write for NEW BULLETIN

This 40 page comprehensive booklet shows typical example of Kirk & Blum fabrication, complete facilities of plant and equipment for jobs ranging from one unit to thousands.

**KIRK AND BLUM**  
METAL FABRICATION





**SLANT** your

requirements to

**INSTRUMENT CORP.  
OF AMERICA**

for miniature

# SLIP RING AND COMMUTATOR ASSEMBLIES

This Instrument Corporation of America plant contains the most modern and complete facilities available anywhere in the world for the exclusive production of Miniature Slip-Ring and Commutator Assemblies to precision standards. It is now in full scale production to meet your requirements in the fastest possible time at the lowest possible cost.

**COMPLETE ENGINEERING AND  
PRODUCTION FACILITIES AVAILABLE**

Our assemblies can be supplied at low cost. Quality is the highest in the industry. Dimensional accuracy and other characteristics are excellent and these units are highly recommended for instruments such as synchros, etc.

**ONE PIECE ELECTRO-PLATED  
TYPES FOR EXTREME ACCURACY**

Wherever extreme dimensional precision, accurate concentricity and high dielectric qualities are required, the electro-deposition method is recommended . . . the production of which is licensed under an exclusive arrangement with the Electro Tec Corporation.

**TYPICAL  
SPECIFICATIONS:**

**Sizes:** .035" to 24"  
Cylindrical or Flat

**Cross-sections:** .005 to  
.060" or more

**Finish:** Polish to 4  
Micro-Inches or Better

**Breakdown:** 1000 V or More  
Hi-Pot Inter-Circuit

**Ring Hardness:** 75 to 90 Brinell

**Rotation Speeds:** To Over 12000 RPM

**Surface Protection:** Palladium and Rhodium or Gold Prevent Tarnish, Minimize Wear

*Our engineering staff is at your  
service at all times for consultation*

**INSTRUMENT  
CORPORATION  
OF AMERICA**  
BLACKSBURG • VIRGINIA

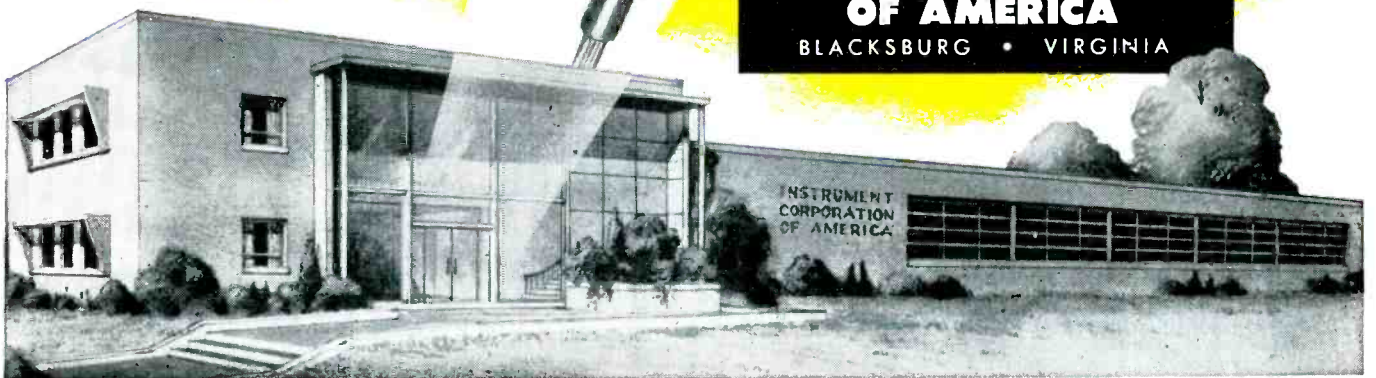

STANDARD

# Radio Interference and Field Intensity

MEASURING EQUIPMENT

Complete Frequency Coverage—14kc to 1000 mc!



NM-10A

VLF

14kc to 250kc  
Commercial Equivalent of  
AN/URM-6B.  
Very low frequencies.



NM-20B

HF

150kc to 25mc  
Commercial Equivalent of AN/PRM-1A.  
Self-contained batteries. A.C. supply  
optional. Includes standard broadcast  
band, radio range, WWV, and commu-  
nications frequencies. Has B.F.O.



NMA-5A

VHF

15mc to 400mc  
Commercial Equivalent of  
TS-587/U.  
Frequency range includes  
FM and TV Bands.

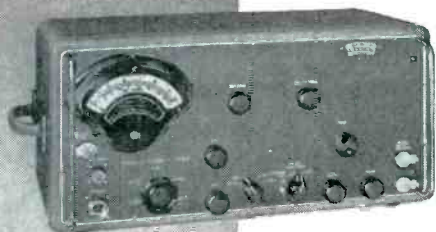

NM-50A

UHF

375mc to 1000mc  
Commercial Equivalent of  
AN/URM-17.  
Frequency range includes  
Citizens Band and UHF  
color TV Band.

These instruments comply with test equipment requirements of such radio interference specifications as MIL-I-6181, MIL-I-16910, PRO-MIL-STD-225, ASA C63.2, 16E4, AN-I-24a, AN-I-42, AN-I-27a, MIL-I-6722 and others.

## STODDART AIRCRAFT RADIO Co., Inc.

6644-A Santa Monica Boulevard, Hollywood 38, California Hollywood 4-9294

tures. The fact that nuclear and paramagnetic resonance at radio and microwave frequencies becomes sharp and strong should be useful in filters and timing circuits. The rare-earth salts that exhibit low-loss ferromagnetics, unusually high permeabilities, and other such properties await application in devices such as magnetic amplifiers.

The material abstracted herein is taken from a forthcoming publication of Arthur D. Little, Inc., Cambridge, Mass.

### Piezoelectric Activity of Barium Titanate

UNLIKE normal crystalline piezoelectric materials such as quartz, Rochelle salts and ADP, the piezoelectric qualities of barium titanate are influenced by the process of manufacture. In addition, the activity of barium titanate elements is a function of the method of polarization.

Theoretically, the determination of piezoelectric coefficients of a material can be readily accomplished by applying known loads to the unit and then measuring the charge and voltage developed. In practice, these measurements require use of sensitive laboratory equipment and are not suitable for rapid routine evaluations.

Another system of measurement is to apply an a-c signal to the element and consider its behavior under these conditions. By evaluating this oscillating system by means of an equivalent electrical circuit, Fig. 1A, the resonant and

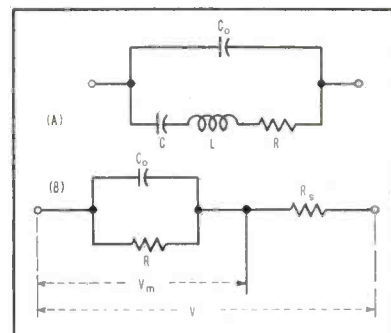
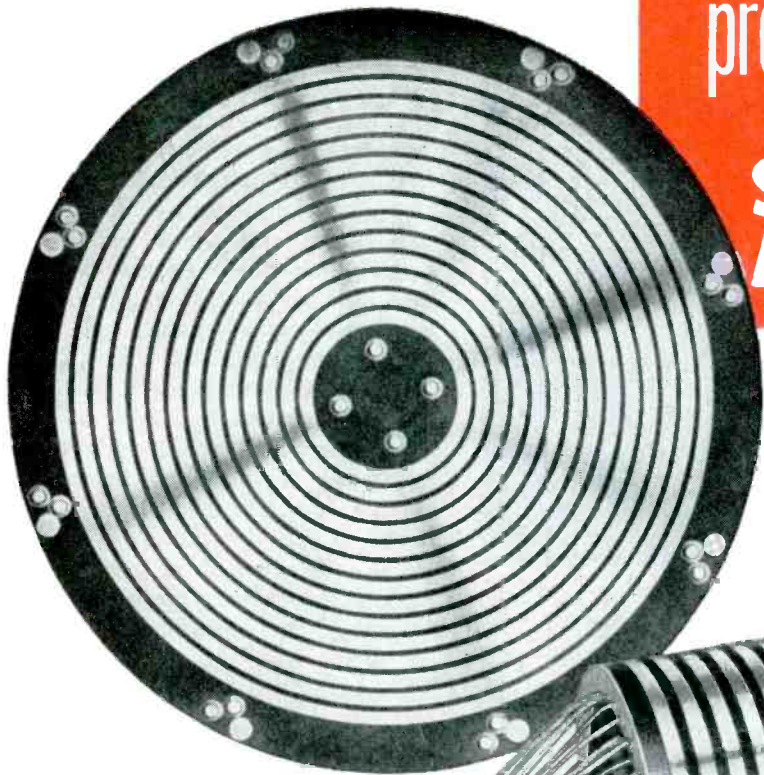

FIG. 1—Equivalent circuit (A) of a piezoelectric element. Circuit in (B) is equivalent circuit at resonance in series with resistance  $R_0$ , used for measuring activity

Now available

the revolutionary  
**ELECTRO TEC**  
process\* for your  
**LARGE**  
**SLIP RING ASSEMBLIES**



- featuring*
- LOWER COST
  - CLOSER TOLERANCES
  - ONE-PIECE CONSTRUCTION
  - JEWEL-LIKE FINISH
  - UNIFORM RING HARDNESS
  - REDUCED WEIGHT



Now a Complete Service  
in all sizes of Slip Ring Assemblies

↑ An assembly with 14 concentric, hard silver rings electro deposited into machined plastic blank. Dovetail locks rings in place. Machined blank insures accuracy. Diameter approx. 11", thickness approx. 5/16".

↑ Cylindrical assembly with 25 rings. Three wide rings accommodate large contact area brushes for high current capacity. Length 14", O.D. approx. 5 3/8".

↑ An assembly with 30 rings of various widths to accommodate various current requirements. Unit is approx. 4-5/16" long, designed for flange mounting.

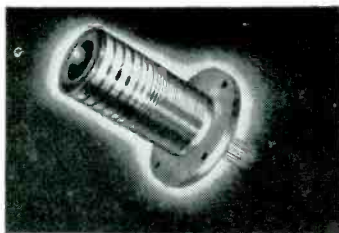

↑ Cylinder type assembly approx. 3 3/4" long with 24 hard silver rings. 1 5/8" O.D. with wall thickness less than 1/4".

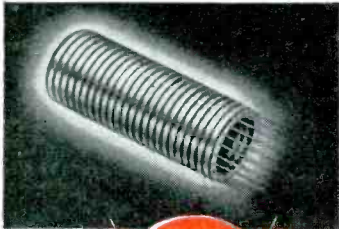

\*PATENTS  
PENDING

Our Engineering Department is available for consultation on any of your slip ring problems without obligation.



**ELECTRO TEC CORPORATION**  
SOUTH HACKENSACK • NEW JERSEY

ELECTRO TEC is now tooled up, with new expanded facilities for production of large Slip Ring Assemblies to exact customer specification. Sizes range up to 24" in diameter, either cylindrical or disc type.

The exclusive ELECTRO TEC PROCESS\*—the electro-deposition of hard silver rings into an accurately machined plastic blank—consistently yields a high degree of dimensional accuracy, excellent concentricity, and a jewel-like ring finish. This process also eliminates expensive tooling and mold charges, frequently lowers costs to 30% of other methods of manufacture. The silver rings are uniformly hard for long life—75-90 Brinell.

ELECTRO TEC one-piece construction precludes dimensional variation due to accumulated errors. The plastic base is fully cured before rings are plated into it, thus preventing separation of base material from the rings.

ELECTRO TEC LARGE SLIP RING Assemblies are widely used in Radar Equipment, Fire Control Systems, Test Tables and many other critical applications. Light weight combined with rugged durability recommends their use in airborne applications.

Every user knows the ELECTRO TEC reputation for quality and superiority in miniature and sub-miniature slip ring assemblies.

# Direct, accurate measurements of signal components—15 to 500 kc

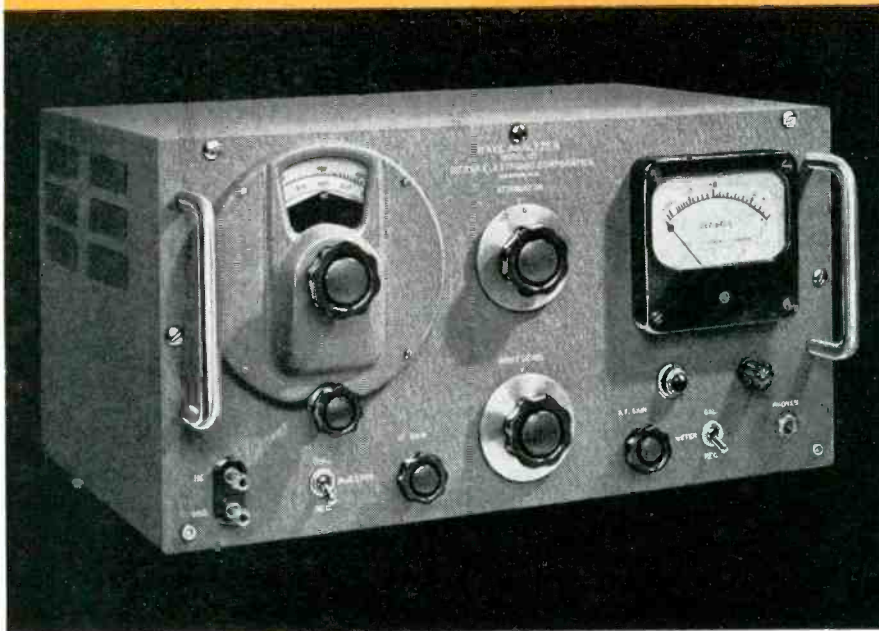

## Model 121 Wave Analyzer

This new Sierra Wave Analyzer is designed to give you maximum operating ease, high accuracy and broad applicability in analyzing complex wave forms between 15 and 500 kc. The instrument is particularly useful for carrier system frequency analysis and induction studies, for determining filter transmission characteristics, or for measuring distortion and intermodulation components of rf signal sources and transmitters.

The Model 121 makes possible direct measurement of signal components throughout its range, and eliminates complex expensive setups with conventional receivers and signal generators. Input level range is +42 to -70 dbm at 600 ohms impedance. Measuring accuracy is  $\pm 2$  db; selectivity is such that response is 45 db down at 1 kc off resonance. Input bridging impedance is 10,000 ohms in the pass band. Price \$695.00 f. o. b. factory.

antiresonant frequencies can be determined. This method is more convenient than direct measurement of charge or voltage but it still requires the use of laboratory instruments capable of frequency determinations within 0.1 percent. Such measurements, while not difficult, are hardly adaptable to production testing.

If we consider the equivalent circuit for a piezoelectric element at resonance the impedance reduces to resistance  $R$  in parallel with capacitance  $C$ , as shown in Fig. 1B. Resistance  $R = U/k^2$  where  $U$  is a constant depending on the dimensions and mechanical constants of the piezoelectric element, and  $k$  is the coupling coefficient. For a unit of given size and fixed mechanical properties,  $k$  can be evaluated by measuring  $R$ . To measure  $R$  a fixed resistance is connected in series with a piezoelectric element as shown in Fig. 1B. Voltages  $V$  and  $V_m$  are determined at resonance. From these measurements  $R$  can be evaluated from the equation

$$R = \frac{V_m R_s (V_m + \sqrt{V^2 - V_m^2 \omega^2 C_o^2 R_s^2})}{V^2 - V_m^2 (1 + \omega^2 C_o^2 R_s^2)}$$

When the coupling coefficient is greater than about 15 percent,  $R$  is small compared with capacitive reactance and a good approximation is

$$R = R_s \frac{V_m}{V - V_m}$$

Measurements made by this method indicate that except at very low values of  $k$ ,  $R$  is a valid measure of piezoelectric activity.

The application of this method to production testing is comparatively simple and does not involve elaborate equipment. The output of a variable-frequency, fixed-voltage oscillator is connected across the unit being tested and an ammeter is used to measure the current through the unit. The meter is calibrated by measuring units of known activity. After calibration piezoelectric units may be sorted for activity by noting the deflection of the meter and rejecting units that pass less than a given current value.

This article has been abstracted from a paper entitled "A Rapid Method for Evaluating the Activity

**Model 122  
LINE-BRIDGING  
TRANSFORMER**

The Sierra 122 L ne-Bridging Transformer instantly converts Model 121 Wave Analyzer from single-ended to balanced input. The transformer is a broad band ferrite core unit operating flat within 0.5 db. from 15 to 500 kc. It is compensated so that Analyzer readings are corrected for the transformer's small insertion loss. Offered in three impedances: Model 122A, 135 ohms; 122B, 500 ohms; 122C, 600 ohms. Price \$35.00 f. o. b. factory.

For complete information see your local Sierra sales representative or request Bulletin 103A

# sierra

## Sierra Electronic Corporation

San Carlos 2, California, U. S. A.

Sales representatives in major cities

Manufacturers of Carrier Frequency Voltmeters, Wave Analyzers, Line Fault Analyzers, Directional Couplers, Wide-Band RF Transformers, Custom Radio Transmitters.



Copyright 1953 Sierra Electronic Corp. Data subject to change without notice.

2769

# BREAKING THE NOISE BARRIER

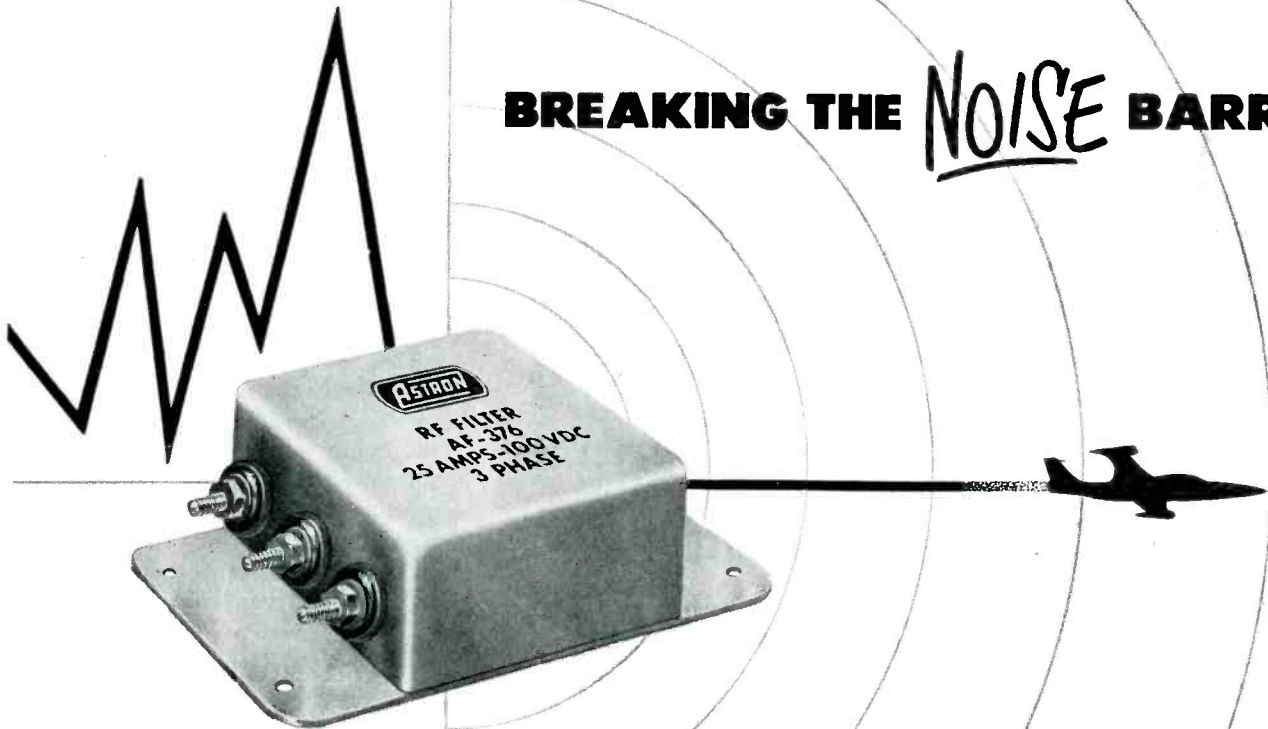

For performance to Radio Interference Specification MIL-I-6181 and other applicable government specifications covering radio noise suppression.

## MIL-I-6181

- In Less Space
- With Less Weight

\*Metallized paper capacitor sections for the maximum in subminiaturization; special paper and foil and metallized paper capacitor sections for operation to 125°C.

# ASTRON

## RF INTERFERENCE SUPPRESSION FILTERS

When you must break the noise barrier, look to ASTRON—the manufacturer *best qualified* to meet your exacting needs in RF Interference Suppression Filters.

Astron is now supplying the top names in the aircraft and electronics industries. Astron has extensive experience in filter design and technique for extreme high altitude and high temperature operation, as well as for extreme variations in atmospheric pressure. All Astron filters are *ruggedized* to withstand severe vibration and shock. Maximum attenuation with unusually small size and light weight is made possible by use of special capacitor sections\*, specially wound inductances, and other special components and engineering techniques. The desirable characteristics of low impedance and low voltage drop with minimum heating are retained and *improved* in these subminiaturized filters. Write today for complete details, outlining your specific requirements.

ASTRON manufactures a complete line of dry electrolytic capacitors, metallized paper capacitors, plastic molded capacitors, standard and subminiature paper capacitors and RF interference filters for every radio, television and electronic use.

DEPEND ON—INSIST ON

ASTRON CORPORATION



255 GRANT AVENUE, EAST NEWARK, NEW JERSEY

Export Division: Rocke International Corp., 13 E. 40th St., N.Y.C.  
In Canada: Charles W. Pointon, 1926 Gerrard St. East, Toronto.

of Piezoelectric Barium Titanate", by H. I. Oshry and Jan Minkowski, presented at the 7th National Instrument Conference in Cleveland.

## Two R-C Oscillator Circuits

By H. L. ARMSTRONG  
National Research Council  
Ottawa, Canada

THE RESISTANCE-CAPACITANCE coupled oscillator has been in common use in the audio and low r-f ranges where it has important advantages over most other types<sup>1</sup>. Essentially, such an oscillator consists of a noninverting amplifier whose output is coupled back to the input by a resistance-capacitance network arranged to give minimum attenuation and zero phase shift at the desired frequency. The noninverting amplifier has usually been of the ordinary two-stage resistance-coupled type, but other arrangements are possible.

In this article two such circuits are described using respectively the cathode-coupled amplifier and the transitron amplifier. These use fewer components than do the more usual arrangements. In addition the circuit leaves one grid free to be used for keying, gating or modulation.

A circuit diagram of the cathode-coupled oscillator is shown in Fig. 1. This principle has been applied to oscillators using an ordinary resonant tank circuit<sup>2</sup>, but the author has not previously seen it used with resistance coupling. This unit was designed for fixed fre-

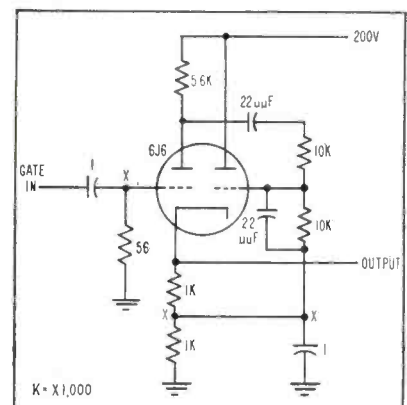
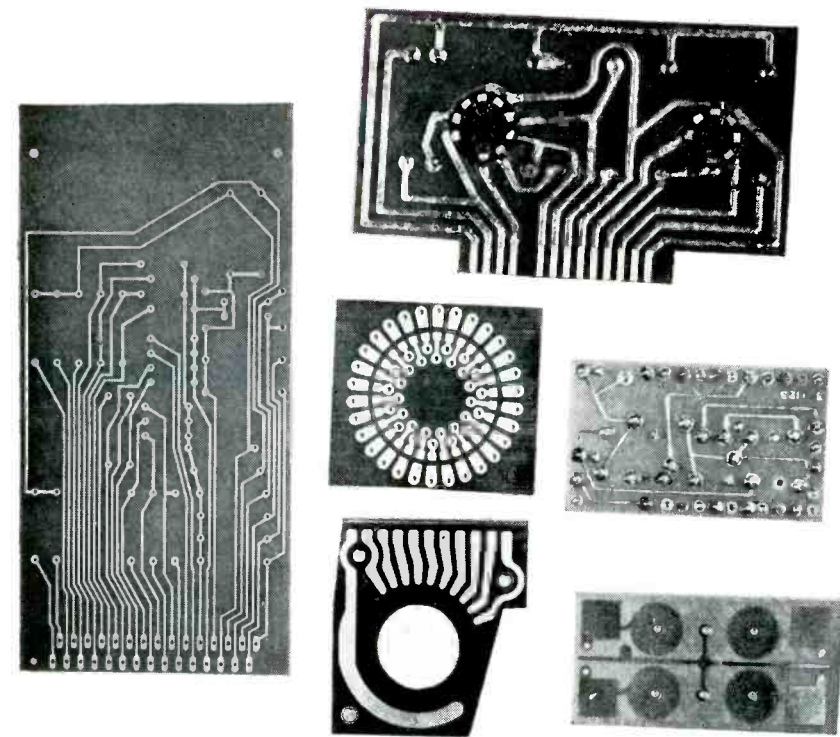

FIG. 1—Circuit diagram of cathode-coupled oscillator



## Are You Switching to Printed Circuits? You Need **CASTOMATIC**® Solder!

Printed circuits save on solder and soldering time. In this work you don't use much solder and it doesn't cost much compared to what you are manufacturing. Therefore the solder should be the best quality you can buy . . . Federated CASTOMATIC bar solder. Here's why *machine-cast* CASTOMATIC is the best:

1. Free of Dross—the patented, pressurized casting system keeps air out; harmful dross-producing oxides are thereby excluded. Solder flows freely through tiniest openings. Your solder bath stays cleaner.
2. Uniform Composition—electronically controlled machine casting eliminates segregation of constituents. Joints are trouble-free. Every bar of a given analysis melts at the same temperature. Each piece of a bar of eutectic solder, for example, will melt at almost exactly 362°F.

Ask for a sample of CASTOMATIC. It will prove itself. Just return coupon for prompt action.

Picture courtesy Photocircuits Corp., Glen Cove, N. Y.

### Federated Metals Division

AMERICAN SMELTING AND REFINING COMPANY  
120 BROADWAY, NEW YORK 5, N. Y.

In Canada: Federated Metals Canada, Ltd., Toronto and Montreal

Please send a salesman.

Please send me a sample of CASTOMATIC solder.



MY NAME \_\_\_\_\_ TITLE \_\_\_\_\_

COMPANY NAME \_\_\_\_\_

ADDRESS \_\_\_\_\_

CITY \_\_\_\_\_ ZONE \_\_\_\_\_ STATE \_\_\_\_\_

# LFE PLUG-IN PACKAGES ARE Reliable • Economical • Compact



**MAGNETIC BINARY COUNTER  
PLUG-IN PACKAGE MODEL 1001**

Nine-stage binary counter designed to perform counting functions with a minimum of components, low power consumption, and maximum reliability. Can be used to perform such functions as integration, addition, multiplication and division as required.

**GATING UNIT PLUG-IN PACKAGE MODEL 1002**

Can be used with LFE Magnetic Binary Counter Model 1001 to permit pulse multiplication and division, scale factoring, and other functions as required. Provides 9 "and" gates and a 9 channel "or" gate.

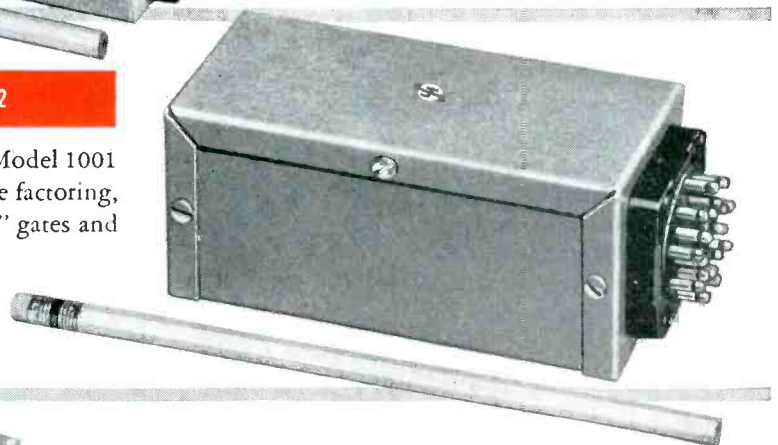

**MAGNETIC PULSE SYNCHRONIZER PLUG-IN PACKAGE MODEL 1003**

Provides means for accepting pulses at random times and synchronizing them with pulses occurring at known times. Design is independent of tube types and input signal characteristics, and has very low input power requirements.

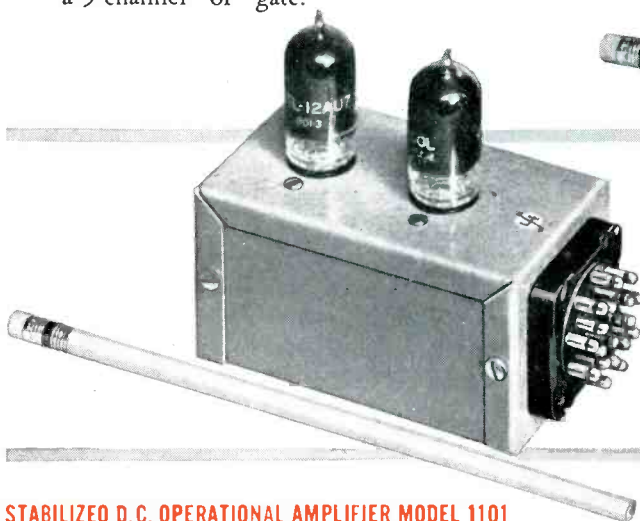

**STABILIZED D.C. OPERATIONAL AMPLIFIER MODEL 1101**

Designed to provide high gain and low drift to meet the stringent need of real time computation. Has low phase shift and wide bandwidth resulting in excellent performance at high solution speeds. Model 1101 may be used with any standard commercial chopper having a make-before-break contact.

**POWER SUPPLY REGULATOR AMPLIFIER MODEL 1102**

Plug-in packaged control amplifier for series regulated D.C. power supplies. Designed to control any type of series tube or tubes as dictated by output current requirements. Provides excellent voltage stability, 60 db. ripple rejection, and low output impedance.

Write today for complete information on LFE Plug-In Packages or other precision products including: 401 Wide-Band Oscilloscope, 101 Magnetometer, Solid Delay Lines, 802 Stabilized Micro-Wave Oscillator X Band and 803 Stabilized Micro-Wave Oscillator S Band.



**LABORATORY for ELECTRONICS, INC.**

75-3 PITTS STREET • BOSTON 14, MASS.

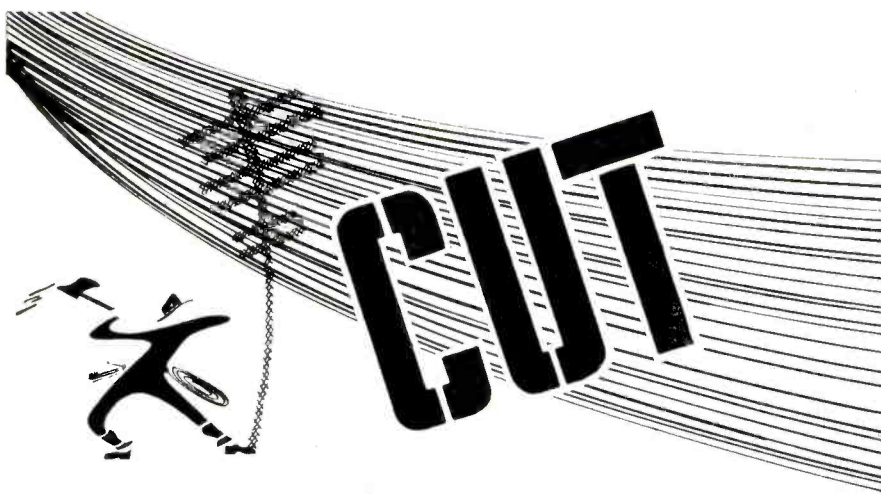

# TRANSMISSION COSTS

## with WORKSHOP Microwave Antennas

Recent installations of Workshop Microwave Antennas have replaced hundreds of telephone lines and several coaxial cables. Railroads, oil companies, and broadcast stations report remarkable savings in installation, operation, and maintenance costs.

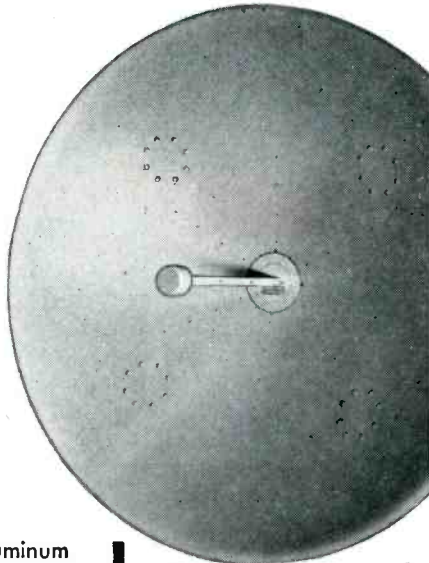

**REFLECTORS**—Precision-formed aluminum and laminated fiberglass reflectors.

**MOUNTINGS**—Popular 3- or 4-point mounts can be supplied with all antennas.

**R. F. COMPONENTS**—Precision machined and heavily silver plated, expertly designed by the Gabriel Laboratories.

**ELECTRICAL DATA**—A series of elaborate measurements of both pattern and impedance are made on production units to assure adherence to specifications. VSWR measurements across the band are furnished with each antenna.

**POLARIZATION**—Either vertical or horizontal polarization can be obtained by a simple adjustment at the rear of the reflector.

**MODELS**—Workshop can supply microwave antennas covering the 940, 2000 and 7000 megacycle bands. A wide range of antenna sizes and feed types are available. For further information write, or phone Norwood 7-3300.

## Other WORKSHOP Products

**UHF Transmitting Antennas**—For UHF television broadcasting—new cosecant antenna.

**Beacon Antennas**—For fire, police, taxicab, and private fleet communications.

**Parabolic Reflectors**—Over 50 different reflector sizes and focal lengths.



**WORKSHOP ASSOCIATES DIVISION  
THE GABRIEL COMPANY**  
ENDICOTT STREET NORWOOD, MASS.

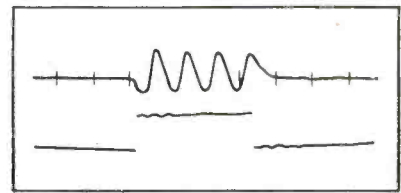

FIG. 2—Oscillogram of cathode-coupled oscillator output with gating pulse

quency operation at about 400 kc. For variable frequency operation the two 22  $\mu\text{f}$  capacitors can be replaced by a two-gang variable. Output is taken from the cathode giving a fairly low output impedance. The circuit shown was designed to be gated on by a pulse from a low-impedance source applied at the gate in terminal. If steady rather than gated operation had been intended, the points marked X would have been grounded directly.

Figure 2 shows an oscillogram of the output when the oscillator is gated on by a pulse of about 10 microseconds duration. Gating pulse is also shown. The output amplitude is about 2.5 volts peak to peak. The rapid starting and stopping of oscillations is apparent.

Another type of noninverting amplifier is the transitron, in which the suppressor control of screen current in a suitable pentode is used. This principle, again, has been used in tank-circuit (or negative-resistance) oscillators<sup>3</sup>, but the use in a resistance-coupled circuit, which is shown in Fig. 3, is believed to be novel. This oscillator gave an output amplitude

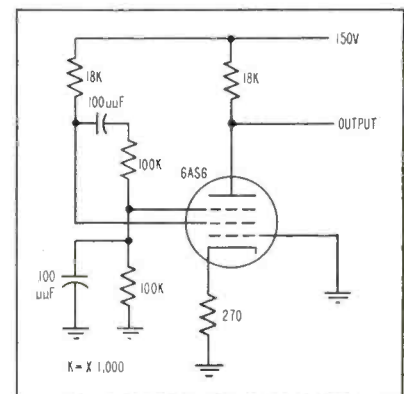

FIG. 3—Circuit diagram of transitron oscillator



### **TAYLOR Built-up Vulcanized Fibre**

is a new material made of many plies of homogeneous vulcanized fibre bonded together with a special resin developed in Taylor Laboratories. It can be machined with the same facility as homogeneous fibre, has high dielectric strength and is available in any thickness desired. Can be furnished in various colors.

## *Want to make something of it?*

*Make it* into many products that require physical and electrical qualities that are equal to, or better than, that of the equivalent thickness of homogeneous fibre. The arc resistance at the adhesive line is equal to that of the fibre itself. The adhesive is unaffected by abrupt changes in relative humidity. It gives built-up fibre greater stability . . . resistance to distortion caused by atmospheric conditions. Edge splitting tests have proven the adhesive stronger than the fibre.

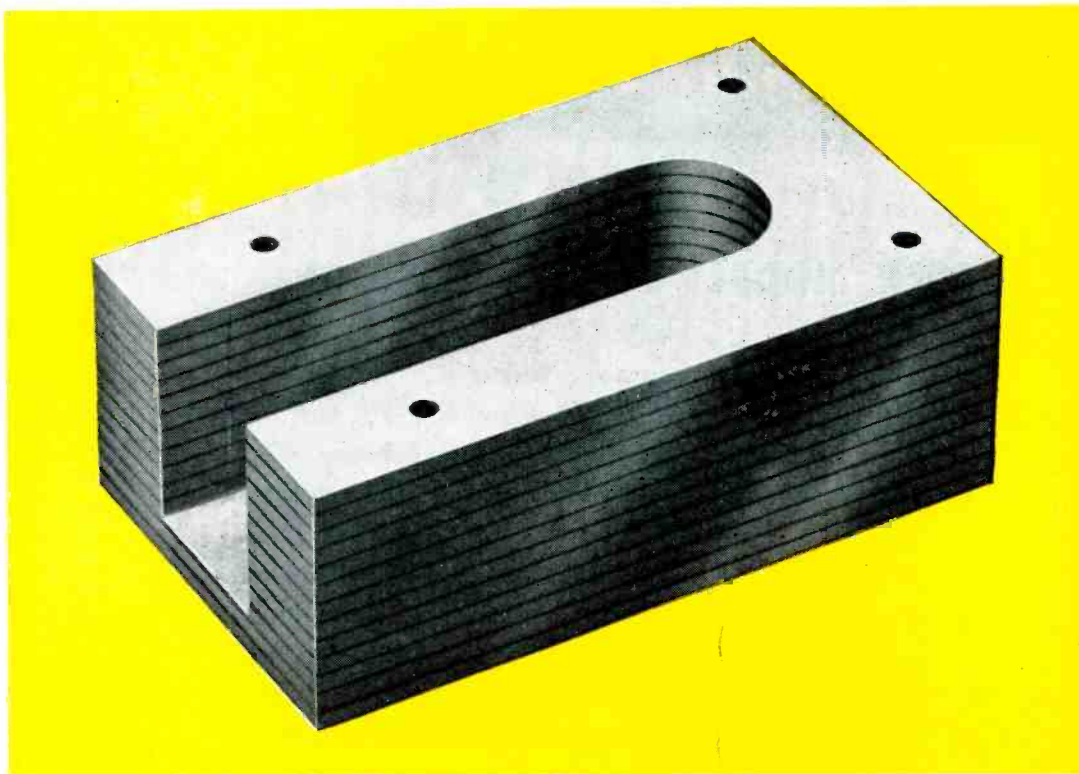

*Make it* from 45" x 56" sheets in any thickness desired. The thickness of individual plies can be varied to suit your particular requirements.

*Make sure* you get complete information on this versatile new material. Call your Taylor engineer . . . he will be glad to work with you . . . see where it can fit into your products. Let him go over your requirements for laminated plastics also. He may be able to suggest ways that *Taylor Phenol, Melamine and Silicone Laminated Plastics* can do a better job . . . lower your costs.

Taylor Fibre Co., Norristown, Pennsylvania—La Verne, California

**TAYLOR**  
Laminated Plastics  
Vulcanized Fibre

of about 25 volts peak to peak, and a frequency of about 20 kc.

## REFERENCES

- (1) F. E. Terman and J. M. Pettit, "Electronic Measurements," 2nd ed. p 482, McGraw-Hill, 1952.
- (2) P. G. Sulzer, *Proc. IRE* 38, p 540, 1950.
- (3) B. Chance, V. Hughes, E. F. Mac-Nichol, D. Sayre, and F. C. Williams, "Waveforms" MIT Radiation Lab. Series, 19, p 124, McGraw-Hill, 1949.

## A-C Voltage Regulation With Ordinary Transformers

W. G. SHEPARD  
Physical Research Unit  
Boeing Airplane Company  
Seattle, Washington

CONNECTING A CAPACITOR of the proper value in series with the primary of a transformer results in secondary voltages that are fairly independent of line voltage. Regulation results because the transformer core is operated in essentially a saturated condition so that the core dimensions, rather than the line voltage, determine the output voltage.

Because of the large size of the capacitors needed for large transformers, this investigation was confined to small transformers. One useful application for transformers used in this manner is to supply the first-stage filaments of a d-c amplifier or sensitive vacuum-tube meter circuit.

### Operation

The primary of the transformer has a certain inductive reactance

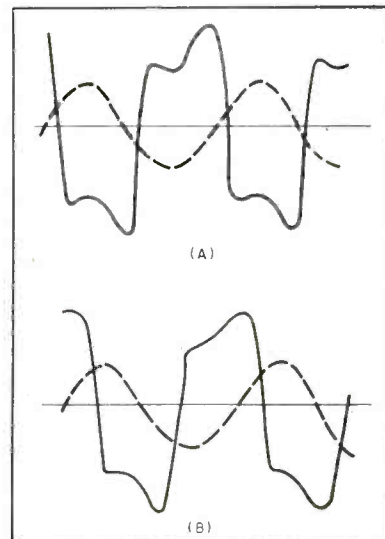

FIG. 1—No-load (A) and load (B) phase relationship of line voltage and voltage across capacitor-regulated transformer primary. Line voltage is dotted

# Precision INSTRUMENT SWITCHES

## STOCK MODELS FOR **YOUR** JOB

There's nothing like stock models of Shallcross Instrument Switches for cutting equipment cost and design problems. For over 20 years Shallcross has made scores of basic switch types with countless variations for practically every electric-electronic application. Single or multi-deck types having up to 60 non-shorting positions are regularly produced. Contact resistance less than 0.001 ohm is a feature of many types. Several unique switches—usually "Special items" with other manufacturers—can quickly be supplied by Shallcross from stock. For a fast solution to any problem involving rotary switches, write to SHALLCROSS MANUFACTURING CO., 522 Pusey Avenue, Collingdale, Pa.

# Shallcross

# General Ceramics' *engineered* STEATITE INSULATORS

*Specified with Confidence for—*

RADIO  
TELEVISION  
UHF CIRCUITS  
ELECTRONICS  
AND ELECTRICAL  
MANUFACTURING

**Pressed and  
Extruded Shapes to  
Close Tolerances**

Engineered Steatite by General Ceramics offers the designer and engineer both excellent electrical and mechanical advantages and the economies of standard catalog body types. Offers low loss factor, zero moisture absorption, high surface and volume resistivity, high tensile and great compressive strength. Steatite insulators can be produced to countless sizes and shapes for practically all requirements.

**Standard Shapes  
AVAILABLE:**

- PILLAR INSULATORS
- LEAD-IN BUSHINGS
- ENTRANCE BUSHINGS
- COAXIAL CABLE INSULATORS
- LEAD-IN INSULATORS
- SPREADER INSULATORS
- STRAIN INSULATORS
- COIL FORMS
- SUPPORT BARS
- COUPLING INSULATORS

### "STEATITE-BONDED-TO-METAL" COMBINATIONS

Steatite bonded to metal by the Solder-Seal method produces a permanent hermetic seal. Also recommended for re-inforcing steatite where exceptional mechanical strength is required.

### FOR UHF CIRCUITS, SPECIAL G-C STEATITE

General Ceramics Special Steatite developed for UHF service. An engineered insulation with extremely low loss factor. Recommendations made on specific applications without obligation.

### CUSTOM DESIGNS TO SPECIFICATION —

Special steatite insulators can be produced in any size or shape by pressing, extruding, casting or machining. Experienced engineers are available for consultation.

FULLY CONFORMS TO THE REQUIREMENTS OF GRADE 2-6A IN ACCORDANCE WITH JAN-1-10.



MAKERS OF STEATITE, TITANATES, ZIRCON PORCELAIN, FERRIMICS, LIGHT DUTY REFRACTORIES, CHEMICAL STONEWARE, IMPERVIOUS GRAPHITE AND FERRIMIC MAGNETIC CORES

**General CERAMICS and STEATITE CORP.**  
Perth Amboy 4-5100  
GENERAL OFFICES and PLANT: KEASBEY, NEW JERSEY

**IF YOU HAVE A PROBLEM —**

For complete information on General Ceramics Steatite Insulators, request the new illustrated catalog; for engineering assistance on specific problems, contact a General Ceramics Sales Engineer.



# ATR

## for A.C. current ANYWHERE!



### STANDARD and HEAVY DUTY INVERTERS

For Inverting D. C. to A.C. ... Specially Designed  
for operating A. C. Radios, Television Sets,  
Amplifiers, Address Systems, and Radio  
Test Equipment from D. C. Voltages  
in Vehicles, Ships, Trains, Planes  
and in D. C. Districts.

See your jobber  
or write factory



# ATR

- ✓ NEW MODELS
- ✓ NEW DESIGNS
- ✓ NEW LITERATURE

"A" Battery Eliminators, DC-AC Inverters, Auto Radio Vibrators

## AMERICAN TELEVISION & RADIO Co.

Quality Products Since 1931

SAINT PAUL 1, MINNESOTA—U. S. A.

at the power line frequency. The capacitor chosen should have a capacitive reactance somewhat less than the inductive reactance of the unsaturated transformer primary. The total reactance equals  $X_L - X_C$  and can be made much less than the reactance of the transformer primary alone. Thus by placing a capacitor of the proper value in series with the primary, much more current is made to flow through the primary and therefore a considerably greater voltage than 115 volts is developed across it.

This increased voltage and current has the effect of producing sufficient lines of force in the transformer core to saturate it and so cause considerable decrease in the inductance of the primary. The inductive reactance therefore decreases, probably becoming much less than the capacitive reactance during the current peaks. The capacitance, since it is the predominating reactance during these peaks, serves to limit the current flow and thus prevents the transformer from overheating.

Transformer saturation is a cumulative process in that a partial saturation lowers the inductive reactance causing more current to

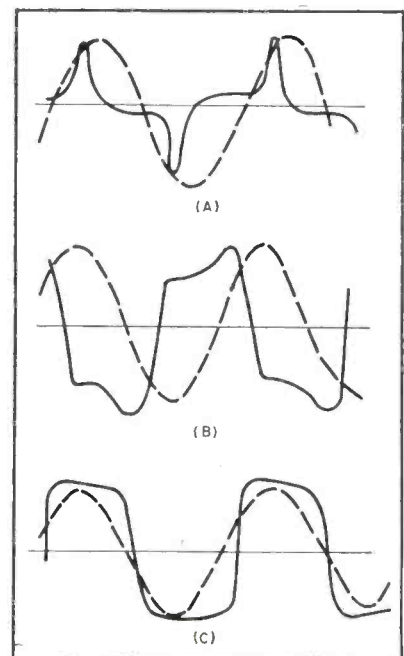

FIG. 2—Primary current (A) with load, voltage output (B) with load and no-load voltage across series capacitor (C) compared with line voltage (dotted) in capacitor-regulated transformer

Send for this *Free* **SAMPLE FOLDER...**

*Contains*  
**25**  
 different Test Samples of  
 high-dielectric  
**INSULATING**  
**TUBING and SLEEVING**



INCLUDES SAMPLES AND DESCRIPTIONS OF THE FOLLOWING...

**VARGLAS SILICONE** Class H insulating materials were pioneered by our Laboratory. Retain flexibility, electrical properties and mechanical strength in temperatures ranging from -85°F. to 500°F. Available in tubing, sleeving, lead wire, tying cord.

**PERMAFIL-IMPREGNATED VARGLAS TUBING** Fiberglass braid coated with General Electric's Permafil resin. Extremely tough, resistant to solvents and elevated temperatures, highly flexible. Can be bent or twisted with little or no loss of dielectric strength. Coils and standard 36" lengths.

**VARGLAS SLEEVING AND TUBING** Numerous types and grades—including synthetic-treated, varnished, lacquered, saturated, litewall and others.

**VARGLAS NON-FRAY SLEEVING** Fiberglass braid normalized to remove all organic impurities. It will withstand temperatures up to 1200°F. Recommended where dielectric properties are not paramount. Three types available.

**VARFLO TUBING AND SLEEVING** Vinyl-coated Fiberglas in full range of sizes, colors and grades. Extremely flexible with excellent heat aging qualities. Low priced.

**VARFLEX COTTON TUBING AND SLEEVING** Varnish or lacquer impregnated—for applications where MIL-I-3190 Class A materials are specified. All NEMA grades.

**SYNTHOLVAR EXTRUDED TUBING** Made in various standard formulations of vinyl polymers. Has high dielectric and tensile strength—will not support combustion nor absorb moisture. Type EG Approved under MIL-I-631A. Several others to meet special requirements.

**NEW! VARGLAS SILICONE RUBBER SLEEVING AND TUBING**—the culmination of 5 years of research—for applications requiring extraordinary flexibility. Details on request.



**MAIL COUPON TODAY FOR SAMPLES!**

**VARFLEX CORPORATION,**  
 308 N. Jay St., Rome, N. Y.

Please send me free folder containing samples of your electrical sleeving and tubing.

I am particularly interested in insulation for:

NAME .....  
 COMPANY .....  
 STREET .....  
 CITY ..... ZONE ..... STATE .....

# TANTALUM CAPACITORS ARE BASIC in current electronic trend.....

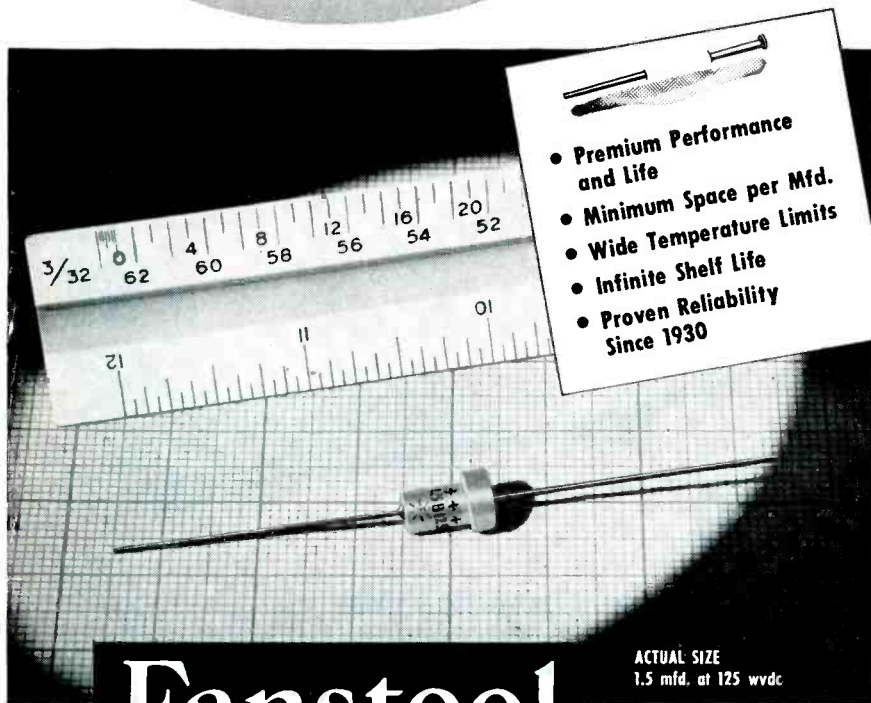

## Fansteel TANTALUM CAPACITORS

Now, through the use of tantalum, new high standards of electrolytic capacitor performance are available. The tantalum oxide film is the most stable dielectric, chemically and electrically, yet discovered. As a result, Tantalum Capacitors offer advantages not found in any other electrolytic type—long life, space saving, wide temperature range, excellent frequency characteristics, no shelf aging.

Tantalum Capacitors are made by Fansteel and other leading capacitor manufacturers. Ask for current information bulletins on Fansteel Tantalum Capacitors.



**FANSTEEL METALLURGICAL CORPORATION**

NORTH CHICAGO, ILLINOIS, U. S. A.

*Tantalum Capacitors... Dependable Since 1930*



32401C

flow, which in turn further saturates the core, and so on.

Typical oscillographs of the voltage and current phase relationships with respect to the input line voltage are shown in Fig. 1 and 2. Figure 3 shows a vector diagram of the relationship to be expected between the line voltage, the primary circuit current and the voltage across the saturated primary. The vector relationship shown is an approximation. In general the relationship applies only to the fundamental part of the current and transformer primary voltage waves, since both of these waves contain harmonics.

One factor to be watched when using this technique is the transformer temperature. Because of the

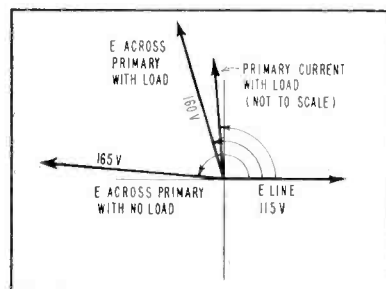

FIG. 3—Vector diagram of relation between primary current and voltage

harmonics present, eddy-current loss is expected to be higher than when the transformer is used in the usual way. This is especially true when thick laminations are used.

### Capacitor Size

Various values of capacitance were tried for each transformer. The capacitance determines the degree of saturation of the core and has an effect on the voltage output and the amount of load possible. If the capacitor is too small, saturation is not reached and the transformer does not regulate. Tests made with a variable line voltage showed that if the capacitor is sufficiently large the transformer snaps into regulation as the line voltage is increased. This happens because the saturation is cumulative, as before mentioned. Regu-



Burtor, bigque advert, sing

**this TV set IMPROVES WITH AGE**

Five years old next week—and now better than ever. When the original tube wore out it was replaced with a Rauland. Now pictures are brighter, sharper, clearer. Another Rauland success story—your cue to sell *improvements* through replacement with Rauland—and chalk up plus business.

THE RAULAND CORPORATION 104 4245 NORTH WEX AVENUE  
CHICAGO 4, ILLINOIS - MULBERRY 5-5000  
ZENITH SUBSIDIARY

# the **Waterman** INDUSTRIAL POCKETSCOPE®



MODEL  
S-11-A

Size:  
11" x 5" x 7"  
8¾ Pounds

## ANOTHER EXAMPLE OF **Waterman** PIONEERING...

The INDUSTRIAL POCKETSCOPE, model S-11-A, has become America's most popular DC coupled oscilloscope because of its small size, light weight, and unique flexibility. This compact instrument has identical vertical and horizontal amplifiers which permit the observation of low frequency repetitive phenomena, while simultaneously eliminating undesirable trace bounce. Each amplifier sensitivity is 0.1 Volt rms/inch. The frequency responses are likewise identical, within -2 db from DC to 200 KC. Their total undistorted outputs permit effective trace expansion of twice the screen diameter. The internal

sweep generator is continuously variable from 3 cycles to 50 KC and can be synchronized from positive going signals. Return trace blanking is optional. Intensity modulation is accomplished by connecting either directly to the grid of the three-inch cathode ray tube or thru an amplifier having a gain of approximately 10 and a flat response to 500 KC. Direct intensity modulation threshold voltage is approximately 1 volt rms. Additional provisions for direct access to all the deflection plates, the second anode, and the amplifier output terminals extend the usefulness of the S-11-A many fold.

lation does not cease until the line voltage is considerably reduced, at which time the action is again a snap action. If, on the other hand, the capacitor is too large, too much heat is developed in the transformer.

Because of the increased voltage across the primary, the secondary voltage exceeds the rated output. This means that, either a transformer with a lower voltage rating than the desired output voltage must be used, a resistance must be placed in series with the load or turns must be removed from the secondary. The latter is an easy operation since the secondary winding of a filament transformer is on the outside.

## High-Power Klystron Amplifier

BY JOHN JASBERG  
*Research Associate  
Microwave Laboratory  
Stanford University  
Stanford, Calif.*

THE HIGH-POWER klystron amplifier shown in cross-section in Fig. 1 is a continuously pumped tube designed to provide power at 10.5 cm for the 1-bev linear electron accelerator now nearing completion at the Stanford Microwave Laboratory. The accelerator will use 21 of these tubes, each delivering 17 megawatts peak power in 2- $\mu$ sec pulses, with a 60-cycle repetition frequency.

The tube is a gridless, three cavity klystron using an oxide-coated,

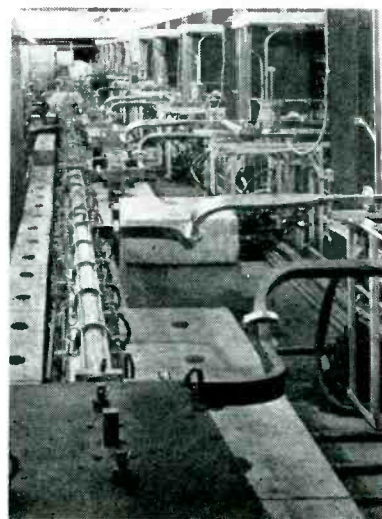

Linear accelerator with row of klystron units at right

## WATERMAN PRODUCTS CO., INC.

PHILADELPHIA 25, PA.

CABLE ADDRESS: POKETSCOPE

### WATERMAN PRODUCTS INCLUDE

S-4-A SAR	<u>PULSESCOPE®</u>
S-5-A LAB	<u>PULSESCOPE</u>
S-12-B JANized	<u>RAKSCOPE®</u>
S-14-A HIGH GAIN	<u>POCKETSCOPE</u>
S-14-B WIDE BAND	<u>POCKETSCOPE</u>
S-15-A TWIN TUBE	<u>POCKETSCOPE</u>

Also RAYONIC® Cathode  
Ray Tubes and Other  
Associated Equipment

MEMO...  
*Write for  
details  
today!*

**WATERMAN PRODUCTS**



*...Another Crucible Service for Magnet Users*

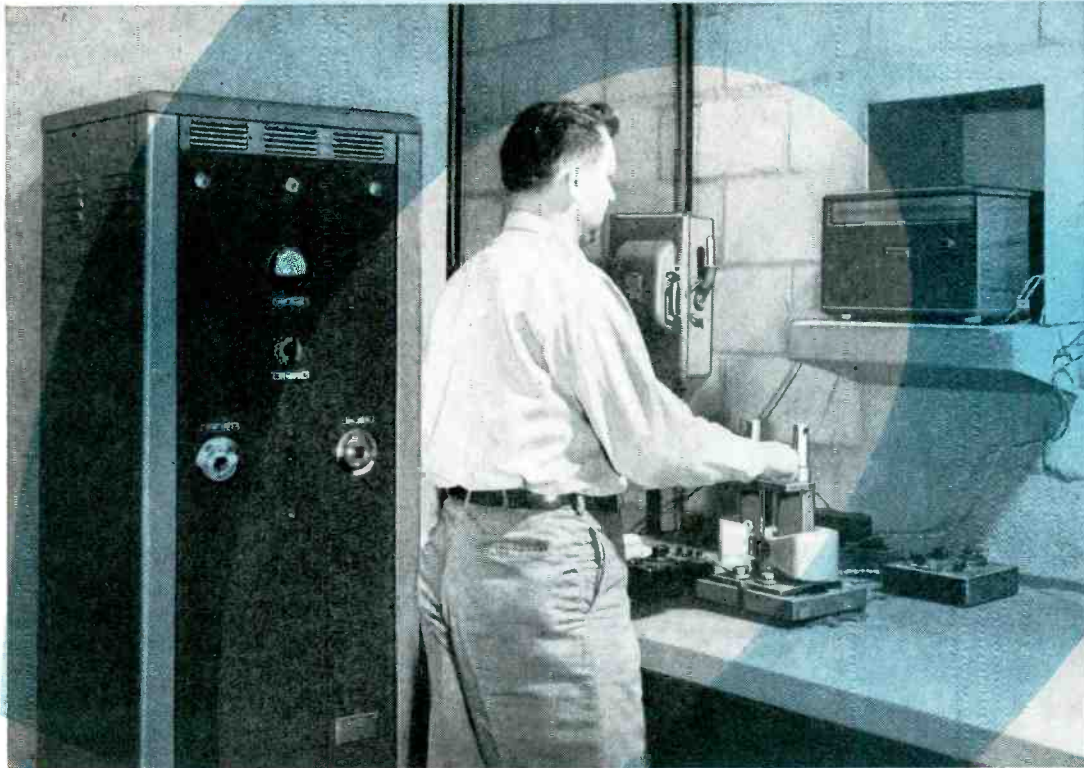

**160,000**

**ampere turn,  
impulse magnetizer  
now available**

Magnet users are reducing manufacturing costs and improving their products through the use of this new, capacitor discharge-type, impulse magnetizer — another example of Crucible's leadership in serving industry.

This Crucible development has an improved firing circuit . . . is more compact . . . requires less maintenance . . . and results in more efficient magnetization.

For further information on the availability and operation of the Crucible Impulse Magnetizer, write to Crucible Steel Company of America, General Sales Offices, Oliver Building, Pittsburgh, Pa.

**CRUCIBLE**

first name in special purpose steels

53 years of *Fine* steelmaking

**ALNICO PERMANENT MAGNETS**

CRUCIBLE STEEL COMPANY OF AMERICA, GENERAL SALES OFFICES, OLIVER BUILDING, PITTSBURGH, PA.

STAINLESS • REX HIGH SPEED • TOOL • ALLOY • MACHINERY • SPECIAL PURPOSE STEELS

# Measure and Record Strain with PRECISION



6-channel  
unit

## The Hathaway TYPE RS-10 PRECISION STRAIN INDICATOR

6, 12, 25 or 50 Channels

### FOR PRECISION MEASUREMENTS OF STATIC STRAIN

Static strain in 1 to 50 channels can be measured in rapid succession. Individually-calibrated 21-inch dial provides an accuracy of  $\frac{1}{4}$  percent. Smooth and accurate balancing controls for each channel. Continuously-variable gage-factor adjustment.

### FOR RECORDING DYNAMIC STRAIN

The RS-10 can be used with an oscillograph (such as the Hathaway type S14-C) for recording dynamic strain, providing accurate balancing and means for precision calibration of the records.

### MULTI-CHANNEL PRECISION MEASUREMENTS OF STATIC STRAIN

### DYNAMIC STRAIN RECORDING TO 300 CPS WITHOUT AMPLIFIERS

Write for Catalog Sheet 3H4K for details.

Write for Your Free Copy of Hathaway Engineering News

*Hathaway*  
INSTRUMENT COMPANY  
1315 SO. CLARKSON STREET • DENVER 10, COLORADO

indirectly heated cathode. The cathode structure is insulated from the tube by a housekeeper-type glass seal, which will withstand 400-kv peak pulse voltage. The cathode assembly is sealed to the tube by a weld made on two nickel eyelets. The cathode may be reached for cleaning and recoating the emitting surface, by cutting off the weld. After repairs are made the eyelet is rewelded.

In operation the cathode is pulsed negatively with respect to the rest of the tube, which is grounded. The

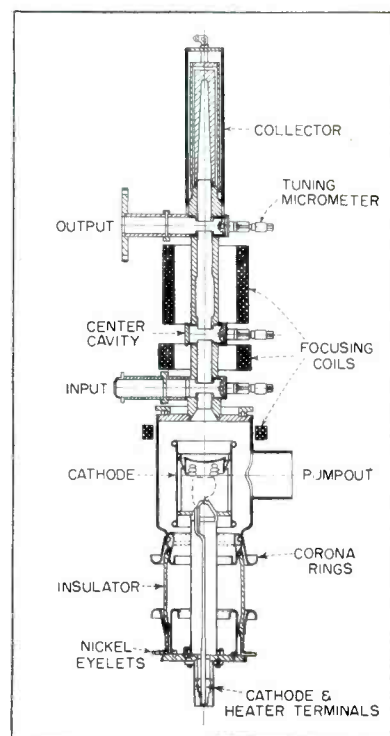

FIG. 1—Cross section of 17-megawatt klystron

peak input power is 100 megawatts. The cavities and drift tubes are surrounded by focusing coils that keep the beam from spreading until it has passed the output cavity. The r-f structure and collector are water cooled. Input and output are fed through resonant windows, glass on the input and ceramic on the output. The output window, not shown on the drawing, is a separate unit bolted to the output waveguide and is still an experimental item. Standard S-band waveguide is used on input and output. The output waveguide is evacuated to prevent voltage breakdown.

The klystron is operated verti-

Meet us at  
**WESTERN ELECTRONIC SHOW**  
San Francisco . . . . . Aug. 19-21



**ALSIMAG<sup>®</sup>**  
**METALLIZED**  
**CERAMICS**

Electronic engineers are gaining one or all of these product advantages from the newly engineered ALSiMag metallized ceramics ideally suited for soft soldering:

- Marked improvements in stability
- Better precision
- More rugged construction
- Increased reliability (Under all operating conditions)
- Space savings
- Lower costs of units or assemblies
- Simplification

For recommendations on your problems, send sketches and complete details on operating conditions.

52ND YEAR OF CERAMIC LEADERSHIP

**AMERICAN LAVA CORPORATION**

CHATTANOOGA 5, TENNESSEE

NEW YORK: METROPOLITAN AREA: 671 Broad St., Newark, N. J., Mitchell 2-8159 • SYRACUSE, N. Y.: 330 Arlington Ave., Phone 76-5068 • CLEVELAND: 5012 Euclid Ave., Room 2007, Express 1-6685  
NEW ENGLAND: 1374 Mass. Ave., Cambridge, Mass., Kirkland 7-4498 • PHILADELPHIA: 1649 N. Broad St., Stevenson 4-2823 • ST. LOUIS: 1123 Washington Ave., Garfield 4959  
CHICAGO: 228 N. LaSalle St., Central 6-1721 • SOUTHWEST: John A. Green Co., 6815 Oriole Dr., Dallas 9, Dizen 9918 • LOS ANGELES: 5603 N. Huntington Dr., Capital 1-9114

For Parts that must be  
TAKEN OFF—PUT BACK—BUTTONED TIGHT

## LION FASTENERS

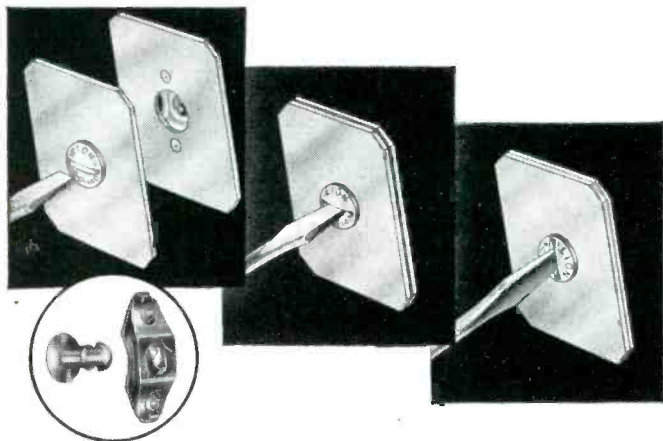

LOCKS TIGHT WITH A QUARTER TURN  
*Always at correct tension*

Lion Fasteners are *right* for buttoning parts that must be removed repeatedly for inspection, maintenance, or other reasons.

Vibration and shock can't loosen a Lion Fastener. Even an inexperienced service man can't replace it wrong. A quarter turn opens it. Another quarter turn locks it. The tension is designed into it.

Lion Fastener Spring Assembly is quickly spot welded or riveted in place. The stud cannot be lost. It is grommeted tight to the sheet. They will button sheets .040 plus or .020 minus over or under standard rating. The misalignment is as much as .156. The one-piece forged stud is tested to 1425 lbs. Write today for demonstration kit and application data.

**TYPICAL APPLICATIONS:** INSPECTION PLATES • COWLING  
ELECTRICAL PANELS • CABINETS • DUCTWORK

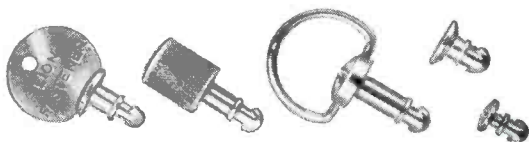

*Free* DEMONSTRATION KIT contains sample Lion Fasteners to help you visualize their adaptability to your product. Write on your company letterhead. No obligation.



**L I O N**  
**FASTENERS, INC.**  
500 MAIN ST., HONEOYE FALLS, N. Y.

cally with the cathode in an oil-filled tank containing a 6-to-1 pulse transformer and an isolating filament transformer. Conventional artificial transmission-line circuits with resonant charging are used in the modulator supplying up to 67-kv pulses to the transformer primary. Switching is done by triggered gaps.

Typical operating conditions for the tube are:

Peak beam voltage...295 kilovolts  
Peak beam current...190 amperes  
Peak power output...17 megawatts  
Power gain .....33 db  
Efficiency .....33 percent

Tubes have run for several hundred hours under these conditions and have been tested to over 20-megawatts output. Other tubes have operated the accelerator for periods up to a year at somewhat lower levels. No failures have been directly due to cathode failure, most breakdowns being caused by failure of the output window after prolonged operation at high power.

### PERTINENT PATENTS

PATENT 2,631,277 for a "Flight Hazard Warning System" was recently granted to Marvin Skoller, assignor to the Hughes Tool Co., of Houston, Texas.

The purpose of this invention is to provide a warning signal within the pilot's view or his hearing when the aircraft he is guiding approaches an obstacle in its path, such as mountainous terrain ahead.

To accomplish this the inventor has provided a pulse-type uhf transmitter that sends out short bursts of r-f energy. An associated gate-forming circuit and delay lines energize a receiver for a period of time covering some predetermined range. Echoes of the energy bursts are received in a superheterodyne receiver when gated to do so, whereupon the equipment provides a visible and audible warning signal when the echoes received are within the range for which the equipment has been set. The circuit of the in-

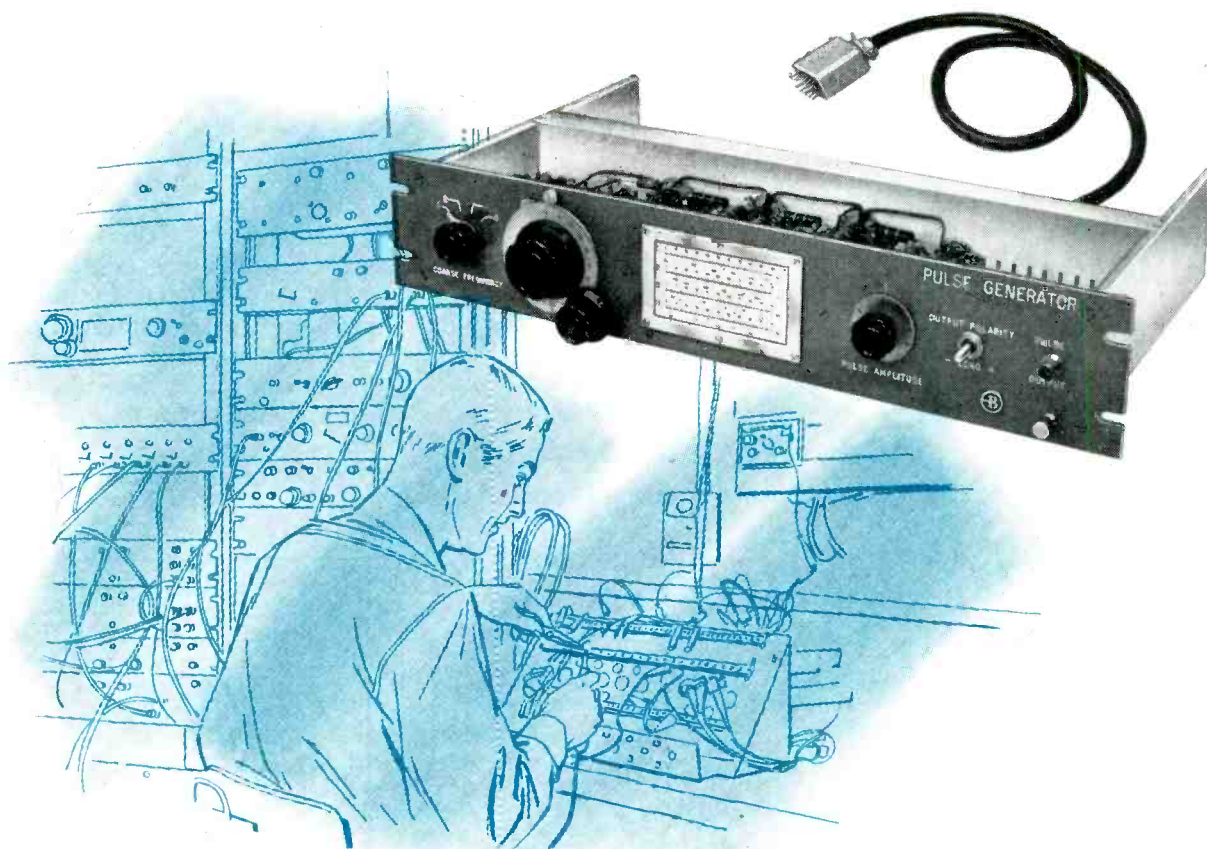

## “Unitized” Pulse Control Equipment saves engineering time and money

WHEN you use Burroughs “Unitized” Pulse Control Equipment, you eliminate much of the costly, time-consuming work of developing electronic test circuits. There is a Burroughs pulse control unit for practically every basic function in pulse circuit engineering. You need only plan a block diagram of the pulse circuits you want, assemble the necessary Burroughs units in the plug-in rack and interconnect them with the various standard coaxial cables and accessories. This can be done because each unit performs *one basic operation* such as generating, counting, mixing, gating, or delay.

### JUST “PLUG IN” A BURROUGHS PULSE GENERATOR

Any of the three pulse generators offered by Burroughs demonstrates the practical one-basic-function principle behind Burroughs “Unitized” Pulse Control Equipment . . . you simply select the pulse generator for the job and plug in the cables.

Burroughs Pulse Generator, Type 1002B, generates 0.1 microsecond pulses at frequencies continuously variable from 0.2 megacycles to 4.5 megacycles in four overlapping bands. A calibrated, L-C controlled, sine-wave oscillator controls

the frequency. Output amplitude, which is only affected by frequency changes in the ranges above 2 megacycles, can be varied from 10 to 32 volts and the polarity of the output pulse is reversible.

Like other Burroughs units, this pulse generator is designed and engineered so that it can be added to equipment now in use, selected as a basic component of new equipment, or used repeatedly for testing or as a component in future pulse control jobs.

*For full information on Burroughs “Unitized” Pulse Control Equipment, call or write Department 12, Electronic Instruments Division, Burroughs Research Center, 511 N Broad St., Philadelphia 23, Pa.*

PULSE GENERATORS  
COINCIDENCE DETECTORS  
PULSE DELAY CIRCUITS  
FLIP-FLOP CIRCUITS  
PULSE GATERS  
CHANNEL SELECTORS  
MIXERS

**ELECTRONIC INSTRUMENTS DIVISION**  
**Burroughs**

# Communication Engineers

with  
experience  
in  
the  
fields  
of

**Systems  
Engineering**

**Information  
Theory**

**Circuit  
Development**

**Electro-  
mechanical  
Development**

**Equipment  
Engineering**

## THE COMPANY

Hughes Research and Development Laboratories, located in Southern California, form one of the nation's leading electronics organizations. The personnel are presently engaged in the development and production of advanced electronics systems and devices.

## AREAS OF WORK

The communication group is concerned with the design and development of unique radio communication systems and with exploiting new radio communication techniques. Specialists in propagation phenomena, antenna sys-

tems, network theory, magnetic recording, wide-band amplification, and intricate electromechanical devices are active in this program.

## THE FUTURE

Engineers who enjoy a variety of problems requiring originality and ingenuity find the proper environment for personal advancement in these activity areas. Widespread future application of advanced communication techniques will enable the Hughes engineer to take full advantage of his experience as the Company expands commercially.

*Write today, giving details of qualifications and experience. Assurance is required that relocation of the applicant will not cause disruption of an urgent military project.*

*How to apply*

# Hughes

RESEARCH AND DEVELOPMENT LABORATORIES

Scientific  
and  
Engineering  
Staff

CULVER CITY,  
LOS ANGELES  
COUNTY,  
CALIFORNIA

vention is shown in Fig. 1.

Obstruction warning systems such as the Skoller invention might well be standard equipment in all commercial and military aircraft since the type of equipment disclosed should not be costly.

## T-W Amplifier

A traveling-wave amplifier tube of an unusual configuration for microwaves is the subject of patent 2,620,458 issued to Percy L. Spencer of West Newton, Mass. and assigned to the Raytheon Mfg. Co.

It has been customary to build

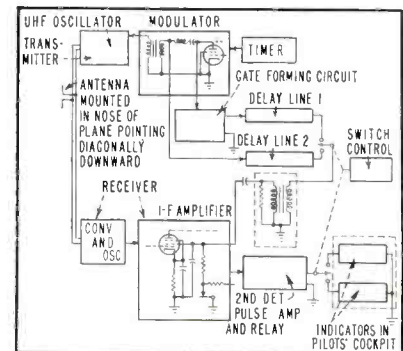

FIG. 1—Flight-hazard warning device employs pulsed uhf transmitter. Receiver is gated to accept reflected echoes

traveling-wave tubes in an elongated configuration with a helical waveguide structure down the center of the tube.

In the present invention the inventor wraps the helical waveguide up in a toroidal form and thereby conserves space and, he claims, reduces manufacturing costs and facilities.

A cutaway view of the microwave amplifier is shown in Fig. 2A. Figure 2B shows the internal details looking down on the structure.

The cathode and heater are familiar structures. The control electrode is a disk-like structure with pins projecting vertically downward between the turns of the toroid of the helical waveguide through which the microwave energy is transmitted. The outer magnetic field coil maintains the circular field to contain the microwave energy within the waveguide toroid.

In operation microwave energy

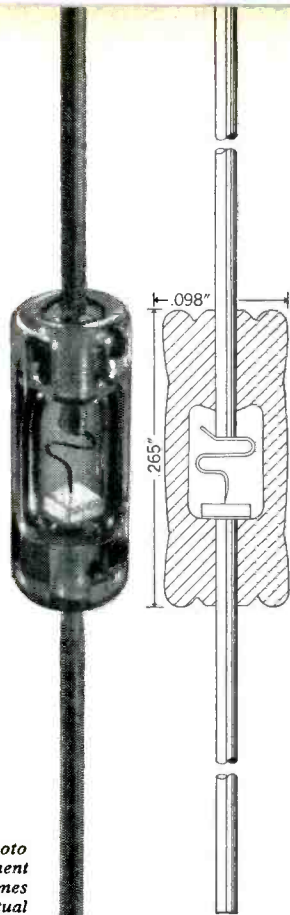

Photo enlargement six times actual size.

Hughes  
Diodes  
are

**FUSION  
SEALED  
IN  
GLASS**

for electrical  
stability

GLASS-TO-METAL fusion sealing for electrical stability is an exclusive feature of HUGHES GERMANIUM DIODES. The final seal in precision assembly operations is made at a temperature exceeding 700° C.

Proved in billions of vacuum tubes, the glass-to-metal seal has been incorporated to full advantage in diode manufacture for the first time by the Hughes-developed process of fusion sealing. The result is a unique germanium diode whose elements are encased in a rigid *one-piece* glass envelope, which assures permanent freedom from moisture penetration.

THE HUGHES GERMANIUM DIODE, developed by Hughes Research and Development Laboratories, employs no wax or solder, and has no mechanical joints or pressed-in parts to shift position.

To insure the satisfactory operation of HUGHES DIODES under adverse conditions of moisture, vibration, and severe shock, a 100 per cent testing procedure has been devised which *invites* instabilities to occur prior to shipment and assures rejection of every defective diode. *Each* HUGHES DIODE is humidity-cycled, temperature-cycled, and JAN shock-tested.

HUGHES GERMANIUM DIODES have proved consistently able to meet exacting requirements in airborne electronic equipment for navigation, fire control and guided missiles.

Volume orders for most types of HUGHES DIODES can be filled from stock. Diodes are also tested to special specifications, including high-temperature electrical requirements.

HUGHES GERMANIUM DIODE ELECTRICAL SPECIFICATIONS AT 25° C.						
Description	RTMA Type	Test Peak Inverse Voltage* (volts)	Maximum Inverse Working Voltage (volts)	Minimum Forward Current @ +1 v (ma)	Maximum Inverse Current (ma)	
High Peak	1N55B	190	150	5.0	0.500 @ -150 v	
	1N68A	130	100	3.0	0.625 @ -100 v	
High Back Resistance	1N67A	100	80	4.0	0.005 @ -5 v;	0.050 @ -50 v
	1N99	100	80	10.0	0.005 @ -5 v;	0.050 @ -50 v
	1N100	100	80	20.0	0.005 @ -5 v;	0.050 @ -50 v
High Back Resistance	1N89	100	80	3.5	0.008 @ -5 v;	0.100 @ -50 v
	1N97	100	80	10.0	0.008 @ -5 v;	0.100 @ -50 v
	1N98	100	80	20.0	0.008 @ -5 v;	0.100 @ -50 v
High Back Resistance	1N116	75	60	5.0	0.100 @ -50 v	
	1N117	75	60	10.0	0.100 @ -50 v	
	1N118	75	60	20.0	0.100 @ -50 v	
General Purpose	1N90	75	60	5.0	0.800 @ -50 v	
	1N95	75	60	10.0	0.800 @ -50 v	
	1N96	75	60	20.0	0.800 @ -50 v	
JAN Types	1N126**	75	60	5.0	0.050 @ -10 v;	0.850 @ -50 v
	1N127†	125	100	3.0	0.025 @ -10 v;	0.300 @ -50 v
	1N128‡	50	40	3.0	0.010 @ -10 v	

\*That voltage at which dynamic resistance is zero under specified conditions. Each Hughes Diode is subjected to a voltage rising linearly at 90 volts per second.  
 \*\*Formerly 1N69A. †Formerly 1N70A. ‡Formerly 1N81A.

Semiconductor  
Sales Department

**Hughes**

AIRCRAFT COMPANY  
CULVER CITY  
CALIFORNIA

Address inquiries to Dept. E

# GALVANOMETERS

## for special applications

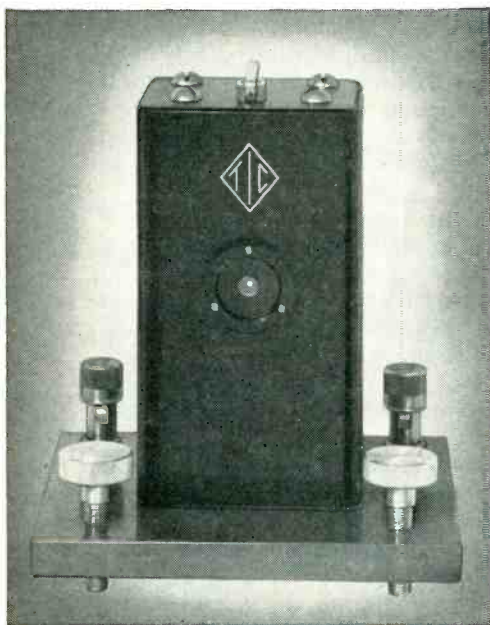

### Super Sensitive

SINGLE UNITS FOR PRECISE  
LABORATORY MEASUREMENTS

#### Specifications:

Size: Height 5", Base 4" square,  
Weight 1 pound, 8 ounces.

Sensitivity: 15" Deflection per  
microampere at distance of  
one meter.

Frequency: One cycle per second  
natural frequency. Other fre-  
quencies and sensitivities  
available.

Resistance: 4000 ohms.

Price: \$100.00 complete.

### High Quality

MULTIPLE-ELEMENT  
GALVANOMETERS  
AT LOW COST

Size: Height 3", Width 2".

Length: Dependent upon number  
of element positions which are  
on .140" centers and in quanti-  
ties of 4 to 50 per housing.

Frequency: Standard 140 cps.  
Other frequencies available on  
special order.

Sensitivity: Standard 15 ohm 140  
cycle suspension gives a 7" de-  
flection per milliampere at a  
distance of 12".

Mirrors: Standard 10" radius of curvature. Spherical. First surface .040"  
wide x .115" long. Other focal lengths available.

Price: 25 Elements in 25 position housing without vertical adjustment  
\$1,000.00. Other models with vertical adjustment and isolated circuits at  
slight extra cost.

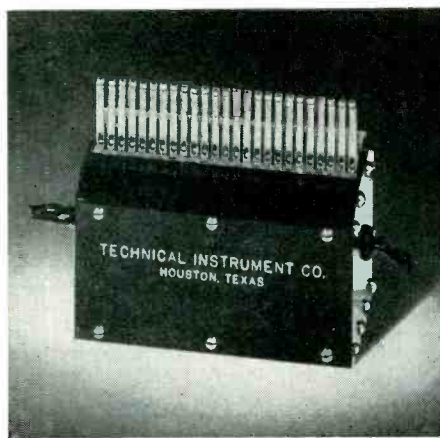

Write us for quotation on your special galvanometer needs

**TECHNICAL INSTRUMENT CO., INC.**  
3732 WESTHEIMER RD. HOUSTON 6, TEXAS

to be amplified is applied to the in-  
put of the waveguide by means of a  
coupling loop. The energy is propa-  
gated around the helical waveguide  
and extracted by a coupling loop at  
the output waveguide. The helical  
form of the waveguide reduces the  
phase velocity of the microwave  
energy to a value below the speed  
of light.

Electrons emitted by the cathode  
are influenced by the electric field  
between the cathode and helical  
waveguide structure and the mag-  
netic field in the space between the  
cathode and waveguide to follow  
paths taken by the electrons in a  
conventional magnetron. In follow-  
ing such paths the electrons give  
up their energy to the microwave  
energy traveling along the wave-  
guide, resulting in amplification of  
the microwave energy when ex-  
tracted from the waveguide.

#### Phase-Modulation Repeater

An ingenious microwave pulse re-  
peater system employing a phase-  
modulation technique with travel-  
ing-wave tubes is the subject of  
patent 2,619,543 granted to Cassius  
C. Cutler of Gillette, N. J., and as-  
signed to Bell Telephone Labora-  
tories of New York.

Ordinarily, microwave repeater  
systems require complex and costly  
equipment incorporating, receiving,  
demodulation, remodulation and  
transmitting apparatus.

In the instant invention all of the  
operations are performed in a single  
vacuum tube with its associated  
equipment thereby effecting a re-  
duction in overall cost.

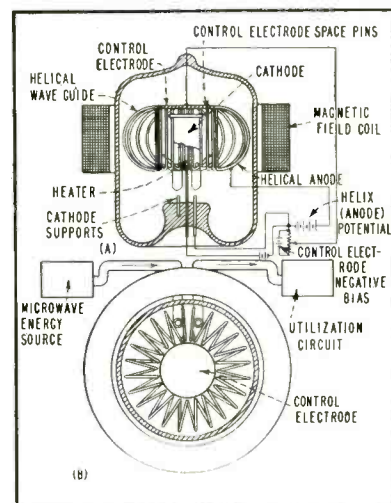
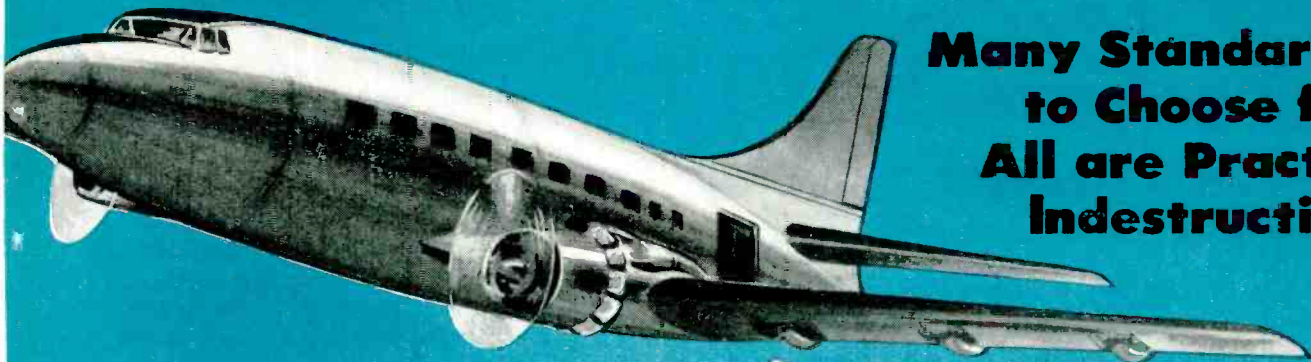

FIG. 2—Toroidal traveling-wave ampli-  
fier tube



Super-rugged for toughest applications

# E-I COMPRESSION TYPE HEADERS



**Many Standard Types  
to Choose from...  
All are Practically  
Indestructible!**

A **NEW SERIES!** Made by an exclusive E-I process and featuring non-flexing solid metal blanks. No stampings are used. The glass remains under constant compression and is, therefore, extremely strong and difficult to place under stress. These new compression types offer far greater resistance to shock and vibration, maximum immunity to humidity and are tin-dipped for easy soldering.

**E-I . . . YOUR HEADQUARTERS  
FOR HERMETICALLY-SEALED  
MULTIPLE HEADERS, OCTAL  
PLUG-INS, TERMINALS, COLOR  
CODED TERMINALS, END SEALS, etc.**

DIVISION OF AMPEREX ELECTRONIC CORP.



## **ELECTRICAL INDUSTRIES**

44 SUMMER AVENUE, NEWARK 4, NEW JERSEY

EXPORT AGENTS:

PHILIPS EXPORT CORP., 100 EAST 42nd STREET, NEW YORK 17, N. Y.

*Write for these Catalogs*

● **BULLETIN 949-A**—Covering standard and special hermetically sealed terminals.

● **BULLETIN 950-A**—On hermetically sealed multiple headers with many optional features.

● **BULLETIN 953**—On individual, color-coded hermetically sealed terminals by E-I.

● **BULLETIN 954**—Featuring end seals for condensers, resistors, and other tubular components.

● **BULLETIN 960**—Describing super-rugged compression type headers of revolutionary design.

● **SPECIAL TYPES**—Custom designs for unusual terminal requirements. Request quotations.



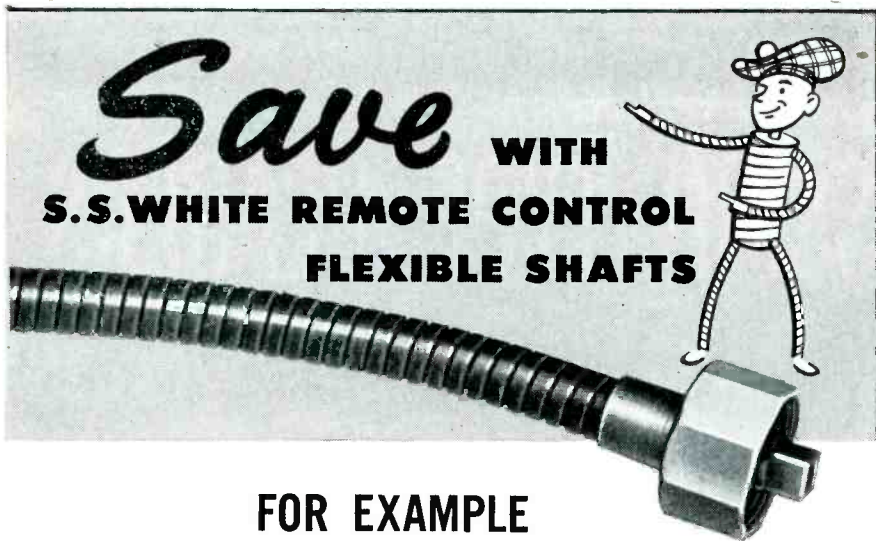

## FOR EXAMPLE

### TO CONTROL AN INACCESSIBLE PART

The designer of the unit pictured below was faced with the problem of providing an economical method of operating an inaccessible rotary switch from a convenient point outside the unit. The control linkage had to have a minimum degree of "backlash" and had to be run around a 90° turn. The designer considered the many ways in which the control set-up could be done and finally decided on

## THE LOW-COST SOLUTION

### AN S.S. WHITE REMOTE CONTROL FLEXIBLE SHAFT

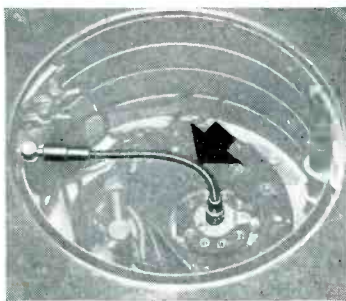

By using an S.S. White remote control flexible shaft, the designer was able to control the switch with a single part which is easy to install, requires no alignment, and needs no attention once installed. As a result, he was able to make substantial savings in manufacturing and assembly costs with full assurance that the

flexible shaft would fully meet his rigid service specifications. Why not discuss your remote control problems with S.S. White engineers. Their helpful advice and cooperation will show you where you can make similar savings.

#### Up-to-date Flexible Shaft Information—

This 256-page flexible shaft handbook will be sent free if you request it on your business letterhead. It contains full facts and data on flexible shaft selection and application.



**THE S.S. White INDUSTRIAL DIVISION**  
**DENTAL MFG. CO.**



Dept. E, 10 East 40th St.  
 NEW YORK 16, N. Y.

Western District Office • Times Building, Long Beach, California

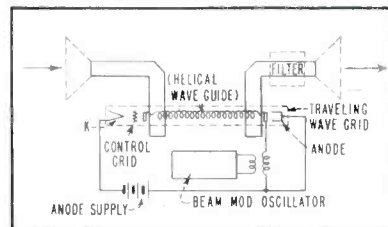

FIG. 3—Pulse-repeater using helical waveguide

In Fig. 3 a single-tube pulse repeater is illustrated wherein there is provided a traveling-wave tube, so designed as to permit a pulse-modulated microwave signal input to the helical waveguide structure within the tube and the application of a periodically varying signal to the output of the helical waveguide. The latter signal is related to the incoming signal in such a way as to phase-modulate the signal passing through the helical waveguide.

Practically, the electron beam of the traveling-wave tube is modulated by a sinusoidal wave of the same frequency as the pulse-repetition frequency of the incoming wave. The frequency and amplitude of the phase-modulating wave are so chosen that the amplification of the amplifier may be varied over wide limits effectively to gate the applied pulses or to generate pulses from a c-w signal to the amplifier.

The resultant effect of the operation is to shift the frequency so that the energy is retransmitted from the output at a different frequency. It is claimed that by this technique frequency shifts of 500 mc are accomplished at a center frequency of 4,000 mc.

The extent of phase shift obtain-

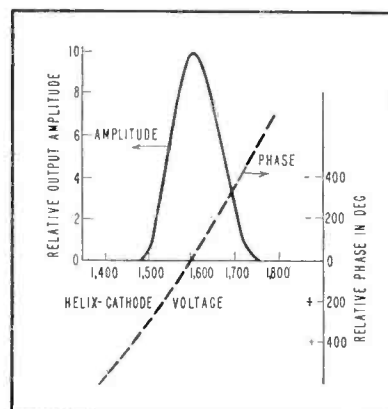

FIG. 4—Phase shift obtained in pulse repeater

# INDUSTRIAL CONTROL



ACTUAL SIZE

MAXIMUM RATINGS ‡	
Relay and Grid-Controlled Rectifier Service (for anode supply frequency of 60 cps)	
<b>PEAK ANODE VOLTAGE:</b>	
Forward	550 max. volts
Inverse	1300 max. volts
<b>GRID-NO. 2 (SHIELD-GRID) VOLTAGE:</b>	
Peak, before anode conduction	-100 max. volts
Average*, during anode conduction	-10 max. volts
<b>GRID-NO. 1 (CONTROL-GRID) VOLTAGE:</b>	
Peak, before anode conduction	-200 max. volts
Average*, during anode conduction	-10 max. volts
<b>CATHODE CURRENT:</b>	
Peak	5 max. amp
Average*	0.5 max. amp
Fault, for duration of 0.1 sec. max.	20 max. amp
<b>GRID-NO. 2 CURRENT:</b>	
Average*	0.05 max. amp
<b>GRID-NO. 1 CURRENT:</b>	
Average*	0.05 max. amp
<b>PEAK HEATER-CATHODE VOLTAGE:</b>	
Heater negative with respect to cathode	100 max. volts
Heater positive with respect to cathode	25 max. volts
<b>AMBIENT TEMPERATURE RANGE</b> ..... -75 to +90° C	
<b>Maximum Circuit Values:</b>	
Grid-No. 1—Circuit Resistance	2 max. megohms
*Averaged over any interval of 30 seconds maximum.	
‡Absolute values	

## NOW — precise electronic control at lower cost with the new RCA-6012 gas thyatron

Expressly designed for industrial control applications, the new RCA-6012 gas tetrode features the ruggedness necessary to withstand rough industrial usage. It has the additional advantages of low cost and nationwide renewal distribution...both of importance to the end user.

For motor-control, electronic-inverter, and general relay service at power supply frequencies, the RCA-6012 is rated to withstand a maximum peak inverse anode voltage of 1300 volts, a maximum peak cathode current of 5 amperes, and a maximum average cathode current of 0.5 ampere.

Operating features of the RCA-6012 include a negative-control characteristic which is essentially independent of the ambient temperature over the range from -75° to

+90° C, low pre-conduction currents, low control-grid-to-anode capacitance, and low control-grid current.

The RCA-6012 is compactly designed, and employs a structure that increases its resistance to both shock and vibration. A button stem is used to strengthen the mount structure and to provide wide inter-lead spacing as a means of reducing susceptibility to electrolysis and leakage.

For complete technical data on the RCA-6012, write RCA, Commercial Engineering, Section 42GR, Harrison, N. J. . . . or contact your nearest RCA field office.

FIELD OFFICES: (East) Humboldt 5-3900, 415 S. 5th St., Harrison, N. J. (Midwest) Whitehall 4-2900, 589 E. Illinois St., Chicago, Ill. (West) Madison 9-3671, 420 S. San Pedro St., Los Angeles, Calif. Tmks. ®

Another new RCA tube

RCA-6080 is a current-regulator tube for use in regulated dc power supplies. Similar to the 6AS7-G, it features a button-stem construction for improved resistance to shock and vibration. The 6082 is a similar tube for aircraft power supplies.



THE FOUNTAINHEAD OF MODERN TUBE DEVELOPMENT IS RCA



**RADIO CORPORATION of AMERICA**  
ELECTRON TUBES  
HARRISON, N. J.

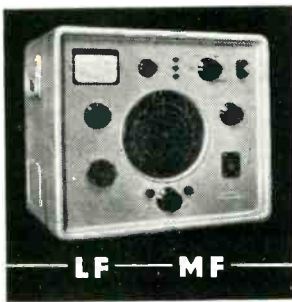

25 cycles to  
5 megacycles.

**VIDEO OSCILLATOR**  
Type TF 885A

1,000 cycles, Inductance  
and Capacitance;  
Resistance at D.C.

**UNIVERSAL BRIDGE**  
Type TF 868

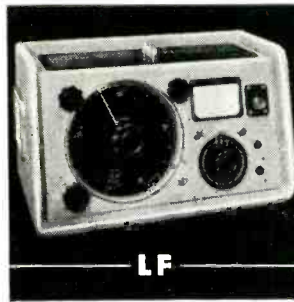

LF

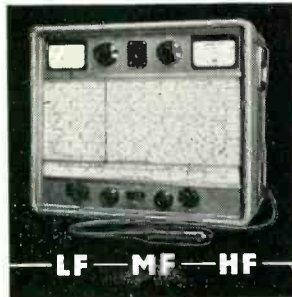

15 kilocycles to  
30 megacycles.

**STANDARD SIGNAL  
GENERATOR** Type TF 867

50 kilocycles to  
50 megacycles.

**CIRCUIT MAGNIFICATION  
METER** Type TF 329G

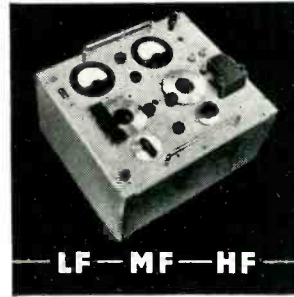

LF — MF — HF

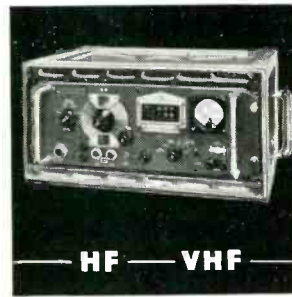

2.5 to 10 megacycles  
and 20 to 100 megacycles.

**CARRIER DEVIATION  
METER** Type TF 934

13.5 to 216 megacycles.

**FM/AM SIGNAL  
GENERATOR** Type TF 995

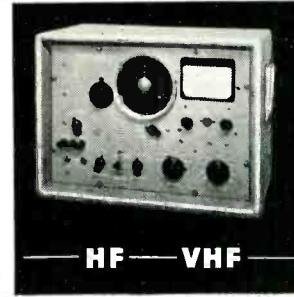

HF — VHF

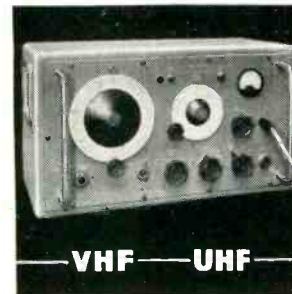

300 to 600 megacycles  
or 200 to 400 megacycles  
or 450 to 900 megacycles.

**SIGNAL GENERATOR**  
Type TF 762C (series)

250 to 4,000 megacycles.

**PORTABLE  
FREQUENCY METER**  
Type TF 1026 (series)



VHF — UHF — SHF

## Covering the radio spectrum

A few examples of telecommunications test equipment, representative of the quality, reliability and precision workmanship of the wide range manufactured by

# MARCONI INSTRUMENTS

VACUUM TUBE VOLTMETERS · FREQUENCY STANDARDS · OUTPUT METERS  
WAVE METERS · WAVE ANALYSERS · Q METERS · BEAT FREQUENCY OSCILLATORS

23-25 BEAVER STREET · NEW YORK 4

CANADA: CANADIAN MARCONI CO., MARCONI BUILDING, 2442 TRENTON AVENUE, MONTREAL  
ENGLAND: Head Office: MARCONI INSTRUMENTS LIMITED, ST. ALBANS, HERTFORDSHIRE

Managing Agents in Export:

MARCONI'S WIRELESS TELEGRAPH COMPANY LIMITED, MARCONI HOUSE, STRAND, LONDON, W.C.2

able is illustrated in the curve of Fig. 4 and illustrates the characteristics of the circuit of Fig. 3.

The effect of variation in amplification during the time in which an r-f pulse is traversing a traveling-wave tube is illustrated in the curves of Fig. 5. Curve (A) illustrates the type of r-f pulse generated in microwave pulse-modulation systems. If this passes through a traveling-wave amplifier having characteristics as shown in Fig. 4, the amplification is varied by the change in helix-to-cathode voltage curve (B) to produce a net result as shown by the r-f pulse in curve (C) which is sharper than the applied pulse.

Pulse separation in the output is accomplished with conventional microwave filters as illustrated in Fig. 3.

### Magnetic Photorelay

A photorelay circuit for which patent 2,627,036 has been granted to N. D. Glyptis of Chicago, Ill., employs a novel technique for increasing photoemission of photoelectric cells.

As is known, the photoelectric effect results from collision of electrons with atoms of an inert or other ionizable gas in the presence of a force such as light. The number of ions released is a function of the number of collisions. If the number of collisions is increased, a greater ion release and consequent increase in output current results. An obvious means of increasing the number of collisions would be to lengthen the path over which the electrons travel. To accomplish this by elongating the tube is prohibitive.

This invention proposes to increase the electron path by the

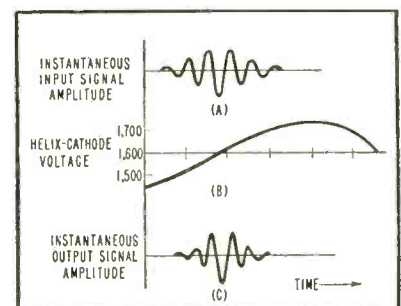

FIG. 5—Variation in amplification during an r-f pulse

*We Believe...*

the  
**CATHODE RAY**  
(in-line)

**EXHAUST OVEN**

We just completed  
is the **LARGEST** ever made

We built the carts, automatic  
bombarding mechanism, conveyor  
—in fact the whole  
"shootin' match" complete.

We will be glad to talk it  
over with you.



**STEINER-IVES COMPANY**

Springfield Road and Battle Hill, Union, New Jersey  
Telephone UNIONville 2-7474

*"Builders of STEINER OVENS Since 1899"*

# Electronic

## BUILDING BLOCKS

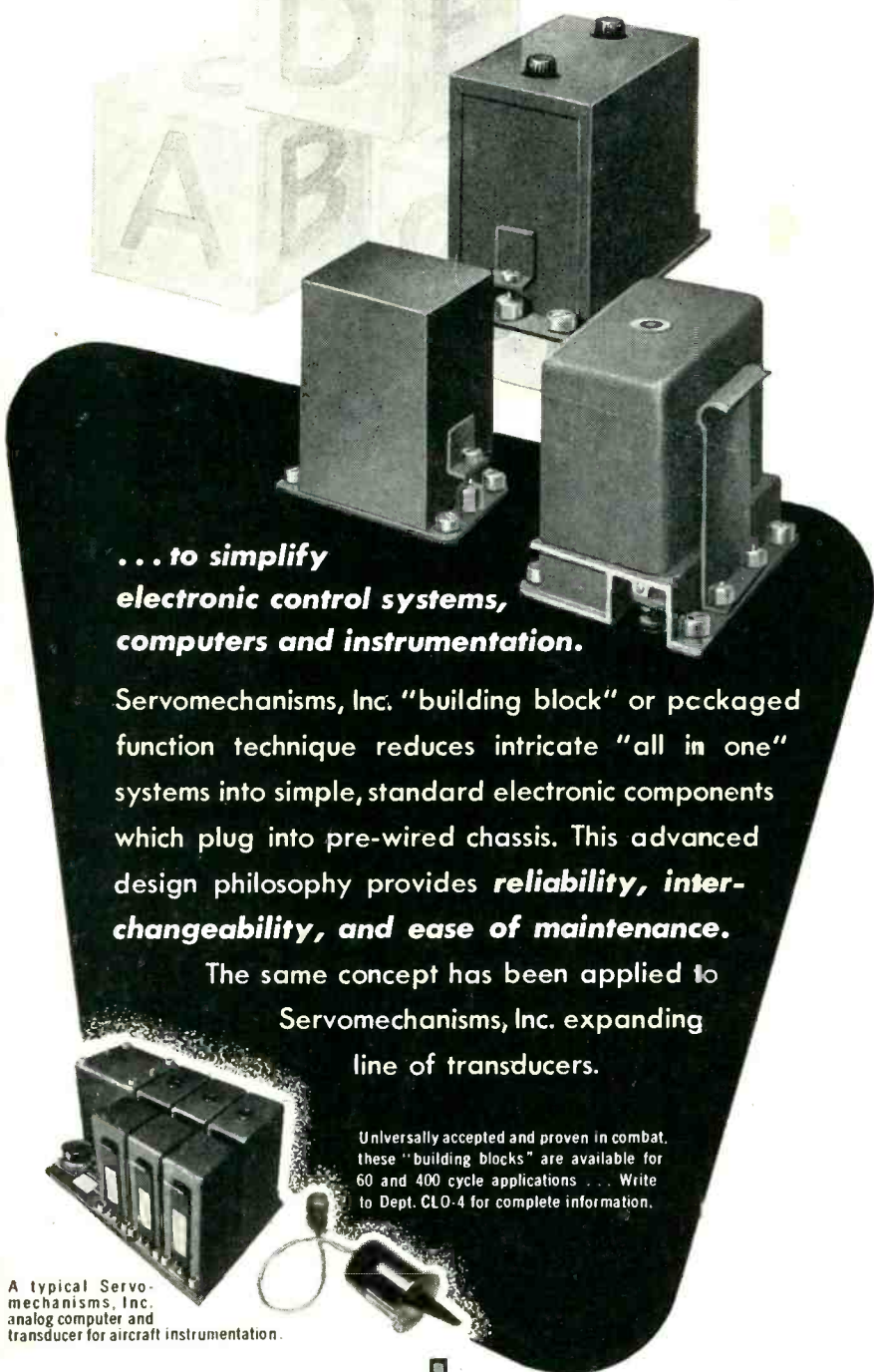

... to simplify  
electronic control systems,  
computers and instrumentation.

Servomechanisms, Inc. "building block" or packaged function technique reduces intricate "all in one" systems into simple, standard electronic components which plug into pre-wired chassis. This advanced design philosophy provides **reliability, interchangeability, and ease of maintenance.**

The same concept has been applied to Servomechanisms, Inc. expanding line of transducers.

Universally accepted and proven in combat, these "building blocks" are available for 60 and 400 cycle applications... Write to Dept. CLO-4 for complete information.

A typical Servomechanisms, Inc. analog computer and transducer for aircraft instrumentation.

# SERVOMECHANISMS INC.

Westbury Division  
Post and Stewart Aves., Westbury, N. Y.

El Segundo Division  
316 Washington St., El Segundo, Calif.

POSITIONING MECHANISMS • SERVO AMPLIFIERS • MODULATORS • POWER SUPPLIES  
SERVO MOTORS • ADAPTERS • TRANSDUCERS • MECHANICAL DEVELOPMENT APPARATUS

Want more information? Use post card on last page.

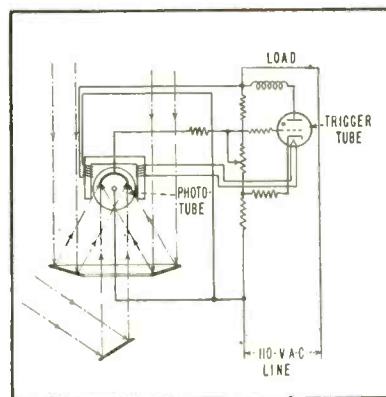

FIG. 6—Magnetic photorelay uses field from filament transformer

application of a magnetic field to the path of electrons thereby to deflect the electrons and increase their length of travel so that more collisions occur in the process.

Figure 6 shows the schematic of an embodiment of the magnetic deflection circuit for the photorelay. The filament transformer forms the magnetic field coil and is wound about the photocell.

Figure 7 shows a form of coil that may be used as a magnetizing element. The rest of the circuit operation is conventional.

### Mass Spectrometer

Patent 2,627,034 was issued to H. W. Washburn and C. E. Berry of Pasadena, Calif., assignors to Consolidated Engineering Corp. of Pasadena, Calif. for "Mass Spectrometry".

Mass spectrometry has been conventionally accomplished by bombarding gas samples with electrons

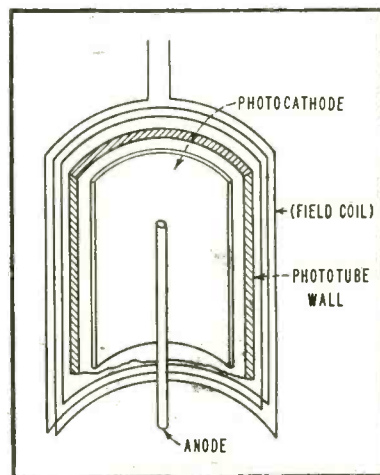
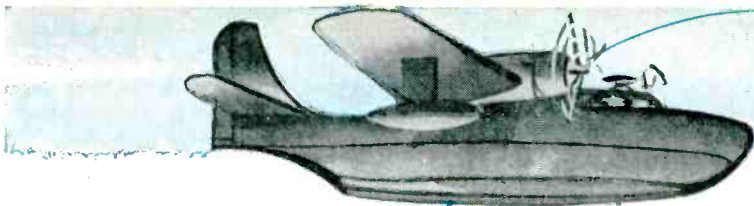
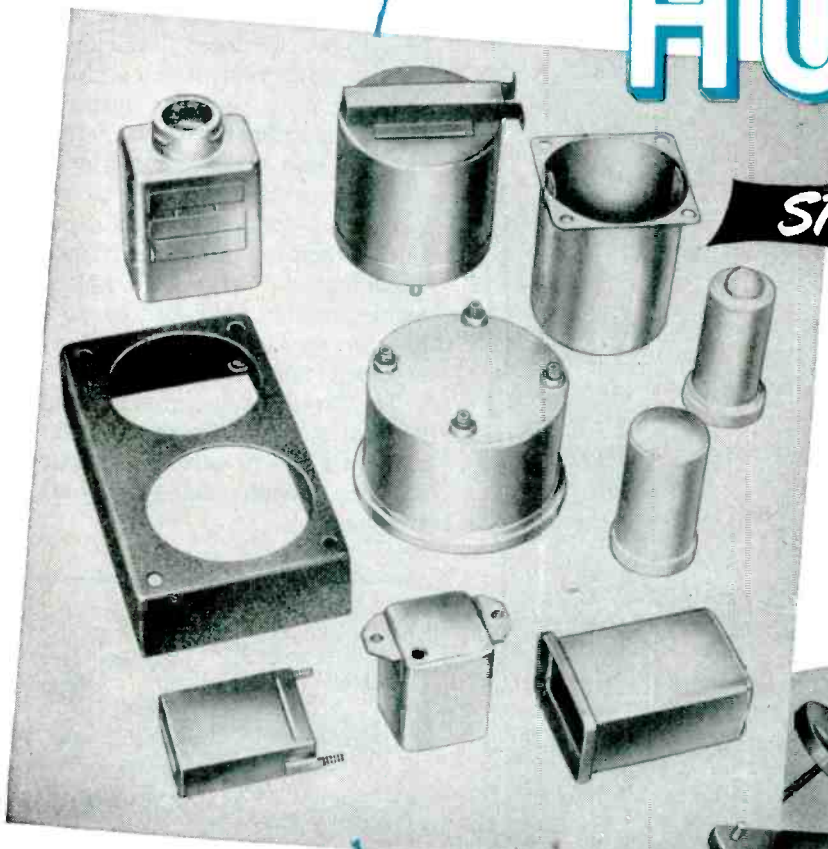

FIG. 7—Magnetizing element using special coil



TODAY'S SPECIALIZED CLOSURE REQUIREMENTS CAN NOW BE SOLVED ECONOMICALLY AND DEPENDABLY, FOR —

# Standard Cases and Covers are only a part of the role played by HUDSON



## SPECIAL SHAPES

Square, rectangular, octagonal and round cans are available at Hudson. All are precision drawn to exact dimensions. Optional features include hole, flanges, lips and many other cost-saving design variations. Sizes range from miniature to extra large. Hudson will cooperate with your design engineers in working out a practical, economical solution to your problem.

## SPECIAL FEATURES

Covers are supplied with a wide variety of design modifications. Hudson covers can include deep or shallow knockouts for headers, holes for terminals and many other special features. Hudson offers the electronic designer custom components at unit costs that reflect mass production methods and economies.

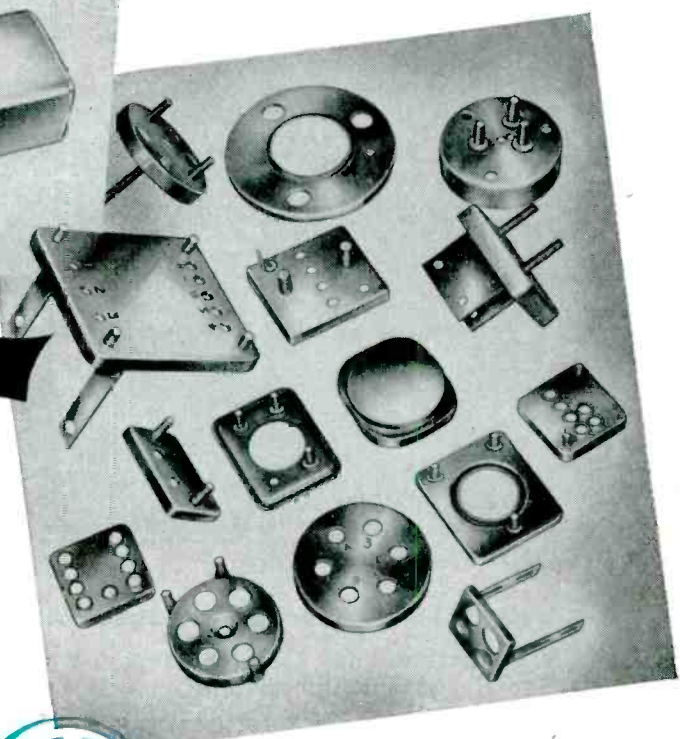

HERE'S HELP FOR ENGINEERS, DESIGNERS AND PRODUCTION MEN! Let Hudson send you the new complete ENGINEERS FILE FOLDER. Lists all Hudson Standard Components available for prompt delivery from stock. Just call or write Dept. 210 now!



**HUDSON TOOL and DIE COMPANY Inc.**

118-122 SO. FOURTEENTH STREET, NEWARK 7, N. J.



# G-V MINIATURE THERMAL RELAY

*Advanced  
Engineering  
Features!*

- Miniature and Octal Sizes
- Hermetically Sealed in Metal Shell
- Adjustable and Non-Adjustable
- Heater Voltages up to 230 Volts
- Fully Temperature Compensated
- Suitable for Military and Industrial Use
- Unequaled for Ruggedness and Precision



*Not Only a*

## TIME DELAY RELAY...

...with performance features that surpass larger octal relays.

**More and more engineers are finding other uses for these precise and rugged units—jobs which thermal relays of the usual bi-metal design often cannot do... such as:**

- TUBE HEATER VOLTAGE REGULATION
- POWER SUPPLY OVERLOAD PROTECTION
- OVER- OR UNDER-VOLTAGE ALARM OR CUT-OFF
- LOW OR HIGH FREQUENCY CUT-OFF

To receive technical information on these new applications, as it comes off the press, and our bulletin on Time Delay Relays, just mail the coupon below.

**G-V  
CONTROLS INC.**  
16 Hollywood Plaza  
East Orange, New Jersey

G-V CONTROLS INC. ● 24 Hollywood Plaza, East Orange, N. J.

Please send me your bulletin on Thermal Time Delay Relays and information on new thermal relay applications. I am particularly interested in

Name \_\_\_\_\_ Position \_\_\_\_\_

Company \_\_\_\_\_

Address \_\_\_\_\_

to produce ions of the various substances in the sample and subjecting the ions to the influence of magnetic or electric fields and selectively collecting the ions of the various components of the sample that arrive at a collector at different velocities in accordance with their mass.

This invention, while employing the well-known basic principles of previously disclosed instruments, obtains improvement and simplicity by subjecting the ions formed in the bombardment to a varying electric and fixed magnetic field that forces the ions in resonance with the field to follow an expanding upward spiral path. Ions not in resonance with the field are sent along another path and so do not impinge on a target set aside for the resonant ions.

The invention features means for generating the fields that cause the spiral stream to exist in pulsations of some predetermined alternating frequency.

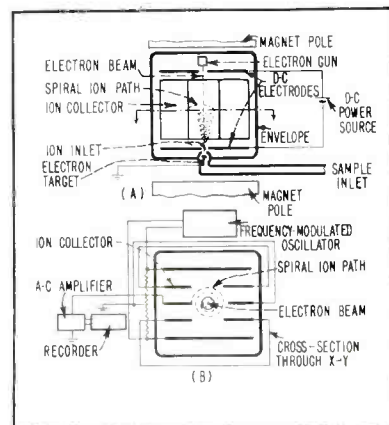

FIG. 8—Mass spectrometer (A) shown in cross section (B)

Referring to Fig. 8, the operation of the mass spectrometer may be seen. An electron gun directs a stream of electrons at a collector in the path of the sample gas. A transverse electric field is generated by differences in the potentials applied to the ion collector and director plates modulated by a frequency-modulated signal.

A magnetic field is set up between the poles seen in Fig. 8A.

The ions are collected at one electrode of the system whence they are applied to an amplifier and recorder.



Look To *Polarad* For . . .

# MICROWAVE EQUIPMENT

**Features:**

- Frequency Range 10 mc-21,000 mc — 4 tuning heads
- Single dial tuning to 1% accuracy
- Spectrum Display variable from 250 kc-25 mc
- Frequency Marker for measuring frequency differences of 0-25 mc
- Supplied with 1-12 kmc broad band attenuators
- Automatic voltage selector for each tuning head

**Uses:**

- Examine pulse spectrum of magnetrons and klystrons
- Measure noise and interference spectrum
- Broad band receiver from 10 mc to 21,000 mc
- Observe and measure harmonic frequencies of transmitter
- Measure signals separated by small frequency differences
- Measure bandwidth of microwave cavities
- Calibration microwave oscillators and preselectors

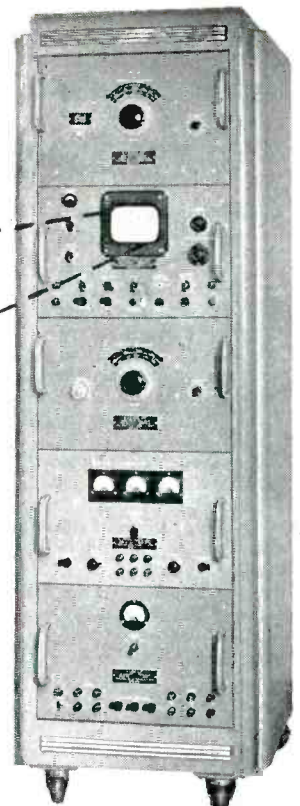
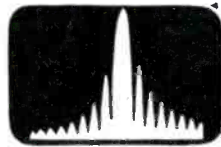

**SPECTRUM ANALYZER**  
Model LSA  
10 mc—21,000 mc

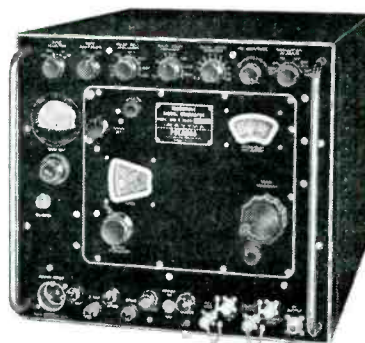

**MICROWAVE SIGNAL GENERATOR**  
Model MSG-4  
7,000 mc—10,750 mc

**Features:**

- Single dial tuning to 1% accuracy
- Tracked reflector-no wavemeter or klystron modes to set
- Contained 0-120 db attenuator to  $\pm 1$  db absolute
- Internal Modulation-pulse-F.M. external pulse input

**Uses:**

- Test Sensitivity and frequency of radar systems
- External Sync output allows use as X-Band Test Set
- Testing of microwave components, waveguides, etc.

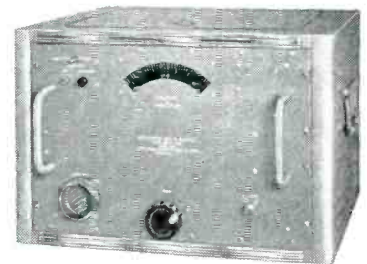

**MICROWAVE SIGNAL SOURCES**

Model:	
SSR	650 mc — 1300 mc
SSL	1000 mc — 2300 mc
SSS	2000 mc — 4500 mc
SSM	4300 mc — 8300 mc
SSX	7900 mc — 10750 mc

**Features:**

- Single dial tuning to 1% accuracy — direct reading dial
- High power output
- Provisions for external modulation
- Large frequency coverage

**Uses:**

- Source of High Microwave Power over wide frequency ranges
- Testing microwave components, waveguides, VSWR etc.
- Antenna measurements

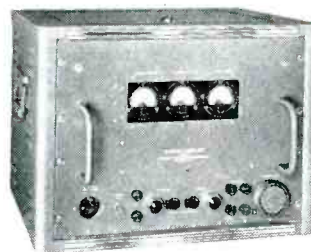

**KLYSTRON POWER SUPPLY**  
Model KK

**Features and Uses:**

- Well regulated supplies for use with Polarad's Series of Microwave Signal Sources
- Used for powering Raytheon's wide band Klystron tubes

**Features and Uses:**

- Frequency response flat from 10 cps to 20 mc
- Amplifier Gain 320 (50 db)
- Phase linear with frequency over entire frequency range
- Contained high impedance attenuator 0-50 db and external probe
- Wide band amplification problem

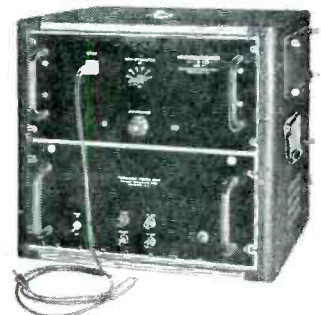

**WIDE BAND VIDEO AMPLIFIER**  
Model VT 10 cps to 20 mc

**Polarad**  
Electronics Corporation

We Manufacture a Complete Line—Write for Catalog

**POLARAD ELECTRONICS CORP.**  
100 Metropolitan Avenue, Brooklyn 11, N. Y.

Export Dept. 13 E. 40th St., New York, N. Y.  
Sales Representatives: Albuquerque • Boston • Bridgeport • Chicago • Cleveland  
Dayton • Kansas City • Los Angeles • New York • Seattle • Ottawa, Canada

# Production Techniques

Edited by JOHN MARKUS

Stockroom Counter Drawers.....	262	Making Small Tubing by Electrode-	
Infrared Soldering of Transformer		position on Nylon .....	278
Headers .....	262	Magnetic Screwdriver .....	279
Winding Technique Used on Large		Filling Transformers with Nitrogen...	280
Cable Board .....	264	Dial Cord Machine .....	282
Cutting Cost of TV Horizontal Oscillator		Illuminated Magnifier Aids Small Parts	
Coils .....	264	Assembly .....	283
Notched Ceramic Terminals Reduce As-		Special Inspection Desks .....	284
sembly Time .....	266	Welding Tube Bases .....	284
Zip-Cord Slitter .....	270	Winding Electrolytics .....	285
Air Cylinder Added to Spinning Lathe	271	Paint-On Solder .....	287
Adjustable Harness Board .....	272	Molten Metal Spray Shields Plastic	
Antenna Holesaw .....	273	Parts .....	288
Counting Output of Plant .....	274	Bracket Aids Removal of Soldering Iron	
Mounting 21-inch Tubes .....	275	Tip .....	290
Imprinting on Plastics .....	277	Testing Television Receivers .....	291

## OTHER DEPARTMENTS featured in this issue:

	Page
Electrons At Work.....	196
New Products .....	292
Plants and People.....	334
New Books .....	364
Backtalk .....	386

## Stockroom Counter Drawers

A POSTOFFICE-BOX system eliminates waiting when a floor leader requires an additional supply of parts in the Coamo, Puerto Rico plant of Carbie Aircraft Radio Corp. The leader fills out an order and places it in her assigned drawer under the counter of the stockroom window, then goes back to her section of the plant. About half an hour later, she returns to pick up the parts which in the meantime have been placed in her drawer by the stockroom clerk.

This procedure eliminates waiting at the window while the stockroom clerk is working elsewhere in the plant. After placing an order in her drawer, the leader rings a bell a few times to attract the attention of the clerk.

The drawers are of simple wood construction, set into a light wood framework under the counter. The name of each leader is neatly lettered on masking tape applied to one side of each drawer.



Floor leader removes order of precut and stripped wires from her drawer under stockroom counter

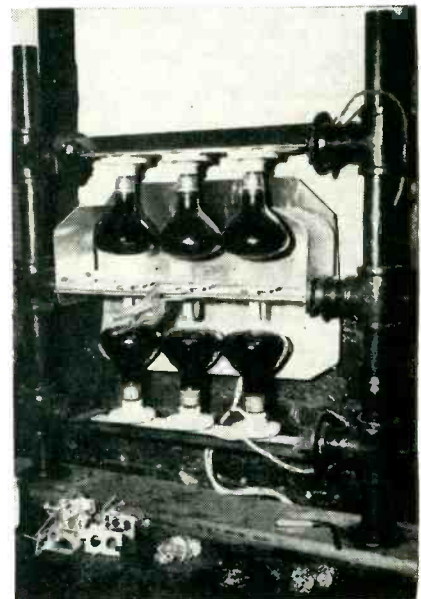

Infrared soldering of hermetic seals with heat from both sides

## Infrared Soldering of Transformer Headers

SOLDERING of hermetically sealed headers to the bases of housings for Keystone excitation transformers is achieved at high speed without cracking the glass terminal beads by applying infrared heat from both sides. Torches gave faster soldering but often cracked the glass, and soldering irons did not give good seals.

Three 500-watt infrared lamps are used on each side of the header. Amplex ruby-red hard glass lamps were needed because they shine into each other and tend to melt each other.

The operator loads three headers



**CAREFUL, MAESTRO,  
DON'T FIDDLE AWAY  
YOUR REPUTATION!**

Yes, you can make one false note and be all washed up . . . with the name you've spent years building, quickly consigned to oblivion. We at Kester know the importance of consistency . . . make sure that the solder alloy and especially the flux formula never varies, never changes. Kester never experiments at the expense of the solder user!

*For best results in efficient, economical soldering, remember this Solder Trio: "44" Resin, "Resin-Five" and Plastic Rosin—all made by KESTER . . . Key Name in Flux-Core Solder for More Than 50 Years.*

# KESTER

**S O L D E R   C O M P A N Y**

4204 WRIGHTWOOD AVENUE, CHICAGO 39, ILLINOIS  
NEWARK 5, NEW JERSEY • BRANTFORD, CANADA



at a time into a hard asbestos panel-type jig, places solder preforms in position, then sets the jig on brackets between the lamps. Vise-Grip pliers with wide jaws, made for sheet metal work, are used to handle the asbestos plate.

After loading, the operator starts an ordinary manual timer, turns on the lamps and proceeds with other work. The lamps apply heat gradually to the glass insulators so there is no cracking. Heat from underneath insures uniform flow of solder.

The infrared soldering setup can be quickly modified for other applications by sliding the lamp-holding brackets up or down on the vertical pipes as required. The lamps are connected in series-parallel to a 220-volt power line.

### Winding Technique Used on Large Cable Board

IN FABRICATING cables that may have up to several thousand feet of wire in as many as 75 different colors and sizes, the layout is planned so that each type of wire can be wound around the pins in one fast operation that puts in all conductors of that particular type. The only cutting done during fabrication of the cable is the terminating cut for each type of wire.

After all conductors have been placed on the board, the cable is laced and tied conventionally with

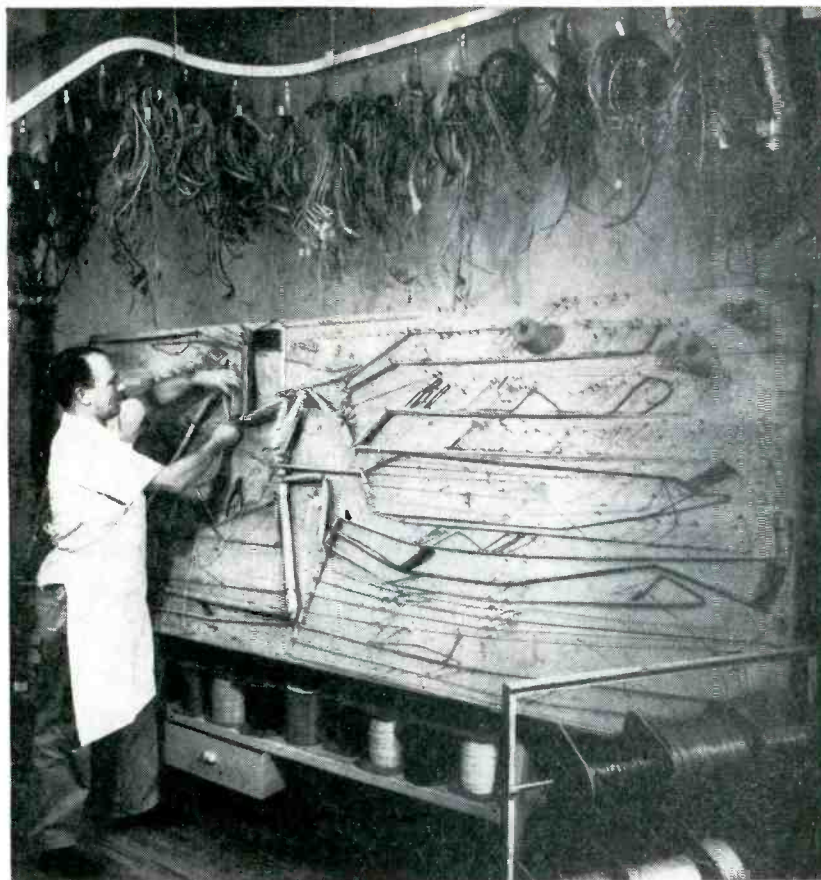

Tying up a cable with linen twine after laying it out by the endless wire technique. Rack for wire spools is at lower right. Finished cable lifts off pegs easily for subsequent cutting and stripping. Overhead conveyor provides safe storage for finished cables and moves them from cable room to assembly positions

linen twine. It is then taken off the board for cutting and stripping of the end loops. This may occasionally involve cutting out sections of wire used to bridge the distance between the end of one conductor

and the start of another conductor of the same type. In the Endicott, N. Y. plant of IBM this cabling technique is used in connection with the production of electronic accounting machines.

### Cutting Cost of TV Horizontal Oscillator Coils

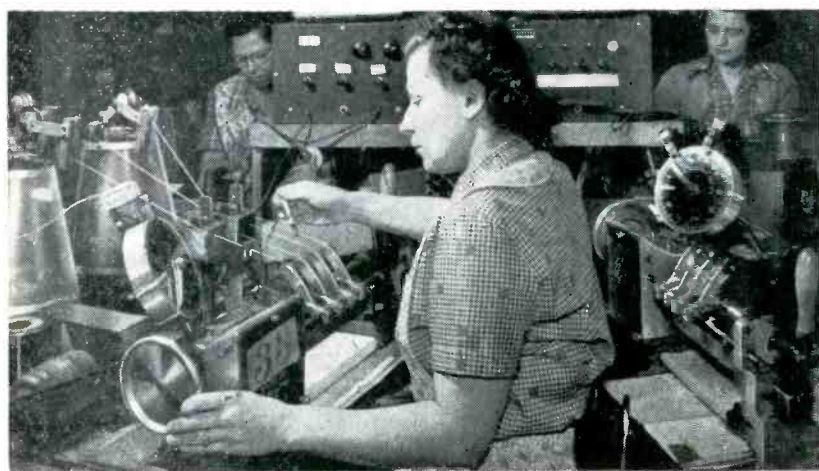

Operator loads four-coil arbor on one winding machine while other machine behind her is winding four horizontal-oscillator coils

BY REDESIGNING a winding machine and its arbors, the cost of winding horizontal-oscillator coils for television receivers was lowered sufficiently to give a total saving of \$11,250.00 per year on 500,000 coils in Motorola's Chicago plant.

The machine was originally tooled to wind one coil at a time, at a production rate of 48 coils per hour. By having the operator tend an additional machine during the winding time of the first machine, production per operator was increased to 78 coils per hour.

As the next cost-cutting step, a removable arbor was developed for holding two coil forms, and two

*An instrument manufacturer sent us this problem:*

"We have a close tolerance, high stability, and high insulation resistance capacitor problem. We need to find a 1.0 mfd. unit, plus or minus 0.5% at 100 VDC for a 1,000 cycle per second bridge. Capacitance change should be less than 0.1% per year. Insulation resistance to approach theoretical infinity."

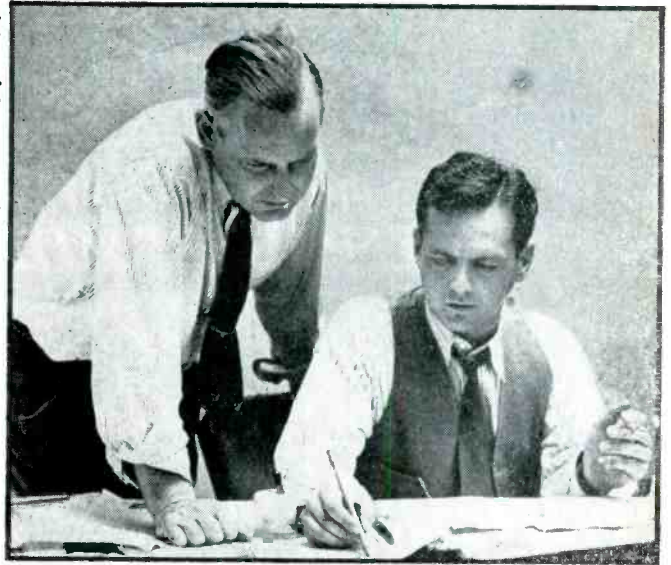

*"CP's" engineers came up with this...*



**TYPE PAC1C1**

The CP Engineering Department designed a plasticon capacitor utilizing CP's Type P plastic dielectric. Specially produced to meet this manufacturer's problem, the PAC1C1 capacitor had the following characteristics at 20° C :

Insulation resistance at 100 VDC—approximately  $10^{14}$  ohms. Capacitance at 1,000 cycles per second 1.0 mfd. plus or minus 0.5%.

After one year, the capacitance changed only .08%.

CP Plasticon Type P capacitors are available in voltage ranges of 100, 400 and 1,000 VDCW—capacitances of 0.1 to 25 mfd. in metal can container, capacitances of .01 to 1.0 mfd. in glassmike container.

Characteristics (at 25° C )

Resistance: 100,000 megohms per mfd. or 100,000 megohms, whichever is less

Power Factor: .05% or less

Dielectric Absorption: .05% max.

Temperature coefficient: Approximately 75 PPM/° C Negative

Temperature Range: -60° C to +90° C

Capacitance Tolerance:  $\pm 10\%$  standard, 5%, 2% and 1% also available

*• Your engineering problem will receive the immediate attention of our design and specification engineers.*

# Condenser Products Company

Division of New Haven Clock & Watch Company

7517 North Clark Street • Chicago 26, Illinois

Send for catalogue sheets and performance charts on any of these CP products:



Plasticon Hi-volt Power Supplies

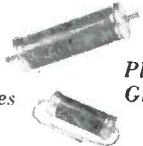

Plasticon Glassmikes



Plasticon Rectangulars



Plasticon Metal-clad Miniatures



Plasticon Pulse Forming Networks

# Autosyn\* SYNCHROS

Precision-Built by  
**ECLIPSE-PIONEER**



For more than 18 years, Eclipse-Pioneer has been a leader in the development and production of high precision synchros for use in automatic control circuits of aircraft, marine and other industrial applications. Today, thanks to this long experience and specialization, Eclipse-Pioneer has available a complete line of standard (1.431" dia. X 1.631" lg.) and Pygmy (0.937" dia. X 1.278" lg.) Autosyn synchros of unmatched precision. Furthermore, current production quantities and techniques have reduced cost to a new low. For either present or future requirements, it will pay you to investigate Eclipse-Pioneer high precision at the new low cost.

\*REG. TRADE MARK BENDIX AVIATION CORPORATION

**AVERAGE ELECTRICAL CHARACTERISTICS—AY-200 SERIES\*\***

	Type Number	Input Voltage Nominal Excitation	Input Current Milliamperes	Input Power Watts	Input Impedance Ohms	Stator Output Voltages Line to Line	Rotor Resistance (DC) Ohms	Stator Resistance (DC) Ohms	Maximum Error Spread Minutes
Transmitters	AY201-1	26V, 400~, 1 ph.	225	1.25	25+j115	11.8	9.5	3.5	15
	AY201-4	26V, 400~, 1 ph.	100	0.45	45+j225	11.8	16.0	6.7	20
Receivers	AY201-2	26V, 400~, 1 ph.	100	0.45	45+j225	11.8	16.0	6.7	45
Control Transformers	AY201-3	From Trans. Autosyn	Dependent Upon Circuit Design				42.0	10.8	15
	AY201-5	From Trans. Autosyn	Dependent Upon Circuit Design				250.0	63.0	15
Resolvers	AY221-3	26V, 400~, 1 ph.	60	0.35	108+j425	11.8	53.0	12.5	20
	AY241-5	1V, 30~, 1 ph.	3.7	—	240+j130	0.34	239.0	180.0	40
Differentials	AY231-3	From Trans. Autosyn	Dependent Upon Circuit Design				14.0	10.8	20

\*\*Also includes High Frequency Resolvers designed for use up to 100KC (AY251-24)

**AY-500 (PYGMY) SERIES**

Transmitters	AY503-4	26V, 400~, 1 ph.	235	2.2	45+j100	11.8	25.0	10.5	24
Receivers	AY503-2	26V, 400~, 1 ph.	235	2.2	45+j100	11.8	23.0	10.5	90
Control Transformers	AY503-3	From Trans. Autosyn	Dependent Upon Circuit Design				170.0	45.0	24
	AY503-5	From Trans. Autosyn	Dependent Upon Circuit Design				550.0	188.0	30
Resolvers	AY523-3	26V, 400~, 1 ph.	45	0.5	290+j490	11.8	210.0	42.0	30
	AY543-5	26V, 400~, 1 ph.	9	0.1	900+j2200	11.8	560.0	165.0	30
Differentials	AY533-3	From Trans. Autosyn	Dependent Upon Circuit Design				45.0	93.0	30

For detailed information, write to Dept. H.

**ECLIPSE-PIONEER DIVISION of**  
TETERBORO, NEW JERSEY



Export Sales: Bendix International Division, 72 Fifth Avenue, New York 11, N. Y.

arbors were provided per machine. One arbor was unloaded and loaded while the other was being wound. This new arbor gave an additional increase of 16 coils per hour.

Next, the arbors were redesigned to accommodate four coils. This increased the production per worker to 106 coils per hour, reducing the original labor cost for winding a coil from \$0.0324 to the present value of \$0.0099 for a saving of \$0.0225 per coil.

## Notched Ceramic Terminals Reduce Assembly Time

SPECIAL ceramic terminal strips used by Tektronix in the manufacture of cathode-ray oscilloscopes and other electronic equipment save assembly time, reduce inspection and test time, save space, reduce wiring errors, require less heat for soldering and are less expensive.

The notches are cut into the



Leads are soldered conventionally to ceramic terminal strips

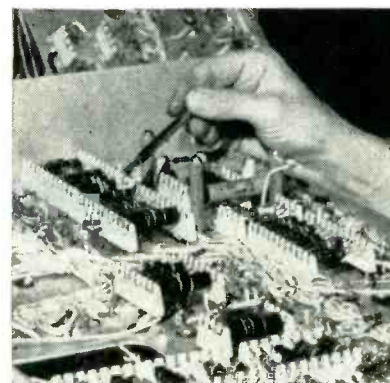

Inspecting completed chassis employing ceramic terminal strips for mounting all components

# Microwave TEST COMPONENTS

PRD offers a complete line of test equipment for precise measurements in the Microwave region. This equipment, the finest obtainable anywhere, includes Frequency Measuring Devices, Signal Sources and Receivers, Attenuators and Terminations, Impedance Measurement and Transformation Devices, Detection and Power Measurement Equipment, Bolometers and Accessories.

**When you test,  
use the best—**

**PRD**

**QUALITY  
DEPENDABILITY  
ACCURACY**

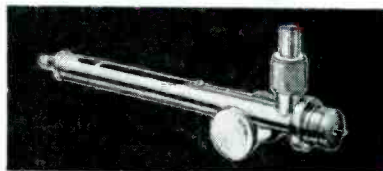

**TYPE 250-A BROADBAND PROBE** — Frequency range of 1 to 12.4 Kmc/s; two tuning knobs permit precise adjustment for maximum power transfer from the probe tip to the crystal or bolometer detector; third knob controls depth of probe tip insertion.

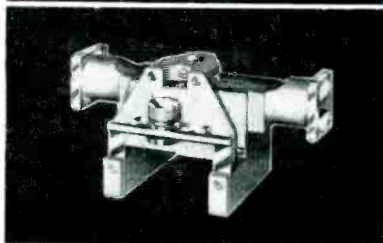

**SLOTTED SECTIONS**—The mechanical and electrical design of PRD slotted sections emphasizes these important features: Instrument accuracy assured indefinitely by virtue of three bearing carriage suspension to minimize wear; waveguide section machined from solid aluminum alloy stock, to avoid warpage no castings are used.

**TYPE 275 VSWR AMPLIFIER** — Featuring high gain; A.G.C. to maintain output constant for slow variation in r-f power source; low input noise level of 0.03 microvolts, wide VSWR ranges of 1:1.3, 1:3, 3:10, 10:30, and 30:100; greater accuracy because VSWR scale on meter is linear.

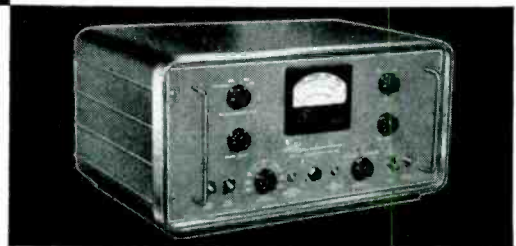

WRITE FOR  
NEW CATALOG  
Address re-  
quests for your  
copy of the  
new catalog to  
Department  
E-7 — no obli-  
gation.



**Polytechnic RESEARCH  
& DEVELOPMENT COMPANY • Inc**



55 JOHNSON STREET, BROOKLYN 1, NEW YORK  
WESTERN SALES OFFICE:  
741½ NO. SEWARD ST., HOLLYWOOD 38, CALIF.

# TOROIDAL COILS

**laboratory  
quality**

**IN MASS PRODUCTION  
QUANTITIES**

For quality conscious users LENKURT supplies toroidal coils of precise inductance values. Distributed capacitance, self-resonance and optimum temperature stability are closely controlled. These toroidal coils can be delivered promptly in any desired quantities, because "Precision Made" is routine production at Lenkurt.

These high standards were set to meet exacting requirements of Lenkurt's line of communication equipment. Hence Lenkurt has developed special toroidal winding and testing techniques to give more consistent production control.

When manufacturers in critical fields like guided missiles, telemetry, radar, sonar and ultra-fidelity recording demand toroidal coils and filters to meet the most stringent requirements, LENKURT is the place they come.

Submit your inductance and filter problems to Lenkurt. Your inquiry will receive prompt attention.

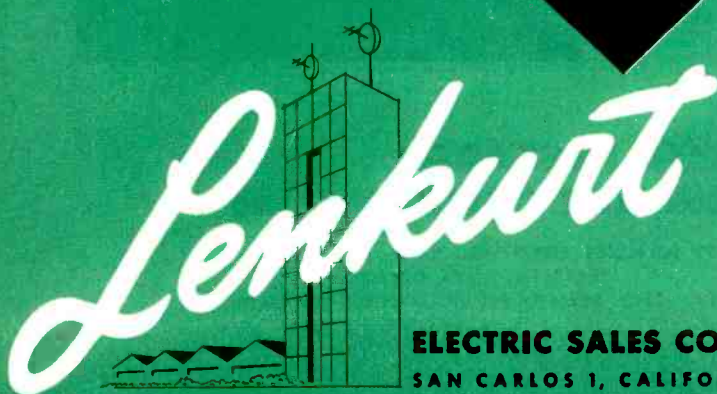

**Lenkurt**

**ELECTRIC SALES CO.**  
SAN CARLOS 1, CALIFORNIA

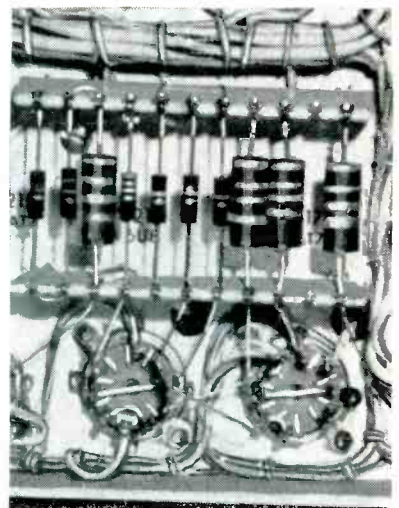

Method of making connections from ceramic terminal strips to adjacent tube sockets

ceramic strips after they are molded, but before hardening, and a silver paste is applied to the notches. After the firing process, the strips are dipped in melted soft solder. A thin coat of solder adheres to the silver, protecting it from oxidation.

Mounting to the chassis is accomplished through studs previously cemented into the bottom of the strip. The position of stand-off nuts on the studs regulates the distance between the strip and the chassis.

In practice, the strips are mounted on the underside of the chassis in parallel pairs, just far enough apart to accommodate the largest component. When the ceramic strips are mounted over tube sockets, the terminals of the sockets are wired before components are added to the strips. This is permissible because no components are soldered directly to the socket and the tube socket wiring itself need never be disturbed in the field. All components are readily accessible

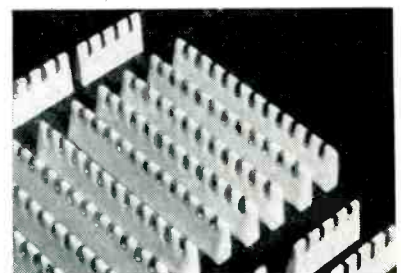

Appearance of terminals before installation in chassis



# YOUR COPY IS READY!

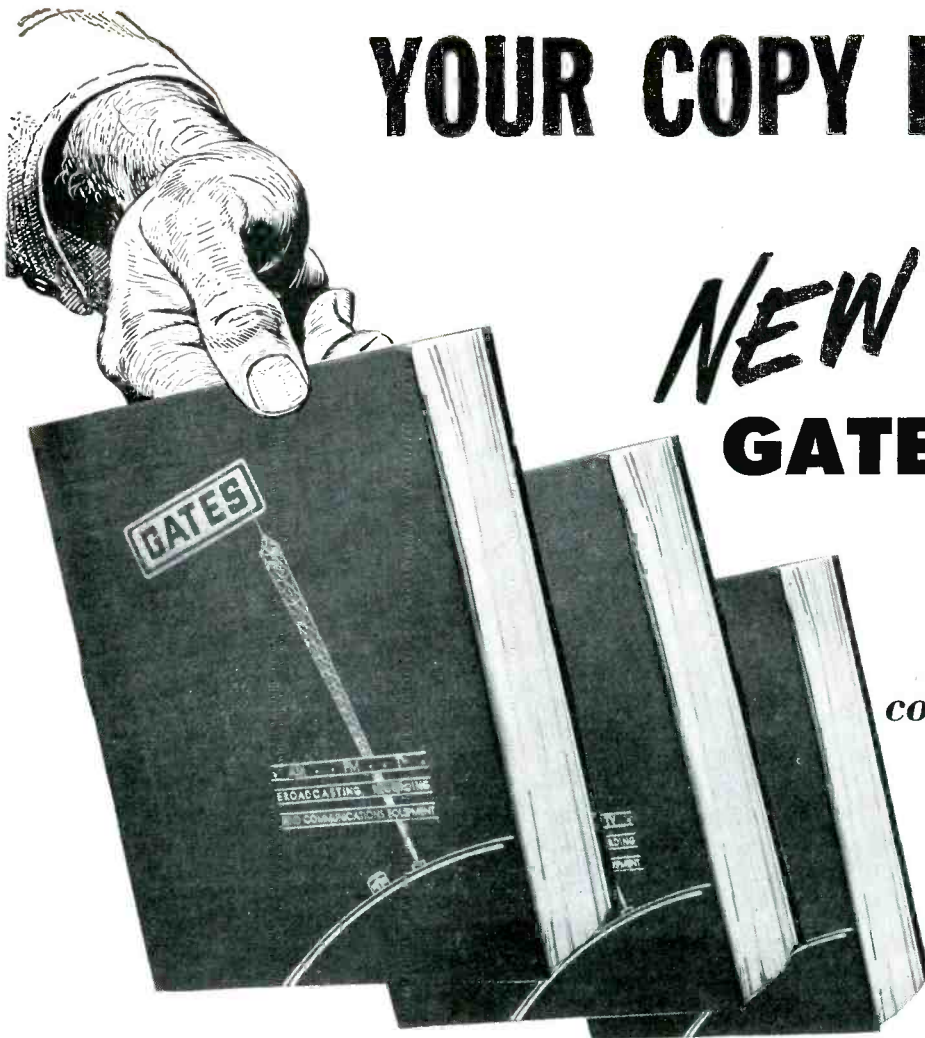

## NEW 250 Page GATES Catalog

*... is finest, most  
complete ever offered  
to the industry!*

Yes, the new big GATES 250 page catalog of radio transmitters, speech input equipment, tape recorders, antenna towers, remote apparatus and hundreds of complete items as well as materials for the radio or TV station is now off the press! It also contains a wealth of informative, handy reference material that no radio station should be without. Over two truck loads of 80 pound enamel paper have gone into what we believe is the finest and most complete catalog ever offered to the specialized industry of radio broadcasting, communications and industrial electronics.

No doubt you are on our mailing list, but we want to be sure. Will you take just a moment and fill out the coupon? Tear it off and mail to:

Richard Eickmeyer, GATES RADIO COMPANY  
Box 290, Quincy, Illinois

He'll do the rest. And of course, if you are not already on the mailing list, you'll be on. No charge of course.

### GATES RADIO COMPANY

Gentlemen:

Please check your mailing list to be sure I will receive the new GATES 250-page catalog.

Name \_\_\_\_\_

Company \_\_\_\_\_

Address \_\_\_\_\_

City \_\_\_\_\_ State \_\_\_\_\_



# GATES

RADIO COMPANY, QUINCY, ILLINOIS, U. S. A.

*Manufacturing Engineers*  
SINCE 1922

- 2700 Polk Avenue, Houston, Texas
- Warner Building, Washington, D. C.
- 51 E. 42nd Street, New York City

- International Division,  
13 E. 40th St., New York City
- Canadian Marconi Co., Montreal, Quebec



# Ground Station Navigation Equipment

VHF Omni-range Systems (VOR)  
 Terminal VHF Omni-range Systems (TVOR)  
 Instrument Landing Systems (ILS)  
 Fan Markers  
 Marker Beacons

*All these are available  
 as single or dual units.  
 We manufacture a complete  
 line of ground navigational aids.  
 Write for literature.*

# Maryland Electronic

MANUFACTURING CORPORATION

College Park, Maryland



for servicing and are easily removed and replaced in the field when ceramic terminal mounts are employed.

Another advantage of these terminals is elimination of chassis subassemblies. The complete chassis wiring job becomes the responsibility of one person, encouraging high-quality workmanship.

Because of the small mass of each terminal point, less heat is required to solder connections on the ceramic strips. Component leads may be clipped very short without risk of damage by soldering heat.

## Zip-Cord Slitter

POWER cords for radio and television sets are slit apart the required distance in one quick movement through a special Crosley-designed slitting fixture. Metal guide blocks mounted on a wood base position the parallel-conductor wire accurately. A razor-sharp cutting blade is vertically mounted midway between the blocks, so that it slits the cord precisely down the middle when the cord is pulled

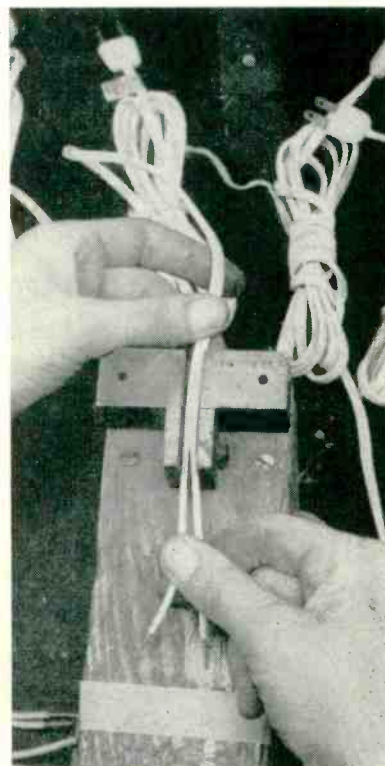

Method of using fixture for slitting power cords

through the blocks. The top of the blade is far enough below the blocks so fingers of operators do not get cut accidentally.

A strip of masking tape on the wood base of the fixture serves as a guide; when a cord is pulled out to the tape, the required length of slit is obtained.

### Air Cylinder Added to Spinning Lathe

THE OPERATION of anchoring insulating cardboard tubing on hermetically sealed paper capacitors in the Pyramid Electric Co. plant involves slipping the tubing over a unit, inserting the axial leads into the headstock and tailstock tools of a spinning lathe, then bringing the motor-driven tailstock up against the headstock to spin the cardboard smoothly over the ends of the metal housing of the capacitor. Both tools are driven at the same speed of 1725 rpm by independent motors. The friction between the stationary capacitor and the rotating tools at the instant of contact melts the impregnating wax in the housing, facilitating the inward flow of paper. The operator holds the capacitor body loosely with her fingers as the tools come together, and lets it loose to spin



Spinning lathe on which air cylinder has been installed for moving tailstock motor back and forth

# One stands out!

**Who's the best performer  
of the miniature choppers?  
the "MIDGET"**

**Airpax chopper, by long odds!**

**THE RIGHT WEIGHT . . . weighs only 1.2 ounces!**  
**THE RIGHT LENGTH . . . measures only 1.625" long!**  
**THE RIGHT DIAMETER . . . .755" and will fit a 7-pin  
miniature shield base!**

**THE RIGHT DESIGN FOR MAXIMUM PERFORMANCE!**  
 Small size and big performance have won wide acclaim for the C747 MIDGET chopper. Available with SPDT contacts, a 6.3 volt drive for 400 cycle operation, usually a 380 to 420 cycle frequency range. Phase angle nominal 65°, dwell time of 135°.

**DESIGNERS**      **PRODUCTS COMPANY**      **ENGINEERS**

MIDDLE RIVER,      BALTIMORE 20, MD.

# BRISTOL SYNCHRONOUS MOTORS

## 2 Inches in Diameter



### BRISTOL "CIRCLE B" SYNCHRONOUS TIMING MOTORS

Provide exceptional power. Range up to 16 in. oz. torque continuous duty and 84 in. oz. torque intermittent duty at 1 r.p.m. Operate in any position with a minimum of vibration or noise. Compact—fit into 2" circle, 1 1/8" deep. Speeds from 1/8 r.p.m. to 1800 r.p.m.

### BRISTOL ELAPSED TIME INDICATORS

For industrial or laboratory applications. Model ET-1A counts to 99,999 hours, by hours. Model ET-1B counts to 9,999.9 by tenths of hours. Advantages: Dependable Bristol "Circle B" synchronous timing motor, extreme compactness—2" diameter by 2 1/8" depth. Low cost. Easy panel or unit mounting.

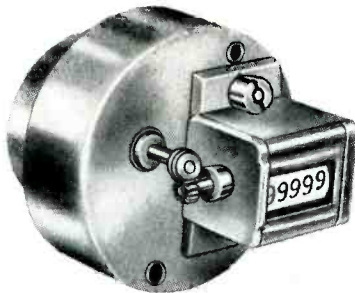

### BRISTOL LOW SPEED MOTORS

Designed for applications calling for extremely low speeds at light loads. S-200 series available at speeds from 10 revolutions per hour to one revolution per month. Features: Small size—2" diameter by 1 5/8" deep. Torque limited by gear train to 1 in. lb. continuous—5 in. lbs. intermittent use.

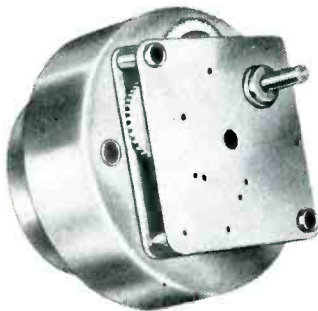

Bristol Motors are available for 24, 110, or 220 volts, 50-60 cycles. They are widely specified for timing devices, motion displays, defrosters, clocks, washers, ranges, dryers, time delay relays, general control equipment, and many other applications. Reversible and tandem motors are available.



## BRISTOL MOTOR DIVISION

VOCALINE COMPANY OF AMERICA, INC.

Coulter St., Old Saybrook, Conn.

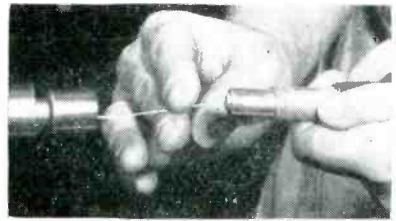

Method of inserting hermetically sealed capacitor in lathe for spinning cardboard tubing over metal housing. Both headstock and tailstock tools rotate continuously

after the crimping action has started.

Previously, a manual foot pedal arrangement was used to move the tailstock motor and tool up after a capacitor had been inserted. Spring loading held the motor back out of the way when the pedal was released. To lessen operator fatigue and obtain faster movement of the tailstock motor, a Schrader air cylinder was mounted behind the motor on the lathe, for use with a foot-operated air valve. This valve has three air lines, to provide positive retraction of the tailstock motor when the foot pedal is released, at the same speed as for advance of the motor at the start of spinning.

### Adjustable Harness Board

THE OPTIMUM working angle for any size and type of wiring harness board can be obtained in a few minutes with the adjustable hardwood easel used for this purpose in the Coamo, Puerto Rico plant of Caribe Aircraft Radio Corp.

Two bolts and wing nuts passing through hardwood strips at the top of the frame serve to lock the harness board in position. Other

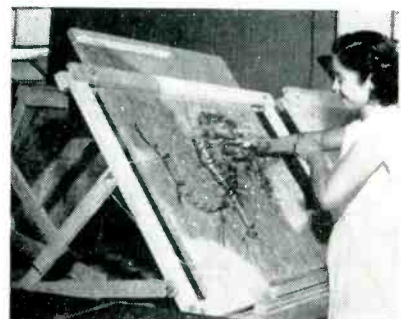

Lacing of finished wiring harness for military radar equipment on board supported by adjustable easel

wing nuts passing through holes drilled in the easel support permit quick change of working angles for the boards. The resulting rigid mounting facilitates tight lacing of a finished harness with Gudebrod nylon lacing cord.

**Antenna Holesaw**

DRILLING of holes for feed-through connectors, terminals and mounts in painted or enameled sheet metal is expedited by modifying a standard 3/4-inch Black and Decker holesaw. This involves mounting a 7/8-inch holesaw concentrically on the same mandrel, and cutting back the teeth of this added unit so that they nest about 1/8-inch behind those of the 3/4-inch holesaw, as shown in the illustration.

When this tool is used in an electric drill, the 3/4-inch holesaw cuts through the sheet metal and is then supported by the added holesaw. This prevents the tool from dropping through and damaging components on the other side. Allowing the tool to rotate a few seconds more is then sufficient for the crude teeth to remove about 1/8-inch of paint around the hole, to get a good ground connection. The entire job

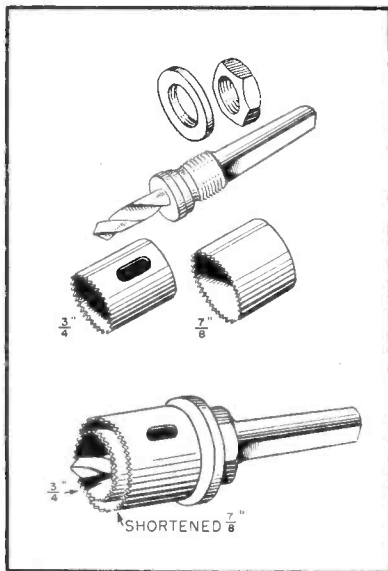

Method of modifying holesaw. Regular washer and locking nut hold both saw blades just as easily as one blade. When grinding down teeth of outer blade, no attempt is made to obtain sharp cutting teeth since they are used only for scraping off the paint

*Specify*

**ADVANCE  
RELAYS**

**FOR PRECISE  
CIRCUITRY**



There are many reasons why Industry *specifies* ADVANCE RELAYS: They meet or surpass Military and Civilian requirements—many types have AN approval—many are hermetically sealed—all are lightweight—small—rugged—compact—and *all* are precision-built for efficient, trouble-free, long life performance.

If you have relay problems involving contact loads, coil resistances, close differential, timing features, input sources, critical environment or any particular requirements involving unusual or accurate circuit behavior, ADVANCE can supply the relay.

A complete line of relays for radar, radio, electronic and electrical equipment applications.

Write for new, descriptive Catalog containing detailed information about ADVANCE Relays and facilities.

**ADVANCE ELECTRIC AND RELAY COMPANY**  
2435 NORTH NAOMI STREET, BURBANK, CALIFORNIA

Sales Representatives in Principal Cities of U.S. and Canada



# PULSE FORMING NETWORKS

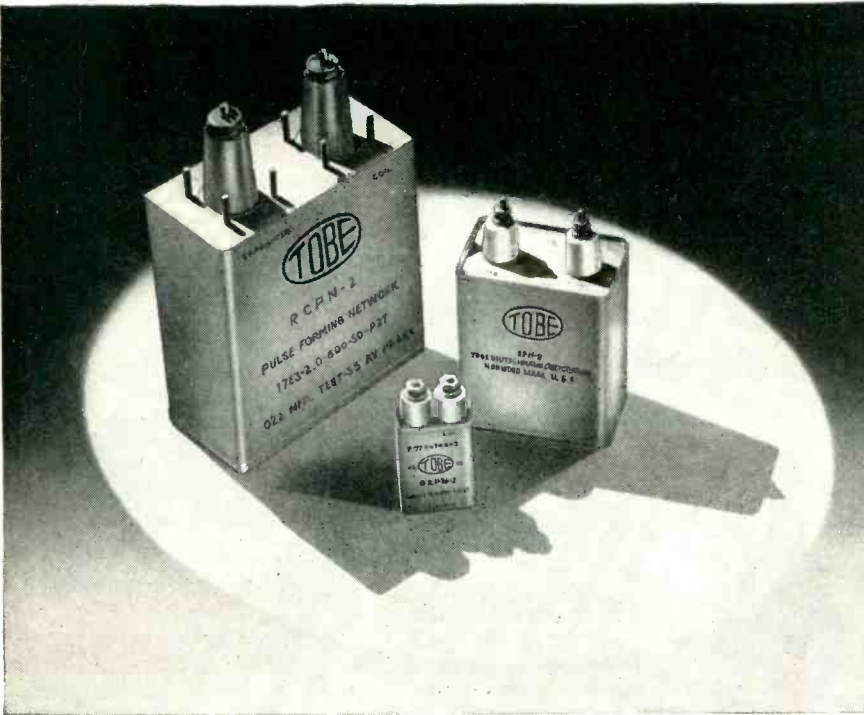

- Any pulse width from 0.1 to 40 microseconds
- Any impedance from 5 to 500 ohms
- Any voltage rating from 1000 to 25000 volts\*

Tobe pulse forming networks have an excellent record of performance, both in radar sets and in seasoning equipment for magnetrons and hydrogen thyratrons. Our design experience and production facilities assure deliveries to your schedule requirements. Widely used networks are tabulated below. Many others are available — write for data sheet.

\*Over 25KV, pulse-type capacitors with external coils are usually recommended; write for data sheet.

TOBE TYPE	CODED IDENTIFICATION	DIMENSIONS (exclusive of terminals)
DPN-1	3 - 0.75 - 800	50P6T 2 1/2 x 3 3/4 x 3 1/2
	9 - 2.25 - 300	
	14 - 3.50 - 200	
GEPN-2	2.64E2 - 0.4 - 800 - 50P2T	1 13/16 x 1 1/16 x 2 3/8
GEPN-4	2 - 0.5 - 2000	50P4T 8 x 4 x 4 1/4
	7 - 0.185 - 380	
	9 - 2.35 - 380	
RCPN-2	17E3 - 2.0 - 600 - 50P2T	3 x 6 x 7
RCPN-4	24E2 - 1.0 - 630 - 25PY2T	10 x 4 1/2 x 7 9/16
RPN-5	11.5E4 - 2.0 - 400 - 16P2T	5 1/4 x 10 x 10
SPN-8	6E4 - 0.45 - 2C00 - 50T2T	3 3/4 x 2 1/4 x 4 3/4
SPN-14	2 - 0.25 - 4000	55P8T 4 x 8 x 2
	4 - 0.50 - 2000	
	7 - 1.0 - 1000	
	12 - 2.0 - 500	
SYPN-6	2E3 - 1.0 - 50 - 50P2T	1 1/16 x 1 13/16 x 3 3/4



**TOBE DEUTSCHMANN**  
CORPORATION  
NORWOOD, MASSACHUSETTS

of drilling and preparing for mounting is thus accomplished neatly with one tool.

The tool has proved particularly advantageous for installing rooftop antennas for mobile radio equipment, where a good antenna ground is essential. There is no danger of the saw dropping through the roof and tearing the headlining.

Credit for suggesting this idea is given to Sherman Wolf in the January-February 1953 issue of Motorola Newsgram.

## Counting Output of Plant

ORDINARY switches and a photoelectric counting system are combined to provide a second-by-second record of daily production on indicators in the office of the director of manufacturing at Olympic Radio & Television. Any interruption in the clicking of these counters is noted immediately by the man responsible for all production, long before anyone would normally call him by phone to tell of trouble.

Belt conveyors are used to take sealed cartons of finished sets from the various floors of the plant down to the loading dock. At the entrance to each of these conveyors is a group of spring-release toggle switches, one for each model of set coming from that floor. After each carton is placed on the outgoing belt, the operator presses the appropriate switch once, thereby actuating the

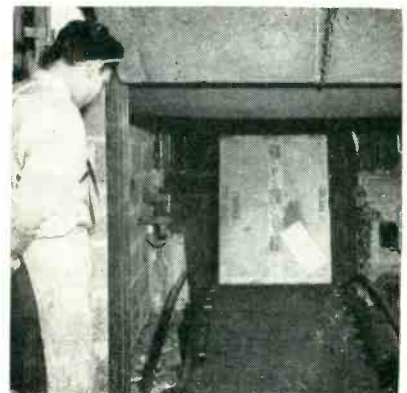

Operator flips switch on wall with left hand as finished set in carton goes down conveyor tunnel to loading dock. Carton has just interrupted light beam of photoelectric system used to obtain totalized count



B. Bordiga, director of manufacturing, studies counters in his office that indicate number of receivers of each type produced since line started in morning

corresponding counter in the head office.

The photoelectric systems are installed in each of the two conveyor tunnels, where they automatically react to all cartons regardless of size and give totalized counts on two separate indicators in the office. This serves as a check on individual counts, since a worker may occasionally forget to flip a switch or may accidentally bump a switch panel and give a false count.

### Mounting 21-Inch Tubes

SIMPLE production tools and techniques permit safe and speedy suspension of heavy 21-inch rectangular picture tubes from the top of the cabinet in Olympic television receivers.

After adhesive-backed sponge rubber strips are pressed around the rim of the tube, it is set face down on a cushioned wood pallet and the steel clamping band is applied;



Tightening clamping band of 21-inch picture tube while face of tube is centered on special pallet

# RESIN-IMPREGNATED RESIN-FILLED CAPACITORS

for 125°C service — without derating

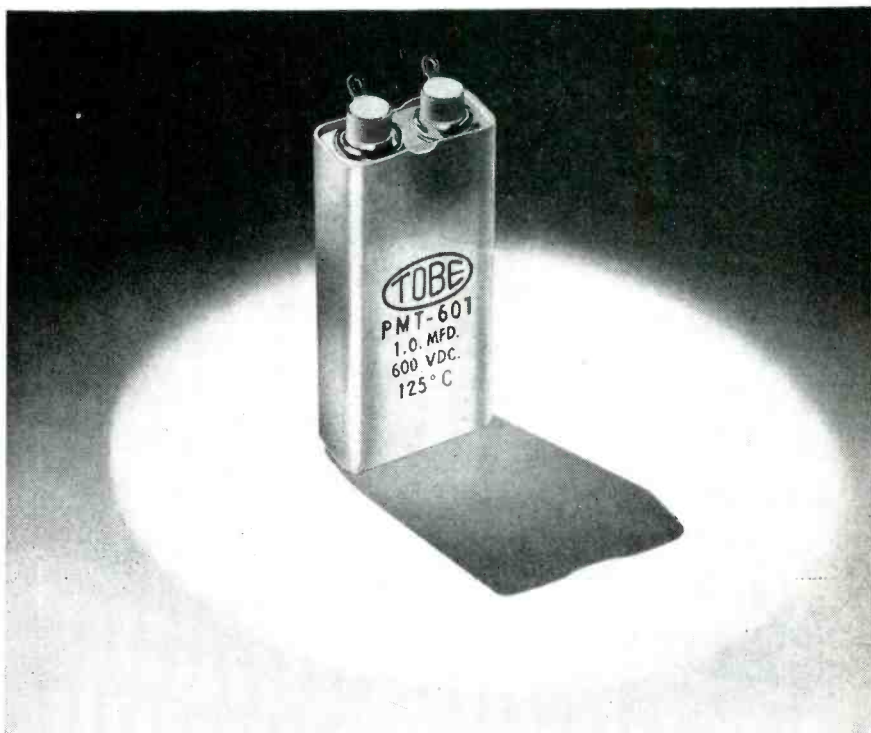

## TOBE DURATOR CAPACITORS

Higher working temperatures at no increase in size are now possible, with Tobe Durators. Features of these capacitors are:

- 125°C ratings in same space as 85°C
- 150°C operation for 20 hours without derating
- Welded terminals with silicon insulators
- Hermetically sealed metal cases in bathtub, deep-drawn, and lock-squeeze-seam styles
- Capacitance drift below 7½% from -65°C to +125°C
- Power factor below 1.5% from -65°C to +125°C
- Suitable as coupling capacitors at minimum voltage

Write for data sheet listing available ratings and sizes.



**TOBE DEUTSCHMANN**  
CORPORATION  
NORWOOD, MASSACHUSETTS

# newest aid

## to users of fasteners.

Everyone who designs, specifies or purchases needs this useful

### RIVET SELECTOR!

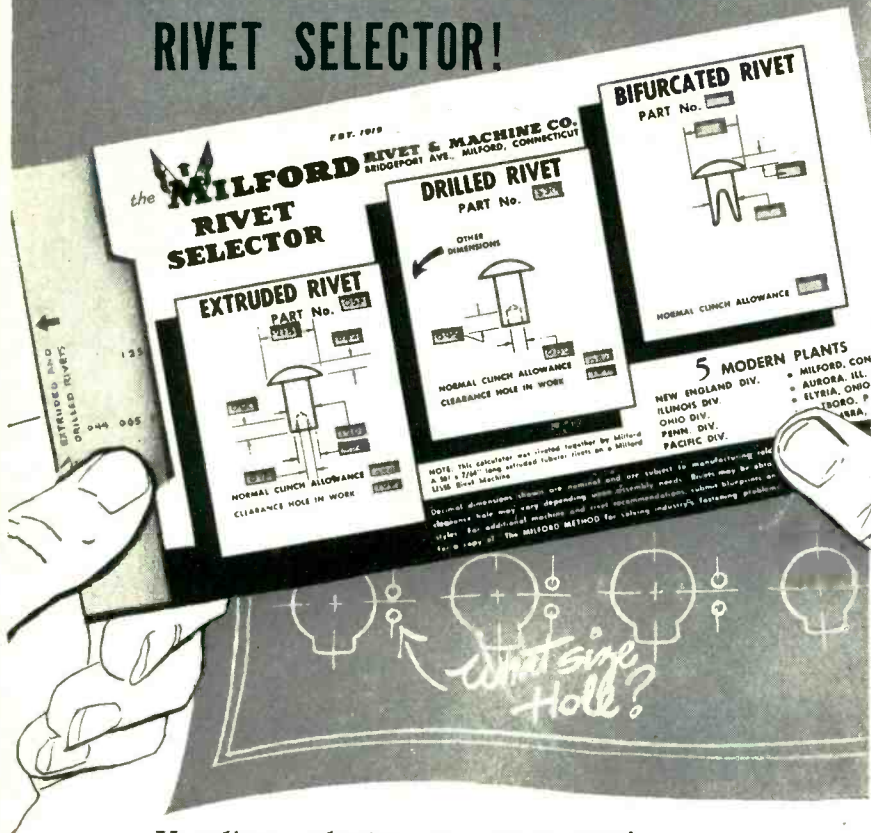

*Handiest selector you ever saw!*

Simplifies your job; saves time, speeds choice of right fastener. Easy to read, easy to use, handsomely lithographed in red, white and blue. Shows various tubular and split rivets, part catalog number, normal clinch allowance, size of clearance hole in work and other details to aid your product manufacturing. Sturdily riveted together for lasting use. Write for yours today!



EST. 1919

# MILFORD

The name to RIVET in your memory for fasteners.

#### THE MILFORD RIVET & MACHINE COMPANY

855 BRIDGEPORT AVENUE, MILFORD, CONNECTICUT  
 806 ILLINOIS AVENUE, AURORA, ILLINOIS  
 1106 WEST RIVER STREET, ELYRIA, OHIO  
 26 PLATT STREET, HATBORO, PENNSYLVANIA  
 715 SO. PALM AVENUE, ALHAMBRA, CALIFORNIA

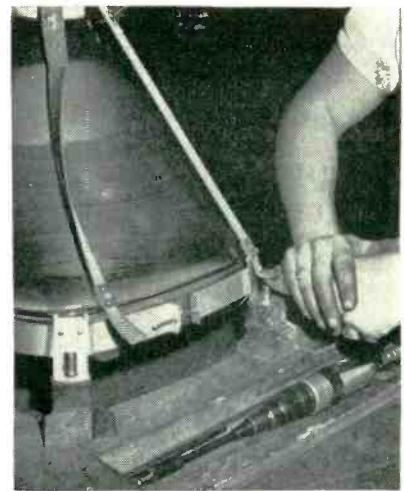

Method of using pliers to pull nylon yoke strap over bracket of clamping band

holes in the front-panel mounting brackets of the band mate with steel studs on the pallet during this operation, to insure accurate alignment of the band. After inserting the locking bolt and nut, the operator holds the nut with a socket wrench while tightening the head of the bolt with an air-powered screwdriver.

Next, the deflection yoke assembly is placed over the neck of the tube and the nylon yoke straps are one by one hooked over the rim clamp brackets. Ordinary pliers are used to get a good grip on the short surplus stub of nylon strap during this operation.

A spring steel wire ring is now placed over the nylon straps, so that it sets in steel hooks riveted to the straps. The ends of the ring are pulled together with a pair of large tin snips having a notch for the pur-

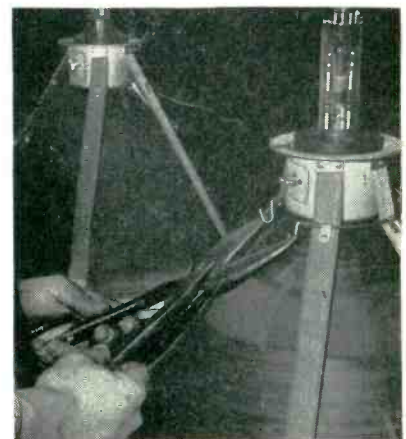

Using notched-blade tin snips to pull ends of spring-steel ring together



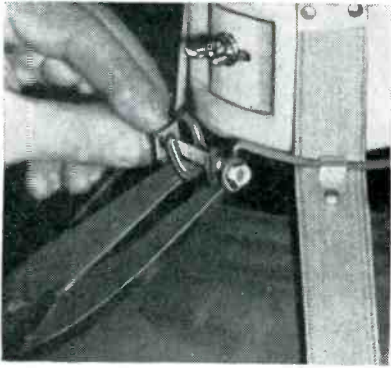

Holding ends of spring-steel ring together while inserting preassembled bolt in V-shaped ends of ring

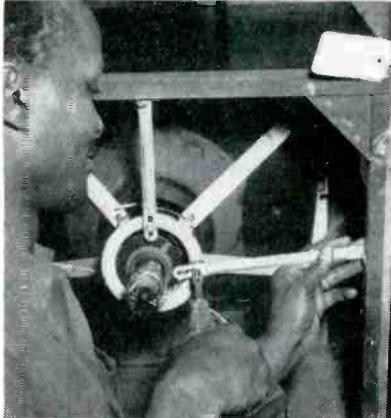

Installing deflection yoke bracket to complete mounting of picture tube in cabinet

pose in the end of each blade. While holding the ring together with the snips in one hand, the operator drops into position a bolt on which the nut has already been started. The ring is now released by removing the snips, and the bolt is tightened conventionally with an air-powered driver until the desired additional tension on the nylon yoke straps is obtained.

With this type of harness, mounting of the picture tube becomes similar to the mounting of loudspeakers in cabinets. The four brackets on the clamping band fit over four stud bolts built into the front panel of the cabinet.

### Imprinting on Plastics

A NEW process for marking lines, scales and figures on thermo-setting plastics is announced by Homalite Corp., 11-13 Brookside Drive, Wilmington, Delaware. Lines as thin as 0.007 inch can be produced to an accuracy of 0.002 inch on the material, with a reported 50-percent saving in cost over conventional methods. The lines and figures may be

## REEVES-HOFFMAN CRYSTAL UNITS

keep the chaos out of communications



Reeves-Hoffman Quartz Crystal Units bring unerring frequency control to thousands of radio signals being transmitted throughout the world.

The inherent accuracy of every Reeves-Hoffman Crystal is the result of extraordinary care taken in each stage of its manufacture.

**REEVES**  
**HOFFMAN Corporation**  
 A subsidiary of Claude Neon, Incorporated  
 CHERRY AND NORTH STREETS — CARLISLE, PENNSYLVANIA

LICENSED UNDER PATENTS OF THE BELL SYSTEM

**FIXED TYPE**

JCSL 100 mmfd.



JCSL 250 mmfd.

JCSL 500  
750 mmfd.JCSL 1000  
1500 mmfd.**VARIABLE TYPE**

UCSL 4-250 mmfd.

UCSL 5-500  
7-750 mmfd.

UCSL 7-1000 mmfd.



UCSL 10-2000 mmfd.

# INTRODUCING

## A FULL LINE OF CLOSE SPACED MINIATURE FIXED AND VARIABLE VACUUM CAPACITORS

Rated at 3 KV and 5 KV



All copper construction  
for  
High amperage loads



Small physical size



Negligible power factor



Extremely wide capacity range

*We invite your inquiries regarding  
specific applications.*

**LITERATURE MAILED UPON REQUEST**



**JENNINGS RADIO MFG. CORP. · P.O. BOX 1278  
970 McLAUGHLIN AVE. · SAN JOSE 8, CALIF.**

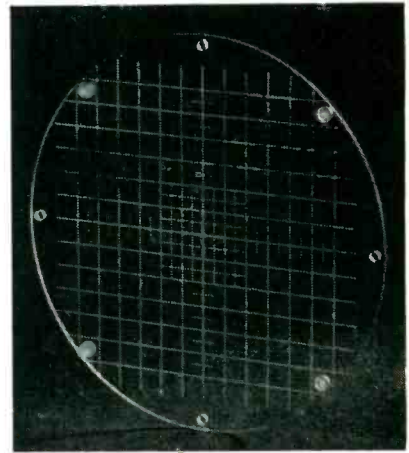

Example of oscilloscope screen window  
made by new technique

applied in any color and are almost impossible to obliterate, since there is no known solvent for the material employed.

The chief applications of the new technique are for internally lighted electronic equipment, including oscilloscopes, radar screens and instrument windows.

### Making Small Tubing by Electrodeposition on Nylon

METAL tubes with diameters from 1 mm down to 0.1 mm or less are often useful in electronic and instrument techniques. Indirectly heated cathodes for electron tubes are one example. Small metal tubes are generally made either by drawing down larger tubes or by electrodeposition on a mandrel. The first method must generally be used for alloy tubes, but it is difficult to obtain very small diameters. The electrodeposition method can be used for pure metals but in the deposition on waxed or oxidized threads it is difficult to pull out the mandrel without destroying the tube, especially with very thin walls and small diameters.

A variation of the electrodeposition method makes use of the excellent mechanical properties of nylon fiber as a mandrel. Drawn nylon fibers of high strength and with very smooth surfaces are obtainable in exact dimensions.

The first step in making tubes is silvering of the nylon fiber by the Brashear or Rochelle salt method used for glass, as described in "Handbook of Chemistry and

Physics", 30th edition, p 2,537. A better adhesion between nylon fiber and the silver coating is obtained if the nylon fibers before the silvering process are dipped in a solution of 1 g SnCl<sub>2</sub> in 1 liter of distilled water and then rinsed in two (not more) baths of distilled water. The silvered nylon fiber is then plated to the necessary wall thickness with the metal desired. In order not to destroy the thin silver coating, the electric circuit must be closed before the fiber is immersed in the electroplating bath.

The nylon mandrel may be removed from the metal tube by holding one end of the tube with tweezers and drawing on the free end of the nylon fiber. The fiber will then contract without breaking and free itself from the inside surface of the tube. It can easily be drawn out. If necessary, the thin silver coating inside the tube can be removed by short dipping in dilute nitric acid.

Tubes several inches in length with inside diameters as small as 0.05 mm can be made in this way. Metals such as copper, silver and nickel have generally been used. It is also possible to make hard and corrosion-resistant tubes of a nickel-cobalt alloy by simultaneous electrodeposition of these two metals.

This technique was described in "Review of Scientific Instruments" by Rolf J. E. Gezelius, Research Institute of National Defense, Stockholm, Sweden.

### Magnetic Screwdriver

A NEW screw-holding tool suitable for repair and test positions comes with three interchangeable bits for slotted and Phillips screws. A mag-

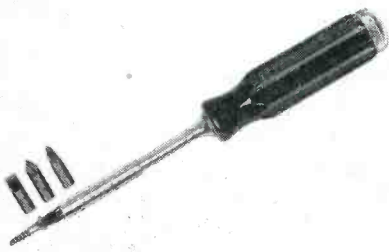

Convenient compartment in plastic handle of magnetic screwdriver serves for storing bits which are not in use

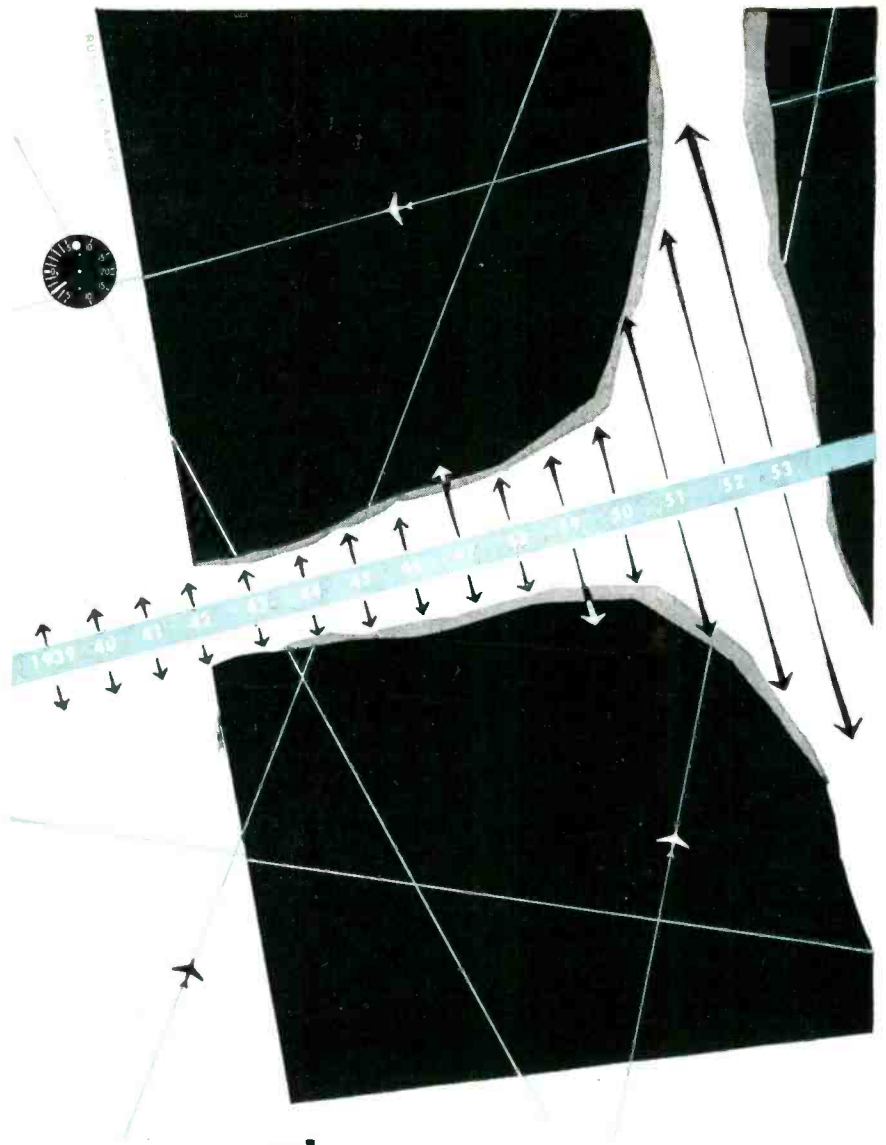

### growth

Due to our long experience, the demand for our engineering services in designing new precision devices and systems has increased tremendously. Our activities now embrace the four distinct yet allied fields of

- AIRCRAFT INSTRUMENTS AND CONTROLS
- OPTICAL PARTS AND DEVICES
- MINIATURE AC MOTORS
- RADIO COMMUNICATIONS AND NAVIGATION EQUIPMENT

Current production is largely destined for our defense forces; but our research facilities, our skills and talents, are available to scientists seeking solutions to instrumentation and control problems.



**kollsman** INSTRUMENT CORP.

ELMHURST, NEW YORK • GLENDALE, CALIFORNIA • SUBSIDIARY OF *Standard* COIL PRODUCTS CO., INC.



## Two MICRO switches speed operation of optical comparators

**WHICH "SEE" THE SIZE, SHAPE AND FIT OF SMALL PARTS**

● Visual inspection now checks measurements of small parts faster and more accurately than ever before. This process has been speeded 50% and more by the use of the new power elevator on Jones & Lamson optical comparators, which gives finger-tip control to the vertical traverse.

Two MICRO switches help make this operation faster, safer and more automatic by making it impossible for the table to raise or lower beyond previously adjusted limits. This leaves the operator free to position his work quickly without fear of damage to machine.

These switches are particularly well-suited for this purpose because of their quick and dependable response, their enclosed housings with sealed plungers to resist entrance of dirt or dust, and their convenient mounting and wiring arrangements.

Over 6000 different types of MICRO switches have been developed to meet other specific requirements. MICRO field engineers are located near you, ready and capable, to consult with you or your design engineers. Write or call the nearest MICRO branch office.

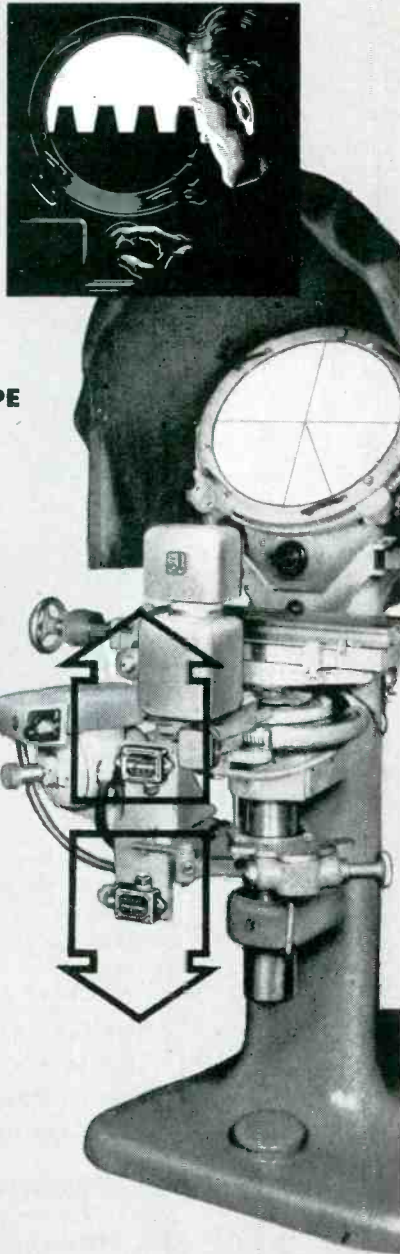

**MICRO** A DIVISION OF  
MAKERS OF PRECISION SWITCHES  
MINNEAPOLIS-HONEYWELL REGULATOR COMPANY  
FREEPORT, ILLINOIS



netized bit holder holds each bit in position and provides magnetic holding power for iron or steel screws. When no bit is in the holder, it may be used as a magnetized socket wrench for driving 1/2-inch hex-head bolts or nuts. The tool was initially available as a premium from Sylvania's advertising department, but is now available through commercial channels as well as from Sylvania distributors.

## Filling Transformers with Nitrogen

IN THE PRODUCTION of excitation transformers for radar antenna stabilizers at Keystone Products Co., simple yet effective techniques are employed to obtain a soldered vacuum seal, pump out the air, put in nitrogen and seal the units.



Use of parallel machinist's clamp for aligning housing while soldering cover

Mounting plates are soldered into the transformer housing by hand rather than by induction soldering. Accurate alignment of the sides of the housing is assured through use of parallel machinist's clamps on which extension jaws have been brazed. A heavy electric soldering iron is used to flow solder into the joint. Absence of pinholes during this operation is attributed to a clean and neat preliminary tin-plating of the components.

A refrigerator unit running backward is used as a vacuum pump to get up to and even over 28 inches of



Arrangement of vacuum and gas lines for filling transformers with nitrogen

vacuum. For this, an old unsealed type of compressor is required. The units to be evacuated are connected to the vacuum line with heavy rubber hose through copper tubulations previously soldered to the cover plate of each transformer. When the units have been pumped out, a valve in the vacuum line is closed and another valve is opened to admit dry nitrogen from a tank under 3 lb pressure. A cam and bar type



Method of cutting and crimping tubulation to seal off a transformer

# INTERNATIONAL RECTIFIER

## C O R P O R A T I O N

1521 E. Grand Ave., El Segundo, Calif. Phone: ORegbn 8-3778  
 CHICAGO: 205 W. Wacker Drive. Phone: Franklin 2-3889  
 NEW YORK: 12 W. 32nd. St. Phone: Chickering 4-0016

**INTERNATIONAL RECTIFIER CORPORATION**  
 EL SEGUNDO CALIFORNIA

**WIDEST RANGE IN THE INDUSTRY**

**WRITE FOR BULLETIN H-1**

# Selenium Cartridges

clamp on each rubber hose is then closed to hold the system under pressure. The copper tubulations of the transformers are then cut and crimped with a dulled cobbler's tool, and the resulting pinch seal is soldered by hand as an extra precaution.

### Dial Cord Machine

A STAPLING MACHINE with a steel scale added at its right permits high-speed production of receiver dial cords in Olympic Radio & Television's plant. When starting up, the operator pulls the dial cord from a free-running spool on a floor rack, threads it around two guides and three pulleys on a bench-mounted jig, then threads a dozen or more



Setup for producing dial cords, each with an attached spring. Tension-controlling jig is in foreground

springs onto the cord. The end of the cord is now run out over the steel scale and around an adjustable peg that can be set at any point on the scale to control the over-all length of the cord.

With one spring in the loop thus formed, the operator places the two ends of the loop in the anvil of the machine and presses the foot pedal to drive the clinching staple. The loop is now lifted off the peg behind the anvil to obtain slack, and a second staple is driven to box in the spring. Without cutting off the finished loop, the operator now slides another spring up, rethreads the

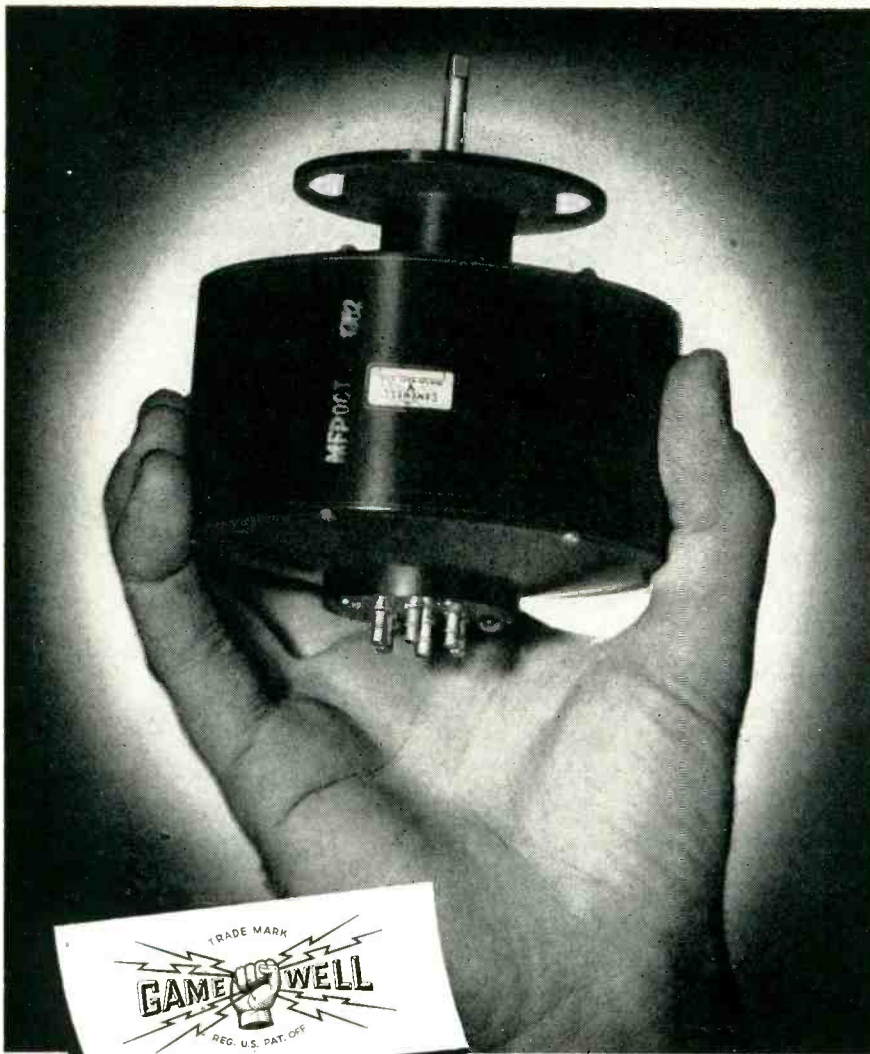

# PRECISION POTENTIOMETERS

*Linear and Non-Linear*

Linear and non-linear units are described in the Gamewell Precision Potentiometer booklet. The booklet also contains a convenient glossary of terms used in conjunction with precision potentiometers. Write for your copy.

To solve your specific precision potentiometer problem, send your specs and sample orders to Gamewell. With over 97 years of experience in manufacturing precision electrical products, Gamewell can provide the answer promptly.

**THE GAMEWELL COMPANY**  
Newton Upper Falls 64, Massachusetts



**PRECISION POTENTIOMETERS**

*Manufacturers of precision electrical equipment since 1855*

### CONDENSED SPECIFICATIONS

Sinusoidal Type	
RL-11C	RL-14MS
Total Resistance (ohms)	
16,000 ± 10%	35,400 ± 1%
Approx. % Resistance within brush circle	
85%	99 ± 1/4%
Angle of Rotation	
360°	360°
Torque (Approximate)	
3/4 oz.-in.	2 oz.-in.
Wire	
80 Ni-20 Cr	80 Ni-20 Cr
Resolution	
0.4°	0.2°
Angular Accuracy	
± 0.6°	± 0.5°
Amplitude Accuracy	
± 0.8%	± 0.6%
Maximum Volts across winding	
150	350
Maximum Speed	
60 RPM	60 RPM
Expected Life	
350,000 cycles	200,000 cycles
Diameter	
2 3/4"	4 3/4"
Length	
1 25/32"	4 11/32"
Shaft Size & Length	
3/16" - 1"	1/4" - 1 1/4"
Weight	
4.75 oz.	1.8 lb.



setup by running the cord around the two pegs, and drives two more staples to complete another dial cord. Cord for each new loop is pulled through the dangling batch of springs and looped around the pegs again. After all springs have been used up in this way, the finished loops are cut apart and the process is repeated.

### Illuminated Magnifier Aids Small-Parts Assembly

A FIVE-INCH-DIAMETER specially-corrected lens surrounded by a circular fluorescent lamp permits binocular vision without strain for inspection and work on small parts. The combination of 2X magnification with 400 to 500 ft-candles of substantially daylight shadowless illumination contribute to visual comfort over long periods.

The lens is designed for use six inches from the eyes, with the ob-



Bench-model Magnivision illuminated lenses being used in Raytheon's Quincy, Mass. plant for precision assembly of miniature and sub-miniature tubes

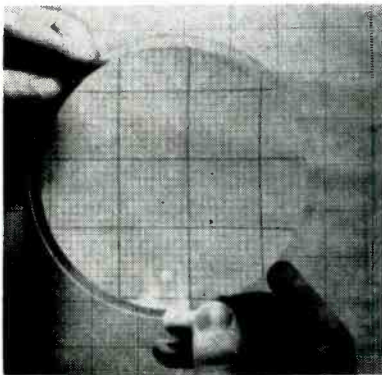

Graphical illustration of distortion-free properties of 2X aspheric lens

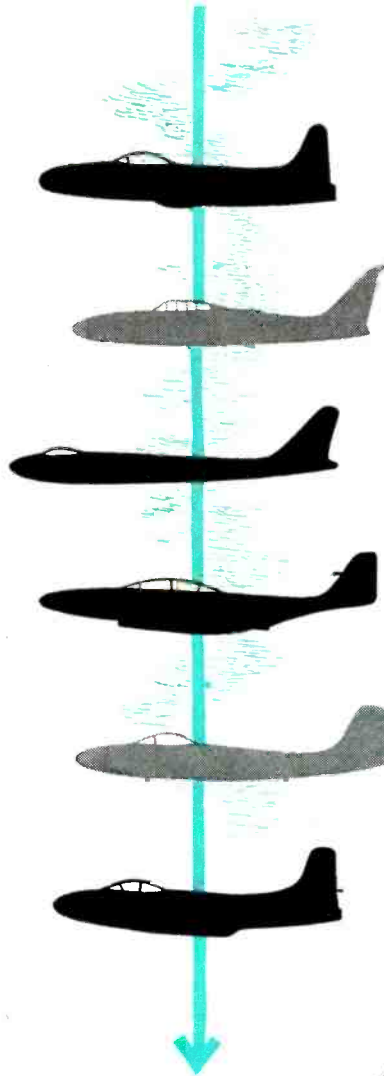

## Common Denominator of all LINK Electronic Equipment... **INFINITE PRECISION**

As aircraft behavior at sub-sonic and super-sonic speeds becomes more and more complex, the need for thorough on-the-ground flight training becomes ever more vital to the success of the Air Training Program. At the same time the simulation of these complex flight conditions demands infinite precision.

Link Electronic Equipment simulates *with infinite precision* every power and aerodynamic factor that influences take-off, flight and landing . . . speed, direction, rate of climb, effect of fuel consumption on trim, flight position, deviation and a host of others.

This infinite precision is built into all Link Electronic Equipment. Link Jet Trainers operate with the dependable certainty of the simplest mechanism. Yet they duplicate *exactly* the "in air" conditions of today's most advanced aircraft.

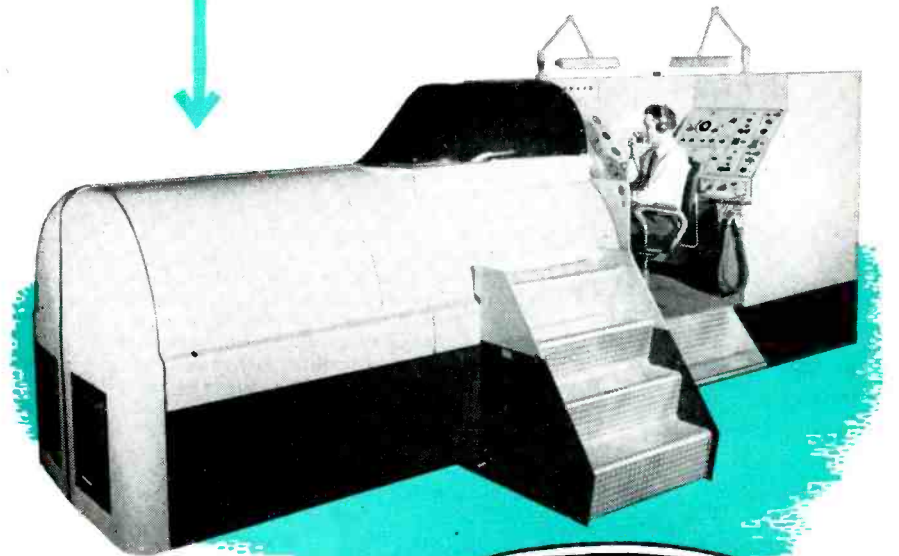

*the connecting  
link between  
ground and sky*



LINK invites employment applications from engineers and draftsmen.



# Speeding Electronic Progress

through

crystal



research

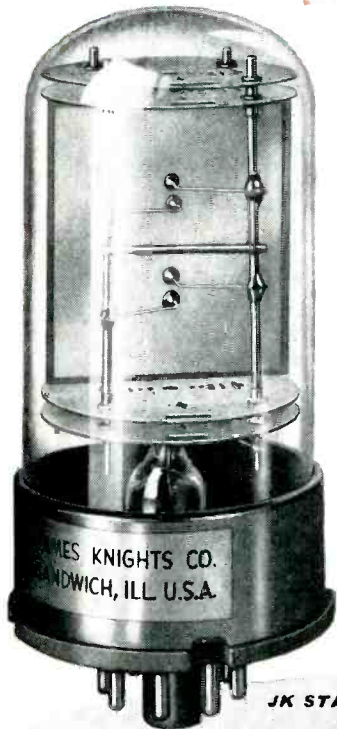

JK STABILIZED G-12 CRYSTAL

The JK G-12 is a precision 100 kc G-T cut crystal intended for operation in Meacham Bridge and similar oscillators. Available for operation at series resonance or into large load capacities. Resistance approximately that of usual lamp used for amplitude stabilization, simplifying bridge circuit design. The JK G-12 is vacuum sealed. Equipped with octal base it is more convenient than usual "soldered-in" type of precision standard crystal. Suitable for transistor oscillators. Will fit JK 07EH temperature control unit. Consult us on specific applications.

## Did you know?

Surgical cleanliness during manufacture is an important reason for the unequalled stability of JK Crystals. In an airconditioned, dust-free plant crystal blanks are repeatedly cleaned with chemicals, washed in distilled water and spun dry — plain tap water or even a fingerprint would impair stability. The final crystal, vacuum sealed in a glass holder, provides stability equal to a watch that would remain accurate to within three seconds over a year's time. Creative research combined with today's most modern production facilities brings you today's finest — JK "Crystals for the Critical".

THE JAMES KNIGHTS COMPANY, SANDWICH 3, ILLINOIS



Long-reach model, which can be mounted at rear of inspection or production bench up to 37 inches back from center of lens

ject five inches behind the lens. Users automatically seem to assume the optimum viewing position. The manufacturer is Engineering Developments, Inc., Portsmouth, Newport, R. I.

## Special Inspection Desks

CONSTRUCTION of special desk-type inspection positions for laboratory tests of incoming materials has boosted the efficiency of Sylvania's inspection department in Emporium, Pa. and at the same time raised employee morale and provided increased protection for costly instruments.

At the rear of each inspection desk are shelves for microscopes, balances and other instruments. Hinged doors close over the fronts of these shelves to keep out dust and protect the instruments during nighttime cleaning operations. The doors swing open to form sides for the work position when the desk is in use.

Construction from ordinary knotty pine lumber proved ideal for the purpose when finished with clear rubbed-effect varnish, giving the atmosphere of an executive office rather than a production laboratory.

## Welding Tube Bases

A TWELVE-STATION indexing table combined with a spot welder enables one operator to assemble stainless steel rings to octal bases at a rate of about 1,500 bases an hour in Sylvania's Warren, Pa. plant. The stainless steel bands that form the upper part of this





Left hand of operator loads stainless steel band onto turntable while right hand places molded plastic base over previously positioned band. Finished bases are blown upward into chute at left of table by air blast; occasional bases which stick, like that shown, are removed manually by operator

type of tube base are loaded in one cavity of the table, and the bases are loaded upside down in the next adjoining cavity.

At the next station, a rotating plunger driven from the center of the turntable acts to turn an outer ring which positions the lockseam of the band correctly with relation to the groove in the base. At the same time, the entire assembly is positioned by means of a keyway engaged in the base key. This insures that the proper pin is in the correct position for welding a ground wire internally from the pin to the band.

At the welding station, an overhead spool feeds nickel wire through the pin and a spot welder under the table joins the lower end of the wire to the inside of the band. After the welding operation the wire is cut just above the tube pin, for subsequent soldering to the pin during simultaneous dip soldering of leads to all pins.

### Winding Electrolytics

LARGE ordinary scissors bolted to the headstock of an improvised machine for winding electrolytic capacitors serve as cutoff shears in Pyramid's plant. The downward-facing blade is rigidly mounted in a

# Double Trace

## STOPS DOUBT!

... WHEN A SINGLE SCOPE WON'T DO THE JOB

If you're trying to compare two phenomena occurring simultaneously with two conventional oscilloscopes, chances are you're having "double-trouble". You just can't fix your eyes on two screens at the same time and, what's worse, hope to measure two high speed transients at the same instant. Even with an electronic switch you're apt to miss those important signals.

ETC Multi-Channel Oscilloscopes reduce such problems to their simplest form—by combining a number of different traces at the same instant on the face of a single tube.

Whether you need to measure 2, 4, 5, 6, or even 8 phenomena . . . in electronic or medical research, material or geological tests . . . there's an ETC Oscilloscope that can do the job. Write for full details on the particular type for your problem.



### MULTI-GUN C.R. TUBES

. . . with 2 to 10 guns . . . round or square face . . . 3 to 12 inches. Special purpose tubes made to your specification.



*electronic tube corporation*

1200 E. MERMAID LANE, PHILADELPHIA 18, PA.



## Measure PHASE Difference Directly 0°-360° . . .

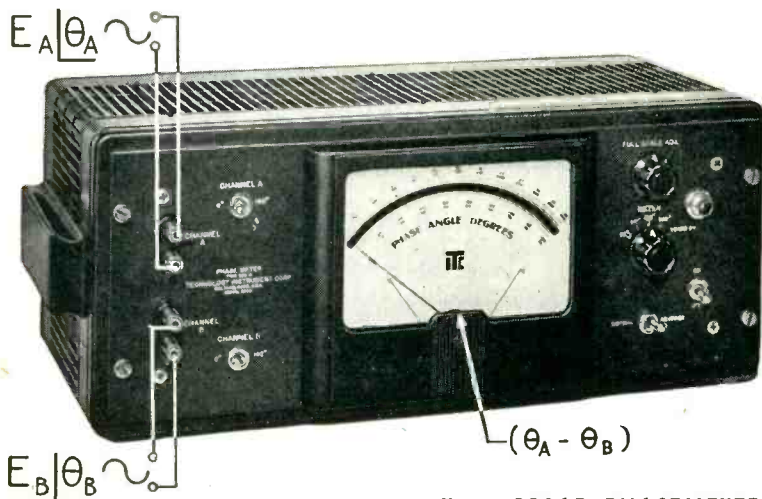

Type 320AB PHASEMETER

- . . . In 4 full scale ranges, 0°-36°, 0°-90°, 0°-180°, 0°-360°, without ambiguity
- . . . Independent of voltage amplitude from 1 to 170 volts peak
- . . . Independent of voltage wave form
- . . . Independent of frequency from 2cps. to 100kc. (accuracy: 20cps-20kc, 1% of full scale +3°; error increases slightly above 20kc.)
- Large, easily read, mirrored scale panel meter
- Ease of operation — ideal for production testing or laboratory use
- Eliminates tedious and inaccurate oscilloscope techniques
- Terminals for recorder . . . instantaneous response of output voltage to phase changes
- Incremental accuracy better than 1% of full scale
- Proven performance and quality workmanship

In audio facilities, ultrasonics, servomechanisms, geophysics, vibration, acoustics, aerial navigation, electric power transformation or signalling, . . . in mechanical applications such as printing register, torque measurement, dynamic balancing, textile and packaging machinery and other uses where an accurate measure of the relative position of moving parts is required . . . the type 320AB Phase Meter has achieved widespread approval as a unique and versatile measuring instrument.

For further information on measuring phase, send for specification bulletin and TIC Laboratory Reports

ENGINEERING REPRESENTATIVES

Chicago, Ill. — UPrown 8-1141  
 Cleveland, Ohio — PProspect 1-6171  
 Waltham, Mass. — WAltham 5-6900  
 Boonton, N. J. — Boonton 8-3097  
 Dayton, Ohio — Michigan 8721

Arnprior, Ont., Can. — Arnprior 400  
 Hollywood, Cal. — HOLLYWOOD 9-6305  
 Dallas, Texas — DIXON 9918  
 Roseland, New Jersey — Caldwell 6-4545  
 Wyncote, Pa. — Ogontz 8805  
 Silver Spring, Md. — Sligo 7-550

# TECHNOLOGY INSTRUMENT CORP.

535 Main Street, Acton, Massachusetts, Tel. ACton 3-7711



Method of using mounted shears to cut strips of insulating paper after winding an electrolytic capacitor

horizontal position just above the strips of insulating paper. The other blade is spring-loaded to keep it normally down, well under the strips of paper. The handle of this blade thus projects upward. Pushing this handle down gives quick cutoff at the end of each winding.

The machine has two foot pedals, one for starting and stopping the arbor and the other for operating the tab-crimping dies just back of the shears. When the pre-cut length of etched aluminum foil has been almost completely wound between the layers of insulating paper, the operator places a metal tab over the

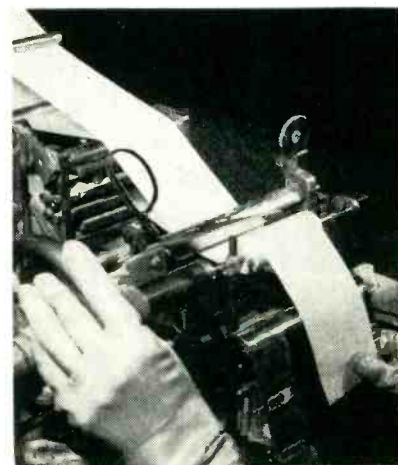

Appearance of winding machine when unit has been almost completely rolled and operator is operating crimping die to fasten a terminal tab to one of the etched foil strips. Die is just back of handle of shears



Method of using sample containers to check diameter of a finished roll

foil in the die and pushes the foot pedal. This drives a number of pointed pins down through tab and foil into mating holes, then flattens the self-riveted assembly. When inserting the etched foil for a new capacitor, it is threaded between the jaws of the crimping die.

This winding machine for electrolytics uses a support for the right-hand end of the arbor to insure uniform winding despite the pull of the relatively heavy metal foil. The pivoted arbor support is spring-loaded to stay upright, but can easily be pushed down out of the way for removal of the arbor pin that locks the start of each winding, then for removal of the finished unit.

One sample of each size of can used for electrolytics is riveted to a metal strip for use as a go-no go gage for occasional checking of capacitor roll diameter. The completely rolled unit must fit smoothly into its can. A tight fit generally means that terminal connections are too bulky.

### Paint-On Solder

A SOLDERING alloy pre-mixed in exactly the right proportions with a specially formulated noncorrosive flux can be applied with a small brush, eliminating the need for using one hand to hold rosin-core solder. The new paste material, known as Tin Weld, is a development of Eutectic Welding Alloys Corp., 172nd St. and Northern Boulevard, Flushing, N. Y.

Parts need only to be painted with the paste and heat applied. After cooling, excess flux can be

# TIC-TALKS

## FEATURE

### Something new in Precision Potentiometers . . .

... the standardization of a Non-Linear Precision Potentiometer, the type RVP3-S59 Sine-Cosine potentiometer, one of the many types standard with the Technology Instrument Corporation, performs two operations in a single potentiometer assembly . . . two wipers spaced 90 degrees apart yield both sine and cosine outputs.

1. Total resistance: 20,000 ohms plus or minus 5 per cent between terminals 1 and 3.
2. Accuracy: Plus or minus .5 per cent of the peak to peak amplitude.
3. Maximum voltage: Conservatively rated as 80 volts between terminal 1 and 3.
4. Life: Guaranteed for at least 500,000 complete cycles in either direction at 30 rpm.
5. Potentiometer base: Precision machined aluminum (originated by TIC) finished with corrosion resistant black Alumilite.
6. All fixed connections are soldered.
7. Wipers: Paliney spring wiper with double contact, for positive electrical connection, long wear and light torque.
8. Resistance Element: Karma wire with temperature coefficient of .00002 parts per degree centigrade.
9. Slip Rings: Inlaid coin silver slip rings. Paliney contacts on dual brushes for positive connection and low contact resistance.
10. Full humidity protection with type 76-S fungus resistant varnish.
11. Units may be ganged, using TIC's patented "Constrict-O-Grip" clamp rings which permit precise phasing with amazing ease.

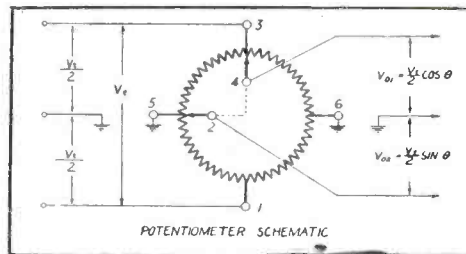

POTENTIOMETER SCHEMATIC

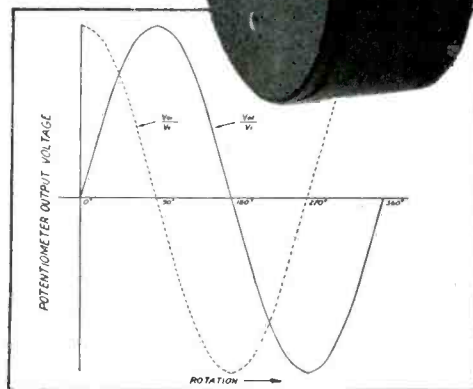
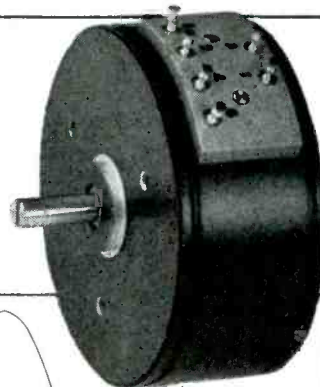

TIC standard potentiometers have the same built-in precision and craftsmanship normally found only in custom-built products. Research, engineering and design facilities for special constructions and non-linear or linear functions are an integral part of TIC services. Submit your potentiometer problem, whether the need is for standard or custom design.

#### Engineering Representatives

Cleveland, Ohio — PProspect 1-6171  
 Chicago, Ill. — UPtown 8-1141  
 Rochester, N. Y. — Monroe 3143  
 Canaan, Conn. — Canaan 649  
 Dayton, Ohio — Michigan 8721  
 Baltimore, Md. — Plaza 7694

Arnprior, Ont., Can. — Arnprior 400  
 New York, N. Y. — MUrray Hill 8-5858  
 Cambridge, Mass. — ELiot 4-1751  
 Hollywood, Cal. — HOLlywood 9-6305  
 Dallas, Texas — Dixon 9918  
 Binghamton, N. Y. — Binghamton 3-1511

## Technology Instrument Corp.

535 Main Street, Acton, Massachusetts, Tel. ACton 3-7711

...an entirely new concept  
of jewel mounting  
for shock protection

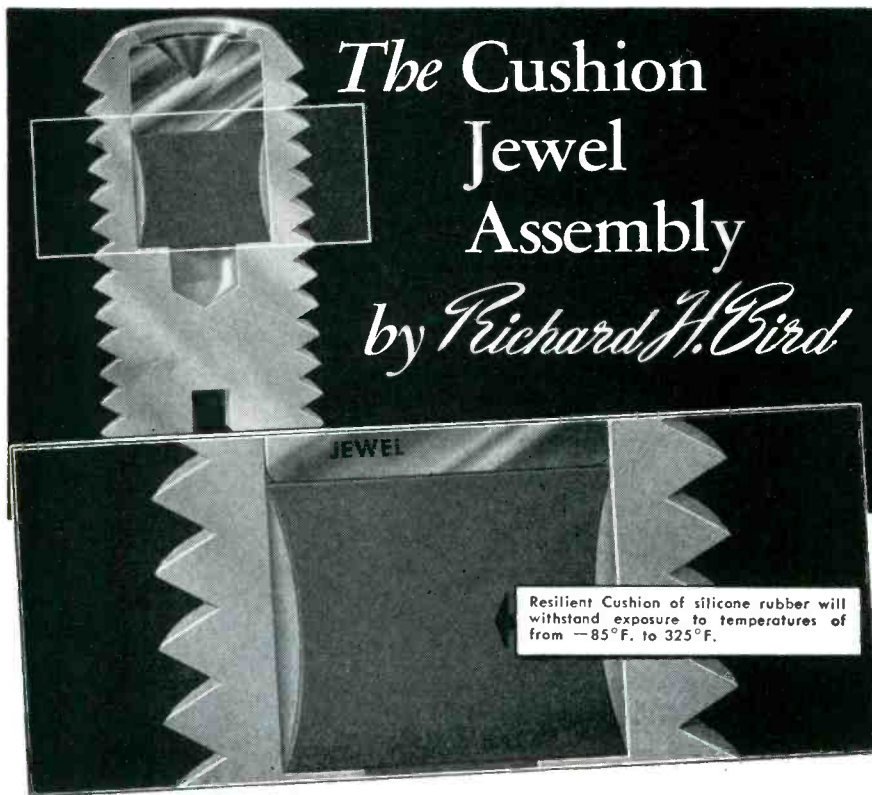

**The Cushion  
Jewel  
Assembly**  
by *Richard H. Bird*

Resilient Cushion of silicone rubber will withstand exposure to temperatures of from -85°F. to 325°F.

Here is your answer to protection for the critical jewel assembly in meters and instruments that must withstand severe shock and vibration conditions. Tests\* show that BIRD Cushion Jewel Assemblies perform better and are less subject to damage than conventionally mounted jewels.

Actual assembly line tests show that damage to jewels through improper adjustments by inexperienced operators is practically eliminated when BIRD Cushion Jewel Assemblies are used. And Cushion Jewels are not expensive to use — you can include them in your production for pennies extra, with the added advantage of "protection" for your instruments under all conditions.

*Bird Cushion Jewels for shock mounting*

- Perform better, provide "protection"
- Variable cushioning to suit different operating conditions
- Produced in any mounting to specification
- Eliminates damage by inexperienced assemblers
- Controls movement of jewel — no loose assemblies
- Inexpensive shock-proofing for any instrument

\* Tests, being conducted at the Squier Signal Laboratories, to compare cushioned and conven-

tional mounts, show that jewels that are cushion-mounted have a better resistance to vibration. Shock tests of instruments using cushion assemblies indicate better performance and less damage susceptibility than instruments using conventionally mounted jewels.

We want to show you how BIRD Cushion Jewel Assemblies can add shock protection to your instruments. A request on your letterhead will bring complete information — or, send us specifications and sizes of jewel bearings in your instruments for samples of Cushion Jewel Assemblies for test in your plant.

The engineering staff of the Bird Company is at your service for all small bearing problems.

Over 40 years of serving industry with Quality jewel bearings

*Richard H. Bird & Co., Inc.*

Sapphire and glass jewels · Precision glass grinding · Ferrite precision products · Sapphire stylii

1 Spruce Street, Waltham 54, Mass.

removed with a damp cloth, or by rinsing in water. There is no need for preliminary tinning of parts.

In connection with assembly of radio receivers, one user reports doubling of output after changing to the new paste solder. It has proved ideal for delicate work requiring minimum solder, and minimizes or completely eliminates waste solder. This latter characteristic often more than counteracts the higher cost of the paste solder, which sells for \$5.60 a 2-pound can.

The paste can also substitute for solder preforms at lower cost, and can be used in locations where ordinary solders cannot reach, as well as for tinning odd-shaped parts. Strength of joints is reported to be at least as great as that obtained with conventional lead-tin solder. All common metals except aluminum and magnesium can be soldered with full solder-bond strength.

**Molten Metal Spray Shields Plastic Parts**

ONE of the problems encountered in manufacturing the new Dictaphone electronic recording instruments was adequate shielding of the closely assembled amplifier components while keeping the recorder compact and light for portability. The solution evolved was use of molded Bakelite housings, with shielding being achieved by metalizing the inside of each with zinc. This coating was sprayed on in



Spraying group of 10 Bakelite pivot blocks for electronic dictating machines with molten metal for shielding

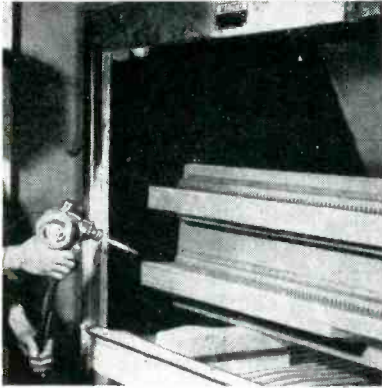

Using molten-metal spray gun to apply shielding layer of zinc to wooden wind chest of an electronic organ

molten form with a Metco metallizing gun, made by Metallizing Engineering Co., Long Island City, N. Y. Cost of the shielded plastic parts was only about one fourth that of solid metal parts, with a comparable saving and weight. The shielded housings are grounded to the chassis just as if they were metal.

Plastic parts to be metallized are masked first to protect surface finishes, then set up in fixtures holding 10 or more parts and sand-blasted to remove surface oxides. This takes a man 3 minutes. After transfer to another similar fixture, the parts are sprayed with molten zinc to give a metallized coating up to 0.003 inch in thickness. This operation takes 6 minutes of one man's time, using 1/8-inch zinc wire in the gun. Cost is figured at \$1.88 per hour for metallizing and \$1.75 per hour for sand blasting, plus the cost of materials and an added 300 percent for overhead.

The alternative procedure of shielding the insides of the plastic parts with inserts of lead, copper, zinc or foil would have cost about four times more than metallizing.

In a somewhat similar metallizing operation at Rudolph Wurlitzer



Examples of molded plastic parts having sprayed metal shields inside, used in electronic dictaphones

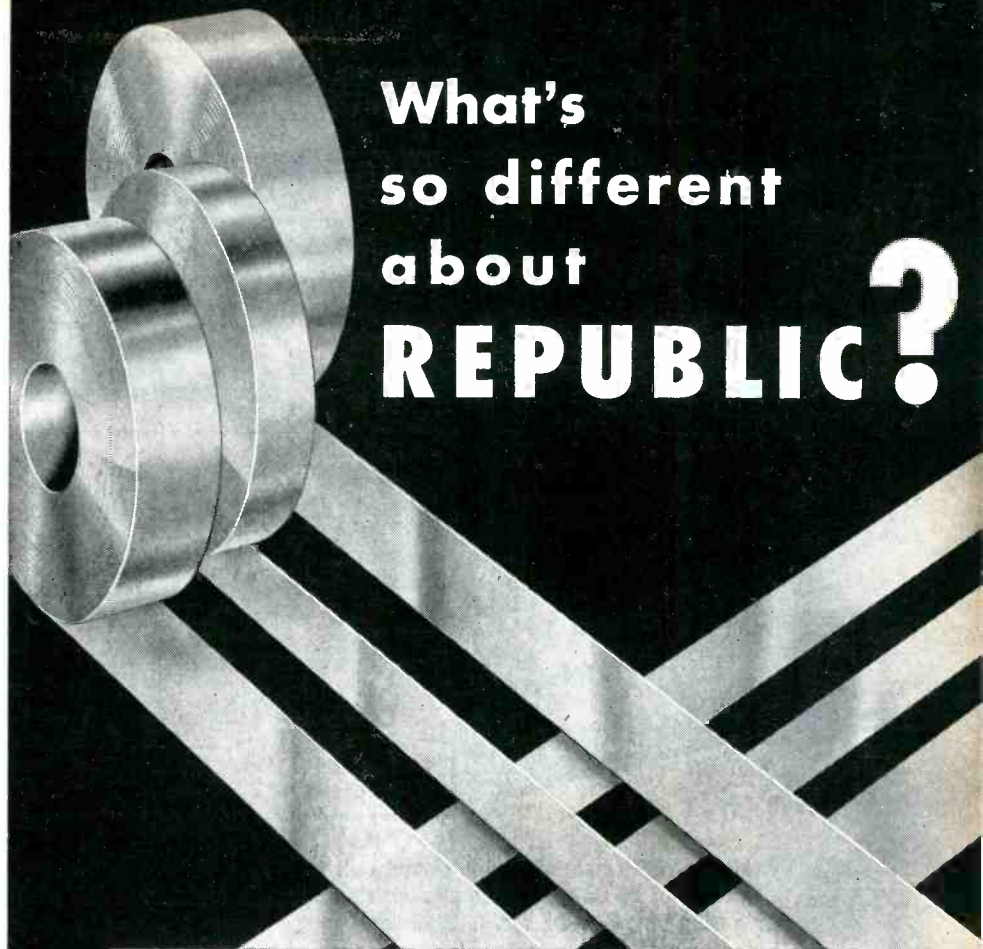

# What's so different about REPUBLIC?

For one thing, freedom from hide-bound thinking and engineering has resulted in manufacturing innovations that provide the best in output from modern precision machinery of Republic's own design.

The habit of being different at Republic has resulted in aluminum foil that has proven to be the most economical. It is custom made for your machines in widths from 1/4" to 28-1/2" and all gages from .0002" to .005". Each roll of Republic foil has clean, straight edges, accurate gage that result in superior windings and minimum breakage. Work stoppages and rejects are cut to the bone, down-time virtually eliminated. Your costs come down, when your production goes up.

Because Republic craftsmen watch *little* things, you benefit from *bigger* production.

**YOUR INQUIRY IS INVITED**

**REPUBLIC FOIL & METAL MILLS**  
INCORPORATED  
**DANBURY CONNECTICUT**

SALES OFFICES: 209 W. Jackson Blvd., Chicago 6, Ill.  
666 Mission St., San Francisco 5, Calif.



Co., North Tonawanda, N. Y., organ wind chests of electronic church organs are shielded by spraying on a 0.005-inch-thick coating of zinc. The sections of the wood chest that are not to be covered are masked off with heavy paper. The sprayed shield is grounded to prevent interference and hum that might be caused by shortwave broadcasts, X-ray machines, power lines and other sources of stray signals.

Outdoor-type power capacitors are being given a 0.01-inch coating of pure zinc by metallizing at one Westinghouse plant, to give electrolytic protection against corrosion. As a result of the success of this protective coating in the field, zinc metallizing of large indoor-type capacitors was also adopted by this company.

**Bracket Aids Removal of Soldering Iron Tip**

THE OPERATING principle of the old boot jack has been successfully applied to the problem of loosening frozen soldering iron tips in the

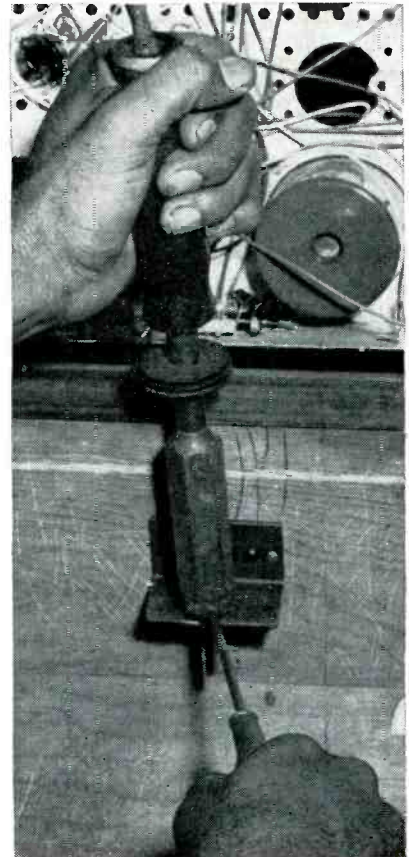

Method of using bench-mounted bracket to aid in removing hot tip of soldering iron used on television receiver line



# Sterling Relays

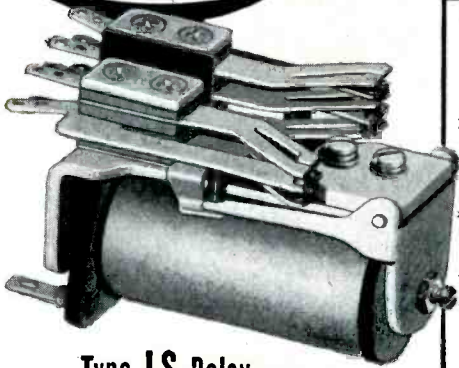

Type LS Relay

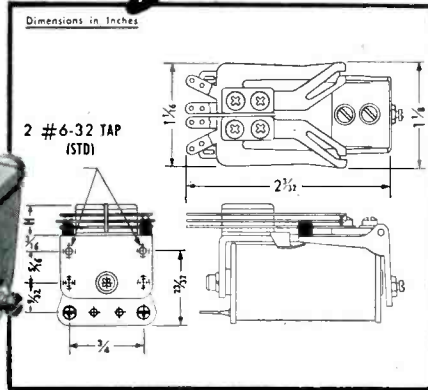

Available with single or double wound coils to 20,000 ohms.  
 Maximum of 20 springs in two pile-ups single or twin contacts.  
 Operating time — .002 sec. to .050 sec.  
 Release time — .005 sec. to .100 sec.  
 Weight — 2 1/2-4 oz. depending on coil fullness and spring pile-up.

## DESIGNED to suit your needs!

Send us your specifications.  
 Let us build a sample relay  
 to meet your requirements.

You will then be able to test  
 this sample relay in just the  
 spot where it is to function.

**No obligation on your part!**

See you at WESCON Booth 206 Aug. 19-20-21

*Sterling Engineering Co., Inc.*

54 MILL STREET — LACONIA, N. H.

Subsidiary of **AMERICAN MACHINE & FOUNDRY CO.** New York

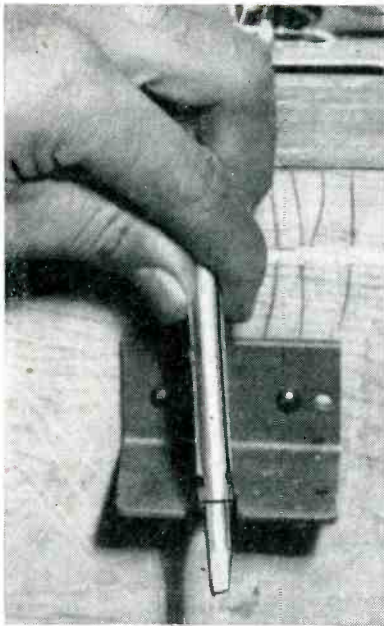

Closeup of bracket, showing also how slots are milled into tip of iron

plant of Olympic Radio & Television, Inc. The tips are notched on opposite sides with a milling cutter, to correspond to the recess just above the heel of the boot.

Within convenient reach of each assembly line soldering position, a small bracket is fastened to the bench with wood screws. A slot is cut into this bracket, just wide enough so the notched part of the tip can get in. To remove a tip, the operator slides it into the bracket, loosens the locking screw, then jerks the handle of the iron upward.

### Testing Television Receivers

TO GET a quick check of the horizontal and vertical sync pulses in a television receiver before the picture tube has been inserted, a small pickup coil can be inserted in the deflection yoke and connected to the vertical input terminals of a cathode-ray oscilloscope. The coil can be 50 turns wound in a single layer on a 3/4-inch outside-diameter form, using any convenient small size of wire. If the sync pulses as viewed on the cro do not stand still, the sync is out of adjustment. This suggestion comes from CBS-Columbia production engineers.

# how do YOU pronounce **HINDE & DAUCH**

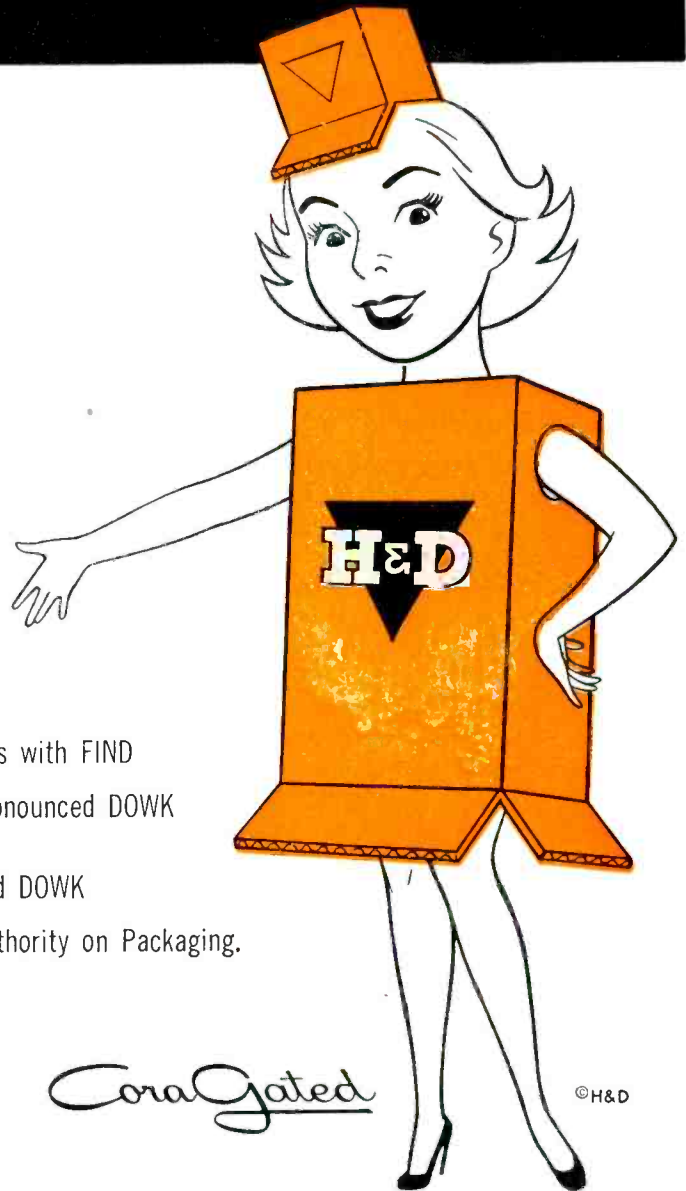

HINDE rhymes with FIND  
DAUCH is pronounced DOWK

Say HIND and DOWK  
America's Authority on Packaging.

our 65th year



*Cora Gated*

©H&D

# HINDE & DAUCH

SANDUSKY, OHIO

17 MILLS AND FACTORIES • 40 SALES OFFICES

Want more information? Use post card on last page.

# NEW PRODUCTS

Edited by WILLIAM P. O'BRIEN

Control, Testing and Measuring Equipment Described and Illustrated . . . Recent Tubes and Components Are Covered . . .  
Forty Trade Bulletins Reviewed

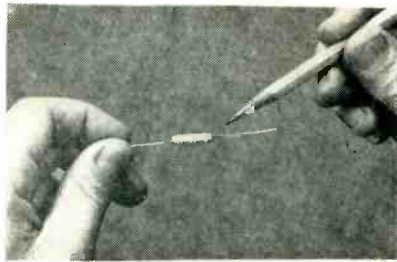

## CAPACITOR for transistor circuits

SANGAMO ELECTRIC CO., Marion, Ill., has developed an electrolytic capacitor for use in transistor audio circuitry. The type EHT capacitor has high-purity tantalum-foil electrodes with high-purity paper separators impregnated with a special electrolyte. Anode and cathode lead wires are securely welded to the foils for maximum electrical contact dependency. Ends are sealed with a polymerizing plastic that embeds the leads and section for maximum rigidity. Solderable leads of tin-coated nickel wire are firmly welded to the tantalum leads external to the capacitor body to preserve minimum leakage current properties necessary in transistor circuits.

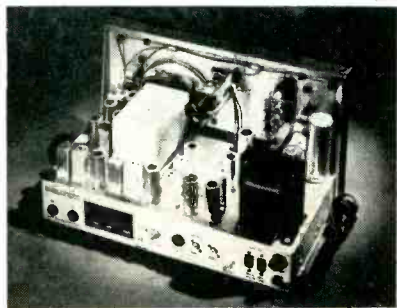

## F-M/A-M TUNER has adjustable afc

FISHER RADIO CORP., 41 E. 47th St., New York, N. Y. Model 50-R

f-m/a-m tuner incorporates a two-band superhet circuit with completely independent r-f channels for f-m and a-m. The f-m section comprises a dual triode, cascode, tuned r-f stage for maximum signal-to-noise ratio, and two i-f stages followed by two cascaded limiters. The unit features a sensitivity of 5  $\mu$ v for 30 db of quieting on 300-ohm antenna input, 2.5  $\mu$ v on 72-ohm antenna input; adjustable afc; a uniform response of 20 to 20,000 cycles,  $\pm 1$  db; distortion of less than 0.04 percent for 1 v output; and 10-kc whistle filter. Size is 14 $\frac{3}{4}$  in. wide, 8 $\frac{1}{2}$  in. high and 9 $\frac{1}{4}$  in. deep. Weight is 17 lb.

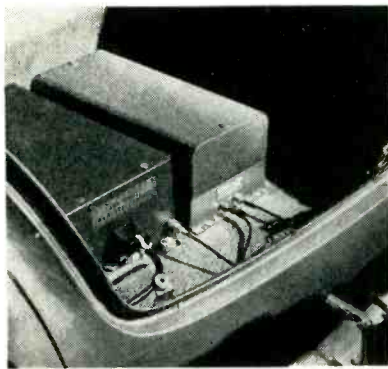

## POWER BOOSTER for the 152-174 mc band

KAAR ENGINEERING CORP., Middlefield Road, Palo Alto, Calif., is now producing a power booster that will increase the power output of any 10-w mobile radiotelephone transmitter six times. The unit is inserted between the low-power transmitter and antenna. The power desired is selected by a switch on the dashboard and the booster is activated when the microphone button is pushed. Because the unit is instant heating, added power is not

## OTHER DEPARTMENTS

featured in this issue:

	Page
Electrons At Work . . . . .	196
Production Techniques . . . . .	262
Plants and People . . . . .	334
New Books . . . . .	364
Backtalk . . . . .	386

drawn from the battery until the mike button is pushed. The power booster may be used with any make of radiotelephone operating in the 152 to 174-mc band.

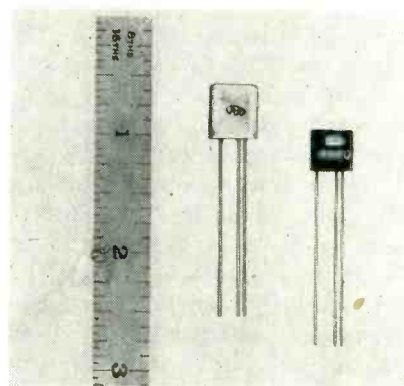

## PNP TRANSISTORS available in three types

RADIO RECEPTOR CO., INC., 251 W. 19th St., New York 11, N. Y., announces availability of three types of pnp junction transistors, useful from d-c to low r-f in high-gain amplifier, oscillators and shaping circuits. These tiny units are sealed in a thin plastic shell only 0.120 in.  $\times$  0.343 in.  $\times$  0.375 in. Leads may be soldered in, or clipped to plug into a standard transistor or hearing-aid-tube socket. The asymmetrical lead spacing insures proper polarity and fits the standard subminiature socket (proposed JETEC standard). Excellent performance can be obtained with as little as 0.5 ma at 1.5 v collector voltage. Under these conditions the type RR 20 has a current amplifica-



# Make your UHF circuits as simple as VHF designs...

Use these two New Sylvania Tubes in tuners and converters

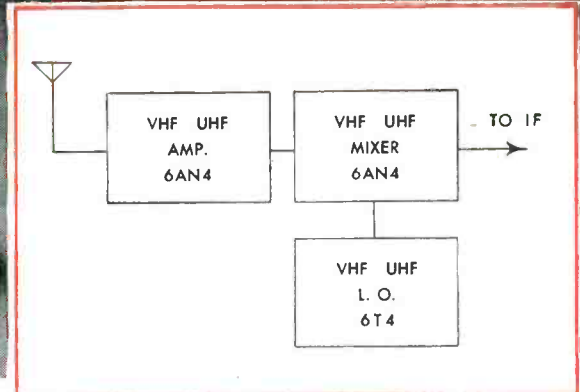
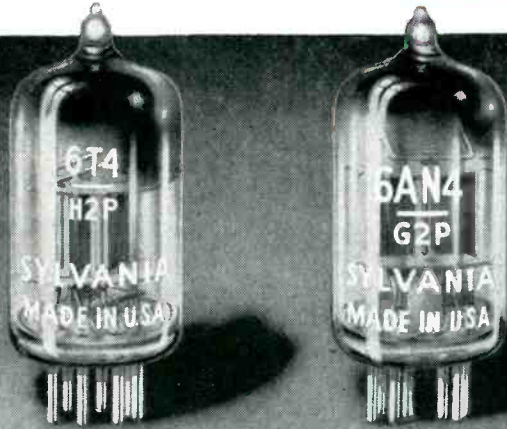

Equipment Manufacturers! Simplify design of combination VHF-UHF tuners, UHF converters for TV! Two new Sylvania-developed tubes permit adaptation of conventional amplifier-mixer-local oscillator circuit to the new frequency bands—completely eliminate complicated switching arrangements or stage duplication. Leading Tuner Manufacturers have adopted these types for current tuner production.

- Short Bulb T-5½ 7-pin miniature construction.
- Requires no special socketry.
- Designed for use at frequencies up to 1000 mc.
- Double plate and grid leads.
- Designed for high production resulting in lower cost, more uniformity and better availability.

**THE SYLVANIA 6T4** is designed for use as a local oscillator at frequencies up to 1000 mc. Used as the companion tube to the 6AN4, it makes possible the design of extremely simple combination tuners and UHF converters.

**THE SYLVANIA 6AN4** can be used as a grounded grid, rf amplifier as a mixer. Its performance in the VHF band is comparable to that obtained with tube types capable only of VHF service.

The 6AN4 is designed for both high  $g_m$  and high  $\mu$ . Under representative operating conditions as a Class A amplifier, the transconductance is 10,000 micromhos and the amplification factor is 70.

When used as a mixer, the 6AN4 offers the advantages of a conversion gain and of relatively low oscillator drive requirements.

Complete technical information on operating characteristics, including performance curves, is included in the manual, "Sylvania's UHF Story." A copy is yours for the asking. Write to: Sylvania Electric Products Inc., Dept. 3R-100, 1740 Broadway, New York 19, N. Y.

Representative block diagram of combination VHF-UHF tuner using the new Sylvania 6AN4 as rf amplifier and mixer, and the 6T4 as local oscillator.

COMPARATIVE PERFORMANCE OF THE 6AN4 AT VHF AND UHF

CONDITIONS	INSERTION GAIN db	BAND WIDTH mc	AMPLIFIER NOISE FIGURE db
Single tube in Channel 13 booster	14	10	9
Two tubes in cascade in Channel 13 booster	22	7.5	8
Single tube in open half-wave tuned amplifier at 450 mc.	12	10	12
Single tube in open half-wave tuned amplifier at 900 mc.	10	10	15

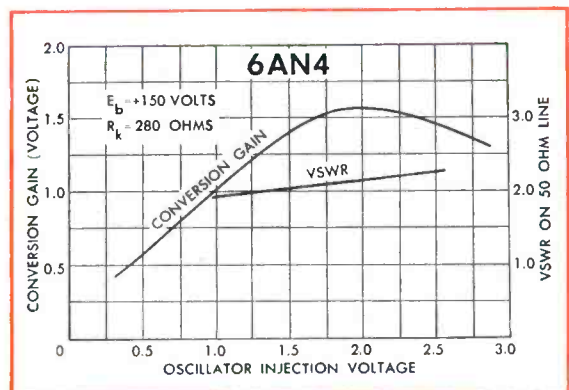

Curve shows conversion voltage gain using 50 ohm input and output, and input VSWR of the type 6AN4 when used as a mixer.

# SYLVANIA



LIGHTING • RADIO • ELECTRONICS • TELEVISION

In Canada: Sylvania Electric (Canada) Ltd.  
University Tower Bldg., St. Catherine St.  
Montreal, P. Q.

tion of 40 and a power gain of 36 db; types RR 14 and RR 21 have current amplification of 25. The RR 14 and RR 20 have cutoff currents of only 10  $\mu$  and a noise figure of 22 db (1,000 cps).



## POTENTIOMETERS

operate from 0 to 80 C

BIRKLAN CORP., 200 E. Third St., Mt. Vernon, N. Y. Series 3500 potentiometer achieves a linearity of 0.01 percent through utilization of advanced servo-controlled winding techniques. Each unit is individually calibrated against a standard accurate to 0.001 percent. Resistance range is 2,000 ohms to 300,000 ohms with a standard resistance tolerance of  $\pm 1$  percent. Temperature range of operation is 0 to 80 C. Low temperature-coefficient resistance wire and thermal cycling is used to stabilize resistance value. Electrical and mechanical rotation may be specified to any value between 360 deg and  $3,780 \pm \frac{1}{2}$  deg.

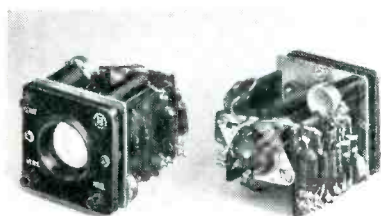

## MINIATURE CRO for instrumentation use

JAMES MILLEN MFG. Co., INC., 150 Exchange St., Malden, Mass. Use of miniature panel-mounting c-r oscilloscopes for instrumentation in place of the conventional

pointer-type moving-coil meters is made practical by the new 1-in. oscilloscope just developed. This scope has a panel bezel matching in size and style the standard 2-in. square case meters. It uses the 1CP1 one-in. crt. This compact tube has an extremely bright and sharp trace. There are many places in receiver, transmitter, amplifier and radar circuits where the wave shape and pulse form are of equal or even greater importance than magnitude. By the use of this new unit, magnitude, phase displacement and wave shape are constantly visible on the scope screen.

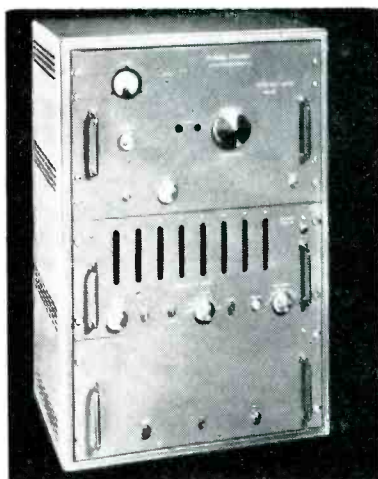

## FREQUENCY METER is direct reading unit

BERKELEY SCIENTIFIC DIVISION of Beckman Instruments, Inc., 2200 Wright Ave., Richmond, Calif. Model 5570 frequency meter offers a direct-reading instrument capable of measuring frequencies from 0 cps to 42 mc. Possible accuracies of 1 part in  $10^7 \pm 1$  count can be attained. The indicated frequency is displayed in digital form on eight banks of illuminated lucite number panels. Basically the model 5570 consists of two sections: (1) a high speed events-per-unit-time meter, and (2) a heterodyne unit. Frequencies from 2 to 42 mc are applied to the heterodyne section, the mc selector knob turned to the proper harmonic and the results are read directly on the eight decade number panels. By means of accessory heterodyne units, the complete range, up to 160 mc, can be read by this instrument.



## DECADE AMPLIFIER has high gain, low noise

KALBFELL LABORATORIES, INC., 1090 Morena Blvd., San Diego 10, Calif. The Kay-Lab model 102B decade amplifier is a general purpose pre-amplifier having stabilized gains of 40 db and 60 db, and maximum gain of approximately 80 db. One of its chief features is a very low hum and noise output for a gain-switching amplifier. Another feature is the high output voltage which, in conjunction with low noise, permits a very wide dynamic range. Maximum output is 50 v rms into 20 K ohms or higher load; 40 v rms into 5 K ohms load; 10 ma rms current into low impedance. Input impedance is 3 megohms shunted by 10- $\mu$ f capacitance. Power requirements are 105 to 125 v, 60 cycles, 75 w.



## CHOPPERS operate at 10 to 500 cps

STEVENS-ARNOLD INC., 22 Elkins St., South Boston 27, Mass., has available two d-c/a-c choppers that feature uniform performance over the entire range of 10 to 500 cps. Characteristics of the type 364 and the 365 choppers are identical ex-

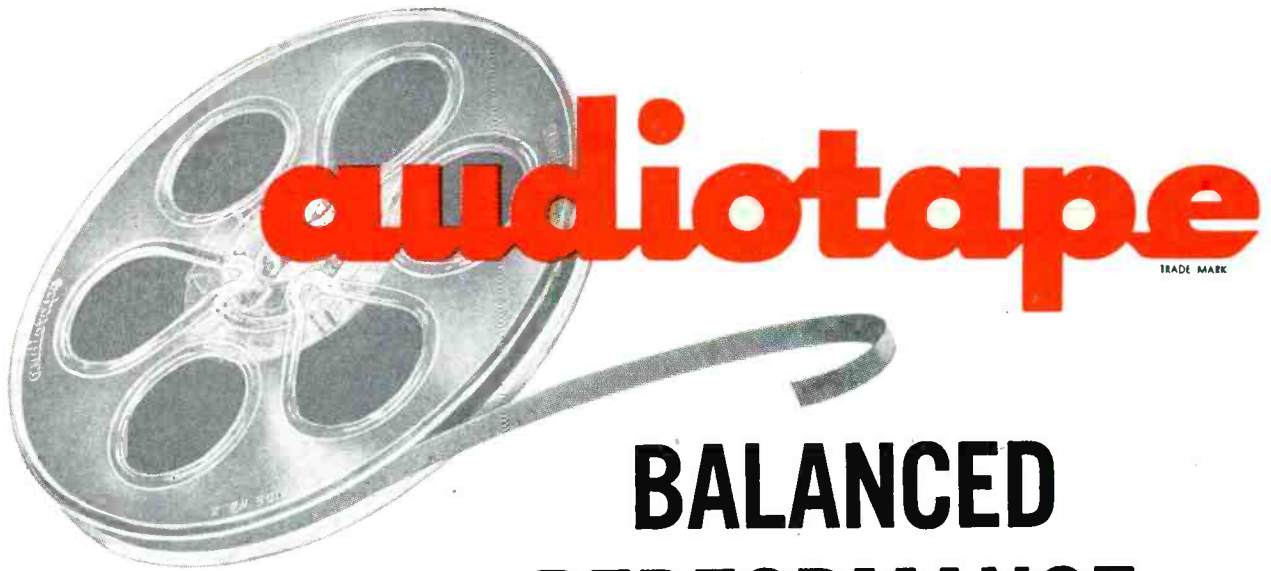

## BALANCED PERFORMANCE

gives you highest overall sound recording quality  
**...at no extra cost**

**audiotape** has been designed, formulated and perfected to meet the most exacting requirements for modern, professional sound recording. Its mechanical and magnetic properties are carefully balanced to assure optimum overall performance in *your* recording machines.

Output, frequency response, noise level and distortion are correctly proportioned for the most satisfactory end result—with no compromise on quality anywhere along the line.

Perfected manufacturing techniques and high production volume enable this premium-quality tape to be offered to you at *no increase in price*.

Here are some of Audiotape's extra-value features:

**More Uniform Frequency Response**—Audiotape's output does not tend to fall off at the higher frequencies. Response remains excellent throughout the complete range of audible sound, requiring no special equalization.

**Low Noise Level**—Extremely uniform dispersion of magnetic particles results in exceptionally low noise level—completely free from troublesome ticks and pops. Overall signal-to-noise ratio is entirely comparable to that obtainable with average production of any premium price tape on the market.

**Low Distortion**—Highest quality magnetic oxide, in a coating of precisely controlled uniform thickness, results in exceptionally low distortion over a wide range of bias settings.

**Maximum Uniformity**—All 7" and 10" reels of plastic base Audiotape are guaranteed to have an output uniformity within the reel of  $\pm \frac{1}{4}$  db or better—and a reel-to-reel variation of less than  $\pm \frac{1}{2}$  db. What's more, there's an actual output curve in every 5-reel package to prove it.

**Complete Interchangeability**—Since Audiotape requires no special equalization adjustments, Audiotape recordings can be interchanged freely between radio stations and studios—played back perfectly on any machine.

**Highest Coating Adhesion**—keeps the magnetic oxide coating from rubbing or flaking off. No danger of fouling heads and guides.

**Guaranteed Splice-Free**—Plastic base Audiotape, in both 1200 and 2500 ft reels, is positively guaranteed to be free from splices.

**Low-Tension Reel Design**—with 2 $\frac{3}{4}$ " hub now standard for all 1200 foot, 7" reels. By eliminating the high tension zone encountered at smaller hub diameters, this reel assures more accurate timing, more constant pitch, slower maximum reel speeds and reduced wear on heads and tape.

**COMPARE AUDIOTAPE** in an end-to-end run with any other sound recording tape available. Compare the *prices*, too. You'll find that Audiotape speaks for itself—in *performance* and in *cost*!

**AUDIO DEVICES, Inc.**

444 Madison Avenue, New York 22, N. Y.

Export Dept.: 13 East 40th St., New York 16, N. Y., Cables "ARLAB"



audiotape  
audiorecords  
audiopoints  
audiofilm

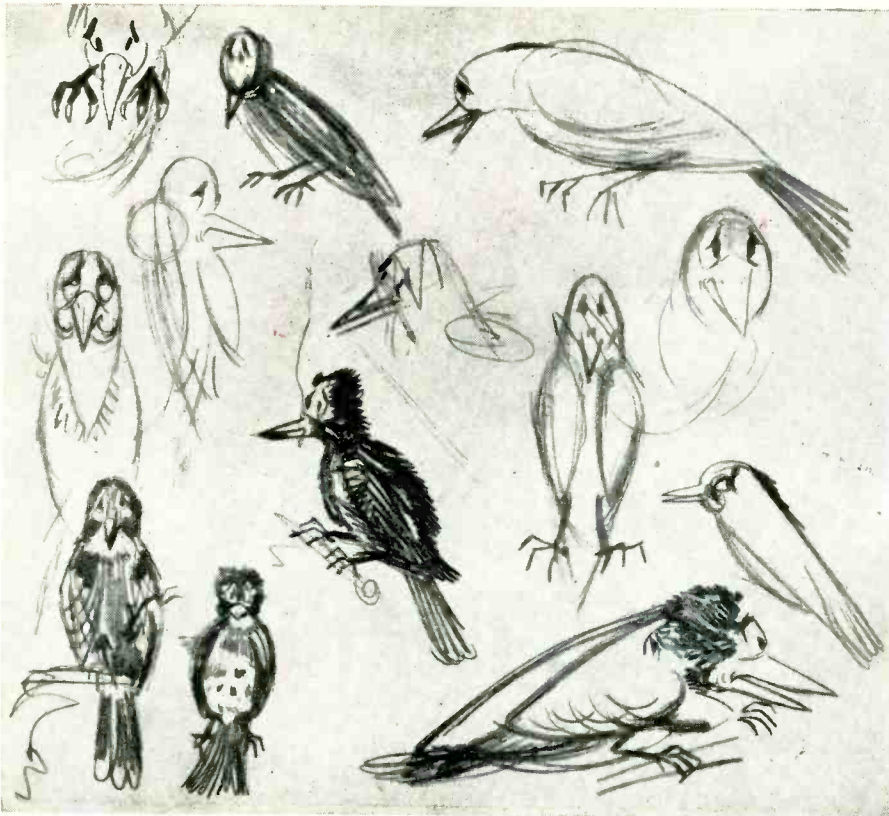

We wish we had something non-military to crow about. We wish we were sure how to stay in business without a lot of soft government money. We wish, when we end a year with a profit, even after taxes and such, that we could feel "We've earned that—there, because 26,063.5 people are glad they bought our product." Instead we have to say "156,000,000.00 people have, grudgingly, paid the check and they admit, grudgingly, that we probably earned it."

If you read this journal\* you get the impression that the entire electronic industry is in about the same spot, only in many cases it hasn't faced it. Of course one sees exceptions, where some character has a whole roomful of bottles and firecrackers which will run one milling machine automatically. But even here it's usually the result of a "development program" sponsored by the poor taxpayer. The Ph D in charge should watch a Brown & Sharpe #00 screw machine built any time after 1895 spitting out complicated and accurate parts every 3-10 seconds! Oh, we know it doesn't have feed-back but it works for George, who is top-kick to a half-dozen #00's and takes care of the feed-back.

How about doing something Useful with this electronics business? Just to keep up morale while we're stuck with military urgency!

P. S. We do make sensitive relays, will dutifully apply them to military needs, and we'll jump thru hoops for the commercial relay user when we find him.

\*Not referring to "The Scientific American"

# SIGMA

SIGMA INSTRUMENTS, INC.

62 PEARL ST., SO. BRAINTREE, BOSTON 85, MASS.

To kill two birds with one stone. If you have any dead crows, or care to kill some, send the 4 big feathers from each wing to C. P. Fisher, c/o Sigma, and receive 5¢ apiece plus an enlarged print of illustration above suitable for framing. This is serious. C.P.F. plays the harpsichord and prefers genuine crow-quill plectra.

cept that the former is plug-in and the later is nonplug-in. Contacts are gold thus assuring adequate performance in the 0 to 1½ volt d-c range. Long-life rating is 1½ v d-c, 1 mil. Both choppers were designed for mobile military and aircraft service. Contact arrangement is spdt.

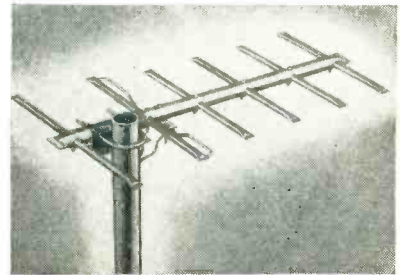

## UHF-TV ANTENNA is unusually rugged

DANFORTH MFG. Co., Monmouth, Ill., is manufacturing the Little Jewel, a new uhf-tv antenna featuring unusually rugged construction. Noncorrosive, heavy ¾-in. aluminum tubing is used for the boom; ⅜ in. for the six elements. Crimped ends eliminate vibration and whistle. The antenna comes fully assembled and ready for instant use. It has high forward gain, excellent front-to-back ratio and directivity. The folded dipole is perfectly matched to a 300-ohm lead-in line.

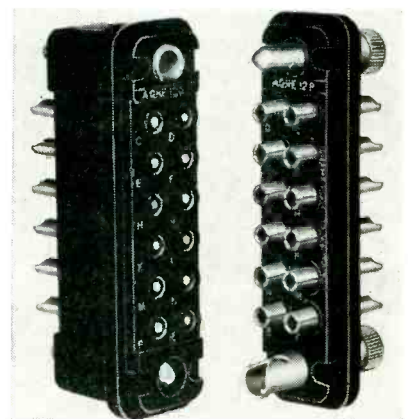

## CONNECTORS for high-current use

WINCHESTER ELECTRONICS, INC., Glenbrook, Conn. A recent addition to the line of quick-disconnecting connectors is the AQR 12. Twelve

large contacts having 0.113 in. diameter solder cups for No. 12 AWG permit the use of higher current (up to 25 amperes) with no sacrifice of electrical characteristics and without increase in overall physical dimensions of the comparable QRE-type connector having the same number of contacts. The specially designed spring-loaded contacts provide easy disengagement of the plug and receptacle, thereby eliminating the need for levers or the use of force which often results in damage. Voltage breakdown between contacts at sea level is 6,250 v d-c; at 60,000 ft altitude, 1,450 v d-c. Weight of plug is 1.2 oz; receptacle, 2.1 oz.

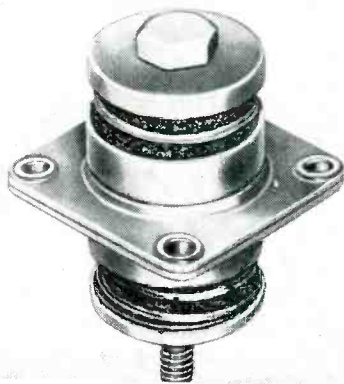

### ALL-METAL MOUNT for vibration and shock

ROBINSON AVIATION, INC., Teterboro, N. J., has developed a special double-acting unit mount, model 9302. Noteworthy features are non-linear deflection characteristic—high damping, low amplification at resonance and ability to withstand any conditions of temperature and environment. Made with the all-metal cushioning material, Met-L-Flex, the mount is suitable for the isolation of vibration and shock for positive, negative and radial loads, thereby protecting sensitive components, such as the all-important electronic guidance systems. It is recommended that the units be mounted in the plane of the center of gravity of the equipment for maximum efficiency. Load ranges are presently available between 1 and 7 lb per mount. A range of natural frequencies above 10 cps can be provided depending upon

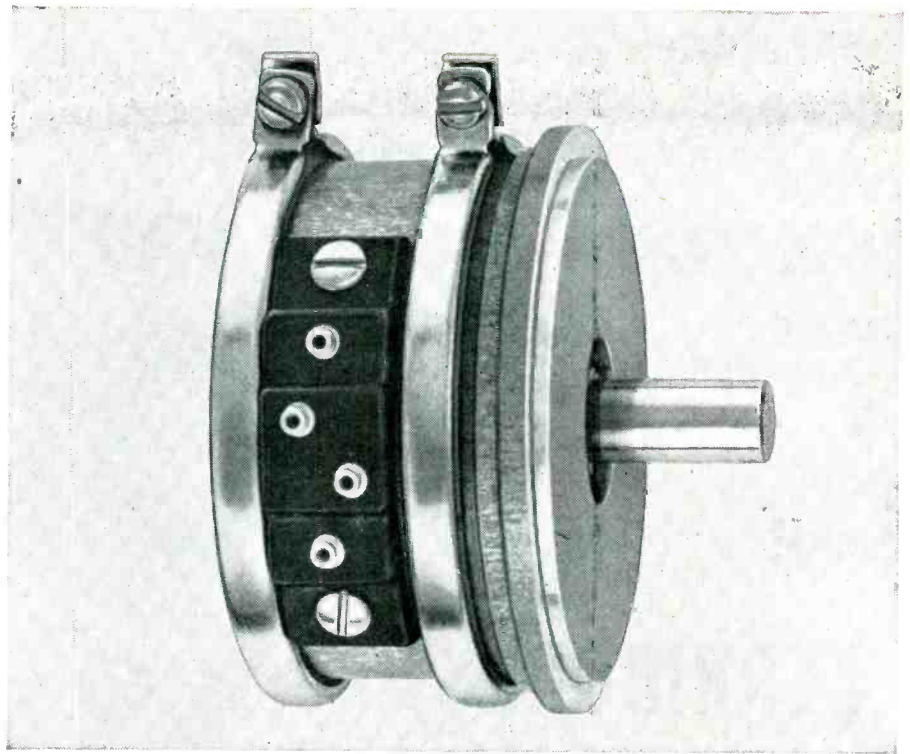

## TYPE 756— Fairchild's latest single-turn PRECISION POTENTIOMETER

*Gives you all these advantages...*

- 1** Extremely low noise level and longer life with sustained high accuracy result from improved windings and wiper design. These improvements also permit higher rotational speeds with minimum of wear.
- 2** Higher resolution (0.05% at 2,000 turns) and close functional tolerances (linear  $\pm 0.25\%$ ; non-linear 0.35% with 3:1 slope ratio in high resistance ranges) give higher point-to-point tracking qualities.
- 3** Standard electrical functional angle is 320 deg. nominal with ORV tolerance of  $\pm 5\%$  in resistance range from 800 to 40,000 ohms. Electrical functional angle of 350 deg. nominal with ORV tolerance of  $\pm 3\%$  in resistance ranges of 50 to 45,000 ohms can be supplied on special order.
- 4** Greater flexibility—For non-linear functions as many as 13 taps can be provided by adding extra terminal boards.
- 5** All the desirable qualities of the well-known Type 746 unit, including easy and more accurate phasing, ganging up to 20 units on a single shaft, all-metal precision-machined housing and shaft, low torque, etc., are included in the Type 756.

Full information about the entire line of Fairchild Precision Potentiometers, including specifications of the Type 756 unit and how we can help solve your potentiometer problems, is available for the asking. Write to *Potentiometer Division, Fairchild Camera and Instrument Corporation, Park Avenue, Hicksville, Long Island, New York, Department 140-39A.*

**FAIRCHILD**  
**PRECISION POTENTIOMETERS**

**Ferrites—  
more  
alike  
than  
peas  
in  
a  
pod!**

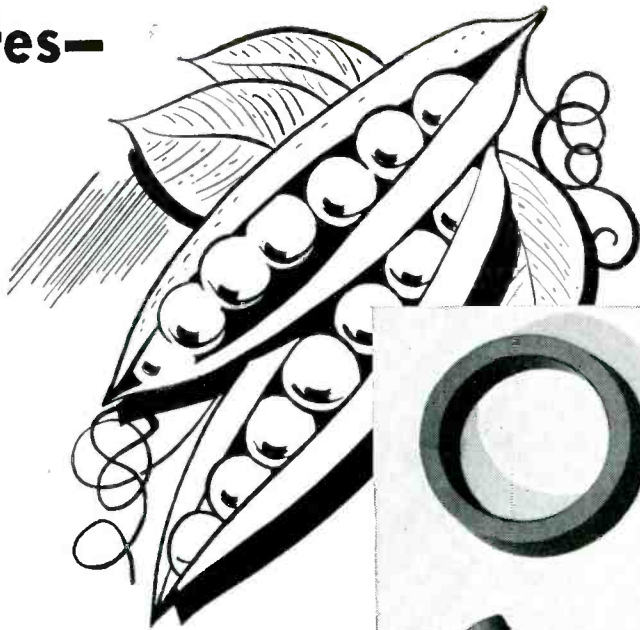

## FERRICORES by MOLDITE

Now!—Moldite's famed precision production facilities have been augmented with a complete plant specializing exclusively in *continuous, uniform production* of ferrite cores. When you use Ferricores by Moldite . . . you can be certain of absolute uniformity from the first to the millionth unit.

A special Ferricore-Moldite material is available for high temperature applications. For higher frequency applications where minimum eddy-current losses are more important than maximum permeability, a new ferrite material is now ready for production.

You'll find Moldite Ferricores will give you lower losses, greater efficiency, higher permeability . . . and **LOWER COST!**

**FERRITE CORES**  
**MOLDED COIL FORMS**  
(iron and phenolic)  
**MAGNETIC IRON CORES**  
**FILTER CORES**  
**THREADED CORES**  
**SLEEVE CORES**  
**CUP CORES**

Samples promptly submitted upon request for design, pre-production, and test purposes

SEND FOR CATALOG 110

Robert T. Murray  
614 Central Ave.  
East Orange, N. J.

Jerry Golten Co.  
2750 W. North Ave.  
Chicago 22, Ill.

Martin P. Andrews  
Mott Road  
Fayetteville, N. Y.

Perlmuth-Coleman & Assoc.  
1335 South Flower  
Los Angeles, Cal.

Jose Luis Pontel  
Cardoba 1472  
Buenos Aires



FERRICORE, INC.  
affiliated with

**NATIONAL**  
**MOLDITE**  
**COMPANY**

1410 CHESTNUT AVE., HILLSIDE 5, N. J.

NEW PRODUCTS

(continued)

the load and performance requirements.



### STABILIZER for power supplies

KALBFELL LABORATORIES, INC., 1090 Morena Blvd., San Diego 10, Calif. Model 122 chopper stabilizer affords standard-cell stability to the output voltage of ordinary power supplies. The model 122B was designed for use with the Super-Regulator, model 121. It can be connected directly to terminals on the regulator provided for this purpose. A unique circuit is employed whereby a fraction of the output voltage is compared to a standard cell. A corrective signal is generated that is fed back to the power supply being regulated. This is a polarized signal of  $\pm 30$  v and 5 ma. A precision attenuator is calibrated to afford the desired output voltage to an absolute accuracy of 0.1 percent. The chopper stabilizer can be adapted to any power supply.

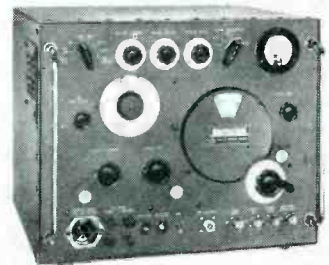

### GENERATOR offers varied pulsing

HEWLETT-PACKARD Co., 395 Page Mill Rd., Palo Alto, Calif. Model 618B signal generator is designed for faster, more accurate measurements of radio-relay, radar, tv-carrier systems and similar applications involving superhigh frequencies. Accuracy and stability is high

throughout the continuous frequency range of 3,800 to 7,600 mc. The equipment may be internally or externally pulse modulated. Repetition rate is continuously variable from 40 to 4,000 pps. Pulse width is variable from 0.5 to 10  $\mu$ sec. Sync-out signals can be simultaneous with the r-f pulse or in advance of the pulse by any interval from 3 to 300  $\mu$ sec. Model 618B may also be synchronized with an external sine wave, or with positive or negative pulse signals.

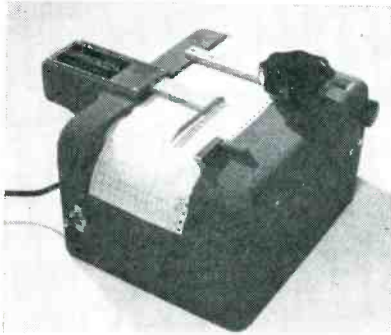

### PLANIMETER for flow-chart totalizing

LIBRASCOPE, INC., 1607 Flower St., Glendale 1, Calif., has developed a square-root planimeter for flow-chart totalizing of 3-in. miniature graphic panel-strip-chart recorders. It provides for a true square-root extraction and integration without approximation over the entire range of flow. Totalizing is accommodated from leading to trailing edge of chart paper by means of a motor-driven sprocket. It gives readout to four places on the counter. Weight is 10 lb.

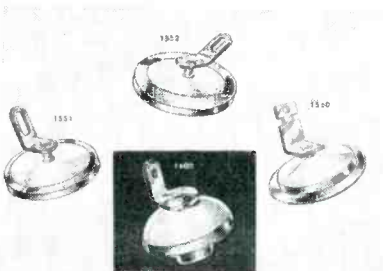

### HERMETIC SEALS with attached lugs

HERMETIC SEAL PRODUCTS CO., 33 S. Sixth St., Newark 7, N. J., has

# Just off the Press...



## THE MOST COMPLETE CATALOG OF CORES IN THE INDUSTRY

### Including Ferrites and Molded Coil Forms

Now . . . with the acquisition of Ferricore, Inc., a plant fully equipped for the precision production of ferrite cores (see ad on opposite page), the famed Moldite line comprises cores for every electronic purpose. In addition to adding ferrite cores,

Moldite has also resumed production of Molded Coil Forms. You'll find everything fully described in our new catalog. Send for a copy . . . NOW. And, at the same time, request samples for design, pre-production and test purposes.

FERRITE CORES  
MOLDED COIL FORMS  
(iron and phenolic)  
MAGNETIC IRON CORES  
FILTER CORES  
THREADED CORES  
SLEEVE CORES  
CUP CORES

## NATIONAL

# MOLDITE

## COMPANY

1410 CHESTNUT AVE., HILLSIDE 5, N. J.

Robert T. Murray  
614 Central Ave.  
East Orange, N. J.

Jerry Golten Co.  
2750 W. North Ave.  
Chicago 22, Ill.

Martin P. Andrews  
Mott Road  
Fayetteville, N. Y.

Perlmuth-Coleman & Assoc.  
1335 South Flower  
Los Angeles, Cal.

Jose Luis Pontet  
Cardoba 1472  
Buenos Aires

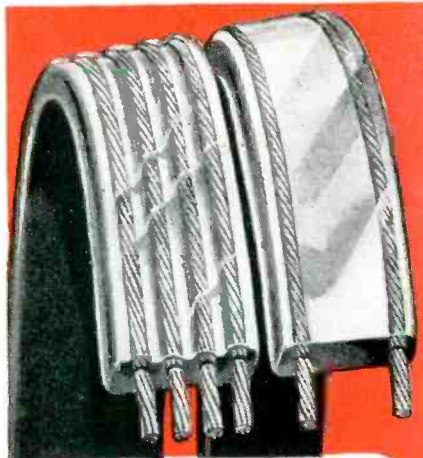

*Tough...  
flexible...  
uniform*

## CAROL antenna cable

Carol antenna cable is ideal for connections to TV and FM receiving antennas and motorized antenna rotators. Insulation is Carol Polyethylene—a low-loss, high strength dielectric that stays flexible and strong over a wide temperature range, and resists moisture, oxidation and corona.

Consistently high quality in the cable you receive is guaranteed by precision extrusion . . . accurate temperature control . . . and strict production control methods including constant inspection and micrometer gauging.

Supplied in twin-conductor types, No. 18, 20 or 22 AWG; and 3, 4 or 5-conductor, No. 20 AWG; with clear, amber, or brown polyethylene.

Write or call Carol today for full details on our complete line of cables for electronic applications.

**CAROL**  
CABLE DIVISION  
of The  
CRESCENT COMPANY  
INC.

Pawtucket, Rhode Island

NEW PRODUCTS

(continued)

designed a complete series of hermetic seals with attached lugs as an associated line of the self-lug tubing seals. Lugs are affixed by a positive method guaranteed to be secure; and are available for every tubular seal and bathtub-capacitor seal currently used in industry. Lugs are available flat or bent through any angle desired; with pierced holes, or notched for wrap-around connection. Solder-lug feed-throughs, parts 1503-04-05-06, are also available in this series.

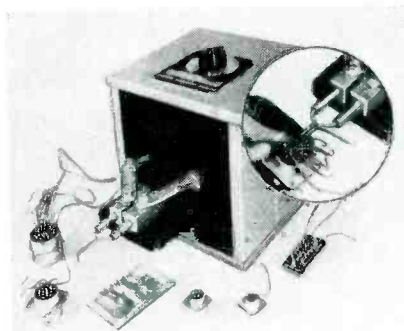

## SOLDERING MACHINE for A-N connectors

JOYAL PRODUCTS, INC., 56 Belmont Ave., Newark 3, N. J., has available a new 250 w A-N connector soldering machine. The equipment can solder from 2 to 30 terminals, and more, on A-N connectors. It can also be used on terminal boards, on printed circuits with high-temperature solder that cannot be handled with a soldering iron, and for military equipment on solder-crimped lugs to government specifications. To use, the operator merely sets the heat and the solder, brings the work to the electrodes and presses the foot switch.

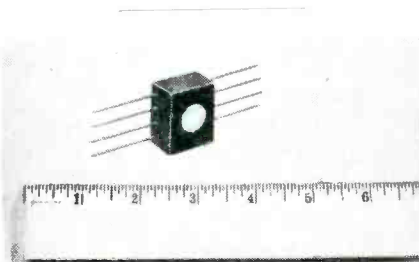

## FLIP-FLOP in tiny, rugged package

COMPUTER RESEARCH CORP., 3348 W. El Segundo Blvd., Hawthorne, Calif. A smaller, more rugged pack-

**kahle  
machines  
make  
the**

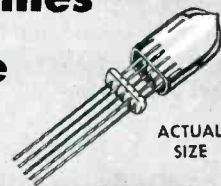

smallest

**and  
kahle  
machines  
make  
the**



**LARGEST**

Whatever the demands in automatic machinery...from the largest to small...Kahle makes them all!

Illustrated above is a T2 x 3 sub-miniature button bulb and sub-miniature stem. The machines which produce these parts can also be used for fast production of transistors (it has recently been demonstrated that transistors must be hermetically sealed in glass and evacuated for complete assurance of long life and reliability). "The Largest" (see above) is a 27" TV tube. Kahle produces a 16 head automatic indexing machine for all TV tube sizes up to 27" in diameter with all heads filled. Today Kahle is one of the major producers of custom-designed machinery for electronics. Kahle equipment is contributing to Development Progress in electronics throughout the civilized world. To overcome your production problems, call on Kahle's experience to benefit you.

**KAHLE — for "built-in know-how"**

**Kahle**

ENGINEERING COMPANY  
1310 SEVENTH STREET  
NORTH BERGEN, N. J.

Want more information? Use post card on last page.

July, 1953 — ELECTRONICS

Want more information? Use post card on last page.



age requiring only  $\frac{1}{3}$  cu in. for mounting space is featured in the new model 133 ferroresonant flip-flop. The unit was developed as a vacuum-tube replacement for certain counting, scaling and storage applications. It has the long life, low power requirements and low heat dissipation of the saturable reactor, and is small, simple and relatively inexpensive. It will operate on a fraction of the power needed by a vacuum tube of comparable output, and can deliver more than 90 percent of the input energy as usable output since copper and core loss are the only sources of power consumption.

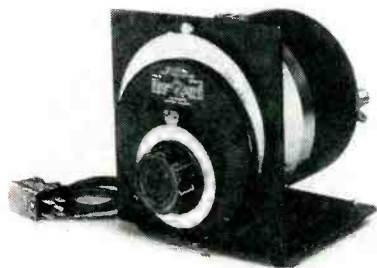

### UNIT OSCILLATOR produces 50 to 250 mc

GENERAL RADIO Co., 275 Massachusetts Ave., Cambridge 39, Mass. Type 1215-A unit oscillator produces frequencies from 50 to 250 mc over a single continuous range. Frequency is read directly from a 6-in. dial with a calibrated slow-motion drive. The tuned circuit is a semibutterfly type that has no sliding contacts. At least 80 mw can be delivered at any frequency into a 50-ohm load. The type 1215-A can be modulated at a-f and r-f; and with the type 1000-P6 crystal-diode modulator and a tv receiver, a tv test generator can be assembled.

### COMPARISON BRIDGE for production lines

SOUTHWESTERN INDUSTRIAL ELECTRONICS Co., 2831 Post Oak Rd., Houston 19, Texas. Designed for production-line operation but capable of lab accuracy, the Model E-1 comparison bridge provides uni-



Theratron built by Radio Receptor Co., Inc.

- 1 Machine mating surfaces to closest tolerances. *Costly and difficult!* And the close fit is often destroyed by warping, corrosion and normal use.
- 2 Install numerous latches, screws, bolts or other fastenings. *Also costly!* And makes maintenance more difficult, more time-consuming.
- 3 **USE METEX ELECTRONIC WEATHERSTRIPPING.**  
*The simple, sure, economical way!*

Made of resilient, compressible *knitted* metal wire mesh, METEX strips and gaskets "close" these openings just as a weatherstrip "closes" windows and doors.

Because they are metallic, METEX strips and gaskets are conductive. Because they are knitted, they are flexible and resilient. They will conform to surface irregularities with no loss in shielding efficiency.

Close manufacturing control assures uniformity in the resiliency and dimensions best adapted to specific applications.

METEX electronic strips and gaskets are easy to install. They are not expensive—in fact, they may well save more than their cost by eliminating the need for many operations formerly thought necessary.

*It will pay you to investigate the production and performance advantages of METEX Electronic Weatherstripping. A bulletin giving detailed information is yours for the asking—just write on your company letterhead.*

**METAL TEXTILE CORPORATION**  
KNITTERS OF WIRE MESH FOR MORE THAN A QUARTER CENTURY

Main Office & Plant, Roselle, New Jersey Canadian Plant, Hamilton, Ont.

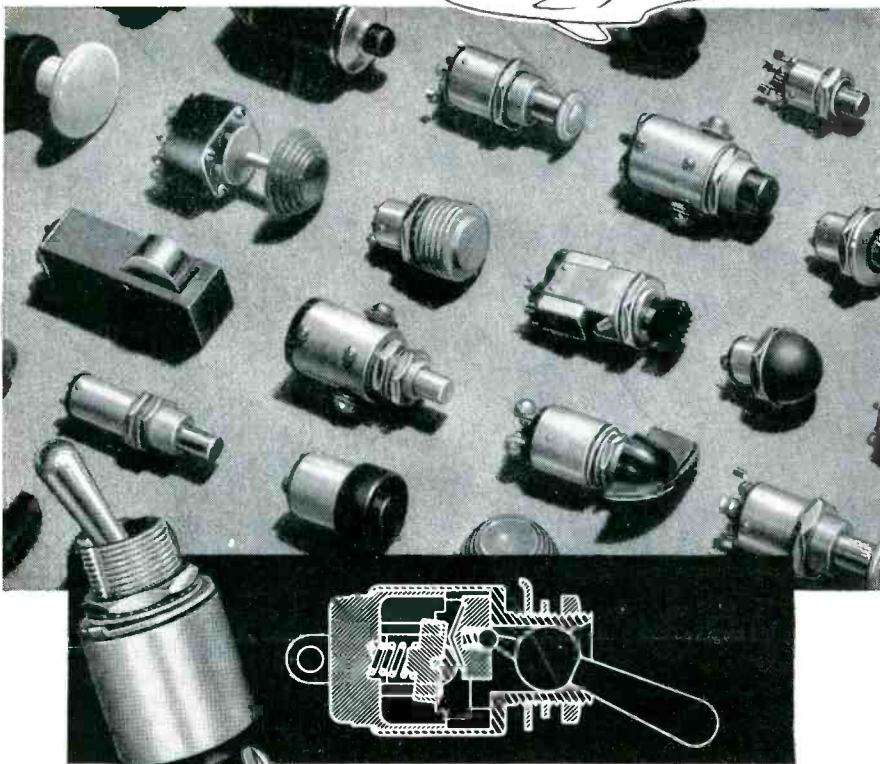

This typical Hetherington T1000 Switch designed for MIL-S-6745 uses reduces size by 25%.

**Built to meet your  
TOUGHEST  
PERFORMANCE STANDARDS  
...with weight and space savings  
in the bargain...**

- Switch Types for
- Fire detection indicators
  - Trim tab control
  - Seat positioning
  - Auto pilot release
  - Tank jettison
  - Microphone circuits
  - Audible signal silencers
  - Equipment testing
  - Fire detection test
  - Canopy release
  - Seat ejectors
  - Bomb or rocket firing mechanisms
  - Auto pilots (holding coil types)
  - Instruments
  - Appliances . . . and many others

Whether for MIL or for the toughest commercial uses, Hetherington Switches and Switch-Pilot Light combinations are designed to do the job—with safety margin to spare. Unique, patented design provides positive switching (to exceed military life cycle requirements) in less space with less weight. Dozens of special aviation types in the 15-50 ampere range plus adaptations for exacting commercial jobs.



**HETHERINGTON, INC. • SHARON HILL, PA.**  
West Coast Division: 8568 W. Washington Blvd., Culver City, Calif.

form characteristics in resistors, capacitors and a-f inductances. The 1-percent scale may be read accurately to indicate differences between components as small as 0.1 percent. A bridge circuit applies 3 v at 60 cycles to the components under test, utilizing a transformer with a special bifilar winding to assure uniformity of two legs. Components with impedances from 1 ohm to 5 megohms at 60 cycles may be compared. The unit operates on 115 v, 60 cycle a-c.



**VIBRATION PICKUP  
is sensitive and light**

TECHNICAL INSTRUMENT Co., 3732 Westheimer Rd., Houston, Texas, has available a new ultra-sensitive inductive vibrometer featuring high sensitivity and light weight. In many applications the highly efficient magnetic circuit provides sufficient output to drive recording galvanometers directly. It can be supplied in natural frequencies ranging from 15 to 80 cps. Units above 22 cps can be mounted in any direction. Output is over 1 v per in. per second for the 600-ohm unit. Size is 1 7/8 in. in diameter x 1 1/2 in. long. Weight is 11 oz.

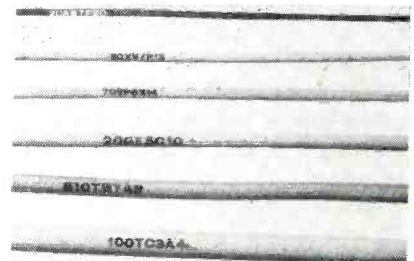

**WIRE MARKER  
for mass production**

RAM METER, INC., Ferndale, Mich., has developed a new wire-marking machine. Designed and built for their own use, the facilities of this device are now available to manu-

facturers and war contractors on a production basis in the Ram Meter plant. Where specifications for electrical equipment require, this machine marks each wire legibly and permanently, with a code designation near each end and at intervals for its entire length. Any size insulated wire from 20 to 4 can be hot embossed with either black or white plastic code letters one inch from each end, with additional imprints at intervals of 2 in. to 12 in. (as desired) along the wire, and the wire cut to any desired length from a 2-in. minimum to a maximum of 12 ft. Any number of characters and spaces up to 15 can be used to code wire sizes 20 to 14, and 12 characters and spaces for 12 to 4 wire.

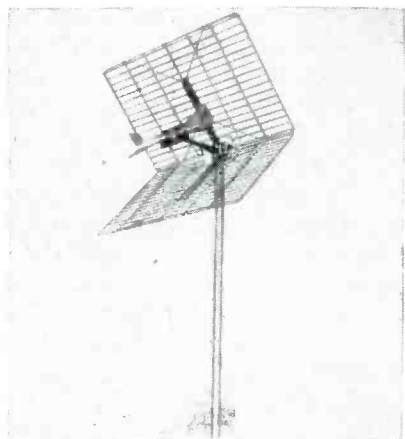

**CORNER REFLECTOR**  
requires no assembly

JFD MFG. Co., INC., 6101 16th Ave., Brooklyn 4, N. Y. A new preassembled uhf corner reflector that opens like a book into receiving position produces excellent broadband gain. The wire-frame construction of the UHF400 provides for greater rigidity, resistance to vibration and extra lightness. An important feature is a heavy-duty, 2-section mast bracket, 2½ in. long for wide grippage over the mast. As this bracket is tightened on the mast, it automatically secures the "bowtie assembly" in optimum receiving position. Large-size reflector sections, which accentuate directivity and minimize reflection and interference, combine with a

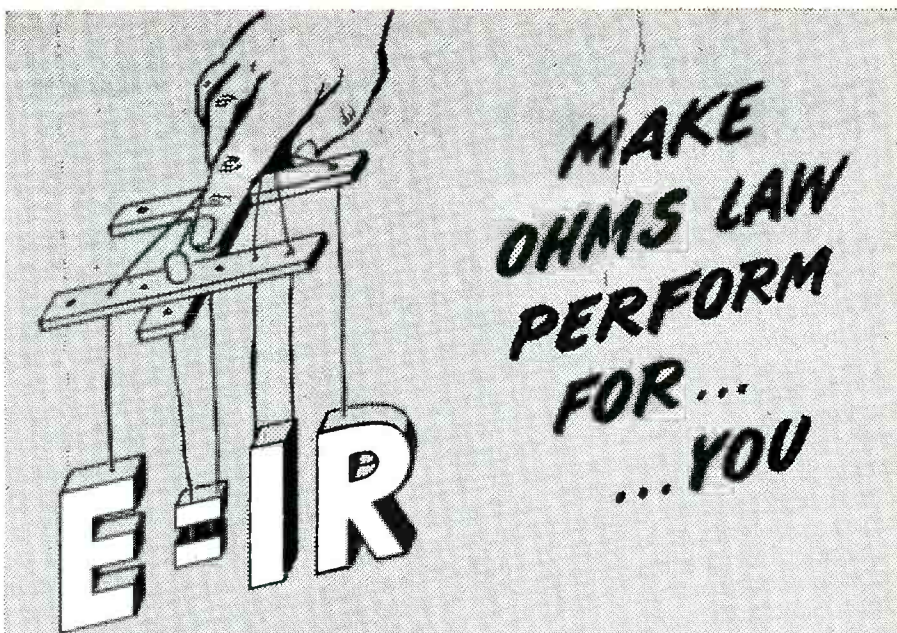

Yes! You can make Ohm's law perform for you. How? By choosing the right Victoreen Component. Whether it is **CONSTANT VOLTAGE, CONSTANT CURRENT, or CONSTANT RESISTANCE** you require, Victoreen offers you a wide range of components specifically engineered to fix accurately the value of any factor in Ohm's law.

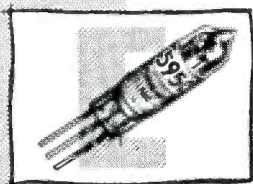

VOLTAGE REGULATOR TUBES  
Range: 50 to 20,000 volts  
currents 5 to 3000 µa  
CLOSE REGULATION—MINIATURIZED—  
LOW DRAIN—LONG LIFE

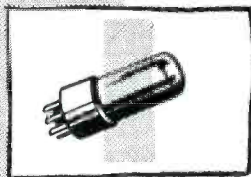

CURRENT REGULATOR TUBES  
Range: 25 to 6000 Milliampères  
voltage drop 1 to 100 V  
MANY TYPES AND BULB SIZES—  
INEXPENSIVE—RELIABLE OPERATION

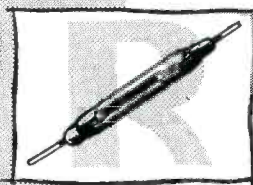

PRECISION RESISTORS  
Range, 200 to 100,000,000,000 ohms  
VACUUM SEALED IN GLASS FOR EXTREME  
STABILITY—POWER TO 5 WATTS—HIGH  
ACCURACY—1% TOLERANCE

Consult our Technical Services department for specifications and recommendations for your applications.

SPECIFY FORM 3016 . . . WHEN REQUESTING FACTUAL CATALOG OF VICTOREEN COMPONENTS



**The Victoreen Instrument Co.**

3800 PERKINS AVE. • CLEVELAND 14, OHIO

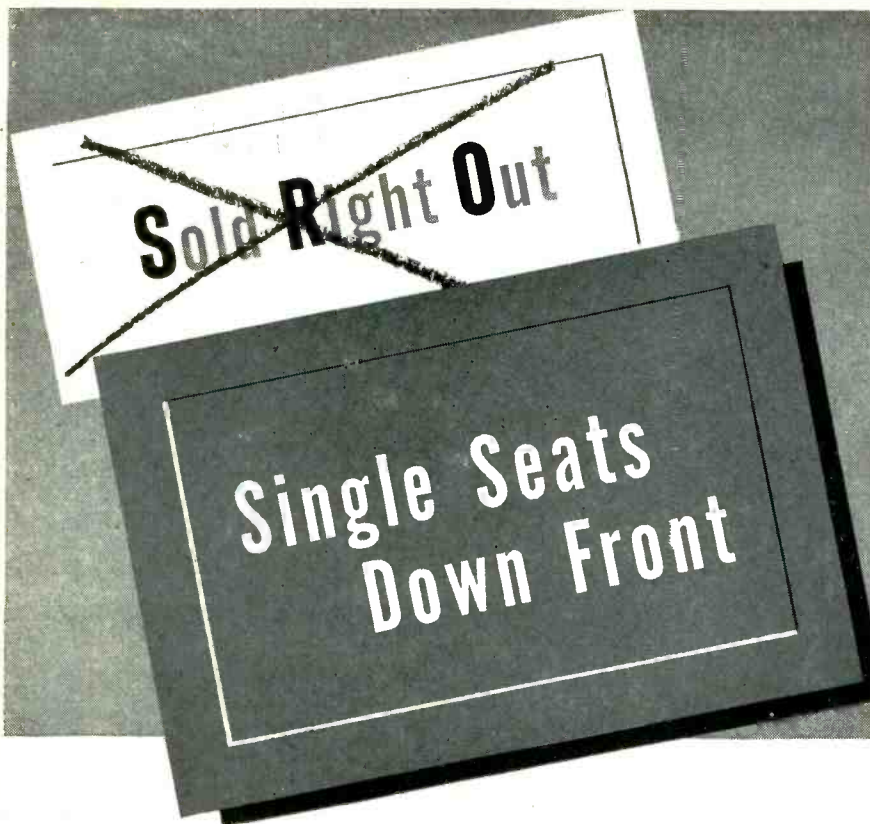

Our previous series of advertisements in this publication explained, in theatrical parlance, that our design and production facilities were pretty well "sold out" by the requirements of our present customers.

Now, we are happy to say (because we enjoy making new friends) that some of the heat has been taken off, and we are able to announce "Limited seating available"—as they say at the box office.

We shall be happy to talk with you about your present and/or future needs.



TRADE MARK

## L. H. Terpening Company

DESIGN • RESEARCH • PRODUCTION

Microwave Transmission Lines and Associated Components

16 W. 61st St. • New York 23, N. Y. • Circle 6-4760

### NEW PRODUCTS

(continued)

low swr that minimizes energy losses.

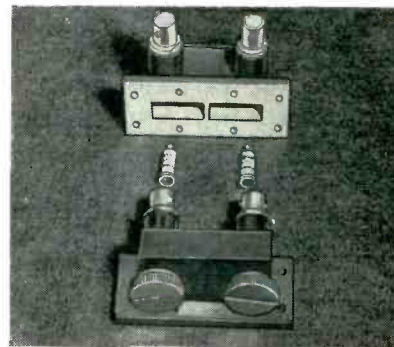

### CRYSTAL DETECTOR takes minimum space

AIRTRON, INC., 20 East Elizabeth Ave., Linden, N. J., offers a new miniaturized dual crystal detector designed to work with the direct and reverse crystals developed by Microwave Associates—1N23B and 1N23BR (furnished as a matched pair under the nomenclature 1N23-BRM). Taking a minimum of space, the detector mates with a special adaptation of the miniaturized contact flanges currently being standardized by the RTMA Committee on Waveguide Connectors. It is furnished with type-N fittings or with wired-on connectors; and is adaptable to any type mixer configuration.

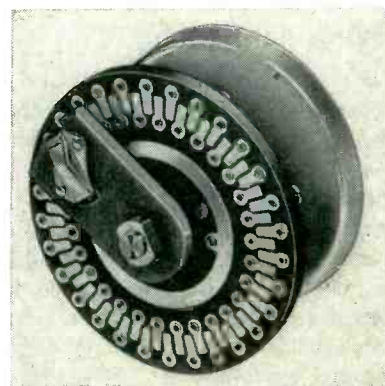

### ROTARY SWITCH is printed-circuit type

THE DAVEN Co., 191 Central Ave., Newark, N. J., announces the printed-circuit rotary switch type PCF-I with 60 positions, shorting-type action. Due to the unusual

segment design, eyelets are provided for solder connections at every position. Switch segments are silver-alloy bonded to the phenolic contact panel. Contact resistance is approximately 0.003 to 0.004 ohm and does not vary more than 0.0003 ohm over the life of the unit. The diameter is 3 in. and the depth is 2 1/8 in.



**TEST PROBE SET**  
contains four probes

PRECISION APPARATUS Co., INC., 92-27 Horace Harding Blvd., Elmhurst 17, N. Y. The series SP-5 oscilloscope test probe set includes four of the most important test probes for general purpose as well as specialized tv signal-tracing, alignment, trouble-shooting and waveform analysis. Each probe has been engineered for its specific use. A single, universal coax cable accommodates each probe through a quick-change connector. A specially designed shielded plug provides positive cable attachment to the ES-500 and ES-500A vertical input posts. Each probe head terminates in a clip-on type of probing tip permitting operator's hands to be free during tests.



**AUDIO OSCILLATOR**  
has 20 fixed frequencies

TELETRONICS LABORATORY INC., 54 Kinkel St., Westbury, L. I., N. Y.,

***Now a NEW***  
**"Pencil Point" SOLDERING TOOL**  
 FOR SMALL OR MINIATURE WORK

**IDEAL Thermo-Tip**

**INSTANT HEAT—  
PINPOINT ACCURACY!  
NOTHING TO HOLD  
BUT AN ELECTRODE  
"PENCIL"**

Tips Screw In to Fit the Job  
**DOUBLE METALLIC**   
**DOUBLE CARBON** 

Other Tips Available

**Pencil-Thin**  
**FOR EASIER, FASTER SOLDERING OF:**

- Electronic Circuits and Parts
- Terminals
- Aircraft Connectors
- Radio and TV Chassis
- Pin Type Plugs
- Instruments
- Wire-to-Wire
- Printed Circuits

Here is an all-new production tool expressly designed to make small and miniature soldering simpler and surer than ever before. It is so fast that some joints can now be soldered in less than 1 second! . . . so much lighter and easier to handle than soldering irons or guns that a woman can use it all day long without fatigue! Check this unique combination of features against your job requirements:

**GETS INTO SMALL, TIGHT SPOTS** because of smaller electrode pencil.

**NO HEAT DAMAGE**—instant resistance heating makes sound joints before resistors, condensers, printed circuits, terminal fibre, etc., can be damaged. Pinpoints the heat!

**NO "COLD FLOW JOINTS"**—resistance principle *requires* that metal be heated before the solder will flow. Tap switch adjust heat as needed.

**SAFE**—soldering pencil uses harmless (6v) voltage and high amperage from separate step-down transformer.

**LESS FIRE HAZARD**—electrodes are hot only when in use.

**LESS REPLACEMENT COST**—only low cost electrodes to buy.

SOLD THROUGH LEADING DISTRIBUTORS

**TIPS FOR EVERY SMALL JOB**  
 —2 sizes of double carbon, single carbon with ground clamp, double metallic. May also BE USED AS SOLDERING IRON —two sizes of chisel tip irons.

**MAIL FOR FURTHER DATA**

IDEAL INDUSTRIES, Inc.   
 1055 Park Avenue, Sycamore, Illinois  
 Please send catalog data on NEW IDEAL THERMO-TIP.

NAME.....  
 COMPANY.....  
 CITY.....ZONE.....STATE.....  
 ADDRESS.....

# 'DIAMOND H' RELAYS



Shown Actual Size

...now even  
**mightier**  
**midgets**

**N**EW CHARACTERISTICS engineered into famous "Diamond H" Series R Relays have now broadened their adaptability for such applications as guided missiles, jet aircraft, fire control and fire detection, radar, communication, high speed camera, geophysical and computer apparatus . . . wherever positive operation is demanded under critical conditions.

A 4PDT hermetically sealed, miniature aircraft relay basically, they are now also available DPDT with two independent coils, either or both of which will operate the units.

In their field still the smallest and lightest, (1.6 cu. in. 3.76 oz.) combining highest operating shock resistance (to 50 "G" and higher), widest temperature range (-65° to + 200° C.) and greatest ability to break high currents and high voltages, Series R Relays consistently operate over 400,000 cycles without failure at 5 A. and go 3,500 or more under 30 A. at 30 V., D.C., resistive. They carry voltages up to 300 D.C. at 4/10 A. for more than 400,000 cycles. With low contact

loading, life expectancy is 10 million cycles or better.

Operating time is 10 ms. or less; drop out time 3 ms. or less. Coil resistances up to 35,000 ohms are standard; to 50,000 ohms available for special units. Sensitivity approaches 100 mw. at 30 "G" operational shock resistance. Inter-electrode capacitance is less than 5 mmf. contacts to case—less than 2½ mmf. between contacts, even with plug-in type relay and socket. Vibration range is from 0 to 500 cycles per second and upward at 15 "G" without chatter.

All standard mounting arrangements, including ceramic socket, are available. Uniquely simple design permits compact grouping . . . and a firm bond between relay and chassis.

Designed to meet all requirements of USAF Spec. MIL-R-5757B, they far surpass many. Bulletin R-150, giving basic performance data under varying conditions, is yours on request. Our engineers are prepared to work with you to develop variations to meet your specific requirements. Tell us your needs.

## THE HART MANUFACTURING COMPANY

202 Bartholomew Avenue • Hartford, Connecticut

announces model TO-100 audio oscillator that is especially useful for checking f-m/f-m telemetering subcarrier equipment. Twenty accurate, fixed center-frequencies are available. The standard model is furnished with frequencies from 400 to 70,000 cps. Each frequency is selected by a push-button control and can be varied  $\pm 10$  percent by means of a calibrated control. Each frequency is accurate to  $\pm 1$  percent. The output of the oscillator is adjustable by means of a continuously variable calibrated level control and available from either low impedance output terminals or a 600-ohm connector. Maximum total distortion at full output is less than 1 percent.

### PREAMPLIFIER

is self-powered unit

THE PLAYMASTER DIVISION of Mark Electric Products, Inc., 145 Seneca St., Buffalo 3, N. Y., has available a self-powered equalized preamplifier for use with the Pfan-Tone pickup. This preamplifier uses a single 12AX7 tube. Provisions are made so that it can be used in conjunction with either a non-compensated input such as provided for crystal cartridges, or the magnetic phono input. This component is very small and mounting brackets are furnished so that it can be readily installed in any cabinet. The unit is approximately 3½ in. square and weighs less than 2 lb.



**DIRECTION FINDER**  
is automatic indicating

SERVO CORP. OF AMERICA, 20-20  
Jericho Turnpike, New Hyde Park,

N. Y. Model DFG-2 is a fully automatic visual-indicating radio direction finder designed for high-frequency applications. It is recommended for fixed-station or transportable field installations, and for applications including aircraft navigation and homing, rescue operations and the location of illicit transmitters. The nominal frequency range for optimum performance is 0.54 to 30 mc. Total power drain is 400 w for visual indication and 150 w for aural-null indication.

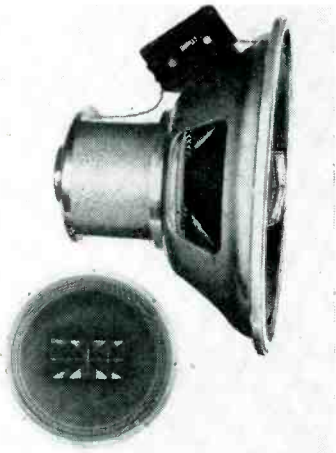

**COAXIAL SPEAKER**  
uses 7½-lb magnet

STEPHENS MFG. CORP., Los Angeles, Calif., has developed a new coax speaker, employing a 7½-lb Alnico V magnet (in a round pot structure) designed to improve and extend the frequency response. The 206AX features a new diaphragm and h-f throat structure, together with other improvements. An aluminum die-cast frame has been incorporated into the speaker to provide greater rigidity and eliminate the possibility of warping.

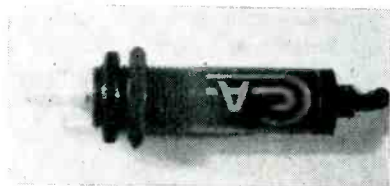

**NEON INDICATOR**  
has 1/25-watt lamp

CIRCUIT CRAFT ASSOCIATES, 5827½ E. Beverly Blvd., Los Angeles 22, Calif., have designed a small-size inexpensive neon indicator for dis-

Introducing **KULGRID**

(NICKEL-CLAD COPPER WIRE)

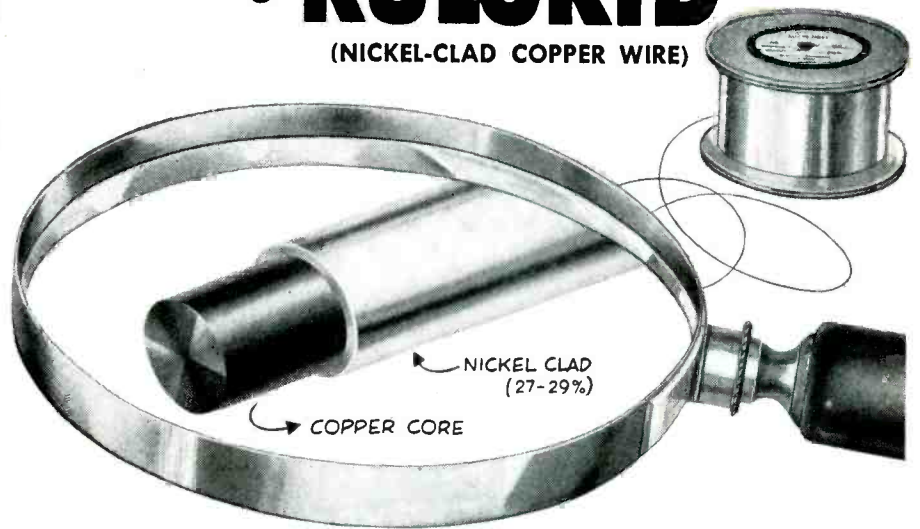

...today's best answer to high temperature electrical-conductive problems

Electrical engineers in many industries now give Sylvania's Kulgrid the highest rating. This improved nickel-clad copper wire maintains excellent electrical conductivity at advanced temperatures. Its heavy nickel coating resists corrosion and guards the copper conductor against oxidation, flaking, brittleness or deterioration.

**KULGRID RESISTS HIGH TEMPERATURES AND CORROSION... FIGHTS OFF BRITTLINESS**



**IDEAL FOR MANY APPLICATIONS**

Kulgrid shows exceptional stability and performance in the high temperature operation of vacuum tubes. Other applications include: wiring of electric furnaces, industrial baking ovens, electric stoves, and numerous aircraft electrical installations, including jet engines.

**AVAILABLE IN STRANDED FORMS**

You can now obtain Kulgrid in stranded forms in various combinations of diameters and numbers of strands. Kulgrid welds readily to itself, nickel, copper, and can be welded to tungsten and molybdenum. New illustrated booklet gives detailed data. For your copy, address: Sylvania Electric Products Inc., Dept. 3A-1007, 1740 Broadway, New York 19, N. Y.



ANOTHER OUTSTANDING DEVELOPMENT BY SYLVANIA

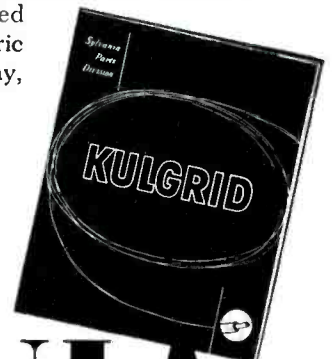

**SYLVANIA**



**LIGHTING • RADIO • ELECTRONICS • TELEVISION**

In Canada: Sylvania Electric (Canada) Ltd., University Tower Building, St. Catherine St., Montreal, P. Q.

**FIRST IN STAINLESS STEEL****FASTENINGS**

ELECTRONIC EQUIPMENT manufacturers count on Anti-Corrosive for fast, dependable service on all types of *precision* stainless steel fastenings. They know that our IN STOCK inventory of more than 8,000 items and sizes is the largest, most complete, in the industry. In addition, our production capacity is geared to produce large or small quantities of stainless fastenings, from large hex head bolts to tiny #0-80 machine screw nuts, faster and more economically!

Write for Catalog 53F today.

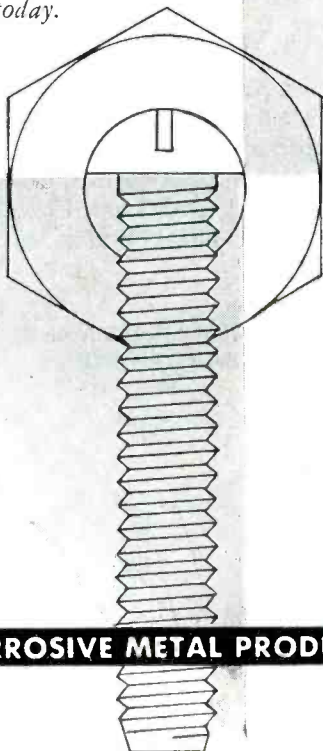

**ANTI-CORROSIVE METAL PRODUCTS CO., INC.**

Castleton-on-Hudson  
New York

playing information in data systems or computers. Though designed for incorporation in new equipment, it can be used to replace present neon pilot lights in existing computers. It has NE-2 type, 1/25-w neon lamp in clear plastic cap (injection-molded styrene base). The anodized aluminum case (1.3 in. long) has  $\frac{3}{8}$  x 32 thread. Assembly is designed to be removable from the rear of panel, thus permitting removal of front panel without disconnecting the soldered connection. Paper-base phenolic-resin insulator at rear of the indicator has a raised center barrier to prevent possible solder short between lugs. Interelectrode capacitance is less than 2  $\mu$ f.

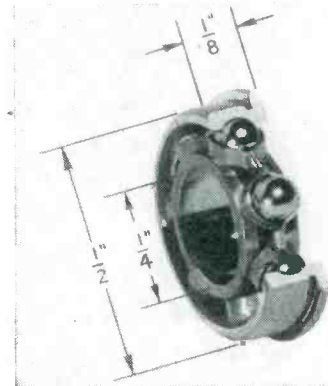

**FLANGED BEARING**  
for precision instruments

NEW HAMPSHIRE BALL BEARINGS, INC., Peterborough, N. H. Micro FR188 extra-light flanged instrument ball bearing features straight rather than tapered O. D., refined processing to superprecision (ABEC class 5 and higher) tolerances and a two-piece, cone-controlled, cylindrical-pocket, pressed metal cage. The balanced design favors low and uniform running torque as well as quiet operation. Construction is extra light, with all excess metal eliminated to conserve weight and space. It is recommended for gimbals and general precision instrument assemblies.

**TRANSFORMERS**

made by molding process

KENYON TRANSFORMER Co., 840 Barry St., New York, N. Y., has announced a new line of molded



transformers marketed under the name "Ken-Seal." They are intended to supply the demand for units of exceptionally light weight, small size and low cost without any sacrifice in hermetic sealing or other efficiency. Molding process was chosen in preference to dipping or encapsulation because it accomplishes this and in addition produces a finished product that is uniform and controllable to definite dimensions.



### SERVO AMPLIFIER is transistor-magnetic

INDUSTRIAL CONTROL Co., Wyandanch, Long Island, N. Y. The 434-B servo amplifier features transistor-magnetic circuitry in a hermetically sealed enclosure. It drives the BuOrd MK14 and MK7 400 cycle servo motors from synchro data in a positional loop. It is completely self-contained, requires no power supply or damping tachometer and has just 6 connections: 2 inputs, 2 outputs, 2 for 117 v 400 cycles. It weighs 17 oz and the can size is  $2 \times 2\frac{1}{4} \times 3\frac{1}{2}$  in.

### TEST CHAMBER simulates altitude

MURPHY & MILLER, INC., 1322 South Michigan Ave., Chicago, Ill., has introduced a new multipurpose environmental test unit that provides an extremely wide range of temperature, vacuum and humidity conditions. Heavy duty electronic control circuits with automatic safety interlocks assure fast, fool-proof operation under any laboratory or

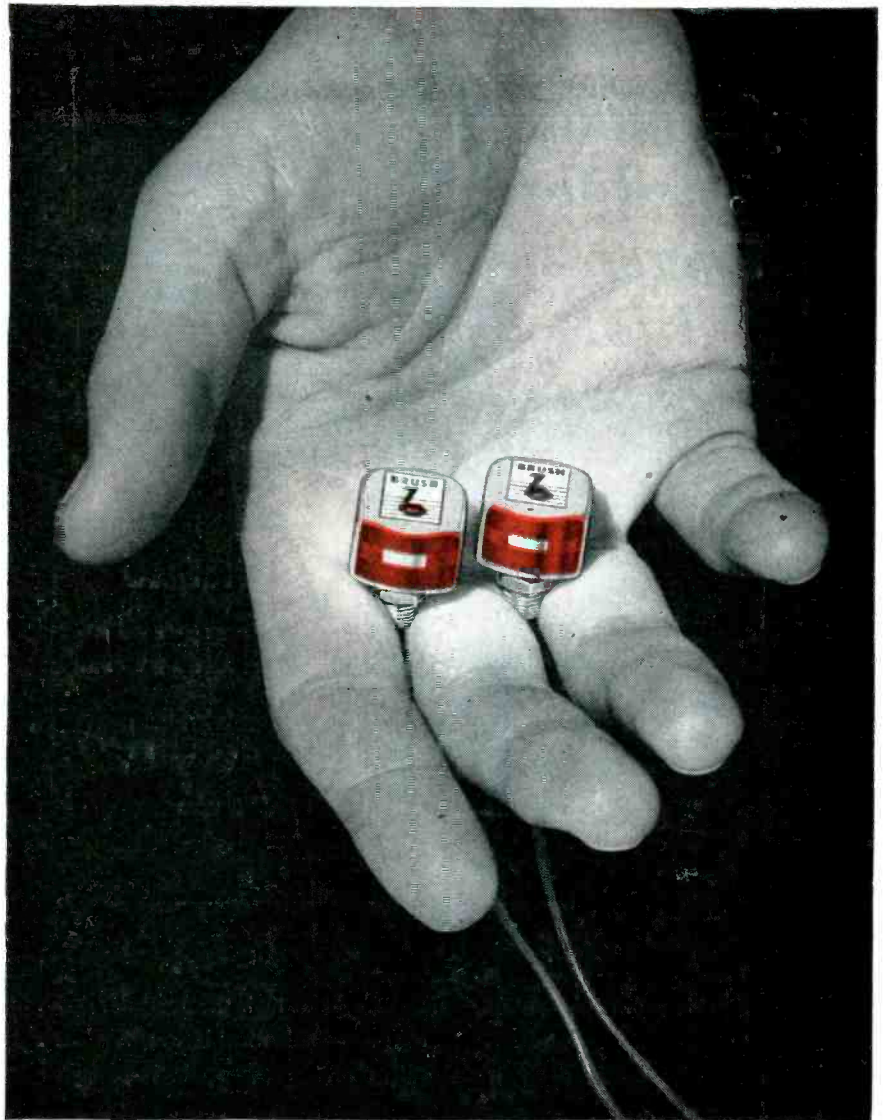

## Meet the Redheads... tops for tape recording

See how the latest additions to the Brush family of magnetic recording components can improve your tape recorders!

The BK-1090 record-reproduce head has the standard track width designed for dual track recording on  $\frac{1}{4}$  inch tape. It provides unusually high resolution and uniformity over an extended frequency range. Cast resin construction assures dimensional stability, minimizes moisture absorption, and affords freedom from microphonics. Its balanced magnetic construction, precision lapped gap, Mu-metal housing, and single-hole mounting provide important design advantages.

The BK-1110 erase head has the same basic construction as the companion record-reproduce unit. Its outstanding feature is its efficient erasing at low power consumption—less than  $\frac{1}{2}$  voltampere.

Investigate these new "Redheads" for your magnetic recording. Your inquiries will receive the attention of capable engineers. Write Brush Electronics Company, Department K-7, 3405 Perkins Avenue, Cleveland 14, Ohio.

**BRUSH ELECTRONICS**



**COMPANY**

INDUSTRIAL AND RESEARCH INSTRUMENTS  
PIEZOELECTRIC MATERIALS • ACOUSTIC DEVICES  
MAGNETIC RECORDING EQUIPMENT  
ULTRASONIC EQUIPMENT

formerly  
The Brush Development Co.  
Brush Electronics Company  
is an operating unit of  
Clevite Corporation.

*performance-  
matched for  
longer  
life!*

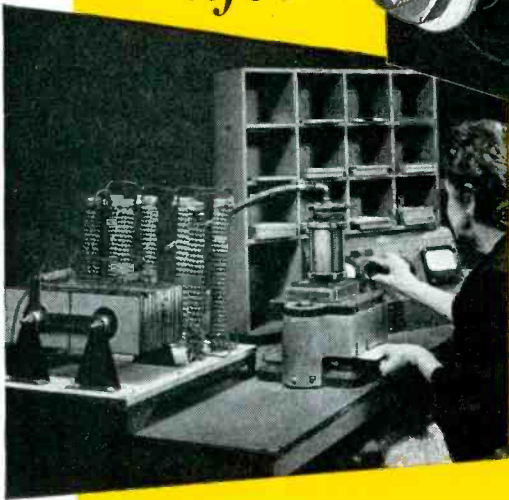
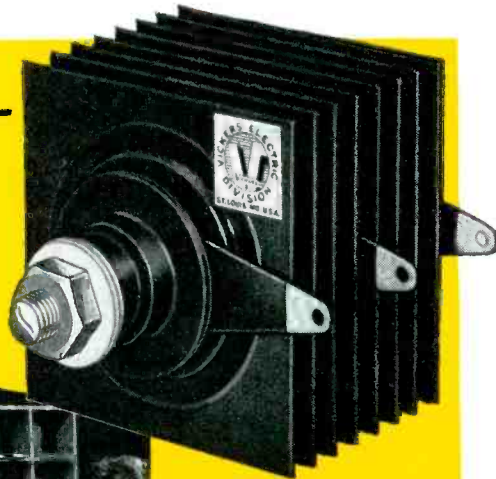

**VICKERS  
SELENIUM  
RECTIFIER  
CELLS**

*are rated and matched EXACTLY  
to guard against OVERLOADING-OVERHEATING*

**R**ectifiers in your equipment are as dependable as their weakest cells. With rectifiers operating at rated load, over-rated cells tend to over-load . . . over-heat and age excessively. If one cell fails, the entire rectifier—and your equipment—may fail.

In Vickers rectifiers, each cell is accurately rated, its performance carefully matched with every other cell. Load is evenly distributed, cell temperatures are safe. There's protective margin for brief circuit overload. Vickers rectifiers, with performance-matched cells, are dependable in your equipment.

*more reasons  
why Vickers  
makes  
a better  
rectifier*

- Automatic electroforming "pre-stresses" cells
- Hydraulic assembly assures mechanical strength and dimension
- Rectifiers shock and vibration tested to military specifications
- 255 tests and inspections guard quality from start to finish

*Write for Bulletin 3000. Vickers engineering service is available without obligation.*

**VICKERS ELECTRIC DIVISION**

VICKERS Inc.

A UNIT OF THE SPERRY CORPORATION  
1801 LOCUST STREET • SAINT LOUIS, MISSOURI

production testing programs. Called an altitude-simulation chamber, the unit permits accurate testing of materials and equipment under all externally imposed conditions of heat, cold, moisture and vacuum. The units are lab tested under all operating conditions before shipment, and only water, drainage and electrical services are required to put them to operation.



**CONSOLE INDICATOR  
saves panel space**

LEEDS & NORTHRUP Co., 4934 Stenton Ave., Philadelphia 44, Pa. A new electronic console indicator saves panel space and permits an operator to scan up to 200 thermocouple temperatures as fast as he can log them. The unit incorporates the model-D Speedomax indicator in a special housing that can be pulled out on tracks from the center of the console mounting. Console switch panels are removable. They hold as many as 100 toggle-type switches for 200 indicator or 100 indicator and recorder readings; as many as 96 pushbutton switches for 96 indicator readings. Terminal boards of the unit are centrally located and easily accessible through wide-swinging doors on the back of the console.

**PRESELECTOR  
covers amateur bands**

RADIO MFG. ENGINEERS INC., 300-302 First Ave., Peoria 6, Ill., has announced the new DB23 preselector designed for coverage of all amateur bands from 3.5 to 30 mc. It has three neutralized push-pull

stages employing 6J6 dual-triodes in a novel combination of selective and wideband r-f amplifiers. It has a constant gain of 25 db or more with an average image-ratio improvement of approximately 12 db on 21 mc and 25 db on all lower frequencies. Improvement in signal-to-noise ratio is better than 7.5 db over that of the receiver itself. Input impedance combinations match any standard antenna of 50 to 600 ohms and output is a shielded line matching any receiver impedance from 52 to 300 ohms, balanced or unbalanced.



### PULSE TRANSFORMER in an octal tube base

BERKSHIRE LABORATORIES, 506 Beaver Pond Road, Lincoln, Mass. Type PT-2 Labtrans pulse transformer is designed for use in the  $\mu$ sec and fractional  $\mu$ sec ranges. It is compact and convenient to use, being built in an octal tube base. When tested as a coupling transformer with 1-8 and 2-7 windings in parallel as primary and 3-4 and 5-6 in parallel as secondary, characteristic impedance was found to be 100 ohms; rise time, 0.04  $\mu$ sec; droop in 1  $\mu$ sec, 20 percent. Diameter is 1.372 in. maximum; and overall height, 1.657 in. maximum.

### CONVERTER can deliver up to 100 va

AVION INSTRUMENT CORP., Div. of American Car and Foundry Co., 299 State Highway No. 17, Paramus, N. J., has developed the model 400 frequency converter, a portable 400-

# New...

## Heiland bridge balance

...and strain indicator

### features:

- One panel operation permits two-position table mounting or standard relay rack mounting.
- Individual channel controls for coarse and fine voltage, balance, calibration and attenuation. Coarse and fine voltage controls give continuous voltage adjustment across each channel from 1 to 30 volts.
- Convenient and positive locking of all control settings.
- One-step precision attenuator.
- High sensitivity, two scale transducer output meter permits direct reading of static and slowly changing phenomena. Scales 25 - 0 - 25 microamps and 1 - 0 - 1 for "unit" calibration.
- Each channel separately fused. Easy access to fuses, matching calibration, attenuation and dummy resistors.
- All component parts carefully selected for maximum operating efficiency under adverse conditions.
- Simple, rugged, cast construction. High-gloss, gray enamel finish.

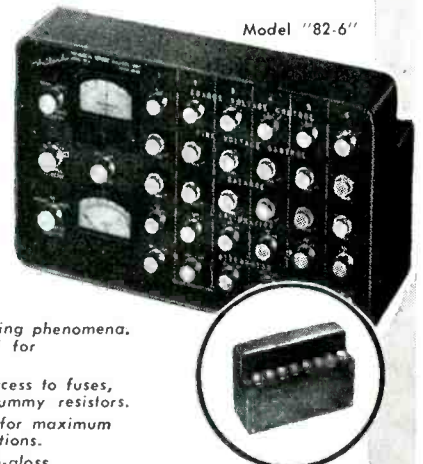

Model "82-6"

**\$ 800.00**  
Delivery  
August 1st

The Heiland "82-6" Bridge Balance provides a simple, accurate means of calibrating static and dynamic output from resistive type transducers or strain gages, before feeding these phenomena into a recording oscillograph. Static and slowly changing phenomena may be read directly on the highly sensitive output meter.

### SPECIFICATIONS:

*Size:* 15 $\frac{3}{4}$ " x 9 $\frac{3}{4}$ " x 5 $\frac{1}{2}$ " including controls

*Weight:* 16 lbs. less cables and mounting

*Power Input:* 0 to 30 volts D.C.

*Application:* Can be used with any resistive type transducer or strain gage having 120 ohms resistance or greater, and having two, three, or four external arms.

*Capacity:* Six channels, each with coarse and fine voltage control, balance control, calibration and attenuation switches.

Write or wire for further information on the Heiland "82-6" Bridge Balance or catalog of other Heiland equipment... oscillograph recorders, galvanometers, associate equipment.



**HEILAND RESEARCH CORPORATION** 130 East Fifth Avenue, Denver, Colorado

**Packed with  
POWER!**

**Silicohm**  
miniature  
**POWER RESISTORS**

**Wire Wound—Silicone  
Coated Resistors**

Complete welded construction from terminal to terminal. Temperature coefficient 0.00002/deg. C. Ranges from 0.1 Ohm to 55,000 Ohms, depending on Type, Tolerance: 0.05%, 0.1%, 0.25%, 0.5%, 1%, 3%, 5%.



**RH TYPE**

Available in 25, 50 and 250 watt sizes. Silicone sealed in die-cast, black anodized radiator finned housing for maximum heat dissipation.

**RS TYPE**

Available in 2 watt, 5 watt, and 10 watt sizes. Silicone sealed offering maximum resistance to abrasion, high thermal conductivity and high di-electric strength.



**DALOHM**  
deposited  
**CARBON RESISTORS**

Dalohm precision deposited carbon resistors offer the best in accuracy, stability, dependable performance and economy. Available in 1/2 watt, 1 watt and 2 watt sizes.



Write, Wire or Phone George Risk,  
1300 28th Ave., Columbus, Nebr.  
for price and delivery.  
Phone 2139.

**DALE PRODUCTS, INC.**  
COLUMBUS, NEBRASKA, U.S.A.

Want more information? Use post card on last page.

NEW PRODUCTS

(continued)

cycle power supply that operates from a standard 60-cycle line and can deliver up to 100 va. It is especially suitable for lab use in the development of low-power aircraft equipment. Output voltage is variable by a front-panel control, from 105 to 130 v, with regulation better than  $\pm 1$  percent. Frequency is adjustable from 380 to 420 cps with less than  $\pm 1$  cps drift. Total harmonic distortion is less than 3 percent. All of these characteristics are independent of the power factor. Model 400 measures 18 in. long x 9 in. wide x 12 in. high.

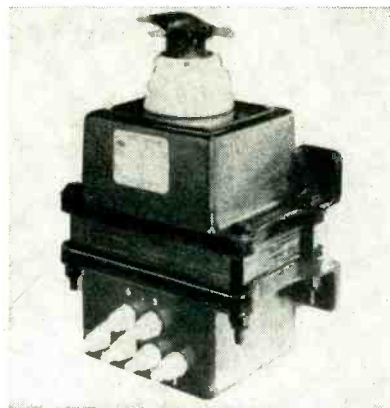

**TRANSFORMER**  
is air-cooled

MAGNATRON, INC., 246 Schuyler Ave., Kearny 1, N. J., announces the addition of an air-cooled filament transformer that is made especially for supplying filament voltages to rectifier tubes because the primary is tapped at several voltages to allow greater accuracy of voltage adjustment. In the model illustrated primary taps are at 200; 210, 220, 230 and 240 v. Any series of taps may be ordered. These may be used on either 50 or 60-cycle lines. Secondary leads are brought out through ceramic insulators and provided with terminal lugs for easy connections. The entire unit is filled with a special compound that effectively transfers heat from coils to case, as well as excluding dust and moisture.

**SEALED RELAY**  
is magnetic-contact type

WESTON ELECTRICAL INSTRUMENT  
CORP., 614 Frelinghuysen Ave.,

**DeJUR**

**EXTERNAL PHASING**

**C-200**

*Potentiometers*

- MULTIPLE GANGING
- INDIVIDUAL EXTERNAL PHASING
- POSITIVE INTERLOCK
- PRECISION MACHINED ANODIZED ALUMINUM CASE
- ADJUSTABLE TAPS WITHIN  $\pm 1/2^\circ$

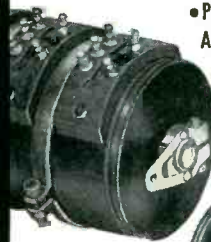

Designers are invited to submit their applications to DeJur engineers for recommendations and suggestions.

- 2" Diameter
- 4 Watts Fully Enclosed
- 10 to 200,000 Ohms Accuracy up to 1%
- Linearity up to 0.3%
- Non Linear Windings
- 360° (Continuous) Mechanical Rotation
- 320° Electrical Rotation
- Taps as Required
- High Resolution 1,000,000 Cycles Operational Life
- Precious Metal Contacts
- Low Torque 1 oz. inch
- Centerless Ground Stainless Steel Shafts
- Ball Bearings to Special Order
- Single or Ganged Units
- Servo Type Mounting or Single Hole Threaded Bushing
- Numerous Shaft Designs

**WRITE FOR  
BULLETIN E-7**



**DeJUR** AMSCO  
CORPORATION

45-01 NORTHERN BOULEVARD, L. I. C. I. N. Y.

Want more information? Use post card on last page.

July, 1953 — ELECTRONICS

Newark 5, N. J. A new relay of the Sensitrol (magnetic-contact) type, model 723, is sealed against moisture and incorporates a newly designed, self-shielded core magnet mechanism and a built-in solenoid release device. Sensitivities as high as 2-0-2  $\mu$ a are available, and both a-c and d-c voltage ranges can be supplied self-contained up to 500 v. Contact capacity of the parallel magnetic contacts is 100 ma at 120 v a-c or d-c. Accuracy is within  $\pm 5$  percent for d-c and approximately 10 percent for a-c depending on circuit conditions.

**POWER AMPLIFIER  
is direct-coupled unit**

SOUTHWESTERN INDUSTRIAL ELECTRONICS Co., 2831 Post Oak Road, Houston 19, Texas. Model B power amplifier has essentially flat response from 0 to 20,000 cps, and will deliver 6.25 w into a 100-ohm load when driven by a 10-v signal. All types of distortion are held to very low levels. The unit may be used to amplify the output of oscillators and signal generators in order to drive Helmholtz coils, underwater-sound transducers, servo systems, and other power-consuming devices. It is particularly useful in dealing with transient phenomena. The amplifier is mounted in two standard 8 $\frac{1}{2}$  in. x 19 in. rack panels, weighs 150 lb and operates on 115 v, 60 cycles a-c at 450 w.

**VOLTMETER  
with extended range**

WAVEFORMS, INC., 333 Sixth Ave., New York, N. Y. Model 520-A extended-range voltmeter is a miniature instrument of high precision and extreme versatility, operating over the frequency range from 10 cycles to 2 mc. A full-scale sensitivity of 1 mv permits measurements as low as 100  $\mu$ v and affords useful indications at still lower levels. Ranges are provided up to 300 v, as well as decibel readings from -72 to +52 db (referred to 1 mw in 600 ohms). The portable unit weighs only 6 lb and the case is only 6 in. high. It will operate

precision connectors by Continental



ACTUAL SIZE

**Sub-Miniature  
Connectors Series SM-20**

afford extreme size reduction without sacrificing pin diameter . . . available in 11, 14, 20, and 34 contacts for #20 AWG wire . . . 5 amp. continuous current rating . . . Submit your special subminiature connector requirements to our engineering department.

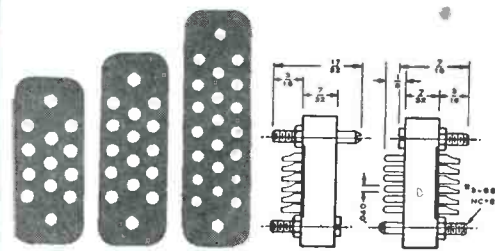

(ACTUAL SIZE)

**Continental  
Connectors**

ELECTRONIC SALES DIVISION

DeJUR-AMSCO CORPORATION

Write Dept. E-7, DeJUR AMSCO CORPORATION, 45-01 Northern Blvd., Long Island City 1, N. Y. West Coast: 405 North Maple Drive, Beverly Hills, California

# Stable I.F. Tuning...

*means peak response at center frequency always!*

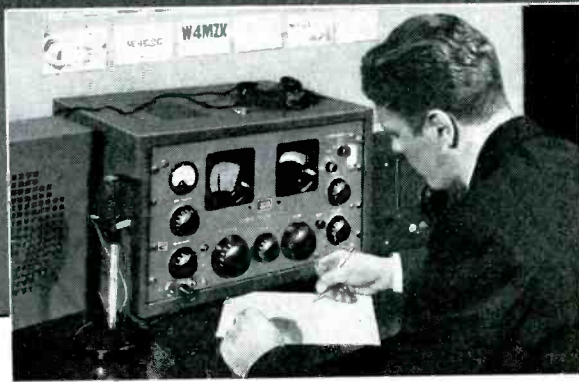

## Change the bandwidth without de-tuning when you operate an "SP-600-JX" Communications Receiver

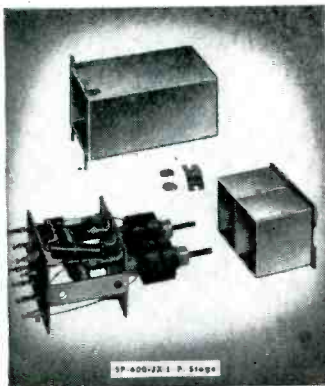

Newest techniques in the art of receiver design and engineering are incorporated into the "SP-600-JX" to make it outstanding in quality and unexcelled in performance. Regardless of your past experience as a radio operator, amateur, or short-wave listener, you will be impressed by the superlative advantages of the "SP-600-JX"

The aim at perfection in engineering and manufacture of the "SP-600-JX" has yielded a design which permits selection of any of six bandwidths (0.2, 0.5, 1.3, 3, 8, and 13 kc) with no de-tuning from center frequency.

Furthermore, these I. F. stages are so stable that once set at the factory, they are unlikely to ever need re-alignment again. Even a change of I. F. tubes has no effect upon alignment of this superior receiver.

Write to the Hammarlund Manufacturing Company, Inc., 460 West 34th St., New York 1, N. Y. for more details on the SP-600-JX. Ask for Bulletin 116.

Hammarlund introduces the new "HQ-140-X"! This medium priced receiver, which was previewed at the recent IRE Show, is a professional type receiver for amateur operators and short-wave listeners. It incorporates all the features that have made "HQ's" famous, along with the most recent advances in the art of receiver design. For detailed information ask for Bulletin 117.

 **HAMMARLUND**

on power lines from 50 to 400 cycles and 95 to 130 v.



## PLUG-IN METERS in 3 or 4-in. sizes

COLE INSTRUMENT Co., 1320 S. Grand Ave., Los Angeles 15, Calif., has announced a line of meters with a convenient plug-in feature. These new instruments can be pulled out and replaced by hand in a few seconds. They are available in a full range of standard calibrations. The meters are supplied in either three or four-in. sizes; the former is available in either round or rectangular cases; the latter in a rectangular case. The use of plug-in meters requires only the installation of the company's plug-in receptacles.

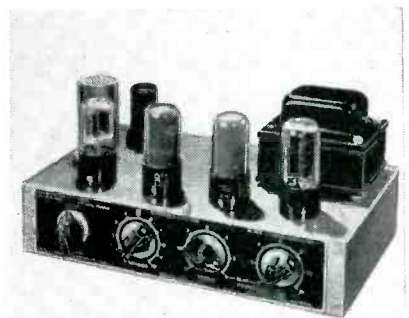

## HI-FI AMPLIFIER has 8-w power output

PRECISION ELECTRONICS, 9101 King Ave., Franklin Park, Ill. Model LJ2 high-fidelity amplifier has a power output of 8 w with a peak of 18w. Distortion at 8w is 1.5-percent harmonic and 4.0-percent intermodulation. Frequency response is  $\pm 1$  db, 20 to 20,000 cps at 3-w level. The unit features the following controls: (1) selector switches from radio channel to magnetic

pickup; (2) volume control; (3) treble control with 18-db attenuation at 10,000 cps; (4) bass control with off-on switch—15-db boost at 50 cps. Hum level is 80 db below 8 w. Other features of the LJ2 include negative feedback and fused, a-c outlet.

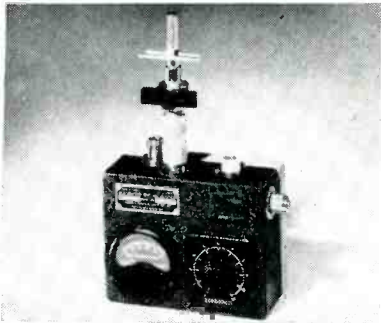

**H-F TEST SET**  
is dual-purpose unit

AMERICAN ENCAUSTIC TILING Co., INC., Kenilworth Ave., Lansdale, Pa. Model 117 wavemeter is designed for measuring operating frequency and making relative power measurements of microve transmitters or signal sources. Applicable to pulsed transmitters as well as continuous wave systems, the operating range of the new wavemeter is 2,400 to 3,400 mc, but it is also being made in other frequency ranges for special applications. A novel feature is the combining of either transmission or reaction type measurements in one instrument. Measurements can be made by direct coupling of the wavemeter to the signal source or at a remote point by means of a self-contained directive antenna.

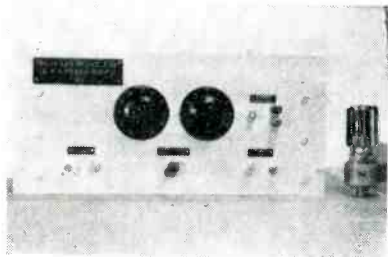

**POWER SUPPLIES**  
for the research lab

THE ATOMIC CENTER FOR INSTRUMENTS & EQUIPMENT, INC., 489

*Here's why those in the know*  
*-demand*

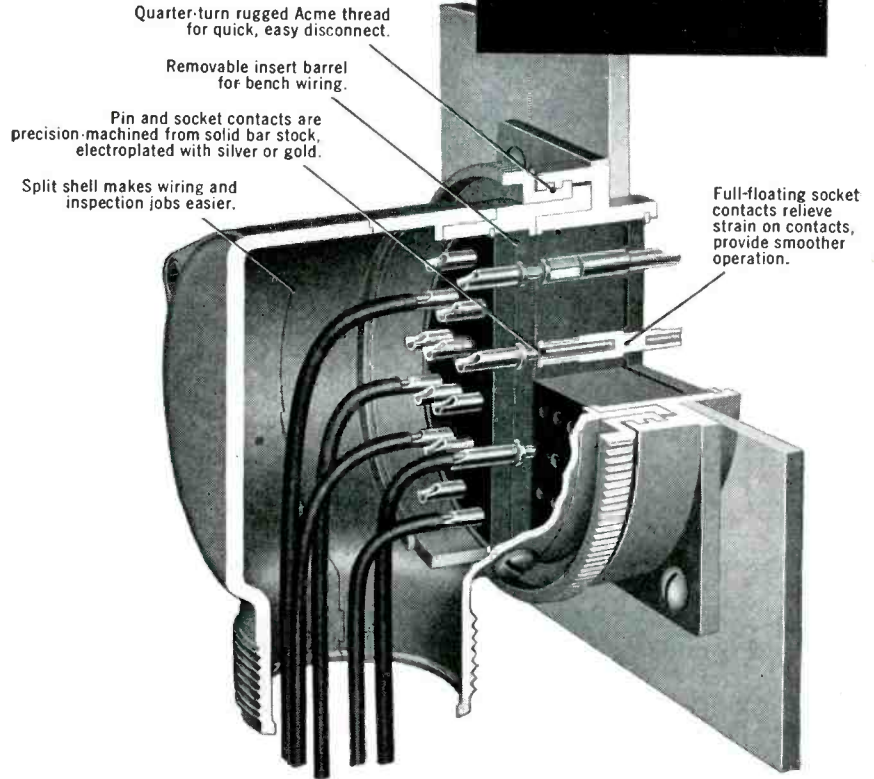

Recognition of Cannon's 36 years of sound engineering and fine, uncompromising construction has built the demand for Cannon Plugs. Here we take an inside look at the lightweight Type "K" 90° connector, forerunner of the Army-Navy Series. More features of the "K" were incorporated into the "AN" design than any other connector.

Constantly improved over the years, Type "K" is now used for numerous applications such as aircraft, radio, television, sound, phone recorders, motion pictures, geophysi-

cal research and widely used throughout the electro-mechanical and electronic instrument fields.

The design and construction details in the Cannon "K" Series are typical of the care Cannon takes in producing more than 18,000 precision, multi-contact connectors to serve the exacting needs of industry.

We will gladly send you engineering bulletins describing each of the many basic types of Cannon Plugs if you will briefly describe your applications.

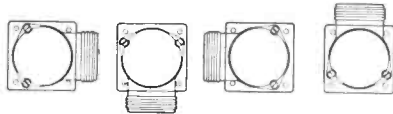

Diagram at left shows how the four positions of cable entry on the large 90° "K" endbell make the wiring job easier. Smaller Type "K" connectors have three positions.

**CANNON**  
**ELECTRIC**

Since 1915

**Cannon Electric Company**  
**Los Angeles 31**  
**California**

Factories in Los Angeles, Toronto, New Haven. Representatives in principal cities. Address inquiries to Cannon Electric Company, Department G-110 Los Angeles 31, California.



Type "K" and "RK" connectors are available in 7 shell types having 8 diameters. Inserts have more than 190 contact arrangements. Some of these have Coax, Twinax or Thermocouple contacts as standard. Integral cable clamps available in all "K" plug types.

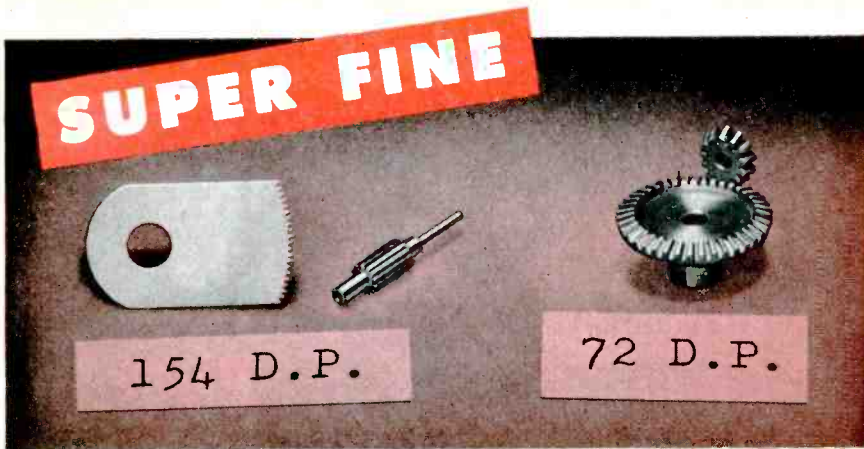

● If your requirements are for extra fine-pitch gears and pinions with precision tolerances, send us your prints for quotation. Beaver Gear engineers are trained to assist you in the design and application of this type gear. Our workmen are specialists in manufacturing small and medium size, fine and extra fine-pitch gears to your most exacting specifications.

MEMBER OF

THE *Finest*

IN GEARS

*Beaver Gear Works Inc.*

1021 PARMELE STREET, ROCKFORD, ILLINOIS

# Specification Coils

—for every requirement—radio, FM, TV and Government Applications!

Including Universal, Bank Wound, Universal Progressive and Solenoid. All are precision-built to highest engineering standards and conform exactly to specifications. For uniform high quality, prompt delivery and economical unit costs, specify coils by Fugle-Miller. Radio, TV and JAN specifications are a specialty. Phone, wire or write for quotations.

ADDRESS INQUIRIES TO DEPT. E6

**FUGLE-MILLER LABORATORIES**  
 MAIN STREET, METUCHEN, NEW JERSEY  
 Telephone: Metuchen 6-2245

Fifth Ave., New York 17, N. Y., presents the Beva models 300 and 301 precision power supplies. These units are used for proportional counting in the radioactivity laboratory and in conjunction with pulse-height analyzer systems, mass spectrographs and other research equipment demanding rigidly precise high voltages. Output voltage for the model 300 is from 500 to 1,600 v d-c, and for the model 301, from 1,000 to 5,100 v d-c. Maximum output current for both units is 1 ma. Regulation is 0.01 percent for load variation from 0 to 1 ma and a line-voltage change from 105 to 130 v. Noise and ripple are less than 0.020 v at 5 kv. Voltage control is obtained by means of 0.1 percent accurate decades and potentiometers. Units can be furnished either positive or negative grounded.



## GENERATOR

produces a square wave

AMERICAN ELECTRONIC LABORATORIES, INC., 641 Arch St., Philadelphia, Pa. Designed for use as a modulator for r-f measurements, the unit illustrated is useful for general experimentation wherever a 1,000 or 400-cps square wave is required. The generator produces a square wave at either 400 or 1,000 cps tunable over a  $\pm 10$ -percent range by means of a front panel control. Output is adjustable in amplitude from 0 to 50 v peak-to-peak, no load, or 12 v peak-to-peak into a 600-ohm load. Both amplitude and frequency are constant within  $\pm 2$  percent for line voltage variations from 105 to 120 v. Pow-



ered from 115 v, 60 cps, the unit is an 8-in. x 8 in. x 8 in. sloping front cabinet with carrying handle.

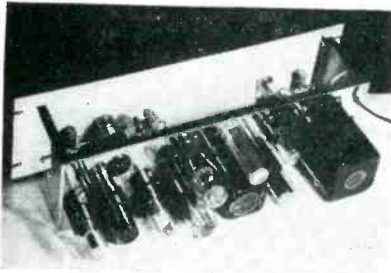

**RADIATION MONITOR**  
is an automatic unit

DETECTOLAB INC., 6544 Sheridan Rd., Chicago 26, Ill. Model DZ14 Radiation Supervisor is designed to provide continuous automatic monitoring of radiation in a laboratory, and can be used to monitor the lab and sound remote-control alarm system in office or in safety-control centers. The unit uses an infinite-life-type counter that plugs directly into top of chassis.

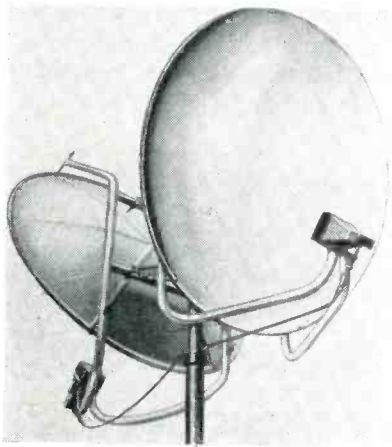

**MICROWAVE ANTENNA**  
features offset feed

WORKSHOP ASSOCIATES DIVISION, The Gabriel Co., Endicott St., Norwood, Mass., has introduced an off-set-feed microwave antenna for the 1,750 to 2,110-mc range. The design uses a parabolic reflector with the vertex 9 in. above the rim. Radiation is practically identical in both horizontal and vertical planes. Polarity can be changed by rotating the feed 90 deg. The 6-ft offset feed reflector is made of fiberglass laminations with a polyester resin. The total laminate is composed of

Burton Trowne advertising

James is the complete source for all vibratory products! \*  
THE ENGINEER'S STANDARD SINCE 1936

\*Send your engineering problems to us



The new James Angle Drive Interrupter Vibrator is now available in manufacturer's quantities at competitive prices.

Dependable starting, long life, hushed performance are inherent features of this new vibrator. Write for engineering samples and circuit consultation.

**JAMES**  
VIBRAPOW  
4038 N. Rockwell St. - Chicago 18, Ill.  
COMPANY

AUTO VIBRATORS • COMMUNICATIONS VIBRATORS • VIBRATOR POWER SUPPLIES • CHOPPERS • VIBRATORY COAXIAL SWITCHES

## What is your Delay or Regulating Problem?

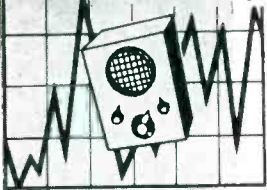

For the most effective solution use the  
**SIMPLEST, MOST COMPACT**  
**MOST ECONOMICAL**  
**HERMETICALLY SEALED**

# AMPERITE THERMOSTATIC DELAY RELAYS



STANDARD

Provide delays ranging from 2 to 120 seconds.

- Actuated by a heater, they operate on A.C., D.C., or Pulsating Current.
- Hermetically sealed. Not affected by altitude, moisture, or other climate changes.
- Circuits: SPST only—normally open or normally closed.

Amperite Thermostatic Delay Relays are compensated for ambient temperature changes from  $-55^{\circ}$  to  $+70^{\circ}$ C. Heaters consume approximately 2 W. and may be operated continuously. The units are most compact, rugged, explosion-proof, long-lived, and—very inexpensive!



MINIATURE

TYPES: Standard Radio Octal, and 9-Pin Miniature.

PROBLEM? Send for Bulletin No. TR-81

## BALLAST-REGULATORS



T9 BULB

- Amperite Regulators are designed to keep the current in a circuit **automatically regulated** at a definite value (for example, 0.5 amp).
- For currents of 60 ma. to 5 amps. Operates on A.C., D.C., or Pulsating Current.
- Hermetically sealed, light, compact, and most inexpensive.

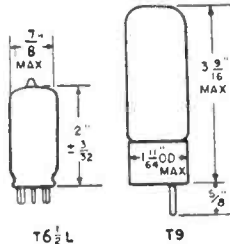
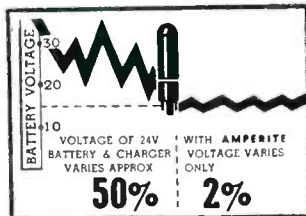

Maximum Wattage Dissipation: T6 1/2 L—5W. T9—10W.

Amperite Regulators are the simplest, most effective method for obtaining **automatic regulation** of current or voltage. Hermetically sealed, they are not affected by changes in altitude, ambient temperature ( $-55^{\circ}$  to  $+90^{\circ}$ C), or humidity. Rugged; no moving parts; changed as easily as a radio tube.

Write for 4-page Technical Bulletin No. AB-51

**AMPERITE CO., Inc. 561 Broadway, New York 12, N. Y.**

In Canada: Atlas Radio Corp., Ltd., 560 King St., W., Toronto 2B

a surface layer of fiberglass and a layer of fine wire mesh screening backed by four layers of fiberglass. The result is a strong, low-cost reflector, accurate to  $\pm \frac{1}{8}$  in.



### RECEIVER

covers 540 kc to 40 mc

THE NATIONAL CO., INC., Malden, Mass., has announced production of a new broadcast and shortwave receiver—the World Master (model NC-88). Designed especially for shortwave listeners and radio amateurs, the receiver covers all frequencies from 540 kc to 40 mc in 4 bands. Features include calibrated bandspread, advanced a-c-powered superhet circuit using 8 miniature tubes, a tuned r-f stage, two r-f stages and a high-fidelity audio output stage.

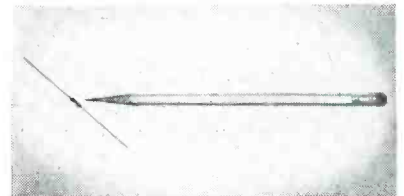

### TINY RESISTOR

is deposited carbon type

ELECTRA MFG. Co., 2537 Madison, Kansas City, Mo., has available a tiny deposited-carbon "transistor" resistor of  $\frac{1}{8}$  w. Designed especially for miniature requirements, the body length is only  $\frac{3}{32}$  in. and body diameter is  $\frac{5}{64}$  in. The new resistor has a resistance range from 4 ohms to 250 K ohms. It is rated at a maximum of 250 v. The deposited-carbon manufacturing process makes possible maximum stability regardless of resistance-value tolerance— $\pm 1$  percent,  $\pm 5$  percent or  $\pm 10$  percent are all equally stable. The resistors are available in

either standard or hermetically-sealed types.

## BRAZING ALLOYS for high-vacuum systems

WESTERN GOLD & PLATINUM WORKS, 589 Bryant St., San Francisco, Calif., announces two new brazing alloys for high-vacuum systems such as power tubes and vacuum capacitors. Incore 60 is an alloy of gold, copper and indium that offers to the industry a nonsilver bearing alloy with a melting range (810 to 830 C) near that of the widely used silver-copper eutectic alloy. Incosil 15 is an alloy of silver, copper and indium having a low vapor pressure and a very low melting range (640 to 687C). It is of interest for step brazing techniques and for those applications where the higher flow point of the silver-copper eutectic alloy is undesirable.

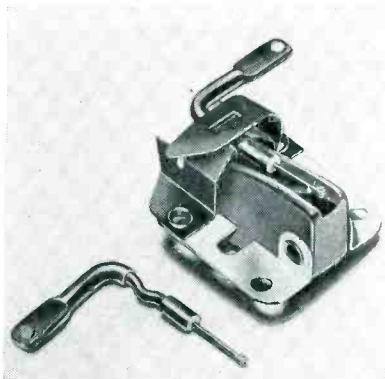

## CERAMIC PICKUP uses turnover method

SONOTONE CORP., Elmsford, N. Y. The Titone Turnover uses a high-compliance, high-sensitivity ceramic element and a revolutionary turnover method. Requiring no equalizers or preamplifiers, the cartridge has an output of one volt and is unaffected by moisture or temperature. The jewel needle tips (either diamonds or sapphires) are mounted back-to-back on a single shank, the entire assembly rotating for needle change. When replacement is required, the complete needle assembly, including the lever handle, is removable as a unit. Complete specifications including

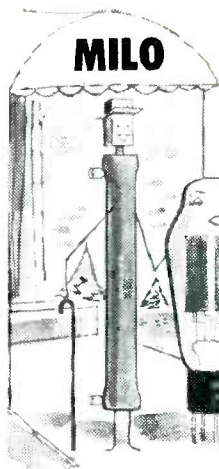

## check list (A-C) of leading brands in stock

Acro-Switch  
Advance Electric  
Aerovox  
Aircraft Marine Products  
Allen-Bradley  
Allied Control  
Alpha Wire  
American Beauty  
Amperite  
Amphenol  
Arco  
Arrow-Hart & Hegeman  
Astron  
A T R  
Barker & Williamson  
Belden  
Birnback  
Bliley  
Bogen  
Bud  
Burgess  
Bussman  
Cannon  
Cardwell  
Carter  
Centralab  
Cetron  
Chathan Electronics  
Chicago Telephone Supply Co.  
Chicago Transformer Co.  
Cinch-Jones  
Clarostat  
Conant Labs  
Consolidated Wire Cos.  
Continental Carbon (Nobleloy)  
Cornell-Dubilier  
Crest Labs.

## HOST to COMPONENT SOCIETY

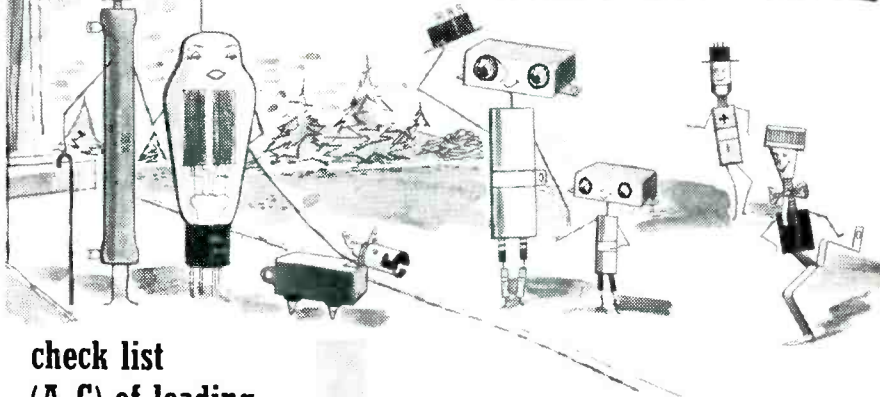

There **IS** an **ELECTRONIC COMPONENT SOCIETY**. Its favorite gathering place is **MILO**. This is an active, working society. Without formal election to membership. But there are certain essential qualifications for inclusion in its highly regarded ranks.

It is comprised of the **LEADING BRANDS** of Electronic Components. Composed of the best elements. Good-looking, dependable, of proven integrity. Some members (Relays, Switches, etc.) have Silver and Gold and Platinum. Others (the Ceramics) are of "uncommon clay." Many wear the latest plastics. Among those which are destined for Military service there is usually a marked distinction (MIL. numbers). All bear proud names and their reputations are well guarded.

In the Connector branch some males and females are known to switch partners, but never indiscriminately; there are rigid barriers. Paradoxically the members with the least tolerance are in the highest strata of component society.

This elite group is noted for good conduct under stress, and has universal acceptance wherever components are assembled. Diverse in type, size, shape, character and origin, more of Electronic Component Society is found at **MILO**, where we know and understand it. And we recommend it to **YOU** without hesitation.

## MIL-Spec. Components Available



### FREE INDUSTRIAL TUBE BOOKLET

Chief Engineers, Purchasing Agents, Purchasing Executives! Write now if you haven't received our Industrial Electronic Tube Booklet #EB. Use company letterhead and state your title. Address Dept. E-7.

the **ONE** source for **ALL** your electronic needs

# MILO RADIO & ELECTRONICS CORP.

## ELECTRONICS FOR INDUSTRY

200 GREENWICH STREET, NEW YORK 7, N. Y. • Phone BEekman 3-2980  
Teletype NY1-1839 • Wire MILO-WUX-N.Y. • Cable MILOELECTRO-N.Y.

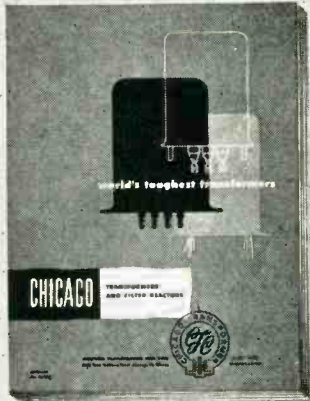

you'll want this  
new guide to  
the world's  
toughest  
transformers

Send for  
the new

**CHICAGO**

**TRANSFORMER AND  
FILTER REACTOR CATALOG**

**easier to use, more complete than ever**

You'll find more than 500 units listed in the new CHICAGO Catalog . . . transformers for every application . . . presented in one complete, easy-to-use specification guide, covering the following categories:

- MIL-T-27 Hermetically-Sealed Transformers
- New Equipment Transformers
- Television Replacement Transformers
- General Replacement Transformers
  - Control & Power Circuit Transformers

You'll want this new CHICAGO Catalog for handy reference. It provides a wealth of terse factual information on CHICAGO Transformers for original or replacement use in the radio, electronic, electrical, aeronautical, geophysical, and automotive industries. Use this Catalog as your buying guide to the World's Toughest Transformers . . . depend on your CHICAGO distributor for prompt, efficient service.

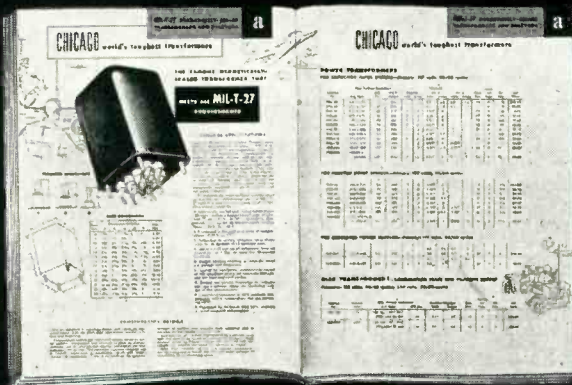

**free**  
Send  
for it!

**CHICAGO TRANSFORMER**  
DIVISION OF ESSEX WIRE CORPORATION  
3501 W. Addison Street • Chicago 18, Illinois

dimensional diagrams are available in a 4-page folder.



### SHIELDING PAINT for c-r tubes and meters

MICRO-CIRCUITS Co., New Buffalo, Mich., is producing RS12 conductive shielding paint for static shielding of c-r tubes, meters, h-v power supplies and h-v generator windings. Special advantages include low cost, high conductivity, excellent adhesion and durability, heat resistance, complete quality control, very mild pigment settling and a viscosity suitable for spraying as received.



### MAGNETIC HEADS feature broad response

STANCIL-HOFFMAN CORP., 921 North Highland Ave., Hollywood 38, Calif., has announced a new line of magnetic recording and reproducing heads that feature broader frequency response, better performance and longer head life. The standard heads record a track 0.200 in. wide. The record/reproduce head has a 1,000-turn coil and a gap width of approximately 0.0005 in. Heads that are to be used for recording only are available with a lower impedance that permits easier matching for high bias frequencies. The gap width is 0.0007 in. as this

has been found to provide the best tape magnetization. Heads for reproduction only have a gap width of approximately 0.0003 in. and a 1,000-turn coil.

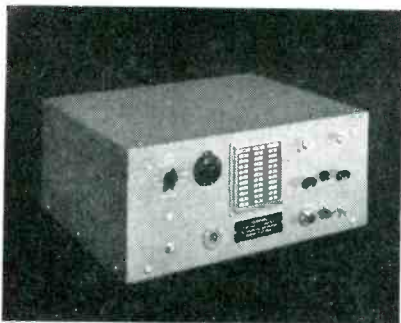

**TELEDUCER**  
digitizes low voltage

TELECOMPUTING CORP., Burbank, Calif. Type 24A Teleducer automatically converts analog voltages into decimal digits with an accuracy of 0.1 percent (1,000 counts full scale). The Teleducer operates upon demand, digitizes an input voltage and holds the digital representation for a controllable period of time for purposes of display, recording or any desired readout form. The digital output can be recorded by means of punched cards, an electric typewriter, magnetic tape or punched tape. The instrument digitizes low voltage without d-c amplification and high voltage by means of attenuators. It uses a simple bridge balancing circuit that does not hunt or oscillate and requires only 0.8 second or less to reach balance.

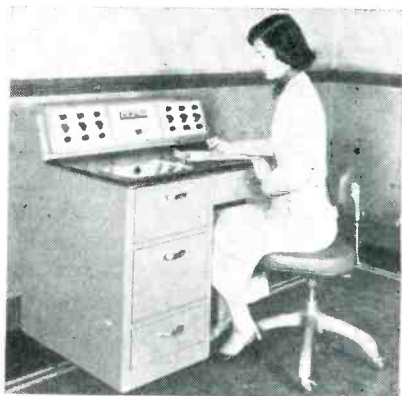

**RECORDER**  
for use with computers

GOODYEAR AIRCRAFT CORP., Akron 16, Ohio. Model R5 GEDA re-

... used extensively by the electronics industry ...

A list of our customers in the Electronics Industry includes many leading manufacturers—Philco, RCA, Federal Tel. & Tel., Collins Radio, Magnecord, Hazeltine Labs, Presto Tape Recording Co., and many more.

Yes, EMC and CYCLOHM fractional h. p. motors are used by leading companies for hundreds of applications. If you have an application for fractional h. p. motors, check with us on your requirements. Write today for our catalog or better yet, ask to see a Howard representative.

HOWARD INDUSTRIES, INC. RACINE, WIS.  
DIVISIONS: **EMC** ELECTRIC MOTOR CORP.  
 CYCLOHM MOTOR CORP.

- Universal and Direct Current**  
1/1000 to 1/2 h.p.
- Shaded Pole** 1/2000 to 1/8 h.p.
- Induction types** 1/1400 to 1/4 h.p.



# GM DIESEL *Stand-by* GENERATOR SETS



WJR—Detroit, Michigan, uses 200 kw. GM Diesel generator set as stand-by power for 50,000-watt transmitter. Compactness of unit permitted installation in garage adjoining transmitter building—eliminating cost of a specially designed building.

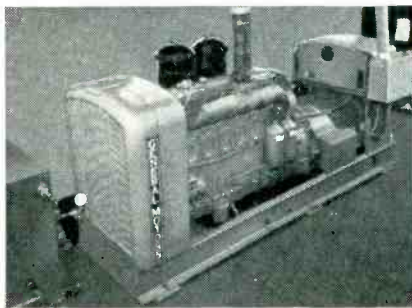

WKTV—UTICA, N. Y., uses a 100 kw. General Motors Diesel generator set for stand-by power. Set can be started remotely from the control room. Low vibration characteristic of engine permitted installation in room adjacent to transmitter and within 30 feet of studio.

If you are planning stand-by power, be sure to check the advantages of General Motors Diesel generator sets, listed briefly below. GM Diesel generators are meeting the exacting requirements of military service in all parts of the world. They supply emergency power for more than 1100 telephone and telegraph exchanges—for microwave relay stations, for hospitals, government buildings, banks, airports. There is a GM Diesel distributor near you who will analyze your power requirements and make his recommendations without obligation. Look in the yellow pages of your phone book for his listing, or write direct to us.

- Wide range of models—12 1/2 to 200 kw., 220 or 440 volts, single or three-phase current.
- Excellent frequency and voltage regulation for the most exacting requirements.
- Powered by General Motors Diesel engines—dependable, smooth 2-cycle operation—low cost maintenance—easy to service.
- Built by one manufacturer—one warranty, one responsibility for both engine and power generator.
- Instant push-button power starting on safe Diesel fuel—or fully automatic starting. Immediate power, no "warm-up" period.
- Dependable starting—no spark-ignition system to fail because of dampness or corrosion—always ready to start.
- Easy to install—compact—lightweight—requires no special building, no special base. Complete instrumentation provided.
- Distributors and Dealers throughout the country.

## DETROIT DIESEL ENGINE DIVISION

GENERAL MOTORS • DETROIT 28, MICHIGAN

SINGLE ENGINES . . . 16 to 275 H.P. MULTIPLE UNITS . . . Up to 840 H.P.

*It pays to Standardize on*

Write for Generator Set Catalog 6 SA 20.



NEW PRODUCTS

(continued)

Recorder, specifically designed for use with analog computers, provides remote operation of computer systems by built-in control units. It features excellent stability and frequency response, a choice of pens and streamlined design. Six channels of recording are provided either in curvilinear coordinates (ink pens) or rectilinear coordinates (hot-wire pens). The operator determines the choice of pens. Coefficient potentiometers may be provided for connection to the computer, so that the operator need not leave the recorder for many runs that differ only in the values of one or two coefficients or initial conditions. Six d-c amplifiers feature calibrated gain controls and negligible drift. Sensitivity is continuously variable between calibrated steps from 0.01 to 100 v per millimeter.



## RELAY RACKS are available in 3 sizes

PREMIER METAL PRODUCTS Co., 3160 Webster Ave., Bronx, N. Y., announces enclosed relay racks that are rigidly constructed of 16-gage cold rolled steel. Rear doors are hung on loose-jointed hinges and have flush snap catches. Racks are shipped knocked down with all necessary bolts for easy assembly. They are available in 3 sizes—43 1/2 × 22 × 18 in., with panel space of 36 1/2 × 19 in., 67 1/2 × 22 × 18 in. with panel space of 61 1/2 × 19 in., and 83 1/2 × 22 × 18 in. with panel space of 77 × 19 in. A complete catalog of the company's products

for the electronic and electrical industries is available.

## Literature

**Hipersil Cores.** Westinghouse Electric Corp., Box 2099, Pittsburgh 30, Pa., has available a 16-page illustrated booklet (B-5402) on type-C Hipersil cores for specialty transformers. The characteristics of Hipersil cores that make them especially suited for electronic and small electrical transformers are discussed. An illustrated section traces the manufacturing procedure from the initial processing of the grain-oriented steel to the packaging of the completed core in a vapor-tight plastic coating. Simple sketches show how type-C cores simplify the assembly of three basic types of transformers—simple core, core-type and shell-type. A number of applications of Hipersil cores are listed, and the adaptability to many transformer designs is illustrated.

**Direct-Writing Magnetic Oscillographs.** The Brush Development Co., 3405 Perkins Ave., Cleveland 14, Ohio. A recent catalog sheet illustrates and describes models BL-201 and BL-202 direct-writing magnetic oscillographs that are designed to furnish an ink recording, for immediate use, of electrical phenomena in the frequency range of 0 to 100 cycles when used with an appropriate equalized amplifier. Complete technical specifications are given.

**Pulse Transformer.** Berkshire Laboratories, 506 Beaver Pond Road, Lincoln, Mass. Descriptive sheet T-36 deals with type PT-1 Labtrans pulse transformer, a versatile unit for use in the micro-second and fractional-microsecond ranges. Along with the description are included four diagrams and a list of technical specifications.

**Tantalum Electrolytic Capacitors.** Sprague Electric Co., 35 Marshall St., North Adams, Mass. Bulletin 350 shows sizes, ratings and per-

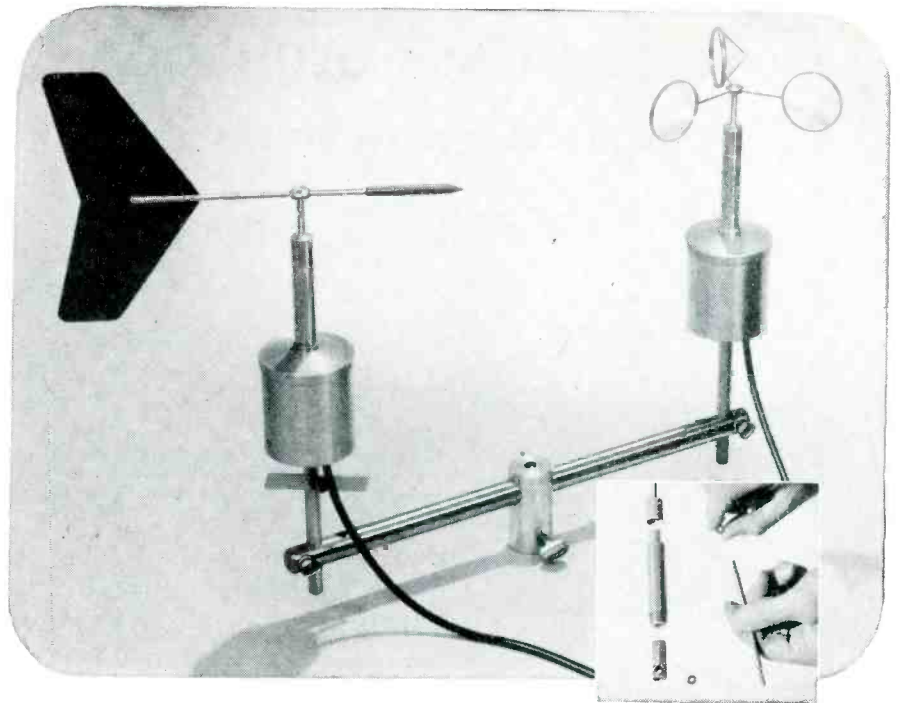

## Micro Bearings Measure Up . . . in this electronic "Climate Survey System"

To combat the problem of smog and atmospheric pollution, Beckman & Whitley, Inc., of San Carlos, California recently introduced this electronic recording anemometer and wind direction instrument, called a "Climate Survey System." It is used to measure the extremely slow air movements associated with such conditions. Prime requirements include an exceptionally low stall point, constant operation throughout a wide range of temperatures, and satisfactory linear recordings despite varying speeds.

We are proud that Micro Ball Bearings measure up in every respect. Used at both ends of the anemometer drive shaft, Micro bearings combine low friction with smooth performance under varying temperature and wind conditions. Processed to a true Micro-finish, they help insure complete uniformity in every instrument.

If you have a problem that calls for savings in friction, weight or space, it will pay you to contact Micro.

# Micro PRECISION INSTRUMENT BALL BEARINGS

NEW HAMPSHIRE BALL BEARINGS, INC. 5 Main Street, Peterborough, N. H.

### CHECK THESE MICRO ADVANTAGES

● **Precision Tolerances**

Fully processed to a true *micro-finish*. Tolerances are ABEC-5 and better.

● **More Sizes and Types**

Available in 135 sizes and types down to .04" bore, 1/8" O.D. Materials include chrome, stainless steel and beryllium copper. Special items and materials considered.

● **Engineering Assistance**

Top staff of design engineers available to help customers at any time.

● **Availability**

Small-quantity orders for items in production are shipped either from stock or as the next run comes through. Large quantities are scheduled for earliest possible delivery prevailing at time of order.

● **Free Catalog**

Send today for Catalog No. 53 which gives full specifications and application data on all types and sizes of Micro Ball Bearings.



# Covering the Coronation

## Despite Magnetic Storm

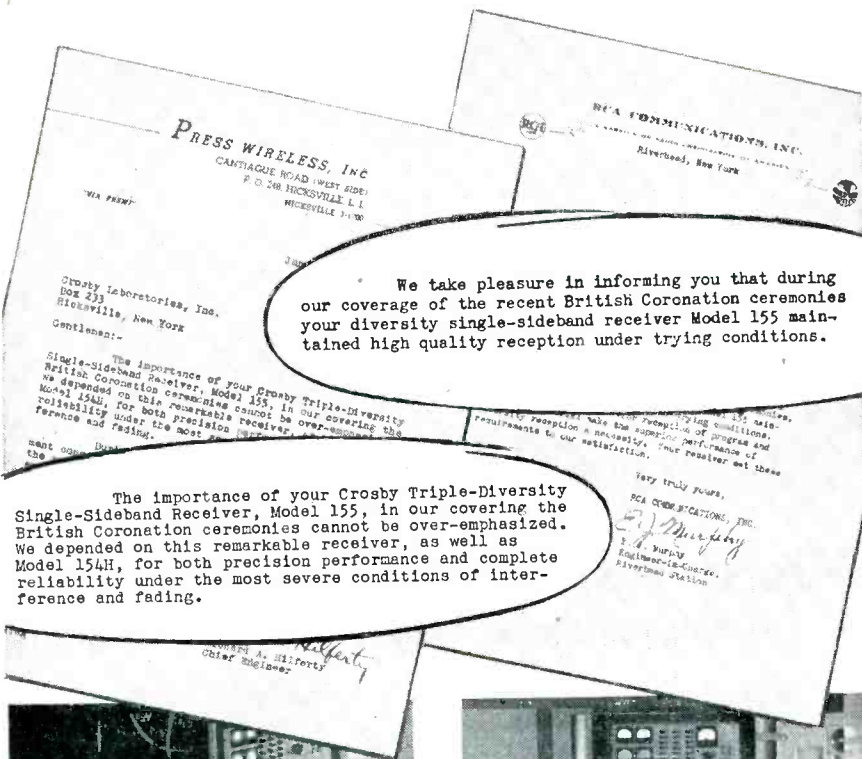

We take pleasure in informing you that during our coverage of the recent British Coronation ceremonies your diversity single-sideband receiver Model 155 maintained high quality reception under trying conditions.

The importance of your Crosby Triple-Diversity Single-Sideband Receiver, Model 155, in our covering the British Coronation ceremonies cannot be over-emphasized. We depended on this remarkable receiver, as well as Model 154H, for both precision performance and complete reliability under the most severe conditions of interference and fading.

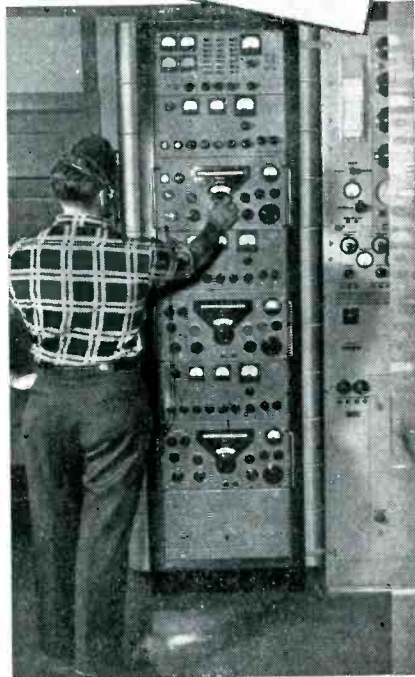
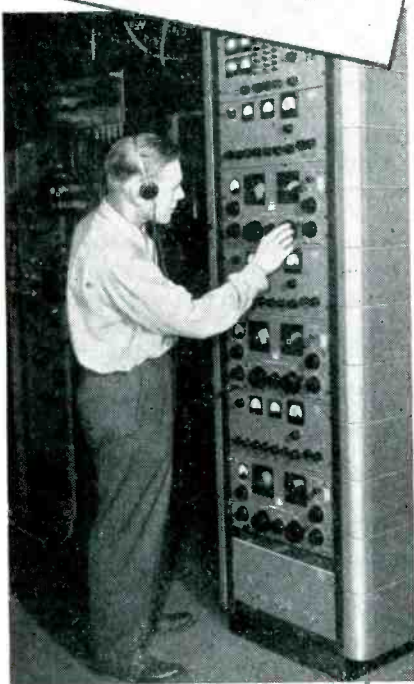

SINGLE-SIDEBAND AND EXALTED CARRIER DIVERSITY RECEIVERS • BROADCAST AND COMMUNICATIONS APPARATUS • MULTIPLEX TRANSMITTING AND RECEIVING EQUIPMENT  
COMPLETE ENGINEERING SERVICE

Founded in 1948, Crosby Laboratories, Inc. is an engineering, development and production firm whose accomplishments include many original contributions to the science of long-range radio communications. The organization is staffed by electronics engineers with more than twenty-five years' experience in the fields of radio communications and applied electronics.

For complete, interesting literature, write to —

**CROSBY LABORATORIES, INC.**

Robbins Lane • Hicksville, N. Y.

NEW PRODUCTS

(continued)

formance data on a new line of tantalum electrolytic capacitors. The 100D Tantalex capacitors discussed are designed for military and industrial applications where low leakage is a primary requirement. The ultra-compact capacitors described are hermetically sealed against moisture, and have ratings available for 85°C or 125°C continuous operation.

**Tape-Handling Unit.** Computer Research Corp., 3348 W. El Segundo Blvd., Hawthorne, Calif. A recent data sheet gives information on the model 126 tape-handling unit that has been designed to be an auxiliary high-capacity memory for use with electronic digital computers. Mechanical and electrical specifications are included.

**Instrument Motors.** Servomechanisms, Inc., Post and Stewart Aves., Westbury, Long Island, N. Y. A 20-page illustrated catalog describes a new line of miniaturized hysteresis synchronous, control and damped control instrument motors. The motors described offer the designer various frame sizes, speeds, and input voltages for military and commercial applications. Typical uses of the units discussed include: analog computers, aircraft fire control systems, differential analyzers, remote indicating systems, telemetering devices, control of industrial machinery and many other systems in these categories.

**Ultrasensitive Relays.** Devtronics, Inc., 221 N. Hermitage Ave., Trenton 8, N. J. A 4-page folder illustrates and describes a line of ultrasensitive relays for laboratory and industry. Included are circuit variations and properties, as well as information on the selection of the proper relay. Also given are prices and specifications of standard stock model relay assemblies with both hermetically sealed and open relays.

**Picture Tube.** Hytron Radio & Electronics Co., A Division of Columbia Broadcasting System Inc., Salem, Mass. Four pages of engineering data cover type 24TP4, a 24-in. rectangular, 90-deg, all-



glass, magnetically-focused picture tube that provides an effective screen area of over 370 sq in. Other features of the tube described are: an aluminized screen for increased brightness spherical filter-glass face plate; single ion-trap gun design and an external conductive coating that serves as a filter capacitor. Electrical and mechanical data and terminal connection information are included.

**Insulating Compounds.** The Acme Wire Co., New Haven, Conn., has available bulletin No. 575, a mimeographed circular letter, and two circulars describing the thermo-setting polyester resin-epoxy combination, a line of insulating compounds for the treatment of coil windings, transformers, or complete electronic assemblies. Transformers impregnated and encapsulated with the components described will meet all the requirements of Government specification MIL-T-27, grade 1, class A, without the use of exterior casings.

**Relay Catalog.** Sterling Engineering Co., Inc., Laconia, N. H. Catalog No. 53 is a 24-page booklet illustrating and describing the company's general line of relays. Included are typical operating data, dimensional diagrams, specifications and complete ordering information.

**H-V Insulating Gas.** General Chemical Division, Allied Chemical & Dye Corp., 40 Rector St., New York 6, N. Y., has issued the 16-page technical service bulletin SF<sub>6</sub>-A covering sulfur hexafluoride, a new gaseous dielectric for use in the electrical and electronics equipment fields. The gas described, furnished in cylinders at 300 pounds pressure, is designed for use in transformers, capacitors, electrostatic generators, x-ray apparatus, coax cables for tv, radar equipment, waveguides and similar apparatus. Complete physical data are included.

**Remote-Control Equipments.** Gates Radio Co., Quincy, Ill. A single-sheet bulletin illustrates and describes the RCM-12 and RCM-14 equipments, a complete remote control system for unattended

A NEW  
*twist*  
FOR YOUR PRODUCT

*Lewis*

can help YOU improve

YOUR product . . .

simplify production!

It's amazing what things as commonplace as springs, coils and wireforms can do to help product performance and sales appeal! But, as Lewis Engineers can show you, there's more to a spring than just a coil of wire. The design and selection of material can "make or break" an otherwise good product. That's why it pays to choose a supplier who has the experience, reputation and facilities to furnish you with springs, coils and wireforms that are expertly designed and engineered to fit your product's exact needs.

**Call on Lewis!** Show us your product . . . tell us your problems . . . see how Lewis Engineers come up with the perfect answer to increased product performance and lower production costs! Drop us a line today!

**LEWIS SPRING & MANUFACTURING COMPANY**

2656 W. NORTH AVENUE, CHICAGO 47, ILLINOIS

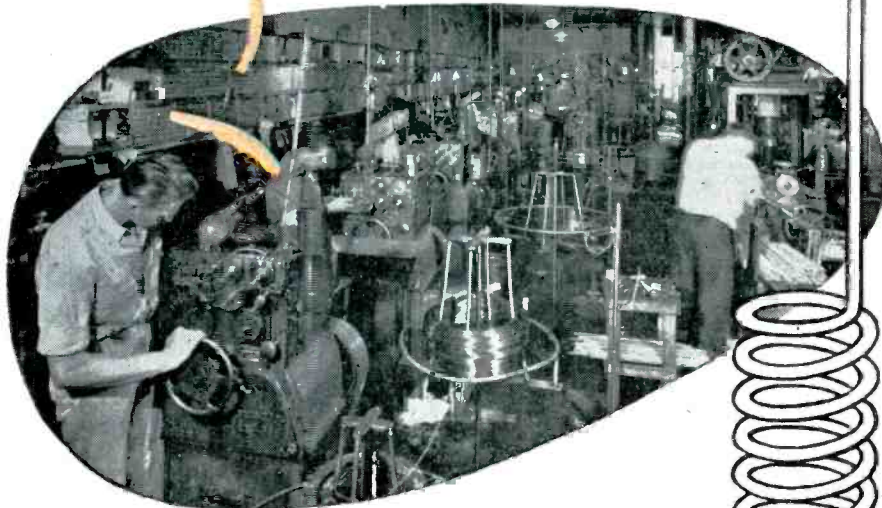

*Lewis* **PRECISION SPRINGS**  
THE FINEST LIGHT SPRINGS AND WIREFORMS OF EVERY TYPE AND MATERIAL



we don't shrink heads...  
but we do shrink

# Transformers!

If you think Jivaro Indians were experts at shrinking things... (human heads, that is)... look what STANCOR engineers have done with transistor transformers! Recently they designed and are now producing the smallest transformer ever built!

How big is this new transformer? Well, it's just  $\frac{1}{4}$ " x  $\frac{3}{8}$ " x  $\frac{3}{8}$ " and it weighs only 0.07 ounce. Designed especially for transistor applications, this unit is no larger than the transistor it powers.

It is one of a series of transistor transformers, being built by Stancor, for development and commercial applications. If you are planning to use transistors, take advantage of Stancor's knowledge of engineering and manufacturing of ultra-miniature transformers.

## STANCOR TRANSISTOR TRANSFORMERS

These stock transistor transformers are available through your Stancor distributor:

TYPE	APPLICATION	PRI. IMP.	SEC. IMP.
UM-110	Interstage	20,000	1,000
UM-111	Output or matching	1,000	60
UM-112	High imp. mic. to emitter	200,000	1,000

Other transistor transformers, built to your special requirements, are available for original equipment production only. Write for Bulletin 462.

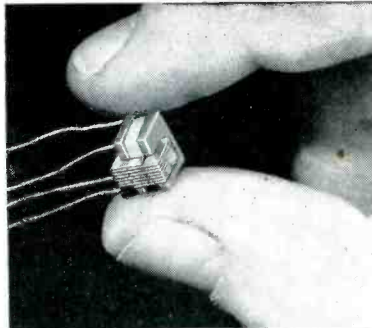

## STANCOR TINYTRANS Miniature, cased audio transformers

Here are four new cataloged high fidelity transformers for use where space is at a premium. These units have a frequency response of  $\pm 1$  db, 30-20,000 cps. They are impregnated and sealed in a  $\frac{1}{8}$ " square, drawn aluminum can, with  $\frac{1}{8}$ " terminals mounted on a phenolic terminal board. Total height is  $1\frac{1}{4}$ ".

TYPE	APPLICATION	PRI. IMP.	SEC. IMP.
TT-11	Mic., pickup or line to single grid.	50, 200/250, 500/600	50,000
TT-12	Mic., pickup or line to push-pull grids.	50, 200/250, 500/600	50,000
TT-13	Dynamic mic., to single grid.	7.5/30	50,000
TT-14	Single plate to single grid.	15,000	60,000

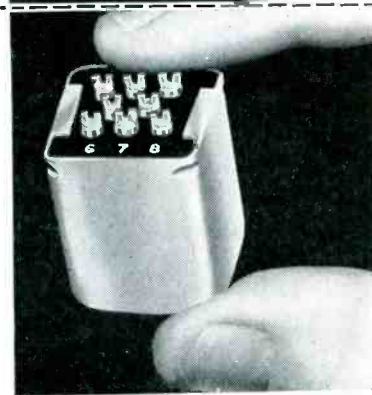

Ask your Stancor Distributor for Bulletin 463 on Stancor Tinytrans, or write us for your free copy.



## STANDARD TRANSFORMER CORPORATION

3578 ELSTON AVENUE • CHICAGO 18, ILLINOIS  
EXPORT SALES: Roburn Agencies, Inc., 39 Warren Street, New York 7, N. Y.

operation in broadcasting stations up to 10,000-w power. Sizes, specifications and equipment supplied are listed.

**Standby Power for Communications Systems.** D. W. Onan & Sons, Inc., Minneapolis 14, Minn., in its folder Form A-307, shows how standby power protects communications systems everywhere. The folder contains examples of portable and mobile electric plants on the job providing primary electric power for mobile tv studios, radio remote broadcasting units, tv maintenance trucks and mobile civil defense centers. Other illustrations describe the company's units used as standby in such vital communications centers as county police departments, taxicab dispatching offices, telephone companies and radio stations. Descriptions of popular models of Onan portable, mobile and standby electric-generating plants as well as automatic line-transfer controls are given.

**Relays.** Potter & Brumfield, Princeton, Ind. Catalog 122 describes relays and contactors for every electrical and electronic application—power, multiple contact, multiple leaf, latching, plate circuit, impulse, space-saver, telephone, miniature, shock-proof, motor starting, supersensitive and photo flash. Also shown are enclosures for sealing individual relays or multiple groups hermetically; and octal, solder-terminal and miniature plug-in connections. Comprehensive presentation facilitates ordering procedure, offers valuable assistance in development problems and in selecting the proper type relay to meet industrial and military requirements. Easy-to-read charts list complete, up-to-date coil and contact data on every relay.

**UHF Antenna Orientation.** United Technical Laboratories, Morristown, N. J. Bulletin No. 2 discusses a novel method of placing and orienting uhf antennas for maximum tv picture signal. The method described eliminates need for rooftop shouting or the use of expensive uhf field-strength measurements. (A single serviceman can

check the entire roof and obtain maximum picture signal strength). The description shows that, at uhf, a difference of as little as 3 ft in antenna placement, and 5 to 10 deg in orientation, can make a large difference in the strength of the received tv picture.

**Educational TV Station Costs.** Radio Corp. of America, Camden, N. J. A complete analysis of estimated equipment and operating costs for typical educational tv stations has been prepared in booklet form. The booklet furnishes a guide to costs for both uhf and vhf stations ranging from low-power outlets with simple studio facilities, to high-power stations featuring complex, multistudio facilities, with variations depending on range of coverage and number of hours of operation desired. Number and type of personnel, and costs of salaries and supplies are also included. In addition to cost estimates, a complete station layout and a sample floor plan for a typical small tv station are presented.

**Gas-Free Metals.** Vacuum Metals Corp., 70 Memorial Drive, Cambridge, Mass., offers technical data sheets on: (1) Cuprovac-E, gas-free high-purity copper with properties suited for vacuum-tube manufacture; and (2) Ferrovac-52100, a gas-free alloy bearing steel, free of inclusions, with greatly improved fatigue properties. The company also offers reprints of a recently published technical article giving details of performance tests and data on Ferrovac-52100.

**Asbestos Electrical Insulations.** Johns-Manville, 22 E. 40th St., New York 16, N. Y. "Quinterra-Quinorgo" is the title of a new 32-page publication recently issued. It gives complete information about these electrical insulations made of purified asbestos—why they were developed, what their characteristics are, and where they may be used to advantage. The bulletin is both a manual of facts and a descriptive brochure. For the designer of electrical equipment there are tables giving test data on physical and electrical

# PICKARD & BURNS HIGH PRECISION TEST EQUIPMENT

## BOLOMETER AMPLIFIERS

P & B Bolometer Amplifiers can be used wherever accurate, repeatable metering or recording of low level outputs is required. They were originally designed to facilitate the measurement of RF field strengths of antenna systems and RF networks, but can be used just as effectively in any region of the radiation spectrum and in several fields of science:—chemistry, biology, nuclear physics and spectroscopy, etc.



### MODEL 100 BOLOMETER AMPLIFIER

**TUNABLE FREQUENCY RANGE** — 400 to 5000 cycles ( $\pm 3\%$  calibration accuracy).

**VARIABLE BANDWIDTH** — ( $1/2$  voltage) 6, 12, 22, 50, 100 and 300 cycles.

**VOLTAGE RATIO EXPANDER** — eighth power expander for the accurate measurement of extremely small variations.

**AUTOMATIC NORMALIZATION** — output voltage holds within  $\pm 1/4$  db for input changes of  $\pm 5$  db to both signal and monitor channels.

**SELF-CONTAINED METERING** — Removable (up to 20 feet) voltmeter, logarithmic scale with 100 db decade.

**RECORDER OUTPUT** — .01 to 100 volts at .01 watt maximum (undecoded). Designed to operate strip-chart recorders for antenna pattern and standing wave ratio determinations. Write for Bulletin L-100.



### MODEL 60 BOLOMETER AMPLIFIER

This model was designed to meet a demand for an inexpensive, yet highly accurate instrument not requiring the special features of the Model 100. Write for Bulletin L-60.

## 500 WATT AUDIO AMPLIFIER

High-precision vibration testing — up to now — has been limited to small components and assemblies. The new P & B 500 Watt Audio Amplifier has greatly extended the test range by making available fairly massive outputs of power to operate shaker tables.

The amplifier is normally driven by a built-in audio oscillator, or if desired, by an outside source such as a tape recording of unique vibration waveforms. It delivers 500 watts over a frequency range of 15 to 500 cycles with minimum distortion and hum. Continuous power metering is provided.



### GENERAL CHARACTERISTICS

**FREQUENCY RANGE** — 15 to 500 cycles.

**POWER OUTPUT** — 500 watts into a resistance load.

**OUTPUT IMPEDANCE** — 0.1, 0.4, 1.0, 4, 10, 40, 125 and 500 ohms at output transformer taps.

**METERING** — Output watts, current and voltage on control panel.

**DISTORTION** — Less than 5% at full power output above 30 cycles.

**HUM** — Less than 0.5% of maximum output voltage.

**STABILITY** —  $\pm 2\%$  power output for line voltage changes of  $\pm 10\%$ .

**POWER INPUT** — 115 volts, 30 amperes at 60 cycles.

**SIZE** — 24" wide, 36" high, 39 1/2" deep.

**WEIGHT** — 850 pounds.

For complete information write to:



**PICKARD & BURNS**  
INCORPORATED

240 Highland Avenue, Needham 94, Mass.

**the inside story of SILICONE RUBBER protection**

**with the NEW BRAND TURBO "117" SLEEVING**

**NEVER CRACKS • WON'T CRAZE • NEVER LOSES ITS DIELECTRIC STRENGTH**

**TURBO 117 SLEEVING**

- ... durable silicone rubber coating fused to fibrous glass braid ... cannot be peeled ... can be supplied to meet all Class "H" performance requirements of MIL-I-3190, NEMA VS-1 ... lasting dielectric strength ... humidity-resistant ... oil-resistant ... flame-resistant ... non-corrosive ... fungus-resistant.

**Inside the Silicone Rubber Sleevings**

**TURBO 117 SLEEVING**

- ... scientifically designed to be kink-proof ... can be knotted, bent, twisted ... engineered to meet extremes of temperature ... flexible at -100° F ... unchanged by temperatures as high as 500° F ...

Samples will be sent to you on separate order. Be sure to ask for Turbo 117 Sleevings.

**Write for Bulletin**

**UNITED TO LAST!**

properties. Test methods are fully explained and there is a separate table for each of the several types of Quinterra and Quinorgo. For the production man there is advice on application techniques and equipment including step-by-step photographic coverage of methods now in use. In addition to photographs, many of the picture stories have sectional diagrams showing how, in a single piece of equipment, Quinterra and Quinorgo are used in many different places—for core tubes, layer insulation, wire wrapping, interlaminar insulation, end washers and the final wrapper insulation.

**Wire-Wound Resistors.** Sprague Electric Co., North Adams, Mass. Engineering Bulletin No. 120 on Durameg accurate wire-wound resistors describes a new type of resistor construction for precision wire-wound resistors, with outstanding performance characteristics. Wattage ratings of the resistors described at 105C are from four to five times the 85C military ratings for the best of conventional resistor constructions. Illustrations and technical data are included in the 4-page bulletin.

**Piezotronics.** Brush Electronics Co., 3405 Perkins Ave., Cleveland 14, Ohio. A 32-page booklet is entitled "Piezotronic Technical Data." This reference compares general properties of piezoelectric materials, describes their basic behavior, lists electronic circuit applications and considerations, and gives basic electrical, mechanical and electromechanical properties and equivalent circuit data.

**Delay Lines.** Anderson Laboratories Inc., 39 Talcott Rd., West Hartford, 10, Conn., has issued a 4-page illustrated bulletin dealing with its solid ultrasonic delay lines. The publication gives chief applications and general technical specifications for the units whose delay times are obtainable in a range from 0.6 μsec to 1,000 and higher.

**Foreign Markets.** Netherlands Industrial Institute, Hotel Biltmore, Madison Ave. & 43rd St., New York 17, N. Y. Market opportunities for American manufac-

INSULATING MATERIAL **TURBO** SPECIALISTS SINCE 1920

**THE WILLIAM BRAND AND CO., INC.**

DEPT. E-7 WILLIMANTIC, CONN., U.S.A. Telephone HARRISON 3-1661

TURBO Insulated Wires • Wire Markers • Extruded Tubing • Glass Sleevings and Tubing • Varnished Saturated Sleevings and Tubing • Cambric Cloths, Tapes, Papers • Mica.

SALES REPRESENTATIVES IN PRINCIPAL CITIES

turers of electrical equipment who are considering establishing manufacturing operations in Holland are outlined in an 8-page booklet "Opportunities for Foreign Participation in the Netherlands Electrical Engineering Industry." The booklet points out that Dutch imports far outbalance exports in such fields as rotating machinery, transformers, rectifiers, storage batteries, switchgear and communications equipment.

**Transformer Catalog.** Triad Transformer Corp., 4055 Redwood Ave., Venice, Calif. The 1953 catalog TR-53 lists more than 500 items. It features an expanded line of tv components and industrial transformers, including toroids, pulse transformers, transistor transformers and additional miniatures. The catalog—with standard 3-hole punch for convenience in filing—also contains a geophysical section.

**High-Temperature Insulation.** Electro-Technical Products Division, Sun Chemical Corp., 113 East Centre St., Nutley 10, N. J. A 4-page folder covers two types of class-H insulation known as Sil-Thin-Glas and Sil-Thin-Bestos. The products described were designed to effect size and weight reduction in the design of electrical equipment required to operate at class-H temperatures. Suggested uses and test data are included.

**Beryllium Copper Components.** Instrument Specialties Co., Inc., Little Falls, N. J. Catalog No. 7A is an 8-page folder entitled "Electronic Components of Beryllium Copper." Included are illustrated descriptions of h-f contact rings, contact strips, short-run specialties, folded-type contact strips, folded-type standard contact rings, a microwave kit and an engineer's assortment that contains 100 beryllium copper helical compression springs, 50 pairs, all different.

**Iron Powders.** Magnetic Powders, Inc., 1014 Fairview Ave., Johnsonburg, Pa., has available an 8-page illustrated catalog 354 covering complete technical data, including the various photomicrographs, frequency-vs-Q charts and permeabil-

# MILWAUKEE TRANSFORMERS



**A TYPE FOR EVERY NEED  
A PERFORMANCE TO EXCEED  
EVERY DEMAND!**

Hermetically Sealed Components That Perform Superbly and Lastingly in Airborne and Ground Applications.

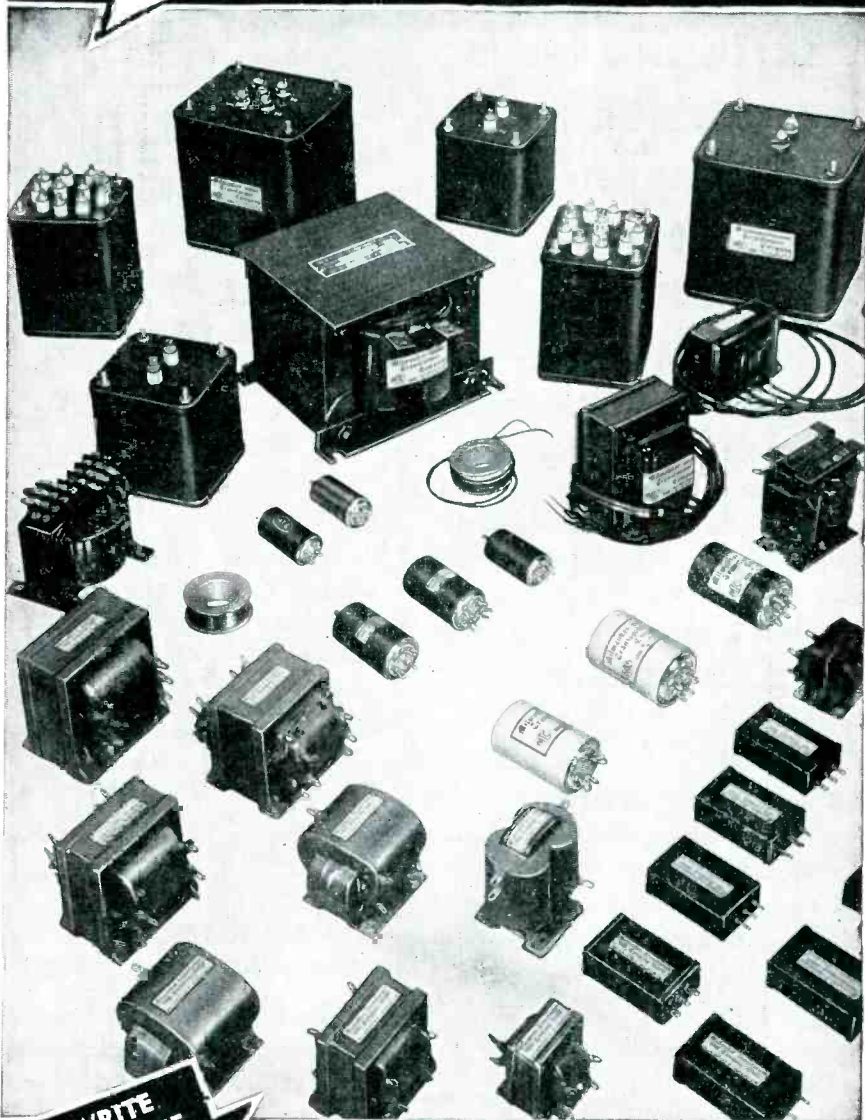

**WRITE FOR FREE BROCHURE**

**AUDIO, POWER, PULSE TRANSFORMERS  
REACTORS — FILTER NETWORKS**

Custom Engineered to rigid MIL T-27 government and commercial requirements.

**MILWAUKEE TRANSFORMER CO.**

5231 NORTH HOPKINS STREET  
MILWAUKEE 9, WISCONSIN



# Announcing THE **Potter**

**DIGITAL**

## **MAGNETIC-TAPE HANDLER**

### **A PRECISION RECORDER AT A REASONABLE PRICE!**

**SPECIFY IT FOR:**  
**START-STOP RECORDING**  
 •  
**DATA REDUCTION**  
 •  
**TELEMETERING**  
 •  
**SORTING**  
 •  
**COLLATING**  
 •  
**LIST PROCESSING**

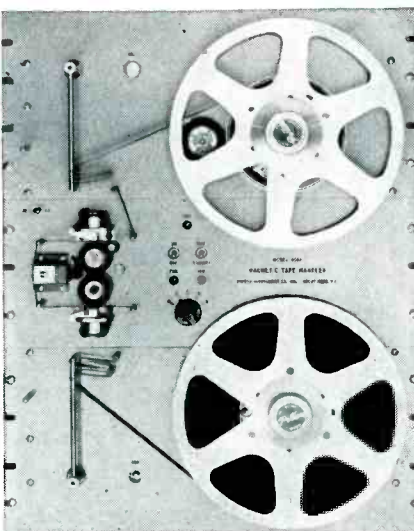

Here is a new high-speed Magnetic Tape Handler for every data recording application. Exclusive features provide maximum versatility, complete dependability, ease of operation, and simplicity of maintenance, and do it at a price thousands of dollars below anything now available.

Unique in every respect, this outstanding Potter precision instrument provides 5 millisecond start and stop, forward or reverse, from external signals. Record, playback, or compare—every desirable function can be accomplished easily.

Do you have a problem in efficient and economical data handling? Check the performance specifications in the column at the right and, for complete information on how to fit the Potter Magnetic-Tape Handler into your program, **write, now, to Dept 7C.**

#### **SPECIFICATIONS**

	Model 901A	Model 901B
Tape Width	½"	¼"
*No. of tracks	6	2
Reel Size	NAB Standard, 10½"	
Reel Capacity	2400 ft.	
Tape Speed	Dual-speed, 15 and 30 inches/sec.	
Start & Stop Time	5 millisecond, either direction.	
Control	Manual, or remote pulses, 15 volts positive.	

\*Greater number of tracks available on special order.

#### **ASSOCIATED DATA HANDLING COMPONENTS**

Complete Data Handling Systems or individual plug-in components are available. Recording and playback amplifiers, electronic counters with transfer gates, shift registers, and other associated data reduction components can be supplied for special data handling problems.

NEW PRODUCTS

(continued)

ity rating graphs, on the uses and applications of annealed carbonyl iron powders, hydrogen reduced iron powders and Magna-tites. The catalog is obtainable for the writing.

**Plastic and Fibre Insulations.** Insulation Manufacturers Corp., 565 W. Washington Blvd., Chicago 6, Ill. Helpful information on the features and uses of fibre and plastic for electrical insulation are incorporated in two catalogs recently published. Imcor reinforced plastics are described in an 8-page catalog while Phenolite laminated plastics, National vulcanized fibre, and Peerless fishpaper products are covered in a 32-page catalog. Both folders give complete descriptions, tabular data and other information on grades, properties and fabricating techniques for sheets, rods, tubes and fabricated or molded parts.

**Components Catalog.** Industrial Hardware Mfg. Co., Inc., 109 Prince St., New York 12, N. Y., has published a catalog describing and illustrating its facilities for the manufacture of a wide variety of component parts. Parts illustrated include: sockets (octal, noval, miniatures, speaker and vibrator, and kinescope); terminal strips; support assemblies, Bakelite stampings and wired assemblies; battery connectors; terminal boards, assemblies and JAN components; and screw machine parts. Specifications are given.

**Solid-Copper Enclosures.** RFI Shielded Enclosures Corp., 3634 N. Lawrence St., Philadelphia 40, Pa. Complete application and performance data on solid-copper enclosures for suppressing r-f interference is available in a new publication. Bulletin No. 1 describes how these portable, weatherproof enclosures may be used to eliminate r-f interference when making tests on sensitive electric and electronic equipment as well as to suppress radiation from industrial equipment that would otherwise cause serious radio or tv interference in the community. An interesting section of the booklet is a graph prepared by the Hopkins Engineering Co., an independent laboratory. Conservatively plotted

**POTTER INSTRUMENT COMPANY**  
 INCORPORATED  
 116 CUTTER MILL ROAD, GREAT NECK, NEW YORK

over a range of 100 kc to 100 mc, this graph proves that the enclosures provide a minimum attenuation of 100 db over that entire range. Standard and special sizes, service facilities and air-conditioning are also discussed.

**Tiny Indicator Lights.** Dialight Corp., 58 Stewart Ave., Brooklyn 37, N. Y. The subminiature lights described in brochure L-153 are made to mount in  $\frac{1}{8}$ -in. clearance hole; and they come equipped with any desired midget flanged base T-1 $\frac{1}{2}$  bulb. Units described fall into the following general categories: (1) For plastic plate edge lighting, qualified products list approval QPL-7806; (2) Indicator lights, nondimming; (3) Dimmer types, mechanical or polaroid; (4) Light shield, for lighting dials and instruments; (5) Indicator lights with patented press-to-test feature and dimming or nondimming lens caps. Diagrams and technical data facilitate procurement of units from the brochure.

**Germanium Transistors.** Radio Corp. of America, Harrison, N. J. An 8-page booklet introduces 4 types of germanium transistors—2 point-contact and 2 junction. Included are descriptions of the 2N32 and 2N33 point-contact transistors and the types 2N34 and 2N35 junction transistors of the pnp and npn type respectively. Each of the four types discussed has a base with three small pins in line and spaced to provide mechanical indexing for socket insertion.

**Germanium Diodes.** International Rectifier Corp., 1521 E. Grand Ave., El Segundo, Calif. Bulletin GD-1 describes fully the characteristics and advantages of a new line of germanium diodes. Included are a cross-sectional diagram, technical specifications and information on special purpose types.

**Automatic Data Analyses.** Minneapolis-Honeywell Regulator Co., Wayne and Windrim Ave., Philadelphia 44, Pa. Automatic analysis of oscillographic data is described in instrumentation data sheet No. 10.0-11. The single-sheet bulletin gives typical applications, accuracy and range, operation in-

# SMALL PARTS can play a BIG PART in...

## Lower Production Costs!

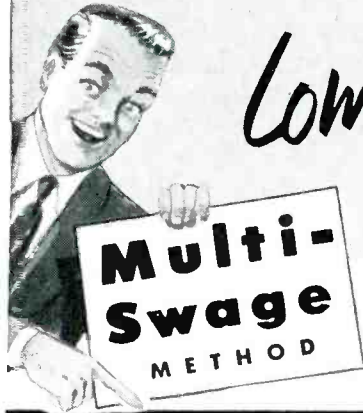

Leading manufacturers in the electronics, machinery, appliance and toy fields have been saving substantially by using precision Multi-Swage parts instead of those previously made by turning, drilling, stamping or forming.

HERE ARE ONLY A FEW TYPICAL TINY PARTS MADE BY BEAD CHAIN'S Economical, Dependable MULTI-SWAGE METHOD

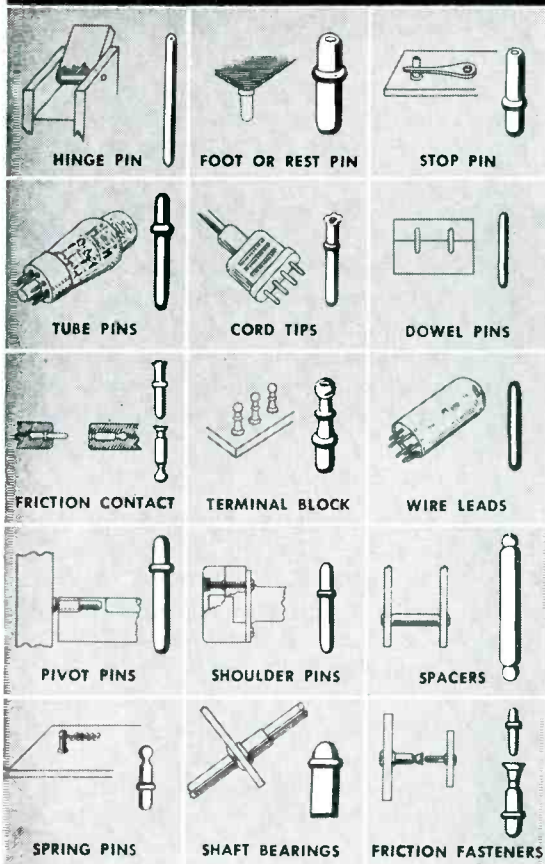

LET BEAD CHAIN MAKE YOUR

### Tiny Parts to your Specifications at far less cost!

The advanced manufacturing method developed and used exclusively by Bead Chain swages practically any type of small tubular part from flat stock into precision forms with positive, tight seams... and does it *Automatically*. If you can use high-volume production... we can deliver it at a much faster rate... and at far less cost! Scrap is eliminated! Deliveries to you are dependably prompt!

We can supply you with parts that are beaded, grooved, shouldered and made with almost any metal. Diameters up to  $\frac{1}{4}$ " lengths to  $1\frac{1}{2}$ "

This catalog can save you a lot of production time and money! Write for it



### GET PROOF-POSITIVE COST COMPARISONS!

Send us a blueprint or sample and quantity requirements. We will quickly show you the big economies we can deliver.

**BEAD CHAIN**   
Original and World's Largest Producer of Bead Chain

THE BEAD CHAIN MFG. CO. BRIDGEPORT 5, CONNECTICUT

Please send me your Catalog of Multi-Swage Parts

NAME \_\_\_\_\_

TITLE \_\_\_\_\_

COMPANY \_\_\_\_\_

ADDRESS \_\_\_\_\_

KEY NO. 88

THE BEAD CHAIN MANUFACTURING CO., BRIDGEPORT 5, CONN.

Improve Tube  
Performance  
with WESGO  
"AL-300"  
ALUMINA  
INSULATORS

97% Al<sub>2</sub>O<sub>3</sub> content

Vacuum tight — extraordinary strength

Low loss factor—High Te value

Non "gassing" — no poisoning of emitters

High strength at all temperatures up to 1500° C.

Can be supplied in most any shape to extremely close tolerances

*Our Engineering Department will gladly answer all inquiries relative to your particular problems*

**WESTERN GOLD & PLATINUM WORKS**  
Ceramic Division  
589 BRYANT STREET  
SAN FRANCISCO, CALIF.

Want more information? Use post card on last page.

formation and general characteristics. An illustration of the system is included.

**Microwave Data.** Sightmaster of California Co., Gillespie Airport, Santee, Calif., has announced new microwave handbook data entitled Introductory Concepts to Microwaves, containing 16 full pages of basic microwave and waveguide information. Also included is a catalog appendix of the company's products and developments in the fields of microwave calorimeters and cast waveguides. This information is in easy-to-understand form and includes several cuts and illustrations to make waveguide phenomena better understandable to those with limited past experience in the microwave art.

**Microwave Data.** Henry L. Crowley & Co., Inc., 1 Central Ave., West Orange, N. J., has available a concise yet profusely illustrated bulletin entitled "Microwave Components." It deals with Polyiron, a material readily molded or machined to any shape, and with which it is possible to attain attenuation up to 300 db per in. with lower standing-wave ratios. The bulletin also deals with various kinds of terminations, stock blank sizes, machining procedures, and drawings of typical Polyiron fabrications.

**R-F Attenuation Filters.** Cornell-Dubilier Electric Corp., South Plainfield, N. J. Bulletin No. NB-148 is a 12-page catalog with descriptions, illustrations and technical data of a portion of a wide line of Quietone filters. More than 135 types of feed-through, PI and universal filters are listed. Besides complete, detailed, electrical characteristics, the descriptions include outline drawings, physical characteristics, circuit diagrams, photographs and charts.

**Automatic Welding Equipment.** Federal Tool Engineering Co., 1386 Pompton Ave., Cedar Grove, N. J. A new bulletin describes Tweezer-Weld automatic welding equipment that will weld almost microscopic parts such as diodes at 1,200 per hr; that will weld studs, for example on c-r cylinders up to 6,000 studs per hr; that will

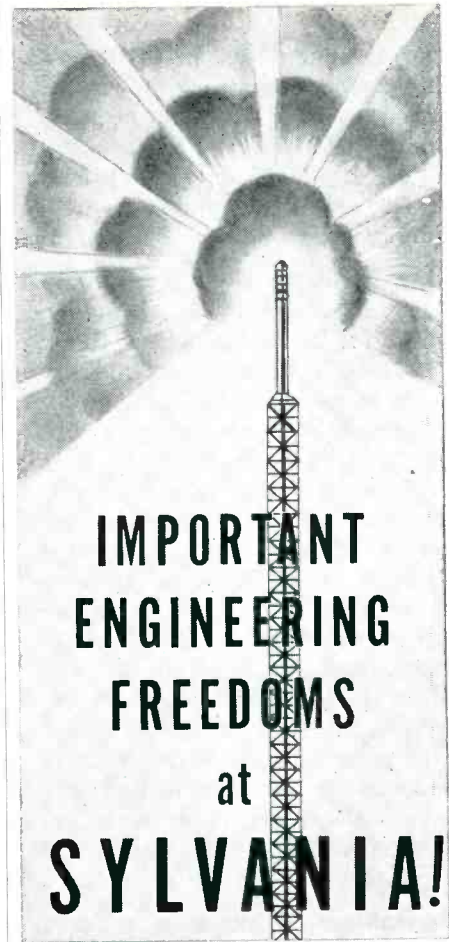

**IMPORTANT  
ENGINEERING  
FREEDOMS  
at  
SYLVANIA!**

All too often, farsighted engineering ideas and aims are held in check by everyday job requirements. Engineers made of the right "stuff" hold a secret yearning to break the shackles of today — to think in terms of the possibilities of tomorrow.

Sylvania thinks that way, too — has thought so for years. As a result, Sylvania encourages its engineers to pioneer, develop, follow through on their ideas, write and speak on their chosen subject to gain professional recognition.

If you are looking for a stimulating challenge that will last a lifetime — investigate the splendid career opportunities with fast-growing Sylvania.

Send your resume to:

JOHN C. WELD  
Supervisor of Employment  
254 Rano Street, Buffalo 7, New York

DONALD BRADLEY  
Personnel Supervisor  
70 Forsyth Street  
Boston, Mass.



**SYLVANIA**  
**ELECTRIC PRODUCTS INC.**

RADIO AND TELEVISION DIVISION  
254 RANO STREET  
BUFFALO 7, NEW YORK

Want more information? Use post card on last page.

July, 1953 — ELECTRONICS



do glass beading at 200 pieces per hr. Also featured are Tweezer-Weld automatics to weld tabs to radio-tube cathodes at 2,600 parts per hour—to weld stems (for example on fluorescent starter switches) at a rate up to 3,600 parts per hr. The bulletin also describes the new heavy duty kva welding head that is extensively used in subminiature, miniature and bantam-tube industry.

**Altitude Chambers.** Tenney Engineering, Inc., 26 Ave. B, Newark 5, N. J., announces a new 4-page bulletin on its standard line of Tenneyzphere altitude chambers. The bulletin covers test chambers for simulating altitudes from sea level to approximately 80,000 ft; temperatures from -100F to +200 F; and relative humidities from 20 to 90 percent. It includes performance data, standard and special features, specifications giving sizes and operating characteristics of all standard models and chamber construction information. Also included are six illustrations showing both inside and outside views of different size chambers and the instrument control panels that make it possible automatically to cycle test conditions.

**Intermediate Shaker Systems.** The Calidyne Co., 751 Main St., Winchester, Mass. Bulletin 6405 is an 8-page booklet dealing with intermediate shaker systems having 600 to 1,250-lb force output. Illustrations and chief features are included for the models 44 and 58 shakers, model 64 control consoles and model 45 rotary power supplies. Data on accessories and ordering information are given.

**Precision Instrument Bearings.** New Hampshire Ball Bearings, Inc., Peterborough 1, N. H. Catalog No. 53 includes 28 pages of dimensional and design data on 137 Micro ball bearings, in bore sizes 0.025 to  $\frac{1}{16}$  in., O. D. 0.100 to  $\frac{1}{2}$  in. Featured are the first ground miniature bearings in the U. S. Loads, speeds, mounting lubrication, tolerances, gaging and handling of instrument bearings are also discussed.

## Sensitive Galvanometer Used in Guided Missile Research...



## ...Protected by an EDISON Time Delay Relay

Malfunction or failure of recording equipment when a guided missile is fired can result in the loss of invaluable research data. The requirement of complete reliability of components used in conjunction with this equipment resulted in the selection of an EDISON Time Delay Relay as a vital part of the Model 46A Sub-Carrier Discriminator manufactured by Electro-Mechanical Research, Inc., Ridgefield, Conn.

The Edison Time Delay Relay is used to protect the sensitive galvanometer in the associated oscillographic recording unit, by allowing the power tube filaments to reach proper operating temperature before the application of high voltage. The thermal action is independent of line voltage variations since the delay characteristics vary in the same proportions as the heating of the filaments. Because of their cooling rate, EDISON relays prevent loss of equipment operating time due to momentary power interruptions.

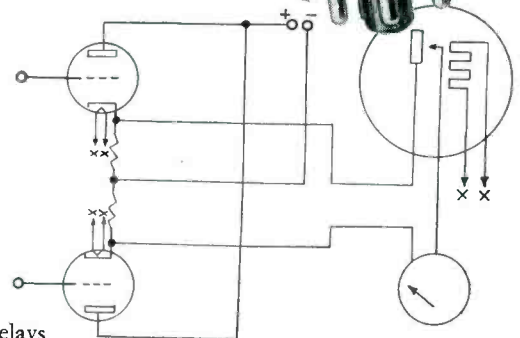

Edison engineers will be glad to help solve your cathode protection problems. Just call or write to:

**Thomas A Edison**  
INCORPORATED  
Instrument Division  
Dept. 54, West Orange, New Jersey

**YOU CAN ALWAYS RELY ON EDISON**



# PLANTS AND PEOPLE

Edited by WILLIAM G. ARNOLD

## Electronic Manufacturers Aid Engineering Education

FOURTEEN new scholarships for electronic and electrical engineering students have been established at Pacific Coast universities and colleges by a group of western electronic manufacturing firms. The new scholarships, ranging from \$600 to \$800 per student will be awarded directly by 8 educational institutions to entering electronic and electrical engineering students. Although designed primarily to encourage first and second year students and junior college transfers to enter engineering, the awards will also be available to graduate engineering students.

Sponsoring the scholarships are the 140 member firms of the West Coast Electronic Manufacturer's Association, a group of concerns employing over 32,000 men and women and contributing over twenty percent of the nation's elec-

tronic production.

The scholarship fund was established and will be maintained by voluntary donations from association members. Awards will be granted annually to deserving and needful students regardless of race, color or creed.

In the East, three Massachusetts electronic manufacturers are strengthening the work of the Graduate School of Arts and Sciences of Harvard University with the provision of 5 industrial fellowships through the Harvard Foundation for Advanced Study and Research.

The General Communication Company of Boston has given \$5,000 to provide two fellowships of \$2,500 each, one in the Division of Applied Science and one in the Department of Physics, for 1953-54; Polaroid Corp. of Cambridge,

## OTHER DEPARTMENTS

featured for this issue:

	Page
Electrons At Work . . . . .	196
Production Techniques . . . . .	262
New Products . . . . .	292
New Books . . . . .	364
Backtalk . . . . .	386

will give \$2,500 for one fellowship in the Department of Physics in 1953-54; Raytheon Manufacturing Co. of Waltham gave \$5,000 for 2 fellowships in the Department of Physics during the present academic year, these to be renewed next year as well.

## WESCON Technical Program Takes Form

GENERAL outlines of the technical papers program for the fourthcoming WESCON (Western Electronic Show and Convention) in San Francisco August 19-21 are crystallized into 17 sessions including approxi-

## NATIONAL TELEVISION SYSTEM COMMITTEE MEETS



The following members and observers were present at a meeting of the NTSC held recently at IRE headquarters in New York City: Seated (left to right), Mrs. Martha Kinzie, NTSC Secretary; A. N. Goldsmith, consulting engineer; A. V. Loughren, Hazeltine, NTSC vice-chairman; E. W. Engstrom, RCA, NTSC vice-chairman; W. R. G. Baker, GE, NTSC chairman; R. H. Harmon, Westinghouse; W. T. Winttingham, Bell Laboratories; Knox McIlwain, Hazeltine; O. H. Caldwell, Caldwell-Clements; Jerome Bresson, Tele-King; G. L. Beers, RCA; R. E. Shelby, NBC; John Rennick, Zenith; D. E. Harnett, GE; A. G. Jensen, Bell Laboratories; R. M. Bowie, Sylvania; Rinaldo De Cola, Admiral; L. M. Clement, Crosley. Standing (left to right) S. J. Melman, CBS-Columbia; J. M. Miller, Jr., Bendix; I. J. Kaar, GE; J. W. Christenson, CBS Laboratories; C. J. Hirsch, Hazeltine; L. R. Fink, GE; R. W. Mueller, Sentinel; W. W. MacDonald, ELECTRONICS; Richard Hodgson, Chromatic Television Laboratories; J. M. Barstow, Bell Laboratories; W. Feingold, Emerson

# THE REMARKABLE PERFORMANCE

# of REXOLITE 1422

**DIELECTRIC CONSTANT VS FREQUENCY**

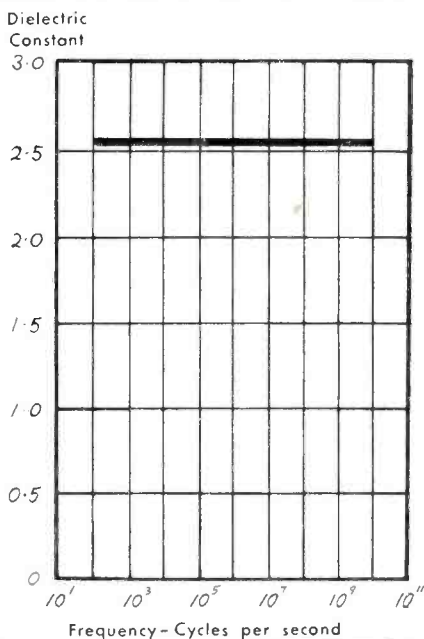

**DISSIPATION FACTOR VS FREQUENCY**

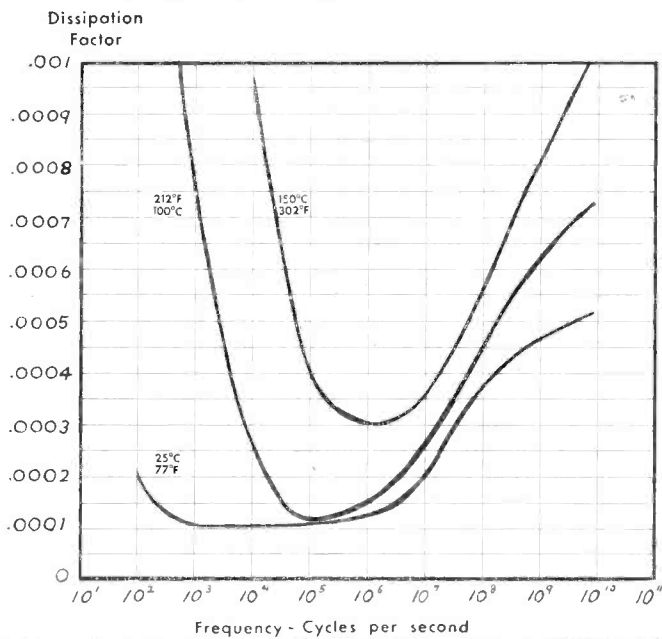

**DISSIPATION FACTOR — EXTREMELY LOW OVER ENTIRE R.F. & U.H.F. RANGE**  
**DIELECTRIC CONSTANT — NO CHANGE WITH FREQUENCY**

This wonderful insulation performance coupled with a high heat distortion point (105°—113°C) and the resulting good machinability make Rexolite 1422 an amazing High Frequency insulation. It equals or excels all but a few of the fine qualities of the much more expensive fluorocarbons. Even in the "few," it is superb in its own right and very close to the fluorocarbons — as

in the case of Dielectric Constant shown in the above chart.

Rexolite 1422 is a carefully controlled cross-linked polystyrene. Developed by two of the country's greatest laboratories and manufactured for 10 years, Rexolite 1422 is highly dependable in quality, uniformity and performance.

*If you have RF or UHF insulating problems calling for sheets, rods, castings or imbedments, check Rexolite 1422. We welcome problems. Write to us for information, full size copies of the above charts and technical bulletins.*

## THE REX CORPORATION

Manufacturers of UHF Insulating Materials, Microwall Wire\*\* Kel-F\* insulated wire, other Wire Specialties, Rextrude\*\* 105 Electrical Tubing and Custom Plastic Extrusions.  
**West Acton, Massachusetts, U.S.A.**



\* T.M. of M. W. Kellogg Co.  
 \*\* Reg U.S. Pat. Off.

mately 85 papers, according to an announcement by Bernard M. Oliver of Hewlett-Packard Co., WESCON papers chairman. WESCON is jointly sponsored by the IRE (7th region) and WCEMA (West Coast Electronic Manufacturers Association).

Still subject to minor changes, shifts and additions, the program will include two sessions each on antennas, propagation, electron devices, circuits, and computers, and one session each on airborne electronics, microwave techniques, servos and telemetering, instrumentation, transistors, and nuclear-radiation measurements.

Of the evening sessions scheduled; one will be on medical electronics, another on audio, and a third on generalized topics of broad scope.

Meetings on related subjects are being scheduled to be held in the San Francisco Bay area preceding the WESCON program. One of these is a joint UCLA-ONR information theory symposium in Berkeley, August 17 and 18. Another is a special discussion of magnetic recording apparatus and techniques, given for the Federal Court Reporters and sponsored by the San Francisco Section of the Audio Engineering Society.

### Electronic Firms Expand Westward and Eastward

CONTRASTING patterns of plant expansion in the electronics industry are indicated by the recent moves of Aerovox Corp. and Hoffman Radio Corp.

Aerovox announced recently through its president, W. Myron Owen, the acquisition of Cinema Engineering Co. of Burbank, Calif. It marks another addition to the company's west coast facilities in recent months. Aerovox is currently constructing a new plant in Burbank, Calif., to augment its present facilities there and a \$900,000 plant in Monrovia, Calif. which

will provide additional manufacturing facilities for the west coast market.

In a two-fold expansion program, Hoffman Radio Corp. will increase its tv set production in California and extend its output for eastern and midwest markets through the construction of a \$1 million factory in Kansas City. This west-to-east expansion is the first such move by a California tv set manufacturer.

Hoffman expects to employ approximately 1,000 people in the 85,000 sq ft Kansas City factory when it begins operations.

### ACCEPTS MILLIONTH RADIOSONDE



Brig. Gen. W. Preston Corderman (right) commanding the Signal Corps Supply Agency, Philadelphia, accepts the millionth radiosonde unit manufactured by the Friez Instrument Division of Bendix Aviation Corp. from LeRoy D. Kiley, Friez general manager. Presentation took place as General Corderman inspected an automatic calibrator, designed by Friez engineers, which enables two employees to handle precision tests formerly requiring 30 skilled technicians

### GE Makes Changes In Engineering Posts

HARRY A. WINNE, vice-president of engineering of the General Electric Co., has been named to a new post performing special assignments for GE president Ralph J. Cordiner. Mr. Winne's move is in anticipation of his retirement from the company in the latter part of the year.

In his new position, Mr. Winne will serve in a consulting capacity in engineering and will also spend several weeks abroad conducting an investigation on engineering progress in the European electrical industry.

Clarence H. Linder, vice-president and general manager of the company's major appliance division, is to succeed Mr. Winne as vice-president of engineering.

Charles K. Rieger, vice-president and general manager of the Small Appliance Division, is to succeed Mr. Linder as vice-president and general manager of the Major Appliance division.

Willard H. Sahloff, general manager of the electronics Division's Radio and TV Department, is to become general manager of the

### Production Under Way At DuMont's New Plant



Allen B. DuMont Laboratories' new Instrument Division plant in Clifton, N. J. was officially opened in May (ELECTRONICS, p 366, May, 1953). It contains 118,000 sq ft of space for the development and manufacture of cathode-ray instruments. Roughly 30 percent of the plant's output will go to the Armed Forces

*Here  
they  
are*

# 3 LOW COST UHF-TV TEST UNITS

At last there are available precise laboratory test equipments in the UHF-TV field sufficiently low in cost to eliminate the nerve-racking debate which often accompanies capital expenditure.

The New London Instrument Company is proud to make this new departure and equally proud to present for your consideration —



## UHF-TV SWEEP GENERATOR

MODEL 130 • 450 to 900 mc.

The Model 130 has been ingeniously designed to enable us to offer you a precise laboratory instrument low enough in cost for use in production test and servicing departments.

Although precise, the 130 is easy to operate. A minimum of controls is used. Moreover, the signal is blanked on the return sweep, providing a reference baseline.

Here are the essential specifications:

FREQUENCY RANGE . . .

450 to 900 mc. (Single Range)

SWEEP WIDTH . . .

.0 to at least 30 mc. over entire band

OUTPUT VOLTAGE . . .

.001 to 1.0 volts into a 75 ohm load

A balun is available for 300 ohm balanced load.

**\$265**

f.o.b. New London, Connecticut



## UHF GRID DIP OSCILLATOR

MODEL 200 • 400 to 900 mc.

The only grid dip oscillator in its frequency range, the Model 200 combines the oscillator and power supply in one compact unit. Featuring a single range, the 200 has remarkably smooth meter indication.

The Model 200 is an absorption wavemeter, a grid dip meter, an auxiliary signal generator, an absorption marker and has many other uses. It is a most convenient instrument to have if you do UHF-TV work.

**\$140**

f.o.b. New London, Connecticut



## VHF-UHF NOISE SOURCE

(BALANCED DIODE)

MODEL 175 • 0 to 900 mc.

The Model 175 is an ideal, low cost instrument for speed and accuracy in making receiver noise measurements. Featuring direct reading and a 0 to 21 db noise figure, the Model 175 requires no tuning.

Output is 300 ohms balanced. A balun is available to convert to 75 ohms.

**\$355**

f.o.b. New London, Connecticut

*for further details or  
to place your order  
write to*

**New London Instrument  
82 UNION STREET  
NEW LONDON, CONNECTICUT**  
*Company*

New

# UHF SWEEP GENERATOR

## for UHF TV Production Testing



TYPE 1211

The Type 1211 UHF Sweep Generator has been specifically designed to rapidly and accurately align UHF Television heads, converters and complete receivers. Pulse type crystal markers appear every 36 MC throughout the UHF spectrum to afford instant frequency identification. An electrostatic piston attenuator gives continuously variable output level control over approximately 80 db from a maximum output of 1 volt. The power supply is electronically regulated to assure constant output under all line voltage conditions.

### SPECIFICATIONS

**FREQUENCY COVERAGE:** 450 to 900 MC. Dial calibrated in 36 MC steps. **BANDWIDTH:** Constant bandwidth of 50 MC over entire spectrum. Can be adjusted to narrower bandwidths with internal controls. **MARKERS:** Pulse type, crystal controlled, accurate to 0.02%, spaced 36 MC throughout the 450 to 900 MC spectrum. **OUTPUT:** At least 1 volt across a 75 ohm load. **ATTENUATOR:** Electrostatically coupled piston type, range approximately 80 db. **AUXILIARY OUTPUT SIGNALS:** 1. Automatically phased saw-tooth sweep for X axis of scope. 2. Marker pulses either plus or minus polarity, continuously variable in amplitude.

**PRICE \$950.00 F.O.B. PLANT**

### THERE'S A TIC SWEEP GENERATOR FOR EVERY TV TEST REQUIREMENT

**Type 1212 VHF Sweep Generator:** Covers the 12 VHF Channels and provides keyed sound and video markers for each channel. Maximum output 0.5 volt across 75 ohm load. Price: \$785.00. (A 13th channel having markers at 41.25—45.75 MC or 125.25—129.75 MC available at a slight additional cost.)

**Type 1500B IF Sweep Generator:** Designed for accurate alignment of TV sound and video IF amplifiers. Unit incorporates factory-set two band oscillator with maximum sweep ratio of 1.45 to 1. Maximum of 5 crystal markers can be provided for each band. Price: \$295.00 less crystals. Crystals \$15.00 each.

Prices F.O.B. FACTORY

Manufacturers of a Complete Line of TV Test Equipment

**Tel-Instrument Co. Inc.**

50 PATERSON AVENUE • EAST RUTHERFORD, N. J.

Small Appliance Division.

Herbert Riegelman, manager of marketing for the Radio and TV Department, is to succeed Mr. Sahloff as general manager of the department.

### ELECTRONICS CONFERENCE HOSTS



Hosts at the electronic conference in Los Angeles during the RTMA Directors meeting (U. S. and Canada) were, left to right: Robert S. Bell, vice-president of Packard-Bell; H. Leslie Hoffman, president of Hoffman Radio and Charles B. Thornton, vice-president of Hughes Aircraft. Mr. Hoffman was chairman of the 3-man committee

### American Car & Foundry Buys Avion Instrument

THE American Car and Foundry Co. has purchased the entire outstanding capital stock of the Avion Instrument Corp., according to Charles J. Hardy, Jr., president of ACF. Avion will continue under the same management, headed by Richard F. Wehrlin, founder and president.

In commenting on ACF's acquisition, Mr. Hardy stated, "The Avion Instrument Corp., in becoming a division of the American Car and Foundry Co., further broadens our field of activity and brings us into the electronics picture. There are unlimited opportunities ahead of ACF and Avion in further developments which will benefit all industry. The combination of Mr. Wehrlin's staff with ACF's re-

sources and stability means a greater contribution to the defense effort in which both companies are playing an important part."

## ARMY HONORS BAKER



Hon. Earl D. Johnson, Under Secretary of the Army, presented the Medal of Freedom to W. R. G. Baker, vice-president and general manager of GE's Electronics Division, for accelerating the application of electronics to the solution of Army research and development problems. He led a mission of leading scientists and industrialists to Korea last summer to study the problem of utilizing electronic devices and principles to the maximum extent in modern war, thereby increasing the effectiveness of the individual soldier and reducing the cost of human life. According to the citation, Dr. Baker "furnished guidance to the Chief of Staff and the Secretary of the Army which will have a significant impact on the Army's future effectiveness."

## Top Executives Change At Sylvania Electric

THE ELECTIONS of Don G. Mitchell as chairman of the board of directors and H. Ward Zimmer as president of Sylvania Electric Products Inc. were announced by the board of directors.

Both officers have assumed their new duties. Their headquarters are at Sylvania's executive offices in New York City.

Mr. Mitchell, who has been president of Sylvania since 1946, succeeds Max F. Balcom, a member of the Sylvania organization and predecessor companies for 25 years. Although Mr. Balcom is retiring from the chairmanship, he will continue to serve Sylvania as a director

**Hitemp**

**Teflon\* magnet wire**  
**Teflon alloy and plated wire**  
 Quantity production: sizes 14-50 AWG  
 Class H Insulation -75C to +250C  
 High Dielectric - Excellent Power Factor  
 Resistant to moisture and chemicals  
 "Essential to Miniaturization"  
 \*Dupont's trade name for Polytetrafluoroethylene

**Hitemp Wires Inc.**  
 26 Windsor Ave., Mineola, New York

*Paul Rand*



## BOESCH AUTOMATIC TOROIDAL COIL WINDER\* with ACCURATE DIRECT READING COUNTER

The Boesch Toroid Coil Winder can now be equipped with a new electronic counter which makes possible the accurate counting of wire turns at extremely high speeds.

\*Available to licensees of the Western Electric Co., Inc.

Designers and Builders of coil winding machinery, special machinery and equipment. Write for brochure.

WORLD'S MOST VERSATILE  
WINDING MACHINES

**BOESCH**  
MANUFACTURING CO., INC.  
DANBURY, CONN.

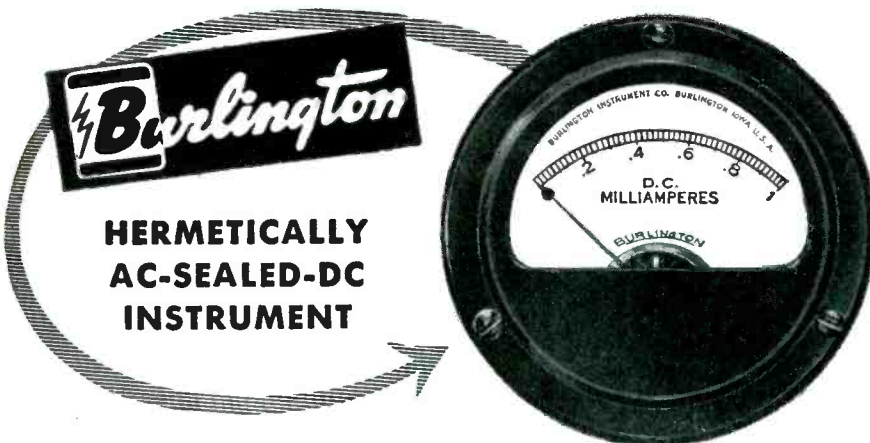

**HERMETICALLY  
AC-SEALED-DC  
INSTRUMENT**

## RUGGED CONSTRUCTION FOR SUPERIOR PERFORMANCE

- Copper — cadmium — dichromate finished case.
- Black satin anodized aluminum bezel.
- Excellent shielding due to case material and construction.
- Double strength clear glass.
- Glass to metal seal under controlled humidity and temperature conditions.
- D'Arsonval permanent magnet type movement for DC applications.
- Magnetically damped, moving iron vane type movement for AC applications.
- Available in 1½" square, 2½" and 3½" round case types.
- Guaranteed for one year against defective workmanship and materials.

Burlington "Hermetically Sealed" Instruments are designed to conform to JAN and MIL specifications.



**BURLINGTON INSTRUMENT COMPANY  
DEPT. F-73, BURLINGTON, IOWA**



Don G. Mitchell

and in a consultative and advisory capacity.

Mr. Zimmer, the new president, has been executive vice-president since 1950 and for 3 years prior to that time was vice-president in charge of operations.

Following his election as president, Mr. Zimmer announced the election of W. Benton Harrison as a vice-president of the company in charge of finance, a newly created post.



H. Ward Zimmer

Mr. Harrison, whose headquarters are also in New York City, has been treasurer of the company for the past two years.

### Giannini Forms European Subsidiary

G. M. GIANNINI & CO., INC. announced the recent formation of a European subsidiary to be known as Giannini Italiana S.p.A., with offices and laboratories located in



Milan, Italy.

The establishment of the Italian company will provide sales and engineering headquarters for the distribution and servicing of the products of G. M. Giannini & Co., Inc. in Europe. In addition, Giannini Italiana will maintain a research laboratory and experimental shop for developing new instruments of European origin.

### Reynolds Named RTMA Staff Attorney

WILLIAM L. REYNOLDS assumed the post of staff attorney at RTMA headquarters, executive vice-president James D. Secrest announced recently. Mr. Reynolds, who replaces Ray S. Donaldson, will work under the direction of RTMA general counsel Glen McDaniel. Mr. Reynolds has been an associate of the Washington law firm of Covington & Burling since 1950.

### Rauland Appoints Research V-P

THE APPOINTMENT of Constantin S. Szegho as vice-president in charge of research for The Rauland Corp. was announced by W. E. Phillips, vice-president and general manager of the company, following action



Constantin S. Szegho

taken at a recent meeting of the Rauland board of directors.

Since 1942, when he joined the staff at Rauland, Dr. Szegho has



## AVIATION PRODUCTS for air-borne quality and dependability



**SAFER FLIGHT**

**EXTRA FIGHT**

Here is an engineering and production skill you can use to help you achieve safer flight, extra fight. For 25 years, OSTER has specialized in electro-mechanical products. A staff of trained field engineers is at your service. Call on us to help you select the product best suited to your job.

#### INSTRUMENT CONTROL MOTORS

- |                                |                             |
|--------------------------------|-----------------------------|
| 1. Synchro Generator           | 6. Synchro Resolvers        |
| 2. Synchro Control Transformer | 7. Two Speed Synchros       |
| 3. Synchro Transmitters        | 8. Reference Generators     |
| 4. Synchro Differentials       | 9. Low Inertia Servo Motors |
| 5. Synchro Receivers           | 10. Servo Torque Units      |
|                                | 11. Tachometer Generators   |

#### DRIVE MOTORS & BLOWER MOTORS

- |                       |  |
|-----------------------|--|
| 1. Permanent Magnet   | 5. 400 Cycle, 2 Phase                  |
| 2. DC                 | 6. 400 Cycle, 3 Phase                  |
| 3. 60 Cycle AC        | 7. 50 — 1600 Cycle, Variable Frequency |
| 4. 400 Cycle, 1 Phase |  |

#### AIRCRAFT ACTUATORS

- |           |           |
|-----------|-----------|
| 1. Rotary | 2. Linear |
|-----------|-----------|



© 1953

## ULTRASONIC SPECTRUM ANALYSIS

#### USES

- Ultrasonic Vibration Measurements
- Harmonic Analysis
- Cross Modulation Studies
- Noise Investigations
- Determining Transmission Characteristics of Lines and Filters
- Monitoring Communications Carrier Systems
- Checking Interference, Spurious Modulation, Parasitics, Effects of load changes, shock, humidity, component variations, etc. upon frequency stability.
- Telemetering

#### SPECIFICATIONS

Frequency Range: 2KC-300KC, stabilized linear scale  
 Scanning Width: Continuously variable from 200 KC to zero  
 Four Input Voltage Ranges: 0.05V. to 50V. Full scale readings from 1 millivolt to 50 volts  
 Amplitude Scale: Linear and two decade log  
 Amplitude Accuracy: Within 1 db. Residual harmonics suppressed by at least 50db.  
 Resolution: Continuously variable. 2KC at maximum scanning width, 500 c.p.s. for scanning width below 8KC.



### MODEL PANORAMIC ULTRASONIC ANALYZER

**EASY FAST SB-7**

An invaluable new direct reading instrument for simplifying ultrasonic investigations, the SB-7 provides continuous high speed panoramic displays of the frequency, amplitude and characteristics of signals between 2KC and 300KC. The SB-7 allows simultaneous observations of many signals within a band up to 200KC wide. Special control features enable selection and highly detailed examination of narrower bands which may contain signals separated by less than 500 c.p.s. SB-7 is unique in that it provides rapid indications of random changes in energy distribution. WRITE NOW for Complete Information, Price, Delivery 10 So. Second Ave., Mount Vernon, N.Y. MOUNT VERNON 4-3970



# GRC CUTS COST AND TIME!



## TINY INJECTION MOULDED PRECISION PLASTIC PARTS



**INDIVIDUAL PARTS**  
No limit on smallness. Intricacy and precision — our unique features.

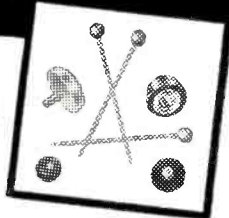

**INDIVIDUAL INSERTS**  
Automatic insert feed permits wide variety of product possibilities.

Completely automatic... parts delivered trimmed, ready for use, in one operation, with Gries' speedy, specialized production facilities.  
**NYLON A SPECIALTY**

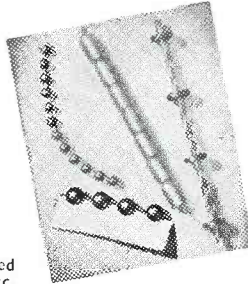

**CONTINUOUS INSERTS**  
Small members accurately spaced on tape cord, wire, chain, etc.

### LOW MOLD COSTS

Write Today for Demonstration Samples

Maximum Size:  
.025 oz.—1 1/4" long  
NO MINIMUM!



## GRIES REPRODUCER CORP.

100 Willow Ave., New York 54 • Phone: MO 5-7400

been serving as director of research.

Dr. Szegho's improvements in cathode-ray tubes and other special tubes used by the government in defense equipment, his development of the first low-voltage focus television tube and his perfection of the "black" tube are some of his contributions to the television tube industry. His other activities include high-voltage cathode-ray tubes used in radar equipment during the war that are now being utilized in theater television equipment, and color television research.

### Magnaflux Opens New Main Plant

MAGNAFLUX CORP. recently opened its newly built main plant in Chicago. It is a one-story building with an area of 74,000 sq ft. nearly double the size of the old plant.



New Magnaflux Plant

With the new facility, the operations of the company are now all combined under one roof. About 65 percent of the space is devoted to research, engineering and field engineering service functions. Approximately 250 people are employed in the plant.

### Buetow Named President Of Minnesota Mining

ELEVATION of Herbert P. Buetow, executive vice-president in charge of finance, to the presidency of Minnesota Mining & Manufacturing Co. was announced by the board of

### A BETTER TOOL for ELECTRONIC ENGINEER or RESEARCH SCIENTIST



### MODEL A-2 TIME DELAY GENERATOR

• A precision instrument for the generation of accurate and variable time intervals from .8 to 100,000  $\mu$ s.

- Low jitter
- High resolution
- High duty factor
- Direct reading
- Fast rise time

Also available: Model A-4—.00001 to 10 seconds.

Write for complete data:  
Our bulletins E-A-2 and E-A-4

## Rutherford ELECTRONICS CO.

3707 S. ROBERTSON BLVD., CULVER CITY, CALIFORNIA

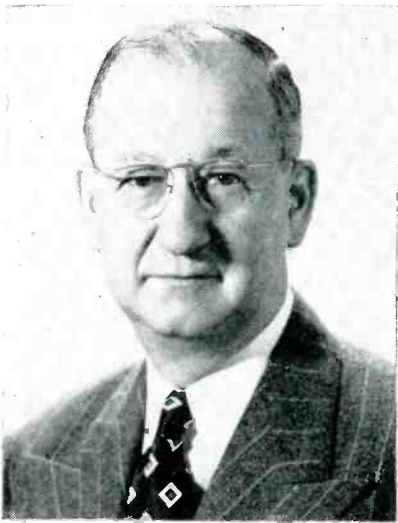

Herbert P. Buetow

directors of the company.

He succeeds Richard P. Carlton who becomes vice-chairman of the executive committee.

Election of H. N. Stephens as vice-president in charge of central research was also announced by the company. He has been in charge of the central research laboratory since 1937.

Earlier this year, 3M announced a long-range building program for research purposes. Ground-breaking ceremonies for the first unit in this program, a \$3 million scientific laboratory for the central research group, will take place about June 1. The new laboratory, located on St. Paul's eastern boundary, is due for completion in mid-1954.

### Mullard of England Plans TV Tube Plant

THE MULLARD CO. has decided to establish a new factory for the manufacture of cathode-ray tubes in England.

At present, the manufacture of these tubes is mainly concentrated in the company's factory at Mitcham, London. Following discussions with the Board of Trade, it was decided to transfer the manufacture to a new factory in the North-West Lancashire Development Area, to be built under facilities provided for by the Distribution of Industry Act.

The factory will be one of the largest and most modern tv tube factories and will provide valuable

## Point Contact Transistors for High-Speed Computers

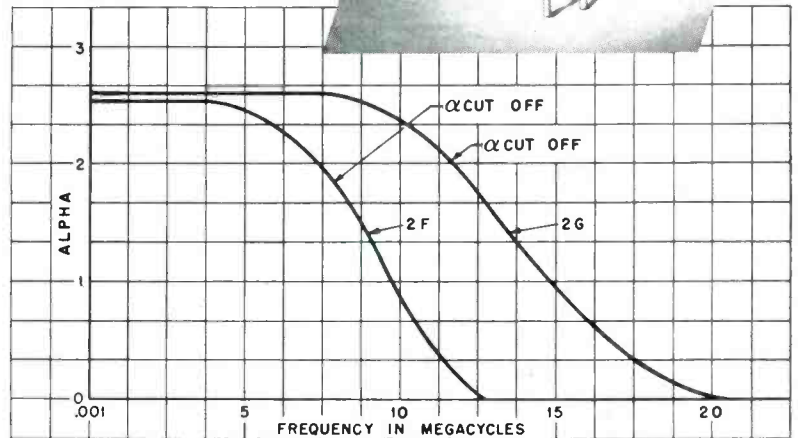
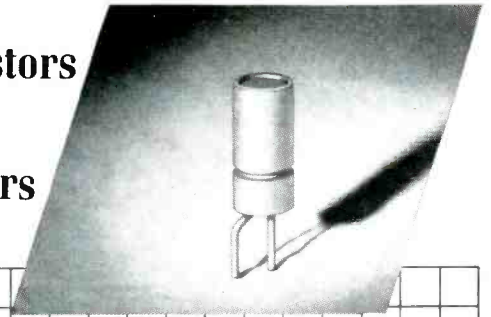

Frequency Response—5mc. a cut off  
0.15 μsec. rise time

Frequency Response—10mc. a cut off  
0.1 μsec. rise time

Write Dept. E7 for detailed specifications

### TRANSISTOR PRODUCTS, INC.

SNOW AND UNION STREETS, BOSTON 35, MASSACHUSETTS  
AN OPERATING UNIT OF CLEVITE CORPORATION

## STERLING

### A DEPENDABLE SOURCE FOR TRANSFORMERS MIL-T-27 & COMMERCIAL

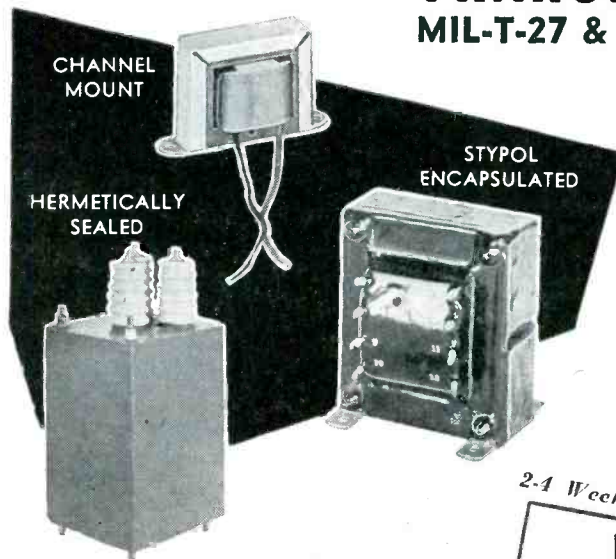

- Pulse
- Audio
- Power
- Filter Choke
- Filament
- RF Coils

Custom Built to your Specifications

2-4 Week Delivery on Prototypes

**WE SOLICIT SAMPLES AND SHORT RUN PRODUCTION**



297 North 7th St., Brooklyn 11, N. Y.

**"Happy Cappy"**

co-operates to build a good name, a steady market for your products



**VITRAMON CAPACITORS**

as constant parameters, teamed with other quality components give

**STABILITY**

to your circuit systems.

Their absolute retrace reduces drift and erratic performance

Even with temperature changes as great as  $-55^{\circ}\text{C}$  through  $+200^{\circ}\text{C}$  drift is less than 0.05%.

Capacity can be depended on to follow the adjacent curve consistently.

Vitramon Capacitors are tough and tiny. Their fine-silver electrodes are buried in a monolithic block of fused porcelain dielectric. This structure assures optimum electrical qualities in all capacities, 0.5 through 2000  $\mu\text{f}$ .

Write today for complete data.

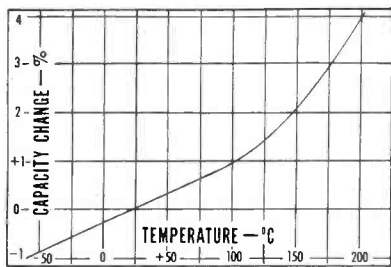

Temperature Characteristic

**Vitramon**  
INCORPORATED  
BOX 544 E • BRIDGEPORT 1 • CONN.

addition to the diversification of industry in the textile towns of North-East Lancashire, the company announcement said.

The transfer of the work from Mitchem will make much-needed space available for the manufacture of other electronic devices and this will absorb the workers at present employed on tv tubes there.

**Stromberg Appoints Chief Engineer**

CHARLES W. FINNIGAN has been appointed chief electronics engineer of the Stromberg-Carlson Co., according to an announcement by Sidney R. Curtis, vice-president in charge of government contracts for the company.

Mr. Finnigan originally joined Stromberg-Carlson in 1941, after considerable experience in the radio engineering and manufacturing field, and remained until 1949, when he took a position with Sylvania Electric Products in Buffalo, N. Y.

In his renewed association with Stromberg-Carlson he will be largely concerned with government contracts. He takes the place of Garrard Mountjoy, who resigned to accept the position of assistant to the vice-president of American Radio-Television, Inc.

**GE Adds To Its Buffalo Tube Works**

INCREASED production of aluminized tv picture tubes is expected at the Buffalo Tube Works of the General Electric Co. when a three-story addition to the works is completed about June 30th.

The addition, which will cost almost \$100,000, will add 7,000 sq ft to the existing 169,000 sq ft. New equipment will be added and certain manufacturing processes will be relocated to improve the flow of production.

**Rola Names Torsch Chief TV Engineer**

THE APPOINTMENT of Charles E. Torsch as chief television engineer for The Rola Co. Inc. was announced recently by Lawrence A. King,

MODEL E-10

**SYNCROGEN**

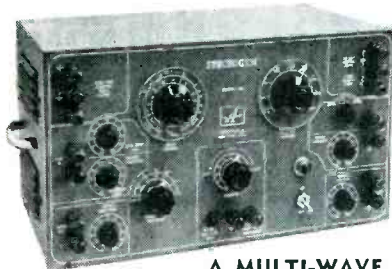

A MULTI-WAVE FORM GENERATOR AND PULSE SYNCHRONIZATION UNIT

The E-10 provides, at repetition rates of 1 cycle per second to 100 kilocycles per second: 1. Sawtooth waves; 2. Square waves or Square Pulses, one microsecond to one second duration with rise time of 0.15 microseconds; 3. Integrated or Differentiated versions of the square waves and pulses. All outputs are simultaneously available and independently variable in amplitude. All outputs may be synchronized, triggered or gated by sine waves, pulses or other complex wave forms.

Additional applications of the SYNCROGEN include: oscilloscope sweep phaser, delayed pulse generator, oscilloscope trace expander, frequency divider, and pulse time or pulse with modulator. The SYNCROGEN is an excellent educational demonstrator and useful electronics laboratory accessory.

Price \$175.00 net f.o.b., N.Y.C.



**AMPLITRONIX**  
INC.  
280 9th Ave. NYC 1, N. Y.

First scientific treatment in English

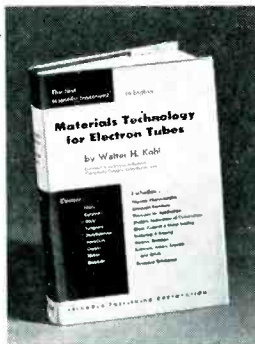

**MATERIALS TECHNOLOGY for ELECTRON TUBES**

by WALTER H. KOHL  
Electronics Research Laboratory  
Stanford University

Much needed critical evaluation of the components of electron tubes and methods of uniting them, such as glass- and ceramic-to-metal seals, soldering and brazing. Covers such materials as glass, ceramics, mica, tungsten, molybdenum, tantalum, copper, nickel and graphite. The book gives extensive and, in some cases, previously unpublished tabulations of physical characteristics, chemical reactions, and processes used in their application. Of particular interest to novices is the special review of atomic theory and the classification of crystals.

1951 496 pages illustrated \$12.50  
Order now for 10 days' free examination

REINHOLD PUBLISHING CORPORATION  
Dept. M-534  
330 W. 42nd St., New York 36, N.Y.

president and general manager.

Prior to joining The Rola Co., Mr. Torsch was with GE, which he joined in 1948 and for whom he organized and headed the cathode-ray sweep systems engineering group. In this capacity he guided the development of the GE 77J1 type ferrite-cored transformers and yokes for 50 degree-90 degree sweep.

Prior to his GE association he was the principal tv receiver design engineer at Bendix Radio. Before that, he was with RCA Victor in various engineering capacities.

### Texas Instruments Expands Facilities

TEXAS INSTRUMENTS, INC. and Geophysical Service, Inc. are building a new \$1 million plant in Dallas, Texas, that is expected to be completed by mid-July. The current enlargement will supply a total of 150,000 sq ft of floor space, more than doubling present facilities.

### Sands Appointed By Langevin



Leo G. Sands

THE APPOINTMENT of Leo G. Sands to the post of sales manager at Langevin Manufacturing Corp. has been announced by Donald S. Morgan, president.

Mr. Sands recently resigned as president of Bogue Railway Equipment Division, manufacturer of railway electrical and communications equipment. He had also served Bogue Electric Manufacturing Co.

**PRECISION-ENGINEERED  
HOUSINGS  
DESIGNED FOR  
ELECTRONICS**

MORE THAN 3000 SIZES,  
IN A COMPLETE RANGE  
OF METALS—**STEEL,  
BRASS, ALUMINUM,  
Mu-METAL.**

**OLYMPIC HOUSINGS** are designed for easy assembly. Minimum variations in dimensions at any stage. Built-in flexibility assures modification and fabrication to meet blueprint specifications.

- Delivery from stock—no shipping delays
- Tooling costs eliminated

**OLYMPIC HOUSINGS** are engineered to incorporate three major elements of construction—*Uniformity, Strength, Compactness.*

On your next project—let OLYMPIC craftsmen give you facts, figures and specifications. Send for new illustrated folder E4 today.

STANDARDIZE WITH OLYMPIC  
**OLYMPIC**  
METAL PRODUCTS COMPANY, INC.  
ALPHA, NEW JERSEY

# NEY'S SMALL PARTS PLAY A

## BIG PART IN PRECISION INSTRUMENTS

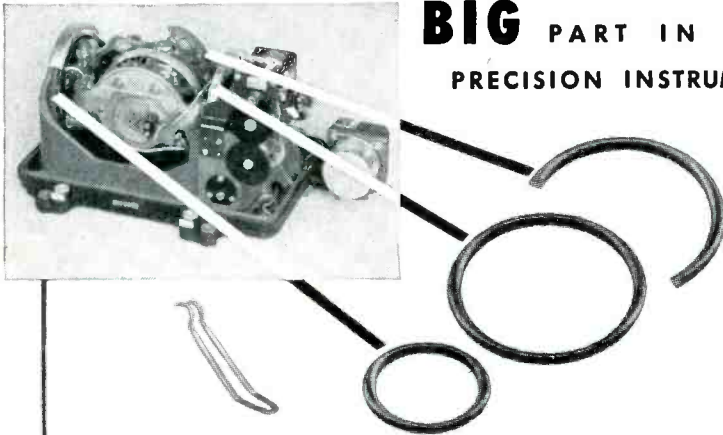

This Cageable Vertical Gyro, for use in stabilization and control systems of aircraft, guided missiles and radar scanners, manufactured by the Aeronautical Division of the Minneapolis-Honeywell Regulator Co., contains three doughnut potentiometers wound with NEY-ORO G high strength, precious metal resistance wire, contacted with wiper brushes of Paliney #7\* (illustrated at far left).

Many other manufacturers of precision instruments specify Ney precious metal component parts for use as slip rings, brushes, wipers, commutator segments, etc. Ney Precious Metal Alloys have specific qualities which mean greater accuracy, longer life and resistance to most corrosive industrial atmospheres.

Call or write the Ney Engineering Department for assistance with your instrument problems.

\*Registered trade mark

THE J. M. NEY COMPANY • 179 Elm Street, Hartford 1, Conn.  
Specialists in Precious Metal Metallurgy Since 1812

13NY83B

as general sales manager.

For several years Mr. Sands was associated with the Radio Division of Bendix Aviation Corp. in several sales management posts, including that of director of public relations and advertising. He has also been associated with Philco Corp.

### Honeywell To Open New Illinois Plant

A NEW FACTORY will be opened shortly at Warren, Ill., to expand the production of the Micro Division of Minneapolis-Honeywell Regulator Co., it was announced recently by W. W. Gilmore, president of the division.

The new plant, a 10,000 sq ft building obtained under a lease arrangement, will become the division's fourth manufacturing operation, the other three being in Freeport, Ill., where the division is headquartered. Warren is about 25 miles north of Freeport.

Approximately 150 persons will be employed initially in the new operation.

## Better Quality - In Any Quantity

SHIELDS • CABINETS  
CHASSIS • DIAL PLATES  
DUST COVERS • PANELS  
RACKS • BRACKETS  
of MuMetal • Aluminum • Steel  
Stainless Steel • Other Alloys



In fabricating sheet metal components, semi- or complete assemblies, Multi-Metal employs the most modern methods, equipment and skill.

The continued patronage of leading electronics manufacturers attests to Multi-Metal's high standards of quality and production economy.

Let Multi-Metal's 40 years' experience and "know-how" help you. What are your problems, your specifications?

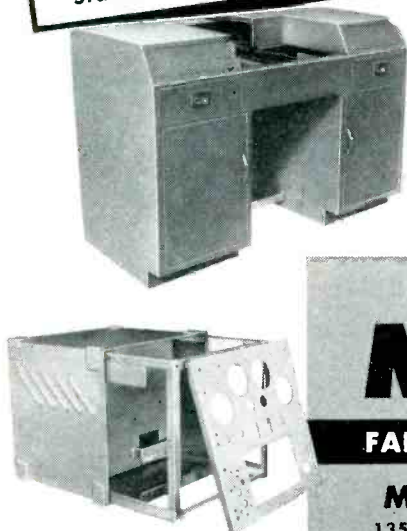

You Can Depend on

# Multi-Metal

FABRICATION IN ALL METALS

**MULTI-METAL COMPANY**

1350 Garrison Avenue • New York 59, N. Y.

### Emerson Names Levy Assistant Works Head



Maurice L. Levy

MAURICE L. LEVY, who was chief engineer of special products for Emerson Radio and Phonograph Corp. from 1943 to 1949, has returned to the company as assistant works manager, it has been announced by E. J. Kelly, vice-president and works manager.

Mr. Levy has been in the elec-

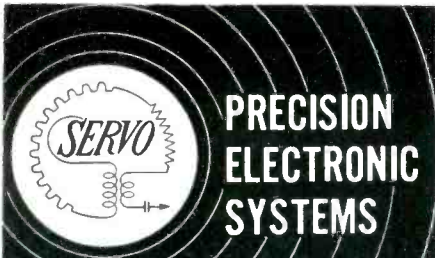

# PRECISION ELECTRONIC SYSTEMS

## SENSING



RADIO DIRECTION FINDING

## INSTRUMENTS

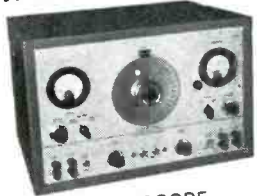

SERVOSCOPE



SERVOBOARD

## CONTROL



THERMISTOR BOLOMETERS  
PRE-AMPLIFIERS  
POWER SUPPLIES  
SELECTIVE AMPLIFIERS

Write today for complete information

# SERVO CORPORATION OF AMERICA

NEW HYDE PARK, N. Y.

Want more information? Use post card on last page.  
ELECTRONICS — July, 1953

tronics field since his graduation from Union College in 1924. He has held important engineering posts with leading radio and tv manufacturers, including Emerson, from that time to the present.

### Rich-Roth Sells Ultra-Viscoson To Bendix

THE ULTRA-VISCOSON, the ultrasonic "dip stick" that automatically and continuously measures, records and controls viscosity, was sold by its developers, the Rich-Roth Laboratories, to Bendix Aviation.

According to Rich-Roth, the heavy demand for the instrument imposed an excessive manufacturing burden upon the Rich-Roth Laboratories which were organized in 1950 for research, development and consulting. The sale of the Ultra-Viscoson to Bendix frees Rich-Roth for further research and developments in the fields of automatic process controls, ultrasonics, electronics and applied physics.

Rich-Roth Laboratories will continue to be closely associated with the Ultra-Viscoson as technical consultants to Bendix. The Ultra-Viscoson is the first of a line of process control instruments to be produced by the Cincinnati Division of Bendix Aviation Corp.

### ERA Names McDonald Director Of Research



Robert E. McDonald

ROBERT E. McDONALD, former director of engineering and maintenance for Braniff International Airways, has been appointed director of manufacturing for Engineering Research Associates Division of

# WET OR DRY

## Resistance is high

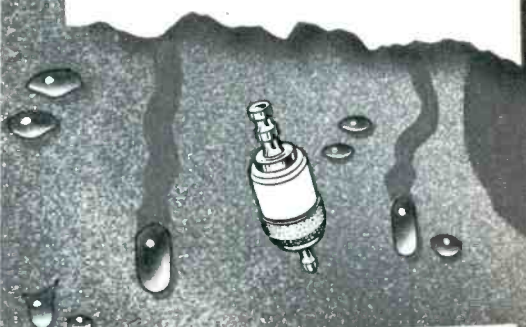

... with **LUNDEY** miniature hermetic terminals!

**TESTS PROVE** — Lundey series #199 miniature hermetic terminals give excellent performance under conditions of high humidity.

In an average test the following results were tabulated:

Relative Humidity	Temp.	Insulation Resistance
90%	80°F	1,000,000 megohms
50%	80°F	3,000,000 megohms

### OTHER FEATURES

- Mounting in simple drilled or punched holes . . . no extrusion needed.
- Effective spring loading
- Teflon external member
- Silicone or neoprene core
- Minimum mounting — 15/64" on centers
- Voltage rating — 500V RMS operating
- Current rating — 8 amperes
- Three electrode styles available
- Production-proved
- Meets MIL-T-27 specifications

If humidity creates a problem for you, let Lundey terminals help you solve it. Write for Bulletin #199, Dept. E.

# LUNDEY ASSOCIATES

694 Main Street, Waltham 54, Mass.

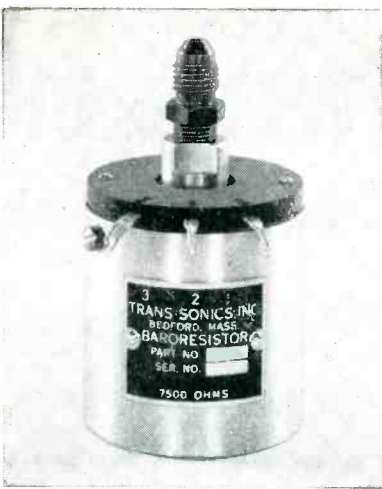

# TRANS-SONICS\*

Type 71-5

## BARORESISTOR

### Important New Servo Component

The Type 71-5 Baroresistor is a pressure actuated potentiometer designed for operational use in aircraft. It features:

#### HERMETICALLY SEALED MECHANISM

The potentiometer winding and operating parts are hermetically sealed in a vacuum. Pressure is applied inside the bellows only. Therefore, the Type 71-5 Baroresistor is not affected by dust, fungi, or moisture.

#### RUGGEDIZED CONSTRUCTION

A special high force mechanism was developed for the Trans-Sonics Baroresistor to avoid the necessity for employing microforce potentiometer elements. Shock of 30g in any direction will not cause electrical discontinuity.

#### MACHINE CALIBRATION

Each instrument is calibrated by machine and its performance is automatically recorded as a graph of resistance versus pressure. Every turn of the winding is inspected. All electrical characteristics are automatically checked in an eleven stage inspection cycle.

#### CONDENSED DATA

Range: 0-15 psi. absolute  
Resistance: 7500 ohms  
Maximum voltage: 75 volts  
Resolution: 1/3%  
Accuracy: 2% of full scale

#### Typical Applications

SERVOs—Vary servo loop gain as a function of altitude.  
COMPUTERS—Voltage divider, P total/P static.  
FIRE CONTROL—Air density measurements.  
TELEMETERING—Pressure transducer.  
RECORDING—Pressure transducer.

Write for  
Bulletin  
No. 71-5  
for further  
details

**TRANS-SONICS, INC.**

5 Forest Street • Bedford, Mass.

\*The word "Trans-Sonics" is a trade mark

Price:  
**\$225.00**  
Short delivery

# BIRNBACH

## Electronic

# COMPONENTS

Cut production costs — speed operations, by specifying BIRNBACH — your reliable Source of Supply for all requirements in Radio, Television, and Electronic Components, Accessories, Wire and Cables.

## COMPLETE WAREHOUSE STOCKS

FOR PROMPT DELIVERY

- Govt. Spec. Hookup Wire
- JAN-C-76 SRIR-SRHV Plastic
- WL-Extruded Nylon Jacket
- Aircraft Wire—Nylon Jacket
- 105° C. UL Approved JAN-C-76 WL-Glass Braid
- Multiconductor Rubber Covered Cables, shielded, unshielded
- Tinned and Bare Wire
- Magnet Wire
- Heavy Formvar Wire
- Vinyl Extruded and Radio Grade Tubing
- Shielded Wires
- Insulated Hardware
- Plugs, Jacks, Sockets
- Test Leads, Switches
- Insulators, Statite and Ceramic
- Terminal Strips

Quality Products  
for the Electronics Industries since 1923



**BIRNBACH RADIO CO. INC.**  
145 HUDSON STREET  
NEW YORK 13, N. Y.

WRITE FOR  
CATALOG 53-E

Remington Rand Inc. He will assume directorship of the manufacturing activities at all of ERA's St. Paul plants.

In 1946, Mr. McDonald became a project electrical engineer and later supervisor of aircraft electrical engineering for Northwest Airlines. When he left Northwest in September, 1950, he was superintendent of radio-electrical and accessory overhaul.

He joined Mid-Continent Airlines as chief engineer and later became director of engineering and maintenance. When Mid-Continent and Braniff Airlines merged in 1952 to form Braniff International Airways, McDonald directed all engineering and maintenance of the northern region, including Minneapolis-St. Paul.

## Pacific Mercury TV Expands Engineering

EXPANSION of engineering activities has necessitated reorganization of the engineering department of Pacific Mercury Television Mfg. Corp., Joe Benaron, president, announced. Bernard Diener has been named chief engineer of the Radio and TV Division and will have charge of home receiver development and design.

Stan Cutler, who is vice-president of the company and has been chief engineer, has assumed the title of director of engineering and will head the expanded engineering program. In addition, he will be acting chief engineer of the new Special Products Division.

Prior to his association with Pacific, Mr. Diener was a physicist and technical consultant on radio and guided missiles electronics at Hughes Aircraft Co. and formerly senior project engineer on f-m radio and tv for Hoffman Radio Corp.

## Gates Promotes Young

HOWARD YOUNG, formerly mechanical and design engineer of the Gates Radio Co., has been promoted to plant manager, it has been announced.

Mr. Young joined the Gates organization as a draftsman in 1945, following army service. Dur-



DEPENDABLE *Miniature*  
**RADIO FILTERS**



Type 111

- Saves space!
- 115 V ac/dc, 20 amp.
- Excellent attenuation
- Feed through installation
- Flange mounting bracket
- Corrosion & fungus resistant

*If you have radio interference problems, write or wire us, TODAY!*

**HOPKINS**  
*Engineering Co.*

FACTORY: 2082 Lincoln Ave.,  
Altadena, Calif. SYcamore 8-1185  
Offices in WASHINGTON, D. C.  
and DETROIT

*Save time...* **ENGRAVE** your own  
**NAME PLATES**  
**DIALS • PANELS**

Send for Catalog IM29

The fastest, easiest method for engraving individual nameplates, dials and panels.

- Automatic depth regulator
- Engraves 15 sizes from One Master alphabet
- Equipped with self-centering device

**NEW HERMES, Inc.** 13-19 University Place, N.Y. 3, N.Y.  
In Canada: 329 St. James St., Montreal • Sales representatives in principal cities  
*World's Largest Manufacturer of Portable Engraving Machines*

**"INDUSTRIAL"**  
for  
**ELECTRONIC COMPONENTS**

Precision engineered electronic components and connecting devices for all your needs.

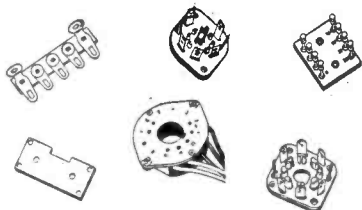

- LAMINATED TUBE SOCKETS
- TERMINAL STRIPS
- WIRED ASSEMBLIES
- METAL or BAKELITE STAMPINGS
- TERMINAL BOARD ASSEMBLIES
- SCREW MACHINE PARTS
- NEW ITEMS —
- TUNER STRIPS, SOCKETS and BRACKETS for UHF



Our extensive design and production facilities are available for developing your special requirements and applications. Representatives in principal cities throughout U.S.A. Call or write for samples and information. ORegon 7-1881.

**INDUSTRIAL HARDWARE Mfg. Co., Inc.**  
109 PRINCE STREET • NEW YORK 12, N. Y.

For all owners of pantograph and routing machines . . .  
**NEW HERMES CUTTER GRINDER**  
The only belt-driven grinder at low cost.

- Smooth, vibration-free operation.
- Ball bearing grinding spindle.
- Tool head indexed for single lip and 2, 3, 4-sided cutters.

\* Write for folder CG 29

**NEW HERMES, Inc.** 13-19 University Place, N.Y. 3, N.Y.

**PRECISION IN MINIATURE!**



**Extended Range AUDIO OSCILLATOR**

- Only 6" x 4 1/4" x 5".
- 18 cycles to 1.2 megacycles.
- Distortion less than 0.2%.
- Constant output  $\pm 0.5$  db.
- 600/150 ohm transformer available.

Price \$150

Literature on request

**Waveforms, inc.**

333 Sixth Avenue  
New York 14, N. Y.

## Design for savings



When you design a new unit, be thrifty—consult us to save time, space, money and future headaches. At the breadboard stage, we can help you as we have so many others during 35 years of experience. Coto-Coil Company, 65 Pavilion Avenue, Providence 5, R. I. New York Office: 10 E. 43rd Street, New York 17.

**Coto** PRECISION WOUND **Coils**



Howard Young

ing the past several years he has been mechanical and design engineer.

It was also announced that Bill Brady has joined the Gates sales staff and will call on Gates customers in North Texas, Mississippi and Eastern Oklahoma.

### Textile Firm Buys Aviation Engineering

THE KNICKERBOCKER TEXTILE CORP. has purchased all of the assets and good will of the Aviation Engineering Corp. and the company will be known as Avien-Knickerbocker, Inc., according to Leo A. Weiss, president of Aviation Engineering and Jacob Granowitz, president of Knickerbocker Textile.

Executive head of the company is Leo A. Weiss, who will act as president. Mr. Granowitz will serve as chairman of the executive committee.

Avien-Knickerbocker will be composed of two divisions: the Aviation Engineering Division under the direction of Mr. Weiss, and the Knickerbocker Division under the direction of Mr. Granowitz.

Purpose of the purchase is to provide for growth and expansion.

### Control Engineering Appoints Peirce

CONTROL ENGINEERING CORP. announced the appointment of Stanley D. Peirce as manager of the Government Contracts Division. He is a graduate of the Harvard University Engineering School and was previously a senior electronic engi-

*Original*  
**BEEDE**  
ELECTRIC  
METERS

**BD**

... have long been known for their high quality, durability, accuracy and advanced design.

Catalog or Information on request

**BEEDE ELECTRICAL INSTRUMENT CO., INC.**  
PENACOOK, N. H.

— FOUNDED BY — WALTER E. BEEDE — 1880 — 1947 —

neer with the Guided Missile Division of the Fairchild Airplane and Engine Co. He also directed guided missile development for the Bureau of Aeronautics of the U. S. Navy, before coming to Control Engineering.

### Silver-Zinc Battery Inventor Honored

ONE of the highest French scientific honors, the Ampere Medal, has been bestowed upon Professor Henri G. Andre by the Societe Francaise de Electriciens in recognition of his



Henri G. Andre

outstanding contributions to electrical science and in particular for his work in the field of electrical energy storage.

Professor Andre, who is actively associated with the Yardney International Corp., has devoted many years to the development of the first practical rechargeable silver-zinc accumulator.

### Ampex Forms New Research Division

TO FURTHER the development of magnetic recording, the Ampex Electric Corp. has organized a new research division headed by Carl Becker.

The new division will conduct basic research on magnetic recording techniques which will apply both to the familiar sound recording applications and equally im-

## END CAPS FOR CONDENSERS . . . HERMASEAL OFFERS THREE SIZES TO FIT MOST NEEDS



When you need End Caps for Condensers that must meet *high quality* standards . . . yet cost is a factor . . . and, you need them in a *hurry* . . . call on Hermaseal!

**HERMASEAL** — is a top specialist in Hermetically Sealed Terminals, Sealed Headers, and allied parts for the radio-electronics industry.

**COMPLETE CATALOG** — Just off the press, a new catalog with descriptions and specifications for most of Hermaseal's stock Terminals and Headers. Write for your copy today! And let us quote you on your End Cap requirements. No obligation, of course.



THE HERMASEAL CO, Inc. Elkhart 10, Indiana



### NOW IN PRODUCTION

Three types of limiters—each made in strict accordance with customer's and "MIL" specifications. All limiters are manufactured under controlled laboratory conditions; over 50 intermediate inspections.

### WE ALSO PRODUCE

Electrical and electronic assemblies, special relays, solenoids, hermetically sealed assemblies, rectifiers, terminal and junction boxes and boards, automatic controls. All work performed in complete compliance with customer's standards.

**OUR CONTRACT SERVICE OFFERS REASONABLE PRICES  
— PROMPT DELIVERY — A FAULTLESS PRODUCT.**

**FOR A QUOTATION** send us your prints, specifications and delivery requirements. Our reply will be prompt.

Manufacturers of Wassco GLO-MELT Resistance Soldering Equipment

**WASSERLEIN MANUFACTURING CO., INC.**  
126 W. Cass St. • Joliet, Illinois

Designed for



Application

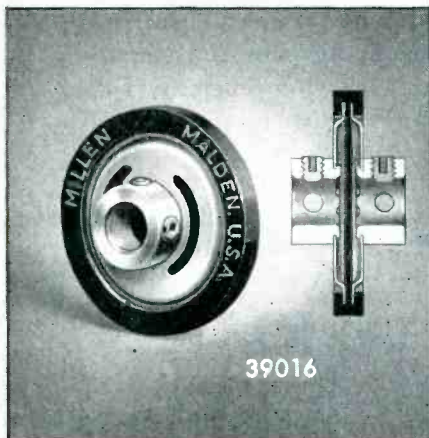

**A Really NEW  
FLEXIBLE COUPLING  
No. 39016**

Incorporating features which have long been desired in a flexible coupling. No Back Lash—Higher Flexibility—Higher Breakdown Voltage—Smaller Diameter—Shorter Length—Higher Alignment Accuracy—Higher Resistance to Mechanical Shock—Solid Insulating Barrier Diaphragm—Molded as a Single Unit.

**JAMES MILLEN  
MFG. CO., INC.**

MAIN OFFICE AND FACTORY  
**MALDEN  
MASSACHUSETTS**



PLANTS AND PEOPLE

(continued)

portant uses in the recording of technical data. Ampex already manufactures a number of models for both fields. New development work will emphasize stereophonic (third dimensional) sound and new data applications.

**Cohn Joins Stanford  
As Microwave Head**

SEYMOUR B. COHN has joined the staff of Stanford Research Institute to head the microwave group in the aircraft radiation systems laboratory.

Dr. Cohn was formerly a research engineer with Sperry Gyroscope Co. in New York for five years. During the war years, he worked as a special research associate in the radio research laboratory at Harvard University.

**Electric Regulator  
Enlarges Plant**

A NEW 2,100 sq ft addition to the plant of the Electric Regulator Corp. is now under construction, it was announced recently by Laurence W. Burn, general manager of the company.

The addition will have three sections. These will be used for receiving shipments, as stockroom and storage area, and to house emergency stand-by power equipment.

**New Transformer  
Company Formed**

SUPERIOR TRANSFORMER CORP. is a new company in Chicago, specializing in all types of transformers and coils.

Walter W. Kunde is president of the organization. Mr. Kunde was formerly chief engineer of Thor-darson Electric Mfg. Division of Maguire Industries.

**Hudson Wire Expands**

A RECORD number of employees, working on a three-shift basis, was registered recently when the Hudson Wire Co. at Ossining, N. Y. attained an all-time peak in shipments of wire manufactured by its



CAN SOLVE YOUR CAPACITOR PROBLEMS

TYPES IMMEDIATELY AVAILABLE			
Property	Poly-styrene	Teflon	Synthetic D
Capacity	.001 up	.001 up	.01 up
Voltage	100 up	300 up	200 up
Power Factor	.01%	.01%	0.5%
I. R.	10 <sup>6</sup> meg mf	10 <sup>6</sup> meg mf	10 <sup>6</sup> meg mf
Max. Op. Temp.	90°C	125°C	125°C
Soakage	.02%	.02%	1.0%
Temp. Coef.	-100 ppm/°C	-100 ppm/°C	+500 ppm/°C
Bulk at lowest voltage given	5 in <sup>3</sup> /mf	10 in <sup>3</sup> /mf	1.2 in <sup>3</sup> /mf

Unicon capacitors have found a wide acceptance among leading electronic laboratories and manufacturers specifying the most exacting requirements.

Representative users of standard and special Unicon capacitors are;

- Mass. Institute of Tech.
- General Electric Co.
- Airborne Instrument Labs.
- Los Alamos Scientific Labs.
- Jet Propulsion Labs.
- Freed Transformer Corp.
- Boeing Airplane Co.
- Northrop Aircraft, Inc.

Capacitors made to your specifications.  
Write for catalog EE

**united condenser corp.**

UNICON  
337 EAST 139th STREET NEW YORK 54, N. Y.

Want more information? Use post card on last page.  
July, 1953 — ELECTRONICS

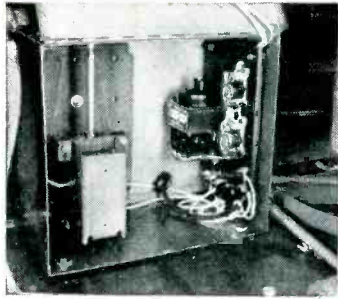

"Years of service—  
and over a million  
operations a year"

D. W. Onan & Sons Inc.



## AGASTAT

light . . . versatile

### TIME DELAY RELAYS

AGASTATS are used by Onan to prevent starting of their standby plant on momentary power failure, to prevent stopping of the plant until power has returned for a given time, and on some lugging presses that operate over a million times a year. Onan reports several years of service with a minimum of attention.

AGASTATS are solenoid actuated and pneumatically timed. They are light, compact, dustproof and can be furnished to operate mounted in any position. There is an AGASTAT model that is right for your needs.

Write for Bulletin  
Dept. A2-74

# A'G'A

Division of Elastic Stop Nut Corporation of America  
1027 Newark Avenue, Elizabeth 3, New Jersey

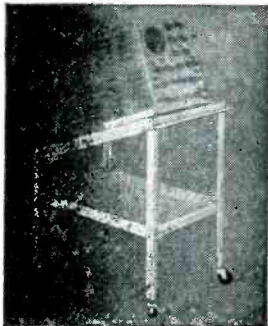

## SCOPE DOLLY Model 1

Convenient Height and Viewing Angle  
Adjustable to Hold Portable Scopes  
Ball Bearing Swivel Rubber Tired Casters  
Lightweight Aluminum Construction  
Recommended by Laboratories Wherever Used

**\$35.00** F.O.B. Louisville, Ky.

Formerly manufactured by UNIQUE DEVICES  
Now manufactured and sold by

**TECHNICAL SERVICE CORPORATION**  
3116 Michigan Drive  
Louisville 5, Kentucky

# PIX

**WIRE FORMING  
SPECIALISTS**

Precision Parts to meet your  
Production and Engineering needs.  
From .002" dia. to .125" dia. Radio  
tube parts—Stampings—Drawings  
Modern facilities, high-production  
equipment.

Metal Crystal Holder Parts

Send sketch or print for quotation.

**PIX MANUFACTURING CO., Inc.**  
24-A Bedford St., Newark 3, N. J.

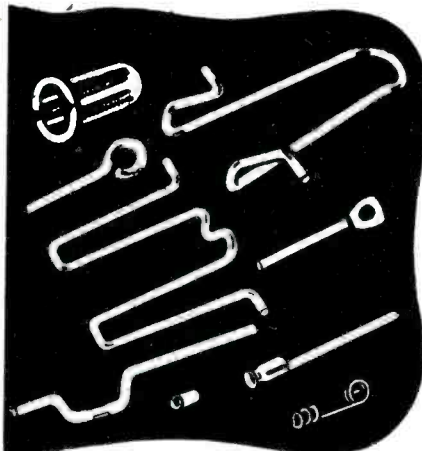

ELECTRONICALLY  
REGULATED

## Laboratory POWER SUPPLIES



BENCH MODEL 50

**0-500 VDC • 0-500 MA**  
CONTINUOUSLY VARIABLE

A general-purpose, heavy-duty  
precision-regulated power supply  
for bench use. Incorporates stable  
5651 reference tube, overload  
circuit-breakers, time-delay tube  
protection.

Also available for standard  
rack mounting (Model 50-R. Panel  
size 10½" x 19". Depth 14¼".)

### Specifications\*

- **INPUT:** . . . 105-125 VAC, 50-60c
- **OUTPUT VOLTAGES**
- 0-500 VDC, 0-500 MA
- Regulation (line): . . . < 0.15%
- Regulation (load): . . . < 0.5%
- Internal Impedance: . . . < 2 ohms
- Ripple and Noise: . . . < 8 mv rms
- Polarity: + or - may be grounded
- 0-50 VDC, 0-200 VDC . . . bias
- Regulation (line): . . . < 0.1%
- Internal Imped: 32,500 ohms max
- Ripple and Noise: . . . < 5 mv rms
- 6.3 VAC, 5A . . . . . unregulated
- 6.3 VAC, 5A . . . . . unregulated
- **STABLE • DEPENDABLE**
- **MODERATELY PRICED**

# LAMBDA

**ELECTRONICS CORP.**

CORONA 68, NEW YORK

\*For complete specifications on these and  
other models write for catalog L-50.

# Rx for HARMONIC TROUBLES

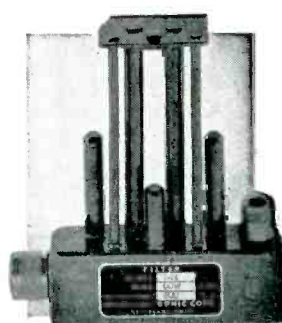
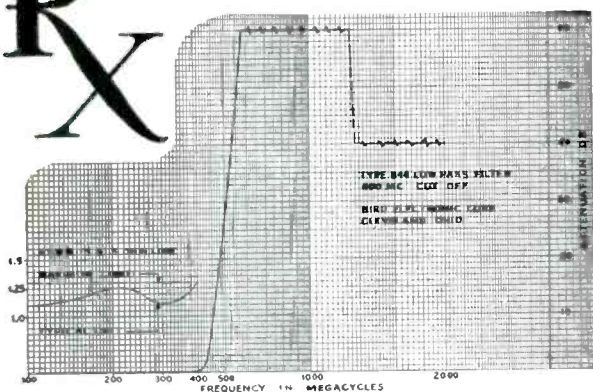

**Model 844  
Low Pass Filter**

• Suppression of low-order harmonics in transmitters operating below 400 mc is the prime function of Model 844 Low Pass Filter. 40 db or more attenuation of 2nd to 5th harmonics of transmitters operating between 225-400 mc is afforded. Insertion loss and VSWR are very low thruout the pass band. Teflon insulation and rugged construction thruout assures reliability.

**FREQUENCY RANGE** — pass band 0-400 mc. Stop band 500-2000 mc.

**POWER RANGE** — 150 watts maximum.

**IMPEDANCE** — 50 ohms. VSWR better than 1.35 thru pass band.

**CONNECTORS** — Type N. One male and one female. Filter is reversible with equal results.

**ATTENUATION** — pass band -3db or less below 400 mc. Stop band -40db or more 500 to 2000 mc.

**PHYSICAL DIMENSIONS** — 5 1/8" H x 5" W x 1". Weight — 12 oz.

## BIRD

### ELECTRONIC CORP.

1800 EAST 38TH ST., CLEVELAND 14, OHIO

TERMALINE Coaxial Line Instruments

**NEELY ENTERPRISES**  
Hollywood • San Francisco  
Albuquerque

**EARL LIPSCOMB ASSOCIATES**  
Dallas • Houston

## Fine Aluminum Wire

- To meet the growing demand from producers of light-weight, high-frequency Galvanometer movements, we have expanded our facilities designed to process Wire of 2S Aluminum . . . This wire can be supplied in diameters ranging from approximately .001 inch through .005 inch . . . Anodized with an exceptionally thin and flexible dielectric coating.
- Also available: wires of aluminum alloys enameled as small as .001 inch diameter, to meet rigid specifications of resistance, size and straightness.

Write for Latest List of Products

**SIGMUND COHN CORP.** 121 So. Columbus Avenue • Mount Vernon, N.Y.

150 employees.

Due to the recent completion of a new factory in Cassopolis, Mich. manufacturing enameled wire' the expansion of the Winsted Division at Winsted, Conn. and the addition of new customers and increased demands from regular customers, the Ossining plant has been called upon to supply greater quantities of fine wire. Because of the nonseasonal character and standardization of the product, steady employment has been made possible.

### Pope Joins Sanders

HAROLD W. POPE, formerly chief engineer at Convair's Guided Missile Division in California, has been elected the fourteenth associate of Sanders Associates, Inc. and is taking direction of its guided missile and aero-mechanical activities.



**Harold W. Pope**

As chief engineer at Convair, Mr. Pope was responsible for the technical and administrative direction of all phases of guided missile development and production engineering.

### Beckman Opens Plant In New Jersey

TRANSFER of its New York offices to a new 20,000 sq ft plant in Mountainside, N. J., has been announced by Beckman Instruments, Inc.

The air-conditioned brick structure triples the size of Beckman's current east-coast operation.

Functioning as northeast sales

and service headquarters for the parent company, this building also will provide a branch manufacturing facility for the Beckman Helipot Division, maker of helical potentiometers. Expansion on a countrywide scale has followed six-fold increases in the company's sales volume since 1949.

**Sonotone Names Battery Chief**



Harold Engstrom

HAROLD ENGSTROM has joined Sonotone Corp. as general manufacturing manager of the Battery Division, with headquarters in Elmsford, N. Y.

Mr. Engstrom was formerly with Sylvania Electric Products, Inc., where for four years he was chief of industrial engineering. He also supervised Sylvania's policies on installation and control of wage incentives and job evaluation and cooperated with the labor relations department on union contract negotiations.

He had previously been associated in a similar capacity with American Home Products Corp. Prior to that he was chief industrial engineer for five plants of the Bendix Aviation Corp. The 12 preceding years he spent with GE in Bridgeport, Conn.

**Warwick Plans New Lab**

WARWICK MANUFACTURING CORP. is opening a new research and development laboratory in Chicago, it was announced by John S. Holmes, president.

Edwin B. Hassler, formerly with

**ELECTRONIC GLASS WORKING EQUIPMENT**

For Radio, Television Tubes, Incandescent Lamps, Glass Lathes for Television Tubes

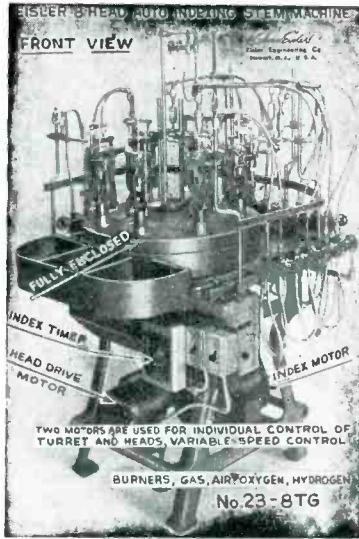

**TURNTABLES ▶**

We make over 100 types of turntables; tilting models and positioners.

More Eisler Stem and Sealing Machines are in use in the Electronics Industry than all other makes combined. There is a reason; they are simple, well-built, compact, last long, have good production, and are constantly being improved to give more production.

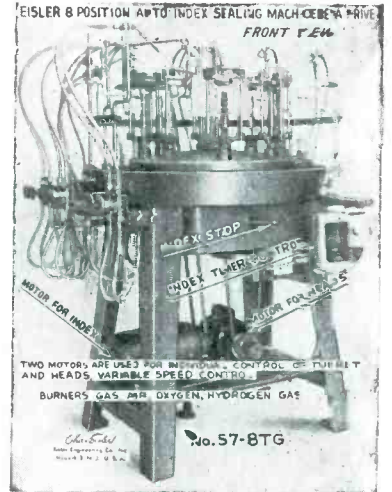

We make Transformers, Spot and Wire Butt Welders, Wire Cutting Machines and 500 other items, indispensable in your production. Eisler Engineers are constantly developing New Equipment. If you prefer your own designs, let us build them for you. Write to Charles Eisler who has served The Industry over 33 years.

Dr. Charles Eisler, President

**EISLER ENGINEERING CO., INC.**

751 South 13th St., Newark 3, N. J. Near Avon Avenue

**New 800-2600 mcs FREQUENCY METERS**  
Lightweight — Portable Units

... For Field and Laboratory Use!

**SPECIFICATIONS**

- 1. ACCURACY**  
Better than .05% from 20°F to 120°F
- 2. SENSITIVITY**  
Usable indication with 1 milliwatt input  
Adjustable for higher levels
- 3. INDICATOR**  
50 Microammeter
- 4. INPUT**  
50 Ohm Type N Connector
- 5. EXTERNAL DC OUTPUT**  
Pin Jacks
- 6. EXCURSION OF MICROMETER**  
One-half inch
- 7. MICROMETER SCALE**  
at 1000 Mc —  
1 Division equals 290 KC at 1400 Mc —  
1 Division equals 350 KC at 2000 Mc —  
1 Division equals 450 KC at 2500 Mc —  
1 Division equals 555 KC
- 8. EXTERNAL SIZE**  
6½ x 9¾ x 7"
- 9. WEIGHT**  
Four pounds

Models

FS-C-171-A	E00-1200	CS
FS-C-172-A	1500-1600	CS
FS-C-173-A	1600-2250	CS
FS-C-174-A	1700-2600	CS

Units consist of cavity body, microammeter control, crystal, suitable connectors and calibration chart. Write for specifications and prices.



**frequency standards**

(Cavity units are also available for custom housing)

P. O. Box 504, Asbury Park, New Jersey



Edwin B. Hassler

Motorola, Inc., has been appointed director of engineering to head the laboratory. He will be in charge of radio, television and electronic product development and the testing and improvement of component parts.

In addition to the standard radio and television set development, the laboratory's engineering staff will work on color television, record players, auto radios and transistor and printed circuit research.

The company recently purchased the 200,000 sq ft Fieldcrest Mills plant in Zion, Ill. which is being remodeled for tv production.

**Consulting Firm Formed**

TECON, TECHNICAL CONSULTANTS, INC. has been formed for the purpose of sales engineering, field servicing and technical consulting in the electrical, electronic, electro-mechanical and mechanical engineering fields.

Officers of the corporation include J. Herrmann, president and P. Marcus, vice president. Mr. Herrmann was formerly associated with the Westinghouse Electric Corp. and Taylor Instrument Co. Mr. Marcus comes to Tecon from Bell Recording Co., where he held the position of chief engineer.

**Auerbach Advances At Burroughs**

ISAAC L. AUERBACH has been appointed manager, special electronic equipment department, in the research activity of Burroughs Corporation, formerly Burroughs Adding

*versatile*

Multi-channel -- telegraph A1 or telephone A3.

FROM GROUND TO AIR OR POINT TO POINT

**STABLE**

High stability (.003%) under normal operating conditions.

**RUGGED**

Components conservatively rated. Completely tropicalized.

*Model 446 transmitter operates on 4 crystal-controlled frequencies (plus 2 closely spaced frequencies) in the band 2.5-24.0 Mcs (1.6-2.5 Mcs available). Operates on one frequency at a time; channeling time 2 seconds. Carrier power 350 watts, A1 or A3 AM. Stability .003% using CR-7 (or HC-6U) crystals. Operates in ambient 0° to +45° C using mercury rectifiers; -35° to +45° C using gas-filled rectifiers. Power supply, 200-250 volts, 50/60 cycles, single phase. Conservatively rated, sturdily constructed. Complete technical data on request.*

Here's the ideal general-purpose high-frequency transmitter! Model 446... 4-channel, 6-frequency, medium power, high stability. Suitable for point-to-point or ground-to-air communication. Can be remotely located from operating position. Co-axial fitting to accept frequency shift signals.

Consultants, designers and manufacturers of standard or special electronic, meteorological and communications equipment.

**AER - O - COM**  
2090 DOUGLAS ROAD MIAMI 33, FLA. Reg. U.S. Pat. Off.

**HEAT RESISTANT WIRES FOR EVERY APPLICATION**

Just a Reminder!

Now is the time to install Lewis heating cable on those outside pipe lines that caused you trouble last winter. Nickel Chrome conductor with special insulation designed for 500°F operation.

*Write for details*

Send your electronic control, communications or appliance wiring specifications for a recommended solution by our engineers.  
FOR A TRIAL ORDER OR A CARLOAD consult

**HEATING UNITS**

**HEATING ELEMENT**

**RESISTANCE LINE CORD**

**THERMOCOUPLE WIRE**

**ASBESTOS LEAD & FIXTURE WIRE**

**INSULATED RESISTANCE WIRE**

**FIBERGLAS INSULATED WIRE**

**WIRE TO ANY SPECIFICATIONS**

THE LEWIS ENGINEERING CO.

Wiring Division

NAUGATUCK CONNECTICUT



# BREW DELAY LINES

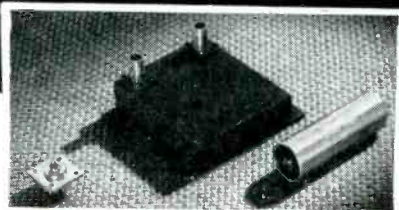

## Ultrasonic Type . . . delay from 10 to 1000 Microseconds

Designers and manufacturers of both government and commercial equipment find Brew's engineering "know-how", manufacturing facilities, prompt delivery, and cooperation go a long way in solving their needs.

**SPECIFICATIONS:** Frequency ranges from 5 to 100 MC. Bandwidth 5 MC at 20 center frequency to 14 MC at 50 MC center. Delays accurate to .1%. Low attenuation of delayed pulse. Spurious responses 60 DB below delayed pulse. Triple travel at least 30 DB below delayed pulse.

Send us your requirements.

# BREW

RICHARD D. BREW  
and Company, Inc.

106 Concord Ave., Belmont 78, Mass.

# Linde

M. S. C.

(Mass Spectrometer Checked)

## RARE GASES

HELIUM · NEON

ARGON · KRYPTON · XENON

LINDE Rare Gases are mass spectrometer checked to assure you gases of known purity and uniformly high quality. Available in commercial-size cylinders and glass bulbs.

LINDE, the world's largest producer of gases derived from the atmosphere, can meet your individual needs of purity...volume...mixture...containers...

LINDE AIR PRODUCTS COMPANY  
A DIVISION OF UNION CARBIDE  
AND CARBON CORPORATION

30 East 42nd Street **UCC** New York 17, N. Y.

In Canada:  
Dominion Oxygen Company, Limited, Toronto

The term "Linde" is a registered trade-mark of Union Carbide and Carbon Corporation



# SWEEPMASTER

Sweep Frequency Generators

give you these

outstanding advantages . . .

- Frequency Marker with an accuracy independent of Sweep Width. Inserted after external detection, it eliminates erroneous interpretation—eliminates possibility of undesirable transient distortion or limiting actions. The Marker is adjustable in amplitude and, after adjustment, remains independent of other controls.

- An attenuator whose performance is free of Frequency, assuring you that the Output

Envelope is the same as that indicated by the Internal Monitor.

- A simple switching operation to permit examination of either Envelope of the Swept Frequency Signal.

- Durable, compact, lightweight Output and Detector Probes, either of which can be detached easily and replaced by cables having standard connectors.

### SPECIFICATIONS

MODEL	CENTER FREQUENCY	RF OUTPUT 50 ohm * TERMINATION	SWEEPWIDTH CONTINUOUS ADJUSTMENT	FREQUENCY MARKER
SM I	100 KC to 14 MC	1 volt RMS	150 KC to 14 MC	100 KC to 14 MC
SM II	500 KC to 50 MC	0.2 volt RMS	150 KC to 20 MC	500 KC to 50 MC
SM III	500 KC to 75 MC	0.1 volt RMS	150 KC to 20 MC	500 KC to 75 MC

FLATNESS: Less than 1 DB variation over maximum sweepwidth range.  
FREQUENCY MARKER: Engraved calibration accurate to ±2%.

HORIZONTAL DEFLECTION: A 60 cps sine wave for application to horizontal input of oscilloscope is supplied.

BLANKING: The RF signal may be operated con-

tinuously or blanked out for 1/2 of each 60 cycle period.

EXTERNAL DETECTOR: Blocking capacitor of 400 volt breakdown capacity.

\*75 ohm available when specified

## MANUFACTURERS ENGINEERING & EQUIPMENT CORP.

15 Mill Road • Hatboro, Pa.

There is Always One Leader in Every Field

# BODNAR INDUSTRIES, Inc.

leads in the field of

## TRANSILLUMINATED PLASTIC LIGHTING PLATES

BECAUSE OF Quality • Uniformity • Performance

Design & Layout "Know-How Service"

Quantity Production Promptly

NEW YORK—19 Railroad Ave., New Rochelle (Home Office)

TEXAS—Jefferson Tower Building, Dallas

CALIFORNIA—11056 Cumpston St., N. Hollywood

CANADA—313 Montreal Trust Bldg., 67 Yonge St., Toronto

DEMONSTRATION PANEL MIL-P-7788 (AN-P-89) Sent on Letterhead Request

## AUDIOTONE CONTINUITY and LEAKAGE TESTER

- WIDE RANGE—0 to 100 Megohms
- SAFE—Current under 1. Ma.
- TESTS BY SOUND—Frequency changes with resistance
- SHELF-LIFE BATTERY
- NO TUBES
- NO VIBRATOR
- SELF CONTAINED

USES — CONTINUITY TESTER —  
LEAKAGE INDICATOR (1 micro-amp.) —  
PRECISION CONTACT INDICATOR —  
AUDIBLE ALARM — TONE SOURCE —  
VOLTAGE & POLARITY INDICATOR,  
AC/DC

# PESCHEL ELECTRONICS, INC.

13 GARDEN STREET, NEW ROCHELLE, N. Y., NEW ROCHELLE 6-3342



# THE KING OF THEM ALL!

**Sensitive Electrostatic Voltmeters**

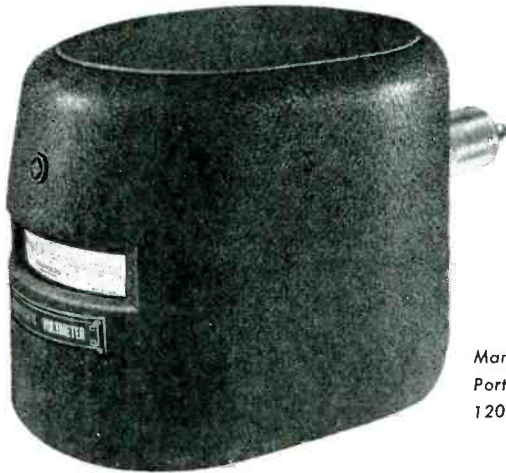

## 50,000 VOLT INSTRUMENT ILLUSTRATED

Scale Length—6"

### ACCURACY

1% on A.C. or D.C.

### INSULATION RESISTANCE

$3.6 \times 10^{15}$  Ohms

### RANGES

- a. SINGLE—5 K.V. to 60 K.V.
- b. MULTI—2, 3, & 4 Ranges from 5 K.V. to 30 K.V.

Manufacturers of a complete line of Portable Electrostatic Voltmeters from 120 Volts to 7500 Volts.

for further information

write

## **SENSITIVE RESEARCH INSTRUMENT CORP.**

10 ELM AVE., MOUNT VERNON, N. Y.

**ELECTRICAL INSTRUMENTS OF PRECISION SINCE 1927**

Machine Company.

At Burroughs Research, Mr. Auerbach has been actively engaged in the design of electronic data processing systems and initiated work on magnetic components and circuits. He was responsible for the design of the static magnetic memory system for the ENIAC.

Prior to joining Burroughs Research in 1949, he worked on the BINAC and UNIVAC systems at the Eckert-Mauchly Division of Remington Rand, Inc., in Philadelphia.

## **Radio City Products Expands**

A 2½-ACRE tract of land has been leased by Radio City Products Co. at Easton, Pa. for the erection of a new one-story manufacturing plant to adjoin their present production center. The new building will provide for an additional 13,000 sq ft, and thus give the company a total production area of 27,000 sq ft. Administration, sales and engineering will continue to be located in New York City.

Jerome M. Hollander, formerly with Allen B. DuMont Laboratories, has been appointed senior engineer of the company. He will be principally responsible for the company's test equipment design.

Mr. Hollander was also previously associated with the engineering departments of GE and Oak Ridge Products.

## **Hughes Labs Adds Two**

MAX A. ANDERSON AND JOHN R. BURGNER have joined the field engineering department of Hughes Research and Development Laboratories. Mr. Anderson was formerly associated with WRAP-TV. Mr. Burgner was formerly with the National Bureau of Standards.

## **Makepeace Co. Builds For Electronic Industry**

THE D. E. Makepeace Company, one of New England's oldest and largest precious metals manufacturers, has a new building under construction as part of a program

# Boost Your Quality Standards with **DX** ELECTRONIC COMPONENTS

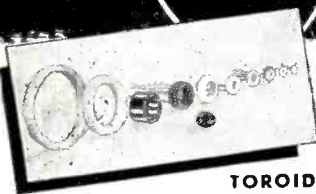

TOROID COILS

SPECIAL ASSEMBLIES

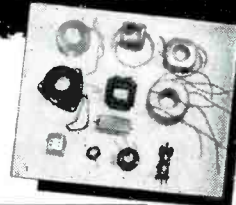

DEFLECTION YOKES

CRYSTALS



TOROID FILTERS... I. F. TRANSFORMERS... R. F. COILS... DISCRIMINATORS  
TRANSFORMERS... TV TUNERS... ION TRAPS... SPEAKERS

If you require exacting quality and dependable performance, let DX engineers figure with you on your next production run. Users of DX components enjoy exceptional freedom from field failures. This advantage can be yours at no extra cost. Write today.

## **DX RADIO PRODUCTS CO.**

GENERAL OFFICES: 2300 W. ARMITAGE AVE., CHICAGO 47, ILL.

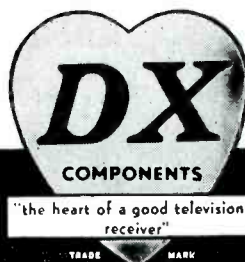

# PIPELINE TO PRECISION



Model WWVR

Designed specifically to conveniently receive and make maximum use of all the Standard Frequency Transmissions of WWV without any special setup.

Send for complete specifications

**SPECIFIC PRODUCTS**  
5864 HOLLYWOOD BOULEVARD  
LOS ANGELES 28, CALIFORNIA



## TRANSFORMERS

" Fill Your Need to a "

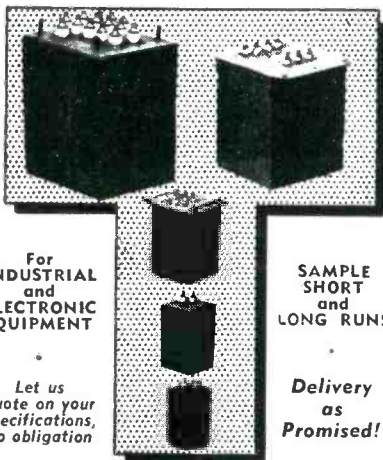

For INDUSTRIAL and ELECTRONIC EQUIPMENT

Let us quote on your specifications, no obligation

SAMPLE SHORT and LONG RUNS

Delivery as Promised!

DESIGNED TO COMMERCIAL AND MILITARY SPECIFICATIONS (MIL-T-27 and AN-E-19)

**EPCO Products Inc.**

2500 Atlantic Ave.  
Brooklyn 7, New York

Want more information? Use post card on last page.

ELECTRONICS — July, 1953

PLANTS AND PEOPLE

(continued)

to diversify and expand production for the electronics industry, it was announced by W. F. Mittendorf, vice-president and manager.

### Weathers Appoints Gately

PAUL WEATHERS of Weathers Industries announced recently the appointment of Edward J. Gately, Jr., as project engineer. Mr. Gately was formerly associated with Clifton Precision Products and is connected with Gately Development Laboratories.

### Allison Named To New Sprague Post



William M. Allison

APPOINTMENT of William M. Allison as technical advisor has been announced by Carroll G. Killen, manager of field engineering of the Sprague Electric Co.

Mr. Allison has been a senior executive in the Sprague research and engineering department for the past 20 years, contributing to nearly all phases of Sprague technological development in his prior posts of supervisory engineer and chief design engineer. He holds six patents pertaining to capacitors.

### Starks Named Head Of Atomic Committee

JAMES C. STARKS, on leave from Sandia Corp., contractor to the Atomic Energy Commission, has been named executive director of

*To remind you that Pennsylvania Optical, one of the oldest optical houses in the nation is now successfully applying spectacle making mass production methods to the lens problems of the Electronics Industry.*

*We're proud of the lenses we are now making for some of the largest manufacturers of electronic equipment. Picture tube face plate lenses. Lenses for Magnetrons, Iconoscopes. Atomic Radiation Windows. Filter Lenses of all kinds. A host of allied "problem children." We take a lot of pride in our control of flat surfaces, of prism tolerances, and diameters.*

*We are inviting additional specialized lens work in the electronics field, leading to volume orders. We're equipped for everything from basic research to making our own tools to meet its demands.*

*Will you let us know your lens problems?*

**PENNSYLVANIA  
OPTICAL  
COMPANY**

234 South Eighth St.  
Reading, Pa.

Telephone  
Reading 4-8397

# MODULATOR by MANSON

## 2.5-MEGAWATT

peak power — Model 200T  
Hydrogen Thyatron Modulator

The Modulator functions at various pulse widths and frequencies up to the indicated peak power, or maximum average power of 5 kilowatts.

The **POWER-SUPPLY** Section supplies 10 KV at 0.5 amperes, and is fully interlocked and protected against DC or AC overload so that it may be used independently for external equipment if desired.

The **PULSER** includes an adjustable filament supply for magnetrons, internally- or externally-synchronized JAN triggers for 5C22 or 1907 Hydrogen Thyatron switch tubes, pulse-current and voltage-view circuits, and peak-reading voltmeter capable of measuring up to 40 KV output pulses.

**MECHANICALLY**, the complete unit is on casters, and is contained in a rigid framework with bench space on top and interlocked doors on three sides. Layout permits ready interchange of pulse transformer, pulse-forming network, and charging choke.

Complete Data in Bulletin E-1



Hard- or Soft-Tube Modulators at all power levels built to specifications.  
Your inquiry is invited.

**MANSON LABORATORIES** / Industrial Control Devices —  
Electronic and  
207 Greenwich Avenue • Stamford, Conn. / Electro-Mechanical Instruments

## MICROWAVE RESISTORS TELEWAVE TYPE R

**SMALLEST  
RESISTOR  
AVAILABLE**

(Ideal for Miniaturization)

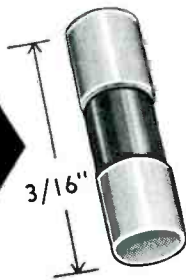

### TYPICAL APPLICATIONS

- Power measurement at any frequency
- Matched terminations for waveguides or coaxial lines
- Resistive power pickup loops
- RF pads or attenuators
- Dummy loads
- Temperature measurements
- Impedance matching

### SPECIFICATIONS

Resistance: 50 ohms standard, other values on request.  
Tolerance: 5% or 10%  
Wattage: 1/4 watt continuous duty at 25°C  
Size: 1/16 inch diam. x 3/16 inch long  
Terminals: Tinned sections 1/16 inch long  
Film Length: Type R-063 — 1/16 inch  
Type R-093 — 3/32 inch  
Temperature Coefficient: approx. 0.0019 ohms/ohm/°C.  
Power Sensitivity: Approx. 10 ohms/watt

AVAILABLE  
FOR  
IMMEDIATE  
DELIVERY

**TELEWAVE LABORATORIES, INC.**  
100 Metropolitan Ave. • Brooklyn 11, New York

**TYPE R RESISTORS** employ noble metal film deposits on specially selected heat resistant glass.

**FILM THICKNESS** offers negligible skin effect, at microwave frequencies.

**POWER CAPACITY** of 1/4 watt provides high power handling ability.

**PHYSICAL STRUCTURE** is ideally suited to impedance matching in standard coaxial line and waveguides.

**FINISH.** Coated with a special silicone varnish to protect the film.

the Research and Development Board's committee on atomic energy. Mr. Starks has been associated successively with McQuay Norris Co., St. Louis, Mo., the Crosley Radio Corp., Cincinnati, Ohio and the Westinghouse Corp. with whom he developed electronic equipment for the Navy.

### Sobin Is President Of Olympic Radio

MORRIS SOBIN, executive vice-president of Olympic Radio & Television, Inc., since July 1952, was elected president of the company at the organization meeting of directors following the annual meeting of stockholders. Mr. Sobin, associated with Olympic since 1942, initially as chief accountant and, from 1946 to 1952, as vice-president and treasurer, succeeded Percy L. Schoenen, who previously announced his retirement.

### Erie Resistor Adds Industrial Department

AN industrial sales department has been organized within the electronics division of the Erie Resistor Corporation, according to an announcement by Allen K. Shenk, sales manager. E. S. Willis, sales representative, has been appointed to head up the new department.

The department will coordinate sales efforts involving all companies except those which primarily manufacture radio and tv home receivers and radio and radar equipment for the U. S.

### Rogers Joins National Bureau Of Standards

GEORGE J. ROGERS has joined the electronics division of the National Bureau of Standards. As a member of the engineering electronics section Mr. Rogers will be engaged in the development of miniaturized electronic equipment.

Before joining the NBS staff, Mr. Rogers was an electronics engineer with the Engineer Research and Development Laboratories, Ft. Bel-

# UNRESTRICTED AUCTION SALE

Entire plant of Heintz-Kaufman, manufacturers of electron tubes. Approximate valuation \$350,000.

For further details see full page advertisement this issue, Page 405.

**IRWIN FRIEDMAN**

*Auctioneers*

764 Mission Street  
San Francisco, California  
Phone EXbrook 2-5864

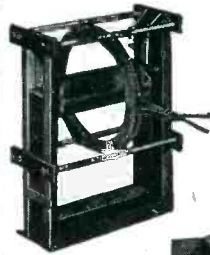

\*High  
Efficiency

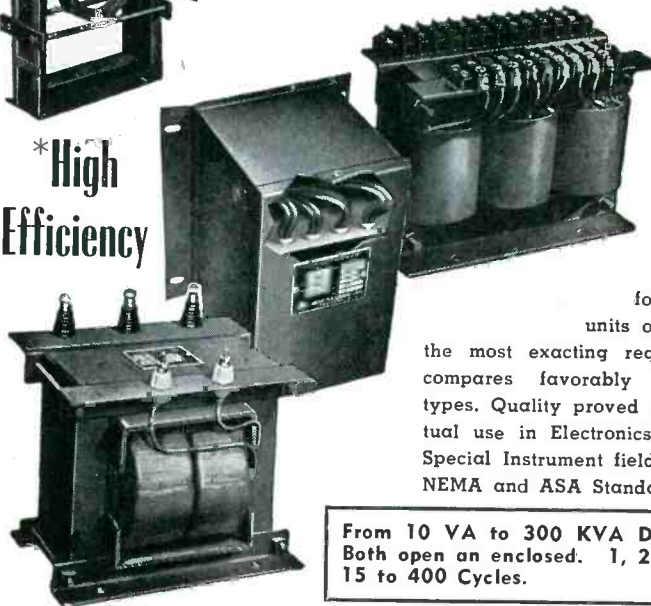

## Interested in H-E\*? Investigate **NOTHELFER "NWL"** SPECIAL TRANSFORMERS

For  
Electronics,  
Research  
and  
Special  
Industrial  
Fields

For 31 years we have been building transformers in single units or in quantity to the most exacting requirements. Cost compares favorably with standard types. Quality proved by years of actual use in Electronics, Research and Special Instrument fields. Built to meet NEMA and ASA Standards.

From 10 VA to 300 KVA Dry-Type only.  
Both open and enclosed. 1, 2 and 3 Phase  
15 to 400 Cycles.

SEND FOR 8 PAGE BULLETIN, AND PRICE LIST



# NOTHELFER

WINDING LABORATORIES  
9 ALBEMARLE AVE., TRENTON 3, N. J.



**BE SAFE WITH**  
**Q-max**  
**A-27**  
**LOW-LOSS LACQUER & CEMENT**

- Q-Max is widely accepted as the standard for R-F circuit components because it is chemically engineered for this sole purpose.
- Q-Max provides a clear, practically loss-free covering, penetrates deeply, seals out moisture, imparts rigidity and promotes electrical stability.
- Q-Max is easy to apply, dries quickly and adheres to practically all materials. It is useful over a wide temperature range and serves as a mild flux on tinned surfaces.
- Q-Max is an ideal impregnant for "high" Q coils. Coil "Q" remains nearly constant from wet application to dry finish. In 1, 5 and 55 gallon containers.

*Communication  
Products Company, Inc.*

MARLBORO, NEW JERSEY  
(MONMOUTH COUNTY)  
Telephone: FReehold 8-1880

**sub-miniature  
AND  
moisture-proof**

**IN-RES-CO  
S-15 & S-30  
WIRE WOUND  
RESISTORS**

*THE ECONOMICAL SOLUTION*  
where moisture proof resistive elements of comparatively small size are required for commercial applications. Type S-15 is 3/8" long by 1/4" diameter; type S-30 measures 3/4" by 1/4" diameter. Both types are moisture proof and capable of high performance over long periods of continuous service. IN-RES-CO Resistors for every ordnance or civilian requirement are available at a cost that solves circuit design problems both performance-wise and cost-wise. Check up now, on the complete line of IN-RES-CO quality wire wound resistors.

TYPE S-15  
1/4" DIA. x 3/8" LG.

TYPE S-30  
1/4" DIA. x 3/4" LG.

**INSTRUMENT  
RESISTORS CO.**

COMMERCE AVENUE UNION NEW JERSEY

FOR JAN SPECIFICATION RESISTORS — consult the new illustrated literature describing the complete In-res-co line. Write for your copy today!

APPLICATION-DESIGNED RESISTORS FOR ELECTRONICS AND INSTRUMENTATION

# LICK SOLDERING FATIGUE!



—with the new **HEXA CON**  
**FEATHERWEIGHT**  
**MODEL 30H**

So light its weight is hardly noticeable, but more powerful than its wattage rating indicates. Hatchet design makes it more comfortable and practical to use than a soldering pencil. No transformer required.

WEIGHT—5½ OUNCES (LESS CORD);  
WATTS—40 OR 60; TIP DIA.—BOTH  
⅛" AND ¼" TIPS FURNISHED WITH  
EACH IRON; PRICE— **\$575**

Write today for catalog describing the complete line of screw tip, plug tip and hatchet irons.

**HEXA CON**  
**ELECTRIC CO.**

130 WEST CLAY AVE.,  
ROSELLE PARK, N. J.

**HEXA CON**

voir, Virginia, where he assisted in the development of electronic mine-detecting equipment for both metallic and non-metallic mines.

## Diener Named Chief Engineer of Pacific TV

BERNARD DIENER of Pacific Mercury Television Manufacturing Corp., Los Angeles, has been named chief engineer of the firm's Radio and Television Division in charge of home receiver development and design. Another change moved Stan Cutler, vice-president and chief engineer, to a post as director of engineering and acting chief engineer of the new Special Products Division.

## Foulds New V-P Of GPL

ELECTION of Blair Foulds as a vice-president General Precision Laboratory, Inc., has been announced by Hermann G. Plance, president of the company.

Mr. Foulds has served for several years as commercial engineering director of the company, with responsibility for government liaison and contract administration as well as marketing of commercial products including broadcast studio and theatre television equipment.

Before joining GPL in 1949, Mr. Foulds was commercial engineering director of Brush Development Company, Cleveland, manufacturers of industrial instrumentation and magnetic recording devices.

## Sightmaster Forms New Subsidiary

THREE electronic and metallurgical companies have been consolidated to form Sightmaster of California as a new subsidiary of Sightmaster Corp. of New Rochelle, N. Y. Headquarters are at Gillespie Airport, Santee, Calif., a suburb of San Diego.

Electronic Division of Transport Products Corp., Louisville, Ky. was acquired by purchase, Technical Products and Services Co. by exchange of stock, and Chemalloy Associates by exchange of stock. The transaction secured for the

for maximum economy...  
**5KW VACUUM TUBE  
BOMBARDER  
OR INDUCTION  
HEATING UNIT**

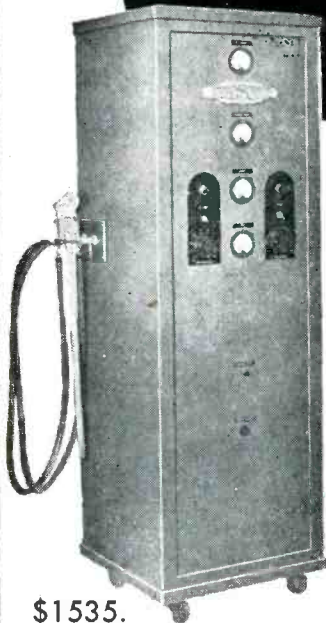

\$1535.

Simple... Easy to Operate... Economical  
Standardization of Unit Makes This New Low Price Possible.

Maximum economies can be obtained only by use of correct frequency and power combinations when applying the techniques of induction heating to manufacturing processes.

It is significant that only Scientific Electric in the present market, can offer you a selection of frequencies depending on power required, in wide power range. 2-3½-5-6-7½-10-12½-15-18-25-40-60 KW (all units above 60 KW are considered custom built). This means that electronic heating equipment produced by Scientific Electric is tailored to your needs... fitted perfectly to the task entrusted to it, enabling you to keep your initial investment in equipment to a minimum while affording you all the proven advantages of electronic heating.

Write now for complete information or send samples of work to be processed. Specify time cycle for your particular job. We will quote on proper size unit for your requirements.

DESIGNERS AND MANUFACTURERS OF HIGH FREQUENCY AND HIGH VOLTAGE EQUIPMENT SINCE 1921

*Scientific Electric*

105-119 MONROE ST  GARFIELD, N. J.

new firm the TPC-KAHL micro-wave calorimeter and other electronic developments and services, as well as the Chemalloy aluminum and zinc fluxless soldering and welding process.

### Bushnell Acting Chief Of Common Carrier Bureau

CURTIS M. BUSHNELL has been designated as acting chief of the common Carrier Bureau of FCC. He succeeds Jack Werner, resigned.

### Bakelite Completes Expansion Plans

COMPLETION of plans for the largest single expansion program in the entire history of the plastics industry was recently announced by Bakelite Co., a division of Union Carbide and Carbon Corp.

In making the announcement, H. S. Bunn, president of Bakelite, stated that a three year expansion program calls for the construction of three large new plants with facilities to produce Bakelite polyethylene plastic, its compounds and other chemicals from natural gas.

"This Union Carbide expansion program, when completed in 1955, will double present U. S. polyethylene production, bringing total annual production of Bakelite polyethylene to over 250 million pounds," Mr. Bunn stated.

On the occasion of the announcement of completion of the company's expansion plans, Under Secretary of the Army Earl D. Johnson revealed that total savings of \$153 million in current defense procurement of wire and cable are largely due to the use of polyethylene.

Replacing old-style cable with a new type using polyethylene insulation has saved taxpayers \$50 million since the Korean fighting began, he said. "The Signal Corps spent just \$288,000 in a research contract granted for the development of this synthetic material as insulation for Army wire and cable. Thus, for \$228,000 the Army's Research and Development program in the fiscal year 1953 will produce savings of about \$12.4 million on field wire alone. Total savings in the last two and one-half years on wire and cable have amounted to over \$153 million."

## IMPEDANCE BRIDGE

*Wide Range*  
Resistance: 1 milliohm to 11 megohms  
Capacitance: 1 mmf to 1100 mfs.  
Impedance: 1 mh to 1100 henrys

*Exceptional Accuracy*  
Resistance: ± 0.1%  
Capacitance: ± 0.25%  
Inductance: ± 1.0%

◆  
**SHOWN  
MODEL 250-C1  
\$340**

9"x11"x11" over-all. Convenient operation from battery, or from AC power lines with Beco accessory amplifier.

◆

Write to factory for literature and analysis of your needs.

**BROWN ELECTRO-MEASUREMENT CORP.**

4312 S. E. Stark St.  
PORTLAND 15, OREGON

# A timely tip on timing

Won't you take a timely tip on timing and take your timing problems to a company with a proven performance record. The A. W. HAYDON CO. has repeatedly been called upon by industry to solve the most difficult timing problems.

Regardless of how difficult your timing problems may appear to be, remember there has to be a solution . . . The A. W. HAYDON CO. are past masters at solving the most difficult and exacting of these problems.

Past performances prove future accomplishments . . . take a timely tip on timing and call The A. W. HAYDON CO. . . their engineer consultants will gladly talk over any problem you may have.

**A. W. HAYDON  
COMPANY**  
235 NORTH ELM STREET  
WATERBURY 20, CONNECTICUT  
Design and Manufacture of Electrical Timing Devices

**PREFERRED WHERE  
PERFORMANCE  
IS PARAMOUNT**

there's a  
**BIRTCHEK CLAMP**  
for *almost*  
every purpose!

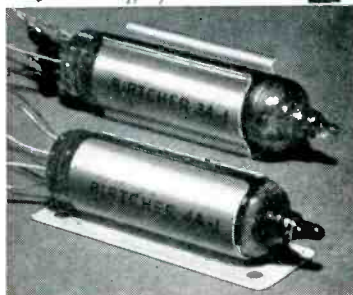
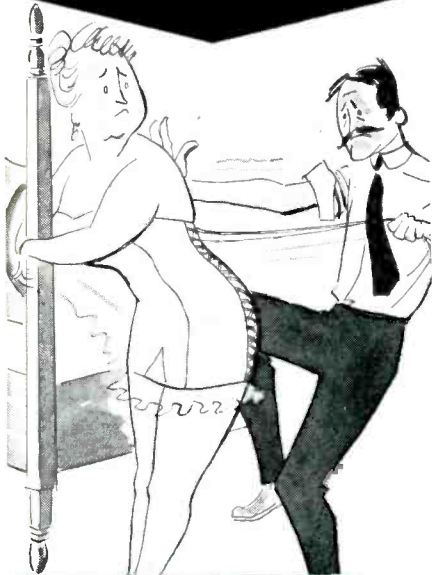

#### NEW SUB-MINIATURE TUBE CLAMPS

The Birtcher KOOL KLAMPS were developed for use under conditions of extreme heat and severe vibration and shock. Made from a heat treatable silver alloy of high thermal conductivity, reducing bulb temperatures by as much as 40° C, KOOL KLAMPS are improving the reliability of miniaturized electronic equipment.

*The Birtcher Corporation, world's largest producer of electro-surgical devices, maintains a separate division for the manufacture and sale of tube and component clamps.*

#### The BIRTCHEK CORPORATION

4371 Valley Blvd.  
Los Angeles 32, California



Please send catalog and samples by return mail.

Company \_\_\_\_\_ E-7-3  
Attention to: \_\_\_\_\_  
Address \_\_\_\_\_  
City \_\_\_\_\_ State \_\_\_\_\_

Want more information? Use post card on last page.

## NEW BOOKS

### Signal, Noise and Resolution in Nuclear Counter Amplifiers

By A. B. GILLESPIE. McGraw-Hill Book Co., New York, 1953, 155 pages, \$4.50.

THIS is the first of a new series of monographs under the general title of "Electronics and Waves" sponsored in London by Pergamon Press, and under the editorship of D. W. Fry, who, like the author of the present volume, is a member of the staff at the Harwell atomic energy establishment.

The title reveals exactly the nature of the book—the factors which determine the signal-to-noise ratio and the resolution in nuclear counters. The first chapter deals with the nature of the signals from an ionization chamber. Then follow discussions of tube and circuit noise, along with the signal-to-noise ratio and how best to maximize it. The final two chapters deal with amplifier sensitivity and proportional and scintillation counters.

Mr. Gillespie evidently writes from experience and not from a mere theoretical interest in the subject. Intermixed with the useful and clear analytical treatment will be found many practical hints involving tube and circuit types and their relative advantages for particular jobs.

This would be an excellent starting point for anyone about to get his first experience with nuclear research.

Other volumes to appear in this new series are "Microsecond Pulse Techniques", "Particle Accelerators", "Probability, Information Theory and Radar", "Secondary Electron Emission", and "The interaction between Electrons and Electromagnetic Waves."—K.H.

### Essentials of Microwaves

By ROBERT B. MUCHMORE. John Wiley & Sons, Inc., New York, 1952, 236 pages, \$4.50.

IN THIS BOOK the author attempts, with considerable success, to present a physical picture of the phenomena which collectively make up the microwave field. Thus, such

## A TRUE ELECTROSTATIC VOLTMETER

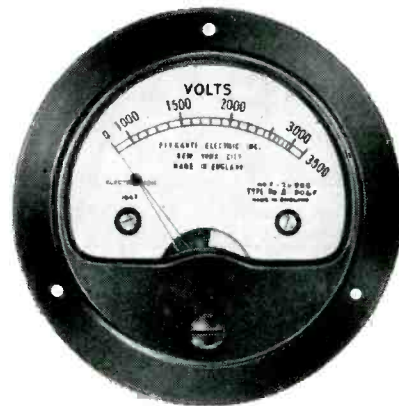

This instrument permits voltage readings on AC or DC circuits of very high resistance. The only current drawn is the very small leakage current and a very low capacitance current on AC circuits. Very useful for the many high voltage—low current circuits employed in nuclear research. Available with full scale voltages ranging between 300 and 3500 volts. Special laboratory instrument available with full scale reading of 150 volts. Full scale capacitance ranges from 8 mmfds for the 3500 volt model to 100 mmfds for the 150 volt instrument. Magnetic damping. 2½" dial. Write for complete specifications.



FERRANTI ELECTRIC, INC.

30 Rockefeller Plaza • New York 20, N. Y.

FERRANTI, LTD., Hollinwood, England  
FERRANTI ELECTRIC, LTD., Toronto, Canada

Want more information? Use post card on last page.

July, 1953 — ELECTRONICS



# TWO NEW TWIN POWER SUPPLIES

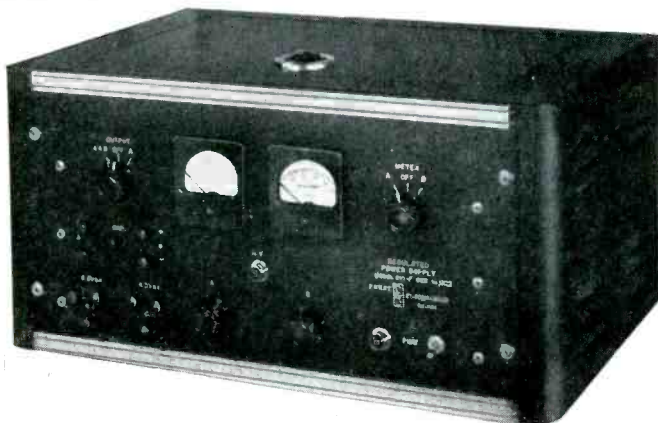

**MODEL 610-F**

- Precise Electronic Regulation.
- 2 Independent Sources of Power.
- 0-325 V.D.C. at 0-100 Milliamperes. Continuously Adjustable.
- 0-325 V.D.C. at 0-200 Mils if the Sources are Combined.
- Both D.C. Outputs Metered for Voltage or Current.
- 6.3 and 12.6 V.A.C. Outputs Provided.
- A.C. Ripple Less than 10 Millivolts.

**MODEL 1210**

- Precise Electronic Regulation.
- 2 Independent Sources of Power.
- 0-500 V.D.C. at 0-150 Milliamperes. Continuously Adjustable.
- 0-500 V.D.C. at 0-300 Mils if the 2 Sources are Combined.
- Both D.C. Outputs Metered for Voltage or Current.
- 6.3 or 12.6 V.A.C. Outputs Provided.
- A.C. Ripple Less than 10 Millivolts.

Also available with regulated bias output

Furst Twin Power Supplies double the usefulness of a single unit at considerable saving in space and cost. Write for complete specifications on these and other Furst Twin Power Supply Models.

## FURST ELECTRONICS

3324 West Lawrence Ave., Chicago 25, Illinois

# HOW Barnstead PURE WATER

# HELPS RCA

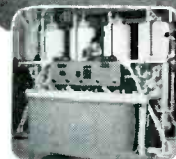
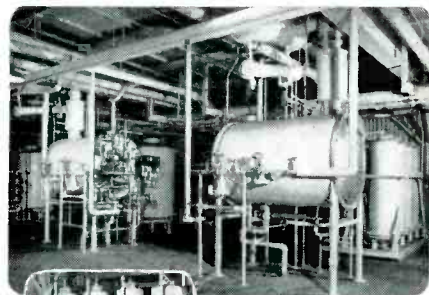

RCA requires Pure Water ... copper-free to an extreme degree and free from organic impurities for trouble-free TV picture tubes. That is why RCA makes use of Barnstead 200 gph double-effect Stills in combination with Barnstead 1000 gph Demineralizers.

## LIKE RCA... THOUSANDS OF PLANTS THE WORLD OVER MAKE USE OF BARNSTEAD EQUIPMENT FOR OBTAINING PURE WATER

If you use water, in any of countless manufacturing and processing operations, you will find that Barnstead equipment producing either demineralized or distilled water, or both, will insure better products, consistent results, fewer rejects; and will cut your costs in many ways. Join the thousands of companies the world over who look to Barnstead for the solution to their Pure Water problems. Write today stating your problem. Our engineers will make recommendations without obligation ... recommendations that will cut costs and increase production.

The Right Equipment For Your Pure Water Needs

75 Years of Progress in Pure Water

We Make Both ... Stills and Demineralizers



84 Lanesville Terrace, Boston 31, Mass.

## It's "TREATMENT" that makes DANO your Best Bet for Coils

DANO's battery of vacuum impregnating tanks and heat controlled ovens for curing varnish impregnations is always at your service. Yes, Dano coils and Dano customers are always treated in the manner that makes your production pay dividends.

Send us samples or specifications with quantity requirements for our recommendations. No obligation!

Also, Transformers Made To Order

- Form Wound
- Paper Section
- Acetate Bobbin
- Molded Coils
- Bakelite Bobbin
- Cotton Interweave
- Coils for High Temperature Application



## THE DANO ELECTRIC CO.

MAIN ST., WINSTED, CONN.

# Ferrites

Purified synthetic products of reagent quality. Controlled particle size and shape contribute to effective control of packing and shrinkage. Our know-how can help you accomplish best results.

Manufactured by highly modern processes under rigid laboratory control. This ad clipped to your letterhead will bring a working sample.



**COLUMBIAN CARBON COMPANY**  
MAPICO COLOR DIVISION  
MANUFACTURER

**BINNEY & SMITH CO., Distributor**  
41 EAST 42ND STREET, NEW YORK, N. Y.



# ELECTRICAL RESOLVERS

- interchangeability
- temperature compensation —  $-60^{\circ}\text{F}$  to  $+160^{\circ}\text{F}$
- highest accuracy
- adaptability to special circuit uses
- 400 cycle frequency

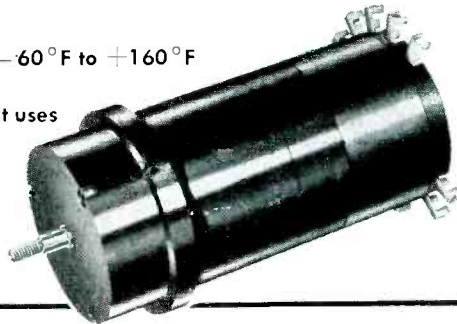

Now you can get the same Ford Electrical Resolvers, precision-built to the highest degree of operating efficiency for our own quality computers and automatic control equipment... to meet your extra special requirements!

**FREE** — fully illustrated brochure gives more details, describes Ford Instrument resolver systems. **WRITE FOR YOUR COPY TODAY!** Address Dept. E-8

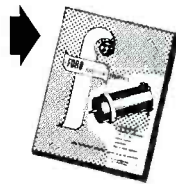

## FORD INSTRUMENT COMPANY

DIVISION OF THE SPERRY CORPORATION  
31-10 Thomson Avenue, Long Island City 1, N. Y.

FOR YOUR

# STAINLESS STEEL FASTENERS...

IT'S **ALLMETAL**

for quality  
and  
delivery

**ALLMETAL**, Specialists in Stainless, Produce Stainless Products Exclusively

## ALLMETAL

the leading source for Stainless Screws, Nuts, Bolts, Washers, Pins, Rivets. Made right, Priced right. "AN" and Standard Types carried in stock. Phillips Recessed Head Screws and Specials available too.

WRITE FOR CATALOG C



MANUFACTURERS SINCE 1929

# ALLMETAL

SCREW PRODUCTS COMPANY, INC.

33 GREENE STREET NEW YORK 13, N. Y.

matters as waves and wave guides, resonators and filters, antennas for microwaves, tubes for generating microwave power, the problems of noise, relay systems, radar, applications of microwaves to physical research, and microwave research are described in turn.

Virtually the only mathematics is in the first chapter, which deals with Maxwell's laws; the reader can easily skip over this. In fact, the average reader—that is, one who does not already know the facts of microwaves—is advised not to worry too much about these equations or their explanation but to plunge into the rest of the book. For the truth is that this attempt to sugar-coat Maxwell is not too successful and might easily frighten away the reader who can grasp all the rest of the book. The mathematics in the appendix is much easier to handle.

The book provides an excellent review for those who have been exposed to the field and is a good first book for those who have had adequate scientific background. A teacher would be required to bring out the best of the concepts described for the man who has limited background.—K.H.

## Radio and Radar Technique

BY A. T. STARR, *Pitman Publishing Corporation, London, Toronto, and New York, 1953, 812 pages, \$15.00.*

THE dollar-outlay for this new British-produced encyclopedic guidebook to the physics and mathematics of radio, broadly defined, is justified for the teacher, scientist, practicing research engineer and technical library. It purposely omits information readily obtainable in elementary undergraduate textbooks; and, devoid of anything but the barest mention of specific applications, packs the broad scope of its title into 510 closely-knit pages on the physics of communication and electronics, followed by 281 pages of mathematical appendices and by author and subject indices to the entire volume. The compression-ratio of the work is enhanced by the copious use of tiny but adequate diagrams and graphs. There are no pictures and no tabulations of data.

The seven chapter headings are:

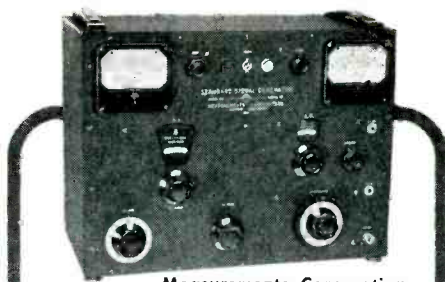

Measurements Corporation  
MODEL 82

## STANDARD SIGNAL GENERATOR

20 Cycles to 50 Mc.

**FREQUENCY RANGE:** 20 cycles to 200 Kc. in four ranges. 80 Kc. to 50 Mc. in seven ranges.

**OUTPUT VOLTAGE:** 0 to 50 volts across 7500 ohms from 20 cycles to 200 Kc. 0.1 microvolt to 1 volt across 50 ohms over most of range from 80 Kc. to 50 Mc.

**MODULATION:** Continuously variable 0 to 50% from 20 cycles to 20 Kc.

**POWER SUPPLY:** 117 volts, 50/60 cycles. 75 watts.

**DIMENSIONS:** 15" x 19" x 12".  
Weight, 50 lbs.

**MEASUREMENTS CORPORATION**

BOONTON



NEW JERSEY

*Runzel* CORD, WIRE & CABLE

PRECISION MADE WIRE

FOR *Quality Products*

The consistent quality standard of Runzel wire, cord and cable offers manufacturers complete assurance of performance. Runzel products undergo such thorough inspections in the process of their manufacture that flaws are reduced to an absolute minimum.

Your wire needs in hook-up, lead-in, shielded wire speaker cords and all types of insulated wire are available from this centrally located source. We maintain a complete engineering service. Your wiring problems are solicited. For their scientific solution, the Runzel Laboratory provides research assistance.



**RUNZEL CORD AND WIRE CO.**  
4727 WEST MONTROSE AVE. CHICAGO, ILLINOIS

Want more information? Use post card on last page.  
ELECTRONICS — July, 1953

NEW BOOKS

(continued)

Methods of Communication and Physical Limits (modulation methods, noise, information theory, pulse and Dropper radar); The Electromagnetic Medium (propagation, guided waves); Microwave and Short-Wave Techniques (discontinuities, couplers, transformers, resonators, filters, measurements); Antennae (dipoles, arrays, horns, lenses, reflectors); Valves (emission, discharge, high-frequency effects, klystron, travelling-wave, magnetron, pulse-modulators); CW Circuit Technique (network theory, transfer impedances, amplifiers, frequency modulators); Waveform Circuit Technique (waveform amplifiers, modern pulsing methods).

Relegation of the mathematics to 30 appendices accelerates the pace of the main text. The appendices include such subjects as Fourier analysis, Bessel's functions, vector analysis, Maxwell's equations, Heaviside analysis and Laplace transforms, as well as extensive treatments of modulation, noise, radiation, space-charge effects and networks.

### Cross-References

The skeletal framework of each subdivision is expository, but the particular historical contributions of each authority in the field are meticulously identified, with cross-references to original source-material, which follows each of the chapters. The author has drawn as freely upon American as British and German books and periodicals for his bibliographical references. His intent, as expressed in the preface, is to lend aid to the radio or electronic engineer ordinarily "confronted with a bewildering task when he tries to find what he may need in the vast literature." One who is familiar with the American technical press will find himself under no parochial handicap in using this British book not only for its own liberal content but as a guide to extended inquiry.

One test of a compendium is to have its minutiae critically probed by experts. With that in mind, I turned over to one of my associates thoroughly conversant with microwaves and waveguides the pertinent



AIR-SPACED ARTICULATED

**CO-AX CABLES**

offer a unique combination of

- ✓ FRACTIONAL CAPACITANCE
- ✓ HIGH IMPEDANCE
- ✓ MINIMUM ATTENUATION
- ALONG WITH
- ✓ EXCEPTIONAL FLEXIBILITY
- ✓ LIGHT WEIGHT

**38 STOCK TYPES**

FOR ANY OF YOUR STANDARD OR SPECIAL APPLICATIONS

A few of the very low capacitance types are:

Type No.	Capacitance $\mu\mu F/ft.$	Impedance ohms	O.D.
C.44	4.1	252	1.03"
C.4	4.6	229	1.03"
C.33	4.8	220	0.64"
C.3	5.4	197	0.64"
C.22	5.5	184	0.44"
C.2	6.3	171	0.44"
C.11	6.3	173	0.36"
C.1	7.3	150	0.36"

WE ARE SPECIALLY ORGANIZED TO HANDLE DIRECT ORDERS OR ENQUIRIES FROM OVERSEAS

SPOT DELIVERIES FOR U.S.

BILLED IN DOLLARS—SETTLEMENT BY YOUR CHECK  
CABLE OR AIRMAIL TODAY

**TRANSRADIO LTD.**  
CONTRACTORS TO  
H.M. GOVERNMENT

**138A CROMWELL RD., LONDON, S.W.7 ENGLAND**

CABLES: TRANSRAD LONDON

Want more information? Use post card on last page.

# variable frequency POWER SUPPLY



*Model VS-500*

Model VS-500. 50 to 3000 Cycles

**INPUT:**

Volts—115v 2 wire or 230v 3 wire single phase; Frequency— 50 to 3000 cycles/sec. Power—1600 V.A.

**OUTPUT:**

Volts—115v or 230v, regulated; Frequency—50—3000 cycles/sec; Power—500 watts.

**WAVEFORM:**

Standard—sine wave; Optional—variable waveform with amplitude factor variation of 1.16 to 1.68. Square wave through sine wave to peaked wave.

**REGULATION OF OUTPUT VOLTAGE:**

Better than 3% from no load to full load.

**SIZE:**

75" H. 26" W. 27" D. Weight Net: 535 lbs.

Furnished with caster base to provide an easy means of moving equipment to desired location.

*Write for descriptive literature now.*

# TRAD

**TELEVISION CORPORATION**

1001 FIRST AVENUE, ASBURY PARK, N. J.

portions of the work under review, for spot-check. (P. S.—He married the book.)—I. S. COGGESHALL, *International Communications, Western Union Telegraph Company, New York, N. Y.*

## Description of a Magnetic Drum Calculator

*Vol. 25 of the Annals of the Computation Laboratory of Harvard University, by the staff of the Computation Laboratory. Harvard University Press, 320 pages, \$8.00.*

THE magnetic drum calculator which is the subject of this book was developed for the Bureau of Ordnance of the U. S. Navy by the Computation Laboratory. It is an electronic computing machine in which numerical quantities and coded operating instructions are stored with the aid of magnetic pulse recording techniques. The calculator has the capacity to store 4,200 quantities of 16 decimal digits each in 4,000 sequencing operations. The device itself appears to be well conceived and a valuable contribution.

The book is divided into 10 chapters and two appendices which cover the following subjects: Organization of the Calculator; Basic Circuits; Storage System; Arithmetic Units; The Elementary Functions; Numerical Input and Output Devices; Sequencing and Control; Instructional Tape Preparation and Solution of Typical Examples; Constants in Fast Storage; List of Codes. It is profusely illustrated with 28 plates and a large number of figures.

It is difficult to review this book because the intended audience is not stated. It appears to be a report of fine accomplishments which has been photo offset for publication. As a report it is thorough, detailed and useful for those already skilled who wish to build, operate or service such a device. It is written by experts for experts. On the other hand, the layman who picks up the book to learn about this type of computer is easily lost in an underbrush of constructional detail. The book needs an introductory chapter to pull it together into an organic whole. It needs the brass-plated admiral painted on the paper jacket

## SIGNAL, NOISE AND RESOLUTION IN NUCLEAR COUNTER AMPLIFIERS

*Just Published!*

A simple theoretical and practical treatment of the signal to noise ratio of nuclear counters and associated amplifiers. Emphasizes ionization chambers, covers proportional and scintillation counters. By A. B. Gillespie, Atomic Energy Research Establishment, England. 155 pp., 61 illus., \$4.50.

## RADIO ANTENNA ENGINEERING

Provides guidance in designing both receiving and transmitting antennas used in point-to-point, ground-to-air, and military communications—as well as in broadcasting. Includes advanced designs suggested by very-high-frequency and ultra-high-frequency techniques, emphasizing their growing importance. Largely deals with custom-built antennas up to 30 megs. Shows how to choose a site, how to choose a working frequency, how to measure soil conductivity, etc. By Edmund A. Laport, Chief Engr., RCA Int. Div., 563 pp., 386 illus., \$10.00

## ELECTRONIC ANALOG COMPUTERS

Gives aid in the design and operation of electronic computers of the d-c analog type used as differential analyzers and equation solvers. Shows procedure for setting up problems that lessen the chief error of faulty assignment of scale factors. Gives samples of practical applications. Covers design of computer circuits, auxiliary components, and complete installations to meet specific needs. By Granino A. Korn, Staff Engr., Lockheed Aircraft Corp., and Theresa M. Korn, formerly Engr., Boeing Aircraft Co. 378 pp., 70 illus., \$7.00

## TELEVISION ENGINEERING

*Second Edition*

Covers the whole television process—from studio to receiver—clearly, and in detail. Treats TV technology, operating principles of TV systems, use of equipment. Provides practical working diagrams, complete with values of parts, tube types, etc. Explains color TV, intercarrier sound reception, distributed amplification, and many other phases. By Donald G. Fink, Editor, *Electronics*. 2nd ed., 721 pp., 512 illus., \$8.75

### SEE THESE BOOKS 10 DAYS FREE

McGraw-Hill Book Co., 330 W. 42St., NYC (36)

Send me book(s) checked below for 10 days' examination on approval. In 10 days I will remit for book(s) I keep, plus few cents delivery, and return unwanted book(s) postpaid. (We pay for delivery if you remit with this coupon—same return privilege.)

- Gillespie—Signal, Noise, in Nuclear Counters—\$4.50
- Laport—Radio Antenna Engineering—\$10.00
- Korn & Korn—Elec. Analog Computers—\$7.00
- Fink—Television Engineering—\$8.75

(Print)  
Name .....  
Address .....  
City ..... Zone ..... State .....  
Company .....  
Position ..... L-7

This offer applies to U. S. only

Want more information? Use post card on last page.

Want more information? Use post card on last page.



## High-Altitude Recording

To record cosmic ray information, a leading university found that Alfax alone allowed them to build a recorder light enough yet dependable enough to go up in a balloon and get the information.

## ALFAX RECORDING PAPER

For the first time there is available an indelible recording paper—ALFAX—that is NOT subject to humidity, temperature or capillary action problems usually associated with pen and ink or papers marked by arcing or heat.

### ELECTRICITY IS THE INK THAT MARKS ALFAX

Alfax paper can be marked by current as low as one volt and is instantaneous, permanent and stable. Highly sensitive Alfax is capable of catching transients and has a tone response capable of fourteen steps by simply varying the current through the paper.

Alfax is the only paper that is capable of high speed recording, stable before or after recording, is non-transferable, has low current consumption at high speeds, can record at high humidity over all temperature ranges, is smudge proof and non-toxic, widths from 1/4" to 72".

Alfax opens a whole new field of monitoring and recording of phenomena which never before have been done easily and cheaply.

Request Booklet—describe your problem

### ALFAX PAPER & ENGINEERING CO.

Alden Research Center, Westboro, Mass.  
Engineering Service to Recorder Manufacturers

## MISSILE Engineers and Technicians

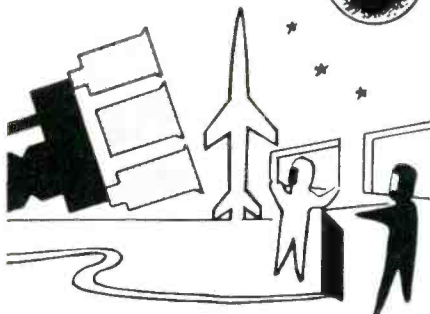

### For Field Test Positions in NEW MEXICO

"The Land of Enchantment"  
ON

Guidance Flight Testing  
Servomechanisms  
Telemetering Test Equipment  
Airborne Electronics Equipment  
**IDEAL WORKING CONDITIONS**

WRITE: FIELD TEST DIRECTOR  
P. O. BOX 391  
HOLLOMAN AIR DEVELOPMENT CENTER  
NEW MEXICO

# BELL Aircraft

CORPORATION

## New! All-Nylon! Fungus-Proof!

# GUDE-NYLACE

## Flat Braided Lacing Tape

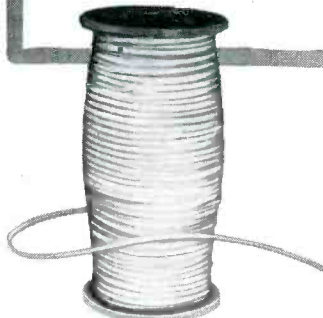

- EASY ON HANDS
- SAVES TIME
- FLAME RESISTANT

Flat braided lacing tape for all electrical harnesses with either continuous or interrupted ties.

Guaranteed free of all wax and foreign materials—only 100% pure Dupont Nylon is used in the construction of Gude-Nylace—excellent for strength, durability.

Slip-proof knots, easy to tie, easy on operator's hands even without gloves.

Complies with fungus resistant requirements of Gov. Spec. Jan-T-713.

Write for samples,  
complete information

### GUDEBROD BROS. SILK CO., INC.

Electronic Division: 225 West 34th Street, New York 1, N. Y.  
Executive Offices: 12 South 12th Street, Philadelphia 7, Pa.

SEALING  
DIPPING  
POTTING  
IMPREGNATING



INSULATING  
FUNGUSPROOFING  
MOISTUREPROOFING  
HEAT CONDUCTING

## WAXES BIWAX COMPOUNDS

Developed and produced for manufacturers of electronic components and other electrical units.

Specifications and samples available on request.

Information relative to your problem or application will enable us to make suggestions and recommendations.

### BIWAX CORPORATION

3445 HOWARD STREET  
SKOKIE, ILLINOIS

## The Green Engraver



ENGRAVES ✓ ROUTS ✓ PROFILES ✓ and MODELS

Used and endorsed by tool and die, electronic, machine, plastics, radio, electrical and instrument manufacturers.  
A real money saver.

Specify the Green Engraver for precision engraving on metal, plastics, wood, glass, hard rubber etc. . . engraves panels, name plates, scales, dials, molds, lenses, instruments, instruction plates, directional signs . . . by simple tracing from master. Routing, profiling and three dimensional modeling indicate its versatility.

Electric etching attachment available.

Special attachments and engineering service available for production work.

FREE: Brochure—yours upon request.

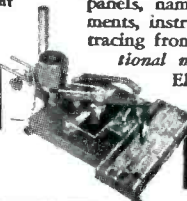

Green Instrument Co.  
INCORPORATED

363 PUTNAM AVENUE • CAMBRIDGE • MASS.

**POLYPHASE**  
announces  
a new  
**transistor**

**CURRENT  
GAIN METER  
& CURVE TRACER**



THE TA-1 TRANSISTOR ANALYZER  
—a Commercial First at a Reasonable Price

- ▶ As a direct reading meter  
measures  $\alpha$  of N-type and P-type point contact transistors  
measures  $\beta$  ( $\alpha_{bc}$ ) of NPN and PNP type junction transistors
  - ▶ In conjunction with an oscilloscope  
traces  $\alpha$  vs.  $I_c$   
traces  $\beta$  vs.  $I_b$
  - ▶ Includes regulated collector power supply which is available for external use
- Sturdy oak cabinet with front panel suitable for relay rack mounting



for complete Model TA-1 specifications and information on other new transistor test equipment write:

**POLYPHASE INSTRUMENT COMPANY**  
BRYN MAWR, PENNSYLVANIA

These days are busy ones for the electronics industry... days when you will especially appreciate the time-saving, time-tested services of "THE REPRESENTATIVES" of Electronic Products Manufacturers, Inc. Here is an organization whose membership numbers the most highly qualified men in the field. It is fully equipped to assist you and your employees in understanding the accepted electronics industry trade practices, and to promote better relations in the industry through ethical sales representation either locally, regionally or nationally.

Since 1935, the REPM has served electronic products manufacturers ably and efficiently.

National Headquarters Office  
"THE REPRESENTATIVES"  
of Electronic Products Manufacturers, Inc.  
600 S. Michigan Avenue, Chicago 5, Illinois  
HARRISON 7-2402

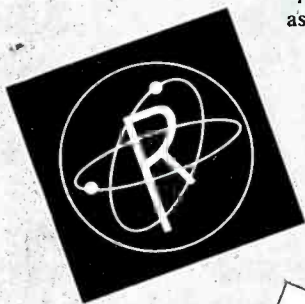

Burton Browne Advertising

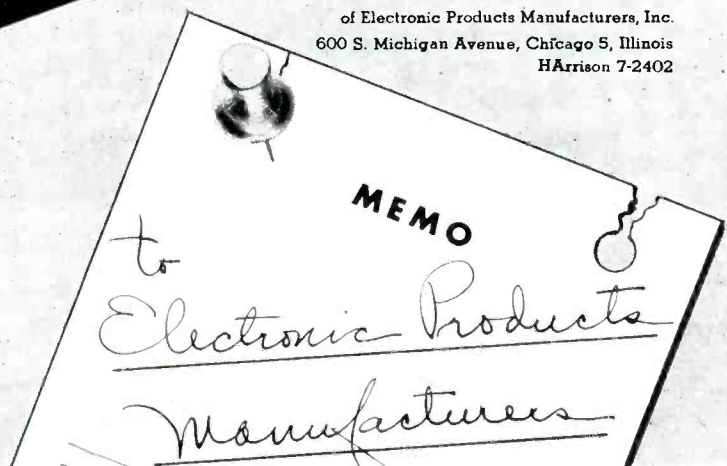

by Artzybasheff to discipline the scattered components into a clear pattern. While the main point is the use of magnetic drums for memory, the relation between this memory and the basic circuits is not visible without considerable digging. No comparison is made with other computers which operate on different principles.

Some of the plates are useless. One of these, Plate IV, shows a typical chassis. The parts of this chassis are unlabelled with the result that it might be part of a television transmitter, a radar amplifier or a computer. Plate XIII, which shows the underside of this chassis, is so full of cables that not a single component is visible. It is as if the authors took pride in complexity. This plate would be more effective if the chassis were shown only partly wired. Plate XV shows the exploded view of cables and connectors. Surely this is superfluous in a book of this sort.

Basic circuits are standard, easily understood, and include gates, ring counters, step switches, cathode followers and phase inverters.

The book is a thorough report of a valuable contribution. As such it is a useful addition to the shelves of a computer library.—C. J. HIRSCH, *Chief Research Engineer, Hazeltine Corporation, Little Neck, N. Y.*

**Recurrent Electrical Transients**

BY L. W. VON TERSCH AND A. W. SWAGO. *Prentice-Hall, Inc., New York, 1953. 399 pages, \$10.35.*

THIS book is one of the Prentice-Hall Electrical Engineering Series. Its object is "primarily to teach a technique of analysis, while acquainting the reader with representative types of circuits in which the steady-state waveform may be considered as a series of recurring transients." It may be used as a textbook in an electrical engineering or physics curriculum. Although prerequisites are not stated, it is apparent that a knowledge of elementary physics and electronics and of mathematics through differential equations will be helpful.

The method of teaching employed

is to consider in detail each of a number of circuits of a given type, obtaining the wave shape of the output wave for given input wave shape. The highest level of mathematics employed is the use of the "D" operator in solving differential equations. Transform methods are not employed and the time-constant concept is used rather than that of frequency response.

After defining fundamental concepts and deducing the response of a number of simple basic combinations of L, R, and C to sine and step-type signals, the authors devote a chapter each to clamping circuits, clipping circuits, electric and magnetic deflection of cathode-ray tubes, trigger circuits and multivibrators. It may be noted that the subjects of pulse amplification and general transient analysis were purposely omitted.

The 347 figures are mostly well-made line drawings of wave shapes and circuits. Some of the graphs are difficult to read because of insufficient contrast between major and minor divisions and because words and symbols were lettered directly on the grid without blanking out a part of the latter.

The authors include numerous solved examples illustrating their methods of analysis. The first of these has two numerical typographical errors, and the second lacks information essential to a numerical solution as well as showing an example of an exponential decay which actually departs considerably from that shape. After these lapses the quality improves.

A notable feature of this book is the large number (376) of references to the technical literature of both this and foreign countries. In a test, the reviewer found every one of his own dog-eared file card references on multivibrators to be in the book, as well as many others.

This book is legibly printed, with few errors in the text or in the drawings. Circuits are frequently shown with only a single input or output terminal, which is to be deplored.

As a college text this book rates well. The style is clear and direct. From a pedagogic standpoint the

*Phaostron*

**SENSITIVE MINIATURE RELAYS**

PERFECTLY COUNTER-BALANCED

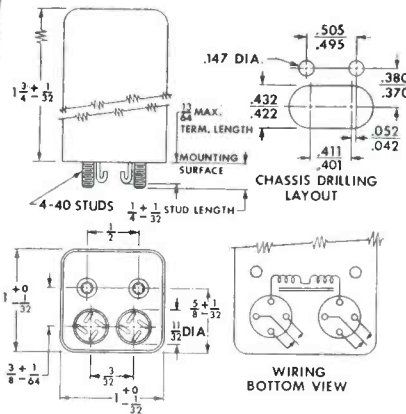

Contact arrangements up to and including DP DT 3 Amp at 28 volts D.C., or 100 Milliamperes at 150 volts D.C. resistive load.

Hermetically Sealed.

Required coil power as low as 20 milliwatts.

Coil resistance up to 15,000 ohms.

Weight, maximum 3.5 oz.

**DUE TO ITS PERFECTLY COUNTER-BALANCED FEATURES THIS RELAY WILL WITHSTAND HIGH ACCELERATION, VIBRATION, SHOCK AND TUMBLING**

Mass Production Requirements Invited

Detailed information on request.



PHAOSTRON COMPANY • 151 PASADENA AVE. • SOUTH PASADENA, CALIF.

**SECON**

**DEVELOPMENT and PRODUCTION METALLURGISTS**

Fine wire and ribbon in base, rare, and precious metals, and alloys for new and highly engineered applications. In small units and sizes, and to close tolerances.

Further details on request.



**SECON METALS CORPORATION**

228 East 45th Street, N. Y. 17, N. Y., MU 7-1594

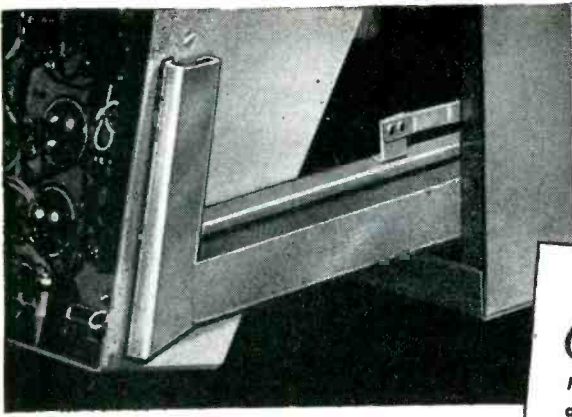

FOR EFFICIENT MAINTENANCE  
SPECIFY REMLER **TILT-UP**  
EQUIPMENT SLIDES

Remler slide rails for rack or cabinet mounting permit complete withdrawal or inspection of top and bottom of apparatus chassis. Positive . . . self-locking. Full roller type . . . handles equip-

ment up to 75 lbs. Stainless steel for military applications. Nickel plated brass rollers; roller studs in stainless or copper flashed cold rolled steel.

\$15.95 per pair

Remler Company Ltd. 2101 Bryant St. San Francisco 10, Calif.

Try Remler for  
Service-Tested  
"Hard-to-Get"  
Components

*Custom  
Components*

Metal-plastic components designed and manufactured to order. Write for quotations specifying electrical and mechanical characteristics. Describe application. No obligation.

Write for quantity prices.

*Remler*  
Since 1918 PIONEERS IN ELECTRONICS AND PLASTICS

better all around...

**Precision  
COIL BOBBINS**

because PRECISION Coil Bobbins are quality controlled you can be sure they'll improve your coils all-around. Every PRECISION Coil Bobbin is precision-engineered to give you:

- Greater Insulation
- Better Heat Dissipation
- Higher Moisture Resistance
- 15 to 20% Greater Strength
- Lighter Weight
- More Winding Space

All at lower unit cost!

PRECISION Coil Bobbins can be designed to your exact specifications . . . any size or shape in dielectric Kraft or Fish Paper, phenol impregnated, Cellulose Acetate or Combinations. Flanges are supplied plain or fitted with leads, slots, holes flat, recessed or embossed to fit any mounting.

Send specifications for free sample.  
and ask for new Arbor list of over 1500 sizes.



**PRECISION PAPER TUBE CO.**

2041 W. Charleston St. Chicago 47, Ill.  
Plant No. 2, 79 Chapel St., Hartford, Conn.  
Also Mfrs. of PRECISION Paper Tubes

criticism may be advanced that this book devotes too much time to the analysis of specific circuits or circuit elements, to the neglect of more general and fundamental considerations. This approach is probably characteristic of the infancy of the art. In due time it may seem more reasonable or feasible to start with Maxwell's equations and show how all things flow from them.

The engineer will find this book somewhat tantalizing. To design, for example, a single-cycle multi-vibrator having given characteristics with the aid of this book requires following the analysis of this circuit until a suitable design equation is encountered among the many that describe the potentials or currents in various parts of the circuit. Nevertheless, the relations are there.

In short, this book should serve its intended purpose well. It does not appear to duplicate any other book in this field.—RAMOND C. WADDEL, *Naval Research Laboratory.*

**Elements of Electricity  
4th Edition**

BY WILLIAM H. TIMBIE AND ALEXANDER KUSKO. *John Wiley & Sons, Inc., New York, 1953, 631 pages, \$5.50.*

MANY years ago when the time came for this reviewer to write a book, he took as his model Timbie's famous "Elements," a fact which has never been regretted. Careful study indicated that Professor Timbie had a way with technical words, a style and technique for explaining technical matters that was not only beautifully clear but positively seductive. If, therefore, homage to an author and a book, which first appeared in 1910, seems a bit overdue, it is still sincere. This reviewer strove hard to duplicate the professor's methods, but he admits he could only approach and not equal them.

The basic idea and style of the earlier editions have been retained in this thorough revision which contains not only what was required previously but which now deals with the newer concepts, newer devices and newer subjects. New material covers such things as ceramic capacitors, transistors, radar, tele-





For a Heavenly Soldering Job,  
Insist on

**Ungar's**  
*Little Angels*

NEED WE  
SAY MORE?

Write for  
Catalog E-1

**Ungar** ELECTRIC TOOLS, INC.,  
P O BOX 312, VENICE, CALIF.

## SQUARE PULSE GENERATORS for the MILLIMICROSECOND TO MICROSECOND RANGE

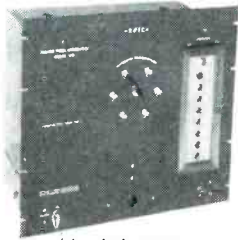

Model 100



Model 200

For nuclear pulse work, radar, TV, wide band amplifiers and in the design, calibration, and servicing of fast electronic systems.

NOW—New Square Pulse Generators with a rise time of one millimicrosecond ( $10^{-9}$  seconds) and a pulse width which can be varied from one millimicrosecond to several microseconds is commercially available. Positive and negative pulses of 100 volts maximum amplitude are generated; the pulse amplitude can be varied from 100 volts to 0.006 volts in 1 db steps. The output impedance is matched to the common impedance coaxial cables in use.

MODEL 100—Single pulse output

MODEL 200—Double pulse output—

(each pulse may be individually attenuated and delayed)

MODEL 300—Three or more pulse outputs

### ELECTRICAL AND PHYSICAL INSTRUMENT CORPORATION DESIGN, DEVELOPMENT AND MANUFACTURE ELECTRONIC AND ELECTRICAL DEVICES

Sales and Business Office

25 West 43rd Street

New York 36, N. Y.

Telephone: Longacre 4-2265

Engineering Division

42-19 27th Street

Long Island City 1, N. Y.

Telephone: Stillwell 4-6389

## 4 CHANNEL CARRIER TELEPHONE TERMINALS CFD-B



and Pilot Regulated CARRIER REPEATERS (for use in conjunction with the CFD-B Terminals on long haul circuits.)

COMPLETELY AUTOMATIC PILOT REGULATION OVER A 20 db RANGE. Built-in "SLOPE CONTROL" includes an extra 10 db equalization for non-conforming telephone pairs.

RYCOM'S CFD-B is assembled from Western Electric component parts, and is mounted COMPLETE with ringing, terminating and power supply equipment in ONE STANDARD AAR 8-FOOT RACK. Standard commercial performance is guaranteed. • Basic line equalization of 15 db by manual controls. • The range of operation is through a maximum of 30 db over an operating range of 3 to 32.3 kilocycles. • Two-way pilot-regulated repeaters are available for circuits having more than the allowable 30 db loss. • 1000/20-Cycle Voice Frequency Ringers are available for one-, two-, three-, or four-channel ringing. A FULL LINE OF ACCESSORIES is offered,

including: • Voice Frequency Repeater Balancing Nets, • Cable Matching Transformers, • Universal Way Station Filters, and • Mounted Sub-cycle Ringing Power Supplies.

RYCOM'S CFD-B provides FOUR DUPLEX VOICE CHANNELS AND RINGERS at a LOWER COST to you than most three-channel carriers now on the market! And WE CAN MAKE IMMEDIATE DELIVERY!

**RAILWAY COMMUNICATIONS**  
INCORPORATED  
FLEMING 2121 • BAYTOWN, MISSOURI • FLEMING 2122

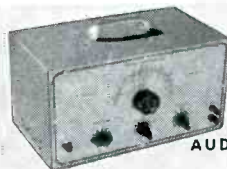

AUDIO GEN. KIT  
\$29.50



R. F. SIGNAL GEN. KIT  
\$19.50



5" SCOPE KIT  
\$43.50



T.V. ALIGN. GEN. KIT  
\$39.50

### BUILD YOUR OWN *Heathkit* TEST EQUIPMENT

Heathkits are completely engineered instruments supplied unassembled. Every kit goes together smoothly and easily. All drilling, punching, and painting has already been done for you. All parts are furnished and are of highest quality.

Detailed construction manual shows clearly where each wire and part goes and tells exactly how to build the kit. Write for free catalog.

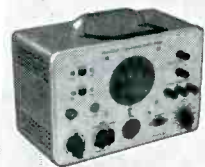

SIGNAL TRACER KIT  
\$22.50



VACUUM TUBE VOLTMETER KIT  
\$24.50



BATTERY ELIMINATOR KIT  
\$24.50

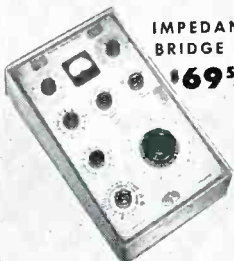

IMPEDANCE BRIDGE KIT  
\$69.50



TUBE CHECKER KIT  
\$29.50

## HEATH COMPANY BENTON HARBOR 14, MICHIGAN

EXPORT AGENT  
**ROCKE INTERNATIONAL CORP.**  
13 East 40th Street  
NEW YORK CITY (16)



GRID DIP METER KIT \$19.50



CONDENSER CHECKER KIT  
\$19.50

# ZOPHAR

## WAXES

## COMPOUNDS

Zophar Waxes, resins and compounds to impregnate, dip, seal, embed, or pot electronic and electrical equipment or components of all types; radio, television, etc.

Cold flows from 100°F. to 285°F.

Special waxes non-cracking at -76°F.

Compounds meeting Government specifications plain or fungus resistant.

Let us help you with your engineering problems.



**ZOPHAR MILLS, INC.**  
112-130 26th Street,  
Brooklyn 32, N. Y.

## PUSH-BUTTON AUDIO OSCILLATOR

MODEL TO-100

**NEW  
ACCURATE  
STABLE**

**FOR CHECKING**

**FM/FM TELEMETERING  
SUB-CARRIER EQUIPMENT**

- 20 accurate, fixed centre-frequencies
- Calibrated control for  $\pm 10\%$  adjustment
- Indicator for beating external signal
- Low distortion and excellent stability
- Constant voltage low impedance output
- Continuously variable calibrated level
- Standard FM/FM frequencies furnished
- Other frequencies available to order

**FOR RAPID PRODUCTION CONTROL TESTS**



**TELETRONICS LABORATORY INC.**  
WESTBURY, L. I., N. Y.

MANUFACTURERS OF ELECTRONIC INSTRUMENTS AND PRODUCTION TEST EQUIPMENT

vision, dry and gaseous rectifiers; revisions in older material include such subjects as circuit analysis, d-c machinery, electromechanical processes and gaseous conduction. New problems deal with contemporary applications of electronics and control; and there are numerous other additions and changes.

This book is still a model of elementary textbook writing.—K.H.

### Hearing Aids, Their Use, Care, and Repair

By MATTHEW MANDL. *The Macmillan Company, New York, 1953, 158 pages, \$3.50.*

A BOOK primarily for the technician but containing considerable material useful to the hard-of-hearing. For the latter the second and third chapters are most useful since they discuss the psychological problems involved in first employing a hearing aid, and the physical problems of how best to use the instrument. In the other chapters, however, are hints which are useful to the non-technician.

Most of the contents deal with the electrical and mechanical characteristics of the instruments, how to care for the units as well as their components, and how to make repairs when they are needed.

The final chapter deals with future trends and mentions the effect transistor will have on the future, as well as such matters as binaural hearing.

### Grundlagen der Elektronenoptik

By WALTER GLASER. *Springer-Verlag in Wien 1, Molkerbastei, Germany, 1952, 699 pages, \$28.60 clothbound.*

DR. GLASER'S pioneering contributions to the theory of electron optics span the past two decades. With this volume he presents the most extensive and up-to-date treatment of electron image formation by static electric and magnetic fields which has appeared so far. The method of presentation is, of course, mathematical. Experimental techniques are alluded to briefly.

The first half of the book is taken up with Gaussian dioptrics and image formation by rays close to the optic axis, while the second half is divided approximately equally be-

# HERE'S BIG HELP IN TERMINAL WIRING!

## The New JONES FANNING STRIP

Connections are made through Fanning Strip, on bench or anywhere apart from barrier strip, and quickly slipped into assembly.

Use with Jones Barrier Terminal Strips, Nos. 141 and 142, for 1 to 20 terminals.

Simplifies soldering. Insures correct connections. Saves time. Ideal for harness or cable assembly. Brass terminals, cadmium plated. Bakelite mounting. Send for complete data.

The correct wire to correct terminal every time!

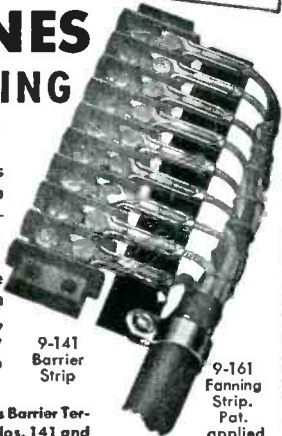

9-141 Barrier Strip

9-161 Fanning Strip. Pat. applied for.

**Jones** HOWARD B. JONES DIVISION  
CINCINNATI MANUFACTURING CORPORATION  
CHICAGO 24, ILLINOIS  
SUBSIDIARY OF UNITED-GAGE FASTENERS CO. INC.

# New! LENK

PENCIL TYPE Industrial Soldering Irons

MINIATURE DESIGN for fast continuous production of precision work

No. 251, 25 watts  
No. 256, 40 watts  
1/4" or 1/8" tip



- Feather-light only 2 oz.
- Plated tips resist corrosion
- Fast heating brass core element
- Extra rugged stainless steel construction
- Extra cool cooling fins, plastic handle
- Balanced easy to handle, fatigue-reducing

Write for name of your nearest distributor  
**THE LENK MFG. COMPANY**  
30 Cummington St., Boston 15, Mass.

Want more information? Use post card on last page.

NEW BOOKS

(continued)

tween aberration theory and the application of wave mechanics to electron imaging.

After a brief introduction answering the question "Why electron optics?" and the establishment of the basic laws of electron motion, the author examines in detail similarities and differences in light optics and electrostatic electron optics. This is followed by the derivation of the path equations in plane and axially symmetric electric fields, including the effect of space charge and, for plane fields, of superposed deflection. The remainder of the first half of the book is taken up essentially with axially symmetric electric and magnetic fields and their imaging properties.

The section on geometric aberrations deduces the aberration expressions from the Hamiltonian characteristic function and discusses their properties in detail. The expressions are given both in terms of object and aperture plane coordinates and in terms of object coordinates and initial aperture and inclination angles of the imaging pencils, a form particularly well suited for the imaging conditions normally realized in the electron microscope. Numerical values are worked out in detail for the magnetic bell-shaped field.

The last section applies the wave concept to electron motion and the imaging process. It is indicated clearly within what range the methods of classical mechanics (or geometric optics) are valid and where a wave-mechanical approach must be employed. A semiclassical approach is found sufficient for determining the resolving power of the electron microscope; here the intensity distribution in the image plane is determined by wave optics from the form of the characteristic function at the exit of the lens system.

The book is to be recommended particularly to anyone who wishes to attain a thorough understanding of the imaging process and the fundamental limitations of the electron microscope—other than those imposed by the properties of the object and plate or screen, which are not covered. The designer of

# DURANT MFG. CO. Specials

For RADAR, ELECTRONIC and INSTRUMENT APPLICATIONS

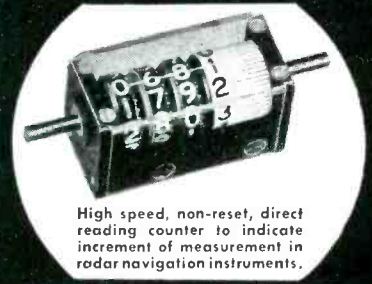

High speed, non-reset, direct reading counter to indicate increment of measurement in radar navigation instruments.

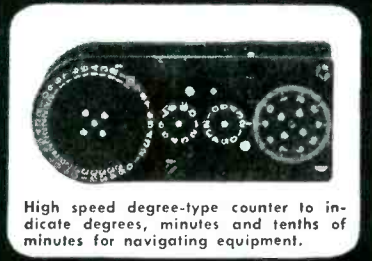

High speed degree-type counter to indicate degrees, minutes and tenths of minutes for navigating equipment.



"Y" 2-figure Rotary Counter used in navigating instruments.



Special counter for use on Tape Recorder to indicate the position of tape passing through the recorder.



Special high speed Y-type counter for Goniometer application.

WRITE FOR LITERATURE  
**DURANT MANUFACTURING CO.**  
1912 N. Buffum St., Milwaukee 1, Wis.  
112 Orange Street, Providence 3, R. I.

**PRODUCTIMETERS**  
SINCE 1879 *Count Everything*

Want more information? Use post card on last page.

cathode-ray tubes and related devices will find the general theory of value but will have to look elsewhere for detail regarding the lenses and fields which he may find useful. The book is scarcely designed for the beginner, in spite of numerous interesting analogies and illustrations. The very wealth of material presented, the extended discussion of fine points, and the insistence on rigor and generality might well prove too overwhelming to him.

Apart from this, the author and publisher are to be complimented on producing a book which should prove a reliable guide through many of the more involved aspects of electron optics which are not covered elsewhere. The unusually large proportion of material derived from original researches of the author and his coworkers make it a monument to the extensive contributions of Dr. Glaser to the science of electron optics.—E. G. RAMBERG, *RCA Laboratories Division, Princeton, N. J.*

**AUTOMATION; The Advent of the Automatic Factory**

By JOHN DIEBOLD, *D. Van Nostrand Company, Inc., New York, 1952, 181 pages, \$3.00.*

THE PUBLISHERS claim, through a blurb on the dust-jacket, that "Automation" is "A provocative study of the possibilities, limitations and social and economic consequences of the revolutionary new machines of the electronic age and what they will mean in terms of jobs, cost of goods and services, standards of living and increased leisure time." However, the author claims, under Scope of This Book, that "This book is primarily an essay on the business problems of automation and indicates the manner in which the technological developments can be useful to the businessman. It points out the obstacles that will confront the businessman in making use of automation and suggests courses of action by which these obstacles may be overcome. Finally, it discusses the important economic and social effects of the new technology."

On reassessing both claims after reading the book, the reviewer is of the opinion that the author's claim



**TIME  
AND WORK-SAVING  
TIP!**

**NO MORE "KNUCKLE BUSTING!"**  
**—Use STUBBY for Quick, Easy  
Nut-Driving in Tight Places**

Because it easily sneaks into small spaces, STUBBY helps you drive nuts home quickly, easily. Takes the "work" out of "close" jobs. Prevents slips. Available in 1/4", 5/16", and 3/8" nut sizes.



Only 3/4" overall!



**AND REMEMBER!**  
**—For Quick, Easy  
Screw-Driving Jobs**

—get the Xcelite exclusive detachable combination. Reverses to regular or Phillips blade instantly. That "other" screw-driver blade is *always* handy on the other end! See the complete Xcelite line today at your dealer's.

**XCELITE, INC.**  
 (Formerly Park Metal Ware Co., Inc.)  
**Dept. C**  
**Orchard Park, N. Y.**



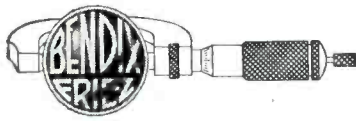

precision-made to your needs . . .

## BENDIX-FRIEZ

### thermistors

Maybe your need for these temperature responsive resistors can be satisfied by a type we carry in stock. Maybe you require a specially-developed type. In either case you can depend on Bendix-Friez to provide precision-made thermistors to serve you with maximum efficiency. High standards of quality control in manufacture make Bendix-Friez Thermistors pre-eminent in their field . . . assure you of utmost satisfaction.

**STANDARD TYPES FOR IMMEDIATE DELIVERY**

Size (inches)	@ +30°C.	@ 0°C.	@ -30°C.
.140 x .75	45.0 ohms	86 ohms	194 ohms
.040 x 1.5	12,250 ohms	26,200 ohms	65,340 ohms
.018 x 1.5	35,000 ohms	82,290 ohms	229,600 ohms

Write for details.

**FRIEZ INSTRUMENT DIVISION of . . .**  
 1454 Taylor Avenue, BALTIMORE 4, MARYLAND  
 Export Sales: Bendix International Division  
 72 Fifth Avenue, New York 11, N. Y.

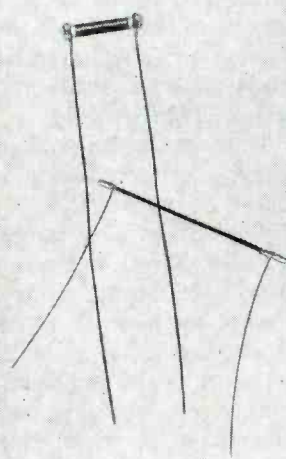



Used in this typical application for sensing the temperature of hydraulic oil.



## For SPECIFIED PERFORMANCE Specify JELLIFF RESISTANCE WIRE

COMPLETE CONTROL OF MANUFACTURE . . .  
A WIDE RANGE OF EXPERIENCE . . .  
A WIDE RANGE OF ALLOYS . . .

make JELLIFF the ideal source of  
Resistance Wire to assure your Product's

### Performance According to Specs.

*Precision resistors—rheostats—  
relays—thermocouples—ohmmeters  
—bridges—high-temperature fur-  
naces can all benefit from the  
PLUS-PERFORMANCE of  
JELLIFF RESISTANCE WIRE*



Detailed Enquiries Welcomed. Address Dept. 25

*for sub-miniature,  
miniature*

# SLIP RINGS

Brush holders, commutators,  
electronic specialties  
Standard sizes or to your specification  
4-6 Micro finish  
Minimum coefficient of friction,  
wear, brush noise  
Diameters from .035 — to  
your specification  
Operating capacities — 1 amp intermittent,  
.6 amp continuous load  
Rhodium or gold plating over silver rings  
No porosity factor  
Concentricity guaranteed to .002 T.I.R.  
— to your specification

*specify*

# ICI

Our staff available  
for consultation on your problem.  
Write for  
ICI catalog  
containing  
complete  
engineering  
data on  
standard sizes.



*Instrument Components Inc.*

1834 Franklin St., Santa Monica, Calif.  
Division: Marshall Engineering Company

## Test Equipment FOR RADAR and PULSE APPLICATIONS

### Model 705 WOBBLATOR

. . . for RF, IF, and Video Amplifier  
alignment and measurement

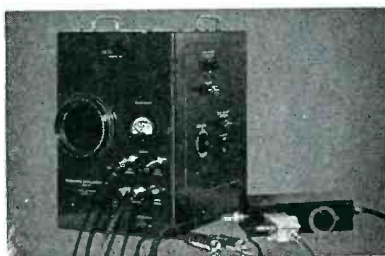

- Center Frequency of Swept Band—2.0 mc to 500 mc.
- Swept Bandwidth—up to 100 mc wide.
- Output—0.1 volt at 50 ohms, with calibrated continuously variable 90 db output attenuator to allow rapid, accurate gain measurement.
- Internal five inch CRT display of response of circuit under tests; 0.05 mv. or more input to the high or low impedance probes from the circuit under test will give an adequate pattern.

*Write  
for complete  
technical data*

# Canoga Corporation

5955 Sepulveda Blvd., Van Nuys, Calif., Box 361

# To Readers Outside North America

Tektronix export sales activities are conducted from the home office, either direct to the ultimate user or through the medium of engineering sales organizations located within the specific country. Tektronix products are available at the published catalog prices, f.o.b. Portland, Oregon, without added premium or markup of any kind, to users throughout the world. CIF, C & F, or FAS pro-forma invoices promptly furnished on request. For complete details on instruments, warranty and maintenance, and the name of your distributor, write to the Export Department at the address below.



## for MILLIMICROSECOND Pulse Observation

The Tektronix Type 517 Cathode-Ray Oscilloscope is a specialized instrument designed primarily for the observation and photographic recording of very fast rising waveforms having a low duty cycle. Vertical amplifier risetime of 0.007  $\mu$ sec and sweeps as fast as 0.01  $\mu$ sec/cm permit step-function reproduction with an accuracy never before attainable in a commercial oscilloscope. Sufficient delay is incorporated in the vertical amplifier to permit the observed signal to trigger the sweep. Built-in rate generator can be used to trigger the circuit under study.

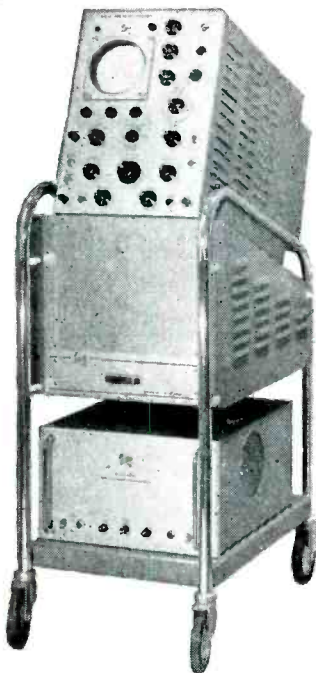

**Sensitivity**—0.1 v/cm  
**Risetime**  
0.007  $\mu$ sec or less

**Amplitude Calibrator**  
25 kc pulse, 0.15 v to 50 v full scale, accurate within 4%

**Net Signal Delay**  
(Total delay minus sweep starting time)  
20 to 50  $\mu$ sec

**Accelerating Potential**  
24 kv  
**Metallized CRT**

**Regulation**—All critical voltages electronically regulated

**Time Bases**—11 fixed,  
0.01  $\mu$ sec/cm to 20  $\mu$ sec/cm, accurate within 2%

Tektronix Type 517 Cathode-Ray Oscilloscope  
\$3500 f.o.b. Portland, Oregon



**Tektronix, Inc.**

P. O. Box 831A, Portland 7, Ore.  
Cable: TEKTRONIX

Want more information? Use post card on last page.

NEW BOOKS

(continued)

is somewhat the more accurate of the two.

Of the seven chapters comprising the text, the first—fittingly enough—encompasses an account of reasons why a businessman ought to read this book. The second, in keeping with the author's remark that "In no sense does this book pretend to be a contribution to the body of technological knowledge on the subject of control", presents a brief *descriptive* resume of the basic concepts of closed-loop control and a like account of the prime factors differentiating analog from digital computers. The third chapter advances a collection of instances illustrating how "rethinking" a process or product may yield substantial automation of the course or manufacture thereof; and the fourth outlines means by which the performance of the correspondingly-needed machinery can be "automized". The fifth chapter discusses the automatic handling of information in such diverse activities as accounting, stock-market trading and reserving plane or train space. The sixth entails conjecture regarding some of the consequences of automation on business proper, while the final seventh chapter closes with speculation as to certain general social and economic effects of automation.

The writing is lucid, fluid and well-paced. The factual content is fairly accurate (in support of this carping adjective the reviewer notes that: Maxwell's paper on governors was published in 1868 rather than "toward the end of the century" (p. 18); Nyquist—not Wyquist—wrote on feedback amplifiers and not on servomechanisms (p. 19); contrary to the author's remark (p. 22) that "Again, tools capable of the required precision were not available; the mechanisms were never built", Lord Kelvin actually constructed machines using integrating and differentiating components—for example, his famed Tidal Harmonic Analyzer, detailed in "Minutes of the Proceedings of the Institution of Civil Engineers, 1882"; and similar remarks could be advanced on points in the re-

# Electron

# Tube

# Technicians

*We now have openings for work in the fabrication and processing of experimental electron tubes.*

Applicants should be high school graduates with a natural aptitude for making small parts. Experience in electronics, precision machine work and experimental tube work is desirable.

Address resume of  
experience and training to

# Hughes

RESEARCH AND DEVELOPMENT  
LABORATORIES

Technical Personnel Department  
Culver City, Los Angeles County,  
California

Use WEST - CAP  
miniature CAPACITORS  
to meet exacting  
requirements



**Hermetically  
sealed in metal case**

Check these important features:

- Positive hermetic sealing
- Small physical size
- Tab or ext. foil construction
- Grounded or insulated sections
- Designed and built to meet most exacting requirements for:

1. Mechanical
2. Electrical
3. Temperature
4. Humidity

Send for complete catalog and specifications

SAN FERNANDO

ELECTRIC MFG. CO.

Box 952  
12900 Foothill Blvd., San Fernando, Calif.  
Phone EMpire 1-8681

Offices: WASHINGTON, D.C.,  
CHICAGO, DETROIT, N. Y.

GEARED FOR FAST DELIVERY

Want more information? Use post card on last page.

maining nine-tenths of the text). The sketch of the present state of automation in industry and business is nicely handled, sharply delineated, and well bulwarked by aptly-chosen examples excellently illustrative of current industrial practice. The author's circumspect, if somewhat convoluted, estimate of the future progress of automation, "(1) Automation will not progress as far as the proponents of a completely automatic society have predicted, and (2) the changes will not occur as quickly as most forecasts have led us to believe", can scarcely be gainsaid. Finally, while his conjecture as to the eventual social and economic effects of automation foretells a less sharply-differentiated state of society than that of the card-programmed, IQ-sorted active engineer or stalagmitic worker type of state envisioned in Vonnegut's recent amusing novel, "Player Piano", it is probably no less accurate in forecast.

Within the framework of the author's own statement of purpose and scope the reviewer is of the opinion that the writer has accomplished a resume of the status of automation which ought be both intelligible and of interest to the business executive concerned primarily with management or production and, also, to those communications engineers who maintain an interest in such socio-economic phases of their work as are discussed in, to name a recent popular work, Norbert Wiener's "The Human Use of Human Beings". However, in this connection it is to be remarked that the discussion of those social and economic effects which may stem from automation that comprises Chapter VII is a rather brief one. Accordingly, a reader with considerable interest in this subject might well complement his reading of this chapter by a subsequent perusal of Wiener's just-mentioned interesting and well-documented book, particularly Chapter X, "The First and the Second Industrial Revolution" and also his very recent article, "The Future of Automatic Machinery", in *Mechanical Engineering*, February 1953, pages 130-132.

In conclusion, it would seem fitting to point out the publisher's



**SHOCK PROOF  
MOISTURE PROOF  
TEMPERATURE PROOF**

## Toroid Coils

The NEW Hycor Type "P" toroid coils are hermetically molded in a special tough plastic compound. They will withstand:

- ▶ Ambient temperatures from -40 C to 135 C.
- ▶ 95% humidity . . . boiling salt water.
- ▶ Amazing degree of mechanical shock.

Space saving: Dimensions of Type EM-3P coils shown in illustration are 1-1/16" O.D. by 1/2" thick. (Inductance up to 7 henries.) Clearance hole for a 6-32 mounting screw is provided.

#### REPRESENTATIVES:

Jack Beebe,  
5707 W. Lake Street, Chicago, Illinois  
George E. Harris & Co.,  
Box 3005, Municipal Airport, Wichita, Kansas  
Marvin E. Nulsen,  
5376 E. Washington St., Indianapolis 19, Indiana  
Burlingame Associates,  
103 Lafayette Street, New York City

Send for Bulletin TP

**HYCOR**

*Company, Inc.*

11423 VANOWEN STREET  
NORTH HOLLYWOOD, CALIFORNIA  
SUNset 3-3860

## PRECISION TRANSFORMERS

. . . for Exacting  
MILITARY AND INDUSTRIAL REQUIREMENTS

Atlas offers a thoroughly reliable source of custom built transformers. We design — to your performance requirements — transformers incorporating the latest manufacturing techniques. Atlas precision controlled processes and inspection assure reliable performance.

Atlas facilities are arranged for fast delivery of small or large scale production. Testing facilities include a wide range of instruments, insuring exhaustive testing of even the most exacting circuits. We manufacture to MIL-T-27 or ANE-19 government specifications. Available are all standard transformers: power, pulse, audio, interstage, output, modulation, phase changing etc., as well as all types of chokes, reactors, bobbins and layer wound coils.

*We specialize in:*

**MAGNETIC AMPLIFIERS** and associated circuit development for industrial sensing and control applications.

**INSTRUMENT TYPE REFERENCE TRANSFORMERS** and bridge transformers featuring: phase errors as low as 1/20°, ratio errors to 1/100 of 1%.



#### Construction Types:

- Hermetically sealed cans
- Fosterite
- Scotch cast
- Open type

**ATLAS**

**ATLAS ENGINEERING CO., Inc.**

3 EDGEWOOD ST., ROXBURY, MASS.

# U. G. CONNECTORS

*Our Coaxial Cable  
Connectors Meet All  
Government Specifications*

★ ALL ORDERS DELIVERED PROMPTLY ★

*Manufacturers of  
Highest Quality Connectors*

## ALLIED INDUSTRIES, INC.

1023 S. 21st STREET  
LOUISVILLE 10, KY.

Phone Arlington 4640

NEW BOOKS

(continued)

contributions to "Automation". These include a nice quality of paper, good binding, excellent typography and a striking dust-jacket. This latter evidences a well-posed photograph of the author, a short account of his professional antecedents and several rather fanciful blurbs. Among these last is one which forecasts the happy lot to accrue to the engineering educator teaching in an "automized" society: "The training of purely management personnel of broad business background with the kind of engineering knowledge necessary to run a modern firm introduces a new concept in the use of this technology and will release our short supply of competent engineers for the all important job of advanced design. Equally important, it will free our engineering schools from the burden of teaching those who make only partial use of their original training". Anent this last surmise, it is the reviewer's thought that the publisher might well have bent his editorial aides to a more knowledgeable effort—THOMAS J. HIGGINS, *Professor of Electrical Engineering, University of Wisconsin.*

### THUMBNAIL REVIEWS

**Generalization of Gravitation Theory.** By Albert Einstein. Princeton University Press, 1953. Reprint of Appendix II from 4th Edition, of the "Meaning of Relativity" in which the eminent author goes further in his attempt to arrive at a pure field theory of the universe and yet to explain the atomic character of energy.

**Radio Frequency Power Measurements.** By Roald A. Schrack. National Bureau of Standards Circular 536, March 16, 1953, 15 cents, U. S. Government Printing Office. A 16-page pamphlet outlining present methods of calorimetry, substitution methods, use of single-value devices (such as voltage or current meters), two-variable-devices (wattmeters) and directional couplers.

**Progress in Nuclear Physics, Volume 2.** By O. R. Frisch. Academic Press, Inc., 125 East 23 St., New York, N. Y., 1952. 295 pages, \$9.25. For physicists. Chapters on magnetic beta-ray spectrometers, nuclear paramagnetic resonance, luminescent materials for scintillation counters, neutron-proton interaction, fission, low-lying excited states of light nuclei, the nuclear shell model, and ionization by fast particles.

**Experimental Nuclear Physics, Volume 1.** By E. Segre, editor. John Wiley &

## PRIMARY BATTERIES for your Specialized Needs

### DRY TYPES

78 Standard Industrial, Laboratory and Government Types.



### LAB-BILT BATTERIES

Our engineers will design and create to your requirements. Send us your specifications.

### HI-DRIVE MINIATURE MOTOR



Precision-built, low-cost, battery-operated — available for delivery now.

Send for FREE Catalog

### RESERVE TYPES

Water activated "One Shot" Batteries.

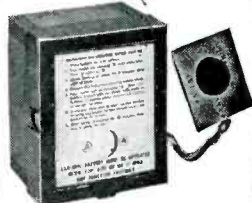

## SPECIALTY BATTERY COMPANY

A division of the **RAYOVAC** Ray-O-Vac Company

MADISON 10, WISCONSIN



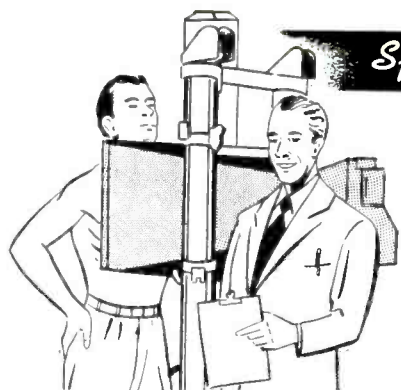

## Speeding X-Ray Photography

### with EPCO-DESIGNED MOTORS

Manufacturing X-Ray equipment calls for precision and dependability in every part.

That's why, when the nation's three leading manufacturers of X-Ray machines chose the motor that moves the delicate negative holders, they selected motors designed and built by EPCO.

These tiny motors of 1/500 h.p. (intermittent service) provide the reliable, steady source of power that revolves the negative changing mechanism. After a photo is made, the exposed negative with its lens and shutter, are automatically moved aside and a new unit moved into the ready position. Handling this task demands an even, slow application of power to avoid damage to the delicate mechanism. This is typical of the many unusual applications to which EPCO-designed motors have been put.

If your particular problem calls for special design, or merely for standard motors that can handle the toughest service, you'll find that EPCO is the source on which to depend. Out of the many unusual requirements filled by EPCO engineers has come experience unsurpassed in industry and always at your disposal.

Equally important, the EPCO plant is well-equipped and staffed to turn out motors for you on a mass-production, low-cost basis when necessary.

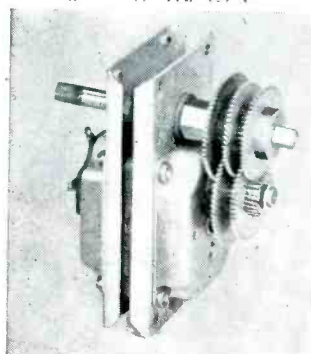

Write today for complete details and catalog information



**ELECTRO ENGINEERING PRODUCTS CO.**  
609 W. LAKE STREET, CHICAGO 6, ILLINOIS

- P-M DC MOTORS & GENERATORS • CAPACITOR TYPE MOTORS • UNIVERSAL MOTORS
- DC MOTORS & GENERATORS • SHADED POLE MOTORS (2-4-6 Pole) • P-M AC GENERATORS

**Cunningham**  
ESTABLISHED 1938

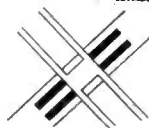

## CROSSBAR

For details of this truly superior switch, write

For broadcast studio master control and monitor switching of audio and video circuits . . . intercoms . . . telegraph . . . computers . . . many other applications.

Extreme flexibility. Fast and quiet switching with low crosstalk level. Any group of setups may be held intact while setting up others.

Provision for spot or remote control.

Model 10X10

Connects any of ten circuits in horizontal plane to any of ten vertical.

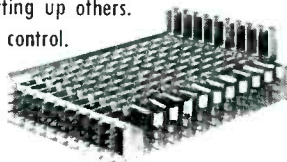

JAMES CUNNINGHAM, SON & CO., Inc. DEPT. E-7 ROCHESTER 8, NEW YORK



**ELECTROLYTIC and PAPER TUBULAR CONDENSERS**

FOR A.C. D.C. SETS PHONOGRAPHS etc.

CONDENSER SPECIALISTS SINCE 1923

**COSMIC RADIO CORPORATION**  
853 Whittier St., Bronx, N. Y.  
Phone LUdlow 9-3360

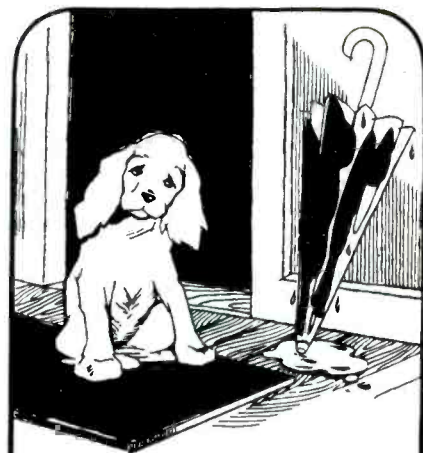

**MOISTURE PROBLEMS ARE ENDED . . .**

**WHEN YOU SPECIFY**

**Standard Piezo CRYSTALS**



Continuing research, "up-to-the-minute" manufacturing methods and constant laboratory and field testing assure you of truly accurate and dependable performance under all types of unfavorable conditions, when you insist on Standard Piezo Crystals for your equipment. Send today for our new, free illustrated catalog.

**Standard Piezo COMPANY**

**CARLISLE, PENNA.**

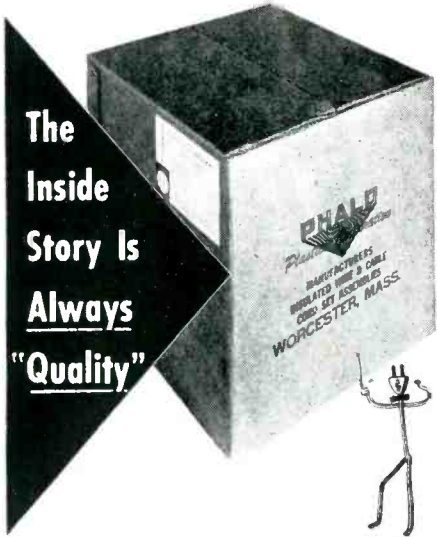

The Inside Story Is Always "Quality"

When the carton is marked PHALO... the inside story is always quality!

The most graphic endorsement of this claim is the steadily increasing number of PHALO cartons and spools being shipped daily!

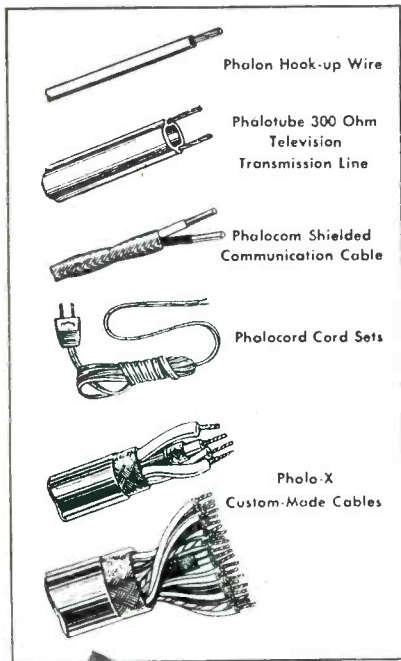

Phalon Hook-up Wire

Phalotube 300 Ohm Television Transmission Line

Phalocom Shielded Communication Cable

Phalocard Cord Sets

Phalo-X Custom-Made Cables



Ask for the new 46 page illustrated PHALO CATALOG

PHALO PLASTICS CORPORATION  
CORNER OF COMMERCIAL ST. • WORCESTER • MASS.  
Thermoplastic Insulated Wire Cables Cord Sets and Tubing

**PHALO**  
TRADE MARK

Want more information? Use post card on last page.

NEW BOOKS (continued)

Sons Inc, New York, N. Y., 1953, 789 pages, \$15.00. Contents: detection methods, passage of radiations through matter, nuclear moments and statistics, nuclear two-body problems and elements of nuclear structure, and charged-particle dynamics.

1952 Book of ASTM Standards. Published in seven parts, American Society for Testing Metals, 1916 Race Street, Philadelphia, 1953, 9,975 pages, \$76.00. Ferrous and non-ferrous metals, cement, concrete, ceramics, thermal insulation, road materials, water proofing and soils; paint, naval stores, wood, building constructions, etc; fuels, petroleum, aromatic hydrocarbons, antifreezes; rubber, plastics and electrical insulation; textiles, soap, shipping containers, etc.

TV Sweep Alignment Techniques. By Art Liebscher. John F. Rider Publisher, Inc., New York, 1953, 122 pages, 5 1/2 x 8 1/2 inches, paperbound, \$2.10. Methods for putting a TV receiver in best working condition by combining conventional peak alignment and sweep alignment into a single system; a new and apparently more responsive technique.

1953 Radio Annual and Television Year Book, 16th Annual Edition. Jack Alicoate, Editor. Radio Daily Corp., New York, 1953, 1,206 pages, included with subscription to Radio and TV Daily at \$15 a year. Reference volume of the broadcasting industry, containing statistics, telephone numbers, personnel, agency listings, station listings by states and by call letters, network data, program producers, film producers and distributors, tv personalities, announcers and MC's, directors, women commentators, disc jockeys, radio-tv newspaper editors, etc.

Vade-Mecum, Equivalent Radio Tubes. P. H. Brans, Ltd., Antwerp, 1953, 303 pages, large format, \$5.50. A quick reference for possible exchanges or substitutions of tubes with equivalent or near-equivalent characteristics but having different type number. Arranged in convenient tables, and including army tubes, power tubes up to 250 watts rated dissipation, crystal diodes and triodes.

UHF Antennas, Converters & Tuners, 1st Edition. By Milton S. Kiver. Howard W. Sams & Co., Indianapolis, 1953, 134 pages, 6 1/2 x 8 1/2 inches, paper cover, \$1.50. Practical aspects of uhf which the tv service technician will require for successful work. Factual, applicable data with many comparisons to vhf practices.

TV Manufacturers' Receiver Trouble Cures. Volume 3. By Milton S. Snitzer. John F. Rider Publisher, New York, 1953, 118 pages, 5 1/2 x 8 1/2 inches, paperbound, \$1.80. Deals with specific tv troubles and their cures; manufacturers are alphabetically arranged from Kaye-Halbert to Philco.

Engineering, A Creative Profession. Engineers' Council for Professional Development, New York, N. Y., 1953,

let **WILLIAMS** help you apply **ferric oxides** to the manufacture of your

**FERRITES**

You'll be well repaid by getting the facts on a special group of Pure Ferric Oxides, developed by Williams especially for use in the manufacture of ferrites.

Williams Ferric Oxides analyze better than 99% Fe<sub>2</sub>O<sub>3</sub>. They contain a minimum of impurities. They are available in a broad range of particle sizes and shapes. Among them, we're certain you'll find one that's "just right" for your requirements. The proper application of Ferric Oxides to the manufacture of Ferrites is our specialty.

Tell us your requirements... we'll gladly send samples for test. Chances are good that our Ferric Oxide "Know How" can save you considerable time and money. Address Dept. 25, C. K. Williams & Co., Easton, Pa.

**WILLIAMS**  
**COLORS & PIGMENTS**  
C. K. WILLIAMS & CO.  
Easton, Pa. • East St. Louis, Ill.  
Emeryville, Cal.

P.S. We also produce IRN Magnetic Iron powders for the Electronic Core Industry, the Magnetic Tape Recording Industry and others. Write for complete technical information.

Want more information? Use post card on last page.

# All business is specialized

*... and nothing  
specializes  
on your business  
like your business paper*



You can sell suntan lotion on Broadway or Beacon Street, but this seagoing salesman can sell a whale of a lot more . . . because he *specializes*.

Your business is specialized, too. That's why it pays to keep up with your business paper. It specializes on business problems you meet every day. It helps you do a whale of a lot better job by keeping you posted on your whole field. You can *move ahead* when you know what's ahead; you can make quicker, surer decisions when you have a clear perspective on what's happening; and you get all this from your business paper.

Every page counts. The editors gather facts, weigh and interpret them. The advertisers line up new products,

materials and equipment . . . tell you what they do and where to buy them. To know what's new that's important to you, read *every* issue—thoroughly! It will keep you one of the best informed people in your field.

---

This business paper in your hand has a plus for you, because it's a member of the Associated Business Publications. It's a paid circulation paper that must earn its readership by its quality . . . And it's one of a leadership group of business papers that work together to add new values, new usefulness, new ways to make the time you give to your business paper still more profitable time.

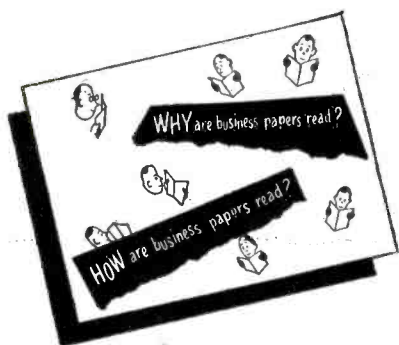

A copy of this quick-reading, 8-page booklet is yours for the asking. It contains many facts on the benefits derived from your business paper and tips on how to read more profitably. Write for the "WHY and HOW booklet." Room 2710.

**McGRAW-HILL PUBLISHING COMPANY**  
330 West 42nd St., New York 36, N. Y.



One of a series of advertisements prepared by THE ASSOCIATED BUSINESS PUBLICATIONS

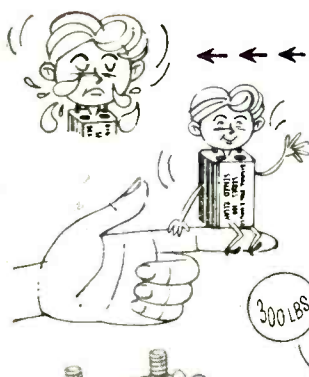

←←← SENSITIVE...

←←← small...

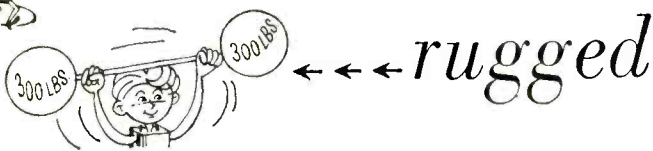

←←← rugged

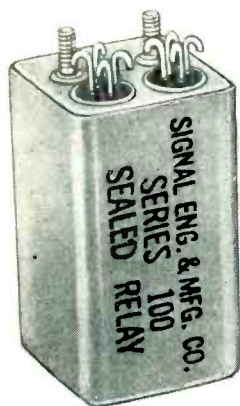

### THE NEW SERIES 100 RELAY (Hermetically Sealed)

One of the greatest challenges in the field of electronics is the designing of components small enough and rugged enough for today's and tomorrow's "miracle" machines and equipment.

The engineers of the Signal Engineering & Mfg. Co., always alert to this challenge, now offer the new Series 100 Miniature Relay which is among the smallest and most sensitive of the double-pole type. It maintains high precision under varying conditions and is ideally suited to such equipment as military guided missile controls which must withstand extremes of shock, vibration, and temperature.

#### DIMENSIONS

1"x1"x1 3/4"

Engineering Representatives in Principal Cities.

Write now for Bulletin SR-6



Pamphlet of 32 pages, 25¢; 20¢ in lots of 50 or more. For young men interested in choosing a career or a college. Nicely written and produced.

**Secondary Electron Emission at High Current Densities.** By Dietrich Alfred Jenny. Verlag Leeman, Zurich, Switzerland, 77 pages, 1952, paper-bound, 8 francs. Study of the multiplication ratio. In English.

**Principles of Television Engineering.** By Carter V. Rabinoff and Magdalena E. Wolbrecht. McGraw-Hill Book Co., New York, 1952, 560 pages, \$7.50. TV servicing guide, practical procedures, up-to-date circuits, shop reference material, trouble-shooting manual.

**A Television Policy For Education.** Edited by Carroll V. Newsom Associate Commissioner for Higher Education of New York State. American Council on Education, Washington, D. C., 285 pages, 1953, \$3.50. Comprehensive handbook on educational television instructs local communities on how to apply for license to operate TV station, finance station construction and operation, produce effective programs, and secure films from other educational stations and commercial producers. Also describes significant types of educational programs that have been produced.

**Electromagnetics.** By John D. Kraus. McGraw-Hill Book Co., 1953, 603 pages, \$9.00. A thorough-going text on the basic principles of electromagnetic field theory, with approximately equal emphasis on electronics, power, radiation and propagation.

**Beama Catalogue 1952-53.** Published for the British Electrical & Allied Manufacturers' Association by Iliffe & Sons, Ltd. London, for private distribution. 1,020 pages, large format. A buyer's guide to electrical products produced in Great Britain plus a five-language glossary of technical terms.

**Ferroelectricity.** By E. T. Jaynes. Princeton University Press, 137 pages, \$2.00. A monograph relating to the change in piezoelectric activities of Rochelle salt and similar materials at certain temperatures. The several theories for this change are given, for the theoretical physicist rather than for the practicing engineer.

**High Fidelity Simplified.** Harold D. Weiler. John F. Rider Publisher, Inc., New York, 1952, 208 pages, paper-covered, \$2.50. Practical information on modern equipment and its proper selection and use, for the enthusiast who prefers ready-made quality equipment. Three opening chapters set the stage theory-wise, three deal with the all-important loudspeaker and its enclosures, two with amplifiers, two with choice and use of record players and one each with tuners, tape recorders and use of the complete home music system.

## electrical weather-stripping

### EIMAC FINGER STOCK Now available!

Silver-plated, spring alloy, pre-formed finger stock especially suited for electrical "weather-stripping" for TVI-proofing cabinet access doors, etc. Also ideal for making coaxially constructed tube connections and many other uses. Available in 17/32", 31/32", and 1 7/8" widths.

- Write for new Eimac Catalogue Summary showing Eimac tubes and other accessories.

**EITEL-McCULLOUGH, INC.**  
San Bruno • California

**Something New!!**  
**ULTRASENSITIVE**  
**D-C VACUUM TUBE VOLTMETER**

50 Millivolts to 500 Volts, d-c  
 (full scale readings)

50 Megohms input resistance  
 (on all ranges)

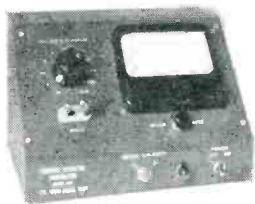

MODEL VM-81

- 11 range positions
- Accuracy 3% of full scale on all ranges
- Large 4½" panel meter
- Excellent stability

Price (f.o.b. plant) \$169.00

For further information write:

**SCIENTIFIC SPECIALTIES CORPORATION**  
 Dept. E-1  
 Snow and Union Streets, Boston 35, Mass.

*The* **S.S. WHITE 80X**  
**HIGH VOLTAGE RESISTOR**

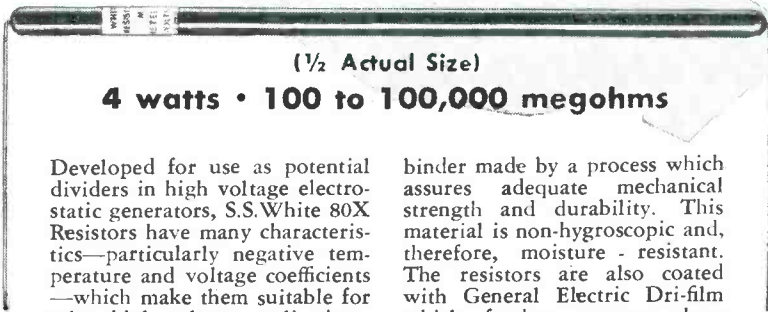

(½ Actual Size)

**4 watts • 100 to 100,000 megohms**

Developed for use as potential dividers in high voltage electrostatic generators, S.S. White 80X Resistors have many characteristics—particularly negative temperature and voltage coefficients—which make them suitable for other high voltage applications.

They are constructed of a mixture of conducting material and

binder made by a process which assures adequate mechanical strength and durability. This material is non-hygroscopic and, therefore, moisture - resistant. The resistors are also coated with General Electric Dri-film which further protects them against humidity and also stabilizes the resistors.

**WRITE FOR BULLETIN 4906**

It gives complete information on S.S. White resistors. A free copy and price list will be sent on request. Send for a copy.



**THE S.S. White INDUSTRIAL DIVISION**  
**DENTAL MFG. CO.**



Dept. R, 10 East 40th St.  
 NEW YORK 16, N. Y.

WESTERN DISTRICT OFFICE: Times Building, Long Beach, Calif.

for the **ELECTRONIC**  
**INDUSTRIES**  
**Quality**

*Ribbons*  
**STRIPS**

**MOLYBDENUM**  
**TUNGSTEN**  
**TANTALUM**  
**FORMED PIECES**

*Your Special Metals Rolled to Thin Sizes & Close Tolerances*

YOUR INQUIRIES WILL  
 RECEIVE PROMPT ATTENTION

**H. CROSS CO.**  
 15 BEEKMAN ST., N. Y. 38, N. Y.  
 WOrth 2-2044 and COrlandt 7-0470

**IMPROVED**  
**214B PULSE**  
**AMPLIFIER**

**200 CPS to**  
**90 mc BANDWIDTH**

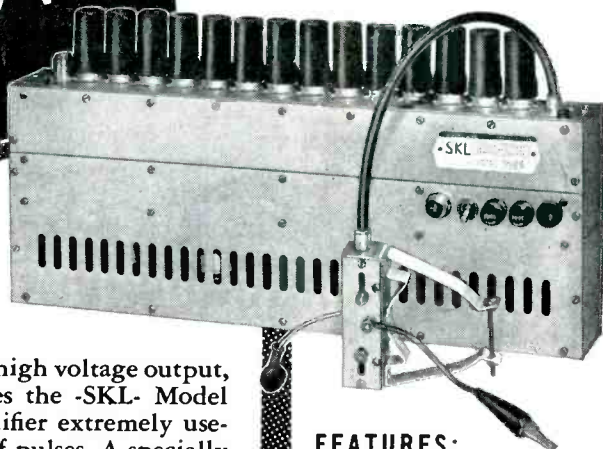

Extended bandwidth, high voltage output, and fast rise time makes the -SKL- Model 214B Chain Pulse Amplifier extremely useful for detailed studies of pulses. A specially designed terminating cable provides direction connection to the deflection plates of a cathode ray tube. The flat frequency response and linear phase shift of the Model 214B Chain Pulse Amplifier are valuable in the testing and development of pulse circuits for radar, nuclear, and UHF research.

For further information  
 write for Bulletin 214-2.

**FEATURES:**

- Rise Time: 0.006  $\mu$ sec.
- Pulse Gain: 30 db
- Maximum Output Voltage: 125V
- Bandwidth: 200 cps — 90 mc
- Stabilized screen supply

**SKL SPENCER-KENNEDY LABORATORIES, INC.**  
 186 MASSACHUSETTS AVE., CAMBRIDGE 39, MASS.

**WHEN  
DESIGN ENGINEERS  
TALK SHOP TODAY  
THEY TALK**

**miniaturization**



... because miniaturization meets today's demands for increased performance from smaller, lighter equipment. It saves vital space and weight on aircraft, guided missile and many similar applications . . . and it is bringing new portability and usability to countless types of commercial and industrial equipment.

If your miniaturization problem involves instrumentation, we can help. International Instruments is devoted exclusively to the design, development and production of miniature instruments and has created many important "firsts". We offer a complete line of 1" and 1½" Meters featuring accuracy and dependability comparable to conventional sized meters . . . plus far greater resistance to shock and vibration. Special scales and ranges can be provided to meet practically any electrical measuring requirement. Use the coupon below to send for data sheets covering our standard instruments — or ask our Engineering Department to help with your special needs.

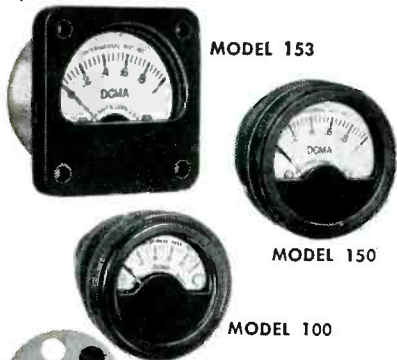

**ii international instruments**  
INCORPORATED

P.O. BOX 2954, NEW HAVEN 15, CONN.

- Please send data sheets covering your standard instruments.
- Arrange to have your representative call.

NAME \_\_\_\_\_  
 POSITION \_\_\_\_\_  
 COMPANY \_\_\_\_\_  
 CO. ADDRESS \_\_\_\_\_  
 CITY \_\_\_\_\_  
 ZONE \_\_\_\_\_ STATE \_\_\_\_\_

Want more information? Use post card on last page.

**BACKTALK**

**Useful Data**

DEAR SIRs:

AS AN AMATEUR of 21 years standing, an advertising agency executive, and a faithful reader of ELECTRONICS, I was much interested in the letters by W9KQX and W5CA on what's wrong with the technical advertising of electronic products (Mar. 1953, p 492; May 1953, p 413).

There is no question but that these gentlemen are right when they recommend that tube manufacturers make available circuitry using the advertised product, and provide other "useful data" for maximum advertising effectiveness.

Many advertisements *do* contain such information—the majority of tube ads show characteristic curves. Unfortunately, it is impossible to put everything into a 7 × 10-in. page; readership studies and keyed coupon returns show that in general a cluttered up ad that looks forbidding does not do as good a sales job as an attractive-looking ad that makes one strong point.

In the case of tubes, the answer to this question (and I'm surprised more companies don't do it) is to print an inexpensive folder, or even a single sheet, which give schematics showing how to use the product, outlines complete operating data, etc. This folder could be offered in the ads, given out at shows and sent to a direct mail list.

One tube company has done an outstanding job along this line where its diodes are concerned.

Two manufacturers may pay the same rate in ELECTRONICS, or any other publication, but all they are buying is white space in which to print a sales message. If advertiser A makes twice as effective use of the space he buys as does advertiser B, then his space cost is one-half of the B's. True rates are determined by how efficiently a company uses the space it buys, not by the publisher's rate card.

W9KQX and W5CA have made a sound suggestion on how tube manufacturers can use their space more effectively.

As far as the Art Directors and

**TERMINAL  
BLOCKS  
NAVY TYPE**

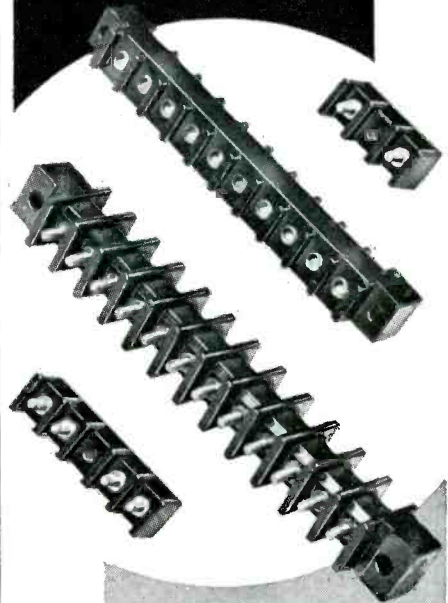

Shaw terminal blocks, produced to Navy specifications are now available from stock.

Supplied with complementary hardware if desired.

Shaw's reputation as an experienced custom molder assures you the highest quality precision-made terminal blocks.

*Write to  
Shaw today  
for complete  
specifications  
and prices.*



**SHAW  
INSULATOR  
COMPANY**

151 COIT ST., IRVINGTON 11, N. J.  
SINCE 1892

Want more information? Use post card on last page.  
July, 1953 — ELECTRONICS

non-technical personnel who prefer a "pretty ad" to a "useful one." I'm afraid the fault lies at the manufacturer's door for permitting this to happen. Nor, I fear, is it true that technical advertising would be of higher quality if engineers' ideas always prevailed. The most effective advertising results from the best thinking of the engineers and of professional printed word salesmen.

Congratulations on doing such a consistently fine editorial job in **ELECTRONICS!**

STUART D. COWAN, JR., W1RST  
*Vice President  
 Cowan and Dengler, Inc.  
 New York, N. Y.*

**Tantalum-Foil Capacitors**

DEAR SIRs:

IT WAS most interesting to read the article "Tantalum-Foil Capacitors Save Space" by L. W. Foster in the "Electrons at Work" section of the May 1953 issue of **ELECTRONICS** (p 242). Articles like this may go a long way toward educating engineers specifically in the properties of components.

There are several points, however, in Table I that do not fit with some of our current knowledge of paper and aluminum-electrolytic capacitors. One line in the table indicated that insulation resistance of paper dielectric capacitors is low, while that of aluminum electrolytic is high. It is well known that any electrolytic capacitor allows some moderate leakage current to flow, while the insulation resistance of even an average quality paper capacitor is on the order of 500,000 megohms.

The shelf life of aluminum-electrolytics at the three temperatures shown in the table is said to be better than that of paper capacitors. This is quite opposite to our experience. A shelf life of two years for an average aluminum-electrolytic capacitor is unusually long.

The cost comparison for capacitors in the 500 to 5,000 volt range shows that the cost of paper units is high while that of aluminum units is low. It is my understanding that it is not feasible to manufacture aluminum-electrolytic capaci-

**FOR  
 MILITARY**

**Acme Electric**

**OR  
 AVIATION  
 APPLICATIONS**



All the experience of 35 years of transformer building is now available to west coast buyers of electronic and MIL-T-27 transformers thru our west coast engineering laboratories. Adequate facilities for designing quality transformers are available on your requirements.

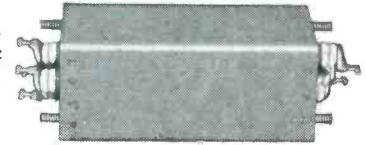

**ACME ELECTRIC CORPORATION**  
**MAIN PLANT: 317 Water Street • Cuba, N. Y.**  
 West Coast Engineering Laboratories: 1375 W. Jefferson Blvd. • Los Angeles, Calif.  
 In Canada: ACME ELECTRIC CORP. LTD. • 50 North Line Rd. • Toronto, Ont.

**Acme Electric**  
 TRANSFORMERS

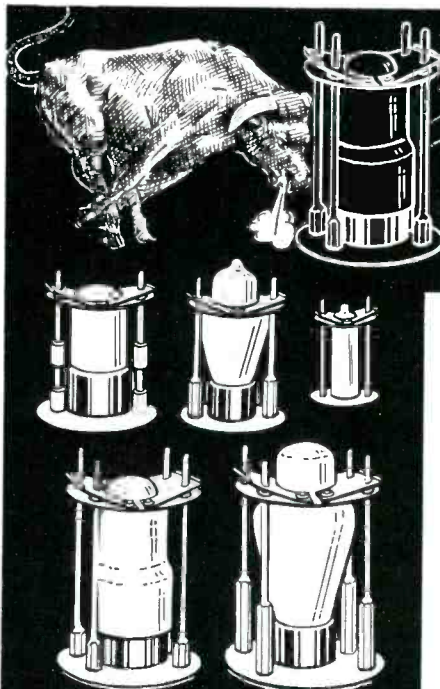

**SHOCK  
 PROOF**

**VACUUM TUBE  
 RETAINERS**

These retainers are used to secure Vacuum Tubes and to resist side motion of Vacuum Tubes used in radio equipment which is subject to shock and vibrations. These retainers meet the requirement of all JAN specifications. The insulated portion is made of a melamine base Fibre Glass Phenol which provides 300 volts insulation to ground and withstands a temperature of 350 F. The insulated plate can readily be fastened or released by hand.

Available for envelope types T7, T8, MT8, T9, T12, ST12, T12ZDL, ST14, S14, ST16, T5 1/2, T8 1/2, MT-IC, ST19, T14, ST128CT-9.

*Manufacturers of  
 Electronic Components*

**JAMES IPPOLITO & CO., INC.**  
**401 CONCORD AVENUE, BRONX 54, N. Y.**

## G. M. GIANNINI & CO., INC.

Pasadena, California, and East Orange, New Jersey

manufacturers of components for servo-mechanisms and computers, has recently established a subsidiary with headquarters in Milano, Italy, where the following activities will be performed:

- Sales and Engineering Office for the distribution and servicing of Giannini products in Europe.
- Research Laboratory and Experimental Shop for the development of new products originating in Europe.

Inquiries are solicited from persons or organizations in Western European countries interested in handling Giannini products. Please submit full details as to territories covered, other products handled, organization and sales possibilities, by writing to:

**Giannini Italiana S.p.A.**

CABLES GIANNINITAL | TELEPHONES 482714-482716

GIANNINI ITALIANA S.p.A., VIA ALBERTO DA GIUSSANO 15, MILANO, ITALY

## STOCK KNOBS IN ANY QUANTITY ... AND NEVER A TOOL CHARGE!



GEE-LAR—The House of Knobs—has hundreds of styles and patterns in stock at all times. Whatever your needs... whether for production, lab or experiment... you can get them faster and at lower cost from GEE-LAR.

WRITE TODAY  
for Gee-Lar Catalog



THE HOUSE OF KNOBS

**GEE-LAR MANUFACTURING COMPANY**

1332 10TH AVENUE • ROCKFORD, ILLINOIS

tors with voltage ratings greater than 600 volts d-c.

The information as given does not seem to present a proper comparison of the merits of the capacitors considered.

B. B. PAINE  
Standards Engineer  
MIT Digital Computer Laboratory  
Cambridge, Mass.

(Editor's Note: A switch in column headings by the printer was not caught by the editor-proofreader and hence ascribes paper-capacitor characteristics to aluminum-electrolytics, and vice versa. A correction by the reader's pen will make the table on p 244 truly useful. Headings should read left to right, Tantalitic, Aluminum-Electrolytic, Paper.)

## Help P-p-please

DEAR SIRs:

WE ARE requesting ideas from your readers on a medical research problem we are considering. We are investigating the tremor rate of the tongue during moments of stuttering. The way the problem was handled before, was to insert a pneumatic pressure bulb in the mouth and have changes in pressure actuate a recording device to obtain amplitude and frequency. The size of the bulb, its mechanical inertia, distracting tubes, etc. limited the usefulness of this system. However, data of definite clinical and therapeutic value were obtained.

It has been suggested that a drop of paint containing iron filings could be placed on the tongue, and by magnetic or electronic means, movements could be recorded. Metal in the teeth would have to be accounted for. Amplitudes of 0.01 to 2 or 3 inches and frequencies of 1 to 100 per second seem to be about the necessary range of the instrumentation.

We are requesting suggestions from your readers on possible systems and procedures and other possible methods that may come to mind.

Full credit on publication.

Please forward replies to Dr. Van Riper, Speech Clinic, Western Michigan College, Kalamazoo, Michigan.

JULIUS LUCOFF  
Professional Engineer  
Seattle, Washington



# CONTACTS

FOR THE FIELD OF ELECTRONICS

**A PRIVATE TECHNICAL PLATING SERVICE**  
 offering . . . . **PALLADIUM**  
                           **RHODIUM** . . . . in  
 flash, intermediate and heavy electrodeposits.  
 Information regarding electroplated thicknesses  
 upon request.  
**DANIEL D. ZIELIK**  
 Brown's Lane Fairfield, Connecticut

**SUB-CONTRACTING**  
**MILITARY and COMMERCIAL**  
 receivers—test equipment  
 transmitters—controls  
 sub-assemblies  
**TELETRONICS LABORATORY, INC.**  
 Westbury, L. I., N. Y. Westbury 7-1028

**SUBCONTRACTING**  
**MILITARY AND COMMERCIAL**  
 Design, development and manufacture of  
 Servomechanisms, Controls, Toroids, Sat-  
 urable Reactors, Magnetic Amplifiers.  
**FIDELITY INSTRUMENT CORPORATION**  
 1320 W. MARKET STREET  
 TEL. 7675 YORK, PENNA.

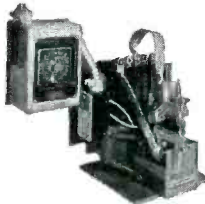

**EISLER MANUFACTURES COMPLETE EQUIPMENT**  
 WELDERS FOR SPOT & WIRE BUTT  
 RADIO, TV TUBE EQUIPMENT & REPAIR UNITS  
 INCANDESCENT, FLUORESCENT MFG EQUIPMENT  
 NEON SIGN MAKERS EQUIPMENT, GLASS LATHES  
 ELECTRONIC EQUIPMENT, VACUUM PUMPS, Etc.  
 Wet Glass SLICING & CUTTING MACHINES for Lab Use  
 TRANSFORMERS, SPECIAL & STANDARD TYPES  
**EISLER ENGINEERING CO., INC.**  
 751 So. 13th St. Newark 3, N. J.

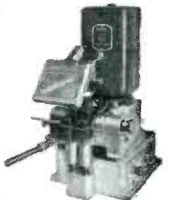

**Have you problems in -  
 Metal to Glass Seals?**

NAME IT . . . WE'LL MAKE IT!  
 TERMINALS  
 HEADERS  
 END SEALS . . . SPECIAL ITEMS

**QUALITY PRODUCTS CO.**  
 387 Charles St., Providence, R. I.

**ELECTRICAL  
 COILS**

Bobbin, spool, form, layer, interleaved,  
 interwoven types. Made of any material,  
 any finish, for any application.

Send blue-prints and specifications  
 for prompt quotation.



**THE FIVE  
 STAR COMPANY**  
 West Main Street  
 Plantsville, Conn.

**One  
 inexpensive  
 modern  
 device . . .**

can frequently help speed up  
 operation and maintenance  
 or production.

One product advertised in the  
 "Contacts" Section may be  
 the answer to your problem  
 . . . a real money-saver.

To be informed—and re-  
 minded—on modern aids to  
 economical operation, main-  
 tenance and production,  
 check "Contacts" advertising  
 regularly . . . every issue.

**Shorted Turn Indicator**

Sensitive, rugged, non-shocking  
 for unmounted coils; \$150. f.o.b.  
 HUNTINGTON BEACH, CALIF.



**WALKIE-RECORDALL** 8 lb. miniature **BATTERY  
 RECORDER-PLAYBACK**

Continuous, permanent, indexed recording, up to 4  
 hrs., only 3c hr. Instantaneous, permanent playback.  
 Picks up sound up to 60 ft. Records conferences, lec-  
 tures, dictation, 2-way phone & sales talks; while  
 walking, riding or flying. Records in closed briefcase  
 with "hidden mike"! Write for Detailed Literature.

**MILES REPRODUCER CO., INC.**  
 812 BROADWAY Dept. E-7 NEW YORK 3, N. Y.

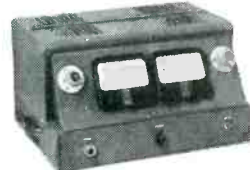

**HIGH  
 VOLTAGE  
 POWER  
 SUPPLIES**

Available in ranges from 2,500 to  
 25,000 volts D.C., with or without built-  
 in meters. Regulated or unregulated  
 types available. Delivery good on all  
 standard models.  
 Send for free catalogue—Dept. E1\*

**PRECISE MEASUREMENTS CO.**  
 942 KINGS HIGHWAY, BROOKLYN 23, N. Y.  
 Phone ES 5-9435

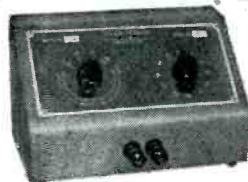

**WIDE RANGE DECADE RESISTOR**

Especially designed for use in development and production  
 laboratories where standardized RTMA resistor values are to be  
 determined easily and quickly.

For descriptive litera-  
 ture write or wire

**Rochester Electronics Co., Inc.**  
 DEPT S-4 Box 227 PENFIELD, NEW YORK

**MICROMETER FREQUENCY METER**

Measures center frequency of any number  
 of transmitters, AM or FM, 0.1 to 175  
 MC., 0.0025% accuracy. Price \$220.00.

**LAMPKIN LABORATORIES, INC.**  
 BRADENTON, FLORIDA



**FLUXES**  
 SOLDERING  
 BRAZING & WELDING  
 L. S. ALLEN CO., INC. Chicago 31, Ill.  
 6751 BRYN MAWR AVE.

*We invite inquiries on*



WRITE FOR CATALOG

**REX RHEOSTAT CO.**  
 BALDWIN, L. I., N. Y.

# PROFESSIONAL SERVICES

## PICKARD AND BURNS, INC.

*Consulting Electronic Engineers*

Analysis and Evaluation  
of Radio Systems

Research, Development and Production  
of Special Electronic Equipment

240 Highland Ave.

Needham 94, Mass.

## ANNIS ELECTRIC RESEARCH LABORATORY, INC.

CONSULTING — RESEARCH — DEVELOPMENT  
AND DESIGN OF RADIO AND ELECTRONIC  
EQUIPMENT  
SPECIALIST

Military Radio Direction Finding  
Equipment and Directional Antennas.  
P. O. Box 581 140½ S. Neil St.  
Champaign, Ill. Tel. 6-1780

## HIGHLAND ENGINEERING CO.

*William R. Spital & Staff*

DESIGN, DEVELOPMENT AND MANUFACTURE  
OF TRANSFORMERS, CHOKES, ETC.  
FOR THE

ELECTRONIC, INDUSTRIAL & ALLIED FIELDS  
Main & Urban, Westbury, L.I., N.Y.  
WE-7-2983

## ALBERT PREISMAN

*Consulting Engineer*

Television, Pulse Techniques, Video  
Amplifiers, Phasing Networks,  
Industrial Appliances

Affiliated with  
MANAGEMENT-TRAINING ASSOCIATES  
3308-14th St., N. W. Washington 10, D. C.

## CROSBY LABORATORIES, INC.

*Murray G. Crosby & Staff*

Radio - Electronic  
Research Development & Manufacturing  
Communications, FM & TV  
Robbins Lane, Hicksville, N. Y.  
Hicksville 3-3191

## HOGAN LABORATORIES, INC.

John V. L. Hogan, Pres.

*Applied Research, Development, Engineering*

Est. 1929. Electronics, Optics, Mechanisms, Fac-  
simile Communication, Digital Computers (Circle),  
Electro-sensitive recording media, Instrumentation.  
155 Perry Street, New York 14. CHelsea 2-7855

## JOSEPH RACKER COMPANY

*Radar Consultants & Editors*

Technical Manuals  
Research and Development

140 Nassau Street, New York 38, N. Y.  
Worth 4-1463

## EDGERTON, GERMESHAUSEN & GRIER, INC.

*Consulting Engineers*

Research, Development and Manufacture  
of Electronic and Stroboscopic Equipment  
Specialists in High-Speed Photography  
160 Brookline Avenue Boston 15, Mass.

## THE KULJIAN CORPORATION

*Consultants • Engineers • Constructors*

Electronic Control

Specialists

Utility • Industrial • Chemical

1200 N. Broad St., Phila. 21, Pa.

## ROTRON RESEARCH CORPORATION

*Research and Development*

Fluid Dynamics and Heat Transfer.  
Exclusively Electronic Applications

Cooling Problems, Heat Exchangers, Fans,  
Turbines and Pump Designs.  
Woodstock, N. Y. Phone 2408

## Eldico of New York, Inc.

Pioneers of Television Interference Elimination from  
Transmitters, Induction Heaters, Diathermy and  
etc.

Donald J. S. Merten & Engineering Staff  
44-31 Douglaston Pkwy Douglaston, N. Y.  
Bayside 9-8686

## MAGNETIC INDUSTRIES, INC.

*Development & Manufacture*

Servo Magnetic Amplifiers and  
Special Relays

2640 Huldy Houston 6, Texas

## SKINNER, HARLAN AND IRELAND, INC.

*Consulting Engineers*

Specializing in Magnetic Materials and  
Their Application

1122 E. 23rd St. Indianapolis 7, Indiana

## ERCO RADIO LABORATORIES, INC.

*Radio Communications Equipment*

Engineering - Design - Development - Production  
Pioneers in Frequency Shift Telegraph  
Garden City • Long Island • New York

## MEASUREMENTS CORPORATION

*Research & Manufacturing Engineers*

Harry W. Houck John M. van Beuren  
Jerry B. Minter

Specialists in the Design and  
Development of Electronic Test Instruments

Boonton, New Jersey

## THE TECHNICAL MATERIEL CORPORATION

*Communications Consultants*

Systems Engineering

General Offices and Laboratory

121 Spencer Place, Manaroneck, N. Y.

## HARRIS GALLAY

*Consultant*

Electronic Project Development for Industry  
Day, Week and Duration of Project Services  
Our Laboratory Facilities Optional

Plymouth 9-4237 60 Perry St., Belleville 9, N. J.

## Eugene Mittelmann, E.E. Ph.D.

*Consulting Engineer & Physicist*

High Frequency Heating—Industrial Electronics  
Applied Physics and Mathematics

549 W. Washington Blvd. Chicago 6, Ill.  
State 2-8021

## TELECHROME, INC.

*Electronic Design Specialist*

COLOR TELEVISION EQUIPMENT

Flying Spot Scanners, Color Synthesizers, Keyers,  
Monitors, Oscilloscopes and Related Apparatus

J. R. Popkin-Curman, Pres. & Ch. Engr.  
88 Merrick Rd. Amityville, L. I., N. Y.

## GENERAL LABORATORY ASSOCIATES, INC.

*Specialists in Glass to Metal Sealing*

Manufacturing and development facilities now  
available covering special vacuum and gas tube  
Development and Fabrication. We invite your  
inquiries.

Norwich, N. Y. Telephone Norwich 4-3264

## NEW ROCHELLE TOOL CORP.

FOR CERTIFICATION OF INDUCTION  
AND DIELECTRIC HEATING EQUIPMENT  
IN ACCORDANCE WITH F.C.C. RULINGS

320 Main St., New Rochelle, New York  
Phone NE 2-5555

'MOBILE UNIT' QUOTATIONS ON REQUEST

## WHEELER LABORATORIES, INC.

Radio and Electronics

Consulting—Research—Development  
R-F Circuits—Lines—Antennas

Microwave Components—Test Equipment  
Harold A. Wheeler and Engineering Staff  
Great Neck, N. Y. Great Neck 2-7806

## GORDON ASSOCIATES, INC.

*Government Contract Liaison and Consulting*

Specializing in Signal Corps Electronic Require-  
ments, Technical Manuals, Tabular List of Parts,  
Drawings.

L. Gordo, Pres. P. Treston, Ch. Engr.  
157 Broad Street Telephone  
Red Bank, New Jersey Red Bank 6-2743

## NIAGARA ELECTRON LABORATORIES

CONSULTATION - DESIGN - CONSTRUCTION  
— MFG. THE THERMOCAP RELAY

Specializing in solution of problems of electronic  
and electro-physical instrumentation for the re-  
search of analytical laboratory. Industrial plant  
problems also invited.

Andover, New York Cable Address: NIATRONLAB

## WIHTOL LABORATORIES

*Consulting - Research - Development*

Electron tubes—Vacuum and gas tube  
manufacturing techniques—Glass  
techniques—Special purpose tubes

2333 Grey, Evanston, Ill. Un. 4-7896

## HANSON-GORRILL-BRIAN INC.

*Products & Mfg. Development*

ELECTRICAL - ELECTRONIC  
HYDRAULIC - MECHANICAL

One Continental Hill Glen Cove, N. Y.  
Glen Cove 4-7300

## MAURICE I. PARISIER & CO.

*Communications Expert*

International Engineering Consulting

RADIO BROADCASTING & COMMUNICATIONS

Planning & Installation Supervision  
Communication Equipment for Armed Forces  
1475 Broadway New York 36, N.Y. Longacre 4-5434  
Offices: Paris-Beunos Aires—Sao Paulo-Bombay

## YARDNEY LABORATORIES, INC.

*Research - Design - Development*

Electro-Chemical Generators of Energy

105 Chambers Street Worth 2-3534, 35, 36  
New York 7, N. Y.

## UNDISPLAYED RATE

\$1.50 a line, minimum 3 lines. To figure advance payment count 5 average words as a line. **POSITION WANTED & INDIVIDUAL SELLING OPPORTUNITY WANTED** undisplayed advertising rate is one-half of above rate, payable in advance. **BOX NUMBERS** count 1 line additional.

## INFORMATION

**DISCOUNT 10%** if full payment is made in advance for four consecutive insertions of undisplayed ads (not including proposals).

**EQUIPMENT WANTED OR FOR SALE** Advertisements acceptable only in Displayed Style.

## DISPLAYED—RATE PER INCH

The advertising rate is \$14.00 per inch for all advertising appearing on other than a contract basis. Contract rates quoted on request.

**AN ADVERTISING INCH** is measured  $\frac{7}{8}$  inch vertically on one column, 3 columns—30 inches—to a page. **ELECT.**

Send **NEW ADVERTISEMENTS** to N. Y. Office, 330 W. 42 St., N. Y. 36, for the August issue closing July 2. The publisher cannot accept advertising in the Searchlight Section, which lists the names of the manufacturers of resistors, capacitors, reohostats, and potentiometers or other names designed to describe such products.

**TRANSFORMER DESIGN ENGINEER**

Immediate opening for Top Level Senior Electrical Engineer with well established electronic component manufacturing concern.

Work includes design of transformer (audio, power and pulse), reactors, and filter networks.

Salary \$10,000 up commensurate with experience and ability.

Write giving age, education, and complete work history.

P-8245, Electronics  
330 W. 42 St., New York 36, N. Y.

**RADIO TUNER (Dev.) \$10,000 TITLE—ASST. CHIEF ENGINEER**

Very aggressive company seeking a promotable man with some exp. in this field.

Contact Ray Edwards

**O'SHEA EMPLOYMENT SYSTEM**  
"America's Largest"  
64 E. Jackson, Chicago, Ill. Tel. WAbash 2-1884

REPLIES (Box No.): Address to office nearest you  
NEW YORK: 330 W. 42nd St. (36)  
CHICAGO: 520 N. Michigan Ave. (11)  
SAN FRANCISCO: 68 Post St. (4)

**POSITIONS VACANT**

**CHIEF DESIGN ENGINEER**—M.E. Degree and outstanding product design achievement in electronic equipment and/or related fields. Should now be assistant chief design engineer. Must have heavy experience in industrial product design; Military Development Contracts; keen appreciation of shop viewpoints. Established Northern New Jersey manufacturer. P-8149, Electronics.

**ELECTRICAL ENGINEER**—Degree and heavy production design experience on 0-10 KVV gas discharge lamp transformers and ballasts. Must have demonstrated ability in production design and cost reduction. To 40 yrs. of age. Established Newark electrical-electronic manufacturer. P-8148, Electronics.

**ASSISTANT CHIEF ENGINEER**. Ohio company manufacturing electronic equipment has opening for electronic engineer approximately 27-31 years of age in capacity of administrative assistant to the Chief Engineer. Duties will include engineering office work, supervision of laboratory projects and occasional traveling. Must have at least 5 years professional experience in the circuit design and project supervision. Starting salary \$7000 per year. Allowance for moving expense. Replies held in confidence. Submit resume to P-8145, Electronics.

**POSITIONS WANTED**

**ELECTRONICS ENGINEER**. Mature administrative eng. with 16 yrs. heavy R. and D. experience radar T.V. and radio, industry and govt., U. S. and Europe. Now with large comp. at high level project direction and customer liaison. Prefer suburban living. Salary \$12,000 or equiv. Full details at personal interview. PW-8119, Electronics.

**When Answering BOX NUMBERS . . .**

to expedite the handling of your correspondence and avoid confusion, please do not address a single reply to more than one individual box number. Be sure to address separate replies for each advertisement.

**MANUFACTURERS' AGENT WANTED**

—one who is now contacting electronic companies in New Jersey, New York, Connecticut and Pennsylvania—to develop continuing subcontracting work for our Machining Division which is now doing extreme precision work on aluminum and stainless steel parts for electronic companies.

**Exact Level and Tool Manufacturing Company, High Bridge, N. J.**

**Leading research and development organization needs the following engineers:**

**ELECTRO-MECHANICAL ENGINEER** for development and application of methods for measurement of mechanical parameters.

**VIBRATIONS ENGINEER** to conduct work on measurement and control of vibration phenomena.

Outstanding opportunity to conduct challenging programs and to grow in professional stature. Financial assistance for graduate study. Write Personnel Manager, Armour Research Foundation of Illinois Institute of Technology, Chicago 16, Illinois.

**POSITIONS WANTED**

**ELECTRONICS ENGINEER**, 35, B.S. 7 yrs. experience development and production eng'g. System em'g. project scheduling, planning, radar and telem. systems, mil. and comm. equip. with eastern firm. Previous Navy exp. 3 yrs. Staff Radar Officer. Seeks growth company. Family. PW-8094, Electronics.

**ELECTRICAL ENGINEER** University degree (Warsaw) A.M.I.E.E. 7 years Design and Production, Electrical Apparatus 11 years Radar (including 7 years R.A.F.) Present adviser to Argentine Air Force. Seeking suitable position. Write S. W. Czarnecki, Echeverria 2685 Buenos Aires, Argentina. Speaks English.

**GRAD. DUTCH Eng.**, 27 yrs., 5 yrs. exp. in des. and constr. of var. sorts of ionosph. meas. eq. and ant. desires pos. in same or allied field in U. S. A. Please write PW-8236, Electronics.

**ELECTRONICS ENGINEER**, age 32, graduate of Technical Institute of Munich, U. S. citizenship in 1954. 3 years experience in television receiver trouble-shooting and improvement. Seeking position as junior engineer. PW-8228, Electronics.

**SELLING OPPORTUNITY WANTED**

**ELECTRICAL LINES** Wanted for Florida by established Manufacturers Agent Contacting Electronic Engineers & Contractors on Gov. Projects. Experience as Mechanical & Elect. Field Engineer on commission. RA-8069, Electronics.

**BUSINESS OPPORTUNITY**

Wanted: Well established manufacturer with versatile manufacturing equipment wishes to contact designer or inventor with some new product or improved element to add to his line under a royalty or licensing agreement. Write P. O. Box 369, Delaware, Ohio.

**NEW YORK EXECUTIVE REPRESENTATION**

Save executive time and travel. Have **ON THE SPOT** representation in New York area.

**ENGINEER - ATTORNEY**

experienced all phases business-engineering management will:

- Initiate and follow thru sales contacts
- Interview new personnel
- Conduct sub-contract liaison
- Expedite orders in this area
- Handle credit problems
- Provide PERMANENT N. Y. office. adjustable annual fee.

RA-8131, Electronics  
330 W. 42 St., New York 36, N. Y.

**EXPERIENCED SALES—TECHNICAL ENGINEERING APPLICATION SERVICE**

For Electro-Mechano-Plastics Components Manufacturers Requiring Concentrated Contacts Among Industrial Maintenance—Manufacturers in Northern New Jersey—Est., 1945.

**JAMES L. FITZSIMMONS**  
39 Lackawanna Plaza, Bloomfield, N. J.

**WANTED**

To Manufacture and Sell  
**NEW**  
Electronic Accessory Items

For—

**FACSIMILE • RADIO TELEPHONE • TELEVISION**

**URGENT**—We have a special immediate need of Facsimile Equipment for Intra-Office and Plant use.

**URGENT**—To locate Doctors in Hospitals. Need miniature Selective Radio Signal Receiver to be carried in pocket — weight must be under 10 ounces.

**WILL FURNISH CAPITAL IF NECESSARY TO COMPLETE DESIRABLE DEVELOPMENTS**

What have you to offer?

**Radio Engineering Co.**  
Inquirer Bldg. Phila. 30, Pa.

# ENGINEERS

## FOR ATOMIC WEAPONS INSTALLATION

Mechanical Engineers, Electronics and Electrical Engineers, Physicists, Aerodynamicists, and Mathematicians. A variety of positions in research and development open for men with Bachelors or advanced degrees with or without applicable experience.

These are permanent positions with Sandia Corporation, a subsidiary of the Western Electric Company, which operates the Laboratory under contract with the Atomic Energy Commission. The Laboratory offers excellent working conditions and liberal employee benefits, including paid vacations, sickness benefits, group life insurance and a contributory retirement plan.

LOCATE IN THE

*Healthful Southwest*

Albuquerque, center of a metropolitan area of 150,000, is located in the Rio Grande Valley, one mile above sea level. Albuquerque lies at the foot of the Sandia Mountains which rise to 11,000 feet. Cosmopolitan shopping centers, scenic beauty, historic interest, year 'round sports, and sunny, mild, dry climate make Albuquerque an ideal home. New residents experience little difficulty in obtaining adequate housing in the Albuquerque area.

APPLICATIONS NOW BEING ACCEPTED  
FOR TECHNICAL WRITERS

*These are not Civil Service Appointments*

Make Application to the

PROFESSIONAL EMPLOYMENT DIVISION

**SANDIA**

*Corporation*

**SANDIA BASE  
ALBUQUERQUE, N. M.**

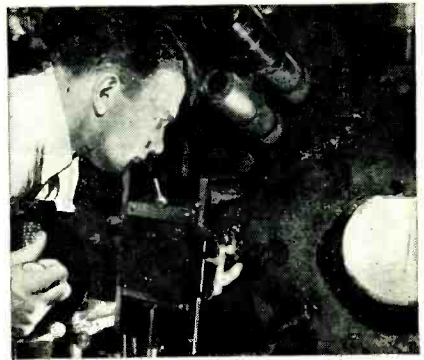

Design, development  
engineers . . .

*Interested in the  
why of things?*

Most engineers are—but too often their jobs don't give much chance to investigate.

Not so at Honeywell. We're always after new basic knowledge—in many fields. Witness our young engineer above making a photometric study of fire.

And right now we have some specially good openings for experienced engineers who would like to know the *why* of things in the following areas:

- Servomechanisms
- Gyros
- Relays
- Transformers
- Vacuum tubes
- Electromechanics
- Aircraft Control Systems

**Duties of the jobs.** Research leading to knowledge that will enable us to bring into design form a new or modified instrument, device or control system.

**Requirements.** B. S. or M.S. in Electrical, Mechanical or Aeronautical Engineering desirable.

**Atmosphere.** A company that understands engineering—where one out of every ten employees is actively engaged in engineering or research.

**Openings.** In Minneapolis, Philadelphia and Freeport, Illinois.

Write J. A. Johnson, Engineering Placement Director, Dept. EL-7-150, Honeywell, Minneapolis 8, Minn. Learn in detail how you can delve into the why of things at Honeywell. Ask for our book, "Emphasis on Research."

**Honeywell**



*First in Controls*

# DESIGN RESEARCH DEVELOPMENT

**key words to your employment opportunities at GOODYEAR AIRCRAFT . . .  
pioneer and leader in lighter-than-air craft . . . an established and growing  
company building an outstanding technical reputation**

**DESIGN ENGINEERING** opportunities exist in the fields of airships, air-  
planes, and components, airframes, power-plant installations, controls,  
hydraulics, electronics systems, fuel cells, canopies, and wheels and brakes

**DEVELOPMENT** of missiles, jet aircraft, and helicopters, electric and elec-  
tronics system, servomechanisms, fiber resin laminates, and many other  
projects present an urgent need for capable engineers

**WELDING ENGINEERS**, civil engineers, mechanical engineers with ability  
in metals fabrication, and industrial engineers experienced in time study  
are needed. Job opportunities also exist for technical editors and illustrators

**POSITIONS** are open at several levels, and inquiries are also invited from  
recent graduates. Salaries are based on education, ability, and experience

**PAID VACATIONS**, free group life insurance, a good hospitalization plan,  
paid sick leave, company-sponsored pension plan, planned recreation, and  
free parking are among the facilities at the plant

**A FRIENDLY CITY**, Akron, Ohio, is located in the center of the midwestern  
industrial region

**IF YOU ARE INTERESTED** in a secure future, write, giving details, or request  
an application from

C. G. Jones, Salary Personnel Department

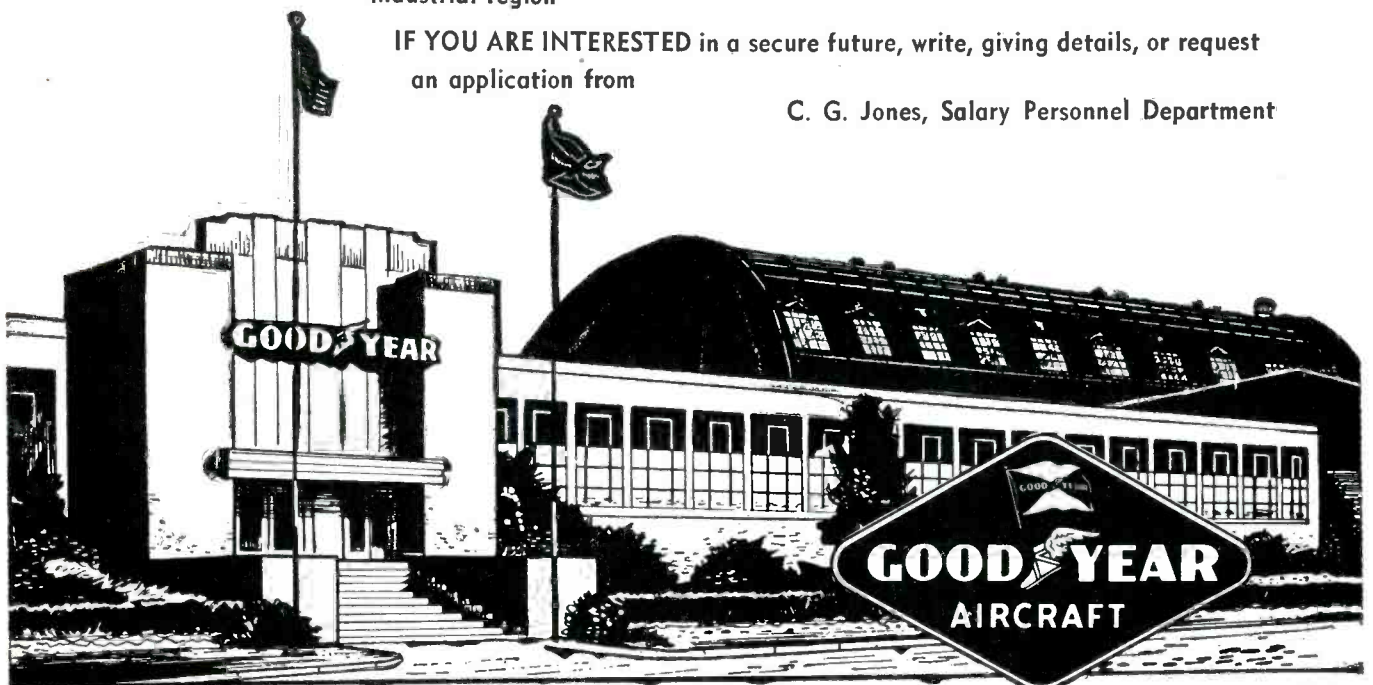

**GOODYEAR AIRCRAFT CORPORATION, 1210 Massillon Road, Akron 15, Ohio**

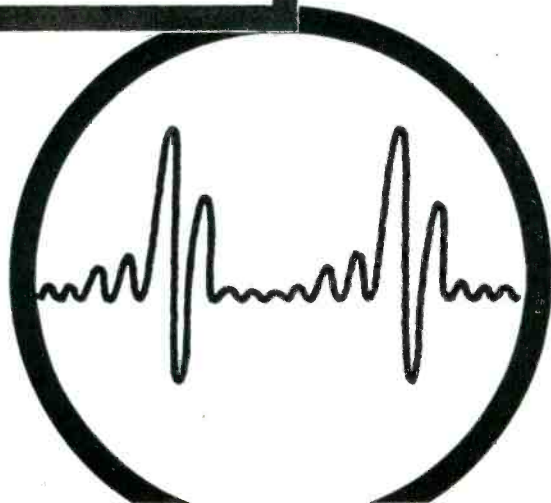
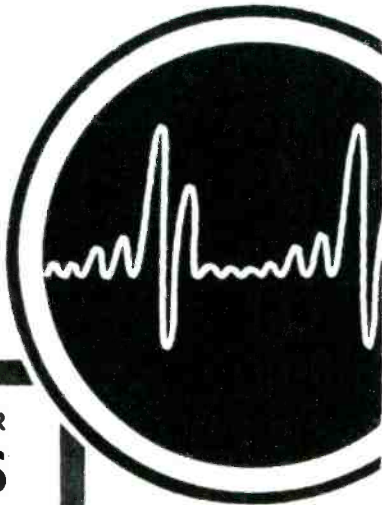
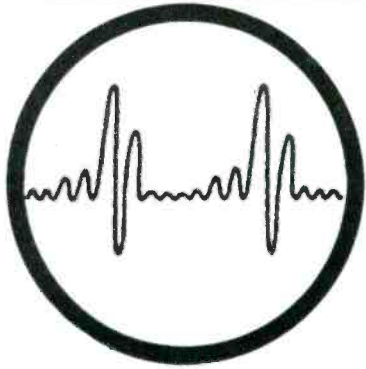

**SPECIAL OPPORTUNITIES FOR SENIOR ENGINEERS**

Convair in beautiful, sunshiny San Diego invites you to join an "engineers" engineering department. Interesting, challenging, essential long-range projects in commercial aircraft, military aircraft, missiles, engineering research and electronics development. Positions open in these specialized fields:

- |                   |                    |
|-------------------|--------------------|
| Electrical Design | Servo-mechanisms   |
| Mechanical Design | Aerodynamics       |
| Structural Design | Thermodynamics     |
| Structures        | Operation Analysis |
| Weights           | System Analysis    |

Generous travel allowances to those accepted. For free brochure, write Mr. H. T. Brooks, Engineering Dept. 900

**CONVAIR**  
IN BEAUTIFUL  
**SAN DIEGO**

3302 PACIFIC HIWAY  
SAN DIEGO 12, CALIFORNIA



**ATTENTION!**

**Former Field Engineers**

We urgently need men with electronic background, and preferably radar or computer experience, to supervise, instruct and assist in installation—maintenance of electronic equipment.

Excellent starting salary during factory training, plus overtime premium in field. Substantial insurance program. Overseas duty not mandatory. Salary will be commensurate with experience.

Please forward your personal experience record to:

L. H. Bailey  
Field Eng. Div.

**Reeves Instrument Corp.**  
Roosevelt Field Mineola, L. I., N. Y.  
Garden City 7-3720

**ENGINEERS  
PHYSICISTS**

**TAKE INVENTORY OF  
YOUR FUTURE  
WHAT MAKES A GOOD JOB?**

Check off the items in the following list that you look for in a good job.

- 1—Professional Recognition
- 2—Interesting work
- 3—Equitable salary
- 4—Recognition of Ability
- 5—Security
- 6—Good future prospects
- 7—Reward for ideas
- 8—Good working conditions
- 9—Liberal benefit program
- 10—Family protection
- 11—Paid vacations and holidays

If you look for all of the above items and more, in a good job, it will be to your advantage to investigate the opportunities in Electronic Circuit Design and specialized vacuum tube research and development at . . . . .

**NATIONAL UNION RADIO CORP.**  
**ELECTRONIC RESEARCH DIVISION**  
P. O. Box 352 Orange, New Jersey

**ENGINEERS:**

**DOES YOUR  
PRESENT JOB  
GIVE YOU**

**ALL THESE**

**RCA**

**CAREER**

**ADVANTAGES?**

**POSITIONS NOW OPEN FOR  
SENIOR DEVELOPMENT  
AND DESIGN ENGINEERS:**

- ✓ ELECTRONIC . . .
- ✓ COMMUNICATIONS . . .
- ✓ MECHANICAL . . .
- ✓ COMPUTER . . .
- ✓ ELECTRON TUBE . . .

**PERSONAL INTERVIEWS ARRANGED  
IN YOUR CITY.** A copy of our booklet  
"Challenge and Opportunity," describing the role of the  
engineer in RCA, will be mailed upon request. Please  
send a complete resume of your education and  
experience to:

**MR. ROBERT E. McQUISTON, Manager**  
Specialized Employment Division, Dept. 200 G  
Radio Corporation of America  
30 Rockefeller Plaza  
New York 20, N.Y.

- Yes No**
- CHECK SHEET**
- PROFESSIONAL RECOGNITION AND PRESTIGE?
  - ADVANCEMENT IN STATUS?
  - SECURITY AND STABILITY?
  - CHALLENGE AND OPPORTUNITY?
  - HIGH SALARY SCALE AND OPPORTUNITIES  
FOR PROMOTION?
  - EXCELLENT SUBURBAN HOUSING AT  
REASONABLE COST?
  - FACILITIES FOR PROFESSIONAL  
ADVANCEMENT?
  - UNEXCELLED TECHNICAL AND LABORATORY  
FACILITIES?
  - ASSOCIATION WITH TOP SCIENTISTS?
  - TUITION REFUND PLAN FOR ADVANCED STUDY?
  - MILITARY OR COMMERCIAL OPPORTUNITY?
  - MODERATE COST OF LIVING?
  - MODERN RETIREMENT PLAN?
  - COMPANY-PAID LIFE INSURANCE?
  - COMPANY-PAID LIBERAL HOSPITAL, SURGICAL  
AND DISABILITY PLAN (FAMILY BENEFITS)?
  - LIBERAL VACATION PLAN?
  - LIBERAL HOLIDAY SCHEDULE?
  - PROFESSIONAL STATUS AND UTILIZATION OF  
YOUR EDUCATION AND EXPERIENCE?



**RADIO CORPORATION of AMERICA**

**ENGINEERS**

**ELECTRONIC  
SERVO  
MECHANICAL**

**DESIGNERS**

**ELECTRONIC  
MECHANICAL**

**"AC" OFFERS  
A Challenge to Men  
of Resourcefulness**

**FIELD ENGINEERS**

- For recent college graduates, here are positions with a challenge —

**ASSIGNMENT** — you will assist in the installation, operation, and maintenance of our equipment at aircraft plants and Air Force bases. The work will include liaison between AC and the customer, training of customer personnel, analysis of problems, and recommendations for improvements. In these positions you'll gain invaluable experience in all phases of both engineering and manufacturing.

**YOUR BACKGROUND** — your educational background can be in any of the fields of AE, EE, ME, Physics, or equivalent. To be successful in these positions you should have a definite interest in people as individuals and be willing to relocate to field assignments. Married men on regular assignment have their families with them.

**TRAINING** — regardless of your background, our theoretical and applied in-plant training (here in Milwaukee) will prepare you for these assignments.

In addition to your salary, you will receive a field allowance — and a substantial bonus if selected for overseas assignment . . . if you're looking for an opportunity with a "present" and a future write us for further facts.

We need men of high caliber, experienced in the field of airborne automatic electro-mechanical control equipment. You will be engaged in the manufacture and development of highly complex equipment of the most advanced type in a steadily expanding division of our company—a division with 20 years of successful operation in the precision instrument field. We offer many advantages to those who join our organization—

**SALARY** increases are based on merit and initiative . . . **two weeks VACATION** with pay . . . **HOSPITALIZATION BENEFITS** . . . **LIVING and RECREATIONAL FACILITIES** are among the best anywhere along Lake Michigan . . . **POSITIONS ARE PERMANENT** due to long-range manufacturing and development programs . . . in short—here at our "AC" Milwaukee plant you get small company advancement opportunities with large company employee benefits . . . **EXPENSES** incident to interviews are all absorbed by us.

For less experienced engineering graduates, we have a Junior Engineer Training Program which makes it possible for you to become acquainted with all phases of our company . . . you can also take advantage of educational opportunities for advanced degrees at Marquette University and the University of Wisconsin.

We answer ALL inquiries . . . write or apply

AC SPARK PLUG DIVISION

**GENERAL MOTORS CORPORATION**  
1925 E. KENILWORTH PLACE • MILWAUKEE 2, WISCONSIN

**ELECTRONIC ENGINEERS**

*Excellent Positions In Research & Development*

Our Modern, well equipped Laboratory has desirable openings for qualified graduate Electrical Engineers capable of working on advanced projects in the Radio and Electronic Fields.

*Interesting Assignments in:*

**MICROWAVE LINKS • PULSE NETWORKS  
RADAR • DIRECTION FINDERS • VIDEO SYSTEMS  
AIR NAVIGATION SYSTEMS • ANTENNAS • COMPUTERS  
GUIDED MISSILES • MICROWAVE AND  
GAS DISCHARGE TUBES • DIELECTRICS**

**FTL Offers you**

- A Long Range Program
- Opportunity to advance
- Generous Employee Benefits



- Postgraduate Facilities Near-by
- Suburban Location
- Convenient to New York City

**Minimum Requirement: B.S. in Electrical Engineering**

*Send complete Resume to Personnel Manager*

**Federal Telecommunication Laboratories, Inc.**

500 Washington Avenue, Nutley, New Jersey

*An Associate of the International Telephone and Telegraph Corporation*

**STAVID  
ENGINEERING, INC.**

has openings for  
**GRADUATE  
ELECTRONIC and  
MECHANICAL  
ENGINEERS**

Experience in Design and Development of Radar and Sonar necessary.

Broad knowledge of Search and Fire Control Systems; Servo Mechanisms, Special Weapons, Microwave, Antennas and Antenna Mounts, etc. Mechanical Engineer should also have experience in packaging of Electronic Equipment to Gov't specifications including design of complex cabinets, shock mounts and sway brace structures.

**FIELD ENGINEERS**

Qualified to instruct in the operation and supervise installation, maintenance and repair of Radar, Sonar and allied electronic equipments in the Field.

A chance to grow with a young and progressive company; salary and advancement commensurate with ability; liberal vacation, sick leave, 9 paid holidays, group life, sickness and accident insurance plans, and a worthwhile pension system.

Personnel Office, 200 W. Seventh St.  
Plainfield, N. J. - Tel. PL. 6-4806



## ELECTRONICS ENGINEERS WANTED SOUTHERN CALIFORNIA

Attractive opportunities offered to Engineers experienced in and qualified to design aircraft flush antennas and radomes.

Complete modern facilities for laboratory testing and evaluation available.

Salary dependent upon experience and ability.

Contact Mr. J. C. Buckwalter,  
Chief Engineer



**DOUGLAS AIRCRAFT COMPANY, Inc.**  
LONG BEACH, CALIFORNIA

## BIG opportunities for JUNIOR ENGINEERS with new Bendix plant!

Here, indeed, are outstanding opportunities for recent college graduates. In this new, fast-growing Bendix Division, the future holds advancement commensurate with your ability to assume additional responsibility. Fascinating work on NEW ELECTRONIC PRODUCTS. Good salaries, paid vacations and holidays and ideal living conditions in beautiful suburban area.

Send Resume of Education and Experience to:  
Mr. L. D. Smith,  
Employment Supervisor

**BENDIX  
YORK ALSO  
NEEDS  
ENGINEERS  
AT THE  
INTER-  
MEDIATE  
LEVEL!**



**AVIATION CORPORATION  
YORK DIVISION**

Phone: York 5521

York, Penna.

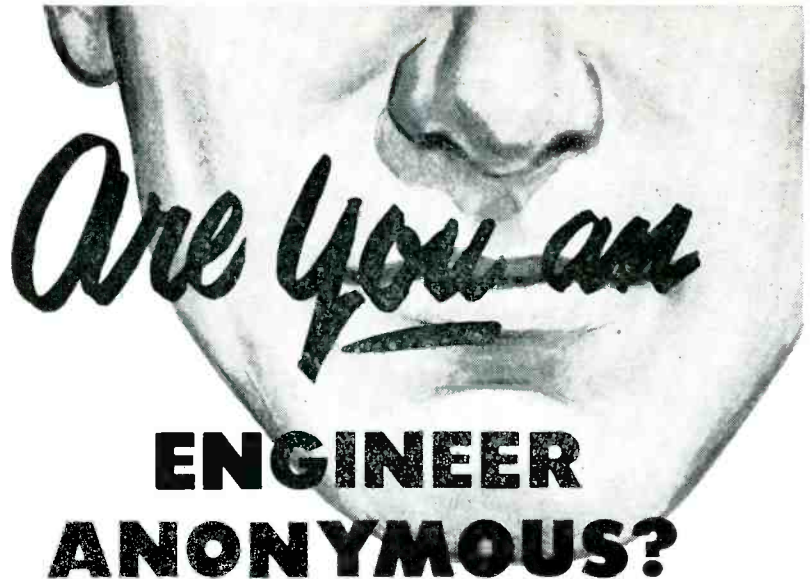

An Engineer Anonymous is one of those capable men with good potential... confined to routine assignments that offer little challenge or opportunity to move ahead.

There are no Engineers Anonymous at Magnavox!

Magnavox is a medium-sized organization with a closely-knit engineering staff working under conditions most engineers consider ideal.

New engineering laboratories, top-notch model shop facilities, a complete drafting department, and a chemical engineering department which cooperates on all material problems—these allow the Magnavox engineer to concentrate on the more creative aspects of his work. And an ably-staffed test equipment design section handles all test equipment design problems—factory as well as laboratory.

With such fine facilities at their command... with active encouragement and recognition by management, it is not surprising that Magnavox engineers have contributed many "firsts" in radio and television, and are today among the leaders in the electronics industry.

Consider, too, the unusually generous insurance and retirement plans which rank with the best in all industry.

You'll be interested in the many advantages offered by Fort Wayne, Indiana, called "The Happiest City in the U. S." by Look Magazine, an ideal community for a well-integrated family life.

### OPPORTUNITIES ARE GROUND FLOOR IN THE FIELDS OF:

Radar	Synchros — Servo Systems
Radio — Commercial and Military	Magnetic Devices
Television — Monochrome and Color	Electro-Mechanical Devices
Magnetic Amplifiers	Navigational Aids — Fire Control

### DESIGN — DEVELOPMENT — CIRCUITRY

Electrical Engineers — Mechanical Engineers — Physicists

Please forward complete resume to:  
MR. BYRON D. SITES

**THE MAGNAVOX COMPANY**  
FORT WAYNE, INDIANA

# Exceptional Opportunities for...

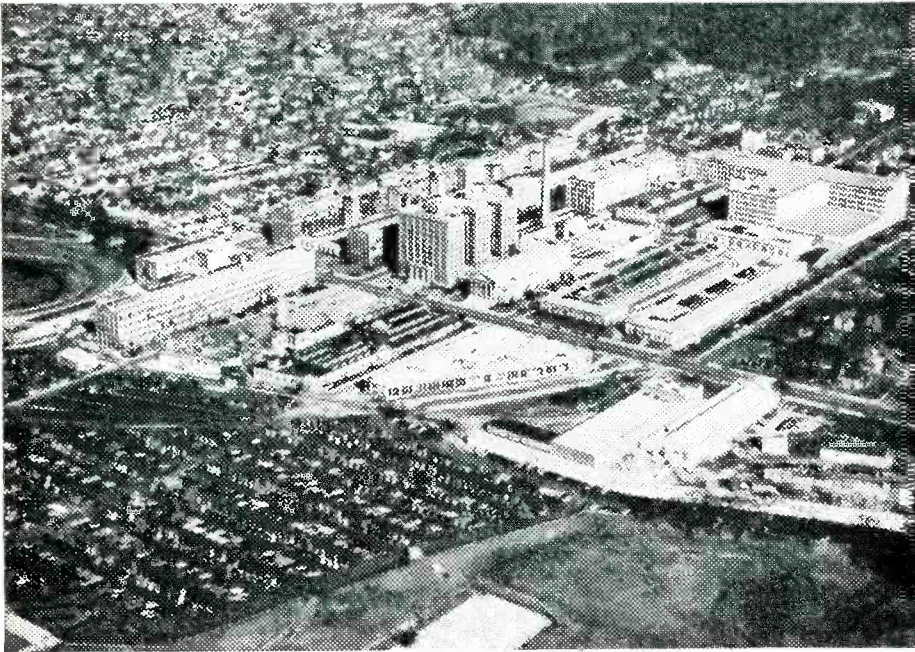

electrical engineers  
mechanical engineers  
mechanical designers

in the field of electronic computers and associated equipment for use in business machines.

Write, giving education and experience to Employment Manager.

Reply to Department A.

THE NATIONAL CASH REGISTER COMPANY, Dayton 9, Ohio

## Electronic Designers

Design of mechanical and electrical components and chassis in UHF and microwave systems.

## Radio Engineers

Development of radio and radar components and systems.

## Engineers

Design of components for magnetic deflection of Cathode Ray Tubes.

**WHAT MAKES  
KOLLSMAN  
A FINE PLACE  
TO WORK?**

Partly, it's the pride of belonging to the organization which designs and manufactures America's finest aircraft instruments . . . a progressive, growing organization in which there's every opportunity to advance. And a big part of it is in the spirit of cooperation and friendliness which prevails among Kollsman men.

Not to be overlooked is the convenient location in a quiet residential section of New York, only 20 minutes from the heart of the city . . . and the many liberal benefits such as paid life, hospitalization, surgical, accident and health insurance.



**KOLLSMAN INSTRUMENT CORP.**  
80-08 45th Avenue, Elmhurst, Long Island, New York

**WANTED  
ENGINEER WITH  
EXPERIENCE IN  
VHF OR UHF**

Interesting creative work with the most resourceful and progressive firm in the field of television equipment.

This position is permanent. It will offer every opportunity for unlimited advancement and for developing a successful career. The plant is now housed in a newly-acquired larger building, only 22 miles from downtown New York City. The surroundings and atmosphere are stimulating and congenial.

**Attractive Salary**  
*Write stating qualifications.*

**BLONDER-TONGUE LABORATORIES**  
526-536 NORTH AVENUE  
WESTFIELD, NEW JERSEY

# ENGINEERS

## Unusual Opportunities for Men with Long-Range Plans

• We are one of the leading Electronics firms in the Chicago area and require Design and Development Engineers with from 3 to 5 years' experience. Positions also available at Project Engineer, Engineer and Junior Engineer levels.

We will consider men with the necessary experience and ability who are ready to take on the responsibilities of these openings. The men selected will be given intermediate and advanced level assignments in our well-equipped Television, Radio, and Government Equipment Laboratories.

We are located in the northwest section of Chicago where living and working facilities are sec-

ond to none. We are within easy access of all shopping centers with convenient city transportation. Close by are many suburbs where one can live and commute back and forth in a short time—adjacent to all great centers of learning.

Our company has a long-range program of design and development in which you may participate . . . all positions are permanent.

• Our requirements concern experience in all phases of the development of monochrome and color TV receivers • color generating equipment • UHF systems • radio receivers (broadcast or military) • radar systems • and laboratory test equipment

We suggest you write Mr. Walter Wecker, Personnel Division, giving educational qualifications and related experience. Interviews will be arranged at your convenience.

## Admiral Corporation

3800 W. Cortland St.  
Chicago 47, Illinois

## ENGINEERS SYSTEMS RADAR SERVO COMPUTER

BACKGROUND:  
Responsible positions open for top level development and project engineers with practical and research experience in:

Advanced Electronic Circuits  
and Systems  
Microwave Radar

Microwave Receivers  
and Transmitters

Also Engineering Design and Analysis  
relating to fields such as:—

Analogue and Digital Computers  
Servomechanisms  
Communications  
Navigation  
Fire Control



Requirements emphasize advanced analytical and/or management experience on highly complex electronic and electro-mechanical systems.

Kindly send resume and salary requirements to

**The W. L. MAXSON Corp.**  
460 W. 34<sup>th</sup> ST., NEW YORK 1, N.Y.

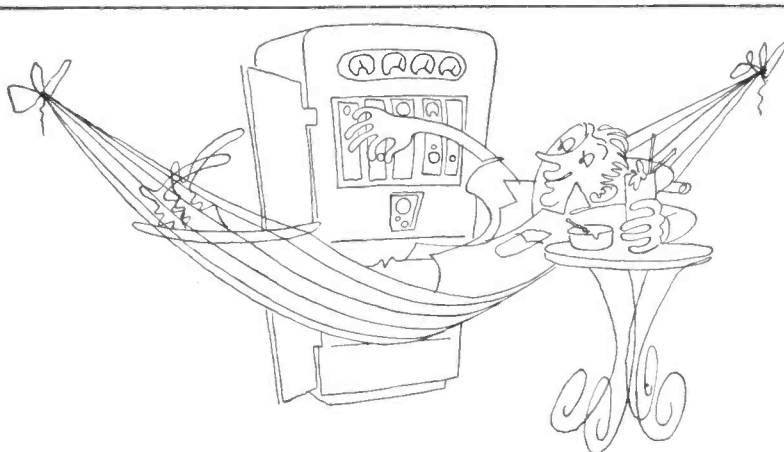

### Pleasant Working Conditions

So we're exaggerating a little! If you want to get technical about it (and you probably do) your life at our company won't be quite this cushy. We can promise this though—even the sky's not the limit for future opportunity. You work with a congenial group of engineers. People will listen to your ideas. The boss's door is always open.

**Who you are**—You're an Electronic or Mechanical Engineer. You're experienced in air communication and navigation circuitry and development. You have worked with low or high frequency circuits, instrumentation, component utilization or associated problems.

**What you do now**—Simple! Just contact:

Arthur E. Harrison, Vice President, Engineering

**wilcox Electric Company, Inc.**

Fourteenth & Chestnut, Kansas City 27, Mo.

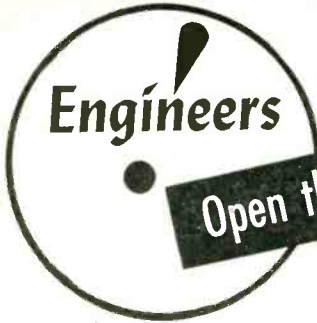

Open this door to a bright future!

- TV RECEIVER DESIGN ENG.
- ELECTRONICS ENG.
- FIELD ENGINEERS
- TEST & INSPECTION ENG.
- COMPONENTS ENG.

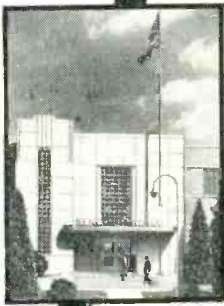

*You're needed* to work on: Radar, G.C.A., Mobile Radio, Auto Radio, Airborne Communication & Navigation Equipment, Television, Antennas, Microwave Equipment, Servo Mechanisms and Guided Missiles.

*You will benefit* from high wages, a modern, air-conditioned plant, paid vacations and holidays, group insurance and a good chance for advancement.

Housing immediately available in the beautiful suburban and county areas that surround the Bendix Radio plant.

Write,  
Wire or Phone  
MR. E. O. COLE  
Dept. J

## Bendix Radio

DIVISION OF BENDIX AVIATION CORPORATION

Baltimore-4, Md. Phone: VALley 3-2200

*Makers of the World's Finest  
Electronic Equipment*

## UHF and MICROWAVE ENGINEERS

This rapidly growing Organization in south central Wisconsin, approximately 100 miles from Chicago, has several openings for Junior and Senior Engineers in the U.H.F. and Microwave fields.

### UNUSUAL SALARY OPPORTUNITIES

exist under ideal working conditions in large, well-equipped laboratories. Personnel benefits such as sickness, accident, and life insurance in addition to a very liberal pension system are offered.

For more information concerning the positions that are open we invite you to write to Personnel Director, Department A.

## GIBBS MANUFACTURING & RESEARCH CORPORATION

Janesville, Wisconsin

## Engineers & Physicists

- Mechanical Engineers
- Servo Engineers
- Operations Research Analysts
- Electrical Engineers
- Chemical Engineers
- Physicists

The diversified research and development programs now in progress at  
**melpar, inc.**  
The Research Laboratory  
of Westinghouse Air Brake Co. and its subsidiaries  
offer excellent opportunities for professional achievement to qualified men.



Write to Personnel Director,  
**MELPAR, INC.,** Dept. E-1  
452 Swann Avenue  
Alexandria, Virginia

## ELECTRO-MECHANICAL DESIGNER

Requires thorough knowledge of hydraulic, pneumatic and electric servo-mechanisms for work on gas turbine control systems. Three to five years experience in design and development of electro-mechanical control devices such as relays, solenoids, actuators, pressure switches, regulators and instruments of aircraft quality.

Unusual opportunity for qualified engineer seeking responsible position with a progressive yet informal company in sunny San Diego. Outstanding employee benefits including profit sharing, low cost group insurance and medical care, free polio insurance to all employees and their families, paid tuition for university night school courses, periodic salary merit and adjustment reviews, paid vacations, and many others.

WRITE TO

**SOLAR AIRCRAFT CO.**  
2200 PACIFIC HIGHWAY  
SAN DIEGO, CALIF.

*"An Unexcelled Opportunity  
For Professional Growth . . . . ."*

## ELECTRONIC ENGINEERS & PHYSICISTS

IN RESEARCH AND DEVELOPMENT

GUIDED MISSILES • RADAR • SOLID STATE PHYSICS •  
VACUUM TUBES • ELECTRONIC NAVIGATION •  
TELEVISION • MICROWAVES • ANTENNAS •  
RADIO • COMPUTERS • TRANSISTORS •

DIRECT INQUIRIES TO:  
THE EMPLOYMENT DEPT.

**CAPEHART-FARNSWORTH**

CORPORATION

FORT WAYNE, INDIANA

AN **IT&T**  
ASSOCIATE

### UHF-VHF

#### SENIOR ENGINEERS

WE ARE LOOKING FOR ENGINEERS FOR OUR NEW ELECTRONIC RESEARCH AND DEVELOPMENT DIVISION.

#### THESE ARE THE REQUIREMENTS:

3 to 5 years genuine design and development experience, specializing in VHF and UHF measurements, and component and tuner engineering projects.

Good theoreticians, but with solid practical experience and excellent records of achievement. Prefer graduate Electrical Engineers.

#### THESE ARE THE ADVANTAGES:

A ground floor connection in the new research and development division of one of the oldest and most highly regarded manufacturers of radio and television components.

The opportunity to work in a fully equipped, completely modern research laboratory on permanent long range commercial projects.

To work directly with prominent electronic research director, who will encourage and give full consideration to your ideas.

To locate in one of the many desirable suburban residential communities adjacent to Philadelphia and within easy driving distance of the seashore.

ADDRESS REPLIES TO:

### RADIO CONDENSER COMPANY

Davis & Copewood Sts.  
Camden 3, N. J.

## Bell Telephone Laboratories

has career openings for experienced

*electrical engineers  
mechanical engineers  
physicists*

For work on Guided Missiles, Radar, Fire Control and Underwater Systems in New Jersey (20 miles from New York City).

The company that has pioneered many of the major developments in the fields of communications and electronics now offers you an opportunity to join its staff. Here you will gain invaluable experience and great satisfaction through the challenging diversified nature of the work. To qualify, you must be a college graduate (preferably not over 40 years of age) with related experience of the following types:

#### Systems Engineering

Analysis  
Coordination  
Evaluation  
Planning  
Studies

#### Systems Development

Fundamental Development  
Circuit Design  
Mechanical Design  
Equipment Development  
Field Testing

Write, giving full details of education and experience to:

**BELL TELEPHONE LABORATORIES Inc.**

Employment Director, Box 2, New York 14, N. Y.



#### RADIO and TV ENGINEER

Interesting, permanent job, testing and analyzing TV sets, FM-AM receivers, high fidelity sound equipment, etc. in NYC lab. Degree and 3 yrs. experience in industry. Familiar with IRE test methods. Salary commensurate with ability and experience. Send resume.

P-8184, Electronics  
330 W. 42 St., New York 36, N. Y.

#### MICROWAVE ENGINEER

For production design and development of waveguide systems, klystron oscillators, attenuators, and echo boxes. Send resume to Personnel Manager.

**VECTRON, INC.**  
400 Main Street  
Waltham, Mass.

## ELECTRONIC ENGINEERS

EE or ME degree, minimum 3 years' experience in research and development work involving circuit development, servo-mechanisms, analogue computers or related equipment.

### FIELD REPRESENTATIVES

A few openings for graduate engineers only with backgrounds similar to above. Continental U.S.A.

What You Can Expect at

## General Precision Laboratory

A progressive group of young, successful men, firmly established as designers and manufacturers of electronic equipment . . . a medium-sized staff in which you receive individual recognition . . . a policy of promotion-from-within that helps qualified men move ahead swiftly . . . a modern laboratory located in a pleasant suburban community ideal for family living.

*Expenses will be paid for qualified applicants who come for interviews. Please submit complete resume to: Mr. H. F. WARE*

## GENERAL PRECISION LABORATORY

INCORPORATED

A Subsidiary of GENERAL PRECISION CORPORATION  
63 BEDFORD ROAD, PLEASANTVILLE, NEW YORK

## ELECTRICAL and ELECTRONIC ENGINEERS

Excellent opportunities in the field of

**AUDIO AMPLIFIER DESIGN  
SERVO AMPLIFIER DESIGN  
COMPONENT DEVELOPMENT  
EQUIPMENT DESIGN**

Senior and Junior Engineers

Write, giving full details to:

Personnel Director, Dept. A,  
**GIBBS MANUFACTURING AND RESEARCH CORPORATION**  
Janesville, Wisconsin

## ELECTRONIC ENGINEERS

FOR DESIGN & DEVELOPMENT WORK IN  
RADAR  
COMPUTERS  
DIGITAL TECHNIQUES

with a young progressive company, send resumé of experience and education, with salary requirements,

to  Electronic Engineering Company

180 SOUTH ALVARADO STREET LOS ANGELES 4, CALIFORNIA  
DUNHIRE 2-7152

## HOUSTON, TEXAS

Precision equipment manufacturer needs qualified experienced engineer for audio and sub-audio transformer design and development. Experience with high permeability alloys desirable. Knowledge of magnetic circuitry must be sufficient for development work on magnetic amplifiers. Salary commensurate with ability.

**SOUTHWESTERN INDUSTRIAL ELECTRONICS CO.**

P. O. BOX 13058, HOUSTON 19, TEXAS

## ELECTRONICS ENGINEERS

Experienced In  
Any One of the Following:

1. Electron Gun Design and Engineering
2. Cathode Ray Tube Engineering
3. Electronic Test Equipment Design
4. Cathode Ray Tube Quality Control
5. Screen Engineering
6. Aluminizing Engineering

THESE ARE EXCELLENT OPPORTUNITIES WITH A LARGE PROGRESSIVE MIDWEST CATHODE RAY TUBE MANUFACTURING PLANT.

Send Complete Resume and Salary Desired

To Box

P-7958, Electronics  
520 N. Michigan Ave., Chicago 11, Ill.

## DEVELOPMENT ENGINEERS PRODUCTION ENGINEERS TECHNICIANS DRAFTSMEN

Career Opportunities  
With Old Established  
Central Connecticut Firm

Interesting Projects  
Top Salaries  
Suburban Living

We Need Men Experienced  
In Servo Mechanisms  
UHF, VHF, Microwave,  
Receivers, Transmitters  
Variable Capacitors

Replies Held In Strict Confidence  
Write Or Phone Collect  
Personnel Mgr.—Sherwood 7-2741

THE  
**ALLEN D. CARDWELL M.G. CORP.**  
Plainville, Connecticut

## RESEARCH ASSISTANTSHIPS

Ph.D. candidates in chemistry and M.S. candidates in chemistry, electrical engineering (Electronics), chemical engineering, physics and geology are wanted by the Institute of Science and Technology, University of Arkansas, Fayetteville, Arkansas.

These positions provide part-time research duties with time for academic work toward advanced degrees. Stipends are up to \$2,150 for 12 months. Nonresident fees are waived.

W. W. GRIGORIEFF, Director  
INSTITUTE OF SCIENCE & TECHNOLOGY  
UNIVERSITY OF ARKANSAS

## Engineers

Research & Development  
Electronic Organs

Well rated company also has government prime contracts.

Reasonable rental housing available.

Write giving full details—education and experience.

**CENTRAL COMMERCIAL INDUSTRIES**  
1215 W. Washington Blvd.  
Chicago 7, Ill.

## ENGINEER

Opening for qualified engineer with interests in field of resistor, rheostat, switches and allied components manufacture. Experience in design, selection of materials and production tooling required. Attractive working conditions, excellent opportunity with medium sized manufacturer. Please give full details of training and experience; state salary desired.

P-8130, Electronics  
520 N. Michigan Ave., Chicago 11, Ill.

## New "SEARCHLIGHT" Advertisements

received by July 2nd will appear in the August issue subject to limitations of space available.

Classified Advertising Division  
**ELECTRONICS**  
330 West 42nd St. New York 36, N. Y.



... An invitation to

Experienced  
**ELECTRONIC  
ENGINEERS**  
and  
**PHYSICISTS**

We have several positions of technical leadership available in our growing Guided Missile Division. Applicants must have over four years experience and/or advanced degrees in either missile guidance systems, radar, servomechanisms, fire control computers, or U. H. F. techniques.

Our plant is located in beautiful suburban St. Louis, where you can enjoy the comforts of "county" living with easy access to "big city" shopping, entertaining, medical and educational facilities. Moving allowance for qualified applicants. Our Housing Representative will assist you in relocating.

Address replies to:

Technical Placement Supervisor  
Box 516, St. Louis 3, Mo.

**MCDONNELL**  
*Aircraft Corporation*  
ST. LOUIS 3, MO.

**ENGINEERS  
AND  
PHYSICISTS**  
**BS—MS—Ph.D.:**

Responsible positions in mechanical, electrical or electronic engineering, physics or engineering physics for advanced development and design of special equipment and instruments. Prefer men with minimum of two years' experience in experimental research design and development of equipment, instruments, intricate mechanisms, electronic apparatus, optical equipment, servomechanisms, control devices and allied subjects. Positions are of immediate and permanent importance to our operations. Southwestern location in medium sized community. Excellent employee benefits. Reply by letter giving age, experience and other qualifications. All applications carefully considered and kept strictly confidential.

Ind. Rel. Manager  
Research & Development Dept.

**PHILLIPS**  
**PETROLEUM COMPANY**  
Bartlesville • Oklahoma

**ENGINEERS:**  
**what's simac\*?**

It's newer than radar, sonar, loran and TV  
Its commercial uses are almost limitless  
It's the fast-growing field in which Sperry ultrasonic equipment is paramount

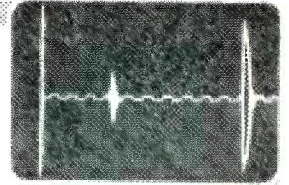

IT'S  
**SONIC  
INSPECTION  
MEASUREMENT  
AND  
CONTROL**

*SIMAC, the most advanced method for non-destructive testing of metal and other materials.*

**ELECTRONIC ENGINEERS**

Sperry Products, Inc. now offers you an opportunity to diversify your experience, to join an expanding, completely independent organization, if you have had experience in planning, design and development of circuits for gating and timing, pulse generation and amplification, sweep generation and amplification or servo mechanisms applications.

- Work for a smaller company in which your ability can be recognized quickly, your talents can thrive.
- Move your family to Danbury, Conn. in the foothills of the Berkshire Mountains, less than 2 hours drive from New York City. Moving expenses paid.

Find out more about available positions:  
send complete resume to W. J. Hatcher.

**SPERRY PRODUCTS, INC.**  
DANBURY CONNECTICUT  
\* trade mark

**ENGINEERS**

Join a leader in electronic development and manufacturing in Southern California. Real opportunity for expressing creative ability and accepting professional challenge.

**Electronic Engineers**                      **Mechanical Engineers**

Qualified and experienced in development of functional circuitry and product design. To design electro-mechanical equipment items.

**Radio Receiver Specialists**

Develop new standard and display types, V.H.F.-U.H.F. range. Advanced concepts of receiver principles. Interesting long term projects.

Relocation expense allowed accepted candidates. Excellent conditions including regular advance review, health and disability insurance, 40 hour week, standard paid holidays and annual vacations. Central location. Relocation should not disturb urgent military projects.

Send complete resume with income history & requirements to engineering employment mgr.

**Hoffman** LABORATORIES, Inc.

3761 SO. HILL ST.

LOS ANGELES 7, CALIF.

(A Subsidiary of Hoffman Radio Corp.)

**PROJECT ENGINEER**  
**FOR DEVELOPMENT WORK**

Well established antenna company is willing to train qualified electrical engineer for antenna development work.

A minimum of 3 to 5 years of electrical design background is required.

Experienced in antenna micro-wave plumbing or net works is desirable but not essential.

Salary to \$9,000 depending upon experience and education.

**DORNE & MARGOLIN**

30 Sylvester St.

Westbury, L. I.

# Buy TOP Radio-Electronic Values!

## SENSITIVE RELAYS



MIDGET TYPE RELAYS

Automatic Electric Type R-45, 6500 ohm Coils. Normally open contacts except as noted.

Stock No.	Contacts	M. A.	Price Each
102152	S.P.S.T.	2.0	\$1.25
102249	2.P.S.T.*	4.5	1.50
102264	3.P.S.T.	6.0	2.00

\*1 Norm. open-1]Norm. closed.

Same type and style as above, but has 24 V.A.C. coil. Intermittent duty. Will operate on 6 V.D.C. Continuous duty. Contacts: S.P.S.T.-N.O. and S.P.D.T.

Stock No.	Price Each
No. 102248A	\$1.25

## U. T. C. TYPE A-25 HI-FIDELITY SINGLE PLATE TO MULTIPLE LINE.

Stock No. 6290A **\$17.50 Value For \$5.95**

## TCS. GENERATORS

High voltage continuous duty fully enclosed D.C. Generator. Delivers 440 volts at 200 M.A. Motor driven by 3450 RPM motor (not furnished). Made to Navy Specs. for Collins Radio TCS. Transmitters.

Stock No.	Price Each
No. 6147A	\$15.00

## THORDARSON AUDIO PASS FILTER

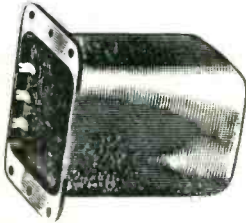

Band pass 800 to 1200 cycles input 10000 ohms — Output 25000 Ohms Level 10DB

Stock No. T48500 Price to \$5.50 ea.

## CONNECTORS

J.A.N.—"UG" and "AN" Types

For immediate service on all types of connectors and fittings meeting the latest J.A.N. specs. Call write or phone us. Certification supplied. We can help you overcome shutdowns resulting from slow or delayed deliveries.

J.A.N. toggle switches and many other items too.

## FILAMENT TRANSFORMER

20 VOLTS TAPPED AT 14 VOLTS @ 20 AMPS. PRIMARY TAPPED IN 5 VOLT STEPS FROM 270 TO 240 VOLTS 50-60 CYCLE STANCOR SS10696. 4" x 5" x 5" HIGH.

Stock No.	Price Each
No. 6292A	\$4.95

## TYPE "J" POTENTIOMETERS

500 Ohm—2 Watt Type J Pot. 3/8" Long Shaft. 1/4" long Bushing. Complete with Knob.

Stock No.	Price Each
No. A6123	49¢

100 ohm Type I with 3/8" bushing and locking nut. Screw-driver slot.

Stock No.	Price Each
No. 6270A	\$1.49

## LAB. POTENTIOMETERS

MODEL 260, 6 Watt 20,000 OHM Laboratory, Potentiometer. Resistance tolerance plus or minus 5%. Five finger bronze wiper. Bakelite shaft 3/8" Diam. x 1 1/4" Long.

Stock No.	Price Each
No. 6277A	\$1.50

## MIL-T-27

## FILAMENT TRANSFORMER

PRIMARY: 107.5; 112.5; 117.5; 122.5; 215; 225; 235 and 245 Volts 50/60 cycle.

SECONDARY: 6.3 Volts @ 5.3 AMPS and 6.3 Volts @ 3 AMPS. Ceramic bushings with solder lug terminals. Rated for continuous duty under Mil-T-127, Class "A" Grade I specs. Hermetically sealed case, 2 3/4" x 3 1/2" x 3 1/2" high.

Stock No.	Price Each
No. 6284A	\$3.50

## MICA CONDENSERS



Type 9 and A2 5000 Volt Test Mica Condensers

Stock No.	Cap. Mfd.	Price Each
6274A	.002	\$.60
6275A	.01	\$1.00

## SWEEP CAPACITOR

5-10 MMFD. Sweep Generator Capacitor. Has cylindrical silver plated rotor, concentric to silver plated stator plates. Rotor has high speed ball bearings. Completely enclosed in moulded bakelite housing. Ideal for motor driven sweep generators.

Stock No.	Price Each
No. 6276A	\$2.00

## 8 MFD—220 V.A.C.

Capacitor. 2" Diam. x 4" high can. Bakelite insulated solder lug terminals.

Stock No.	Price Each
No. 6278	\$8.00

## 2 x 4 MFD—600 VOLT

Capacitor made for "TCS" equipment. Mounted in transformer style case with flange mtg. Case 2 1/4" x 2 3/8" x 3" high.

Stock No.	Price Each
No. 6279A	\$2.00

## 10 MFD.—600 VDC

Sprague No. R2-157, 10 Mfd. 220 VAC 600 VDC Capacitor with Universal Mounting Ring. 2-7/16" Diameter, 3 3/4" high. Bakelite insulated terminals.

Stock No.	Price Each
No. 5958A	\$1.25

## HEAVY DUTY SWITCH



H&H 4.P.D.T. Toggle Switch. 5 AMP. @ 250 Volt. 10 Amp. @ 125 Volt. Single 3/4" hole mount. Ball handle.

Stock No.	Price h
No. 6203A	\$1.95

## CUTLER HAMMER TYPE 8905K628

4 Pole D.T. Neutral Center Toggle Switch. Luminous Tip—Bat Handle. 2 Hole Mtg.

Stock No.	Price Each
No. 6291A	\$1.95

## RECTIFIERS

A precision balanced copper oxide double bridge rectifier. Housed in a sealed metal container 1" x 1-3/4" x 1" high. Tapped mtg holes in bottom. Discs have vaporized gold contact surfaces. Made by Bradley Labs. to W. E. spec. D 220005. Nominal input volts 10.5 V.A.C. 5 MA.

Stock No.	Price Each
No. 6283A	\$1.50

## BRADLEY INSTRUMENT RECTIFIER

BRADLEY #CX2E4E-69 Copper Oxide Rectifier. 3 color coded insulated wire leads.

Stock No.	Price
No. 6184A	50¢

## 304TL's

EIMAC JAN 304TL's INDIVIDUALLY BOXED \$10.95

## SPECIAL PURPOSE AND TRANSMITTING TUBES

Tubes listed below are "Jan" types in original boxes and are new. Some in limited quantities. All are standard brands such as RCA, G.E., Nat. Union, Western Electric, Machlet, Etc.

Type	Price Each	Type	Price Each
OB3/VR90	\$.85	814	\$ 2.75
OC3/VR150	.85	826	.85
1B22	2.00	837	1.00
1B23	7.50	860	4.50
2C22/7193	.25	864	.35
2J36	75.00	955	.25
204A	75.00	956	.35
3B7/1291	.50	10Y	.35
3D6/1299	.50	12GP7	14.95
3B24	5.00	CK1090	1.00
3BP1	5.95	1616	.75
316A	1.25	1619	.25
371B	.75	1625	.35
450TL	45.00	1626	.35
5FP7	5.00	1B32/532A	5.00
705A	2.00	GL-8002R	95.00
718BY	40.00	8020	1.25
724B	3.00	8025	4.00
801	.45	9001	1.50
807	1.75	9006	.30

## SIGNAL CORPS & NAVY TRANSFORMER

Over 200,000 transformers, chokes etc. For Signal Corps and Navy Equipment. Send us your requirements, or ask for our catalog listing, by Signal Corps Numbers. DON'T DELAY!

## 6.3 VOLT FILAMENT TRANSFORMERS

Primary 115 Volt 60 Cycle 1600 Insulation Three 6.4 Volt Secondaries

6.3 Volts @ 4.9 Amps.  
6.3 Volts @ 4.5 Amps.  
6.3 Volts @ 1.1 Amps.  
Stock No. 5254A

Horizontal Half Shell Mounting. 2 1/4" x 2 13/16" Mounting Centers. 2 13/16" x 3 3/8" Core Size. 1/2" above Chassis. Soder Lug Terminals—All Terminals Marked.



Price Each
\$2.65

## TERMS:

Open Accounts to rated or Acceptable reference accounts. Others pre-payment of 25% deposit with order, balance C.O.D. Price F.O.B. Chicago and subject to change without notice. Merchandise subject to prior sale.

**ORDER TODAY!!**

# Radio Surplus Corp.

732 South Sherman Street  
Chicago 5, Illinois  
Phone: HARRISON 7-5923



Approx. VALUATION—\$350,000.00 WORTH OF MODERN

# ELECTRON TUBE <sup>MFG.</sup> EQUIPMENT

TO BE SOLD AT UNRESERVED PUBLIC

## A U C T I O N

ON THE PREMISES OF

HEINTZ-KAUFMAN-LTD. 947 BROADWAY,  
REDWOOD CITY, CAL. 30 Miles So. of San Francisco, Cal.

**On July 14th — 10:30 A. M. Sharp**

A complete manufacturing plant for the production and engineering of Internal anode, glass envelope transmitting and special purpose electron tubes. Consisting of the following:—Glass lathes—Stem Press machines—annealing ovens—wet wheel and flame glass cutting equipment—punch presses—Spot welders—Roll welders—Hydrogen bell-jars—Chemical cleaning facilities—Thermostatically controlled bake-out ovens—mechanical vacuum pumps—diffusion pumps—Exhaust Power Supplies—Transformers & Rectifiers—RF induction heating equipment—vacuum furnaces—hydrogen furnaces—basing equipment—production test equipment—complete sets of dies, jigs and fixtures for manufacturing many standard tube types—completely equipped maintenance department—Engineering department including universal static test equipment, meter standards equipment, meter calibration equipment, life test equipment, drawings and data of many tube types, engineering library—hundreds of other items too numerous to list. This is an unrestricted Sale, AND - TO - BE - SOLD - IN - LOTS - SUITABLE - TO - BUYERS - Present. Don't forget date of Sale July 14th—10:30 A.M. on Premises.

WRITE FOR A COMPLETE BROCHURE OR FOR FURTHER INFORMATION CONTACT

**IRWIN FRIEDMAN, AUCTIONEER**

764 MISSION ST., SAN FRANCISCO, CAL.

EXBROOK 2-5364

WRITE FOR OUR FREE BULLETIN MORE GOOD ITEMS

GUARANTEED BRAND NEW

ELECTRONIC RESEARCH

Table listing various electronic tubes (6A1, 6AV6, 6B6, etc.) with columns for Receiving Tubes, Type No., Price, and Transmitting and Special Purpose Tubes.

COAXIAL CONNECTORS

FULL LINE OF JAN APPROVED COAXIAL CONNECTORS IN STOCK UHF-N-PULSE-BN-BNC

Table listing various coaxial connector types (UG-7/AP, UG-12/U, etc.) with prices and specifications.

QUOTATIONS UPON REQUEST ON ANY CONNECTORS NOT LISTED HERE

Table listing COAXIAL CABLE types (RG-58/U, RG-59/U, etc.) with prices per foot and quantities.

OIL FILLED CONDENSERS

Table listing oil-filled condenser types (MFD, VDC, Price) with various specifications.

Table listing CILMITES types (MFD, V., TYPE, Price) with various specifications.

CM EQUIPMENT
K Band RF Head RT-99/AP...
Radar Transmitter T-85/AP...
10 CM Crystal Mixer-Pound Type...

PULSE TRANSFORMERS
UTAH OA-18 9278 9340
X124T-2 9280 9311
9262 9318 9350
G.E.-K2464 AN/APN-9 (352-7250)

FILAMENT TRANSFORMERS
INPUT-115 V., 50/60 CYCLES
Kenyon-5V 60A INPUT 105-125V...
Amertran Insul 105-125V Sec 5V, 150A...

Terms 25% cash with order, balance C. O. D. unless rated. All prices net F. O. B. our warehouse, Phila., Penna., subject to change without notice.
CABLE ADDRESS "ELECTRONIC PHILADELPHIA"

TUBE SPECIALS

STANDARD BRANDS ONLY

WRITE FOR OUR FREE BULLETIN MORE GOOD ITEMS

Table of vacuum tube types, prices, and specifications. Columns include Type No., Price, and various tube designations like 5C22, 5CP1, etc.

Crystal Diodes

Table of crystal diode types and prices, including models like IN21, IN21A, etc.

VARIABLE TRANSFORMERS
Amertran-Type RH-Input 115V 300 cycles. Output -75-120V 6 Amp. \$6.95 ea.

TRANSFORMERS
Westinghouse-Hipersil-Pri-115V 60 cy.-3/4 KVA
Sec #1-240V @ 1.56A.; Sec #2-240V @ 1.56A. \$18.75

TYPE "J" POTENTIOMETERS \$1.25 ea.
Resis. Shaft Resis. Shaft Resis. Shaft
60 SS 5K 1/4" 50K 3/8" 50K 1/2"

DUAL "JJ" POTS-\$2.95 ea.
50 SS 500 SS 10K SS 2.5 meg SS
50 1 1/2" 1K SS 220 K 1/2" 5 meg SS

TRIPLE "JJJ" POTS-\$3.95 ea.
100K/100K/100K 2 / 150K/15K 3/4"

2 phi LOW INERTIA SERVO MOTORS
Dielco FPE-25-11-75V 60 cy. .11 Amp 4 Watts. Each \$34.50

TACHOMETER GENERATOR
Elinco type PM-1M. DC Tachometer Generator-New \$27.50

SYNCHROS ARMY ORDNANCE-NAVY ORDNANCE-COMMERCIAL
1CY-101D SD 6DG X C-78248
1DG 5SDG 6G C-78249
1F 5F 7DG C-56701

SYNCHRO CAPACITORS SYNCHRO BLOWN FUSE INDICATORS
FREE! 165 Page Navy Synchro Manual, When Requested, With Each Synchro Order

GENERATORS AND INVERTERS
Pioneer 12133-1A Inverter-28VDC to 115VAC 400 cy 3 phi 250 VA 0.8PF-Volt. and Freq. Regulated. ea. \$225.00

GAMMA RADIATION SURVEY METER
Victoreen Model 217A-Range 0-2.5/25/250/2500 milli-roentgens Per hour
NEW \$179.50

Pioneer type 716-3A (Navy Model NEA-3A) Output-AC 115V 10-4A 800 to 1400 cy. 1 phi. DC 30 Volts 60 Amps. Brand new. \$38.50

A.C. MOTORS
HAYOON SYNCHRONOUS TIMING MOTOR-110V 60 cy. -2.2W -4 RPM. EA. \$2.29

Pioneer type 1235-3A. Output-30 Volts DC 15 Amps. Brand New-Original Packing. \$15.50

EAD TYPE LH71-NCJ-2 SYNCHRONOUS HYSTERESIS MOTOR - 115V - 1 phi. - 60 cy. - 1.0 Amp. - 1800 RPM - 1/50 HP - Cont. Duty - Uses 4 MFD. Capacitor - Dim. 3 3/4" dia. x 4 3/8" lg. EA. \$37.50

Pioneer type 12116 Inverter-28 VDC to 115 VAC 400 cy 1 phi 50 VA. ea. \$79.50

CERAMIC-CASED TYPE G MICA CONDENSERS
.09 MFD 1500 VDC G1. ea. \$9.25
.02 MFD 3000 VDC G1. ea. 9.25

BARBER-COLMAN PYAZ 4278 SPEED REDUCER MOTOR - 115V - 60 cy. - 3 1/2" - Gear Ratio 100:1 - 2 RPM - stall torque - 65 lb.-in. EA. \$19.50

ELECTRONIC RESEARCH LABORATORIES 715-129 ARCH ST. PHILA. 6, PA. Telephones - MARKET 7-6771-2-3



**ALNICO FIELD MOTORS**  
(Approx. size overall . . .  
3 3/4" x 1 1/4" diameter)  
**DELCO TYPE #5069600:**  
27.5 volts DC; 250 RPM  
\$19.95  
**PM Motor, Delco Type #5069371:** 27.5 volt;  
DC Alnico Field; 10,000 r.p.m.; dimensions  
1" x 1" x 2" long; shaft extension 1/2", diam-  
eter 0.125" . . . \$15.00

**PIONEER GYRO FLUX GATE AMPLIFIER**  
Type 12076-1-A, complete with tubes  
\$27.50 ea.

**AC CONTROL MOTOR**

**A. C. SYNCHRONOUS MOTOR** Type RBC  
2505; Volts 115; Cycles 60; RPM 60; Mfg.  
**HOLTZER CABOT ELECT.** Approx. size:  
2 3/4" x 2 3/8" x 2 3/8" . . . \$15.00 ea.

**400 CYCLE MOTORS**

**BENDIX-PIONEER,** Type CK1000-1-A;  
400 cycle . . . \$35.00  
**PIONEER: TYPE CK5** 2 Phase; 400 cycles  
\$35.00 ea.

**EASTERN AIR DEVICES TYPE J49A:** 115  
V; 0.1A; 7000 r.p.m. Single phase 400  
cycle . . . \$17.50 ea.

**AIRESEARCH:** 115V, 400 CPS; Single  
phase 6500 RPM; 1.4 amp; Torque 4.6 in.  
oz.; HP .03 . . . \$10.00 ea.

**EASTERN AIR DEVICES TYPE JM6B:**  
200 VAC; 1 amp; 3 phase; 400 cycles.  
6000 RPM . . . \$12.50 ea.

**EASTERN AIR DEVICES, TYPE J31B:**  
115 V. 400-1200 Cycle. Single Phase  
\$12.50 ea.

**AIRESEARCH: AC Induction,** 200 V; 3  
Phase, 400 Cycle, 2 H.P.; 11,000 RPM; 8  
amps. . . \$79.50 ea.

**AIRESEARCH: AC Induction,** 200 V; 3  
Phase, 400 Cycle, 12 H.P., 6500 RPM; 1.5  
amps. . . \$25.00

**Electric Motor: PNT-1400-A-1-A** Serial  
No. 207, 208 V., 400 cycles, 3 phase Kearfott  
Co., Inc. . . \$17.50 ea.

**SERVO MOTOR 10047-2-A; 2 Phase;**  
400 Cycle, with 40-1 Reduction Gear

**SMALL DC MOTORS**

**DELCO #5072000:** 27.5 VDC; 11.75 rpm  
\$15.00

**DELCO #5068750:** constant speed; 27 VDC;  
160 RPM; built-in reduction gears and  
governor . . . \$17.50 ea.

**J. OSTER:** series reversible motor; 1/60th  
H.P.; 10,000 RPM; 27 1/2 VDC; 2 amps;  
**SPERRY #806069;** approx. size 1 1/2" x 3 1/2"  
\$7.50 ea.

(Approx. size . . . 4" long x 1 1/4" dial.)  
**General Electric Type 5A180AJ37:** 27 volts,  
DC; 5 amps, 8 oz. inches torque; 250 RPM,  
shunt wound; 4 leads; reversible; \$15.00 ea.

**General Electric, Mod. 5BA10FJ33:** 12 oz.  
inches torque, 12 V DC, 56 RPM, 1.02 amp.  
\$15.00 ea.

**General Electric-Type 5BA10AJ52C:** 27  
volts, DC; 5 amps, 8 oz. inches torque;  
145 RPM; shunt wound; 4 leads; reversible  
\$15.00 ea.

**GENERAL ELECTRIC DC MOTOR** Mod.  
5BA10AJ64, 160 r.p.m.; 65 amp.; 12 oz.-in.  
torque; 27V DC . . . \$19.95 ea.



**REVERSIBLE MOTOR**  
U.S.N. No. 451-1314  
Rotational Speed 2.3 RPM.  
A lightweight unit suit-  
able for all types of rota-  
tion application. Excellent  
for rotating light beams,  
antennas or anywhere a  
low RPM high torque  
motor is needed. Output  
torque approx. 100 lbs.  
Consists of high speed series reversible  
motor. Requires 24 VDC or 24-40 VAC @ 1  
amp. Overall size 6" L x 4" W x 4 3/8" dp.  
Shipping wt. 6 lbs. USED, GOOD . . . \$11.95



**BLOWER**  
Eastern Air Devices,  
Type J31B; 115 volt;  
400-1200 cycle; single  
phase; variable fre-  
quency; continuous  
duty; L & R #2  
blower; approx. 22 cu  
ft./min. . . \$15.00



**BLOWER ASSEMBLY**  
115 Volt, 400 Cycle, Westinghouse Type  
FL, 17CFM, complete with capacitor.  
New . . . \$12.50 ea.



**SENSITIVE ALTIMETERS**  
Pioneer Sensitive altimeters,  
0-35,000 ft range, cali-  
brated in 100's of feet. Baro-  
metric setting adjustment. No  
hook-up required . . . \$12.95 ea.

**INVERTERS**

**10563 LELAND ELECTRIC**  
Output: 115 VAC; 400 cycle; 3-phase;  
115 VA; 75 PF. Input: 28.5 VDC; 12  
amp. . . \$69.50 ea.

**PE 218 LELAND ELECTRIC**  
Output: 115 VAC; Single Phase; PF 90;  
380/500 cycle 1500 VA. Input: 25-28 VDC;  
92 amps; 8000 RPM; Exc. Volts 27.5  
**BRAND NEW** . . . \$39.95 ea.

**PE 109 LELAND ELECTRIC**  
Output: 115 VAC, 400 cyc.; single phase;  
1.53 amp.; 8000 RPM; Input: 13.5 VDC;  
29 amp. . . \$69.50

**MG-0-75 ONAN**  
Navy Type PU/11 . . . Output: 115 VAC;  
480 cyc.; single phase; 5.3 amp and 26 VDC  
@ 3.8 amp. Input: 115/230 VAC; 60 cyc.;  
single phase . . . \$225.00

**MG 153 HOLTZER-CABOT**  
Input: 24 V. DC, 52 amps; Output: 115  
volts—400 cycles, 3-phase, 750 VA. and 26  
Volt—400 cycle, 250 VA. Voltage and fre-  
quency regulated . . . \$95.00 ea.

**PIONEER 12130-3-B**  
Output: 125.5 VAC; 1.15 amps, 400 cycle  
single phase, 141 VA. Input: 20-30 VDC,  
18-12 amps. Voltage and frequency regu-  
lated . . . \$89.50 ea.

**12116-2-A PIONEER**  
Output: 115 VAC; 400 cyc; single phase;  
45 amp. Input: 24 VDC 8 amp. . . \$90.00 ea.

**10285 LELAND ELECTRIC**  
Output: 115 Volts AC, 750 V.A., 3 phase,  
400 cycle, .90 PF, and 26 volts, 50 amps,  
single phase, 400 cycle, .40 PF. Input:  
27.5 VDC, 60 amps. cont. duty, 6000 RPM.  
Voltage and Frequency regulated. . . \$195.00

**10486 LELAND ELECTRIC**  
Output: 115 VAC; 400 Cycle; 3-phase; 175  
VA; .80 PF. Input: 27.5 DC; 12.5 amp; Cont.  
Duty . . . \$90.00 ea.

**PIONEER 10042-1-A**  
DC INPUT 14 Volts; OUTPUT 110 Volts; 400  
Cycle 1-Phase; 50 Watt . . . \$90.00

**94-32270-A LELAND ELECTRIC**  
Output: 115 Volts; 190 VA; Single Phase;  
400 Cycle; .90 PF. and 26 Volts; 60 VA;  
400 Cycle; .40 PF. Input: 27.5 Volts DC;  
18 amps; cont. duty, voltage and freq.  
regulated . . . \$95.00

**115 VOLT GENERATORS**  
Brand new Eclipse  
generators: 115 VAC;  
9.4 amp; 1000 watts;  
single phase; 800  
cycles, 2400-4200 rpm.  
DC output is 30 volts  
at 25 amp. Unit has spline drive shaft and  
is self-excited . . . \$29.95

**MICROPOSITIONER**  
Barber Colman AYLZ 2133-I Polarized D.C.  
Relay: Double Coil differential sensitive,  
Alnico P, M, Polarized field. 24V contacts;  
.5 amps; 28 V. Used for remote positioning,  
synchronizing, control, etc. . . \$12.50 ea.

**TRANSFORMERS**  
**SOLA TRANSFORMER, #30663;** 1 KVA;  
210-270 Volts; 240 Sec.; 3-Phase . . . \$100.00  
**FILAMENT, Gen. Elec. #7455321:** Primary  
110/125 Volts. Secondary 11 Volts 65 Amps.  
975 KVA. Shipping wt. approx. 60 pounds.  
\$24.95  
**FILAMENT, AMERTRAN #29048:** Primary  
115 Volts, 50/60 cycle. Secondary 5 volts,  
190 amp. Shipping weight approx. 75 lbs.  
\$36.50  
**VARIABLE, AMERTRAN #29144:** 250 VA,  
103-126 commutator range, fixed windings,  
115 volts, max. 2.17 amps. . . \$19.95  
**BROWN CONVERTER, CHOPPER**  
Type CARL 20380; 50/60 Cycle . . . for use  
with Brown Recorders. Special . . . \$19.95

**Immediate Delivery**  
**ALL EQUIPMENT FULLY GUARANTEED**  
All prices net FOB Pasadena, Calif.

**TACHOMETER INDICATOR**



**SINGLE**  
Sensitive Type, Kollsman  
Mark V; Range 0-3500 RPM  
in 3 1/2 revolutions of the  
indicating pointer. \$9.95 ea.  
**Tachometer Indicator and Generator**  
(above) Both \$33.50  
**TACHOMETER GENERATOR (MARK V)**  
\$25.50 ea.



**G. E. GENERATORS**  
General Electric Type 5ASB-  
31J3; 400 cycles out at 115  
volts; 7.2 amps; 8,000 rpm.;  
size 6" long x 6" dia.  
\$99.50 ea.

**SINE-COSINE GENERATORS**

(Resolvers)  
**Diehl Type FJE43-9** (Single Phase Rotor).  
Two stator windings 90° apart, provides  
two outputs equal to the sine and cosine of  
the angular rotor displacement. Input vol-  
tage 115 volts, 400 cycle. . . \$30.00 ea.  
**Diehl Type FPE-43-1** same as FJE-43-9  
except it supplies maximum stator voltage  
of 220 volts with 115 volts applied to  
rotor . . . \$25.00 ea.  
**Arma Resolver Type 213014;** equal in size  
to size 5 synchro; 55-60 cycle; single phase  
primary, 2 phase secondary . . . \$79.50

**VOLTAGE GENERATORS (RATE)**  
**ALNICO MIDGET D.C. VOLTAGE GENER-**  
**ATOR** Type B-35-D. . . \$17.50  
**ALNICO MIDGET D.C. VOLTAGE GENER-**  
**ATOR** Type B-44-D. . . \$17.50  
**A.C. GENERATOR:** 67 V., 20 Cyc., 2-Phase,  
.015 Amps, Type PM-1, 1200 R.P.M. . . \$15.00



**SYNCHRONOUS SELSYNS**  
110 volt, 60 cycle,  
brass cased, approx.  
4" dia. x 6" long.  
Mfg. by Diehl and  
Bendix.  
Quantities Available.  
**REPEATERS** . . . \$20.00 ea.  
**TRANSMITTERS** . . . \$20.00 ea.

**SYNCHROS**  
**AUTOSYN MTR, KOLLSMAN** Type #403;  
32 VAC; 60 cycle; single phase . . . \$22.50  
**AUTOSYN MTR., BENDIX** Type #851; 32  
VAC; 60 cycle; single phase . . . \$22.50  
**SYNCHRO TRANSMITTER, KEARFOTT**  
Type R-212-1A-A Rotor; 26 Volts; single  
phase; Stator: 11.8 Volts; 3 phase; 400 cycle  
\$25.00  
**MICROSYN UNIT,** Type 1C-006-A . . . \$35.00  
**IF Special Repeater (115V-400 Cycle)**  
\$15.90 ea.  
**2JIF 3 Generator (115-400 cyc.)** . . . \$10.00 ea.  
**5CT Control Transformer; 90-50 Volt;** 60  
Cy. . . \$50.00 ea.  
**5F Motor (115/90volt—60 cyc.)** . . . \$60.00 ea.  
**5G Generator (115/90 volt—60 cyc.)**  
\$50.00 ea.  
**5/DG Differential Generator (90-94 volts**  
**—400 cyc.)** . . . \$30.00 ea.  
**TRANSMITTER, BENDIX C-78248;** 115  
Volt, 60 Cycle . . . \$25.00 ea.  
**Differential—C-78249;** 115 Volt; 60 Cycle  
\$27.50

**REPEATER, BENDIX C-78410;** 115 Volt,  
60 Cycle . . . \$37.50 ea.  
**REPEATER, AC synchronous 115 V., 60**  
**cycle, C-78863** . . . \$15.00 ea.  
**REPEATER, DIEHL MFG. No. FJE 22-2;**  
115 Volt; 400 Cycle; Secondary 90 Volt  
\$27.50  
**7G Synchro Generator (115/90 volt; 60**  
**cycle)** . . . \$75.00  
**6G Synchro Generator (115/90 volt; 60**  
**cycle)** . . . \$60.00  
**6DG Synchro Differential Generator (90/90**  
**volt; 60 cycle)** . . . \$60.00  
**2JF5J Selsyn Control Transformer: 105-55**  
**Volts; 60 Cycle** . . . \$50.00  
**5JD5HA1 Selsyn Generator: 115-105 Volts;**  
**60 cycle** . . . \$50.00  
**2JIF1 GENERATOR: 115—57.5 Volt;** 400  
cycle . . . \$12.50 ea.  
**2J1H1 DIFFERENTIAL GENERATOR:** 57.5—  
57.5 Volt; 400 cycle . . . \$12.50 ea.  
**2J1G1 CONTROL TRANSFORMER:** 57.5—  
57.5 Volt; 400 cycle . . . \$7.50 ea.

**PIONEER AUTOSYNS**  
AY-1 . . . 26 Volt—400 Cycle . . . \$6.95  
AY-5 . . . 26 Volt—400 Cycle . . . \$7.95  
AY27D . . . . . \$12.50  
AY6—26 Volt—400 cyc . . . \$4.95 ea.  
AY30D—26 Volt—400 cyc. . . \$25.00 ea.  
AY14D . . . . . \$10.00  
AY34 . . . . . \$20.00  
AY20—26 Volt—400 cyc. . . \$12.50 ea.

**PIONEER TORQUE UNITS**  
**TYPE 12625-7-A;** 400 Cycles, 26 Volts \$95.00  
**TYPE 12604-3-A:** Contain CK5 Motor cou-  
pled to output shaft through 125.1 gear re-  
duction train. Output shaft coupled to auto-  
syn. follow-up (AY43). Ratio of output  
shaft to follow-up Autosyn is 15:1 \$70.00 ea.  
**TYPE 12602-1-A:** Same as 12606-1-A ex-  
cept it has a 30:1 ratio between output shaft  
and follow-up Autosyn . . . \$70.00 ea.  
**TYPE 12602-1-A:** Same as 12606-1A ex-  
cept it has base mounting type cover for  
motor and gear train . . . \$70.00 ea.



**BOX 356-X EAST PASADENA STATION • PASADENA 8, CALIFORNIA**

# Reliance Specials

## GEAR ASSORTMENT

100 small assorted gears. Most are stainless or brass. Experimenter's dream! Only \$6.50



**HAYDON TIMING MOTOR**  
1 R.P.M., 115 V., 60 Cycle... \$1.95

**TIMING MOTOR**  
8 RPM 115 V 60 cyc  
E. Inghram Co.



**\$1.79**

## 400 CYCLE INVERTERS

Leland Electric Co.

=10800 in: 20-28 V.D.C., 82 A. 8000 R.P.M. Out: 115V. 400 Cvc. 1 phase, 1500 V.A. 90 PF. \$29.50

3 AG FUSES			
Amp.	Per 100	Amp.	Per 100
1/8	\$4.00	3/4	\$4.00
3/8	4.00	1	3.00
1/2	4.00	5	3.00

## RESISTORS

Type EB 1/4W 10%	6¢ ea.	\$4.00 per C
EB 1/2W 10%	12¢ ea.	8.00 per C
GB 1W 5%	9¢ ea.	7.00 per C
GB 2W 10%	18¢ ea.	14.00 per C
Type HB 2W 10%	12¢ ea.	9.00 per C
HB 2W 5%	24¢ ea.	18.00 per C

AVAILABLE IN ALL STANDARD RMA VALUES

## RAYTHEON PLATE TRANSFORMER

TYPE UB355A

PRI. 110V/220V/440V/60 cy.  
SEC. #1 300V @ 4 AMPS  
SEC. #2 300V @ 4 AMPS  
1780 RMS TEST  
9 3/4" x 9 1/2" x 8 1/2" HIGH **\$19.95**

## Brand New Meters—Guaranteed

0-10 ma. D.C. 3 1/2". \$3.95 0-80 Amp. D.C. 2 1/2". \$2.50  
0-1 Ma D.C. 3 1/2" DeJury. (Scale Reads 0-4 KV). \$5.75

## SELENIUM RECTIFIERS

Full Wave 200 MA 115V. \$1.70  
Half Wave 100 MA 115V. .91

## TS-10 SOUND POWERED HANDSET

Used, Excellent Condition



INCLUDES 8 FT. CORD & CLAMPS—USES NO BATTERIES OR EXTERNAL POWER SOURCE **\$18.95 PAIR**

Dynamotor DM 33A. \$3.95 ea.  
Rheostat 8 ohm 50 W S.S. shaft. \$9.22  
Power Tap Switch—OHMITE (#312-5 Taps) nonshorting 25A 150 V. A.C. \$3.95  
Timer—Industrial Timer Corp. 15 min. on 15 min. off continuous 115 V. A.C. Fully cased Plugs into octal socket. \$5.50  
BC 221 FREQUENCY METER. \$80.00

## Sound Powered Chest Set RCA



With 24 Ft. Cord  
Per Pair  
**USED \$17.60**  
**NEW \$26.40**

## POSTAGE STAMP MICAS

AVAILABLE IN ALL STANDARD RMA VALUES  
PRICE SCHEDULE

5 mmf to 910 mmf.	5¢
.001 to .0013 mfd.	8¢
.0015 to .0056 mfd.	15¢
.0062 to .0091 mfd.	20¢
.01 mfd.	28¢

## SILVER MICA

mmf	mmf	mmf	mmf	mmf	mfd	mfd	mfd
10	50	100	170	360	510	.001	.0024
18	51	110	180	370	525	.0011	.0025
22	56	115	208	390	560	.0013	.0027
23	60	120	225	400	570	.0015	.0028
24	62	125	240	410	680	.0016	.006
25	68	130	250	430	700	.0018	.0063
27	69	135	255	470	800	.0022	.0069
30	75	150	280	488	900	.0023	.004
40	82	155	270	500			

## Price Schedule

10 mmf to 700 mfd.	10¢
.0011 mfd to .002 mfd.	20¢
.0022 mfd to .0082 mfd.	50¢
.01 mfd.	95¢

## PULSE TRANSFORMERS

UTAH—9262 9278 9289 9318 9340 9350  
WESTERN ELECTRIC—D 168173 D161310  
K88696, KS9800, KS9862, KS13161  
GENERAL ELECTRIC—80-G-5  
JEFFERSON ELECTRIC—C-12A-1318  
DINION COIL—TR1048 TR1049  
also 352-7250-2A; 352-7251-2A; T-1229621-60

## COAXIAL CABLE CONNECTORS



14c	\$1.2*	30c	70c	40c	12c
UG175/U	83-1F	83-1AP	83-1J	SO-239	HOOD
83-1AC	\$0.42	PL-274	\$1.10	UG-88/U	.90
83-1AP	.30	PL-275	2.10	UG-89/U	1.10
83-1BC	.35	SO-239	1.70	UG-102/U	.80
83-1F	1.10	UG-13/U	1.05	UG-103/U	.68
83-1H	.12	UG-18B/U	1.05	UG-104/U	1.40
83-1HP	.22	UG-20B/U	1.60	UG-105/U	1.50
83-1J	.73	UG-21/U	.85	UG-106/U	.15
83-1R	.40	UG-21B/U	1.00	UG-107B/U	2.70
83-1RTY	.65	UG-21C/U	1.05	UG-146/U	2.05
83-1SP	.45	UG-21D/U	1.45	UG-167/U	3.75
83-1SPN	.50	UG-22/U	1.30	UG-175/U	.42
83-1T	1.30	UG-22A/U	1.60	UG-176/U	.12
83-2AP	1.95	UG-22B/U	1.20	UG-185/U	.95
83-2J	2.10	UG-23/U	1.20	UG-196/U	1.65
83-2P	1.65	UG-23B/U	1.50	UG-203/U	.65
83-22A	1.40	UG-23C/U	1.10	UG-224/U	1.15
83-22F	2.10	UG-24/U	1.30	UG-255/U	1.95
83-22J	1.40	UG-27/U	1.25	UG-261/U	.85
83-22R	.68	UG-27A/U	2.25	UG-261/U	1.10
83-22SP	.80	UG-27B/U	2.95	UG-262/U	1.10
83-22T	1.95	UG-28A/U	2.95	UG-273/U	1.45
83-168	.12	UG-29/U	1.75	UG-274/U	2.30
83-185	.12	UG-30/U	1.75	UG-290/U	1.90
CW-123A/U	.45	UG-57B/U	1.85	UG-291/U	.95
M-358	1.30	UG-58/U	.70	UG-306/U	2.65
M-359	.30	UG-58A/U	.90	UG-414/U	1.95
M-359A	.65	UG-59/U	1.90	UG-499/U	1.25
PL-259	.45	UG-85/U	1.75	UG-625/U	1.35
PL-259A	.50	UG-87/U	\$1.40		

## NEW COAXIAL CABLES

	Price per 1000 ft.		Price per 1000 ft.
RG 5/U*	\$140.00	RG 22/U*	\$150.00
RG 6/U*	180.00	RG 22A/U*	285.00
RG 7/U*	180.00	RG 24/U*	675.00
RG 8/U*	100.00	RG 29/U*	475.00
RG 9/U*	250.00	RG 34/U*	50.00
RG 9A/U*	275.00	RG 35/U*	900.00
RG 10/U*	240.00	RG 41/U*	295.00
RG 11/U*	100.00	RG 54A/U*	97.00
RG 11A/U*	150.00	RG 62/U*	110.00
RG 12/U*	240.00	RG 65/U*	325.00
RG 13/U*	216.00	RG 68/U*	60.00
RG 17/U*	650.00	RG 68A/U*	70.00
RG 18/U*	900.00	RG 69/U*	55.00
RG 19/U*	1250.00	RG 77/U*	75.00
RG 21/U*	220.00	RG 77/U*	100.00

Add 25% for orders less than 500 feet.  
\* No minimum order—other 250 minimum.

**UNIVERSAL JOINT ALUMINUM**  
Includes 1/4" hole x 1/2" O.D.  
Two 6-32 Set Screw Holes **85¢**

## TYPE "J" POTENTIOMETERS

100 S.S.*	1,500 1/4S.S.	15K 1/4	200K S.S.*
150 S.S.*	2,000 1/4	25K S.S.	250K 5/8
300 S.S.*	2,500 S.S.	70K S.S.	250K S.S.*
400 S.S.*	3,000 3/8	80K S.S.	500K S.S.*
500 S.S.*	4,000 3/8	100K 7/16	1 Meg S.S.
1,000 3/8	5,000 3/4*	100K S.S.*	
1,000 S.S.	10K 5/8	200K 5/8	

\*Split Locking Bushing **\$1.25 EACH**

## TYPE "JJ" POTENTIOMETERS

Ohms	Shaft	Ohms	Shaft	Ohms	Shaft
1000	S.S.	30K-10K	3/8"	1 Meg.	1/2"
10K	5/16"	3K-90K	1/4"	1 Meg.	S.S.
15K	S.S.			1 Meg.	S.S.

SD—Screw Driver \*—Split Locking Bushing  
+—Weld Switch

PRICE—\$2.50 EACH

## JONES BARRIER STRIPS

2-140Y	\$0.17	3-141W	\$0.27	8-141 1/2 W	\$0.64
3-140 1/2 W	.21	4-141	.24	9-141	.48
6-140	.28	5-141	.29	9-141Y	.71
10-140W	.59	5-141 1/2 W	.41	3-142	.24
10-140 1/2 W	.59	7-141 1/2 W	.56	2-150	.43
3-141 1/2 W	.27	8-141	.44	3-150	.60

## TIME DELAY RELAY

Raytheon CPX 24166  
1 Min. Delay. 115 V., 60 Cycle  
2 1/2" second recycling time spring return • Microswitch contact, 10A • Holds ON as long as power is supplied • Fully Cased • ONLY **\$6.50**

## TELEPHONE FIELD WIRE

W-110-B  
1/2 MILE COIL... \$7.95  
1 MILE REEL... \$14.95

## PRECISION RESISTORS—1/4 WATT—30¢

2	5	11	13.52	62.54	125	301.8	2,193
3.5	6.08	11.25	13.89	79.81	147.5	366.8	3,600
10.48	12.32	15.8	14.98	105.8	147.8	414.3	8,000
10.84	13.02	16.37		123.8	220.4	705	59,148

## PRECISION RESISTORS—1/2 WATT—35¢

.25	13.3	125	1,500	6,500	16,000	36,000
.334	25	130	2,200	6,600	16,700	37,000
.502	30	180	2,200	7,000	17,000	45,000
.557	46	210	2,250	7,300	20,000	48,000
.627	50	235	2,500	7,500	20,150	47,000
.76	52	260	2,850	8,000	25,000	50,000
1	55.1	270	3,427	8,500	26,500	54,600
1.01	65	298.3	4,000	8,800	30,000	59,000
1.53	66.6	400	4,285	10,000	32,700	68,000
2.04	75	723	4,300	12,000	32,888	79,012
5.26	87	750	4,451	14,825	33,000	80,000
11.1	97.8	855	5,000	15,000	33,300	100,000
13.15	97.85	970	5,900	15,700	36,888	

## PRECISION RESISTORS—1 WATT—45¢

2	4.3	13.52	38	2,200	10,000	55,000
.861	4.35	14	54.26	3,300	12,000	56,000
1.01	5.1	15	250	5,000	17,300	65,000
2.55	5.21	20	270	7,000	20,000	88,000
2.88	12	22	430	8,250	50,000	84,000
3.39	13.333	28	425	8,900		

## PRECISION RESISTORS—1 WATT—60¢

100,000	130,000	260,000	348,000	590,000
105,000	132,000	270,000	500,000	600,000
120,000	150,000	296,000	520,000	645,000
128,000	240,000	320,000	522,000	700,000

## PRECISION RESISTORS—2 WATT—75¢

4,385	6,000	10,000	19,977	23,000
-------	-------	--------	--------	--------

**1 MEGOHM 1 WATT 1% \$1.50**

## DIFFERENTIAL Used \$4.95

115 V, 60 Cycle **New \$9.95**



#C78249  
3 3/8" dia. x 5 1/2" long  
Used between two C78248's as a dampener. Can be converted to 3600 RPM Motor in 10 minutes. Conversion sheet supplied. (Converted) \$5.50  
Mounting Brackets—Bakelite for selsyns, and differentials shown above. .35¢ pair

## OIL FILLED CONDENSERS

MFD	V.D.C.	Price	MFD	V.D.C.	Price
6	400	\$0.85	1	3,600	\$3.95

**LOW  
PRICES**

**IMMEDIATE  
DELIVERY**

**FULLY  
GUARANTEED**

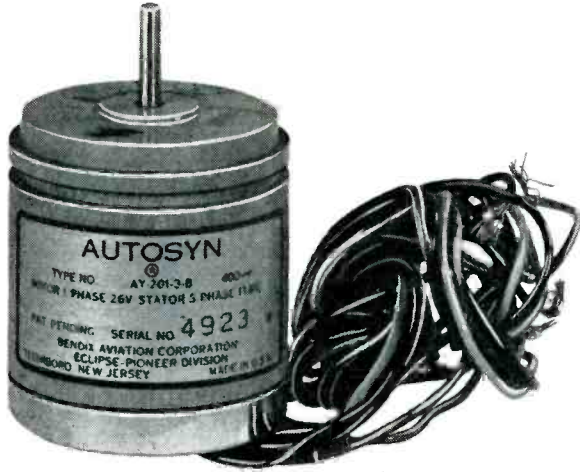

**PIONEER PRECISION AUTOSYNS**

AY-101D—Transmitter or Control Transformer—\$24.50

AY-131D—Differential—\$27.50

AY-201-3-B—Transmitter or Control Transformer—\$27.50

AY-231-3-B—Control Transformer—\$34.50

New with minimum 5" lead length

**DIEHL PM MOTOR**

Type FD6-21. 27.5 volts d-c 10,000 rpm. May be used as rate generator.

Special at \$8.75 each

**B-64 D-C SERVO MOTOR**

1/165 hp at 3100 rpm—Shuntwound with high impedance rotor for operation from "hard" or small thyratron tubes. Armature 80 volts, 20 ma. at no load. Field 200 ma. at 27.5 volts.

SA-211 ..... \$16.50

**1/100 HP SHUNT MOTOR**

Universal Electric—W.E. Type KS-5603-L02 27.5 volts at .6 amp. 4 lead reversible type motor. Speed approx. 6500 rpm.

SA-233 ..... \$6.75

**400 CYCLE SERVO MOTOR**

KEARFOTT TYPE R-108-2A  
Two phase 115/115 volts, 400 cycles at 15-20 watts per phase. 2.4 in.-oz stall torque. 1.4 in.-oz at 6000 rpm. 10,000 rpm no load.

SA-413 ..... \$39.50

**SELSYN-SPECIALS**

General Electric 2J1F1—2J1G1—2J1F3 115 volt 400 cycle Selsyns in small size. Will operate from 30 volts 660 cycle. Army Type VII (C-78248) 115 volt, 60 cycle Synchro Generator—Similar to size 5G Army Type IX (C-78410) 115 volt, 60 cycle Synchro Repeater—Similar to size 5F. Send for special prices.

**HIGH FREQUENCY MG SETS**

Electric Specialty—Input 220 volts 3 phase 60 cycle. 10 hp motor at 3450 rpm. Output 220 volts, 2000 cycles at 21 amp., .8 p.f. Cont. duty.

Priced for quick sell-out ..... \$275.00

**DELCO D-C SHUNT MOTOR**

27.5 volts at 1.5 amp. 4 in. oz torque at 5400 rpm

SA-240 ..... \$9.75

**PERMANENT MAGNET D-C MOTOR**

John Oster 27.5 volts—10,000 rpm. As a rate generator—2 volts per 1000 rpm. Open construction.

SA-281 ..... \$6.75

**D-C TO A-C ROTARY CONVERTER**

Holtzer-Cabot. Input 220 volts d-c at 5 amp. Output 600 watt, 150 volts at 60 cycles.

SA-351 ..... \$29.50

**DIEHL FD52-2 SHUNT MOTOR**

27.5 volts d-c at 2 amp. 3000 rpm. Used by Sperry (No. 803010) as a "follow-up motor". 4 lead reversible.

SA-363 ..... \$4.75

**1SF NAVY SYNCHRO**

115 volts 400 cycle. May be used as transmitter or receiver. Will operate from 30 volts 60 cycle.

SA-29 ..... \$49.50 each

**400 CYCLE INVERTERS**

LELAND 10563

Input 28 volts d-c at 12 amp. Output 3 phase 115 volts at 115 va. Adjustable frequency and voltage. Weighs only 8.7 lbs.

SA-159 ..... \$79.50

**G-E 5AS131NJ3**

Input 24-28 volts at 100 amp. Delivers 1500 va of 115 volt 400 cycle power at 9 p.f.—Western Electric #KA-5601-L1. Weight 37.5 lbs.

SA-286 ..... \$19.50

**PIONEER 12120-4-A**

Input 115 volts d-c at 1.0 amp. Output 115 volts 400 cycles single phase. Adjustable frequency and voltage. Only 4000 rpm. (very quiet running).

SA-406 ..... \$119.50

**E.A.D. J-49B MOTOR**

115 volt 60 cycle induction motor. Rated 1/250 hp at 3000 rpm. 4 leads. Uses a 1 mfd. capacitor.

SA-238 ..... \$9.75

**DELCO 5072520 GEARHEAD PM MOTOR**

24-28 volts d-c. Output speed is 190 rpm. Output gear designed to fit sub-assembly.

SA-416 ..... \$17.50

WRITE FOR LISTING

Prices F.O.B. Hawthorne

Telephone: HAWthorne 7-3100

1086 GOFFLE ROAD  
HAWTHORNE, N. J.  
Cable Address: SERVOTEK  
WUX Hawthorne, N. J.

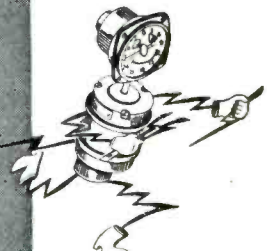

## A LEADING SUPPLIER OF ELECTRONIC &amp; AIRCRAFT EQUIPMENT

A. C.  
SYNCHRONOUS  
MOTORS

## 110 Vt. 60 Cycle

HAYDON TYPE 1600, 1/240 RPM  
 HAYDON TYPE 1600, 1/60 RPM  
 HAYDON TYPE 1600, 4/5 RPM  
 HAYDON TYPE 1600, 1 RPM  
 HAYDON TYPE 1600, 1 1/5 RPM  
 TELECHRON TYPE B3, 2 RPM  
 TELECHRON TYPE BC, 60 RPM  
 HOLTZER CABOT, TYPE RBC 2505, 2 RPM,  
 60 oz. 1 in. torque.

## SERVO MOTORS

PIONEER TYPE CK1, 2  $\phi$  400 CYCLE  
 PIONEER TYPE 10047-2-A, 2  $\phi$ , 400 CYCLE,  
 with 40:1 reduction gear.

## D. C. MOTORS

BODINE NFHG-12, 27 VTS., governor controlled,  
 constant speed 3600 RPM, 1/30 HP.  
 DELCO TYPE 5068750, 27 VTS., 160 RPM,  
 built in brake.  
 DUMORE, TYPE EIY2PB, 24 VTS., 5 AMP.,  
 .05 H.P., 200 RPM.  
 GENERAL ELECTRIC, TYPE 5BA10AJ18D,  
 27 VTS., 110 RPM, 1 oz. 1 ft. torque.  
 GENERAL ELECTRIC, TYPE 5BA10AJ37C,  
 27 VTS., 250 RPM, 8 oz. 1 in. torque.  
 BARBER COLMAN ACTUATOR TYPE AYLC  
 5091, 27 VTS., .7 amp., 1 RPM, 500 in.  
 lbs. torque.  
 WHITE ROGER ACTUATOR TYPE 6905, 12  
 VT., 1.3 amp., 1 1/2 RPM, 75 in. lbs.  
 torque.

## AMPLIDYNE AND MOTOR

AMPLIDYNE, GEN. ELEC. 5AM31NJ18A input  
 27 vts., at 44 amp. output 60 vts. at  
 8.8 amp., 530 watts.  
 MOTOR, GEN. ELEC. 5BA50LJ22, armature  
 60 vts. at 8.3 amp., field 27 vts. at 2.9  
 amp. 1/2 H.P., 4000 RPM.

PIONEER AUTOSYNS  
400 CYCLE

TYPE AY1, AY5, AY14G, AY14D, AY20,  
 AY27D, AY38D, AY54D.  
 PIONEER AUTOSYN POSITION.  
 INDICATORS & TRANSMITTERS.  
 TYPE 5907-17, single, Ind. dial graduated  
 0 to 360°, 26 vts., 400 cycle.  
 TYPE 6007-39, dual Ind., dial graduated  
 0 to 360°, 26 vts., 400 cycle.  
 TYPE 4550-2-A, Transmitter, 2:1 gear ratio  
 26 vts., 400 cycle.

## INVERTERS

WINCHARGER CORP. PU 16/AP, MG750,  
 input 24 vts. 60 amps. outputs 115 vts.,  
 400 cycle, 6.5 amp., 1 phase.  
 HOLTZER CABOT, TYPE 149F, input 24 vts.  
 at 36 amps., output 26 vts. at 250 V.A.  
 and 115 vts. at 500 V.A., both 400 cycle,  
 1 phase.  
 PIONEER TYPE 12117, input 12 vts., output  
 26 vts. at 6 V.A., 400 cycle.  
 PIONEER TYPE 12117, input 24 vts., output  
 26 vts. at 6 V.A., 400 cycle.  
 WINCHARGER CORP., PU/7, MG2500 input  
 24 vts. at 160 amp., output 115 vts. at  
 21.6 amp., 400 cycle, 1 phase.  
 GENERAL ELECTRIC, TYPE 5D21NJ3A, in-  
 put 24 vts. at 35 amps., output 115 vts.  
 at 485 V.A., 400 cycle, 1 phase.  
 LELAND, PE 218, input 24 vts. at 90 amps.  
 output 115 vts. at 1.5 K.V.A., 400 cycle,  
 1 phase.  
 LELAND, TYPE D.A. input 28 vts., at 12  
 amp. output 115 vts. at 115 V.A., 400  
 cycle, 3 phase.

## ENGINE HOUR METER

JOHN W. HOBBS, MODEL MI-277 records  
 time up to 1000 hours, and repeats,  
 operates from 20 to 30 volts.

## VOLTAGE REGULATOR

LELAND ELEC. CO. TYPE B, CARBON PILE.  
 Input 21 to 30 volts D.C. regulated out-  
 put 18.25 vts. at 5 amp.  
 WESTERN ELEC. TYPE BC937B, input 110  
 to 120 volts, 400 cycle. Output variation  
 0 to 7.2 ohms at 5 to 2.75 amps.  
 WESTERN ELEC. TRANSTAT, input 115  
 vts., 400 cycle output adjustable from  
 92 to 115 vts., rating .5 K.V.A.  
 AMERICAN TRANS. CO., Transtat input  
 115 vts., 400 cycle output 75 to 120 vts.  
 or 0 to 45 volts, rating .72 K.V.A.

## SYNCHROS

1 F SPECIAL REPEATER 115 vts. 400 cycle.  
 2J1F1 GENERATOR, 115 vt. 400 cycle.  
 2J1F3 GENERATOR, 115 vt. 400 cycle.  
 2J1G1 CONTROL TRANSFORMER 57.5 vt.  
 400 cycle.  
 2J1H1 DIFFERENTIAL GEN. 57.5/57.5 vt.  
 400 cycle.  
 5G GENERATOR, 115 vt. 60 cycle.  
 5DG DIFFERENTIAL GEN. 90/90 vts. 60  
 cycle.  
 5HCT CONTROL TRAN. 90/55 vts. 60 cycle.  
 5CT CONTROL TRAN. 90/55 vts. 60 cycle.  
 5SDG DIFFERENTIAL GEN. 90/90 vts. 400  
 cycle.

ALL PRICES  
 F. O. B.  
 GREAT NECK  
 N. Y.

**IMMEDIATE  
 DELIVERY -- FULLY  
 GUARANTEED**

TACHOMETER GENERATOR  
& INDICATOR

GENERAL ELECTRIC, GEN. TYPE AN5531-1,  
 Pad mounting 3 phase variable frequency  
 output.  
 GENERAL ELECTRIC, GEN. TYPE AN5531-2,  
 Screw mounting 3 phase variable fre-  
 quency output.  
 GENERAL ELECTRIC, IND. 8DJ13AAA,  
 works in conjunction with above genera-  
 tors, range 0 to 3500 RPM.

## D. C. ALNICO FIELD MOTOR

DIEHL TYPE FD6-23, 27 vts. 10,000 RPM.

GENERAL ELECTRIC  
D. C. SELSYNS

BTJ9-PAB TRANSMITTER 24 VTS.  
 BTJ11- INDICATOR, dial 0 to 360°, 24  
 vts.

## RECTIFIER POWER SUPPLY

HAMMETT ELECTRIC MFG. CO. MODEL  
 SPS-130. Input voltage 208 or 230 volts,  
 60 cycle, 3 phase, 21 amps. Output 28  
 volts at 130 amps. continuous duty, 8  
 point tap switch, voltmeter ammeter,  
 thermo reset all on front panel.

## MISCELLANEOUS

PIONEER MAGNETIC AMPLIFIER ASSEM-  
 BLY Saturable reactor type, designed to  
 supply variable voltage to a servo motor  
 such as CK1, CK2, CK5 or 10047.  
 SPERRY A5 CONTROL UNIT, part No.  
 644836.  
 SPERRY A5 AZIMUTH FOLLOW-UP AM-  
 PLIFIER, part No. 656030.  
 SPERRY A5 DIRECTIONAL GYRO, part No.  
 656029, 115 vt. 400 cycle, 3 phase.  
 SPERRY A5 PILOT DIRECTION INDICA-  
 TOR, part No. 645262 contains AY 20.  
 ALLEN CALCULATOR, TYPE C1, TURN &  
 BANK IND., part No. 21500, 28 vts. D. C.  
 TYPE C1, AUTO-PILOT FORMATION STICK,  
 part No. G1080A3.  
 PIONEER GYRO FLUX GATE AMPLIFIER,  
 Type 12076-1-A, 115 vt. 400 cycle.

**INSTRUMENT  
 ASSOCIATES**

363 GREAT NECK ROAD, GREAT NECK, N. Y.  
 Telephone Great Neck 4-1147

Write for Catalog NE100

U. S. Export License-2140

Western Union address:  
 WUX Great Neck, N. Y.

COMMUNICATIONS EQUIPMENT CO.

HIGH-POWER GEAR

TRANSTAT:

Type TH45BG: Input 130/260V, 50-60 cy, 1 ph. Output Range: 0-260V, 45A. Max. 11.7 KVA two-unit bank, parallel connected. Completely enclosed in cabinet with handwheel atop. Brand New \$325.00

CIRCUIT BREAKER:

ITE Model KJ. Will handle 600 VAC at 115A. Break time adjustable from instant to 10 minute. Break amperes adjustable from 15A to 1000% overload. Brand New \$15.00

ALTERNATOR:

Louis-Allis Co. Type "AL", 198-C: Output 110/220V -1 ph, 60 cy. 9 P.F. 1200 RPM, completely self-regulating with built-in exciter. Brand new, original crates \$795.00

10 KW TRANSMITTER PARTS

1) Plate XFMR: Amertran 33134, Pri: 198/220/240V, 60 cy, 1 ph. Sec: 3650V, 16.7 KVA, 30 KV. Uses 2C40, 2C43, 1B27, Tunable APX 2400-2700 MCS. Silver Plated. \$49.50
2) Reactor, Modulation, Amertran 33153, 50 H @ 3.0 amps. DCR-80 ohms. Freq.-.03 cy. to 10 KC. Level: 63 DB. 40 KV Test. Impedance: 3000 ohms. A great value. \$695.00
Both units (Trans & Choke) for

P-4 SYNCHROSCOPE

For observing Magnetron or Radar Modulator Pulses, Waveforms, Transients, etc. Designed by the Radiation Laboratory, this versatile scope has the following specifications:

Writing Speed: .04/0.1666/0.5/2 inches/ USEC
Local Oscillator: 500/1000/2000/4000 PPS
Trigger Gen. Output: 135V positive
Tube Line-up: 1-5LP1/ 2-2X2/ 1-5Z3/ 1-6SK7/ 2-6SL7 6-6SN7/ 1-7V7
\$125.00
P-4 Synchroscope, used, A-1 cond.

T-1 BOMBIGHT PARTS

Main Servo Unit, Complete Mfr's. Pt. #1594486
Double Angle Servo Unit Assy. Pt. #1592448
Servo Motor Assy. Pt. #1590816
Write for prices

PULSE TRANSFORMERS

UTAH X-151T-1: Dual Transformer, 2 Wdgs. per section 1:1 Ratio per sec. 13 MH inductance 30 ohms DCR \$7.50
UTAH X-150T-1: Two sections, 3 Wdgs. per section, 1:1:1 Ratio, 3 MH, 6 ohms DCR per Wdg. \$7.50
68G711: Ratio: 4:1, 6.7 Ohms, Pri: 0.25 Ohms sec. \$4.50
TR1049: Ratio: 2:1 Pri. 220 MH, 50 Ohms, sec. 0.75H, DCR 100 Ohms. \$6.75
K-901695-501: Ratio 1:1, Pri. Imp. 40 Ohm, Sec. Imp. 40 Ohms. Passes pulse 0.6 usec with 0.05 usec. rise \$8.95
G.E.K.-2745 \$39.50
G.E.K.-2744-A: 11.5 KV High voltage, 3.2 KV Low voltage @ 200 KV over. (270 KW max.) 1 microsec. or 25 usec. @ 600 PPS. \$39.50
G.E. K2450A. Will receive 13KV, 4 micro-second pulse on pri. secondary delivers 14KV. Peak power out 100 KW G. E. \$34.50
Ray UX 7896-Pulse Output Pri. 5v. sec. 4iv. \$7.50
Ray UX 8442-Pulse Inversion -40v + 40v. \$7.50
RAY UX 361 \$5.00
PHILCO 352-7250, 352-7251, 352-7287 \$5.00
RAYTHEON: UX8693, UX5986. \$5 ea.
W.E.: D-166310, D-166638, KS 9800, KS9948,
UTAH # 9262, with Cracked Beads, but will operate at full rated capacity. \$5.00
UX 8693 (SCS # 229627-54): 3 Wdgs, 32 turns #18 wire, DCR is: .362/.372/4 ohms. Total voltage 2500 vdc. \$39.00
D169271: Pulse input transformer. Unit 2, 3 Sections, 1me Sec. Imp. ratios: 16.507/16.547/16.592 ohms. Turns ratio: 5.75/6.2/6.46. \$27.50
D-166173: Input: 50 ohms Z. Output: 900 ohms, 3 Wdgs. Freq. range 10 kc-2mc. P/O AN/APQ-13 \$12.50

PULSE NETWORKS

15A-1-400-50: 15 KV, "A" CKT. 1 microsec. 400 PPS, 50 ohms imp. \$37.50
G.E. #3E (3-84-810) 8-2.24-405) 50P4T: 3KV "E" CKT Dual Unit; Unit 1, 3 sections, 0.84 Microsec. 810 PPS, 50 ohms imp.; Unit 2, 3 Sections, 2.24 microsec. 405 PPS, 50 ohms imp. \$6.50
7-5E3-1-200-67P. 7.5 KV "E" Circuit, 1 microsec 200 PPS, 67 ohms impedance 3 sections. \$7.50
7-5E4-16-60, 67P. 7.5 KV, "E" Circuit, 4 sections 16 microsec. 60 PPS, 67 ohms impedance. \$15.00
7.5E3-3-200-6FT, 7.5 KV, "E" Circuit, 3 microsec. 200 PPS, 6 ohms imp. 3 sections. \$12.50
#755: 10KV, 2.2usec., 375 PPS, 50 ohms imp. \$27.50
#754: 10KV, 0.85usec., 750 PPS, 50 ohms imp. \$27.50
KS8965 CHARGING CHOKE: 115-150H @ 0.2A, 32-40H @ 0.8A, 30,700V Corona Test, 21KV Test \$37.50
G.E. 25E5-1-350-50 P2T. "E" CKT, 1 Microsec. Pulse @ 350 PPS, 50 OHMS Impedance. \$69.50
KS9623 CHARGING CHOKE: 16H @ 75 MA, 380 OHMS DCR, 9000 Vac test. \$14.95
G.E. 6E3-5-2000 50 P2T: 6 KV, "E" Circuit 0.5 usec /2000 PPS/50 ohms/2 sections. \$7.50

MAGNETRONS

Table with columns: Type, Price, Type, Price. Lists various magnetron models and their prices.

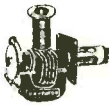

MICROWAVE COMPONENTS

"S Band" RG48/U Waveguide

POWER SPLITTER for use with type 726 or any 10 CM. Shepherd Klystron. Energy is fed from Klystron antenna through dual pick-up system to 2 type "N" connectors. \$22.50 EACH
DIRECTIONAL COUPLER, Broadband type "N" Coupling, 20 db. with std. flanges, Navy #CABV 47AAN-2 \$37.50
LHTR, LIGHTHOUSE ASSEMBLY, Part of RT39 APG 5 & APG 15. Receiver and Trans. Cavities w/assoc. Tr. Cavity and Type N CPLEG. To Recv. Uses 2C40, 2C43, 1B27, Tunable APX 2400-2700 MCS. Silver Plated. \$49.50
BEACON LIGHTHOUSE cavity 10 cm. Mfg. Bernard Rice, each \$47.50
MAGNETRON TO WAVEGUIDE Coupler with 721A Duplexer Cavity, gold plated. \$45.00
RT-39 APG-5 10 cm. Lighthouse RF head c/o Xmtr.-Recvr. TH, cavity compl. recvr. & 30 MC. TP strip using 60K5 (2C40, 2C43, 1B27 lineups) w/Tubes. 721A TR BOX complete with tube and tuning plungers \$12.50
MCNALLY KLYSTRON CAVITIES for 707B or 2K28 \$4.00
WAVEGUIDE TO 3/4" RIGID COAX "DOORKNOB" ADAPTER CHOKE FLANGE, SILVER PLATED BROAD BAND \$32.50
AS14A AP-10 CM Pick up Dipole with "N" Cables \$4.50
OAJ ECHO BOX, 10 CM TUNABLE. \$22.50
HOMERELL-TO-TYPE "N" Male Adapters, W.E. #D167284 \$2.75
I. F. AMP. STRIP: 30 MC. 30 d.b. gain, 4 MC Bandwidth, uses 6AC7's-with video detector. A.F.C. less tubes \$24.50
POLYROD ANTENNA, AS31/APN-7 in Lucite \$22.50
Type "N" Feed \$3.11
ANTENNA, AT49A/APR: Broadband Conical, 300-3300 MC Type "N" Feed. \$12.50
"E" or "H" PLANE BENDS, 90 Deg. less flanges \$7.50

7/8" RIGID COAX-3/8" I. C.

ROTARY JOINT, Stub-supported, UG 46/UG 45 fittings \$27.50
10 CM STABILIZER Cavity, tunable, standard UG46/UG 45 fittings \$45.00
RG 44/U RIGID COAX, stub support, 5 ft. sections, with UG46/UG45 connectors. \$12.50
RIGHT ANGLE BEND, with flexible coax output pickup loop \$8.00
RT ANGLES for above \$2.50
SHORT RIGHT ANGLE BEND, with pressurizing nipple \$3.00
RIGID COAX to flex coax connector \$3.50
RT. ANGLE BEND 15" L. OA. \$3.50
FLEXIBLE SECTION, 15 L. Male to female. \$4.25
3/4" RIGID COAX, BULKHEAD FEED-THRU \$14.00

X Band-RG 52/U WAVEGUIDE

UG 39 Flanges. \$1.10
UG 40A/U Broadband Choke Flanges. \$1.65
1" x 1/2" waveguide in 5' lengths, UG 39 flanges to mounting. With UG40 flanges. each, \$7.50
Bulkhead Feed-thru Assembly \$15.00
Pressure Gauge Section 15 lb. gauge and press nipple \$10.00
Pressure Gauge, 15 lbs. \$2.50
Directional Coupler, UG-40/U Take off 20 db. \$17.50
TR-ATR Duplexer section for above. \$8.50
Waveguide Section 12" long choke to cover 45 deg. twist & 2 1/2" radius, 90 deg. bend. \$4.50
Waveguide Section 2 1/2" long silver plated with choke flange. \$5.75
Rotary Joint choke to choke with deck mounting \$17.50
3 cm. mitered elbow "E" plane. \$12.00
90 degree elbows "E" or "H" plane 2 1/2" radius \$12.50
90 degree twist 6" long \$8.00
90 degree twist, 3 CM. Sensitivity: 10-13 u Watts. Complete with L.O. and AFC Mixer and Waveguide Input Circuits. 6 I.F. Stages give approximately 120 DB gain at a bandwidth of 1.7 MC. Video Bandwidth: 2 MC. Uses latest type AFC circuit. Complete with all tubes, including 723A/B Local Oscillator \$175.00

K Band-RG 53/U WAVEGUIDE

APS-34 Rotating Joint. \$49.50
Right Angle Bend E or H Plane, specify combination of couplings desired. \$12.00
45° Bend E or H Plane, choke to cover. \$12.00
Mitered Elbow, cover to cover. \$4.00
Flexible Section 1" choke to choke. \$4.00
"SI" Curve Choke to cover. \$4.50
APS-34 K-Band Pillbox Antenna. \$22.50
Slotted Section, with Carriage & Probe. \$45.00

MICROWAVE MIXER



CV-12/APR-6: Waveguide/mixer unit, 4000-6000 mc. Designed for use with microwave receiver. Has pick up loop for coupling to lighthouse cavity local oscillator. RF input is 1" x 2" waveguide (contact flange). Output (thru in21 x1) is from standard 50-ohm coax connector. Brand new, complete with crystal. As shown. \$35

THERMISTORS

D-164699 Bead Type DCR: 1525-2550 Ohms @ 75 Deg. F. Coefficient: 2% Per Deg. Fahr. Max. Current 25 MA AC/DC \$2.50
D-167332 Bead Type DCR is 1525-2550 Ohms. Rated 25 MA at .825-1.175 VDC 1.50
D-167613 Disk Type DCR: 355 Ohms @ 75 Deg. F. P.M. 2.5% 1Watt. 1.50
D-166228 Disk Type 7120 Ohms @ 60°F. 4220 Ohms @ 80°F. 2590 Ohms @ 100°F. 1640 Ohms @ 120°F. 1.50

MICROWAVE ANTENNA EQUIPMENT

AT49A/APR-Broadband Conical. 300-3300 MC. Type N Feed \$12.50
AS-31/APN-7: 10 cm Polyrod in Lucite Ball. Type N Fitting Coax Feed. \$22.50
Relay System Parabolic reflectors approx. range 2000 to 6000 Mc. Dimensions 1 1/2" x 3". New. \$10.00
TDY "JAM" Radar rotating antenna, 10 cm. 30 deg. beam, 115 V AC drive. New. \$150.00
Paraboloid Peel. Radiation pattern approx. 25 deg. in horizontal 33 deg. in vertical planes. \$35.00
Cone Antenna. AS 125 APR. 1000-3200 mc. Stub supported with type "N" connector. \$14.50
AS14A/AP, 10 CM pick up dipole Assy, complete w/length of coax and "N" connectors. \$3.50
AS46A/APG-4 Yagi Antenna, 5 element array. \$22.50
30" Paraboloid Reflector Spun Aluminum dish. \$4.85
APS-34 Pillbox Antenna, waveguide Input: 2400-27000 MC \$22.50

RADAR ANTENNAS

AS-12/APS-3 AS-125/APR
AS-17/APS-2 AS-217/APG-15
AS-13/APG-2 AT49/APR
AS69/APT AS14/AP

400 CYCLE TRANSFORMERS

Table with columns: Stock, Ratings, Price. Lists various transformer models and their specifications.

MAIL ORDERS PROMPTLY FILLED. ALL PRICES F.O.B. NEW YORK CITY. SEND M.O. OR CHECK. ONLY SHIPPING SENT C.O.D. RATED CONCERNS SEND P. O. ALL MDSE. SUBJECT TO PRIOR SALE AND PRICES SUBJECT TO CHANGE WITHOUT NOTICE. PARCELS IN EXCESS OF 20 POUNDS WILL BE SHIPPED VIA CHEAPEST TRUCK OR RAIL.

131 Liberty St., New York 7 N. Y. Dept E-7 Chas. Rosen Phone: Dlgby 9-4124



COMMUNICATIONS EQUIPMENT CO.

RECTIFIER TRANSFORMERS

- Pri: 115V/60 Cy. Sec. 12/14/16 V @ 3.5A.....\$ 2.49
Pri: 115V, 60 Cy. Sec: 28V/3.1A, 26V/8.4A.....
Pri: 115V 60 Cy. Sec: 20 V @ 10A..... 12.95
Pri: 115V 60 Cy. Sec: 8.1V @ 1.5A..... 1.39
Pri: 115V 60 Cy. Sec: 18.5V @ 3.5A..... 2.79

SELENIUM RECTIFIERS\*

Table with columns: Current (Continuous), 18/14 Volts, 36/28 Volts, 54/42 Volts, 130/100 Volts. Rows include 1 Amp, 2 Amps, 2 1/2 Amps, 4 Amps, 5 Amps, 6 Amps, 10 Amps, 12 Amps, 20 Amps, 24 Amps, 30 Amps, 36 Amps.

TELEVISION TEST GEAR

- KAY MEGASWEEP T.V. Algm. Gen. ....\$215.00
KAY MEGAPIPPER T.V. Mark. Gen. .... 85.00
KAY MEGAMARKER SR. Chan 2-13 Marker Gen. .... 95.00

RCA TEST PANEL

Complete RCA TV Service and Test Laboratory comprising the WV-95A Master Volt/hmyst, VA-54A Beat Frequency Oscillator, WO-55A Oscilloscope, WR-67A Test Oscillator, WR-59A TV Sweep Generator, WR-39A TV Calibrator on a sturdy metal display rack. A complete TV service bench \$597.00

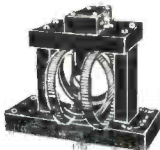

HELMHOLTZ PHASE-SHIFTER

Stator consists of 4 loops oriented at 90 degrees to each other. Total stator inductance is 40 MH. rotor: 10MH. total phase shift 0-360 deg. Designed for range unit of SCR-268. \$3.95 each

APN-3 SPARE PARTS

- K-901684-501: SCS #229632-306, Trans. ....\$2.49
K-901689-501: SCS #229631-238, Trans. .... 2.25
K-901692-503: SCS #229617-70, Xfmr, Fil. .... 2.49
K-901699-501: SCS #229617-68, Fil. Xfmr. .... 3.45
K-901698-501: SCS #229618-38, Plate Xfmr. .... 4.29
K-901695-501: SCS #229627-19, Pulse Xfmr. .... 3.50

AUDIO TRANSFORMERS

- AT SUB Subcouer, Multimatch, 200 ohms to 15 K ohm C.T. and 100 K ohm Grids.....\$ 9.09
AT731 H.F. Plate (1500 ohm C.T.) to V.C. (16/4 ohms) 20-15KC..... \$3.29
AT501 HI-FI Special: PRI: 3000 ohms P-P/Sec: 4/16/12/50/200 ohms 60-10,000 CY.—1 db 50W.....\$3.49
AT152 HI-FI Driver Pri: 10,000 ohms Sec: 40,000 ohms PP Grids 50-15 KC/1 db.....\$1.49
AT602 Output to H. S. or line PRI: 14,200 ohms SEC: 8000/600 ohms CY.....\$1.10
AT449 HI-FI Driver (5000 ohms) to P.P. output grids (4,000 ohms) 100-10,000 CY, 10 W 6V6 to PP 805's.....\$2.39
AT666 Intercon Input: Sokr (-4-8 ohms) to grid (250,000 ohms).....\$0.69
AT415 Plate (18,000 ohms C.T.) to line (125 ohms) 175 w.—500-600 CY.....\$1.95
AT758 Plate (10,000 ohms C.T.) to line (125 ohms) 125130 ohms) HI-FI—50 W.....\$8.95
AT070 Mike-or-Line (250 ohms) to grid (250,000 ohms C.T.).....\$1.20
AT765 Mike-or-Line (600 ohms to grid (50,000 ohms C.T.).....\$0.69
AT-694 HI-FI Output: 3 Watts, 8500 Ohms P-P to V.C. (15 Ohms) 15-15KC PM 1 db.....\$1.49
AT4-1: Mike (35 ohms Carbon) to Line 600 ohm/200 ohm.....\$1.19
AT-649: Line (500 ohms) to Grid (75K ohms).....\$0.89
AT-448: Line (600 ohms) to V.C. (6 ohms) 17 db. Level.....\$1.19
AT-631: Mike-or-Line (200 ohms) To Single or P-P Grids (50K Ohms).....\$0.59
AT 718 Line (300 ohms) to Line (600/30 Ohm) Response 50-20KC P.M. 1 db.....\$0.49

BIRTHING TUBE CLAMPS

- 926B-16 926C-19 926C-24
926B-15 926C-15 926K-2
PRICE: 18¢ EACH OR \$16.50/100

TELEPHONES



DESK TYPE PHONE, IDEAL FOR PRIVATE INTERCOM, AMATEUR MIKE ETC. USES HI-QUALITY CARBON TRANSMITTER, POWERFUL MAGNETIC RECEIVER. A GREAT, ONCE-IN-A-LIFETIME VALUE. AS SHOWN, used, excellent. \$3.50 RINGER BOXES FOR ABOVE. WOOD CASE 3.00 RINGER BOXES FOR ABOVE. METAL CASE 5.00

DYNAMOTORS

Table with columns: TYPE, INPUT VOLTS, INPUT AMPS, OUTPUT VOLTS, OUTPUT AMPS, PRICE. Includes items like PE 86, DM 316, DM 33A, BD AR 93, 23350, B-19 Pack, DA-3A\*, 5053, PE 73 CM\*\*, 337.

\* Replacement for PE 94. \*\* Price sent on request.

INVERTERS

PE-218-H: Input: 25/28 vdc. 92 amp. Output: 115 v. 350/500 cy 1500 volt-amperes. New. \$44.50
PE-206: Input: 28 vdc, 38 amps. Output: 80 v 800 cy, 500 volt-amps. Dim: 13"x5 1/2"x10 1/2". New \$22.50
NAVY CQR-21(095): Input 22-30 VDC/75-60A. OUTPUT: 115V/400 CY, 1 KVA/8.7A. RPM: 4800. With coupling provision for motor. Brand New, Original packing \$150.00

MOBILES! C. D. MEN! CAP!!

IDEAL DYNAMOTOR - CONVERTS EASILY TO SUPPLY UNIT DELIVERING 12 Volt Input— 6 Volt Input 610 V @ 150 MA OR 300V @ 90 MA 325V @ 125 MA OR 160V @ 110 MA Brand New with Conversion Data.....\$3.75

VIBROPACK, Mallory Type G-556. Input 12 VDC. Output: 225/250/275/300 VDC @ 100 MA. Brand New with 2 spare vibrators \$12.50

VIBRATOR, TR 1210. For use in industrial inverters delivering 115 Vac @ 100 Watts from 12 VDC. \$1.69

GN 35 HAND GENERATORS

BRAND NEW, IN ORIGINAL CARTONS. WILL DELIVER 8 V @ 2.5A AND 325-365 V @ 100 MA OR 10 V 1.25A AND 380-420 V @ 70 MA. LESS HAND CRANKS. A GREAT VALUE \$17.50

H.V. FILAMENT XFMR

NO. FT-38A— Primary: 115V 60 Cy. 1 PH. SEC.: 2 Wdgs. 2.5V at 7 Amps each, and 1 wdg. 6.3V @ 2.5A tested at 7500 VDC between all points. HERM. SEALED. Size 5 1/2" H x 3 1/2" D x 4" W. Has 4 studs, 1/2" L on 2 1/2" x 3" Centers. As shown \$2.79

BAND PASS FILTERS

INPUT IMPEDANCE: 2000 OHMS. OUTPUT: TO GRID. AVAILABLE IN FOLLOWING RANGES: CHANNEL, Fr., F1\*, F2\*... \* Fr.: Center Freq. in CPS; F1 and F2 are lower and upper limits (CPS) respectively, at -20 db points. Price, \$4.95 Each

JAN/UG CONNECTORS

Table with columns: UG 9/U, UG 10/U, UG 21/U, UG 22B/U, UG 22/U, UG 27/U, UG 27A/U, UG 58/U, UG 89/U, UG 102/U, UG 188/U, UG 254/U, UG 261/U, D-166366. Prices range from \$0.70 to \$2.50.

SPARES FOR APN-9

- Power Trans., Pt. No. 352-7295-2.....\$4.95 each
Counter Trans., T11, T12, T17, Pt. No. 352-7251-2.....\$2.50 each
Counter Trans., T113, T114, T115, T116, T118, T119, T120, Pt. No. 352-7250-2.....\$2.50 each
I. F. Trans. T107-T110 Pt. #352-1554S.....\$1.00 each
Resistor: R150, R157, R162 84,000 OHMS......50 each
Resistor: R130, 220,600 ohms......50 each
Resistor: R159 120,000 ohms......50 each
Resistor: R152, R164, 17,000 ohms......35 each
Resistor: R142, 4300 ohms......35 each

POWER TRANSFORMERS

- Comb. Transformers—115V/50-60 cps Input
CT-J5-2-600VCT/2A, 5V/6A.....\$5.95
CT-15A 550VCT .085A 6.3V/6A, 6.3V/1.8A.....2.85
CT-164 4200V, .002A, 12KV Test. 5VCT/3A/12KV Test. 6.3V/0.6A/5400V Test.....12.95
CT-341 1050 10 MA—625V @ 5 MA, 26V @ 4.5A 2x2.5V/3A, 6.3V @ 3A.....9.95
CR 825 360VCT .340A 6.3VCT/3.6, 6.3VCT/3A.....3.95
CT-626 1500V .160A 2.5/12, 30/100.....9.95
CT-071 110V .200A 33/200, 5V/10, 2.5/10.....4.95
CT-367 580VCT .050 A 5VCT/3A.....2.25
CT-403 350VCT .026 A 5V/3A.....2.75
CT-931 585VCT .086 A 5V/3A, 6.3V/6A.....4.25
CT-456 390VCT .30 MA 6.3V/1.3A, 5V/3A.....3.45
CT-931 585VCT 86 MA 5V/3A, 6.3V/6A.....4.95
CT-442 525VCT 75 MA 5V/2A, 10VCT/2A, 50V/200 MA.....3.85
CT-720 550-0-550V/250 MA, 6.3V/1.8A.....8.95
CT-43A 600-0-600V/0.8A, 2.5VCT/6A, 6.3VCT/1A.....6.49
CT-7-501 650VCT/200MA, 6.3V/3A, 6.3V/5A.....6.49
CT-444 230-0-230V/.085A, 5V/3A, 6V/2.5A.....3.49

- Filament Transformers—115V50-60 cps Input
Item Rating Each
FT-157 4V/16A, 2.5V/1.75A.....\$2.95
FT-101 6V/25A......79
FT-924 5.25V/21A, 2x7.75V/6.5A.....14.95
FT-824 2x26V/2.5A, 16V/1A, 7.2V/7A, 6.4V/10A, 6.4V/2A.....8.95
FT-463 6.3VCT/1A, 5VCT/3A, 5VCT/3A.....5.49
FT-55-2 7.2V/21.5A, 6.5V/6.85A, 5V/6A, 5V/3A.....8.95
FT-986 16V @ 4.5A or 12V @ 4.5A.....3.75
FT-38A 6.3/2.5A, 2x2.5V/7A.....4.19
FT-A27 2.5V/2.5A, 7V/7A, TAP 2.5V/2.5A, 16 KV TEST.....18.95
FT-608 6.3V/3A/750V Test.....1.79
FT-873 4.5A/5A, 7V/7A.....2.19
FT-899 2x5V A 5A, 29KV Test.....24.50

- Plate Trans.—115V, 60 cps
Item Rating Price
PT-699 300/150V/.05A, 300/150V/.05A.....\$2.79
PT-108 17,600V/144 MA.....120.00
PT-671 62V/3.5A.....7.95

- Special Fil. Transformers—60 cps
Item Pri. Volts Secondaries Price
STF-370 220/440 3x2.5V/5A, 3KV Test 2.5V/15A.....6.95
STF-11A 220V 2x40V/.05A, 2x5V/6A 12.6V/1A.....4.49
STF-608 220V 24V/0.6A, 5V/3A, 6.3V/1A, 6.3V/1A.....3.45
STF-968 230V 2.5V/6.5A.....3.50
STF-631 230V 2x5V/27A, 2x5V/9A.....17.59

- Special Plate Transformers—60 cps
Item Pri. Volts Secondaries Price
STP-613 230V 230/.05A, 230V/.05A.....\$1.79
STP-409 220/440V 136VCT/2.5A.....5.89
STP-129 230V 240/40, 3ph 1310V/67A, 6KV Test.....27.50
STP-129 230V 3850V/3.12KVA.....42.59
STP-823 137V 222VCT/3A.....2.35
STP-08B 50V 2x750V/.001A.....1.79
STP-945 210/220/230 550-0-550V/.3A.....5.95

- Special Comb. Transformers—60 cps
Item Pri. Volts Secondaries Price
STC-16A 220V 260V/.03A, 100V/1A, 6.3V/4.2A.....\$4.69
STC-609 220V 220V/3A.....6.95

FILTER CHOKES

- Stock Description Price
CH-366 20H/.3A.....\$6.95
CH-322 .35H/350 MA—10 Ohms DCR.....2.75
CH-141 Dual 7H/75 MA, 11H/60 MA 5KV DC Test.....4.69
CH-119 8.5H/125 MA.....2.79
CH-69-1 Dual: 120H/17 MA.....2.35
CH-8-35 2/.5H/380 MA/25 Ohms.....1.79
CH-776 1.28H/130 MA/75 ohms.....2.25
CH-344 1.5H/145MA/1200V Test.....2.35
CH43A 10HY/15MA—850 ohms DCR.....1.75
CH-366 20H/300MA.....6.95
CH-999 15HY/15MA—400 ohms DCR.....1.95
CH-511 6H/80MA—310 ohms DCR.....2.45
CH3-501 2 x 5H/400MA.....2.79
CH-188M 5HY 200MA.....1.79
CH-488 10HY .030A.....1.19
CH-791 Dual 1.75-125 HY 100 MA.....1.27
CH-981 15HY 110A.....1.27
CH-22-1 1 HY .100A.....1.17
CH-779 .6 HY .490A.....1.25
CH-25A SW .09/.018 HY 3/.3A.....8.95
CH-922 10000 HY 0 MA.....2.75
CH-043 2.2 HY 80 MA......98
CH-89A 2 x 1.52H @ .167A.....1.39
CH-69A Mult. Choke
SECT. 1. Swing 3-12H/52-.05A
SECT. 2. Smooth 5H/52A
SECT. 3. Swing 3.25-18H/138-014A
SECT. 4. Smooth 3.4H/138A.....14.95
CH-445 0.5 HY/200 MA, 32.2 OHMS, 3000V.T. 1.39
CH-170 2x0.5H/380 MA, 25 OHMS.....2.79
CH-533 13.5H, 1.0 AMP DC, 13.5KV INS. 39.95

MAIL ORDERS PROMPTLY FILLED. ALL PRICES F.O.B. NEW YORK CITY. SEND M.O. OR CHECK. ONLY SHIPPING SENT C.O.D. RATED CONCERNS SEND P.O. ALL MDSE, SUBJECT TO PRIOR SALE, AND PRICES SUBJECT TO CHANGE WITHOUT NOTICE. PARCELS IN EXCESS OF 20 POUNDS WILL BE SHIPPED VIA CHEAPEST TRUCK OR RAILCAR.

131 Liberty St., New York 7, N. Y. Dept E-7 Chas. Rosen Phone: Dlgby 9-4124

# NEW YORK'S RADIO TUBE EXCHANGE

TYPE	PRICE	TYPE	PRICE	TYPE	PRICE	TYPE	PRICE	TYPE	PRICE	TYPE	PRICE		
OA2.....	51.40	2J21A.....	17.95	4E27.....	17.50	RK-73.....	1.95	450TH.....	45.00	806.....	27.50	955.....	.55
OA3.....	1.10	2J22.....	17.95	4J25.....	199.00	100TH.....	9.95	450TI.....	45.00	807.....	1.69	956.....	.89
OB2.....	1.35	2J26.....	27.75	4J26.....	199.00	FG95.....	24.95	464A.....	9.95	808.....	3.50	957.....	.29
OC3.....	1.25	2J27.....	29.95	4J27.....	199.00	FG105.....	19.00	471A.....	2.75	810.....	11.00	958A.....	.69
OD3.....	1.25	2J31.....	29.95	4J31.....	199.00	203A.....	8.95	527.....	15.00	811A.....	3.95	991.....	.65
C1B.....	3.85	2J32.....	69.95	4J32.....	199.00	211.....	.95	WL530.....	22.50	813.....	9.95	F1148.....	.35
1B21A.....	2.75	2J36.....	105.00	4J33.....	199.00	217C.....	18.00	WL531.....	3.50	814.....	3.95	1280.....	1.25
1B22.....	3.95	2J38.....	17.95	4J37.....	199.00	242C.....	10.00	WL533.....	17.50	815.....	3.50	1611.....	1.95
1B23.....	9.95	2J39.....	12.50	4J38.....	89.00	244A.....	12.95	700A/D.....	25.00	816.....	1.45	1613.....	1.38
1B24.....	17.95	2J40.....	35.00	4J39.....	199.00	249C.....	4.95	701A.....	7.50	829.....	12.95	1616.....	2.95
1B26.....	2.95	2J42.....	109.00	4J41.....	199.00	250TH.....	22.50	703A.....	6.95	829A.....	13.95	1619.....	.89
1B27.....	13.50	2J49.....	109.00	C5B.....	3.95	250TL.....	19.95	705A.....	3.95	829B.....	15.95	1622.....	2.75
1B32.....	4.10	2J50.....	195.00	5BP1.....	6.95	274A.....	3.00	707A.....	13.95	830B.....	2.50	1624.....	2.00
1B38.....	33.00	2J62.....	45.00	5BP4.....	6.95	204B.....	3.00	707B.....	17.95	832.....	7.95	1625.....	.45
1B42.....	19.95	2K25.....	29.50	5CP1.....	6.95	304TH.....	10.00	714AY.....	17.95	832A.....	9.95	1851.....	1.85
1B51.....	9.95	2K28.....	37.50	5D21.....	21.00	307A.....	4.95	715A.....	7.95	833A.....	49.95	5326.....	50.00
1B56.....	49.95	2K29.....	37.50	5J1.....	27.50	310A.....	6.95	715B.....	12.00	834.....	7.95	2050.....	1.85
1B60.....	69.95	2K41.....	150.00	5J2.....	19.50	311A.....	6.95	715C.....	25.00	836.....	4.95	2051.....	1.80
1N21.....	1.35	2K45.....	149.50	5JP4.....	27.50	312A.....	3.95	717A.....	1.95	837.....	2.95	5326.....	\$350.00
1N21A.....	1.75	2V3G.....	2.10	WE6AK5.....	2.50	323A.....	15.00	718AY/EY.....	48.50	838.....	6.95	8012.....	4.25
1N21B.....	4.25	3BP1.....	7.50	C6A.....	12.50	327A.....	3.95	719A.....	29.50	845.....	5.99	8013.....	2.95
1N22.....	1.75	3B24.....	5.50	C6J.....	10.95	328A.....	6.95	721A.....	3.95	849.....	52.50	8013A.....	5.95
1N23.....	2.00	3BP1A.....	7.50	7BP1.....	7.95	350A.....	6.95	722A.....	3.95	861.....	29.50	8019.....	1.75
1N23A.....	2.75	EL5C.....	5.95	7DP4.....	10.00	350A.....	6.95	723A/B.....	24.95	866A.....	1.79	8020.....	3.50
1N23B.....	4.25	3C22.....	120.00	12AP4.....	55.00	350B.....	5.95	724A.....	4.95	869B.....	57.50	8025.....	6.95
1N34A.....	.96	3C24.....	1.95	15E.....	1.95	357A.....	20.00	724B.....	6.95	872A.....	3.95	PD8365.....	89.00
1N43.....	2.50	3C31.....	3.95	15R.....	.95	368AS.....	6.95	725A.....	9.95	878.....	1.95	9001.....	1.75
2B22.....	1.95	3DP1A.....	10.95	NE16.....	.66	371B.....	2.95	726A.....	24.00	884.....	1.95	9002.....	.95
2B26.....	3.75	3DP182.....	12.00	FG17.....	6.95	385A.....	4.95	726B.....	56.00	885.....	1.75	9003.....	1.75
2C34.....	3.75	3E29.....	15.50	FG33.....	12.95	388A.....	2.95	728AY.....	69.00	889R.....	199.50	9004.....	1.75
2C40.....	10.00	3GP1.....	5.50	35T.....	4.95	394A.....	7.95	730A.....	24.00	914.....	75.00	9005.....	1.90
2C43.....	15.00	4A21.....	2.75	45 Special.....	.35	MX408U.....	.75	801A.....	1.00	954.....	.35	9006.....	.35
2C44.....	.90	4B26.....	6.95	RR39.....	2.95	434A.....	19.95	802.....	4.25				
2D21.....	1.75	4C27.....	25.00	HF50.....	1.75	446A.....	1.95	803.....	7.95				
2E22.....	2.75	4C28.....	35.00	VT52.....	.25	446B.....	5.40	805.....	5.95				
2E30.....	2.75												

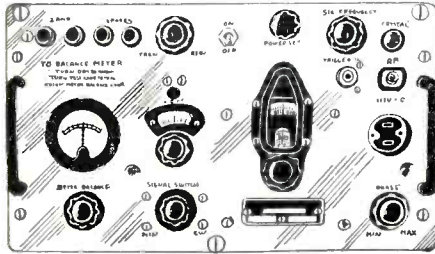

## TS-147 C/UP TEST SET Hard-to-get X-BAND SIGNAL GENERATOR Now Available

Test Set TS 147 C/UP is a portable Microwave Signal Generator designed for testing and adjusting beacon equipment and radar systems which operate within the frequency range of 8500 MC to 9600 MC.



## MICROWAVE TEST EQUIPMENT TS148/UP SPECTRUM ANALYZER

Field type X Band Spectrum Analyzer, Band 8430-9580 Megacycles.  
Will check Frequency and Operation of various X Band equipment such as Radar Magnetrons, Klystrons, TR Boxes. It will also measure pulse width, c-w spectrum width and Q or resonant cavities. Will also check frequency of signal generators in the X band. Can also be used as frequency modulated Signal Generator etc. Available new complete with all accessories, in carrying case.

## Other test equipment, used checked out, surplus.

- TSK1/SE K Band Spectrum Analyzer
- TS3A/AP Frequency and power meter S Band
- RF4A/AP Phantom Target S Band
- TS10/APN Altimeter Test Set
- TS12/AP VSWR Test Set for X Band
- TS13/AP X Band Signal Generator
- TS14/AP Signal Generator
- TS15/AP Flux Meter
- TS16/AP Altimeter Test Set
- TS19/APQ 5 Calibrator
- TS33/AP X Band Power and Frequency Meter
- TS/34AP Western El. Synchroscope
- TS34A/AP Western El. Synchroscope

- T35/AP X Band Signal Generator
- TS36/AP X Band Power Meter
- TS47/APR 40-400 MC Signal Generator
- TS69/AP Frequency Meter 400-1000 MC
- TS100 Scope
- TS102A/AP Range Calibrator
- TS108 Power Load
- TS110/AP S Band Echo Box
- TS125/AP X Band Power Meter
- TS126/AP Synchroscope
- TS147 X Band Signal Generator
- TS251 Range Calibrator APN9
- TS270 S Band Echo Box

- TS174/AP Signal Generator
- TS175 Signal Generator
- TS226 Power Meter
- TS239A Synchroscope

### SURPLUS EQUIPMENT

- APA10 Oscilloscope and panoramic receiver
- APA38 Panoramic Receiver
- APS 3 and APS 4 Radar
- APR5A Microwave Receiver
- APT2 Radar Jamming Transmitter
- APT5 Radar Jamming Transmitter

MINIMUM ORDER  
25 Dollars

YOU CAN REACH US ON TWX NY1-3235

Cables:  
TELSERSUP

### SPECIAL

Wide Band S Band Signal Generator 2700/3400MC using 2K41 or PD 8365 Klystron, Internal Cavity Attenuator, Precision individually calibrated Frequency measuring Cavity. CW or Pulse Modulated, externally or internally.

Large quantities of quartz crystals mounted and unmounted.  
Crystal Holders: FT243, FT171B others.  
Quartz Crystal Comparators.  
North American Philips Fluoroscopes Type 80.  
Large quantity of Polystyrene beaded coaxial Cable.



**LIBERTY ELECTRONICS, INC.**  
135 LIBERTY STREET NEW YORK 6, N. Y.  
PHONE WORTH 4-8262

SEE OUR PREVIOUS ELECTRONICS ADS FOR LISTINGS OR WRITE FOR CIRCULARS

MINIATURE RELAYS

- COOK #82; 24VDC; DPDT; 500 ohm #R918 .....\$1.75
- G.E. CR2791G110F2 24VDC; DPDT; 300 ohm; #R919 .....\$1.50
- CLARE A20545; 8VDC; 1B; 45 ohm; #R920 .....\$1.25
- AUTOMATIC 754A; 12VDC; DPDT 6 Amp; 200 ohm; #R921 .....\$1.75
- AUTOMATIC 754; 6VDC; DPDT 6 Amp; 50 ohm; #R922 .....\$1.75
- POTTER BRUMFIELD KR11D; 6VDC; DPDT; 75 ohm; #R923 .....\$1.95
- SIGMA 41F; 6VDC; SPDT; 62 ohm; #R924 .....\$1.75
- SIGMA 41F; 12VDC; SPDT; 340 ohm; #R925 .....\$1.95
- D163221 AMER. TOTALIZATOR, 24 VDC, DPDT 300 ohms, Anti-Capacity Arms, #R134 .....\$1.75
- CLARE 24VDC; 4PDT; 300 ohms; #R524 .....\$2.50
- MINIATURE 24VDC; 4PDT; 425 ohms; #R525 .....\$3.25
- 23012-0 RBM, 24VDC, SPDT, 250 ohms, #R172 .....\$1.50
- 7251 ARC, 24VDC, SPDT, 300 ohm #R406 .....\$1.50
- 7252 ARC, 24 VDC, DPST, n.o. (2As) 300 ohm, Anti-Capacity Arms, Ceramic Insulation, #R354 .....\$1.50
- A21577 CLARE, 24VDC, DPST n.o. (2As) 250 ohms, #R352 .....\$1.50
- P3 LEACH (Pair on Bakelite Strip) Each relay; VDC, SPDT, 1 ohm #R353 pr. \$2.50
- ZH77628-1 AUTOMATIC, 12VDC, Make One, Break Two (1B, 1C) 640 ohms Dual Telephone Type Contacts #R244 .....\$1.50
- 73A23 ALLIED, 24VDC, Make 3 Break 1, (2As, 1C) 300 ohms, #R403 .....\$1.75
- TB 302 PRICE, 24VDC, Make 3, Break 1, (2As, 1C) 300 ohms, #R404 .....\$1.75
- RIO COOK, 12-24VDC, 3PST n.o. (3As), One contact 10A, 250 ohm, #R427 .....\$1.75

ARC 1 & 3 MINIATURES



- 23025 RBM 48VDC, SPDT, 8000 ohm, 6 ma #R428 .....\$2.50
- 55251 Telechron, 24VDC, SPST n.o. (1A) 300 ohm, #R174 .....\$1.25
- 55340 Price, 24VDC SPST n.o. (1A) 300 ohm #R170 .....\$1.25
- 55342 Telechron, 24VDC, Makes 3 Breaks One (2As, 1C) 300 ohm, Anti-Capacity Arms, Low Loss Bakelite Insulation #R171 .....\$1.75
- 55526 Cook, 24VDC, Makes 2, Breaks One, (1A, 1C) 300 ohm Ceramic Insulation, #R107 .....\$1.75
- 55528 G.E. 12VDC, 6PST n.o. (6As), 150 ohm, #R426 .....\$2.00
- 55531 Cook, 12-24VDC, Makes 4, Breaks (2As, 2Cs) 150 ohm #R405 .....\$1.95
- 55836 G.E. 24VDC, SPDT, 250 ohm, #R402 .....\$1.50
- 55837 G.E. 24VDC, Double Make, 300 ohm, #R108G .....\$1.25
- 55837 RBM, Same as #R108G, #R108R .....\$1.50
- 55837 Allied, Same as #R108G, #R108 .....\$1.75
- 23012-0 RBM, 24VDC, SPDT, 250 ohms, #R172 .....\$1.50

AIRCRAFT SOLENOID CONTACTORS

All types B2; B2A; B4; B4A; B5; B5A; B5B; B6A; B6B; B7A; B7B; B8; B9; 12041-1; 1204-3, etc. available from stock in quantities in popular makes at low prices. SEND US YOUR REQUIREMENTS.

WESTON MODEL 705 SENSITROL



Combines high sensitivity and comparatively high contact capacity (5 watts at 110 volts). Positive action at 10 microamperes d-c. Stationary contact is small permanent magnet; movable contact is iron rider mounted on D'Arsonval movement pointer. Operating torque moves pointer into magnetic field of stationary contact which draws movable contact and holds it firmly. Contacts remain closed until reset.

WESTON 705 TYPE 4: 10 XX microamp; SPST n.o. (1A); 24V AC or DC reset solenoid; #1523 .....\$1.10 for \$200.00 .....\$22.50 ea.

WESTERN ELECTRIC MERCURY RELAY 275C: Hermetically sealed; 2 coils; 700 & 3300 ohm. With coils in series, makes at 6.6 ma, breaks at 5.2; SPDT; High current capacity; High speed; #R464 .....\$17.50 ea. 10 for \$150.00

STEPPING SWITCHES

AUTOMATIC ELECTRIC TYPE 13



25 Position; Self Interrupter Springs; Norm. Oper. Volts: 24 VDC; Max 30VDC; 0.6 Amps; 30 Ohm. Three Levels Auto. Elec. RA92; #R900 .....\$17.75  
Four Levels Auto Elec. RB12; #R901 .....\$19.50  
Five Levels Auto. Elec. RB20; #R902 .....\$22.50



STEPPING RELAYS GUARDIAN SERIES R

Three basic types for 24V AC operation:

1. Continuous rotation: In this type the contact finger advances one step each time the circuit is made and broken.
  2. Electrical reset. Resets when a second coil is energized.
  3. Add and subtract. Steps back one or more contacts at a time instead of resetting completely.
- 10 Pulses per second. Contacts are rated at 1 ampere at 110 volts, 60 cycles, non-inductive AC. The electrical reset type has up to 36 active contacts while the continuous rotation types each have 40 contacts. SEND US YOUR REQUIREMENTS.

TELEPHONE TYPE RELAYS

These relays have been standardized so that coils and frames of most manufacturers can be interchanged without affecting adjustments. A wide variety of applicable combinations are thus possible from a comparatively small number of relays.

Listed below are frames and coils from our stock. They may be purchased separately. However, a complete relay consists of coil and frame. In ordering complete relays specify which coil with which frame, i.e.: F101 with K117.

Representative completed relays are also listed with voltage and current ratings. Values are indicative of sensitivity that may be expected from similar combinations.

- CLARE, 6500 ohm, 8maDC, 3 makes (3As) #R276 .....\$4.25
- 5035A7 AUTOMATIC, 1300 ohm, 8maDC, SPST n.o. (1A), #103 .....\$1.75
- CLARE K101, 6500 ohm, SPDT, 2 ma DC, Fast Action #175 .....\$4.25

FERRULE AND OTHER WIRE WOUND RESISTORS

AT A FRACTION OF MANUFACTURERS' ORIGINAL COST!



IMMEDIATE DELIVERY

From Our Wide Assortment from 0.2 Ohms to 15 Megohms.

ENAMEL • GLASS  
FIXED • ADJUSTABLE

New and in Perfect Condition. Nearly all made to JAN Specifications.

Send us your requirements. We have 250,000 wire wound resistors in a large variety of sizes in stock.



FRAMES



(For Cost of Relay Add Price of Frame to Price of Coil)

Stock No.	Contacts	Price each	Stock No.	Contacts	Price each
F101	1A	1.25	F114	1B, 3A	2.00
F102	2A	1.50	F113	1B, 1C	1.75
F103	3A	1.75	F108	1B, 1A, 1C	2.00
F104	4A	2.00	F131	1B, 9A, 1C	4.00
F127	8A	3.00	F107	2B, 1A	1.75
F128	12A	4.00	F135	2B, 1C	2.00
F106	1A, 1B	1.50	F112	2B, 2A, 2C	3.00
F107	1A, 2B	1.75	F129	2B, 2A, 6C	5.00
F108	1A, 1B, 1C	2.00	F136	2B, 3A, 1C	2.75
F109	1A, 1C	1.75	F121	5B, 1C	2.75
F110	1A, 2C	2.25	F122	1C	1.50
F111	2A, 1B	1.75	F123	2C	2.00
F137	2A, 1C	2.00	F109	1C, 1A	1.75
F112	2A, 2B, 2C	3.00	F137	1C, 2A	2.00
F129	2A, 2B, 6C	5.00	F117	1C, 5A	2.75
F114	3A, 1B	2.00	F133	1C, 1B	1.75
F136	3A, 2B, 1C	2.75	F135	1C, 2B	2.00
F115	3A, 2C	2.75	F108	1C, 1A, 1B	2.00
F117	5A, 1C	2.75	F136	1C, 3A, 2B	2.75
F130	6A, 4C	4.50	F121	1C, 5B	2.75
F131	9A, 1B, 1C	4.00	F131	1C, 9A, 1B	4.00
F120	1B	1.25	F110	2C, 1A	2.25
F132	2B	1.50	F115	2C, 3A	2.75
F134	3B	1.75	F112	2C, 2A, 2B	3.00
F106	1B, 1A	1.50	F130	4C, 6A	4.50
F111	1B, 2A	1.75	F129	6C, 2A, 2B	5.00

SPECIAL CONTACT ARRANGEMENTS

We can supply any contact arrangement up to 20 contact leads (10 form A or 10 form B; or combinations; or 6 form C) for a nominal extra charge. To compute cost of custom made frame add: 1.00 for blank frame plus .50 for each form C, plus .25 for each form A or B and 2.00 as the nominal extra charge. Thus a frame with 2A, 3B, 1C would cost 1.00 + .50 + .75 + .50 + 2.00 = 4.75.

TERMS:—All Prices F.O.B. Our Plant. Rated Firms Net 10 Days: All Others Remittance with Order.

Orders Under \$10 Requisite With Order, Plus Approximate Shipping Charges (coverage will be returned.)

COILS (For Cost of Relay Add Price of Coil to Price of Frame)

Stock No.	Ohms	Price each	Stock No.	Ohms	Price each
K101	0.75	1.25	K109	1000	1.75
K131	5.0	1.25	K136	1200	2.00
K102	.12	1.25	K111	1300	1.75
K132	1.75	1.25	K137	1425	2.25
K153	300	1.50	K138	1500	2.25
K154	400	1.50	K139	1600	2.25
K104	450	1.50	K112	2000	2.25
K105	500	1.50	K140	2300	2.50
K133	600	1.50	K155	2500	2.50
K134	700	1.50	K113	3000	2.50
K107	750	1.50	K116	6500	2.75
K135	800	1.75	K118	40,000	3.25
K108	900	1.75			

SLOW-ACTION COILS SLOW-RELEASE

Stock No.	Ohms	Price each	Stock No.	Ohms	Price each
K122	33	1.50	K149	3.9	1.50
K146	125/1300	2.50	K123	75	1.50
K147	500/1500	2.50	K124	200	1.50
K148	1300	2.00	K150	800	2.00
K146	1300/125	2.50	K151	1000	2.00
K147	1500/50	2.50	K152	1300	2.25
			K127	2500	2.50

A-C COILS

Stock No.	Voltage	Price each
K119	6VAC	1.75
K121	110VAC	2.60

DUAL COILS

Stock No.	Ohms	Price each	Stock No.	Ohms	Price each
K141	50/2000	2.25	K145	1000/1000	2.25
K142	125/1300	2.25	K106	1100/500	2.00
K143	200/1000	2.00	K142	1300/125	2.25
K106	500/1100	2.00	K144	1800/500	2.50
K144	500/1800	2.00	K141	2000/50	2.25
K143	1000/200	2.50			

A = Normally Open; B = Normally Closed; C = Double Throw.

324 CANAL ST., N.Y.C., 13, N.Y. Walker 5-9642

Universal general corp.

DIRECTION SELENIUM RECTIFIERS

Buy Direct From M'facturer

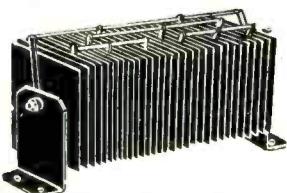

We can manufacture other Selenium Rectifiers, Selenium Rectifiers Supplies, XFMRs., & Chokes.

New Selenium Rectifier Transformers

PRI: 115 V., 60 cycles in.	4 Amps.	\$8.75
SEC: 9, 12, 18, 24, and 36 volts	12 Amps.	16.75
	24 Amps.	35.75
	30 Amps.	45.00
	50 Amps.	59.75

New Selenium Rectifier Chokes

4 Amps.—.07 Hy.—.6 ohm.	\$7.95
12 Amps.—.01 Hy.—1 ohm.	\$14.95
24 Amps.—.004 Hy.—.025 ohm.	\$29.95

Full-Wave Bridge Types

Current (Continuous)	18/14 Volts	36/28 Volts	54/42 Volts	130/100 Volts
1 Amp.	\$1.35	\$2.15	\$3.70	\$7.50
2 Amps.	2.20	3.60	5.40	10.50
2 1/2 Amps.			6.00	13.00
4 Amps.	4.25	7.95	12.95	25.25
6 Amps.	4.75	9.00	13.50	33.00
10 Amps.	6.75	12.75	20.00	40.00
12 Amps.	8.50	16.25	25.50	45.00
20 Amps.	13.25	25.50	38.00	79.50
24 Amps.	16.25	32.50	45.00	90.00
30 Amps.	20.00	38.50		
36 Amps.	25.00	48.50		

FILTER CAPACITORS

Capacity	W. Voltage	Ea.
500 MFD.	50 V.	.98
1000 MFD.	12 V.	.50
1000 MFD.	65 V.	3.25

LISTINGS OF PARTIAL TUBES AND DIODES IN STOCK

0A2	.90	3AP1	9.00	6AK5	.65
0A4G	1.00	3B28	7.50	6AK6-W	.90
0B2	1.00	3B29	9.95	6AK6	.98
OD3/VR150	.88	3BP1	5.75	6AL5	.50
1A7GT	.80	3BP11	9.50	6AN5	2.26
1A4	.90	3C23 (GE)	9.50	6AS5	.70
1B3GT	8.50	3C24/24G	1.35	6AT6	.60
1B23	8.00	3C27	7.50	6AU6	.59
1B27	12.50	3C33	9.00	6AV6	.49
1L4	.60	3D6/1299	.50	6B8	.70
1LA6	.90	3DP1/52	6.50	6BE6	.55
1N21B	2.50	3E29/829B	8.95	6BG6-G	1.35
1N21C	17.50	3Q5GT/G	.99	6BH6	.60
1N23A	2.25	3S4	.80	6BQ6GT	1.20
1N23B	3.49	4D22	19.95	6BZ7	1.35
1N34A	.75	4D32	19.95	6C4	.45
1N44/400B	1.21	4X150A	25.00	6CB6	.55
1N45/400C	1.39	4-125A	22.00	6CB6-G	1.60
1N47	4.95	4-250A	32.00	6CG-M	.69
1N48 (GE)	.55	5D21 (WE)	14.75	6FG-G	.85
1N54 (Syl.)	.77	5R4GY	1.25	6F8-G	.85
1N64	.75	5U4G	.55	6G6-G	.85
1X2A	.90	5V4G	.95	6H6	.70
2C43	13.95	6AB7	.98	6J5GT	.45
2C51	3.95				
2C52	5.50				
2D21	1.25				
2E24	2.50				
2E30	1.95				
2J22	6.50				
2J32	29.95				
2J34	25.25				
2J39	40.00				
2J40	27.50				
2J55	68.00				
2K23	32.50				
2K48	24.25				
2K25	27.00				
2K39	99.50				
2K45	110.00				
2X2	.50				
2X2 A	1.40				
3A4	.59				

STANDARD BRANDS VACUUM CAPACITORS

50 MMF. @ 20,000 Volts

Stock Up at Only \$9.95 Each

6AC7	.77	6J6	.62
6AF4	1.50	6J7	.70
6AG5	.70	6K4 (Sylv.)	3.50
6AC7	1.25	6K4A	3.50
6AH6	1.00	6K6GT	.59
6AJ5	1.30	6K7 Mtl.	.70
6AJ5 (syl)	1.50	6L5-G	.49

6L6-G	1.19	12B1H7	1.15	304-TH	7.75
6L6GA	1.20	12SA7	.70	304-TL	8.75
6L6 Mtl.	1.95	12SF5	.75	310-A (WE)	3.95
6L7	.80	12SG7	.80	311-A (WE)	6.50
6N7 Mtl.	.80	12SH7	.63	328-A (WE)	5.00
6Q7GT	.80	12SJ7	.69	359-A (WE)	4.00
6S7 Mtl.	.98	12SK7	.79	371-B	.35
6SD7	.79	12SL7	.65	373-A (WE)	4.00
6SG7	.72	12SN7GT	.70	374-A (WE)	3.50
6SJ7	.69	12SQ7GT	.63	387A (WE)	2.50
6SMTGT (Syl)	.62	12SR7	.60	403-B (WE)	7.50
6SL7GT	.60	14F7	.80	407-A (WE)	5.00
6SN7GT	.70	25AV5	1.25	408-A (WE)	2.75
6VG6T	.55	25BQ6GT	1.00	417-A 5842	5.95
6W4GT	.55	25L6GT	.65	464A/2C43	7.95
6W6GT	.85	25Z6	.67	700-D	40.00
6Y6-G	.86	28D7	1.50	707-A	5.00
6X5GT	.54	35B5	.49	707-B	9.95
7A7	.69	35C5	.49	715-A	5.00
7B7	.85	35L6	.69	717-A	.88
7A8	.69	35-T (Eimac)	3.00	725-A	4.95
7C5	.69	35Z5GT	.49	726-C	78.00
7C6	.62	50C5	.65	803	3.95
7C30	85.00	50C5	.50	805	3.25
7F7	.69	50L6GT	.55	806	19.50
7B7P	3.95	101-F (WE)	1.00	807	1.59
7H7	.72	FG-105	17.00	811	2.90
12A6	.50	117Z6	1.00	811-A	3.50
12AT7	.75	F-123A	6.50	812	2.70
12AU7	.62	211 (GE)	.50	812-A	3.50
12AV6	.49	250TH	17.00	814	3.75
12AX7	.79	FG-271/		816	1.25
12BA6	.57	5551	.55	829-B	12.95
12BD6	.75	274A & B	3.00	832-A	8.50
12BE	.57	275-A (WE)	3.00	837	1.45



136-C LIBERTY STREET • NEW YORK 6, N. Y.

838	2.95	2051	1.00	5838	3.00
841	.40	5514 (Hyt.)	4.50	CK-5886	3.00
843	.55	5516 (Hyt.)	4.50	5800 (Vict.)	6.50
860	3.95	5528/C6L	12.00	5803 (Vict.)	2.75
861	15.00	5608-A	3.95	5814	2.95
866-A	1.55	5634	4.50	5844	3.00
872-A	3.95	5637	3.00	5910	7.5
955	.35	5638	3.00	5955	3.50
991/NE16	.50	5646 (Syl)	8.25	8020	.98
NE48	.50	5654	1.75	9001	1.20
1613	.75	5655	.80	9002	.85
1616	.70	5670	3.50	9003	.95
1622 (6L6M)	1.95	5686	3.00	9004	.35
1625	.35	CK-5702	1.50	9006	.30
1626	.18	CK-5703	2.00	AX9903	17.75
1632	.70	CK-5744	2.25	SD-917A	3.00
2050 (RCA)	1.35	5751	3.50	SN-980D	3.00

PANORAMIC RADIO 5" SPECTROSCOPE

Model SB1—Type T-200

115 Volts—60 CY. Sweeps 100-0-100 KCS Good, used condition

Only \$69.50

Terms: F.O.B. N.Y.C.—25% Deposit with order—or send full remittance to save C.O.D. charges—Rated Firms (D.&B.) Net 10 days—All merchandise guaranteed. CABLE: BARRYLECT, N. Y. Phone: REctor 2-2562

A NEW BUILDING IMPROVED FACILITIES for the manufacture of WESTON TEST EQUIPMENT

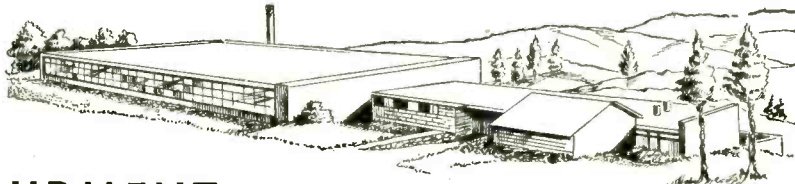

ANNOUNCING THE AVAILABILITY OF NEW TS-125 S BAND POWER METERS

This precision instrument, now being produced by Weston Laboratories, Incorporated provides for quick visual measurement of CW, modulated or pulsed average power output from 0.2 MW to more than four watts. Calibrated in two scales (MW of power and DB above and below one milliwatt). Temperature compensated thermistor construction with 1/4 wave matching stub RF element. Supplied with complete accessories and instruction book available now.



AN-APA-10	BC-959-TU	1-117	1-212	QAW	TS-32A/TRC-1	TS-89/AP*	TS-148/UP*	TS-218/UP	TS-338
AN-APR-1	BC-1060A	1-122	1-222/A	P4	TS-33/AP	TS-90	TS-153	TS-220/TSM	TS-359A/U
AN-APR-4	BC-1066A	1-126	1-223/A	P4E	TS-34/AP	TS-92/AP	TS-155	TS-226A	TS-363/U
AN-TSM-4	BC-1201A	1-130A	1-225	SG-8/U	TS-35/AP	TS-96/TPS-1	TS-159-TPK	TS-230B	TS-377/U
AN-UPM-13	BC-1203	1-134B	1-233	TAA-L6WL	TS-36/AP	TS-98/AP	TS-164-AR	TS-232/TPN-2	TS-389/U
AS-23	BC-1236/A	1-135	1-245	TS-1ARR	TS-39/TSM	TS-100/AP	TS-170/ARN-5	TS-239B	TS-418
AT-67	BC-1255/A	1-137A	1E-21A	TS-1ARR	TS-45/APM-3	TS-101/AP	TS-173/UR	TS-250/APN	TS-419
AT-68	BC-1277	1-139A	1E-36	TS-8A/U	TS-46/AP	TS-102/AP*	TS-174/U	TS-251	TS-421/U
AT-39	BC-1287A	1-140A	1F-12/C	TS-10A/APN-1	TS-47/APR	TS-108/AP*	TS-175/U*	TS-257/AWR	TS-433/U
AT-48	1-48B	1-145	1S-185	TS-11/AP*	TS-51/APG-4	TS-110/AP	TS-182/UP	TS-263	TS-465/U
BE-67	1-49	1-147	1S-189	TS-12/AP*	TS-55/AP	TS-111/CP	TS-184/AP	TS-268*	TS-480/U
BC-221*	1-56	1-153A	LAD	TS-13/AP*	TS-56/AP	TS-117/GP*	TS-189/U	TS-270A	TS-505
BC-376	1-61B	1-157A	LAE-2	LAF	TS-14/AP	TS-59	TS-192/CPM-4	TS-281/TRC-7	TS-589/U
BC-438	1-83A	1-163	LAE-2	LM*	TS-15B/AP	TS-60/U	TS-194/CPM-4	TS-285/GP	TS-616/U
BC-439	1-86A	1-168	LAF	LU-2	TS-16/APN	TS-61/AP	TS-195/CPM-4	TS-293	TS-616/U
BC-638	1-95A	1-177	LZ	LZ	TS-18	TS-62/AP	TS-197/CPM-4	TS-297*	TS-617/U
BC-639	BC-96A	1-178	ME-6/U	ME-6/U	TS-19	TS-63/AP	TS-198/CPM-4	TS-301/U	TS-620/U
BC-906D	1-97A	1-186	OA	OA	TS-23/AP	TS-65A/FM2-1	TS-203/AP	TS-303/AG	TS-621/U
BC-918B	1-98A	1-196A	OAA-2	OAA-2	TS-24/APM-3	TS-69A	TS-204/AP	TS-311/FSM-1	TS-621/U
BC-923A	1-106A	1-198A	OAK	OAK	TS-24/ARR-2	TS-76-APM-3	TS-205AP	TS-323	TS-621/U
BC-936A	1-114	1-203A			TS-26/TSM-1*	TS-78/U	TS-207	TS-324/U	TS-621/U
BC-949/A	1-115	1-208			TS-27/TSM	TS-87/AP	TS-210/MPM	TS-328	TS-621/U

WESTON LABORATORIES, INC. HARVARD, MASS.

Cable: WESLAB Tel: HARVARD 250—AYER 300—TWX 193

# SPECIAL PURPOSE TUBES

C1A... \$6.25	3DP1A... 5.00	RK-73... 1.00	310A... 4.50	706AY... 30.00	812... 2.00
1B22... 1.75	3E29... 10.50	FG-81A... 3.00	311A... 4.75	706FY... 30.00	813... 9.00
1B24... 7.75	3EP1... 3.50	FG-95... 16.50	313C... 2.25	706GY... 30.00	814... 2.50
1B35... 8.00	3FP7... 1.00	100TH... 7.00	316A... 1.00	707A... 4.50	815... 2.50
2AP1... 6.75	3GP1... 3.00	F-128A... 65.00	323A... 11.25	707B... 9.50	829A... 7.50
2C40... 5.75	3JP12... 15.00	VI-158... 50.00	328A... 4.25	708A... 2.75	829B... 9.00
2C43... 8.75	3KP1... 9.75	FG-172... 18.75	329A... 6.00	709A... 2.75	832... 6.00
2C44... 1.00	4C27... 12.75	FG-190... 9.00	348A... 4.50	714AY... 4.25	832A... 7.50
2E22... 1.75	5BP1... 3.50	203A... 4.50	349A... 6.50	715A... 3.50	833A... 30.00
2J22... 5.25	5BP4... 3.50	204A... 37.50	353A... 3.25	715B... 4.50	836... 2.50
2J26... 11.25	5CP1... 3.50	F-207... 180.00	354A... 15.00	715C... 13.75	837... 1.00
2J27... 11.25	5CP7... 7.00	212E... 32.00	355A... 10.50	719A... 18.25	838... 2.50
2J31... 20.25	5D21... 13.75	WL-218... 35.00	368AS... 5.25	721A... 1.50	846... 65.00
2J32... 22.50	5FP7... 1.50	221A... 1.50	375A... 10.50	722A... 1.50	849... 22.50
2J33... 20.25	5FP14... 12.25	F-232CH... 180.00	394A... 3.00	723A/B... 13.50	860... 2.75
2J34... 18.75	5JP1... 16.75	250R... 7.00	417A... 6.00	724A... 2.00	861... 10.00
2J38... 9.00	5JP4... 16.75	250T... 10.00	GL-434A... 9.75	724B... 2.00	866A... 1.00
2J50... 15.75	5JP11... 16.75	250TH... 13.50	446A... 1.00	725A... 4.75	872A... 2.25
2J55... 63.75	5J23... 30.00	250TL... 11.25	446B... 2.25	726A... 9.25	878... 1.50
2J56... 122.50	5J29... 9.00	253A... 11.75	450TH... 35.00	726B... 35.00	884... 1.25
2J61... 30.00	5J30... 29.50	2678... 8.75	450TL... 35.00	728CY... 25.00	902-P1... 4.75
2X2A... 1.25	5R4GY... 1.00	271A... 7.25	GL-451... 3.00	728DY... 25.00	918... 1.25
3AP1... 6.00	6C21... 18.25	272A... 5.25	464A... 6.00	728EY... 25.00	927... 1.00
3BP1... 3.75	6CF... 12.75	274B... 2.25	WL-530... 12.75	728GY... 25.00	931A... 3.75
3B24... 3.75	C6L... 9.00	276A... 7.50	575A... 10.50	730A... 18.75	CK-1006... 2.75
3B26... 2.75	7BP7... 4.50	282A... 10.25	700A... 12.50	803... 3.00	1622... 1.50
3C23... 8.75	9LP7... 2.25	286A... 6.00	700D... 12.50	805... 2.25	1624... 1.00
3C24... 1.25	12DP7... 10.75	304B... 5.75	701A... 4.50	807... 1.25	2050... 1.00
3C31... 2.50	12GP7... 13.50	304TH... 6.00	702A... 2.00	808... 2.00	8012... 2.00
3D21... 2.25	RX-21... 2.75	304TL... 5.00	703A... 3.50	810... 7.50	8013... 2.00
3DP1... 3.00	RK-60... 1.50	307A... 3.25	705A... 1.25	811... 2.25	8025... 3.50

- Receiving tube quotations upon request
- Usual terms apply

## western engineers

ELK GROVE, CALIFORNIA

GEORGE WHITING, OWNER

- Unconditional guarantee extended
- Subject to prior disposition

### WANTED

ARC-1, 3, ART-13, BC-342, 348, APS-10, 15, TS-13, 35, 146, 147, 148, 174, 175, 263 ETC. ALL SCR, BC, AN, TS. ALL TUBES.

## RADALAB

1964 Webster Ave., Bronx 57, N. Y.  
TEL: WE 3-3232-3

**TERMS**—Minimum order \$25.00 all prices FOB New York City. 25% deposit with order, balance COD. Rated firms open account. Prices subject to change without notice.

### RADAR

#### APS-15A&B

Complete sets available checked out.

#### APS-3

Complete sets avail. checked out..\$1050.00

#### APS-4

Complete sets avail. checked out..\$1050.00

#### APN-2

Complete sets avail. checked out  
SCR729 also avail.

#### ASD

3CM search & nav. radar compl. sets avail.  
\$1000.00

APS-10 3cm lightweight navigational & search radar 5" PPI

UPN-4 3cm portable radar beacon

APR-1 38-1000mc receiver

APR-4 38-4000mc receiver

APR-5 1000-6000mc receiver

APT-5 300-1300mc Trans.

SCR-522 100-156mc Xmit-Rec.

SCR-555 18-65mc long range direction finder

SCR-536 Handi-Talkies

BC-312 and BC-342 1.5-1.8mc Receivers

Many other airbourne, ground and marine military equipment available. "WRITE"

### TUBES ALL FULLY GUARANTEED

OA2... \$89	845... 5.40
OB2... 95	866A... 1.40
1B24... 9.75	869EX... 52.50
1P21... 29.75	872A... 3.25
2C40... 9.25	884... 1.80
2C42... 8.50	931A... 5.25
2C43... 12.95	958A... .75
2J41... WRITE	959... 2.95
2K25... 30.00	1603... 5.15
2K28... 31.50	1623... 1.40
2K50... WRITE	5516... 5.25
3C45... 14.95	5643... 7.25
3D21A... 4.69	5651... 2.65
3DP1... 3.50	5654... 1.95
3DP1/S2... 5.95	5670... 4.00
3E29... 11.75	5672... 1.40
3J21... WRITE	5676... 3.30
5LP1... 14.75	5687... 3.95
6C21... 19.75	5691... 7.65
6J4... 5.90	5692... 7.65
100TH... 8.95	5693... 6.50
211... .96	5702... 2.95
250TH... 16.50	5703... 1.89
250TL... 16.50	5704... 2.40
304TH... 7.90	5718... 6.80
304TL... 7.90	5719... 3.65
307A... 6.25	5726... 1.69
703A... 3.95	5814... 2.75
705A... 1.85	5876... 16.50
707A... 7.95	6005... 4.35
707B... 15.95	8005... 6.40
715B... 9.25	8020... 1.10
715C... 19.75	8025... 4.75
721A... 2.80	9001... 1.40
723A/B... 18.75	9003... 1.50
725A... 7.40	FG17... 3.50
726A... 14.50	FG32... 11.75
803... 3.75	FG57... 17.50
805... 4.25	FG97... 22.50
807... 1.69	FG105... 17.50
811... 2.95	FG172... 35.00
813... 10.25	OA3/VR75... .97
814... 2.95	OB3/VR90... .89
815... 3.75	OC3/VR105... .95
829B... 11.75	OD3/VR150... .98
832... 7.95	WL676... 49.50
832A... 8.40	WL677... 45.00
833A... 3.90	

Complete stock of receiving tubes available

### TEST SETS

TS-3/AP S band power, freq. meter.	\$215.00
TS-13/AP 3 CM sig. gen. power meter, freq. meter 110 v. 60 cycle.	
TS-14/AP 10 CM sig. gen. power meter, freq. meter. 110v 60 cycle.	\$650.00
TS-34/AP portable synoscscope.	\$290.00
TS-35/AP 3 CM sig. gen. power meter, freq. meter 110v 60 cycle.	
TS-45/AP 3 CM sig. gen. and freq. meter.	
TS-61/AP 10 CM echo box.	
TS-62/AP 3 CM echo box.	
TS-125/AP 10 CM precision power meter.	
TS-148/UP 3CM spectrum analyzer.	
TS-226/AP 300-1000 MC power meter.	
I-100 radio compass test set.	
I-208 V.H.F. field radio test set.	
BC-221 freq. meter Mod.	\$175.00
Unmodulated	\$125.00
IE-19 100-156MC test set.	
IE-36 SCR 522 test set.	\$40.00
TSX-4SE spectrum analyzer.	

### SPECIAL

K-band 23,000, 24,000 MC RF heads using 2K50 klystrons and 3J21 packaged magnetron and magic TEE AFC mixer very late type. Also K-band complete dual-scanner antenna system. TS-259A/AP K-band sig. gen. power meter, freq. meter also available. Write

### X and K-band Wave Guide Components

Slotted lines, term., adapt., crys. mounts, etc. in stock. SEND YOUR REQUIREMENTS.

**WRITE FOR OUR CATALOGUES**



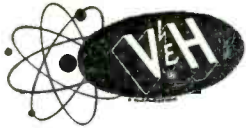

**CHECK AND COMPARE OUR COMPLETE STOCKS**

The following is just a partial list of the current electronic and aircraft equipment now in our warehouse. Write for complete information. Prompt replies to all inquiries.

**RC-103 & AN/ARN-5 ILS**

New in original cartons. Complete. Consists of all accessories, plus AS-27A, R89B/ARN-5 and BC-733D. Modified to flag alarm.

**TBS 4 & 5, NEW, COMPLETE IE-17 TEST SET**  
 AN/ARN-7 COMPLETE  
 SCR-269 COMPLETE  
 AN/ARC-1 VHF EQUIPMENT

**BC-611 & BC-721 HANDIE TALKIES, Plus SPARE PARTS.**  
 Quantity available.

**AN/ART-13 EQUIPMENT**  
 ATC XMTR T-47A/ART-13 XMTR  
 T-47/ART-13 XMTR CU-24 ANT. LOAD  
 CU-25 ANT. LOAD DY-11 & 12 Dynam't'r  
 MT-283 MOUNT 0-16 LFO  
 MT-284 MOUNT ATC DYNAM'T'R  
 SA-22 ANT. LOAD C-87 CONTROL BOX

**AN/APG-13A RADAR**  
 Absolutely complete, brand new

AN/APN-2	MG-153
SCR-729 New	APS-2, 3, & 15
TA2J-24	Components
RTA-1B	AN/ARC-5 VHF
BC-1016	SCR-274 & ARC-5
APA-6 INDICATOR	Command Equipm't
APA-11 INDICATOR	R-4/ARR-2 Receivers
APA-17 RADAR	BC-640 VHF XMTR
HS-33 HEAD SETS, NEW	SCR-510
MG-149F & H	SCR-522
	MG-153

**SPARE PARTS**

SCR-720	SCR-522
SO-7	AN/ARC-13
AN/ARN-7	AN/ARC-1
SCR-269	BC-611

**SCR-718 A, AM, B & C**  
 Altimeter equipment—complete

To insure the finest of service and quality of merchandise, we have just recently put into operation our own reconditioning and function-testing plant, complete with all facilities.

**WANTED**  
 ART-13 CFI UNITS ART-13 BC-788  
 1-152 BC-348 Q & R  
 TOP DOLLAR PAID

**EXPORT INQUIRIES INVITED**  
 We carry an unusually large stock of Airline Equipment, Test Equipment, Radar Sets, etc. Write for our low prices and complete information. We furnish immediate answers to all inquiries. Write today!

**V & H ELECTRONIC INDUSTRIES INC.**  
 2033 West Venice Blvd.—Dept. E-24  
 Los Angeles 6, California  
 Phone: REpublic 3-1127

Perhaps the smallest reversible  
**GEARED-MOTOR** in the world

Delco-PM-Permanent Magnet Alnico Field Motor #5971895 some with 11/16" gear, some with smooth 1/4" shaft. 250 RPM, 27 volts, 100 ma. Speed depending on the voltage. Designed to be used in bombsights, automatic pilots, etc. Cost at the factory \$26.10. Delivery 4 months. **\$17.50**  
 OUR PRICE, Immediate Delivery!!

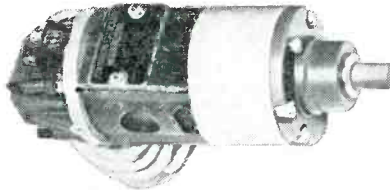

Packaging for parcel post costs money; it costs no more to pack two motors in the same box, so you can take advantage of our

**SPECIAL COMBINATION 1/2 Price OFFER**

1st motor... \$17.50, 2nd motor... \$8.75  
**2 MOTORS AT FRACTION OF FACTORY COST... \$26.25**  
 Also #5067127

Clamps to hold motor: \$1.50 ea.  
 Subject to prior sale

**GRAIN OF WHEAT LAMPS**



#322	3 V.	.19 amp
#328	6 V.	.2 amp.
<b>100 for \$25.00 10 for \$3.00</b>		



**MARKTIME 5 HOUR SWITCH**

A 10 amp. timing device. Pointer moves back to zero after time elapses. Ideal for shutting off radios and TV sets when you go to bed. Limited supply at this special PRICE... **\$4.90**

Also available in 15 min., 30 min., 1 hr. at \$5.90

**10 Seconds to 24 Minutes Timer**

A hand wound electric TIMING SWITCH. Pointer moves back to ZERO and shuts off RADIO—TV—Electric Mixer—Photographic Devices—Time Delay etc. Furnished with Calibration Chart and Pointer Knob. Biggest \$1.25 bargain we ever had...



3" Round Elapsed	\$12.50
Time Meter	.....
General Electric	.....\$15.50
Westinghouse Square	.....\$16.00



**REDMOND Powerful 5" Blower or Ventilator** 115 volts AC 60 cycles 18 watts. For Kitchen — Laboratory. Heat or Cold or Chemicals...\$7.50

A Miracle Switch that will not leave you in the Dark. Delayed Action Light Switch

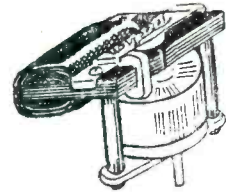

Genuine **TELECHRON Motors**

2 RPM....	\$2.90
3 RPM....	3.90
4 RPM....	3.90
3.6 RPM....	3.15
1 RPM....	3.95
60 RPM....	4.30

1800 RPM SYNCHRONOUS Motor; 115 volts AC, 18 watts 1 1/2 lbs.; 2"x3"x2".... **\$4.50**

Hand Cranked A.C. Generators { 2 bar. \$4.50  
 Removed from Ancient Telephones { 3 bar. \$5.50  
 5 bar. \$6.50

Polarized Bell or Buzzer Works on Magneto or 115 volt A.C. .... **\$1.50**  
 Complete 2 Station Magneto Ringer Telephones. Incl. Batteries—wire... **\$17.50**

ZENITH Motorized Remote control made for T.V. but ideal for opening doors—windows—Turntables—Gadgets—Tuning Radios. Complete with Transformer 16 ft. cable and reversing button. **\$8.95**  
 A few more left.....

<b>NE-2</b>	1/25 Watt NEON Pilot lamp. 10 for \$1.00, 100 for...	<b>\$7.50</b>
<b>NE-16</b>	1/4 Watt NEON lamp D.C. Bayonet Base. 10 for.....	<b>\$3.00</b>
<b>NE-21</b>	1/4 Watt NEON lamp S.C. Bayonet Base. 10 for.....	<b>\$2.50</b>
<b>NE-48</b>	1/4 Watt NEON lamp D.C. Bayonet Base. 10 for.....	<b>\$2.00</b>
<b>NE-30</b>	1 Watt NEON lamp Med. Screw Base. 10 for.....	<b>\$2.50</b>
<b>AR-1</b>	2 Watt ARGON lamp Med. Screw Base. 10 for.....	<b>\$3.00</b>
<b>NE-40</b>	3 Watt NEON lamp Med. Screw Base. 10 for.....	<b>\$3.50</b>
<b>#313</b>	28 volt .2 Amp. Pilot lamp Miniature Bay. Base. 10 for	<b>\$2.80</b>
<b>#1820</b>	28 volt .1 Amp. Pilot lamp Miniature Bay. Base. 10 for	<b>\$2.00</b>
<b>#49</b>	2 volt .06 Amp. Pilot lamp Min. Bayonet Base. 10 for	<b>\$1.00</b>
<b>1 3/4 volt</b>	Transformer made for #26 tube filament. Will light 30 of the above #49 lamps....	<b>\$1.50</b>
<b>#C1256</b>	.6 volt Automobile lamp D.C. but no pins to hold it in socket. 20 for.....	<b>\$1.00</b>
	Special—100 for.....	<b>\$3.50</b>
<b>#1800</b>	1.35 volt .06 Amp. Pilot lamp Miniature Screw Base 10 for	<b>\$1.00</b>
<b>#112</b>	1.1 volt Flashlight lamp single pen-lite Battery. 20 for	<b>\$1.00</b>

**HAYDON SYNCHRONOUS TIMING MOTOR**

110 v. 60 cycle 30 RPM...	<b>\$2.60</b>
110 v. 60 cycle 1/10 RPM...	<b>\$2.35</b>
110 v. 60 cycle 1 RPM...	<b>\$2.85</b>
220 v. 60 cycle 2 RPM....	<b>\$1.65</b>

New Sound Powered HAND SET TELEPHONES. 50' Flex. Rubber covered cable FREE. Pair ..... **\$19.00**

ALL PRICES F.O.B. N. Y.

EST. 1923 **BLAN** EST. 1923  
 64 Dey St. New York 7, N. Y.

**POWER TUBES REBUILT**

**UNIVERSAL VACUUM TUBE CORP.**  
 137 Alexander Ave., Yonkers 2, N. Y.

**X-RAY**

All types for industrial and experimental application. Tubes, cables and components.  
**MEDICAL SALVAGE CO., INC.**  
 217 E. 23rd St., New York 10, N. Y.  
 Murray Hill 4-4267

**AIRCRAFT ELECTRONICS**

ARC-1's, ART-13's, RTA 1B's, BC348's  
 AND COMPONENT PARTS FOR ABOVE

WRITE OR CALL FOR BULLETIN

**MERRICK ELECTRONICS**

166-08 DOUGLAS AVE.

JAMAICA, N. Y.

RE 9-5960

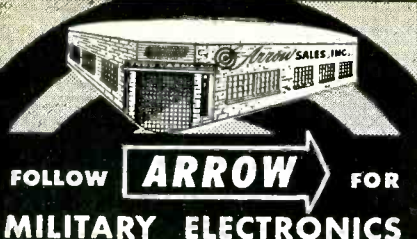

FOLLOW **ARROW** FOR  
**MILITARY ELECTRONICS**



**EE-99 PHONE AMPLIFIER** Booster amp. for voice frequency. Battery operated. Complete with 12 V. power supply. New. \$24.50

**Radar**

- APR-4 New. APT-1 APT-2 RC-1841FF
- Complete APT-3 RC-2141
- APR-5 " APT-4 RC-224 1
- APS-4 New. Mark 16 RC-266
- Complete MD4/AP2 RT34/APS13
- APS-6 New MD5/APS3 TS35/APT-5
- Complete MD22/UPN2 MD38/APQ13

**Test Equipment**

**Complete Line**

- DuMont 224-A Oscilloscope TS159
- 1-77 Hickok Tube Checker TS-159/TPX
- 1-208 FM Signal Generator RC-2170/ARN
- RPC Model 644 Multimeter TS-173/UR
- Hewlett Packard 200-C TS-174/UR
- 1-198 TS27/TSM TS-175/UR
- BC-638 TS32/UP TS182/UP
- BC-1255 TS34/AP1 TS184A/AP
- TS36/AP TS204/AP2
- 1E-36 TS-35/AP TS-218
- 1-95 TS36/AP TS-218
- 1-96-A TS-45/A TS251
- 1-122 APM-3 TS311A/UP
- 1-130A BC-59/APN TS123/UP
- 1-139 TS61/AP 1-146
- 1-145 TS62/AP TS-268/U
- 1-212 TS89 Boonton Mod.
- 1-222 TS92 78B, Sig. Gen.
- TS-3A/AP TS100/AP Boonton Type
- TS10A/APN TS-102 Sig. Gen.
- TS12/AP TS111/CP LAD Sig. Gen.
- TS16/APN TS126 LAE-2
- TS19/APQ TS127/U LVAOIE Freq.
- TS-23/APN TS131 Meter: 300-
- TS-24A TS-148/UP 600 Mc.
- TS-28/UPN
- HEWLETT-PACKARD #205

**RECEIVERS—TRANSMITTERS**

- ARC-1 PE-125AX RTA/1B
- RRC-3 R-9/APN-4 SCR-522
- R-4/ARR-2 BC-733-D TAJ-24
- ID-6/APN-4 R-57/ARN R-89/ARN
- MP-10G BC-738-A-AM-C R-1/ARR-1
- RC-640 BC-639 RM-25
- RM-26 SCR-284 SCR-536
- SCR-540 MN-26 Complete Installation
- Motorola Model Fstr-250

EE-99 phone amplifier

**EQUIPMENT WANTED**

To meet government and industrial orders we urgently need all types of new and used Test Equipment, Radar, Receivers, and Transmitters. WE PAY HIGHEST PRICES. Tell us what you have.



**FLUXMETER**  
Used to calibrate field strength of magnets from 500 to 4000 gauss and indicate polarity. Probe has gap of 1 1/4". Beautifully built in hardwood case with hinged cover. Instructions for operation on under side of cover. Size 1 1/2" x 9" x 6" in. for lab and school use. New. \$29.50  
An exceptional value at.....

**MANUALS!** We have up-to-date collection of Radar and Radio MAINTENANCE MANUALS. Write for complete list.

**GOVERNMENTS, AIRLINES AND INDUSTRIALS!**  
Send for FREE Catalogue No. 112 for complete list of Military, Industrial and Aviation Electronics. WE HAVE THE LARGEST INVENTORY OF SUCH EQUIPMENT IN THE UNITED STATES.

**ARROW SALES INC.**  
Mailing Address: P. O. BOX 3878-E, N. HOLLYWOOD, CALIF.  
Office-Warehouse: 7460 VARNA AVENUE, N. HOLLYWOOD, CALIF.  
POPlar 5-1810 • STANley 7-6005 • Cable Address: ARROWSALES

**SUMMER SPECIALS  
Oil Condensers**

**10 mfd.—600 v. . . . . \$ .98**  
Three term, bot. mtg. channel type. Dims. 3 3/4" x 2 1/2" x 2". Two 5 mfd. sections rated 400 V at 72 deg "C". 1800 V test. Meets commercial specs. for 600 V operation up to 40 degs "C". Ideal for filter or power factor application. Repeat sales prove this rugged high quality condenser to be of outstanding value. Carton of 24, weight 42 lbs. Large qua. available **\$ .89**

**8 mfd.—600 V . . . . . \$1.49**  
2" dia. x 4 1/2" H. Bkt.

**2 mfd.—600 V . . . . . \$ .85**  
3 S.T. Bathtub. Lots of 100 10% disc.

**.25 mfd.—600 V . . . . . \$ .53**  
Standard Brand OM-625

**4 mfd.—1000 V . . . . . \$1.75**

**16 mfd.—600 V . . . . . \$1.75**  
Dual 8 mfd. herm. sealed and packed. Type PT-SC-11 measuring 3 3/4" x 2 5/8" x 2 5/8". Stud. mtg. centers 2". Plugs into standard for prong socket. Quantity discount.

mfd	Volts	Price	mfd	Volts	Price
.005-.005			1	20KV	P.U.R.
.01	5000	2.95	1	25KV	82.00
.01	10KV	4.75	2	600V	59.79
.01	10KV	4.75	2	600V	TLAD.85
.012	25KV	22.50	2	1000V	.85
.02	20KV	17.90	2	1000V	TLA1.29
.025-.025			2	1500V	1.79
.03	50KV	55.00	2	2200V	2.80
.03	8000	3.95	2	2500V	3.95
.03	16KV	15.95	2	5000V	14.95
.05	5KV	2.98	2	4000V	8.95
.08	12.5KV	15.95	2	6000V	19.95
.1	1500V	.59	2	1500V	P.U.R.
.1	2000V	.49	2-2	600V	1.25
.1	3500V	1.39	3	600V	1.59
.1	3000V	1.89	3	4000V	P.U.R.
.1	7500V	1.75	3-3	150V	.35
.1	7500V	3.50	3-3	400V	1.05
.1	10KV	9.50	3-3	1000V	1.59
.1	10KV	12.95	4	600V	1.25
.1	12KV	14.95	4	1000V	1.95
.1	15KV	16.95	4	1800V	2.65
.1-1	7500V	3.50	4	2000V	4.85
.16-18	8000V	1.95	4	3000V	7.95
.2	10KV	10.95	4	4000V	P.U.R.
.2	16KV	17.95	4-4-4	800V	2.40
.25	2000V	1.35	5	330VAC	1.75
.25	3000V	2.05	5	600V	1.75
.25	6000V	1.75	5	1000	1.99
.25	18KV	15.95	5	1500V	2.95
.25	20KV	19.95	6	330VAC	1.75
.25	50KV	85.00	6	600V	1.85
.3	2000V	1.45	6	1000V	2.49
.3	10KV	14.95	6	1500V	3.65
.5	1500V	1.20	6	2000V	3.95
.5	2000V	1.85	7	800V	1.45
.5	2500V	2.20	7	800V	1.90
.5	3000V	2.39	7	1000V	2.49
.5	4000V	3.15	8	500V	1.35
.5-1	2000V	.90	8	600V	1.49-2.25
.5-5	600V	.69	8	600VAC	3.50
.5	25KV	55.50	8	1000V	4.45
1	400V	.45	8	1500V	4.65
1	500V	.59	8	2000V	7.25
1	1000V	1.69	8-8	600V	1.75
1	1500V	1.35	10	600V	2.75
1	2000V	1.95	10	1000V	4.55
1	2500V	2.50	10	1500V	6.25
1	3000V	3.50	10	6000V	P.U.R.
1	5000V	5.25	12	1000V	4.95
1	6000V	8.98	15	1000V	5.35
1	7000V	12.00	15	2000	9.25
1	10KV	P.U.R.	17	25V	.69
1	10KV	P.U.R.			

**— ALSO —**  
**BATHTUB & CHANNELS  
TUBULAR OILS  
MICAS—TRANS & REVG  
"J" POTS  
RHEOSTAT—25 WATT  
RELAYS  
TOGGLE SWITCHES  
MICRO SWITCHES**

**See Previous Issues**

**WANTED**  
Oil & Mica Condensers in any quantity.  
Also other Standard Components.  
Write: Art Hankins

**MONMOUTH  
RADIO LABS.**  
BOX 159 OAKHURST, N. J.  
Long Branch 6-5192



**ELECTRONIC  
EXPEDITERS**

SUPPLYING

**THE NEEDS OF INDUSTRY —  
GOVERNMENT — FOREIGN  
PURCHASING COMMISSIONS  
WITH  
COMMUNICATIONS  
EQUIPMENT, RECEIVING  
AND TRANSMITTING TUBES,  
AIRCRAFT ELECTRONICS—  
INSTRUMENTS—**

**IN STOCK—OIL BATHTUB CONDENSERS,  
OIL FILLED CAPACITORS, INSULATED  
CARBON RESISTORS, SIGNAL CORPS  
TRANSFORMERS, RADIO-TELEVISION COM-  
PONENTS.**

**PROMPT ATTENTION  
GIVEN TO ALL INQUIRIES**

Rated—Dun & Bradstreet

*Electronic Expeditors*

New Address—1217 W. Morse Ave.  
Chicago 26, Illinois • HOLLYCOURT 5-0820  
Cable Address: "ELEXPEDITE"

**An  
Investment !**

Productive advertising is an INVESTMENT rather than an EXPENDITURE.

"Searchlight" advertisers almost invariably report prompt and satisfactory results.

BE CONVINCED — send us your advertisement TODAY.

Address  
*Classified Advertising Division*  
**ELECTRONICS**  
330 W. 42nd St., N. Y. 36, N. Y.



## TELEPHONE RELAYS



Large Stock of  
CLARE, TYPES C D & E  
COOKE, AUTOMATIC—ELECTRIC  
ALL TYPES OF COILS and PILE-UPS

Send Us Your Specs. for Our Quote  
CLARE TYPE C STANDARD SIZE SENSITIVE TELEPHONE RELAYS

Coil	Contacts	Will Close at	Price
1) 6500 ohms	1A	4 MA	\$2.25 ea.
2) 6500 ohms	1C	2 MA	3.00 ea.
3) 6500 ohms	1B-1C	3.5 MA	2.75 ea.
4) 6500 ohms	2A	4 MA	3.00 ea.
5) 6500 ohms	3A	4 MA	3.00 ea.
6) 6500 ohms	3A-1B	4 MA	3.00 ea.
7) 6500 ohms	5A	5 MA	3.25 ea.

CLARE TYPE G HALF SIZE SENSITIVE TELEPHONE RELAYS

Coil	Contacts	Will Close at	Price
1) 6500 ohms	2A	5 MA	\$2.50 ea.
2) 5800 ohms	3A	4 MA	2.50 ea.
3) 5800 ohms	1B-1C	5 MA	2.50 ea.
4) 4850 ohms	1C	4 MA	2.50 ea.
5) 3600 ohms	1C	6 MA	2.00 ea.
6) 4850 ohms	1A	5 MA	2.00 ea.
7) 3300 ohms	(None)	ACTUATOR	1.50 ea.

All above Relays may be used for continuous duty operation on 110V. D.C.

OTHER TYPE G TELEPHONE RELAYS

1) 1300 ohms	1A-1C	24 or 48V.	\$2.50 ea.
2) 400 ohms	1A	12 or 24V.	1.65 ea.

CONTACT SYMBOLS

A=Norm. Open B=Norm. Closed C=S.P.D.T.

G.E. Relays #CR2791-B109P36 Coil—10,000 ohms Contacts 1A, 1B Operates on 8 MA. Price \$1.65  
Signal Wheelock Relays #KS9865 Coil—2,000 ohms Contacts 1A, 1B, 1C Oper. at 9 MA Price—2.75 ea.  
Leach Relays Type 1025-SN-BF. Coil—24V. 425 ohms. Contacts—D.P.S.T. Norm. closed. Rated at 10 Amps. Price—\$1.50 ea.  
Five Prong CR-2791 G.E. Plug In Relays.  
1) C-103C25 2200 ohms SPDT 4.5 MA. \$4.00 ea.  
2) C-104B28 700 ohms SPDT 6 MA. \$3.00 ea.

Slow Release (For SCR-522-A) Telephone Relays. Part #A18258, Signal #227650. Price \$2.00 ea.

Clare SK-5032 (Hermetically Sealed) Plug-In Relays. Coil—30 ohms 6 volts Contacts—DPDT. Price—\$4.00 ea.

Sigma Type 5F Sensitive Relays Coil Resistance—70 ohms each, contacts—S.P.D.T. Price \$3.00 ea.

TYPE H TRANSMITTING MICA CONDENSERS

1) .003 MFD	2500v.	DCW	\$4.5 ea.
2) .01 MFD	1200v.	DCW	.45 ea.
3) .001 MFD	1200v.	DCW	.35 ea.

# Chase

Electronic Supply Co.  
222 Fulton St.  
New York 7, N. Y.  
Digby 4-3088  
Hollis 4-5033

## INVERTERS:

5D21 NJ3A—27 VDC input; output 110 Volt 400 cycle, 1 Phase 485 VA. \$39.50  
PE-109D—Input 13.5 VDC 29 A; output 115 V 400 cycle, 1 Phase 1.53 Amps. \$59.50  
PU-7/AP—Input 28 VDC 160 A; output 115 V 21.6 A 400 cycle 2500 VA. \$89.50  
PE-116—Input 28 VDC 100 A; output 115 V 400 cycle, 1 Phase 1500 VA. Used: \$14.95  
PE-218—Input 28 VDC 100 A; output 115 Volt 400 cycle, 1 Phase 1500 VA. Used: \$24.95  
NEW: \$49.95  
PE-115 or PE-206—Input 28 VDC 36 A; output 80 Volts 800 cycle 7.2 Amps. Like New: \$12.95  
TYPE 800-1-D—Input 28 Volts 62 A; output 115 V 7 Amps, 1 Phase 800 cycle. Used: \$39.95  
NEW: \$69.95

## TRANSFORMERS AND CHOKES:

400 TO 2600 CYCLE

PLATE TRANSFORMER—Primary: 0-80-115 Volt 400-2600 CPS Max. VA 785; Sec: 2000-0-2000 3 Amps. Ins. 9000 Volts, Thermador #CS-5626 \$19.95

FILAMENT TRANSFORMERS:  
Primary: 0-80-115 Volt 400-2600 CPS Max. VA 35; Sec: 2.5 Volts 10 Amps. Ins. 5000 Volts. Thermador #CS-8751 \$6.95

Primary: 0-80-115 Volt 400-2600 CPS Max. VA 100; Sec: 5 Volts 15 Amps. Ins. 5000 Volts. Thermador #CS-8750 \$9.95  
FILTER REACTOR—Inductance 2 Hy. DC current. 0.3 Amp. Ins. 5000 Volts. \$6.95

## BLOWERS

115 Volt 60 cycle BLOWER (pictured), approx. 100 CFM Dis. 2 1/4" intake; 2" outlet. Quiet running. Motor size: 2 1/2"x3 1/4". NEW — not Gov't surplus. \$8.95



Order No. 1C939  
DUAL BLOWER—Same as RN-520 above, except has blower assembly in each side of motor. Order No. 1C880 \$13.95  
COMPACT TYPE—108 CFM. motor built inside squirrel case. 4-1/2" Intake: 3-3/4" x 3" Dis. Complete size: 4-1/4" W. x 9-3/8" H x 8-1/8" D. Order No. 2C067 \$14.50  
FLANGE TYPE—140 CFM. 3-1/2" Intake: 2-1/2" Dis. Complete size: 8-1/2" W x 7-1/2" H x 6-3/4" D. Order No. 1C807 \$13.95  
FLANGE TWIN—275 CFM. 4-1/2" Intake: 3-1/2" x 3" Dis. Complete size: 11-3/4" W x 9-3/8" H x 8-1/8" D. No. 2C069 \$21.95

## DYNAMOTORS:

PE-103 Dynamotor with Filter Base and Cables, 6 or 12 VDC input; output 500 VDC 160 MA. NEW: \$39.95 — Used: \$29.95  
DYNAMOTOR and BLOWER: 9 Volts DC Input; output 450 Volts 60 MA. 4500 RPM. At 6 Volts DC input: output 260 Volts 65 MA. 3000 RPM. \$4.95

ALSO—PE-73; PE-36; DM-63; DM-33; 5055; DM-416.

ADDRESS DEPT E • All Prices Are F.O.B., Lima, Ohio • 25% Deposit on C.O.D. Orders

# FAIR RADIO SALES • 132 SOUTH MAIN ST. LIMA, OHIO

## MOTORS:

24 VOLT DC 1/10 H P  
2800 RPM Reversible Motor, Size: 5-1/4" x 3-1/2". Shaft Size: 1" x 1/4". Emerson #180-0412 — Price \$5.95  
GEAR HEAD for above motor. Ball Bearing Gearing Shaft, 10 to 1 reduction. Price: \$5.95  
COMBINATION: Motor and Reduction Gear \$10.00



24 VAC OPEN FRAME—20 RPM Double Shaft Back Gear Motor with Disengage Clutch. Shaft size: 1-1/2" x 3/16". Price: \$6.95

24 VAC OPEN FRAME—3 RPM Back Gear Motor. Shaft size: 3/8" x 3/16". Price: \$5.95

24 VDC REVERSIBLE—5000 RPM with Magnetic Brake, Flange Mount, Spline Shaft—size: 5/8" x 3/16". Motor: 4" L. x 2-1/4" Dia. GE Motor only #5BA25AJ32A. Price: \$8.95

24 VDC AIRWAY MOTOR—Model #Z-350. Approx. 5000 RPM. Motor size: 2-1/2" x 1-1/2". Shaft size: 1/2" x 1/4". Price: \$4.95

26 VOLT 60 CYCLE—60 RPM Synchronous Cramer Motor #1147. Shaft size: 1" x 3/8". \$1.95

110 VOLT 1/70 HP 1550 RPM. Motor size: 4" x 2-1/2". Shaft size: 1" x 3/16". Redmond #157. \$4.95

6 VDC 1/20 HP. 4000 RPM. Motor size: 5" x 3". Shaft size: 3/4" x 1/4". Redmond #E-56. Price: \$4.95

12 VDC 1/30 HP. 4500 RPM. Motor size: 3" x 2-1/4". Shaft size: 1" x 3/16". Delco #5047520. \$4.95

## 24 VDC REVERSIBLE

MOTOR—3.7 RPM. 40 lb. Torque Motor. Size: 5-1/2" x 4-1/32" x 3-5/16". Shaft Size: 2 1/32" x 5/16". Also operates 24 VAC. Philco No. 441-1008 \$5.95

27.5 VDC—6000 RPM. 1.5 cy. in. Shaft Size: 1-1/8" x 1/4". Motor Size: 2-1/2" x 1-1/2". No. 5069-207 \$6.95

27VDC—1-10 HP—3500 RPM. Shaft Size: 5/8" x 1/4". Motor Size: 4" x 3-1/2", Air Assoc. No. EE-763 \$6.95

80 VDC—1/50 HP—3000 RPM. Shaft Size: 5/8" x 1/4". Motor Size: 5" x 3". G.E. No. 5 PN35HA10. \$6.95

28.5 VDC—1/35 HP—2200 RPM. Shaft Size: 1-1/2" x 3/4". Motor Size: 4-1/2" x 3-3/4". Electrolux No. 16876. \$5.95



## TRANSFORMERS—100V. 60 Cycle Pri.

5 VOLT CT-25A—10,000 V. Ins. OPEN FRAME—6" x 5" x 4-1/2". \$7.95

Sec. Two 12 V. 4 A. Windings—gives 12 V. 8 A. or 24 V. 4 A. \$5.95

Sec. 24 Volt 1/2 Amp. \$1.50

Sec. 24 Volt 1 Amp. \$1.95

Sec. 24 Volt 6 Amp. \$5.95

Sec. 6-24 or 30 Volts 8 Amp. \$5.95



## CARRIER EQUIPMENT

Western Electric CF-1A 4-channel carrier telephone terminals.  
EE-101-A 2-channel 1000/20 cycle carrier ringers.  
CF-D-B 4-channel carrier pilot regulated telephone terminals complete with four channels 1000/20 cycle ringing.  
CF-D-B 4-channel pilot regulated telephone repeaters.  
C-42-A V. F. telegraph in from 2- to 12-channel terminals.  
FMC 1 of 2 channels carrier telephone terminals, automatic regulation, duplex signaling, each channel. Carrier frequencies above 35 KC. Ideal for adding channels above type "C". Complete engineering and installation services offered.

RAILWAY COMMUNICATIONS, INC.  
Raytown, Missouri  
Telephone: FLeming 2121

## SOLA CONSTANT VOLTAGE TRANSFORMERS

250 VA	30.00
95-125/115 V	
500 VA	50.00
95-125/115 V	

### western engineers

ELK GROVE, CALIFORNIA

## RELAY SPECIALISTS

AUTHORIZED FACTORY DISTRIBUTORS  
STRUTHMANN • DUNN • POTTER & BRUMFIELD

WE CARRY A COMPLETE LINE OF ACRO COIN & SNAP SWITCHES

Guardian Relays... Type #110, 110v. 60 cycles 1A and 2B. \$1.95; 3A and 1C. \$2.50; 2A and 2C. \$2.50

Allied Control Relay—80 635—DPDT—24v. DC coil. \$1.95

SIGMA SENSITIVE RELAYS

Type 4A—Plug in—2000 ohm coil. \$3.95

Type 4F—8000 ohm coil. \$6.86

Type SR—Plug in—Dual 100 ohm coil. \$4.95

Type SRJ Hermet. sealed—7500 ohm coil. \$5.99

Type SRLP Dust cover—Dual 70 ohm coil. \$4.95

ARC 3 RELAYS

Colonial Electric #55340 and #55342. \$1.95

W. E. Single 1000 ohm coil operates on 6v. DC—S.P.D.T. contacts. \$2.95

ADVANCE RELAYS AND GUARDIAN STEPPERS & SOLENOIDS ALWAYS IN STOCK

RADIO DEVELOPMENT & SALES CO.  
323 ATLANTIC AVE. • ULSTER 5-0488 • BKLYN 1, N.Y.

## 4PDT RELAY

26.5 vdc midget, coil 280, or 425 ohm. \$2.95  
RELAY 3PDT 24 vdc 250 ohm Clare Type K. 2.75  
RELAY 4PDT 12 vdc 70 ohm midget. 1.75  
RACK CONNECTOR 15 pin Amphenol #26-151 69c  
5 BAND CONVERTER Navy CC-46ABW 10 cm. 99.50  
ISOLATION XFORMER 35 watts 115v prim., sec. 115v or 135v & 6.3. 45A tap 2 1/4" x 2 1/2" x 3". 2.45  
SELBYN—17S 115/90 v 400 cycles. \$1.95  
BLOWER MOTOR 400-1800 cyc 115v EAD J31C.995  
SILVER TRIMMER Erie TS2A 1.5-7 7-45. .36c  
LINK mobile xmts #25CFM 30-40 MC. \$9.50  
SUBMINIATURE tube socket 5 pin. 100 for 10.00  
CHOKER 4H 70 ma. .69c 2H 70 ma 110 ohm .39c  
VARIABLE 3-15 mmf Hammar. HF 1 1/2" shift. 69c  
PL-144. SO-124. PL-68. AN-3106-10s-2s. 89-1H  
BIRTCHEER CLAMPS 926A, 926B, 926C. . . . 25c  
FUSES: 3ag, mdl, mikes, switches j pots  
SPARES for: EC1298A. MK11 Radar. AN/ATP-2  
2% .002 Silver Mica CM30. Ask for flyer  
300-3500 cycle 1400 v variable freq. electronic generator. 220v 60 cy. input. CML #1400.

EMPIRE ELECTRONICS COMPANY

409 Avenue L, Brooklyn 30, N. Y. Cloverdale 2-2411

## CONNECTORS IS OUR BUSINESS

WORLD'S MOST COMPLETE STOCK

Types in stock: AF, AN, AP, ARC, BN, BNC, C, CLT, CN, CUF, D, DPB, DPD, E, F, FK, FM, FT, FW, GK, HN, IOH, IK, JJ, JK, LC, LF, LK, LN, M, MC, N, NK, P, RJ, PL, PM, PYE, RF, RNK, RKG, RNK, RCT, RWK, S, SF, SK, SKL, SO, U, UG, UHF, WK, XL, ZA.

HAROLD H. POWELL CO.

2104 Market St. LOcust 7-5285  
Philadelphia 3, Pa.

## "SEARCHLIGHT" IS

Opportunity Advertising  
—to help you get what you want.  
—to help you sell what you no longer need.

Take Advantage Of It

For Every Business Want

"THINK SEARCHLIGHT FIRST"

### SEARCHLIGHT SECTION

#### HEAVY DUTY TRANSFORMERS



#1221.—1.8 KVA. Input 120 volts 60 cycle. Output: 12.0, 14.5, 16.0, 17.0, 17.2, 17.8, 18.0 volts at 100 amps. Pri. leads 28" long. Sec. leads 17" long. Size 7x7x7". Wt. 28½ lbs. Price Brand NEW .....\$23.50

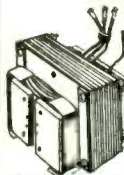

GENERAL ELECTRIC.— #79G907. 2 KVA Intermit-tent duty. Input: 100/110/120 volts 60 cycle. Output: 0.8 (eight-tenths) volt at 2,500 amps. Can be used for quick-heat applications, spot welders, testing, etc. Size 5½ x 6¾ x 5". Wt. 27 lbs. Price NEW .....\$14.50

#### SLIP RING ASSEMBLY



Emerson Electric—Part ET35300 (shown with and without housing). Used to transfer volt-ages between stationary and moving parts as in turrets or revolving dis-plays. Full 360° rota-tion up to 15 RPM. Rating 12 conductors—ten 10 amp and two 100 amp at 28 VDC. Adaptable to higher voltages. Also has swivel plumbing designed to transfer oxygen at 15 P.S.I. Size 9x6x10". Wt. 10 lbs. Price complete NEW .....\$8.50

#### DC MOTOR SPECIALS



EMERSON ELECTRIC—Type D44FZ-454-0417. 1 H.P. 5800 RPM. 27v-40a armature and 27v-2.5a field, reversible. Shaft extends 2¼" in front and ¾" in back. 24" leads. Size 4¼ x 4¼ x 10". Wt. 14 lb. Price NEW ONLY .....\$8.75



GENERAL ELECTRIC—½ H.P. #5BA50LJ2A-4000 RPM. 60v 8.3a armature and 27v-2.3a field, reversible. Wt. 9 lbs. Price NEW .....\$12.50

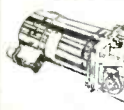

GENERAL ELECTRIC—DC motor #5BA50LJ22, ½ H.P. 4000 RPM. 60v 8.3a armature and 27v-2.9a field, reversible and has magnetic Brake. Gear Box #7925425G1, with two 380 RPM take-off. Thuro-ut type clutch actuated by lever on front top. Size 6x8x12". Wt. 14 lbs. Acquisition cost \$194.00. Our Price NEW .....\$12.95



SYNCHRO—DIFFERENTIAL.—Bendix #C78249. 115V 60 cycle. Used as a dampener between two C78248 Synchros. Easily converted to 3600 RPM motor (instructions included). Size 3-3/8x5-3/8". Price Brand New in original containers.....\$5.50

PROMPT DELIVERIES ON ALL ORDERS ALL MERCHANDISE FULLY GUARANTEED Terms: Prices FOB St. Louis. Cash or 25% with orders. Balance COD. Rated Concerns (D&B) Net 10 days cash. Prices subject to change without notice.

### McNEAL ELECTRIC & EQUIPMENT CO.

4736 Olive St. St. Louis 8, Mo.

## SPECIAL VALUES!

WRITE FOR PRICES

- |                        |   |
|------------------------|---|
| APS3 components        | TS19/AP05                                 |
| BC1306                 | EE8 Telephones                            |
| PE237                  | R-44/APR5                                 |
| BC433G                 | BC314                                     |
| TS251                  | BC342                                     |
| MG153                  | BC639 with RA52 Rectifier                 |
| TN16, TN17, TN18, TN19 | TS184/APS13                               |
| BC1033                 | SCR714 (BC1137)                           |
| APS13                  | Dynamotor DM28 (large quantity available) |
| ARN7                   | BC376                                     |
| SCR269F&G              | BC638                                     |
| SCR619                 | RA42                                      |
| TS 100/AP              | RTA1B                                     |
| TS159/TPX              | CRT3                                      |
| TS3                    | MP10                                      |
| TS10                   | MN26Y                                     |
| TS16                   | LP21LM                                    |
| TS19                   | TS69                                      |
| TS59                   | TS92                                      |
| APR2                   | BC1277                                    |
| ARP4 with tuning units | BC1287                                    |
| APR5                   | IE19A                                     |
| SCR625                 | MN26C                                     |
| SCR 508 crystal        |   |
| 300 ft.-RG 54U cable   |   |

large quantity available write for prices!

- PL166 PL171 MC277 PL169  
PL170 PL172 ART-13-U6U

Write for our new 1953 catalog!

Shipments FOB warehouse. 20% Deposit on orders. Minimum order \$5.00. Illinois residents, add regular sales tax to remit-tance. Prices subject to change without notice.

## R W ELECTRONICS

Dept. EL, 1712-14 S. Michigan Ave. Chicago 16, Ill. PHONE: HArrison 7-9374

### RADIO Surplus Buys

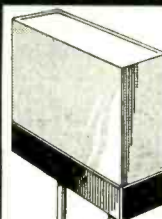

#### CRYSTALS

... in FT 241-A Holders—½" Pin SPC. Marked 54th OR 72nd Harmonic MC Freq. Listed below by fundamental frequency with fractions omitted.

500 KC Crystals ea. **\$1.95**  
1000 KC Crystals ea. **\$3.95**  
200 KC Crystals

370	407	444	476	509
372	408	445	477	511
374	409	446	479	512
375	411	447	480	513
376	412	448	481	514
377	413	450	483	515
379	414	451	484	516
380	415	452	485	518
381	416	453	486	519
383	418	454	487	520
384	419	455	488	522
385	420	456	490	523
386	422	457	491	525
387	423	458	492	526
388	424	459	493	527
390	425	461	494	529
391	426	462	495	530
392	427	463	496	531
393	429	464	497	533
394	430	465	498	534
395	431	466	501	536
396	433	468	502	537
397	434	469	503	538
398	435	470	504	540
400	436	472	505	
401	437	473	506	
402	438	474	507	
403	440	475	508	
404	441			
405	442			
406	443			

**\$100 EACH**

0 for \$8.00, Postpaid

#### FOLLOWING CRYSTALS AVAILABLE IN FT 243 HOLDERS ½" PIN SPACING

4165	5127.5	6875
4240	5205	6975
4280	5285	7350
4310	5435	7450
4330	5485	7750
4335	5587	7875
4350	5660	7950
4370	5730	8273.3
4440	5852.5	8350
4445	5875	8450
4540	6073.3	
4635	6140	
4710	6356	
4880	6525	
4980	6550	
4995	6700	
5035	6825	

**\$100 EACH**

11 for \$10.00, Postpaid

PLEASE ENCLOSE FULL AMOUNT WITH ORDER QUANTITIES AVAILABLE WRITE FOR YOUR REQUIREMENTS

### C & H SALES CO.

BOX 356-ME EAST PASADENA STA. • PASADENA 8, CALIF.

#### ATTENTION BUYING AGENTS

Limited quantity first quality RG11 cable. Pur-chase orders will be accepted as long as quantity lasts on full reel quantities at basic rate of \$70.00 per M foot. Reels average 500/1100 feet and will be billed accordingly. Also available, 100 foot rolls at \$10.00 per C. Prices F.O.B. Warehouse New York City. Rated firms net 10 days others 25% deposit balance C.O.D.

#### AMERICAN TRADAIR CORPORATION

405 Lexington Avenue New York, New York

### SHEET METAL MACHINERY

#### NEW & USED—COMPLETE LINE OF

Box Brakes, Press Brakes, Notchers, Shears, Punches, Rolls, Spot Welders—Di-Acro, Pexto, Whitney Equipment, etc.

B. D. BROOKS, INC. 310 Atlantic Ave. Boston, Mass. Tel. HAncock 6-5200

#### 10,000 SQUARE FEET OF ELECTRONIC COMPONENTS

#### IF IT'S A DEAL YOU WANT

WRITE • PHONE • WIRE

### RADIO CENTER

656 Smith St., Detroit, Mich. Trinity. 1-9447

#### Your Best Source For JAN Type Tubes

0B3/VR90	.95	9P7	7.50	9X5	3.75
0C3/VR105	.85	10T1	1.75	9X5	4.95
0D3/VR150	.85	10Y	.33	96A	1.10
1B22	2.25	F1G17	4.00	872A	3.25
1B26	2.25	RW50/1841	1.75	876	.70
1P23	4.00	RK72	.85	88A	1.50
2C21	.35	100TH	6.75	918	1.50
2C26	.25	VU111	1.00	931A	3.95
2C39A	19.75	120A W.E.	5.00	954	.35
2C40	7.25	121A W.E.	2.50	955	.35
2C42	17.50	F123A	7.00	957	.35
2C46	15.00	F127A	15.00	958A	.55
2C51	5.25	211/VT4C	.49	1003	.75
2D21W	2.25	231B	2.00	1005	.50
2E22	1.75	250TH	20.00	1006	3.00
2E24	1.65	304YL Eimac	6.75	1007	.85
2E30	3.75	307A	3.25	1013	.80
2J22	6.75	309A	5.00	1016	.85
2J26	1.75	310A W.E.	5.00	1019	.80
2J31	22.50	312A	6.00	1024	1.25
2J32	22.50	313C	3.00	1025	.30
2J34	22.50	327A Eimac	3.95	1026	.30
2J38	22.50	318E	1.50	1029	1.00
2K22	50.00	394A	3.00	1041	1.75
2K24	35.00	417A	7.00	1044	.50
2K27	27.50	471A	2.00	1051	.75
2X2/879	.45	507AX	1.25	5070	3.25
3AP1	5.00	559	2.50	5726	1.75
3B76	3.50	W1681/685	32.50	7183	.40
3BP1	4.00	705A	1.50	8011	.85
3C24/24G	1.75	707A	7.00	8013A	4.00
3C31/C1B	3.00	715A	4.50	8020	1.25
3DP1	3.50	715E	7.50	9001	1.00
3DP1A	5.00	715C	15.00	9002	.80
3E29	12.50	717A	1.50	9003	1.25
3GP1	3.50	721A	1.75	9004	.25
3CZ2	40.00	801A/VT62	.92	9006	.25
5N1P1	4.00	813	9.25	Castal Diodes	
6CJ1	5.75	814	2.25	1N21	1.00
6G2	18.00	829B	9.25	1N23A	2.50
6G7	5.00	843	1.20	1N23B	1.75
7BP7	5.00	843	.50	1N26	6.75

#### ALLIED ELECTRONICS SALES

Write For Our Special Prices on Receiving Type Tubes and others not listed. Rated Firms send P.O. F.O.B. N.Y.C. 74 Cortlandt St., New York 7, N. Y. Telephone BRa clay 7-5839, 5840

### TELEPHONE EQUIPMENT & PARTS

- New TS9 handsets .....ea. \$7.00  
New TS13 & TS15 handsets .....ea. \$10.50  
EE8 telephones tested .....ea. \$19.50  
New Receiver and transmitters for TS9 .....ea. \$1.00
- Dials W.E. 4H .....ea. \$2.50  
Batteries New BA70-taps 4 ½V-60V-90V .....ea. \$5.00  
Battery BA40 Taps 1.5-90 Volts .....ea. \$3.00  
Battery BA 205/U, Tap 30 Volts .....ea. \$3.00  
Batteries BA 39 Taps 7.5 & 150 Volts .....ea. \$5.00  
Batteries BA 206/U Taps 9 Volts .....ea. \$2.00  
Desk telephones tested (For extensions, intercom, etc.) .....ea. \$2.95  
Linemans Safety belts .....ea. \$5.00  
Terms: Check with order F.O.B. Brooklyn 5, N. Y.

**EASTERN TELEPHONE COMPANY**  
323 VANDERBILT AVENUE  
BROOKLYN 5, N. Y. MA 2-3753

We have one of the largest stocks of special purpose tubes in the United States for immediate shipment. We sell tubes only and consequently each order receives individual attention from tube specialists. We sell only new tubes, standard brands, either JAN or commercial specifications depending on stocks on hand.

OA2	.98	304	.59	231A	4.95	830B	2.60
OA3/VR75	1.04	4AP10	3.95	350B	5.95	832A	4.50
OB2	1.25	4B25	2.95	353A	4.25	836	4.95
OB3/VR90	1.05	4J42/700A	24.50	357A	14.95	837	1.95
OC3/VR105	.99	5AP1	3.49	371B	1.95	841	.59
OD3/VR150	.85	5C30/C5B	3.75	388A	1.49	843	.39
1B22	2.25	5FP7	1.95	394A	4.75	860	3.75
1B26	2.25	5G5	3.75	WL417A	14.95	861	14.75
1B27	13.95	5R4GY	1.49	480TH	48.95	864	.75
1B29	2.45	6C6	5.75	530	16.95	865	1.25
1B32	3.50	6AK5	5.79	531	16.75	866A	1.49
1B36	6.95	6B8	.85	532A	3.50	869BX	49.50
1B56	34.50	7BP5	14.95	533	16.95	872A	3.95
EL1C	2.49	7C4	.59	559	1.00	874	1.19
1D8GT	.59	7E5/1201	.59	H1615	.39	876	.35
1L4	.59	10Y	.75	700A	22.50	879	.49
1N21B	2.75	12A6	.59	701A	4.50	931A	4.95
1N23A	2.50	24G	1.39	702A	2.49	954	.35
1N23B	3.50	30Spec.	.69	703A	4.75	955	.55
1N34A	1.19	RK34	.59	704A	.89	956	.69
1N38A	1.19	35TE1vac	2.75	705A	1.49	957	.35
1N54A	1.19	45Spec.	.33	706A-Y-DY	39.50	958A	6.95
1N58A	1.19	VT52	.19	706EY-GY	39.50	E1148	.33
1R4/1294	.89	VT62	2.75	707A	7.49	EF50	1.09
1T4	.69	FG81A	3.49	708A	3.75	CK1005	.75
2C21/1642	.59	RK72	1.25	710/8011	.89	1291	.59
2C22/7193	.30	RK73	1.25	713A	.95	1294	.89
2C26	.19	RK75	5.75	714AY	9.95	1299	.39
2C26A	.45	REL5	16.95	715A	6.95	1608	3.95
2C34/RK34	.59	VT90	.89	715B	14.95	1616	1.95
2C40	8.95	VT98	16.95	715C	22.50	1619	.75
2C43	14.95	100TH	7.75	717A	1.25	1625	.40
2C44	1.15	VU111	.95	718BY	39.95	1626	.40
2J21	16.95	HY114B	.95	721A	2.95	1629	.39
2J22	16.95	VT127	1.75	722A	2.95	1636	2.95
2J26	14.95	VT127A	2.95	723AB	24.50	1642	.59
2J27	14.95	F128A	89.50	724B	2.50	2051	.89
2J39	9.95	205B	1.49	725A	8.95	7193	.39
2J40	29.95	211RCA	1.75	800	1.75	8011	.59
2J61	39.95	211(VT4C)RCA	1.75	801A	1.75	8012	3.95
2J62	39.95	217C	6.95	803	4.95	8013A	3.95
2K25	27.50	250TH	18.75	805	3.90	8020	2.95
2V3G	.89	250TL	16.95	807	1.65	8021	2.95
2X2	.55	285A	8.95	808	2.50	9001	1.50
3B7/1291	1.19	286A	5.75	811	2.90	9002	.95
3B22	2.99	304TH	9.95	812	2.70	9003	1.75
3C24/24G	1.39	304TL	9.95	813A	3.50	9004	.33
3C28	4.95	307A	5.75	813	11.95	9005	1.90
3CP1/S1	1.49	316A	1.25	814	3.75	9006	.25
3D6/1299	.39	328A	4.95	815	3.25	6 Amp Tungar Bulbs	2.95
3E29	14.95	329A	7.95	826	1.75		
3FP7	1.95						

**MARITIME INTERNATIONAL COMPANY**

11 STATE STREET  
Phone: DIgby 4-3192

NEW YORK 4, N. Y.  
Cable Address: FOXCROFT

**NOW! CUT COSTS! INCREASE PROFITS!**

Save on POTS • TUBES • RESISTORS

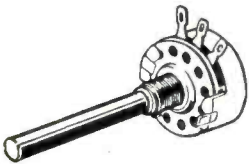

Carbon Potentiometers  
TYPE JU—RATED AT  
2 WATTS Shafts up to  
2" long

1 to 5.....1.10  
6 to 11.....1.05  
12 to 24.....1.00

25  
and  
over } **.95**

1B22	2.00
1B24	9.50
2C39A	27.00
2C43	17.95
2C51	5.75
2D21	1.35
3Q4	.75
3S4	.75
6FP7	2.49
6AK5	.65
6AK6	.79
6AL5	.60
6AR5	.75
6AS7G	4.25
6J5W	3.50
6SG7W	3.75
6S7J	.75
6V6GT	1.75
725A	5.98
18Y	1.25
24G	1.39
100TH	7.95
304TH	9.95
394A	5.75
801A	.35
954	.25
955	.38
956	.38
957A	1.98
9670	5.25
9687	5.25
9702	4.00
9704	2.40
9705	1.50
9728	2.10
9743	3.98
9763	1.50
9787	4.50
9829	2.25
9813	2.50
9006	1.25
9006C	4.50
9006E	.38
9006F	.38
ELC4J	7.50
ELC6C	13.95

Type EB—½ WATT  
Type GB—1 WATT  
Type HB—2 WATTS

Insulated  
Carbon  
Resistors.  
Standard  
R.M.A. Values.  
10 ohms to  
22 megohms.  
Money Back  
Guarantee!  
Immediate  
Delivery!

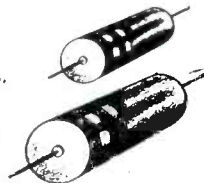

Type	Watt.	Tol.	100 to 499	500 to 999	1000 and over
EB	½	5%	.08	.075	.07
		10%	.04	.037	.035
GB	1	5%	.14	.12	.11
		10%	.07	.06	.055
HB	2	5%	.18	.16	.16
		10%	.09	.08	.08

TREMENDOUS STOCK  
LOWEST PRICES  
IMMEDIATE DELIVERY

Write for  
FREE color code sheet

**R**esisco Corporation  
SERVING THE WORLD OF ELECTRONICS  
366 Broadway, N.Y.C. 13. RE 2-0284

**24 HOUR DELIVERY FROM STOCK!**

# RELAYS

Our stock of more than a million relays — in over a thousand different types — is the world's largest. Don't delay your production for want of large or small quantities of relays of any type.

Telephone, wire or write for quotations.

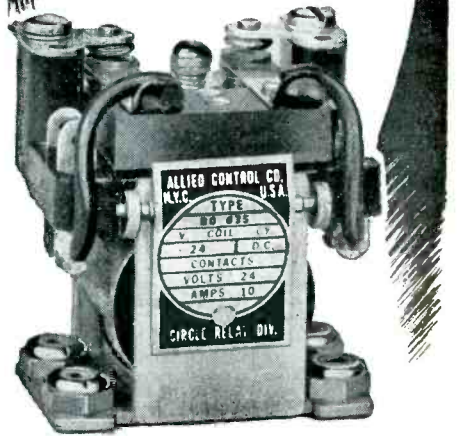

NEW AND MORE  
COMPREHENSIVE

**1953 RELAY SALES CATALOG**  
NOW READY

Be sure to send for your copy



**Relay Sales**

Telephone  
SEeley 8-4146

833 W. CHICAGO AVE.  
DEPT. CHICAGO 22, ILL.



# Electronics, INC. 92 Broad Street, Babson Park 57, Mass. — Wellesley 5-5210-1

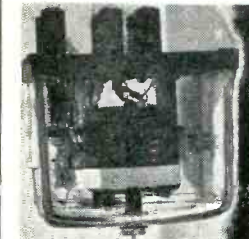

**TIME DELAY RELAY—WESTINGHOUSE:**  
Type TD 115 volts 60 cycles  
single pole adjustable 0-90  
secs. \$19.75



**K BAND CAVITY — TKF-75W:**  
calibrated  
Gear Tuning, 24500 MCs.  
range 23600—24500 MCs.  
Panel mounting \$47.50

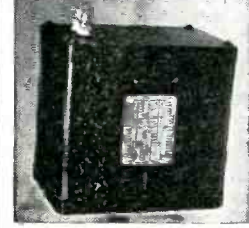

**FILTER REACTOR—AMERICAN TRANSFORMERS:**  
Type FR 500 VOLT TYPE FB  
5 henries @ 300 m. to 25  
KDC. Resistance 65 ohms  
5 henries @ 30 m. to 25  
henries @ 30 m. Size:  
5/8" x 4/8" x 5-3/8" \$8.50

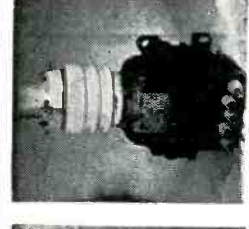

**FILAMENT TRANSFORMER—AMERICAN TRANSFORMERS:**  
Type FT 500 VOLT TYPE FB  
KDC. Resistance 65 ohms  
5 henries @ 30 m. to 25  
henries @ 30 m. Size:  
socket #23-210. Height 1 1/2"  
\$14.95



**HIPASS FILTER: over 1000 MCS. Type "N" coils:**  
\$12.50



**REDMOND BLOWER MOTOR: 3/4" fan 5 1/2" length 115 volts 60 cycles 140 CFM 1600 RPM \$0.50**

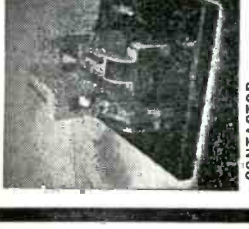

**CONTACTOR—HEAVY DUTY: G.E. #2249960-G186: 40 amps, 230 volts, 60 cycles, single pole. Base mounting centers 6/8" x 7/8" \$9.95**

**PULSE TRANSFORMERS**

Model	Rating	Price
UTAH: 9286	150 WATTS	1.10
9287	150 WATTS	1.10
9288	150 WATTS	1.10
9289	150 WATTS	1.10
9290	150 WATTS	1.10
9291	150 WATTS	1.10
9292	150 WATTS	1.10
9293	150 WATTS	1.10
9294	150 WATTS	1.10
9295	150 WATTS	1.10
9296	150 WATTS	1.10
9297	150 WATTS	1.10
9298	150 WATTS	1.10
9299	150 WATTS	1.10
9300	150 WATTS	1.10
9301	150 WATTS	1.10
9302	150 WATTS	1.10
9303	150 WATTS	1.10
9304	150 WATTS	1.10
9305	150 WATTS	1.10
9306	150 WATTS	1.10
9307	150 WATTS	1.10
9308	150 WATTS	1.10
9309	150 WATTS	1.10
9310	150 WATTS	1.10
9311	150 WATTS	1.10
9312	150 WATTS	1.10
9313	150 WATTS	1.10
9314	150 WATTS	1.10
9315	150 WATTS	1.10
9316	150 WATTS	1.10
9317	150 WATTS	1.10
9318	150 WATTS	1.10
9319	150 WATTS	1.10
9320	150 WATTS	1.10
9321	150 WATTS	1.10
9322	150 WATTS	1.10
9323	150 WATTS	1.10
9324	150 WATTS	1.10
9325	150 WATTS	1.10
9326	150 WATTS	1.10
9327	150 WATTS	1.10
9328	150 WATTS	1.10
9329	150 WATTS	1.10
9330	150 WATTS	1.10
9331	150 WATTS	1.10
9332	150 WATTS	1.10
9333	150 WATTS	1.10
9334	150 WATTS	1.10
9335	150 WATTS	1.10
9336	150 WATTS	1.10
9337	150 WATTS	1.10
9338	150 WATTS	1.10
9339	150 WATTS	1.10
9340	150 WATTS	1.10
9341	150 WATTS	1.10
9342	150 WATTS	1.10
9343	150 WATTS	1.10
9344	150 WATTS	1.10
9345	150 WATTS	1.10
9346	150 WATTS	1.10
9347	150 WATTS	1.10
9348	150 WATTS	1.10
9349	150 WATTS	1.10
9350	150 WATTS	1.10
9351	150 WATTS	1.10
9352	150 WATTS	1.10
9353	150 WATTS	1.10
9354	150 WATTS	1.10
9355	150 WATTS	1.10
9356	150 WATTS	1.10
9357	150 WATTS	1.10
9358	150 WATTS	1.10
9359	150 WATTS	1.10
9360	150 WATTS	1.10
9361	150 WATTS	1.10
9362	150 WATTS	1.10
9363	150 WATTS	1.10
9364	150 WATTS	1.10
9365	150 WATTS	1.10
9366	150 WATTS	1.10
9367	150 WATTS	1.10
9368	150 WATTS	1.10
9369	150 WATTS	1.10
9370	150 WATTS	1.10
9371	150 WATTS	1.10
9372	150 WATTS	1.10
9373	150 WATTS	1.10
9374	150 WATTS	1.10
9375	150 WATTS	1.10
9376	150 WATTS	1.10
9377	150 WATTS	1.10
9378	150 WATTS	1.10
9379	150 WATTS	1.10
9380	150 WATTS	1.10
9381	150 WATTS	1.10
9382	150 WATTS	1.10
9383	150 WATTS	1.10
9384	150 WATTS	1.10
9385	150 WATTS	1.10
9386	150 WATTS	1.10
9387	150 WATTS	1.10
9388	150 WATTS	1.10
9389	150 WATTS	1.10
9390	150 WATTS	1.10
9391	150 WATTS	1.10
9392	150 WATTS	1.10
9393	150 WATTS	1.10
9394	150 WATTS	1.10
9395	150 WATTS	1.10
9396	150 WATTS	1.10
9397	150 WATTS	1.10
9398	150 WATTS	1.10
9399	150 WATTS	1.10
9400	150 WATTS	1.10
9401	150 WATTS	1.10
9402	150 WATTS	1.10
9403	150 WATTS	1.10
9404	150 WATTS	1.10
9405	150 WATTS	1.10
9406	150 WATTS	1.10
9407	150 WATTS	1.10
9408	150 WATTS	1.10
9409	150 WATTS	1.10
9410	150 WATTS	1.10
9411	150 WATTS	1.10
9412	150 WATTS	1.10
9413	150 WATTS	1.10
9414	150 WATTS	1.10
9415	150 WATTS	1.10
9416	150 WATTS	1.10
9417	150 WATTS	1.10
9418	150 WATTS	1.10
9419	150 WATTS	1.10
9420	150 WATTS	1.10
9421	150 WATTS	1.10
9422	150 WATTS	1.10
9423	150 WATTS	1.10
9424	150 WATTS	1.10
9425	150 WATTS	1.10
9426	150 WATTS	1.10
9427	150 WATTS	1.10
9428	150 WATTS	1.10
9429	150 WATTS	1.10
9430	150 WATTS	1.10
9431	150 WATTS	1.10
9432	150 WATTS	1.10
9433	150 WATTS	1.10
9434	150 WATTS	1.10
9435	150 WATTS	1.10
9436	150 WATTS	1.10
9437	150 WATTS	1.10
9438	150 WATTS	1.10
9439	150 WATTS	1.10
9440	150 WATTS	1.10
9441	150 WATTS	1.10
9442	150 WATTS	1.10
9443	150 WATTS	1.10
9444	150 WATTS	1.10
9445	150 WATTS	1.10
9446	150 WATTS	1.10
9447	150 WATTS	1.10
9448	150 WATTS	1.10
9449	150 WATTS	1.10
9450	150 WATTS	1.10
9451	150 WATTS	1.10
9452	150 WATTS	1.10
9453	150 WATTS	1.10
9454	150 WATTS	1.10
9455	150 WATTS	1.10
9456	150 WATTS	1.10
9457	150 WATTS	1.10
9458	150 WATTS	1.10
9459	150 WATTS	1.10
9460	150 WATTS	1.10
9461	150 WATTS	1.10
9462	150 WATTS	1.10
9463	150 WATTS	1.10
9464	150 WATTS	1.10
9465	150 WATTS	1.10
9466	150 WATTS	1.10
9467	150 WATTS	1.10
9468	150 WATTS	1.10
9469	150 WATTS	1.10
9470	150 WATTS	1.10
9471	150 WATTS	1.10
9472	150 WATTS	1.10
9473	150 WATTS	1.10
9474	150 WATTS	1.10
9475	150 WATTS	1.10
9476	150 WATTS	1.10
9477	150 WATTS	1.10
9478	150 WATTS	1.10
9479	150 WATTS	1.10
9480	150 WATTS	1.10
9481	150 WATTS	1.10
9482	150 WATTS	1.10
9483	150 WATTS	1.10
9484	150 WATTS	1.10
9485	150 WATTS	1.10
9486	150 WATTS	1.10
9487	150 WATTS	1.10
9488	150 WATTS	1.10
9489	150 WATTS	1.10
9490	150 WATTS	1.10
9491	150 WATTS	1.10
9492	150 WATTS	1.10
9493	150 WATTS	1.10
9494	150 WATTS	1.10
9495	150 WATTS	1.10
9496	150 WATTS	1.10
9497	150 WATTS	1.10
9498	150 WATTS	1.10
9499	150 WATTS	1.10
9500	150 WATTS	1.10

**RESISTORS**

Model	Rating	Price
STANDARD BRANDS: 25 WATTS	25 WATTS	1.10
50 WATTS	50 WATTS	1.10
100 WATTS	100 WATTS	1.10
200 WATTS	200 WATTS	1.10
400 WATTS	400 WATTS	1.10
800 WATTS	800 WATTS	1.10
1600 WATTS	1600 WATTS	1.10
3200 WATTS	3200 WATTS	1.10
6400 WATTS	6400 WATTS	1.10
12800 WATTS	12800 WATTS	1.10
25600 WATTS	25600 WATTS	1.10
51200 WATTS	51200 WATTS	1.10
102400 WATTS	102400 WATTS	1.10
204800 WATTS	204800 WATTS	1.10
409600 WATTS	409600 WATTS	1.10
819200 WATTS	819200 WATTS	1.10
1638400 WATTS	1638400 WATTS	1.10
3276800 WATTS	3276800 WATTS	1.10
6553600 WATTS	6553600 WATTS	1.10
13107200 WATTS	13107200 WATTS	1.10
26214400 WATTS	26214400 WATTS	1.10
52428800 WATTS	52428800 WATTS	1.10
104857600 WATTS	104857600 WATTS	1.10
209715200 WATTS	209715200 WATTS	1.10
419430400 WATTS	419430400 WATTS	1.10
838860800 WATTS	838860800 WATTS	1.10
1677721600 WATTS	1677721600 WATTS	1.10
3355443200 WATTS	3355443200 WATTS	1.10
6710886400 WATTS	6710886400 WATTS	1.10
13421772800 WATTS	13421772800 WATTS	1.10
26843545600 WATTS	26843545600 WATTS	1.10
53687091200 WATTS	53687091200 WATTS	1.10
107374182400 WATTS	107374182400 WATTS	1.10
214748364800 WATTS	214748364800 WATTS	1.10
429496729600 WATTS	429496729600 WATTS	1.10
858993459200 WATTS	858993459200 WATTS	1.10
1717986918400 WATTS	1717986918400 WATTS	1.10
3435973836800 WATTS	3435973836800 WATTS	1.10
6871947673600 WATTS	6871947673600 WATTS	1.10
13743895347200 WATTS	13743895347200 WATTS	1.10
27487790694400 WATTS	27487790694400 WATTS	1.10
54975581388800 WATTS	54975581388800 WATTS	1.10
109951162777600 WATTS	109951162777600 WATTS	1.10
219902325555200 WATTS	219902325555200 WATTS	1.10
439804651110400 WATTS	439804651110400 WATTS	1.10
879609302220800 WATTS	879609302220800 WATTS	1.10
1759218644416000 WATTS	1759218644416000 WATTS	1.10
3518437288832000 WATTS	3518437288832000 WATTS	1.10
7036874577664000 WATTS	7036874577664000 WATTS	1.10
14073749155328		

**WHEN YOU ORDER  
WELLS  
COMPONENTS...**



**HERE'S WHAT  
YOU GET**

- 1 IMMEDIATE DELIVERY FROM STOCK  
(in any quantity)
- 2 FINEST QUALITY OF FAMOUS BRANDS
- 3 GENERALLY LOWER PRICES
- 4 RETURN PRIVILEGE FOR FULL CREDIT IF NOT SUITED TO YOUR REQUIREMENTS

The valuable service Wells provides to the industry is being used by many of our greatest manufacturers as a matter of course.

Our vast stock (the world's largest) may contain just the components you need to fill urgent orders — at a substantial savings in time and cost.

ADEL CLAMPS • ANTENNAS, Insulators, Mast Sections • BINDING POSTS • BLOWERS • CABLE ASSEMBLIES • CHOKES • COILS • CONDENSERS Oil Filled, Bathub, Hearing Aid; Transmitting Micah, Silver Micah, Ceramic, Variable, Trimmer • CRYSTALS • FILTERS • FUSES & MOUNTINGS • GENERATORS • GROUND RODS • HEADSETS • I.F. COILS • JACKS • JACK BOXES • KEYS, Telegraph KNOBS • LAMPS • LORD MOUNTS • LUGS MOTORS & BRUSHES • PLUGS • RECTIFIERS Selenium, Copper Oxide, Meter, Diode • RESISTORS—All Types • SELSYNS • SOCKETS • SWITCHES Aircraft, Micro, Switchettes, Toggle • TIMERS • TUBING—Flexible • TUNING SHAFTS • TRANSFORMERS All Types • VIBRATORS • WALKIE TALKIES

**DYNAMOTORS**



**OVER 100,000  
NEW DYNAMOTORS  
IN STOCK!**

DM 32A — DM 53A — PE 86 — PE 101C  
DM 33A — D 101 — PE 94, etc.  
Large quantities of brushes for all types of dynamotors and motors.

Write us for quotations. Advise us your requirements.

A complete Signal Corps stock number listing of items in our stock. Write for listing No. SG-200. (For government agencies and contractors only.)

Manufacturers and distributors—write for new Condenser Catalog C-10 now available.

Write, Wire, Phone Your Requirements  
all phones: **SEEley 8-4143**

**WELLS  
SALES, INC.**

833 W. CHICAGO AVE., DEPT. 5L, CHICAGO 22, ILL.

**INDEX TO THE  
SEARCHLIGHT ADVERTISERS**

JULY, 1953

This index is published as a convenience to the readers. Care is taken to make it accurate but ELECTRONICS assumes no responsibility for errors or omissions.

SEARCHLIGHT SECTION  
(Classified Advertising)  
H. E. Hilty, Mgr.

**EMPLOYMENT**

- Positions Vacant.....391-403
- Selling Opportunities Offered..... 391
- Positions Wanted..... 391
- Selling Opportunities Wanted..... 391
- Employment Services..... 391

**BUSINESS OPPORTUNITIES**

- Offered..... 391

**NOTICES**

- Auction..... 405

**EQUIPMENT**  
(Used or Surplus New)

- For Sale.....405-428

**WANTED**

- Equipment..... 424

**ADVERTISERS INDEX**

- Admiral Corporation..... 399
- Allied Electronics Sales..... 422
- Alltronics..... 418
- Amber Co..... 424
- American Tradair Corp..... 422
- Armour Research Foundation of Illinois Institute of Technology..... 391
- Arrow Appliance Co..... 424
- Arrow Sales Inc..... 420

- Barry Electronics Corp..... 416
- Bell Machine Co., The..... 424
- Bell Telephone Laboratories Inc..... 401
- Bendix Aviation Corp., York Division..... 397
- Bendix Radio, Div. of Bendix Avia. Corp. 400
- Plan..... 419
- Blonder-Tongue Laboratories Inc..... 398
- Brooks Co., Inc., B. D..... 422

- Capehart Farnsworth Corp..... 401
- Cardwell Manufacturing Corp., Allen D..... 402
- Central Commercial Industries..... 402
- Chase Electronic Supply Co..... 421
- C & H Sales Co..... 408, 422
- Communications Equipment Co..... 412, 413
- Convail..... 394

- Dorne & Margolin..... 403
- Douglas Aircraft Co., Inc..... 397

- Eastern Telephone Co..... 422, 424
- Electro Sales Co., Inc..... 427
- Electronic Engineering Co. of California..... 402
- Electronic Expeditors..... 420
- Electroncraft Inc..... 424
- Electronics Inc..... 425
- Empire Electronics Co..... 421
- Engineering Associates..... 418
- Exact Level & Tool Co..... 391

- Fair Radio Sales..... 421
- Federal Telecommunication Laboratories..... 396
- Finnegan, H..... 424
- Fitzsimmons, James L..... 391
- Friedman Auctioneers, Irwin..... 405

- General Motors Corp., A.C. Spark Plug Div..... 396
- General Precision Laboratory Inc..... 402
- Gibbs Manufacturing & Research Corp. 400, 402
- Goodyear Aircraft Corp..... 393

- Horman Laboratories Inc..... 403
- Houde Supply Co..... 424

- Instruments Associates..... 411

- J.S.H. Sales Co..... 418

- Kollsman Instrument Corp..... 398

- Lapirow Bros..... 424
- Leetronic Research Laboratories..... 406, 407
- Liberty Electronics Inc..... 414

- Magnavox Co., The..... 397
- Maritime International Co..... 423
- Maritime Switchboard Co..... 418
- Maxson Corp., W. L..... 399
- McDonnell Aircraft Corp..... 403
- McNeal Electric & Equipment Co..... 422
- Medical Salvage Co., Inc..... 419
- Melpar Inc..... 400
- Merrick Electronics..... 419
- Minneapolis Honeywell Regulator Co..... 392
- Mogull Co., Inc., Alexander..... 424
- Monmouth Radio Laboratories..... 420

- National Cash Register Co., The..... 398
- National Union Radio..... 394

- O'Del Electronics Corp..... 418
- O'Shea Employment System..... 391

- Phillips Petroleum Co..... 403
- Photocon Sales..... 424
- Powell Co. Harold..... 421

- Radalab..... 417
- Radio Center..... 422
- Radio Condenser Co..... 401
- Radio Corporation of America..... 395
- Radio Development & Sales Co..... 421
- Radio Engineering Co..... 391
- Radio Surplus Corp..... 404
- Radio & Electronics Surplus..... 418
- Railway Communications, Inc..... 421
- Reeves Instrument Corp..... 394
- Relay Sales..... 423
- Reliance Merchandizing Co..... 409
- Resisco Corporation..... 423
- R W Electronics..... 422

- Sandia Corp..... 392
- Servo Tek Products Co., Inc..... 410
- Solar Aircraft Co..... 400
- Southwestern Industrial Electronics Co..... 402
- Sperry Products Co..... 403
- Stavid Engineering Inc..... 396

- "TAB"..... 428

- Universal General Corp..... 415
- Universal Vacuum Tube Corp..... 419
- University of Arkansas..... 402

- Vectron, Inc..... 401
- V & H Radio & Electronics..... 419

- Wells Sales Inc..... 426
- Western Engineers..... 417, 421
- Weston Laboratories Inc..... 416
- Wilcox Electric Co., Inc..... 399

OUTSTANDING MID-YEAR SPECIALS

SELSYNS—SYNCHROS

Immediate Delivery Fully Guaranteed

Table listing various Selsyn and Synchro models and their prices, including items like 1CT Control Transformer, 2G Generator, etc.

Table listing various Selsyn and Synchro models and their prices, including items like 2J5F81 Control Transformer, 2J5G2 Motor, etc.

Table listing various Selsyn and Synchro models and their prices, including items like 6G Generator, 7G Generator, etc.

HIGH VOLTAGE CAPACITORS

Table listing high voltage capacitors with columns for Cat. #, Mfd., WVDC, and Price.

Small table listing capacitor models 14F126 and 14F97 with their values and prices.

SINE-COSINE GENERATORS

(Resolvers)

Diehl Type FJE43-9 (Simple Phase Rotor). Two stator windings 90° apart, provides two outputs equal to the sine and cosine of the angular rotor displacement.

TRANSTATS

Amertran type 29144, 250VA, 103-126V Commutator Range, Fixed Windings, 115V, 2.17A max.

PULSE NETWORKS

Table listing pulse networks with columns for model number, specifications, and price.

HEAVY DUTY COPPER OXIDE RECTIFIERS

Hammett Model SPS-130. Input AC: 208/230V, 60/50 Hz. Output DC: 130V @ 130A.

DIEHL AC CONTROL MOTORS

Table listing Diehl AC control motors with columns for model number, specifications, and price.

TRANSMITTING AND SPECIAL PURPOSE TUBES

Large table listing various transmitting and special purpose tubes with columns for tube number, specifications, and price.

The above listings represent only a small portion of our tremendous instrument stock. Allow us to quote you on your instrument or test equipment requirements. All prices F.O.B. Boston. Subject to change without notice. Merchandise Fully Guaranteed.

ELECTRO Sales Company, Inc. 50 EASTERN AVE., BOSTON 13, MASS. CAPITOL 7-3456

RM29 For Field Phone Use or Remote Control of 2-Wire 15 Mile Operation. Includes talk listen & NEW 3-Circuit. \$10.95

MICROWAVE Klystron (K3AB) & Coupling to 2 Type "N" Co-Ax Fittings. As Shown \$9.98. 2 to \$18.00

CONDENSER SPECIALS 2 MFD 330 VAC 1000 VDC 25¢ STD MFRG Lots of 10

METER BUYS 0-50MA DC Tuning: Aircraft P.M. "A" Type 1.49; 2.49

FEDERAL RECTIFIER KIT "Federal's" all purpose selenium rectifier kit you can make 24

SELENIUM RECTIFIERS We specialize in Rectifiers and Power supplies to your specifications. Immediate delivery.

DC POWER SUPPLY 0 to 150VDC/2 AMP variable D supply. Includes Lab supply, flat cut DC plate.

RECTIFIER CHOKES 4 amp .17 Ohm .5 Ohm \$7.95 12 Amp .01 Ohm 1 Ohm 14.95

BATTERY CHARGER RECTIFIER 10-100 Volts (CT) 100 Amp (Fan Cooled). Replaces Your Old Lead Acid Rectifier.

GENUINE SWEDISH CROSSCUT SAWS FIRST QUALITY

FL-5 FILTER Range or voice. Filters 1000 cycles down to 20 cps.

BANDPASS FILTER Sharp Cutoff HIQ, Cased & Shielded 60, 90, 180 cycles.

SELSYNS 21H1 GE Selsyns... Each \$6.95 21H3 GE Brand New 115V/400 cyc. 9.75

DYNAMOTORS INPT 6VDC, Output 200V/100ma, or 12V/250V

TABBY STORAGE BATTERIES 36 Volt WILLARD Mini-Brand NEW 5 or 6 Designed Portable Equip. Models... 4 for \$33

UHF ANTENNAS Microwave Antenna AS125/APR 1000 to 3400 MC W/UG8U Terminal.

POTENTIOMETERS - Type J 10 ohm Type J 1/2" shaft. 5.93 200 ohm Type J 1/2" Slotted shaft.

YOU PICK THEM 39¢ WHILE THEY LAST LOTS OF 10 LAST ELECTROLYTIC CONDENSERS

TUBES

Table listing various vacuum tubes with their part numbers and prices. Columns include tube types like 6A2, 6X4, 6X5, etc., and their corresponding prices.

CRYSTAL DIODES IN23B Sylvania \$1.98 Lots of 10 Smaller Quantity, Unit Price \$2.25

INFRARED SNOOPSCOPE SEE IN DARK TUBE HiSensitivity simplified design 2" dia. Willomite screen - Resolution up to 180 Lines/Inch.

KITS AND COMPONENTS Oil Condensers Assorted... 5 for \$1.25 Electrolytics Assorted... 5 for 1.25

AUDIO COMPONENTS Western Electric Push-Pull Pentode Output Transformer 197A. Rated 10 Watts for 6V's or 6A0's.

TRANSFORMERS All 115 V 60 Cyc Input TV & CR Pwr Xfmr up to 20' Tubes. Hi VOLTS 20 KV 1KV (Quadrapler)

FILTER CHOKES 12H/80ma/3KVins... 2.25 10H/75ma... 1.25 10H/125ma (UTC/Cad)... 1.49

"AN" CONNECTORS 70% OFF LIST AN-3102-105-2P 23c AN-3108-22-45 \$1.32

"TAB" TESTED & GUARANTEED PRICES SUBJECT TO CHANGE WRITE FOR COMPLETE TUBE LISTING

Table listing vacuum tubes with their part numbers and prices. Columns include tube types like 6A2, 6X4, 6X5, etc., and their corresponding prices.

Others in Stock, Write for Qty Price 866A KIT AND XFORMER

DIODE PROBE TUBE Unsolicited for No-Loss VHF testing. Ultra sensitive subminiature-type. 25c; 5 for \$3.

RELAY SPECIAL SP5C Mini Size 115VAC 3A CTD... 98c; 3 for \$2.75

CHROME VANADIUM SPEED DRILLS 29 Drills Chrome Vanadium Speed Steel.

WRITE FOR TOOL CATALOG

MICA CONDENSERS

Table listing mica condenser specifications. Columns include capacitance (e.g., .01, .02, .05), voltage (e.g., 600V, 1000V), and price.

ABOGRAM WE STOCK LARGE VARIETY OF COMPONENTS TO MEET YOUR NEEDS. WRITE FOR IT

THAT'S "TABBY" THAT'S A BUY A BUY PH. RECTOR 2-6245 Dept. 7E 111 Liberty Street, New York 6, N. Y., U. S. A.

Money Back Guarantee (Cost of Mds. Only) \$5 Min. Order FOB NYC. Add Shpg. Charges or 25% Dep. Tubes Gtd. via R-Exp. only. Prices Subject to Change Without Notice.



# INDEX TO ADVERTISERS

Acheson Colloids Co.....	23
Acme Electric Corporation.....	387
Advance Electric & Relay Co.....	273
Aeronautical Communications Equip- ment, Inc.....	356
Aerovox Corporation.....	87
A'G'A' Div. of Elastic Stop Nut Corpora- tion of America.....	353
Airpax Products Company.....	271
Alden Products Company.....	75
Alifax Paper & Engineering Co.....	369
Allen-Bradley Co.....	43
Allen Co., Inc., L. B.....	389
Allied Control Company, Inc.....	114, 115
Allied Industries, Inc.....	380
Allmetal Screw Products Co., Inc.....	366
American Lava Corporation.....	247
American Phenolic Corporation.....	100
American Television & Radio Co.....	240
American Time Products, Inc.....	106
Amperite Co., Inc.....	318
Ampex Electric Corp.....	113
Amplitronx, Inc.....	344
Andrew Corporation.....	225
Anti-Corrosive Metal Products Co., Inc....	308
Arnold Engineering Co.....	64
Astron Corporation.....	233
Atlas Engineering Co., Inc.....	379
Andlo Devices, Inc.....	295
Aviation Engineering Div., Avien-Knack- erbocker, Inc.....	54, 55
Ballantine Laboratories, Inc.....	208
Barnstead Still & Sterilizer Co.....	365
Barry Corp., The.....	15
Bead Chain Mfg. Co.....	331
Beaver Gear Works, Inc.....	316
Beede Electrical Instrument Co., Inc.....	350
Bell Aircraft Corporation.....	369
Bell Telephone Laboratories.....	125
Bendix Aviation Corporation.....	
Eclipse-Pioneer Div.....	266
Friez Instrument Div.....	376
Pacific Div.....	89
Bentley, Harris Manufacturing Co.....	219
Berkeley Scientific, Division of Beckman Instruments, Inc.....	222
Bird & Co., Inc., R. H.....	288
Bird Electronic Corp.....	354
Birnback Radio Co., Inc.....	348
Bircher Corporation.....	364
Biwax Corporation.....	369
Bodnar Industries, Inc.....	357
Boesch Manufacturing Co., Inc.....	340
Boonton Radio Corp.....	197
Brand & Co., Inc., Williams.....	328
Brew & Co., Inc., Richard D.....	357
Bridgeport Brass Company.....	102
Bristol Brass Corporation.....	108
Bristol Motor Div., Vocaline Company of America, Inc.....	272
Brown Electro-Measurement Corp.....	363
Brush Electronics Company.....	309
Burlington Instrument Company.....	340
Burnell & Company.....	99
Burroughs Research Center, Electronic Instruments Div.....	249
Bussmann Mfg. Co.....	65
Cambridge Thermionic Corp.....	34
Cannon Electric Company.....	315
Canoga Corporation.....	377
C.B.S. Hytron, Div. of Columbia Broad- casting System.....	119
Centralab, A Div. of Glube-Union, Inc....	11, 12, 13
Chase Brass & Copper Co.....	70
Chester Cable Corp.....	61
Chicago Telephone Supply Corp.....	41
Chicago Transformer, Div. of Essex Wire Corp.....	320

Ciba Company, Inc.....	127
Cinch Manufacturing Company.....	193
Clarostat Mfg. Co., Inc.....	211
Cleveland Container Co.....	215
Cohn Mfg. Co., Inc., Sigmund.....	354
Cole Instrument Co.....	218
Collins Radio Company.....	45
Columbian Carbon Company.....	365
Communication Accessories Co.....	121
Communication Products Company, Inc.....	361
Computer Research Corporation.....	85
Condenser Products Company, Div. of New Haven Clock & Watch Co.....	265
Consolidated Vacuum Corp.....	209
Continental Connectors, DeJur Amseco Corp.....	313
Control Engineering Corp.....	67
Cornell-Dubiller Electric Corp.....	217
Corning Glass Works.....	105
Cosmic Radio Corp.....	381
Coto-Coil Company.....	350
Crescent Company, Inc.....	300
Crosby Laboratories, Inc.....	324
Cross Co., H.....	385
Crucible Steel Company of America.....	245
Cunningham, Son & Co., Inc., James.....	381
Dale Products, Inc.....	312
Dalmo Victor Company.....	97
Dano Electric Co.....	365
Daven Co., The.....	Thldr Cover
DeJur Amseco Corp.....	312, 313
Detroit Diesel Eng., Div. General Motors Corp.....	322
Dialight Corporation.....	46
Driver-Harris Company.....	223
Durant Mfg. Company.....	375
DX Radio Products Co.....	358
Eastman Kodak Company, Special Products Sales Div.....	205
Edison Incorporated, Thomas A.....	333
Edo Corporation.....	110
Elsler Engineering Co., Inc.....	355, 389
Eitel-McCullough, Inc.....	117, 384
Electrical & Physical Instrument Corp....	373
Electrical Industries Division Amperex Electronic Corp.....	253
Electro Engineering Products Co.....	381
Electro Tec Corporation.....	231
Electronic Associates, Inc.....	430
Electronic Tube Corporation.....	285
Engineering Research Associates, Inc....	212
Epcos Products, Inc.....	359
Erie Resistor Corporation.....	92
Fairechild Camera & Instrument Corp....	297
Fansteel Metallurgical Corp.....	242
Federal Telephone & Radio Corporation.....	21
Federated Metals Div., American Smelting & Refining Co.....	234
Ferranti Electric Inc.....	364
Fidelity Instrument Corp.....	389
Five Star Company.....	389
Ford Instrument Company.....	366
Frequency Standards.....	355
Friedman Auctioneers, Irwin.....	361
Fugle-Miller Laboratories.....	316
Furst Electronics.....	365
G & M Equipment Co., Inc.....	74
G-V Controls, Inc.....	260
Gamewell Company.....	282
Gates Radio Company.....	269

Precisely  
fabricated  
to the most

*Critical  
Tolerances*

for electronic devices



Miniature and Subminiature  
Radio Tubes-Television Tubes  
Hearing Aid Tubes

Our technical skill will improve the performance of condensers, neon electrodes, soldering irons, electrical appliances, gauge glasses, diaphragms, stoves, mica washers, and for all other mica applications.

We guarantee that the quality of our mica will reduce your shrinkage costs!

Send for our "HANDBOOK  
on FABRICATED  
NATURAL  
MICA"



Quality—



Since 1929

**INDUSTRIAL  
MICA CORPORATION**

225 So. Van Brunt St.  
Englewood, New Jersey

Want more information? Use post card on last page.

# CONSTANT

## RESEARCH

and

## DEVELOPMENT

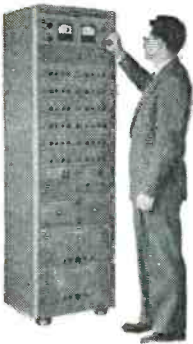

**AMPLIFIER GROUP, TYPE 16-31C**—provides 28 contact stabilized operational amplifiers for use as summers, differentiators, integrators, and inverters. Also in the cabinet are all necessary power supplies and a complete test panel.



**MULTIPLIER GROUP, TYPE 16-31L**—is a servo-mechanical multiplier and incremental function generator. There are 20 channels, each of which is capable of multiplying four variables by a fifth.



**RESOLVER GROUP, TYPE 16-31D**—furnishes 4 resolving channels and 12 operational amplifiers. Each resolving channel may also be used for multiplying three variables by a fourth. Furnished complete with test panel, reference supplies, and power supplies.



**CONTROL CONSOLE, TYPE 16-24E**—Houses the grounded metal problem board and its bay, attenuators, initial condition potentiometers, networks, limiters, and all operating controls.

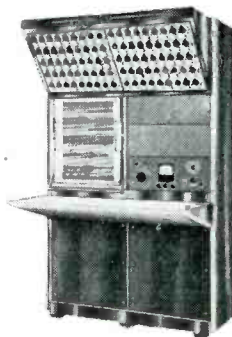

**SERVO GROUP, TYPE 16-31P**—For the operations of resolving and multiplying when used with external amplifiers. There are two resolving and four servo-multiplying channels. The equipment is furnished with test panel and power supplies.

HAS ENABLED US TO PRODUCE ONE OF THE FINEST COMPUTERS AVAILABLE TODAY.



INQUIRE SALES DEPARTMENT

**LONG BRANCH, NEW JERSEY**

Gee-Lar Manufacturing Co.	388
General Cable Corp.	30, 31
General Ceramics & Steatite Corp.	239
General Electric Company	
Apparatus Dept.	72, 109
Tube Dept.	19
General Precision Laboratory, Inc.	213
General Radio Company	17
Giannini & Co., Inc., G. M.	388
Green Instrument Co., Inc.	369
Gries Reproducer Corp.	342
Gudebrod Bros. Silk Co., Inc.	369
Guthman & Co., Inc., Edwin L.	104

Hallett Manufacturing Company	93
Hammarlund Manufacturing Co., Inc.	314
Hart Manufacturing Co.	300
Hathaway Instrument Co.	246
Haydon Co., A. W.	363
Heath Company	373
Heiland Research Corporation	311
Helipot Corporation, The	199
Hermascol Company, Inc.	351
Hermetic Seal Products Co.	81
Hetherington, Inc.	302
Hewlett-Packard Company	83
Hexacon Electric Co.	362
Hinde & Dauch	291
Hitemp Wires Inc.	339
Hopkins Engineering Co.	349
Howard Industries, Inc.	321
Hudson Tool & Die Company, Inc.	259
Hughes Aircraft Company	251
Hughes Research & Development Laboratories	250, 378
Hycor Company, Inc.	379

Ideal Industries, Inc.	305
Indiana Steel Products Co.	50, 51
Industrial Hardware Mfg. Co., Inc.	349
Industrial Mica Corp.	429
Instrument Components, Inc.	377
Instrument Corporation of America	229
Instrument Resistors Co.	361
International Instruments, Inc.	386
International Nickel Company, Inc.	84
International Rectifier Corp.	281
Ippolito & Co., Inc., James	387
Irvington Varnish & Insulator Co.	71

James Vibrapowr Company	317
Jelliff Manufacturing Corp., C.O.	377
Jennings Radio Mfg. Co.	278
Johnson Company, E. F.	210
Jones Div., Howard B. Cinch Mfg. Co.	375
Joy Manufacturing Company	116

Kable Engineering Company	300
Karp Metal Products Co., Inc.	91
Kartron	389
Kay Electric Company	221
Kester Solder Company	263
Ketay Manufacturing Corp.	101
Keuffel & Esser Co.	62, 63
Keystone Products Company	207
Kirk & Blum Mfg. Co.	228
Knights Company, James	284
Kollsman Instrument Corporation	279

Laboratory for Electronics, Inc.	39, 235
Lambda Electronics Corporation	353
Lampkin Laboratories, Inc.	389
Lamson & Sessions Co.	28
Lapp Insulator Company, Inc.	226
Leeds & Northrup Company	90
Lenk Mfg. Company	375
Lenkurt Electric Sales Co.	268
Lewis Engineering Co.	356
Lewis Spring & Mfg. Co.	325

Lindberg Engineering Co., Transformer Div. ....	66
Linde Air Products Co., A Div. of Union Carbide & Carbon Corp. ....	357
Link Aviation, Inc. ....	283
Lion Fasteners, Inc. ....	248
Lundey Associates ....	347

MB Manufacturing Co., Inc. ....	88
Maine Development Commission ....	86
Mallory & Co., Inc., P. R. ....	128, 195
Manson Laboratories ....	360
Manufacturers Engineering & Equipment Corp. ....	357
Marconi Instrument, Ltd. ....	256
Maryland Electronic Manufacturing Corp. ....	270
McGraw-Hill Book Co. ....	368
Measurements Corporation ....	367
Mepeco, Inc. ....	60
Metal Textile Corp. ....	301
Metals & Controls Corp., General Plate Div. ....	82
Mica Insulator Company ....	96
Micro, A Division of Minneapolis-Honeywell Regulator Co. ....	280
Midland Manufacturing Co., Inc. ....	203
Miles Reproducer Co. ....	389
Milford Rivet & Machine Co. ....	276
Millen Mfg. Co., Inc., James ....	352
Milo Radio & Electronics Corp. ....	319
Milwaukee Transformer Co. ....	329
Miniature Precision Bearings, Inc. ....	201
Minneapolis-Honeywell Regulator Co., Industrial Div. ....	29
Mitchell-Rand Insulation Co., Inc. ....	42
Moloney Electric Company ....	124
Muirhead & Co., Ltd. ....	3
Multi-Metal Company ....	346

National Company, Inc. ....	216
National Moldite Co. ....	298, 299
National Research Corporation ....	76
Natvar Corporation ....	56
New Hampshire Ball Bearings, Inc. ....	323
New Hermes, Inc. ....	349
New London Instrument Co. ....	337
New York Transformer Co., Inc. ....	220
Ney Company, J. M. ....	346
North American Aviation, Inc. ....	80
Nothelfer Winding Laboratories ....	361

Ohmite Mfg. Co. ....	32A, 32B
Olympic Metal Products Co., Inc. ....	345
Oster Manufacturing Co., John ....	341
Owens-Corning Fiberglas Corp. ....	58, 59

Panoramic Radio Products, Inc. ....	341
Pennsylvania Optical Co. ....	359
Peschel Electronics, Inc. ....	357
Phalo Plastics Corporation ....	382
Phaotron Company ....	371
Helps Dodge Copper Products Corp., Inca Manufacturing Division ....	36, 37
Pickard & Burns, Inc. ....	327
Pix Manufacturing Co., Inc. ....	353
Polarad Electronics Corp. ....	261
Polyphase Instrument Co. ....	370
Polytechnic Research & Development Company, Inc. ....	267
Potter Instrument Company, Inc. ....	330
Precise Measurements Co. ....	389
Precision Apparatus Co., Inc. ....	432
Precision Paper Tube Co. ....	372
Pyroferrie Co., Inc. ....	44

Quality Products Co. ....	389
---------------------------	-----

Radio Corporation of America ....	255
Back Cover	

**UNITED STATES GASKET**

is the foremost

for **TEFLON** and

sheets, rods, tape,

bars, cylinders

custom-molded

to exact



**CO.**

source

**KEL-F**

tubing,

and parts,

and machined

specifications

The United States Gasket Company was one of the pioneers in the fabrication of Fluoro-carbon Plastics.

- Profit from this broad experience, greater "Know-how" and their completely modern specialized facilities for low-cost, close tolerance production of Teflon\* and Kel-F† Stock and custom-molded or machined parts.
- If you have a problem, U.S.G. engineers will show you how to cut corners and costs to incorporate the superior qualities of these plastics in your products.
- Ask for Catalogs No. 300 and 500.

\*du Pont Trademark
†W. M. Kellogg Trademark



**UNITED STATES GASKET COMPANY**

**FLUOROCARBON PRODUCTS DIVISION**

CAMDEN 1, NEW JERSEY

Representatives in Principal Cities Throughout the World

# PRECISION SERIES EV-10A VTVM-Megohmmeter



## TRUE ZERO CENTER VTVM 7" FULL VIEW METER

with DIRECT PEAK READING HIGH FREQ. SCALES  
Plus Standard 1000 Ohms per Volt Functions

**59 Ranges to: 6000 Volts, 2000 Megohms  
12 Amperes, + 77DB**

D.C. VTVM ranges to ±60 KV when used  
with TV-4 High Voltage Safety Test Probe.

### RANGE SPECIFICATIONS

- ★ EIGHT ZERO-CENTER VTVM RANGES:  
±3, ±12, ±60, ±120, ±300, ±600,  
±1200, ±6000 volts D.C.
- ★ HIGH INPUT RESISTANCE—  
13 1/3 megs. to 600 V., 26 2/3 megs. at  
1200 V., 133 1/3 megs. at 6000 volts.
- ★ FOUR DIRECT PEAK READING RANGES:  
0-3-12-60-120 peak volts.  
(Requires Series RF-10A High Frequency  
Probe described below.)
- ★ SIX OHM and MEGOHMMETER RANGES:  
0-2000-200,000 ohms.  
0-2-20-200-2000 megohms.
- ★ EIGHT EXTRA A.C.-D.C. VOLT RANGES  
at 1000 Ω/V. for routine circuit testing.  
0-3-12-60-120-300-600-1200-6000 volts.
- ★ EIGHT D.C. CURRENT RANGES:  
0-300 microamperes.  
0-1.2-6-30-600-1200 MA. 0-1.2 Amperes.
- ★ EIGHT DB RANGES: —20 to + 77 db.  
Calibrated for 1 MW., 600 ohms zero db.

### IMPORTANT FEATURES

- ★ Voltage Regulated-Bridge Type Circuit.
- ★ True Zero-Center VTVM—Simultaneously  
indicates both voltage and polarity.
- ★ Rotary Range and Function Selectors.
- ★ Recessed 6000 volt Safety Jacks.
- ★ Shielded Coax Test-Cable Connectors  
for both D.C. and R.F. probes.
- ★ Electronic-Bridge Ohm-Megohmmeter.  
Uses 2 self-contained 1.5 V. batteries.
- ★ Extra-large 7" Rectangular PACE Meter.  
200 microampere, ±2% sensitivity.
- ★ 1% Film Type and Wire-Wound Resistors.

EV-10A (MCP) In black ripple finished,  
heavy gauge steel case. Size 10 1/2" x 12"  
x 6". Complete with coaxial circuit isolat-  
ing test probe, shielded ohmmeter test  
cable, standard test leads, ohmmeter  
battery and manual.....\$99.75



### SERIES RF-10A R.F. Probe

Accessory for Series  
EV-10A above; affords  
direct high frequency  
peak voltage measure-  
ments. Employs 9002  
miniature tube.....\$14.40

## PRECISION APPARATUS COMPANY, INC.

92-27 HORACE HARDING BLVD., ELMHURST 13, N. Y.  
Export Division 438 Broadway, New York 13, U.S.A. • Cables—Morse  
In Canada: Atlas Radio Corp., Ltd., 560 King Street, W., Toronto 28.

Want more information? Use post card on last page.

Radio Materials Corporation.....	227
Radio Receptor Company, Inc.....	77
Railway Communications, Inc.....	373
Railway Express Agency, Air Express Div. ....	32
Rauland Corporation .....	243
Raytheon Manufacturing Company.....	35
R-B-M Division, Essex Wire Corp.....	202
Reeves Hoffman Corporation .....	277
Reinhold Publishing Corp.....	344
Remler Company, Ltd.....	372
Representatives of Electronic Products Manufacturers, Inc., The.....	370
Republic Foll & Metal Mills, Inc.....	289
Rex Corporation .....	335
Rheostat Co., Rex .....	389
Rochester Electronics Co., Inc.....	389
Rome Cable Corporation.....	120
Runzel Cord & Wire Co.....	367
Rutherford Electronics Co.....	342

San Fernando Electric Mfg. Co.....	378
Sanborn Company .....	2
Scientific Electric Div. of "S" Corrugated Quenched Gap Co.....	362
Scientific Specialties Corp.....	385
Secor Metals Corporation.....	371
Sensitive Research Instrument Corp.....	358
Servo Corporation of America.....	347
Servomechanisms, Inc.....	258
Shalleross Manufacturing Co.....	238
Shaw Insulator Company.....	386
Sierra Electronic Corp.....	232
Sigma Instrument, Inc.....	296
Signal Engineering & Mfg. Co.....	384
Sorenson & Company, Inc.....	103
Specialty Battery Company.....	380
Specific Products .....	359
Spencer-Kennedy Laboratories, Inc.....	385
Sperry Gyroscope Company.....	118
Sprague Electric Company.....	9, 95
Stackpole Carbon Co.....	79
Standard Electric Time Company.....	98
Standard Plezo Co.....	381
Standard Transformer Corp.....	326
Steiner-Ives Company .....	257
Sterling Transformer Corp.....	343
Sterling Engineering Co., Inc.....	290
Stoddart Aircraft Radio Co.....	230
Stone Paper Tube Company, Inc.....	107
Struthers-Dunn, Inc.....	206
Superior Electric Co.....	57
Superior Tube Co.....	38
Sylvania Electric Products, Inc.....	7, 293 307, 332

Taylor Fibre Co.....	237
Tech Laboratories, Inc.....	214
Technical Instrument Co., Inc.....	252
Technical Service Corporation.....	353
Technology Instrument Corp.....	286, 287
Tektronix, Inc.....	378
Tel-Instrument Co., Inc.....	338
Telechron Dept., General Electric Co....	68
Telecomputing Corporation .....	33
Teletronics Laboratory, Inc.....	374, 389
Telewave Laboratories, Inc.....	360
Terpening Company, L. H.....	304
Thompson-Bremer & Company, Sub. of American Machine & Foundry Co.....	73
Tinnerman Products, Inc.....	122
Tobe Deutschmann Corporation.....	274, 275
Trad Television Corp.....	368
Transistor Products, Inc.....	343
Transradio, Ltd.....	367
Trans-Sonics, Inc.....	348
Triplett Electrical Instrument Co.....	94
Tung-Sol Electric, Inc.....	64A, 64B

Union Carbide & Carbon Corp., Linde Aire Products Div. ....	357
United-Carr Fastener Corp.....	49
United Condenser Corp.....	352
United Manufacturing & Service Com- pany .....	78
United States Gasket Company.....	431
United States Radium Corp.....	224
United Transformer Co.....	Second Cover

Varflex Corporation .....	241
Varlan Associates .....	123
Veeder-Root, Inc.....	112
Vickers Electric Division .....	310
Victoreen Instrument Co.....	303
Vitramon, Inc.....	344

Waldes Kohinoor, Inc.....	69
Ward Leonard Electric Co.....	52, 53
Warren Wire Company .....	47
Wasserlein Manufacturing Co., Inc.....	351
Waterman Products Co., Inc.....	244
Waveforms, Inc.....	349
Webber Manufacturing Company, Inc.....	25
Western Gold & Platinum Works.....	332
Westinghouse Electric Corp.....	27, 126
Weston Electrical Instrument Corp.....	111
White Dental Mfg. Co., S. S.....	254, 385
Williams & Co., C. K.....	382
Winchester Electronics, Inc.....	204
Workshop Associates Div., Gabriel Com- pany .....	236

Xcelite, Incorporated .....	376
-----------------------------	-----

Ziolk, Daniel D.....	389
Zophar Mills, Inc.....	374

### PROFESSIONAL SERVICES..... 390

### SEARCHLIGHT SECTION

(Classified Advertising)

H. E. HILTY, Mgr.

### SEARCHLIGHT ADVERTISERS INDEX 427

This index is published as a convenience to the  
readers. Every care is taken to make it accurate, but  
ELECTRONICS assumes no responsibility for errors  
or omissions.

Uelnite Co., The.....	48
Ungar Electric Tools, Inc.....	373

*Only*

**DAVEN SWITCHES**

**Have It!**

...The  
**"KNEE-ACTION"**  
Rotor



**DAVEN's** exclusive, patented, "KNEE-ACTION" Rotor embodies the most advanced principles in switch engineering.

Developed by DAVEN's own staff of switch specialists, it makes possible the fabrication of units with a greater number of switch positions and poles in smaller space than previously possible.

"KNEE-ACTION" insures low contact resistance and uniform contact pressure over the life of DAVEN Switches. Silver alloy contacts, slip rings, and rotor arms are used on all units.

Because a greater number of poles per deck is available, more compactness is possible . . . a feature which is in line with the present trend toward smaller size components which will render maximum performance in minimum space.

DAVEN also offers you every facility for solving your particular switch problems. It stocks a large assortment of standard parts . . . will develop special switches from these standard components . . . or will engineer special switches to meet unusual requirements. DAVEN's Development Engineering Department is at your service to help you. Call on DAVEN today!

*Write for your Free copy of DAVEN's new, 28-page brochure on SWITCHES.*

THE **DAVEN** CO. 191 CENTRAL AVENUE, NEWARK 4, NEW JERSEY

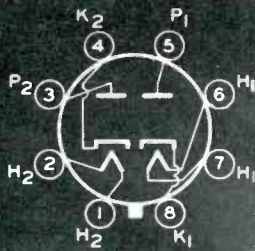

**NEW**  
**"SPECIAL RED" RECTIFIER**  
**RCA-5690**  
 Full-wave, vacuum type

## 10,000 HOURS — *Minimum Life!*

**For dependable service in Industrial, Aircraft, and Military Equipment**

RCA-5690 is your answer for a "long-life" rectifier designed especially for industrial and aircraft applications. The tube is conservatively rated to take a peak inverse plate voltage up to a maximum of 1120 volts, a peak plate current up to 375 ma per plate, and an average plate current up to 75 ma per plate. Operating at maximum rated voltages, RCA-5690 will withstand a continuous vibration of 2.5 g at a frequency of 25 cps for hundreds of hours — and impact accelerations of 500 g for short periods.

In this tube each rectifier unit has its

own heater and cathode—with separate base terminals for each. The heaters can be operated in parallel from a 6.3-volt supply—or in series from a 12.6-volt supply. Unique tube base design provides exceptionally high resistance to leakage between base pins and minimizes arc-over at high altitudes (you can operate the RCA-5690 at full ratings up to 40,000 feet).

For rectifier applications where 10,000-hour life and extreme dependability are paramount, specify RCA-5690's—and be secure. Get technical data from RCA, Commercial Engineer-

ing, Section 42GR, Harrison, N. J. Or call your nearest RCA Field Office:

- (EAST) Humboldt 5-3900  
415 S. 5th St., Harrison, N. J.
- (MIDWEST) Whitehall 4-2900  
589 E. Illinois St., Chicago, Ill.
- (WEST) Madison 9-3671  
420 S. San Pedro St., Los Angeles, Cal.

Other RCA "Special Red" Tubes  
 (Minimum life—10,000 hours)



RCA-5691  
High-Mu  
Twin Triode

RCA-5693  
Sharp-Cutoff  
Pentode

RCA-5692  
Medium-Mu  
Twin Triode



**RADIO CORPORATION of AMERICA**

**ELECTRON TUBES**

**HARRISON, N. J.**