

electronics

A MCGRAW-HILL PUBLICATION

JANUARY • 1953

PRICE 75 CENTS

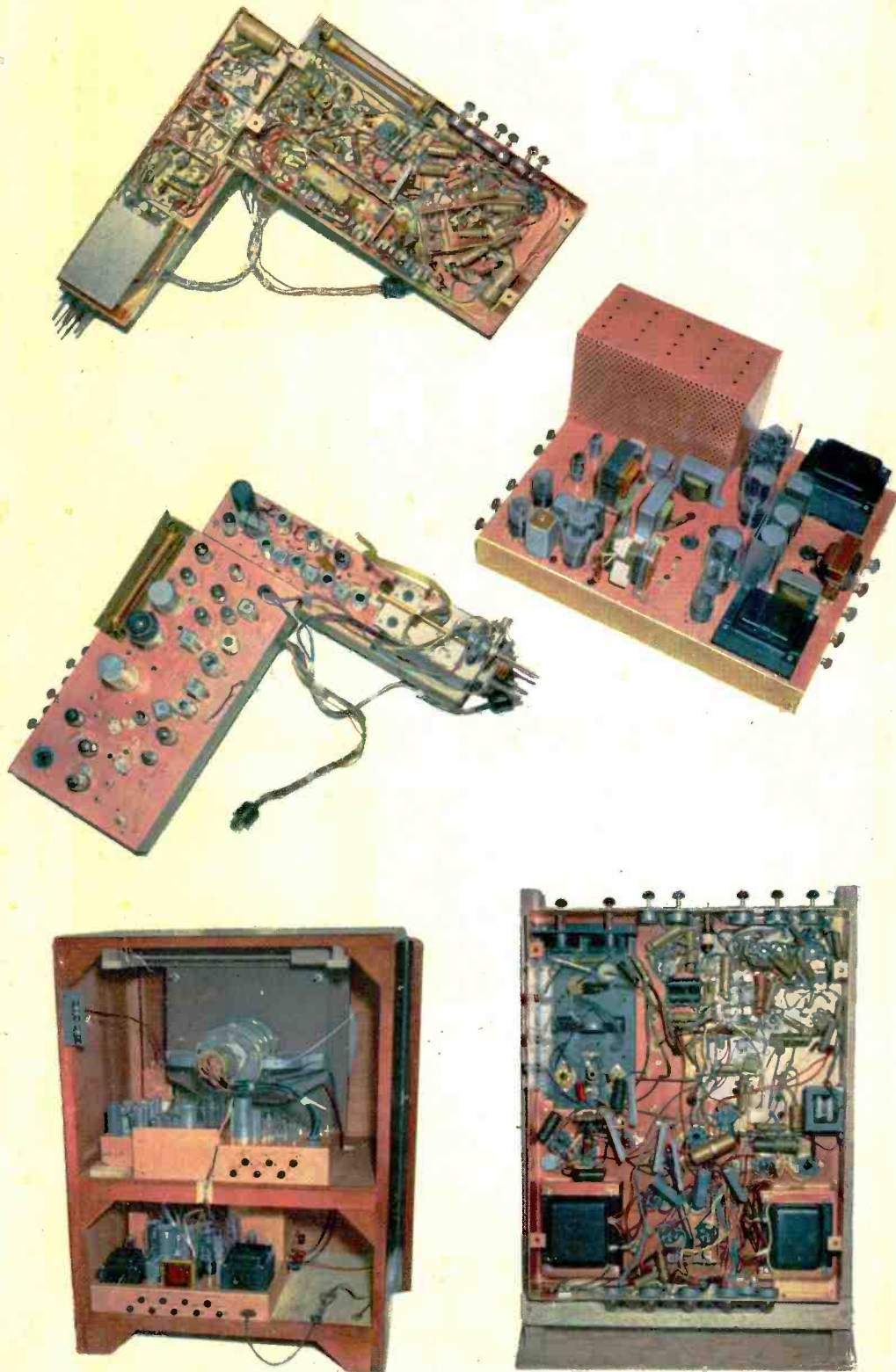

Monochrome effect results when saturation control is turned off. Normal setting of control provides complete color pictures

**COMPATIBLE
COLOR
TV RECEIVER**



PERMALLOY DUST TOROIDS FOR MAXIMUM STABILITY...

The UTC type HQ permalloy dust toroids are ideal for all audio, carrier and supersonic applications. HQA coils have Q over 100 at 5,000 cycles... HQB coils, Q over 200 at 4,000 cycles... HQC coils, Q over 200 at 30 KC... HQD coils, Q over 200 at 60 KC... HQE (miniature) coils, Q over 120 at 10 KC. The toroid dust core provides very low hum pickup... excellent stability with voltage change... negligible inductance change with temperature, etc. Precision adjusted to 1% tolerance. Hermetically sealed.



HQA, HQC, HQD CASE
1 13/16" Dia. x 1 3/16" High



HQB CASE
1 5/8" x 2 5/8" x 2 1/2" High



HQE CASE
1 1/2" x 1 5/16" x 1 3/16" High

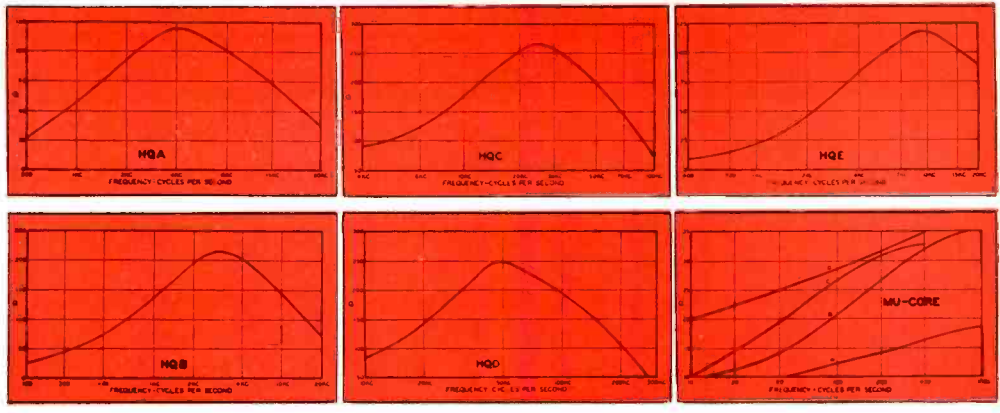

Type No.	Inductance Value	Net Price	Type No.	Inductance Value	Net Price	Type No.	Inductance Value	Net Price
HQA-1	5 mhy.	\$7.00	HQA-16	7.5 hy.	\$15.00	HQC-1	1 mhy.	\$13.00
HQA-2	12.5 mhy.	7.00	HQA-17	10. hy.	16.00	HQC-2	2.5 mhy.	13.00
HQA-3	20 mhy.	7.50	HQA-18	15. hy.	17.00	HQC-3	5 mhy.	13.00
HQA-4	30 mhy.	7.50	HQB-1	10 mhy.	16.00	HQC-4	10 mhy.	13.00
HQA-5	50 mhy.	8.00	HQB-2	30 mhy.	16.00	HQC-5	20 mhy.	13.00
HQA-6	80 mhy.	8.00	HQB-3	70 mhy.	16.00	HQD-1	.4 mhy.	15.00
HQA-7	125 mhy.	9.00	HQB-4	120 mhy.	17.00	HQD-2	1 mhy.	15.00
HQA-8	200 mhy.	9.00	HQB-5	.5 hy.	17.00	HQD-3	2.5 mhy.	15.00
HQA-9	300 mhy.	10.00	HQB-6	1. hy.	18.00	HQD-4	5 mhy.	15.00
HQA-10	.5 hy.	10.00	HQB-7	2. hy.	19.00	HQD-5	15 mhy.	15.00
HQA-11	.75 hy.	10.00	HQB-8	3.5 hy.	20.00	HQE-1	5 mhy.	6.00
HQA-12	1.25 hy.	11.00	HQB-9	7.5 hy.	21.00	HQE-2	10 mhy.	6.00
HQA-13	2. hy.	11.00	HQB-10	12. hy.	22.00	HQE-3	50 mhy.	7.00
HQA-14	3. hy.	13.00	HQB-11	18. hy.	23.00	HQE-4	100 mhy.	7.50
HQA-15	5. hy.	14.00	HQB-12	25. hy.	24.00	HQE-5	200 mhy.	8.00

UTC INTERSTAGE AND LINE FILTERS



FILTER CASE M
1 3/16 x 1 1/16,
1 5/8 x 2 1/2 High

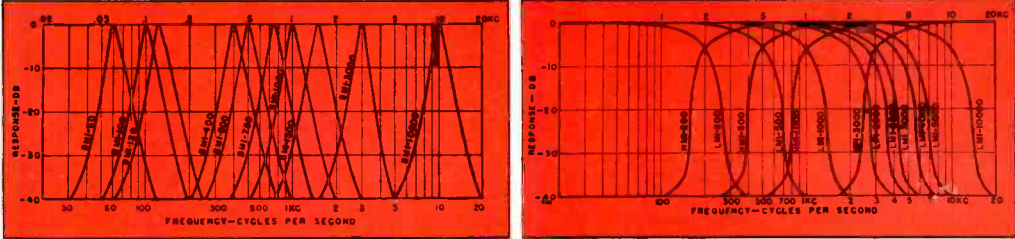

These U.T.C. stock units take care of most common filter applications. The interstage filters, BMI (band pass), HMI (high pass), and LMI (low pass), have a nominal impedance at 10,000 ohms. The line filters, BML (band pass), HML (high pass), and LML (low pass), are intended for use in 500/600 ohm circuits. All units are shielded for low pickup (150 mv/gauss) and are hermetically sealed.

STOCK FREQUENCIES
(Number after letters is frequency)
Net Price \$25.00

BMI-60	BMI-1500	LMI-200	BML-400
BMI-100	BMI-3000	LMI-500	BML-1000
BMI-120	BMI-10000	LMI-1000	HML-200
BMI-400	HMI-200	LMI-2000	HML-500
BMI-500	HMI-500	LMI-3000	LML-1000
BMI-750	HMI-1000	LMI-5000	LML-2500
BMI-1000	HMI-3000	LMI-10000	LML-4000
			LML-12000

United Transformer Co.
150 VARICK STREET NEW YORK 13, N. Y.
EXPORT DIVISION: 13 EAST 40TH STREET, NEW YORK 16, N. Y., CABLES: "ARLAB"

COMPATIBLE COLOR TV RECEIVER—Unretouched reproductions of crt screen of 42-tube color receiver developed by Westinghouse engineers. Chassis of receiver used in field tests of NTSC system contain all circuits for color or monochrome reception (see p 98).....COVER

FIGURES OF THE MONTH	4		
Includes Electronics Output Index, a business barometer for management			
INDUSTRY REPORT	5		
Top-level news, trends and market interpretations, plus year-end electronigraphs			
COMPATIBLE COLOR TV RECEIVER , by Kenneth E. Farr.....	98		
42-tube receiver uses tricolor picture tube			
MEASURING MINUTE CAPACITANCE CHANGES , by George W. Cook.....	105		
Resonant bridge system measures capacitance changes of 0.001 μmf and less			
F-M RECORDING IN GUIDED MISSILES , by Albert A. Gerlach.....	108		
Conventional graphical recordings are made from 198-channel magnetic recording made inside nose of missile			
HIGH-FREQUENCY TRANSISTOR TETRODE , by R. L. Wallace, Jr., L. G. Schimpf and E. Dickten.....	112		
Fourth electrode added to junction transistor allows operation at 130 mc			
PRESS SAFETY CONTROL USES RADIOACTIVE WRISTBAND , by M. E. Simonton and John Yeiser.....	114		
Geiger tubes mounted on press prevent operation when radium-plated disk on operator's wrist is in danger zone			
STRIPPING TECHNIQUES FOR INSULATING FILMS ON WIRE , by R. George Roesch.....	116		
Evaluation of six different production techniques for removing film-type insulations from magnet and resistance wire			
TELEVISION SWITCHER FOR BROADCASTERS , by Harry E. Thomas.....	120		
Pushbutton unit for video programs allows instantaneous switching or manual lap dissolves			
ELECTRON-MICROSCOPE POWER MONITOR , by Francis W. Bishop.....	124		
Simple two-tube amplifier and eye-tube indicator detect fluctuations that cause blurred photographs			
QUICK-CHANGE BREADBOARD FOR CIRCUIT RESEARCH , by Robert E. Prouty.....	126		
Complete circuit can be wired without drilling holes, through use of removable insert panels on chassis			
WIDE-ANGLE SCAN RADAR ANTENNA , by H. N. Chait.....	128		
Microwave analog of Schmidt optical system permits 20-beamwidth scan			
EFFECT OF RADIATION ON RESONANT LINES , by R. A. Chipman.....	133		
Influence of radiation resistance on resonant characteristics is studied			
BIPOLAR LOGARITHMIC CORONA-CURRENT AMPLIFIER , by Seville Chapman and Leonard Bogdan.....	136		
Measures entire range from milliamperes to millimicroamperes for study of snowstorm and thunderstorm corona current			
TEST SCOPE CHECKS TELEVISION BROADCASTS , by Clifford H. Moulton.....	138		
Special features provide laboratory or field test of video signals			
CHART FOR TE₁₁ MODE PISTON ATTENUATOR (Reference Sheet) , by Charles M. Alfred.....	142		
Nomograph speeds finding attenuation constant			
CROSSTALK.....97	ELECTRONS AT WORK.....144	PRODUCTION TECHNIQUES.....226	NEW PRODUCTS.....264
PLANTS AND PEOPLE.....334	NEW BOOKS.....346	BACKTALK.....358	INDEX TO ADVERTISERS.....421

W. W. MacDONALD, Executive Editor; VIN ZELUFF, Managing Editor; John Markus, A. A. McKenzie, James Fahnestock, Associate Editors; William P. O'Brien, John M. Carroll, William G. Arnold, Assistant Editors; Ann Mastropolo, Marilyn Wood, Mary J. Johnson, Editorial Assistants; Gladys T. Montgomery, Washington Editor; Harry Phillips, Art Director; Eleanor Luke, Art Assistant

KEITH HENNEY, Editorial Director

H. W. MATEER, Publisher; WALLACE B. BLOOD, Manager; R. S. Quint, Buyers' Guide Manager; N. F. Cullinan, Promotion & Research Assistant; H. E. Hilty, Classified Manager; D. H. Miller, James Girdwood, New York; Wm. S. Hodgkinson, New England; Warren W. Shew, Philadelphia; C. D. Wardner, Chicago; J. L. Phillips, Cleveland; T. H. Carmody, R. C. Alcorn, San Francisco; Carl W. Dysinger, Los Angeles; Ralph C. Maultsby, Atlanta



January, 1953

ELECTRONICS
Member ABC and ABP

Vol. 26, No. 1



Published monthly with an additional issue in June by McGraw-Hill Publishing Company, Inc., James H. McGraw (1860-1948), Founder. Publication Office, 99-129 North Broadway, Albany 1, N. Y.

Executive, Editorial and Advertising Offices: McGraw-Hill Building, 330 W. 42nd St., New York 36, N. Y. Curtis W. McGraw, President; Willard Chevallier, Executive Vice-President; Joseph A. Gerardi, Vice-President and Treasurer; John J. Cooke, Secretary; Paul Montgomery, Senior Vice-President, Publication Division; Ralph B. Smith, Vice-President and Editorial Director; Nelson Bond, Vice-President and Director of Advertising; J. E. Blackburn, Jr., Vice-President and Director of Circulation.

Subscriptions: Address correspondence to Electronics—Subscription Service, 99-129 N. Broadway, Albany 1, N. Y., or 330 W. 42nd St., New York 36, N. Y. Allow one month for change of address. Subscriptions are solicited only from persons engaged in theory, research, design, production, maintenance and use of electronic and industrial control components, parts and end products. Position and company connection must be indicated on subscription orders.

Single copies 75¢ for United States and possessions, and Canada; \$1.50 for Latin America; \$2.00 for all other foreign countries. Buyers' Guide \$2.00. Subscription rates—United States and possessions, \$6.00 a year; \$9.00 for two years. Canada, \$10.00 a year; \$16.00 for two years. Other western hemisphere countries, \$15.00 a year; \$25.00 for two years. All other countries \$20.00 a year; \$30.00 for two years. Entered as second class matter August 20, 1936, at the Post Office at Albany, N. Y., under act of Mar. 3, 1879. Printed in U.S.A. Copyright 1952 by McGraw-Hill Publishing Co., Inc.—All Rights Reserved. BRANCH OFFICES: 520 North Michigan Avenue, Chicago 11, Ill.; 68 Post Street, San Francisco 4; McGraw-Hill House, London, E.C. 4; Washington, D. C. 4; Philadelphia 3; Cleveland 15; Detroit 26; St. Louis 8; Boston 16; 1321 Rhodes-Haverty Bldg., Atlanta 3, Ga.; 1111 Wilshire Blvd., Los Angeles 17; 738-9 Oliver Building, Pittsburgh 22. ELECTRONICS is indexed regularly in The Engineering Index.



Figure...First!

Yes . . . it pays to figure *first* . . . instead of afterward . . . how Veeder-Root Counters can profitably be *built into* your new products, machines, or processes . . . to build up sales appeal and new markets.

Much easier to call in a Veeder-Root engineer *now*, than waiting until *later*, when your design is in production.

And remember that you can count on Veeder-Root to help you, consistent with defense commitments.

VEEDER-ROOT INCORPORATED

"The Name That Counts"

HARTFORD 2, CONNECTICUT

Chicago 6, Ill. • New York 19 • Greenville, S.C. • Montreal 2, Canada
Dundee, Scotland • Offices and Agents in Principal Cities



Series 1205
Magnetic Counter

Hand Tally

2-3 Convertible Pick
Counter For Textile Looms.

Computing Head
for Gasoline
Pumps.

THIS INTERESTING QUARTERLY WILL BE MAILED FREE TO ANY PART OF THE WORLD

AUSTRALIA

Messrs. Watson Victor Limited,
9-13, Bligh Street,
Sydney, N.S.W.

BELGIUM

Paul Groeninckx,
4-6, Avenue Hansen-Soulie,
Brussels.

CANADA

The J. W. Ellis Industries,
42, Lombard Street,
Toronto.

DENMARK

Ditz Schweitzer,
Norre Voldgade, 48,
Copenhagen, K.

FRANCE

Jacques Pérès Fils,
4, Avenue de l'Opéra,
Paris 1.

HOLLAND

Geo. C. F. Kauderer,
Muiden.

INDIA

Adair, Dutt & Co. (India) Ltd.,
5, Dalhousie Square,
Calcutta.

ITALY

Ing. Silvio Garrone,
Piazza Della Marina, 1,
Rome.

NEW ZEALAND

Richardson, McCabe & Co. Ltd.,
P.O. Box 792,
Wellington.

NORWAY

J. L. Nerlien A/S,
Nedre Slottsgt. 13,
Oslo.

SOUTH AFRICA

Johnson & Phillips South Africa
(Pty.) Limited,
P.O. Box 552,
Germiston.

SWEDEN

Ingenjorsfirma Hugo Tillquist,
Nybrokajen 7, Postbox 7026,
Stockholm 7.

SWITZERLAND

Camille Bauer,
Dornacherstrasse 18,
Basel.

U.S.A.

Muirhead & Co. Ltd.,
Elmers End, Beckenham,
Kent, England.



TECHNIQUE IS ALSO PUBLISHED IN FRENCH. IF THIS EDITION
IS REQUIRED, MARK YOUR COUPON "EDITION FRANÇAISE"

FILL IN THIS COUPON AND MAIL TO US OR OUR AGENTS

(SEE LIST ABOVE)

*Please mail me, free of charge,
the quarterly journal
of instrument engineering
"technique"
published by
Muirhead & Co., Limited.*

NAME _____
POSITION _____
COMPANY _____
ADDRESS _____

ELECTRONICS 74

MUIRHEAD & Co. LTD.
PRECISION ELECTRICAL INSTRUMENT MAKERS
BECKENHAM · KENT · ENGLAND

Telegrams and Cables: MUIRHEADS ELMERS-END

PRECISION

MUIRHEAD

ELECTRICAL INSTRUMENTS

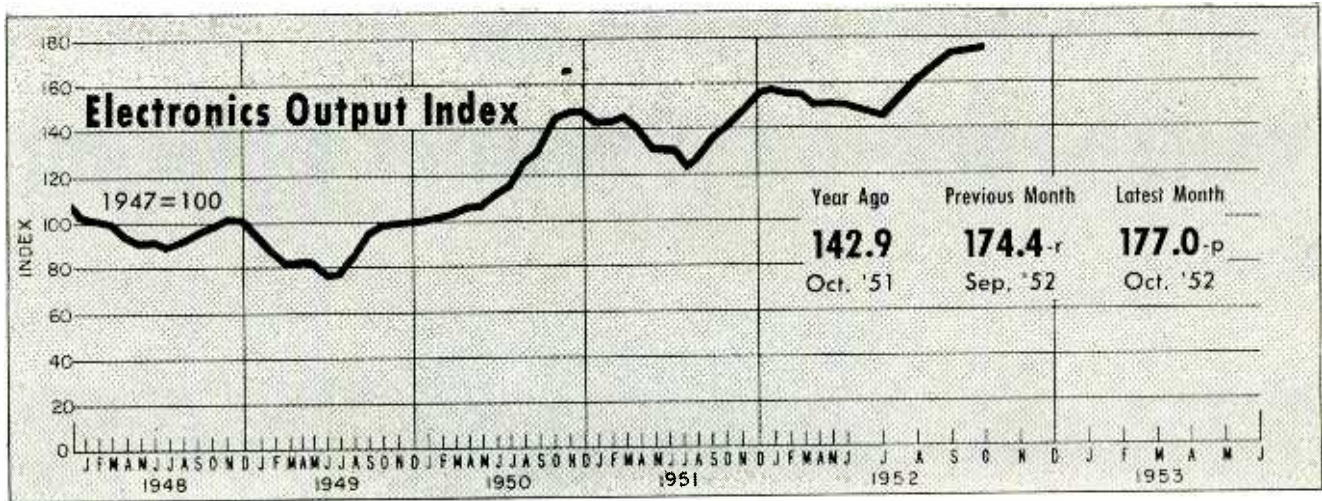

FIGURES OF THE MONTH

	Year Ago	Previous Month	Latest Month	Year Ago	Previous Month	Latest Month
RECEIVER PRODUCTION (Source: RTMA)			Oct. '51	Sept. '52	Oct. '52	
Television sets	411,867	755,665	724,117-p			
Home sets	513,609	324,786	314,459-p			
Clock Radios	-----	183,496	180,841-p			
Portable sets	94,053	126,666	113,552-p			
Auto sets	267,061	230,706	163,494-p			
RECEIVER SALES (Source: RTMA)			Sept. '52	Oct. '52		
Television sets, units	-----	875,290	847,219			
Radio sets (except auto)	-----	892,761	580,077			
RECEIVING TUBE SALES (Source: RTMA)			Oct. '51	Sept. '52	Oct. '52	
Receiv. tubes, total units	34,137,519	34,196,286	41,880,318			
Receiving tubes, new sets	21,103,669	23,826,408	29,132,068			
Rec. tubes, replacement	9,615,159	7,435,333	8,791,404			
Receiving tubes, gov't.	1,567,190	2,032,539	3,105,005			
Receiving tubes, export.	1,851,501	902,006	851,841			
Picture tubes, to mfrs.	455,636	640,793	862,431			
BROADCAST STATIONS (Source: FCC)			Nov. '51	Oct. '52	Nov. '52	
TV Stations on Air	108	114	116			
TV Stns CPs—not on air	0	77	114			
TV Stns—Applications	463	840	836			
AM Stations on Air	2,321	2,368	2,374			
AM Stns CPs—not on air	85	138	139			
AM Stns—Applications	302	255	250			
FM Stations on Air	635	624	626			
FM Stns CPs—not on air	12	17	14			
FM Stns—Applications	10	8	9			
COMMUNICATION AUTHORIZATIONS (Source: FCC)			Oct. '51	Sept. '52	Oct. '52	
Aeronautical	31,989	34,462	33,630			
Marine	33,309	37,437	37,914			
Police, fire, etc.	9,965	11,615	11,772			
Industrial	10,930	14,761	15,090			
Land Transportation	4,542	5,250	5,346			
Amateur	97,587	116,629	116,102			
Citizens Radio	674	1,767	1,788			
Disaster	22	80	80			
Experimental	442	282	519			
Common carrier	834	1,026	1,032			
TV AUDIENCE (Source: NBC Research Dept.)			Nov. '51	Oct. '52	Nov. '52	
Sets in Use—total	14,555,800	19,124,900	19,751,200			
Sets in Use—netw'k conn.	13,777,700	19,095,500	19,720,900			
Sets in Use—New York	2,630,000	3,135,000	3,180,000			
Sets in Use—Los Angeles	1,045,000	1,255,000	1,270,000			
Sets in Use—Chicago	1,020,000	1,255,000	1,290,000			
NETWORK BILLINGS (Source: Pub. Info. Bureau)			Oct. '51	Sept. '52	Oct. '52	
AM/FM—ABC	\$3,158,714	\$2,533,785	\$2,887,571			
AM/FM—CBS	\$5,615,723	\$4,847,138	\$5,817,930			
AM/FM—MBS	\$1,759,468	\$1,607,107	\$2,304,804			
AM/FM—NBC	\$4,414,200	\$3,898,867	\$4,230,576			
TV—ABC	\$1,897,427	\$1,203,917	\$1,453,811			
TV—CBS	\$4,731,219	\$5,835,622	\$6,754,231			
TV—DuMont	\$768,684	\$809,475	\$995,376			
TV—NBC	\$7,060,289	\$6,581,618	\$7,805,668			
EMPLOYMENT AND PAYROLLS (Source: Bur. Labor Statistics)			Sept. '51	Aug. '52	Sept. '52	
Prod. workers, electronic	247,300	280,300-r	296,600-p			
Av. wkly. earnings, elect.	\$62.75	\$66.54-r	\$67.06-p			
Av. wkly. earnings, radio	\$59.40	\$63.11-r	\$63.45-p			
Av. weekly hours, elect.	41.2	41.2-r	41.5-p			
Av. weekly hours, radio	40.8	40.9-r	41.2-p			
STOCK PRICE AVERAGES (Source: Standard and Poor's)			Nov. '51	Oct. '52	Nov. '52	
Radio—TV & Electronics	245.7	310.9	321.9			
Radio Broadcasters	231.3	288.1	300.3			
INDUSTRIAL EQUIPMENT ORDERS (Source: NEMA)			3rd '51	2nd '52	3rd '52	
Dielectric Heating	\$210,000	\$510,000	\$320,000			
Induction Heating	\$4,060,000	\$2,410,000	\$1,760,000			
Welding Control	\$1,280,000	\$1,480,000	\$1,810,000			
Other Electronic Control	\$720,000	\$1,020,000	\$920,000			
INDUSTRIAL TUBE SALES (Source: NEMA)			3rd '51	2nd '52	3rd '52	
Vacuum (non-receiving)	\$8,420,000	\$12,110,000	\$10,580,000			
Gas or vapor	\$2,620,000	\$3,150,000	\$2,950,000			
Phototubes	\$270,000	\$480,000	\$570,000			
Magnetrons and velocity modulation tubes	\$3,740,000	\$9,830,000	\$8,500,000			

p—provisional; r—revised; e—estimated

INDUSTRY REPORT

electronics—JANUARY • 1953

John Q. Meets the Transistor

Raytheon announces mass availability of junction types; RCA shows uses

THE YEAR 1952 ended with a flourish, electronically speaking, as the word transistor became public property.

Raytheon announced availability in large numbers of junction types and RCA demonstrated practical applications. Cornell University introduced a course in transistors for electrical engineering students, and amateur George Rose, K2AH, made three contacts on 2-meter phone using a transistor transmitter (could be call this a transmister?).

It is significant to note that these announcements came in the third year of existence of practical semiconductor amplifying devices.

► **A First**—From the industry's standpoint, Raytheon's announce-

ment probably created the most stir. Junction transistors, hitherto available only in sample lots from pilot runs, were suddenly available for mass application, and at reasonable cost.

First to take advantage of Raytheon's \$750,000 transistor production facilities were hearing aid manufacturers who were willing to accept higher initial cost to offer greater operating economy. Battery costs for subminiature tube hearing aids run between \$30 and \$50 per year, while the transistor hearing aid might require \$5 to \$10 worth of 1½-volt cells.

► **Circus**—Adaptability of transistors to other practical applications was demonstrated by RCA in a showing of experimental transistorized entertainment and industrial devices. An automobile radio operated directly from the 6-volt car battery, without vibrators or other



In this four-transistor audio amplifier pnp and npn types are combined to provide transformerless class-B amplification with direct coupling to loud-speaker voice coil

voltage stepup devices. Power taken from the battery for a half-watt output is less than that required to light two pilot lights for the dial.

A good-quality audio amplifier was shown that used only junction

ELECTRONIGRAPHS—A Year-End Glance at Electronics Industry Figures

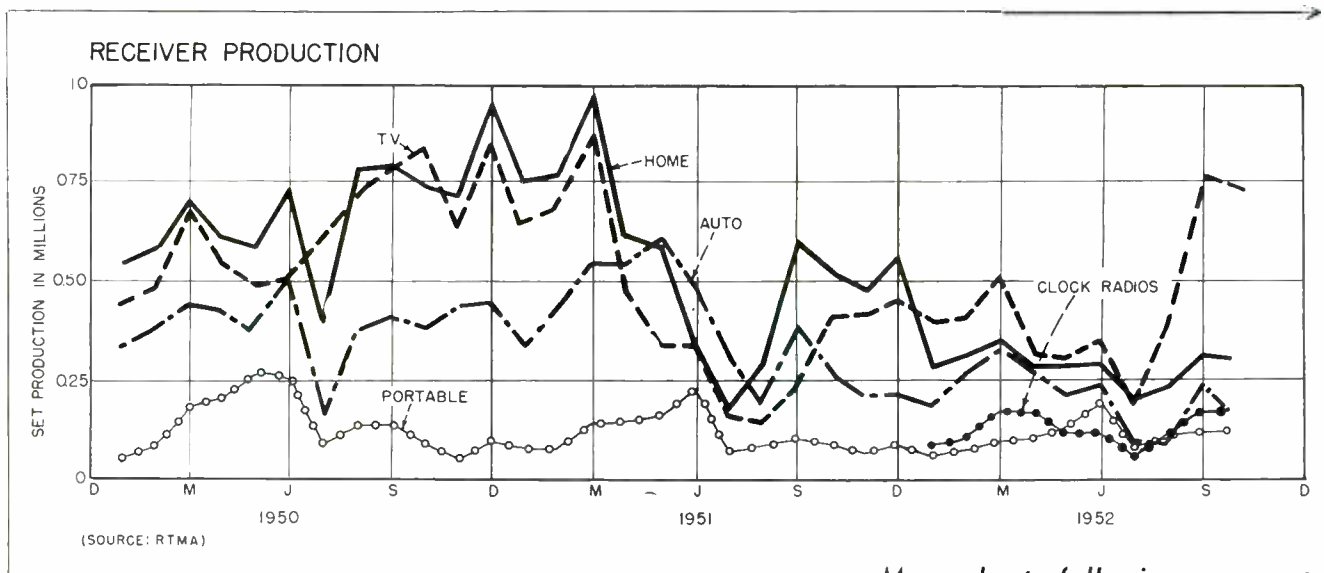



Thirty-six transistors perform all the functions in this 5-inch battery-powered tv set, except for c-r tube

transistors and no transformers. Four junction transistors in a circuit using 'complementary symmetry', for which there is no vacuum-tube analogy, automatically transform signal to push-pull and provide class-B amplification and impedance transformation for direct coupling to a 15-ohm voice coil.

A transistor-operated 6-note toy organ was demonstrated that plays through any conventional a-m radio. A single broadcast-band oscillator is quenched at different audio frequencies to obtain the desired notes in the receiver. A single-transistor phono oscillator smaller than a package of cigarettes was

also shown that had a self-contained power source capable of powering the oscillator for 3,000 hours.

The application that created most public interest was a portable tv receiver in which the only electron tube was a 5-inch picture tube. Thirty-six transistors performed the rest of the functions in the set and self-contained batteries provided the necessary power. This set was, however, demonstrated to show what *could* be done—battery life is prohibitively short.

Petroleum Radio Service Continues Uptrend

GEOPHYSICAL explorers for oil began early to use radio communications techniques. They are inclined to smile and remark wistfully that their use of frequencies antedates both the old Federal Radio Commission and its successor, the Federal Communications Commission.

With the formalizing of the Petroleum Radio Service by FCC in 1949, a growth to 10,000 stations was forecast. There are now 20,000 stations and applications are coming in at the rate of 5,000 a year.

► **Figures**—At present, Region 4 of the National Petroleum Radio Frequency Co-ordinating Associa-

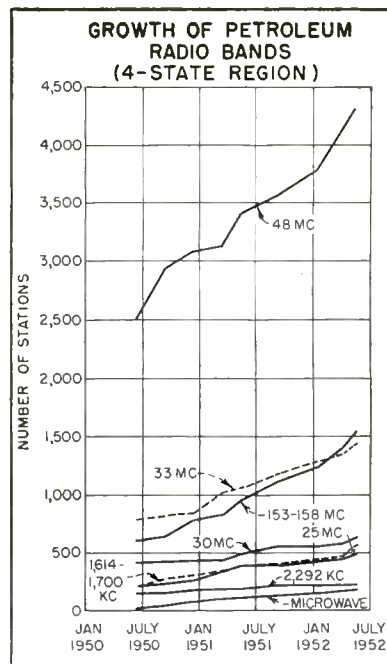

tion, comprising Texas, Louisiana, Arkansas and Mississippi, is the most active.

Figures showing the upswing of communications are plotted in the graph. It is apparent that channels allotted to 48 mc are in greatest demand at present, with future expansion here probable. Experiments now in progress show that it is possible to operate equipment satisfactorily in half the bandwidth as-

(Continued on page 8)

ELECTRONIGRAPHS Continued

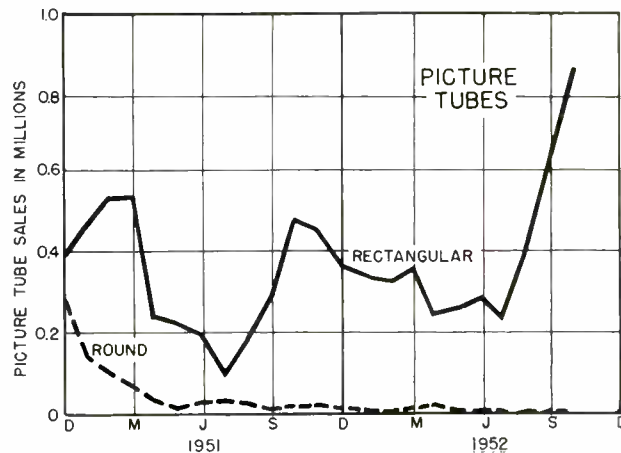
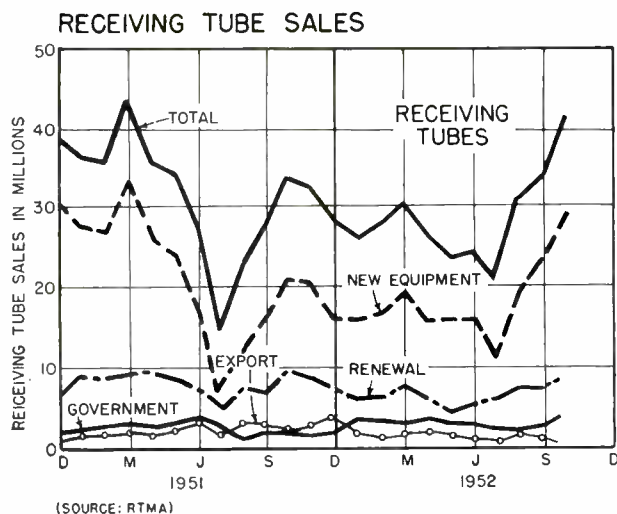

550 TO 3800 MEGACYCLES

with Sylvania 6BM6 Broadband Tunable **KLYSTRONS**

Sylvania now offers 4 different Klystron types, designed for external cavity resonators covering a frequency range from 550 to 6500 megacycles.

Types 6BM6 and 6BL6 are designed for CW applications, while types 5836 and 5837 may also be used in pulse modulated oscillation.

Sylvania Klystrons provide continuous tunable output over wide ranges of the micro-wave spectrum. New illustrated catalog gives complete specifications. Mail the coupon for your copy now.

We also welcome your inquiries regarding the designing of cavities for various types of circuits.

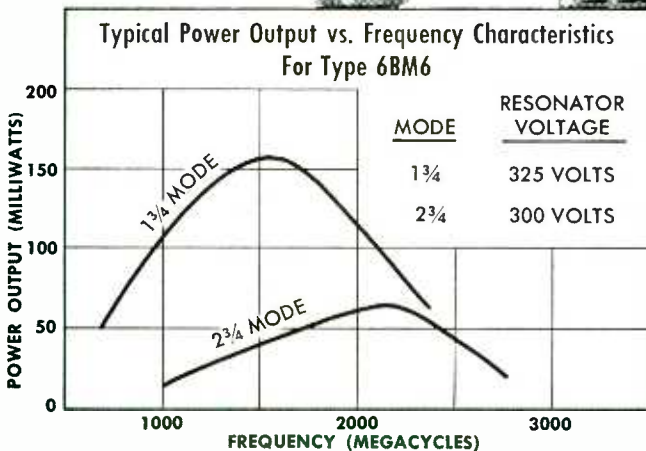
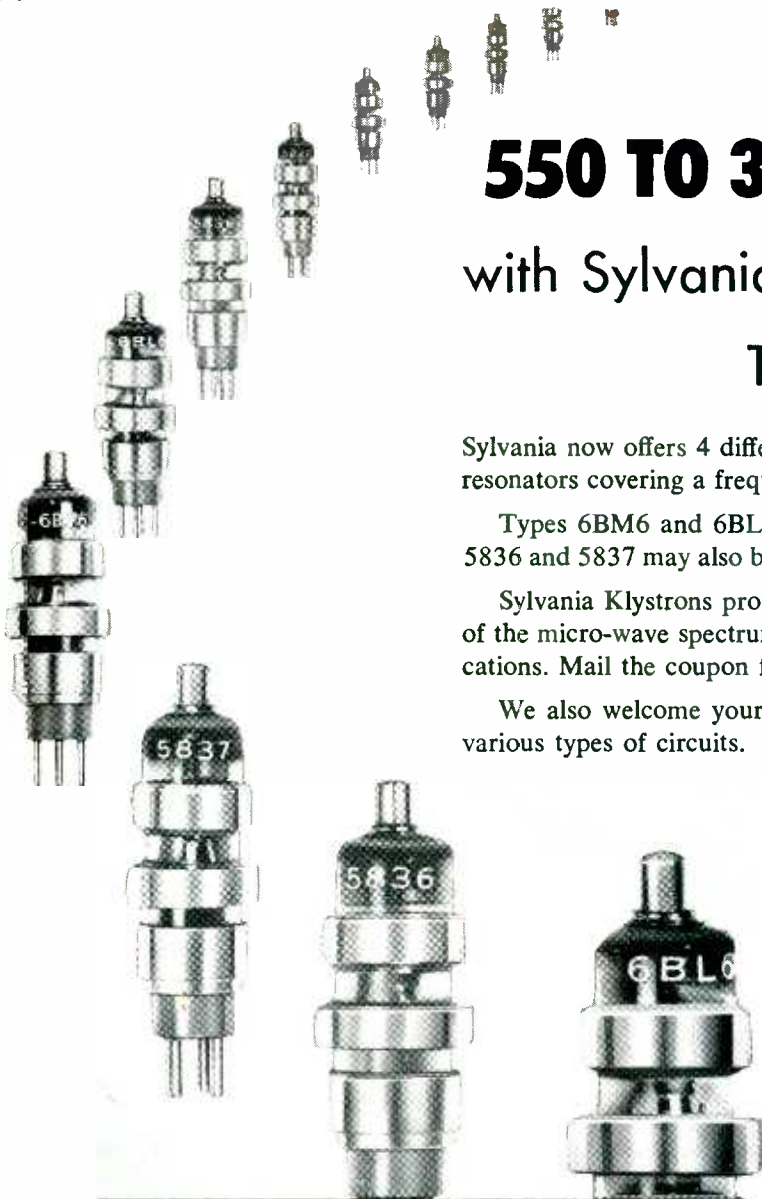

SYLVANIA

ELECTRONIC DEVICES; RADIO TUBES; TELEVISION PICTURE TUBES; ELECTRONIC TEST EQUIPMENT; FLUORESCENT TUBES, FIXTURES, SIGN TUBING, WIRING DEVICES; LIGHT BULBS; PHOTOLAMPS; TELEVISION SETS



Sylvania Electric Products Inc.
Dept. 3E-1001, 1740 Broadway
New York 19, N. Y.

Please send me new catalog describing Sylvania's line of Reflex Klystrons

Name _____

Street _____

City _____ Zone _____ State _____

signed each channel by FCC. Although halving the channel width does not automatically produce quite twice the station potential, it does permit continued healthy growth in this mobile two-way radio band.

Electronics Gains In Business-Machine Field

More office equipment companies adopt electronics as applications increase

ALL-ELECTRONIC offices may be far in the future but the business-machine industry is getting ready now for this multi-million dollar market of the future.

Although business-machine manufacturers have been moving into the field for some years, the trend last year was accelerated. Most recent entrants are National Cash Register, which recently acquired control of Computer Research Corp., and the Friden Calculating Machine Company, which now controls Computyper Corp. Nearly every major business-machine manufacturer now has an electronic division.

IBM, one of the largest companies in the field, is producing elec-



Electronic calculator made by IBM has 1,400 tubes. Over 1,000 of the machines are now used in business offices in the U. S.

tronic machines for business use in greater volume. In addition to the machine pictured, more than 100 of its electronic card-programmed calculators are now used in business applications.

► **Business Show**—Growing importance of electronics in the business-machine field was apparent at the recent National Business Show in New York, where a wide variety of electronic items were on display. Among them was an electronic sorter which sorts alphabetically and numerically at a speed of 800 cards a minute by means of a photoelectric cell that reads the punched

card values.

Also on display was a device that integrates the operations of an electric typewriter and a calculating machine so that the calculating results are automatically recorded by the typewriter at the rate of ten characters per second.

► **Business Trends**—The recent Office Management Conference in New York City also showed the increasing potential of electronics for business. One full day of the two-day meeting was devoted to electronics in office management. Topics discussed ranged from an evaluation of present electronic computers for use in business to an analysis of what the smaller office can do now to be ready for the shift to electronics.

Vehicular Radio Group Ponders Expansion

Channel splitting and systems co-ordination seen as solution to present overcrowding

SOME 250 engineers of the IRE group on vehicular communications met in Washington early in December to discuss, in particu-

(Continued on page 10)

ELECTRONIGRAPHS Continued

BROADCAST STATIONS

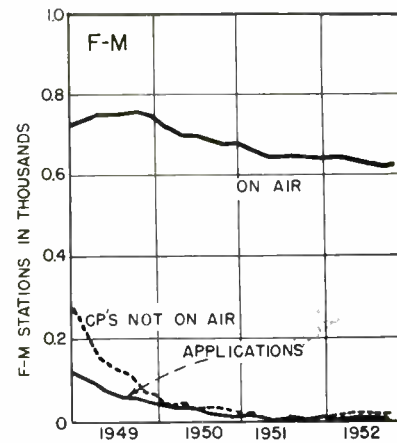
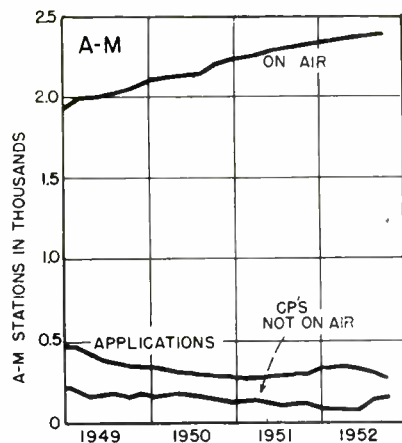
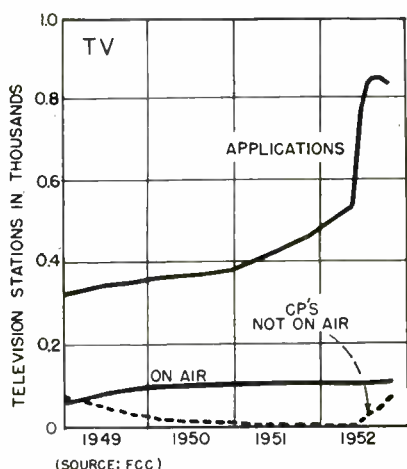

THE MOST EFFECTIVE CAPACITORS FOR R-F NOISE SUPPRESSION...

...are the
NEW
SPRAGUE
THRU-PASS[®]
CAPACITORS

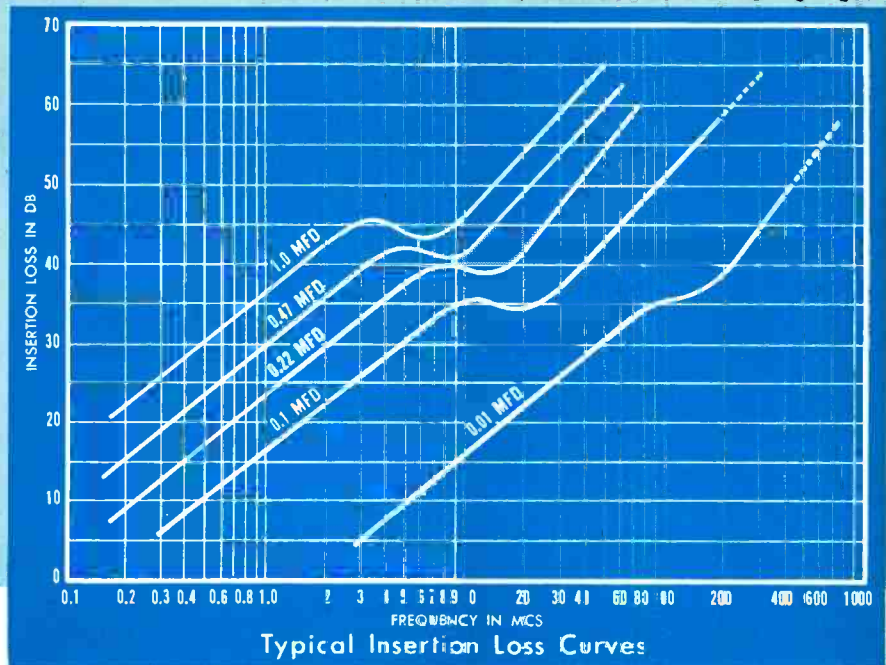

THRU-PASS CAPACITORS are a new Sprague development for use in radio interference reduction in communication and radar equipment.

- Thru-Pass Capacitors not only reduce to a negligible value the effect of external connection inductance to a capacitor but they also have a minimum length of internal path for radio interference currents. *Their performance is closer to that of a theoretically ideal capacitor than that of any other paper capacitor!*

- Electrically, Thru-Pass Capacitors are three-terminal feed-thru devices which are connected in a circuit in a manner similar to a low pass filter; the tab or lead terminals are connected in series with the circuit being filtered while the case is grounded.

- The threaded-neck mounting on Type 102P and 103P Subminiature Thru-Pass Capacitors is designed to give a firm metallic contact with the mounting surface over a closed path encircling the feed-thru conductor and to eliminate unwanted contact resistance so that the theoretical effectiveness of these new units is realized in practice. The milled flats on the threads help ensure vibration-proof mounting since the capacitors cannot rotate if mounted in a flatted opening instead of the usual circular hole.

- Type 102P and 103P Capacitors are all hermetically encased. Glass-to-metal solder-seal terminals are

employed in order to assure positive protection against severe atmospheric conditions.

- Both types are impregnated with Vitamin Q, Sprague's exclusive inert synthetic impregnant, in order to provide maximum insulation resistance and minimum capacitance change with temperature. Type 102P units are processed for -55°C to $+85^{\circ}\text{C}$ operation while Type 103P units have their top operating temperature extended to $+125^{\circ}\text{C}$.

- Engineering Bulletin 215 gives full details and standard ratings. Write on your business letterhead for your copy to Sprague Electric Co., 35 Marshall St., North Adams, Massachusetts.



TYPES 102P AND 103P 5 AMPERE THRU-PASS CAPACITORS SHOWING CHOICE OF LEAD OR TAB TERMINALS



WORLD'S LARGEST CAPACITOR MANUFACTURER

EXPORT DIVISION: CABLE SPREXDIV, NORTH ADAMS, MASS.

"THRU-PASS" AND VITAMIN "Q" ARE SPRAGUE TRADEMARKS.

lar, band crowding. They received a summation of the results of tests culminating in those conducted by the Joint Technical Advisory Committee at Syracuse, N. Y. during late October. From this information JTAC will propose new standards to FCC, by whom it had been asked for recommendations.

It is expected that the JTAC report will be issued during February or March, but that FCC will probably not take immediate action on it. Instead, as each service in the mobile field encounters intolerable interference, it can come to FCC and ask for relief under the new plan. In this way, the burden of choice is put upon the user.

► **Big Business**—Keynote speaker at the Washington meeting was W. R. G. Baker of GE, who estimated two-way radio as a \$34 million business that will grow to \$50 million a year by 1962. Other engineers think the present figure, undoubtedly based on FCC authorization, is a little high and that the true gross is between \$25 and \$30 million. They point out that applicants usually ask for more than the immediately required number of mobile authorizations and FCC customarily honors this blank check to save future bookkeeping when all equipment

finally comes into full-scale operation. But there is no quibbling regarding the health of mobile radio or doubts as to its future.

► **Techniques** — Increased engineering knowhow has made it possible to split present FCC-assigned channels in half. While, for various abstruse technical reasons, splitting doesn't double the total number of channels, it helps.

In some very crowded areas, it may be necessary for licensees to get together and establish a common transmitting point (in much the manner that television broadcasters use the Empire State tower) to cut down interchannel interference at the mobile receiver. Fixed receivers to pick up the mobile transmitters will have to be spotted around the working area. Wire lines will bring the strongest mobile signal for each user into his operating room. A further advantage to this scheme will be the fact that each mobile transmitter will need only two or three watts of power.

Communications Center Goes Underground

COMMUNICATIONS center designed to resist atomic attack, located inside Raven Rock Mountain, about

5 miles East of Fort Ritchie, Md., is being completed by the U. S. A half million cubic yards of hardest rock was blasted out for the equivalent of a 3-story communications building. Five microwave stations will tie the "Ritchie Project" into signal facilities of Army, Navy and Air Force already constructed in the Washington, D. C., area.

Theater Television Moves Ahead

Equipment sales were down last year but the outlook for 1953 is bright

DESPITE a decline in sales last year, theater television equipment represented an important and growing business for electronic manufacturers. About 40 systems were sold last year compared to 1951 sales of near 50 units. In 1950, less than 12 units were installed. Even these small unit sales represented substantial dollar volume for electronic manufacturers. The average price for the equipment is between \$15,000 and \$20,000.

With about 100 systems now installed, the theater tv equipment

(Continued on page 14)

ELECTRONIGRAPHS Continued

COMMUNICATION AUTHORIZATIONS

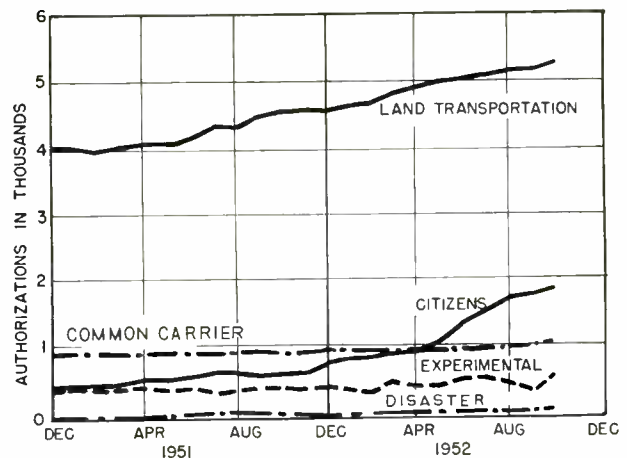
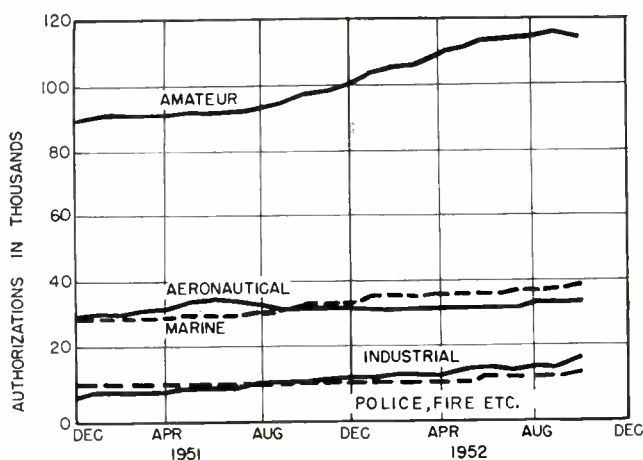

how to handle orders for
military electronic equipment...

better and faster!

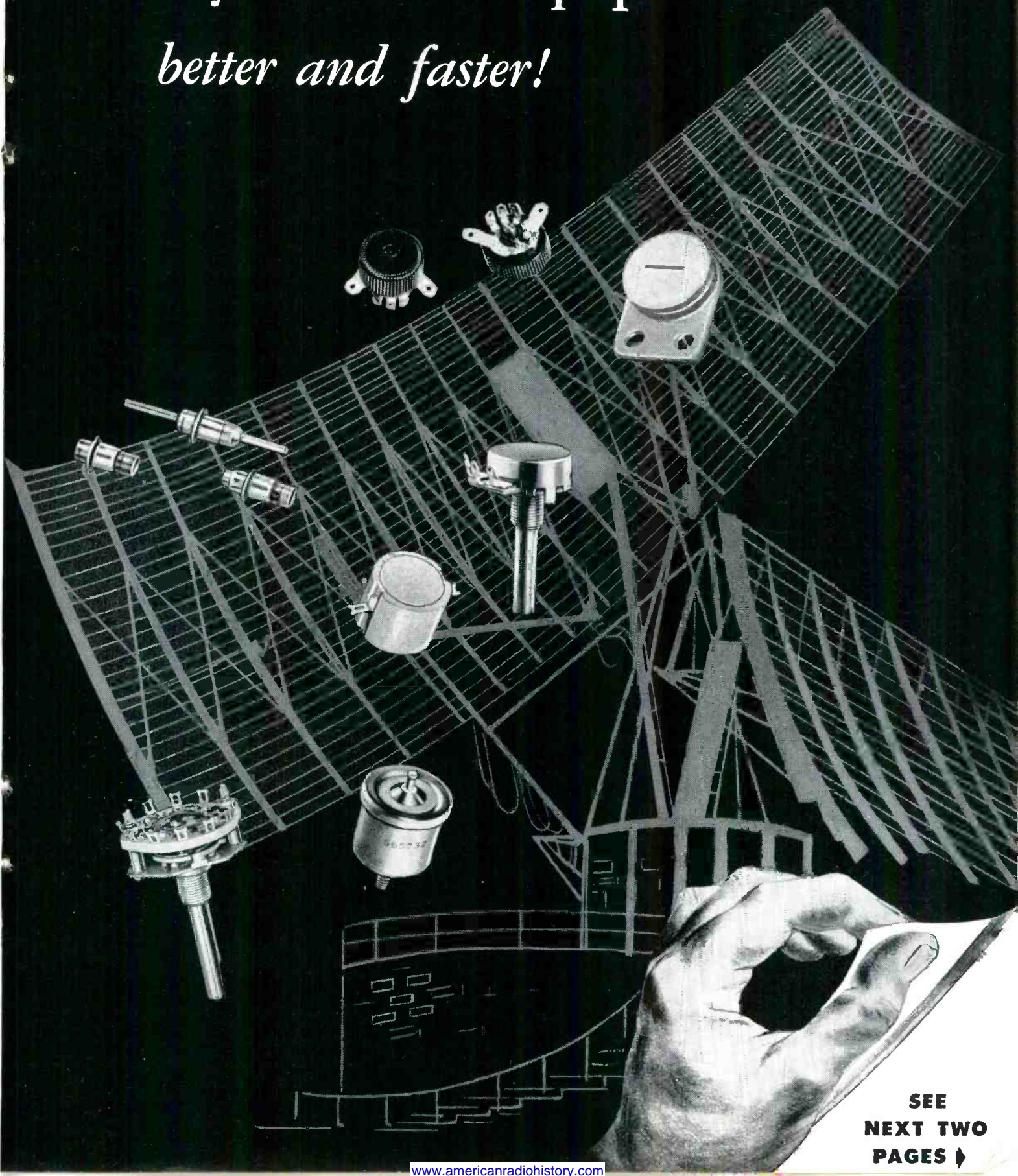

**SEE
NEXT TWO
PAGES** ↓

Choose **CENTRALAB**...

America's widest line of components that meet military specifications



Type
RV2A

Type
RV2B

CENTRALAB MODEL 2 VARIABLE RESISTORS

There's no prior contract approval or waivers required if you specify Centralab's Model 2 variable resistors on your next military order. They meet JAN R94, characteristic U requirements. Two types available — RV2A and RV2B — plain or with attached switches. Ratings from 2000 ohms to one megohm. For complete engineering data, check Bulletin No. 42-85 in coupon below.



Model 1, miniature variable resistors . . . no bigger than a dime . . . available in Standard or Hi-torque types. Either with or without on-off switch. Also available with slot—front or rear—for screw-driver adjustment. Hi-torque units hold settings under conditions of vibration or shock. For complete data check No. 42-158 in coupon below.



For miniature switches — specify Centralab's Series 20 with Steatite or Phenolic sections. Steatite is Grade L5. Meets JAN I-8 specs. Phenolic sections conform to JAN P-13 . . . Grade LTSE4. Available in 2 to 11 positions with stops, or 12 positions, continuous rotation—single or multiple sections—with or without attached on-off switch. Check No. 42-156.

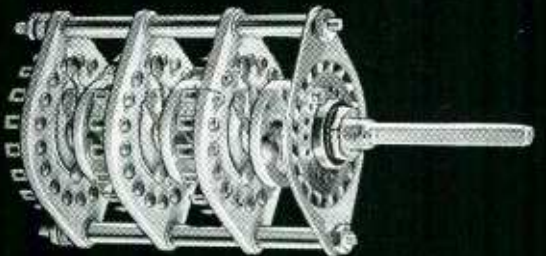

Centralab's Medium-Duty Power Switches. Use for R. F. or 110-115 V. application . . . 7½ amps. Voltage breakdown to ground — 3000 volts—RMS 60 cycles. Available with Grade L5 (JAN I-8) Steatite sections — shorting or non-shorting contacts. Models in 1, 2 or 3 poles, 18 contacts per section with adjustable stops, can be furnished up to 20 sections per shaft. Contacts and collector rings are coin silver. For complete data, check No. 42-136 in coupon.

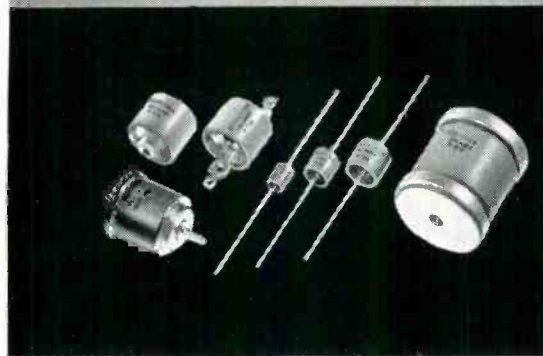

Centrallab's Type 850 high voltage ceramic capacitors are especially designed for high voltage, high frequency circuits. Centrallab's Type 950 high accuracy ceramic capacitors are especially developed for exacting electronic applications. Check bulletin No.'s 42-102 and 42-123.

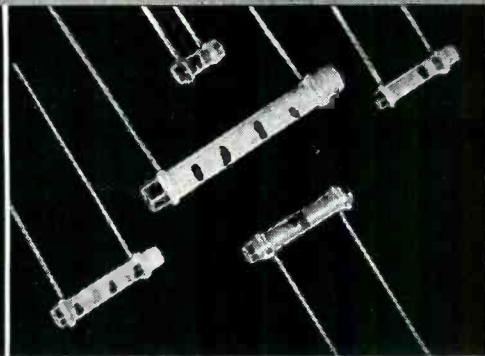

TC (Temperature Compensating) Tubulars — No prior contract approval or waiver necessary. Meet JAN-C-20A requirements. Type TCZ shows no capacitance change over wide range of temperature. Type TCN has special ceramic body to vary capacitance according to temperature. Bulletin No. 42-18.

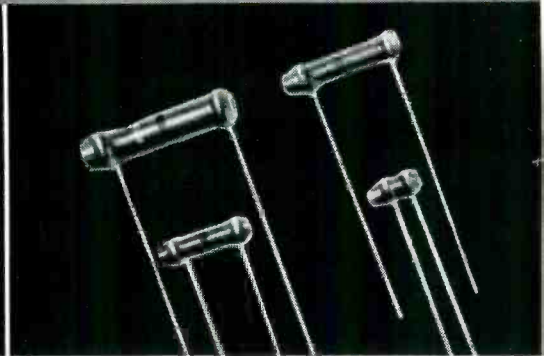

BC (Bypass Coupling) Tubulars — Recommended for bypass coupling. Well suited to general circuit use. Centrallab's own Ceramic X body provides imperviousness to moisture and low power factor. Easily withstands temperatures normally encountered in most electronic equipment. Bulletin No. 42-3.

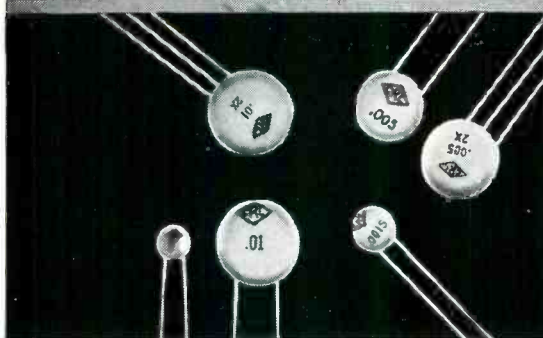

Ceramic Disc Hi-Kap Capacitors hold thickness to a minimum . . . have very high capacity in extremely small size. Use in h.f. circuits for bypass and coupling. Ceramic body assures low inductance. Other characteristics—humidity resistance, power factor, etc. — similar to BC Tubulars, Bulletin No. 42-4R.

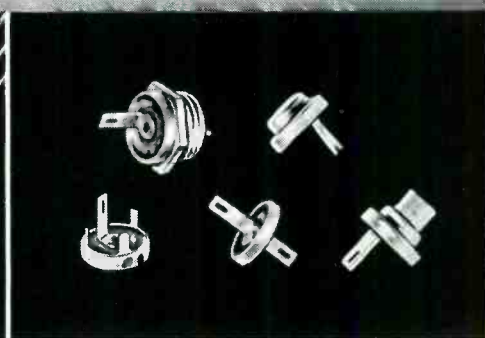

Something new in miniature ceramic capacitors! These "button types" are available in 5 different styles. Used for bypassing in low-power, high-frequency applications where small size, low inductance and light weight are essential. Check Bulletin No. 42-122 in coupon for more information.



Centrallab Ceramic Trimmers meet applicable portions of JAN-C-81. Very small size. Screw driver adjustment over full capacity range (180° rotation). Maintain stability in any position and under vibration. Spring pressure contact for rotor and stator. Bulletin No. 42-101.

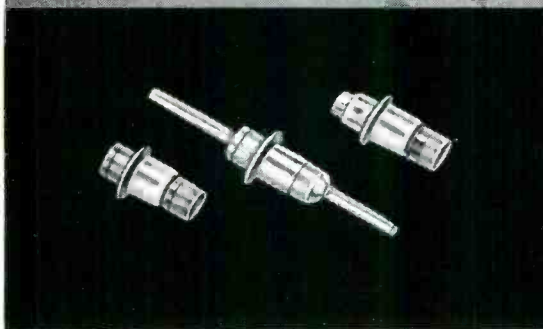

Centrallab's New Eyelet-Mounted Feed-Through Ceramic Capacitors are smallest available. They meet applicable portions of JAN-C-20A specifications. Capacities range from 10 to 3000 mmf . . . the widest range on the market. Voltage rating, 500 V.D.C.W. Check No. EP-15 in coupon.

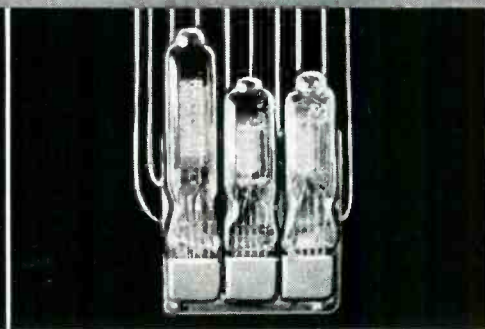

New Sub-miniature Model III Ampec — a full three-stage speech amplifier of remarkably small dimensions — approximately 1 1/32" x 1 1/16" x 1 1/32" (barely larger than a postage stamp!). Excellent for microphone preamplifiers and similar applications. Check No. 42-130 on coupon for complete information.

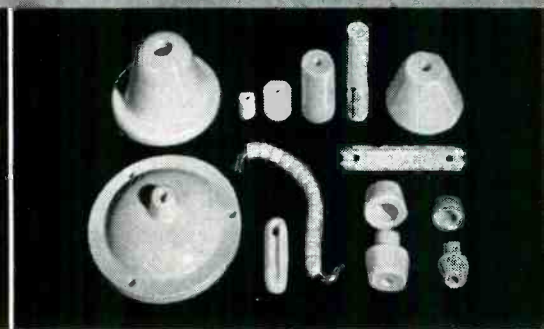

Centrallab standard and custom-molded Steatite ceramics plain or metallized . . . fully comply with JAN I-8. Steatite is Grade L5 for military use. Characteristics — high dielectric strength, low loss at high frequencies, high mechanical strength. For data on standard parts or custom molding, check No. 720.

Centrallab

A Division of Globe-Union Inc.
900 EAST KEEFE AVENUE • MILWAUKEE

E

Please send me Technical Bulletins as marked

- 42-85 42-158 42-156 42-136 42-102 42-123 42-18
 42-3 42-4R 42-122 42-101 EP-15 42-130 720

Name.....

Title.....

Company.....

Address.....

City..... State.....

market has only been scratched. There are more than 18,000 theaters in the U. S. Some theater tv proponents estimate that 10,000 theaters will be equipped within the next 5 years, representing an equipment sales volume of nearly \$200 million. This year sales of at least 100 units are expected.

► **Equipment**—Instantaneous and delayed film are the two types of equipment that make up the 100 systems now in use. Largest sales volume has been done with instantaneous systems. Only eight film systems have been installed. General Precision Laboratories, a leading manufacturer of film equipment, has discontinued production for theater tv use. The company is now concentrating on instantaneous equipment exclusively. They found that film systems were too costly for the average theater owner (\$30,000.) and were too bulky for easy installation.

A new type of instantaneous theater tv equipment called Eidophor, introduced by Twentieth Century Fox in recent months, may be the successor to film systems. It will be competitive in price with present instantaneous units and is adapted for CBS color television. Although no sales have been made as yet, it is reported

that production of 500 units is planned for this year.

► **Manufacturers**—Three companies are producing and installing theater tv equipment at the present time: RCA, General Precision Laboratories and Trad Television Corp. RCA has sold about 75 percent of all units installed to date. General Precision and Trad follow in that order. General Electric will become the fourth company in the field when it begins production of Eidophor equipment for Twentieth Century Fox. Other electronic manufacturers are working on theater tv systems but have not yet announced definite production plans.

► **Future**—Theater tv manufacturers agree that the outcome of current FCC hearings on exclusive channels for theater tv will have a profound effect on overall development of the field. But they do not see any great immediate effect on equipment sales. They are more concerned with theater tv programs, which have been few and far between. Such programming has made many theater owners reluctant to buy equipment.

Manufacturers are optimistic about future program schedules for theater tv. At least 12 programs have already been scheduled for 1953.

Communications Firms Expand Facilities

Companies sold more stocks and bonds in 1952 to buy new plants and equipment

EXPANSION that took place in 1952 and is continuing this year in the communications industry is indicated by new corporate securities that were offered for cash sale in the first 9 months of last year. Estimated gross proceeds from such offerings made by the end of September (latest reported month) were expected to total over \$651 million, topping full year proceeds in 1951.

As shown in the chart, last year's volume of security offerings by the communications industry reached the highest point since 1948. It reflected the continuing need for external financing by communications companies to carry out substantial capital expansion programs.

► **Expansion**—Proposed uses of estimated net proceeds from the offerings in 1952 was almost entirely for plant and equipment. Out of the total estimated net proceeds of \$645 million, communications companies planned to use more than

(Continued on page 16)

ELECTRONIGRAPHS Continued

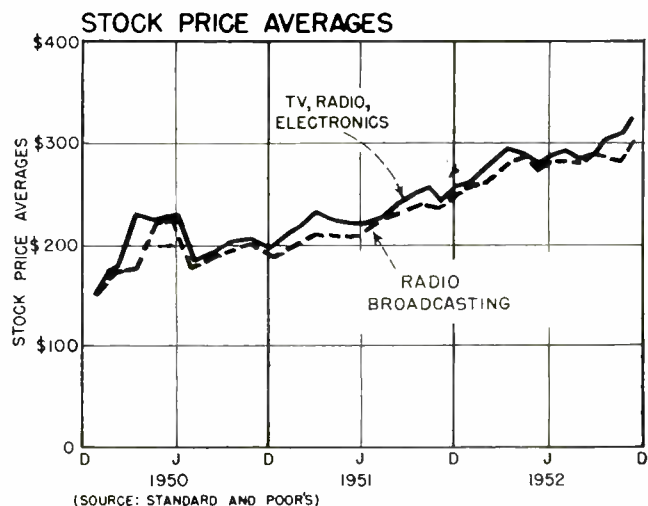
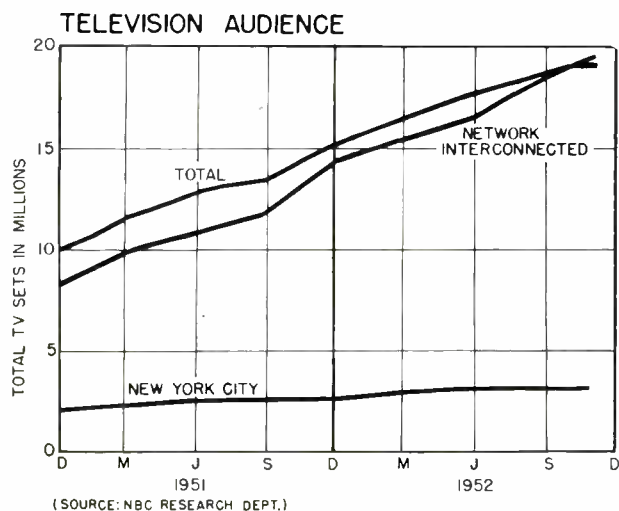

SHOCK AND VIBRATION

NEWS

Builder Claims Smooth Performance and Quiet Operation thru the use of Barrymounts in Dehydrator



The 2-way protection given by Barrymounts is applied in AUTO-DRYAIR® dehydrators as a design feature of these automatic pressurizing units for high-frequency transmission lines.

In this service, Type C-2000 Barrymounts prevent transmission of air-compressor vibration to the supporting surface. They also cushion the mounted apparatus to protect active parts, piping, and controls within the dehydrator from external shock and vibration.

The maker of AUTO-DRYAIR®, Communication Products Company, Inc. of Marlboro, N. J., states: "We have used Barry Isolators for several years. The excellent service they have rendered in our equipment is the primary reason for their continued use."

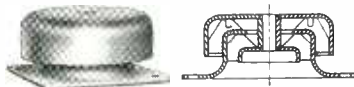

Type 2000 Barrymount

Barry "cup" mounts are satisfying a wide variety of needs in industrial, mobile, and marine service. Ask our Field Engineering Department for help with YOUR vibration problems. FREE CATALOG 504-B tells about these and other vibration isolators.

Miniaturized Vibration Isolators Help Cut Space and Weight in Fuel-Gauge Power Unit



70% size reduction and 50% weight reduction — with no loss of performance — is the effective miniaturization obtained in the new Minneapolis-Honeywell aircraft-fuel-gauge power unit. Miniature, air-damped Barrymounts, Type 6465, helped M-H engineers in this achievement.

These vibration isolators, in which size and weight have been cut while operating characteristics have been maintained, will help you redesign for miniaturization.

Check these useful features of miniaturized Barrymounts.

Light weight — only 5/16 ounce each.
Small size — 1" diameter 11/32" loaded height.

Resonant frequency — 9 cps

Transmissibility at resonance — 3

Wide load range — 0.1-3 pounds

4 different styles available — for plate or stand-off mounting.

Write for data sheets 605 and 606 giving details of dimensions and load ratings.

FREE CATALOGS

- 523-A — Air-damped Barrymounts for aircraft service; also mounting bases and instrument mountings.
- 509-A — ALL-METL Barrymounts and mounting bases for unusual airborne applications.
- 504-B — Shock mounts and vibration isolators for marine, mobile, and industrial uses.
- 607 — How to cut maintenance costs by using Barrymounts with punch presses.

THE **BARRY** CORP.

707 PLEASANT ST., WATERTOWN 72, MASSACHUSETTS

SALES REPRESENTATIVES IN

Atlanta Chicago Cleveland Dallas Dayton Detroit Los Angeles Minneapolis New York Philadelphia
Phoenix Rochester St. Louis San Francisco Seattle Toronto Washington

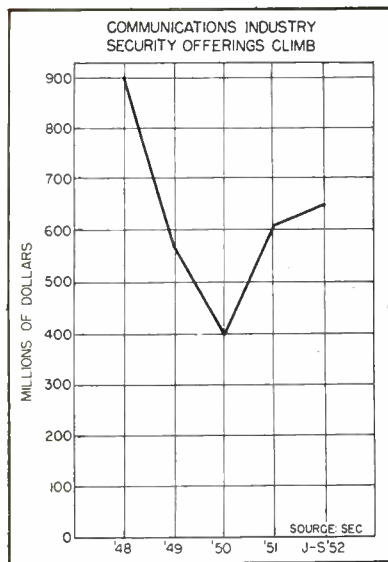

\$638 million in this manner. A total of \$3.8 million was to be used for working capital. The remainder, which amounted to less than \$5 million, was to be set aside for retirement of debts, preferred stocks and other purposes.

► **Securities**—Bonds were the predominant type of security offered for cash sale during the first 9 months of 1952 by communications companies. About \$607 million out of total security offerings of \$651 million were of this type. The remaining volume of \$42 million was split equally between preferred and

common stock sales.

Bond offerings have been predominant in the communications industry since World War II. In fact, most corporate offerings by all industry groups are made in bonds. Two reasons for this are: taxes are

less on bonds; less money needs to be paid out on them before investment of the offering's proceeds begin to pay off. It is expected that future security offerings by the communications industry will be largely in bonds for these reasons.

Television Sales Boom in Canada

Cumulative sales total \$80 million as broadcasting begins above the border

SCHEDULED television broadcasting in both Toronto and Montreal has given new impetus to retail sales of tv receivers in Canada and their manufacture is now well established in the dominion.

Cumulative retail sales total \$80 million, representing 172,000 sets; 92,800 sets were sold during the first ten months of 1952.

► **Set Makers**—Twenty-two Canadian set manufacturers are active in the field, many of them subsidiaries of U. S. concerns. Several European firms, mostly British, are also represented.

Importation of sets from the states, formerly a big factor in Canadian televiewing, is expected

to decline proportionately as protective tariffs encourage Canadian set manufacturers. Set production is restricted somewhat by a shortage of cathode-ray tubes.

► **Market**—The tv receiver market is expected to expand even further as more Canadian stations go on the air. Thus far, 40 percent of set sales have been in the Toronto-Hamilton area and 28 percent in the Montreal area. Remaining sales have been largely in the Windsor area and on the Niagara peninsula, where reception is from U. S. stations.

Canadian Broadcasting Corporation plans include stations in Ottawa, Halifax, Winnipeg and Vancouver. However, the CBC has recently announced that privately-owned stations will be permitted in cities where no CBC outlet is contemplated. A good deal of

(Continued on page 18)

ELECTRONIGRAPHS *Continued*

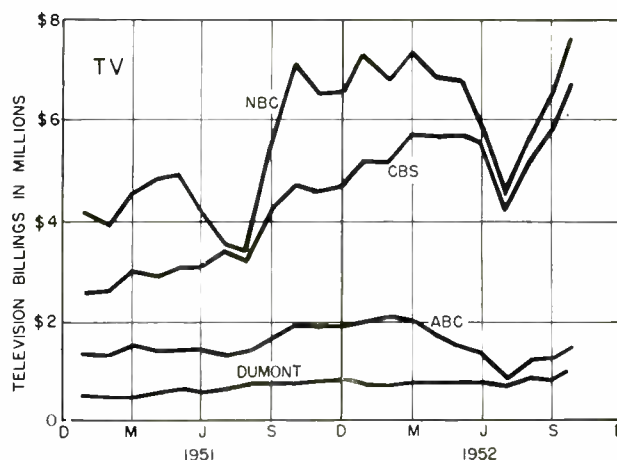
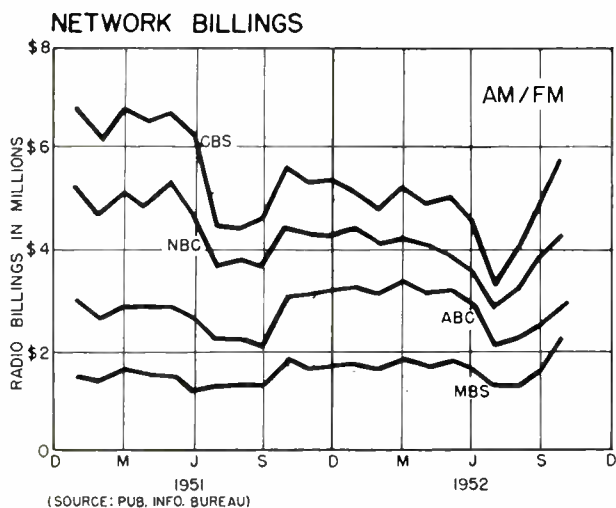

Precision Decade Resistors

**FOR USE AT D C
AUDIO and RADIO
FREQUENCIES**



★ Either three, four or five decades are available in welded aluminum cabinets

★ High basic accuracy — $\pm 0.05\%$ for all decades except $\pm 0.5\%$ for the 0.1-ohm decade, and $\pm 0.15\%$ for the 1-ohm decade

★ Excellent stability of calibration — mica cards and special phenolic forms are shaped and heat treated to minimize aging effects — temperature coefficient of resistance is less than 0.002% per degree C. at room temperature; slightly higher for the 0.1-ohm decade

★ Low residual impedance — less than 0.003 ohm per decade at dc; 0.04 ohm at 1 Mc. Zero inductance per decade is 0.10 microhenry. Effective shunt capacitance varies from 10 to 45 micromicrofarads depending on combinations of decades in use

★ Excellent frequency characteristic permits use up to several hundred kilocycles

★ Excellent mechanical and electrical shielding provided by welded aluminum cases

★ TYPE 1432 DECADE RESISTORS in ten sizes with resistance ranges from 0 to 111 ohms in 0.1-ohm steps, to 1,111,100 ohms in steps of 10 ohms. PRICES: \$56 to \$133

For use as variable laboratory resistance standards, in arms of a-c and d-c bridges, as dummy loads and almost anywhere electrical measurements are made, a variety of G-R precision decade resistors are available.

These boxes have very high accuracy, low residual impedance, excellent stability and good frequency characteristics from zero to several hundred kilocycles.

The individual decades of the Type 1432 boxes are ideal for assembly into production test instruments, laboratory apparatus and custom-built equipment. These Type 510-D Resistance Units are available in ranges from 1 ohm to 1,000,000 ohms, maximum, at prices from \$7.50 to \$40.00, each.



Type 670-F Compensated Decade Resistor . . . \$74.00

This unit is used when even the very low inductance of the Type 1432 Decade Resistors is too large. This decade resistor is valuable wherever non-reactive increments in resistance are required, as tuned-circuit substitution measurements and variable resistance elements in antenna measuring circuits.



★ Inductance remains constant within 0.1 microhenry at any resistance setting

★ Resistance increments are correct within $\pm 0.1\%$ for 10-ohm steps; $\pm 0.25\%$ for 1-ohm steps, and $\pm 1\%$ for 0.1-ohm steps

★ Temperature coefficient is less than .002% per degree C. at room temperatures

★ Resistance range is 0 to 111 ohms in steps of 0.1 ohm



GENERAL RADIO Company

275 Massachusetts Avenue, Cambridge 39, Massachusetts

90 West St., NEW YORK 6 · 920 S. Michigan Ave., CHICAGO 5 · 1000 N. Seward St., LOS ANGELES 38

pressure is being exerted on the CBC to allow operation of privately-owned stations in competition with CBC outlets.

Canadian tv station building may affect favorably sales of receivers in American towns near the border not now adequately served by U. S. stations.

► **Problems** — Cathode-ray tubes and tuners are not yet made in appreciable quantities in Canada. Tariff on these components adds materially to Canadian tv set prices. Assembly costs, too, are

higher and smaller production runs have also served to increase unit costs.

In Toronto costly modifications are necessary to make tv receivers run satisfactorily on 25-cycle current.

In Montreal, a bilingual population demands programs in both French and English, with accompanying time-sharing difficulties.

Rediffusion, a wired television system operating in Montreal, is also a factor in development of broadcast television.

which new tv cp grantees went on the air did not catch television receiver manufacturers napping. Set sales estimates for the six new markets seem to indicate that they were far ahead of the game. In Austin, for example, it is estimated that between 12,000 and 15,000 sets were in the area on December 1, just 4 days after the station went on the air. NBC estimated that on November 1, there were just 4,000 receivers in Austin.

Reliable set estimates for Honolulu have been difficult to get even for tv station representatives but educated guesses set the figure between 3,000 and 5,000 as of December 1. It is reported that both stations are completely covering the city so that sets in use are expected to increase rapidly.

Set estimates for El Paso; Roanoke and Spokane were 8,000; 26,000 and 6,000 respectively when the stations began operations in December.

Set makers were also ready for KKTV's debut in Colorado Springs. There were from 1,500 to 2,000 sets in the area long before a cp was granted to the station. Manufacturers had begun selling sets there when Denver stations went on the air. As of December 8, it was estimated that 10,000 sets were in

(Continued on page 20)

More New Television Stations On Air

Honolulu, Austin, Colorado Springs, El Paso, Roanoke, and Spokane debut

LAST two months of 1952 saw a flurry of new vhf tv stations go on the air, expanding the market for television receivers. Activity was also evident in the uhf tv field.

Following the debut of KDUB-TV in Lubbock, Texas (ELECTRONICS, p. 10, Dec.) KONA, channel 11 in Honolulu, took to the air. The transmitter went by air to the island. It began operating on November 17. Then Austin's KTBC-TV, channel 7, went on the air Thanks-

giving Day, followed on December 1 by another new tv station in Honolulu, KGMB-TV channel 9. Less than one week later KKTV, channel 11, in Colorado Springs, made its air debut. The station made record time in getting on the air despite the fact that it had to build a second transmitter building after its cp was issued, to comply with FCC requirements.

On December 4, KROD-TV in El Paso began tests. WSLs-TV in Roanoke and Spokane's KHQ-TV began regular programming on December 11 and 15 respectively.

► **Market Status** — Speed with

ELECTRONIGRAPHS Continued

EMPLOYMENT AND PAYROLLS

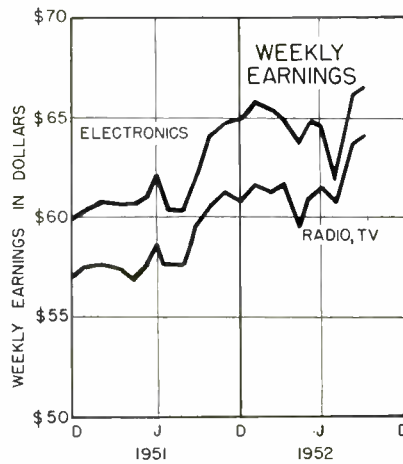
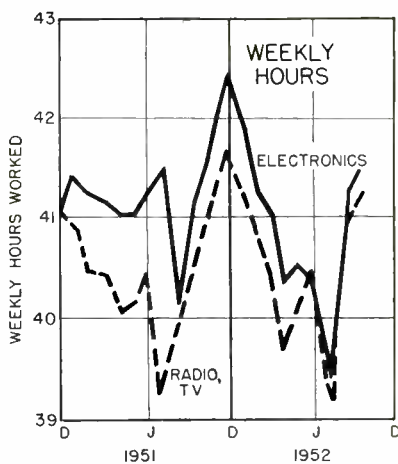
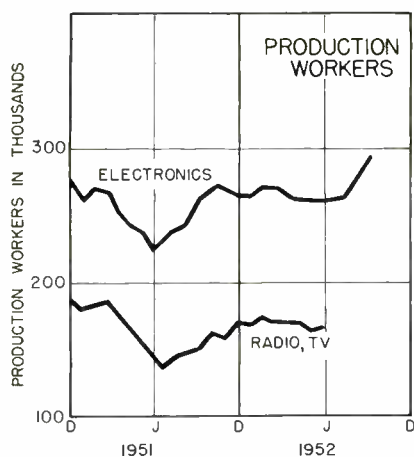

marion

INDUCTION SOLDERING UNIT MODEL PM1

for soldering small metal parts
and assemblies

SPEEDS UP PRODUCTION REDUCES COSTS IMPROVES QUALITY



The Marion Model PM1 Induction Heating Units, pictured above, are in service at the Clyde, New York, plant of the General Electric Company.

Germanium diodes, diffused junction rectifiers and transistors are manufactured at the Clyde plant and the Model PM1 Induction Heater plays an important role in a sub-assembly operation on the whisker diode line. A very small pellet of germanium metal is soldered to the end of a nickel pin and the Induction Heater is used to elevate the temperature to the desired value.



This Marion low cost, low powered, portable Induction Soldering Unit (Model PM1) simplifies, improves and speeds up the production of magnet assemblies, relay armatures, connectors, capacitors, transformer cans, germanium diode assemblies and other parts and assemblies in the manufacture of electrical and electronic components. In addition, the Marion PM1 Induction Soldering Unit has many applications in other fields such as jewelry, watches, toys, automotive parts, household fixtures, etc. Wherever the application of intense heat to small units is required chances are that it can be done better, faster and easier with this Marion Unit.

The unit was originally designed and has been used successfully for many years by Marion in the true glass-to-metal sealing of Ruggedized and other hermetically sealed instruments.



Power Supply: 115 volts, 60 cycles
Size: 15 $\frac{3}{4}$ " x 21 $\frac{1}{2}$ " x 15"
Mounting: Standard relay rack cabinet
Weight: 150 pounds

SPECIFICATIONS

Power: 775 watts at full power output, 100 watts standby.
The entire unit is rigidly assembled and mounted to prevent arc-over and failure of components. It easily meets latest F. C. C. requirements on radiation.

For further information write Marion Electrical Instrument Co., 401 Canal Street, Manchester, N.H., U.S.A.

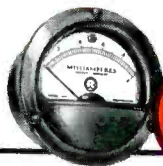

marion meters

Reg. U.S. Pat. Off.

MANUFACTURERS OF **RUGGEDIZED**, HERMETICALLY SEALED AND STANDARD PANEL INSTRUMENTS

KKTV's area, which includes Pueblo as well as Colorado Springs.

► **UHF Status**—The uhf tv station picture brightened in December when GE made its first shipment of a uhf transmitter, a 100 watt unit, to WKAB-TV in Mobile. Delivery of the antenna, however, was not expected until January.

WHUM, the uhf station in Reading, was also awaiting delivery of equipment. It reported that one of the chief reasons for delay in uhf operations was a shortage of waveguides. Vendors were reported to be unable to supply the much needed equipment in the volume and at the time needed.

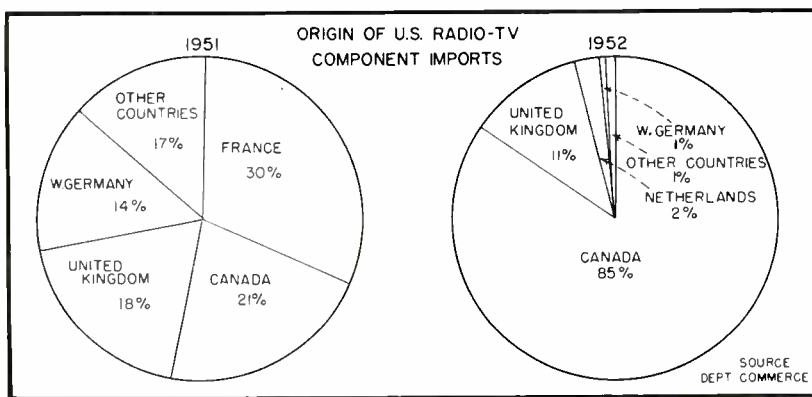

CANADA gained but Western Europe lost as . . .

Component Imports Rose In 1952

Totals for first 8 months topped 1951 figures as Canada increased U. S. trade

RADIO-TV apparatus and parts imports to the U. S. reached a total of \$4,161,366 by the end of August last year (latest reported month) compared to \$4,066,891 for the same period in 1951. As shown in the charts, only Canadian imports increased substantially during the period. Other countries lost.

Volume of U. S. imports of radio-tv apparatus and parts by country of origin during the first 8 months of 1952 were: Canada, \$3,371,125; United Kingdom, \$463,333; Netherlands, \$88,476; West Germany, \$25,263. In 1951, for the same period, the totals of leading countries were: France, \$1,256,903; Canada, \$847,436; United Kingdom, \$753,515; West Germany, \$566,103.

► **Gain**—Canada increased her volume of radio-tv apparatus and

parts exports to the U. S. by almost 400 percent over 1951 totals. Her volume was larger than all other countries combined. It represented 85 percent of total radio-tv imports for the period.

Most of the expanded volume of radio-tv imports from Canada is attributed to the increasing number of U. S. electronic equipment manufacturers who have opened branch plants in the Dominion. The general overall expansion of the country as well as the rising amount of U. S. investment capital that is going to Canada have also contributed to the rise.

► **Outlook**—With the upswing in business experienced by all segments of the industry in the last quarter of 1952, it is expected that final radio-tv apparatus and parts import totals will show a substantial increase over 1951's volume. However, it is considered unlikely that the totals for countries of Western Europe will change appreciably.

Financial Roundup

REFLECTIONS of the slump in radio and tv sales that took place in early 1952 are apparent in the latest income statements released by companies in the field. Continued expansion of the industry is evident, however, in the stock offerings and filings that were made.

► **Profits**—For most of the following companies, net profits for the first 9 months of 1952 were lower when compared to those of the same period in 1951:

Company	1952	1951
Admiral	\$3,741,107	\$5,400,156
American Cable & Radio	445,055	1,024,506
American Phenolic	922,803*	631,356*
AT & T	264,846,327	243,308,956
CBS	3,807,101	3,532,666
General Cable	3,618,489	3,679,997
Hallcrafters	378,460**	678,946**
Hoffman	994,282	-126,957
Motorola	4,079,262	5,327,442
Philco	6,073,000	7,963,000
Standard Coil	1,963,945	1,164,957
Stewart Warner	2,828,306	3,056,754
Stromberg Carlson	779,614	158,921
Tung-Sol Electric	1,288,324	1,524,628
Webster-Chicago	-607,118	368,739
Westinghouse	48,741,000	42,757,000
Zenith	2,576,212	2,689,630

* Adjusted to reflect retroactive aspects of 1951 Revenue Act.

** Fiscal year ending August 31, 1952.

► **Stocks Offered**—Standard Tungsten offered publicly 284,499 shares of common stock (par 10 cents) at \$1 per share "as a speculation". Net proceeds will be used to acquire additional properties, to buy equipment and for working capital.

Telecomputing Corporation offered 1,000 shares of capital stock (par \$1) at \$29 per share (dealers discount of \$1.50 per share). The issue was quickly sold. Net proceeds went to W. W. Beman, selling stockholder.

Standard Coil Products registered with SEC for an offering of \$5 million of 5 percent convertible subordinated debentures due Dec. 1, 1967 and 250,000 shares of common stock. Proceeds will be added to working capital and used to repay present short term bank loans of \$3 million and to provide additional working and expansion capital.

Electronic Devices publicly offered "as a speculation" an issue

(Continued on page 22)

AN IDEAL COMBINATION

ATLAS ENGINEERING TRANSFORMERS



manufactured with

Heldor

**CANS &
TERMINALS**

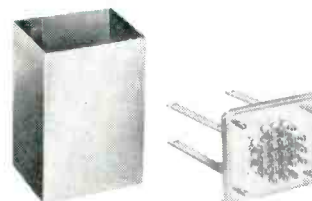

Built to Meet
MIL-T-27 SPECIFICATIONS

Atlas Engineering Company, Inc. of Boston selected Heldor Transformer Cans and Terminals as ideal components for their products . . . Heldor Transformer components give them *better quality* and *consistent uniform production*.

Whether your production is military or civilian, it will pay you to investigate the time-saving, money-saving and inventory-reducing features of HELDOR's complete package . . . transformer cans with compression-type hermetic-seal bushings pre-assembled in cans.

Mail specifications of your present can and terminal assemblies for a convincing, money-saving quotation.

FREE! New Can Catalog! Write today for your copy!



HELDOR MANUFACTURING CORPORATION

HELDOR BUSHING & TERMINAL CO., INC.

225 Belleville Ave.

Bloomfield, N. J.

of 3 million shares of common stock (par 1 cent) at 5 cents a share. Proceeds will be used to expand operations and for working capital.

► **Stocks Filed**—Electronics and Nucleonics (no relation to us) filed with SEC for 1.2 million shares of common stock (par 1 cent) to be offered at 25 cents per share. Net proceeds to be used to expand current operations and for working capital.

Sightmaster filed with SEC for 5,000 shares of common stock (par 5 cents) to be offered at the market (about 44 cents per share).

No general public offering is contemplated. Proceeds are to go to M. L. Kaplan, president, who is the selling stockholder.

Trad Television filed with SEC for 130,000 shares of common stock (par 1 cent) to be offered at the market (approximately 27 cents per share). Proceeds go to Victor Trad, president who is the selling stockholder.

General Electronics Distributors filed with SEC for 1,000 shares of non-voting common stock offered at \$37 per share. Proceeds to be used for business operations.

FCC Tosses Ball to JTAC On Interference

Government group outlines five-point program aimed towards spectrum conservation

ANY GI knows the dangers of volunteering. Willing volunteers, the members of the Joint Technical Advisory Committee recruited from Radio and Television Manufacturers Association and the Institute of Radio Engineers, have just learned some of the hard facts of life from the Federal Communications Commission.

► **How It Started**—JTAC's comprehensive report on spectrum utilization, based on present uses and future needs, was recently published by McGraw-Hill in book form under the title "Radio Spectrum Conservation" (\$5). In it, the Committee points out some present inefficient practices and suggests general principles for future betterment.

At the same time, RTMA (which constitutes half of the JTAC combination) has been carrying on a gentle epistolary feud with FCC, which thinks all television set manufacturers should reduce set radiation interference and start using the new standard 41.25-mc intermediate frequency before more stations and receivers go into circulation.

► **What FCC Wants**—Now that the JTAC report has outlined broad solutions, including reduction of all interfering signals from transmitters and receivers, FCC is asking that specific suggestions with teeth in them be formulated. It asks that special attention be given to these subjects:

(1) Limits be put on useless but interfering radiations that fall outside the assigned frequency bands. (This is to safeguard broadcasting, aircraft communications and navigational aids.)

(2) Review technical problems of reducing radiation from various non-communications devices (like

(Continued on page 24)



GERMAN V-2 (left) carried its 2,000-lb warhead 250 miles at 3,600 mph; multistage rocket gains range when 'Wac Corporal' in V-2's nose is fired at top of trajectory (right); intercontinental missiles seem closer today because . . .

Tiny Gyro May Guide Missiles

Available components can furnish essentials of guidance

PILOTLESS supersonic parent missiles, able to make round-trip flights and launch air-to-ground atomic missiles at important targets en route, are seen by Arma Corporation engineers as entirely possible.

Using miniaturized gyroscopes, computers and servomechanisms, the 'inertial' guidance system would be wholly self contained, dependent upon the earth's course through space and impervious to enemy deception or jamming.

► **Pilotless Flight**—Aside from missile applications, programmed

flight based upon inertial navigation is forseen as a means for safe supersonic flight where the human pilot's reaction time is now the limiting factor.

The complete system would weigh about 200 lbs and require no more space than a human pilot. In addition, pilot equipment such as G-suits, parachutes and oxygen would be unnecessary.

► **Inertial Navigation**—The missile's flight plan referred to a free gyroscope could be stored in computers.

With error sensing by accelerometers, the system could be made continuously self-correcting through closed-loop servo systems.

SKATING RINKS



FUNERAL PARLORS



DANCE STUDIOS



STEAMSHIPS



AMUSEMENT PARKS AND RECREATION CENTERS

strikes a **NEW NOTE** in continuous performance playback music

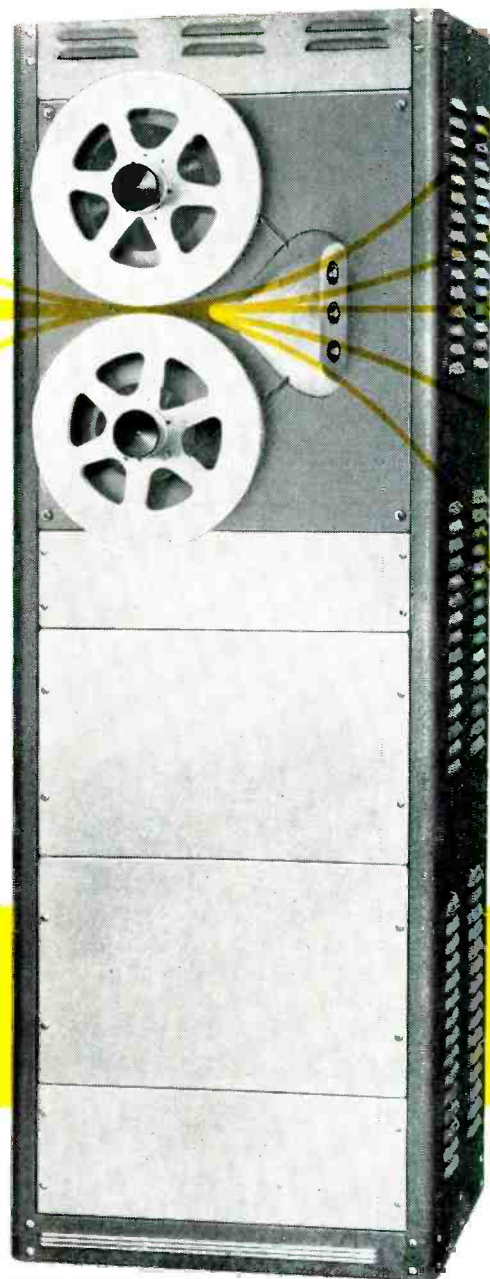

Model 450 rack-mounted. Also available in portable or console mount.

INTRODUCING THE

AMPEX 450

- Up to eight hours of uninterrupted performance — day after day, year after year
- Requires no attention during operation
- Lowest cost per hour

The new AMPEX 450 gives you hours of high-quality background music delivered at lowest cost per hour of any musical reproduction system. With the AMPEX there are no interruptions, no records to change and no attendants since it needs no attention during operation. It plays at the touch of a button and keeps on playing for as long as eight hours without repetition. Because tape doesn't lose quality with repeated playings, music is always scratch-free and pleasant, with less background noise and distortion.

The Model 450 is engineered to rigid AMPEX standards and is capable of delivering thousands of hours of service with no breakdowns and minimum maintenance.

For further information, write to Dept. E

IF YOU PLAN FOR TOMORROW, BUY AN AMPEX TODAY

FEATURES

- 50 to 7500-cycle frequency response at 3¾ inch tape speed
- Standard NARTB reels up to 14 inches
- Pushbutton controls
- Automatic reverse control available as an accessory permits full eight hour program without interruption.

AMPEX

MAGNETIC RECORDERS

AMPEX ELECTRIC CORPORATION
934 CHARTER STREET • REDWOOD CITY, CALIF.

diathermy, welding apparatus and high-frequency heaters) to determine the feasibility of attaining the limits outlined above.

(3) Review the instrumentation problem necessary to put over a national program of spurious radiation control.

(4) Study the procedure and organizational effort in this field to find whether additional effort is needed to co-ordinate interference-reduction efforts.

(5) Determine whether action is needed to co-ordinate "external performance" of receiver with engineering of service and station allocations.

► **TV Proposal**—FCC has already proposed a change in its tv broadcast rules. Inviting industry comment before Jan. 12, 1953, it suggests that all emissions removed in frequency in excess of 3 mc above or below the respective channel edge shall be attenuated no less than 60 db below the visual transmitter power. In the event of interference caused to any service, greater attenuation will be required. Manufacturers have already indicated that such suppression at the transmitter output terminals can readily be obtained by harmonic filters.

Parts Industry Set To Appeal Putnam Action

MANUFACTURERS of radio-tv parts and tubes prepared through RTMA to make a joint industry protest to OPS under appeal procedures when Roger L. Putnam, Administrator of the Economic Stabilization Agency, did not lift present price lids on radio-tv parts and tubes (*ELECTRONICS*, p. 8, Dec. '52).

RTMA will base the new protest on the points that the OPS action is not supported by facts, is contrary to the intent of Congress and the law, and that it is arbitrary and capricious. The Association plans to carry the fight to the courts if the joint appeal fails.

Tubes Speed Magazine Mailing

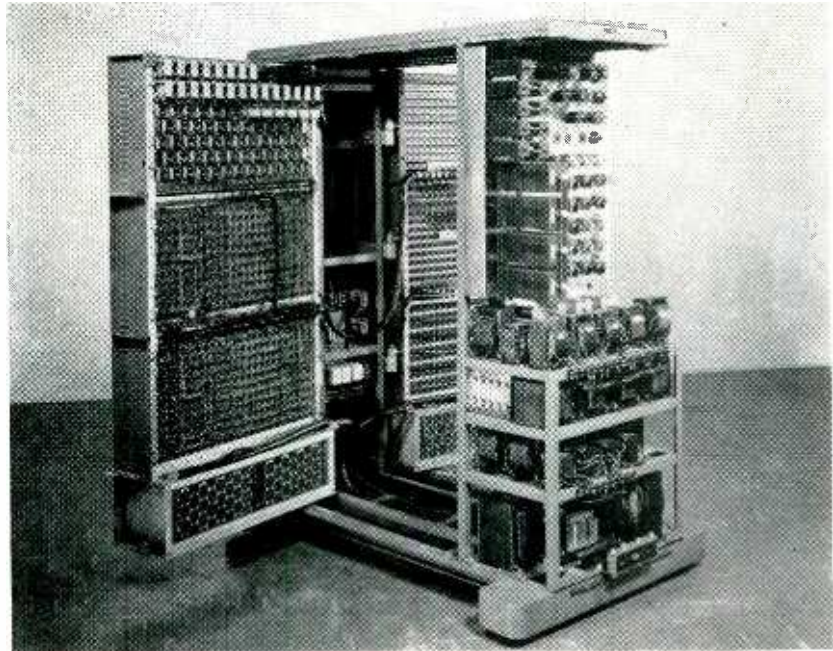

Highlight of the second annual joint AIEE-IRE-ACM Computer Conference held in New York, Dec. 10-12 was Eastman Kodak's multiple-stylus electronic printer, the electronic portion of which is shown above. Printing capacity is 400 characters per second. Machine is designed for printing magazine and mailing envelope labels, utility bills and insurance premium notices. Address labels can be turned out at six hundred per minute

'Booster' TV Stations Aborning

Too YOUNG to denote a trend, booster and satellite tv stations now operating nevertheless hold promise for areas too far from ordinary stations to get decent reception and too sparsely populated to support local stations.

The FCC has never authorized such stations commercially, but two of them are operating experimentally. Applications for two more are pending. When results of the experiments are reported, the Commission will consider whether commercial operation should be permitted.

A booster station rebroadcasts the originating station's signal on the same frequency. A satellite rebroadcasts on a different frequency.

► **Operating Now**—One satellite is in Emporium, Pa., owned by Sylvania Electric, which operates a tube plant there. It is KG2XDU,

radiating 300 watts on uhf channel 22 (518-524 mc). The company also has a construction permit for KG2XEL, to operate on channel 82 (878-884 mc), with 50 watts. Propagation, interference and coverage of the two will be compared. Signals of commercial station WJAC-TV, Johnstown, Pa., are rebroadcast.

A 5-watt installation at Lawrenceburg, Tenn., is operated by WSM-TV, Nashville, as a booster. Like WSM-TV, it employs channel 4, but it radiates vertically polarized signals while WSM-TV transmits conventional horizontally polarized signals. The idea is to determine whether this technique will minimize cochannel interference which would otherwise occur.

► **Future Business**—A pending satellite application was filed by Howard-Yale Inc., of Palm

(Continued on page 26)

New!

weighs only 1 lb. 14 ozs.

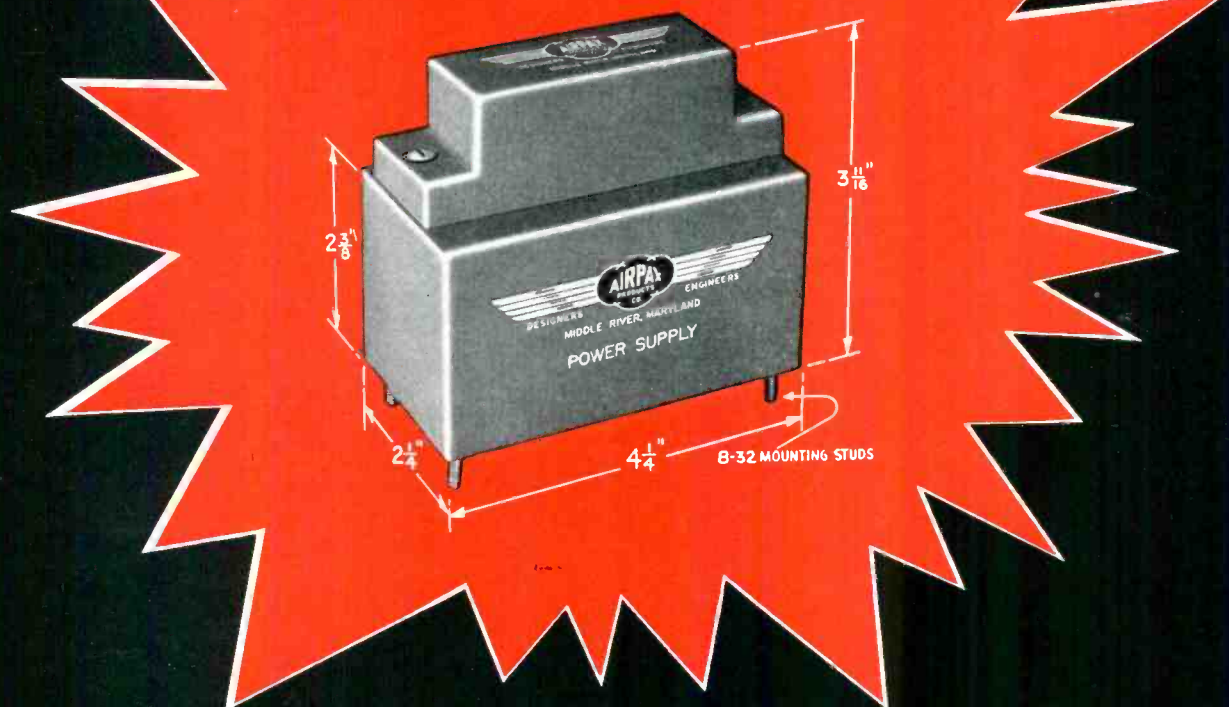

**the smallest . . . lightest
power supply available!**

the AIRPAX "PICK-A-BACK"

Model A-1220 vibrator power supply is designed to deliver 15 watts, 150 volts DC, 100 ma, is filtered to 1% peak ripple, has DC to DC efficiency of approximately 70%. Very small size and weight are possible because of the high frequency (450 cycle) vibrator. Vibrator and power supply are hermetically sealed. Vibrator is replaceable, using Dzus snap fasteners for easy removal. Supply obtainable for 6 or 12 or 26.5 VDC input, on special order any input voltage from 4 to 110 may be used; outputs up to 20 watts and 300 volts can be furnished. Power supply will operate with a 20% input voltage variation, and under severe vibration and shock. It won't be damaged by exposure to high humidity or high altitude. Internal temperature rise is 38° C, permitting maximum external ambient of 75° C.

Write for Bulletin A-1220.



Springs, Cal., which seeks to rebroadcast the signals of Los Angeles stations, scramble them, and institute a pay-as-you-look system in Palm Springs.

Also pending is the booster application of WSAZ-TV, Huntington, W. Va., which proposes a one-watt station at Williamson, W. Va., to pick up and rebroadcast the mother station's signals for the benefit of Williamson residents. Engineers calculate that one watt, into a directional antenna, can serve 7,000-10,000 people in a 5.57-square mile area.

KGMB-TV in Honolulu plans to put a satellite tv station in operation this year.

The FCC has been in no hurry to authorize boosters and satellites commercially, feeling that regular stations should be given time to develop first. However, if it can be proved that boosters and satellites don't create interference to existing or prospective regular stations, their chances of getting approval will be considerably enhanced. And if proponents of such baby stations can satisfy the Commission that they will bring tv to people who would otherwise get little or none for years, if ever, they're likely to get favorable action.

Transistors In Use



Long-distance dialing service in Englewood, N. J., is a Bell Telephone proving ground for transistor oscillator equipment. The oscillators are used to generate electrical signals by called numbers sent from one central office to another. Each oscillator unit uses six transistors

MEETINGS

- JAN. 6: N. Y. AIEE, Lecture on "Storage Devices In High Speed Digital Computers," Engineering Societies Bldg., New York, N. Y.
- JAN. 6-8: 1953 Surplus Show, Hotel Statler, New York, N. Y.
- JAN. 8-9: AIEE, IRE, Symposium on Industrial Applications of Automatic Computing Equipment, Midwest Research Institute, Kansas City, Mo.
- JAN. 14-16, 1953: Joint AIEE-IRE Conference on High Frequency Measurement, Washington, D. C.
- JAN. 16: Mica Symposium, American Ceramic Society, Oscar's Restaurant, New York, N. Y.
- JAN. 19-23: AIEE Winter Meeting, Hotel Statler, New York, N. Y.
- JAN. 26-27: Seventh Regional IRE Conference, University of New Mexico, Albuquerque, N. M.
- FEB. 4-6: Western Computer Conference, Hotel Statler, Los Angeles, Calif.
- FEB. 5-7: IRE Southwestern Conference and Electronics Show, Plaza Hotel, San Antonio, Texas.
- FEB. 5-7: Audio Fair, Alexandria Hotel, Los Angeles, Calif.
- MARCH 9-12: NEMA, Edgewater Beach Hotel, Chicago, Ill.
- MARCH 23-25: Sixth Annual Conference for Protective Relay Engineers, A & M College of Texas, College Station, Texas.
- MARCH 23-26: IRE National Convention, Waldorf-Astoria Hotel and Grand Central Palace, New York, N. Y.
- MARCH 23-27: Western Metal Exposition, Pan-Pacific Auditorium and Western Metal Congress, Statler Hotel, Los Angeles, Calif.
- APRIL 18: Seventh Annual Spring Technical Conference, Cincinnati IRE, Cincinnati, Ohio.
- APRIL 27-MAY 8: British Industries Fair, Birmingham & London, England.
- APRIL 28-MAY 1: Seventh Annual NARTB Broadcast Engineering Conference, Burdette Hall, Philharmonic Auditorium, Los Angeles, Calif.
- APRIL 29-MAY 1: 1953 Electronic Components Symposium, Shakespeare Club, Pasadena, Calif.
- MAY 11-13: National Conference on Airborne Electronics, Dayton, Ohio.
- MAY 18-21: 1953 Electronic Parts Show, Conrad Hilton Hotel, Chicago, Ill.
- MAY 18-23: Third International Congress On Electroheat, Paris, France.
- MAY 24-28: NAED, 45th Annual Convention, Conrad Hilton Hotel, Chicago, Ill.
- MAY 24-28: Scientific Apparatus Makers Association Annual Meeting, The Greenbrier, White Sulphur Springs, W. Va.
- JUNE 15-19: Exposition of Basic Materials for Industry, Grand Central Palace, New York, N. Y.
- JUNE 16-24: International Electro-acoustics Congress, The Netherlands.
- JUNE 20-Oct. 11: German Communication and Transport Exhibition, Munich, Germany.
- AUG. 19-21: Western Electronic Show & Convention, Municipal Auditorium, San Francisco, Calif.
- AUG. 29-SEPT. 6: West German Radio and Television Exhibition, Duesseldorf, Germany.

Business Briefs

▶ MIT's computer-controlled milling machine (ELECTRONICS cover, Nov. 1952) is now being used to turn out special parts for jet aircraft. One particular part once took 30 hours to produce by conventional methods. With the computer, the job takes 4 minutes.

▶ Cow Service in the Lehigh Valley is now being facilitated by two-way radio. Artificial inseminators are speedily dispatched to the receptive animal that can ordinarily be bred only during a 17-hour period every 21 days.

▶ Siam is expected to have its first television station on the air this month. A second station expects to begin operations in the early summer of 1953. All equipment for both installations, from transmitters to 16-inch receivers, is being supplied by Marconi.

▶ Suppressing devices to prevent tv interference will be compulsory in England on new cars, motorcycles and motorboats sold after July 1, 1953. All such interference radiations between 40 and 70 mc must not exceed 50 microvolts beyond 35 feet. Fines will be imposed if suppressors are not used.

HICKOK

Choice of the Experts

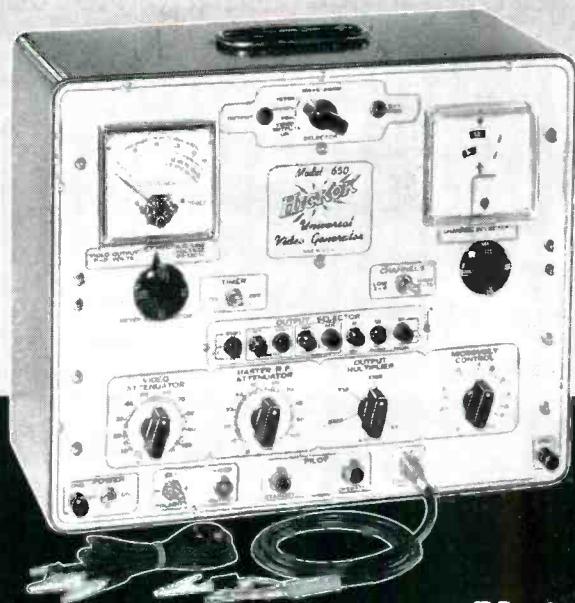

**Model
650**

**Universal Video
Generator**

Hickok, through 42 years of uninterrupted quality production has pioneered and developed numerous well-known electrical and electronic equipments now recognized as standards for the industry.

The newest Hickok contribution is the Model 650 Universal Video Generator. It accurately and rapidly localizes trouble in any stage of a TV receiver. Its use accomplishes in minutes tasks that normally take hours.

THE HICKOK ELECTRICAL INSTRUMENT COMPANY
10514 Dupont Avenue • Cleveland 8, Ohio

Why **PHELPS DODGE ROUND** ***THE YARDSTICK FOR***

- ✓ *Up-to-the-Minute Research*
- ✓ *Quality Controlled
for Maximum Performance*
- ✓ *Leader in Application Engineering*
- ✓ *Experience Over Complete Range—
#4 to #44, AWG—All Grades and Colors*

"It takes the best"

PHELPS DODGE COPPER PRODUCTS
CORPORATION

FORMVAR has become **FILM WIRE QUALITY!**



PHELPS DODGE, recognizing the advantages of round Formvar magnet wire, became the leader in replacing enamel, fabric and paper-covered wires. Today, round Formvar is used extensively in motors, transformers and coils, with resultant overall cost reductions and quality improvements in the insulation system.

Where greater spacing or additional safety factors are indicated, fabrics such as cotton or

paper can be added. For higher temperature operation Phelps Dodge Formvar, with a wrap of fiberglass, has been widely used.

For some applications a thin sheath of Nylon has been applied over the Formvar and identified as Phelps Dodge Nyform magnet wire.

★ ★ ★

Any time magnet wire is your problem, consult Phelps Dodge for the quickest, easiest answer!

to make the best!"



INCA MANUFACTURING DIVISION

FORT WAYNE, INDIANA

Plastic Capacitors



In the design of electrical and electronic circuits, where operating temperatures run fairly high, it is extremely important that the voltage ratings of components such as capacitors conform exactly to nameplate designations.

P-C Capacitors, designed for temperatures ranging from minus 90° C. to plus 200° C., depending upon the type, are guaranteed to operate without voltage derating at temperatures specified.

You can design your circuits around P-C Capacitors with complete assurance of their performance at specified temperatures.

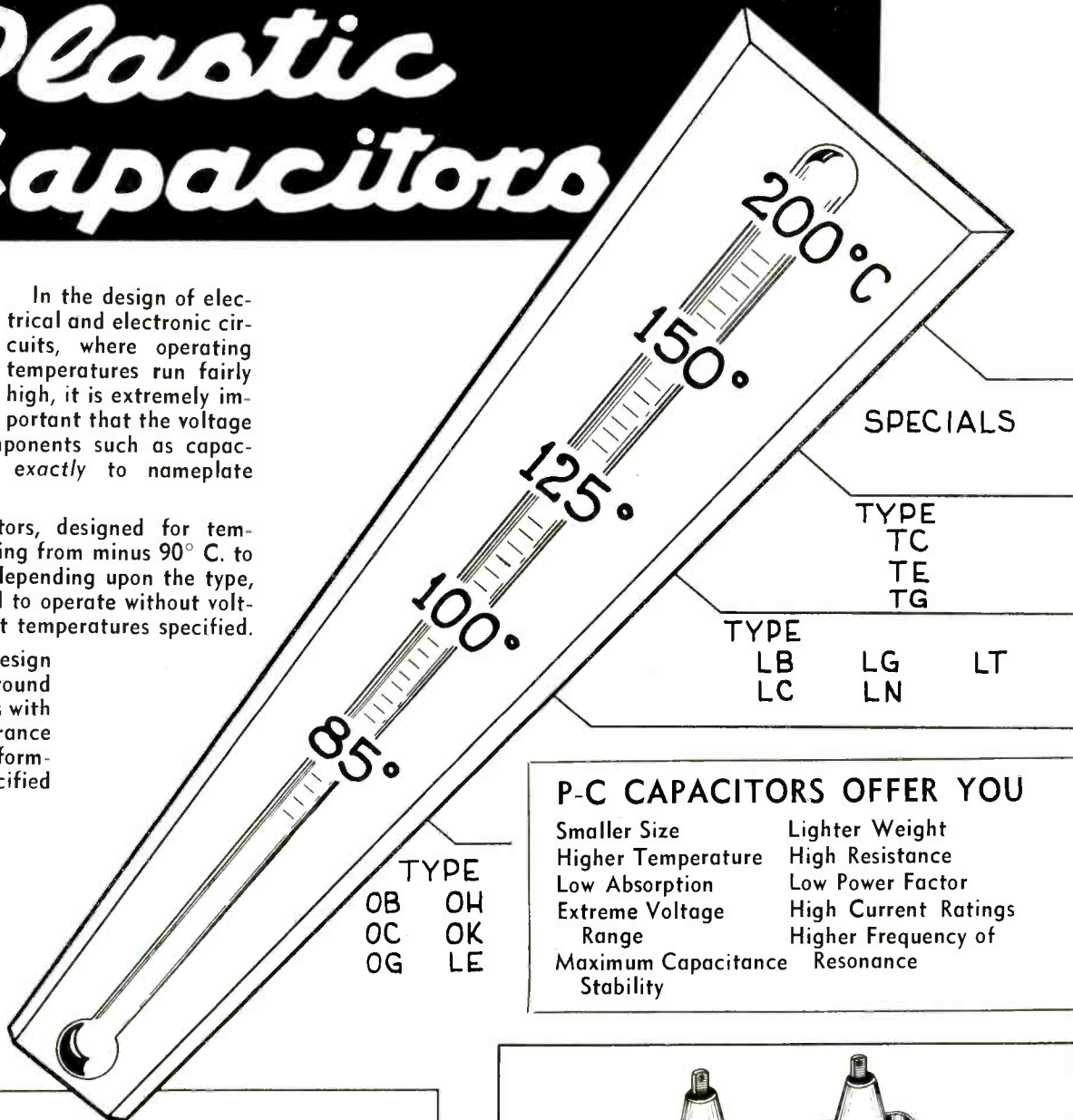

SPECIALS

TYPE
TC
TE
TG

TYPE
LB LG LT
LC LN

TYPE
OB OH
OC OK
OG LE

P-C CAPACITORS OFFER YOU

Smaller Size	Lighter Weight
Higher Temperature	High Resistance
Low Absorption	Low Power Factor
Extreme Voltage Range	High Current Ratings
Maximum Capacitance Stability	Higher Frequency of Resonance

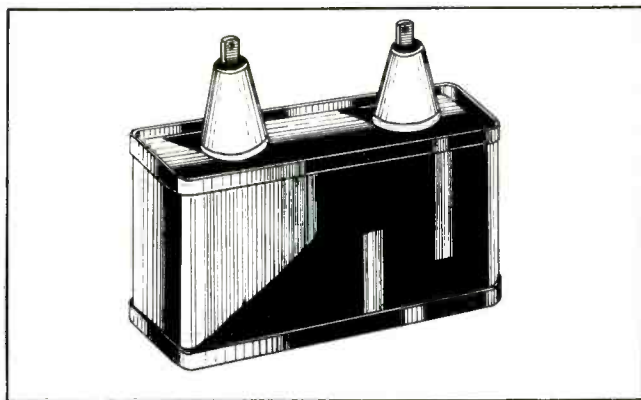

Get Your Copy of This Catalog

Plastic Capacitors, Inc.

PLASTIC FILM CAPACITORS • HIGH VOLTAGE POWER PACKS
• PULSE FORMING NETWORKS

2511 WEST MOFFAT STREET • CHICAGO 47, ILLINOIS

"We need an 82-channel tuner
—only one line of receivers
for all sales areas!"



TRIM TV COSTS WITH G-E VHF-UHF TUNER TUBES!

AVOID DOUBLE INVESTMENT IN WAREHOUSE STOCKS . . . cut production expense . . . with the aid of G.E.'s tuner-tube trio! Now you can have one-dial tuning through all TV channels—economically.

45-TO-870-MC RANGE! No need to switch tubes between high and low bands! General Electric tuner tubes are usable at *all* TV frequencies. Layout of your combined head end can be simple, saving tubes, components, and circuitry.

HERE ARE PERFORMANCE PLUSSES YOU OBTAIN: (1) low noise level, with less snow, (2) less radiation interference, (3) high r-f gain. They add up to a far better head-end circuit, as well as one that provides single-dial tuning at low cost.

GET FURTHER FACTS—TODAY! Phone, wire, or write for Booklet ETD-591, giving complete tuner-tube information! Or, if you wish, a G-E tube engineer will be glad to call. Address *Tube Department, General Electric Company, Schenectady 5, N. Y.*



6AJ4
Grounded-grid
r-f triode
(2 stages)



6AM4
Grounded-grid
mixer triode



6AF4
Local-oscillator
triode

GENERAL  ELECTRIC

162-1A1

Selected stock. Always free from defects and surface blemishes.

Moisture and fungus proof coatings, varnish or lacquer smoothly applied. No wrinkles or unsightly heavy deposits.

C.T.C. standard terminals. Types for all applications. Silver-plated, cadmium plated, electro tinned, hot tinned or gold plated as required.

Precisely located, clearly defined imprinting: rubber stamped, silk-screened, engraved or hot stamped.

Riveting or staking of terminals, brackets and other components accomplished without radial cracks or splitting of rivet shanks, and without damaging the finish.

Clearly cut or punched edges and holes. No signs of delamination.

Little details on terminal boards ...make the big difference in quality

C.T.C. is constantly supplying special terminal boards to the top names in electronics. These boards are built to strict government specifications, are fabricated of certified materials to fit the job. Among the specifications involved are: MIL-P-3115A, MIL-P-15037, MIL-P-15035, MIL-P-15047, MIL-P-997A.

Our Custom Engineering Service is well-equipped to fill these specifications for you. We are thoroughly familiar with the JAN and MIL-approved materials and finishes in accepted usage by government agencies and the armed forces. This, combined with assembly know-how developed over many years of supplying electronic components and equipment to the government, enables us to meet your needs for

quality above and beyond the basic government standards.

Boards can be made of cloth, paper, nylon or glass laminates (phenolic, melamine or silicone resin), and can be lacquered or varnished to specifications: JAN-C-173, MIL-V-173 and JAN-T-152. Lettering and numbering is done by rubber stamping, silk screening, hot stamp-

ing, engraving. Inks used in rubber stamping contain anti-fungus and fluorescent additives.

For complete information write: Cambridge Thermionic Corporation, 437 Concord Avenue, Cambridge 38, Mass. West Coast manufacturers, contact: E. V. Roberts, 5014 Venice Blvd., Los Angeles, or 988 Market St., San Francisco, Cal.

CAMBRIDGE THERMIONIC CORPORATION

custom or standard... the guaranteed components

See our listing in *Electronics Buyers' Guide*

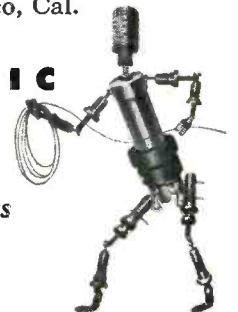



ELECTRONIC TEST INSTRUMENTS

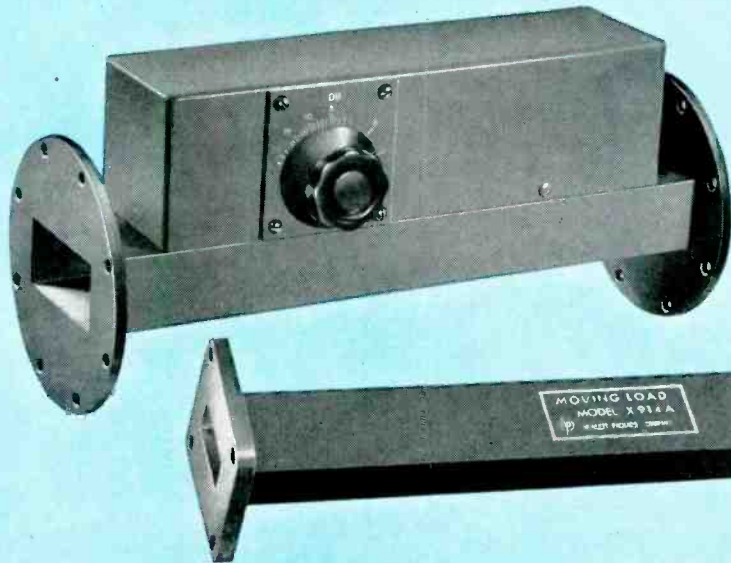

-hp- 375A Variable Flap Attenuators

-hp- 914A Moving Loads

New measuring accuracy and convenience, broad-band operation with low-cost **-hp-** Attenuators and Loads

These Attenuators and Moving Loads are integral parts of a complete new line of high-quality *-hp-* waveguide equipment. Like all elements in the line, they cover the full frequency range of their waveguide sizes, and are wholly integrated with other *-hp-* instruments. They have the simplest possible design consistent with basic function. Their novel circuitry and simple mechanical design insure high accuracy, stability and operating ease, and permit quantity production at low cost.

Waveguide Attenuators

Model 375A Variable Flap Attenuators provide a fast, simple means of adjusting power level or isolating source and load. They consist of a single slotted section in which a matched resistive strip is inserted a variable amount. The degree of strip penetration determines attenuation. A dial shows average reading over the complete frequency band. A shielded dust cover reduces radiation and eliminates hand capacity effects.

Model 375A Attenuators have a maximum VSWR of less than 1.15 full range. Attenuation is variable 0 to 20 db and power dissipated is 1 watt ($\frac{1}{2}$ watt for smaller sizes). Dial calibration is accurate within ± 1 db, 0 to 10 db; ± 2 db, 10 to 20 db. Typical frequency sensitivity ± 1 db entire band. Models for all frequencies 2.6 to 18.0 kmc. \$50.00 to \$75.00

In addition to Model 375A, *-hp-* offers Model 370 Fixed Waveguide Attenuators (6, 10 or 20 db attenuation, VSWR 1.15 full range) and Model S380A Calibrated Variable Attenuators (micrometer adjustment, VSWR 1.15 full range). Model 370 is available for all frequencies 2.6 to 18.0 kmc, \$55.00 to \$75.00. Model 380A is offered in the 2.6 to 3.95 kmc band only; \$225.00

Moving Loads

Model 914A Moving Load consists of a waveguide section in which is mounted a sliding, tapered, low-reflection load. A plunger controls the position of the load; and load is variable at least $\frac{1}{2}$ wavelength at the lowest frequency. This facilitates reversing phase so residual reflections can be separated from other minor reflections in the system. Load reflection is less than $\frac{1}{2}\%$ full range. Model 914A is available for all frequencies 2.6 to 18.0 kmc. \$40.00 to \$80.00

Data subject to change without notice. Prices f.o.b. factory

For complete details, see your *-hp-* field representative or write direct.

HEWLETT-PACKARD COMPANY
2608A PAGE MILL ROAD • PALO ALTO, CALIFORNIA, U. S. A.
Export: Frazer & Hansen, Ltd., San Francisco, Los Angeles, New York City



Instruments for Complete Coverage

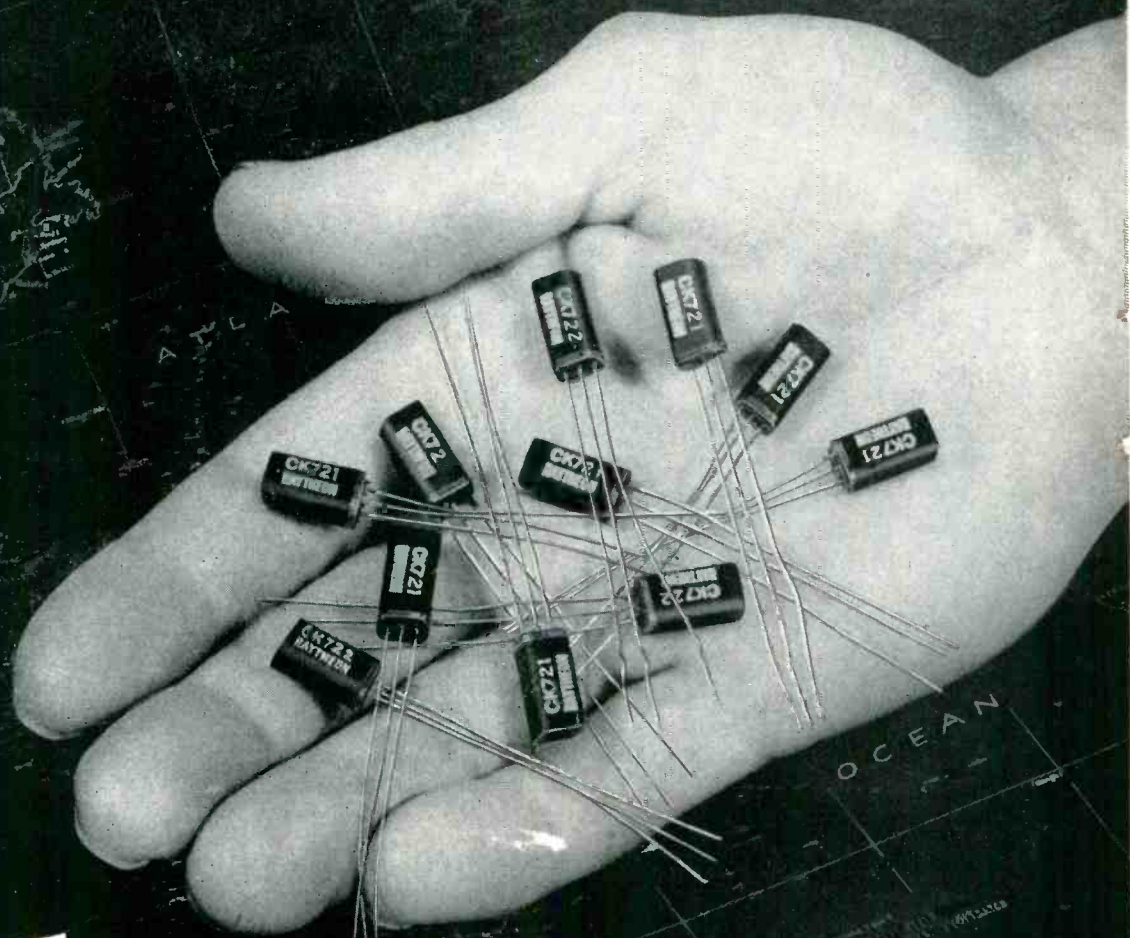

FIRST IN

AVAILABILITY

ACTUAL SIZE

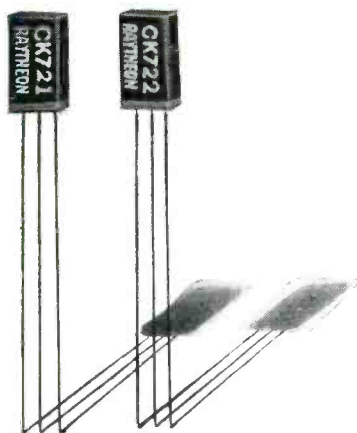

RAYTHEON, the pioneer and world leader in the development and mass production of dependable, top quality Subminiature Tubes, naturally takes the lead in the development and quantity production of PNP Junction Transistors.

Raytheon Germanium Junction Transistors are ready for you, *now*.

AVERAGE CHARACTERISTICS AT 30° C

	CK721	CK722
Collector Voltage (volts)	-1.5	-1.5
Collector Current (ma.)	-0.5	-0.5
Base Current* (ua.)	-6	-20
Current Amplification Factor*	40	12
Power Gain* (db)	38	30
Noise Factor* (1,000 cycles) (db)	22	22

*Grounded Emitter connection

DATA SHEETS may be obtained from the nearest Raytheon office listed below.



RAYTHEON MANUFACTURING COMPANY *Excellence in Electronics*

Receiving Tube Division — for application information call

Newton, Mass. Bigelow 4-7500 • Chicago, Ill. NAional 2-2770 • New York, N. Y. Whitehall 3-4980 • Los Angeles, Calif. Richmond 7-5524

RAYTHEON MAKES ALL THESE:

RELIABLE SUBMINIATURE AND MINIATURE TUBES • GERMANIUM DIODES AND TRANSISTORS • NUCLEONIC TUBES • MICROWAVE TUBES • RECEIVING AND PICTURE TUBES

www.americanradiohistory.com

HERE
AND NOW

RAYTHEON

JUNCTION TRANSISTORS
IN PRODUCTION QUANTITIES

CK722

IMMEDIATELY available in
PRODUCTION quantities

CK721

available in limited
quantities until April, 1953

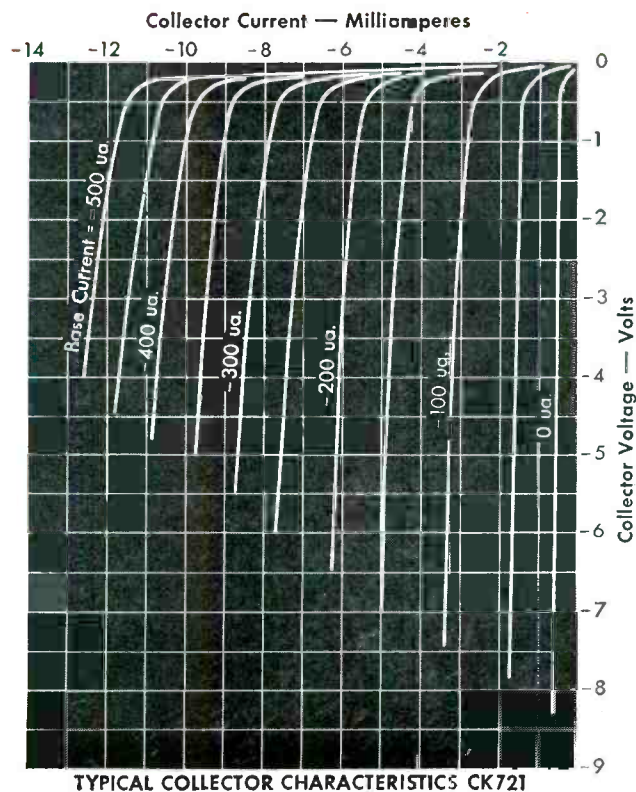
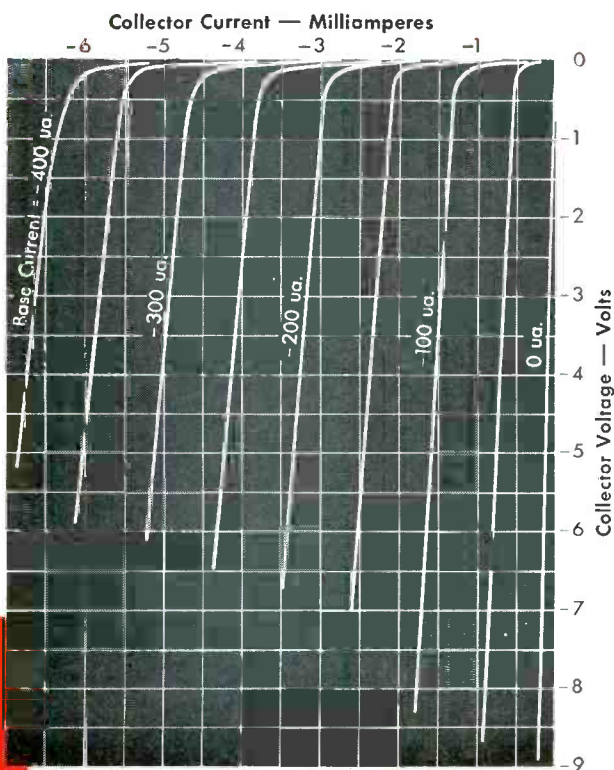

YOU NAME IT

WE'LL MAKE IT

economically
at

CRITICAL CONTROLS HEADQUARTERS

Ingenuity saves you money when Clarostat engineers collaborate. Mainly because certain basic designs, parts and production procedures are applied to both *standard* and *special* control requirements.

Take the Series 42a high-precision wire-wound controls, for example. The basic unit is a marvel of *quality* production. Exceeds JAN-R-19 specs where applicable.

Used alone or in multi-tandem assemblies, it meets tolerances even to 0.5%.

But Clarostat doesn't stop with the standard unit. Series 42a is made in many variations—all kinds of shafts; high-torque; continuous rotation; many different mountings; etc.

Typical of Clarostat engineering ingenuity—channeled to your exceptional control needs—and at real savings!

Don't hesitate to submit that "difficult" control problem to Clarostat engineers. They thrive on making the "impossible", possible. Engineering data on request.

STAND PAT WITH

CLAROSTAT Controls & Resistors

CLAROSTAT MFG. CO., INC., DOVER, NEW HAMPSHIRE

In Canada: Canadian Marconi Co., Ltd., Toronto, Ontario

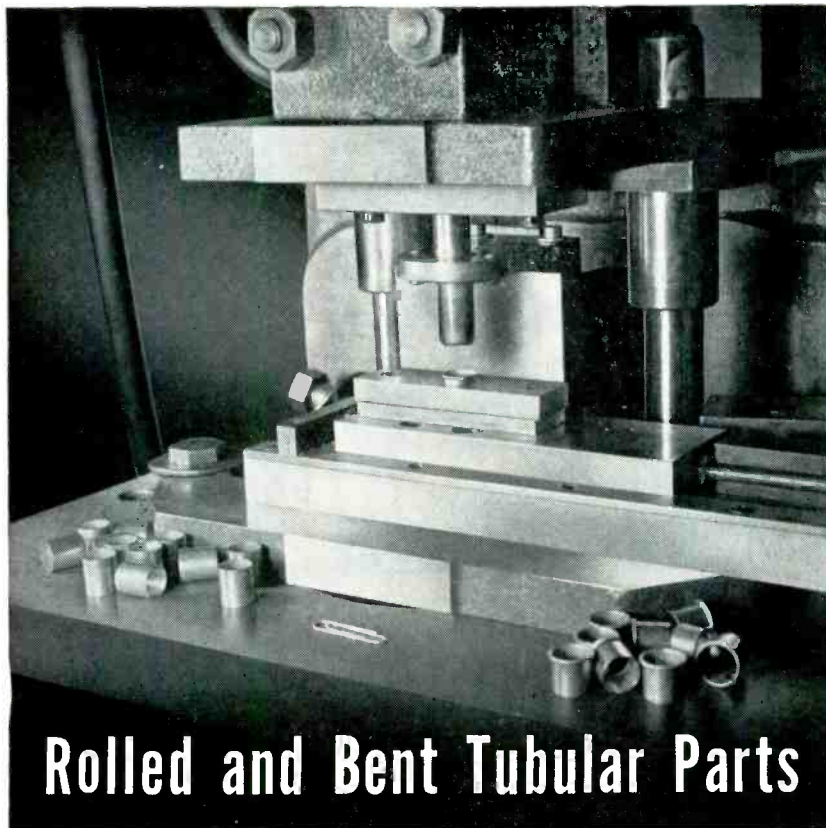

Rolled and Bent Tubular Parts

— A Superior Specialty

Men, experience, and machines—that-do-everything-but-talk, are generally the answer to a problem of obtaining parts of complex shape and precise dimension.

Here at Superior, customers for parts of this kind get a particularly good answer. We have the experienced men with a solid background of tubular parts production who are willing and able to take the time and care required for top-quality products. And we have the machines.

The delivery end of one of them is shown above. The part coming out came into our plant as a 2" tube, went through several redraw and annealing operations, was finally cut to exact length, tumbled to remove cutting burrs, then rolled by a controlled process to the

precise dimensions established by customer specifications.

There's nothing spectacular in the story... it's just the outline of one of the many jobs that we know how to do well. Behind the story, however, is a thought for you.

Our production story is backed by our ability, facility and desire to help you. If you are an experimenter in electronics or a manufacturer of electronic equipment and you need a tubular part to do a tough job well, better check with us. We'll be glad to assist with research, development, and design aid toward the solution of your problems. Tell us about them by writing Superior Tube Company, 2500 Germantown Ave., Norristown, Pennsylvania.

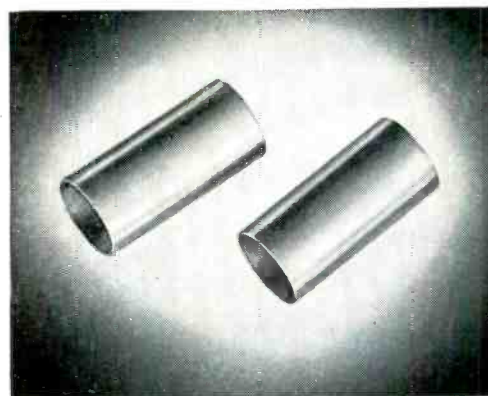

Cutting and Tumbling. Cutting machines and jigs of many types and sizes are combined with extensive tumbling equipment to permit fast, accurate production of quantities of parts at Superior.

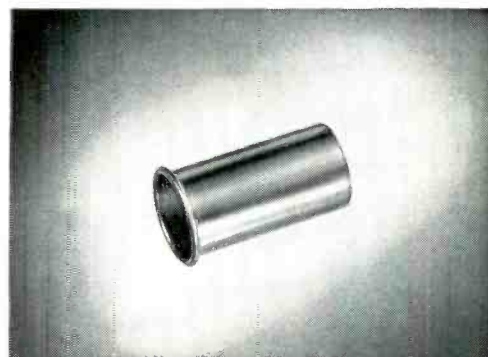

Fabrication. Parts can be readily rolled at either or both ends, flared, flanged, expanded, or beaded (embossed) as required. The anode above is one of many such parts we produce at high speed and low cost.



The Finished Part. Final stage in the fabrication of the part, shown above at three stages of production, is a bend nicely controlled for both precise angle and freedom from other, unwanted distortion.

**This Belongs in Your Reference File
... Send for It Today.**

NICKEL ALLOYS FOR OXIDE-COATED CATHODES: This reprint describes the manufacturing of the cathode sleeve—from the refining of the base metal; includes the action of the small percentage impurities upon the vapor pressure and sublimation rate of the nickel base. Future trends of cathode materials are also evaluated.

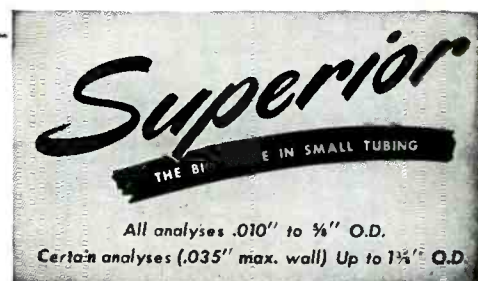

SUPERIOR TUBE COMPANY • Electronic products for export through Driver-Harris Company, Harrison, New Jersey • Harrison 6-4800

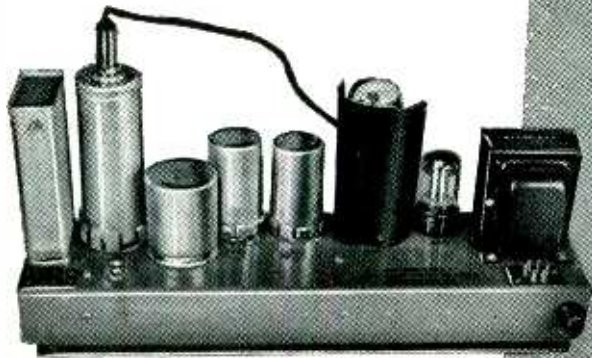

Good engineering shows in this Amplifier's wide range of sensitivities, and of impedances, thorough filtering and plug-in connection to the rest of the Speedomax instrument.



Good engineering shows in this Converter's phenomenally low noise level and in its long-lived performance.

Good engineering shows in this Slide-wire's non-inductive winding and in absence of any flexible leads which might form inductive loops.



Good engineering shows in this balancing motor's small size, and in its torque ample to operate accessory control and signaling fitments.

A lot of
Engineering
for an Amplifier,
but...

it helps Speedomax to fit your ideas!



• Your needs and ideas put this electronic "tool" to work on an amazing variety of jobs. Controlling furnaces and peering into atoms; counting bottles and spying on the weather; taking the "shine" out of rayon or putting it on hardware, to name six out of thousands of uses. For, in general, if you can feed Speedomax a tiny electrical signal, representing the condition you wish to measure, the instrument will not only put "calipers" on it, but will amplify it enormously to direct anything that can be directed through electrical or pneumatic means.

The Speedomax way of handling this job provides particularly accurate results and an especially good fit in meeting your individual ideas. For instance, there's the matter of receiving the signal in a way suited to its size—or, more usually, to its smallness.

We have no less than twenty-three carefully-engineered Speedomax Amplifiers covering a wide range of sensitivity and impedance levels. One Amplifier in the series enables the Speedomax to respond to a signal of only 10-16 watt—one ten-billionth of a microwatt. No other recorder amplifier comes within 3 magnitudes of this figure. Such sensitivity means corresponding accuracy in detecting the tiny unbalance—called "error" by circuit engineers—which actuates the rebalance system.

In terms of power, all 23 Amplifiers deliver the same—5 or 6 watts. This is from 2 to 4 times the output of other recorder amplifiers; permits a more powerful balancing motor. And the Amplifier-Motor team provides an especially high torque gradient just where it's needed—centering around the balance point—for prompt, positive balancing and easy, effortless operation of a "heavy" load of control or signal devices in the motor shaft.

The Speedomax story for industry is told in Catalog ND46(1); for Research, in Tech. Pub. ND46(1). We will send either on request; address our nearest office or 4979 Stenton Ave., Phila. 44, Pa.

CAREER OPPORTUNITIES
AT L&N

Expansion program of this long-established firm has many features to attract outstanding recent graduates in engineering and science. Opportunities are in sales field engineering, product and application engineering, research, advertising, market development. Widely-respected policies assure recognition of progress and achievement. Address Personnel Manager for preliminary interview at nearest of 17 L&N offices.

LEEDS

instruments



NORTHROP

automatic controls • furnaces

Jrl. Ad. ND46(7)

2 Waldes Truarc Rings Replace 2 End Plugs ... Eliminate 3 Operations... Save \$.066 Per Unit

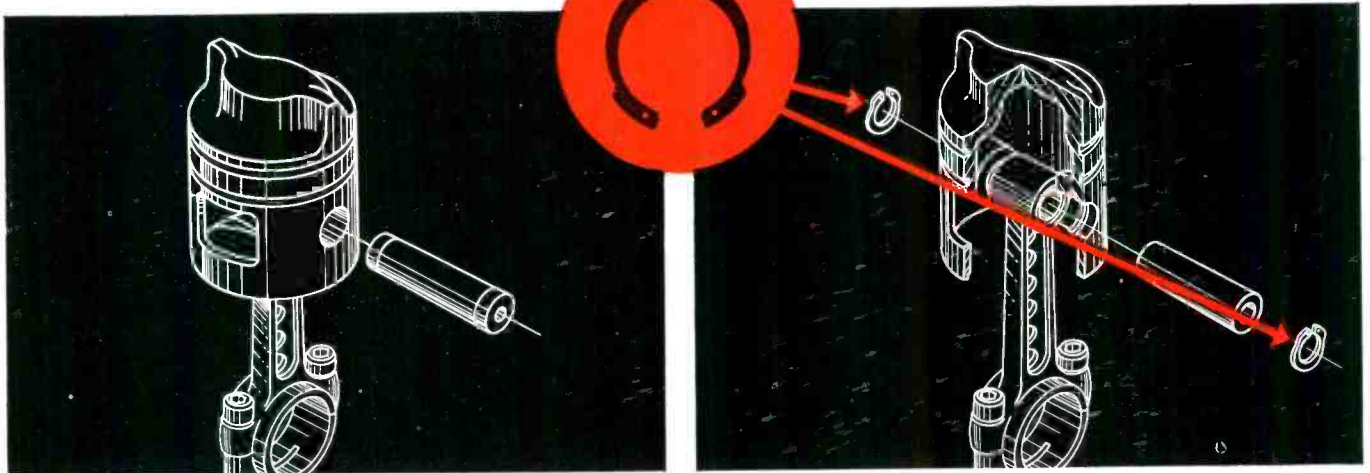

OLD WAY Two inserted-plug type wrist pin locks hold wrist pin in place. 3 operations involved: costly machining, pressing in place, post-assembly machining. Costly maintenance problem—resulting from end plugs hammering loose.

TRUARC WAY Two Truarc Inverted Retaining Rings (Series 5008) hold wrist pin in place. Truarc Rings snap into grooves easily cut in piston, provide positive lock . . . practically eliminate maintenance costs. Quick assembly, disassembly.

Titan Chain Saws, Inc., Seattle, Washington, uses 2 Waldes Truarc Rings to replace old-style inserted-plug type wrist pin locks in their Titan chain saws. Use of Waldes Truarc Retaining Rings eliminates 2 press fit end plugs. Machining of plugs, pressing in place, finish machining—no longer required. Truarc way holds rejections to a minimum. Unit efficiency is greatly increased.

Redesign with Truarc Rings and you, too, will cut costs. Wherever you use machined shoulders, bolts, snap

USE OF 2 WALDES TRUARC RINGS PERMITTED THESE SAVINGS PER UNIT:

OLD WAY	
Cost of 2 end plugs	} \$.169
Cost of pressing in and machining	
TRUARC WAY	
Cost of grooving piston	}103
Cost of 2 Truarc Rings	
Saving per Unit \$.066	

rings, cotter pins, there's a Waldes Truarc Retaining Ring designed to do a better job of holding parts together.

Waldes Truarc Rings are precision-engineered . . . quick and easy to assemble and disassemble. Always circular to give a never-failing grip. They can be used over and over again.

Find out what Waldes Truarc Retaining Rings can do for you. Send your blueprints to Waldes Truarc engineers for individual attention, without obligation.

For precision internal grooving and undercutting . . . Waldes Truarc Internal Grooving Tool.

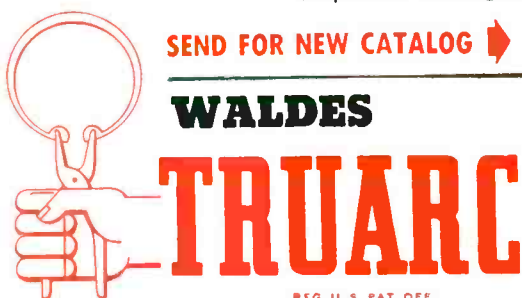

RETAINING RINGS

WALDES KOHINOOR, INC., LONG ISLAND CITY 1, NEW YORK

WALDES TRUARC RETAINING RINGS AND PLIERS ARE PROTECTED BY ONE OR MORE OF THE FOLLOWING U. S. PATENTS: 2,382,947; 2,382,948; 2,416,852; 2,420,921; 2,420,341; 2,439,785; 2,441,846; 2,455,165; 2,483,380; 2,483,383; 2,487,802; 2,487,803; 2,491,306; 2,509,081 AND OTHER PATENTS PENDING.



Waldes Kohinoor, Inc., 47-16 Austel Place, L. I. C. 1, N. Y.

Please send me the new Waldes Truarc Retaining Ring catalog.

(Please print)

Name.....

Title.....

Company.....

Business Address.....

City..... Zone..... State.....

Complete HIGH-FREQUENCY ANALYSIS

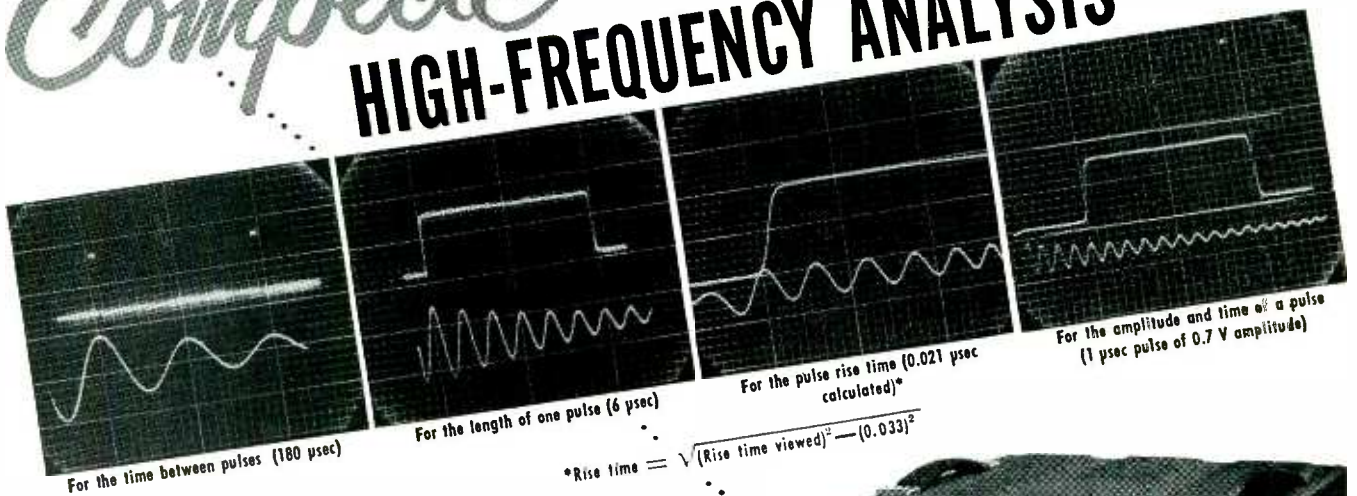

with a **DU MONT HIGH-VOLTAGE TYPE 303-AH**

The new Du Mont Type 303-AH is the high-voltage, high-frequency instrument for you — why?

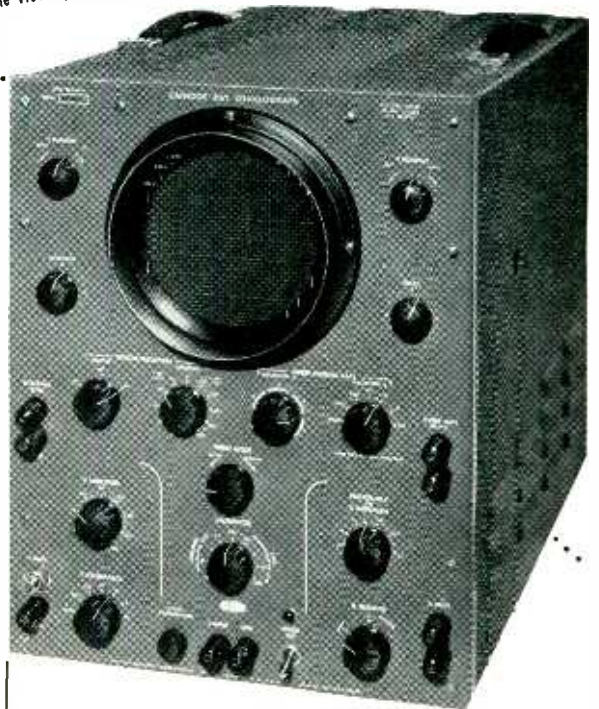

The 10,000 volts applied to the cathode-ray tube provides a bright, highly resolved presentation for viewing or recording short duration transients or high-frequency signals even at low repetition rates.

The metallization of the cathode-ray tube greatly increases brightness over normal screen brightness and prevents buildup of spurious screen charges, thus allowing faithful reproduction of short-duration transients having low repetition rates.

The BNC-type coaxial input permits convenient connection of pulse-type signals usually carried on coaxial lines.

The wideband vertical amplifier (3 db down) 10 MC has a pulse response of 0.033 μ sec for faithful reproduction of short rise-times without overshoot.

The fast linear sweeps, 6"/ μ sec (0.065 μ sec/cm) at 10 KV, take fullest advantage of the wideband amplifier for expanding and measuring short rise-times.

The 0.25 μ sec signal delay line introduces no signal distortion and allows sufficient time for the sweep to start before the signal appears.

The provision for both amplitude and time calibration of 0.1, 1, 10 and 100 volts peak to peak and 0.1, 1, 10 and 100 μ sec intervals insures accuracy and convenience of measurement.

The variable-intensity illuminated scale facilitates visual or photographic measurements.

Type 316-A probe available for low capacity input. Price \$27.00.

- METALLIZED CATHODE-RAY TUBE
- SELF-CONTAINED
- HIGH VOLTAGE
- LIGHT WEIGHT
- FAST SWEEPS
- LOW COST

PRICE
\$990

DU MONT

WRITE FOR FULL DETAILS AND SPECIFICATIONS

ALLEN B. DU MONT LABORATORIES, INC. • INSTRUMENT DIVISION • 1500 MAIN AVE., CLIFTON, N. J.

Consistently Dependable

C-D MINIATURIZED

CAPACITORS

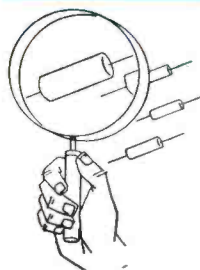
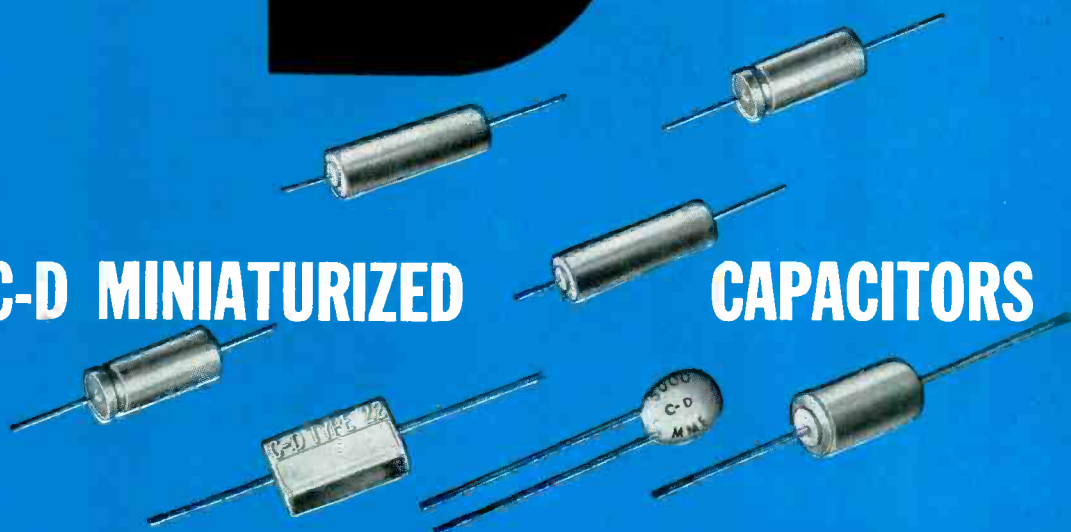

Tiny but tough! The smaller capacitors become, the greater the premium on trustworthiness. Cornell-Dubilier has a dependable miniaturized capacitor for practically every known application. Typical are the High Temperature Tubulars, Metallized Paper Tubulars, Midget Micacs, Disc and Tubular Ceramics. For the complete catalog write to: Dept. K-13, Cornell-Dubilier Electric Corp., General Offices, So. Plainfield, N. J.

CORNELL-DUBILIER

world's largest manufacturers of capacitors



ANTENNAS



ROTATORS



CAPACITORS



VIBRATORS



CONVERTERS

SOUTH PLAINFIELD, N. J. • NEW BEDFORD, WORCESTER AND CAMBRIDGE, MASS. • PROVIDENCE, R. I. • INDIANAPOLIS, IND. • FUQUAY SPRINGS, N. C. • SUBSIDIARY, THE RADIART CORP., CLEVELAND, O.

What Rauland means by "Perfection Through Research"

Rauland is one of the few companies devoting so much top engineering talent full time to picture tube improvement and perfection.

The result has been to give you more picture tube advancements since the war than any other manufacturer... first chance at the latest developments

for companies using Rauland tubes as original equipment... and a real selling edge at the retail level because of the extra satisfaction which Rauland advantages offer.

That's why so many alert manufacturers look to Rauland for the best in picture tubes.

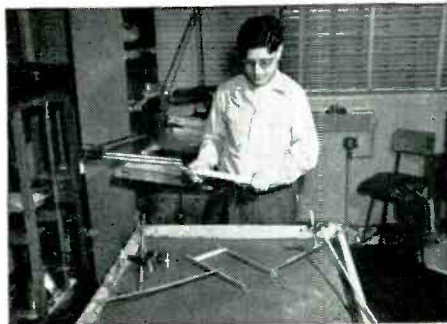
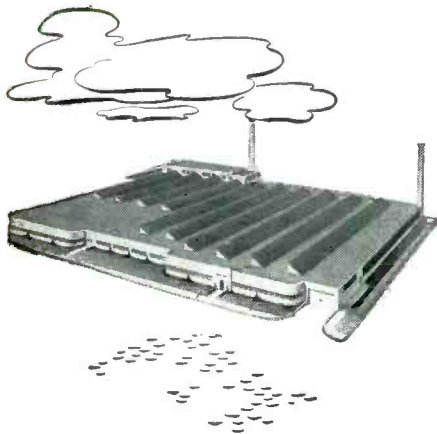

Rubber model for studying electron optical designing—basis for Rauland's exclusive Indicator Ion Trap.

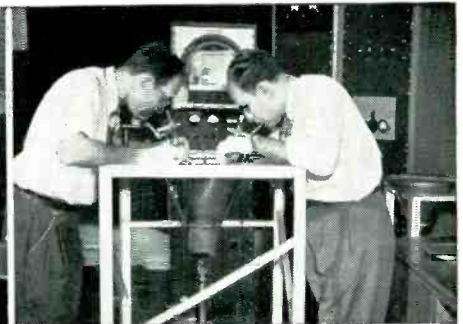

Alignment of the screen and parallax mask of tri-color tube containing approximately a million fluorescent dots.

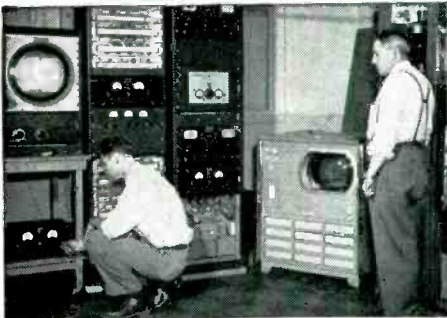

All-electronic tri-color tube in electronic receiver system (left) in comparison with mechanical system (right).



Inspection and checking of perforations .0075" in diameter in masks of tri-color picture tubes.



Rauland large-screen projectors using three different optical systems, all of which give theater-size pictures.

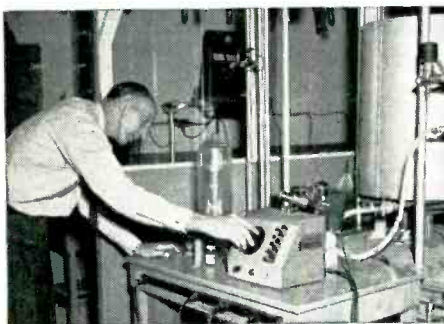

Careful study of the formation of thin metallic films in a vacuum... basis for the aluminizing of tubes.



Examination with polarimeter permits careful control of strains for superior glass-to-metal sealing.



A physicist using a Rauland-developed radiation meter in checking X-ray radiations from cathode ray apparatus.

THE RAULAND CORPORATION



Perfection Through Research

2425 N. KNOX AVENUE • CHICAGO 41, ILLINOIS



Basic Foundation Components, Plug-in, Connecting & Fastening Devices for the Electronic Control Industry

Making it possible to build quickly any electronic circuit into practical production design (you supply the circuit — we supply the components).

- by giving you basic components of tremendous flexibility which simplify layout time in production of your equipment.
- by providing you a technique to solve mechanical, space, connecting, interconnecting, fastening, sensing and indicating problems for you.

Giving you equipment that is easy to operate and maintain

- so that — with spares — your equipment never needs to be out of operation more than 30 seconds.
- so that non-technical personnel can set up, operate and maintain your equipment.



WORKING WITH "ALDEN'S HANDBOOK", THE DESIGN ENGINEER AUTOMATICALLY CREATES PRACTICAL PRODUCTION DESIGN, as follows —

1. Anything electrical or electronic usually operates with an outside source of power and may be connected to outside circuits. So Alden provides for this with the efficient Detachable Line Cord for bringing in 110V AC power. Available in lengths to your specs for making a neat connection. Sure grip plug is self-piloting for quick mating.

SEE "ALDEN HANDBOOK" PAGES 4A & B FOR COMPLETE DETAILS

2. A great deal of equipment will have a front panel with such things as sensing controls, jacks for testing and fuseholders. For this Alden provides a basic slide-in chassis with a detachable front and back panel so that rheostats, indicator lights, test jacks, interwiring, etc. are all easy-to-work subassembly operations.

SEE "ALDEN HANDBOOK" PAGES PI-TE thru G FOR COMPLETE DETAILS

3. Sensing Units — telltales that all is well or not — in simple indicator light — fuse holders that glow when blown — memory or pulse circuits including Static Magnetic Memory that sense — or command — or keep on repeating so that units or elements almost assume brain functions.

SEE "ALDEN HANDBOOK" PAGES E5-5A & B; DL-5A & B; TE-3A & B; CG — all pages

4. The telephone, telegraph, electric light companies have always brought the incoming circuits to a bus bar or terminal board so that the incoming circuits could always be checked at one point — and equipment connected not being condemned because of imperfect outside circuits. So Alden provides in its Back Connectors and supporting Back Plates the one area in which all incoming circuits can be checked.

SEE "ALDEN HANDBOOK" PAGES PI-2A & B; 4D FOR COMPLETE DETAILS

5. The next problem is to house the components and have them do the electrical or electronic work required. Any such circuitry will have certain main functions and branching from it other functions. Many of these functions can be layered — so circuits go direct from back connector to front panel. Alden provides: simple component mounting panels for putting any circuit in layers. (And incidentally such component panel simplify the thinking, should the circuits give sufficient volume to be printed.) So Alden has the Terminal Panel Boards to make equipment easy to lay out by putting any function in one plane — plus the unit cables of correct lengths with stripped ends ready for interconnecting the Terminal Panels.

SEE "ALDEN HANDBOOK" PAGES PI-1B thru D FOR COMPLETE DETAILS

6. Not all circuits can be a simple, straight circuit from back connector to front panel because there are auxiliary functions and branches that have to be in the main functions. The usual chassis carries tubes, transformers and components that rise vertically from the chassis, often leaving vacant spaces. In these spaces can be placed the plug-in units which have these secondary circuits; using the plug-in technique usually removes the congestion of the wiring below the chassis, provides automatically for shielding and heat dispersion and yet gives you largest amount possible circuitry per cubic space, the circuits free from interaction.

SEE "ALDEN HANDBOOK" PAGES PI-1A thru H FOR COMPLETE DETAILS

7. Again these techniques often lead to putting one function such as a power supply and amplifier on separate chassis and so the back connectors or the chassis itself may need interconnecting unit cables to either chassis or racks. Alden provides sufficient variety of connectors to choose from — and designed so that any cable, no matter how involved, cannot be wrongly plugged in.

SEE "ALDEN HANDBOOK" Sec. PC - Sec. MP5 FOR COMPLETE DETAILS

8. To design so that no equipment — whether plug-in unit or slide-in chassis — needs to be out of operation for more than 30 seconds (having adequate spares on hand), Alden provides quick detaching and quick fastening devices for chassis. The Serve-a-Unit locks that will move chassis against weight or the resistance of gaskets. There is the Target Screw (coin operated), a Tool-less screw — the Captive Screw which becomes part of the equipment.

SEE "ALDEN HANDBOOK" PAGE PI-11 FOR COMPLETE DETAILS

9. Government designers and those in the electronic control industry want elements of equipment so that they can be portably operated or tested, can be carried by one man with spares, parts easily sent by mail or airborne and also prefer that the same design equipment can be used in conventional racks. Those designing for field operation use, at sea, prefer to have the equipment so it can be unloaded by two people, set up and immediately interconnected. This is provided by the Alden Basic Chassis using Back Connectors, Unit Cables and for the last purpose, the Uni-Rack which can be set on top of one another and immediately interconnected with each other.

SEE "ALDEN HANDBOOK" PAGE PI-11 FOR COMPLETE DETAILS



CORD LENGTH TO YOUR SPECS.

Avoid floorful of over-length cords.

Avoid midget cords that compel added extension cords.

Front panel (various sizes) carries controls, indicators, sensing elements, with their interwiring.

Detachable front panel hinged giving accessibility for ease of assembly and servicing.

Fuses that indicate when blown.

Indicator lamps always easily replaced so always functioning.

Insulated test point jacks for plate voltages up to 6,000V.

Plug-in Memory or Pulse Circuits.

Alden Back Connectors, color coded, with accessible unconnected solder terminals — permits easy servicing and rapid circuit checks at central point.

Back Connectors permit direct efficient wiring — avoid conventional rat's nest wiring.

Back Connectors mount on Back Plate to give one point to check all chassis connections.

Terminal Panel Board with all components mounted in one plane, and Alden Unit Cable for interconnecting all panel elements with leads.

Layering of circuits using Alden Terminal Panels to segregate each main function and associate elements in one plane — for ease of assembly and check.

Massing of essential electronic elements yet with efficient heat dispersion and freedom from interaction, in a Basic Chassis.

How Alden Terminal Panel groups main functions and how plug-in units have parallel functions for largest amount circuitry per cubic space.

Alden "20" Packages house plug-in Units give independent shielding and heat dispersion.

Separate chassis may be stacked in Alden Uni-Rack Cabinet. Cabinet can be interconnected within by Alden unit plug-in cables.

Alden Unit Cable — with variety of plug-in connectors. Carries wiring from chassis to chassis or rack to rack.

A turn of the Serve-a-Unit Lock handle — located in front panel — draws in unit against pressure — reverse turn ejects.

Alden Target Screw The Toolless Screw

The Captive Screw, never lost.

Chassis in carrying or servicing case or case to house spare.

Same chassis fits in Uni-Rack Cabinet for field or permanent use. In field all elements can be connected as fast as you can unhook them.

SEND FOR the Alden Handbook — your key to practical production design — with components already tooled — yet can be modified — ready for volume production without delays or procurement headaches.



ALDEN PRODUCTS COMPANY 127 North Main Street, Brockton, Massachusetts

www.americanradiohistory.com



Courtesy Lear, Inc.

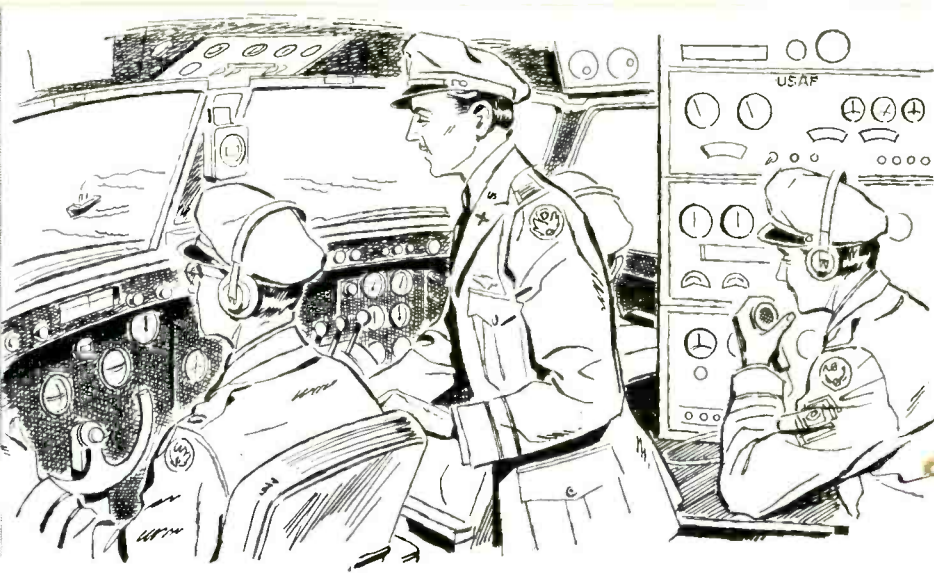

in instruments where reliability is imperative

SILASTIC works

where other materials fail

To assure maximum service life and accuracy, engineers at Lear, Incorporated, planned to protect their new vertical gyro-mechanism from corrosion by housing it in a completely inert and dehydrated atmosphere.

Sealing the housing, however, proved to be more easily said than done. Despite the most elaborate precautions, solder and flux fumes often penetrated the joint and contaminated the delicate mechanism. Once sealed, it was impossible to reopen the case without loss of the expensive cover and harness.

To both of these problems a simple and ingenious solution was found. A thin O-ring of Silastic molded to fit snugly under the cover flange is used to exclude the

corrosive fumes generated in soldering a metal strip over the entire joint. The Dow Corning silicone rubber O-ring is not damaged by soldering temperatures. And, the gyro-mechanism is just as accessible for repairs as the contents of a hermetically sealed can of coffee.

Lear also uses a large ring washer of Silastic at each end of the housing to serve as resilient, shock-absorbing cushions for the apparatus at stratospheric temperatures.

And that's just one of hundreds of examples of how Silastic is used to improve the performance of products ranging from cable to traction motors, from domestic steam irons to aircraft.

*T. M. Reg. U. S. Pat. Off.

For more information
about the properties or
fabricators of Silastic, mail
this coupon today or phone
our nearest branch office.



Dow Corning Corporation, Dept. BE-1, Midland, Mich.

Please send me:

- Silastic Facts 10a with new data on properties and applications of all Silastic stocks and pastes.
- "What's A Silicone?", your new 32-page booklet on silicone products and applications.

Name _____ Title _____
Company _____
Address _____
City _____ Zone _____ State _____

FIRST IN
SILICONES

**DOW CORNING
SILICONES**

MIDLAND, MICHIGAN

Atlanta • Chicago • Cleveland • Dallas • New York • Los Angeles • Washington, D. C. • In Canada: Fiberglas Canada Ltd., Toronto • In England: Midland Silicones Ltd., London

Want more information? Use post card on last page.

www.americanradiohistory.com

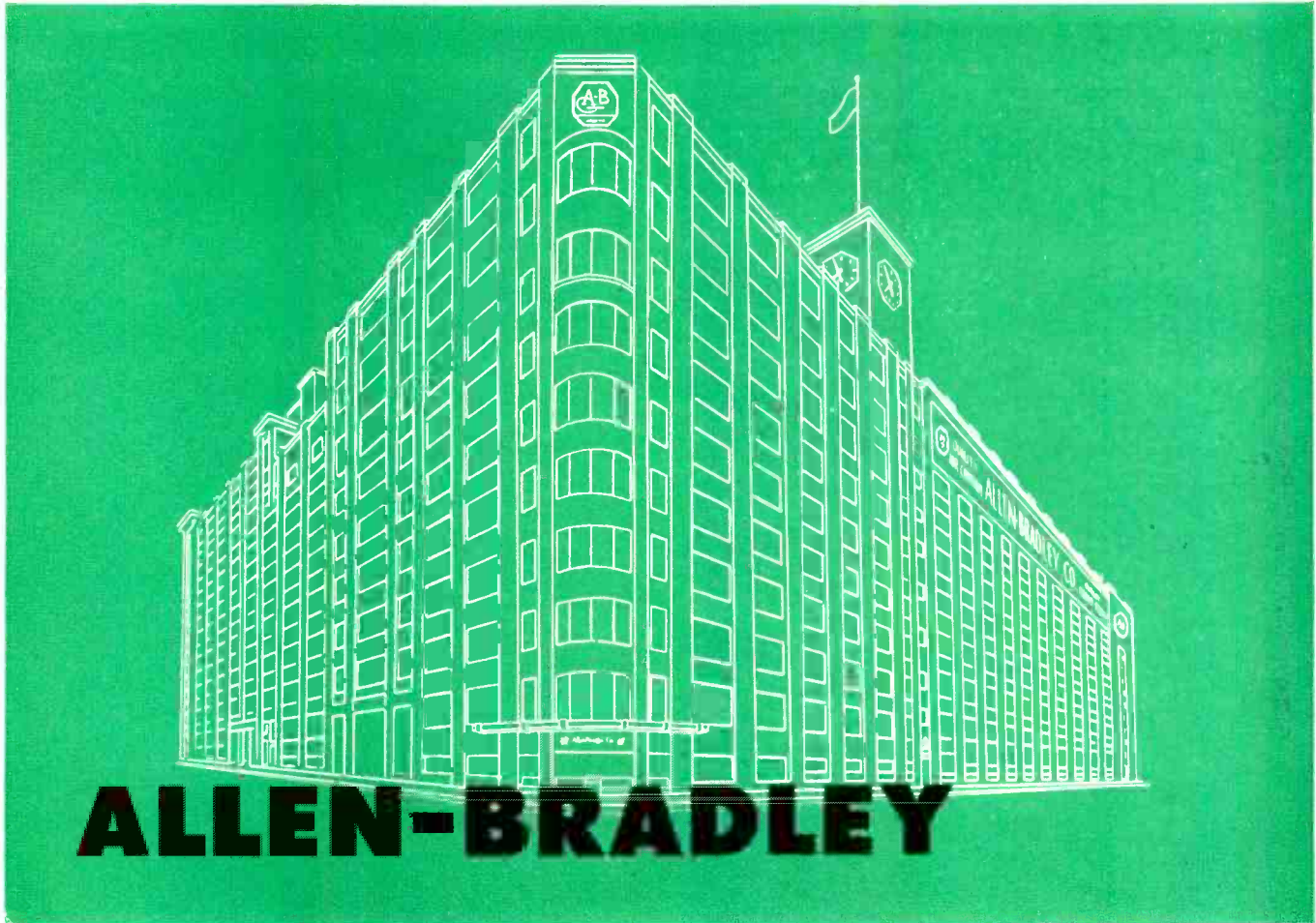

... **A NEW AND DEPENDABLE SOURCE OF HIGH QUALITY CERAMIC CAPACITORS**

If you use ceramic capacitors, you will be interested in Allen-Bradley as a source, because we make the entire capacitor, from the dielectric disc to the finished and tested unit. Send for samples for your qualification tests. Available from 0.001 to 0.01 microfarads.



Allen-Bradley makes its own
Ceramic Discs

To assure dependable production and consistent capacitor quality, Allen-Bradley molds and sinters its own ceramic discs. All manufacturing processes are Allen-Bradley controlled.



Allen-Bradley ceramic capacitors are approved by the engineering departments of leading electronic, electrical, and telephone laboratories. Allen-Bradley . . . long famed for high quality electronic components . . . is at your service as a major supplier of ceramic capacitors of superlative quality.

Allen-Bradley Co., 110 W. Greenfield Ave., Milwaukee 4, Wis.

ALLEN-BRADLEY
RADIO & TELEVISION COMPONENTS

QUALITY



Allen-Bradley ceramic discs of high K dielectric material are molded by precision methods. After discs are sintered, silver paste is applied to each side and heat treated. After leads are soldered to silver surfaces, the capacitor is insulated and wax impregnated.

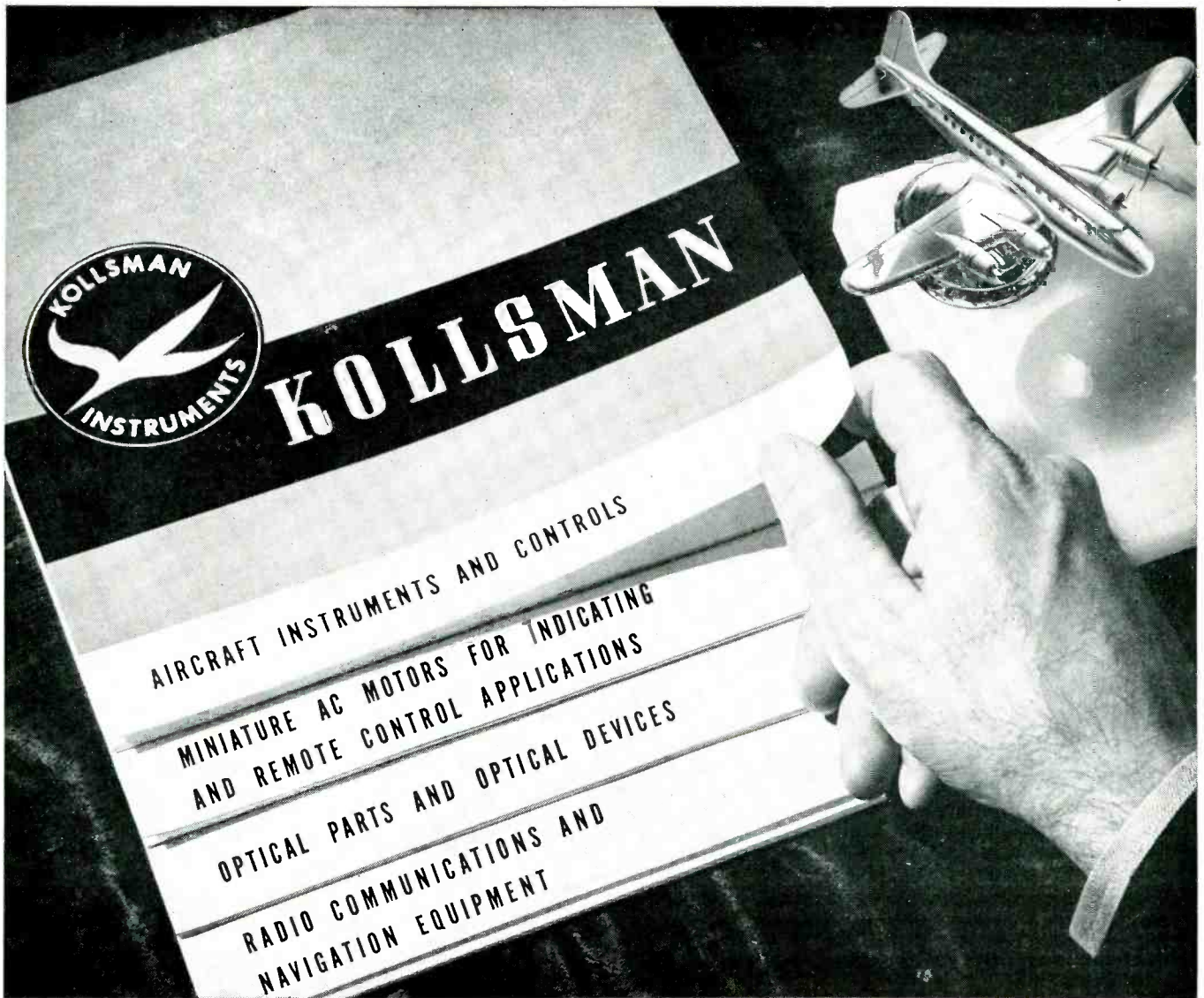

*Which part
interests
YOU?...*

Perhaps that's one question that rightfully belongs with your future planning.

For, like ourselves, your manufacturing divisions may be toiling night and day in the interests of America's safety.

But to research scientists—seeking the solution to some intricate problem of instrumentation and control—Kollsman offers an experienced hand. A reputation based on inventive ingenuity, precision craftsmanship and world-over acceptance of its products.

In manufacture or research, there is no finer name than Kollsman—designers, developers and makers of:

Aircraft Instruments and Controls

Miniature AC Motors for Indicating and Remote Control Applications • • • Optical Parts and Optical Devices

Radio Communications and Navigation Equipment



KOLLSMAN INSTRUMENT CORPORATION

ELMHURST, NEW YORK

SUBSIDIARY OF

GLENDALE, CALIFORNIA

Standard COIL PRODUCTS CO. INC.

SORENSEN

electronically

REGULATES AND CONTROLS

**HIGH-VOLTAGE
DC
LOW-CURRENT**

SORENSEN'S EXPANDED LINE OF B-SUPPLYS NOW INCLUDES THIS NEW MULTI-RANGE DUAL SUPPLY.

Many users of Sorensen Nobatrons* and AC Regulators are unaware that the standard Sorensen line includes a wide range of "B-Nobatrons" — high voltage, low-current DC sources.

Are you familiar with the number of units in the line? Two of them — models 360BB and 520BB — are low-cost units for those not requiring outputs adjustable down to zero, but which can be paralleled for higher current requirements. The other models are highly flexible, all-purpose laboratory instruments. All of them provide voltage and current well in excess of the specifications given below (these "plus values" are shown graphically in the new Sorensen DC catalog).

You owe it to yourself to get acquainted with these Sorensen B-NOBATRONS. You'll find they are reasonably priced — surprisingly so — yet in all ways live up to the Sorensen reputation for sound engineering, quality construction, dependable operation. Write for information.

*Reg. U.S. Pat. Off. by Sorensen & Co., Inc.



MODEL 350-B SPECIFICATIONS

INPUT	105 - 125 VAC, 50 - 60 ~, 1ϕ.
OUTPUT	1. 175-350 VDC @ 0-60 Ma simultaneously from two independently adjustable outlets. 2. 175-350 VDC @ 0-120 Ma from one outlet. 3. 0-175 VDC @ 0-60 Ma from one outlet. 4. 6.3 VAC @ 3.5 amps., C.T., unregulated.
OUTPUT REGULATION	±1.0%
RIPPLE	10 mv
SIZE	13" x 7½" x 8"



520BB

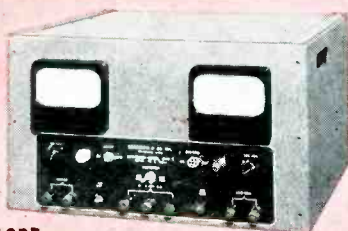

560BB

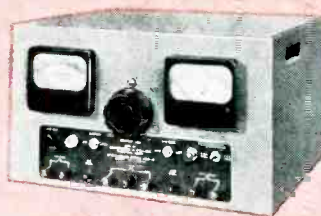

500BB

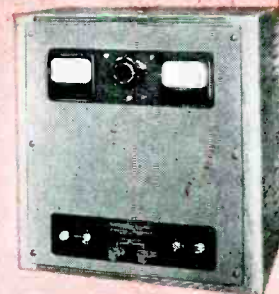

1000BB



325BB



360BB

MODEL NO.	325BB	360BB	520BB	560BB	500BB	1000BB
Output voltage	0-325	175-360	200-500	0-500	0-500	200-1000
Output current	0-125 Ma	0-120 Ma	0-200 Ma	0-200 Ma	0-300 Ma	0-500 Ma
Output voltage, bias	0-150			0-150	0-150	
Output current, bias	0-5 Ma			0-5 Ma	0-5 Ma	
Ripple	10 mv	10 mv	10 mv	10 mv	10 mv	20 mv
Low AC voltage (center tapped, unregulated)	6.3 at 10 amp.	6.3 at 10 amp.	6.3 at 10 amp.	6.3 at 10 amp.	6.3 at 10 amp.	

Regulation accuracy: ±0.5% (±1% in 360BB and 520BB)
 Input: 105-125 volts AC, 50-60 cycles, single phase.
 Models 325BB, 560BB, 500BB and 1000BB are metered.
 Units are normally self-contained. All can be provided with a front panel for rack mounting.

SPECIFY

SORENSEN

For Complete Information Write

SORENSEN & COMPANY, INC.

375 Fairfield Avenue

Stamford, 1 Conn.



DESIGNER'S

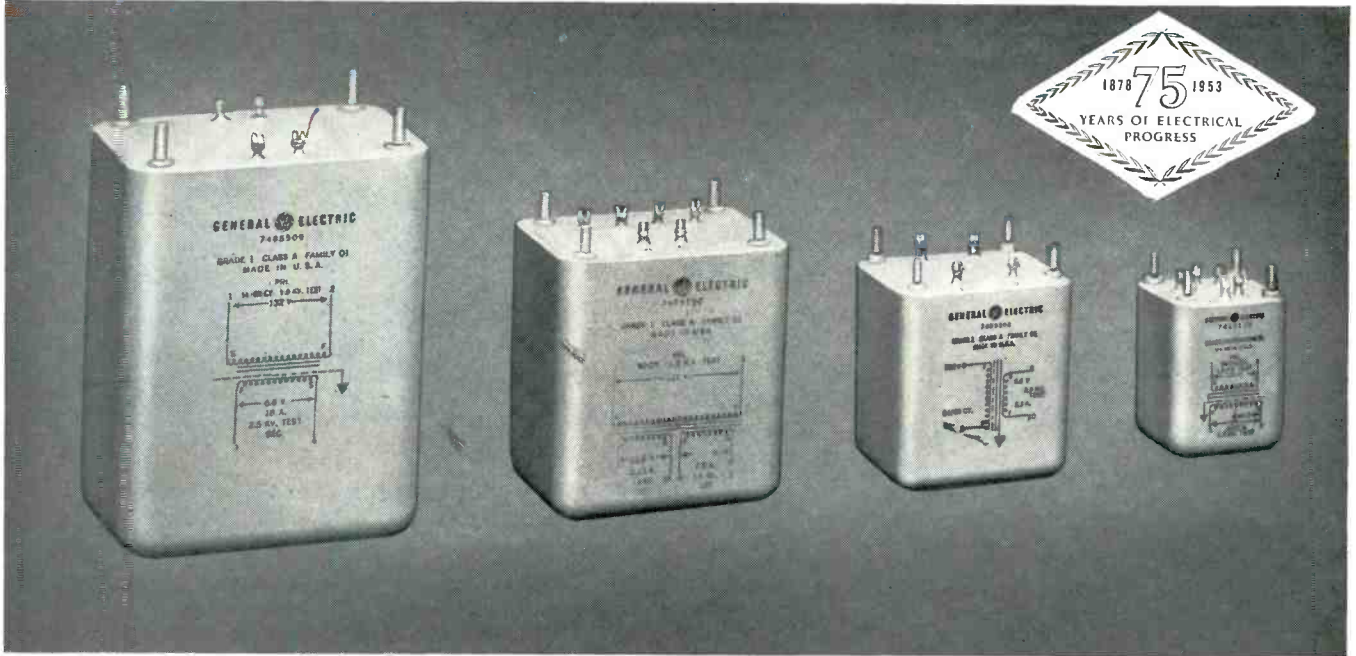

"SEALED-IN" DESIGN eliminates need for metal enclosures and fungus-proof coating.

New G-E cast-permafil transformers are 20% smaller, "sealed for life"

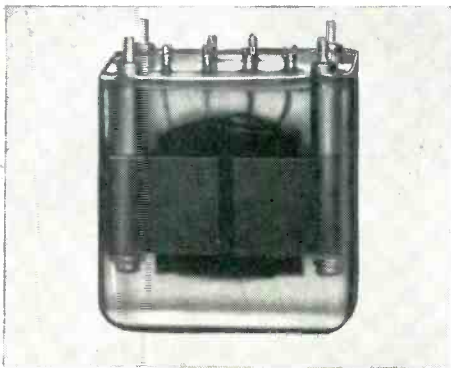

TRANSPARENT MODEL shows simple construction of new transformer. Terminals are anchored directly in mixture to cut size and weight.

Meet MIL-T-27 (Grade 1) performance requirements

Greater flexibility in many electronic designs is made possible by General Electric's new line of cast-permafil transformers, thanks to their light weight and small size.

These solventless-resin-type transformers are completely moisture-proof. They have fewer machined and punched parts. Tough, solid, shatter-resistant cast permafil ends the necessity for fungus-proof protective coatings.

At 130C ultimate, these transformers have an expected life of 1000 hours or more. The complete line of 11 sizes, available in various terminal arrangements, averages about 20 per cent smaller than previous metal-encased transformer models.

For further information, write to Section 667-23, General Electric Company, Schenectady 5, New York.



DIGEST

TIMELY HIGHLIGHTS ON G-E COMPONENTS

Permafil d-c capacitors have 80% less weight, bulk

They operate in ambients up to 125C for 10,000 hours without derating

High or low temperatures have little effect on the electrical stability of G-E permafil capacitors. Their paper dielectric is impregnated with a solid plastic compound—they can't leak. Insulation resistance is high, and change in capacitance with temperature is slight. With proper derating, these units can be used at temperatures as high as 150C.

Permafil capacitors average about

1/5 the size and weight of liquid-filled capacitors properly derated to operate at 125C. Because of their small size and excellent electrical characteristics they are ideal for most high-ambient blocking, bypass, filtering, coupling and timing applications. They are available in ratings of 0.05 to 1.0 muf, 400 volts d-c. All are housed in hermetically sealed metal containers, with G-E all-silicone bushings. Check coupon for Bulletin GEC-811.

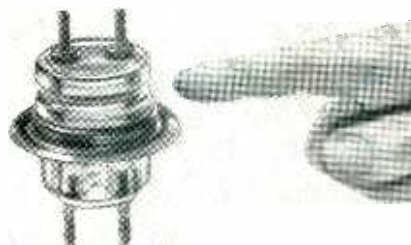

Bushings for hermetic sealing

More and more designers are specifying G-E glass bushings—the type used on capacitors, rectifiers, and instrument transformers. For use where permanent hermetic sealing of electric apparatus is desired, these bushings are easily attached by soldering, brazing, or welding to form a permanent, vacuum-tight seal. Bulletin GEA-5093.

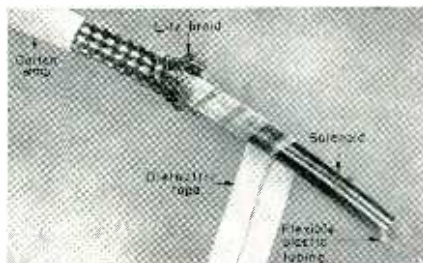

Immediate shipment on delay line

G-E delay line, ideal for delaying signals in electronic circuits, is now available for immediate shipment. Nominal 1000-ohm line delays signals 1/2 microsecond per ft. Light weight and flexible, it is used widely in military and industrial electronics. Can be obtained in bulk to be cut to desired lengths. Bulletin GEC-459.

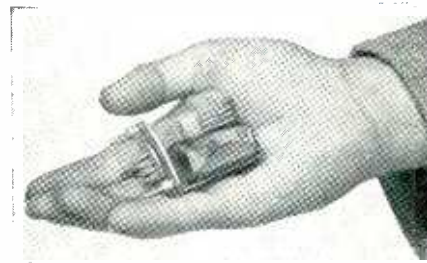

New relay doubles tip pressure

This new *hermetically sealed* relay has a larger magnet delivering double average tip pressure yet doesn't exceed Air Force-Navy size and weight specs. Sealed in a standard-size enclosure against dirt, salt, moisture, and pressure changes, it withstands 50g shocks and instantaneous voltage surges up to 1500 volts. Bulletin GEA-5729.



EQUIPMENT FOR ELECTRONICS MANUFACTURERS

Components

Meters, Instruments
Dynamotors
Capacitors
Transformers
Pulse-forming networks
Delay lines
Reactors
Thyrite*
Motor-generator sets
Inductrols
Resistors
Voltage stabilizers

Fractional-hp motors

Rectifiers
Timers
Indicating lights
Control switches
Generators
Selsyns
Relays
Amplidyne
Amplistats
Terminal boards
Push buttons
Photovoltaic cells
Glass bushings

Development and Production Equipment

Soldering irons
Resistance-welding control
Current-limited high-potential tester
Insulation testers
Vacuum-tube voltmeter
Photoelectric recorders
Demagnetizers

*Reg. Trade-mark of General Electric Co.

General Electric Company, Section C 667-23
Schenectady 5, New York

Please send me the following bulletins:

for reference only

for planning an immediate project

GEA-5093 Glass Bushings

GEA-5729 Hermetically Sealed Relays

GEC-459 Delay Lines

GEC-811 Permafil Capacitors

Name.....

Company.....

City..... State.....

Wanted!

Tough circuit problems for

GLOBAR

Ceramic Resistors

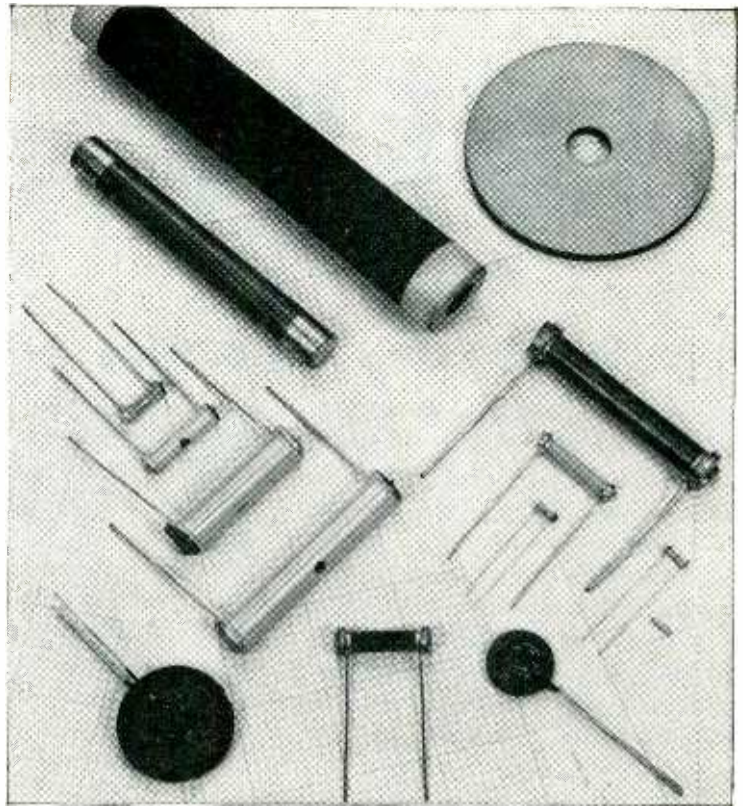

To help you solve those tough problems, five types of GLOBAR Brand Ceramic Resistors, with distinctly different characteristics, are available in a wide range of shapes and sizes. Whenever you have difficult temperature or voltage compensation problems in your electrical or electronic circuits, you can count on GLOBAR Ceramic Resistors to help you out. In ordinary circuits, too—wherever maximum resistor life and dependability are required—try GLOBAR Ceramic Resistors.

GLOBAR Ceramic Resistors are engineered to meet your *exact* requirements. They are electrically fired in one piece, and will withstand the severest service. They are always uniform, because they are strictly controlled from design and manufacture to final inspection.

GLOBAR Brand Ceramic Resistors			
TYPE	TEMPERATURE COEFFICIENT	VOLTAGE COEFFICIENT	DISSIPATION CAPABILITY
"A"	LOW	LOW	NORMAL
"CX"	LOW (POSITIVE)	PRACTICALLY ZERO	EXCEPTIONAL
"B"	MODERATE (NEGATIVE)	MODERATE	NORMAL
"F"	HIGH (NEGATIVE)	PRACTICALLY ZERO	ABOVE NORMAL
"BNR"	MODERATE (NEGATIVE)	EXTREMELY HIGH	NORMAL



← For useful engineering data on GLOBAR Ceramic Resistors, write for your copy of Bulletin R to Dept. E 87-124.

"Carborundum" and "Globar" are registered trademarks which indicate manufacture by The Carborundum Company, Niagara Falls, New York

If you have a resistor problem, let our engineers help you—without obligation, of course. Just send complete circuit information.

GLOBAR

TRADE MARK

Ceramic Resistors

by CARBORUNDUM

ONLY THE LFE 401 OSCILLOSCOPE

Offers all these Important Features

HIGH SENSITIVITY AND WIDE FREQUENCY RESPONSE OF Y-AXIS AMPLIFIER

The vertical amplifier of the 401 has been designed to provide uniform response and high sensitivity from D-C. The accompanying amplifier response curve shows the output down 3 db. at 10 Mc. and 12 db. at 20 Mc. Alignment of the amplifier is for best transient response, resulting in no overshoot for pulses of short duration and fast rise time. Coupled with this wide band characteristic is a high deflection sensitivity of 15 Mv./cm. peak to peak at both D-C and A-C.

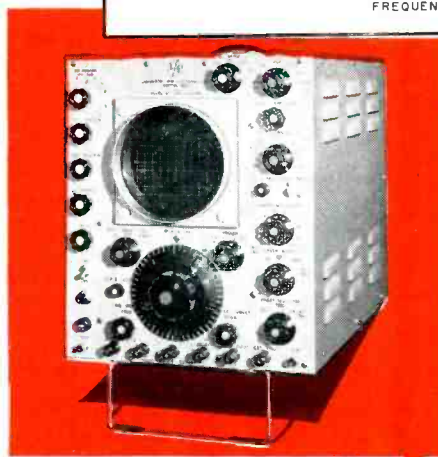
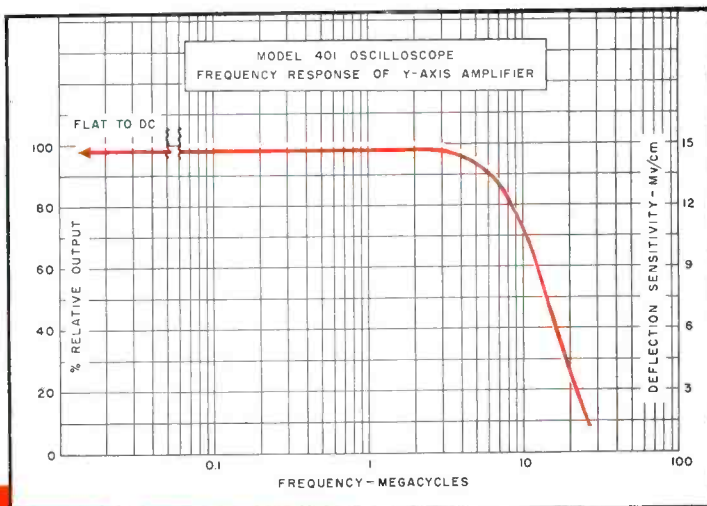

SPECIFICATIONS

Y-Axis

Deflection Sens.—15 Mv./cm, peak-to-peak.
 Frequency Response—DC to 10 Mc
 Signal Delay—0.25 μ sec
 Input line terminations—52, 72 or 93 ohms, or no termination
 Input Imp.—Direct—1 megohm, 30 μ mf
 Probe—10 megohms, 10 μ mf

X-Axis

Sweep Range—0.01 sec/cm to 0.1 μ sec/cm
 Delay Sweep Range—5-5000 μ sec in three adjustable ranges.
 Triggers—Internal or External, + and -, trigger generator, or 60 cycles, undelayed or delayed triggers may be used.
 Built-in trigger generator with repetition rate from 500-5000 cps.

General

Low Capacity probe
 Functionally colored control knobs
 Folding stand for better viewing
 Adjustable scale lighting
 Facilities for mounting cameras
 Price: \$895.00

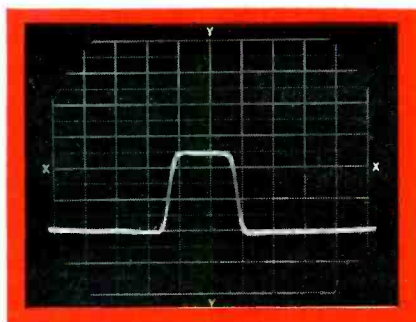

37.5 Mv., 0.2 μ sec width, 1 μ sec sweep full scale

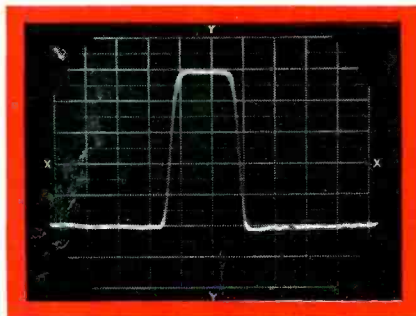

75 Mv., 0.2 μ sec width, 1 μ sec sweep full scale

LINEARITY OF VERTICAL DEFLECTION

The vertical amplifier provides up to 2.5 inches positive or negative uni-polar deflection without serious compression; at 3 inches, the compression is approximately 15%. The accompanying photographs illustrate transient response and linearity of deflection.

SWEEP DELAY The accurately calibrated delay of the 401 provides means for measuring pulse widths, time intervals between pulses, accurately calibrating sweeps and other useful applications wherein accurate time measurements are required.

The absolute value of delay is accurate to within 1% of the full scale calibration. The incremental accuracy is good to within 0.1% of full scale calibration.

Additional Features:

An INPUT TERMINATION SWITCH for terminating transmission lines at the oscilloscope.
 A FOLDING STAND for convenient viewing.
 FUNCTIONALLY COLORED KNOBS for easier location of controls.

Designed and built for electronic engineers, the 401, with its high gain and wide band characteristics, and its versatility, satisfies the ever-increasing requirements of the rapidly growing electronics industry for the ideal medium priced oscilloscope.

TRIGGER GENERATOR with variable repetition rate from 500 to 5000 cps.
 POSITIVE & NEGATIVE UNDELAYED TRIGGERS and a POSITIVE DELAYED TRIGGER are externally available.



Write for Complete Information

LABORATORY for ELECTRONICS, INC.

75 PITTS STREET • BOSTON 14, MASS.

PRECISION ELECTRONIC EQUIPMENT • OSCILLOSCOPES • MAGNETOMETERS • COMPUTERS • MICROWAVE OSCILLATORS • MERCURY DELAY LINES

VOLTAGE REGULATED POWER SUPPLIES

For Industrial and Research Use



MODEL 815

DC POWER SUPPLY SPECIFICATIONS

REGULATION: 1/2% for both line (105-125 volts) and load variations.
 REGULATION BIAS SUPPLIES: 10 millivolts for line 105-125 volts.
 RIPPLE: 5 millivolts RMS 1/2% for load at 150 volts.

VOLTS	CURRENT	MODEL	VOLTS	CURRENT	MODEL
100-325 0-150 Bias 6.3 AC.CT.*	0-150 Ma. 0-5 Ma. 10 Amp.	131	0-600	0-2.25 Amp.	770
100-400 6.3 AC.CT.	0-150 Ma. 10 Amp.	141	0-600	0-3.00 Amp.	780
200-500 6.3 AC.CT.	0-200 Ma. 6 Amp.	245	#1 0-600 #2 0-600 #3 6.3 AC.CT. #4 6.3 AC.CT.	0-200 Ma. 0-200 Ma. 10 Amp. 10 Amp.	800
0-300 0-150 Bias 6.3 AC.CT.	0-150 Ma. 0-5 Ma. 5 Amp.	315	0-600 0-150 Bias 6.3 AC.CT.	0-200 Ma. 0-5 Ma. 10 Amp.	815
0-500 6.3 AC.CT.	0-300 Ma. 10 Amp.	500R	0-1000 Ripple 10 mv. 6.3 AC.CT.	0-50 Ma. 10 Amp.	1020
#1 200-500 #2 200-500 #3 6.3 AC.CT. #4 6.3 AC.CT.	0-200 Ma. 0-200 Ma. 6 Amp. 6 Amp.	510	0-1200 Ripple 10 mv. 6.3 AC.CT.	0-20 Ma. 10 Amp.	1220
0-500 0-150 Bias 6.3 AC.CT.	0-300 Ma. 0-5 Ma. 10 Amp.	615	200-1000 Ripple 20 mv.	0-500 Ma.	1250
0-350	0-750 Ma.	700	0-1000 Ripple 20 mv.	0-500 Ma.	1350
0-350	0-1.50 Amp.	710	100-400 Regulation 0.01% Ripple 1 Mv. 6.3 AC.CT.	0-150 Ma. 10 Amp.	2000
0-350	0-2.25 Amp.	720	0-30 Ripple 0.1%	0-30 Amp.	3030
0-350	0-3.00 Amp.	730	0-3 Regulation 5 Mv. Ripple 1 Mv.	0-100 Ma.	3100
0-600	0-750 Ma.	750			
0-600	0-1.50 Amp.	760			

*All AC Voltages are unregulated. All units are metered except Models 131, 315 and 3100
 All units designed for relay rack mounting or bench use.

The Kepco Voltage Regulated Power Supplies are conservatively rated. The regulation specified for each unit is available under all line and load conditions, within the range of the instrument. Write for specifications.

MANUFACTURERS OF ELECTRONIC EQUIPMENT • RESEARCH • DEVELOPMENT

KEPCO

LABORATORIES, INC.

131-34 SANFORD AVENUE • FLUSHING 55, N.Y.

REAL Miniaturization... PLUS Low Loss for UHF...



ERIE STYLE 535 TUBULAR TRIMMER

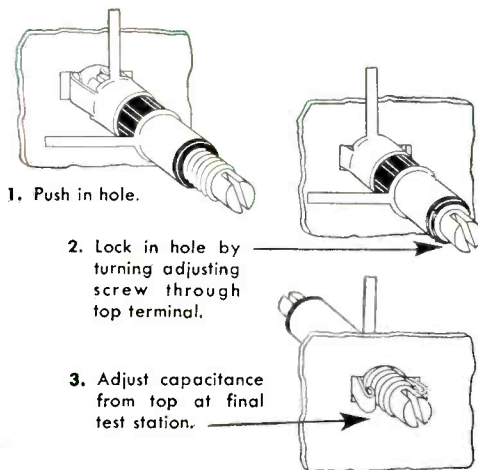
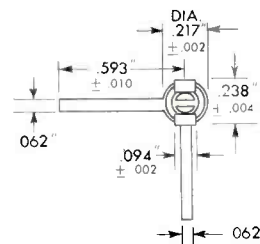
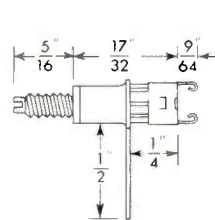
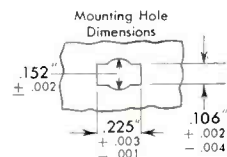

The chassis punch-out required for the Style 535 is identical to that for the tubular ceramic trimmers that are in general usage.

Simplicity of design makes possible the extremely small size of the ERIE Style 535 Trimmer. The same simplicity of design results in very low inductance and uniform, straight-line, noiseless adjustment. It can be mounted close to associated circuit elements, and the ribbon type leads help to minimize inductance in UHF circuits.

When mounted, the high temperature, polystyrene body, extends only 17/32" from the underside of the chassis, and is only 7/32" in diameter. As shown at the left, the operator works from only one side of the chassis when installing the trimmer . . . a production cost saving feature . . . no additional hardware required.

The ERIE Style 535 Tubular Trimmer combines the desirable features of small size, easy mounting, stable performance and economical price. Capacity range is from 0.7 to 3.0 mmf and working voltage is 500 volts. Write for full information and samples.

ERIE components are stocked at leading electronic distributors everywhere.



ERIE RESISTOR CORPORATION . . . ELECTRONICS DIVISION

Main Offices: ERIE, PA.

Sales Offices: Cliffside, N. J. • Philadelphia, Pa. • Buffalo, N. Y. • Chicago, Ill.
Detroit, Mich. • Cincinnati, Ohio • Los Angeles, Calif.

Factories: **ERIE, PA. • LONDON, ENGLAND • TORONTO, CANADA**

How tracing paper is made and why **ALBANENE*** is Different

**TOUGH, LONG-FIBER PAPER
NOT TRANSPARENTIZED**

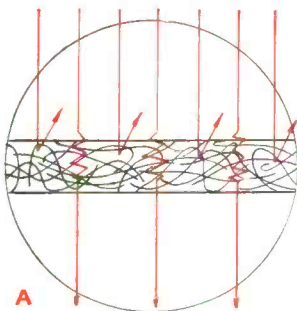

Diagrammatic enlargement of cross section of paper with high strength but low transparency. Fibers are surrounded by air, which has different index of refraction. Many light rays are bent back and do not get through.

**SAME PAPER
TRANSPARENTIZED WITH
FLUID MATERIAL**

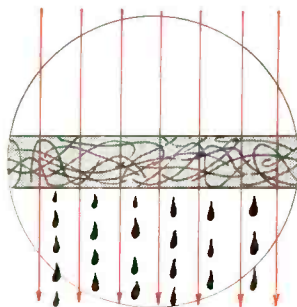

Same paper as "A", filled with oil or other fluid material, giving spaces between fibers same index of refraction as fibers. Reflection and refraction of light are reduced and paper becomes highly transparent. But transparency is not permanent because fluids "bleed" out. †

**SAME PAPER
TRANSPARENTIZED THE
ALBANENE WAY**

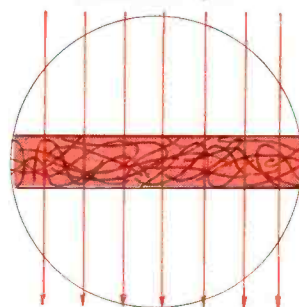

Same paper as "A", filled with an inert synthetic resin, with correct index of refraction. This is how Albanene is made. Its transparentizer does not "bleed" out. Albanene holds its color and strength and is permanently transparent. †

**PAPER TRANSPARENTIZED BY
CRUSHING AND BEATING FIBERS**

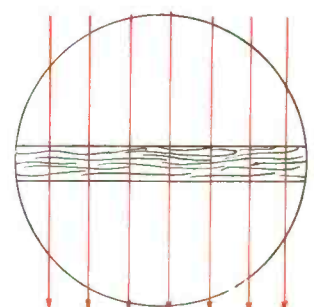

Papers are also transparentized at the mill by a "beating" process. The fibers are crushed, flattened and compacted. Reflection and refraction of light are reduced. But the process weakens the fibers and the strength of the transparent paper is low.

More than 15 tests are made during production of Albanene. For example, each production roll is tested for pencil "take", for pencil erasing and the taking of drawing ink. To eliminate human variables, pencil lines are drawn by machine. In this way you are assured of the uniformity of working surface so much desired by draftsmen, and assured of a paper that makes cleaner, sharper prints . . . now or a generation later. Ask your K&E Distributor or Branch for further information.

† Prove this by making the "drafting tape test" Press a short piece of drafting tape on fluid-transparentized paper, and another on Albanene. Strip them off the next day and examine both papers. Notice that enough fluid has drifted out of the ordinary paper into the tape to destroy much of the transparency. And notice that Albanene is not affected. What drafting tape does overnight, time will do naturally.

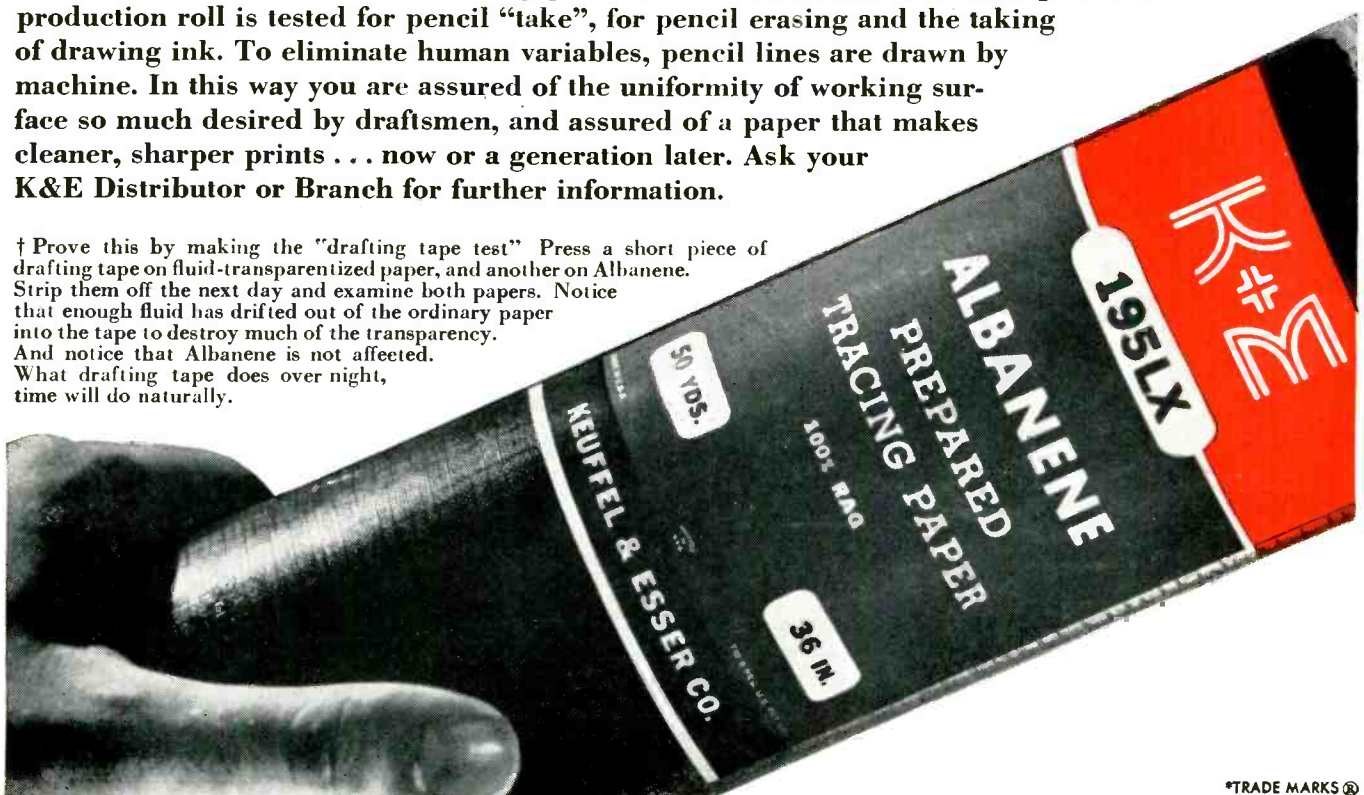

*TRADE MARKS ®

Transparent... and Better!

AVAILABLE IN MANY FORMS FOR MANY USES

Albanene comes in 20-yard and 50-yard rolls in various widths and in three different weights. For those who like the convenience of cut sheets, a new Albanene package has been designed. It strongly protects the paper in shipment and storage, and may be opened without mutilating the container, thus serves as a dispenser in drafting room or stock room. Albanene cut sheets can be supplied imprinted to your specifications.

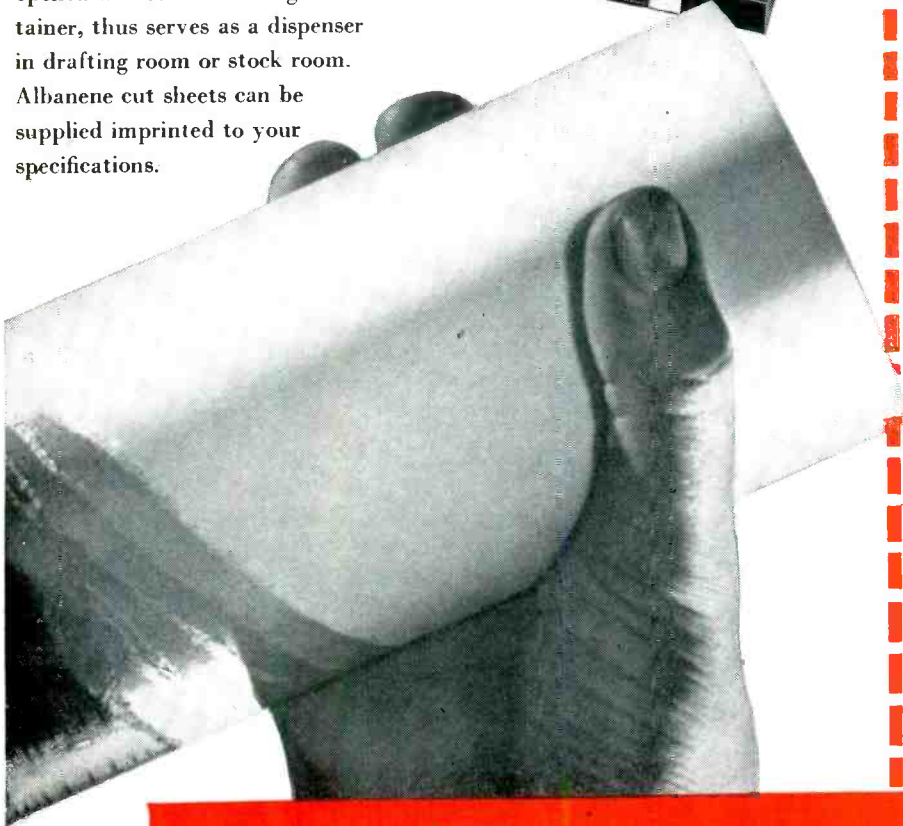

The Right Angle

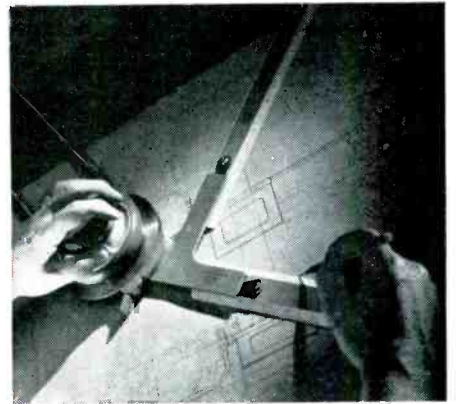

Once you've discovered the pleasure of drawing on Albanene, the next logical step is to save time, trouble and eyesight with a K&E PARAGON* Drafting Machine. You control your calibrated straight edge with a light touch of one hand, for parallel lines and lines at any angle.

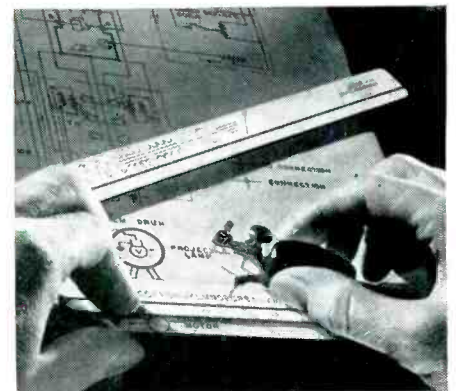

Make your lettering letter-perfect and save wear and tear on your nerves by using a LEROY* lettering outfit. Template grooves guide your pen so the finished result looks like printers' type, and the whole process is relaxing. There's a wide choice of sizes, styles and symbols.



PARTNERS IN CREATING

KEUFFEL & ESSER CO.

EST. 1867

*Drafting, Reproduction, Surveying Equipment
and Materials, Slide Rules, Measuring Tapes*

NEW YORK • HOBOKEN, N. J.
CHICAGO • ST. LOUIS • DETROIT
SAN FRANCISCO • LOS ANGELES • MONTREAL

Quality...in quantity



PRECISION RESISTORS

JAN R-93 or MIL R93A SPECS.

CHECK THESE FEATURES

LOW-EXPANSION WINDING FORMS

(non-hygroscopic) prevent distorted windings, breaking of seal, breakdown of dielectric.

HIGH-STABILITY RESISTANCE WIRES

—pure, carefully selected, pretested alloys.

PRECISION WINDING

—uniformly wound, mechanically tied under scientifically controlled conditions.

NON-CORROSIVE, ANCHORED TERMINALS

—strong, tin-dipped copper terminals, securely and permanently attached to winding form.

HERMETIC SEALING

A special process, employing chemically inert compounds, seals winding against destructive effects of salts, moisture, and atmospheric conditions.

PRETESTED FOR ACCURACY

—quality assured by temperature cycling, salt water immersion, humidity, and overload tests.

If finding reliable, lightweight, precision wire wound resistors is your problem, investigate the I-T-E product. I-T-E precision resistors have been developed by experts to meet the exacting requirements of the electronics industry.

Simple basic design, engineering skill, extensive production facilities, and close quality control are all combined to give you lightweight resistors that far exceed requirements of JAN R-93 or MIL R93A specifications. You get quality—close tolerance in every unit—in any quantity you need.

RATINGS:

I-T-E precision wire wound resistors can be supplied in quantity all the way from 0.01 ohms to 10 megohms—0.125 to 5 watts. Standard tolerances $\pm 1\%$. Available in specified tolerances down to $\pm 0.05\%$. Ideal for all JAN "A" and "B" as well as MIL applications.

FOR DETAILED INFORMATION—Get in touch with your nearest I-T-E representative or write direct to:

I-T-E RESISTOR DIVISION
1924 Hamilton Street
Philadelphia 30, Penna.

specify



RESISTORS

I-T-E CIRCUIT BREAKER COMPANY • RESISTOR DIVISION • PHILADELPHIA 30, PA.

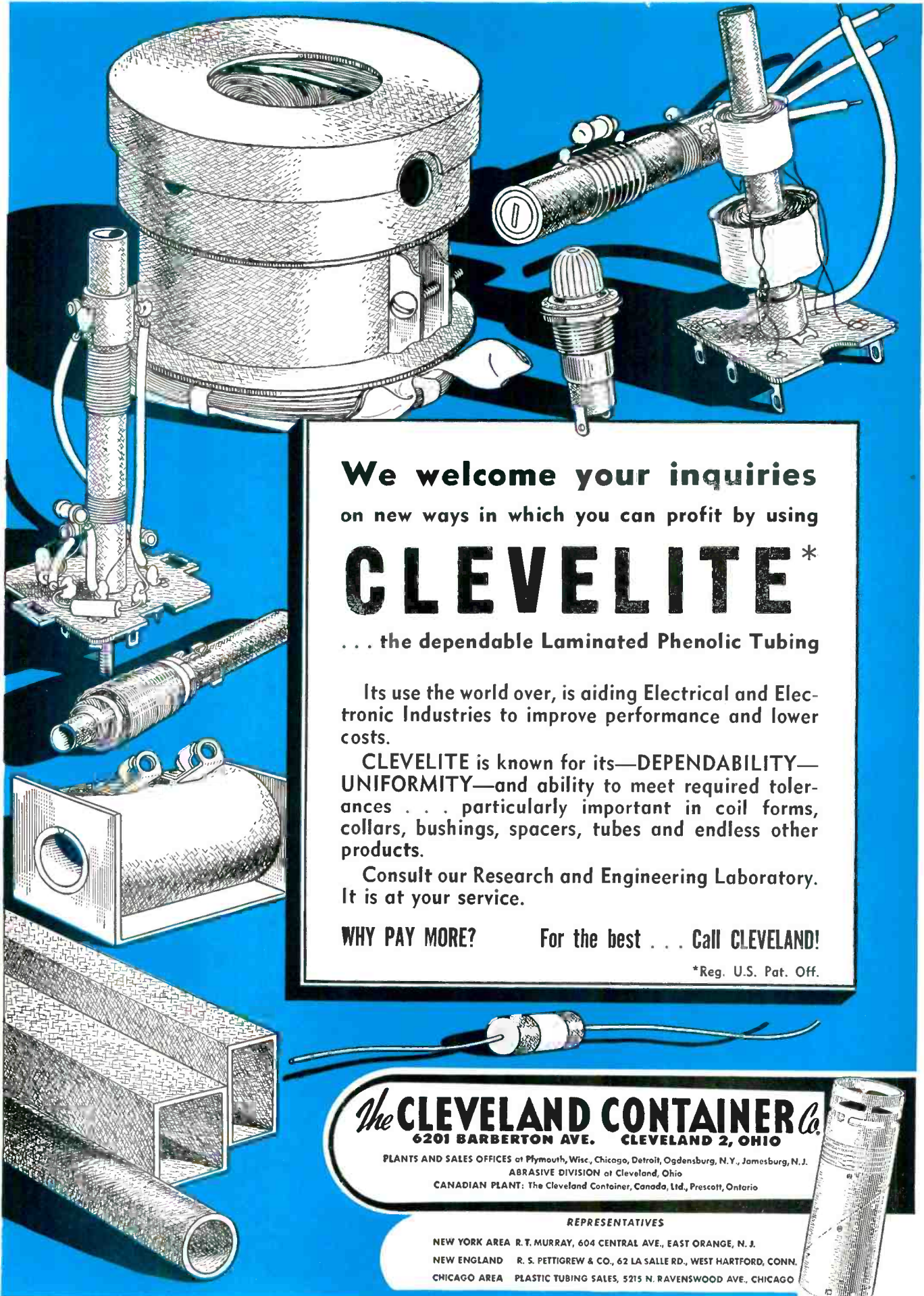

We welcome your inquiries
on new ways in which you can profit by using

CLEVELITE*

... the dependable Laminated Phenolic Tubing

Its use the world over, is aiding Electrical and Electronic Industries to improve performance and lower costs.

CLEVELITE is known for its—DEPENDABILITY—UNIFORMITY—and ability to meet required tolerances . . . particularly important in coil forms, collars, bushings, spacers, tubes and endless other products.

Consult our Research and Engineering Laboratory. It is at your service.

WHY PAY MORE?

For the best . . . Call CLEVELAND!

*Reg. U.S. Pat. Off.

The **CLEVELAND CONTAINER Co.**
6201 BARBERTON AVE. CLEVELAND 2, OHIO

PLANTS AND SALES OFFICES at Plymouth, Wisc., Chicago, Detroit, Ogdensburg, N.Y., Jamesburg, N.J.
ABRASIVE DIVISION at Cleveland, Ohio
CANADIAN PLANT: The Cleveland Container, Canada, Ltd., Prescott, Ontario

REPRESENTATIVES

NEW YORK AREA R. T. MURRAY, 604 CENTRAL AVE., EAST ORANGE, N. J.
NEW ENGLAND R. S. PETTIGREW & CO., 62 LA SALLE RD., WEST HARTFORD, CONN.
CHICAGO AREA PLASTIC TUBING SALES, 5215 N. RAVENSWOOD AVE., CHICAGO

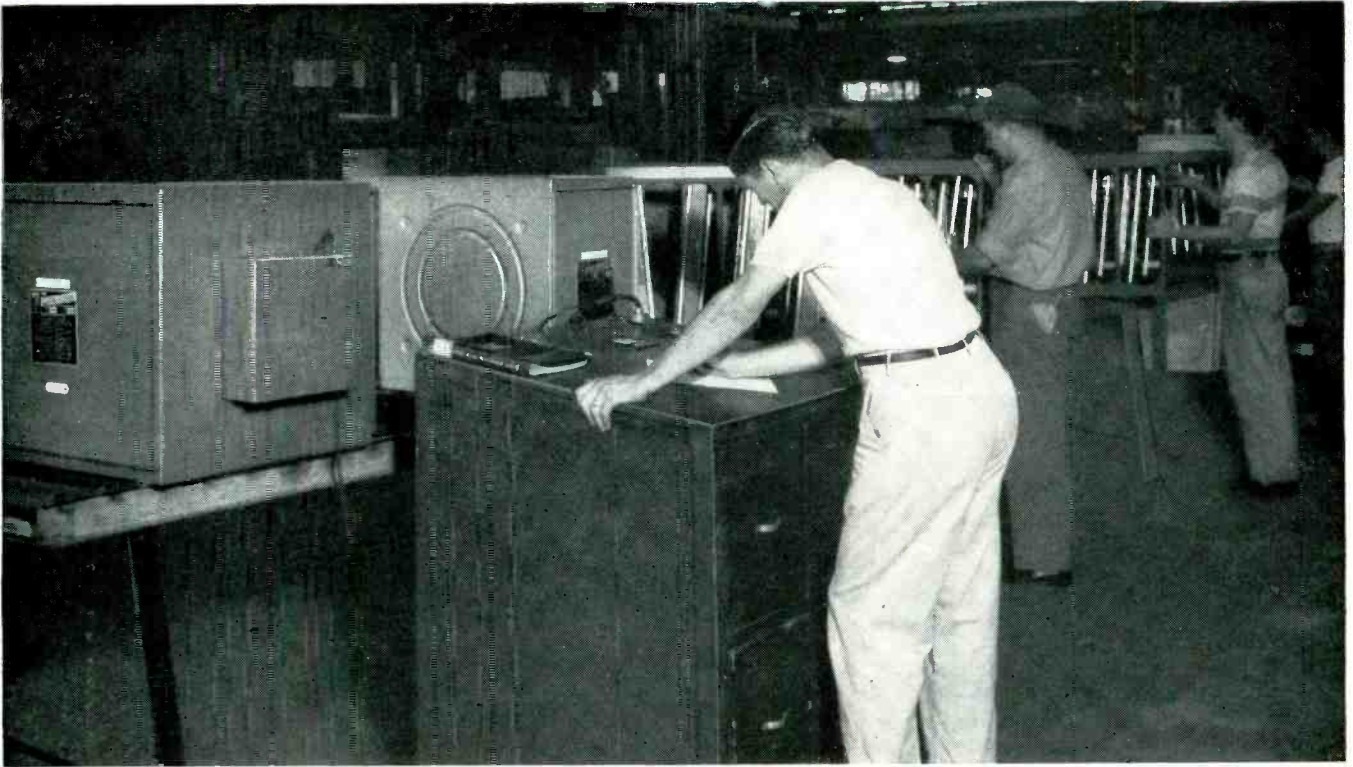

AMERICAN AIR FILTER COMPANY ASSEMBLY LINE FOR HOME AIR FILTERS. UNITS USE G-E SELENIUM STACKS FOR POWER SUPPLY.

G-E selenium rectifiers assure long life for new Electro-Klean home air filter



"IN OUR PRODUCT," states Mr. William M. Reed, President of American Air Filter Co., "we required uninterrupted and long-lasting performance from every component. We get both in General Electric selenium rectifiers."

American Air Filter Co. recently introduced an electronic precipitator air filter for home use, the Electro-Klean. The direct current used is supplied by General Electric selenium rectifiers in a new, high-voltage power pack.

G-E rectifiers were chosen because of their uniform high-quality and long life. As Mr. W. M. Reed, American Air Filter President has said, "Our experience has proved that G-E selenium rectifiers assure not only a dependable and uniform power supply for the product, but an extra long life as well. They make a major contribution to its quality and consumer acceptance."

QUALITY MEANS SAVINGS—G-E selenium stacks have exceptionally low forward resistance and back leakage. The lower these characteristics are initially, the slower the aging, and the longer the life of the rectifier. Also, these mean higher output, greater efficiency, and cooler operation. Frequently, they permit you to save with a more compact assembly made up of smaller components.

MORE INFORMATION? For the full story of how G-E selenium rectifiers can improve your product, contact your nearest G-E Apparatus Sales Office, or write for Selenium Application Bulletin, GET-2350. Address Section 461-24, General Electric Co., Schenectady 5, New York.

GENERAL  ELECTRIC



- APPLICATIONS**
- I-F TRANSFORMERS
 - PERMEABILITY TUNING DEVICES
 - LOW-LOSS INDUCTORS
 - SATURABLE CORE REACTORS
 - HORIZONTAL OUTPUT TRANSFORMERS
 - DEFLECTION YOKES
 - TELEPHONE LOADING COILS
 - RECORDING HEADS
 - PULSE TRANSFORMERS
 - ANTENNA CORES

FERROXCUBE ... first in ferrites!

Nickel-free Ferroxcube 3 and 3C cores are the modern, superior ferrites now performing with outstanding success in television and military electronics. Both materials have higher permeabilities than the nickel-zinc ferrites that are sometimes supplied for these applications.

For the higher-temperature applications, Ferroxcube 3C cores are recommended. Where maximum initial permeability is the prime requirement, Ferroxcube 3 is generally indicated.

In any case, you can specify either of these excellent manganese-zinc ferrites with full assurance that deliveries will be

made to meet your specified schedules.

For higher-frequency applications, where minimum eddy-current losses are more important than maximum permeability, the Ferroxcube 4 series of nickel-zinc ferrites are recommended. Their uses include I-F Transformers, R-F Tuning Coils, Antenna Cores, etc.

The broad experience of Ferroxcube Corporation Engineers — an accumulated knowledge of manufacture and application over a 16-year period — is the "reference library" which is available to assist you. Write for technical data applicable to your design problems. ★ ★ ★ ★

FERROXCUBE

THE MODERN CORE MATERIAL

FERROXCUBE CORPORATION OF AMERICA

• A Joint Affiliate of Sprague Electric Co. and Philips Industries, Managed by Sprague •

SAUGERTIES, NEW YORK

**WANT EXCEPTIONAL PRECISION FOR
MICROWAVE-UHF-VHF
GAIN OR LOSS MEASUREMENTS?
YOU CAN HAVE IT WITH
the NEW
MICROWAVE GAIN SET**

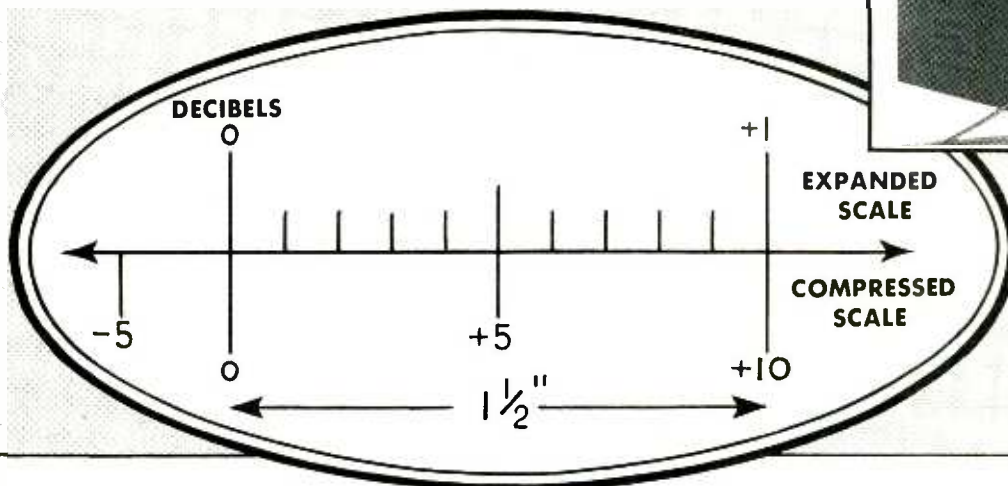
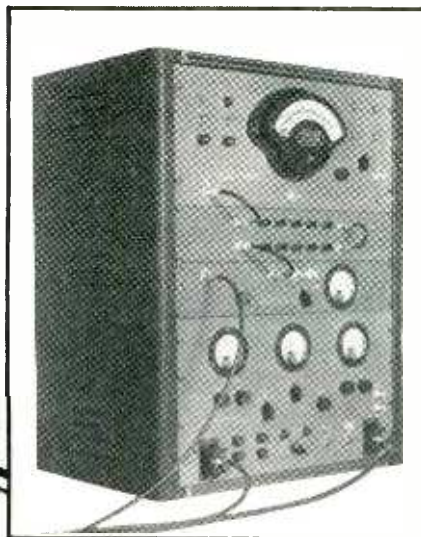

**READABLE
TO
0.025 DB.**

- Readable to 0.025 db.
- Accuracy within 0.1 db of attenuator calibration.
- Measurements with available power as low as -80 dbm.
- Available with or without RF-Heads. May be used in conjunction with klystron signal source and local oscillator for any frequency range.
- Extremely well regulated to prevent disturbance of measurements due to drift of gain or tuning.

The Microwave Gain Set is a complete system for making precision measurements of gain or loss in microwave components or systems. The IF amplifier-metering portion, available separately as the Model 620-A Amplifier-Detector Set, having an input frequency of 70 mcs, may be used with other signal sources and local oscillators to provide measurements down to the VHF range. It consists of a preamplifier, calibrated attenuator, amplifier-detector, and power supply. The 500-A Double Klystron Power Supply and "Centilators," Microwave Signal Sources, both optional, are also available. With its high gain and high ultimate accuracy, the Microwave Gain Set is capable of accurate loss measurements in the vicinity of zero loss, as well as where losses are as great as 80 db.

SEND FOR DETAILED FOUR-PAGE BROCHURE ON THE NEW GAIN SET



KAY ELECTRIC COMPANY

14 Maple Avenue

Phone CAldwell 6-4000

Pine Brook, New Jersey

Engineered today for your needs tomorrow!

MYCALEX

PRECISION-MOLDED MYCALEX 410[®]

TRANSISTOR SOCKETS

— now in the pilot production stage
— engineered in advance of actual need

In keeping with the MYCALEX policy of progressive design in advance of needs, these Transistor Sockets were engineered months ago and are now in small scale pilot production. They'll be available in quantity in advance of actual needs.

Mycalex 410 Transistor Socket shown actual size

Mycalex 410 Transistor Socket enlarged to show detail



Achievement in PRECISION MOLDING!

The production of Mycalex Transistor Sockets is a real accomplishment of precision molding in miniature. The holes for the leads are the smallest ever molded. All tolerances are exceedingly close. Mycalex production engineers are proud of their achievement . . . particularly because low-cost, mass production techniques can be adhered to.

The body is precision-molded of MYCALEX 410, glass-bonded mica insulation for lasting dimensional stability, low dielectric loss, immunity to high temperature and humidity exposure combined with maximum mechanical strength. The loss factor is only 0.014 at 1 MC and dielectric strength is 400 volts/mil.

Contacts can be supplied in brass or beryllium copper. The sockets are readily solderable. The socket bodies will not warp or crack when subjected to high soldering temperature. They function in ambient temperatures up to 700° F.

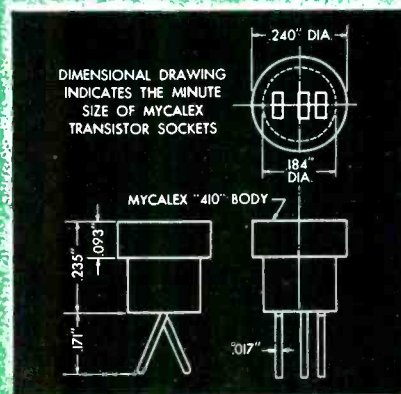

Mycalex Low-loss Tube Sockets and Multiple Headers

A complete line of tube sockets including sub-miniature types is available in Mycalex 410 and Mycalex 410X glass-bonded mica insulation. Comparative in cost to ordinary phenolic sockets they are far superior in every respect. Dimensional accuracy is unexcelled. For complete information on standard

and custom Tube Sockets or Multiple Headers, call, wire or write . . . there is no obligation, of course.

MYCALEX TUBE SOCKET CORPORATION

Under Exclusive License of Mycalex Corporation of America
30 ROCKEFELLER PLAZA, NEW YORK 20, N. Y.



MYCALEX CORPORATION OF AMERICA

Owners of 'MYCALEX' Patents and Trade-Marks

Executive Offices: 30 ROCKEFELLER PLAZA, NEW YORK 20—Plant & General Offices: CLIFTON, N. J.



Air Strike....Submarine Style

Guided missiles launched from submarines promise to be major offensive weapons in case of war. A missile of this type travels to its distant destination under unerring electronic orders. The brain center for such missiles will be typical of the electronic systems developed and manufactured by Arma Corporation.

In close collaboration with the Armed Forces since 1918, and more recently with the Atomic Energy Commission, Arma has contributed much

in basic research, design, development and manufacture to the advancement of electronic and electro-mechanical weapon control, navigation, and other precision remote control systems. There is every reason to believe that engineering background and techniques—first used successfully in these devices—will see widespread industrial applications. *Arma Corporation, Brooklyn, N. Y.; Mineola, N. Y. Subsidiary of American Bosch Corporation.*

ARMA

ADVANCED ELECTRONICS FOR CONTROL



PRESTIGE of the **BUSS** Name and
PROTECTION of BUSS **FUSES** means

PROFIT For You

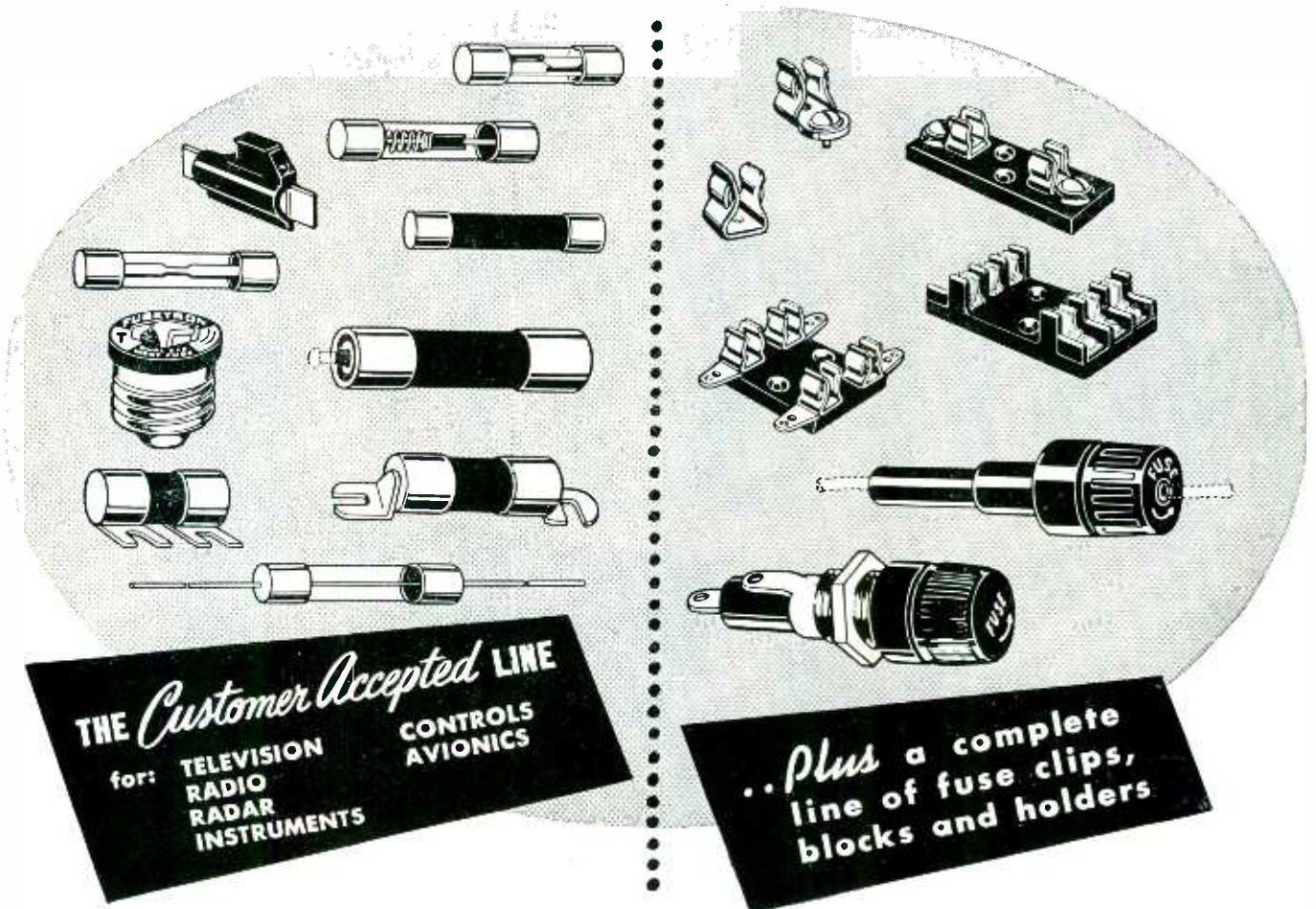

THE Customer Accepted LINE
 for: TELEVISION
 RADIO
 RADAR
 INSTRUMENTS
 CONTROLS
 AVIONICS

*.. Plus a complete
 line of fuse clips,
 blocks and holders*

For more than a third of a century BUSS has lead in the research, design and development of fuses for electrical protection. To maintain this standard of unquestioned high quality, each and every BUSS fuse for the electronic field is tested in a highly sensitive electronic device that rejects any fuse that is not correctly calibrated — properly constructed — and right in all physical dimensions.

The complete BUSS line makes it easy and economical for you to select the fuse that is right for any requirement. Choose from Dual-Element (Fusetron slow blowing fuses), Renewable, and One-Time types which are available in all standard sizes, and many special sizes and designs.

BUSSMANN Mfg. CO., *Division McGraw Electric Company*
 University at Jefferson, St. Louis 7, Missouri

Do You Have A Protection Problem?

Let our fuse engineers help you select or design the right fuse or fuse mounting to meet your needs. Submit a sketch or description that shows the type of fuse contemplated, number of circuits; type of terminals, and the like. We welcome your requests — and our staff is always at your service.

You're Invited

**TO MAIL THIS
 HANDY COUPON TODAY!**

BUSSMANN Mfg. Co. (Division of McGraw Electric Co.)
 University at Jefferson, St. Louis 7, Mo.
 Please send me bulletin SFB giving the facts on
 BUSS small dimension fuses and fuse holders.
 Name.....Title.....
 Company.....
 Address.....
 City & Zone.....State..... ELRC-153

SAFE AGAINST HIGH HUMIDITY IN TROPICAL CLIMATES!

RESISTS MOISTURE

...IT'S THE

Blue Jacket[®]



**WIRE-WOUND
RESISTOR**



You're safe when you "batten down the hatches" against high humidity with Sprague Blue Jackets! They're rugged vitreous enamel power resistors that can take abuse . . . that eliminate electrolysis failure in the most humid atmospheres . . . that deliver top wattage ratings in every size . . . that assure unmatched stability and resistance to thermal shock. Yes, the Blue Jacket is outstanding even among the many noteworthy Sprague developments in the resistor art. ★ ★ ★ ★ ★ ★ ★

Blue Jacket resistors are made in types to meet the tough performance requirements of Military Specification JAN-R-26A, Characteristic "G". See Engineering Bulletin 110 for complete details. Blue Jackets are also available in commercial styles that excel in the most severe industrial electronic service. Engineering Bulletin 111 describes these superior units—that cost no more than ordinary resistors! Send for your copies to:

SPRAGUE ELECTRIC COMPANY
35 Marshall Street, North Adams, Mass.



**YOU'LL RECOGNIZE THESE SUPERIOR RESISTORS BY
THEIR BRIGHT BLUE VITREOUS ENAMEL JACKETS**

PIONEERS IN ELECTRIC AND ELECTRONIC DEVELOPMENT

How many research hours in a day?



TESTING LUBRICANTS for ball bearings, research men at Sinclair Research Laboratories utilize *ElectroniK* instruments to record temperatures of bearings running on a test stand.

In addition to a complete line of instruments for measuring and controlling temperature, flow, and dozens of other variables, Honeywell offers these special *ElectroniK* instruments of interest to research men:

Function Plotter: automatically plots the relation of two independent variables.

Two-Pen Recorder: simultaneously measures two variables on a single chart.

Extended Range Indicator: featuring automatic range-changing, readable to one part in 5000.

Narrow Span Recorder: measures spans as narrow as 100 microvolts, without external pre-amplifier.

Brown Electrometer: measures currents as low as 10^{-15} ampere.

High Speed Recorder: features pen speed of only one second for full scale travel.

OBSERVING tests, measuring critical conditions, collecting data, plotting curves . . . the routine labor of research takes a lot of time out of each day . . . each week . . . each month.

You'll find that *ElectroniK* instruments can save countless scientific man-hours by doing all these laborious but essential jobs for you. They free highly trained scientists for more important work . . . giving them an opportunity to use their brainpower most effectively. And these instruments do the routine work faster, more accurately than could be done by human hands.

ElectroniK potentiometers are accelerating the pace of research in academic and industrial laboratories, atomic energy projects, pilot plants, and test centers throughout the world. For a discussion of how they can help your own research programs, call our nearest engineering representative . . . he is as near as your phone.

MINNEAPOLIS-HONEYWELL REGULATOR Co., *Industrial Division*, 4428 Wayne Ave., Philadelphia 44, Pa.

REFERENCE DATA: Write for Research Bulletin 15-14, "Instruments Accelerate Research" . . . and for Data Sheets on specific instruments.

MINNEAPOLIS
Honeywell
BROWN INSTRUMENTS

First in Controls



edwin i. guthman & co., inc.

15 s. throop st. chicago 7, ch 3-1600 • also attica, indiana

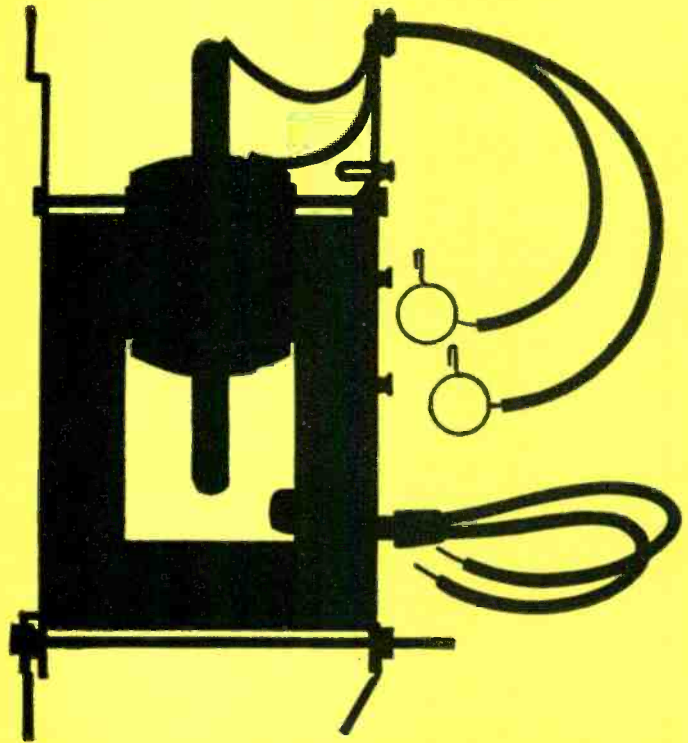

flyback transformers

For reliability in high voltage specify Guthman Flybacks—they won't break down even under the most severe voltage requirements. Wire used in Guthman Flybacks is fabricated in our own plant and is quality controlled from raw material to finished product guaranteeing a superior uniformity of performance. The excellent linearity and voltage regulation characteristics of Guthman Flybacks aids in preserving picture quality.

Coils used in Guthman Yokes are form wound. Complete isolation between vertical and horizontal coils achieved by a molded nylon piece permits a yoke rating of 5,000 volts pulse maximum. Anti-magnetic core retainer band and brass mounting nut assures no magnetism in Guthman Yokes.

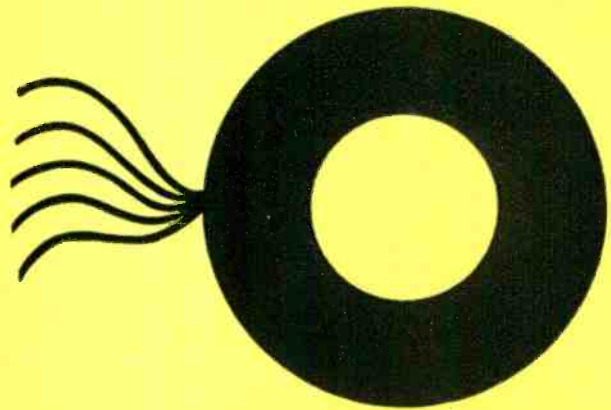

DELAY LINES
SHIELD CANS
ANTENNA COILS
OSCILLATOR COILS
COMPRESSION TYPE
MICA TRIMMERS
I.F. TRANSFORMERS
LOOP ANTENNAS
R.F. TUNERS

yokes

BURTON BROWNE ADVERTISING



YOURS... WITH OUR COMPLIMENTS

**This New, 12-Page
Microwave Components
Data Book**

*Send
Today!*



SEND FOR YOUR COPY

Contains diagrams and tables of sizes and types—detailed Government specifications for rigid and flexible waveguides—manufacturing and testing operations. If you're working on electronic contracts, this Handbook belongs on your desk. The coupon brings you as many copies as you need.

TITEFLEX, INC.

524 Frelinghuysen Avenue
Newark 5, N. J.

Please send me without cost _____ copies of your new Microwave Components Data Book.

NAME _____

TITLE _____

FIRM _____

ADDRESS _____

CITY _____ ZONE _____ STATE _____

No. 108 machine makes coil winding more profitable

Quick set-up and
greater accuracy
LOWER COSTS



Leesona® No. 108 Coil Winder for high accuracy, top production and lowest costs in shops where change-overs are frequent. Takes long or short runs; easy to set up; no cams or gears to remove when making set-up changes; all controls are within easy reach of the operator even when seated.

Prize-Winning Design

So simple, the operator can make set-up changes in a matter of minutes. So moderate in price you can easily replace older, less satisfactory equipment and soon see savings write off your investment.

This is the manual paper feed machine which won the "Electrical Manufacturing" magazine's design prize. Set-up time is reduced to a minimum by external controls and change-over from job to job is quick and easy. It winds wires

from #20 to #44 (A.W.G). Coil lengths may be from $\frac{1}{4}$ " to $3\frac{5}{8}$ ", with outside diameters up to 5" round or square.

ACCURACY CONTROLLED, because leadscrew traverse and quick-reversing clutch give positive control of wire layer. Indicators help operator time paper feeding accurately even at high speed.

Send for Bulletin 108A and read *all* the good news about this flexible high production, low cost coil winder.

UNIVERSAL WINDING COMPANY

P. O. Box 1605, Providence 1, R. I.

Chicago office and Demonstration Room, 9 So. Clinton St., Chicago 6, Ill.

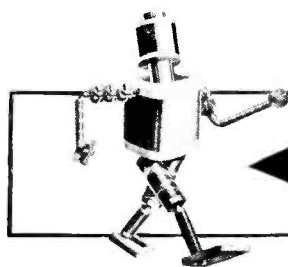

For winding coils in quantity
accurately . . . automatically
use Universal Winding Machines



hell on earth...

...all the punishment nature can deliver... and MORE... is duplicated within this mammoth test chamber. From the arid desert or steaming tropical jungle's environment — of up to +200°F at sea level to a high of +100,000 feet and -100°F — this unit enables test engineers at McDonnell Aircraft to predetermine the effects of environmental conditions on aircraft parts and assemblies in accordance with JAN and MIL specs. Its contribution to tomorrow's avionic design is beyond measure.

This is but one of the many Merritt & Zaleski test chambers serving industry today... Both stock and custom-built models are available with virtually limitless ranges... low and high temperature, humidity, pressure and complete environmental duplication. Discover, without obligation, how Merritt & Zaleski can solve your particular testing problem.

Write, in detail, for an analysis and specific proposal.



MERRITT & ZALESKI INC.

ATMOSPHERE
UNLIMITED

33-66 12TH STREET, LONG ISLAND CITY 6, N. Y.
PRATT OVAL, GLEN COVE, L. I., N. Y.

The Inside Story

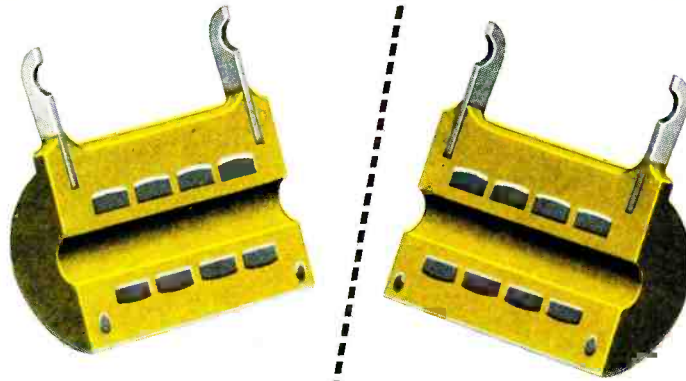

The NEW CE Series

ACCURATE WIRE WOUND RESISTORS

HERMETICALLY SEALED IN CAST EPOXY. EXCEEDS MIL R-93A SPECIFICATION

Scientific progress has made the demand and we believe the CE series resistors are the answer: —

In the cross-section above, we illustrate the single homogenous mass that means so much to stability and provides the ample moisture vapor barrier of this new resistor. Bobbin and encapsulation become one homogenous mass, surrounding the resistance wire with a minimum of strain.

Write today if your requirements are for a hermetically sealed resistor to withstand a wide variety of environments. Ask for the literature covering the CE series resistors.



CINEMA ENGINEERING CO

1510 WEST VERDUGO AVENUE, BURBANK, CALIFORNIA

IN NEW YORK:
Audio & Video Products Corporation
730 Fifth Ave. • Plaza 7-3091

EXPORT AGENTS:
Frazar & Hansen, Limited
301 Clay Street
San Francisco, California, U.S.A.

High-frequency... for use in studying gaseous... sorption of microwave signals. They have also designed a generator for use with a measuring test bridge. This company has also developed...

Electronic Associates, Inc. was formed just after the end of the last war and has grown in the past years into one of the largest electronic equipment manufacturers in their field. In their Long Branch, New Jersey, they have developed new equipment that industry sorely needs. For the first time now scientists are trying to develop an analog plotter system recently by Electronic Associates, Inc., with no operator; the operator firms and industries are putting their plants, for a long time an

It's News!

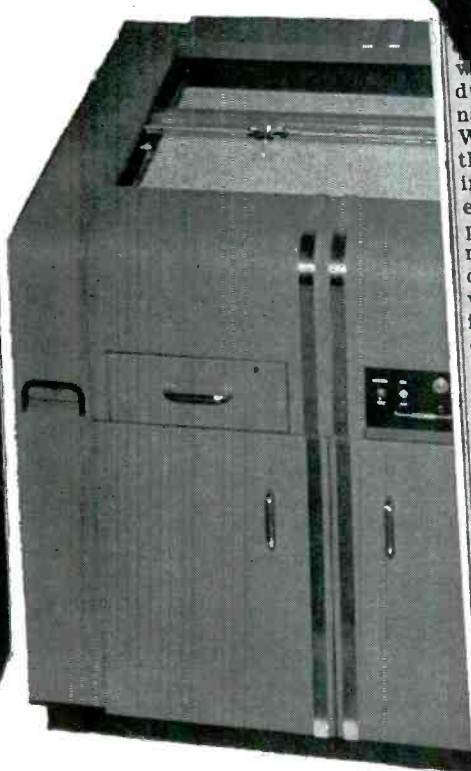

EAI's Dataplotter . . .

An Electronic System That Converts Digital Data To An Analog Plot . . .

Here is a system that will save countless man-hours and costs, and will insure accurate and clear presentation of data. This new Dataplotter, designed and developed by Electronic Associates Inc., will automatically plot a cartesian curve composed of incremental points or symbols from IBM card data at maximum machine reading speed. It will accept data from other inputs - Magnetic tape, keyboards, digital computers, etc. It will retain at all times the basic accuracy of the digital system. Here's what the Dataplotter system consists of:

- Variplotter Model 205G
- Digital-to-analog converter, Model 417
- Data input keyboard

For further information, clip out and mail the coupon below. No obligation.



Electronic Associates Inc.
Long Branch
New Jersey

Gentlemen: Would you be kind enough to send me detailed information on your Dataplotter.

Name Title

Company Title

Address Zone State

City Zone State

Write →

Electronic Associates, Inc. scores again
announcement today were producing a to the commercial Electronic Associates, Inc. one more new development in their history. It is remembered that Electronic Associates, Inc. was first companies to develop the commercial field. The research and development work of the company has been reported that the computer system is one of the great many achievements of the recording industry. "This system," says a spokesman, "will solve many problems related to efficiency. This system is as far as data processing is concerned, and will save down the time of data information. It will undoubtedly save for many, many years of the work in a time that would otherwise require a large crew of equipment has been reported that it has resulted in savings of time. An person interested in complete information is urged to contact Electronic Associates, Inc.

Men From
Electronic
inized w
ere and
the N
Det
na
ps. a
Wa
The
the
ing
led t
ever
bal
prod
on
ment
ene
dust
Org
with
so
d
ern
ag
to 50
m
T
ciates
dated
tific
prod
These
ideal
build
feet
land
An
com
origi
well
resear

The
labor
tract
and
and
library
gained
depart
clar
ified
Natio
and
The
Elect
tr
fi
div
pr
te
in
bu
is
sull
ar
This
premi
tronics
This
y
acre
perfor
109%
The
scien
Des
and
b
p
plotte
of as
tract
last
from
100
p
con

COMPLETE MILITARY LINE

Immediate delivery from stock on 189 types including JAN-R-94 and JAN-R-19 types of variable resistors.

NEW 38-PAGE ILLUSTRATED CATALOG—

Describes Electrical and Mechanical characteristics, Special Features and Constructions of a complete line of variable resistors for military and civilian use. Includes dimensional drawings of each resistor. Write today for your copy.

TYPE 45, (JAN-R-94, Type RV2)
1/4 watt, 15/16" diameter variable composition resistor. Also available with other special military features not covered by JAN-R-94 including concentric shaft tandem construction. Attached switch can be supplied.



TYPE 35, (JAN-R-94, Type RV3)
1/2 watt, 1 1/8" diameter variable composition resistor. Also available with other special military features not covered by JAN-R-94 including concentric shaft tandem construction. Attached switch can be supplied.



TYPE 252, (JAN-R-19, Type RA20)
2 watt, 1 17/64" diameter variable wirewound resistor. Also available with other special military features not covered by JAN-R-19 including concentric shaft tandem construction. Attached switch can be supplied.



TYPE 25, (JAN-R-19, Type RA30)
(May also be used as Type RA25)
4 watt, 1 17/32" diameter variable wirewound resistor. Also available with other special military features not covered by JAN-R-19 including concentric shaft tandem construction. Attached switch can be supplied.

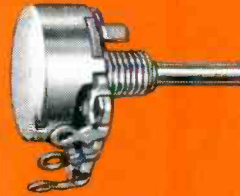

TYPE 65, (Miniaturized)
1/2 watt 70°C, 3/4" diameter miniaturized variable composition resistor.

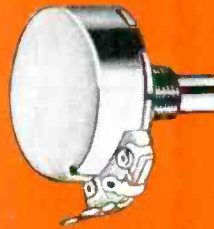

TYPE 90
1 watt 70°C, 15/16" diameter variable composition resistor. Attached switch can be supplied. Also available in concentric shaft tandem construction.

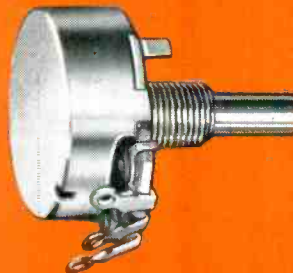

TYPE 95, (JAN-R-94, Type RV4)
2 watt 70°C, 1 1/8" diameter variable composition resistor. Also available with other special military features not covered by JAN-R-94 including concentric shaft tandem construction. Attached switch can be supplied.

See the complete CTS military and civilian lines of variable resistors at the

IRE SHOW

Grand Central Palace, New York City

MARCH 23-26, 1953

BOOTH 4-608

UNPRECEDENTED PERFORMANCE CHARACTERISTICS

Specially designed for military communications equipment subject to extreme temperature and humidity ranges. -55°C to +150°C...aridity to saturation.



CHICAGO TELEPHONE SUPPLY Corporation

ELKHART • INDIANA

Burton Browne Advertising

Precision Mass Production of Variable Resistors

keeping communications **ON THE BEAM**



Her Ship-to-Shore is Ship Shape

Her decks may be awash but there's fair weather in the radio shack. Despite wind and waves the Captain's message will reach the home port. In fair weather or foul, you'll find JK Crystals rate a Navy "E" for their part in keeping marine communications "ship shape."

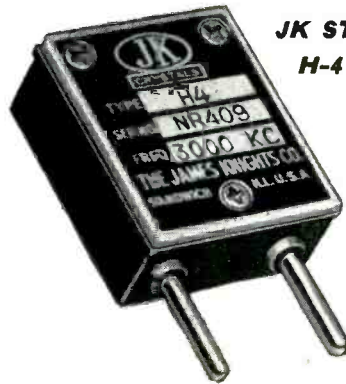

**JK STABILIZED
H-4 CRYSTAL**

CRYSTALS FOR THE CRITICAL

A versatile crystal the JK H-4 is widely used as a replacement crystal in marine and other communications systems. Pressure mounted, dust and water proof, stainless steel electrodes. Frequency range 1800 kc to 15 mc. Military type holder. Another of the many JK Crystals available to serve every need.



the JK
FD-12

FREQUENCY & MODULATION MONITOR

Monitors any four frequencies anywhere between 25 mc and 175 mc, checking both frequency deviation and amount of modulation. Keeps the "beam" on allocation, guarantees more solid coverage, too!

THE JAMES KNIGHTS COMPANY
SANDWICH ILLINOIS

G-E Hydrogen Thyratrons!

—1/10 standard-tube recovery time

—12,500 kw max power delivered

Design your new pulse circuits about these G-E tubes, to take advantage of their short recovery time and high peak ratings!

IDEAL FOR radar applications
 —cyclotrons and synchrotrons
 —advanced electronic test equipment



GL-6130

Peak anode voltage 3 kv
 Peak current 35 amp
 Max power delivered 52.5 kw
 Replaces GL-3C45, also is suited to high-altitude applications.

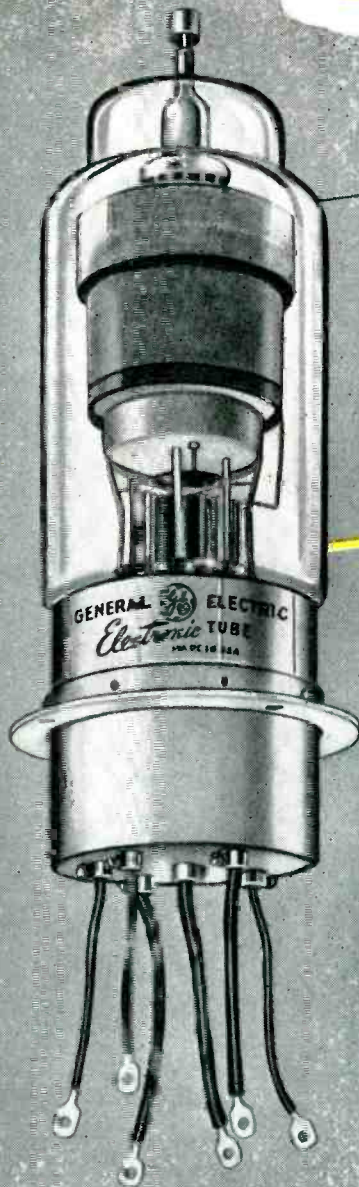

GL-5948

Peak anode voltage 25 kv
 Peak current 1,000 amp
 Max power delivered 12,500 kw

EXTREMELY HIGH VOLTAGE AND CURRENT PEAKS. See ratings at left. These fast-cycling G-E thyratrons perform at far greater peak powers than standard types, because (1) the cathodes are specially designed to deliver very high currents, and (2) hydrogen has high dielectric strength. The GL-5948's rating of 25 kv is some 10,000 v above any standard thyatron. The smaller GL-6130's 3 kv is approximately 3 times the rating of standard tubes of the same size. You can switch top voltages with G-E hydrogen thyratrons!

LIGHTNING-FAST RECOVERY TIME! Almost instantaneous tube recovery permits pulse cycling some 10 times faster than with other gas-filled tubes. Atoms of hydrogen—lightest of the elements—ionize and deionize quickly enough to make possible thyratrons that will "trigger" your high-repetition pulse circuits.

BACKED BY EXTENSIVE G-E FACILITIES. General Electric's large research, engineering, and test facilities combine to assure continued progress in hydrogen-thyatron design. Ask for further facts by return mail—or, if you wish, a G-E tube engineer will be glad to call! Wire or write *Tube Department, General Electric Company, Schenectady 5, New York.*



GENERAL ELECTRIC



163-1A1

New!

LAPP TUBE SUPPORTS

for mounting forced-air-cooled tubes

Now available as a standardized line, these Lapp insulated supports for mounting forced-air-cooled tubes facilitate design of transmitter and other high-power circuits. They are simple, compact and efficient. For high frequency tubes they are available either in Lapp porcelain or Lapp steatite; for standard broadcast frequencies in Lapp porcelain.

WRITE for specification sheets. Radio Specialties Division, Lapp Insulator Co., Inc., Le Roy, N.Y.

Lapp





To the project engineer about to have a “baby”

You're busy solving the functional design problems of that new project. It's taking all your working hours. But what about the chassis or housing? That's where more problems arise.

And that's where Karp helps by answering difficult questions like: how to make your design functional yet attractive...how to make a water-tight seal...how to provide adequate ventilation...in fact, how to solve *all* the problems of planning a low-cost sheet metal assembly.

By calling Karp in *early*, your “packaging” problems can be ironed out as you solve your functional problems. And with its creative engineering staff, its vast assortment of available dies, its 77,000 square feet of facilities, Karp can show you how to cut costs and delivery time. We'll be glad to talk it over with you.

KARP METAL PRODUCTS CO., INC., 215 63rd St., BROOKLYN 20, N. Y.

MOST COMPLETE FACILITIES FOR LARGE AND SMALL RUNS OF ENGINEERED SHEET METAL FABRICATION
ENGINEERING + TOOLING + PRODUCTION + FINISHING =

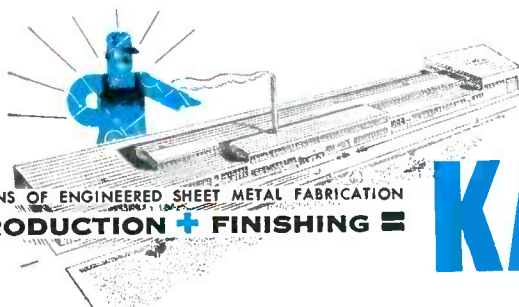

KARP

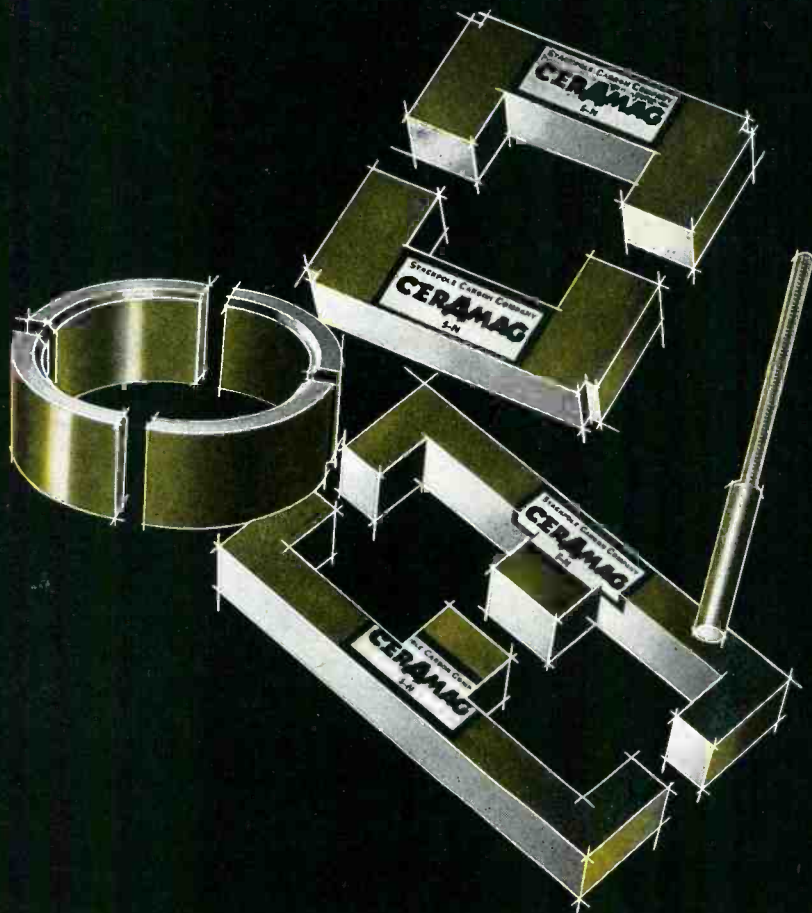

**THE PRODUCTION UNIT
IS LIKE THE SAMPLE . . . AND
EACH PRODUCTION UNIT IS LIKE THE
OTHER . . . ELECTRICALLY AND
MECHANICALLY!**

STACKPOLE
Ceramag[®]
FERRITE CORES

Electronic Components Division, STACKPOLE CARBON COMPANY, St. Marys, Pa.

Two 21-inch Metal Cone Picture Tubes Announced by Westinghouse

21AP4 and 21MP4 now available for immediate delivery

Manufacturers faced with problems of handling, cost and uniformity in large picture tubes now may order Westinghouse 21-Inch RELIATRON™ Metal Cone Picture Tubes for immediate delivery. The new tubes—almost 33 1/3% lighter in weight—are manufactured under the most rigid quality control system in the country. Superior face plate quality assures greater freedom from blemishes and glass imperfections. Uniform face plate thickness greatly reduces optical distortion over the viewing area. The etched glass of the face plate eliminates glare from external light sources.

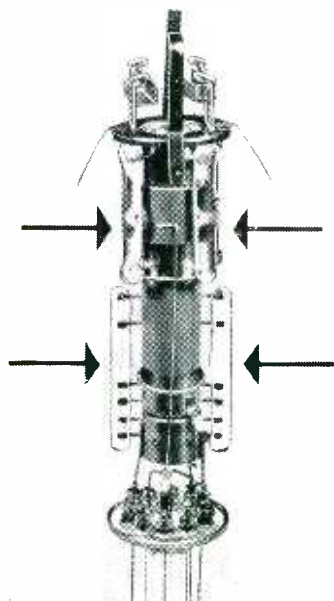

Improved Gun Employs Glass Beads. Westinghouse makes the new metal cone electrostatic focus tube with glass-beaded assembly. This assures accurate element spacing within close tolerances to improve spot size and picture uniformity.

Improved Corner Focus

Frosted Face Plate Cuts Distortion, Glare

Uniform Thickness of Face Plate Gives Uniform Brightness Over Viewing Area

Glass Enamel Coating of Metal Cone Permits Leak-Proof Seal

Metal Cone Construction Strong, Light, Economical

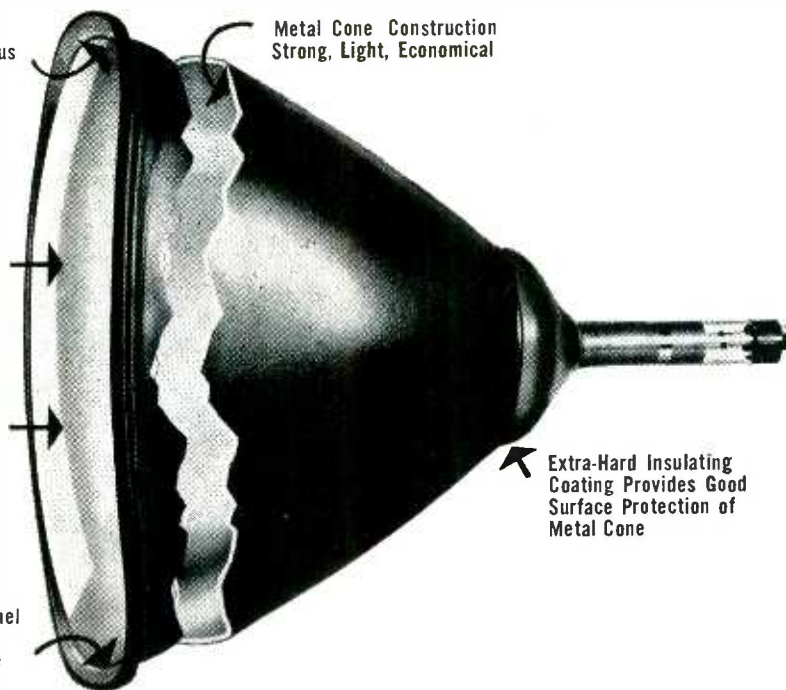

Extra-Hard Insulating Coating Provides Good Surface Protection of Metal Cone

The 21-Inch RELIATRON Picture Tubes feature still another important improvement. The face plate is sealed to the metal cone using an intermediate glass-enamel frit.

PRODUCTION SAVINGS

The 21-Inch RELIATRON Picture Tubes introduce new economies throughout TV set production. Their lighter weight cuts shipping costs. The 21MP4 tube is electrostatically focused, requiring no focusing coil or focusing magnet. The 21AP4 is designed for magnetically focused operation.

Metal cone tubes give increased mechanical strength, and because of their light weight are easier to handle and assemble in TV receivers.

BETTER PICTURES

Metal cone picture tubes permit the use of spherical face plates of uniform thickness that allow receiver manufacturers to use standard available deflection components that produce pictures of consistently high quality.

Employment of the Westinghouse 21-Inch RELIATRON Metal Cone Picture Tubes enables you to meet the growing demand for larger screen TV receivers, to deliver a better picture, and at the same time, to realize important savings in your production operations.

The new RELIATRON metal cone tubes now are available in quantities which permit immediate delivery of production-size orders. For complete details, write Dept. A-201.

RELIATRON™

TUBES

YOU CAN BE SURE...IF IT'S
Westinghouse

ELECTRONIC
TUBE DIVISION

Westinghouse Electric Corporation
Box 284, Elmira, N. Y.

ET-95016

MORE Than Meets The Eye...

UNSEEN, but all-important in a crystal are the skills, precision standards, and exacting tests that go into its processing. These are the things that add up to dependable performance under toughest conditions.

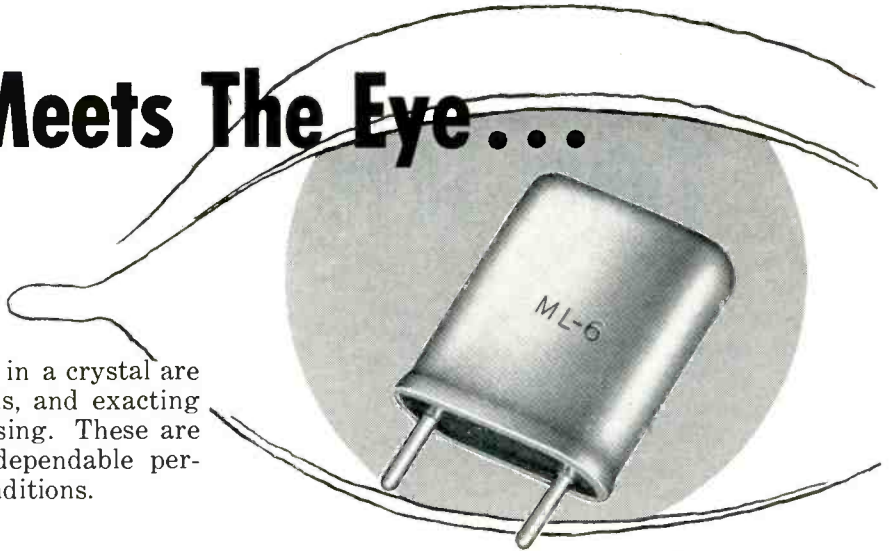

Midland CRYSTALS

Give You

CRITICALLY CONTROLLED QUALITY

TOP PERFORMANCE IN EVERY APPLICATION OF 2-WAY RADIO

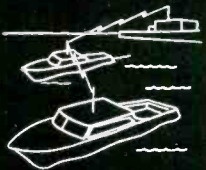
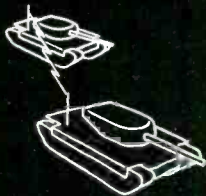

MIDLAND QUALITY starts with highly critical selection of raw quartz, inspected and precisely graded for its intended use. Midland optical and mechanical measurement facilities are unexcelled in the industry.

FOR EXAMPLE, STRICT ADHERENCE to prescribed angular relationships is required to give oscillator plates the properties best suited to specific jobs. Constant vigilance is maintained through Midland processing steps to be sure that no deviation of angle or improper contour develops.

THIS CRITICAL QUALITY CONTROL extends through to final mounting, sealing and testing — assuring you the best crystal unit science and top-level craftsmanship can produce.

Whatever your crystal need — conventional or highly specialized . . .

***TYPE ML-1A—RANGE:**
2.0 — 15.0 mc
Supplied per Mil type CR-1A when specified.

***TYPE ML-4 — RANGE:**
1.0 — 10.0 mc
Supplied per Mil type CR-5; CR-6; CR-8; CR-10 when specified.

***TYPE ML-6 — RANGE:**
1.4 — 75.0 mc
Supplied per Mil type CR-18; CR-19; CR-23; CR-27; CR-28; CR-32; CR-33; CR-35; CR-36 when specified.

When It Has to Be EXACTLY RIGHT . . . Contact

Midland

MANUFACTURING CO., INC.
3155 Fiberglas Road Kansas City, Kansas

Manufacturer of Quartz Crystals for Electronic Frequency Control

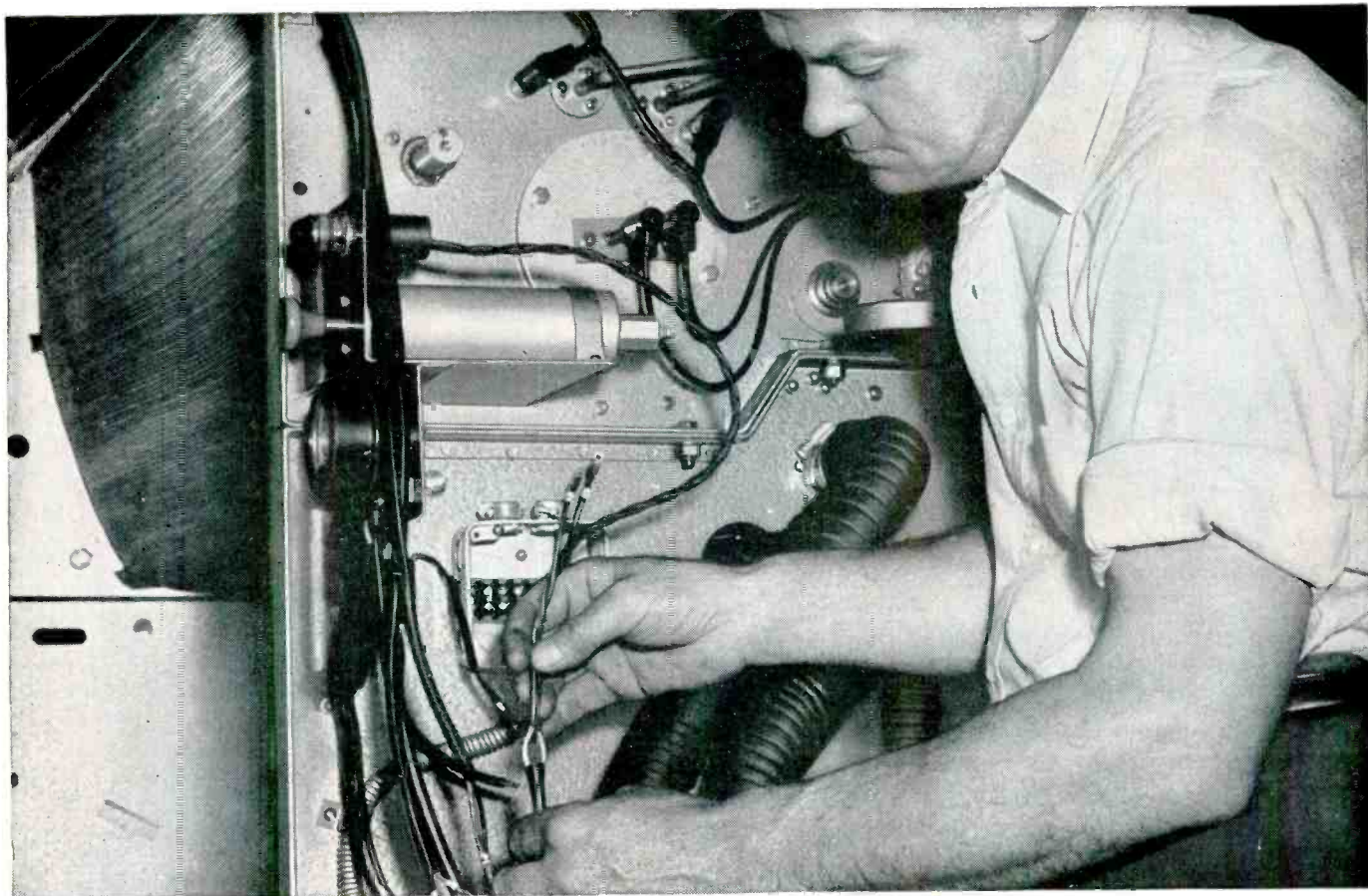

Ozalid saves time and money in Printmaster wiring

... with smooth, flexible Irvington **FIBRON**[®] Tubing

The job of wiring Printmasters and other duplicating and copying machines is simplified by the smooth interior surface and unusual flexibility of Irvington Fibron Extruded Plastic Tubing, according to the Engineering Department of Ozalid Division of General Aniline & Film Corporation. The tubing slips over the wires easily and quickly—thus saving time and money in assembly.

Ozalid's choice among the many available types of Fibron Tubing is IRV-O-LITE XTE-30—an unusually effective insulation for normal operating conditions. For more severe service—particularly where high ambient temperatures are encountered—many leading manufacturers of electrical equipment turn to Temflex 105. This Irvington Fibron Tubing is UL approved for 90° C. operation in oil—as well as for continuous service at 105° C.

Specifically formulated for *high-temperature* operation, Temflex 105 has the added advantage of retaining its flexibility at temperatures as low as -40° C!

There's a type of Fibron Tubing for just about every type of service requirement—why not look into the *entire* line? Just mail the coupon for the Fibron Catalog.

Look to

IRVINGTON

for insulation leadership

INSULATING VARNISHES

VARNISHED CAMBRIC

VARNISHED PAPER

VARNISHED FIBERGLAS

INSULATING TUBING

CLASS "H" INSULATION

EL-1/53

Send this convenient coupon now

Irvington

VARNISH & INSULATOR COMPANY

Irvington 11, New Jersey

Plants: Irvington, N. J.; Monrovia, Calif.; Hamilton, Ontario, Canada

Irvington Varnish & Insulator Co.
11 Argyle Terrace, Irvington 11, N. J.

Gentlemen:

Please send me your catalog on IRV-O-LITE XTE-30, Temflex 105 and other types of Fibron Extruded Plastic Tubing.

Name..... Title.....

Company.....

Street.....

City..... Zone..... State.....

MOLONEY *HiperCore* ELECTRONIC CORES

... NOW AVAILABLE IN QUANTITY
IN OVER 1000 STANDARD SIZES



STANDARD TEST

All 12 mil cores are tested for core loss (true watts) and exciting volt-amperes (apparent watts) at 60 cycles. 4 mil cores are tested at 400 cycles. Following table gives maximum test values. Average values are approximately 20% less than maximum.

	12 Mil—60 Cycle @ 15000 gauss	4 Mil—400 Cycle @ 10000 gauss
Core Loss (TW)	0.95 x lbs.	4.4 x lbs.
Exciting Volt-Amps (AW)	1.75 x lbs. + 6.25A*	5.0 x lbs. + 16.6A*

* A = Gross Area of core face in Sq. In.

All 2 mil cores are tested for pulse permeability by using a 2 microsecond pulse width at 400 P. P. S. and maximum flux density of 10000 gauss. The minimum permeability will be 500.

All 1 mil cores are tested for pulse permeability by using a 0.25 microsecond pulse width at 4000 P. P. S. and maximum flux density of 3000 gauss. The minimum permeability will be 175.

Moloney HiperCore Electronic Cores now available in quantity to manufacturers of electronic equipment whose product is manufactured for ultimate use by U. S. Government. Produced in lamination thickness from 1 mil to 12 mil and in standard widths from 1/4".

Better transformer performance is assured when HiperCore Electronic Cores are used because these wound cores have greater flux carrying capacity and lower losses than other types of cores of comparable sizes. The overall result, in addition to better performance, is a lighter, smaller core. Because HiperCores are wound cores, they permit accelerated production through savings in assembly time.

Rigid core production control permits these cores to test well within industry tolerances. Typical test requirements for various types are listed in the panel above. Special tests for specific operating conditions will be made if desired.

ME52-22

Write today for information concerning your needs.

MOLONEY ELECTRIC COMPANY

Manufacturers of Power Transformers • Distribution Transformers • Load Ratio Control Transformers Step Voltage Regulators • Unit Substation.



SALES OFFICES IN ALL PRINCIPAL CITIES • FACTORIES AT ST. LOUIS, MO. AND TORONTO, ONT., CANADA

3 EIMAC KLYSTRONS

FOR UHF-TV

Eimac announces the availability of the 3K20,000L type of five kilowatt klystrons, the most practical and dependable tubes ever developed for high power UHF-TV. With only three klystrons covering the entire UHF-TV spectrum (470-890 mc), manufacturing and supply is no problem, and equipment design is simplified.

Along with these attributes go exclusive Eimac features such as ceramic cavities, external tuning, and true metal to ceramic seals that give the 3K20,000L series a quality of construction that fulfills the rigorous demands of television transmitting. As a performer, each of these new klystrons has a power gain of 20 db., and will deliver five to six kilowatts peak sync output when driven by an Eimac 4X150G.

3K20,000LA — Channels 14 thru 32

3K20,000LF — Channels 33 thru 55

3K20,000LK — Channels 56 thru 83

- For more information about the five kilowatt klystrons write to our application engineering department
- Visit the Eimac display at the March I. R. E. show



3K20,000LK

Length 37 inches • Weight 35 pounds



EITEL-McCULLOUGH, INC.
SAN BRUNO, CALIFORNIA

Export Agents: Frazar & Hansen, 301 Clay St. San Francisco, California

The five kilowatt klystrons are another Eimac contribution to electronic progress

From **VERY SMALL...to LARGE CAPACITY**

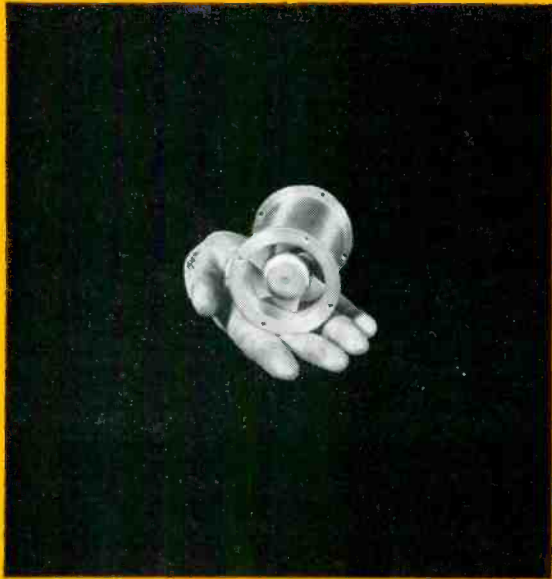

JOY AXIVANE[®] FANS

are available to meet any
ELECTRONIC COOLING NEED

Joy AXIVANE Electronic Cooling Fans are expressly designed to meet the needs of this exacting field of service. They are built in a complete range to suit any requirements, such as: spot cooling of ventilated units where local high-temperature conditions arise; heat removal from pressurized or hermetically-sealed units; or heat removal where space is so restricted that natural ventilation through the unit or over its surface is insufficient. Important operating advantages of these fans are their strength, high resistance to shock and vibration, and efficiency in low or high-pressure service. Aluminum and magnesium construction keeps weight at a minimum.

Available in sizes from 2" I.D. up, these Joy Fans are built to meet all present Air Force

and Naval electronic specifications. They can be furnished with totally enclosed or explosion-proof motors, if desired.

In general, keep these facts in mind: that the light, compact design, low power consumption and high overall efficiency of Joy AXIVANE Fans provide more satisfactory cooling for electronic equipment in either air-borne or surface units. ● If you have a problem in heat dissipation from electronic units, let us place at your disposal JOY's experience as the world's largest manufacturer of vaneaxial-type fans.

Consult a Joy Engineer

Over 100 Years of Engineering Leadership



W&D 1 4064

JOY MANUFACTURING COMPANY

GENERAL OFFICES: HENRY W. OLIVER BUILDING · PITTSBURGH 22, PA.

IN CANADA: JOY MANUFACTURING COMPANY (CANADA) LIMITED, GALT, ONTARIO

SMALL . . . IN SIZE BIG . . . in PERFORMANCE

1/4" PANEL THICKNESS

2" DIAL
GRADUATED
0-100

SINGLE
HOLE
MOUNTING

1/16" HIGH PROJECTION
FOR KEYING TO PANEL

TYPE 10

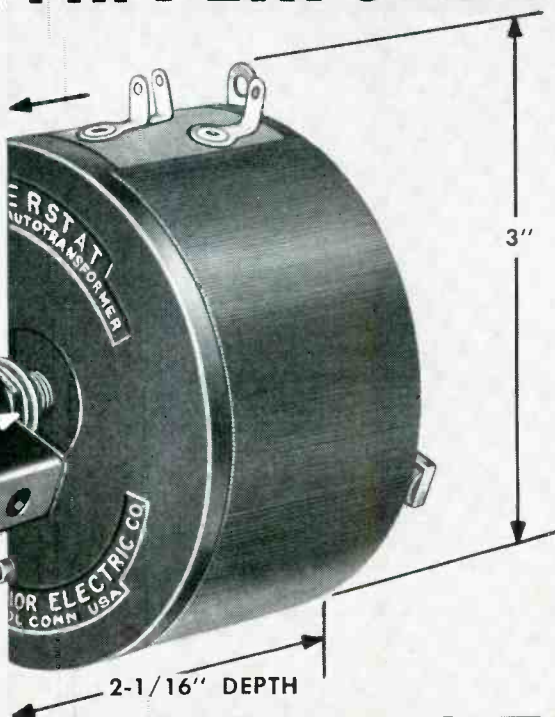

ACTUAL
SIZE

POWERSTAT VARIABLE TRANSFORMER

RATED:

INPUT: 120 Volts, 60 Cycles
1 Phase

OUTPUT: 0 - 120/132 Volts,
1.25 Amperes
150/165 VA

APPLICATIONS

of POWERSTAT Type 10 are as innumerable as is the need for a variable a-c voltage control in today's low wattage electric and electronic equipment. It is ideal as the variable a-c voltage component in electronic tube testers; low wattage power supplies and rectifiers; low wattage heaters, furnaces, plastic molding equipment . . . and in any a-c voltage application where 50, 100 and 150 watt rheostats are now being employed.

A COMPACT VARIABLE A-C VOLTAGE CONTROL FOR LOW WATTAGE APPLICATIONS

To date, the many low wattage (50 . . . 100 . . . 150 watts) applications requiring variable a-c voltage control have had to be content with the inefficient, heat dissipating rheostats and other resistance types of control. With the introduction of the new POWERSTAT Type 10, the many advantages of POWERSTAT variable transformers are available for these low wattage requirements. A continuously adjustable output voltage from 0 to 120 or 132 volts is at the fingertips to control loads up to 165 VA. Type 10 does not have to be tailored to the load — it will deliver a variable voltage to any load up to its capacity. Type 10 is highly efficient — does not control by dissipating power in the wasteful form of heat. Other features: glass smooth commutator surface . . . advanced winding technique . . . superior core and coil design . . . rugged construction . . . single hole mounting . . . can be installed under a 3" chassis saving valuable space.

For additional information on the new, compact POWERSTAT Type 10, send for Bulletin P252.

Write to: 201 Mae Avenue, Bristol, Connecticut

THE SUPERIOR ELECTRIC CO.
BRISTOL, CONNECTICUT



... and plan to see the new, compact POWERSTAT Type 10 at The Superior Electric display, booths 108, 110 at the I.R.E. Show, March 3-6



WHAT ABOUT

Stability

IN PRECISION WIREWOUND RESISTORS?

Stability—the most intangible and least understood resistor characteristic—is extremely important in critical electronic applications requiring mass-produced precision wirewound resistors. Unfortunately, a truly stable resistor of this type has never been made. If it could, such a resistor would never change in ohmic value despite environment, power dissipation, or time. The only way to obtain stability is to minimize the factors that work against it—unfavorable environment, power dissipation, and time.

ARTIFICIAL AGING IMPROVES STABILITY—The processes of winding, terminating, and impregnating a resistor produce strains in the winding. These must be relieved if the resistor is to remain stable at various temperatures. This is done by artificial aging—periodically subjecting the resistor to high ambient temperatures and power dissipation.

Hidden material and manufacturing faults can destroy stability. The effect of such faults can be accelerated by overload testing and temperature cycling at extremes of high and low temperatures. After this, unstable resistors may readily be detected by measurement and eliminated.

HUMIDITY AND IMPREGNATION—Absorption or adsorption of moisture by the winding, bobbin, impregnant, or label can appreciably lower resistance. Unless impregnation is adequate, the wire may corrode at the terminating points. In the presence of

a polarizing voltage electrolysis may also take place. Shallcross uses high grade steatite bobbins, carefully inspected wire, special "BX" impregnation, and a three-layer acetate label for protection against humidity. For severe humidity—including salt water immersion—Shallcross manufactures resistors which are hermetically sealed in steatite.

POWER DISSIPATION AND BREAKDOWN—Electrical energy, when converted to heat, affects stability as mentioned in connection with the artificial aging process. The potential gradient concurrent with high power may also cause insulation breakdown between turns, thus lowering resistance permanently or temporarily.

The effects of power dissipation may be minimized by using wire and bobbins of the largest practicable sizes. If size is restricted, the resistor must be operated within the conservative ratings and deratings of JAN and Mil Specifications. Within these ratings, and in normal indoor environments, a stability of 1/10 tolerance can be expected without special treatment.

TIME—The insulating elements of the best resistor will deteriorate with time. However, an aged and selected resistor operating in a fixed environment with negligible power dissipation can have a stability of $\pm 0.001\%$. Under severe conditions, but within commercial ratings, a standard Shallcross resistor will have a stability better than $\frac{1}{3}$ tolerance.

Further details on Stability and other resistor characteristics are available in Shallcross Bulletin R-3C.

SHALLCROSS MANUFACTURING COMPANY • 522 PUSEY AVENUE, COLLINGDALE, PA.

The second of a series to promote a better understanding of the performance characteristics of precision wirewound resistors.





SPECIALLY AGED RESISTOR

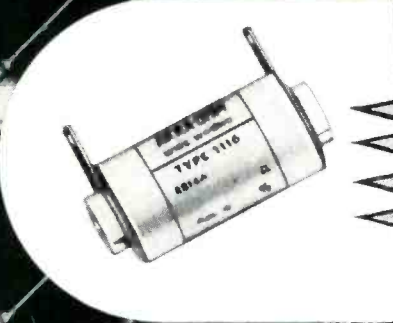

The new Shallcross Type 1116 hermetically sealed resistor is typical of the high stability of precision wirewounds. Tolerance $\pm 0.01\%$. Guaranteed stabilities to $\pm 0.003\%$. Maximum resistance using Mil-R-93 minimum wire sizes is 3.5 megohms.

NEW SUBMINIATURE RESISTOR

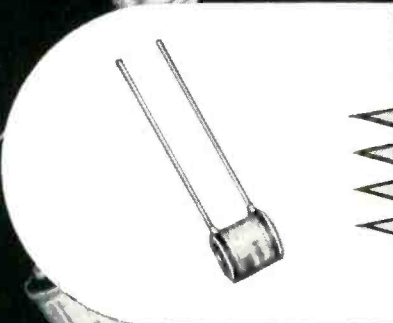

This tiny 0.1 watt resistor measures only $\frac{1}{8}$ " L. by $\frac{1}{4}$ " Diam., yet mounts by a #2 screw. Exclusive Shallcross "BX" impregnation withstands prolonged exposure to high humidity. Resistance of the Type BX16 resistor is 150,000 ohms max. Standard tolerance $\pm 1\%$.

NEW AXIAL LEAD RESISTOR

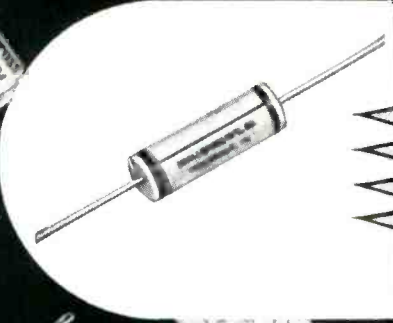

Save space in subminiature applications with this new 0.25 watt resistor—Type BX18. Only $\frac{3}{4}$ " L. by $\frac{1}{2}$ " Diam. Non-inductive winding is "BX" impregnated against high humidity. Maximum resistance is 400,000 ohms. Standard tolerance $\pm 1\%$.

Shallcross

Flying Saucers?

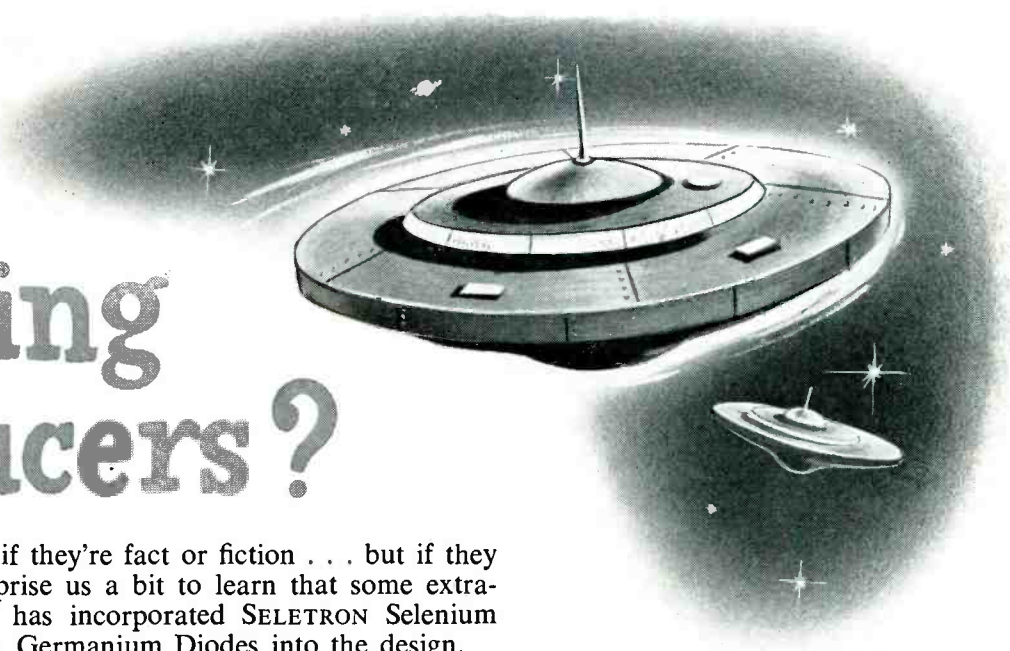

Frankly we don't know if they're fact or fiction . . . but if they *are* fact it wouldn't surprise us a bit to learn that some extra-terrestrial manufacturer has incorporated SELETRON Selenium Rectifiers and R. R. Co. Germanium Diodes into the design.

That's because—as pioneers in the field of electronic development—we've had our hand in some of the most difficult projects and met some of the stiffest requirements ever cooked up! Making drawing board dreams come true are daily chores at Radio Receptor Co.!

RR GERMANIUM DIODES

Radio Receptor's new Germanium Diodes feature polarity at a glance combined with simplicity of construction and sound design principles. The tapered shape speeds assembly because operators can see at a glance the correct direction of assembly. Users are enthusiastic over the quality of the product which is currently being used in walkie-talkies, computers, TV sets, tuners and other electronic applications.

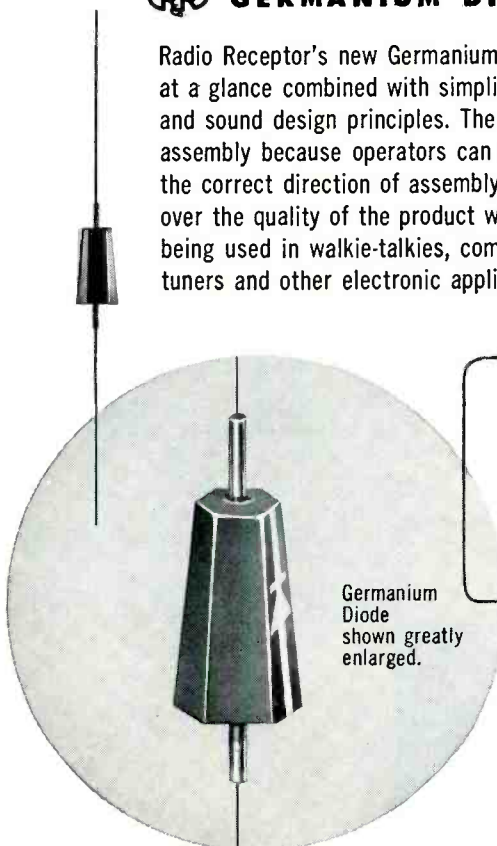

Germanium Diode shown greatly enlarged.

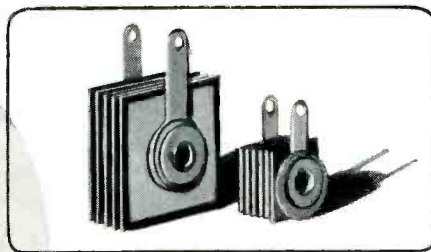

Our Germanium Diodes and Seletron Selenium Rectifiers may hold the answer to many of your problems. Radio Receptor Engineers will be glad to study your requirements and submit their recommendations on both of these products.

Germanium Transistors available in limited quantities.

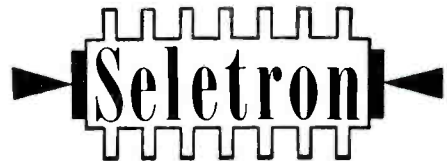

SELETRON **RECTIFIERS**

Seletron Selenium Rectifiers, in both miniature and industrial types, are in constant demand by an increasingly large number of engineers throughout the world because they are completely dependable under the most grueling conditions. Years of experience have given Radio Receptor Co. a deep insight into the idiosyncrasies of rectification.

**Seletron
and Germanium
Division**

RADIO RECEPTOR COMPANY, Inc.

RR Since 1922 in Radio and Electronics **RR**

SALES DEPT: 251 West 19th Street, New York 11, N. Y. • FACTORY: 84 North 9th Street, Brooklyn 11, N. Y.

GPL REMOTE CONTROL CAMERAS

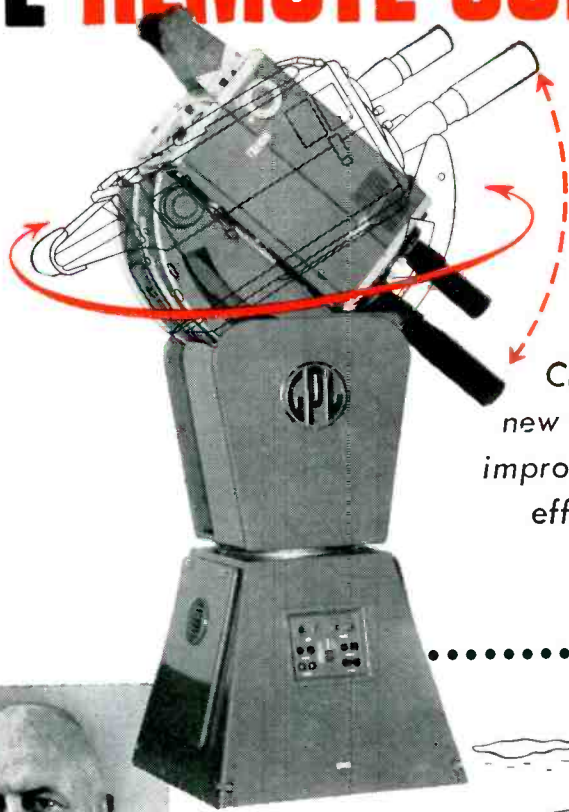

make debut as WHUM-TV
puts UHF in Major Operation

Channel 61 in Reading uses 4 of
new GPL chains to cut costs,
improve studio-field
efficiency

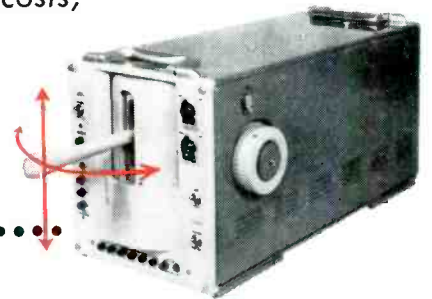

Humboldt Greig, president of WHUM-TV, says: "We picked GPL cameras to gain a truly major reduction in costs by adding remote control. In fact, we feel these will be self-liquidating cameras due to the savings. We have tested them under the roughest conditions with our mobile unit in the past two months and encountered absolutely no difficulties."



Marking two major milestones in television, WHUM-TV introduces both high powered UHF and remote control for new techniques in camera operation.

For the opening 30 live-hours per week from this 260,000-watt UHF station, 4 GPL image orthicon chains will be used with remote control pedestals. From as far as 1,000 feet away, all actions of pan and tilt, lens change and focus and iris are easily controlled.

Each camera has a "memory" of 6

pre-set positions. With a four-chain set-up, a director has a choice of 24 camera shots. Pushing a "pre-set" button automatically swings the camera on target . . . with lens, focus and iris in correct adjustment. Speed and ease of operation save time, camera handling, and dollars.

For field operations — covering sports and news — WHUM-TV uses the GPL studio-field interchangeability . . . again cutting costs. Two cameras, complete with remote control pedestals, fit atop the station's mobile unit. Pedestals disassemble in minutes for easy transfer between bus and studio.

WHUM-TV is the first station to equip all its cameras with remote control . . . for tops in quality, for utmost in economy.

STATION OWNERS

Our engineers will be pleased to show you, without obligation, how you can get maximum efficiency and economy in either UHF or VHF operations with GPL studio and field equipment. Write, wire or phone:

General Precision Laboratory

INCORPORATED
PLEASANTVILLE NEW YORK

Cable address: Prelab

GPL

Export Department:
13 East 40th St., New York City
Cable address: Arlab

TV Camera Chains • TV Film Chains • TV Field and Studio Equipment • Theatre TV Equipment



Hot off the griddle!

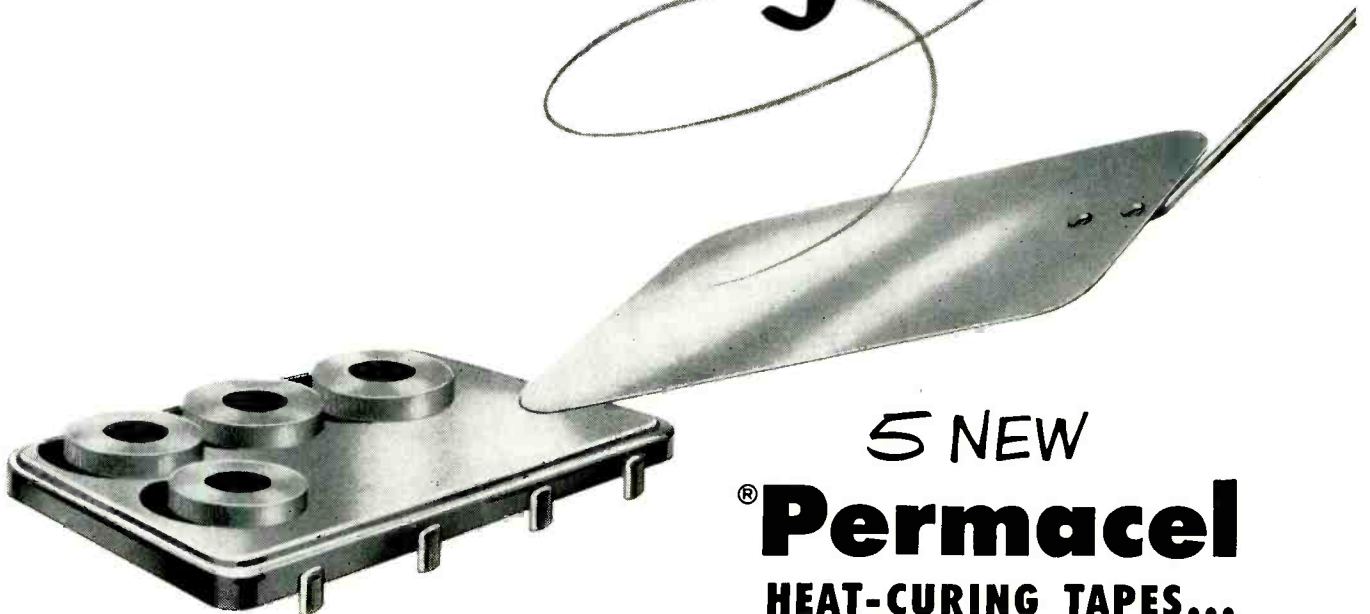

5 NEW
Permacel
HEAT-CURING TAPES...

NOW ROUND OUT A COMPLETE LINE OF 18 ELECTRICAL TAPES FOR EVERY PRODUCTION NEED.

- | | |
|-----------------------------------------------------|--------------------------------------|
| 1. White Acetate Cloth—P243 | 3. Yellow Flatback Paper—P271 |
| 2. Acetate Fiber—P245 | 4. Yellow Crepe Paper—P281 |
| 5. Orange-Yellow Polyester "Mylar" Film—P252 | |

→ For further information write Dept. E

INDUSTRIAL TAPE CORP., NEW BRUNSWICK, N. J. Makers of **TEXCEL®** and **PERMACEL®** pressure sensitive tapes for plant, office and the home.

MICROWAVE RECEIVERS

WIDE BAND • HIGH SENSITIVITY

**POLARAD
SCORES
AGAIN**

The first . . . the only MICROWAVE
RECEIVERS to cover wide
frequency ranges.

1,000 to 10,750 mc.



Microwave receivers of high sensitivity, wide tuning range and selectivity. Image rejection is greater than 60 db. Gain stability better than ± 2 db, permits application as a field intensity meter. Extra large dials enable frequency to be clearly read to an accuracy of 2%. Video bandwidth is 3.0 mc. Input power required is 105-125 v, 50/1000 cps.

- Single Dial Tuning
- Low Noise Figure
- Tracked R.F. Preselection, Triple-Tuned
- Linear db Output Indication
- AM-FM Reception
- Video Output — 10 v Pulse across 100 ohms
- Audio — BFO
- Recorder Output
- Provisions for Using external Attenuators in I.F. Channel
- Frequency Calibration Accuracy —2%
- Separate Audio & Video Channels
- AFC
- Calibrated Tuning Meter

Polarad
Electronics Corporation

100 METROPOLITAN AVE.

BROOKLYN 11, N. Y.

STagg 2-3464

Vibration Engineering that solves your problems

PROBLEM: To provide superior vibration control while simplifying suspension design

SOLUTION: The Isomode* Type 5 Mount that isolates all modes of motion



HOW to get optimum isolation into a product design? The answer is not always easy. But it was made much easier to find when Isomode Mounts were developed. They offer what's needed for outstanding results—namely, control of horizontal and rocking motions as well as vertical vibrations.

And here's why. Isomode Mounts have equal spring rates in all directions. They therefore absorb vibrations from all directions equally well. As a result, they can be mounted at any angle, permitting location of ideal suspension points and simplifying design.

In addition, Isomode Mounts have high load

capacity in compact size, saving both space and weight. Large rubber volume for their size lends softness for good isolation, yet the mounts are stable, self snubbing and long lasting.

These mounts are an example of the kind of vibration engineering put to work for you at MB. Many companies have found it good practice to make MB their headquarters for vibration information. You will too—on vibration *isolation, control, testing, detection or measurement*. For more details on Isomode Mounts, be sure to write for Bulletin 410-5.

**Trade Mark Reg. U.S. Pat. Off.*

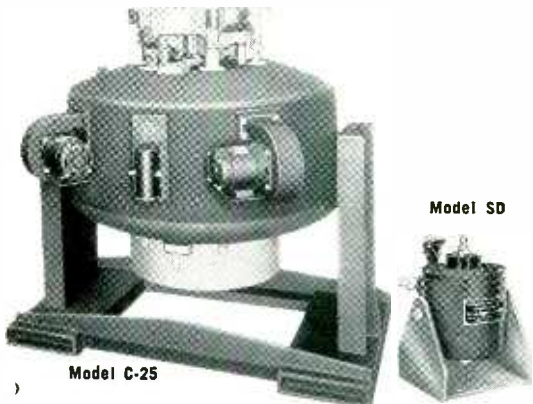

A vibration exciter to meet your needs

Whether your shake testing requirements are of large order or small, there's an MB Shaker for the job. Model SD, for example, has rated force output of 10 pounds; while the C-25 provides 2500 pounds. Model also available for 10,000 pounds. So if you have to vibration test to MIL-E-5272, be sure to check up with MB. Bulletin No. 1-VE-5 gives technical data on MB Shakers. Write for it.

THE MB MANUFACTURING COMPANY, INC.
1060 STATE STREET, NEW HAVEN 11, CONN.

PRODUCTS AND EQUIPMENT TO CONTROL VIBRATION • TO MEASURE IT • TO REPRODUCE IT

EXPANDING PRODUCTION

in Toroids & Coils

At every management meeting in Burnell & Company there is an unseen but highly respected visitor. He is the spectre of all our customers and his opinions carry weight. Recently he suggested that in addition to our other expansion measures that we must find a way to improve deliveries for emergency and special sample orders. Our solution is certainly not original but no less effective.

Burnell & Company's new sample department has been able to produce audio filters from proverbial 'scratch' to the customer's waiting hands in as little as ten days!

Frankly, this cannot always be accomplished but our average has been ranging between three to four weeks for emergency samples and four to six weeks for regular prototypes instead of the former twelve weeks of the pre-sample department days.

Adding this to our new winding department and our new testing and finishing departments the sum total has been a *still* better product at a better delivery than ever before.

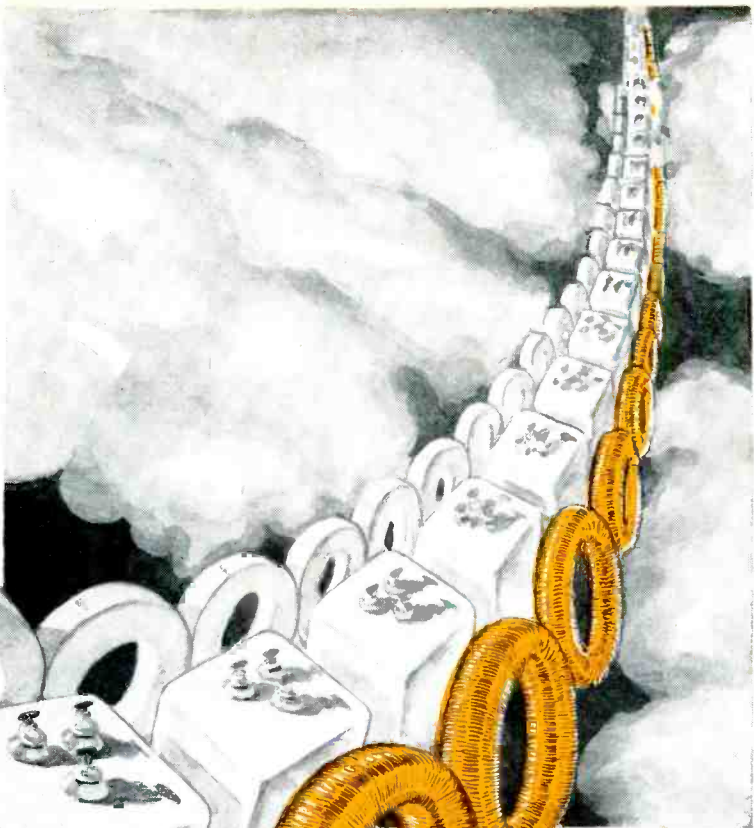
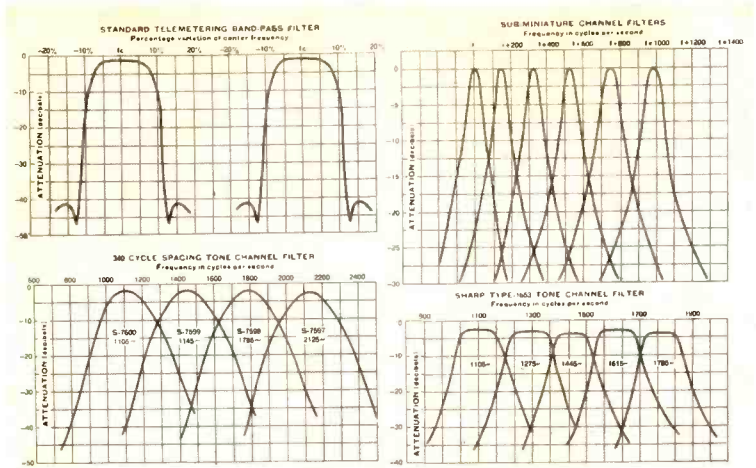

Burnell & Company
 YONKERS 2, NEW YORK
 CABLE ADDRESS "BURNELL"

EXCLUSIVE MANUFACTURERS OF COMMUNICATIONS NETWORK COMPONENTS



ONE OF U. S. A.'s LEADING MAKERS OF ELECTRONIC TUBES
AND MICROWAVE COMPONENTS

Bomac is 100% High-Vacuum-Equipped by NATIONAL RESEARCH

Type 710 Thermocouple-Ionization Gauge Control. One instrument for scientific and industrial vacuum gauging. Incorporates two thermocouple gauges. (1-1000 microns) and one ionization gauge (10^{-3} mm to 10^{-9} mm. Hg. range) in one control.

Alphatron* Vacuum Gauge. Accurate gauging from 10 mm. to 1 micron. Specially fabricated for low leak rate and calibrated for hydrogen.

Vacuum Seals. For connecting pump and manifold.

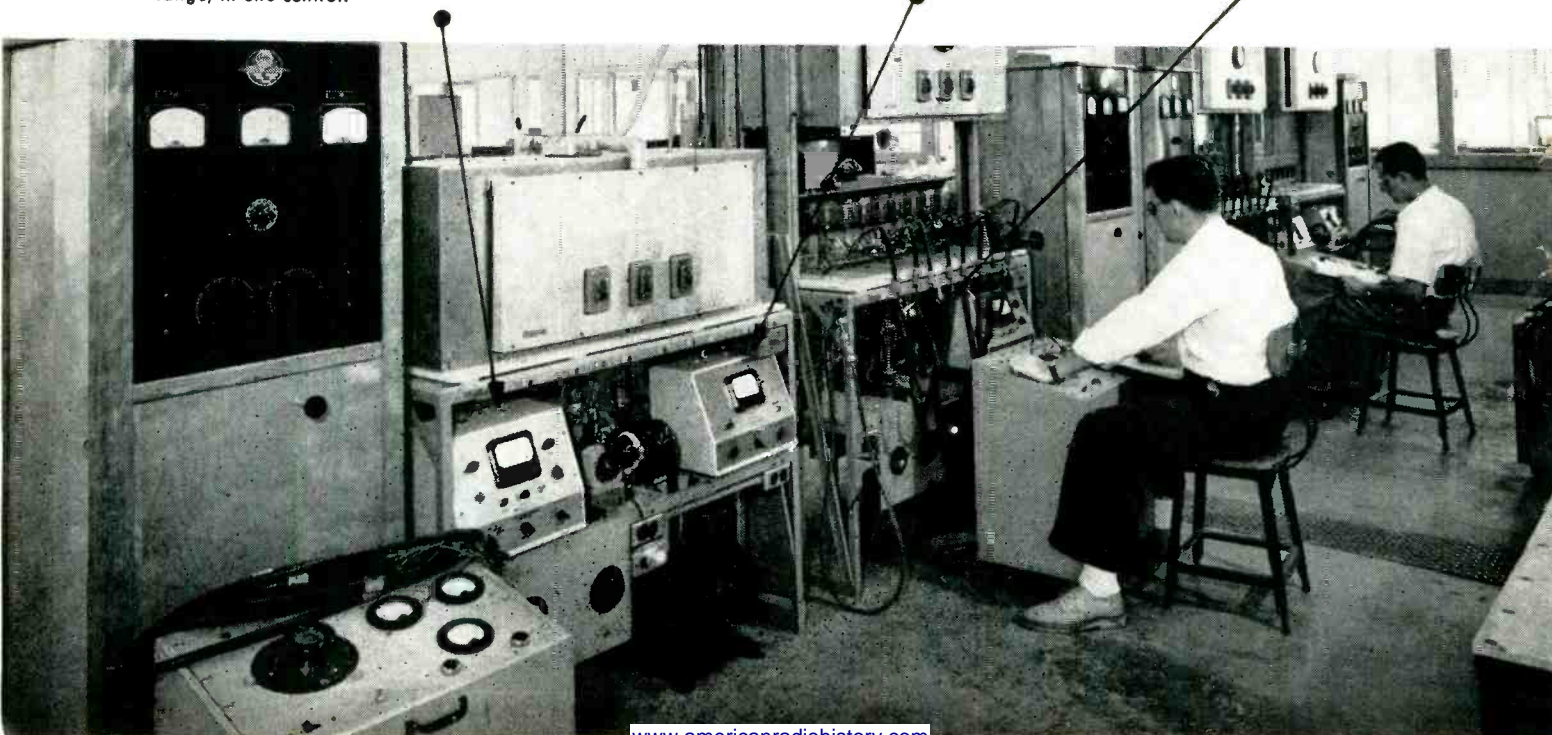

As one of U.S.A.'s fastest growing electronic tube manufacturers, Bomac has established severe standards for their production equipment to assure an uninterrupted flow of tubes with minimum rejects.

National Research high vacuum equipment meets these rigid standards so well that it was again specified exclusively in Bomac's

recent expansion of facilities.

When you want the same — a single source for all your high vacuum equipment needs . . . with a single unexcelled standard of quality — look to National Research. For further details write National Research Corporation, Memorial Drive, Cambridge, Massachusetts.

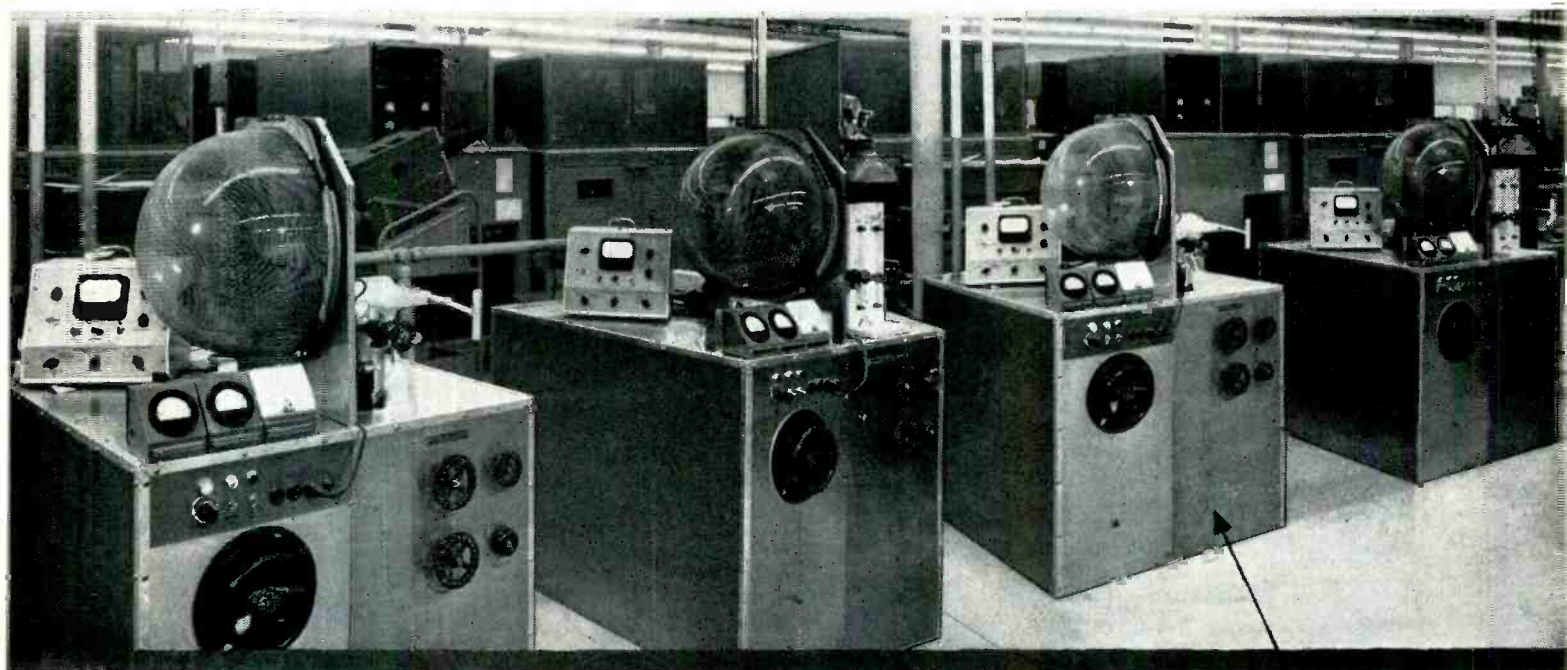

H-2-P Purifying Diffusion Pump. Over 50 liters per second from 10^{-3} to 10^{-6} mm. range. Operates against forepressures as high as 0.300 mm. Blank-off 2×10^{-7} mm.

Standard Vacuum Furnace. A versatile packaged unit to melt, pour, heat treat, degas, sinter, and anneal under high vacuum or controlled atmospheres. Temperatures up to 2000°C.

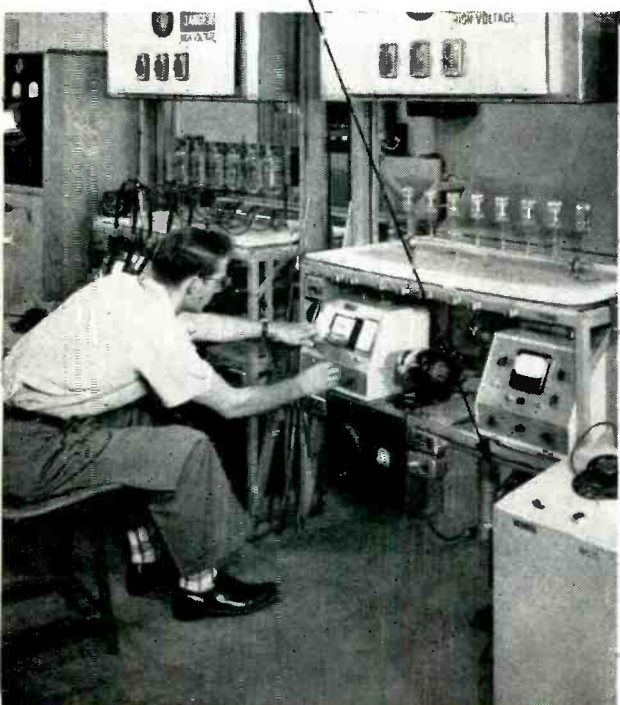

INDUSTRIAL RESEARCH · PROCESS DEVELOPMENT
HIGH VACUUM ENGINEERING AND EQUIPMENT



METALLURGY · DEHYDRATION · DISTILLATION
COATING · APPLIED PHYSICS

National Research Corporation

Equipment Division

SEVENTY MEMORIAL DRIVE, CAMBRIDGE, MASSACHUSETTS

*Reg. U.S. Pat. Off.



It's A Specialized Job . . .

designing vibrator power supply circuits



To avoid trouble with yours,

Call On P. R. MALLORY & CO. INC. **MALLORY**

If your mobile radio equipment is going to operate properly, under *all* sorts of conditions, the power circuit must be carefully designed. Experienced engineering must go into the design and selection of each element so the vibrator characteristics are in balance with the transformer and buffer capacitor.

These are some of the reasons vibrators can't be selected simply by size and rating alone if you are going to get long, trouble-free performance.

We have worked with leading manufacturers of electronic equipment on their vibrator power supply problems since we introduced the first commercial vibrator over 20 years ago. Our experience includes supplying more vibrators for original equipment than all other makes combined.

To avoid vibrator power supply troubles . . . call on Mallory in the design stage. Our engineers are thoroughly qualified by experience to study your specifications to be sure the power circuit will give maximum performance.

Our engineers will be glad to discuss your vibrator power supply problems. Write or call us today.





CROSS TALK

► **GREETINGS . . .** From the staff of *ELECTRONICS* a simple but sincere *Happy New Year*.

We think the new year will indeed be happy from a business standpoint. Military orders could go up, probably will remain more or less level, might go down. If the last occurs this industry is in a better position than most to take up the slack by increasing its service to the civilian market.

► **BOOTSTRAPS . . .** Our business, right from the start, has shown remarkable ability to lift itself by its own technical bootstraps. In many instances aggressive engineering has opened up new markets without destroying the old ones.

Take television, for example. Replacement of existing receivers with sets having larger screens is proceeding at a healthy rate. New business centering around recently licensed stations is developing so rapidly that even as we write an industry committee is revising a year-old estimate of the market potential. And standards for compatible color tv are now far enough along so that this obvious lift will be ready long before uhf areas are saturated with monochrome.

Radio, then tv, knocked the phonograph market down but didn't knock it out. Long-playing

records built an important market among high-fidelity fans and now binaural reproduction shows promise of doubling the expenditures of the upper fringe. The future of broadcast radio itself is in doubt but even here a bootstrap operation is conceivable in the light of past history. Meanwhile, rapidly increasing use of radio by industry is cushioning the blow.

► **PROGRESS . . .** The engineering liveliness that keeps electronics perennially young is by no means limited to assembled equipment. The transistor, most important component part to come down the pike since the tube itself, is everywhere in the news despite the fact that it was generally unknown four short years ago and is even now very much in the development stage.

Technical journals are bulging with early design data. Public demonstrations of electronic devices using transistors have been staged. Several new types have been announced. Point-contact units are being widely sampled. And the time schedule for production of junction transistors has been advanced. Unlikely as it seemed just a month ago, there is now evidence that several specialized devices employing transistors will find their way into limited commercial use in 1953.

► **EXPANSION . . .** We've just returned from an editorial swing through Texas and Oklahoma. This is an area to watch, as heavy industry builds new plants to take advantage of low power costs and population follows. Here is not only a growing market for goods but also future manufacturing competition.

Already a modest electronics industry is building up around aircraft factories, chemical plants and petroleum refineries. Gear is for the most part highly specialized, ranging from geophones to mass spectrometers, but it is from such starts that national distribution frequently comes. And the Texans, in particular, are ambitious. We called on one who is a transistor licensee.

► **QUOTES . . .** At a recent symposium on airborne equipment it was said that "the carbon microphone is the world's most expensive loose connection."

Elsewhere, a scientist who kindly omitted any reference to raucous commercials maintained that "electrically charged hairs in the cells of the inner ear bend and flex in response to noise and act like variable resistances."

Then there is the wag who frequently, with some humanitarianism if not technical accuracy, talks about "misguided missiles."

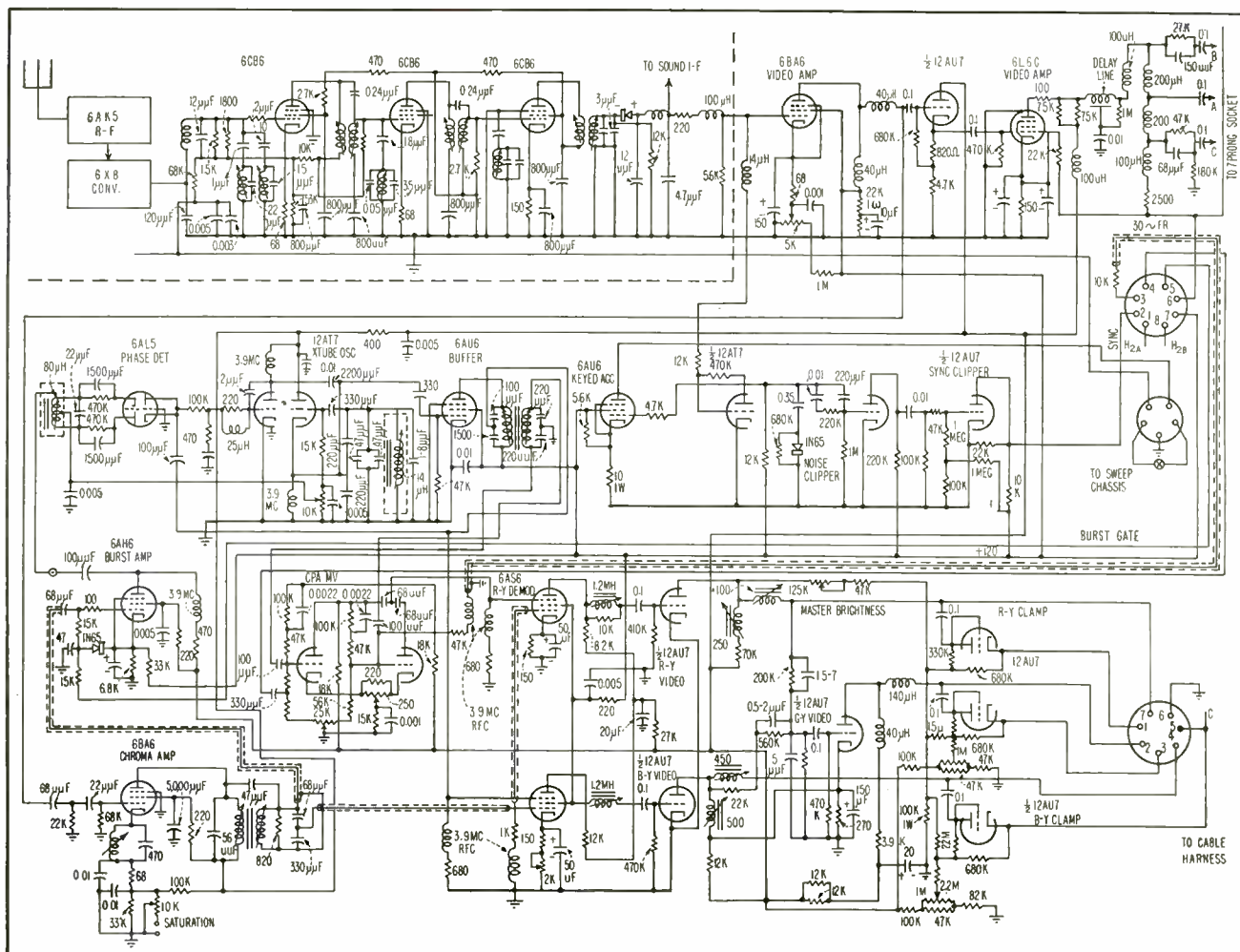

Circuits of chassis shown on front cover of this issue of **ELECTRONICS**

Compatible Color TV Receiver

COLOR PICTURES produced by the receiver to be described are equivalent in size to a 12½-inch black and white picture. The receiver accommodates all vhf channels as well as UHF channels, and is capable of black and white as well as color reception. An overall block diagram showing the basic functions of the receiver is given in Fig. 1.

The upper portion of the block diagram is essentially a conventional black and white television receiver. It includes the tuner and i-f

By **KENNETH E. FARR**

*Westinghouse Electric Corp.
Metuchen, N. J.*

the video channel, deflection and sync circuits and a sound channel. The portion which shows the features particular to the color section includes the color decoders, color difference amplifiers, the color sub-carrier generator, and the dynamic convergence and focus circuits which are peculiar to the RCA tri-color picture tube.

The essential monochrome elements of this receiver include the main signal and video channel, the sync and deflection circuits, and the intercarrier sound system. The sync separator, the tuner, i-f and sound portion are patterned closely after present black and white circuits. The i-f passband requirements for color reception are somewhat more critical but the essential difference from standard black and white in this portion of the receiver is in the video section. This has somewhat more gain and driving

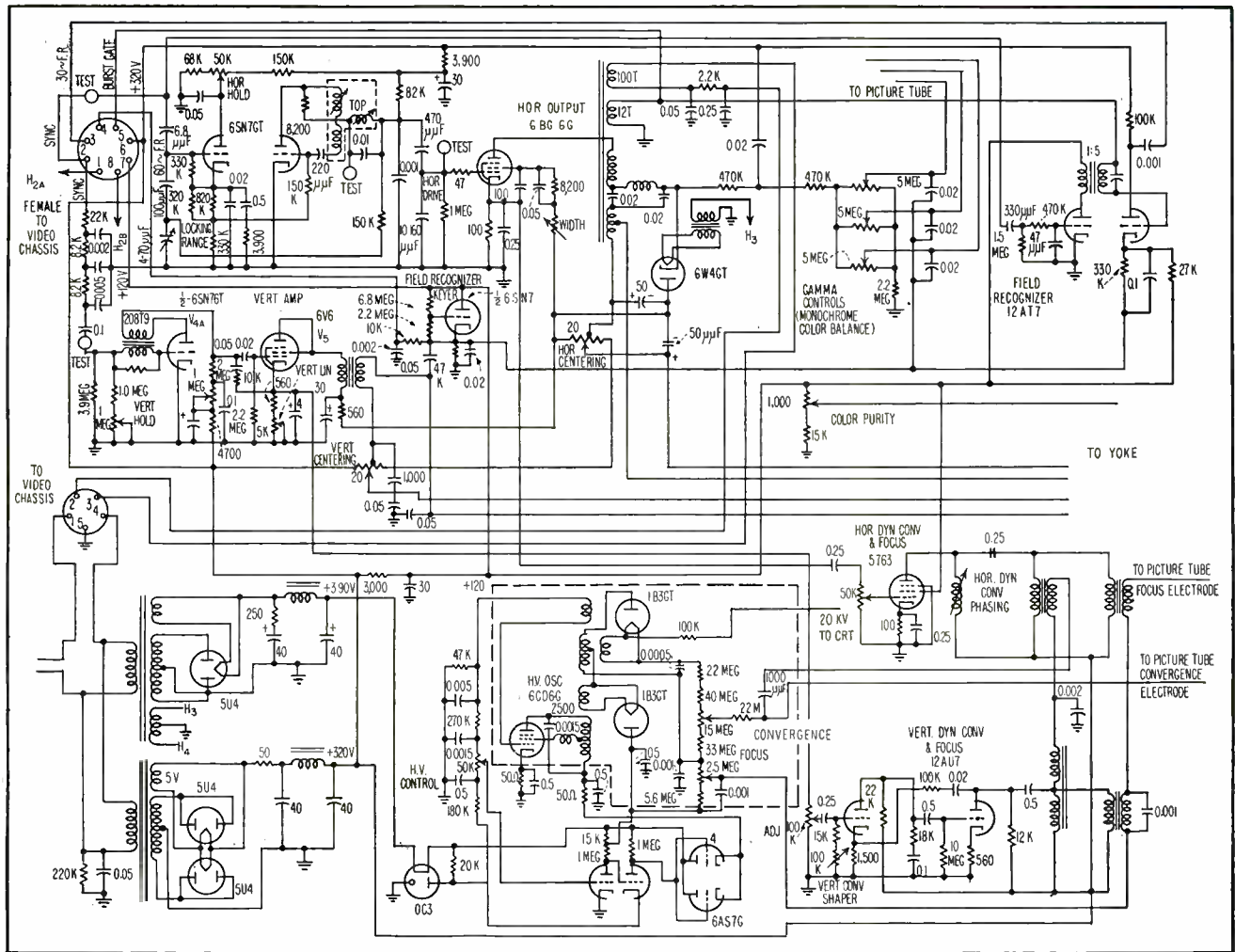

Front-end and sound channel circuits are omitted for clarity

A straightforward approach to the problem of receiver design for the NTSC color system results in this 42-tube receiver. Used in numerous NTSC field tests of color tv, its performance on monochrome transmissions is comparable to current black and white receivers

capability than the average receiver, due to the requirements of the tricolor tube.

The receiver is designed for a compatible color television system, namely the NTSC system.¹ In this system, information is added to a standard black and white transmission to produce color in an appropriately designed receiver. A normal black and white receiver is capable of receiving a black and white picture from the transmission without any modifications.

There are several ways of speci-

fying color. One way, which is probably the most familiar, is to break the colors down to three primaries—green, red and blue. Any visible color may then be specified in terms of the percentage of red, green and blue which could be used to duplicate the impression of this color as far as the viewer is concerned. Another method of specifying color is to describe the color sensation to the eye in terms of brightness, hue and saturation. Brightness is self-explanatory.

Hue is the attribute normally

called color by the layman. That is, whether it is red, green, orange, and so on.

Saturation is a term which describes the amount of white mixed with the color, or as the artist would call it, the tint. This describes the difference between red and pink, for instance. Pink is a lower saturation red and 100-percent saturation would be the pure, strong color. Zero-percent saturation would be white.

The latter system of specifying color is utilized in the NTSC sys-

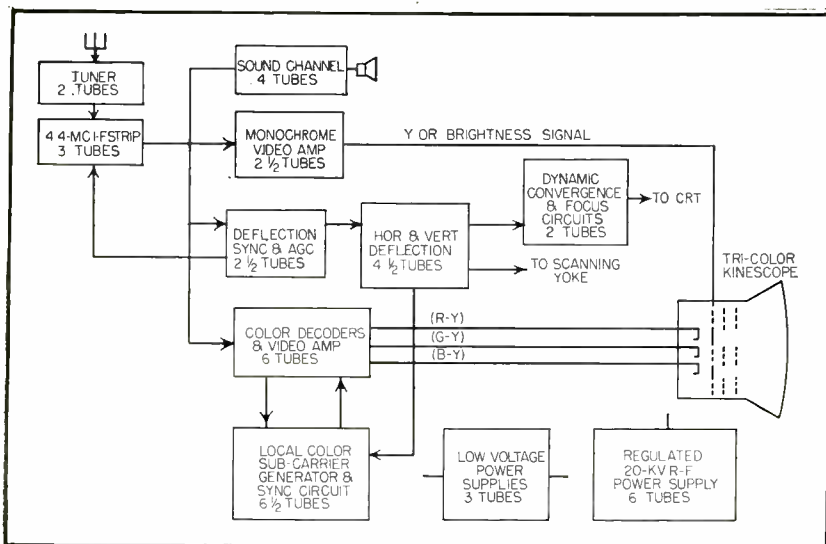

FIG. 1—Arrangement of stages in the overall receiver

tem. The brightness information is what is presently transmitted in the standard black and white system. This is modified somewhat in the NTSC system so that the black and white pictures represent the true brightness of all colors in accordance with the luminosity curve of the eye. To this brightness signal, two further degrees of information are added relating to the hue and saturation of the color.

Bandwidth

The brightness signal conveys the detail information or the resolution of the picture, and it should be transmitted at the full bandwidth of which the system is capable. It has been demonstrated,² however, that the eye is much less sensitive to detail in color than in brightness.

Translated into engineering terms, this means that less bandwidth is required for the hue and saturation signals than for the brightness signals. Taking advantage of this limitation of the eye, the hue and saturation signals can be transmitted over a much narrower bandwidth without notable degradation of the picture. In actual practice, approximately four megacycles of bandwidth is used to transmit the brightness signal, and from 1 to 2 mc for the combined hue and saturation information.

This might seem to require at least a 5-mc channel. However, use is made of an additional phenomenon—the frequency makeup of a

scanned television signal.⁸ Since the scanning occurs at a constant repetition rate, frequency components of the signal lie in groups at line frequency and harmonics thereof. Definite gaps exist between these frequencies.

Figure 2 shows the frequency spectrum of the television video signal. The solid lines represent the harmonics of line frequency with 30 and 60-cycle sidebands corresponding to the field and frame information. The spaces between groups can be noted. This diagram shows the 200th and 201st harmonic of line frequency. The same pattern, however, exists from zero frequency up to the maximum transmitted in the signal.

The question might be raised that if there are no signal components present between these groups, what might happen if signals were placed there. From the theory of scanning,³ it can be shown that a

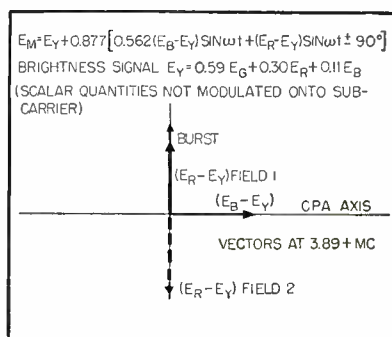

FIG. 2—Frequency spectrum of color signal

signal existing between the harmonics of line frequency, or more specifically at an odd multiple of half the line frequency, such as the 401st as shown here, will not be visible in the television picture. This is because it will be of opposite polarity on alternate lines and will thus integrate out to the eye.

The hue and saturation information is amplitude modulated onto a color subcarrier whose frequency is such that all this color information falls in these odd multiples of half line frequency between the brightness components and thus have low visibility to the eye. This information, however, can be extracted by an inverse process in the color receiver and used to recreate the colors of the original subject.

The color subcarrier used is at the upper end of the brightness band, namely 3.898125 kilocycles, which is the 495th harmonic of half-line frequency. This high frequency was selected to further reduce the visibility of these color components in the brightness channel.

Hue and saturation information can be modulated onto a single subcarrier by using two subcarriers of the same frequency 90 degrees apart in phase. One piece of information is modulated onto one carrier and one onto the other. Synchronous demodulation at the receiver will recover each piece of information separately.

Suppressed-carrier transmission is used to further reduce the visibility of the color information on black and white receivers. Thus, only the sidebands are transmitted and the carrier, or subcarrier in this case, is reinserted at the receiver. This technique is not common in the television field.

To obtain maximum use of the bandwidth, vestigial sideband transmission is used with the upper sideband extending approximately 0.4 mc above the color subcarrier and the lower sideband extending 1 to 2 mc below it. Thus, the entire color information is interleaved in the video frequency region of 3 to 4.5 mc.

A vector diagram of the color subcarrier with modulation is shown in Fig. 3. The equation at the top is the expression for the entire

color signal. It is written as a brightness term E_Y plus another term which is the color information. The brightness signal is made up of 59-percent green, 30-percent red and 11-percent blue, in accordance with the color sensitivity of the human eye.

The color term consists of two parts. The plus or minus sign on the phase of the second part indicates color phase alternation. That is, this second term alternately leads and lags the first term by 90 degrees.

The vector diagram of Fig. 3 shows the various components of the color subcarrier. The vertical vector marked BURST is the color sync. It consists of about 9 cycles of color subcarrier transmitted on the back porch of each horizontal blanking interval. This burst is designated as the reference phase of the system. Lagging this burst phase by 90 degrees is the blue color signal ($E_B - E_Y$). This signal is derived by subtracting the brightness video signal from the blue video signal and modulating the color subcarrier with this difference. How this is accomplished in the actual equipment will be shown a little more clearly in what follows. It should be noted, however, that if the brightness signal is added back to the color difference signal, the blue signal E_B results.

Shown in phase with the burst is the red color difference signal. This phase is that obtained in the so-called odd field. On alternate fields, the phase is reversed 180 degrees, as shown dashed. This periodic reversal of the phase of this component of the color subcarrier, known as color phase alternation, is necessary when vestigial sideband color transmission is used. It cancels out the quadrature components that result from the single-sideband portion of the transmission, and cause cross modulation between the two components of the signal. The amplitude of these $E_B - E_Y$ and $E_R - E_Y$ vectors is a function of the color content of the picture is zero for black and white areas of the picture. Thus, the entire vector diagram with the exception of the burst disappears on black and white pictures.

No green signal is used as such

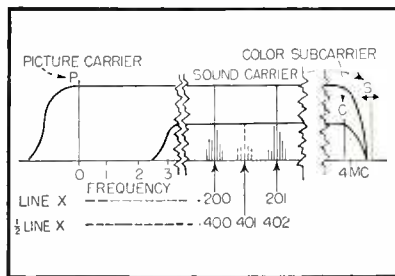

FIG. 3—Specification of NTSC signal. Color information is modulated onto subcarrier for vestigial sideband suppressed-carrier transmission

to make up a component of the subcarrier. The reason for this can be seen in the actual makeup of the ($E_G - E_Y$) color difference signal.

$$E_Y = 0.59 E_G + 0.30 E_R + 0.11 E_B \quad (1)$$

$$\begin{aligned} E_G - E_Y &= E_G - 0.59 E_G \\ &\quad - 0.30 E_R - 0.11 E_B \\ &= 0.41 E_G - 0.30 E_R - 0.11 E_B \end{aligned} \quad (2)$$

Similarly,

$$E_R - E_Y = -0.59 E_G + 0.70 E_R - 0.11 E_B \quad (3)$$

$$E_B - E_Y = -0.59 E_G - 0.30 E_R + 0.89 E_B \quad (4)$$

Each of these color difference signals contain all three of the color video signals. By taking 0.51 unit of the $E_R - E_Y$ signal, combining it with 0.19 unit of the $E_B - E_Y$ signal, and reversing the polarity of the combination, the $E_G - E_Y$ signal will result. This operation can be expressed by

$$\begin{aligned} -0.51 (E_R - E_Y) - 0.19 (E_B - E_Y) \\ = E_G - E_Y \end{aligned} \quad (5)$$

Thus it is not necessary to transmit the ($G - Y$) signal as a separate vector, since it can be derived from the proper combination

of the red and blue color difference signals in the receiver.

Typical Transmitter

A simplified block diagram of a color transmitter may make this somewhat clearer. In Fig. 4 is shown a color camera that splits the light from the image into red, blue and green components, and delivers signals corresponding to each of these three colors to a mixer. This mixer is essentially a linear adder which combines green, red and blue in the proper proportions to form the Y or brightness signal which is shown at the top of the diagram.

The mixer also produces the red and blue color difference signals which are shown written in both forms, for instance ($R - Y$), and underneath ($0.6G - 0.7R - 0.1B$), which is the actual make-up of this signal. The blue and red color difference signals then are passed through 2.5-mc filters to a pair of balanced modulators. These modulators are supplied with color subcarriers at 3.89 mc, which modulate the ($B - Y$) signal in the reference phase and modulate the ($R - Y$) signal at 90 degrees and 270 degrees, alternately at field rate. This is the color phase alternation described above.

The sync and color burst is generated and added to the output of the two balanced modulators, and this mixture is then added to the brightness signal to produce a com-

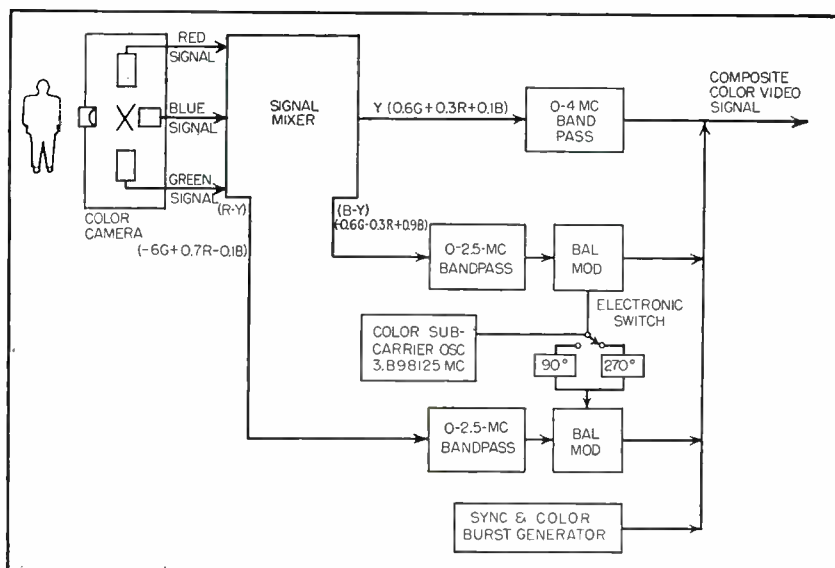

FIG. 4—Color transmitter video circuits

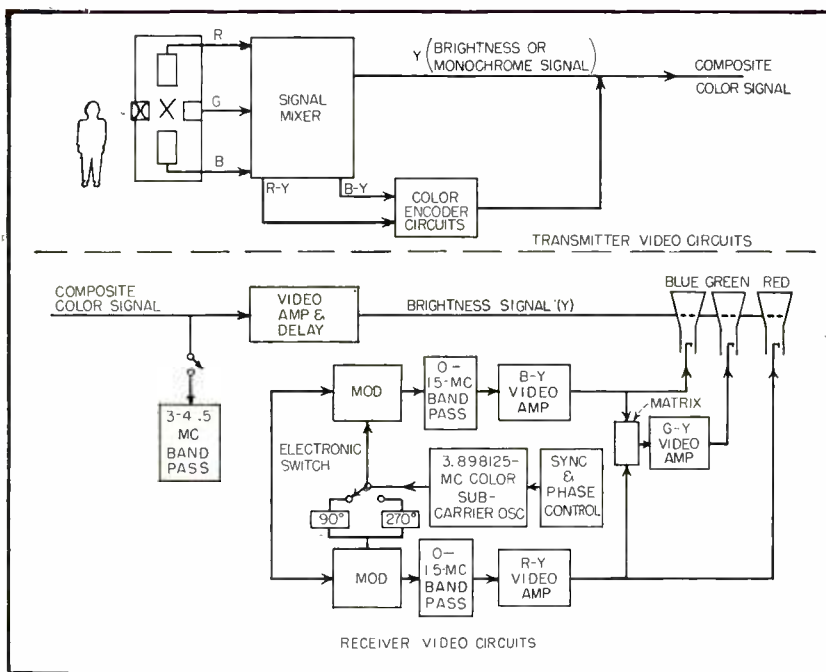

FIG. 5—Video circuit functions of receiver are inverse of those in transmitter

posite color video signal. The upper portion of Fig. 4, with the addition of the sync, produces a standard black and white picture. The lower portion of the diagram generates the color information which is added to this brightness information.

Figure 5 shows this transmitter schematic simplified further, and below it, for comparison, is shown the video section of a typical receiver. In the transmitter schematic, the brightness or monochrome signal circuits are at the top, and below them are the color encoder circuits, producing the color information that is added to the brightness signal. The receiver video circuits perform the inverse of this transmitter function.

The composite color video signal is supplied through the video amplifier to the grids of the tricolor kinescope. If the circuit shown in the lower portion of the block diagram is made inoperative, an ordinary black and white picture will be obtained. The color subcarrier information existing in the region of 3 to 4.5 mc in the composite video signal is applied through a bandpass circuit, to eliminate unwanted monochrome components, to a pair of modulators in a very similar fashion to that done in the transmitter. These modulators are

supplied with a local subcarrier generated and controlled in phase by receiver circuits to be described later.

The color subcarrier modulates the information in the 3 to 4.5-mc region, beating it down to low-frequency even harmonics of half line frequency from zero to 1 mc. This demodulated information will then be the $(B - Y)$ signal, and the $(R - Y)$ signal as originally derived at the transmitter.

By combination of the $(B - Y)$ and the $(R - Y)$ signals in the matrix, which is simply a resistive mixing pad, the $(G - Y)$ signal is produced as was shown earlier. These three color difference signals are then applied to the cathodes of the blue, green and red guns of a tricolor kinescope or other suitable display device. Addition of the color difference signals to the brightness signal takes place within the kinescope. Thus the blue gun gets the Y signal on its grid, and the $(B - Y)$ signal on its cathode, and the effective signal applied between the grid and cathode of this tube then is B .

The same is true for the green and red tubes, so that finally the red, green and blue signals are used to control the beam current of the tube. The three images are superimposed to produce the complete color picture.

Turning to more specific details of the receiver design, it might be interesting to look at the receiver i-f passband requirements. Figure 6 shows the transmitted frequency spectrum of the composite video signal. The picture carrier is shown at zero frequency, with the lower vestigial sideband, the full upper sideband, and the sound carrier shown in their relative positions. The location of the color subcarrier and its components is also shown in the region of 2 to 4.5 mc.

Receiver I-F System

For proper reception of the vestigial sideband monochrome signal, the receiver passband should locate the picture carrier at the 50-percent response point, and the passband response should be down to essentially zero within the region of the vestigial lower sideband. This locates one edge of the i-f response rather critically. Since the color information is also a vestigial sideband transmission, it becomes necessary to locate the color subcarrier at the 50-percent response point on the upper slope of the i-f passband. This upper slope must be down to essentially zero at about 4.3 mc, which is the minimum width of the vestigial sideband called for in the NTSC standard proposal.

The sound carrier must, of course, be suppressed at least 26 db for intercarrier sound reception. Actually, it must be down somewhat further than this, approximately 30 to 40 db, to prevent an undesirable beat between the color subcarrier and sound carrier in the monochrome channel. The lower curve marked receiver i-f characteristic shows the idealized receiver passband for proper reception of the color signal. The receiver described has essentially this passband, centered at 44 mc.

Color Decoders and Video

In Fig. 7 is shown a block diagram of the color decoder section of the receiver. The composite video from the second detector is amplified in the chroma amplifier. The gain of this stage is adjustable from the front panel by the saturation control. Its function is to vary the saturation of the color in the picture. When turned completely

off, a black and white picture results. As the control is advanced, the colors become more brilliant. If the control is set above normal, an appearance of fluorescent colors can be produced.

The output of the chroma amplifier, after going through a bandpass circuit, consists primarily of the interleaved color information. This is applied to the grids of the decoders or demodulators. The 3.89-mc local color subcarrier oscillator signal is applied directly to the suppressor of the (B - Y) demodulator tube, and through a 90-degree phase shift network (which is simply a tuned circuit), to the suppressor of the (R - Y) decoder.

The output of these decoders are the low-frequency color difference signals. These are applied to the cathodes of the red and blue guns of the tricolor kinescope. The (G - Y) signal, derived from the matrix, is applied to the cathode of the green gun of the kinescope.

The d-c restorers are shown as they are actually connected from the common Y signal to the respective color difference signals. The signals seen by each restorer and by each respective gun of the kinescope are then actually the reconstructed red, green and blue signals. These color difference signals are restricted in bandwidth to about 1 mc in the receiver while the brightness signal has a 4-mc pass-band. This causes the color difference signal to suffer a delay relative to the brightness signal. To correct this condition and make the components coincident in time, a delay line is inserted in the monochrome

channel. This line has a bandwidth of approximately 4 mc and introduces a delay of one micro-second.

Color Sync and Subcarrier Generator

The local color subcarrier generator and sync circuit is shown in block diagram form in Fig. 8. The 3.89-mc signal is generated at the transmitter by a crystal oscillator. In the receiver, this frequency must be generated and held to an exact phase relationship relative to that at the transmitter. This is accomplished by using the color synchronizing information or burst, consisting of about 9 cycles of the 3.89-mc subcarrier on the back porch following each horizontal sync pulse.

The signal from the output of the chroma amplifier is applied to the burst amplifier, which is a high-gain amplifier gated on by the hori-

zontal retrace for the duration of the burst interval. The output of this amplifier then contains only the separated burst signal. This signal is applied to a 6AL5 phase detector where it is compared with the signal from the local 3.89-mc oscillator.

A d-c voltage is developed which is proportional to the phase difference between these two signals. This d-c voltage is applied to a reactance tube to control the phase and frequency of the local 3.89-mc oscillator. The output of this local oscillator, through a buffer stage, is used to modulate the (B - Y) decoder directly, and through a tuned circuit introducing a 90-degree phase shift, it is applied to the color phase alternation multivibrator. This is a flip-flop multivibrator which reverses the polarity of this local oscillator wave at field rate. Thus the signal applied to the (R - Y) modulator will lead that

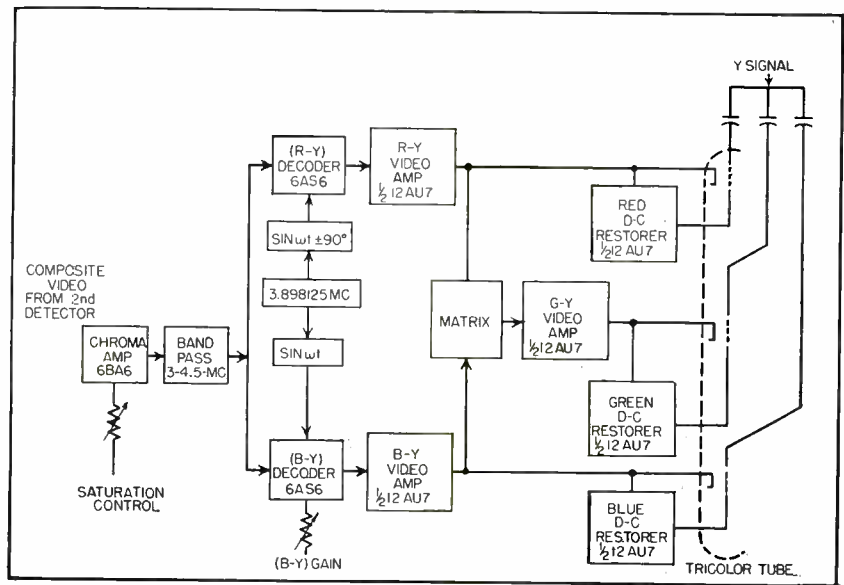

FIG. 7—Color decoder section and the signals handled

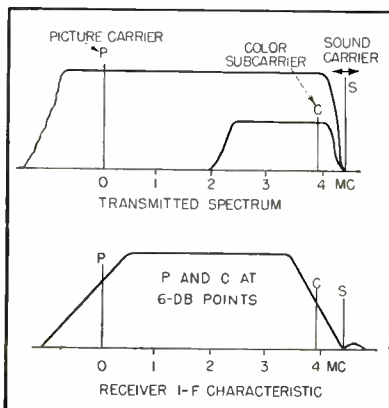

FIG. 6—Idealized receiver passband and location of color subcarrier

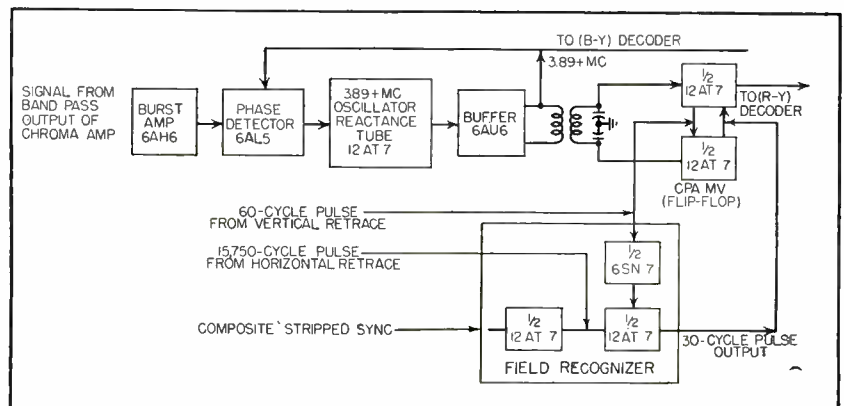

FIG. 8—Local color subcarrier generator and sync circuits

applied to the (B - Y) modulator by 90 degrees in one field and lag it by 90 degrees in the next field.

Attention must be paid to the phase of this alteration. It must flip when the transmitter flips and flop when the transmitter flops. To accomplish this, a unit called a field recognizer is used.⁴ The necessary sensing information is implicit in the ordinary black and white synchronizing signal, in the alternate field interlacing. The field recognizer gates in a horizontal sync pulse on alternate fields, thus producing a 30-cycle output.

The field recognizer circuit is shown in Fig. 9. The composite stripped sync is partly integrated and applied to the grid of a 12AT7 tube. In the plate circuit of this tube is a transformer having a secondary resonant at one-half the horizontal line frequency. The integrated stripped sync, consisting primarily of vertical sync pulses, excites this resonant circuit.

On one field the peaks of this damped wave will occur in phase with the horizontal sync pulses while on the alternate field the horizontal sync pulses fall on the axis of the damped wave. A voltage pulse from the horizontal retrace, picked up from a winding on the horizontal output transformer, is added to this damped wave, and the combined signal is applied to the grid of the other half of the 12AT7 tube.

The horizontal pulse at the beginning of one field will ride on the peaks of the damped wave and have higher amplitude than the horizontal pulses at the beginning of the next field, which are riding on

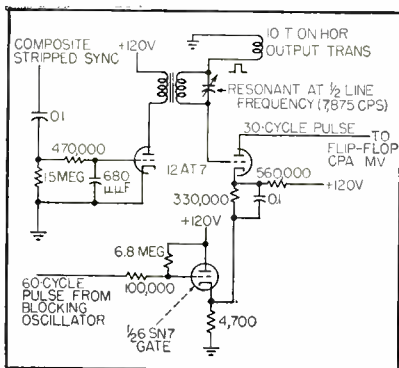

FIG. 9—Field recognizer circuit controls flip-flop multivibrator for color phase alternation

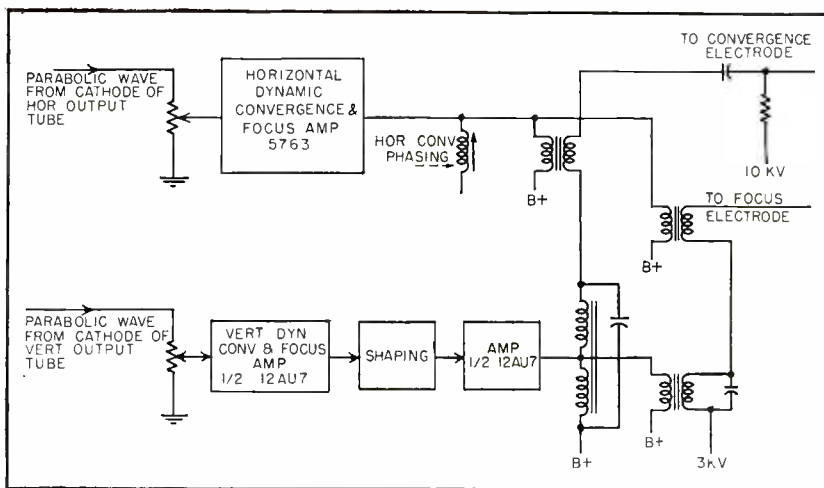

FIG. 10—Dynamic convergence and focus circuits control color registration on picture tube screen

the axis of the damped wave. By clipping the peaks of this composite wave in the output half of the 12AT7, one or two horizontal pulses are gated out on alternate fields. This then is the 30-cycle wave having a definite sense relative to the transmitted signal.

The 6SN7 gate tube, shown at the bottom of the diagram, gates on this field recognizer circuit only during the vertical retrace interval to improve its signal-to-noise ratio, since it is then only responsive for a fraction of the total time. The 30-cycle pulse from this field recognizer unit is applied to one grid of the cpa flip-flop multi-vibrator. The 60-cycle vertical retrace pulse is applied to the other grid, with the result that the flip-flop multivibrator is driven in the correct phase at all times.

Scanning Circuits

The horizontal and vertical scanning circuits are quite conventional. The main difference between those used in this receiver and those in standard black and white receivers is that somewhat more scanning power is required, since the tricolor kinescope has a 2-inch neck with a large yoke and requires more scanning current. The high voltage for the kinescope is a regulated r-f supply delivering 20,000 volts at about 300 microamperes for an average picture. Regulation is required in this supply to maintain color registration under variations in beam current.

Some special circuitry in conjunc-

tion with the scanning is required for the RCA tricolor tube to maintain correct color registration.⁵ These circuits, known as dynamic convergence circuits, are outlined in Fig. 10. After the d-c potentials and magnets at the tube neck are adjusted to bring the beams from all three guns into registry at the center of the tube, a-c signals must be applied to the convergence and focus electrodes to maintain convergence and focus of the three beams over the entire face of the tube.

Parabolic waves derived from the cathodes of the horizontal and vertical output tubes are applied to amplifiers. Some phasing and shaping of these waves is done in these amplifier stages. The outputs of the two amplifiers are combined in series, through transformers, to form the combined dynamic convergence and focus waves, which are applied to the picture tube. By careful adjustment of the amplitude and phase of these convergence waves, good registration of the colors can be obtained over the entire face of the tube.

REFERENCES

- (1) C. J. Hirsch, W. F. Bailey, and B. D. Loughlin, Principles of NTSC Compatible Color Television, ELECTRONICS, Feb. 1952.
- (2) A. V. Bedford, Mixed Highs In Color Television, Proc. IRE, Sept. 1950.
- (3) Pierre Mertz and Frank Gray, A Theory of Scanning and Its Relation to the Characteristics of the Transmitted Signal in Telegraphy and Television, BSTJ, July, 1934. Pierre Mertz, Television—The Scanning Process, Proc. IRE, Oct. 1941.
- (4) D. Richman, Frame Synchronization for Color Television, ELECTRONICS, Oct. 1952.
- (5) A. W. Friend, Deflection and Convergence in Color Kinescopes, Proc. IRE, Oct. 1951.

Measuring Minute Capacitance Changes

Resonant bridge carrier system permits accurate resolution of minute mechanical motions that produce capacitance changes as small as $0.001 \mu\text{f}$ or less. Equipment is unaffected by relatively severe extraneous disturbances

By **GEORGE W. COOK**

*Chief, Electronics Engineering Division
David Taylor Model Basin
United States Navy
Washington, D. C.*

VARIOUS METHODS have been developed for the measurement of minute changes in capacitance. The method to be described has been employed successfully to solve many problems in the measurement of physical quantities which heretofore have been considered very nearly insuperable. Other methods tried have fallen far short by comparison.

The system utilizes a doubly-resonant capacitance bridge circuit and a unique phase-amplitude-sensitive discriminator. The circuits are extremely stable and little affected by changes in circuit-parameter values other than in the bridge arms. A wide dynamic range of frequency response extending from 0 to 20,000 cps or more is an inherent property of the system.

Figure 1 is a functional block diagram of the system, and Fig. 2 shows a typical response curve.

Measurement System

In the bridge, resonance at a low radio-frequency carrier is induced in two modes. This bridge circuit is excited via a low-impedance transmission line from the crystal-controlled oscillator.

The bridge is initially balanced. When unbalance occurs, the resultant signal current is trans-

mitted via another low-impedance transmission line to the signal amplifier. The output voltage of the amplifier is impressed on a special discriminator circuit in which the sense or direction of the bridge unbalance is determined. A d-c signal voltage of the proper amplitude and polarity is imposed on the output stage which serves as

a voltage or current amplifier to drive an appropriate recording device.

Bridge Circuit

The arms of the bridge consist of four capacitors, one or two of which are active in the measurement process. It is the purpose of the bridge circuit to modulate



Complete system for measuring dynamic pressure under wing of aircraft in flight

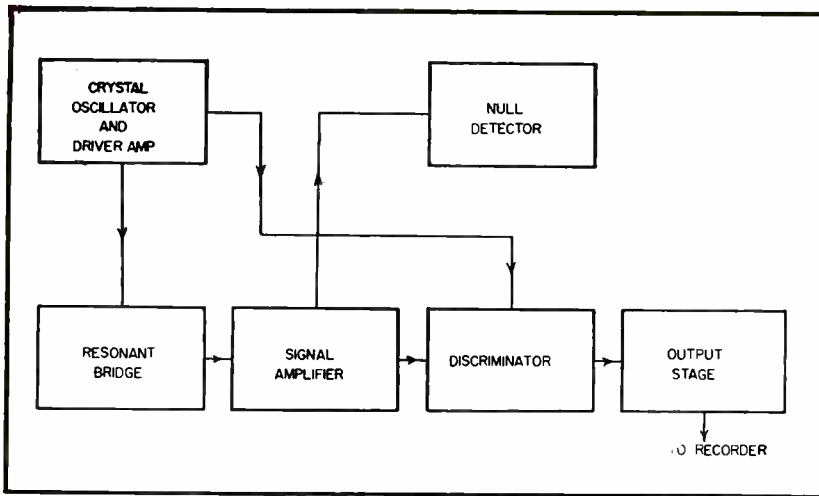

FIG. 1—Resonant bridge is key to high sensitivity of the capacitance-increment-measuring system shown in block diagram

the driving voltage in a manner such that only the sideband components of a modulated carrier-voltage wave are produced at the output terminals of the bridge. The bridge circuit is shown schematically in Fig. 3.

The inductive elements that link the driver amplifier to the bridge are critically coupled under operating conditions. A very high bridge-exciting voltage is thus developed with little actual driving energy. The driver transformer is resonated by the diagonal capacitance of the bridge from the point 1 to the point 3.

Likewise the detector transformer is resonated by the other diagonal capacitance. This condition of resonance is independent of that induced in the driver-transformer. The detector transformer is overcoupled to the amplifier to improve the sideband frequency response.

With the bridge in perfect balance, no voltage is developed across the detector-transformer even though a resonant condition exists which includes this transformer. Since the capacitors are part of a resonant circuit with the driver transformer, and the circulating current in each of the four arms is relatively high, the most minute unbalance in the capacitance of the arms produces a relatively large output voltage across the resonant detector-transformer.

The magnitude and phase of the output voltage are proportional to

the degree and sense of unbalance, and to the magnitude of the quiescent resonant currents induced in the bridge arms.

Calibration

The method chosen for calibration is precise and accuracy may be made as high as desired by the exercise of reasonable care, and by the selection of high-quality materials.

As shown in Fig. 4A, one arm of the bridge is shunted by a series circuit consisting of a very small capacitor and a very large capacitor. If the large one is short circuited, the effective capacitance change induced in the arm may be derived quite easily.

Balancing

The bridge may be balanced at some physical distance from the gage by means of a cable as shown in Fig. 4B. This method is somewhat similar to the balancing method employed in the Wien Bridge circuit. The balancing controls are shunted by the cable capacitance and their effectiveness and range of compensation is reduced as the length of the cable is increased.

Stability

This measurement system has been designed around one particular theme; that there must be output signal to the recorder *only* when there is a change in balance in the bridge. The present limitation in

practical use is not associated with the measurement system at all but rather turns out to be inconstancy in the capacitance of the bridge arms themselves.

It is imperative that the wiring in the bridge compartment be rigidly fixed relative to adjacent circuit components. This is accomplished by embedding the complete bridge section in a thermosetting plastic or resin.

It is essential that the driver

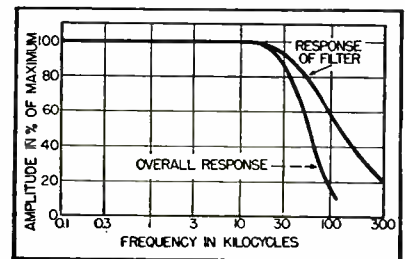

FIG. 2—Overall frequency-response of measurement system

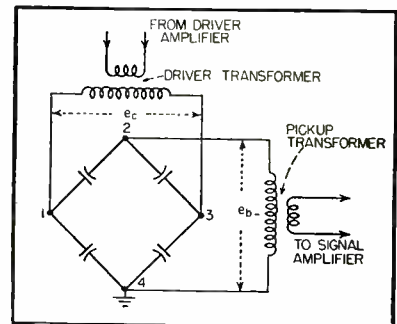

FIG. 3—Driver and pickup transformer windings resonate with their respective diagonal capacitances at operating frequency

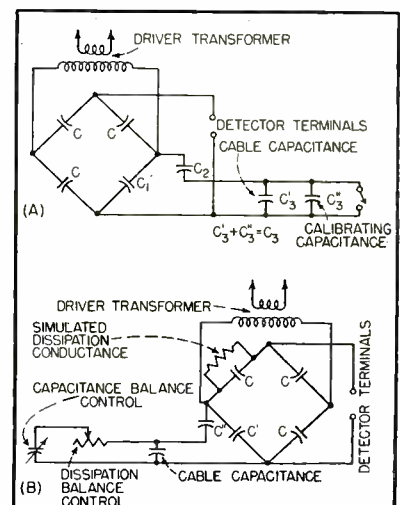

FIG. 4—Schematics showing circuits for calibration and remote balancing

F-M Recording in

Information on tape from battery-operated magnetic recorder in guided missile is decoded and recorded. High accuracy in speed control is obtained by separate 4-kc channel on tape that minimizes speed variation between recorder and playback drive motors

TWO METHODS of recovering information originating at a remote location consist of telemetering the information over a wire or space link and of recording the information on a medium such as magnetic tape and later transcribing this information into suitable form for evaluation. This paper is concerned with the second method.

Equipment was used in conjunction with a 198-channel, 100-track battery-operated magnetic recorder designed to fit into the nose of a missile during flight. Operating conditions of the recorder were such as to require the use of stainless-steel recording tape. Tape speed variations had to be held to closer than about 2½ percent tolerance.

After a recording is made of the pertinent flight data, the magnetic tape record is jettisoned and later recovered for playback and transcription at a ground station. The f-m transcriber accepts a multiplex signal from a playback head of the ground playback machine and records the information on a suitable graphical recording medium.

F-M Channels

Information at the input of the transcriber is in the form of two f-m signals, each occurring in a band or channel of frequencies separated from the other by 100 cycles. The first band, channel 1, ranges from 4,100 to 5,600 cycles and the second band, channel 2, ranges from 5,700 to 7,900 cycles. The transcriber separates the two channels of information, demodulates the information by discriminating the exact signal frequencies in each channel, and records this information as a function of time

on a suitable graphical recorder.

Since the information in either channel is determined by the instantaneous signal frequency in that channel, any difference in the instantaneous tape speed of recording and playback will result in an erroneous signal frequency. Concurrent with the information signal, the transcriber is furnished a reference frequency from a second magnetic playback head for tape speed error compensation. This reference frequency is recorded on the magnetic tape as a constant frequency of four kc and, during playback, any difference in the instantaneous speed of recording and playback will result in variations of the reference frequency. These variations are detected in playback and are used to correct for errors in the information channels.

Principle of Operation

The basic idea of the f-m transcriber is illustrated in Fig. 1. The signal input is fed into the preamp-

plifier where it is amplified and fed to two selective filters which separate the two channels. The information in each channel is then further amplified and limited. At this point the signals are fed separately into the signal discriminator where they are further limited and deprived of their harmonic content by the low-pass filters. The resulting signals are then of constant amplitude with the information in either signal a function of its instantaneous frequency. The signals are then fed through compensating amplifiers and R-C discriminators producing a voltage output in each case which is directly proportional to the recorded signal frequency.

Reference Signal

A second reference signal, originating from a second magnetic track on the same tape as the information signals, is fed into the reference discriminator. This signal is amplified, limited and filtered in the

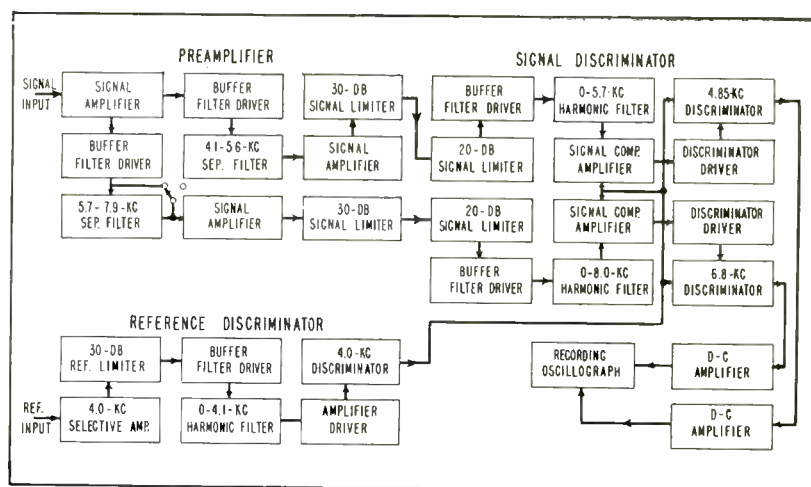

FIG. 1—Block diagram of the f-m transcriber

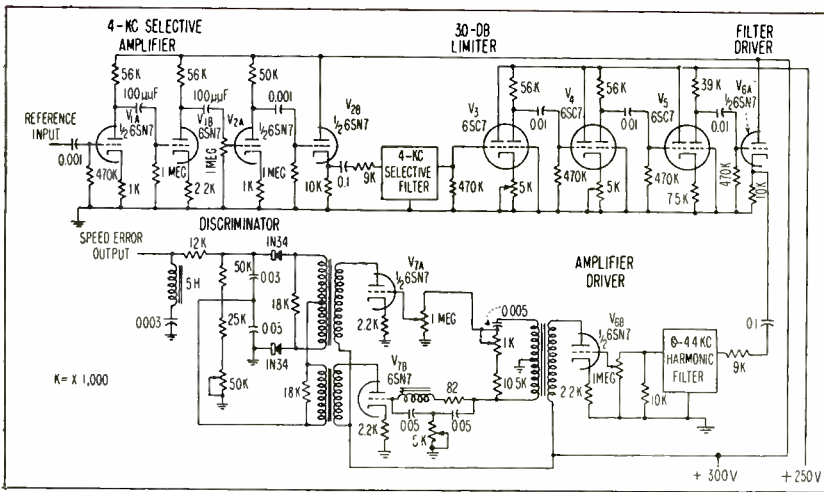

FIG. 3—Schematic diagram of the reference discriminator

in the cathode circuits adjusts for symmetry of the output wave.

Discriminator Circuits

The purpose of the reference discriminator is to provide an output voltage proportional to the instantaneous frequency of the reference signal input. The required voltage difference to correct for ± 2.5 -percent tape speed variation was determined to be of the order of \pm two volts. This required a discriminator whose sensitivity was about 10 volts per kc, which is considerably greater than any standard discriminator circuit. A special discriminator was developed for this application.

Figure 3 shows the circuit of the reference discriminator. Amplifier and limiter sections are similar to those employed in the information channels. Output of the amplifier-driver is applied across an R-C phase splitting circuit whose output voltages are equal and essentially 90 deg out of phase over the frequency range of 4 kc $\pm 2\frac{1}{2}$ percent. One of the outputs of the phase splitter is fed directly to V_7 , and then into a balanced rectifier. The second output is fed into a bridged-T network, amplified and fed to the rectifiers in push-push fashion.

In order to understand the discriminator action, consider Fig. 4 which shows a plot of the amplitude and phase characteristics of the bridged-T network. The inductor is adjusted so that f_0 occurs at 4 kc. Next consider Fig. 5 which illustrates the discriminating action at

the rectifier circuit. When the reference frequency is equal to $f_0 = 4$ kc, e_s will be in quadrature with e_1 , and with magnitude zero. As the reference frequency deviates on either side of the design center frequency, a positive or negative voltage will occur at the output terminals of the rectifier.

The basic function of the signal discriminator is to supply two output voltages which are proportional to the instantaneous signal frequencies recorded. To perform this function, an R-C discriminator is used in conjunction with a compensating amplifier to make a highly linear frequency discriminator over the channel bandpass regions. To correct for tape speed variations, the capacitive arm in the discriminator circuits is instantaneously adjusted by the reference discriminator output voltage. The resulting effect is to shift the signal discriminator output characteristics in such a way that the output voltage is proportional to the signal frequencies recorded rather than those being played back.

The circuit diagram of one channel of the signal discriminator unit is shown in Fig. 6. The symmetrically clipped wave of the limiter is fed through the low-pass filter that removes the harmonics. The filter is flat to within 0.7 percent over the channel bandpass frequencies and is down greater than 40 db at the third harmonic of the lowest frequency in the channel region.

The discriminator consists of an R-C voltage divider and a rectifier

circuit. The capacitance arm of the R-C circuit is composed of a fixed capacitor and a high Q variable capacitor¹ (6J6) in parallel. If e_{RC} is the voltage applied to the R-C network, the rectified output voltage will be

$$V_o \propto \frac{1 - \frac{\omega}{\omega_o}}{\sqrt{1 + \left(\frac{\omega}{\omega_o}\right)^2}} e_{RC} \quad (1)$$

where $\omega_o = 1/RC$. Except for the denominator in Eq. 1, this is exactly the relation required for a pure ratio discriminator. To obtain the desired expression, a compensation amplifier was inserted between the harmonic filter and the R-C network whose transfer function is

$$\left| \frac{e_{AC}}{e} \right| = \frac{g_m R_p \sqrt{1 + \left(\frac{\omega}{\omega_o}\right)^2}}{\sqrt{(1 + g_m R_c)^2 + \left(\frac{\omega}{\omega_o}\right)^2}} \quad (2)$$

where g_m is the transconductance of the 6AC7, R_p is amplifier plate resistance, R_c is amplifier cathode resistance, e is a constant voltage

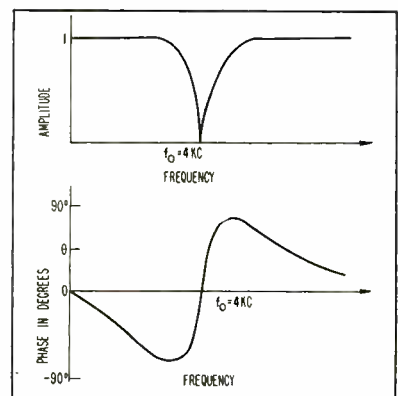

FIG. 4—Transfer characteristics of the bridged-T network

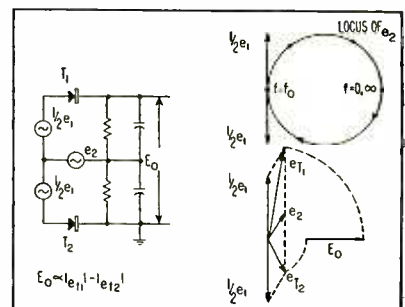

FIG. 5—Discriminating characteristics of the rectifying circuit

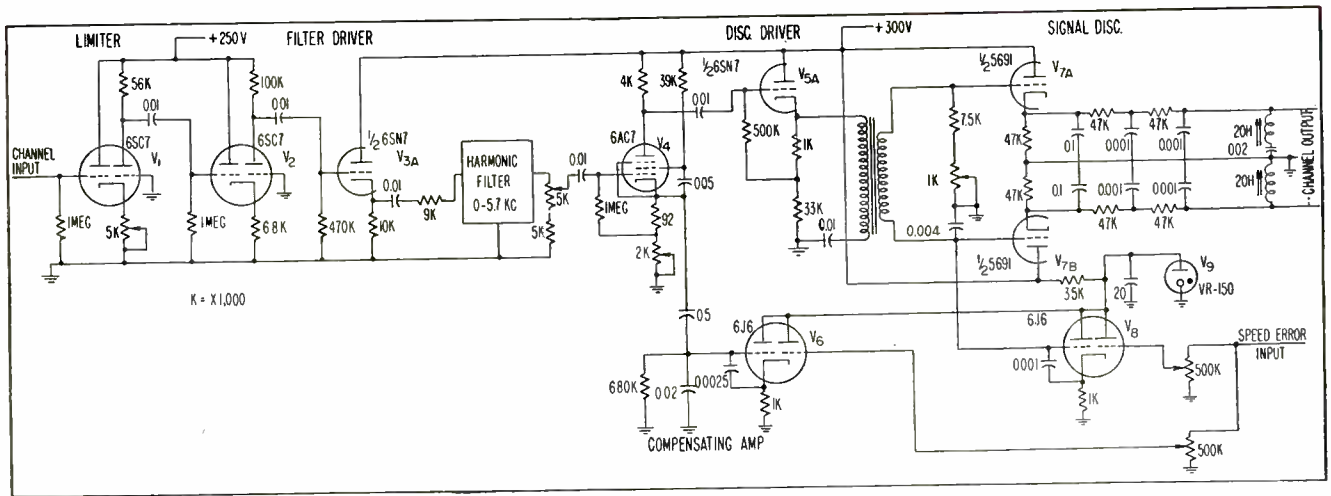

FIG. 6—Schematic diagram of the signal discriminator unit

input from the harmonic filter, C_c is cathode bypass capacitance and $\omega_w = 1/R_c C_c$.

It is evident that if $g_m R_c$ is sufficiently large, the denominator of Eq. 2 will be substantially constant over the channel bandpass region and the rectified output will become

$$V_o \propto \left(1 - \frac{\omega}{\omega_o}\right) e \quad (3)$$

With the values used in the compensation amplifier circuit, Fig. 6, the denominator of Eq. 2 is constant to within 0.2 percent over the channel bandpass frequencies.

The reactance tube employed in both the R-C circuit and the compensating amplifier is used to vary ω_o in Eq. 3 to correct automatically for tape speed variations.

D-C Amplifier

The purpose of the d-c amplifier in the transcriber is to transform the voltage outputs of the signal discriminator into suitable form for application to the galvanometer elements in a recording oscillograph. This essentially requires that the d-c amplifier act as a voltage-to-current converter.

The circuit of one channel of the d-c amplifier is shown in Fig. 7. The circuit consists of two stages of cross-coupled d-c amplification⁹ and a stage of 6AC5 current drivers. Sensitivity of the d-c amplifier is 22 ma per volt when loaded with a 45-ohm resistance. This sensitivity may be varied over a range of about three to one by use of the 1,000-ohm series potentiometer.

Experimental tests show that the amplifier is linear to within 0.5 percent of its full-scale output of 20 ma. The output may be coupled to almost any standard recording galvanometer.

Conclusion

The transcriber was designed to decode and to record graphically

signal frequencies.

The over-all linearity of the transcriber was checked by recording a series of known standard frequencies and on playback measuring the deviations recorded on the recording oscillograph. A resulting plot of the spot deviation as a function of signal frequency is linear to within 0.5 percent. Dynamic response is considerably more difficult to define explicitly because of the complex nature of the angular modulation process⁸. However, the instrument was designed to be flat out to 100 cycles.

The present limiting factor on dynamic response is the filter response at the output of the signal discriminators and this may be modified to increase the frequency response of the output signal. The only requirement of these filters is that they eliminate the channel carrier frequencies from the detected output. Beyond this they may be designed to cutoff at as high a frequency as desired.

The author wishes to acknowledge major contributions by J. N. Van Scoyoc, J. L. Murphy, W. Goss and H. L. Reichert of the Armour Research Foundation. Appreciation is also expressed for the cooperation of the United Aircraft Corporation, Hartford, Connecticut.

REFERENCES

- (1) J. N. Van Scoyoc and J. L. Murphy, High-Q Variable Reactance, *ELECTRONICS*, 22, p 118, Jan. 1949.
- (2) J. N. Van Scoyoc and G. F. Warnke, A D-C Amplifier with Cross-Coupled Input, *ELECTRONICS*, 23, p 104, Feb. 1950.
- (3) A. A. Gerlach, Distortion-Bandpass Considerations in Angular Modulations, *Proc. IRE*, 38, p 1,203, Oct. 1950.

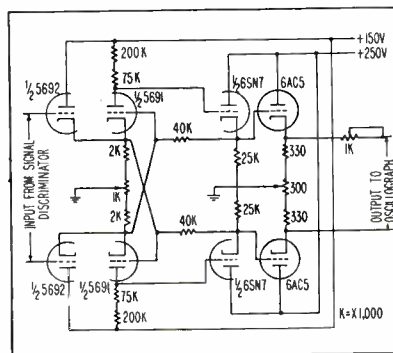

FIG. 7—Circuitry of the d-c amplifier

f-m information which had been remotely recorded on a multitrack magnetic tape. The problem of decoding f-m on magnetic tape is aggravated by errors introduced by variations between the recording and playback speeds of the magnetic tape. To correct for these errors, a constant reference frequency is recorded on one of the magnetic tracks and the frequency of this reference signal on playback is used to automatically adjust the information signal discriminators to produce an output voltage proportional to the original recorded

High-Frequency

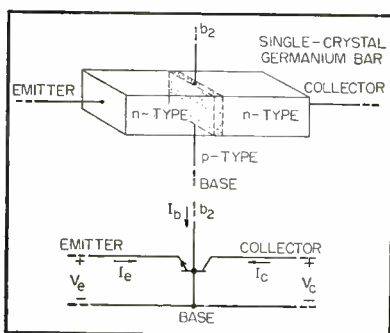

FIG. 1—The tetrode structure and the symbol used to represent it

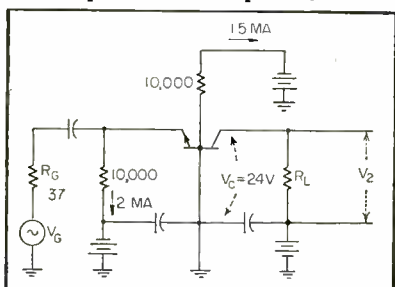

FIG. 2—Transistor tetrode used as a grounded-base amplifier

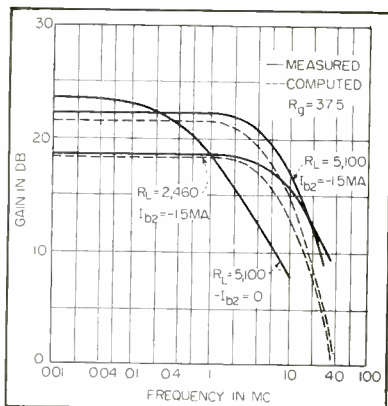

FIG. 3—Measured and computed gains for the circuit shown in Fig. 2

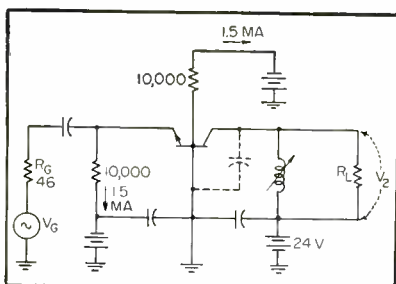

FIG. 4—Simple tuned amplifier circuit

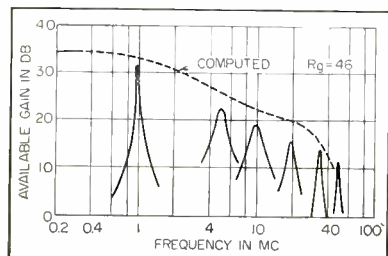

FIG. 5—Peaks of these response curves show the available gain in the circuit of Fig. 4. The dotted curve shows the computed focus of the peaks

By R. L. WALLACE, JR., L. G. SCHIMPF and E. DICKTEN

Bell Telephone Laboratories, Inc.
Murray Hill, N. J.

IF A FOURTH electrode is added to a conventional junction transistor and biased in a suitable way, the base resistance of the transistor is reduced by a substantial factor. Because of this reduction in base resistance, the transistor may be used at frequencies ten times or more higher than would otherwise be possible.

Two other factors that are responsible for the improvement in high-frequency response are that the cutoff frequency of the current gain α has been increased by using thinner p layers and that the collector capacitance has been reduced by decreasing the area of the collector junction to approximately 10^{-4} square inches.

The configuration of the junction tetrode and its symbol designation are shown in Fig. 1. The fourth electrode, designated b_2 , is connected to the p layer in the same manner as the base connection is made but on the opposite side of the bar.

Performance of the tetrode transistor, as discussed in the succeeding portion of this paper, will be under the conditions of a fixed current bias I_{b_2} applied between the base and the added electrode. A suitable value of this bias makes the potential of b_2 and -6 v with respect to base. Emitter and collector electrodes are biased about the same as in conventional junction transistors.

With these operating conditions, the part of the emitter junction near b_2 is biased in the reverse direction and does not emit electrons into the p layer. That part of the emitter junction in the immediate

vicinity of the base contact is the only part of the emitter junction biased in the proper direction to serve as an emitter. All the transistor action therefore takes place near the base contact and this fact accounts for the reduction in base resistance r_b and the resultant improved high-frequency performance. Good high-frequency properties are not dependent on a critical setting of b_2 bias. All values between one and two ma have been found satisfactory.

For one particular junction transistor tetrode, with no bias on b_2 , the base resistance was 1,100 ohms. As $-I_{b_2}$ was increased to two ma, r_b decreased to about 40 ohms. As $-I_{b_2}$ was increased from 0 to two ma, current gain decreased from 0.99 to about 0.75, causing an increase in bandwidth at the expense of gain.

Collector resistance r_c is reduced appreciably by the bias applied to b_2 in the direction of decreasing gain. Emitter resistance r_e is increased as $-I_{b_2}$ is increased in the range from one to two ma but the total change in r_e is not very great.

High-Frequency Considerations

When considering the dependence of α on frequency, it is convenient to define an α cutoff frequency $f_{c\alpha}$ as the frequency at which the magnitude of α has been reduced from its low-frequency value by a factor of $1/\sqrt{2}$. This frequency is in the order of 15 to 20 mc.

It has been shown¹ that $f_{c\alpha}$ should be inversely proportional to the square of the thickness of the p layer and should be about 20 mc for

Transistor Tetrode

Sine-wave oscillators at frequencies up to 130 mc and tuned amplifiers with substantial gain at frequencies of 50 mc or higher are obtained by using junction transistors with an added connection to the base electrode biased negative at six volts

the *p* layers of roughly 0.0005 in. used in these transistors.

Figure 2 is a circuit in which the transistor tetrode is used as a grounded-base amplifier between a generator of internal resistance R_G and a load resistance R_L . A transistor having the following characteristics was used in the circuit: $r_e = 6.9$ ohms, $r_b = 92.5$ ohms, $r_c = 0.825$ megohms, $\alpha_o = 0.82$, $f_c \alpha = 18.5$ mc and $C_c = 1.5 \mu\mu f$.

Response

Measured response of this transistor in the circuit of Fig. 2 is shown in Fig. 3. With $R_L = 5,100$ ohms, the gain is 22.3 db and the 3-db point is at 5 mc. This is comparable with the performance of good vacuum tubes. If the transistor is used as a triode in the same circuit by making $-I_{b2} = 0$, the cutoff frequency is reduced to approximately 0.5 mc.

As shown in the lower solid curve of Fig. 3, reducing R_L to 2,460 ohms raises the cutoff frequency to 10 mc and reduces the low-frequency gain to 18.4 db.

If a grounded-base amplifier is driven by a resistive generator, the output impedance of the amplifier looks like a resistance and a capacitance in parallel. If the amplifier is loaded by a shunt inductance and resistance as shown in Fig. 4, the inductance will resonate with the output capacitance to give a peaked response. Maximum gain will be obtained at the frequency of resonance when R_L is adjusted for match.

The curves shown in Fig. 5 were obtained by varying the load in-

ductance to obtain various resonant frequencies and then adjusting R_L at each frequency to give maximum gain. Measured gain at 50 mc is

11.8 db. Figure 6 shows the measured values of output impedance of the stage in terms of an equivalent parallel resistance and capacitance.

Bandpass Amplifiers

The low values of output capacitance and resistance shown in Fig. 6 indicate that it should be possible to build reasonably wide bandpass amplifiers without much sacrifice in gain as compared to the values shown for narrow-band amplifiers in Fig. 5. The stage shown in Fig. 7 was designed to pass a 9-mc band of frequencies centered around 32 mc. The resultant gain is 15 db, giving a gain-band product of 280 mc.

The circuit of Fig. 8 was used to observe the performance of transistor tetrodes as oscillators at high frequencies. Provision is made for adjusting the value of capacitance in the feedback path to the emitter. At higher frequencies, the input impedance at the emitter tends to become inductive and it is necessary to adjust the capacitor.

Most of the tetrodes used in this circuit produced sinusoidal oscillations up to frequencies as high as 80 to 100 mc, with some at 100 and 130 mc. Between 40 and 75 mc, measured output was approximately one milliwatt for one transistor. At 100 mc, output is 0.25 milliwatt and at 115 mc, 0.06 milliwatt. Collector dissipation was held to about 30 milliwatts during the measurements.

REFERENCE

- (1) W. Shockley, M. Sparks and G. K. Teal, P-N Transistors, *Phys. Rev.*, 83, p 151, 1951.

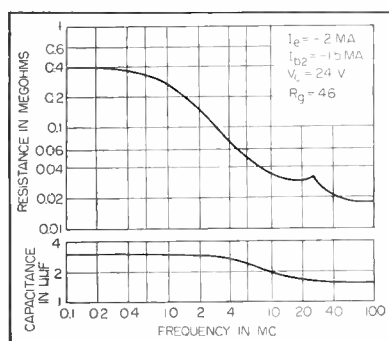

FIG. 6—Output impedance of a grounded-base stage in terms of shunt resistance and capacitance

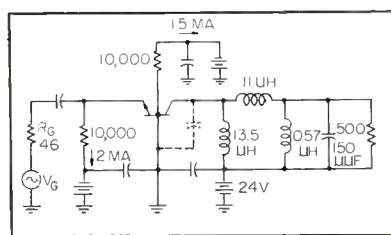

FIG. 7—Bandpass amplifier stage

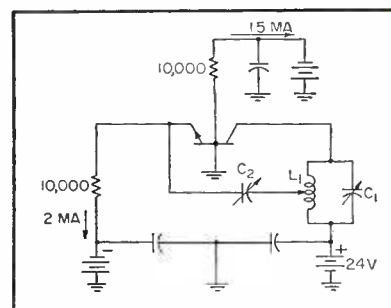
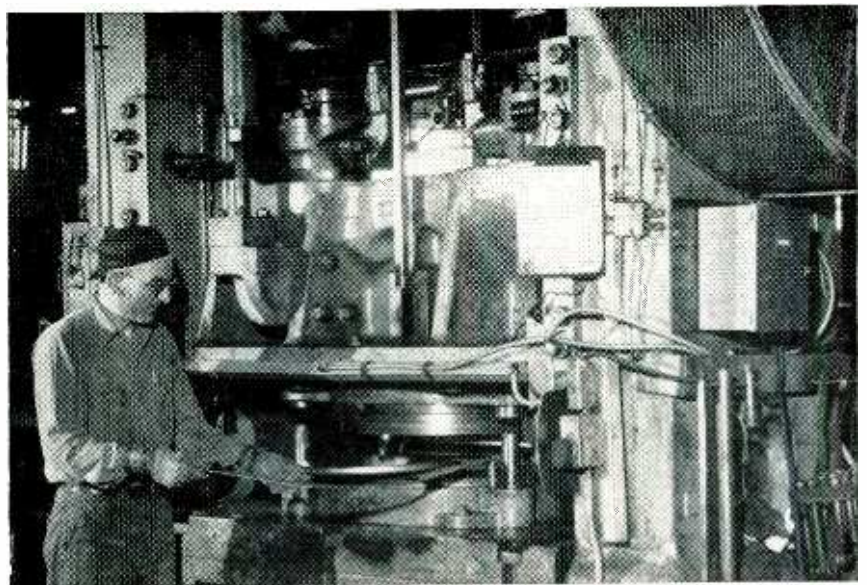

FIG. 8—An oscillator circuit suitable for use with junction tetrodes



Radiation-type safety control installed on small motor-driven punch press



Installation of Hazatrol unit on 215-ton draw press. Geiger tubes are mounted horizontally in housing just above die, and control cabinet is at right on press

ting of potentiometer R_1 .

The thyratron and relay are used in the normally on condition for fail-safe operation.

The power supply uses a conventional half-wave rectifier to supply negative 700 volts d-c to the Geiger tubes. Regulation is accomplished by corona regulator tube V_s .

Geiger-Tube Detector

The halogen-quenched Geiger tubes used are of all-metal construction and have a life unlimited by use. The recent development of these reliable tubes has made the use of radiation controls practical.

The tubes are shock-mounted in the detecting head, and have a $\frac{3}{8}$ -inch sheet of lead shielding on the side away from the danger area as in Fig. 2 to give a sharp transition zone. This is necessary to reduce the region of uncertain operation and to permit the press operator to hold stock in the machine with his hands close to, but not in, the danger area. As many tubes as are required to protect a given size of press are connected in parallel. The leads are brought out through flexible conduit to the control unit, usually on the press frame.

The manner in which the tubes are used, with a large series resistor, results in a nearly logarithmic response of the system to radiation. This is due to the fact that the signal voltage developed across

R_1 is in effect subtracted from the high voltage supplied to the GM tube. At high radiation intensities, the tube terminal voltage becomes progressively lower, the Geiger pulses become smaller, and the average current is somewhat less than a linear function of count rate. The voltage developed across R_1 then varies approximately linearly with distance between radiation source and GM tube, as radiation intensity is proportional to the inverse square of this distance.

Since pulses are not being transmitted, there is virtually no limit to the length of cable that can be employed. The 100,000-ohm resistors in series with the Geiger tubes reduce the instantaneous current surges.

Wristbands

The radioactive material contained in the wristbands is radium, plated on nickel discs. These discs are backed with lead on the surface next to the skin. The maximum range of the equipment is limited by the amount of radiation which can safely be worn on the hands; 1.5 Rep per week is the accepted figure. A wristband safely below this amount (having about three times the amount of radium as the average luminous-dial wristwatch) will give a range of twelve to eighteen inches, inasmuch as the maximum sensitivity of the instrument

is set by the cosmic ray background. Finger rings can also be made radioactive for use in applications where the operator must hold small work close to the die.

Press Controls

With the existence of a suitable electronic system, the safety problem is not yet solved in its entirety. Power presses differ from one type to the next as to clutching and tripping arrangements. In many of the larger presses, control may be accomplished by merely opening an electric circuit. Hydraulic or air controls are also common and are adaptable by use of suitable solenoid pilot valves. Mechanical foot-treadle and dog-clutch types of power machinery, a good example of which is a riveting machine, may be controlled by use of a secondary overtravel linkage inserted into the system at some convenient point. This overtravel mechanism is essentially a solenoid-operated pilot clutch. In all cases, nonrepeat action is desirable.

The system can also be applied to other control problems. The same basic circuit, used with a fixed beta source located in proximity to the detector, is being used as a floor level control on passenger elevators in the San Francisco area. Control is accomplished through interruption of the beta beam by a metal plate.

Stripping Techniques for

Evaluation of hand sanding, chemical stripping, wheel-type stripping, burning, solder-dipping and welding techniques for removing film-type insulations from magnet and wires. Suggestions and examples aid in choosing the best method for each job

By **R. GEORGE ROESCH**

*President, The Eraser Co., Inc.
Syracuse, N. Y.*

WIRE STRIPPING is the method or means used to remove the insulation from a wire, so the remaining wire may serve as a conductor when attached to other wires or terminals. Before soldering a wire to a terminal, the insulation must be stripped off to provide a clean, bright surface. The importance of obtaining good connections cannot be over-emphasized because over 90 percent of all conductor failures occur at or near the joints. Detrimental effects of poor stripping have shown up in coils as long as two years after the coil was wound.

The demand for better and better insulated wires has resulted in

wires that are harder to strip. Insulation has been made thinner to conserve space, tougher to resist abrasion, more flexible to withstand sharp bends, more resistant to heat, more adherent to bare copper, and more resistant to chemicals. Thus, in trying to provide better insulated wire, the wire manufacturers are making wire-stripping problems more difficult. No single method nor no single machine can possibly prove equally efficient under all conditions.

As a guide in the selection of the best method for a particular problem, the commonest methods of stripping film-insulated wires will be considered one by one.

Sandpaper, emery or crocus cloth may be used to remove any type of insulation which may be abraded from the wire. The selection of the best abrasive material depends upon the gage of the wire and the skill of its user. Extreme care needs to be exercised if fine wires are to be completely stripped without damage to the wire.

Time-wise, hand-sanding may or may not prove efficient, depending on specific conditions. There are some situations where it would be virtually impossible to improve upon a hand-sanding method.

Many chemical strippers are available. Generally speaking, these are suitable for nearly all film-type

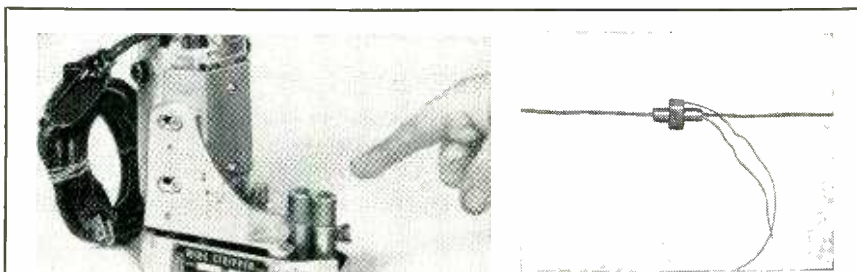

CASE HISTORY NO. 1—A typical choke coil (right) wound with AWG 32 Formvar-insulated wire has two leads wrapped loosely around the coil. These are to be stripped as close to the coil as possible. Conventionally, an operator would unwrap and strip the leads, wrap them around the core again, trim off excess wire and solder and tin the joints.

By thinking in terms of wire processing, the procedure reduces to: (1) Wrap a stripped end of wire around the core wire and wind the coil as usual; (2) Strip the wire coming from the spool, stripping twice as much as needed; (3) Cut the wire in the middle of the stripped portion and wrap the finishing lead around the core wire; (4) Tin-dip both ends or solder and break off the excess wire. The stripped end of wire, as it comes from the spool, is used to start the next winding of another choke coil. The actual stripping operation can be performed either by using sandpaper or by using a small wheel-type stripper (left) that is conveniently located, even on a swinging bracket

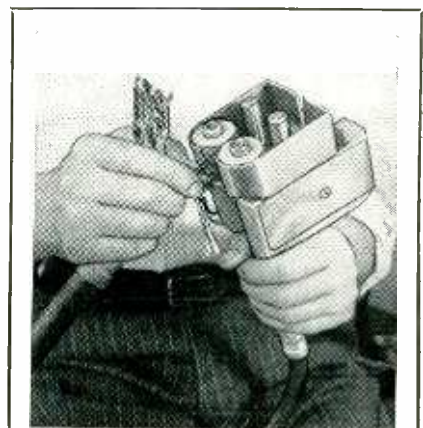

CASE HISTORY NO. 2—The problem here involved stripping heavy stranded leads of a large multi-conductor cable, one end of which was anchored. A selected pair of stripping wheels, driven by a flexible shaft, proved to be the best solution in this example

Insulating Films on Wire

insulations, except Teflon and Ceroc or similar insulations for which there may be no presently known solvent.

There are chemical strippers which have no unpleasant odor and which are not injurious to the skin, but allergies of individuals can cause varying reactions to almost any chemical.

Chemical Stripping

With all chemical strippers, care must be exercised to stop the chemical from creeping, which is often impossible, and to prevent the chemical from coming in contact with the coil or winding. Damage to a coil or winding destroys its value.

Chemical stripping leaves a clean, bright surface. Any size or shape of wire may be chemically stripped. For aluminum wire, chemical stripping seems ideal. Chemical stripping methods may be developed so the stripping can be done as rapidly as by any other method.

Cost-wise, comparisons must be made, considering the cost of the equipment used and the chemicals used, as against the overall produc-

tion attained, per dollar of investment and expense.

For small-scale chemical stripping, just set up a line of test tubes. Fill with chemical stripping solution to the desired level. Use as many test tubes as are necessary, so that by the time the insulation has been wiped off the coil in the last tube in the line, the operator can start at the head of the line again.

If there is a chance that the fumes from the chemical will prove harmful to the winding, float a layer of thin oil on the surface of the chemical.

Wheel-Type Wire Strippers

Perhaps the best known method of removing film-type insulations is by the use of wheel-type wire strippers.

Wires as fine as AWG 50 can be stripped. Depending upon the handling methods, there may be no limit in either the size or shape of wires which can be stripped with stripping wheels.

The determination of the best handling methods is most im-

portant. It will frequently be found more economical to strip wires singly than in groups. Likewise, it may be faster to strip components singly than in groups, even though it may appear on the surface that the more wires you strip at one time, the faster the operation. Handling time is worth careful study.

Many sizes and varieties of stripping wheels are made, each for a particular type and size of wire. The commonest materials are brush wire and glass fibers, used separately or in combination in the stripping wheels.

There is an ideal relationship to be attained between the diameter of the stripping wheels, the surface speed of the stripping wheels, the surface characteristics of the stripping wheels, the density of the stripping wheels and the actual wires to be stripped. This ideal relationship can only be attained by experimentation on the production line, since handling methods produce different results.

Wheel costs are worthy of study. Accurate records should be kept to



CASE HISTORY NO. 3—Because a ballast coil was in very high production, the stripping operation was conveyerized as shown. Three girls on each side at the far end pick out the coil leads, apply a piece of tape, place the coils on the moving conveyor chain and dress the leads outward as above. The leads then pass automatically between the stripping wheels, after which the coils discharge at the front end onto a conveyor belt (not shown) going to the next position. Only two of the three wire strippers on each side are active, the third being a spare. Two strippers insure perfect stripping despite variations in lead positioning and variations in the wires or in their insulation. The two motors at the front end drive the conveyors. A vacuum system draws dust

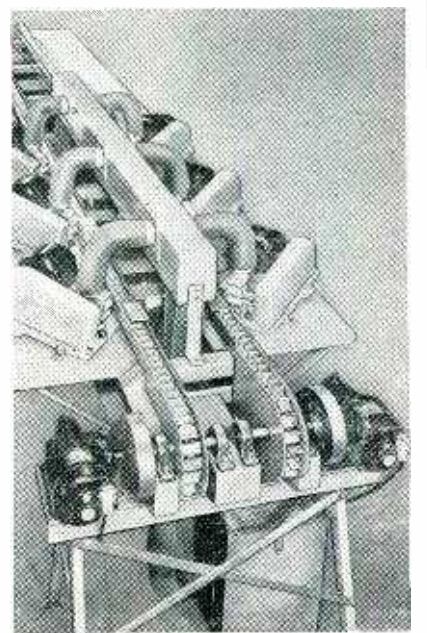

determine the cost of stripping wheels in terms of the number of wires stripped per pair of wheels. It may be that high-priced stripping wheels will prove most economical in terms of cost per-thousand-wires-stripped.

If the stripped wires are to be tinned, the selection of proper stripping wheels may eliminate a fluxing operation. If the operator of a wire stripper can dip the stripped wires directly into a solder pot, time will be saved and costs reduced.

Wheel-type wire strippers have one disadvantage, but it is the users' fault. They expect to be able to do any kind of a stripping job with the same wheel without considering its limitations.

The predominating advantage of wheel-type wire strippers is their versatility. It is only necessary to change from one kind of stripping wheel to another, in order to strip a different gage wire or strip a different kind of insulation from the wire. All film-type insulations may be stripped, including those which cannot be removed by chemical or burning methods. Fiberglass and other kinds of servings may also be stripped.

Litz wires of almost any number and gage may be stripped, using the proper stripping wheels. Even braided insulated wires may be unbraided and stripped on wheel-type

wire strippers if care is used.

Burning or Open-Flame

Equipment has been developed for removing insulation by burning. The copper oxide thus formed is then removed by brushing.

Some insulations, such as Teflon and Ceroc, cannot be burned off. Aluminum wire may melt before the insulation melts. Wires finer than AWG 30 may melt before the insulation melts.

Since it is nearly always necessary to brush the wires after burning, an all-brushing method is generally preferable unless there is some other reason for using the burning method, such as sealing the serving on Litz wires before stripping.

Hot Solder

Formex, Formvar and similar insulations can be removed and copper wires tinned in the same operation. Some so-called Formvar films cannot always be uniformly removed by this method, hence erratic results may be encountered.

If the hot-solder method is used, the pot should contain 50-50 lead-tin solder at not less than 500 deg C.

Wires finer than AWG 30 are almost impossible to strip by the hot-solder method, because one cannot get them in and out of the pot fast enough.

Solder splatter may prove harmful. The tin content must be kept in balance with the lead content by replenishing the tin.

Frequently, insulated wires are twisted together and dipped in hot solder. This may result in high-resistance joints because all of the insulation is not always completely removed. If wires processed by this method can be readily untwisted, there is no complete mechanical bond.

Cost-wise, the hot-solder method may be no less costly than any other method, even though the stripping and tinning is done in the same operation.

Brazing or Welding

Lead wires and coil leads are frequently welded. This method is not ordinarily used on wires under AWG 20. A high-temperature gas flame is applied to heat the twisted or spliced lead to a temperature that just melts the copper. By this method, all the film coating is burned off.

Low-Temperature Solder

There are some thermoplastic films which can be removed by using a resin-alcohol flux and the application of a soldering iron, or by dipping in 650-deg F lead-tin solder. Both wires must have the same insulation on them, or one of

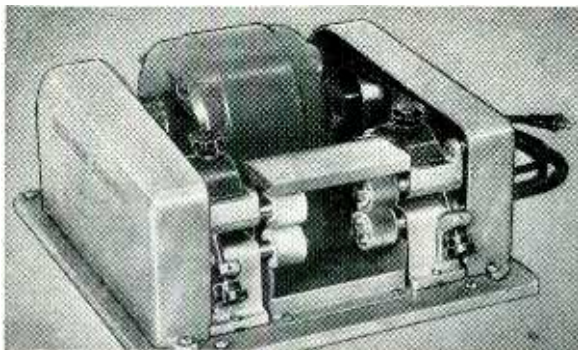

CASE HISTORY NO. 4—Leads of a typical transformer coil (right) having two widely different gages of wire were to be stripped. Sizes were AWG 24 and AWG 36. A single machine has drawbacks; if the leads tangle, the small wire may be broken, and with the wheels set for the finer wire there will be excessive wire on the wheels and high wheel cost. The answer is the twin-headed stripper shown above, having one pair of wheels for each wire. Machine can be set for any size wire

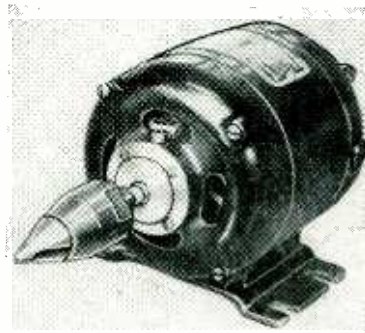

CASE HISTORY NO. 5—Enamel-insulated telephone switchboard wires were to be stripped. The outer covering was removed with a hot-blade stripper, and the ends then inserted in the cone-shaped head of the above stripper to remove enamel. This machine is suitable only for AWG 20 to AWG 24

the wires must be a clean, bare wire.

As with all other stripping methods, the time-cycle needs to be considered. Some claim that the soldering operation is sufficiently faster when the wires are pre-stripped to more than offset the advantages of stripping and soldering at the same time.

Close-Up Stripping

One way to strip wires close up to a coil form is to use a one-wheel stripper with a stripper blade in contact with the stripping wheel. By passing the wires between the blade and the wheel and giving them a quarter-turn, the insulation can be stripped off to within $\frac{1}{8}$ inch of the average coil.

If the coil is small and the wires very fine, AWG 36 or smaller, perhaps a small wheel-type stripper will be the best solution to close-up stripping.

High-Production Considerations

Think in terms of wire processing. Begin to study the operation as the wire leaves the spool or reel. Remember that wire stripping is only one of the many operations performed on each wire. Follow each wire through all operations, until that wire is connected to another wire or terminal. Consider all operations in conjunction with all others.

In following any given wire through its various processing operations, seek out the best time to perform the wire-stripping operation. Here are a few things to be considered:

(1) Speed at which the wire stripping operation should be performed, to tie in with prior and subsequent operations.

(2) Cost of the wire stripping operation, in terms of cost of equipment, amortization period, cost of using and cost of maintenance.

(3) Convenience of using, in terms of ease of operation, operator fatigue and operator training.

(4) Equipment used, in terms of location with reference to other operations, floor space required, accessibility and portability.

To arrive at some of the answers to the foregoing, it is necessary to take into consideration these other factors:

(1) Size, shape and weight of the winding on which there are wires to be stripped. Can the winding be taken to the stripping operation, or should the stripping equipment be brought to the winding?

(2) Size and shape of the wires to be stripped, plus the kind of insulation on the wires.

(3) Location of the stripped portion of the wire with reference to the rest of the wire or the winding. The less the amount of stripping,

the lower the cost.

(4) Number of wires which must be stripped in the same operation and at the same time.

(5) Are the wires to be stripped relatively straight or are they kinked and tangled together? By any stripping method, these conditions will lead to trouble.

(6) Do the windings come to the stripping operation in a convenient and orderly fashion and leave there the same way?

(7) What is to be done with the wires after they have been stripped? How soon will they be connected to another wire or terminal? Will it be necessary to treat the wires to prevent oxidation and with what can they be most economically treated?

Conclusions

Do not try to put all wire-stripping jobs into one class and hope to find a single method or a single piece of equipment which will give satisfactory results in all cases.

Try to think in terms of wire processing, beginning with the spool or reel of wire and following the wire all the way through, until it is connected to another wire or to a terminal. This will invariably reveal ways to improve some operations and make the wire-stripping operation easier, resulting in higher quality and lower costs.



CASE HISTORY NO. 6—Location and length of stripped wires on ignition coils had to be controlled accurately. A rotary stripper having rotating blades was adjusted to the diameter of the bare wire, and the length of stripping was controlled by an adjustable stop inside the machine. Not suitable for wires finer than AWG 24. Housing at left foreground fits over cutting blades, and wire is inserted in conical hole in end of housing. Stripping blades can be removed for sharpening

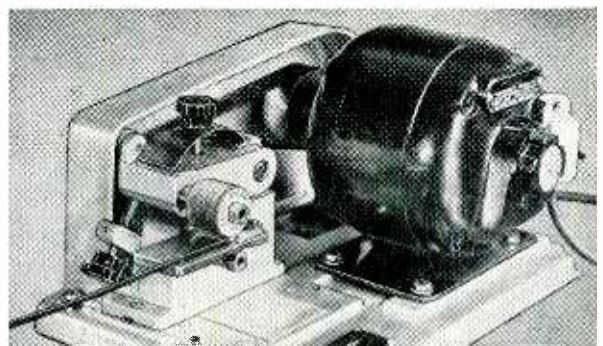

CASE HISTORY NO. 7—To eliminate tedious sandpapering of short rectangular wires for removing $\frac{1}{4}$ inch of insulation from the ends, this one-wheel stripper was developed. A wheel setting is made for stripping the flat sides of the wire and a batch is stripped on both ends, by moving each side of each wire in turn across the entire face of the wheel from one side to the other. This insures even wear of the wheel. The setting is then changed for stripping each edge of each wire end

Television Switcher

By HARRY E. THOMAS

Federal Telecommunication Laboratories
Inc.
 (an I. T. & T. affiliate)
 Lodi, New Jersey



Control console with six inputs and six outputs can be expanded with growth in studio operations. Relays normally furnished in console can be remotely operated if it is desired to shorten video lines

VIDEO transfer or switching is accomplished by connecting a signal source to some particular destination. Such a transition may be made gradually through electronic mixing circuits or abruptly by means of switches and relays. The common video switcher employed in studio equipment uses both types of transfer, the former for programming effects and the latter for rapid and convenient performance of multiple switching.

Rapid or abrupt video switching circuits may in turn be divided into two general categories; those employing direct pushbutton-actuated switches or those employing pushbutton keying switches together with relays to make the actual video transfer at some remote point.

In abrupt switching the transfer may be made by either gap or lap switching—the former meaning break-before-make and lap meaning make-before-break. The usual types of gradual transfer are called fading or lap dissolve. Fade from one signal to another implies complete extinguishment of one signal source before another source is gradually brought up to the appropriate signal level. A lap dissolve means a conjugate variation between two signals but with the signal levels overlapping each other at some predetermined value. These operations are usually accomplished by use of manually operated fader potentiometers associated with the input and output systems of the two sources. Automatic fade and dissolve may be done by variable-time-delay networks in the grid of the mixer amplifier.

Direct switching with interlocking pushbuttons has the advantage

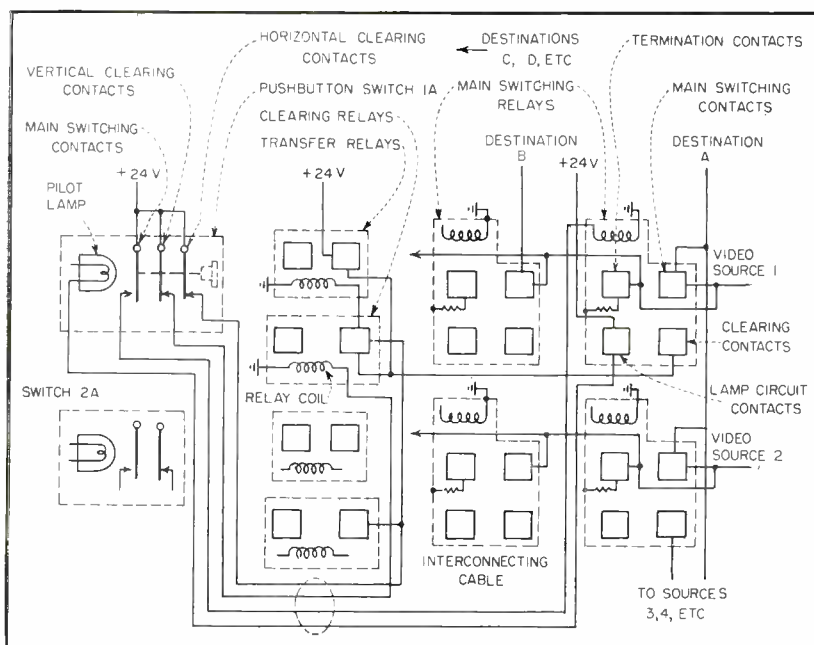

FIG. 1—Simplified block diagram of the switching action. Small squares are relay contacts, relay coils are shown as inductances and termination contacts are grounded through resistors

for Broadcasters

Video transfer unit is compact enough to allow its use near the program director. Push-button operation of relays either mounted in unit or remotely controlled provides channeling as many as twelve inputs to six destinations. Manually operated fader can be used for lap dissolves through distribution amplifiers

of compactness by allowing for a location where the video lines can be connected directly to the switches. Low capacitance contacts make this method fairly free from discontinuity in the transmission line. For local switching with short direct runs of the video cables, this method is probably as compact as any other. Switch timing, however, is not adjustable, and complete interlock is not always mechanically convenient. Remote control is impossible.

Indirect switching allows the video transfer relays to be remotely located from the control panel. For master control or video control centers this results in the advantage of shortened video lines since relay racks can be located near video circuit terminations.

Selecting lap or gap switching sequence is of considerable importance in smooth operation of the studio and any system should have sufficient flexibility to allow for either type in at least part of the switching system. For local signals employing video signals linked to a common sync generator source, overlap switching is used to keep continuity of sweep and synchronizing conditions while transfer is made. For switching remote-to-local using independently synchronized signals, gap switching with fade to black is preferable since otherwise synchronizing circuits in receivers would be upset by the simultaneous presence of two non-synchronous signals. This interval should not be over ten milliseconds to effect synchronism within one field.

Gradual signal transfer by lap dissolve switching or fading by manual control requires auxiliary

equipment centering about geared-down potentiometers and electronic mixing. The manual execution is for convenience, arranged through lever control of two back-to-back potentiometers located directly at the switcher panel. The levers arranged for simultaneous operation move through an arc of about 90 deg arranged so that when they move together the fading is a smooth lap dissolve. At opposite ends of their control, both outputs are conjugate (one full on and the other full off). When automatic control of gradual transition is used, it is accomplished through the inclusion of adjustable time-delay circuits associated with the grid circuits in mixer amplifiers.

General Considerations

A system should operate quickly, smoothly and with a minimum of operations for any one transfer operation. A single push of the finger should form a complete operation.

Since controls are usually in the dim light of a studio control booth the pushbuttons should be illuminated and marked for quick cognizance; they should be in direct view of the operator.

A relay system should generally have mechanical features of reliability, replaceability, ease of switching and convenience of operation. The relays and switches, heart of the system, are preferably d-c operated and should be rugged enough to withstand all vibration and life-test standards including temperature and overvoltage operation.

Ease of adjustment is an important feature. Relays and switches should be accessible to bending and

adjusting tools for arranging the lap or gap sequence. Dust covers should be provided for long unattended operation and the lamps, switches and relays should be readily replaced.

The design should provide flexibility by which the small station may have opportunity to add channels when facilities are expanded without unduly revising the whole studio setup by addition of new racks and rerouting of wiring.

The switcher unit should have versatility within the studio to serve the dual purpose of a program director's console or to be usable in master control or video control positions. For a program director's console where short lines can run direct to the relay racks, it is advantageous to have the relays in the console. A director can thus have control of the switching and fading of two, three or four cameras and still be divorced from the intricacies of technical direction. The unit should be equally adaptable to master or video control positions where other requisites occur.

A large switching capacity in the way of input lines and output lines should exist in a console layout to give master control a wide surveillance of all studio, remote and film sources. Economy of design in simple inexpensive switches and relays is an attractive feature for the small station.

Electrical Characteristics

Electrically, the system should have the following characteristics.

True lap or gap switching are provided with flexibility to adjust for a certain amount of either. Cross-talk between the input and output

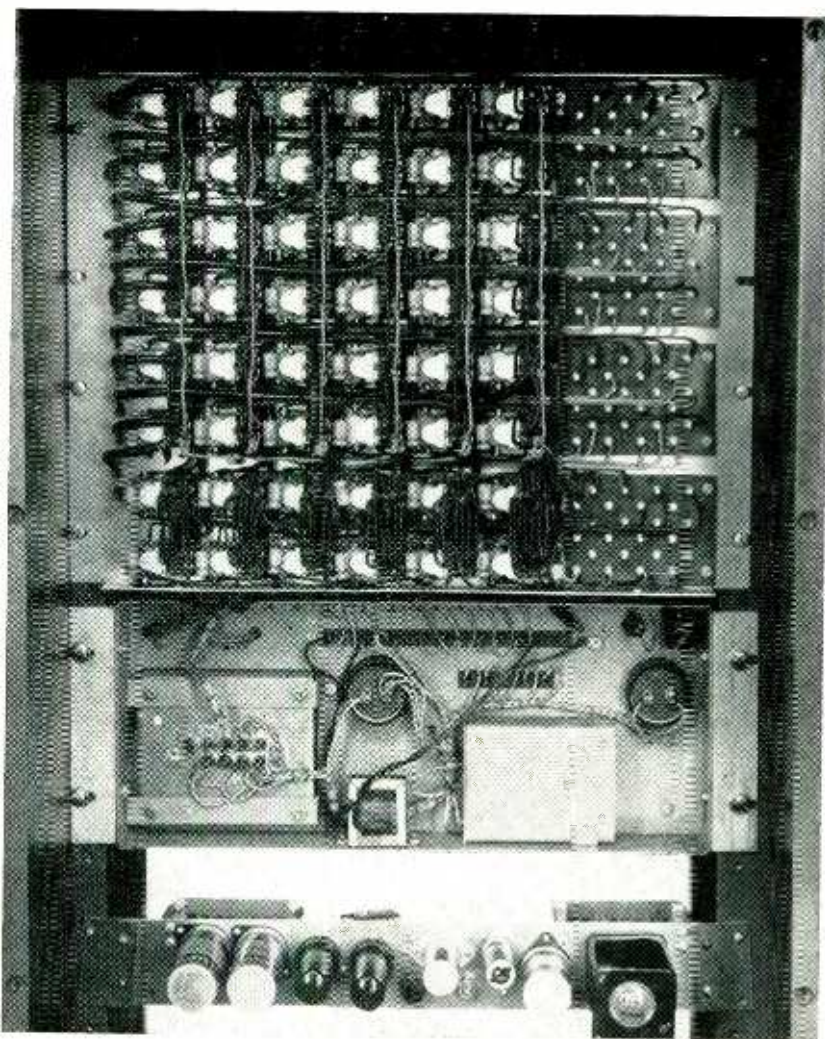

Rear view of the control console shows relays mounted on rack within. Below are power supplies for tally lights and relay operation on direct current. A single distribution amplifier is included

lines should be lower than 60-db interference on any one output from any other output. Transmission line mismatch should be of sufficiently low magnitude to maintain picture resolution and eliminate reflection troubles. Interference from relay transients, arcing contacts and induced hum on signal circuits should be of a low value and never visible on a monitored video signal. Gradual electronic transfer should be accomplished conveniently whether by manual or automatic means.

Ideally in such a system the actuation of any one button should perform the following functions. Input and output circuits should be automatically cleared; that is, all sources or signal destinations connected with the pushbutton under operation other than the connection to be made should be automatically

disconnected. For instance, if the signal source buttons are arranged in horizontal rows and the destinations are in columns, the pushing of any one button should clear the column and also clear the row in which is located the selected button. Clearing can be accomplished by a separate operation, but in many cases, particularly during a program, such lost time is annoying and automatic clearing is a distinct advantage.

Objection to the feature of destination clearing or vertical clearing when two outputs are connected to one input is overcome by the provision of extra input facilities; for instance, when two outputs from the same input are desired, duplicate inputs are usually supplied through a distribution amplifier and these two sources punched up; that is, switched to the two desired

destinations. In this way, either common input can be switched independently of the other with no interference encountered from vertical clearing.

After clearing, the relay actuated should complete the video switching desired, and connect some source to its desired destination; this is the central action of the complete system.

The active relay should apply power to illuminate the actuated pushbutton.

Sources disconnected by the clearing action should be automatically terminated by the switching relay.

Release of the actuated button should keep the system functioning or switched to the above desired set of conditions but in readiness for starting the complete cycle over again.

Equipment for Use

The FTL-89A, as a fundamental structure, is an indirect switching system arranged to be mounted as a completely self-contained unit in a 19-inch console. It is designed to be expanded from a six input-six output system to a six input-twelve output system. A fader mounted on the desk-top shelf is interconnected to the main switching system through a mixer amplifier to make available the various types of gradual transfer.

Although the switches and relays are mounted in a single console the system allows the relays to be remotely located so the pushbutton switch panel may be placed wherever most convenient. An auxiliary arrangement can be made to include a remote fader system where such is desired. Relay power is supplied from 110 volts a-c through a 24-volt self-contained power supply.

The circuit arrangement employs automatic clearing and internally illuminated pushbutton switches. Relays are accessible by an operator directly from the front of a console cabinet; lamps and switch adjustments are likewise available by tilting back the front panel. Automatic clearing, automatic termination of video sources and automatic holding after momentary pushbutton action are included. Adjustment of the switches allows for either gap or lap switching. A lap of several

milliseconds can be attained and gaps of any time between zero and twenty milliseconds are possible.

Although the relay contacts on video sources and destinations are in parallel and add capacitance to ground, relays are closely spaced with sufficiently low capacitance to ground that the transmission line discontinuity is negligible. Cross talk between lines is likewise low.

Switching Details

The automatic clearing system uses auxiliary relays that conveniently tie in cycle-wise with the remainder of the system. This method was chosen in preference to mechanically actuated systems because the latter must clear the circuits by means of latch bars or auxiliary clearing mechanisms. Complete clearing of both source and destination circuits by this method in a simple mechanism may sometimes be mechanically difficult.

In the momentary pushbutton switch that is used (in which the actuating button when once operated returns to its original position) there is a need for a second set of auxiliary relays to maintain the system in operated condition while the switch is moving back to original position. These so-called transfer or holding relays have operating characteristics similar to the other relays in the system and likewise tie in with the overall switching cycle.

The internally illuminated pushbutton assembly utilizes a simple commercial switch with a 6.3-volt

pilot lamp and a lens system incorporated in the pushbutton plunger. Pilot lamps are easily changed through the rear of the switch panel.

The fundamental switching cycle is accomplished by three contact operations in the switch itself besides four in the main video switching relay as shown in Fig. 1. Briefly, one break contact in the switch clears the sources in any one row of signal inputs; another clears the destinations in any column of signal outputs while the third makes contact to apply power to the relay directly connected to the button actuated and thus performs the control function or makes the desired connection between input and output.

The relay functioning can be best described in a direct example. When relay 4C has been actuated (input 4 and output C) one set of its contacts completes the desired connection of input and output. The second set of contacts automatically disconnects the terminating resistor from source 4 so that the connection of C output will not provide double termination. The third set of contacts applies filament power back through the interconnecting cable to 4C pushbutton to illuminate it. The fourth set of contacts operates through the transfer and clearing relays to hold power on the relay coil itself while the pushbutton is returning from its momentary contact.

With the pushbutton back in original position video switching

has been accomplished. The horizontal and vertical clearing circuits are restored through closure of switch 4C contacts and the clearing and transfer functions disengaged. The system is ready for re-enactment of another cycle.

The timing of gap and lap switching is thus a function of the timing of break and make of the switch contacts since the time of relay opening of the clearing relays and the time of closing the main video switching cancel each other. By adjusting the gap between break of the clearing contacts and the make of the main video switching interval can be controlled.

Fading System

A two-channel video amplifier, for which one channel is shown in Fig. 2, permits the output of each of its channels being fed into a

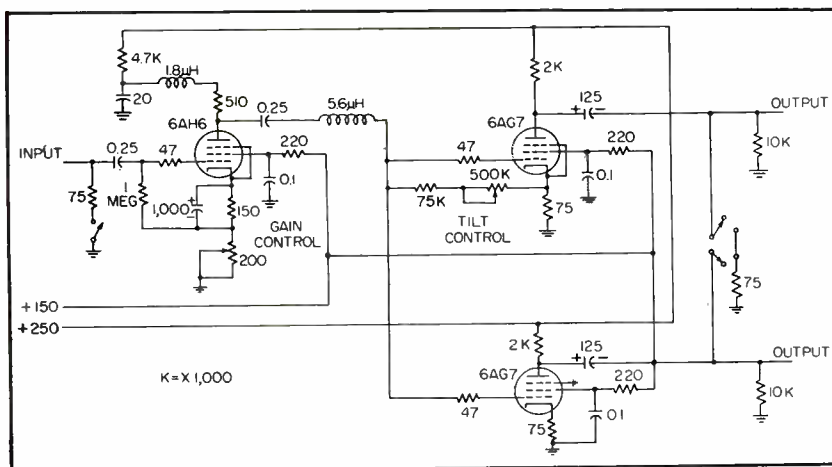

FIG. 2—One channel of two-channel distribution amplifier with frequency 3 db down at 10 mc. Output impedance is either 75 or 10,000 ohms. Tilt control maintains 60-cps square wave within ± 2 percent

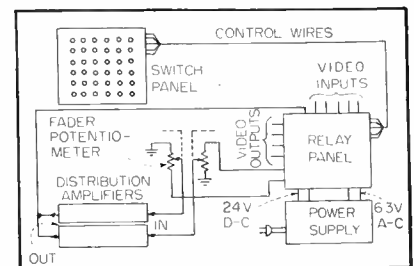

FIG. 3—Any two sources may be controlled or faded and fed back into video inputs for further switching

fader control potentiometer. By appropriate switching of two destination connections to the input of the video amplifier, its two outputs can be mixed in the control potentiometers. With the single fader output connected to another switcher source terminal, any two signal sources may be controlled, faded and routed out through any of the remaining channels. A sample block diagram of the unit interconnections to accomplish this effect is given in Fig. 3.

In order visually to tie the fader tally lights into the destination video outputs, they are colored to match the buttons of the bottom two rows of pushbuttons on the switcher panel. A row of red buttons located elsewhere on the panel is provided to indicate an important output—usually the line output to the transmitter or relay link.

Electron-Microscope

Simple two-tube balanced amplifier operating tuning-eye tube detects power-supply fluctuations not indicated by panel meters or on the final viewing screen. Blurred photographs are eliminated when circuits are checked before operation. Worn controls show up quickly during servicing

PERFORMANCE of the electron microscope depends in large part upon the stability of the power supplies for the various lenses and for the high voltage used to accel-

erate the electron beam. The most critical power supplies are those for the high voltage and for the objective lens.

The electron microscope is com-

monly energized from a 1-kva constant-voltage transformer plus a regulated 370-volt d-c supply in the chassis for the plates of various tubes. In addition, individual electronic stabilizing circuits are used to correct fluctuations in the high-voltage unit as well as in the several lens supplies. The high-voltage ripple is usually not allowed to exceed 0.5 volt peak-to-peak at 50 kv. The objective lens current is held constant to within about 0.002 percent.

Defocusing Causes

Minimal fluctuations having an adverse effect upon the image are not visible on the standard panel meter in the circuits involved, so that from time to time an oscilloscope or other instrument must be used to check the power supplies. Noisy reference batteries, poor contacts in the focusing controls and corona or other difficulties in the high-tension circuits may have deleterious effects upon the final image.

Balanced Amplifier

It appeared desirable in view of the number of sources of possible trouble to add a permanent monitoring unit to the microscope, which could be switched from circuit to circuit and would respond only to the fluctuations. It could serve as a check at all times on the stability of the power supplies and as a device for the localization and correction of troubles in these circuits.

Accordingly, a two-stage resistance-capacitance coupled amplifier

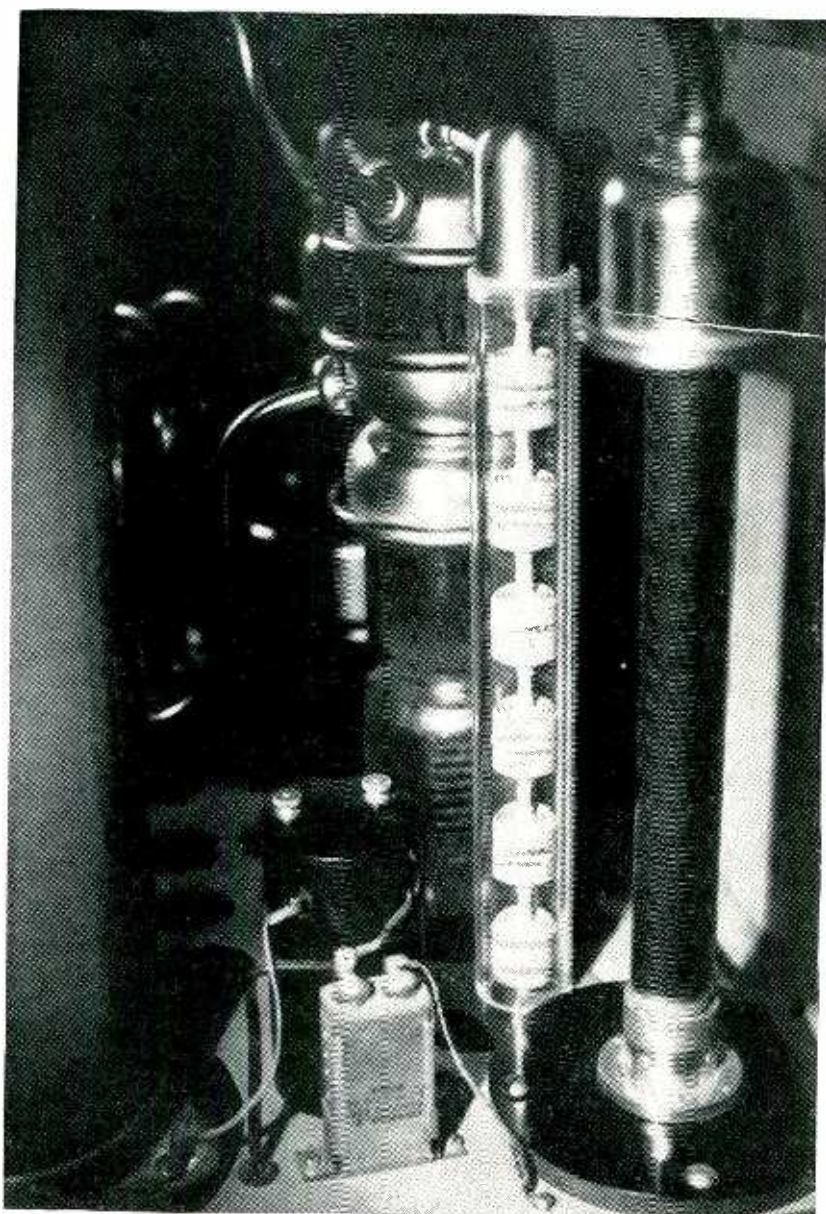

Capacitor voltage divider mounts on the high-voltage shelf of standard electron microscope. Lucite tube protects the stack from dust

This paper was based on work performed under contract AT-04-1-GEN-12 between the United States Atomic Energy Commission and the University of California at Los Angeles.

Power Monitor

By FRANCIS W. BISHOP

Atomic Energy Project
School of Medicine
University of California
Los Angeles

was constructed using two 6SC7 twin-triode tubes. These tubes have a common cathode and in a balanced circuit are quite insensitive to fluctuations in their own power supply. The input is capacitance-coupled to the various circuits to be measured by means of a double-pole five-position selector switch. One setting short-circuits the input terminals for balancing the unit itself. The other four positions as shown in Fig. 1 are connected to the condenser, objective and projector lenses and the high voltage, respectively.

Voltage Divider

A capacitor voltage-divider was installed on the high-voltage shelf with terminals for connecting an oscilloscope if desired. It was necessary to include an r-f filter to eliminate pickup from the 75-kc oscillator of the high-voltage power supply. All leads to the various lenses, the windings of which are several hundred volts above ground potential, are shielded. The posi-

tive terminal of the high-voltage supply is grounded. The connections to the amplifier are made by plugs at the back of the control panel for easy disconnection when this part of the microscope requires servicing or other maintenance attention.

Output Monitor

The output of the amplifier may be brought to a high-resistance voltmeter on the panel or to a tuning eye tube. When switched to the various lenses, the slightest

movement of the focusing controls produces large fluctuations in a zero-centered indicating meter or the tuning eye. Several previously unnoticed spots of poor contact in these controls were discovered the first time the device was used. Although the controls were set at the points where the fluctuations as seen on the eye were comparatively large, no change in the image could be noted visually on the final viewing screen. Examination of plates exposed under these conditions revealed, however, a slightly blurred image. The photographs were sharp when the disturbances were absent.

The instrument is capable of revealing fluctuations in the power supplies that are considerably less than those able to affect the image on the photographic plate. Extremely slow changes may not be detected but on the other hand these are not a serious factor for the photographic exposures are relatively short.

The device may be used to maintain the microscope at a high level of operating perfection, to detect and correct incipient difficulties and to function as a trouble-shooting instrument as needed.

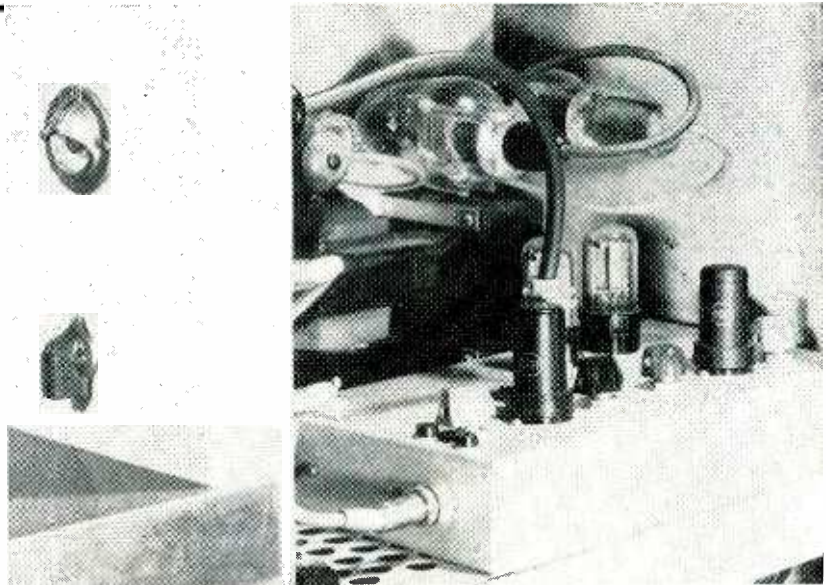

Tuning-eye tube and selector switch are mounted on the front panel of the cabinet. Amplifier chassis fits into space behind panel

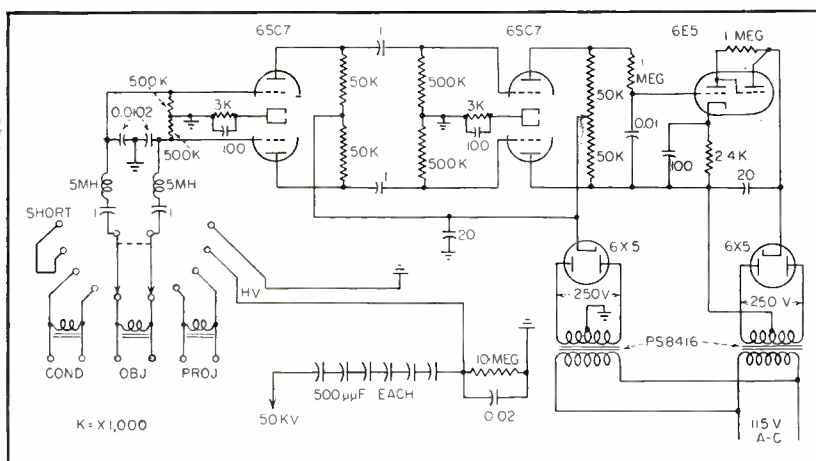

FIG. 1—Complete circuit diagram of the power-supply monitor for electron microscopes

Quick-Change Breadboard

Versatile breadboard design uses standard insert panels for individual sockets and larger components, arranged in any desired order between permanent ground and plate-voltage bus-bars. Finished assembly is sufficiently sturdy for rigorous field testing

A TRULY versatile breadboard assembly system should provide a means for collecting and storing mounting panels so they can be inserted and fastened in whatever order the circuit demands. The design shown in Fig. 1 meets these requirements for any conceivable electronic circuit, by permitting the addition or subtraction of complete tube stages with minimum effort. Laying out a blank chassis and cutting mounting holes for components are practically eliminated.

By **ROBERT E. PROUTY**

*Airborne Sonar Branch, Sound Division
Naval Research Laboratory,
Washington, D. C.*

Use of the versatile breadboard involves choosing a mounting panel for a particular socket or component, fastening the component to the panel, then inserting and securing the panel on the special chassis frame in its proper sequence according to the schematic diagram. Blank inserts are provided to permit adequate spacing

between larger components. Without relying upon guesswork or broad experience, the average engineer can develop on this breadboard a prototype of a compact well-designed chassis. After working out circuit design problems and dressing critical leads, the breadboard can be immediately bolted to a blank panel and rack-mounted for field testing.

Special mounting panels can be manufactured in quantity for any conceivable type of component. Two

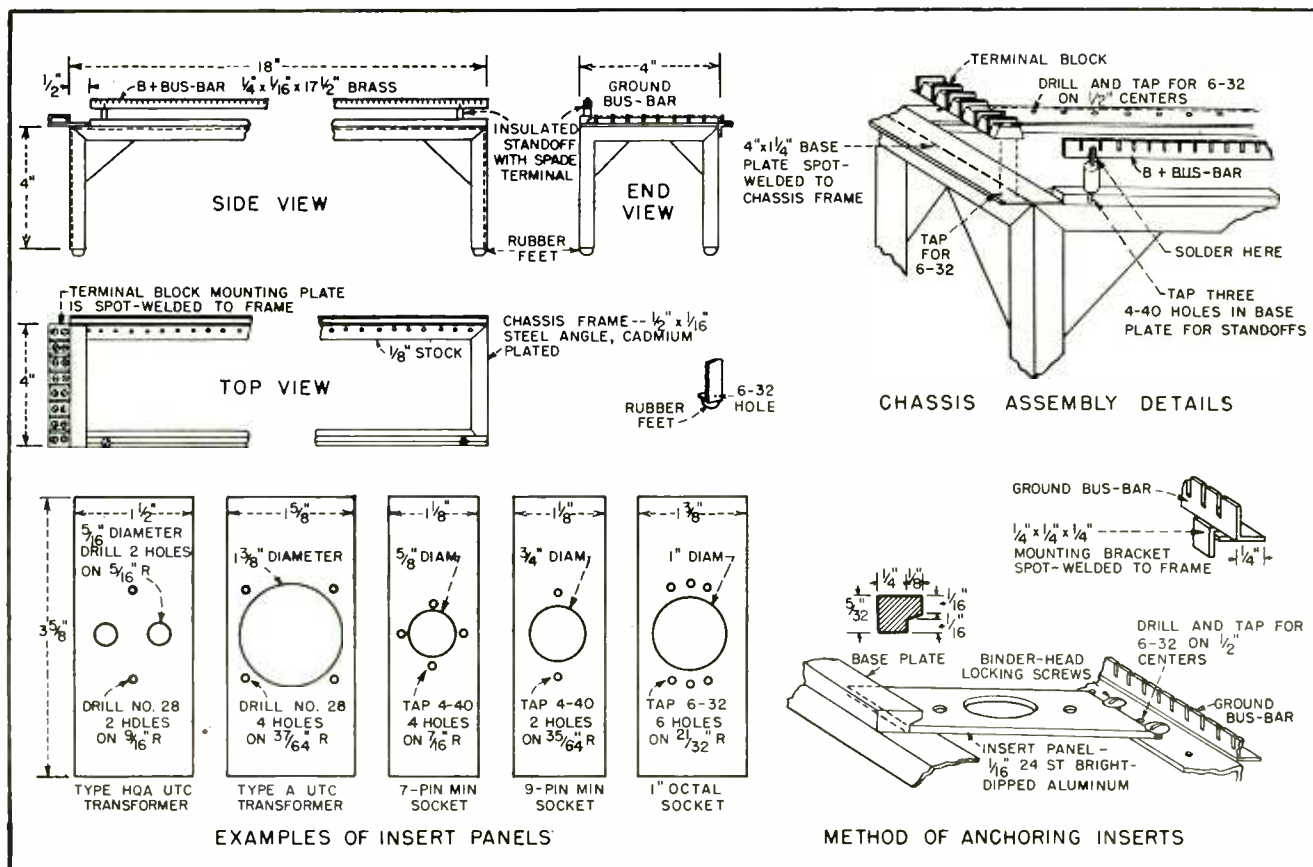
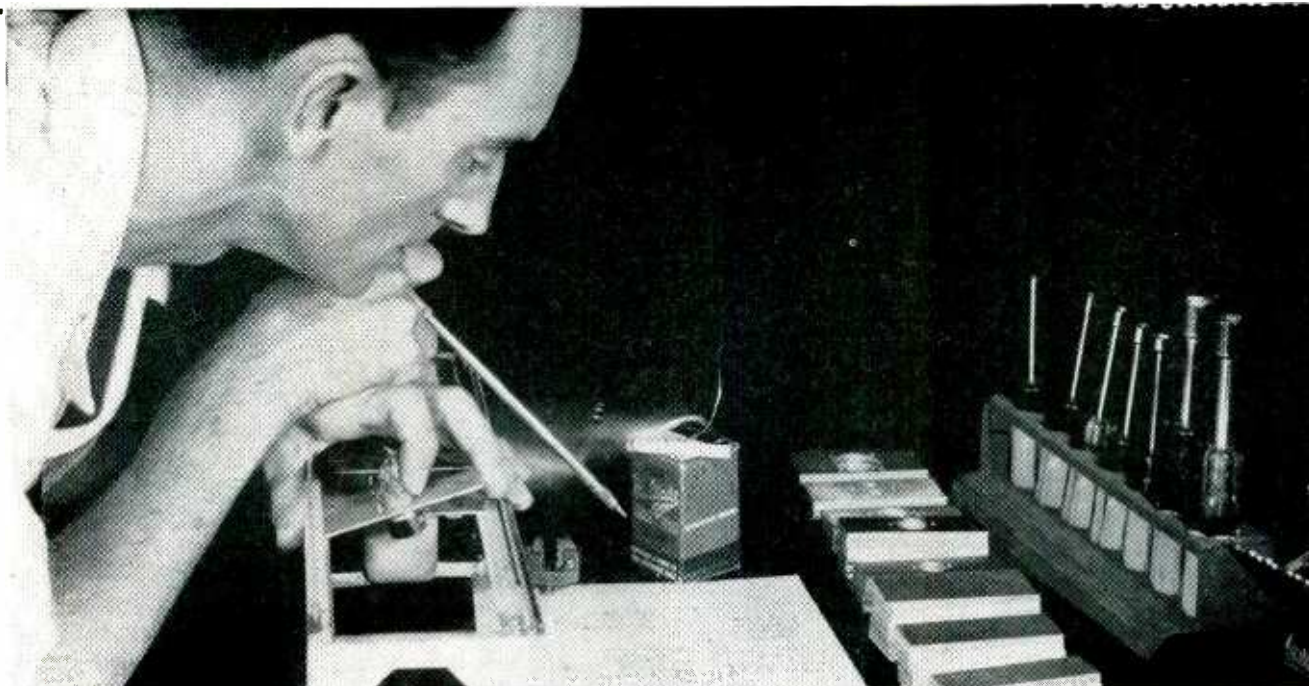

FIG. 1—Suggested construction and dimensions for versatile breadboard chassis capable of holding as many as ten tube stages. Blank insert panels of various widths are kept on hand for use as spacers, to get room for small components wired between tube sockets.

for Circuit Research



With good stock of insert panels, complete circuit can be produced directly from schematic diagram, without laying out and drilling a single chassis hole

requirements must be met—the thickness of the panel should not exceed $\frac{1}{8}$ inch and the length or vertical dimension must be exactly $3\frac{3}{4}$ inches. For economy, 24ST bright-dipped aluminum is suggested for the construction of the mounting panels. The panels can be expendable, or reused, as desired.

Construction Details

Considerable time was spent in developing a bus-bar that would satisfactorily accommodate all soldered components. The final design was subjected to field tests over a period of months. Not one joint came unsoldered, nor did a single component vibrate loose. The bus-bars provide solid joints and yet permit much easier removal of components when necessary, since there are no wrap-around connections.

The ground bus-bar is $\frac{1}{4} \times \frac{1}{4} \times 18$ -inch brass angle stock $\frac{1}{8}$ inch thick. The B+ bus-bar is $\frac{1}{4} \times 18$ -inch brass strip $\frac{1}{8}$ inch thick. The notches in both bus-bars are milled with a 0.050-inch blade to a depth of 0.15 inch on $\frac{1}{4}$ -inch centers. The finished bus-bars are silver-plated.

Any metal which is a good conductor and which can be soldered is satisfactory as bus-bar material. A $\frac{3}{16}$ -inch thickness might be more desirable than the $\frac{1}{8}$ -inch strips for bus-bars.

The chassis frame is made of $\frac{1}{2}$ -inch cadmium-plated steel angle iron $\frac{1}{8}$ inch thick, with $\frac{1}{4}$ -inch thickness for the tapped-hole strip to insure that the tapped holes will remain satisfactory after repeated usage. Binder-head screws are used in these holes to secure the panels in position. Where circulating chassis currents are involved, the ground bus-bar should be riv-

eted or screwed to the chassis directly opposite each critical tube or part.

Insert Panels

Dimensions for some panel holes are not given, primarily because these are suggested types of panels which may or may not appeal to everyone. Blank insert panels can be made up to any desired width, to serve as spacers.

All rights to this versatile breadboard design have been assigned to the United States Government by the author, for the best interests of the electronic field.

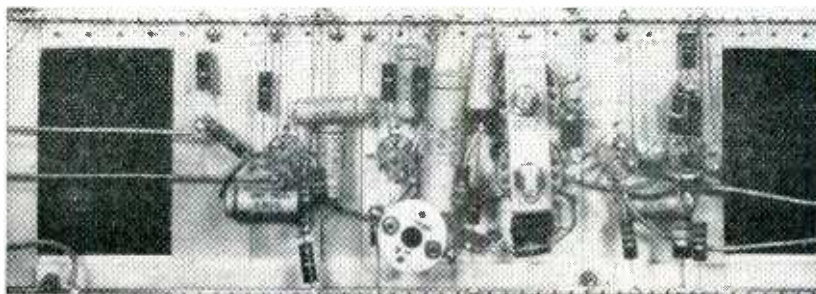

Top view of breadboard on which complete four-tube circuit has been wired. Tubes are upside down underneath, and remain that way during testing. Plate-voltage bus-bar is at bottom, and ground bus-bar at top in this picture

Wide-Angle Scan

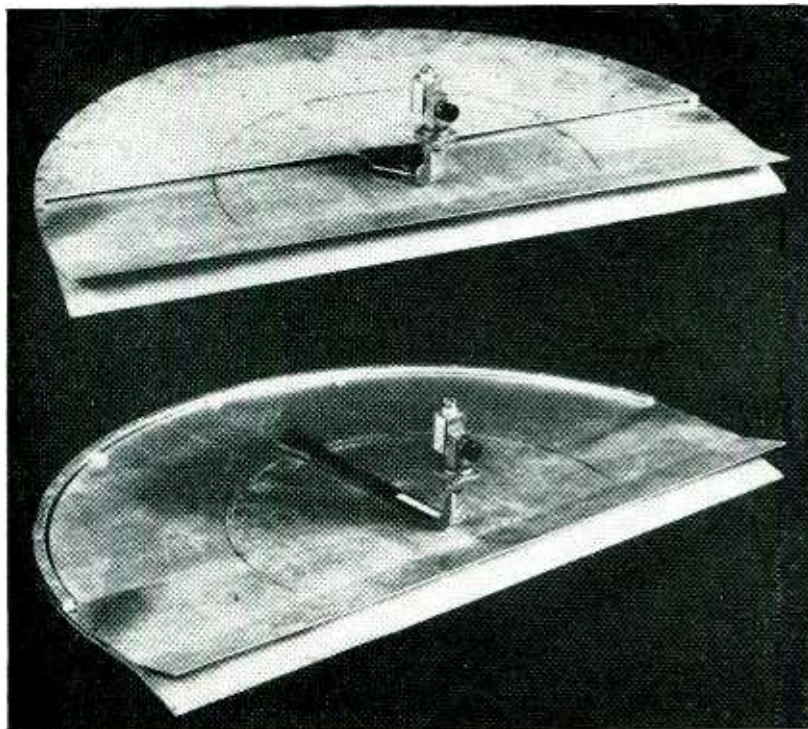

Microwave Schmidt antenna is two-layer pillbox (top). With top plate removed (bottom), rotating feed horn, cylindrical reflector and coupling slit are visible

By H. N. CHAIT

Naval Research Laboratory
Washington, D. C.

width can be varied from three to at least 12 degrees simply by varying the feed-horn aperture size from about 0.9 to four inches. Side-lobe level was -20 db or lower at all times. Thus, a scanning system may be designed in which beamwidth can be varied over the scan sector.

The Schmidt microwave focusing system, shown in the photographs, consists of two parallel-plate regions separated by a common plate. The upper region contains the rotating feed horn and the lower region contains the correcting lens and output aperture.

In the lower photograph the top plate of the antenna has been removed to show the rotating feed horn. The long slit in the common plate is of proper dimensions¹ to effect coupling between upper and lower regions. The radius of the circular reflector of this 3.2-cm antenna is 18 inches providing an available aperture width of 36 inches.

A sectional view of the two-layer pillbox is shown in Fig. 1. The feed-horn aperture is located on the focal surface of the circular reflector and is pivoted about the center of curvature to produce the angular scan.

Energy leaving the feed horn propagates through the upper region of the pillbox until it strikes the circular reflector. The dimensions of the long slit in the common plate are so chosen that the energy passes from the upper to the lower region of the pillbox. Energy now propagates through the lower region of the pillbox and the correcting lens to free space. The correcting lens is made of polystyrene.

The lens corrects for aberrations introduced by the circular reflector

MILITARY and commercial radar systems frequently require that a volume in space be scanned by the radar beam. Scanning in some radar fire-control systems requires oscillation of the radar antenna array while in certain air-navigation approach-control systems, scanning is accomplished by mechanically switching the antenna feed system to produce dual narrow radar beams that alternately illuminate each side of the airport runway.

The problem of developing a microwave antenna system for more rapid scanning is under study at Naval Research Laboratory. One proposed solution is the organ-pipe radar scanner¹. Another approach is the adaptation of wide-angle optical systems to microwave use. This paper describes some results obtained in adapting the Schmidt optical system, almost universally used in projection television receivers², to microwave use. A method for improving off-axis per-

formance of Schmidt systems in general is also described.

The study has shown that the Schmidt system can be used at microwave frequencies to provide a good wide-angle scanning antenna. A 20-beamwidth scan has been obtained with the corrected Schmidt system without deterioration of beam characteristics. It is possible that this can be extended for systems with narrower beamwidths.

The Schmidt antenna was also found to be useful as a variable beamwidth antenna. Antenna beam-

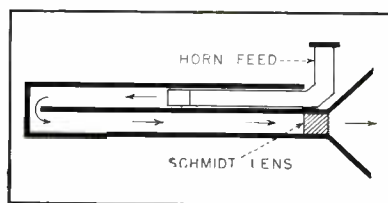

FIG. 1—Cross section of Schmidt pillbox shows path of microwave energy from horn feed to output aperture

Radar Antenna

Microwave analog of Schmidt optical system permits 20-beamwidth scan with side-lobes 20 db down from peak intensity. Feed horn pivots about center of curvature to illuminate cylindrical reflector while special polystyrene lens restores plane wave front

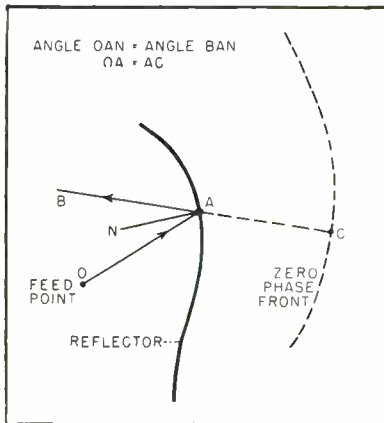

FIG. 2—Snell's Law construction illustrates zero phase front of a reflector

so that the outgoing wave can be considered plane. The parallel-plate mode utilized is the TEM mode although it is possible to design a similar pillbox using the TE_{10} mode.

Equations of Lens Surface

The optical Schmidt system⁴ consists of a spherical mirror together with a thin, refractive lens located at the mirror's center of curvature. The focal surface is spherical in shape and concentric with the mirror. It is located approximately half-way between the mirror and the lens.

Optical workers have employed a variety of techniques⁵ to determine the contour of the aspheric Schmidt corrector. In most cases a series-type approximation was used to simplify the calculations. Since the work at NRL required investigation of a system with a small focal-length-to-aperture ratio, an exact rather than an approximate series-type solution was needed in calculating the correcting lens for the microwave analog of the Schmidt optical system.

An exact solution was obtained by employing the zero phase front method⁶. The zero phase front of a reflector is found in the following manner. It is first assumed that all rays obey Snell's Law, that is, the angle of incidence is equal to the angle of reflection, and the incident ray, the reflected ray and the normal to the surface lie in a plane.

Referring to Fig. 2, if a reflected ray such as AB is extended backwards a distance AC equal to the distance between the feed point O

and the point of reflection A, then the zero phase point of this ray is determined at C. The zero phase front is defined as the locus of the zero phase points for all rays striking the reflector.

Zero Phase Method

An exact solution may be found by use of the zero phase method. If the outer surface of the lens is made plane, the co-ordinates of the points on the inner surface of the lens are found to be

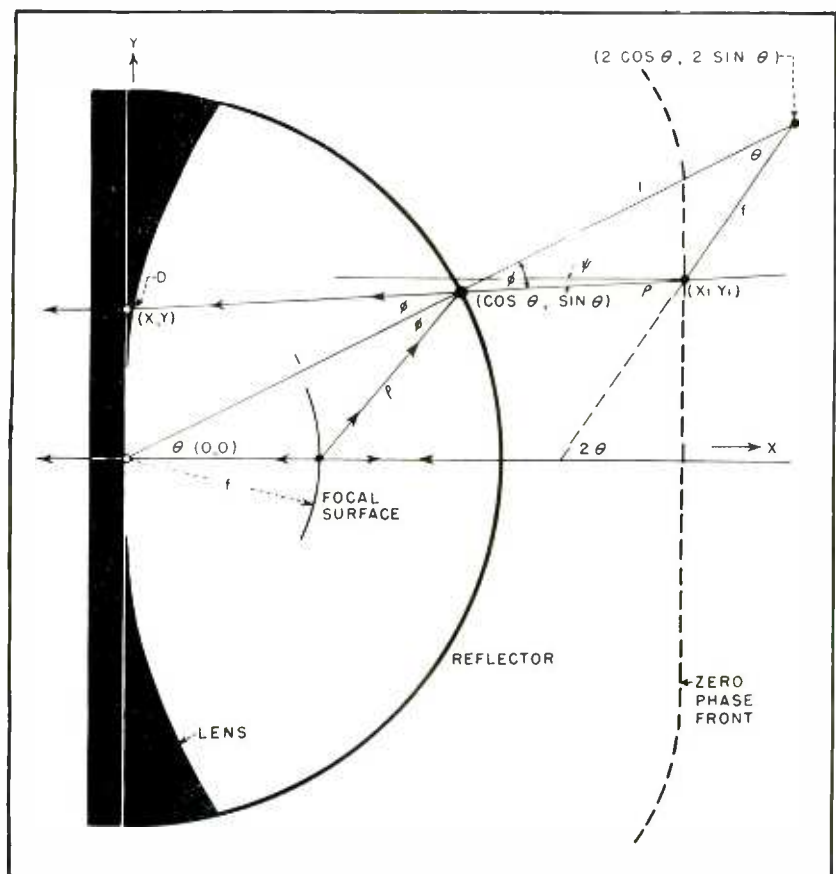
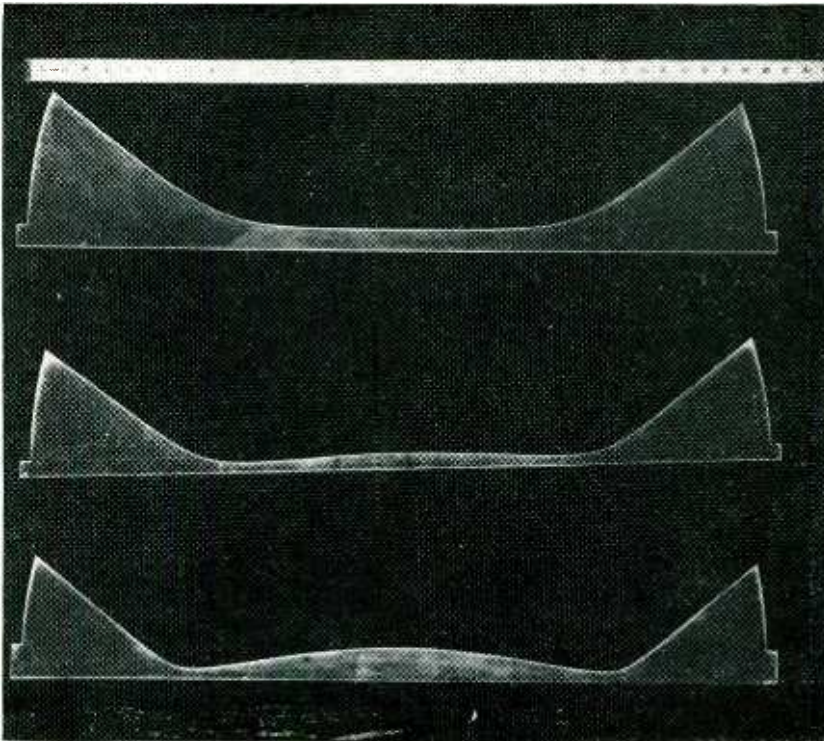

FIG. 3—Diagram of Schmidt optical system defines parameters used in solving for co-ordinates of correcting lens surface by zero phase front method



Correcting lenses made from polystyrene dielectric. From top downwards these lenses have focal lengths of 9.0, 9.9 and 10.8 inches

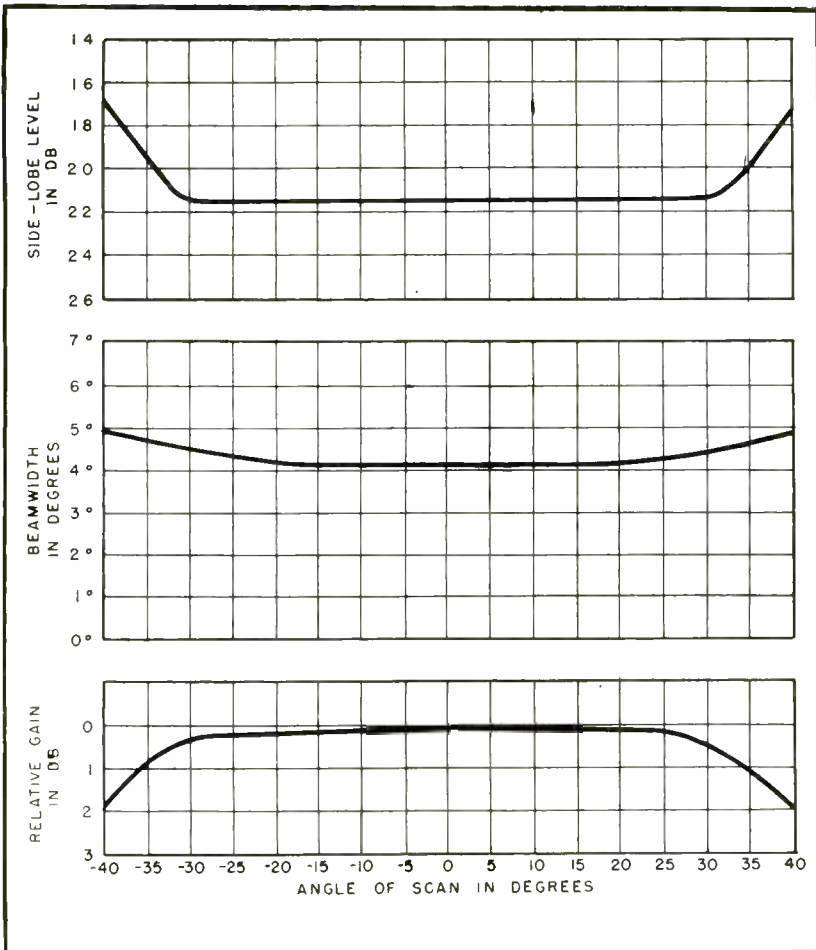

FIG. 4—Variation of side-lobe level, beamwidth and relative gain with scanning for Schmidt antenna with 9.9-inch focal length lens

$$\begin{cases} x = 1/\Delta [2 \cos \theta - f \cos 2\theta - c \cos \psi] \\ y = 1/\Delta [(2 \sin \theta - f \sin 2\theta) (1 - n \cos \psi) \\ - c \sin \psi + n \sin \psi (2 \cos \theta - f \cos 2\theta)] \end{cases}$$

where

$$\begin{aligned} \Delta &= 1 - n \cos \theta \\ \psi &= \theta - \phi \\ \phi &= \sin^{-1} f \sin \theta / \rho \\ \rho &= [1 + f^2 - 2f \cos \theta]^{\frac{1}{2}} \\ c &= 2 - f \end{aligned}$$

The above parameters are defined in Fig. 3, except for n which is the index of refraction of the material from which the lenses are fabricated.

The equations show that the lens contour is uniquely determined once the index of refraction n and the focal length f are chosen. The focal length is defined as the distance from the center of curvature of the reflector to the paraxial focus.

For any values of these parameters, the Schmidt provides perfect focusing when the beam is on axis. However, once the beam is moved off axis the system is no longer in perfect focus, but it was thought that the off-axis behavior of the Schmidt could be optimized by the proper choice of the parameters f and n .

Microwave Adaptation

For convenience it was decided to fix the index of refraction n and to investigate the properties of the Schmidt as its focal length f was varied. Polystyrene was chosen for the lenses because of its low loss, its availability in pieces of sufficient size and because its index of refraction ($n = 1.59$) at microwave frequencies is close to that of glass at light frequencies.

The choice of f was more difficult. However, it was possible to examine the effect of this parameter on the system by employing standard techniques from optics.

As a result of previous theoretical study, focal lengths of $f = 0.50, 0.55$ and 0.60 were chosen and three lenses were designed to fit the 36-inch reflector. The three polystyrene lenses are shown in the photograph. Their actual focal lengths from top to bottom respectively are 9.0, 9.9 and 10.8 inches. These actual focal lengths correspond to the normalized focal lengths quoted above.

Far-field radiation patterns of

the two-layer pillbox alone were first taken to check its design. These measurements indicated that the pillbox was satisfactory and could be used in further testing of the Schmidt system.

Side-lobe level, rather than beam-width and gain, was used as a measure of merit of the various patterns of the Schmidt because the side-lobe level is more sensitive to changes in the system than either the beamwidth or gain.

The off-axis performance of each of the three lenses was checked by taking far-field radiation patterns as various feed horns were used as primary radiators. It was found that all on-axis patterns were equally good, that is, the side lobe level was at least 20 decibels below peak intensity at all times. However as the beam was scanned off axis, rapid deterioration of the beam occurred with certain combinations of feed horns and lenses.

Off-Axis Behavior

It was found that the lens designed for the normalized $f = 0.55$ had better off-axis characteristics, that is, lower side lobes and a narrower beamwidth, than the other two lenses when illuminated by the same feed horn. It was also found that the performance of this lens could be optimized by using a feed horn whose intensity is 10 db down from peak intensity at ± 40 degrees. If $f = 0.55$ then θ can be as great as ± 40 degrees without serious aberration.

Figure 4 shows the variation in side-lobe level, beamwidth, and gain (relative to the on-axis condition) as the beam is scanned. Notice that a total scan of 16 beamwidths can be obtained with a side-lobe level of 20 db or more below peak intensity. The deflection of the beam, as the feed horn was moved along the focal surface, agreed very closely with the angular deflection of the feed. In other words, the Schmidt has a beam factor of unity.

Off-Axis Correction

Ray tracing conducted on the Schmidt indicated that the physical aperture increased as the beam was scanned off axis. Referring to Fig. 5, it can be shown that the aperture AA' is equal to:

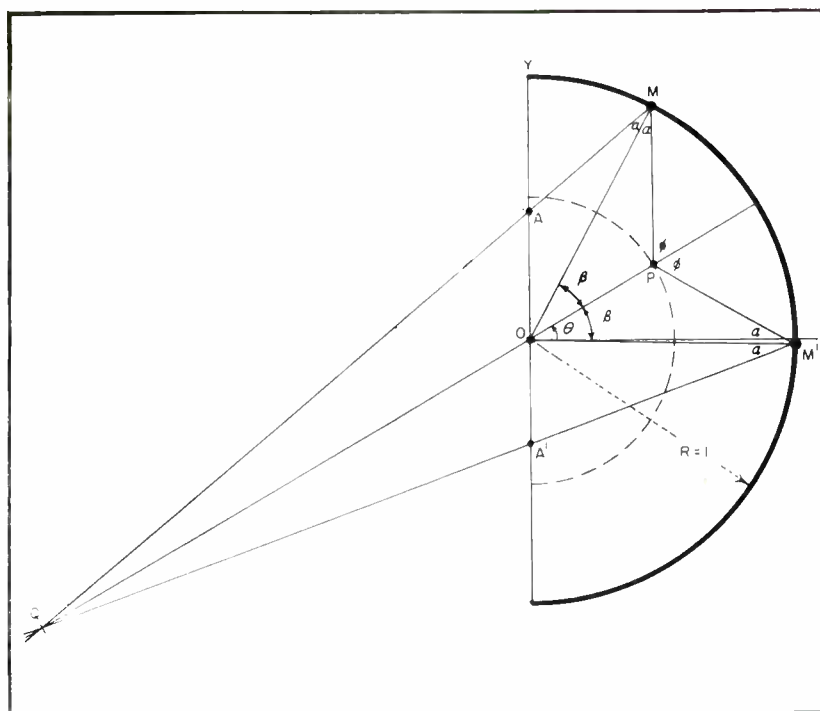

FIG. 5—Ray tracing with Schmidt system illustrates increase in physical aperture as beam is scanned off axis

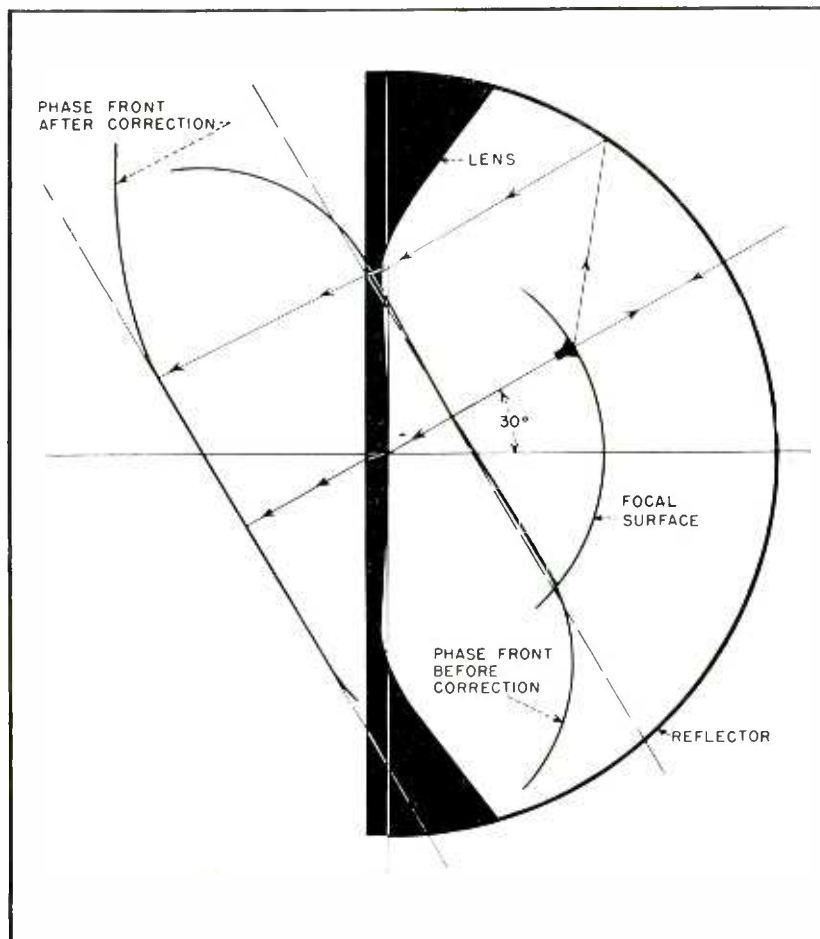

FIG. 6—Off-axis ray tracing shows that normal Schmidt lens overcorrects edges of wave front

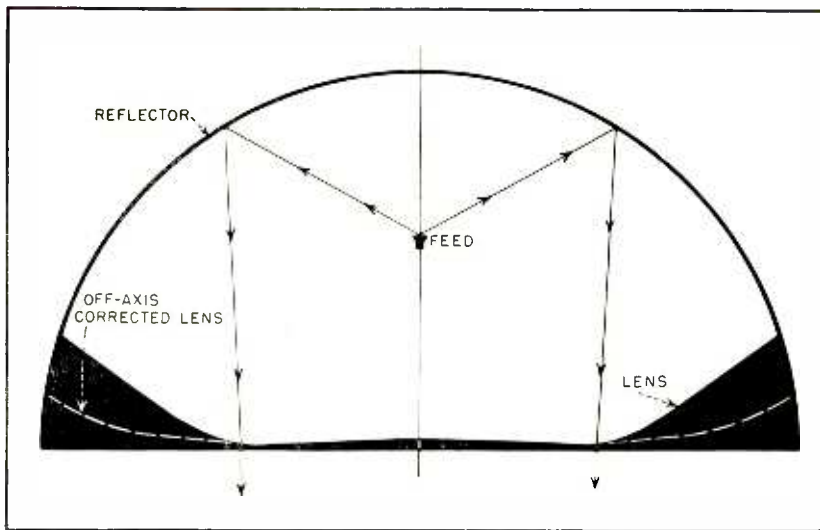

FIG. 7—Schmidt system showing profiles of both normal correcting lens and lens with off-axis correction

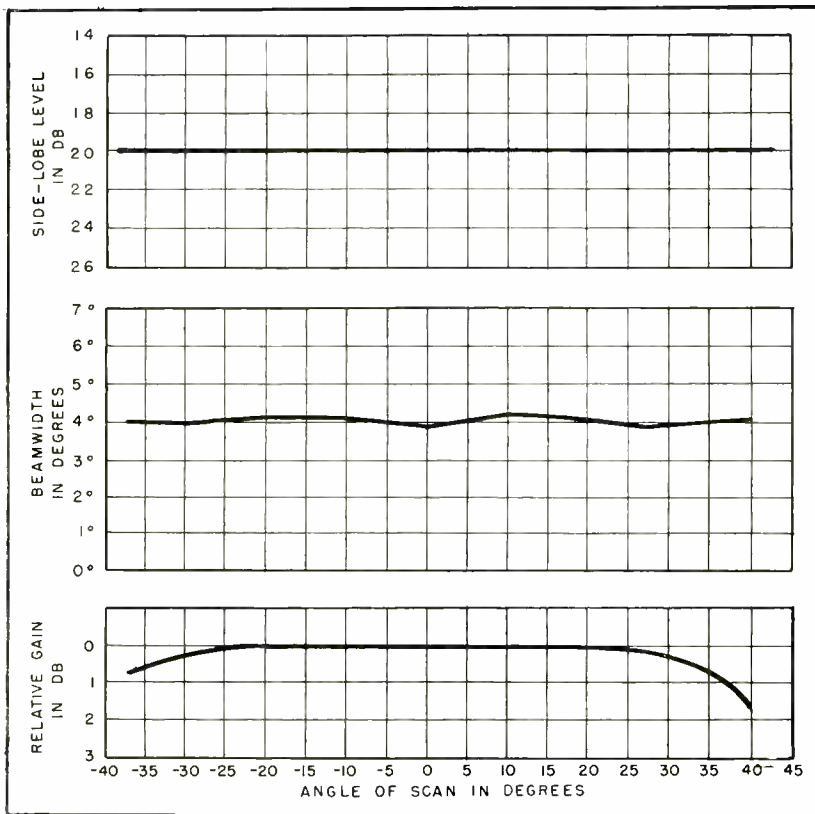

FIG. 8—Variation of side-lobe level, beamwidth and relative gain with Schmidt antenna using lens with off-axis correction

$$AA' = 2 \cos \theta \sin \beta + \cos(\theta - \beta) \tan \left\{ \theta + (\alpha - \beta) \right\} - \cos(\theta + \beta) \tan \left\{ \theta - (\alpha - \beta) \right\}$$

where $\alpha = \sin^{-1} [r_0 \sin \phi]$ and $\beta = \phi - \alpha$. The effective aperture is $AA' \cos \theta$. Using a value of $\phi = 60$ degrees (one-half the 10 db width of open waveguide), the value of $AA' \cos \theta$ was calculated and found

to be constant within 2 percent from $\theta = 0$ to $\theta = 40$ degrees. Thus if the Schmidt provided perfect correction both the beamwidth and gain should remain constant over the entire field of view. Examination of Fig. 4 shows that this was not the case. The variation in gain and beamwidth is probably due to phase errors, which increase as the

angle of scan increases.

Further off-axis ray tracing showed that the lens actually over-corrected the edges of the wave front as shown in Fig. 6, even though it did flatten the center.

An attempt was made to weaken the edges of the lens to provide better off-axis correction. A method⁷ was derived which would allow calculation of the lens profile to provide approximate correction both on axis and at two symmetrically chosen scan angles.

The method consists of designing the lens in three sections. The center section is contained between the zero slope points, the zero slope point being the point at which a tangent to the lens is parallel to the Y-axis. These points correspond to values of $\pm \theta_0$ where $\cos \theta_0 = \frac{1}{2} f$.

The upper and lower sections lie outside the zero-slope points. For the center section, the lens was designed as though the horn was at $\theta = 0$ degrees. For the upper and lower sections, the designs were based on horn positions of $\theta = -30$ deg. and $+30$ deg. respectively. A new lens was then constructed and tested in the same pillbox. Figure 7 shows the old and the new lenses. Figure 8 shows the variation in side-lobe level, beamwidth and gain as the beam is scanned. A 20 beamwidth scan is now possible with a side-lobe level of -20 db or lower with both constant beamwidth and fairly constant gain. This is quite an improvement over the old model which provided only a 16-beamwidth scan under the same restrictions.

The author wishes to thank M. L. Kales and K. S. Kelleher for their help and encouragement during the course of this development.

REFERENCES

- (1) K. S. Kelleher and H. H. Hibbs, Organ-Pipe Radar Scanner, *ELECTRONICS*, p 126, May 1952.
- (2) I. G. Maloff and D. W. Epstein, Reflective Optics in Projection Television, *ELECTRONICS*, p 98, Dec. 1944.
- (3) Taggart and Fine, "Parallel-Plate Bends", MIT Rad. Lab. Report No. 760.
- (4) B. Schmidt, "Ein Lichtstarkes Komafreies Spiegelsystem", *Mitt. Hamburger Sternwarte in Bergedoff* 7, p 15, Bergedoff, 1932.
- (5) C. Caratheodory, "Elementare Theorie des Spiegelteleskops von B. Schmidt", *Hamburg Math. Einzelschriften*, 28, Nov. 1940.
- (6) J. E. Eaton, Zero Phase Fronts in Microwave Optics, *Trans. IRE, PGAP-1*, p 38, Feb. 1952.
- (7) H. N. Chait, "A Microwave Schmidt System," NRL Report 3989, May 14, 1952.

Effect of Radiation on Resonant Lines

Two-wire transmission-line calculations are made considerably more accurate by including effect of line radiation. Problems are solved using graphs of theoretically-derived equations that have been verified experimentally

By **R. A. CHIPMAN**

*Electrical Engineering Department
McGill University
Montreal, Canada*

RADIATION RESISTANCE is usually neglected in making calculations for resonant parallel-conductor transmission lines but results obtained in this manner are liable to serious errors.

A means for taking radiation resistance (which may be appreciable, depending on frequency and other factors) into consideration in making optimum design calculations is suggested.

Resistance Calculation

Recent measurements in this laboratory¹ have shown that the radiation resistance of certain resonant unshielded two-wire transmission line sections is given with good accuracy by the equation.

$$R_{rad} = 120 \pi^2 (d/\lambda)^2 \text{ ohms} \quad (1)$$

when d , the separation of the conductor centers, is small compared with the wavelength λ and large compared with the conductor radius r . The measurements were made for line sections an odd number of half-wavelengths long with open-circuit termination at each end, and for sections an even number of half-wavelengths long with short-circuit termination at each end. There are now² theoretical reasons for assuming that the same equation applies to all resonant sections of such transmission line with any combination of open-circuit and short-circuit terminations. Typical examples are shown in Fig. 1.

The usual analysis of uniform transmission lines, neglecting radiation losses, leads to the well-known equation for the Q of any low-loss resonant section

$$Q = \frac{\beta}{2\alpha} \quad (2)$$

where α is the attenuation constant in nepers per meter, and β is the phase propagation constant in radians per meter. The approximations involved in deriving this equation are valid with useful accuracy for line sections whose total attenuation does not exceed a few tenths of 1 db.

The input impedance at any point

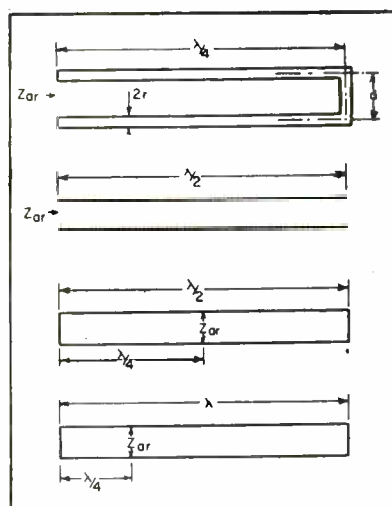

FIG. 1—Typical resonant transmission-line sections for which effect of radiation on the resonant properties is analyzed

of antiresonance of the same sections, (see Fig. 1) is given by

$$Z_{ar} = \frac{Z_o}{\alpha L_o} = \frac{4}{\pi n} Q Z_o \text{ ohms} \quad (3)$$

where Z_o is the characteristic impedance of the line in ohms and $L_o = n\lambda/4$ is the line length for resonance.

In Eq. 2, β is directly proportional to frequency and is independent of conductor size, material or separation, at high frequencies. When dielectric losses are negligible, the attenuation constant α is given by

$$\alpha = \frac{R_c}{2Z_o} \text{ nepers per meter} \quad (4)$$

where R_c is the total conductor resistance in ohms per meter. The value of R_c increases as the square root of the frequency at high frequencies, while Z_o is independent of frequency.

For a line having two identical circular conductors of radius r meters, center separation d meters, and conductivity σ ohms per meter

$$Z_o = 120 \cosh^{-1} (d/2r) \left\{ (d/2r) + [(d/2r)^2 - 1]^{1/2} \right\} \text{ ohms} \quad (5)$$

$$R_c = \left(\frac{16f}{10^7 \sigma} \right)^{1/2} \frac{1}{2r} \left\{ 1 - (2r/d)^2 \right\}^{-1/2} \text{ ohms per meter} \quad (6)$$

where f is the frequency in cycles per second.

It follows from Eq. 2, 3 and 4 and the nature of the frequency

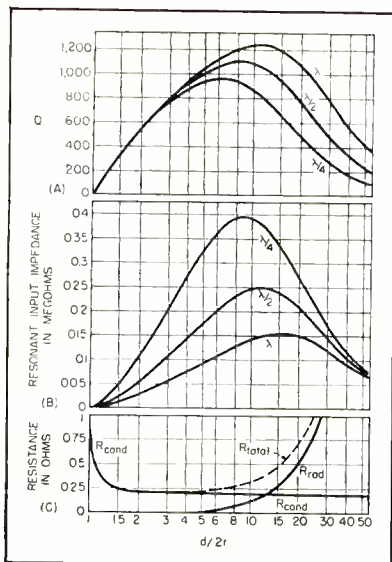

FIG. 2—Curves show resonant properties of two-wire line sections at 100 mc for $\frac{1}{8}$ -inch copper conductors

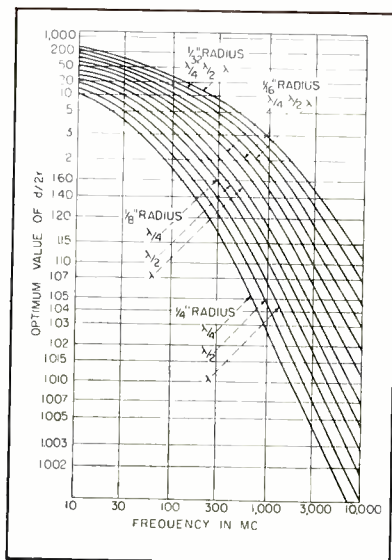

FIG. 3—Optimum separation of conductors for optimum Q expressed in conductor diameters

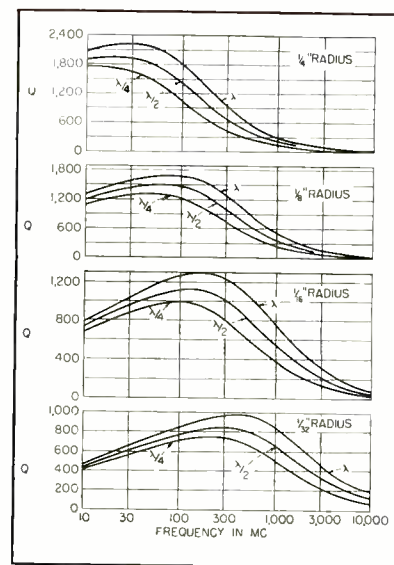

FIG. 4—Curves show Q values of resonant-line sections at optimum conductor separations given in Fig. 3

variation of the parameters involved, that both the Q and the antiresonant input impedance Z_{ar} should increase as the square root of the frequency for resonant line sections of constant electrical length (n constant).

When Eq. 2 is combined with Eq. 5 and 6 it is easily shown that the Q of any resonant section is a maximum at all frequencies for fixed conductor separation d , when the conductor radius is given by $d/2r = 2.275$, but that for fixed conductor radius the Q increases indefinitely with conductor separation.

Similarly it is found on combining Eq. 3 with Eq. 5 and 6 that, for fixed conductor separation the antiresonant impedance of any section is a maximum at all frequencies when the conductor radius is given by $d/2r = 4.43$, and that again for fixed conductor radius the antiresonant impedance increases indefinitely with conductor separation.

The calculations in the following sections show that when account is taken of radiation resistance all the conclusions of the last three paragraphs are either totally wrong or seriously in error for practical resonant sections of unshielded two-wire line at high frequencies.

Including R_{rad}

Combining Eq. 2 and 4, and using $\beta = 2\pi/\lambda$ and $L_o = n\lambda/4$, leads to

$$Q = \frac{\frac{1}{4}\pi n Z_o}{\frac{1}{2}R_c L_o} \quad (7)$$

In this equation the denominator is one-half the total conductor resistance of a resonant line section of length n quarter-wavelengths.

Because of the approximately sinusoidal distribution of current along a high-Q resonant line section, the total distributed resistance $R_c L_o$ introduces only one-half as much loss as the same amount of resistance located at a point of maximum current. By definition, a radiation resistance is referred to such a point of maximum current.

It is evident, therefore, that the Q of a resonant line section whose total radiation resistance is R_{rad} ohms will be given by

$$Q = \frac{\frac{1}{4}\pi n Z_o}{\frac{1}{2}L_o R_c + R_{rad}} \quad (8)$$

a result which is confirmed by more rigorous analysis.

When the two conductors of a line are separated by twenty or more diameters, the line currents are uniformly distributed around the circumference of each. For decreasing separation the currents become more and more concentrated on the adjacent sides of the conductors. This is the proximity effect, which results at high frequencies in the characteristic impedance of a two-wire line approaching zero and the distributed

conductor resistance approaching infinity as the two line conductors approach contact. Equations 5 and 6 include this proximity effect for Z_o and R_c respectively.

It is to be expected that the conductor separation d occurring in Eq. 1 for radiation resistance is physically of the nature of a separation of effective current centers in the two-line conductors. It should therefore approach d for large values of $d/2r$ and should approach zero as the conductors approach contact and $d/2r$ approaches unity.

Since no analysis of this aspect of the problem seems ever to have been made, it will be postulated here for purposes of calculation that the effective separation of the conductor current centers for radiation resistance purposes, as modified by proximity effect, is given by

$$d_{eff} = d [1 - (2r/d)^2]^{1/2} \quad (9)$$

an expression whose proximity effect term is similar to that in Eq. 5 and 6.

Substituting Eq. 5, 6 and 9 into Eq. 8 and using $L_o = n\lambda/4$ and $\lambda = 300/f_{mc}$, where f_{mc} is the frequency in megacycles, leads to

$$Q = \frac{\frac{1}{4}\pi n 120 \cosh^{-1}(d/2r)}{\left\{ \frac{2250}{\sigma} \right\}^{1/2} \left\{ n f_{mc} \right\}^{1/2} \frac{1}{2r} \left\{ 1 - (2r/d)^2 \right\}^{-1/2}} + \frac{\pi^2}{750} f_{mc}^2 (2r)^2 \left\{ (d/2r)^2 - 1 \right\} \quad (10)$$

which is the working equation from

which the Q of any resonant section of line can be calculated.

The corresponding equation for antiresonant input impedance can be written directly using Eq. 3.

It is not possible to draw significant conclusions from Eq. 10 simply by inspection, except to say that Q is no longer independent of n or proportional to the square root of the frequency, as was the case when radiation losses were neglected. The full implications of the equation can be found only by direct numerical solution.

Graphical Solution

Figure 2A shows the variation with $d/2r$, on varying d , of the Q of quarter-wavelength, half-wavelength, and one-wavelength resonant line sections having copper conductors of $\frac{1}{16}$ -in. radius, at a frequency of 100 mc, as calculated from Eq. 10. Because of the radiation losses, the Q does not increase indefinitely with d , but has a maximum value at a relatively small value of d , about $1\frac{1}{2}$ inches for the quarter-wavelength section. The optimum conductor separation is somewhat greater for longer resonant sections, being almost three inches for a full wavelength section.

Figure 2B shows similarly the variation with $d/2r$, on varying d , of the antiresonant input impedance for line sections of the same lengths at the same frequency. The maxima in these curves occur at somewhat higher values of $d/2r$ than the maxima in the Q curves.

Figure 2C shows, for the same quarter-wavelength line section only, the variation with $d/2r$ of the two effective resistance components of the section, being the two terms of the denominator of Eq. 10. The increase of the conductor resistance term with proximity effect at low values of $d/2r$ and the increase of radiation resistance at high values are evident. The term $\cosh^{-1} d/2r$ in the numerator of Eq. 10 is mainly responsible for the maximum values of Q and Z_{in} occurring at considerably higher values of $d/2r$ than the value that results in minimum total effective resistance for the line section.

It should be noted that the opti-

imum values of $d/2r$ in Fig. 2A and 2B are not to be compared with the values of 2.275 and 4.43 respectively given above. These latter values are for the case where the line separation is fixed and the conductor radius is varied.

The value of $d/2r$ to give maximum Q has been calculated for quarter-wavelength, half-wavelength and one-wavelength line sections of copper conductors of $\frac{1}{32}$, $\frac{1}{16}$, $\frac{1}{8}$ and $\frac{1}{4}$ -in. radius at several frequencies between 10 and 10,000 mc. The results are shown in Fig. 3.

The optimum $d/2r$ values were obtained either by plotting curves similar to Fig. 2A or by solving the equation obtained on differentiating Eq. 10 with respect to $d/2r$ and equating to zero, the two pro-

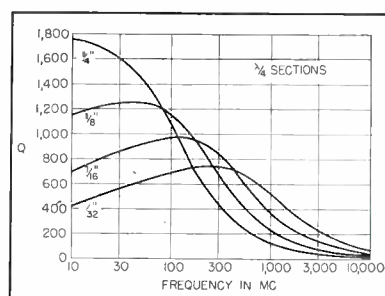

FIG. 5— Q curves for quarter-wavelength resonant sections of Fig. 4 are presented together for comparison

cedures being about equally tedious.

The most striking feature of these curves is the indication that, especially for the larger conductor radii, the optimum value of conductor spacing is very small. For example, for a quarter-wavelength section having conductors of $\frac{1}{4}$ -in. radius, the optimum value of $d/2r$ at 100 mc is about 1.8; at 300 mc the optimum value is 1.17, and at 1,000 mc it is 1.03. These values correspond to actual spacings between the adjacent conductor surfaces of about $\frac{1}{16}$, $\frac{1}{32}$ and $\frac{1}{16}$ -in. respectively.

Q Values

The Q values at the optimum values of $d/2r$ for the line sections of Fig. 3 are shown in Fig. 4. Up to a certain frequency the Q values increase with frequency though not as rapidly as the square root of the frequency for any of the curves

shown. At higher frequencies they drop off fairly sharply. Longer line sections at a given frequency have higher Q values and their maximum Q occurs at higher frequency.

An interesting feature is that at frequencies above about 300 mc sections made from conductors of $\frac{1}{16}$ -in. radius can have higher Q values than sections made from conductors of $\frac{1}{4}$ -in. radius. This is shown more clearly in Fig. 5, where the Q curves for each of the quarter-wavelength lines of Fig. 4 are plotted together. This indicates also that at 300 mc, for example, the optimum quarter-wavelength section using conductors of $\frac{1}{16}$ -in. radius has a higher Q value than the optimum sections with either larger or smaller conductors.

It follows that at any frequency there is an optimum conductor size for sections of any particular electrical length and that the section using this conductor size and the optimum value of $d/2r$ will have the absolute maximum Q value obtainable at that frequency and line length.

Figure 5 shows that at 300 mc a quarter-wavelength section made of copper conductors of $\frac{1}{16}$ -in. radius with $d/2r = 2.7$ (from Fig. 3) has a Q value of about 850, and no higher Q value can be obtained for any quarter-wavelength line at this frequency. The center separation of the conductors for this section is slightly less than $\frac{3}{8}$ in.

If similar curves for larger and smaller conductor radii were added to Fig. 5, the envelope of the resulting set would give the maximum possible Q value obtainable at each frequency.

Curves similar to those of Fig. 3, 4 and 5 could also be calculated for line sections of maximum antiresonant input impedance.

A grant-in-aid from the National Research Council of Canada, and the assistance of Judith M. Veith on the calculations involved in this work are gratefully acknowledged.

REFERENCES

- (1) R. A. Chipman, E. F. Carr, N. A. Hoy, and M. Yurko, The Radiation Resistance of Resonant Transmission Lines, *Jour. Appl. Phys.*, 23, p 613, June 1952.
- (2) Storer and King, Radiation Resistance of a Two-Wire Line, *Proc. IRE*, 39 p 1408, Nov. 1951.

Bipolar Logarithmic

Simple circuit using two type 9004 biased diodes back to back measures d-c corona signals of both polarities over entire range from milliamperes to millimicroamperes.

Used in studying earth's electric field during snowstorms and thunderstorms

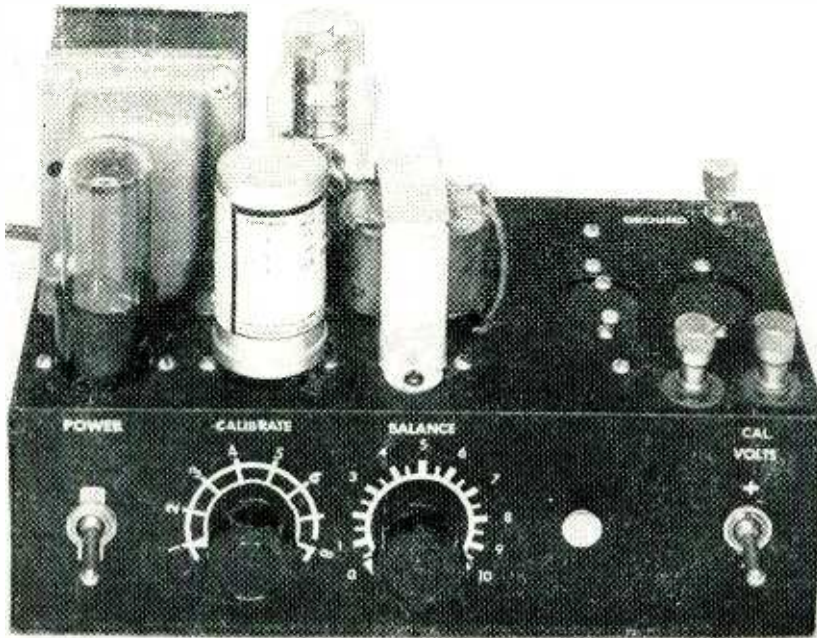

Amplifier chassis, with power supply tubes on top; 9004 and 954 tubes are under the chassis

IN A STUDY of the earth's electric field during snowstorms and thunderstorms, it was necessary to measure the corona current to a corona point exposed 54 feet above the ground. The current range to be covered was approximately from 10^{-7} ampere to 10^{-3} ampere with either polarity. Because of the wide range of current to be measured, a logarithmic device was needed.

The logarithmic relationship between retarding voltage and current in a temperature-limited diode having a pure metal cathode has been known¹ at least since 1914, and various experimenters have constructed logarithmic amplifiers using this principle or variations of it²⁻⁶. The theory of such tubes has been discussed in several places⁷⁻⁹. Ordinarily, only a single polarity of current has been considered during this early research.

A particularly interesting report⁶ indicates that, under proper conditions, for one polarity the 9004 acorn diode has a logarithmic range of 10^6 . For the present application, however, it was necessary to deal with both polarities. After trying several other circuits with unsatisfactory results, the one given in detail in Fig. 1 was constructed. As shown in Fig. 2, it consists essentially of two biased diodes back to back, shunted by a resistor R , the output of which is fed to a simple d-c amplifier which in turn feeds a 0.5-ma zero-center Esterline-Angus recorder.

In the case where the anode of a diode is biased negatively relative to the cathode (even when the cathode is not a pure metal), the relationship between diode current i and retarding potential $-V$ may be given by

$$i = i_0^{-V_e/kT}$$

where e is the electron charge, k is Boltzmann's constant, T is the absolute temperature of the cathode and i_0 is a constant depending upon geometry and other factors.

In practice, this equation becomes invalid at various parts of the range because of such effects as positive ion current in the tube, shunting leakage or circuit resistance, currents to grids of following stages, saturation of the diode leading to a space charge situation (at the high end of the current range), photoelectric emission from the anode or grid, rectification from a-c pickup in high-impedance leads and even heater leakage or rectification. In fact, in the bipolar case where two diodes are required, it is virtually impossible to operate the circuit without a separate filament transformer for the heater of the diode with the high-impedance cathode.

For the temperatures of typical cathodes, the quantity e/kT corresponds to from 4 to 5 decades per volt. In Fig. 3 the output voltage of the two diodes back to back is sketched in qualitative fashion relative to the logarithm of the current. Naturally no logarithmic function goes through zero. Whether or not there is a shunting resistor, there must be a linear region near zero so that the actual relationship is of the form of a hyperbolic sine ($2 \sinh x = e^x - e^{-x}$, which is a function that is linear near zero and logarithmic far from zero).

Practical Circuit

The location of the region of transition from a logarithmic to a linear relationship may be changed by adjusting the shunting resistor R or by adjusting the biases applied to the two diodes. When the biases have fairly large values, the location of the linear range is determined by the shunting resistance R .

Corona-Current Amplifier

By SEVILLE CHAPMAN
and LEONARD BOGDAN

Cornell Aeronautical Laboratory
Buffalo, N. Y.

Figure 3 has been drawn for this case.

The circuit as constructed actually had a logarithmic range from 3×10^{-9} to 3×10^{-4} amperes for both polarities. Unquestionably the ranges could have been extended to smaller currents, but since the smallest currents which could be measured already were less than required for this application, further development was not undertaken. The Victoreen 5800/VX41A has also been operated between 3×10^{-14} and 3×10^{-8} amperes as a logarithmic diode without reaching the ends of the range, and the Raytheon CK5886/CK571 has been worked over 7 decades.

The biases were adjusted as shown in Fig. 1 to yield the calibration given in Fig. 4. Changing the biases changes the circulating current through the diodes. On the assumption that the cathode temperature is proper, the relationship between current i and output voltage V is given as indicated in Fig. 3 as

$$i = \frac{V}{R} + i_0 10^{V/V_b/0.25} \left(10^{V/V_b/0.25} - 10^{-V/V_b/0.25} \right)$$

where i_0 is a constant and V_b is the bias voltage.

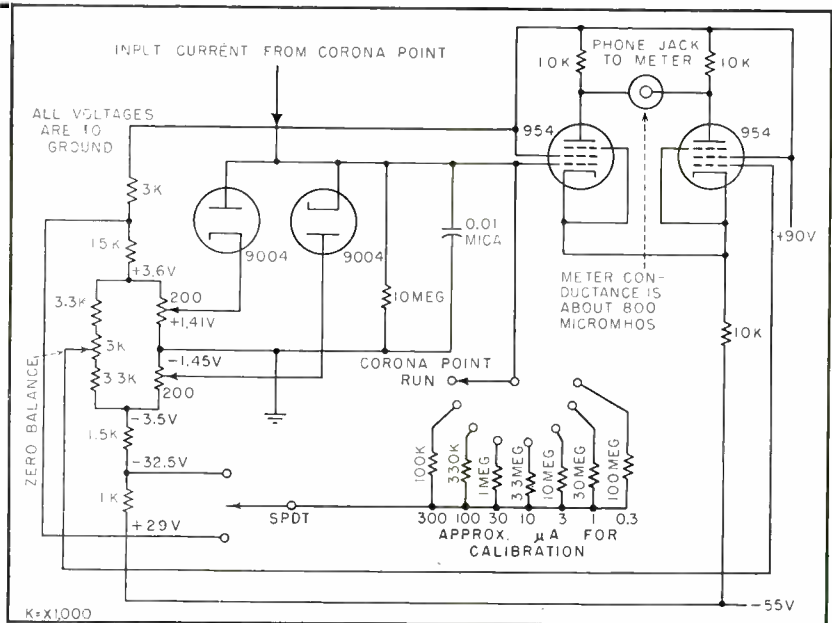

FIG. 1—Complete signal circuit of bipolar logarithmic amplifier. Power supply, not shown, uses 5Y3GT full-wave rectifier with VR150 across ungrounded filter to give 145 volts. Circuit ground divides this as indicated by voltage values. Separate filament transformer is used for the 9004 tubes

The practical amplifier shown in Fig. 1 has several built-in calibration points. The meter current is about 800 microamperes per volt input, corresponding to about 200 microamperes per decade of corona current. The equipment has been in service for about 15 months, and providing the tubes are replaced after their rated life, it behaves very well.

REFERENCES

(1) W. Schottky, *Ann. d. Physik*, 44, p 1,011, 1914.

(2) John P. Taylor, D-C Amplifier for Logarithmic Recording, *ELECTRONICS*, p 24, March 1937.
 (3) R. E. Meagher and E. P. Bentley, *Rev Sci Instr.*, 10, p 336, 1939.
 (4) W. G. James, Logarithms in Instrumentation, *Oak Ridge National Laboratory Report* 413, Sept. 26, 1949; refers to type 9004 tubes.
 (5) T. S. Gray and H. B. Frey, Acorn Diode Has Logarithmic Range of 10^9 , *Rev Sci Instr.*, 22, p 117, 1951; uses type 9004.
 (6) W. F. Goodyear, Logarithmic Counting Rate Meter, *ELECTRONICS*, p 208, July 1951; uses type 6AL5.
 (7) W. R. Ferris, Some Characteristics of Diodes with Oxide-Coated Cathodes, *RCA Review*, p 134, March 1949.
 (8) M. A. H. El-Said, Novel Multiplying Circuits with Application to Electronic Wattmeters, *Proc IRE*, 37, p 1,003, 1949.
 (9) H. B. Michaelson, Variations of Grid-Contact Potential and Associated Grid Currents, *Jrl Fr Inst*, 249, p 455, 1950.

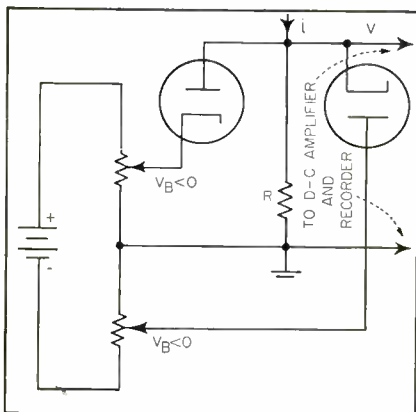

FIG. 2—Simplified circuit of bipolar logarithmic amplifier

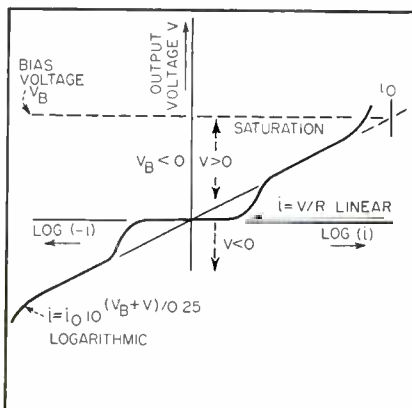

FIG. 3—Variation of output voltage with log of input current

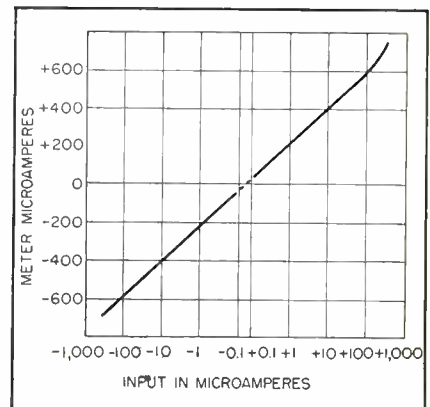

FIG. 4—Calibration curve for measuring circuit of Fig. 1

Test Scope Checks

Special design features of a new broad-band oscilloscope include sweep-delay circuit, sweep magnifier, time markers for sync pulses and vertical-amplifier calibrator. Individual lines or sync pulses of standard tv signal can be examined and identified

TELEVISION BROADCAST equipment frequently needs maintenance or adjustment that can best be accomplished with a cathode-ray oscilloscope. Station equipment to be tested includes synchronizing generators and video amplifiers as well as camera, monitor and switching equipment. Since any portion of the transmitted video signal must be presented accurately and in good detail, the test oscilloscope must have high input resistance, low input capacitance, good transient response and broad bandwidth. The instrument to be described contains a number of features designed for the purpose of tv testing, including a 10-megacycle bandwidth, an input impedance of one megohm shunted by 40 μf , and a test probe (with ten times attenuation) that provides 10 megohms and by 14 μf . The sweep circuit of the oscil-

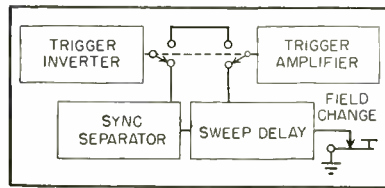

FIG. 1—Block diagram of the sweep-delay circuit

loscope has a range from 0.01 sec per cm to 0.1 μsec per cm and is a hard-tube, triggered type. Composite fields or complete frames may be observed by triggering the sweep from vertical sync pulses and selecting a slow-sweep rate that presents the desired amount of information during each sweep.

When individual lines or sync pulses are to be observed throughout the picture, the sweep must be set fast enough to spread out the desired information. It becomes

necessary to delay the start of the sweep until the picture has progressed to the desired portion and then trigger the sweep with one of the horizontal-sync pulses.

The sweep delay introduced is adjustable through about 1.5 fields by means of a sweep-delay control. The sweep-delay circuit operates at the frame rate of 30 cps, so that individual lines are observed from only one of the interlaced fields at any time. A field-shift switch allows the operator to change to the other interlaced field. A block diagram of the sweep-delay circuit is shown in Fig. 1.

Sweep Delay

A trigger delay phantastron V_4 with 25-millisecond rundown time will accept alternate vertical-sync pulses from the sync separator. The field-shift switch, normally closed

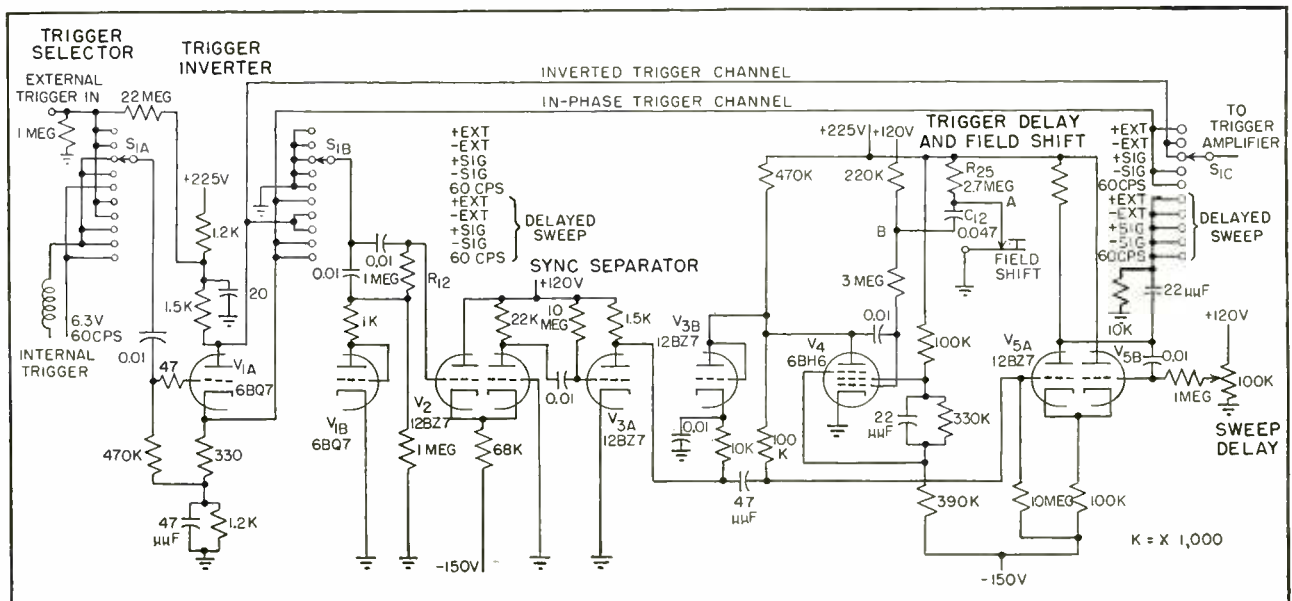

FIG. 2—Circuit of the trigger-delay and field-shift elements of the oscilloscope

TV Broadcasts

By **CLIFFORD H. MOULTON**

*Tektronix, Inc.
Portland, Oregon*

(Fig. 2), provides a unique means of forcing the phantastron to skip one extra trigger and hence change to the other field.

Reversed Phantastron

When the pushbutton is depressed R_{25} charges C_{12} so that point A approaches +225 volts. When the switch is released, point A is again grounded and C_{12} instantaneously forces point B 225 volts negative with respect to its normal voltage. This actually reverses the phantastron and forces it to run up for a short time instead of down. Point B returns to normal voltage approximately according to the time constant $R_{25}C_{12}$, interrupting the phantastron only long enough to skip one trigger. The comparator V_6 will always be triggered by one of the differentiated horizontal-sync pulses from the sync separator that are superimposed on the phantastron waveform.

Sweep Magnifier

It is frequently desirable to look carefully at a small detail on the screen without upsetting the sweep-circuit settings. A magnifier principle has been incorporated in this oscilloscope that gives either three or ten times magnification of any detail that has been positioned to the center of the screen by a three-turn horizontal-position control. With magnification on, the operator may explore the entire trace by slowly turning this control. If a detail is located with the magnifier on, the position of the detail with respect to the entire sweep may be determined by turning off the magnifier and observing which part of the trace is centered on the screen.

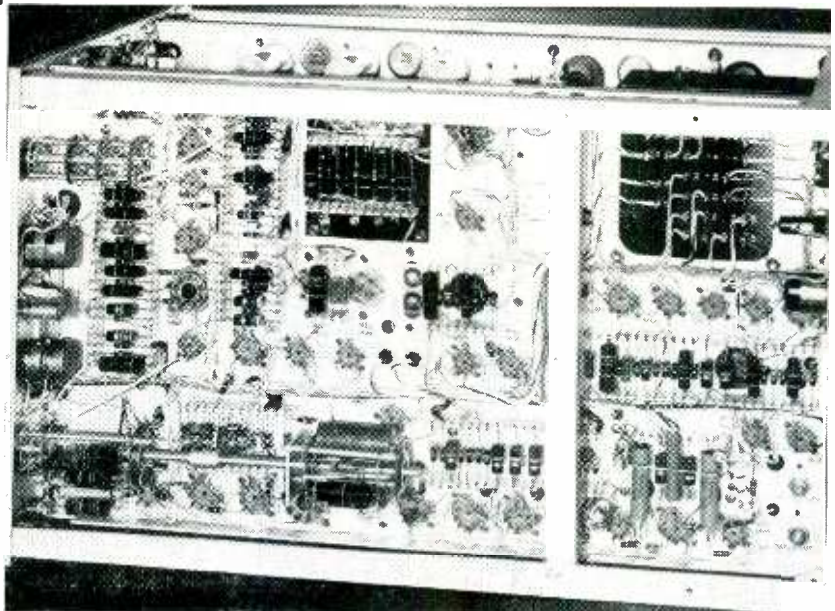

Underchassis view of the television oscilloscope looking towards front panel (left)

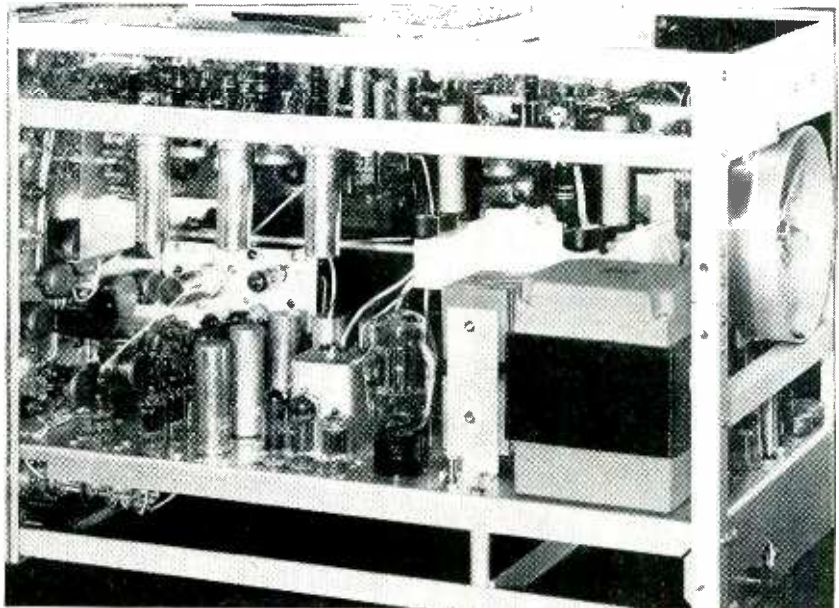

Blower (right) provides cooling for greater stability and longer component life

The principle of operation of the magnifier can be explained with the block diagram of Fig. 3. Normally the high-gain amplifier is held to unity gain by feedback networks R_1C_1 and R_2C_2 . Three and ten-times magnification are obtained by switching R_2 and C_2 to allow corresponding voltage gains.

Time markers are inserted as intensification pips in the crt beam at time intervals of 1 μ sec, 0.1 μ sec, 0.05 μ sec or 200 pips per television line.

These markers provide a means of accurately timing the sync pulses of a composite signal. A horizontal-sync pulse with markers is

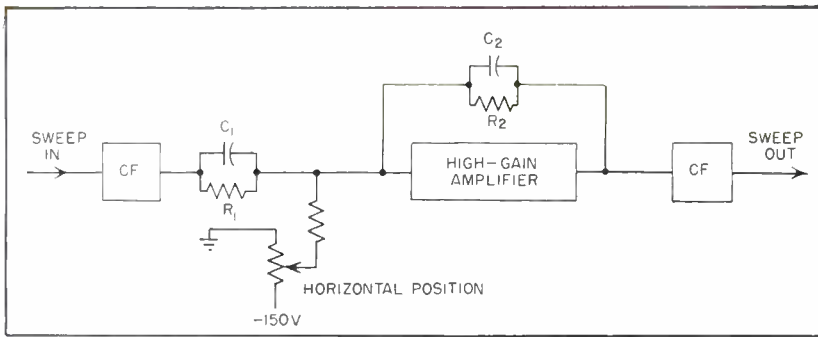

FIG. 3—Elements of the sweep-magnifier feature

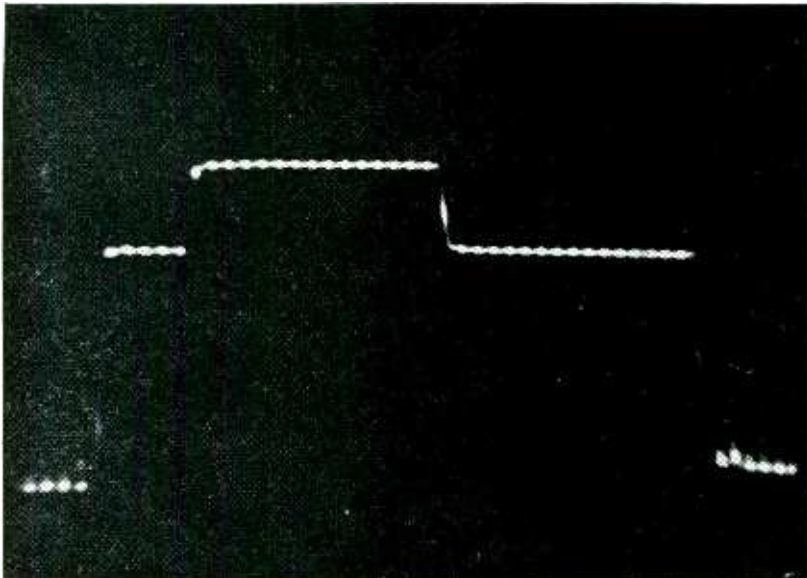

FIG. 4—Horizontal sync pulse with markers supplied from scope

shown in Fig. 4 above.

The marker oscillator is an electron-coupled Colpitts type with split capacitance from grid to cathode to ground. Cathode follower V_{1B} of Fig. 5 acts as a low resistance, damping the oscillator tuned circuit and preventing oscillations except during the sweep, at which time V_{1B} is gated off. Magnetic energy stored in the oscillator coil by cathode current from V_{1B} becomes oscillating energy when the tube is gated off at the start of a sweep.

Tube V_2 provides positive feedback that maintains the oscillations until V_{1B} is gated on again at the end of the sweep. The triode section V_{1A} amplifies the oscillator signal and provides sharp differentiated pulses to the grid of output amplifier V_3 .

Pips spaced 200 per television line ($0.005 H$, where H is $62.5 \mu\text{sec}$) are useful for adjusting both color and black-and-white equipment.

Timing of sync pulses, specified by the FCC in terms of H , can be measured directly by counting the number of $0.005 H$ pips between specified points of the waveforms.

An improved circuit technique is employed in the crt unblanking circuit. With the new technique a given intensity control setting will result in the same crt beam current at any sweep speed or duty cycle. A separate floating high-voltage rectifier supplies a direct voltage coupling from the unblanking generator to the crt grid. The floating power supply is a radio-frequency type operating at about 25 kilocycles, and is part of the regular crt high-voltage supply.

A vertical-amplifier calibrator allows the operator to compare an observed signal amplitude to an internal square wave having an amplitude known accurately within 3 percent. The square wave has adjustable duty cycle from 1 percent to 99 percent allowing the duty cycle of the calibrator to be matched to the duty cycle of the observed signal. This adjustment minimizes error in amplitude comparison of an a-c coupled signal resulting from change in amplifier operating bias with the duty cycle of the signal.

A 60-cycle internal sweep with phasing through approximately 150 deg is provided to facilitate bandwidth measurements with a video sweep generator.

Positive and negative gate waveforms produced simultaneously with each sweep are provided so that if desired either intensification or blanking may be produced in a picture monitor to indicate the portion of the picture being observed by the oscilloscope.

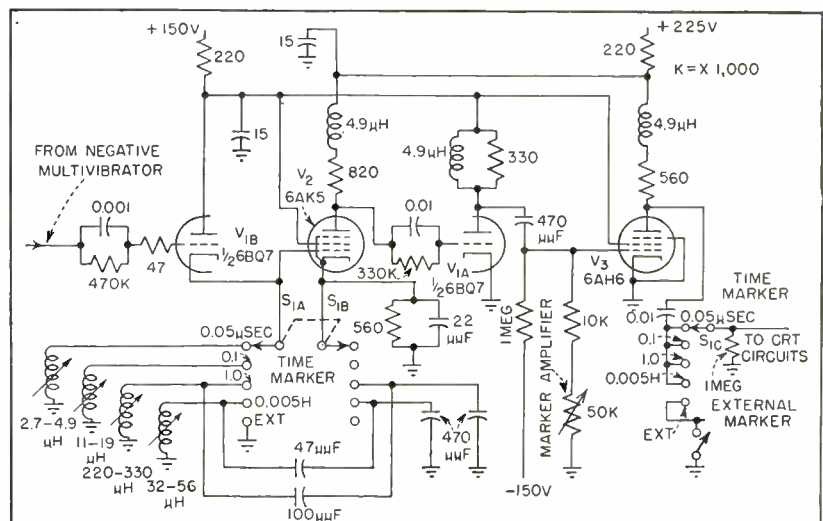
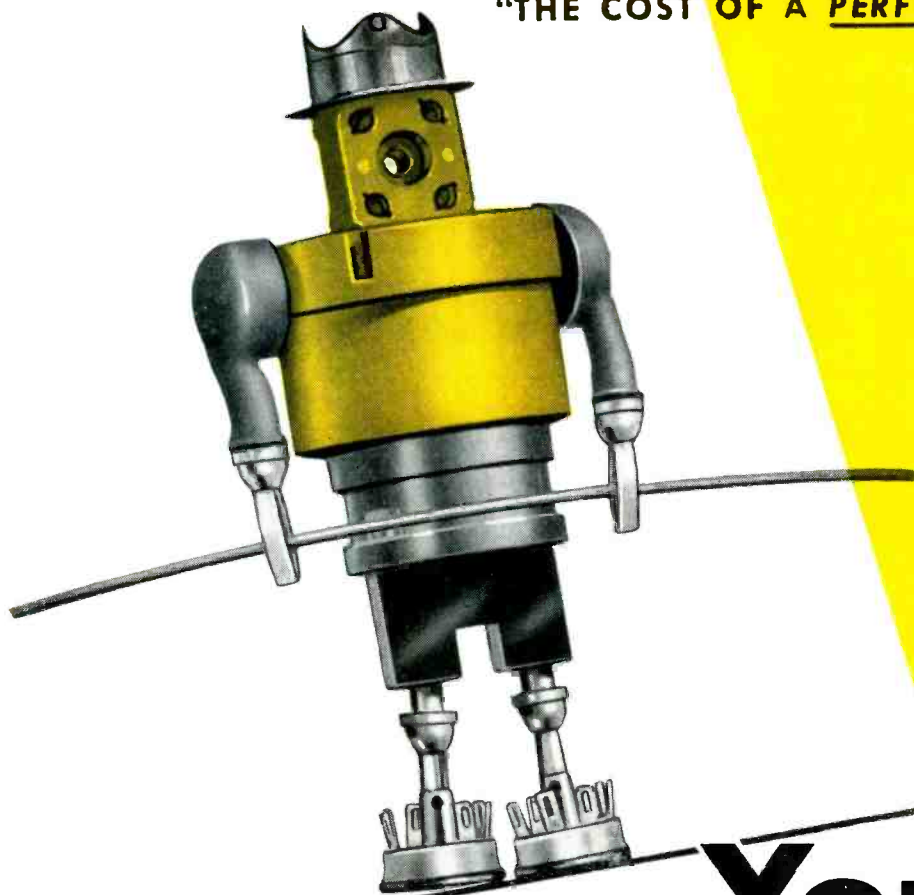

FIG. 5—Time-mark generator for providing pips shown in Fig. 4

"THE COST OF A PERFECT PERFORMANCE IS LOW"



For nearly a quarter of a century
Cinch has produced electronic
components that were made
"standard"—by demand.

You WANT THE
ORIGINAL...THE *"perfect performance"*
...YOU CAN'T AFFORD A SUBSTITUTE

From the CINCH organization has come many "firsts" in electronic components. Added to these CINCH engineers have developed numbers of metal plastic assemblies for specific needs of set manufacturers and communication systems. Components that by satisfactory performance became STANDARD. The number of CINCH parts in the leading TV and Radio sets, and in communication systems testify to their quality . . . to the reputation of the maker.
CONSULT CINCH!



Cinch
ELECTRONIC
COMPONENTS

CINCH MANUFACTURING CORPORATION

1026 South Homan Ave., Chicago 24, Illinois

Subsidiary of United-Carr Fastener
Corporation, Cambridge, Mass

Cinch electronic components are available at leading jobbers—everywhere.

Chart for TE₁₁ Mode Piston Attenuator

Nomograph speeds finding attenuation constant for cylindrical waveguide operated in TE₁₁ mode below cutoff. May be used to design piston attenuators with minimum frequency dependence over given range

PISTON attenuators are useful because of their linear decibel scale and potentially high accuracy.¹ However, their attenuation constant is a slowly changing function of frequency due to the proximity of operating frequency to cutoff frequency and the frequency dependence of skin-depth.

The nomograph expedites determination of the attenuation constant, A , for the TE₁₁ mode in cylindrical waveguide. Effect of skin-depth is negligible for the TM₀₁ mode and nomographs

By **CHARLES M. ALLRED**
National Bureau of Standards
Washington, D. C.

for this mode and the TE₁₁ mode for the case of infinite conductivity are available.²

The nomograph may be used to design attenuators having minimum frequency dependence over a given range and to determine that dependence after fabrication. In the latter case, consider radius $a = 2$ cm, conductivity $\sigma = 1.5 \times 10^7$ mhos per meter, and the frequency f

$= 1 \times 10^9$ cycles per second; then $a\sigma = 3 \times 10^5$ mhos, $af = 2 \times 10^4$ meters per second and extension to the A scale of a straight line through these points gives 15.94 db per radius for A . In attenuator design, choose values of a and σ to place the operating point at the right of the $a\sigma$ scale and about the knee of the af scale.

REFERENCES

- (1) R. E. Grantham and J. J. Freeman, A Standard of Attenuation for Microwave Measurements, *Trans AIEE*, 67, p 535, 1948.
- (2) R. E. Lafferty, Piston Attenuator Chart, *ELECTRONICS*, p 132 Feb. 1948.

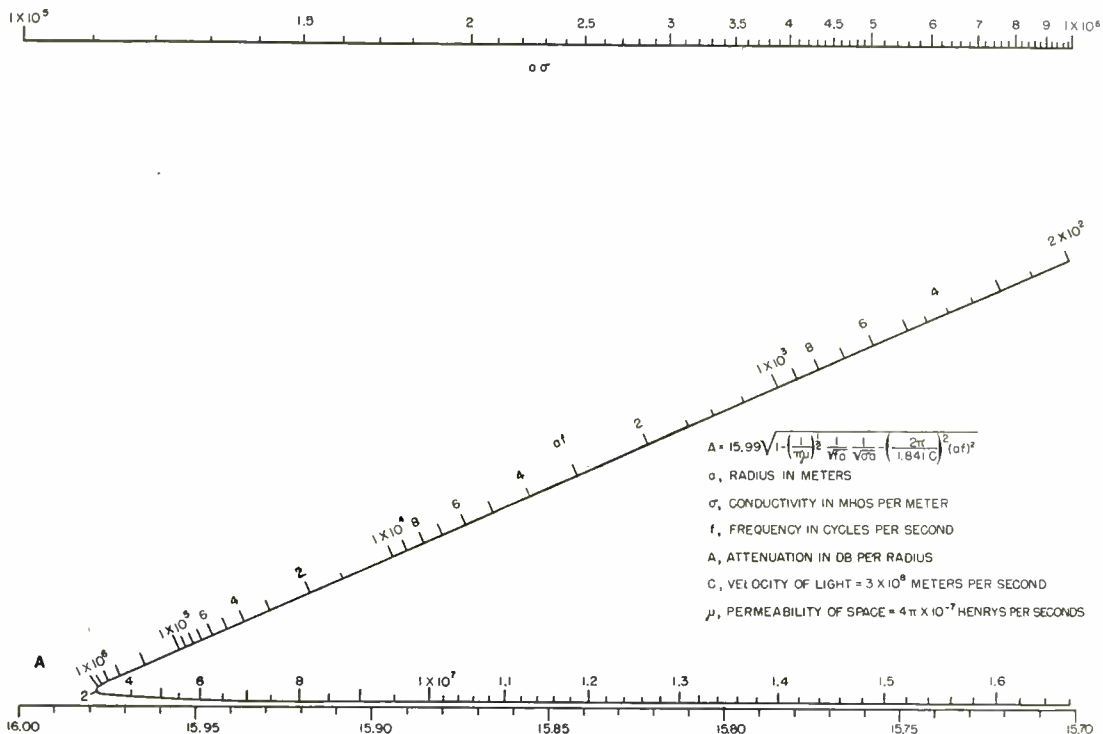

This TE₁₁ mode piston attenuator chart shows dependence of attenuation constant on frequency, conductivity and radius in cylindrical waveguide

To Reduce Your Contact Assembly Costs

Use the same specialized experience that solved this problem . . .

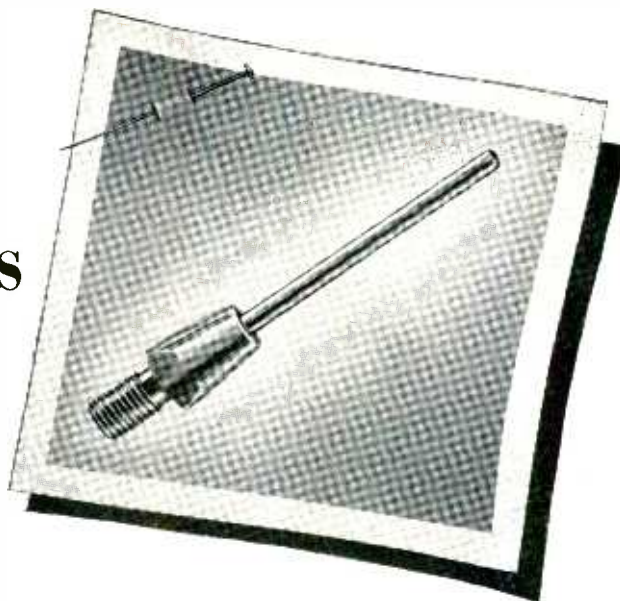

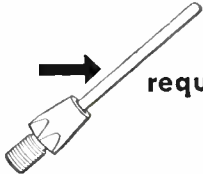
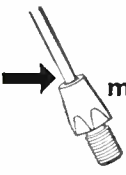
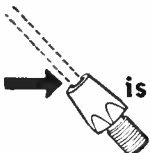
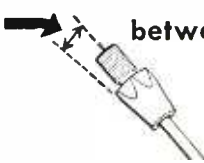
This tungsten electrode  requires grinding to a tolerance of $\pm .00025$ of an inch to insure absolute concentricity. This braze  must withstand the centrifugal forces of the highspeed generator in which it is mounted. The hole in the chuck  is held to a tolerance of $\pm .00025$ of an inch. This angle  between the chuck and electrode is held to within ± 6 minutes of a degree.

Originally Mallory produced only the tungsten electrode for this assembly. Another firm manufactured the chuck, and a third did the brazing and chrome plating . . . a complicated, costly process. Now, Mallory produces the entire assembly. The customer's problems of quality control, sub-contracting and divided responsibility are entirely eliminated . . . and his costs are lower.

This is just one more example of how many manufacturers have improved the performance and lowered the cost of contact assemblies by having Mallory do the entire job. No matter what your requirements are, Mallory's specialized production facilities . . . experience in designing and mass-producing over 5000 different types of contacts . . . can turn out precision contact assemblies for you at lower cost.

Expect more . . . Get more from **MALLORY**

In Canada, made and sold by Johnson Matthey and Mallory, Ltd., 110 Industry St., Toronto 15, Ontario

Electrical Contacts and Contact Assemblies

P. R. MALLORY & CO. Inc.
MALLORY

SERVING INDUSTRY WITH THESE PRODUCTS:
Electromechanical—Resistors • Switches • Television Tuners • Vibrators
Electrochemical—Capacitors • Rectifiers • Mercury Dry Batteries
Metallurgical—Contacts • Special Metals and Ceramics • Welding Materials

P. R. MALLORY & CO., INC., INDIANAPOLIS 6, INDIANA

ELECTRONS AT WORK

Including INDUSTRIAL CONTROL

Edited by ALEXANDER A. MCKENZIE

Ultrasonic Thickness Measurement.....144	Slide Rule Computes Radio Refractive Index of Air.....182
Germans Develop Electronic Robot.....144	Multiple-Feedback Oscillators.....200
Corrosion Detection by Rotogeneration..146	Measurement of Flashlamp Characteristics.....208
High Temperature Carbon-Film Resistors.....148	Phonograph Needle Drag Distortion...214
Signal Corps Buses Measure Noise....148	Signal Generator System for Low Output Levels.....218
An Electronic Telephone.....154	
Thermal Relays Control Heater Voltage.166	

OTHER DEPARTMENTS featured in this issue:

	Page
Production Techniques...	226
New Products	264
Plants and People.....	334
New Books	346
Backtalk	358

Ultrasonic Thickness Measurement

BECAUSE THICKNESS is inversely proportional to resonant frequency, the latter can be used for thickness determinations. The Magnaflux Co. has used this principle in a measuring instrument that gives direct readings on the face of a calibrated oscilloscope.

In making the measurement a quartz-crystal probe, driven by a continuously varying ultrasonic wave, is held against the material. When the varying signal reaches the resonant frequency of the material the resonance causes a reinforcement of the crystal vibration, changing the loading on the oscillator producing the ultrasonic wave. By placing the oscillator signal on the vertical plates of an oscilloscope and synchronizing the horizontal sweep with variation in crystal frequency, a standing wave is produced with a pip at the frequency where resonance occurs. To allow direct determination, a screen calibrating thickness to frequency is placed over the tube.

Variation of the ultrasonic frequency is produced by a motor-driven sweep capacitor in the oscillator circuit. A cam arrangement triggers the horizontal sweep at the beginning of each frequency cycle. Five separate ranges allow a total frequency coverage from 8.8 to 0.23 mc, suitable for measuring steel thicknesses from 0.15 to 0.500 in. with the fundamental. Using harmonic readings the range can

be extended to about 5.0 in.¹ For materials other than steel, measurements can be made by using the ratio of the speed of sound in the material to the speed in steel. In production use, the oscilloscope can be calibrated for the material being measured.

The crystal used to translate the electrical output of the oscillator into mechanical vibrations is an

X-cut type radiating the ultrasonic waves perpendicular to the face of the crystal. For most surfaces, a flat crystal is used but on curved surfaces under six or eight in. in diameter a curved crystal gives a more pronounced indication on the oscilloscope screen. Five separate crystals driven over a two-to-one frequency range cover the entire range of the instrument. The thick-

GERMANS DEVELOP ELECTRONIC ROBOT



Mr. "Sabor IV" the 500-pound robot shown in the photograph, has its movements directed by a built-in short-wave radio receiver. Cost of the metal giant was \$7,140

3

UNIVERTERS

...for extending the coverage
of B.R.C. Signal Generators



UNIVERTER—Type 207-A

A frequency converter for use with FM-AM Signal Generators 202-B and 202-C. Output frequency range of Signal Generators is 54 to 216 mc. Additional output when using 207-A:

Frequency Range: 0.1 to 55 mc.

Output: 0.1 to 100,000 microvolts at X1 jack, approximately 7.5 times these values at high output jack.

Frequency Increment Dial: \pm 300 kc in 5 kc increments.

Modulation: FM and AM controlled by Signal Generator.

Price: \$345.00 fob Factory.

UNIVERTER—Type 207-B

A frequency converter for use with FM-AM Signal Generator 202-D. The 202-D is applicable to telemetering problems over frequency range of 175-250 mc. Additional output when using 207-B:

Frequency Range: 0.1 to 55 mc.

Output: 0.1 to 100,000 microvolts at X1 jack and approximately 7.5 times these values at high output jack.

Frequency Increment Dial: \pm 300 kc in 5 kc increments.

Modulation: FM and AM controlled by Signal Generator.

Price: \$345.00 fob Factory.



UNIVERTER—Type 207-C

A frequency converter for use with FM Signal Generator 206-A. The 206-A is applicable to mobile communications problems over a frequency range of 146 to 176 mc. Additional output when using 207-C:

Frequency Range: 0.1 to 50 mc.

Output: 0.1 to 100,000 microvolts at X1 jack and approximately 7.5 times these values at high output jack.

Modulation: FM controlled by Signal Generator.

Price: \$345.00 fob Factory.

Write for complete information.



BOONTON RADIO

BOONTON, N. J.

Corporation



FIG. 1—Thickness-measuring instrument being used with special jig-holder device to determine cylinder wall thickness in automotive engine

ness measurements in each range are also in a two-to-one relationship, for example from 0.080 to 0.160 in.

Since the readings depend on the loading of the oscillator circuit by the material under test, it is essential that the circuit be sensitive to loading. For this reason the Q of the circuit must be as high as possible. Low-loss materials and high- Q inductances are used as well as low-loss coaxial cable for the connection to the crystal probe.

The high sensitivity of the oscillator circuit presented difficulties in the design of the high-speed

rotating sweep capacitor. Electrical noise was caused by the contacts and ball-bearing mountings of the rotor. The most efficient contact was found to be a silver-graphite brush riding on a silver pad at the end of the rotor shaft. Cone-type bearings that serve as both sleeve and thrust type bearings eliminated the mounting noise.

In addition to thickness measure-

ments, the ultrasonic test unit can be used to test the bonding of metals. Poor bonding will produce a single peak at the point on the screen corresponding to the thickness of only one of the pieces. Good bonding will show a pip at the thickness of both pieces.

REFERENCES

- (1) C. B. Betz, Thickness Measurement by Ultrasonic Frequencies, *Electrical Manufacturing*, p 86, Aug. 1950.

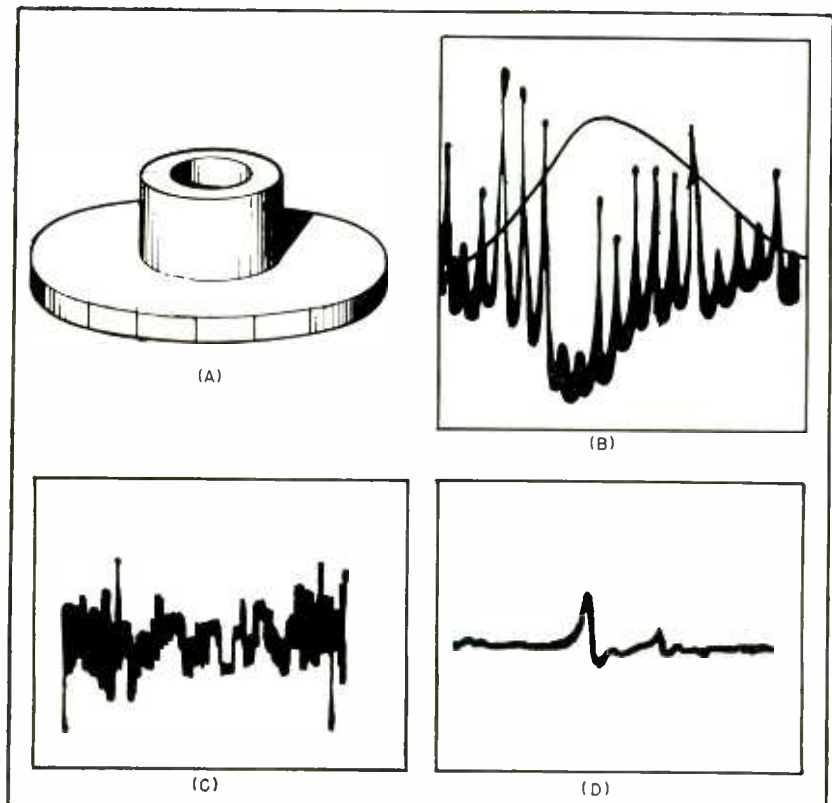

Silver-plated steel disk specimen (A) has twenty equally spaced lines of steel. Waveform produced by corrosive activity of dilute hydrochloric acid solution is shown in (B). Aluminum-copper alloy specimen in a sodium chloride-hydrogen peroxide solution produced waveform (C). Effect of adding sodium chromate rust inhibitor to this combination is shown in (D)

Corrosion Detection By Rotogeneration

CORROSION, the oxidation of a metal in contact with a solution, causes a minute flow of current in the corroding solution at the point under attack. Since these currents are quantitatively related to the corrosive activity they can be used to observe the corrosion process. In the past, d-c instruments have been limited by the small potentials to be measured, difficulty of obtaining high gain from d-c amplifiers and the interference of the general instability of the corroding system.

To eliminate these difficulties, the Armour Research Foundation has developed a "rotogenerative" apparatus that uses the d-c corrosion currents to generate a-c potentials. The device, shown in Fig. 1, is described in the September 1952 issue of *The Frontier*. A motor is used to rotate the specimen under test, and corrosion currents rotating with the specimen produce a varying potential as they pass the stationary electrode. This potential may be regarded as a complex a-c

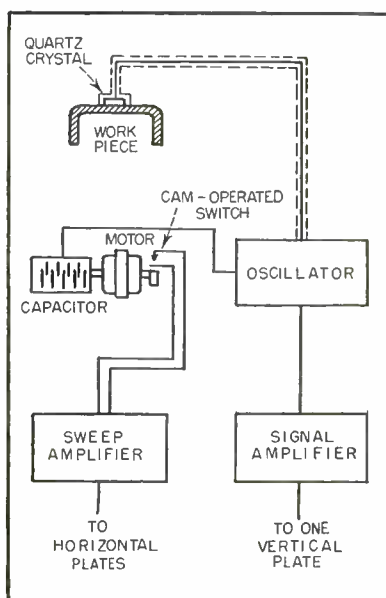
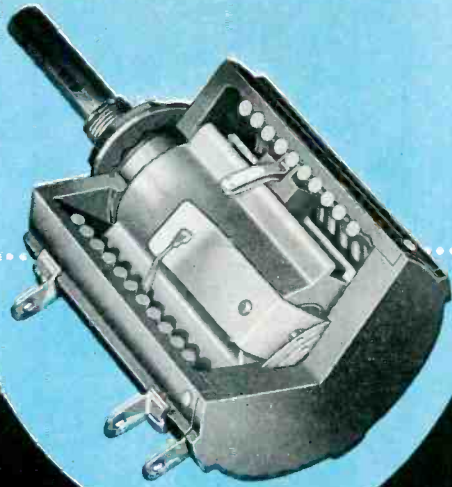

FIG. 2—Block diagram of ultrasonic thickness measurer. One vertical plate of oscilloscope (not shown) is grounded

From the world's largest manufacturer
of precision potentiometers . . .



come to **Helipot**
for the largest
selection of
multi-turn
precision
potentiometers

advanced engineering! volume production!

HELIPOT is the organization that originated the helical potentiometer—the device that brought to electronic engineering new horizons of precise control by its greater resolution, higher linearity, mechanical precision, and broad range of resistance values. HELIPOT's policy of constantly working to anticipate the needs of the industry has led to steady advancement in the basic multi-turn principle—and today, HELIPOTS are available in the industry's widest selection of ranges and designs to meet varying requirements.

HELIPOT offers you . . .

▶ **Advanced Engineering.** Through its years of leadership HELIPOT has built an organization unequalled in the industry—with trained engineers, specially-designed equipment, overall facilities to solve *tough* potentiometer problems.

▶ **Volume Production of Special Designs.** HELIPOT not only welcomes tough potentiometer problems, but also has expanded facilities to mass-produce special designs to rigid specifications—at economical cost!

▶ **Versatile Basic Designs.** Most of the basic units shown below can be readily adapted to special requirements—ganged assemblies, servo mountings, single or double shaft extensions, taps spot-welded to a *single* turn of winding at virtually any desired point, and many other individualized features to meet your *particular needs!*

Illustrated below are typical basic models of Multi-Turn Helipot . . .

MODEL A:



A 10-turn unit, approximately 1 3/4" diameter with 12 to 14 times the resolution of single-turn units of same diameter. Very versatile—low in price—wide range of applications.*

MODEL C:



Similar to Model A, but 3 turns of resistance winding instead of 10.*

MODELS B, D, & E:



Larger-diameter (3 5/16") designs. B has 15 turns—D, 25 turns—E, 40 turns, for applications requiring extreme ranges of adjustment and highest possible resolution.*

ultra-precision



MODELS AN, BN, & CN:

Similar to Models A, B & C in size and performance but feature precision ball-bearings and extra-close tolerances throughout. Have approximately twice the linearity accuracy of equivalent standard Helipot—are ideal servo units.*

miniature



MODELS AJ, AJS, AJSP:

Tiny multi-turn Helipot the diameter of a penny, weight 1 oz. All have 18.5" slide wire for high resolution (1/6550—50 K unit). AJ has threaded bushings, sleeve bearings . . . AJS, servo mountings, sleeve bearings . . . AJSP, servo mountings, ball bearings. Many other features.*

THE Helipot CORPORATION
SOUTH PASADENA 2 CALIFORNIA

Field Offices: Boston (CO. 7-1967), New York (Rockville Center 6-1014), Philadelphia (Collingswood 5-3515), Rochester (CU. 7640), Schenectady (DE. 2319), Cleveland (PR. 1552), Detroit (TO. 8-3130), Chicago (PA. 5-1170), St. Louis (SW. 5584), Los Angeles (RY. 1-8345), Seattle (FR. 7515), Dallas (ST. 3335), Ft. Myers, Fla. (FO. 1269-M). In Canada: Cossor, Ltd. Toronto (PR. 1226) and Halifax (4-6488). Export Agents: Frithom Co., New York City 18, (BR. 9-1296).

* See Your nearest Helipot Representative for complete details—
or write direct!

"HELIPOT" —T. M. REG.

High-Temperature Carbon-Film Resistors

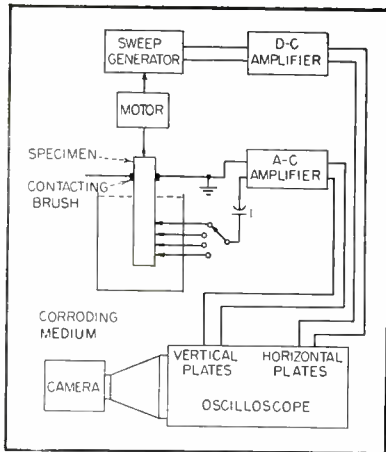

FIG. 1—Diagram of the "rotogenerative" apparatus for study of corrosion

waveform that can be amplified for observation on an oscilloscope.

A sweep generator driven by the same motor maintains the horizontal sweep of the oscilloscope at the same rate. In this manner, a standing wave is produced on the screen that can be correlated with the position of corrosive activity around the specimen. Changes in overall corrosion occur at a relatively slow rate and will not be amplified by the a-c instruments.

An alternative method of oscilloscope presentation uses the amplified corrosive-current signals to modulate the oscilloscope traces.

The resulting trace forms a picture of the surface of the specimen with the light and dark areas corresponding to the position and intensity of corrosive activity.

HIGH-STABILITY fixed-composition resistors capable of high-temperature operation result when a film of carbon is deposited on a ceramic base. The film is deposited when hydrocarbon vapor is decomposed by heat. This chemical process is known as pyrolysis and development of these deposited carbon-film resistors is being carried on at Battelle Memorial Institute under Air Force auspices. The resistors under development will have ratings of $\frac{1}{2}$ to two watts and will operate at ambient temperatures of 200 C without deterioration or change in resistance. Figure 1A illustrates stability of carbon-film resistors at high ambient temperatures. Figure 1B shows results when ambient temperature is maintained at 400 F for an extended period of time.

Study shows that porcelain-base pyrolytic carbon-film resistors having values from ten ohms to five megohms, can be made to withstand operating temperatures of 200 C.

Variations in resistor characteristics that exceed specified limits are functions of geometrical variations of the conducting path in the resistive element.

The problem is to achieve a stable geometry of the conducting path in the resistor, which will remain stable during severe tests. Sources of unstable geometry are film non-uniformity, characteristics of the

ceramic base in relation to those of the carbon films and nature of contacts to the carbon films.

A New Pyrolysis System

Uniformity and continuity of film thickness and structure is necessary for stable geometry of the conducting path. Some factors important in design of a pyrolysis system to produce such films are that film thickness is a direct function of the amount of hydrocarbon vapor contacting each unit area of the porcelain surface during exposure at high temperatures, structure of the film and its electrical

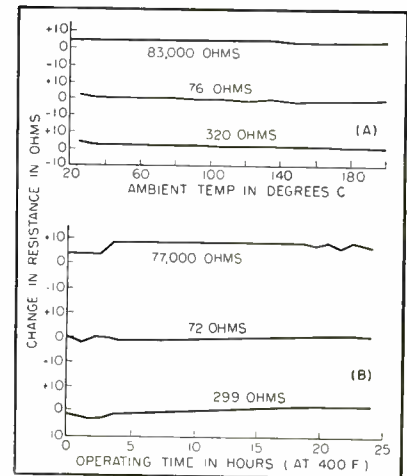

FIG. 1—Charts showing operating characteristics of carbon-film resistors

SIGNAL CORPS BUSES MEASURE NOISE



A fleet of 16 buses, specially adapted at the Fort Monmouth Army Signal Corps Laboratories, is used to measure noise output from electrical equipment that could cause interference with communications services. By taking the mobile measuring laboratories to the manufacturer, time and money are saved in shipping equipment for tests and duplication of measuring facilities. Bus visits are part of Signal Corps and other armed forces contracts where noise specifications are involved. Photographs show buses ready for action and interior view showing part of equipment

Pioneers in Precision



Actual photo of radar screen picture from ship in San Diego Harbor.



Raytheon Manufacturing Company, a division of which disclosed the world's first complete radar system in 1930. Pioneers in the development and perfection of magnetrons, the "heart" of all radar systems . . . the first to produce marine radar with 16" presentation. The "Mariners Pathfinder" radar, as installed on vessels of leading steamship lines, is a product of this world's largest producer of marine radar.

Miniature Precision Bearings

are made by the originators and pioneer developers of ball bearings in this size range. **MPB** supplies the finest miniature ball bearings to over three thousand discriminating customers.

Exclusive, exacting production and inspection details (practically every new concept in this field has been by **MPB** designers and engineers) assure highest quality bearings. Fully ground, lapped, honed, and/or burnished to ABEC 5 tolerances or better, **MPB** ball bearings are torque tested, ultrasonically cleaned, supplied in specific clearances, and classified within the tolerances for prompt assembly and maximum service.

More than a million **MPB** ball bearings have been supplied for many unusual operating applications — extreme temperature — shock — continuous high load capacity. The most extensive engineering knowledge in miniature bearing applications is available to you. Write for Catalog and survey sheet E1

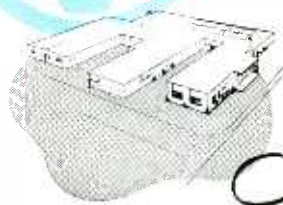
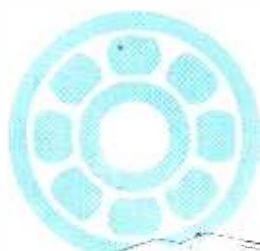

Though recently expanded, our production facilities are still not entirely adequate to always immediately satisfy the demand for ultra quality bearings. Continuing expansion, and newest exclusive processes will soon enable us to supply you promptly.

Miniature precision Bearings

Incorporated



Keene, New Hampshire

"Pioneer Precisionists to the World's foremost Instrument Manufacturers"

*save
space
weight
friction*

AMPHENOL

electronic components

by AMPHENOL

POLYETHYLENE CABLES



BLUE RIBBON CONNECTORS



AN Type CONNECTORS



POWER PLUGS



RF Type CONNECTORS



AUDIO CONNECTORS

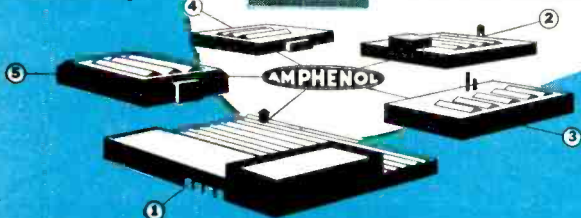

The various categories of cataloged electronic components listed below are an indication of the intensive research and development program at Amphenol. Whatever your application problem, some one of the extensive list of Amphenol components will probably provide you with the quality cable, connector or socket you need. If no existing component will serve your purpose, then Amphenol will pinpoint its vast engineering resources on your problem and custom-engineer the part you need.

- AN Type CONNECTORS
- RF Type CONNECTORS
- AUDIO CONNECTORS
- POWER PLUGS
- BLUE RIBBON CONNECTORS
- RACK and PANEL Type CONNECTORS
- INDUSTRIAL SOCKETS
- MINIATURE SOCKETS
- TUBE SOCKETS and RADIO COMPONENTS
- MICROPHONE CONNECTORS
- RG COAXIAL CABLES, TEFLON and POLYETHYLENE CABLE and WIRE ASSEMBLIES
- PLASTICS—EXTRUDED and INJECTION MOLDED

WRITE Department 13J for your copy of General Catalog B-2

AMERICAN PHENOLIC CORPORATION
1830 South 54th Avenue • Chicago 50, Illinois

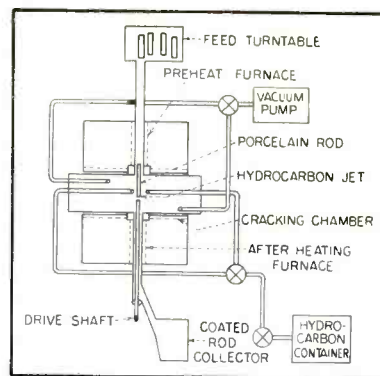

FIG. 2—Diagram of pyrolysis system showing how porcelain rods are coated with carbon film

properties depend on the uniformity and invariance of the temperature of the porcelain rod; amount of carbon deposition is related to rate of flow of the hydrocarbon vapor past the rod.

In addition, surface roughness, localized catalytic agents, and porosity of the porcelain can play an important part in production of uniform carbon films. However, these factors cannot be controlled by design of the pyrolysis system.

Figure 2 is diagram of a pyrolysis system. A ceramic rod approximately six inches in length is introduced into the preheating furnace where it is heated to uniform temperature per unit length and held at a constant temperature. After heating, the rod moves at a uniform velocity through the central furnace, which is maintained at some lower temperature. While in motion, it receives a carefully-regulated blast of a controlled amount of hydrocarbon from all sides. The rod then moves out through an after-heating chamber, which is held at an even lower temperature. To avoid carbon combustion and contaminations, the whole system is evacuated or filled with an inert atmosphere.

Process Control

Measurements of the porcelain temperature for unit length just before it is sprayed with hydrocarbon can be obtained by an optical pyrometer using a window at one end of the horizontal furnace to control porcelain temperature. The jet system can be designed to achieve the condition of equal amounts of hydrocarbon vapor striking each unit area of the rod

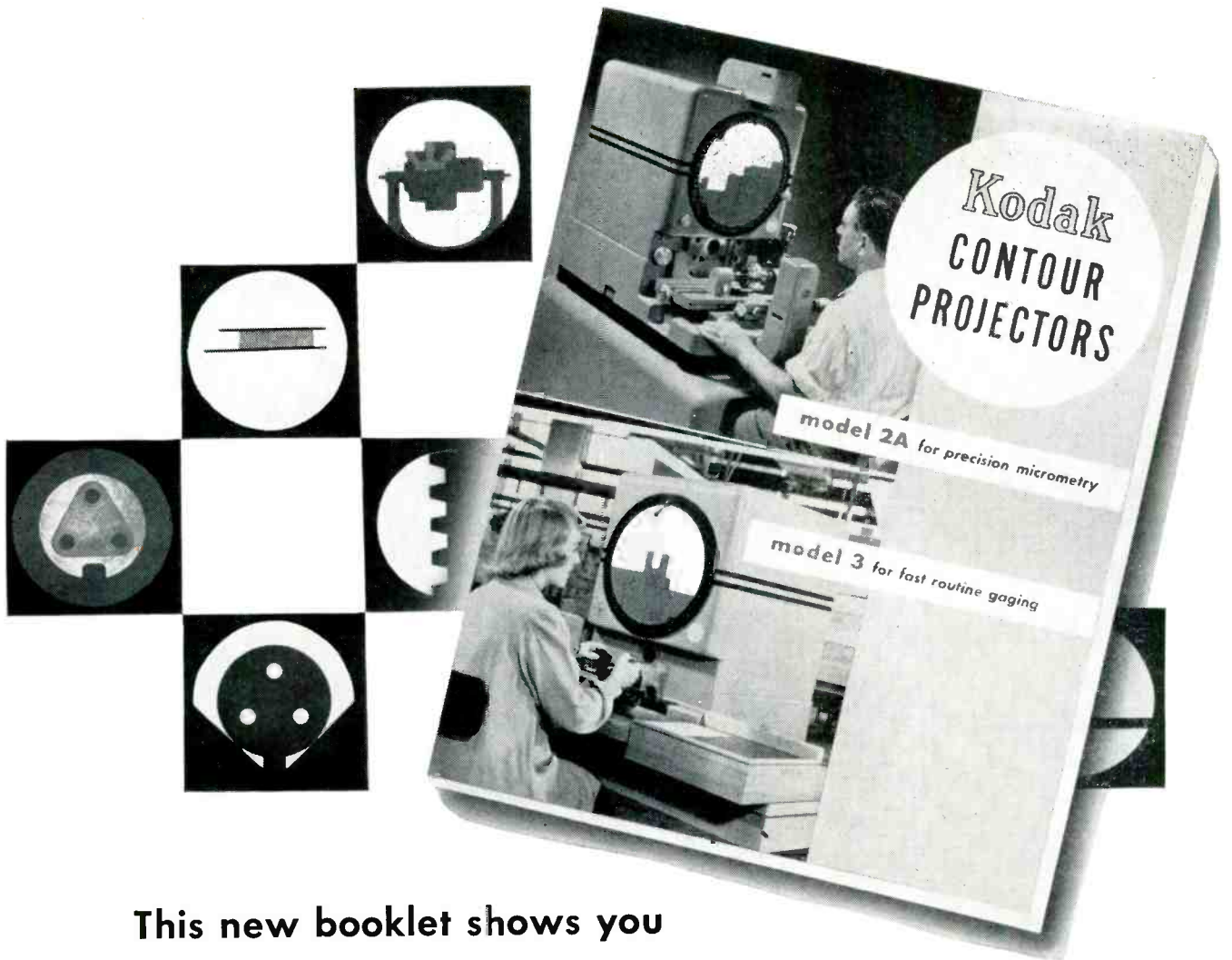

This new booklet shows you how Kodak Contour Projectors can simplify your inspection and measurement problems

Just off the press is the most informative booklet on Kodak Contour Projectors we've ever published.

- It shows by example and case history how you can inspect large parts, small parts, long parts, curved parts, delicate parts, complex parts, all sorts of parts on the Kodak Contour Projector.
- It gives details of both the Model 2A for precision micrometry, and the Model 3 for fast, routine gaging.
- It describes the features that make Kodak Contour Projectors adaptable to such a wide variety of work.
- It lists the accessories that extend their versatility.
- It discusses the measuring attachments that provide critical accuracy.

Whether your interest lies in toolroom measurement or production assembly and inspection, Kodak Contour Projectors will do the job quickly, completely, and accurately with little training of operators. For complete details, send for your complimentary copy of this new 12-page booklet. Just write to Eastman Kodak Company, Industrial Optical Sales Division, Rochester 4, N. Y.

the KODAK CONTOUR PROJECTOR



A new sound movie, Optical Gaging, shows how to simplify complex inspection problems. We'll tell you how to get it for a showing.

Kodak
TRADE-MARK



All wound up
 trying to make your own
 R. F. Choke Coils?

Standardize on **Jeffers**
RF. Choke Coils-

*save time, labor
 and expense*

Other Jeffers Products

ceramic capacitors • disc capacitors
 high voltage condensers • capristors

**Other Speer Products
 for the Electronics Industry**

anodes • contacts • resistors • iron cores
 discs • brushes • molded notched* coil forms
 battery carbon • graphite plates and rods

* Patented

Now you can stock a wide range of R. F. choke coils just as you do resistors, capacitors and other similar components.

Jeffers Electronics is ready to deliver to you a complete line of R. F. choke coils with the widest range of inductance values available. No longer do you have to waste time, labor and money on slow, tedious hand assembly from miscellaneous forms, wires and coatings.

Instead you receive a standardized product from Jeffers, completely assembled and ready for use. Coils that are well made, too. Insulated copper wire instead of bare wire for windings . . . husky, molded jackets instead of those fastened by glue. All windings are soldered to leads . . . shorted end-turns completely eliminated.

Why not give Jeffers R. F. choke coils a try on your next order? *Write today for our specification sheets.*

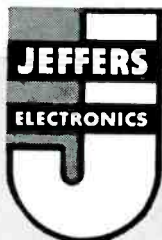

Jeffers Electronics Division
 Speer Carbon Co.
 Du Bois, Pennsylvania

Other Divisions: Speer Resistor, International Graphite & Electrode

Are you profiting from these advantages of Class H insulation?



1. More power for "full speed ahead." Class H motors and cables are setting new performance standards for naval vessels—with the help of MICO Class H electrical insulating materials. Class H equipment packs more power with less weight, less copper, less insulation... has a longer useful life... is less subject to breakdown.

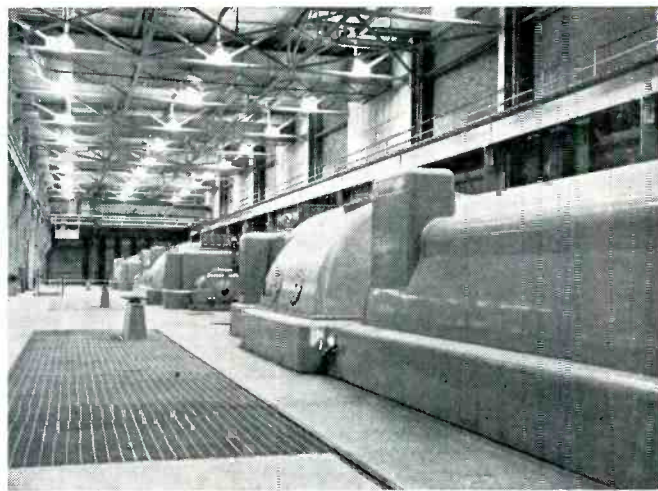

2. Built-in protection for fewer power interruptions. Class H generators and transformers provide more efficient and reliable operation... need less maintenance... take more frequent overloads. Although the initial cost of Class H insulating materials is somewhat higher, Class H means long-term savings... increased profits.



3. Maximum power, minimum maintenance. More and more Diesel-electric locomotives are using Class H electric motors and MICO Class H insulating materials. MICO was one of the original developers and is today one of the leading manufacturers of these superior insulating materials.

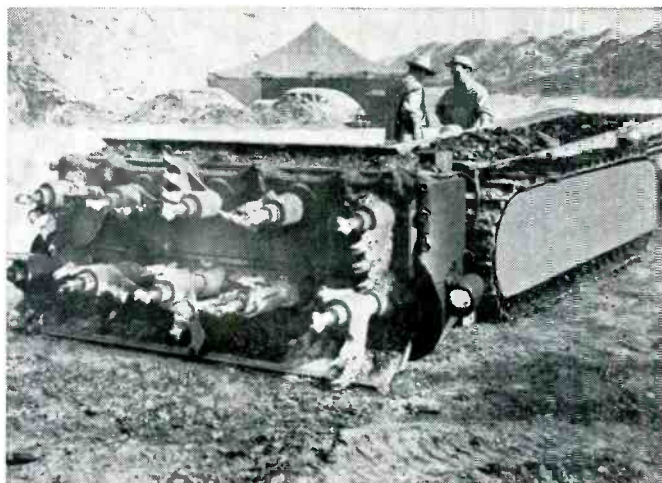

4. Increased safety against hazards. Risk of fire and explosion is minimized in automatic mining equipment designed with Class H electrical insulation. MICO's Class H insulating materials are also helping to make possible more compact design in this type of equipment.

When you turn to Class H, take advantage of MICO's experience in this fast-moving field. MICO has the finest equipment in the country for producing extremely high-quality silicone fabrics, silicone laminates and silicone-mica combinations.

MICO produces a complete line of Class H insulating materials, as well as all standard types... and fabricates special parts to your specifications. We will be glad to consult with you about your electrical insulation problems. Write today.

1893-1953
60 Years
of Leadership
in Electrical
Insulation



MICA Insulator COMPANY

Schenectady 1, New York

Offices in Principal Cities

LAMICOID® (Laminated Plastic) • MICANITE® (Built-up Mica) • EMPIRE® (Varnished Fabrics and Paper) • FABRICATED MICA

50% SMALLER LIGHTER

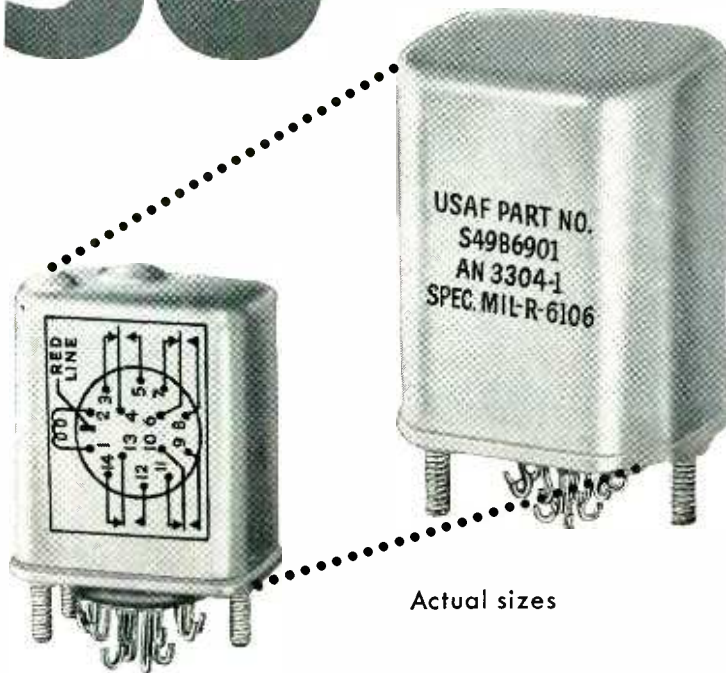

R-B-M 22300 SERIES Hermetically Sealed Relays

The R-B-M 22300 hermetically sealed telephone type relay is the electrical and mechanical equivalent of AN 3304-1, except for smaller size and mounting dimensions.

An improved armature design, plus high temperature molded nylon coil bobbin, provides greatly improved magnetic efficiency and enables R-B-M to reduce the overall size of the relay. The R-B-M 22300 design still retains palladium cross-bar contacts identical to those used in the larger size.

Maximum contacts—6 Form A and 4 Form C—3 ampere 28 Volts. D. C. coil construction only. Maximum coil resistance 5000 ohms. Minimum power .75 watts. Also available in AN 3304 can for dynamotor or low capacitance application.

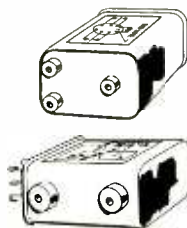

Optional Mounting Arrangements

Write Dept. B-1 for ASR Bulletin.



**R-B-M DIVISION
ESSEX WIRE CORP.**
Logansport, Indiana

MANUAL AND MAGNETIC ELECTRIC CONTROLS
— FOR AUTOMOTIVE, INDUSTRIAL, COMMUNICATION AND ELECTRONIC USE

at the same velocity. The total length of the rod can be uniformly coated, because of uniform movement through the vapor system.

An automatic feed and release of the rods provides the means for continuous operation. Calibrations of the various factors involved in processing a rod through this system against the resistance of the film produced will allow predetermination of any desired value of resistance.

The ceramic base upon which the carbon film is deposited is made of ball-milled alumina mixed with other ingredients such as silicon dioxide and calcium oxide in an alcohol binder. The bases are pressed and ground then fired at 2,950 F. A smooth surface for coating can be achieved by grinding with 600 carborundum powder in water. Gold contacts are used.

An Electronic Telephone

A MICROPHONE, amplifier and loudspeaker are part of an electronic telephone system developed by Societe le Teleampliphone of France. The device, known as the Neophone, makes it possible for several persons to speak into the same instrument for telephone conferences. The system does not use a talking-listening key.

Some of the proposed solutions for such a system are as follows: Basic to the various principles employed, one generally finds two amplifiers, each functioning in a single direction and almost always two terminal pieces, a transmitter and a loudspeaker. One system might be to block one of the two amplifiers while the other functions. This could be done by rectifying the signal with a diode element or a dry-disk rectifier in order to set in motion a relay that would cut off a tube in the amplifier circuit. With symmetrical circuits, each amplifier could function in turn, according to the necessities of the conversation.

A simple circuit uses negative rectification of the signal and a negative voltage obtained by carrying the bias of one of the amplifier tubes to cutoff. Unfortunately, such

NO NEED TO "STILL HUNT" FOR

SPECIAL SIZES IN CASES & COVERS

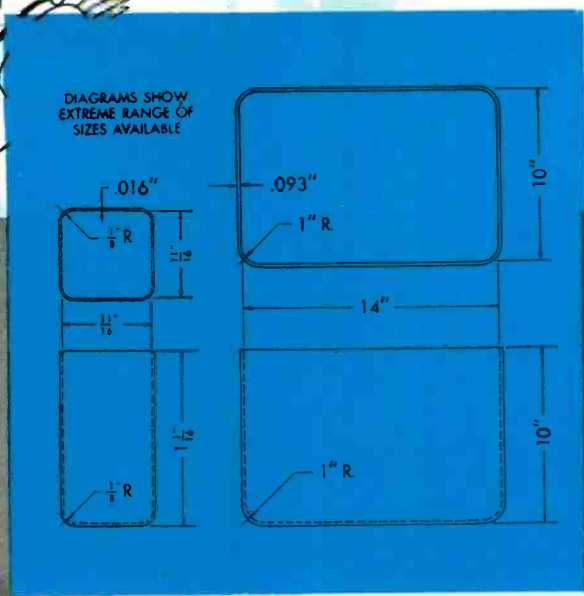

HUDSON

— is a bear for
punishment in producing extra
large, small or miniatures!

When you need cans or covers in unusual sizes, large to sub-miniature, consult Hudson first! Most likely, your particular size and shape will be a standard item at Hudson. Not only will you enjoy prompt delivery but prices quoted will reflect standardized tools and dies, and economical mass production runs.

Hudson stocks square, rounds, rectangulars— hundreds of stock sizes, with many optional features, are available in precision-drawn cases and covers to meet all but the most unusual circuit requirements.

Consult the Hudson Engineer-Designer Catalog File for "Bulls-eye" Purchasing of Cases, Covers, Stampings

Keep a copy handy in both your engineering and purchasing departments. Calling Hudson first will save you time, money and detail work. Ask for your catalogs, today. Just call or write Desk 210.

HUDSON TOOL AND DIE COMPANY • INC

PRODUCERS OF CASES, COVERS AND CUSTOM METAL STAMPINGS FOR ELECTRICAL, ELECTRONIC AND NUCLEONIC INDUSTRIES

118-122 SO. FOURTEENTH STREET, NEWARK 7, NEW JERSEY



Smallest ar

...with outstanding **STABILITY** and **RELIABILITY**
for application in radar, missile control, and
similar guided systems!

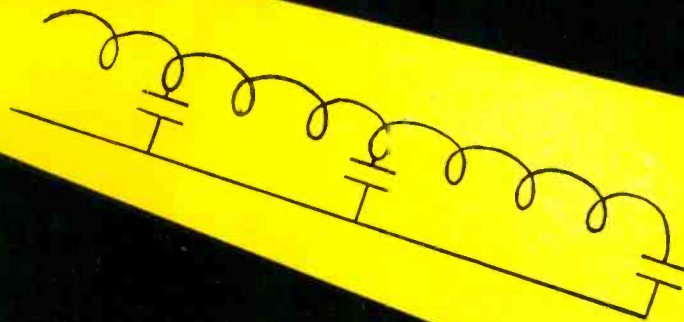

AMP CAPITRON* Capacitors and Pulse Forming Networks are particularly suited for radar and guided systems not only because of their remarkable size and weight characteristics, but also because of their outstanding stability and reliability in operation. AMP Pulse Forming Networks are fabricated with AMPLIFILM,* a startling new synthetic dielectric, chemically similar to mica, which imparts its unique combination of extremely high dielectric strength, stability over wide temperature ranges, low power factor, and good dielectric constant to these products.

For this reason CAPITRON* High Voltage Capacitors and Pulse Forming Networks are designed and fabricated for either A-C or D-C use in applications where the mechanical, electrical or thermal requirements are such that standard or catalog capacitors made with mica, paper or plastic dielectrics would be inadequate. These Capacitors and Networks are not made in a standard line of types or models.

They are designed in each instance for the specific requirements as to size, shape, working or test voltage, capacitance, life or other operating conditions of the equipment in which they are to be used. Inquiries are invited.



AMP is also nationally recognized leader in
the field of solderless terminals, simplified wiring
devices and, automatic wire termination.

Write for our "Quality Control" brochure.

AMP Trade-Mark Reg. U. S. Pat. Off.
* Trade-Mark

and Lightest!

AMP CAPITRON
Trade-mark
**HIGH VOLTAGE
CAPACITORS
AND PULSE
FORMING
NETWORKS**

**up to 70% size and
weight reduction**

**wide temperature
range**

**close capacity
tolerance**

no derating

no drift

**highest known leakage
resistance**

low absorption

meets jan-c-25 (3) specs.

dimensional flexibility

AMP

**AIRCRAFT-MARINE PRODUCTS, INC.
CHEMICALS AND DIELECTRICS DIVISION
2100 Paxton Street, Harrisburg, Pa.**

"We made \$1.00
do the work of \$2.00!"



...with **SEAMLESS**
Molybdenum
TUBING
and **Fansteel Fabrication**

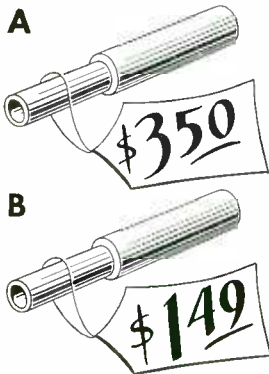

"Here's how. Look closely at the two cathodes at the left. They look alike. They are alike — yet one costs 57.4% less. Our old method was to drill a solid molybdenum rod and machine the outside diameters. This involved a high percentage of scrap waste. Fansteel suggested we use Seamless Molybdenum Tubing as the base material with cut to finish lengths of the desired dimensional tolerances, and with the necessary smooth finish inside. Now Fansteel does *all* the fabricating for us — even grinding the minor outside diameter and cutting a small chamfer in one end. The net result is a big cost saving!"



Users of molybdenum are invited to consult Fansteel for assistance in design and the most economical fabrication. To the user, Fansteel fabrication eliminates the scrap and reject problem, minimizes inspection costs, and releases equipment and personnel for other work.

Write for the informative booklet: "FANSTEEL TUNGSTEN AND MOLYBDENUM"

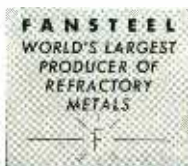

FANSTEEL MOLYBDENUM

22502-C

Fansteel Metallurgical Corporation NORTH CHICAGO, ILLINOIS, U.S.A.

a system involves difficulties that render it useless; namely the Larsen feedback effect.

Two solutions seem likely. One is to use a circuit that is inverse to the one described previously. Such a system would start, from the off position, with two blocked amplifiers and only the necessary amplifier would be unblocked during conversation. Here again, the signal tends to interfere with the operation due to the two auxiliary amplifiers. For example, if the amplifiers are blocked by a tube at cutoff in each amplifier, one could rectify the signal positively and thereby restore the bias to its normal value. In order to transmit in full with this system, all the words, syllables

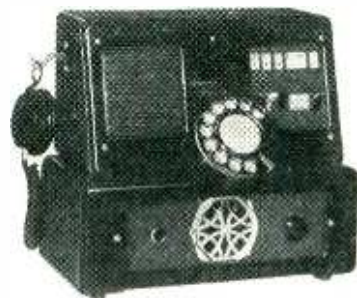

Earphone on the left allows reception of a call with the same privacy as with conventional sets if desired

and sounds, the operation must start very rapidly. It would be necessary to have extremely short time constants on all the rectifying and signal filter circuits.

A second solution consists of two amplifiers that are not blocked but are working at reduced gain. After blocking the idle amplifier, the gain of the other functioning amplifier is increased. The circuits are relatively simple with the idea being to prevent the overloading of one amplifier by blocking the other. The system which has given the best results uses a cutoff tube by counter reaction.

Counter-Reaction Tube

The counter-reaction tube has a distinct advantage in securing a cutoff in proportion to the input voltage. In the absence of all sound or noise before the microphone,



VITREOUS ENAMELED RESISTORS

The resistor line which is specified by engineers employed by the nation's foremost manufacturers of original equipment.

DELIVERY

... two separate self-contained resistance plants guarantee prompt delivery.

QUALITY

... as the world's leading manufacturers of wire wound resistors, we assure you that only the finest engineering techniques and material are utilized.

PRICE

... our tremendous manufacturing capacity enables us to offer resistors ... in any quantity ... at exceptionally attractive prices.

ENGINEERING

... our factories include the most modern machine shops and engineering facilities. Our experienced engineering department is at your service to assist in designing any resistance unit to meet your requirements and to meet JAN Specifications.

We invite your inquiries.

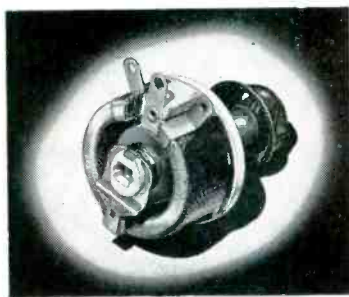
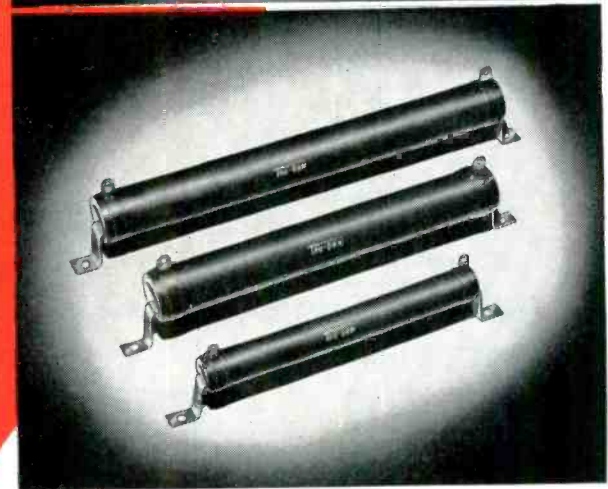
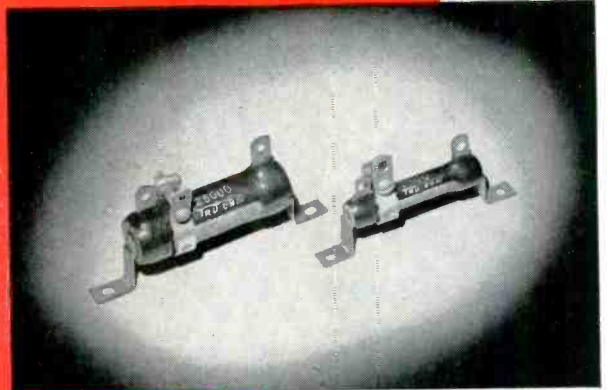

Our new multi-colored catalog, complete with engineering data and illustrations, is yours without obligation. WRITE TODAY!

The New TRU-OHM Power RHEOSTAT

... the practical rheostat in its most exacting form, with a compensating constant pressure contact brush ... designed to meet JAN Specifications. Write for complete technical literature.



PRODUCTS

Division of
Model Engineering
& Mfg., Inc.

General Sales Office: 2800 N. Milwaukee Avenue, Chicago 18, Ill.

Factory: Huntington, Indiana

MANUFACTURERS: Power Rheostat, Fixed Resistors, Adjustable Resistors, "Econohm" Resistors

For *Critical* Applications
Triplett 630-A Has No Counterpart

Accuracy
 to 1½%

Readability
 with a Mirror-Scale

Adaptability
 with ½% resistors

**Try This Volt-Ohm-Mil-Ammeter
 at your distributor's**

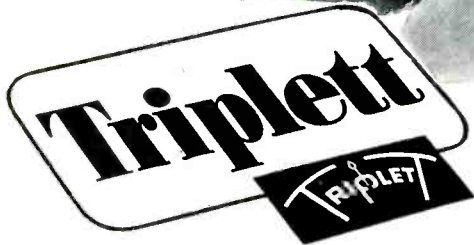

TRIPLETT ELECTRICAL INSTRUMENT CO., BLUFFTON—

OHIO



Your inquiries are cordially invited and will receive our prompt and interested attention.

Specify "MAKEPEACE" for

PRECISION RINGS

DEMCO collector rings and ring assemblies give you these advantages . . .

ECONOMY . . . laminated construction provides contact metal where required . . . base metal for strength.

HIGH FINISH . . . on contact surface for long wear and noise-free operation.

PRECISION MADE . . . it is unnecessary to add further machine operations.

COMPLETE . . . rotor or pancake type multi-ring and ring-and-brush assemblies supplied.

PRECISION TUBING

PRECISION DRAWN . . . ID held as close as $\pm .001$. Solid coin silver, brass or aluminum Rev. MIL-T-85.

LAMINATED SILVER . . . on ID for

- Low attenuation
- Corrosion resistance
- Highest mirror finish

Laminated silver ID and OD for round tuned lines.

PRECISION "KNOW-HOW"

With nearly sixty years of experience in the production of both laminated and solid precious metals, MAKEPEACE is today an accepted "headquarters" for the many special precious metal products and assemblies called for in the electronic field.

Our staff of thoroughly experienced design and production engineers and metallurgists . . . as well as our research and testing laboratory . . . are all at your service.

D. E. MAKEPEACE COMPANY

Laminated and Solid Precious Metals for Industrial Use • Fabricated Parts and Assemblies • Bar Contact Material • Precious Metal Solders

**MAIN OFFICE AND PLANT, ATTLEBORO, MASSACHUSETTS
NEW YORK OFFICE, 30 CHURCH STREET
CHICAGO OFFICE, 55 EAST WASHINGTON STREET**

MILO is a bridge!

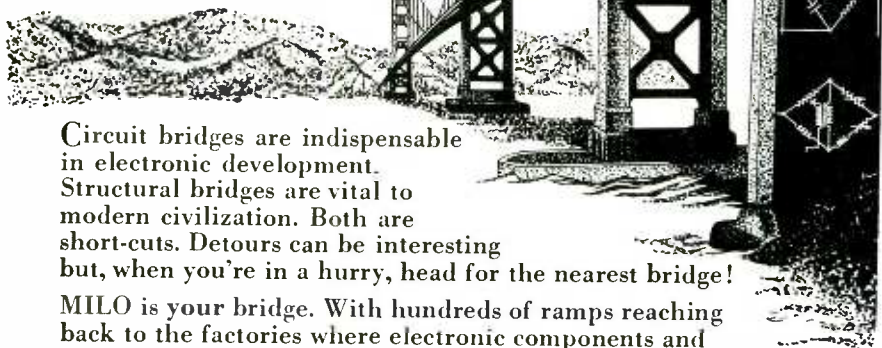

Circuit bridges are indispensable in electronic development. Structural bridges are vital to modern civilization. Both are short-cuts. Detours can be interesting but, when you're in a hurry, head for the nearest bridge!

MILO is your bridge. With hundreds of ramps reaching back to the factories where electronic components and test instruments are made. With thousands of ramps leading to your plants where they are used.

MILO anticipates your needs. When you must have many different components to produce electronic devices quickly, there's no time to meander about the headwaters — no need to go way back to the source. The material is already "on the bridge" at MILO. A phone call will start it down the ramp to you.

Check List (A-D) of LEADING BRANDS IN STOCK

Advance Electric	ATR	Chicago Telephone Supply
Aerovox	Belden	Cinch-Jones
Aircraft Marine Products	Bliley	Clarostat
Allen-Bradley	Bogen	Consolidated Wire Cos.
Alpha Wire	Bud	Cornell-Dubilier
Amphenol	Burgess	Dialco
Arrow-Hart & Hegeman	Centralab	Drake

JAN-APPROVED COMPONENTS



FREE INDUSTRIAL TUBE BOOKLET

Chief Engineers, Purchasing Agents, Purchasing Executives! Write now if you haven't received our Industrial Electronic Tube Booklet #EB. Use company letterhead and state your title. Address Dept. E-1.

the ONE source for ALL your electronic needs

MILO RADIO & ELECTRONICS CORP.

Electronics for Industry

200 GREENWICH STREET, NEW YORK 7, N.Y. • Phone BEekman 3-2980
Teletype NY1-1839 • Wire MILO-WUX-N.Y. • Cable MILOLECTRO-N.Y.

there is no voltage on the grids, no counter reaction and no cutoff. The two amplifiers are practically free to use their entire sensitivity. Every impulse to the input of one amplifier, likely to start the Larsen effect, will start the cutoff by counter reaction, reducing the gain sufficiently to avoid the appearance of this effect. By tapping at each input, an auxiliary amplifier will permit blocking the idle amplifier and suppressing the counter-reaction of the working amplifier by biasing to cutoff. The same rectifier secures these two reactions simultaneously.

This latter system is the one actually used. It requires a system of very rapid time constants on the telephone networks to avoid the possible errors introduced by garbling of words. Sensitivity of the blocking circuits must be great enough to respond even on high-loss lines and yet not deliver prohibitive voltages on conversation at high levels.

Transmitter Circuit

For transmitting, the principal amplifier comprises a 6AV6, a 6SL7 and a 6AQ5 which drives an ensemble of two transformers connected differentially toward the line. The auxiliary transmission amplifier includes the same 6AV6 of the input, the same 6SL7 and a special 6AV6 which drives its two diodes by a push-pull transformer.

The counterreaction tube, a 6SL7, cuts off the 6AQ5 of the line by impressing on the cathode of the 6AQ5 a portion of the signal and by retransmitting it 180 deg out of phase on the grid of the 6AQ5.

On the receiving end, the circuits are almost symmetrical. In the principal amplifier a 6SL7 drives the 6AQ5 at its output. In the auxiliary amplifier, a 6AV6 drives its two diodes by a push-pull transformer. The 6SL7 counterreaction tube cuts off the 6AQ5 between cathode and grid. The 6AV6's are mounted in such a way that the voltage which drives the diodes is practically constant beginning at a certain level. The rectified voltage is limited to 15 v. For transmission, a controlled fraction of this voltage serves to block the 6SL7 at the receiving input and another por-

in TELECHRON TIMERS only . . .

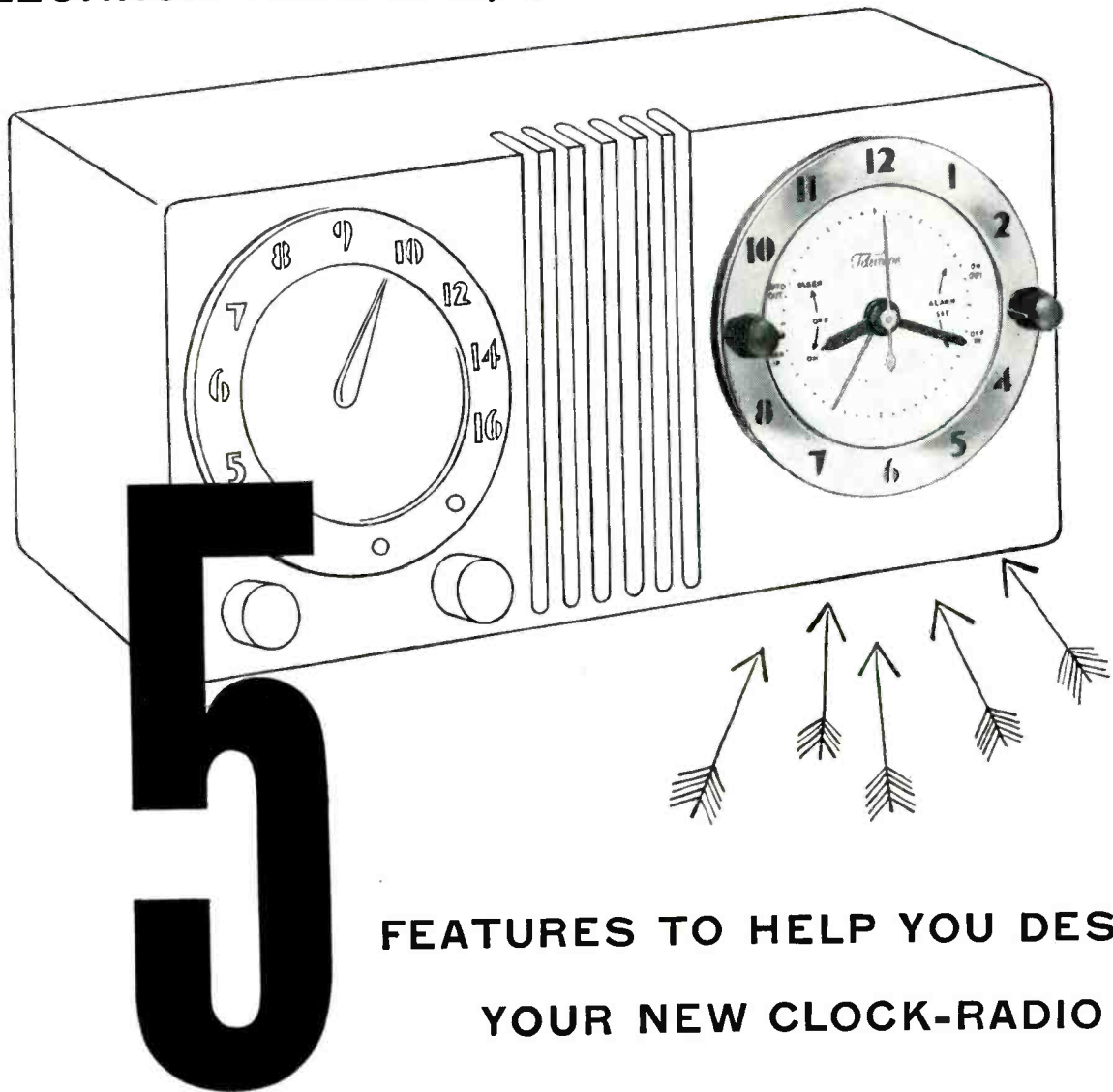

5 FEATURES TO HELP YOU DESIGN YOUR NEW CLOCK-RADIO

- **1** TWO KNOBS do the work formerly done by three. The new Telechron Timer, model C-78, means unmatched simplicity in clock-radio operation. One knob for alarm . . . the other for radio.
- **2** SIGNAL ALARM. It's a must for heavy sleepers. And it's a sales-boosting extra talking point for your clock-radio. In the clock-radio field only Telechron Timers have the signal alarm.
- **3** RADIO ALARM "ON" SWITCH. Contacts rated at 15 A. at 115v. a-c. Adequate to carry the load of a variety of electrical appliances through an auxiliary outlet on your clock-radio.
- **4** DEPENDABLE SLEEP SWITCH. Simple design—friction geared to clock movement—insures accuracy, dependability, and sturdy endurance even with rough handling.

- **5** FREEDOM OF STYLING. Two-knob control and separate alarm hand mean greater freedom for your styling people. Telechron Timers are available with round or square face . . . any color dial, hands or bezel.



Sales-Boosting Extra Benefit
 You are free to display the Telechron trade-mark and the Telechron Seal of Accuracy on your clock-radio. Ask for full information. Telechron Department, General Electric Company, 41 Homer Ave., Ashland, Massachusetts.

Telechron[®]
 MARK OF TIMING LEADERSHIP

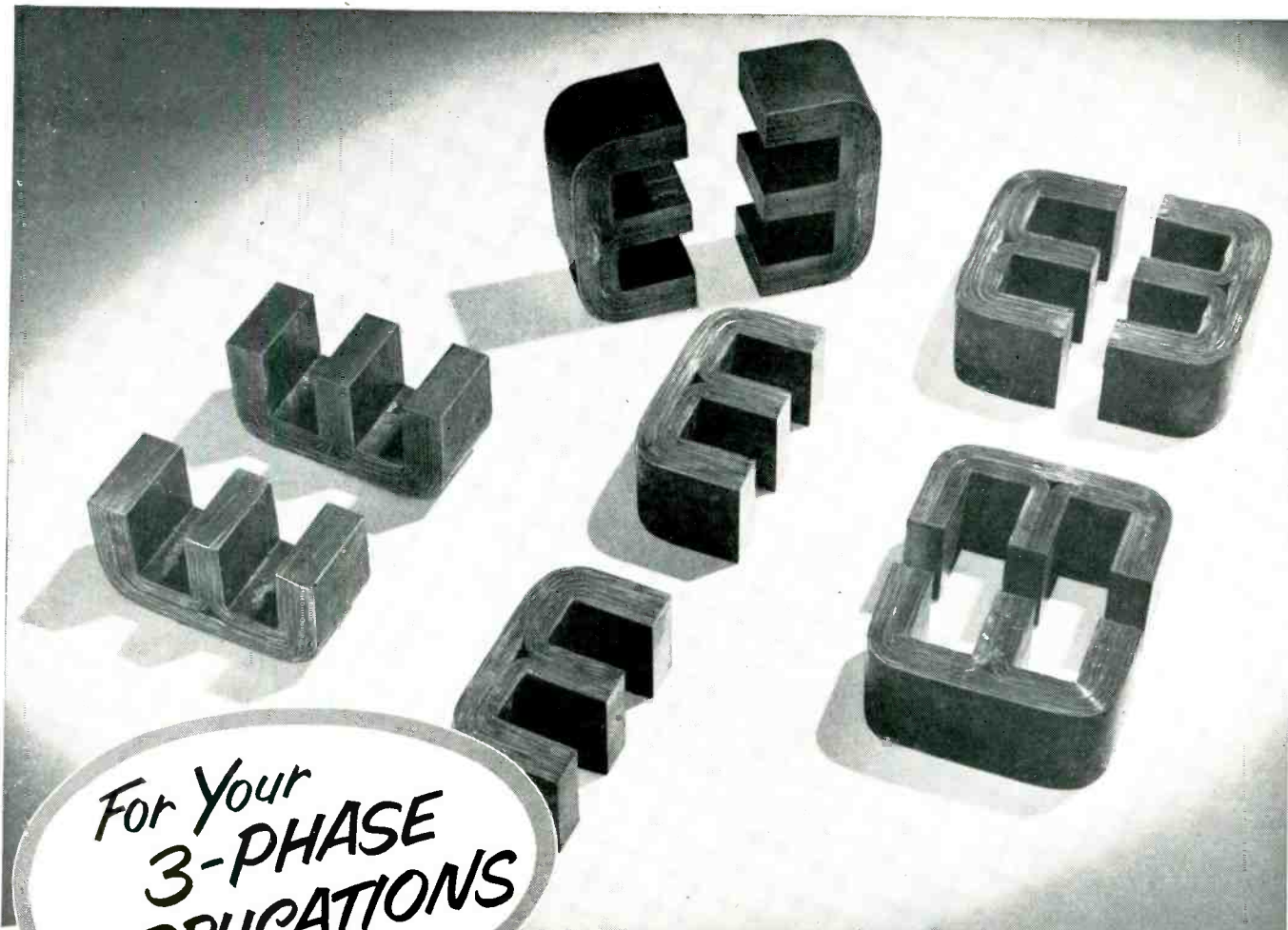

For Your
3-PHASE
APPLICATIONS

Arnold E-CORES

made from SILECTRON strip
(*grain-oriented silicon steel*)

The use of "E" cores, wound from grain-oriented silicon steel, results in weight and size reduction as well as higher efficiency and possible cost savings. "E" cores can be supplied in a variety of window sizes and core areas from 1, 2, 4 or 12-mil Silectron strip, for high or low frequency 3-phase applications. • All Arnold cores are made by precision methods, and carefully tested under closely controlled conditions to assure highest quality and reliability. *We'll welcome your inquiries.*

W&D 4437

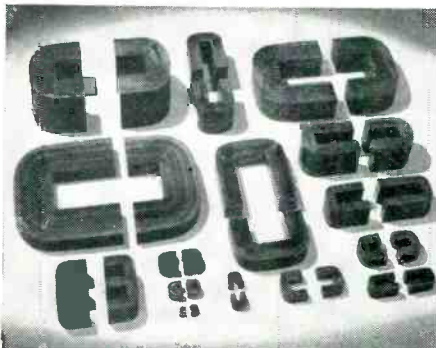

C-Cores to meet any requirement

For your single-phase applications, Arnold "C"-Cores are available in any shape and quantity, and in any size from fractions of an ounce to hundreds of pounds . . . wound from Silectron strip in a wide range of ultra-thin and heavier gauges.

THE ARNOLD ENGINEERING COMPANY



SUBSIDIARY OF ALLEGHENY LUDLUM STEEL CORPORATION

General Office & Plant: Marengo, Illinois

Besto-Wire[®]

JAN-C-76 Type SRIR, Unbraided, Spiral Striped

JAN-C-76 Type SRRF, Plain or Braided

JAN-C-76 Type SRIR, Braided — Cotton, Rayon, Glass

Wire and Cable

AN-J-C-48a Braided — Cotton, Glass, Nylon Jacket

JAN-C-76 Type WL with Nylon Jacket

JAN-C-76 or AN-J-C-48a Shielded

JAN-C-76 Type SRHV, Plain or Braided

For Aviation and Electronics

Tell us the type of wire or cable you need — the chances are excellent that it is one of our regular production numbers. If it isn't already in our extensive line, we will design the wire especially for you. We have had long experience in coming up with the right answers in wire and cable for many leading manufacturers in the fields of aviation and electronics. Try us. You Specify — We Supply!

Ask us for our new complete catalog. We'll gladly send you a copy.



RHODE ISLAND INSULATED WIRE CO., Inc.

50 BURNHAM AVENUE

CRANSTON, RHODE ISLAND

National Sales Offices: 624 S. Michigan Blvd., Chicago, Ill.



field-proved

Workshop microwave antennas proved in use

On a Major Midwest R.R. . . .
WORKSHOP parabolic antennas are an integral part of this microwave system installed by Philco. Operating between Norton and Goodland, Kansas, this system faces weather conditions ranging from 27° below zero to 110° above, plus snow, wind and sand storms.

Calling for utmost reliability, the system uses several WORKSHOP 7000 mc. reflectors. It is another field-proved installation of WORKSHOP microwave antennas—another reason why more WORKSHOP parabolas are in use than all other makes combined.



At the Levant, Kansas, repeater stations, two WORKSHOP reflectors beam towards passive reflectors which direct the signal to adjacent stations. Drain holes carry away any moisture that may collect — guarantee uninterrupted performance.

WORKSHOP parabola mounted on grain elevator at Rexford, Kansas. Over 150' in the air, servicing is extremely difficult and dependability a "must".

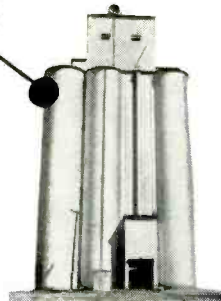

**WORKSHOP ASSOCIATES DIVISION
THE GABRIEL COMPANY**

Endicott Street • Norwood, Mass.

DESIGNERS AND MANUFACTURERS OF A
COMPLETE LINE OF MICROWAVE ANTENNAS

more
Workshop dishes
are used
than any other kind!

tion blocks the 6SL7 of the transmission counter reaction.

For receiving, the 6SL7 transmission element is blocked and then the 6SL7 of the receivers. The time constants are such that the line blocking precedes the counter-reaction blocking and, inversely, the counterreaction unblocking precedes the line unblocking.

Thermal Relays Control Heater Voltage

BY C. D. GEER & W. C. BROEKHUYSEN

*G-V Controls Inc.
East Orange, N. J.*

MAINTAINING uniform heating of tube cathodes over wide variations in supply voltage, especially in the design of newer mobile equipment using miniaturized components is an important problem. Limitations of space and weight and variations in supply frequency often rule out conventional voltage-regulating devices for this purpose.

Several effective arrangements for regulating this heating by the use of miniature critical-voltage or critical-current relays of the thermal type have been developed recently.

A critical-voltage or critical-current relay is arranged to operate its contacts when the potential across its operating coil (or the current through that coil), reaches a predetermined value. In a thermal relay, contacts are actuated by the heating effect of the current passing through the energizing coil rather than by the electromagnetic effect as in magnetic relays.

Two general methods have been

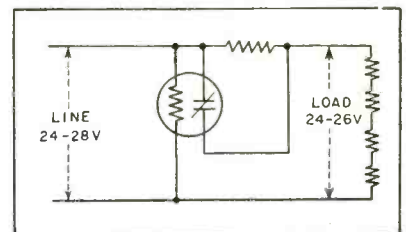
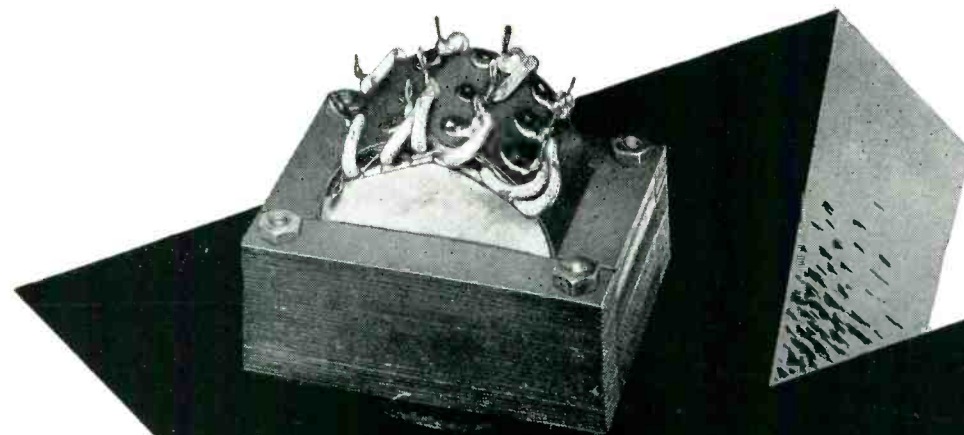

FIG. 1—Thermal-relay circuit for introducing a dropping resistor in series with vacuum-tube heaters when the supply voltage exceeds a certain value



LEFT—Open view of a typical Keystone Aircraft Power Transformer to show construction. This particular unit was supplied hermetically sealed.

Aircraft Power TRANSFORMERS

The more rugged your transformer requirements—the more you need Keystone quality production. Unit shown is 400 Cycle, Single Phase aircraft power transformer. High voltage and Filament Supply. Every Keystone Transformer and every Keystone Magnetic Amplifier is custom-built. Open or hermetically sealed. Prices gladly quoted on request. Please send your prints and specifications by registered mail for safety.

KEYSTONE PRODUCTS COMPANY

UNION CITY 2, N. J.

UNion 6-5400

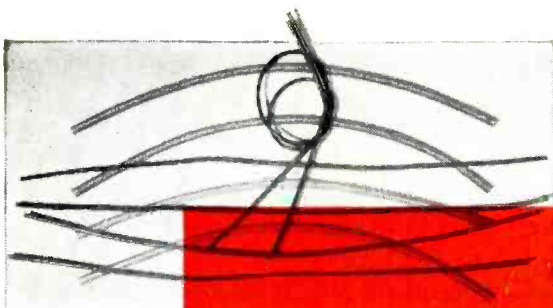

MITCHELL-RAND
electrical
insulation headquarters
features...

hygrade
and
flexite
tubings and sleeveings

to meet every particular insulation requirement

In the Mitchell-Rand line of HYGRADE and FLEXITE Tubings and Sleeveings, there is a particular grade and class to meet the specific insulation requirement of temperature resistance, dielectric strength, abrasion resistance, flexibility and push-back. HYGRADE Tubings and Sleeveings conform to the NEMA Standards VSI-1950 and to the Armed Services Specification MIL-1-3190.

The "Select-It" chart details the various grades and classes of HYGRADE Tubings and Sleeveings... grades differ according to amount of insulating coating applied and class is a A.I.E.E. standardization to indicate the ability of varnished coated products to withstand heat and temperature rises: Class A: 105° C or 221° F, class B: 130° C or 277° F, class H: 200° C or 392° F. Class A is organic, treated with organic varnishes or coatings. Class B and H are fiberglas treated with organic varnishes or coatings.

Flexite Plastic Tubings... made from various grades and types of resins offer an extraordinary combination of qualities including high dielectric strength, flexibility, non-flammability, abrasion resistance, oil and chemical resistance, heat stability, and resistance to aging... are low priced to make them the most desirable tubings for many insulation problems.

Hygrade Tubings and Sleeveings and Flexite in standard sizes of copper wire are available in black, red and yellow for Class A and B, and natural for Class H. Other colors are available on special order.

TYPE	GRADE	Minimum Dielectric *48/25/50	CLASS			USE FOR APPLICATIONS REQUIRING:
			A	B	H	
HYGRADE IMPREGNATED	A-1	7000 v	X	X	—	Thin wall, smooth interior and exterior • no wicking, disintegration or swelling • thoroughly impregnated.
	B-1	4000 v	X	X	—	
	C-1	2500 v	X	X	—	
	C-2	1500 v	X	X	—	
	C-3	—	X	X	—	
HYGRADE SN	A-1	7000 v	X	X	—	Excellent electric characteristics, high insulation resistance under high humidity, good dielectric flexibility after flexing.
	B-1	4000 v	X	X	—	
HYGRADE VF	A-1	7000 v	—	X	—	Extreme flexibility, constant dielectric strength, abrasion resistance, non-burning, non-corrosive, non-stiffening.
	B-1	4000 v	—	X	—	
	C-1	2500 v	—	X	—	
HYGRADE H	A-1	7000 v	—	—	X	Extreme temperature resistance. Flexible over temperature range —65° C to 260° C.
	B-1	4000 v	—	—	X	
	C-1	2500 v	—	—	X	
	C-2	1500 v	—	—	X	
THERMOFLEX "1200" THERMOFLEX Colored		Dielectric provided by space factor	—	—	X	Free of all organic matter ("1200" only). Fray-resistant to temperatures to 1200° F.
			—	—	X	

ELECTRICAL GRADES OF EXTRUDED PLASTIC TUBING

FLEXITE HT 105C	Approx. 800 v/mil	Underwriter approved for continuous operating temperatures to 105° C. Good resistance to heat deformation, excellent oil resistance.
FLEXITE STANDARD	Approx. 800 v/mil	Continuous operation to 80° C, bright colors, transparent.
FLEXITE E	Approx. 800 v/mil	Low temperature flexibility to —60° F, very flexible.
FLEXITE POLYTHENE	Approx. 1200 v/mil	High insulation resistance, chemically inert and insensitive to moisture. Flexible from —80° C to +85° C. Excellent for high frequency units.



Write to MITCHELL-RAND for free samples and descriptive data.

MITCHELL-RAND INSULATION COMPANY, INC.
 51 MURRAY STREET COrtland 7-9264 NEW YORK 7, N. Y.

A PARTIAL LIST OF M-R PRODUCTS: FIBERGLAS VARNISHED TUBING, TAPE AND CLOTH • INSULATING PAPERS AND TWINES • CABLE FILLING AND POTHEAD COMPOUNDS • FRICTION TAPE AND SPLICE • TRANSFORMER COMPOUNDS • FIBERGLAS SATURATED SLEEVEING • ASBESTOS SLEEVEING AND TAPE • VARNISHED CAMBRIC CLOTH AND TAPE • MICA PLATE, TAPE, PAPER, CLOTH, TUBING • FIBERGLAS BRAIDED SLEEVEING • COTTON TAPES, WEBBINGS AND SLEEVEINGS • IMPREGNATED VARNISH TUBING • INSULATING VARNISHES OF ALL TYPES • EXTRUDED PLASTIC TUBING

Marconi Television for Venezuela

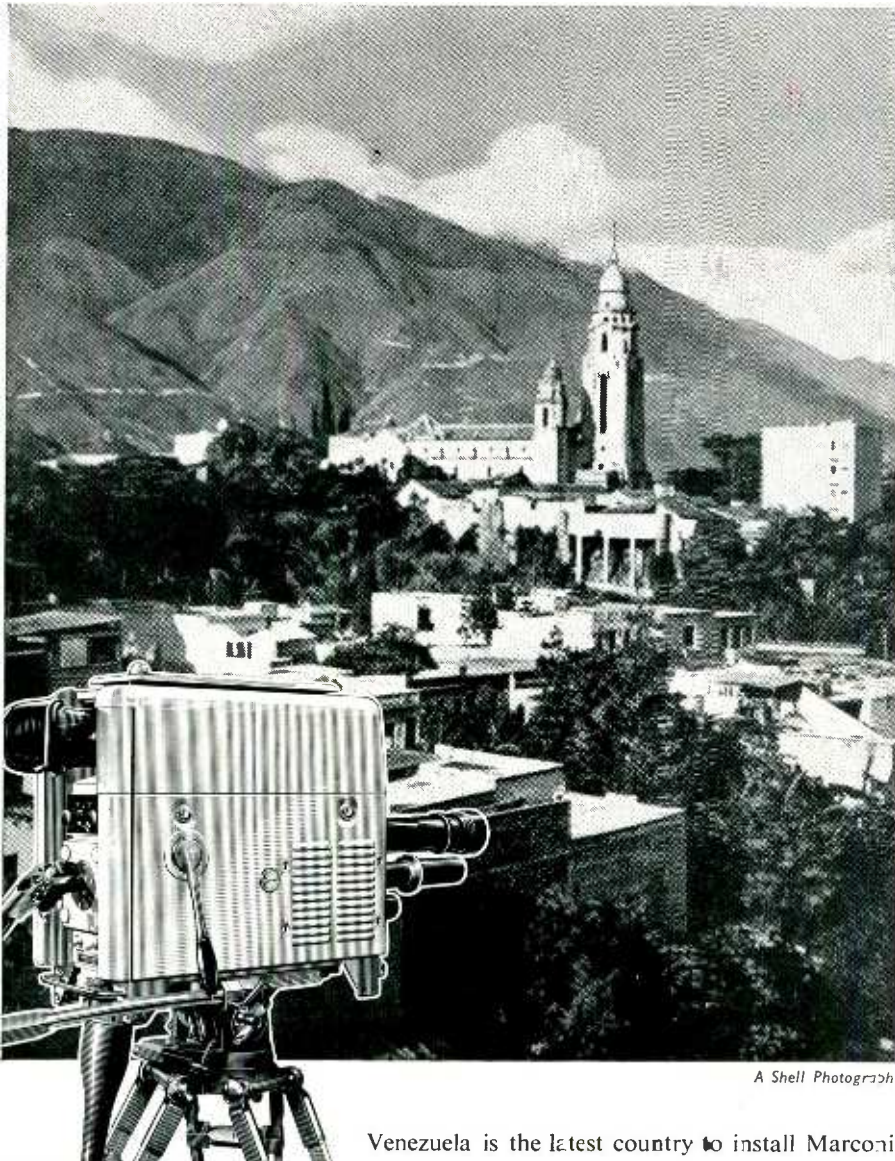

A Shell Photograph

Equipment for the Caracas Television Station, sponsored by 'Televisa', includes:

- 5 kW vision transmitter
- 3 kW sound transmitter
- Associated aerial system
- Complete studio installation
- Complete mobile O/B television unit, with two camera channels and micro-wave links

Venezuela is the latest country to install Marconi television equipment.

Marconi cameras are used by the United Nations to televise their Sessions, and the television systems of both Canada and Spain bear the name Marconi. Marconi transmitters and aerials have been installed in every one of the B.B.C.'s five television stations.

MARCONI of England
television transmitting
equipment

MARCONI'S WIRELESS TELEGRAPH COMPANY LTD • CHELMSFORD • ESSEX • ENGLAND

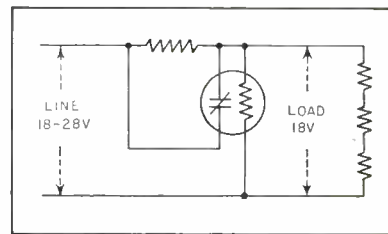

FIG. 2—Circuit used for producing a pulsating potential as described in text

used for reducing effect of voltage variations by means of thermal relays. The first method uses a critical-voltage relay to introduce a dropping resistor into the circuit when the supply voltage exceeds a certain value. Figure 1 illustrates a typical circuit. Four 6.3-v heaters are connected in series across a 24 to 28-v supply. A thermal relay, set to open its normally closed contacts when the voltage across its heater exceeds 26 v, is connected across the supply.

Whenever the supply voltage rises above 26 v, the thermal relay cuts a dropping resistor into the circuit to reduce by two volts the voltage applied to the cathode heaters. As the supply voltage rises from 24 to 26 v, the voltage per tube increases from 6 to 6.5 v. When the supply voltage goes above 26 v, the tube voltage drops back to 6 v, reaching 6.5 once more when the supply voltage goes to 28 v.

On decreasing voltage, the dropping resistor is cut out at the same voltage at which it was introduced.

Variation of cathode heater voltage is reduced to one half of the variation in supply voltage. For effective protection against overheating, the thermal time constant of the relay should not exceed that of the cathode heaters.

The second method produces closer regulation of heating over a substantially wider range of supply-

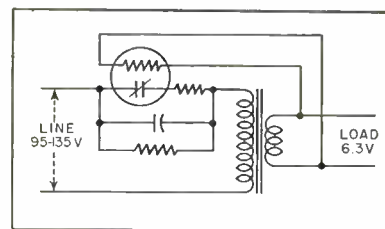
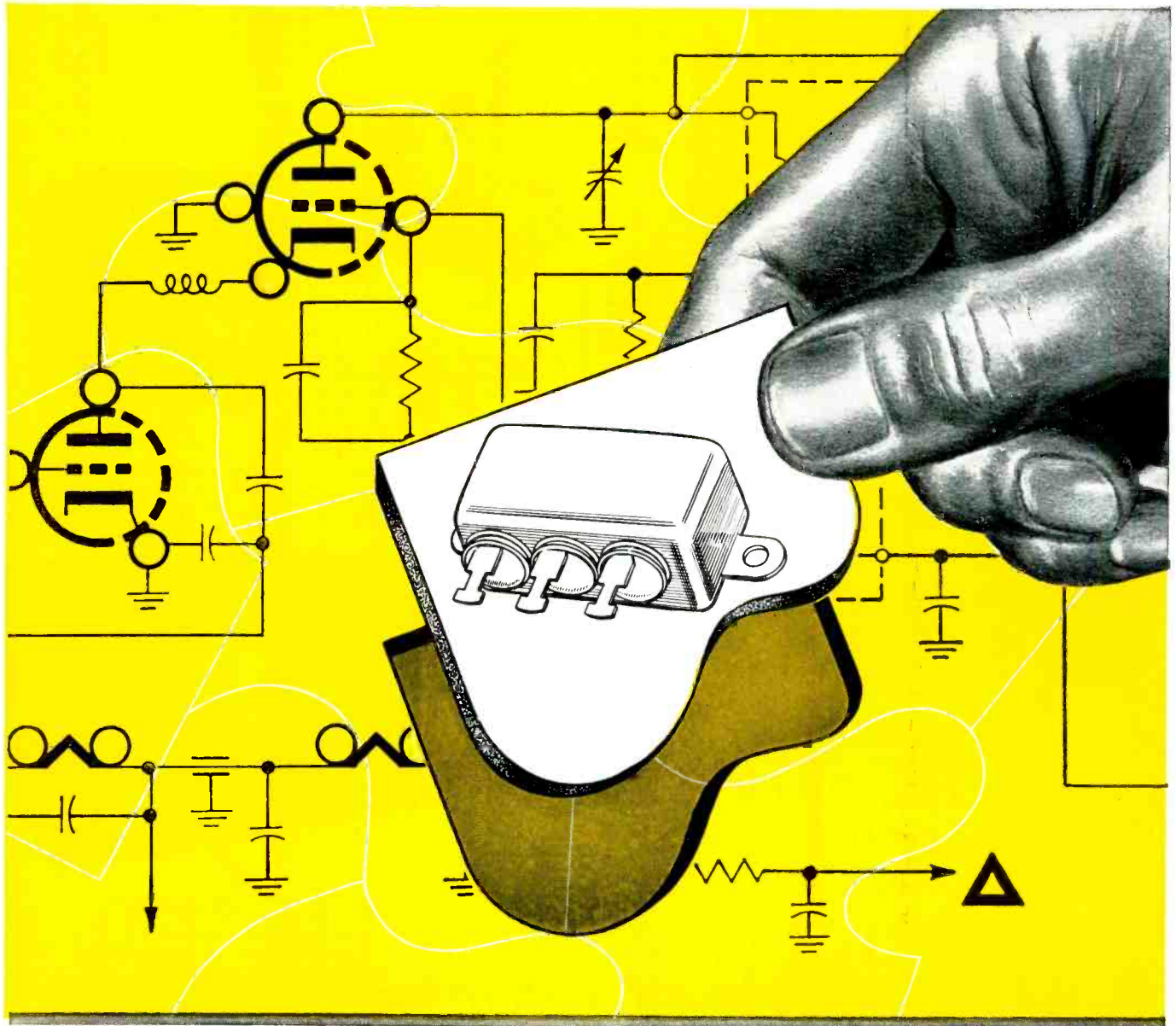

FIG. 3—Regulating contacts and resistor in the primary circuit of a transformer and relay heater in the secondary



Function-Fitted capacitors



The best capacitor at lowest cost results from the experienced interpretation of your circuitry, your associated components, your operational requirements.

That is why Aerovox engineers are so inter-

ested in HOW their capacitors are used. If you wish, they are prepared to collaborate on the details of your entire assembly.

Such capacitor application experience, second to none, is yours for the asking.



AEROVOX CORPORATION

NEW BEDFORD, MASS.

Hi-Q[®] DIVISION
OLEAN, N. Y.

WILKOR DIVISION
CLEVELAND, OHIO

Export: 41 E. 42nd St., New York 17, N. Y. • Cable: AEROCAP, N. Y. • In Canada: AEROVOX CANADA LTD., Hamilton, Ont. JOBBER ADDRESS: 740 Belleville Ave., New Bedford, Mass.

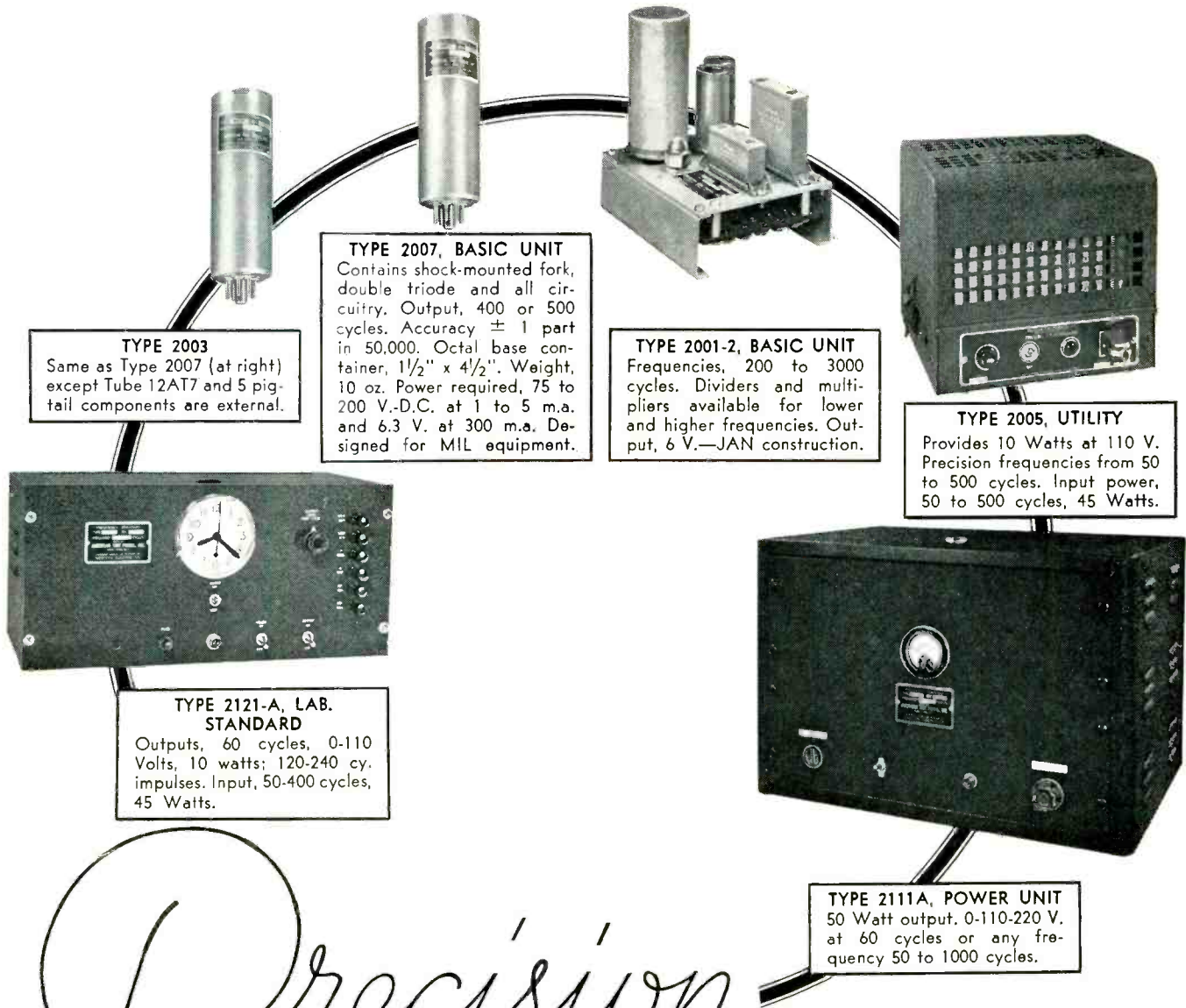

TYPE 2003
Same as Type 2007 (at right) except Tube 12AT7 and 5 pig-tail components are external.

TYPE 2007, BASIC UNIT
Contains shock-mounted fork, double triode and all circuitry. Output, 400 or 500 cycles. Accuracy ± 1 part in 50,000. Octal base container, $1\frac{1}{2}$ " x $4\frac{1}{2}$ ". Weight, 10 oz. Power required, 75 to 200 V.-D.C. at 1 to 5 m.a. and 6.3 V. at 300 m.a. Designed for MIL equipment.

TYPE 2001-2, BASIC UNIT
Frequencies, 200 to 3000 cycles. Dividers and multipliers available for lower and higher frequencies. Output, 6 V.—JAN construction.

TYPE 2005, UTILITY
Provides 10 Watts at 110 V. Precision frequencies from 50 to 500 cycles. Input power, 50 to 500 cycles, 45 Watts.

TYPE 2121-A, LAB. STANDARD
Outputs, 60 cycles, 0-110 Volts, 10 watts; 120-240 cy. impulses. Input, 50-400 cycles, 45 Watts.

TYPE 2111A, POWER UNIT
50 Watt output, 0-110-220 V. at 60 cycles or any frequency 50 to 1000 cycles.

Precision FREQUENCIES

GUARANTEED ACCURACY
1 PART IN 100,000 (.001%)
except where otherwise noted

The basis of these frequency standards is an electronically actuated high-precision fork, temperature-compensated and hermetically sealed against barometric changes. The partial list of uses at the right not only suggests the broad range of applications but also proven dependability where there can be no compromise with accuracy. Please request details by Type No. Our engineers are available for advice or cooperation on related problems.

- WIDELY USED
IN SUCH FIELDS AS**
- Aviation, Navigation
 - Ordnance, Ballistics
 - High Speed Photography
 - Viscosity Measurement
 - Fluid Flow
 - Nuclear Physics, Telemetry
 - Chemical Reaction
 - Radiation Counting
 - Computers
 - Facsimile
 - Fire Control
 - School and Indl. Research Labs.
 - Accurate Speed Control

American Time Products, Inc.
580 Fifth Avenue New York 36, N. Y.

OPERATING UNDER PATENTS OF WESTERN ELECTRIC COMPANY



TOPS

in transmission line for **HF · VHF · UHF**

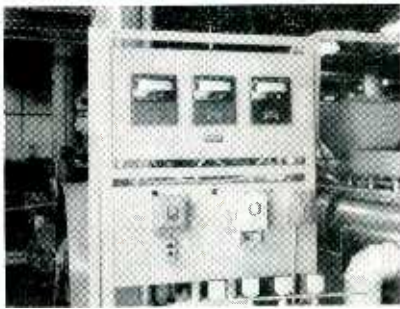
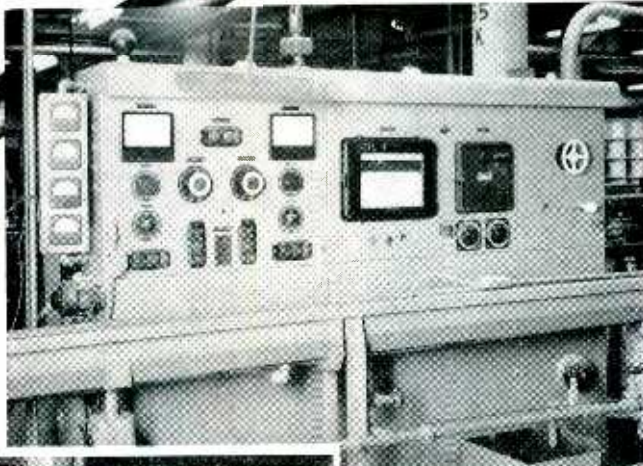

Federal's "Precision Production" is assured by this electronic panel board which controls diameter and speed of cables during extrusion.

Control panel for maintaining plastic materials at precise temperature and viscosity.

Federal's

highest-quality

RG TYPE

CABLES

including the Federal-developed low-temperature, non-contaminating thermoplastic jacket

DESIGNED FOR: H-F communications, television, industrial electronics, radio and TV lead-ins, aviation, test equipment, radar, pulse and experimental equipment

QUALITY of product is the secret of dependable cable performance and *quality* is what you get in every inch of Federal RG type coaxials . . . from jacket to conductor!

Only the finest materials—quality-controlled throughout the entire manufacturing process—are used in Federal cables. Every possible test is made to insure constant efficiency of physical and electrical properties under the most rugged conditions encountered by general and military applications.

Whatever your transmission line requirement—specify Federal RG types. You'll always be sure you've made the *right choice!*

COMPLETE COAXIAL CABLE ASSEMBLIES also are available from Federal to meet your requirements. This service offers the same "Precision Production" that made "Federal" the outstanding name in coaxial cables.

Manufacturer of America's most complete line of solid dielectric cables

Federal



Telephone and Radio Corporation

SELENIUM-INTELIN DIVISION 100 KINGSLAND ROAD, CLIFTON, NEW JERSEY

In Canada: Federal Electric Manufacturing Company, Ltd., Montreal, P. Q.
Export Distributors: International Standard Electric Corp., 67 Broad St., N. Y.

Why Federal Cables are **SUPERIOR**

- **CONDUCTORS**—meet highest ASTM standards
- **DIELECTRICS**—of stabilized polyethylene
- **BRAIDS**—meet highest ASTM standards
- **JACKETS**—of latest developments in vinyl and polyethylene

Every Federal Cable Fully Tested for:

- Capacitance
- Attenuation
- Continuity
- High Voltage

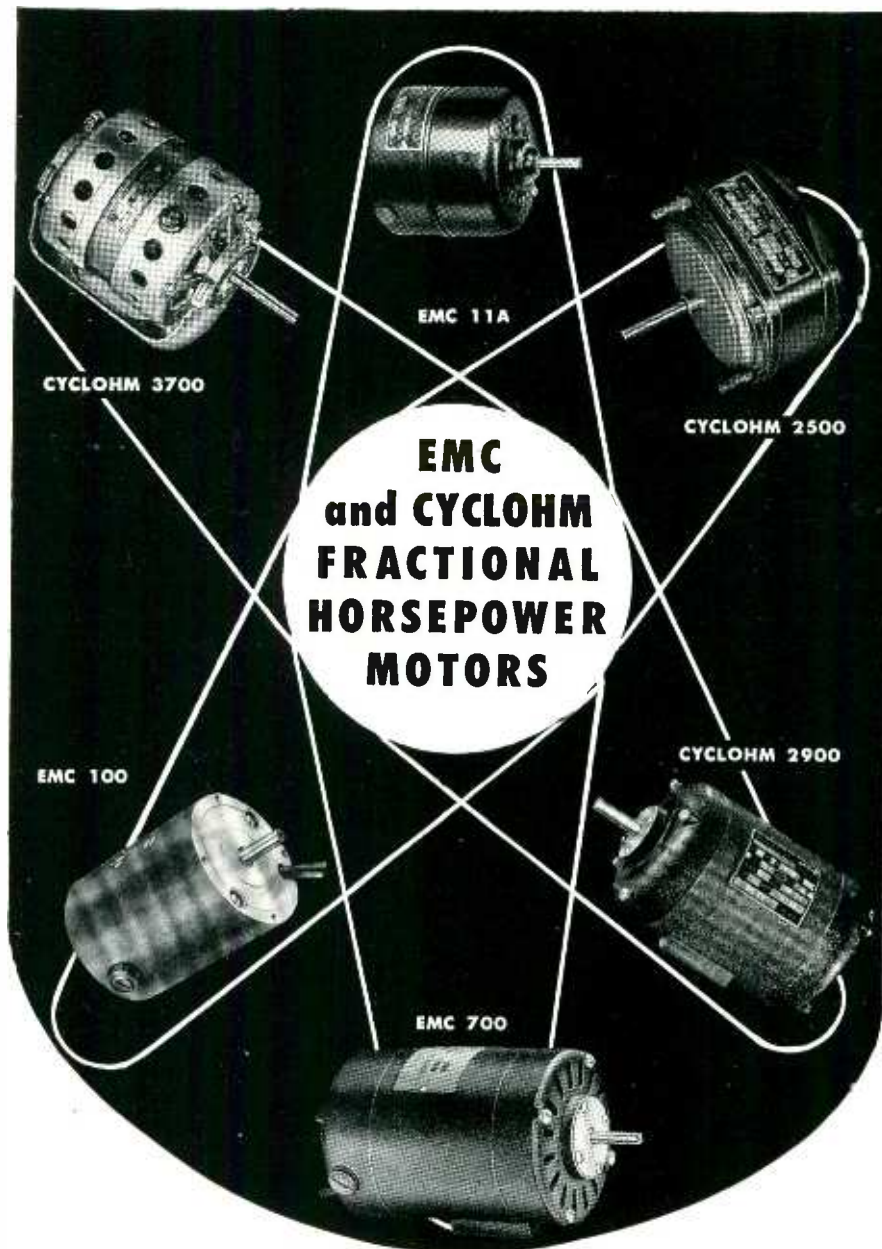

• • • used extensively by the electronics industry • • •

A list of our customers in the Electronics Industry includes many leading manufacturers—Philco, RCA, Federal Tel. & Tel., Collins Radio, Magnecord, Hazeltine Labs, Presto Tape Recording Co., and many more.

Yes, EMC and CYCLOHM fractional h. p. motors are used by leading companies for hundreds of applications. If you have an application for fractional h. p. motors, check with us on your requirements. Write today for our catalog or better yet, ask to see a Howard representative.

HOWARD INDUSTRIES, INC. RACINE, WIS.
 DIVISIONS: **EMC** ELECTRIC MOTOR CORP.
CYCLOHM MOTOR CORP.

Universal and Direct Current
 1/1000 to 1/2 h.p.
Shaded Pole 1/2000 to 1/15 h.p.
Induction types 1/1400 to 1/4 h.p.

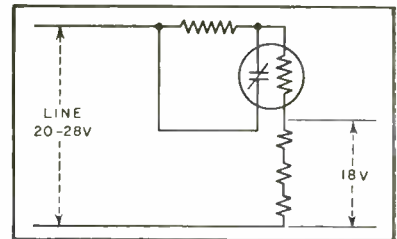

FIG. 4—Heater of the thermal relay placed in series with the cathode heater circuit

voltage variations. If the normally closed contacts of a thermal relay are connected so that, on opening, they interrupt the voltage applied to the heater of the relay, then these contacts will supply to the relay heater a pulsating potential of constant integrated heating value, regardless of voltage. As the voltage is increased, the proportion of ON time to OFF time is automatically reduced to compensate. The relay heater receives a pulsating potential with a heating effect equivalent to that of a continuous potential equal to its critical voltage setting. Any cathode heaters connected across the thermal relay heater will also receive this pulsating potential of constant heating effect regardless of supply voltage.

In actual operation, a resistor is usually connected across the relay contacts so that the potential is periodically reduced rather than completely interrupted but the net effect is the same. Figure 2 illustrates a circuit frequently used to produce a pulsating potential as described. It may be preferable to place the regulating contacts and resistor in the primary circuit of a transformer with the relay heater in the secondary, as shown in Fig. 3.

The heater of the thermal relay is sometimes placed in series with the cathode heater circuit as shown in Fig. 4. The result is to produce the effect of a constant current through the chain of heaters rather

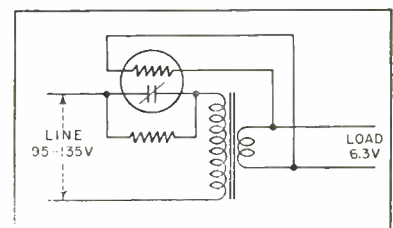
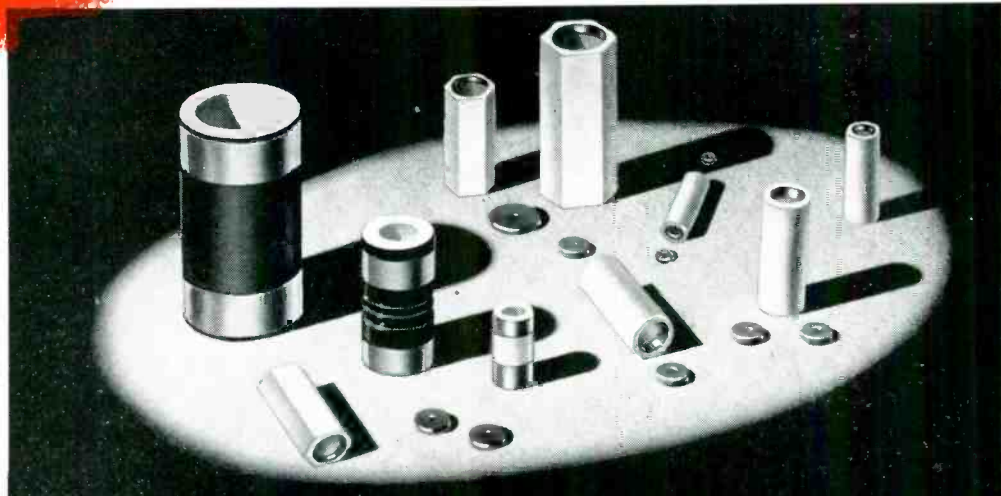

FIG. 5—Circuit for reducing interference caused by the opening and closing of the relay contacts

ALSiMAG[®]

METAL-CERAMIC COMBINATIONS

*Open new fields of design
New flexibility
in production planning
New usefulness of
ceramic parts
Opportunities for
product improvement.*



METALLIZED CERAMIC CASES WITH METALLIZED END SEALS FOR HERMETIC SEALING OF RESISTORS, CAPACITORS, CHOKES AND OTHER COMPONENTS

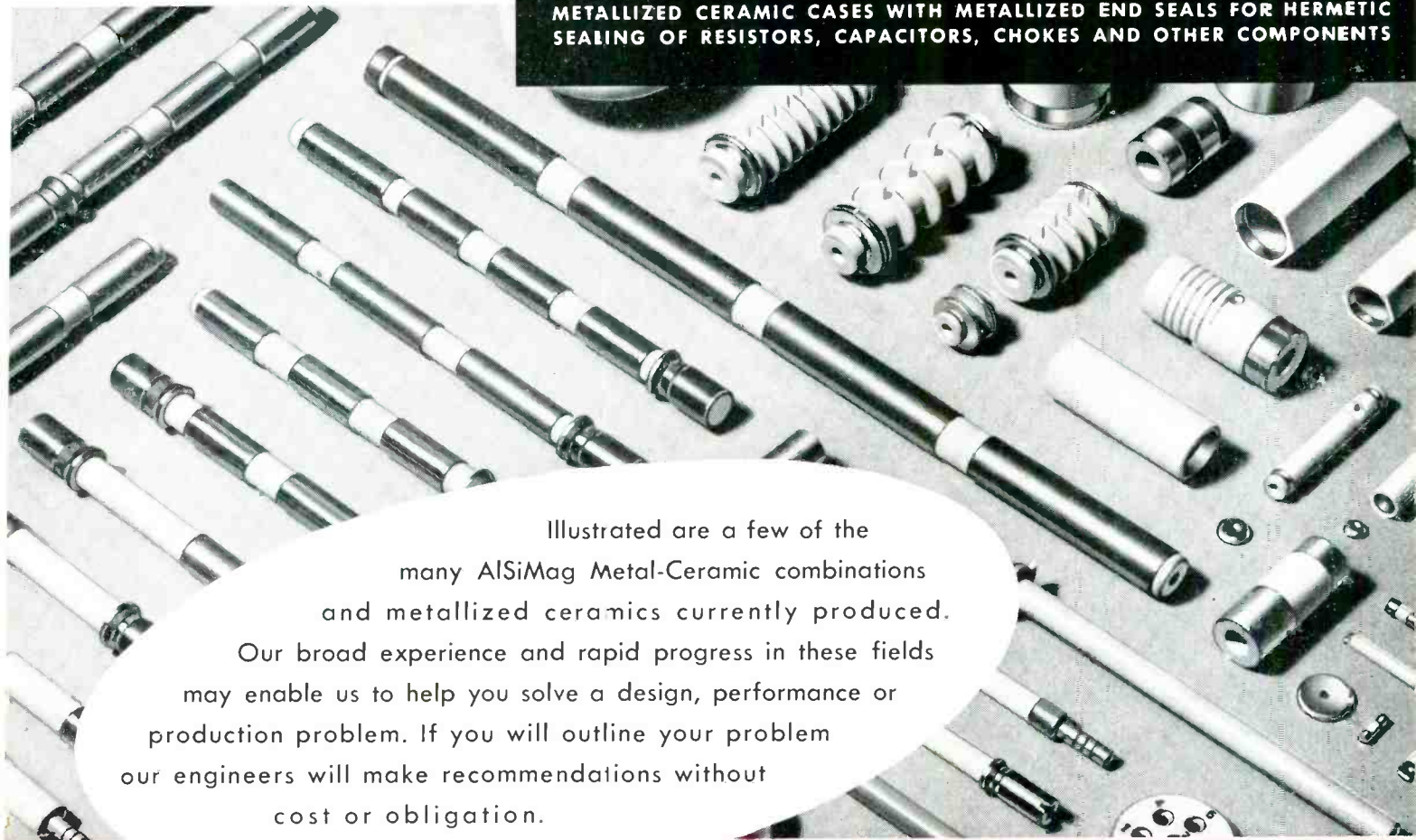

Illustrated are a few of the many ALSiMag Metal-Ceramic combinations and metallized ceramics currently produced. Our broad experience and rapid progress in these fields may enable us to help you solve a design, performance or production problem. If you will outline your problem our engineers will make recommendations without cost or obligation.

51ST YEAR OF CERAMIC LEADERSHIP

AMERICAN LAVA CORPORATION

CHATTANOOGA 5, TENNESSEE

OFFICES: METROPOLITAN AREA: 671 Broad St., Newark, N. J., Mitchell 2-8159 • PHILADELPHIA, 1649 North Broad St., Stevenson 4-2823
SOUTHWEST: John A. Green Co., 6815 Oriole Drive, Dallas 9, Dixan 9918 • NEW ENGLAND, 1374 Massachusetts Ave., Cambridge, Mass., Kirkland 7-4498
LOS ANGELES, 5603 North Huntington Drive, Capitol 1-9114 • CHICAGO, 228 North LaSalle St., Central 6-1721 • ST. LOUIS, 1123 Washington Ave., Garfield 4959

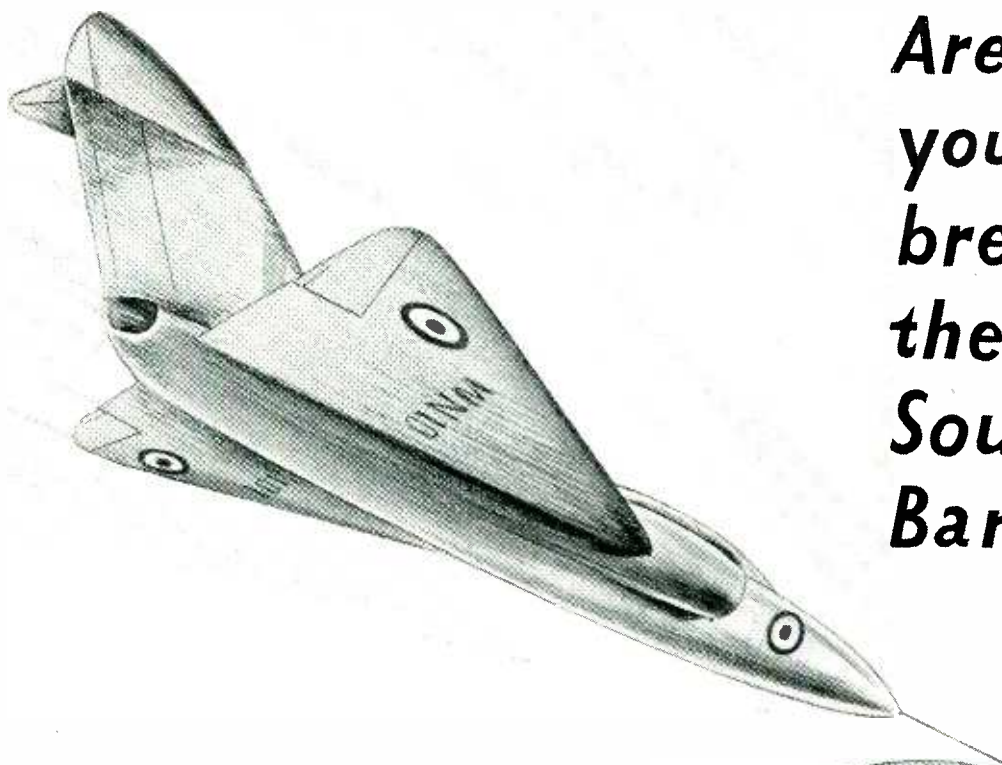

Are you breaking the Sound Barrier?

The amplifying stages of your equipment may be generously designed with plenty of inverse feedback and the electrical characteristics may be 99.9% perfect, but the transition from electrical to acoustic energy may present a serious barrier. **LECTRONA** speakers, incorporating many special design features, will enable you to penetrate this sound barrier with high efficiency and minimum distortion. A wide range of models is available for radio requirements and other special technical applications.

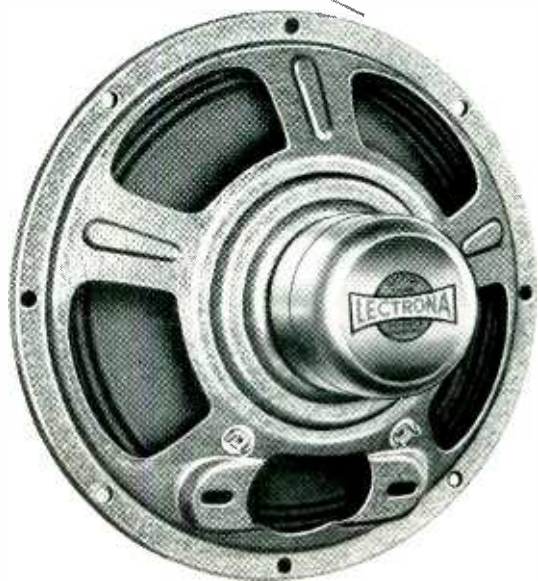

STANDARD TYPE C. 6104

Diameter 6 1/2"
Flux density 10,000 lines per sq.cm.
Peak power handling capacity
(speech and music) 4 watts.

Speech coil impedance, 3 ohms
at 400 cycles.
Frequency response chosen to
suit requirements.

Other models are available in this diameter, with alternative values of flux density and power handling capacity.

LECTRONA LOUDSPEAKERS

Designed and Manufactured by

ACOUSTIC PRODUCTS LIMITED

STONEFIELD WAY, VICTORIA ROAD, S. RUISLIP, MIDDX., ENGLAND PHONE: RUISLIP 6093/4

SALES: EDSTONE LIMITED

15, BUCKINGHAM PALACE GARDENS, LONDON, S.W 1, ENGLAND PHONE: SLOANE 0621

FOR BETTER ELECTRICAL INSULATION

TUBINGS AND SLEEVINGS

BH

Name your insulation problem . . . there is a BH Tubing or Sleeveing to solve it. Whether you're concerned with excessive current loads, vibration, extremes in temperatures, fungus resistance, or what . . . let us help you. Send us the facts on your requirements, voltages and temperatures encountered. We'll make our recommendations and send you production testing samples. Address Dept. E-1

Bentley, Harris Manufacturing Co., Conshohocken, Pa.

BH "1151" SILICONE RUBBER FIBERGLAS TUBING AND SLEEVING

A revolutionary Fiberglas Class H (inorganic) insulation suitable for continuous operation through a temperature range of -90°F . to 400°F . No dielectric loss through handling, bending or operational stresses. Won't craze or crack when used to cover bent wire. No deterioration at high spot temperatures of 500°F . for 4 hours. Grades H-A-1 through H-C-2.

BH 649 FIBERGLAS TUBINGS AND SLEEVINGS

A superior insulation which retains its rated dielectric strength after rough handling and severe abrasion. Flexibility and other physical properties unaffected after 1500 hours at 105°C ., as well as standard tests for NEMA Classes B-A-1, B-B-1 and B-C-1.

BH EXTRA FLEXIBLE FIBERGLAS SLEEVING

Comparable to single saturated (B-C-3) sleeveings but completely flexible, even after exposure to heat aging, since no hardening varnish is used. Non-fraying because of patented treatment of the basic braid.

BH SPECIAL TREATED FIBERGLAS SLEEVING

An unsaturated sleeveing for temperature applications up to 1200°F . Patented process retards raveling without the use of impregnants or binders.

BEN-HAR SPECIAL TREATED FIBERGLAS TUBING

Grades A-1 and B-1, meets normal operating and baking temperatures without stiffening or cracking. Will not fray or split in handling.

BH GRADE C-3 SILICONE FIBERGLAS SLEEVING

Non-raveling and non-combustible. Working temperatures range from 400°F . to -85°F . It is moisture-proof with high leakage resistance.

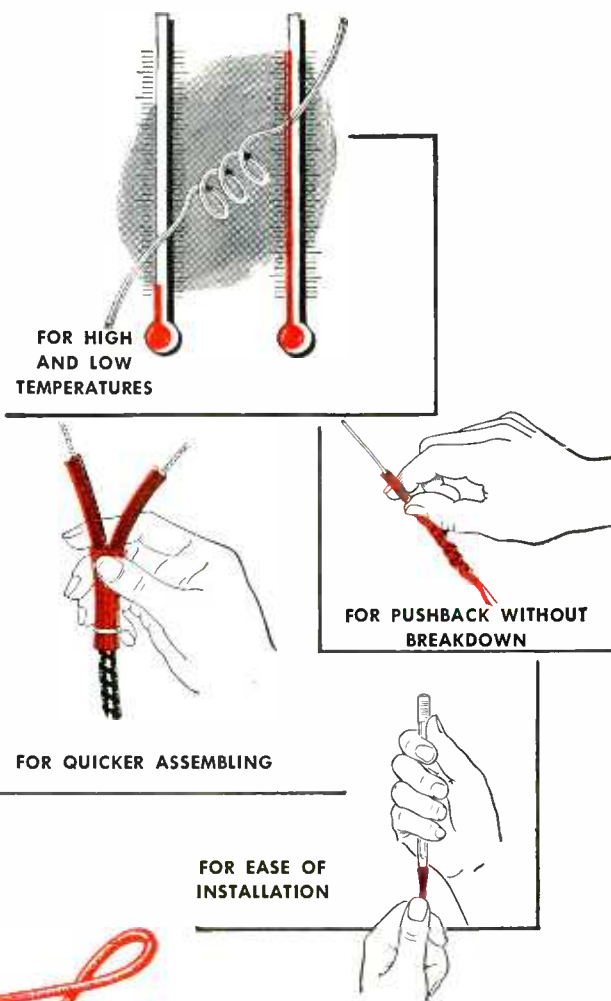

BH Fiberglass* SLEEVINGS

*BH Non-Fraying Fiberglass Sleeveings are made by an exclusive Bentley, Harris process (U. S. Pat. No. 2393530). "Fiberglass" is Reg. TM of Owens-Corning Fiberglass Corp.

BOURNS

presents
the New

TRIMPOT

TRADE MARK

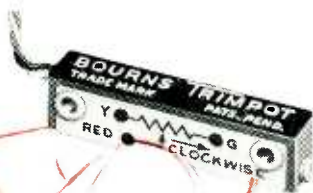

An adjustable sub-miniature potentiometer for precise gain control and circuit trimming or balancing

BOURNS **TRIMPOT**, a revolutionary wire-wound potentiometer, is easily and accurately adjusted. The slotted shaft is self-locking, and settings are maintained during severe shock, acceleration and vibration.

The **TRIMPOT** is easily mounted singly or in stacked assemblies.

Superior electrical characteristics are achieved through use of precious metal contacts and windings of exceptional temperature coefficient.

BOURNS designs and manufactures other potentiometer instruments which measure such physical variables as gage pressure, differential pressure, altitude and acceleration.



BOURNS LABORATORIES

6135 Magnolia Ave., Riverside, California

Technical Bulletins on request, Dept. 112

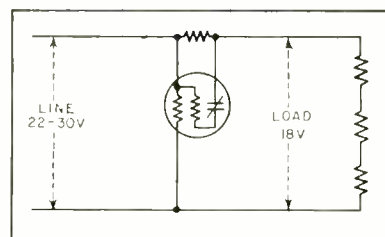

FIG. 6—Circuit incorporating a relay with two separate heater windings

than that of a constant potential across them.

In order to reduce the amount of heat that has to be dissipated at the upper end of the range, the resistor across the contacts in Fig. 3 may be replaced with a choke. The same is true for Fig. 2 if the supply is a-c.

Due to the resistor shunting the thermal relay contacts, the interference caused by the opening and closing of this contact is usually not serious. In cases where it is still found objectionable and where the usual type of line filter is not sufficiently effective, the interference can be further reduced by the circuit shown in Fig. 5.

In choosing circuit values for regulation of this kind, the supply voltage must be such that when it is at its minimum value it can produce the heater voltage desired, for the thermal relay can only reduce the supply voltage by interrupting it. It cannot increase it. The dropping resistor across the relay contacts must be such that at the highest supply voltage and with the smallest connected load, it will drop the heater voltage sufficiently. The thermal relay cannot produce a greater reduction in this voltage than that resulting from holding its contacts open continuously.

The thermal relay regulator offers the important advantage of being independent of frequency. In addition, it is small and light and has high efficiency.

An even wider, but as yet largely unexplored field is opened up by the availability of relays with tapped heater windings or with two separate heater windings. Just one circuit using such a relay is shown in Fig. 6. This circuit is similar to Fig. 1 with the addition of a second heater winding of much lower resistance connected in series with



Kenyon **TRANSFORMERS**

**FOR STANDARD AND SPECIAL
APPLICATIONS**

**KENYON
TRANSFORMERS
FOR**

JAN Applications

Radar

Broadcast

Atomic Energy Equipment

Special Machinery

Automatic Controls

Experimental Laboratories

For more than 25 years, Kenyon has led the field in producing premium quality transformers. These rugged units are (1) engineered to specific requirements (2) manufactured for long, trouble-free operation (3) meet all Army-Navy specifications.

Write for details

KENYON TRANSFORMER CO., Inc.

840 Barry Street, New York 59, N. Y.

Engineers—

Your best future is with
WESTINGHOUSE
in Baltimore

The Westinghouse 296-million dollar expansion program has produced exceptional career opportunities in the Electronics Division, and in the new Air Arm Division in suburban Baltimore, housed in a modern new plant adjacent to Friendship International Airport.

Immediate openings are available for those trained in any of the Engineering sciences. Graduates in Electrical, Mechanical, Aeronautical, Industrial, and Sales Engineering, as well as Physicists, Mathematicians, Business Administration graduates. Electronic Technicians and others

with related training, are invited to inquire about the attractive openings available.

Challenging, absorbing assignments are offered both at the plant and in the field on such projects as Guided Missiles, Automatic Pilots, Computers, and other advanced electronic products.

To insure your future, Westinghouse provides leading employe benefits, graduate study opportunities, employe scholarships, relocation expenses, in addition to unlimited ground-floor growth opportunities depending only on individual initiative and ability.

Send resume of qualifications to:

Manager, Industrial Relations, Dept. M

WESTINGHOUSE ELECTRIC CORPORATION

41 HOPKINS PLACE, BALTIMORE, MD.

*Those employed at their highest skill in
a defense industry should not apply.*

*Purchasing
Agents
like
TAYLOR VULCANIZED FIBRE
because...*



*In the
sporting goods
industry...*

Tough, shock-resistant, resilient... these are the characteristics that make Taylor Vulcanized Fibre ideal in the manufacture of football helmets and pads, baseball protectors and golf club faces. Why not fit this versatile material into your purchasing picture?



This comprehensive 24-page booklet literally brings the entire Taylor Organization to your fingertips... tells in words and pictures how the many Taylor Laminated Plastics are made... shows you how you can use these basic materials to make your product better, at lower cost. Write today for a copy of Booklet E1.



VULCANIZED FIBRE • TAYLOR INSULATION

TAYLOR FIBRE CO.
NORRISTOWN, PA. • LA VERNE, CALIF.

PHENOL, SILICONE & MELAMINE LAMINATES • FABRICATED PARTS

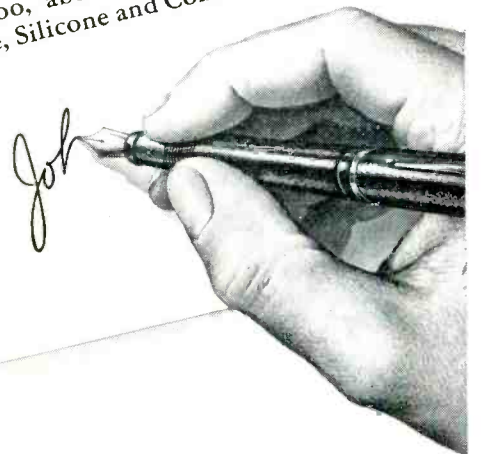



ELECTRO-STABILIZING

of VICKERS RECTIFIERS

Assures

In-Service Dependability... Consistent Quality!

In the Vickers-developed forming process (where the invisible rectifying barrier "heart of a rectifier cell" is created)... Vickers Selenium Rectifier performance factors are stabilized... cells actually "pre-stressed" to guarantee rated performance—with long life. Forming time and rate... current and voltage... humidity and temperature are automatically controlled by the cells themselves to assure ideal forming (without forced forming—or less than complete forming). Such precise cell control guards against overheating or leakage—weaknesses often found in improperly formed rectifiers.

more reasons why VICKERS makes a better rectifier:

- Precision-matched cells prevent overload-overheating.
- Hydraulic assembly equipment assures mechanical strength and dimension.
- Rectifiers shock and vibration tested to military specifications.
- 255 tests and inspections guard quality from start to finish.

Write for Bulletin 3000. Vickers engineering service is available without obligation.

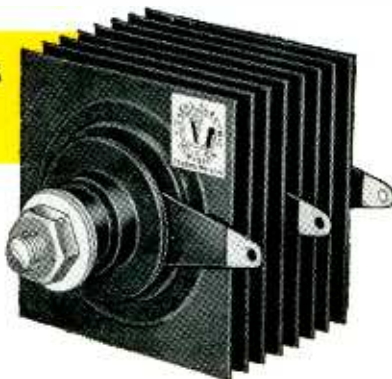

VICKERS ELECTRIC DIVISION

VICKERS Inc.

A UNIT OF THE SPERRY CORPORATION
1801 LOCUST STREET • SAINT LOUIS, MISSOURI

the relay contacts. The relay contacts remain closed up to 22 v input and are permanently open above 30 v. Between 22 and 30 v input, the contacts will alternately open and close with an ON to OFF ratio that will maintain the equivalent of 19½ v across the load. The circuit of Fig. 6 gives the same type of regulation as the circuits in Fig. 2 and 3 except that the change in watts in the relay while flashing is less than one half as great and the flashing consequently substantially slower. For the same rate of flashing as obtained with the circuits of Fig. 2 and 3, the thermal capacity of the relay heater can be reduced and the warm-up period correspondingly shortened. The output voltage will vary somewhat with a change in load. The two resistors as well as the auxiliary heater winding must be properly matched to the load for best results.

Slide Rule Computes Radio Refractive Index of Air

BY STANLEY WEINTRAUB
National Bureau of Standards
Boulder, Colorado

STUDIES of tropospheric radio propagation often require computing the refractive index of air from meteorological parameters. Computation becomes extremely tedious in making a climatic study of refraction (bending of ray paths) that requires computation of refractive indices from meteorological radiosonde ascents.

This has led to the development of numerous devices designed to facilitate computation¹, most of which are of low precision or limited usefulness. A slide rule method of computing N , where $N = (n - 1) 10^6$, n being the refractive index, has been developed by the National Bureau of Standards. This method attains a precision of ± 0.5 N -units under almost any conditions likely to be encountered in the troposphere, while being less tedious than other comparable methods now in use.

Details below are carried out with pressure in millibars, temperature in deg C and relative humidity as the parameters. The method is equally applicable when other



WHICH PILOT LIGHT DO YOU NEED?

DIALCO

THE BIG ONE

This Pilot Light Assembly was first made to accommodate the *S-11 lamp* and was intended for use in the cabs of great diesel locomotives.

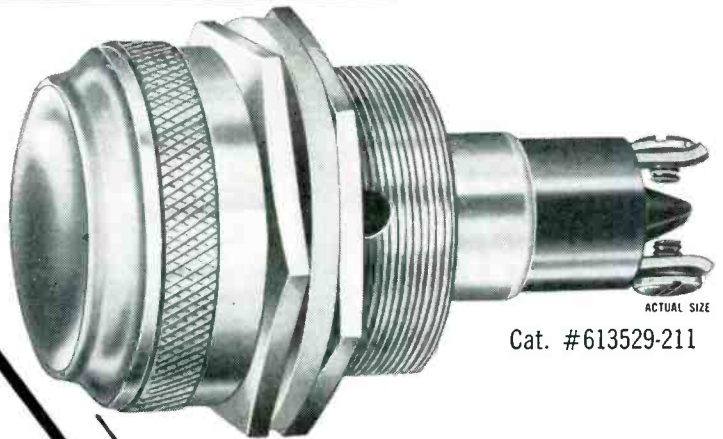

ACTUAL SIZE
Cat. #613529-211

Dialco HAS THE COMPLETE LINE OF INDICATOR and PANEL LIGHTS

This **BIG** one

or

this **LITTLE** one

THE LITTLE ONE

The miniaturization program on defense products required the development of this *sub-miniature* light. It is used on communication equipment and aircraft. Midget flanged base bulbs to fit are rated 1.3, 6, 12, and 28 volts.



ACTUAL SIZE
Cat. #8-1930-621

Samples

to suit your own special conditions and requirements will be sent promptly and *without cost*. Just outline your needs. Let our engineering department assist in selecting the *right lamp* and the *best pilot light* for YOU.



Write for the Dialco HANDBOOK of PILOT LIGHTS

Foremost Manufacturer of Pilot Lights

DIALIGHT CORPORATION

60 STEWART AVE., BROOKLYN 37, N. Y.

HYACINTH 7-7600

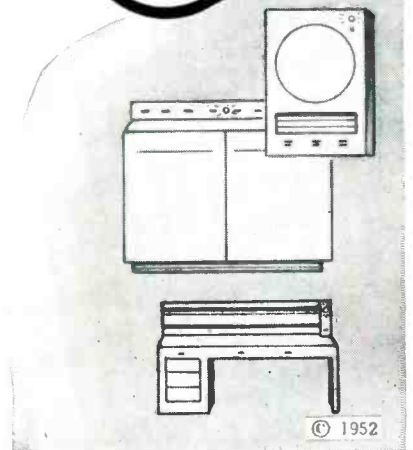

© 1952

PROBLEM:

Manufacture of a Thermopile Calibrated to Measure Heat Exchange Over a Large Area.

SOLUTION:

General Plate Provided the Solution with Copper Edge Bonded to Constantan...a Composite Metal.



The American Society of Heating and Ventilating Engineers, developing a calorimeter for the measurement of heat exchange between the human body and its surroundings, was faced with the problem of obtaining material for large area thermojunctions.

The heat flow meters used in this calorimeter had to possess characteristics such as uniformity of response of similar meters, stability of calibration and ability to integrate heat flow over the entire area of the meter. A principal factor in their performance was the thermopile material used.

General Plate satisfied these thermopile material requirements with a composite metal — copper edge bonded to constantan and rolled to .002" thick.

No matter what your metal problem, it will pay you to consult with General Plate. Their vast experience in bonding precious metals to base metals, or base to base metals can overcome your problems — often reduce costs.

General Plate products include . . . precious metals clad to base metals, base metals clad to base metals, silver brazing alloys, electrical contacts, buttons and rivets, TRUFLEX® thermostat metals, ALCUPLATE®, platinum fabrication and refining, #720 manganese age-hardenable-alloy. Write for General Plate's latest catalog.

**Have You a Composite Metal Problem?
General Plate can solve it for you**

**METALS & CONTROLS CORPORATION
GENERAL PLATE DIVISION**

31 FOREST STREET, ATTLEBORO, MASS.

"ZERO" PHASE SHIFT

COMPUTER REFERENCE VOLTAGE TRANSFORMERS

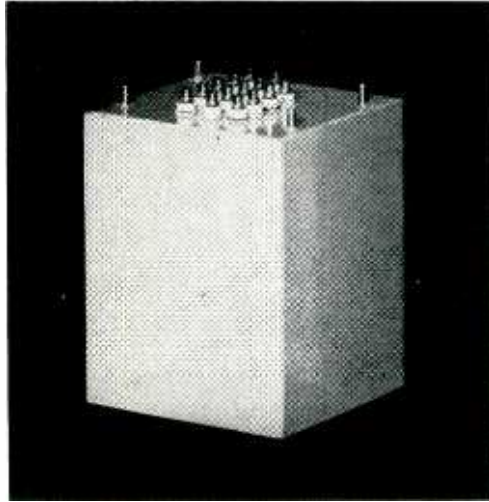

LESS THAN 0.1 MILLIRADIAN PHASE SHIFT
± .02% ACCURACY OF VOLTAGE RATIOS

A radical new approach to the design and manufacture of precision transformers makes it possible to have calculable minimum errors.

The actual measurement of phase shift and voltage ratio is in complete agreement with the calculation to lowest value that measurement is possible.

MIL-T-27 TRANSFORMERS

TOROIDAL TRANSFORMERS

INSTRUMENT TRANSFORMERS

PULSE TRANSFORMERS

VIDEO TRANSFORMERS

INPUT-INTERSTAGE-OUTPUT

POWER TRANSFORMERS

MAGNETIC AMPLIFIERS



INDUCTANCE MEASUREMENT — Any operating condition can be simulated in the range of 0-1000V A.C. and 0-5 Amps. D.C.

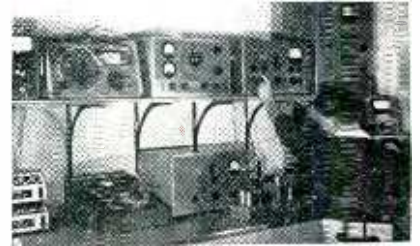

DEVELOPMENT OF AUDIO TRANSFORMERS — All characteristics of audio transformers in the range of .01 cycle to 10 Megacycle can be measured and evaluated.



POWER LOSS MEASUREMENT — Losses as low as 1.5 micro watts in the range of 20 c to 200 K.C. can be measured and analyzed and possible improvements effected.



PULSE TRANSFORMER DESIGN — The cut and try methods commonly used in the design of pulse transformers has been largely supplanted by the use of special equipment.



TRANSFORMERS INC.

532 NORTH STREET

Telephone ENDICOTT 8-1801

ENDICOTT, NEW YORK

STATIC ELECTROMAGNETIC DEVICES

units are used, such as millimeters or inches of mercury for pressure, deg F for temperature, and water vapor pressure, absolute humidity or dew point for humidity. The mixing ratio can also be utilized, but with somewhat less convenience.

Radio refractive index may be expressed with sufficient accuracy by the formula²

$$N = 77.6 \frac{p}{T} + 3.73 \times 10^5 \frac{e}{T^2} \quad (1)$$

where $N = (n - 1)10^6$, n being the refractive index; p , total pressure in mb; e , water vapor pressure in mb; T is the temperature in deg K, equal to $273 + t$, where t is in deg C.

The present method of computation employs two separate slide rules, one for each term in the formula. However, it is possible to use two sides of a standard slide rule.

The slide rule illustrated in Fig. 1, used to compute the term $77.6 \frac{p}{T}$, is a standard 20-inch type with C , D , CF and DF scales modi-

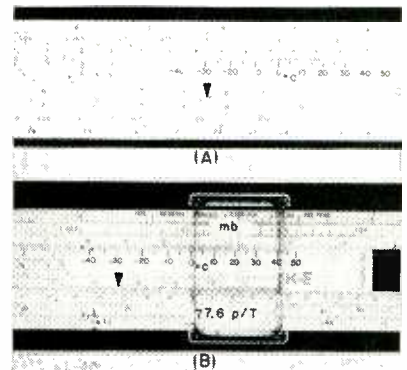

FIG. 1—Slide rules for the radio refractive index of air (A) for term $77.6 \frac{p}{T}$ and (B) for second term

fied by attaching a paper scale with rubber cement. This does not impair the slide rule for other purposes. The paper scale serves to relabel the graduations on the CF scale without obscuring them, so weather data in deg C is set up on the slide in deg K without the tedium of a formal conversion.

For example, the interval 273 . . . 283 is labeled by the new scale as 0 . . . 10 deg. By using all four scales, C , D , CF and DF , the setting and reading is confined to a small



**IN THE LONG RUN—
The Least Expensive
... Most Effective
Mountings You Can Buy!
LORD, of course!**

The use of Lord Mountings and Bonded-Rubber Parts in every field of automotive transportation results in longer service life and greater economy of operation. And as a bonus . . . Lord Mountings improve operator and passenger comfort. Hundreds of Designers and Engineers of transportation equipment have consulted profitably with Lord Engineers for experienced and field-proved advice in isolating shock and vibration. They draw from over 27,000 Lord Vibration-Control Mountings designed to meet specific requirements.

If you manufacture any of the following transportation equipment or supply component parts or assemblies, Lord Engineering can help you:

Railway Cars and Locomotives . . . Trucks and Buses . . .
Airframes and Aircraft Engines . . . Earthmoving, Farm
and Road Machines . . . Air Compressors . . . Air Con-
ditioners . . . Engine Generator Sets . . . Communication and
Signal Equipment.

Lord Mountings are protecting the performance of many more transportation units.

FIELD ENGINEERING OFFICES —

BURBANK, CALIFORNIA 233 South Third Street	DALLAS, TEXAS 413 Fidelity Union Life Building	PHILADELPHIA 7, PENNSYLVANIA 725 Widener Building	DAYTON 2, OHIO 410 West First Street
DETROIT 2, MICHIGAN 7310 Woodward Ave.	NEW YORK 16, NEW YORK 280 Madison Avenue	CHICAGO 11, ILLINOIS 520 N. Michigan Ave.	ERIE, PENNSYLVANIA 1635 West 12th Street

LORD MANUFACTURING COMPANY • ERIE, PA.



Headquarters for
VIBRATION CONTROL

BEAM POWER

...from DC to 175 Mc!

RCA-6146 is uniquely versatile

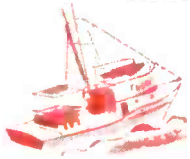

MARINE TRANSMITTERS



AMATEUR TRANSMITTERS



MOBILE TRANSMITTERS



AUDIO & VIDEO MODULATORS

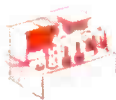

SERVO AMPLIFIERS



RCA-6146, actual size!

FROM dc amplifier to VHF services, the remarkable RCA-6146 beam power tube is setting a record for circuit versatility attained by few other tubes. Power sensitivity is high, regardless of plate voltage—or frequency. Small size offers wider latitude for compact equipment. Low cost contributes to genuine economy in circuit design—without sacrificing efficiency.

In class C rf service (ICAS) at 600 volts, a single RCA-6146 unmodulated can handle an input of 90 watts at frequencies as high as 60 Mc... and 60 watts at 175 Mc with a plate voltage of 400 volts. In class AB₁ (ICAS) two 6146's can deliver up to 120 watts

of audio... and in class AB₂, 130 watts. Triode-connected, two 6146's will deliver 19 watts of power!

RCA-6146 is designed for all general services calling for a 6.3-volt heater. Where tubes with 26.5-volt heaters are required, as in aircraft applications, RCA can supply Type 6159... similar in all other characteristics to the 6146.

For technical data, write RCA, Commercial Engineering, Section 42AR, Harrison, N. J. Or call your nearest RCA Field Office.

FIELD OFFICES:

(EAST) Humboldt 5-3900, 415 S. 5th St., Harrison, N. J.
(MIDWEST) Whitehall 4-2900, 589 E. Illinois St., Chicago, Ill.
(WEST) Madison 9-3671, 420 S. San Pedro St., Los Angeles, Cal.

IN PRODUCT IMPROVEMENT **RCA** NEVER STANDS STILL



RADIO CORPORATION of AMERICA
ELECTRON TUBES

HARRISON, N. J.

..... **PACKAGED POWER FOR SELLING**

12 REGULAR MONTHLY ISSUES OF ELECTRONICS

and

THE ELECTRONICS MID-JUNE BUYERS' GUIDE

Plan NOW for these 13 sales-producing issues in your '53 ad-budget

There's a big year ahead for manufacturers of electronic components, equipments and materials. But that big year will also bring big, tough competition. Now is the time to make definite plans, both sales and advertising-wise, that will see your company on the top of its market. In making those plans, don't feel that your present customers and prospects are all yours — tied up in a neat bundle for you — loyalty like that just doesn't exist. And don't forget the new customers — brand new ones never heard of before, that are entering the field

in large numbers for its amazing promise of profits. You have got to keep after them, both new and old, telling them your product story month after month. There are many ways to do that in this so-called electronics business — but the best, most economical, most effective, most resultful way is in a consistent advertising campaign in **ELECTRONICS** — the book that penetrates every portion of the industry and is must-reading for everyone connected with it. So make your plans now and be sure they include **ELECTRONICS**.

Business in the billions ahead for electronic manufacturers

There's no bunk in those billions for 1953. They are actual fact and add up to more than 5½ billion. That's a lot of dollars and many factors play a part in building it up in the major classifications of military and consumer expenditures. Industry's increasing use of elec-

tronic equipment and color TV will buoy up those billions — not only for '53, but for years to come. The aggressive, advertising-minded manufacturer will be sure of his share. 1953 promises to be a year upon which the future of many companies may depend.

Manufacturers who should use the sales pages of these 13 issues

Most manufacturers, by the very nature of their products, recognize **ELECTRONICS** as their most effective sales medium, and for years have consistently utilized its sales pages. The advertisers in **ELECTRONICS** in reality constitute the Who's Who of the industry. But, due to the tremendous technological advances in electronics, many new and strange products enter its sales

field. What are those products that can profitably be advertised in **ELECTRONICS**? Well, the list is long — 1,445 long. They're all in the Buyers' Guide issue, every one judged necessary by the industry itself. Go through them carefully (borrow it from your engineer, he's using it) and if you make one or more, plan now to advertise it — in **ELECTRONICS**, of course.

BE SURE IT'S 13 FOR '53 IN...

electronics

12 MONTHLY ISSUES and the BUYERS' GUIDE

A MCGRAW-HILL PUBLICATION

330 West 42nd Street • New York 36, N. Y.

When

a single 'scope won't do your job!

Anytime two or more different—but related—phenomena must be measured at the same time . . . under the same conditions . . . more and more engineers and scientists are finding that multi-channel oscilloscopes are the only economically sound answer.

No other equipment can give them such correct time relationships for a number of simultaneous phenomena. No other equipment saves the array of instruments and varying test procedures required by other means of coincident analysis, nor gives them such a convenient photographic record.

Speed and vibration . . . input and output signals of circuits . . . displacement time with associated dynamic strains and pressure . . . or even the relation between brain waves and muscular potentials are just a few of the many applications being discovered daily. Are you missing an opportunity in your field?

If your problem is multi-fold, chances are there's an ETC multi-channel oscilloscope that can do the job. Standard 'scopes are available in 2, 4, 5, 6, 8 or even 10 channel models. ETC also produces many special models for specific uses. A free catalog describing these 'scopes and tubes will gladly be sent upon request. Write today.



ETC

electronic tube corporation

1200 E. MERMAID LANE, PHILADELPHIA 18, PA.

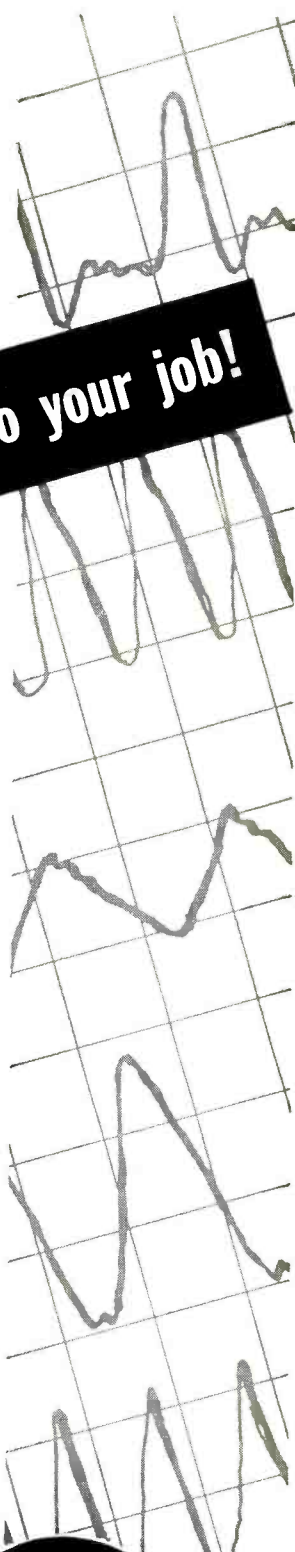

area of the rule, thus speeding the work. The computation of the first term is performed in the following manner:

1. The temperature in deg C on scale *CF* is set at the pressure in millibars on scale *DF*.

2. The value of this term is read on scale *D* opposite 77.6 on scale *C*. A distinguishing marker has been placed at this point on scale *C* in order to facilitate reading of the value.

The special slide rule in Fig. 2 is used to compute the second term, $3.73 \times 10^5 e/T^2$. In terms of the parameters temperature *T*, and relative humidity *RH*, given as a fraction, this expression may be closely approximated by³

$$A (RH) = 3.73 \times 10^5 e_s/T^2 (RH) \quad (2)$$

where e_s is the saturated vapor pressure. $A = 3.73 \times 10^5 e_s/T^2$ and is a function only of *T*.

The slide rule is constructed in the usual way by laying out distances proportional to the logarithm of *A* on one scale, and proportional to the logarithms of numbers in linear sequence on the other scale. The first decade of the latter scale represents humidities from 10 to 100 percent as well as values of the term from 1 to 10 in *N* units.

The *A* and *B* scales of a slide rule may readily be modified by cementing a new scale to the latter and laying off values of *A* on it. Indices of the temperature scale are placed at -42.7 , -15.9 and $+19.7$ deg C, points at which *A* has the values 1, 10 and 100, respectively. These indices are marked by $\times 0.1$, $\times 1$ and $\times 10$ in the figures, the appropriate multiplier to be used with each index. The second term is

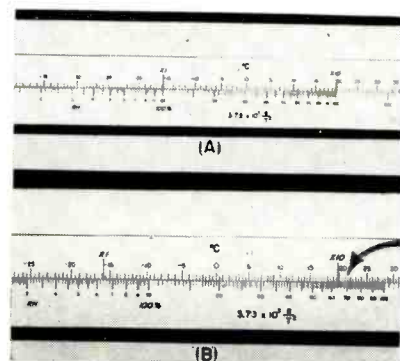
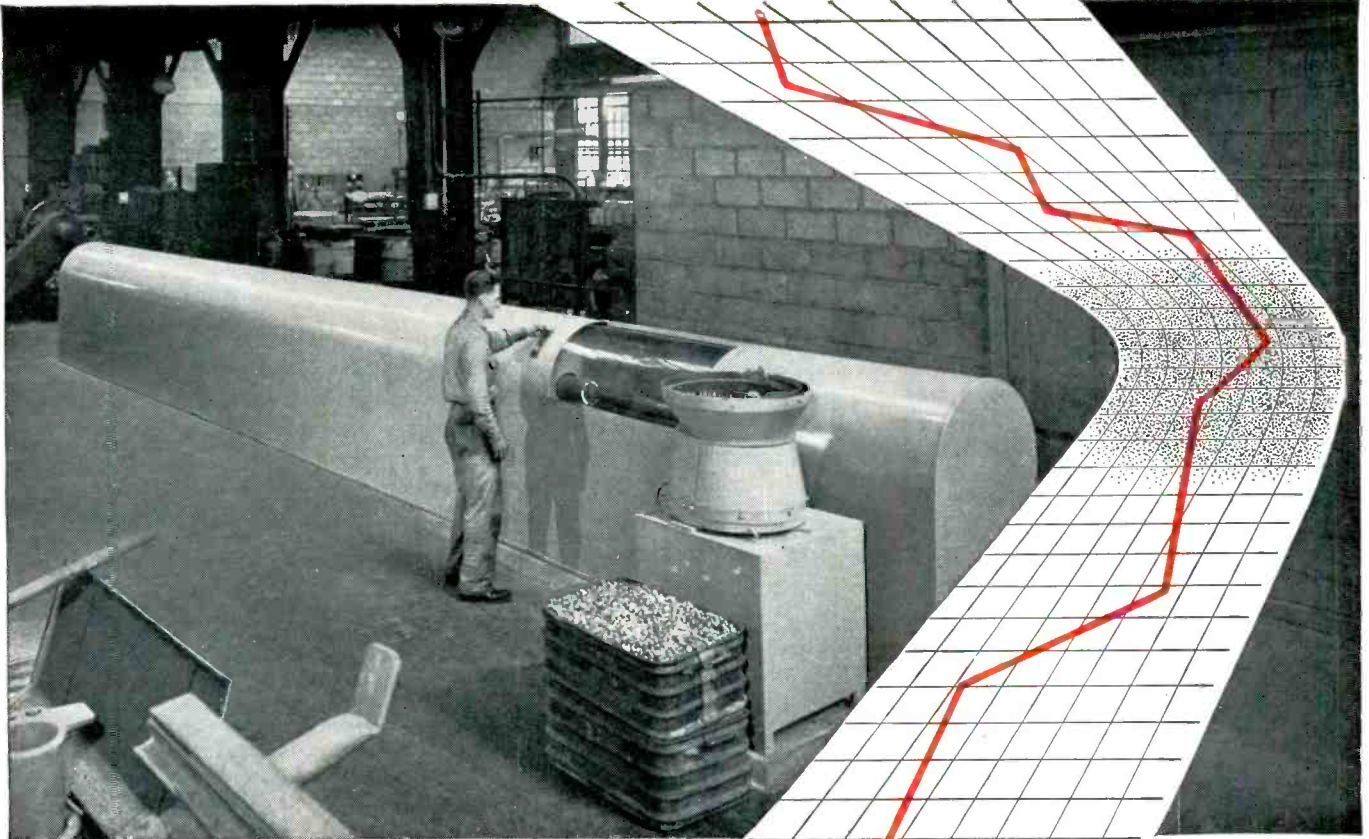

FIG. 2—Operation of slide rules for first term (A) and second term (B)



An automatic heat treat machine. Production is about 3 times that possible with manual methods while quality is held within very close limits.

CRUCIBLE ALNICO MAGNETS

KEEP COSTS DOWN ... through
automatic production that gives quality control

Alnico magnets have been getting smaller and lighter, thanks to production techniques in use at Crucible. Automatic machinery cuts the possibility of human error to a minimum, so rejections are low. This helps to maintain stable price levels in the face of rising material and labor costs. At the same time, Crucible's rigid inspection standards and attention to quality have developed a magnet with the *highest gap flux per unit weight of any on the market.*

Today, Crucible can offer lighter, magnetically stronger Alnico magnets because of these automatic production techniques developed over the sixteen years that we have been producing the Alnico alloys. And behind our familiarity with permanent magnets lies more than 52 years' experience with specialty steelmaking. Let us advise you on your magnet problem.

CRUCIBLE

first name in special purpose steels

52 years of *Fine* steelmaking

PERMANENT ALNICO MAGNETS

CRUCIBLE STEEL COMPANY OF AMERICA, GENERAL SALES OFFICES, OLIVER BUILDING, PITTSBURGH 30, PA.
STAINLESS • REX HIGH SPEED • TOOL • ALLOY • MACHINERY • SPECIAL PURPOSE STEELS

How to fly a guided missile in your laboratory



Practically any electrical, mechanical or physical phenomenon—even the full flight of a guided missile—can be precisely re-created in the laboratory from Ampex magnetic tape recordings.

Ampex retains and plays back data in the same electrical form in which it is received, making its playback in effect equivalent to a rerun of the original test. But it has these added advantages: Data can be repeated at any time or place, can either be scanned or studied in whole or part, can be speeded up or slowed down, can be fed to automatic reduction systems. Furthermore, desired portions of the data can be reduced to oscillograph traces, pen recordings or any other form that could have been made at the time of the original test.

Besides the convenience and versatility of the data itself, Ampex Magnetic Recorders and the tape they use have these desirable physical qualities:

- Ampex Tape Recorders, being rugged, compact and portable, are usable where other equipment would not be feasible;
- Tape requires no processing, hence is immediately available for playback;
- Tape stores an enormous quantity of information at low cost and in minimum bulk.
- Ampex Tape Recorders cover extremely wide frequency range:
Model 306 — 0 to 5000 cycles/sec.
Model 307 — 100 to 100,000 cycles/sec.
Model 303 — Pulse width modulation
Many other models are also available.

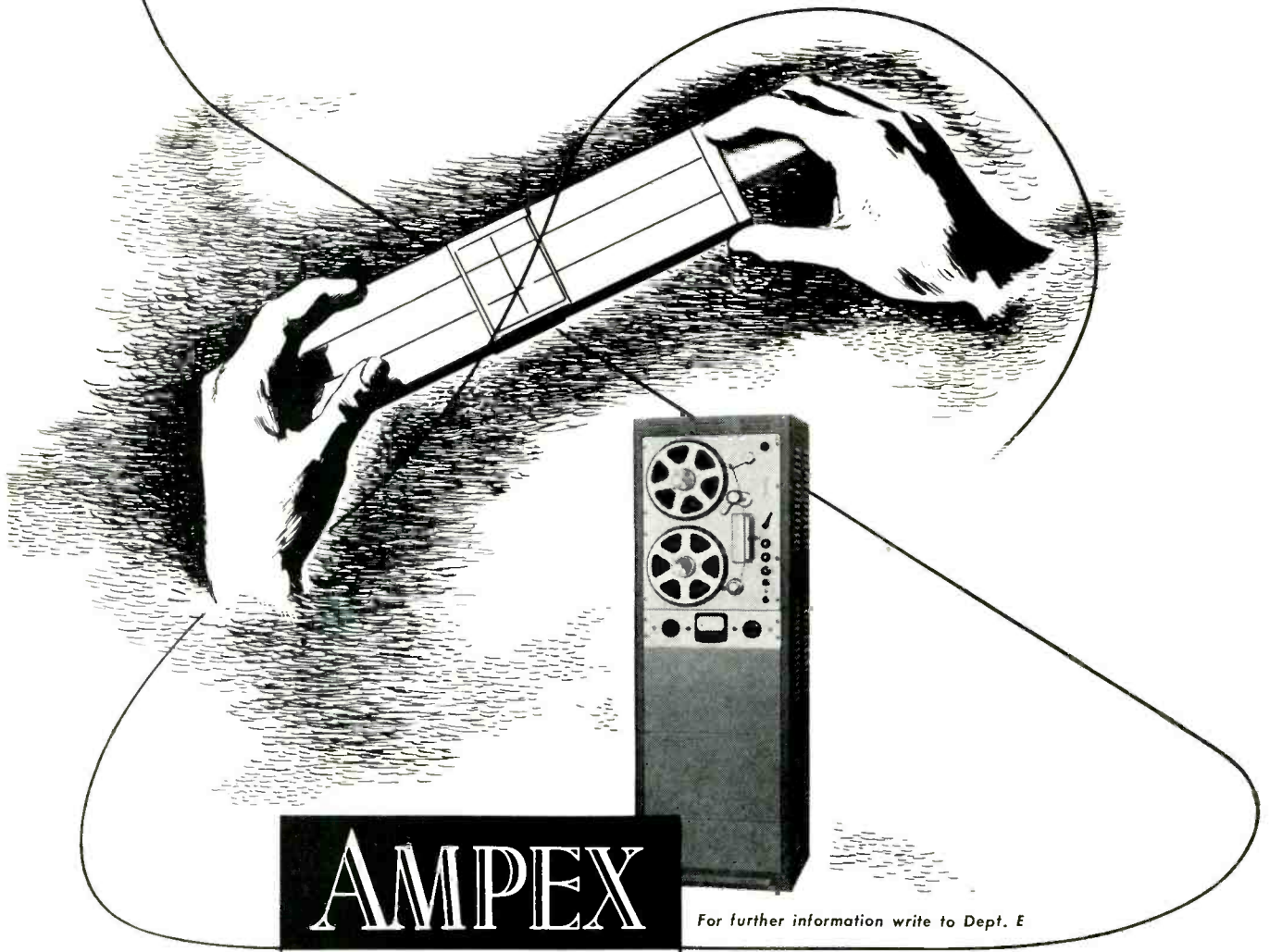

AMPEX
MAGNETIC RECORDERS

For further information write to Dept. E
AMPEX ELECTRIC CORPORATION
934 CHARTER STREET • REDWOOD CITY, CALIF.



ACTUAL SIZE

New CBS-HYTRON

Germanium Diodes

Guaranteed Moisture-Proof!

GENERAL PURPOSE TYPES

1N48

1N51

1N52

1N63

1N64

1N65

1N69*

1N70*

1N75

1N81*

*JAN TYPES

JAN types 1N69, 1N70 and 1N81 now being shipped.

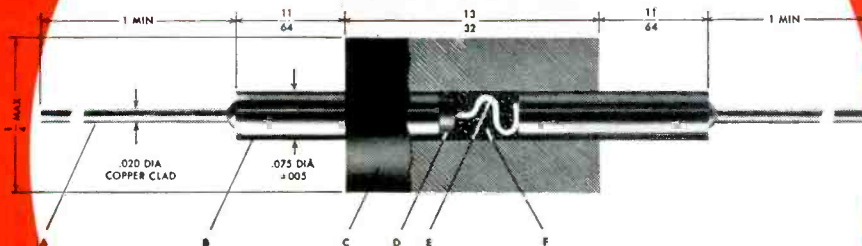

Mechanical Specifications

- A. .020" copper-clad wire
- B. Nickel-silver "clip-in" pin
- C. Glass-filled plastic case
- D. Germanium crystal soldered directly to base
- E. .005" tungsten cat whisker
- F. Moisture-resistant impregnating wax

WHY CBS-HYTRON GERMANIUM DIODES ARE BETTER RECTIFIERS

1. **MOISTURE-PROOF** . . . eliminates humidity and contamination problems
2. **SELF-HEALING** . . . self-recuperating from temporary overloads
3. **SUBMINIATURIZED** . . . only $\frac{1}{2}$ inch long, $\frac{1}{4}$ inch in diameter
4. **SOLDERED WAFER** . . . omission of plating eliminates flaking
5. **LOW SHUNT CAPACITY** . . . $0.8 \mu\text{mfd}$ average
6. **SELF-INSULATING CASE** . . . mounts as easily as a resistor
7. **EXCEPTIONAL LIFE** . . . 10,000 hours minimum under rated conditions
8. **NO FILAMENTS** . . . low drain, no hum

Vital germanium wafer in a CBS-Hytron diode is *guaranteed moisture-proof*. Sealed against deadly moisture . . . fumes . . . and contamination, a CBS-Hytron diode keeps moisture where it belongs . . . out! First, by a chemically and electrically inert impregnating wax. Second, by a glass-filled phenolic case. With *moisture-proof* CBS-Hytron germanium diodes, you can be sure of maximum trouble-free life.

Superior techniques also permit CBS-Hytron to omit plating of the germanium wafer. Soldering is directly to the base. Thus flaking is eliminated and quality improved. Universal design of CBS-Hytron diodes follows Joint Army-Navy specifications. "Clip-in" feature gives you versatility, ruggedness, and electrical stability. Flexible pigtailed of copper-clad steel welded into sturdy nickel pins also insure you against damage by soldering heat.

Check the eight important-to-you reasons why CBS-Hytron *moisture-proof* germanium diodes are better rectifiers. Send today for complete data and interchangeability sheets. Specify CBS-Hytron *guaranteed moisture-proof* diodes for superior, trouble-free operation.

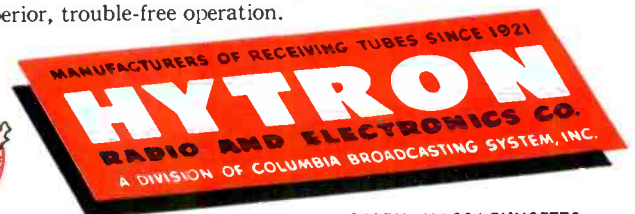

SALEM, MASSACHUSETTS

**"CANNING"
THE
HEARTBEAT
OF
AMERICA'S
COMMUNICATIONS**



LICENSED UNDER PATENTS
OF THE BELL SYSTEM

The ability of today's complex network of communications to function without interference is dependent upon the precision with which its crystal components are manufactured. Each Reeves-Hoffman Crystal is built with exacting care and submitted to rigid tests to meet the most precise commercial and military specifications.

REEVES HOFFMAN Corporation

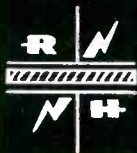

A subsidiary of Cloude Neon, Incorporated
CHERRY AND NORTH STREETS — CARLISLE, PENNSYLVANIA

computed as follows:

1. The index of the temperature scale is set at the relative humidity on the RH scale.

2. The value of the second term is read on the sequential scale opposite the temperature in deg C on the temperature scale.

The following is an example of a refractive index calculation from radiosonde data showing pressure, 1,014 mb; temperature, 21.5 deg C; relative humidity (RH), 64 percent.

1. To find the value of the first term, $77.6 p/T$, set 21.5 on the paper scale of the first slide rule at 1,014 on scale *DF* (Fig. 2A). The value is read on scale *D*, opposite the marker at 77.6 on scale *C*, as 267.0.

2. To find the value of the second term, $3.73 \times 10^5 e_s/T^2$ (RH), set the index of the temperature scale on the second slide rule at 64 on the RH scale (Fig. 2B). The value is read on the sequential scale, opposite 21.5 on the temperature scale, as 70.5.

3. The value of *N* is obtained by adding the first and second terms, found in (1) and (2) and is equal to 337.5.

This method may also be applied to a circular slide rule, which has the advantage of having a continuous scale. An example of the utilization of a circular slide rule for computing the second term is given in Fig. 3.

Values of $A = 3.73 \times 10^5 e_s/T^2$ vs *T* at intervals of one degree over a range of -45 C to +50 C are given in Table I. Adaptations of the slide rule may be made to ac-

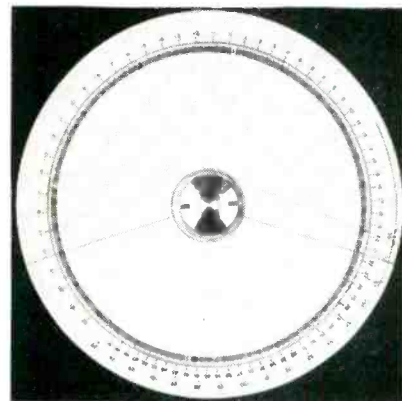
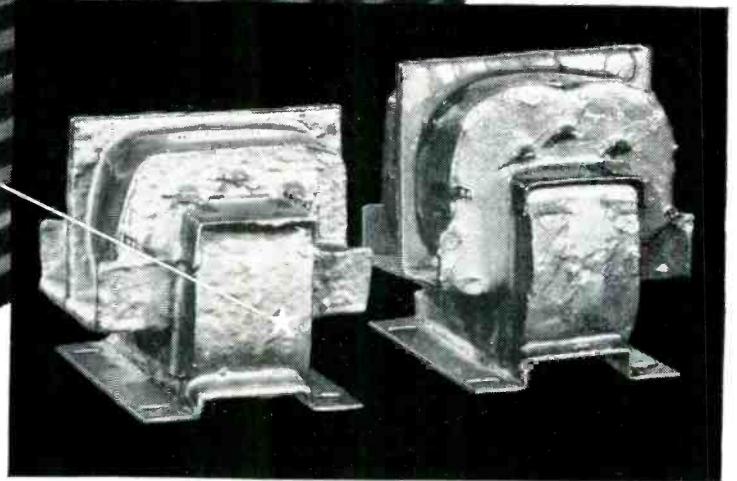
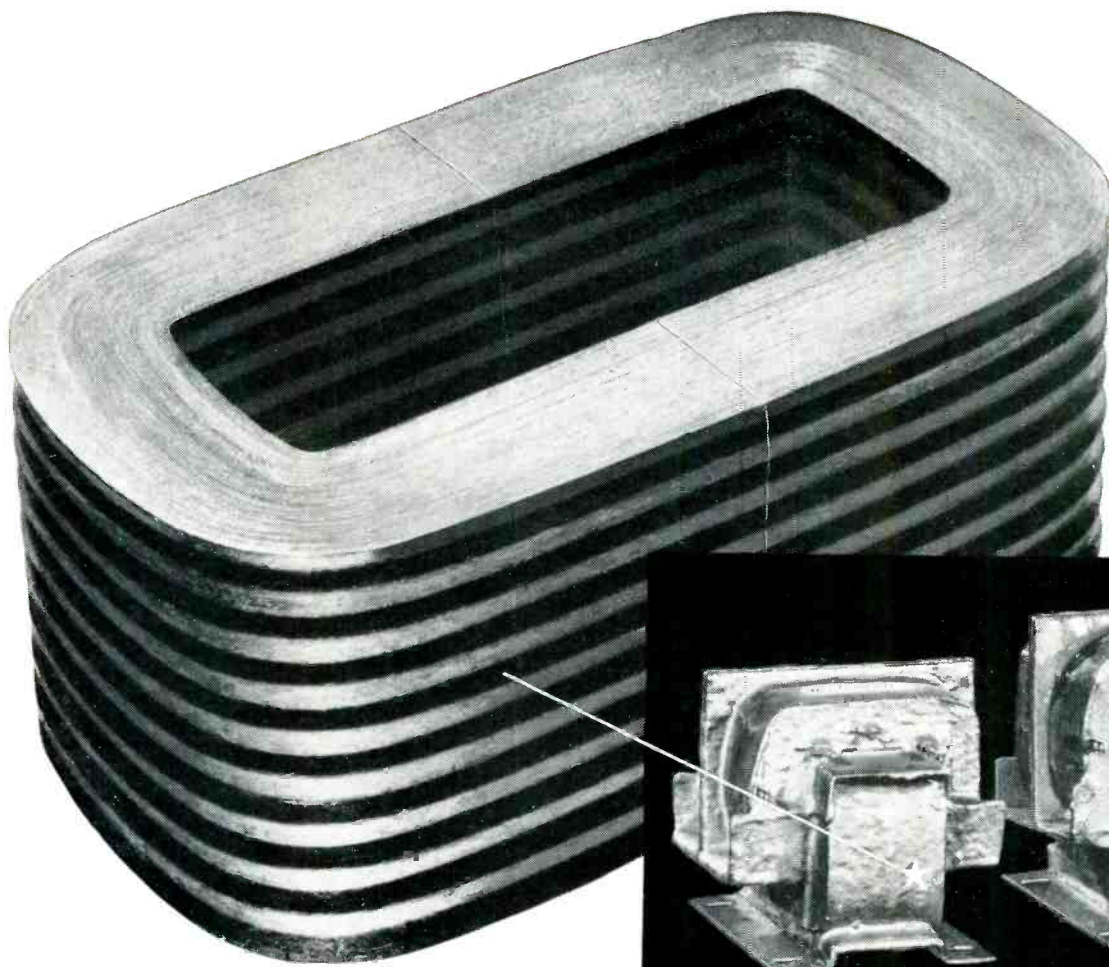

FIG. 3—Special circular slide rule for finding second term



New HIPERSIL CORE cuts air-borne transformer size and weight

Transformer weight reduced 25%, size cut 20% in a single unit of air-borne electronic equipment. This is the mark set by a new lightweight Hipersil® Core designed by Westinghouse for the Navy Bureau of Aeronautics.

Adaptable to commercial as well as military use, the new core makes possible more powerful equipment within the size and weight limitations of previous models. A special silicon steel, rolled to a new 4-mil thickness, with grain structure super-oriented by a refinement of the Hipersil process, achieves the size and weight reductions.

Hipersil Cores cut size and weight in *all* types of electrical and electronic transformers. They combine highest permeability with lowest losses in a wide

range of sizes (1 through 5 and 12 mils). Two-piece assembly simplifies transformer manufacturing, cuts fabricating costs. Greater flux-carrying capacity, increased mechanical strength help to make them the best core on the market. For specific information on how to apply Hipersil Cores to your product, write Westinghouse Electric Corporation, P. O. Box 868, Pittsburgh 30, Pennsylvania.

J-70632

YOU CAN BE SURE... IF IT'S
Westinghouse
HIPERSIL CORES

commodate it to variables other than those cited above as follows:

Vapor Pressure for Relative Humidity

When the water vapor pressure e in mb is used in the relation, Eq. 2 may be written

$$3.73 \times 10^5 e/T^2 = Be$$

where $B = 3.73 \times 10^5/T^2$ and is a function of T only. Distances proportional to the logarithm of B may now be laid out on one scale, as was done with A previously. The value of e is set directly on the same scale previously used for relative humidity. The operation of this slide rule is similar to that of the one using relative humidity.

Absolute Humidity

If the absolute humidity ρ_w in grams per cu cm is used, the second term^{5,6} may be closely approximated by $1.72 \times 10^8 \rho_w/T$. This term is now in the same form as the first term, and a slide rule similar in construction to that shown in Fig. 1A can be made, using the A and B scales, to aid in its computation.

When the dew point is used, the slide rule for use with water vapor pressure can be utilized by adding a supplementary scale to the one on which the water vapor pressure was set that will relate dew point to water vapor pressure.^{3,4}

Mixing Ratio

By using an approximation⁷ for the mixing ratio w in grams per kilogram, Eq. 1 may be written as:

$$N = 77.6 \frac{p}{T} \left(1 + 7.73 \frac{w}{T} \right)$$

A slide rule similar to that for the first term in Eq. 1 may be used for the second term in the parentheses above. The first term may then be computed and multiplied by the parenthetic expression.

Use of Fahrenheit

For temperatures given in deg F, and pressures in millibars, Eq. 1 becomes

$$N = 140 \frac{p}{T'} + 1.21 \times 10^6 \frac{e}{T'^2}$$

where T' is equal to $460 + t'$, t' being in deg F. The slide rules must be modified accordingly.

Mercury Pressure

If mm Hg are used, the constants multiplying pressure terms in the

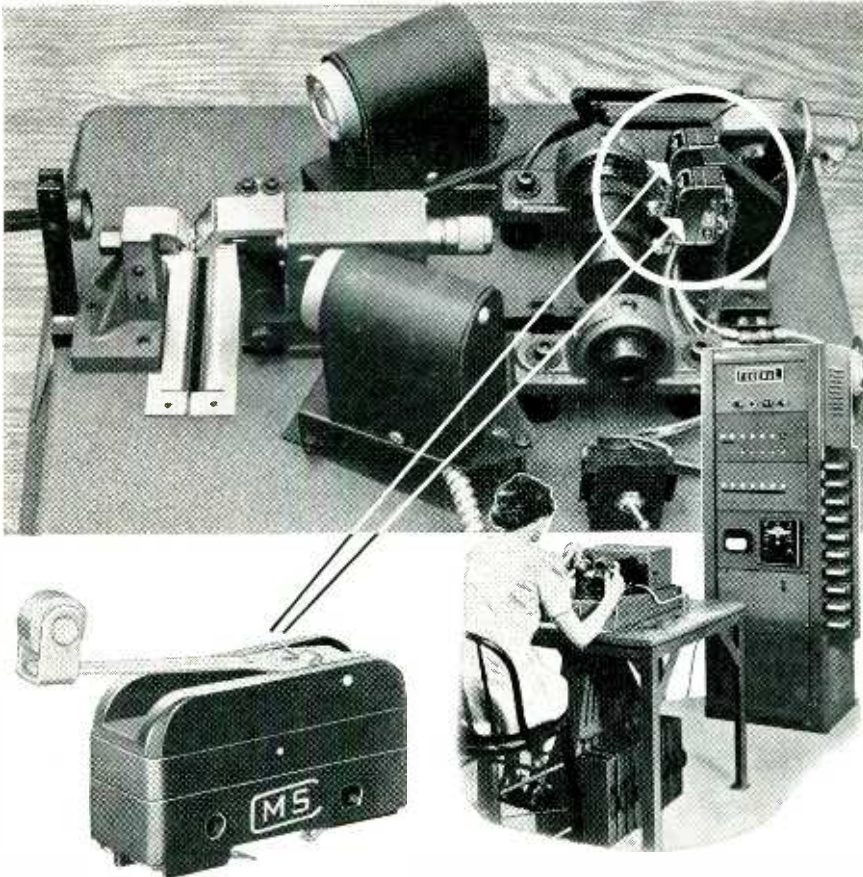

Federal Electronic Sorting Gage uses MICRO precision switches in high-speed gaging cycle

PRECISE and extremely accurate repeat operations of MICRO precision switches recommended them to the design engineers of Federal Products Corporation to control the gaging cycle of their electronic sorting gage. This machine sorts manually loaded mica parts into eight thickness classifications plus over and undersize at an adjustable speed of from 60 to 120 pieces a minute.

The operator breaks the photoelectric beam with the mica in her hand to initiate the gaging cycle. The electronic gage head moves forward, grips the mica and measures

its thickness. This signal, amplified and classified, causes the correct thickness disposal trap door below gage to open. The two MICRO switches (upper right) are operated by timing cams to control the various steps of the gaging cycle.

Design engineers are finding hundreds of uses for these small, precise switches in the control of electronic circuits. MICRO engineers, skilled in the switch requirements of this rapidly expanding industry, are ready to cooperate with you in the selection of the right switch for your application. Write or call the nearest MICRO branch.

MICRO
MAKERS OF PRECISION SWITCHES
FREEPORT, ILLINOIS

A DIVISION OF
MINNEAPOLIS-HONEYWELL REGULATOR COMPANY



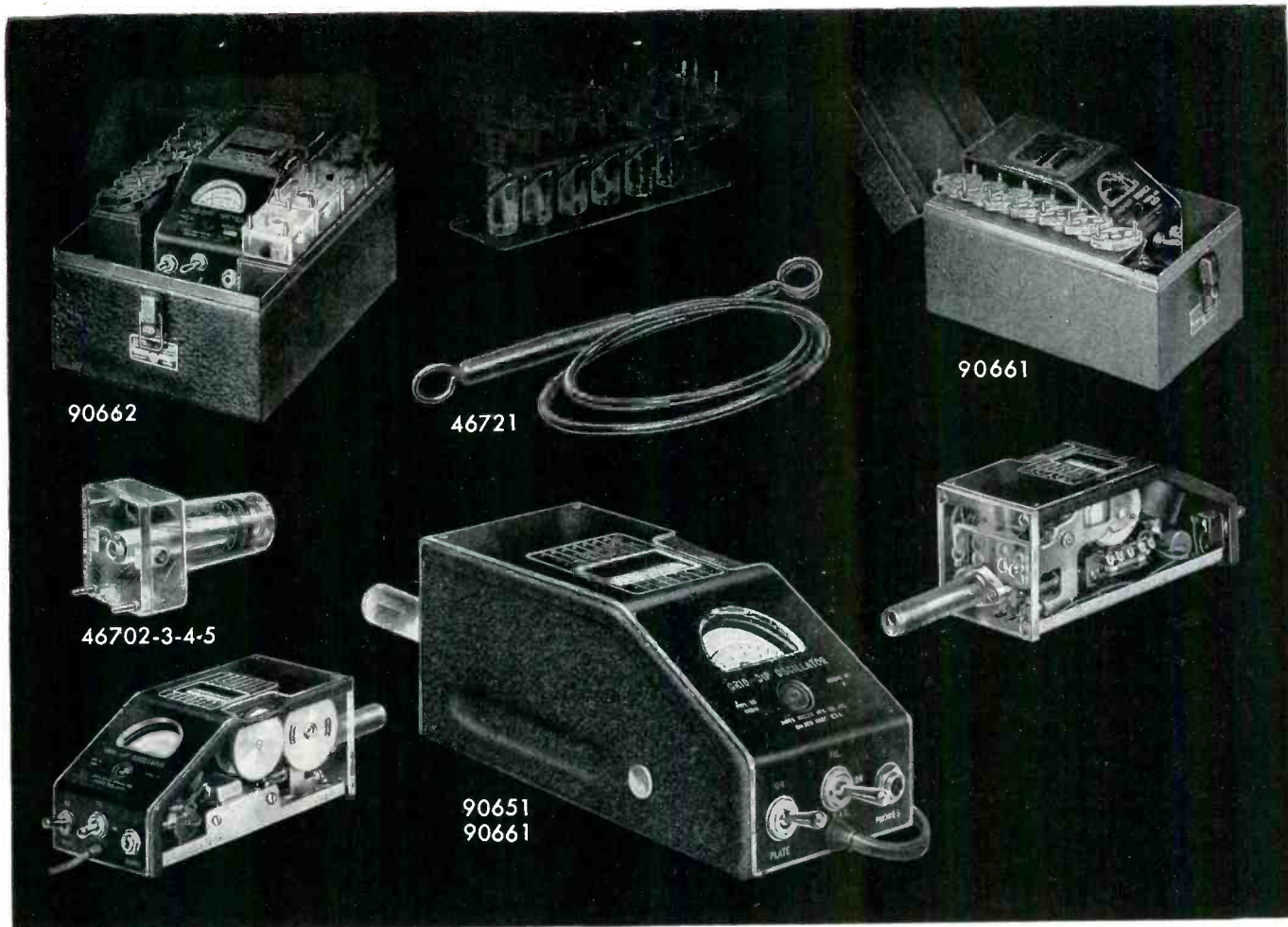

Designed for Application

Grid Dip Meters

Millen Grid Dip Meters are available to meet all various laboratory and servicing requirements.

The 90662 Industrial Grid Dip Meter completely calibrated for laboratory use with a range from 225 kc. to 300 mc. incorporates features desired for both industrial and laboratory application, including three wire grounding type power cord and suitable carrying case.

The 90661 Industrial Grid Dip Meter is similar to the 90662 except for a reduced range of 1.7 to 300 mc. It likewise incorporates the three wire grounding type cord and metal carrying case.

The 90651 Standard Grid Dip Meter is a somewhat less expensive version of the grid dip meter. The calibration while adequate for general usage is not as complete as in the case of the industrial model. It is supplied without grounding lead and without carrying case. The range is 1.7 to 300 mc. Extra inductors available extends range to 220 kc.

The Millen Grid Dip Meter is a calibrated stable RF oscillator unit with a meter to read grid current. The frequency determining coil is plugged into the unit so that it may be used as a probe.

These instruments are complete with a built-in transformer type A.C. power supply and interterminal terminal board to provide connections for battery operation where it is desirable to use the unit on antenna measurements and other usages where A.C. power is not available. Compactness

has been achieved without loss of performance or convenience of usage. The incorporation of the power supply, oscillator and probe into a single unit provides a convenient device for checking all types of circuits. The indicating instrument is a standard 2 inch General Electric instrument with an easy to read scale. The calibrated dial is a large 270° drum dial which provides seven direct reading scales, plus an additional universal scale, all with the same length and readability. Each range has its individual plug-in probe completely enclosed in a contour fitting polystyrene case for assurance of permanence of calibration as well as to prevent any possibility of mechanical damage or of unintentional contact with the components of the circuit being tested.

The Grid Dip Meters may be used as:

1. A Grid Dip Oscillator
2. An Oscillating Detector
3. A Signal Generator
4. An Indicating Absorption Wavemeter

The most common usage of the Grid Dip Meter is as an oscillating frequency meter to determine the resonant frequencies of de-energized tuned circuits.

Size of Grid Dip Meter only (less probe): 7 in. x 3½ in. x 3¾ in.

JAMES MILLEN

MAIN OFFICE



MFG. CO., INC.

AND FACTORY

MALDEN, MASSACHUSETTS, U. S. A.

Table I— $A = 3.73 \times 10^5 \frac{e_s}{T^2}$

deg C	A	° C	A
-45	0.797	3	37.1
-44	0.881	4	39.5
-43	0.972	5	42.1
-42	1.07	6	44.8
-41	1.18	7	47.6
-40	1.30	8	50.6
-39	1.43	9	53.8
-38	1.57	10	57.2
-37	1.72	11	60.7
-36	1.89	12	64.4
-35	2.07	13	68.3
-34	2.26	14	72.4
-33	2.47	15	76.6
-32	2.70	16	81.2
-31	2.95	17	85.9
-30	3.21	18	90.9
-29	3.50	19	96.1
-28	3.81	20	101.6
-27	4.15	21	107.3
-26	4.51	22	113.3
-25	4.89	23	119.6
-24	5.31	24	126.1
-23	5.76	25	133.0
-22	6.24	26	140.2
-21	6.75	27	147.7
-20	7.31	28	155.6
-19	7.90	29	163.8
-18	8.53	30	172.4
-17	9.21	31	181.3
-16	9.94	32	190.7
-15	10.7	33	200.4
-14	11.5	34	210.5
-13	12.4	35	221.1
-12	13.4	36	232.1
-11	14.4	37	243.6
-10	15.4	38	255.5
-9	16.6	39	268.0
-8	17.8	40	280.9
-7	19.1	41	294.3
-6	20.4	42	308.3
-5	21.9	43	322.8
-4	23.4	44	337.9
-3	25.1	45	353.6
-2	26.8	46	369.8
-1	28.6	47	386.7
0	30.6	48	404.2
1	32.6	49	422.3
2	34.8	50	441.2

equations are to be multiplied by the factor 1.333. If in. Hg are used, the factor is 33.86.

The author wishes to thank H. E. Bussey, under whose supervision this method was developed, for supplying the original idea, and also B. R. Bean, who assisted in the design of the original slide rules.

REFERENCES

- (1) L. J. Anderson, "Calculator for Atmospheric Refractive Index," Report 279, U. S. Navy Electronics Laboratory, San Diego, California, 1952.
- (2) E. K. Smith, Jr. and S. Weintraub,

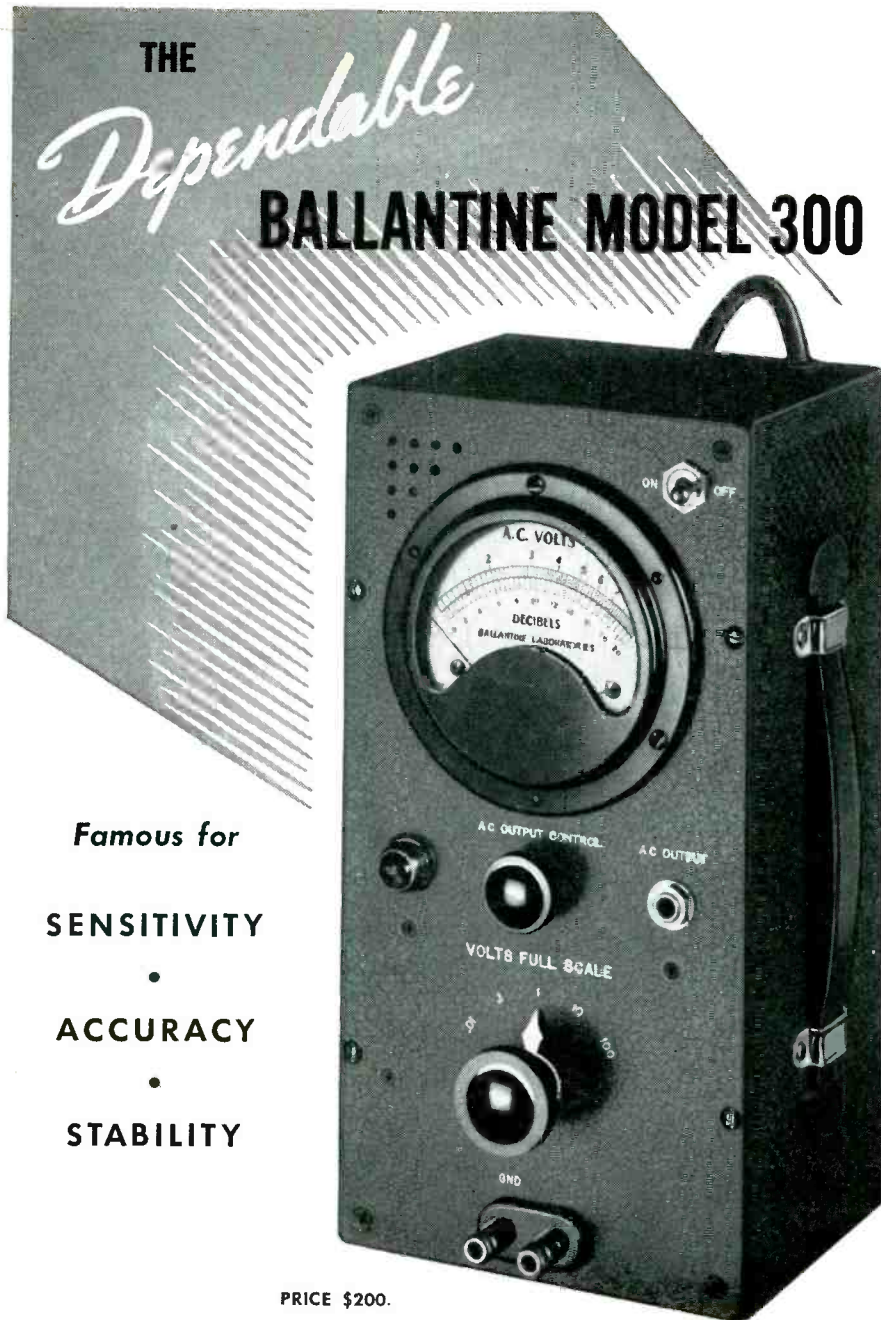

PRICE \$200.

VOLTAGE RANGE001v to 100 v
 FREQUENCY RANGE 10 cps to 150 kc
 ACCURACY 2% ENTIRE RANGE
 INPUT IMPEDANCE ½ meg shunted by 30 uuf

- Stability insured by the exclusive use of wire-wound resistors in the attenuator and feedback network.
- Same accuracy of reading at ALL points on the logarithmic voltage scale and linear decibel scale.
- Only ONE voltage scale to read with decade range switching.
- No "turn-over" discrepancy on unsymmetrical waves.
- Accessories available to extend the range to 20 uv and to 10 kv.
- Provides 70 DB amplifier flat within 1 DB from 10 cps to 150 kc.

Write for further details of this and other Ballantine voltmeters and accessories

BALLANTINE LABORATORIES, INC.

100 FANNY ROAD, BOONTON, NEW JERSEY



PROVED IN PRODUCTION

TESTED IN USE

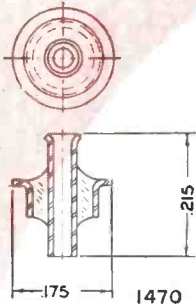

HERMETIC's Miniature Feed-Through Terminals for All Electronic Applications

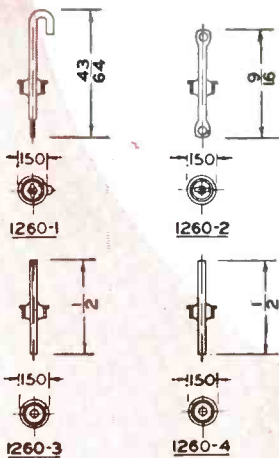
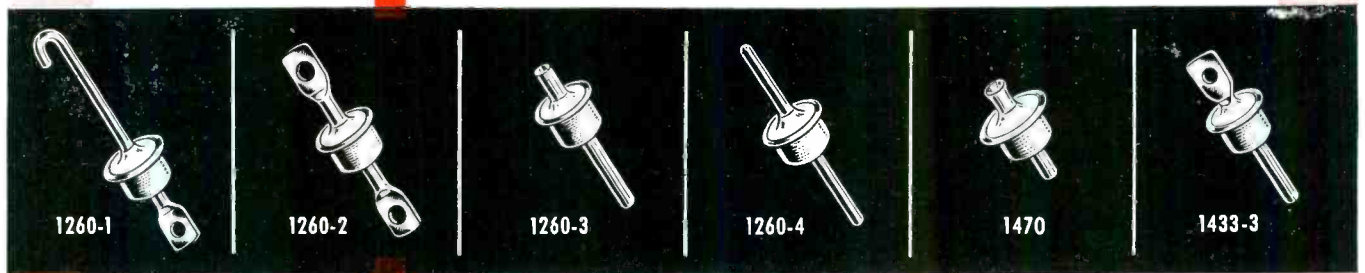

These units are typical of the miniatures which HERMETIC is now producing with barrel dimension as small as 1/8" and with a mounting flange dimension as low as .150". The center conductor is available tubular or solid in a wide variety of terminations. The reduction in overall dimensions which HERMETIC has achieved makes these units suitable for a great many applications.

Because the parts shown represent only a fraction of the vast production achieved by HERMETIC, contact the one and only dependable source of supply, and be sure that your problems will be solved, too.



WRITE for your FREE copy of HERMETIC's colorful, informative, new, 32-page brochure, the most complete presentation ever offered on hermetic seals.

Hermetic Seal Products Co.

First and Foremost in Miniaturization

31 South Sixth Street, Newark 7, New Jersey

PART NO.	A	B
1433-3	.175 ^{±.010}	3/16

ALLIED

your complete supply source for

RCA INDUSTRIAL TUBES & TEST EQUIPMENTAuthorized  Distributor

RCA electron tubes for Industry

Quick Service on All Types. ALLIED maintains in constant stock for quick shipment, the world's largest distributor inventory of RCA special-purpose tubes —of all types. We specialize in supplying the tube needs of industrial, broadcast, governmental and other users. Phone, wire or write—we ship from stock to any part of the nation within hours after we receive your order. Save time, effort and money—fill all your tube needs at ALLIED—the complete, dependable electronic supply source for industry.



Always
in stock at
ALLIED

RCA-8008 Rectifier (illustrated).
We stock the full line of RCA mercury-vapor rectifiers including the 575-A, 673, 816, 857-B, 866-A, 869-B, 872-A and 5558.

Look to ALLIED for RCA: Vacuum Power Tubes • Thyratrons • Cold-Cathode Tubes • Oscillograph Tubes • Vacuum & Gas Rectifiers • Ignitrons • Phototubes • Camera Tubes • Monoscopes

FREE Interchangeability Directory

Send for this valuable guide to the selection of proper RCA tube type replacements. Lists 1600 type designations, covering non-receiving electron tubes. Write for your FREE copy of RCA Guide No. 37-046.

RCA test instruments

For All Lab Requirements. Order your RCA laboratory measurement instruments from our extensive stocks. We specialize in the supply of electronic test and measurement equipment for research, development, maintenance and production requirements. Simplify and speed your purchasing—send us your consolidated orders for RCA Tubes and Test Instruments—have the advantages of quick, expert shipment from the world's largest stocks of Electronic Supplies for Industry

We can supply for quick shipment, all types of RCA test instruments, including the following well-known lab measuring equipment:

- WO-56A 7" Oscilloscope • WV-87A Master VoltOhmyst*
- WO-88A 5" Oscilloscope • WV-77A Junior VoltOhmyst*
- WR-39C TV Calibrator • WR-59B TV Sweep Generator

*T. M. Reg



Always
in stock at
ALLIED

WV-97A Senior VoltOhmyst* (illus.)

Improved RCA VTVM. Direct peak-to-peak measurement of complex waves from 0.2 volts to 2000 volts. Overall dc measurement accuracy of $\pm 3\%$ full scale. Measures dc voltages 0.02-1500 volts; rms values of sine wave from 0.1-1500 volts. Frequency response flat from 30 cps to 3 mc. No. 84-075. Net. \$67.50

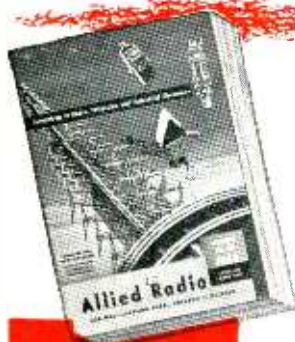

236 PAGE ALLIED CATALOG

Send today for the 1953 complete 236-page ALLIED Catalog—the authoritative buying guide to all electronic supplies. ALLIED offers the world's largest stocks of special tubes, parts, test instruments, audio equipment—complete quality lines of electronic apparatus. Save time, energy and money—simplify your purchasing by sending your orders to ALLIED—the single, dependable electronic supply source.

ALLIED RADIO CORP.

833 W. Jackson Blvd., Dept. 11-A-3, Chicago 7, Illinois

FREEEverything in Electronics from **ONE RELIABLE SOURCE**

"The Constants in the Equation for Atmospheric Refractive Index at Radio Frequencies," NBS Report No. 1938, Sept. 19, 1952.

(3) Smithsonian Meteorological Tables, 6th Revised Edition, p 367 and p 348, 1951.

(4) Same as ref (3) p 351 and 352.

(5) Same as ref (3) p 347 to 381.

(6) B. Haurwitz, "Dynamic Meteorology", McGraw-Hill Book Co., Inc., New York and London, p 7, 1941.

(7) Same as ref (6), p 10.

Multiple-Feedback Oscillators

USING A NUMBER of feedback circuits in connection with a single tank circuit has made possible the construction of oscillators able to operate over a wide range of frequencies with the L-C of the tank circuit remaining fixed. The circuits and the theory on which they are based are described in a patent by M. Morrison¹. Some of the important points of the theory are as follows:

In a tuned-grid reactively loaded oscillator the generated frequency is determined by the frequency at which the grid must operate to produce the required grid operating voltage angle, the phase angle at which the grid operates under a given load.

Grid operating voltage angle will either lead or lag the plate voltage depending on the character of the load. Under reactive loads the plate voltage, current and grid voltage are always out of phase with each other.

If an attempt is made to bring the phase position of an oscillator operating under a reactive load into a phase position other than that naturally assumed, the frequency of operation will be shifted to a new out-of-phase position that will be consistent with the load conditions. On a reactive load the phase position cannot be corrected to any arbitrary position.

In a tuned-grid reactively loaded oscillator, the frequency generated is determined by the frequency at which the grid tank circuit must operate to produce the required grid operating voltage angle, which may be leading or lagging depending on the character of the load.

The frequency stability of a resistance-stabilized oscillator is not necessarily critical to the Q of the tank circuit, because the frequency stability depends on the grid oper-

**IT'S READY NOW!
LET THE POSTMAN BRING YOU
THIS UP-TO-THE-MINUTE EDITION
OF A BOOKLET SPECIALLY
WRITTEN TO HELP YOU . . .**

Find answers to metal-selection problems



**36
PAGES OF**

When you're looking for a metal that stands up under severe conditions . . .

Here's a booklet that will help you find it!

The new, revised edition of "66 Practical Ideas" is just off the press. Get your copy and keep it handy for reference.

You'll save time . . . trouble . . . needless research. For "66 Practical Ideas" shows you how designers of electronic, electrical, and allied equipment have solved scores of metal-selection problems by using Inco Nickel Alloys such as Monel®, Nickel, or Inconel®.

And it's pretty easy to see *why*. The twelve Inco Nickel Alloys resist corrosion, heat, abrasion and fatigue. They provide the characteristics so often sought when you're trying to get a design off the drawing board and into production . . . or when you're trying to make a good product into a *better* one.

Right now, of course, all Inco Nickel Alloys are on extended delivery because so much is taken for defense. But you don't have to wait for "66 Practical Ideas." The booklet is ready for distribution, ready to start working for you at once.

Send for your copy now. The coupon is here for your convenience. Fill it in while you have it in front of you . . . and mail it to Bruce B. Winter at Inco. He'll see that your personal copy of "66 Practical Ideas" goes into the next mail. THE INTERNATIONAL NICKEL COMPANY, INC., 67 Wall Street, New York 5, N. Y.

Successful Ideas

For improving electrical products by using

where resistance to CORROSION
HEAT
FATIGUE
ABRASION

or other hard-to-find qualities are required

CONTENTS

WHEN THE HEAT'S ON	4
ALLOYS AGAINST CORROSION	7
SPRINGS ETERNAL	10
VIBRATION STAMINA	12
WHERE THE RUB COMES	15
SPARK EROSION STOPPED HERE	17
INSIDE THE ELECTRONIC TUBE	20
MAGNETOSTRICTION PLUS	23
ATTRACTIVENESS PAYS	25
SHAPES, SIZES UNLIMITED	27
TAILOR-MADE IDEAS	30
QUICK TECHNICAL FACTS	34
ALLOYS AND AVAILABLE MILL FORMS	38



Bruce B. Winter
THE INTERNATIONAL NICKEL COMPANY, INC.
67 Wall Street, New York 5, N. Y.

E-1-53

"66 Practical Ideas" sounds like a really worthwhile booklet. Please send me a free copy for my reference file.

Name _____

Firm _____

City _____ Zone _____ State _____

Title _____

JENNINGS VACUUM CAPACITORS in the

RCA 5 and 10 KW BROADCAST TRANSMITTER

Jennings
RADIO
VACUUM ELECTRONIC COMPONENTS

"RCA" T. M. Reg. U. S. Pat. Off.
Radio Corporation of America



JENNINGS TYPE UCS, 25-500 MMFD, 15 KV
VACUUM VARIABLE CAPACITOR



JENNINGS
TYPE M-500 MMFD
15 KV VACUUM FIXED
CAPACITOR

Capacitor Problems Solved
Ad No. 7 in a Series.

"Power Amplifier" stage showing two types of Jennings Capacitors used in this new BTA-5-G and 10-G transmitter.

RCA states in their descriptive literature that:

"Vacuum Capacitors, which are virtually failure-proof are used in the power amplifier tank circuit."

"The plate circuit of the power amplifier is tuned by a variable vacuum capacitor..."

"There are no air dielectric condensers in the transmitter, thus reducing arc-over possibilities due to dust collection."

You too, may find that Jennings Vacuum Capacitors can simplify and improve your circuits.



LITERATURE MAILED ON REQUEST

JENNINGS RADIO MANUFACTURING CO. · 970 McLAUGHLIN AVE. · P. O. BOX 1278 · SAN JOSE 8, CALIFORNIA

ating voltage angle being maintained at the correct position with variations in other circuit parameters rather than the circuit dissipation.

Variation in tank-circuit Q with different applied tank circuit voltages plays an important part in compensating for variation in phase angle of the load current with different applied tank circuit voltages.

Changes in the inductance and/or Q of the load on an oscillator cause changes in the load-imposed current angle. For each change in this current angle there is required a correct change in grid operating voltage angle to maintain the operating frequency. Oscillator stability is attained when the grid tank circuit automatically adjusts the grid operating voltage angle for the new load-imposed current angle at the same operating frequency.

In a resistance stabilized grid-tank-circuit oscillator having an inductive plate load and a single-feedback circuit, a frequency is best stabilized against plate voltage variations and is most purely sinusoidal when the tank circuit is operating at a frequency considerably removed from the resonant value.

An oscillator tank circuit having an intermittent drain imposed on it distorts the sinusoidal character of the tank circuit voltage. Therefore an oscillator should not be

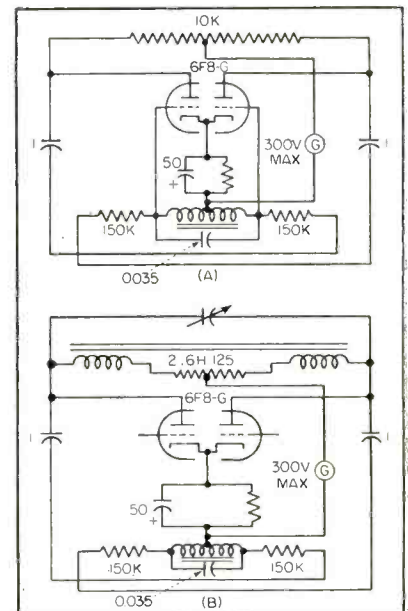

FIG. 1—Circuit arrangements for determining the effects of inductors on the operating frequency of an oscillator

There are hundreds of jobs open to engineers today! *but few opportunities like these*

Westinghouse is in nuclear power to stay. We believe in the development of atomic energy as man's next great source of power. If you want to get in on a new era in industry, we want to talk to you.

**Atomic power opportunities are waiting
for electronic engineers
with 4 to 10 years of this kind of experience...**

ELECTRONIC COMPUTERS, employing pulse amplifying wide range linear amplifying and rate circuits.

NULL BALANCE DEVICES, employing both vacuum tube and magnetic amplifiers, **SERVOMECHANISMS**, **PLANT CONTROL SYSTEMS**.

LIAISON with customers, contractors, designers of component equipment.

SUPERVISION of drafting work.

REMEMBER! We are primarily interested in good experienced application and development engineers—lack of previous reactor development experience is no handicap in this type of work.

HOW TO APPLY! What Westinghouse wants to know is: Where and when you obtained your degree . . . how you did in school . . . where you have worked at your profession . . . what kind of work you have done.

In other words, right now we're more interested in your ability to fill current openings and to develop in the Westinghouse Atomic Power Division than we are in your vital statistics. Write your letter of application accordingly.

You will be in communication with men who are experienced in keeping secrets. All negotiations will be discreet, and your reply will be kept strictly confidential.

Address your application letter to: Manager, Industrial Relations Department, Westinghouse Electric Corporation, P. O. Box 1468, Pittsburgh 30, Pennsylvania.

What do you want?

MONEY? Good jobs are open here now—waiting for good men who want to make a permanent connection.

A PERMANENT JOB? Many of the engineers who joined Westinghouse 20 and 25 years ago are still with Westinghouse—and in key positions—and engineers who join us now will have the opportunity to make this work their lifetime careers. When many other industries may be going through slack times, atomic energy will still be in a stage of expansion.

SUBURBAN LIVING? It's here—within easy driving distance of your work. Within a few minutes of shopping centers . . . schools . . . metropolitan centers.

JOB EXTRAS? Westinghouse offers: Low cost life, sickness and accident insurance with hospital and surgical benefits. A modern pension plan. Westinghouse stock at favorable prices. Westinghouse appliances for your home at discount.

YOUR KIND OF ASSOCIATES? Every fourth person in the Division is an engineer or scientist. More than half the top Westinghouse executives are engineers.

FASCINATING WORK? What other branch of science offers such exciting challenges? So many opportunities for discovery? So many chances to benefit mankind? So many opportunities for original work?

GROWTH OPPORTUNITIES? Never again in your lifetime will you be able to get into such a sure-to-expand industry so early in its development.

YOU CAN BE SURE.. IF IT'S **Westinghouse**

operated with these two factors in phase if sinusoidal operation is desired.

Inductively loaded oscillators have an inherent tendency to produce sinusoidal currents and distorted plate voltages. Capacitive loading induces distorted currents and sinusoidal plate voltages. Oscillators with capacitive loading are more difficult to stabilize than those with inductive plate loads, but are more sensitive to synchronizing currents than the latter.

If the oscillator in Fig. 1A were removed and adjusted independently to a given frequency, it could be placed back in the circuit. By adjusting the feedback control resistor the whole circuit could then be made to oscillate at the same frequency. If, however, the center-tapped resistor in the plate circuit were replaced by inductances, as in Fig. 1B, it would be found that the circuit will not oscillate at the given frequency but at a higher one. It will also have a lower output with the same plate impedance, because it will be found that the grid voltage is lower. To bring the oscillator to the given frequency it is necessary to place a variable capacitor across the inductance and increase the capacitance until the frequency and grid voltage reach the same values as in the original circuit. This shows that an oscillator can be made to operate at various frequencies by varying the L-C of the parallel oscillatory circuits and that an oscillator operating under inductive plate loading must operate at a frequency higher than the

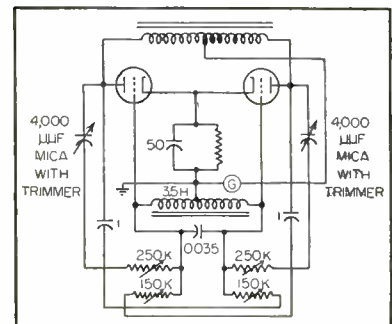

FIG. 2—An oscillator circuit with a wide range of operating frequencies. Because of the small size of the plate circuit capacitors stabilization is difficult



PRECISION POTENTIOMETERS

Linear and Non-Linear

Linear and non-linear units are described in the Gamewell Precision Potentiometer booklet. The booklet also contains a convenient glossary of terms used in conjunction with precision potentiometers. Write for your copy.

To solve your specific precision potentiometer problem, send your specs and sample orders to Gamewell. With over 97 years of experience in manufacturing precision electrical products, Gamewell can provide the answer promptly.

THE GAMEWELL COMPANY
Newton Upper Falls 64, Massachusetts



PRECISION POTENTIOMETERS

Manufacturers of precision electrical equipment since 1855

CONDENSED SPECIFICATIONS

Sinusoidal Type	
RL-11C	RL-14MS
Total Resistance (ohms)	16,000 ± 10% 35,400 ± 1%
Approx. % Resistance within brush circle	85%
Angle of Rotation	99 ± 1/4°
360°	360°
Torque (Approximate)	3/4 oz.-in. 2 oz.-in.
Wire	80 Ni-20 Cr 80 Ni-20 Cr
Resolution	0.4° 0.2°
Angular Accuracy	± 0.6° ± 0.5°
Amplitude Accuracy	± 0.8% ± 0.6%
Maximum Volts across winding	150 350
Maximum Speed	60 RPM 60 RPM
Expected Life	350,000 cycles 200,000 cycles
Diameter	2 5/8" 4 3/8"
Length	1 25/32" 4 11/32"
Shaft Size & Length	3/16" - 1" 1/4" - 1 1/4"
Weight	4.75 oz. 1.8 lb.



CHASE[®] PHOSPHOR BRONZES

are worth knowing about



WHAT metal is best for bearings? For diaphragms? For *any* tough production job that requires a metal of superior qualities? Chase Phosphor Bronzes may be the answer.

These tin bronzes are superior to many other metals for a wide variety of functions. Some Chase Phosphor Bronzes are ideal for fuse clips, spring contacts, bellows, lock washers. Others are suited for bearings, bushings, gears, pinions, screw machine parts. They are made in Rod, Strip or Wire.

Chase Phosphor Bronzes... like all Chase metals... are carefully controlled as to quality to provide a high standard of surface finish and excellent internal characteristics. Fill in the coupon below and we'll send you the free Chase folder.

FREE Folder gives tables of Chase Phosphor Bronze properties (hardness, tensile, fabrication, physical) as well as uses and forms.



Chase BRASS & COPPER

WATERBURY 20, CONNECTICUT - SUBSIDIARY OF KENNECOTT COPPER CORPORATION

• The Nation's Headquarters for Brass & Copper

Albany†	Cleveland	Kansas City, Mo.	New York	San Francisco
Atlanta	Dallas	Los Angeles	Philadelphia	Seattle
Baltimore	Denver†	Milwaukee	Pittsburgh	Waterbury
Boston	Detroit	Minneapolis	Providence	
Chicago	Houston†	Newark	Rochester†	(†sales office only)
Cincinnati	Indianapolis	New Orleans	St. Louis	

Chase Brass & Copper Co., Dept. ELEC153
Waterbury 20, Conn.
Please send me the free folder on Chase Phosphor Bronzes.

Name _____
Position _____
Company _____
Street _____
City _____ State _____

4 NEW

Potter

FREQUENCY-TIME COUNTERS...

Automatically READS
FREQUENCY, TIME INTERVAL
AND PERIOD



NEW

COMPACT DESIGN
CIRCUITS
FEATURES
LOWER PRICES

USE THEM FOR

FREQUENCY MEASUREMENTS

PERIOD MEASUREMENTS

TIME INTERVAL MEASUREMENTS

FREQUENCY RATIO MEASUREMENTS

SECONDARY FREQUENCY STANDARD

TOTALIZING COUNTER

DIRECT RPM TACHOMETER

Every known need in frequency and pulse measurement is now satisfied by four completely new designs of Potter frequency-time counting equipment.

The simplified Potter 100 KC Frequency, Models 820 and 830, are suitable for rapid and precise production line applications. The versatile Potter 100 KC and 1 MC Frequency-Time Counters, Models 840 and 850, include all gating, switching, timing and counting circuitry required for any conceivable counting-type measurement.

All models feature the convenience of smaller size, lighter weight, and functional panel layout. And, optional readout indication—either the dependable Potter 1-2-4-8 decimal readout or the conventional 0-9 lamp panels—is available.

Tells All

about Frequency-Time Counters—both laboratory and industrial applications.



For further data or engineering assistance write Dept. 1-C.

Potter

POTTER INSTRUMENT COMPANY, INC.

115 CUTTER MILL ROAD
GREAT NECK, N. Y.

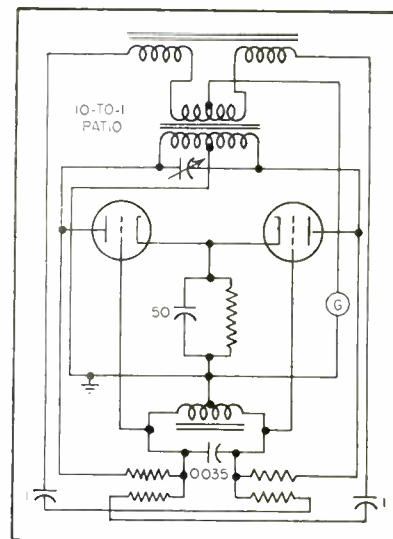

FIG. 3—A circuit similar to Fig. 2 but using a 10 to 1 current transformer to eliminate the small capacitors, making it easier to stabilize the oscillator

resonant frequency of the tank circuit.

Applying the information derived from the oscillators in Fig. 1, the multiple-feedback oscillator circuits in Fig. 2 and 3 may be explained. The tank circuits have fixed L-C combinations and a conventional feedback circuit to supply feedback current in phase with the plate voltage.

If the tank circuit of Fig. 2 is to work at resonance with the tank circuit, feedback current must be in phase with the grid operating voltage angle. This is accomplished by a direct feedback circuit comprising two 150,000-ohm resistors and a second feedback circuit with two 4,000- μ f variable mica capacitors. This second circuit provides a current having an out-of-phase position of such magnitude and phase difference relative to the reverse feedback circuit that it will cause the desired magnitude of feedback current and proper grid operating voltage angle to maintain the oscillator operating at the proper frequency. Although there are only two phases of feedback current used here, any number can be employed to obtain the proper phase angle and current magnitude to produce the desired phase relation to the reference phase of the circuit.

In this oscillator circuit it is not necessary for the L-C of the tank circuit to be set at the resonant

For the Answer to Your Insulation Problem

Look Through *this* Line...



● Can't guarantee that the Varflex Line will solve every insulation problem. But . . . Many's the problem—large, small, unusual—that Varflex Electrical Sleeving or Tubing has solved. The Varflex range of application is vast—chances are you'll find the solution to your Electrical insulating problem somewhere in the Varflex line.

- **VARGLAS SILICONE.** That's the insulating sleeving and tubing—pioneered by Varflex—that takes temperatures ranging from 500° F above to 85° F below in its efficient, resistant stride. Lead wire and treated cord too.
- **VARGLAS TUBING IMPREGNATED WITH GENERAL ELECTRIC PERMAFIL.** Tough, flexible, heat-resistant—available in coils. Premium tubing at a reasonable price.
- **VARGLAS SLEEVING AND TUBING.** Numerous types and grades—including synthetic treated, varnished, lacquered, saturated, litewall and others.
- **VARGLAS NON-FRAY SLEEVING.** Three types—may be subjected to temperatures up to 1200° F—for applications where dielectric requirements are not primary.
- **VARFLO TUBING AND SLEEVING.** New, low-priced — for applications where unusually high temperatures are not a factor. A real economy line, this.
- **VARFLEX COTTON TUBING AND SLEEVING.** Varnish or lacquer impregnants — for applications where Fiberglas products are not required.
- **SYNTHOLVAR EXTRUDED PLASTIC TUBING.** Low temperature flexibility—high dielectric and tensile strength—made from a standard formulation of vinyl polymers.

SAMPLES? All you want with our compliments. For free folder of our complete line, just clip and mail this coupon.



**VARFLEX
CORPORATION**

**MAKERS OF ELECTRICAL INSULATING
TUBING AND SLEEVING**

VARFLEX Corporation, 308 N. Jay St., Rome, N. Y.

Please send me information as well as free samples of your electrical Sleeving and Tubing.

I am particularly interested in samples suitable for _____

Name _____

Company _____

Street _____

City _____ Zone _____ State _____

TAKE PERFECTION FOR GRANTED

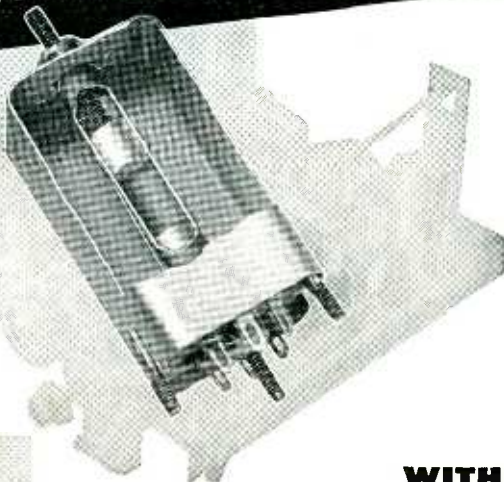

**WITH
MOLDITE
IRON CORES**

It's smart to use parts you can depend on completely . . . that are exactly right. Moldite Iron Cores are at the heart of the dependable electronic performance of product after product. They are made with absolute precision . . . by a company that specializes in making iron cores only . . . that

has developed its own exclusive formulas and production techniques for assuring uniformity, quality, dependability and economy.

MAGNETIC IRON CORES • FILTER CORES • MOLDED COIL FORMS
THREADED CORES • SLEEVE CORES • CUP CORES

NATIONAL

MOLDITE

COMPANY

1410 Chestnut Ave., Hillside 5, N. J.

Robert T. Murray Jerry Golten Co. Martin P. Andrews Perlmutth-Colman & Assoc. Jose Luis Pontet
614 Central Ave. 2750 W. North Ave. Mott Road 1335 South Flower Cardoba 1472
East Orange, N. J. Chicago 2, Ill. Fayetteville, N. Y. Los Angeles, Cal. Buenos Aires

frequency of the oscillator. It may be set at many other values for the same operating frequency if the polyphase feedback circuits are adjusted to provide the required grid operating voltage angle for the load at the operating frequency.

The oscillator of Fig. 3 uses a special current transformer, with a 10 to 1 ratio to accomplish phase alteration of the feedback current. The transformer, with a variable capacitor across the output, is constructed and adjusted to provide feedback load current in phase with the a-c component of the plate load current.

REFERENCES

(1) M. Morrison, Vacuum Tube Oscillator System, Patent No. 2,587,750, Mar. 4, 1952.

Measurement of Flashlamp Characteristics

THE MOST INTENSE light source commonly available is the brilliant flash produced by the discharge of a capacitor through a gas at reduced pressure. In appearance the light is an intense white and produces an effective duplication of daylight illumination for photographic purposes. Intensities as high as 10^6 candles per sq cm have been obtained in single flashes in lamps where the average power input is 10 megawatts during the flash. Light output efficiencies in the order of 50 lumens per watt have been measured in single-flash, high-current discharge tubes.

A testing circuit has been developed to measure the electrical and radiation characteristics of flash discharge in gas-filled tubes. Shown in Fig. 1, the device uses a triggering circuit to produce synchronous current pulses for repetitive flashing. Current, potential, power input to the discharge and light output are measured and recorded on an oscilloscope.

The test apparatus consists of a 10 in. disk of Dow metal driven at 3,600 rpm by a 1/20-hp synchronous motor. A 0.2 mm radial slit on the periphery of the disk passes light from a movie exciter lamp to a multiplier phototube to provide

Samples promptly submitted upon request for design, pre-production, and test purposes
SEND FOR CATALOG 110

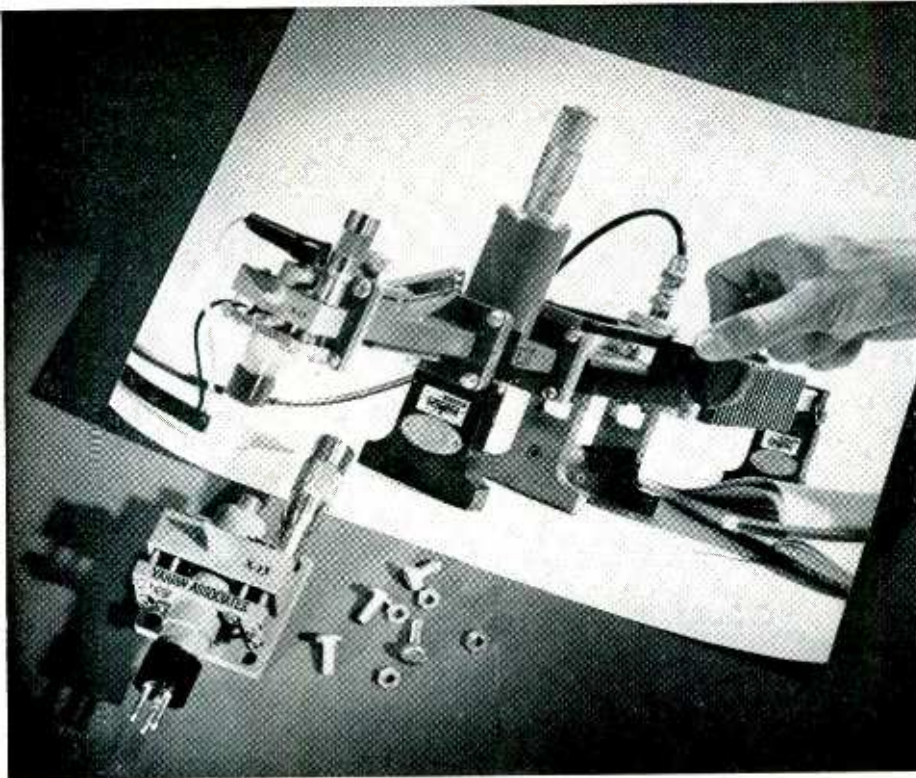

IN LABORATORIES throughout the electronic field, the Varian X-13 Klystron is widely used as a general-purpose x-band signal source. In the typical setup above (checking load reflection), note the compactness, the convenience of connection, and the way the tube bolts directly to the waveguide.

OUTPUT POWER typically reaches half a watt at center frequency and exceeds 150 milliwatts over the full frequency range 8.2 to 12.4 kmc. The X-13 exhibits extremely low microphonic levels and operates directly into matched waveguide. Tuning is done with a single control. The tube is air cooled and has clearance dimensions of $4\frac{1}{2}$ by $2\frac{1}{2}$ by $2\frac{1}{2}$ in., weight of only 6 oz.

Typical Power Output - Varian X-13 Klystron
 (Beam Voltage, 500 v)

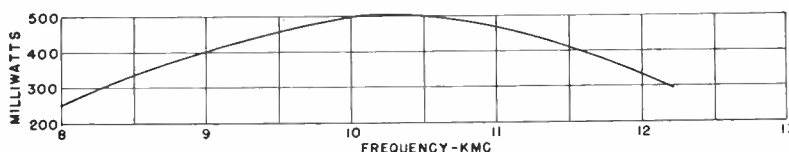

OTHER VARIAN KLYSTRONS extend and expand the functions of the X-13. An extensive line of tubes with designs based on that of the X-13 offers a wide selection of output powers, types of tuning devices and terminations, as well as capabilities for withstanding vibration and shock ranging far beyond 30 times gravity.

SEND FOR DATA on these or other klystrons from the extensive Varian line, many of which are necessarily unpublicized. You are invited to submit your microwave problems to the Varian application-engineering group for recommendations.

VERSATILE X-BAND SIGNAL SOURCE

Varian X-13
 reflex klystron

... 8.2-12.4 kmc

... 150-500 mw

* TRADE MARK



FIELD ENGINEERING
 REPRESENTATIVES
 IN PRINCIPAL CITIES

Precision ATTENUATION to 3000 mc!

- VSWR less than 1.2 at all frequencies to 3000 mc.
- **TURRET ATTENUATOR** featuring "Pull - Turn - Push" action with 0, 10, 20, 30, 40, 50 DB steps.
- Accuracy $\pm .5$ DB, no correction charts necessary.
- 50 ohm coaxial circuit. Type N Connectors.

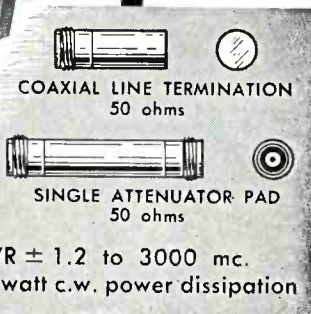
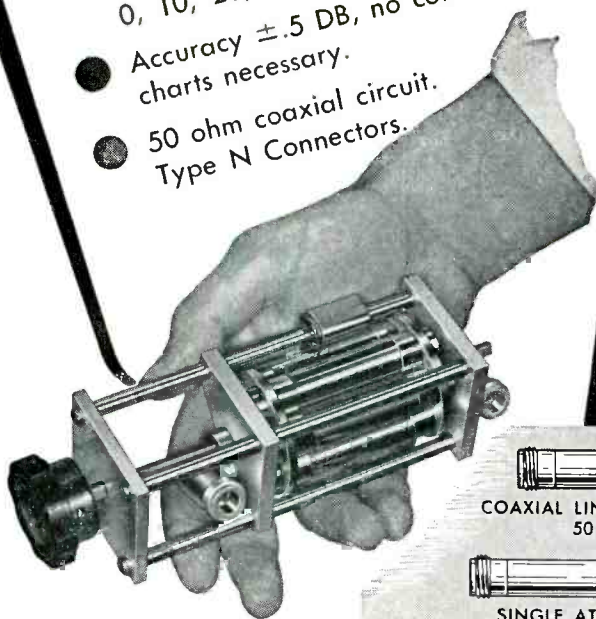

VSWR ± 1.2 to 3000 mc.
One watt c.w. power dissipation

Inquiries are invited concerning single pads and turrets having other characteristics

STODDART AIRCRAFT RADIO CO.
6644-A SANTA MONICA BLVD., HOLLYWOOD 38, CALIFORNIA
Hillside 9294

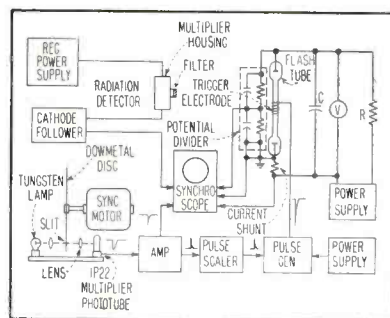

FIG. 1—Block diagram of flashlamp testing apparatus

sharply defined current pulses. These pulses are amplified and used to trigger the oscilloscope sweep and also to initiate the discharge in the flash tube.

A scaler circuit provides pulsing rates lower than the 60 pps set up in the multiplier tube. Consisting of six binary stages, the scaler is arranged so any desired number of stages may be inserted in the circuit to reduce the pulsing rate by a factor 2^n , where n is the number of stages used. Thus, in addition to the 60 pps rate there are six other rates available, 30, 15, 7.5, 3.75, 1.88 and 0.94 pps.

Discharge of the tube is initiated by an external trigger electrode located near the center of the quartz envelope. A capacitor across the electrodes is charged to a potential less than the breakdown voltage of the gas used. When a rapidly changing potential is placed on the trigger electrode it produces sufficient ionization of the gas for discharge to occur. The potential of the capacitor decreases in a few microseconds from an initial value between 1,500 and 3,000 to a few hundred volts. The dielectric strength of the nonionized gas is restored in a few tenths of a millisecond after initiation of the high-current arc.

To provide high-voltage pulses for initiating the discharge, the amplified photocurrent pulses are transformed to sharp positive pulses by a thyratron tube. These pulses are then impressed on the grid of a hard tetrode tube, normally biased to cut off, reducing the plate impedance from a high to a very low value. The trigger electrode is connected directly to the plate of the tetrode, and when a



BRIDGEPORT BRASS COMPANY

COPPER ALLOY BULLETIN



MILLS IN BRIDGEPORT, CONN. AND INDIANAPOLIS, IND.—IN CANADA: NORANDA COPPER AND BRASS LIMITED, MONTREAL

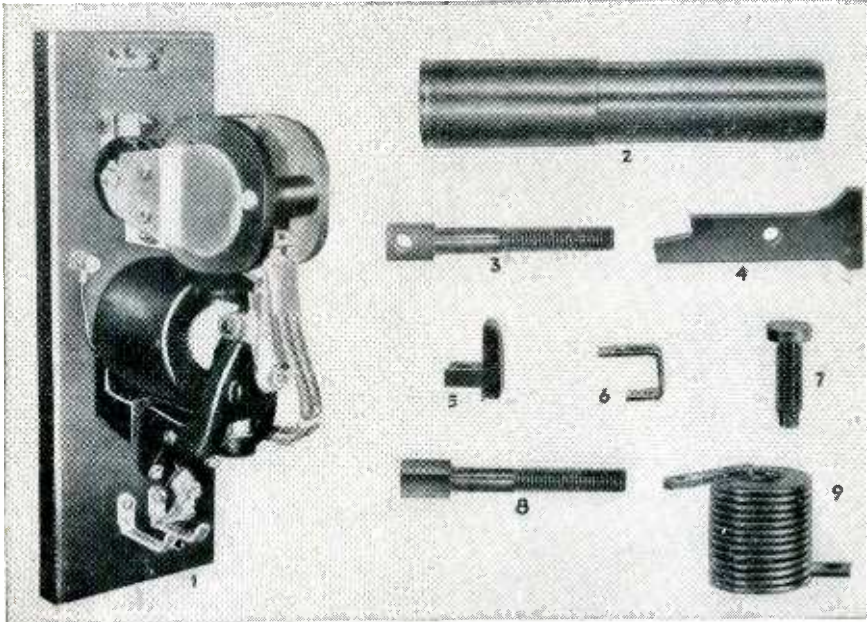

Vari-Time Magnetic Contactor and copper-base alloy parts, courtesy The Clark Controller Co., Cleveland, Ohio.

Copper and its Alloys Ideal for Heavy Duty Contactors

D.C. Magnetic Contactors are used as motor starters, crane controls, press controls, furnace controls, etc. They must be capable of handling anywhere from 25 to 900 amperes, open and close rapidly with a minimum of arcing and burning, and withstand corrosion even when exposed to the elements. In order to meet these requirements, high conductivity copper and alloys such as free cutting brass and Phosphor Bronze are used to manufacture those parts which form the electrical circuit. Some parts such as the studs, contact tips and arc horns, which require machining, are less costly to produce because of less tool wear and spoilage when using copper or brass.

Vari-Time Contactor

Illustrated is a Clark Controller Vari-Time Magnetic Contactor (1) which contains a special core providing

an adjustable time delay before closing after the coil has been energized. The timer (2) consists of a core tube machined from free-cutting brass bar stock. The I.D. of the tube is reamed smooth and has a tolerance of $\pm .0005"$. Other copper-base alloy parts are the core cap and valve seat, both machined from free-cutting brass and a washer made from commercial bronze. The assembled core is filled with a special oil of controlled viscosity, and then the core tube is sealed with the core cap which is soldered in place. The timing is adjusted by an adjustable stop stud on the front of the contactor which varies the gap between the armature and the front of the core. The entire VT Core is so designed and constructed as to give exceptionally long life. At various times, after years of hard service, Vari-Time cores have been taken apart and rigidly inspected with no appreci-

able wear or deterioration.

Other copper alloy parts used on the contactor are as follows:

Blowout Stud (3) — This stud is machined from high conductivity hard copper square bar stock and then silver coated. It holds the blowout coil to the slate and also provides a terminal for power connection.

Rear Contact Stud (4) — This extruded part is made from free cutting brass rod which is silver coated after being drilled and tapped. To this stud are connected the other end of the blowout coil, the stationary contact tip and the rear arc horn.

Contact Tips (5) — A heated billet of high conductivity copper is forced through a die producing an oversized cross-section of the tip. This extrusion is then cold drawn through a sizing die which also imparts the correct hardness to the copper. Two contact tips are used on each contactor.

Front Arc Horn (6) — The front arc horn is formed from a Phosphor Bronze Grade A (95% copper, 5% tin, 0.15% phosphorus) strip while the rear arc horn, not illustrated, is formed from a high conductivity copper strip. Both arc horns are silver coated. The horns extinguish the arc by lengthening it until it is broken.

Stop Stud (7) — Machined from Phosphor Bronze Grade B-1 alloy, this stud acts as a stop for the contact arm.

Connector Stud (8) — This part is machined from high conductivity hexagon-shaped copper rod. It connects one end of the connector assembly to the slate, and also serves as a power terminal connection.

Before you decide what copper alloy to use for a particular application, many factors must be taken into consideration. Bridgeport Brass produces many alloys, each one with its own distinctive properties. Contact the nearest Bridgeport branch office for assistance with any of your metal problems. (9247)

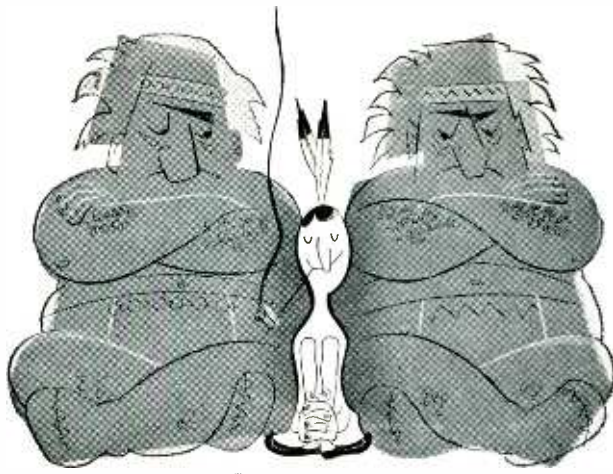

no seating problem

when you use Sangamo Paper Capacitors

They meet the physical and electrical requirements of JAN-C-25 specifications



Type CP 40

Space-saving, high-voltage filter capacitors for transmitting, receiving, or industrial electronic equipment. Easy to mount.



Type CP 50

Unusually small but stable by-pass capacitors of the "bathtub" type. Available in single, double, and triple section units.



Type CP 60

These filter capacitors are available with seamless drawn steel or non-magnetic cases that are smaller than JAN specs.



Type CP 70

Compact, fabricated can type for power supply in transmitting, sonar, radar, or ground control equipment.

Sangamo hermetically sealed paper capacitors for filter, by-pass, coupling or power supply applications can be furnished in types that give excellent performance with long life over a temperature range from -55°C to $+125^{\circ}\text{C}$! Diaclor*, or mineral oil impregnation for 85°C operation—and Sangamo developed E-therm impregnation for exceptionally high thermal stability and superior electrical performance over a range of operating temperatures up to 125°C . Write for further information. Complete story in Catalog No. 800A and Engineering Bulletin No. 104.

*TM Registered (Chlorinated Dielectric Oil)



Those who know...  choose Sangamo

SANGAMO
ELECTRIC COMPANY
MARION, ILLINOIS

SC53-2

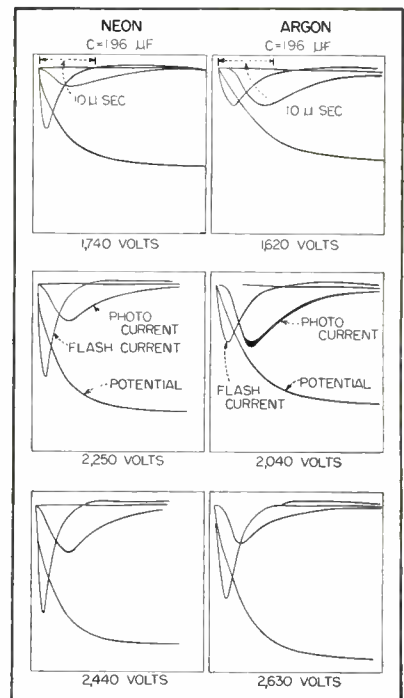
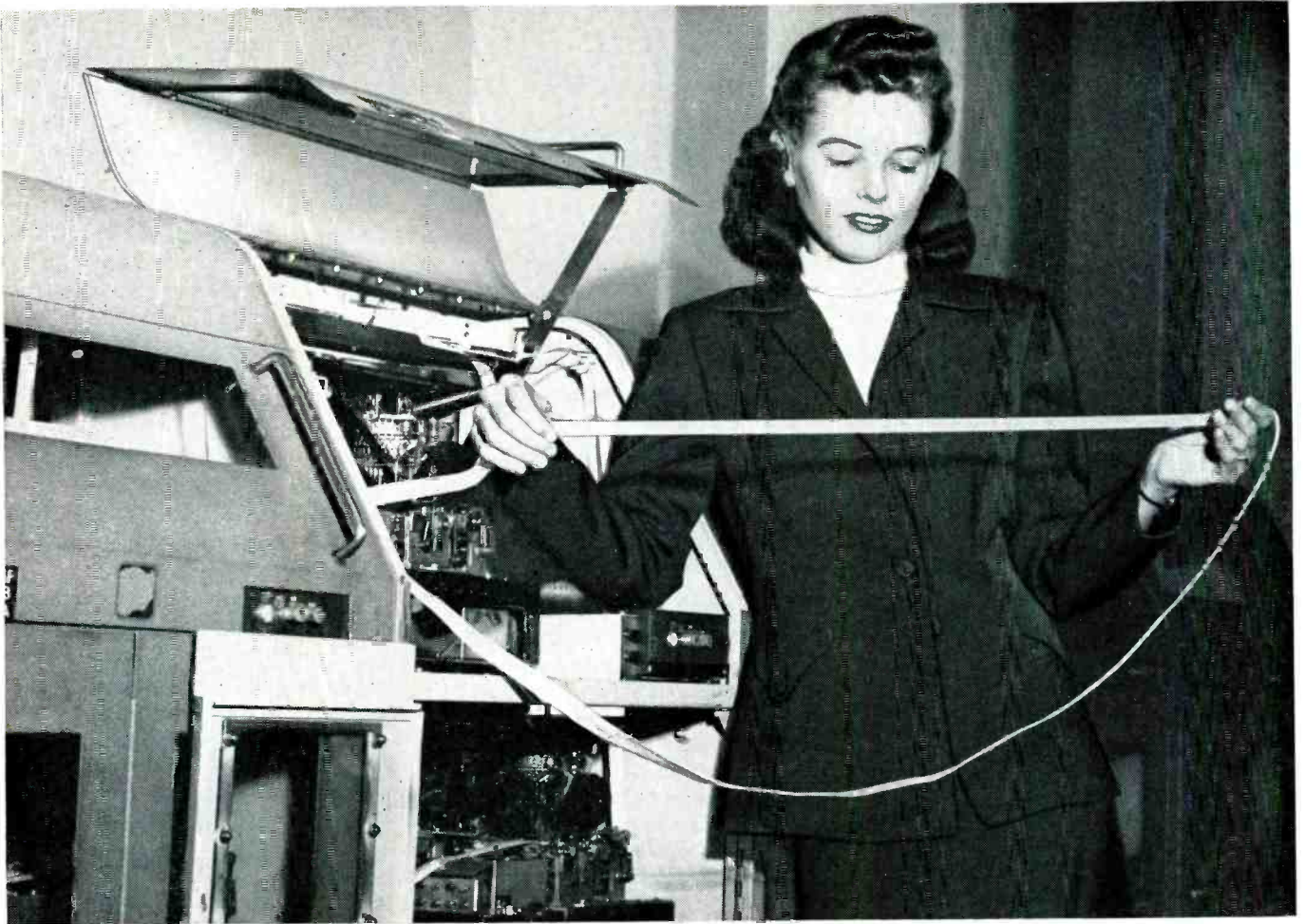

FIG. 2—Typical traces of flash current, potential and photocurrent

positive pulse causes the tube to conduct, the potential of the electrode drops from several thousand volts to a very low value. Observations using the fast sweep of the synchroscope indicates that the change occurs in less than $0.1 \mu\text{sec}$, or at a rate greater than $10^{11} \text{ v per sec}$. Using 6,000 to 8,000 v on the trigger electrode it is possible to pulse all the tubes in a perfectly consistent manner at any rate for which overheating of the electrode did not occur.

Measurements are made on a Navy radar synchroscope having sweep ranges of 1, 2, 10, 25 and 60 μsec with the sweep triggered by the pulse from the pulse generator circuit. The low-impedance input circuits are properly matched with well-shielded coaxial cables. Identical cables are used to give proper phase relations between current, potential and light pulses.

Measurement of tube potentials is carried out by means of a compensated and shielded voltage divider. Check measurements showed that tube potential errors are not more than ± 5 percent. Current pulses are obtained by the use of a specially constructed bifilar element having a resistance of 0.089 ohm. The average deviation in mean current values as determined by com-



These signals find the way

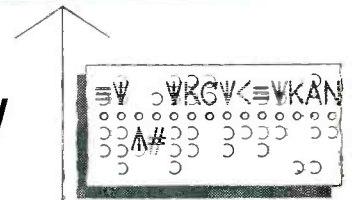

SEND NG

When you dial a telephone number, high-speed switching mechanisms select your party and connect you. Through a new development of Bell Telephone Laboratories, similar mechanisms are doing the same kind of job in private wire teletypewriter systems which America's great businesses lease from the telephone company.

Company X, for example, operates an air transportation business with scores of offices all over the country. At one of these offices, a teletypewriter operator wishes to send a message, let us say, to Kansas City. Ahead of the message, she types the code letters "KC". The letters become electric signals which guide the message to its destination.

Any or all stations in a network, or any combination of stations, can be selected. Switching centers may handle 50 or more messages a minute . . . some users send 30,000 messages a day. Delivery time is a few minutes.

Defense manufacturers, automobile makers, airlines and many other American businesses are benefiting by the speed and accuracy of the new equipment — another example of how techniques developed by the Laboratories for telephone use contribute to other Bell System services as well.

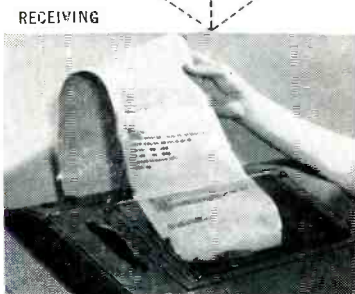

RECEIVING



BELL TELEPHONE LABORATORIES

Improving telephone service for America provides careers for creative men in scientific and technical fields.

No more worries about FREQUENCY RESPONSE or WRITING SPEED.

The NEW and PHENOMENAL HATHAWAY Type SC-16 OSCILLOGRAPH

with 6 elements is flat from
0 to 200,000 cycles per second, and its traces
have a writing speed of 5 million inches per second.

Fast transients and high-frequency phenomena now can be accurately recorded.

Several types of continuous-drive record magazines are available for 6-inch sensitized paper and film, and for 35-mm film. The magazine shown on the oscillograph at the left accommodates 100-foot rolls of record paper.

Drum-type magazines, both small and large, are valuable for short high-speed records. The large drum-type magazine at the left has a drum 3 feet in diameter and 6-inches wide. It can be driven at 3000 RPM for a chart speed of 6000 inches per second when high resolution is needed. It can be used to take one 10-foot record or a larger number of shorter records.

The ASC-10 6-element direct-coupled amplifier will drive the SC-16 oscillograph from potentials of millivolt level.

Useful for strain recording to 100 Kilocycles.

AUTOMATIC OPERATION Initiate a transient with the oscillograph, or let the transient start the oscillograph.

QUICK-CHANGE TRANSMISSION for wide range of record speeds.

PRECISION TIME LINES.

Z-AXIS MODULATION for timing to one-tenth millisecond.

QUICKLY-INTERCHANGEABLE LENS STAGES for different record and trace widths.

Write for Bulletin 2G1-K for details.

Write for FREE copy of Hathaway Engineering News

Hathaway
INSTRUMENT COMPANY
1315 SO. CLARKSON STREET • DENVER 10, COLORADO

paring the charges delivered by the capacitor with the charges obtained by graphical integration of the synchroscope current trace amounted to ± 3 percent.

Radiation measurements in the ultraviolet region are made with a 1P28 multiplier phototube with a Corning 9863 filter to give an overall response extending from 2,400 Å to 4,200 Å with a peak at 3,350 Å. In the visible region a 931A multiplier is used without a filter. A six-stage multiplier with Cs-Ag-O cathode is used in conjunction with a Wratten A (No. 25) filter provides a response range from 6,000 to 12,000 Å with a peak at 8,500 Å in the near infrared region.

Since peak light intensities ranging up to 10,000,000 lumens are encountered at the highest flash energies, considerable attenuation is required to limit the operation to the region of linear response of the multipliers. To provide a fixed amount of attenuation a piece of exposed photographic film is placed over the opening in the multiplier housing.

This article is abstracted from a paper entitled "Electrical and Radiation Characteristics of Flash-lamps" by H. N. Olsen and W. S. Huxford, which appeared in the *Journal of the Society of Motion Picture and Television Engineers*, p 285, Sept. 1950.

Phonograph Needle Drag Distortion

MOTION of a phonograph needle in a direction tangential to the record groove will cause what is known as drag distortion. If present in a record playing system this distortion may result in spurious tones having greater amplitude than those originally recorded.

Phonograph records are usually recorded laterally, with the audio frequency motion of the needle at right angles to the groove. For accurate reproduction the playback needle should duplicate the exact motion of the recording stylus. If forces act on the reproducing needle to cause longitudinal motion, its movement will no longer duplicate



"We would pay a premium for these 50,000 Air Shipments yet we actually saved thousands of dollars!"

Robert S. Woolf, Mgr., Teletranscription Dept., Dumont Television Network

"When we ship TV film, we're interested in *service*. We can't afford to take any other attitude. We've bought program time all over the country, and those programs *must* be filled.

"We at Dumont use Air Express. It's the fastest. It has all-point coverage. Above all, it is **DEPENDABLE**.

"As to cost — Air Express costs Dumont *less* than other air services would, by thousands of dollars per year! For instance, on our regular shipments

to Detroit, other services cost 37% to 337% *more* than Air Express. And we can't duplicate the service at any price!

"The Air Express people have carried upwards of 50,000 shipments for Dumont in the last four years. Their ability to trace shipments — especially when being shuttled between stations — is almost uncanny! It has helped us out in many an emergency.

"It pays to specify Air Express — in more ways than one!"



AIR EXPRESS

GETS THERE FIRST

Division of Railway Express Agency

How the EDISON thermal relay protects electronic tubes

Delays plate voltage application
until cathode is properly heated

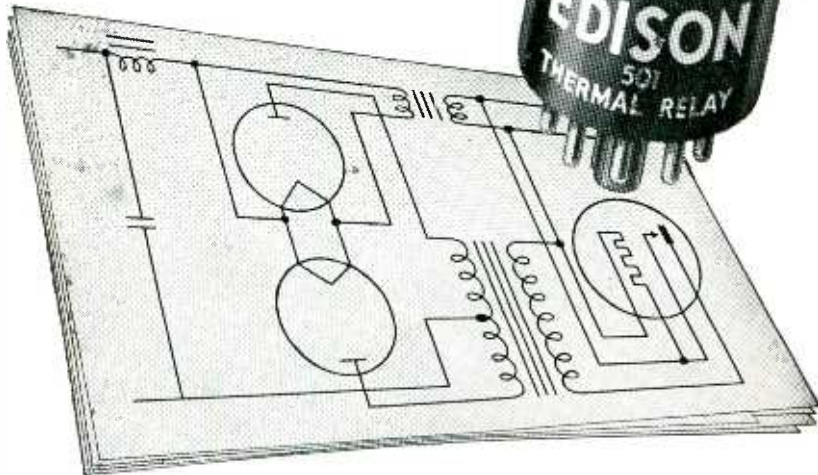

PROTECTION OF CATHODES in electronic tubes, such as thyratrons and gas filled rectifiers, depends on allowing cathodes to reach operating temperature rather than delaying application of plate voltage for a fixed time. A thermal relay, since its operation also depends on attaining a predetermined temperature, is eminently suitable for cathode protection.

THE EDISON THERMAL RELAY is widely used for this purpose because (a) its delay characteristics vary with line voltage as does cathode heating; (b) it is suitable for continuous operation; (c) it offers sustained accuracy; (d) it has a wide range of delay

periods; (e) it is silent and positive in operation; (f) it is as independent of ambient temperatures as the cathode it is protecting; (g) it is relatively inexpensive; (h) it is small and lightweight. The cooling rate of the EDISON Thermal Relay prevents loss of equipment operating time due to momentary power interruptions.

EDISON ENGINEERS will help you solve your cathode protection problems if you will write and give them the data.

Just address Instrument Division, THOMAS A. EDISON, Incorporated, 94 Lakeside Ave., West Orange, New Jersey.

Thomas A Edison
INCORPORATED

Instrument Division • West Orange, New Jersey

OTHER INSTRUMENT DIVISION PRODUCTS

Sealed Time Delay Relays • Sensitive Relays • Electronic Temperature Controls • Critical Temperature Monitors • Electrical Resistance Bulbs.

YOU CAN ALWAYS RELY ON EDISON

that of the recording stylus and distortion will be introduced.

Some of the causes of this longitudinal motion are; the varying force that the sides of the groove exert on the needle; the pinch effect due to the uneven width of the record groove and the change in friction with changes in velocity and pressure of the needle in the groove.

In a series of experiments made by the National Bureau of Standards it was found that when playing a recording consisting of a pure tone of constant amplitude, drag distortion will produce only

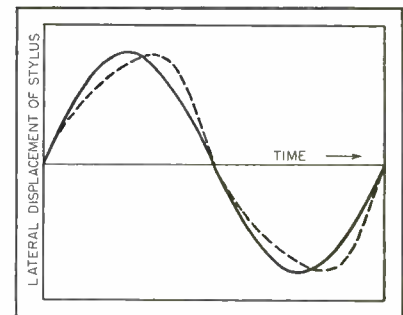

FIG. 1—Graphical reproduction of drag distortion in a pure sine wave recording. Solid line is path of ideal stylus having only lateral motion. Dotted line shows distorted path followed by needle free to move longitudinally as well as laterally

even harmonics with the second harmonic predominating.

Two methods were tried to measure the longitudinal motion of the needle. A photoelectric arrangement with longitudinal needle motion modulating a light beam did not prove satisfactory. The second method, in which the longitudinal movement frequency-modulated a 50-mc oscillator was found to be more accurate. Two small metal plates were mounted near the needle so that any longitudinal motion would vary the capacitance between the plates. With the plates connected across the tank coil of the oscillator, an f-m signal was picked up on a standard f-m receiver. When tuned properly, the output of the receiver varied with the instantaneous longitudinal position of the needle. A dual-beam oscilloscope indicated simultaneously both the

*Quality Controlled**

TO THE HIGHEST STANDARDS OF THE INDUSTRY

CHESTER

plasticord-plasticote

WIRES and CABLES

***Quality Control works
2 ways at CHESTER**

It's a fact and here's why! First, Chester quality control engineers certify every phase of manufacture from raw material to finished product packed for shipment. No detail is too small or unimportant to merit their full attention. Second, quality in turn governs production — not a single foot of Chester wire or cable is ever "hurried through" to meet a shipping date or heavy schedule. Extra shifts, not faster production is the method used to break bottlenecks at Chester.

This two way quality control is just one of many important reasons why electrical and electronic men, in increasing number, specify Chester wire and cable for an extra measure of reliability. Why not check your requirements with Chester today.

FOR EVERY APPLICATION —

JAN-C-76 • 80°-90°-105°C
 Hook-Up Wire • Shielded Wire and Cable
 Flexible Cords • Coaxial Cable • Television
 Lead-In Cable • Gas Tube High Tension
 Cable • Oil Burner Ignition Cable • Blast-
 ing Wire • Thermostat Cable • Bell and
 Office Wire • TW Building and Fixture Wire



JAN-C-76 SRIR



UL APPROVED 105°C



JAN-C-76 SRRF



UL APPROVED 90°C



JAN-C-76 SRHV



UL APPROVED 80°C



JAN-C-76 WL



SHIELDED WIRES & CABLES



FLEXIBLE CORD



INSTRUMENT WIRES



TV LEAD-IN WIRES



COAXIAL CABLE



COMMUNICATION WIRES & CABLES

SPECIAL WIRES & CABLES TO SPECIFICATION



"Chester" says —
 Rely on Plasticord and
 Plasticote — write for
 the new Catalog today

CHESTER CABLE CORP.
 CHESTER, NEW YORK

MANUFACTURERS OF QUALITY WIRE AND CABLE FOR EVERY ELECTRICAL AND ELECTRONIC REQUIREMENT

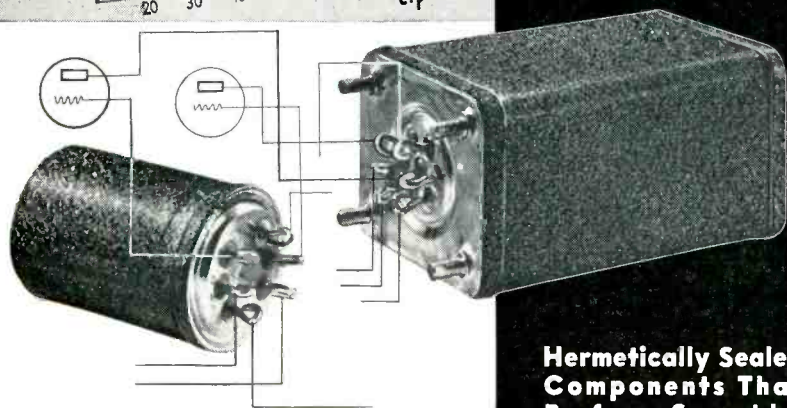

Hermetically Sealed Components That Perform Superbly, Lastingly In Airborne, Ground Applications.

AUDIO, POWER, PULSE TRANSFORMERS — REACTORS, FILTER NETWORKS

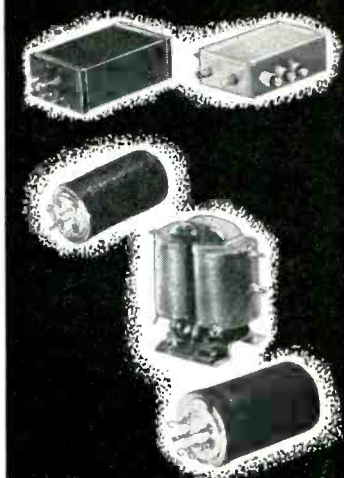

More and more exacting engineers and designers are getting first-hand, *proof* of the rigid, round-the-clock performance standards built into every Milwaukee Transformer Co. product.

Stringent quality control methods combined with modern production facilities and skilled engineering are reasons why you can expect and get "Performance that Exceeds the Demand."

Custom-engineered components for MIL-T-27 government, and commercial requirements.

Quotations submitted upon request.



Write for your *Free* copy of Catalog MTR-1

SPECIALTY ENGINEERING . . . DESIGN, DEVELOPMENT AND PRODUCTION

MILWAUKEE TRANSFORMER CO.

5231 NORTH HOPKINS STREET MILWAUKEE 9, WISCONSIN

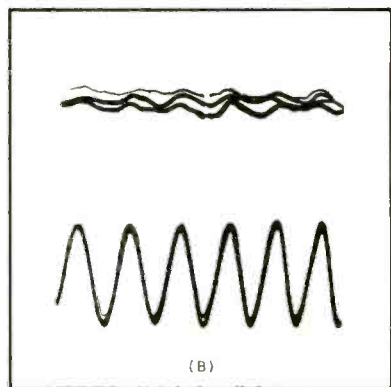
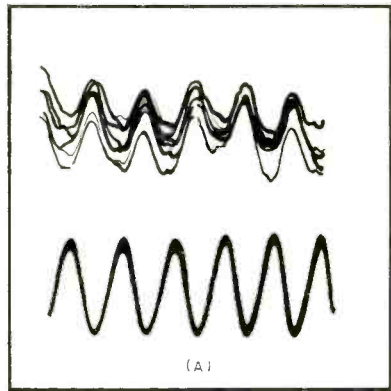

FIG. 2—Dual oscilloscope presentation with upper waveform showing longitudinal oscillation (A) at 300 cycles and diminished-amplitude waveform (B) with needle tied back. Improved lateral waveform (lower oscillogram) is apparent at (B)

longitudinal displacement of the needle tip and the output of the pickup.

In tests made with recordings of pure tones from 20 to 10,000 cps an unrestrained needle showed significant motion. When the needle was tied back with a piece of wire longitudinal motion was minimized.

Signal Generator System for Low Output Levels

BY JACK W. HERBSTREIT
National Bureau of Standards
Boulder, Colorado

LOW STANDARD signal generator calibration voltages were necessary for recent measurements of signal strengths of transmissions from Cheyenne Mountain in Colorado as received at points far beyond the radio horizon.

Primary object of the measurements, made in the frequency range 92 to 1,047 mc, was to es-

Admiral

Arvin

Caphart

CROSLY

DEWALD

DUMONT

Emerson

FADA

GENERAL ELECTRIC

General Instrument

hallicrafters

Hoffman

JACKSON

Magnavox

Majestic

Meck

MIDWEST

Motorola

Olympic

Packard Bell

PILOT



SCOTT

Sentinel

Spartan

Standard Coil

STROMBERG CARLSON

SYLVANIA

Tele King

WARWICK

Westinghouse

ZENITH

Our Best References Are Our Customers

RMC DISCAPS[®] ... Specified and Used by Leading TV Makers

The list of satisfied RMC DISCAP customers reads like the "Blue Book" of the TV industry. Few are missing from this top level roster.

RMC offers a full line of by-pass as well as temperature compensating ceramic disc capacitors.

Engineers specify them for their uniform high quality, low inherent inductance and small size.

Purchasing agents specify them because they can depend on RMC to make delivery when needed.

RMC temperature compensating disc capacitors (which meet the RTMA spec for class one ceramic capacitors) are designed to replace tubular ceramic and mica capacitors at a lower cost.



Send for Samples and Technical Data

DISCAP CERAMIC CONDENSERS

RMC

RADIO MATERIALS CORPORATION

GENERAL OFFICE: 3325 N. California Ave., Chicago 18, Ill.

FACTORIES AT CHICAGO, ILL. AND ATTICA, IND.

DISTRIBUTORS: Contact Jobber Sales Co., 146 Broadway St., Paterson 1, N. J.



Measure PHASE Difference Directly 0°-360° . . .

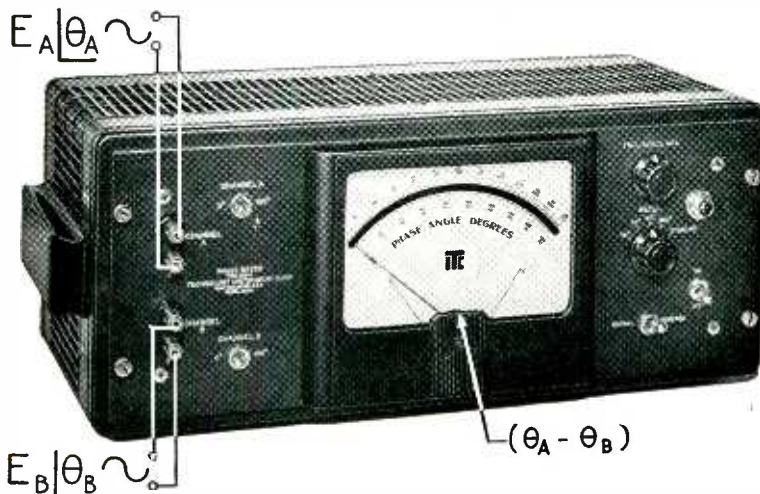

Type 320AB PHASEMETER

- . . . In 4 full scale ranges, 0°-36°, 0°-90°, 0°-180°, 0°-360°, without ambiguity
- . . . Independent of voltage amplitude from 1 to 170 volts peak
- . . . Independent of voltage wave form
- . . . Independent of frequency from 2cps. to 100kc. (accuracy: 20cps-20kc, 1% of full scale +3°; error increases slightly above 20kc.)
- Large, easily read, mirrored scale panel meter
- Ease of operation — ideal for production testing or laboratory use
- Eliminates tedious and inaccurate oscilloscope techniques
- Terminals for recorder . . . instantaneous response of output voltage to phase changes
- Incremental accuracy better than 1% of full scale
- Proven performance and quality workmanship

In audio facilities, ultrasonics, servomechanisms, geophysics, vibration, acoustics, aerial navigation, electric power transformation or signalling, . . . in mechanical applications such as printing register, torque measurement, dynamic balancing, textile and packaging machinery and other uses where an accurate measure of the relative position of moving parts is required . . . the type 320AB Phase Meter has achieved widespread approval as a unique and versatile measuring instrument.

For further information on measuring phase, send for specification bulletin and TIC Laboratory Reports

Engineering Representatives

Chicago, Ill. — Uptown 8-1141	Arnprior, Ont., Can. — Arnprior 400
Cleveland, Ohio — PProspect 1-6171	New York, N. Y. — Murray Hill 8-5858
Waltham, Mass. — WAltham 5-6900	Hollywood, Cal. — HOLLYWOOD 9-6305
Canaan, Conn. — Canaan 649	Dallas, Texas — DIXON 9918
Dayton, Ohio — Michigan 8721	

TECHNOLOGY INSTRUMENT CORP.

535 Main Street, Acton, Massachusetts, Tel. ACton 3-7711

establish the interference levels to be expected in this frequency range. It was necessary to measure signal levels far below those which would ordinarily be considered useful for communications.

Narrow-band, crystal-controlled receivers were used to measure the signals transmitted from unmodulated crystal-controlled transmitters. Use of these narrow-band receivers effectively reduced cosmic and receiver noise levels at 100 mc to such an extent that useful measurements could be made of the available received signal energy at 170 db below one watt, corresponding to a 50-ohm signal generator output level of only 0.022 microvolts.

The method adopted was to use a heterodyning system with two standard signal generators and a crystal mixer, Fig. 1, the desired frequency being either the sum or difference frequency of the two signal generator frequencies¹. Since the desired frequency is displaced from the output frequency of either of the signal generators, leakage fields from the signal generator are effectively eliminated.

When a square-law mixer is used, the output voltage at the sum or difference frequencies, E_{sd} , is directly proportional to the product of the two signal-generator voltages E_1 and E_2 . When a linear mixer is used, the output voltage E_{sd} is proportional to the signal-generator voltage E_1 when $E_1 \ll E_2$ and also E_{sd} is independent of E_2 .

In both cases, if E_2 is made much larger than E_1 , the output voltage E_{sd} is proportional to E_1 when E_2 is fixed. The mixers actually used had over-all characteristics other than square-law or linear. The output voltage E_{sd} , however, was found to be proportional to the E_1 as long as E_1 was very small in comparison to E_2 , since the mixing then occurred only over the very small portion of the characteristic curve which is essentially linear.

The fact that the mixer output voltage E_{sd} is proportional to the smaller input voltage E_1 is made use of in obtaining calibrated voltages from the mixer for calibrating signal-strength recording re-

New Technical Data on STUPAKOFF's complete line of

ELECTRICAL and ELECTRONIC CERAMICS

New from cover to cover . . . this Stupakoff Catalog is a handbook for the designer of appliances and electronic parts and equipment . . . contains factual data on ceramic insulation never before published.

Engineers and manufacturers will find it a practical guide for selecting ceramic parts that (1) will provide the desired characteristics, (2) can be produced economically, and (3) meet the user's standards.

Contains full information on these and other products:

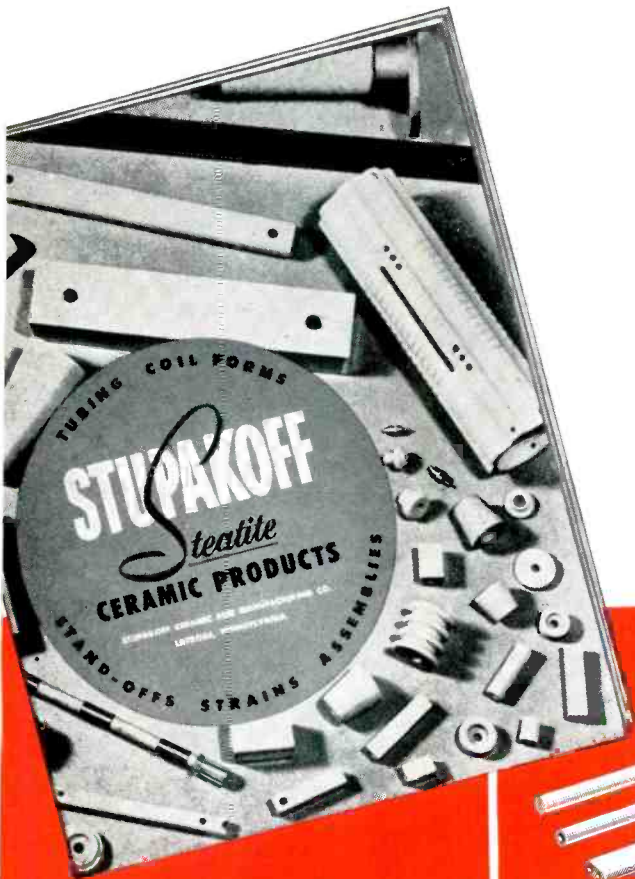

ROD AND TUBING



PILLAR INSULATORS



BUSHINGS AND CUPS



STRAIN AND SPREADER INSULATORS

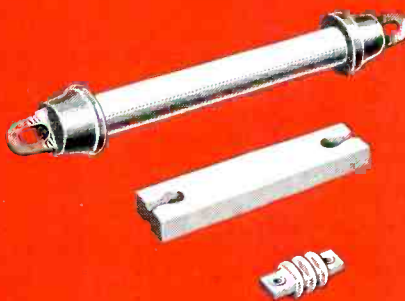

ASSEMBLIES

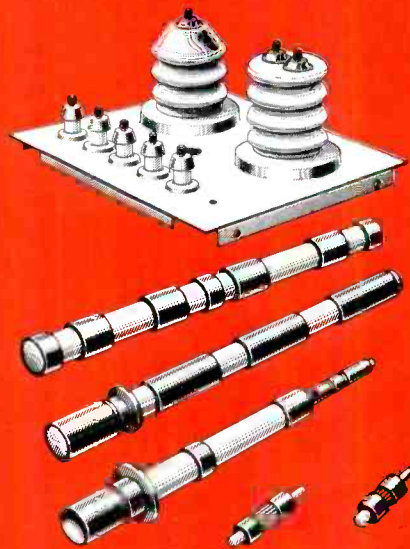

COIL FORMS

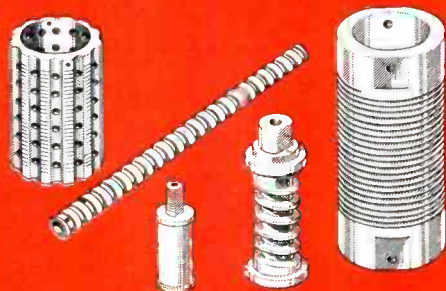

PRESSED PARTS

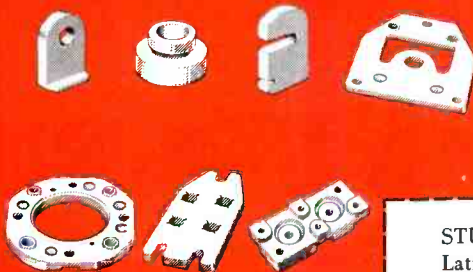

STUPAKOFF CERAMIC & MANUFACTURING CO.
Latrobe, Pennsylvania

Please send me a free copy of your Catalog 951.

Name _____ Title _____

Company _____

Address _____

(Please attach to your letterhead)

Send for your copy today ➔

Stupakoff

CERAMIC & MANUFACTURING CO.

LATROBE, PENNSYLVANIA





DESCRIPTION—The Berkeley Preset Counter is an electronic decade with provisions for producing an output signal or pulse at any desired preset count within the unit's capacity. Any physical, electrical, mechanical or optical events that can be converted into changing voltages can be counted, at rates from 1 to 40,000 counts per second. Total count is displayed in direct-reading digital form. Presetting is accomplished by depressing pushbuttons corresponding to the desired digit in each column. Model 730 Preset Decimal Counting Units are used. These are completely interchangeable plug-in units designed for simplicity of maintenance and replacement.

APPLICATIONS—Flexibility and simplicity of operation make the Berkeley Preset Counter suitable for both production line and laboratory use. It has practical applications wherever signalling or control, based on occurrence of a predetermined number of events or increments of time is desired. Output signals from the unit can be used to actuate virtually any type of process control device, or to provide aural or visual signals.

SPECIFICATIONS

	Model				
	422	423	424	425	426
MAX. COUNT CAPACITY	100	1000	10,000	100,000	1,000,000
INPUT SENSITIVITY (MIN.)	± 1 v. to ground, peak; at least 2 μ sec. wide				
OUTPUT	Choice of pos. pulse and relay closure, or pos. pulse. SP5T relay closure approx. 1/30 sec; pulse output is + 125 v. with 3 μ sec. rise time and 15 μ sec. duration.				
PANEL DIMENSIONS	15 3/8" x 8 3/4"		19" x 8 3/4"		
OVERALL DIMENSIONS	16 5/8" x 10 1/4" x 13"		20 3/4" x 10 1/2" x 15"		
POWER REQUIREMENTS	117 v. ± 10% @ 90w.		117 v. ± 10% @ 180 w.		
PRICE (F.O.B. FACTORY)	\$375	\$450	\$595	\$695	\$795

M 3

For complete information, please request Bulletin 101

Berkeley Scientific

division of BECKMAN INSTRUMENTS INC.
2200 WRIGHT AVENUE • RICHMOND, CALIFORNIA

"DIRECT READING DIGITAL PRESENTATION OF INFORMATION"

ceivers at very low signal voltages. This may be expressed mathematically:

$$E_{sd} = E_1 \times f(E_2) \quad (1)$$

for mixers operating over an essentially linear portion of characteristic ($E_1 \ll E_2$), where $f(E_2)$ is, for a fixed value of E_2 , simply a constant of proportionality.

The constant $f(E_2)$ is determined experimentally by direct calibration of the output voltage of the mixer against the output voltage of a standard signal generator tuned to f_{sd} , the same desired frequency as the mixer output. This calibration is made at a voltage level sufficiently high that leakage from the standard signal generator is effectively zero (say $E_{sd} = 10$ microvolts). At the same time, the voltages of the mixer signal generators at their fundamental frequency should be completely out of the receiver pass band on the fundamental or spurious response points and should not be so high or so close in frequency to the desired sum or difference frequency that the receiver is overloaded.

Figure 1 is a block diagram of the heterodyne standard signal-generator arrangement. A 1N34 crystal is used as the mixer. The 1N34 mixer with a load resistance of 50 ohms is approximately square law in the low signal range and thus $f(E_2) \cong kE_2$.

With this mixer, or any other essentially square law mixer, it is convenient to insert an appropriate attenuator pad in the output of the mixer and then adjust the output voltage E_2 until $f(E_2) = 0.1$ or 0.01 as determined by a direct calibration. Then the output voltage E_{sd} can be read directly on the attenuator of the signal generator supplying E_1 after multiplying by the appropriate decimal constant. With a constant $f(E_2) = 0.01$, E_1

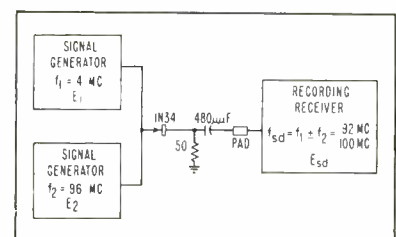

FIG. 1—Block-schematic diagram of heterodyne signal-generator method described in text

FERRAMIC*

CORES by GENERAL CERAMICS

—high frequency, soft magnetic materials featuring —

- HIGH PERMEABILITY
- LOW LOSS
- HIGH EFFICIENCY
- LIGHT WEIGHT

Ferramic cores effect important savings in the size and weight of coils and transformers at the same time increasing efficiency and overall performance. They eliminate laminations thereby reducing assembly time and cost in many types of components. The advantage of Ferramics are so numerous and outstanding that adoption of this material has been rapid and broad in scope for both the improvement of existing designs as well as the achievement of basically new techniques. Call or write for information on how Ferramics can improve your product.



TABLE OF MAGNETIC PROPERTIES OF FERRAMICS

PROPERTIES	UNIT	A-106	B-90	C-159	D-216	E-212	G-254	H-419	H1-1102	I-141	J-472
Initial Perm. at 1 mc/sec	-	20	95	250	410	750	410	850	550	900	330
*Max. Perm.	-	100	183	1100	1030	1710	3300	4300	3800	3000	750
*Sat. Flux Density	Gauss	1500	1900	4200	3100	3800	3200	3400	2800	2000	2900
*Residual Mag.	Gauss	1000	830	2700	1320	1950	1050	1470	1500	700	1600
*Coercive force	Oersted	5.0	3.0	2.1	1.0	.65	.25	.18	.35	.30	.80
Temp. Coef. of initial perm.	%/°C	.15	.04	.40	.30	.25	1.3	.66	.80	.30	.22
Curie Point	/°C	300	260	330	165	160	160	150	125	70	180
Vol. Resistivity	ohm-cm.	1x10 ⁷	2x10 ⁵	2x10 ⁶	3x10 ⁷	4x10 ⁵	1.5x10 ⁸	1x10 ⁴	2x10 ⁴	2x10 ⁵	5x10 ⁷
Loss Factor:											
At 1 mcs/sec	-	.0005	.00016	.00007	.00005	.00008	.00008	.00030	.0004	.0003	.000055
At 5 mcs/sec	-	.0007	.0011	.0008	.0012	.002	.00075	.00155	.001	.005	.0004

*Measurements made on D.C. Ballistic Galvanometer with H_{max}=25 oersteds. Above data is based on nominal values.

General
**CERAMICS and
STEATITE CORP.**

GENERAL OFFICES AND PLANT:
KEASBEY, NEW JERSEY
Telephone: Perth Amboy 4-5100



*REGISTERED
TRADEMARK

WANT IT LATER?

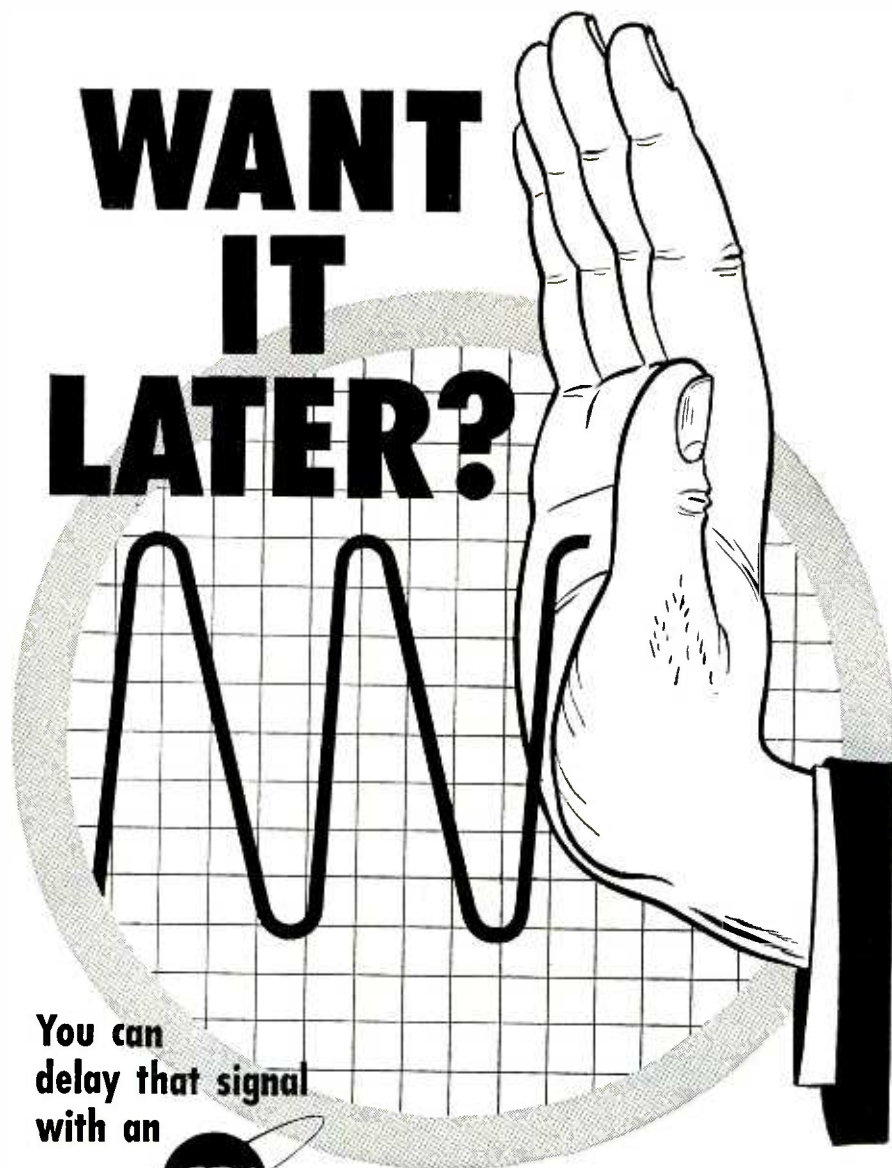

You can
delay that signal
with an



BOUNDARY-DISPLACEMENT MAGNETIC RECORDING DELAY LINE

FREQUENCY RANGE—any five-octave band between 5 cps and 30,000 cps, with appropriate drum speed.

DELAY—up to 1000 wavelengths of information storage per channel; 200-second delay maximum at 5 cps—proportionately less with increase in frequency.

NUMBER OF CHANNELS—1 to 16.

MAGNETIC DRUM NON-CONTACT RECORDING—eliminates wear of recording medium; permanent drum recording surface may be used indefinitely.

BOUNDARY-DISPLACEMENT TECHNIQUE—provides a high degree of amplitude linearity; minimizes modulation effects due to non-homogeneity of recording medium or slight variations in head-to-drum spacing.

YOUR DELAY-LINE REQUIREMENTS will receive prompt and careful study by our engineering specialists. Investigate the possible application of a custom-engineered ERA Magnetic Recording Delay Line to your signal-delay problem. Send your requirements to:

Engineering Research Associates, Inc.

A Subsidiary of *Remington Rand*

1902 West Minnehaha Avenue, Dept. E-7, St. Paul 4, Minnesota

DIGITAL COMPUTERS . . . DATA-HANDLING SYSTEMS . . . MAGNETIC STORAGE SYSTEMS . . .
INSTRUMENTS . . . ANALOG MAGNETIC RECORDING SYSTEMS . . . COMMUNICATIONS EQUIPMENT

is set at 100 microvolt for $E_{sd} = 1$ microvolt and E_1 is set at 1 microvolt for $E_{sd} = 0.01$ microvolt.

An example of the calibration procedure for the mixer signal generator in Fig. 1 is as follows: A calibrated 92 or 100-mc standard signal generator is connected directly to the input of the 92 or 100-mc recording receiver and adjusted to a convenient signal level E_{sd} which is appreciably above leakage, say 10 microvolts. The output reading of the measuring receiver is recorded as the reference output. The calibrated standard signal generator is then removed and the mixer signal generators shown in Fig. 1 are substituted.

For $f(E_2) = 0.01$, E_2 is set to an output voltage 100 times that of the calibrated standard signal generator voltage used to obtain the reference output ($E_2 = 1,000$ microvolts when $E_{sd} = 10$ microvolts). Voltage E_1 is then adjusted to a convenient value greater than 10 times the highest E_2 which is expected to be used and an appropriate attenuator pad is selected so that the receiver again has the reference output. For these particular values of E_1 and attenuator pad, the mixer output voltage will be $0.01 E_2$.

Other useful applications of the heterodyne principle described above in laboratory receiver measuring procedures are for bandwidth measurements at very high frequencies and as a method for tuning relatively unstable high-frequencies signal sources to a narrow bandwidth receiver. In both of the latter mentioned cases, frequency of E_2 is set relatively close to the desired frequency and the frequency of E_1 is a relatively low frequency. Relatively high percentage changes in frequency of E_1 are then small percentages of the desired frequency. This permits much greater ease in adjustment to the final desired frequency. For even better frequency stability, voltage E_2 may be derived from a crystal-controlled source.

REFERENCES

- (1) G. F. Gainsborough, A Method of Calibrating Standard-Signal Generators and Radio Frequency Attenuators, *Jour. I.E.E.*, 94, p 203, 1947.
- (2) F. E. Terman, "Radio Engineers Handbook", McGraw-Hill Book Co., Inc., New York, 1943, p 565.



Information Wanted...

about your uses for

C-D-F METAL GLADS

Grade of laminate
 Sheet size
 Overall thickness
 Thickness tolerances
 a. Standard NEMA
 b. Closer tolerances requiring sanding
 Metal: Copper Aluminum
 Other Thickness
 Metal facing: One side Both sides
 Minimum bond strength
 Punching requirements
 Any other specifications

Did you know that C-D-F supplies a full range of metal clad laminates in both Dilecto and Teflon grades? With mounting interest in printed circuits it pays to consider the respective advantages of these new C-D-F materials . . . it also pays to line up all the Information Wanted facts and discuss your specific application with your C-D-F sales engineer (Offices in principal cities). He's a good man to know!

Dilecto METAL GLADS

Printed circuits depend upon stable, uniform core material and Dilecto has years of proven insulation service (Dilecto is a laminated thermosetting plastic made only by C-D-F from paper, cotton, glass or asbestos fabric base, or a mat base). Normally phenolic or melamine impregnating resins are used for METAL CLAD sheet stock. There are many grades of Dilecto, but only the better electrical grades are supplied with metal foil surfaces. Outstanding is C-D-F grade XXXP-26, a hot punching grade with high insulation resistance, low and stable dielectric losses and excellent moisture resistance. Green color. New C-D-F Catalog GF-53 gives complete data on Dilecto grades. Write for your copy today.

Teflon METAL GLADS

Glass fiber cloth is first coated with Teflon resin and laminated into C-D-F GB-112T sheet stock. This base withstands high heat (200°C. maximum operating temperature) with the dissipation factor and dielectric constant extremely low over a wide frequency range. No adhesive film is needed to bond metal to the Teflon laminate, thus the inherently good electrical properties of the core material are maintained. GB-112T has practically zero water absorption, so a METAL CLAD with this core offers consistent high insulation resistance with excellent stability of dielectric loss properties.

METAL CLAD Surfaces

Copper foil (usually .00135" or .0027" thick) is bonded on one or both faces of the sheet grade of Dilecto selected. The foil used is a special grade of electrolytic deposition copper particularly adaptable for cementing onto laminated materials. An adhesive film is placed between the metal and the Dilecto, and cemented during the pressing and curing cycle. When closer tolerances are required C-D-F sands the Dilecto to the required thickness before bonding. Aluminum, silver, or other alloys of various metals may be supplied.

Better Bond Strengths

One of the most important physical properties of a metal clad product is its peel strength, the pounds pull required to separate the foil surface from the core material. Working with years of laminating know-how, C-D-F has been successful in obtaining the following average test values for its METAL CLAD sheet stocks:

	Lbs. pull per 1" width
XXXP-26 plus .00135" copper	5 to 8
XXXP-26 plus .0027" copper	7 to 10
XXXP-26 plus .0015" aluminum . . .	9 to 12
GB-112 Teflon plus .00135" copper . .	6 to 9

Sheet sizes: Dilecto grades — 38 x 38", 38 x 42"
 Teflon grades — 16 x 36"

THE NAME TO REMEMBER . . . FOR PRINTED CIRCUIT METAL CLAD STOCK

Continental-Diamond Fibre Company
 NEWARK 16, DELAWARE



*DU PONT TRADE MARK

Write for new C-D-F General Catalog GF-53, new C-D-F Teflon folder T-52, and talk METAL CLADS with your C-D-F sales engineer.

Production Techniques

Edited by JOHN MARKUS

Magnetic Amplifier Breadboard.....	226	Cutting and Stripping Long Leads....	250
Automatic Cutter and Splitter for Adhesive Tape	226	Three-Iron Soldering	252
Trays for Precision Parts.....	228	Capacitor Test Set	254
Easy-to-Reach Storage Racks and Trays	228	Central Vacuum System Draws Off Soldering Fumes	256
Chains Aid Soldering	240	Label-Positioning Mirror	257
Cable Life Tester	242	Inserts Protect Threads Tapped in Copper	257
Tube-Holding Tool	242	Cold Soldering Technique for Printed Circuits	259
Jig Borer Speeds Die-Making	244	Induction Soldering Setups	260
Transformer Designer	246	Parts-Mounting Fixture	262
Plastic-Faced Quality Chart	248		

OTHER DEPARTMENTS

featured in this issue:

	Page
Electrons At Work....	144
New Products	264
Plants and People ...	334
New Books	346
Backtalk	358

Magnetic Amplifier Breadboard



Appearance of breadboard setup for two-stage self-excited magnetic amplifier voltage regulator being designed for use in the atomic-powered submarine Nautilus

WHEN TRYING out new magnetic amplifier circuit arrangements in Bogue Electric's Paterson, N. J. plant, engineers use sheets of quarter-inch Pressdwood as the chassis and a two-level steel caster-mounted table as the chassis frame. Most parts are heavy enough to stay in position without need for mounting. Brackets of wire-wound resistors and other smaller components are fastened to the Pressdwood with small metal screws. All connections are made to terminal screws on the

parts, using leads having spade lugs or eyelet lugs. Interconnections are made on terminal strips having pairs of screw terminals, just as in the final design of industrial magnetic amplifiers.

Automatic Cutter and Splitter for Adhesive Tape

AN AUTOMATIC dispenser that slits tape into narrower strips and simultaneously cuts the tape to desired lengths is used in the Crosley Division of Avco Mfg. Corp. to make one roll of tape go twice as far. The machine permits purchasing economical one-inch-wide pressure-

sensitive tape, reducing tape costs and tape handling time as compared to use of half-inch rolls of tape.

The machine is set to cut the tape into 1½-inch lengths for wrapping around the end of coaxial cable after stripping. One movement of a hand lever on the dispenser ejects a length of tape for immediate application to the cable in this television receiver subassembly operation.

The tape dispenser is commercially available as the Big Inch model 4-0, manufactured by Bitter Packages Inc., Shelton, Conn. It can be set to slit one-inch tape into two, three or four narrow strips by loosening a thumbscrew adjustment and flipping appropriate

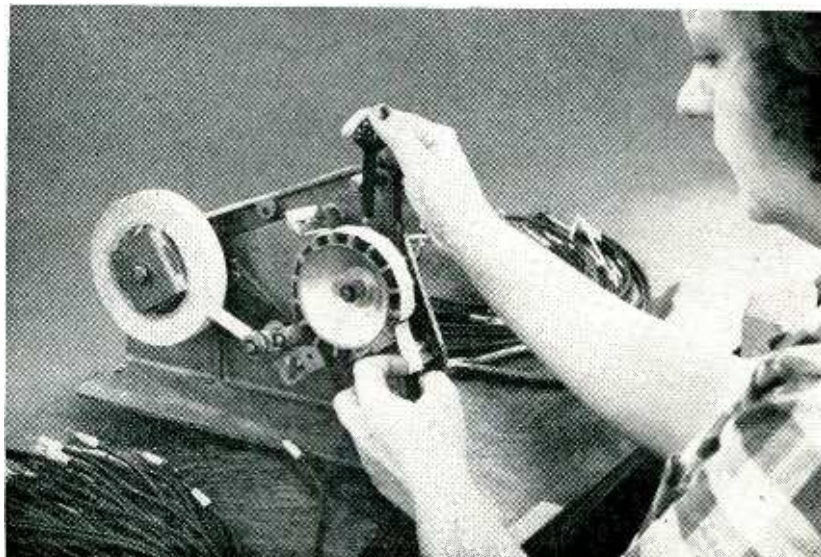

Automatic dispenser with side cover removed. Cutoff blade at top of spoked wheel is operated by hand lever simultaneously with tape feed mechanism. Slitter blades are under spoked wheel, behind thumb screw

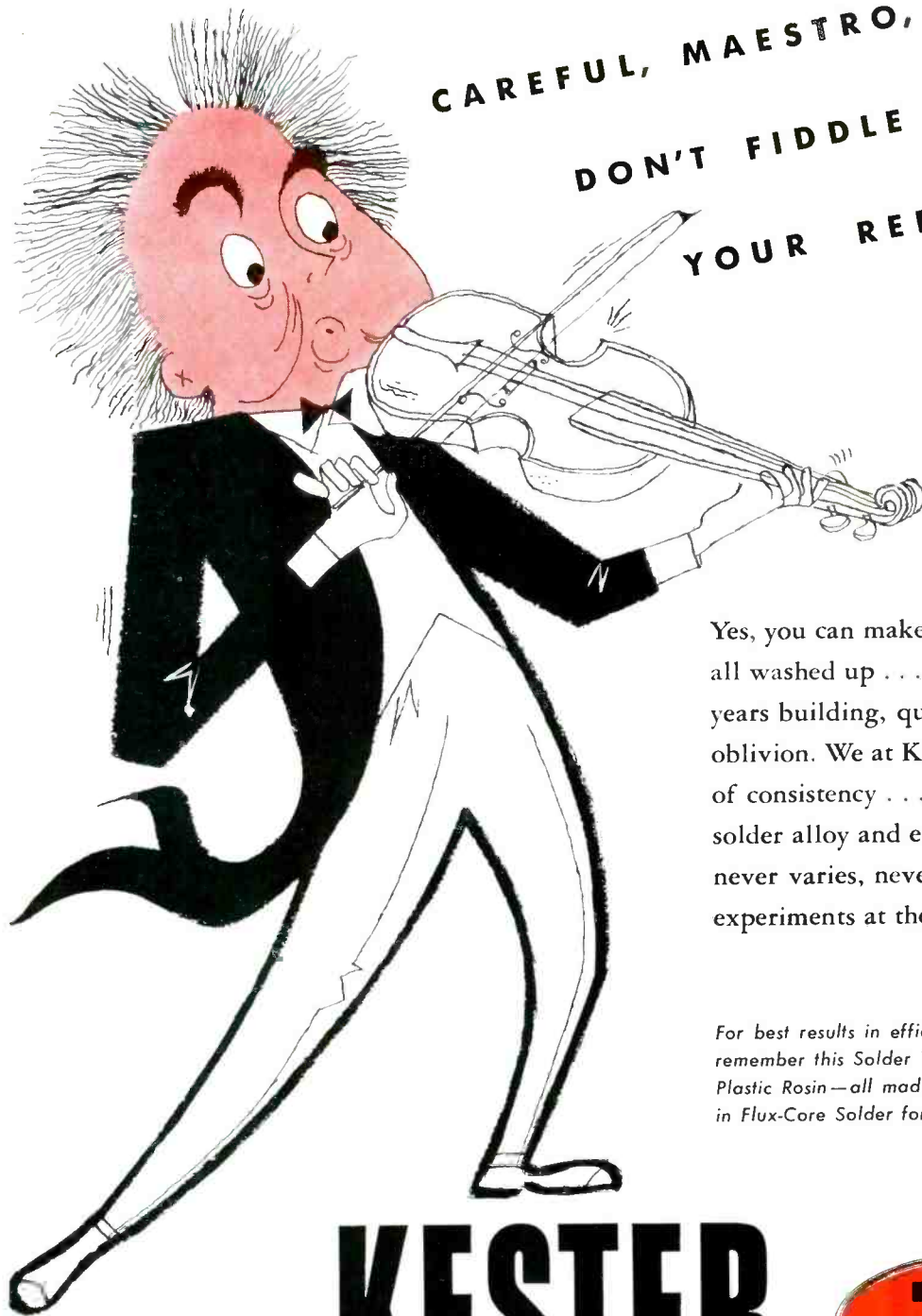

CAREFUL, MAESTRO,
DON'T FIDDLE AWAY
YOUR REPUTATION!

Yes, you can make one false note and be all washed up . . . with the name you've spent years building, quickly consigned to oblivion. We at Kester know the importance of consistency . . . make sure that the solder alloy and especially the flux formula never varies, never changes. Kester never experiments at the expense of the solder user!

For best results in efficient, economical soldering, remember this Solder Trio: "44" Resin, "Resin-Five" and Plastic Rosin—all made by KESTER . . . Key Name in Flux-Core Solder for More Than 50 Years.

KESTER

S O L D E R C O M P A N Y

4204 WRIGHTWOOD AVENUE, CHICAGO 39, ILLINOIS
NEWARK 5, NEW JERSEY • BRANTFORD, CANADA



blades into position. When the full width is required, all blades may be disengaged. The tape cutoff blade may be set to give 1 in., 1½ in., 2 in. or 2½ in. lengths. The machine is designed to take 6½-in. diameter rolls.

Trays for Precision Parts

MULTIPLE-CAVITY plastic trays are being used to protect delicate precision parts when transferring them from one operation to another on production floors. Plastic covers are provided for use when individual trays are handled. One com-



Examples of plastic parts-handling trays fabricated to order by Mercury Plastics, Springfield, Mass.

pany uses only the bottoms for interdepartmental handling, as the trays are designed with interlocking construction for easy stacking. Each tray then forms a cover for the tray underneath.

The new parts trays are produced from a low-pressure formable plastic sheet material known as Boltaron, which is chip-proof, acid-proof and oil-resistant. Availability of the material in a large variety of colors permits color-coding for individual departments. Inventory of a day's production is simplified and readily accounted for because each tray holds a definite number of parts.

Easy-to-Reach Storage Racks and Trays

MAKING NEEDED materials easily available to workers is one important goal of production engineers at this time. With labor costs rising, a saving of as little as one second in time needed to reach

for a chassis or part can amount to a substantial yearly boost in output and lowering of cost.

Chassis-transporting racks using inexpensive wood construction are equipped with rubber-tire casters in

Sylvania's Buffalo plant, for movement of auto radio tuner units. Two casters are fixed and two are on swivels. The slides on which the tuners rest are slanted inward so no unit can fall out. The capacity of

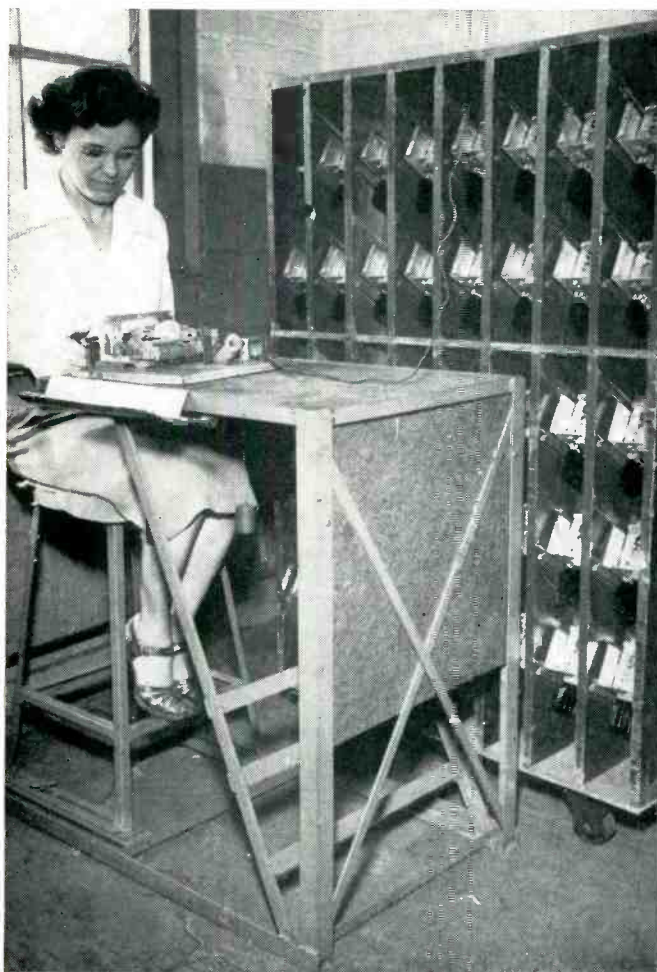

Tuner-storing rack and movable inspection table



Hand-carried racks for housings



HiVolt Power Supplies*

*where size and weight
must be kept to a minimum*

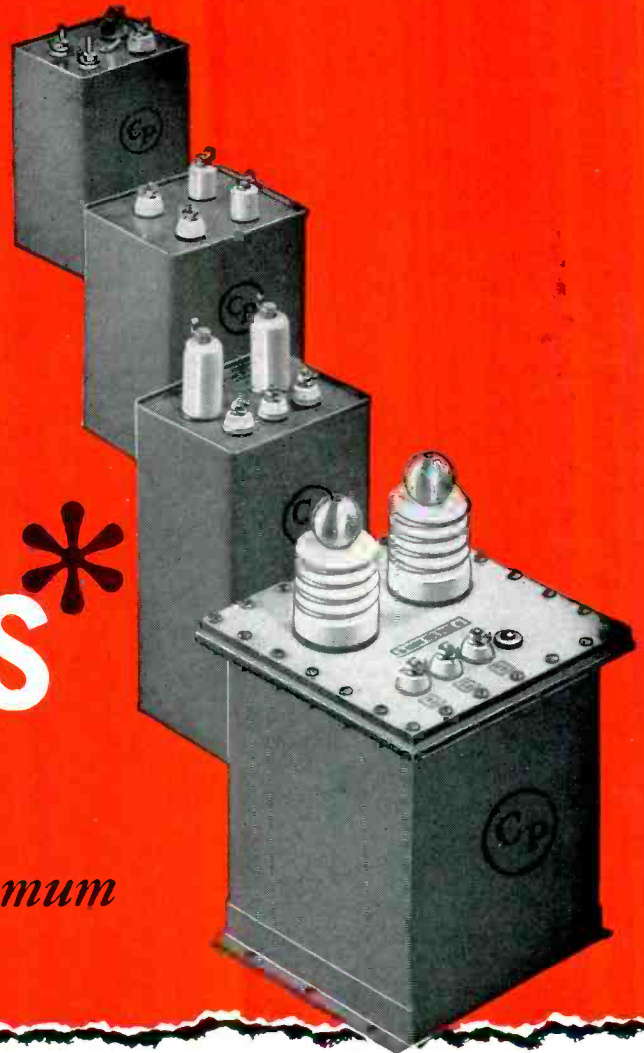

These hermetically-sealed, self-contained power supplies are designed to transform AC to high voltage—low current DC for many applications. Our exclusive engineering techniques and oil-filled construction assure smaller, lighter, more flexible units.

Applications:

radiation counters
photoflash devices
spectrographic analyzers
projection television sets

dust and electrostatic precipitators
oscilloscopes
display tubes
etc.

Send us your requirements and we will recommend the best HiVolt Power Supply.

MANUFACTURERS
Glassmike Capacitors
Plasticon Capacitors
HiVolt Power Supplies
Pulse Forming Networks

Condenser Products Company
Division of New Haven Clock & Watch Co.

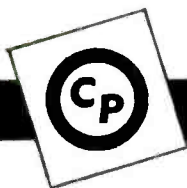

7517 North Clark Street • Chicago 26, Illinois

* HiVolt Power Supplies . . . occupy as little as 1/3 the space; weigh as little as 20% of conventional supplies

Here's why those in the know

—demand

CANNON PLUGS

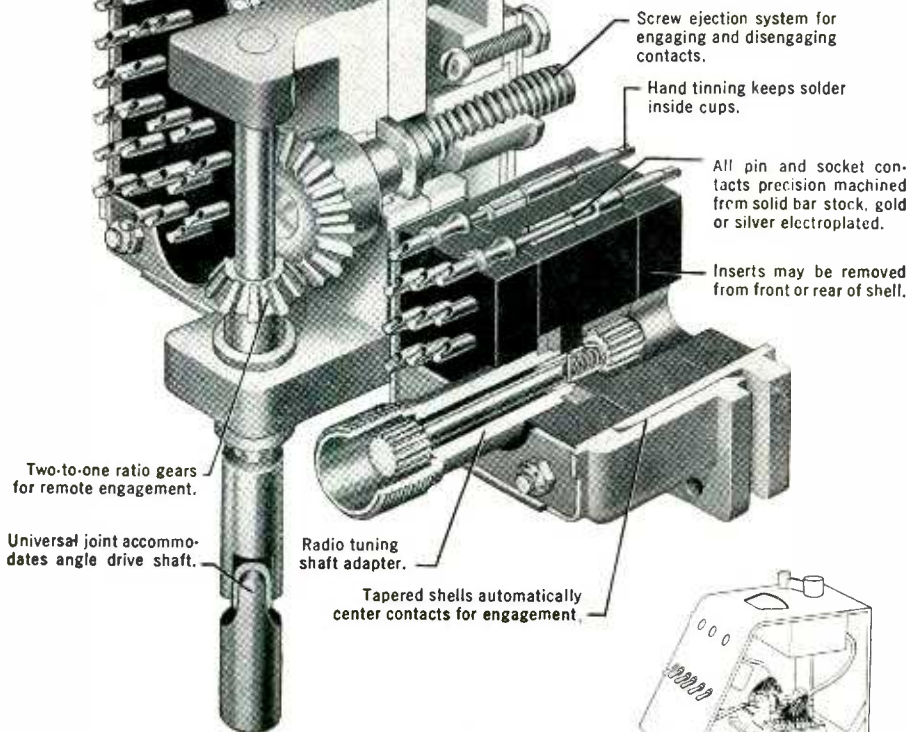

This highly specialized DPD2 Cannon Plug, a member of the DP Series, has its principal use in aircraft instrument panels and remote radio control equipment. But, like many other Cannon Plugs, it has found its way into other fields where the highest quality is needed and where the value of long, trouble-free performance is recognized.

Originally this 2-gang connector was designed to assist in the standardization of radio and instrument assemblies so that such equipment might be interchangeable between similar aircraft. It allows for compact design in close quarters with access from the front only. This type of application and variations of the fittings are shown at right. Any Cannon DPD insert may be placed within the shell, with or without tuning shaft, coax, twinax, large or small contacts, provided the separation forces of both halves are similar.

This plug typifies the close attention to important detail that distinguishes every Cannon Plug—the world's most extensive line. If you are looking for real value, regardless of the field you work in, your best bet is Cannon.

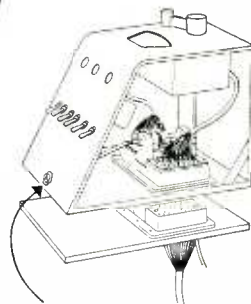

Connector is separated by turning slotted shaft here. Complete unit may then be removed from pedestal, shown below.

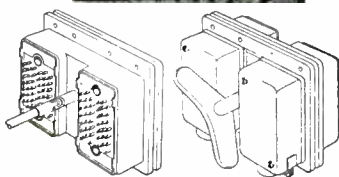

(Left) Same Cannon Plug without tuning shaft. Straight drive instead of 90° gear. (Right) Similar DPD2 with Dzus wing nut extraction method and junction shells. There are several other variations. Write for details.

CANNON ELECTRIC

Since 1915

CANNON ELECTRIC COMPANY
LOS ANGELES 31, CALIFORNIA

Factories in Los Angeles, Toronto, New Haven. Representatives in principal cities. Address inquiries to Cannon Electric Company, Dept. A-110, P.O. Box 75, Lincoln Heights Station, Los Angeles 31, California.

the rack is doubled by arranging to load from both sides, with a sheet of Masonite serving as a divider in the middle.

An additional doubling of flexibility and efficiency is achieved in the same plant through use of movable combination chair-tables for inspection of incoming material. These can be slid easily by one man to any desired location. The metal-frame stool, of conventional design, is welded to slotted plates that fit over the table frame. By loosening two knobs, the operator can slide the stool toward or away from the bench to the most comfortable position, then lock the stool in place. An extension cord plugging into a nearby power outlet brings power to the bench when needed for a test set. The entire table assembly is slid out of the way when not needed.

Wooden tote boxes with a somewhat similar slanting-shelf arrangement are used in the plant of Argus, Inc. for transporting and storing various assemblies. Here the racks are smaller, have no casters, are accessible from only one side, and are carried by means of a handle fastened to the top. Wood cross-boards at the base minimize tipping of the rack.

Hundreds of transparent boxes on wood racks are used for stocking pre-cut lengths of various sizes of



Rack for plastic boxes containing pre-cut wires

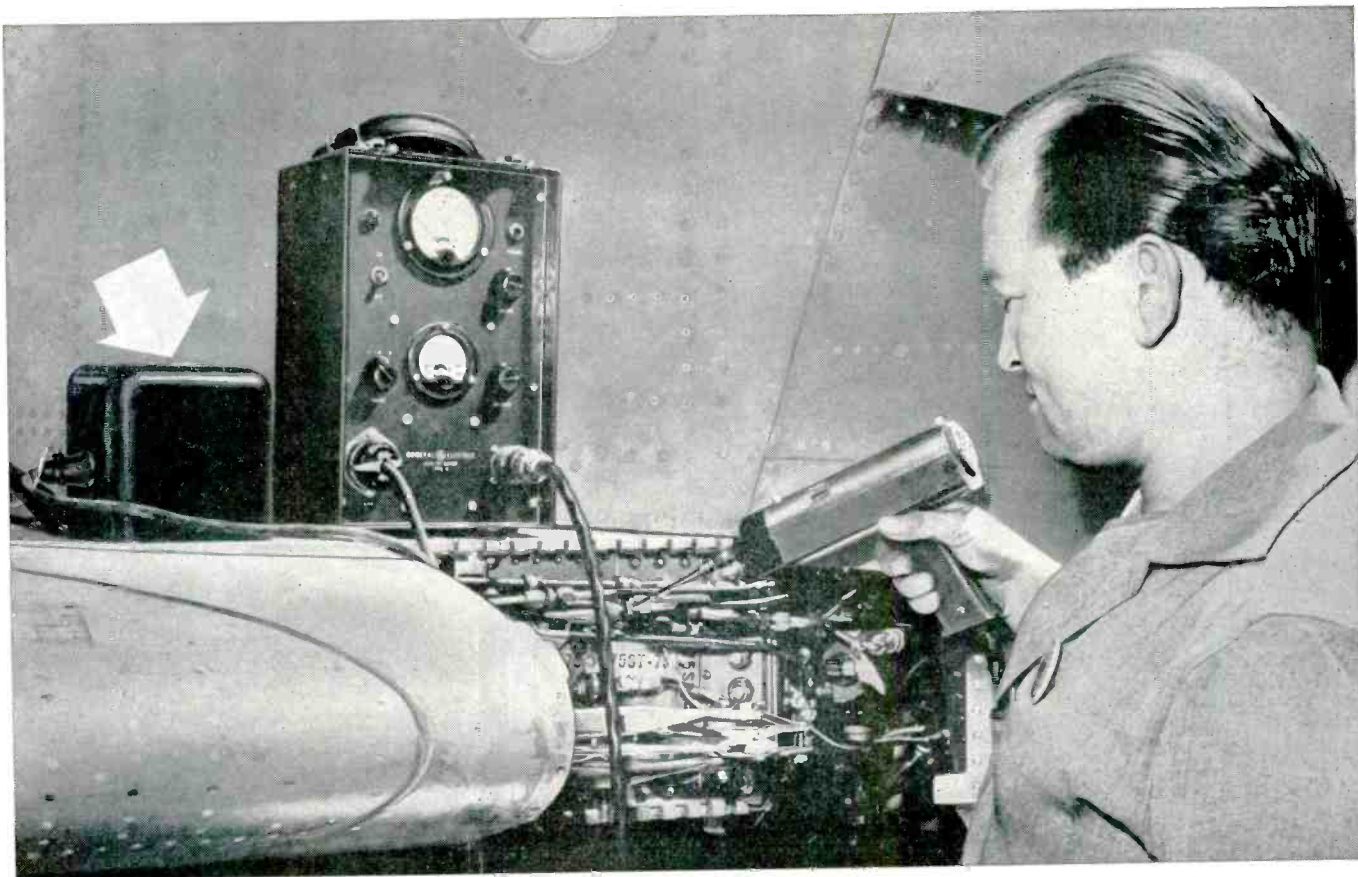

PRECISE INSTRUMENT DETECTS LEAKS AS SMALL AS 1/100 OUNCE A YEAR, USES G-E VOLTAGE STABILIZER.

For Precision Performance Use G-E Voltage Stabilizers

Accurate to within $\pm 1\%$ in standard models, G-E Automatic Voltage Stabilizers correct voltage fluctuations between 95 and 130, or 190 and 260 volts, delivering a stable 115 or 230 volts to your product.

AUTOMATIC OPERATION: Compact standard models are now made in sizes 15 to 5000va. Special designs are available for specific applications, and others can be engineered for your purpose. Operation on all G-E Voltage Stabilizers is completely automatic. Whatever your varying voltage problem, G-E experience will provide the answer.

SIMPLE INSTALLATION: G-E Automatic Voltage Stabilizers have only two sets of terminals to connect—one for supply, one for load.

NO MAINTENANCE: Since there are no moving parts or electronic components, there is virtually no need for replacement parts, adjustments, or any other maintenance. General Electric Co., Schenectady 5, N. Y.

MORE HELPFUL INFORMATION

The "why" and "how" of stabilization, including specific details on operating characteristics, uses, and application information, is explained in a new bulletin number GEA-5754. To get your free copy of this practical, helpful manual on voltage stabilization, fill in and mail the coupon below.



General Electric Company
Section 411-108
Schenectady 5, New York

Please send me, without charge, Manual GEA-5754 on Automatic Voltage Stabilization.

For immediate project _____ For reference only _____

NAME _____ TITLE _____

COMPANY _____

ADDRESS _____ CITY _____ STATE _____

Product or type of product for which stabilizers are to be used,
if not confidential: _____

GENERAL  **ELECTRIC**

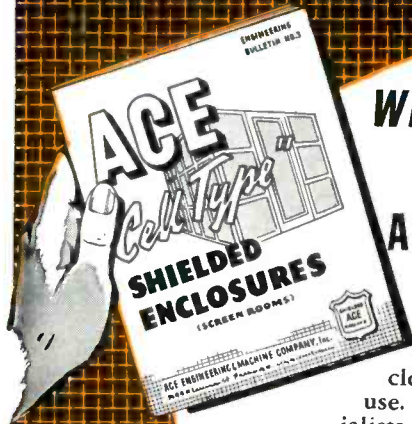

Write today for your New ACE SCREEN ROOM GUIDE

This helpful booklet brings you the latest data on shielded enclosure construction, selection and use. Prepared by Ace screen room specialists, it includes latest Ace design features, an analysis of the factors influencing measurements of attenuation versus frequency, and suggestions for assuring maximum shielded enclosure efficiency. Ask for Ace Bulletin No. 3.



ELIMINATE RADIO INTERFERENCE INFLUENCE

in meeting JAN-I-225, MIL-I-6181, 16E4 (SHIPS)
and other stringent specification requirements

As long-time leaders in modern shielded enclosure development, Ace offers a complete range of "cell type" screen room shapes and sizes. Ace rooms are guaranteed to produce a minimum attenuation of 100 db from 0.15 to 1000 mc., and to closely approach this attenuation at 10,000 mc. Supplied in pre-built sectional form, they incorporate the latest developments in door design, line filters and service entrances. The list of Ace users includes top-ranking military and civilian equipment producers and laboratories throughout the world.

ACE ENGINEERING and MACHINE CO., INC.

3644 North Lawrence St., PHILADELPHIA 40, PA. • Telephone REgent 9-1019

PIONEERS IN SHIELDED ENCLOSURE DEVELOPMENT

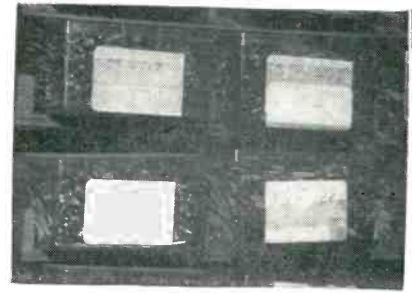

Closeup of wire-storing boxes

wire in the Ampex plant in Redwood City, California. The wires are machine-cut in quantities and stored in the plainly marked boxes, making it a simple matter for workers to select the materials needed for construction of wiring harnesses. Gummed stickers are used as labels. In the quantities employed, the rectangular boxes cost about 12 cents each; these are approximately 3 inches wide, 7 inches long and 1½ inches high including their covers. The circular boxes, approximately 6 inches in diameter and 1½ inches high, cost about 15 cents each. The source of supply was Southern California Plastic Co., Glendale.

The real advantage in using these plastic boxes is that no complicated system of inventory control of pre-cut wires is needed. The person in charge of the department can tell at a glance which boxes need a new supply of wire, with no need to open the boxes.

A definite procedure is used for withdrawing wire from the storage rack. When the lead man on an assembly line needs a given size and length of wire, he takes an unmarked plastic box over to the rack, fills it from the appropriate storage box.

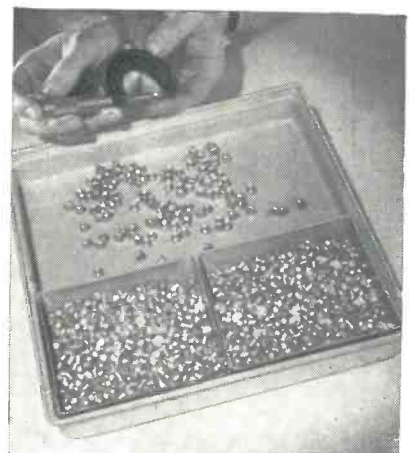

Plastic inspection tray set

The HOSTESS CALL LIGHT SWITCH "GOES TO TOWN"



Frequently, where indicator lights must be used in conjunction with switches, modern aircraft design affects a worthwhile weight and panel space saving by using Hetherington switches with *built-in* lights. Developed originally by Hetherington as hostess call lights, these compact little units are now available for a broad range of exacting commercial or military aircraft services. Write for catalog.

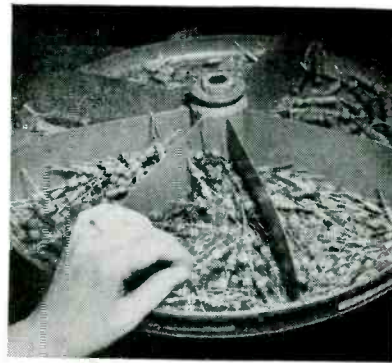

Rotating holder for small parts



TYPE A300

Push-pull snap switch with "on-off" light and auxiliary momentary contact.



TYPE A304

Push-button momentary-contact switch-indicator light combination.



TYPE A8500

"Push off—pull on" or Type A13800 "push on—pull off" snap switch with built-in "on-off" light.

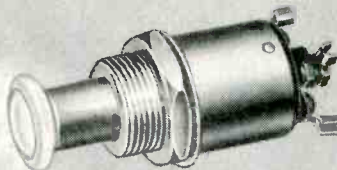

TYPE A311

"Push on, pull off" switch also operates "on-off" independent lamp circuit. "Pull on, push off" Type A312 also available.



TYPE A314

Push-button normally-open momentary-contact switch plus independent, unbroken lamp circuit. Type A315 (not shown) has normally-closed contacts.



TYPE A325

"Push off—pull on" switch with independent unbroken lamp circuit. Developed for bomber fire extinguisher panel.

HETHERINGTON PANEL INDICATOR LIGHTS

SWITCH-INDICATOR LIGHT COMBINATIONS
PUSH-BUTTON AND SNAP ACTION SWITCHES
AIRCRAFT AND ELECTRICAL EQUIPMENT ASSEMBLIES

HETHERINGTON, INC., Sharon Hill, Pa.

(West Coast Division: 8568 W. Washington Blvd., Culver City, Calif.)

then marks the length and size of the wire on his own plastic box with a grease pencil. When the assembly run is completed, he returns the unused wire to the proper box on the storage rack and erases the grease pencil mark from his box, leaving it free for another use.

Plastic tray sets without covers have recently been made available in a nonchipping Boltaron plastic that is light in weight, durable, and noncontaminating. When used for inspection, the insert trays are set into the larger tray for segregation of rejects. At assembly-line work positions, the insert trays can hold hardware and small parts within easy reach of the operator. The trays are available in various colors from Durable Formed Products, Inc., 6 Greene St., N. Y. C.

Another type of work-position tray, seen at many bench positions



Transferring materials from stockroom bins to containers on cart

23,698

HOURS of SERVICE

...and still no change in
Performance Quality!

That's what Earl F. Lucas, Chief Engineer

WPAT

Paterson, N. J.

says about

Federal's

F-5680

2.5 KW POWER TRIODE

**Here's another record of the long life
and operating stability of Federal Tubes!**

STILL on the job after 23,698 broadcast-hours! That's the record Federal's F-5680 has scored to date for WPAT, popular 5,000-watt station of the North Jersey Broadcasting Company, Inc.

Moreover, says Chief Engineer Lucas, "periodic comparison with our spare tubes shows no performance differences, so I anticipate many more hours of use."

Based on amazing service records of other Federal broadcast tubes, WPAT's F-5680 should be on the job *for years to come!*

Here's *proof* of the solid-rock ruggedness and dependable performance built into *all* Federal tubes by Federal craftsmen—drawing on tube design and production experience dating from the very birth of the industry... *on experience with hundreds of broadcasters!*

Get the facts of longer-life Federal tubes... write to Dept. K-813.



"Federal always has made better tubes"

Federal Telephone and Radio Corporation

VACUUM TUBE DIVISION

100 KINGSLAND ROAD, CLIFTON, NEW JERSEY

In Canada: Federal Electric Manufacturing Company, Ltd., Montreal, P. Q.
Export Distributors: International Standard Electric Corp., 67 Broad St., N. Y.

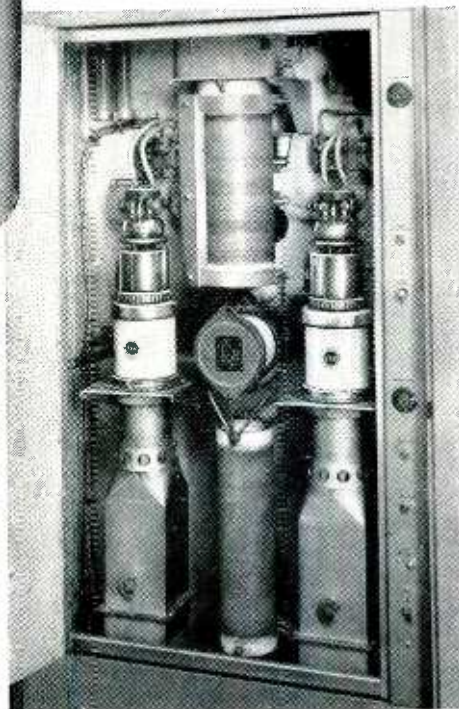

Federal F-5680 Power Triodes—
in WPAT's Federal 196-A AM Transmitter
—providing one of the most powerful signals
in the New York-New Jersey area.

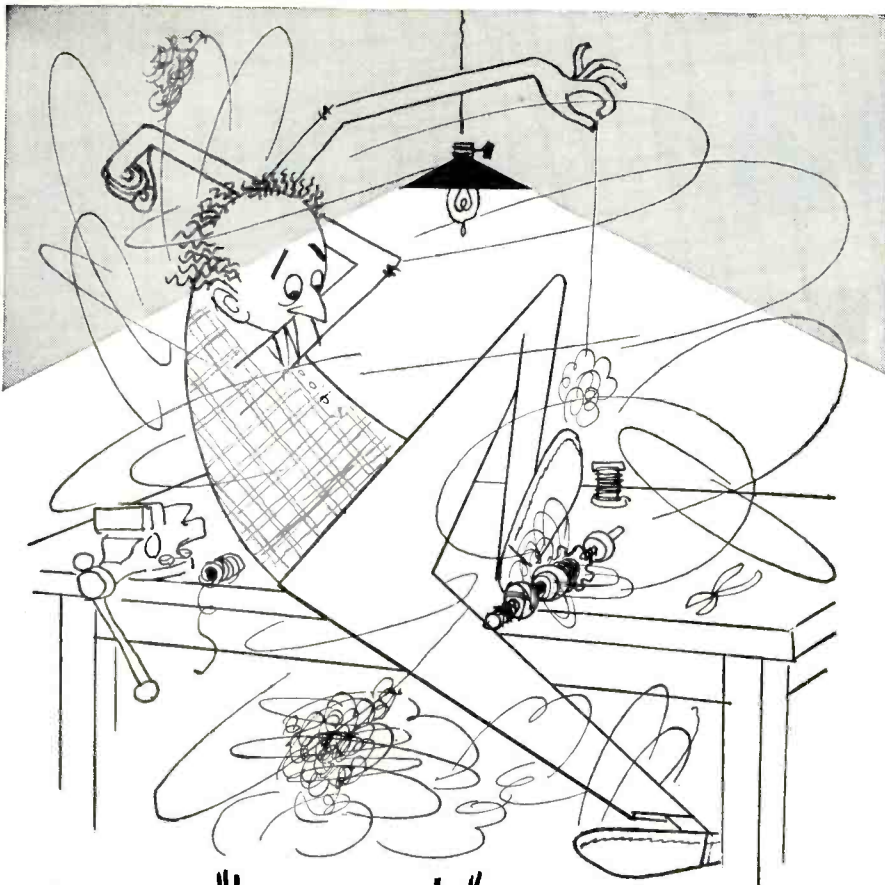

what are "home-made" coils costing you?

"Home-made coils cost us far too much", you'll say when you balance *all* the costs, wasted time and materials, production delays and excessive rejects against Clippard production-engineered coils.

Clippard specialists have made a career of coil and sub-assembly work... quickly turn out runs of 1,000... 10,000... 1,000,000 or more units using specially designed high-speed equipment of laboratory accuracy.

For you, as for many of the nation's leading electronic and electrical manufacturers, they'll whip production delays, hasten delivery dates, cut costs.

Often, Clippard works out design improvements that save money, critical materials and valuable time.

Devote your production facilities to more profitable work. Turn your coil winding and sub-assembly jobs over to Clippard. Savings will be greater than you thought possible.

WRITE TODAY,
describing your requirements.



**PRODUCTION TESTING
Resistors and Condensers?**

Send for catalog sheets describing Clippard PR-5 Resistance Comparator and PC-4 Capacitance Comparator. Each will soon earn its keep in your plant by allowing unskilled operators to check more than 30 components per minute with laboratory accuracy.

Clippard

INSTRUMENT LABORATORY INC.

7350-90 Colerain Road • Cincinnati 24, Ohio

MANUFACTURERS OF R. F. COILS
AND ELECTRONIC EQUIPMENT

Phone JACKSON 4261



Loading work-position racks from supplies on cart

in Sylvania's Buffalo plant, is the Rota-Bin. Based on the theory that in high-speed production you pay for reach, this tray brings from 4 to 8 different types of small parts within the same constant reach distance of the operator. The tray has four permanent dividers, and four more can be inserted at the 45-degree positions to give 8 compartments in all. The tray turns freely on its vertical shaft. Masking-tape labels on the rim identify the contents of each compartment for stock boys as well as for operator.

The close relationship required between stockroom and assembly line for continuous output of electronic products has received major attention in RCA's Camden plant. Elaborate self-nesting stock bins with hinged doors are stacked up

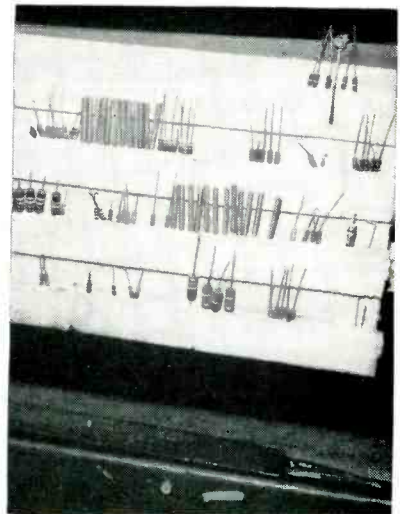

Repair-parts holder made from corrugated cardboard

The Dimensional Stability of Stability of **NILVAR**^{*} Spells Perfect Product Performance

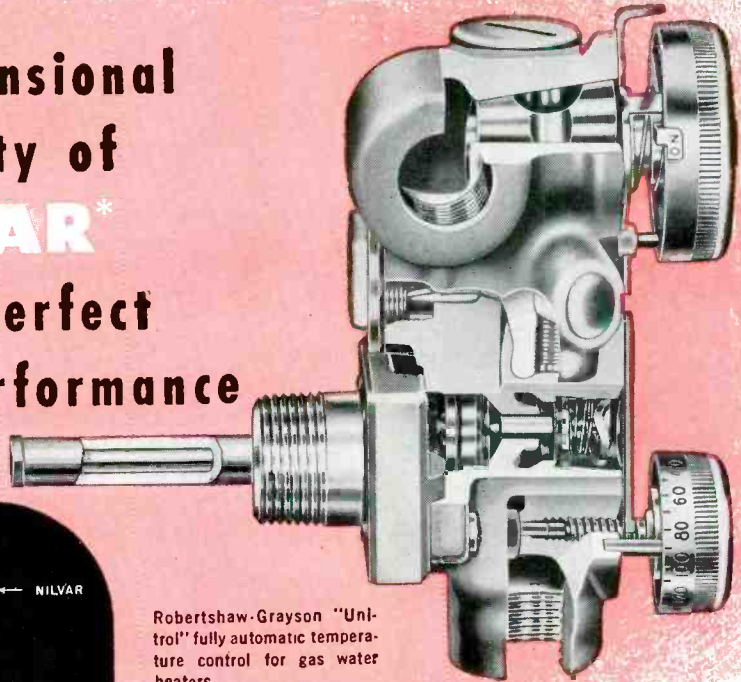

Robertshaw-Grayson "Unitrol" fully automatic temperature control for gas water heaters

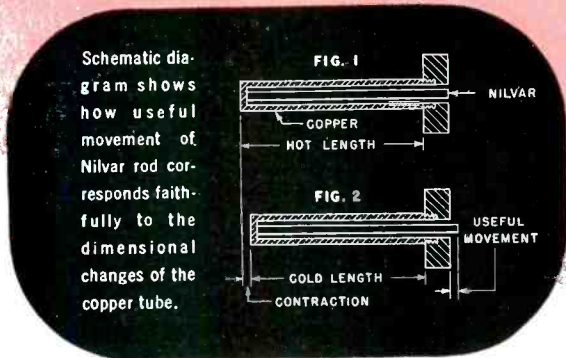

Schematic diagram shows how useful movement of Nilvar rod corresponds faithfully to the dimensional changes of the copper tube.

How Robertshaw-Fulton built a better Water Heater Control with **Driver-Harris NILVAR**

The new "Unitrol" Robertshaw-Grayson gas water heater control streamlines three essential controls into one valve body: a snap action thermostat, a snap action pilot, and a large-capacity gas cock. This reduces inventory for the water heater manufacturer and simplifies part stocking for the dealer.

The "Unitrol" provides a thermostat capable of delivering maximum amount of useful movement, by employing a copper tube enclosing a Nilvar alloy rod. The tube expands and contracts very appreciably in response to immersion temperatures. But the Nilvar rod, because it is dimensionally stable, does not vary in length. Since the free end of the Nilvar rod actuates the working gas valve, the slightest movement of the temperature-

sensitive copper tube is fully utilized to control flow of gas to the burner.

Says Robertshaw-Fulton: "The outstanding dimensional stability of Nilvar actually permits minute changes in water temperature to regulate the heat supplied by the burner, thus assuring extremely accurate operation."

Nilvar has a temperature coefficient of expansion as low as .000001 per degree C., lowest of any alloy; comparable to that of quartz. Somewhere in your engineering operations such extraordinary dimensional stability may solve a problem—help to perfect product performance. We shall be glad to make recommendations based on your particular needs.

*T.M. Reg. U.S. Pat. Off.

Nilvar is produced only by

Driver-Harris Company

HARRISON, NEW JERSEY

BRANCHES: Chicago, Detroit, Cleveland, Los Angeles, San Francisco

In Canada: The B. GREENING WIRE COMPANY, Ltd., Hamilton, Ontario.



MAKERS OF THE MOST COMPLETE LINE OF ELECTRIC HEATING, RESISTANCE, AND ELECTRONIC ALLOYS IN THE WORLD

3 WAYS TO MAKE PANELS, LIDS and DOORS RF TIGHT



Thermaltron built by Radio Receptor Co., Inc.

from the floor to a height of about 7 feet in the stock room. Each bin has its own prominently displayed number, keyed to a master list identifying its contents. Parts are transferred from the bins to bags and boxes on a caster-mounted truck resembling a tea cart. From this cart, the stock man refills bench-position trays as he moves down the assembly line one or more times a day.

Two ingenious ways of keeping a large number of different types of parts within easy reach at repair positions may be seen in Sylvania's Buffalo plant. The simplest version uses corrugated cardboard as a backing sheet. Strips of corrugated cardboard are cemented to this horizontally, to provide vertical in-



Plywood repair-parts holder

dividual receptacles for the leads of resistors and capacitors and for shafts of tuning slugs. The entire parts-storing sheet is wired to a metal strut alongside the test position.

The more elaborate rack uses a plywood backboard having a variety of supports. Long springs threaded through screw eyes stretch horizontally across the rack, with leads of small parts pressed between the turns of the springs. Spring clips, sometimes called tool holders, are used to support spare electrolytics. Other parts are hung on cup hooks, wood pegs and steel nails. A wood

- 1

Machine mating surfaces to closest tolerances.
Costly and difficult! And the close fit is often destroyed by warping, corrosion and normal use.
- 2

Install numerous latches, screws, bolts or other fastenings.
Also costly! And makes maintenance more difficult, more time-consuming.
- 3

USE METEX ELECTRONIC WEATHERSTRIPPING.
The simple, sure, economical way!

Made of resilient, compressible *knitted* metal wire mesh, METEX strips and gaskets "close" these openings just as a weatherstrip "closes" windows and doors.

Because they are metallic, METEX strips and gaskets are conductive. Because they are knitted, they are flexible and resilient. They will conform to surface irregularities with no loss in shielding efficiency.

Close manufacturing control assures uniformity in the resiliency and dimensions best adapted to specific applications.

METEX electronic strips and gaskets are easy to install. They are not expensive—in fact, they may well save more than their cost by eliminating the need for many operations formerly thought necessary.

It will pay you to investigate the production and performance advantages of METEX Electronic Weatherstripping. A bulletin giving detailed information is yours for the asking —just write on your company letterhead.

METAL TEXTILE CORPORATION
KNITTERS OF WIRE MESH FOR MORE THAN A QUARTER CENTURY

Main Office & Plant, Roselle, New Jersey Canadian Plant, Hamilton, Ont.

HOW MANY *db-*

AT 5,000

MEGACYCLES?

AT 25,000

MEGACYCLES?



PRD

precision variable attenuators

- METALLIZED GLASS ATTENUATING ELEMENTS
- PRECISE, PERMANENT CALIBRATION
- BROADBAND CHARACTERISTICS
- NEGLIGIBLE INSERTION LOSS
- BACKLASH-FREE
- LOW REFLECTION
- WELL SHIELDED CASING

The use of metallic-film-on-glass techniques to provide attenuation at microwave frequencies is no longer new. This type of PRD attenuator is now well recognized for its constancy of attenuation with time as well as for its insensitivity to variations of humidity and temperature.

PRD has now augmented this line of attenuators with units employing metallized mica elements to provide broader-band characteristics for the millimeter region of the microwave spectrum. As a consequence, it is now possible to offer complete coverage of the range from 2,600 to 40,000 megacycles per second in designs varying from a simple level set attenuator to a precisely calibrated secondary standard. Write today for our complete new catalog of microwave test equipment — address Dept. E-1.

Polytechnic



**RESEARCH
& DEVELOPMENT
COMPANY, Inc.**

55 JOHNSON STREET, BROOKLYN 1, NEW YORK

WESTERN SALES OFFICE

741½ NO. SEWARD STREET, HOLLYWOOD 38, CALIF.

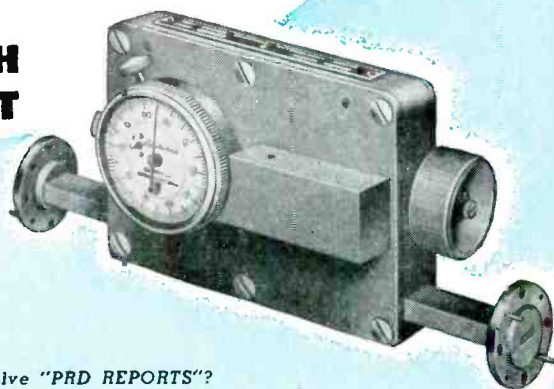

Are you on our mailing list to receive "PRD REPORTS"?

high gain

LOW COST



Andrew Omnidirectional Antenna for VHF Communications

No, this new High Gain Communications Antenna isn't cheap, but it does offer the most economical solution to your coverage problem. Whether you want maximum coverage for a specific transmitter power, minimum power or shortest tower for a specific coverage, or freedom from dead spots, the ANDREW Type 3000 Antenna is the least expensive solution. Why? Because talk-back is the limiting factor in mobile communications. Gain in the central station antenna costs less than increased power in every mobile unit.

ANDREW Type 3000 High Gain Communications Antenna offers better than 6 db gain in the 148-174 MCS band. This means that the power delivered to the receiver on both talk-out and talk-back is increased four times. The horizontal radiation pattern is circular.

Write for the ANDREW High Gain Antenna bulletin today!

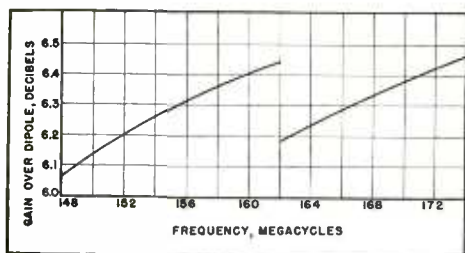

Andrew

CORPORATION

363 EAST 75TH STREET, CHICAGO 19

ANTENNA SPECIALISTS

TRANSMISSION LINES FOR AM-FM-TV-MICROWAVE • ANTENNAS • DIRECTIONAL ANTENNA EQUIPMENT • ANTENNA TUNING UNITS • TOWER LIGHTING EQUIPMENT

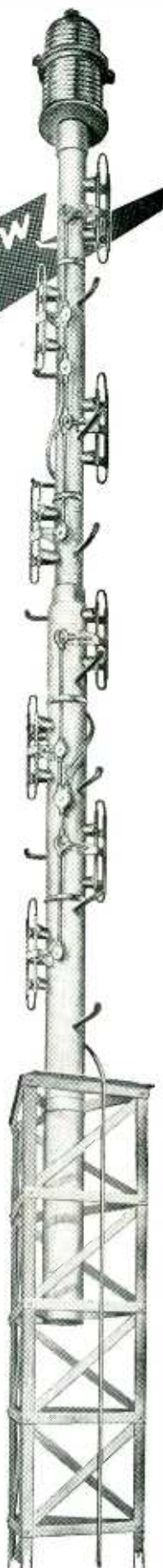

strip with drilled-out recesses provides individual shelves for spare potentiometers.

Chains Aid Soldering

To IMPROVE the accuracy of positioning when soldering the antenna loop in the cavity of a pencil triode, foot-operated chain drives are used to bring the loop up to position and bring up a needle-point gas flame. The operator then applies solder by hand. Both feet thus participate in the soldering operation, giving the equivalent of four hands as is



Setup for soldering antenna lead inside cavity for RCA uhf pencil triode. Solder is applied to inside wall of cavity after needle-point gas flame at right end of fixture has heated wall from outside

so often needed for intricate soldering operations.

As shown in the photo, the chains work against springs that move the positioning lever and gas flame out of the way for unloading and loading.

The positioning lever moves the right-angled piece of antenna wire to the correct position for a butt joint to the cavity wall. The gas flame moves up to the outside of the wall in this region, to heat the wall so solder will flow down it to the butt joint without disturbing

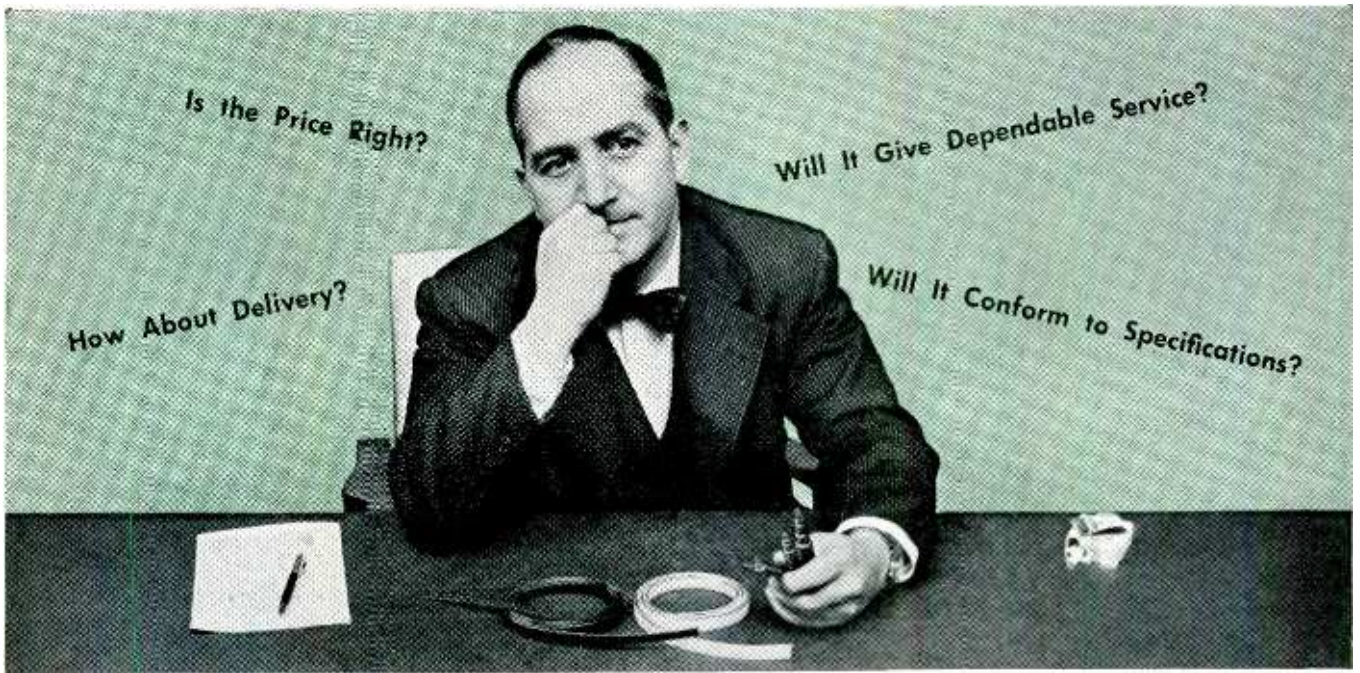

CHOOSE SYNKOTE CABLE AND WIRE

for Value — for Service — for Dependability

FIRST IN COMMUNITY TV: this ultra-rugged Synkote coax cable (RG 59/U and 11/U) is double-shielded and double-jacketed, transmits signals over long distances with virtually no radiation losses.

NEW FOR UHF: Synkote "Ovaltube" twin-lead is a tubular air-dielectric construction, features low attenuation. Fits ordinary hardware, can be made weathertight in seconds. Uniquely practical, nothing else like it.

30 CONDUCTOR CABLE: — a Synkote custom-engineered cable designed and manufactured from simple specifications read over the telephone. Difficult-looking, but "duck-soup" to Plastoid engineers.

"JUMBO" TWIN-LEAD: — 185 mil web—the strongest TV lead-in ever introduced. Withstands gales, extreme heat, cold and humidity. Low loss — gives excellent reception in fringe areas.



"Manufactured by the mile - tested by the inch"

PLASTOID
Corporation

plant: HAMBURG, N. J. • offices: 42-61 24th St., Long Island City, N.Y.

1. Choose for Dependable Construction

You want to be sure that the wire you buy will give dependable service. SYNKOTE wire is warranted by Plastoid to be made of the finest materials, and will meet all applicable specifications.

2. Choose for Engineering Know-How

Possibly, you may know what general characteristics you desire, but not how to put these into wire. Plastoid's large staff of engineers can transform your generalized requirements into a finished wire or cable. Simply give us your electrical and physical requirements — we'll design the cable.

3. Choose for Rapid Delivery

Plastoid's modern manufacturing facilities mean faster production . . . more rapid deliveries to you.

4. Choose for Friendly Service

You'll find everyone at Plastoid — executive, salesman or engineer — friendly, warm and informal . . . pleasant to work with and eager to do business with you.

5. Choose for Reasonable Cost

Remember, "bargains" seldom save you money. In the long run, it pays to pay a fair price and get dependable wire. For true wire economy specify SYNKOTE — manufactured only by Plastoid Corporation, Long Island City, New York

THE

Mayhill PLATING PROCESS

GUARANTEES ACCURATE PLATING IN ELECTRONICS!



Since 1946, M-W LABORATORIES has electroplated precious metal for suppliers to the U. S. Army, U. S. Navy, Atomic Energy Commission and to leading manufacturers in the electronics industry.



M-W LABORATORIES, featuring their Mayhill Plating Process, are equipped to plate these precious metals: gold, silver, rhodium, palladium and indium.



Controlled thickness, smoothness, color, hardness and adhesion of plating is assured through constant testing by our own chemists and engineers, in our chemical and metallographic laboratory.



Contact us for a no-cost-to-you consultation on your plating problems.



M-W Laboratories, Inc.
1824 N. Milwaukee Ave.
Chicago 47, Illinois

the position of the antenna lead. The part is ejected by a hand lever, falls into a chute and slides into a tray.

This soldering setup is used in the Harrison, N. J. plant of the RCA Victor Division.

Cable Life Tester

AN ELECTRIC motor drive imparts an oscillating movement to a horizontal pipe from which handset cable connectors are suspended, for life tests of the sleeves that serve as waterproof gaskets through which

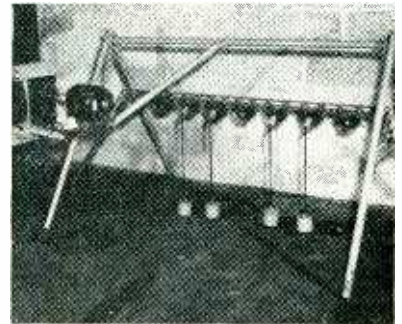

Setup used by Utility Electronics for life-testing up to seven cables at a time. Weights are heavy enough to pull out cables when breaks occur

the cable enters the connector. A weight suspended from each cable holds it vertical as the overhead rod moves back and forth over a 90-degree arc. The cable connectors are attached to standard cable receptacles mounted on brackets that are in turn fastened to the pipe with U bolts.

Tube-Holding Tool

INSERTION of miniature tubes in radio receivers is simplified by use of a Crosley-designed holding tool. A solid fiber or Formica rod slightly greater in diameter than the tubes was drilled out at one end to the diameter of a miniature tube. The other end was drilled to take the shank of a screwdriver with a tight fit. Four slots were then cut in the tube-holding end to a depth of 1½ in., and rubber bands placed around this end to obtain tube-gripping action.

With this tool, the operator can easily remove a tube from the rack-supported cartons at the back of the bench, even though the tubes are

ENGINEERED FOR RUGGED ASSIGNMENTS!

3 PHASE DIRECTIONAL POWER RELAY

FOR AIRCRAFT POWER SYSTEMS
UTILIZING PARALLEL CONNECTED
3 PHASE, 4 WIRE ALTERNATORS



Provides absolute protection for generators and connected loads —

This relay is designed for use on power systems of two or more 208/120 volt, 4 wire, three phase, alternators operating in parallel. Its function is to protect the system by removing an alternator in the event of a drive failure, a shutdown of the drive without prior disconnection of the alternator, a balanced three phase fault within the alternator or a high resistance three phase fault between the relay and alternator. The relay operates if reverse power in any phase exceeds 1500 watts. It has an inverse time characteristic. At 2000 watts the relay operates in 0.4 seconds.

Completely environment-proofed to meet critical requirements —

Designed for critical aviation applications, all components except the current transformers are mounted on a single shock-mounted chassis with all items including wiring 100% potted for complete immunity to environmental conditions or changes. Rugged cable connectors permit quick, easy replacement of the entire unit or current transformers. This equipment is readily adaptable to power systems of other voltages and frequencies.

Call or Write for New Illustrated Brochure on Gavco's Standard Aviation Components—Inquiries on other than standard equipment will receive prompt attention.

GAVCO CORPORATION

A Subsidiary of General Aviation Corporation

540 EAST 80th ST., NEW YORK 21, N. Y. • Tel. TRafalgar 9-8800

DESIGNERS AND MANUFACTURERS OF PRECISION ENGINEERED POWER RELAYS, VOLTAGE REGULATORS, FREQUENCY CHANGERS AND SPECIAL PURPOSE ELECTRONIC EQUIPMENT FOR COMMERCIAL AND MILITARY APPLICATIONS

GET THE INSIDE STORY

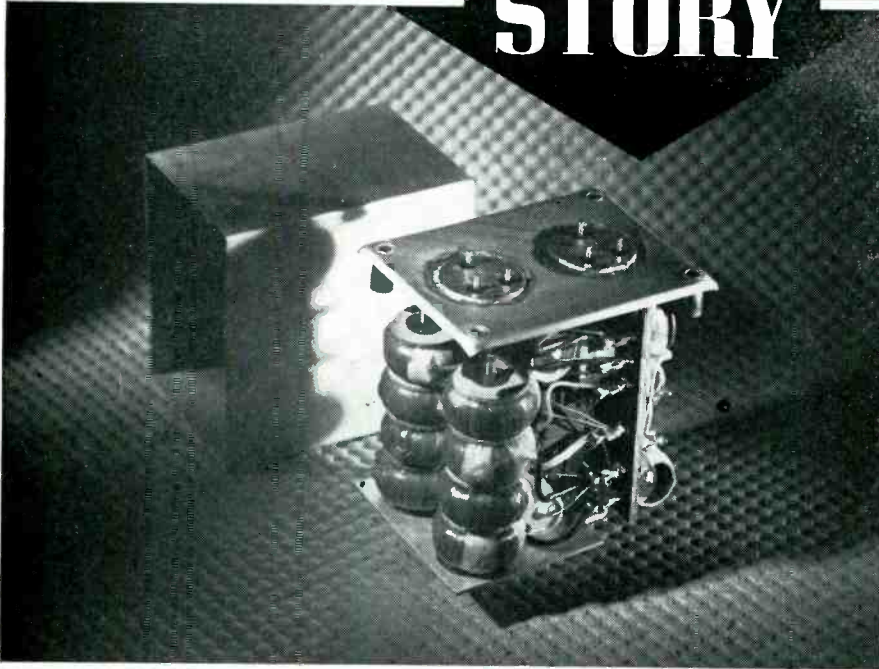

...WHEN YOU BUY FILTERS

RESPONSE CURVES and cases may look alike, but component quality and internal construction are the things that determine dependability—in a filter, and in the associated equipment.

TO BE SURE components are the best, Lenkurt presses its own cores, winds the coils, and subjects all parts to the most rigorous checks possible.

IN A LENKURT FILTER, parts are firmly fastened to sturdy headers, connections made to rigid terminal boards. Units are impregnated, cased, and/or hermetically sealed as required.

LENKURT FILTERS are engineered and built to your most exacting specifications on delivery schedules to meet any quantity need by Lenkurt Electric Company—largest independent manufacturers of telephone toll transmission equipment.

**LENKURT ELECTRIC
SALES COMPANY**
San Carlos 1 California

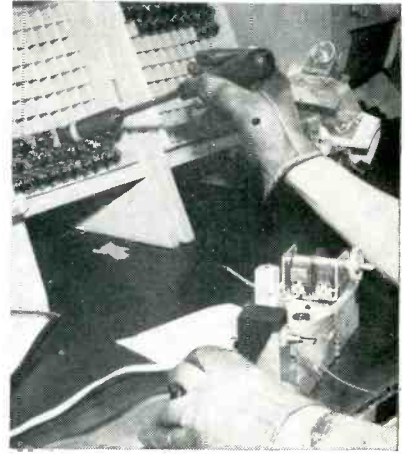

Picking tube out of carton with holding tool

beyond convenient arm reach. Once a tube is picked up, the tool can easily be turned in the fingers to align the tube correctly with respect to the socket.

When the tube is pushed in with the tool, socket contacts grip the pins tightly enough to hold it while the tool is withdrawn. A felt pad inside the tool permits applying pressure to the top of the tube without danger of breaking the glass tit.

Jig Borer Speeds Die-Making

FLAT DIES for punching chassis holes or stamping out parts for electronic components can be made without preliminary layouts on the



Use of new jig borer in Sylvania's Buffalo plant for drilling required holes in punching die for auto-radio switch contact

It's Tung-Sol for radio and tv



Quality -that keeps pace with the growth of the electronic industry
-that meets fully the performance requirements of all
radio and tv set manufacturers
-that safeguards dealer service work

TUNG-SOL
RADIO, TV TUBES, DIAL LAMPS

TUNG-SOL ELECTRIC INC., Newark 4, N. J. — Sales Offices: Atlanta • Chicago • Culver City • Dallas • Denver • Detroit • Newark
Tung-Sol makes All-Glass Sealed Beam Lamps, Miniature Lamps, Signal Flashers, Picture Tubes, Radio, TV and Special Purpose Electron Tubes

Put dependable **MOSINEE** Forest Fibres to work for you!



Remember . . . MOSINEE means more than "paper" in the field of electronics and electrical products. MOSINEE stands for FIBRES that have scientifically controlled electrical, chemical and physical properties, to perform specific functions . . . fibres of dependable technical uniformity vital to your quality standards and production requirements.

MOSINEE fibres can be made to your specifications, with

- good dielectric strength, high tensile or tear strength . . .
- specified pH for maximum-minimum acidity or alkalinity . . .
- accurate caliper or density . . .
- proper impregnation characteristics for resin, wax or other substances . . .
- proper characteristics for plastics operations and parts . . .
- uniform softness, stiffness, flexibility, toughness . . . or other vital technical characteristics.

MOSINEE has its sources of quality forest fibres, practical experience, laboratory facilities, and scientific production controls to create and produce the type of fibres your operations require. Contact MOSINEE.



MOSINEE PAPER MILLS COMPANY
MOSINEE, WISCONSIN

MOSINEE

makes fibres work for industry

metal, through use of a precision jig borer made by Moore Special Tool Co., Inc., Bridgeport, Conn. The only requirement is that all dimensions on the layout drawing be made with respect to the left side and rear of the die.

After the die stock is locked in position on the carriage of the machine, the two crossfeeds are zeroed in with respect to the left and rear sides of the stock. Now, by setting the precision micrometer dials on the crossfeed wheels to the indicated blue print coordinate values, the operator can center the drilling spindle precisely over the desired location. This eliminates laying out and marking the center of each hole beforehand.

Transformer Designer

DESIGN of exactly the optimum horizontal output transformer for a new television receiver circuit is achieved in a few minutes without calculations through use of special test transformers developed by CBS-Columbia engineers. Two models are in use, differing primarily in mechanical construction. Both have 42 taps on the primary winding, one with 15 turns between taps and the other with 18 turns between

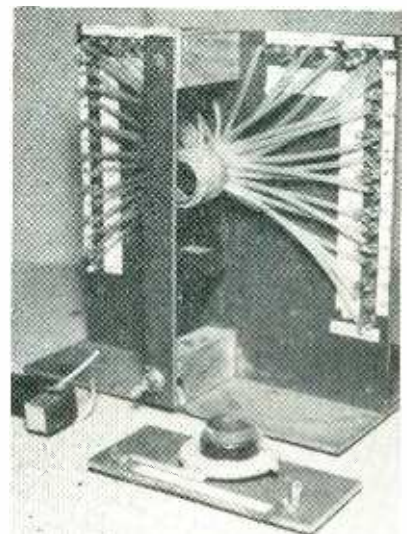

Rear view of early model of test transformer, with half of core removed. Core is replaced after swinging Bakelite locking strip out of way and placing secondary coil (in foreground) over other leg of mounted half of core. Each tap is labeled with number of turns from start of primary lettered on masking tape



HERE IT IS!

**An Oil-Filled, Open-Type Transformer
Only Possible With**

FORM FLEX[®]
Patent Pending

Better corona suppression, longer life—better heat dissipation—less noise. And all this in a transformer that is 40% lighter and 30% less bulky. Manufactured only by Aircraft Transformer Corporation and its licensees.

Complete data available—write to

AIRCRAFT TRANSFORMER CORPORATION 

MANUFACTURERS OF INDUCTIVE EQUIPMENT • LONG BRANCH, NEW JERSEY, LONG BRANCH 6-6250

RELAYS...SWITCHES...CONNECTORS...ELECTRO-MECHANICS

PRODUCTION TECHNIQUES

(continued)

P & B CUSTOM MANUFACTURING FACILITIES

mean

service

3 large plants
to serve you

Over 50,000 square feet of floor space . . . fully equipped with modern, up-to-date production equipment including complete tooling, coil winding, plastic molding, heat treating, glass metalizing, welding, hermetic sealing and machine tools for every operation.

quality

20 years
specialized
experience

Widely diversified technical knowledge acquired in the design, development and custom manufacture of more than 15,000 versions of relays, switches, controls and small electro-mechanical assemblies enables P & B to meet critical standards at lowest cost.

REMEMBER, if your problem concerns the development or production of electro-mechanical components for any electronic or electrical apparatus, Potter & Brumfield offers you the quickest, most practical and most economic solution. Send specifications for samples, recommendations and quotations. (Catalog available on request.)

Potter & Brumfield

PRINCETON, INDIANA

Export: 13 E. 40th St., N. Y., N. Y.

SALES OFFICES IN PRINCIPAL U. S. AND CANADIAN CITIES

P & B CATALOGUED RELAYS AVAILABLE AT YOUR ELECTRONICS PARTS DISTRIBUTOR

10,000 relays per day

Orderly, efficient plant layout plus competent, well-trained personnel assure speedy, precise assembly line production . . . single shift capacity 10,000 relays per day!

unequaled engineering facilities

Extensive research, laboratory, development, type test and model shop facilities at your service any time. Test samples and pilot runs completed quickly at reasonable cost.

industry's leading supplier

For many years, the leading supplier of electrical and electronic relays to America's foremost industrial organizations.

specialists in relays for military equipment

Complete file of latest MIL specifications. All necessary laboratory and testing instruments available. Certified test reports on request.

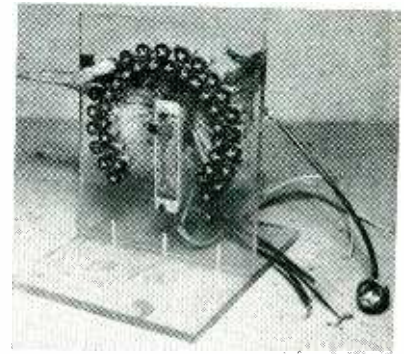

Deluxe version of test transformer, mounted on Lucite panel

taps. Both permit quick removal of half the Ferroxcube core for changing the secondary coil. The earlier model has terminals for taps, while the refined version has jacks into which a test lead can be inserted for quick change of primary coil design.

The test transformer is connected directly into the television receiver circuit, with its top cap connector going directly to the top cap of the horizontal output tube.

Plastic-Faced Quality Chart

TRANSPARENT plastic sheets mounted over large inked charts permit using the charts over and over again on statistical quality control bulletin boards in Crosley Division's Cincinnati television receiver plant. Hourly or daily records are plotted on the plastic covering with a china marking crayon, using a ruler as a guide. These can easily be wiped off with

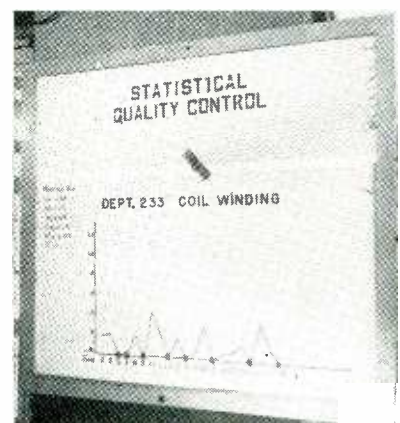

Example of monthly quality control chart with plastic facing. Working days in month are hand-crayoned on plastic as horizontal scale

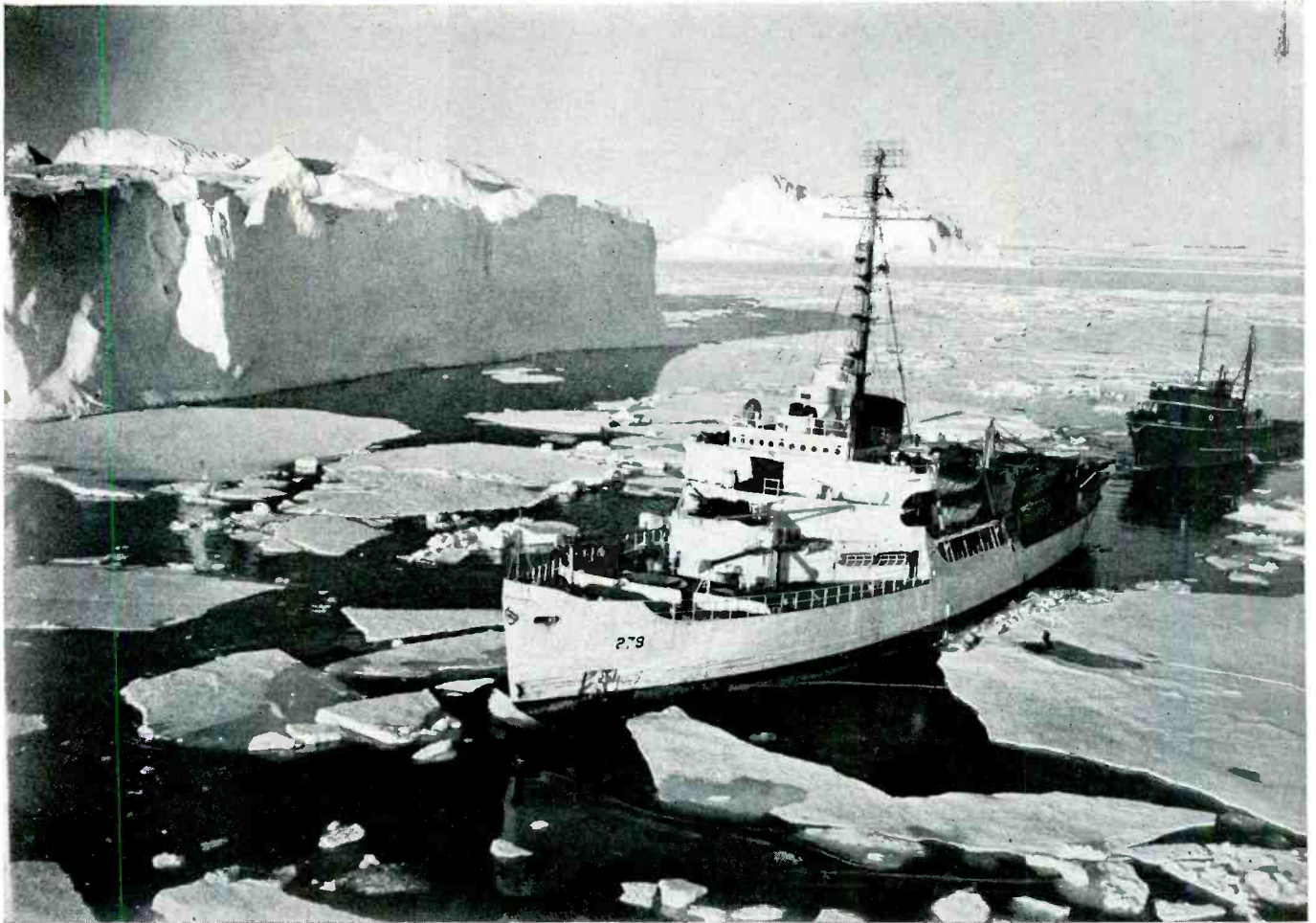

U. S. Coast Guard Official Photo

farthest north... *deepest down*

Last summer, on a mission to supply weather station "Alert", the Coast Guard ice breaker "Eastwind" reached what is believed to be the northernmost point ever attained by a vessel under its own power — 442 nautical miles from the North Pole.

Under far different tropical settings in 1949, a United States Navy vessel set another mark, this time related to the "deepest". The E-PCE(R)850, equipped with an Edo deep depth sounder of advanced design, recorded contours of the Brownson Deep off Puerto Rico.

It was not the first time that sonar had measured depths of more than 4000 fathoms from a stationary position, but it was the first time that ocean depths so far down had been so accurately measured by continuous recordings while the vessel was under way. This test and

others have since lead to the installation of Edo depth sounders on many vessels of the U. S. Navy.

The ability of Edo equipment to measure depths from zero to 6000 fathoms is the result of highly significant research and development in the electronic laboratories of the Edo Corporation where the most up-to-date developments in electronics are blended with more than a quarter of a century of precision manufacturing know-how — just one reason why Edo has come to be known as a leader in the application of electronics to under-water detection equipment.



EDO CORPORATION • COLLEGE POINT, N. Y.

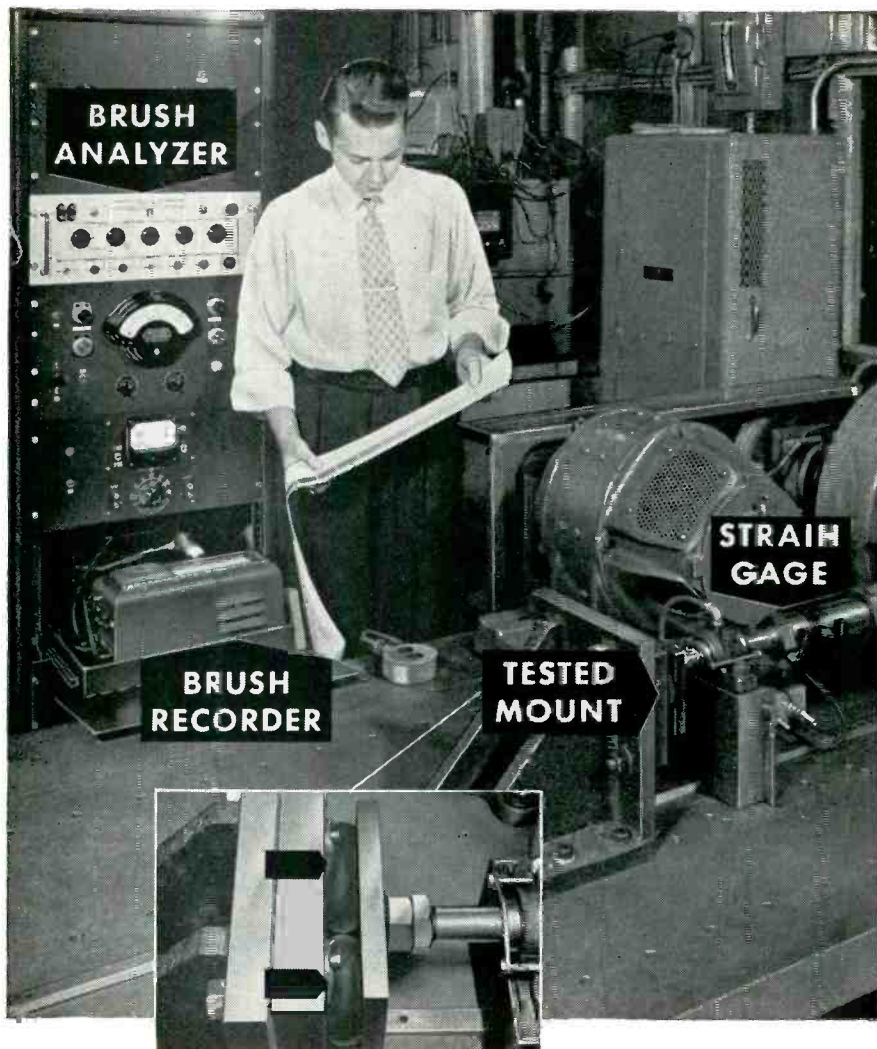

a cloth at the end of the time period for the chart, to put on new scale values and new curves. A thumb-tack with the letter Q on it is pushed in each time the curve hits zero, to emphasize perfect work. Monthly averages are added in crayon at the left of the chart.

Cutting and Stripping Long Leads

ADDITION of a solenoid-operated V trough at the output end of a standard Artos wire cutting and stripping machine makes it possible to catch and collect long wires automatically without getting them tangled. This enabled one operator to handle three such machines in Crosley's Cincinnati television receiver plant.

In one setup, the machine makes two 14½ in. passes and then cuts, to obtain a 29 in. lead. This lead slides down the added V trough smoothly because of the downward slant and smooth surface of the trough. After cutting, solenoids pull the hinged sides of the trough apart, dropping the lead neatly on a collecting table underneath. Two snap-action switches were added to the machine to insure that the trough opens only after the wire has been cut and not after a pass.

In contrast, a new model CS-10 machine for cutting long leads is also shown. This machine, made by Artos Engineering Co. of Milwau-

VIBRATION STUDY

saves time and money with Brush Analyzer

HERE, in the plant of a large automotive manufacturer, this test of vibration characteristics of rubber engine mounts requires no laborious plotting of test data. The shock mounts are tested under dynamic conditions. Using strain gages on the actuating driver, the Brush Recording Analyzer charts test results instantaneously while the test is underway. Saves valuable engineering time, and the charts provide a complete history of test. Find out how you can simplify the solving of many electrical and mechanical test problems with Brush Instruments. Write for bulletin F-618.

For the finest electronic products for instrumentation, acoustics, piezoelectric materials, ultrasonics and magnetic recording—look to Brush. Brush Electronics Company, Dept. K-1, 3405 Perkins Avenue, Cleveland 14, Ohio.

BRUSH ELECTRONICS

ELECTRONIC INSTRUMENTS FOR INDUSTRY
PIEZOELECTRIC MATERIALS • ACOUSTIC DEVICES
ULTRASONIC EQUIPMENT • TAPE RECORDERS
RECORDING EQUIPMENT



COMPANY

formerly
The Brush Development Co.
Brush Electronics Company
is an operating unit of
Clevite Corporation



Standard Artos machine with a V trough for catching long leads

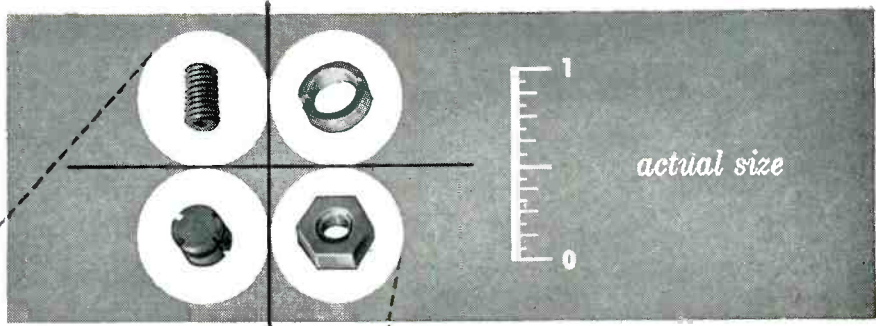

pyroferric

IRON CORES

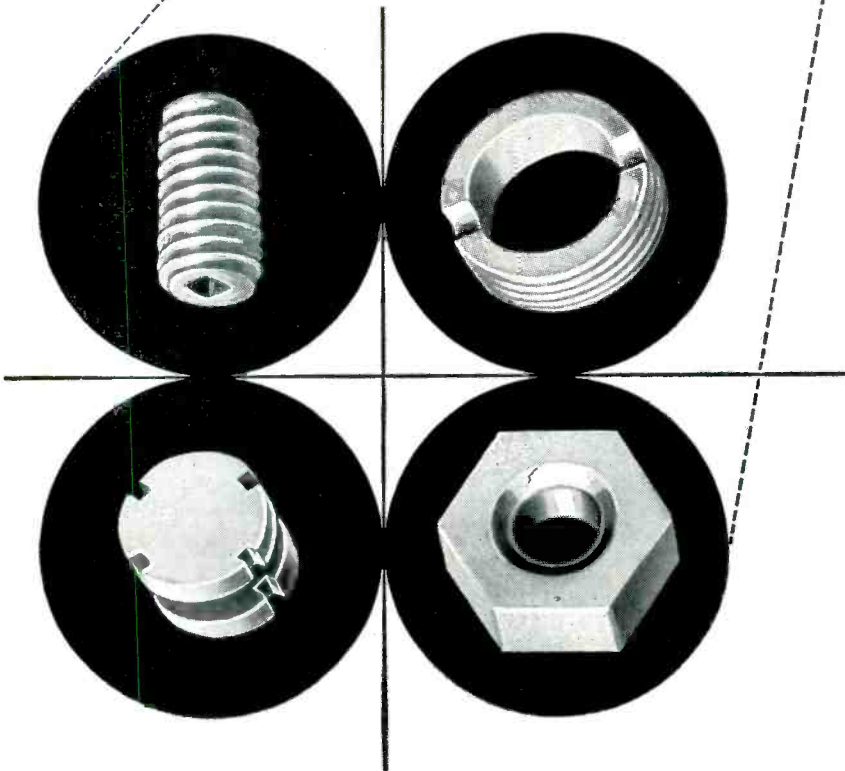

PYROFERRIC IRON CORES
 are scientifically manufactured,
 under strictest quality controls
 and rigid maintenance of close
 electrical and mechanical tolerances.

PYROFERRIC services
 are available for the engineering
 of your core production requirements . . .
 your letterhead request for Catalog 22B
 will bring you complete information
 including the manufacture of iron
 cores, their electrical properties,
 materials, design considerations,
 standardization data, uses
 and other helpful information.

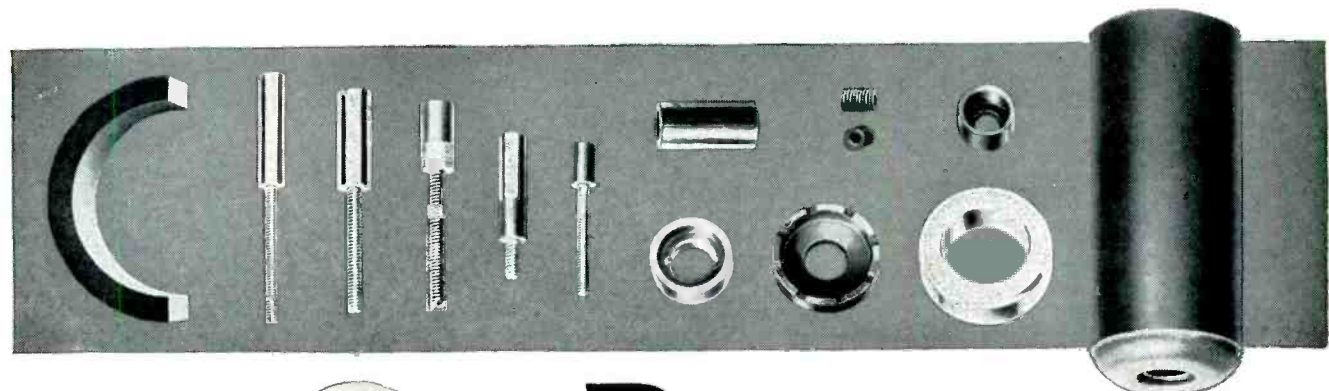

PYROFERRIC

PYROFERRIC BLDG.

**BRONX BOULEVARD
 at 216th St., N.Y.C. 67**

For SPECIFIED PERFORMANCE Specify JELLIFF RESISTANCE WIRE

A WIDE RANGE OF ALLOYS . . .
A WIDE RANGE OF EXPERIENCE . . .
COMPLETE CONTROL OF MANUFACTURE . . .

make JELLIFF the ideal source of
Resistance Wire to assure your Product's

Performance According to Specs.

precision resistors—rheostats—
relays—thermocouples—ohmmeters
—bridges—high-temperature fur-
naces can all benefit from the
PLUS-PERFORMANCE of
JELLIFF RESISTANCE WIRE



Detailed Enquiries Welcomed. Address Dept. 17.

Do You Want to Measure
Or Generate Any Frequency
From 20 — 640 M. C.*
Within 10 Parts Per Million?



Direct Reading VHF Frequency
Meter Model FM-3

Accuracy: $\pm 0.001\%$
Stability: $\pm 0.001\%$
Resetability: . . . $\pm 0.0005\%$

*Under certain conditions can be used
below 20 mc and above 640 mc.

GERTSCH PRODUCTS
INC.

11846 Mississippi Avenue
P.O. Box 13856
Los Angeles 25, California
In Canada, Atlas Radio Corp. Ltd., Toronto.

Teflon*



MAGNET, RESISTANCE and ALLOY WIRE

- Small space factor
- Unaffected by chemicals or corrosive atmosphere
- Capable of withstanding 250° centigrade
- High dielectric
- Excellent flexibility and abrasion resistance
- Sizes: 10 through 50 A.W.G.

Send for NEW Warren Wire Specification 1001

WW

WARREN WIRE CO.
POWNAI VERMONT

Producers of Nylon, Plain Enamel and
Served Magnet Wire, Tinned and Bare
Copper Wire.

*Du Pont trademark for Polytetrafluoroethylene Enamel

Over 85% of the torque wrenches
used in industry are

STURTEVANT TORQUE WRENCHES

Read by Sight, Sound or Feel.

- Permanently Accurate
- Practically Indestructible
- Faster—Easier to use
- Automatic Release
- All Capacities

in inch ounces . . . inch
pounds . . . foot pounds
(All Sizes from 0-5000
ft. lbs.)

Every manufacturer, design and production man should have this valuable data. Sent upon request.

PA **STURTEVANT CO**
ADDITION QUALITY ILLINOIS

BIRTCHEER TUBE CLAMPS

Hold Tubes in Sockets
under all Vibration,
Impact and
Climatic
Conditions

83
VARIATIONS
FOR
STANDARD
TUBES



NEW
CLAMP
FOR
MINIATURE
TUBES

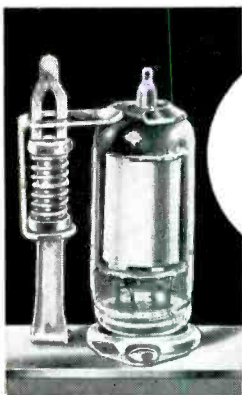

You can't shake, pull or rotate a tube out of place when it's secured by a Birtcher Tube Clamp. The tube is there to stay. Made of Stainless Steel, the Birtcher Tube Clamp is impervious to wear and weather.

BIRTCHEER TUBE CLAMPS can be used in the most confined spaces of any compact electronic device. Added stray capacity is kept at a minimum. Weight of tube clamp is negligible.

Millions of Birtcher Tube Clamps are in use in all parts of the world. They're recommended for all types of tubes: glass or metal—chassis or sub-chassis mounted.

**THERE'S A BIRTCHEER TUBE CLAMP
FOR EVERY STANDARD AND
MINIATURE TUBE!**

Write for samples, catalogue and price lists.

THE BIRTCHEER CORPORATION
4371 Valley Blvd.
Los Angeles 32, Calif.

Want more information? Use post card on last page.

ELECTRONICS — January, 1953

PRODUCTION TECHNIQUES

(continued)

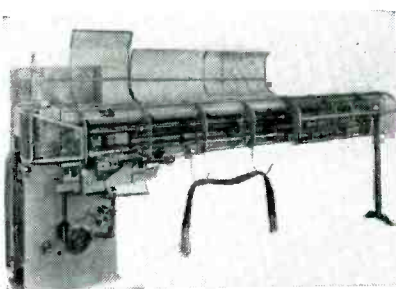

Special machine for automatically cutting and stripping leads up to 45 feet long

kee, Wis., is available in six different models having various cutting ranges and production rates. Three of the models are capable of cutting 400 45-foot lengths per hour, and up to 1,200 pieces per hour in shorter lengths down to a minimum of 40 inches. These machines use a travelling gripper to pull out the desired lead length, and have hooks to catch and collect the cut wires.

Three-Iron Soldering

THREE soldering irons are mounted with points up to speed soldering of contacts to cavity sections for the RCA type 5794 fixed-tuned

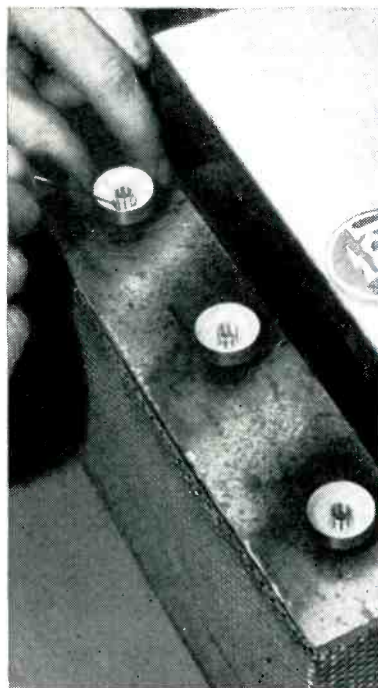

Protective metal cage encloses three vertically mounted electric soldering irons having machined tips on which three cavity sections are resting

NEW...

MICRODUAL
TWO-SPEED
PRECISION DRIVE

(Patents U.K.,
U.S., etc.)

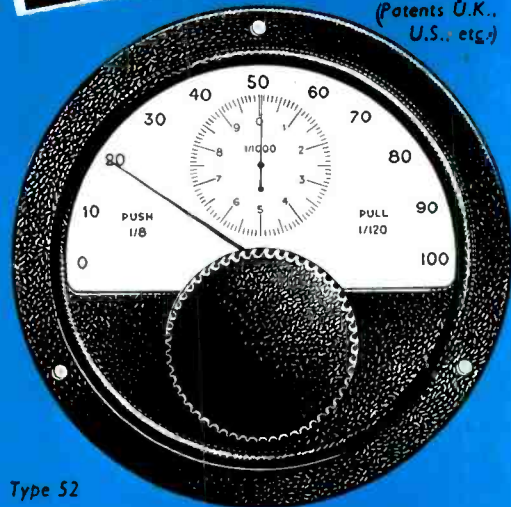

Type 52

**TWO SPEEDS · SINGLE CONTROL
FREE OF BACKLASH**

- Accuracy of scale reading 100%
- Coarse searching speed plus fine setting control.
- Single control knob displaced axially to select the speed ratio.
- Spring-loaded gears with automatic take-up of any wear or play between primary and secondary drives.
- Pointers geared directly to centre spindle.
- Security in operation: friction clutch obviates overdriving.

TYPE No.	NUMBER OF DIAL MARKINGS	EFFECTIVE SCALE LENGTH	SPEED RATIOS	
			COARSE	FINE
52	1,000	3.3 feet	1 : 8	1 : 120
63	1,000	3.3 feet	1 : 8	1 : 120
57	2,000	6.6 feet	1 : 15	1 : 200
56	2,000	6.6 feet	1 : 15	1 : 200
53	2,000	6.6 feet	1 : 15	1 : 200

We are specially organized to handle direct enquiries and orders from U.S.A.
Billed in dollars. Settlement by your check.

CABLE OR AIRMAIL TO-DAY

TRANSRADIO LTD
CONTRACTORS TO H.M. GOVERNMENT
138A CROMWELL ROAD, LONDON, S.W.7., ENGLAND
CABLES — TRANSRAD, LONDON

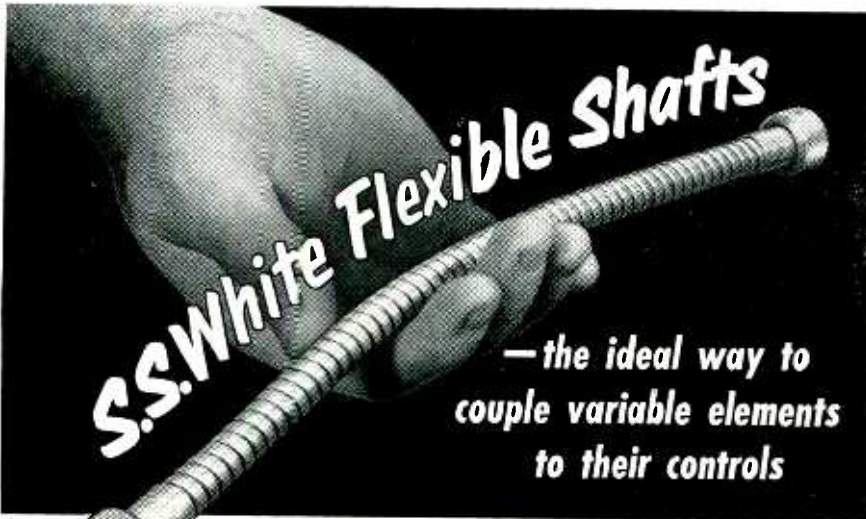

HERE ARE SOME of the advantages you gain by using S.S. White remote control flexible shafts to control parts that require operational adjustment:

LOWER COST. One S.S. White flexible shaft can replace an entire system of bevel gears, universal joints, pulleys, straight shafts, etc., resulting in substantial savings in costs and assembly time.

EASIER ASSEMBLY. S.S. White flexible shafts are furnished as ready-to-install units. Just couple one end to the control knob—the other end to the controlled part—and the assembly is complete. No skilled assembly operations are required.

GREATER DESIGN FREEDOM. Mounting control knobs and variable elements in the most favorable locations is easy when you couple them with S.S. White flexible shafts. The shafts will carry control to any point in your equipment.

SENSITIVE CONTROL. Close, sensitive tuning is possible with S.S. White flexible shafts because they have been built expressly for remote control service. What's more they never lose their sensitivity.



An S.S. White flexible shaft is a simple, economical way to bring control around a turn. Here's how one designer did it in bringing control to an otherwise inaccessible rotary switch.



As shown here, S.S. White flexible shafts enable you to get a convenient, orderly grouping of control knobs, no matter where the variable elements are located.

Send for the Flexible Shaft Handbook—

This 256-page handbook has complete information on flexible shafts including details about their selection and application. Copy sent free if you request it on your business letterhead.



THE S.S. White INDUSTRIAL DIVISION
DENTAL MFG. CO.



Dept. E 10 East 40th St.
 NEW YORK 16, N. Y.

Western District Office • Times Building, Long Beach, California

oscillator triode for 1,680-mc radio-sonde service. The operator solders at one position while the other two positions are heating. She then removes the soldered piece, replaces it with an unfinished piece and proceeds to solder at the next position.

A heavy asbestos top plate minimizes burning of fingers as the operator removes soldered pieces and places new ones over the appropriately machined tips of the soldering irons. Three working positions give sufficient time so the operator can solder, unload and load continuously.

Capacitor Test Set

INCOMING INSPECTION of capacitors to check for adherence to tolerances is carried out with a rugged bridge-type test set in the Tarrytown, N. Y. plant of Simmonds Aerocessories Inc. Preliminary sorting and checking facilitates production of electronic fuel gages by making available the exact capacitor values needed.

The bridge is constructed in



Using test bridge to check values of mica capacitors. After value is measured, operator uses rubber date stamp to stamp exact value in $\mu\mu\text{f}$ directly on the capacitor, then places each capacitor on the stack having that value. Units on bench range from 1,947 $\mu\mu\text{f}$ at lower left to high of 1,990 $\mu\mu\text{f}$ at lower right, with each pile having a different value

three sections for easy servicing. The 5-kc oscillator circuit is shown in Fig. 1, the bridge circuit is shown in Fig. 2 and the null detector in Fig. 3. The accuracy achieved with these circuits is plus or minus 3 μf from 50 to 4,000 μf . Continued accuracy is assured by frequent checking against labo-

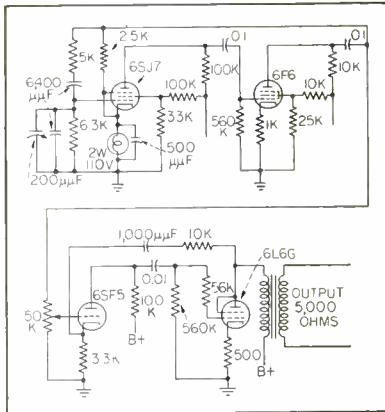

FIG. 1—Circuit of 5-kc RC oscillator

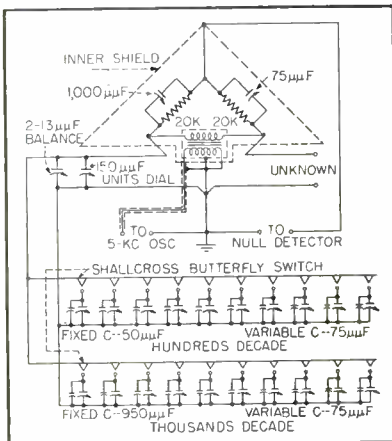

FIG. 2—Capacitance bridge circuit

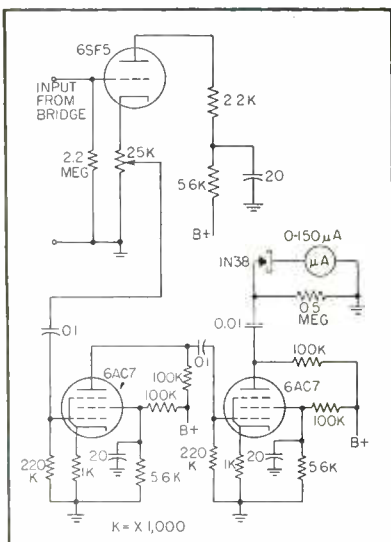
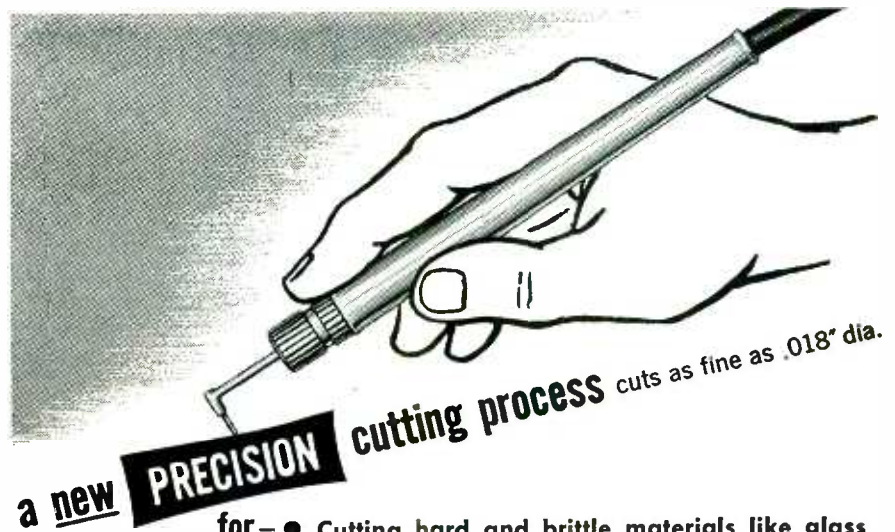

FIG. 3—Circuit of null detector used with capacitor test bridge



- for —
- Cutting hard and brittle materials like glass and germanium.
 - Controlled removal of surface coatings on printed circuits and deposited carbon resistors.
 - Drilling holes in thin sections.
 - Cutting small holes, cavities and slits.
 - Light etching and finishing operations.



The S.S.White "Airbrasive" Unit produces a cutting action by means of a high-velocity stream of abrasive particles which are directed at the work through an .018" diameter nozzle. The cutting action is cool and eliminates the vibration and pressure ordinarily associated with other cutting methods. Furthermore, the accuracy of the cut is not affected by surface irregularities of the work or by wear, as might be the case with a standard cutting tool. The Unit is ideal for laboratory work and can be readily adapted to any production set-up.

Write for Bulletin 5212. It gives full details about the S.S.White Industrial "Airbrasive" Unit, including specifications, prices and operating and performance data.

THE S.S. White INDUSTRIAL DIVISION
DENTAL MFG. CO.

Dept. E 10 East 40th St.
 NEW YORK 16, N. Y.

Western District Office • Times Building, Long Beach, California



CUSTOM BUILT

Electrical Enclosures

by **KIRK AND BLUM**

CONTRACT MANUFACTURING FACILITIES for

- Control Desks • Instrument Panels
- Boiler, Turbine, Generator Panels
- Power Distribution, Control Panels
- Switch Gear Housings • Cubicles
- Machine Bases • Instrument Panels
- Weatherproof Housings • Breechings
- Transformer Enclosures • Air Ducts
- Stacks • Casings • Hoppers

For industry, power plants and utilities, KIRK & BLUM can produce any type of metal enclosure . . . quickly and economically.

Complete facilities for fabrication of sheet steel, plate, light structurals, stainless, aluminum, monel and other alloys.

Whether you need a complex control panel or a thousand boxes, send prints to Kirk & Blum for prompt quotation. For complete details . . . literature on electrical enclosure fabrication facilities and experience . . . write to: The Kirk & Blum Mfg. Co., 3211 Forrer Street, Cincinnati 9, Ohio.

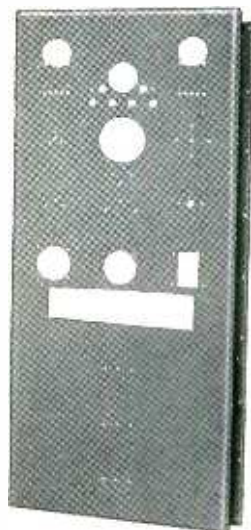

KIRK AND BLUM
METAL FABRICATION



ratory standard capacitors that have been certified by the National Bureau of Standards.

Various types of test fixtures are used in connection with the bridge to provide quick connections to each capacitor in turn. The fixtures are designed to insure precise positioning, eliminating measuring errors that would be particularly serious with smaller sizes of capacitors.

Central Vacuum System Draws Off Soldering Fumes

FLEXIBLE metal tubing about two inches in diameter, connected to the central vacuum system in Crosley's Cincinnati television plant, is used at each soldering position to keep the area clear of fumes produced by soldering operations. The tubing is easily bent to a position that is just a few inches away from the tip of the soldering iron and yet is out of the way of the operator.

When soldering small parts such as the peaking coil shown, a special stand is used to hold the soldering iron. This leaves the left hand of the operator free to hold a cluster of the small parts while applying solder to each in turn with the right hand as they are held on the

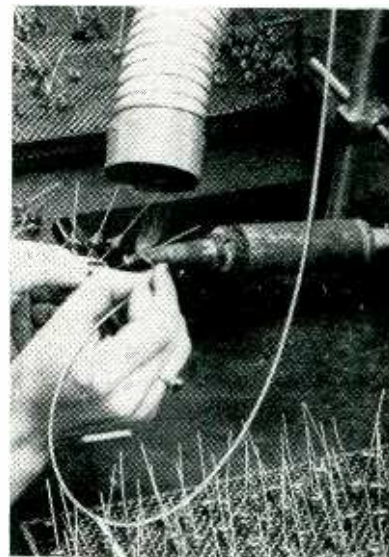

Vacuum-system duct used to pull off soldering fumes, and stand for supporting soldering iron rigidly at optimum working position

soldering iron tip. The stand and clamp are of the type used in chemical laboratories, and were purchased commercially at far less than it would have cost to make them. The slide that locks the clamp at the desired height on the vertical rod was made in the Crosley shop. Total cost of the entire holder was about \$2.25.

Label-Positioning Mirror

TO BALANCE out a moving-conveyor assembly line for television sets, the operation of pasting a tube layout diagram on the back of the chassis was assigned to one work position. The back of the chassis was facing

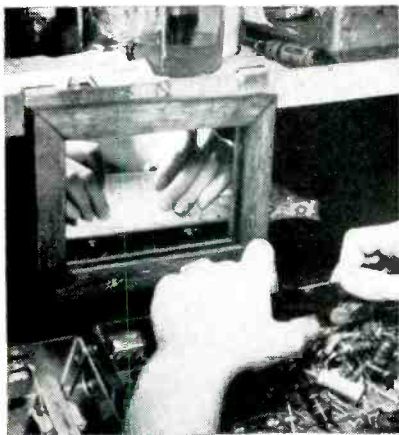

Method of using mirror to aid in positioning a chassis label in Sylvania's Buffalo plant

away from the operator here, hence she could not see it and might possibly cover adjustment holes with the gummed label.

The problem was solved by hanging a small mirror from the back shelf of the bench. The mirror hooks over the edge of the shelf, so that it can easily be slid lengthwise or removed as desired.

Inserts Protect Threads Tapped in Copper

WORK COILS used with induction heaters must be removed frequently and replaced with new coils to accommodate differing sizes and shapes of parts being heat treated. These coils, also known as induction blocks, are secured to threaded holes in the outlet plates of the out-

**THIS
STEEL
CORE**

**CUTS
COSTS
OF**

REPUBLIC
Aluminum Foil

Republic's development of steel cores for spooling capacitor foil can save you money. No more time-wasting cleaning of cores, no more sorting and guessing as to which supplier owns them, no more bother or fuss. Simply discard Republic's steel cores and sell them for scrap. This is just one of the many little things that make it economical to buy Republic Aluminum Foil.

Some of the really big things are that Republic capacitor foil has clean, straight edges, consistently accurate gage, and that coils are individually boxed for protection. These are the things that make for economy through maximum production.

Republic capacitor foil is available in widths of 1/4" and wider, and in gages from .00017" to .005".

**REPUBLIC FOIL & METAL MILLS
INCORPORATED**
DANBURY CONNECTICUT

Branch Sales Offices: 209 W. Jackson Blvd., Chicago 6, Ill.
666 Mission St., San Francisco 5, Cal.



Panel Indicators for all Applications

JOHNSON PILOT LIGHTS

All the qualities needed for clear, positive indication are available in all Johnson Pilot Lights. Furnished from stock with full or controlled brilliance; faceted or smooth jewels, plain or frosted. Colors are clear, red, green, amber, blue or opal.



WIDE ANGLE

147-1220 UL Approved. For economical, continuous operation with neon or low powered incandescent bulbs. Double contact bayonet base contains series current-limiting resistor. Red, amber or clear Lucite cap transmits light with good efficiency.



VARIABLE LIGHT INTENSITY

147-1519 Camera type shutter. Rotation of jewel head varies light from full brilliance to off. Uses G6 double contact bayonet based bulb. Other types available with polarized discs for light variation.

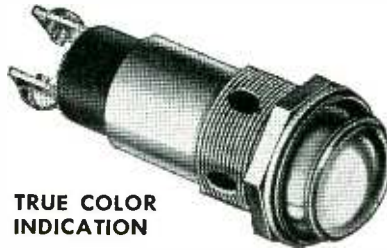

TRUE COLOR INDICATION

147-1034 UL Approved. Internally frosted jewel with plastic backing color disc eliminates false indication from external light. Color does not appear until lighted. Disc may be specially imprinted and arranged for continuous visibility or only when lamp is lighted.



ECONOMY DETACHABLE SOCKET

147-800 Chrome plated friction jewel holder. Lamp replaceable from front or rear of panel. Socket detachable from panel bushing. Insulated solder terminals. For miniature screw, candelabra screw or bayonet based bulbs.

Send for Catalog 973

Select Pilot Lights exactly suited to your needs from the complete Johnson line. Write us your requirements and we will be glad to suggest suitable selections.



E. F. JOHNSON COMPANY

CAPACITORS, INDUCTORS, SOCKETS, INSULATORS, PLUGS, JACKS, DIALS, AND PILOT LIGHTS

228 SECOND AVENUE SOUTHWEST • WASECA, MINNESOTA

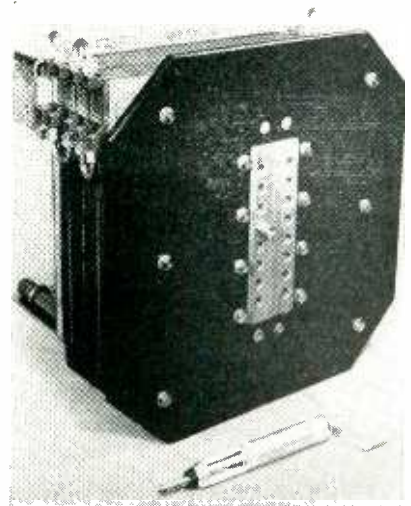

Outlet plate of induction heater transformer, with one insert partly installed and fifteen others already in the threaded holes. Wire-inserting tool is shown below

put transformer of the heater. The problem of thread wear and thread stripping at this point has been solved by the use of stainless steel wire inserts made by Heli-Coil Corporation, Danbury, Conn. The thread inserts provide much higher resistance to wear and corrosion than unprotected threads, and permit higher loading.

The 3-16 wire inserts, resembling



Example of induction heater using wire thread inserts in transformer panel face. Fixture in foreground is bolted to the generator and its inductor blocks are mounted securely on the transformer panel with cap screws that go into the insert-protected holes. The fixture serves to locate a sprocket during heating and hardening of its teeth

coil springs, are inserted with a special tool. Once installed, they insure good electrical and physical connections between inductor blocks and transformer outlet plates in induction heating units such as those manufactured by the Tocco Division of Ohio Crankshaft Co. Another use for the inserts, still experimental, is for protection of threads in insulating materials.

Cold Soldering Technique for Printed Circuits

AS A substitute for lead-tin solders for making electrical connections in printed circuits, a composition of powdered silver and Araldite resin known as cold solder has merit in that only low curing temperatures are required. Formula No. 1 consisted of 14 grams Araldite 101 (made by Ciba Co.), 35 grams DuPont Silver Powder V-9 and 1.5 grams Araldite Catalyst HN-951. This was mixed at 150 F for ten minutes. Since the mixture is too viscous (viscosity of vaseline) for hand mixing, a mechanical means will have to be used until a suitable solvent for lowering the viscosity is found.

Test joints for measuring bond strength were made using metal strips 1 in. x 3 in. x 0.005 in., cemented together at the ends so that they overlapped 1/2 in. The cement was applied by means of a spatula and the strips pressed together. Specimens prepared in this manner were allowed to cure at room temperature over night. Other specimens were cured at 100 C for one hour. Joints made with strips of copper, aluminum and brass were tested to see if different metals had any bearing on bond strength. The specimens were ruptured on an Olsen tensile Test Machine. Ultimate shear strength in lb per sq in. averaged 1,720 for aluminum to aluminum, 1,640 for copper to copper and 1,830 for brass to brass.

Formula No. 2, using 0.5 gram more catalyst to accelerate curing time, gave lower shear strength values (1,300 for Cu-Cu cured 1 hr at 100 C, and 1,400 for Cu-Cu cured overnight at room temperature).

A variety of electrical connec-



No matter how marginal the weather, planes land safely on fields equipped with TVOR. This new let-down facility keeps your airport operating through rain, low ceilings and restrictions to visibility—extends its usefulness by 40%. TVOR provides all the security of VOR—at less than one-fourth the cost.

TVOR was developed to meet the needs of small and medium-sized airports. Its single installation provides a terminal omnidirectional radio range that can be installed in an inexpensive shelter directly on the airport.

Any plane with standard VOR instrumentation can make positive approaches to a TVOR equipped field. On course indication is steady. Over the station cone is definite. Fifty watts of antenna power provides ample coverage for omnirange navigation. TVOR is built by the Maryland Electronic Manufacturing Corporation, producers of similar installations for the CAA.

The cost of a complete TVOR installation is less than a quarter that of VOR. Yet the components are of the same high quality and the system is given the same rugged tests!

Corporation, municipal and private airfields can't afford to be without the safety and convenience of this all-weather let-down facility. Installations are ready for 90 day delivery. Write or call today for further information. Or flight test and inspect the equipment at the College Park Airfield.

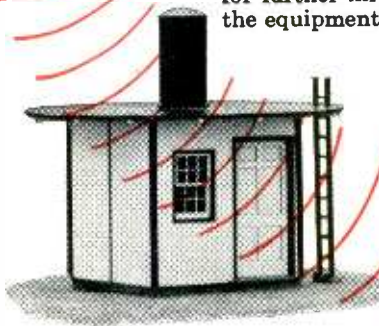

TVOR changes fair-weather to all weather airline service.

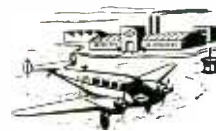

TVOR guides corporation aircraft safely to their home fields, in spite of low ceilings.



TVOR works with standard instrumentation. Private planes "home" on their own airfield.

MARYLAND ELECTRONIC MANUFACTURING CORPORATION
 COLLEGE PARK 24, MARYLAND

PULSE FORMING NETWORKS

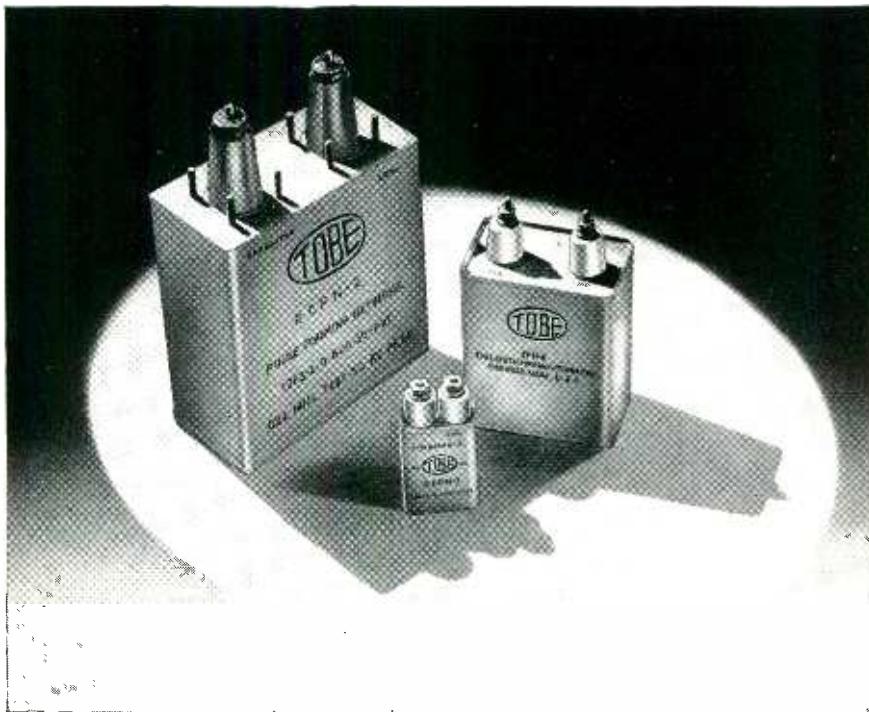

- Any pulse width from 0.1 to 40 microseconds
- Any impedance from 5 to 500 ohms
- Any voltage rating from 1000 to 25000 volts*

Tobe pulse forming networks have an excellent record of performance, both in radar sets and in seasoning equipment for magnetrons and hydrogen thyratrons. Our design experience and production facilities assure deliveries to your schedule requirements. Widely used networks are tabulated below. Many others are available — write for data sheet.

*Over 25KV, pulse-type capacitors with external coils are usually recommended; write for data sheet.

TOBE TYPE	CODED IDENTIFICATION	DIMENSIONS (exclusive of terminals)
DPN-1	6E { 3 - 0.75 - 800 9 - 2.25 - 300 14 - 3.50 - 200 20 - 5.00 - 200 }	50P6T 2½ x 3¼ x 3½
GEPN-2	2.64E 2 - 0.4 - 800 - 50P2T	1½ ₁₆ x 1½ ₁₆ x 2½ ₁₆
GEPN-4	14E { 2 - 0.5 - 2000 7 - 0.185 - 380 9 - 2.35 - 380 }	50P4T 8 x 4 x 4¼
RCPN-2	17E3 - 2.0 - 600 - 50P2T	3 x 6 x 7
RCPN-4	24E 2 - 1.0 - 630 - 25PY2T	10 x 4½ x 7 ⁹ / ₁₆
RPN-5	11.5E4 - 2.0 - 400 - 16P2T	5¼ x 10 x 10
SPN-8	6E4 - 0.45 - 2000 - 50T2T	3¾ x 2¼ x 4¾
SPN-14	8E { 2 - 0.25 - 4000 4 - 0.50 - 2000 7 - 1.0 - 1000 12 - 2.0 - 500 }	55P8T 4 x 8 x 2
SYPN-6	2E3 - 1.0 - 50 - 50P2T	1½ ₁₆ x 1½ ₁₆ x 3¼



TOBE DEUTSCHMANN
CORPORATION
NORWOOD, MASSACHUSETTS

tions were tested using cold solder as the bonding agent. For example, several sizes of composition resistors were soldered on a printed-circuit base plate and the assembly was then subjected to a temperature of -65 C. The soldered connections were strong enough to withstand pressure applied by the fingers.

Resistance measurements were made on the cold-soldered joint. Resistance values of the joints varied between 0.1 to 0.01 ohm at room temperature.

The information presented here was abstracted from a technical report, "Development and Application of Automatic Assembly Techniques for Minaturized Electronic Equipment", prepared by Stanford Research Institute for the Wright Air Development Center.

Induction Soldering Setups

TWO DIFFERENT techniques for bringing work to be soldered up to the work coil of a high-frequency induction heater eliminate loss of time in waiting for parts to cool enough so they can be handled. One technique uses a rotary work table, and the other a jig that holds sixteen parts at a time.

In soldering the seams on tin-plated steel housings for signal drops, Federal employs a rotating table located in front of the induc-



Six-position pedal-operated work table brings tin-plated steel housings under work coil for soldering of seams. Strips of precut solder are in wood box, and unsoldered housings are stacked neatly on table. Finished housings go into bin on floor at right of operator

tion heater. The operator brushes on flux and places a strip of tape solder along the seam, then sets the piece on the work table at the position just ahead of the heating coil. He then operates the foot pedal to move the piece under the coil and turn on the generator. An electronic timer controls the soldering interval; it takes about 2 seconds for the solder to melt and fill the seam.

The six-position work table allows ample time for the solder to

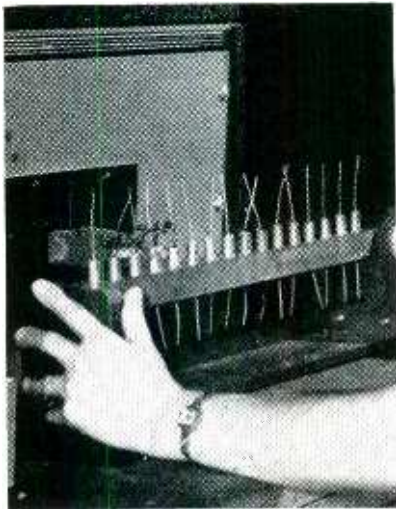

Jig used to push each of 16 paper capacitors in turn between loops of work coil to obtain soldered hermetic seal

harden and cool. The finished piece is removed just before a new piece is put on. Clearance between the piece and the lower edge of the work coil is $\frac{1}{16}$ inch. A fluorescent tube hung in the electromagnetic field of the generator lights up when power is on, to serve as an indicator and a warning that the equipment is energized.

End plates of metalized paper capacitors are hermetically sealed to the metal housings by induction soldering in Astron's plant. A simple jig having holes drilled part way through a wood crossbar to take 16 capacitor units is used to bring each part in turn to the work coil. The operator energizes the machine by foot pedal each time a part is in position. A power application of a few seconds is adequate to fuse the circular solder preform, thus soldering the housing to the

FEED-THRU FILTER

for easy installation and efficient operation

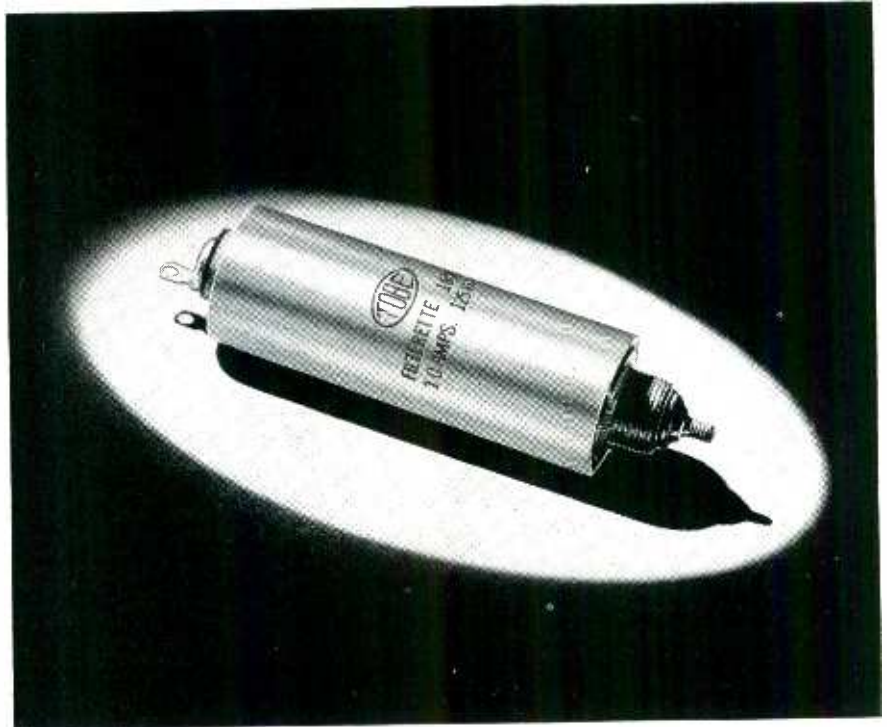

THE TOBE TYPE 1600 POWER LINE FILTER utilizes the efficient, feed-thru design to provide high attenuation over a broad frequency band. Installation is rapid and easy — the threaded bushing permits mounting and grounding in a single operation. Feed-thru construction places the shield afforded by the metal mounting surface between filtered and unfiltered circuits.

FEATURES

- Handles 10 amperes at 125 volts a.c., 0-1000 C.P.S.
- High attenuation — 150 KC to 1000 MC
- Low voltage drop
- Low temperature rise at full load
- Operates at ambients from -40°C to $+85^{\circ}\text{C}$
- Compact — $3\frac{1}{4}$ inches long by $1\frac{1}{8}$ inches diam.
- Hermetically sealed
- Meets JAN specifications for vibration, shock, and salt-spray resistance

Write for data sheet.

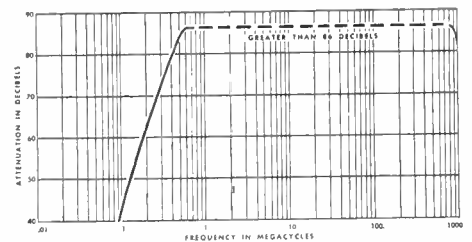

TOBE DEUTSCHMANN
CORPORATION
NORWOOD, MASSACHUSETTS

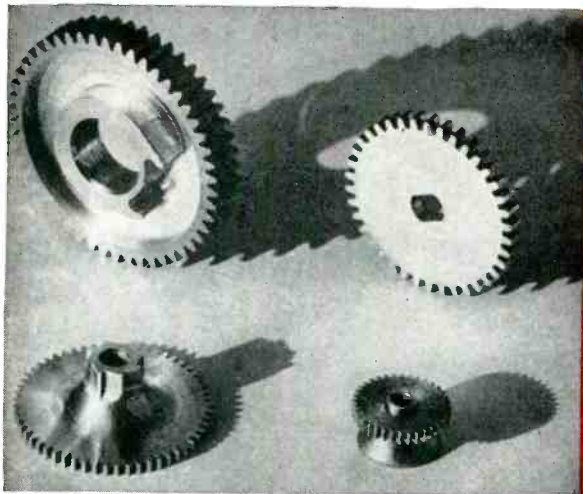

GEARS WITH SHAPES

- SPUR
- WORM
- SPLINE
- HELICAL
- SPROCKET
- STRAIGHT BEVEL
- GROUND THREADS

Special Shapes and Features? . . . Tolerances within .0005" . . . Let our experience in supplying precision small and medium sized gears with such features solve these production problems for you . . . Ask for quotation on your job specifications. Circular on Request.

THE *Finest*



IN GEARS

Beaver Gear Works Inc.

1021 PARMELE STREET, ROCKFORD, ILLINOIS

MIL-B-233A
JOINT ARMY-NAVY
SPECIFICATIONS

SPARE AND REPAIR PARTS BOXES



Write for Catalog and Price List.

ART-LLOYD Metal Products Corp.

2973 Cropsey Ave., Brooklyn 14, N. Y. • CO 6-5100

PRECISION SHEET METAL PRODUCTS, MASS PRODUCTION SPECIALISTS.

Manufactured to meet material, workmanship and finish requirements of Army-Navy specifications.

Accessories: Internal framing, partitions, trays and wood chucks as required.

Complete Facilities under one roof for quality mass production, including Heliarc welding, baking and finishing. Whistler and Wiedermann equipment for short runs. Tool and die engineering and designing. Completely conveyerized finishing facilities. Large assortment of stock and special dies for radio and television and electronic field.

outer ring of the glass-to-metal seal for the lead. Each part is left in position for about 15 seconds to permit the solder to harden, before the jig is pulled back and moved for soldering of the next part.

After leads have been soldered to one end of a batch of 16 capacitors, each unit is pulled out and turned over in the jig for soldering of the other leads. The finished leads project downward through small holes in the center of each large hole.

Parts-Mounting Fixture

BOLTING of four large components to an auto-radio chassis is speeded through use of a simple positioning fixture that holds the parts upside-down in their correct final positions. The chassis can then be placed over all of them in one operation. Nuts are quickly applied with an air gun, after which the mounting tabs for the electrolytic capacitor are twisted.

Wherever feasible, magnetic chucks are used in air guns to hold the mounting nuts. A small piece of Alnico in the chuck provides ample lifting power for steel Palnuts.

When driving brass nuts, a large piece of beeswax is kept alongside the working position. The driver is jabbed into this after about each dozen nuts, to maintain the stickiness required to grip the nut.

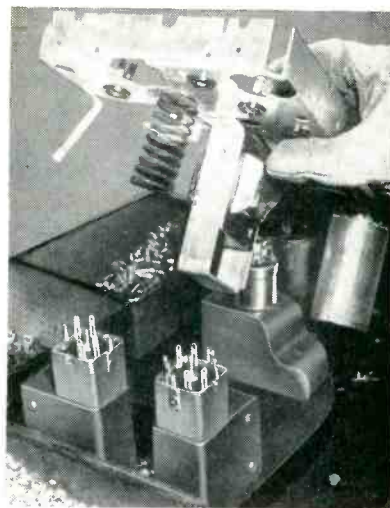

Fixture used in Sylvania's Buffalo plant to hold two i-f transformers, an electrolytic capacitor, a vibrator and a vibrator transformer so that the chassis can be placed over all of them at once



JFD MFG. CO.
 BROOKLYN 4, N. Y.
 BENSONHURST 6-9200

*world's largest manufacturer
 of tv antennas & accessories*

leading manufacturers use
JFD PISTON TYPE VARIABLE TRIMMER CAPACITORS
 in both civil and military equipment

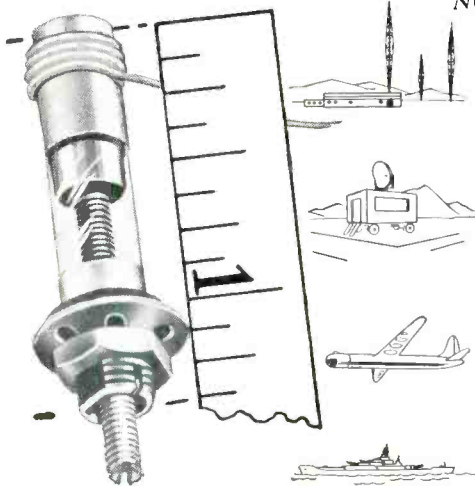

NO OTHER LIKE IT!

- Spring loaded piston made of special invar alloy having extremely low temperature coefficient of expansion.
 - Silver band fused to exterior of precision drawn quartz or glass tube serves as stationary electrode.
 - Piston dimensional accuracy is held to close tolerance maintaining minimum air gap between piston and cylinder wall.
 - Approximately zero temperature coefficient for quartz and ± 50 P.P.M. per degree C. for glass units.
 - "Q" rating of over 1000 at 1 mc.
 - Dielectric strength equals 1000 volts DC at sea level pressure and 500 volts at 3.4 inches of mercury.
 - 10,000 megohms insulation resistance minimum.
 - Operating temperatures, -55 C. to +125 C. with glass dielectric. And -55 C. to +200 C. with quartz dielectric.
 - Over 100 megohms moisture resistance after 24 hours exposure to 95% humidity at room temperature.
- Write for Form No. 199

SEALING
 DIPPING
 POTTING
 IMPREGNATING



INSULATING
 FUNGUSPROOFING
 MOISTUREPROOFING
 HEAT CONDUCTING

WAXES BIWAX COMPOUNDS

Developed and produced for manufacturers of electronic components and other electrical units.

Specifications and samples available on request. Information relative to your problem or application will enable us to make suggestions and recommendations.

BIWAX CORPORATION 3445 HOWARD STREET
 SKOKIE, ILLINOIS

WASHERS—ALL KINDS



WASHER SPECIALISTS for nearly half-a-century. Dies in stock will produce most sizes. Big runs made with automatic presses. An economical, accurate, and highly reliable source for washers, also all kinds of metal stampings. **HAVE WHITEHEAD'S CATALOG ON FILE; write for it.**

BEVELED CUP
 D-HOLE RETAINER
 LOCK SPACERS
 SPRING TENSION SQUARE HOLE
 STAR LOCK THRUST TONGUE

WHITEHEAD STAMPING COMPANY
 EST. 1903
 1691 W. LAFAYETTE • DETROIT 16, MICH.



For
AC CURRENT ANYWHERE



STANDARD AND HEAVY DUTY INVERTERS
 For Inverting D. C. to A. C.
 Specially Designed for operating A. C. Radios, Television Sets, Amplifiers, Address Systems, and Radio Test Equipment from D. C. Voltages in Vehicles, Ships, Trains, Planes and in D.C. Districts.

ATR ✓ NEW MODELS
 ✓ NEW DESIGNS
 ✓ NEW LITERATURE
 "A" Battery Eliminators, DC-AC Inverters, Auto Radio Vibrators
See your jobber or write factory
AMERICAN TELEVISION & RADIO CO.
 Quality Product's Since 1931
 SAINT PAUL 1, MINNESOTA—U. S. A.

NEW PRODUCTS

Edited by WILLIAM P. O'BRIEN

Control, Testing and Measuring Equipment Described and Illustrated . . . Recent Tubes and Components Are Covered . . .
Forty-Two Trade Bulletins Reviewed

OTHER DEPARTMENTS

featured for this issue:

	Page
Electrons At Work	144
Production Techniques	226
Plants and People	334
New Books	346
Backtalk	358



Junction Transistors

RAYTHEON MFG. CO., 55 Chapel St., Newton 58, Mass., announces the immediate availability of two *pn*p germanium junction transistors types CK721 and CK722. Although CK722 may be had in production quantities, CK721 will be limited in quantity until April 1953. Both types have noise factors averaging 22 db at 1,000 cycles. Type CK721 has an average power gain of 38 db while CK722 averages 30 db. The units require a volume of 0.03 cu in. and leads may be soldered or welded into the circuit or cut for insertion into standard subminiature sockets.

roof-top to receiver. Design characteristics include a high-strength Copperweld conductor surrounded by polyethylene spiral thread that acts as a centering medium, allowing the conductor to float within its individual polyethylene tube. The brown polyethylene jacket assures better protection against weather and greater resistance to abrasion, assuring longer life of lines and greater protection against mechanical damage. The new cable has been tested and found equally reliable over the entire range of both vhf and uhf channels. Considerable savings on critical materials, particularly on copper, are represented in the new line.



TV Scanner

FEDERAL TELECOMMUNICATION LABORATORIES, INC., Nutley, N. J., has developed an improved version of its Poly-Efex Scanner, FTL-93A, for tv station application. Incorporating advanced circuits and expanded operational features, the scanner now allows a single operator to take complete charge of a station's program sources and to present them in the most effective manner. The unit, basically a dual

flying spot scanner, has in addition to its two self-contained slide sources, a four-channel video switcher and a special effects or montage section. An integral gamma correction circuit has been built into the unit to compensate for the nonlinearity of the raster produced by the c-r tube. This gives an overall effect of greater contrast range.



Sensitive Relay

NEOMATIC, INC., Los Angeles, Calif., announces the sensitive relay, a hermetically sealed unit especially well adapted for use with transistors and germanium diodes. The hermetic seal may be either air or an inert gas. Sensitivity runs as low as 10 mw and the unit will operate as low as 0.0008 ampere. Contacts are spdt to 3 amperes, 24 v d-c; 115 v a-c, noninductive. Coil resistances are available from 4 to 20,000 ohms. Standard temperature range is -55 C to +85 C. The unit is noteworthy for high-speed



UHF Transmission Line

ANACONDA WIRE & CABLE CO., New York 4, N. Y., has developed a new all-weather uhf transmission line for tv service. Known as type ATV-270, the line serves as lead-in from

SYLVANIA PICTURE TUBES

Lasted Longer than others tested!

"IT'S A TRUE
BLUE-RIBBON
TUBE"



BEST IN
OVER-ALL
POINT
QUALITY!

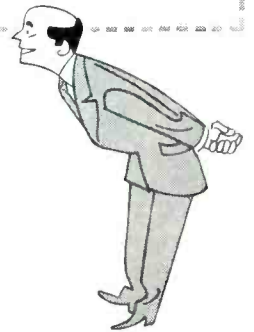

SYLVANIA
OUTLASTED
ALL TUBES
TESTED



Only Sylvania tubes showed NO FAILURES after 1400 hours . . . at accelerated voltages

Exhaustive tests conducted under the supervision of an outside impartial laboratory, the United States Testing Company, showed Sylvania Picture Tubes lasted longer than any others tested.

These tests included the picture tubes of nine leading manufacturers. All tubes were placed in identical test racks and tested under identical accelerated voltages. At the end of 1400 hours, only the Sylvania

Picture Tubes showed *no failures*.

These tests definitely establish the outstanding dependability of Sylvania Picture Tubes. They prove that these tubes will best uphold your reputation for fine performance in the sets you manufacture, sell or service. Send today for complete details about Sylvania Picture Tubes. Sylvania Electric Products Inc., Dept. 3R-1001, 1740 Broadway, New York 19, New York.

TESTS CONDUCTED
BY U.S. TESTING
COMPANY



SYLVANIA

RADIO TUBES; TELEVISION PICTURE TUBES; ELECTRONIC PRODUCTS; ELECTRONIC TEST EQUIPMENT; FLUORESCENT TUBES, FIXTURES, SIGN TUBING, WIRING DEVICES; LIGHT BULBS; PHOTOLAMPS; TELEVISION SETS

operation, operating as rapidly as 2 to 3 milliseconds, depending somewhat upon coil inductance. Its small size is an additional feature. Weight is 2.14 oz.

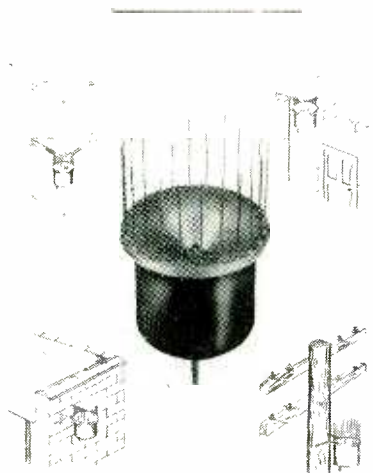

Weather Sensing Equipment

MOTOROLA, INC., 4545 W. Augusta Blvd., Chicago 51, Ill., has developed a weather sensing unit known as the Snow Detector. Designed primarily for the de-icing of microwave antennas, it also has numerous other applications. The unit, only 7¼ in. in diameter, detects precipitation when the ambient temperature drops below 37 F. Fully automatic, it will turn on heating elements whenever icing conditions exist. Up to 30 amperes at 117 v a-c can be switched without external relays. The heaters will then remain on until the icing hazard is past, being automatically turned off by the detector.



Regulated Rectifier

INET, INC., 8655 South Main St., Los Angeles 3, Calif., has announced a new type of high-performance a-c to d-c regulated

rectifier. Named the MagniVolt, it combines ruggedness and close regulation of low voltage in a highly dependable low-cost unit. Regulation by the instrument is better than 1.0 percent for no load to full load with ± 10 -percent a-c line variation. Response is faster than 0.2 second, even under extreme contrast of load conditions. The rms ripple is less than 1.0 percent. The MagniVolt is designed to operate on 115 v, single phase, 60-cycle current. It is built in standard models ranging from 1.2 v to 28.0 v and from 2.5 amperes to 30.0 amperes. It features a magnetic amplifier that contains no moving parts or vacuum tubes.



Transmitter

RADIO LABORATORIES, INC., 1846 Westlake Ave. North, Seattle 9, Wash. Model 75 transmitter was designed for marine, aeronautical and fixed station use. Any two frequencies may be monitored simultaneously, using the crystal receiver for one and the tunable receiver for the other. The crystal receiver features a new improved noise limiter, a variable squelch circuit, plus automatic blanking of the tunable receiver. When a carrier is received on the crystal receiver it electronically disables the tunable receiver so the message may be clearly received. The transmitter features eight independent, separately-tuned channels for maximum efficiency. Also available are 35 watts of audio for paging, public-address or deck horn operation.



Voltage Tester

HOLUB INDUSTRIES, INC., 413 DeKalb Ave., Sycamore, Ill., has announced a voltage tester having only one test lead and other new design features. It is called the Hi-Test and indicates a-c or d-c voltage from 115 to 600 v. The second test prod is permanently mounted in one end of the tester making it easy to hold the tester in one hand and still press the prod firmly against contact or wire. The voltage scale is located in the end of the tester opposite the prod where it is always in full view. Flashover between ends of the solenoid coil is completely eliminated as the wires are brought out of the case at opposite ends of the coil. Overall length of the tester is 8½ in.; test lead with 4-in. plastic handle, 48 in.; and weight, with carrying case, 10 oz.

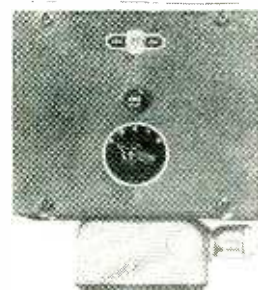

Selenium Rectifier Power Supplies

RAPID ELECTRIC Co., 2881 Middletown Road, New York 61, N. Y., has announced a new line of selenium rectifier power supplies

the **RIGHT COMBINATION** for
maximum performance at minimum cost



audiotape*

that meets the most exacting
professional requirements

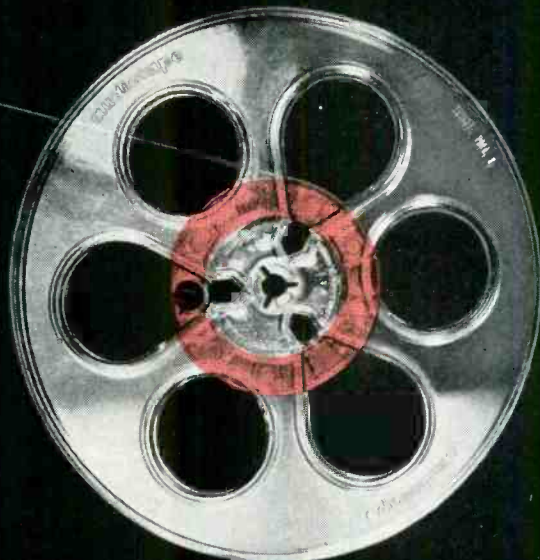

NEW 7" REEL

that eliminates the
"high-tension" zone

NO SPLICES. As always, plastic-base Audiotape in 1200 and 2500 ft reels is guaranteed *splice-free*.

NO FRICTION SQUEAL. Perfected anti-friction process eliminates annoying tape squeal—prevents "tackiness" even under extreme temperature and humidity conditions.

MINIMUM DISTORTION. Audiotape's oxide coating is especially formulated to give *maximum undistorted output*. Comparative tests show its marked superiority in this respect.

MAXIMUM UNIFORMITY. All 7" and 10" reels of plastic-base Audiotape are *guaranteed* to have an output uniformity within $\pm\frac{1}{4}$ db—and a reel-to-reel variation of less than $\pm\frac{1}{2}$ db. And there's an actual output curve in every 5-reel package to prove it!

PRECISION TIMING. Improved reel design with $2\frac{3}{4}$ " hub reduces timing errors by eliminating the tension and speed changes formerly encountered at the beginning and end of the winding cycle. Ratio of OD to hub diameter is the same as the standard NAB 2500 ft reel.

CONSTANT PITCH is another advantage of the new reel design resulting from the more uniform tape speed throughout the winding cycle.

SLOWER ROTATIONAL SPEED, due to larger hub diameter, minimizes vibration and avoids possible damage to tape on fast forward and rewind.

REDUCED HEAD WEAR can also be expected, because the maximum tape tension is materially decreased.

audiotape gives you all these advantages at no extra cost!

* Trade Mark

This new 1200 ft plastic reel with $2\frac{3}{4}$ " diameter hub is now being supplied on all orders for 7" reels unless otherwise specified... at no increase in price. Remember—with Audiotape, there's only *one* quality—the finest obtainable! Audiotape is available in all standard size reels from 150 to 5,000 feet.

AUDIO DEVICES, Inc.

444 Madison Ave., New York 22, N. Y.

Export Dept. 13 East 40th St., New York 16, N. Y., Cables "ARLAB"

audiodisks audiotape audiofilm audiopoints

CTRP's*

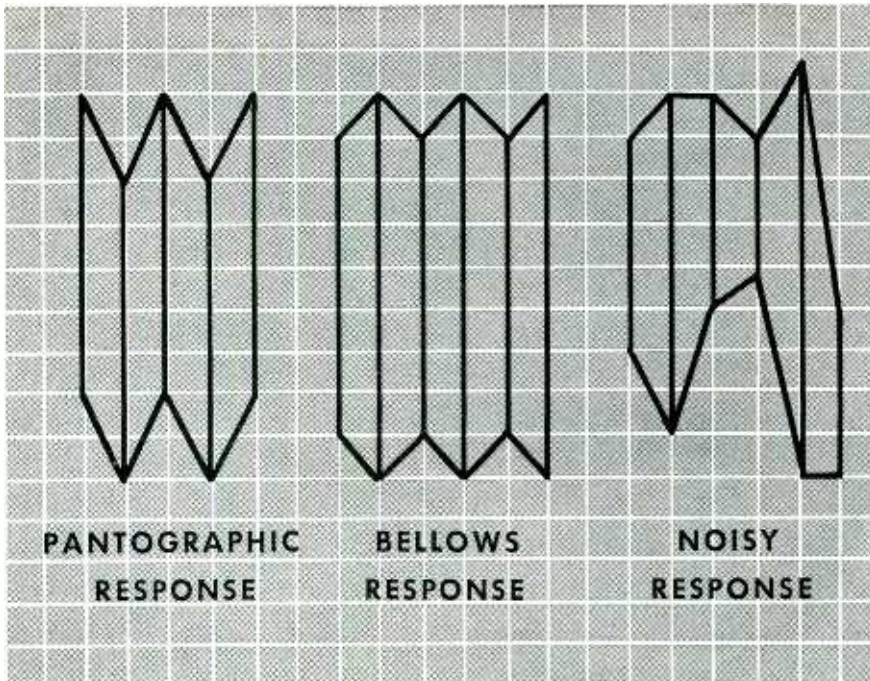

In a recently published document*, reference was made to the "Cyclic Thermal Response Pattern — CTRP". The significance of this concept was overlooked by many who believed the publication was not a serious work. The error undoubtedly springs from the rather free (hand) treatment of the block and pictorial diagrams.

Actually, the CTRP concept arose in an effort to make sense out of one of the worst difficulties faced in trying to expand manufacturing capacity enough to satisfy the current military demand.

The response of sensitive relays to variable ambient temperature

varies considerably both between individuals and types. In the CTRP diagram, successive vertical lines represent relay response at successive extremes of ambient temperature. Top and bottom lines trace excursions of pull-on and drop-out values.

Often the Pantographic tendency overshadows the Bellows factor and, not infrequently, neither one emerges above the "thermal noise level". The sensitive relay, however, is like the bumblebee which, cheerfully unaware of the aerodynamic facts of life, goes right ahead and flies! With no really good excuse, thousands of them operate with reasonable reliability.

*See "Tri-Stable Two-Stage Caloriferer with Biased Viewpoint Adjustment" — Sigma Instruments, Inc. publication.

SIGMA

SIGMA INSTRUMENTS, INC.

62 PEARL ST., SO. BRAINTREE, BOSTON 85, MASS.

designed for installation at individual work stations. Each of the two models currently in production, a 300-watt unit and a 500-watt unit, operates from a 115-v 60-cycle line, and furnishes from 90 to 135 v of filtered d-c output. Output voltage may be varied in approximately equal steps by a 5-position tap switch. Output ripple is less than 5 percent at full load. Both units are rated for continuous duty at full load. Over load protection is built into the circuit.

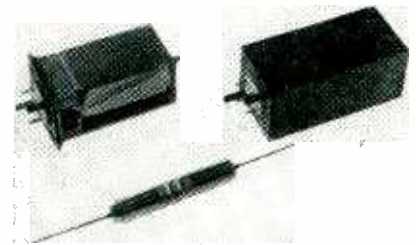

Ball Relay

MAGNEX CORP., 90-28 Van Wyck Expressway, Jamaica 18, N. Y., has announced a shock-proof hermetically-sealed relay of unique design, capable of operating at speeds over 100 cps, for use on d-c circuits. It uses magnetic balls as the contact medium providing new contact surfaces on each operation and preventing misoperation under vibration in locations such as aircraft and automobiles. A special non-magnetic plating on the balls and the pole pieces provides a long life contact and avoids sticking caused by current interruption. The special material used also prevents contact holding due to residual magnetism. The pole pieces are insulated from each other and are the terminals of the circuit to be closed.



Carbon Film Resistors

CHASE RESISTOR Co., 9 River St., Morristown, N. J., is producing two

high stability carbon film resistors. For maximum stability these are sealed in glass envelopes, evacuated, baked at high temperatures under vacuum, and finally sealed in helium of spectroscopic purity. These units are stable to 0.01 percent under all environmental conditions, and have long time drift of 0.01 percent per year or less. They can be supplied in networks with ratios and temperature coefficients held to close tolerances. Less expensive units are made by solder-sealing resistors in ceramic tubes with metallized ends. The stability of these is less than that of the glass-helium sealed resistors, but much better than that of varnished resistors, particularly under conditions of high humidity and temperature.



Decimal Counting Unit

BERKELEY SCIENTIFIC Division of Beckman Instruments, Inc., 2200 Wright Ave., Richmond, Calif. Model 730 preset decimal counting unit is a direct-reading electronic counter capable of producing output information at any selected count. It will operate at speeds up to 40,000 counts per second and resolve pulse pairs separated by as little as 5 μ sec. Each counter is a plug-in unit designed for ease of replacement and simplification of maintenance problems in high-speed counting equipment. Units are completely interchangeable. The preset decimal counting unit counts from 0 to the preset number and produces an output pulse. By employing additional circuits this out-



**Need
Linear and
Non-Linear
ACCURATE
Functions?**

Use Fairchild Precision Potentiometers

Experience with Fairchild potentiometers in hundreds of applications shows that these units are unusually precise. Accuracies of $\pm 1\%$ in non-linear types and as high as $\pm 0.05\%$ in linear types can be guaranteed. Service life as high as 10,000,000 cycles, under certain conditions, also can be provided. High resolution, low torque, and low noise level are other performance features worth noting.

Fairchild Precision Potentiometers perform mathematical computations in electrical computing systems for machine-tool controls, process controls, telemetering, guided missiles, flight control, fire control, and analog computers of all types. They are available in non-linear and linear types and in ganged combinations of either or both windings to meet your requirements.

Use the coupon below to get full details.



THIS COUPON MAY HELP SOLVE YOUR POTENTIOMETER PROBLEMS!

Department 140-32A
 Potentiometer Division
 Fairchild Camera and Instrument Corporation
 Hicksville, Long Island, New York

Gentlemen:

Please send me complete information about Fairchild Precision Potentiometers, and tell me how you might solve my potentiometer problems.

Name _____
 Title _____
 Company _____
 Address _____

FOR MAXIMUM FLEXIBILITY IN WAVEFORM TIMING



The Browning Model GL-22A Sweep Calibrator is designed to free its users from limitations encountered in the use of crystal calibrators.

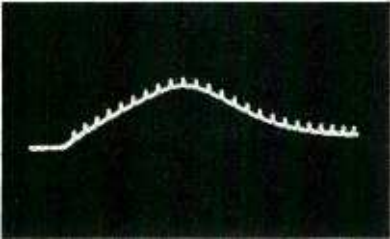

Positive pulse with markers to provide deflection—modulated display.

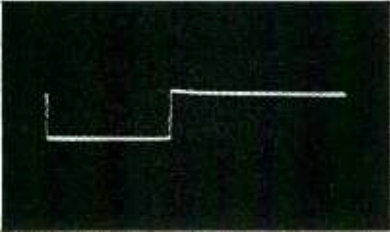

Negative gate pulse.

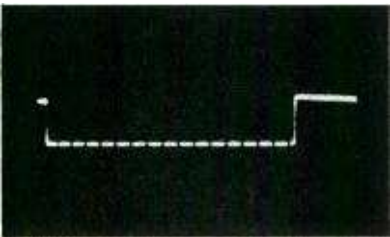

Negative pulse with markers used to blank sweep.

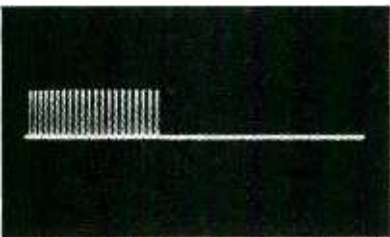

Positive marker output.

here are its advantages

It can be used as the triggering source, or can be triggered externally by the output of the device to be calibrated. The external trigger may be recurrent, up to 100 KC, random, or "one shot".

Using the internal trigger, the interval between successive markers is wholly independent of the trigger rate. The internal trigger is continuously variable from 200 to 5000 pulses per second.

The markers are produced through the keying action of a continuously variable gate, and thus can be restricted to the desired portion of an observed waveform. The gate pulse itself is also available as a useful output, of either polarity, and known duration.

The output markers, at 0.1, 1.0, 10, or 100 microseconds, accurate to $\pm 1\%$, of either polarity, can be continuously varied to 50 volts amplitude—sufficient for either intensity or deflection modulation use. The available intervals, in conjunction with the customary ruled screens, permit accurate measurement of intervals from 0.01 microsecond to several thousand microseconds.

Send for data sheet giving full details.

NEW PRODUCTS

(continued)

put pulse can be used electronically to reset the unit.



Octal Sockets

SYLVANIA ELECTRIC PRODUCTS INC., Warren, Pa. Designed to specification JAN-S-28A, the company's new octal sockets are available with either grade L-4B or better ceramic insulating base or with type MFE low-loss phenolic plastic insulation. Mounting saddles are brass nickel-plated with four ground lugs hot tinned for solderability. Saddles are available with 0.156-diameter mounting holes or with threaded extrusions for 6-32 screws. Contacts are available in either phosphor bronze or beryllium copper, silver plated. The sockets are designed for high tube retention and pin contact even under severe vibrating conditions.

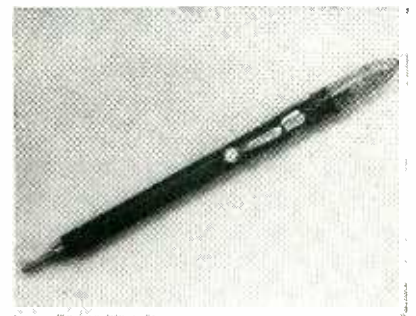

Testing Tool

KAPNER HARDWARE, INC., 2248 Second Ave., New York 29, N. Y., has introduced a testing tool that permits instant tracing of the cause of trouble in the high voltage section of any tv receiver. It will instantly indicate the presence or absence of high voltage. It will check if high voltage supply is operating properly. Operation of horizontal am-



ENGINEERED
FOR
ENGINEERS

BROWNING
Laboratories, Inc.
Winchester, Mass.

On a Coast-to-Coast Hook-up

PHALON
TRADEMARK

ELECTRONIC THERMOPLASTIC HOOK-UP WIRE

There is no mistaking quality performance . . . and PHALON hook-up wires are proving their quality in top performances coast-to-coast.

Hook-up, lead or fixture wires . . . whatever your requirement, there is a PHALON wire just made for the job! Get strong, tough, easy stripping with PHALON hook-up wires.

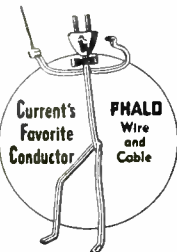

PHALO PLASTICS CORPORATION
CORNER OF COMMERCIAL STREET
WORCESTER, MASS.
Manufacturers of Thermoplastic Insulated Wire, Cables, Cord Sets and Tubing



LOOK WHAT'S NEW!

MADE TO YOUR SPECIFICATIONS

TECHNITROL Type TE PULSE TRANSFORMERS

SEALED IN CASTING RESIN

Currently available in one physical size— $\frac{3}{4}$ " diam. x $\frac{9}{16}$ " deep, with 2" leads of No. 20 wire—made to your order within the following range of specifications.

Pulse Width: 0.1 to 2.0 microseconds
Maximum Pulse Repetition Rate: 2.0 mc.
Operating Range: -55° to $+105^{\circ}$ C.

One or two secondaries may be provided, either inverting or non-inverting.

NOW YOU CAN SIMPLIFY AND MINIATURIZE YOUR SHORT-PULSE CIRCUITS

WRITE US YOUR SPECIAL REQUIREMENTS including a brief outline of the contemplated circuit, or ask for our blank specification sheets.

LOOK AT THESE PRICES!

1 to 3	\$7.50 each
4 to 10	6.35 each
11 to 100	5.85 each

Write us for quotations for quantities over 100

TECHNITROL
ENGINEERING COMPANY
2751 North 4th Street, Philadelphia 33, Pa.

TAKE NO CHANCES WITH VITAL EQUIPMENT... Specify

SERIES 6918 or 6924

RACKS
by **PAR-METAL**

18½" or 24" DEEP, for 19" WIDE PANELS

- Panel Spaces: 61¼", 70", or 77" high.
- Finished in Prime Coat, Black Wrinkle, Grey Lacquer, Grey Wrinkle.
- Series 6918 or 6924 Racks may be used in "rows" or "gangs," as corner trims are removable from front of cabinet.
- Standard shelves and roller trucks are manufactured by us for use with these Racks.

THESE RACKS ARE MODERATELY PRICED and AVAILABLE FOR SHIPMENT FROM STOCK

Planning an electronic product? Consult Par-Metal for **RACKS • CABINETS CHASSIS • PANELS**

Remember, Par-Metal equipment is made by electronic specialists, not just a sheet metal shop.

Made by Electronic Specialists!

Our P-6924 Rack as used by Gal-Tronics, Inc., Reading, Pa.

PAR-METAL
PRODUCTS CORPORATION
32-62 — 49th ST., LONG ISLAND CITY 3, N. Y.
Tel.: Astoria 8-8905
Export Dept.: Rocke International Corp.
13 East 40 Street, New York 16, N. Y.

WRITE FOR CATALOG!

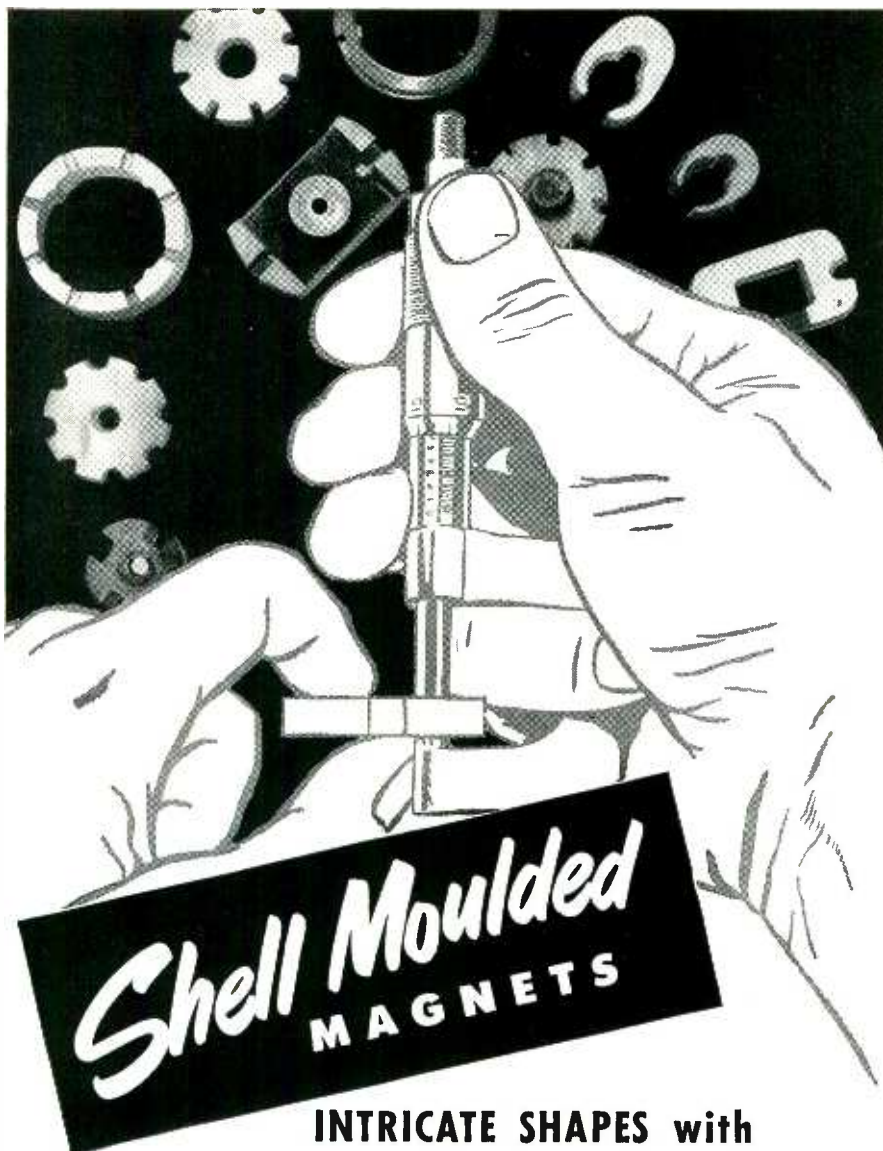

**Shell Moulded
MAGNETS**

**INTRICATE SHAPES with
tolerances often as close as $\pm .005$
without Grinding or Finishing!**

The costly headaches and limitations of loose tolerances—which have vexed the engineer with variations of $1/32''$ in permanent magnet design—have been virtually eliminated by Thomas & Skinner, specialists in magnetics for more than half a century.

Now your engineers can specify the intricate casting shapes—with sharply defined relief—which in the past have been too difficult or too expensive to produce. Through radically new techniques, Thomas &

Skinner permanent magnets are cast with such close precision that little or no grinding and finishing is required for dimensional accuracy.

Call in a Thomas & Skinner engineer—let him work with your own development specialists—learn how your permanent magnet problems of close tolerances and intricate designs may be solved by the new Thomas & Skinner technique—now! Write today—ask for the new Thomas & Skinner Permanent Magnet Bulletin, No. 151.



THOMAS & SKINNER Steel Products Company
1120 East 23rd Street • Indianapolis, Indiana

plier and high voltage transformer are easily checked. The Detecto probe is equipped with a built-in lamp that lights up if high voltage is present.

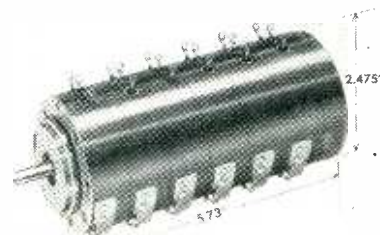

Ganged Potentiometer

THE G. M. GIANNINI CO., INC., Pasadena, Calif., has produced a vernier phasing ganged potentiometer known as the Gangpot. Gangpots are available with from two to six individual sections; a 6-section unit operating on 1.5 oz-in. of shaft torque. Assembly is without external clamps or bolts. Mechanical rotation is 360 deg continuous; electrical rotation may be 360 deg or less. Sections are available in resistances from 2,000 to 300,000 ohms and each will dissipate 4 watts continuously at 25 C. Sections may have linear or nonlinear outputs, one or two brushes, and taps as desired. A simple screwdriver vernier phasing for each section permits phasing to 0.2 deg over an angle of 22 deg.

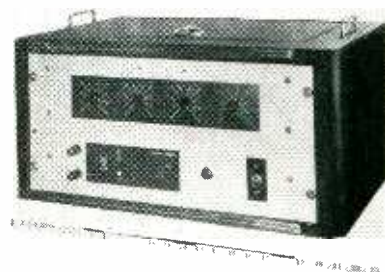

Meter Calibrator

BRUCK INDUSTRIES INC., Syosset, L. I., N. Y., has developed an instrument designed specifically for the

rapid calibration of d-c volt and milliammeters and for testing and adjustment of d-c type analog computers. The M-DC-1 calibrator is completely self contained. It consists of four major components: two regulated power supplies, a normalizer and the calibrator proper. The normalizer is referenced to a built-in standard cell. The output can be preset on four decade dials, and is maintained automatically constant and accurate to within 0.1 percent over 90 percent of its range, independent of load, input voltage or ambient conditions. Both the normalizer and the calibrator are controlled and compensated by electromechanical transducers in conjunction with high gain 60-cycle amplifiers and all manual operations are completely eliminated.



Oscilloscope Probe

LINEAR EQUIPMENT LABORATORIES, INC., Brightwater Place, Massapequa, N. Y. The new model HF2A Lo-C Oscilloprobe introduces no signal attenuation. Measurements of low-level signals in high impedance video circuits can be readily made without affecting the true waveforms. Heretofore such measurements required engineering interpretations, as the relatively large input capacitances of conventional probes distorted the signal under observation. The dynamic output impedance is approximately 60 ohms and the maximum undistorted output is 1.5 v rms. The input voltage range can be selected by a three-position switch. Signals up to 150 v rms can be applied to the probe without overload. Input impedance

Attention!... ELECTRONIC DEVELOPMENT ENGINEERS

Reduce your problems with the

NEW EUREKA "SNAPPER"

THERMAL TIME DELAY RELAY

Features . . . Snap action. Single Pole Double Throw. Lightweight. Low operating temperature. Operates in any position. High contact rating. Gas filled. Low heater current. Durability and long life.

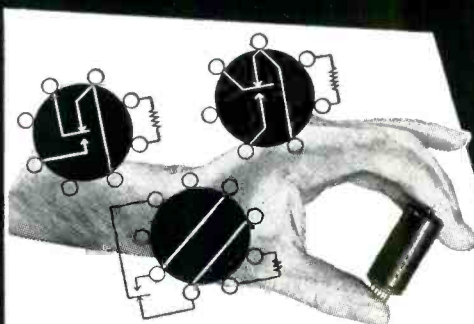

EUREKA'S "SNAPPER"

VOLTAGE: 6.3, 26.5
115 volts (A.C. or D.C.)
or as required

AMBIENT TEMPERATURE RANGE:
-60°C. to +80°C.

ENVELOPE: Miniature,
or octal metal.

TIME DELAY PERIODS:
Preset from 5 seconds up.

VACUUM: Evacuated, inert
gas filled.

HEIGHT: 1 3/4" maximum seated.

EUREKA PRESENTS POSITIVE

SNAP ACTION

The ELIMINATION OF CHATTERING is accomplished with the incorporation of "POSITIVE SNAP ACTION" in the EUREKA "SNAPPER" . . . LEADING ELECTRONIC MANUFACTURERS have acknowledged the new EUREKA "SNAPPER" as a major advancement in this field, and have already accepted this relay as a standard component of their latest equipment.

Inquiries are invited . . . send for our "Bulletin Number Snapper"

EUREKA TELEVISION AND TUBE CORP.

Manufacturers of Cathode-Ray Tubes and Electronic Products
69 FIFTH AVE., HAWTHORNE, N. J. • TEL. HAWTHORNE 7-3907



GRID AND PLATE CONNECTORS

High quality grid and plate connectors of both the insulated ceramic (meeting JAN I-10 specifications) and the non-insulated spring clip types for use on tubes having contacts of $\frac{1}{4}$ ", $\frac{3}{8}$ ", and $\frac{1}{2}$ " diameters. All lugs are designed to provide strong mechanical connection. Write for drawings.

TURRET SOCKET ASSEMBLIES

Designed for National's 7-pin and 9-pin miniature tube sockets. Permit compact sub-assembly wiring at base of socket. Cadmium-plated brass center support has a standard length of two inches. Silver-plated brass terminal studs. Available with holes through which leads can be drawn or with solid studs.

Center supports of varying lengths and other types of terminals can be supplied to manufacturers in quantity. Write for drawings.



Write for drawings



on all ranges is 4.5 megohms with 1.5 μ f.

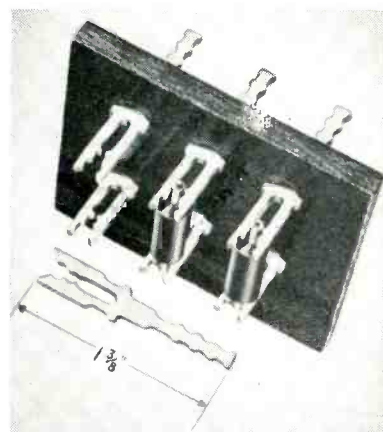

Diode Clip

COMPUTER RESEARCH CORP., 3348 W. El Segundo Blvd., Hawthorne, Calif., has developed a new diode clip that permits quick, easy insertion and removal of diodes. The clips will accommodate most types of diodes now in use. They require no rivets or other fasteners for mounting. The clip is simply pressed into a hole on the diode board. Spring tension holds the diode securely in the clip, and a special plating assures excellent surface contact. Other advantages include greater ease in removing defective diodes, faster assembly of diode boards and quicker initial checkout of finished equipment. They also facilitate preventive maintenance tests and the keeping of performance records on individual diodes.

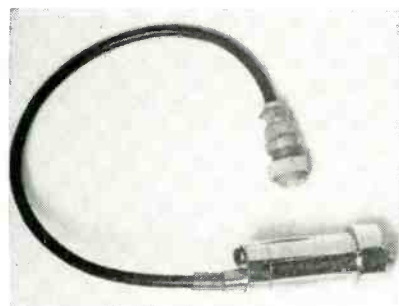

Pressure Transducer

CONSOLIDATED ENGINEERING CORP., 300 N. Sierra Madre Villa, Pasadena, Calif.

IF THE WIRING FAILS



SO DOES YOUR
PRODUCT'S REPUTATION

FOR DEPENDABLE PRODUCT WIRING USE

UNILECTRIC WIRING SYSTEMS

Year after year — for over ten years — UNILECTRIC has produced millions of wiring systems, for more than 150 leading manufacturers of electric and electronic products. From controls to complex armed forces equipment, these wiring systems have consistently met the most exacting requirements and provided substantial savings to each customer.

To assure utmost dependability plus cost saving engineering assistance, low cost production and "on-schedule delivery" investigate UNILECTRIC today.

UNILECTRIC WIRING SYSTEMS

Manufactured by
UNITED MANUFACTURING & SERVICE COMPANY
409 SOUTH 6th STREET • MILWAUKEE 4, WISCONSIN

SCOPE DOLLY

Model 1

Convenient Height and Viewing Angle
Adjustable to Hold Portable Scopes
Ball Bearing Swivel Rubber Tired Casters
Lightweight Aluminum Construction
Recommended by Laboratories Wherever Used

\$35.00 FOB LOUISVILLE, KY.

Formerly manufactured by UNIQUE DEVICES

Now manufactured and sold by

TECHNICAL SERVICE CORPORATION

3116 Michigan Drive Louisville 5, Kentucky

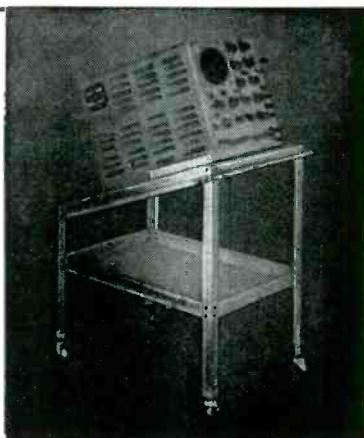

Specify GM SERVO MOTORS

PRECISION
ENGINEERED

RELIABLE PERFORMANCE • RUGGED CONSTRUCTION

In the operation of • GUNFIRE CONTROLS • ROCKET CONTROLS
GUIDED MISSILES • AIRCRAFT CONTROLS • INDUSTRIAL CONTROLS

G-M Servo Motors can be supplied to meet rigid military specifications with regard to humidity, temperature range, vibration and altitude. Available in 2, 4 or 8 pole construction and for frequencies from 60 to 400 cycles.

Write today for complete information.

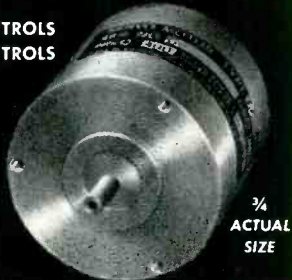

3/4
ACTUAL
SIZE

Another product of **GM LABORATORIES INC.** 4336 NORTH KNOX AVENUE
CHICAGO 41, ILLINOIS

The Spotlight's On

DALOHM

Miniature POWER RESISTORS!

WIRE WOUND— SILICONE COATED RESISTORS

Complete welded construction from terminal to terminal. Temperature coefficient 0.00002/deg. C. Ranges from 0.1 Ohm to 55,000 Ohms, depending on Type. Tolerance 0.05%, 0.1%, 0.25%, 0.5%, 1%, 3%, 5%.



RH TYPE — Available in 25, 50 and 250 watt sizes. Silicone sealed in die-cast, black anodized radiator finned housing for maximum heat dissipation.

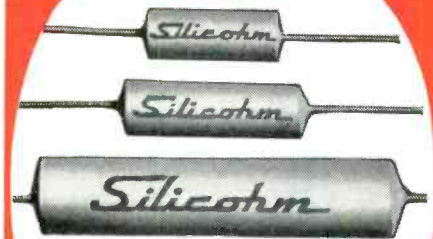

RS TYPE — Available in 2 watt, 5 watt, and 10 watt sizes. Silicone sealed offering maximum resistance to abrasion, high thermal conductivity and high dielectric strength.

DEPOSITED CARBON RESISTORS



Dalohm precision deposited carbon resistors offer the best in accuracy, stability, dependable performance and economy. Available in 1/2 watt, 1 watt and 2 watt sizes.

Carefully crafted in every respect, Dalohm resistors are true power in miniature — provide the answer to those space problems.

Write, wire or phone George Risk
1300 28th Ave., Columbus, Nebr.
for price and delivery
Telephone 2139

DALE

DALE PRODUCTS, INC.

In Canada: Teletronics Corp. Ltd.
Toronto and Montreal

only **TURBO**

miniaturization wire
stands temperatures
from -55°C to
 $+105^{\circ}\text{C}$

AND MEETS OR
BEATS ALL OTHER
REQUIREMENTS OF
JAN-C-76 AND MIL-W-5086

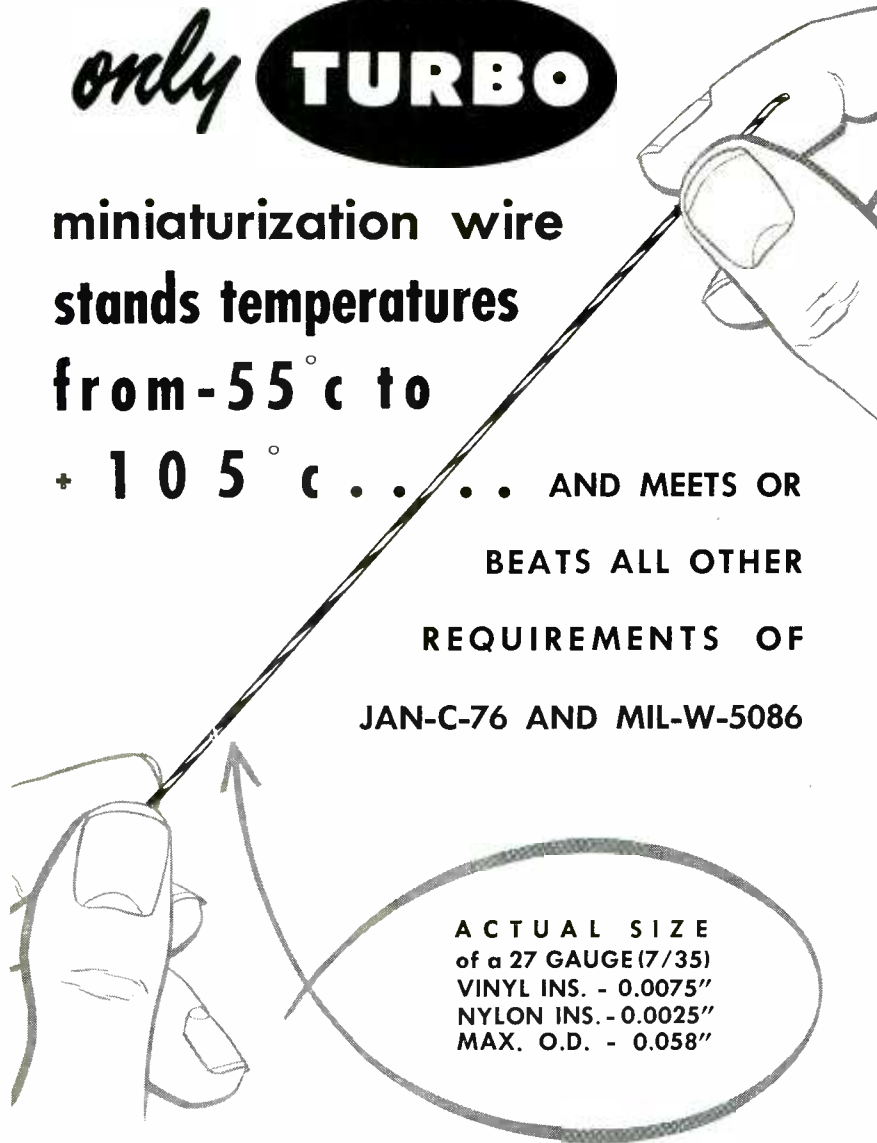

ACTUAL SIZE
of a 27 GAUGE (7/35)
VINYL INS. - 0.0075"
NYLON INS. - 0.0025"
MAX. O.D. - 0.058"

- **PROVE TO YOURSELF** that wire does not need bulky insulation to stand extreme temperatures, or give you insulating values above 1000 megohms per 1000 ft.
- **SEND FOR A SAMPLE** of Turbo Miniaturization Wire. Test it on any electronic application where the continuous operating voltage does not exceed 600 volts R.M.S. See how its thin extruded vinyl primary insulation and thinner extruded nylon jacket resist boiling water, oils, fuels, hydraulic fluids, fungus, abrasion, etc.
- **TURBO MINIATURIZATION WIRE COMES IN AWG SIZES FROM 30 TO 12 GAUGE . . .** in standard or flexible wiring . . . in solid colors, or candy-striped colors with 1, 2 or 3 tracer combinations, to fit your circuit coding needs.
- **BULLETIN A-4662** gives you more information about TURBO insulation. Ask for it when requesting your samples of TURBO Miniaturization Wire. Write Dept. E-1.

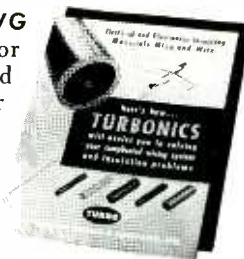

INSULATING MATERIAL

TURBO

THE BRAND ONLY BRAND MAKES

THE WILLIAM BRAND AND CO., INC.

North and Valley Streets, Willimantic, Connecticut — Phone 3-1661

dena 8, Calif. Extremely rapid transient pressure surges and high-frequency pressure pulsations, both frequently encountered in present-day processing equipment, vehicles and hydraulic systems, can be easily and accurately measured with the new type 4-301 pressure transducer. It may also be used for measuring static or slowly varying pressures over an extremely wide temperature range in both gaseous and liquid systems. The transducer's output may be either recorded on an oscillograph, when extremely rapid pressure changes must be analyzed in relation to time, or it may be used to indicate pressure changes on meters or oscilloscopes, which can be monitored visually or photographed. Output is linear within ± 0.5 percent of full scale. The pickup, complete with cable and plug, weighs only 9 oz and measures $1\frac{1}{2}$ in. in diameter.



Preservative and Noise Eliminator

GRAYBURNE CORP., 103 Lafayette St., New York 13, N. Y., has developed a new chemical solution for the elimination of noise and the preservation of moving contacts in home radios and television sets. The formula cleans and preserves all controls and contacts without any harm to insulation and soldered joints. It has been so prepared that each drop has the same chemical content as any other. Perfect equalization has resulted in a sediment-free solution that does not clog contacts. Known as Q-T, it contains only the pure basic ma-

CLIMATE-PROOF PACKAGING

CARGO



Here's a quick solution to

MILITARY PACKAGING

CARGO PACKERS CLIMATE-PROOF PACKAGING

Meets all Specifications for Signal Corps, Navy and Air Force Shipments of Electronic Equipment with Facilities that include—

- SPECIAL PACKAGING EQUIPMENT
- EXPERTS IN MILITARY SPECIFICATIONS
- ECONOMICAL ASSEMBLY LINE METHODS
- FULL COMPLIANCE IN EVERY DETAIL
- COMPETENT CONSULTING SERVICE

NEW ILLUSTRATED BROCHURE explains in detail how Cargo Packers can economically handle all details of your military packaging problems. You save valuable plant space, costly equipment and the need for experienced specification packaging experts. Find out now, how Cargo Packers production line methods save you time, money, endless detail work, and costly errors. Request your copy, now!

CARGO PACKERS INCORPORATED

73 RUTLEDGE STREET
BROOKLYN 11, NEW YORK

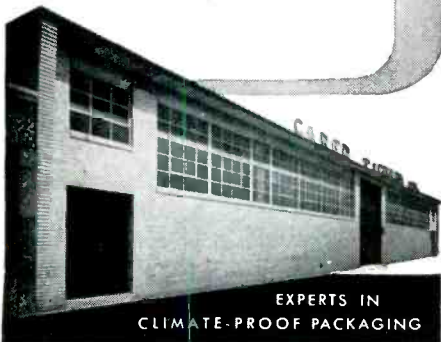

EXPERTS IN CLIMATE-PROOF PACKAGING

Want more information? Use post card on last page.

ELECTRONICS — January, 1953

NEW PRODUCTS

(continued)

materials and has no artificial coloring.

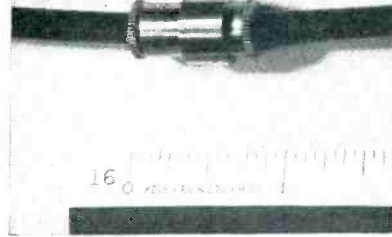

R-F Coax Connector

TELETRONIC LABORATORIES, INC., 1835 West Rosecrans Ave., Gardena, Calif., has developed a new miniaturized r-f coaxial cable connector designed for use at microwave frequencies with either RG-55/U or RG-58/U coax cable. It shows a vswr of less than 1.3 over the entire band, operating between 8,400 and 9,600 mc. Compression-sealed against moisture and atmospheric changes, this smaller, lighter connector is manufactured from brass, Teflon, phosphor bronze and beryllium copper.



Indicator Light

HETHERINGTON, INC., Sharon Hill, Pa., has developed a new indicator light for edge-lit AN-P-89 aircraft panels. Known as the type L2000, the light flange-mounts on the back-up plate and the socket extends through the edge-lit panel. The plastic lens screws into the light socket from the front of the panel. The light 1 1/4 in. long overall and weighs less than 1/4 oz. A 327 miniature lamp is used for 6, 12 or 28-v operation, and amber, blue, green,

Do you need

A RELIABLE AND CONVENIENT MEANS FOR CHECKING BOTH LEAKAGE AND CONTINUITY OF ELECTRICAL COMPONENTS?

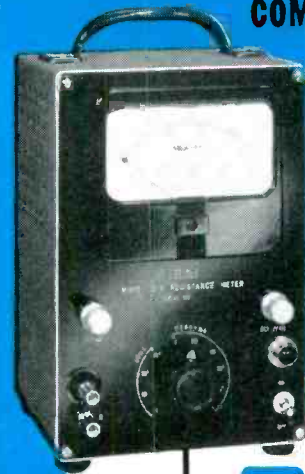

SIE

MODEL C-3 RESISTANCE METER IS YOUR ANSWER

The Model C-3 Resistance Meter is designed for use by manufacturers in checking both leakage and continuity of electrical components. It is particularly valuable for making rapid checks of the insulation resistance of transformer windings, condensers, and electrical wiring, as well as measuring the ohmic value of resistors and windings.

ELECTRICAL SPECIFICATIONS

ACCURACY: Plus or minus 3% of full scale deflection plus 1 ohm on the OHMS ranges.

Plus or minus 3% of full scale deflection (approximately 3 degrees) on the MEGOHMS ranges except 10¹ range.

Plus or minus 5% of full scale deflection on 10¹ megohms range.

RANGES: 1 ohm to 1 million megohms

The ohmmeter applies a maximum of 1 1/2 volts to the resistor under test. It has a scale of from 0 to 500 ohms and a selector switch for selecting scale multipliers of x 1, x 10, x 10², and x 10³.

The leakage tester applies a maximum of 105 volts to the unit under test. Its scale reads from 1 to 100 megohms and has multipliers of x .1, x 1, x 10, x 10², x 10³, and x 10⁴.

SOUTHWESTERN INDUSTRIAL ELECTRONICS COMPANY

2831 Post Oak Road • Houston 19, Texas

A NEW WAY TO

lower manufacturing costs
increased plant output
better product quality

through Milford's scientific approach
to product and parts assembly
... "THE MILFORD METHOD"

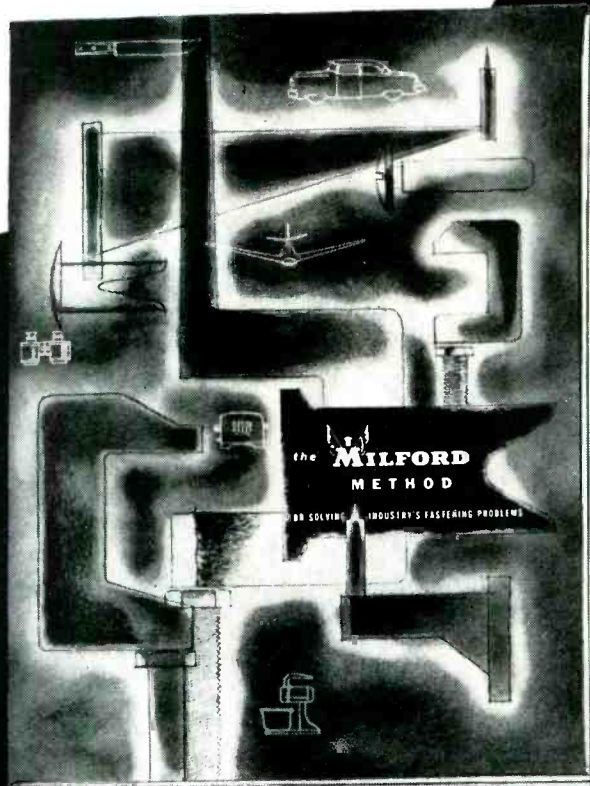

EVERYONE WHO DESIGNS, SPECIFIES OR BUYS
fasteners should have this important brochure at his
fingertips. Write for your copy today.

See our catalog in the 1953
Sweet's Product Designers File.

Est. 1919
the **MILFORD RIVET & MACHINE CO.**

MILFORD . . . the name to rivet in your memory for fasteners

855 BRIDGEPORT AVE. 1106 W. RIVER ST. 26 PLATT ST. 806 ILLINOIS AVE. 715 SO. PALM AVE.
MILFORD, CONN. ELYRIA, OHIO HATBORO, PA. AURORA, ILLINOIS ALHAMBRA, CALIF.

red or white plastic lens is available. The molded-in terminal will not vibrate or pull loose.

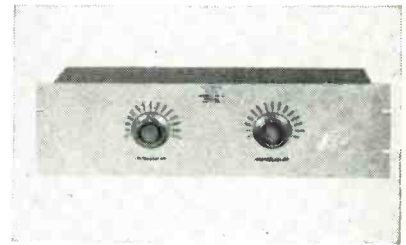

Filter

CINEMA ENGINEERING Co., 1510 West Verdugo Ave., Burbank, Calif., is in production on its new variable high and low-pass filter, type 6517-D. This sound effects filter is used for sound and electronic lab research and control; and for sound recording, transmission and reproduction control. Minimum input level is -70 dbm; maximum, $+28$ dbm. Insertion loss is zero. It features wide frequency spectrum with overlapping cutoff frequencies; zero phase distortion over the transmission range; and clickless steps of control. All inductors are toroidally wound.

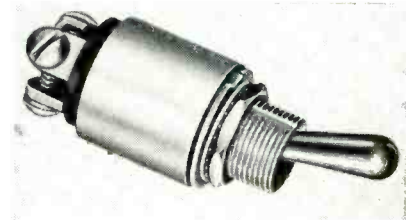

Toggle Switch

HETHERINGTON, INC., Sharon Hill, Pa., has introduced a new aviation type (MIL-S-6745) miniature toggle switch with a unique cylindrical design that reduces size approximately 25 percent by comparison with conventional rectangular switches. Features include exceptionally effective contact wipe; positive cam-roller snap action that makes it impossible to tease the switch off contact; and strong lever operating action to break any contact welding that may result from an accidental overload. Four circuit arrangements are available: on-off and spdt maintained contact

HYCOR

the **NEW**
700 series

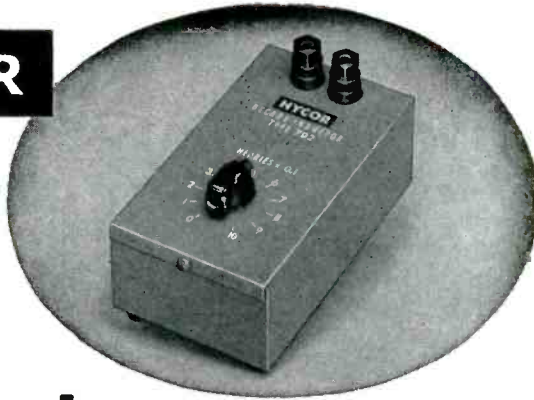

Decade-Inductor units

- **HYCOR DECADE — INDUCTOR** units are indispensable for design and experimentation work on audio filters.
- The units are available in four ranges up to 10 henries. Units may be used individually or all four may be connected in series to obtain 11.11 henries in 1 milli-henry steps.
- Toroid coils are used to obtain high "Q", stability and low pickup from external fields. Inductance accuracy is 2%.

Send for bulletin D-2

HYCOR COMPANY, INC.

11423 VANOWEN STREET, NORTH HOLLYWOOD, CALIFORNIA • UNset 3-3860

Manufacturers of Toroid Inductors, Decade Inductor Instruments, Wave Filters, Resistive Networks, and Precision Resistors

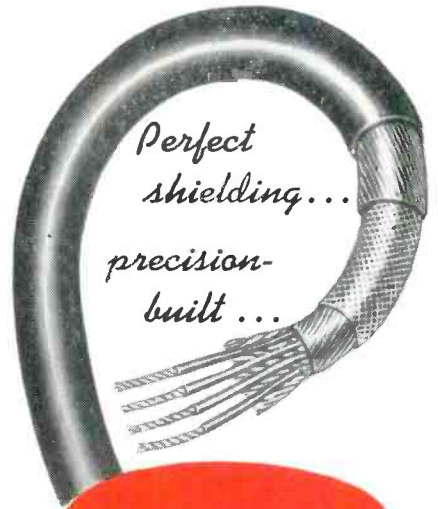

Perfect shielding...
precision-built ...

CAROL

multi-conductor cable

Here's the cable that gives the best in electrostatic and interference shielding — for stationary and portable microphones, speakers, P. A. systems, automobile radios and other electronic devices.

Tinned soft copper conductors are stranded for exceptional flexibility, paper served for easy stripping, individually insulated with low capacitance rubber or polyethylene, in some sizes. Wires are cabled to perfect roundness, cotton served and shielded with tinned copper braid. Outer jacket is either rubber, neoprene or plastic, depending on service requirements.

For expert engineering assistance and prompt service on all your cable applications, write or call Carol today.



CAROL
CABLE DIVISION
of The
CRESCENT COMPANY
INC.

Pawtucket, Rhode Island

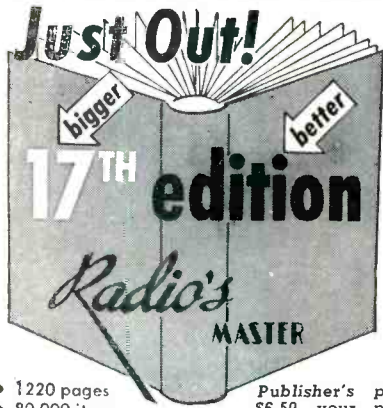

- 1220 pages
- 80,000 items
- 8,000 illustrations
- 8" x 11" — 5 lbs.

Publisher's price \$6.50—your price through your regular parts distributor \$1.95

The right part when you need it for production or laboratory requirements

This permanent, hard cover Official Buying Guide of the electronic-TV parts and equipment industry with its comprehensive detailed index, eliminates the need for maintaining files of small catalogs and manufacturers' literature. RADIO'S MASTER catalogs 90% of TV and electronic equipment. Not merely part number listings—complete descriptions, specifications and illustrations written and compiled by each manufacturer. Enables you to make comparisons or substitutions right now!



No More Files of Small Catalogs and Loose Literature

UNITED CATALOG PUBLISHERS, INC.
110 Lafayette St., New York 13

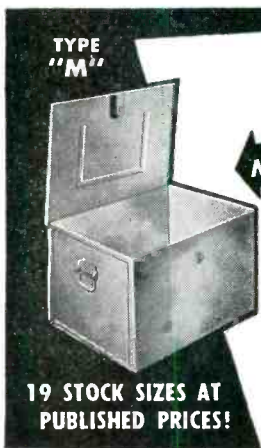

19 STOCK SIZES AT PUBLISHED PRICES!

NOW available to you... without costly sub-contracting problems
MIL-B-233A SPARE-PARTS BOXES...

FOR THE PROTECTION OF ON-BOARD REPAIR PARTS
Stock standard TYPE M STEEL SPARE OR REPAIR PARTS BOXES, made in strict accordance with Military Specifications.

To better service your need for Specification Spare-Parts Boxes we have put them on a mass production line.

Write for Size and Price Chart
DOLIN METAL PRODUCTS INC.
319 LEXINGTON AVE., BROOKLYN 16, N. Y.

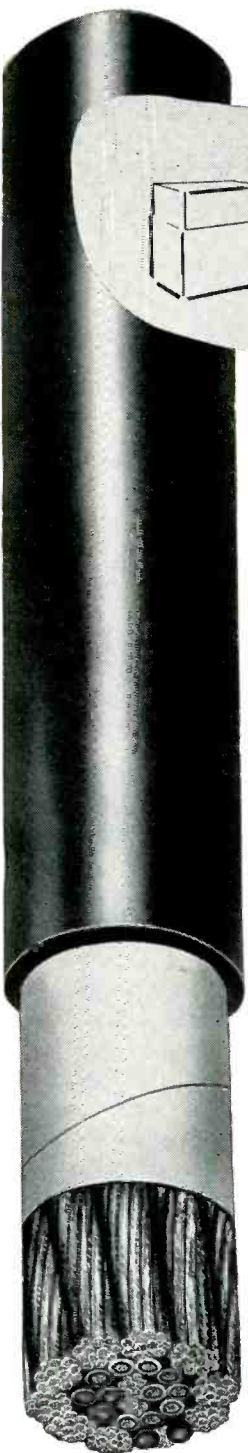

*T. M. REG.

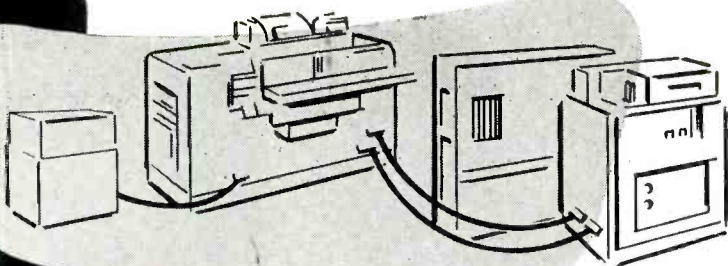

If you have a
special wiring problem
look to
Rome Cable

The number and complexity of the circuits in large electronic computers make it imperative that the cables used not only stand up in heavy service, but consume as little space as possible. The special 136 conductor Rome Synthinol* insulated cable illustrated was manufactured by Rome Cable for this purpose. And, there are good reasons why Rome was asked to do the job.

Leading manufacturers have found that Rome Cable's facilities, experience and engineering "know-how" make Rome their best source for complicated electronic cables of the highest quality . . . cables that meet the most exacting specifications.

Rome Cable, also, manufactures a complete line of standard Underwriters' approved, as well as military type radio and television hook-up wires utilizing both rubber and thermoplastics. So, whatever your wire or cable requirements, look to Rome for dependable quality. The coupon below will bring you descriptive literature. Mail it today!

• • •

types, and momentary on or momentary off and on-momentary on types.



Relay Racks

PREMIER METAL PRODUCTS CO., 3160 Webster Ave., Bronx, N. Y., announces the manufacture of a line of table-type relay racks rigidly constructed of 16-gage cold-rolled sheet steel. The base is of one-piece construction, similar to a chassis. Panel mounting holes are tapped for 10/32 machine screws in Western Electric spacings. Racks are shipped knocked down with all necessary bolts for easy assembly. They are available in two different sizes—25 in. x 21 in. x 12 in. with panel space of 21 in. x 19 in., and 32 in. x 21 in. x 12 in. with panel space of 28 in. x 19 in. A complete catalog of the company's products for the electronic and electrical industries is also available.

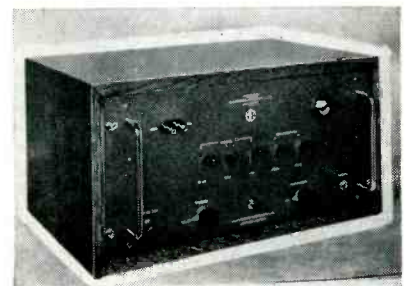

Frequency Calibrator

MEASUREMENT ENGINEERING LTD., Arnprior, Ontario, Canada. Model CFR-1 portable self-contained secondary frequency standard provides accurate frequencies in the range of 10 kc to 500 mc with a stability of 1 part per million. Designed originally for the military, it is manufactured to Joint Can-

----- IT COSTS LESS TO BUY THE BEST -----

ROME CABLE CORPORATION
Dept. E-1 • Rome, N. Y.

Please send me information on Electronic Wiring.

Name.....
Company.....
Address.....
City.....State.....

ROME CABLE CORPORATION
ROME, NEW YORK and TORRANCE, CALIFORNIA

adian Navy-Army-Air Force specifications, which are similar to but not identical with JAN specifications. Electrical and mechanical features, uses and circuit description are given in a loose-leaf perforated catalog sheet.

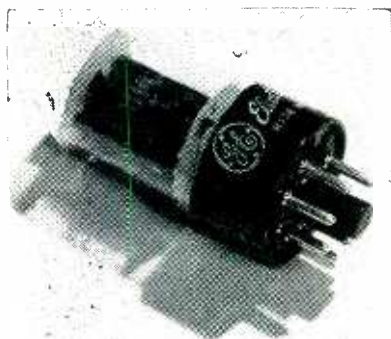

Vertical Deflection Amplifier

GENERAL ELECTRIC Co., Schenectady 5, N. Y., has announced a new high-perveance triode for vertical output service in television receivers. The tube, type 6AH4-GT, is expected to be particularly useful in receivers with large-deflection-angle picture tubes. Typical operating characteristics with 250 v on the plate include: heater voltage, 6.3 v; grid voltage, -33 v; plate current, 30 ma; transconductance, 4,500 μ mhos; amplification factor, 8.0; and plate resistance, 1,780 ohms.



Carrier System

LENKURT ELECTRIC Co., 1113 County Road, San Carlos, Calif. Up to 24 broad-band voice channels can be

Winchester Electronics



RECEPTACLE
AQRE 12S-L

PLUG
AQRE 12P-LT

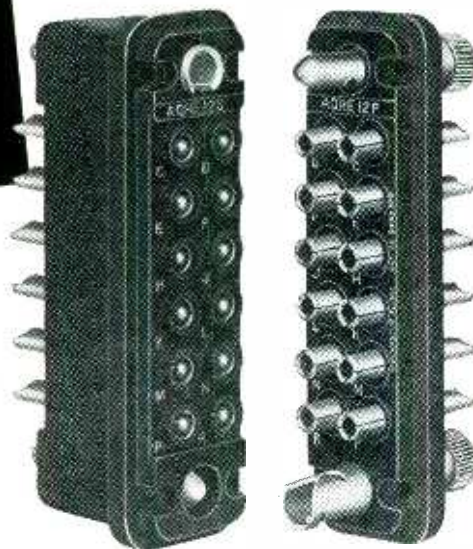

ACTUAL
SIZE

The AQRE Connector, particularly suitable for power circuits, permits the use of higher currents (up to 25 amps) and provides the quick-disconnect, self-aligning features of our widely accepted QRE-type connectors. 12 extra-large contacts with .113" dia. solder cups for #12 A.W.G. wire are housed in a molded melamine (high dielectric) insert body. Knob (as shown in illustration right) or lever actuated bayonet locking guides assure positive engagement of plug and receptacle at all times and prevent accidental disconnection due to vibration in rugged field applications. Hoods fit plug or receptacle (and are obtainable by including the letter "H" in the code number).

QUALITY FEATURES OF THE AQRE 12

QUICK DISCONNECTING. The separately spring loaded contacts used in this connector eliminate the annoying prying and pulling necessary when separating ordinary multi-contact connectors. Forcing, which frequently results in serious damage, is eliminated and special levers are not required.

SELF-ALIGNING. Individually floating contacts assure self-alignment.

PRECISION MACHINED CONTACTS. Pins are from brass bar (QQ-B611) and sockets from spring temper phosphor bronze bar (QQ-B746a). They are gold plated over silver for consistent low contact resistance, reduction of corrosion and ease of soldering.

MONOBLOC* CONSTRUCTION eliminates unnecessary creepage paths, moisture and dust pockets and provides stronger molded parts.

MOLDED MELAMINE BODIES (in accordance with MIL-P-14) Mineral-filled—are fungus-proof and provide mechanical strength as well as high arc and dielectric resistance.

MOUNTING. A die cast aluminum, black anodized bracket for rack and panel mounting permits necessary float for self-alignment.

NOTE! Plug and receptacle can be furnished with regular guides for alignment and polarization only. For locking guides, the addition of "LT" to the plug or receptacle code number indicates the *actuating mechanism* . . . the locking device is actuated from *one side — plug or receptacle — only*. The letter "L" must then be added to the mating side. Illustration above shows the plug with knob-actuated locking guides, i.e., AQRE 12P-LT. The mating receptacle is therefore coded as AQRE 12S-L. For levers instead of knobs add "LT type B" to code number. For hoods with locking guides add "HLT type C" to plug or receptacle code number on which hood will be used.

Receptacle Code No.	Plug Code No.	Weight oz.		Number of Contacts
		Rec'pl'e	Plug	
AQRE 12S	AQRE 12P	2.10	1.23	12
D.C. Volts Breakdown (Connector Engaged)				
Wire Size A.W.G.	Sea Level Normal Humidity		60,000 Feet Altitude	
	Between Contacts	Contacts to Ground	Between Contacts	Contacts to Ground
	#12	6250	9150	1450

PHYSICAL AND ELECTRICAL DATA

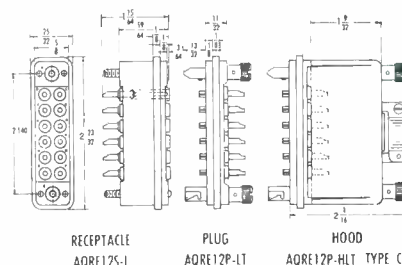

Wire or write for catalog of other types or advise your special requirements.

West Coast Branch: 1729 Wilshire Blvd.,
Santa Monica, California

* Trademark



GLENBROOK, CONN., U.S.A.



**you'll want this
new guide to
the world's
toughest
transformers**

Send for
the new

CHICAGO

**TRANSFORMER AND
FILTER REACTOR CATALOG**

easier to use, more complete than ever

You'll find more than 500 units listed in the new CHICAGO Catalog . . . transformers for every application . . . presented in one complete, easy-to-use specification guide, covering the following categories:

- MIL-T-27 Hermetically-Sealed Transformers
- New Equipment Transformers
- Television Replacement Transformers
- General Replacement Transformers
 - Control & Power Circuit Transformers

You'll want this new CHICAGO Catalog for handy reference. It provides a wealth of terse factual information on CHICAGO Transformers for original or replacement use in the radio, electronic, electrical, aeronautical, geophysical, and automotive industries. Use this Catalog as your buying guide to the World's Toughest Transformers . . . depend on your CHICAGO distributor for prompt, efficient service.



**free
Send
for it!**

CHICAGO TRANSFORMER
DIVISION OF ESSEX WIRE CORPORATION
3501 W. Addison Street • Chicago 18, Illinois

transmitted over a wide-band radio channel with the new type 33C carrier telephone system. Designed specifically for application to radio links, this frequency division multiplex system is comprised of three eight-channel groups. A single group or less can be installed initially and expanded to the maximum capacity in the future as traffic increases. Because the problem of channel co-ordination common to wire line carrier operation does not apply to radio operation, the channels have been spaced at 5-kc intervals. Two frequency allocations are available: one uses frequencies up to 135 kc; and the other, frequencies up to 150 kc. Each channel includes a broad speech band of approximately 300 to 3,400 cycles with provision for out-of-band signaling at 3.9 kc.

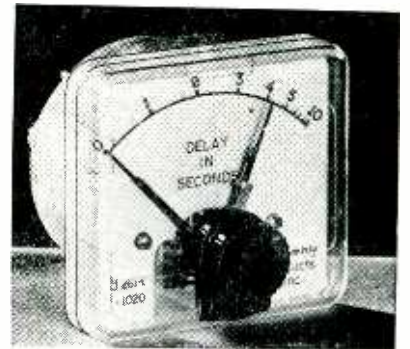

Time Delay Relay

ASSEMBLY PRODUCTS INC., Main at Bell Street, Chagrin Falls, Ohio. This new moving coil, permanent magnet-type relay, model CMR-TD, offers adjustable time delays for many ranges of voltage and current, both a-c and d-c. The dial is calibrated directly in delay in seconds. The timing is adjusted by hand-setting a pointer to the time indicated on the dial. Full-scale ranges of less than 10 seconds can be furnished. Timing is relatively unaffected by changes in temperature or barometric pressure. Delay action results from the magnetic drag inherent in sensitive microammeters. There are no capacitors, dash pots nor motors. Contacts are self-locking and rated at 5 ma, 100 v d-c for one million operations. Ratings up to 500 ma can be supplied for a reduced number of operations. Contacts are locked by an

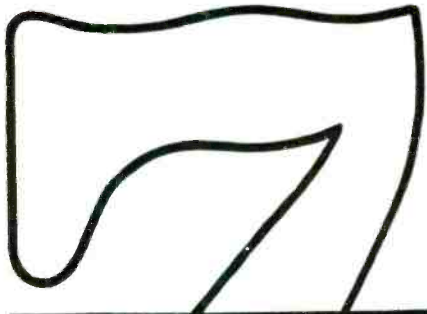

REASONS WHY Precision COIL BOBBINS

improve your coils...

- Quality Controlled
- Greater Insulation
- Better Heat Dissipation
- Higher Moisture Resistance
- 15 to 20% Stronger
- Lighter Weight
- More Winding Space

PRECISION Coil Bobbins are finished to your exact specifications. Only the finest dielectric materials are used.

Cores furnished in an infinite variety of sizes and shapes—kraft, fish paper, acetate, or combinations. Flanges cut to specifications—plain or fitted with leads, slots or holes; embossed or recessed.

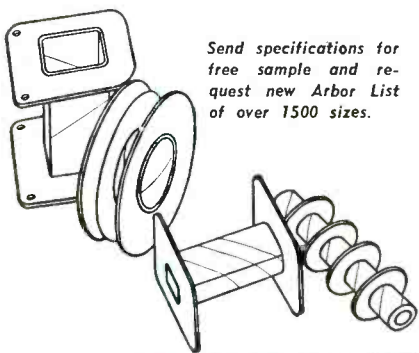

Send specifications for free sample and request new Arbor List of over 1500 sizes.

PRECISION PAPER TUBE CO.

2041 W. Charleston St. Chicago 47, Ill.
Plant No. 2, 79 Chapel St., Hartford, Conn.

Also Mfrs. of Precision Paper Tubes

ENGRAVING and MARKING

The Green Engraver

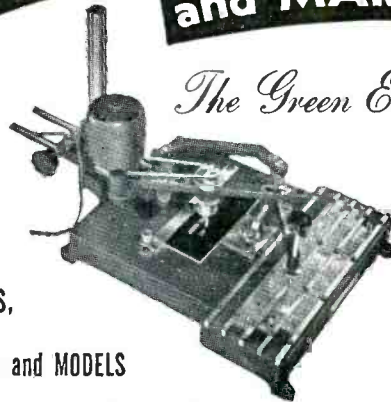

ENGRAVES,
ROUTS,
PROFILES and MODELS

A real money saver for industry. Proven by the experience of tool and die, electronic machine, radio, electrical and instrument manufacturers.

The Green Engraver zips out precision work on metal, plastics, wood, glass, hard rubber etc. . . . engraves panels, name plates, scales, dials, molds, lenses, instruments, instruction plates, directional signs . . . by simple tracing. Routing, profiling and three dimensional modeling indicate its versatility. Electric etching attachment available.

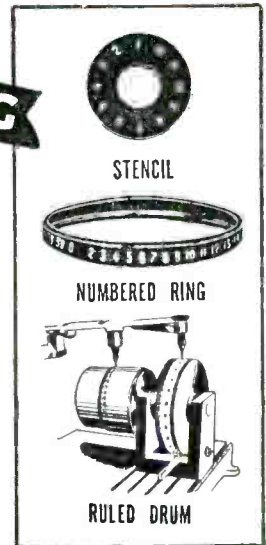

Specify the Green Engraver for the best in low cost performance. Special attachments and engineering service available for production work.

FREE — Fact-packed folder yours upon request.

Green Instrument Company
INCORPORATED

363 PUTNAM AVENUE • CAMBRIDGE, MASS.

RAHM TRANSDUCERS . . .

Typical Data

Linearity:

with pressure: $\pm 0.25\%$ to $\pm 0.75\%$
with altitude: $\pm 0.5\%$ (0-70000 ft.)

Resolution: 0.15% to 0.4% of pressure.

Design Features

Operation from -60°C to $+160^{\circ}\text{C}$
and to 60G acceleration.

a-c or d-c output usable without amplification.

Special Features

Protection from corrosive media or atmosphere. Multiple output from single instrument. Output non-linear with pressure.

REQUEST BULLETIN A-452

FOR

PRESSURE

ALTITUDE

AIR SPEED

ACCELERATION

RAHM INSTRUMENTS, INC.

12 WEST BROADWAY, N. Y. 7, N. Y.

Here's how

ELECTRO TEC

miniature slip ring and commutator assemblies

-solve TOUGH DESIGN PROBLEMS

- 6 INSULATED CONTACT RINGS
- RING WIDTH .030"
- BARRIER WIDTH .015"
- RING DIAMETER .045"
- WEIGHT 5.5 GRAINS (1/80 OUNCE)
- RINGS 60-70 BRINELL FINE SILVER
- TARNISH RESISTANT, FRICTION MINIMIZING SURFACE DEPOSITS
- 1000 VOLT HI-POT BETWEEN RINGS
- COLOR CODED LEADS



PROBLEM: ULTRA MINIATURIZATION — Design and mass produce an extremely miniaturized slip ring assembly. Reduce diameter of rings to absolute minimum to lessen torque friction. Maintain micro-tolerances; eliminate accumulated errors common to "assembled" slip rings.

SOLUTION: ELECTRO TEC EXCLUSIVE* METHOD of unitized, one piece construction provided a prompt, economical solution to this problem. Final design was even smaller than was originally specified and tolerances were held to closer limits.

TESTED AT 12,000 RPM

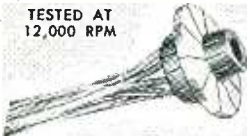

SILVER ON ONE PIECE NYLON FORM



8 FLAT RINGS WITHIN 5/8" RADIUS



Same Exclusive* One-Piece Construction Used in All Electro Tec Assemblies

Diameter of Electro Tec assemblies range from .045" to 24" cylindrical or flat. Cross sections of the rings may range from .005" to .060" or more. Rings are polished to a jewel-like finish... can be held to four micro-inches or better. Regardless of size, the same exclusive Electro Tec manufacturing technique is used to guarantee precise concentricity, higher dielectric strength, longer life and closer tolerances.

WRITE FOR LITERATURE!

A completely illustrated, four page folder contains full information on Electro Tec Miniature Slip Rings and Commutators. Describes the Exclusive* method of construction that has made Electro Tec the leading supplier to America's major instrument manufacturers. Send for your free copy today on company letterhead.



*PATENTS PENDING

ELECTRO TEC

SO. HACKENSACK



CORPORATION

NEW JERSEY

PRODUCTS OF PRECISION CRAFTSMANSHIP
BY A NEW AND REVOLUTIONARY PROCESS

extra coil in the meter. Relays with nonlocking contacts can be supplied for special applications.

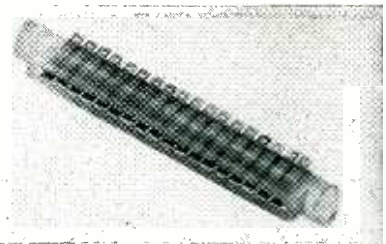

Printed Circuit Connectors

DEJUR-AMSCO CORP., 45-01 Northern Blvd., Long Island City 1, N. Y. The series PC miniature printed circuit connectors have precision phosphor bronze contacts, silver and gold plated, tinned on the solder end for easy soldering at assembly. They feature positive polarization, minimum insertion and disengagement force, and a molded body from melamine mineral filled. Literature on miniature, subminiature, power and E-Z release connectors is available on request.

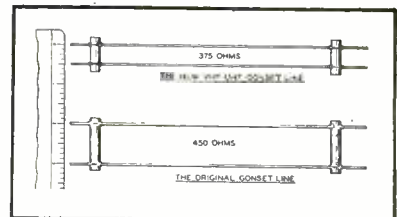

Open Wire Line

GONSET Co., 801 S. Main St., Burbank, Calif., has released a new, closer-spaced open wire transmission line more suited for uhf tv use than the more standard 1-in.-spaced line. Using No. 18 gage solid copper wire spaced 1/2 in., it utilizes polystyrene spacers and is similar to the standard 1-in. line except for spacing. The closer spacing restricts the field and minimizes the dissipation losses and reflection bumps that occur at uhf when open wire line is brought close to almost any physical object. Surge impedance is 375 ohms, sufficiently close to 300 ohms that the new line may be used interchangeably without concern over mismatch. Attenuation is approximately 2 db per 100 ft at the low end of the uhf band

and approximately 3 db at the high end (dry). Unlike conventional ribbon line using a web of polyethylene, the uhf attenuation increases only moderately when the line is wet. The line is also well suited to use at vhf.

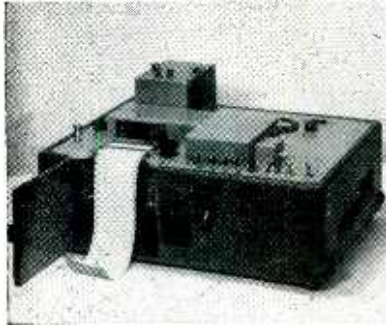

High-Speed Level Recorder

SOUND APPARATUS Co., Stirling, N. J. Recent electronic and mechanical design changes have been made in the model HPL high-speed level recorder. Frequency response has been improved. Sensitivity has been increased and can be adjusted from 7 to 12 mv. A new semiautomatic electronic damping is provided that controls the writing stylus and is particularly useful when the input potentiometers or writing speed are changed. The electronic chassis is an integral part of the recorder and can be easily substituted with circuits of different functions. Mechanical changes have been made for a more convenient chart roll insertion and manual chart setting. A chart rewinding mechanism has been added.

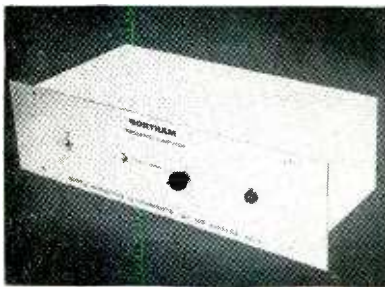

Frequency Computer

NORTH AMERICAN INSTRUMENTS, INC., 3445 Cahuenga Blvd., Los Angeles 28, Calif. The Northam frequency computer is the result of

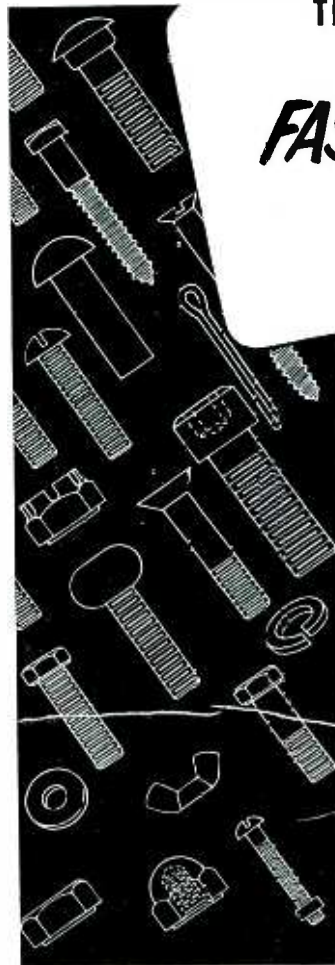
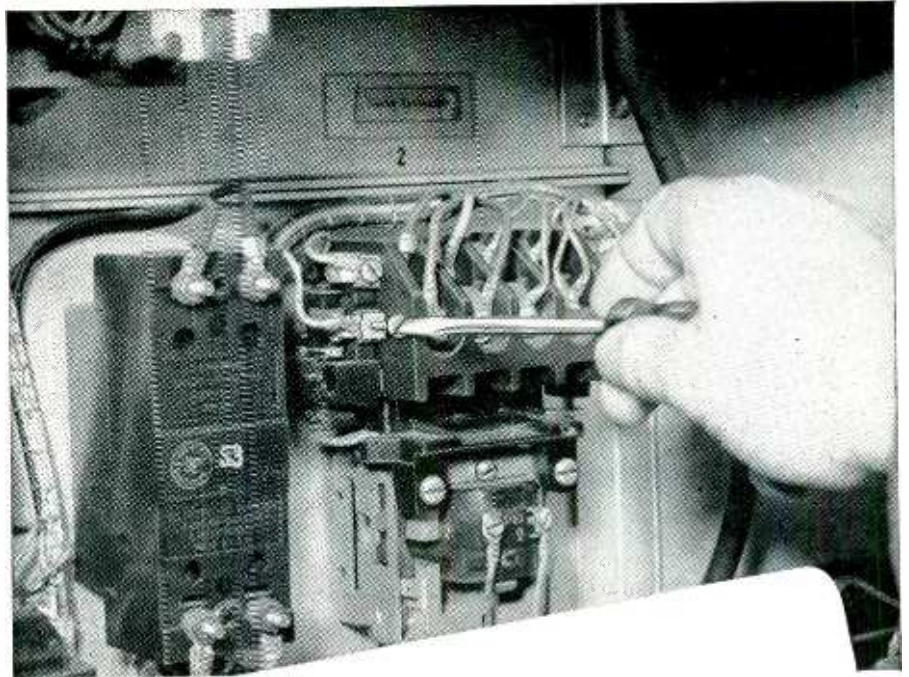

THE HIGH QUALITY EQUIPMENT YOU BUILD DESERVES

FASTENINGS by HARPER

If you manufacture any type of electronic equipment, you know how important high quality, non-corrosive fastenings can be to your production.

H. M. Harper is the largest manufacturer specializing in fastenings of non-ferrous metal and stainless steel. Over 7,000 items carried in stock.

Harper Everlasting Fastenings offer manufacturers of electronic equipment:

- fastenings of brass, naval bronze, silicon bronze, Monel, nickel, aluminum, all stainless steel—many non-magnetic materials
- high quality and extreme accuracy
- a vast metallurgical and engineering background capable of solving any fastening problem
- twenty-nine years of manufacturing experience
- one source of supply for all your needs, with the added advantages of one source of responsibility, one account to handle, one bill to pay.

There is a Harper distributor near you with stocks to fill your order. Harper engineers and metallurgists will be glad to assist you in the solution of any fastening problem.

THE H. M. HARPER COMPANY
8244 Lehigh Avenue, Morton Grove, Ill.

Mail the coupon below for complete catalog of Harper Everlasting Fastenings. There is a Harper distributor near you with stocks to fill your requirements.



Specialists in all Non-Corrosive Metals

The H. M. Harper Company
8244 Lehigh Avenue
Morton Grove, Illinois
Please send the complete catalog of Harper Everlasting Fastenings.

Name.....
Position.....
Company.....
Address.....
City.....Zone.....State.....

What is your Delay or Regulating Problem?



For the most effective solution use the
SIMPLEST, MOST COMPACT
MOST ECONOMICAL
HERMETICALLY SEALED

AMPERITE

THERMOSTATIC DELAY RELAYS



STANDARD

Provide delays ranging from 2 to 120 seconds.

- Actuated by a heater, they operate on A.C., D.C., or Pulsating Current.
- Hermetically sealed. Not affected by altitude, moisture, or other climate changes.
- Circuits: SPST only—normally open or normally closed.

Amperite Thermostatic Delay Relays are compensated for ambient temperature changes from -55° to $+70^{\circ}\text{C}$. Heaters consume approximately 2 W. and may be operated continuously. The units are most compact, rugged, explosion-proof, long-lived, and—very inexpensive!



MINIATURE

TYPES: Standard Radio Octal, and 9-Pin Miniature.

PROBLEM? Send for Bulletin No. TR-81

BALLAST-REGULATORS



T9 BULB

- Amperite Regulators are designed to keep the current in a circuit **automatically regulated** at a definite value (for example, 0.5 amp).
- For currents of 60 ma. to 5 amps. Operates on A.C., D.C., or Pulsating Current.
- Hermetically sealed, light, compact, and most inexpensive.

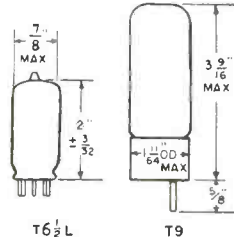
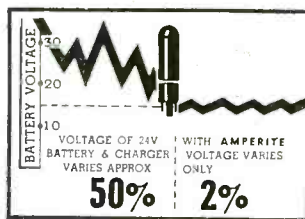

Maximum Wattage Dissipation: T6 $\frac{1}{2}$ L—5W. T9—10W.

Amperite Regulators are the simplest, most effective method for obtaining **automatic regulation** of current or voltage. Hermetically sealed, they are not affected by changes in altitude, ambient temperature (-55° to $+90^{\circ}\text{C}$), or humidity. Rugged; no moving parts; changed as easily as a radio tube.

Write for 4-page Technical Bulletin No. AB-51

AMPERITE CO., Inc. 561 Broadway, New York 12, N. Y.

In Canada: Atlas Radio Corp., Ltd., 560 King St., W., Toronto B8



a development for the Navy to provide a simple and accurate frequency measuring unit for a flow-metering system. This system is used for the continuous measurement of flow of difficult fluids. The frequency computer is operable with pulses as low as 1 mv in amplitude. Ranges of 5 to 100 cps and higher with an accuracy of ± 0.5 percent full scale are available. An internal frequency reference is incorporated to provide overall system standardization. The frequency computer, in addition to its flow meter application, may be used as a tachometer, with a photoelectric or magnetic pickoff; as a frequency deviation meter; or in other applications where accurate measurement of frequency is desired.

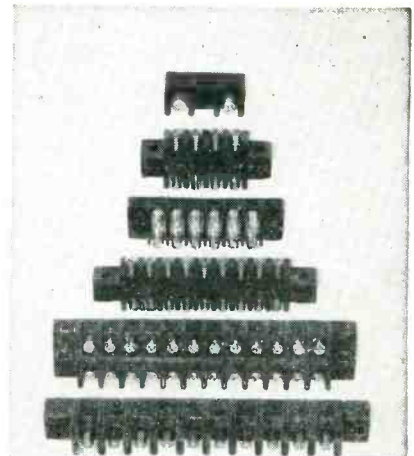

Terminal Boards

GENERAL PRODUCTS CORP., Union Springs, N. Y. The terminal boards illustrated represent a few of the many types, sizes and ratings that are available. They are in strict accordance with Navy Dept., Bureau of Ships drawing 9000-S6505-73214 and Bureau of Ordnance drawing 564101, both to latest revision. The many sizes, types and ratings available permit their use in a variety of electrical and electronic power, lighting and signalling applications. All terminal boards are molded of high-impact, high heat resistant electrical grade molding compound. Identifying numbers are molded into each barrier adjacent to the terminals, thus eliminating the need for marker strips. The terminal studs are

NEY'S

SMALL PARTS PLAY A **BIG** PART IN PRECISION INSTRUMENTS



NEY slip rings are used very satisfactorily on all AVIEN Fuel Gage Indicators.

Do you have our Bulletins R-12, R-13, and R-14?

THE J. M. NEY COMPANY, 179 Elm St., Hartford 1, Conn.
Specialists in Precious Metal Metallurgy Since 1812

15NY52A

HIGH CAPACITY
5 Cubic Feet
(140-Liters) Per Min.

Duo-Seal Vacuum Pump
GUARANTEED VACUUM
0.0001 mm Hg. or 0.1 Micron

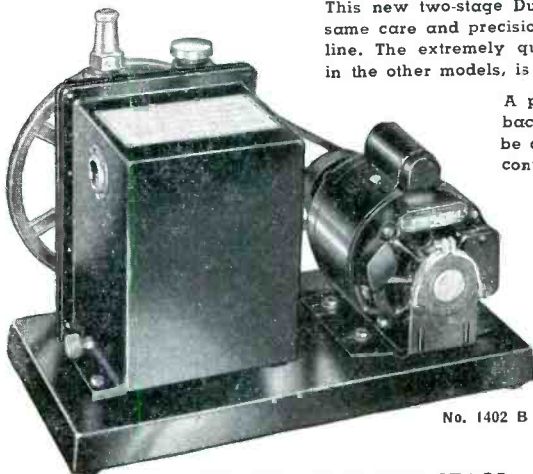

No. 1402 B

Available for Immediate Shipment.

1402. DUO-SEAL TWO STAGE VACUUM PUMP. Pump unit only, not mounted on a base, but with a 10 inch grooved pulley, a supply of oil, and directions for use. Each \$190.00

This new two-stage Duo-Seal pump is constructed with the same care and precision as its fore-runners in the Duo-Seal line. The extremely quiet operation, so much appreciated in the other models, is also characteristic of this unit.

A positive oil seal prevents the oil from backing into the exhaust line. Oil may be changed in a few minutes due to the conveniently located oil drain.

- FASTER PUMPING
- QUIET OPERATION
 - VISIBLE OIL LEVEL
 - COMPACT DESIGN

Overall dimensions for pump and motor 15½" high and 11" wide x 19¾" long.

1402B. DUO-SEAL PUMP, MOTOR-DRIVEN. A No. 1402 Pump mounted on a base with a ½ H.P. 115-volt A.C. motor. Complete with pulleys, belt, and cord. Each \$250.00

1402BG. BELT GUARD for 1402B Duo-Seal Pump. . . . Each \$15.00

W. M. WELCH SCIENTIFIC COMPANY
DIVISION OF W. M. WELCH MANUFACTURING COMPANY
ESTABLISHED 1880
1515 SEDGWICK STREET DEPT. H CHICAGO 10, ILLINOIS, U.S.A.

speed up production . . .
bring your costs down!

ALPHA

SOFT SOLDER PREFORMS

Alpha's preformed solders, in any shape or size, cut many hours from your production time. You can select washers, rings, coils, cut shapes, drops, pellets, solder foil, to fit your specific needs. They save you considerable money and materials in repetitive soldering processes.

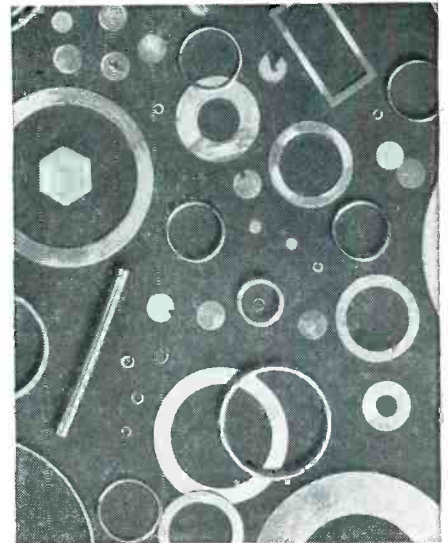

SPEED AUTOMATIC SOLDERING
for flame, oven or induction heating

Increase Production • Melts Faster • Guarantee Product Precision • With Or Without Self-Flux Save Labor Costs • Designed For Your Application All Sizes, Shapes, Alloys • Stronger, Smoother Joints

AVAILABLE IN

- ★ CEN-TRI-CORE ENERGIZED
- ★ TRI-CORE LEAK-PRUF
- ★ ROSIN-FILLED
- ★ ACID-FILLED
- ★ SINGLE-CORE
- ★ SOLID WIRE
- ★ SHEET SOLDER

Please consult us on your soldering problems. Trained Field Engineers always available to assist you. Small or large quantities.

write to **ALPHA** for further information

ALPHA METALS, INC.
58 Water St., Jersey City 4, N. J.



designed
by Microtran...
for transistor
circuitry

*Hermetically sealed transformers
available as stock items*

With miniaturization as a keynote these MICROTRAN transformers were designed specifically for Transistor Circuitry. Available in miniature, sub-miniature and micro-miniature sizes, dependent upon current, power, and frequency response requirements.

At MICROTRAN you will find a well staffed circuit design department prepared to assist you in your miniaturization problems. Our recent developments of H I "Q" audio transformers for single frequency applications have permitted substantial reduction in equipment complexity.

These ruggedized military type units are stock items. Immediate delivery on hermetically sealed and open frame units.

Open units are Resin impregnated to provide thorough protection from adverse climatic conditions and are supplied with flexible 3" color coated leads.

Standard MIL type cases for military applications are available on special order.

TRANSISTOR TRANSFORMERS

PART NO.	MIL TYPE	APPLICATION	PRIMARY IMPED.	SEC. IMPED.	LIST PRICE	
					M	SM & MM
*T1	TF1A10YY	Input-Line to emitter	500	500	\$14.50	\$14.15
*T2	TF1A10YY	Input-Hi impedance mike to emitter	50,000	500	15.70	14.15
*T3	TF1A15YY	Interstage-collector to emitter	50,000	500	15.70	14.15
*T4	TF1A13YY	Output-collector to line	50,000	500	15.70	14.15
*T5	TF1A13YY	Output-collector to speaker	50,000	6	14.50	14.15

* Add M Prefix to indicate miniature size, SM for sub-miniature size, MM for micro-miniature size. Size to be used depends on D.C. current, frequency response and power output requirements. Write for full details.

molded in and have a minimum tensile strength of 80,000 psi. Terminal nuts and connectors are supplied where required.

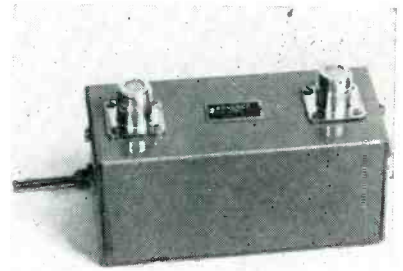

Step Variable Delay Line

ADVANCE ELECTRONICS Co., P. O. Box 394, Passaic, N. J. For variable time delay where faithful reproduction of input signal pulses, complete freedom of time jitter and no limit on repetition rate are desired, the type 601 step variable delay line is extremely valuable. It consists of 44 sections of lumped-parameter L-C networks. Time delay is variable in step of 0.2 μ sec up to 2.2 μ sec. Characteristic impedance is 190 ohms nominal for both input and output. Maximum rise time is less than 0.1 μ sec at any step. Cutoff frequency is 6.37 mc nominal. Maximum input voltage is 500 v peak. Accuracy is ± 1.0 percent of maximum delay.

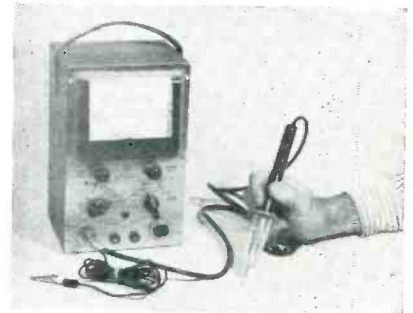

Multiplier Probe

INSULINE CORP. OF AMERICA, 3602-35th Ave., Long Island City 1, N. Y., has available a multiplier probe that extends the d-c voltage ranges of standard vtvm's 100 times. The device is of special value to tv engineers, servicemen, x-ray workers and other technicians who

Write for catalogue w and name of nearest representative

MICROTRAN[®] CO.

an affiliate of Crest Laboratories, Inc.

WHITEHALL BUILDING, FAR ROCKAWAY 91, N. Y.

have occasion to measure very high voltages. If the meter has a normal top range of 300 v, it reads up to 30,000 v; if it has a range of 500 v, it reads up to 50,000 v. Complete safety for the user is assured by a heavily insulated handle fitted with a finger guard. The probe is 8½ in. long and has a 5-ft flexible cord and an accompanying grounding wire.



Single Phase Inverter

EICOR, INC., 1501 W. Congress St., Chicago 7, Ill., has developed a 40-va single phase inverter designed to operate at a nominal input of 28 v, d-c, with an output of 26 v, 400 cycles, a-c. A novel method for mounting the thermistor-resistor combination is incorporated in the design, achieving a minimum size package. The combination is mounted on the a-c end bracket—affording easy access for adjustments and repairs. Speed of the inverter is controlled by a centrifugal governor. The unit is self-cooled by an internal fan.



Portable Sound Recorder

BROADCAST EQUIPMENT SPECIALTIES CORP., 135-01 Liberty Ave., Rich-

The RVC-2 Precision Potentiometer
... a basic part of the **ERCO**
flight simulator.

John P. Poth,
 Chief Engineer, ERCO says:

"Precision potentiometers play a primary part in the construction of the present day Operational Flight Trainers and Simulators developed by the Engineering and Research Corporation. They constitute a basic part of the high accuracy analog computers which solve varied and complex mathematical functions in completely simulating flight of all types of modern aircraft. Such potentiometers are a necessary part of circuits for multiplication and division and, when equipped with taps, are used in the generation of many non-linear functions."

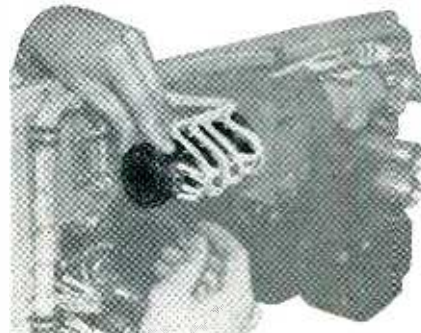
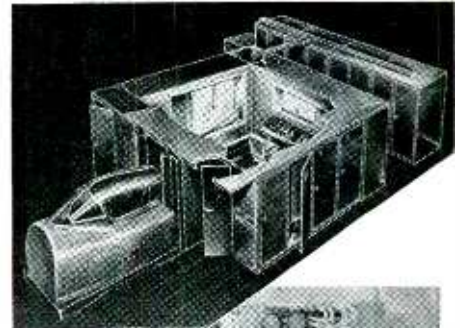

Photos show complete simulator and internal application of precision potentiometers, courtesy of ERCO

RVC-2 "UNITIZED" CONSTRUCTION provides:

- Maximum versatility
- Units interchangeable
- Standardization of individual units
- Maximum economy
- Ease of service and maintenance
- Ideal for both experimental and production application
- Meet the most exacting standards of quality and performance

IMMEDIATE DELIVERY small or large quantities



Bulletin B1
 upon request



PAT. NOS. 2,543,228 2,543,673

Servotrol manufactures under license agreement with Technology Instrument Corp.

ENGINEERING REPRESENTATIVES

- Cleveland, Ohio — PProspect 1-6171
 Chicago, Ill. — UPtown 8-1141
 Rochester, N. Y. — Monroe 3143
 Canaan, Conn. — Canaan 649
 Dayton, Ohio — Michigan 8721
- Arnprior, Ontario, Can. — Arnprior 400
 New York, N. Y. — MURray Hill 8-5858
 Cambridge, Mass. — ELiot 4-1751
 Hollywood, Cal. — HOLLYwood 9-6305
 Dallas, Texas — Dixon 9918
 Baltimore, Md. — Plaza 7694



SERVOTROL COMPANY

114 WEST ILLINOIS STREET, CHICAGO 10, ILLINOIS • TEL. SUPERIOR 7-3082
 EASTERN BRANCH OFFICE—FRAMINGHAM CENTRE, MASS. • TEL. FRAMINGHAM 4421

Want more information? Use post card on last page.



Pacing Relay Progress



"UPSTAIRS" as well as **down**

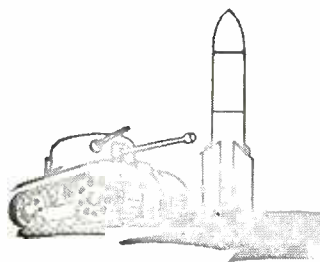

Recent additions to the broad array of Struthers-Dunn relay types play vital defense roles in a wide variety of applications ranging from 70,000 feet in the air to below the ocean surface. Important S-D design and engineering advances materially improve relay performance under shock, vibration, ambients to 200°C., high humidity and other adverse conditions encountered in military operations.

STRUTHERS-DUNN

5,348 RELAY TYPES

STRUTHERS-DUNN, INC., 150 N. 13th St., Philadelphia 7, Pa.

BALTIMORE • BOSTON • BUFFALO • CHARLOTTE • CHICAGO • CINCINNATI
CLEVELAND • DALLAS • DETROIT • KANSAS CITY • LOS ANGELES
MINNEAPOLIS • MONTREAL • NEW ORLEANS • NEW YORK • PITTSBURGH
ST. LOUIS • SAN FRANCISCO • SEATTLE • SYRACUSE • TORONTO



OVER 17,000 COPIES NOW IN USE

"RELAY ENGINEERING," the famous 640-page handbook brings you full benefit of Struthers-Dunn's experience in producing thousands of relay types. The ideal guide to modern relay selection, use, maintenance and circuitry. Price \$3.00.

Want more information? Use post card on last page.

mond Hill 19, L. I., N. Y., has available the Tapak portable, self-powered walk-about type of sound recorder, suitable for making on-location magnetic tape recordings in a form ready for direct broadcast. It turns out finished continuity ready for immediate airing or playback. This entails ability to monitor continuously while recording, to erase when desirable, to play back material for on-the-spot evaluation and to edit conveniently in the field. The unit, including microphone, headphone and spare tape all fit inside a 14-in. x 10-in. x 5½-in. space. Rewind is 44 in. per second. Tapak operates continuously (with cover open, removed or closed) for up to 19 minutes with 0.0017-in. thickness tape or 15 minutes with 0.0022-in. tape. It may be rewound while operating without disturbing speed.



Industrial Abrasive Unit

THE S. S. WHITE DENTAL MFG. CO., 10 E. 40th St., New York 16, N. Y. Cutting by means of a high-velocity stream of gas-propelled abrasive particles, the recently developed Airabrasive unit provides a fast, accurate method of doing a number of high precision operations. The cutting action is accomplished without the usual increase in temperature and without the pressure and vibration ordinarily experienced with other cutting methods. This is of particular significance when working on materials such as germanium, whose physical or electrical properties might be affected by heat and shock. The unit's place in the electronics field also includes printed circuit applications and work on spiral wound carbon resistors. It operates on 110 v, 60 cycles



KEL-F
(trifluorochloroethylene) loses none of its properties in temperatures as high as 390°F. Matter of fact, it runs the temperature gamut all the way up from -320°F. . . . a range of 710 fahrenheit degrees!

You'll find reason upon reason for liking this high polymer thermo-plastic. For one thing, it has an excellent memory. Press it out of shape and it returns, once pressure is released, to its original form.

KEL-F has unusually high chemical and electrical resistance. Conducts little heat. Resists "wetting". Humidity, moisture and fungus bother it not at all.

Largest Single Sheet

Besides rods, tubes, compression and injection molded forms, we are now making this versatile insulating material in the *biggest single sheets* ever known—up to 5 ft. discs.

Lowest Cost Ever

Expanded production now enables us to offer KEL-F in all its forms at the *lowest prices* in history. We'll be glad to quote on your own requirements. Write today for KEL-F Brochure #202.

ELECTRONIC MECHANICS
INC.

101 CLIFTON BOULEVARD,
CLIFTON, NEW JERSEY

MICROWAVE RESISTORS TELEWAVE TYPE R

SMALLEST RESISTOR AVAILABLE
(Ideal for Miniaturization)

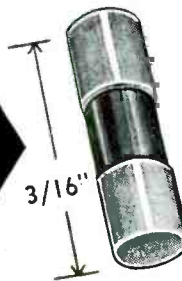

TYPICAL APPLICATIONS

- Power measurement at any frequency
- Matched terminations for waveguides or coaxial lines
- Resistive power pickup loops
- RF pads or attenuators
- Dummy loads
- Temperature measurements
- Impedance matching

SPECIFICATIONS

Resistance: 50 ohms standard, other values on request.
Tolerance: 5% or 10%
Wattage: 1/4 watt continuous duty at 25°C
Size: 1/16 inch diam. x 3/16 inch long
Terminals: Tinned sections 1/16 inch long
Film Length: Type R-063 — 1/16 inch
Type R-093 — 3/32 inch
Temperature Coefficient: approx. 0.0019 ohms/ohm/°C.
Power Sensitivity: Approx. 10 ohms/watt

TYPE R RESISTORS employ noble metal film deposits on specially selected heat resistant glass.

FILM THICKNESS offers negligible skin effect, at microwave frequencies.

POWER CAPACITY of 1/4 watt provides high power handling ability.

PHYSICAL STRUCTURE is ideally suited to impedance matching in standard coaxial line and waveguides.

FINISH. Coated with a special silicone varnish to protect the film.

AVAILABLE FOR IMMEDIATE DELIVERY

TELEWAVE LABORATORIES, INC.
100 Metropolitan Ave. • Brooklyn 11, New York

7 OUT OF 10 MAJOR POLICE DEPARTMENTS USE

JAMES

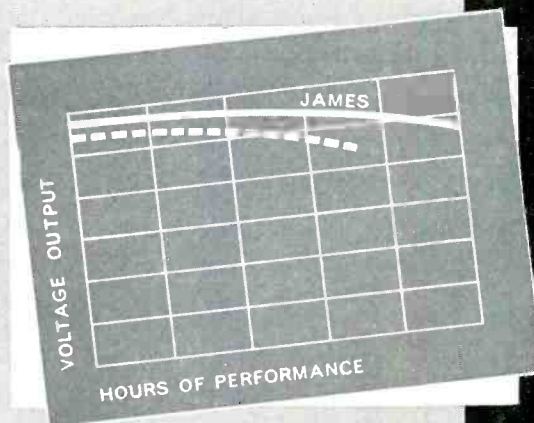

high receiver voltage insures high system performance

JAMES "Red Ball" design results in higher voltage output, lower "hash" influence . . . your assurance of longer life and increased receiver performance. Try the JAMES model designed for your specific communications equipment and you will know why JAMES is specified where "vibrators must not fail!"



See your Distributor or write directly for FREE booklet on "Improving Vibrator Life Through Good Maintenance."

JAMES VIBRAPOW COMPANY

4038 N. Rockwell St. • Chicago 18, Ill.

Continuous Operation

UP FROM +210°C (+410°F) TO -90°C (-130°F) AND BELOW

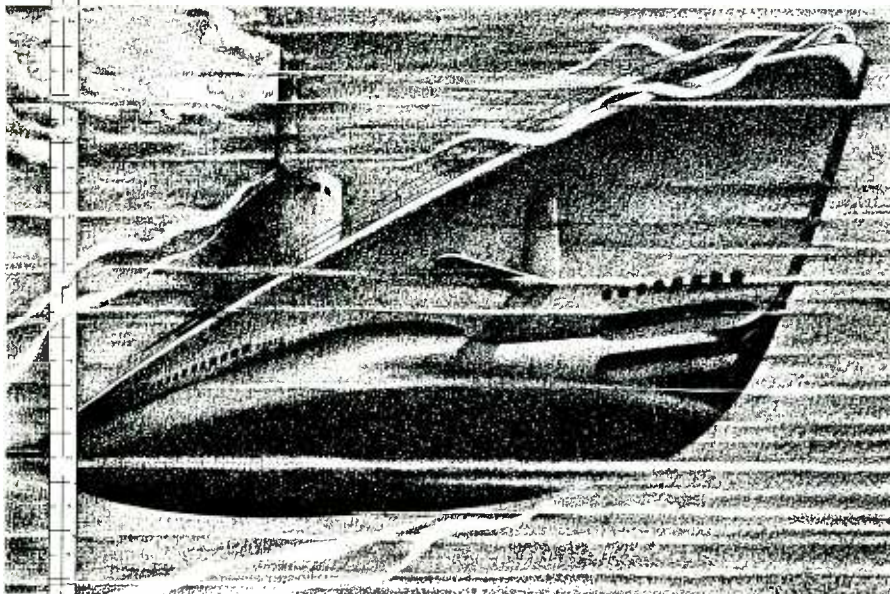

Extruded Teflon HOOK-UP WIRE

EXTRUDED TEFLON (Tetrafluoroethylene) hook-up wire is organically capable of sustained operation from +210°C to -90°C with no appreciable decomposition. This wide range of operating efficiency continually opens new applications for EXTRUDED TEFLON — especially where constant stability under exceptional temperature conditions is required for long periods. **EXTRUDED TEFLON +210°C -90°C is non-inflammable . . . is resistant to most chemicals . . . has no known solvent.**

Because of low electrical losses, EXTRUDED TEFLON is adaptable for high frequency use. It has very high volume and surface resistivity. EXTRUDED TEFLON is available in hook-up wire sizes, with shield or jacket and also as coaxial cable.

NOW AVAILABLE in 10 colors — black, brown, red, orange, yellow, green, blue, violet, gray, white. Samples available.



Surprenant MFG. CO.

199 WASHINGTON ST. BOSTON 8, MASS. Plant CLINTON, MASS.

Engineered Wire and Cable for the Electronic and Aircraft Industries

NEW PRODUCTS

(continued)

a-c, and measures 8½ in. × 15 in. × 12½ in. high and weighs 42 lb.



Accelerometer

ENDEVCO CORP., 180 E. California, Pasadena 1, Calif. A new thimble-size accelerometer provides an improved research instrument for the measurement of high-frequency shock and vibration. It is designed for missile, aircraft and vibration table measurements. The instrument gives a self-generated output of 5 mv per g. Output is flat (+5.0 percent) over the range from 5 cps to 5,000 cps and is stable to within 5.0 percent over a temperature range of -20 C to +70C.



C-R Tube Analyzer

THE JACKSON ELECTRICAL INSTRUMENT Co., 20-32 S. Patterson Blvd., Dayton 2, Ohio. Model 707 dynamic c-r tube analyzer completely and accurately tests all tv picture tubes, deflected types. It will also analyze both magnetic and electrostatic oscilloscope, radar and other special purpose c-r tubes, without removal from chassis or carton. Four classes of tests are made: a beam current test, grid test, gas test and interelement leakage test. The instrument is designed around a highly sensitive, balanced bridge-type

v_{tvm}. A continuously variable line voltage adjustment is provided to assure accurate readings.

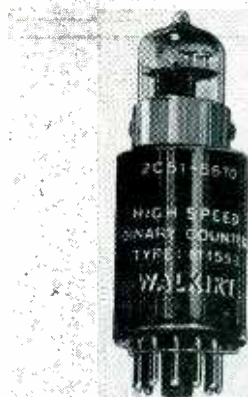

Binary Counter

THE WALKIRT Co., Inglewood, Calif., announces the type 1552 high-speed binary counter for all types of counting and frequency division to rates in excess of 3 mc. It has an 11-prong, octal-type, base plug that allows access to all tube elements and other important circuit points. Input is 75 v negative pulses with a rise time of 0.2 usec. Output is 125 v with a rise time of 0.2 usec. Power is 17 ma at 250 v. The unit operates over an ambient temperature range of -40 C to +70 C.

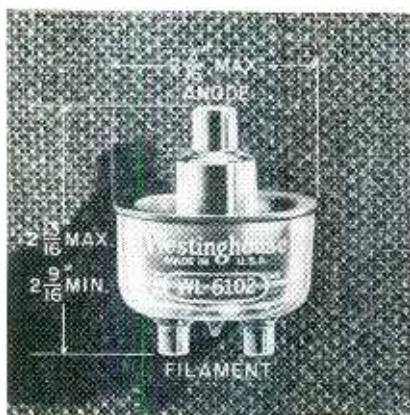

H-V Rectifier Tubes

WESTINGHOUSE ELECTRIC CORP., 401 Liberty Ave., Pittsburgh 30, Pa., has available two new high-vacuum diodes for industrial use in high-voltage rectifier applications. Type 6102 (illustrated) is designed for use in rectifier applications involving peak inverse voltages up to 40 kv. Maximum average current is 150 ma and peak current is 900

Close-up view of Babson Bros. Co.'s Surge Fence Controller showing location of Honeywell Mercury Switch which tilts back and forth as motor is operated.

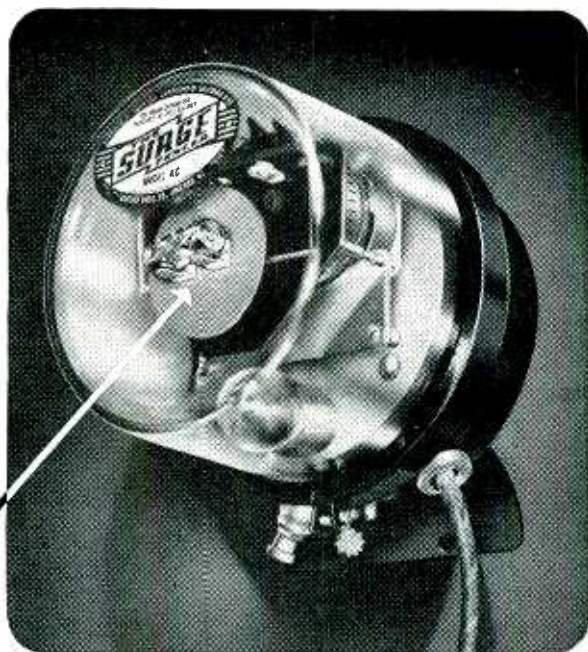

Babson Bros. Co.'s Surge Fence Controller shown in dairy house. Glass enclosure protects motor and working parts.

HONEYWELL Mercury Switch delivers low current once every second in Babson Surge Electric Fencer

Babson Bros. Co.'s electric stock control unit which pulses electric current through a wire fence and permits a strand or two of wire to keep animals in the field is an interesting application of Honeywell Mercury Switches.

This electrical device takes current from the high line, cuts it down to an approved 25 milliamperes, and delivers a safe but effective electric impulse once every second. The

mercury switch is housed in a glass enclosed control unit. It tilts back and forth and causes an electric shock through the fence.

This use of Honeywell Mercury Switches for applications which require low current capacity and long-time continuous operation is typical of the many uses of these switches in industrial controls. MICRO engineers are fully trained and experienced in switching problems and can give you helpful advice and cooperation in selecting the Honeywell Mercury Switch best suited to your requirements. Call the nearest MICRO branch office today.

MICRO A DIVISION OF
MAKERS OF PRECISION SWITCHES MINNEAPOLIS-HONEYWELL REGULATOR COMPANY
FREEPORT, ILLINOIS



**For *Low-Cost,*
High-Production Stripping
of Film Insulation
from Wires AWG 50 to AWG 25**

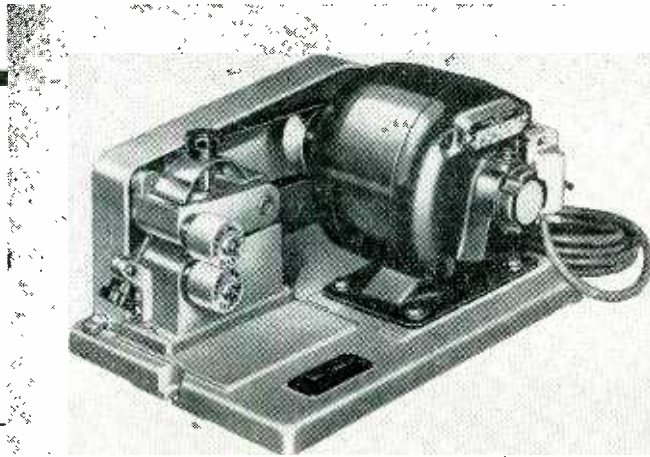

IN STOCK—For Immediate Delivery
Purchase or Test-Rental Plan

These highly efficient wire strippers, equipped with stripping wheels especially selected for YOUR wire-stripping operation, give you high production at low cost with rejects reduced to the very minimum.

Instead of digging off the insulation, RUSH WHEELS develop FRICTIONAL HEAT to melt the insulation and brush it off. Space Regulator keeps the wheels from coming closer together than the bare-wire diameter—prevents scoring or breaking the wire or reducing its diameter. Pressure Regulator permits simultaneous stripping of any number of strands. Particularly efficient on LITZ WIRE.

Speed your wire-stripping production—cut your wire-stripping costs. Send samples of the wire you are stripping together with description of your stripping operation for recommendation and Test-Rental Plan Offer.

Rush Wire Stripper Division

THE ERASER CO., INC.

114 S. State Street

Syracuse 2, N. Y.

ma. It is intended for oil-immersed operation and is only 2 13/16 in. long and 2 3/16 in. in diameter. Type 6103 is for use in applications involving peak inverse voltages up to 20 kv. It has the same average and peak current as the 6102. It is provided with an integral radiator for forced-air cooling. The tube is only 2 15/16 in. long and 2 3/16 in. in diameter. It weighs 8½ oz.

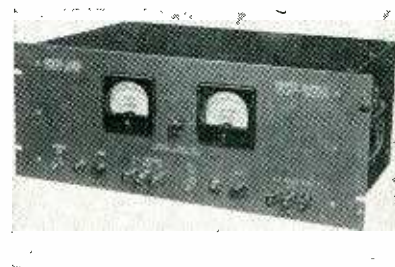

Voltage-Regulated Power Supply

KEPCO LABORATORIES, INC., 131-38 Sanford Ave., Flushing 55, N. Y. Model 141 voltage-regulated power supply features one regulated B supply and one unregulated filament supply. It is distinguished by excellent regulation, low ripple content and low output impedance. The B supply is continuously variable from 100 to 400 v and delivers from 0 to 150 ma. In the 100 to 400-v range output voltage variation is less than 0.5 percent for both line fluctuations from 105 to 125 v and load variations of minimum to maximum currents. Ripple is less than 5 mv peak to peak. The unregulated filament supply is 6.3 v, 10 amperes, unregulated, center tapped and ungrounded.

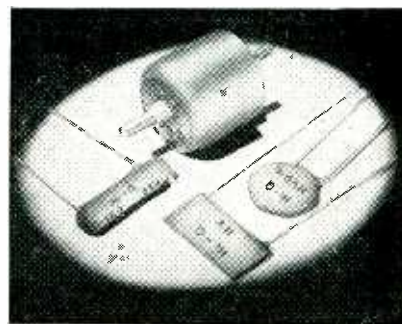

Ceramic Capacitors

AEROVOX CORP., Olean, N. Y. Voltage ratings of from 1 to 20 kv are

ELECTRICAL and ELECTRONIC ENGINEERS

With Several Years' Experience
or Advanced Degrees for Permanent Positions with

Endicott, N. Y. **IBM** Poughkeepsie, N. Y.
TRADE MARK

Excellent Opportunities in the Fields of:
Audio Amplifier Design • Servo Amplifier Design • Servo and Computer Theory • Receiver-Transmitter Design • Small Transformer Design • Regulated Power Supply Design • Circuit Design • Test Equipment Design • Logical Design • Pulse Techniques • Programming • Electrostatic Storage • Magnetic Recording • Component Development • Environmental Testing • Production Engineering

Good salaries, unusual opportunities for professional development, exceptional employee benefits, excellent working and living conditions, moving expenses paid.

Write, giving full details, including experience and education to: Mr. E. H. Getkin, Coordinator of Engineering Recruitment, International Business Machines, Dept. 686 (4), 590 Madison Avenue, New York 22, N. Y.

There is Always One Leader in Every Field
BODNAR INDUSTRIES, Inc.

leads in the field of
TRANSILLUMINATED PLASTIC LIGHTING PLATES

BECAUSE OF *Quality • Uniformity • Performance*
Design & Layout "Know-How Service"
Quantity Production Promptly

NEW YORK — 19 Railroad Ave., New Rochelle (Home Office)
TEXAS — Jefferson Tower Building, Dallas
CALIFORNIA — 11056 Cumpston St., N. Hollywood
CANADA — 313 Montreal Trust Bldg., 67 Yonge St., Toronto

DEMONSTRATION PANEL MIL-P-7788 (AN-P-89) Sent on Letterhead Request

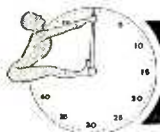

MODEL A-4 TIME DELAY GENERATOR

- A precision device for the generation of accurate and variable time intervals from .00001 to 10 seconds.
- Used by research and development laboratories for investigations into the operation of SONAR, geophysical, biological and other circuits.



Also available:
Model A-2 — .8 to 100,000 μ s.

Write for complete data:
Our bulletins E-A-4 and E-A-2

Rutherford **ELECTRONICS CO.** 3707 S. ROBERTSON BLVD.
CULVER CITY, CALIFORNIA

2 MUSTS

*For Low-Cost Servicing
of Mobile Radio Systems*

Lampkin equipment gives you the lowest cost per channel, whether you supervise a large multiple-frequency system, or whether you service numerous smaller installations! Lampkin equipment measures center frequency and modulation deviation, to FCC specifications!

The Type 205 FM Modulation Meter
For Multiple Mobile Frequencies.



The Type 205 FM Modulation Meter measures peak frequency swing due to voice modulation of FM transmitters, as required by the FCC. Indicates 0-25 KC. deviation. Instantly tunable to any frequency from 25 MC. to 200 MC. Simple to use. Direct reading. No charts. No tables. \$240.00.

For Any Number of Frequencies,
AM or FM. The Type 105-B
Micrometer Frequency Meter



The Type 105-B Micrometer Frequency Meter measures center frequency deviation on any number of transmitters, AM or FM, from 0.1 MC. to 175 MC. The accuracy, determined by over 500 field tests, is conservatively guaranteed better than 0.0025%, surpassing FCC requirements. Readily checked against WWV. \$220.00

Return coupon TODAY for complete literature.



LAMPKIN LABORATORIES, INC.
Instruments Div., Bradenton, Florida

Please send me complete technical literature and delivery information on the following Lampkin-designed instruments:

- Type 205 FM Modulation Meter
 Type 105-B Micrometer Frequency Meter

Name

Address

City Zone..... State.....

How Hammarlund Solves Your Signaling Problems



for remote
supervisory control

DUPLEX SIGNALING UNIT

VERSATILITY

This small, compact unit—transmitter, frequency selective receiver and power supply in a single package—is a vastly improved, new approach to remote signaling and supervisory control system design. It may be used for remote on-off switching, continuous supervisory indication of operating conditions, ringdown signaling, dialing terminal equipment, automatic detection of system functional failures, or for providing channels for transmitting and receiving telemetering information.

FLEXIBILITY

These Hammarlund Duplex Signaling Units have the flexibility required for efficient system design. Up to 36 individual functions can be controlled over a single circuit when they are installed in multiple. Transmitters and receivers operate on the same or different frequencies between 2000 and 6475 cycles per second. Center frequencies in the 2000 to 3500-cycle range are spaced at 100-cycle intervals. And center frequencies in the 3625 to 6475-cycle range are spaced at 150-cycle intervals.

RELIABILITY

Ruggedized, quality-recognized components throughout. A highly stable tone generator, and an amplifier designed for bridging a 600-ohm circuit, assure reliable operation over wire lines, telephone or power line carrier, and radio or microwave communications circuits. It is designed to operate in the range of -30° to $+60^{\circ}$ C. with excellent frequency stability, and under high humidity and other adverse conditions. Harmonic distortion is negligible.

Write for detailed information



HAMMARLUND

HAMMARLUND MANUFACTURING CO., INC.
460 WEST 34th ST. • NEW YORK 1, N. Y.

now made available in Hi-Q ceramic capacitors of the slug, disk, plate and tubular types. In the new slug type, utilizing thick disk dielectrics, the strength of the capacitor is greatly increased by an exacting jacketing procedure in conjunction with a newly developed plastic that provides excellent arc-resistant properties. Terminals are silvered brass integrally soldered to silver electrodes fired directly to the ceramic dielectric. Insulation resistance is in the order of 50,000 megohms. Working voltage is 20,000 v d-c and flash test 27,000 v d-c. The high-voltage tubulars have been developed specifically for use in horizontal sweep and deflection sections of tv receivers, and come in standard capacitances from 4.7 to 1,000 μf , voltage pulse ratings of 1 to 7 kv and capacitance tolerances of ± 5.0 percent.



Insulation Tester

THE HERMAN H. STICHT CO., 27 Park Place, New York, N. Y., has developed a new model P-1 plug-in type Megohmer insulation tester for portable or bench use. It was specifically developed to meet the need for a direct-reading megohmmeter where a large number of tests have to be performed in one location such as in production testing. The unit has a true ohmmeter movement that is independent of voltage variations and requires no adjustment whatsoever during normal operation. It is provided with a self-contained power unit to step up and rectify 115-v 60-cycle a-c supply. Output voltages of 500 v d-c and 1,000 v d-c are available. The instrument comes in single-range or double-range

models. Ranges available are 100 or 1,000 or 2,000 megohms.

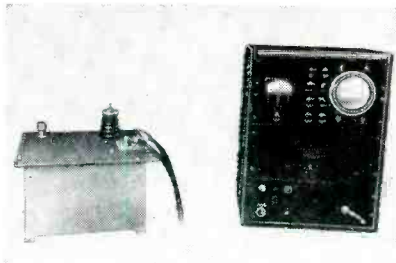

Corona Ionization Detector

NETWORK MFG. CORP., 213 West 5th St., Bayonne, N. J. The corona ionization detector is designed for testing corona initiation and extinction levels in coaxial cables, transformers and other insulated electrical components. It will perform corona test requirements of JAN-C-17A specifications for coaxial cables and MIL-T-27 for transformers. It is especially useful for the study of insulating materials and dielectrics before rupture by breakdown. It is suitable for non-destructive testing of valuable specimens.

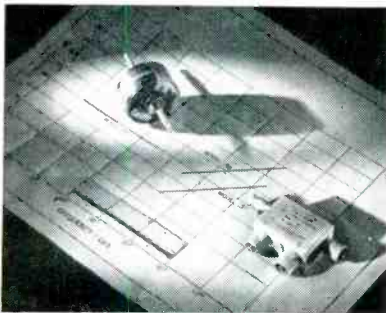

Wideband Directional Couplers

SIERRA ELECTRONIC CORP., 810 Brittan Ave., San Carlos, Calif. Widely applicable tools for measuring numerous parameters relating to transmission lines, the new wideband directional couplers are available in three models. Model 137 operates over the entire frequency range from 30 to 1,500 mc with a sensitivity rising from -70 to -35 db. Model 138 covers the same frequency range but has a sensitivity ranging from -55 to -20 db. Operating in a 51.5-ohm coaxial line, these couplers are usable from 0.1 w up. Frequency-independent at a sensitivity of -50 db over the

meets

MIL-T SPECS

52 TRANSFORMERS

CHICAGO HERMETICALLY SEALED TRANSFORMERS MEET GRADE I, MIL-T-27 CLASS A REQUIREMENT

Meeting all requirements of Grade I, MIL-T-27 specifications for operation, Chicago hermetically sealed transformers are approved for airborne, marine and ground communication equipment, parts research and development applications, pilot usage, production quantities. Also ideal where maximum sealing and quality are desired for Class A equipment designed for tropical and sub-tropical climates, etc. Sealed dry cases with bonded one-piece steel base covers, rubber gasketed terminals. Rigid internal mounting brackets.

POWER TRANSFORMERS FOR CAPACITOR INPUT SYSTEMS—PRIMARY 117 VOLTS, 50-60 CYCLES

Cal. No.	Type	AC Volts	DC Output	DC Other	Ins. Test	Case Size	Term. Type	Wt. Lbs.	Net Price
13-770	PHC-10	250-0-250	10	320	—	6.1	0.00	14	R 13.73
13-771	PHC-20	250-0-250	20	300	—	6.3	0.6	15	R 14.03
13-772	PHC-40	225-0-225	40	210	5	6.0	1.2	17	R 11.61
13-726	PHC-55	270-0-270	55	260	5	6.0	1.2	17	R 12.73
13-727	PHC-70	315-0-315	70	320	5	6.0	1.5	19	R 13.79
13-728	PHC-85	310-0-310	85	320	5	6.0	1.5	20	R 14.79
13-729	PHC-105	345-0-345	105	320	5	6.0	1.5	21	R 16.39
13-730	PHC-120	375-0-375	120	300	5	6.0	1.5	22	R 17.21
13-731	PHC-150	370-0-370	150	300	5	6.0	1.5	22	R 21.34
13-732	PHC-200	385-0-385	200	300	5	6.0	1.5	22	R 22.66

FILAMENT TRANSFORMERS FOR RECTIFIER INPUT SYSTEMS—PRIMARY 117 VOLTS, 50-60 CYCLES

Cal. No.	Type	Volts	Amperes	Ins. Test	Case Size	Term. Type	Wt. Lbs.	Net Price
13-736	FH-210	2.5CT	10	5000	16	S	3.5	\$13.02
13-737	FH-210H	2.5CT	10	9000	19	T	4.3	15.14
13-738	FH-54	5.0CT	4	2500	15	R	2.5	9.47
13-739	FH-58	5.0CT	10	2500	17	R	3.5	13.02
13-760	FH-516	5.0CT	20	2500	21	R	6.5	18.82
13-761	FH-530	5.0CT	30	2500	22	R	10	24.25
13-762	FH-65	6.0CT	5	2500	16	R	3.5	10.91
13-763	FH-610	6.0CT	10	2500	19	R	5	15.43
13-764	FH-104	10.0CT	4	2500	17	R	3.5	12.11
13-765	FH-100	10.0CT	10	2500	21	R	6.5	18.82

* Terminal Types Indicated are for secondaries, primaries have R Type Terminals

FILTER REACTORS

Cal. No.	Type	Inductance	Max. DC Current	DC Resistance	Insulation Test	Case Size	Term. Type	Wt. Lbs.	Net Price
13-734	RH-1510	10	60	600	1000	10	H	1.0	6.76
13-735	RH-1520	15	20	475	2500	10	H	1.0	6.76
13-742	RH-1540	15	40	475	2500	10	H	1.0	6.76
13-743	RH-1055	10	55	250	2500	10	H	1.0	6.76
13-744	RH-1555	15	55	420	2500	10	H	1.0	6.76
13-745	RH-1085	10	85	175	2500	10	H	1.0	6.76
13-746	RH-1585	15	85	285	2500	10	H	1.0	6.76
13-747	RH-8105	8	105	100	2500	10	H	1.0	6.76
13-748	RH-12105	12	105	170	2500	10	H	1.0	6.76
13-749	RH-8150	8	150	95	2500	10	H	1.0	6.76
13-750	RH-12150	12	150	150	2500	10	H	1.0	6.76
13-751	RH-8200	8	200	85	2500	20	H	1.0	6.76
13-752	RH-12200	12	200	140	2500	20	H	1.0	6.76
13-753	RH-8300	8	300	70	2500	22	H	1.0	6.76

* Inductance measured at 10 volts, 60 cycles.

CHICAGO HERMETICALLY SEALED DIMENSION DATA

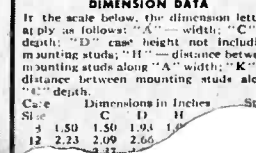

FREE! RADIO SHACK AND CHICAGO CATALOGS

CHICAGO Hermetically Sealed Transformers meet all requirements of Grade I MIL-T-27 specifications for Class A operation.

RADIO SHACK'S stock of Chicago transformers meets your entire need — for any type — and for production quantities.

Please send me the new 1953 Radio Shack Catalog and the new 1953 Chicago Transformer Catalog.

NAME

COMPANY

STREET

CITY STATE

RADIO SHACK CORPORATION
167 Washington St., Boston 8, Mass.

30-kc to 1-mc range, the model 139 coupler is applied to balanced two-wire lines at power levels ranging up to 15 kw.

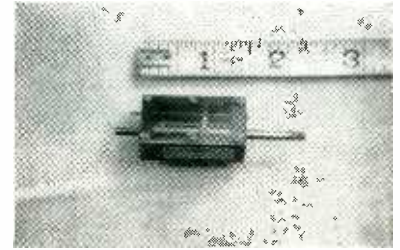

Subminiature Potentiometers

GALETRONICS, INC., Pasadena, Calif., is manufacturing a new line of subminiature precision potentiometers for the telemetering and electronics industries. The rotary type RC can be furnished up to 320,000 ohms with a resolution of 0.1 percent, in a $\frac{3}{4}$ in. diameter case. Type LE (illustrated), a rectilinear potentiometer in a case $1\frac{3}{8}$ in. long, can be furnished up to 1,000,000 ohms with a resolution of 0.05 percent.

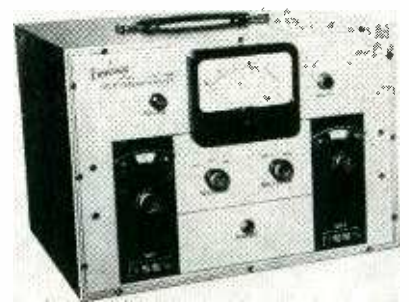

Field Strength Meter

ERWOOD, INC., 1770 Berteau St., Chicago 13, Ill., has introduced a uhf-vhf field strength meter. The unit was designed to determine the strength of signals available at any given location and covers all the frequencies used today in broadcasting tv and f-m programs. It is also useful in determining the relative efficiency of different types of antennas as well as the optimum heights. The vhf range is continuous from 52 to 218 mc, with sensitivity at 60-percent meter deflection per 100-mv input. The uhf range is continuous from 470 to 890 mc, with sensitivity at 50-percent meter



We're sorry, but we think it's only fair to tell possible new customers our Standing Room Only sign must be changed to Sold Right Out!

The design and production facilities of our microwave department are now taken over by the increasing requirements of our present customers. Because of our responsibility to them, this situation may continue quite a while.

We are sorry to say this because we enjoy making new friends. But we feel that we should tell those who might be interested in our engineering and manufacturing facilities, that for some time we may not be able to serve them.

Any change in the situation will be announced in this publication.



L. H. TERPENING COMPANY
 DESIGN • RESEARCH • PRODUCTION
 Microwave Transmission Lines and Associated Components
 16 West 61st St. • New York 23, N. Y. • Circle 6-4760

U. G. CONNECTORS

*Our Coaxial Cable
Connectors Meet All
Government Specifications*

★ ALL ORDERS DELIVERED PROMPTLY ★

*Manufacturers of
Highest Quality Connectors*

ALLIED INDUSTRIES, INC.

1023 S. 21st STREET
LOUISVILLE 10, KY.

Phone Arlington 4640



Announces

a NEW 90° YOKE for 27" TUBES



**It's Engineered for
TOP PERFORMANCE
... in Production NOW!**

This new DX 90° Deflection Yoke has everything a television receiver manufacturer wants . . . a sharp full-screen focus, a minimum of pincushioning, the ultimate in compactness and a price that's downright attractive. Because this yoke has been brilliantly designed for mass production on DX's specialized equipment, it warrants immediate consideration in your 27" receiver plans. Write us today.

DEFLECTION YOKES . . . TOROID COILS . . . CRYSTALS
I. F. TRANSFORMERS . . . R. F. COILS . . . DISCRIMINATORS
SPEAKERS . . . TV TUNERS . . . ION TRAPS . . . TRANSFORMERS

DX RADIO PRODUCTS CO.

GENERAL OFFICES: 2300 W. ARMITAGE AVE., CHICAGO 47, ILL.



**experience...
still the
best teacher!**

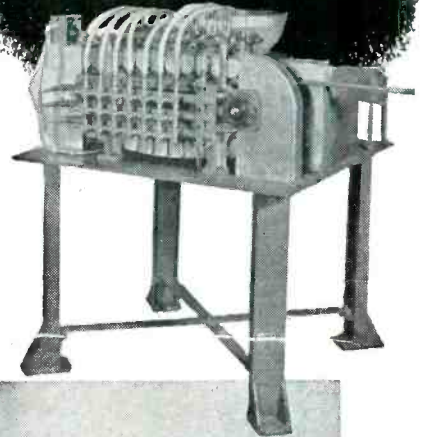

A large manufacturer of miniature lamps for switchboard and telephone use, came to Kahle recently with a production problem. The client had been using a low-production tube bottoming machine that required frequent adjustment and maintenance due to its method of uneven shifting of the tubing. This also caused excessive tube breakage within the machine and a high reject rate on the finished tubes. Kahle's solution was to build the fully automatic machine shown above, Model 2048. This machine, producing 4,000 units per hour, eliminates the lifting of the glass from one position to the next by using a continuous conveyor principle. The glass is indexed straight through the machine and is not 'jumped' or 'bumped' in the process. In-machine breakage and rejects are held to a minimum. In addition, Model 2048 is ideal for production of round or flat bottomed test tubes, vials and containers.

If your production involves special-purpose machinery, learn —without obligation—how Kahle's more than 40 years of practical experience can benefit you. Write Kahle today.

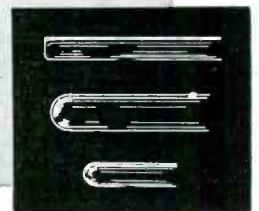

Kahle

ENGINEERING COMPANY

1310 SEVENTH STREET
NORTH BERGEN N. J.

Ruggedly Designed for Dependable, Heavy-Duty Operation

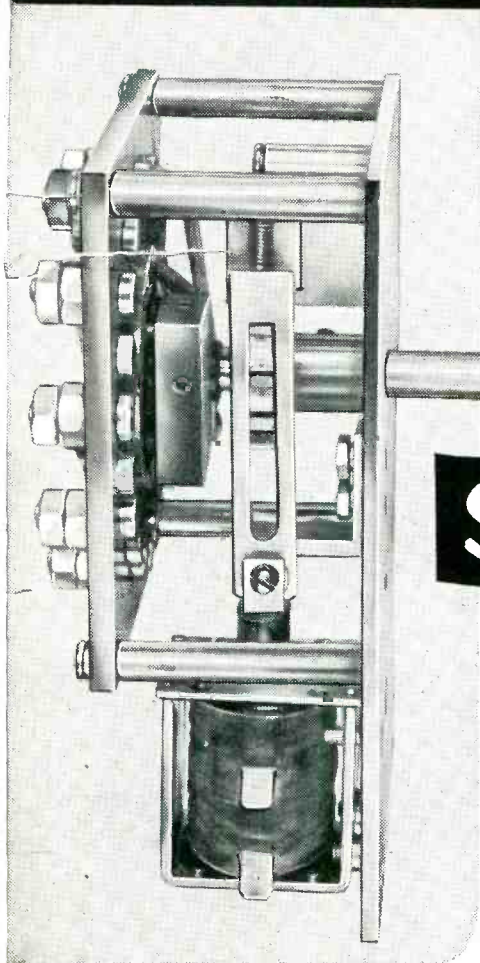

TECH LABS SOLENOID OPERATED

SWITCHES

When operating conditions demand a solenoid switch that will stand up under the most rugged requirements, always choose Tech Laboratories Solenoid Switches. These multi-pole units are built to "take it" and are designed and produced to meet your individual requirements.

According to your specifications you can get:

- Remote push-button operation, with or without manual reset.
- Single or dual direction operation.
- Single, or up to 8 decks.
- Single pole to 4 poles per deck.
- Two contacts up to several hundred contacts per deck.
- Shorting or non-shorting.
- Ceramic or phenolic insulation.
- Load capacities up to 10 Amp.—120 Volts AC (depending on number of contacts).
- Long, trouble-free service life.

Information on these and our additional line of motor operated switches is yours for the asking . . . Write today for complete catalog.



Manufacturers of Precision Electrical Resistance Instruments
PALISADES PARK, NEW JERSEY

deflection per 100-mv input. The meter uses 11 tubes. Power consumption is 70 watts, 110 v a-c.

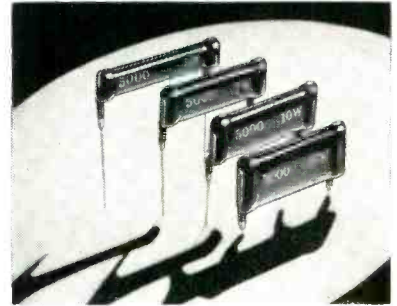

Wire Wound Resistor

HAMILTON-HALL MFG. CO., 227 N. Water St., Milwaukee, Wisc. The Hall-Ohm resistor is completely impervious to high humidity and the abuses encountered during assembling operations. The unique coating will not chip or flake and provides excellent surface radiation. These resistors are available up to 25,000 ohms resistance value and up to 20 watts dissipation.

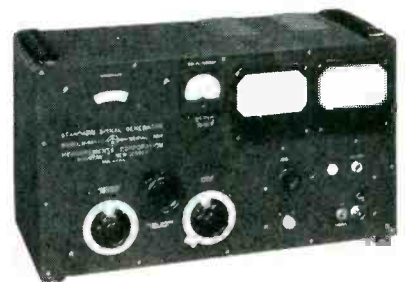

UHF Signal Generator

MEASUREMENTS CORP., Boonton, N. J. Model 84-TV standard signal generator, with frequency range of 300 to 1,000 mc, is useful for determining the characteristics of tv receivers for the uhf band, and other equipment operating within that range. Output voltage is continuously variable from 0.1 μ v to 1 v across a 50-ohm load. Output impedance is 50 ohms and vswr is 1.3 to 1 or better. Provision is made for operating the filament of the oscillator tube from an external d-c supply to remove residual hum. Modulation, continuously variable from 0 to 30 percent, may be obtained from an internal 400-cycle oscillator. Provision is also made for applying external modulation

within the range of 50 to 20,000 cycles. Percentage modulation is indicated by a panel meter.

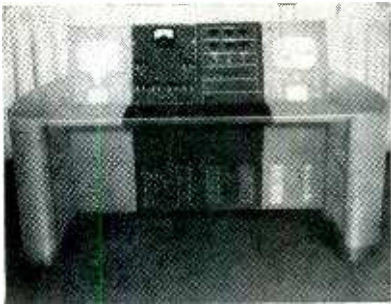

TV Console Unit

RADIO CORP. OF AMERICA, Camden, N. J. This versatile two-section console, which provides centralized audio and video control and monitoring facilities, is a practical basic unit for almost any tv station, large or small. The type TC-4A console ties together transmitter operation and primary program sources. Add-on console units of the same flexible construction, may be added as program functions are expanded.

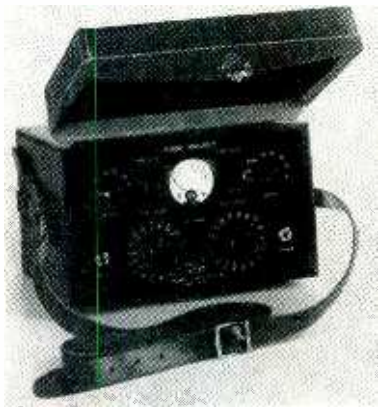

Sound Analyzer

HERMON HOSMER SCOTT, INC., 385 Putnam Ave., Cambridge 39, Mass. Type 420-A sound analyzer separates noise, sound and vibration signals into their component frequency bands. The high and low-pass filters can be independently adjusted in steps of 0.5 octave. A simple interlock permits the pass-band width to be fixed in any multiple of 0.5 octave. The position of this pass-band can then be adjusted throughout the audible range by a single control. The analyzer exceeds all proposed speci-

A Precision Scope

...that can GO PLACES

THE TYPE 315-D

How often have you wished for a precision oscilloscope that you could easily take on long trips and into tight spots? The TEKTRONIX Type 315-D is that kind of instrument—weighs only 36 lbs., measures only 12 3/8" high, 8 5/8" wide, 18 1/4" deep. Designed for portability, it works on power supply frequencies from 50 to 800 cycles. And it has all the features you expect in a fine laboratory oscilloscope . . . plus several new features never before commercially available.

Time base range . . . 1 μ sec to 50 sec
Sensitivity 0.01 v/division ac
(double the originally published sensitivity)
Vertical bandwidth dc to 5 mc
Risetime 0.07 μ sec

Sensitivity — 12 Calibrated Ranges
 ac only—0.01, 0.02, 0.05 v/division 5 cycles to 5 mc
 dc and ac—0.1, 0.2, 0.5, 1, 2, 5, 10, 20, 50 v/division dc to 5 mc

Signal Delay—0.25 μ sec

Time Base — 24 Calibrated Ranges
 —3 per decade, 0.1 μ sec/division to 5 sec/division. 100 second sweep available but not calibrated

Graticule — Edge lighted, marked in 1/4" divisions

5X Magnifier — Expands time base to right and left of center

Direct coupled unblanking

Trigger amplitude discriminator

Flat-faced high-definition 3" CRT

Square wave voltage calibrator

Sawtooth and + Gate available at front panel

TEKTRONIX Type 315-D—\$785 f.o.b. Portland, Ore.
Call or write your TEKTRONIX Field Engineer for demonstration of the Type 315-D.

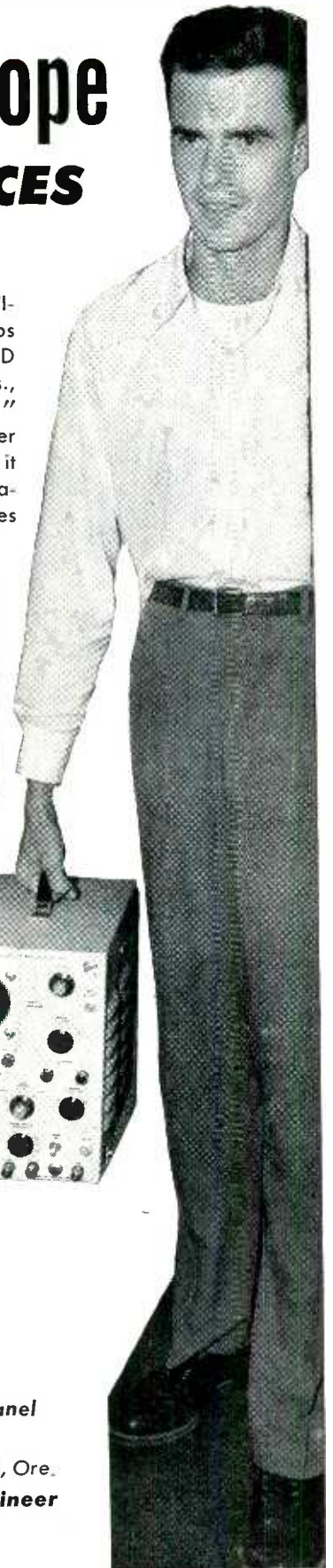
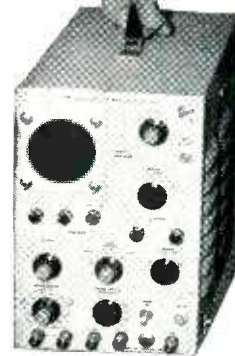

TEKTRONIX, Inc.

P. O. Box 831A, Portland 7, Oregon Cable: TEKTRONIX

These American Electric Miniatures do **BIG** jobs!

Cooling and Ventilating



CENTRIFUGAL BLOWERS

400 cycle, 60 cycle, or variable frequency types (320 to 1000 cps.)

Substantially flat output over full frequency range on variable frequency models with minimum watts loss.

Blower scrolls of latest design are molded of fibre-glass reinforced plaskon; practically unbreakable, highly resistant to impact, deformation, heat and cold. Blower unit unusually small in size and weight for compact installations. Generally used when working against pressure heads ranging up to 1.2" water. Single or double end blowers. Clockwise or Counterclockwise rotation. *Output range: 24 to 200 cfm. Made in sizes: Numbers 1½, 2, 2½, 3.*



AXIAL FLOW FANS

400 cycle operation

In its smallest size this compact, light weight unit is equipped with a 2" fan protected with 18" mesh 2¼" O.D. screen shroud. Other larger sizes special. Air stream is conical. Recommended for use at 0 static pressure where semi-directed air flow is required. Motor diameter 1.45". Rotation: Clockwise or Counterclockwise. *Output: 30 cfm.*



PROPELLER FANS—400 cycle operation

Built for limited space applications requiring maximum air movement widely dispersed.

Operates at 0 static pressure in ambient temperatures from -65° to +65° C. Made in 2, 3, 4 and 5½" fan diameters. *Output range: 33 to 680 cfm.*

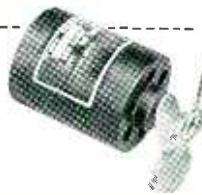

Motivating Cams, Timing Devices, Antennas, Clutches, Optical Equipment, etc.



MINIATURE INDUCTION MOTORS

400 cycle, 60 cycle, single and poly phase, 2 to 8 pole. Frame diameters: 1.45", 1.75", 2", 2½" & 3-5/16". *Output torque range: ½ in. oz. to 50 in. oz.*



SYNCHRONOUS MOTORS

400 cycle, 60 cycle, hysteresis and reluctance types. Single and poly phase: 2, 4 and 6 pole. Frame diameters: 1.45", 1.75", 2", 2½", 3-5/16". *Output torque range: .01 in. oz. to 10 in. oz.*

Both induction and synchronous motors can be supplied for intermittent or continuous duty, with standard or high temperature insulation. Drive and synchronous motors: any standard shape.

Manufacturers also of
INSTRUMENTS,
SERVO-MOTORS AND
SYNCHROS,
HIGH FREQUENCY
POWER SUPPLIES
(Inductor—Alternator type—
500 watt to 75 KVA output).



fications of the ASA for filter-type sound analyzers. Weight of the unit is 20 lb, and measurements are 10 in. × 10 in. × 6 in.

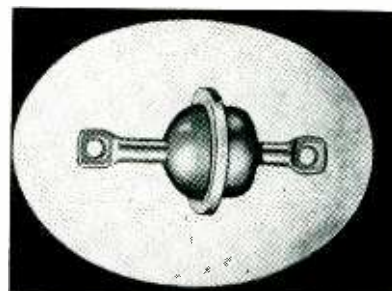

Thermosetting Plastic

MELKOR RESEARCH LABORATORIES, INC., 11740 Detroit Ave., Cleveland 7, Ohio, has developed a new plastic material that withstands continuous temperatures of 200 C and also possesses a high dielectric strength. It is particularly advantageous where hermetic sealing and gas sealing under pressure is needed for perfect functioning of electrical components. The terminal shown is being manufactured in three sizes— $\frac{1}{8}$ in., $\frac{1}{4}$ in. and $\frac{3}{8}$ in. mounting holes. Chief applications of the new terminal are in the assembly of instruments meters and various types of electric and electronic equipment requiring hermetic sealing.



Oscillograph Tube

RADIO CORP. OF AMERICA, Harrison, N. J. The 7-in., c-r tube 7VP1 is designed especially to give sharp focus and to provide high brightness of the trace in general oscillographic applications. Utilizing electrostatic focus and electrostatic deflection, it has a small, brilliant spot and high-deflection sensitivity

**PRECISION
IN MINIATURE!**

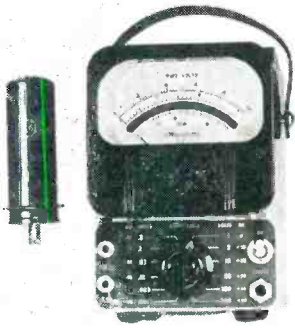

520-A VOLTMETER
1 Millivolt Full Scale To 300 Volts
10 Cycles To 2 Megacycles
Only 4 1/4" x 6" x 6" Deep
\$180 FOB, N. Y.

ALSO — MATCHING
510-B OSCILLATOR
18 Cycles To 1.2 Megacycles
Distortion Less Than 0.2%
Constant Output ± 0.5 db
\$150 FOB, N. Y.

Literature on Request

Waveforms, inc.

333 SIXTH AVE.
NEW YORK, N. Y.

more **LISTENING
COMFORT** with
lightweight **TELEX** headsets!!

THE ONLY
PERSONAL PART
OF ANY
COMMUNICATION
SYSTEM

Modern, light-weight, durable . . . Easily adjustable and built for hard usage, **TELEX** Headsets give top quality reception without the punishment of extra weight and pressure.

***MONOSET**

The modern styling and dependability and superior performance of the **TELEX** Mono-set have made old fashioned head-phones obsolete. Magnetic.



***DYNASET**

New dynamic under-chin **TELEX** Dynaset, with more highs and lows of both music and speech, is the delight of radio and TV monitors. Weighs only 1.25 oz.



***TWINSET**

This lightweight 1.6 oz. **TELEX** Twinset pipes signal directly into the ear, blocking out background noises and banishing listening fatigue. Magnetic.



***EARSET**

Sensitive **TELEX** Earset slips onto ear and is preferred by all who use single-phone headsets. Weighs only 1/2 oz. and leaves other ear free for phone calls or conversation.



**STANDARD OF THE
WORLD FOR
QUALITY HEADSETS**

Telex produces headsets to manufacturers' specification

*Trade Mark

Commercial Communications • Electronic Laboratories
Office Transcribing Machines • Radio Monitoring
Telecasting • Amateur Radio • Record Stores • Theaters
Phone-Order Boards • Wired Music Installations

For complete information on any of the above headsets, write

TELEX, ELECTRO-ACOUSTIC DIV.
Department 9-E • St. Paul 1, Minnesota
In Canada, **ATLAS RADIO CORP.**, Toronto

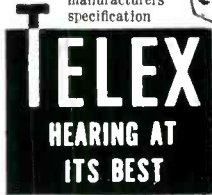

FOR PUBLIC
ADDRESS, RADIO,
and kindred fields,
JONES 400
SERIES
PLUGS & SOCKETS

of proven quality!

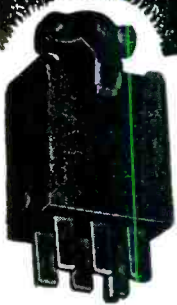

P-406-CCT



S-406-AB

Socket contacts phosphor bronze cadmium plated. Plug contacts hard brass cadmium plated. Insulation molded bakelite. Plugs and sockets polarized. 2, 4, 6, 8, 10, 12 contacts. Steel caps with baked black crackle enamel. Catalog No. 18 gives full information on complete line of Jones Electrical Connecting Devices — Plugs, Sockets and Terminal Strips. Write

Jones **HOWARD B. JONES DIVISION**
CINCH MANUFACTURING CORPORATION
CHICAGO 24, ILLINOIS
SUBSIDIARY OF UNITED-CARR FASTENER CORP.

photograph it!

A photo record is quicker, more accurate; and it may prove to be priceless.

THE ADVANCED single-lens reflex design of the 35-mm. **PRAKTICA FX** makes it easier for you to get expert photomicrographs, oscillographs, extreme close-ups, copy work, etc., in black and white or natural color. Use it for: Recording lab and field observations, quality control, inspections, photographing equipment in field, training personnel, etc. Excellent for the home photographer, too. From \$99.50 to \$199.50 (tax incl.). The Praktica Co., Inc., 48 W. 29 St., N. Y. 1, N. Y.

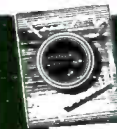

**39 tested ideas
Free for you!**

**PRAKTICA
FX**

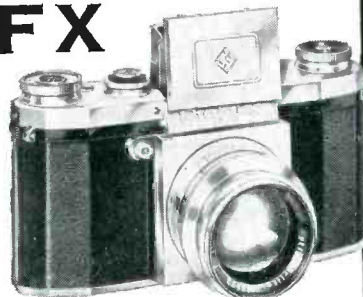

35-MM. SINGLE-LENS REFLEX CAMERA

The Praktica Co., Inc. Dept. F-13
48 West 29th Street, N. Y. 1, N. Y.

Please send me a copy of "PHOTOGRAPHY IN SCIENCE AND INDUSTRY."

Name.....

Position.....

Company.....

Address.....

City..... Zone... State.....

EAD ALTERNATORS

For "POSITIVE"
Performance —
"NEGATIVE"
Distortion



N3E-2

Low harmonic content, dual frequency alternator with less than 3% total distortion on each frequency

N2B-2

Two phase, 30 cycle alternator with less than 2% total distortion on each phase.

EAD offers you the answer to your small permanent magnet alternator requirements; units designed for special applications where Size, Weight and Efficiency are top considerations.

There's an EAD Alternator for Your Every Application

TYPE	OUTPUT	VOLTS	PHASES	FREQUENCY (CYCLES)	SPEED (RPM)
N2A	45 Volt Amps	115	3	400	6000
*N2B-1	7	1	30	1800
**N2B-2	7	2	30	1800
N3C-1	10-15	1	1000	20,000
†N3E-2	7	1	90/150	1800
N5B	8 watts	20/40	1	1000	5000
N6A	20 watts	40/80	1	1000	5000
N6B	60 watts	30	1	400	8000

*Less than 2% Total Distortion

**Less than 2% Total Distortion on each phase

†Dual frequency alternator less than 3% Total Distortion on each frequency.

Solving special problems is routine at EAD

If your problem involves rotating electrical equipment, bring it to EAD. Our completely staffed organization will modify one of our standard units or design and produce a special unit to meet your most exacting requirements.

EASTERN AIR DEVICES, INC.

585 DEAN STREET, BROOKLYN 17, NEW YORK

for its relatively short length. Having the same shape, dimensions, basing and deflection factors as the 7JP1, it can be used in place of the latter to give superior performance in all oscilloscope equipment having a high-voltage supply up to 4,000 v.



Capacitors

INDUSTRIAL CONDENSER CORP., 3243 N. California Ave., Chicago 18, Ill. The Stabelex D series of capacitors are particularly adapted for use in equipment subjected to extreme altitude and climatic changes or similarly difficult operational variables. They have an unusually low temperature coefficient of capacitance, as is evidenced by only a 0.8-percent change in capacitance from +20 C to -80 C. Power factor is 0.00025 at 1 kc. These capacitors have time constants in excess of 4,800 hours.



Sensing Switch

THOMPSON PRODUCTS, INC., 2196 Clarkwood Road, Cleveland 3, Ohio, has developed an airborne sensing switch actuated by a 115 v a-c, 380 to 1,000-cycle motor. It has two independent double-throw r-f circuits which are switched at a rapid rate (15 to 35 cps) to furnish

A LINK IN YOUR FUTURE

DESIGN AND LAYOUT DRAFTSMEN

who wish to locate in the attractive lake country of Central New York.

Link Aviation, Inc., has outstanding permanent opportunities for electrical

draftsmen in chassis and schematic layout.

These openings are on long range programs in the flight simulator and industrial electronic fields.

Top salaries—good benefits—good housing in suburban area.

Write full details to

Manager of Industrial Relations.



It's "TREATMENT" that makes DANO your Best Bet for Coils

ways at your service. Yes, Dano coils and Dano customers are always treated in the manner that makes your production pay dividends.

- Form Wound
- Paper Section
- Acetate Bobbin
- Molded Coils
- Bakelite Bobbin
- Cotton Interweave
- Coils for High Temperature Application

Send us samples or specifications with quantity requirements for our recommendations. No obligation!

Also, Transformers Made To Order



THE DANO ELECTRIC CO.
93 MAIN ST., WINSTED, CONN.

ELECTRONIC ELECTROPLATING TO EXACTING SPECIFICATIONS

**PALLADIUM • GOLD
SILVER • RHODIUM
LEAD • other metals
PLATED ON**

- Contact Pins
- Wave Guides
- Conductors
- Cavities
- Terminals

**ALUMINUM • STAINLESS STEEL
MU-METAL • BERYLLIUM COPPER
MONEL • PHOSPHOR BRONZE
POWDERED METALS ETC.**

During the growth of the Electronic Industry, MERIT PLATING CO., has been in the forefront in solving Electroplating problems arising from the highly specified requirements for plating Electronic Components and Equipment.

MERIT PLATING COMPANY

218 East 141st Street

New York 51, N. Y.

CYpress 2-7251

Specify

ADVANCE RELAYS

for
precise
circuitry

There are many reasons why Industry specifies ADVANCE RELAYS: They meet or surpass Military and Civilian requirements—many types have AN approval—many are hermetically sealed—all are lightweight—small—rugged—compact—and all are precision-built for efficient, trouble-free, long life performance.

If you have relay problems involving contact loads, coil resistances, close differential, timing features, input sources, critical environment or any particular requirements involving unusual or accurate circuit behavior, ADVANCE can supply the relay.

A complete line of relays for radar, radio, electronic and electrical equipment applications.

Write for new, descriptive Catalog containing detailed information about ADVANCE Relays and facilities.

**ADVANCE ELECTRIC
AND RELAY
COMPANY**

2435 NO. NAOMI ST.,
BURBANK, CALIF.



Sales Representatives in Principal
Cities of U.S. and Canada

For Parts that must be
TAKEN OFF—PUT BACK—BUTTONED TIGHT

LION FASTENERS

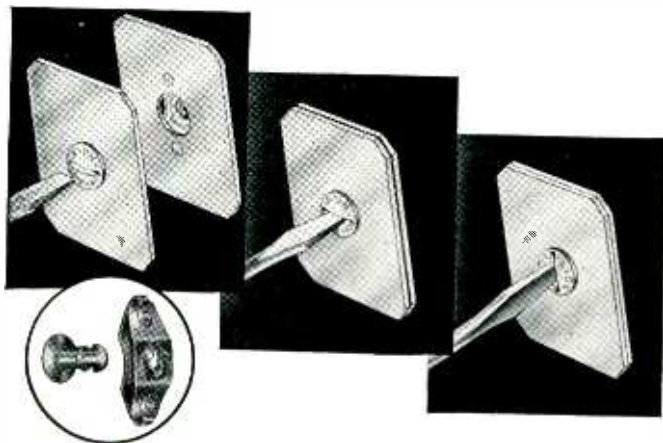

LOCKS TIGHT WITH A QUARTER TURN *Always at correct tension*

Lion Fasteners are right for buttoning parts that must be removed repeatedly for inspection, maintenance, or other reasons.

Vibration and shock can't loosen a Lion Fastener. Even an inexperienced service man can't replace it wrong. A quarter turn opens it. Another quarter turn locks it. The tension is designed into it.

Lion Fastener Spring Assembly is quickly spot welded or riveted in place. The stud cannot be lost. It is grommeted tight to the sheet. They will button sheets .040 plus or .020 minus over or under standard rating. The misalignment is as much as .156. The one-piece forged stud is tested to 1425 lbs. Write today for demonstration kit and application data.

TYPICAL APPLICATIONS: INSPECTION PLATES • COWLING
ELECTRICAL PANELS • CABINETS • DUCTWORK

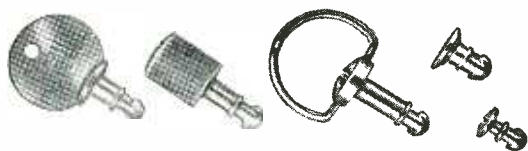

Free DEMONSTRATION KIT contains sample Lion Fasteners to help you visualize their adaptability to your product. Write on your company letterhead. No obligation.



500 MAIN ST., HONEOYE FALLS, N. Y.

accurate circuit time sharing. The connectors are type BNC and are for use with RG-58/U cable applications. In the frequency range to 250 mc it has a maximum vswr of 2.0 to 1. Insertion loss is less than 1.0 maximum and crosstalk is in excess of 32 db. Its life is greater than 500 hours continuous operation.

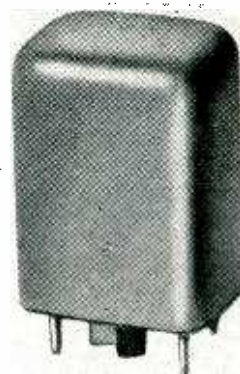

Tiny Hermetic Transformers

UNITED TRANSFORMER Co., 150 Varick St., New York 3, N. Y., has announced stock hermetic sealed transformers that cover the entire range of audio requirements for subminiature equipment. They include input, interstage and output transformers, as well as a reactor. Overall case dimensions are only $\frac{1}{2}$ in. \times $\frac{1}{4}$ \times $\frac{3}{8}$ in. The units weigh only 0.8 oz. This miniaturization is made possible through the use of special nickel-iron alloy laminations and fine wire windings on nylon bobbin. Mounting is effected through a unique single threaded-stud arrangement with case tabs to prevent twisting.

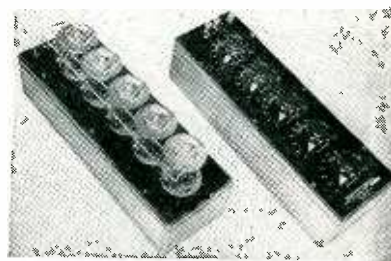

Resistance Boxes

THE DAVEN Co., 191 Central Ave., Newark, N. J., has available its new type 750 resistance boxes. The units are complete assemblies of

MINIATURE SLIP RING ASSEMBLIES

Commutators and other Electro-Mechanical Components

PRECISION MADE TO YOUR OWN SPECIFICATIONS

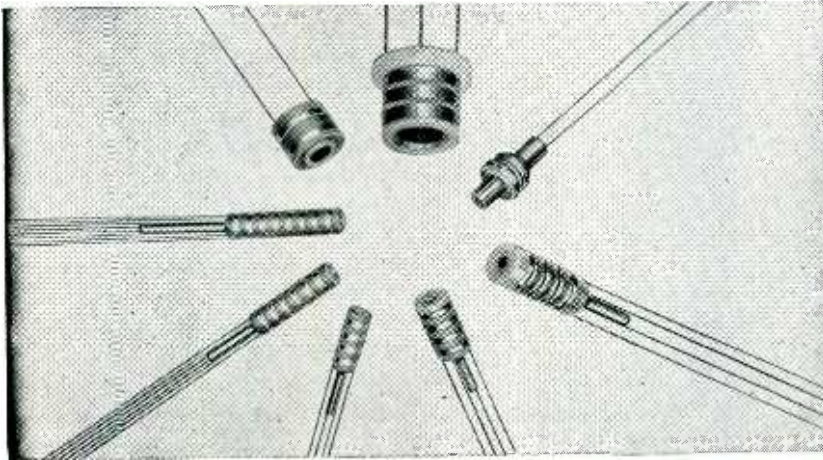

Our Swiss methods and techniques are geared to meet exacting requirements. We invite your inquiries.

COLLECTRON CORPORATION

216 EAST 45th STREET • NEW YORK 17, N. Y.

Murray Hill 2-8473

ELECTRIC INSTRUMENT & CONTROL HEADQUARTERS

YES, OFF-THE-SHELF SERVICE



Electro-Tech maintains one of the largest and most complete stocks in the country of electrical meters, instruments and industrial control equipment—representing over 250 top lines.

Yes, our warehouse is bulging with standard stocks of

- | | | |
|--------------------------|--------------|---------------------|
| Counters | Solenoids | Toggle Switches |
| Panel Meters | Tachometers | Shunts (Electrical) |
| Transformers | Thermometers | Meggers |
| Switchboard Meters | Thermostats | Solenoid Valves |
| Micro Switches | Rectifiers | Pyrometers |
| Photo Electric Equipment | Rheostats | Multimeters |
| Relays | Timers | Oscilloscopes |

and Laboratory Standard Instruments

In addition, we manufacture and stock *Special Test Equipment* • Electric Heating Units • Current Transformers • Pyrometers • Thermocouples • Rectifiers.

Our laboratory is available for repair work, rescaling, recalibration and special calibration of your electrical and industrial instruments. Often months are saved by rescaling and calibrating stock instruments to your specifications.



FOR SPEED
Wire — Code RDL
Teletype — NY 1-2906
Phone — BArlay 7-4209

CONSULT US ABOUT YOUR REQUIREMENTS

"The Industries Buying Guide" our GENERAL CATALOG E-13 FREE

ELECTRO-TECH EQUIPMENT CO.

55 LISPENARD ST., NEW YORK 13, N. Y.

TAKE THE New APPROACH...

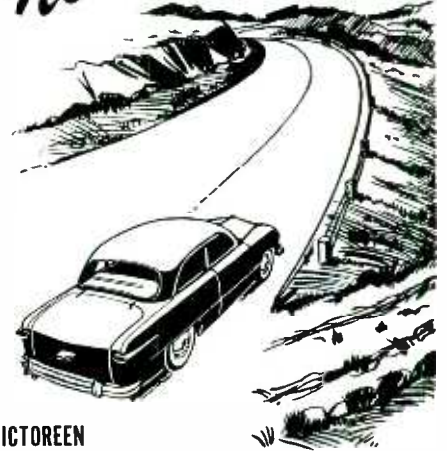

VICTOREEN

Subminiature Corona Regulator Tubes open a new road to better voltage regulation.

If your application requires reliable voltage regulation, be it 50 or 15,000 volts, or even higher, consider the advantages of a single tube—dependable, inexpensive, low-drain, space-saving, long life.

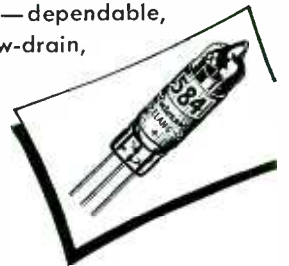

KNOWN APPLICATIONS INCLUDE

- Regulation of anode potentials for TV picture tubes
TV camera pickup tubes
Klystron and Mognetron tubes
Projector tubes
Oscilloscopes
Image converters
 - RF and vibrator power supplies
 - Converter tube and photomultiplier tube power supplies
 - Reference voltage for regulator systems
- Check these characteristics—then tell us your particular application problem. Our Tube Circuit Engineers will be happy to make recommendations.

CHARACTERISTICS

Type	*Regulating Voltage (Volts)	Regulating Range (Micro-amperes)	Regulation Maximum (%)
5950	700	2.0-50	1.5
5841	900	2.0-50	1.5
VXR1000	1,000	2.0-50	1.5
6143	1,200	2.0-50	1.5
VXR1500	1,500	2.0-50	1.5
6119	2,000	2.0-50	1.5
VXR2500	2,500	2.0-50	1.5
VXR10,000	10,000	5.0-50	2.0
VXR15,000	15,000	5.0-50	2.0

*Other voltages within the 50 to 15,000 volt range, available from stock or made to order. Write for further specifications.



Victoreen Instrument

3800 PERKINS AVE.

CLEVELAND 14, OHIO

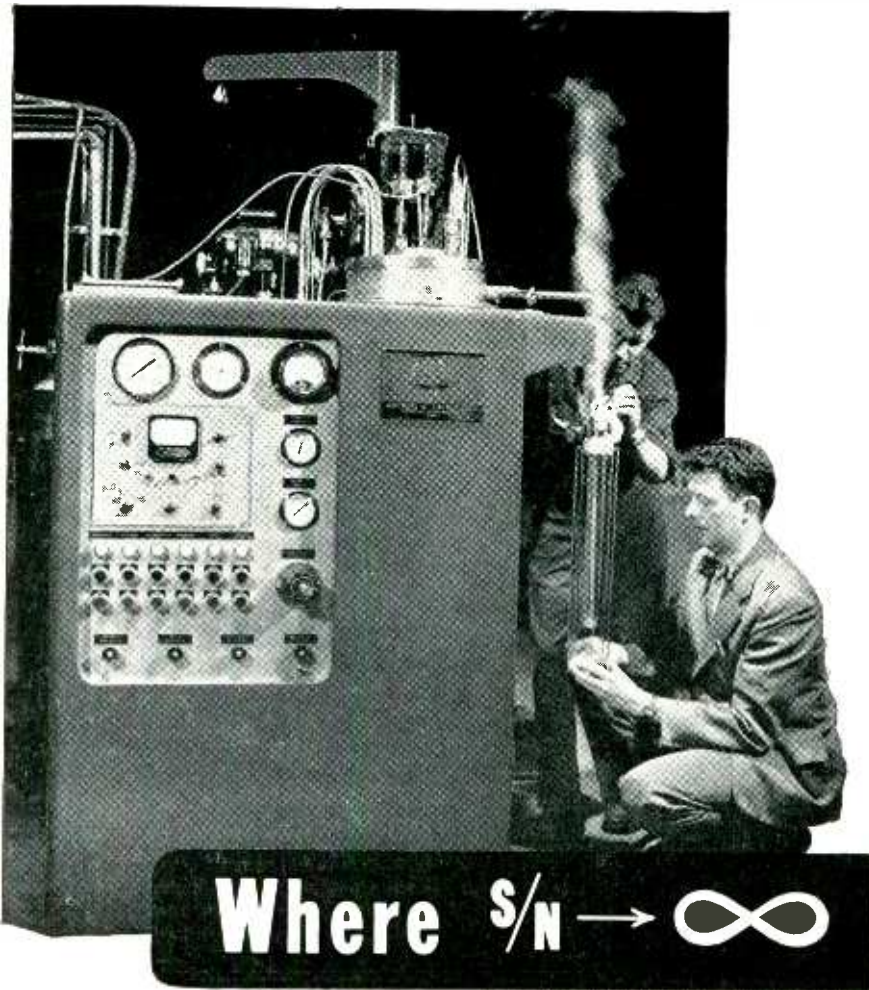

... We had stopped to watch the test run of a new Collins Helium Cryostat. As liquid helium poured into the dewar our guests, both electronic research workers, talked about Absolute Zero and Thermal Noise. As they talked we became interested ... perhaps you will too.

... apparently they've based a recent research project on the theory that thermal motion ceases at absolute zero which might mean that a Signal-to-Noise Ratio at 0°K. would approach infinity. Using one of our Collins Helium Cryostats to get within 4° of absolute zero, they actually minimized thermal noise in circuit components.

... their guess was that perfection of this technique might conceivably lead to new control devices operating from minute energy changes ... scintillation counters and voice modulation were mentioned as possibilities.

Perhaps your industry, equipped for low-temperature research, could profitably perfect a technique just like this.

Write for Bulletin E10-3
on the Collins Helium Cryostat
and Low-Temperature Research in Electronics



ARTHUR D. LITTLE, Inc.
Mechanical Division

30 MEMORIAL DRIVE • CAMBRIDGE, MASS.

two or more type 275 decade units. The cabinet shielding consists of a full copper lining making electrical contact with the metal panel for complete isolation of the resistive elements. There is no electrical circuit between the shield and resistance elements. Three terminals are provided, two for the resistance circuit and the third as a ground connection to the shield. These precision boxes may be used as laboratory standards, as direct-reading resistor elements in bridge circuits, as shunt or series elements in transmission networks, as dummy loads, or other applications where accurate, stable, adjustable resistance elements are applicable. They are equally suitable for the college or industrial laboratory, production test circuits, direct current, audio-frequency work and many applications in the radio-frequency range up to 10 mc when properly applied.



Resistance Meter

SOUTHWESTERN INDUSTRIAL ELECTRONICS Co., 2831 Post Oak Road, Houston 19, Texas, has announced a new combined ohmmeter and leakage tester. Model C-3 resistance meter is a compact, portable instrument designed for production testing of transformers and capacitors, with a useful range of 1 ohm to 1 million megohms. The four ohmmeter ranges are powered by a 1.5-v battery. The six-megohm ranges apply a maximum of 105-v to the unit under test, providing a quick and accurate indication of insulation resistance or dielectric leakage. Accuracy is ± 3.0 percent of full-scale deflection for all ranges except



ONE OF A SERIES OF

Modernized...

REGULATED POWER SUPPLIES

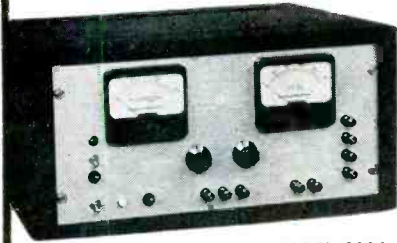

MODEL 300A

A laboratory instrument designed to meet research requirements

- 0 to 500V DC at 0 to 300MA
- HV regulation within 0.2V at any setting
- HV hum level within 2MV
- 0 to -150V bias, stabilized, 5MA max.
- 6.3V AC filament, 6A

Send for Bulletin E-300A

Also available: general purpose units for industrial or laboratory use.

Universal 
Electronics Co.
 2012 South Sepulveda Boulevard
 Los Angeles 25, California

INSULATION

FORMVAR • FORMEX • ENAMEL

STRIPPED CLEAN IN SECONDS

with **X-VAR**

IN



1. DIP WIRE in X-VAR for 3 seconds.

OUT



2. WITHDRAW and watch coating disintegrate.

WIPE



3. WIPE CLEAN. Operation completed in seconds.

X-VAR is non-corrosive, non-creeping — leaves wire ready for soldering. Now in use by leading manufacturers of electrical products. Write for FREE SAMPLE for testing.

FIDELITY CHEMICAL PRODUCTS CORP.

472 Frelinghuysen Avenue, Newark 5, New Jersey

Linde
Trade-Mark

M. S. C.

(Mass Spectrometer Checked)

RARE GASES

HELIUM • NEON

ARGON • KRYPTON • XENON

LINDE Rare Gases are mass spectrometer checked to assure you gases of known purity and uniformly high quality. Available in commercial-size cylinders and glass bulbs.

LINDE, the world's largest producer of gases derived from the atmosphere, can meet your individual needs of purity...volume...mixture...containers...

LINDE AIR PRODUCTS COMPANY

A DIVISION OF UNION CARBIDE
AND CARBON CORPORATION

30 East 42nd Street  New York 17, N. Y.

In Canada:
Dominion Oxygen Company, Limited, Toronto

The term "Linde" is a registered trade-mark of Union Carbide and Carbon Corporation

New ALTITUDE SIMULATION CHAMBER



• Altitude Range to 120,000 feet.

- Temperature Range from 300°F. to -140°F.
- Micrometer Temperature Adjustments hold $\pm 2^\circ\text{F}$.
- Compact Design... Requires less Floor Space
- Humidity Cycle available

Providing extreme flexibility in temperature and vacuum ranges, M & M Altitude Simulation Chambers give you precise control and easier, simpler operation that will reduce test costs considerably. Custom-quality built in every detail, M & M Chambers are designed to meet Government altitude simulation test standards. Available with many optional features to speed testing, such as Program Heating, Cooling, and Humidity Cycles, Automatic Recorder for controlling and integrating temperature, humidity and altitude. Write for details on Altitude SIMULATION Chambers as well as M & M Cold Temperature Test equipment.

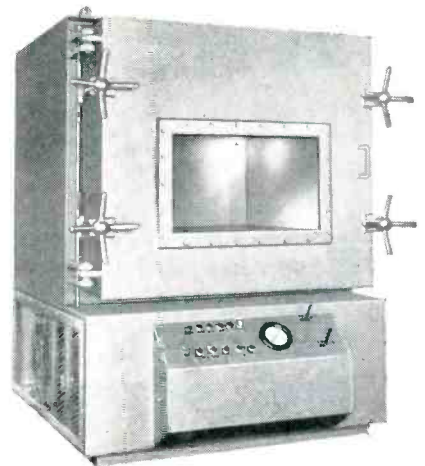

MURPHY & MILLER, Inc.

1322 South Michigan Avenue

Chicago 5, Illinois



TRANSFORMERS

NEW PRODUCTS

(continued)

the highest megohm range which is ± 5.0 percent.

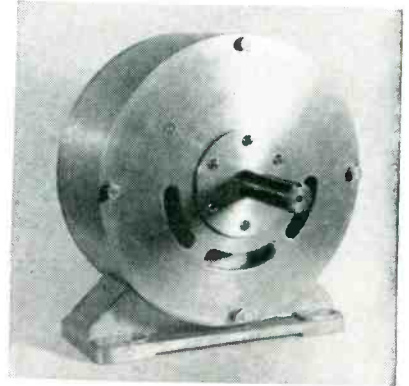
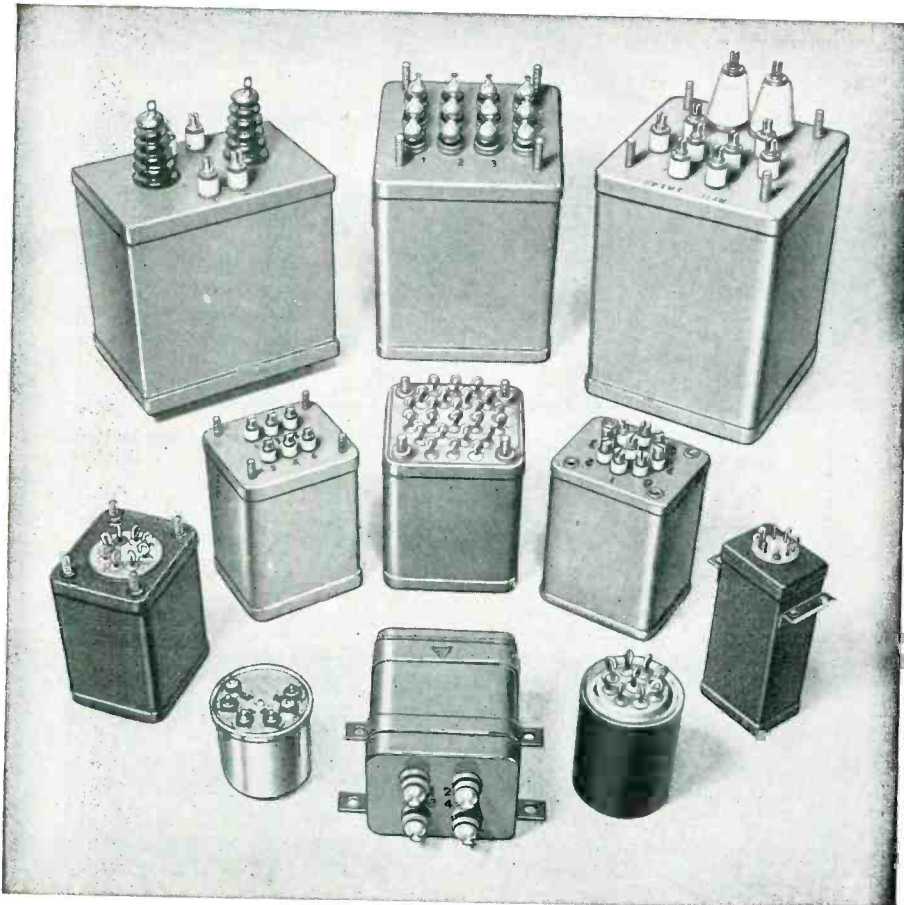

Permanent Magnet Generator

GEORATOR CORP., Arlington 9, Va., announces an improved electric generator that avoids brushes entirely by a permanent magnet construction. The generator is adapted for aircraft use, for field or laboratory supply of 400 cycles, for portable power units, for mounting in marine craft or vehicles, or for operation of newer high-frequency portable power tools. Outputs range from 250 va to 25 kva. Usual voltages, single or three-phase are provided.

Stainless Steel Strip

AMERICAN SILVER CO., 36-07 Prince St., Flushing 54, N. Y., has available stainless steel strip, rolled to precision tolerances and ultrathin gages. Stainless steels are being produced in strip up to 8 in. wide and down to 0.0005 in. thin—to tolerances as close as ± 0.0001 in. The strip is available in any quantity from one pound to thousands of pounds. Typical uses for stainless steel strip in the electrical, electronics and communications industry include: nonmagnetic components, instrument paneling, corrosion-resistant parts (such as springs, stampings and ball-bearings), name plates, veneers and decorative trim.

HERMETICALLY SEALED TO MIL-T-27 SPECIFICATIONS

NYT offers a wide variety of transformer types to meet military and civilian specifications, designed and manufactured by specialists in transformer development.

Latest NYT service for customers is a complete test laboratory equipped and approved for on-the-spot MIL-T-27 testing and faster approvals.

**NEW YORK
TRANSFORMER CO., INC.**
ALPHA, NEW JERSEY

Instrument Resistor

SHALLCROSS MFG. Co., Collingdale, Pa., has announced type 245S, a

"INDUSTRIAL"

for
**ELECTRONIC
COMPONENTS**



Precision engineered electronic components and connecting devices for all your needs.

- LAMINATED TUBE SOCKETS
- TERMINAL STRIPS
- WIRED ASSEMBLIES
- BAKELITE STAMPINGS
- TERMINAL BOARD ASSEMBLIES

Our extensive design and production facilities are available for developing your special requirements and applications. Representatives in principal cities throughout U. S. A. Call or write for samples and information.
©Regon 7-1881.



INDUSTRIAL HARDWARE Mfg. Co., Inc.
109 PRINCE STREET • NEW YORK 12, N. Y.

Make a **GM**

PORTABLE D'ARSONVAL

GALVANOMETER

*the Heart
of Your
Instrument*

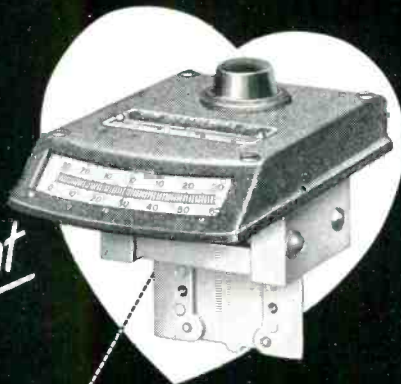

FOR MEASURING LIGHT reflectance and color, the Photovolt Corporation of New York uses a Model 600 G-M Galvanometer for its popular Reflection Meter (left). Whatever your own particular instrument field, you can achieve this same self-contained portability, ruggedness and high sensitivity with G-M Galvanometers. Complete catalog on request.



GM LABORATORIES - INC.

In Canada: Cossor (Canada) Ltd.,
301 Windsor St., Halifax, N. S.

4336 NORTH KNOX AVE., CHICAGO 41

Now
PL-4D21

**POWER
TETRODE**



125 WATT PLATE DISSIPATION.
FULL RATINGS TO 120 Mc.
HIGH OVERLOAD CAPABILITIES.
AVAILABLE IMMEDIATELY.

For data, Write:



PENTA LABORATORIES INC.
216 North Milpas Street
SANTA BARBARA, CALIFORNIA



HEAT RESISTANT WIRES FOR EVERY APPLICATION . . .

IS IT COLD OUT YOUR WAY?

If you are experiencing trouble with outside pipe lines freezing up, try Lewis heating cable for non-freezing protection. Nickel Chrome conductor with special insulation good for temperatures to 500° F.

- HEATING UNITS
- HEATING ELEMENT
- RESISTANCE
LINE CORD
- THERMOCOUPLE WIRE
- ASBESTOS LEAD
& FIXTURE WIRE
- INSULATED
RESISTANCE WIRE
- FIBERGLAS
INSULATED WIRE
- WIRE TO ANY
SPECIFICATIONS

Send your electronic control, communications or appliance wiring specifications for a recommended solution by our engineers.
FOR A TRIAL ORDER OR A CARLOAD consult



THE LEWIS ENGINEERING CO.

Wire Division
NAUGATUCK CONNECTICUT

EDIN Simplifies Your Instrumentation

with this *New*
Expandable
Consolette
Recorder



Start with a
2 Channel System

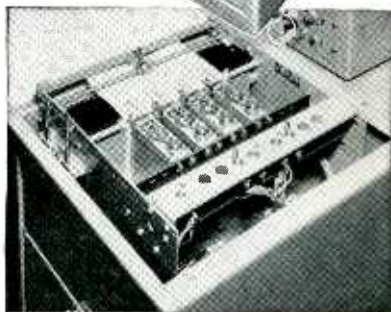
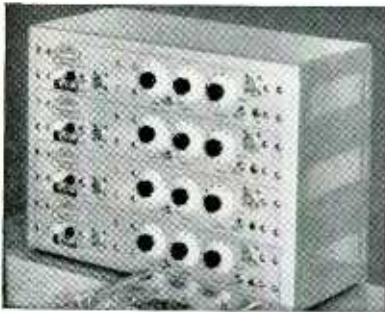

Add units, as you need them, to make a 4, 6 or 8 Channel System.

The Consolette gives you rack mounted dimensions with option of Direct Coupled, Condenser Coupled or Carrier Amplifiers; a wide variety of chart speeds and galvanometer types; full writing desk for review of intelligence; and an efficient, modern and beautifully designed instrument.

MAIL
COUPON
TODAY!

THE EDIN COMPANY
207 Main St., Worcester 8, Mass., Dept. B
Gentlemen:

Send complete information on the
new Edin Consolette Recording Instru-
ments Companion Amplifiers.

Name.....

No.....Street.....

City.....State.....

Position.....

THE

EDIN

COMPANY

207 Main St. • Worcester, Mass.

new 1-watt precision wire-wound resistor for decades and other applications requiring low resistance values with close tolerances, low temperature rise and low inductance. The new resistor can be calibrated to a tolerance of ± 0.1 percent or better and is available in values from 0.1 ohm to 1,000 ohms. A single layer bifilar winding protected by a moisture resistant lacquer coating is used for all values. The Steatite bobbin and axial wire leads at the same end make it easy to mount the resistor directly on decade switch decks or other similar equipment. Size is $1\frac{1}{8}$ in. long by $\frac{3}{8}$ in. diameter.

Line Voltage Booster

RADIO APPARATUS CORP., 55 New Jersey St., Indianapolis 4, Ind., has designed the V-15 booster for areas where line voltage is below normal. This compact, portable booster provides full rated performance from any 110-v electrical device requiring between 500 and 1,500 w. The meter reads actual line voltage and load voltage-switch increases 5 v per step. It can raise 85 v to 120 v with a 1,250-w load. Television servicemen will find the booster valuable for checking line voltage and to provide adequate power supply to test equipment when servicing in low-line-voltage areas. Measurements are $7\frac{3}{8}$ in. high, $4\frac{3}{8}$ in. deep and $5\frac{3}{8}$ in. wide. Weight is approximately 10 lb.

Literature

Fabricated Mica. Mica Fabricators Association, 420 Lexington Ave., New York 17, N. Y., has available a handbook that brings together pertinent facts on natural sheet and block mica with particular emphasis on characteristics required in the electrical industry. It is expected that the book will serve as a guide for manufacturers of electrical, radio and electronic equipment in selecting the best and

BOGART MANUFACTURING CORPORATION

Since
1942

Engineers and Manufacturers of the finest
**MICROWAVE COMPONENTS and
PRECISION EQUIPMENT**

DUPLEXER

Bogart produces these units in large quantities, and at the same time insertion loss, a. f. c. coupling and gate attenuation are held to less than half of normally accepted tolerances, resulting in extremely fine performance at lowest cost.

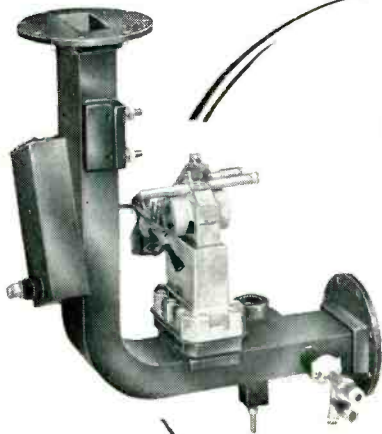

FEEDHORN

This Feedhorn, one of many different types manufactured by Bogart, is characterized by a reflection coefficient and bandwidth not ordinarily found in a multiple twist and bend unit of this kind. Each Horn is calibrated and the complete data forwarded to the customer at time of shipment.

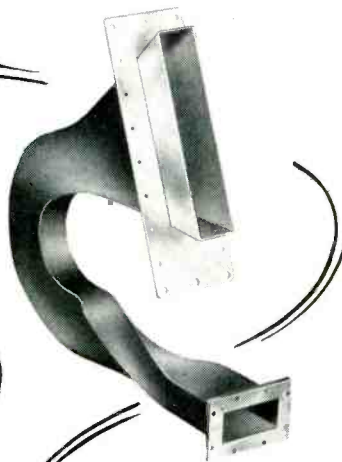

**MICROWAVE TRANSMISSION COMPONENTS
and
SPECIALIZED ELECTRONIC ASSEMBLIES**

- DUPLEXERS
- ROTATING JOINTS
- DIRECTIONAL COUPLERS
- CRYSTAL MIXERS
- FEEDHORNS
- MAGNETRON COUPLERS
- PHASE SHIFTERS
- OSCILLATING JOINTS
- -AND SPECIAL DESIGNS
- BROADSIDE ARRAYS
- DOUBLE-STUB TUNERS
- CAVITIES
- WAVEGUIDES

Bogart is fully equipped to execute stamping, spinning, electroplating, and special precision machine work. (Our laboratory, one of the finest in the East, is fully equipped to electrically test all products of our manufacture.)

Inquiries and problems concerning the manufacture, development and calibration of any microwave units are cordially invited. *Write to...*

BOGART MANUFACTURING CORPORATION
315 SIEGEL STREET • BROOKLYN 6, N. Y.



most economical grade and quality of mica available for any given application.

Potentiometer Noise. The Helipot Corp., 916 Meridian Ave., South Pasadena, Calif., has available the reprint of a paper entitled "Electrical Noise in Wire Wound Potentiometers". The 8-page bulletin describes the source and nature of the six major types of electrical noise found in potentiometers. It develops and assigns a unit of measurement to electrical noise, and describes how each source can be isolated and measured. Diagrams and sketches show sources and measuring circuits. Results of the latest studies of the subject undertaken by the company are presented.

Transformers. Altec Lansing Corp., Peerless Electrical Products Division, 9356 Santa Monica Blvd., Beverly Hills, Calif., has released a new 15-page transformer catalog and price list containing 92 items, representing an increase of 50 percent over previous issues. It lists many new items including the line of 20-20 Plus transformers, and also describes facilities for the design and manufacture of Class A, B and H transformers, which are built to meet JAN-T-27 and MIL-T-27 specifications.

Industrial Instrumentation. Berkeley Scientific, division of Beckman Instruments, Inc., 2200 Wright Ave., Richmond, Calif. A 32-page booklet briefly describes electronic instruments providing direct-reading digital presentation of information, and their principal industrial applications. It covers high speed counting, counting plus control, precise interval timing, measurement of rpm, pressure, temperature, flow, viscosity, velocity, frequency and distance.

Signaling Temperature Controllers. Thermo Electric Co., Inc., Fair Lawn, N. J., has published an 8-page Catalog Section 55 illustrating and describing their new "Thermo Electronic" signaling temperature controller and resistance bulbs. Illustrations, chief features

PRODUCTIMETER "SPECIALS"

for Radar and Electronic Applications

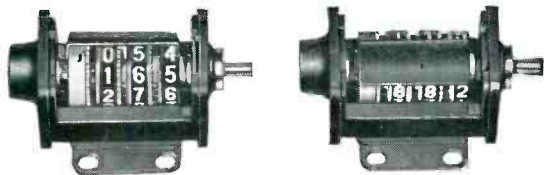

Companion shutter counters used as dual direction indicators. One counter adds while the other subtracts. Shutter blanks out counter which is on negative side of 000.



"Y" 2-figure Rotary Counter used in navigating instruments.



High-speed, non-reset "Y" type counter for building into radar instruments.



Special Model "Y" with window at rear designed for use in radar equipment.

These are a few of the "specials" developed by Durant for Radar and Electronic applications. When one of the many standard Productimeters is not the exact answer to a problem, Durant engineers modify, combine, or develop entirely new counters to meet the particular requirements of the job.

Write for Bulletin

DURANT MFG. COMPANY
1912 N. Buffum St. 112 Orange St.
Milwaukee 1, Wis. Providence 3, R. I.
Representatives in Principal Cities

PRODUCTIMETERS
SINCE 1879 *Count Everything*

YOUR PRODUCTS HERMETICALLY SEALED



- Meet Military Specifications
- Provide permanent protection from dust and corrosive atmospheres
- Insure reliability
- Forever free from humidity effects
- Unexcelled high altitude operation

Our engineers will design suitable enclosures for your electronic parts. We assemble and seal your units in dry air or inert gas. All assemblies are evacuated and 100% leak tested by the Veeco Mass Spectrometer. Write for complete information.

GENERAL HERMETIC SEALING CORPORATION

99 E. Hawthorne Ave.,
Valley Stream, L. I., N. Y.
Tilden 4-6300

WE CARRY IN STOCK



ALNICO PERMANENT MAGNETS
CAST AND SINTERED CARBOLOY PERMANENT MAGNETS

EXPERIMENTAL OR PRODUCTION QUANTITIES

Catalog upon request

PERMAG services include:
• ENGINEERING
• PRECISION CUTTING
• PRECISION GRINDING
• MAGNETIZING

PERMAG CORP. 214 TAAFFE PLACE, BROOKLYN 5, N. Y.

NOW

an RF STEP ATTENUATOR

0-500 MC.

Geared Drive output connector accessible through front panel

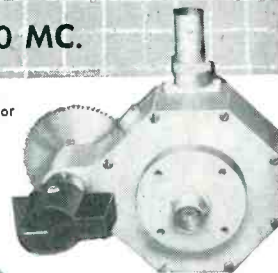

Direct Drive for use with output cable

New Model AT-120 RF is designed to meet size and weight restrictions with tight performance specs.

- Flat attenuation characteristic from DC to UHF
- Low VSWR
- Perfect Shielding
- Supplied with attenuation values to your specifications:
Up to 120 db total; Up to 20 db per step; Up to 10 steps
- *Output impedance*; nominal 50 ohms unbalanced or optional at lower frequencies
- *Output and input*:
BNC jacks or attachments for RG55U or RG58U Cable
- Available with crystal diode voltmeter mount for monitoring input level at 1 to 2.0 volts.
- Special mechanical features provide flexibility of mounting and drive.
- *Dimensions*: Diameter — 2½"; Depth — 1½"
- *Weight*: 10 ounces.

Suitable for Standard Signal Generators, Precision Microvolts and many specialized test equipment applications.

Write for detailed performance data depending on the attenuation values desired.



TELEVISION CORPORATION
1001 FIRST AVENUE ASBURY PARK, N. J.

SHE'D BE STUCK WITH NO MOVING PARTS!



BUT . . . THE C. G. S. **INCREDUCTOR*** LINE OF CONTROLLABLE INDUCTORS NEED NO MOVING PARTS

THIS FEATURE, COMBINED WITH RUGGED,
SHOCK RESISTANT, COMPACT AND LIGHT
WEIGHT CONSTRUCTION PROVIDES THE
IDEAL UNIT FOR ADVANCED CIRCUITRY.

SOME OF THE OUTSTANDING AND VALUABLE FEATURES
OF THE **INCREDUCTOR UNITS** ARE:

- WIDE RANGE • REMOTE CONTROL • FAST RESPONSE •
- HIGH SENSITIVITY • EXTREME FLEXIBILITY •

THE **INCREDUCTOR** UNIT IS A NATURAL FOR
ADVANCED TECHNIQUE APPLICATIONS SUCH AS:

- High Speed Switching • F. M. Oscillators •
- Automatic Frequency Control Systems •
- Receiver Front Ends • Sweep Oscillators •
- Amplitude Controls • Variable Filters •

Write on your company letterhead for engineering data and technical bulletins covering standard types. We will be glad to give you our recommendations regarding your specific problems.



* TRADE MARK

C. G. S. LABORATORIES, INC.
391 LUDLOW STREET, STAMFORD, CONN.



One-half size.

NEW PRODUCTS

(continued)

and operating principles are included.

Attenuators. Kay Electric Co., 25 Maple Ave., Pine Brook, N. J. A single-page bulletin covers models 20 and 21 high-frequency switchable attenuators. An illustration, description and technical specification are included.

Nickel Containing Alloys for Permanent Magnets. The International Nickel Co., Inc., New York 5, N. Y., has published a 16-page booklet showing 8 graphs and a list of sources of supply on nickel containing alloys for permanent magnets. It reviews the commercially available p-m alloys, especially the Alnico family. Advantages and limitations of these are highlighted. Characteristics of ductile permanent magnets (Cunife and Cunico) and of special permanent magnets (silver or platinum) alloys are described. A table gives representative magnetic properties and composition of 23 alloys.

X-Ray Trouble Chart. North American Philips Co., Inc., 750 South Fulton Ave., Mt. Vernon, N. Y., has available a new 11×15 in. chart titled "Locating Common Electrical Faults in X-Ray Generators." Developed to aid plant engineers and laboratory technicians, the chart lists symptoms, suspected location, trouble possibilities and methods for locating and correcting generator troubles common to all makes of x-ray generator equipment. It shows nine different trouble symptoms, 14 possible locations, 31 trouble possibilities and the corresponding correction procedures.

Electric Tachometers. The Bristol Co., Waterbury 20, Conn., has published a 20-page bulletin (No. S1402) describing a full line of recording and indicating electric tachometers. The instruments described include models for measuring speed of rotation or travel, processing time, speed ratios, sum or difference of speeds and average of speeds. Featured in the bulletin are the recently announced electric Dynamaster recording tachometers. Engineering information and com-

PREMAX



Mobile Antennas

For All Regular and Emergency Service

Car-top, Whip, Center-Loaded, Zone and Sector Civil Defense Control . . . a complete line for every purpose including Marine. Send for special bulletin.

PREMAX PRODUCTS
DIVISION CHISHOLM-RYDER CO., INC.

5301 Highland Ave., Niagara Falls, N. Y.

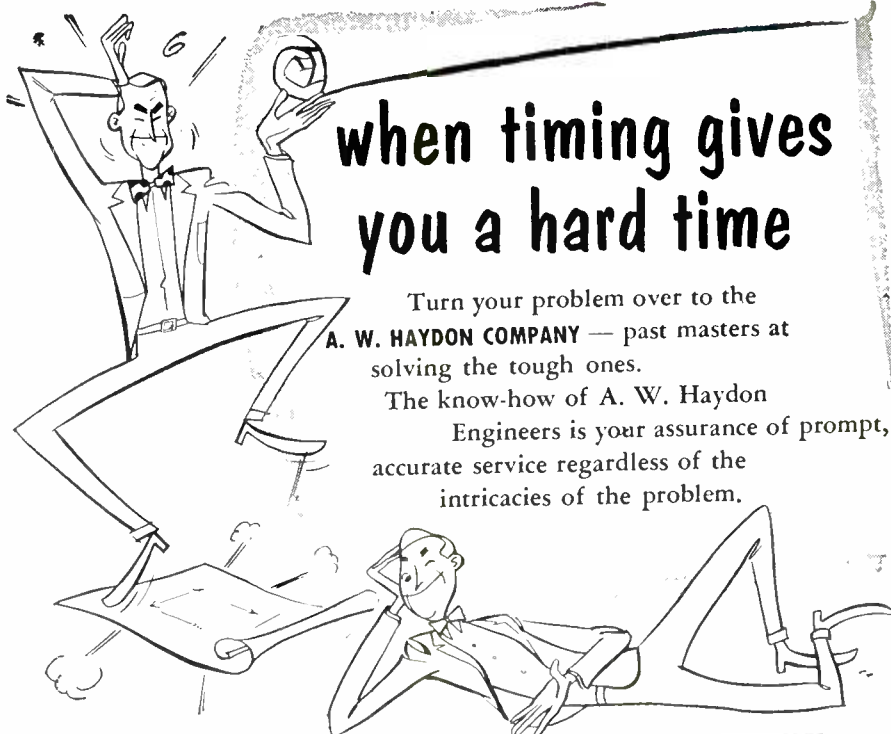

when timing gives you a hard time

Turn your problem over to the **A. W. HAYDON COMPANY** — past masters at solving the tough ones.

The know-how of A. W. Haydon

Engineers is your assurance of prompt, accurate service regardless of the intricacies of the problem.

Send for catalog.

Would you like to work with us? We need qualified engineers *now*. Excellent opportunities for men who are looking to the future.



The **A. W. HAYDON**

COMPANY

235 NORTH ELM STREET
WATERBURY 20, CONNECTICUT

Design and Manufacture of Electrical Timing Devices

for the **ELECTRONIC INDUSTRIES**
Quality

Ribbons
STRIPS

**MOLYBDENUM
TUNGSTEN
TANTALUM
FORMED PIECES**

Your Special Metals Rolled to Thin Sizes & Close Tolerances

YOUR INQUIRIES WILL RECEIVE PROMPT ATTENTION

H. CROSS CO.

15 BEEKMAN ST., N. Y. 38, N. Y.
Worth 2-2044 and COrtlandt 7-0470



CHOKE
(Channel Mounted)



POWER
(Stypol Encapsulated)



PLATE
(Hermetically Sealed)

A NAME YOU CAN RELY ON FOR TRANSFORMERS MIL-T-27 & COMMERCIAL

- Pulse
- Audio
- Power
- Filter Choke
- Filament
- RF Coils

Custom Built to your Specifications

WE SOLICIT ONLY SAMPLES AND SHORT RUN PRODUCTION



297 North 7th St., Brooklyn 11, N. Y.

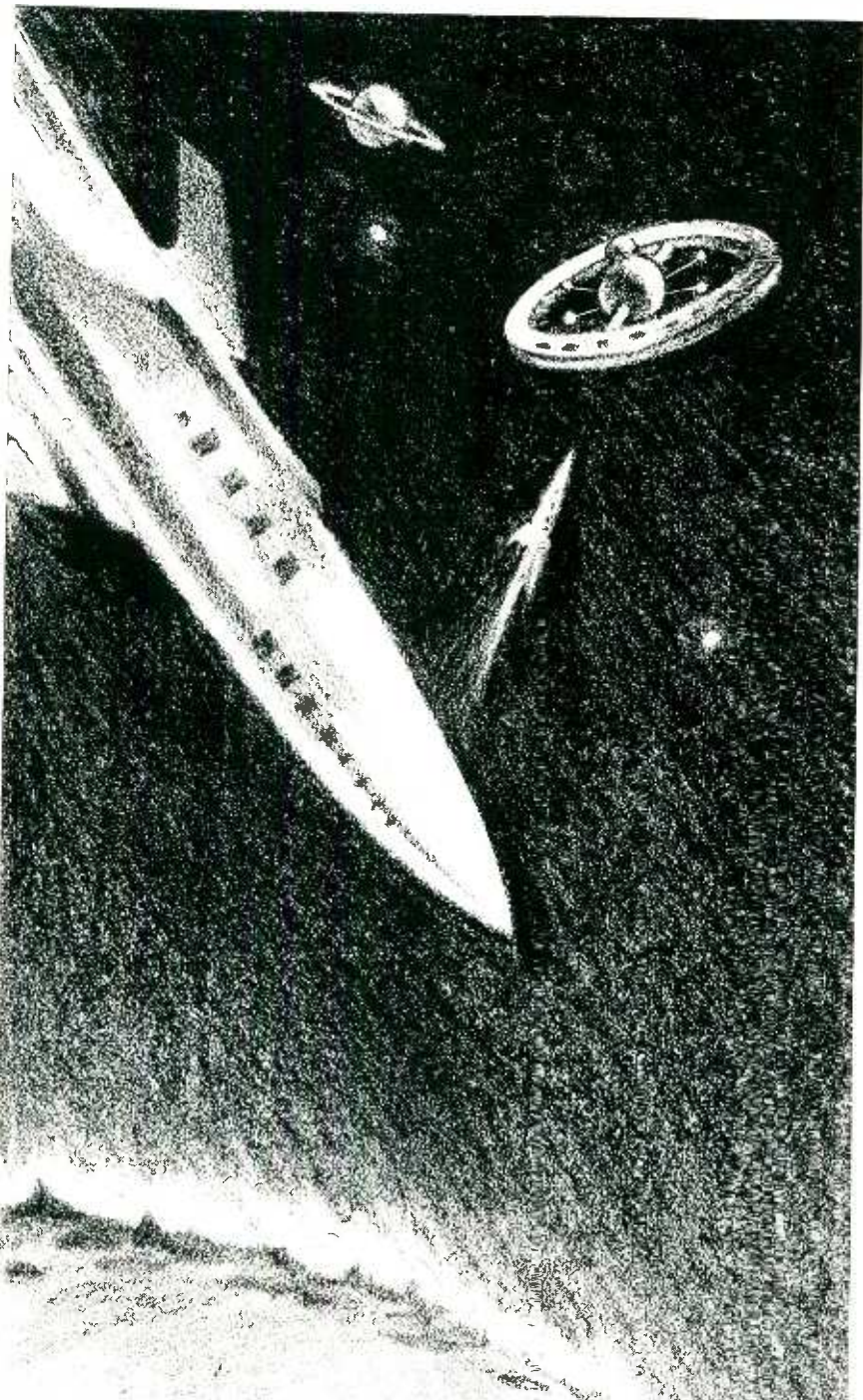

the future...?

"Precision" . . . "precision instruments." Common words today. Not so twenty years ago when Norden first completed the Mark XI Timing Sight. Its ability was almost uncanny, so much so that "bombsight" and "Norden" became synonymous. It was made possible by highest caliber talent, creative engineering and precision manufacturing. This was true at Norden yesterday . . . it is today . . . it will be *tomorrow and in the future.*

Norden

MILFORD, CONNECTICUT

*instruments and systems
of highest precision*

WHITE PLAINS, NEW YORK

plete specifications on magnetos and the various types of magneto drives are given. The bulletin is liberally illustrated with photos and drawings showing methods of application, reproductions of actual chart records and dimensions.

UHF Antennas. Technical Appliance Corp., Sherburne, N. Y. Catalog 83 announces a line of antennas designed specifically for uhf reception. Included in the line described are parabolic-reflector types, yagis, modified X (Bow-Tie) and Vee-type antennas. With the exception of the modified-X design, all the antennas discussed are of the sharp directivity type. The modified-X will be marketed for areas where reception from channels in opposite directions is required.

Dynamic Temperature and Strain Recorder. Allegany Instrument Co., Inc., 1000 Oldtown Road, Cumberland, Md. An 8-page folder discusses the model 204 dynamic temperature and strain recorder designed for the quantitative study of strains, temperatures and d-c potentials. Besides the general description and uses are included component descriptions and performance specifications.

Radiation Detection Instruments. Radiation Counter Laboratories, Inc., 5122 West Grove St., Skokie, Ill. Illustrated price list No. 12 is a new 16-page brochure describing in detail all types of radiation detection and health instruments. Included are electronic instruments; Geiger, proportional and scintillation counters; health instruments; shields and safety devices. Cataloged for the first time is complete reactor control instrumentation.

Circuit Breakers. Heinemann Electric Co., 307 Plum St., Trenton 2, N. J., has published a new manual explaining operating principles of basic circuit breaker designs, and providing engineering data on factors of application. Included are simplified diagrams showing the three basic types of circuit breakers in general use today with brief descriptions. Through colored charts and dia-

A NEW RACK-MOUNTING 5" BASIC SCOPE



A new 5" rack mounted basic oscilloscope of high quality parts and design.

- Push-Pull input with blanking post.
- Potted power transformer.
- 2,200 volt anode supply for short, medium and long persistence screens.
- Astigmatism control on panel.
- 1/4" Lucite safety glass and grating.
- Flanged bezel for scope cameras.
- Mu metal C. R. tube shield.
- Standard 8 3/4" x 19" rack panel in black or grey engraved crackle.

All high quality parts and workmanship are used in this excellent indicating unit. Balanced input signal connections are at rear of C. R. tube with low capacity leads. Furnished with 5UP1, 5UP7 or 5UP11 as requested. Available for immediate delivery.

Manufactured by

TINKER & RASOR

P.O. Box 281

San Gabriel, California

ZOPHAR

WAXES

COMPOUNDS

Zophar Waxes, resins and compounds to impregnate, dip, seal, embed, or pot electronic and electrical equipment or components of all types; radio, television, etc.

Cold flows from 100°F. to 285°F.

Special waxes non-cracking at -76°F.

Compounds meeting Government specifications plain or fungus resistant.

Let us help you with your engineering problems.



ZOPHAR MILLS, INC.

112-130 26th Street,
Brooklyn 32, N. Y.

CUT COSTS

with

EthoLoc* CABLE CLIPS

TRADE MARK
PAT. PEND.

Made of tough, durable Ethyl Cellulose plastic. This cable clip will hold wires or groups of wires neatly and securely in position . . . no possibility of shorts or grounds. Only one fastener is required (screw, nail, rivet or eyelet) with these loop type supports.

Write for samples
details, prices

WECKESSER CO.



5267 N. Avondale Ave. • Chicago 30, Ill.

SHOCKPROOF VACUUM TUBE RETAINERS

These retainers are used to secure Vacuum Tubes and to resist side motion of Vacuum Tubes used in radio equipment which is subject to shock and vibrations. These retainers meet the requirement of all JAN specifications. The insulated portion is made of a melamine base Fibre Glass Phenol which provides 300 volts insulation to ground and withstands a temperature of 350 F. The insulated plate can readily be fastened or released by hand.

Available for envelope types T7, T8, MT8, T9, T12, ST12, T12ZDL, ST14, S14, ST16, T5 1/2, T6 1/2, MT-IC, ST19, T14, ST128CT-9.

Manufacturers of
Electronic Components

JAMES IPPOLITO & CO., INC.

401 CONCORD AVENUE, BRONX 54, N. Y.

FAST...economical assembly of motors, gear trains, electro-mechanical computing and transmission devices with mechanical development apparatus

Servomechanisms, Inc., versatile Mechanical Development Apparatus is intended for numerous applications in the research, instrumentation, and servo control fields. Typical applications of these precision built components include analog computers, signal generators, process programmers ... Assembly is made with standard tools ... each component is designed for repeated use.

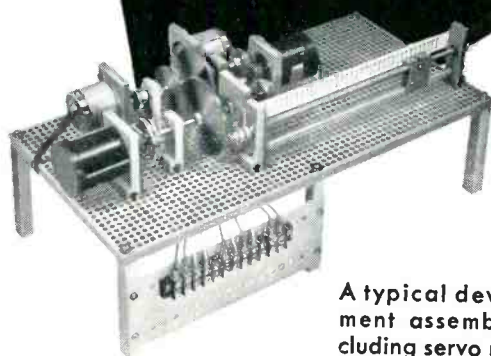

A typical development assembly including servo motors and synchros.



Foundation Boards and Legs

Mounting and Bearing Blocks

Stainless Steel Shafts and Gears

Limit stop, Couplings, Lead screws, Clutch, Dials, Cams, Switch

Write for Descriptive literature MDA-200



NEW CASSEL, NEW YORK • POST & STEWART AVENUES, WESTBURY, N. Y. • EL SEGUNDO, CALIFORNIA

grams, explanations of temperature factors, inrush current effects, tripping and reset time, and time delay curves are provided. Also discussed are the questions of quick or slow make-and-break, and wire deterioration rates at various ampere values.

Rectifier Bulbs. General Electric Co., Schenectady 5, N. Y. A new 8-page, two-color data manual on Tungar bulbs (used for rectifying a-c power to d-c) has been announced. Designated GEA-5677, the bulletin contains charts and graphs illustrating the characteristics, construction, operation and application of Tungar bulbs.

Infrared Analyzer. Minneapolis-Honeywell Regulator Co., Brown Instruments Division, Wayne and Windrim Aves., Philadelphia 44, Pa. Instrumentation data sheet 10.16-7a describes a newly designed selective infrared analyzer produced by Process Controls Div. of Baird Associates. The data sheet illustrates and discusses the application, operation, design features and uses of the unit for plant stream service. It also discusses the ability of the equipment, which incorporates a Brown Elektronik potentiometer, for use as a process control medium.

Slide Rule Instructions. The Frederick Post Co., 3650 N. Avondale Ave., Chicago, Ill., has published a new self-instruction text showing the practical application of mathematical principles. The text is divided into three distinct sections and deals with the improved principles of the Versalog slide rule as it applies to electrical, mechanical and civil engineering. Each section of the 120-page booklet presents a practical, easy-to-comprehend guide to the efficient use of the Versalog in these specialized fields.

Relays for Industry. Automatic Electric Co., 1033 W. Van Buren St., Chicago 7, Ill. A complete line of telephone-type relays, including hermetically sealed (in metal and glass containers) subminiature, and plug-in types is described in a new, color-illustrated brochure

Are Your Laboratories Overloaded?

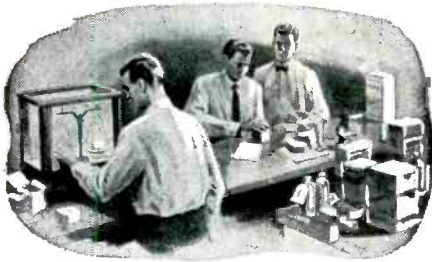

A PRACTICAL SOLUTION TO THE PROBLEM OF TECHNICAL MANPOWER SHORTAGE

Are you interested in the possibility of getting some of your testing analysis and trouble shooting work done without hiring additional technical help?

Our solution is very direct. No doubt many of your trained engineers and chemists are tied down by routine but essential testing and analytical tasks. You can release these men for more demanding, more responsible duties by entrusting our laboratories with your routine testing and analytical schedules.

Why is this possible? Because Testing is our Business. Your assignments to us will be handled by men who live and think testing. They will receive the care and attention that only a specialized laboratory can give. That means speed, accuracy, and real economy.

We would like to get together and discuss your manpower problems and possibly point the way to a solution.

UNITED STATES TESTING COMPANY, Inc.

ESTABLISHED 1880

1550 Park Avenue, Hoboken, N. J.
PHILADELPHIA • BOSTON • PROVIDENCE
CHICAGO • NEW YORK • LOS ANGELES
MEMPHIS • DENVER • DALLAS

Member of American Council of Commercial Laboratories

MODEL 300 VARIABLE ELECTRONIC FILTER

Two simple controls are all that are necessary to operate the Model 300 Variable Electronic Filter. With the variable frequency dial and range switch any cut-off frequency from 20 cps to 200 KC may be quickly and accurately selected and reselected. With the range switch either low-pass or high-pass filter action may be chosen. In either case the rate of attenuation is 18 db per octave and the insertion loss 0 db. For higher rates of attenuation or continuous band pass operation two or more sections can be cascaded. Its low noise level and flexibility of operation make the Model 300 indispensable in geophysical and acoustic research, industrial noise measurements, in the automotive and aircraft industries as well as the radio broadcasting, recording and motion picture studio.

Write for further information today.



SPECIFICATIONS

- CUT-OFF RANGE
20 cps to 200 KC
- ATTENUATION RATE
18 db per octave
- SECTIONS
Single, can be high pass and low pass
- INSERTION LOSS 0 db
- PASS BAND LIMITS
2 cycles to 4 MC
- NOISE LEVEL
80 db below 1 volt

SKL SPENCER-KENNEDY LABORATORIES, INC.
181 MASSACHUSETTS AVE., CAMBRIDGE 39, MASS.

Fine Wire for TRANSISTORS

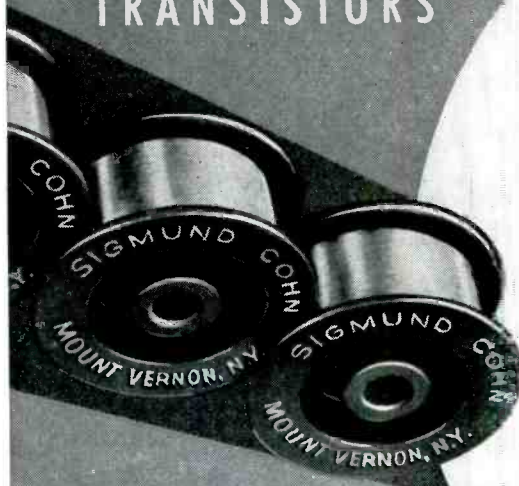

Write for Latest
List of Products

In line with our specialization in wire for new applications, we produce wires of composition suitable for the manufacture of Transistors; including GALLIUM GOLD and ANTIMONY GOLD. These alloys have been made to fill a specific need arising from new developments in this field.

Other wires we make regularly for similar application are PHOSPHOR BRONZE, bare or electroplated, and PLATINUM Alloys produced to meet rigid specifications of tensile strength, size and straightness.



SINCE 1901

SIGMUND COHN CORP. 121 So Columbus Avenue • Mount Vernon, N.Y.

Autosyn*

SYNCHROS

Precision-Built by

ECLIPSE-PIONEER



For more than 18 years, Eclipse-Pioneer has been a leader in the development and production of high precision synchros for use in automatic control circuits of aircraft, marine and other industrial applications. Today, thanks to this long experience and specialization, Eclipse-Pioneer has available a complete line of standard (1.431" dia. X 1.631" lg.) and Pygmy (0.937" dia. X 1.278" lg.) Autosyn synchros of unmatched precision. Furthermore, current production quantities and techniques have reduced cost to a new low. For either present or future requirements, it will pay you to investigate Eclipse-Pioneer high precision at the new low cost.

*REG. TRADE MARK BENDIX AVIATION CORPORATION

AVERAGE ELECTRICAL CHARACTERISTICS—AY-200 SERIES**

	Type Number	Input Voltage Nominal Excitation	Input Current Milliamperes	Input Power Watts	Input Impedance Ohms	Stator Output Voltages Line to Line	Rotor Resistance (DC) Ohms	Stator Resistance (DC) Ohms	Maximum Error Spread Minutes
Transmitters	AY201-1	26V, 400~, 1 ph.	225	1.25	25+j115	11.8	9.5	3.5	15
	AY201-4	26V, 400~, 1 ph.	100	0.45	45+j225	11.8	16.0	6.7	20
Receivers	AY201-2	26V, 400~, 1 ph.	100	0.45	45+j225	11.8	16.0	6.7	45
Control Transformers	AY201-3	From Trans. Autosyn	Dependent Upon Circuit Design				42.0	10.8	15
	AY201-5	From Trans. Autosyn	Dependent Upon Circuit Design				250.0	63.0	15
Resolvers	AY221-3	26V, 400~, 1 ph.	60	0.35	108+j425	11.8	53.0	12.5	20
	AY241-5	1V, 30~, 1 ph.	3.7	—	240+j130	0.34	239.0	180.0	40
Differentials	AY231-3	From Trans. Autosyn	Dependent Upon Circuit Design				14.0	10.8	20

**Also includes High Frequency Resolvers designed for use up to 100KC (AY251-24)

AY-500 (PYGMY) SERIES

Transmitters	AY503-4	26V, 400~, 1 ph.	235	2.2	45+j100	11.8	25.0	10.5	24
Receivers	AY503-2	26V, 400~, 1 ph.	235	2.2	45+j100	11.8	23.0	10.5	90
Control Transformers	AY503-3	From Trans. Autosyn	Dependent Upon Circuit Design				170.0	45.0	24
	AY503-5	From Trans. Autosyn	Dependent Upon Circuit Design				550.0	188.0	30
Resolvers	AY523-3	26V, 400~, 1 ph.	45	0.5	290+j490	11.8	210.0	42.0	30
	AY543-5	26V, 400~, 1 ph.	9	0.1	900+j2200	11.8	560.0	165.0	30
Differentials	AY533-3	From Trans. Autosyn	Dependent Upon Circuit Design				45.0	93.0	30

For detailed information, write to Dept. C.

ECLIPSE-PIONEER DIVISION of
TETERBORO, NEW JERSEY



Export Sales: Bendix International Division, 72 Fifth Avenue, New York 11, N. Y.

recently released. Ask for circular No. 1702-A.

Printed Circuits. Photocircuits Corp., Glen Cove, N. Y. Printed circuits, their function, fabrication and application are comprehensively outlined and described in a new 8-page brochure. Lower wiring costs, reduced assembly time, circuit reproducibility, improved reliability and miniaturization are the advantages shown by this method of wiring. The brochure includes information on methods of application, materials, electrical characteristics with tables of values, components such as capacitors, resistors, tube sockets and switches. Assembly methods are described and costs are suggested.

Accessories for Testing Machines. Tinius Olsen Testing Machine Co., 1022 Easton Road, Willow Grove, Pa. Detailed information on instrumentation, tools and accessories for universal testing machines is given in catalog No. 46. Electronic recorders; electronic strain instrumentation; mechanical extensometers; tension compression, wood and plastics testing tools; and control accessories are only a few of the topics covered in the 24-page catalog.

Delay Lines. Electronic Systems Co., 578 E. 161st St., New York 56, N. Y. A recent booklet deals with custom-built delay lines that are offered now as stock items. The delay lines described are constructed to meet military specifications, including temperature specifications ranging from -55 C to +80 C. Next to each model number are listed the delay in μ sec, bandwidth in mc and price.

Radiotelephones and Direction Finders. Applied Electronics Co., Inc., 1236 Folsom St., San Francisco 3, Calif. Eight radiotelephone models, two radio direction finder models and various accessory units are described in an 8-page catalog identified as form 852. Besides a description of the basic design features of these units, the catalog includes a full tabulation of models showing number and types of channels, frequency ranges,

MICO

Precision Apparatus

TOROID COIL



WINDERS

Flexible machines for your laboratory prototype development work.

Production machines built for volume manufacturing of specific coils.

MICO INSTRUMENT CO.

76E Trowbridge St. Cambridge, Mass.

MIDGET TELEPHONE TYPE RELAYS

in hermetically sealed containers



Surface mounting, open type, Series 80 Relay — size: $1\frac{15}{32}$ " l. x $\frac{5}{8}$ " w. x $1\frac{25}{64}$ " h.

Compact, multiple contact with vibration and shock-proof characteristics. Designed to meet various operating requirements typical of Armed Services applications.

Unique pile-up arrangement reduces width below the conventional relay, thereby reducing over-all space volume.

Coils are varnish-impregnated to resist high humidity conditions. All ferrous parts are treated to pass salt-spray tests.

Engineering Representatives in Principal Cities

WRITE FOR
BULLETIN
MTR-6

Wheelock RELAYS
SIGNAL
ENGINEERING & MFG. CO.
154 WEST 14TH ST. NEW YORK 11, N.Y.

ELECTRONICALLY REGULATED LABORATORY POWER SUPPLIES

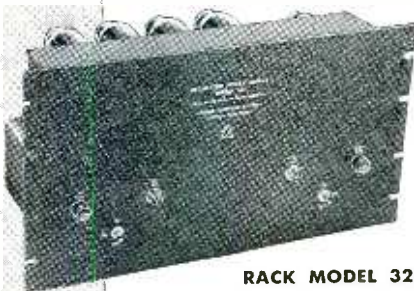

RACK MODEL 32

STABLE
DEPENDABLE
MODERATELY
PRICED

- **INPUT:** 105 to 125 VAC, 50-60 cy
- **OUTPUT #1:** 200 to 325 VDC at 300 ma regulated
- **OUTPUT #2:** 6.3 Volts AC CT at 5A unregulated
- **OUTPUT #3:** 6.3 Volts AC CT at 5A unregulated
- **RIPPLE OUTPUT:** Less than 10 millivolts rms

For complete information write for Bulletin E

STANDARD
RACK
MOUNTING
PANEL SIZE
10 1/2" x 19"
DEPTH 9"
WEIGHT 38 LBS.



LAMBDA ELECTRONICS
CORPORATION
CORONA NEW YORK

FOR YOUR

STAINLESS STEEL FASTENERS...

IT'S **ALLMETAL**

for quality
and
delivery

ALLMETAL, Specialists in Stainless, Produce Stainless Products Exclusively



ALLMETAL

the leading source for Stainless Screws, Nuts, Bolts, Washers, Pins, Rivets. Made right, Priced right. "AN" and Standard Types carried in stock. Phillips Recessed Head Screws and Specials available too.

WRITE FOR CATALOG C



MANUFACTURERS SINCE 1929

ALLMETAL

SCREW PRODUCTS COMPANY, INC.

33 GREENE STREET NEW YORK 13, N. Y.

WESGO

ALUMINA CERAMIC INSULATORS

- ★ High purity . . . free of all impurities such as Iron, Titania, Alkali group elements.
- ★ Made to various formulations with Alumina content from 94% to a pure sintered Alumina with 99.85% minimum Al_2O_3
- ★ Available in porosities ranging from 20% to an impervious, vacuum tight body.
- ★ Formed to dimensional tolerances of plus or minus $\frac{1}{2}$ %, minimum of plus or minus .001".
- ★ Completely homogeneous structure.

Our Engineering Department will gladly answer all inquiries relative to your particular problems.

WESTERN GOLD & PLATINUM WORKS

Ceramic Division

589 Bryant Street
SAN FRANCISCO, CALIF.

NEW PRODUCTS

(continued)

receiver sensitivities, transmitter power outputs ranging from 40 to 500 peak, tube complements, power requirements, dimensions and weights. Accessory units listed include a sectionalized spun glass whip antenna, plug-in crystals, a model 106 mobile p-a system, indoor and outdoor extension speakers, microphones and press-to-talk hand sets.

Small Predetermined Counters. Durant Mfg. Co., 1929 North Buffum St., Milwaukee 1, Wisc. Bulletin 501 covers the SP small predetermined Productimeters designed for both stroke and rotary application, to control production to exact quantities required, and eliminate losses due to over-runs and under-runs. Complete description, specifications, dimensional data, and switch capacities are included.

Picture Tube. Hytron Radio and Electronics Corp., Salem, Mass. A recent series of engineering data sheets give a technical description of the type 27EP4, a 27-in. rectangular, 90-deg, all-glass, magnetically focused picture tube. Terminal connections are shown and dimensional drawings included.

Coax Connectors. Mendelsohn Speedgun Co., Inc., 457 Bloomfield Ave., Bloomfield, N. J., has published two four-page bulletins covering the types C and N coaxial connectors. Listed with dimensional drawings for both types are plugs, cable jacks, panel jacks, bulkhead jacks, receptacles, angle adapters, angle plugs, tee adapters and straight adapters.

Picture Tube Comparison Chart. Sylvania Electric Products Inc., Emporium, Pa., has available a wall chart for tv picture tube comparison. It lists 136 types and includes in tabular form information on the face, body, focus, deflection and maximum length of each.

Pressure Pickup. Consolidated Engineering Corp., 300 North Sierra Madre Villa, Pasadena 15, Calif., has issued a 12-page brochure on its type 4-310 flush-diaphragm pressure pickup, a small

Headquarters for ...
HUDSON
 RADIO & TELEVISION CORP.

In Stock for Prompt Delivery!

Hudson carries a complete line of **RCA TUBES** to meet every **INDUSTRIAL, LABORATORY and COMMUNICATIONS** requirement

Complete Line of
 RCA TEST EQUIPMENT
 RCA BATTERIES • RCA PARTS

FOR FAST SERVICE
 ON RCA TUBES, TEST INSTRUMENTS,
 BATTERIES, PARTS . . . Call HUDSON
 your complete, dependable Source!

FREE!
 New 1953
HUDSON
CATALOG

One Call for All!

HUDSON
 RADIO & TELEVISION CORP.

Includes The New, larger edition of
JAN Cross Reference **GUIDE**

The most complete buying guide of its kind! INCLUDES the latest JAN CROSS-REFERENCE GUIDE and all types of fully approved JAN COMPONENTS. Over 196 pages of the latest and largest selection of Industrial Electronic Equipment, Tubes, Test Instruments, Recording and High Fidelity Audio and Sound Equipment. Complete lines. Wide selection. All Standard Makes in Stock for Prompt Delivery at LOWEST PRICES!

Send for your **FREE Catalog** today!
 Dept. M-1
48 WEST 48th ST. • 212 FULTON ST.
 New York 36, N. Y. New York 7, N. Y.

THE
RAYONIC
 CATHODE RAY TUBES
 BY WATERMAN

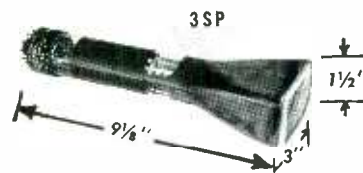

Since the introduction of Waterman RAYONIC 3MP1 Tube for miniaturized Oscilloscopes, Waterman has developed a rectangular Tube for multi-trace oscilloscopy. Identified as the Waterman RAYONIC 3SP, it is available in P1, P2, P7 and P11 screen phosphors. The face of the Tube is $1\frac{1}{2} \times 3$ " and the over-all length is $9\frac{1}{8}$ ". Its unique design permits two 3SP Tubes to occupy the same space as a single 3" round tube, a feature which is utilized in the S-15-A TWIN-TUBE POCKETSCOPE. On a standard 19" relay rack, it is possible to mount up to ten 3SP tubes with sufficient clearances for rack requirements. Thus 3SP RAYONIC tube is ideal for multi-trace oscilloscopic work.

Maximum 2nd anode voltage 2750 volts
 ... Satisfactory operation can be achieved at 600 volts ... Vertical deflection factor 52 to 70 volts DC per inch per kilovolt ... Horizontal deflection factor 73 to 99 volts DC per inch per kilovolt ... Grid cut-off voltage 2.8 to 6.7% of 2nd anode potential ... Focusing voltage 16.5 to 31% of 2nd anode voltage ... Heater 6.3V at .6 amp ... Twelve pin small shell duodecal base ... Tube can be mounted in any position ... 3SP1 JAN approved.

WATERMAN PRODUCTS CO., INC.

PHILADELPHIA 25, PA.
 CABLE ADDRESS: POKETSCOPE

WATERMAN PRODUCTS INCLUDE:

- 3JP1 & 3JP7 JAN RAYONIC CR TUBES
- 3JP2 & 3JP11 RAYONIC CR TUBES
- 3MP7 & 3MP11 RAYONIC CR TUBES
- 3RP1, 2, 7, 11 RAYONIC CR TUBES

Also POCKETSCOPES,
PULSESCOPES, RAKSCOPES
 and other equipment



Century **MODEL 210**
RECORDING GALVANOMETERS



COIL: Anodized aluminum wire. High space factor and low mass result in unprecedented efficiency.
SUSPENSION: Gold, silver or platinum ribbon, either flat or round depending on frequency.
STANDARD FREQUENCIES: 100, 200, 500, 850, 2000, 3300 cps.
DAMPING: Normally damped 64% of critical. Fluid or electro-magnetically damped depending on frequency.
MAGNETIC ASSEMBLY: Permanent Magnet type . . . Alnico V-DG. Assembly permits independent vertical and horizontal adjustment of each element with positive locking of adjustment.

SPECIFICATIONS:

Mirror: Cylindrical, focal lengths 11.5" or 6.2" are standard.
 Size: 2.5" length; .125" diameter.
 Weight: .11 oz.
 Mounting: Plug in — no external wiring.
 Pole Pieces: Integral with tubular case, except in fluid damped units.
 Terminals: Within magnetic assembly. All elements are electrically isolated.
 Balance: .010 per g at 15 1/2".

Write for Bulletin CGC-301

Patented Century Nos. 2519591, 2519689,
 2439576; Konnestine No. 2149442.

Century **GEOPHYSICAL CORPORATION**
TULSA, OKLAHOMA

4447 No. Badine Philadelphia 40, Pa. 3406 W. Washington Blvd. Los Angeles 18, Calif. 238 Lafayette St. Dayton 2, Ohio 309 Browder St. Dallas, Texas EXPORT OFFICE 149 Broadway, N. Y. City

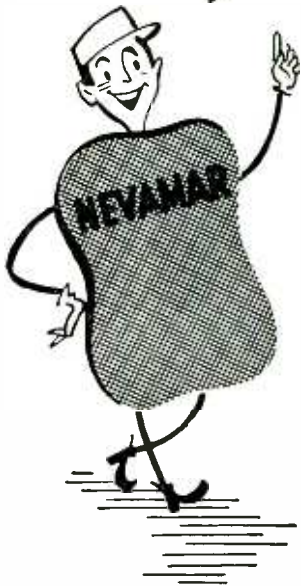

NEVAMAR[®]

**speaks the
language
industrial
laminates users
understand**

NEVAMAR industrial grade laminates are manufactured by one of the nation's foremost producers of high-pressure decorative laminates. This is immediate assurance of engineering and manufacturing "know how" . . . the ability gained from research and experience to produce industrial grade laminates of superior quality and dependable performance. NEVAMAR is produced in many grades to meet varying requirements. It meets or exceeds the standards of the National Electrical Manufacturers' Association. Would you like to see samples?



 **The NATIONAL Plastic Products Company**

Manufacturers of Nevamar Decorative and Industrial Laminates • SARAN FILAMENTS • Wynene Molded Products
ODENTON, MARYLAND • NEW YORK: EMPIRE STATE BUILDING • LOS ANGELES: 5025 HAMPTON ST.

instrument that features negligible temperature sensitivity, resistance to acceleration effects and wide adaptability to many test conditions and mounting requirements. Included are diagrams showing the transducer used in a direct recording system and in a carrier amplifier system. Operating characteristics are also given.

Calibrator. Bruck Industries Inc., Syosset, N. Y. Catalog sheet 06 gives general and technical descriptions and specifications for the type M-DC-1 meter calibrator. The instrument described is needed in industry, research and test laboratories where d-c meters are used and must be checked for accuracy; and it is particularly useful as an accessory equipment in the design of electronic analog computers.

Radiant Heating. The Thermflex Division of Radio Ceramics Corp., 109 South Superior St., Angola, Ind., has published a brochure dealing with printed circuit techniques as applied to electric heating. Description, illustrations, applications and chief advantages are included.

Printed Circuits. Erie Resistor Corp., Erie, Pa., has issued a bulletin describing and illustrating a complete line of five types of electronic printed circuits, each in a range of capacities: diode filters, triode plate couplers, vertical integrators, pentode plate couplers and audio output circuits. In the units described all plates are ceramic, lead wires are tinned copper wire and insulation is thermosetting dipped phenolic.

Precision Instruments. Minneapolis-Honeywell Regulator Co., Brown Instruments Div., Wayne and Windrim Aves., Philadelphia 44, Pa. Catalog 1520 contains factual information concerning Electronik noncontrol precision instruments, which employ a potentiometer, Wheatstone bridge, or other measuring circuit to measure temperature, pressure, flow, pH and a host of other variables. It presents detailed specifications for each particular model. Also in-

drawn cases

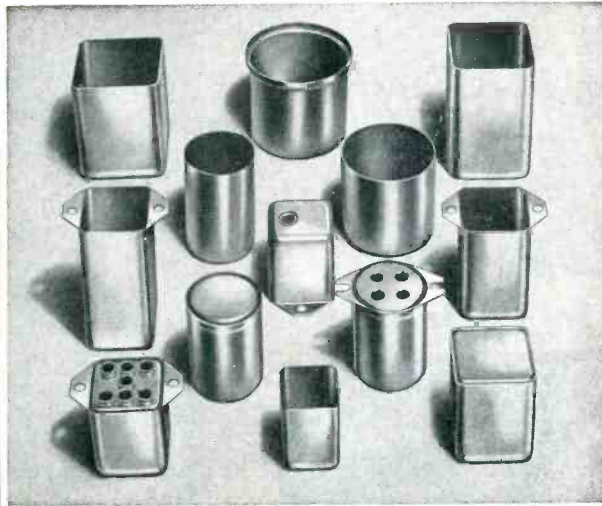

hot tin dipped . . . fabricated terminal and vent holes . . . smooth, one-piece construction using cold rolled steel . . . draw depths up to 2½" . . . inside fit covers for easy hermetic sealing in all sizes . . . available as stock sizes and as special fabrications.

OLYMPIC METAL PRODUCTS COMPANY, INC.
P. O. BOX 71A PHILLIPSBURG, N. J.

optimum solution

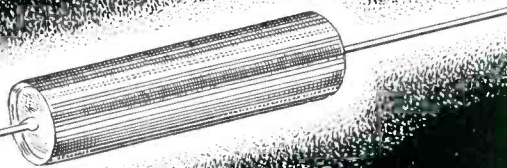

Unicon Polystyrene capacitors are characterized by extremely low losses. Exact values are given in the table.

Possessing very high electrical qualities, they are ideal elements for use in electronic analyzers and computers, in tuned circuits and wave filters, as standards of capacitance, in radiation detection, and power supply circuits.

Unicon Polystyrene capacitors are available in many different types of housings, as well as uncased for potted assemblies.

Prices on Unicon Polystyrene capacitors are reasonable, and delivery excellent.

Unicon always gives your capacitor problems the Optimum Solution.

unicon PLASTIC DIELECTRIC capacitors

TYPES IMMEDIATELY AVAILABLE

Property	Poly-styrene	Teflon	Synthetic D
Capacity001 up	.001 up	.01 up
Voltage	100 up	300 up	200 up
Power Factor01%	.01%	0.5%
I. R.	10 ⁶ meg/mf	10 ⁶ meg/mf	10 ⁶ meg/mf
Max. Op. Temp.	90°C	125°C	125°C
Soakage02%	.02%	1.0%
Temp. Coef	-100 ppm/°C	-100 ppm/°C	+500 ppm/°C
Bulk at lowest voltage given	5 in ³ /mf	10 in ³ /mf	1.2 in ³ /mf

Capacitors made to your specifications.

Write for catalog EE

united condenser corp.

UNICON

337 EAST 139th STREET NEW YORK 54, N. Y.

improve your memory



with



In electronic computers,

Andersen

SOLID ultra-sonic delay lines are:



and **SOLID** delay lines mean minimum size and weight.

Spurious signals — 40db. or better.

Investigate Andersen **SOLID** ultra-sonic delay lines. Complete facilities for research and development.

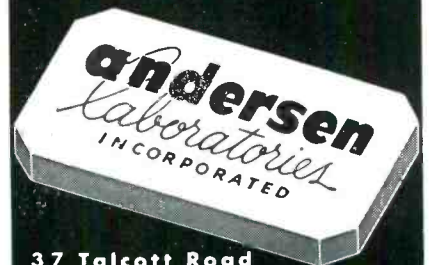

37 Talcott Road West Hartford 10, Conn.

NEW Type 2113, 12-Channel PICTURE SIGNAL GENERATOR

for Production Testing and Closed-Loop T.V.



The Type 2113, 12 Channel Picture Signal Generator has been specifically designed for production line testing of TV receivers. Used in conjunction with the equipment listed below, the manufacturer can produce his own "Indian Head" test pattern and is no longer dependent on local transmissions. This signal generator has also received wide acceptance for dealer demonstrations of TV receivers in areas where transmitting facilities are not yet available.

SPECIFICATIONS

OUTPUT SIGNALS AND ACCURACY: Picture and sound R. F. signals on all 12 standard TV channels. Picture carrier accuracy 0.01%; sound carrier better than ± 4.5 KC of "standard" on all channels.

PICTURE CARRIER OUTPUT: At least 50,000 microvolts into a 75 ohm terminated coaxial cable.

R. F. OUTPUT IMPEDANCE: Output is into a 75 ohm coaxial cable. Two probes are supplied for use with 75 ohm cable to match 75 or 300 ohm receiver antenna input circuits.

VIDEO INPUT IMPEDANCE: 75 ohms single ended.

VIDEO INPUT: Minimum 1 Volt Peak to Peak, black negative polarity.

PICTURE CARRIER MODULATION: Continuously variable 0 to 87%.

D. C. RESTORER: A D.C. restorer is provided to maintain constant average picture brightness when using program material for video modulation.

SOUND CARRIER DEVIATION: Continuously variable 0 to 40 KC.

SOUND MODULATION: Modulation from 400 cps internal oscillator or external signal such as music. Input either high impedance, unbalanced, or 600 ohms balanced. Either input can be selected by front panel switch.

Price \$565.00

These other TIC Instruments complete the "package"

TYPE 2120 PICTURE SIGNAL GENERATOR: A single channel TV transmitter for use where a high percentage of picture modulation is required for checking inter-carrier buzz. Price \$700.00

TYPE 1311 VIDEO DISTRIBUTION AMPLIFIER: A 5 channel amplifier recommended where multiple 75 ohm, unity gain outlets are desired. Price \$550.00

TYPE 2200 SYNC. SIGNAL GENERATOR: Provides all necessary RTMA sync, blanking and drive signals plus linearity blanking, in either polarity, for monoscope or studio camera operation. Price \$1900.00

TYPE 2300 MONOSCOPE: A "must" for checking linearity, resolution and smear in TV receivers and video distribution facilities. Recommended for use with Type 2200 Sync-Generator. Price \$1200.00

All prices FOB Factory.

TIC Manufacturers of a Complete Line of TV Test Equipment
Tel-Instrument Co. Inc.
50 PATERSON AVENUE • EAST RUTHERFORD, N. J.

cluded is information on specially adapted Elektronik instruments such as the electrometer, function plotter, scanning system, TV-Dial recorder, double-range precision indicator and console desk precision indicator.

UHF Antenna Systems. The La-Pointe Plascomold Corp., 155 W. Main St., Rockville, Conn. An eight-page catalog called "UHF Antenna Systems—How, What and Where for Every UHF Area" was recently published. The brochure includes considerable important uhf data such as a page of questions and answers for the technician; a page on the Vee-D-X Mighty Match for separating vhf and uhf; two pages on newly developed uhf antennas; a page describing the new Vee-D-X universal mounting bracket and its many uses; and a page showing typical installations that combine both vhf and uhf.

Microwave Components. Titeflex, Inc., 500 Frelinghuysen Ave., Newark 5, N. J. A 12-page folder shows the company's facilities for manufacture of a wide range of microwave components. Rigid and flexible waveguides are described and illustrated, and complete technical specifications and dimensional drawings are included.

Instrumentation Catalog. Tektronix, Inc., P. O. Box 831, Portland 7, Oregon. Short form catalog 5207 illustrates and technically describes seven types of oscilloscope, two square wave generators, an amplifier, two pre-amplifiers, a time mark generator and a waveform generator. Prices for all are included.

Microwave Measurements. Kay Electric Co., 25 Maple Ave., Pine Brook, N. J. A 4-page brochure shows how microwave measurements may be simplified by using (1) the Mega-Nodes as primary standards for noise figure measurements on microwave receivers; (2) the new Centilators, as signal sources, swept, c-w or pulsed for measurements of frequency and transient response of microwave systems; and as experimental mi-

Combining
Simplicity of Operation,
Reliability and Accuracy



Model SI-1 \$375.

Strain Indicator

Also—complete line of high quality strain gage switches, balancing boxes and associated equipment.

POLYPHASE
INSTRUMENT COMPANY
BRYN MAWR, PA.

☆ FIRST PRACTICAL.... 24 HOUR ELECTRIC CLOCK

DIRECT READING, SYNCHRONOUS, SELF-STARTING
READS FROM 0001 to 2400 (one minute past midnight
to midnight), FOR 115-VOLT 60-CYCLE OPERATION.

FIVE MECHANICALLY INTERLOCKED METAL DRUM
DIALS - SELF-CONTAINED ILLUMINATION - SECONDS
DIAL HAS FOUR COLOR SECTORS - OTHER DIALS
HAVE BLACK NUMERALS ON WHITE BACKGROUND

Panel or Case Mounting
4 1/16" H., 7 7/16" W., 4 1/2" D.
2-Hole Mtg. Rugged, Light-
weight construction.
Currently in production.
Price & Delivery on request

50 cycle motor and white
numerals optional

Wicker
ENGINEERING & CONSTRUCTION
COMPANY
P. O. BOX 590
CAMDEN 1
NEW JERSEY

Patent Applied for

WOODLAWN 4-4912

BE SAFE WITH

Q-max

A-27

LOW-LOSS LACQUER & CEMENT

- Q-Max is widely accepted as the standard for R-F circuit components because it is chemically engineered for this sole purpose.
- Q-Max provides a clear, practically loss-free covering, penetrates deeply, seals out moisture, imparts rigidity and promotes electrical stability.
- Q-Max is easy to apply, dries quickly and adheres to practically all materials. It is useful over a wide temperature range and serves as a mild flux on tinned surfaces.
- Q-Max is an ideal impregnant for "high" Q coils. Coil "Q" remains nearly constant from wet application to dry finish. In 1, 5 and 55 gallon containers.

*Communication
Products Company, Inc.*

MARLBORO, NEW JERSEY
(MONMOUTH COUNTY)
Telephone: FReehold 8-1880



quality
hand-wound
COILS
of Tungsten
and Molybdenum

quality
"precision"
LEADS
of
TUNGSTEN
MOLYBDENUM
NICKEL
NICKEL-CLAD
COPPER
and ALLOYS

quality
**MACHINED
TUBE
COMPONENTS**
to customers'
specifications

Your products can
only be as good as
the parts you put
into them!

SEND US YOUR BLUEPRINTS or
SPECIFICATIONS FOR QUOTATIONS!

ELECTRONIC PARTS MANUFACTURING CO.
508 25th St., Union City, N. J.

VECO VICTORY

HOW
ARE
YOU

THERMISTORS
VARISTORS ANALYSIS CELLS
COMBUSTION EFFICIENCY TESTERS

Measuring
and
Controlling

- TEMPERATURE
- CURRENT
- POWER
- VOLTAGE ?
- PRESSURE
- VOLUME
- COMPOSITION
- FLOW OF
AIR, GAS,
AND LIQUIDS ?

VECO THERMISTORS, approved and accepted by Government Agencies, are highly versatile new circuit elements - electrical resistance varies extensively with relatively minute thermal changes.

QUANTITY PRODUCTION - stocked in a wide range of specific resistance values and made in the forms of rods, discs, washers, and beads.

Western Electric and Victory have a cross-license arrangement covering thermistors, and are the only manufacturers in the U. S. making the bead type.

VECO VARISTORS are used in voltage control and limiting circuits, and VECO GAS ANALYSIS CELLS incorporate the extremely sensitive VECO THERMISTORS.

Submit your unusual or new measurement or control problem to Victory for a prompt complete analysis and recommendation.

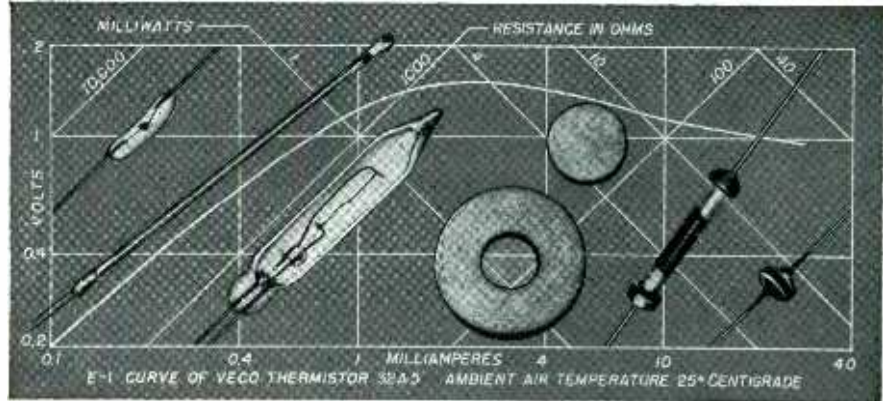

Visit Victory at the IRE Show, 3rd Floor, Booth 403 - Grand Central Palace, New York, N. Y. - March 23-26.

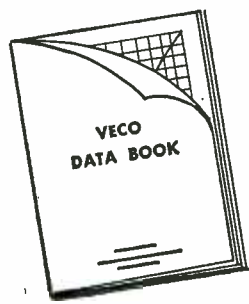

Victory ENGINEERING CORPORATION

SPRINGFIELD ROAD, UNION, NEW JERSEY
Telephone UN ionville - 2-7150

Please send me your VECO DATA BOOK On THERMISTORS

NAME _____
COMPANY _____
ADDRESS _____

crowave transmitters; and (3) the Mega-Match as an X-band impedance match indicator that displays reflection coefficient of a line termination vs frequency over broad bands.

Industrial Freezers. Webber Appliance Co., Inc., 2740 Madison Ave., Indianapolis 3, Ind. Information on industrial freezers as well as complete temperature range testing units is now available in an 8-page folder. Included are data on performance characteristics, sizes, temperature range and applications regarding the company's industrial freezers and complete range testing units. The units described perform low temperatures to -165 F and on heat range to +350 F. Twelve models are illustrated with complete information regarding thirty-six standard models.

Counting Rate Meter. Measurement Engineering Limited, Arnprior, Ontario, Canada. A single-sheet loose-leaf perforated bulletin covers the A.E.P. 1902A general-purpose counting rate meter that is intended for accurate research measurements of the average rate of arrival of random pulses as derived from radioactivity detectors. Included are an illustration, electrical and mechanical features, uses and information on circuitry and operation.

Picture Tube Interchangeability Chart. Transvision, Inc., New Rochelle, N. Y. A recent 4-page folder lists most television picture tubes, giving the popular types that replace hard-to-get tubes. Where direct replacement is difficult, notes are included showing changes necessary.

Automatic Voltage Stabilizers. General Electric Co., Schenectady 5, N. Y., has announced a new 12-page, two-color bulletin on automatic voltage stabilizers ranging from 15 to 5,000 volt amperes. The booklet (GEA-5754) contains photographs and diagrams of the equipment, explains operation principles and construction, and gives complete specifications. It also describes the causes and effects of

Opportunities at
BECKMAN
 for
ENGINEERS - SCIENTISTS

To Develop Instruments
 and Electronic Components

Use your training, aptitudes and experience in the following (or allied) fields:

Spectroscopy . . . Precision Electronics
 Optics . . . Physics . . . Electromechanics
 Mechanics . . . Feedback Systems

Men who combine fields will find our projects especially interesting. Typical developments include spectrophotometers at all wavelengths, pH meters, electrometers, flame photometers, computers, radiation instruments, titrators and others to be announced.

Unusual opportunities in all divisions: Helipot and Beckman Instruments—So. Pasadena, California; Berkeley Scientific—Richmond, California. Our company is a leader in the fast growing instrument industry, which is not dependent for its future on military contracts, but is of fundamental importance to all types of research and industry.

Write for application and information about our company.

Personnel Department

Beckman Instruments, Inc.

1001 El Centro Street
 South Pasadena 59, California

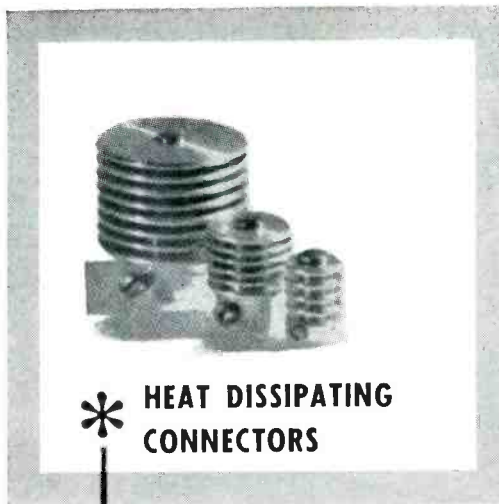

* **HEAT DISSIPATING CONNECTORS**

**Vacuum Tube Accessories
 By Eimac — Now Available!**

Type HR heat dissipating connectors are designed to provide an efficient method of heat transfer from tube elements and seals to the air. Also facilitate electrical connection to plate or grid leads of most popular transmitting tube types. Machined from solid dural rod, come complete with necessary machine screws for use.

* Write for new Eimac Catalogue Summary showing Eimac tubes and other accessories.



Eitel-McCullough, Inc.
 San Bruno, California

Roanwell

Style No. 2906

CLOTHES CLIP

Sturdily constructed for maximum life. Finished in semi-gloss black enamel. Ribbed, firm-gripping clamping pads made of hard neoprene. Mounting plate enables clip to be attached to hard surface, such as a switch case. Hard drawn steel spring wire insures optimum spring action.

WITH MOUNTING HOOK FOR USE ON CORDSETS. This model utilizes a steel mounting hook which can be hooked directly on a cordset molded for this purpose.

DATA SHEETS ON REQUEST.

ROANWELL CORPORATION
 27 SIXTH AVENUE, BROOKLYN 17, NEW YORK



Here at Coto-Coil . . .

. . . the High Speed Covering Department winds outer covers of natural or synthetic yarns over Coto Coils. These top quality yarns positioned and hold down leads according to specifications, provide electrical insulation and physical protection. Here power winders and expert operators insure maximum production output of the highest quality. These modern production facilities, plus 35 years of experience, combine to make Coto Coils the first choice for engineered coils. Coto-Coil Company, 65 Pavilion Avenue, Providence 5, R. I.

Coil with cotton yarn covering



GTC Transformers

demanded for

Unusual Applications



The illustrated new automatic pin-spotter is a product of the American Machine & Foundry Company. An exceptionally high degree of precision is necessary for proper performance.



"GTC" Transformers are used in the AUTOMATIC PIN-SPOTTER because of their accepted ability to meet the most rigid specifications. If your application is most unusual or standard, we suggest you consider "GTC" — proven transformers where maximum performance is essential.

We welcome your inquiries.

GENERAL TRANSFORMER COMPANY

serving industry since 1928

18240 Harwood Avenue, Homewood, Illinois
(Suburb of Chicago)

voltage variations and lists typical applications for stabilizers.

TV Transformers. Standard Transformer Corp., 3580 Elston Ave., Chicago 18, Ill., has announced its new simplified television transformer catalog and replacement guide, listing replacement information on over 4,400 tv models and chassis. Manufacturers' part numbers are conveniently listed in numerical order with the proper replacement listed next to them. The guide also features a separate section listing 117 tv replacement transformers with complete electrical and physical specifications.

Solderless Terminals. Aircraft-Marine Products, Inc., 2100 Paxton St., Harrisburg, Pa. Two new illustrated booklets present the highlights of the industrial films, "All's Well That Ends Well" and "By the Millions." One demonstrates the use and application of solderless terminals with precision hand tools. The others shows how solderless terminals in strips fed from reels can be applied to write at rates of up to 4,000 per hour with automatic machines.

Auto Radio Replacements. Merit Coil & Transformer Corp., 4427 N. Clark St., Chicago 40, Ill., has prepared an 8-page replacement guide for auto radios that includes 4 pages on transformers and 4 pages on i-f/r-f coils. Ask for Form No. 3.

Acoustical Insulations. Gustin-Bacon Mfg. Co., Kansas City, Mo. A new four-page folder titled "A Complete Line of Glass Fiber Acoustical Insulations" includes all relevant details on Ultralite, Ultrafine and Ultraacoustic. The folder describes the physical properties of each of the three products, such as sound absorption and thermal conductivity. It points out the qualities the three have in common, including their principal uses, their ease of application and the choice of facings available with each. Sizes and dimensions for each are given, along with information on the engineering service the company makes available since each acoustical problem is different.



Phaostron

CARB-OHM

A DEPOSITED CARBON RESISTOR
HERMETICALLY SEALED

1% PRECISION RESISTOR



AVAILABLE FROM 1/3 to 2 WATTS

"Here is a resistor that will withstand ambient temperatures of 105°C for at least 1000 hours with full rated loads.

"Certified inspection after 1000 hours found these resistors remained within 1% of their original resistance."

Technical information available upon application

ENVIRONMENT FREE
ELECTRICAL EQUIPMENT



PHAOSTRON COMPANY, 151 PASADENA AVE., SOUTH PASADENA, CALIF.



AUDIO GEN.
KIT
\$29.50



R. F. SIGNAL
GEN. KIT
\$19.50

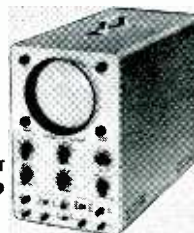

5"
SCOPE KIT
\$43.50



T.V. ALIGN.
GEN. KIT
\$39.50

BUILD YOUR OWN *Heathkit* TEST EQUIPMENT

Heathkits are completely engineered instruments supplied unassembled. Every kit goes together smoothly and easily. All drilling, punching, and painting has already been done for you. All parts are furnished and are of highest quality.

Detailed construction manual shows clearly where each wire and part goes and tells exactly how to build the kit. Write for free catalog.



SIGNAL
TRACER KIT
\$22.50



VACUUM TUBE
VOLTMETER KIT
\$24.50

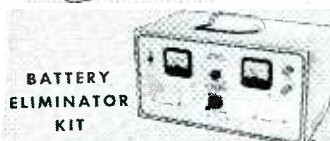

BATTERY
ELIMINATOR
KIT
\$24.50

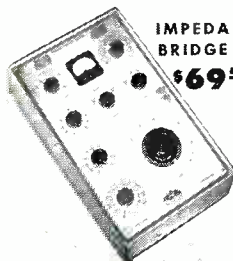

IMPEDANCE
BRIDGE KIT
\$69.50



TUBE CHECKER
KIT
\$29.50



GRID DIP METER
KIT \$19.50



CONDENSER
CHECKER KIT
\$19.50



REXOLITE 1422

(FORMERLY G. E. TEXTOLITE 1422)

COMBINES EVERY DESIRABLE
PHYSICAL, CHEMICAL, &
ELECTRICAL
PROPERTY IN ONE INSULATING
MATERIAL FOR U. H. F.

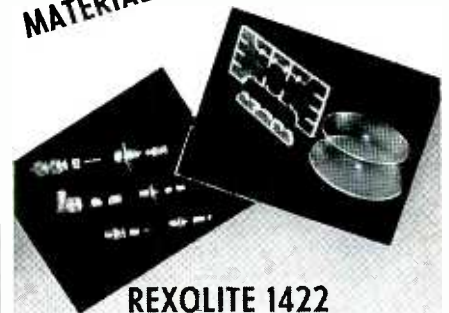

REXOLITE 1422

- Specifically designed to meet the growing need for a U. H. F. insulating material that's low in cost.
 - Meets JAN-P-77 and MIL-P-77A specifications.
 - Withstands high temperature due to its thermosetting nature.
 - Has outstanding electrical properties.
 - Has low specific gravity — is strong and rigid with unusually high compressive and tensile strengths.
 - Has excellent impact strength and hardness allowing its use under highly abusive conditions.
 - Its dimensional stability and unusual chemical inertness allow its use where other materials fail.
 - Readily machinable to extremely close tolerances.
 - Available as centerless ground rods in any diameter up to 1". Also cast in larger diameter rods and sheets.
- Write today for technical bulletins and samples. Our engineering staff is always at your disposal.

Manufacturers of Non-slip wire, High Temperature Electrical Tubing and other extruded plastic products.

THE REX CORPORATION
66 LANDSDOWNE STREET
CAMBRIDGE 39, MASS.

PLANTS AND PEOPLE

Edited by WILLIAM P. O'BRIEN

Radio Engineers to Honor Sarnoff, Others

FIRST recipient of the newly established Founders Award of the IRE will be David Sarnoff, chairman of the board of RCA. The award, which will be given only on special occasions and not annually, was established to recognize an outstanding leader in the radio industry and to commemorate the three radio pioneers who founded the IRE forty years ago—Alfred N. Goldsmith, editor of the *Proceedings of the IRE* and consulting engineer; John V. L. Hogan, president of Hogan Laboratories, New York, N. Y.; and Robert H. Marriott, deceased.

Other awards announced by the Institute's board of directors are as follows:

Robert M. Page, superintendent of Radio Division III and associate to the director of research of the

U. S. Naval Research Laboratory, Washington, D. C., was named recipient of the 1953 Harry Diamond Memorial Award, given annually to a person in government service, for his "outstanding contributions to the development of radar through pioneering work and through sustained efforts over the years."

The 1953 Browder J. Thompson Memorial Prize will go to Richard C. Booton, Jr., of MIT for his paper entitled, "An Optimization Theory for Time-Varying Linear Systems with Nonstationary Statistical Inputs." This award is bestowed annually on an author under 30 whose paper constitutes the best combination of technical contribution and presentation of the subject.

Edward O. Johnson and William M. Webster, Jr., of RCA Labora-

OTHER DEPARTMENTS featured for this issue:

	Page
Electrons At Work	144
Production Techniques	226
New Products	264
New Books	346
Backtalk	358

tories Division, Princeton, N. J., were named recipients of the 1953 Editor's Award for their paper entitled, "The Plasmatron, A Continuously Controllable Gas-Discharge Developmental Tube." The award recognizes literary excellence.

Presentation of all the awards will be made at the annual banquet to be held at the Waldorf-Astoria, New York City, on March 25, 1953, during the Institute's national convention.

WCEMA AWARD WINNERS

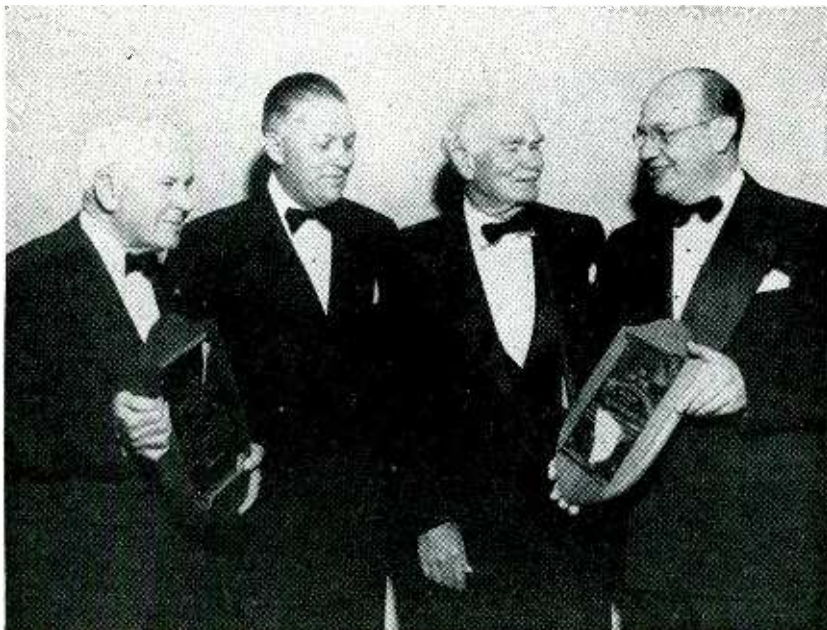

Robert A. Millikan, Assistant Secretary of the Navy John Floberg, Lee DeForest and A. M. Zarem, director of the Stanford Research Institute, study the plaques awarded Drs. Millikan and DeForest by the West Coast Electronic Manufacturers Association for their contributions to the electronics industry. Presentation was made following the association's tenth anniversary banquet in Los Angeles, Calif.

DuMont Fills Three Key Posts

PROMOTION of three members of the Instrument Division, Allen B. DuMont Laboratories, Inc., to new key posts within the division was recently announced.

The appointees and their new positions are as follows:

H. B. Steinhauser has been named manufacturing engineer. He was formerly a senior engineer.

L. E. Florant moves from an intermediate engineer to head of the engineering services section.

A. W. Russell is now head of the electrical design section. He was formerly a senior engineer.

Philadelphia Plant Acquires More Space

EL-TRONICS, INC., designers and manufacturers of nucleonic and electronic instruments, has announced the expansion of its research and industrial facilities by the acquisition of an additional

*To: Senior Servo Engineers
Senior Electrical Engineers*

*You are invited to join the Bell
Aircraft Engineering team and to
contribute YOUR imagination and cre-
ative talents to revolutionary invest-
igations and developments in the field
of auto-navigation.*

*Experience and ability command a premium at
Bell Aircraft Corporation. Challenging oppor-
tunities are available NOW at responsible
levels for:*

- 1. Engineers experienced in autopilots, gyro-stabilized systems, and automatic control systems.*
- 2. Instrument design engineers experienced in the design of precision mechanisms and special devices.*



*ENGINEERING PERSONNEL OFFICE
P. O. BOX 1 BUFFALO 5, N. Y.*

R. S. V. P.

**INERTIAL GUIDANCE SYSTEM DEVELOPMENT IS
A LONG-RANGE PROGRAM AT BELL AIRCRAFT**

17,000 sq ft of space in new and modern quarters. General offices, research and engineering are now located in the new building at Fifth and Noble Streets, Philadelphia, Pa. The entire plant facilities at 2647 North Howard St. are being devoted to production manufacturing operations.

Hunkins Advances at Federal

APPOINTMENT of Harold R. Hunkins as chief engineer in the Selenium-Intelin Division of Federal Telephone and Radio Corp., Clifton, N. J., has been announced.

Mr. Hunkins, who has been with Federal for eight years, is the former project manager for three



H. R. Hunkins, chief engineer

of the company's government contracts. Previously he was in the Wire and Radio Transmission Division, first as product line man-

ager, then as chief systems engineer and finally as sales manager. In his new position he directs the design of new products and the development of new processes and material for the Selenium-Intelin Division, which produces selenium rectifiers, high-frequency coaxial cable, television lead-in wire and other wire products in Federal's Clifton and East Newark plants.

IRE Elects Officers for '53

ONE of the nation's highest professional honors was recently accorded James W. McRae, vice-president of Bell Telephone Laboratories, New York, N. Y., with the announcement of his election as president of the IRE for 1953. He succeeds Donald B. Sinclair, chief engineer of General Radio Co., Cam-

Time and Place Set for Western Show

ESTABLISHING show dates of August 19 through 21, 1953 was the first order of business as the new WESCON (Western Electronic Show and Convention) board of directors recently held its first organizational meeting for next season in San Francisco. Location of the show will be the San Francisco Municipal Auditorium.

In 1952 a total of 15,092 individuals attended WESCON in Long Beach, Calif., and plans for 1953 envision a substantial increase, not only in general attendance, but also in the 1952 figures of 2,692 who registered for the technical sessions and 199 exhibitors who displayed products and services in 224 booths.



J. W. McRae, new IRE president

bridge, Mass., as head of the society.

S. R. Kantebet, general manager of the Government of India Overseas Communications, succeeds Harold L. Kirke, assistant chief engineer of the British Broadcasting System, as IRE vice-president.

Elected as directors for the 1953-1955 term are Stuart L. Bailey, partner of Janskey and Bailey, Washington, D. C., and B. E. Shackelford of RCA International Division, New York, N. Y.

Regional directors elected for 1952-'53 are as follows:

Region 2 (North Central Atlantic), John R. Ragazzini of Columbia University, N. Y.; Region 4 (East Central), Conan A. Priest of General Electric Co., Syracuse, N. Y.; Region 6 (Southern) Archie W. Straiton of the University of Texas,



Composition of the new WESCON board of directors is as follows: (standing, left to right) W. D. Hershberger of the University of California, member; Leon B. Ungar of Ungar Electric Tools Inc., member; Howard G. Grove of West Coast Electronics Co., member; (seated) Noel E. Porter of Hewlett-Packard Co., secretary-treasurer; W. E. Noller of Remler Co., Ltd., vice-chairman; Heckert Parker, WESCON business manager; Richard G. Leitner of Packard-Bell Co., past chairman; Joseph H. Landells of Westinghouse Electric Corp., chairman; Jeanne Jarrett, WESCON recording secretary; and (foreground) Richard A. Huggins of Huggins Laboratories, vice-chairman. WESCON, as an operating organization, is jointly sponsored by WCEMA and the Seventh Region IRE.

Sensational Advancements In Science & Industry

Created the Need for **THE NEW** *Stabelex "D"* **CAPACITORS**

YOUR FREE
INDUSTRIAL CONDENSER CORPORATION
Stabelex "D" Capacitor Catalog
may prove to be the most important
new single piece of literature for
you this year!

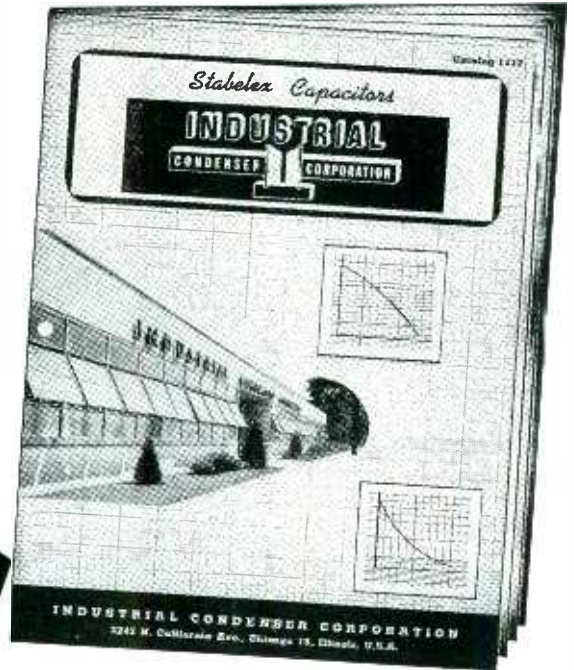

Curve #1107 illustrates the low temperature coefficient of capacity. This low coefficient, therefore, makes these capacitors highly desirable in circuits, the constants of which depend on unvarying capacity.

Performance curves illustrating various characteristics of the Stabelex "D" Capacitor will appear in this magazine each month.

OUTSTANDING FEATURES

INSULATION RESISTANCE AT 20° C. AFTER THREE MINUTES CHARGE—900,000 megohm microfarads

INSULATION RESISTANCE AT 75° C.—78,000 megohm microfarads

INSULATION RESISTANCE AT -75° C.—In excess of 5 million megohm microfarads

CHANGE IN CAPACITANCE FROM 25° C. TO -80° C; +0.76%

SELF TIME CONSTANT OF 10 MFD CAPACITOR—4800 hours

Q AT 50 KILOCYCLES—10,000

POWER FACTOR AT 1 KC—0.00025

SEND FOR CATALOG 1117 TODAY

After a long period of research, Industrial Condenser Corporation now offers to industry for the first time the first of their family of Stabelex capacitors, Stabelex "D", which has been produced for special applications for some time.

Complete information performance curves, characteristics, and suggested applications of the various types now available will be found in this catalog.

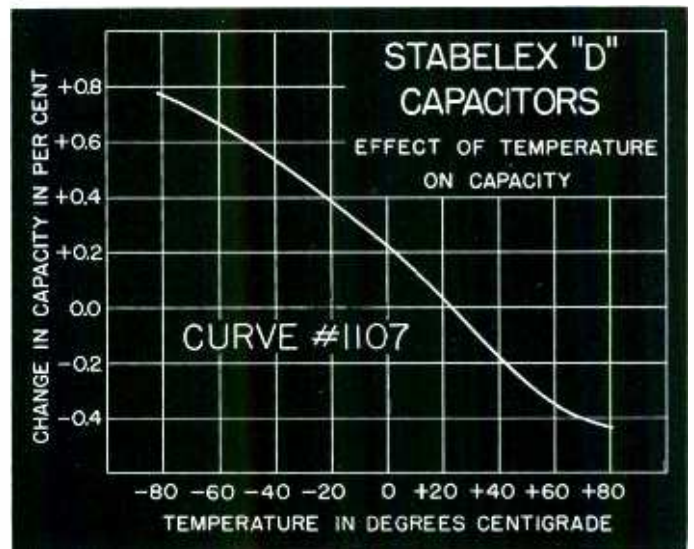

INDUSTRIAL CONDENSER CORPORATION

3244 N. California Avenue
Chicago 18, Illinois, U.S.A.

Please send me my FREE copy of your new Catalog 1117 on Stabelex "D" Capacitors.

Name

Company Position

Street

City Zone State

Mfrs. of OIL, WAX, ELECTROLYTIC, PLASTIC CAPACITORS and RADIO INTERFERENCE FILTERS

For RF interference suppression

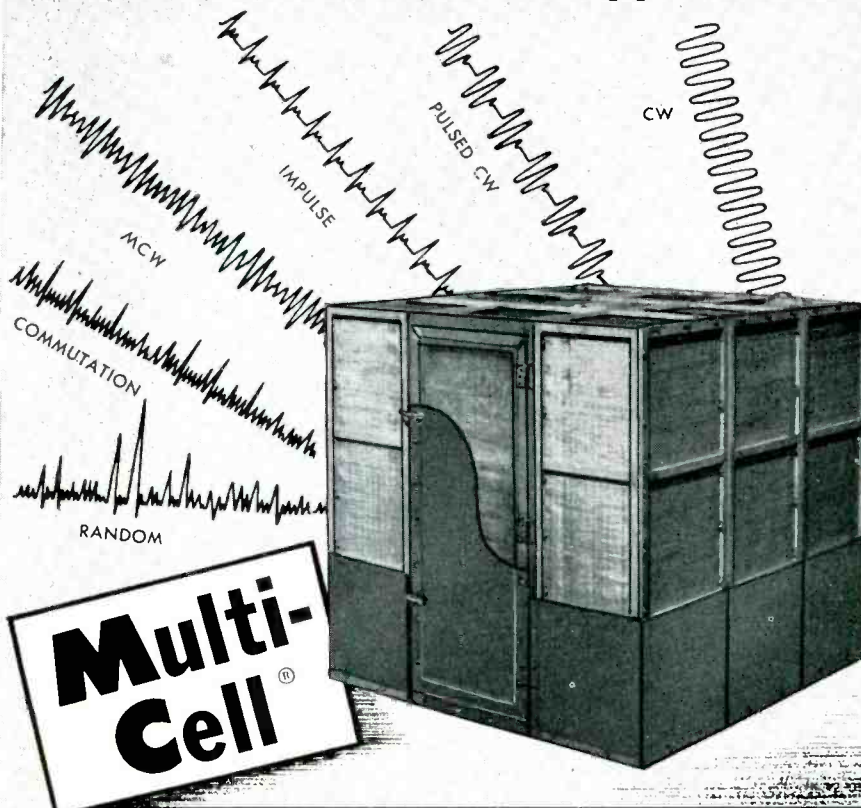

SHIELDING ROOMS

Many Superior and Exclusive Features!

1. HIGHER ATTENUATION min. 100db from .15 to 10,000 MC
2. POSITIVE CONTACT BETWEEN ALL SEAMS
3. DOOR CONTACT STRIPS HEAVILY SILVER PLATED
4. AIR INLET FOR CHOICE OF VENTILATION
5. IMPROVED HANDLES FOR LEAK-PROOF DOORS
6. BUFFER PANELS FOR PROTECTION OF OUTSIDE SCREENS
7. PANELS UNDER CONSTANT PRESSURE WITH EXCLUSIVE BOLTING SYSTEM
8. COPPER FILTER PANEL SUPPLIED WITH LINE FILTER
9. ALL PANEL SECTIONS INTERCHANGEABLE

Designed and built by AMERICA'S MOST EXPERIENCED SHIELDING ROOM ENGINEERS

Backed by years of experience in hundreds of major installations. MULTI-CELL® Screen Rooms meet Jan-1-225, 16E4 (Ships), MIL-1-16910 and all other specifications for electrical and electronic equipment performance in research, development and production.

Let us show you how to SAVE MONEY AND TIME—

Not only is our service exceptionally fast but our price will cut your expenses. We construct every type and size of enclosure: Solid or screen. Double shield, multiple cell. Double shield, isolated cell. Single shield. No obligation for engineering consultation.

Write for
Bulletin
No. 10

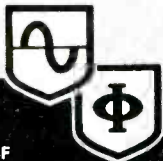

SHIELDING, INC.

R-F
SHIELDING ROOMS

RIVERSIDE PARK, N. J.

Phone: Riverside, N. J. 4-1202

"The Talent to Create—
The Skill to Produce!"

Austin, Texas; Region 8 (Canadian) John T. Henderson of the National Research Council, Ottawa, Ont., Canada.

Magnavox Names V-P

RICHARD A. WILSON, general manager of industrial and defense products of The Magnavox Co., has been appointed a vice-president of the company.

Before joining Magnavox, he was manufacturing manager of the apparatus division of RCA, Indianapolis, Ind.; vice-president and director of the Hudson American Corp., Brooklyn, N. Y.; vice-president and director of Reeves-Ely Laboratories, New York City; division manager of P. R. Mallory & Co., Inc., and executive vice-president and director of the Elizabethtown Corp., subsidiary of the Muzak Corp., New York City. He was also vice-president and a director of Muzak.

Hycon Ups Crisp

RAYMOND F. CRISP was recently appointed manager of technical services for Hycon Mfg. Co., Pasadena, Calif. Prior to his recent assignment, he had held the position of chief electronics engineer for the company.

New England Plant Expands

THE ANDERSEN LABORATORIES INC., 37 Talcott Road, West Hartford, Conn., has completed an addition to the plant that doubles its facilities. The expansion was made necessary by the broadening demand for solid ultrasonic delay lines, particularly in the electronic computer field. It will increase the facilities for research and development as well as manufacture.

RTMA Sets Up Reliability Group

WITH a view toward helping the military obtain higher reliability in

ONLY Heminway & Bartlett Produces this Sensational NEW FUNGUS-PROOF NYLON LACING CORD

Meets Army, Navy and
Civilian Requirements

The special synthetic resin coating on Heminway & Bartlett's Nylon Lacing Cord resists the growth of mold and microorganisms—factors most often responsible for the deterioration of linen and cotton lacing cords. In addition, Heminway & Bartlett's Nylon Lacing Cords have high abrasion resistance, low moisture absorption and the finish has the desirable malleability of wax. The finish is also non-toxic to humans.

For fine wire lacing, we have developed a Nylon Flat Braided specially treated Tape. We'll be glad to send you samples of both the Nylon Lacing Cords and the Nylon Flat Braided Tape. Why not write us today!

The Heminway & Bartlett Mfg. Co., 500 Fifth Avenue, New York 36. Sales Offices: Chicago, Boston, Philadelphia, St. Louis, Cincinnati, San Francisco, Charlotte, N. C., Gloversville, N. Y.



TYING TWINE

GREATER RESOLUTION

SLOWER SWEEP RATE



PANADAPTOR SA-8a PANALYZOR SB-8a

More Valuable Than Ever!

New Panoramic engineering achievements embodied in these improved instruments open important new applications involving modulation and interference problems.

SA-8a and SB-8a enable spectrum analysis of signals so close in frequency that their corresponding indications would normally mask one another.

- IMPROVED RESOLUTION down to 50 cps for RF spectrum analysis where maximum resolution is a "must"
- LOW SWEEP RATES down to 1 scan per second for analysis of pulsed RF signals with low p.r.f.'s
- LONG PERSISTENCE DISPLAYS
- CONTINUOUSLY VARIABLE SCANNING WIDTH

3 types available with maximum sweepwidths of 200 KC., 1 MC. and 10 MC.

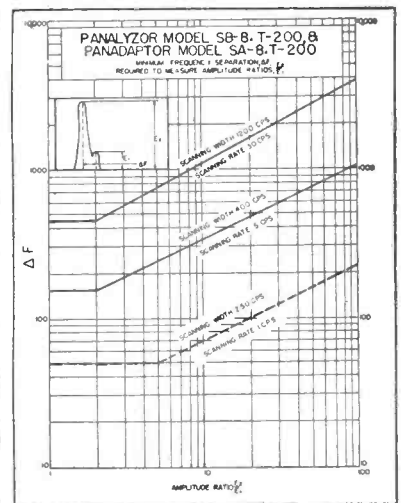

WRITE TODAY FOR
COMPLETE
SPECIFICATIONS
AND PRICES



10 South Second Avenue, Mount Vernon, N. Y.
Mount Vernon 4-3970

PIX WIRE FORMING SPECIALISTS

Precision Parts to meet your Production and Engineering needs. From .002" dia. to .125" dia. Radio tube parts—Stampings—Drawings Modern facilities, high-production equipment.

Metal Crystal Holder Parts
Send sketch or print for quotation.

PIX MANUFACTURING CO., Inc.
24-B Bedford St., Newark 3, N. J.

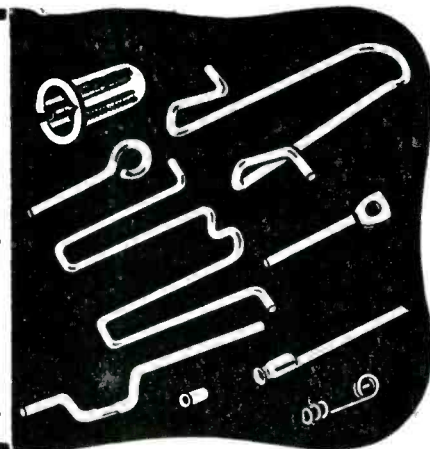

FOR QUALITY • QUANTITY — QUICKLY SPECIFY DAGE RADIO FREQUENCY CONNECTORS

● Dage specializes in the manufacture of the finest in Type BNC, Type N and special radio frequency connectors. Your requirements for radio frequency connectors will be met quickly and efficiently by Dage. All Dage connectors are manufactured in strict accordance with military specifications. Write Dage today.

TYPE BNC R.F. CONNECTORS
UG-88/U UG-290/U
UG-260/U

QUALITY QUANTITY QUICKLY

DAGE DAGE ELECTRIC COMPANY, INC.
62 North Second Street • Beech Grove, Indiana

to the

ELECTRICAL ENGINEER

or

PHYSICIST

with experience in

RADAR

or

ELECTRONICS

Hughes Research and Development Laboratories, one of the nation's leading electronics organizations, are now creating a number of new openings in an important phase of their operations.

Here is what one of these positions offers you:

THE COMPANY

Hughes Research and Development Laboratories, located in Southern California, are presently engaged in the development and production of advanced radar systems, electronic computers and guided missiles.

THE NEW OPENINGS

The positions are for men who will serve as technical advisors to government agencies and companies purchasing Hughes equipment—also as technical consultants with engineers of other companies working on associated equipment. Your specific job would be essentially to help insure successful operation of Hughes equipment in the field.

THE TRAINING

On joining our organization, you will work in the Laboratories for several months to become thoroughly familiar with the equipment which you will later help users to understand and properly employ. If you have already had radar or electronics experience, you will find this knowledge helpful in your new work.

WHERE YOU WORK

After your period of training—at full pay—you may (1) remain with the Laboratories in Southern California in an instructive or administrative capacity, (2) become the Hughes representative at a company where our equipment is being installed, or (3) be the

Hughes representative at a military base in this country or overseas (single men only). Compensation is made for traveling and moving household effects, and married men keep their families with them at all times.

YOUR FUTURE

In one of these positions you will gain all-around experience that will increase your value to our organization as it further expands in the field of electronics. The next few years are certain to see large-scale commercial employment of electronic systems. Your training in and familiarity with the most advanced electronic techniques now will qualify you for even more important future positions.

How to apply:

HUGHES

RESEARCH AND
DEVELOPMENT LABORATORIES

Engineering Personnel Department
Culver City,
Los Angeles County, California

If you are under thirty-five years of age, and if you have an E.E. or Physics degree, write to the Laboratories, giving resumé of your experience.

Assurance is required that relocation of the applicant will not cause disruption of an urgent military project.

electronics apparatus, the engineering department of the RTMA has announced the establishment of an Electronic Applications Committee. The committee, under the chairmanship of Lewis M. Clement of the Crosley Division, Avco Mfg. Corp., will collect and disseminate information on the design, manufacture and installation of electronic equipment as an aid to obtaining more reliable military apparatus. It plans to work and cooperate with other associations, research laboratories, manufacturers and government agencies in furthering its program.

The following duties have been assigned the new committee:

(1) To act as a central collecting agency to which all reports and data from surveys relating to reliability of equipment in the field would be referred.

(2) To set up routines with various RTMA and JETEC committees so that data collected in the course of their operations could be referred to proper groups for study and action.

(3) To correlate data from various types of users to determine if their needs follow certain patterns that would be of interest to manufacturers. It may be found that a general class of components or tubes would serve many groups of users.

Announce New Chief Engineer

F. CLARK CAHILL has been appointed chief engineer of the engineering and production division of Airborne Instruments Laboratory, Inc., Mineola, L. I., N. Y. He formerly served in the Laboratory's research and engineering division as supervisor of the radar section.

With Airborne since its founding as an independent electronic research and development laboratory in 1945, he was associated during World War II with the Radio Research Laboratory at Harvard University, an organization sponsored by the government's Office of Scientific Research and Development, as the head of a war research work division. During this same period, he also was associate director of



F. C. Cahill

the affiliated American British Laboratory in Great Britain.

In his new position with the Laboratory's production division, which recently moved into a new and modern plant in Garden City, L. I., N. Y., he will direct production engineering activities.

Avco Elects V-P

LEONARD F. CRAMER, assistant general manager of the Crosley division of Avco Mfg. Corp. since 1951, was recently elected a vice-president of Avco. Prior to joining Avco, Cramer was executive vice-president of the Allen B. DuMont Laboratories and was the first manager of WABD, pioneer tv station of the DuMont network. He will be in charge of Crosley's entire radio-tv activities.

Wiener Joins SKL

FRANCIS M. WIENER has become section head in the engineering department of Spencer-Kennedy Laboratories in Cambridge, Mass. Dr. Wiener comes to SKL from the Bell Telephone Laboratories at Murray Hill, N. J., where he worked on acoustic diffraction theory and the fundamental communication aspects of speech, as well as on classified problems for the Office of Naval Research.

AES Names Fellows

SEVERAL outstanding engineers in the audio industry were recently

VERSATILITY Plus...



Induction Motors Corp.

WHEN YOU NEED A SUB-FRACTIONAL HORSEPOWER
MOTOR, FAN or BLOWER

OUR NEWEST TYPE...

This 60 cycle single phase blower was custom built to exacting Navy specifications. It is driven by a self-cooled motor for high ambient temperature operation, and is especially impregnated for humid atmosphere. This compact model is designed for such applications as cooling transmitting tubes, cabinets, chassis, amplifier assemblies, and a wide variety of electronic controls.

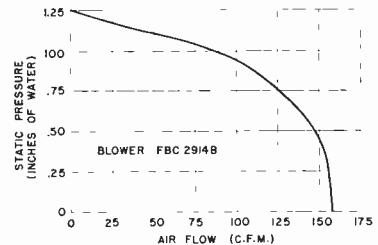

YOUR REQUIREMENTS

If you need synchronous type or induction type, motors, **IMC** makes them.

LIGHTER — MORE EFFICIENT — COOLER for **LONGER LIFE** under extreme temperatures.

RANGE: 1/1000hp. to 1/10hp. 60 cycle, 400 cycle variable frequency

SEND US YOUR PROBLEM

We are leading specialists in the design and production of actuators, gear motors and torque motors for application in automatic devices, electronic controls, radar equipment, timing devices, fire controls, sine wave alternators, aircraft cameras, etc.



INDUCTION MOTORS CORP.

55-15 37th AVENUE • WOODSIDE 77, N. Y.

Call on *Lewis*

when you need

DEPENDABLE

SPRINGS



WIREFORMS



STAMPINGS



QUALITY, ECONOMY and PROMPT SERVICE
on Every Order—Large or Small!

There is never any letdown in Lewis quality or service. Your order will be given prompt, efficient attention regardless of size. You can be sure that the springs, wireforms or stampings you order will be fairly, economically priced. What's more, Lewis has the extensive, modern facilities, the long-experienced engineers and skilled production craftsmen to supply you with springs, wireforms and stampings tailored to your exact needs.

If you have any tricky or tough problems involving springs, Lewis's engineers will be glad to help you solve them. Or, if you need large or small quantities of standard springs in a hurry—just call on Lewis! Send us your drawings, specifications or samples today!

LEWIS SPRING & MANUFACTURING CO.
2656 W. NORTH AVENUE, CHICAGO 47, ILLINOIS

Lewis **PRECISION SPRINGS**

The Finest Light Springs and Wireforms of Every Type and Material

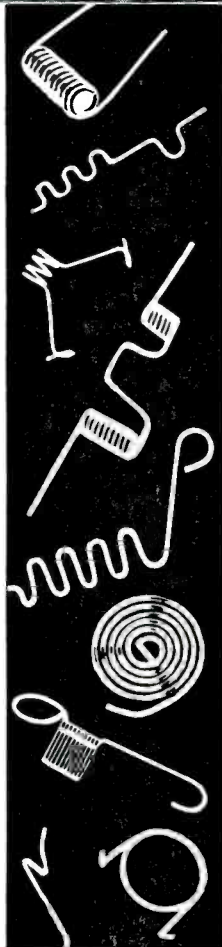

raised to the rank of Fellows in the Audio Engineering Society at the annual banquet in New York City. They are:

Lindsay Black of Bell Telephone Laboratories, Inc.; Harold Burriss-Meyer of Stevens Institute of Technology; Isabel Capps of Frank L. Capps, Inc.; James Y. Dunbar of William J. Scully Acoustic Corp.; Price Fish of Columbia Broadcasting System; Ernest W. Franck of Reeves Soundcraft Corp.; Lewis S. Goodfriend of Audio Instrument Co., Inc.; John K. Hilliard of Altec Lansing Corp.; William F. Jordan of Fox Movietone News; Harry F. Olson of RCA Laboratories; Norman Pickering of Pickering & Co.; John Preston of RCA Laboratories; Albert A. Pulley of RCA Victor; Richard H. Ranger of Rangertone, Inc.; H. I. Reiskind of RCA Victor; C. R. Sawyer of Bell Telephone Laboratories; Hermon H. Scott of H. H. Scott, Inc.; J. T. Mullin of Bing Crosby Enterprises; J. P. Smith of Daven Co.; S. Edward Sorenson of Columbia Records, Inc.; W. E. Stewart of RCA Victor; Myron J. Stolaroff of Ampex; W. J. Temple of Brooklyn College; and S. F. Lybarger of E. A. Myers & Sons, Inc.

Beckman Builds Eastern Plant

BECKMAN INSTRUMENTS, INC., South Pasadena, Calif., manufacturer of scientific and industrial instruments and precision components comprising a line from pH meters to computers, has started construction on a new 20,000-sq ft building in Mountainside, N. J.

To be used as eastern sales and service offices for the parent company and as an eastern manufacturing facility for the Beckman subsidiary, Helipot Corp., manufacturer of helical potentiometers, the new plant will employ more than 150 people.

Langevin Appoints Engineering Director

WILLIAM W. DEAN has been appointed director of engineering of

free! NEW AGF BURNER CATALOG

The first complete catalog of never before available technical data.

Gives hole sizes, flame patterns, gas consumption on various gases and complete information with illustrations of —



BURNERS
BLOW PIPES
GAS FIRES
MIXERS
INSERTS
BALL JOINTS
MANIFOLDS
CROSSFIRES
MACHLET TIPS
GOVERNORS
TUNNELS
OXYGEN —
GAS BURNERS

Write for your copy today on your company letterhead.



AMERICAN GAS FURNACE CO.

130 SPRING ST., ELIZABETH 4, N. J.

Precision drilling made easy!

Phillips & Hiss 204-C

6" Throat
0-1/8" Capacity
1" Quill Travel

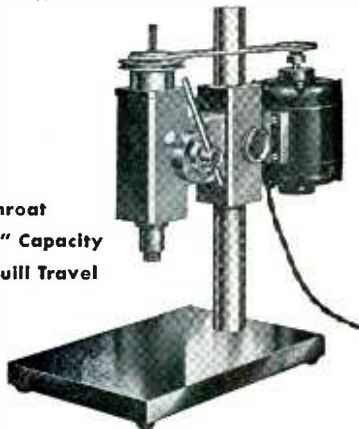

Sensitive "Feel"

Sensitive Speed Control:

Foot-operated, leaves both hands free

High Precision: Selected

Chuck and Bearings. Spindle true within .0002". Table square .0005" in 5" circle. Permanent accuracy, castings annealed and ground.



WRITE: Bulletin E2
Phillips & Hiss Co., Inc.
1155 N. McCadden Place
Hollywood 38, California

FOR MARKING...



PLASTIC • METAL
GLASS • PAPER
RUBBER • CERAMIC
CARDBOARD

in such products as Resistors, capacitors, valves, tubes, labels, sleeves, spark plugs, car-tons, etc., etc.

THESE PRODUCTS AND MANY OTHERS OF ALMOST ANY MATERIAL AND SHAPE CAN BE IMPRINTED

ON THE REJAFIX MARKING MACHINE

Why not send us samples of your products? They will be test-printed and returned to you for your examination!

- REJAFIX HAND-OPERATED MODELS FOR SMALL RUNS. FULLY AUTOMATIC MODELS FOR MASS PRODUCTION.

EST. 1922

POPPER & SONS INC. 300 FOURTH AVENUE
NEW YORK 10, N. Y.

REGULATED HIGH VOLTAGE POWER SUPPLY

Provides Electronically Regulated Continuously Adjustable Voltages from 150 to 1500 VDC at 0-5 Milliamperes



This unit is specially designed to supply proper power for making precise quantitative measurements with photomultiplier tubes, klystrons and similar applications. Voltages are held to close limits even with wide line voltage and load variations. No meter is required. Accurate voltage readings are made directly from a 15 turn vernier dial which is calibrated to read 1 volt per scale division.

MODEL 810-P SPECIFICATIONS

- OUTPUT VOLTAGE: 150 to 1500 VDC at 0-5 Milliamperes.
 - REGULATION: Output voltage varies less than .01% per volt change of line voltage and less than .1 volt with variation of output current from 0 to 5 Milliamperes.
 - RIPPLE: Less than 5 Millivolts r.m.s.
- Positive output terminal is grounded. 5 negative output connectors (type AN-3102A-18-16-s) are connected in parallel and mounted on front panel.

See the Model 810-P and other Furst Power Supplies at the I.R.E. Convention

Write for Descriptive Bulletin



FURST ELECTRONICS

3324 W. Lawrence, Chicago 25, Ill.

it's NEW!... A WIDE RANGE

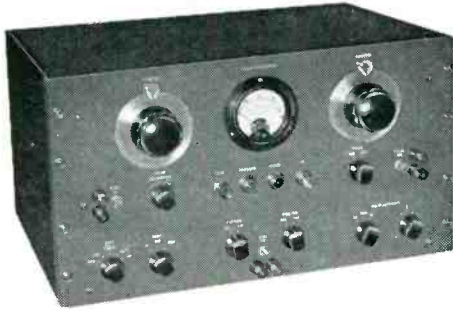

LABORATORY PULSE GENERATOR

.....
MODEL PG-200

- Internally generated single pulses and recurrent pulses 20 cycles to 20 KC
- External synchronization 0 to 20 KC from almost any waveform
- Direct reading Recurrence Rate Meter, 20 cycles to 20 KC
- Pulse duration continuously variable and calibrated from 0.1 to 50 μ seconds
- Rise and decay times less than 0.03 μ seconds, 10% to 90% amplitude
- Position continuously variable and calibrated from 50 μ seconds advanced to 50 μ seconds delayed with respect to synch output trigger
- Amplitude 1 to 100 volts open circuit, positive or negative, driving impedance 50 ohms
- Amplitude control isolated from un-terminated DC coupled output for maximum flexibility
- Maximum average load current 0.1 amperes automatically limited



W. W. Dean

the Langevin Mfg. Corp., New York City. He will direct all engineering activities of that concern, manufacturers of broadcast and sound systems, audio equipment and transformers.

Mr. Dean was associated with General Electric Co. for eleven years prior to joining the Langevin organization on Nov. 1. Since 1945 he has been audio facilities project engineer in the broadcast engineering section of GE at Electronics Park. During the war years he was in the radio transmitter engineering department where he did development work on high-power transmitters and military radio equipment.

Resonant Moves to New Quarters

OPEN for business in its new Belmont, Calif., home is the Resonant Co., subcontractor for Dalmo Victor, of San Carlos, Calif., in the manufacture of microwave components. The new plant covers a 31,000-sq ft area.

Zenith Appoints Associate Director

ROBERT ADLER, a member of the corporation's research division since 1941, has been appointed associate director of research for Zenith Radio Corp., Chicago, Ill.

During the past eleven years Adler has been responsible for numerous contributions to the ad-

TELETRONICS LABORATORY INC.
WESTBURY, L. I., N. Y.

MANUFACTURERS OF ELECTRONIC INSTRUMENTS AND PRODUCTION TEST EQUIPMENT

GOAT Electronic Components

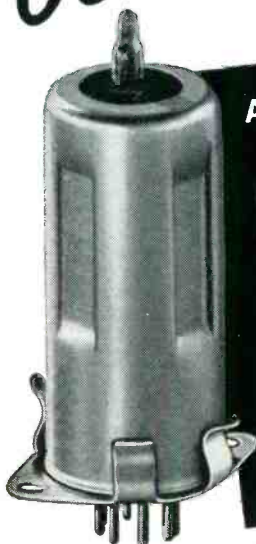

GOAT lanced tube shield
G1702-2 and clip G1770

An example of GOAT engineering
—THE TUBE SHIELD WITH
BUILT-IN SPRING ACTION GRIP

Particularly suited for high vibration situations involving uhf tubes, the four spring-like lances of this shield expand with the tube without sacrificing full shielding efficiency.

This is only ONE of a wide variety of stock miniature and standard size GOAT shields.

A complete design service is available for those long-run, tough-spec custom jobs.

For a full description of tube shields, clips and other GOAT electronic components, send for GOAT catalog E52.

The Fred Goat Co., Inc.
308 DEAN ST. BROOKLYN 17, N. Y.

Pioneers in metal stamping
Serving the electronics industry since 1926



Established 1893

vancement of the electronics industry and the improvement of communications equipment used by the armed services.

One of the most significant is the gated-beam tube for television, which represents an entirely new concept in the field of vacuum tubes. The use of this tube has greatly simplified the sound system in tv receivers, markedly improving reception by screening out certain types of sound interference while lowering the cost of the sound channel.

He was also instrumental in originating and developing a synchronizing circuit that permits better picture stability even in fringe areas of tv reception.

Fontaine Rejoins Bendix

RAYMOND P. LANSING, vice-president and group executive in charge of six eastern divisions of Bendix Aviation Corp., has announced the appointment of A. P. Fontaine as staff assistant.

Fontaine, recently vice-president and general manager of Consolidated Vultee Aircraft Corp. and previously with Bendix in 1944-46, returns to the company to help di-



A. P. Fontaine

rect vastly expanded operations in aircraft control, navigation and instrument equipment, electron tubes, ignition systems, meteorological instruments, precision electrical units and many other products. These operations at six of Bendix' 17 manufacturing divisions embrace nearly half the company's 40,000 employees.

There's More to a Good Filter Than Meets the Eye!

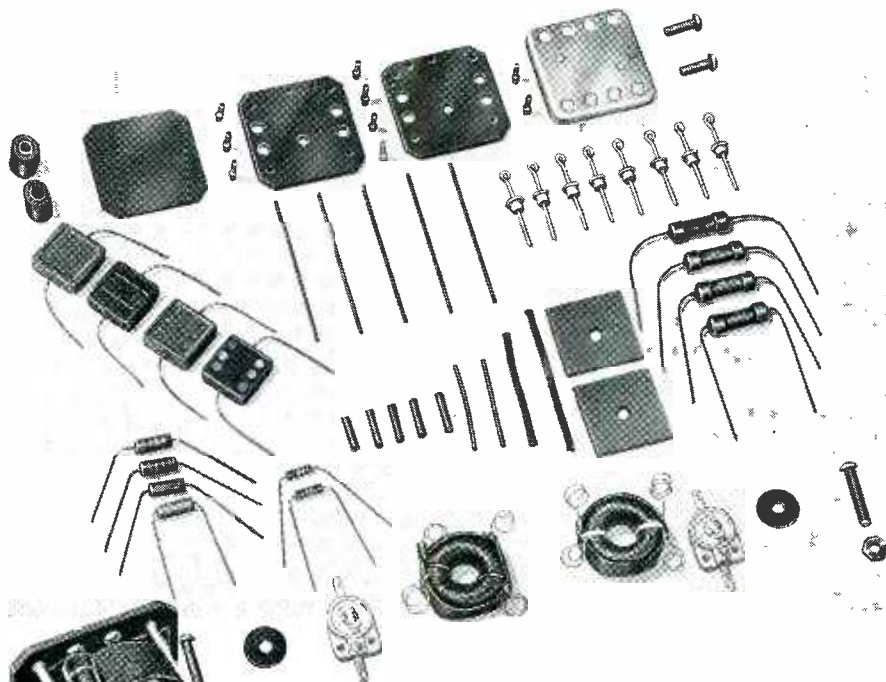

All of these 66 parts are from a single B & W Toroidal-coil type discriminator only $1\frac{3}{4}$ " square by $3\frac{1}{2}$ " long exclusive of terminals!

Throughout, the job is one calling for precision components plus a wealth of engineering "know how" in producing and assembling them for maximum performance and effectiveness.

Like all other B & W Special Components, the one illustrated here was designed and produced for a specific application—in this instance a critical military use.

FILTERS

In addition to "tailor-made" discriminators, B & W offers a complete line of performance-proved filters including high-pass, low-pass, band-pass and band suppression types.

TOROIDS

B & W Toroidal Coils of various styles and sizes are available in a wide range of inductance values in open, shielded, potted and hermetically sealed types.



Barker & Williamson, Inc.

237 Fairfield Ave., Upper Darby, Pa.

Let WILLIAMS
help you apply
ferric oxides to
the manufacture
of your

ferrites

You'll be well repaid by getting the facts on a special group of Pure Ferric Oxides, developed by Williams especially for use in the manufacture of ferrites.

Williams Ferric Oxides analyze better than 99% Fe_2O_3 . They contain a minimum of impurities. They are available in a broad range of particle sizes and shapes. Among them, we're certain you'll find one that's "just right" for your requirements. The proper application of Ferric Oxides to the manufacture of Ferrites is our specialty.

Tell us your requirements... we'll gladly send samples for test. Chances are good that our Ferric Oxide "Know How" can save you considerable time and money. Address Dept. 25, C. K. Williams & Co., Easton, Pa.

WILLIAMS
COLORS & PIGMENTS

C. K. WILLIAMS & CO.
Easton, Pa. • East St. Louis, Ill.
Emeryville, Cal.

P. S. We also produce IRN Magnetic Iron powders for the Electronic Core Industry, the Magnetic Tape Recording Industry and others. Write for complete technical information.

NEW BOOKS

Radio Spectrum Conservation

REPORT OF THE JOINT TECHNICAL ADVISORY COMMITTEE, IRE-RTMA. McGraw-Hill Book Co., New York, 1952, 220 pages, \$5.

ANYONE who, during the past 25 or 30 years, has watched the radio spectrum grow in extent but become parceled out piecemeal as circumstances demanded will read this excellent survey with mixed feelings. In the first place he will hope to find strong language applied to our methods of conserving a natural resource which, having an infinite life, has limited boundaries; and secondly, he will have a feeling of relief that, at last, a calm, dispassionate, objective survey of this type has been made. In his hope for excoriation, the reader will be disappointed but he will not be deprived of the pleasure of thinking what he would have said had he the chance! As befits engineers dealing with the facts of nature, this report is restrained, it is thorough, and should be the property of all who have anything to do with the communication spectrum.

The book is remarkably easy to read, couched, as it is, in layman's language for the most part. Where the going is rough, the layman can skip into easier reading. This means that non-technical administrators and legislators can get a judicial point of view on a matter of utmost importance and urgency. For if we continue to hand out channels without due regard to their properties for the services intended, the next step will have to be taken—those who do not make the best use of their franchises will have to be ousted—a job that no one wants and few would undertake.

In five chapters, much information is packed. The first deals with the history of the allocation of the radio spectrum, then follows a long and very important chapter on the propagation characteristics of the spectrum which is divided into five reasonable portions whose characteristics are relatively similar; next an ideal approach to the allocation problem, a critique of present allo-

What Makes A Mailing Click?

● Advertising men agree
—the list is more than half
the story.

McGraw-Hill Mailing Lists, used by leading manufacturers and industrial service organizations, direct your advertising and sales promotional efforts to key purchasing power. They offer thorough horizontal and vertical coverage of major markets, including new personnel and plants. Selections may be made to fit your own special requirements.

New names are added to every McGraw-Hill list daily. List revisions are made on a twenty-four hour basis. And all names are guaranteed accurate within two per cent.

In view of present day difficulties in maintaining your own mailing lists, this efficient personalized service is particularly important in securing the comprehensive market coverage you need and want. Ask for more detailed information today. You'll probably be surprised at the low over-all cost and the tested effectiveness of these hand-picked selections.



USE
Mc GRAW-HILL
DIRECT MAIL LIST SERVICE

McGraw-Hill Publishing Co., Inc.

DIRECT MAIL DIVISION
330 WEST 42nd ST.
NEW YORK 18, N. Y.

Want more information? Use post card on last page.

346

Want more information? Use post card on last page.

January, 1953 — ELECTRONICS

GALBRAITH OUTDOOR SPEAKERS

All bronze housings, complete with mounting brackets, 15" horn diameter, double re-entrant type. Frequency response from 400 to over 6000 cycles. Thoroughly weatherproof. Powered with Alnico-V-Plus driver unit, U.S. Coast Guard approved made by specialists in the manufacture of Marine equipment and Controls, Emergency Loud-speaker Systems, Public Address Systems, Music Broadcast Systems and Docking and Navigating Systems.

**C. C. GALBRAITH & SON
ELECTRIC CORP.**

450 Ave. of the Americas
New York 11, N. Y.



Weatherproof, E-27, 544
Front and Back View, showing assembly details

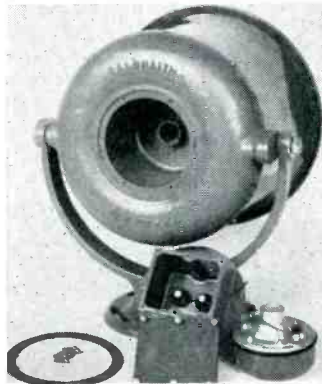

DIGITAL COMPUTER ENGINEERS

ELECTRICAL ENGINEERS and PHYSICISTS

needed for circuit design and development. Engineers and Physicists with 1 to 4 years experience in pulse circuits, pulse handling techniques, and systems development. Openings also for recent graduates.

● Replies strictly confidential

● Interviews arranged at our expense

Engineering Research Associates, Inc.



A Subsidiary of *Remington Rand*.

Leaders in the Development of Digital Computers

1902 W. Minnehaha, St. Paul 4, Minn. ● "You Will Enjoy Living in Minnesota"

HERMETIC SEALS

- Vacuum Tight — Glass to Metal
- Standard Types from Stock
- Special Designs to Fit Your Product
- Write or Call for Full Information



Representatives:

PAUL D. AARON
J. R. GASTON CO.

120 Liberty St., New York 8, N. Y.
213 Locust St., Harrisburg, Pa.
or 618 N. Calvert St., Baltimore, Md.

SCIENTIFIC ELECTRONIC LABS, INC.
266 Bergen St. Bigelow 8-6553 Newark 8, N. J.

DeJUR

EXTERNAL PHASING

C-200

Potentiometers

- MULTIPLE GANGING
- INDIVIDUAL EXTERNAL PHASING
- POSITIVE INTERLOCK
- PRECISION MACHINED ANODIZED ALUMINUM CASE
- ADJUSTABLE TAPS WITHIN $\pm 1/2^\circ$

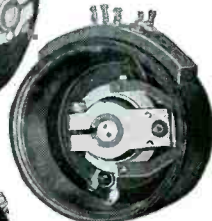
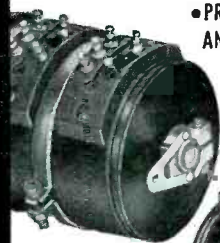

Designers are invited to submit their applications to DeJur engineers for recommendations and suggestions.

- 2" Diameter
- 4 Watts Fully Enclosed
- 10 to 200,000 Ohms Accuracy up to 1%
- Linearity up to 0.3%
- Non Linear Windings
- 360° (Continuous) Mechanical Rotation
- 320° Electrical Rotation
- Taps as Required
- High Resolution 1,000,000 Cycles Operational Life
- Precious Metal Contacts
- Low Torque 1 oz. inch
- Centerless Ground Stainless Steel Shafts
- Ball Bearings to Special Order
- Single or Ganged Units
- Servo Type Mounting or Single Hole Threaded Bushing
- Numerous Shaft Designs

WRITE FOR
BULLETIN E-1



DeJUR AMSCO CORPORATION

45-01 NORTHERN BOULEVARD, L. I. C. I., N. Y.

versatile
Multi-channel
telegraph A1 or
telephone A3

STABLE
High stability (.003%) under
normal operating
conditions.

RUGGED
Components
conservatively
rated. Completely
tropicalized.

Model 446 transmitter operates on 4 crystal-controlled frequencies (plus 2 closely spaced frequencies) in the band 2.5-13.5 Mcs (16-2.5 Mcs available) Operates on one frequency at a time; channeling time 2 seconds. Carrier power 350 watts. A1 or A3 AM Stability 0.03% using CR-7 (or HC-6U) crystals Operates in ambient 0° to +45° C, using mercury rectifiers; 35° to +45° C using gas filled rectifiers. Power supply, 200-250 volts, 50/60 cycles, single phase. Conservatively rated, sturdily constructed. Complete technical data on request.

Here's the ideal general-purpose high-frequency transmitter! Model 446... 4-channel, 6-frequency, medium power, high stability. Suitable for point-to-point or ground-to-air communication. Can be remotely located from operating position. Co-axial fitting to accept frequency shift signals.

Consultants, designers and manufacturers of standard or special electronic, meteorological and communications equipment.

AERO-COM
Reg. U. S. Pat. Off.
AERONAUTICAL COMMUNICATIONS EQUIPMENT, INC.
3090 Douglas Road, Miami 33, Florida

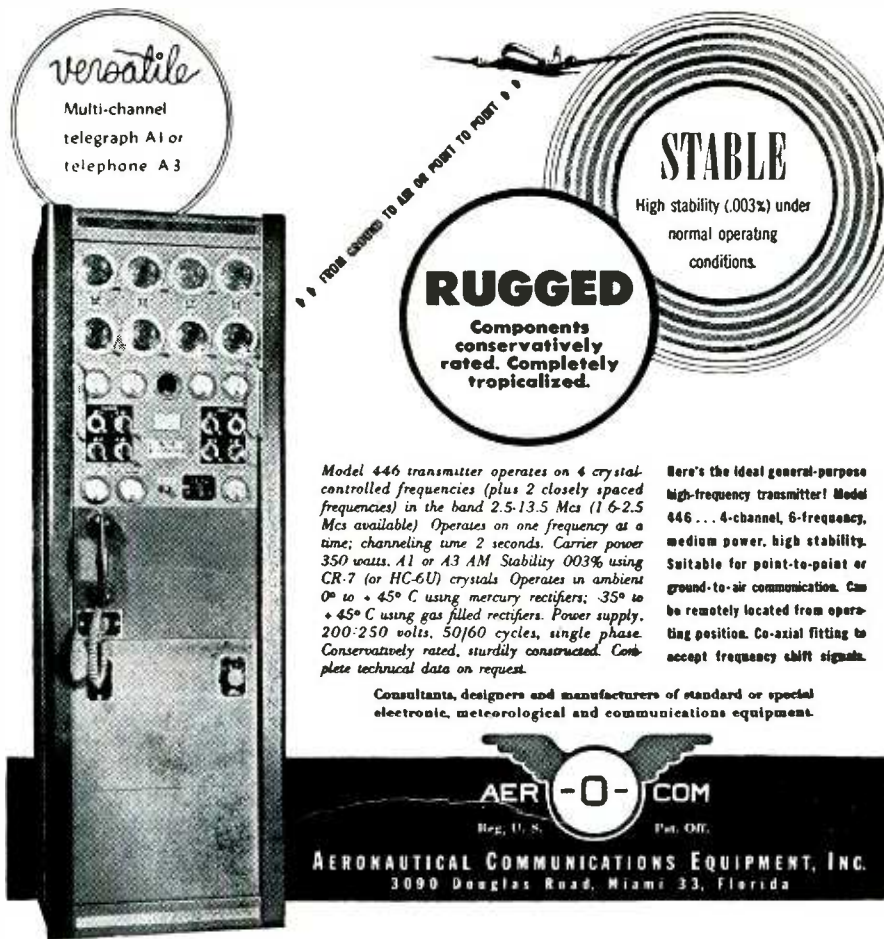

cations and, finally, a chapter on the dynamic conservation of spectrum resources. An extensive bibliography and an appendix containing the charter of JTAC complete the book.

A highly recommended report of an important public service undertaken by busy men, this book could be made the basis for an excellent study course in allocations, if such a course were ever contemplated. —K.H.

Electrodynamics

Lectures on Theoretical Physics, Vol. III. BY ARNOLD SOMMERFELD, University of Munich. Translated by Edward G. Ramberg. Academic Press Inc., New York, 371 pages, 1952, \$6.80.

THE THIRD volume, "Electrodynamics," of Arnold Sommerfeld's "Lectures on Theoretical Physics," has now been translated into English. The reputation of Sommerfeld is too widespread to require biographical introduction. His translator, Mr. Ramberg, has spent most of his life in the United States and is eminently qualified, having been awarded the degree of Ph. D. in Physics by the University of Munich.

The subject of this volume is Maxwell's equations, presented from the viewpoint of Hertz and extended to their more general implications as far as the theory of relativity, matter and energy. Among the other philosophers whose approaches are followed, the outstanding are Einstein, Lorentz, Minkowski and Schwarzschild.

In general, the first half of the book (Parts I & II) is devoted to an axiomatic development of classical electromagnetic theory from Maxwell's equations, while the second half (Parts III & IV) deals with the generalizations and extensions thereof following the theory of relativity. Dimensional analysis, the historical origins of physical concepts, and the limitations of these concepts as valid descriptions of the universe are critically examined. The book may be read separately from the rest of "The Lectures," to which only occasional reference is made, prin-

NEW... THE C B MODEL 712 C-R-L BRIDGE

MEASURES CAPACITANCE, RESISTANCE, INDUCTANCE, INSULATION RESISTANCE, THE TURN RATIO OF TRANSFORMERS, DC LEAKAGE CURRENT OF CAPACITORS, DISSIPATION FACTOR "D" AND STORAGE FACTOR "Q"

- 10 MMF to 1100 MFD
- 1 OHM to 11 Megohms
- 100 Microhenries to 110 Henries
- Insulation Resistance Up to 10,000 Megohms
- Turns Ratio .01 to 110
- DC Voltage for Polarizing Electrolytics 0-500 V
- Meter Measures Polarizing Voltage and Leakage Current



CB MODEL 712

SMALL SIZE - LIGHT WEIGHT - HIGH ACCURACY
FOR COMPLETE CONSTRUCTION DETAILS AND
PERFORMANCE DATA WRITE FOR BULLETIN 30D



Capacitor Quality Test
for Open or Shorted Capacitors
Without Disconnecting from Circuit

The CLOUGH BRENGLE CO.

6014 Broadway

Chicago 40, Ill.

cially for mathematical justification.

The Maxwell equations are specialized for static fields and some elementary problems of electrostatics and magnetostatics are treated. The discussion of circuit theory is brief but its relation to the field theory is well stated. The sections on general electromagnetic fields includes an extensive treatment of "wave fields of cylindrical symmetry". Sommerfeld's original solutions to the problems of propagation over a conducting plane and along a straight wire are given as follows:

Parts III and IV deal with the invariance of Maxwell's equations in four dimensions and the special theory of relativity. The Lorentz force is derived in a natural way. Application is made to the behavior of a single electron. Minkowski's equations, which are Maxwell's equations for moving media, are developed and analyzed. Special topics of the general theory of relativity are discussed briefly.

A set of rather formidable problems is appended. As the solutions to these problems are given in detail, they form a supplement to the text.

Special attention is paid to the philosophy of various systems of units. The MKS rationalized system is generally employed, occasionally with suffixes Q for coulomb (electric pole strength) and P for magnetic pole strength, where the author feels the need for these restrictions. The reader appreciates the author's continual effort to purify concepts and to clarify terminology; the term "wave resistance" is an example of the commendable results.

The organization of the book is somewhat loose. This is sometimes disturbing, and detracts from the readability and the reference value of the text. On the other hand, the frequent discursions are enlightening in themselves, and impart a freshness uncommon in textbooks. Many well labeled figures illustrate the text. The notation has been revised to correspond to current American practice, with minor exceptions. The use of the dot to represent differentiation (either



VOLTAGE STABILIZERS



MAINTAIN VOLTAGE OUTPUT

Tested with input voltage varying plus or minus 15% from normal and temperatures ranging from 10° to 104° F, standard Raytheon Voltage Stabilizers maintained output from 115.1 to 114.6 volts, or a change of only 0.5 volts. Under the same conditions ordinary voltage regulators varied as much as 2 volts.

WITHIN $\pm \frac{1}{2}\%$

Compare the performance of Raytheon magnetic Voltage Stabilizers with any other make. You'll find at least ten good reasons why they guarantee better, more reliable operation of any electrical or electronic equipment. All models are compact, light in weight and ruggedly built with no moving parts to wear out.

Raytheon Voltage Stabilizers rated from 15 to 2000 watts are carried in stock by 125 parts distributors strategically located from coast to coast. Custom-engineered units, ranging from 5 to 10,000 watts are also available for military or commercial applications.

Write for complete information and performance data.



Excellence in Electronics

RAYTHEON

MANUFACTURING COMPANY
EQUIPMENT SALES DIVISION

DEPT. 6270-A, WALTHAM 54, MASSACHUSETTS

DISTRICT OFFICES: BOSTON, NEW YORK, CLEVELAND, CHICAGO, NEW ORLEANS, LOS ANGELES (WILMINGTON), SAN FRANCISCO, SEATTLE
INTERNATIONAL DIVISION: 19 RECTOR ST., NEW YORK CITY

RAYTHEON PRODUCTS INCLUDE: WELDPower* welders; Voltage stabilizers (regulators); Transformers; Sonic oscillators for laboratory research; Standard control knobs; Electronic calculators and computers; Radio, television, subminiature and special purpose tubes and other electronic equipment.
*Reg. U. S. Pat. Off.

**TESTS PROVE
10 POINTS OF
RAYTHEON
SUPERIORITY**

1. Deliver accurate AC voltage within $\pm \frac{1}{2}\%$
2. Stabilize output with more precision
3. Regulate better at full load
4. Hold up better under overload
5. Better no-load to full-load regulation
6. Accept wider input voltage range
7. Less voltage change as units heat up
8. Less change in output as frequencies fluctuate
9. Smaller, lighter, more compact, no moving parts
10. Cost less to operate

**MULTIPLE ASSEMBLIES FOR SMALL PARTS
BELONG TO HORSE-AND-BUGGY DAYS**

GRIES DIE CASTINGS GIVE YOU
TINY PARTS LIKE THESE IN



COMPLETE OPERATION



Compare GRC zinc alloy die castings with small parts produced by other methods. See how Gries completely finished parts save you time, labor, money. Die cast in one high-speed operation, they open broad opportunities for your new design and product ideas. GRC offers fast delivery of 100,000 pieces to many millions. Write today for bulletin and samples. Send prints for quotations.

Manufacturers of Small Castings Exclusively

America's
Foremost
PRODUCERS
Of Tiny Die
Castings



Smallness Unlimited
Max. Wt. 1/2 oz.
Max. Lgth. 1 3/4"

GRIES REPRODUCER CORP.

100 Willow Ave., New York 54. MOtt Haven 5-7400



**Small DC Motor or Generator
Permanent Magnet Type**

Low current consumption ball-bearing motor or generator as a motor: 1/125 H.P. at 6000 RPM continuous duty. As a generator: output 4 watts at 6000 RPM—5 volt per 1000 RPM. Dimensions 1 29/32" x 1 1/2" x 1 15/100. Two other standard models in production.

Write for catalog information.

**ROTARY
ELECTRICAL
EQUIPMENT**

*... designed to meet
your specifications*

The precision engineered permanent magnet type motor shown above is typical of the many special solutions provided by EEPCO engineers for tough military and industrial applications. Thoroughly field tested and proved, this motor performs satisfactorily under the most extreme conditions of service.

Whether your power problem relates to a highly developed radar unit or an industrial control device, EEPCO'S research and development engineering facilities are available to you. Because of our specialized experience in the design and manufacture of precision rotary electrical equipment, we can often save you both time and money in finding the most practical answer for you.

Moreover, once the design is established, you can count on EEPCO'S manufacturing skill to produce the equipment you need with unsurpassed, unvarying quality. Whatever your power problem—simple or complex—EEPCO engineers will welcome the opportunity to work with you.

ELECTRO ENGINEERING PRODUCTS CO.

609 WEST LAKE STREET, CHICAGO 10, ILLINOIS

- P-M DC MOTORS & GENERATORS
- CAPACITOR TYPE MOTORS
- UNIVERSAL MOTORS
- DC MOTORS & GENERATORS
- SHADED POLE MOTORS (2-4-6 Pole)
- P-M AC GENERATORS

total or partial) with respect to time is to be regretted. The arrangement of the table of symbols, and its lack of several minor symbols, again lowers the ready reference value.

The prerequisites for the reader are, at least, a well rounded background of classical physics with emphasis on electromagnetics, and a mathematical preparation through vectors and tensors, as far as an introduction to the special functions of Bessel, Hankel and Mathieu.

Sommerfeld's presentation is in the form of a philosophical treatise rather than a textbook or reference handbook. Each topic usually receives just enough attention to cover the basic principles, stopping short of the simple concepts, theorems, rules and design formulas of recent years. Therefore it is best adapted for side reading by the advanced student of physics and electromagnetics.—

WALTER K. KAHN AND HAROLD A. WHEELER, *Wheeler Laboratories, Great Neck, N. Y.*

Technical Reporting

BY JOSEPH N. ULMAN, Jr., *Massachusetts Institute of Technology. Henry Holt & Co., New York, N. Y., 1952, 290 pages, \$4.75.*

AS AN editor who, in nearly thirty years of technical publishing, has read, edited, rejected with regret, published, listened to and written literally thousands of technical reports and papers, far too many of which were dull, or too long, or written wrong-end-to, or just plain awful for any number of reasons, this reviewer unhesitatingly recommends this book to technical people whether they be students or Ph.D's with a long record of accomplishment behind them. For the facts are that engineers and scientists do not take with enough seriousness the importance of being able to tell others about their work. They do not seem to realize that oral and written reports of their work are their salestalk; that advancement in their job or their profession often depends upon a simple, concise, easy-to-understand description of

SLIDE RULE USERS!

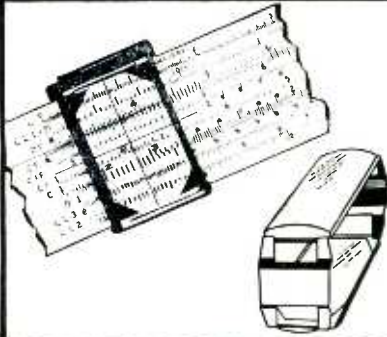

INSURE ACCURA-SEE!

P. E. G. Duplex Magnifier, with genuine precision-ground glass lenses, gives accurately-magnified readings on both faces of duplex rule, without having to remove and reverse magnifier. Folds to fit scratch-proof chamois case.

Save your eyes
Send for your
P.E.G. Duplex Magnifier
today!
Order by width of rule.

P.E.G. DUPLEX MAGNIFIER

Pocket slide rule size \$2.50
(magnifies 3X)

Standard rule sizes (magnify 2 1/2 X)

1 15/16 in.	order # 1	3.50
1 5/8 in.	order # 2	3.50
1 9/16 in.	order # 3	3.50
1 3/8 in.	order # 4	3.50

Send check or money order to
manufacturer's representative:

FLATTO Mgt. Co.

70 W. 40 ST., N. Y. 18, N. Y.

ELECTRONIC SHIELDING at its best!

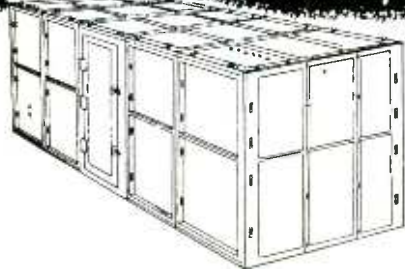

The recent development and improved LINDGREN DOUBLE SHIELDED SCREEN ROOMS — designed, engineered and constructed to incorporate *True Insulated* double shielding — for maximum shielding efficiency and the highest possible attenuation. TWO close mesh copper screens are each physically separated and electrically insulated from each other. Each screen is independently grounded. No soldered connections. A true laboratory screen room made in sections—easily assembled. Can be supplied in Special Sizes. Built to be a permanent investment.

QUICK FACTS by return mail, with construction diagrams and engineering test reports. Write us today.

ERIK A. LINDGREN & ASSOCIATES

Established 1939

4515-17 N. Ravenswood Avenue
Chicago 40, Illinois
Phone Sunnyside 4-0710

Sales Engineering Representatives Throughout
The United States

ELECTRONICS — January, 1953

AIR-MITE

AIR ARBOR PRESSES

[AIR OR SPRING RETURN]

Completely Flexible

AIR-MITE now supplies solid steel upright columns in any lengths required to give you these important flexibility features:

- 1** Normal ram clearance of 0" to 6" may be increased to any clearance required for special application.
- 2** Supplementary or replacement cylinders with any ram stroke required are available for quick, easy mounting on same brackets.
- 3** Rapid socket wrench adjustment cylinder bracket swivels for perfect alignment with work.

Presses are available in 1/4, 1/2, 3/4 and 1 ton capacities—for staking, riveting, marking, punching and similar operations.

Write for complete catalog of Air-Arbor Presses and single and double acting Air Cylinders.



AIR-MITE

4417-E West Carroll Ave.,
Chicago 24, Ill.

Tips form the TOPS in engineering

WHEN YOUR PROBLEMS YOU CAN'T ABIDE
LOOK IT UP IN THE **BUYERS' GUIDE***



*He means the **electronics BUYERS' GUIDE**

When you don't know who makes the component, equipment or material you need just look it up in the "GUIDE"

A MCGRAW-HILL PUBLICATION, 330 WEST 42ND STREET, NEW YORK 36

Want more information? Use post card on last page.

351

Precision Resistors

METAL FILM TYPE

1% TOLERANCE

for

HIGH STABILITY

Under Severe Conditions

IN AMBIENT TEMPERATURES
from 125° C. to -65° C.

AT FULL RATED LOAD
up to 100° C. ambient.

IN HIGH RELATIVE HUMIDITY
less than 1% change.

TEMPERATURE COEFFICIENTS
under 0.03% per degree C.

VOLTAGE COEFFICIENTS
less than 0.0005% per volt.

DURABLE—Remain stable over long periods.
Difficult to damage by rough handling.

Available for use in equipment for the U. S. Government in 1 watt size in values from 1000 ohms to 1.0 megohm.

Write for details

Electronics of Colorado

1026 SOUTH TEJON STREET • COLORADO SPRINGS, COLORADO

what they have been doing. And anyone who has had the humiliating experience of losing credit for an accomplishment simply because he did not write up his notebook with completeness as well as with clarity knows the value of good writing.

It is all in this book—the fine points, the mechanics—how to write lab reports, technical papers, memos and job-seeking letters, visual means for presenting information, and how to deliver a talk that will keep your audience awake as well as inform them on a highly technical subject. The do's and don'ts are set forth in a way anyone can read, enjoy and learn from.—K.H.

Harmonics, Sidebands, and Transients in Communication Engineering

By C. LOUIS CUCCIA. McGraw-Hill Book Co., New York, 1952, 465 pages, \$9.00.

THIS book summarizes under one cover the use of practically all the mathematical tools with which every practicing communications engineer should be familiar. The text is written in such a fashion that it is easily usable by any graduate from a recognized engineering college. It is an excellent textbook for an undergraduate or a graduate course which is constructed around its content.

The mathematical tools are presented in the first four chapters covering Functions of a Complex Variable, Trigonometric and Complex Fourier Series, Fourier Transforms, and Laplace Transforms. The development of these tools is the smoothest, clearest and most logical presentation the reviewer has ever seen under one cover. Mathematical rigor is replaced by "horse sense" and physical reasoning. The use of each idea is more than adequately illustrated by practical engineering problems.

Chapter 5 through 22 show the applications of the mathematics to the solutions of problems of linear and non-linear networks and the representation of communications

Square Wave Generator



MODEL 71

SPECIFICATIONS

FREQUENCY RANGE: 5 to 100,000 cycles.

WAVE SHAPE: Rise time less than 0.2 microseconds with negligible overshoot.

OUTPUT VOLTAGE: Step attenuator giving 75, 50, 25, 15, 10, 5 peak volts fixed and 0 to 2.5 volts continuously variable.

SYNCHRONIZING OUTPUT: 25 volts peak.

R. F. MODULATOR: 5 volts maximum carrier input. Translation gain is approximately unity—Output impedance is 600 ohms.

POWER SUPPLY: 117 volts, 50-60 cycles.

DIMENSIONS: 7" high x 15" wide x 7½" deep, overall.

MANUFACTURERS OF
Standard Signal Generators
Pulse Generators
FM Signal Generators
Square Wave Generators
Vacuum Tube Voltmeters
UHF Radio Noise & Field
Strength Meters
L-C-R Bridges
Megohm Meters
Megacycle Meters
Intermodulation Meters
TV & FM Test Equipment

MEASUREMENTS CORPORATION

BOONTON NEW JERSEY

waves. Most of the illustrations are of problems encountered by every communications engineer. A few are fictitious from the practical standpoint but are very useful for illustrating techniques of solution.

Most of the chapters are followed by groups of excellent problems which range in difficulty from the "Substituting in the formula type" to those requiring a real engineering insight. Throughout each chapter is scattered a bibliography, listing, in most cases, the works of the communication pioneers.

The reviewer has found a phenomenally small number of mistakes and no blunders in the text.—
CHARLES A. HACHEMEISTER, Associate Professor of Electrical Engineering, Polytechnic Institute of Brooklyn.

Advanced Antenna Theory

By S. A. SCHELKUNOFF. John Wiley & Sons, 216 pages, \$6.50, 1952.

THIS recent book by Dr. Schelkunoff is an advanced treatment of certain phases of antenna theory. The author assumes that the reader has a fair degree of mathematical maturity so that the book will be of interest mainly to those engineers who have an adequate mathematical background.

After an introductory chapter on spherical waves, the second chapter concerns itself with the mode theory of antennas. This chapter, which constitutes more than a third of the book, treats the method of antenna analysis which was originated by Dr. Schelkunoff. In addition to discussing the well-known problems of the conical antenna and the spherical antenna, such problems as the end-fed antenna and the problem of a current element above a circular ground plane of finite size are also treated. The chapter closes with a discussion of waves on thin wires. There is a very interesting physical explanation of the formation of plane waves on parallel wires and of the radiation loss at the ends of the wires.

Chapter 3 is a discussion of the

MINIATURIZATION
 Thru constant research, Acme transformer engineers have developed designs, that save pounds and ounces in weight and provide long-life performance. We build miniature transformers by the thousands, each individually performance tested.



PRESSURIZED SEAL
 Here is a transformer design with terminals sealed under pressure with a resilient sleeve that accommodates expansion and contraction of temperature changes.



PLASTIC COATING
 This is one of a number of ways that plastic has been adapted to seal transformers or individual coils for service in humid atmospheres or under conditions which breed fungi.



ACME ELECTRIC CORPORATION
 311 WATER STREET • CUBA, NEW YORK
 IN CANADA: ACME ELECTRIC CORPORATION LTD.
 50 NORTH LINE ROAD • TORONTO, CANADA

"Back Home in Indiana"

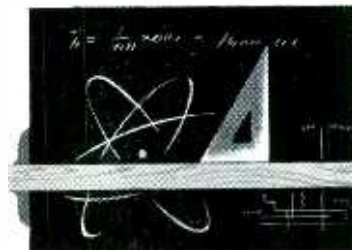

I.D.E.A., Inc., is looking for a design engineer:
 Someone who would like to make Indianapolis his permanent home—who would like to work for a young, forward looking company that is already the leader in its field. If you are that man, address full information about yourself to: R. A. Morris, Chief Engineer, I.D.E.A., Inc., 7900 Pendleton Pike, Indianapolis 26.

Makers of the Regency VHF Booster, UHF Converter and other electronic devices.



Regency

INDIANAPOLIS, INDIANA

BIRNBACH

Electronic Components

Cut production costs — speed operations, by specifying BIRNBACH — your reliable Source of Supply for all requirements in Radio, Television, and Electronic Components, Accessories, Wire and Cables.

COMPLETE WAREHOUSE STOCKS

FOR PROMPT DELIVERY

- Govt. Spec. Hookup Wire
- JAN-C-76 SRIR-SRHV Plastic WL-Extruded Nylon Jacket Aircraft Wire—Nylon Jacket 105° C. UL Approved
- JAN-C-76 WL-Glass Braid
- Multiconductor Rubber Covered Cables, shielded, unshielded
- Tinned and Bare Wire
- Magnet Wire
- Heavy Formvar Wire
- Vinyl Extruded and Radio Grade Tubing
- Shielded Wires
- Insulated Hardware
- Plugs, Jackets, Sockets
- Test Leads, Switches
- Insulators, Steatite and Ceramic
- Terminal Strips

Quality Products for the Electronics Industries since 1923

WRITE FOR CATALOG 53-E



NEW BOOKS

(continued)

theory of spheroidal antennas. Chapter 4 is on integral equations and treats the basis for the method used by Hallén in his theory of cylindrical antennas. In chapter 5, the theory of the cylindrical antenna is further developed and various solutions are obtained. The last chapter on natural oscillations contains an excellent discussion of equivalent networks. One of the more interesting points is the network representation of the radial wave impedances which had previously been used by Chu to demonstrate the impracticality of super-gain antennas. The chapter closes with a discussion of the resonant properties of thin wires.

A comprehensive set of problems which will enable the reader to test his skill is followed by a set of appendices containing integrals and numerical data useful in antenna theory.

The book represents an excellent treatment of the present status of the theory of dipole antennas. As such, the book will prove valuable to engineers and mathematicians interested in this branch of the antenna field.—HENRY JASIK, *Consulting Engineer, Westbury, New York*

Musical Engineering

BY HARRY F. OLSON, *RCA Laboratories, McGraw-Hill Book Co., 1952, 369 pages, \$6.50.*

A ONE-VOLUME encyclopedia on all the interrelated elements that enter into the production and reproduction of vocal and instrumental music, written from the engineering viewpoint. It should be useful, and interesting, to all engineers in the radio, sound picture and recording field. Each engineer will have his own special interests, of course, but the author, drawing from his long experience has placed a vast quantity of material in his book, covering virtually all aspects. It should help to bridge the gap between the musicians whose work is largely subjective and who have very faint knowledge of the science, and the engineer whose work is purely objective and whose knowledge of the

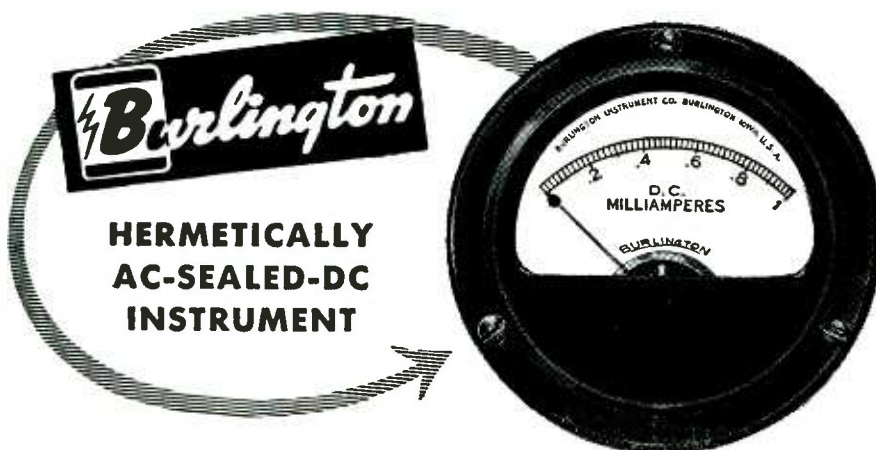

RUGGED CONSTRUCTION FOR SUPERIOR PERFORMANCE

- Copper — cadmium — dichromate finished case.
- Black satin anodized aluminum bezel.
- Excellent shielding due to case material and construction.
- Double strength clear glass.
- Glass to metal seal under controlled humidity and temperature conditions.
- D'Arsonval permanent magnet type movement for DC applications.
- Magnetically damped, moving iron vane type movement for AC applications.
- Available in 1½" square, 2½" and 3½" round case types.
- Guaranteed for one year against defective workmanship and materials.

Burlington "Hermetically Sealed" Instruments are designed to conform to JAN and MIL specifications.



BURLINGTON INSTRUMENT COMPANY
DEPT. F-13, BURLINGTON, IOWA



North American encourages advanced thinking, because they know looking ahead is the only way to maintain leadership in the aviation industry. That's why North American needs men of vision. If you like hard thinking and would like to work for a company that will make the most of your ideas, you'll find real career opportunities at North American. North American offers you many extra benefits, too.

North American Extras —

Salaries commensurate with ability and experience • Paid vacations • A growing organization • Complete employee service program • Cost of living bonuses • Six paid holidays a year • Finest facilities and equipment • Excellent opportunities for advancement • Group insurance including family plan • Paid sick leave • Transportation and moving allowances • Educational refund program • Low-cost group health (including family) and accident and life insurance • A company 24 years young.

Write Today

Please write us for complete information on career opportunities at North American. Include a summary of your education, background and experience.

IS YOUR FIELD LISTED HERE?

- Airborne Electronic Equipment
- Equipment Flight Tests
- Precision Instruments
- Automatic Controls
- Propulsion Systems
- Servo-Mechanisms
- Airframe Studies
- Radar Devices
- Instrumentation
- Micro Wave Techniques
- Metallurgical
- Electroplating
- Engineering Planning

NORTH AMERICAN AVIATION, INC.

Aerophysicists, Electro-Mechanical Research Division

Dept. 3, Personnel Section,
12214 Lakewood Blvd., Downey, California
North American Has Built More Airplanes Than Any Other Company In The World

ELECTRONIC GLASS WORKING EQUIPMENT for RADIO, TELEVISION TUBES, INCANDESCENT LAMPS, GLASS LATHES for TELEVISION TUBES

We make Transformers, Spot and Wire Butt Welders, Wire Cutting Machines and 500 other items, indispensable in your production. Eisler Engineers are constantly developing New Equipment. If you prefer your own designs, let us build them for you. Write to Charles Eisler who has served The Industry over 32 years. Machines for small Radio Tubes of all kinds.

Charles Eisler, President and Founder Charles Eisler, Jr., Vice President
Joseph A. Morick, Plant Manager
Howard F. Kingdon, Manager of Transformer Dept., and our entire organization send

SEASON'S GREETINGS AND BEST WISHES FOR THE COMING YEAR

TO ALL of our customers and friends in the United States as well as in all foreign countries. We all thank you for your patronage for the past 33 years.

Charles Eisler takes pleasure in announcing three new catalogs. If you are interested, they will be sent to you for the asking.

- 1—Glass Lathes with holding devices.
- 2—High Temperature Furnaces. A very complete line of all kinds of furnaces and ovens.
- 3—Turntables and Positioners for welding, brazing, and soldering, and other rotating devices. Over 100 types.

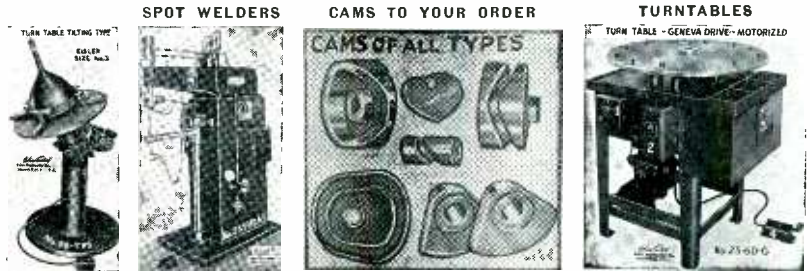

EISLER ENGINEERING CO., Inc. 751 So. 13th St
Newark 3, N. J.

REDUCE COSTS ON "SMALL-WORK" GRINDING & FINISHING

JOBS with

Freedom FLEXIBLE SHAFT MACHINES

YOU GET ALL these features superior

- Feather-weight, finger-tip-controlled handpiece (pencil size or larger) which eliminates operator fatigue.
- Choice of 5 handpiece types (all instantly interchangeable). You fit the handpiece to the job at hand.
- Extra good flexing qualities in the flexible shaft assembly for effortless maneuverability.

BENCH OR HANG UP MODELS FOR HEAVY OR LIGHT DUTY

Also flexible shaft tools attachable to your own drill press or motor.

Use Freedom to GRIND, POLISH, DRILL, ROUT, CARVE, MILL, SAW, SLOT, CLEAN, SAND, ETCH, ENGRAVE, etc., etc.



Quality Since 1922

- Longer motor life because motor is not dwarfed to fit the hand.
- High speed which does not drop precipitately under load.
- Silencer - equipped flexible shaft for vibration-free performance.

MAIL COUPON FOR CATALOG

FOREDOM ELECTRIC CO., Dept. 8001, 27 Park Place, New York 7, N. Y.

Send your catalog No. 8001, showing different uses of Freedom Flexible Shaft Machines.

Name
Address
City & Zone State.....

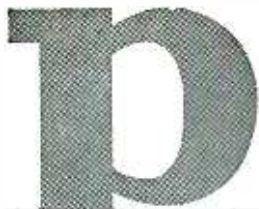

POLYPENCO TEFLON*

available for economical fabrication

ROD	Extruded .187" dia. to 2.0" dia. Tolerance +.002" — .000" up to 1" dia. Molded 2.25" dia. to 4.0" dia. Beading .030" to .187" dia.
TUBING	Extruded .50" to 2.0" O.D. 3/16" to 1.0" I.D. min. wall 1/8" Molded 1 1/4" to 8" O.D. at 1/4" intervals Wall thickness 3/8" — 2 3/4"
OTHER SHAPES	Strip thickness .002" to .060" Slab thickness 1/8" to 1 1/2" Special extruded shapes to customer specifications

Outstanding properties of TEFLON

Advantage

WIDE SERVICE TEMPERATURE RANGE	-100°F to +500°F
CHEMICALLY INERT	Resists all known acids, alkalis and commercial solvents over the service temperature range.
ZERO WATER ABSORPTION	Water will not wet the surface.
LOW POWER FACTOR	.05% p.f. constant over entire frequency spectrum.
STABLE DIELECTRIC CONSTANT	2.0 unchanged over entire spectrum.
TOUGHNESS AT LOW TEMPERATURE	Izod impact strength -70°F 2 ft. lbs./in.

*Teflon is a trademark of the E. I. DuPont Co.

also available to your specifications

MACHINED PARTS • MOLDED PARTS

POLYPENCO / nylon teflon

Write for technical data and prices on Polypenco Teflon and Nylon

The POLYMER CORPORATION of Pennsylvania • Reading, Penna.

Canadian Representative: C-H Engineering Company, Montreal, Quebec and Toronto, Ontario

fine points of why music has such universal appeal may be quite limited.

The descriptions of musical instruments is very interesting and show how our modern devices have grown, by cut and try, from very primitive noise and music makers. The complexities of musical scales is made clear from the engineering standpoint as is the theory of music, musical terminology and the relations between musical symbolic notation and the physical characteristics of tones.

The nine chapters give only an inadequate indication of the great amount of information packed between the book's covers: sound waves, musical terminology, musical scales, resonators and radiators, musical instruments and their characteristics, properties of music, theater, studio and room acoustics, sound-reproducing systems.

Although the chapter headings might indicate that most of the book is concerned with music per se, this is not the fact for there is much engineering as well.—K. H.

Sound Recording and Reproduction

BY J. W. GODFREY AND S. W. AMOS, *British Broadcasting Corporation, England. Iliffe and Sons Ltd., 1952, 272 pages. Available from British Book Centre of New York at \$6.75, 122 East 55th Street, New York, New York.*

"Sound Recording and Reproduction" presents an introduction to three general methods of sound transcription. It is intended as a training manual for technicians concerned with disc, film, and magnetic tape recording and reproduction. As such it offers a concise and clearly presented exposition of the history, development and basic concepts employed in the recording and reproduction of sound as practiced by a typical broadcasting organization.

Major emphasis in this manual is given to disc recording and reproduction, the mechanical parameters, equalization and processing. A brief introduction to magnetic tape and sound film recording is also included. Discussion of the chrono-

logical development of equipment actually in use by the British Broadcasting Corporation is integrated with fundamental design considerations. Several appendices of special interest and convenience to recording engineers are included. "Sound Recording and Reproduction" provides an interesting alternate to the more familiar idiom of American technical presentations on the subject. It gives a different slant to everyday problems of sound recording in that differences in the use of the language often illuminate the simplest explanation of well known engineering problems. — PRICE FISH, *Columbia Broadcasting System*

THUMBNAIL REVIEWS

ESSENTIALS OF MICROWAVES. By Robert B. Muchmore, Hughes Aircraft Co. John Wiley & Sons, 236 pages, 1952, \$4.50. Elementary explanation of Maxwell's laws and the many devices and phenomena following these laws.

ASTM 50 YEAR INDEX. American Society for Testing Materials, 1916 Race St., Philadelphia. 216 pages, \$6.000, 1952. Detailed author and subject index to all ASTM technical papers and reports dealing with materials, particularly their properties and testing, appearing in ASTM publications during period 1898 through 1950.

TITAN—SYSTEM No. 41. Geology, geochemistry, metallurgy, chemistry, physics and technology of titanium, the world's literature up to January 1, 1950. Available from Walter J. Johnson, Inc., 125 East 23 st, New York or Stechert-Hafner, Inc., 31 East 10th, New York. 511 pages plus index, 1952. \$27.20.

ADVANCES IN GEOPHYSICS: Edited by H. E. Landsberg, Airforce Cambridge Research Center. Vol. 1, 362 pages, 1952, \$8.50. To keep geophysicists and meteorologists abreast of research in the field.

TABLES OF BESSEL FUNCTIONS $Y_0(x)$, $Y_1(x)$, $K_0(x)$, $K_1(x)$, $0 \leq x \leq 1$. National Bureau of Standards Applied Mathematics Series 25, 60 pages, 40 cents, Government Printing Office, Washington 25, D. C. Tables computed at much closer intervals than existing tabulations. Useful to nuclear physicists and other design engineers and physicists.

CORRECTION. By error, the price of "Survey, R-F Transmission Lines and Waveguides" by E. S. Winlund, published by the Radio Club of America, was stated in the November **ELECTRONICS** to be \$1, whereas the correct price is \$1.50.

NEW!

... an instrument for all your magnetic measuring problems.

Dyna-Labs D-79 GAUSSMETER

This precision built instrument measures flux density, determines direction of flow. It locates and measures stray fields and plots variations in strength and checks production lots against a standard. Simple to operate. No ballistic readings... no jerking or pulling. Supplied with protective carrying case.

- Other Features -
- Reads 10 to 30,000 Gauss Flux Fields
- Probe is only .025" thick
- Active area .01 square inches
- Overall size 13" x 6-3/4" x 10-1/2"
- Net weight only 10-1/2 lbs
- Power supply 105-125 volts, 50-60 cycles



We invite inquiries. For literature write Department E-153

Dyna-Labs

INC.

1075 STEWART AVENUE, GARDEN CITY, L. I., N. Y.

GARDEN CITY 3-2700

The S.S. WHITE 80X HIGH VOLTAGE RESISTOR

(1/2 Actual Size)

4 watts • 100 to 100,000 megohms

Developed for use as potential dividers in high voltage electrostatic generators, S.S.White 80X Resistors have many characteristics—particularly negative temperature and voltage coefficients—which make them suitable for other high voltage applications.

They are constructed of a mixture of conducting material and

binder made by a process which assures adequate mechanical strength and durability. This material is non-hygroscopic and, therefore, moisture resistant. The resistors are also coated with General Electric Dri-film which further protects them against humidity and also stabilizes the resistors.

WRITE FOR BULLETIN 4906

It gives complete information on S.S.White resistors. A free copy and price list will be sent on request. Send for a copy.



THE S.S. White INDUSTRIAL DIVISION
DENTAL MFG. CO.



Dept. R, 10 East 40th St.
NEW YORK 16, N. Y.

WESTERN DISTRICT OFFICE: Times Building, Long Beach, Calif.

BACKTALK

Mobile Radio Service

DEAR SIRs:

I WAS very much interested in the article beginning on page 140 of the October 1952 issue of ELECTRONICS, by Maurice E. Kennedy, entitled, "Servicing Mobile Radio Equipment".

I became interested in this field two years ago and approached one of the larger manufacturers of two-way equipment for information, but I did not even receive a reply to either of the two letters I sent. This is in marked contrast to statements made in Kennedy's article: "... servicemen have found the equipment manufacturers interested in helping them do a good job. Most manufacturers will gladly furnish service manuals, circuits and a wealth of technical data to qualified servicemen. . . ."

I found Mr. Kennedy's article very helpful in that it is very specific, and I am at this time looking into local possibilities in this field, with a view to obtaining the necessary license and equipment.

Would it be possible for you to inform me who the manufacturers are who are referred to in the paragraph quoted above?

W. A. GEIGER

W. A. Geiger Radio Shop
Ellensburg, Washington

(Editor's Note: It occurred to us that the information requested in this letter might be of value to many of our readers. We wrote to a representative selection of manufacturers of two-way mobile radio equipment and asked them to outline the facilities they make available to servicemen. The following are excerpts from the letters we received in reply.)

FEDERAL

"Federal Telephone and Radio Corporation does make available to servicemen information of the kind described in your article. Information of this category can be obtained by any qualified field service organization by writing to our Mobile Radio Service Department.

"Field service assistance to servicemen is limited, at the present time, to resolving service problems beyond the ability of the local service organization. In some areas of the country, it is possible for a serviceman to obtain direct assist-

TOP opportunity for TOP electronic engineers with communication backgrounds

Here is your big opportunity —

IF . . .

IF you are a top-flight electronic engineer with a degree in electrical engineering from a fully recognized college or university.

IF you have a successful background in communications.

IF you have the creative and inventive spark to come up with new and sound ideas.

IF you can offer all these, National can offer you an enviable position with a world-respected leader in the communication field — an exceptionally good salary, generous social benefits and a fine group of people to work for and with.

W. A. Ready, President, National Co., Inc.

Send complete resume (education, experience, present salary, marital status, etc.) to Industrial Relations Dept., National Co., Inc., 61 Sherman Street, Malden, Mass.



Want more information? Use post card on last page.

January, 1953 — ELECTRONICS

SILVER GRAPHALLOY

BRUSHES

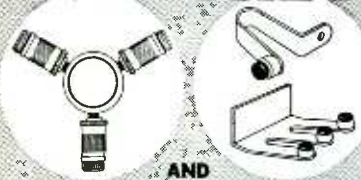

AND

CONTACTS



... for applications requiring low electrical noise, low and constant contact drop, high current density and minimum wear.



EXTENSIVELY USED IN

SELSYNS

ROTATING THERMOCOUPLE and STRAIN-GAGE CIRCUITS

**ROTATING JOINTS
GUN-FIRE CONTROLS
DYNAMOTORS etc.**

Wide range of grades available for standard and special applications.

Brush holders and coinsilver slip rings available for use with Silver Graphalloy Brushes.

OTHER GRAPHALLOY PRODUCTS:

Oil-free self-lubricating Bushings and Bearings, Oil-free Piston Rings, Seal Rings, Thrust and Friction Washers, Pump Vanes.



Write us for Data Sheets and further information.

GRAPHITE METALLIZING CORPORATION

1055 NEPPERHAN AVENUE • YONKERS, NEW YORK

- Please send data on Graphalloy BRUSHES and CONTACTS.
 Send data on BUSHINGS.

NAME _____

COMPANY _____

STREET _____

CITY _____

ZONE _____

STATE _____

Want more information? Use post card on last page.

Western IS READY
TO SERVE YOU



Radio and electronics manufacturers in the West know from experience that Western Coil Co. is completely reliable, its products completely dependable. Western has the facilities to serve you—in design, development and manufacturing. We invite your inquiries relative to your needs and problems.

Western
COIL PRODUCTS CO.
2993 Middlefield Rd.
Palo Alto, Calif.

High Sensitivity . . . Logarithmic **AC VOLTMETER** 50 MICRO VOLTS TO 500 VOLTS

MODEL 47 VOLTMETER

SELF-CONTAINED
ALL AC OPERATED UNIT

An extremely sensitive amplifier type instrument that serves simultaneously as a voltmeter and high gain amplifier.

- Accuracy $\pm 2\%$ from 15 cycles to 30 kc.
- Input impedance 1 megohm plus 15 uuf. shunt capacity.
- Amplifier Gain 23000

Also MODEL 45
**WIDE BAND
VOLTMETER**
.0005 to 500 Volts!
5 Cycles 1600 kc

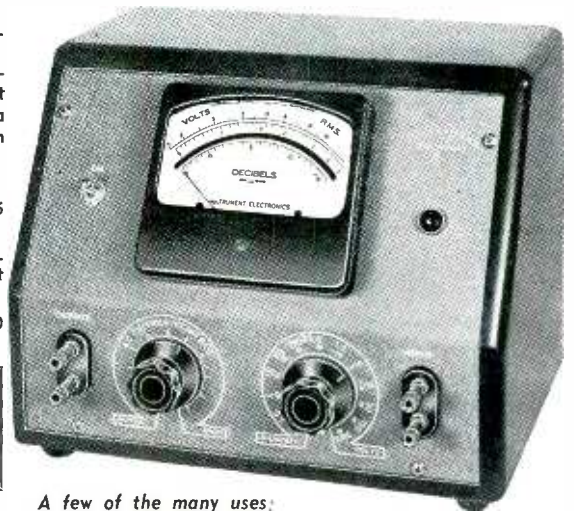

A few of the many uses:

- Output indicator for microphones of all types.
- Low level phonograph pickups.
- Acceleration and other vibration measuring pickups.
- Sound level measurements.
- Gain and frequency measurements for all types of audio equipment.
- Densitometric measurements in photography and film production.
- Light flux measurements in conjunction with photo cells.

Write for Complete Information

Instrument Electronics Corp.

90 MAIN STREET
PORT WASHINGTON, N. Y.

Runzel
**WIRE CORD
and
CABLE**



*"Products of
Science"*

The Runzel Laboratory insures that every inch of Runzel wire, cord and cable is thoroughly tested before shipping. Your wiring needs in hook-up, lead-in, shielded wire and cords, speaker cords and all types of insulated wire products, in almost endless variety of colors, sizes and specifications, are available from this centrally located plant.

WRITE FOR
SAMPLES



RUNZEL CORD & WIRE CO.
4723 Montrose Avenue
Chicago 41, Illinois

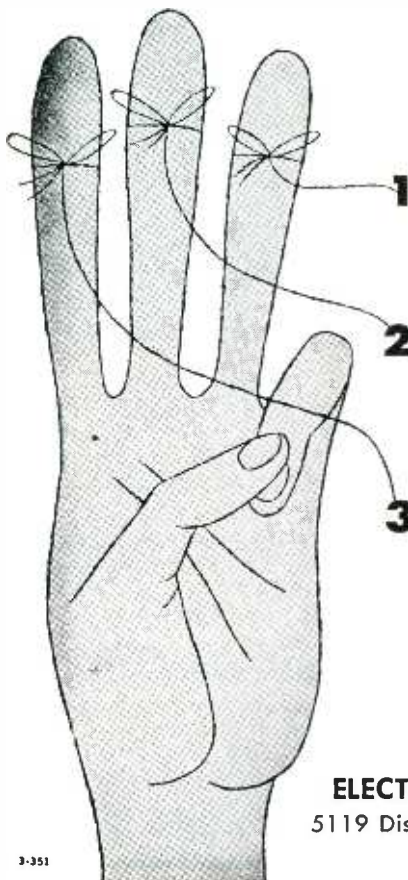

THERMADOR TRANSFORMERS BECAUSE:

- 1 Wide Selection . . .**
The new catalog line includes units for amateur, audio, broadcast, aircraft, television, geophysical, radio and radar applications.
- 2 Design and Testing Facilities . . .**
Thermador has complete facilities for designing and testing transformers for prototype equipment and compliance with JAN specifications.
- 3 Long Experience—Big Manufacturing . . .** Years of learning how and the West's largest transformer manufacturing facilities give you precision and quality in quantity.

THERMADOR
ELECTRICAL MANUFACTURING CO.
5119 District Boulevard, Los Angeles 22, Calif.

3-351

ELECTRO SNAP
Environment-Free!
LIMIT SWITCHES

HERMETICALLY-SEALED
 for positive proof against
 • COLD and HEAT (from -100°F. to +250°F.)
 • MOISTURE • CORROSION • DIRT
 • OIL • ICE JAMMING

Here's a dependable limit switch that provides true *Environment-Free* performance. With operating parts fully sealed in an inert gas, this switch will not freeze or jam. It is impervious to moisture, oil, dirt, tampering and mis-adjustment.

Accuracy with Long-Life
 Rigid tests by users have proved that Electro-Snap Switches last longer—while

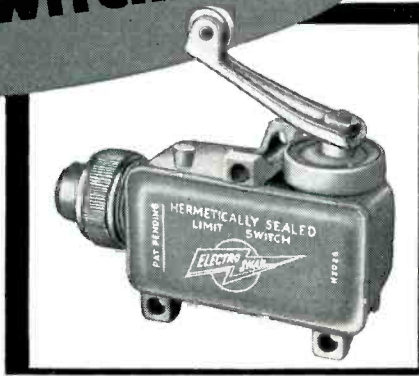

retaining complete accuracy and reliability of operation . . . both electrically and mechanically. They are available with mountings and actuators to fit them to a broad range of uses.

Whatever your use for precision switches, get the facts on the ELECTRO-SNAP Line. Write for FREE Basic Switch and Catalog.



ELECTRO-SNAP SWITCH & MFG. CO.
 4218-30 WEST LAKE ST., CHICAGO 24, ILLINOIS



ROLLING "IMPROVED" COMPOSITE SHEET STOCK TO .005" THICK (± .0025") X 4" WIDE

"IMPROVED'S" highly skilled craftsmen working with the most modern of precision equipment are able to provide composite sheet stock for numerous industrial applications.

As shown here, tons of pressure are exerted on the bonded bar to produce a compact, hard wearing surface of silver for highest electrical conductivity while the bronze base lends strength and economy to your completed part.

Write today for additional information

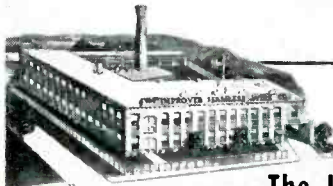

The Home of IMPROVED Service
 Rhode Island's largest manufacturer of Laminated Metals.

The IMPROVED SEAMLESS WIRE COMPANY
INCORPORATED 1898
 775 Eddy Street, Providence 5, Rhode Island

ance from our sales representatives. Requests for this service can be addressed as indicated above."

J. J. McDEVITT
 Manager
 Mobile Radio Communications Dept.
 Federal Telephone and Radio Corp.
 Passaic, New Jersey

GENERAL ELECTRIC

"We make available to all our customers who so request, and to their servicemen, service bulletins concerning not only General Electric Company equipment, but also allied equipment. This year we have issued 70 odd to date and expect to issue 25 more before Christmas. All customers, of course, receive instruction books with the equipment.

"These bulletins are obtained usually by the customer requesting us to send bulletins, using a post-card he receives with his instruction manual or by direct requests from our various Field Representatives on behalf of customers. A surprisingly large percentage of our customers are using this free service.

"We have in addition an "Authorized Service Shop" program. This program insures that the serviceman who has "Authorized Service Shop" status will have all instruction manuals and service bulletins applicable to our equipment at his fingertips. We make special effort to see that these shops obtain service bulletins normally not of interest to many customers; such as installation and maintenance instructions covering antennas, alternators and so on.

"We maintain a field group to assist the "Authorized Service Shop" wherever possible in training and guidance. This same group helps customer service personnel with their problems. In addition, customer problems peculiar to a customer installation are referred back to Syracuse when they cannot be solved in the field."

C. C. FALLON
 Field Service—Commercial Products
 Commercial and Government Equipment
 Dept.
 General Electric Company
 Electronics Park, Syracuse, New York

LINK

In answer to your inquiry concerning servicing information, the Link Radio Corporation does make

available service information to any interested parties. We normally supply service manuals with equipment shipped from the plant. Additional manuals are available by writing to the Technical Services Division of the Engineering Department and a minimum charge of \$2.50 is made to cover handling costs. In addition to this, Engineering Bulletins and Production Change Notices are available to all persons servicing our equipment by writing for same, including the Model No. and Serial No. of said units. There is no charge for this latter service.

To answer your second question, Link has a number of representatives throughout the country who are available to inspect individual service organizations who might be considered for servicing our equipment. These arrangements are made through the New York Plant and interested parties should write to the Engineering Department.

STUART MEYER

Chief Engineer
Link Radio Corporation
New York, N. Y.

MOTOROLA

"Much of the two-way radio communications equipment in use in the field today is serviced by qualified technicians operating out of authorized service stations. These stations are privately owned and operated and function under a working agreement or franchise with Motorola, Inc. For these authorized companies, we offer engineering consultation, warranty service assistance, business management guidance and a complete technical manual library supported by a continuing program of technical bulletins and service hints. In addition to this basic service, the contract includes a formal arrangement for discount procurement of replacement parts and servicing equipment.

"The above arrangement is restricted to those service stations operating under Motorola Communications and Electronics Division franchise. This does not extend to unaffiliated service stations or to Motorola dealers concerned only with the consumer

Test Proven Hermetic Sealing

OC-8 and OC-12
"8 and 12 Pin Octal Type Plug In Headers, molded with NEO-SIL, are applicable for use on MIL requirements. They will withstand thermal shocks, vibrations, mechanical strains and excessive pressures with no impairment to the seal or other functional characteristics. For use with standard Octal Type Sockets."

1/4" SHAFT WATERSEAL BUSHING
"Rotary Waterseal Panel Assemblies, with GRAF-SIL Packing Glands, have an excellent seven year customer history on gas filled pressurized components. They are available for 1/4" shafts and for potentiometers and switch bushings."

We welcome your inquiries on any phase of design, development or production.

NEO-SIL
CORPORATION

26 CORNELISON AVE., JERSEY CITY 4, N. J.

THIS IS IT!

World-wide recognition for this outstanding line of electric soldering irons —

HEXACON

— specified by the big names for the TOUGH JOBS!

- ★ MINNEAPOLIS HONEYWELL
- ★ RADIO CORP. OF AMERICA
- ★ STROMBERG-CARLSON
- ★ WESTERN ELECTRIC
- ★ WESTINGHOUSE
- ★ EMERSON
- ★ KAISER
- ★ BENDIX
- ★ SPERRY, etc.

Here's the famous **HEXACON HATCHET TYPE**

These irons feature better balance for reduced operator fatigue. Efficiency is stepped up, and quality of work is improved. The ideal iron for inaccessible and intricate jobs.

HEXACON ELECTRIC CO.
130 W. CLAY AVE., ROSELLE PARK, NEW JERSEY

PLUG OR SCREW TIPS
40 to 700 Watts
1/8" to 1 1/4" Tip Dia.

Follow the leaders and you'll specify HEXACON! They'll efficiently solve your soldering problems too! Write for literature.

**Try Remler for Service-Tested
"Hard-to-Get" Components**

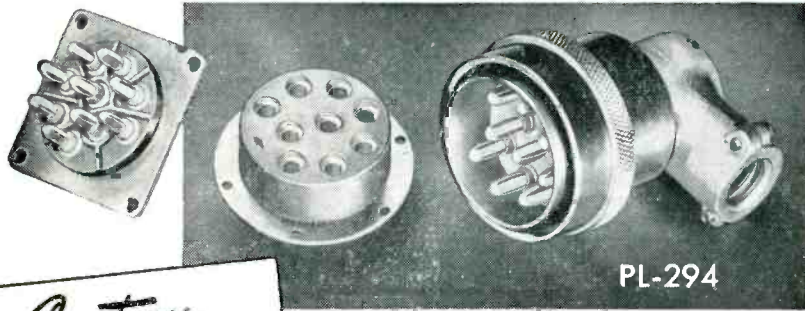

PL-294

*Custom
Components*

Metal-plastic components designed and manufactured to order. Write for quotations specifying electrical and mechanical characteristics. Describe application. No obligation.

PLUGS & CONNECTORS

BANANA PIN TYPES...JAN SPECIFICATIONS

Multi-contact connectors and mating chassis counterparts. Melamine or alkyd insulation; steel or brass nickel-plated shells. Banana springs are heat treated beryllium copper. Unexcelled low resistance contact. Highest quality... good for thousands of connects and disconnects.

Special Connectors to Order—Miniatures; water tight and pressure proof types to JAN specifications.

Remler Company Ltd. 2101 Bryant St. San Francisco 10, Calif.

Since 1918 **Remler** PIONEERS IN ELECTRONICS AND PLASTICS

**SPACE SAVERS FOR
MODERN CIRCUITRY -
MONEY SAVERS FOR
PRODUCTION ECONOMICS -**

**IN-RES-CO
TYPE IR
WIRE WOUND
RESISTORS**

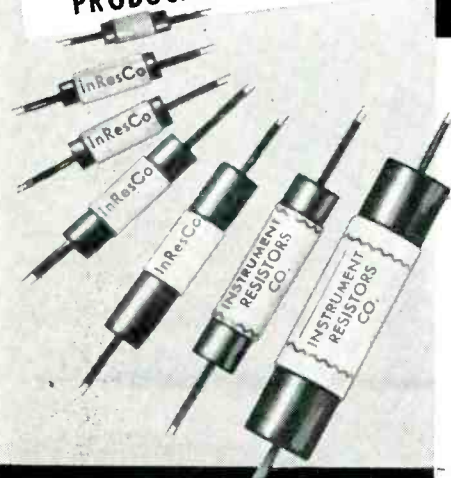

The practical, low cost solution for circuit designers striving for the sub-miniature. Type IR units offer precision resistance values capable of retaining stability through long periods of continuous or intermittent service. Type IR resistors are available at prices based on mass production methods of manufacture. Wound to a tolerance of $\pm 1\%$, they are permanently accurate. Conservative ratings allow ample safety margin in all classes of service. Special Bakeite forms eliminate shrinking, swelling and temperature effects. IN-RES-CO moisture and fungus proof coating offers absolute protection against climatic extremes. Specify IR Type resistors for all applications where precision performance and limited space are important determining factors.

**INSTRUMENT
RESISTORS CO.**

COMMERCE
AVENUE



UNION
NEW JERSEY

APPLICATION-DESIGNED RESISTORS FOR ELECTRONICS AND INSTRUMENTATION

WRITE FOR NEW RESISTOR
HANDBOOK - Contains
complete data and recom-
mended applications
for resistors for every
purpose.



products.

"Many of the larger users of our equipment employ their own maintenance technicians. These companies and individuals are supplied with complete servicing literature and are assisted on unusual problems by our field engineers and authorized service stations.

HAROLD A. JONES

Manager
Technical Information Center
Communications & Electronics, Div.
Motorola, Inc.
Chicago, Illinois

RCA

"The RCA Service Company through its national organization services RCA mobile equipment either under service contract or at a flat rate on a demand basis. The company's service technicians are specially trained and kept posted with the latest information on this equipment.

"Buyers of our mobile communications equipment receive standard instruction books with the equipment. These instructions include information on both operating and servicing. Customers and their independent service organizations (in the case of customers who do not use our service staff) also receive special technical service notes on the equipment they have purchased."

E. C. CAHILL

President
RCA Service Co.
Camden, New Jersey

Quarantine

DEAR SIRS:

IN CARRYING out his obviously distasteful but necessary duty of quarantining the highly "insanitary" 40-DB Feedback Amplifier (letter to ELECTRONICS for October 1952 re our article in the March 1952 issue), Mr. E. F. Good forgot to include another damning reason why innocent audio experimenters should be sternly discouraged from contact with so fundamentally "unfit" a design.

Not only are 0.1-percent matched resistors demanded for the feedback chain and phase-splitter stage (according to the Good book), but other "absurd" requirements are some ultra-special tubes that can

HOW TO GET 0.05% Accuracy! — for Rotational Speed Measurement

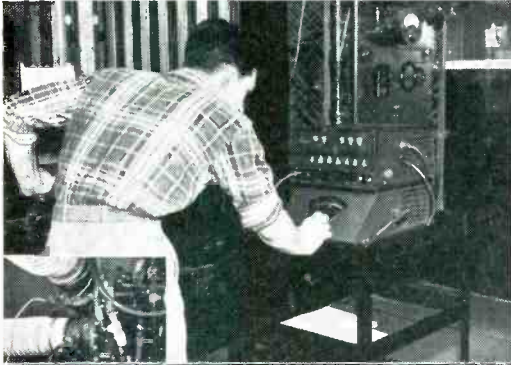

Stratos Division of Fairchild Engine & Airplane Corp., measures the impeller speed of their superchargers without direct contact with the impeller. A magnetized nut on the impeller shaft generates a signal which is registered by the STROBOCONN to measure impeller r.p.m. to an accuracy of 0.05%.



NEW 6T-4 *Stroboconn*

The 6T-4 measures all types of repetitive frequencies, both constant and variable—no waiting or computation. Frequencies become continuous, visual patterns for the duration of the signal, from which precise analysis and measurement can be made at any instant. Whether your problem is determining frequency drift under varying conditions, measuring natural or line frequencies, calibrating precision oscillators or tachometers, or measuring rotational speeds, you can always be sure of accuracy to 0.05%.

Free FOLDER

Informative folder on request. Explains and illustrates operation, specifications and applications.



Write C. G. CONN Ltd., Electronics Div., Dept. 112, Elkhart, Ind.

Standard Piezo CRYSTALS
Rugged! Dependable! Accurate!

Send today for our new completely illustrated catalog of crystals or outline your particular crystal problem. Our engineers will be glad to make recommendations, at no obligation to you.

TYPE 24
STANDARD PIEZO
COMPANY
CARLISLE, PA.
3105 KC.

TYPE 10
3105 KC
MADE BY
STANDARD
PIEZO COMPANY

20 STD PIEZO

24 STD

Standard Piezo Co.
CARLISLE, PENNSYLVANIA

The Nonmelting Silicone Insulating and Waterproofing Compound that is stable from -70° to over 400° F.

Meets all Requirements of AN-C-128a

DOW CORNING
4 COMPOUND



Dow Corning 4 applied by brushing to AN connector receptacle of pilot's "jack box" prevents interference caused by moisture at this critical junction in aircraft communications system.

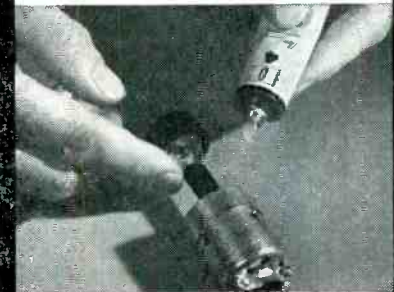

Dow Corning 4 applied by brushing to AN connector on V. H. F. Transmitter/Receiver excludes moisture without appreciable change in resistance across properly mated pin and socket connections.



Arrows show where Dow Corning 4 is used on variable inductance rollers in a Collins-Western Electric V. H. F. Transmitter/Receiver to lubricate, minimize resistance and reduce leakage losses.

Photos courtesy Braniff International Airways.

More waterrepellent than paraffin, Dow Corning 4 Silicone Compound is highly resistant to oxygen, ozone and deterioration caused by corona discharge.

Write Today! for your copy of our new booklet on Dow Corning 4 Compound. Address Department BD.



MIDLAND, MICHIGAN

NOTHELPER "NWL" Special TRANSFORMERS

Proven by Past Performance



Over 28 years' experience in the manufacture of special transformers to meet individual requirements. Built in quality proved by years of actual use.



From 10 VA to 300 KVA Dry-Type only. Both Open and Encased. 1, 2, and 3 Phase. 15 to 400 cycles.



Send for NEW 8 page BULLETIN



NOTHELPER
WINDING
LABORATORIES



9 ALBEMARLE AVE., TRENTON 3, N. J.

provide far better μ -matches than ordinary 6SJ7's and 6L6's. For even the best JAN types admit variations in gain up to ± 25 percent (2 db per tube or 4 db for a pair).

The audio-amplifier literature (at least outside the pages of ELECTRONICS) has indeed included so many dubious designs in recent years that Mr. Good has strong justification for his skepticism. But if that skepticism extends to the practical as well as the theoretical field, he might (as many others have done) throw together the 40-db feedback amplifier, using quite ordinary resistors and tubes, and taking no extraordinary matching pains. And when he discovers that what shouldn't work, actually does work, we are sure that he'll be good enough to lift his quarantine warning.

He may be shocked to discover, for instance, that deliberately unbalancing this circuit by the insertion of output tubes mismatched by a plate-current factor of 5 to 1, or by mismatching one of the phase-inverter load resistors by as much as 10 percent (neither of which, we hasten to add, is recommended as normal practice)—the only discernible result is a less than 0.5-db reduction in undistorted power output.

Or he might go so far as to remove the mutual impedance between the halves of the output circuit by using a separate transformer for each 6L6, and then achieve maximum unbalance by bypassing one of the exciter-tube cathodes to eliminate the 40-db feedback entirely from one-half of the push-pull stages. Getting rid of the center-tapped output autotransformer makes it meaningful to measure the output unbalance at the 6L6 plates. What started out as a 40-db unbalance proves to be reduced to between 4 and 5 db at the output.

Of course, many of those who have actually built and used this amplifier have shared Mr. Good's dubiety to some extent—at least to that of adding one of the many varieties of manual-balancing adjustments currently so dear to the hearts of most American and British amplifier designers. Doing so

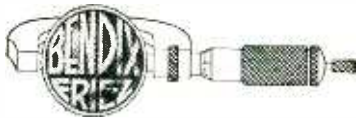

precision-made to your needs . . .

BENDIX-FRIEZ thermistors

Maybe your need for these temperature responsive resistors can be satisfied by a type we carry in stock. Maybe you require a specially-developed type. In either case you can depend on Bendix-Friez to provide precision-made thermistors to serve you with maximum efficiency. High standards of quality control in manufacture make Bendix-Friez Thermistors pre-eminent in their field . . . assure you of utmost satisfaction.

STANDARD TYPES FOR IMMEDIATE DELIVERY

Size (inches)	@ +30°C.	@ 0°C.	@ -30°C.
.140 x .75	45.0 ohms	86 ohms	194 ohms
.040 x 1.5	12,250 ohms	26,200 ohms	65,340 ohms
.018 x 1.5	35,000 ohms	82,290 ohms	229,600 ohms

Write for details.

FRIEZ INSTRUMENT DIVISION of . . .
1454 Taylor Avenue, BALTIMORE 4, MARYLAND
Export Sales: Bendix International Division
72 Fifth Avenue, New York 11, N. Y.

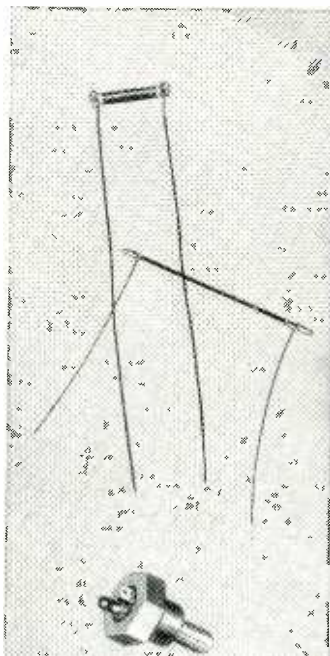

Used in this typical application for sensing the temperature of hydraulic oil.



they may have helped to equalize the output tube lives, but no matter how they twiddled the knobs, they didn't affect the quality of output sound, whether judged by acute ears or measured instrumentally.

It is of course quite true that when 6L6's are operated in the current vogue at maximum or over-maximum ratings, well-regulated screen supplies indeed are advisable. It should be re-stressed, however, that the present design calls for operation of the output tubes at a modest 14 watts or so of plate dissipation—under which condition the omission of screen and cathode bypasses results in no perceptible change in undistorted power output.

The proof of any pudding is in the eating—and of any amplifier design in the hearing and measuring. Even though Mr. Good may not have any 0.1-percent resistors handy, we hope he'll try out this circuit, subjecting it to the most rigorous listening and distortion-measurement tests he can devise.

BENJAMIN B. DRISKO
Hingham, Mass.

R. D. DARRELL
New York City

On a Limb

DEAR SIRs:
THE MEN who developed the Vidicon (P. K. Weimer, S. V. Fogue, R. R. Goodrich and A. D. Cope—see *ELECTRONICS*, May 1950, p 70) have an acute feeling of having been pricked by the branches of your sapling rather than of having reclined comfortably on the strong limbs of your oak tree (see "Evolution of Electronics" *ELECTRONICS*, Sept. 1952, p 98). The unique aspects of the Vidicon represent a solid state problem in photoconductivity of insulators rather than a tube problem in electron optics.

ALBERT ROSE
*Radio Corporation of America
Princeton, New Jersey*

(Editor's Note: We asked tree-designer Bill White about this one. His answer is as follows:)

Falling Leaves

DEAR SIRs:
MR. ROSE is certainly correct in pointing out that the Vidicon de-

SECON

DEVELOPMENT and PRODUCTION METALLURGISTS

Fine wire and ribbon in base, rare, and precious metals, and alloys for new and highly engineered applications. In small units and sizes, and to close tolerances.

Further details on request.



SECON METALS CORPORATION
228 East 45th Street, N. Y. 17, N. Y., MU 7-1594

2KW
VACUUM TUBE
BOMBARDER
OR
INDUCTION
HEATING UNIT

only \$650

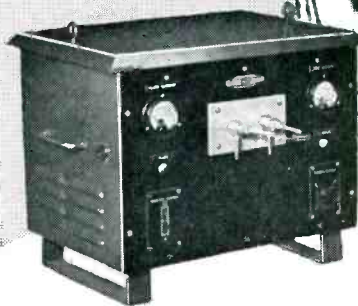

Simple .. Easy to Operate .. Economical
Standardization of Unit Makes This New
Low Price Possible

Never before a value like this new 2-KW bench model "Bombarder" or high frequency induction heater ... for saving time and money in surface hardening, brazing, soldering, annealing and many other heat treating operations.

This compact induction heater saves space, performs with high efficiency Operates from 220-volt line. Complete with foot switch

and one heating coil made to customer's requirements. Send samples of work wanted. Specify time cycle required for your particular job. We will quote on proper size unit for your requirements. Immediate delivery.

Scientific Electric Electronic Heaters are made in the following ranges of power: 1-2-3½-5-7½-10-12½-15-18-25-40-60-80-100-250KW.

Scientific Electric

DIVISION OF "S" CORRUGATED QUENCHED GAP CO.
107-119 MONROE STREET GARFIELD, NEW JERSEY

ACME'S *New* REGULATED D.C. POWER SUPPLIES

NO TUBES

Incorporating the use of magnetic amplifier techniques — eliminating all vacuum tubes — this new Acme Regulated Power Supply provides an extremely dependable, trouble-free precision unit for both industrial and laboratory use. Because of the absence of all tubes, the equipment will give a minimum of 20,000 hours continuous service. It is available in a variety of voltages and frequencies.

Write for complete information.

ACME ELECTRONICS, INC., 300 N. LAKE AVENUE, PASADENA 4, CALIF.

Acme Model S-715 60-cycle Regulated Power Supply. 300 volt D.C. output with $\pm 1\%$ regulation from 0 to 200 MA, with less than .1% ripple.



acme
ELECTRONICS, INC.

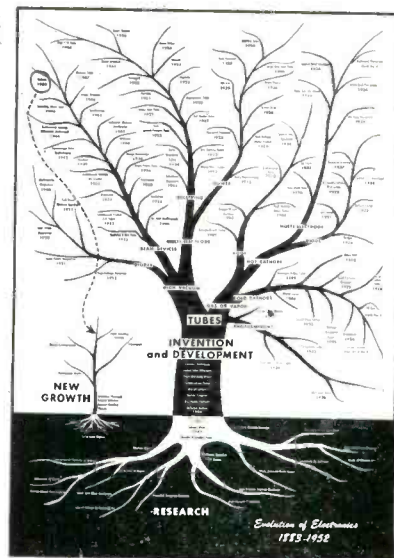

depends as much, if not more, for its action on the semiconductor science as on the use of an electron beam. Therefore, I might well have included it also on the semiconductor tree rather than merely a general reference to the selenium photocell as a development.

Perhaps, in keeping with the analogy to growing things, I should have attempted somehow to portray the Vidicon as a hybrid.

You, with admirable foresight, provided a spare unnamed twig at the top of each main branch. Such an unnamed twig also appears at the top of the semiconductor sapling. I certainly will "write in" the Vidicon alongside this top twig and suggest that others also make this addition.

W. C. WHITE
*Electronics Engineer
Research Laboratory*

(Editor's Note: The change required to give the Vidicon its rightful place on the electronics industry's sapling is indicated in the accompanying reproduction of the "Electronics Tree".)

Ternary Memory

DEAR SIRS:

I WOULD like to clear up two points in connection with my article entitled, "High Speed Counter Uses Ternary Notation" which appeared in the October 1952 issue of ELECTRONICS (p 118).

The title used implies that the feature of the counter is ternary notation. Actually, the interesting

COILS to exact specification for every requirement



QUALITY BUILT COILS FOR RADIO, FM, TV AND GOVERNMENT APPLICATIONS

Uniform high quality, fast delivery and low cost have made Fugle-Miller coils the choice of many leading manufacturers in the radio and electronics industry. All types are supplied including Universal, Bank Wound, Universal Progressive and solenoid coils. JAN specifications are our specialty. Call, wire or write today for prompt quotations.

FUGLE-MILLER LABORATORIES

MAIN STREET, METUCHEN, NEW JERSEY
Telephone: Metuchen 6-2245



FLEXIBLE

DELAY LINES

to meet military specifications

Delay .1 to 2 usec.
Tol. $\pm .05$ usec.
 Z_0 1200 ohms $\pm 15\%$
Delay lines are hermetically sealed and are of non-nutrient construction.

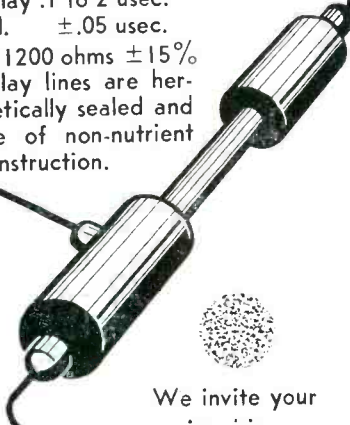

We invite your inquiries.

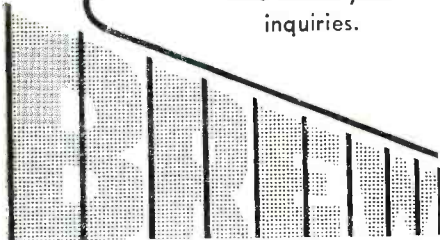

RICHARD D. BREW and CO., INC.
106 CONCORD AVE., BELMONT 78, MASS.

ENGRAVING • PROFILING

for heavy production

with the **Engravo**
graphTM



TRACER
GUIDED FOR
UNSKILLED
LABOR

NEW HERMES, Inc.

13-19 University Place, New York 3, N.Y.

DOUBLE BARREL ADVERTISING

Advertising men agree—to do a complete advertising job you need the double effect of both Display Advertising and Direct Mail.

Display Advertising keeps your name before the public and builds prestige.

Direct Mail supplements your Display Advertising. It pin-points your message right to the executive you want to reach—the person who buys or influences the purchases.

In view of present day difficulties in maintaining your own mailing lists, our efficient personalized service is particularly important in securing the comprehensive market coverage you need and want.

Ask for more detailed information today. You'll be surprised at the low overall cost and the tested effectiveness of these hand-picked selections.

for Results



Mc GRAW-HILL
DIRECT MAIL LIST SERVICE

McGraw-Hill Publishing Co., Inc.
330 West 42nd St., New York 36, N. Y.

Engravo
graphTM

Write for literature describing:

1. Heavy Duty model (as illustrated) — Catalog H 29
2. Portable models — Catalog IM 25

NEW HERMES, Inc. 13-19 University Place, N.Y. 3, N.Y.

In Canada: 359 St. James St., Montreal

World's Largest Manufacturer of Portable Engraving Machines

FS MICROMETER HEAD

for the Electronics Industry

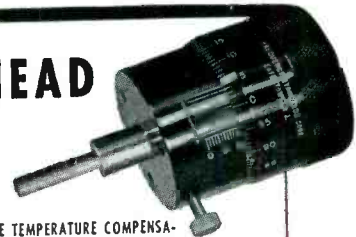

ENGINEERS USING FS MICROMETER HEADS FOR VARIOUS APPLICATIONS FIND THE TEMPERATURE COMPENSATION CONSTRUCTION AND AUTOMATIC COMPENSATION FOR WEAR OF SPINDLE AND NUT THREAD CONTRIBUTING FACTORS TO THE INSTRUMENT'S PRECISE ACCURACY . . . A DEGREE OF ACCURACY IN READING, HITHERTO UNATTAINABLE IN ANY MICROMETER HEAD. SEND TODAY FOR YOUR COPY OF THE NEW DESCRIPTIVE BULLETIN.

FREQUENCY STANDARDS

P. O. BOX 66, EATONTOWN, N. J. • TELEPHONE ASBURY PARK 1-1018

Priced
Right!

WIRE FORMS

& Metal Stampings

High-speed, quality production with custom-made precision. Wire formed to any shape for every need.

**IMMEDIATE CAPACITY FOR
DEFENSE SUB-CONTRACTS
STRAIGHTENING & CUTTING**
Perfect straight lengths to 12 ft.

.0015 to .125 diameter

WIRE FORMS

.0015 to .125 diameter

SMALL METAL STAMPINGS

.0025 to .035 thickness

.062 to 3 inches wide

Specializing in Production of Parts for
Electronic, Cathode Ray Tubes & Transistors

Write for illustrated folder.

Send Blueprints or Samples
for Estimate.

**ART WIRE and STAMPING
COMPANY**
1 BOYDEN PLACE
NEWARK 2, N.

BACKTALK

(continued)

and original feature is the ternary *memory* circuit. The notation is a property merely of the indicating system and could be changed to suit the need.

A second point, which had me puzzled for a while, occurs in the bankhead, presumably written by your staff. It took a lot of thought to figure out the meaning of the statement "Circuit described operates reliably up to 175,000 counts per second using only nine stages." In the first place, the circuit is not restricted to any number of stages. Secondly, what has the number of stages to do with the speed of the counter?

After some deliberation, I concluded that what the statement means is that after nine stages, the input repetition rate will be divided by 3⁹, permitting the use of a mechanical counter with a speed of seven counts per second or higher, to realize the maximum speed of the ternary counter with regularly spaced pulses.

RICHARD WEISSMAN
Cook Research Laboratories
Chicago, Illinois

Vhf Dx

DEAR SIRs:

HAVING read your account of vhf transmission from Cedar Rapids, Iowa to Sterling, Va. in the June 1952 issue of *ELECTRONICS*, I thought your readers might be interested in a series of experiments conducted between my amateur station, W3QKI, and that of Mr. J. A. Kmosko, W2NLY at South Plainfield, New Jersey. By quite a coincidence we began scheduled transmissions also in January of 1951. There were, however, the following noteworthy differences:

(1) Our stations were separated by approximately 330 miles, over fairly rough terrain, including the Appalachian Range in eastern Penna. Thus we were working over about half the distance as from Collins to NBS.

(2) Frequency was at 144 mc or about 3 times Collins' frequency of 49.8 mc.

(3) Transmitter power was about 400 watts as compared to 23 kw



Portable Communication Masts

Available in . . .

STANDARD MILITARY DESIGNS INCLUDING
AB-38/CR, AB-26/CR, AB-54/FR, AB-72, AB-282/GRC

Also in Special Designs to meet particular requirements

- Criton Masts and Antenna Supports are made of Fibre Glass Reinforced Thermosetting Plastic Tubing
- Weight—approx. 1/5 of Steel, 1/2 of Aluminum
- Non-Corrosive—Can't rust, oxidize or mildew
- Not affected by weather, sun or salt spray
- Highly shock resistant
- Easy to erect (90 ft. in less than 1 hour)

MANUFACTURED BY

Southern Industries
OF MARYLAND, INC.

Pikesville

Baltimore 8

Maryland

Phone: Pikesville 3316

*Trademark Reg.

Want more information? Use post card on last page.

ELECTRONICS — January, 1953

at Collins, or about 17 db less.

(4) Antenna gains were about 10 db and 20 db or a net circuit gain of some 30 db. Collins to NBS antenna gain totaled about 36 db.

(5) Receivers employed bandwidths of about 1 kc, and noise figures of about 2.5 db, which gave us a possible edge on receiver performance.

Results

Starting on January 29, 1951, we carried out schedules three nights a week, each time at 10 p.m. These schedules continued through the month of July, reducing to once a week toward the end. It soon became apparent that we could exchange very weak signals with consistency. Due to severe, rapid fading it was difficult to exchange much information, but the amazing fact was that signals were so consistently weak, always fading in and out rapidly, and never reaching more than the same few db above noise level.

Both stations are familiar with super refraction through the troposphere, as well as aurora reflection, and have contacted frequently by these mediums, but the consistent scheduled contacts were definitely of a different nature. After reading the story of Collins' transmissions to NBS at Sterling, Va., I feel it is quite likely that the same, or a similar reflecting medium was used between Erie, Penna. and S. Plainfield, N. J.

One final, significant clue. During August 1951 both stations dismantled antennas, and replaced them with larger and higher arrays. Tests from both stations indicated that average ground wave signals at 100 miles or so had increased considerably in strength, which of course is what we thought we wanted. But, attempted schedules have failed completely since. Apparently our angle of radiation is now too low. A new antenna under construction at W3QKI has a tilt mechanism for controlling the angle, and it is expected that results will prove interesting as well as useful.

HERBERT JOHNSON
W3QKI
Erie, Pennsylvania

COAXSWITCH

COAXIAL SELECTOR SWITCH

CUT-A-WAY VIEW, MODEL 74

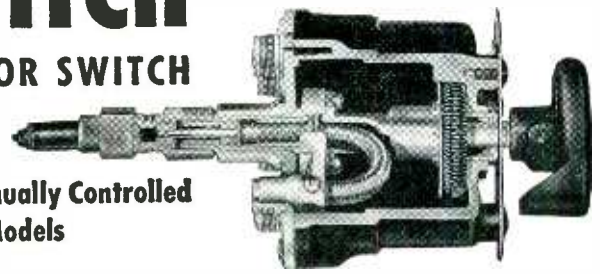

50 Ohms—
Type N Connectors—Manually Controlled
Low VSWR—4 Models

The COAXSWITCH is an RF switch for use in coaxial circuits where it is important that the 50 OHM impedance of the cables be maintained. In a circuit sense, this switch consists of two pairs of "N" connectors spaced 4 1/2" apart using RG-8/U as the connecting link. The COAXSWITCH itself introduces no VSWR other than that of connectors. Characteristic impedance is maintained thru all switch details. Cut-a-

way view shows that shield as well as center conductor is switched. Beryllium copper contacts, on the gooseneck, mate directly with male "N" (Type UG-21B/U) connectors, which connect directly to back plate of switch. Since all connectors come out in line with axis of switch, right angle connectors are usually unnecessary.

Literature Gladly Sent

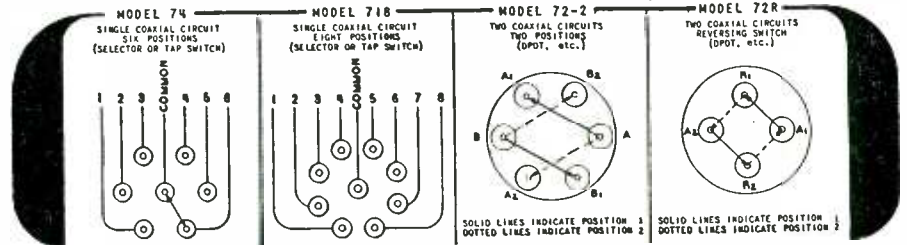

BIRD
ELECTRONIC CORP.
TERMALINE COAXIAL LINE INSTRUMENTS

1800 EAST 38TH ST.
CLEVELAND 14,
OHIO
West Coast:
NEELY ENTERPRISES
HOLLYWOOD 46, CAL.

the only → **HIGH STABILITY OSCILLATOR**
with *Resetability*
and *Stability* to
5 cps/mc

Covering **FREQUENCY RANGE**
from 100 KC to 16 MC • 5 WATT OUTPUT
purpose High stability oscillator designed to give stability equivalent to that obtained by temperature controlled crystal oscillators. Unit may be used as a transmitter-exciter or for laboratory measurement purposes. Completely shielded.

description The final frequency is derived by mixing a crystal controlled frequency with a tunable hi-stability low frequency oscillator and extracting the difference frequency through a variable tuned filter. These frequencies are fed into a balanced modulator where the higher frequency is greatly reduced and the difference frequency or lower side band is passed through a tuned filter. Here it is amplified and used to drive the power output stage.

now in use 500 KW Voice of America Transmitters.

Model 12C specifications

Model	Frequency Range	Power Output (or 75 Ohms)	Price
11 A	100-500 KC	2 watts	\$1600
12 C	500-1500 KC	2 watts	\$1600
13 A	1 MC-16 MC	5 watts	\$1800
14 A	10 MC-60 MC	5 watts	\$1800

Other models to 1000 MC

WUNDERLICH RADIO COMPANY
2 FIFTH AVE.
New York 11, N. Y.

CONTACTS

FOR THE FIELD OF ELECTRONICS



EISLER MANUFACTURES COMPLETE EQUIPMENT

WELDERS FOR SPOT & WIRE BUTT
 RADIO, TV TUBE EQUIPMENT & REPAIR UNITS
 INCANDESCENT, FLUORESCENT MFG EQUIPMENT
 NEON SIGN MAKERS EQUIPMENT, GLASS LATHES
 ELECTRONIC EQUIPMENT, VACUUM PUMPS, Etc.
 Wet Glass SLICING & CUTTING MACHINES for Lab Use
 TRANSFORMERS, SPECIAL & STANDARD TYPES

EISLER ENGINEERING CO., INC.
 751 So. 13th St. Newark 3, N. J.



ELECTRO PLATING

SPECIALISTS IN
 Silver, Cadmium & Zinc
 Barrel Plating

Iridite and Cronak
 Processes

To Government Specifications
 Government Certified

EVEREADY PLATING CO.
 1790 FIRST AV. N.Y.C.
 EN 9-1222

MICO "SOLDERUX"

INSTRUMENT SOLDERING FLUXES

Non-Corrosive. Especially recommended for soft soldering fine wires and small parts of many metals including steel, brass, chromel, constantan, nickel, silver and copper. Mico Solderux Liquid for vigorous action—Mico Solderux Cream for strong action—Mico Solderux Paste for milder action. These fluxes are unique in that chemical action, so necessary in cleaning metals of oxides, grease, and dirt, does not begin until soldering temperatures are reached. When the work cools, any remaining flux subsides into a chemically inert material of low conductivity having non-hygroscopic properties. 1 oz. trial jar — 50¢.

MICO INSTRUMENT CO.
 76E Trowbridge St. Cambridge 38, Mass.

ELECTRICAL COILS

Bobbin, spool, form, layer, interleaved, interwoven types. Made of any material, any finish, for any application.

Send blue-prints and specifications for prompt quotation.



THE FIVE STAR COMPANY

West Main Street
 Plantsville, Conn.

HAVE YOU PROBLEMS IN METAL TO GLASS SEALS?

Name it, We'll make it!
 TERMINALS, HEADERS
 END SEALS, SPECIAL ITEMS
 QUALITY Products Co.
 387 CHARLES STREET
 PROVIDENCE, R. I.

REX RHEOSTAT CO.



MICA

Gauge Glass Gasket Mica in any size also any other large size for electrical use buy direct from nine owners known for quality, honesty and reasonableness. Airmail your requirements to

ARUNA BROTHERS
 3 Keeling Road. New Delhi (India)
 Cables: "MUKTI".

SUBCONTRACTING MILITARY and COMMERCIAL.

Power supplies, controls, test equipment, sub-assemblies, cable and harness work.

PESCHEL ELECTRONICS, INC.
 13 GARDEN ST. NEW ROCHELLE, N. Y.
 New Rochelle 6-3342

This CONTACTS Section

supplements other advertising in this issue with these additional announcements of products essential to efficient and economical production and maintenance. Make a habit of checking this page, each issue.

ANALYSIS OF ALTERNATING CURRENT CIRCUITS

Just Published

Here's a modern introduction to a-c circuits completely devoted to the steady state in lumped linear networks. Notations for potential differences follow newly recommended practices, and the two dimensional quantities used in network analysis likewise are in accord with the latest trends. The appendix gives you a comprehensive coverage of d-c circuits. By Wilbur R. LePage, Professor of Electrical Engineering, Syracuse University. 444 pp., 520 illus., \$6.50

ELECTRONIC MEASUREMENTS

Second Edition

Just Published

Covers measurement fundamentals in many fields beyond conventional radio, including television, radar, and other pulsed systems, microwave techniques, and techniques of value to engineers in other areas who use electronics in their instrumentation. Treats circuit constants and lumped circuits; wave-form, phase, and time interval measurements; receiver and antenna measurements; generators of special waveforms; attenuators and signal generators, etc. By F. E. Terman, Dean, School of Engineering, and J. M. Pettit, Associate Professor of Electrical Engineering, Stanford University. Second Edition, 683 pp., 450 illus., \$10.00

PRINCIPLES OF RADAR

Third Edition

Just Published

Deals with the fundamental concepts and techniques of pulse radar. Presents the engineering principles of the pulse circuits and the high-frequency devices common to nearly all radar systems. Describes the general features of radar systems and system components; discusses pulse circuits and their application to radar modulators, indicators, and receivers. Covers radio-frequency aspects of radar, including basic concepts pertaining to transmission lines, wave-guides, cavity resonators, and antennas, and the techniques of their use in radar systems. By the Massachusetts Institute of Technology Radar School Staff. Revised by J. F. Reintjes, MIT, and Godfrey T. Coate, formerly of MIT. Third Edition, 887 pp., 565 illus., \$7.75

HANDBOOK OF INDUSTRIAL ELECTRONIC CIRCUITS

A ready, practical source of information on the circuits you need for industrial electronic applications. Provides a clearly-drawn diagram for every one of 433 circuits . . . and includes concise descriptions of how the specific circuit works . . . its performance . . . its characteristics. Valuable cross-reference index. By John Markus and Vin Zeiff. Editors, Electronics, 272 pp., 433 illus., \$7.00

SEE BOOKS TEN DAYS FREE!

McGraw-Hill Book Co., 330 West 42 St., N.Y.C. 36
 Send me book(s) checked below for 10 days' examination on approval. In 10 days I will remit for book(s) I keep, plus a few cents for delivery, and return unwanted book(s) postpaid. (We pay for delivery if you remit with this coupon; same return privilege.)
 LePage—ANALYSIS OF A-C CIRCUITS, \$6.50
 Terman—ELECTRONIC MEASUREMENTS, 2nd Ed., \$10.00
 M.I.T.—PRINCIPLES OF RADAR, 3rd Ed., \$7.75
 Markus—HNBK. OF IND. ELECTRONIC CIRCUITS, \$7.00

Name
 Address
 City..... Zone..... State.....
 Company
 Position
 This offer applies to U. S. only.

Shorted Turn Indicator

for unmounted coils

MODEL 101C BULLETIN 42
 HUNTINGTON BEACH, CALIF.
KARTRON

WALKIE-RECORDALL

Continuous, permanent, indexed recording, up to 4 hrs., only 3¢ hr. Instantaneous, permanent playback. Picks up sound up to 60 ft. Records conferences, lectures, dictation, 2-way phone & sales talks; while walking, riding or flying. Records in closed briefcase with "hidden mike"! Write for Detailed Literature.

MILES REPRODUCER CO., INC.

812 BROADWAY Dept E-1 NEW YORK 3, N. Y.

SUB-CONTRACTING

MILITARY and COMMERCIAL

receivers—test equipment
 transmitters—controls
 sub-assemblies

TELETRONICS LABORATORY, INC.
 Westbury, L. I., N. Y. Westbury 7-1028

PROFESSIONAL SERVICES

CROSBY LABORATORIES, INC.

Murray G. Crosby & Staff
Radio - Electronic
Research Development & Manufacturing
Communications, FM & TV
Robbins Lane, Hicksville, N. Y.
Hicksville 3-3191

Professional Assistance . . .

in solving your most difficult problems in the specialized field of electronic devices is offered by consultants whose cards appear on this page.

ALBERT PREISMAN

Consulting Engineer
Television, Pulse Techniques, Video
Amplifiers, Phasing Networks,
Industrial Appliances
Affiliated with
MANAGEMENT-TRAINING ASSOCIATES
3308-14th St., N. W. Washington 10, D. C.

DUBROW DEVELOPMENT CO.

Design — Development — Mfr.
Quality Electronic Equipment
347 High St. Burlington, N. J.
Burlington 3-0446

R. W. HODGSON

PATENT AGENT SPECIALIZING
IN ELECTRONICS
Registered to Practice Before the U. S. &
Foreign Patent Offices
Office—6600 Lexington Ave., Hollywood 38, Calif.
All Mail to Box 874, Sherman Oaks, Calif.
GLadstone 9680

JOSEPH RACKER COMPANY

Radar Consultants & Editors
Technical Manuals
Research and Development
140 Nassau Street, New York 38, N. Y.
Worth 4-1463

EDGERTON, GERMESHAUSEN & GRIER, INC.

Consulting Engineers
Research, Development and Manufacture
of Electronic and Stroboscopic Equipment
Specialists in High-Speed Photography
160 Brookline Avenue, Boston 15, Mass.

HOGAN LABORATORIES, INC.

John V. L. Hogan, Pres.
Applied Research, Development, Engineering
Est. 1929. Electronics, Optics, Mechanisms, Fac-
simile Communication, Digital Computers, Electro-
sensitive recording media, Instrumentation.
155 Perry Street, New York 14. CHelsea 2-7855

W. C. ROBINETTE CO.

MOTRON DEADBEAT HIGH GAIN SERVOS
Speed control of any Prime Mover 1/2% to .001%
average. Electric Transmissions 1/2 to 50 HP plus
controls—Zero droop—No load to full load.
802 Fair Oaks Ave. South Pasadena, Calif.
Py 11594

Eldico of New York, Inc.

Pioneers of Television Interference Elimination from
Transmitters, Induction Heaters, Diathermy and
etc.
Donald J. S. Merten & Engineering Staff
44-31 Douglaston Pkwy Douglaston, N. Y.
Bayside 9-8686

THE KULJIAN CORPORATION

Consultants • Engineers • Constructors
Electronic Control
Specialists
Utility • Industrial • Chemical
1200 N. Broad St., Phila. 21, Pa.

SKINNER, HARLAN AND IRELAND, INC.

Consulting Engineers
Specializing in Magnetic Materials and
Their Application
Office and Laboratory Indianapolis 7, Indiana

ERCO RADIO LABORATORIES, INC.

Radio Communications Equipment
Engineering - Design - Development - Production
Engineers in Frequency Shift Telegraph
Garden City • Long Island • New York

MEASUREMENTS CORPORATION

Research & Manufacturing Engineers
Harry W. Houck Jerry B. Minter
John M. van Beuren
Specialists in the Design and
Development of Electronic Test Instruments
Boonton, N. J.

THE TECHNICAL MATERIEL CORPORATION

Communications Consultants
Systems Engineering
General Offices and Laboratory
121 Spencer Place, Mamaroneck, N. Y.

HARRIS GALLAY

Consultant
MICROWAVE AND
PULSE TECHNIQUES
BE Belleville 2-4237 60 Perry St., Belleville 9, N. J.

Eugene Mittelmann, E.E., Ph.D.

Consulting Engineer & Physicist
High Frequency Heating—Industrial Electronics
Applied Physics and Mathematics
549 W. Washington Blvd. Chicago 6, Ill.
State 2-8021

TELECHROME, INC.

Electronic Design Specialist
COLOR TELEVISION EQUIPMENT
Flying Spot Scanners, Color Synthesizers, Keyers,
Monitors, Oscilloscopes and Related Apparatus
J. R. Popkin-Clurman, Pres. & Ch. Engr.
88 Merrick Rd. Amityville, L. I., N. Y.

HANSON-GORRILL-BRIAN INC.

Products & Mfg. Development
ELECTRICAL - ELECTRONIC
HYDRAULIC - MECHANICAL
One Continental Hill Glen Cove, N. Y.
Glen Cove 4-1922

NIAGARA ELECTRON LABORATORIES

CONSULTATION - DESIGN - CONSTRUCTION
MFG. THE THERMOCAP RELAY
Specializing in solution of problems of electronic
and electro-physical instrumentation for the re-
search of analytical laboratory. Industrial plant
problems also invited.
Andover, New York Cable Address: NIATRONLAB

HARRIS A. THOMPSON

Microwave Electronic Radar
Electro-Mechanical
Consulting
MFG. & DEVELOPMENT PROBLEMS
2525 Penn., Boulder, Colorado Phone 1202W

HIGHLAND ENGINEERING CO.

William R. Spittal & Staff
DESIGN, DEVELOPMENT AND MANUFACTURE
OF TRANSFORMERS, CHOKES, ETC.
FOR THE
ELECTRONIC, INDUSTRIAL & ALLIED FIELDS
Main & Urban, Westbury, L.I., N.Y.
WE 7-2933

PHYSICS RESEARCH LABORATORIES, INC.

Applied Mechanics, Thermodynamics, Heat Trans-
fer, Optics, Magnetic and Electrical Devices, Elec-
tronics, Nuclear Physics.
507 Hempstead Turnpike,
West Hempstead, L. I., N. Y.

WHEELER LABORATORIES, INC.

Radio and Electronics
Consulting—Research—Development
R-F Circuits—Lines—Antennas
Microwave Components—Test Equipment
Harold A. Wheeler and Engineering Staff
Great Neck, N. Y. Great Neck 3-7806

R. W. HODGSON

RESEARCH & DEVELOPMENT ENGINEERS
SPECIALIZING IN ELECTRONICS, NUCLE-
ONICS, INSTRUMENTATION, SERVOMECHA-
NISMS & CYBERNETICS
Office—6600 Lexington Ave., Hollywood 38, Calif.
All Mail to Box 874, Sherman Oaks, Calif.
GLadstone 9680

PICKARD AND BURNS, INC.

Consulting Electronic Engineers
Analysis and Evaluation
of Radio Systems
Research, Development and Design
of Special Electronic Equipment
240 Highland Ave., Needham 94, Mass.

YARDNEY LABORATORIES, INC.

Research - Design - Development
Electro-Chemical Generators of Energy
105 Chambers Street WOrth 2-3374, 35, 36
New York 7, N. Y.

UNDISPLAYED RATE

\$1.50 a line, minimum 3 lines. To figure advance payment count 5 average words as a line. POSITION WANTED & INDIVIDUAL SELLING OPPORTUNITY undisplayed advertising rate is one-half of above rate, payable in advance.

BOX NUMBERS count 1 line additional.

NEW ADVERTISEMENTS ADDRESS N. Y. Office, 330 W. 42 St., N. Y. 36, for the February issue closing January 2nd. The publisher cannot accept advertising in the Searchlight Section, which lists the names of the manufacturers of resistors, capacitors, rheostats, and potentiometers or other names designed to describe such products.

INFORMATION

DISCOUNT 10% if full payment is made in advance for four consecutive insertions of undisplayed ads (not including proposals).

EQUIPMENT WANTED OR FOR SALE Advertisements acceptable only in Displayed Style.

DISPLAYED—RATE PER INCH

The advertising rate is \$14.00 per inch for all advertising appearing on other than a contract basis. Contract rates quoted on request.

AN ADVERTISING INCH is measured $\frac{7}{8}$ inch vertically on one column, 3 columns—30 inches—to a page.

ELECT.

ENGINEERS WITHOUT COLLEGE DEGREES...

We put *no limits* on your engineering future!!

● Are you capable of doing real professional-level engineering work? If you have demonstrated your ability to do first class engineering work but feel you are being handicapped by the lack of a college degree, get in touch with this company.

WE ARE a large manufacturer of Electronic Equipment (Military, Aviation, Automotive, Television) and have over 100-million-dollar backlog. Located on Eastern Seaboard.

● There are many responsible positions open in our organization which offer unlimited opportunity. We want them filled by competent men, regardless of their formal educational backgrounds.

P-5912, Electronics
330 W. 42 St., New York 36, N. Y.

RESEARCH ASSISTANTSHIPS

Ph.D. candidates in chemistry and M. S. candidates in chemistry electrical engineering (Electronics), chemical engineering, physics and geology are wanted by a South-western State University.

These positions provide part-time research duties with time for academic work toward advanced degrees. Stipends are up to \$2,150 for 12 months. Nonresidents fees are waived.

P-5756, Electronics
520 N. Michigan Ave., Chicago 11, Ill.

**ELECTRONIC ENGINEERS
5 OR MORE YEARS EXPERIENCE**

Small electronic research and development laboratory, located 8 miles outside of Washington, D. C., has several openings for senior electronic engineers. Degree essential. Varied projects, including considerable Defense work. Liberal salaries dependent upon experience. Excellent personnel policies.

THE DAVIES LABORATORIES
Incorporated
4705 Queensbury Road, Riverdale, Maryland

SENIOR • JUNIOR

**ENGINEERS
★
TECHNICIANS**

FOR PERMANENT POSITIONS

With a well established progressive organization engaged exclusively in the design and manufacture of specialized electronic equipment; both for defense and for an expanding commercial line. Projects are varied and include radar systems, computers, antenna systems, microwave equipments, airway navigation aids, transmitters and receivers.

Write full resume of education and employment record.
Located in suburban Washington, D. C.

**MARYLAND ELECTRONIC
MANUFACTURING CORPORATION**
5009 Calvert Road
College Park 26, Md.

**ENGINEERS
ELECTRONIC ORGANS**

Design
Development
Quality Control

Unusual opportunities exist with expanding manufacturer in a fascinating field. Send resume to President

ALLEN ORGAN COMPANY
Allentown, Pennsylvania

ELECTRONIC ENGINEERS

We are looking for electronic engineers, with experience in the development of electronic digital computers, to work in the development of business machines. Plenty of opportunities for advancement.

Write, giving full details, including education and experience.

THE NATIONAL CASH REGISTER CO.
South Main and "K" Streets
Dayton 9, Ohio

CANADIAN FIRM

well established in Electronic field wishes to affiliate with U. S. company to manufacture electronic components (or complete equipments) in Canada.

Excellent manufacturing facilities, machine shop and plant with fully trained personnel.

CW-5496, Electronics
330 W. 42 St., New York 36, N. Y.

Patent Available
New Microwave Tube

This unusual tube has interesting possibilities as a new product, as a supplement for existing types, or for new microwave applications. Further development required.

Inventor-ownership; principals only
BO-6270, Electronics
330 West 42nd St., New York 36, N. Y.

REPLIES (Box No.): Address to office nearest you
NEW YORK: 330 W. 42nd St. (36)
CHICAGO: 520 N. Michigan Ave. (11)
SAN FRANCISCO: 68 Post St. (4)

POSITIONS VACANT

ELECTRONICS ENGINEERS and Chief Electronics Engineer required in new electronics division of established company. Must have considerable electro-mechanical development experience preferably in instrumentation, transducers, servomechanics. Salary—Open. These positions are permanent with an opportunity to advance with an entirely new product. Control Cells. 321 West Douglas, Wichita, Kansas.

SALES ENGINEER under 30 years old with a flair for writing wanted. Good job and future open in advertising department of a well-known instrument company located in New England. P-6062, Electronics.

TECHNICAL WRITER wanted. If you have a technical background, some sales experience, and can write we have a good job with a future waiting for you in the industrial advertising field. P-6061, Electronics.

YOUNG ENGINEER wanted who likes to write. Should have some experience in sales work. P-6060, Electronics.

WANTED

Wanted: by U. S. Forest Service, 2760 N. W. Yeon Avenue, Portland, Oregon, Signal Corps Radio Signal Generators, Type I-208. Advise price and condition.

ANYTHING within reason that is wanted in the field served by Electronics can be quickly located through bringing it to the attention of thousands of men whose interest is assured because this is the business paper they read.

RESEARCH AND DEVELOPMENT

*forge the KEY to America's future in the AIR
take YOUR place . . . with GOODYEAR AIRCRAFT*

The continued and steady growth of established research and development projects presents a number of unusual opportunities for outstanding and experienced men.

SCIENTISTS

ENGINEERS

DESIGNERS

Positions are available in our organization for qualified personnel in the following fields:

- | | | |
|----------------------|-----------------------|-------------------|
| • Electrical Systems | • Structures | • Stress Analysis |
| • Circuit Analysis | • Aerodynamics | • Flight Test |
| • Analog Computers | • Applied Mathematics | • Missile Design |
| • Servomechanisms | • Electronics | • Dynamics |
| • Test Equipment | • Physics | • Microwaves |

Openings also exist for welding engineers, civil engineers, and mechanical engineers with experience in metals fabrication; and for personnel with ability and experience in technical editing, art, and motion pictures.

Positions are available at several levels, and inquiries are also invited from recent graduates. Salaries are based on education, ability, and experience. Liberal salary, vacation, insurance, and retirement plans are yours if you qualify.

If YOU are interested in a secure future, write, giving full details, to
Mr. C. G. Jones, Salary Personnel Department.



GOODYEAR AIRCRAFT CORPORATION, 1210 Massillon Road, Akron 15, Ohio

Engineers... **S**cientists...

Mechanical Engineers — Electrical Engineers

Servo Engineers — Aerodynamicists — Physicists — Mathematicians

Do You Know the MELPAR Story?

For complete information about the opportunities available for qualified engineers and scientists write to

PERSONNEL DIRECTOR

melpar, inc.

The Research Laboratory of Westinghouse

Air Brake Co. and its subsidiaries

452 Swann Avenue, Alexandria, Virginia



A NEW Bendix Division! A NEW Electronic Product! NEW JOB OPPORTUNITIES

In our modern plant at York, Pennsylvania, this new division of Bendix Aviation Corporation is producing a new electronic product. This division has a big future; and this is your opportunity to get in on the ground floor, with excellent possibilities for rapid advancement. We need the following:

- **ELECTRONICS ENG.**
- **MECHANICAL ENG.**

Also We have many openings for men qualified by education or experience in all phases of electronics.

YOU BENEFIT

With the Bendix York Division, you will benefit from high wages, paid vacations and holidays and ideal living conditions in a beautiful suburban area.

Write, Wire or Phone,
Department Y-1



**AVIATION CORPORATION
YORK DIVISION**

Phone: York 5521

York, Penna.

electronic designers

For design and layout of UHF equipment, Microwave components and systems.

radio engineers

Minimum 5 years' experience. For research and development in radio and radar systems and components.

engineers

Experienced in the design and development of components for the magnetic deflection of Cathode Ray Tubes.

What can Kollsman mean to you?

OPPORTUNITY

The progressive, growing Kollsman organization offers continuing opportunities in the design and development of America's finest aircraft instruments.

CONVENIENCE

An easy-to-reach modern plant, located in a quiet, residential section of New York.

SATISFACTION

The finest facilities at your disposal . . . friendly, cooperative co-workers . . . many liberal benefits including completely paid life, hospitalization, surgical, accident and health insurance.

Find Out For Yourself — Contact Kollsman Today!

KOLLSMAN INSTRUMENT CORP.

80-08 45th Avenue, Elmhurst

Long Island, N. Y.

ENGINEERS

interested in

COLOR TELEVISION!

Sylvania is leading the field in its development of an all-electronic compatible color television receiver. Your imagination and engineering talent can be used in furthering this development. Here is your chance to get real professional recognition.

Sylvania, a sound, well established firm, is still expanding, still reaching out for new ideas. If you are interested in challenging assignments and definite opportunity for personal growth.

Investigate NOW!

All replies will be held in strict confidence. Send your personal resume' to

JOHN WELD

Supervisor of Employment
Department B

Sylvania Electric Products, Inc.

Radio & Television Division
254 Rano Street

Buffalo 7,

New York



you...

... are headed for a better future —when you come to RCA

If you want to work where you enjoy the highest professional recognition among your colleagues, come to RCA. Here your accomplishments are recognized and rewarded. Here your future is brighter, through challenging assignments that lead to better opportunities, better positions. Here you set goals for future attainment at advanced levels.

If your talent and skill are not being used in a way for which your education and experience has equipped you, come to RCA. Here you will find unusual opportunities to work in close association with distinguished scientists and engineers in research . . . development . . .

design . . . and application of specialized electronic equipment for military projects as well as for an ever-increasing line of diversified commercial products.

Positions open are lifelong *career* opportunities. They are not "temporary" jobs. Unlike "feast or famine" industries,

RCA has forged ahead regardless of war or depression. You can continue advanced study at recognized universities under RCA's modern tuition refund plan. You and your family enjoy outstanding Company benefits. Yes, your future is better at RCA.

LIFETIME OPPORTUNITIES FOR

**ENGINEERS—Electronic . . . Electrical . . . Communication . . .
Mechanical . . . Computer . . . METALLURGISTS and PHYSICISTS**

In Research—Development—Design—Application: in the following fields:

**RADAR • MISSILE GUIDANCE • SERVO MECHANISMS • COMPUTERS • TRANSFORMERS AND
COILS • NAVIGATION AIDS • TELEVISION • ELECTRON TUBES • COMMUNICATIONS
TECHNICAL SALES • ELECTRONIC EQUIPMENT FIELD SERVICE**

Send a complete résumé of
your education and experience.

Personal interviews
arranged in your city.



RADIO CORPORATION of AMERICA

ELECTRONICS — January, 1953

Send résumé to:
Mr. ROBERT E. McQUISTON, Manager
Specialized Employment Division,
Dept. 200A
Radio Corporation of America
30 Rockefeller Plaza, New York 20, N. Y.

**MAKE THIS YOUR HOME
FOR IMPORTANT WORK
UNDER IDEAL CONDITIONS**

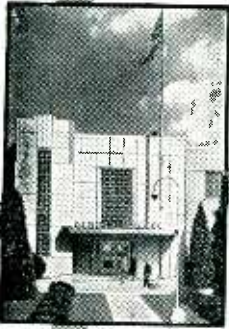

- TV RECEIVER DESIGN ENGINEERS
- ELECTRONICS ENGINEERS
- FIELD ENGINEERS
- TEST & INSPECTION ENGINEERS
- LAB. TECHNICIANS

NEEDED TO WORK ON: Radar, G.C.A., Mobile Radio, Auto Radio, Airborne Communication & Navigation Equipment, Television, Antennas, Microwave Equipment, Servo Mechanisms, Guided Missiles and Test Equipment Design.

YOU BENEFIT AT BENDIX RADIO: from high wages, a modern, air-conditioned plant, paid vacations and holidays, group insurance and a good chance for advancement.

Housing immediately available in the beautiful suburban and country areas that surround the Bendix Radio plant.

Write, Wire or phone
MR. E. O. COLE, DEPT. J. **Bendix Radio**

DIVISION OF BENDIX AVIATION CORPORATION
BALTIMORE-4, MD. Phone: TOWSON 2200

*Makers of the World's Finest
Electronic Equipment*

**ENGINEERS
SYSTEMS
RADAR
SERVO
COMPUTER**

You gain MORE with W. L. MAXSON. Top salaries . . . greater opportunities . . . more responsibilities. Advance with W. L. Maxson.

BACKGROUND: Practical and research experience in advanced Electronic Circuits and Systems Engineering DESIGN & ANALYSIS, related to: Instrumentation, Fire Control, Communications, Navigation, or Optical Fields. Ability in management and supervision desirable.



If your skills are now being fully utilized in a vital defense industry please do not apply.

Kindly send resume and salary requirements to

The W. L. MAXSON Corp.
460 W. 34th ST., NEW YORK 1, N.Y.

We desire personnel of the highest caliber—experienced in the field of airborne automatic electro-mechanical control equipment.

ENGINEERS

MECHANICAL DESIGN
ELECTRONIC
SERVO

DESIGNERS-LAYOUT MEN

ELECTRONIC
MECHANICAL

This work deals with the manufacture and development of highly complex equipment of the most advanced type in a new and expanding division of an established firm with 20 years of successful experience in the precision instrument field.

We cite a few of the good reasons why you might like to join our organization . . .

SALARY increases are based on merit and initiative—two weeks **VACATION**, **HOSPITALIZATION BENEFITS**, GM's own **INSURANCE PLAN**—POSITIONS ARE **PERMANENT** due to long range manufacturing and developing programs—**EXPENSES** incident to interviews and moving all absorbed by company—**HOUSING** and **LIVING CONDITIONS** among the best and finest of any along Lake Michigan.

● We have a Junior Engineering Training Program of one year for inexperienced engineering graduates. Opportunity to become acquainted with all phases of industry.

● For the convenience and direct use of engineers in our Engineering Department, we have our own model shop where highest skilled mechanics are employed.

● Educational opportunities for advanced degrees available at U. of W., Marquette. Technical engineering offered at Milwaukee Vocational School.

. . . all inquiries answered—write or apply . . .

★ AC SPARK PLUG DIVISION

GENERAL MOTORS CORPORATION

1925 E. KENILWORTH PL.

MILWAUKEE 2, WIS.

**ENGINEERS
AND
PHYSICISTS
BS—MS—Ph.D.:**

Responsible positions in mechanical, electrical or electronic engineering, physics or engineering physics for advanced development and design of special equipment and instruments. Prefer men with minimum of two years' experience in experimental research design and development of equipment, instruments, intricate mechanisms, electronic apparatus, optical equipment, servomechanisms, control devices and allied subjects. Positions are of immediate and permanent importance to our operations. Southwestern location in medium sized community. Excellent employee benefits. Reply by letter giving age, experience and other qualifications. All applications carefully considered and kept strictly confidential.

Ind. Rel. Manager
Research & Development Dept.

**PHILLIPS
PETROLEUM COMPANY**
Bartlesville • Oklahoma

Electronics
Research & Development
Positions Open

Cornell Aeronautical Laboratory, Inc. has several professionally challenging and rewarding positions open in the field of Electronic Engineering.

The laboratory was acquired in January, 1946, by Cornell University in response to a widespread need for a stable, highly competent research organization in the aeronautical sciences. Since its acquisition the laboratory has grown steadily to a multi-million dollar annual contract level with a staff of over 850.

The laboratory's projects deal largely with applied science. Typical electronics projects include computer design, radar and microwave applications, precision instrumentation, missile guidance, telemetering, and complex control systems.

Professional growth of staff members is encouraged through regular seminars, attendance at meetings of scientific societies, a graduate study tuition refund program, and constant interchange of ideas and discussions with senior level scientists. Salary level and employee benefit programs are on a par with industry. While the pace of projects is high, the informal organization of the laboratory tends more toward a friendly, thought-stimulating, academic atmosphere. Practical scientists and engineers work closely together in making important contributions to America's scientific progress.

If you would like to learn more about this unique organization or its personnel needs, please feel free to write. No obligation, of course.

**CORNELL AERONAUTICAL
 LABORATORY, INC.**

P.O. BOX 235

BUFFALO 25, NEW YORK

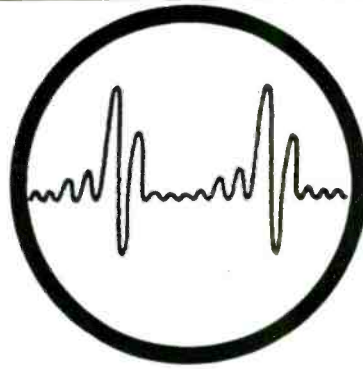

**SPECIAL OPPORTUNITIES FOR
 SENIOR ENGINEERS**

Convair in beautiful, sunny San Diego invites you to join an "engineers" engineering department. Interesting, challenging, essential long-range projects in commercial aircraft, military aircraft, missiles, engineering research and electronics development. Positions open in these specialized fields:

Electrical Design	Servo-mechanisms
Mechanical Design	Aerodynamics
Structural Design	Thermodynamics
Structures	Operation Analysis
Weights	System Analysis

Generous travel allowances to those accepted. For free brochure, write Mr. H. T. Brooks, Engineering Dept. 900

CONVAIR
 IN BEAUTIFUL
SAN DIEGO

3302 PACIFIC HIWAY
 SAN DIEGO 12, CALIFORNIA

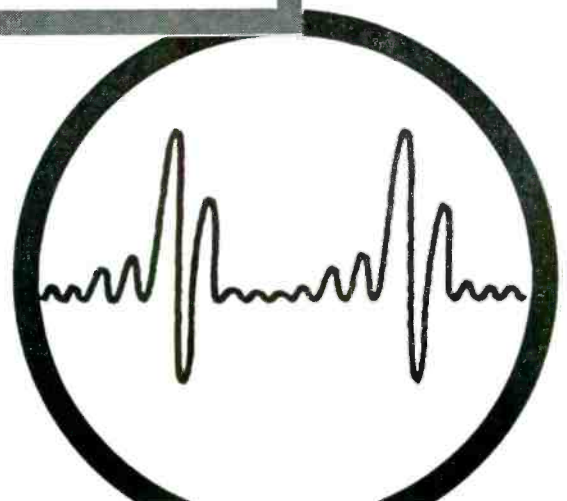

STAFF ENGINEERS

Design and Development

Leading Chicago Electronics firm is seeking the services of qualified men to fill several staff openings in its Electronic Design and Development Division. Persons selected will be given intermediate and advanced level assignments in our well equipped Television, Radio and Government Equipment Laboratories.

Experience in monochrome receivers, deflection and high voltage circuits, radiation interference, NTSC color receivers, color generating equipment or UHF systems essential.

These are permanent positions and offer excellent opportunities for advancement. Company has well planned, long range program of design and development.

Please write Mr. Paul White, Personnel Division, giving related experience and educational qualifications.—Or telephone SPauding 2-0100.

Interviews arranged at your convenience.

Admiral Corporation

3800 W. Cortland St.

Chicago 47, Illinois

SYSTEMS ENGINEERS

For design and installation of radio communication systems of all types in HF, VHF and Microwave bands for use in foreign countries.

Applicants should have experience in either radio propagation studies and antenna design or in the application of telephone and telegraph terminal equipment.

These positions are not dependent on government contracts and would be based in New York with occasional overseas duty.

Send full details to
Personnel Dept.

Radio Corporation of America

RCA International Div.
30 Rockefeller Plaza
New York 20 New York

Electronic ENGINEERS

- CAN YOU PRODUCE?
- LOOKING FOR ADVANCEMENT?
- DO YOU HAVE IMAGINATION?
- ENGINEERING TALENT?
- BROADCAST STUDIO EXPERIENCE?

Our commercial expansion program offers attractive and unusual opportunities for electrical engineers in the sound recording field. Electronic design and development background with mechanical "know-how" required. Positions open include design and development, administration, and Sales Engineering. Replies held in the strictest confidence.

Write or Call Mr. George

Magnecord INC.

225 W. Ohio Street, Chicago 10, Ill.
Whitehall 4-1889

MICROWAVE ENGINEER

1-10 cm. Antenna Design

AND

COMPUTER ENGINEER

Circuits and Systems

Unusual problems on both commercial and defense equipment. Need originality, solid theoretical background and five or more years of design experience.

Excellent opportunity for full development of the professional engineer. An unusual laboratory location in a rapidly growing, well established firm encouraging a broad contribution and giving wide responsibilities.

VICTOR Adding Machine Co.

3900 N. Rockwell Chicago 18

TWO ENGINEERS

... Two engineers, mathematicians or physicists are needed to plan and execute theoretical studies in two general problems of communications and control systems.

Exceptional ability and a Ph. D. or equivalent experience are essential. Training in mathematics and statistics, noise and communication theory, and systems analysis necessary.

Problems involve the synthesis of reliable mechanisms from unreliable components by parallelism or other means, and the application of information and noise theory to radar and communications systems, both as applied to guided missiles.

Send resume including education, scholastic record, experience and references to

California Institute of Technology

Jet Propulsion Laboratory

4800 Oak Grove Drive
Pasadena 3, California

STAVID ENGINEERING, INC.

has openings for
**GRADUATE
ELECTRONIC and
MECHANICAL
ENGINEERS**

Experience in Design and Development of Radar and Sonar necessary.

Broad knowledge of Search and Fire Control Systems; Servo Mechanisms, Special Weapons, Microwave, Antennas and Antenna Mounts, etc. Mechanical Engineer should also have experience in packaging of Electronic Equipment to Gov't specifications including design of complex cabinets, shock mounts and sway brace structures.

FIELD ENGINEERS

Qualified to instruct in the operation and supervise installation, maintenance and repair of Radar, Sonar and allied electronic equipments in the Field.

A chance to grow with a young and progressive company; salary and advancement commensurate with ability; liberal vacation, sick leave, 9 paid holidays, group life, sickness and accident insurance plans, and a worthwhile pension system.

Personnel Office, 200 W. Seventh St.
Plainfield, N. J. - Tel. PL. 6-4806

UHF and MICROWAVE ENGINEERS

This rapidly growing Organization in south central Wisconsin, approximately 100 miles from Chicago, has several openings for Junior and Senior Engineers in the U.H.F. and Microwave fields.

UNUSUAL

SALARY OPPORTUNITIES

exist under ideal working conditions in large, well-equipped laboratories. Personnel benefits such as sickness, accident, and life insurance in addition to a very liberal pension system are offered.

For more information concerning the positions that are open we invite you to write to Personnel Director, Department A.

GIBBS MANUFACTURING & RESEARCH CORPORATION

Janesville, Wisconsin

ENGINEERS

FOR ATOMIC
WEAPONS INSTALLATION

Mechanical Engineers, Electronics and Electrical Engineers, Physicists, Aerodynamicists, and Mathematicians. A variety of positions in research and development open for men with Bachelors or advanced degrees with or without applicable experience.

These are permanent positions with Sandia Corporation, a subsidiary of the Western Electric Company, which operates the Laboratory under contract with the Atomic Energy Commission. The Laboratory offers excellent working conditions and liberal employee benefits, including paid vacations, sickness benefits, group life insurance and a contributory retirement plan.

LOCATE IN THE

Healthful Southwest

Albuquerque, center of a metropolitan area of 150,000, is located in the Rio Grande Valley, one mile above sea level. Albuquerque lies at the foot of the Sandia Mountains which rise to 11,000 feet. Cosmopolitan shopping centers, scenic beauty, historic interest, year 'round sports, and sunny, mild, dry climate make Albuquerque an ideal home. New residents experience little difficulty in obtaining adequate housing in the Albuquerque area.

THIS IS NOT A
CIVIL SERVICE APPOINTMENT

Make Application to the
PROFESSIONAL EMPLOYMENT DIVISION

SANDIA

Corporation

**SANDIA BASE
ALBUQUERQUE, N. M.**

ELECTRONIC ENGINEERS & PHYSICISTS

OUR STEADILY EXPANDING LABORATORY OPERATIONS ASSURE PERMANENT POSITIONS AND UNEXCELLED OPPORTUNITY FOR PROFESSIONAL GROWTH IN

RESEARCH & DEVELOPMENT

GUIDED MISSILES

TELEVISION

ELECTRONIC NAVIGATION

SOLID STATE PHYSICS

VACUUM TUBES

RADAR

THE EMPLOYMENT DEPT.

ADDRESS

INQUIRIES TO **CAPEHART FARNSWORTH CORP.**

FORT WAYNE, IND.

ELECTRONICS ENGINEERS WANTED SOUTHERN CALIFORNIA

Attractive opportunities offered to Engineers experienced in and qualified to design aircraft flush antennas and radomes.

Complete modern facilities for laboratory testing and evaluation available.

Salary dependent upon experience and ability.

Contact Mr. J. C. Buckwalter, Chief Engineer



DOUGLAS AIRCRAFT COMPANY, Inc.
LONG BEACH, CALIFORNIA

ELECTRONIC ENGINEERS

Mechanical Designers for Research and Engineering

To work in the design and development of new electronic equipment. Excellent working and living conditions, good salaries and exceptional employee benefits. Write, giving full details including education and experience. Personal interviews will be arranged.

THE NATIONAL CASH REGISTER COMPANY

Main & K Sts., Dayton 9, Ohio

FLORIDA CALLS ELECTRONIC ENGINEERS

Graduate engineers for R & D in microwave components and receivers, SONAR, transistors, nonlinear circuitry and computers.

Ideal sports, living & working conditions with excellent pay, unusual employee benefits and profit sharing.

Write for application to:

RADIATION, INC.
MELBOURNE, FLORIDA

WILCOX ELECTRIC COMPANY, INC.
of
KANSAS CITY, MISSOURI
requires
ENGINEERS!

with Experience in

- HF and VHF systems
- Aeronautical Equipment
- Application of Advanced Circuit Technique
- Ability to combine associated engineering skills in electronic systems also needed

PROJECT ENGINEERS (2)

who can accept responsibility for successful completion of a system design
These positions are available in a company which supplies equipment to the major airways of the world.

Write stating Education & Professional history to:
A. E. HARRISON, Director of Engineering

WILCOX ELECTRIC COMPANY, INC.
1400 Chestnut Street
Kansas City 27, Missouri

ELECTRONIC ENGINEERS
FOR DESIGN & DEVELOPMENT WORK IN
RADAR

COMPUTERS
DIGITAL TECHNIQUES
with a young progressive company,
send resumé of experience and
education, with salary requirements,
to



Electronic Engineering Company

of California

180 SOUTH ALVARADO STREET LOS ANGELES 4, CALIFORNIA
DUNKIRK 7-7353

NATIONAL MANUFACTURER
of
D.C. POWER SUPPLIES
Desires

Sales Engineering Representatives

Write: Stating present lines and territory.

RW-6215, Electronics
68 Post St., San Francisco 4, Calif.

WANTED
MANUFACTURERS AGENTS
All Territories

Expanded sales policy affords unusual opportunity to represent manufacturer of highest quality open type and hermetically sealed relays and electrical or electronic assemblies. Direct to industry—no jobber sales. Liberal arrangement, prompt quotations and deliveries, good business tactics assured. In reply please mention territory travelled, number of salesmen employed, lines you carry and firms you represent. Write.

RW-6100, Electronics
330 W. 42 St., New York 36, N. Y.

Don't forget

THE BOX NUMBER...

when answering the classified advertisements in this magazine. It's our only means of identifying the advertisement you are answering.

ELECTRONIC ENGINEER WANTED!

An established business organization engaged in development and manufacture of products for VHF and UHF Television Application, requires an individual qualified to work independently, to organize, and to supervise development projects.

This position is to be permanent and will offer the opportunity for unlimited advancement to a successful career. Offers stimulating and congenial surroundings in a newly acquired plant.

Attractive Salary

Write stating qualifications

Blonder-Tongue

LABORATORIES
526-536 North Avenue
Westfield, New Jersey

THE DE HAVILLAND AIRCRAFT OF CANADA LTD.

is requiring experienced engineers for development work on special new projects. Applicants should possess an honours degree together with at least two years industrial experience. Preference will be given to Canadian Nationals.

Employment is offered in four general categories as follows:—

- Physicists.* Men with a sound background of basic physics to work on optical, electronic and mechanical devices.
- Servo Engineers.* A thorough knowledge of basic servo-mechanism theory is essential together with experience in the design and operation of electronic servo systems. A knowledge of air-operated servos would be an advantage.
- Gyro Engineers.* Applicants should have had first hand experience in development work on electrically driven gyros preferably from both the electrical and mechanical viewpoints. A knowledge of production techniques is essential.
- Electro-Mechanical Engineers* to work on accelerometers, proportional relays, high-frequency motors and similar devices. A knowledge of production methods is desirable.

Successful applicants are to be sent to the U.K. for a period of one to two years to work on the research and development team of the parent De Havilland Company. After this period, they will return to Canada continuing the work at De Havilland, Toronto. There, a team of engineers will be built up with the U.K. trained personnel as a nucleus.

Please apply to: Mr. D. G. Simpson

The De Havilland Aircraft of Canada Ltd.

Postal Station "L", Toronto, Canada

WANTED

BD110 Telephone Switchboards, BD100 Telegraph Switchboards, BD90 Power Boards, EE101 V-F Ringers, BE72 Cabinets, FM19 Frames, RA43, REC30, KS5988, RA87, PA37, RA91 Rectifiers, BD101 Test Boards, SB6 Switchboards, Type CF1A, CF3A, CF2B Carrier Equipments. Any condition and quantity.

W-6205, Electronics
330 W. 42 St., New York 36, N. Y.

WANTED

- AN/TRC-1 Equipments.
- T14 Transmitters.
- R19 Receivers.
- TS92 Test Oscillators.

Any condition or quantity

W-3858, Electronics
330 W. 42nd St. New York 36, N. Y.

WE BUY

All kinds of surplus electronic equipment and components.

ELECTRONICRAFT, Inc.

27 Milburn St. Bronxville 8, N.Y.
Bronxville 2-0044

WANTED

MN-53A Marker Beacon Receivers
28 VDC 110 RPM G.E. #5BA10AJ18D motors
28 VDC 120 RPM Delco #506925 motors
28 VDC G.E. #5BA50L157 motors
Westinghouse type CA or CV percentage differential relays.

Furnish full details and prices.

HARBER INDUSTRIALS

3520 W. Ogden Ave. Chicago 23, Ill.

WANTED

Federal type

101B Voice-frequency Ringers
Signal Corps type TA-3/FT.

W-4814, Electronics
330 W. 42 St., New York 36, N. Y.

WANTED

Western Electric gray-finished
EQUIPMENT CABINETS

For 19" panels, Heights of 2' 6", 3' 6",
7' 0" and 7' 6".

W-5956, Electronics
330 W. 42 St., New York 36, N. Y.

Will buy "ALL"

ART - 13 / type T-47A, BC-348 modified, \$55.00.
\$200.00. APN-9, \$200.00.
ART - 13 / type T-47, ARC-3 complete, \$750.00.
\$150.00. R77 Receivers, \$400.00.
BC-348 unmodified, ARC-1, \$600.00.
\$75.00. BC312, \$65.00.
BC342, \$60.00.
Ship via Express C.O.D., subject to inspection to:
H. FINNEGAN
49 Washington Ave. Little Ferry, N. J.

WE BUY...

all kinds of

DOGS

SURPLUS MATERIAL
Aircraft & Electronics

- Amplidynes
- Dynamotors
- Motor Generators
- Switches
- Wire

or What Have You?

ATLAS EQUIP. CO.

229 Southwest Blvd.
KANSAS CITY, MO.

Watch—
the Searchlight Section
for
Equipment Opportunities

WILL PAY TOP PRICE
DM 35 DYNAMOTORS
IN QUANTITY

Must Be in Excellent Working Condition

W-6278, Electronics
330 W. 42 St., New York 36, N. Y.

OIL FILLED CONDENSERS

MFD	VDC	Price	MFD	VDC	Price	MFD	VDC	Price	MFD	VDC	Price
2	400	\$.55	1	1500	\$.69	1	6000	\$9.95	1	25KV	\$85.00
5-5	400	1.65	.5	1500	1.25	.1	7000 R'd	1.79	.001	50KV	24.50
1	600	2.50	3	1500	2.50	1.-1	7000	5.95	.025	50KV	42.50
2	600	.69	4	1500	2.95	1	7500	2.85	.2	50KV	85.00
2-2	600 R'd	.69	1.-5	2000	.95	.075-.075	8KV	6.50	.25	50KV	95.00
3	600	1.65	.25	2000	1.30	1	10KV	29.50	7.5	220VAC	1.95
4	600	.95	3	2000	1.30	1	12KV	8.95	10	330VAC	3.95
4	600 R'd	1.65	1	2000	1.95	1	15KV	45.00	12.75	330VAC	4.10
5	600	1.75	12	2000	8.95	.045	16KV	4.70	15	330VAC	4.50
6	600	1.85	1	2500	2.75	.05	16KV	4.95	5	440VAC	3.10
8	600 R'd	1.85	1.-1	2500	3.85	.05	16KV	8.95	2.9	660VAC	4.25
8-8	600	1.95	32	2500	15.80	.075	20KV	19.95	8	660VAC	4.50
4x4-4	600	2.50	.5	3000	2.40	.25	20KV	54.00			
4x3	600	2.50	1	3000	3.40	1	20KV				
10	600	3.25	2	3000	4.50						
1	1000	.65	.03	4000	1.25						
2	1000	.95	3 x .2	4000	6.95	MFD	VDC	TYPE	Price		
2	1000 R'd	.95	2	4000	1.60	.02	600	OM-6002	\$.45		
3.5-.5	1000	1.85	1	5000	2.50	.05	600	OM-6005	.48		
4	1000	1.95	.2	5000	4.88	.1	600	OM-610	.51		
6	1000	2.50	1	5000	18.50	.25	600	OM-625	.55		
8	1000	3.25	2	5000	29.50	.5	600	OM-650	.60		
1	1200	1.85	5	5000	1.65	1.0	600	OM-601	.85		
1-1-1	1200	1.85	.01-.03	6000							

SOUND POWERED TELEPHONES
 U. S. NAVY TYPE M HEAD AND CHEST SETS
 U.S.I. A-260 W.E. D-173013
 A.E. GL832BA0
 ANY TYPE—\$14.88 EACH
 TS-10 Type Handsets \$9.25

GENERATORS AND INVERTERS
 Eclipse-Pioneer type 716-3A (Navy Model NEA-3A)
 Output-AC 115V 10.4A 800 to 1400cy. 1φ; DC 30
 Volts 60 Amps. Brand new \$38.50
 Eclipse-Pioneer type 1235-1A. Output-30 Volts DC
 15 Amps. Brand New-Original Packing—\$15.50
 PE-218 Inverters-28 VDC to 115 VAC 400 cy 1500
 VA. (New) \$49.50
 Pioneer type 800-1B Inverter-28VDC to 120V 800
 cy 7 amp AC (used) \$22.65
 G. E. Inverter-28 VDC to 120 VAC 800 cy 750 VA
 1φ \$39.50
 ATR Inverter 6VDC to 110 VAC 60 cy 75W \$22.95
 PU-7/AP Inverter-28 VDC to 115 VAC 400 cy 2500
 VA (used) \$75.00
 Eclipse-Pioneer type 12121-A Inverter—Voltage and
 frequency regulated—24VDC 18 Amp Input—AC
 output 115V 3φ 400 cy 250VA 0.7 PF — (New)
 \$225.00

OILMITES

MFD	VDC	Price	MFD	VDC	Price
1	600	\$.45	1	600	\$.45
2	600	.48	1	600	.55
1	600	.60	1	600	.60
1	600	.85	1	600	.85

COAXIAL CONNECTORS



Part No.	Price	Part No.	Price	Part No.	Price
83-1AC	\$.42	83-1RTY	\$.65	83-22R	\$.68
83-1AP	.30	83-1SP	.50	83-22S	.50
83-1F	1.20	83-1SPN	.56	83-22T	1.95
83-1H	.12	83-1T	1.30	83-168	.15
83-1HP	.22	83-2AP	1.95	83-185	.15
83-1J	.75	83-22AP	1.40	83-765	.24
83-1R	.40	83-22J	2.10	83-776	.85

FULL LINE OF JAN APPROVED COAXIAL CONNECTORS
 IN STOCK
 UHL—N—PULSE—BN—BNC

Part No.	Price	Part No.	Price	Part No.	Price
UG-7/AP	\$6.30	UG-22C/US1	6.65	UG-37/U	\$17.50
UG-12/U	.95	UG-23/U	1.20	UG-57B/U	1.85
UG-15/U	1.50	UG-23B/U	1.75	UG-58/U	.80
UG-18/U	1.25	UG-23C/U	1.90	UG-58A/U	1.15
UG-18B/U	1.60	UG-24/U	1.30	UG-59A/U	2.15
UG-19/U	1.80	UG-25/U	1.35	UG-83/U	2.25
UG-20B/U	1.60	UG-27/U	1.30	UG-85/U	1.75
UG-21/U	.95	UG-27A/U	2.95	UG-86/U	2.50
UG-21A/U	1.50	UG-28A/U	3.75	UG-87/U	1.60
UG-21B/U	1.35	UG-29/U	1.55	UG-88/U	1.10
UG-21C/U	1.45	UG-30/U	2.30	UG-89/U	1.35
UG-22/U	1.35	UG-34/U	16.50	UG-90/U	1.60
UG-22B/U	1.50	UG-36/U	17.50	UG-98/U	1.85

QUOTATIONS UPON REQUEST ON ANY CONNECTORS NOT LISTED HERE

Part No.	Price	Part No.	Price
M-358	MC-277	PL-259A	PL-325
M-359	MC-320	PL-274	SO-239
M-359A	PL-258	PL-284	SO-264
M-360	PL-259	PL-293	TM-201

Part No.	Price	Part No.	Price
93-C	49120	D-163950	ES-685696-5
93-M	49121A	D-166132	ES-689172-1

COAXIAL CABLE

Type	Price Per M Ft.	Type	Price Per M Ft.	Type	Price Per M Ft.
RG-5/U	\$140.00	RG-13/U	\$216.00	RG-26/U	\$175.00
RG-6/U	180.00	RG-17/U	650.00	RG-29/U	50.00
RG-7/U	85.00	RG-18/U	900.00	RG-34/U	300.00
RG-8/U	100.00	RG-19/U	1250.00	RG-35/U	900.00
RG-9/U	250.00	RG-20/U	1450.00	RG-54A/U	97.00
RG-9A/U	275.00	RG-21/U	220.00	RG-55/U	110.00
RG-10/U	240.00	RG-22/U	150.00		
RG-11/U	100.00	RG-23A/U	285.00		
RG-12/U	240.00	RG-24/U	675.00		

ADD 25% TO PRICES SHOWN FOR QUANTITIES UNDER 500 FT.

2 φ LOW INERTIA SERVO MOTORS

KOLLSMAN—45 Volt 60 cycle 4 watts 1500 RPM—
 new \$22.50
 PIONEER—10047-2-A 20 volt 400 cycle with 40:1 re-
 duction gear \$10.50
 PIONEER—CK 13 115 volt 400 cycle—includes damp-
 ing signal generator (auto syn) \$47.50

HIGH VOLTAGE TRANSFORMERS

G.E.—Pri. 115V 60 cy. Sec. 6250V 80 MA—12.5 KV
 insulation \$18.50
 G.E.—Pri. 115V 60 cy. Sec. 6250/3850/2600V 56 MA
 12.5 KV insulation \$18.50

ANTENNAS

AT-4/ARN-1 \$8.25
 AT-38A/APT (70 to 400MC) 13.70
 AT-49/APR-4 (300 to 3300MC) 13.70
 AN-65A (P/O SCR-521) 1.50
 AN-65A (P/O SCR-521) 1.75
 A1A-3CM conical scan 125.60
 ASB Yagi—5 element 450 to 560MC. 14.70
 ASB Yagi—Double stacked 6 element. 14.70
 ASA Yagi—Double stacked 370 to 430MC. 29.40

RELAYS

Sigma type 4AH—2000Ω 4 ma DC coil—SPDT con-
 tacts—hermetically sealed 5 pin plug-in base \$3.30
 Sigma type 4R—8000Ω 1 ma DC coil—SPDT con-
 tacts—enclosed type 5 pin plug-in base. \$4.25
 Stevens Arnold type 171 Millisec relay—300 ohm coil
 SPST NO contacts \$3.00
 Cutler Hammer and Square D type B-7A contactor—
 24 VDC coil—SPST NO 200 amp contacts—\$4.75
 Price Bros. type I61-M—220 VAC contactor—SPST
 No double bk 50A contacts \$3.25
 G.E. CR5181-1A6—115 V 60 cy. AC contactor—4PST
 30 Amp contacts plus two auxiliary SPDT con-
 tacts \$14.50
 RBM—115 V 60 cy. AC coil—DPDT 3 amp Con-
 tacts \$3.20

METERS

1 MA DC 3 1/2" R Dejar Mod 310 (0-4KV scale) \$5.75
 500 Microamps, DC—2 1/2" round—Sun \$4.30
 1 ma. DC Fan type—4" scale (rem. from equip.) 3.95
 500 ma. DC 2 1/2" R.—General Electric. 2.95
 2 amp. RF 2 1/2" Sq.—Simpson. 3-15
 5 amp. AC 4 1/2" R.—JBT 4.11
 30 V DC 2 1/2" R.—General Electric. 3.95
 3 amp. RF 3 1/2" R.—Weston. 6.00

CRYSTAL DIODES

Part No.	Price	Part No.	Price	Part No.	Price
IN21	\$1.19	IN27	\$1.79	IN41	\$11.25
IN21A	1.69	IN31	8.10	IN42	18.75
IN21B	3.50	IN34	.66	IN45	.94
IN22	1.09	IN34A	.95	IN52	1.05
IN23	3.95	IN38	1.70	IN55	3.15
IN23A	3.25	IN39	6.25	IN55	3.15
IN23B	4.25	IN40	10.60	IN60	.55

TYPE "J" POTENTIOMETERS

Resis.	Shaft	Resis.	Shaft	Resis.	Shaft
60	9/16"	5K	1/4"	50K	3/8"
100	SS	5K	1/2"	50K	1/2"
200	SS	10K	SS	150K	1/2"
250	1/8"	10K	3/8"	200K	3/8"
500	SS	10K	1/2"	250K	SS
500	5/16"	15K	1/2"	250K	3/4"
500	1/2"	15K	1/2"	250K	3/8"
500	5/8"	20K	SS	500K	SS
650	1/2"	25K	SS	500K	1/4"
1K	SS	25K	1/4"	500K	7/16"
2K	SS	30K	1/8"	1 Meg	SS
2500	SS	40K	SS	2.5 Meg	SS
4K	SS	50K	SS	5 Meg	SS
5K	SS	50K	1/4"		

DUAL "J" POTS.—\$2.95 ea.

TRIPLE "JJJ" POTS.—\$3.95 ea.
 100K/100K/100K 3/8" 20K/150K/15K 3/8"

PULSE TRANSFORMERS

Part No.	Price	Part No.	Price
G.E. K541318	9318	Westinghouse 187AW2F	9340
G.E. 68G-627	9278	Westinghouse 232-AW2	9340
G.E. 68G828	9280	Westinghouse 232-BW-2	9350
G.E. 68G929G1		AN/APN-4 Block Osc.	
G.E. 80G13		Philco 352-7149	
G.E. K-2468B		Philco 352-7150	
G.E. K-2469A		Philco 352-7071	
G.E. K-27448		Philco 352-7178	
AN/APN-9 (901756-501)		Raytheon UX-7350	
AN/APN-9 (901756-502)		Raytheon UX-10066	
AN/APN-9 (332-7250)		W.E. D-161310	
AN/APN-9 (352-7251)		W.E. D-163247	
Westinghouse 132-AW		W.E. D-163325	
Westinghouse 139DW2F		W.E. D-164661	
Westinghouse 166AW2F		W.E. K8-9563	
Westinghouse 176AW2F			

SPARE PARTS FOR ARMY AND NAVY RADIO, RADAR & SONAR EQUIPMENT

Part No.	Price	Part No.	Price
AN/AP5-2	AN/APN-4	AN/ARC-5	OCB
AN/AP5-3	AN/APN-9	SF	OCJ
AN/AP5-4	AN/ARC-1	SL	QCL
AN/AP5-15	AN/ARC-3	SO	WEA

QUOTATIONS UPON REQUEST

SPRAGUE PULSE NETWORKS

7.5 E3-1-200-67P 7.5 KV "E" Circuit 1 Microsec.
 200 PPS 67 ohms impd. 3 sections \$4.30
 7.5 E3-3-200-67P 7.5 KV "E" Circuit 3 Microsec.
 200 PPS 67 ohms impd. 3 sections. \$6.75
 7.5 E4-16-60-67P 7.5 KV "E" Circuit 4 sections.
 16 microsec. 60 PPS 67 ohms impd. \$8.25
 15 E4-91-400-50P 15 KV "E" Circuit 91 microsec.
 400 PPS 50 ohms impd. 4 sections. \$37.50
 15-A-1-400-50P 15 KV "A" Circuit 1 microsec.
 400 PPS 50 ohms impd. \$32.50

"CABLE ADDRESS—LECTRONIC DELPHIA"

LECTRONIC RESEARCH LABORATORIES
 715-19 ARCH ST. PHILA. 6, PA.
 Telephones - MARKET 7-6771-2-3

TUBE SPECIALS

GUARANTEED
BRAND
NEW

STANDARD
BRANDS
ONLY

Receiving Tubes	6AG7	1.59	6SK7	.89	14A7	.97	3GP1	4.95	2050	1.80	EL-5B	8.95	WE-252A	5.65	806	24.50		
OOA	\$1.50	6AH5	1.39	6SK7GT	.89	14B6	.97	3HP7	4.91	2051	1.15	4B24	5.75	WE-254A	5.90	807	1.70	
O1A	.67	6AK5	1.10	6SN7GT	.89	14B8	1.09	4AP10	4.75	Transmitting & Special Purpose Tubes	4E27	17.25	WE-257A	3.77	808	2.65		
O2A	.74	WE-6AK5	2.85	6SN7WGT	2.30	14C5	1.29	5AP1	5.95	OA2	\$.95	4J36	150.00	WE-274A	5.50	809	2.40	
O4A	.90	6AK6	3.95	6SO7	.75	14C7	1.15	5BP4	4.75	OA3	1.51	4J38	120.00	WE-283A	2.85	810	10.95	
1A5GT	.72	6AL5	.99	6SQ7GT	.75	14E6	1.09	5BP4	5.75	OB2	4.95	4J50	375.00	WE-285A	5.57	811	3.60	
1A6	.72	6AL5W	2.90	6SR7	.81	14E7	1.29	5BP4	5.75	OB3	1.29	4J52	400.00	WE-286A	5.57	812	3.95	
1A7GT	.99	6AO5	.89	6ST7	1.25	14F7	.93	5CP1	4.95	OC3	1.20	5D21	26.50	WE-294A	5.75	815	2.95	
1AB5	.99	6AO6	.79	6T7G	1.09	14H7	.93	5HP1	5.75	OD3	1.15	5I23	52.50	304TH	9.75	826	1.45	
1B3GT	.99	6AR5	.79	6T8	1.11	14J7	.93	5HP4	5.75	OB21A	2.85	5J29	18.50	304TL	9.75	828	13.48	
1B4P	1.17	6AS5	.99	6U5	1.19	14K7	.93	5HP4	5.75	IB22	3.25	5K29	18.50	307A	5.50	829	9.95	
1C5GT	.85	6AS6	3.30	6U7G	1.80	14X7	.93	5J2	26.50	IB24	9.95	6AN5	5.95	WE-309A	6.45	829A	14.50	
1C6	.69	6AS7G	4.53	6V6	1.68	19T8	1.16	5LP1	19.75	(West)	12.95	6AR6	3.35	WE-310A	7.50	829B	14.50	
1C7G	.69	6AT6	.63	6V6G	.89	19T8	1.16	5LP5	19.75	1B24(Sylv)	18.95	6C21	29.50	WE-313C	4.15	830B	3.95	
1D5GP	.69	6AU5GT	1.21	6V6GT	.79	22A	1.16	5MP1	10.65	1B24	39.50	6C24	52.50	316A	.89	832	9.95	
1D7G	.69	6AU6	.69	6V6GT	.72	24A	1.16	5MP1	10.65	1B26	7.73	6F4	5.95	327A	4.25	833A	45.00	
1D8GT	.71	6AV6	.63	6W6GT	.99	25A6	1.16	7BP1	8.75	1B26	19.50	7-7-11	1.19	WE-343A	185.00	836	4.10	
1E5GP	.71	6B4	1.60	6X4	.59	25L6GT	.99	7BP12	14.95	1B29	2.90	10T1	.88	WE-346A	2.75	837	1.85	
1F4	.69	6B5	1.20	6X5GT	.59	25Z5	.99	7BP14	14.95	1B32	3.95	10Y	.45	WE-350A	6.95	838	3.25	
1F5G	.69	6B7	.97	6Y6G	.89	26	.79	7CP1	14.95	1B35	11.00	13-4	.27	350B	4.95	841	.59	
1F6	.71	6B8	.99	6Z5GT	.89	27	.69	9G7P	12.85	1B36	12.50	15E	2.35	VE-356B	4.95	841	.59	
1G5GT	.69	6BR8G	.85	7A4	.79	28D7	1.75	9LP7	9.95	1B38	32.50	16A	6.14	361A	4.75	845	5.75	
1G5G	.69	6BA6	.72	7A5	.88	30	.72	10CP4	18.95	1B42	4.95	REL-21	2.25	368A	6.95	845W	6.75	
1G6GT	.69	6BA7	1.20	7A6	.83	30 Spec.	.48	10FP4	24.50	1B41	47.50	24G	1.85	371A	.95	849	29.50	
1H4G	.89	6BC5	.88	7A7	.83	31	.89	10DP7	16.50	1B42	9.80	HK-24	3.95	371B	.95	851	67.00	
1H5GT	.74	6BC7	1.10	7A8	.83	32	.92	12HP7	16.50	1B54	32.50	HK-25	3.82	388A	2.95	852	22.60	
1H6G	.79	6B6GT	1.60	7AD7	1.44	32L7GT	.87	12HP7	16.50	1H20	.88	FG-52	9.50	WE-399A	4.70	853	4.95	
1H6GT	1.01	6BD6	.99	7AD7	1.44	33	.99	902P1	9.50	1S21	3.75	555A	6.75	417A	16.95	861	24.50	
1J5G	.74	6BE6	.72	7B4	.83	34	.83	905	4.45	1S21	3.75	RK-34	4.44	434A	17.50	864	.39	
1J6G	.95	6BF5	1.10	7B5	.83	35	.83	Photo Cells	2B22	2.20	35T	4.95	446A	1.95	365	1.28		
1L4	.69	6BF6	.83	7B6	.83	35B5	.87	IP21	\$35.00	2C21	.75	35T Ion auode	5.95	446B	1.95	366A	1.48	
1LA4	.97	6BG6G	1.92	7B7	.83	35B5	.87	IP23	4.10	2C22	.75	35T Ion auode	5.95	446B	1.95	366B	1.48	
1L6	1.10	6BH6	.99	7B8	.89	35L6GT	.87	IP24	1.27	2C22	.75	35T Ion auode	5.95	446B	1.95	366B	1.48	
1LB4	1.01	6BJ6	.99	7C4	.69	35W4	.85	IP24	1.27	2C24	.49	35T Ion auode	5.95	446B	1.95	366B	1.48	
1LC5	.81	6BK7	1.60	7C5	.83	35Y4	.85	1P18	1.65	2C24	.49	35T Ion auode	5.95	446B	1.95	366B	1.48	
1LC6	.93	6BL7GT	1.45	7C7	1.20	35Z5GT	.59	1P18	1.65	2C24	.49	35T Ion auode	5.95	446B	1.95	366B	1.48	
1LD5	.93	6BN6	1.59	7E5	.58	36	.69	927	1.85	2C40	22.00	EF-50	.79	471A/	1B21A	2.75	886	3.50
1LE3	.93	6D6GT	1.70	7E7	.83	37	.69	931A	6.95	2C42	26.50	53A	5.60	SS-501	12.30	886	3.50	
1LH4	.93	6D6GT	1.70	7E7	.83	37	.69	931A	6.95	2C43	19.25	53A	5.60	SS-501	12.30	886	3.50	
1LN5	.91	6C5	.75	7F7	.99	38	.99	1645	1.95	2C43	19.25	53A	5.60	SS-501	12.30	886	3.50	
1N5GT	.85	6C6	.89	7F8	1.59	39/44	.59	Thyratrons & Ignitrons	7-71	2C46	29.50	53A	5.60	SS-501	12.30	886	3.50	
1N6G	.97	6C6	.88	7G7	1.32	41	.71	OA4G	\$1.32	2C51	5.75	53A	5.60	SS-501	12.30	886	3.50	
1P5GT	.69	6C8G	.96	7H7	1.32	43	.89	EL-CIA	4.75	2C53	12.85	53A	5.60	SS-501	12.30	886	3.50	
1Q5GT	.99	6CD6G	2.40	7H7	1.32	43	.89	2A4G	1.25	2E22	1.80	53A	5.60	SS-501	12.30	886	3.50	
1R4	.69	6D6	.88	7K7	1.32	45	.89	2B4	2.10	2E24	4.10	53A	5.60	SS-501	12.30	886	3.50	
1R5	.89	6D8G	.83	7L7	.97	45Z5GT	.81	2D53	4.95	2J21A	9.95	53A	5.60	SS-501	12.30	886	3.50	
1S4	.71	6E5	1.10	7N7	.97	46	.79	2J22	1.55	2J22	9.95	53A	5.60	SS-501	12.30	886	3.50	
1S5	.81	6F5GT	.83	7O7	.83	47	.89	3C23	9.95	2J26	26.50	53A	5.60	SS-501	12.30	886	3.50	
1T4	.81	6F6	.99	7S7	1.11	49	1.10	3C31/EL	1.95	2J27	24.50	53A	5.60	SS-501	12.30	886	3.50	
1T5GT	.81	6F6G	.99	7S7	1.11	49	1.10	C1B	3.95	2J31	39.50	53A	5.60	SS-501	12.30	886	3.50	
1U4	.86	6F7	.85	7V7	1.11	50A5	1.41	C1B	3.95	2J32	39.50	53A	5.60	SS-501	12.30	886	3.50	
1U5	.81	6F8G	.91	7W7	1.11	50A5	1.41	C1B	3.95	2J32	39.50	53A	5.60	SS-501	12.30	886	3.50	
1V	.69	6G6G	1.06	7Y4	.73	50B5	.88	C1B	3.95	2J32	39.50	53A	5.60	SS-501	12.30	886	3.50	
1X2	1.09	6H6	.83	7Z4	.73	50B5	.88	C1B	3.95	2J32	39.50	53A	5.60	SS-501	12.30	886	3.50	
2A3	1.28	6H6GT	.83	7Z4	.73	50B5	.88	C1B	3.95	2J32	39.50	53A	5.60	SS-501	12.30	886	3.50	
2A5	.65	6J7GT	1.70	12A15	.89	57	.89	EL-C5B	4.95	2J34	39.50	53A	5.60	SS-501	12.30	886	3.50	
2A7	.89	6J5G	.64	12A6	.65	50Y6GT	.92	5C22	53.45	2J36	85.00	53A	5.60	SS-501	12.30	886	3.50	
2B7	.79	6J5GT	.64	12A6GT	.69	55	.69	C6A	6.75	2J37	13.70	53A	5.60	SS-501	12.30	886	3.50	
2E5	.94	6J6	1.09	12A7	1.16	BK55B	.49	C6J	9.95	2J38	17.50	53A	5.60	SS-501	12.30	886	3.50	
2X2	.89	6J7	.99	12A8GT	1.32	56	.69	FG-17/55575.25	6.25	2J38	17.50	53A	5.60	SS-501	12.30	886	3.50	
2X2A	1.85	6J8G	1.28	12A15	.89	57	.89	FG-43	17.50	2J40	49.50	53A	5.60	SS-501	12.30	886	3.50	
3A4	.65	6J8G	1.28	12A15	.89	57	.89	FG-41	12.50	2J48	49.50	53A	5.60	SS-501	12.30	886	3.50	
3A5	1.89	6K5GT	.99	12A16	.59	58	.89	FG-67	14.80	2J49	65.00	53A	5.60	SS-501	12.30	886	3.50	
3A8GT	2.25	6K6GT	.69	12A17	1.15	59	1.24	FG-81A	4.95	2J50	39.50	53A	5.60	SS-501	12.30	886	3.50	
3B7	.15	6K7	.83	12A16	.59	58	.89	91	7.85	2J51	2.50	53A	5.60	SS-501	12.30	886	3.50	
3C6	1.57	6K7G	.88	12A16	.59	58	.89	FG-95/	25.00	2J55	87.50	53A	5.60	SS-501	12.30	886	3.50	
3D6	1.20	6K8G	1.28	12A17	1.15	59	1.24	5560	25.00	2J56	150.00	53A	5.60	SS-501	12.30	886	3.50	
3L4	.91	6L8GT	1.06	12A17	1.15	59	1.24	5561	24.60	2J61	45.20	53A	5.60	SS-501	12.3			



Micro-Wave Lavoie Freq. Meter 375 to 725 MCS

Model TS-127/U is a compact, self-contained, battery powered, precision (± 1 Mc) frequency meter which provides quick, accurate readings. Requires a standard 1.5V "A" and 45V "B" battery. Has 0.5 MIN. time switch. Contains sturdily constructed HI-"Q" resonator with average "Q" of 3000 working directly into detector tube. Uses 957, L88 and 8S4 Tubes. Complete, new with inst. book, probe and spare kit of tubes. Less batteries.

Full data on request \$79.50

HIGH VOLTAGE OIL CAPACITORS

.001 MFD 50,000V DC	\$37.50
.01 MFD 5,000V DC	\$2.95
.02 MFD 8,000V DC	\$9.50
.025 MFD 50,000V DC	\$45.00
.025/.025 MFD 50,000V DC	\$59.50
.1 MFD 500V DC	\$3.95
.1 MFD 3,000V DC	\$2.95
.135 MFD 7,500V DC	\$6.95
.15 MFD 12,000V DC	\$7.50
.2 MFD 50,000V DC	\$69.50
.25 MFD 15,000V DC	\$22.50
.25 MFD 20,000V DC	\$26.50
.25 MFD 50,000V DC	\$79.50
1. MFD 7,500V DC	\$12.50
1. MFD 15,000V DC	\$44.50
2. MFD 6,000V DC	\$14.50



RADIO MODULATOR

Type BC-423-B, or tweeter, is a miniature keying unit, modulator and transmitter combined. A diode mounted atop the tweeter case radiates a signal pulse at 205 megacycles modulated by pulses occurring at 4.098 CPS. Uses 2-6J7, 1-6F6, 1-955, 1-5W4 tubes. Operates from 115V. 60 cy. source. Brand new including tubes and instruction book... \$29.50

MOTOR GENERATORS

2.5 KVA Diehl Elec. Co. 120DC to 120AC, 60 cy., 1 Ph., Complete with Magnetic Controller, 2 Field Rheos and full set spare parts including spare armatures for generator and motor. New. \$295.00
 2 KVA O'Keefe and Merritt. 115DC to 120AC, 50 cy., 1 Ph. Export Crated, New. \$195.00
MOTOR GENERATOR, TYPE CGU-2
 Unit of U. S. Navy TCK-7 Transmitter
 Motor: 2 H.P., 230 V.D.C., 10 amps.
 Generator: 1800V. D.C., 0.4 A, 500V, D.C., 0.35A, 115 V.D.C., 1.5A, 12 V. D.C., 2A, 3480 R.P.M. Self excited. Brand new including spare armature \$365.00

INVERTERS

Onan M-G-215H. Navy type PU/13, Input 115/230, 60 cy., 1 Ph. Output: 115, 480 cy., 1 Ph., 1.2Kw and 26V DC at 4 amps. New. \$295.00
 Leland Elec. Co. PE200A. Input: 28DC at 38 Amps. Output: 80V, 800 cy., 1 Ph., 485VA. New. \$22.50
 G.E. 18169172. Input: 28DC. Output: 115, 400 cy., 1 Ph., 1.5KVA. New. \$32.50
 G.E. 5AS131511A. Model 218A. Input: 28DC. Output: 115, 400 cy., 1 Ph., 1.5KVA. Regulated. New. \$89.50
 Holtzer-Cabot M.G. 164. Input: 440, 3 Ph., 60 cy. Output: 70V, 146 cy. 3 Ph., 0.140KVA. New \$67.50
 Elcor. 74DC to 110AC, 60 cy., 1 Ph. at 2.4 Amps. New. \$39.50

DYNAMOTORS

Navy type CA10-211444. Input: 105 to 130DC. Output: either 26DC at 20 amps, or 13DC at 40 amps. Radio filtered and complete with line switch. New. \$89.50
 Type PE94CM. For SCR-522. Brand new in overseas cases \$19.50

AMPLIDYNES

G.E. 5AM211J7. Input: 27VDC. Output: 60VDC. 150 Watts, 4600 RPM. Type MG-27-B. New \$34.50
 Edison 5AM31RJ18A. Input: 27VDC, 44 Amps. 8300RPM. Output: 60VDC at 8.8 Amps. \$22.50
 Watts. New

SMALL D.C. MOTORS

G.E. 5BA50LJ2A. Armature 27VDC at 8.3 Amps. Field 60VDC at 2.3A RPM 4000. I.P. 0.5. New. \$27.50
 Oster E-7-5. 27.5DC. 1/20HP, 3600RPM. Shunt Wound. New. \$9.50
 Dumore Co. type ELBG. 24VDC. 40-1 gear ratio. For type B-4 Intervalometer. New. \$8.50

BLOWERS

Westinghouse. Type FL. 115V, 400 cy., 6.700 RPM. Airflow 17C.F.M. New. \$9.50
 E.A.D. Type J50-CW-60 cycle-NEW. \$15.50

SYNCHROS

Ford Inst. Co. Synchro Differential Generator. Mod. 3 Type 5SDG. 90/90V, 400 cy., Ord. Dr. 173020. New. \$22.50
 Armor. Synchro Differential Generator. Type 6DG. \$60.00
 Hobart Mfg. Co. Synchro Differential Synchro Type XIX 115V. 60 cy. New. \$9.50

RELAYS

Struthers-Dunn 1BXX129, 110 A.C. \$2.60
 Advance type 455C, SPDT, 115 A.C. \$1.95
 Leach type 1154A, SPDT, 115 A.C. \$2.35
 Leach type 1054, BSN 20-28V D.C. \$2.35
 Clare Plug-in base No. 20FMX 115 A.C. \$2.45
 G.E. Plug-in base Sensitive K274853. \$3.25
 Western Electric D-163781 Plug-in. \$4.95
 Guardian Time Delay type B-9SPDT. \$2.95

SWEEP GENERATOR CAPACITOR



High speed ball bearings. Split stator silver plated coaxial type 5/10 mufd. Brand new
 Price \$2.25

RADAR EQUIPMENT

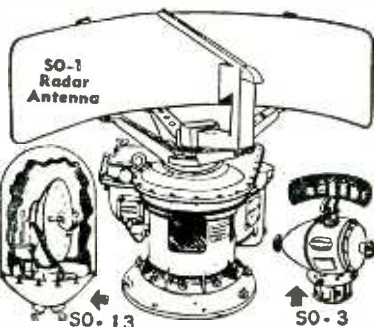

RADAR ANTENNAS

Type SO-1 (10CM) assembly with reflector, waveguide nozzle, drive motor, etc. New. \$279.50
 Type SO-3 (3 CM.) Surface Search type with reflector, drive motor, etc., but less plumbing. New in original cases. \$189.50
 Type SO-13. (10CM.) Complete assembly with 24" dish, dipole, drive motor, bearing, etc. New \$149.50
 Also in stock — spare reflectors, nozzles, probes, right angle bends for SO-1 antennas.

MODEL AN/APA-10 PANORAMIC ADAPTER



Provides 4 Types of Presentation:
 (1) Panoramic (2) Aural
 (3) Oscillographic (4) Oscilloscopic

Designed for use with receiving equipment AN/ARR-7, AN/ARR-5, AN/APR-4, SCR-587 or any receiver with 1.P. of 455 kc. 5.2mc or 30mc. With 21 tubes including 3" scope tube. Converted for operation on 115 V. 60 cycle source.
 Price \$245.00
 Gov't Cost \$1800.00
 AN/APA-10 80 Page Tech Manual. \$2.75

TERMS: Rated Concerns Net 30, FOB Bronxville, New York. All Merchandise Guaranteed
 Prices Subject to Change

400 CYCLE TRANSFORMERS

AUTO. 400 cy. G.E. Cat. No. 80G184.
 KVA .945S-520P Volts 460/345/200/115. New \$4.50
FILAMENT—400/2600 CPS. Input—0/75/80/85/105/115/125V. Output—5V3A/5V3A/5V6A/6.3V 0.5A. No. 7249010—New \$11.95
PLATE WECO KS 9560 800 cy. Pri: 115V. Sec: 1350-0-1350 at .057A (2700 V. Total). Elecstat shielded. Wt. 2.3 lbs. New. \$2.95
 Plate. Thordarson #T46889. 1650 VA. Pri: 105-120V. 500 cy. 1 PH. Sec: 5600V. Center tapped. 1.5KV. insulation. Brand new. \$29.50
PLATE & FIL WECO KS9555, 400 cy. Pri: 115V. Sec. #1: 630-930. Sec. #2: Three 6.3V windings. \$3.95
FILAMENT, 400/2400 cps. WECO KS9553. Pri: 115V. Sec: 8.2V1.25A/6.35V1.5A Elecstat shielded. Wt. 0.5 lbs. New. \$2.95
PLATE & FIL, 400/2600 cy. Pri: 0/80/115V. Sec: #1=1200VDC at 1.5MA. Sec. #2=400 VDC at 130MA. Fil. Secs: 6.4V4.3A/6.35V0.8A (Ins. 1500V)/5V2A/5V2A \$4.95
RETARD, 400 cy. WECO KS9598. 4 Henry 100 MA \$1.75

PULSE TRANSFORMERS

PULSE WECO KS-9563 Supplies voltage peaks of 3500 from 807 tube. Tested at 2000 Pulses/sec and 5000 peak. Wdg. 1-2=18 ohms. Wdg. 1.3=72 ohms. L of Wdg. 1.3=82H at 100 cps. \$3.95
PULSE, WECO KS-161310, 50 KC to 4MC, 1 1/2" Dia. x 1 1/2" high, 120 to 2550 ohms. New. \$3.95
 High Reactance Trans. G.E. type Y-3502A—60 cy. Voltage 1200-135. Inductance H.V. Winding 135 Henries. Output: Peak Voltage 22.8KV. Cat. 8318065G1. New \$39.50

HIGH POT TRANSFORMERS

High Voltage Trans. Westinghouse Pri: 115. 60 cy. Sec: 15,000 C.T., 60 MA. Good for Hi-Pot test set up. C. T. ungrounded. \$39.50

TEST EQUIPMENT

TS-127/U Lavoie Freq. Meter—375 to 725 MC. New with instruction book. \$79.50
 TS-47/APR Test Oscillator. Range on fundamentals 40 to 500 MC. Part of APR test set-up. New with instruction book. \$275.00
 TS-487/U Peak to Peak V.T.V.M. New with instruction book. \$59.50
 R114/APR-5A Receiver. Range from 1000 to 6000 MC. with instruction book. \$575.00
 APR-1 Receiver with TN-18 tuning unit 300 to 1000 MC. with instruction book. \$450.00
 APR-1 Receiver with TN-17 tuning unit and instruction book. \$450.00
 APR-1 Receiver with TN-16 tuning unit. \$450.00
 TU-58 tuning unit (110-370MC). \$85.00

HIGH QUALITY CRYSTAL UNITS

Western Electric—type CR-1A/AR in holders. 1/2" pin spacing. Ideal for net frequency operation. Available in quantities: 5910-6350-6370-6470-6510-6610-6670-6700-7270-7350-7390-7390-7480-7580-9720. All fundamentals in KC. Good multipliers to higher frequencies. \$1.25 each

RAYTHEON VOLTAGE REGULATORS

Adj. Input taps 95-130V., 60 cy. 1 Ph. Output: 115V. 60 Watts, 1/2 of 1% Reg. Wt. 20 lbs. 6 1/2" H x 8 1/2" L x 4 1/2" W. Overload protected. Sturdily constructed. Tropicalized.

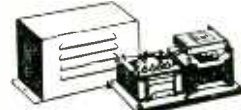

PRICE—NEW \$16.75

ELECTRONICRAFT INC.

27 MILBURN ST. BRONXVILLE 8, N. Y.
 PHONE: BRONXVILLE 2-0044

AMPLIFIERS

GE Servo type 2CV1C1 400 cycle
Constant Output Line RC-730C
Synchro Amplifiers for Radar
Intercommunication type BC-605

ANTENNAS

MR-162 Coast Guard 2 1/2 ft. whips
AS-33 APT-2, AT-38A/APT, AS-62/APS-13
AS-125/APR for APR-5A
TDY RADAR JAMMER HORNS
PARABOLOIDS, MAGNESIUM DISHES 17 1/2" dia.
SCR-623-A (part of RC-153-B Antenna)
CU 64/APT Antenna matching unit 50 ohm unbal.
to 100 bal.

POTENTIOMETERS

W.E. KS-15138 Linear Sawtooth
W.E. KS-8732 for SCR1547 Radar
W.E. KS-8801 Motor Driven

**LINEAR SAWTOOTH
POTENTIOMETER**

W.E. No. KS 15138



The d-c potentiometer consists of a closed type die-cast aluminum alloy frame consisting of a continuous resistance winding to which electric power is supplied through two fixed taps 180 degrees apart. Two rotating brushes (180 degrees apart and bearing on the resistance winding) and two take-off brushes are provided for the output voltage. Varying the position of the brushes varies the output voltage in accordance with a linear sawtooth wave. The potentiometer is excited with 24-volt direct current, is arranged for panel or bracket mounting, is approximately 3-11/16 inches in diameter, 3 inches deep, 4 3/4 inches long, and has an approximate weight of one pound. External connections are made through a standard AN type connector.

Brand New \$5.75

**REPAIR PARTS FOR
BC-348 RECEIVERS (H, K, L, R, Only)**

Also BC 224 Models F, K., Coils for ant., r.f., det., osc., I.F., c.w. osc., xtal filters, 4 gang cond., front panels, dial assemblies, vol. conts., etc. Write for complete list and free diagram.

AUTO TRANSFORMER



G.E. 400 cy. Cat. No. 80G184
K.V.A. .945S—520P Volts 460/
345/230/115 New \$4.50

**G. E.
400 CYCLE
SERVO
AMPLIFIERS**

Type 2CV1C1

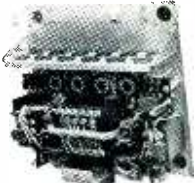

Brand New \$29.50
Metal Dust Cover Included

RADAR EQUIPMENT

Model S.Q. 10CM Portable Radar Set. Operates on 90-130 volt, 60 cy., 1 Phase. Presentation: A, B and P.P.I. Complete with tech. manual and full set of spare parts.

Model ASG-1 Radar with Parabola.
S.O.-11 Modulator unit.
Pulse Timer units for SD5 Radar.
Radar: Crystal units—Raytheon 98.35kc.
S.O. Radar Accessory Control Panels.
S.O. Transmitter-Receiver units.
S.O. Radar Bearing Control Units.
Spare Parts Kit for S.Q. Radar.

PARABOLOIDS

17 1/2" diameter, s p u n
magnesium dishes, 4
inches deep. Reinforced
perimeter. Two sets of
mounting brackets on
rear. Opening at apex
for waveguide dipole
assembly 1 1/2 x 1 3/8".

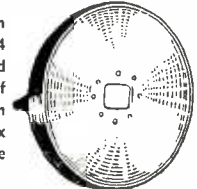

BRAND NEW PER PAIR \$12.50

**G. E. BATTERY CHARGER
Charges 54 cell battery
at from 1 to 10 ampere rate**

Input 115V., 60 cy. 1 Phase.
The model 6RC89F16 Copper Oxide battery charger consists of a transformer, a secondary reactor, a copper oxide rectifying element, a ventilating fan, control circuits and auxiliary equipment necessary for proper operations. Transformer tapped for various supply voltage. Eight secondary taps for adjusting changing rate. Built into metal cabinet. Metered.

Complete with spare fan and fuses. New in original packing cases. Shipping weight approx. 305 lbs.

Price \$255.00

CRYSTAL DIODE

Sylvania 1N21B. Individually boxed and packed in leaded foil.
\$3.00



Westinghouse "Variac type" Controllers; 600 watts; 110/220 designed as an adjustable speed controller but can be used for any application requiring a variable transformer. Brand new and an exceptional buy at \$12.00

FLUXMETER

Used to calibrate field strength of magnets from 500 to 4000 gauss and indicate polarity. Probe has gap of 1 1/4". Beautifully built in hardwood case with hinged cover. Instructions for operation on under side of cover. Size 12 3/4 x 9 x 6 in. Ideal for lab and school use. New. An exceptional value at \$29.50



RELAY



Clare octal base Relay No. 30FMX 115V. 60 cy. 0.140 amp. Res. 75 ohms. Makes two breaks one.

Brand new \$2.45

MISCELLANEOUS

- Cathode Ray Shields for 3" tube. \$3.75
- Variac type Motor Controls 600 watt. \$12.00
- 10 CM Waveguide 90° elbow. \$20.00
- Adel Clamps assorted types—write for samples
- Shock Mounts Lord #20. \$4.40
- Shock Mounts U. S. Rubber #5150. \$4.30
- Commando Pole Jacks (Cook Elec. Co.) \$1.00
- Switchboard Lamp Receptacles & Jewels. . . \$4.40
- SCR522 Transmitter Receivers. Brand New
- Fire Detector Wilcolator
- No. A-4242, Ord. No. B 257736. \$1.00
- Dial Drive Assembly for Bendix, MN-28-Y. . . \$4.50
- Instruction Manual for SCR 193A, B, C, D, E. \$2.00
- Solenoid Cannon 24 V.D.C.—New. \$1.45
- Attenuators Tech-Lab 500/500 type 700. . . \$4.75
- Volume control Dual for RC-433G. \$2.85
- Switch 600 V., 60A. Bendix CB19078. \$9.50
- Switch Arkless 9 sec. Rotary. \$4.50
- Switch Arkless 16 sec. Rotary. \$7.50
- Switch Panels SA-2-TRC. \$12.50
- Switch Micro R-RL2T. \$6.85
- Switch Navy Rotary #647491. \$17.50
- Contact (CRP-23A)GO for SG-1 radar. . . . \$24.75
- Band-Switch assembly for AR-88 receiver. . . \$9.50
- RT-7-AN/APN-1 Receivers
- RC-423B Modulators
- RC-1386M Jack Boxes—Large quantity

AN/APA-10

**POWER
SUPPLY**

Input:
80 or 115 volts.
400 to 2600 cycles



Output:
1200 volts D.C. at 1.5 MA.
400 volts D.C. at 130 MA.
Includes tubes: 1—5R4GY, 1—2x2, 1—6AK5, cathode ray tube socket, resistance capacitance filter, two focus controls, an intensity control and 6AK5 reinsertor circuit. Brand new.
Complete \$13.75

**RADAR REPEATER
ADAPTERS
NAVY TYPE CBM-50AFO**

A repeater unit for video signals and trigger pulses designed to work in conjunction with standard Navy radar equipments wherein provision is made for operation of remote P.P.I. sets. This adapter provides four video and trigger pulse lines for operating one or more remote P.P.I. installations. The equipment contains its own D.C. power supply; 115 Volts, 60 cycles A.C. from ships' power supply line is required for operation. Dimensions are 3 1/2 x 21 x 15 in.

Description:
A: Output Video Signal Lines.
B: Output Trigger Lines.
C: Video Amplifier Bandwidth.
less than 3 db down at 5mc.
4 lines at +2 volts amplitude.
4 lines at +50—+65V. Amplitude.
Flat within 1 db from 60 cy. to 3.5mc.
Uses 8—6AG7, 1—OD3, 3—6SN7, 2—5R4GY.
Full details on request.

**MICRO-SWITCH
S.P.ST NORMALLY CLOSED**

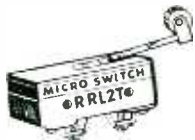

BRAND
NEW
\$.85
EACH

TERMS: Rated Concerns Net 30, FOB Bronxville, New York. All Merchandise Guaranteed. Prices Subject to Change

**24V DC SOLENOID
2 LB. PULL—3/4" STROKE**



BRAND
NEW
\$1.45 Each

**ELECTRONICRAFT
INC.**

27-MILBURN ST. BRONXVILLE 8, N. Y.
PHONE: BRONXVILLE 2-0044

Reliance Specials

GEAR ASSORTMENT
100 small assorted gears. Most are stainless or brass. Experimenters' dream!Only \$6.50



HAYDON TIMING MOTOR
1 R.P.M., 115 V., 60 Cycle.....\$1.95

TIMING MOTOR
8 RPM 115V 60 cyc
E. Inghram Co.



\$1.79

400 CYCLE INVERTERS
Leeland Electric Co.

4000 in: 20-28 V.D.C., 92 A, 8000 R.P.M. Out: 115V, 400 Cyc. 1 phase, 1500 V.A. 90 PF.....\$24.95

3 AG FUSES

Amp.	Per 100	Amp.	Per 100	Amp.	Per 100
1/8	\$4.00	3/4	\$4.00	8	\$3.00
3/8	4.00	1	3.00	10	3.40
1/2	4.00	5	3.00	15	3.00

3 AG FUSE HOLDERS (Finger) 25c

DELAY NETWORK—ALL 1400Ω

T 114—Approx. 2.2 micro sec. delay.....95c
T 115 Similar to T 114 with tap brought out.....1 each

AC LINE CORDS 6 ft. long with molded plug.....10c

BALL BEARINGS

Mfg. No.	ID	OD	Thick	Price
MRC5028-1	5 1/2	6 1/2	1	\$3.75
MRC7026-1	5 5/8	6 5/8	1	3.50
MRC106M2	1 17/64	2 7/16	25/64	1.75
MRC106M1	1 13/64	2 7/16	25/64	1.60
Federal I.S.11	1 1/8	2 1/2	5/8	1.75
Norma S.1R	1 1/8	2 1/8	5/8	1.70
Federal AS41	1 1/16	1 1/2	9/32	1.50
Schatz	3/4	1 3/4	9/16	1.00
Norma 20S	5/8	1 9/16	7/16	.90
ND5202-C13M	1 1/2	1 3/8	1 3/8	1.00
ND 3200	25/64	15/32	11/32	.60
ND R6	3/8	7/8	7/32	.40
MRC39R1	11/32	1 1/32	5/16	.45
MRC38R3	S/16	55/64	13/32	.45

NEEDLE BEARINGS

TORRINGTON B108 3/8" wide 3/4" 13/64".....30c

Brand New Meters—Guaranteed

0-10 ma. D.C. 3 3/4".....\$3.95 0-80 Amp. D.C. 2 1/2".....\$2.50
0-1 Ma D.C. 3 3/4" Delur. (Scale Reads 0-4 KV).....\$5.75

SELENIUM RECTIFIERS

Full Wave 200 MA 115V.....\$1.79
Half Wave 100 MA 115V......91

SOUND POWER HANDSET
BRAND NEW

Includes 5 ft. cord.—Uses no batteries or external power source.
\$18.50 pr

Sound Powered
Chest Set RCA—
With 24 Ft. Cord



Per Pair
USED \$17.60
NEW \$26.40

POSTAGE STAMP MICAS

mmf	mmf	mmf	mmf	mmf	mmf	mmf	mmf	mfd	mfd
10	40	70	125	240	400	680	.0016	.004	
20	47	75	135	250	430	800	.002	.0044	
22	50	80	150	270	470	820	.0027	.005	
23	51	82	160	300	500	910	.0033	.006	
24	56	90	175	330	510	.001	.0036	.0065	
25	60	100	180	360	580	.0012	.0068		
33	62	110	200	370	600	.0013	.0082		
39	62	120	220	390	650	.0015	.01		

Price Schedule

10 mmf to 820 mmf..... 5c
.001 mfd to .0016 mfd..... 5c
.002 mfd to .0052 mfd..... 15c
.01 mfd..... 28c

SILVER MICAS

mmf	mmf	mmf	mmf	mmf	mmf	mmf	mmf	mfd	mfd
10	50	100	170	360	510	.001	.0024	.0047	
18	51	110	180	370	525	.0011	.0025	.005	
22	56	115	208	390	560	.0013	.0027	.0051	
23	60	120	225	400	570	.0015	.0028	.0056	
24	62	125	240	410	680	.0016	.003	.006	
25	66	130	250	490	700	.0018	.0033	.0068	
27	68	135	255	470	800	.0022	.0039	.0082	
30	75	150	260	488	900	.0023	.004		
40	82	155	270	500					

Price Schedule

10 mmf to 700 mfd..... 10c
.0011 mfd to .002 mfd..... 20c
.0022 mfd to .0082 mfd..... 30c

PULSE TRANSFORMERS

UTAH—9262 9278 9289 9318 9340 9350
WESTERN ELECTRIC—D166173 D161310
KS8696, KS9800, KS9862, KS131614
GENERAL ELECTRIC—80-G-5
JEFFERSON ELECTRIC—C-12A-1318
DINION COIL—TR1048 TR1049
also 352-7250-2A; 352-7251-2A; T-1229621-60

COAXIAL CABLE CONNECTORS



UG175/U	51.20	83-1F	30c	83-1AP	75c	83-1J	40c	SO-239	12c	HOOD
83-1AC	\$0.42	UG-23/U	\$1.20	UG-175/U	\$0.15	UG-176/U	15	UG-185/U	.99	
83-1AP	.30	UG-23B/U	1.75	UG-224/U	1.15	UG-255/U	1.95	UG-260/U	.80	
83-1F	1.20	UG-23C/U	1.90	UG-261/U	1.10	UG-262/U	1.10	UG-274/U	2.30	
83-1H	.12	UG-24/U	1.30	UG-280/U	.90	UG-291/U	1.05	UG-306/U	2.65	
83-1HP	.22	UG-25/U	1.35	UG-307/U	1.20	UG-314/U	1.2	UG-499/U	1.25	
83-1J	.75	UG-27/U	1.25	UG-315/U	1.25	UG-514/U	1.25	UG-525/U	1.00	
83-1R	.40	UG-27B/U	3.05	UG-526/U	1.00	UG-527/U	1.00	UG-528/U	1.00	
83-1RTY	.65	UG-28A/U	3.75	UG-529/U	1.00	UG-530/U	1.00	UG-531/U	1.00	
83-1RTP	.45	UG-30/U	2.30	UG-532/U	1.00	UG-533/U	1.00	UG-534/U	1.00	
83-1RSPN	.80	UG-37B/U	1.70	UG-535/U	1.00	UG-536/U	1.00	UG-537/U	1.00	
83-1T	1.30	UG-38/U	2.80	UG-538/U	1.00	UG-539/U	1.00	UG-540/U	1.00	
83-2AP	1.95	UG-58A/U	1.10	UG-541/U	1.00	UG-542/U	1.00	UG-543/U	1.00	
83-2J	2.10	UG-59A/U	2.15	UG-544/U	1.00	UG-545/U	1.00	UG-546/U	1.00	
83-2R	1.70	UG-83/U	1.75	UG-547/U	1.00	UG-548/U	1.00	UG-549/U	1.00	
83-22AP	1.40	UG-85/U	1.70	UG-550/U	1.00	UG-551/U	1.00	UG-552/U	1.00	
83-22R	.68	UG-87/U	1.50	UG-553/U	1.00	UG-554/U	1.00	UG-555/U	1.00	
83-22SP	.80	UG-88/U	1.70	UG-556/U	1.00	UG-557/U	1.00	UG-558/U	1.00	
83-168	.15	UG-89/U	1.10	UG-559/U	1.00	UG-560/U	1.00	UG-561/U	1.00	
83-185	.15	UG-102/U	.80	UG-562/U	1.00	UG-563/U	1.00	UG-564/U	1.00	
UG-13/U	1.70	UG-103/U	.68	UG-565/U	1.00	UG-566/U	1.00	UG-567/U	1.00	
UG-21/U	.95	UG-104/U	1.40	UG-568/U	1.00	UG-569/U	1.00	UG-570/U	1.00	
UG-21B/U	1.05	UG-106/U	1.2	UG-571/U	1.00	UG-572/U	1.00	UG-573/U	1.00	
UG-22/U	1.30	UG-146/U	2.00	UG-574/U	1.00	UG-575/U	1.00	UG-576/U	1.00	
UG-22A/U	1.60	UG-167/U	5.70	UG-577/U	1.00	UG-578/U	1.00	UG-579/U	1.00	

NEW COAXIAL CABLES

RG 5 U*	Price per 1000 ft.	RG 22 U*	Price per 1000 ft.
RG 6 U	\$140.00	RG 22A U	\$135.00
RG 7 U	180.00	RG 24 U	285.00
RG 8 U	80.00	RG 24A U	675.00
RG 9 U	100.00	RG 26 U	475.00
RG 10 U	250.00	RG 27 U	325.00
RG 11 U	275.00	RG 34 U	300.00
RG 12 U	240.00	RG 35 U	900.00
RG 13 U	100.00	RG 41 U	295.00
RG 14 U	150.00	RG 51A/U	97.00
RG 15 U	240.00	RG 55/U	110.00
RG 16 U	250.00	RG 57/U	325.00
RG 17 U	650.00	RG 58/U	60.00
RG 18 U	900.00	RG 58A/U	65.00
RG 19 U	1250.00	RG 59/U	70.00
RG 20 U	1450.00	RG 62/U	70.00
RG 21 U	220.00	RG 77 U	100.00

Add 25% for orders less than 500 feet.

* No minimum order—others 250' minimum.

UNIVERSAL JOINT ALUMINUM
1/4" hole x 1/2" O.D.
1 1/8" long **85c**

SPAGHETTI SLEEVING—assortment—99 feet.....\$1.00

TYPE "J" POTENTIOMETERS

100 S.S.*	1,500 1/4S.S.	15K 1/4	200K S.S.*
150 S.S.*	2,000 1/4	25K S.S.	250K 5/8
300 S.S.*	2,500 3/8	70K S.S.	250K S.S.*
400 S.S.	3,000 3/8	80K S.S.	500K S.S.*
500 S.S.	4,000 3/8	100K 7/16	1Meg S.S.*
1,000 3/8	5,000 3/4	100K S.S.*	
1,000 S.S.	10K 5/8	200K 5/8	

* Split Locking Bushing **\$1.25 EACH**

TYPE "JJ" POTENTIOMETERS

Ohms	Shaft	Ohms	Shaft	Ohms	Shaft
1000	S.S.	30K-10K	3/8"±	1 Meg.	1/2"
10K	5/16"	3K-90K	1/4"	1 Meg.	S.S.
15K	S.S.			1 Meg.	S.S.

SD—Screw Driver
* Split Locking Bushing
± With Switch

PRICE—\$2.00 EACH

JONES BARRIER STRIPS

2-140Y	\$0.17	3-141W	\$0.27	9-141Y	\$0.71
3-140 3/4 W	.21	4-141	.24	3-142	.24
6-140	.28	5-141	.29	2-150	.43
10-140W	.59	5-141 3/4 W	.41	3-150	.60
10-140 3/4 W	.59	7-141 3/4 W	.56		
3-141 3/4 W	.27	8-141 3/4 W	.64		

TIME DELAY RELAY

Raytheon CPX 24166
1 Min. Delay, 115 V., 60 Cycle
2 1/2 second recycling time spring return •
Microswitch contact, 10A • Holds ON as long as power is applied • Fully Cased •
ONLY \$6.50

AN CONNECTORS
IMMEDIATE SERVICE
PHONE! WIRE! WRITE! YOUR NEEDS

RELIANCE MERCHANDIZING CO.

Arch St., Cor. Croskey Phila. 3, Pa. Telephone Rittenhouse 6-4927

PRECISION RESISTORS—1/4 WATT—30c

2	10.48	12.32	14.98	62.54	147.5	705
2.5	10.84	13.02	15.8	79.81	220.4	2,193
3.5	11.25	13.52	16.37	105.8	301.8	3,500
5	11.74	13.89		123.8	306.6	
6.68				125	414.3	59,148

PRECISION RESISTORS—1/2 WATT—35c

.25	11.1	75	400	6,500	16,000	36,000
.334	13.15	87	723.1	7,000	16,700	37,000
.444	13.3		855	7,300	17,000	45,000
.502	15	125	970	7,500		47,000
.575	25	178	1,500	8,000	20,150	60,000
.627	44.					

ALNICO FIELD MOTORS



(Approx. size overall) . . .
3 3/4" x 1 1/4" diameter)
Delco-Type #5069370: 27.5
volts; DC; 145RPM. . . \$19.95 ea.

PM Motor, Delco Type #5069370: 27.5 volt;
DC Alnico Field; 10,000 r.p.m.; dimensions
1" x 1" x 2" long; shaft extension 1/2", diam-
eter 0.125" . . . \$12.50
PM Motor, Diehl Mfg. SS FD6-21: 27.5 volt;
DC Alnico Field; 10,000 r.p.m.; dimensions
1" x 1" x 2" long; shaft extension 1/2" diam-
eter 0.125" . . . \$12.50

AC CONTROL MOTOR

Diehl Mfg. Co., FPE-25-7, 20 Volts, 2 ph
1600 RPM, .85 amps. . . \$15.00
Diehl Mfg. Co., FPE-25-11: 75 to 115 volts;
11 amps, 60 cycle, 2 phase 2 pole. Low in-
ertia motor, 5 watts output. . . \$30.00
AC CONTROL MOTOR, DIEHL FPE 19-2:
115 Volt; 60 Cycle; .32 Amp; 2 Phase; OUT-
PUT; 11 Watts; 2 Pole. . . \$69.50 ea.
A. C. SYNCHRONOUS MOTOR TYPE RBC
2505: Volts 115; Cycles 60; RPM 60; Mfg.
HOLTZER CABOT ELECT. Approx. size;
2 5/8" x 2 5/8" x 2 5/8" . . . \$15.00 ea.

400 CYCLE MOTORS

PIONEER: TYPE CK5 2 Phase; 400 cycles
\$35.00 ea.
EASTERN AIR DEVICES TYPE J49A: 115 V;
0.1A; 7000 r.p.m.; Single phase 400
cycle . . . \$17.50 ea.
AIRESEARCH: AC Induction, 200 V; 3
Phase, 400 Cycle, 2 H.P.; 11,000 RPM; 8
amps. . . \$79.50 ea.
AIRESEARCH: AC Induction, 200 V; 3
Phase, 400 Cycle, 12 H.P., 6500 RPM; 1.5
amps. . . \$25.00
Electric Motor; PNT-1400-A1-A Serial
No. 207, 208 V., 400 cycles, 3 phase Kearfoot
Co., Inc. . . \$17.50 ea.

SERVO MOTOR 10047-2-A; 2 Phase;
400 Cycle; with 40-1 Reduction Gear
\$10.00 ea.

SMALL DC MOTORS

(Approx. size, . . . 4" long x 1 1/4" dia.)
General Electric Type 5BA10AJ33: 27 volts;
DC; .5 amps; 8 oz. inches torque; 250 RPM;
shunt wound; 4 leads; reversible. \$12.50 ea.
General Electric, Mod. 5BA10AJ33: 12 oz.
inches torque, 12 V DC, 56 RPM, 1.02 amp.
\$15.00 ea.
General Electric-Type 5BA10AJ52C: 27
volts, DC; .5 amps; 8 oz. inches torque;
145 RPM; shunt wound; 4 leads; reversible
\$12.50 ea.
GENERAL ELECTRIC DC MOTOR Mod.
5BA10AJ64, 160 r.p.m.; 65 amp; 12 oz.-in.
torque; 27V DC. . . \$19.95 ea.

BLOWER



Eastern Air Devices,
Type J31B: 115 volt;
400-1200 cycle; single
phase; variable fre-
quency; continuous
duty; L & R #2
blower; approx. 22 cu.
ft./min. . . \$15.00

BLOWER ASSEMBLY

115 Volt, 400 Cycle, Westinghouse Type
FL 17CFM, complete with capacitor
New . . . \$12.50 ea.

MICROPOSITIONER

Barber Colman AYLZ 2133-I Polarized D.C.
Relay; Double Coil Differential sensitive,
Alnico F. M. Polarized field, 24V contacts;
.5 amps; 28 V. Used for remote positioning,
synchronizing, control, etc. . . \$12.50 ea.



SENSITIVE ALTIMETERS

Pioneer Sensitive altimeters,
0-35,000 ft. range . . . cali-
brated in 100's of feet. Baro-
metric setting adjustment. No
hook-up required. . . \$12.95 ea.

INVERTERS



10563 LELAND ELECTRIC

Output: 115 VAC; 400 cycle; 3-phase;
115 VA; 75 PF. Input: 28.5 VDC; 12
amp. . . \$80.00 ea.

PE 218 LELAND ELECTRIC

Output: 115 VAC; Single Phase; PF 90;
380/500 cycle 1500 VA. Input: 25-28 VDC;
92 amps; 8000 RPM; Exc. Volts 27.5.
BRAND NEW . . . \$39.95 ea.

MG 153 HOLTZER-CABOT

Input: 24 V, DC, 52 amps; Output: 115
volts—400 cycles, 3-phase, 750 VA, and 26
Volt—400 cycle, 250 VA. Voltage and fre-
quency regulated. . . \$95.00 ea.

PIONEER 12130-3-B

Output: 125.5 VAC; 1.15 amps, 400 cycle
single phase, 141 VA. Input: 20-30 VDC,
18-12 amps. Voltage and frequency regu-
lated . . . \$89.50 ea.

E-1616-2 EICOR, INC.

100 V.A.; 3 Phase; 115 Volts; 400 Cycle
.95 P. F. Input: 27.5 Volts, 9.2 Amps; Con-
tinuous duty . . . \$79.50 ea.

12116-2-A PIONEER

Output: 115 VAC; 400 cycle; single phase;
45 amp. Input: 24 VDC 5 amp. . . \$90.00 ea.

10285 LELAND ELECTRIC

Output: 115 Volts AC, 750 V.A., 3 phase,
400 cycle, .90 PF, and 26 volts, 50 amps,
single phase, 400 cycle; 40 PF. Input:
27.5 VDC, 60 amps, cont. duty, 6000 RPM.
Voltage and Frequency regulated. . . \$195.00

10486 LELAND ELECTRIC

Output: 115 VAC; 400 Cycle; 3-Phase; 175
VA; .80 PF. Input: 27.5 DC; 12.5 amp; Cont.
Duty . . . \$90.00 ea.

METERS

AMMETER; DC; 2" 100-100, complete
with external shunt. . . \$5.95 ea.
AC Volt, Westinghouse, Type NA-35—3-
inch round, F.S.-10 MA. . . \$6.95 ea.
AMP METERS; D.C., 0-300 amps, 3" round
type complete with external shunt. \$6.95 ea.
ELAPSED TIME METER, Aero Instru-
ment Co.—Model 1001. Records operating
time of AC electrical and electronic equip-
ment. Registers up to 9,999.9 hours in
1/10th hour increment . . . then automati-
cally resets. Diameter 3 1/2" with glass cov-
ered face. 120 VAC; 60 cycle. NEW. \$14.95



**SCHWEIN
REMOTE CONTROL
DUAL GYRO**

Free and rate gyro type
45600. Contains two 28 volt
D C constant speed gyros . . .
one operates horizontally,
the other vertically. Vertical
master gyro influences hori-
zontal gyro position, which
in turn will actuate a series of limiting
switches controlling any number of elec-
trical devices. Both gyros turn in excess of
the 30,000 rpm. Size 8" x 4 1/4" x 4 1/4". Comes
with metal cover. . . \$22.50 ea.

BLACK & DECKER

MOTOR AN 94-32159-
A; Volts 24; 1 amp;
series wound; 12,000
RPM; 1/75 H.P.; Cont.
duty; overall size 5-3/4" x 3" dia. . . \$9.95 ea.



PIONEER GYRO FLUX GATE AMPLIFIER
Type 12076-1-A, complete with tubes
\$27.50 ea.



G. E. GENERATORS

General Electric Type 5ASB-
31JJ3; 400 cycles out at 115
volts; 7.2 amps; 8,000 rpm.;
size 6" long x 6" dia.
\$99.50 ea.

**SINE-COSINE GENERATORS
(Resolvers)**

Diehl Type FJE43-9 (Single Phase Rotor).
Two stator windings 90° apart, provides
two outputs equal to the sine and cosine of
the angular rotor displacement. Input volt-
age 115 volts, 400 cycle. . . \$30.00 ea.
Diehl Type FPE-43-1 same as FJE-43-9
except it supplies maximum stator voltage
of 220 volts with 115 volts applied to
rotor. . . \$25.00 ea.
Arma Resolver Type 213044; equal in size
to size 5 synchro; 55-60 cycle; single phase
primary, 2 phase secondary. . . \$79.50

GENERATORS

Eclipse-Pioneer; 716-3A (Navy Model NEA-
3A) OUTPUT: 115 VAC; 1400 amps; 800
cycle; single phase; 28.6 VDC; 60 amps @
2400 rpm; spline drive; self exciting; wt.
60#. . . \$39.95 ea.

POWER UNIT PU-6/TPS-1

Gasoline driven 2-cycle engine. Dual volt-
age generator; 120 VAC; 1400 watt; 400
cycle; 28 VDC; 14.3 amp.
BRAND NEW . . . \$295.00

**SYNCHRONOUS
SELSYNS**

110 volt, 60 cycle,
brass cased, approx.
4" dia. x 6" long.
Mfg. by Diehl and
Bendix.



Quantities Available.

REPEATERS . . . \$20.00 ea.
TRANSMITTERS . . . \$20.00 ea.

SYNCHROS

IF Special Repeater (115V-400 Cycle)
\$15.00 ea.
2JIF3 Generator (115-400 cyc.) . . \$10.00 ea.
5CT Control Transformer; 90-50 Volt; 60
Cyc. . . \$50.00 ea.
5F Motor (115/90 volt—60 cyc.) . . \$60.00 ea.
5G Generator (115/90 volt—60 cyc.)
\$50.00 ea.
5/DG Differential Generator (90/90 volts
—400 cyc.) . . \$30.00 ea.
TRANSMITTER, BENDIX C-78248; 115
Volt, 60 Cycle . . . \$25.00 ea.
Differential—C-78249; 115 Volt; 60 Cycle
\$5.00
REPEATER, BENDIX C-78410; 115 Volt;
60 Cycle . . . \$37.50 ea.
REPEATER, AC synchronous 115 V, 60
cycle, C-78863 . . . \$15.00 ea.
7G Synchro Generator (115/90 volt; 60
cycle) . . . \$75.00
6G Synchro Generator (115/90 volt; 60
cycle) . . . \$60.00
6DG Synchro Differential Generator . . \$60.00
voltage; 60 cycle) . . . \$60.00
2J5F1 Selsyn Control Transformer; 105-55
Volts; 60 Cycle . . . \$50.00
2JD5J2 Selsyn Motor; 115-90 Volts; 60 cycle
\$50.00
5JD5HA1 Selsyn Generator; 115-105 Volts;
60 cycle . . . \$50.00
2JIF1 GENERATOR; 115—57.5 Volt; 400
cycle . . . \$12.50 ea.
2JIIH DIFFERENTIAL GENERATOR; 57.5
—57.5 Volt; 400 cycle. . . \$12.50 ea.
2JIG1 CONTROL TRANSFORMER; 57.5—
57.5 Volt; 400 cycle. . . \$7.50 ea.

PIONEER AUTOSYNS

AY-1 . . . 26 Volt—400 Cycle. . . \$6.95
AY-5 . . . 26 Volt—400 Cycle. . . \$7.95
AY27D . . . 400 Cycle. . . \$25.50
AY6—26 Volt—400 cyc. . . \$4.95 ea.
AY30D—26 Volt—400 cyc. . . \$25.00 ea.
AY14D . . . \$14.00
AY34 . . . \$20.00
AY20—26 Volt—400-cyc. . . \$12.50 ea.

PIONEER TORQUE UNITS

TYPE 12604-3-A: Contain CK5 Motor cou-
pled to output shaft through 125:1 gear
reduction train. Output shaft coupled to auto-
syn, follow-up (AY43). Ratio of output
shaft to follow-up Autosyn is 15:1. \$70.00 ea.
TYPE 12602-1-A: Same as 12606-1-A ex-
cept it has a 30:1 ratio between output shaft
and follow-up Autosyn. . . \$70.00 ea.
TYPE 12603-1-A: Same as 12606-1-A ex-
cept it has base mounting type cover for
motor and gear train. . . \$70.00 ea.

Immediate Delivery

ALL EQUIPMENT FULLY GUARANTEED

All prices net FOB Pasadena, Calif.

C and H Sales Company

BOX 356-X EAST PASADENA STATION • PASADENA 8, CALIFORNIA

NEW YORK'S RADIO TUBE EXCHANGE

TYPE	PRICE	TYPE	PRICE	TYPE	PRICE	TYPE	PRICE	TYPE	PRICE	TYPE	PRICE
OA2	\$1.40	2E30	2.75	4B26	10.95	45 Special	.35	434A	29.95	803	7.95
OA3	1.75	2J21	17.95	4C27	25.00	RK39	2.95	446A	1.95	804	13.50
OB2	1.75	2J22	17.95	4C28	35.00	HF50	1.75	446B	5.40	805	5.95
OC3	1.25	2J26	27.75	4E27	17.50	VT52	.25	450TH	45.00	806	25.00
OD3	1.25	2J27	29.95	4J25	199.00	RK72	1.95	450TL	45.00	807	1.69
C1B	6.95	2J31	29.95	4J26	199.00	RK73	1.95	464A	9.95	808	3.50
1B21A	2.75	2J32	69.95	4J27	199.00	100TH	9.95	471A	2.75	810	11.00
1B22	3.95	2J36	105.00	4J31	199.00	FG105	19.00	527	15.00	811A	3.15
1B23	9.95	2J38	17.95	4J32	199.00	203A	8.95	WL530	3.50	813	9.95
1B24	17.95	2J40	35.00	4J33	199.00	211	.95	WL531	22.50	814	3.95
1B26	2.95	2J42	189.00	4J37	199.00	217C	18.00	WL533	17.50	815	3.50
1B27	13.50	2J49	195.00	4J38	89.00	242C	10.00	700A/D	25.00	816	1.45
1B32	4.10	2J50	195.00	4J39	199.00	244A	12.95	701A	7.50	829	12.95
1B38	33.00	2J55	95.00	4J41	199.00	249C	4.95	703A	6.95	829A	13.95
1B42	19.95	2J61	75.00	C5B	3.95	250TL	19.95	705A	3.95	829B	15.95
1B51	9.95	2J62	75.00	5BP1	6.95	274A	3.00	707A	17.95	830B	3.50
1B56	49.95	2K25	37.50	5BP4	6.95	274B	3.00	707B	27.00	832	7.95
1B60	69.95	2K28	37.50	5CP1	6.95	304TH	15.00	714AY	17.95	832A	9.95
1N21	1.35	2K29	37.50	5D21	27.50	304TL	14.50	715A	7.95	833A	49.95
1N21A	1.75	2K41	150.00	5J1	27.50	307A	4.95	715B	18.00	834	7.95
1N21B	4.25	2K45	149.50	5J2	19.50	310A	7.95	715C	25.00	836	4.95
1N22	1.75	2V3G	2.10	5J4	27.50	311A	7.95	717A	1.95	837	2.95
1N23	2.00	3BP1	7.50	WE6AK5	2.50	312A	3.95	718AY/EY	48.50	838	6.95
1N23A	2.00	3B24	5.50	6C21	29.50	323A	25.00	719A	29.50	845	5.95
1N23A	3.75	3B24W	7.50	C6A	12.50	327A	3.95	721A	3.95	849	52.50
1N23B	6.00	EL3C	5.95	C6J	10.95	328A	9.95	722A	3.95	851	80.50
1N27	5.00	3C22	120.00	7BP7	7.95	350A	7.95	723A/B	24.95	860	4.95
1N43	2.50	3C24	1.95	7DP4	10.00	350R	5.95	724A	4.95	861	39.50
2B22	1.95	3C31	5.95	12AP4	55.00	357A	20.00	724B	6.95	866A	1.79
2B26	3.75	3DP1A	10.95	15E	1.95	360AS	6.95	725A	9.95	869B	57.50
2C34	.35	3DP182	12.00	15R	.95	371B	2.95	726A	24.00	869C	35.00
2C40	20.00	3DP182	12.00	NE16	.68	385A	4.95	726B	56.00	872A	3.95
2C43	27.00	3GP1	5.50	FG17	6.95	388A	2.95	726C	69.00	878	1.95
2C44	.90	SN4	5.50	RX21	3.95	394A	7.95	728AY	27.00	884	1.95
2D21	1.75	4A1	1.75	FG33	12.95	MX408U	.75	801A	1.00	885	1.75
2E22	3.75	4A21	2.75	35T	4.95	417A	27.95	802	4.25	889R	199.50

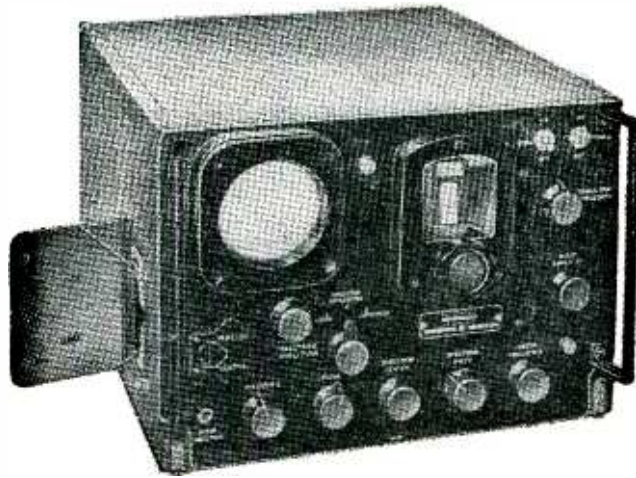

MICROWAVE TEST EQUIPMENT TS148/UP SPECTRUM ANALYZER

Field type X Band Spectrum Analyzer, Band 8430-9580 Megacycles.

Will check Frequency and Operation of various X Band equipment such as Radar Magnetrons, Klystrons, TR Boxes. It will also measure pulse width, c-w spectrum width and Q or resonant cavities. Will also check frequency of signal generators in the X band. Can also be used as frequency modulated Signal Generator etc. Available new complete with all accessories, in carrying case.

Also available of new production TS239A Synchroscope.

Other test equipment, used checked out, surplus.

- TSK1/SE K Band Spectrum Analyzer
- TS3A/AP Frequency and power meter S Band
- RF4A/AP Phantom Target S Band
- TS10/APN Altimeter Test Set
- TS12/AP VSWR Test Set for X Band
- TS13/AP X Band Signal Generator
- TS14/AP Signal Generator
- TS15/AP Flux Meter
- TS16/AP Altimeter Test Set
- TS19/APQ 5 Calibrator
- TS33/AP X Band Power and Frequency Meter
- TS/34AP Western El Synchroscope
- TS34A/AP Western El. Synchroscope

- T35/AP X Band Signal Generator
- TS36/AP X Band Power Meter
- TS47/APR 40-400 MC Signal Generator
- TS69/AP Frequency Meter 400-1000 MC
- TS100 Scope
- TS102A/AP Range Calibrator
- TS108 Power Load
- TS110/AP S Band Echo Box
- TS125/AP X Band Power Meter
- TS126/AP Synchroscope
- TS147 X Band Signal Generator
- TS251 Range Calibrator APN9
- TS270 S Band Echo Box

- TS174/AP Signal Generator
- TS175 Signal Generator
- TS226 Power Meter
- TS239A Synchroscope

SURPLUS EQUIPMENT

- APA10 Oscilloscope and panoramic receiver
- APA38 Panoramic Receiver
- APS 3 and APS 4 Radar
- APR5A Microwave Receiver
- APT2 Radar Jamming Transmitter
- APT5 Radar Jamming Transmitter

MINIMUM ORDER
25 Dollars

YOU CAN REACH US ON TWX NY1-3235

Cables:
TELSERSUP

SPECIAL

Wide Band S Band Signal Generator
2700/3400MC Using 2K41 or PD 8365
Klystron, Internal Cavity Attenuator,
Precision individually calibrated
Frequency measuring Cavity. CW or Pulse
Modulated, externally or internally.

Large quantities of quartz crystals mounted and unmounted.
Crystal Holders: FT243, FT171B others.
North Crystal Comparators.
North American Philips Fluoroscopes Type 80.
Large quantity of Polystyrene beaded coaxial Cable.



LIBERTY ELECTRONICS, INC.

135 LIBERTY STREET NEW YORK 6, N. Y.
PHONE WORTH 4-8262

SEE OUR PREVIOUS ELECTRONICS ADS FOR LISTINGS OR WRITE FOR CIRCULARS

PHASE SHIFT CAPACITORS

W.E. #D150734. S.C. stock No. 2C6996-1053A/C2

As Used in BC1053A, SCR-545 and other Radar Equipment. New, in original boxes. 10 for \$150.00. 100 for \$1250.00.

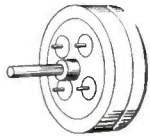

\$17.50 each

MU-METAL LAMINATIONS

Es, Fs, Is, Ls. Ten Sizes. Quantities Available.

Sample Kit, 6 Lbs, Sufficient Quantity of Each Size for One Unit—Postpaid in U. S. A.

\$19.75

H-F TIE POST

Low-loss Melamine Insulation, pictured actual size (4-40 Thread)....\$7.50/C \$67.50/M



ULTRA SENSITIVE RELAYS

KURMAN BK35 — Nominal Operating Characteristics, 11,000 Ohms. 0.4 Ma. 4V DC SPDT. Adjustable contacts and armature. #R277, 10 for \$5.00, 100 for 475.00.

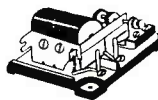

\$5.95 each



SIGMA 5RJ: 5000 ohms Hermetically sealed SPDT; 1.5 ma. DC. #R281

\$6.95 each

KOVAR GLASS TO METAL SEALS HIGH-VOLTAGE FEED THRU

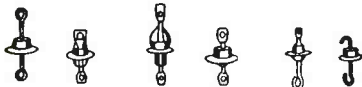

Many types and sizes. Send us your blueprint or sample for our quote. Our prices are a fraction of original factory cost.

SAMPLE KIT 96 Seals (8 ea. 12 types) 500 postpaid in USA
LAB KIT 300 Seals (20 types) 1500 postpaid in USA

DELAY RELAYS



PARAGON Model 815; 115V, 60 cyc; Adjustable 0 to 100 sec; 2 1/2 sec Recycling time; SPDT, 10 Amp contacts; #R944\$13.95

PARAGON Model 810B; 115V, 60 cyc; 60 sec Delay, 2 1/2 sec Recycling time; SPST, n.o., 10 Amp contacts; #R945\$7.95

AMPERITE THERMAL TIME DELAY

Single Pole No.	Volts	Normally Delay	Open No.	Volts	Normally Delay	2.40 ea.
R946	115	30	R936	24	2	
R947	115	30	R950	6	60	
R948	115	15	R951	6	30	
R943*	115	5	R952	6	15	
* Edison Type 501			R953	6	5	

TELEPHONE TYPE RELAYS

These relays have been standardized so that coils and frames of most manufacturers can be interchanged without affecting adjustments. A wide variety of applicable combinations are thus possible from a comparatively small number of relays.

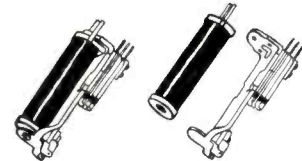

Listed below are frames and coils from our stock. They may be purchased separately. However, a complete relay consists of coil and frame. In ordering complete relays specify which coil with which frame, i.e.: F101 with K117.

Representative completed relays are also listed with voltage and current ratings. Values are indicative of sensitivity that may be expected from similar combinations.

107 COOK, 3-6VDC, 6 make, 1 break (5As, 1C), 12 ohm. Part of BC654, #R407.....\$ 3.95

CLARE, 8500 ohm, 8maDC, 3 makes (3As), R276 4.25

5035A7 AUTOMATIC, 1300 ohm, 8maDC, SPST n.o. (1A), #R103..... 1.75

A18258 BENDIX (Cook 102) 8-12 VDC, Cop-per Slug, Slow Release, SPDT, 200 ohm, Part of SCR 522, #R365..... 2.49

R5229A1 AUTOMATIC 6VDC, 3PST n.o. (3As), 75 ohms, Slow Release. #R412..... 2.50

R5021A1 AUTOMATIC 1300 ohm, 20maDC, SPST n.c. (11), #R413..... 2.95

FRAMES

(For Cost of Relay Add Price of Frame to Price of Coil)



Stock No.	Contacts	Price each	Stock No.	Contacts	Price each
F101	1A	1.25	F111	1B, 2A	1.75
F102	2A	1.50	F114	1B, 3A	2.00
F103	3A	1.75	F108	1B, 1A, 1C	2.00
F104	4A	2.00	F107	2B, 1A	1.75
F105	5A	2.25	F112	2B, 2A, 2C	3.00
F106	1A, 1B	1.50	F113	2B, 5A, 1C	3.25
F107	1A, 2B	1.75	F113	5B, 2A	2.75
F108	1A, 1B, 1C	2.00	F121	5B, 1C	2.75
F109	1A, 1C	1.75	F122	1C	1.50
F110	1A, 2C	2.25	F123	2C	2.00
F111	2A, 1B	1.75	F109	1C, 1A	1.75
F112	2A, 2B, 2C	3.00	F116	1C, 4A	2.50
F113	2A, 5B	2.75	F117	1C, 5A	2.75
F114	3A, 1B	2.00	F121	1C, 5B	2.75
F115	3A, 2C	2.75	F110	2C, 1A	2.25
F116	4A, 1C	2.50	F115	2C, 3A	2.75
F117	5A, 1C	2.75	F108	1C, 1A, 1B	2.00
F118	5A, 2B, 1C	3.25	F118	1C, 5A, 2B	3.25
F120	1B	1.25	F112	2C, 2A, 2B	3.00
F106	1B, 1A	1.50			

COILS

(For Cost of Relay Add Price of Coil to Price of Frame)



Stock No.	Ohms	Price each	Stock No.	Ohms	Price each
K101	0.75	1.25	K106	1100/500 Dual	2.00
K102	12	1.25	K111	1300	1.75
K103	250	1.25	K112	2000	2.25
K104	450	1.50	K113	3000	2.50
K105	500	1.50	K114	3600	2.50
K106	500/1100 Dual	2.00	K115	4600	2.75
K107	750	1.50	K116	6500	2.75
K108	900	1.75	K117	10,000	3.00
K109	1000	1.75	K118	40,000	3.25

A-C COILS

Stock No.	Voltage	Price each
K119	8V AC	1.75
K120	24V AC	1.75
K121	110V AC	2.50

SLOW ACTION COILS

Stock No.	Ohms	Slow Action	Price each
K122	33	Make	1.50
K123	75	Release	1.50
K124	200	Release	1.50
K125	300	Make	1.75
K126	2000	Make	2.00

FRAMES WITH MICROSWITCH

F125	1A, 1C (Microsw.)	1.75
F126	1A, 1A (Microsw.)	1.75

A = Normally Open; B = Normally Closed; C = Double Throw.

LEACH RELAYS

(Many Others in Stock)



Type No.	Coil No.	Volts D.C.	Ohms	Cir-cuit	Stock Price No. Each
1010	356C	22.5	325	1A	R212 1.50
1016	357D	24	375	1A	R286 1.50
1024A1	356A	24	265	2A	R214 2.25
1025SNBF	357CX	24	425	2 3	R216 2.00
1054B	356A	24	265	2A	R253 2.25
1077BF	355D	24	160	2C	R213 3.25
1154	371BL	50AC	2A	R 215 2.25
1204	355	12	95	2A	R217 2.25
1204	356A	24	265	1A	R218 2.00
1224DE	355	12	95	2A	R219 2.25
1251	366	2.4	4	1A	R220 2.00
1251	354D	12	67	1A	R221 2.00
1251	361	120	10,000	1A	R222 3.75
1254A	355	12	95	1A	R248 2.0
1257WC	354D	12	67	2C	R249 3.25
1257M	372D	24	250	1C	R250 3.00
2024DE	354C	12	42	4A	R251 3.25
2024DE	355D	24	160	4A	R252 3.25

LEACH LATCHING RELAY

Type No.	Amps	Volts D.C.	Ohms	Cir-cuit	Stock No.	Price Each
2406DN Release	358A	24	265	1A, 1B	R285	4.50
	356A	24	265	1A		

LEACH SOLENOIDS

5023C17	50	24	100	1A, 1B	R282	5.00
5030CSP	50	12	25	1A	R125	2.50
5058	200	24	10	1A	R283	6.00
7064-12C	50	12	40	1A	R284	2.25

SELENIUM RECTIFIERS

Full-Wave Bridge Types

Current (Con-tinuous)	18/14 Volts	36/28 Volts	54/42 Volts	130/100 Volts
1 Amp.	51.25	52.20	53.60	58.95
2 Amps.	2.20	5.60	6.50	10.50
2 1/2 Amps.	13.00
4 Amps.	3.75	6.75	8.75
5 Amps.	4.95	7.95	12.95	27.00
6 Amps.	5.50	9.00	14.00	36.00
10 Amps.	6.75	12.00	20.00	45.00
12 Amps.	8.50	16.00	25.50	52.50
20 Amps.	13.25	24.00	36.00	90.00
24 Amps.	16.00	31.00	39.50	98.00
30 Amps.	18.50	36.00
36 Amps.	25.50	45.00

RELAYS!

RELAYS!

RELAYS!

324 CANAL ST., N.Y.C., 13, N.Y. WALKER 5-9642

Universal general corp.

TERMS:—All Prices F.O.B. Our Plant. Rated Firms Net 10 Days. All Others Remittance with Order. Orders Under \$10 Remittance With Order, Plus Approximate Shipping Charges (overage will be returned.)

COMMUNICATIONS EQUIPMENT CO.



24 VOLT TRANSFORMERS

For operating surplus gear, toy trains, gadgets, etc. Operates from 115V, 60 cy. supplies 24 VAC at 1.2 Amp. herm. sealed and cased. A Great Buy at Only **\$1.49**

RECTIFIER TRANSFORMERS

Pri: 115V, 60 Cy. Sec: 28V/3.1A, 26V/8.4A	\$12.95
Pri: 216/215/220/225/230/235/240V, 60 Cy., 1 Phase	
Sec: 11/10" 5VCT @ 35A	\$19.50
Pri: 115V 60 Cy. Sec: 20 V @ 10A	3.95
Pri: 115V 60 Cy. Sec: 8.1V @ 1.5A	1.39
Pri: 115V 60 Cy. Sec: 18.5V @ 3.5A	2.79

POWER TRANSFORMERS

Comb. Transformers—115V/50-60 cps Input

CT75B 600-0-600V/6A, 2X5VCT/6.2A, 6.3VCT/3A, 6.3V/3A	\$12.95
CTJ5-2-600VCT/2A, 5V/6A	5.35
CT-15A 550VCT/.085A 6.3V/6A, 6.3V/1.8A	2.85
CT-164 4200V.002A/12KV Test, 5VCT/3A/12KV Test, 6.3V/0.6A/5400V Test	12.95
CT-341 1050 10 MA., -625V @ 5 MA, 26V @ 4.5A 2x2.5V/3A, 6.3V @ 3.5VCT/3.6	16.95
CR 825 360VCT .340A 6.3VCT/3.6	3.95
CT-626 1500V -160A 2.5/12, 30/100	9.95
CT-071 110V .200A 33/200, 5V/10, 2.5/10	4.95
CT-367 580VCT .050 A 5VCT/3A	2.25
CT-89A 2x110VCT .030 A 6.3V/2A, 2.5VCT/7A	3.25
CT-403 350VCT .026 A 5V/3A, 5VCT/7A	2.75
CT-931 585VCT .086 A 5V/3A, 6.3V/6A	4.25
CT-456 390VCT 30 MA 6.3V/1.3A, 5V/3A	3.45
CT-160 800VCT 100 MA 6.3V/1.2A, 5V/3A	4.95
CT-931 585VCT 86 MA 5V/3A, 6.3V/6A	4.95
CT-442 525VCT 75 MA 5V/2A, 10VCT/2A, 50V/200 MA	3.85
CT-720 550-0-550V/250 MA, 6.3V/1.8A	8.95
CT-43A 600-0-600V/.08A, 2.5VCT/6A, 6.3VCT/1A	6.49
CT7-501 650VCT/200 MA, 6.3V/8A, 6.3V/5A	6.49
CT-444 230-0-230V/.085A, 5V/3A, 6V/2.5A	3.49

Filament Transformers—115V/50-60 cps input			
Item	Rating	Each	
FT-674	8.1V/1.5A	\$11.10	
FT-157	4V/16A, 2.5V/1.75A	2.95	
FT-101	6V/25A	7.79	
FT-924	5.25V/21A, 2z7.75V/6.5A	14.95	
FT-824	2x26V/2.5A, 16V/1A, 7.2V/7A, 6.4V/10A, 7, 6.4V/2A	8.95	
FT-463	6.3VCT/1A, 5VCT/3A, 5VCT/3A	5.49	
FT-55-2	7.2V/21.5A, 6.3V/6.85A, 5V/6A, 5V/3A	8.95	
FT-986	16V @ 4.5A, 12V @ 4.5A	3.75	
FT-38A	6.3/2.5A, 2x2.5V/7A	4.19	
FT-A27	2.5V/2.5A, 7V/7A, TAP 2.5V/2.5A, 16KV TEST	18.95	
FT-608	6.3V/3A/750V Test	1.79	
FT-873	4.5V/5A, 7V/7A	2.15	
FT-899	2x5V A SA, 29KV Test	24.50	

Plate Trans.—115V, 60 cps			
Item	Rating	Price	
PT-699	300/150V/.05A, 300/150V/.05A	\$2.79	
PT-302	120-0-120V/350 MA	4.69	
PT-108	17,600V/144 MA	120.00	
PT-671	62V/3.5A	7.95	

Special Fil. Transformers—60 cps			
Item	Pri. Volts	Secondaries	Price
STF-370	220/440	3x2.5V/7A, 3KV Test	\$6.95
STF-11A	220V	2x40V/.05A, 2x5V/6A	4.49
STF-608	220V	12.6V/1A, 6.3V/1A	3.45
STF-968	230V	2.5V/6.5A	3.50
STF-631	230V	2x5V/27A, 2x5V/9A	17.59

Special Plate Transformers—60 cps			
Item	Pri. Volts	Secondaries	Price
STP-613	230V	230/.05A, 230V/.05A	\$1.79
STP-409	220/440V	136VCT/3.5A	5.69
STP-815	240/440, 3ph	1310V/67A, 6KV Test	27.50
STP-129	230V	3850V/3.12KVA	42.59
STP-823	137V	222VCT/3A	2.35
STP-08B	50V	2x750V/.001A	1.79
STP-622	210/220/230	5000V/1A	59.75
STP-945	210/220/230	500V/1A, 500V/1A, 3A	5.95

AUDIO TRANSFORMERS

Special Comb. Transformers—60 cps			
Item	Pri. Volts	Secondaries	Price
STC-16A	220V	260V/.03A, 300V/1A, 6.3V/4.2A	\$4.69
STC-609	220V	220V/3A	6.95

AT201 50L6 output (4000 ohms) to V.C. (3 ohms) \$5.40
 AT SUB Subinizer, Multimatch, 200 ohms to 15 K ohm C.T. and 150 K ohm Grids \$5.99
 AT731 H.F. Plate (1500 ohm C.T.) to V.C. (16/4 ohms) 20-15K \$5.29
 AT501 HI-FI Special Pri: 3000 ohm P.P. Sec: 4/16/12/50/200 ohms 60-10,000 Cy.—1 db 50W \$5.49
 AT152 HI-FI Driver Pri: 10,000 ohms Sec: 40,000 ohms PP Grids 50-15 K/3 db \$5.19
 AT622 Output to H.S. or line Pri: 34,200 ohms Sec: 8000 600 ohms \$5.10
 AT449 HI-FI Driver (5000 ohms) to P.P. output grids (4,000 ohms) 100-10,000 Cy, 10 W 6V6 to PP 805'S \$2.39
 AT666 Intercom Input: Spkr (4-8 ohms) to grid (250,000 ohms) \$0.69

This Month's Special

SA4A/APA-1 Motor Driven Coaxial Ant. Switch DPDT, Continuous Operation from 24VDC. Completely Enclosed	\$24.50
MP-22 MAST BASE Mobile Antenna Mount. SA1A/APN-1 Altitude Limit Switch for APN-1 Altimeter	4.59
ALTIUDE INDICATOR for APN-1	12.50
C-387-D Final P.A. Coil for BC610 2-3.5 MC, Variable Link	7.95
RA-74 Power Supply for Super Pro	4.89
J-17/ARC-5 Junction Box for ARC-5	69.50
J-22/ARC-5 Junction Box	7.95
SUPERSONIC CRYSTALS, Rochelle salt MOTOR, 24 vdc. 3 HP 3800 rpm, New	3.49
TV LEAD-IN WIRE, 300 ohms, HI-Q, Lo-Loss	75.00
BC 306 ANTENNA TUNING UNIT, NEW	\$17.50/M FT Roll
RS/APN-4, New, With Tubes	75.00
ID6/APN-4, New, With Tubes and Crystal	75.00
A-62 Phantom Antenna	8.50
2 Meter Choke, 1000 MA, 20-144	1.00
Supersonic Crystal Head, M-1, 22-27KC	8/
R HI-2	27.45

G.E. RELAYS*

CR2792B116A3
 SPST—50 Amp Contacts. Operates from 22-30 VDC. Coil Res. 200 Ohms. Completely enclosed in transparent plastic case, which may be removed for adjustments... **\$1.59**

GE#CR2791B116W3
 Same as above, except additional terminal brought out from contact arm... **\$1.74**

GE#CR2791-F100D3
 Differential: DPST, Norm. open. Dual coil, 1500 ohms per coil—25 Ma. Operating Current. Contacts: 20 Amp. **\$2.25**

GE#CR2791F100G3
 Same as above, except has extra 1A contact. Rated 5 Amp **\$2.35**

GE#CR2791D101F3
 All Ceramic Insulation, DPDT, Coil—12V DC, 100 Ohms DCR. Contacts designed for fast operation. Rated at 5 Amps. **\$1.25**

GE#CR2791B106J3
 3PDT, 5 Amp contacts. Coil rated 22-30VDC. 150 Ohms DCR. Contacts are designed for fast operation, and enclosed by clear plastic cover **\$1.35**

GE#CR2791B106C3
 SPDT, Dual Contacts will handle 20 Amps. Coil: 18-28VDC 125 Ohms DCR **\$1.25**

*THESE RELAYS AVAILABLE IN MFRS. QUANTITIES

DYNAMOTORS

Type	Input Volts	Input Amps	Output Volts	Output Amps	Radio Set
PER8	28	1.25	250	.050	RC 32
DM416	14	6.2	330	.170	RU 19
DM33A	28	2.6	540	.250	BC 456
PE1301	13/24	12.6	400	.135	SCR 515
BD AR 93	28	3.25	375	.150	
23350	27	1.75	285	.075	APN-1
ZA0515	12/24	4/2	500	.050	MARK 11
B-19 pack	12	9.4	275	.110	
D-104	12		225	.100	
DA-3A	28	10	440	.200	SCR 522
			300	.060	
			150	.010	
5053	28	1.4	250	.060	APN-1
PE73CM	28	19	1000	.350	BC 375
CW21AAX	13	12.6	400	.135	
	26	6.3	800	.020	
PE94	28	10	300	.200	SCR 522
			150	.101	
			15.5	.5	

INVERTERS

PE-218-H: Input: 25 28 vdc, 92 amp. Output: 115 v, 350 500 cy 1500 volt-amperes. New	\$44.50
PE-206: Input: 28 vdc, 38 amps. Output: 80 v 800-cy, 500 volt-amperes. Dims 13" x 10 1/2" x 10 1/2"	\$44.50
LELAND No. 10536: In: 28 VDC, 12A. OUT: 115V, 115VA, 400 CY 3 PHASE. EXC. COND	\$70.00

ELECTROLYTIC CAPACITORS

Cap. Mfd	WVDC	Price	
8	450	\$0.16	
30	300	.18	
40	450	.38	
50	400	.36	
60	300	.21	
80	150	.29	
8/8	450	.24	
30-20	25	.16	
20-20	150	.23	
80-80	300	.21	
90-10	350	.21	
80-10	450	.49	
150-50-25	150	.49	
80-10-10-10	300	.21	
40-40-20-20	150	.28	
30-15-15-15	300	.28	
80-10-10-10	350	.32	
40/10	450/350	.55	
40/20	150/25	.21	
40/50	400/300	.28	
80/50	450/50	.65	
250/1000	10/6	.30	
8-8-10	450/25	.26	
10-10/10	150/25	.23	
10-10/20	450/25	.26	
10-15/20	350/25	.18	
15-15/10	450/350	.23	
80-40/150	400/50	.36	
120-60/20	150/25	.45	
30-30-15/30	300/50	.39	
40-40-20/20	350/15	.28	
60-40-20/50	300/25	.28	
60-40-20/200	150/10	.39	
80-40-30/20	150/25	.36	
80-40-30/100	150/25	.36	
8/8/8	475/100/100	.23	
10/50/100	350/100/50	.23	
10/50/100	450/100/50	.27	
20/20/10/20	350/300/300/25.35	.15	

SELENIUM RECTIFIERS

F. W. BRIDGE			
UP TO 18 VAC IN—	UP TO 14 VDC OUT		
2A	\$2.50	26-30	220-1.35
4A	4.00	43-65	110-1.25
6A	6.00	43-48	110-1.25
10A	7.50	50-75	110-1.25
12A	9.00	53-60	220-1.50
24A	18.00	61-69	320-1.60
UP TO 36 VAC IN—			
UP TO 28 VDC OUT		64-72	110-1.25
1A	\$3.00	73-87	110-1.25
2A	4.00	88-106	110-1.50
5A	10.00	107-129	110-1.65
10A	14.50	130-157	110-1.75
12A	18.00	130-150	70-1.50
24A	36.00	130-180	110-1.85
UP TO 54 VAC IN—			
UP TO 42 VDC OUT		158-191	110-1.85
2A	\$6.50	161-180	110-1.75
4A	8.50	189-210	110-1.95
UP TO 120 VAC IN—			
UP TO 100 VDC OUT		200-220	110-1.95
2A	\$11.00	270-300	110-2.10
10A	48.00	324-360	110-2.40
12A	60.00	378-420	175-3.00
		432-480	110-2.75
		485-540	110-2.85

FILTER CHOKES

Stock	Description	Price
CH-366	20H/3A	\$6.95
CH-322	.35H/350 MA—10 Ohms DCR	2.75
CH-141	Dual 7H/75 MA, 11H/60 MA 5KV D.C. Test	4.69
CH-119	8.5H/125 MA	2.79
CH-69-1	Dual: 120H/17 MA	2.35
CH-8-28	2 x .5H/380 MA/25 Ohms	1.79
CH-776	1.28H/130 MA/75 ohms	2.25
CH-344	1.5H/145 MA/1200V Test	2.35
CH-43A	10H/15 MA—350 ohms DCR	1.95
CH-366	20H/300 MA	6.95
CH-999	15H/15 MA—400 ohms DCR	1.95
CH-511	6H/80 MA—310 ohms DCR	2.45
CH3-501	2x5H/400 MA	2.79
CH-188M	5H/200 MA	1.79
CH 303	30H/0.2A, 2500V Test	1.69
CH 932	SWING 9-60H/4-.05A, 10KV	7.95

UNIVERSAL SUPPLY KIT

Delivers 230V @ 40MA DC. From 110/220VAC. 60 Cy. Kit consists of 1 Transformer, 1-5 Hy @ 40MA Choke, 2-8MFD @ 450V Filter Cond. 1-6x5 Tube. A Great buy at only **\$3.95**

INTERPHONE AMPLIFIER

Easily converted to an Ideal Inter-Communications set for office, home or factory. Original. New **\$4.75**



COMMUNICATIONS EQUIPMENT CO.

MICROWAVE COMPONENTS

S BAND—3" x 11 1/2" W.G. 10 CM.



DIRECTIONAL COUPLER, Broadband, 20 db. Coupling, Type "N" Takeoff. Complete with all Hardware. Navy Spec. # GABY-47AAN-2. As shown. \$37.50

WAVEMETER 2700-3400 MC. Reaction Type with counter Dial-Mfg. W.E. \$92.50

REACTION WAVEMETER, Mfg. G.E. 3000-3700 MC. Misc. Head. \$125.00

LHTR LIGHTHOUSE ASSEMBLY. Part of RT39 APO 5 & APG 15. Receiver and Trans. Cavities w/assoc. Tr. Cavity and Type N CPLG. To Recvr. Uses 2C40, 2C43, 1B27. Tunable APX 2400-2700 MCS. Silver Plated. \$49.50

BEACON LIGHTHOUSE cavity 10 cm. Mfg. Bernard Rice, each \$47.50

MAGNETRON TO WAVEGUIDE Coupler with 721A Duplexer Cavity, gold plated. \$45.00

RT-39/APG-5 10 cm. lighthouse RF head c/o Xintr. Recvr. TR cavity, compl. recvr. & 30 MC 1P strip using 6AK5 (2040, 2C43 1B27 lineup) w/Tubes. \$75.00

721A TR BOX complete with tube and tuning slug. \$12.50

MENALLY KLYSTRON CAVITIES for 707D or 2K28 \$4.00

F 29/SPR-2 FILTERS, type "N" input and output III-Pass Over 1000 MC. \$12.50

WAVEGUIDE TO 7/8" RIGID COAX "DOORSTOP" ADAPTER CHOKE FLANGE SILVER PLATED BROAD BAND \$32.50

ASI4A/AP-10 CM Pick up Dipole with "N" Cables \$4.50

DAJ ECHO BOX, 10 CM TUNABLE \$22.50

HOMEDELL-TO-TYPE "N" Male Adapters, W.E. #D167284 \$27.50

I. F. AMP STRIP, 90 MC 120 db. gain, 2 MC Bandwidth, uses 6AC7S—with video detector. Less tubes \$24.50

POLYROD ANTENNA, AS31/APN-7 in Lucite Ball. Type "N" feed. \$22.50

ANTENNA, AT49A/APR1; Broadband Conical, 3000 MC Type "N" Head. \$12.50

"E" or "H" PLANE BENDS, 90 Deg. less flanges \$7.50

7/8" RIGID COAX—3/8" I. C.

ROTARY JOINT, Stub-supported, UG 46/UG 45 fittings \$27.50

10 CM STABILIZER Cavity, tunable, standard UG46/UP 45 fittings. \$45.00

RG 44/U RIGID COAX, stub support, 5 ft. sections, with UG46/UG45 connectors. \$12.50

RIGHT ANGLE BEND, with flexible coax output pick-up loop \$8.00

SHORT RIGHT ANGLE BEND, with pressurizing nipple \$3.00

RIGID COAX to flex coax connector. \$3.50

RT ANGLES for above. \$2.50

RT. ANGLE BEND 15" L. OA. \$3.50

FLEXIBLE SECTION, 15 L. Male to female. \$4.25

7/8" RIGID COAX, BULKHEAD FEED-THRU. \$14.00

X BAND—1" x 1/2" W.G. 3 CM. CROSS-GUIDE COUPLER

MAIN SECTION, 7" long with 90 deg. bend (E-Plane), 2 1/2" radius. Broadband coupling figure is 20dB, individually calibrated. \$22.50

1" x 1/2" waveguide in 5' lengths, UG 39 flange to UG40 cover. per length \$7.50

Rotating joints supplied either with or without deck mounting. With UG40 flanges. each, \$17.50

Bulkhead Feed-thru Assembly. \$15.00

Pressure Gauge Section, 15 lb. gauge and press nipple \$10.00

Pressure Gauge, 15 lbs. \$2.50

Dual Oscillator, Mount. (Back to back) with crystal mount, tunable termination attenuating slug. \$18.50

TR-ATR Duplexer section for above. \$8.50

723AB Mixer—Beacon dual Osc. Mnt. w/xtal holder \$12.00

Waveguide Section 12" long choke to cover 45 deg. twist & 2 1/2" radius, 90 deg. bend. \$4.50

Twist 90 deg. 5" choke to cover w/press nipple. \$6.50

Waveguide Section 2 1/2" ft. long silver plated with choke flange \$5.75

Rotary joint choke to choke with deck mounting. \$17.50

3 cm. mitered elbow "H" plane. \$12.00

UG 39 Flanges. \$.85

90 degree elbows, "E" or "H" plane 2 1/2" radius. \$12.50

45 degree twist. \$8.00

APS-4 Under Belly Assembly, less tubes. Write for price.

1 1/4" x 5/8" WAVEGUIDE

CG 98B/APO 13 1/2" Flex. Sect. 1 1/4" x 5/8" OD. \$10.00

X Band Wave GD. 1 1/4" x 5/8" O.D. 1/16" wall aluminum. \$7.50

Slup Tuner Attenuator W.E. guide, Gold plated. \$6.50

B1-Directional Coupler, Type "N" Takeoff 25 db. coupling. \$27.95

B1-Directional Coupler, UG-52, Takeoff 25 db. coupling. \$24.95

Waveguide-to-Type "N" Adapter, Broadband. \$22.50

K BAND—1/2" x 1/4" W.G. 1.25CM.

APS-34 Rotating joint. \$49.50

Right Angle Bend E or H Plane, specify combination of couplings desired. \$12.00

MAGNETRONS

Tube	Tube	Tube
2J97	2J49	790BY
2J31	2J61	795-A
2J91	700	730-A
2J92	706	OK 62
2J96	2J62	OK 61
2J32	3J31	OK 60
2J37	5J30	2J56
2J38	718DY	2J32
2J39		



THERMISTORS VARISTORS

D167018	\$1.50	D171812	\$1.50
D167332	1.50	D172155	1.50
D167613	1.50	D167176	1.50
D166228	1.50	D168687	1.50
D164699	2.50	D167208E, D171858	1.50
D163903	1.95	308A, 27-B	1.50
D166792	2.15	D168403	2.15

AMPEREX TUBES COMPLETE LINE MAGNETRONS—THYRATRONS SPECIAL PURPOSE GEIGER-MULLER AMATEUR — INDUSTRIAL GERMANIUM DIODES SEND FOR COMPLETE LISTING

TEST EQUIPMENT

- Signal Gen. RCA 710A, 370-560 MC. \$350.00
- Signal Gen. 20A Microvibrator. \$175.00
- TS 10A Altimeter Test Set. \$2.50
- TS 16/AP Altimeter Test Set. \$2.50
- TS 35 Power Meter, 35CA1
- TS 47/APR Test Osc. 50-3000 MC. \$325.00
- TS 56/AP Slotted Line, 500 MC. \$325.00
- TS 127/UP Wavemeter, 300-700 MC. \$27.50
- TS 69/AP Wavemeter, 340-1000 MC. \$27.50
- TS 70/AP Pwr. Meter, 200-800 MC
- TS 110/AP Echo Box, 2400-2700 MC

MICROWAVE ANTENNA EQUIPMENT

AT49A/APR—Broadband Conical, 300-3000 MC. Type N Feed. (AS SHOWN) \$12.50

AS-31/APN-7: 10 cm Polyrod in Lucite Ball. Type N Flitting Coax Feed. \$22.50

Relay System Parabolic reflectors approx. range 2000 to 6000 Mc. Dimensions 4 1/2" x 9". New. \$100.00

Dipole for above. \$12.00

TDY "JAM" Radar rotating antenna, 10 cm. 30 deg. beam, 115 V AC Drive. New. \$150.00

Parabolic Peel. Radiation pattern approx. 25 deg. in horizontal 33 deg. in vertical planes. \$35.00

Cone Antenna, AS 125 APR, 1000-3200 mc. Stub supported with type "N" connector. \$14.50

30' SIGNAL CORPS RADIO MASTS

Complete set for erection of a full flat top antenna. Of fused plywood construction telescoping into 3 ten-foot sections for easy storage and transportation. A perfect set-up for getting out. Supplied complete: 2 complete masts, hardware, shipping crate. Shipping wt. approx 300 lbs. Sig. Corps No. 2A289-223-A. New. \$49.50 per set

AS44A/AP, 10 CM pick up dipole base, complete w/length of coax and "N" connectors. \$3.50

AS46A/APG-4 Yagi Antenna, 5 element array. \$22.50

30' Parabolic Reflector Spun Aluminum dish. \$4.85

10 CM GUN-SIGHT ANTENNA

SPHERICAL RADOME HOUSES DRIVE MOTOR, DISH, FEED AND GUNMOUNT TOTAL DIAMETER: APPROX. 15 INCHES, DISH: 18" DIAM. FEED: DIPOLE AND DISK VERTEX. SCAN: CONICAL AT 2400 RPM. BEAMWIDTH: 25°-30°. ENTIRE UNIT MAY BE PRESSURIZED UP TO 15 LBS./IN. AND ENERGY MAY BE FED BY ANY FLEXIBLE COAX CABLE. COMPLETE UNIT WITH DRIVE MOTOR AND RADOME. \$325.00

PULSE TRANSFORMERS

G.E. # K2731 Repetition Rate: 635 PPS. Pri. Imp: 50 Ohms. Sec. Imp: 450 Ohms. Pulse Width: 1 Microsec. Pri. Input: 9.5 KV PK. Sec. Output: 28KV PK. Peak Output: 800 KV Bifilar 2.75 Amp. \$65.00

U-10198 Pri: 4-5KV, 97A Pk Sec: 18KV, 26A, PRR-350-500 C/s. Duration 1.5 usec. \$42.50

D-166173: Video. Ratio = 50:900 Ohms 10KC-2MC. \$12.50

G.E.K.-2745 \$39.50

G.E.K.-2744-A, 11.5 KV High voltage, 3.2 KV Low voltage @ 200 KW oper. (270 KW max.) 1 microsec. or 1 microsec. @ 600 PPS. \$39.50

W.E. D169271 Hi Volt input pulse Transformer. \$27.50

G.E. K2450A, Will receive 13KV, 4 micro-second pulse on pri. secondary delivers 14KV. Peak power out 100 KW G. E. \$34.50

G. E. K2748A, Pulse Input line to magnetron. \$36.00

Ray UX 7896—Pulse Output Pri. 5v. sec. 41v. \$7.50

Ray UX 8442—Pulse Inversion—40v + 40v. \$7.50

RAY UX7361 \$5.00

PHILCO 352-7250, 352-7251, 352-7287

UTAH 9332, 9278, 9341.

RAYTHEON: UX8693, UX5986 \$5 ea.

W.E.: D-166310, D-16638, KS 9800, KS9948

DELAY LINES

D-168184: 0.5 microsec. up to 2000 PPS 1800 ohms imp. \$4.00

D-170499: 25.50 .75 microsec. 8 KV 50 ohms imp. \$16.50

D-165997: 134 microsec. \$7.50

RCA 255686-502, 2.2u sec. 1400 ohms. \$2.00

PULSE NETWORKS

G.E. #E3-5-2000-50P2T, 6KV "E" circuit, 3 sections .5 microsecond, 2000 PPS 50 ohms impedance. \$6.50

15A-1-400-50: 15 KV, "A" CKT. 1 microsec. 400 PPS, 50 ohms imp. \$37.50

G.E. #3E-3-200-6T, 7.5 KV, "E" Circuit, 3 microsec. 200 PPS, 6 ohms imp. 3 sections. \$12.50

#755: 10KV, 2.2u sec., 375 PPS, 50 ohms imp. \$27.50

#754: 10KV, 0.85u sec., 750 PPS, 50 ohms imp. \$27.50

PULSE EQUIPMENT

H/I-Volt Pulse Bulkhead, Feed-thru. Fits UG-36 Connector. \$15.00

APQ-13 PULSE MODULATOR, Pulse Width .5 to 1.1 Micro Sec. Rep. rate 624 to 1348 Pps. Pk. Power out 35 KW Energy 0.018 Joules. \$49.00

TPS-3 PULSE MODULATOR, Pk. power 50 amp. 24 KW (1200 KW pk) pulse rate 200 PPS, 1.5 microsec. pulse line impedance 50 ohms. Circuit rises charging version of DC Resonance type. Uses two 705-A's as rectifiers. 115 v. 400 cycle input. New with all tubes \$49.50

400 CYCLE TRANSFORMERS

Stock	(All Primaries 115V, 400 Cycles)	Price
352-7039	640VCT @ 250MA, 6.3V/.9A, 6.3V/6A, 5V/6A	55.49
702724	980V/800 @ 32MA	17.95
12033	4540V/250MA	8.50
K59584	5000V/290MA, 5V/10A	22.50
52J652	13.500V/3.5MA	14.65
K59607	734VCT/177A, 1710VCT/177A	6.79
352-7273	700VCT/350MA, 6.3V/0.9A, 6.3V/2.5A, 6.3/.06A, 5V/CA	6.95
352-7070	2X2.5V/2.5A (2KV TEST) 6.3V/2.25A, 1200/1000/75 OV @ .005A	7.45
352-7196	1140V/1.25MA, 2.5V/1.75A, 2.5V/1.75A 5KV Test	3.95
352-7176	320VCT/50MA, 4.5V/3A, 6.3VCT/20A, 2X6.3VCT/6A	4.75
RA6400-1	2.5V/1.75A, 6.3V/2A—5KV Test	2.39
901692	13V/9A	2.49
901699-5011	2.77V @ 4.25A	3.45
901698-501	900V/75MA, 100V/0.04A	4.28
UX 8855C	900VCT/.067A, 5V/3A	3.79
RA6405-1	800VCT/65MA, 5VCT/3A	3.69
T-48852	700VCT/80MA, 5V/3A, 6V/1.75A	4.25
352-7098	2500V/6MA, 300 VCT, 435MA	5.95
KS 9336	1100V/50MA TAPPED 625V 2.5V/2A	3.95
M-7474319	6.3V/2.7A, 6.3V/66A, 6.3VCT/25A	4.25
KS 8984	27V/4.3A, 6.3V/2.9A, 1.25V/0.2A	2.95
52C080	526VCT/50MA, 6.3VCT/2A, 5VCT/2A	3.75
32332	400VCT/35MA, 6.4V/2.5A, 6.4V/15A	3.85
68G631	1150-0-1150V	2.75
80G198	6VCT/.0006 KVA	1.75
302433A	6.3V/1A, 6.3VCT/6.5A, 2.5V/3.5A, 2.5V/3.5A	4.85

MAIL ORDERS PROMPTLY FILLED. ALL PRICES F.O.B. NEW YORK CITY. SEND M.O. OR CHECK. ONLY SHIPPING SENT C.O.D. RATED CONCERNS SEND P.O. ALL MDSE. SUBJECT TO PRIOR SALE, AND PRICES SUBJECT TO CHANGE WITHOUT NOTICE. PARCELS IN EXCESS OF 20 POUNDS WILL BE SHIPPED VIA CHEAPEST TRUCK & RAILEX.

131 Liberty St., New York 7, N. Y. Dept E-1 Chas. Rosen Phone: Dlgby 9-4124

A LEADING SUPPLIER OF ELECTRONIC & AIRCRAFT EQUIPMENT

IMMEDIATE
DELIVERY -- FULLY
GUARANTEEDA. C.
SYNCHRONOUS
MOTORS

110 Vt. 60 Cycle

HAYDON TYPE 1600, 1/240 RPM
 HAYDON TYPE 1600, 1/60 RPM
 HAYDON TYPE 1600, 4/5 RPM
 HAYDON TYPE 1600, 1 RPM
 HAYDON TYPE 1600, 1 1/5 RPM
 TELECHRON TYPE B3, 2 RPM
 TELECHRON TYPE BC, 60 RPM
 HOLTZER CABOT, TYPE RBC 2505, 2 RPM,
 60 oz. 1 in. torque.

SERVO MOTORS

PIONEER TYPE CK1, 2 ϕ 400 CYCLE
 PIONEER TYPE 10047-2-A, 2 ϕ , 400 CYCLE,
 with 40:1 reduction gear.

D. C. MOTORS

BODINE NFHG-12, 27 VTS., governor controlled,
 constant speed 3600 RPM, 1/30 H.P.
 DELCO TYP 5068750, 27 VTS., 160 RPM,
 built in brake.
 DUMORE, TYPE EIY2PB, 24 VTS., 5 AMP.,
 .05 H.P., 200 RPM.
 GENERAL ELECTRIC, TYPE 5BA10AJ18D,
 27 VTS., 110 RPM, 1 oz. 1 ft. torque.
 GENERAL ELECTRIC, TYPE 5BA10AJ37C,
 27 VTS., 250 RPM, 8 oz., 1 in. torque.
 BARBER COLMAN ACTUATOR TYPE AYLC
 5091, 27 VTS., .7 amp., 1 RPM, 500 in.
 lbs. torque.
 WHITE ROGER ACTUATOR TYPE 6905, 12
 VT., 1.3 amp., 1 1/2 RPM, 75 in. lbs.
 torque.

AMPLIDYNE AND MOTOR

AMPLIDYNE, GEN. ELEC. 5AM31NJ18A input
 27 vts., at 44 amp. output 60 vts. at
 8.8 amp., 530 watts.
 MOTOR, GEN. ELEC. 5BA50LJ22, armature
 60 vts. at 8.3 amp., field 27 vts. at 2.9
 amp. 1/2 H.P., 4000 RPM.

PIONEER AUTOSYNS
400 CYCLE

TYPE AY1, AY5, AY14G, AY14D, AY20,
 AY27D, AY38D, AY54D.
 PIONEER AUTOSYN POSITION.
 INDICATORS & TRANSMITTERS.
 TYPE 5907-17, single, Ind. dial graduated
 0 to 360°, 26 vts., 400 cycle.
 TYPE 6007-39, dual Ind., dial graduated
 0 to 360°, 26 vts., 400 cycle.
 TYPE 4550-2-A, Transmitter, 2:1 gear ratio
 26 vts., 400 cycle.

INVERTERS

WINCHARGER CORP. PU 16/AP, MG750,
 input 24 vts. 60 amps. outputs 115 vts.,
 400 cycle, 6.5 amp., 1 phase.
 HOLTZER CABOT, TYPE 149F, input 24 vts.
 at 36 amps., output 26 vts. at 250 V.A.
 and 115 vts. at 500 V.A., both 400 cycle,
 1 phase.
 PIONEER TYPE 12117, input 12 vts., output
 26 vts. at 6 V.A., 400 cycle.
 PIONEER TYPE 12117, input 24 vts., output
 26 vts. at 6 V.A., 400 cycle.
 WINCHARGER CORP., PU/7, MG2500 input
 24 vts. at 160 amp., output 115 vts.
 at 21.6 amp., 400 cycle, 1 phase.
 GENERAL ELECTRIC, TYPE 5D21NJ3A, input
 24 vts. at 35 amps., output 115 vts.
 at 485 V.A., 400 cycle, 1 phase.
 LELAND, PE 218, input 24 vts. at 90 amps.
 output 115 vts. at 1.5 K.V.A., 400 cycle,
 1 phase.
 LELAND, TYPE D.A. input 28 vts., at 12
 amp. output 115 vts. at 115 V.A., 400
 cycle, 3 phase.

ENGINE HOUR METER

JOHN W. HOBBS, MODEL MI-277 records
 time up to 1000 hours, and repeats,
 operates from 20 to 30 volts.

VOLTAGE REGULATOR

LELAND ELEC. CO. TYPE B, CARBON PILE.
 Input 21 to 30 volts D.C. regulated output
 18.25 vts. at 5 amp.
 WESTERN ELEC. TYPE BC937B, input 110
 to 120 volts 400 cycle. Output variation
 0 to 7.2 ohms at 5 to 2.75 amps.
 WESTERN ELEC, TRANSTAT, input 115 vts.,
 400 cycle output adjustable from 92 to
 115 vts., rating .5 K.V.A.
 AMERICAN TRANS. CO., Transtat input
 115 vts., 400 cycle output 75 to 120 vts.
 or 0 to 45 volts, rating .72 K.V.A.

SYNCHROS

1 F SPECIAL REPEATER 115 vt. 400 cycle.
 2J1F1 GENERATOR, 115 vt. 400 cycle.
 2J1F3 GENERATOR, 115 vt. 400 cycle.
 2J1G1 CONTROL TRANSFORMER 57.5 vt.
 400 cycle.
 2J1H1 DIFFERENTIAL GEN. 57.5/57.5 vt.
 400 cycle.
 5G GENERATOR, 115 vt. 60 cycle.
 5DG DIFFERENTIAL GEN. 90/90 vts. 60
 cycle.
 5HCT CONTROL TRAN. 90/55 vts. 60 cycle.
 5CT CONTROL TRAN. 90/55 vts. 60 cycle.
 5SDG DIFFERENTIAL GEN. 90/90 vts. 400
 cycle.

ALL PRICES
 F. O. B.
 GREAT NECK
 N. Y.

TACHOMETER GENERATOR
& INDICATOR

GENERAL ELECTRIC, GEN. TYPE AN5531-1,
 Pad mounting 3 phase variable frequency
 output.
 GENERAL ELECTRIC, GEN. TYPE AN5531-2,
 Screw mounting 3 phase variable frequency
 output.
 GENERAL ELECTRIC, IND. 8DJ13AAA,
 works in conjunction with above genera-
 tors, range 0 to 3500 RPM.

D. C. ALNICO FIELD MOTOR

DIEHL TYPE FD6-23, 27 vts. 10,000 RPM.

GENERAL ELECTRIC
D. C. SELSYNS

8TJ9-PAB TRANSMITTER 24 VTS.
 8TJ11- INDICATOR, dial 0 to 360°, 24
 vts.

RECTIFIER POWER SUPPLY

HAMMETT ELECTRIC MFG. CO. MODEL
 SPS-130. Input voltage 208 or 230 volts,
 60 cycle, 3 phase, 21 amps. Output 28
 volts at 130 amps. continuous duty, 8
 point tap switch, voltmeter ammeter,
 thermo reset all on front panel.

MISCELLANEOUS

PIONEER MAGNETIC AMPLIFIER ASSEMBLY
 Saturable reactor type, designed to
 supply variable voltage to a servo motor
 such as CK1, CK2, CK5 or 10047.
 SPERRY A5 CONTROL UNIT, part No.
 644836.
 SPERRY A5 AZIMUTH FOLLOW-UP AMPLIFIER,
 part No. 656030.
 SPERRY A5 DIRECTIONAL GYRO, part No.
 656029, 115 vt. 400 cycle, 3 phase.
 SPERRY A5 PILOT DIRECTION INDICATOR,
 part No. 645262 contains AY 20.
 ALLEN CALCULATOR, TYPE C1, TURN &
 BANK IND., part No. 21500, 28 vts. D. C.
 TYPE C1, AUTO-PILOT FORMATION STICK,
 part No. G1080A3.
 PIONEER GYRO FLUX GATE AMPLIFIER,
 type 12076-1-A, 115 vt. 400 cycle.

INSTRUMENT
ASSOCIATES363 GREAT NECK ROAD, GREAT NECK, N. Y.
Telephone Great Neck 4-1147

Write for Catalog NE100

U. S. Export License-2140

Western Union address:
WUX Great Neck, N. Y.

FROM A to Z POWELL SERVICE IS BEST

AN Connectors—over 2500 different types in stock. Write for new four page reduced price list. World's best service on AN connectors, Liberal Discount!

BATTERY—RA 210—6V dry cell dated Nov. 1951, orig. cases guar. \$4.40
 RA35—same except 1 1/2 V. \$4.40

COAXIAL Cable, new current manufacture

RG 5/U	\$.13	RG 58/U	\$.07
RG 6/U	.19	RG 59/U	.07
RG 8/U	.12	RG 62/U	.07
RG 11/U	.12	K 109	.09
RG 17/U	.60	K 110	.12

price is per foot. Add 25% for quantities less than 250 feet of type.

COAXIAL Connectors—stock delivery, C of C. NEW LOW PRICES.

No.	Price	No.	Price
UG 9/U	\$1.11	UG 185/U	\$.99
UG 12/U	.95	MX 195/U	\$.89
UG 18 B/U	1.08	UG 201/U	2.25
UG 19 B/U	1.59	J 201	4.50
UG 20 B/U	1.61	UG 203/U	.75
UG 21/U	.95	UG 208/U	1.45
UG 21A/U	1.78	UG 212A/U	3.25
UG 21B/U	1.19	UG 213A/U	3.99
UG 21C/U	1.54	UG 215/U	3.85
UG 21D/U	1.42	UG 224/U	1.15
UG 22A/U	1.50	UG 229	4.40
UG 22B/U	1.40	UG 242/U	4.27
UG 22C/U	1.40	UG 245/U	2.25
UG 23/U	1.20	UG 252/U	5.25
UG 23C/U	1.58	UG 254A/U	2.66
UG 23D/U	1.89	UG 255/U	1.98
UG 24/U	.90	PL 258	.73
UG 25/U	.90	PL 259	.47
UG 27/U	1.30	PL 259A	.58
UG 27A/U	2.25	UG 260/U	.89
UG 27B/U	3.15	UG 261/U	1.10
UG 27C/U	3.75	UG 262/U	1.06
UG 28A/U	3.75	UG 271/U	5.45
UG 29/U	1.40	UG 273/U	1.49
UG 29B/U	1.65	PL 274	1.10
UG 30/U	2.50	UG 274/U	2.31
UG 37B/U	1.72	PL 275	2.10
UG 38A/U	1.12	UG 276/U	5.10
UG 38/U	1.18	UG 278/U	9.00
UG 39A/U	2.15	UG 290/U	1.05
UG 39/U	1.49	UG 291/U	1.05
UG 39B/U	2.45	UG 296/U	3.75
UG 39C/U	1.51	UG 306/U	2.75
UG 40/U	1.70	UG 323/U	2.29
UG 41/U	1.70	UG 333/U	4.90
UG 42/U	2.40	UG 335/U	3.95
UG 43/U	1.50	UG 342/U	2.95
UG 44/U	.90	UG 349/U	2.70
UG 45/U	1.09	UG 352A/U	6.40
UG 46/U	1.10	M 353	1.50
UG 47/U	1.13	M 359	.30
UG 48/U	2.13	UG 413/U	2.00
UG 49A/U	2.74	UG 414/U	1.95
UG 49B/U	1.63	UG 421/U	2.86
UG 49C/U	1.68	UG 422/U	2.86
UG 49D/U	1.53	UG 423/U	2.40
UG 49E/U	3.15	UG 483/U	3.49
UG 49F/U	3.15	UG 495/U	6.40
UG 49G/U	3.36	UG 498/U	2.95
UG 49H/U	4.00	UG 535/U	1.98
UG 49I/U	.84	UG 536/U	1.54
UG 49J/U	.84	UG 584/U	2.40
UG 49K/U	.84	UG 585/U	2.61
UG 49L/U	.15	UG 586/U	9.65
UG 49M/U	3.75	UG 587/U	5.02
UG 49N/U	3.25	UG 588/U	1.60
UG 49O/U	3.67	UG 589/U	1.95
UG 49P/U	1.85	UG 570/U	1.85
UG 49Q/U	1.65	UG 571/U	3.11
UG 49R/U	2.45	UG 573/U	2.72
UG 49S/U	7.50	UG 625/U	1.05
UG 49T/U	1.99	MX 913/U	3.85
UG 49U/U	32.50	IPC2250	.39
UG 49V/U	3.48	IPC2350	.39
UG 49W/U	2.50	IPC9175	.39
UG 49X/U	.29	IPC27000	2.49
UG 49Y/U	.14	IPC28000	2.49
UG 49Z/U	.14	MC-10	.48
UG 180A/U	5.95	MC-20	.39
UG 181A/U	5.65	MC-210	.53
UG 182A/U	5.65	MC-250	.53

DIFFERENTIAL, Gear 643268, 1 13/16" OD x 1 3/4" shaft w two ball bearings, our #658. \$2.45
 DIFFERENTIAL, Dual, 206832, probably part of a gun director unit, add four pieces of information and give sum. Only 1 1/2" O. D. by 3 3/4" long. Cost about \$200. New in overseas pack. ONLY \$5.50

EZY-MOUNT—Breadboard chassis in stock with individual mounts for various components, Kit EM666...\$19.95

FILTER, Line—D170738, 60 db att. 15K KC to 30 MC—Permalloy toroidal coils herm sealed, tiny, rated 10 AMP. \$2.95

GEAR DRIVE—5:1—Crows 296 tiny planetary. 1/2" to 3/4" — reg. \$6.00. Sale \$2.90

HEADER—8 different color seals, Fusite, 267535, 1"x1/2"x1/8", for herm sealed relays transformers, etc. \$2.20 Many others in stock, write for list.

INSULATORS—Pillar, ceramic glazed, slapped both ends.

Dia.	High	Tap	Price
1/4"	1/2"	6-32	\$.05
1/2"	1/2"	6-32	\$.05
3/8"	1/2"	6-32	\$.05
cone	9/16	6-32	\$.09
3/8"	5/8"	8-32	\$.05
3/8"	5/8"	6-32	\$.05
3/8"	1"	6-32	\$.07
1/2"	1 1/2"	8-32	\$.08

JOINT—Universal Aluminum 1/2" bore 1 1/2" overall length. \$8.50

KNOBS—National and Eby in stock include new Eby S67 bar. \$0.88

LAMP—Black Light—4 W-T5 1/2" dia. x 5 3/8"—New \$3.35
 NE-51 \$0.69
 NE-2 \$0.69
 AR-1 Argon 2 1/2 W std. base. \$2.25

MOTOR 1 RPM Synchron. \$3.50
 30 RPM Telechron—6 Watt. \$4.30

NETWORK—DELAY, 1400 ohm. .21
 alum. can. 1 1/2 x 1 3/4 x 3 3/4", 2.1
 micro second #661 \$2.90

NON-LINEAR Coil-RET-D164820 tiny saturable reactor used in RC 604 Useful as harmonic generator, in DC amplifiers etc. Formally tape core only .0004 inches thick. Cost twice this. \$2.90

These ultra high quality condensers are made by leading manufacturers. Features:

- 20,000 megohms or more
- Subminiature
- Glass seal terminals
- As high as \$7.70 regular

POTENTIOMETERS—50 & 100 watt.

Ohms	Watt	Cat. #	Price
15	50	WL	\$1.41
500	50	D	1.41
500	100	O-K	2.19
800	50	O-J	1.48

POTENTIOMETERS, Wire-wound 2 or excellent wirewound controls are made by the leading manufacturers and are in original cartons. Priced ridiculously low, only 20% of list. Satisfaction guaranteed! Substantial stock, up to 7000 pieces of a size:

Ohm	Bush	Shaft	Cat. #	Price
5-3	5/8	1/8sd	O-H	\$1.04
3-3	1/2	1/2	I	1.04
15	3/8	1"	C	1.04
15	1/2	1 1/8	D-245	1.04
20	1/2	1/2F	D-245	1.04
25	3/8	1	D-245	1.04
30	3/8	1	C	1.04
50	3/8	1 1/8	D-245	1.04
50	5/8	1/8sd	O-H	1.04
75	1/2	7/8	O-H	1.04
100	3/8	1	D-245	1.04
350	3/8	1 1/8	O-H	1.04
500	3/8	1 1/8	D-245	1.04
5K	1/2	1/8sd	I	1.24
5K	3/8	7/8	D-245	1.24
20K	1/2	1/8sd	D-245	1.40

SELENIUM Rectifiers Stock delivery of Sarkes high quality units.

VDC	VAC	AMP	Cat. #	Price
10	13	2	D10	\$3.05
10	13	4	D11	3.95
10	13	6	D12	4.50
10	13	12	D14	5.60
10	13	15	D15	8.90
10	13	22.5	D16	10.10
20	26	2	D17	5.55
20	26	4	D18	7.45
20	26	6	D19	8.00
20	26	12	D21	12.25
20	26	22.5	D23	18.20
40	52	2	D24	10.10
40	52	6	D26	14.65
40	52	12	D28	19.05
40	52	22.5	D30	34.30
60	78	2	D31	13.60
100	130	.5	D38	9.85
120	156	2	D47	23.95
120	156	4	D48	36.00

RECTIFIERS—low current bridge

VDC	VAC	MA	Cat. #	Price
20	26	10	A200	\$ 2.70
20	26	50	A201	1.05
100	130	10	A204	2.00
300	390	10	A210	6.00

RECTIFIERS—high voltage half wave.

VDC	Inverse	MA	Cat. #	Price
130	370	5	A221	\$.80
130	370	25	A222	.80
260	740	5	A224	1.50
260	740	25	A225	1.60
650	1850	5	A227	3.60
650	1850	25	A228	4.20
975	2760	5	A230	5.10
1300	3700	5	A232	10.90
1300	3700	5	A233	6.60
1300	3700	25	A234	8.20
1625	4600	5	A237	9.10
1625	4600	25	A239	10.20
1950	5515	5	A239	9.60
2275	6430	5	A242	11.10
2275	6430	25	A243	14.00

RECTIFIERS—small 130 VAC

35 Ma.	\$.54	250 Ma.	\$1.42
65 Ma.	.96	300 Ma.	1.60
100 Ma.	.92	450 Ma.	2.13

TIME DELAY Relay—adjustable from 1-60 seconds, 1/16" spaced one second marks for accurate, easy setting. Contacts SPDT, 100W, 115 VAC oper. 2 second spring recycle when deenergized. Fully enclosed in attractive black bakelite 3" round case. Brand new. Reg. price \$26.48. Model TD-1M. \$11.95

TRANSFORMER—400 cycle, hermetically sealed, 117V in; 568 Volt. @ 157MA, 5V @ 2A, 6.3V @ 0.6A, 6.3V @ 4.5A, 6.3V @ 4.5A out 3 3/4 x 4 1/2 x 5 1/2. Brand New. ONLY \$4.95

TRANSFORMERS, Pulse—901756-501 RCA, 15/16 dia. x 3 1/2" high, 165 turns on primary, 330 turns secondary, core is 4" stack, .007 inch "F" laminations. Magnetic Metals Co. Audio 58, used to form 7.3 microsecond pulses...\$1.50
 901756-502, RCA, same core & can as 501, 100 to 200 turns, used to form 2.2 microsecond pulses...\$1.50

UL Approved Cord Set, 6 ft., fresh, D709 Brown...\$2.23

VIBRATOR Power Supply, PE204A Radiart, 12VDC in, supply plate and screen volts for telephone repeater E299 plus TY14, 6" x 7" x 5 1/2", with cable & 18 contact Jones, spare VS-1 6 pin vibrator & schematic in case, orig. overseas pack, two in the case. Checked output, not simultaneously: 190V-0MA, 92V-40MA, 150V 16MA, 130V-42MA, 125V-28MA (above of filter) \$5.95

WIRE, Non-Strip Rex, CJB red or blue #26-19/38 50 ft. spools. This tiny wire can be soldered without stripping, excellent for that intricate job. Reg. \$16.50 per m., 500 ft. \$2.75

XTRA Care taken to make sure all shipments have the right items, are shipped at the right time to the right place with the right packing.

YOU will be pleased with our stock and service on these regular lines too: Akro-Mils, Alpha, Automatic, Cannon, Carling, Chicago Transformer, Crest Labs, Eby, Electro Mfg's., Federal, Grayhill, Greenlee, JCT Kings, Labelon, National, Sarkes, Switchcraft, Tuck, USECO, Vector.

ZENITH—Remote Control unit 115 VAC input 4 1/2 RPM output either direction with control cable, switches, etc. Ideal for moving "hot" items in measurements labs. A dozen were used in a psycho lab for remote control of potentiometers. Plenty of torque. New in orig. ctn. Few left! HURRY! \$8.95

SPECIALIST

IN

ELECTRONIC SUPPLIES

HAROLD H. POWELL

Widely Known for Fair Dealing
and Good Service

2104 MARKET ST. PHILA. 3, PENNA. LOCust 7-5285



OIL FILLED Subminiature Vitamin Q Condensers.

Mfd.	Volt	Type	Price
.0033	600	*774-606A	\$.74
.0082	400	G191P2394TA	1.48
.01	100	G191P10391	1.35
.01	200	G91P1392	1.44
.01	400	G88P16394	1.49
.01	600	G91P10396	1.49
.01	200	G191P10392TA	1.89
.012	200	G191P12392TA	1.44
.015	200	G191P15392TA	1.19
.015	400	G191P15394TA	1.44
.022	100	G191P22391	1.65
.027	200	G191P27392TA	1.44
.033	400	G191P33394TA	1.44
.033	200	G191P33392TA	.98
.043	200	G191P43352TA	1.29
.056	200	G191P56392TA	1.44
.068	200	G191P68352TA	.89
.082	400	G191P82394	1.49
.1	400	G191P10494TA	1.59
.15	100	G91P15491T	.98
.15	200	G191P15492TA	

U. G. CONNECTORS

"UHF" COAXIAL CABLE CONNECTORS

The following low loss RF connectors and adapters have been especially designed for use with RG coaxial cable. There is a connector for every RF and UHF application.



- All Connectors Are Brand New
- All Connectors Are JAN Approved

**IMMEDIATE DELIVERY
FULLY GUARANTEED**

Certificate of Compliance on Request

NO.	JAN NO.	DESCRIPTION
83-IR	SO 239	RECEPTACLE
83-1SP	PL 259	PLUG
83-168	UG 176/U	ADAPTER
83-185	UG 175/U	ADAPTER
83-1SPN	PL 259A	PLUG
83-776	UG 203/U	PLUG
83-1RTY	RECEPTACLE
83-1H	UG 106/U	HOOD
83-1HP	HOOD
83-765	UG 177/U	HOOD
83-1AC	CAP & CHAIN
83-1BC	CAP & CHAIN
83-1T	M 358	T CONNECTOR
83-1AP	M 359	ADAPTER
83-1AP	M 359A	ADAPTER
83-1J	PL 258	JUNCTION
83-1F	PL 274	FEED THRU
83-22SP	UG 102/U	TWIN PLUG
83-22R	UG 103/U	RECEPTACLE
83-22AP	UG 104/U	ADAPTER
83-22J	UG 105/U	JUNCTION
83-22T	UG 196/U	T CONNECTOR
83-22F	PL 275	FEED THRU
83-2SP	PL 295	PLUG
83-2R	SO 265	RECEPTACLE

WILGREEN INDUSTRIES

• 99 MURRAY STREET, NEW YORK 7, N. Y. •

WOrth 4-2490

TYPE	TYPE	TYPE	TYPE	TYPE	TYPE	TYPE
U/6/U	UG 37 A/U	UG 97 A/U	PL 156A	PLP 200	PLP 256	UG 421/U
U/7/U	UG 38 A/U	PL 98	UG 156/U	UG 201/U	PLQ 256	UG 422/U
UG 7A/P	UG 39/U	UG 98/U	UG 157/U	UG 202/U	UG 256/U	UG 423/U
U/8/U	UG 40/U	UG 98 A/U	UG 158/U	UG 203/U	PLP 257	UG 478/U
UG 8A/P	UG 45/U	UG 100/U	CW 159/U	UG 204 A/U	PLQ 257	UG 479/U
U/9/U	UG 46/U	UG 100 A/U	UG 159/U	UG 206/U	UG 257/U	UG 482/U
UG 9/U	UG 49/U	UG 101/U	PL 160	UG 207/U	PL 258	UG 483/U
U/10/U	UG 50/U	UG 101 A/U	UG/160 A/U	PL 208	UG 259/U	UG 484/U
UG 10/U	UG 57/U	UG 102/U	UG 160 B/U	UG 208/U	PL 259	UG 486/U
U/11/U	UG 57 B/U	PLP 104	M 160	UG 212 A/U	PL 359A	UG 487/U
UG 11/U	UG 58/U	PLQ 104	M 161	PL 213	UG 259/U	UG 489/U
U/12/U	UG 58 A/U	UG 106/U	M 162	UG 213 A/U	UG 260/U	UG 491/U
UG 12/U	UG 59/U	UG 107 A/U	M 163	UG 215/U	UG 260 A/U	UG 492/U
UG 13/U	UG 59 A/U	UG 107 B/U	M 164	PL 216	UG 261/U	UG 493/U
UG 14/U	PLP 60	PL 108	PLP 164	UG 216/U	UG 261 A/U	UG 494/U
UG 15/U	PLR 60	UG 108/U	UG 166/U	UG 217/U	UG 262/U	UG 495/U
U/16/U	UG 60/U	UG 108 A/U	PL 167	UG 218/U	UG 266/U	UG 496/U
UG 16/U	UG 60 A/U	UG 109/U	PLQ 167	UG 219/U	UG 267/U	UG 497
UG 17/U	PL 61	UG 109 A/U	PLP 167	UG 220/U	UG 269/U	UG 499/U
UG 18/U	PLQ 61				UG 270/U	UG 503/U
UG 18 A/U	UG 61/U				UG 271/U	MX 504
UG 18 B/U	UG 61 A/U				UG 272/U	UG 505/U
UG 19/U	UG 61 B/U				UG 273/U	UG 506/U
UG 19 A/U	PL 63				UG 274/U	UG 507/U
UG 19 B/U	PLQ 63				PL 274	UG 526/U
UG 20/U	PLP 64				UG 275/U	UG 530/U
UG 20 A/U	PLQ 64				UG 276/U	UG 531/U
UG 20 B/U	PL 71				MC 277	UG 532/U
UG 21/U	PL 72	UG 110/U	UG 167/U	UG 222/U	MC 277A	UG 533/U
UG 21 A/U	UG 73/U	PL 112	UG 167 A/U	UG 223/U	UG 279/U	UG 535/U
UG 21 B/U	PLP 74	PL 114	PLP 169	UG 224/U	UG 282	UG 536/U
UG 21 C/U	PLP 77	UG 114/U	M 170	PLP 227	UG 286/U	MX 539
UG 21 D/U	PLQ 77	UG 115/U	PL 170	PLQ 227	PLP 230	UG 541/U
UG 22/U	PL 80	PL 118	M 171	PLQ 230	UG 287/U	UG 541/U
UG 22 A/U	UG 80/U	PL 119	PL 171	UG 231/U	UG 290/U	MX 543
UG 22 B/U	UG 83/U	UG 119 U/P	PL 172	UG 231/U	UG 291/U	MX 54/U
UG 22 C/U	UG 85/U	PL 122	UG 159 A/U	UG 233/U	UG 294/U	UG 557/U
UG 23/U	UG 85/U	PL 123	UG 160 A/U	UG 234/U	PL 295	MX 564/U
UG 23 A/U	UG 86/U	CW 123 A/U	UG 160 B/U	UG 235/U	UG 299/U	UG 564/U
UG 23 B/U	UG 87/U	LP 126	UG 166/U	UG 236/U	UG 306/U	UG 565/U
UG 23 C/U	UG 88/U	M 130	UG 167/U	UG 237/U	UG 309/U	UG 567/U
U/26/U	UG 88 B/U	UG 131/U	UG 167 A/U	SO 239	UG 318/U	UG 568/U
UG 27 A/U	UG 89/U	PL 133	UG 173/U	UG 240/U	UG 333/U	UG 569/U
UG 27 B/U	UG 90/U	PL 138	UG 174/U	UG 241/U	UG 334/U	UG 570/U
UG 28/U	UG 91/U	UG 146/U	UG 175/U	UG 242/U	UG 335/U	UG 571/U
UG 28 A/U	UG 91 A/U	PL 147A	UG 176/U	UG 243/U	UG 347/U	UG 572/U
UG 28 B/U	UG 92/U	PL 148A	UG 180 A/U	UG 244/U	UG 348/U	UG 573/U
UG 29/U	UG 92 A/U	UG 148 A/U	M 181	UG 245/U	UG 349/U	UG 586/U
UG 29 A/U	UG 93/U	UG 149 A/U	UG 181 A/U	UG 246/U	UG 352/U	UG 593/U
UG 29 B/U	UG 93 A/U	M 150	UG 182 A/U	UG 249/U	M 358	UG 625/U
UG 30/U	UG 94/U	M 151	PL 184	UG 250/U	M 359A	UG 627/U
UG 32/U	PL 151A	PL 151A	PL 188	UG 251/U	UG 361/U	UG 628/U
UG 33/U	UG 95/U	PL 152A	UG 188/U	UG 252/U	UG 402/U	UG 631/U
UG 34/U	UG 95 A/U	PL 154A	UG 190/U	UG 253/U	MT 412	UG 634/U
UG 35 A/U	PL 96	UG 154/U	UG 192 A/U	PLP 254	UG 413/U	UG 643
UG 36/U	UG 96/U	CW 155/U	M 192	PLQ 254	UG 414/U	MX 913/U
UG 37/U	UG 96 A/U	UG 155 A/U	MX 195/U	UG 254 A/U	UG 415/U	
	UG 97/U	UG 155/U	UG 197/U	UG 255/U	UG 419/U	

WILGREEN INDUSTRIES U. G. DIVISION

"A N" CONNECTORS - Immediate Delivery

Buy TOP Radio-Electronic Values!

AIR TRIMMER CONDENSERS

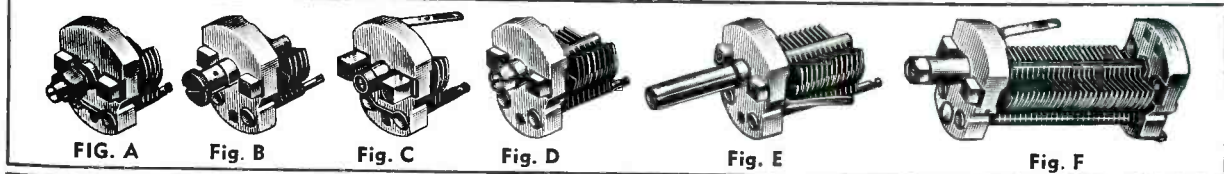

STOCK NO.	CAPACITY Min. Max.	MANUFACTURER'S NUMBER	FIGURE	SHAFT LENGTH	POST LENGTH	GROUND LUG	PRICE EACH
2937	2.5 - 7	Hamm 250034	D	5/16	3/32	Right	18¢
5716*	3 - 8	ASP 17A224	A	9/16	3/32	Top	25¢
5717	3 - 10	ASP 22G192	A	9/16	3/32	To Post	18¢
4090	2 - 15	ASP 482212	E	1" x 1/4" D.	3/32	Left	25¢
2939	3 - 15	ASP 217-2	C	5/16	1/4	Top	20¢
5718	3 - 15	Telrad 682070-30	D	5/16	3/32	Right	20¢
5719	3 - 15	Hamm 682070-30	D	5/16	3/32	Right	20¢
231	3 - 25	CAIM 481881	D	9/16	3/32	Left	25¢
5720	3 - 27	Hamm 11725-1	A	5/16	3/32	Right	25¢
5721	2.5 - 28	Comar M420864-6	D	5/16	3/32	Top	25¢
5723	3 - 29	ASP 22G190	A	9/16	3/32	To Post	25¢
5724	4.5 - 30	OB7751E-25	D	5/16	5/16	Right	30¢
5086	5 - 30	Hamm SBL-72265-3	B	1/2	3/32	Bottom	30¢
232	5 - 54	Hamm ESA682070-35	D	5/16	3/32	Left	40¢
5087	5 - 54	Hamm BL 72265-4	B	1/2	3/32	Right	40¢
236**	8 - 140	ASP 19A34504	E	5/16	3/32	To Post	55¢
6124	6 - 140	ASP 19A54023	D	5/8"	1/4"	D	75¢
5726	9 - 204	OAK 114M510	F	9/16	3/32	Top	95¢

* Double spaced plates.
** Adjusts both ends, some available w/dust cover.
Fig. A Round Shaft Screwdriver adj. w/locknut.
Fig. B Bakelite Knob Ins. Screwdriver adj.

Fig. C Round Shaft Screwdriver adj.
Fig. D Hexnut Screwdriver adj.
Fig. E 3/4 Round Shaft.
Fig. F Double End Plate.

RELAYS

LEACH TYPE 1204, D.P.S.T.
1/4" Diam. Normally open contacts. Bakelite base. 24 V.D.C., 265 ohm Coil.

Stock No. 6169A Price Each **\$1.95**

ALLIED CONTROL TYPE BOX 60
D.P.D.T. 1/4" Diam. Contacts. One Pole makes before break. 9.6 V.D.C., 40 ohm Coil.

Stock No. 6170A Price Each **\$1.25**

STRUTHERS-DUNN TYPE 61AXX100, S.P.
S.T. Normally open contacts rated at 20 amps @ 24 V.D.C. 80 ohm, 24 V.D.C. Coil.

Stock No. 6171A Price Each **75¢**

10 MFD. — 600 VDC

Sprague No. R2-157, 10 Mfd. 220 VAC 600 VDC Capacitor with Universal Mounting Ring. 2-7/16" Diameter, 3/4" high. Bakelite insulated terminals.

Stock No. 5958A Price Each **95¢**

BUTTERFLY CONDENSERS

FIG. 1

FIG. 2

9-62 mmfd per section. 6-34 mmfd sections in series. Double ceramic end plates and bearings. 1/4" diam. shaft, 5/16" long. 065 Plate spacing end plates 1-3/8" square.

Stock No. 5076-A FIG. 1 Price Each **90¢**

4-22 mmfd per section. 3-12 mmfd sections in series. Single ceramic end plate 1-3/8" square, 1/4" diam. x 1/4" long shaft.

Stock No. 5077-A FIG. 2 Price Each **60¢**

POWER TRANSFORMER

Horizontal double half shell type.
PRI: 117 Volt—60 Cycle.
SEC: 265-0-265 V.A.C. @ 40 MA.
SEC: 6.3 V.A.C. @ 1.65 amps.
MTG. Centers 2 1/2" x 2".
H.V. Center tap is grounded to core.

Stock No. 6183A Price Each **\$1.25**

CANNON CONNECTORS

Popular 3 contact polarized latch lock connectors for low-level sound transmission circuits. 6172 is straight cord female type. 6173 is wall mount receptacle male type.

Stock No.	Type	Price Each
6172 A	XL-3-11	35¢
6173 A	XL-3-14	30¢

PLANETARY DRIVE

CRONAME PLANETARY DRIVE. 5 to 1 ratio. Fits 1/4" Shaft. Front shaft takes 1/4" Knob for rotation drive or will accommodate 3/8" Knob for direct drive.

Stock No. 6146A Price Each **25¢**

BRADLEY INSTRUMENT RECTIFIER

BRADLEY #CX2E4E-69 Copper Oxide Rectifier, 3 color coded insulated wire leads.

Stock No. 6184A Price Each **50¢**

OIL FILLED CONDENSERS

Stock No.	Capacity MFD.	D. C. WKG. Voltage	Dimensions	Price Each
6057A	2	600	1" x 1-3/4" x 2-3/4"	\$0.59
5994A	4	600	1-1/4" x 2-1/2" x 3-1/4"	1.75
6101A	4	1500	1-1/4" x 3-3/4" x 4-1/2"	2.75
6103A	0.5	5000	2-1/4" x 4" x 4-1/8"	2.95
6104A	1	5000	3-5/8" x 4-1/2" x 4-1/8"	4.25
5399A	0.045	16000	1-3/4" x 3-1/2" x 4-3/4"	4.95
6052A	2 X .15	8000	1-3/4" x 3-1/2" x 4-3/4"	4.95

All have ceramic insulated terminals. All are NEW, standard name brands.

RCA and KENRAD
Individually Boxed
JAN 826's

75¢ Each
100 Lots **85¢ ea**

RAYTHEON
Individually Boxed
JAN VT-127's

\$1.95 Each
100 Lots **35¢ each**
3 for \$1.00

6.3 VOLT FILAMENT TRANSFORMERS

Primary 115 Volt 60 Cycle 1600 Insulation Three 6.4 Volt Secondaries

6.3 Volts @ 4.9 Amps. Horizontal Half Shell Mounting. 2 1/4" x 6.3 Volts @ 4.5 Amps. 2 13/16" Mounting Centers. 2 13/16" x 6.3 Volts @ 1.1 Amps. 3 3/8" Core Size. 2 1/2" above Chassis. Soder Lug Terminals—All Terminals Marked.

Stock No. 5254A Price Each **\$2.65**

TERMS:

Open Account to rated or Acceptable reference accounts. Others Pre-payment of 25% deposit with order, balance C.O.D. Price F.O.B. Chicago and subject to change without notice. Merchandise subject to prior sale.

ORDER TODAY!

Radio Surplus Corp.

732 South Sherman Street
Chicago 5, Illinois
Phone: HARRISON 7-5923

TIME'S PRICES CAN'T BE BEAT!

UG CONNECTORS

KINGS — IPC — AMPHENOL — DIAMOND

THE MOST COMPLETE INVENTORY OF UG CONNECTORS AT PRICES THAT ARE UNBEATABLE

ALL CONNECTORS IN FULL COMPLIANCE WITH JAN SPECIFICATIONS



Type	Price	Type	Price	Type	Price	Type	Price
UG 7/AP	\$6.75	UG 888/U	1.10	UG 219/U	5.25	UG 482/U	30.00
UG 8/AP	6.25	UG 89/U	1.25	UG 220/U	10.00	UG 483/U	3.75
UG 9/U	1.25	UG 90/U	1.25	UG 222/U	30.00	UG 484/U	5.50
UG 10/U	1.95	UG 91/U	1.60	UG 223/U	5.00	UG 486/U	2.10
UG 11/U	1.80	UG 91A/U	1.40	UG 224/U	1.20	UG 487/U	6.25
UG 12/U	1.25	UG 92/U	1.40	UG 231/U	2.50	UG 491/U	1.95
UG 13/U	2.25	UG 92A/U	1.75	UG 233/U	17.00	UG 492/U	5.25
UG 14/U	1.75	UG 93/U	1.60	UG 234/U	17.00	UG 492A/U	11.25
UG 15/U	1.25	UG 93A/U	1.75	UG 235/U	34.00	UG 493/U	6.75
UG 16/U	2.25	UG 94/U	1.60	UG 236/U	9.50	UG 494/U	4.75
UG 17/U	2.25	UG 94A/U	1.35	UG 237/U	22.50	UG 495/U	6.75
UG 18/U	1.60	UG 95/U	1.40	UG 240/U	12.00	UG 496/U	2.75
UG 18A/U	1.65	UG 95A/U	1.50	UG 241/U	2.75	UG 499/U	2.25
UG 18B/U	1.15	UG 96/U	1.60	UG 242/U	3.50	UG 503/U	30.00
UG 19/U	1.60	UG 96A/U	1.70	UG 243/U	3.95	MX 504	.65
UG 19A/U	1.75	UG 97A/U	3.75	UG 244/U	3.30	UG 504/U	30.00
UG 19B/U	1.80	UG 98/U	2.25	UG 245/U	2.95	UG 505/U	30.00
UG 20/U	1.90	UG 98A/U	2.25	UG 246/U	2.50	UG 506/U	30.00
UG 20A/U	1.95	UG 100/U	1.75	UG 249/U	17.00	UG 507/U	30.00
UG 20B/U	1.85	UG 100A/U	3.25	UG 250/U	17.00	UG 516A/U	2.70
UG 21/U	.95	UG 101/U	4.75	UG 251/U	17.00	UG 519/U	24.00
UG 21A/U	1.60	UG 101A/U	4.00	UG 252/U	5.95	UG 526/U	3.75
UG 21B/U	1.00	UG 107A/U	3.25	UG 253A/U	6.00	UG 530/U	4.25
UG 21C/U	1.05	UG 107B/U	2.75	UG 254A/U	2.35	UG 531/U	4.95
UG 21D/U	1.50	UG 108A/U	3.00	UG 255/U	2.20	UG 532/U	5.75
UG 22/U	1.35	UG 109A/U	2.50	UG 256/U	14.50	UG 533/U	3.50
UG 22A/U	1.60	UG 110/U	12.00	UG 257/U	14.50	UG 536/U	1.95
UG 22B/U	1.20	UG 114/U	1.90	UG 259/U	5.25	MX 539/U	.75
UG 22C/U	1.20	UG 115/U	1.85	UG 260/U	.90	UG 541/U	3.75
UG 22D/U	1.25	UG 119U/P	7.50	UG 260A/U	1.10	MX 543/U	.75
UG 23/U	1.25	CW 123A/U	.45	UG 261/U	1.10	MX 554/U	2.00
UG 23A/U	1.60	UG 131/U	5.00	UG 262/U	1.20	UG 557/U	4.95
UG 23B/U	1.50	UG 146/U	2.70	UG 266/U	1.25	MX 564/U	.65
UG 23C/U	1.10	UG 148A/U	7.00	UG 269/U	3.25	UG 564/U	2.95
UG 23D/U	2.10	UG 149A/U	5.00	UG 270/U	8.50	UG 565/U	7.95
UG 27A/U	2.50	UG 154/U	7.50	UG 271/U	8.50	UG 566/U	3.95
UG 27B/U	2.95	CW 155/U	.45	UG 272/U	20.00	UG 567/U	1.95
UG 27C/U	3.95	UG 155/U	7.00	UG 273/U	1.75	UG 568/U	2.25
UG 28A/U	2.95	UG 156/U	5.50	UG 274/U	2.75	UG 569/U	2.25
UG 28B/U	3.95	UG 157/U	5.50	UG 275/U	5.95	UG 570/U	2.50
UG 29/U	.95	UG 158/U	45.00	UG 276/U	5.95	UG 571/U	3.50
UG 29A/U	1.95	CW 159/U	2.95	UG 279A/U	5.50	UG 573/U	3.50
UG 29B/U	1.75	UG 159A/U	2.00	UG 286/U	4.25	UG 586/U	5.00
UG 30/U	2.35	UG 160A/U	2.00	UG 287/U	6.95	UG 589/U	1.25
UG 30C/U	11.25	UG 160B/U	2.00	UG 290/U	.95	UG 593/U	1.95
UG 32/U	19.00	UG 166/U	45.00	UG 291/U	.95	UG 602/U	3.00
UG 33/U	19.00	UG 167/U	3.75	UG 294/U	1.95	UG 603/U	3.00
UG 34/U	6.00	UG 167A/U	4.25	UG 299/U	6.00	UG 625/U	1.45
UG 35A/U	18.00	UG 173/U	.36	UG 306/U	2.75	UG 626/U	3.95
UG 36/U	12.50	UG 174/U	9.00	UG 309/U	2.75	UG 627/U	4.50
UG 37A/U	19.00	UG 175/U	.12	UG 332/U	3.50	UG 628/U	4.50
UG 38A/U	21.00	UG 176/U	.12	UG 333/U	5.25	UG 629/U	2.95
UG 39/U	1.50	UG 180A/U	6.50	UG 334/U	6.50	UG 631/U	4.50
UG 40/U	1.65	UG 181A/U	6.50	UG 335/U	3.25	UG 632/U	4.50
UG 45/U	3.75	UG 182A/U	6.50	UG 347/U	2.50	UG 634/U	4.50
UG 46/U	3.75	UG 185/U	1.10	UG 348/U	1.50	UG 635/U	4.50
UG 49/U	19.00	UG 188/U	1.20	UG 349/U	2.95	UG 636/U	4.50
UG 50/U	19.00	MX 195/U	.95	UG 350/U	24.00	UG 642/U	4.95
UG 57/U	2.00	UG 197/U	4.25	UG 352/U	6.75	UG 643/U	4.50
UG 57B/U	1.85	UG 201/U	1.95	UG 352A/U	7.50	UG 701/U	12.00
UG 58/U	.90	UG 202/U	3.50	UG 361/U	1.95	UG 702/U	8.95
UG 58A/U	2.25	UG 203/U	.65	UG 400/U	24.00	UG 703/U	8.95
UG 59/U	1.90	UG 204A/U	2.95	UG 402/U	24.00	UG 704/U	12.00
UG 59B/U	2.60	UG 206/U	2.00	MT 412	.90	UG 705/U	12.00
UG 60/U	2.25	UG 207/U	22.50	UG 413/U	30.00	UG 706/U	8.95
UG 60A/U	1.65	UG 208/U	22.50	UG 414/U	2.25	UG 707/U	14.00
UG 61/U	2.35	UG 212A/U	2.75	UG 419/U	1.95	UG 708/U	14.00
UG 61A/U	2.25	UG 213A/U	3.75	UG 421/U	3.10	UG 709/U	18.95
UG 63/U	1.90	UG 215/U	3.95	UG 422/U	3.10	UG 710/U	18.95
UG 85/U	1.75	UG 216/U	12.00	UG 423/U	3.10	UG 711/U	18.95
UG 86/U	2.25	UG 217/U	5.25	UG 427/U	1.50	MX 913/U	.65
UG 87/U	1.55	UG 218/U	9.75	UG 478/U	50.00	UG 923/U	2.75
UG 88/U	.95			UG 479/U	30.00	UG 931/U	3.00
						UG 932/U	3.00

memo

Time Electronics proudly offers these Listings as a sampling of the vast inventory and low low prices to be found at Time ... It's Time for a change to dependable service, complete inventory.

Leon May

R.G.

COAXIAL CABLES By FEDERAL

Type	Price per 1000 ft.	Type	Price per 1000 ft.
RG 5/U	\$130.00	RG 34/U	\$250.00
RG 5B/U	275.00	RG 35/U	850.00
RG 6/U	175.00	RG 39/U	180.00
RG 7/U	60.00	RG 41/U	350.00
RG 8/U	95.00	RG 42/U	210.00
RG 9/U	175.00	RG 54/U	50.00
RG 9A/U	225.00	RG 54A/U	60.00
RG 9B/U	375.00	RG 55/U	100.00
RG 10/U	200.00	RG 57/U	125.00
RG 11/U	95.00	RG 57A/U	400.00
RG 11A/U	160.00	RG 58/U	60.00
RG 12/U	190.00	RG 58A/U	65.00
RG 13/U	200.00	RG 58C/U	75.00
RG 13A/U	250.00	RG 59/U	55.00
RG 14/U	290.00	RG 59A/U	95.00
RG 14A/U	350.00	RG 62/U	65.00
RG 15/U	300.00	RG 63/U	120.00
RG 17/U	500.00	RG 63B/U	200.00
RG 17A/U	700.00	RG 63C/U	750.00
RG 18/U	650.00	RG 71/U	120.00
RG 19/U	850.00	RG 74/U	350.00
RG 19A/U	1250.00	RG 74A/U	475.00
RG 20/U	1100.00	RG 77/U	80.00
RG 21/U	220.00	RG 78/U	80.00
RG 22/U	150.00	RG 79/U	220.00
RG 22A/U	260.00	RG 83/U	220.00
RG 22B/U	320.00	RG 87A/U	2990.00
RG 23/U	500.00	RG 89/U	360.00
RG 23A/U	600.00	RG 108/U	90.00
RG 24/U	275.00	RG 111/U	390.00
RG 25/U	400.00	RG 114/U	170.00
RG 26/U	400.00	RG 122/U	80.00
RG 27/U	400.00	RG 125/U	300.00
RG 28/U	600.00	RG 130/U	360.00
RG 29/U	30.00	RG 131/U	550.00

"UHF" COAXIAL CABLE CONNECTORS



No.	Jan No.	Description	1 to 99	100 to 999	1000 or more
83-1R	SO 239	RECEPTACLE	\$4.40	\$3.38	\$3.36
83-1SP	PL 259	PLUG	.50	.48	.45
83-168	UG 176/U	ADAPTER	.12	.11	.10
83-185	UG 175/U	ADAPTER	.12	.11	.10
83-1SPN	PL 259A	PLUG	.60	.55	.50
83-776	UG 203/U	PLUG	.65	.60	.55
83-1RTY		RECEPTACLE	.75	.70	.65
83-1H	UG 106/U	HOOD	.15	.14	.12
83-1HP		HOOD	.20	.18	.16
83-765	UG 177/U	HOOD	.24	.22	.20
83-1AC		CAP & CHAIN	.50	.48	.45
83-1BC		CAP & CHAIN	.35	.31	.30
83-1T	M 358	T CONNECTOR	1.50	1.25	1.15
83-1AP	M 359	ADAPTER	.35	.30	.25
83-1AP	M 359A	ADAPTER	.80	.75	.65
83-1J	PL 258	JUNCTION	.75	.70	.65
83-1F	PL 274	FEED THRU	1.25	1.20	1.10
83-22SP	UG 102/U	TWIN PLUG	.80	.75	.70
83-22R	UG 103/U	RECEPTACLE	.80	.75	.70
83-22AP	UG 104/U	ADAPTER	1.25	1.15	1.00
83-22J	UG 105/U	JUNCTION	1.50	1.40	1.30
83-22F	UG 106/U	T CONNECTOR	1.65	1.50	1.40
83-22T	PL 275	FEED THRU	2.00	1.80	1.75
83-2SP	PL 295	PLUG	2.25	2.15	2.00
83-2R	SO 265	RECEPTACLE	1.65	1.55	1.50

TIME ELECTRONIC SALES

368 BROADWAY NEW YORK 13, N. Y. **BARclay 7-3922**

Checked-Tested and APPROVED

It has to be right! . . . when it's from Semler. Semler is one of the leading suppliers of precision test equipment to the aircraft industry. Semler is a recognized and approved source of supply for many foreign and U.S. Government agencies.

... WHEN IT'S FROM

SCR-291 Direction Finding Equipment



A semi-portable radio direction finder using U-Adcock type antenna system for ground station operation. Instantaneous visual bearing indications are given on the fact of a 5" cathode ray tube with an illuminated 360 degree azimuth scale projected in the same plane. The indicator instrument is equipped with a motor driven goniometer and bearings may be read directly without any mental calculation.

An extremely efficient unit for the location of gun installations; radio stations and portable transmitting equipment. By the use of a dual installation and placing the units in diverse locations, the signal is received on the two separate indicators and the exact point of convergence can be readily and accurately calculated.

Illustrated herewith are the radio receiving and control equipment as well as the bearing indicator with goniometer.

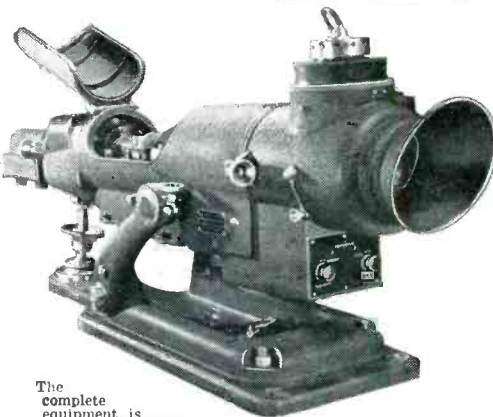

The complete equipment is available for immediate delivery and includes: Hucks, Control panel, Telephone panel, Bearing indicator with goniometer, Receiver, Junction boxes, Phase inverters, Antennas, Target transmitter, Connecting cables, Power cords, Transmission lines, and Gasoline driven Motor Generator.

Although the complete system contains a considerable amount of equipment, it is so designed to be easily dismantled and packed so that no unit weighs in excess of 500 pounds with the exception of the motor generators. Frequency—1.5 to 30 Mcs. Tube Complement—2 RF and 2 IF Stages. Power—115 Volt 60 Cycle—Single Phase.

Semler

ASSOCIATED INDUSTRIES, INC.

PHOTOGRAPHIC

5730 Wilshire Blvd.
Los Angeles 36,
California

ELECTRONIC

6855 Tujunga Ave.
North Hollywood,
California

AIRCRAFT

118-18 Ventura Blvd.
North Hollywood,
California

AIRBORNE COMMUNICATION EQUIPMENT

RT18/ARC1 Trans/ceiver

10 & 20 Channel

AN/ARC3 Trans/ceiver

SCR 718C Absolute

Dadar Altimeter

AN/ARN5 ILS

3 & 6 Channel

RC-103 ILS

T47A/ART13 Transmitter

BC348 Superhet. Receiver

R5/ARN7 Radio Compass

SCR522 Trans/ceiver

RTA 1B Trans/ceiver

MN62A Radio Compass

CRT53 Dual Channel

Emergency Transmitter

LOOP ANTENNAS

MN24C

MN20E

AT4/ARN1

LP21A

LP21LM

LP21AM

BORESIGHT KITS

- To boresight free and fixed .30-Cal., .50-Cal., 20 mm. guns.
- For boresighting from breech or muzzle.
- Includes muzzle and breech sights, adapters, extension and right angle tubes.
- For precise optical alignment and laboratory use.

MARK 1—Bell & Howell. TYPE J-1—Bell & Howell. TYPE J2—American Scientific. AN-1—Bell & Howell. For aligning optical axis of camera and gun sight on 16mm. GSAP Camera. MARK 11—Model O—Western Union. Electrically operated using Type 2C light source. An excellent laboratory instrument and precision optical collimator.

OSCILLOGRAPH RECORDING EQUIPMENT

For photographic recording of oscillographs. For automatic developing of oscillograph paper.

ST. GEORGE RECORDING CAMERA—Originally designed for use with APQ-7 radiator. An electrically operated 35mm automatic recording camera complete with control panels.

DEVELOPING OUTFITS—The following are electrically operated and completely automatic. They include geared motor drives, three stainless steel tanks and developing reels. Excellent for developing either film or paper.

Type B-5—9½" x 200' Model K-7" x 75'
Type B-4—9½" x 200' Type K-20—3½" x 50'

Aircraft and Communications Inverters

MG-149F Inverter—Holtzer Cabot

Input: 28V DC—36 Amp.
Output: 26V 400 Cycle—500 V. Amp.—Single Phase
115 V 400 Cycle—750 V. Amp.—
Single Phase \$65.00

MG-149H Inverter—Holtzer Cabot

Input: 28V—DC—44 Amp.
Output: 26V—400 cycle—250 V. Amp.—Single Phase
115V/400 Cycle 500 V. Amp.—
Single Phase \$145.00

MG-153F Inverter—Holtzer Cabot

Input: 28V—DC—52 Amp.
Output: 26V—400 Cycle—250 V. Amp.—Single Phase
115V—400 Cycle—750 V. Amp.—
Three Phase \$125.00

94-32270A Inverter—Leland #10285

Input: 27V—DC—60 Amp.
Output: 26V—400 cycle 50 V. Amp. Single Phase
115V—400 cycle 750 V. Amp.—
Three Phase \$90.00

PU-7 Inverter—Wincharger

Input: 28V DC—160 Amp.
Output: 115V—400 cycle—2500 V. Amp.—
Single Phase \$100.00

PU-16 Inverter—Wincharger

Input: 28V DC—60 Amp.
Output: 115V—400 cycle—6.5 Amp.—
Single Phase \$90.00

10563 Inverter—Leland

Input: 28½V DC—12 Amp.
Output: 115V—400 cycle—115 V. Amp.—
Three Phase \$75.00

PE-206 Inverter—Leland

Input: 28V DC—38 Amp.
Output: 500V—800 cycle—500 V. Amp.—Single Phase
30V—800 cycle—500 V. Amp.—
Single Phase \$40.00

PE-218 Inverter—Leland—Wincharger—

Gen. Electric
Input: 28V DC—92 Amp.
Output: 115V—380/500 cycle—1500 V. Amp.—
Single Phase \$40.00

778-B Inverter—Bendix

Input: 28V DC—250 V. Amp.
Output: 26V 400 cycle—60 V. Amp.—Single Phase
115 V—400 cycle—90V. Amp.—
Single Phase \$65.00

Semler Photographic Division;
COMPLETE LINE OF AERIAL
CAMERAS, LABORATORY, &
SPECIALIZED PHOTOGRAPHIC
RECORDING EQUIPMENT. Semler
Aircraft Division; COMPLETE
LINE OF AIRCRAFT INSTRUMENTS
& ACCESSORIES.

Magnetron and Special Purpose TUBES

2J26	\$15	2K25	\$20
2J27	15	2K48	100
2J30	100	3C22	70
2J31	40	4C22	25
2J32	30	4J31	75
2J33	30	4J50	75
2J34	40	4J52	185
2J48	35	700C	15
2J55	75	700D	15
2J56	125	706FY	25
2J61	30	723AB	15
2J62	35	725A	7
	851		\$45



**PHONE
COLLECT**

if you have any of the following: TS3, TS12, TS13, TS33, TS35, TS45, TS62, TS117, TS120, TS146, TS147, TS148, TS155, TS174, TS175, TS239, TS251, TS268, TS375; 1-100, 1-182, 1-201; TSX45E; AN/ARC3; 1-152C; APN9; BC788C. Semler pays TOP BUCK for all electronic equipment. WRITE IN.

Semler

AN/ARC12

More than one 10 channel,
crystal controlled, 225-
350 Mcs., 24 V., D.C. **\$1450**

Semler has one of the most complete and extensive stocks of Electronic Test Equipment. What are your requirements?

One only . . . Just released!
RT178/ARC27

1750 Channel, manufactured by Collins, crystal controlled, **\$2500**
225-400Mcs., 24 V., D.C.

Prospective purchaser must have U. S. government clearance.

ASSOCIATED INDUSTRIES, Inc. 6855 Tujunga Ave., North Hollywood, Calif.
Phone: STANley 7-5458

QUARTZ CRYSTALS

NEW LISTING

Made from the finest Brazilian Quartz. Will provide a high degree of activity and frequency stability. All tested and marked by the manufacturer to a very close tolerance. In the frequencies outlined below the crystals itemized under the heading "From & To" are mostly in progressive frequencies between the limits shown (as for example: "From 3300 to 3377," are as follows: 3300KC, 3301KC, 3302KC—, 3377KC.) are of limited quantities in each frequency. Those listed singly are in quantities of 50 or more.

FT243			CR 1A/AR or FT241			XL5 Dual		FT241A		
Prong centers 1/2", Prong dia. 3/32"			Prong spacing 1/2", Prong dia. 1/8"			3 prongs 1/2" x 1 19/32" prong dia.		SPECIAL TYPE WE.		
Price \$1.15 ea. (25 for \$25.00)			Price 79¢ ea. 12 for \$9.00			Price \$1.95 ea.		Prong spacing 1" CTS. Prong Size 3/32" dia.		
FROM	TO	FROM	TO	TO	FROM	TO	These are in successive steps of .1 MC variation from 20.0 MC to 27.9 MC			
								Suitable for low frequency purposes (1/54 of Stated Values)		
								Price \$1.15 ea.		
1915	1998	6100	6173.3	7906	2853	7620				
2030	2068	6225		8000	3988	7650				
2175	2158	6250		8025	4188	7738				
2300		6275		8050	4285	7740				
2320	2390	6300	6292	8100	4300	7750				
2420	2490	6300	6375	8100	4785	7760				
2604		6400	6438	8200	5020	7770				
2605		6500	6500	8385	5100	7775				
3105		6500	6500	8400	5120	7780				
3652	3689	6700	6675	8475	5200	7780				
3729		6800	6875	8500	5250	7790				
3805		6815		8600	5300	7800				
		6830		8786.25	5396	7810				
4104		6900	6975	8876.25	5470	7825				
4244		6975		8921.25	5470	7830				
4305		7225	7281	8921.25	5470	7850				
4400		7325	7375	9342	5810	7851				
4600		7458.75		9500	5820	7851				
4800		7444	7475	9515	5910	7851				
4913		7500	7597	9583	5923	7900				
5100		7606		9608	5931	7910				
5300		7625	7673.3	9608	6130	7925				
5320	5897.5	7650		12608	6203	7930				
5500		7675		12700	6275	7930				
5630		7700		12800	6300	7950				
5633.3		7725		12902	6370	7970				
5655.5		7725		13004	6400	7970				
5677.7		7750		13102	6499	8002				
5700		7750		13100	6490	8007				
5706.6		7750		13100	6500	8012				
5722.2		7775	7790	13123	6585	8092				
5744.4		7775		13202	6600	8298				
5800		7800		13213	6744	8205				
5800	5892	7800		13302	6815	8308				
5855		7850		13400	6815	8308				
5900		7850		13500	6905	8300				
5955		7875		13500	7270	8407				
6000		7925		13903	7330	8412				
6150		7950		14038	7400	8405				
6175		7950		14092	7500	8596				
				14138	7540	8645				
					7540	8630				
					7560	8985				
					7600	11677				

EDLIE ELECTRONICS, Inc. 154 Greenwich Street, New York, N. Y. Telephone DIgby 9-3143

NEW-GUARANTEED METERS

R.F. AMMETERS		A.C. AMMETERS	
1.5 GENERAL ELECTRIC DW-52, 2 1/2" rd metal case, black scale.....	\$3.50	100 MAAC, WESTON 476, 3 1/2" rd.....	7.50
2 WESTINGHOUSE RT-35, 3 1/2" square.....	6.95	3 AMP, SIMPSON 55, 3 1/2" rd.....	8.10
2.5 WESTINGHOUSE NT-35, 3 1/2" round, S.C. type IS-111, Stock # 2F311.....	7.50	5 AMP, SIMPSON 55, 3 1/2" rd.....	8.10
3 WESTON 425, 3 1/2" rd, with external couple and leads.....	9.50	10 AMP, BURLINGTON 142, 4" sq. mtd. @ Transformer.....	6.00
4 GENERAL ELECTRIC DW-52, 2 1/2" rd.....	4.95	150 AMP, WESTINGHOUSE NA-35, 3 1/2" rd., 5 amp mvt., use with external Current Transformer.....	6.00
6 GENERAL ELECTRIC DW-44, 2 1/2" rd., black scale, S.C. type IS-182, Stock # 3F382.....	5.50	CURRENT TRANSFORMER, 150/5, for above.....	7.50
10 WESTON 425, 3 1/2" rd.....	10.50	A.C. VOLTMETERS	
D.C. MICROAMMETERS		3 SIMPSON 55, 3 1/2" rd.....	8.10
15-0-15 ZERO CENTER GALVANOMETER, WESTON 731, 3" square approx. 1850 ohms.....	\$18.50	10 SIMPSON 55, 3 1/2" rd.....	8.10
0-25 WESTON 731, 3" square.....	17.50	15 WESTINGHOUSE NA-35, 3 1/2" rd., AWS type MR35W015ACVV.....	5.50
0-50 SIMPSON 29, 4" x 4 1/2".....	13.05	50 SIMPSON 55, 3 1/2" rd.....	8.10
0-100 SIMPSON 25, 3 1/2" round.....	11.25	150 SIMPSON 55, 3 1/2" rd.....	9.60
SPECIAL METERS		300 SIMPSON 55, 3 1/2" rd.....	9.60
RUNNING TIME METER, totals to 9,999.9 hours and repeats, R.W. Cramer type RT-2H, 3 1/2" round, 110 volt, 60 cycle.....	\$12.50	300 TRIPLETT 232C, 2 1/2" rd. metal.....	6.00
RECTIFIER TYPE A.C. MILLIAMMETER, 270° circular scale, approx. 5 1/4" long, 1.3 MAAC, 1.3 MADC, with internal copper oxide rectifier, Weston Model 545, 4" aircraft type case, black scale, luminous markings, scale calibrated 0 to 270 in degrees.....	56.50	500 SIMPSON 55, 3 1/2" rd., with external resistor.....	13.50
D.C. VOLTMETERS		D.C. MILLIAMMETERS	
0-5/125 WESTON 506, 2 1/2" rd., dual range, ring mtd. metal case.....	\$4.00	5-0-5 WESTERN ELECTRIC, 3 1/2" rd. concentric mvt., 50-0-50 scale.....	\$4.00
0-15 SIMPSON 27, 3" sq.....	8.85	0-15 SIMPSON 25, 3 1/2" rd., AWS type MR35W015DCMA.....	6.00
0-75 H. E. DO-41, 3 1/2" rd.....	5.95	0-150 ELECTEL 350, 3 1/2" rd., made by Electel Div. U. S. Time Corp.....	4.00
0-150 HOTT 17-L, 3 1/2" rd. metal case.....	4.50	0-150 GAUEN 508, 2 1/2" rd., knife edge pointed.....	3.95
0-300 SUN 2AUP346, 2 1/2" rd., 1000 ohms per volt.....	6.00	0-200 MARRON, 3 1/2" rd., knife edge pointed.....	4.00
0-300 SUN 2AP380, 2 1/2" rd., 1000 ohms per volt, AWS type MR25W300DCVV.....	7.00	0-200 SIMPSON 26, 3" sq.....	5.95
0-500 WESTON 506, 2 1/2" rd., 1 MA, with external type 3 Resistor Box AWS type MR25W500DCVV.....	9.50	0-200 SIMPSON 25, 3 1/2" rd., AWS type MR35W200DCMA.....	5.95
		0-300 SIMPSON 25, 3 1/2" rd.....	8.70
		0-500 DEJUR 312, 3" sq.....	5.00
		0-300 DEJUR 312, 3" sq.....	4.50

This only a partial listing. We also stock a wide variety of shunts, transformers and multipliers.
338 Canal Street

MARITIME SWITCHBOARD

INSTRUMENTS—ACCESSORIES
Worth 4-8217
New York 13, New York

All items are new in original cartons and are fully guaranteed. All prices are net, F.O.B. New York City.

ATTENTION ONE EACH SPECIALS

Panoramic Adaptor
Model AN/APA-10. For 115 volt 400 cycle operation. Easily converted to 115 volt 60 cycle by transformer change.
Special Price \$175.00

Du Mont AR Range Unit
An ideal Radar Laboratory or TV Laboratory scope for observation short time duration pulses. Complete description in MIT Radiation Lab. Series Vol. 20. Special Price..... \$600.00

Call ARmory 4-8989

Electro Devices, Inc.
4-6 Godwin Ave. Paterson, N. J.

SELSYNS

211H GE Diff. New.....	\$ 2.95
C78248 115V 60Cy Bendix Trans.....	\$19.50
C78249 115V 60Cy Bendix Diff.....	\$11.50
MICRO-SW ACRO NEW	
TC I A or TC 78L SPST NC.....	\$.39
LOW PRESSURE GAUGE U. S.	
20 Ounce 2.5 Inch New.....	\$ 2.95

GARFIELD INDUSTRIES
10615 So. Highland Ave. Tel. DI 11759
Cleveland 25, Ohio

IMMEDIATE DELIVERY COAXIAL CONNECTORS

WRITE, WIRE OR PHONE FOR LIST

AMBASSADOR 2-2903 GRIFFITH M. MORGAN & CO. 1217 W. MORSE AVE. CHICAGO 26, ILL.

DYNAMOTORS

From our inventory. New, original containers, BD-77; DM-21; DM-32; DM-36; DY-22; PE-86 and others. Substantial quantities. Also John Oster Co. fractional horsepower motors.

LINE HARDWARE CO.
1515 N. 26th St. Phila. 21, Pa.

FOLLOW ARROW



**FOR
MILITARY
ELECTRONICS**

ATR-13 TRANSCEIVER

Dynamotor powered, either 14 or 28 V. Shock mounted, remotely controlled, transceiver. Tunable receiver, range 108-160 M.C., 4-channel crystal controlled VHF transmitter, built-in provisions for omni. Weight, complete with plugs, less cable, 19 Lbs. Less crystal, new **\$245.00**

Radar

APR-4 New. Complete	APT-2 APT-3 APT-4	RC-1841FF RC-214 RC-224 RC-266
APS-4 New. Complete	Mark 16 MD4/APS2 MD5/APS3 MD22/UPN2 MD38/APQ13	RT34/APS13 T-85/APT-5
APT-1		

PORTABLE RADAR

Model SQ. 12 cm. Used on small ships. Has PPI indicator. Max. range 20 miles. 1 Kw. output. Operates from 110 VAC, 60 cps. P.U.R.

AN/ART-13 PARTS

Part #	Item
Transmitter 564916	T-47A/ART-13
565027	Barometric Switch
K7890443	4-Pile Ceramic, Variable Cap.
564605	6-Pile Ceramic, Variable Cap.
	4 Centralap-Type 843-003 Cap Assembly
Antenna Loading	CU-25

GAS ENGINE POWER SUPPLY

1½ Kw. 110 V. 60 cps. Complete gas engine power supply. New, with spare parts. P.U.R.

GOVERNMENTS AIRLINES & INDUSTRIALS!

Send for FREE Catalogue No. 112 for complete list of Military, Industrial and Aviation Electronics. WE HAVE THE LARGEST INVENTORY OF SUCH EQUIPMENT IN THE UNITED STATES.

Test Equipment Complete Line

DuMont 224-A Oscilloscope	TS159
1-7 Hickok Tube Checker	TS-159/TPX
1-208 FM Signal Generator	TS170/ARN
RPC Model 644 Multimeter	TS-173/UR
Hewlett Packard 200-C	TS-174/UR
1-198 TS27/TSM	TS175/UR
BC-538 TS-33	TS182/UP
BC-1255 TS34/AP	TS184A/AP
IE-36 TS-35/AP	TS204/AP
1-95 TS36/AP	TS-218
1-96-A TS-45A/APM-3	TS251
1-122 TS-59/APN	TS311A/UP
1-13A TS61/AP	TS323/UP
1-139 TS62/AP	1-146
1-145 TS89	TS-268/U
1-212 TS92	Boonton Mod.
1-222 TS100/AP	78B Sig. Gen.
TS-3A/AP	Boonton Type
TS1C/APN	102F Sig. Gen.
TS1E/AP	LAD Sig. Gen.
TS1G/APN	LAE-2
TS1S/APQ	LAVOIE Proc.
TS-2/APN	TS131
TS2A/ARR-2	TS-148/UP

SUPREME TEST EQUIPMENT

Model 600 Tube and Set Tester.....\$89.50
Model 616 Tube and Battery Tester.... 69.50

FLUX METER

For measuring flux density between magnet poles. Has two meters in series with a potentiometer and battery for power supply. Range: 500-4000 Gauss in 3 scales. Requires 1 battery which mounts in case. NEW.....\$37.50

MISCELLANEOUS

MINE DETECTOR: SCR-425 for prospecting, min. g., etc. NEW.....\$59.50
LP-21 LOOPS: Mod. LM, AM, A, Excel. cond.

TRANSCEIVER—MODEL 52

5W. 2-way, 2-channel radio transmitter-receiver unit. Complete with tubes, battery charger, microphone. Less crystal and antenna. Operates from 6 V. battery. New\$89.95

Headsets & Handsets

HS-23	HS-38	TS-13-C
HS-30	TS-1-G	HS-18
HS-33	T-26	EE-8

TRANSTAT

11-5 KVA50/60 cycles. Commutator range 0-115 V. Max. 100 amp. Good cond...\$125.00

Specials

RECEIVERS—TRANSMITTERS

ARC-1	PE-125AX	RTA/1B
ARC-3	R-9/APN-4	SCR-522
R-4/ARR-2	BC-733-D	TA2F-24
ID-6/APN-4	R-57/ARN	1E-89/ARN
MP-10G	BC-788-A-AM-C	R-1/ARR-1

RA-52 RECTIFIER

Transtat controlled to produce high voltage DC from 110 VAC 60 cycle source. Up to 11,600 VDC @ 50 W. Metered high voltage (0-15 KV) and current (10-20 MA). NEW.....\$74.50

EQUIPMENT WANTED!

To meet government and industrial orders we urgently need all types of new and used Test Equipment, Radar, Receivers, and Transmitters. WE PAY HIGHEST PRICES. Tell us what you have.

Arrow SALES INC.

Mailing Address: P. O. BOX 3878-E. N. HOLLYWOOD, CALIF.
Office-Warehouse: 7460 VARNA AVE., N. HOLLYWOOD, CALIF.
POplar 5-1810 * STANley 7-6005 * Cable Address: ARROWSALES

Columbia
GEM OF THE SURPLUS

AIRCRAFT—MARINE—INDUSTRIAL BUYERS

We carry huge, complete line of new and used electronic equipment—Radar, Test Sets, Transmitters, Receivers, Hi-Voltage Condensers, Meters, Motors—and hundreds of other items. See our ad Nov/52 Electronics. Call, cable, write or phone your exact needs. REMEMBER: We pay top dollar for new and used radio gear!

COLUMBIA ELECTRONICS SALES
522 S. San Pedro St., Los Angeles 13, Calif.

**WORTH 5 TIMES THE PRICE!
REMOTE CONTROL UNIT**

ELECTRONIC THYRATRON THERMOSTAT CONTROL THAT USES A PLATE CIRCUIT TRIGGER RELAY!

A terrific value! . . . an electronic unit that not only can be changed over to serve many purposes but is loaded with valuable standard parts (for anyone who recognizes an outstanding buy and wants to buy it for the parts alone). The relay alone is worth the price we're asking for the entire unit . . . check the list below:



2.49
POSTPAID

COMPLETE WITH CABINET

10 UNITS \$22.39

PRODUCTION RUNS AVAILABLE

DON'T PASS UP THIS OPPORTUNITY FOR ONLY

- 1—115V—6.3V Filament Transformer
- 1—S.P.S.T. Sensitive Plate Relay
- 6—Carbon Resistors
- 7—Wire Wound Resistors
- 1—S.P.S.T. Switch
- 4—Paper Tubular Condensers
- 1—Electrolytic Condenser
- 1—Potentiometer
- Plastic Cabinet—5¼ x 5 x 3¼
- 3—Tube Sockets
- Pilot Lamp, Dial Assembly
- Knobs, Feet & Assorted Hardware
- Schematic Diagram

MANUEL KLEIN CO.

94D Chambers St., New York 7, N. Y.
REctor 2-6460

SEARCHLIGHT SECTION

SEARCH RECEIVER—ARD-2

Frequency range 80 to 3000 Mcs.

Measures RF signals from 80 to 3000 Mcs and pulse rates from 50 to 8000 cycles. The ARD-2 can be used as a Direction Finder to locate signals, or as a frequency meter, by VISUAL and AURAL indicators, provide Originally designed and used by USN aircraft. Ideally suited for military, laboratory and general purpose use.

Equipment consists of the following:

Antenna Detector-CMD-66AFH—Has variable length antennas, diode detector and silver plated tuning stub with calibrated scale.

AMPLIFIER CMD-50ADC—has three stage pulse amplifier, a trigger circuit, a pulse rate counter circuit and audio amplifier, visual signal indicator, rectifier power supply which is operative on 115 Volts AC 60 to 2400 cycles current, regulated.

Test OSCILLATOR-CMD-60ABG—Has cavity frequency of 400 cycles with selection of four pulse repetition rates.

ALL CABLES AND FITTINGS, ACCESSORIES AND SHOCK MOUNTED RACK for immediate installation, plus two Technical Manuals.

SPARE PARTS—Steel chest includes spares for components and two extra sets of spare tubes.

Guaranteed NEW

All the above in original export packed cases. Wt.: 113-lbs

Price each . . . \$27500

EQUIPMENT SPARE PARTS

We can ship from stock all the important spares for the following:
SCR-300 Walkie Talkie

TWX—NY1—2223

Cable—Communidev, N. Y.

Tel. ADironclack 4-6174

SCR-536 Handy Talkie
SCR-506 (BC-652 & 653)
SCR-211 (BC-221 Freq. Meter)
SCR-508, 528, 608, 628 Series
TCS—US Navy Transmitter & Receiver and many others, in lesser quantities. Requests for quotations immediately answered.

TRANSMITTERS

Western Electric, Type 34-A Carrier Shift C.W. Transmitter for 220 V. AC. Output 350 watts medium freq. New.

Federal Tel & Tel, BC-365 Radio Range, 150-550 kc 350 watts output, C.W., from 110/220 VAC. New.

Westinghouse US Navy Type TDE 300 to 18,100 kcs 125 watts conservative, CW and less on phone, in most input voltages. M.O. controlled.

R.C.A. US Navy Type TCR Radiotelephone 6 crystal channels, 125 watts output, 2000-3000 kcs high level modulation. 110/220 VAC input.

BC-325 400 watt CW, less on phone. Many others in single lots in all power outputs.

GUARANTEE:

Our equipment carries with it an unqualified guarantee of satisfaction to the user.

Inquiries for material other than those briefly listed here are welcome. We offer and sell only material owned by us.

Export packing facilities on the premises to expedite fast quotations overseas.

RADIO TELEPHONE COMBINATIONS

Bendix 70 watt Transmitter and Receiver, covering low and high frequencies, emission A-1 & A-3, complete and new with spare parts. 24/28 V DC input.

AS-1C PERSONAL PLANE TRANSMITTER & POWER SUPPLY

General Electric compact 12 watt output 'phone only, with 3105 KCS crystal. Includes 6V6 Xtal OSC, 2 6V6 R F Amp., 2 6V6 Modulators, and 2 6x5 Rectifiers. 12 V DC (with vibrator) input, with cable. Measures 9" long; 6" wide and 4 1/2" high. New each \$59.50

R.C.A. Model AVT-112A Trans: 10 watt output AVR-20A Recvr; AVA-126A power supply. In three compact units for either 6 or 12 volts DC input, 2300 kcs to 6300 kcs phone or CW, complete with antenna, mike, key and cables. New, less Xtals.

MICROPHONE, WESTERN ELECTRIC

(#1120-DA), high quality, single button press-to-talk upright telephone stand type new, individually boxed with cord and W.E. Swbd plug similar to PL-58. Perfect for airport, police commercial radiotelephone installations. New, Each . . . \$8.50

COMMUNICATION DEVICES CO.

2331 TWELFTH AVENUE

NEW YORK 27, N. Y.

AVIATION ELECTRONIC EQUIPMENT

All equipment tested in our shops and guaranteed ready for installation in aircraft. Complete reconditioning facilities for all Electronic Equipment.

"Specializing in Installations of the Highest Quality"

MATERIAL IN STOCK READY FOR IMMEDIATE SHIPMENT

T1A Bombsight Sets, Complete with Computers and Fittings. New	\$195.00	Set
SCR-522 A or AM. Installations Complete. Reconditioned. Guaranteed	125.00	ea.
SCR-183. Installations Complete. New	45.00	ea.
RT22/APX1 Transceiver. New	49.50	ea.
AVR7-HLN Receivers. New	55.00	ea.
IE-36 Test Sets. New	39.50	ea.
FT220A-SCR 274 N Rack. New	1.60	ea.
BC-221 Frequency Meters. Reconditioned. Guaranteed	84.50	ea.
ART-13/T47 A Transmitters. Reconditioned. Guaranteed	P.U.R.	
DY-17 Dynamotors. Reconditioned. Guaranteed	P.U.R.	
DY-12 Dynamotors. Reconditioned. Guaranteed	P.U.R.	

Inquiries given prompt attention—Early deliveries

SPECIALS!!

800—HB-7 Headbands. Useable	\$.80	ea.
31—ARB Spare Parts Kits. New Sealed	12.50	ea.
175—ARC-1 Autotune Sections less Knobs. New	1.95	ea.
6—BG Radar Spare Parts Kits (450 lbs.). New	50.00	ea.
94—PE-94 Dynamotors. Some New. All Good	1.15	ea.
8000 ft.—RG-8U Coaxial Cable. New11 1/2	ft.

JAMES S. SPIVEY COMPANY

1406 G. ST. N.W. - Tel. STerling 3-2215 - WASHINGTON, D. C.

"Buyers of Surplus Aviation Electronic Materials"

— MANUFACTURERS send us your termination inventory —
— SCHOOLS, COLLEGES send us a list of electronic items surplus to your operation —

MOVED

TO A BIGGER & BETTER WAREHOUSE
PILED HIGH WITH
HARD-TO-FIND PARTS & EQUIPT.

Just a partial list of our present stock:

- BC-348 • BC-342 • ART-13
- ARC-3 • APN-9 • LM
- BC-221 • BC-611
- VARIOUS TEST EQUIPMENT

NEW EXPORT DIVISION FOR ALL FOREIGN ORDERS

Prompt attention to all inquiries—all languages!

Attn: Schools, Labs, Hams!

WE PAY MORE
FOR RADIO PARTS & EQUIPMENT
Cash in on your surplus equipment—
or we'll trade for something you really need. Write today!

NEW ADDRESS:

CANDEE-AIRCO

Dept. E-9

P. O. Box 1187
Magnolia Park Station
BURBANK, CALIFORNIA

CHarleston 0-1486 • ROckwell 9-1070



COMPASS

COMMUNICATIONS COMPANY

393 GREENWICH STREET
NEW YORK 13, N. Y.

CABLE ADDRESS: COMPRADIO, N. Y.
ALL PHONES: BEEKMAN 3-6509

WE MAINTAIN
OUR OWN FULLY
EQUIPPED TESTING
LABORATORY TO
TEST AND GUARANTEE
ANYTHING WE SELL

Suppliers of

MARINE, GROUND & AIRBORNE

TRANSMITTERS

FROM 25 WATTS TO 5 KILOWATTS

RADAR

SONAR

TEST SETS

TELEPHONE EQP'T.

CONVERSION EQP'T.

- MOTOR GENERATORS
- CONVERTORS
- DYNAMOTORS
- INVERTERS
- POWER SUPPLIES
- RECTIFIERS

AND

TUBES— SPECIAL PURPOSE and TRANSMITTING TYPES

TCS—Collins mfd. Navy radiotelephones for shipboard and mobile use, complete with all accessories for operation from 12, 24, 110, 230 volts d.c. and 110 or 220 volts a.c.

TDE—Navy or commercial marine transmitters, complete 110 & 220 volts d.c. and a.c.

TBK—Navy high frequency transmitter, 2-20 mcs; 500 watts output. Supplied complete with m/g and starter for d.c. or a.c. operation.

TBM—same transmitter but with speech input equipment to give 350 watts phone.

TBL—Navy all-wave transmitter; 350 watts output: CW and phone. Supplied complete with m/g and starter for d.c. or a.c. operation.

TAJ—Navy intermediate freq. transmitter, 175-550 kcs; 500 watts output. Supplied complete with m/g and starter for a.c. or d.c. operation.

SCR-284—the famous mobile and ground station for field use. Large quantity of complete sets available.

MAG—10 cm. portable link radar transmitter receivers, 6-volt operation.

TBN—200-500 kcs, complete with 220/440 volt, 3 ph. 50-60c. power supply—conservatively rated at 1 kw. output.

SCR-510 and 610 in quantity.



• BEACONS

AN/CPN-8 10 cm.
AN/CPN-6 3 cm.
YJ and YG . . . for shipboard use

Portable Instruments

Molded Bakelite case 7" x 4½" x 3"

D.C. MICROAMMETERS
5 . 10 . 50 microamperes
THERMOCOUPLE MILLIAMMETERS
1 . 5 . 5 . 10 milliamperes
THERMOCOUPLE VOLTMETERS
5 to 500 volts

Available in multiple range combinations

Precision Electrical Instrument Co.

146 Grand Street New York 13, N. Y.

T-47/ART 13 & ATC Transmitters
DY-12 Dynamotors. LM & BC-221 frequency meters. SCR-694-C & SCR-284-A. Teletype equipment. Motors, Parts. Panoramic Adaptors.

ARROW APPLIANCE COMPANY
Box 19, Boston 1, Mass.
Tel: Lynn 8-3100 or Richmond 2-0916

TELEPHONE RELAYS

Large Stock of
CLARE, TYPES C, D & E
COOKE, AUTOMATIC—ELECTRIC
ALL TYPES of COILS and PILE-UPS
Send Us Your Specs. for Our Quote



OIL FILLED CONDENSERS

Conservative Govt. Rating
.25 MFD—18,000 V. DC W.
Length 13½"—Width 4"
Height 12"—4" H.V. Terminals

BRAND NEW \$25.00

Chase

Electronic Supply Co.
222 Fulton St.
New York 7, N. Y.
Digby 4-3088
HOLLIS 4-5033

STANDARD BRAND JAN TUBES

ALL ARE NEW & GUARANTEED

2C40	\$7.25	394A	\$3.95
2C51	6.25	417A	17.00
2K22	37.50	446B	3.50
2K23	29.50	507AX	1.35
3BP1	3.75	721A	2.25
3CP1/51	1.75	807	1.50
3EP1	3.75	811	2.75
3E29	12.50	813	7.75
6AS6	2.00	814	2.50
7BP7	5.00	829B	11.00
9GP7	9.75	832A	8.00
100TH	7.50	837	1.25
250TH	17.50	866A	1.35
304TH	6.50	931A	3.95
307A	4.00	1624	1.75
SPECIAL***	6C21	\$18.75	
SPECIAL***	125G760	
SPECIAL***	6SN7GT65	

Many other Tubes at above low prices.
Query us for prompt action.

Remit in full or 20% deposit on C.O.D. orders.
Rated Firms send P.O. Order.

Minimum order \$5.00 F.O.B. N.Y.C.

ALLIED ELECTRONIC SALES

74 CORTLANDT STREET, NEW YORK 7, N. Y.
Phone Barclay 7-5839-5840

SAVE ON	TUBES	BRAND NEW	TUBES	GUARANTEED	TUBES
OA2..... \$1.00	2J34..... 27.50	4J30..... 49.50	RX-21..... 4.05	205F..... Write	446B..... 3.50
OA3/VR75.. 1.10	2J36..... 110.00	4J31..... 95.50	FG-27A..... 4.05	211/VT4C.. .75	450TH..... 42.50
OB2..... 1.40	2J48..... 27.50	4J41..... 200.00	FG-32..... 12.95	217C..... 4.95	451..... 3.95
OB3/VR90.. 1.09	2J55..... 85.00	4J52..... 27.50	IN34A..... .32	FX-233A..... 3.50	464A..... 13.95
OC3/VR105. 1.00	2J56..... 39.50	4X150A..... 75.00	45 Spec..... 6.95	FG-235A..... Write	469..... 13.95
OD3/VR150. 2.25	2J62..... 39.50	5C52..... 7.50	2C51..... 4.95	250R..... 8.95	471..... 12.95
1B23..... 8.95	2K22..... 39.50	5A1..... 4.95	RK47..... Write	250TH..... 18.00	527..... 16.95
1B24..... 16.50	2K23..... 28.50	5B1..... 4.50	52HAP7.....		530..... 5.75
1B26..... 2.35	2K25..... 79.50	5C1..... 35.00			532..... 2.95
1B27..... 14.50	2K26..... 32.00	5C2..... 19.95			536..... Write
1B32..... 3.10	2K28..... 110.00	5D1..... 1.95			551..... 1.49
1B42..... 2.75	2K41..... 110.00	5F7..... 16.50			559..... 13.95
1N21B..... 14.95	2K45..... Write	5FP14..... 4.50			575..... Write
1N21C..... 1.25	2K48..... Write	5GP1..... 6.95			587..... Write
1N22..... 1.25	2K54..... Write	5HP1..... 4.95			605CX..... Write
1N23..... 2.25	2K55..... Write	5HP4..... 19.95			605..... Write
1N23A..... 3.50	2K56..... 115.00	5JP1..... 19.95			615..... Write
1N23B..... 7.50	3AP1..... 8.95	5JP2..... 19.95			632..... Write
1N26..... .69	3B23..... 4.95	5JP4..... 19.95			KU676..... 39.50
1N38..... 1.50	3B24..... 4.95	5JP5..... 59.50			700A..... 16.50
1N40..... 8.50	3B24W..... 7.50	5J23..... 11.95			700B..... 14.95
1N47..... 4.50	3B26..... 3.50	5J29..... 39.60			700C..... 16.50
1N55..... 2.75	3B28..... 6.50	5J30..... 1.50			700D..... 4.50
1N56..... .89	3BP1..... 4.95	5R4GY..... 1.98			701A..... 2.75
1N58A..... 1.25	3C22..... 75.00	5T4..... 12.50			702A..... 4.95
1N60..... 2.39	3C23..... 1.50	6A1J5..... 1.95			703A..... Write
1N63/K63.. .30	3C24/24G... 3.75	6A1J5WE... 1.75			704A..... Write
1N64..... 1.95	3C31..... 3.15	6A1J5W..... 3.65			705A..... 39.50
1T5GT..... 2.95	3C33..... 14.95	6AR6..... 2.25			706Y..... 39.50
V5-2..... 8.95	3C45..... 3.95	6A56..... 2.30			706BY..... 29.50
2AP1..... .69	3DP1..... 9.95	6B16..... Write			706FY..... 45.00
2C21/1642. 27.50	3DP152..... 13.95	6BM6..... Write			706Y..... 4.95
2C39..... 29.95	3EP7..... 1.95	6C21..... 24.50			707A..... 14.95
2C40..... 9.95	3GP1..... 3.95	6F4..... 4.50			707B..... 3.95
2C43..... 15.00	3HP7..... 3.95	6J4..... 6.95			708A..... .95
2C44..... 1.19	4-125A..... 25.00	6K4..... 2.50			713A..... 5.50
2C52..... 4.95	4B24..... 6.95	6S17WGT... 2.50			7144Y..... 6.25
2D21W..... 4.65	4C27/CV92.. 17.50	6SU7GT..... Write			715A..... 8.95
2E24..... 4.50	4C28..... 25.00	6C23..... 69.50			715B..... 22.75
2E25A..... 2.95	4E27..... 14.95	9LP7..... 4.95			715C..... .98
2E26..... 6.95	4J21..... 129.50	12AY7..... 3.00			717A..... 24.50
2J21A..... 6.95	4J22..... 129.50	12DP7..... 16.95			719A..... Write
2J22..... 14.95	4J23..... 129.50	12HP7..... 13.50			720A..... Write
2J26..... 27.50	4J26..... 129.50	15E..... .69			720BY..... Write
2J31..... 39.50	4J28..... 129.50	FG-17/5557. 3.95			721A..... 12.50
2J32..... 27.50	4J29..... 149.50	T-20..... 3.75			721B..... 1.95
					722A..... Write
					723A/B..... 18.95
					724B..... 2.75
					725A..... 7.50
					955..... Write
					956..... 59.50
					957..... 25.00
					958A..... 89.50
					959..... .39
					977CX..... 3.95
					980D..... 10.95
					991..... 3.25
					1005..... 1.59
					1006..... 9.95
					1007..... 2.95
					1069P7..... 2.95
					1613..... Write
					1616..... 2.90
					1619..... 2.75
					1624..... 11.95
					1625..... 2.95
					1631..... 2.90
					1644..... 1.95
					2050..... 9.95
					2051..... 9.95
					5514..... 11.95
					5523..... 2.75
					5526..... 3.95
					5611..... 34.95
					5635..... 3.45
					5646..... 1.45
					5651..... 8.50
					5654..... 19.95
					5670..... 3.75
					5672..... Write
					5676..... 19.95
					5687..... .39
					5694..... .98
					5702..... 1.50
					5704..... 1.25
					5787..... 53.00
					5844..... 2.75
					5845..... 1.10
					5915..... .59
					6026..... 1.50
					6026..... 1.60
					8012..... 139.50
					8014A..... 3.25
					8020..... 1.25
					8025..... 1.25
					9001..... 5.95
					9002..... Write
					9003..... 1.50
					9004..... .69

YOUR SURPLUS WANTED
We Pay Highest Prices!

5 FIGURE only
VEEDER ROOT
COUNTERS **95¢**
MODEL S-1
Size 3/4" wide x 1-5/16" long. Dove-tail mounting—removable lever.

J-100..... Write	316A..... .75
100-L..... Write	327A..... 4.50
100TH..... 8.50	331A..... 10.95
FG-104..... 29.95	349A..... 8.50
FG-105..... 19.00	350A..... 5.95
VU-111..... .95	350B..... 3.95
114B..... Write	355A..... Write
HF120..... 9.95	371B..... .75
F-123A..... 7.75	374B..... 3.95
VF-127A..... 3.75	383A..... 1.49
HF-140..... Write	393A..... 8.95
FG-172..... 29.50	394A..... 3.95
HF200..... 14.50	417A..... 8.50
201A..... 98.00	423A..... 4.50
201C..... 98.00	434A..... 19.95
204A..... 49.50	446A..... 1.19

Special: VACUUM CAPACITORS
12 mmfd., 20,000 v. \$ 7.50
12 mmfd., 32,000 v. \$10.00

Special: VACUUM CAPACITORS
50 mmfd., 32,000 v. \$12.50
100 mmfd., 20,000 v. \$14.50

J. S. H. SALES CO.
Dept. E-20, 7552 Melrose Ave.
Los Angeles 46, California

All Prices F.O.B. Los Angeles, subject to change without notice. Minimum order \$3.00.

Thousands of other types in stock. Send us your requirements.

K-RK-ARC-UG-PL-AN

CONNECTORS

In Stock for Immediate Delivery

Connector Corporation

OF AMERICA

137 Hamilton St., New Haven 11, Conn. Phone: Spruce 7-2513
New York Phone: LExington 2-6254

MOTOR GENERATORS

NEW

1 KVA Allis Chalmers 230 Volt D.C. to 120 Volt, 60 Cycle, A.C. Single Phase, Speed 3600 R.P.M.—packed for export. \$250.00

Immediate Shipment, F.O.B. Keyport, N. J.

C. C. GALBRAITH & SON, Inc.
99 Park Place New York, N. Y.

FOR SALE
Tantalum Wire: .002"—.01"—.015"—.03"—.05"—.06" Ribbon .003"x.125"
Tungsten Ribbon: .0015x.03"—.0015x.062"—.003x .05"—.003x.03"—.005x.03"
Moly Ribbon: .005x075", Tungsten mesh, KOVAR wire .030"—.020"—.015"—.010"
Kovar tubing: 1/4"—1/8" O.D. 50% of manufacturers price.
F. ALEXANDER 115 W. 23d Str., N. Y. C.

WHOLESALE ONLY

ELECTRONIC COMPONENTS
AIRCRAFT EQUIPMENT
HYDRAULICS

RADIO & ELECTRONIC SURPLUS
13933-9 BRUSH STREET
Detroit 3, Mich. TO 9-3403

RELAY SPECIALISTS
AUTHORIZED FACTORY DISTRIBUTORS
STRUTHERS-DUNN POTTER & BRUMFIELD

100,000 RELAYS

Write for Catalog



MINIATURE AIRCRAFT TYPE—4 Pole D.T. contacts. 1 1/2" overall, 280 ohm coil. 24 V.D.C. **\$2.95**

RADIO DEVELOPMENT & SALES CO.
323 Atlantic Ave. Brooklyn 2, N. Y. ULster 5-0488

FOR SALE
1 DuMont 208-B
1 Sensitive Research Model D, 1/4%, 0-1 Volt
FS-6239, Electronics
330 W. 42 St., New York 36, N. Y.

"Opportunity" Advertising:
Think
"SEARCHLIGHT"
First

WAREHOUSE CLEARANCE TUBE SALE

NEW, STANDARD MANUFACTURERS, IMMEDIATE DELIVERY

0B3/VR90 . . . \$.99	5JP2 . . . \$ 19.50	450TL . . . \$44.50	2051 . . . \$.95
0C3/VR105 1.15	5T4 . . . 1.50	464A . . . 9.50	8007 . . . 5.85
0D3/VR150 .85	6AC795	531 . . . 14.50	8020 . . . 2.50
1A385	6AG7 . . . 1.20	532A/1B32 . . . 3.95	9001 . . . 1.75
1A5GT78	6AJ5 . . . 1.75	705A . . . 3.75	9002 . . . 1.50
1B22 . . . 3.75	6AJ6 . . . 2.10	706AB . . . 22.50	9003 . . . 1.75
1B24 . . . 11.50	6B6G75	705AY-GY . . . 32.50	9004 . . . 1.75
1B27 . . . 17.50	6C679	707A . . . 14.50	900675
1B32/532A . . . 3.95	6C8G79	721A . . . 2.45	CE22/918 . . . 1.50
1N21 . . . 1.25	6H669	723AB . . . 22.50	CK501LX . . . 1.50
1N22 . . . 1.25	6K775	724A . . . 2.95	CK1089 . . . 1.50
1N23 . . . 1.25	6SA774	724B . . . 5.95	EL5B/4822 . . . 9.75
1N27 . . . 1.95	6SC797	725A . . . 8.50	ELC5B . . . 9.75
1P23/CE-1 . . . 3.50	6SH7GT79	726A . . . 14.95	ELC6A . . . 7.50
1R4/129485	6SH779	750TL . . . 79.50	ELC6F . . . 8.95
1T459	7C4/1203A75	80185	EL302.5/3B21 . . . 4.50
2A395	7E5/120195	803 . . . 3.95	FG27A . . . 8.95
2AP1 . . . 8.95	7E655	804 . . . 10.50	FG-90 . . . 6.50
2B22 . . . 4.25	10Y . . . 1.50	805 . . . 4.95	GL-316A . . . 3.40
2C33/RX233A . . . 3.45	12A685	807 . . . 1.65	GL-434A . . . 22.50
2C40 . . . 17.50	12C889	810 . . . 10.95	GL-446A . . . 2.50
2E22 . . . 3.49	12H669	811 . . . 2.85	GL-605 . . . 49.95
2J21 . . . 9.95	12J5GT57	813 . . . 8.95	ML-531 . . . 14.50
2J21A . . . 12.95	12SF775	814 . . . 2.79	QK-59 . . . 85.00
2J22 . . . 14.95	12SJ7GT65	815 . . . 3.40	QK-60 . . . 85.00
2J27 . . . 22.50	14H797	816 . . . 1.45	QK-61 . . . 85.00
2J34 . . . 38.45	14J7 . . . 1.10	826 . . . 1.39	QK-72 . . . 85.00
2J50 . . . 69.50	15R . . . 1.00	830B . . . 2.95	RK-25 . . . 3.69
2J55 . . . 84.50	23D465	832 . . . 7.95	RK-65 . . . 26.50
2X289	3048	832A . . . 9.50	RK-72/CRP72 . . . 1.95
2X2A . . . 2.15	4535	836 . . . 3.75	RX21 . . . 3.85
3A485	53A . . . 3.95	838 . . . 3.50	RX233A/2C33 . . . 3.45
3B7/129162	71A69	838W . . . 6.50	VR-9099
3B24 . . . 5.50	7658	845 . . . 3.95	VR-105 . . . 1.15
3C23 . . . 9.95	7765	845W . . . 6.95	VR-15085
3C24/24G . . . 1.95	7880	866A . . . 1.10	VT-127A . . . 2.95
3DP1 . . . 3.95	100TH . . . 10.50	872A . . . 3.65	WL-417A . . . 22.50
3D6/129962	112A49	884 . . . 1.50	WL-653B . . . 75.00
3EP1 . . . 4.95	211 . . . 1.25	902P1 . . . 7.50	ZP-653 . . . 65.00
3FP7 . . . 4.50	227A . . . 4.50	95745	
3GP1 . . . 3.95	274B . . . 2.95	95860	
3JP12 . . . 14.50	304TH . . . 13.95	991/NE1625	
4B22/EL5B . . . 9.75	304TL . . . 19.50	1616 . . . 2.95	
4B25/EL6CF . . . 8.95	350A . . . 6.95	161989	
4I36 . . . 145.00	359A . . . 2.50	1624 . . . 1.95	
4I37 . . . 145.00	371B . . . 2.95	1625 . . . 2.00	
5BP1 . . . 5.95	388A . . . 2.95	1629 . . . 2.00	
5D21 . . . 23.95	394A . . . 4.25	1655/6SC797	
5FP7 . . . 1.65	450TH . . . 44.50	1846 . . . 115.00	

IMMEDIATE DELIVERY
ON HARD-TO-FIND

ICA RELAY RACKS

Steel relay racks are hard to get when you need them in a rush, due to their long delivery cycle, but a fortunate purchase enables us to help speed up your government projects. We have in stock brand new ICA type 3912 racks for standard 19" panels. Strongly welded 1/8" steel, top cross-braced. Base depth 22". Overall size: 7 3/4 x 20 x 20 7/8". Panel space 7 1/4". Black ripple finish.

Order No. 37E-010 Net \$22.11



KURMAN SENSITIVE RELAY



~~\$7.25~~ **\$2.65**

Used extensively in circuits of burglar alarms, electronic vacuum tubes, fire alarms, temperature controlled incubators, for protection of delicate instruments. Opens and closes with a fraction of a milliampere of current. 11,500 ohm coil. SPDT silver contacts rated at 115 VAC @ 2A. Opens at 6 mils, closes at 7 mils. Mounted on 2 1/2 x 2 1/4" bakelite base. Individually boxed. All brand new. Buy 'em in quantity and save even more.

Order No. RE-3503 Sale Price \$2.65

RADIO SHACK

CORPORATION

167 Washington St., Boston 8, Mass.

WRITE TODAY FOR
FREE 8-PAGE FLYER.
HUGE LISTING OF
OFF-PRICE VALUES!

RESISTORS EB-GB-HB

all makes

1-99 ea.	100-999 ea.	
1/2 Watt .06 EB — 4.00/C	other makes 2.75/C	Lots of 1000 of each special prices
1 Watt .09 GB — 6.00/C	other makes 4.50/C	
2 Watt .15 HB — 10.00/C	other makes 6.50/C	

Above are prices for Resistor 10% tolerance.
For 5% tolerance add 100%.

POTENTIOMETERS "J"

1-24 ea.	25-99 ea.	100 + over
Single J 1.80 ea.	1.50 and up (x)	1.20 and up (x)
Dual JJ 5.50 ea.	4.25 and up (x)	3.85 and up (x)
Triple JJJ	on spec. quote	

(x) depends on bushing, shaft and taper

CERAMIC CAPACITORS and DISCS

any makes any values 5.-per C and up or 35/M and up

● IMMEDIATE DELIVERY from stock in New York ●

LEGRI S Company

158 West 99 St., New York 25, N. Y.

Phone: University 5-4111

Since 1945—Resistors is our business.

TRANS. MICA CONDS.

Mfd	Wvdc	Price	Mfd	Wvdc	Price
-000024	2500	.15	00025	2500	.42
-00003	2000	.75	0003	6000	5.95
-000047	2500	.21	00035	2500	.55
-00005	2500	.29	0004	2500	.65
-00008	1200	.21	00048	2500	.79
-00009	3000	.75	00045	600	.24
-0001	2000	.23	0005	1200	.43
-0001	1200	.32	0006	600	.29
-0001	2000	.85	0006	1200	.45
-0001	6000	.95	01	600	.40
00015	6000	1.95	.01	1200	.69
0002	15KV	Quote			
00025	1200	.35			
00025	5000	2.05			
00027	2500	.35			
001	600	.23	.0125	6000	Quote
001	1200	.32			
001	2500	.48			
001	4500	1.45			
001	8000	3.95	.02	6000	.39
0015	5000	2.25	.02	1200	.85
002	1200	.40	.02	2500	1.25
002	2500	.50	.03	600	.49
0024	5000	2.35	.033	600	.59

MICA CONDENSERS

5, 6, 8, 10, 15, 25, 30, 34, 39, 50, 70, 75, 100, 140, 150, 185, 200, 230, 240, 250, 300, 350, 390, 440, 470, 500, 510, 600, 650, 700, 750, 1000, 1200, 1250, 1400, 1500, 1600, 2000, 2400, 3000, 3300, 3700, 3900, 4000, 4700, 5000, 5100, 6000, 6200, 6500, 7900, 7950, 7980, 8000, 9100, & 10000 M.Mfd.

PRICE SCHEDULE

5 to 750 m.mfd. 4c
1000 to 1500 m.mfd. 6c
2000 to 5100 m.mfd. 10c
9100 to 10000 m.mfd. 26c

Special Mica Kit 100 @ \$3.50

SILVER MICA CONDENSERS

7, 24, 25, 33, 50, 60, 75, 95, 100, 120, 150, 170, 200, 270, 300, 330, 390, 400, 450, 500, 750, 800, 1000, 1400, 1450, 1700, & 2500 m.mfd.
7 to 95 m.mfd. 8c
100 to 1700 m.mfd. 14c
100 to 90 m.mfd. 5c
2500 m.mfd. 16c

Special S. Mica Kit—100 @ \$6.50

CHOKES

5 Hen 2 amps	14 Hen 13 amps
2 6 Hen 83 amps	15 Hen 50 amps
7 Hen .67 amps	Thor'd'n T00650
8 Hen .52 amps	Thor'd'n T19C45
12 Hen .10 amps	Specialty Priced

CERAMICON CONDS.

10.56 & 100 m.mfd @ .05
1000 to 5000 m.mfd @ .06
.01 400 V

MICRO SWITCH

WLR-31—SPST-M.C. \$.29
Y23 RDT—SPST-M.C. \$.39
Many others specially priced

WANTED

Condensers of all types in any quantity. Also other standard components. Top prices.

CONDENSERS

MICRO & TOG. SWS. - RELAYS - "J" POTS

10 mfd.—600 V. \$.98

AIRCRAFT TOG. SWS.

Aircraft type-20A @ 24VDC-10A @ 125VAC-C-H
 Circuit
 Govt. Spec.
 8201K4 R-3A
 8211K5 R-6B
 8208K4 R-7A
 8210K5 R-1B
 8200K8 AN3022-1B
 Flush Mounted—In tinous Tip—Handle—
 Price—\$22 ea. \$20/100; \$170/1000.

— TRANSTAT —

115V. 1 phase, 100 amps. Kva. 11.5. Range
 0-115 V. Amertran #29145.
 Specialty priced.

Three term. bal. mtg. channel type. Dims.
 3 1/2" x 3 1/2" x 2". 20 mfd. sections rated
 400 V. at 72 deg. "C". 1870 V. test. Meets
 commercial specs. for 600 V. operation up to
 40 degs. "C". Ideal for filter or power factor
 application. Retest sales prove this rugged
 high quality condenser to be of outstanding
 value. Carton of 24, weight 43 lbs. Large
 quantities available. \$.89

JAN APPROVED

Mfd	Volts	Price	Mfd	Volts	Price
0005-01	10KV	3.75	2	1500V	1.65
01	10KV	4.75	2	2000V	2.80
012	25KV	19.50	3	3000V	3.39
02	20KV	15.90	4	3000V	4.69
03	10KV	Quote	2	4000V	5.69
075	7.5KV	3.95	2	5000V	10.95
075	15KV	15.95	2-2	600V	1.25
	1500V	.59	3	800V	.49
	2000V	.49	3	4000V	7.95
	2500V	1.29	3	13.5KV	Quote
	3000V	1.75	3	150V	.35
	7500V	4.24	4	400V	.75
	10KV	8.95	4	900V	1.25
	15KV	15.95	4	1000V	1.95
	20KV	19.50	4	1500V	2.79
	3000V	1.95	4	2000V	4.25
	10KV	10.95	4-4	3000V	7.55
	2000V	1.25	5	330VAC	1.75
	3000V	2.15	5	600V	1.35
	6000V	1.75	5	800V	2.49
	15KV	15.95	5	1500V	2.89
	20KV	19.50	5-1	400V	.89
	3000V	1.25	6	600V	1.45
	6000V	1.02	6	330VAC	2.49
	15KV	15.95	6	1000V	2.49
	20KV	19.50	6	1500V	3.25
	3000V	1.39	6	2000V	3.95
	6000V	1.29	6	3000V	4.65
	15KV	15.95	6	600V	1.45
	20KV	19.50	6	800V	2.49
	3000V	1.39	7	1000V	2.49
	6000V	1.29	7	1500V	3.25
	15KV	15.95	8	2000V	3.95
	20KV	19.50	8	3000V	4.65
	3000V	1.39	8	600V	1.45
	6000V	1.29	8	800V	2.49
	15KV	15.95	8	1000V	3.25
	20KV	19.50	8	1500V	4.25
	3000V	1.39	8	2000V	4.95
	6000V	1.29	8	3000V	5.25
	15KV	15.95	8	600V	1.45
	20KV	19.50	8	800V	2.49
	3000V	1.39	8	1000V	3.25
	6000V	1.29	8	1500V	4.25
	15KV	15.95	8	2000V	4.95
	20KV	19.50	8	3000V	5.25
	3000V	1.39	8	600V	1.45
	6000V	1.29	8	800V	2.49
	15KV	15.95	8	1000V	3.25
	20KV	19.50	8	1500V	4.25
	3000V	1.39	8	2000V	4.95
	6000V	1.29	8	3000V	5.25
	15KV	15.95	8	600V	1.45
	20KV	19.50	8	800V	2.49
	3000V	1.39	8	1000V	3.25
	6000V	1.29	8	1500V	4.25
	15KV	15.95	8	2000V	4.95
	20KV	19.50	8	3000V	5.25
	3000V	1.39	8	600V	1.45
	6000V	1.29	8	800V	2.49
	15KV	15.95	8	1000V	3.25
	20KV	19.50	8	1500V	4.25
	3000V	1.39	8	2000V	4.95
	6000V	1.29	8	3000V	5.25
	15KV	15.95	8	600V	1.45
	20KV	19.50	8	800V	2.49
	3000V	1.39	8	1000V	3.25
	6000V	1.29	8	1500V	4.25
	15KV	15.95	8	2000V	4.95
	20KV	19.50	8	3000V	5.25
	3000V	1.39	8	600V	1.45
	6000V	1.29	8	800V	2.49
	15KV	15.95	8	1000V	3.25
	20KV	19.50	8	1500V	4.25
	3000V	1.39	8	2000V	4.95
	6000V	1.29	8	3000V	5.25
	15KV	15.95	8	600V	1.45
	20KV	19.50	8	800V	2.49
	3000V	1.39	8	1000V	3.25
	6000V	1.29	8	1500V	4.25
	15KV	15.95	8	2000V	4.95
	20KV	19.50	8	3000V	5.25
	3000V	1.39	8	600V	1.45
	6000V	1.29	8	800V	2.49
	15KV	15.95	8	1000V	3.25
	20KV	19.50	8	1500V	4.25
	3000V	1.39	8	2000V	4.95
	6000V	1.29	8	3000V	5.25
	15KV	15.95	8	600V	1.45
	20KV	19.50	8	800V	2.49
	3000V	1.39	8	1000V	3.25
	6000V	1.29	8	1500V	4.25
	15KV	15.95	8	2000V	4.95
	20KV	19.50	8	3000V	5.25
	3000V	1.39	8	600V	1.45
	6000V	1.29	8	800V	2.49
	15KV	15.95	8	1000V	3.25
	20KV	19.50	8	1500V	4.25
	3000V	1.39	8	2000V	4.95
	6000V	1.29	8	3000V	5.25
	15KV	15.95	8	600V	1.45
	20KV	19.50	8	800V	2.49
	3000V	1.39	8	1000V	3.25
	6000V	1.29	8	1500V	4.25
	15KV	15.95	8	2000V	4.95
	20KV	19.50	8	3000V	5.25
	3000V	1.39	8	600V	1.45
	6000V	1.29	8	800V	2.49
	15KV	15.95	8	1000V	3.25
	20KV	19.50	8	1500V	4.25
	3000V	1.39	8	2000V	4.95
	6000V	1.29	8	3000V	5.25
	15KV	15.95	8	600V	1.45
	20KV	19.50	8	800V	2.49
	3000V	1.39	8	1000V	3.25
	6000V	1.29	8	1500V	4.25
	15KV	15.95	8	2000V	4.95
	20KV	19.50	8	3000V	5.25
	3000V	1.39	8	600V	1.45
	6000V	1.29	8	800V	2.49
	15KV	15.95	8	1000V	3.25
	20KV	19.50	8	1500V	4.25
	3000V	1.39	8	2000V	4.95
	6000V	1.29	8	3000V	5.25
	15KV	15.95	8	600V	1.45
	20KV	19.50	8	800V	2.49
	3000V	1.39	8	1000V	3.25
	6000V	1.29	8	1500V	4.25
	15KV	15.95	8	2000V	4.95
	20KV	19.50	8	3000V	5.25
	3000V	1.39	8	600V	1.45
	6000V	1.29	8	800V	2.49
	15KV	15.95	8	1000V	3.25
	20KV	19.50	8	1500V	4.25
	3000V	1.39	8	2000V	4.95
	6000V	1.29	8	3000V	5.25
	15KV	15.95	8	600V	1.45
	20KV	19.50	8	800V	2.49
	3000V	1.39	8	1000V	3.25
	6000V	1.29	8	1500V	4.25
	15KV	15.95	8	2000V	4.95
	20KV	19.50	8	3000V	5.25
	3000V	1.39	8	600V	1.45
	6000V	1.29	8	800V	2.49
	15KV	15.95	8	1000V	3.25
	20KV	19.50	8	1500V	4.25
	3000V	1.39	8	2000V	4.95
	6000V	1.29	8	3000V	5.25
	15KV	15.95	8	600V	1.45
	20KV	19.50	8	800V	2.49
	3000V	1.39	8	1000V	3.25
	6000V	1.29	8	1500V	4.25
	15KV	15.95	8	2000V	4.95
	20KV	19.50	8	3000V	5.25
	3000V	1.39	8	600V	1.45
	6000V	1.29	8	800V	2.49
	15KV	15.95	8	1000V	3.25
	20KV	19.50	8	1500V	4.25
	3000V	1.39	8	2000V	4.95
	6000V	1.29	8	3000V	5.25
	15KV	15.95	8	600V	1.45
	20KV				

RADCOM'S HOTTEST BUYS for '53

5,000 LOADING COIL UNITS

A Toroidal coil for matching telephone equipment, to line. Heavy duty type in watertight case. Used with EE8 field telephone.



Type C-114

25,000 MAST SECTIONS

Type MS-49 to MS-55. Also Canvas Bags BG-56 for same.

ALL TUNING COILS for BC-610

All Frequencies

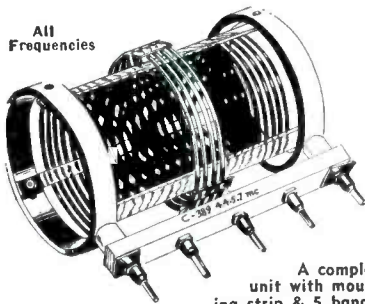

A complete unit with mounting strip & 5 banana plugs.

1,000 DYNAMOTORS, DM-21

Input 14 Volts @ 3.3 amps. Output 235 Volts @ .09 amps. 5,400 R.P.M. Used with BC 312 receiver.

ANTENNA MAST INSULATORS

Type 106A

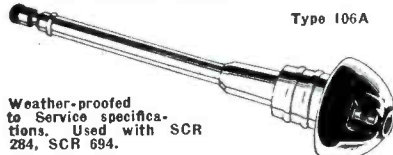

Weather-proofed to Service specifications. Used with SCR 284, SCR 694.

Write for prices and details.

- AVAILABLE: Large quantities of Radio Receivers and Transmitters, Parts, Tubes and Accessories.
- SERVICE: Complete Reconstruction and Custom Building of Electronic Equipment.

Bigelow 2-6666 Wire: WUX - Newark

Always Right With Earl White

RADCOM Engineering Co.
LIVINGSTON ST. NEWARK 3, N. J.

TIME DELAY

RELAY 115v 60cy adjustable 6 sec. to 2 minutes
Cramer TD2-120S. Also TD60S 6 to 60 sec. \$12.95
RELAY 3PDT 24 vdc 250 ohm Clare Type K. \$3.25
RELAY 4 PDT 12 vdc 70 ohm Mint tel type. \$1.95
SELSYN-1F Special 115/90 v 400 cy. \$11.95
FIL XFMR 6.3 @ 1.3A (other sizes avail.) \$3.99
CHOKO 4H 70ma. 69c; 2H 70ma 110 ohm. \$4.49
BLOWER MOTOR 400-1800cy 115v EAD J31C. \$9.95
BIRCHER CLAMPS 926A, 926B, 926C. \$1.25
VARIABLE 3-15 mmf Hammer HP 1 1/2" shft. \$4.95
ISOLATION XFORMER 35 watts prim 115v sec 115 or 135v & 6.3 tap 2 1/4x2 1/2x3" \$2.45
SUBMINIATURE tube socket 5 pin. 100 for. \$10.00
POWER XFMR 760VCT @ 170ma5 @ 3.6.3 @ 4. \$4.25
SILVER TRMR ERIE 782A 1.5-7. 7-45. \$2.99
AN-3106-105-25. P1-68. 23-11H. JK-33a. JK-34. 29c
CONDENSERS: BATHUB, MICA, AIR, OIL, HV, CER.
IPOTS, RELAYS, MIKES, 3AG&MDL fuses, SWITCHES
SPARES for: BC-1296A, MK11 Radar, AN/TPN-2
2% .002 Silver Mica CM30. Ask for flyer.

EMPIRE ELECTRONICS COMPANY

409 Avenue L. Brooklyn 30, N. Y. CLoverdale 2-2411 BRYant 9-1220

GEAR HEAD MOTORS

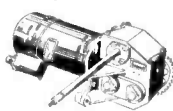

GENERAL ELECTRIC.—DC motor model 5BA50-L122, 1/2 H. P. 4000 RPM, 60v-8.3a armature and 27v-2.3a field, reversible and has magnetic brake. Gear Box No. T8254261-G1, has two 160 RPM and one 120 RPM take-offs, controlled by throw-out type clutch. Ball-bearings. Size, less shaft extension, 6x8x13". Wt. 18 lbs. Acquisition cost \$207.00. Our price NEW \$13.95

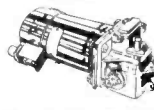

GENERAL ELECTRIC.—Motor also No. 5BA50L122 (Refer to description above). Gear Box No. T8254252G1, with two 380 RPM take-offs. Throw-out type clutch actuated by lever on front top. Ball-bearings. Size 6x8x12". Wt. 14 lbs. Acquisition cost \$194.00. Our price NEW \$12.95



EMERSON ELECTRIC.—DC motor type D44FZ-454-0417, 1 H. P. 5800 RPM, 27v-40a armature and 27v-2.5a field, reversible. Throw-out type clutch on gear box controls two 480 RPM take-offs. Ball-bearings. Size 6 1/2 x 4 1/2 x 11". Wt. 15 1/2 lbs. Price NEW \$12.95

Note: Above Gear Box available with an Elcor 1/2 H. P. DC motor, 4000 RPM, 60v-8.3a armature and 27v-2.3a field. Shafts on Gear Box turn 330 RPM. Price NEW \$10.95



EMERSON ELECTRIC.—DC motor model 5BA50LJ1, 0.4 H.P. 3000 RPM, armature 60v-6.5a, field 27v-2.5a field, reversible. Throw-out type clutch controlling two 280 RPM take-offs. Ball-bearings. Size 5x12x10". Wt. 14 lbs. Price NEW \$12.95



DUMORE.—Spec. #5277. Series wound 1/2 H. P. 24 volts AC or DC, 20 amps. 3/4" power shaft with removable sprocket gears, turns 200 RPM. Size 3x3 1/2 x 6". Wt. 3 lbs. Price NEW ONLY \$4.45

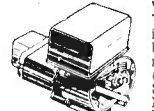

WHITE-ROGER SERVO MOTORS.—24 VDC. Torque 150 in.-lbs. Reversible. Control box on top has limit switches, relays, and selenium rectifiers (to block AC out of motor). Size 5x5x6". Can be supplied in Models 6904-5 RPM or 6904-1 1/2 RPM. Price each NEW \$8.50

DC MOTORS

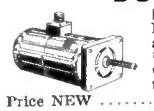

EICOR.—Part No. 82706. 1/2 H.P. 4500 RPM, 60v-8.3a armature, 24v-2.3a field, reversible. 3/4" spline shaft 9/16" long. Comes with 3" long spline adapter. Size 6x4 1/2 x 7 1/2. Wt. 9 lbs. Price NEW \$7.45



EICOR.—Part No. 305975. 1/2 H.P. 4000 RPM, 60v-8.3a armature, 24v-2.3a field, reversible. 7/16" shaft 1" long has keyway and threaded end for lock-nut. Size 5 1/2 x 4 1/2 x 8 1/2. Wt. 9 lbs. Price NEW \$7.45

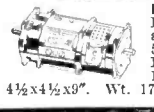

EMERSON ELECTRIC.—Type D44F0447-0417. Can be used as motor or generator. 1 H.P. 5400 RPM, 12 volts 100 amps. Double-end shaft 3/4" dia. by 1-3/16" length on each end. 4 1/2 x 4 1/2 x 9". Wt. 17 lbs. Price NEW \$8.50

SPECIALS

60 VOLT AMPLIDYNE MOTOR GENERATOR

Made to supply 60v armature voltage for amplidyne motors. Emerson Electric. #5AM31N118A. Input 27 VDC-44 amps. Output 60 VDC-8.8 amps. 530 watts, 8300 RPM. Two can be connected in series across 120 VDC line to give out 27 volts at 88 amps or 54 volts at 44 amps—vice versa. 6x8x12". Wt. 34 lbs. Complete with A-N cable. Price NEW \$9.50

3750 WATT RECTIFIERS TUBE.—Continental Electric Co. Type CE202. Half-wave mercury vapor. Rated up to 250 VDC at 15 amp. Filament 2.5 volt-20 amps. Mogil base. Price NEW \$9.50

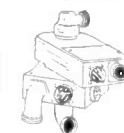

SLIP RING ASSEMBLY

(Shown with and without housing)

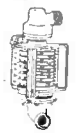

EMERSON ELECTRIC.—Used to transfer voltages between stationary and moving parts as in turrets and revolving antennae. Full 360° rotation. Silver-plated rings and carbon brushes. Capacity twelve conductors. Unit also incorporates brass plumbing for transferring liquids. Size 9x6x10". Wt. 10 lbs. Price complete NEW \$8.50



SYNCHO - DIFFERENTIAL

Bendix #C78249. 115V 60 cycle. Used as a dampener between two C78248 Synchos. Easily converted to 3600-RPM motor (instructions included). Size 3-3/8 x 5-3/8". Price Brand New in original containers. \$8.50



HAND CONTROL

Emerson Electric. #250-CE15. For Martin Power Gun Turret which this unit completely controls. Handle assembly moves in two planes, operating built-in elevation and azimuth field rheostats. Six switchettes, built into molded plastic handles, control signals and circuit breakers, resistors, gears, AN connectors and cables, etc. Size 12x11 1/2 x 6 1/2". Wt. 10 lbs. Acquisition Cost over \$200.00. Price NEW in original boxes \$8.95

HEAVY DUTY TRANSFORMERS



#1221.—1.8 KVA. Input 120 volts 60 cycle. Output: 12.0, 14.5, 16.0, 17.0, 17.2, 17.8, 18.0 volts at 100 amps. Pri. leads 28" long. Sec. leads 17" long. Size 7x7x7". Wt. 28 1/2 lbs. Price Brand NEW \$23.50

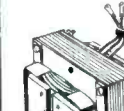

GENERAL ELECTRIC.—#79G907. 2 KVA Intermittent duty. Input: 100/110/120 volts 60 cycle. Output 0.8 (eight-tenths) volt at 2,500 amps. Can be used for quick-heat applications, spot welders, testing, etc. Size 5 1/4 x 6 1/4 x 5". Wt. 27 lbs. Price NEW \$12.50

ATTENTION MANUFACTURERS. LARGE QUANTITY OF THESE TRANSFORMERS ARE AVAILABLE.

PROMPT DELIVERY ON ALL ORDERS—ALL MERCHANDISE FULLY GUARANTEED

Terms: Prices FOB St. Louis. Cash or 25% with orders. Balance COD. Rated Concerns (D&B) Net 10 days cash. Prices subject to change without notice.

McNEAL ELECTRIC & EQUIPMENT CO.

4736 OLIVE STREET

ST. LOUIS 8, MO.

AIRCRAFT ELECTRONICS

ARC-1's, ART-13's, RTA 1B's, BC348's AND COMPONENT PARTS FOR ABOVE

WRITE OR CALL FOR BULLETIN

MERRICK ELECTRONICS

166-08 DOUGLAS AVE.

JAMAICA, N. Y.

RE 9-5960

Headquarters for Microwave Test Equipment

THE WIDEST ASSORTMENT, THE STRONGEST DEPTH AND THE MOST IMMEDIATE AVAILABILITY OF ANY SOURCE ON TEST EQUIPMENT.

We are currently producing and delivering the TS-117, TS-125, TS-108, TS-102A, TS-89, TS-268, TAA-16EA, TSX-4SE, and the newly certified BC-221 frequency meters.

A more complete listing follows:

TS-1ARR	TS-62/AP	TS-170/APN-5	TS-301/U	I-145	BC-1201/A
TS-3A/AP	TS-63/AP	TS-173/UR	TS-303A/G	I-147	BC-1203
TS-8A/U	TS-64	TS-174/U	TS-311/FSM-1	I-153A	BC-1236/A
TS-10A/APN-1	TS-76/APM-3	TS-175/U	TS-323	I-167A	BC-1255/A
TS-11/AP	TS-78	TS-184/AP	TS-324/U	I-177	BC-1287/A
*TS-12	TS-87/AP	TS-189/U	TS-328	I-178	BC-1277
*TS-13	TS-89/AP	TS-192/CPM-4	TS-338	I-196A	BE-67
TS-14	TS-92	TS-194/CPM-4	TS-359A/U	I-198A	LAD
TS-15B/AP	TS-96/TPS-1	TS-197/CPM-4	TS-363/U	I-208/A	LAF
TS-16/APN	TS-98/AP	TS-198/CPM-4	TS-375	I-212	LAE-2
TS-18	TS-100/AP	TS-203/AP	TS-377/U	I-222/A	LM-(*)
TS-19	TS-101/AP	TS-204/AP	TS-389/U	I-223A	LU-2
TS-23/AP	TS-102/AP	TS-205/AP	TS-421/U	I-225	LU-3
TS-24/APM-3	TS-108/AP	TS-210/MPM	TS-437	I-233	LZ
TS-26/TSM	TS-110/AP	TS-218/UP	I-56	IE-21/A	ME-11
TS-27/TSM	TS-111/CP	TS-220/TSM	I-61B	IE-35	OAA-2
TS-32A/TRC-1	*TS-117/GP	TS-226A	I-83A	IF-12/C	OAW
TS-33/AP	TS-118/AP	TS-230/B	I-95/A	IS-185	PAE
TS-34AP	*TS-125/AP	TS-233/TPN-2	I-98/A	IS-189	SG/8U
TS-34A/AP	TS-127/U	TS-239A	I-106/A	AN-PNS-1	TAA-16EA
TS-35/AP	TS-131/AP	TS-251	I-114	BC-221(*)	TS-45E
TS-36/AP	TS-142/APG	TS-263	I-115	BC-376	TSX-3SE
TS-46/AP	TS-143/CPM-1	TS-268	I-122	BC-438	TSX-4SE
TS-47/APR	TS-144/TRC-6	TS-270A/UP	I-122-B	BC-439	TTS-4BR
TS-18	TS-146	TS-281/TRC-7	I-126	BC-838	TTX-10RH
TS-51/APG-4	*TS-147/UP	TS-285/GP	I-130A	BC-906/D	TUN-9HU
TS-55/AP	*TS-148/UP	TS-293	I-134B	BC-949/A	UPM-13
TS-60/U	TS-153	TS-294/U	I-137A	BC-1060/A	
TS-61/AP	*TS-155	TS-297/U	I-139A	BC-1066/A	

*Of new manufacture.

Before selling your idle test equipment, please get our offer

Cable: WESLAB

Tel: Boston: WE 5-4500

Weston Laboratories

Weston 93. Mass.



RELAYS

Our stock of more than a million relays — in over a thousand different types — is the world's largest. Don't delay your production for want of large or small quantities of relays of any type.

Telephone, wire or write for quotations.

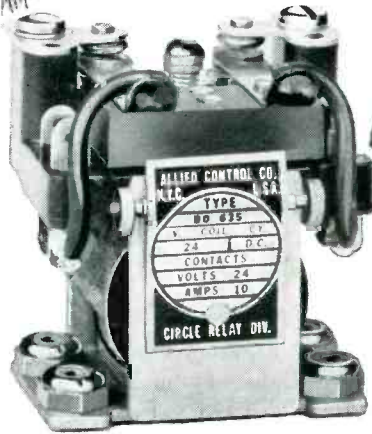

NEW AND MORE COMPREHENSIVE

1953 RELAY SALES CATALOG

NOW READY

Be sure to send for your copy

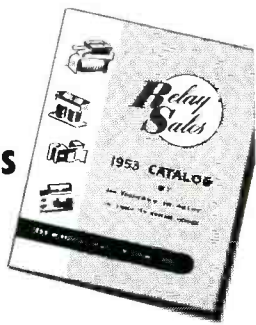

Telephone Seeley 8-4146



833 W. CHICAGO AVE. DEPT. 4, CHICAGO 22, ILL.

PULSE TRANSFORMER

Tube base plug in type

Here are precision made, high quality compact pulse transformers wound on hypersil cores. They are built in octal bakelite tube bases and can be adapted to many uses. They are completely impregnated and sealed.

SUGGESTED USES

- ★ Blocking Oscillator, Multivibrator and Scope Circuits.
- ★ Wherever Accurate Timing and Triggering are necessary.
- ★ Unexcelled in circuit applications for generating low power and low voltage pulses.
- ★ Can be used in circuits utilizing repetition rates from 0 to well over 1 MC and pulse widths ranging from .05 Microsecond up.

Price \$4.50 each Immediate Delivery

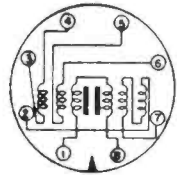

TYPE UX 7350
EACH COIL - 50-T@ 36E
MAX. DC RES. OHMS
1 0 8 • 4.02 A
2 0 7 • 4.542 A
3 0 6 • 2.357 A
6 0 6 • 2.100 A

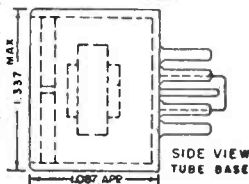
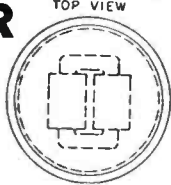

HATRY and YOUNG

THE Elect IN ELECTRONICS

811 Boyston St., Boston 16, Mass. CO 7-4700

WIRE-CABLE TUBES PARTS

CORDAGE

CO-122 3 conductor each #22 AWG neoprene jacket 550' lengths
 CO-127 single #14 AWG braided and tinned copper braid shield

MULTI-CONDUCTOR

2 conductor AWG 12 7 conductor AWG 16
 7 conductor AWG 14 19 conductor AWG 16
 14 conductor AWG 16 6 conductor AWG 20
 11 conductor shielded 10 conductor AWG 16 AWG 20 22 conductor AWG 16
 2 conductor AWG 18
 2 conductor shielded AWG 10

AMOUR

DRIA-23 DHFA-100 FRIA-4

SINGLE CONDUCTOR AWG 10

shielded cable with terminal lug each end 100' and 150' lengths

WIRE

AWG 18 copperweld
 AWG 29 tinned copper
 Resistance wire AWG 32
 AWG 22 with nylon core plastic insulation

OIL FILLED CONDENSERS

MFD	VDC	Each	Ten	MFD	VDC	Each	Ten
1	600	.85	.80	5	2000	2.00	1.90
2	600	.95	.95	25	3000	2.85	2.80
4	600	1.40	1.40	5	3000	2.95	2.90
5	600	1.65	1.60	2	5000	4.50	4.25
1-8	600	2.50	2.35	1	7500	3.95	3.95
.01	1000	.85	.80	1	7500	12.50	12.00
.5	1000	.95	.90	1	12000	7.95	7.95
2	1000	1.65	1.60	0008	15000	12.50	11.75
1	1200	1.65	1.60	2	15000	14.95	14.80
1	1500	1.75	1.65	.045	16000	12.95	12.50

SPECIALS

80-86 Crystal in Holder \$2.50
 Balloon with Hydrogen Generator \$2.50
 300 Feet Aerial Wire \$2.00

SWITCHES—BATHTUB—OIL FILLED—MICA CONDENSERS—POTENTIOMETERS. SEND FOR CATALOG

MICROWAVE TEST EQUIPMENT

10 CM echo box CABV 14ABA-1 of OBU-3, frequency range 2890 MC — 3170 MCS. Direct reading micrometer head. Ring prediction scale plus 9% to minus 9% Type "N" input. Resonance indicator meter. With accessories, spares and 10 CM directional coupler. Brand New.

TUBES

2C34	\$.45	803	3.60	CEQ72	7.85
2X1/879	.55	826	.65	CK 70	4.15
3B24	4.95	864	.25	CRP 72	.85
3C24	1.60	931A	4.45	E 1148	.30
7C4/1203A	.70	955	.30	HY 615	.20
10V	.35	957	.35	RKR 72	.85
15R	.85	CK 1005	.45	RK 73	.45
30 Spec.	.40	CK 1007	.90	5BP4	4.25
39/44	.25	1626	.35	5FP7	1.75
45 Spec.	.35	1629	.25	1J6 G	.70
WE 203A	6.75	2051	1.10	1B3 GT	.80
316A	.60	7193	.50	3A4	.60
WL 531	4.95	8011	1.50	5U4G	.57
713A	.90	9006	.30	6K6GT	.60
801A	.25	C5	8.00		

HI VOLTAGE FILTER CHOKES

4 HY 4.5 Amp DC 3 ohms 1230 RMS to ground. New.
 1 HY 3.2 Amp DC 3.5 ohm GE69G459. New.
 1.7-3 HY 2 AMP DC 34,000 VDC GE Y346A. New.

NAVY ENTERING TYPE INSULATOR

Porcelain flanged bowl with brass rod, fittings and aluminum shield. Dimensions 4 3/4" high, 6-5/16" OD at base. Brand new \$4.50.

10 CM ROTATING ANTENNA

24" Parabola in turret 360° span at 12 RPM DC, motor control and reversing switch New.

TIME DELAY SWITCHES

1 Minute 115 VAC 60 cycle Enc. in Waterproof Metal Case New \$5.25
 3 Micro Switches Contact at 40-41-42 Second Time Delay 110 VAC Motor New \$4.50
 Thermo Switch 50° to 300° F 115 VAC @ 6A 230 VAC @ 5A
 Breaks Contact with increase in Temperature New \$1.35

CONTACTORS

DPST 115 VAC 60 cycle 15 Amp De-Ion Line Starter Westinghouse \$6.95
 DPST 115 VAC "AB" #700 \$5.95

RELAYS

12 VDC DPST Allied Control Box 32 \$1.25
 24 VDC DPST Allied Control BJD36 \$1.45
 24 VDC 3PDT 8 Amp. \$1.50
 110 VAC DPST 1 Amp Contacts Struthers
 Dunn CKA 1970 \$3.65
 115 VAC DPST Struthers Dunn CXA 2997 \$3.65
 220 VDC DPST Struthers Dunn CK 2122 \$4.50
 230 V 50 cycle DPST G.E. 12HG11A2 \$4.00

ROLLER INDUCTANCE COIL 0-15

MH WITH VERNIER ADJUSTMENT
 Coil is wound on ceramic form 3 1/8" long. Right angle drive gear with 5/8" shaft. Three position switch for vernier operation New—Meissner—C-625

METERS

Portable 0-25 Amps AC Weston #433 Brand New \$37.50
 Switch Board Panel 0-100 Amps DC Weston #269 with 100 Amp Shunt Brand New \$24.95

EQUIPMENT

Walkie-Talkies 2.3-4.6 MC
 MN-26Y Bendix Compass Receiver
 BC-733 Glide Path Receiver
 DAB-3—Direction Finder
 RDF Receiver Equipment 200-550 KC Fixed Tuned

COMET ELECTRONIC SALES CO.

22 Washington St.

Tel. BEacon 2-7863

Brighton 35, Mass.

TERMS: Minimum order \$5.00 — Mail orders promptly filled—All prices F.O.B. Boston, Mass. Send M.O. or check. Shipping charges sent C.O.D. 25% deposit required with all C.O.D. orders.



State Labs Inc.

Nation's Largest Wholesale Supplier
 Specializing ONLY in Buying and Selling

ELECTRONIC TUBES AND CRYSTALS

OVER 4000 TYPES AVAILABLE
 TOP STANDARD BRANDS
 IMMEDIATE QUOTATIONS

WRITE FOR FREE WEEKLY MARKET GUIDE



State Labs Inc.

37 EAST 28 STREET, NEW YORK 16, N. Y.
 PHONE: MURRAY HILL 3-9502
 WIRE: STATE LABS, WUX, N. Y.
 TELETYPE: N. Y. 1-1807 CABLE: STATELABS

SOLA
 Constant voltage transformer
 Model #30807

Input 95-125V **\$35.00** Output 115.0V
 DRILLICK ELECTRONIC SALES CO.
 5281 W. Pico Blvd. Los Angeles 19, Calif.

OIL FILLED UPRIGHT CAPACITORS

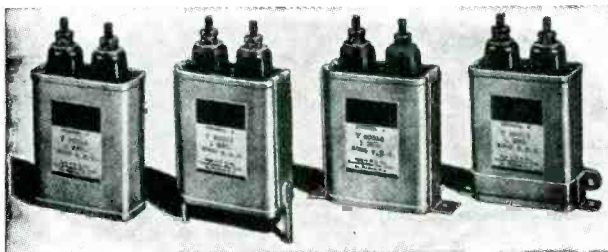

Cap. MFD.	Voltage	Cap. MFD.	Voltage	Cap. MFD.	Voltage
4.0	400	2x3	600	.15	4000
.1	500	2x4	600	.25	4000
1.12	600	2.0	800	2.0	4000
1.0	600	1.0	1000	.01	5000
4.0	600	2.0	1000	.2	5000
5.0	600	4.0	1000	.25	6000
6.0	600	2x.5	1000	1.0	6000
7.0	600	.25	2000	2x.1	7000
8.0	600	.5	2000	.1	7500
9.5	600	1.0	2000	2.0	7500
10.0	600	.25	3000	.03	10000

All above Standard Brands and in stock—Write, wire, phone your requirements.

Oil Filled Filter Condensers—Super-Special

Here's a sensational Standard Brands buy in 10 mfd. 600 VDC/220 VAC, Type R2-157 or Type CRA-2100. 2 3/8" diam. 3 3/8" high. These condensers are now being used for hundreds of industrial applications. Rated at 220 VAC they are successfully used in circuits of 800 VDC. A once in a 95¢ ea lifetime buy! (Lots of 100 89¢ each) Single lots.....



400 Mfd. C-D Photoflash Condensers

These 400 mfd. 450 WV photoflash condensers are equivalent to 40 watts/seconds output each. 4" high, 2 3/8" diam. Each \$4.95



ACORN ELECTRONICS CORP.

76-E Vesey St. Worth 4-3270 New York 7, N. Y.

END OF YEAR CLEARANCE ON OUR ENTIRE STOCK OF SPECIAL PURPOSE & TRANSMITTING TUBES. ADDITIONAL DISCOUNTS FOR QUANTITY SHIPMENTS

OA2.....	.89	5C30/C5B.....	3.75	371B.....	.79	832A.....	8.50
OA3/VR75.....	1.04	5CP1.....	4.50	388A.....	1.29	841.....	.39
OB2.....	1.05	5D21.....	24.00	394A.....	4.75	843.....	.25
OB3/VR90.....	1.05	5FP7.....	1.95	417A.....	14.95	846.....	49.95
OC3/VR105.....	1.10	5C5B.....	3.75	450TH.....	42.50	860.....	6.50
OD3/VR150.....	.85	5R4GY.....	1.49	530.....	16.95	861.....	21.50
IB22.....	1.95	6A6.....	5.75	531.....	6.75	864.....	.75
IB26.....	2.25	6K7G.....	.45	533.....	19.95	865.....	1.25
IB27.....	12.50	6K7G.....	.45	559.....	.75	866A.....	1.35
IB29.....	2.45	7BP5.....	14.95	575.....	.15	872A GE.....	3.59
IB36.....	7.50	7C4.....	.35	700A.....	17.50	874.....	.69
IB56.....	24.50	7E5.....	.39	701A.....	4.95	876.....	.59
ELIC.....	2.49	10Y.....	.39	702A.....	2.49	879.....	.49
ID8GT.....	.59	12A6.....	1.49	703A.....	2.75	931A.....	4.25
IL4.....	.59	24G.....	.39	704A.....	1.69	955.....	.45
IR4/1294.....	.69	RK34.....	.29	705A.....	39.50	956.....	.45
IT4.....	.45	Special.....	4.50	706AY-DY.....	39.50	957.....	.45
2C21/1642.....	.29	FG17.....	.75	706EY-GY.....	7.95	958A.....	.59
2C22/7193.....	.15	RK72.....	3.50	707A.....	3.75	E1148.....	.29
2C26A.....	.39	RK75.....	19.95	710/8011.....	.75	CK1005.....	.59
2C34/RK34.....	7.50	REL5.....	3.49	713A.....	.92	1608.....	3.95
2C40.....	14.95	FG81A.....	.75	714AY.....	4.95	1616.....	.69
2C43.....	.95	VT90.....	19.95	715A.....	4.95	1619.....	.35
2C44.....	7.50	VT98.....	7.75	715B.....	6.95	1625.....	.40
2J22.....	14.95	100TH.....	7.75	715C.....	19.95	1626.....	.40
2J26.....	14.95	HY114B.....	.50	717A.....	.98	1629.....	.30
2J27.....	19.50	VT127.....	1.75	721A.....	1.75	1636.....	2.95
2J39.....	26.50	205B.....	1.49	722A.....	1.89	1642.....	.59
2J40.....	39.50	211.....	.75	724B.....	2.49	1851.....	1.29
2J61.....	39.50	217C.....	6.95	800A.....	6.75	2051.....	.95
2J62.....	.75	250TH.....	18.50	805A.....	1.45	8013.....	.75
2V3G.....	.49	250TL.....	16.95	801A.....	3.75	8012.....	2.75
2X2.....	.39	285A.....	4.95	803.....	3.50	8013A.....	2.95
3B7/1291.....	2.49	286A.....	6.95	805.....	1.59	8020.....	1.25
3B22.....	1.49	304TH.....	6.50	807.....	2.25	8021.....	1.95
3C24.....	4.95	304TL.....	8.75	808.....	2.75	8025A.....	5.45
3C28.....	1.49	307A.....	3.50	811.....	3.50	9001.....	1.25
3CP1/S1.....	.35	316A.....	4.95	812.....	2.75	9002.....	.95
3D6/1299.....	4.75	328A.....	7.25	812A.....	3.50	9003.....	1.25
3D23.....	1.75	329A.....	6.95	813.....	13.95	9004.....	.35
3FP7.....	2.95	350B.....	3.95	814.....	2.95	9006.....	.25
3Q4.....	17.50	353A.....	3.95	829B.....	12.95	6 Amp Tungar.....	2.4
4B28.....	3.49	357A.....	14.95	830B.....	2.75	Bulbs.....	
4J42 700A.....							
5AP1.....							

SEND US YOUR INQUIRIES ON TYPES NOT LISTED

MARITIME INTERNATIONAL COMPANY
11 STATE STREET NEW YORK 4, N. Y.

POWER RHEOSTATS



r1	W	W	W	W	W	W	W
.5	25	1.98 75	25	1.98 500	300	9.49	
.5	50	2.81 75	75	3.90 585	150	6.59	
1	150	5.93 80	50	2.53 750	25	2.23	
1	50	2.81 80	500	1.42 750	150	5.46	
2	50	2.81 100	25	1.98 1000	25	2.53	
2	100	4.48 100	50	2.53 1000	50	2.66	
2	300	8.42 100	100	4.48 1200	225	7.20	
3	100	4.67 125	25	2.23 1200	300	8.40	
3	225	6.58 150	50	2.53 1250	50	2.66	
4	225	6.60 175	25	2.23 1250	150	6.10	
4	25	1.97 185	25	2.23 1500	25	2.53	
5	50	2.53 200	25	2.23 1500	50	2.66	
5	100	4.68 200	100	4.48 1800	150	6.19	
6	25	2.23 200	150	5.04 1800	150	6.19	
6	50	2.53 225	50	2.53 2000	25	2.53	
7	75	3.90 250	25	2.23 2000	50	2.66	
7	25	1.98 250	50	2.53 2250	150	6.26	
7.5	75	3.95 300	50	2.53 2500	50	2.66	
8	50	2.53 300	75	3.90 2500	100	4.68	
10	25	2.23 300	100	4.48 2500	150	6.24	
10	50	2.53 300	150	5.04 3000	25	2.66	
10	100	4.37 350	25	2.25 3000	100	4.95	
12	25	2.23 350	100	4.48 5000	25	2.66	
12	50	2.53 375	25	2.23 5000	50	2.90	
15	25	1.98 378	150	6.59 7500	50	2.90	
15	75	3.90 400	25	2.23 7500	100	5.32	
15	100	4.38 400	75	3.90 10000	50	2.99	
20	50	2.53 500	25	2.23 10000	100	5.32	
22	50	2.53 500	50	2.53 10000	100	5.51	
25	25	2.23 500	75	3.95 15000	25	3.25	
25	25	1.98 500	100	4.50 20000	150	8.75	
50	50	2.53 500	150	5.15			

Specify Type Shaft Required "S" or "Knob" Special Prices to Quantity Users.

LARGEST VARIETIES OF NEW SURPLUS AT LOWEST PRICES

- OIL CAPACITORS**
LARGE RECTANGULARS
SMALL RECTANGULARS
BATHTUBS; TUBULAR
- MICA** SILVER TRANS. G-1-2-3-4
- ELECTROLYTIC FP CANS**
- AMPHENOL-CANNON**
- AN-UG-UHF CONNECTORS**
- LORD SHOCK MOUNTS**
- BIRTCHEER Tube CLAMPS**
- JONES** PLUGS—SOCKETS
BARRIER STRIPS
- POWER RHEOSTATS**
- SWITCHES** TOGGLE, ROTARY
MICRO, PUSH-MOM.
- POTENTIOMETERS** J.
J.J.
- OTHER** CARBON WIRE-WOUND
POTS
- MOSSMAN** LEVER SWITCHES
- AIRCRAFT** NOISE FILTERS
- RESISTORS** GLASS FERRULE
PRECISION
- FUSEHOLDERS-MOUNTS**
- INSTRUMENT KNOBS**
- MANY OTHER ITEMS**

HIGH POWER TRANS. MICA



G-1 Type	G-2 Type	G-3 Type	G-4 Type
.0001 6kv	.0001 10kv	.001 20kv	.00025 30kv
.00015 5kv	.00015 10kv	.00015 20kv	.0006 35kv
.0002 6kv	.0002 10kv	.0004 20kv	.0025 25kv
.0008 6kv	.00025 12kv	.00045 15kv	.003 20kv
.01 4kv	.0005 10kv	.0047 20kv	.0039 20kv
.032 2kv	.000375 10kv	.005 20kv	.0075 15kv
.04 1kv	.0004 5kv	.00095 5kv	.01 12kv
.051 1.5kv	.0005 10kv	.001 20kv	.03 8kv
.08 1.5kv	.00067 10kv	.0011 20kv	.056 5kv
.09 1.5kv	.00065 10kv	.00124 15kv	
	.01 10kv	.01 5kv	
		.015 3kv	
		.25 1.6kv	

C-D Type #56		
.000155	30kv	.001 30kv
.0004	30kv	.03356 2.5kv
.000533	30kv	.00715kv—70A/300kv

Full ratings and prices upon request. Specify your needs.

A. MOGULL CO.
50 West Broadway N. Y. 7, N. Y.
Phone: WORTH 4-0865

Radar

SCR-545A Search and Track. Complete trailer, power supply and spare parts. Nearly New. Write for description and price.

Transformers & Chokes

- New 10 K.W. Amertran oil cooled plate transformers 115v./230v. 60 cy. single phase primary, 17,600 volts, .5 amp. secondary. Can be furnished center tapped or two wire 3800 volts, 1.0 amp. State primary and secondary voltage desired. Priced \$75.00 each f.o.b. Los Angeles.
- Filament, American Transformer Co. Spec. 28106, Type WS, .050 KVA, 50/60 cy. S.P., 35 KVA test, 12 KV d-c operating. Pri. 115 v., Sec. 5 v., 10 amps w/integral stand-off insulator and socket for #371,872, etc., rectifier tubes. \$15.00 each. Transit, line voltage regulator, 115 v. 60 cy. Range .03-126 v. 2.17 amp. Amertran Spec. #29144. \$9.50 each.
- Battery Charger, G.E. Cat. #WS-99316. Pri. 105-115-125 V. 60 C. Sec. 105-90-75-60-45-30 v. @ 6 amps. each side of center tap. Voltage reduced 10% and 20% thru tapped primary; two x 5 v. 18 amp. C.T. (Tungar filaments) and two x 7 v. 10 amp. 7/4" h. x 8-3/4" w. x 5 1/2" d. Wt. 56 lbs. New, orig. packing. G. E. Price \$52.00. \$17.50, 2 for \$30.00.
- Choke, swinging 15,000 v. d-c line, ripple frequency 120, 149 ohms. .02 amp. @ 900 henrys; .52 amp. @ 25 henrys; 48% ripple. Amertran Spec. #29107. \$42.00.

Capacitors

- 9.12 mfd., 1265 v. 60 c. a-c or 4000 v. d-c power factor correction 5.0 K.V.A.R. Cat. #2528908. \$17.50
- .25-.25. 6000 v. d-c or .125 @ 12,000 v. d-c., Fast Cat. #A7548 oil. \$3.75.
- 1.25/1.25 mfd., 7500 v. Pyranol Cat. #26F360. \$17.50

* Quantities available—subject to special discounts.

EPCO

1527 E. Seventh Street Los Angeles 21, Calif.

GLASS TUBING

PYREX - NONEX - URANIUM BULBS & CYLINDERS

WRITE FOR FREE MONTHLY LIST

HOUE SUPPLY COMPANY

PHONE KEYPORT 7-1286

M. R. # 1 Box 86X Keyport, N. J.

SHEET METAL MACHINERY

NEW & USED—COMPLETE LINE OF

Box Brakes, Press Brakes, Notchers, Shears, Punches, Bells, Spot Welders—Di-Acro, Festo, Whitney Equipment, etc.

B.D. BROOKS, INC. 310 Atlantic Ave. Boston, Mass. Tel. HANcock 4-5293

**FOR THE BEST
IN ELECTRONICS!**

**PARTIAL LISTING
OF OUTSTANDING
SURPLUS COMMUNI-
CATIONS EQPT.**

MARINE

TCS X'mtr-Receiver for Ship or Shore.

TBK HF 500W. Transmitter with MG, Starter, and Spares.

TAJ 500 Watts Output, 175-550 KC. New. Equipment, with Spares, Motor Generator (AC and DC available) Starter, Tubes, Complete.

GO-9 100/125 W. IF/HF Ship or Aircraft Transmitter, A1 or A2 Emission. All New with Spares.

150-AY Mackay IF Ship X'mtrs.

8707 RMCA Ship Radio Compass

SCR-610 Crystals, in sets (120 channels) or individually. TESTED. Write for PRICES.

TELEMARINE COMMUNICATIONS CO.

3040 W. 21ST STREET,
B'KLYN 24, NEW YORK.
PHONE: ESPLANADE 2-4300
CABLE: TELEMARINE, N. Y.

**IMMEDIATELY
AVAILABLE
FROM STOCK**

**GROUND, SHIP & AIR
COMMUNICATIONS**

EXTRA!

PE-104 POWER SUPPLIES for Receiver of SCR-284, NEW, with Spare Vibrator, Export-Packed. Large Quantity Available. **WRITE FOR PRICES.**

MISCELLANEOUS

DZ-2 Direction Finders

GP-7 Aircraft Transmitters

ZB-3 ILAS Eqpt.

SCR-283 Rcvg & X'mtng Eqpt. Complete.

RT-3/ARN-1 Altimeter

RADIOSONDES AN/AMQ-1A to D. New.

APR-4 TUNING UNITS:

TN-18, 300-1000 MC \$149.50 ea.

TN-19, 1,000-2,000 MC \$149.50 ea.

New, Original Cases.

TDQ VHF 100-156 MC 50W. AM X'mtr for 110 V. 50/60 C. AC.
BC-797 VHF 110-126 MC, 50W. AM Output for 110 V. 50/60 C. AC.
SCR-284 Ground Portable AM, Trans-Rcvg Eqpt. for Field Communications.

SCR-522 VHF, 4-Channel, 100-156 MC Trans-Rcvg. Eqpt. for Plane or Ground Communications.

SCR-511, Walky-Talky, 3-6 MC, Crystal Controlled Trans-Rcvg. with Plug-In Units for Freq. Changing.

96-200A, 2 KW Wilcox X'mtr. 125-525 KC, 3 Cabinets: RF Unit, Modulator, Rectifier; A1, A2 and A3 Emission.

250 & 500 WATT SOUND SYSTEMS for Airports, Shipyards, Amusement Parks, Civilian Defense, Etc. Write for Prices and Literature.

PHOTOCON SALES

417 N. Foothill Blvd. SY camore 2-4131
Pasadena 8, Calif. RY an 1-6751

FREE 24 PAGE WINTER
SURPLUS SALES CATALOG

WANTED new or clean used electronic surplus. Please state exact description of the condition and details of modification. Indicate lowest price in first letter.

804C Signal Generator 8-330 mc.	Exc.	PUR*
Hewlett-Packard 410A VTVM	Like new	185.00
Simpson Gonescope	New	275.00
LM & BC-221 Frequency Meter with cal. book, crystal, and tubes	Exc.	99.50
TS-352/U Weston Test Set	Exc.	150.00
TS-148/UP	New Mig.	PUR*
Signal Generator 196A	Like new	PUR*
Million Signalizer Radio & TV	Like new	PUR*
Dumont 208 Scope	Exc.	PUR*
TS-146/UP X-Band Signal Generator	Exc.	PUR*
305B Floor model Oscilloscope 9" tube RCA mfg.	Exc.	PUR*
TS-34/AP Portable Oscilloscope	Exc.	350.00
TS-12 Test Set for X-Band Box 1 & 2 complete	Exc.	PUR*
APR-4 Search Receiver	Exc.	PUR*
Tuning Units for APR-4 Receiver	Exc.	PUR*
BC-348, BC-312, BC-342 Receivers	Exc.	PUR*
APS-3	Exc.	PUR*
SCR-284 Fields Sets	Exc.	PUR*
APN4A or B	Exc.	PUR*
APR-5A	Exc.	PUR*
SCR-545 Itadar Trailer	Exc.	PUR*
Type 120A Q meter 130-210 mc.	Exc.	PUR*
Boonton Radio Corp.	New	20.00
Antenna AT 104/APN9	New	
Automatic Pilot Inverter		
Type DA Input 28VDC. @ 12 amps. Output 115V., 3 phase, 400 cps. 115VA.	Exc.	80.00
T-17 Hand Microphone with cord and PL-68	Exc.	4.50
Impedance Bridge 650A General Radio	Like new	PUR*
HS-23 8000 ohm. Used \$2.95	New	5.95
HS-18 8000 ohm. Used 1.75	New	2.25
HS-23 600 ohm. Used 3.50	New	6.95
HS-38 600 ohm. Used 1.75	New	2.25

*PUR—PRICE upon request.

NOTE: One of the largest and most complete electronic surplus stocks in the country. We have thousands of tubes, capacitors, plugs, accessories, transmitters-receivers, test equipment, etc. Send us your requirements.

TERMS: Prices F.O.B. Pasadena, California. 25% on all C.O.D. orders. Californians add 3% Sales Tax. Prices subject to change without notice.

SAVE! SAVE! SAVE!

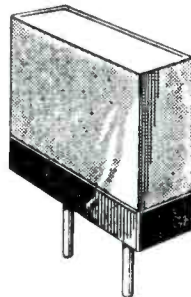

SURPLUS RADIO CRYSTALS

**PRICED TO SELL . . . AT A FRACTION OF THEIR ORIGINAL COST
MFG. BY WESTERN ELECTRIC AND FEDERAL TEL. & RADIO**

ALL FT-241-A HOLDERS

Available As Follows For:

SCR 608-A and SCR 628-A SCR 528 and SCR 538
BC 684 120 per set BC 604 80 per set

500 KC Crystals \$1.95 ea.
1000 KC Crystals \$3.95 ea.

QUANTITIES AVAILABLE

Write For Price Quotation On Your Requirements.

C and H Sales Company

BOX 356-Z EAST PASADENA STATION • PASADENA 8, CALIFORNIA

**WHEN YOU ORDER
WELLS
COMPONENTS...**



**HERE'S WHAT
YOU GET**

- 1 IMMEDIATE DELIVERY FROM STOCK
(in any quantity)
- 2 FINEST QUALITY OF FAMOUS BRANDS
- 3 GENERALLY LOWER PRICES
- 4 RETURN PRIVILEGE FOR FULL
CREDIT IF NOT SUITED TO YOUR
REQUIREMENTS

The valuable service Wells provides to the industry is being used by many of our greatest manufacturers as a matter of course.

Our vast stock (the world's largest) may contain just the components you need to fill urgent orders — at a substantial savings in time and cost.

ADEL CLAMPS • ANTENNAS, Insulators, Mast Sections • BINDING POSTS • BLOWERS • CABLE ASSEMBLIES • CHOKES • COILS • CONDENSERS Oil Filled, Bathub, Hearing Aid, Transmitting Mic, Silver Mic, Ceramic, Variable, Trimmer • CRYSTALS • FILTERS • FUSES & MOUNTINGS • GENERATORS • GROUND RODS • HEADSETS • I.F. COILS • JACKS • JACK BOXES • KEYS, Telegraph KNOBS • LAMPS • LORD MOUNTS • LUGS MOTORS & BRUSHES • PLUGS • RECTIFIERS Selenium, Copper Oxide, Meter, Diode • RESISTORS—All Types • SELSYNS • SOCKETS • SWITCHES Aircraft, Micro, Switches, Toggle • TIMERS • TUB-ING—Flexible • TUNING SHAFTS • TRANSFORMERS All Types • VIBRATORS • WALKIE TALKIES

DYNAMOTORS



**OVER 100,000
NEW DYNAMOTORS
IN STOCK!**

DM 32A — DM 53A — PE 86 — PE 101C
DM 33A — D 101 — PE 94, etc.
Large quantities of brushes for all types of dynamotors and motors.

Write us for quotations. Advise us your requirements.

A complete Signal Corps stock number listing of items in our stock. Write for listing No. 5G-200. (For government agencies and contractors only.)

Manufacturers and distributors—write for new Condenser Catalog C-10 now available.

Write, Wire, Phone Your Requirements
all phones: **SEeley 8-4143**

**WELLS
SALES, INC.**

833 W. CHICAGO AVE., DEPT. SL, CHICAGO 22, ILL.



**CHECK AND COMPARE OUR
COMPLETE STOCKS**

The following is just a partial list of the current electronic and aircraft equipment now in our warehouse. Write for complete information. Prompt replies to all inquiries.

RC-103 & AN/ARN-5 ILS

New in original cartons. Complete. Consists of all accessories, plus AS-27A, R89B/ARN-5 and BC-733D. Modified to flag alarm.

- BC-611 & BC-721 HANDIE TALKIES,
Plus SPARE PARTS, Quantity available.
- IE-17 TEST SET
- AN/ARN-7 COMPLETE
- SCR-269 COMPLETE
- TBS 4 & 5, NEW, COMPLETE
- AN/ARC-1 VHF EQUIPMENT
- BC-348 RECEIVERS
- BC-342 RECEIVERS

31 KVA BUDA DIESEL PLANT

3 phase, 110 V, 60 cycles. Spare parts and generator available. Has been run only 40 hours.

AN/ART-13 EQUIPMENT

- ATC XMTR
- T-47A/ART-13 XMTR
- T-47/ART-13 XMTR
- CU-24 ANT. LOAD
- CU-25 ANT. LOAD
- DY-11 & 12 Dynam't'r
- MT-283 MOUNT
- 0-16 LFO
- MT-284 MOUNT
- ATC DYNAM'T'R
- SA-22 ANT. LOAD
- C-87 CONTROL BOX

AN/APG-13A RADAR

Absolutely complete, brand new

- AN/APN-2
- MG-153
- SCR-729 New
- APS-2, 3, & 15
Components
- TA2J-24
- AN/ARC-5 VHF
- RTA-1B
- SCR-274 & ARC-5
- BC-1016
- Command Equip'm't
- APA-6 INDICATOR
- R-4/ARR-2 Receivers
- APA-11 INDICATOR
- BC-640 VHF XMTR
- APA-17 RADAR
- SCR-510
- HS-33 HEAD SETS,
NEW
- SCR-522
- MG-149F & H
- MG-153

SPARE PARTS

- SCR-720
- SCR-522
- SO-7
- AN/ART-13
- AN/ARN-7
- AN/ARC-1
- SCR-269
- BC-611

SCR-718 A, AM, B & C

Altimeter equipment—complete

To insure the finest of service and quality of merchandise, we have just recently put into operation our own reconditioning and function-testing plant, complete with all facilities.

EXPORT INQUIRIES INVITED

We carry an unusually large stock of Airline Equipment, Test Equipment, Radar Sets, etc. Write for our low prices and complete information. We furnish immediate answers to all inquiries. Write today!

**V & H
ELECTRONIC
INDUSTRIES
INC.**

2033 West Venice Blvd.—Dept. E-19
Los Angeles 6, California
Phone: **REpublic 3-1127**

**Excellent
"RW" Values!**

RA-52 RECTIFIER

Transtat controlled to produce high voltage DC from 110 VAC 60 cycle source. Up to 11,500 VDC @ 50 W. Metered high voltage (0-15 KV) and current (0-20 MA).
New\$74.50

**TS159/TPX
COMBINATION SIGNAL GENERATOR
AND FREQUENCY METER**

Freq. range: 150-200 MC., crystal calibrated. Has separate 30MC signal output, crystal cal: 3-stage, AF amplifier. Power measurements by built-in VTVM circuit. 0-1 MA. meter as 2-range voltmeter. Built-in 400 cps. voltage regulated power supply. New\$69.95

**WOBULATOR
BUILD TV-FM-AM SWEEP GENERATOR**

You can build "Versatile Sweep Frequency Generator" with APN-1 magnetic units...
\$5.95

WANTED!

All TS, APR, APS, ARC, ARN, ART, SCR, R89 and BC equipment... write today!

Quote lowest prices in your first letter

RM 29 with the TS-13 handset
\$14.95 ea. 2 for \$27.50
RL-42 Reversible Motor with antenna reel and clutch, used.....\$2.95

WRITE FOR PRICES

- | | | |
|--------------|-------|--------|
| BC1033 | BC376 | LP21LM |
| BC939 | BC638 | TS61 |
| APS13 | RA42 | TS92 |
| ARN7 | RA52 | BC1277 |
| SCR269F&G | RTA1B | BC191 |
| SCR619 | TA2J | BC1287 |
| BOONTON SIG. | CRT3 | APR-4 |
| GEN. I. 26 B | MP10 | MN26C |
| TS 100/AP | MN26Y | |

SCR 625 Famous Army Mine-Detector For Prospectors, Miners, Oil Companies, Plumbers, etc.

This unit is being offered now at a considerable reduction in price. Recently advertised at \$79.50 it is now available in the same brand new wrappings in suitcase style carrying case (less batteries) at

**\$59.50 WHILE THEY
LAST!**

Used, \$39.50

Shipments FOB warehouse. 20% Deposit on orders. Minimum order \$5.00. Illinois residents, add regular sales tax to remittance.

Prices subject to change without notice.

R W ELECTRONICS

Dept. EL, 1712-14 S. Michigan Ave.
Chicago 16, Ill.

PHONE: **Harrison 7-9374**

DIRECTRON SELENIUM RECTIFIERS

Buy Direct From Manufacturer

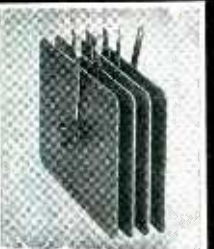

Full-Wave Bridge Types

Current (Continuous)	18/14 Volts	36/28 Volts	54/42 Volts	72/50 Volts
1 Amp.	\$1.35	\$2.15	\$3.70	\$7.50
2 Amps.	2.20	3.60	5.40	10.50
4 Amps.	3.75	6.15	9.15	18.00
5 Amps.	4.25	7.95	12.95	25.25
6 Amps.	4.75	9.00	13.50	33.00
10 Amps.	6.75	12.75	20.00	40.00
12 Amps.	8.50	16.25	25.50	45.00
20 Amps.	13.25	25.50	39.00	75.50
30 Amps.	16.25	32.50	45.00	90.00
36 Amps.	20.00	38.50	55.00	105.00

• New Selenium Rectifier Transformers
 PRI: 115 V. 60 cycles in. 4 Amps. \$ 8.75
 SEC: 9, 12, 18, 24, and 36 12 Amps. 16.75
 24 Amps. 35.75

• New Selenium Rectifier Chokes
 4 Amps.—.07 Hy.—6 ohm \$7.95
 12 Amps.—.01 hy.—1 ohm \$14.95
 24 Amps.—.004 hy.—.025 ohm \$29.95

We can manufacture other Selenium Rectifiers, Selenium Rectifier Supplies, XFRMRS. & Chokes.
SOLA HEAVY-DUTY PLATE TRANSFORMER.
 PRI: 200, 220, 240 volts—60 cy.
 SEC: 700-0-700, @ conservative 200 MA. 5" x 6" x 3"
 6 1/2"—NEW—Wt. 10 lbs. Special @ \$17.50

• LEEDS & NORTHRUP WHEATSTONE BRIDGES—MODEL 5430-A EXCELLENT CONDITION \$99.50

TRANSFORMER SPECIALS
 • 115V. PRI—36V. 50 amp second XFMR. \$59.50
 • 115V. PRI—5V. @ 190 Amp. SEC. \$59.95

TUBES

0A2	.95	6BE6	.45	304-TH	7.00
0B2	1.10	6C4	.45	304-TL	8.75
0C3/VRI105	1.10	6F6-M	.60	310A (WE)	5.95
0F3/VRI150	.95	6F8-G	.89	311A (WF)	6.50
0Y4	.50	6G6-G	.95	313C (WF)	1.95
1A7GT	.89	6J5	.49	328-A (WE)	5.00
1A4	.90	6J7	.59	337-A (WE)	3.00
1B3GT	.85	6K6GT	.59	349A (WE)	1.35
1B22	2.00	6K7-M	.70	359-A (WE)	4.00
1R23	8.00	6L6-G	1.19	371-B	.85
1B27	14.98	6L7	.80	373-A (WE)	4.00
1L4	.60	6N7-M	.95	374-A (WE)	3.50
1L21(GE)	4.00	6GT	.80	387-A (WE)	3.50
1L6A	.90	6S7-M	.98	400-A (WE)	2.50
1N21-B	2.90	6SD7	.79	401-A (WE)	3.50
1N23-A	2.25	6SG7	.88	403-B (WE)	7.50
1N23-B	3.49	6SH7	.64	407-A (WE)	5.00
1N34	.64	6SJ7	.69	408-A (WE)	2.75
1N34-A	.90	6SK7GT	.62	421-A (WE)	3.50
1N44/400B	1.23	6-L7GT	.60	464-A/2C43	9.49
1N45/400C	1.39	6N7GT	.70	4L-559	1.00
1N48	.55	6V6GT	.60	4U-676	25.00
1N52	1.71	6X5GT	.52	700-D	55.00
1N54	.89	6V6-G	.92	711-A	19.00
2B7	.75	7A6	.85	717-A	8.50
2C43(GE)	15.98	7A8	.75	803	3.25
2C52	5.00	7C6	.69	805	2.50
2D21	1.35	7C30	.85	807	1.50
2E24	2.75	7F7	.73	811	2.70
2E30	2.10	7H7	.73	811-A	3.50
2J22	6.50	12A6	.55	812	2.75
2J34	27.25	12AT7	.75	814-A	3.50
2J48	24.25	12AU7	.69	816	1.05
2J49	34.00	12BD6	1.00	829	9.95
3A4	.59	12C8	.65	835	1.45
3AP1	9.00	12H6	.65	869	3.95
3B28	7.50	12SA7-GT	.69	861	22.50
3B29	12.00	12SF5	.70	866-A	1.35
3HP1	5.75	12SG7	.83	872-A (GE)	3.95
3HP11	9.50	12SH7	.63	1200	.80
3C23	70.00	12SJ7	.69	1614	2.75
3C23(GE)	9.50	12SK7	.72	1614	2.25
3C24/24G	1.50	12SL7	.65	1616	.74
3C27	7.50	12SN7GT	.75	1622 (6L6M)	1.95
3C33	9.95	12SR7-M	.63	1625	.40
3D6/1290	.50	14R7	.80	1629	.50
30SG7/G	.99	25A5V5	1.25	5082	1.50
3S4	.00	25BQ6GT	.79	1612	.70
4-125A	25.00	25L6GT	.64	2050	1.40
4C35	26.50	25Z6	.85	2051	1.10
4X-150A	27.50	35L6	.69	5516	6.95
5D21(W.E.)	19.95	35L6 (Eimac)	4.50	5528/Col.	1.00
5FP7	1.05	35Z5GT	.49	608-A	3.95
5R4GY	1.29	42	.65	5654	2.00
5U4G	.55	50C5	.50	CK 5702	4.50
5V4-G	1.05	RR-72	.75	CK 5744	2.25
5X4G	.85	RR-73	.75	CK 5886	4.00
5Y3GT	.45	11Z6	1.00	5814	2.50
6AB7	.98	FG-105	1.70	5910	.75
6AC7	.94	F-123-A	6.95	8000	.98
6AG5	.65	211	.75	9001	1.35
6AG7	1.25	250-TH	18.75	9082	.95
6AH6	1.00	274-A	2.95	9004	.39
6AJ5	1.75	274-B	2.95	9006	.39
6AK5	.74	275-A(W.E.)	3.00	AX-9903	17.95
6AN5	2.25	276-F & G	15.00		

WRITE ON TYPES NOT LISTED
 Terms: FOB-NYC-25% Deposit with order—or send full remittance to save GOD charges—Rated Firms (D.&B.) Net 10 days—All merchandise guaranteed. Phone: Rector 2-2562

BARRY ELECTRONICS CORP.
 136 LIBERTY STREET • NEW YORK 6, N. Y.

DC SMALL MOTORS:

- 27.5 VDC—6000 RPM, 1.5 oz. In. Shaft Size: 1-1/4" x 1/4". Motor Size: 2-1/2" x 1-1/2". No. 5069-267 \$6.95
- 27 VDC—1/10 HP—3500 RPM. Shaft Size: 5/8" x 1/4". Motor Size: 4" x 3-1/2". Air Assoc. No. EE-763 \$6.95
- 80 VDC—1/50 HP—3000 RPM. Shaft Size: 3/4" x 1/4". Motor Size: 5" x 3". G. E. No. 5 BN38HA10. \$8.95
- 28.5 VDC—1/35 HP—2200 RPM. Shaft Size: 1-1/4" x 1/4". Motor Size: 4-1/2" x 3-3/4". Electrolux No. 16376 \$5.95
- 24 VDC—Reversible—3.7 RPM, 40 lb. Torque. Shaft Size: 21/32" x 5/16". Motor Size: 5-1/2" x 4-1/32" x 3-5/16". Also operates 24 VAC. Philco No. 441-1008 \$5.95

TRANSFORMERS—100V. 60 Cycle Pri.

- 5 VOLT CT-25A—10,000 V. Ins. OPEN FRAME—6" x 5" x 4-3/4" \$7.95
- Sec. 20 12 V. 4 A. windings—gives 12 V. 8 A. or 24 V. 4 A. \$3.95
- Sec. 24 Volt 1/2 Amp. 1.50
- Sec. 24 Volt 1 Amp. 1.95
- Sec. 24 Volt 6 Amp. 5.95
- Sec. 6-24 or 30 Volts 8 Amp. 5.95

MOUNTING AND CLAMPS:

- FT-150 for BC-348 Receiver \$2.50
- FT-474 Mounting & Clamp \$1.00
- MC-476 Maple Ball for above—1/4" Fairlead \$1.00
- MC-396 Wood Clamp for Fairlead .75
- M-235 Bobbin & 250 Ft. W-106 Antenna Wire. 3.50
- WT-7 Weight for Trailing Antenna. 1.50

BLOWERS:

- 115 Volt 60 cycle BLOWER (pictured), approx. 100 CFM Dis. 2 1/2" intake; 2" outlet. Quiet running. Motor size: 2 1/2" x 3 1/2". NEW — not Cor's surplus. Order No. 1C939 \$8.95



DUAL BLOWER—Same as RN-520 above, except has blower assembly in each side of motor. Ord. No. 1C880 \$13.95

COMPACT TYPE—108 CFM motor built inside squirrel cage, 4-1/2" Intake: 3-3/4" x 3" Dis. Complete size: 4-1/4" W x 9-3/4" H x 8-3/4" D. Order No. 2C067 \$14.50

FLANGE TYPE—140 CFM, 3-1/2" Intake: 2-1/2" Dis. Complete size: 8-1/2" W x 7-1/4" H x 6-3/4" D. Order No. 1C807 \$13.95

FLANGE TWIN—275 CFM, 4-1/2" Intake: 3-1/4" x 3" Dis. Complete size: 11-3/4" W x 8-3/4" H x 8-1/16" D. No. 2C069 \$21.95

AERIAL WIRE—Phosphorus Bronze #16 Stranded. 200 lb test. Weatherproof. 150 ft. on Reel. RL-3 with Clips \$1.50

TELEPHONE WIRE—3 Cond. copper & steel, 525 ft. \$4.75

SELENIUM RECTIFIER UNITS

HEAVY DUTY—30 VOLT DC OUTPUT:

- 115/200 V. Three Phase 400 Cycle Input: TYPE 143 w/Transformer & VR 100 Amp. \$69.50
- TYPE 3FS-5 w/Trans., VR, & Blower—200 Amp. \$69.50
- TYPE 52A-II Rectifier Only, Cased, 200 Amp. \$39.50
- TYPE A-I Rectifier Only, Cased, 300 Amp. \$49.50

ADDRESS DEPT. E • All Prices Are F.O.B., Lima, Ohio • 25% Deposit on C.O.D. Orders

FAIR RADIO SALES 132 S. MAIN ST. LIMA, OHIO

New SPARE ARMATURES FOR PE95A, B, C. 23 IN CRATES SIG 5 #3H4595/AS

TELETYPE PERFORATOR TAPE 11/16" x 8" 8800 ROLLS, OILED, FRESH #4A2702.2

GEORGE BELLING
 170 - 12th St. Oakland, Calif.

HIGH VOLTAGE POWER SUPPLY

Many models available in ranges from 2500 to 25,000 volts D.C., with or without built-in meters. Send for free catalogue Dept. E. PRECISE MEASUREMENTS CO. 942 KINGS HIGHWAY, BROOKLYN 23, N. Y.

GIGANTIC SURPLUS SALE!

- Power Plants • Air Compressors • Paint Spray Outfits
 - Hand Winches • Water Pumps • Gasoline Chain Saws
 - Telephones • Electric Tools • Weed Spray Outfits
 - Binoculars • Floodlights • Electric Drills
 - Barometers • Air Grease Guns • Hydraulic Units
- We pay all freight. Rush card for large catalog. Many Electronic Surplus Items.

BURDEN SALES COMPANY
 842 10th St. LINCOLN, NEBRASKA

MOTOR—GENERATOR:

Navy type CCL-211014. 115 VDC—3/4 HP—1750 RPM. Generator 27 VDC, 9.3 Amp. Direct Drive Price: \$39.50

ANTENNA EQUIPMENT

MAST BASES—INSULATED:

MP-132 BASE—(As illustrated at left) 1" heavy coil spring, 2" insulator. Overall length: 11-1/2". Weight: 2-3/4 lbs. Price \$3.95

MAST BASE—Insulated type with heavy coil spring and 5" dia. insulator. Requires 1 inch hole for mtg. Weight: 9 lbs. \$5.95

MAST SECTIONS For ABOVE BASES

Section screw-in type. MS-53 can be used to make any length with MS-51-51-50-49 for taper. Any section 50¢ Each
 Larger Diameter Sections: MS-55-54... \$1.25 Each
 AN-104B Antenna—100-156 MC—Copper... \$5.95
 AN-104A Antenna—100-156 MC—Steel... 3.95
 AN-104A Antenna—100-156 MC—Steel... 2.00
 AN-117 Whip Steel—6 Ft. length... 1.50
 AN-109A Whip Steel, 5 Ft. w-Base... 1.50
 AS-27/ARN-5 Ram's Horn, 10 MC.—USED... 5.95
 AT-37/APT Stub—113-115 MC... 6.95
 AT-42/APT-3 or APT-1 Stub—113-150 MC... 5.95
 AS-87/ARQ-3 Spike with coaxial lead in base... 4.95
 AS-61/ARN-5 Half-Wave Dipole—335 MC... 3.95
 AT-2/APN-2... 4.95

AIRCRAFT CONTROL CABLE—3/32"—7 x 7 Strand, Weatherproofed, Galvanized, Preformed, 920 lb. test. Ideal for Television Guying and many other uses. Prices: 4-1/2¢ per Ft.—1000 Ft. or more at 4¢ per Ft.

CORDS—CABLES

- C-501 Cord—1/GN-45 Generator \$2.50
- CD-318 Cord w/PL-68 & SW-141 & JK-48F. .89
- CD-307 Cord—6.5 Ft. w/PL-55 & JK-26... .89
- CD-604 Cord w/C-410 Trans. & PL-54 Plug... .89
- CD-365 Cord for LP-21-Loop... 1.75
- MC-215 Tuning Shaft for 27AN... 2.00

PLUGS AND CONNECTORS

- PL-118 Plug for I-81 and I-82... \$1.50
- PL-103 Plug for LP-21 Loop... \$1.25
- MC-211 Rightangle Adapter for Comm. Sets... .50
- M-359 Rightangle Coaxial Connector... .25

DYNAMOTORS:

DYNAMOTOR and BLOWER: 9 Volts DC input: output 450 Volts 60 MA. 4500 RPM. At 6 Volts DC input: output 260 Volts 65 MA. 3000 RPM. \$4.95

Input	Output	Stock No.	Price
14 V. DC	600 V. 300 MA.	BD-86	\$9.95
12 V. DC	220 V. 70 MA.	DM-24	6.95
12 V. DC	220 V. 100 MA.	DM-18	4.95
12 or 24 V. DC	44 V. 200 MA. & 220 V. 100 MA.	D-104	14.95
14 V. DC	375 V. 150 MA.	DM-375	8.95
14 V. DC	330 V. 135 MA.	DM-330	7.95
14 V. DC	500 V. 500 MA.	PE-59	14.95
12 or 24 V. DC	275 V. 110 MA.	USA/0516	3.95
12 or 24 V. DC	500 V. 50 MA.	USA/0515	3.95
ALSO—PE-73; PE-86; DM-53; DM-33; 5055; DM-416; PE-101, etc.			

ERIE CERAMICONS

Large quantities in stock; immediate delivery. All values and tolerances.

N.P.O. & TEMPERATURE COEFFICIENT FEED-THRU, STANDOFF, DISC, CERAMICONS. LITTLEFUSE FUSE—ALL VALUES.

BELOW FACTORY PRICE.

CAP ELECTRONICS INC.

102 Warren Street
 New York 7, N Y

Worth 2 4363

0A2..... 90	3A5..... 1.50	6J5..... .50	12SN7..... .75	717A..... 1.25	5643..... 7.50	FG97..... 22.50
0B2..... 1.00	3B4..... 2.25	6J6..... 1.00	12SR7..... .75	718CY..... 35.00	5647..... 2.75	FG105..... 17.50
0C3..... 1.00	3B24..... 4.75	6J6W..... 3.00	24G..... 1.25	728AY-GY..... 35.00	5650..... 5.50	GL591..... 1.75
0D3..... .90	3B24W..... 7.50	6K7..... .75	25Z6GT..... .85	801A..... .35	5686..... 3.75	HY31Z..... 2.50
1AE4..... 1.25	3B26..... 3.50	6L6..... 1.50	35T I.G..... 3.00	805..... .75	5687..... 5.25	HY114B..... .50
1E1..... .50	3B27..... 3.75	6N7..... 1.10	81..... .50	807..... 1.25	5702..... 4.00	HY615..... .25
1B22..... 2.00	3B28..... 7.50	6SC7..... .85	101L WE..... 1.00	807W..... 7.50	5705..... 1.50	KC4..... 47.50
1B24..... 9.50	3B29..... 4.50	6SP5..... .75	203Z..... 4.50	826..... .75	5704..... 2.50	KC4-3..... 37.50
1B26..... 2.00	3E29..... 14.50	6SG7W..... 3.75	227A..... 8.50	827R..... 125.00	5744..... 4.00	KY21A..... 8.75
1B37..... 15.00	3Q4..... .75	6SJ7..... 15.00	252A..... .75	829B..... 12.00	5744..... 4.00	LBV..... 3.50
1P23..... 2.75	3S4..... .75	6SL7..... .75	286A..... 7.50	835..... 17.50	5763..... 1.50	QK117..... 50.00
1Z2..... 3.75	4A1..... 1.00	6SN7..... .75	304TH..... 6.75	837..... 1.25	5787..... 4.50	QK117A..... 65.00
2C22..... .25	4B24..... 5.75	6V6GT..... .75	304TL..... 7.50	861..... 20.00	5829..... 2.25	RK34..... .75
2C26..... .40	4B25..... 8.00	6V6GT..... 1.25	307A..... 4.50	872AS..... 3.00	6101..... 8.50	RK47..... 4.50
2C26A..... .40	5D21..... 15.00	6X5GT..... .75	313C..... 2.75	874..... .90	6099..... Write	RK72..... 1.00
2C34..... .60	5J29..... 11.50	6Y6..... .65	316A..... 1.25	954..... .25	8013..... 2.50	RK73..... 1.25
2C40..... 12.50	5RAGY..... 1.50	6Y6..... 1.25	327A..... 4.25	955..... .35	8020..... 1.25	RX212..... 15.00
2C51 (W.E.)..... 5.75	6-4..... .50	7AG7..... 1.75	371A..... .75	956..... .35	8025..... 4.50	SD828A..... 7.50
2D21..... 1.35	6-4B..... .75	7C24..... 11.00	394A..... 3.75	957..... .45	9004..... .35	VS1..... 12.50
2E25..... 5.00	6AG7..... 1.25	10Y..... .35	412A WE..... 1.25	958A..... .60	9006..... .35	VT31..... 50.00
2J21A..... 6.50	6AJ5..... 1.35	12A6..... .60	450TL..... 35.00	1616..... .65	CE2..... 1.50	VU508..... 1.50
2J26..... 15.00	6AK5..... .65	12AU7..... 1.00	471A..... 2.25	1625..... .35	CE2A..... 3.50	WL481..... 1.00
2J27..... 15.00	6AK5WE..... 1.50	12AX7..... 1.00	700-A/B/C..... 25.00	1626..... .35	CE2B..... 3.50	WL532A..... 3.00
2J33..... 22.50	6AK5W..... 2.00	12J5GT..... .60	702A..... 3.00	1630..... .85	CE2C..... 2.50	WL670A..... 7.50
2J32..... 25.00	6AK6..... 1.00	12K8Y..... .60	704A..... .75	1632..... .70	CE27..... 1.50	WL8120..... 10.00
2J33..... 25.00	6AL5..... .60	12SG7..... .75	707A..... 7.50	1633..... .70	CE25/327..... 1.25	45X674..... 10.00
2J34..... 25.00	6A05..... .50	12SK7..... .75	708A..... 4.50	1644..... .75	CE25C..... 2.50	SAP1..... 3.75
2J40..... 35.00	6AR6..... 2.75	12SL7..... .75	715B..... 8.50	2050..... 1.25	ELC1B..... 3.25	SBP4..... 3.75
2J61..... 35.00	6AS7..... 4.25	12S17..... .60		2051..... 1.00	ELC5B..... 2.50	SHP1..... 4.75
2J61A..... 45.00	6AMP-Tungar..... 4.00	12S18..... .75			ELC6A..... 3.50	SSP7..... Write
2K22..... 45.00	6B8..... .75	12S19..... .75			ELC7..... 7.50	7BP7..... 7.50
2K23..... 35.00	6C4..... .50	12S20..... .75			ELC8..... 7.50	7HP4..... 7.50
2K25..... 35.00	6H6..... .75	12S21..... .75			ELC9..... 7.50	8LP7..... 4.50
2K28..... 27.50	6HG6..... .75				FG57..... 17.50	
3A4..... .85						

102 WARREN STREET ROSE PRODUCTS COMPANY NEW YORK 7, N. Y.
REctor 2-8078-9

R.C.A. Model MI-8167 TRANSMITTERS
Point-to-point communications



Freq. Range: 2000 to 20,000 Kcs.
Output: 350 Watts C.W. 250 Watts Radio telephone
Input: 190 to 250 Volts AC 50/60 cps.
Size: 60" high, 17" wide, 27" deep.
Tubes: 807s, 813s, 805s, 866s.
Crystal Oscillator unit built-in, fully shielded and stable. All self contained including antenna network. Master Oscillator unit (available) fits in place of Xtal unit. Speech amplifier is only external unit and has 110/220 v. AC input, four stages, high gain. Total net weight, 625 lbs.

Complete! Now! From Stock! Quantities! Prices on Request.

COMMUNICATION DEVICES CO. INCORPORATED
2331 Twelfth Ave. N. Y. 27, N. Y.

LARGE INVENTORY
OIL FILLED CAPACITORS CONNECTORS
BATHTUB CONDENSERS SWITCHES
TYPE "J" AND "JJ" POTENTIOMETERS
IMMEDIATE DELIVERY
LEMAR ELECTRONICS CO.
135 LIBERTY ST. N. Y. 6, N. Y.
PHONE: BARCLAY 7-8675

TUBE REBUILDING
Large Transmitting and Power types
Economical • Guaranteed
FREELAND PRODUCTS CO.
700 DRYADES ST., N. O., LA.

WE BUY AND SELL GOVERNMENT SURPLUS
electronic components, units, wire, etc.
Your Inquiries Invited
LAPIROW BROS.
1649 Hoffner St. Cincinnati 23, Ohio
Kirby 1285

New "SEARCHLIGHT" Advertisements received by January 2nd will appear in the February issue subject to limitations of space available.
Classified Advertising
ELECTRONICS
330 West 42nd St. New York 18, N. Y.

Prompt ANSWERS to your business problems...

MISCELLANEOUS business problems are daily being solved, quickly and easily, by the use of the Searchlight Section of this and other McGraw-Hill publications.

The Searchlight Section is classified advertising; you can use it at small cost, to announce all kinds of business wants of interest to other men in the fields served by these publications. It has long been the accepted meeting place of men with business needs and the men who can fill those needs.

When you want additional employees or a position, want to buy or sell used or surplus new equipment, want products to manufacture, seek new capital or factory sites or have other business wants—advertise them in the Searchlight Section for quick, profitable results!

Classified Advertising Division

McGRAW-HILL PUBLISHING CO., Inc.
330 West 42nd Street • New York 36, N. Y.

SEARCHLIGHT
(Classified Advertising)

SECTIONS
are found in these
McGRAW-HILL Publications:

- American Machinist
- Aviation Week
- Business Week
- Bus Transportation
- Chemical Engineering
- Chemical Week
- Coal Age
- Construction Method & Equipment
- Electrical Construction & Maintenance
- Electrical Merchandising
- Electrical World
- Electronics
- Engineering & Mining Journal
- Engineering News Record
- E. M. J. Metal Mineral Markets
- Factory Man. & Maint.
- Fleet Owner
- Food Engineering
- Nucleonics
- Power
- Product Engineering
- Textile World
- Welding Engineer

10 Seconds to 24 Minutes Timer

A hand wound electric TIMING SWITCH Pointer moves back to ZERO and shuts off RADIO—TV—Electric Mixer—Photographic Devices—Time Delay etc. Furnished with Calibration Chart and Pointer \$1.25 Knob. Biggest bargain we ever had.



HAYDON SYNCHRONOUS TIMING MOTOR

110 v. 60 cycle 30RPM... \$2.60
110 v. 60 cycle 1/10 RPM... \$2.35
110 v. 60 cycle 11RPM... \$2.85

ISOLATION TRANSFORMER

Step-Up or Step-Down
4 1/2 lbs. \$2.85

230 volts to 115 volts
115 volts to 230 volts
115 volts to 57 volts

LUCKY 7% COBALT
ALNICO PURCHASE ENABLES US TO OFFER YOU THESE
MAGNETS!
39¢ EACH 3 FOR \$1.00



REDMOND Powerful 5" Blower or Ventilator 115 volts AC 60 cycles 18 watts. For Kitchen—Laboratory. Heat or Cold or Chemicals...\$7.50

Genuine TELECHRON Motors



2 RPM..... \$2.90
3 RPM..... 3.90
3.6 RPM... 3.15
1 RPM..... 3.95
60 RPM... 4.30
One of each \$15.00

Westinghouse ELAPSED TIME METERS \$15.50



General Electric Round Case Smaller Numerals \$15.50

ALL BRAND NEW

1800 RPM SYNCHRONOUS Motor; 115 volts AC, 18 watts 1 1/2 lbs.; 2"x3"x2" \$4.50

Assorted Micro Switches, Aero Switches, MU-Switches \$1.00

DID YOU EVER WISH FOR A 3RD HAND?
A FOOT SWITCH MADE OF NEW SURPLUS MATERIAL
\$4.95 KIT \$5.75 COMPLETE
USING A 15 AMP. MICRO SWITCH

ALL PRICES F.O.B. N. Y.

EST. 1923 **BLAN** EST. 1923
64 Dey St. New York 7, N. Y

CARRIER EQUIPMENT

Western Electric CF-1A 4-channel carrier telephone terminals.
EE-101-A 2-channel 1000/20 cycle carrier ringers.
CFD-B 4-channel carrier pilot regulated telephone terminals complete with four channels 1000/20 cycle ringing.
CFD-B 4-channel pilot regulated telephone repeaters.
C-42-A V. F. telegraph in from 2- to 12-channel terminals.
FMC 1 or 2 channels carrier telephone terminals, automatic regulation, duplex signaling each channel. Carrier frequencies above 35 KC. Ideal for adding channels above type "C".
Complete engineering and installation services offered.

RAILWAY COMMUNICATIONS, INC.
Raytown, Missouri
Telephone: FLEMing 2121

PREMIER

Special Purpose and Transmitting Tubes

MX408U.....	70c	304TL.....	9.95
RKR 79.....	48c	450TH.....	37.50
VT25A/2C25	50c	450TL.....	62.00
2C26A.....	40c	708A.....	1.20
2C34/RK34..	60c	715A.....	6.39
2E22.....	2.95	715B.....	7.75
2J21A.....	9.50	800.....	1.75
2J31.....	20.00	801.....	1.20
2J32.....	25.00	807.....	1.55
2J33.....	25.00	808.....	2.69
2J34.....	25.00	813.....	8.75
2X2, 879.....	74c	826.....	69c
3BP1.....	5.95	850.....	4.20
3DP1.....	3.95	860.....	3.95
3E29.....	12.95	864/VT24..	60c
5BP1.....	3.95	872.....	2.75
5BP4.....	3.95	954.....	25c
5CP1.....	3.95	955.....	35c
6-8B.....	1.00	1089.....	1.30
C6J.....	8.95	1090.....	1.30
6C21.....	21.95	1616.....	69c
7BP7.....	5.95	1625.....	35c
10BP4.....	10.95	1629.....	25c
12LP4.....	12.95	1632.....	72c
100TH.....	6.95	1642.....	90c
211.....	.59	1661.....	98c
215A/VT5....	1.20	8020.....	98c
250TH.....	19.95	9006.....	27c
250TL.....	16.95		

TV PICTURE TUBES

One Full Year Guarantee—All Types

SIZE	PRICE	SIZE	PRICE
10-inch.....	\$9.95	17-inch.....	\$16.95
12-inch.....	\$11.95	19-inch.....	\$18.95
14-inch.....	\$13.95	20-inch.....	\$19.95
7-inch.....	\$15.95	21-inch.....	\$20.95
16-inch.....	\$15.95		No Minimum Order

866 A, Standard gas rectifier... \$1.49
866 A, Special noise-free vacuum type
—6000V @ 800 MA..... \$1.49
DIRECTLY INTERCHANGEABLE
IMPROVED PERFORMANCE

SPECIAL TUBE BUYS

1B3GT... .57	6BC5... .46	12AU7... .47
1L4... .50	6BD6... .41	12AV7... .47
1R5... .48	6BE6... .40	12AX6GT... .54
15Y... .39	6BG6G... 1.21	12AX7... .53
1T4... .49	6BH6... .50	12BA6... .38
1U4... .48	6BJ6... .41	12BE6... .40
1U5... .39	6BQ6GT... .77	12SN7GT... .47
3A4... .54	6C4... .32	19T8... .70
3Q4... .54	6C56... .46	25BQ6GT... .77
35A... .51	6CD6G... 1.58	25L6GT... .43
3VA... .52	6E4... .41	35B5... .41
3V4G... .36	6E6GT... .53	35C5... .41
5Y3GT... .25	6E7GT... .77	35L6GT... .45
6AG5... .46	6SL7GT... .53	35WA... .25
6AK5... .36	6SN7GT... .47	35Z5GT... .31
6AL5... .36	6T8... .70	50B5... .41
6AQ5... .41	6V6GT... .40	50C5... .41
6AT5... .32	6W4GT... .40	50L6GT... .43
6AU5... .37	6X4... .29	11Z3... .34
6AV6... .37	12AT6... .51	
6AX4GT... .54	12AT7... .61	
6BA6... .38	12AU6... .37	

Critical tubes are always on hand and at the right prices . . . in quantity

We Will Be Pleased to Quote Special Prices for Large Quantity Purchases OVER 1,000,000 TUBES IN STOCK

Since 1926 Prime Source for

TUBES Receiving Special Purpose and Picture Tubes

PARTS All Types - All Brands - Special Lots

• Manufacturers • Jobbers • Exporters

We invite your inquiries on electronic components of all descriptions!

PREMIER T.V. RADIO SUPPLY

Division of Continental Corp.
3241 W. North Ave. • Chicago 47, Ill.
ARmitage 6-5550

Servo-Tek...

is pleased to announce the removal of its plant in Paterson to its NEW and LARGER quarters at

1086 GOFFLE RD.
Hawthorne, N. J.
TELEPHONE: HAWthorne 7-3100

Complete line of

- DC Motors
- AC Motors
- Aircraft Inverters
- AC Servo Motors
- DC Servo Motors
- Servo Controls
- 400 Cycle Blowers
- Navy Ordinance Synchronos
- DC & AC Generators

Standard Brands **Electronics, INCORPORATED** All Items Fully Guaranteed

We Own and Have In Stock All Items Listed Below.
 Note: This is only a partial listing of our vast inventory of electronic components.

TUBES

1822	2132	3E29	6C12	HY-114-B	GL-502	708-A	829	958-A	1656
1823	2134	3EP1	6N4-A	17N1-GT	527	709	829-B	959	1808-P1
1824	2135	3EP2	6N4-B	17N1-GT	527	713-A	830-B	966-A	1960
1826	2150	3FP7-A	7BP7	C-120	559	714-AV	832	966-A	2050
1827	2154	3FP7-B	7C23	121-A	559	715-A	832-A	CK-1006	2051
1832	2154-B	3J30	7H12/6G12	VR-150	GL-562	715-B	833	CK-1089	2052
1835	2161	3J31	7JP4	CV-172	HY-615	715-C	833-A	RA-11090	2053
1836	2K22	3RP1	40	2H1-E	516	719-A	834	R1130-B	5692
1837	2K23	4-65A	40T1	FX-215	531	720-CV	837	1201	5693
1838	2K25	4-65B	40T2	FX-215	531	720-CV	838	1203-A	6050
1839	2K28	4B25	40T3	350-A	531	721-A	841	1232	7193
1840	2K29	4C35	13-A	350-B	531	721-A	843	1232	8000
1841	2K33-A	4D32	15-R			722A/B	849	1273	8000
1842	2K34	4E27	15-R			722A/B	849	1273	8000
1843	2K35	4J32	19BG6			728-B	859	1299-A	8011
1844	2K36	4J33	19BG6			728-B	860	1299-A	8012
1845	2K43	4J35	19BG6			728-B	860	1299-A	8013
1846	2K44	4J35	19BG6			728-B	860	1299-A	8014-A
1847	2K45	4J35	19BG6			728-B	860	1299-A	8014-B
1848	2K46	4J35	19BG6			728-B	860	1299-A	8020
1849	2K47	4J35	19BG6			728-B	860	1299-A	8025
1850	2K48	4J35	19BG6			728-B	860	1299-A	9002
1851	2K49	4J35	19BG6			728-B	860	1299-A	9003
1852	2K50	4J35	19BG6			728-B	860	1299-A	9004
1853	2K51	4J35	19BG6			728-B	860	1299-A	9005
1854	2K52	4J35	19BG6			728-B	860	1299-A	9006
1855	2K53	4J35	19BG6			728-B	860	1299-A	9007
1856	2K54	4J35	19BG6			728-B	860	1299-A	9008
1857	2K55	4J35	19BG6			728-B	860	1299-A	9009
1858	2K56	4J35	19BG6			728-B	860	1299-A	9010
1859	2K57	4J35	19BG6			728-B	860	1299-A	9011
1860	2K58	4J35	19BG6			728-B	860	1299-A	9012
1861	2K59	4J35	19BG6			728-B	860	1299-A	9013
1862	2K60	4J35	19BG6			728-B	860	1299-A	9014
1863	2K61	4J35	19BG6			728-B	860	1299-A	9015
1864	2K62	4J35	19BG6			728-B	860	1299-A	9016
1865	2K63	4J35	19BG6			728-B	860	1299-A	9017
1866	2K64	4J35	19BG6			728-B	860	1299-A	9018
1867	2K65	4J35	19BG6			728-B	860	1299-A	9019
1868	2K66	4J35	19BG6			728-B	860	1299-A	9020
1869	2K67	4J35	19BG6			728-B	860	1299-A	9021
1870	2K68	4J35	19BG6			728-B	860	1299-A	9022
1871	2K69	4J35	19BG6			728-B	860	1299-A	9023
1872	2K70	4J35	19BG6			728-B	860	1299-A	9024
1873	2K71	4J35	19BG6			728-B	860	1299-A	9025
1874	2K72	4J35	19BG6			728-B	860	1299-A	9026
1875	2K73	4J35	19BG6			728-B	860	1299-A	9027
1876	2K74	4J35	19BG6			728-B	860	1299-A	9028
1877	2K75	4J35	19BG6			728-B	860	1299-A	9029
1878	2K76	4J35	19BG6			728-B	860	1299-A	9030
1879	2K77	4J35	19BG6			728-B	860	1299-A	9031
1880	2K78	4J35	19BG6			728-B	860	1299-A	9032
1881	2K79	4J35	19BG6			728-B	860	1299-A	9033
1882	2K80	4J35	19BG6			728-B	860	1299-A	9034
1883	2K81	4J35	19BG6			728-B	860	1299-A	9035
1884	2K82	4J35	19BG6			728-B	860	1299-A	9036
1885	2K83	4J35	19BG6			728-B	860	1299-A	9037
1886	2K84	4J35	19BG6			728-B	860	1299-A	9038
1887	2K85	4J35	19BG6			728-B	860	1299-A	9039
1888	2K86	4J35	19BG6			728-B	860	1299-A	9040
1889	2K87	4J35	19BG6			728-B	860	1299-A	9041
1890	2K88	4J35	19BG6			728-B	860	1299-A	9042
1891	2K89	4J35	19BG6			728-B	860	1299-A	9043
1892	2K90	4J35	19BG6			728-B	860	1299-A	9044
1893	2K91	4J35	19BG6			728-B	860	1299-A	9045
1894	2K92	4J35	19BG6			728-B	860	1299-A	9046
1895	2K93	4J35	19BG6			728-B	860	1299-A	9047
1896	2K94	4J35	19BG6			728-B	860	1299-A	9048
1897	2K95	4J35	19BG6			728-B	860	1299-A	9049
1898	2K96	4J35	19BG6			728-B	860	1299-A	9050
1899	2K97	4J35	19BG6			728-B	860	1299-A	9051
1900	2K98	4J35	19BG6			728-B	860	1299-A	9052
1901	2K99	4J35	19BG6			728-B	860	1299-A	9053
1902	2K100	4J35	19BG6			728-B	860	1299-A	9054
1903	2K101	4J35	19BG6			728-B	860	1299-A	9055
1904	2K102	4J35	19BG6			728-B	860	1299-A	9056
1905	2K103	4J35	19BG6			728-B	860	1299-A	9057
1906	2K104	4J35	19BG6			728-B	860	1299-A	9058
1907	2K105	4J35	19BG6			728-B	860	1299-A	9059
1908	2K106	4J35	19BG6			728-B	860	1299-A	9060
1909	2K107	4J35	19BG6			728-B	860	1299-A	9061
1910	2K108	4J35	19BG6			728-B	860	1299-A	9062
1911	2K109	4J35	19BG6			728-B	860	1299-A	9063
1912	2K110	4J35	19BG6			728-B	860	1299-A	9064
1913	2K111	4J35	19BG6			728-B	860	1299-A	9065
1914	2K112	4J35	19BG6			728-B	860	1299-A	9066
1915	2K113	4J35	19BG6			728-B	860	1299-A	9067
1916	2K114	4J35	19BG6			728-B	860	1299-A	9068
1917	2K115	4J35	19BG6			728-B	860	1299-A	9069
1918	2K116	4J35	19BG6			728-B	860	1299-A	9070
1919	2K117	4J35	19BG6			728-B	860	1299-A	9071
1920	2K118	4J35	19BG6			728-B	860	1299-A	9072
1921	2K119	4J35	19BG6			728-B	860	1299-A	9073
1922	2K120	4J35	19BG6			728-B	860	1299-A	9074
1923	2K121	4J35	19BG6			728-B	860	1299-A	9075
1924	2K122	4J35	19BG6			728-B	860	1299-A	9076
1925	2K123	4J35	19BG6			728-B	860	1299-A	9077
1926	2K124	4J35	19BG6			728-B	860	1299-A	9078
1927	2K125	4J35	19BG6			728-B	860	1299-A	9079
1928	2K126	4J35	19BG6			728-B	860	1299-A	9080
1929	2K127	4J35	19BG6			728-B	860	1299-A	9081
1930	2K128	4J35	19BG6			728-B	860	1299-A	9082
1931	2K129	4J35	19BG6			728-B	860	1299-A	9083
1932	2K130	4J35	19BG6			728-B	860	1299-A	9084
1933	2K131	4J35	19BG6			728-B	860	1299-A	9085
1934	2K132	4J35	19BG6			728-B	860	1299-A	9086
1935	2K133	4J35	19BG6			728-B	860	1299-A	9087
1936	2K134	4J35	19BG6			728-B	860	1299-A	9088
1937	2K135	4J35	19BG6			728-B	860	1299-A	9089
1938	2K136	4J35	19BG6			728-B	860	1299-A	9090
1939	2K137	4J35	19BG6			728-B	860	1299-A	9091
1940	2K138	4J35	19BG6			728-B	860	1299-A	9092
1941	2K139	4J35	19BG6			728-B	860	1299-A	9093
1942	2K140	4J35	19BG6			728-B	860	1299-A	9094
1943	2K141	4J35	19BG6			728-B	860	1299-A	9095
1944	2K142	4J35	19BG6			728-B	860	1299-A	9096
1945	2K143	4J35	19BG6			728-B	860	1299-A	9097
1946	2K144	4J35	19BG6			728-B	860	1299-A	9098
1947	2K145	4J35	19BG6			728-B	860	1299-A	9099
1948	2K146	4J35	19BG6			728-B	860	1299-A	9100
1949	2K147	4J35	19BG6			728-B	860	1299-A	9101
1950	2K148	4J35	19BG6			728-B	860	1299-A	9102
1951	2K149	4J35	19BG6			728-B	860	1299-A	9103
1952	2K150								

ELECTRONIC TUBES

RECEIVING		TRANSMITTING	
6L7G.....	55	39J44.....	25
6N4.....	70	40.....	69
6Z4.....	75	41.....	69
6N7GT.....	85	43.....	65
6A4.....	70	45.....	75
6Q7.....	70	45B5.....	75
6AQ7.....	85	60C5.....	65
6AR7.....	85	50L6GT.....	75
6AT7.....	85	50Z7G.....	75
6BA6.....	85	53.....	68
6BE6.....	85	54.....	135
6BD6.....	85	70L7.....	135
6BG6.....	85	71A.....	135
6BR6.....	85	71B.....	135
6BS6.....	85	76.....	55
6BT6.....	85	77.....	55
6CA6.....	85	78.....	55
6CB6.....	85	79.....	55
6CD6.....	85	79T.....	60
6CE6.....	85	81.....	75
6CF6.....	85	82.....	75
6CG6.....	85	83.....	75
6CH6.....	85	84.....	75
6CL6.....	85	85.....	75
6CM6.....	85	86.....	75
6CN6.....	85	87.....	75
6CO6.....	85	88.....	75
6CP6.....	85	89.....	75
6CQ6.....	85	90.....	75
6CR6.....	85	91.....	75
6CS6.....	85	92.....	75
6CT6.....	85	93.....	75
6CU6.....	85	94.....	75
6CV6.....	85	95.....	75
6CW6.....	85	96.....	75
6CX6.....	85	97.....	75
6CY6.....	85	98.....	75
6CZ6.....	85	99.....	75
6DA6.....	85	0A2.....	11.10
6DB6.....	85	0A3.....	1.25
6DC6.....	85	0A4G.....	1.12
6DD6.....	85	0B1.....	1.15
6DE6.....	85	0B2.....	1.15
6DF6.....	85	0B3.....	1.15
6DG6.....	85	0C3.....	1.05
6DH6.....	85	0Z1.....	.95
6DI6.....	85	0Z2.....	.95
6DJ6.....	85	0Z3.....	.95
6DK6.....	85	0Z4.....	.95
6DL6.....	85	0Z5.....	.95
6DM6.....	85	0Z6.....	.95
6DN6.....	85	0Z7.....	.95
6DO6.....	85	0Z8.....	.95
6DP6.....	85	0Z9.....	.95
6DQ6.....	85	0Z0.....	.95
6DR6.....	85	0Z1.....	.95
6DS6.....	85	0Z2.....	.95
6DT6.....	85	0Z3.....	.95
6DU6.....	85	0Z4.....	.95
6DV6.....	85	0Z5.....	.95
6DW6.....	85	0Z6.....	.95
6DX6.....	85	0Z7.....	.95
6DY6.....	85	0Z8.....	.95
6DZ6.....	85	0Z9.....	.95
6EA6.....	85	0A1.....	1.10
6EB6.....	85	0A2.....	1.10
6EC6.....	85	0A3.....	1.10
6ED6.....	85	0A4.....	1.10
6EE6.....	85	0A5.....	1.10
6EF6.....	85	0A6.....	1.10
6EG6.....	85	0A7.....	1.10
6EH6.....	85	0A8.....	1.10
6EI6.....	85	0A9.....	1.10
6EJ6.....	85	0A0.....	1.10
6EK6.....	85	0A1.....	1.10
6EL6.....	85	0A2.....	1.10
6EM6.....	85	0A3.....	1.10
6EN6.....	85	0A4.....	1.10
6EO6.....	85	0A5.....	1.10
6EP6.....	85	0A6.....	1.10
6EQ6.....	85	0A7.....	1.10
6ER6.....	85	0A8.....	1.10
6ES6.....	85	0A9.....	1.10
6ET6.....	85	0A0.....	1.10
6EU6.....	85	0A1.....	1.10
6EV6.....	85	0A2.....	1.10
6EW6.....	85	0A3.....	1.10
6EX6.....	85	0A4.....	1.10
6EY6.....	85	0A5.....	1.10
6EZ6.....	85	0A6.....	1.10
6FA6.....	85	0A7.....	1.10
6FB6.....	85	0A8.....	1.10
6FC6.....	85	0A9.....	1.10
6FD6.....	85	0A0.....	1.10
6FE6.....	85	0A1.....	1.10
6FF6.....	85	0A2.....	1.10
6FG6.....	85	0A3.....	1.10
6FH6.....	85	0A4.....	1.10
6FI6.....	85	0A5.....	1.10
6FJ6.....	85	0A6.....	1.10
6FK6.....	85	0A7.....	1.10
6FL6.....	85	0A8.....	1.10
6FM6.....	85	0A9.....	1.10
6FN6.....	85	0A0.....	1.10
6FO6.....	85	0A1.....	1.10
6FP6.....	85	0A2.....	1.10
6FQ6.....	85	0A3.....	1.10
6FR6.....	85	0A4.....	1.10
6FS6.....	85	0A5.....	1.10
6FT6.....	85	0A6.....	1.10
6FU6.....	85	0A7.....	1.10
6FV6.....	85	0A8.....	1.10
6FW6.....	85	0A9.....	1.10
6FX6.....	85	0A0.....	1.10
6FY6.....	85	0A1.....	1.10
6FZ6.....	85	0A2.....	1.10
6GA6.....	85	0A3.....	1.10
6GB6.....	85	0A4.....	1.10
6GC6.....	85	0A5.....	1.10
6GD6.....	85	0A6.....	1.10
6GE6.....	85	0A7.....	1.10
6GF6.....	85	0A8.....	1.10
6GG6.....	85	0A9.....	1.10
6GH6.....	85	0A0.....	1.10
6GI6.....	85	0A1.....	1.10
6GJ6.....	85	0A2.....	1.10
6GK6.....	85	0A3.....	1.10
6GL6.....	85	0A4.....	1.10
6GM6.....	85	0A5.....	1.10
6GN6.....	85	0A6.....	1.10
6GO6.....	85	0A7.....	1.10
6GP6.....	85	0A8.....	1.10
6GQ6.....	85	0A9.....	1.10
6GR6.....	85	0A0.....	1.10
6GS6.....	85	0A1.....	1.10
6GT6.....	85	0A2.....	1.10
6GU6.....	85	0A3.....	1.10
6GV6.....	85	0A4.....	1.10
6GW6.....	85	0A5.....	1.10
6GX6.....	85	0A6.....	1.10
6GY6.....	85	0A7.....	1.10
6GZ6.....	85	0A8.....	1.10
6HA6.....	85	0A9.....	1.10
6HB6.....	85	0A0.....	1.10
6HC6.....	85	0A1.....	1.10
6HD6.....	85	0A2.....	1.10
6HE6.....	85	0A3.....	1.10
6HF6.....	85	0A4.....	1.10
6HG6.....	85	0A5.....	1.10
6HH6.....	85	0A6.....	1.10
6HI6.....	85	0A7.....	1.10
6HJ6.....	85	0A8.....	1.10
6HK6.....	85	0A9.....	1.10
6HL6.....	85	0A0.....	1.10
6HM6.....	85	0A1.....	1.10
6HN6.....	85	0A2.....	1.10
6HO6.....	85	0A3.....	1.10
6HP6.....	85	0A4.....	1.10
6HQ6.....	85	0A5.....	1.10
6HR6.....	85	0A6.....	1.10
6HS6.....	85	0A7.....	1.10
6HT6.....	85	0A8.....	1.10
6HU6.....	85	0A9.....	1.10
6HV6.....	85	0A0.....	1.10
6HW6.....	85	0A1.....	1.10
6HX6.....	85	0A2.....	1.10
6HY6.....	85	0A3.....	1.10
6HZ6.....	85	0A4.....	1.10
6IA6.....	85	0A5.....	1.10
6IB6.....	85	0A6.....	1.10
6IC6.....	85	0A7.....	1.10
6ID6.....	85	0A8.....	1.10
6IE6.....	85	0A9.....	1.10
6IF6.....	85	0A0.....	1.10
6IG6.....	85	0A1.....	1.10
6IH6.....	85	0A2.....	1.10
6II6.....	85	0A3.....	1.10
6IJ6.....	85	0A4.....	1.10
6IK6.....	85	0A5.....	1.10
6IL6.....	85	0A6.....	1.10
6IM6.....	85	0A7.....	1.10
6IN6.....	85	0A8.....	1.10
6IO6.....	85	0A9.....	1.10
6IP6.....	85	0A0.....	1.10
6IQ6.....	85	0A1.....	1.10
6IR6.....	85	0A2.....	1.10
6IS6.....	85	0A3.....	1.10
6IT6.....	85	0A4.....	1.10
6IU6.....	85	0A5.....	1.10
6IV6.....	85	0A6.....	1.10
6IW6.....	85	0A7.....	1.10
6IX6.....	85	0A8.....	1.10
6IY6.....	85	0A9.....	1.10
6IZ6.....	85	0A0.....	1.10
6JA6.....	85	0A1.....	1.10
6JB6.....	85	0A2.....	1.10
6JC6.....	85	0A3.....	1.10
6JD6.....	85	0A4.....	1.10
6JE6.....	85	0A5.....	1.10
6JF6.....	85	0A6.....	1.10
6JG6.....	85	0A7.....	1.10
6JH6.....	85	0A8.....	1.10
6JI6.....	85	0A9.....	1.10
6JJ6.....	85	0A0.....	1.10
6JK6.....	85	0A1.....	1.10
6JL6.....	85	0A2.....	1.10
6JM6.....	85	0A3.....	1.10
6JN6.....	85	0A4.....	1.10
6JO6.....	85	0A5.....	1.10
6JP6.....	85	0A6.....	1.10
6JQ6.....	85	0A7.....	1.10
6JR6.....	85	0A8.....	1.10
6JS6.....	85	0A9.....	1.10
6JT6.....	85	0A0.....	1.10
6JU6.....	85	0A1.....	1.10
6JV6.....	85	0A2.....	1.10
6JW6.....	85	0A3.....	1.10
6JX6.....	85	0A4.....	1.10
6JY6.....	85	0A5.....	1.10
6JZ6.....	85	0A6.....	1.10
6KA6.....	85	0A7.....	1.10
6KB6.....	85	0A8.....	1.10
6KC6.....	85	0A9.....	1.10
6KD6.....	85	0A0.....	1.10
6KE6.....	85	0A1.....	1.10
6KF6.....	85	0A2.....	1.10
6KG6.....	85	0A3.....	1.10
6KH6.....	85	0A4.....	1.10
6KI6.....	85	0A5.....	1.10
6KJ6.....	85	0A6.....	1.10
6KK6.....	85	0A7.....	1.10
6KL6.....	85	0A8.....	1.10
6KM6.....	85	0A9.....	1.10
6KN6.....	85	0A0.....	1.10
6KO6.....	85	0A1.....	1.10
6KP6.....	85	0A2.....	1.10
6KQ6.....	85	0A3.....	1.10
6KR6.....	85	0A4.....	1.10
6KS6.....	85	0A5.....	1.10
6KT6.....	85	0A6.....	1.10
6KU6.....	85	0A7.....	1.10
6KV6.....	85	0A8.....	1.10
6KW6.....	85	0A9.....	1.10
6KX6.....	85	0A0.....	1.10
6KY6.....	85	0A1.....	1.10
6KZ6.....	85	0A2.....	1.10
6LA6.....	85	0A3.....	1.10
6LB6.....	85	0A4.....	1.10
6LC6.....	85	0A5.....	1.10
6LD6.....	85	0A6.....	1.10
6LE6.....	85	0A7.....	1.10
6LF6.....	85	0A8.....	1.10
6LG6.....	85	0A9.....	1.10
6LH6.....	85	0A0.....	1.10
6LI6.....	85	0A1.....	1.10
6LJ6.....	85	0A2.....	1.10
6LK6.....	85	0A3.....	1.10
6LL6.....	85	0A4.....	1.10
6LM6.....	85	0A5.....	1.10
6LN6.....	85	0A6.....	1.10
6LO6.....	85	0A7.....	1.10
6LP6.....	85	0A8.....	1.10
6LQ6.....	85	0A9.....	1.10
6LR6.....	85	0A0.....	1.10
6LS6.....	85	0A1.....	1.10
6LT6.....	85	0A2.....	1.10
6LU6.....	85	0A3.....	1.10
6LV6.....	85	0A4.....	1.10
6LW6.....	85	0A5.....	1.10
6LX6.....	85	0A6.....	1.10
6LY6.....	85	0A7.....	1.10
6LZ6.....	85	0A8.....	1.10
6MA6.....	85	0A9.....	1.10
6MB6.....	85	0A0	

RADAR — COMMUNICATIONS — TEST EQUIPMENT

AN/ARC-1—Transceiver 100-156 mcs	
APA-11—Pulse Analyzer	
APN-1—Airborne Radio Altimeter	
ARC-4—VHF Transceiver 140-150 MC	
ARN-5—Glide Path Receiver	\$69.50
ARN-7—Airborne Direction Finder	
ARR-2—Home & Receiving Equipment	
BC-223—30 Watt Transmitter 2-2 MC	
BC-342—Receiver—1.5 to 18 MC 110v AC	
BC-348—Receiver—1.5 to 18 MC 28v DC	
BC-375E—Radio Transmitter	
BC-639—VHF Receiver 100-156 MC	\$400.00
BC-640—VHF Transmitter 100-156 MC	\$950.00
BC-1206—Beacon Receiver 200-400 KC	
RC-103—Airborne Localizer Receiver	
SCR-269—Radio Compass	\$129.50
SCR-274N—Command Equipment	
SCR-284—Field Radio Station	\$365.00
SCR-291—Semi-Portable Direction Finder	
SCR-300—Field Transmitter and Receiver	
SCR-522—VHF Transmitter and Receiver	\$129.50
SCR-536—Handi-Talkie PAIR: \$185.00	
SCR-555—Semi-Portable Direction Finder	
SCR-694—Portable Field Transceiver	
SCR-718A-AM-C—High Altitude Altimeter	
TS-50—Radio Telegraph Transmitter	
TS-3/AP—S-Band Power Frequency Meter	
TS-10/AP—APN-1 Test Set	\$25.00
TS-12/AP—X-Band V.S.W.R. Test Set	
TS-13/AP—X-Band Signal Generator	
TS-14/AP—S-Band Signal Generator	\$400.00
TS-15/AP—Flux Meter	
TS-16/AP—APN-1 Test Set	\$29.95
TS-18/AP—Capacity Divider	
TS-23/APN—SCR-718 Test Set	
TS-33/AP—X-Band Frequency Meter	
TS-34/AP—Synoscope complete with acces.	\$290.00
TS-35/AP—X-Band Test Set	
TS-36/AP—X-Band Power Meter	\$140.00
TS-45/APM-3—X-Band Signal Generator	\$225.00
TS-59/APN—APN-1 Test Set	\$140.00
TS-61/AP—S-Band Echo Box	\$140.00
TS-62/AP—X-Band Echo Box	
TS-69/AP—300-1000 MC Frequency Meter	\$69.50
TS-89/AP—Pulse Voltage Divider	
TS-95/AP—Pulse Voltage Divider	
TS-102/AP—Range Calibrator	
TS-111/AP—S-Band Wavemeter	
TS-118/AP—Power Meter	
TS-125/AP—S-Band Power Meter	
TS-153/UP—S-Band Signal Generator	
TS-170/ARN-5—I.L.S. Test Set	
TS-184/AP—Test Set	
TS-226/AP—300-1000 MC Power Meter	
TS-268/UP—Crystal Test Set	
TS-278/AP—APS-13 Test Set	
IE-19—SCR-522 Test Set	\$290.00
IE-36—SCR-522 Test Set	
BC-221—Frequency Meter	\$125.00
BC-1277—S-Band Signal Generator	\$275.00
TBN/3EV—Thermistor Bridge	
CW/60/ABM—S-Band Frequency Meter	\$97.50
FLUX METER—1000 Gauss	\$32.50
APA-10—Parabolic Antenna	\$225.00
APA-17—Automatic Direction Finder 250-1000 MC	
APQ-5—Low Altitude Tracking & Bombing Equip.	
APR-1—Radar Search Receiver 40-3400 MC	
APR-2—Radar Search Receiver 85-1000 MC	

APR-4—Radar Search Receiver 38-4000 MC	
APR-5—Radar Search Receiver 1000-3100 MC	
APR-6—Radar Search Receiver 3000-6000 MC	
APS-2—S-Band Search Radar	
APS-3—X-Band Search Radar	
APS-4—X-Band Search & Homing Radar	
APS-6—X-Band Search & Gun Laying Radar	
APB-15A—X-Band Blind Bombing Radar	
APT-4—Radar Jamming Xmitter 165-780 MC	
APT-5—Radar Jamming Xmitter 350-1400 MC	\$189.50
SO-13—S-Band Marine Radar, Lightweight	
SQ-10—CM Portable Radar \$850.00	
TPS-1—Portable Search Radar	
TPS-3—1-Band Search Radar	
UPN-1 & 2—S-Band Portable Beacon Battery or 110v AC	
RA-34—Power Supply for BC-375E	\$225.00
RA-62—Power Supply for SCR-522	
BC-1016—Ink Tape Recorder	
PE-103—Dynamotor Power Supply	\$24.50
GN-58—Hand Cranked Generator W/Logs & Seat	
SCR-578—Gibson Girl (Emergency Xmitter)	
CRT-3—Victory Girl Dual Freq. Emergency Xmitter Sound Powered Chest & Headsets MI-2454-B: Type O. Mfg. RCA.	
AS-32/APX-1—Antenna	\$2.75
AN/CRO-7—V.I.F. Handi-Talkies 112MC Xtal Controlled PAIR: \$200.00	
MN/26-Y—Compass Receiver	
BC-733D—Receiver with Tubes	\$18.95
C-3—Navy Snoopscope in Carrying Case	\$400.00
BC-1284—Lighthouse Tube Preamplifier	
BC-959—Interphone Amplifier	\$6.75
RL-42—Motor Antenna	\$6.25
30 MC—I.F. Strips Using 6AK5	
RD-7/APA-23—Recorder for APR	
AS-27/ARN-5—Antenna	\$3.50
ARA—Receiver—500-1500 KC	\$16.50
ID/80/APA-17—Indicator	
R-28/ARC-5—Receiver—100-156 MC	\$24.50
RM-29—Remote Control	
BC-455—Receiver—6-9 MC	\$16.50
BC-454—Receiver—3-6 MC	\$16.50
BC-800—Transmitter/Receiver	
BC-950—Transmitter—100-156 MC	\$34.50
FL-300—FM Exciter (Mfg. Tempco)	\$19.50
FL-8—Filter	
FL-5—Filter, Less Cables	
3C-16-D GSAP—Gun Camera Computers with All Accessories; in Carrying Case	\$14.50
AT-2A/APN-2—Antenna	\$3.75

PANEL METERS
2" SQUARE WESTON—SANGAMO

0-20 Volts D.C.	\$2.95	0-5 Ma	\$2.95
0-40 Volts D.C.	2.95	0-500 Microamp.	4.95
0.5 Amp. R.F.C.	2.95 (scale)	0-100 Ma (0-300 scale)	2.95

XMITTING TUBES

OA3/VRT5	\$1.04	15R	\$0.69	866A	\$1.35
OA3/VR80	1.15	28D7	1.95	866JR	1.29
OC3/VR150	1.15	30 Spec	1.95	869B	65.00
OD3/VR150	.95	35T	3.25	872A	3.50
1B23	9.75	45 Spec	32	874	1.19
1B24	9.75	100FH	7.98	877	1.59
1B27	14.95	211	65	885	1.39
1B28	2.45	250TH	19.95	902A	9.95
1N21B	1.35	262B	17	918	1.10
1N22A	2.38	274B	3.95	922	1.25
1N23B	3.69	304TH	8.95	923	3.95
1N34	.76	304TL	8.95	930	.95
1N35	10.95	316A	3.59	931A	4.45
2C40	7.50	328A	8.95	955	.49
2C43	14.95	358A	6.95	956	.35
2C44	1.15	350B	3.95	957	.38
2C46	7.95	368AS	7.50	958	.56
2C51	6.25	371A	6.99	991/NE16	2.95
2D21	1.35	371B	7.95	1603	4.95
2E22	1.75	393A	4.65	1613	.75
2E23	4.65	394A	8.75	1616	1.59
2E26	3.15	417A	27.50	1619	2.24
2K25/723A	28.75	434A	32.50	1622	2.45
2K28	32.50	446A	3.75	1624	1.45
2K33A	310.00	446B	15.75	1625	1.35
3AP1	9.95	575A	5.25	701A	1.25
3B24	7.95	703A	2.25	1626	.25
3B24W	7.95	703A	1.65	1630	.72
3B26	3.59	705A	1.65	1632	.72
3BP1	5.95	707B	7.95	1638	.45
3C22	115.00	714AY	6.39	1851	1.55
3C24/24G	1.75	715A	1.95	715B	1.65
3C45	1.95	715C	19.95	5670	6.95
3CP1	1.95	715C	.98	8008	5.95
3CP1S1	1.95	717A	6.95	723A/B	2.59
3DP1	4.45	721A	9.50	8012	2.65
3DP1A	6.95	723A	18.95	8013	2.59
3DP1-52A	8.95	723A/B	3.25	724B	.98
3D21	3.25	724B	6.75	9001	1.50
3E29	13.95	715A	18.95	9002	.98
3FP1	1.65	726A	29.50	9003	1.65
3GP1	4.45	803A	27.50	800	1.45
4-125A	27.50	802	11.75	CL1A	9.95
4-250A	37.50	804	3.75	CGA	7.95
4AP10	4.45	803A	24.95	CJ16	6.39
4E27	14.95	805	1.59	CK1005	4.48
5AP1	3.45	807	2.69	F123A	7.75
5BP1	4.45	808	2.75	F127A	27.50
5BP4	4.45	810	2.85	F128A	89.50
5CP1	4.59	811	2.85	F129A	4.89
5CP2	11.75	812	2.75	F131	4.95
5CP21	19.95	813	1.75	F132A	8.95
5JP2	1.85	814	2.69	F137	14.95
5JP21	4.85	815	2.05	F138A	3.49
5L45	4.45	816	.69	F139	17.95
5LP1	22.50	826	8.45	F140	33.50
5LP2	22.50	829	10.95	F141A	29.50
6AN5	3.30	829B	12.95	GL502A	1.79
6AS6	2.50	830A	2.75	HF100	8.95
6AS12	4.45	832	2.75	HF300	22.45
6C21	21.00	832B	8.50	HV114B	.69
6J4	6.75	837A	3.45	HV115	.69
7B7	6.35	837A	2.25	REL21	1.95
7DP4	14.50	838	27.50	RK60/1641	2.25
8LP1	4.95	845W	47.50	RK65	29.50
10BP4	17.45	849C	22.50	RK72	.48
10Y	.39	851	22.50	VT127A	2.45
12DP7	14.75	861	.98	WL616	34.50
15E	1.35	865			

STOCK DELIVERY

- SEALED RELAYS
- TELEPHONE RELAYS
- DIFFERENTIAL RELAYS
- PLATE CURRENT RELAYS
- ANTENNA SWITCHING RELAYS
- MINIATURE RELAYS
- STEPPING RELAYS
- CURRENT RELAYS
- AUTOSYN AIRCRAFT INSTRUMENTS
- MERCURY SWITCHES
- TIMING MOTORS
- MAGNESYN COMPASS INDICATORS
- REMOTE COMPASS SYSTEMS
- HYDRAULIC PRESSURE GAUGES
- AIR PRESSURE GAUGES
- AIRCRAFT ENGINE GAUGES
- AIRCRAFT OR MARINE SEXTANTS
- SENSITIVE ALTIMETERS
- TURBO SUPERCHARGER AMPLIFIER
- PITOT STATIC TUBES
- TACHOMETER INDICATORS
- MECHANICAL TACHOMETERS
- HYDRAULIC CYLINDER SERVOS
- TEMPERATURE INDICATORS
- FORMICA AIRCRAFT PULLEYS
- BALL BEARINGS
- DYNAMOTORS
- ELECTRIC METERS
- AMPERE DEMAND METERS
- MICRO SWITCHES
- LEVER SWITCHES
- TOGGLE SWITCHES
- WAFER SWITCHES
- INTERVALOMETERS
- PILOT LIGHT ASSEMBLIES
- SWEEP GENERATOR CAPACITORS
- OIL FILLED CAPACITORS
- BLOWER WHEELS
- RANGE CALIBRATOR (I-108)
- POTENTIOMETERS
- FUSE HOLDERS
- THYRATRON TUBES etc.

See our previous Electronic ads.

Your catalogue requests and quotation requests will receive our prompt attention. Call ARmory 4-8989.



RECEIVING TUBES

OA2	\$0.95	6AK5	\$0.88	6ST7	\$0.98
OA4G	1.05	6AK6	1.09	6SU7GY	2.75
OD1	1.20	6AV6	.57	6V6	.95
OD2	.59	6AQ5	.57	6V6	.65
OD4	.70	6AQ6	.85	6V6GT	.65
1A7CT	.80	6AV6	.65	6X4	.65
1B3-8016	1.25	6AT6	1.19	6X5CT	.65
1C5GT	.75	6AU5	.59	6V6C	.95
1D8GT	.65	6AV6	.55	6V7C	.75
1G6GT	.65	6AV6	.55	6V7C	.75
1L4	.67	6B4G	1.25	7A6	.75
1L4A	.85	6B6	.65	7C7	.75
1L6A	.95	6B8C	.75	7C7	.75
1L8A	.98	6B6A	.65	7C7	.75
1L8C	.95	6B6C	.65	7F7	.75
1L6C	.91	6B6E	.65	7N7	.85
1L8E	.75	6B6F	.72	7Y4	.59
1L8G	.65	6B6G	1.89	7Z4	.65
1P5GT	.69	6BH6	.95	12A7	.90
1R4	.69	6B16	.95	12AH7GT	1.19
1R5	.65	6B6	1.15	12AG6	.65
1S4	.69	6C2	.65	12AT7	1.10
1S5	.65	6C2	.60	12AU6	.65
1T4	.65	6C5	.59	12AV7	.88
1U4	.67	6C8C	.85	12BA6	.69
1V2	.65	6D6	.72	12CB8	.69
1X2	.65	6D6	.85	12CA6	.69
2A3	1.10	6E5	.79	12K8	.72
2X2	1.50	6F6	.85	12SA7GT	.79
2A2A	1.15	6E5	.85	12S7GT	.85
3A4	.65	6H6	.65	12S7C	.85
3B7/1291	.85	6H6GT	.65	12S7GT	.85
3B7/1299	.42	6J5	.55	12S7GT	.80
3D6/1299	.43	6J5GT	.55	12S7GT	.75
3G5GT	.63	6J6	.55	12S7GT	.75
3S4	.74	6J7G	.60	12S7R7	.72
3V4	.74	6K6GT	.55	14B6	.75
5R4CV	1.65	6K7	.79	14H7	.85
5T4	1.32	6K8GT	1.15	25L6	.90
5U4C	.69	6L6	2.25	25Z5	.65
5V4C	.88	6GC	1.50	25Z6GT	.68
5W4	.79	6L6CA	1.50	41	.69
5Y3GT	.45	6L7	.85	43	.75
5Y4C	.85	6N7GT	.79	50A5	.89
5Z3	.85	6N7GT	.79	50A5	.89
5Z4C	.95	6S7GT	.65	50B5	.65
6A3	.95	6S7GT	.65	50C5	.65
6A6	.82	6S7	.75	50G5	.65
6A7	.82	6S7	.75	50G7	.65
6A8GT	.95	6S7H7	.65	50V6	.72
6A9	.98	6S7J	.75	53	.68
6G5GT	1.05	6S7GT	.72	75	.82
6AC7	.75	6N7GT	.75	80	.65
6AC5	.75	6N7GT	.65	83	.85
6AG7	1.29	6S7GT	.68	83V	.82
6AH6	1.29	6S7GT	.80	84/6Z4	.75
6AJ5	1.95	6S7	.80	84/6Z4	.75

WANTED! WANTED!

Needed for Government Defense Projects—all types of military electronic gear with the prefix TS, RC, SCR, APIT, APS, etc. Highest prices paid or will exchange for your needs. No offer too small or too large.

Prices subject to change without notice. F.O.B. NYC. minimum order \$10.00. 20% deposit required. All merchandise guaranteed. Open account to rated firms. Telephone DObey 9-0342.

RADIO HAM SHACK Inc.
189 GREENWICH STREET • NEW YORK, N. Y.

HELIPOTS POTENTIOMETER PRECISION 1000 Ohm, 10 Turn, 0.5% Tol. Type 20KAZ... \$7.98

HIGH CURRENT MICA CAPS CYLINDRICAL SIMILAR TYPE "G" MFD K V M C \$ EACH

MICA CAPACITORS NEW Made to Rigid Gov't Specs.

Table with columns: Mfd, Fig. B, Fig. C, Fig. D, Fig. E, Xmts Micas, Each. Lists various capacitor specifications and prices.

Table with columns: Mfd, Fig. E, Xmts Micas, Each. Lists various capacitor specifications and prices.

Table with columns: Mfd, Fig. E, Xmts Micas, Each. Lists various capacitor specifications and prices.

Table with columns: Mfd, Fig. E, Xmts Micas, Each. Lists various capacitor specifications and prices.

VARIATOR & AUDIO COMPONENTS WE D-9706B, Mfgd to Rigid Western Electric Specs.

Infrared Snopescope Image-Converter Tube Hi-Sensitivity Simplified design 2" dia. Williams Opt. Resolution to 350 line/in.

RELAY SPECIAL SPDT Mini Bias 115VAC 3A CTS \$8.95 3 for \$27.50

BENCH TOOLS Pliers, Long Nose & Side Cutters, Screw Drivers, etc.

PHOTOFLASH KIT Includes DLX15 Flash Lamp Rated 200 Watt Sec.

PHOTOFLASH CAPACITORS 100MFD 500VDC \$2.89 200MFD 500VDC \$2.89

PHOTOFLASH CAPACITORS 100MFD 500VDC \$2.89 200MFD 500VDC \$2.89

TAB BATTERIES THAT'S A BUY STORAGE BATTERIES

★ TEST EQUIPMENT ★ MODEL 103 AC/DC 24 ranges VOM: AC & DC 10 rgs to 3000V, DB-5 rgs to -64DB, AC currents 3 rgs to 600 MA, DC current 4 rgs to 1.2 amp.

★ TEST EQUIPMENT ★ MODEL 106 VAC/DC 24 ranges VOM: AC & DC 10 rgs to 3000V, DB-5 rgs to -64DB, AC currents 3 rgs to 600 MA, DC current 4 rgs to 1.2 amp.

★ TEST EQUIPMENT ★ MODEL 106 VAC/DC 24 ranges VOM: AC & DC 10 rgs to 3000V, DB-5 rgs to -64DB, AC currents 3 rgs to 600 MA, DC current 4 rgs to 1.2 amp.

★ TEST EQUIPMENT ★ MODEL 106 VAC/DC 24 ranges VOM: AC & DC 10 rgs to 3000V, DB-5 rgs to -64DB, AC currents 3 rgs to 600 MA, DC current 4 rgs to 1.2 amp.

OIL CAPACITORS Mfd Each Price Mfd Each Price Mfd Each Price

OIL CAPACITORS Mfd Each Price Mfd Each Price Mfd Each Price

TRANSFORMERS All 115 V 60 Cyc Input TV & CR Pwr Xfmr up to 20"

TAB "SUN-FLASH" LAMPS "Tab" Replaces Max. Each

HIV PHOTOFLASH KIT Includes V4X4 Flash Lamp Rated 200 Watts Seconds.

LO-VOLT PHOTOFLASH KIT Includes DLX15 Flash Lamp Rated 200 Watt Sec.

PHOTOFLASH CAPACITORS 100MFD 500VDC \$2.89 200MFD 500VDC \$2.89

PHOTOFLASH CAPACITORS 100MFD 500VDC \$2.89 200MFD 500VDC \$2.89

PHOTOFLASH CAPACITORS 100MFD 500VDC \$2.89 200MFD 500VDC \$2.89

VARIAC Made by General Radio Model 200CU Rated 0-185 Volts at 5 Amps, Reconditioned, Tested, and Guaranteed.

RHEOSTATS 2 ohm 50W Model J \$2.28 5 for \$10.00 6 ohm 25W Model LH \$1.98 3 for 5.00

SHARPENING STONE INDISPENSABLE for Lab or Workshop. Finest Silicon Carbide No. 124 Carborundum Co. Unsurpassed for Precision Grinding of Crystals.

KITS AND COMPONENTS ELECTROLYTICS Condens Asst. .25 for \$4.98 OIL CAPACITORS Asst. .25 for 4.98

TEST CORDS 15 Foot Extension Cord Hyp Duct Rubber Covered \$1.10 6 Foot Line Cord W/Plug & Rubber Covered .55c

FILAMENT TRANS. 2.5V/2A @ 79c, 2 for \$1.49, 10 for \$13.99

TRANSFORMERS All 115 V 60 Cyc Input TV & CR Pwr Xfmr up to 20"

TV WAVE TRAP Television interference eliminator. Rejects everything below 45 Mc's.

FILTER CHOKES Dual 80 H/50ma Cad. \$3.98 15H/40ma AC/DC sets \$3.98

TUBE CLAMPS 928B-5, 928B-10, 928B-15, 928B-20 \$1.00

TUBE SPECIALS 1B3GT, 6H6, 6K6GT, 6SN7GT, 12BN7GT

METER SPECIALS O-30VDC Aircraft Type "AN" as Illustrated \$1.95 3 for \$5.25

METER SPECIALS O-30VDC Aircraft Type "AN" as Illustrated \$1.95 3 for \$5.25

METER SPECIALS O-30VDC Aircraft Type "AN" as Illustrated \$1.95 3 for \$5.25

PRECISION RESISTORS Over 2 1/2 Million in Stock "TAB" Specialists in Precision Resistors

Table with columns: Resistance, Price, Resistance, Price, Resistance, Price. Lists various resistor values and prices.

Table with columns: Resistance, Price, Resistance, Price, Resistance, Price. Lists various resistor values and prices.

Table with columns: Resistance, Price, Resistance, Price, Resistance, Price. Lists various resistor values and prices.

Table with columns: Resistance, Price, Resistance, Price, Resistance, Price. Lists various resistor values and prices.

Table with columns: Resistance, Price, Resistance, Price, Resistance, Price. Lists various resistor values and prices.

Table with columns: Resistance, Price, Resistance, Price, Resistance, Price. Lists various resistor values and prices.

Table with columns: Resistance, Price, Resistance, Price, Resistance, Price. Lists various resistor values and prices.

Table with columns: Resistance, Price, Resistance, Price, Resistance, Price. Lists various resistor values and prices.

Table with columns: Resistance, Price, Resistance, Price, Resistance, Price. Lists various resistor values and prices.

Table with columns: Resistance, Price, Resistance, Price, Resistance, Price. Lists various resistor values and prices.

Table with columns: Resistance, Price, Resistance, Price, Resistance, Price. Lists various resistor values and prices.

Money Back Guarantee (Cost of Mids Only) \$5 Min. Order FOB NYC. Add Sph. Charges & 25% Dep. Tubes Ctd via R-Exp. only. Prices Subject to Change Without Notice.

CONTINENTAL

PRECISION E-Z RELEASE[®] Power CONNECTORS

SERIES
EZ-16



AVAILABLE IN:
12 - 18 - 24 - 34
CONTACTS

EZ-12-16S EZ-12-16P

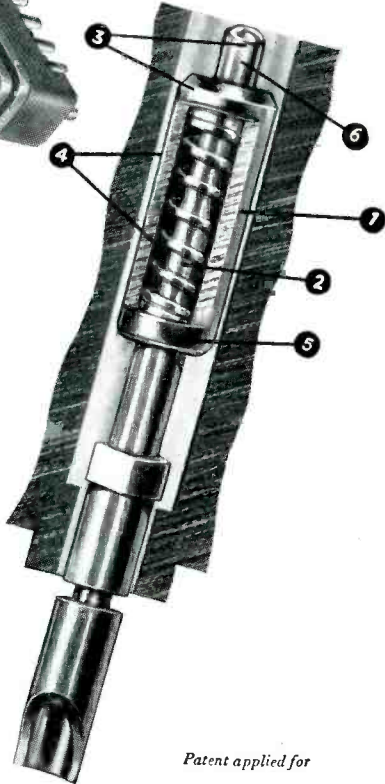

Patent applied for

1. Spring completely enclosed and retained in barrel riding inside moulding so that dirt cannot impair ejection of contacts.
2. Pin contact is of uniform diameter and does not contain any undercut to weaken or bend contact at any point.
3. Since the pin contact is of uniform diameter and does not contain any undercuts, full current capacity is carried uninterruptedly throughout the pin contact. Since the spring barrel and compression spring do not ride on the pin contact, no current is carried away from the pin contact.
4. Since the spring barrel which completely retains the compression spring rides within the walls of the moulded section and does not ride on the pin contact, the pin contact has the necessary free floating action so essential for self-alignment.
5. Extreme vibration cannot affect this contact assembly structurally or electrically since it is a permanently affixed, irremovable component, which cannot be jarred loose.
6. Pin contact projects above spring barrel to immediately self-align itself with socket contact before spring is compressed.

SPECIFICATIONS

- Voltage breakdown at sea level.....4000 VRMS
- Current rating10 AMPS
- Contact size#16 AWG
- Creepage path between contacts.....1/4" Min.
- Air space1/8" Min.
- Mechanical Spacing9/32"

MATERIALS:

- Mineral filled Melamine, MIL-P14A, flame resistant, high-dielectric and mechanical strength with unusually long effective creepage making these connectors ideally suited for operation above normal altitudes as well as at sea level. Standard material used on this series unless otherwise designated.
- Plaskon Reinforced (glass) Alkyd type 440A for high impact strength and arc-resistance, designated by adding "A" to standard type number i.e.; E-Z 12-16 PA, E-Z 12-16 SA.
- Diallyl Phthalate (Blue) contains high dimensional stability and excellent dielectric properties designated by adding "D" to standard type number i.e.; EZ-12-16 PD, E-Z 12-16 SD.

DESIGN FEATURES

- Available in 12, 18, 24, and 34 contacts for #16 AWG Wire.
- PRECISION WIPING CONTACTS insure clean contact after engaging and disengaging of connector.
- FLOATING, NON-ROTATING CONTACTS on plug and receptacle insure self alignment of each individual contact.
- POLARIZATION is unusually positive with an extra heavy reverse guide pin and socket.
- PRECISION MACHINED CONTACTS from spring temper phosphor bronze on the plug and the mating pin contacts are of precision machined brass to insure the uniformity necessary for maximum current capacity and minimum voltage drop. Contacts are silver plated with gold plated finish for low resistance and non-corrosion.

CATALOG E
AVAILABLE

IMMEDIATE DELIVERY
Continental Connector has, for immediate delivery, standard models in the E-Z Release series, the Series #20 Precision Connectors, the Series #14 and Series #16 Power Connectors. Special orders to specification requested.

Exclusive Sales Agents



DeJUR AMSCO
CORPORATION

45th STREET and NORTHERN BLVD., L. I. C. 1, N. Y.
West Coast: 405 N. MAPLE DRIVE, BEVERLY HILLS, CAL.

General Hermetic Sealing Corp.	315
General Precision Laboratory, Inc.	89
General Radio Company	17
General Transformer Company	332
Gertsch Products, Inc.	252
GM Laboratories, Inc.	275, 311
Goat Co., Inc., Fred.	344
Graphite Metallizing Corporation	358
Green Instrument Co., Inc.	283
Gries Reproducer Corp.	350
Guthman & Co., Inc., Edwin I.	66

Hammarlund Mfg. Co., Inc.	296
Harper Company, H. M.	285
Hathaway Instrument Company	214
Haydon Company, A. W.	317
Heath Company	333
Helland Research Corp.	421
Heldor Manufacturing Co.	21
Helipot Corporation	147
Heminway & Bartlett Mfg. Co.	339
Hermetic Seal Products Co.	199
Hetherington, Inc.	284
Hewlett-Packard Company	33
Hexacon Electric Co.	361
Hickok Electrical Instrument Co.	27
Howard Industries, Inc.	174
Hudson Radio & Television Corp.	325
Hudson Tool & Die Company, Inc.	155
Hughes Research & Development Laboratories	340
Hycor Company, Inc.	279
Hytron Radio & Electronics Co.	193

Improved Seamless Wire Company	360
Induction Motors Corp.	341
Industrial Condenser Corp.	337
Industrial Hardware Mfg. Co., Inc.	311
Industrial Tape Corp.	90
Instrument Electronics Corp.	359
Instrument Resistors Co.	362
International Business Machines	295
International Nickel Company, Inc.	201
Ippolito & Co., Inc., James	319
Irvington Varnish & Insulator Co.	81
I-T-E Circuit Breaker Company	56

James Vibrapower Co.	291
Jeffers Electronics, Division Speer Carbon Co.	152
Jelliff Manufacturing Corp.	252
Jennings Radio Manufacturing Co.	202
JFD Mfg. Co.	263
Johnson Co., E. F.	258
Jones Div., Howard B. Cinch Mfg. Corp.	303
Joy Manufacturing Company	84

Kable Engineering Co.	299
Karp Metal Products Co., Inc.	77
Kartron	370
Kay Electric Company	60
Kenyon Transformer Co., Inc.	179
Kepco Laboratories, Inc.	52
Kester Solder Company	227
Keuffel & Esser Co.	54, 55
Keystone Products Company	168
Kirk & Blum Mfg. Co.	256
Knights Company, James	74
Kollsman Instrument Corporation	46

Laboratory for Electronics, Inc.	51
Lambda Electronics Corp.	323
Lampkin Laboratories, Inc.	293
Lapp Insulator Co.	76
Leeds & Northrup Co.	38
Lenkurt Electric Sales Company	244
Lewis Engineering Co.	311
Lewis Spring & Mfg. Co.	342
Linde Air Products Company, A Div of Union Carbide & Carbon Corp.	309

Lindgren & Associates, Erik A.	351
Link Aviation, Inc.	305
Lion Fasteners, Inc.	306
Little, Inc., Arthur D.	308
Lord Manufacturing Co.	186

Makepeace Company, D. E.	161
Mallory & Co., Inc., P. R.	96, 143
Marconi's Wireless Telegraph Co., Ltd.	170
Marion Electrical Instrument Co.	19
Maryland Electronic Mfg. Corp.	259
MB Manufacturing Company, Inc.	92
McGraw-Hill Book Co.	370
Measurements Corporation	352
Merit Plating Company	305
Merritt & Zaleski, Inc.	69
Metal Textile Corp.	238
Metals & Controls Corp., General Plate Div.	184
Mica Insulator Company	153
Mico Instrument Company	323, 370
Micro Div. of Minneapolis-Honeywell Regulator Co.	196, 293
Midland Manufacturing Co., Inc.	80
Miles Reproducer Co., Inc.	370
Milford Rivet & Machine Co.	278
Millen Mfg. Co., Inc., James	197
Milo Radio & Electronics Corp.	162
Milwaukee Transformer Company	213
Miniature Precision Bearings, Inc.	149
Minneapolis-Honeywell Regulator Co., Industrial Div.	65
Mitchell-Rand Insulation Company, Inc.	169
Moloney Electric Company	82
Mosinee Paper Mills Company	246
Muirhead & Co., Ltd.	3
Murphy & Miller, Inc.	309
M-W Laboratories, Inc.	242
Mycalex Corporation of America	61

National Company, Inc.	274, 358
National Moldite Company	208
National Plastic Products Co.	326
National Research Corporation	94, 95
Neo-Sil Corporation	361
New Hermes, Inc.	367
New York Transformer Co., Inc.	310
Ney Company, J. M.	287
Norden Instruments, Inc.	318
North American Aviation, Inc.	355
Northeastern Engineering, Inc.	283
Nothelfer Winding Laboratories	364

Olympic Metal Products Co., Inc.	327
----------------------------------	-----

Panoramic Radio Products, Inc.	339
Par-Metal Products Corporation	271
Penta Laboratories, Inc.	311
Permag Corp.	315
Peschel Electronics, Inc.	370
Phalo Plastics Corporation	271
Phaotron Co.	333
Phelps Dodge Copper Products Corp., Inca Manufacturing Division	28, 29
Phillips & Hiss Co., Inc.	343
Pix Manufacturing Co., Inc.	339
Plastic Capacitors, Inc.	30
Plastoid Corporation	241
Polarad Electronics Corporation	91
Polymer Corporation	356
Polyphase Instrument Company	329
Polytechnic Research & Development Company, Inc.	239
Popper & Sons, Inc.	343
Potter & Brumfield	248
Potter Instrument Company, Inc.	206
Praktica Co., Inc.	303
Precision Apparatus Co., Inc.	424
Precision Paper Tube Co.	283
Premax Products, Div. Chisholm-Ryder Co., Inc.	317
Pyroferrie Co., Inc.	251

Quality Products Co.	370
----------------------	-----

CHEMELEC

MADE OF TEFLON

ELECTRONIC PARTS

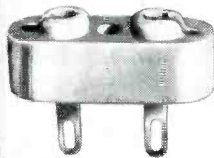

Chemelec Teflon*-insulated electronic components include a complete line of 7 and 9 pin miniature tube sockets, crystal sockets, feed-through insulators and terminals.

All provide the same high performance which this superior insulating material assures. Surface resistivity 3.5×10^{13} ohms. Loss factor less than 0.0005. Dielectric constant 2.0 (60 cycles to 30,000 megacycles). Serviceable at -110°F . to 500°F . Won't carbonize under arcing. Zero water absorption by ASTM Test. Unaffected by extreme humidity. Won't DC plate. Chemically inert, non-gassing, immune to corrosive atmospheres, fungus, oil, solvents. Non-flammable, tough, resilient, withstands and absorbs mechanical shock and vibration.

TEFLON and KEL-F STOCK and Custom-Fabricated Parts

Fabricating "Know-how", the result of years of specialized experience—and the most modern facilities for rapid, low-cost, close-tolerance production are at your command when you specify Teflon or Kel-F†, fabricated by the United States Gasket Company. Ours is the most complete line in the country—sheets, tape, rods, cylinders, tubing, bars, and custom-machined or molded parts to manufacturers' specifications.

*DuPont's trademark for its tetrafluoroethylene resin.

†Trademark AL W. Kellogg Co.

UNITED STATES GASKET COMPANY

FLUOROCARBON PRODUCTS DIVISION

FABRICATORS OF "TEFLON", "KEL-F" AND OTHER FLUOROCARBON PLASTICS

CAMDEN 1, NEW JERSEY



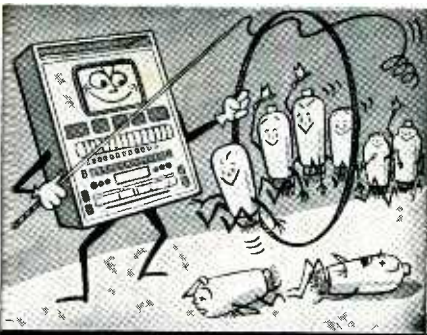

You Get **OVERALL** Test Performance With

PRECISION-
SERIES 10-12
Electronamic
TUBE PERFORMANCE TESTER
 with 12 ELEMENT free-point Master Lever Selector System

To test modern tubes for only one characteristic will not necessarily reveal overall performance capabilities. Tube circuits look for more than just Mutual Conductance or other single factor.

In the Precision Electronamic Circuit, the tube PERFORMS under appropriately phased and selected individual element potentials, encompassing a wide range of plate family characteristic curves. This complete Path of Operation is integrated by the indicating meter in the positive PERFORMANCE terms of Replace-Weak-Good.

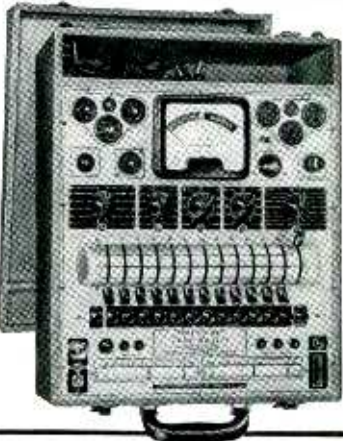

MODEL 10-12-P: in sloping, portable hardwood case with tool compartment and hinged removable cover. Size 13 3/4 x 17 1/4 x 6 3/4" ... \$104.50
 Also in counter or rack-panel mounts.

- ★ Facilities to 12 element prongs.
- ★ Filament voltages from 3/4 to 117 volts.
- ★ Tests Noval 9 pins; 5 and 7 pin acorns; double-capped H.F. amplifiers; low power transmitting tubes; etc. REGARDLESS OF FILAMENT OR ANY OTHER ELEMENT PIN POSITIONS.
- ★ ISOLATES EACH TUBE ELEMENT REGARDLESS OF MULTIPLE PIN POSITIONS.
- ★ DUAL short check sensitivity for special purpose tube selection.
- ★ Battery Tests under dynamic load conditions.
- ★ Built-in Dual-Window, brass-gear roller chart.
- ★ 4 1/2" Full Vision Meter.

SEE the "Precision" Electronamic Tube Tester at leading radio equipment distributors. Write for new 1952 catalog describing Precision Test Equipment for all phases of modern electronics.

Precision Apparatus Co., Inc.
 92-27 HORACE HARDING BLVD. • ELMHURST 10, N. Y.
 *Reg. U.S. Patent Office

Export: 458 B'way, N.Y.C., U.S.A. Cables: MORHANEX
 in Canada: Atlas Radio Corp. Ltd., Toronto, Ontario
 Want more information? Use post card on last page.

Radio Corporation of America	Fourth Cover, 187
Radio Materials Corporation	219
Radio Receptor Company	88
Radio Shack Corporation	297
Rahm Instruments, Inc.	283
Railway Express Agency, Air Express Div.	215
Rauland Corporation	42
Raytheon Manufacturing Company	34, 35, 349
R-B-M Division, Essex Wire Corp.	154
Reeves Hoffman Corporation	194
Regency	353
Remler Company, Ltd.	362
Republic Foll & Metal Mills, Inc.	257
Rex Corporation	333
Rex Rheostat Co.	370
Rhode Island Insulated Wire Co., Inc.	165
Roanwell Corporation	331
Rome Cable Corporation	280
Runzel Cord & Wire Co.	359
Rutherford Electronics Co.	295
Sangamo Electric Company	212
Scientific Electric Div. of "S" Corrugated Quenched Gap Co.	365
Scientific Electronic Labs, Inc.	347
Secon Metals Corporation	365
Servomechanisms, Inc.	320
Servotrol Company	289
Shalleross Mfg. Company	86, 87
Shieldings, Inc.	338
Sigma Instruments, Inc.	268
Signal Engineering & Mfg. Co.	323
Sorensen & Co., Inc.	47
Southern Industries of Maryland, Inc.	368
Southwestern Industrial Electronics Co.	277
Specialty Battery Company	313
Spencer-Kennedy Laboratories, Inc.	321
Sprague Electric Company	9, 64
Standard Piezo	363
Sterling Transformer Corp.	317
Stoddard Aircraft Radio Co.	210
Struthers-Dunn, Inc.	290
Stupakoff Ceramic & Mfg. Co.	221
Sturtevant Co., P. A.	252
Superior Electric Co.	85
Superior Tube Company	37
Surprenant Mfg. Co.	292
Sylvania Electric Products, Inc.	7, 265

Taylor Fibre Co.	181
Tech Laboratories, Inc.	300
Technical Service Corporation	275
Technitrol Engineering Company	271
Technology Instrument Corp.	220
Tektronix, Inc.	301
Tel-Instrument Co., Inc.	328
Telechron Dept., General Electric Company	163
Teletronics Laboratory, Inc.	344, 370
Telewave Laboratories, Inc.	291
Telex, Electro-Acoustic Div.	303
Terpening Company, L. H.	298
Thermador Electrical Mfg. Co.	359
Thomas & Skinner Steel Products Co.	272
Tinker & Razor	319
Titeflex, Inc.	67
Tobe Deutschmann Corporation	260, 261
Trad Television Corp.	315
Transformers, Inc.	185
Transradio, Ltd.	253
Triplett Electrical Instrument Co.	160
Tru-Ohm Products, Div. of Model Engineering & Mfg., Inc.	159
Tung-Sol Electric, Inc.	245

Union Carbide & Carbon Corp., Linde Air Products Div.	309
United Catalog Publishers, Inc.	279
United Condenser Corp.	327
United Manufacturing & Service Co.	275
United States Casket Co.	423
United States Testing Company	321

United Transformer Corp.	Second Cover
Universal Electronics Co.	309
Universal Winding Company	68
Varflex Corporation	207
Varian Associates	209
Veeder-Root Incorporated	2
Vickers, Inc.	182
Victoreen Instrument Co.	307
Victory Engineering Corp.	330

Waldes Kohinoor, Inc.	39
Warren Wire Company	252
Waterman Products Co., Inc.	325
Waveforms, Inc.	303
Weckesser Company	319
Welch Scientific Co., W. M.	287
Western Coil Products Co.	359
Western Gold & Platinum Works	324
Westinghouse Electric Corp.	79, 180, 195, 203
White Dental Mfg. Co., S. S.	254, 255, 357
Whitehead Stamping Company	263
Wickes Engineering & Construction Co.	329
Williams & Co., C. K.	346
Winchester Electronics, Inc.	281
Workshop Associates Div., The Gabriel Company	166
Wunderlich Radio Company	369

Zophar Mills, Inc. 319

PROFESSIONAL SERVICES 371

SEARCHLIGHT SECTION

(Classified Advertising)

H. E. HILTY, Mgr.

SEARCHLIGHT ADVERTISERS INDEX 416-417

This index is published as a convenience to the readers. Every care is taken to make it accurate, but ELECTRONICS assumes no responsibility for errors or omissions.

READ THIS!

To Find Out
Why More &
More Companies

Specify Only

**SUPER
DAVOHM**

Precision

Wire Wound

RESISTORS

SUPER DAVOHM
Precision Wire Wound
RESISTORS

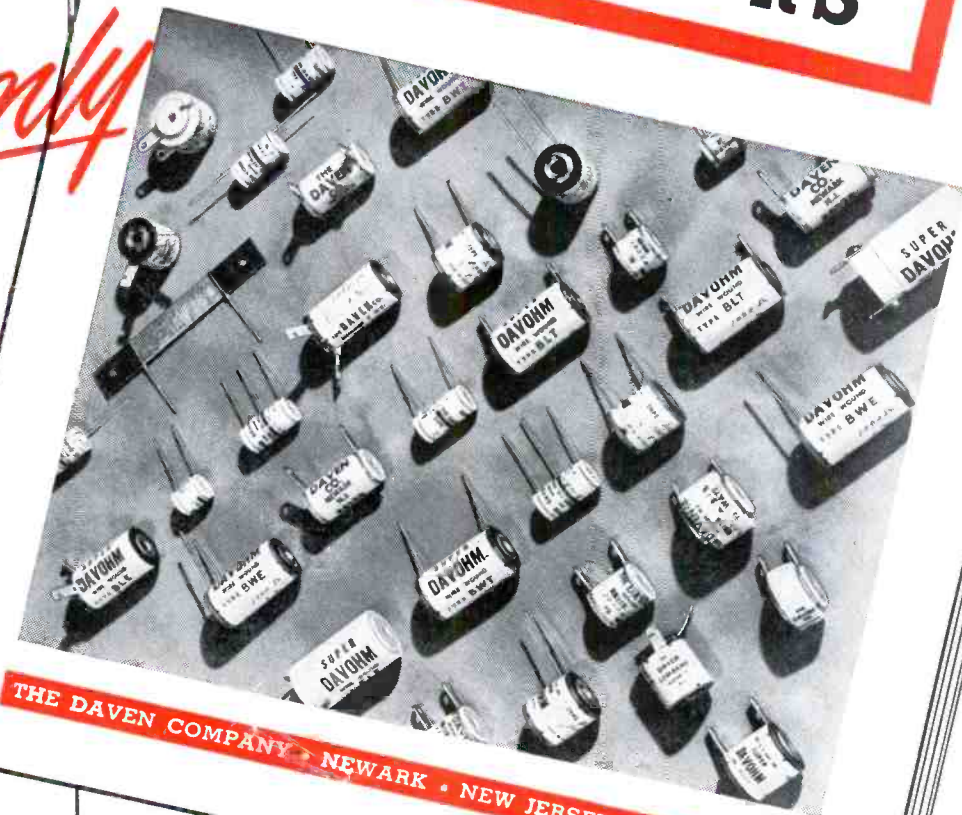

THE DAVEN COMPANY • NEWARK • NEW JERSEY

Section R

It's FREE

Write for
Bulletin R Now!



THE **DAVEN** CO.

191 CENTRAL AVENUE
NEWARK 4, NEW JERSEY

Early glass
Kinescope

Modern metal-shell
Kinescope

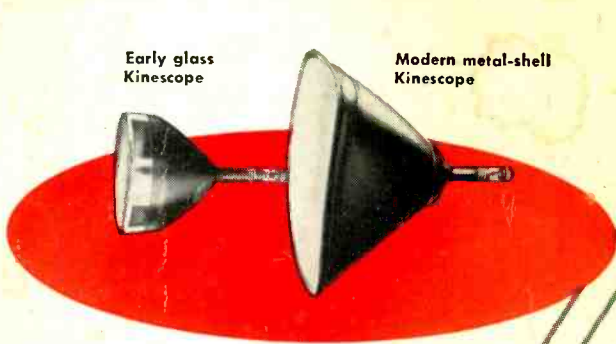

IN PRODUCT IMPROVEMENT

RCA

NEVER STANDS STILL

Early 50°
deflecting yoke

New 90° deflecting yoke for
27" picture tubes

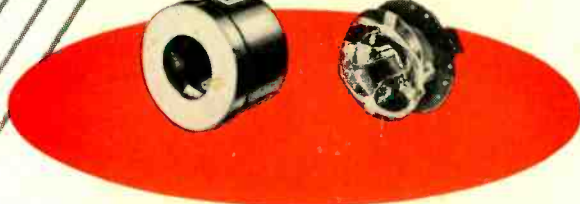

Early radiator
design used on
RCA-7C24

Improved design of
radiator now used on
similar type, RCA-5762,
cools with only one-half
the air flow

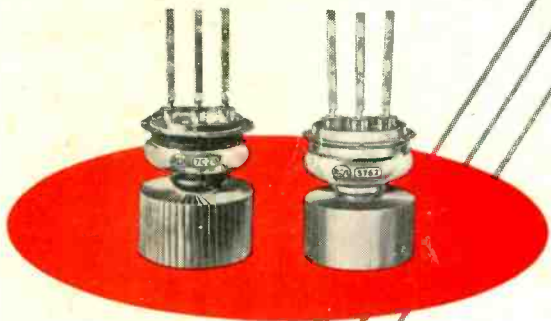

Early vacuum
rectifier for receivers

Improved RCA-5U4G
has greater stability,
longer life.

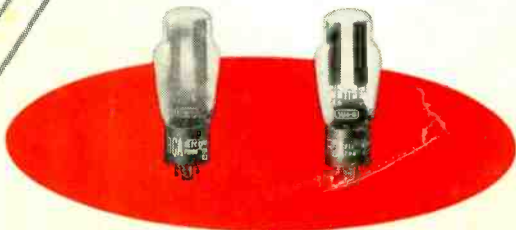

IT IS ONE THING to develop new products for the market. It's another thing to improve them . . . to conceive advanced designs . . . after they are on the market.

RCA engineers take nothing for granted—even after design has been "frozen." RCA engineers continue to work closely with equipment designers to solve problems dealing with the performance of tubes and components. RCA engineers never "let go" in their efforts to provide the ultimate in useful performance of the product.

Take the tubes and components illustrated here.

- The improved rectangular kinescope features a metal shell which permits use of a reflection-free faceplate having uniform thickness and high quality; it weighs less; it allows new flexibility in chassis layout.
- The improved plate radiator of the power tube reduces operating temperature, increases tube life, saves customers' money.
- The improved deflecting yoke provides beam deflection through a diagonal deflection angle of 90°—with inherent compensation for deflection defocusing.
- The improved rectifier tube has a greater reserve of emission, greater stability, longer life . . . is better suited for TV receiver requirements.

You can rely on RCA engineering leadership for continuous product improvement.



RADIO CORPORATION of AMERICA

ELECTRON TUBES

HARRISON, N. J.