

FEBRUARY · 1950

# electronics

A MCGRAW-HILL PUBLICATION

TESTING CRYSTAL TRIODES



# FILTER SPECIALISTS

PRODUCERS OF PERMALLOY DUST TOROID COILS AND FILTERS FOR OVER A DECADE!

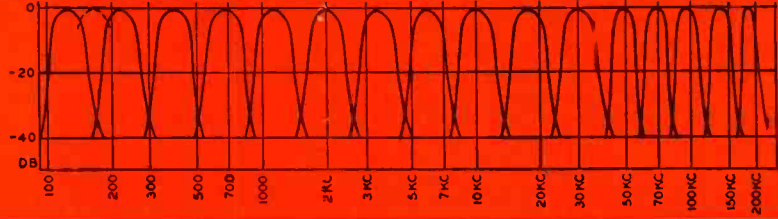

## FOR FILTERS

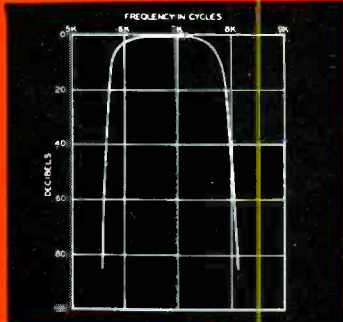

**BROAD BAND  
SHARP CUTOFF  
FILTER**

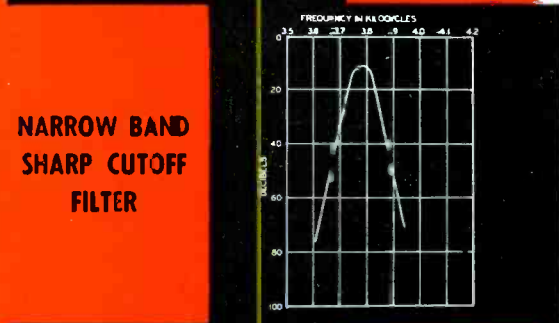

**NARROW BAND  
SHARP CUTOFF  
FILTER**

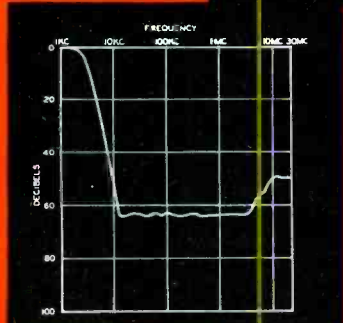

**ATTENUATES  
10K TO 30  
MEGACYCLES**

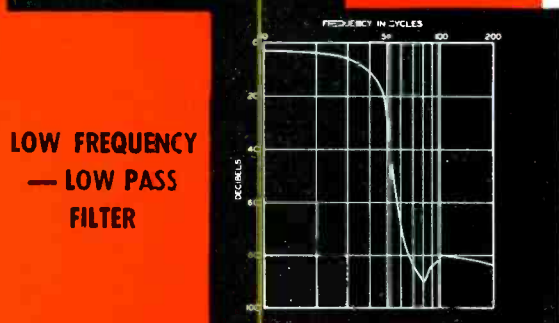

**LOW FREQUENCY  
— LOW PASS  
FILTER**

### SUB-OUNCER TOROID FILTERS

Filters employing SUB-OUNCER toroids and special condensers represent the optimum in miniaturized filter performance. The band pass filter shown weighs 5 ounces.

## FOR HIGH Q COILS

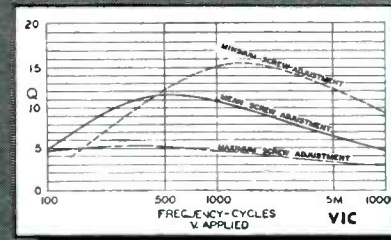
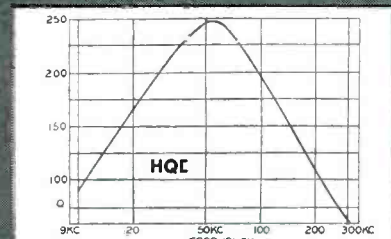
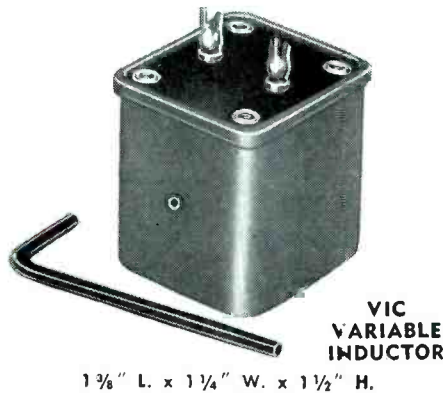
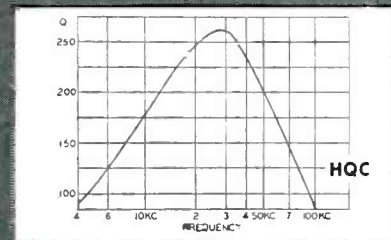
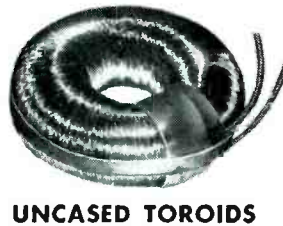
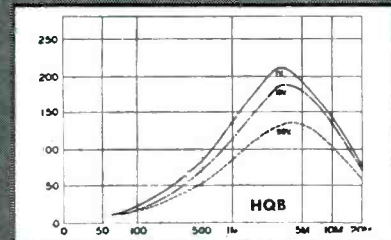
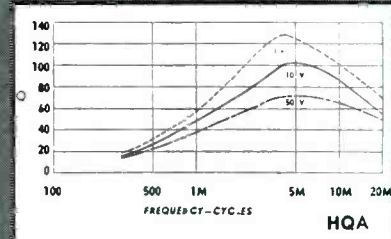

*United Transformer Co.*

150 VARICK STREET

NEW YORK 13, N. Y.

EXPORT DIVISION: 13 EAST 40th STREET, NEW YORK 16, N. Y.,

CABLES: "ARL 28"

write for catalog PS-409

# electronics

A McGRAW - HILL  
PUBLICATION



FEBRUARY • 1950

<b>TESTING CRYSTAL TRIODES</b> .....		<b>COVER</b>			
Micromanipulator developed in Physics Laboratories of Sylvania Electric Products Inc. permits independent adjustment of each whisker on semiconductor materials mounted on bar clamped to microscope stage (see p 118)—Photo by L. A. Ankerson					
<b>ELECTRONIC AIDS TO AIR NAVIGATION</b> .....		<b>66</b>			
Present and future equipment leading to the billion-dollar Transition Program under CAA					
<b>CONSTRUCTING HELICAL ANTENNAS</b> , by E. D. Smith.....		<b>72</b>			
How to build compact amateur and Citizens Radio antennas that give high gain					
<b>MANUFACTURING METALLIZED PICTURE TUBES</b> , by Earl R. Ewald.....		<b>76</b>			
Techniques used in forming and bonding aluminum backing to phosphor coating					
<b>GAS-FLOW SPEEDOMETER</b> , by Glenn L. Mellen.....		<b>80</b>			
Velocity of any gas is measured at rates from 20 to 400 mph without disturbing the flow					
<b>A GATED BEAM TUBE</b> , by Robert Adler.....		<b>82</b>			
Two-control-grid tube employs electron optics to obtain extremely useful f-m characteristics					
<b>IMPROVED TELEVISION MODULATOR</b> , by John Haughwout.....		<b>86</b>			
Provides accurately aligned pedestals with constant-output black level					
<b>TIME-BRIDGE PHOTOMETER</b> , by R. E. Corby and Stewart Becker.....		<b>89</b>			
Eliminates inaccuracies usually introduced by d-c amplification of phototube output					
<b>VOICE-OPERATED SWITCHING OF CARRIER SYSTEMS</b> , by R. C. Fox, F. S. Beale, G. W. Symonds.....		<b>92</b>			
All-electronic transfer unit permits two-way conversation over single-frequency power-line or radio carrier systems					
<b>DIFFERENTIAL AMPLIFIER NULL DETECTOR</b> , by Matthew Conrad.....		<b>96</b>			
Uses a transformerless circuit to couple the null-detecting device to an a-c bridge					
<b>VARIABLE HIGH-VOLTAGE POWER SOURCE</b> , by Walter S. Ramsey.....		<b>98</b>			
Two separate r-f supplies furnish 0 to 40 kv at 2 ma					
<b>STABILIZED CIRCUIT FOR PHOTOMULTIPLIERS</b> , by W. S. Plymale, Jr. and D. F. Hansen.....		<b>102</b>			
Line fluctuations are minimized and key manual controls provided					
<b>A D-C AMPLIFIER WITH CROSS-COUPLED INPUT</b> , by J. N. Van Scoyoc and G. F. Warnke.....		<b>104</b>			
Takes either single-ended or push-pull input without circuit changes					
<b>MEASURING COLOR OF CATHODE-RAY SCREENS</b> , by A. E. Martin and S. N. Roberto.....		<b>108</b>			
Recording spectroradiometer traces spectral energy distribution curve of phosphor on paper in 48 seconds					
<b>OPTIMUM COAX DIAMETERS</b> , by Phillip H. Smith.....		<b>111</b>			
Equations and charts give optimum diameter ratios for ten properties of coaxial transmission lines					
<b>BUSINESS BRIEFS</b> .....	<b>60</b>	<b>ELECTRON ART</b> .....	<b>120</b>	<b>NEW BOOKS</b>	
<b>CROSSTALK</b> .....	<b>65</b>	<b>NEW PRODUCTS</b> .....	<b>124</b>	<b>BACKTALK</b>	
<b>TUBES AT WORK</b> .....	<b>116</b>	<b>NEWS OF THE INDUSTRY</b> .....	<b>128</b>	<b>INDEX TO ADVERTISERS</b>	

**DONALD G. FINK**, Editor; **W. W. MacDONALD**, Managing Editor; John Markus, Vin Zeluff, A. A. McKenzie, Associate Editors; William P. O'Brien, James D. Fahnstock, Assistant Editors; Ann Mastropolo, Marilyn Wood, Editorial Assistants; Gladys T. Montgomery, Washington Editor; Harry Phillips, Art Director; Eleanor Luke, Art Assistant

**KEITH HENNEY**, Consulting Editor

**H. W. MATEER**, Publisher; **WALLACE B. BLOOD**, Manager; R. S. Quint, Directory Manager; D. H. Miller, James Girdwood, New York; Wm. S. Hodgkinson, New England; Warren W. Shew, Philadelphia; C. D. Wardner, Chicago; J. L. Phillips, Cleveland; J. W. Otterson, San Francisco; Carl W. Dysinger, Los Angeles; Ralph C. Maultsby, Atlanta; Bernard H. Butler, London, England

Contents Copyright 1950, by McGraw-Hill Publishing Company, Inc. All rights Reserved. McGRAW-HILL PUBLISHING COMPANY, INCORPORATED, JAMES H. McGRAW (1860-1948), founder • PUBLICATION OFFICE, 99-129 North Broadway, Albany 1, N. Y., U. S. A. EDITORIAL AND EXECUTIVE OFFICES, 330 West 42nd St., New York 18, N. Y., U. S. A.—Member A. B. P., Member A. B. C.

James H. McGraw, Jr., President; Curtis W. McGraw, Vice-President and Treasurer; Eugene Duffield, Senior Vice-President, Publications Division; Nelson Bond, Vice-President and Director of Advertising; J. E. Blackburn, Jr., Vice-President and Director of Circulation; James A. Gerardi, Secretary; Dexter Keezer, Director Economics Department; Russell F. Anderson, Editor, World News.  
**ELECTRONICS**: February, 1950, Vol. 23; No. 2. Published monthly, with an additional issue in June, price 75¢ a copy for U. S. and possessions, and Canada; \$1.50 for Latin America; \$2.00 for all other foreign countries. Directory issue \$2.00. Allow at least ten days for change of address. All communications about subscriptions should be addressed to the Director of Circulation. Subscription rates—United States and possessions, \$6.00 a year, \$9.00 for two years, \$12.00 for three years, Canada (Canadian funds accepted), \$10.00 a year, \$16.00 for two years, \$20.00 for three years; Latin American countries \$15.00 for one year, \$25.00 for two years, \$30.00 for three years. All other countries \$20.00 for one year, \$30.00 for two years, \$40.00 for three years. Please indicate position and company connections on all subscription orders. Entered as Second Class matter August 29, 1936, at Post Office, Albany, New York, under the act of March 3, 1879. **BRANCH OFFICES**: 520 North Michigan Avenue, Chicago 11, Ill.; 68 Post Street, San Francisco 4; Aldwych House, Aldwych, London, W.C. 2; Washington, D. C. 4; Philadelphia 3; Cleveland 15; Detroit 26; St. Louis 8; Boston 16; Atlanta 3, Ga.; 621 So. Hope St., Los Angeles 14; 738-9 Oliver Building, Pittsburgh 22. **ELECTRONICS** is indexed regularly in The Engineering Index.

# Exceeding Expectations!

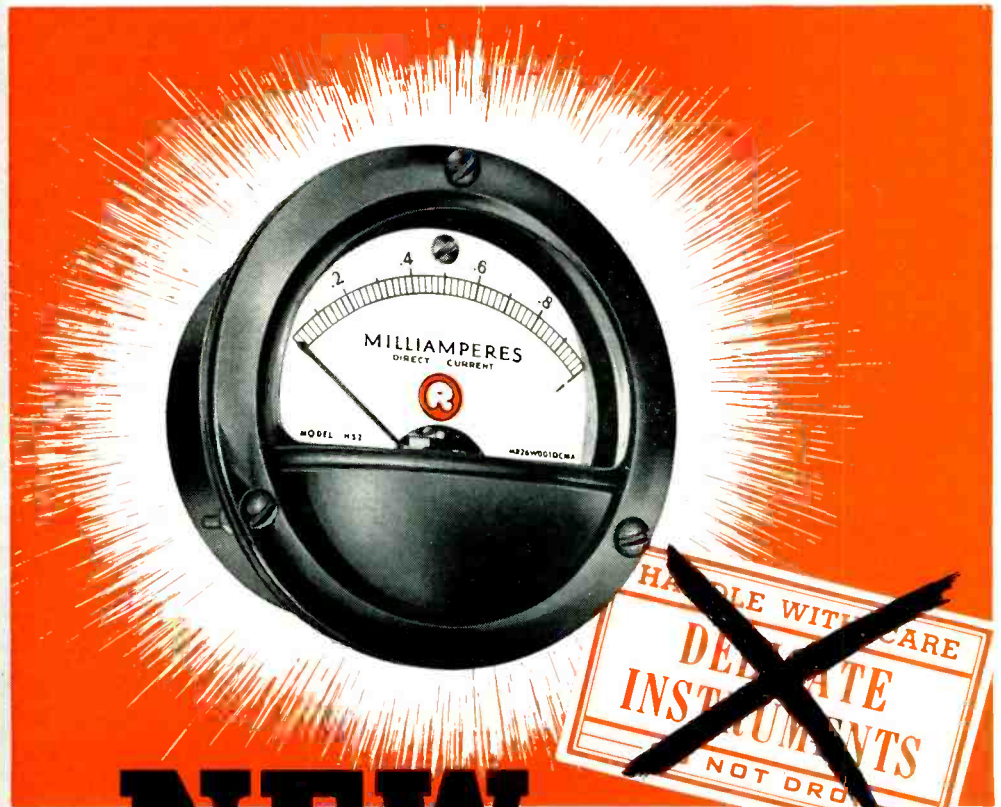
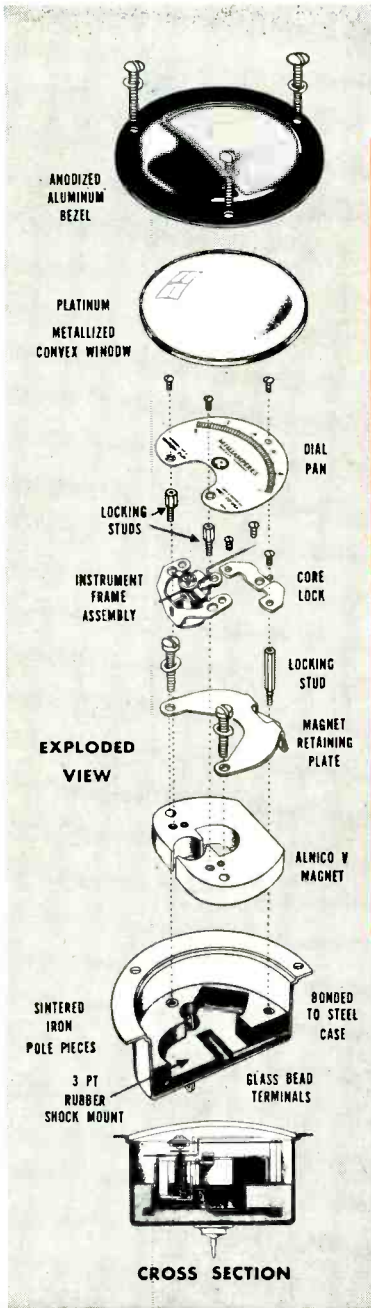

## NEW marion ruggedized meter

Marion Ruggedized Meters introduce a brand new family of panel instruments produced to give outstanding performance under *extreme* conditions of Shock . . . Vibration . . . Mechanical Stress or Strain. Hermetically sealed, they are impervious to the weather conditions of *any* climate.

Marion Ruggedized Instruments give you new freedom of application. They are extremely accurate, highly sensitive meters that may be used in places where no one has ever before *dared* use "delicate instruments." Count on them to exceed your greatest expectations in *any* application.

Send for your free copy of our booklet on the new Marion Ruggedized Meters today. See how Ruggedized Meters meet the dimensional requirements of JAN-I-6 and are interchangeable with existing standard JAN 2½" and 3½" types. Learn why their electrical and mechanical performance far *exceeds* existing JAN requirements. Discover for yourself some of the developments that made the ruggedized meter possible.



Manufacturers of  
Hermetically Sealed  
Meters Since 1944

MADE BY THE MAKER WHOSE NAME MEANS THE MOST IN METERS



MARION ELECTRICAL INSTRUMENT COMPANY  
MANCHESTER, NEW HAMPSHIRE  
Export Division, 458 Broadway, New York 13, U.S.A., Cables MORHANEX  
In Canada: The Astral Electric Company, Scarborough Bluffs, Ontario

# IT'S AS EASY AS THIS —



**TO  
BUY MUIRHEAD**

**O**UR plant may be 3,000, 4,000 or even 5,000 miles away, but you can reach us in 24 hours, and usually we can ship immediately. You'll need our catalog of course, and our quarterly journal "Technique" tells you about new developments and applications, so you'd better have that.

**MAIL  
THIS COUPON  
NOW**

TO MUIRHEAD & Co. LTD. • BECKENHAM • KENT • ENGLAND

*Please send me your catalog and  
quarterly journal "TECHNIQUE"*

NAME .....

POSITION .....

COMPANY .....

ADDRESS .....

**ORDER BY CABLE — PAY BY YOUR OWN DOLLAR CHECK**

**MUIRHEAD & Co. LTD.**  
PRECISION ELECTRICAL INSTRUMENT MAKERS  
BECKENHAM • KENT • ENGLAND

Telegrams and Cables: MUIRHEADS ELMERS-END

PRECISION  
**MUIRHEAD**  
ELECTRICAL INSTRUMENTS

M.U.13

# Specialization is



*for resistors too!*

Specialization—and *only* specialization—can keep manufacturers abreast of today's resistance needs.

The constantly-growing multitude of resistor applications demands full-time concentration on resistance products. *IRC has concentrated*—for 25 years! Result:—The widest line of resistance products in the industry; parts designed to suit specific circuit requirements in virtually every type of application; unbiased recommendations.



**LOW-WATTAGE WIRE WOUND REQUIREMENTS** are met efficiently by IRC Type BW Wire Wound Resistors. Exceptional low-range stability and economy suit these small, completely insulated resistors to use in meters, analyzers, cathode bias resistors, television circuits, low-range bridge circuits, high stability attenuators, low-power ignition circuits. Check coupon for Bulletin B-5.

# important

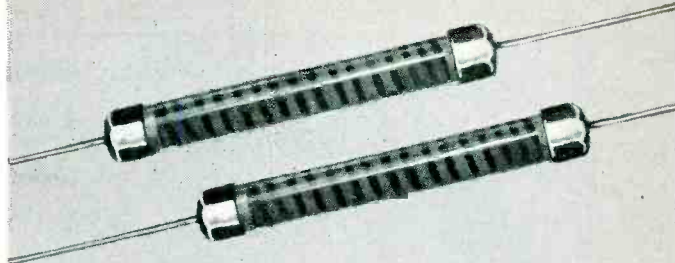

**IN HIGH VOLTAGE APPLICATIONS** where high resistance and power are required, Type MVX high ohmic, high voltage resistors afford exceptional stability. Construction is similar to that of Type MV, but distinctive terminal permits mounting through a hole in mounting block of insulating material without terminal interference.

Long resistance path permits use of high voltage on resistor while keeping voltage per unit length of path comparatively low. Check coupon for Catalog G-2.



**IN CRITICAL HIGH-FREQUENCY CIRCUITS**, Type MP High Frequency Resistors offer dependable performance and unusual stability. Special resistance film on a steatite ceramic form provides a stable resistor with low inherent inductance and capacity—entirely suitable for broad band RF amplifiers, RF probes, dummy loads for transmitters, television side-band filters, radar pulse equipment, and other circuits involving steep wave fronts. Send coupon for Bulletin F-1.



**NEW TYPE Q CONTROL** offers many advantages to engineers and purchasing agents. Its modern  $\frac{3}{16}$ " diameter size features a one-piece dual contactor of thiri, high-stress alloy; simplified single-unit collector ring; molded voltage baffles; and special brass element terminals that will not loosen or become noisy when bent or soldered. Increased arc of rotation provides same resistance ratio as larger IRC controls. Salt-spray materials are employed. Complete mechanization in manufacture assures absolute uniformity and provides a dependable source of supply for small control requirements. Coupon brings you full details in Catalog A-4.

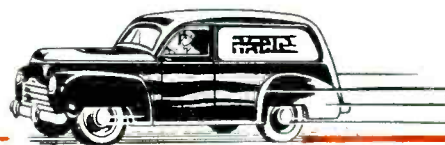

When you have special need of maintenance or experimental quantities of standard resistors in a hurry, simply phone your local IRC Distributor. IRC's Industrial Service Plan keeps him fully stocked with the most popular types and ranges—enables him to give you 'round-the-corner delivery of small order requirements. We'll gladly send you his name and address.



*Wherever the Circuit Says*

- Power Resistors • Voltmeter Multipliers
- Insulated Composition Resistors • Low Wattage Wire Wounds • Controls
- Rheostats • Voltage Dividers • Precisions • Deposited Carbon
- Precisors • HF and High Voltage Resistors • Insulated Chokes.

**INTERNATIONAL RESISTANCE COMPANY**

401 N. Broad Street, Philadelphia 8, Pa.

In Canada: International Resistance Co., Ltd., Toronto, Licensee

INTERNATIONAL RESISTANCE CO.  
403 N. BROAD ST., PHILADELPHIA 8, PA.

Please send me complete information on the items checked below:

- New "Q" Controls
- MP High Frequency Resistors
- BW Insulated Wire Wounds
- MVX High Voltage Resistors
- Name of Local IRC Distributor

NAME .....

TITLE .....

COMPANY .....

ADDRESS .....

J. F. ARNOT & CO., ADV. AGENCY

# NOW

# STABILIZED and REGULATED

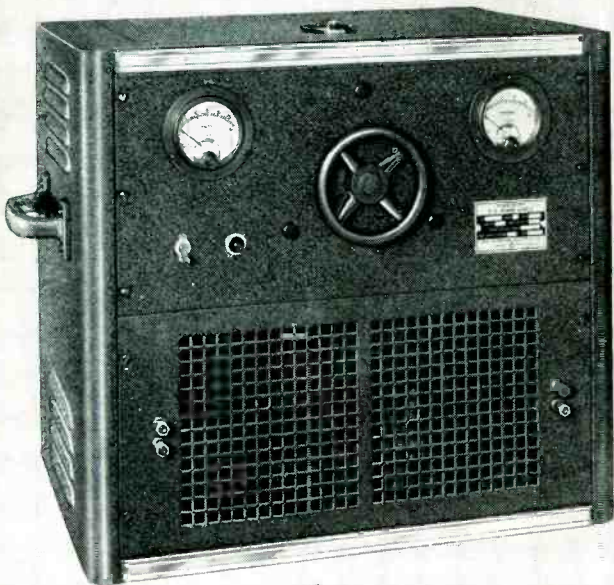

VARIABLE **DC** VOLTAGE  
FROM 0-30 VOLTS

FROM AN **AC** SOURCE

ALL IN **ONE** UNIT

Again The Superior Electric Company offers a new regulator — this time for the control of D-C voltage. The new unit is pictured above; is called the VARICELL. It meets today's demand for a stabilized and regulated source of variable D-C voltage. This unit operates from a 95-135 volt, 60 cycle, single phase ALTERNATING CURRENT line. Its output is settable to any value from 0-30 volts DIRECT CURRENT. The allowable output current at any voltage setting is 15 amperes.

The D-C output is stabilized — *the unit holds the output to the set value regardless of line variations.* And the D-C output is regulated — *unit automatically compensates for load fluctuations.* Stabilization and regulation is 0.25 per cent for an output setting between 6 and 30 volts. The r.m.s. ripple voltage does not exceed  $\pm 0.1$  volts.

Only the VARICELL offers stabilized and regulated variable D-C voltage from A-C lines. One unit — built to give long, trouble-free service — gives you the flexibility of several. It is unnecessary to purchase one unit for 6 volts output — one for 12 volts output — one for 28 volts output. The VARICELL gives you any desired D-C output voltage ranging from 0-30 volts. There are no extras to buy — no accessories or special parts are needed to achieve these advertised characteristics.

WRITE TODAY FOR  
COMPLETE INFORMATION  
402 MEADOW STREET

**THE SUPERIOR ELECTRIC CO.**  
BRISTOL, CONNECTICUT



POWERSTAT VARIABLE TRANSFORMERS • VOLTBOX A-C POWER SUPPLIES • STABLINE VOLTAGE REGULATORS



# Erie Disc and Plate Ceramicon<sup>®</sup>

## for By-passing and Coupling Applications

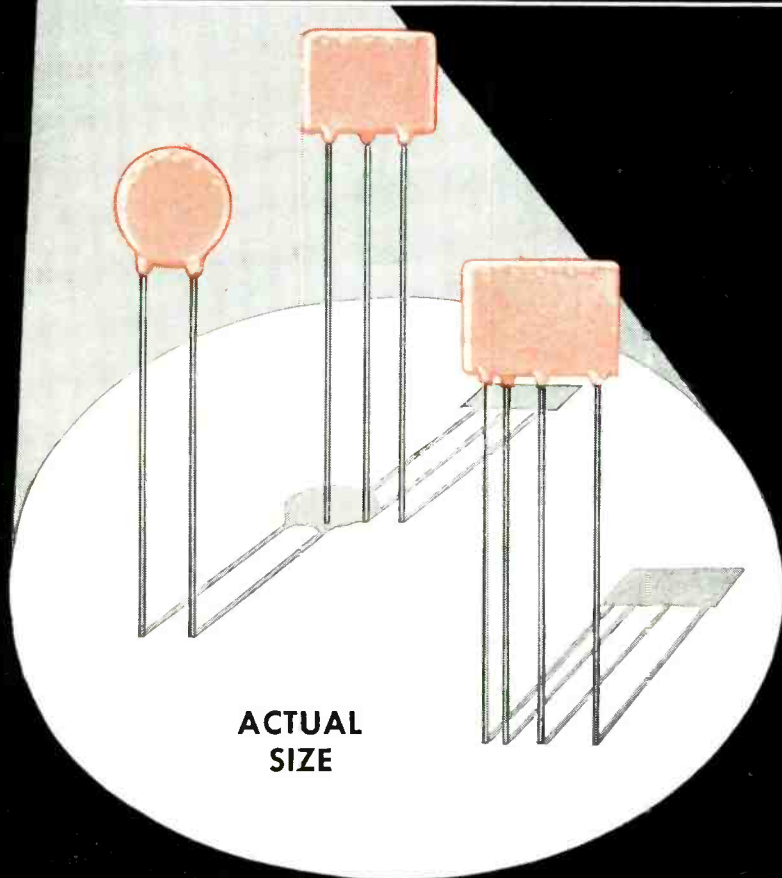

ACTUAL  
SIZE

### STANDARD AVAILABLE CAPACITIES

ERIE TYPE	SIZE	CAPACITY RANGES	COLOR CODE OR MARKING
811	1 <sup>9</sup> / <sub>32</sub> " Max. Dia.	.001 MFD	Silver, Brown, Black, Red, Blue
		.0015	Silver, Brown, Green, Red, Blue
		.002	Silver, Red, Black, Red, Blue
		.005	Gold, Green, Black, Red, Blue
		.01	Gold, Brown, Black, Orange, Blue
882	9 <sup>1</sup> / <sub>16</sub> " x 3 <sup>1</sup> / <sub>4</sub> " Max.	Dual .001	Stamp 2—1,000
		Dual .0015	Stamp 2—1,500
		Dual .002	Stamp 2—2,000
		Dual .003	Stamp 2—3,000
		Dual .004	Stamp 2—4,000
883	9 <sup>1</sup> / <sub>16</sub> " x 3 <sup>1</sup> / <sub>4</sub> " Max.	Triple .0015	Stamp 3—1,500

High capacity in extremely compact size is the distinguishing feature of Erie Disc and Plate Ceramicon. For example, .01 mfd is now available in 19/32" diameter. Illustrations are exact size, and their shape as well as their compactness make them amazingly easy to install in small spaces. They simplify soldering and wiring operations and speed up the assembly line.

Erie Disc and Plate Ceramicon consist of a flat ceramic dielectric with silver plates fired onto the dielectric. Lead wires of 24 gauge tinned copper wire are firmly soldered to the silver electrodes and the unit is given a protective coating of phenolic.

Such simplicity of construction results in low series inductance and unusual efficiency in high frequency by-passing.

For complete information and samples to meet your particular needs, write us today.

### SPECIFICATIONS

**Voltage:** Units are rated at 500 VDC, except Type 811 .01 mfd which is rated at 400 VDC based on life test of 1,000 hours at 800 VDC and at 85° C. Dielectric strength Test; 1,500 VDC.

**Power Factor:** 2.5% at 1 K.C. at not more than 5 volts RMS.

**Insulation Resistance:** 7,500 meg.Ω min.

**Capacity:** Capacity measurements are made at room temperature (25° C) at 1KC and at not more than 5 Volts RMS.

### Temperature Characteristics:

The capacity of all units with the exception of Type 811—1,500 MMF shall not decrease more than 50%, nor increase more than 25% from its value at room temperature (25° C), as the temperature is varied from +10° C to +75° C.

Type 811—1,500 MMF units shall not decrease more than 20%, nor increase more than 10% from capacitance value at room temperature (25° C), as the temperature is varied from -40° C to +85° C.

*Electronics Division*

**ERIE RESISTOR CORP., ERIE, PA.**

LONDON, ENGLAND • • TORONTO, CANADA



# NEW GENERAL PURPOSE PULSE GENERATOR

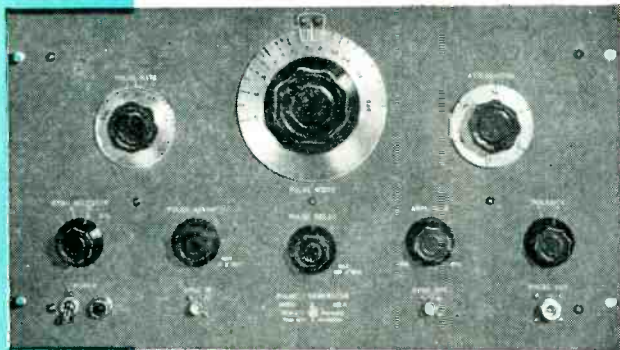

-hp- MODEL 212A

TYPICAL 1 MICRORSECOND PULSE INTO 50-OHM LOAD

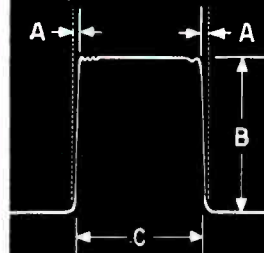

- A.** 0.02  $\mu$ sec rise and decay time. Minimum overshoot.
- B.** 50 watt peak power. (50 v. to 50  $\Omega$  load.)
- C.** Pulse length variable 0.07 to 10  $\mu$ sec.

## SPECIFICATIONS

### PULSE LENGTH:

Continuously variable, 0.07 to 10  $\mu$ sec.  
Direct reading panel control.

### PULSE AMPLITUDE:

50 v. into 50  $\Omega$  load. Pos. & neg. pulses.  
100 v. open circuit.

### AMPLITUDE CONTROL:

Continuous control throughout range. 50 db in 10 db steps. 10 db fine adjustment.  
ment.

### INTERNAL IMPEDANCE:

50  $\Omega$  or less.

### PULSE SHAPE:

Rise and decay time approx. 0.02  $\mu$ sec.  
(10% to 90% amplitude.)

### REPETITION RATE:

50 pps to 5,000 pps. Internally or externally controlled.

### SYNC IN:

May be triggered by pos. or neg. pulse of 5 v. at rates up to 5,000 pps.

### SYNC OUT:

50 v. into 200  $\Omega$  load. Approx. 2  $\mu$ sec long. Approx. 0.25  $\mu$ sec rise time.

### PULSE DELAY:

Main pulse delayable 0 to 100  $\mu$ sec from sync output pulse.

### PULSE ADVANCE:

Main pulse can be advanced 0 to 10  $\mu$ sec from sync output pulse.

### POWER SUPPLY:

110/220 v; 50/60 cps.

### SIZE:

Panel 10½" high, 19" wide. Depth 12".

### PRICE:

\$550.00 f.o.b. Palo Alto.

Data Subject to Change Without Notice

## CONTINUOUSLY VARIABLE, HIGH POWER PULSES OF SUPERIOR WAVE FORM!

THIS NEW -hp- 212A PULSE GENERATOR saves you time and work testing "fast" circuits as well as making everyday laboratory checks of other generators, rf circuits, peak-measuring equipment, etc. It is the first commercial pulse generator to successfully combine broad laboratory usefulness with the fast rise time, high power, variable pulsing and other features demanded in radar, television and nuclear work.

### ACCURATE PULSES AT END OF LONG TRANSMISSION LINE

The pulse length is continuously variable from 0.07  $\mu$ sec to 10  $\mu$ sec, and is varied by a direct reading panel control. Extremely fast rise and decay time, together with freedom from ringing or overshoot

provide a virtually distortion-free pulse. A low internal impedance (50 ohms or less) insures a pulse shape virtually independent of load. This low impedance also makes it possible to deliver accurate pulses at a distance from the instrument, if the transmission lines are correctly terminated.

The Model 212A's repetition rate is continuously variable from 50 to 5,000 pps. It can be controlled internally, or from an external synchronizing source. Synchronizing pulses are available from the instrument either in advance of or following the output pulse. An amplifier-attenuator output system gives a low source impedance, and makes possible continuously variable pulse amplitude, positive or negative.

*Brief specifications of this new -hp- instrument are shown in the adjoining column. For complete details... see your local -hp- representative... or write to the factory.*

## HEWLETT-PACKARD COMPANY

2040A Page Mill Road • Palo Alto, California

Export: FRAZAR & HANSEN, Ltd., 301 Clay St., San Francisco, Calif., U. S. A. Offices: New York, N. Y. and Los Angeles, Calif.

2040

 **laboratory instruments**  
FOR SPEED AND ACCURACY

# ADVENTURES IN ELECTRONIC DESIGN

## Centralab's Great New Model 2 Radiohm\*

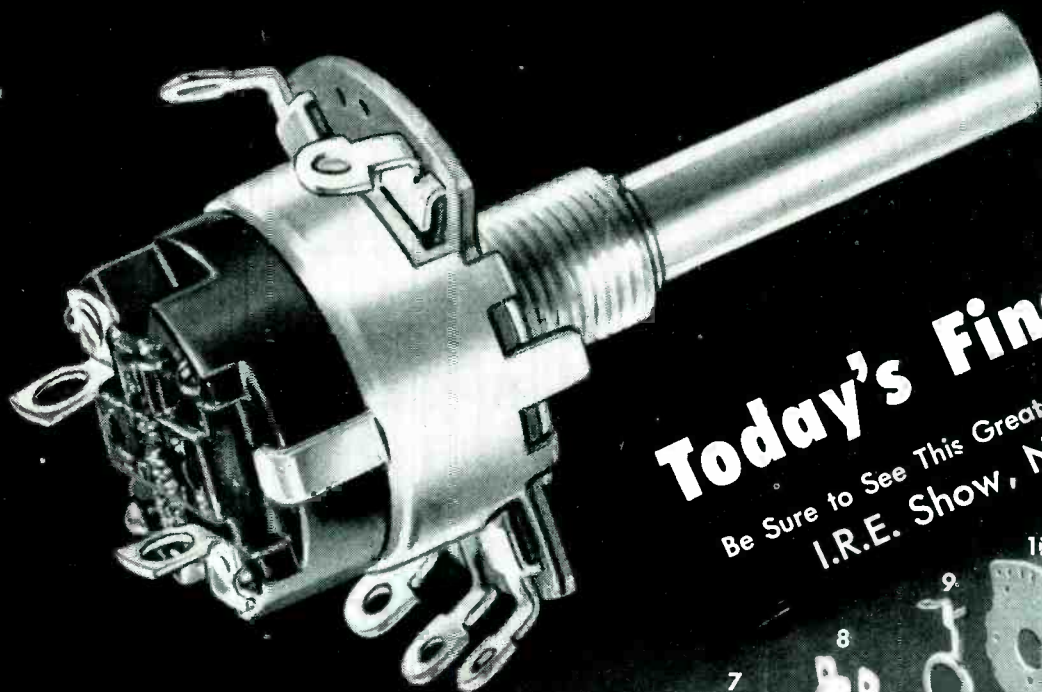

**Today's Finest Control!**  
 Be Sure to See This Great Control at Our Booth No. 232-33  
 I.R.E. Show, New York, New York, March 6-9

### 14 Good Reasons Why CRL'S Model 2 Radiohm is the Control for You!

1. *Switch* — with positive detent in both on and off positions. *Terminals* — with surfaces elevated to eliminate danger of shorting to cover legs . . .  $\frac{1}{16}$ " hole diameter for simplified wiring . . . hot tin dipped for easy soldering . . . mechanical lock to prevent loosening in soldering operations.
2. Cadmium plated steel *cover* completely shields resistor.
3. *Insulator's* high dielectric strength permits breakdown test at 1000 volts R. M. S. Dust and dirt can't get in.
4. *Stop*, of cup design provides superior switch shielding . . . gives you excellent torque strength without distortion.
5. High grade laminated phenolic *shoe* maintains high insulation resistance under humidity conditions.
5. *Contact Spring* gives you double wiping contacts on both resistor and center terminal ring . . . is accurately formed to maintain uniform pressures and minimize noise.
7. Electro tin-plated *terminals* provide soldering ease. Tightly crimped terminals give you direct contact to re-

- sistor . . . assure constant contact under humidity and soldering conditions.
8. *Resistor* is made of special resistance material bonded to high quality phenolic for smooth operation, low noise level, outstanding humidity characteristics.
9. Cadmium-tipped *center terminal* provides easy soldering . . . good shelf life without oxidation. Adequately lubricated for good rotation life, center terminal is finished to give you smooth take-off . . . minimum noise.
10. Laminated phenolic *base* maintains high insulation resistance under humidity conditions.
11. Cadmium-plated steel *ground plate* assures positive grounded cover.
12. Cadmium-plated steel *bushing* is accurately finished and fit to shaft for smooth rotation.
13. *Retaining ring*.
14. *Shaft*. Unlimited variations available to meet your specifications.

\*Switch Type, Tapped. Exploded View: Switch Type, Untapped.

# Centralab — DEVELOPMENTS THAT CAN HELP YOU

Division of GLOBE-UNION INC. • Milwaukee

# Centralab reports to

**FEBRUARY, 1950**

Small Size  
makes  
Model 2 Radiohm  
the Right Control  
for many  
different uses!

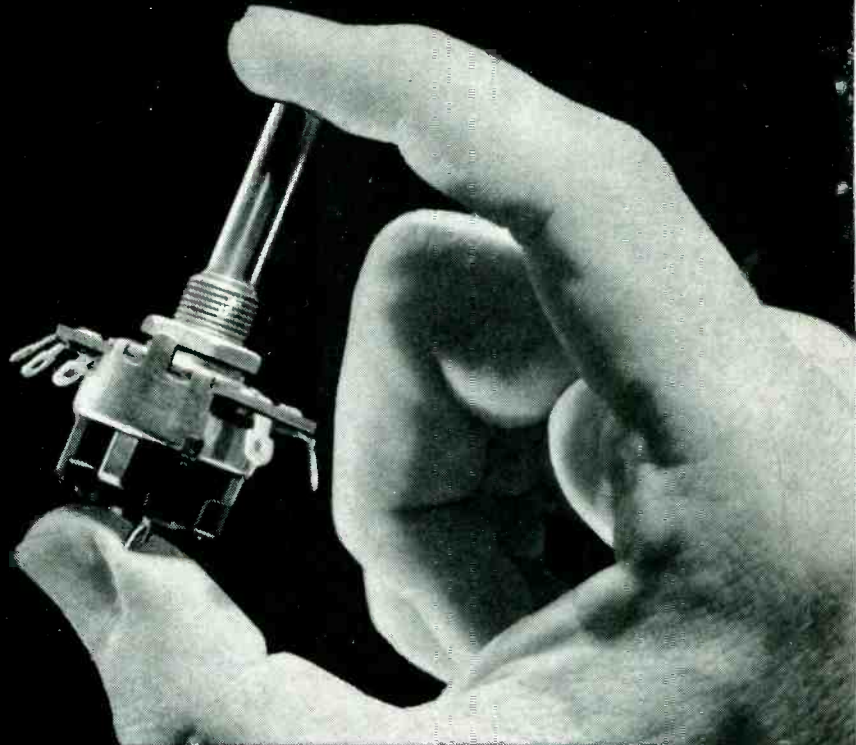

**I.R.E.  
SHOW**  
Grand Central Palace  
New York City  
March 6-9  
Centralab Booth  
No. 232-33

**I**MAGINE the large variety of uses for peak-quality controls that are only  $15/16$ " in diameter, yet rated at  $1/2$  watt. That's Centralab's great new line of Model 2 Radiohms. Designed for television and radio sets, sound and test equipment, the versatile Model 2 is just what you need for many other electronic uses where a combination of small size and finest performance is essential. CRL Model 2 Controls are precision built of the finest materials to give you lower noise level . . . longer life. Their clinched terminals insure rigid contact to the resistance element under humidity and soldering conditions. What's more, Model 2's complete line of 3 basic switches — 5, 8, and 1 amp. — provide 24 switch combinations for real flexibility in application and design. For all the facts, see your CRL representative or write direct.

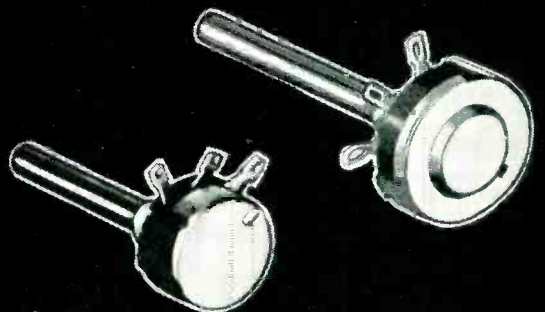
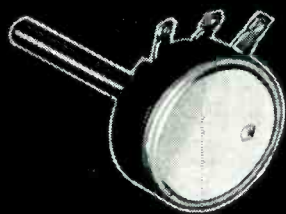
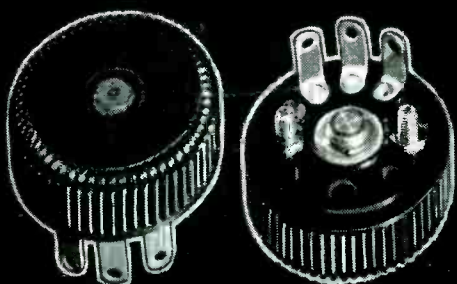

**1** Model "1" *Radiohm* control, rated  $1/10$  watt — plain and switch types. No larger than a dime. Designed for miniature uses.

**2** Let Centralab's complete *Radiohm* line take care of your special needs. Wide range of variations: Model "R" — wire wound, 3 watts; or composition type, 1 watt. Model "E" — composition type,  $1/4$  watt. Direct contact, 6 resistance tapers. Model "M" — composition type,  $1/2$  watt.

# Electronic Industry

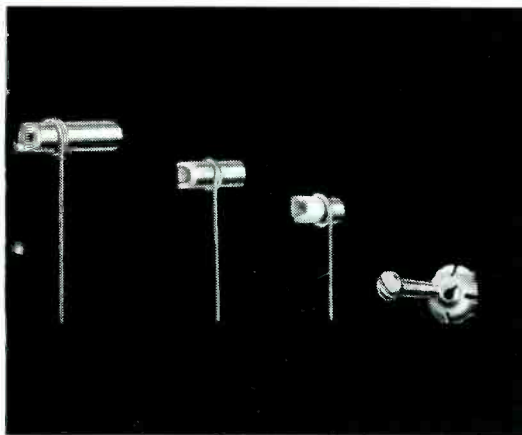

**3** CRL's new Tubular *Trimmers* come in 3 basic types, 3 capacity ranges. Tinnerman locknut and adjusting screw available on special request.

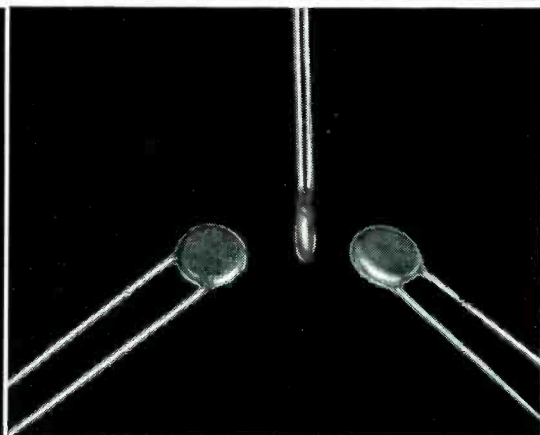

**4** For by-pass or coupling applications, check Centralab's original line of ceramic disc *Hi-Kaps*. Disc *Hi-Kaps* are smaller than a dime!

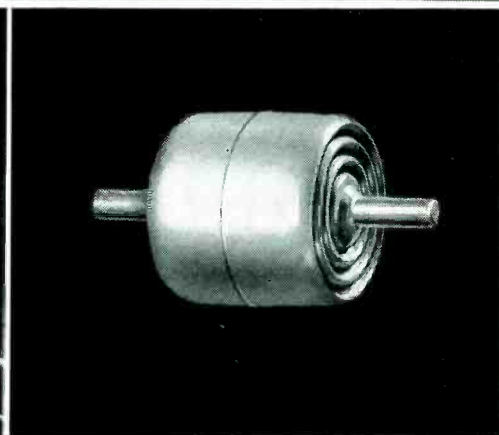

**5** *Hi-Vo-Kaps* are filter and by-pass capacitors combining high voltage, small size and variety of terminal connections to fit most TV needs.

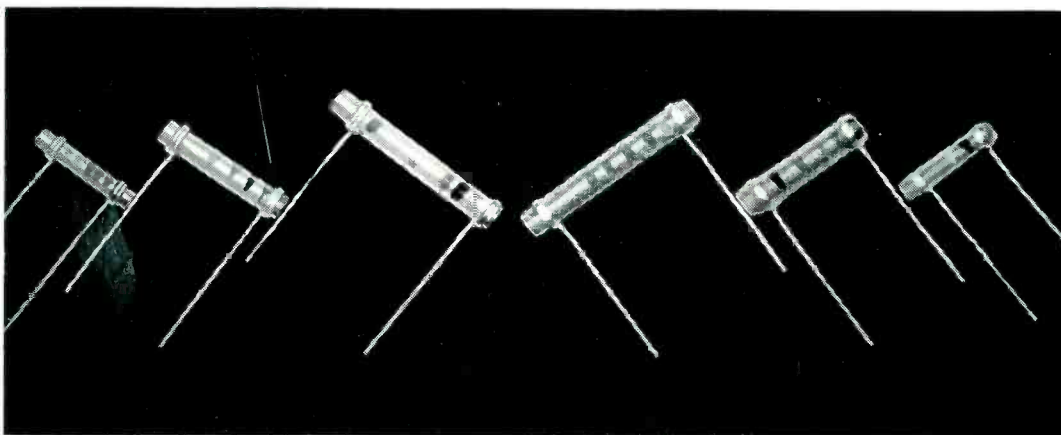

**6** Centralab's TC (Temperature Compensating) Tubular *Hi-Kaps*, left, are the most stable capacitors available. With TC *Hi-Kaps*, there's practically no variation due to aging or changes in temperature or humidity. For applications where temperature compensation is unimportant, use Tubular BC *Hi-Kaps*, right.

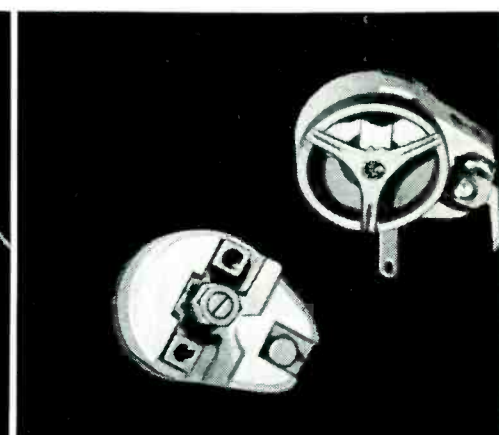

**7** *Ceramic Trimmers* are made in five basic types. Full capacity change within 180° rotation. Spring pressure maintains constant rotor balance.

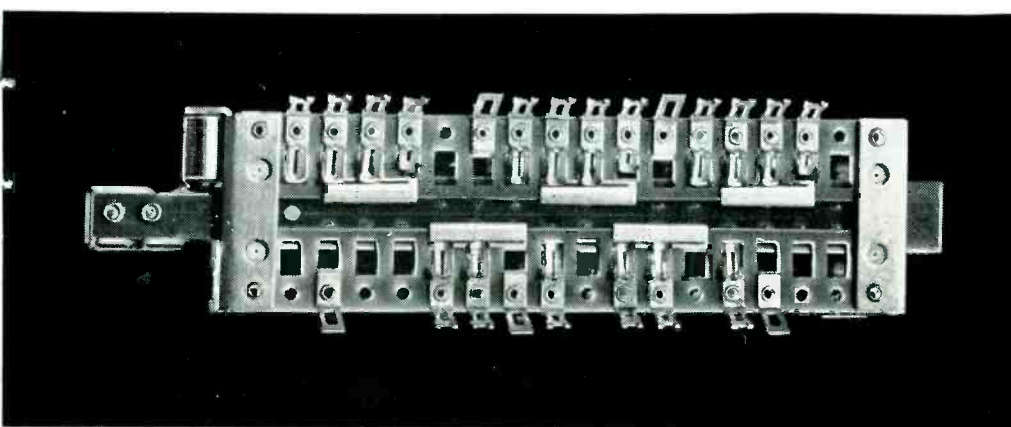

**8** Centralab's development of a revolutionary, new *Slide Switch* gives you improved AM and FM performance! Flat, horizontal design saves valuable space, allows short leads, convenient location to coils, reduced lead inductances for increased efficiency in low and high frequencies. CRL *Slide Switches* are rugged and dependable.

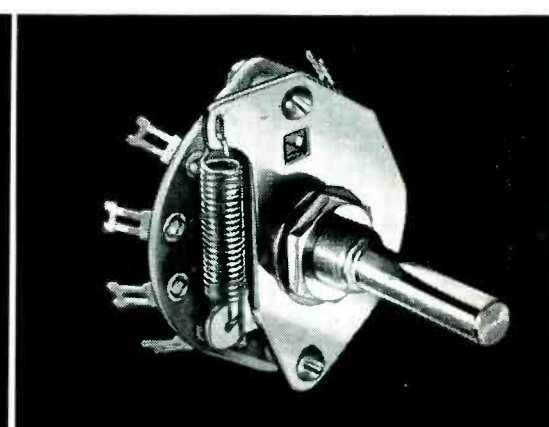

**9** Great step forward in switching is CRL's New *Rotary Coil and Cam Index Switch*. Its coil spring gives you smoother action, longer life.

# IMPORTANT BULLETINS FOR YOUR TECHNICAL LIBRARY!

*They're factual!*



**THEY'RE FREE!**

## Choose From This List!

### Centralab Printed Electronic Circuits

- 973 — AMPEC — three-tube P. E. C. amplifier.
- 42-6 — COUPLATE — P. E. C. interstage coupling plate.
- 42-22 — VERTICAL INTEGRATOR — for TV application.
- 42-24 — CERAMIC PLATE COMPONENTS — for use in low-power miniature electronic equipment.
- 42-27 — MODEL 2 COUPLATE — for small or portable set applications.
- 999 — PENTODE COUPLATE — specialized P. E. C. coupling plate.
- 42-9 — FILPEC — Printed Electronic Circuit filter.

### Centralab Capacitors

- 42-3 — BC TUBULAR HI-KAPS — capacitors for use where temperature compensation is unimportant.
- 42-4 — BC DISC HI-KAPS — miniature ceramic BC capacitors.
- 42-10 — HI-VO-KAPS — high voltage capacitors for TV application.
- 695 — CERAMIC TRIMMERS — CRL trimmer catalog.
- 981 — HI-VO-KAPS — capacitors for TV application. For jobbers.

- 42-18 — TC CAPACITORS — temperature compensating capacitors.
- 814 — CAPACITORS — high-voltage capacitors.
- 975 — FT HI-KAPS — feed-thru capacitors.

### Centralab Switches

- 953 — SLIDE SWITCH — applies to AM and FM switching circuits.
- 970 — LEVER SWITCH — shows indexing combinations.
- 995 — ROTARY SWITCH — schematic application diagrams.
- 722 — SWITCH CATALOG — facts on CRL's complete line of switches.

### Centralab Controls

- 42-7 — MODEL "1" RADIOHM — world's smallest commercially produced control.

### Centralab Ceramics

- 967 — CERAMIC CAPACITOR DIELECTRIC MATERIALS.
- 720 — CERAMIC CATALOG — CRL steatite, ceramic products.

### General

- 26 — GENERAL CATALOG — Combines Centralab's line of products for jobber, ham, experimenter, serviceman or industrial user.

**Look to CENTRALAB in 1950!** First in component research that means lower costs for the electronic industry. If you're planning new equipment, let Centralab's sales and engineering service work with you. For complete information on all CRL products, get in touch with your Centralab Representative. Or write direct.

CENTRALAB  
Division of Globe-Union Inc.  
900 East Keefe Avenue, Milwaukee, Wisconsin

203-6

Yes—I would like to have the CRL bulletins, checked below, for my technical library!

- |                                |                                |                               |                                |                                |                              |                               |
|--------------------------------|--------------------------------|-------------------------------|--------------------------------|--------------------------------|------------------------------|-------------------------------|
| <input type="checkbox"/> 973   | <input type="checkbox"/> 42-24 | <input type="checkbox"/> 42-9 | <input type="checkbox"/> 42-10 | <input type="checkbox"/> 42-18 | <input type="checkbox"/> 953 | <input type="checkbox"/> 42-7 |
| <input type="checkbox"/> 42-6  | <input type="checkbox"/> 42-27 | <input type="checkbox"/> 42-3 | <input type="checkbox"/> 695   | <input type="checkbox"/> 814   | <input type="checkbox"/> 970 | <input type="checkbox"/> 967  |
| <input type="checkbox"/> 42-22 | <input type="checkbox"/> 999   | <input type="checkbox"/> 42-4 | <input type="checkbox"/> 981   | <input type="checkbox"/> 975   | <input type="checkbox"/> 995 | <input type="checkbox"/> 720  |
|                                |                                |                               |                                |                                | <input type="checkbox"/> 722 | <input type="checkbox"/> 26   |

Name.....

Address.....

City..... State.....

**TEAR OUT COUPON**

for the Bulletins you want

**Centralab**  
  
 Division of GLOBE-UNION INC. • Milwaukee

# "Heaven on Earth"

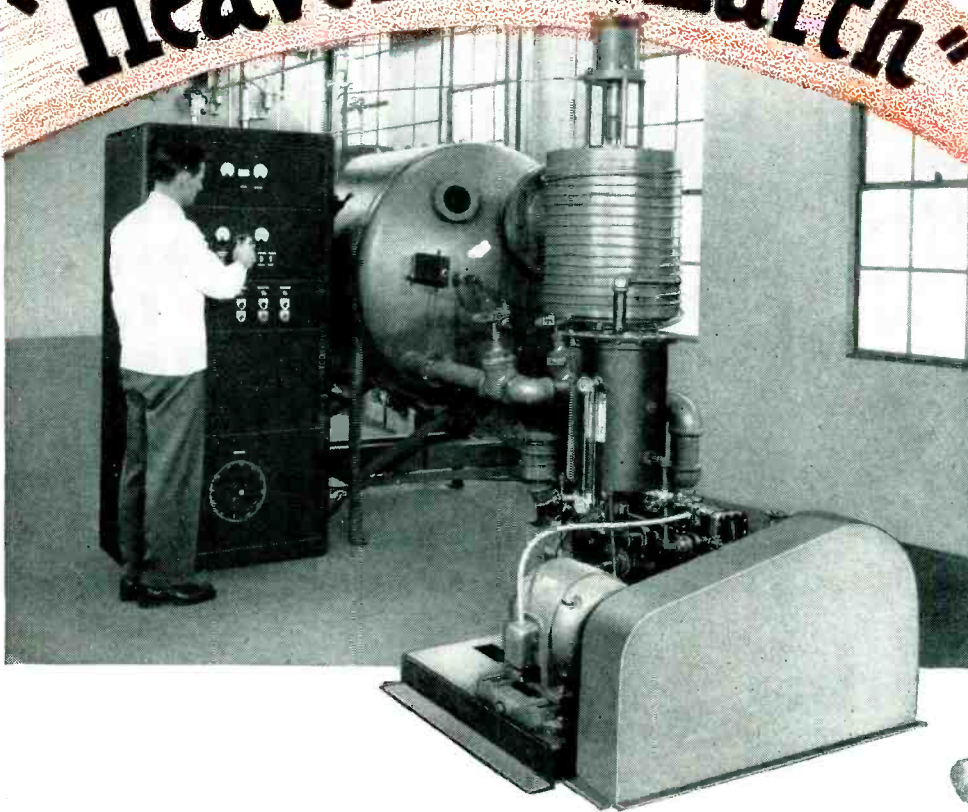

Using this test chamber with its Kinney High Vacuum Pump, engineers are now able to create controlled high-altitude conditions right in the laboratory. This artificial "Heaven on Earth", designed and built by Distillation Products, Inc., is a great boon to the aircraft industry. It permits precise observation of what happens to equipment under the extremely low absolute pressures encountered miles above the earth.

On the production line, too, Kinney Pumps are essential to many modern products and processes. Vacuum production of light bulbs and electronic tubes, vacuum coating of mirrors, vacuum dehydration of foods and pharmaceuticals — these and many other operations rely on the dependable low absolute pressures created by Kinney Pumps. For detailed information, write for Bulletin V-45.

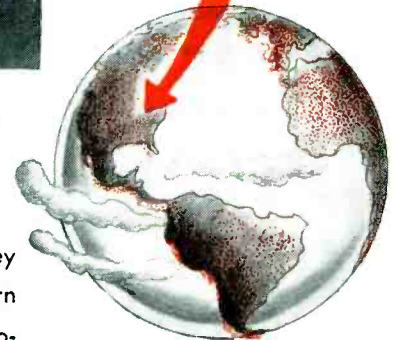

## KINNEY MANUFACTURING COMPANY

3565 WASHINGTON STREET, BOSTON 30, MASS.

NEW YORK • CHICAGO • CLEVELAND • HOUSTON • NEW ORLEANS  
PHILADELPHIA • LOS ANGELES • SAN FRANCISCO • SEATTLE

### FOREIGN REPRESENTATIVES

GENERAL ENGINEERING CO. (RADCLIFFE) LTD. Station Works, Bury Road, Radcliffe, Lancashire, England  
HORROCKS, ROXBURGH PTY., LTD., Melbourne, C. I. Australia  
W. S. THOMAS & TAYLOR PTY., LTD., Johannesburg, Union of South Africa  
NOVELECTRIC, LTD. . . . . Zurich, Switzerland

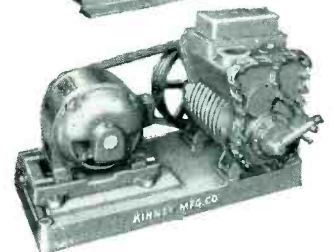
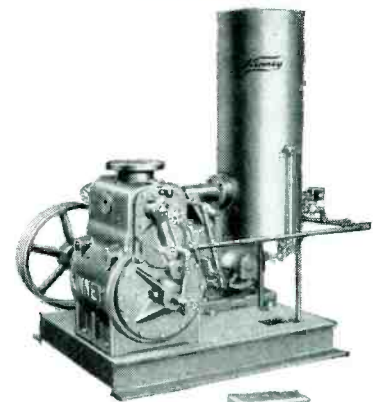

Available in eight Single Stage and two Compound models . . . capacities from 13 to 702 cu. ft. per min. . . . for pressures down to 0.5 micron abs.

**Making old things BETTER**  
**Making new things POSSIBLE**

# KINNEY HIGH VACUUM PUMPS

*"This unit serves us very well"*

THE KELLEY-KOETT MANUFACTURING CO.

# HEINEMANN MAGNETIC CIRCUIT BREAKER

Protects the  
Valuable Equipment  
Shown Below



KELLEY-KOETT MULTIFUNCTION CONTROLS Showing  
HEINEMANN CIRCUIT BREAKER Installed



Two Pole - All Purpose,  
Magnetic Circuit Breaker,  
15 amps., 250 Volt.

The Kelley-Koett Manufacturing Co. of Covington, Kentucky, is well pleased with the efficient, flexible protection provided by HEINEMANN CIRCUIT BREAKERS for the equipment it manufactures. The Breaker shown above is used as a combination Main Line Switch and Overload Circuit Breaker. It is placed in the circuit where the tripping coil is shunted by a tapped resistor, thereby allowing an adjustment for tripping it at various loads.

Positive protection is provided against dangerous overload by the INSTANT trip of the breaker, while flexibility is secured by a time-delay device that permits minor overloads to pass for a limited period of time.

Dangerous arcing is prevented by a high speed blow-out.

The equipment that YOU manufacture deserves the same certain protection at all times. Write NOW for further information.



## HEINEMANN ELECTRIC COMPANY

97 PLUM STREET

TRENTON, NEW JERSEY



**\*No. 1  
of a  
Series**

# Another Engineer's Problem Solved\*

**SUBJECT:** 100°C Miniature  
Pulse Forming Networks

**PROBLEM:** To design a 2 mesh PFN to the following specifications:

Pulse width	— .5 microsecond
Impedance	— 50 ohms
Charging Volts	— 6000V (reactance charging)
Repetition Rate	— 2000 pulses per second
Ambient Temperature	— 55°C to +100 C
Size	— ½ volume of a 75°C mineral-oil paper capacitor PFN



**TSG503-6PFN**

**SOLUTION:** A standard 75°C paper capacitor PFN is cased in a metal can  $3\frac{3}{4}'' \times 1\frac{1}{4}''$  base  $\times 2\frac{3}{4}''$  high plus terminals  $1\frac{1}{2}''$  high. At 100°C the most important design factor is dielectric heating. At this temperature, the losses in the paper PFN amount to  $7\frac{1}{2}$  to 9 watts (including  $1\frac{1}{2}$  to 2 watts loss in the coil). It is evident that a still larger can is required for even minimum life expectancy (at 100°C).

On the other hand Plasticon Type TS Capacitors used in the above PFN at 100°C have a total loss of only .3 to .4 watts. Their useful temperature range is  $-65^\circ\text{C}$  to  $+200^\circ\text{C}$  as compared to  $-55^\circ\text{C}$  to  $+105^\circ\text{C}$  for mineral oil paper capacitors. Thus the major design factor is volts per mil rating at 100°C rather than heating. Since this figure is considerably greater for Type TS than for paper, a much smaller PFN results.

In fact, the coil and the Type TS Capacitors can be cased in our Glassmike construction. The size of the illustrated PFN is  $1\frac{3}{8}''$  OD  $\times 4\frac{1}{2}''$  long. The 8-32 studs provide a convenient mounting method. The flashover distance between bands is  $3\frac{3}{4}''$  across the glass tube. This is more than ample for 6000 volts at high altitude.



What is YOUR engineering problem?

Your inquiries will receive immediate attention.



*We manufacture a standard line of Plasticon Capacitors, Pulse Forming Networks and High Voltage Power Supplies. Write for our catalog*

## Condenser Products Company

1375 NORTH BRANCH STREET • CHICAGO 22, ILLINOIS

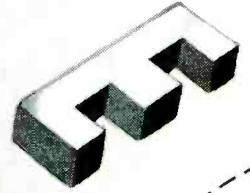

# NATIONAL MOLDITE CO.

Manufacturers of  
MAGNETIC IRON CORES  
POWDERED METAL PRODUCTS

December 28, 1949

1410 CHESTNUT AVENUE  
HILLSIDE 5, NEW JERSEY  
WAVERLY 6-2801

Mr. T. R. Moore, Sales Manager  
Antara Products -- General Aniline & Film Corporation  
444 Madison Avenue  
New York 22, New York

Gentlemen:

We all know that a man does better work with better tools. In terms of your Carbonyl Iron Powders, we have proved that it also costs less to work with the finest materials.

We have proved this to our own satisfaction in the making of our top quality Moldite Cores. We have proved it to the satisfaction of the leading radio, television and electronics manufacturers to whom we supply these important units.

Moldite cores -- made with Carbonyl Iron Powder -- give stable performance, increased inductance, increased "Q Value". Simultaneously, they save space, weight and wire.

It is reassuring to know that you have stepped up your production capacity in the past year. We wish you the best for 1950.

Very truly yours,

NATIONAL MOLDITE COMPANY

*Sidney Lowenberg*  
Sidney Lowenberg  
Sales Manager



SL

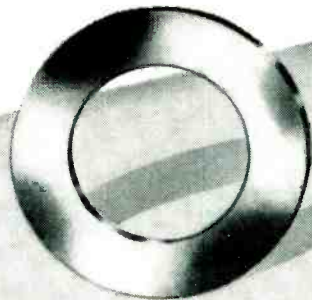

# G.A.&F. Carbonyl

# "It also costs less to work with the finest materials"

In high-frequency magnetic fields — in radio, TV, short-wave, FM, radar and in many forms of telephonic apparatus — *the core is the heart of the set.* Only the finest materials produce the dependable, stout heart.

National Moldite Company is one of the major core manufacturers who know this fact. As their letter attests, they also know that it costs the receiver and equipment manufacturer less — when he specifies cores made with G. A. & F. Carbonyl Iron Powders.

Some manufacturers are still penny-wise and pound-foolish on this subject.

The savings and the gains are both more numerous and more important than are here indicated. Study the list below. Let us send you the book described below . . . Ask your core maker, your coil winder, your industrial designer, how G. A. & F. Carbonyl Iron Powders can improve the performance of the equipment you manufacture. It will cost you nothing to get the facts.

**Visit our Exhibit — March 6th to 10th, inclusive — Grand Central Palace, Booth 28.**

**These unique properties tell why G. A. & F. Carbonyl Iron Powders are superior:**

#### PROPERTY

Spherical structure .....	Facilitates insulation and compacting
Concentric shell structure (some types only) .....	Low eddy current losses
High iron content .....	Exceptional permeability and compressibility
Absence of non-ferrous metals .....	Absence of corresponding disturbing influences
Relative absence of internal stress; regular crystal structure .....	Low hysteresis loss
Spheres of small size .....	Low eddy current losses; usable for high frequencies
Variations of sphere size .....	Extremely close packing

#### ADVANTAGE

**THIS FREE BOOK** — fully illustrated, with performance charts and application data — will help any radio engineer or electronics manufacturer to step up quality, while saving real money. Kindly address your request to Dept. 11.



## ANTARA® PRODUCTS

**GENERAL  
GA  
NILINE & FILM CORPORATION**

444 MADISON AVENUE

NEW YORK 22, N. Y.

# Iron Powders . . .



*When seconds mean lives  
and dollars - you can  
depend on Ward Aerials ---*

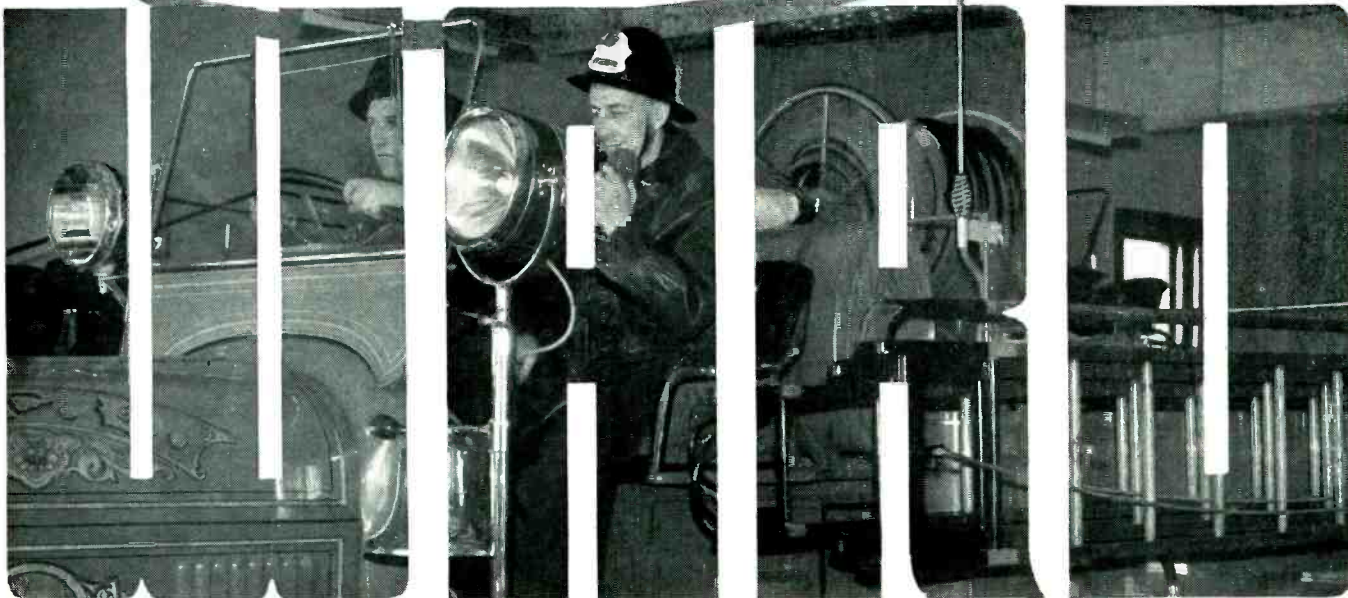

Fire fighting efficiency has been increased by the use of mobile 2-way radio in dispatching equipment. Ward Products Corporation is proud of America's heroic fire fighters.

And we are proud of the part Ward antennae play in the transmission and reception of messages when seconds saved mean lives and dollars.

Most fire companies rely on Ward aerials because they are ruggedly constructed to withstand the abuse to which they are subjected.

Ward whip rod aerials are made of a special alloy to provide the greatest possible durability and resilience.

Model SPP-3 is a non-rusting alloy swivel base for mounting at any point desired.



Model SPP-3A is a shock mounting spring for fullest protection against impact damage.

Model SPP-3B is an 84½" stainless steel whip rod, shown here attached to Model SPP-3 swivel base and Model SPP-3A shock mounting spring.



*Ward is the largest and oldest  
exclusive maker of auto radio  
and television aerials.*



**WARD PRODUCTS CORPORATION**

1523 E. 45th STREET

CLEVELAND, OHIO

*Division of the Gabriel Company*

# AVAILABLE TO ENGINEERS



## THIS NEW 128-PAGE RESISTANCE HANDBOOK



A complete, authoritative reference handbook compiled by Wilbur B. Driver Company to guide you in the correct selection of resistance and special alloys. Engineers and purchasing officials may obtain a copy without obligation by writing on company letterhead.

COMPOSITE VIEW OF THE THREE  
WILBUR B. DRIVER CO. PLANTS

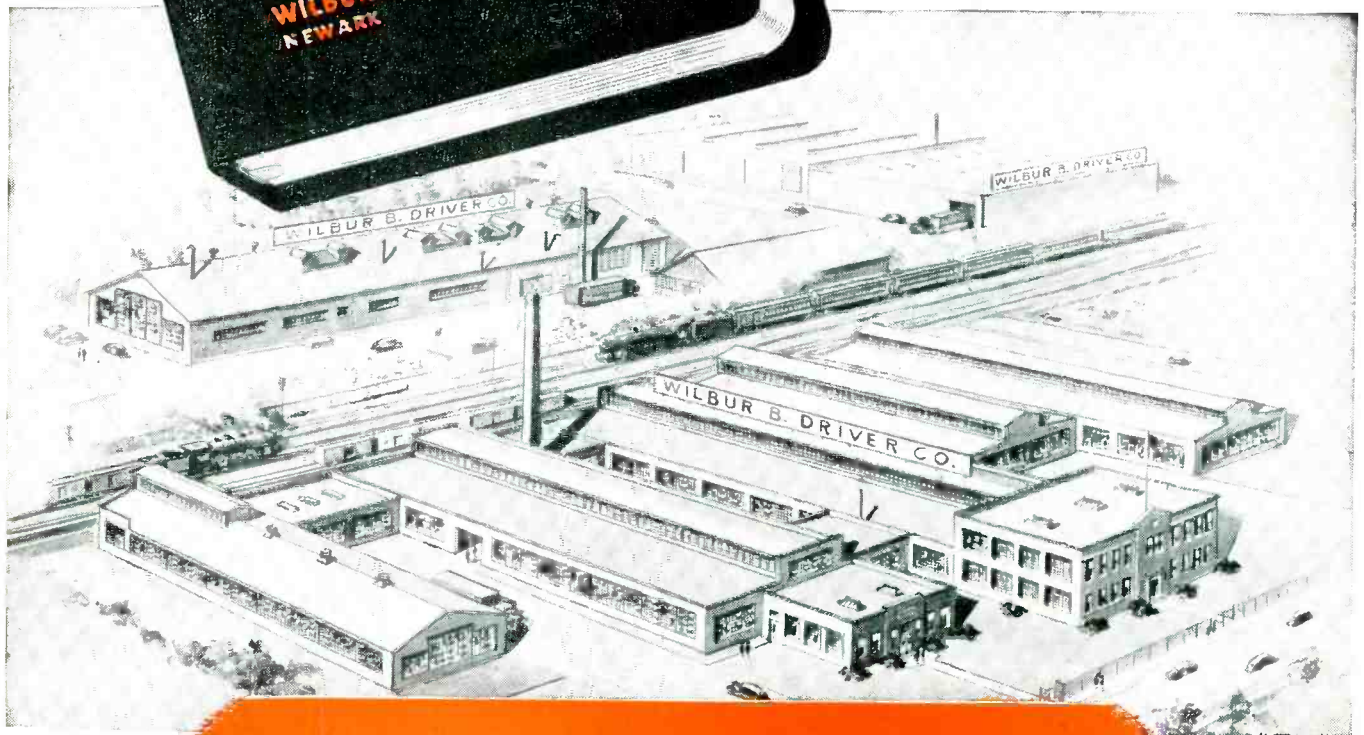

### WILBUR B. DRIVER COMPANY

150 RIVERSIDE AVENUE, NEWARK 4, NEW JERSEY

# Here's WIRE with "WIND-ABILITY" PLUS

FOR MINIMUM  
OVER-ALL WINDING  
COST AND MAXIMUM  
UNIFORMITY

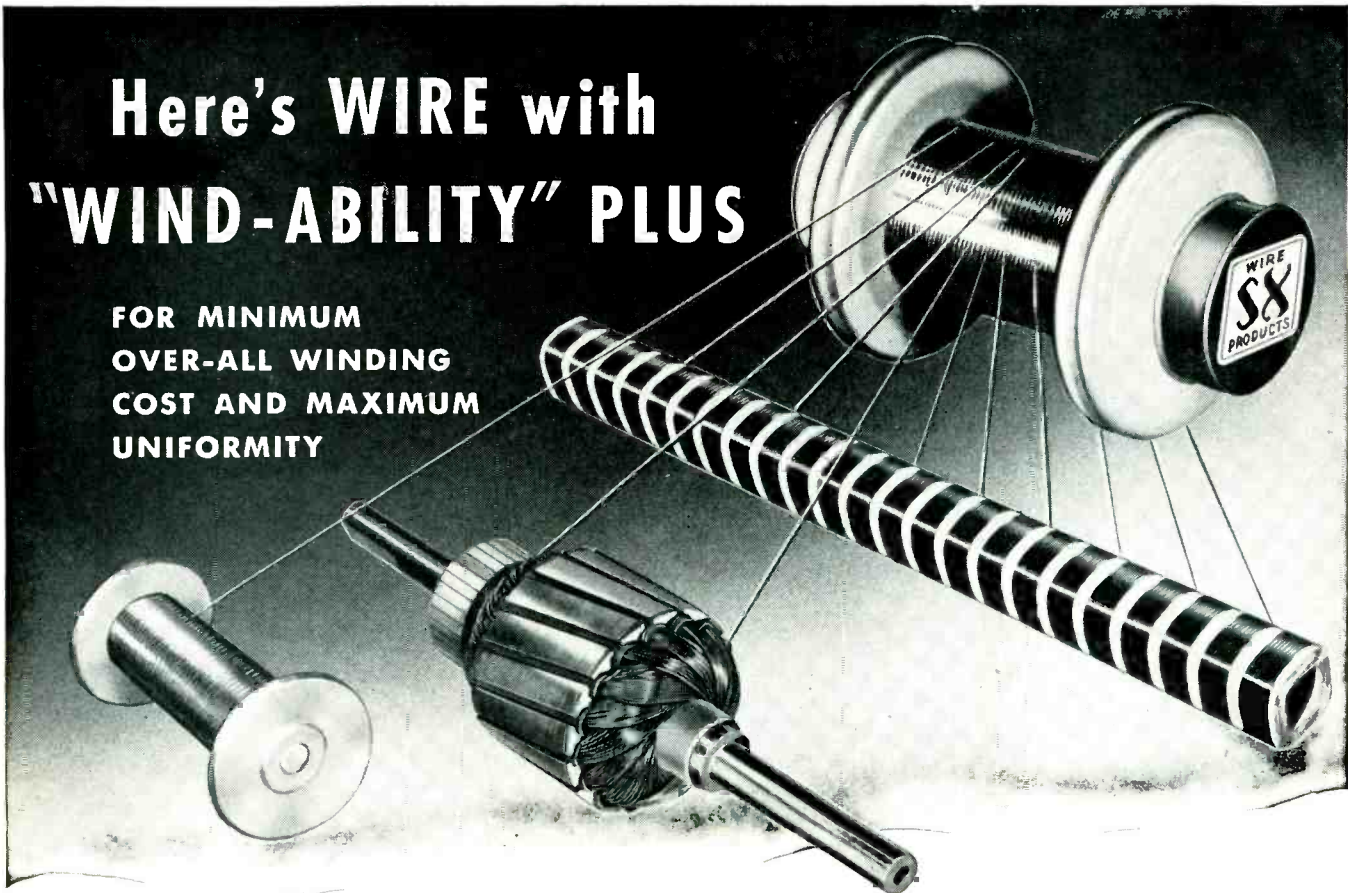

**H**IGH SPEED winding—whether bobbin, random or gang—subjects magnet wire to punishing treatment. Insulating film must be tough, yet pliable. Copper must have the proper degree of anneal. The spool-to-spool uniformity must be right.

Essex Extra-Test Magnet Wire has earned an unexcelled reputation in the most exacting applications. It helps insure coils of uniform size and resistance value—maximum turns in available space—freedom from broken wires, pile-ups, crossed turns, runbacks, spaced turns, and frequent tension

adjustments. When you specify Essex Extra-Test Magnet Wire you can be *sure*.



## ESSEX WIRE CORPORATION

FORT WAYNE 6, INDIANA

Plants: Anaheim, Calif.; Detroit, Mich.; Fort Wayne, Ind. Warehouses\* and Sales Offices:  
\*Atlanta, Ga.; \*Boston, Mass.; \*Chicago, Ill.; Cleveland, Ohio; Dallas, Texas; Dayton, Ohio;  
\*Detroit, Mich.; \*Kansas City, Mo.; \*Los Angeles, Calif.; Milwaukee, Wis.; \*Newark, N. J.;  
Philadelphia, Pa.; \*Portland, Oreg.; \*St. Louis, Mo.; \*San Diego, Calif.; \*San Francisco, Calif.  
EXPORT SALES OFFICE—LIONEL-ESSEX INTERNATIONAL CORPORATION, 15 E. 26th ST., NEW YORK 10, N. Y.

# Television Industry Adopts Another Rauland "First"!



**1** The Rauland-developed aluminized tube—giving the most brilliant picture in Television.

**2** The light-weight 12" metal tube — still available only from Rauland. And now . . .

**3**

**THE SENSATIONAL NEW RAULAND LUXIDE SCREEN WITH ITS VISIBLY BETTER CONTRAST AND CLARITY**

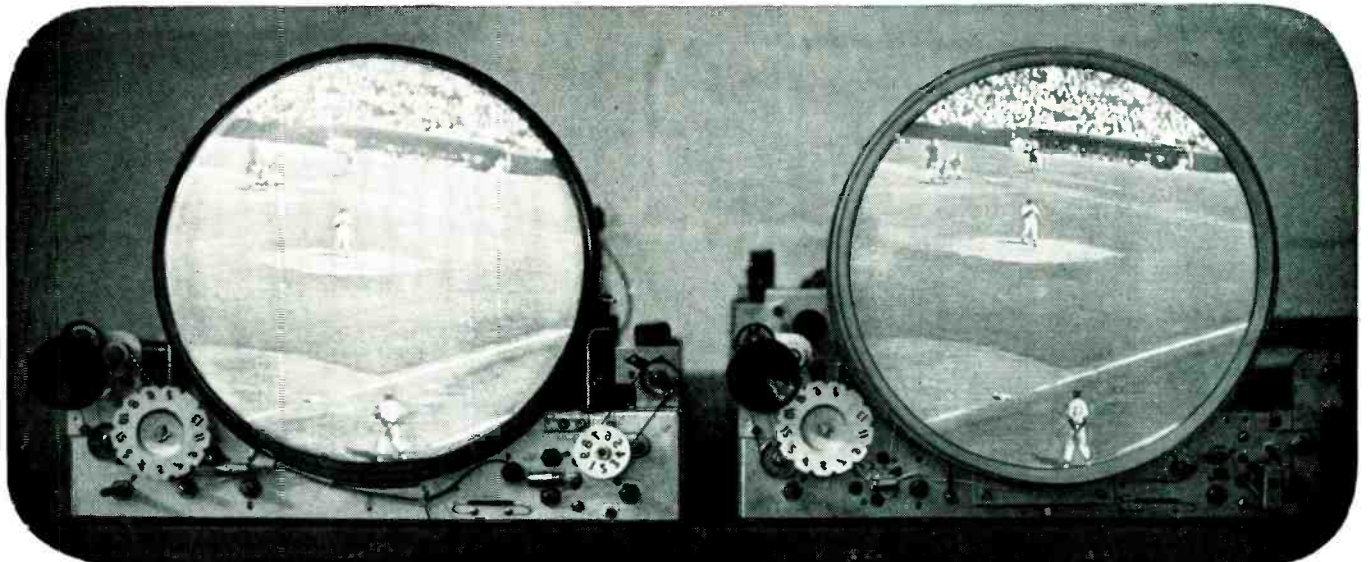

Luxide Screen (right) shows how improved contrast and clarity under high ambient light eliminates "washing out." (Standard tube at left.)

No single improvement in Television has won such quick and enthusiastic public acceptance as the Rauland Luxide Screen (black) picture tube—pioneered by Rauland from its conception to its present universal acceptance.

Rauland—first manufacturer of tubes of this type—received its initial production quantity of Luxide tube faces in mid-June, 1949. Sets featuring these new tubes were announced to the public in September. The public received them with such enthusiasm that the Television industry, almost without exception, has already adopted this Rauland-developed idea and now offers it under a variety of names.

The Rauland Luxide Screen improves picture quality by greatly reducing two former troubles—first, reflection of ambient light and second, halation within the tube face. The results to the viewer are a great reduction in apparent "blurring" and a much improved contrast and clarity, especially in lighted rooms. The improvement is so impressive that it has been given considerable editorial publicity.

Rauland is glad to have made another important contribution to the Television industry and the Television viewing public. The headline-making Luxide Screen is an additional example of Rauland's "Perfection Through Research."

## THE RAULAND CORPORATION



*Perfection Through Research*

4245 N. KNOX AVENUE • CHICAGO 41, ILLINOIS



*Watch*  *Master*

# Frequency Standards



**GUARANTEED  
ACCURACY**  
1 part in 100,000  
(.001%)

## *Uses*

Time bases, rate indicators, clock systems, chronographs, geo-physical prospecting, control devices and for running small synchronous motors.

## *Features*

1. Bimetallic, temperature-compensated fork, no heating or heat-up time is required.
2. Fork is hermetically sealed, no barometric effects on frequency.
3. Precision type, non-ageing, low coefficient resistors used where advantageous.
4. Non-linear negative feedback for constant amplitude control.
5. No multi-vibrators used.
6. Synchronous clock simplifies checking with time signal.

## *Specifications*

Accuracy—1 part in 100,000 (.001%).

Temperature coefficient—1 part in 1,000,000 per degree centigrade (or better).

Outputs—

1. 60 cycles, sine wave, 0-110 volts at 0 to 10 watts (adjustable).
2. 120 cycle pulses, 30 volts negative.
3. 240 cycle pulses, 30 volts positive and negative. Pulse duration, 100 micro-seconds.

*product of*

**AMERICAN TIME PRODUCTS  
INC.** New York 19, N. Y.

580 Fifth Avenue  
*Operating under patents of the Western Electric Company*

### Type 212

TERMINATION

Front and Rear

CONSTRUCTION

Standard 8 $\frac{3}{4}$ " x 19" Panel

HOUSING

8 $\frac{3}{4}$ " x 19" x 8" Metal Cabinet

WEIGHT

25 pounds

American Time Products, Inc.,  
580 Fifth Ave., New York 19, N. Y.

Gentlemen:

Please send descriptive folder, No. 212

Name.....

Company.....

Address.....

City..... State.....



# New Dust-Tight Plug-in Enclosure for CLARE TYPE "J" TWIN CONTACT RELAY To Meet Severe Operating Conditions



Steel cover, securely held by a slotted-head screw, is easily removed for inspection.

● This new CLARE dust-tight plug-in enclosure for the small Type "J" Relay offers designers a number of unusual features for installation on industrial equipment.

Entrance of dust is prevented by the steel cover and by use of a Neoprene gasket which is closely fitted at the factory to the relay terminals. The dust-tight cover is easily removed for inspection. Use of standard radio plug simplifies installation and cuts wiring costs. Base is secured to chassis to prevent plug from being jarred or accidentally pulled from its socket.

Exclusive design of the CLARE Type "J" Relay allows the twin contacts to operate independently of each other. One contact is sure to close, reducing contact failure to the practical limit. This relay combines all the best features of the conventional telephone-type relay with small size and light weight. It provides unusually high current-carrying capacity, large contact spring capacity, extreme sensitivity and high operating speed.

This new dust-tight enclosed relay is one of many outstanding CLARE contributions in the development of new and better relay components for industry. CLARE Sales Engineers are located in principal cities to consult with you on your relay problems. Call them direct or write: C. P. Clare & Co., 4719 West Sunnyside Avenue, Chicago 30, Illinois. Cable Address: CLARE-LAY. In Canada: Canadian Line Materials Ltd., Toronto 13.

Write for Bulletin No. 108

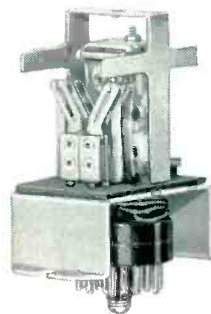
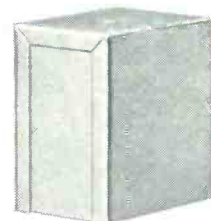

Neoprene gasket, closely fitted at factory to relay terminals, between base and cover, effectively occludes dust.

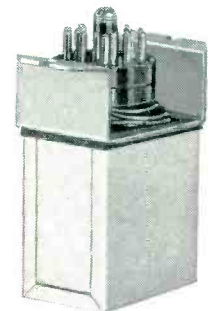

Plug is standard radio-type plug. Standard finishes are silver lustré lacquer for cover, cadmium for base. Retaining screws hold base securely to panel.

## CLARE RELAYS

*First in the Industrial Field*

For a Real  
 "Beauty Treatment"  
 both in  
 Manufacturing and  
 in Merchandising

...top equipment-makers use **AMERICAN PHILLIPS SCREWS**

**BEAUTIFY COSTS!** Assembly costs never look so good as when they're *slimmed down to 50% of what they used to be*... simply by equipping all assembly departments with skid-proof, slash-proof American Phillips Screws. That's why leading makers of beauty-shop equipment use this modern fastening that saves half the time and the spoilage imposed by slotted screws.

**BEAUTIFY SALES!** The modern mark of the American Phillips crossed recess is a buy-sign that the public has learned to accept with confidence on everything from autos to model railroads... and that industry has long since accepted (in fact, *specified*) on everything from trucks to machine tools. That mark means that the product is built right, all the way through. Yes, American Phillips Screws are potent sales-promoters as well as cost-cutters. Get both these advantages *for your own product*. Write and tell us to prove that "American Phillips Screws always cost least to use."

**AMERICAN SCREW COMPANY, Providence 1, R. I.**

Plants at Willimantic, Conn., and Norristown, Pa.

Warehouses at: 589 E. Illinois St., Chicago 11

502 Stephenson Building, Detroit 2

4-WINGED DRIVER CAN'T SLIP OUT  
 OF PHILLIPS TAPERED RECESS

AMERICAN  
 PHILLIPS  
 Screws



ALL TYPES

ALL METALS: Steel,  
 Brass, Bronze, Stain-  
 less Steel, Aluminum,  
 Monel, Everdur (sil-  
 icon bronze)

# News in V.H.F.!

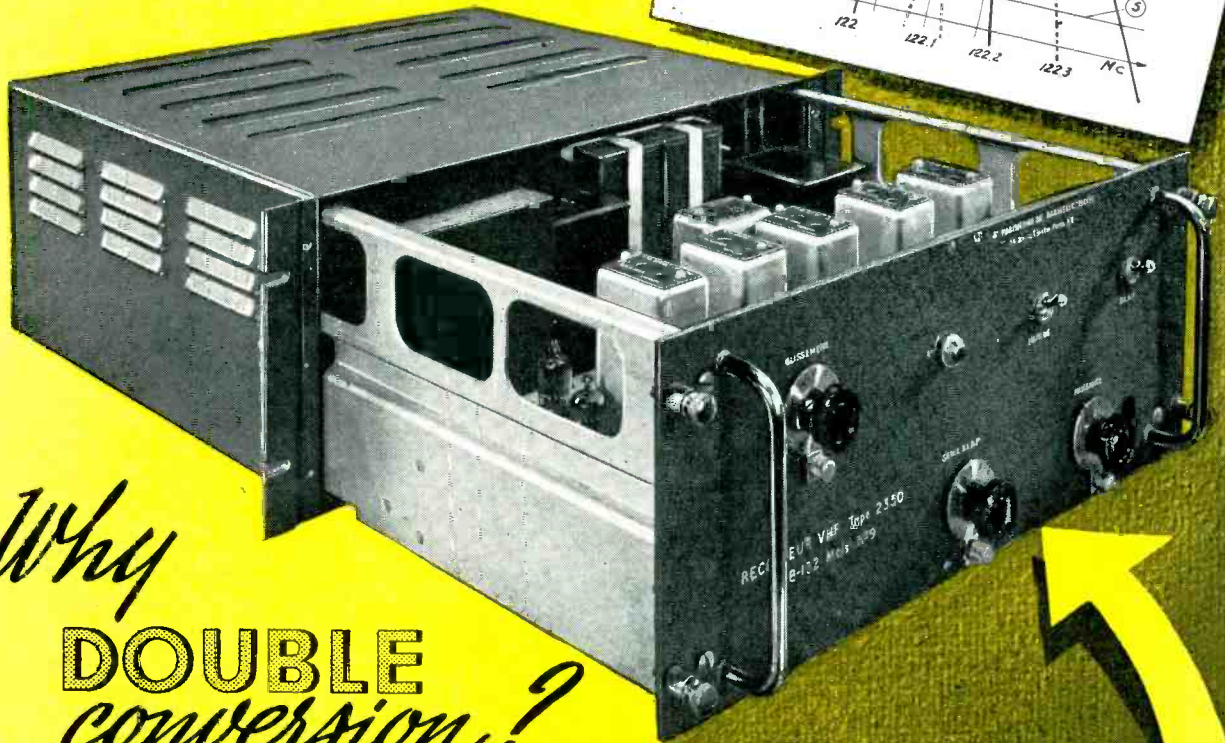
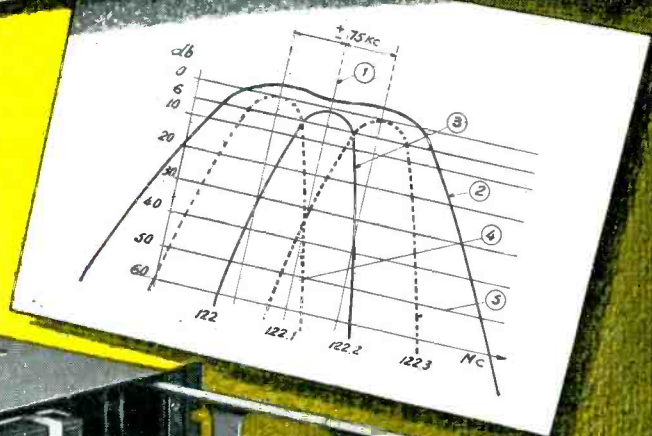

## Why DOUBLE conversion?

- HIGHER SELECTIVITY . ( $\pm 200$  KC/s at 60 dB)
- HIGHER I. F. GAIN . . . . . (120 dB)
- LOCAL OR REMOTE FREQUENCY ADJUSTMENT . . . . . ( $\pm 75$  KC/s)
- STABILITY OF PERFORMANCES



H. F. one Frequency Receiver in the 1,2/30 MC/s band. Frequency adjustment  $\pm 4$  KC/s . . \$ 300  
 H.F. Tropical one Frequency Receiver in the 1,5/30 MC/s band. Frequency adjust.  $\pm 5$  KC/s. \$ 500  
 V.H.F. Tropical one Frequency Receiver in the 108/132 MC/s band. Frequency adjust.  $\pm 75$  KC/s. \$ 500  
 H.F. Tropical Communication Receiver 1,75/40 MC/s. . . \$ 1,000

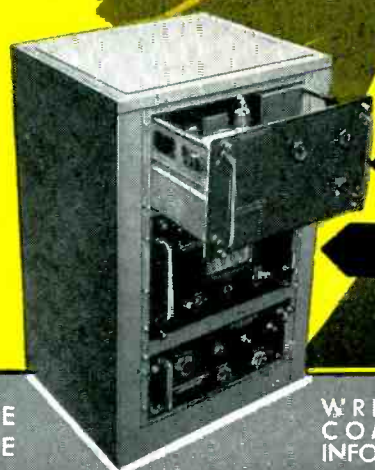

TRANS  
MITTER  
  
POWER  
SUPPLY

**SOPAREL** 54, RUE DU THÉÂTRE PARIS (15<sup>e</sup>) — FRANCE WRITE FOR COMPLETE INFORMATION

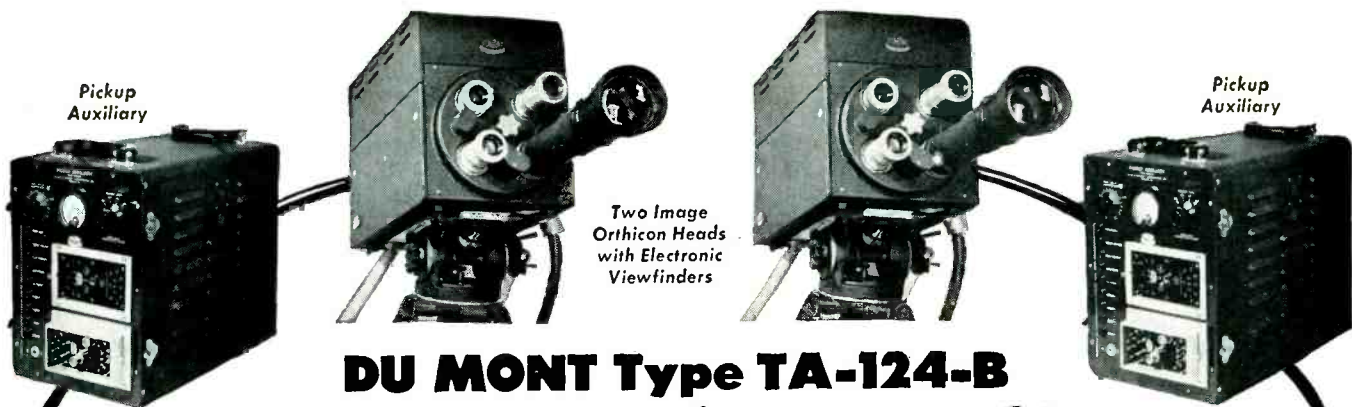

Pickup Auxiliary

Two Image Orthicon Heads with Electronic Viewfinders

Pickup Auxiliary

## DU MONT Type TA-124-B

# Dual Image Orthicon Chain

► Split-second action through quick setup and finger-tip controls; accessibility for time-saving inspection and immediate maintenance; superlative image pickup with precise electronic viewfinder checkup; handy matched units for all required power, synchronizing, amplifying and monitoring functions plus latest camera effects—such explains the popularity of the Du Mont Type TA-124-B Dual

Image Orthicon Chain for studio and outdoor telecasts alike.

Whatever your telecasting plans or requirements—from modest start (Acorn Package) to most ambitious setup—whether local station or network—be sure to get the details of this outstanding camera equipment. From camera to antenna, it's DU MONT for "The First with the Finest in Television."

### FEATURES...

**Heavy-duty cables and "Jiffy" Connectors** for trouble-free operation. Built-in intercommunications.

**Camera:** Four-lens turret. Electronic viewfinder and camera integral assembly, but separately operable. Heater and blower for wide variation of ambient temperatures. Pan-handle operation of focus control. Remote iris adjustment from camera rear. No screwdriver controls. Factory-aligned peaking in video pre-amplifier.

**Auxiliary:** Pentode control of focus-coil current. Independent cable delay compensation for multiple camera hook-ups.

**Power Supplies:** Rugged construction. Super-regulating supplies for video circuits.

**Control and Monitor:** Thumb-wheel controls. Line-to-line clamp circuits. Single-camera chain operation if necessary.

**Sync Generator:** Smallest and lightest

portable unit extant. Better rise time of pulses and freedom from adjustments than most studio type sync generators.

**Distribution Amplifier:** Equipment set up to handle up to four cameras without use of junction boxes.

**Mixer Amplifier and Monitor:** Automatic lap dissolve and fading circuits (four speeds) applicable up to four channels. Normal manual mixing and fading, also built in.

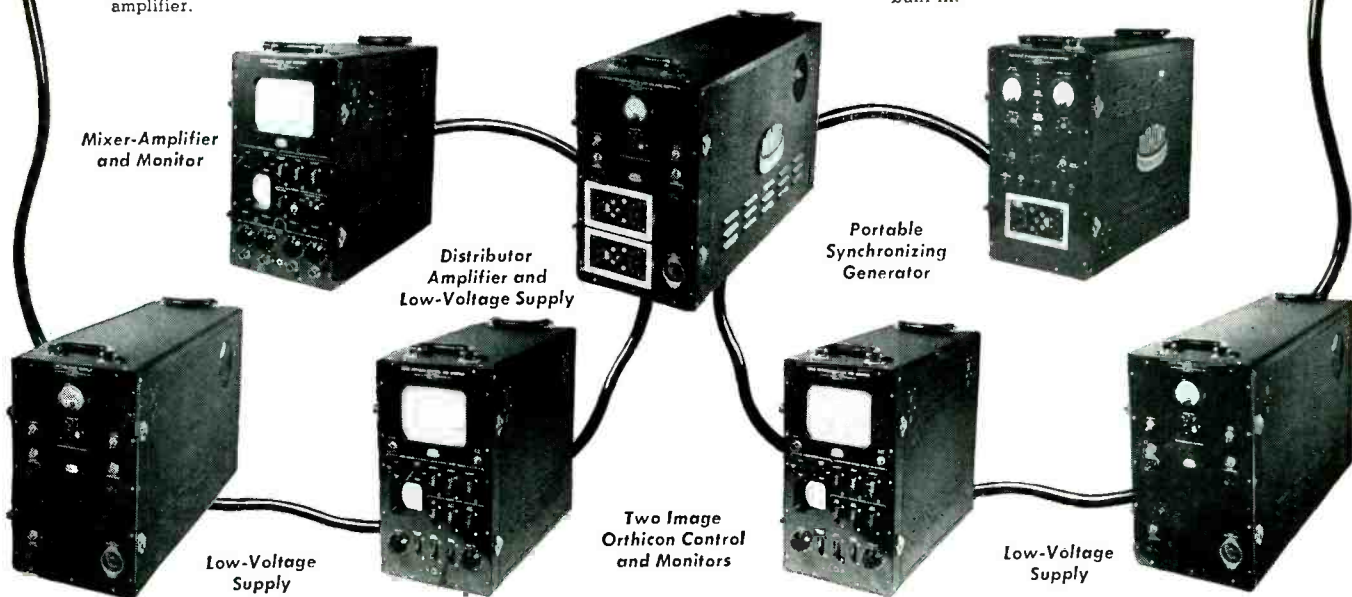

Mixer-Amplifier and Monitor

Distributor Amplifier and Low-Voltage Supply

Portable Synchronizing Generator

Low-Voltage Supply

Two Image Orthicon Control and Monitors

Low-Voltage Supply



ALLEN B. DU MONT LABORATORIES, INC. • TELEVISION TRANSMITTER DIVISION, CLIFTON, N. J. • DU MONT NETWORK AND WABD, 515 MADISON AVE., NEW YORK 22, N. Y. • DU MONT'S JOHN WANAMAKER TELEVISION STUDIOS, NEW YORK 3, N. Y. WTTG, WASHINGTON, D. C. • STATION WDTV, PITTSBURGH, PA. • HOME OFFICES AND PLANTS, PASSAIC, CLIFTON, ALLWOOD, AND EAST PATTERSON, N. J.

# Hiawatha was a PIKER!



"Go out into the world," said Pops\*  
"and don't come back 'till you're proved tops!"



The water test he passed with ease,  
Earning a feather was just a breeze...



Heat was applied to test his worth  
In "hot spots" he then won a berth...



The life test took a long, long time  
Though others quit — he kept his prime...



His leads proved strong—his casing tough  
It did no harm to treat him rough!

His Pops was pleased when he came through  
We know you'll like the Redskin, too!

## Sangamo's New Molded Paper Tubular Capacitor gives LONG LIFE under severe conditions!

The REDSKIN is easy to work with—on production line or on the bench—because the especially designed flexible leads resist breakage and can't pull out! It offers greater mechanical strength because of its plastic construction. It is molded under *low* pressure, assuring elements undamaged in fabrication, longer life and greater dependability. It is an 85° C tubular which offers assurance of long life under television and other severe operating conditions.

A trial of these *better* molded tubulars will convince you. See your jobber—if he can't supply you, write us.

\*Big Chief Sangamo

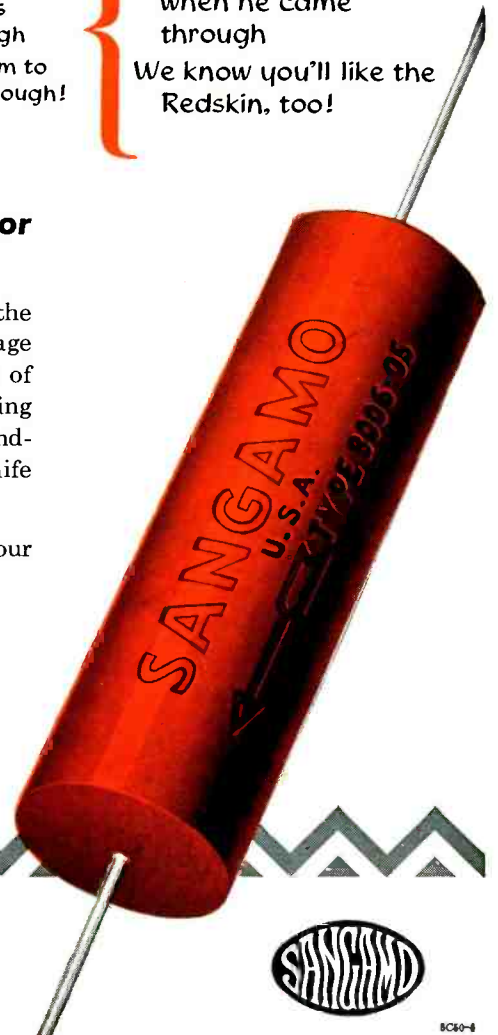

**SANGAMO ELECTRIC COMPANY**  
**SPRINGFIELD, ILLINOIS**

In Canada: Sangamo Electric Company Limited, Leaside, Ont.



SC80-4

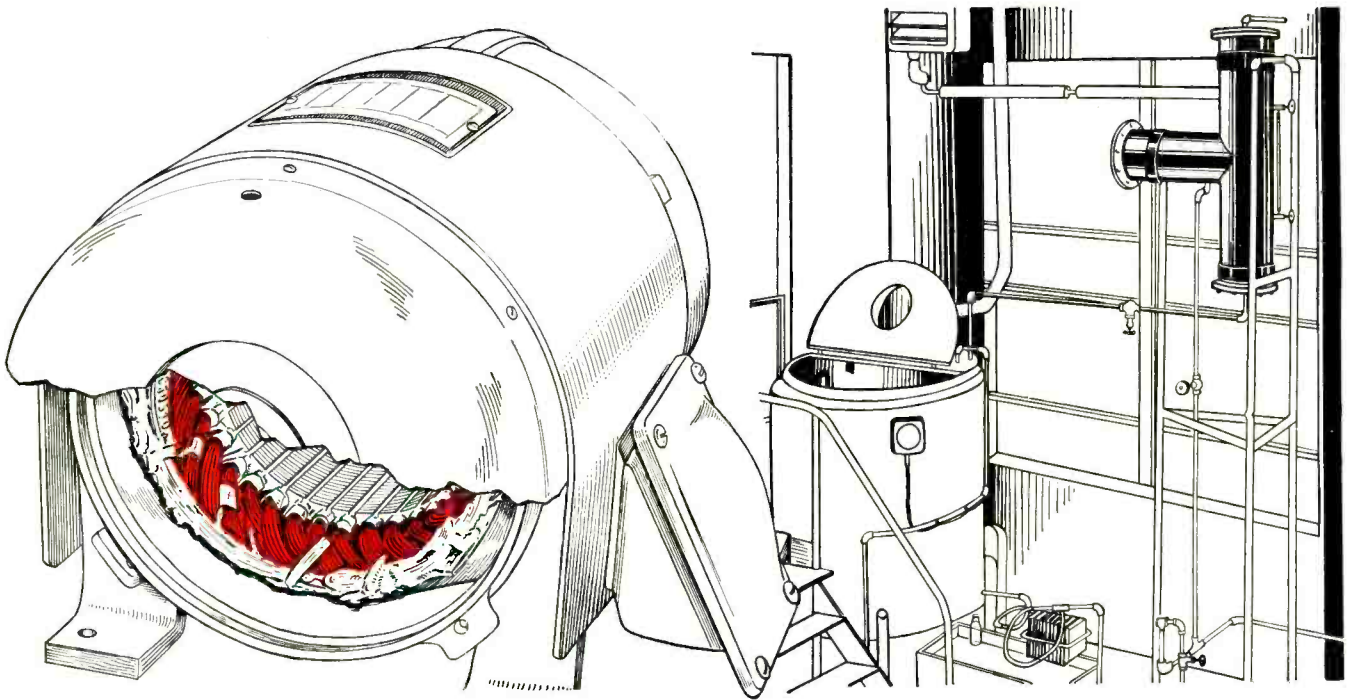

# Why Reliance Electric is "Fussy" about Insulation

Consider how motors are used—in the high ambient temperatures of a steel mill; in the damaging fumes of a chemical plant; sometimes running steadily night and day.

That's the background for the punishment tests devised for BH "649" Fiberglas Tubing by Reliance Electric & Engineering Company.

They bent it . . . twisted it . . . soaked it . . . baked it. And when the punishment tests were over, they specified BH "649" Fiberglas Tubing for Reliance Precision-Built Motors.

BH "649" takes the roughest handling in assembly or service without impairing its electrical qualities, making it possible in many cases to drop one insulation grade and still maintain a generous margin of safety.

BH "649" is a superior Fiberglas insulation—at a price comparable to cotton. It is unaffected by moisture, oil, grease or ordinary chemicals.

BH "649" is available in Grades A-1, B-1, C-1 and C-2. In all sizes from No. 24 to 5/8" inclusive. Try it on your tough insulation jobs.

BENTLEY, HARRIS MFG. CO., CONSHOHOCKEN, PA.

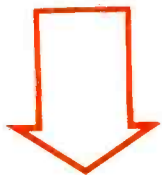

## BH *Fiberglas*\* SLEEVINGS

\*BH Non-Fraying Fiberglas Sleeveings are made by an exclusive Bentley, Harris process (U. S. Pat. No. 2393530). "Fiberglas" is Reg. TM of Owens-Corning Fiberglas Corp.

### COUPON

Bentley, Harris Mfg. Co., Dept. E-39, Conshohocken, Pa.

I am interested in BH "649" Fiberglas Tubing and Sleeveing. Send samples for production testing of Grade \_\_\_\_\_ in sizes as follows \_\_\_\_\_ for \_\_\_\_\_ operating at temperatures of \_\_\_\_\_°F. at \_\_\_\_\_ volts.  
(size or I.D.) (product)

NAME \_\_\_\_\_

ADDRESS \_\_\_\_\_

Send samples, pamphlets and prices on other BH Products as follows:

- BH non-fraying Fiberglas Sleeveing
- Cotton or Rayon-base Sleeveing and Tubing

# **sorensen** — The most *ECONOMICAL* line of Electronic Voltage Regulators



## AC REGULATORS

### GENERAL APPLICATION

Model NOS. 150S 250S 500S  
Load-Range (VA) 0-150 0-250 0-500



### MEDIUM CAPACITY

Model NOS. 1000S 2000S 3000S  
Load-Range (VA) 0-1000 0-2000 0-3000

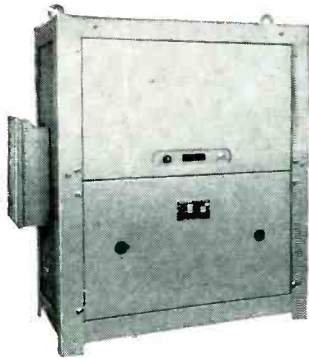

### HEAVY DUTY UNITS

Model NOS. 5000S 10000S 15000S  
Load-Range [VA] 0-5000 0-10000 0-15000

### STANDARD AC SPECIFICATIONS

MODEL IN VA CAPACITY	150S 500S	250S 1000S	2,000S 3,000S	5,000S 10,000S 15,000S
Harmonic Distortion	3% max.	2% max.	3% max.	3% max.
Regulation Accuracy	±0.1% against line or load			
Input Voltage	95-130 VAC; also available for 190-260 VAC Single Phase 50-60 cycles			
Output Voltage	Adjustable between 110-120; 220-240 in 230 VAC models.			
Load Range	0 to full load			
P. F. Range	Down to 0.7 P. F. All models temperature compensated.			

NOTE: REGULATORS CAN BE HERMETICALLY SEALED

SORENSEN ELECTRONIC VOLTAGE REGULATORS are designed to meet the need for rugged, economical, low-maintenance-cost units. There is no need to buy extras — no need to buy more than you require when you purchase a SORENSEN regulator. Depend on SORENSEN — the FIRST line of STANDARD electronic voltage regulators.

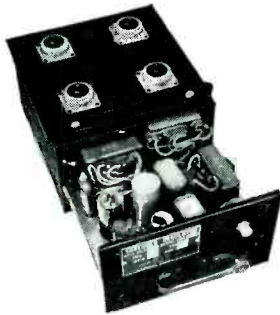

### 400 CYCLE LINE

Model NOS. D 100, D 500, D 1200, D 2000  
Load-Range (VA) 0-100, 0-500, 0-1200, 0-2000

Accuracy ± 0.5% against line and load.  
Maximum distortion 5%

Frequency Range 400 cycles ± 10%

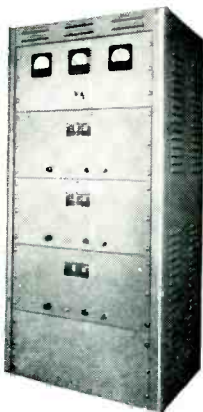

### 3 — PHASE REGULATION

All types of three-phase systems effectively handled. Sorensen Engineers available to review your particular problems.

Load range 450 VA to 15 KVA

WRITE for FREE COPY of the "SORENSEN REGULATOR PERFORMANCE CHART"

Copyright 1949

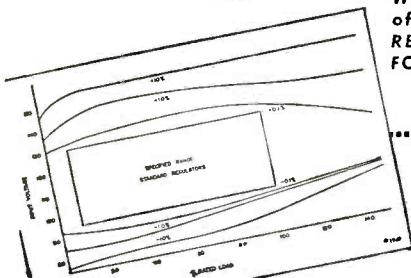

## DC REGULATORS

The SORENSEN NOBATRON (DC REGULATION) in effect eliminates the need for Batteries without losing any battery features. It maintains a constant voltage output against load variations, can be over compensated against line drop. It is a clean and self-sustaining source of DC power.

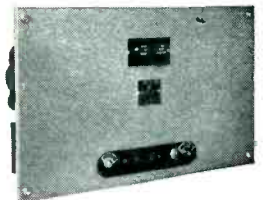

### STANDARD DC SPECIFICATIONS

*Output Voltage	6	12	28	48	125
**Load in Amperes	5-15-40-100	5-15-50	5-10-30	15	5-10
Input Voltage	95-130 VAC single phase 50-60 cycles; adapter available for 230 VAC operation.				
Regulation Accuracy	0.2% from 0.1 to full load.				
Ripple Voltage RMS Maximum	1%.				
Recovery Time	0.2 seconds-value includes charging time of filter circuit for the most severe change in load or input conditions.				

\*Adjustable + 10% — 25%.

\*\*Individual models identified by indicating output voltage first than amperes.  
Example: E-6-5 = 6 VDC @ 5 amperes.

SPECIAL REQUIREMENTS can be met by employing the ORIGINAL SORENSEN CIRCUIT. Engineering Consultation available without cost.

JAN SPECIFICATIONS met by all AC models.

**Sorensen** and Company, Inc.  
375 Fairfield Ave., Stamford, Connecticut

**LOOK! "300 VDC TEST, 1. MFD."—It's another of those Aerovox "Space Misers"—typical of the perfected**

**AEROLITE\***

*Metallized-paper*

**CAPACITORS**

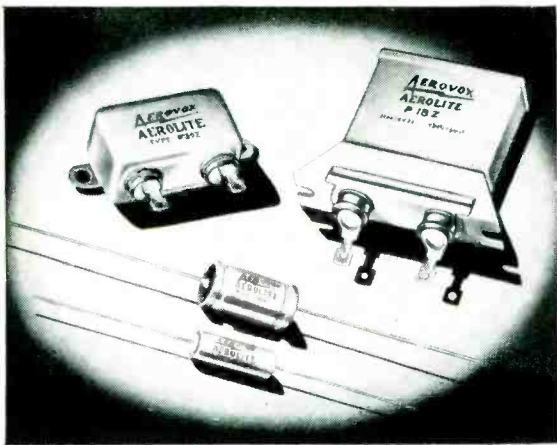
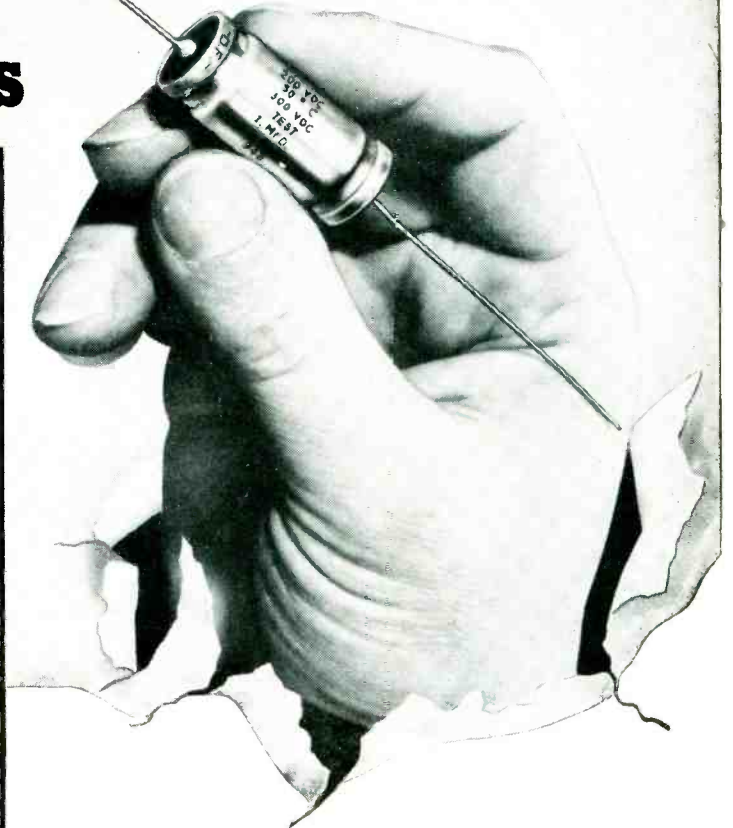

● Minimum weight, slashed bulk. Improved reliability. That's the why-and-wherefore of AEROLITES\* Aerovox's new, improved metallized-paper capacitors. Now available in the same variety of types as corresponding paper-and-foil sections — cardboard tubulars, hermetically-sealed tubulars, and the usual oil-filled metal-cased units.

AEROLITES\* are self-healing when subjected to voltage overloads. Yet such units provide a generous margin between rated voltage and overload test. Likewise, satisfactory insulation resistance. AEROLITES\* meet JAN vibration, temperature, immersion cycling and life-test requirements.

● Aerovox Application Engineering assures performance satisfaction with AEROLITE\* metallized-paper capacitors. For literature and answers to your particular application problems, write on your letterhead to AEROVOX CORPORATION, DEPT. A-150, NEW BEDFORD, MASSACHUSETTS.

**HERMETICALLY-SEALED AEROLITES\* MEAN ...**

... marked reduction in bulk and weight.

... operating temperatures of  $-55^{\circ}\text{C}$  to  $+55^{\circ}\text{C}$  without derating. Operation at ambient temperatures up to  $95^{\circ}\text{C}$  with voltage derating.

... power factor same as conventional mineral-oil-impregnated ca-

pacitors.

... extended electrode type construction for minimum r-f impedance.

... immersion proof.

... time-and-service-proven Aerovox terminals and cases.

... backed by Aerovox engineering experience and "know-how."

\*Trade-mark



**FOR RADIO-ELECTRONIC AND INDUSTRIAL APPLICATIONS**

AEROVOX CORPORATION, NEW BEDFORD, MASS., U.S.A.

SALES OFFICES IN ALL PRINCIPAL CITIES • Export: 13 E. 40th St., NEW YORK 16, N. Y.

Cable: 'ARLAB' • In Canada: AEROVOX CANADA LTD., HAMILTON, ONT.



# REDUCE CONTROL COSTS

# TO A FRACTION

with the

**VICKERS, Inc.** *Standard*

# MAGNETIC AMPLIFIER

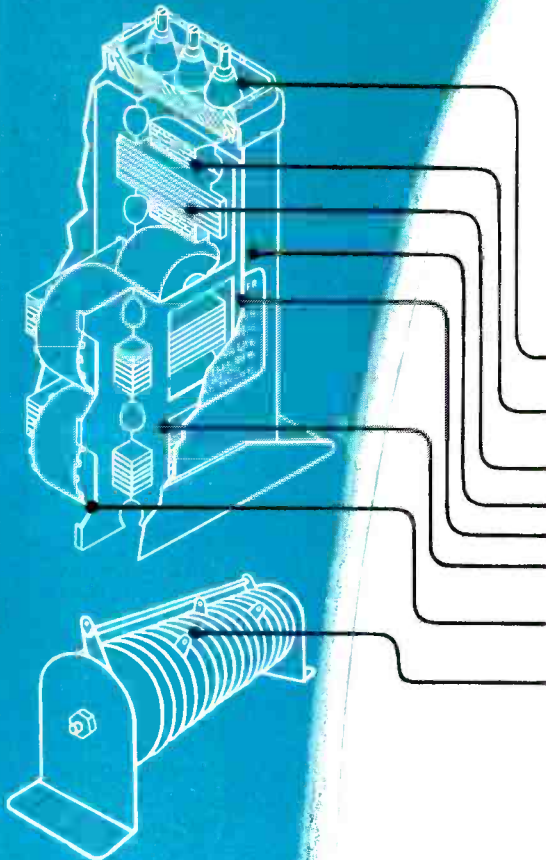
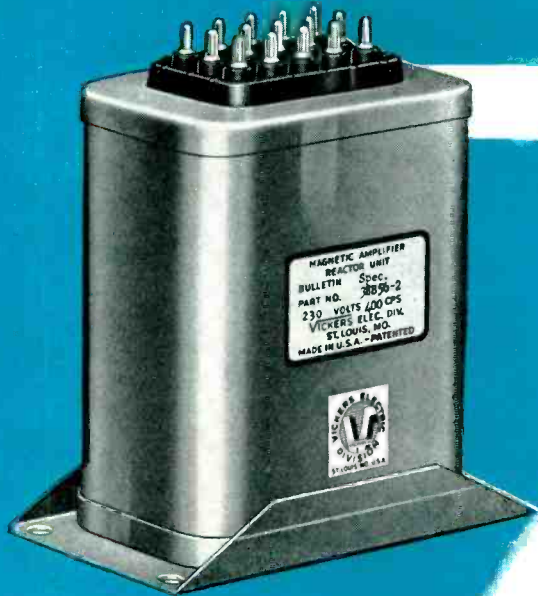

For the many applications where magnetic amplifiers were desirable but prohibitive because of cost, Vickers now offers *standard* magnetic amplifiers pre-engineered and laboratory-tested for you.

Vickers supplies from stock 28 styles of *standard* magnetic amplifiers for 60 cycle control applications with a choice of dc or ac output. Output power levels range from milliwatt to 108 watts maximum (dc output).

Application data sheets are furnished to enable you to select the *standard* magnetic amplifier to fit your specific need.

Molded-in terminal blocks with visible terminal identification. Navy and A.S.A. creepages preserved between terminals and ground.

Formvar wire coils, cellulose-acetate taped and impregnated with Grade AA Cerese wax.

Gapless high permeability cores, annealed after punching.

Gray enameled, tinned steel cans with spot welded base.

Each amplifier is rated and data sheet furnished.

Potting compound seals assemblies against atmospheric and mechanical damage.

Entire assembly is precision jig-assembled before potting, assuring accurate positioning.

Low-leakage Vickers Selenium Rectifiers.

• **You are invited** to send for the Vickers Magnetic Amplifier Design Handbook which specifies characteristics of *standard* magnetic amplifiers and illustrates circuits. Please make request on your letterhead.



## VICKERS ELECTRIC DIVISION

VICKERS Inc.

1801 LOCUST STREET • ST. LOUIS 3, MISSOURI

A UNIT OF THE SPERRY CORPORATION

## Insulation Cements for Electric Heaters

# ZIRCON meets these five basic requirements

**1** Easy application.

**2** Refractoriness.

**3** Current leakage minimized at operating wattage under humid conditions or under an externally applied stress voltage.

**4** Stability of insulation and structure through a 1000 hour-life test.

**5** Reasonable cost.

### TYPICAL CHARACTERISTICS

(The results shown apply to a particular structure for cement applied in a specific manner. Any variation may alter results.)

Type of Cement	A	A	B	C
ASSEMBLY METHOD	Dry Press Flat Iron	Strip Heaters	Mud Cast Range Element	Dry Press Flat Iron
OPERATING LEAKAGE	0.002 M.A.	0.002 M.A.	0.02 M.A.	0.02 M.A.
HUMIDIFICATION LEAKAGE	0.2 M.A.	—	<0.5 M.A.	0.03 M.A.
RETURN TO NORMAL*	15 to 30 sec.	—	10 to 15 sec.	—

\*After current is turned on.

Performance of Zircon insulation cements indicates an outstanding group of compositions, both electrically and chemically. Our trained field engineers will be glad to bring you detailed information on individual characteristics and applications. Write us. No obligation.



Registered U. S. Pat. Off.

TAM is a registered trademark.

## TITANIUM ALLOY MFG. DIVISION

### NATIONAL LEAD COMPANY

Executive and Sales Office: 111 BROADWAY, NEW YORK CITY • General Offices, Works, and Research Laboratories: NIAGARA FALLS, N. Y.

A decorative laurel wreath is positioned on the left side of the page, extending from the top towards the bottom. It is rendered in a light blue or grey color, with branches and leaves curving upwards and then downwards.

# **OHMITE**

*25th Anniversary*

*1925-1950*

*Contributing to*  
**ONE-QUARTER CENTURY of PROGRESS**  
*in the*  
**ELECTRICAL CONTROL INDUSTRY**

**OHMITE MANUFACTURING COMPANY**

***Rheostats • Resistors • Tap Switches***

Here's Why  
You Get

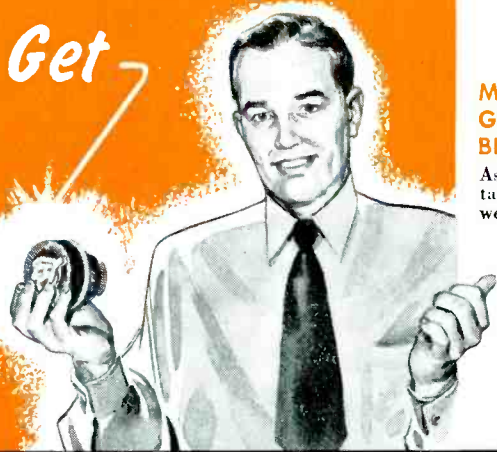

**UNFAILING  
DEPENDABILITY**

with  
**OHMITE**  
RHEOSTATS

Years of field experience emphasize the underlying soundness of Ohmite rheostat design. These rheostats are constructed entirely of ceramic and metal—contain nothing to char, burn, shrink, or deteriorate. Ceramic parts insulate the shaft and mounting. The resistance winding is permanently locked in place by vitreous enamel. Every turn is contacted by the smoothly gliding metal-graphite brush, assuring smooth, gradual, close control.

**OHMITE MANUFACTURING CO.**  
4816 Flournoy St.  
Chicago 44, Ill.

Be Right with

**OHMITE**

Reg. U. S. Pat. Off.

**RHEOSTATS • RESISTORS • TAP SWITCHES**

**UNIFORM CONTACT PRESSURE**

Spring steel contact arm forms a long spring which assures uniform contact pressure at all times.

**METAL-GRAPHITE BRUSH**

Assures perfect contact with negligible wear on the wire.

**UNIFORM SLIP-RING PRESSURE**

Compression spring maintains uniform pressure and electrical contact between slip ring and center lead. Pressure here is independent of that at the contact brush.

**SHAFT INSULATED FROM LIVE PARTS**

High-strength ceramic hub insulates shaft and bushing from all live parts.

**STOP PREVENTS STRAIN ON CONTACT ARM**

Stop, keyed to the shaft, limits the rotation of the arm. No torsional strain is imposed on the arm in stopping.

**THREE TERMINALS**

Ohmite rheostats are provided with three terminals, so they can be used as potentiometers (voltage dividers), or to permit alternate rheostat connections.

**WEAR-RESISTANT BEARING**

Brass bushing for the steel shaft provides a wear-resistant, wobble-free bearing.

**LOCKED-IN WINDING**

Special alloy resistance wire is wound over a porcelain core. Each turn is firmly locked in vitreous enamel.

**VITREOUS ENAMEL BOND**

Vitreous enamel bonds the ceramic core and base together into one integral unit.

**BEND-UP LOCK WASHER**

Bend-up lock washer provides positive assurance against loosening of the assembly nut.



Write on Company Letterhead for Catalog and Engineering Manual #40.

25th Anniversary

1925-1950

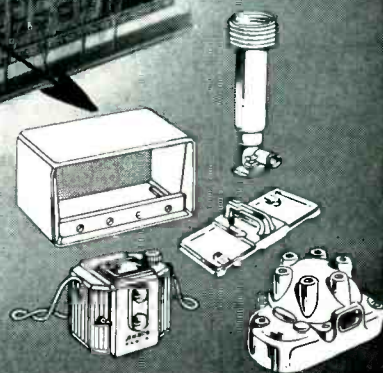
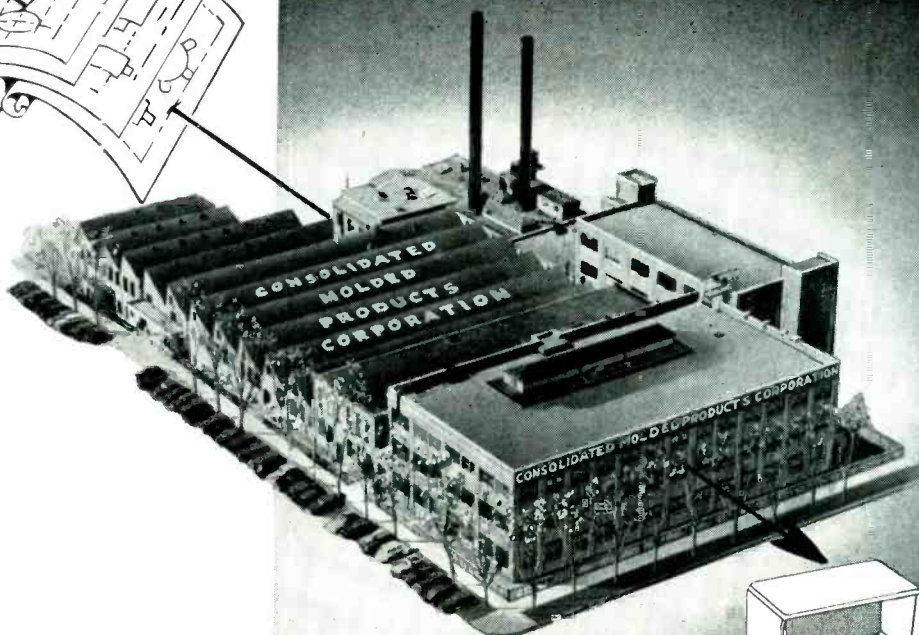
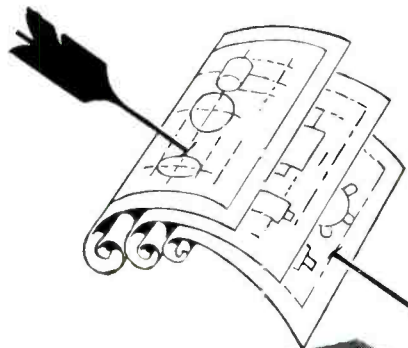

## Consolidated's *Straightline* Facilities Speed Your Blueprints into Plastic -at *Least Cost!*

**C**URRENTLY, A foremost plastic materials supplier is investing good advertising money to bring home this thought . . . "It pays to use your custom molder's know-how!"

This timely bit of advice, so well given, is deserving of being equally well taken.

Here, at Consolidated, we offer manufacturers a degree of production know-how that is long on experience—advantageously diversified—desirably a complete under-one-roof responsibility — thoroughly dependable — alert — cooperative!

When we are asked . . . "How much?"—our answering bid usu-

ally reveals "How little!" With on-premise facilities in excess of a million dollars, we've what it takes to save you those important pennies per piece!

That the types of service we render can custom-fit your particular plastic requirements, is indicated by the customer confidence reposed in us by America's leading manufacturers in practically every field of industry.

Call in a Consolidated sales engineer . . . and do so during the early stages of your plastic thinking. His assistance—qualifications will enable you to plan properly . . . and profitably. Your inquiry is cordially invited!

Please address Dept. D-2

## **C**onsolidated Molded Products Corporation

Plant & Executive Offices: 309 CHERRY ST., SCRANTON 2, PA.

Branch Offices and Representatives in New York, Chicago, Milwaukee, Detroit, Cleveland, Bridgeport, Philadelphia—and other principal cities

### Travel Consolidated's Thoroughway to Plastics Satisfaction

- 1 Product Design Cooperation
- 2 Experienced Mold Planning
- 3 Precise Mold Construction
- 4 Laboratory-Checked Materials
- 5 Selective Production Processes  
COMPRESSION      TRANSFER  
PLUNGER              INJECTION
- 6 Statistical Quality Control
- 7 Complete Finishing Facilities



"Your Blueprint in Plastics"

# COPPER ALLOY BULLETIN

REPORTING NEWS AND TECHNICAL DEVELOPMENTS OF COPPER AND COPPER-BASE ALLOYS

Prepared Each Month by BRIDGEPORT BRASS COMPANY "Bridgeport" Headquarters for BRASS, BRONZE and COPPER

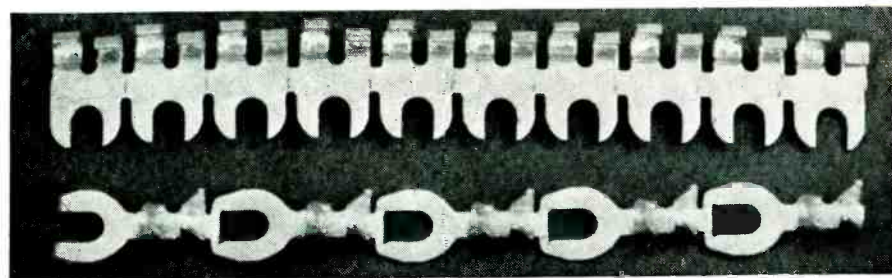

Self-soldering tandem terminals are attached by machine which contains heating unit. Courtesy Patton-MacGuyver Co., Providence, R. I.

## Cutting Costs by Mechanizing Slow Hand Operations

Elimination of expensive hand operations is one of the important ways open to fabricators for substantially cutting costs.

This is always a challenge to the ingenuity of machine and product designers to develop methods for changing old-time hand operations to semi or completely automatic cycles. This may involve both the development of a special-purpose machine and the re-design of the product itself.

### Cutting High-Cost Soldering

The method for soldering copper terminals to insulated wires is an example of such cost-cutting. Originally the terminals were handled individually and required fluxing, tinning, bending and soldering with either an open flame or soldering iron.

The mechanization of this job involved the development of a machine to do the job automatically, with the exception of inserting the wires. It also required redesigning the terminals in strip form.

Progressive dies were made to blank, pierce and bend the terminals but not clip them off. This permitted tinning and depositing the solder on a mass production basis. The fact that the terminals remain joined until fed into the machine does away with the troublesome problem of hand feeding individual terminals which tend to tangle up.

The machine feeds the roll of tandem terminals into a die. When the wire is inserted and the lever tripped, the die closes, cutting off a single terminal, bending the locking lugs around the wire and simultaneously applying heat to melt the solder. Instead of a few hundred by hand, the machine is capable of producing 1200 or more assemblies per hour.

### Copper-Base Alloys Can Help Cut Fabricating Costs

Copper, with its high electrical conductivity, is eminently suited for this job. It can be blanked, formed and clipped with minimum power.

It is extremely ductile which permits the cold bending of locking lugs around the wire without breaking. Copper's high heat conductivity makes it possible to heat the terminal speedily, and dissipate the heat rapidly when the current is shut off.

Product designers interested in cutting production costs will appreciate the fine workability and versatility of the copper-base alloys. Much valuable information on the characteristics of copper, brass, tin, bronze, silicon bronze and aluminum bronze can be gleaned from Bridgeport's Technical Handbook. Contact our nearest Bridgeport sales office for technical help on your metal problems.

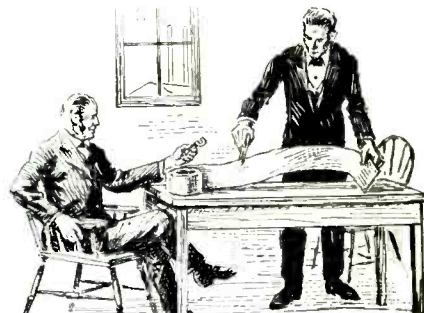

## Did You Know...

### Bridgeport Brass Developed First Mike?

It was 1867, two years after Bridgeport Brass was founded. The Union Metallic Cartridge Company (now Remington Arms) had returned a quantity of brass because it was "out of gauge".

S. R. Wilmot, superintendent, applied his "finger" gauge on several rolls and stoutly denied the charge. However, the customer's gauge did not agree with Mr. Wilmot's, or with a third.

Mr. Wilmot then took matters into his own hands and called in Mr. Laws, of the Mechanical Department. He demanded a gauge with a calibrated moving part that would measure thicknesses accurately.

Meeting emergencies was nothing new to Bridgeport Brass and soon the first "mike" was born. Mr. Laws made five more to fulfill requests from most important customers, but when more were called for, he rebelled. The firm of Joseph R. Brown and Lucian Sharpe was asked to take this task off his hands.

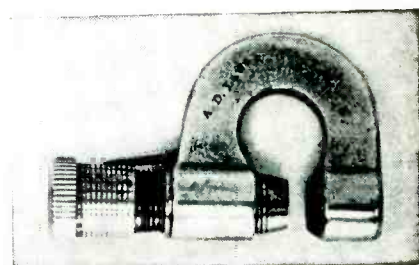

Granddaddy of the micrometer caliper—designed and made by Bridgeport Brass in 1867.

With some minor modifications in the method of reading, the micrometer caliper of today is essentially the same as the one which Bridgeport developed for its own use in 1867.

Industry is indebted to Bridgeport Brass for this universal instrument of precision.

BRASS • BRONZE • COPPER • DURONZE — STRIP • ROD • WIRE • TUBING

MILLS IN  
BRIDGEPORT, CONNECTICUT  
INDIANAPOLIS, INDIANA

In Canada:  
Noranda Copper and Brass Limited,  
Montreal



BRIDGEPORT BRASS COMPANY  
BRIDGEPORT 2, CONNECTICUT

Established 1865  
"Bridgeport" District Offices and Warehouses in Principal Cities

# HIGH-POWER TRANSMITTING TUBES FOR AM

**Big stations serving big areas know G-E triodes will keep them on the air effectively... dependably!**



GL-891-R and GL-892-R



GL-9C22



GL-895-R



### GL-891-R and GL-892-R

10 kw power output typical operation, Class C Telegraphy. (The two tubes are similar except for the amplification factor, which is 8.5 for the GL-891-R, 50 for the GL-892-R.)

### GL-9C22

65 kw power output typical operation, Class C Telegraphy.

### GL-895-R

84 kw power output typical operation, Class C Telegraphy.

**Y**ou have plenty at stake in the performance of your power tubes. On them, your station owners, advertisers, and listening public all rely in terms of signal volume and continuity. Play safe by choosing General Electric! Install superior tubes . . . as built by a foremost manufacturer, and backed by a responsibility that is alert to your needs and to the importance of your tube investment.

All commonly used types, such as those illustrated, are in the G-E line —many of them water-cooled or forced-air-cooled according to your requirements. Also, there are G-E modulator and driving-stage tubes; receiving types; *rectifier tubes* of all capacities for a-c to d-c conversion.

You can get all General Electric tubes for broadcasting from one source—your G-E tube distributor. He's near you, so in a position to give fast delivery. Moreover, his extensive and varied stock enables you to economize in respect to your own inventory of "spares."

Phone your distributor today! Learn how he can help you keep tube performance up, costs down. Also—ask him for your copy of the new booklet on increased tube life prepared by G-E engineers as an aid to radio-station operators. It's free! *Electronics Department, General Electric Company, Schenectady 5, New York.*

**GENERAL  ELECTRIC**

180-JA

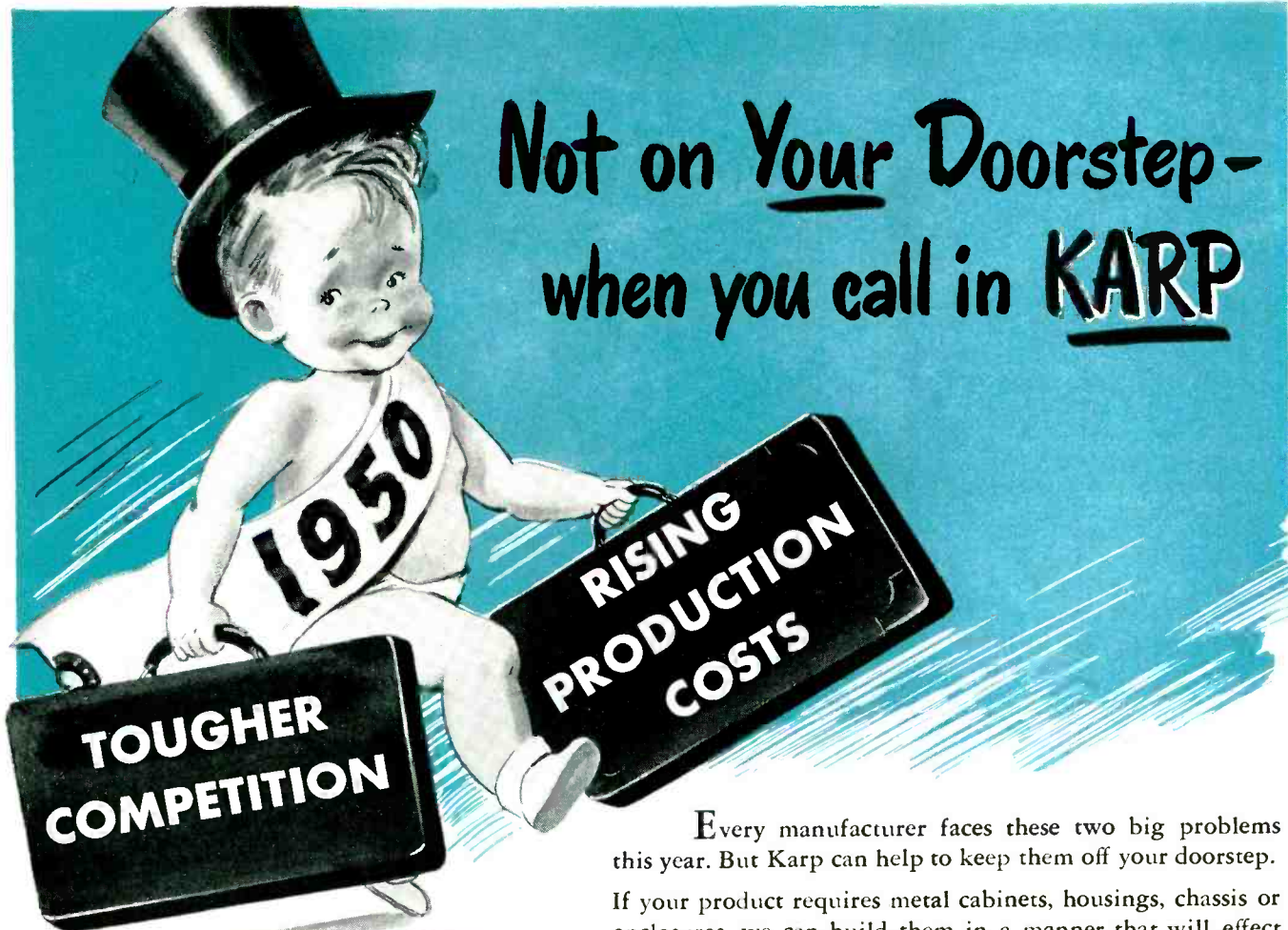

# Not on Your Doorstep - when you call in KARP

Every manufacturer faces these two big problems this year. But Karp can help to keep them off your doorstep.

If your product requires metal cabinets, housings, chassis or enclosures, we can build them in a manner that will effect time and money savings on your assembly line. Karp craftsmanship is so accurate and thorough in detail that all units will be completely uniform. All your components will fit quickly and easily into place without forcing—without extra efforts on your part.

The resultant savings of your time and effort can help cut your costs and permit more competitive pricing, without cheapening your product in quality and value.

Let us prove that Karp's superior craftsmanship also means true economy. Pin the coupon below to your letterhead for more information.

Right: Desk panel cabinet rack

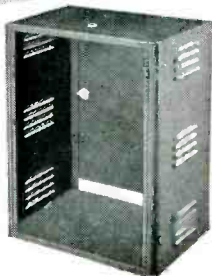

Below: Electronic control cabinet

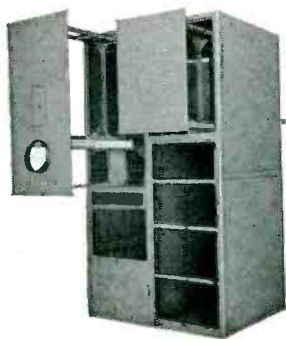

## WHAT KARP CUSTOM CRAFTSMANSHIP OFFERS

- Practical help with design problems, to improve product and cut cost.
- Our large accumulation of tools and dies often can save you special die costs and time.
- The specialized skill of several hundred of the finest metal craftsmen; expert forming, drawing, bending . . . welding with all latest techniques.
- Finest quality painting and finishing of all types in dustproof chambers equipped with water washed spray booth. Baking ovens with timing controls.
- Everything in sheet metal, from a simple chassis or panel to the most elaborate electronic apparatus housings. Any metal, any gauge, any size, any quantity—from a single lot to large run quantities.
- Efficient production and on-time deliveries.

**KARP METAL PRODUCTS CO., INC.**  
215 63rd Street, Brooklyn 20, New York

Yes! Please send more information and *PROOF* of how your sheet metal workmanship can help us cut our production costs.

Name .....

Title .....

Company .....

Address .....

City ..... State .....

**KARP METAL PRODUCTS CO. INC.**

215 63rd Street, Brooklyn 20, N. Y.

*Custom Craftsmen in Sheet Metal*



# Designed for TV 666

Normal sync pulses in a video amplifier presented accurately by use of the low-capacitance probe.

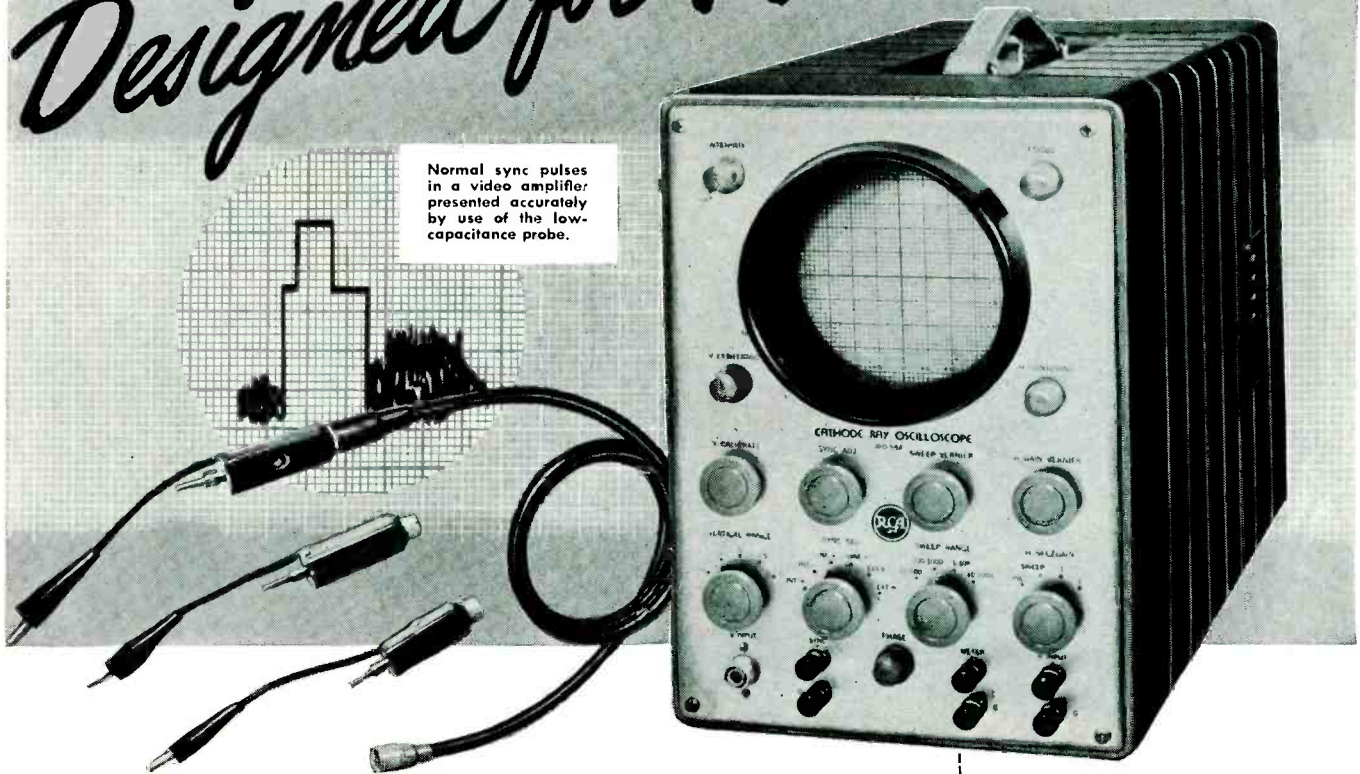

## ...the RCA WO-58A — now priced at \$249.50 — is in a class by itself

The RCA WO-58A is a wide-band, 5-inch oscilloscope with a useful range of 1 cycle to 4 megacycles. It is expressly designed for the testing and alignment of television equipment in the laboratory or in production and quality-check positions.

The WO-58A displays sync pulses, blanking pedestals, and deflection waveforms accurately. Side-panel terminals are provided for Z-axis (intensity modulation) operation and for direct connection to vertical deflecting electrodes of the c-r tube.

In addition, the WO-58A performs all regular oscilloscope functions. A cali-

brating voltage source and a 5-position frequency-compensated switch providing 3-to-1 voltage ranges make the instrument a direct-reading VTVM. Sweep circuits include a vacuum-tube sawtooth multi-vibrator and an auxiliary 60-cycle sine-wave source with phasing control. *Supplied complete* with crystal probe, direct probe, and low-capacitance probe.

Ask your local RCA Test Equipment Distributor for catalog sheet giving complete details, or write RCA, Commercial Engineering, Section B42Y, Harrison, New Jersey.

**RCA 715-B 5-inch Laboratory Oscilloscope—now priced at \$885.** For detailed examination of extremely short, sharp-fronted pulses and unusual waveforms. Displays steady, clear traces even with random recurrence of signal. Vertical amplifier flat within  $\pm 1$  db from 5 to 11 Mc. Triggered sweep is initiated by signal observed during that sweep. Has built-in time-marker generator, and input calibrating meter.



**RCA WO-79B 3-inch Portable Laboratory Oscilloscope—\$550.** For detailed observation and accurate measurement of voltages produced by TV sync and deflection circuits, ignition systems, and pulse generators. Horizontal-deflection capability up to twice screen diameter. Calibrating meter for voltage measurements. Built-in delay line. Vertical amplifier flat from 10 cycles to 5 Mc.



Available from your RCA Test Equipment Distributor



**RADIO CORPORATION of AMERICA**

TEST EQUIPMENT

HARRISON, N. J.

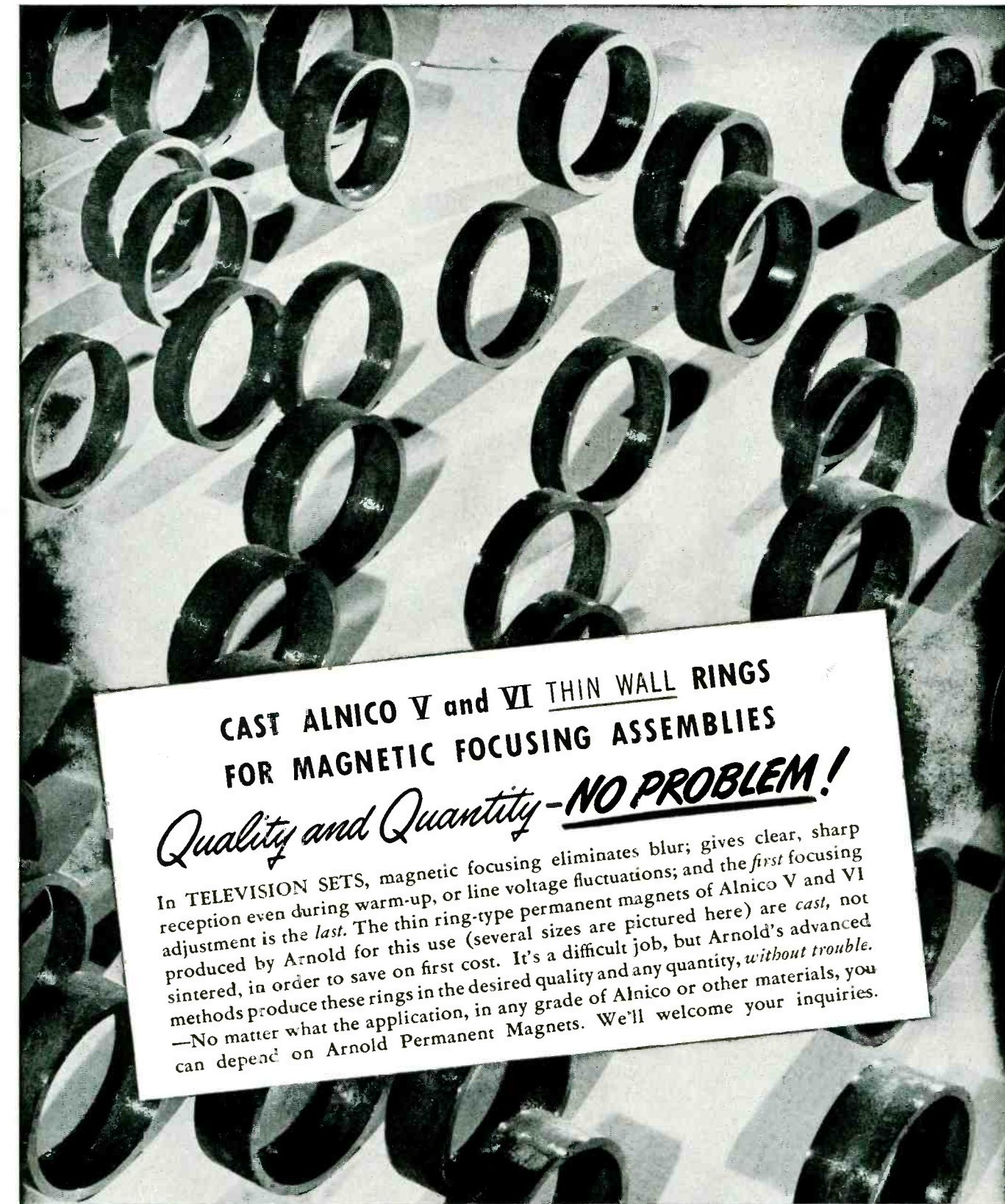

**CAST ALNICO V and VI THIN WALL RINGS**  
**FOR MAGNETIC FOCUSING ASSEMBLIES**

*Quality and Quantity* - **NO PROBLEM!**

In TELEVISION SETS, magnetic focusing eliminates blur; gives clear, sharp reception even during warm-up, or line voltage fluctuations; and the *first* focusing adjustment is the *last*. The thin ring-type permanent magnets of Alnico V and VI produced by Arnold for this use (several sizes are pictured here) are *cast*, not sintered, in order to save on first cost. It's a difficult job, but Arnold's advanced methods produce these rings in the desired quality and any quantity, *without trouble*. —No matter what the application, in any grade of Alnico or other materials, you can depend on Arnold Permanent Magnets. We'll welcome your inquiries.

**THE ARNOLD ENGINEERING COMPANY**



Subsidiary of

**ALLEGHENY LUDLUM STEEL CORPORATION**

147 East Ontario Street, Chicago 11, Illinois

**Specialists and Leaders in the Design, Engineering and Manufacture of PERMANENT MAGNETS**

# Check YOUR NETWORK PROBLEM WITH LOGIC

In any technical business the specialist has a unique value in his specific field. It is logical that a manufacturer of a specialty product should be of greater value in his particular field.

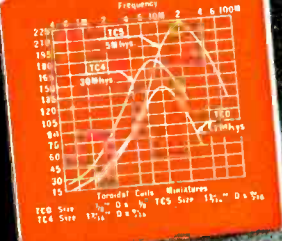
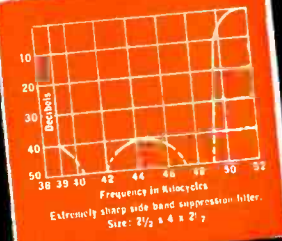
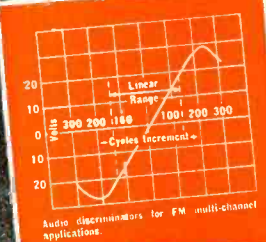
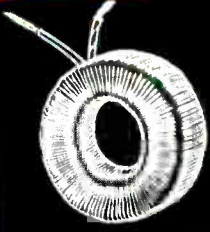
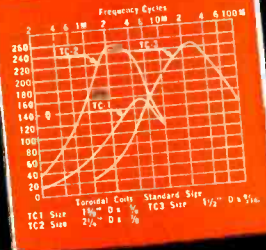
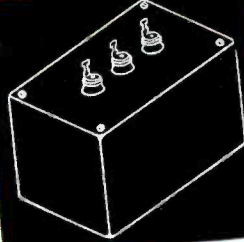
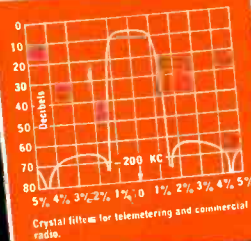
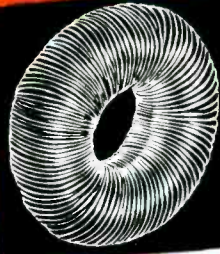
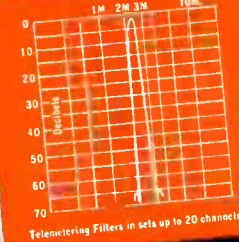
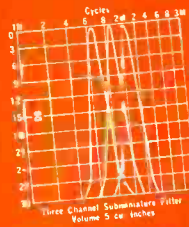
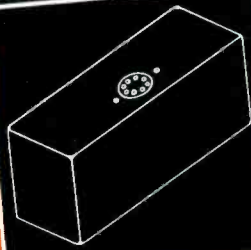
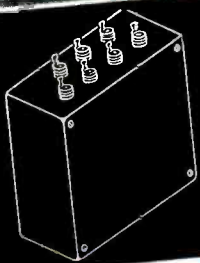

As one of the largest producers of toroidal coils and filters Burnell & Co's facilities and production experience have been of immeasurable technical and economical value to our customers. Many engineers have benefitted by our prompt technical service. Why not bring your network problem to us for the most practical and economical solution?

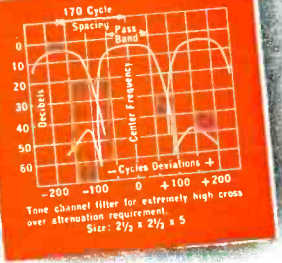
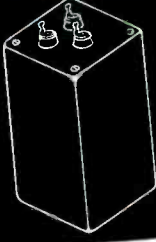

**EXCLUSIVE MANUFACTURERS OF COMMUNICATIONS NETWORK COMPONENTS**

WRITE FOR TECHNICAL INFORMATION  
ALL INQUIRIES WILL BE PROMPTLY HANDLED

**Burnell & Company**  
YONKERS 2, NEW YORK  
CABLE ADDRESS "BURNELL"

# a simplified, outstandingly dependable LINE SWITCH for Stackpole Controls

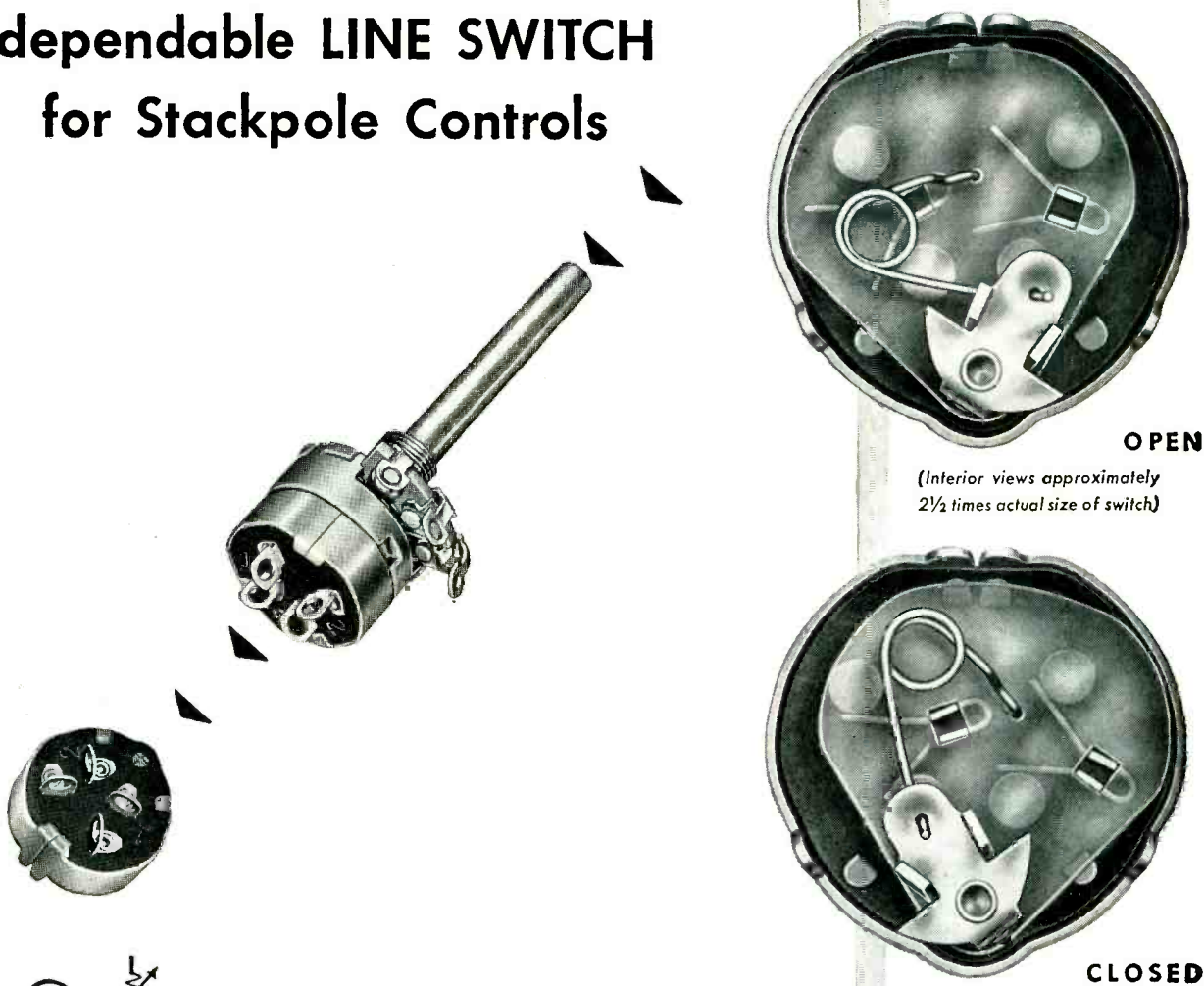

(Interior views approximately 2½ times actual size of switch)

Only .888" in diameter by .312" thick, this Type A-10 double-pole, single-throw line switch fits even the smallest Stackpole controls. Rated 1 ampere at 250 volts AC-DC or 3 amperes at 125 volts AC-DC, it combines outstanding ruggedness of design with ample-sized contacts and positive contact wiping action. Stationary contacts are

mounted on a fiber surfaced Bakelite base to reduce arc tracing. The base is held securely in the can. Throughout, the switch is constructed for long, trouble-free service and in suitable ratings for portable and auto radios and numerous other applications. A similar single-pole design (Type A-11) with dummy terminal is also available.

*Write for Stackpole Bulletin RC-7*

ELECTRONIC COMPONENTS DIVISION  
**STACKPOLE CARBON COMPANY, ST. MARYS, PA.**

# STACKPOLE

**VARIABLE RESISTORS FOR MODERN RADIO AND TELEVISION NEEDS**

**Don't Worry**



**About Fluctuating Voltage**

**You Can Do Something**



**About It**



**VOLTAGE STABILIZERS**  
*...deliver a steady 115 Volts*

Worried about tubes and circuits or relays and controls acting up when voltage fluctuates? One easy solution: *don't let the voltage vary!* With a General Electric Voltage Stabilizer, voltage stays right at 115 v. You can simplify circuits, save money, and get better operation too!

Stabilization is nearly instantaneous (less than 3 cycles) and within  $\pm 1$  per cent for fixed, unity-power-factor loads. All voltage fluctuations between 95 and 130 volts are *automatically* leveled out.

These stabilizers are of the transformer type. They have no moving parts and require virtually no maintenance. They will operate continuously at no load or short circuit without damage to them-

selves. They automatically limit short-circuit current to approximately 200 per cent of rated full-load current.

The stabilizer shown here is rated 1000 volt-amperes. Others are available with ratings from 15- to 5000-va. For general information, write for Bulletin GEA-3634B, Apparatus Department, General Electric Company, Schenectady 5, N. Y.

*Your G-E office will be glad to evaluate your particular needs, or we can advise you by mail if you will give us data and a description of the circuit and load. Address inquiries to Specialty Transformer Sales Division, 1635 Broadway, Ft. Wayne, Indiana.*

**GENERAL**  **ELECTRIC**

411-71

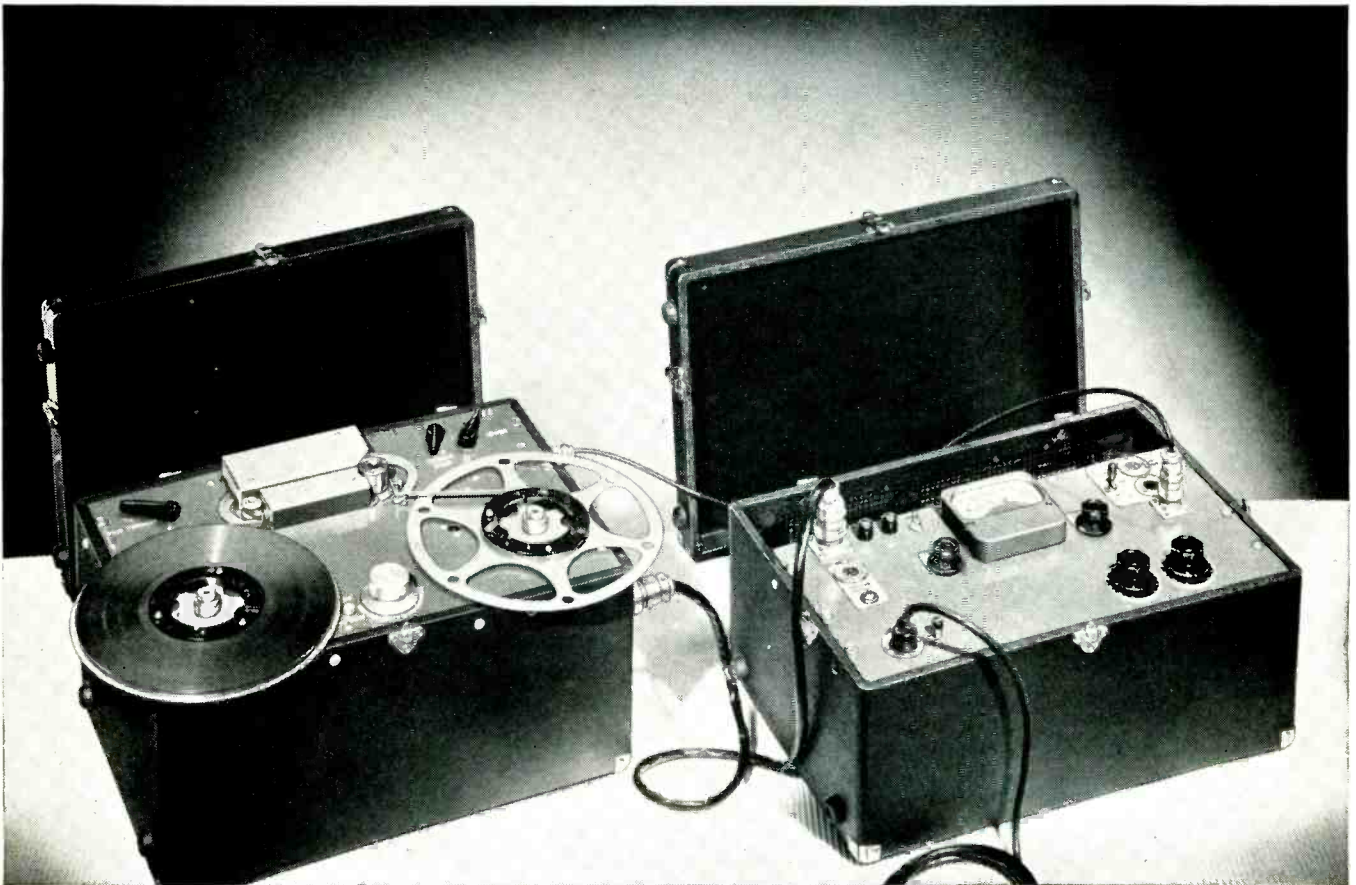

*Radio broadcast engineers  
will appreciate the new*

## **EKOTAPE**

*Broadcast Model 107*

The NEW EKOTAPE Broadcast Model has been designed especially to meet the many requirements expressed by broadcast station engineers as their ideas of an ideal tape recorder. Every facility at the command of Webster Electric Company has been used to make this the most outstanding achievement in tape recorders at a price that places it

within reach of all broadcast stations, large or small. Check the features listed here, then have your nearest dealer demonstrate the tone perfection, simplicity of operation and its absolute dependability.

EKOTAPE is distributed by Graybar and independent distributors in all major cities.

**WEBSTER**  **ELECTRIC**

Webster Electric Company, Racine, Wisconsin • Established 1909 • Export Dept.  
13 East 40th Street, New York 16, N. Y. Cable Address: "Arlab", New York City.

"Where Quality is a Responsibility and Fair Dealing an Obligation"

### **A Few of the Many SPECIFICATIONS and DETAILS**

Compact and portable; units may be removed for installation in standard R. M. A. rack. It can be purchased less carrying case.

Powerful oversize two speed synchronous motor; heavy flywheel and special drive give constant tape speed.

Tape speed 15" per second for full half hour or 7½" per second speed for full hour program.

"A" "B" Selector switch for tape or program.

Switch connects VU Meter for measuring either recording or output level.

Safety button prevents accidental erasing of a recording.

Operator is able to start recording on cue without time lag.

Triple heads, erase, record and playback assure neutral tape and distortion-free playback.

Overall frequency response is  $\pm 2\text{db}$  60 to 12,000 cycles at 15" per second tape speed.  $\pm 2\text{db}$  60 to 7,000 cycles at 7½" per second tape speed.

**Write Today For Complete  
Specification Sheet**

February, 1950 — ELECTRONICS

# These Broadcasters Felt Just Like You Do . . .



Front view of the Collins 20T 1 kw broadcast transmitter

<b>WSPC</b>	Anniston, Alabama
<b>WFPA</b>	Ft. Payne, Alabama
<b>KROP</b>	Brawley, California
<b>KGST</b>	Fresno, California
<b>KTED</b>	Laguna Beach, California
<b>KVON</b>	Napa, California
<b>KSGN</b>	Sanger, California
<b>WGRA</b>	Caira, Georgia
<b>WGBA</b>	Columbus, Georgia
<b>WDWD</b>	Dawson, Georgia
<b>WROY</b>	Carmi, Illinois
<b>WWCA</b>	Gary, Indiana
<b>KFNF</b>	Shenandoah, Iowa
<b>KCLO</b>	Leavenworth, Kansas
<b>KSCB</b>	Liberal, Kansas
<b>WSID</b>	Baltimore, Maryland
<b>WBET</b>	Brockton, Massachusetts
<b>WLYN</b>	Lynn, Massachusetts
<b>WJMS</b>	Ironwood, Michigan
<b>WPBC</b>	Minneapolis, Minnesota
<b>KRAM</b>	Las Vegas, Nevada
<b>WWNH</b>	Rochester, New Hampshire
<b>WIRC</b>	Hickory, North Carolina
<b>KSMI</b>	Seminole, Oklahoma
<b>KASH</b>	Eugene, Oregon
<b>WCMB</b>	Lemoyne, Pennsylvania
<b>WMUU</b>	Greenville, South Carolina
<b>KWAT</b>	Watertown, South Dakota
<b>KDET</b>	Center, Texas
<b>KEYS</b>	Corpus Christi, Texas
<b>KULP</b>	El Campo, Texas
<b>KOGT</b>	Orange, Texas
<b>KITE</b>	San Antonio, Texas
<b>KNAL</b>	Victoria, Texas
<b>KSVC</b>	Richfield, Utah
<b>WOAY</b>	Oak Hill, West Virginia
<b>WWYO</b>	Pineville, West Virginia
<b>WLIN</b>	Merrill, Wisconsin
<b>KVRS</b>	Rock Springs, Wyoming

## They wanted a 1 kw transmitter that they could be sure of so they bought the 20T

● Any time you talk about money in four figures, you are talking about a lot of it. For instance, you can buy the finest automobile, refurnish your home, pay for a substantial portion of a new house or any one of a number of grand things with the amount of money you put into a 1 kw broadcast transmitter. Whenever you buy any of these things you shop carefully, investigate the supplier and manufacturer and, most of all, the quality of the product itself before you sign on the dotted line.

When you buy a transmitter for your 1 kw installation you should be careful. When you buy a 20T it's a sign you have considered your purchase carefully. You have weighed quality, convenience, work-

manship, ease of operation against cost. You have made comparison.

In the end you do the same thing the broadcasters listed above decided to do. You choose the 20T. Why? Because you get a real buy in the 20T. It is unsurpassed by any comparison, be it appearance, workmanship, operation, convenience—or the service of the Collins Radio Company—which is a feature of your purchase that lasts the many years that you will enjoy fine service from your installation.

Whether you are starting a new station or replacing present equipment, find out about the 20T so you will know what a really good broadcast transmitter is.

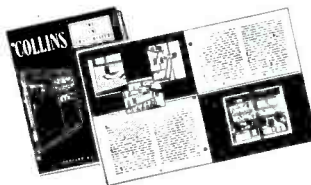

### New Booklet

A letter addressed to Dept. E-1, Collins Radio Company, Cedar Rapids, Iowa, will bring you the newest information on the 20T transmitter.

FOR BROADCAST QUALITY, IT'S . . .



**COLLINS RADIO COMPANY, Cedar Rapids, Iowa**

11 W. 42nd St.  
NEW YORK 18

2700 W. Olive Ave.  
BURBANK

M & W Tower  
DALLAS 1

Dogwood Rd., Fountain City  
KNOXVILLE

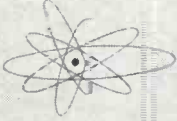

# Designers

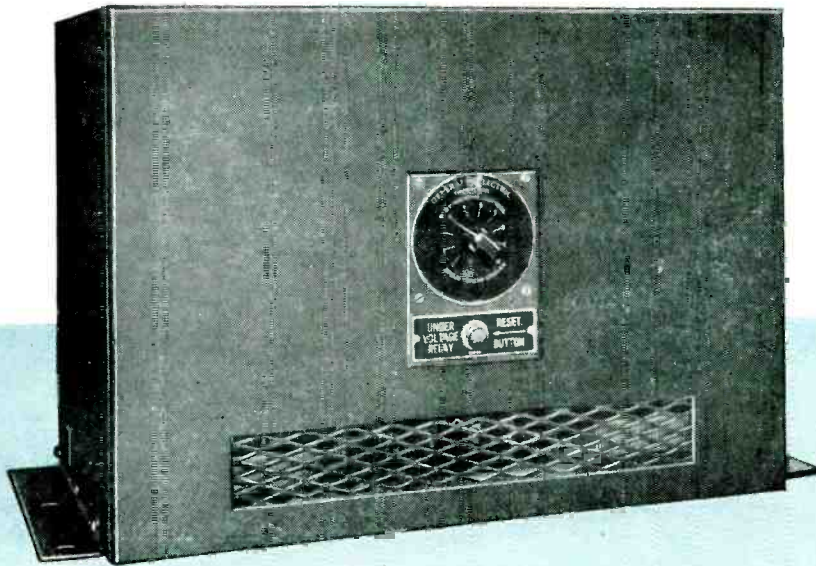

## low-cost welding speeds up production

General Electric engineers have developed a new low-cost method of precision-control resistance welding for use in many expensive assembly operations in the manufacture of electronic equipment.

This new welding method makes it possible for a single operator to weld 15 grounding ribbons and one resistor lead to the chassis of a television set in two minutes.

The control panel shown above provides for welding-current adjustment to control the amount of heat produced in the welds. Once set, this control will keep successive welding currents constant to insure accurate and consistent welding of connections. Write for complete data in Bulletin GEA-4175.

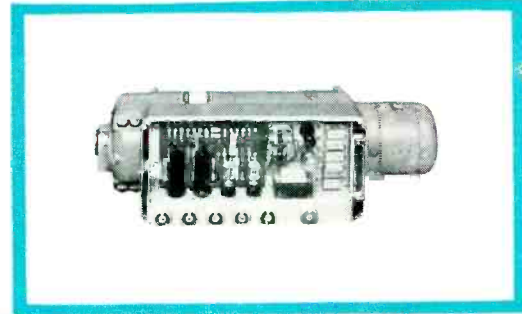

### one package— Amplidyne plus Amplifier

The G-E electronic amplidyne consists of a motor-amplidyne set, a high-gain d-c balanced amplifier, and a reference voltage supply. It is similar to equipments used in drive systems for radar antennas, searchlights, and ship and aircraft gun mounts. Commercially, it can be used in many kinds of motor control systems for close regulation of current, voltage and speed—to limit torque, hold tension, speed up acceleration, and position accurately.

The electronic amplifier makes the amplidyne respond quickly to sudden changes in the control signal, and gives it high sensitivity to small gradual changes. These and other features make it readily adaptable to automatic programming and closed-cycle processing control.

Applications range from power supply for  $\frac{1}{4}$  to  $1\frac{1}{2}$  horsepower motors to field excitation for large adjustable voltage drives up to 200 horsepower. For information, see Bulletin GEA-4889.

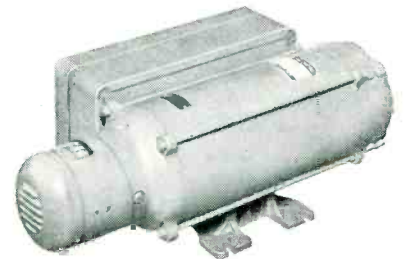

**GENERAL**



**ELECTRIC**



# Digest

## TIMELY HIGHLIGHTS ON G-E COMPONENTS

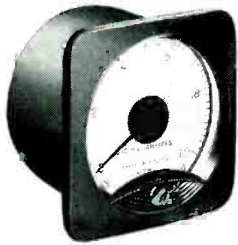

250 degrees of meter scale

General Electric's new long-scale panel instruments are designed for applications where space is limited, but ease and accuracy of reading are required. These 3½-inch instruments have a 4.92-inch scale which covers 250 degrees.

The sturdy, attractive, molded Textolite cases (round or square) harmonize with other G-E panel instruments. The mechanism is the internal-pivot type—a reliable unit construction which permits minimum behind-the-panel depth. Accuracy is within 5% of full scale on the rectifier type, 2% on all others. For full details, write for Bulletin GEA-5425.

If you need it—  
± one degree accuracy



Electronic engineers are well aware of the usefulness of selsyns. Whether used for indicating or control, they have proved themselves a reliable, accurate, and rapid means of communication.

G.E. produces a complete line of selsyns—the high-accuracy type with an accuracy of ± one degree, and the general-purpose type with a ± five-degree accuracy. All units have high operating torque and are totally enclosed with no exposed terminals. Indicators and transmitters are also available in several models. See Bulletin GEA-2176.

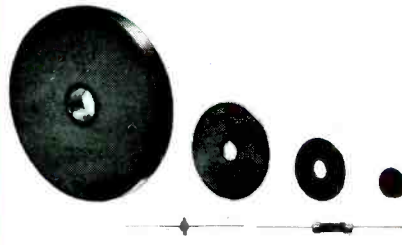

R varies inversely as E<sup>4</sup>

Thyrite® resistance material is inorganic and has the unique electrical property of varying inversely in resistance as the fourth power (or even higher) of an applied voltage. It has stable electrical characteristics over a wide range of operating conditions and can be used with a-c, d-c, or short-duration pulses. Because of this, it has solved many problems for the electronic design engineer.

Its most widely known applications are in the limiting of voltage surges, the stabilization of rectifier output voltages, the controlling of voltage-selective circuits, and the potentiometer division of voltages.

It is usually supplied in disk form in diameters from 0.25 to 6.00 inches, with or without mounting holes. Smaller sizes are furnished with wire leads. Complete information is contained in Bulletin GEA-4138.



Cast glass bushings  
make possible new designs

Originally developed by General Electric for use in vital communication equipment, these unique bushings are now successfully used on such apparatus as power capacitors, transformers (filament, modulator or pulse), and rectifiers. They're made of cast glass with sealed-in nickel-steel hardware and can be readily welded, soldered or brazed directly to the apparatus. This eliminates the need for gaskets and provides a permanent hermetic seal.

Because they are small and compact, as well as vibration and weather resistant, glass bushings make possible new designs, especially where apparatus is to be airborne or where high humidity or fungus growth are special problems. Glass bushings will not puncture or shatter under excess potentials—either 60 cycle or impulse. For more data, including sizes and ratings, see Bulletin GEA-5093.

General Electric Company, Section A667-4  
Apparatus Department, Schenectady 5, N. Y.

Please send me the following bulletins:

- |  |  |
|--|--|
| <input type="checkbox"/> GEA-2176 Selsyns          | <input type="checkbox"/> GEA-4889 Electronic Amplidyne |
| <input type="checkbox"/> GEA-4138 Thyrite Material | <input type="checkbox"/> GEA-5093 Glass Bushings       |
| <input type="checkbox"/> GEA-4175 Welding Control  | <input type="checkbox"/> GEA-5425 Panel Instruments    |

NAME .....

COMPANY .....

ADDRESS .....

CITY ..... STATE .....

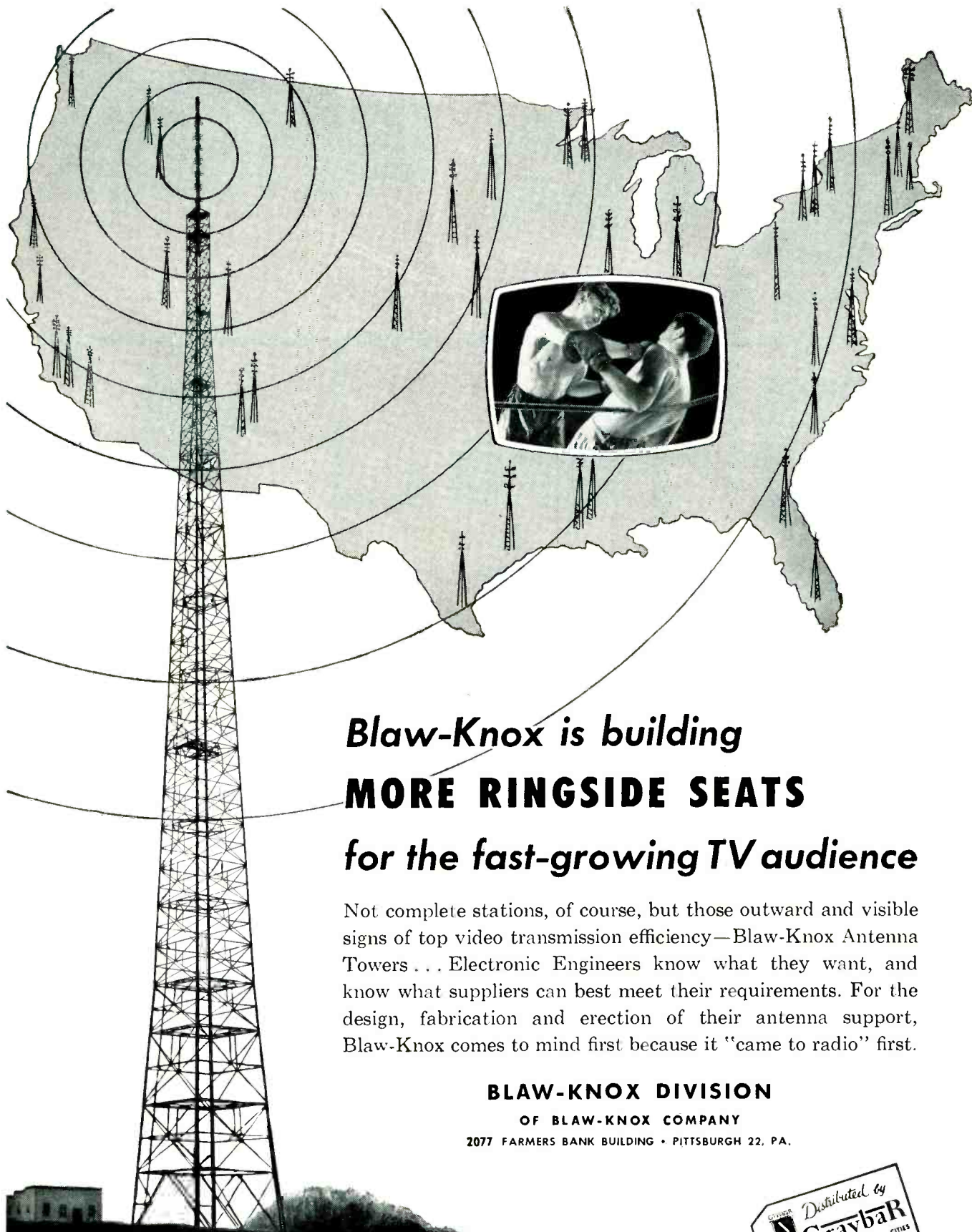

*Blaw-Knox is building*  
**MORE RINGSIDE SEATS**  
*for the fast-growing TV audience*

Not complete stations, of course, but those outward and visible signs of top video transmission efficiency—Blaw-Knox Antenna Towers . . . Electronic Engineers know what they want, and know what suppliers can best meet their requirements. For the design, fabrication and erection of their antenna support, Blaw-Knox comes to mind first because it "came to radio" first.

**BLAW-KNOX DIVISION**  
OF BLAW-KNOX COMPANY  
2077 FARMERS BANK BUILDING • PITTSBURGH 22, PA.



**BLAW-KNOX ANTENNA TOWERS**

**NEW**

# DRIVER-HARRIS ELECTRONIC TESTING

## Obsoletes Previous Methods of Testing Enameled Wire Insulation



This revolutionary Dielectric Continuity Tester at Driver-Harris checks the quality of coating on 19 strands of wire simultaneously—as the wire leaves enameling furnaces. Top switches on the test units are calibrated in impulses per minute required to operate an alarm. With the speed of the wire known, and also the maximum number of faults per 100 feet permitted by specification, each test unit is readily set to operate in conformance with the terms of the test imposed.

In order to guarantee the quality of a spool of enameled wire, every inch of the wire should be checked for dielectric faults, not just a few feet. In general practice, however, only a short sample of wire is examined. This is passed through a mercury cup held at a fixed potential, and shorts through the insulation are indicated on a voltmeter. If faults do not exceed a specified maximum for a given length of wire, insulation throughout the entire spool is assumed to be satisfactory.

This inefficient, compromise method has two important disadvantages: (1) the small portion of wire tested may not truly represent the condition of insulation throughout the spool; (2) insulation failures are not discovered until long after the enameling process is completed.

By checking insulation continuously, as wire leaves the enameling furnaces—the only 100% dependable way—

Driver-Harris' new test equipment obsoletes such ineffectual and wasteful procedure.

So long as specifications are met, the new Driver-Harris electronic tester permits the enameling process to continue uninterrupted. When the rate at which faults occur approaches the maximum number of faults permitted by specifications, the test mechanism sounds an alarm and a record is made on a moving chart.

In this way, enamel coating is not only tested for continuity throughout the entire length of spooled wire, but sub-standard enameling is detected—and can be corrected—as soon as it occurs.

Thus makers of wire-wound resistors—particularly in finer sized wire, where shorts are more likely to occur—are enabled to eliminate time-waste and material-waste in their production, and obtain superior, more dependable products.

Makers of world-famous Nichrome\* and over 80 alloys for the electrical, electronic and heat-treating fields

## Driver-Harris Company

HARRISON, NEW JERSEY

BRANCHES: Chicago, Detroit, Cleveland, Los Angeles, San Francisco

Manufactured and sold in Canada by

The B. GREENING WIRE COMPANY, LTD., Hamilton, Ontario, Canada



\*T. M. Reg. U. S. Pat. Off.

# Q.

## Why is "dag" Colloidal Graphite best for CRT Exterior Wall Coating?

# A.

- It's cheaper
- ... Has better adhesion
- ... Requires no baking
- ... Resists scratching

### BLEEDS STATIC FROM CABINETS TOO!

Static charges built up in TV sets—particularly where metal CRT's are used—can be successfully bled off by coating the inside of cabinets with "dag" Dispersion #194. This reduces picture interference and also precludes shock. Easy to apply by spraying or brushing.

"dag" Dispersion #194 is a lacquer-base dispersion of microscopically small graphite particles. It is easily applied to CRT surfaces by spraying, and dries very rapidly, enabling tubes to be handled in 2 or 3 minutes. Maximum adhesion is obtained by drying at room temperature for 24 hours, or by forced infra-red drying for ½ hour.

"dag" Dispersion #194 forms a smooth, uniform, conductive black coating on any type glass. Its adhesive properties are so good that it will resist scratching by a thumb nail or soaking in water.

Prominent CRT manufacturers have found "dag" colloidal graphite dispersions satisfactory and usually cheaper for wall coatings . . . for other electronics work, too. Let Acheson Colloids engineers show YOU how these versatile dispersions can solve many and varied electronics problems. Send the coupon NOW for more information.



ACHESON COLLOIDS CORPORATION  
Port Huron, Michigan

Send me more information on:

\_\_\_\_\_ "dag" Dispersion # 194 for Exterior Wall Coating

\_\_\_\_\_ "dag" Colloidal Graphite in Electronics

Name \_\_\_\_\_

Company Name \_\_\_\_\_

Address \_\_\_\_\_

City \_\_\_\_\_ Zone \_\_\_\_\_ State \_\_\_\_\_

**ACHESON  
COLLOIDS  
CORPORATION**

Port Huron,  
Michigan



**"Carillonic Bells"**

SCHULMERICH ELECTRONICS, INC., Carillon Hill, Sellersville, Pa. "Carillonic Bells" feature KENYON transformers. KENYON "T" line transformers mounted in weather-proof housings in the bell-tower match the amplifier output to the belfry speakers. The high fidelity amplifiers incorporate a variety of KENYON transformers designed specific-

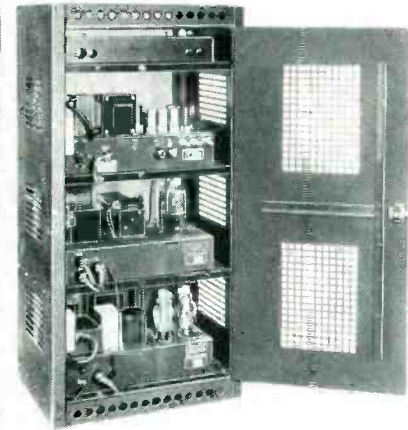

ally for this unique application. KENYON transformers again ring the bell! This time, literally—in the ringing of Schulmerich "Carillonic Bells" from church steeples and towers.

**Amplifier Power/Supply**

PRESTO RECORDING CORP., P. O. Box 500, Hackensack, N. J. The 900-A1 has two amplifiers, one for recording or remote, the other for playback or monitoring. Power input 115 volts, 50/60 cycles, single phase, 70 watts. Has 3 microphone channels. Input impedance-30/50 ohms; output impedance-500/600 ohms. Gain of remote amplifier-85db 3db.

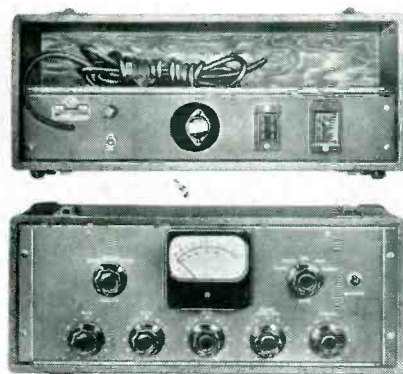

The Presto 900-A1, the amplifier of the Presto Portable Tape Recorder PT-900 uses KENYON Transformers exclusively. Leading manufacturers and engineers in all fields specify KENYON "T" Line Transformers for many industrial, communication, sound and electronic applications. Presto too, calls upon KENYON "T" Line Transformers for rugged, dependable service in its high-quality equipment!

(ADVERTISEMENT)

Here's the "Q" in Transformers



It's **KENYON** Quality

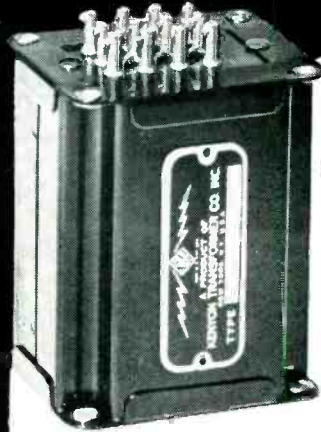

*Custom-built  
to your  
Specifications*

**KENYON** one of the oldest names in transformers, offers you high quality specification transformers custom-built to your requirements — *practically at catalog prices!* For over 20 years the KENYON "K" has been a sign of skillful engineering, progressive design and sound construction.

**KENYON "Specials" Are Designed For:**

- |                      |                           |
|----------------------|---------------------------|
| JAN APPLICATIONS     | AUTOMATIC CONTROLS        |
| BROADCAST            | AUDIO AMPLIFIERS          |
| INDUSTRIAL MACHINERY | EXPERIMENTAL LABORATORIES |
| RADAR                | ATOMIC ENERGY EQUIPMENT   |

*Among many others*

Consult our engineering staff on any of your "special" problems at no obligation to you. Call or write now for our representative.

**KENYON** "T's"— famous line of high quality, uniform transformers are ready for immediate delivery from stock. Our standard line can save you much time and expense. For a complete story about specific ratings on all transformers, send for your copy of the latest KENYON Catalog edition now!

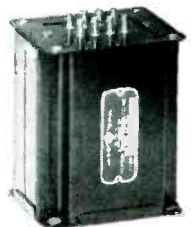

**KENYON TRANSFORMER CO., Inc.**

840 BARRY STREET

NEW YORK 59, N. Y.

**SEND FOR LATEST CATALOG NOW!**

**KENYON Transformer Co., Inc.**

840 Barry Street, New York 59, N. Y.

Send me the latest edition of your new catalog without obligation.

Name..... Address.....

Position..... City..... Zone.....

Company..... State.....

We need "special" transformers —

Please have your representative call

# Flexite

THE FLEXIBLE, EXTRUDED  
PLASTIC TUBING THAT  
RESISTS HIGH  
TEMPERATURES

**APPROVED**

by the  
**UNDERWRITERS  
LABORATORIES**  
under their reexamination service

**ABOVE  
105° C**

**Flexite**

## PHYSICAL & ELECTRICAL PROPERTIES

- a**—tensile strength, minimum average ..... 2500 PSI
  - b**—ultimate elongation, minimum average ..... 300%
  - c**—dielectric strength, minimum ..... 800 v/mil
  - d**—flammability ..... non-inflammable
  - e**—heat resistance — after 100 hours at 300° F. the tubing is not brittle and when flexed does not crack.
  - f**—heat endurance — recommended for continuous operating temperatures up to 105° C., and when baked at 125° C. for 2,000 hours does not become brittle.
  - g**—low temperature flexibility ..... -30° C.
  - h**—heat shrinkage ..... ASTM Standards
    - # 20 — # 17 incl. — less than 8%
    - # 16 — # 6 incl. — less than 5%
    - # 5 and larger — less than 3%
  - i**—oil resistance — highly resistant to effects of transformer and lubricating oils, does not stiffen when continuously exposed to them.
- Colors** — black, white, red, green, yellow and blue are standard colors.
- Dimensions and Tolerances** — standard sizes to fit B & S wires #20 to #0 inclusive, as specified by ASTM Spec. D922-47T.
- Wall Thickness** — in accordance with ASTM Spec. D922-47T, as follows:
- # 20 — # 10 incl. — .016" ± .003"
  - # 9 — # 0 incl. — .020" ± .003"
- Standard Lengths** — Standard 36" lengths or continuous lengths in coils. Sizes #20 — #10 incl., will be supplied on paperboard spools when so ordered.
- Quality** — uniform in quality and condition, smooth on both inside and outside, free of defects such as pin-holes, blisters, foreign inclusions and other imperfections.
- Test Methods** — properties enumerated in above specifications shall be determined according to Tentative Methods of Testing Non-rigid Polyvinyl Tubing, American Society for Testing Materials, Designation D876-46T.

**YES, FLEXITE** is the electrical insulation tubing that sets new standards for resistance to extreme high temperatures. Compounded of a plasticized copolymer of vinyl chloride and vinyl acetate and manufactured with a true wall thickness, smooth inside and outside, FLEXITE PLASTIC TUBINGS offer the greatest resistance to high and low temperatures, are extremely flexible and have great tensile strength.

FLEXITE compares more than favorably with tubings of similar nature. Check the specifications of FLEXITE, compare them with the requirements for your products and against other insulations for identical use. . . .

**YES, You will find that FLEXITE** sets a new high standard for protection against high temperatures, high dielectric, stretching, tearing, abrasion, exposure to acids, oils and alkalis, flammability, etc., etc., etc. — . . . samples and additional information will be sent upon request.

And for a Plastic Tubing to Withstand Normal High Temperatures Mitchell-Rand Offers . . . Flexite-Norm . . . write for specifications.

Whatever your  
electrical insulation problem  
Mitchell-Rand has the answer.

And for a Plastic Tubing to Withstand Normal High Temperatures  
Mitchell-Rand Offers . . . Flexite-Norm . . . write for specifications.

M-R THE  
ELECTRICAL  
INSULATION  
HEADQUARTERS  
FOR 60 YEARS.



**MITCHELL-RAND INSULATION CO. Inc.**

51 MURRAY STREET • Cortland 7-9264 • NEW YORK 7, N. Y.

A PARTIAL LIST OF M-R PRODUCTS: FIBERGLAS VARNISHED TUBING, TAPE AND CLOTH • INSULATING PAPERS AND TWINES • CABLE FILLING AND POTHEAD COMPOUNDS • FRICTION TAPE AND SPLICE • TRANSFORMER COMPOUNDS • FIBERGLAS SATURATED SLEEVING • ASBESTOS SLEEVING AND TAPE • VARNISHED CAMBRIC CLOTH AND TAPE • MICA PLATE, TAPE, PAPER, CLOTH, TUBING • FIBERGLAS BRAIDED SLEEVING • COTTON TAPES, WEBBINGS AND SLEEVINGS • IMPREGNATED VARNISH TUBING • INSULATED VARNISHES OF ALL TYPES • EXTRUDED PLASTIC TUBING

# ANNOUNCING

EIMAC TUBE TYPE

## 4X150G

Another Engineering Achievement by Eimac



2 x  
ACTUAL SIZE

The 4X150G is a new coaxially constructed UHF tetrode, a modification of the popular Eimac 4X150A. The new design has resulted in lower lead inductance, reduced the UHF grid driving-power requirements, and increased upper frequency limits of efficient performance.

The 4X150G can be operated as either a conventional radio-frequency amplifier or oscillator over a wide range of plate voltages at frequencies up to 1000 Mc. In pulse service efficient performance is obtained up to 1500 Mc.

Operating as a class-C amplifier in the 750 Mc. region, the Eimac 4X150G will provide a power-gain of 8. (100 watts output, 12½ watts driving power.) In pulse oscillator service at 1250 Mc., tests indicate peak output-powers of over 20 kw per tube.

Maximum ratings and other operational characteristics for this new tetrode are available from the Eimac Field Engineering Department.

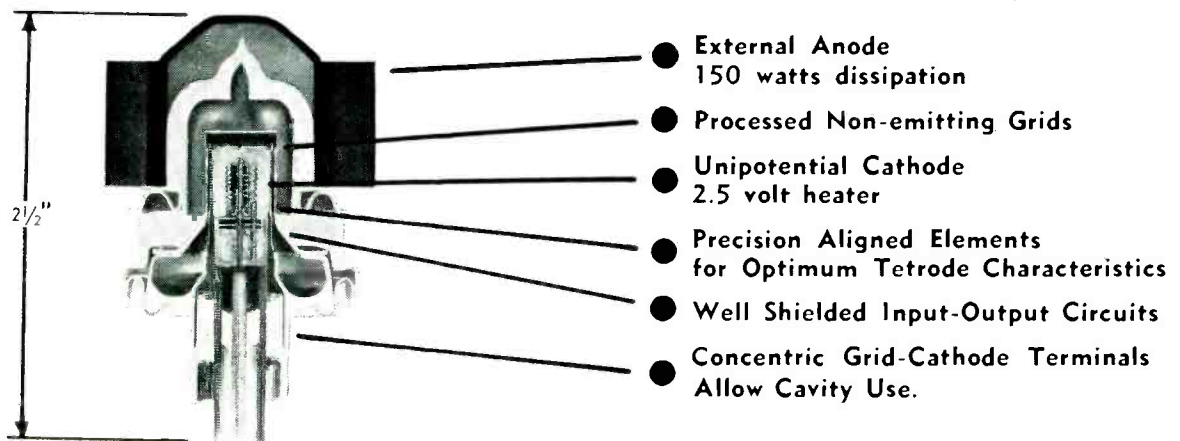

**EITEL-McCULLOUGH, INC.**  
**San Bruno, California**

Export Agents: Frazar & Hansen, 301 Clay St., San Francisco, California

Follow the Leaders to

**Eimac**  
**TUBES**  
The Power for R-F

244

# 4 PROBLEMS 4 ANSWERS

You, as a Communications Engineer, will be interested in the four *Aerocom* products illustrated below. They are designed and built to solve your communications problem. They are the result of engineering knowledge and experience gained during 18 years of manufacturing communications equipment for more than 200 installations throughout the world.

**WEATHERPROOF LOW FREQUENCY ANTENNA TUNER.** Sturdily constructed; using heavy aluminum sheet and rustless hardware. Ample ventilation provided, yet insect and vermin proof. Suitable for 1-2 kw carrier, 200-415 kcs; coupling coil matches either coaxial or 2 wire line. Illustration shows cabinet with protective and weatherproof (no gaskets) covers removed. Locking facility provided.

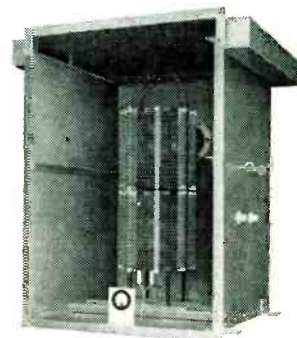

**AUTOMATIC KEYER** provides continuous or interrupted identification signals for beacon or Aerophare service. Small, compact ( $6\frac{5}{8}'' \times 9'' \times 7''$ ) this keyer gives long, trouble-free service. Two synchronized cams, one for call letters, the other for spacing between calls or making long dashes; available in two types: (1) cut at factory (2) adjustable with maximum 3 letter call. Motor - 105/115 V (or 210/230 V) - 50/60 cy. Oilite or ball bearings.

**METEOROLOGICAL INSTRUMENTS** -- Aerocom's group assemblies; anemometer and wind direction indicator on mast for outside installation, and reading instruments in cabinet or standard rack panel, give constant and reliable weather information. Instruments available: wind direction, wind speed, Kollsman station barometer (altimeter), 24 hour clock, or any combination thereof. Mast assembly may be remotely located from instruments.

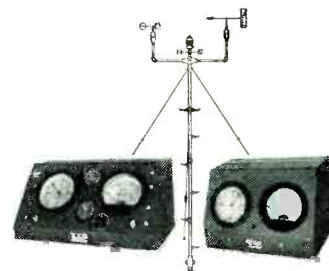

**LINE MATCH INDICATOR:** Made in two models (a) LMI-72 for coaxial lines and frequencies from 0.2 to 10 mcs; (b) LMI-500 for balanced pair lines and frequencies from 0.2 to 2 mcs., or 2 to 20 mcs. These instruments permit adjustment of load for optimum line match. Sturdy and rugged, engineered for field use.

FOR OVER EIGHTEEN YEARS CONSULTANTS, DESIGNERS, AND MANUFACTURERS OF STANDARD OR SPECIAL ELECTRONIC, METEOROLOGICAL AND COMMUNICATIONS EQUIPMENT.



**AERONAUTICAL COMMUNICATIONS EQUIPMENT, INC.**  
3090 Douglas Road, Miami 33, Florida

DEALERS: Equipetro Ltda., Caixa Postal 1925, Rio de Janeiro, Brazil \* Henry Newman Jr., Apartado Aereo 138, Barranquilla, Colombia \* Radelec, Reconquista 46, Buenos Aires, Argentina



Typical of the C-D line of capacitors with built-in quality characteristics is the

**TYPE UP**  
for TV applications

Tested and proved in thousands of television receivers, the type UP electrolytic capacitors are available in capacities from 1/4 mfd. to 2,000 mfd. in any capacity combination. Voltages range from 6 volts to 500 volts. Standard ambient temperature range is -25° C to +85° C. Special, exclusive C-D design and construction assures maximum capacity stability in operation. A better capacitor for more difficult TV applications.

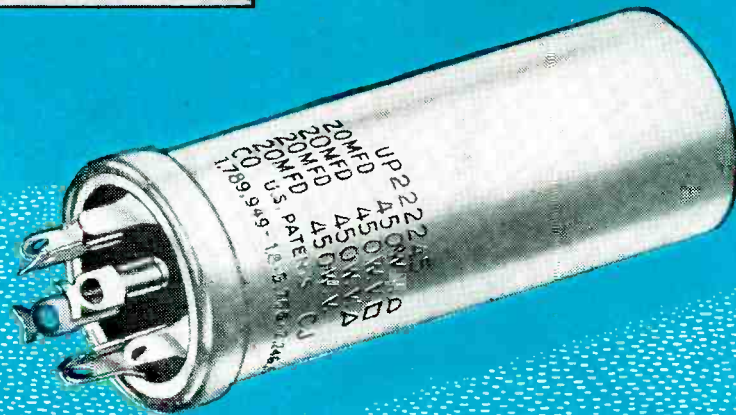
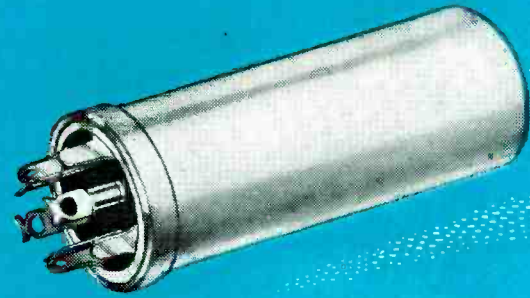

**ARE THEY ALIKE?**

*or do they only look alike?*

**Cornell-Dubilier capacitors might look like others... but differ where it counts!**

That there's more than meets the eye—when it comes to capacitors—is a fact well known to radio engineers for many years. Anyone who knows his way around in the industry, as you do, is not fooled for a moment by external appearance. It's what's *inside* that counts—which is why you can count on Cornell-Dubilier.

Engineers specify C-D because over a period of 40 years they have learned they can count on C-D capacitors for complete dependability, for long years of trouble-free performance, for really genuine economy. Perhaps that's why an impressive percentage make it a point to specify C-D's. Inquiries cordially invited. Catalog available on request.

Cornell-Dubilier Electric Corporation, South Plainfield New Jersey, Dept. K-20. Other plants in New Bedford, Brookline and Worcester, Mass.; Providence, R. I.; Indianapolis, Ind., and subsidiary, The Radiart Corp., Cleveland, Ohio.



*C-D Best by Field Test!*

# These Three

## ALLIED POWER RELAYS

FROM SINGLE-POLE TO FOUR-POLE

### TYPIFY ALLIED VERSATILITY

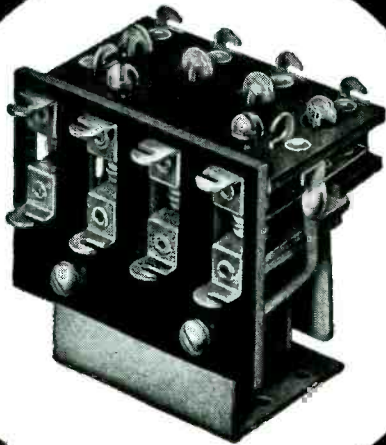

#### 3-POLE & 4-POLE "PO" TYPE RELAY

This medium power relay is supplied with contact arrangements up to 4-pole double-throw. Standard silver contacts rated at 15 amperes for 24 volts DC or 110 volts AC non-inductive. Coil rating 2.5 watts up to 112 volts DC and 10.5 volt-amperes up to 230 volts AC. Dimensions: 3-pole 2-1/4" x 1-7/8" x 1-5/8". 4-pole 2-1/4" x 1-7/8" x 2-3/16".

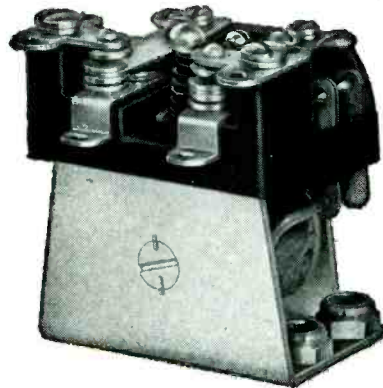

#### DOUBLE-POLE "BO" TYPE RELAY

This all-purpose power relay is supplied with single or double-throw contacts. Molded insulation throughout. Standard silver contacts rated at 15 amperes for 24 volts DC or 110 volts AC non-inductive. Coil rating of 2.5 watts up to 112 volts DC and 4.5 volt-amperes up to 250 volts AC. Dimensions: 1-7/8" x 1-13/32" x 1-5/8".

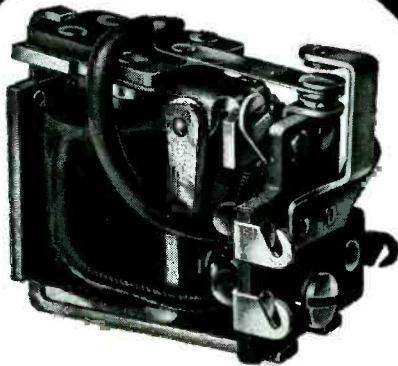

#### SINGLE-POLE "AS" TYPE RELAY

This small, light-weight power relay is supplied with single or double-throw contacts. Standard silver contacts rated at 5 amperes for 24 volts DC or 110 volts AC non-inductive. Coil rating 1 watt up to 95 volts DC and 3.5 volt-amperes up to 230 volts AC. Dimensions: 1-3/8" x 1-5/8" x 15/16".

Like all Allied Relays, types "AS," "BO" and "PO" may be had hermetically sealed, with choice of standard octal plug-in base or solder-type terminals.

For complete information on these and other Allied Relays, write for latest Bulletin.

#### NEW RELAY GUIDE

This new folder shows 24 small, compact Allied Relays with a carefully detailed table of characteristics and specifications. Write for YOUR free copy today.



## ALLIED CONTROL COMPANY, INC.

2 EAST END AVENUE, NEW YORK 21, NEW YORK



## You can solve many problems and prove results with the New BRUSH "Universal Analyzer"

● Brush announces an important addition to its complete line of Recording Analyzers. The New Brush "Universal Analyzer" gives instantaneous, accurate recording of a wide variety of physical variables such as strain, pressure, acceleration, torque, force, temperature, displacement and vibration . . . to help you solve a host of research, development and production problems . . . and to give you definite *proof* of results!

This new Brush Analyzer consists of a Carrier Type Bridge Amplifier and Direct-Inking Oscillograph . . . is used in conjunction with conventional primary

pickup elements. With proper calibration resistors, the ink-on-paper records of the Brush "Universal Analyzer" can be interpreted immediately and easily in any desired units of physical measurement.

Write today for complete details on this new Brush aid for accurate measurements and *proven* results.

### THE *Brush* DEVELOPMENT COMPANY

3405 Perkins Avenue, Cleveland 14, Ohio, U. S. A.

Canadian Representatives: A. C. Wickman (Canada) Ltd., P. O. Box 9,  
Station N, Toronto 14, Ontario



*Put it in writing with a*

## BRUSH RECORDING ANALYZER

STRAIN ANALYZERS • SURFACE ANALYZERS • CONTOUR ANALYZERS • UNIVERSAL ANALYZERS • UNIFORMITY ANALYZERS



# extreme precision, instant response in remote indication and control

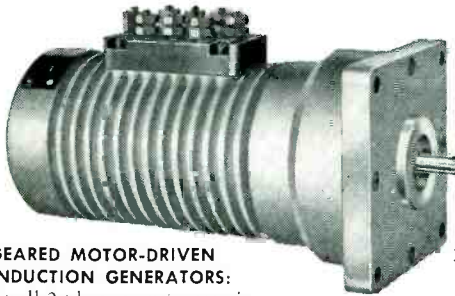

**GEARED MOTOR-DRIVEN INDUCTION GENERATORS:** Small 2-phase servo motor in combination with a compact gear-reducer and a low residual induction generator. Motor has high torque/inertia ratio and develops maximum torque at stall. Gear-reducer permits a maximum torque output of 25 oz. in. and is available in ratios from 5:1 to 75,000:1.



**INDUCTION MOTORS:** miniature 2-phase motors of the squirrel cage type. Designed specifically to provide fast response to applied control signals and maximum torque at zero r.p.m. Unit shown weighs 6.1 oz. and has stalled torque of 2.5 oz. in.

**CIRCUITROL UNITS:** rotary electromagnetic devices for use as control components in electronic circuits and related equipment. Single and polyphase rotor and stator windings are available in several frame sizes. Deviation from sine accuracy of resolver shown is  $\pm 0.3\%$  of maximum output.

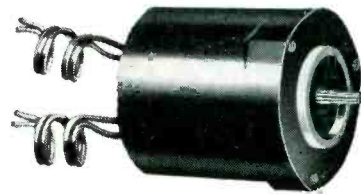

**SYNCHRONOUS MOTORS:** for instrumentation and other applications where variable loads must be kept in exact synchronism with a constant or variable frequency source. Synchronous power output up to 1/100 H.P.

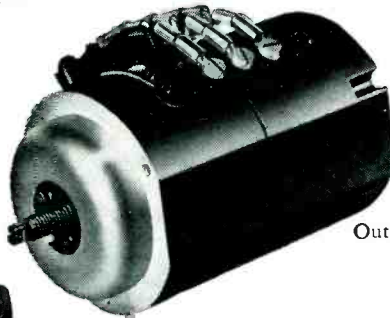

**SYNCHRONOUS DIFFERENTIAL UNITS:** electro-mechanical error detectors with mechanical output for use in position or speed control servo systems. These torque-producing half-speed synchros are composed of two variable frequency synchronous motors and a smoothly operating system of differential gearing.

$$\text{Output: Speed} = \frac{N_1 - N_2}{2}; \text{ Torque up to 1.0 oz. in.}$$

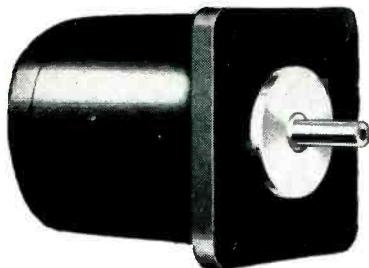

**TELETORQUE UNITS:** precision synchros for transmitting angular movements to remote points. Accurate within  $\pm 1^\circ$ . May be actuated by mechanisms that produce only 4 gm. cm. (.056 oz. in.) of torque.



## ADDITIONAL SPECIAL PURPOSE AC UNITS BY KOLLSMAN

With the recent addition of new units to Kollsman's already widely diversified line, the electronics engineer will find the solution to an even greater variety of instrumentation and control problems. These lightweight, compact units offer the high degree of accuracy and positive action essential in dealing with exact quantities. They are the product of Kollsman's long experience in precision instrumentation and aircraft control — and of considerable work done in this field by Kollsman for special naval and military application. Most units are available at various voltages and frequencies. For complete information, address: Kollsman Instrument Division, Square D Company, 80-64 45th Avenue, Elmhurst, N. Y.

## KOLLSMAN INSTRUMENT DIVISION



# "Main Office" Service from . . .

# TUNG-SOL in CHICAGO

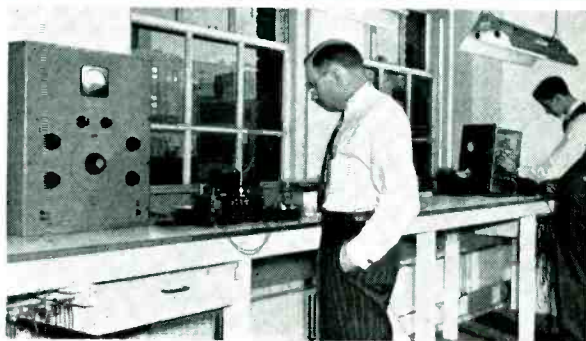
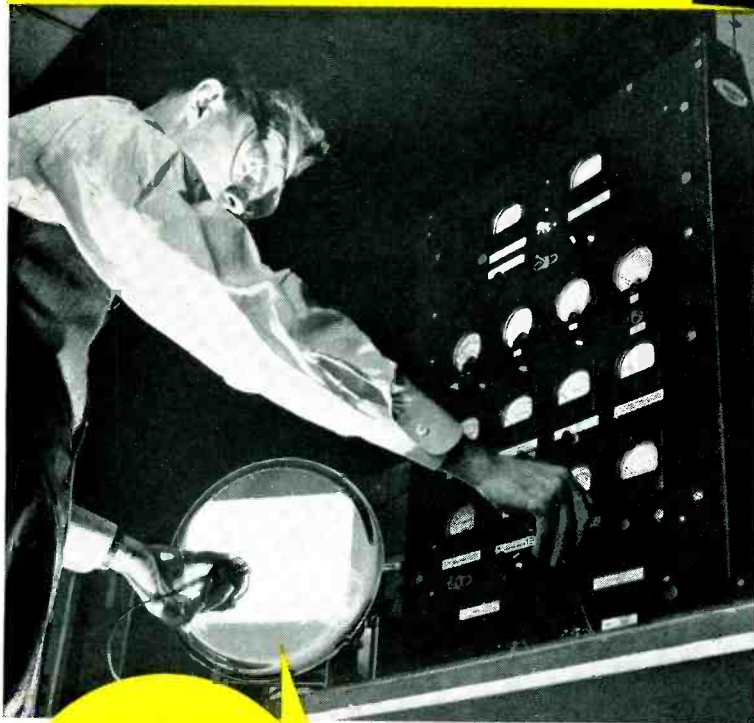

**Manufacturers  
of Sets and Electronic  
Devices!**  
**Distributors of  
Electronic  
Equipment!**

## Is Chicago handier to you than Newark, New Jersey?

You will find TUNG-SOL's Chicago office a priceless time saver in the factory engineering and sales cooperation you need, if Chicago is handier to you than Newark, New Jersey.

**PRODUCT DESIGN** TUNG-SOL in Chicago is organized to give what amounts to "main office" service right from development to delivery.

**ENGINEERING** TUNG-SOL in Chicago provides the services of top-flight engineers, aided by the finest laboratory equipment. Every facility is available for the application and development of electron tubes.

**SALES** TUNG-SOL in Chicago has a complete sales organization, ready to give prompt help in supplying the TUNG-SOL products you need.

So . . . if you have an application or a problem involving electron tubes, TUNG-SOL can serve you from either Newark or Chicago . . . whichever will best help keep your production rolling. Write, or phone and tell us what we can do for you.

**IN CHICAGO** Jack Van der Veer, Manager of Western Equipment Sales, 315 East Grand Avenue.

TUNG-SOL LAMP WORKS INC., NEWARK 4, N. J.  
Sales Offices: Atlanta, Chicago, Dallas, Denver, Detroit, Los Angeles, Newark

## TUNG-SOL ELECTRON TUBES

ALSO AUTO LAMPS, ALL-GLASS SEALED  
BEAM LAMPS AND SIGNAL FLASHERS

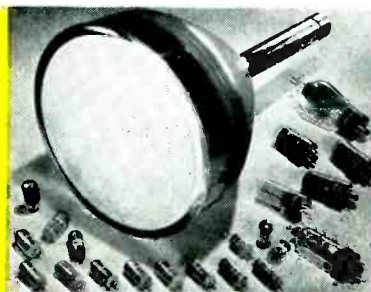

# NEW HIGH-SPEED COIL WINDER TO BE UNVEILED AT I.R.E. SHOW

*Double Winding Speed Increases Operator Output on Spool-Wound Coils Having High Number of Turns*

To accommodate the market's need for higher production on high-turn coils, Universal has redesigned the No. 102 Multi-Head Coil Winder to *double* its winding speed.

With a new maximum speed of 5000 rpm, the High-Speed 102 is now particularly adaptable to the winding of timing motor coils, telephone relays and other high-turn coils.

Full efficiency on this type of machine is realized when winding time and manual coil-handling time are so synchronized that there is no waste time.

On a three-head machine, it is desirable that handling time be no greater than one-half the winding time. Thus, if handling time per coil is thirty seconds and spindle speed is 2500 rpm, coil size is limited to 2500 turns, unless there is to be some waste time.

With the new high speed of 5000 rpm, the operator of the High-Speed 102 can handle three coils up to 5000 turns requiring 30 seconds handling time — without any unproductive waiting time.

The machine can also be run at lower rates of speed for coils with fewer wire turns — thus providing the maximum in flexibility. Also, at high speed it is possible to wind only one coil per spindle. In order to wind two coils per spindle, it is necessary to cut down the maximum speed to 2500 rpm because of the double amount of handling time required.

## PROTECTION AGAINST OIL LEAKAGE

In redesigning the No. 102 for higher speed, oil seals were added at the driving shaft bearings and an extra lip added to the spindle case cover and gear cover to protect against oil leakage. Even at

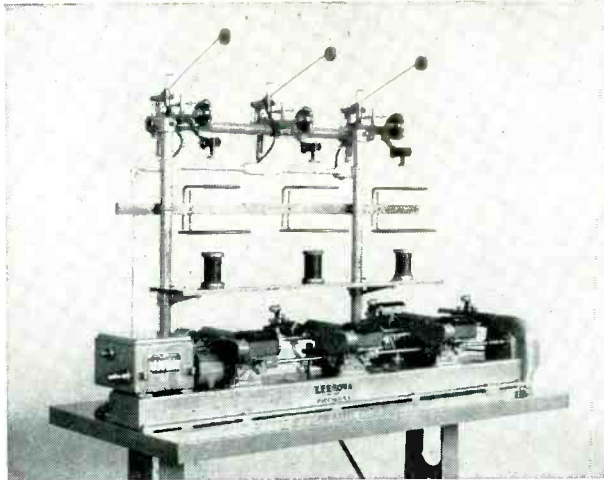

No. 102  
High-Speed  
Coil Winder.

the new high speed, the machine is oil-tight.

## FEWER GEARS NEEDED

The shafts, sleeves, etc., in the auxiliary gainer case have been redesigned to permit the use of a single type of gear instead of the two types formerly required. This change permits the entire range of the machine to be covered by a set of 53 gears instead of the 100 gears formerly needed to effect the same coverage. The first cost of the gears is materially reduced and inventory is smaller.

The same table is used and the general over-all appearance of the machine has not been changed. However, a 1/2 hp motor replaces the former 1/4 hp motor.

No other changes have been made, except that like the more recent models of No. 102 Winder, the High-Speed 102 is equipped with the latest Over-End Tension and the new Wire Breakage Detector. The over-end supply is particularly adaptable to high speed winding, because the wire is taken off over the end of the spool without having to overcome spool

inertia and perfect control of the wire is maintained by the compensator. The Wire Breakage Detector controls the winding so that when a wire spool runs out or breaks, the winding arbor will stop promptly. This prevents the counting of extra wire turns that are not being wound.

The High-Speed 102 is priced no higher than the previous model.

See it at the I.R.E. Show, March 6-9, Grand Central Palace, New York, Booth A and B in the mezzanine, together with other new developments in coil winding by Universal Winding Company engineers.



## UNIVERSAL WINDING COMPANY

P. O. Box 1605 Providence 1, R. I.

\* REG. U. S. PAT. OFF.



FOR WINDING COILS IN QUANTITY  
ACCURATELY . . . AUTOMATICALLY  
USE UNIVERSAL WINDING MACHINES

# Announcing Two ARMA INDUCTION POTENTIOMETERS

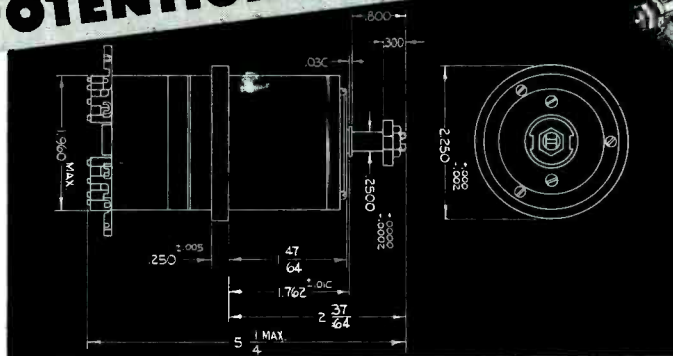
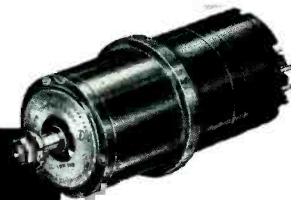

TYPE IA400

## ... Time Saving, Cost Saving Components in Arma's Post-War Technique of electrical "Brain Block" instrumentation

"Brain Block" instrumentation quickly describes any custom arrangement of light, small, accurate standard Arma components to make precision instruments and controls.

**For instrumenting problems of addition, subtraction, multiplication and division.**

These two Arma induction potentiometers are high precision 400 cycle signal transformers having transformation ratios (of

secondary voltage to primary voltage) which may be varied continuously between fixed minus and plus values by mechanical rotation of a projecting shaft. The transformation ratios are exact linear functions of the angular displacement of the shaft, within the inherent accuracy tolerances, from  $-45^\circ$  to  $+45^\circ$ . The shaft rotation may be continuous and also it may be in either direction.

### Features of Induction Potentiometers

- Can be used in computing with the introduction of minimum gear error, backlash and spring since all functions except the angle are handled electrically.
- Can eliminate physical proximity as a requirement of motions representing the quantities entering the computation (except for shaft angle).

### Advantages of Arma Units

- All circuits isolated—no common leads.
- High mechanical accuracy—shaft diameter, shaft runout, flange runout held to exceptionally close tolerances.
- Small friction torque—about 3 milliwatts required to drive it from 0 to full output in 1 second.
- Self contained terminal blocks.
- Exceptionally well insulated.
- Convenient clamping on shaft.
- Workmanship of highest quality.

### Specific Advantages over Wire-wound Types

- Stepless operation—outputs are smooth and uninterrupted by "wire-stepping".
- Unlimited rotation with no circuit interruptions.
- Many times longer life.
- Permanent accuracy—accuracy will not change as a result of use.

### New Opportunities in Other Arma Components too

While you re-examine, in the light of these Induction Potentiometers, designs once limited by available components, you are invited to request whatever information you may need to explore the possibilities of using any Arma product which has been released from security restrictions.

### TYPICAL CHARACTERISTICS

	Type IA400 (Dwg. 715689-1)	Type 1B400 (Dwg. 715690-1)
Input Voltage Range	2 to 20	2 to 20
Frequency	400 $\pm$ 5%	400 $\pm$ 5%
Temperature	0° to 55° C.	25° C.
Transformation Ratio at 45° position	0.5000 $\pm$ 0.0005	1.0000 $\pm$ 0.0010
Phase (Output to Input)	0° 00' $\pm$ 8'	3° 00' $\pm$ 8' Leading
Booster Amplifier Req.	#709825	none
Harmonic Voltages (Max. % of Input Voltage)	0.1%	0.2%
Weight	2 lb.	2 lb.
Moment of Inertia	1.2 oz. in. <sup>2</sup>	1.2 oz. in. <sup>2</sup>
Output Voltage	<ol style="list-style-type: none"> <li>1. Quadrature Component Less than 0.25% of output voltage at 45° position.</li> <li>2. Inphase Component See Note 1</li> </ol>	

Note 1: Type IA400. The inphase component is a function of rotation between  $-45^\circ$  and  $+45^\circ$  and of input voltage in the range of 2 to 20 volts. In the temperature range 0° to 55° C. the inphase component of output voltage may be closely predicted from the following equation:

$$E_i = kE \frac{A}{45^\circ} \pm 0.1\% kE$$

where  $E_i$  = Inphase output voltage

$E$  = Input voltage

$k$  = 0.5000  $\pm$  .0005 (the nominal ratio of output voltage to input at  $+45^\circ$  position)

$A$  = Mechanical angle through which the shaft has been turned from electrical zero, in degrees clockwise.

Note 2: Type 1B400. The above applies to type 1B400 except temperature must be 25° C. and  $k$  = 1.0000  $\pm$  .0010.

## ARMA CORPORATION

254 36th STREET, BROOKLYN 32, N. Y.

SUBSIDIARY OF AMERICAN BOSCH CORPORATION

ARMA  
PRODUCTS  
RELEASED  
FOR  
PRIVATE  
INDUSTRY

ARMA ELECTRICAL RESOLVERS\* ARMA SYNCHROS ARMA INDUCTION MOTORS ARMA INDUCTION GENERATORS ARMA MECHANICAL DIFFERENTIALS ARMA ALTERNATING VOLTAGE COMPARATOR COMPUTING MECHANISMS INDUSTRIAL CONTROLS STABILIZATION DEVICES NAVIGATIONAL EQUIPMENT LIMITRON AUTOMATIC INSPECTION SYSTEM

\* Licensed for use under Arma patents Nos. 2,465,624 and 2,467,646. License information available.

QUALITY **ARMA** PRECISION  
INSTRUMENT

# BUSINESS BRIEFS

By W. W. MacDONALD

Choose  
**PYRAMID**  
ELECTROLYTICS  
for  
Top performance  
at **85c**



Pyramid Type 85TM Capacitors  
are now in volume production  
for leading TV-receiver  
manufacturers throughout the  
U.S.A. and Canada.



**PYRAMID**  
CAPACITORS

**PYRAMID ELECTRIC COMPANY**

155 Oxford Street  
Paterson, N. J., U.S.A.

TELEGRAMS: WUX Paterson, N. J.  
CABLE ADDRESS: Pyramidusa

**Predictions For 1950** by Don Mitchell of Sylvania: "Less emphatic seasonal swings. . . . Buyers' Market. . . . Continued price pressure but less price weakness. . . . 3,750,000 television receivers. . . . 5,000,000 picture tubes. . . . New sets 90 percent or more with 12½-inch or larger screens. . . . 200,000,000 receiving-type tubes. . . . Near full capacity production of tubes of other types. . . . Reduced exports.

**Concerning Devaluation**, the impression we get now is that the effect on our export market was originally underestimated, and that manufacturers who relied upon it for an appreciable part of their 1950 business are concerned. Fortunately, most manufacturers did not.

**Trans-Canada Air Lines** checked tube failures in 27 aircraft flown 45,600 miles between July 1 and December 31, 1947. Some 1,104 were taken out of service, and these were broken down by types as follows:

6AK5	18.6%
6N7	11.7
12A6	10.7
6K7	10.1
12SK7	5.7
6L7	5.3
6F6	4.1
12C8	3.5
6B8	3.3
6J5	3.0
12SG7	2.9
6J6	2.8
6L6	2.7
12SC7	2.6
12SQ7	2.5
12SJ7	2.1
12SA7	2.0
832A	1.8
807	1.7
6C4	1.4
12SL7	.7
6V6	.3
6V6GT	.3
2051	.3

Anyone have any later figures on aviation or other industrial uses of receiving-type tubes?

**Competitive Bids** are in the making on the first units of the new radar defense network for the United States. The Army Corps of Engineers will probably direct construction. Lt. Gen. Ennis C. Whitehead of Mitchell Field is to supervise work in this country. Brig. Gen. Frank A. Armstrong,

Jr. will handle work in Alaska.

Congress has already authorized \$85,000,000 for construction of the network. The Air Force has made available \$50,000,000 from its 1950 appropriation to speed up the project.

**Jet Engines** of the future will probably incorporate electronic control. They are critical with respect to factors such as temperature and fuel-feed, and servo-mechanisms seem ideally suitable for the coordination of such functions.

**Tubeless Devices** that are electronic in principle are appearing on the horizon at a rapidly increasing rate, and it is already apparent that people in this business must broaden their thinking to include such devices. The tendency of designers in the future will be to use tubes where only tubes can do the job, or where tubes do the job best. In other applications look for increased use of such things as crystal diodes, transistors, magnetic amplifiers and dry-disc rectifiers.

**Selenium Rectifiers** have come a long way since the war. They now handle high voltage and plenty of current and the other day we saw a 50-kw broadcast transmitter that uses not one single tube rectifier.

In some industrial electronic apparatus that we have looked over in the past month dry-disc rectifiers apparently cost a little more than tube types, but not very much when the elimination of associated components is considered. And long life plus comparative freedom from maintenance worries appears to be attractive to many customers.

**For Conglomerate Aggregations** of parts, gypped-up circuits and quickie designs that plainly show lack of time or lack of thought or both Walter E. Benoit of the Westinghouse Radio Stations has a phrase that should go far. He



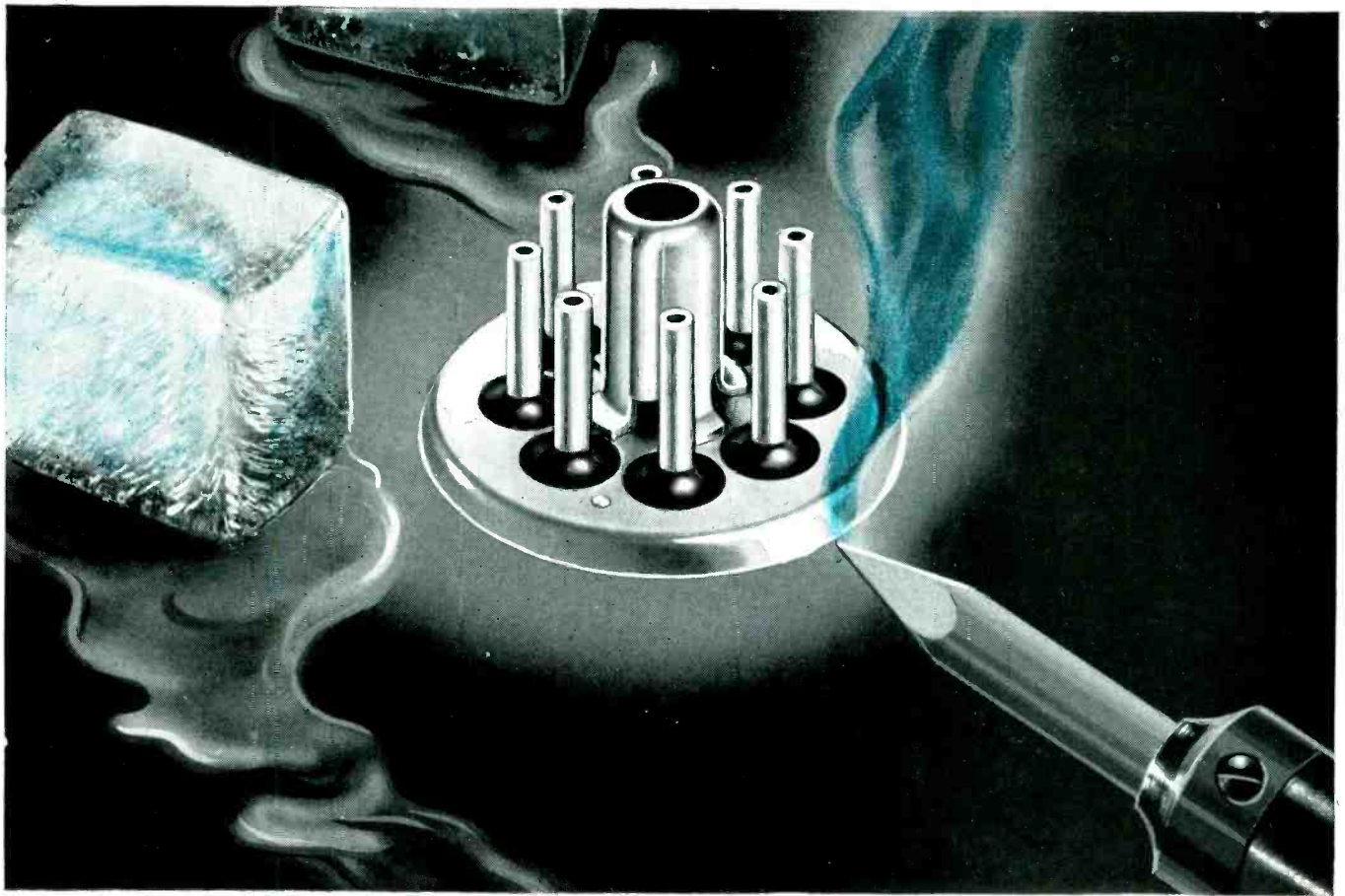

## Let's Put the Chill on a Hot Subject . . .

As you read this message engineers the country over are hard at work planning, experimenting on fused hermetic sealing for their company's electrical product.

When the subject of a so-called glass terminal comes up (and it's bound to) they're apt to talk in terms of thermal shock. That's where Fusite Hermetic Terminals come in.

Take the interfusion of steel and inorganic glass that is a Fusite terminal. Apply the sizzling heat of a soldering or welding operation. And if you want to be ornery, shove it right out on the shipping dock on a zero day.

What happens?

Absolutely nothing. Your seal remains as tight as your production skill made it. All Terminals remain as smooth, as rugged, and uniform as only Fusite makes them.

Would you like to know more, or see samples? Write to Dept. E.

**TERMINAL ILLUSTRATED 908HTO**—For plug-in to standard "Octal" sockets. Available with two to eight hollow tube electrodes.



# THE FUSITE CORPORATION

CARTHAGE AT HANNAFORD, NORWOOD, CINCINNATI 12, OHIO

# SHOCK AND VIBRATION NEWS

## THE NEW MARION



### RUGGEDIZED METER

uses a  
specially designed

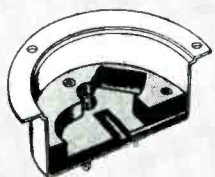

## BARRYMOUNT FOR ASSURED CONTROL of SHOCK and VIBRATION

By the radically new RUGGEDIZED construction, Marion makes "delicate" electrical instruments capable of sustained accuracy under violent shock and vibration.

**An important part of this RUGGEDIZING is the specially built-in BARRYMOUNT which isolates the meter movement from the outer case.**

This shock-isolating means — a joint development of Marion and Barry engineers — comprises a molded rubber base bonded to the meter case and to tapped inserts that hold the mechanism-mounting screws. Dimensions and resiliency of the rubber are closely controlled in manufacture to assure consistent performance under all service conditions.

**This example indicates what our specialized consulting engineering service can do to broaden the usefulness of your product.**

Whatever your shock or vibration problem, Barry experience and consulting engineering facilities offer a sure solution. Write for free catalog listing stock BARRYMOUNTS; for special information, call our nearest office or write to

THE **BARRY** CORP.

Main Office 177 Sidney St.

Cambridge 39 Massachusetts

New York Rochester Philadelphia Washington Cleveland Dayton  
Chicago Minneapolis St. Louis Los Angeles Toronto

BUSINESS BRIEFS

(continued)

classifies them under the general heading of *Casual Engineering*.

Tele Set Shipments by RMA members in the third quarter of 1949 break down by areas as follows:

Albany	5,305
Albuquerque	119
Atlanta	3,586
Baltimore	13,674
Birmingham	1,319
Boston	30,695
Buffalo	7,431
Charlotte	3,396
Chicago	52,906
Cincinnati	16,729
Cleveland	13,070
Dallas	3,741
Davenport	2,542
Detroit	23,766
Erie	1,091
Greensboro	713
Houston	1,722
Huntington, W. Va.	418
Indianapolis	3,016
Jacksonville	1,140
Kansas City, Mo.	8,425
Los Angeles	52,962
Louisville	1,685
Memphis	769
Miami	857
Milwaukee	6,907
Minneapolis	8,585
Nashville	141
Newark	33,842
New Haven	5,434
New Orleans	852
New York City	80,055
Oklahoma City	1,467
Omaha	5,138
Philadelphia	48,842
Phoenix	158
Pittsburgh	8,119
Portland, Ore.	148
Richmond	1,417
St. Louis	11,206
St. Petersburg	16
Salt Lake City	797
San Antonio	293
San Francisco	4,785
Seattle	1,553
Syracuse	2,724
Toledo	6,325
Tulsa	122
Washington, D. C.	14,820
Unallocated	8,529

Shipments in the third quarter totalled 503,352 sets.

Free Home Demonstration of television receivers, simplified by built-in antennas, is speeding up saturation of the New York market, and the market in several other big cities. Newspaper ads and radio programs plug such offers and salesmen are Johnny-on-the-spot to follow up.

Think of the time it took to saturate urban markets with radio sets. Then cut it in half when you think of television.

Several Months Ago we noted that one of our readers working for a major airline had developed a device that appeared to have many commercial possibilities, and offered to forward letters from interested manufacturers.

Carl Peterson now writes again to tell us that, judging from the

response, "Business Briefs" is read by almost everyone in the industry, and that while he does not yet have any definite commitments interest leads him to believe that someone will soon develop a special tube for his device and take it over.

We wish Carl's first statement were true. We hope his second is too.

Now Another Reader tells us that he has partially developed what he calls a "video image recorder" and needs help. He doesn't tell us too much about the device but we gather it might store up radar signals by means of a "time amplifier" or frequency decriaser used in conjunction with disks, wire or tape. Relaying of television signals via a channel having narrow bandwidth also seems possible.

From Ben Bauer of Shure Brothers comes an interesting and informative note referring to our recent comment (p 62, Oct.) concerning double-entry bookkeeping. Says Ben:

"I was as baffled as you are by the mysterious process which permits both sides of the balance sheet to always add up to an equality until I discovered that the answer lies in that all-inclusive term 'surplus.' Surplus on balance sheets is analogous to the term 'radiation losses and unaccounted for' in heat analysis.

"Accounting, just like engineering, is not an exact science."

Today's Transport Airplane is the most highly instrumented transportation medium in existence. Commercial mail and passenger planes were once flown with only four or five instruments. A modern United Mainliner 300 mounts 83 on the pilot's instrument board and, at that, 25 of them are dual indicators doing double duty to conserve space.

Newspapers Say a new book entitled "Natural History" will be printed with ink that gives forth the odor of a pine forest. Suggestions suitable for ELECTRONICS are in order. When submitting them be kind, gentlemen, be kind.

# SIGMA

## *Sensitive Relays*

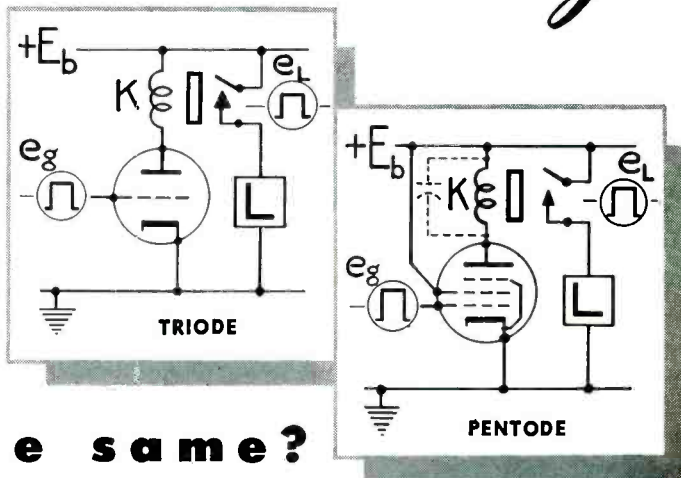

**the same?**

... Not if timing of load operation as a function of input signal is considered.

The pentode circuit will generally give faster current rise in the relay coil K. It will nearly always give faster decay, other things equal. The contact response will, of course, follow the same pattern. Explanation lies in the shape of plate current-voltage curves typical of the two tube types.

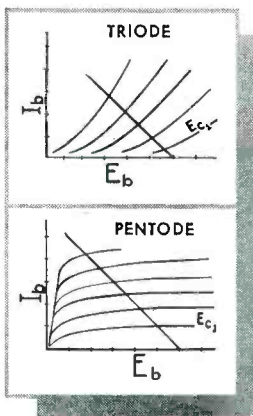

With the pentode, when the grid is biased approximately to cut-off and the plate current starts to fall, the stored energy in the relay causes a sharp transient rise in plate voltage. But since in a pentode, plate current is little affected by plate voltage, no significant transient current flow occurs. Plate current falls as fast as grid voltage. With the triode, on the other hand, the transient voltage rise does cause increased current flow, or delays the current decay. "Cut-off" is only cut-off at one particular plate voltage.

Often when pentodes are used in this way transient voltages are so high that a small by-pass condenser is necessary to limit them and avoid damage to the relay winding.

*The pentode circuit, with equal energy stored in the relay, de-energizes faster by dissipating the energy as a high voltage low current transient on the plate.*

*The triode circuit provides more damping, less tendency toward bounce, and reduces disparity between make and break times.*



Write for Catalogue

The facts behind such relationships are common knowledge; their influence on relay behavior is knowledge acquired through practice. Ours is freely available to you.

# SIGMA Instruments, Inc.

**SENSITIVE RELAYS**

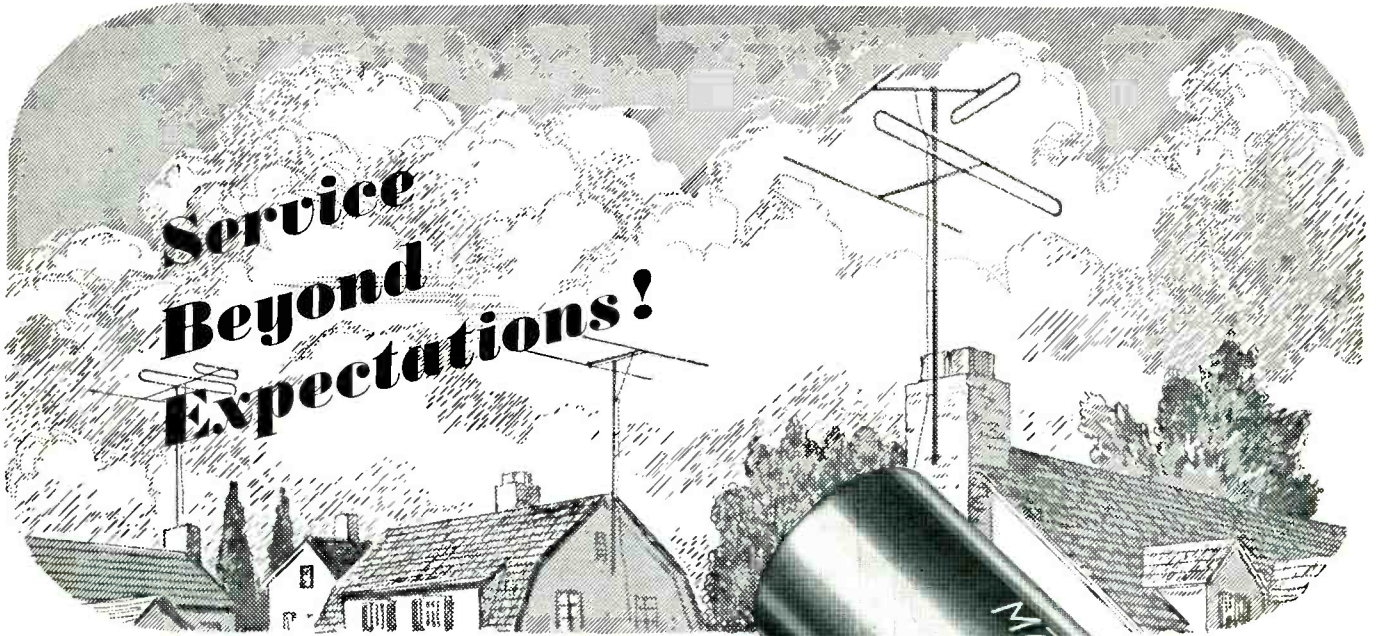

## Critical Requirements of Television Prove Remarkable Performance of Mallory FP Capacitors!

There can be no more convincing proof of superiority than the performance records hung up by Mallory FP Capacitors in the demanding field of television service.

In one case, an outstanding television manufacturer kept detailed records of field failures of component parts over a six month period . . . found only six Mallory failures, with nearly 400,000 FP Capacitors in service!

*That's service beyond expectations!*

That's why so many leading manufacturers insist on Mallory Capacitors that have set the pace in the industry for years. That's why you should specify Mallory, at no premium in price, for any application that demands continuous, trouble-free performance.

### MALLORY FP CAPACITORS

Mallory FP Capacitors are designed to operate continuously at 85° C— and are famous for their long *shelf life*. Write for your copy of the Mallory FP Capacitor data folder.

*FP is the type designation of the Mallory-developed electrolytic capacitor having the characteristic design pictured and famous throughout the industry for dependable performance.*

P. R. MALLORY & CO., Inc.  
**MALLORY**

P. R. MALLORY & CO., Inc., INDIANAPOLIS 6, INDIANA

#### SERVING INDUSTRY WITH

Capacitors	Contacts
Controls	Resistors
Rectifiers	Vibrators
Special Switches	Power Supplies
Resistance Welding Materials	



## CROSS TALK

► **VIDEO TAPE** . . . The following line of reasoning was suggested to us by Howard Chinn of CBS, who is no visionary. Says Howard: The television film transcription is a very complicated device for storing a video signal. It involves transferring the signal to a phosphor image, to a negative film image, to a positive film image, to a mosaic image, and back to the video waveform. There are too many electrical, chemical and optical processes involved, too many potential sources of distortion. And the tv transcriptions of the day show it. So, asks Mr. Chinn, why not store the video signal on magnetic tape? Suppose you divide the video band of 4 mc up into eight adjacent 0.5-mc bands. Suppose you work up the tape speed so that 500-kc signals could be accommodated, and record in eight parallel tracks on an extra-wide tape. The modulating, recording and demodulating equipment is probably not beyond attainment. Such a scheme would use up a lot of tape, but it might well be worth it, especially since the tape could be erased and re-used almost indefinitely. No originality for the idea is claimed. We'll bet there are some miners and manufacturers in Minnesota, not to mention audio developers and devisers in Cleveland and New York, who think highly of it. Any takers?

► **WHICH ONE?** . . . We don't know how much money is earmarked this year for research in the electronic sciences, but we have a mark to shoot at. The Toni Company has appropriated for 1950 the tidy sum of \$500,000 for research into the properties of human hair and skin, enough to keep a full-time staff of 100 trained scientists busy. It seems to us that many companies and individuals, including tv comedians who lived on Toni jokes for several months last year, ought to ante up a similar amount for research into the properties of the human eye and ear. Most of us in electronics live, one way or

another, trying to satisfy these organs. We ought to know at least as much about them as the hair-curling industry knows about hair.

► **JUNK** . . . Recently in Dublin Georgia, 150 miles from the nearest tv station, a junk man was called in to bid on the belongings of a deceased resident. A hand-driven Singer sewing machine brought \$10, an old churn \$1, a rocking chair with broken springs \$1. But for a radio set, not a plugged nickel was offered. The receiver was a type known to old timers. It was built by American Bosch some 15 years ago. It had expanding i-f's, push-pull 6L6's in the output, shortwave, longwave and broadcast, 12 tubes in all, in a good cabinet. Excellent working condition. But the junkman wouldn't even haul it away. Said he, "You can't give a secondhand radio set away in this town. People all waiting for television."

► **MEMORY** . . . We are used to being called to task for mistakes or omissions in this column, particularly by that careful group of readers who make up the Bell Telephone Laboratories. In the December issue we found the synchronized multiplex system of color television of interest on the score that it sent information on three color signals on a single sine-wave, just as if that were something new. M. W. Baldwin, Jr. picked us up on that one. Seems that Nyquist in 1928 worked up an analysis of the subject. And in 1943, Norgaard gave a paper on the subject (as related to selective sideband systems) before the IRE National Convention, which was duly reported in the technical press. What periodical? ELECTRONICS. What reporter? D.G.F.

► **PERIL** . . . We recommend the review (p 230, this issue), of Professor Wiener's newly published book on stationary time series, affectionately known as the "Yellow Peril" during the war. It's a classic.

# Electronic Aids to AIR NAVIGATION

Scheduled aircraft movements without regard to weather conditions will be possible only by using the equipment described. Over a billion dollars worth of Government-directed development and equipment has been estimated necessary to provide this Transition program. A more complex Ultimate program is being planned

● The requirements for U. S. aircraft navigational aids have been set up through the meeting of many minds, and the implementation of the program as well as the evolution of further requirements depends in a complex way upon several groups.

In brief, the present plan was fathered by Special Committee 31 of the Radio Technical Committee for Aeronautics. Its so-called Transition Program already under way can expect to see the conclusion of development work by January 1952. Only the later work of its Transition development will be affected, in the blueprint stage, by the Air Navigation Development Board.

The ANDB was chartered in November 1948 and

comprises members from the services, from the Civil Aeronautics Administration and the industry. Its chairman, Ralph S. Damon, president of TWA, reports both to the Secretary of Defense and the Secretary of Commerce. Implementation of plans approved by ANDB is accomplished by CAA. Through indications from the Research and Development Board, problems of the military are integrated as far as possible with those of commercial flying. From the international viewpoint, the United States is signatory to the provisions of the International Civil Aviation Organization (ICAO.) All these agencies contribute toward the development of the Ultimate Program.

● THE NAVIGATIONAL AIDS to be described are arbitrarily grouped for the convenience of the electronics engineer and include only those aids that are either now in use or about to come into service for domestic flights. Particularly in the international field we have ignored such important long-range

aids as loran and Consol as well as the OSV (Ocean Station Vessel). Similarly neglected are ground-based radio direction-finding networks.

Technical details of the various aids have already appeared in the pages of ELECTRONICS and later ones will be described in due time.

## COMPASS SYSTEMS

### Flux-Gate

*Equipment:* The earth's field is caused to cut the windings of the gyro-supported Flux Gate. The voltage induced in the Autosyn is amplified and causes the motor to reset the Autosyn to a condition of balance. At the same time, the gear train resets the direction indicator and the repeaters to the new heading. Illustration is oversimplified.

*Operation:* There is essentially no operation required of the pilot in normal service.

### Gyrosyn

*Equipment:* The earth's field is caused to cut the windings of the pendulously-mounted Flux Valve. Voltage induced in the signal selsyn is amplified and applied to a precession mechanism in the indicator gyro. As the gyro precesses, the signal selsyn is brought into balance, the indicator shows the new heading, and the data selsyn pro-

Table I—Transition Aids Program Inside and Outside Continental U. S. A.

Type	Approximate Total Units Transition Program	Units Under Construction Fiscal '50	Units Commissioned By Nov. 1, 1949	Approximate Balance to Come After Fiscal '50
L-F Ranges*	0	3	377	0
VAR*	0	0	68	0
VOR	465	27	306**	130
MOR*	0	2	1	?
DME	815	20	0	795
ILS	350	88	93	170
Airport	170	49	3	120
Surveillance Radar				
Precision	95	22	3	70
Approach Radar				
Racons***	75	.....	.....	.....

\* Not in Transition program. \*\* 249 are commissioned and 57 are operating but not commissioned. \*\*\* Racons are military installations outside Transition program.

duces a signal to reset all repeaters. Illustration is oversimplified. *Operation:* There is essentially no operation required of the pilot in normal service.

### Radio Magnetic Indicator (RMI)

*Equipment:* This instrument is merely a repeater used with the earth inductor compasses in combination with other facilities such as ADF and VOR to eliminate computation in converting relative bearings to magnetic. A possible means of making such an instrument is shown.

*Operation:* Serves as combination indicator and requires no operation in itself.

*Example:* An aircraft flying a magnetic course 29 degrees is using both VOR and ADF for navigation. At the moment shown, the relative bearings of these aids are automatically converted to magnetic bearings in the RMI.

## DIRECTION FINDERS

### Simple Radio Direction Finder (D-F)

*Equipment:* Rotatable loop; shielded receiver tunable from about 100 to 1,800 kc, aural (headphones) or visual null indicator; manual control for rotating loop and azimuth scale to show orientation of loop (with 180-degree ambiguity) when receiving null signal. Ground equipment may comprise l-f range, compass locators and other stations.

*Operation:* Pilot tunes in radio station on which bearing is to be taken, then adjusts loop to null signal from the station. Azimuth indicator shows bearing of station from the nose of the plane.

*Example:* Aircraft is homing on radio station. Azimuth indicator reads 0 and 180 degrees.

### Automatic Direction Finder (ADF)

*Equipment:* Motor-driven loop; sense antenna, special receiver tunable from about 100 to 1,800 kc; motor control circuits; azimuth indicator. Ground equipment same as for simple D-F.

*Operation:* Receiver is tuned to de-

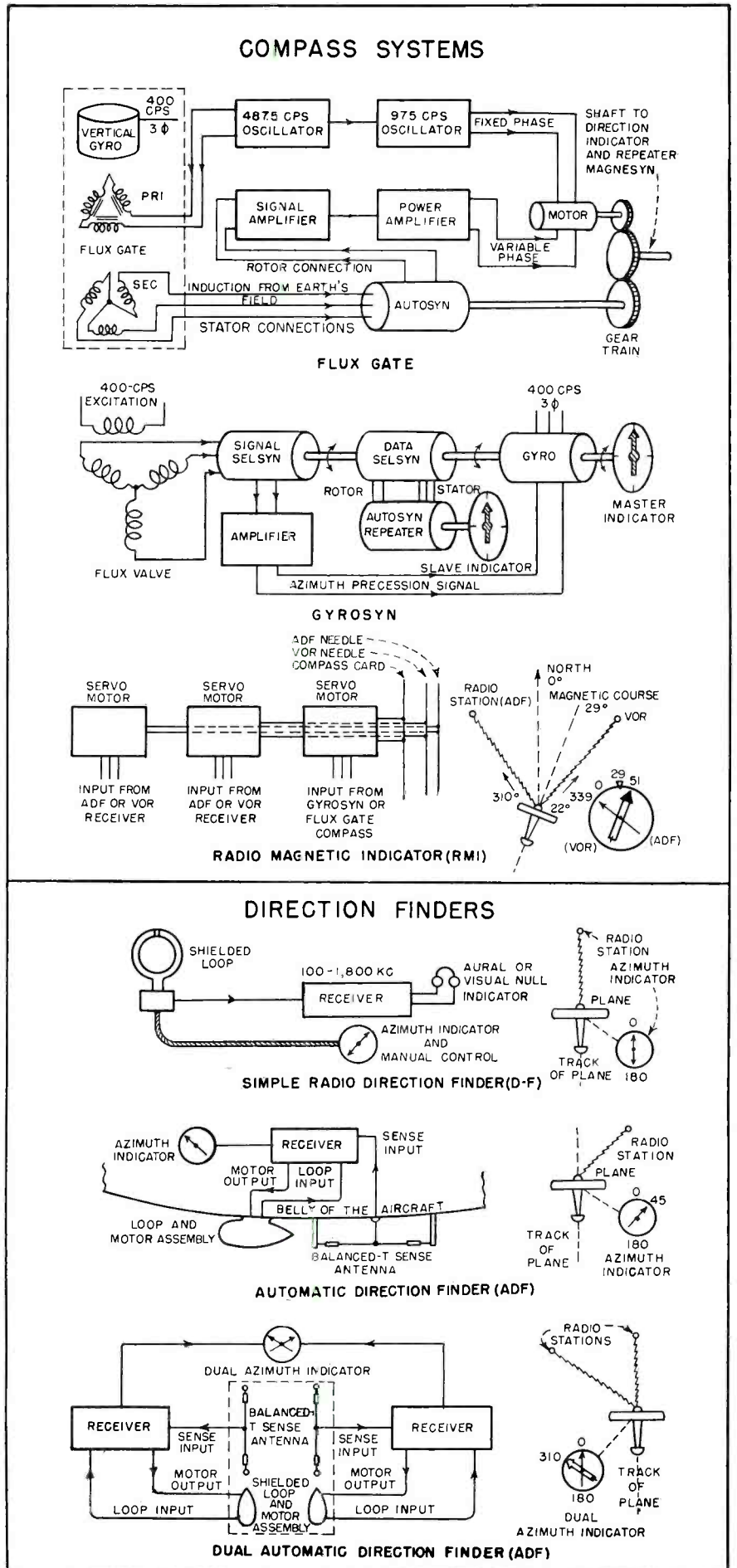

sired radio station. Loop is automatically held at null by motor-control circuits. Indicator shows bearing relative to nose of plane without ambiguity.

*Example:* Plane continuously and automatically takes bearing on radio station even though it is not homing.

### Dual Automatic Direction Finder

*Equipment:* Two motor driven loops; two sense antennas, two special receivers tunable from about 100 to 1,800 kc; dual motor control circuits; dual azimuth indicator.

*Operation:* Each receiver is tuned to a desired signal. Loops are automatically held at respective nulls by motor control circuits. Dual indicator shows bearings relative to nose of plane.

*Example:* Plane homes on one radio station and continuously checks position by angle between that and second station (location of the stations being known).

## RADIO RANGES

### Low-Frequency Radio Range

*Equipment:* Ground station transmits continuous carrier (which can be voice modulated) from center antennas and keyed carrier 1,020 cycles higher in frequency alternately from diagonal pairs of antennas. Antennas transmitting double figure eight patterns are phased to place equisignal beams along desired airways. Equisignal is caused by interlocking of A (-) and N (-) keyed characters at same signal strength. Airborne equipment comprises receiver tuning range between 200 and 400 kc, 1,020-cycle band-pass filter (for range reception), 1020-cycle band-rejection filter (for voice reception) and switching system.

*Operation:* Pilot tunes in desired range (frequencies shown are illustrative) which is identified by call letters (LGA, La Guardia; EWR, Newark; BOS, Boston) repeated every twenty-five seconds. For

operational reasons, pilot flies to right of the equisignal beam center in the so-called twilight zone so that he just distinguishes the 1,020-cycle A or N above the steady equisignal.

*Example:* Pilot maintains craft to right of 142-degree leg by signal in headphones. Cone of silence over most range antenna systems, and reversal of signal immediately after shows that plane has passed over transmitter. (See also Z-Marker)

*Disadvantage:* Only four courses provided; ambiguity as to quadrant; night effect; multiple courses; bent or swinging beams; static.

*Variations:* Transmitters employing loop antennas have little or no cone of silence and bad night effect. Those with Adcock antennas (vertical polarization) have good cone of silence and less night effect. The latter can be used for direction finding.

### VHF Visual-Aural Range (VAR)

*Equipment:* This variation of the familiar radio range operates at frequencies between 108 and 112 mc. It will later be replaced by the omnirange. Instead of four A-N beams it produces two Blue-Yellow beams oriented along the airway with two A-N beams at right angles for quadrantal determination. Requires special receiving and presentation equipment.

*Operation:* Pilot follows the course by a visual meter presentation, using aural signal as quadrantal check and for voice broadcasts.

*Example:* Pilot flies to one side of beam (in the Blue region) and his meter indicates this condition. He receives N signal. As he crosses beyond range station, meter will still indicate Blue, but aural signal will change to A.

*Advantage:* This range is superior to standard low-frequency because it operates at vhf where propagation characteristics are more favorable, and it provides quadrantal determination.

*Disadvantage:* This range is not so useful as the omnidirectional type with which it is being replaced and requires a complex receiver as compared with that for 1-f range.

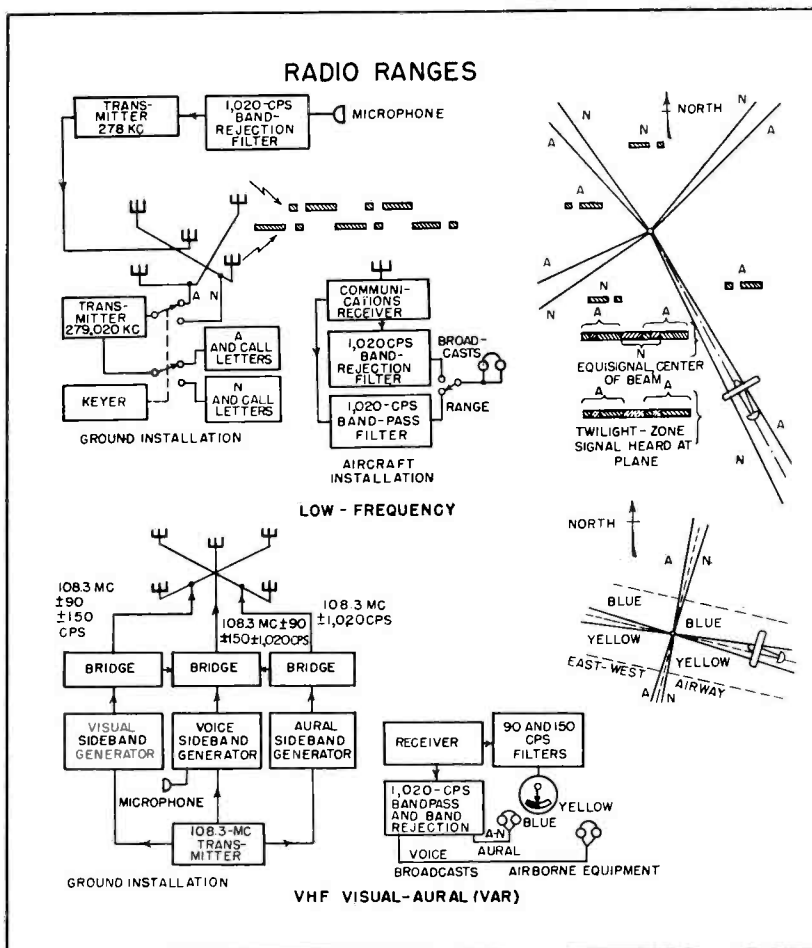



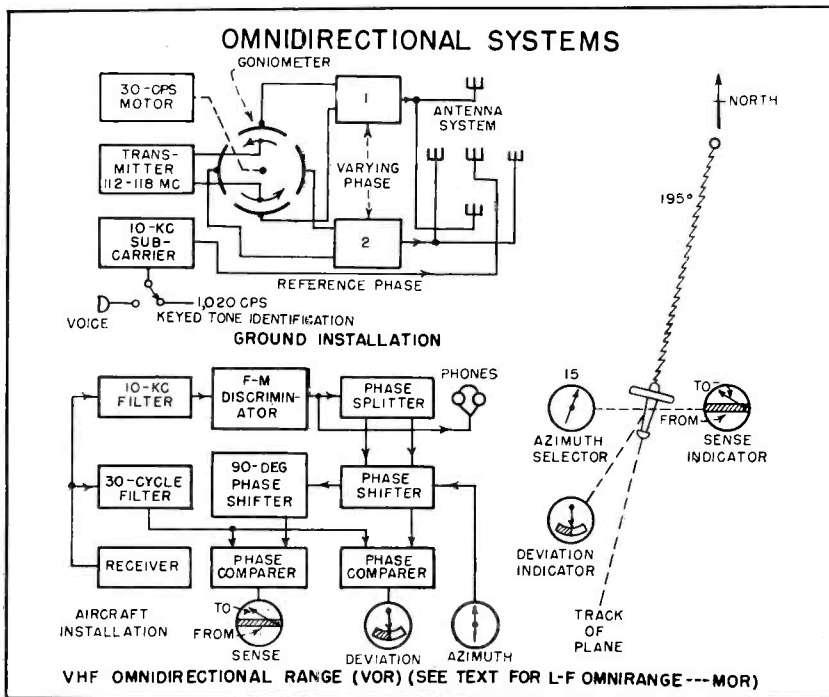

## OMNIDIRECTIONAL SYSTEMS

### VHF Omnidirectional Range (VOR)

**Equipment:** Airborne equipment utilizes filters, phase splitters and phase shifters to choose and identify the course produced by signals of fixed and varying phase. Frequencies used are between 112 and 118 mc.

**Operation:** Pilot sets azimuth selector, notes position of TO-FROM indicator and flies aircraft with minimum deviation to desired point.

**Example:** Plane flying azimuth of 15 degrees to VOR station. No deviation shows. If azimuth selector indicated 195, the sense indication would be FROM.

**Advantage:** Compared to low-frequency range and VAR, the omnirange has many courses instead of four and is therefore much more useful.

### Low-Frequency Omnidirectional Range (MOR)

**Operation:** The low-frequency omnirange is identical with the VOR facility but uses radio frequencies between 365 and 415 kc. It has a coverage approximating 500 miles radius. The course is sharper than VOR, being about 2 degrees wide. The MOR is designed for long distance use.

## DISTANCE MEASURING

### Racon (Radar Beacon)

**Equipment:** The racon, radar beacon or transponder, is a secondary radar that is triggered by impulses from a primary radar. It comprises a receiver, time-delay device and transmitter. Some means of coding the outgoing pulses is customarily provided. Aircraft equipment comprises a primary radar operating on an appropriate frequency for challenging the racon.

**Example:** Aircraft flying west of north challenges racon east of north getting back coded reply indicating identity, azimuth and distance.

### Distance Measuring Equipment (DME)

**Equipment:** Ground equipment (DME transponder) is essentially a racon. Airborne equipment shows

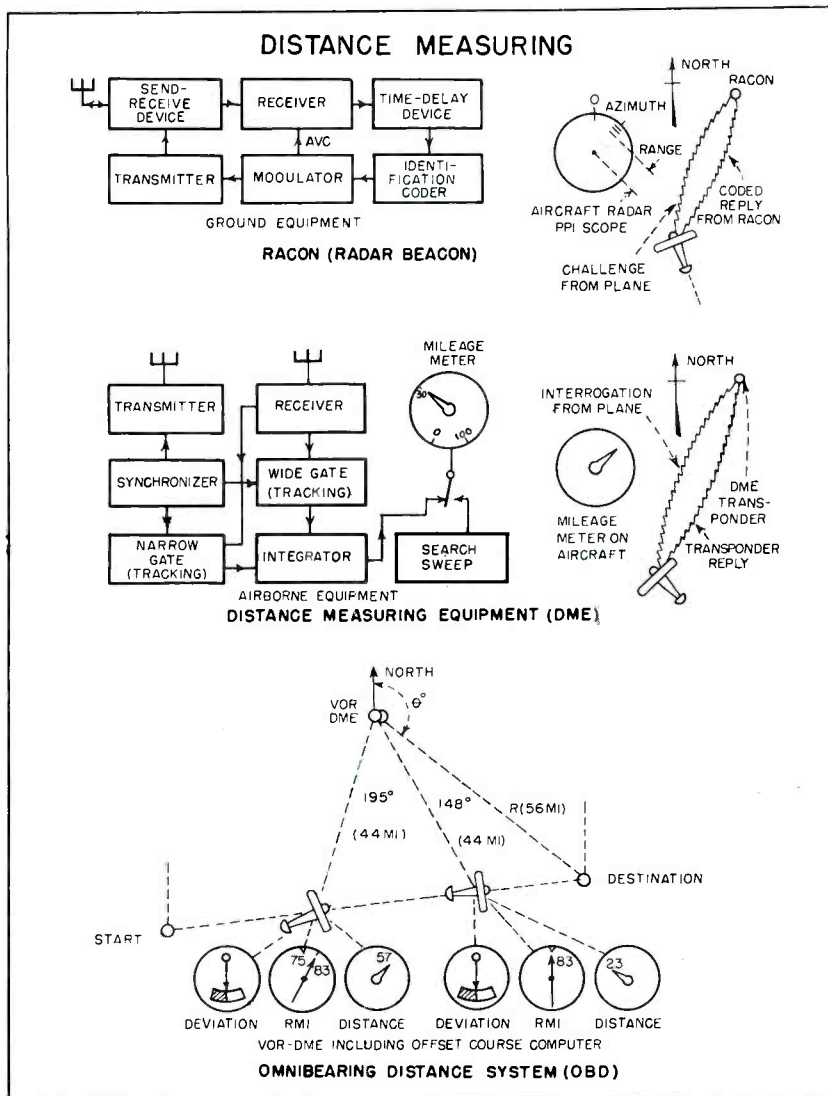

## APPROACH CONTROL AND LANDING SYSTEMS

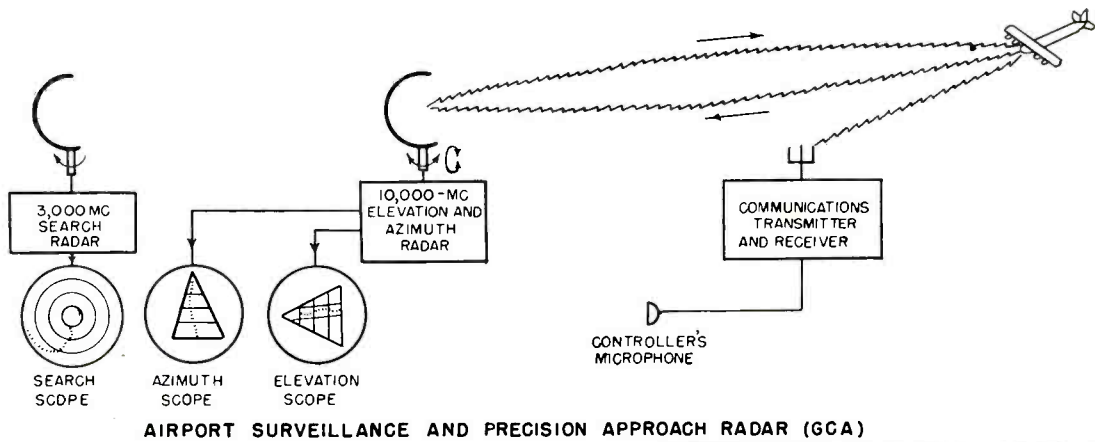
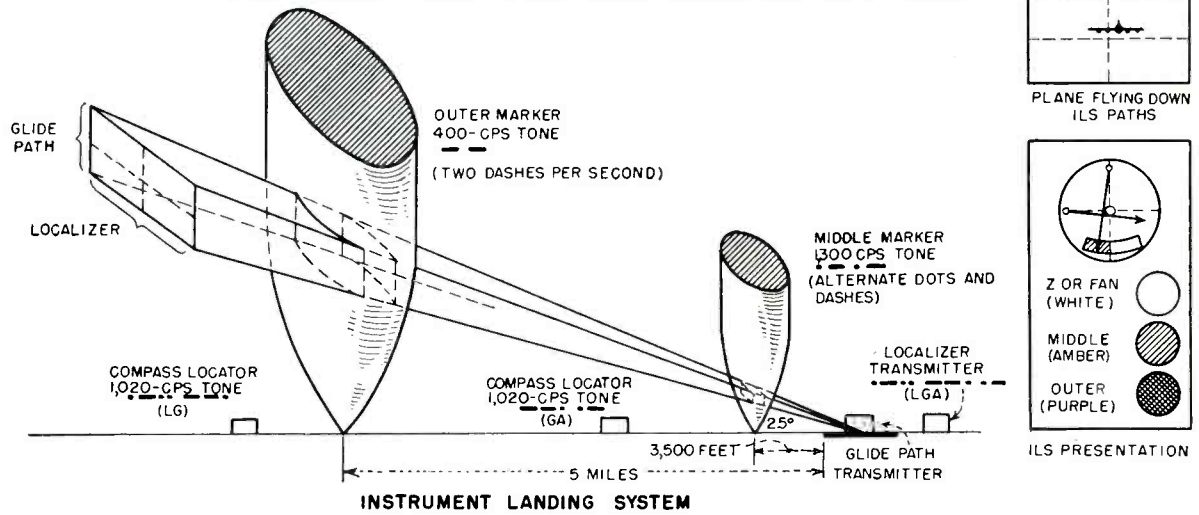

distance by a meter reading. Because of multiple challenges from several aircraft, receiving equipment uses a search sweep to pick up possible correct reply pulse, switching to tracking circuit when correct reply is obtained consistently over reasonable time interval. *Example:* Plane challenges or interrogates beacon and receives signal that actuates a mileage meter showing distance to beacon. *Advantage:* Meter reading is less ambiguous than scope presentation and allows incorporation of information into the OBD system.

### Omnibearing Distance System (OBD)

*Equipment:* Ground station equipment requires both VOR and DME transmitters. Airborne equipment must be capable of receiving and interpreting VOR and DME signals and can also include a course-line or offset-course computer so that the craft will not be

obliged merely to fly a course directly to the OBD ground station. *Operation:* Pilot is obliged to pre-set the angle of the desired course to the destination, the angle of the destination from the OBD facility, and the distance between the facility and the destination. *Example:* The example shows an enroute aircraft at two points. At the left position, the craft has not deviated from the course but the radio magnetic indicator shows that the heading is momentarily not the desired one. The distance furnished by the computer is that still to be made good on the course and not the actual distance from the OBD facility. In the position at the right, the pilot is still on course, his heading is momentarily correct and has 23 miles to go. *Advantage:* The OBD system including offset course computer is a true navigational system that allows the aircraft to fly any course within range of the navigational aid facilities. Even using only the

VOR-DME signals, the aircraft is furnished a distance  $R$  and an angle  $\theta$  that determines his position continuously.

## APPROACH CONTROL AND LANDING SYSTEMS

### Instrument Landing System (ILS)

*Equipment:* Ground equipment comprises transmitters and special antenna arrays that send out localizer beams at about 109 mc, the right side modulated at 150 cps and the left at 90 cps. A glide-path beam at about 333 mc is modulated at the top by 90 cps and on the lower side by 150 cps. Outer and middle marker transmitters at 75 mc send up location identification as the plane passes down the beam. *Operation:* Using compass locators and other navigational aids, the aircraft is flown to interception of the localizer beam and the course is flown so that the localizer indi-

indicator needle remains midway between the Blue (left) and Yellow (right) sectors on the indicator. These correspond with the Blue (right) and Yellow (left) sectors of the course. This presentation allows the pilot to identify his craft with the center circle of the indicator and correct by appearing to move the circle with relation to the needle arms. While flying the localizer, he will finally intercept the glide path beam and now will maintain the horizontal needle as closely as possible at its center position. The outer and middle markers serve further to identify the aircraft position in relation to the landing strip.

*Example:* A plane is shown in silhouette not quite on the localizer and glide path beams. The corresponding ILS presentation to the pilot is shown below. As the outer and middle markers are passed, the appropriate lamps are illuminated and the tone and identification can also be heard in the headphones. The white Z-marker lamp identifies the cone of silence over a radio range station. A 3,000-cycle tone is associated with it.

### Airport Surveillance and Precision Approach Radar (GCA)

*Equipment:* Ground equipment comprises a long-range search radar and a short-range, high definition radar with limited coverage. Military equipment was known as Ground Controlled Approach (GCA). Airborne equipment is simply ordinary plane-to-tower communications radio. Equipment shown is oversimplified.

*Operation:* There is essentially no operation required of the pilot who flies his plane according to instructions received from the ground. A controller watching the radar return in elevation and azimuth communicates instructions to the pilot. *Example:* The search, azimuth and elevation scopes are represented as showing the complete track of an aircraft, whereas they would actually show a small portion of the track depending upon the persistence of the cathode-ray screen. In practice, it is possible to display both azimuth and elevation on one scope. The presentation is also cus-

tomarily combined with a radar map of the location to aid the controller in his interpretation.

## MARKERS

### Radio Range Z-Marker

*Equipment:* The Z-marker positively identifies the cone of silence directly above a radio range transmitter by sending up a 75-mc beam modulated at 3,000 cps.

*Operation:* The Z-marker is continuously operated. When the plane passes over it a white light is caused to glow and 3,000-cps tone can be heard in the headphones.

*Example:* The illustration shows the relative audio levels experienced at the 1,000-foot altitude above a low-frequency radio range. The Z-marker signal is heard within the cone of silence.

### Fan Markers

*Equipment:* Transmitting equipment similar to that used for Z-markers is required at the ground and frequency-selective circuits are required for the 75-mc receiver in the aircraft.

*Operation:* Fan markers indicate points along the legs of a radio range and are used for identification and traffic control. The standard fan marker is broader than it is thick being 4 miles thick (along the airway) at 3,000 feet. The new bone-shaped marker is only 1.5 miles thick and gives a sharper indication both for identification and control.

*Examples:* Cross sections for both the standard and bone-shaped markers at the 3,000-foot level are shown. The coding is also given. Fan markers are modulated by dashes of 3,000-cps tone. Starting at the north and proceeding clockwise the dashes increase in number with the course legs. If there are two fan markers on one leg, the outer one has its dash preceded by two dots as shown.

### ILS Markers and Compass Locators

*Equipment:* ILS markers belong to the fan-marker family but are modulated at different frequencies. Compass locators are low-power non-directional radio beacons used in approaching ILS facilities. They are provided in pairs.

*Operation:* Markers give both an aural signal and a lamp display as the aircraft passes above the vertical beam. Compass locators operating between 200 and 400 kc (modulated at 1,020 cps) are used with ADF equipment.

*Example:* Markers are shown in the ILS drawing. Since the compass locator has an omnidirectional pattern it is shown only in block form. The locator near the outer marker uses the first two letters of the localizer transmitter identification and that near the middle marker uses the last two letters of the three-letter designation.

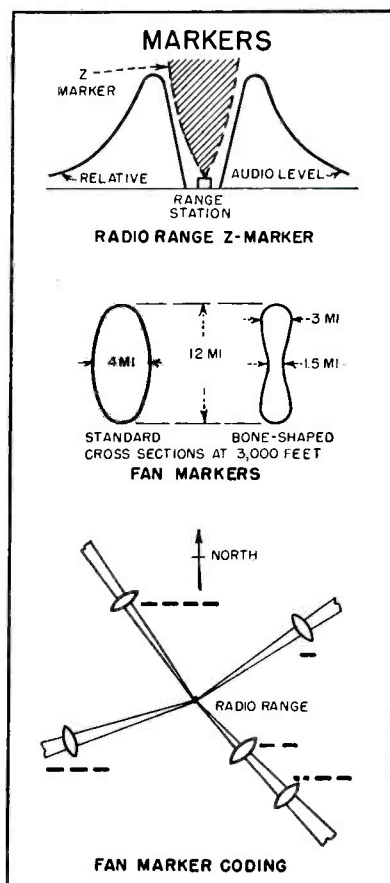

### ACKNOWLEDGMENT

Grateful acknowledgment is made of assistance from several individuals both in the Civil Aeronautics Administration and industry in obtaining basic information. The interpretation and arrangement of information from many sources has been made solely by the author in abridged form.—A. A. McK.

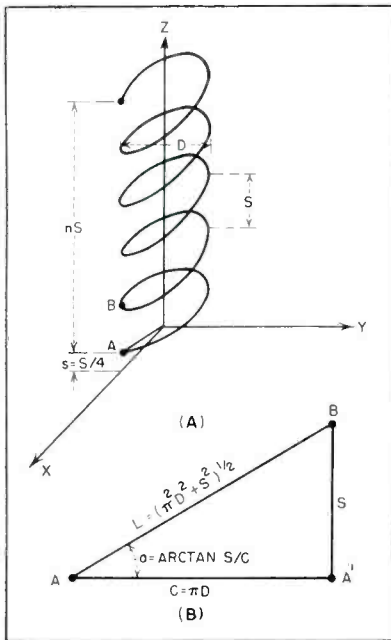

FIG. 1—Geometry of a helical antenna (A) and of one turn of the helix (B)

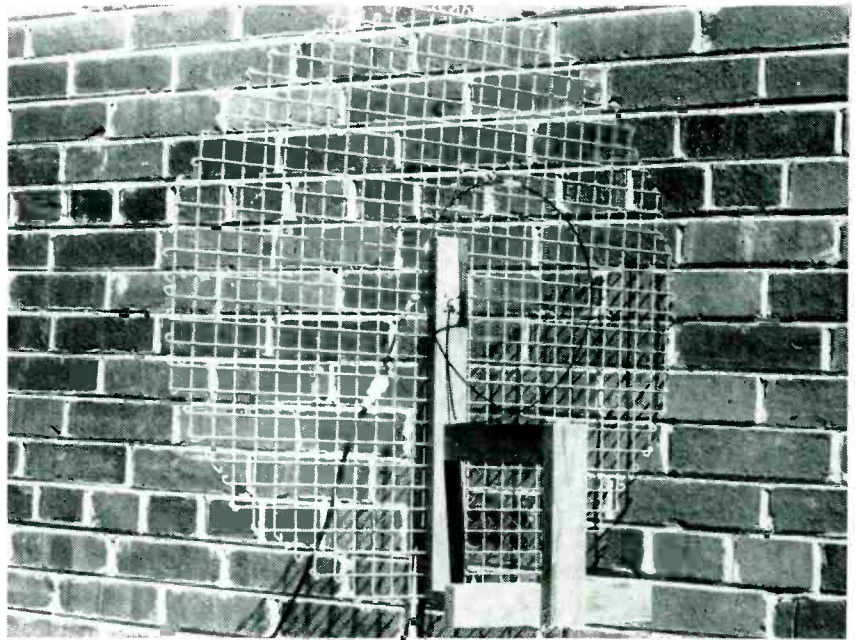

FIG. 3—Single-turn circular antenna with one-wavelength ground screen of large-mesh supported on wooden framework

# Constructing HELICAL

Physically small and mechanically simple antennas with extremely high gain can be built for the 435-mc amateur band and for Citizens Radio on 465 mc. Constructional details for several types are given, as well as dimensions of an impedance-matching transformer for use with coaxial line

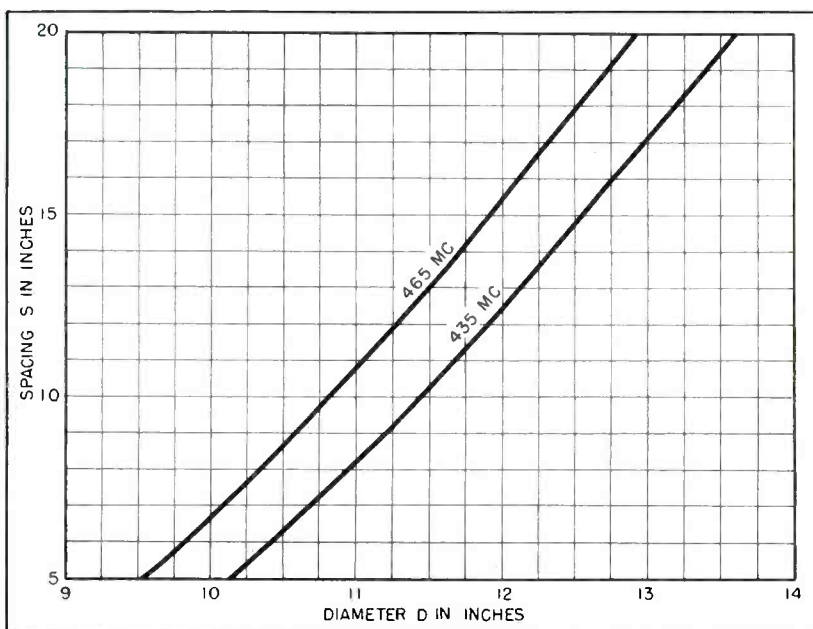

FIG. 2—Design chart for 435 and 465 mc using Fig. 1A notation

By **E. DILLON SMITH**

*KG2XCN-W3PZ  
Consulting Engineer  
Washington, D. C.*

**A** GREAT DEAL has been written about the use of circular polarization employing helical antennas<sup>1, 2, 3, 4, 5</sup> but there is little information available describing the construction of antennas for specific frequencies in the regions most commonly used for communications. Citizens Radio and amateur communications above 400 mc are particularly susceptible to the use of high-gain antennas that are sufficiently compact and wieldy at these frequencies. The antennas to be described and the method of feeding them from coaxial lines have been proved in practice for the

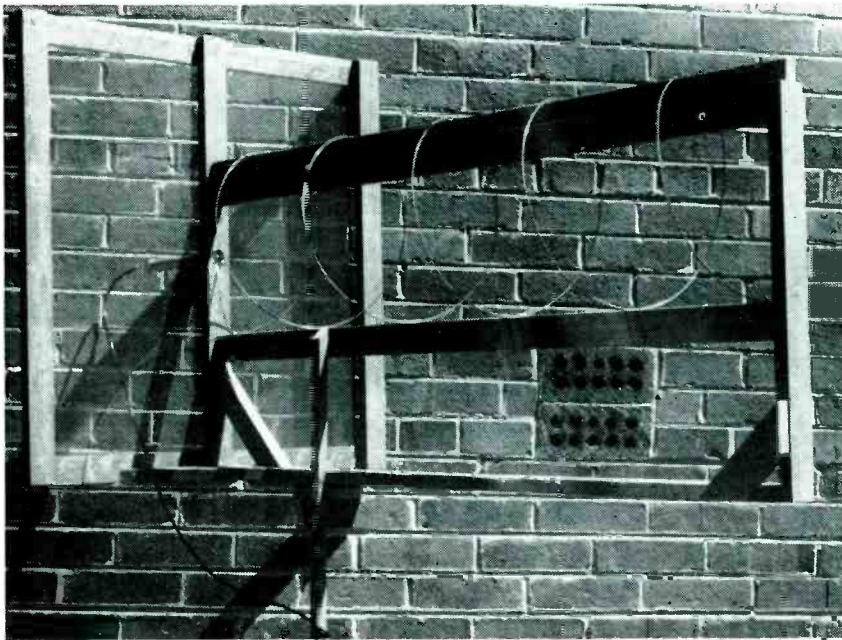

FIG. 4—Experimental 5-turn antenna with fine-mesh ground screen. Wooden frame is suitable for low-power use in dry weather

# ANTENNAS

region of 435 mc, as well as for various other frequencies including 465 mc.

Although the type of antenna to be described is in the form of a helix to give end-fire circularly polarized radiation, it is technically nothing more than a long wire antenna. In the design, the turns product  $nS$  can be fixed, or the total length of wire  $nL$  (in which  $L$  is the length of one turn) can be selected. The former method is the more convenient. Right circular polarization was used.

## Magnitude of Gain

A circular transmitting antenna operating into a linear receiving antenna can be visualized, for illustrative purposes only, as being about equivalent to two parallel linear stacked end-fire arrays fed in phase. For example, a five-turn helix with a screen is here visualized as a ten-element array in front of a screen. Such a linear array properly designed has a theoretical gain of 26 db over a dipole but is unusual to obtain in practice. A

circular antenna circuit as compared with a linear circuit has shown a measured gain of 18.9 db.

Figure 1 gives the geometry of an antenna of  $n$  (five) complete

turns wound as a right circular helix of diameter  $D$  with turn spacing  $S$ . If one complete turn of the helix is developed onto a plane the general dimensions are those given in Fig. 1B. The diameter  $D$  and the turn spacing  $S$  (or  $D$  and the pitch angle  $a$ ) completely specify the antenna. Practical design curves for 435 and 465-mc antennas are given in Fig. 2.

The antenna works because its dimensions are so chosen that an exciting signal radiated from  $A$  (Fig. 1) will arrive at  $B$  in proper phase relation with the signal arriving via the wire path  $L$  and to be radiated at  $B$  to reinforce the  $A$  or  $A'$  signal.

Specific design data for two single-turn and five five-turn circular antennas are given in Table I. These data follow the notation of Fig. 1 with dimensions taken from the design chart of Fig. 2. The frames for the original one and five-turn antennas were made of redwood, shown in Fig. 3 and 4. Because the voltages in the antenna are high, wood frames are not suitable for all-weather high-power operation (more than 1 watt or so) unless well insulated. One ground screen is copper mesh while that for the one-turn radiator is one-inch galvanized mesh. The eight-turn antenna shown in Fig. 5 is mounted on special compression-

Table I—Sample Antenna Design Data

Antenna Number Fig. Number	1	2	3	4	5	6	7
$S$ —spacing, in.	4.1	8.1	8.1	10.8	15.3	9.4	12.7
$D$ —diameter, in.	9.8	10.9	10.9	11.6	12.6	10.7	11.4
$n$ —turns	5	1	5	5	5	5	1
$s$ —1st turn, in.	1.0	2.0	2.0	2.7	3.8	2.5	3.0
$d$ —reflector diam, in.	27.2	27.2	27.2	27.2	27.2	25.4	25.4

Table II—Performance Data

Antenna Number Fig. Number	0	1	2	3	4	5	6
Turns $n$	0	5	1	5	5	5	8
Power number (Fig. 3)	0	—	1	—	2	—	3
Half-power beam width $\beta_0$	78.2	39	49	35	33	37	22
Ratio $\beta_0/\beta_h$ ( $\beta_h$ for doublet)	1.00	0.50	0.63	0.45	0.41	0.47	0.28
Circular vs horizontal circuit							
Power gain	1	10.2	—	74.2	77.6	21.6	216.0
Gain in db	0	10.1	—	18.7	18.9	13.9	23.9
Circular ant to half-wave ant							
Power gain over two half-wave antennas	—	2.6	4.0	18.6	19.5	6.2	49.0
Gain in db	—	4.1	6.0	12.7	12.9	7.9	16.9

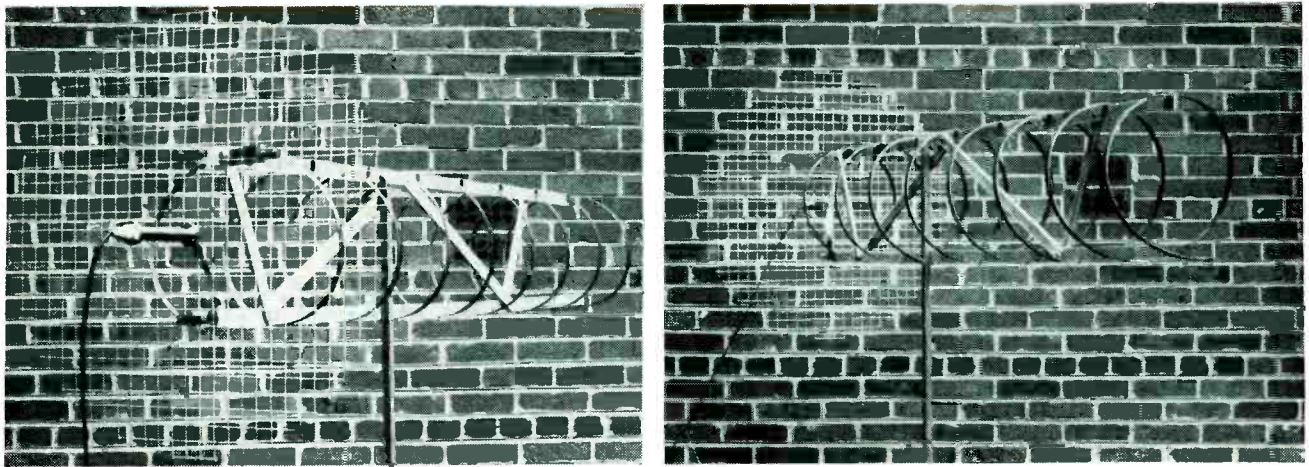

FIG. 5—All-weather high-gain antenna for 435 mc giving measured power gain of 246. Insulation is compression-molded glass strip. Method of mounting impedance transformer is indicated at left

molded glass strips, resulting in a mechanically strong and electrically efficient design.

In order to match the 130-ohm surge impedance of the antenna to a 53.5-ohm coaxial transmission line there is required an 83.2-ohm transformer. A suggested design for which details are given in Fig. 6 is illustrated in Fig. 7 in exploded, assembled and mounted form. If losses are to be kept at a minimum at these frequencies it is highly important that all transformer internal finish be perfectly smooth, and silver plated. A 5/32-inch center conductor rod must be attached to the receptacle as shown in Fig. 7. This transformer has been used to connect an RG-58/U transmission line to a 435-mc circularly polarized antenna.

### Performance Data

The effectiveness of these directive antenna systems was conveniently obtained from the ratio of the power at the terminals of the receiving circular antenna to that at the terminals of a dipole, with the same power applied to the transmitting antennas. This ratio can be expressed as power gain or in decibels.

The results of the performance tests on six circularly polarized antennas compared to a half-wave horizontal dipole are given in Table II. They are expressed in terms of beam width  $\beta$ , the power-gain ratio, and the gain in db. Antenna No. 0 is the half-wave dipole used as the basis of comparison. Thus, these data are relative and not absolute.

Table III—Circularly Polarized Arrays

Array Number	1	2	3	4	5
Elements in array					
Vertically	3	3	3	2	3
Horizontally	1	1	1	2	3
Total	3	3	3	4	9
Turns $n$ per element	1	5	8	8	8
Circular vs horizontal circuit					
Power gain	—	$5 \times 10^5$	$1.6 \times 10^7$	$4 \times 10^3$	$4 \times 10^{11}$
Gain in db	—	57	72	96	216
Circular antenna to half-wave antenna					
Power gain (over pair of half-wave)	63	$7.9 \times 10^3$	$1.3 \times 10^5$	$6.3 \times 10^6$	$2 \times 10^{15}$
Gain in db	18	39	51	68	153
Beam width in degrees					
$\beta_v$ , vertical	30	24	16	18	16
$\beta_h$ , horizontal	49	33	22	18	16

Since a horizontal half-wave dipole has a directional radiation pattern its beam width would be descriptive of its ability to radiate power in any given azimuth or horizontal direction. For sake of convenience the beam width,  $\beta$ , is taken as the angle between the points where the power density of the radiation pattern is equal to one-half of the maximum value—the beam angle of half-power points.

It can be shown mathematically, and practically demonstrated, that for a horizontal dipole the azimuth half-power points are plus or minus 39.1 degrees from the maximum, or the half-power beam width is 78.2 degrees. For comparison or reference purposes, the power radiated by the dipole is taken as unity, with all other antennas referred to it.

It should be noted that the beam width of the one-turn helix is 63 percent of that of the dipole, or 49 degrees. As the number of turns increases the beam becomes nar-

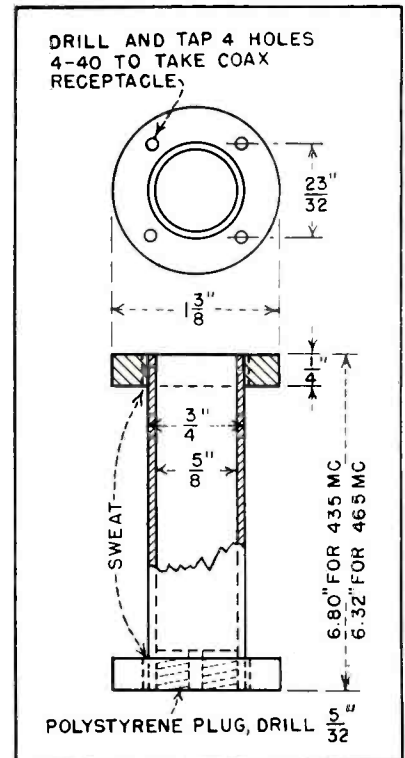

FIG. 6—Detail of impedance-matching unit fabricated from brass

rower, the 8-turn antenna being 22 degrees or 28 percent of the dipole.

Characteristics of several antennas are plotted in Fig. 8. A side lobe is shown, for example, in the 5-turn pattern, but this is to be expected owing to intensifying more power into a smaller beam width. The front-to-back ratio of these antennas is essentially infinite, which is far from the case with spaced or Yagi arrays.

Transmission data for two types of circuits are also given in Table II. The first set of data compares the transmission of a wholly circularly polarized circuit with one wherein the transmitting and receiving antennas are both half-wave dipoles. The second compares the transmission from a circular antenna to a dipole, or vice versa.

A well-designed circularly polarized circuit with a one and five-turn antenna on each end will have a power gain of over 75 or 18.8 db as compared to a horizontal dipole circuit, while the one and eight-turn antenna combination will have a power gain of about 250, or 24 db, without constructive or destructive interference.

If both ends of a communications circuit are operated with 8-turn antennas the power gain would then be about 15,849 or 42 db over a dipole circuit. In other words, the equivalent effect of a circular circuit over that of a horizontal dipole circuit with one watt input to the circular transmitting antenna would be the same as 15.8 kw into the dipole. Other similar comparisons can be made with the aid of Table II.

### Other Applications

These antennas have many additional uses. For the 13 amateur bands from 14 to 21,000 mc, a circularly polarized antenna would appear to be of considerable advantage. For example, at 14 mc, a power gain of 45 to 80 over a dipole can be obtained, depending on the physical dimensions of the antenna. At the higher frequencies, even higher gains can and have been realized, especially at 2 meters.

In the microwave region, the circularly polarized antenna can eliminate the need for spinning the antennas (this does not refer to con-

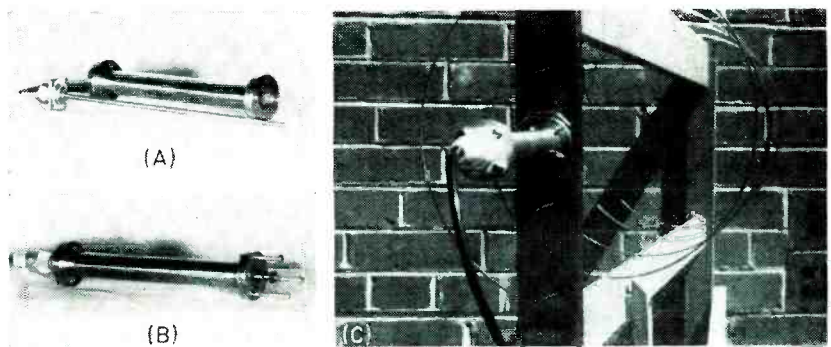

FIG. 7—Unassembled (A), assembled (B) and mounted (C) views of the 83.2-ohm impedance-matching transformer

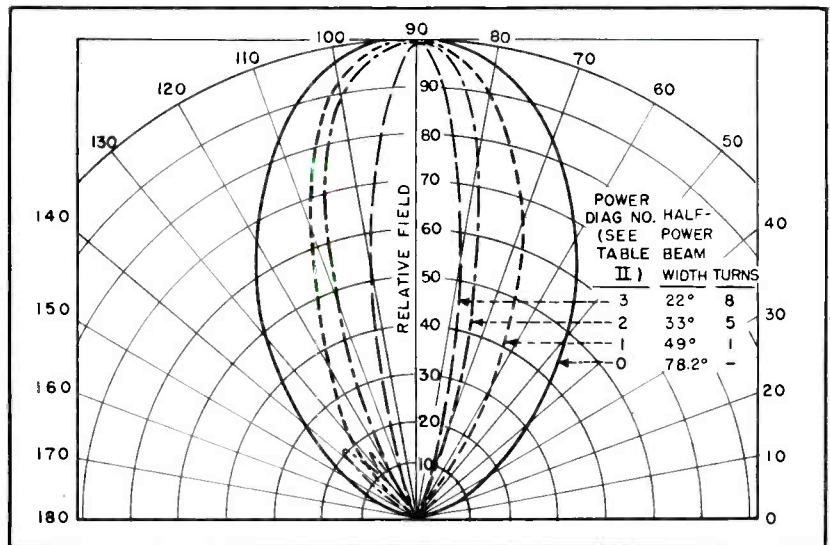

FIG. 8—Power-density field-strength patterns of three antennas (see Table II) for circular polarization, compared with half-wave horizontal dipole

cal scan), as is done in some cases for radiation-pattern-gap filling. At the same time, higher gains are realized. This antenna can also replace the dipole used to illuminate a parabolic dish.

The data on five selected circularly polarized arrays are given in Table III. The arrays with three vertically stacked elements materially increase the forward gain, the amount depending on the type of element used, and the vertical beam width is reduced without altering the already sharp horizontal beam. For example, the vertical three-element array with 5 turns in each has a power gain of 0.5 million or 57 db over a horizontal circuit; its vertical beam has been reduced 9 degrees, from 33 to 24 degrees. Thus, one watt in this array would be equivalent to 500 kw into a dipole circuit.

As a further example, a 2 by 2 or 4-element array with 8-turn individual elements would have a power

gain of  $6.31 \times 10^6$  or 68 db; the beam would be narrowed in both directions to 18 by 18 degrees. A 3 by 3 or 9-element broadside screen array would have a power gain of  $2 \times 10^{15}$  or 153 db, with the beams narrowed 6 degrees to 16 by 16 degrees. In other words, one watt into these latter two arrays would be equivalent to 6,310 kw or 2 million million kw, respectively, into a dipole, other things being equal. It is highly important, however, that proper feeding of and phasing among the elements in the array be established in order to secure such expected high gains.

### REFERENCES

- (1) John D. Kraus, Helical Beam Antenna, *ELECTRONICS*, p 109, April 1947.
- (2) H. A. Wheeler, A Helical Antenna for Circular Polarization, *Proc. IRE*, p 1,484, Dec. 1947.
- (3) John D. Kraus, Helical Beam Antennas for Wide-Band Applications, *Proc. IRE*, p 1,236, Oct. 1948.
- (4) John D. Kraus, The Helical Antenna, *Proc. IRE*, p 263, March 1949.
- (5) John D. Kraus, Helical Beam Antenna Design Techniques, *Communications*, p 6, Dec. 1949.

# Manufacturing

Details of techniques by which the phosphor coating of a television picture-tube screen is covered by a membrane or film on which a thin mirror-like coating of aluminum is evaporated. Membrane is later removed by heat before final evacuation

**P**RODUCTION of aluminum-backed screens requires two basic steps in addition to those involved in the normal manufacture of picture tubes.

These steps are the formation of a basic carrier upon which the metal is evaporated on the phosphor screen surface and the evaporation of the metal on the carrier. Minor adjustments of materials and processes constitute other requirements.

Screens may be deposited on the interior of the television picture bulb by conventional methods such as settling the phosphor from suspensions, spraying from suspensions, dusting onto binders and

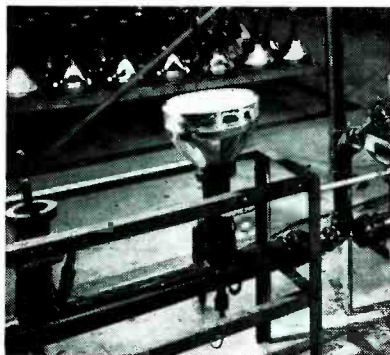

FIG. 1—Two vacuum manifolds on which tube blanks are evacuated for phosphor checking. The antenna used for excitation is visible on the vacant port at left

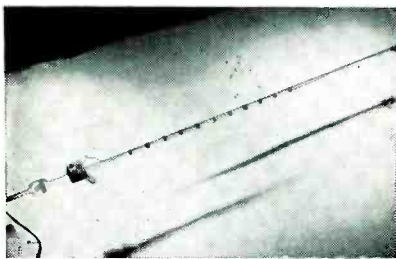
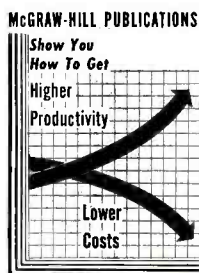

FIG. 2—Pipette for dispensing liquid that forms the membrane. The exit valve is at right



centrifugal application. However, problems may arise with various methods due to the type of chemicals used and their final elimination from the screen proper. For example, certain sulfates used as electrolytes, during screen deposition from suspensions, may remain in sufficient quantity to produce a deleterious effect on the aluminum carrier during its application. Therefore, the complete process may be partial to a definite combination of methods.

A shift of color in the color zone diagram of the operating tube between aluminized and non-aluminized tubes is noted. This is due to the light reflection from the interior side (electron beam) of the screen and its resultant reflection through the phosphor. Since the phosphor usually has a color off-white, it acts as a filter and consequently shifts the picture color.

To overcome the resultant shift from a non-aluminized tube, the color may be compensated for by a change in the phosphor chromaticity or by a change in quantity of powder per unit of screen area.

## Drying Operation

Having applied the screen, it is customary to thoroughly dry the screen before applying the aluminum carrier. This may be done by a thorough hot-air drying, heating by infrared, oven baking or

vacuum drying. The heat-drying methods usually require internal air change to prevent non-uniform drying which may result in screen discolorations depending on the method of screen application. Vacuum drying has become an economical, quick and thorough method of moisture and solvent removal. At the same time, actual fluorescing phosphor examination may be made to select minute screen defects before additional processing is continued. Since the vapor pressure of water is 18.65 mm Hg, a mechanical vacuum pump is ample.

Figure 1 illustrates a simple unit for fluorescing a screen while the tube is evacuated. A polished ball electrode or antenna is excited by a simple Tesla coil for ionization of residual gases, which in turn provides phosphor excitation. If the screen is not thoroughly dry and firmly bonded to the glass surface, subsequent operations may cause interference with adherence of the metal carrier in its application process or may cause the screen to peel and separate behind the metal carrier.

The metal carrier is next applied. The primary purpose of this carrier is to provide the proper medium upon which the evaporated metal may be deposited as a continuous smooth high-lustre backing directly adjacent to the phosphor powder.

It is important that the final metal film resemble a smooth continuous sheet resting lightly on the high points of the phosphor and eventually acting as a mirror to reflect the light forward as desired and be opaque to the normal internal reflections of the tube.

To obtain this eventual smooth metallic layer, a thin membrane or film is placed across the surface of the phosphor and upon it the metal



# Metallized Picture Tubes

By EARL R. EWALD

*The Rauland Corporation  
Chicago, Illinois*

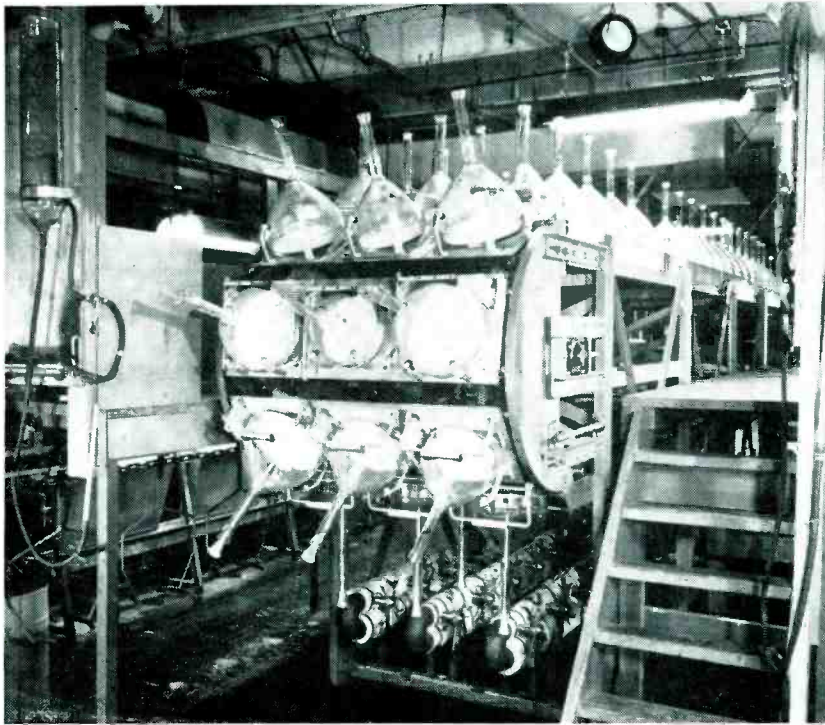

FIG. 3—Automatic conveyor for forming the membrane. Bulbs are loaded at the end shown and water is introduced by dispenser and tubing at left. Film solution is put into bulbs on top of conveyor as they travel away from the operator. Pouring off is done at the far end of the machine and a drying tube put into the bulb neck to guide warm air from nozzles on the manifold under the conveyor

is evaporated in a vacuum.

To place the membrane across the phosphor, several techniques may be used. Early methods utilized water added to the screen in such quantity to just fill all the crevices and holes and then froze the water. Over this smooth surface, thin solutions of Formvar or organic materials of proper thickness were applied. After ample setting, the water is removed through the film by evaporation or equivalent methods.

Another means is to apply an organic solution by centrifugal means. The bulb is rotated at moderate speed and the solution is applied by depositing it on the screen surface. It consequently spreads to the edge in a thin smooth continuous membrane. The control of the quantity of solution, the viscosity and application conditions are important.

The widely accepted method is to place a shallow level of water (approximately 0.25 inch) over the screen. After it becomes still with-

out maintaining any movement or circulating currents, a few drops of organic solution are applied to the surface of the water. After spreading over the surface, the material hardens and maintains itself as a membrane over the entire surface. The water is then removed from beneath the membrane by slow and uniform tipping of the bulb until it is completely removed from the screen so the membrane will recede to the surface of the phosphor screen.

It is important that the membrane be air dried (4-10 minutes depending on application conditions) to drive off excess moisture and harden the membrane. This leaves the bulb with the phosphor screen in place and the sheet uniformly stretched across its surface.

## Composition of Membrane

There are several critical requirements in the addition of the membrane solution. To be done properly, precise control of the material and composition must be

maintained. The material is prepared of selected dry nitrocellulose powder which is dissolved in an acetate solvent. To this is added one of several plasticizers which provide the solution with elastic properties and toughen the thin film so it can be handled in the process.

The entire film composition must be such that it is insoluble in water but will readily set in the essentially saturated volume within the bulb during application. The thickness of a suitable film is approximately  $6.2 \times 10^{-8}$  inch.

Accurate means of dispensing the proper amount of material must be employed. A simple technique is to use a pipette, a thin transparent tube with graduated volumetric markings. A stainless steel valve in the exit end is employed for proper control so that accurate volume measurement is attained. See Fig. 2. The solution is deposited on the water surface at a distance of 0.125 inch. Drops must not be permitted or discontinuity of the film may develop. This would also produce non-uniformity of the film which in turn may produce bare areas or edges.

Small deposits of dust and some of the chemicals used in phosphor

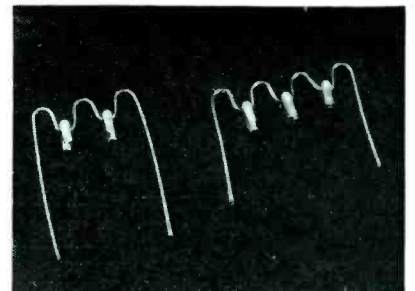

FIG. 4—Tungsten heater wires with aluminum slugs in place ready for evaporation. Assembly at left is for ten-inch picture tube; at right for twelve-inch

screen application have detrimental effects on the surface of the membrane proper. The proper appearance of a good film is a satin-sheen surface free of all bubbles, swirls or interference colors when observed under reflected light. Discontinuity of the membrane results as a spot or blemish in the screen after metal has been evaporated on its surface.

### Quantity Processing

A continuous-moving smooth-riding conveyor provides a means of high-volume production with satisfactory results. See Fig. 3. The water is introduced at the up-sweep end just after the bulbs are loaded. On the upper level the water comes to rest and the film solution is introduced. It is timed to harden on its travel across the machine. As each tube blank turns over the pour-off end of the machine the water flows from underneath the membrane. The pour-off time is not particularly critical but it must be done smoothly.

Air drying tubes are inserted which, upon the lower return level of the machine, engage in an air-valved paddle wheel. These wheels permit air passage during the engaging portion of their cycle and this in turn permits warm air to enter the bulb for drying of the film.

Simpler equipment for small output may consist of a table that is mobilized to remove the water from beneath the film. The bulbs are placed on the tilting platform and the water is introduced to cover the phosphor screen. After it has come to rest the film solution may be applied as described above. After

the proper delay time the water is removed by slowly and uniformly tilting the table top around a central pivot position until all water has drained from the bulb. The bulb may then be dried with an internal air stream.

### Metal Coating

The bulb is now ready to receive the evaporated metal which serves as the light reflector from the interior screen side, the light attenuator from internal light sources and the ion filter. The process to effect this result constitutes vacuum evaporation of metal. The filmed bulb is connected to a vacuum system which is of such a degree of vacuum that bright metal deposits are evaporated and formed with relatively uniform distribution.

The evaporating source must be so positioned as to obtain a uniform thickness of evaporated metal. Otherwise the electron penetration through the metallic film may have sufficient non-uniform retardation of velocity for screen excitation that a shift in the screen color may result over various areas. This is due to the change in spectral distribution of the phosphor to different bombarding voltages. The ideal location for the evaporating source would be near the center of curvature of the bulb face radius. This is not practical in most television bulbs and a compromise must be made or an elaborate evaporating source provided.

The most common metal used for the metallic layer is aluminum. Pure commercial grades are quite suitable. Other metals such as magnesium, silver and chromium which provide bright surfaces when

evaporated in vacuum may be used but they do not lend themselves to economy, good evaporating characteristics and stability in subsequent tube processing.

For each size of tube or area a determined amount of aluminum is evaporated. This may be prepared from weighed slugs and attached to a medium whereby the material may be heated until it has been totally evaporated.

Simple evaporator sources are shown in Fig. 4. These are connected to an a-c source. Another means to evaporate the metal is by induction heating from evaporator loops or suitable crucibles.

### Effect of Coating

The amount of metal evaporated on the phosphor screen surface has a definite influence on the light performance characteristic of the finished tube. Since the loss in velocity of the electron beam is proportional to the thickness of the metal deposited, the effective operating potential of the tube will be affected. Figure 5 illustrates the effect of variations in light output with several thicknesses of aluminum deposited. It shows that there is a point at which the light output is equal to that of a non-metallized screen. In the zone below this point there is a reduction in light output and above this point there is a definite increase in light output.

Figure 6 illustrates the effect of tube brightness for varying anode current at a constant anode potential with several thicknesses of aluminum. There is little practical influence due to current change for varying densities of metal but the effect is notable for current saturation on the non-aluminized tube at high current density.

The suitable thickness of the metal film for most direct view tubes is about  $6.8 \times 10^{-6}$  inch.

### Application Method

The effective procedure for obtaining a suitable vacuum requires a closed vacuum system with a suitable means of attaching the bulb to be metallized, a pumping system consisting of a diffusion pump with a fore pressure mechanical pump, and a suitable means to hold the metal to be evaporated with a power

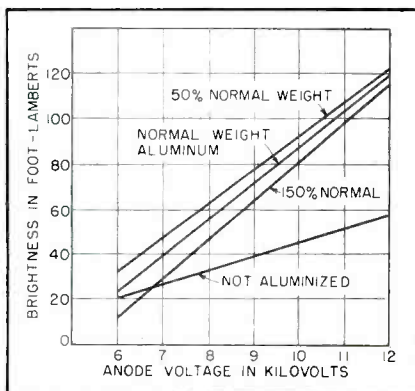

FIG. 5—Light output from 10FP4 tubes having different thicknesses of aluminum

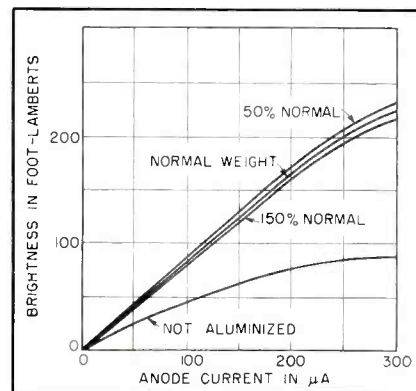

FIG. 6—Tube brightness at various values of anode current

source for evaporation.

Since a vacuum pressure of  $10^{-6}$  mm Hg is ample for aluminum evaporation, it is important that a system-to-bulb seal be able to attain this pressure. This is not an extremely high vacuum so consequently a rim seal developed by atmospheric pressure on a rubber or synthetic material is suitable. This permits a maximum opening for pumping out the air and consequently permits large pumps to be employed to produce a fast vacuum cycle prior to evaporation.

Vacuum pumps of almost any size may be employed depending upon the process cycle that is desired. For fast completion the diffusion pump may be bypassed during the roughing cycle, which permits the diffusion pump to remain hot and ready for work at any time. After a short period of roughing, the final high-vacuum system may be valved into operation.

The aluminum must be evaporated through a cycle by first slowly heating the material to degas it and transfer it into a molten state. Then more power is applied until it is all evaporated. If too rapid heating takes place the metal has a tendency to sputter and may carry to the film and rupture it. The whole interior of the bulb is usually coated with the metal along with the screen. This provides a conductive coating over the bulb wall surface which is a normal requirement in a tube.

### Machine Method

Modern techniques have made volume output relatively simple through the application of automatic mechanized equipment. Figure 7 illustrates a rotary evaporating machine. The charge of metal to be evaporated is attached to the electrical terminals. The bulb is inserted in the port over these terminals. As the machine is constantly rotating, at a predetermined point the port is opened through a solenoid valve for air passage through one section of a dual-passage central rotating valve which is connected to the large mechanical vacuum pump.

The evacuation to approximately  $5 \times 10^{-6}$  mm Hg pressure is fast (less than 1 minute for a 12½-inch

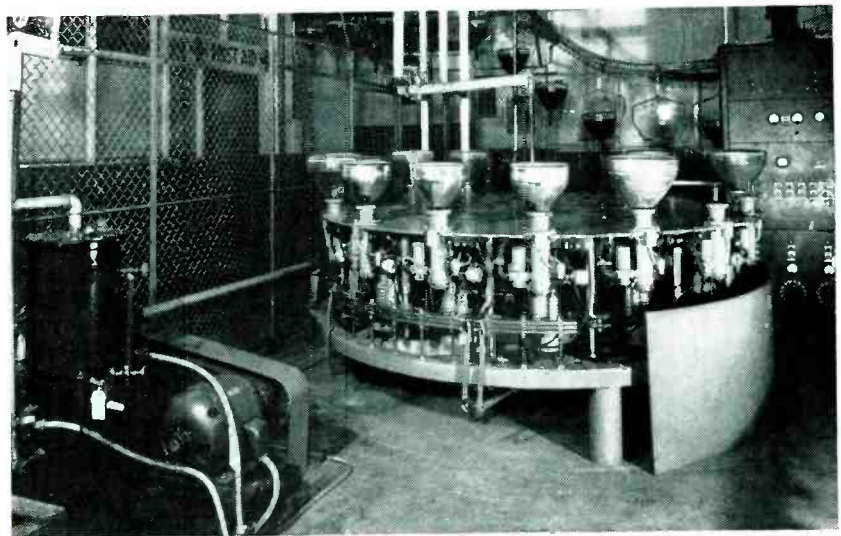

FIG. 7—In this aluminizer machine, each tube position has a separate diffusion pump and electrically operated roughing and bypass valves. Mechanical backer pump at left connects through a rotating joint

picture tube bulb) and permits cutting in the high-vacuum system through solenoid valve action and feeding through the other portion of the dual-passage central rotating valve. This high-vacuum system is always ready to work in that the oil vapor diffusion pumps are always hot and ready for action any time they are introduced into the cycle.

Each port carries its own diffusion pump which feeds into a common manifold which in turn is attached to a mechanical roughing pump. Then there is a period of pumping to bring the pressure to the suitable evaporating pressure. At this time the electrical terminals are energized through commutator action and with progressive wattage input the complete metal evaporation cycle takes place.

The evaporation cycle being complete, solenoid valves close off the high-vacuum system and open a filtered air inlet to bring the bulb back to atmospheric pressure so that it may be removed from the machine. If the pressure is not low enough in the roughing stage or in the cycle of metal evaporation a sensing control will automatically stop the rotation of the machine.

### Removal of Membrane

With the interior of the bulb completely aluminized (except for the lower cone extension or the bulb neck which requires a conductive coating to carry the anode

potential to the electron gun area) the tube is ready to receive the conventional high-temperature bake so that all volatiles and moisture be removed as fully as possible prior to final tube evacuation.

The final baking temperature is 340 to 400 C, depending upon the time of the baking cycle. It is important that the organic film be thoroughly removed by its complete disintegration from behind the metal film. Subsequent electron bombardment of the screen area after the tube has been finally completed would result in gas release if the film had not been completely removed. It is an oxidation process principally to remove the film and not one of temperature alone. For instance, the exhaust or final evacuation of a tube passes the bulb through a similar heat cycle as on the final bake, but the air has been removed and there is no disintegration of the film. The exhaust heat cycle cannot replace the air bake.

The finished tube requires a normal final electrical test inspection. Omission of the ion trap makes tube tests and final application very simple. The minimum light output is raised to a higher level and the cathode drain in electron current is lessened with consequent improvement in tube life. Many cases of operation in excess of 9,000 hours have been entirely satisfactory, with no ion spot indicated and the electron yield still in a healthy condition.

**By GLENN L. MELLEN**  
 Director, Physics Department  
 National Research Corporation  
 Cambridge, Massachusetts

**M**EASUREMENT of gas flow velocities has generally involved the use of some scheme that offers impedance to the flow. An orifice plate, pitot tube or venturi section are the commonly encountered devices of this nature. These have their application where lost pressure head is not intolerable and where flow velocities are sufficiently low that shock phenomena are not experienced.

Typical of this latter limitation is the case where gas is moving at supersonic velocities past or through a fixed object, or a projectile is moving with such velocities through a relatively motionless gas. In this case, the formation of shock waves, through which there are large pressure gradients, prevents the use of means of flow measurement that rely upon gas pressure as a source of intelligence.

### Electronic System

A union of radar, ionization and electrometer techniques to the field of fluid dynamics has resulted in some success in the solution of this problem. Thus far, tests have been confined to subsonic velocities because of the ease with which these may be produced; however, the principle being proven is not affected by speed relative to that of sound and its extension to all velocities is conceivable.

Figure 1 shows the basic elements of the measuring system. If some means of ionization produces a cloud of ions at a predetermined point in the flowing gas and the ion cloud is timed in its transit between

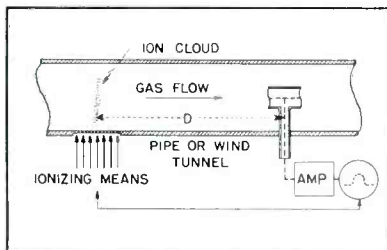

FIG. 1—Basic principle of the instrument involves creation of an ion cloud in the gas stream which is detected downstream and fed to a video amplifier and succeeding stages

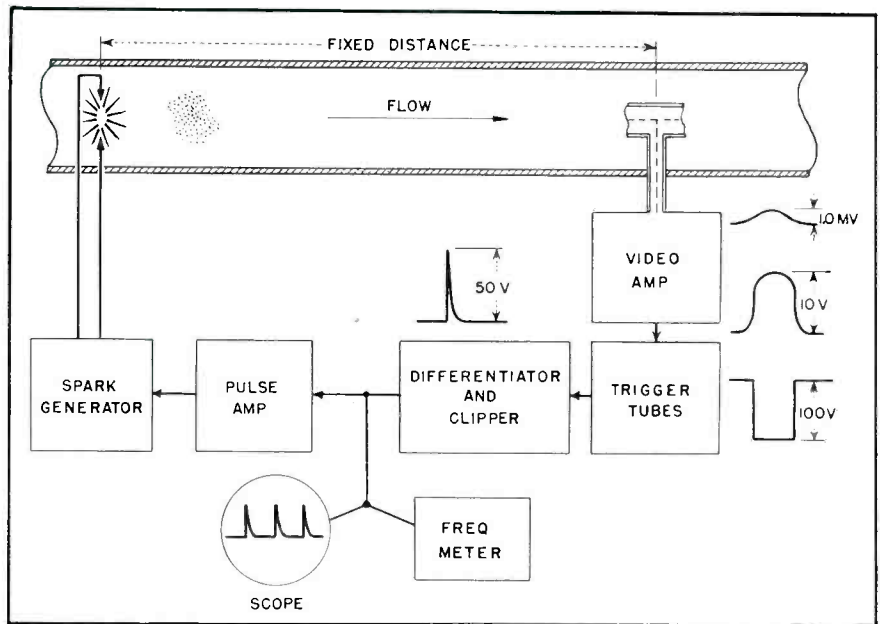

FIG. 2—Complete setup of equipment includes a feedback arrangement for each detected pulse to trigger the spark generator to produce another ion cloud

# Gas-Flow

Useful in gas synthesis and chemical fields, this instrument measures the rate of flow of air or gas over a range from 20 miles per hour to 400 mph without introducing foreign matter into the system. It measures the transit time of an ion cloud in the gas over a known distance

the point of formation and a detection station, then the gas velocity is measured directly.

The essentials of this system are that the time involved in producing the ion cloud must be short as compared with the transit time between stations; the gas velocity being measured must be large as compared to diffusion velocity so that the character of the ion pulse is not lost; the density of ionization must be sufficiently high so that the ion signal may be differentiated from all noises generated within the system; the time of collection of ions of the receiving station must be short as compared to the transit time; and the phase shift through the amplifier must be negligible as compared to the transit time.

Feedback connections between

the output of the amplifier and the ionizing means are shown in Fig. 1. This provides a recycling system whose repetition frequency is a linear function of gas velocity and any minor perturbations in the transit time are integrated and averaged.

In Fig. 2 a block diagram is shown of the elements of a successful flow meter of this type. A simple spark gap is installed in the test section of a small wind tunnel capable of producing velocities in excess of 400 miles per hour. Located a fixed distance downstream from this spark gap is a coaxial collector arrangement of electrodes which serves as an ion collector.

The magnitude of the collected signal realized across a 10-megohm input resistor in the video amplifier

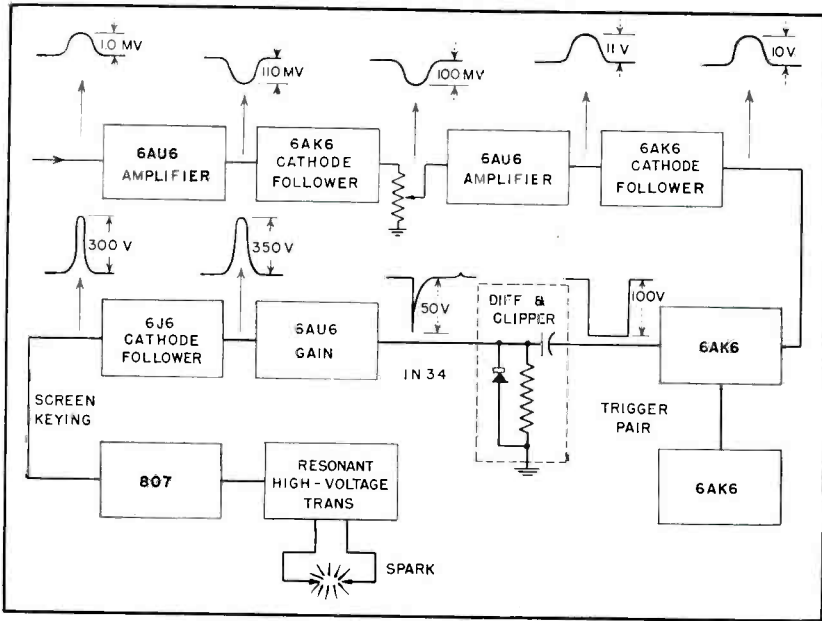
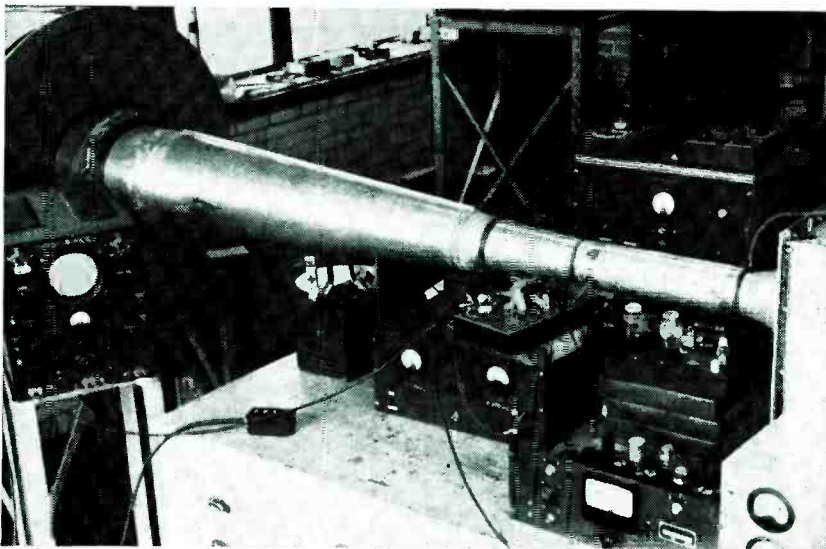

FIG. 3—Arrangement of stages in the video amplifier and feedback circuit. Detected waveshapes and voltages are also shown

# Speedometer



Continuous indication of air speed is provided by having the collected signal feed back and trigger the spark generator. Air flow in the wind tunnel shown above is from right to left

is of the order of 1 millivolt. The ion pulse duration is of the order of a hundred microseconds.

The output of the video amplifier at a level of approximately 10 volts operates a pair of asymmetrically biased trigger tubes that produce a square wave front at a predetermined signal level above a zero reference. This is differentiated and clipped to feed the pulse amplifier, the oscilloscope and the frequency

meter as shown in Fig. 2.

The pulse amplifier keys the screen circuit of the spark generator which produces another cloud of ions. The fixed distance is one foot, and the repetition rate gives gas velocity directly in feet per second.

The video amplifier must have broadband characteristics as well as work with input currents approaching the electrometer range.

This was solved by the brute-force type of circuit shown in Fig. 3. The interstage voltages are shown. It will be noted that two high-gain stages feed cathode followers that act as impedance transformers. These cathode followers offer minimum loading on the previous high-gain stage and serve as low-impedance driving sources.

A six lead cell is used as a source of filament supply to eliminate 60-cycle pickup in the input stage. The power gain is approximately 120 db at a bandwidth in excess of half a megacycle. The rest of the circuitry is straightforward and involves amplification of the differentiated pulse, with low-impedance drive on the screen of the oscillator tube that is connected to a television power-supply type resonant transformer.

The variable gas velocity through the wind tunnel is controlled by the blast gate on the outlet of a turbo compressor. Gas velocities as low as 20 miles an hour and in excess of 400 miles an hour have been measured by this system. Below 20 miles an hour the character of the ion pulse is lost appreciably due to radial and axial diffusion and recombination.

## Improvements

Since the development of this device is directed toward its ultimate use at supersonic velocities, the elimination of the spark gap becomes necessary. The presence of the spark electrodes in the flowing gas at supersonic velocities would cause intolerable shock lines with consequent flow disturbance, and thus a means of producing ionization without physical embodiments is necessary. Investigations are going forward along this line.

Ionization could be achieved by particles from radioactive sources, but these do not lend themselves readily to pulse operation and therefore electron beams are being investigated. Electrons are chosen over x-rays because of their higher specific absorption in the gas. The electron beam is being produced by a linear accelerator of the resonant cavity type. Energies of the order of 100 kilovolts at a peak current level of  $10^{-5}$  amperes are desirable for the present application.

# A Gated Beam Tube

Sharply focused electron beam passes through two control grids, each of which has unusually steep and linear transfer characteristic. Tube is especially well suited for use in f-m limiter-discriminator circuits, as a sync separator or as a square-wave generator

By **ROBERT ADLER**

*Research Department  
Zenith Radio Corporation  
Chicago, Illinois*

**W**HEN A SHARPLY FOCUSED electron beam, emanating from a narrow opening in a solid positive electrode, is thrown against a control grid which is followed by an anode, unusually sharp transition between cutoff and high-plate-current conditions may be expected. Transconductances of several thousand micromhos per ma of anode current can be realized, and higher slopes up to the point of anode current instability can be obtained under laboratory conditions. Figure 1A is a drawing of a tube using the principle.

The tube was originally developed as a result of a search for a single-tube f-m limiter-discriminator with a minimum of components; but, as is often the case in such a specific search, other applications have been found in which the unusual characteristics of the gated beam tube can be used.

## Characteristics

The most important feature of the gated beam tube is the step-

This article is based on a paper presented at the 1949 National Electronics Conference. The conference paper will appear in the *N. E. C. Proceedings*.

shaped control characteristic of its first grid, as shown in Fig. 2. In response to a grid potential which changes from negative to positive (left to right in the oscillogram), the plate current rises abruptly from zero to a sharply defined maximum level. No further change occurs in the plate current, no matter how strongly positive the grid may go.

The tube contains a second control grid which has similar properties; if it is made strongly negative, the plate current is cut off. Over a narrow range of potentials in the vicinity of zero, the second control grid acquires control over the height of the platform to which the plate current may rise. If the second control grid is made strongly positive it also loses control over the plate current, which can never rise beyond a predetermined level.

Figure 1B shows schematically the operation of a gated beam tube in one of its early experimental forms. On the left the gate or

control grid is open; the potential in the vicinity of the grid may be quite close to zero, forcing the electrons to move very slowly, but if the beam is accurately aimed and the balance between beam current and accelerator voltage is correctly chosen, most electrons will travel along substantially straight lines and pass through the grid.

On the right, the grid voltage has been made a few volts more negative. A few electrons may have started the trend by turning back in front of the grid; in doing so they increased the space charge and made others turn around, until an avalanche of desertions from the main stream blocked the path entirely. Because most of the space charge is concentrated in the center of the beam, most of the returning electrons diverge; like the spray from a fountain, they fall back but they miss the small opening from which they came.

To obtain high transconductance, electrons should approach a control grid head-on; no uncontrolled fraction of their kinetic energy must be squandered on lateral motion. But electrons approaching the grid head-on, if they are rejected, will return along the same line. In tubes of conventional construction they would come near the cathode, increasing the space charge there, reducing the outgoing current and flattening the control characteristic. In the gated beam tube, however, their chances of finding their way back through the narrow opening in the accelerator are small, especially because of the concentration of space charge in the thin beam.

The static characteristic of a simple gated beam tube is shown in Fig. 3. Such a tube may well serve as limiter or clipper. To make it perform the additional function

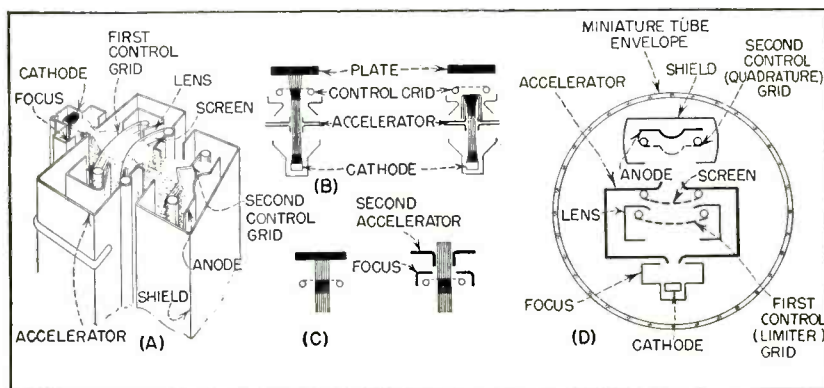

FIG. 1—Schematic representation of gated beam tube construction, showing position and effects of tube electrodes

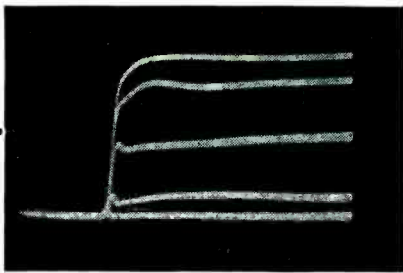

FIG. 2—Characteristics for second grid voltages of +2 (top), +1, 0, -1 and -2v

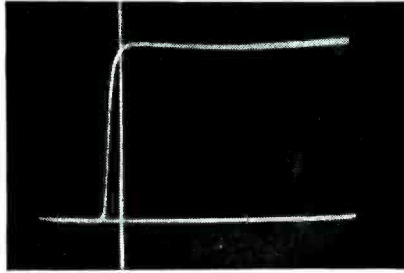

FIG. 3—Static characteristic oscillogram of simple gated beam tube

of a discriminator, a second control grid is needed. Because the electron beam arrives at the plate of Fig. 1B in the form of a thin sheet, a slot cut into this plate may serve as the starting point for another gated beam system, as indicated in Fig. 1C. Early experimental tubes were built in this manner, with various grounded focusing electrodes added on the sides to keep the beam from spreading.

Later it was found that much more uniform tubes could be made by combining a separate electron lens with the second slot. Figure 1D shows a cross-section of the final laboratory model after which the final production type 6EN6 was patterned. The focus electrode, together with the first accelerator slot, forms an electron gun which projects a thin sheet stream upon the first control grid. The curved screen grid, together with the grounded lens slot and aided by the slight curvature of the first control grid, refocuses the beam and projects it through the second accelerator slot upon the second control grid. This grid and the anode which follows are enclosed in a shield box. Focus, lens and shield electrodes are internally connected to cathode. The assembly fits into a 7-pin miniature tube envelope.

With 60 volts on the accelerator, the cathode current is about 5 ma, of which slightly over 3 ma can be switched to the anode. Zero potential on the first control grid permits nearly full plate current flow; slightly over two volts of negative bias produces cutoff. The position of the lower and upper knee of the second control grid depends on the anode voltage, since these two electrodes have triode characteristics with respect to each other.

If the control grids are driven

positive they will draw current, but they cannot draw more than their proportionate share of the total beam current. With 60 volts on the accelerator, the current to either control grid levels off at about 500 microamperes. It is therefore quite permissible to drive the grids positive, without incurring any danger of overloading the tube or damping the driving circuits too much. This feature is frequently useful.

#### Limiting and Discriminator

Perhaps the most straightforward of all applications is the use of the gated beam tube as limiter only. Figure 4B shows the circuit. The arrangement looks like a linear amplifier, and its limiting properties are entirely due to the plate current characteristic shown in Fig. 3. The optimum bias (about 1 or 2 volts) corresponds to the center of the steep part of this curve, and, in operation, this bias should remain fixed. The control grid should be returned to ground through a low d-c resistance, preferably a coil. Figure 4A shows the plate current for signals from 1 to 30 volts applied to the first grid. Limiting occurs instantaneously without the use of energy storage; nothing is carried over from one cycle to the next. This type of limiting is helpful in the suppression of impulse noise and adjacent channel interference.

The second control grid of the 6BN6 is not needed for straight limiting. To obtain the largest output amplitude, it should be connected to the plate. If limiting at the smallest possible input signal is more important, while some output amplitude can be sacrificed, the second control grid is grounded.

Figure 5A shows the 6BN6 as a limiter-discriminator for frequency-

modulated signals. This circuit, long known for conventional converter tubes<sup>2,3,4</sup>, involves the use of space charge coupling, which is not regarded as a useful tool.

With the 6BN6, the first control grid serves as limiter grid. Biased near the mid-point of its control characteristic, it passes the beam during positive half-periods of the applied signal and rejects it during negative half-periods. The chopped electron beam then goes through the second accelerator and forms a periodically varying space charge in front of the second control grid. By electrostatic induction (space-charge coupling), a periodic charging current (about 15 microamperes per megacycle) is produced in the ground return of the second control grid. Across the tuned circuit inserted between this grid and ground (the quadrature circuit), approximately 5 volts of a signal which lags the input voltage on the first control grid by 90 degrees is developed if the quadrature circuit is at resonance.

We may now think of the two grids as gates which open and close periodically, the second gate lagging behind the first. The beam can reach the plate only when both gates are open; plate current flow starts with the delayed opening of the second gate and ends with the closing of the first.

Modulation of the frequency of the applied signal results in a corresponding variation of the phase shift between the two grids. This, in turn, varies the length of the period during which plate current can flow, as illustrated in Fig. 5B. A demodulated signal appears in the plate circuit.

Figure 5C shows a typical discriminator response for an f-m receiver with 10.7-mc center frequency. The most conspicuous difference between this curve and the one for a conventional discriminator lies in the absence of any sharp curvature at frequencies beyond the range of normal signal deviations. This property aids in making the receiver easier to tune; it also provides improved adjacent-channel selectivity, as was first shown by I. Pluse<sup>1</sup> in 1947.

One of the important characteristics of an f-m detector is its abil-

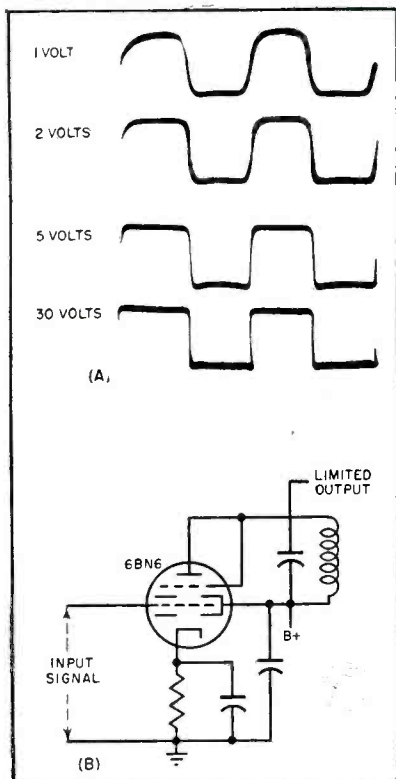

FIG. 4—The gated beam tube will produce the above waveforms (A) when used in the circuit shown (B)

ity to suppress amplitude modulation. The gated beam tube, when working as limiter only, surpasses the Armstrong grid-bias limiter in this respect, even at low modulation frequencies where the grid-bias limiter is not yet hampered by its time constant.

In the limiter-discriminator circuit, the gated beam detector cannot do quite as well because the audio output is taken directly from the anode, so that amplitude modulation may slip through as a result of spurious plate-bend detection. This tendency is minimized by careful adjustment of the limiter grid bias, normally determined by the cathode resistor. When this precaution is observed, the a-m suppression compares favorably with that of other f-m detectors in commercial use. The gated beam detector appears to have the edge in the suppression of ignition interference where other circuits are burdened by time constants.

To obtain performance equivalent to that of a balanced discriminator, the plate current should not change when a center-tuned signal is suddenly applied or removed. In obtaining this balance, the bias on

the second control grid is the determining factor, though plate supply voltage and resistance values have some influence. The tube is so designed that the bias voltages required for both grids are equal so that only a single cathode resistor is needed.

The bandwidth of the usable portion of the discriminator curve is proportional to the bandwidth of the quadrature circuit. Higher L/C ratio in this circuit results in a broader curve. Further broadening can be obtained by damping the quadrature circuit but this results in somewhat impaired audio output and poorer a-m suppression.

### Increasing Bandwidth

Figure 5A shows the anode bypassed to ground for the intermediate frequency which is applied to the limiter grid. If a small resistance is inserted between anode and bypass capacitor, i-f voltage appears on the anode, and through the interelectrode capacitance between anode and quadrature grid it is also coupled into the quadrature circuit. The phase relations are fortunate so that this contribution aids in driving the quadrature circuit, already energized by space-charge coupling. At the same time, however, it must be remembered that the capacitance from quadrature grid to anode is part of the total tuning capacitance of the quadrature circuit. There is now a resistance in series with this capacitance so that the circuit is damped.

Thus, insertion of a small series resistor (300 to 1,000 ohms) into the anode lead has two effects: it damps the quadrature circuit, but it also supplies more energy to it. As a consequence, the voltage across the quadrature circuit may stay constant or even rise while the bandwidth is increased. Good audio output and improved a-m suppression are the result.

The chopped electron beam which drives the quadrature grid already carries an amplitude-limited signal. The voltage induced on the quadrature grid is therefore substantially constant from about one volt signal input up to perhaps fifty or more. In practice, a small drop in the quadrature voltage at higher input signals is caused by narrowing of

the beam in the 6BN6 at high positive limiter grid voltages. This is harmless as long as stray coupling between the two grids, or between the tuned circuits connected to them, is carefully avoided. Residual coupling will show up most at high input levels.

The internal capacitance between the two grids of the 6BN6, or between first grid and anode, is less than 0.004  $\mu\text{f}$ . The plate bypass capacitor is normally made of such a size that it provides the correct amount of de-emphasis.

The audio output which can be obtained with low distortion is largely a function of the plate supply voltage. In f-m receivers where the highest available well-filtered voltage is about 80 volts, 4.5 volts rms are obtained for full deviation (75 kc at 10.7 mc.) In intercarrier sound in television receivers, where at least twice as much plate supply voltage can be expected, 15 volts rms for full deviation (25 kc at 4.5 mc) is normal. This latter output is enough to omit the usual audio stage and go directly into the power tube. The input voltage for the 6BN6 can be derived from the first video stage so that the entire sound channel is reduced to two tubes and two tuned circuits.

For signal levels of one volt or more, the audio output remains substantially constant. In this respect, the gated beam detector acts very much like the conventional combination of grid-bias limiter and double-diode discriminator.

The gated beam f-m detector is adjusted by tuning the quadrature circuit for maximum audio output on an f-m signal of the correct intermediate frequency.

The loading which the 6BN6 presents to an input circuit varies with the signal level. With normal bias, loading is negligible for small signals up to limiting level (about one volt). Then the load resistance drops, goes through a minimum of about 20,000 ohms at two to three volts signal, and finally rises again toward infinity. This behavior is a consequence of the flat grid current characteristic mentioned previously.

### Use as Sync Clipper

The step-function-like characteristics of the 6BN6 make it an excel-



lent tool for the task of separating the sync pulses from the picture content in a composite video signal. Figure 6 shows the simple circuit required for this purpose and illustrates the waveforms involved.

The composite video signal, with the sync pulses positive, is fed to the limiter grid through a large coupling capacitor. Grid current flows during each sync pulse. Across the grid-leak resistor, negative bias builds up to the point where only the sync pulses are capable of driving the tube into conduction. The plate current itself is limited by the characteristics of the tube. Across the plate load resistor, therefore, there appear negative voltage pulses of constant amplitude with clean-cut tops.

Figure 6 also shows a noise spike, much higher than the sync pulses, at the input to the sync clipper. In the plate circuit, this spike is clipped off at the same level as the sync pulses. In the grid circuit, each

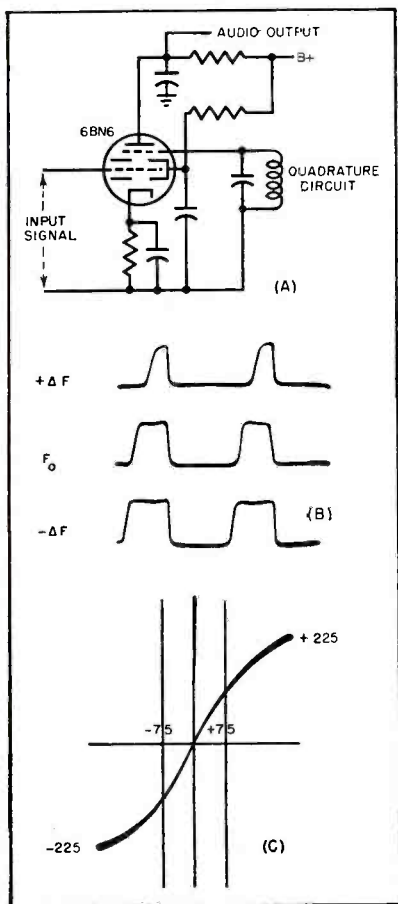

FIG. 5—Limiter-discriminator circuit (A), curves showing effect of frequency deviation on plate current flow (B), and typical discriminator response to f-m signal having 10.7-mc center intermediate frequency (C)

sync pulse draws the maximum available grid current of about 500 microamperes; noise pulses can draw no more, so that even very large noise pulses do not disturb the grid bias any more than moderate ones.

The size of the grid-leak resistance is determined by the required bias according to the following considerations: if the bias is allowed to rise too high, only the sync pulse tips remain effective in producing plate current flow, and with a noisy signal many pulses will get lost. As the bias is gradually reduced, cleaner pulses are produced in the output. Eventually, however, picture content appears between the sync pulses. To obtain optimum bias, which lies between these two extreme conditions, the grid leak resistance should be one megohm or slightly less.

The second control grid is not used in this circuit, and the rules previously given for limiters apply here. If maximum output is required, the second grid may be connected to the anode. Less output but cleaner clipping of the pulse tips is obtained by connecting it to ground or to a fixed d-c potential. It is also possible to apply a gating signal to the second control grid in order to suppress noise between sync pulses, or for the purpose of producing a control voltage for synchronizing the horizontal oscillator.

The input voltage to the sync clipper should be between 20 and 80 volts peak to peak of composite video. This makes it possible for the 6BN6, with its 2-volt cutoff-to-top range, to slice a small section out of the sync pulses which themselves represent only one quarter of the total video signal.

In the circuit of Fig. 6 the sync pulses are extracted from the plate load, and they are of negative polarity. Because in the gated beam tube the total cathode current stays constant no matter what voltage is applied to the grids, the accelerator current drops whenever the plate current rises, and it is possible to derive positive sync pulses from the accelerator. Experience has shown that it is practical to obtain positive vertical pulses in this manner with an integrating capacitor connected from accelerator to ground. Hori-

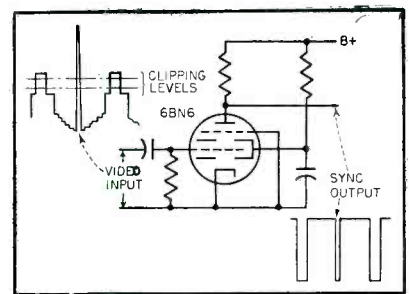

FIG. 6—Circuit for using gated beam tube as a sync clipper

zontal pulses are best derived from the anode; fortunately, the balanced phase detectors used in most horizontal sync systems will work with either polarity. The 6BN6 seems to show promise as a slicer in pulse time modulators and in some forms of phase modulators, and its two grids invite uses in computer coincidence circuits.<sup>8</sup>

#### Acknowledgments

Starting from the well-known limiting characteristics of converter tubes<sup>5,6</sup>, the gated beam tube, in which improved limiting is achieved by electron-optical means, was developed at Zenith's laboratory in Chicago. Preliminary information about it appeared in *ELECTRONICS*<sup>7</sup> in May 1948. The author wishes to express his thanks to E. C. Ewing for his valuable assistance during the period of development which led to the final experimental models.

Credit for developing the production version goes to W. T. Millis, A. P. Haase and many others of the General Electric Co. in Owensboro and Schenectady. The author is indebted to J. S. Spracklen for much of the circuit work on the f-m detector. The sync clipper circuits were suggested and developed by E. M. Roschke and W. S. Druz. All three are members of the Research Group of Zenith Radio Corporation.

#### REFERENCES

- (1) I. Plusc, Investigation of Frequency-Modulation Signal Interference, *Proc. IRE*, p 1,054, Oct. 1947.
- (2) I. Zakarias, U. S. Patent 2,208,091.
- (3) H. P. Kalmus, U. S. Patent 2,233,706.
- (4) J. A. Sargrove and R. E. Blaise, F-M and P-M Demodulator, *ELECTRONICS*, p 165, Jan. 1949.
- (5) J. J. Okrent, Limiter Using a Multigrad Tube, Hazeltine Report No. 1152W, Oct. 1940.
- (6) J. J. Okrent, U. S. Patent 2,343,263.
- (7) IRE National Convention-1948 Report, *ELECTRONICS*, p 72, May 1948.
- (8) J. L. H. Jonker and A. J. W. M. van Overbeek, The  $\Phi$ -detector, a detector valve for F-M, *Philips Techn. Rev.*, p 1, July 1949.

# Improved Television Modulator

Circuit provides constant sync output with accurately aligned pedestals and constant black level independent of output sync magnitude. Receiver picture tube is blacked out during resynchronization when transmitter signal source is switched

By **JOHN HAUGHAWOUT**  
General Electric Company  
Syracuse, New York

**A** CONSTANT SOURCE OF ANNOYANCE to the television viewer is the flip-flopping of the picture when the program shifts from one signal source to another, for example, when the station switches from network to local. If the modulator described here is used, the picture simply fades out during resynchronization and returns smoothly when the process is completed.

The circuit presents several other novel and interesting features. For example, it accurately lines up the pedestals and holds the output black level at a predetermined voltage above ground, independent of the

output sync magnitude. It will maintain a constant sync in the output regardless of sync input variations over a considerable range. Other minor refinements are included, such as provision for emergency operation should the keyed clamp circuits fail.

The block and circuit diagrams

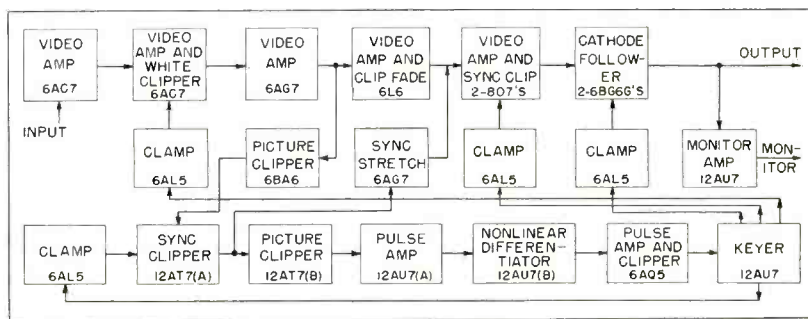

FIG. 1—The second, fifth and sixth video stages are clamped to a d-c value during the interval immediately following equalizing pulses

of the modulator are presented in Fig. 1 and Fig. 2 respectively. Details of the circuit will be described with reference to Fig. 2.

### Circuit Details

The control grids of the second, fifth and sixth video stages are clamped to a d-c value immediately following the fall to black level of each sync pulse. This stabilization is accomplished by a keyed clamping system which will be explained later.

The second stage is further refined by a series clipping diode in its plate circuit. This diode,  $V_{21}$ , cuts off white signals which would otherwise overmodulate the carrier.

Amplified sync is fed into the video lineup at the plate of  $V_{22}$ . The grid bias of  $V_1$  is controlled by a potentiometer at the transmitter console. When the video source is switched at the console, all composite signals passing through  $V_1$  can be cut off. Only amplified sync from the sync-stretch stage passes the modulator. Receivers are then reproducing a black picture and will not show any visual effect of synchronizing with a new signal.

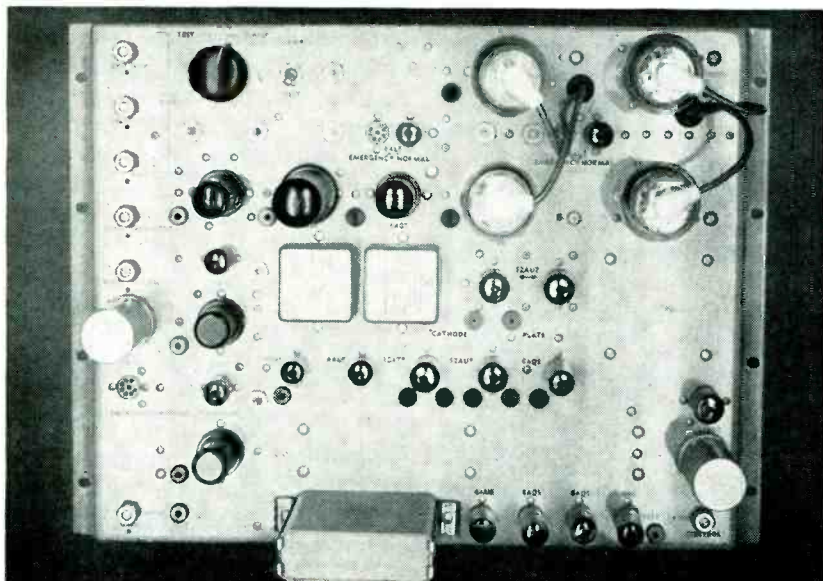

Controls and tubes are readily accessible for adjustment and replacement

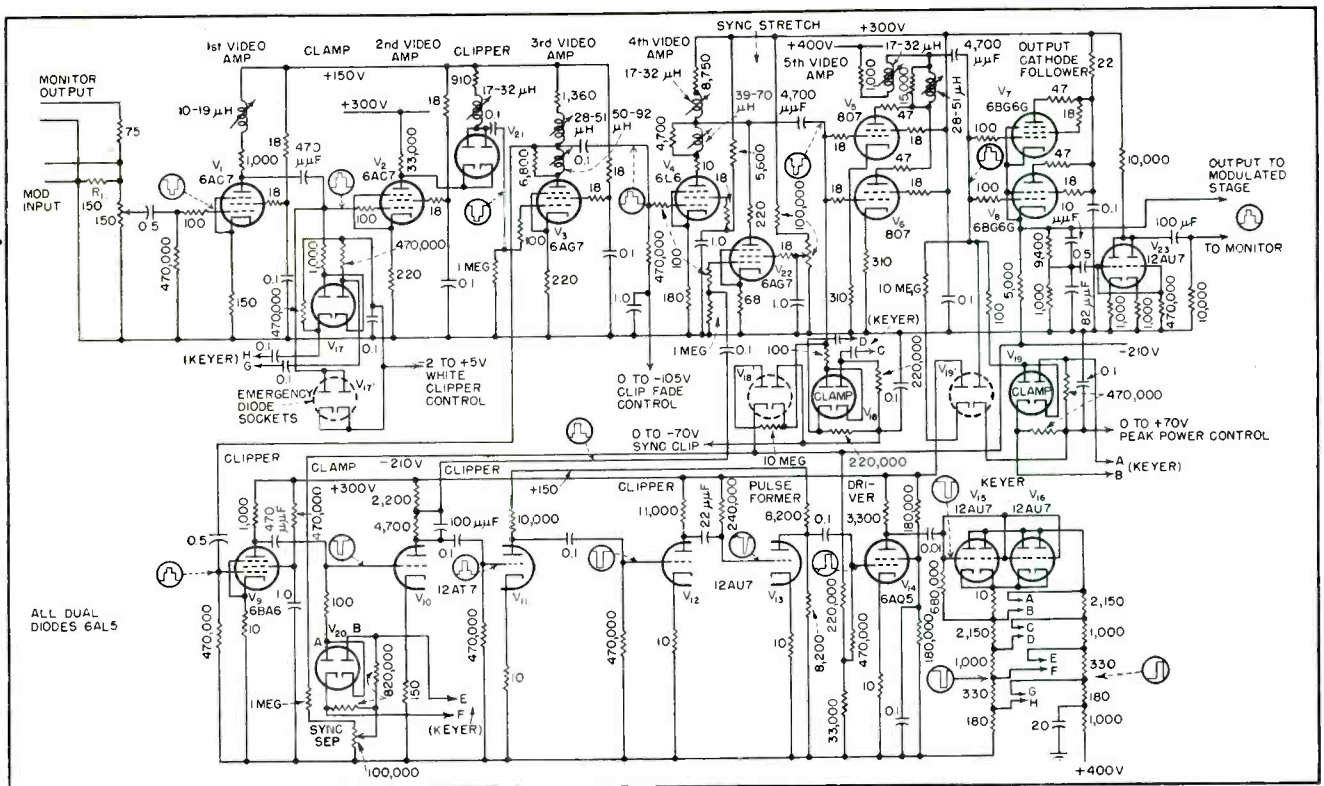

FIG. 2.—Dashed circles indicate alternate positions for clamp diodes for emergency use when signal cannot be clamped due to errors in signal waveform

The amount of sync in the composite signal is approximately 50 percent after the sync-stretching stage. The sync is negative on the grids of  $V_6$  and  $V_8$  and drives from black level to a voltage below the cutoff of the parallel 807's leaving only the percentage of sync that is desired.

### Sync Pulse Formation

Tubes  $V_6$  through  $V_{16}$  constitute a sync-separating and pulse-forming circuit supplying sync-stretch signals and generating pulses for the keyed clamping system. A composite signal (sync positive) from the plate of  $V_3$  feeds  $V_6$  and sets the d-c on sync peaks by grid rectification.

The remote cutoff characteristic of the 6BA6 clipper  $V_6$  insures that all the sync and a small part of the video is passed, most of the video being clipped.

On the grid of  $V_{10}$ , sync is negative and is clipped when it drives from black level below the cutoff. The keyed clamp  $V_{20}$  holds black level at a constant voltage on the tube characteristic and maintains the amount of sync output in the

plate almost constant. The clamp also restores the low frequencies so that no vertical sync will be lost.

A portion of the output of  $V_{10}$  is fed through a pulse-shaping network to the grid of the sync-stretch tube,  $V_{22}$ . The correct amount of sync supplied to  $V_{22}$  is just enough to set d-c bias by grid rectification (sync is positive) on the peaks, and yet allow black level to come through slightly above cutoff.

The part of the amplified sync used for sync stretching is that immediately adjacent to black level. The sides of the original sync pulse are somewhat sloping, and if any section of the sync pulse is added for sync stretching other than that next to black level, the additional sync will appear as a jog in the rising side of the sync pulse. In setting the pulse-forming clamp level care must be taken to allow only enough sync through  $V_{10}$  that will be completely passed by  $V_{22}$ .

The total plate output of  $V_{10}$  is coupled to the grid of  $V_{11}$  (sync positive), where d-c bias is set by grid rectification, and the video signal is clipped leaving sync pulse only. The sync signal is amplified

to approximately 200 volts and the sync peaks are clipped by  $V_{12}$ .

### Nonlinear Differentiator

Positive sync peaks are impressed on the nonlinear differentiator at the grid of  $V_{18}$ . This circuit produces the clamping pulse which follows each horizontal, vertical and equalizing pulse. The coupling circuit consists of a 22- $\mu\text{mf}$  capacitor and a 240,000-ohm grid resistor which returns to +300 volts. The grid current through this resistor holds the grid at zero at the instant before a pulse rise occurs. The leading edge of the pulse causes grid conduction and charges up the small capacitor quickly with the result that only a small positive pip with rapid decay to zero occurs.

When the negative excursion takes place, however, the grid is driven about 30 volts negative and immediately commences to charge toward +300 volts at a rate determined by the coupling capacitor and grid resistor. When the grid reaches zero volts, grid current prevents further rise and the voltage remains constant until the next pulse when the cycle repeats. The

resulting grid voltage wave is shown on the schematic. Magnitude of the negative derivative is several times the grid cutoff voltage. The result in the plate is a heavily clipped positive pulse and a decaying negative spike. Tube  $V_{14}$  sets d-c by grid rectification and clips the negative spikes, thus producing a 150-volt delayed pulse for application to the keyer ( $V_{15}$  and  $V_{16}$ ). Keyer outputs are equal and opposite clamping pulses from cathode and plate. Several values of pulses are needed for the clamps and are obtained from the taps arranged symmetrically about the tube.

### Clamp Circuit

Equal and opposite clamping pulses from the keyer tube are supplied through coupling capacitors to each clamping bridge circuit. Because the clamping diodes and their resistors are connected to ground (through a level-determining potentiometer) at only one point the average current from bridge circuit to the potentiometer is zero. Therefore current in each diode resistor is equal to that in the other diode resistor and the connection of the two resistors is at a potential half way between the potentials at the ends of the bridge.

During clamp pulse the capacitors are charged through the diodes so that during diode cutoff the potential at each end of the bridge is equal and of opposite polarity, and equal to the magnitude of the clamp during the pulse, but decays slightly during nonconduction of the diodes. The amount of the decay is determined by the value of the coupling capacitors and the resistors in the bridge. The clamping pulses bring the diodes into conduction because of the decay; the d-c across the bridge is opposite and almost equal to the sum of the pulses. Assuming that the drop across each diode during conduction is the same value, the point between diodes is brought to the same potential as the setting on the control pot.

### Output Monitor

The output monitor provides a means for examining the output signal without disturbing that signal. An R-C network divides the

output signal by approximately ten and supplies the grids of two parallel 12AU7 sections. By coupling to the monitor output with a high value capacitor (100 microfarads), the low frequencies are maintained. Peak-to-peak output is 0.9 volt. The actual a-c plate load is the 75-ohm terminating resistor at the transmitter control console end of the monitor line.

### Emergency Operation

To provide for operation of the modulator when the clamp circuit fails or when the signal cannot be clamped due to errors in waveform such as insufficient sync or a foreshortened back porch, a peak rectification diode circuit has been built into the chassis near each keyed clamp diode in the video amplifier. Moving the three clamp diodes to the emergency tube sockets  $V_{17}$ ,  $V_{18}$  and  $V_{19}$  removes all connection of the grids to the corresponding keyed clamp circuits and connects to these grids a diode which conducts on sync peaks.

One half the double diode,  $V_{18}$ , sets the bias on sync peaks. The other half acts as a switch connecting the grid through a 10-meg resistor to -210 volts. This negative connection forces the diode to rectify more current on the peaks, and causes changes of picture content to have less effect on the difference in level between vertical and horizontal sync peaks.

At the grids of the output stage ( $V_7$  and  $V_8$ ) sync peaks are positive. The plate of  $V_{19}$ , the emergency diode, connects to the grid. The cathode is tied to the keyed clamp control pot. The other diode section connects the grids through a 10-meg resistor to +300 volts to eliminate partially the effect of picture content change. Each sync peak causes rectification in the peak-setting diode, enabling the peak d-c voltage at the modulator output to be adjusted to the correct operating point.

The grid of  $V_2$  is left open except for the peak-setting diode which conducts on positive peaks but leaves the grid-to-ground resistance infinite during diode nonconduction. Clipping level of the white clipper diode in the plate circuit of  $V_2$  is determined by the setting of the

white clipper potentiometer at the transmitter control console. Peak-setting diode  $V_{17}$  and its potentiometer control the operating position of the wave on the grid characteristic curve, and therefore the position on the plate characteristic curve. The plate of the series clipper  $V_{21}$  is held at +150 volts. When white spikes in the video carry the diode cathode more positive than 150 volts, the diode cuts off, sharply clipping the spikes.

Note that no emergency operation is provided for the grid of  $V_{10}$ . Each diode section of  $V_{20}$  conducts on a wave peak; diode section A conducting on video peaks and section B on sync peaks. Plate A then assumes the voltage of the positive peak and B the voltage of the negative peak. Voltage from A to B is the peak-to-peak voltage. The voltage at the potentiometer determines the potential of the junctions of the bridge resistors. Therefore the bridge resistors being equal, the midpoint of the peak-to-peak wave on the grid is set at the voltage of the potentiometer.

If emergency operation is required because of faulty clamp pulses, it is necessary to prevent the clamp pulses from being transmitted to  $V_{15}$  and  $V_{16}$  and yet desirable to maintain  $V_9$  and  $V_{10}$  for sync stretching. For complete emergency operation,  $V_{14}$  should be removed when the three clamping 6AL5 tubes are shifted to emergency positions.

### Control

The input circuit is designed so that one connector is available for the input signal and another for monitoring the input. This combination of resistors and a potentiometer gives a 75-ohm input impedance. When the monitoring line is plugged in,  $R_1$  must be disconnected to keep input impedance at 75 ohms. The far end of the monitoring line is also terminated by 75 ohms.

For operation under ordinary conditions the output of the modulator is controlled by the video gain control at the transmitter console. The input control potentiometer at the modulator chassis is set for maximum signal input to the first stage grid.

# Time-Bridge Photometer

System provides good sensitivity and stability and eliminates inaccuracies usually introduced by successive stages of d-c amplification. Applied to astronomy, the photometer makes a valuable research tool out of a relatively inexpensive telescope. The time-bridge circuit may be used to advantage in more general applications of d-c amplification

By **ROBERT E. CORBY** and **STEWART BECKER**

*Department of Physics  
University of Arizona  
Tucson, Arizona*

**T**HE NEED FOR a more stable and sensitive photometer led to the application of the time-bridge to the measurement of low intensities of illumination such as those encountered in astronomical photometry.

The time-bridge, so named because a small change in time is made apparent by balancing out all except this change, is basically the comparison of two pulse widths by the generation of one pulse whose width is the difference between the widths of the first two. The fact that light is basically a d-c phenomenon, when measured by means of phototubes now in existence, has led to the almost universal use of d-c amplifiers for the measurement of low intensities of illumination.<sup>1,2</sup> Unfortunately, d-c amplifiers have their limitations as far as stability is concerned,<sup>3</sup> and it is always lack of stability that limits the usable sensitivity that can be realized from a d-c amplifier. The time-bridge is essentially a d-c amplifier but one in which the major part of the amplification is obtained in the time-bridge rather than by successive stages of d-c amplification.

The time-bridge circuit is, of course, not limited to the photometric application described herein, but could be substituted for many d-c amplifiers where high sensitivity and good stability are required.

## Block Diagram

Figure 1 shows a block diagram of the time-bridge photometer, the

time bridge itself consisting of the two delay gates and the rocker arm. Simultaneous and identical pulses are generated by the two pulse generators which are triggered by a sinewave voltage from the 60-cycle power supply. Thus, the pulse delay times of the two delay gates are initiated simultaneously. The delay time of one gate is fixed, while the delay time of the other gate is a linear function of the intensity of the light falling on the phototube.

The rocker arm extracts information from the two delay gates in the form of a single positive pulse, the width of which is the difference between the widths of the pulses from the two delay gates. This pulse is fed to the amplifier and is of sufficient amplitude to swing the grid of the first tube

of the amplifier from cutoff bias to zero bias. The negative pulse at the plate of this tube is inverted and fed to the grid of a power tube which is also working at cutoff. The grid of this power tube is also swung from cutoff to zero bias and an average value of the pulse appearing in its plate circuit is read on a milliammeter. The reading of this average plate current is a linear function of the intensity of the light falling on the phototube.

The function of the coupling amplifier between the phototube and the variable-delay gate is to convert the variable d-c voltage output of the phototube to a variable resistance which can swing in potential with the grid of the last tube of the variable delay gate and control its delay time in accordance with the intensity of the light falling on the phototube.

## Pulse Generators

Figure 2 shows a complete schematic diagram of the time-bridge

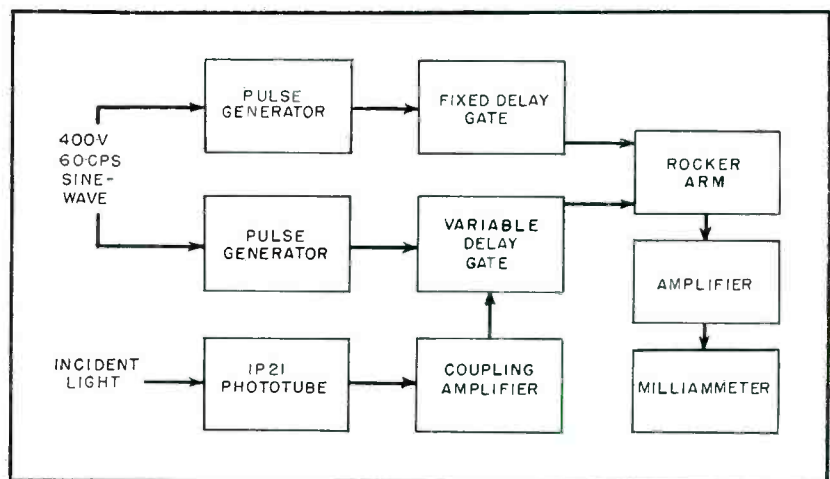

FIG. 1—Two pulse generators are triggered simultaneously by a sinewave voltage taken from the secondary of the power transformer, and delay introduced by the variable-delay gate is determined by the amount of light falling on the phototube

photometer. The 400-volt, 60-cycle sinewave voltage from the secondary of the power transformer is converted by the pulse generators into negative pulses 650 microseconds wide. Two pulse generators are used for decoupling reasons only.

If only one pulse generator is used, the delay gates are tied together at the outputs of the pulse generators, and this prevents the delay gates from operating independently.

The pulse generator for the standard gate consists of  $V_{1A}$  and  $V_{2A}$ , and the pulse generator for the variable gate consists of  $V_{1B}$  and  $V_{2B}$ . In each of these pulse generators, the first tube is cut off so that it will select the positive half of the incoming sinewave voltage. A certain amount of clipping also takes place in this stage. This half-wave, clipped voltage is differentiated between the plates of  $V_1$  and the cathodes of  $V_2$ , and  $V_2$  produces a sharp negative pulse from this differentiated wave. At the plate of each pulse generator then there exists a sharp negative pulse which is identical in wave shape and occurs at the same instant in time as the pulse appearing at the plate of the other pulse generator. These

two pulses are used to key two independent delay gates.

### Fixed-Delay Gate

The fixed-delay gate consists of  $V_{3A}$ ,  $V_{4A}$ ,  $V_{5A}$  and  $V_{6A}$ . In this circuit  $R$  and  $C$  are the delay-time determining elements. The delay time  $T$  can be expressed by  $T = k(RC)$  where  $k$  depends on the plate resistances of the tubes in the gates and their associated resistors. In the circuit of Fig. 2,  $k = 0.25$  and so the delay time is  $T = 0.25(RC)$  second.

Since the gate is pulsed every 16.6 milliseconds and the delay time of the gate should not exceed this time,  $R$  was chosen as 5 megohms and  $C$  was chosen as 0.01 microfarad giving a delay time of 12.5 milliseconds. Tube  $V_{4A}$  with its 22-megohm plate resistance is used to bias  $V_{3A}$  so that the delay gate will not run freely,  $V_{3A}$  being held in a cutoff condition when the gate is neither delaying nor being pulsed. When the plate of  $V_{3A}$  is pulsed negatively,  $V_{6A}$  is cut off thus initiating the delay time. The delay time continues until  $C$  has charged through  $R$  sufficiently to raise the grid of  $V_{6A}$  to the point where it can again conduct, thus ending the delay time. A

negative pulse is generated in the cathode circuit of  $V_{6A}$  and a positive pulse is generated in the plate circuit of  $V_{6A}$ . The width of each of these two pulses is equal to the delay time of the gate.

### Variable-Delay Gate

The variable-delay gate consists of  $V_{3B}$ ,  $V_{4B}$ ,  $V_{5B}$  and  $V_{6B}$ , and this gate is identical with the fixed gate except that  $R$  is replaced by the plate resistance of  $V_{11}$ . If the average plate resistance of  $V_{11}$  during the delay time is 5 megohms, the delay time of the two gates will be equal. A negative pulse will exist at the cathode of  $V_{5B}$  which is the same in all respects as the negative pulse at the cathode of  $V_{6A}$  and the positive pulse at the plate of  $V_{6B}$  is the same in all respects as the positive pulse at the plate of  $V_{6A}$ .

### The Rocker Arm

Now consider the operation of a resistance network consisting of two resistors connected between the cathode of  $V_{6A}$  and the plate of  $V_{6B}$ , designated in Fig. 2 as the rocker arm. Consider specifically the potential of the midpoint of this rocker arm. Both delay gates are pulsed at the same instant, so the initiation of the negative pulse at

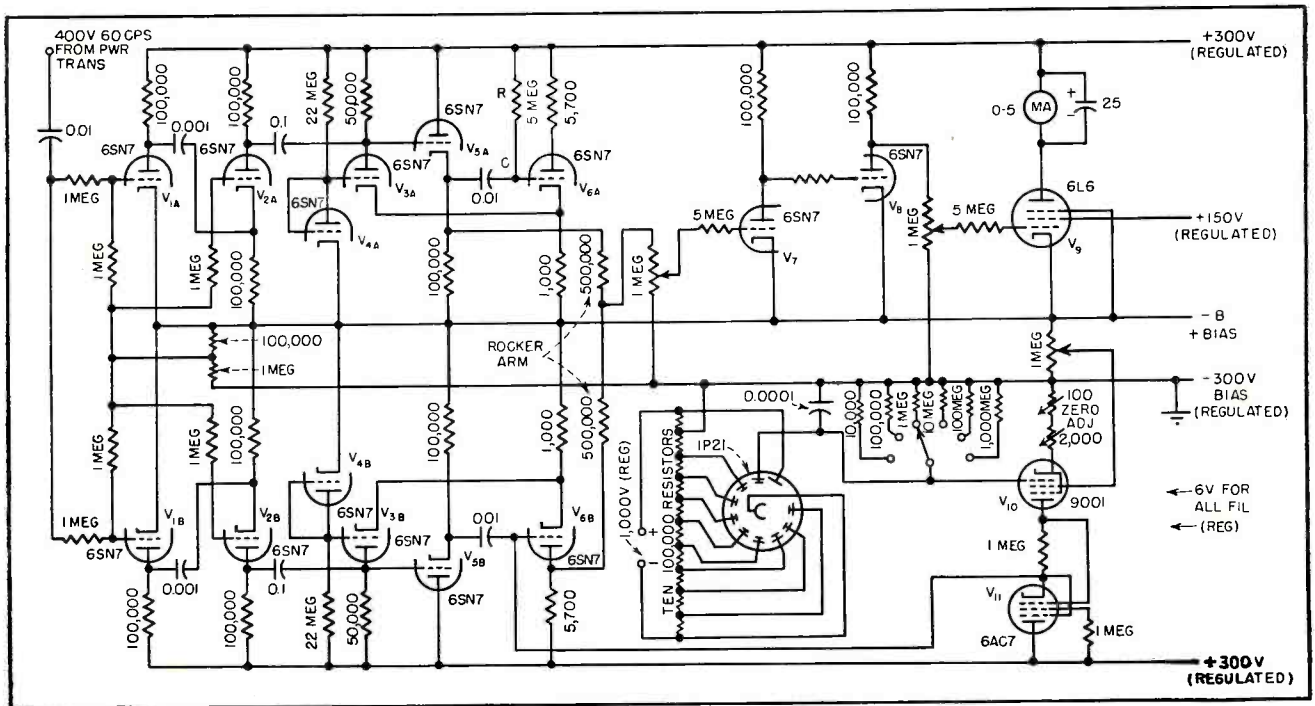
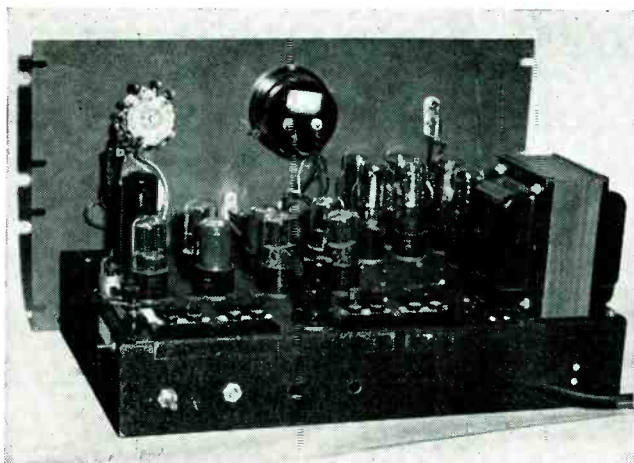
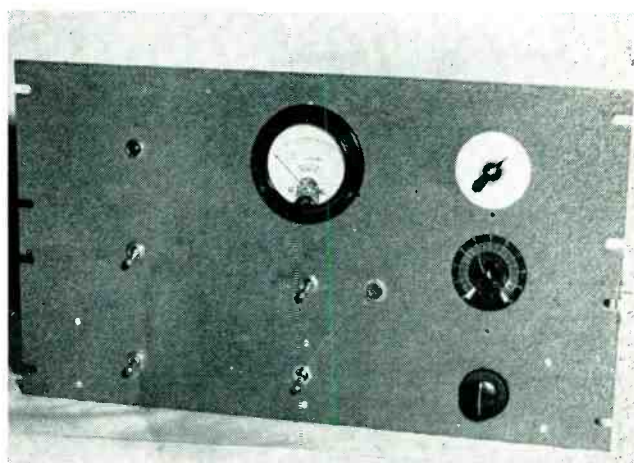

FIG. 2.—The voltage pulse appearing at the center of the rocker arm resistance network has a duration equal to the difference in length of the pulses generated by the two delay gates independent of amplitude



Rear view of experimental model of time-bridge photometer



The 5-ma meter may be calibrated in light units if desired

the cathode of  $V_{6A}$  occurs at the same instant as the initiation of the positive pulse at the plate of  $V_{6B}$ . The circuit constants have been so chosen that the amplitudes of these two pulses are equal, the one being negative and the other positive. At the initiation of these two pulses the potential at the center of the rocker arm will not change. However, if the fixed gate ends its delay time first, the potential of the cathode of  $V_{6A}$  rises and at this instant (since the variable gate is still delaying), the potential of the plate of  $V_{6B}$  does not change, and the potential at the center of the rocker arm rises by an amount equal to one half of the rise in potential of the cathode of  $V_{6A}$ .

At a certain time later when the variable gate ends its delay time, the potential at the plate of  $V_{6B}$  falls, and at this instant there is no change in the potential of the cathode of  $V_{6A}$ , since this gate is waiting for the next set-pulse. The center of the rocker arm drops at this instant and the positive pulse, which was initiated by the end of the delay time of the standard gate, is ended.

Thus at the center of the rocker arm there exists a positive pulse whose width is the difference between the delay times of the two delay gates. The amplitude is, of course, independent of the width. The amplitude of this pulse, as fed to the grid of  $V_7$ , is sufficient to swing this grid from cutoff bias to zero bias. It is necessary that this pulse be direct coupled to all

stages following the rocker arm because, if it is capacitively coupled, the zero voltage reference level is lost and the amplifier can not tell the difference between a positive pulse of short duration and a negative pulse of long duration and erroneous readings result.

Tube  $V_7$  is working at cutoff as determined by the setting of the one-megohm potentiometer in its grid circuit. The negative pulse appearing at the plate of  $V_7$  is inverted by  $V_8$  and the positive pulse appearing at its plate is fed to the grid of  $V_9$ , which is also working at cutoff. Its grid is swung from cutoff bias to zero by this pulse. The bypassed milliammeter in the plate circuit of  $V_9$  reads an average value of the plate current of this tube as its grid is pulsed.

#### Phototube Circuit

The 1P21 phototube circuit is standard and the intelligence in the form of a d-c voltage which appears across a resistance in its ninth dynode lead is used as bias on  $V_{10}$ . The variation in voltage which this causes across the plate load resistor of  $V_{10}$  is used as bias on  $V_{11}$ . This change in bias on  $V_{11}$  causes its plate resistance to vary accordingly and, since the plate resistance of  $V_{11}$  is one of the delay-time determining elements in the variable delay gate, the delay time of this gate depends upon the intensity of the light falling on the phototube. The circuit is arranged so that an increase in the intensity of light causes an in-

crease in the delay time of the variable gate.

In order to compensate for the bias on  $V_{10}$  produced by the dark current of the phototube and to allow for other circuit variations, a zero adjustment has been placed in the cathode of  $V_{10}$ . If more dark current flows than this adjustment is capable of compensating for, an adjustable d-c voltage can be inserted in series with the grid of  $V_{10}$  which is opposite in polarity to the voltage produced by this dark current.

The purpose of the adjustment in the screen grid voltage of  $V_{10}$  is to find an operating point at which no grid current flows in  $V_{10}$ . Grid current in this tube causes degeneration in this stage when very high grid resistors are used.

This time-bridge is also suitable as a general purpose d-c amplifier. For this use the d-c to be amplified is merely fed between the grid of  $V_{10}$  and ground, the grid being connected to the positive side of this voltage. It is extremely linear and has a sensitivity of 8 millivolts for a full-scale deflection of 5 milliamperes. It is obvious that greater sensitivity can be obtained by the use of a more sensitive indicating instrument and the usable sensitivity which can be realized will depend to a large extent upon how well all of the supply voltages are regulated.

#### REFERENCES

- (1) "Phototubes", RCA Publications, Form PT-20R1, p 13, 1940.
- (2) G. E. Kron, *Electronics in Astronomy*, ELECTRONICS, 21, Aug. 1948.
- (3) Maurice Artz, *Survey of D-C Amplifiers*, ELECTRONICS, 18, p 112, Aug. 1945.

# Voice-Operated Switching

By R. C. FOX,

F. S. BEALE

and G. W. SYMONDS

*Electronics and X-Ray Division  
Westinghouse Electric Corporation  
Baltimore, Maryland*

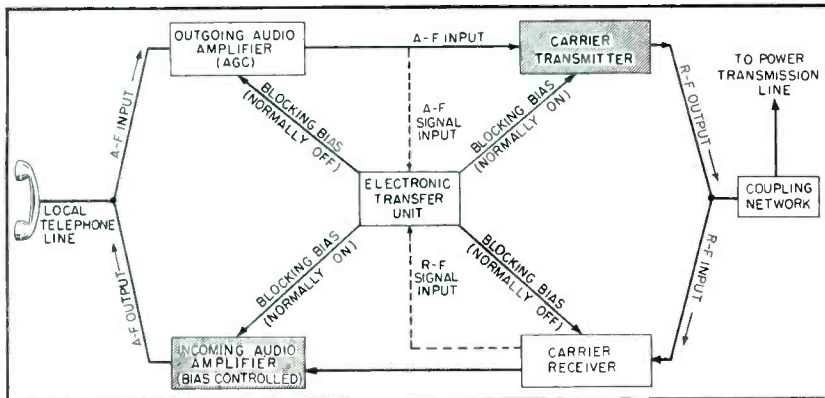

FIG. 1—One complete station of Westinghouse type JY power-line carrier equipment for two-way telephone communication using a single carrier frequency. Required switching operations are performed automatically by voice-operated electronic transfer unit in center of diagram

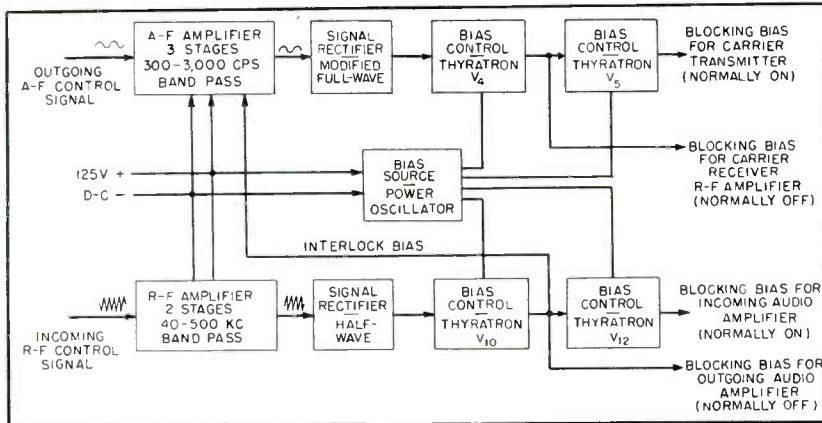

FIG. 2—Electronic transfer unit, which delivers appropriate combinations of blocking bias voltages to carrier transmitter and carrier receiver at a station in response to incoming or outgoing signals. Power oscillator provides bias voltages for thyratrons; only other voltage source is 125 v d-c

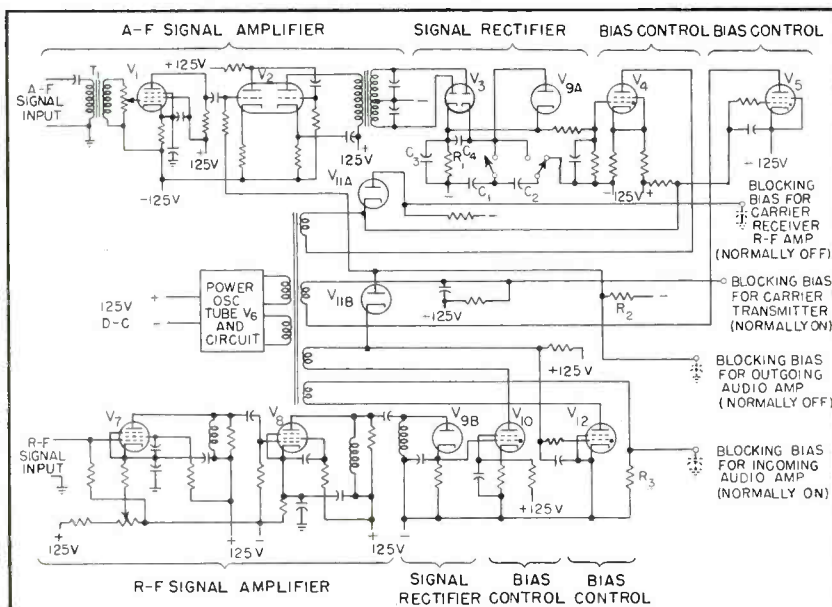

FIG. 3—Electronic transfer unit. Arrangement of stages corresponds to block diagram in Fig. 2. Capacitors shown dotted at blocking bias output terminals are in other units of station equipment but serve to determine time constants for blocking functions indicated. No mechanical relays or other moving parts are used

IN a radio or power line carrier system of communication, break-in operation with all stations on the same frequency speeds operation, eliminates tuning complications, reduces equipment needs and increases the number of communication channels possible in a given frequency spectrum. Automatic break-in can be achieved by use of a voice-operated device for automatic switching, sometimes called vodas.

In earlier power line carrier applications, vodas systems usually produced excessive speech clipping at the beginning of each period of transmission, because of sluggish interlock circuits. This necessitated waiting before speaking until the other carrier transmitter had shut down.

Satisfactory break-in operation requires that the voice-operated switching device act at high speed in transferring the system from standby condition to the talk or listen condition. It must return the system to standby less quickly, preferably with a choice of time constants, to prevent such action between syllables and words. Also, the sequence of switching operations should be independent of circuit adjustments and tube characteristics.

In a network of several stations on a power line carrier channel, the first operator to speak actuates his carrier transmitter. This must be made the basis for blocking the remaining transmitters, yet the system must be designed to return quickly to the standby condition so that quick replies and even interruptions of the first speaker can be made.



# of CARRIER SYSTEMS

New all-electronic transfer unit, fast enough to permit break-in between words, provides satisfactory two-way or party-line communication over power line or radio carrier systems using a single frequency. Oscillograms show negligible clipping of speech at start

The electronic transfer unit to be described closely approaches these qualifications. It was designed for use with conventional power line carrier equipment comprising one receiver and one transmitter, as shown in Fig. 1. The entire system is inserted between a standard two-wire telephone line and a power line coupling network.

## Switching Sequences

When no one is talking, the transfer unit places the system in the ready or standby condition wherein both the carrier transmitter and the audio amplifier of the receiver are blocked by bias voltages, as indicated by shading on the boxes in Fig. 1. Either an outgoing audio signal or an incoming r-f signal can, under this condition, reach the transfer unit and initiate the next switching sequence.

If an outgoing audio signal reaches the transfer unit first, this unit acts to remove the blocking bias from the carrier transmitter so the signal can go out over the power line. Simultaneously the transfer unit applies blocking bias to the carrier receiver, to prevent an incoming carrier signal from actuating the transfer unit while the other party is talking.

If an incoming r-f signal reaches the transfer unit first, this unit acts to remove the blocking bias from the audio amplifier of the receiver. Simultaneously the transfer unit blocks the outgoing audio amplifier so an outgoing audio signal cannot actuate the transfer unit. This scheme provides absolute interlocking of sequences at each carrier equipment terminal.

Cessation of either the initiating

audio signal or the r-f signal permits the system to revert to the ready condition. Transfer from the transmit condition to the receive condition is never made directly, but always by first returning the system to the ready condition. This feature, coupled with the ability to function at a high speed, permits a rapid-fire conversation to be handled successfully and makes it possible for the speaker to be interrupted by the listener.

## Transfer Unit Details

The electronic transfer unit consists of two amplifier channels (with two associated bias rectifiers in each) and a power-oscillator type bias supply, as indicated in Fig. 2. One amplifier channel is designed for audio frequencies, the other for r-f signals. Both terminate in gas-thyratron rectifier circuits arranged to provide the correct control bias voltages in the proper sequence without any adjustments. The gas thyratrons used contain no mercury vapor and therefore will give no trouble at low temperatures. They cannot damage themselves since their anode-supply oscillator limits any surge current to a value considerably less than the peak rating of the tube. The gain of each amplifier channel is controllable to allow adjustment for the noise levels encountered.

One reason for using a power oscillator as bias source is that the associated carrier equipment is designed for operation from a 125-volt d-c source and a separate bias supply is therefore required. The power oscillator output, rectified by the gas thyratrons as and when required, provides voltages that are

independent of the primary source of power, hence can be added to it. Another reason for using the oscillator is that its a-c output is conveniently controlled and rectified by thyratron tubes.

The oscillator operates at about 10 kc, which is well above the highest audio frequency involved. Filter requirements for the control rectifiers are quite simple at 10 kc. The output transformer for the power oscillator has four independent secondary windings that supply the separate voltages to the four gas-thyratron control tubes.

## Circuit of Transfer Unit

The circuit of the transfer unit is shown in simplified form in Fig. 3. Considering the r-f channel first, the amplified and rectified r-f signal is filtered sufficiently to give an adequately smooth d-c firing potential for the first thyratron,  $V_{10}$ , which is normally biased to cutoff. When sufficient control grid potential is developed, the thyratron snaps into conduction.

The thyratron current passing through diode  $V_{11B}$  and load resistor  $R_2$  develops a negative potential which is used as blocking bias for the outgoing audio amplifier. This negative potential is also applied to the grid of the second thyratron,  $V_{12}$ , which is normally conducting but now is blocked off. This permits the bias which was developed across load resistor  $R_2$  to discharge and unblock the incoming audio amplifier, thus permitting the audio output of the carrier receiver to be delivered to the telephone line. This sequence cannot be violated in this direction. The outgoing audio amplifier blocking

bias must exist before the incoming audio amplifier blocking bias can be removed, since the output of  $V_{10}$  controls the conditions of  $V_{12}$ .

The bias developed across  $R_2$  by  $V_{10}$  is also applied to the first grid of  $V_2$  to interlock the audio channel against transient disturbances that may arise in the audio circuits connected to this channel.

When the incoming r-f signal stops,  $V_{10}$  extinguishes within a few hundred microseconds, removing the bias applied to the outgoing audio amplifier and grids of  $V_2$  and  $V_{12}$ . This audio bias circuit is separated from the grid circuit of  $V_{12}$  by diode  $V_{11B}$ , however, so the time taken for the removal of the blocking bias is determined by the discharge time constant of load resistor  $R_2$  and a bypass capacitor located in the outgoing audio amplifier. This time delay is about five milliseconds. A similar condition, except that a capacitor must be charged, meantime controls the length of time required to block the incoming audio amplifier; the delay here is about one millisecond. Thus, the sequence of the output bias functions has been reversed by pitting an R-C charge curve of short duration against an R-C discharge curve having a larger time constant.

The trigger-like action of thyatron  $V_{10}$  insures that the output control bias voltages will be either full on or full off instead of at some intermediate value. They are independent of the varying level of the r-f input signal which is used as the primary control signal, as long as the minimum level does not drop below the threshold set by the r-f amplifier channel gain control.

The a-f signal amplifier channel of the transfer unit is similarly arranged except that it accepts audio-frequency signals for control and has a fairly sharp 300 to 3,000-cycle bandpass characteristic to help the control system discriminate between noise and useful voice frequencies.

### Delay of Release

It is desirable for the transmit condition to occur as soon as possible after the start of speech, to minimize clipping. The equipment accomplishes this in approximately

2.5 milliseconds. Upon cessation of the signal, however, the transmitter control system should have a certain minimum delay of release. Otherwise the transmitter would be keyed on and off by individual cycles of speech, especially fundamental low-frequency components which for a man's voice are between 100 and 200 cycles. The circuit containing double-diode detector  $V_3$  and isolating diode  $V_{3A}$  accomplishes this in addition to permitting a choice of four different delay-of-release time settings (by means of two switches). This circuit permits altering the delay of release from approximately 27 milliseconds to about 340 milliseconds without affecting the

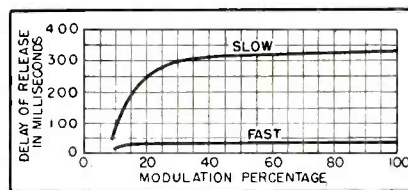

FIG. 4—Average delay of release of carrier transmitter vs percentage modulation. Slow curve compares approximately with amount of delay found in many vodas schemes, while fast curve corresponds to maximum speed at which electronic transfer unit is now arranged. Choice of delay of release time is affected by personal preferences, room and line noise level

charge time, and hence the time of transfer to the transmit condition.

The delay-of-release circuit is a modification of a full-wave detector. The amplified audio signal appears at the secondary of audio output transformer  $T_2$  and is rectified by double-diode  $V_3$ . The filter for the d-c output of this rectifier is separated into two sections by diode  $V_{3A}$ . A small filter, consisting of equal capacitances  $C_3$  and  $C_4$  with load resistor  $R_1$ , is connected permanently across the d-c output. Additional capacitors  $C_1$  and  $C_2$  are arranged to be connected into this circuit by two switches to alter the discharge time constant. Due to diode  $V_{3A}$ , the charge time constant with respect to  $C_3$  and  $R_1$  is not affected.

Assume, for instance, even half cycles of output from  $T_2$  to be rectified at  $V_{3A}$ . The output voltage

across  $R_1$  will rise quickly to its full value because of the small amount of capacitance in  $C_3$ . Capacitors  $C_1$  and  $C_2$  are relatively large and require more time to charge to full voltage, therefore the cathode of  $V_{3A}$  becomes positive with respect to its anode, isolating  $C_4$ ,  $C_1$  and  $C_2$  from  $R_1$  and  $C_3$  until the charges become equal.

### Action of Release Circuit

After any selected capacitance of  $C_1$  and  $C_2$  has been charged to full voltage, this capacitance then adds to that of  $C_3$  during those instants when the voltage across  $R_1$  drops enough to make the  $V_{3A}$  anode positive with respect to its cathode—and both sections of capacitance contribute to the filtering of the then full-wave output.

Upon the cessation of the audio signal and the consequent decay of the d-c output of  $V_3$ , the effect of the larger capacitors,  $C_1$  and  $C_2$ , is evident. The small fast-time-constant capacitor  $C_3$  would tend to discharge quickly through  $R_1$ , but this would place its potential below that of the larger capacitors, which therefore act through  $V_{3A}$  to maintain the voltage across  $R_1$ , changing the effective R-C product for the period of the discharge.

Upon application of audio input there is developed immediately a d-c output voltage to fire the first thyatron,  $V_1$ . When the audio input is stopped, the d-c output decays rapidly or more slowly according to the delay time chosen, keeping  $V_1$  fired for this delay period.

Figure 4 shows the relationship of delay of release to the percentage modulation of the carrier transmitter. Above 30-percent modulation, the delay of release characteristic is relatively flat. The outgoing audio amplifier employs automatic gain control, which materially assists in obtaining this flat response characteristic.

### Oscillogram of Response

Figure 5 is an oscillogram taken with a laboratory setup including two complete power line carrier, single-frequency automatic simplex equipment assemblies, operating over an artificial line providing 80 db of attenuation. Trace 1 is a 60-cycle timing wave. Traces 2, 3 and

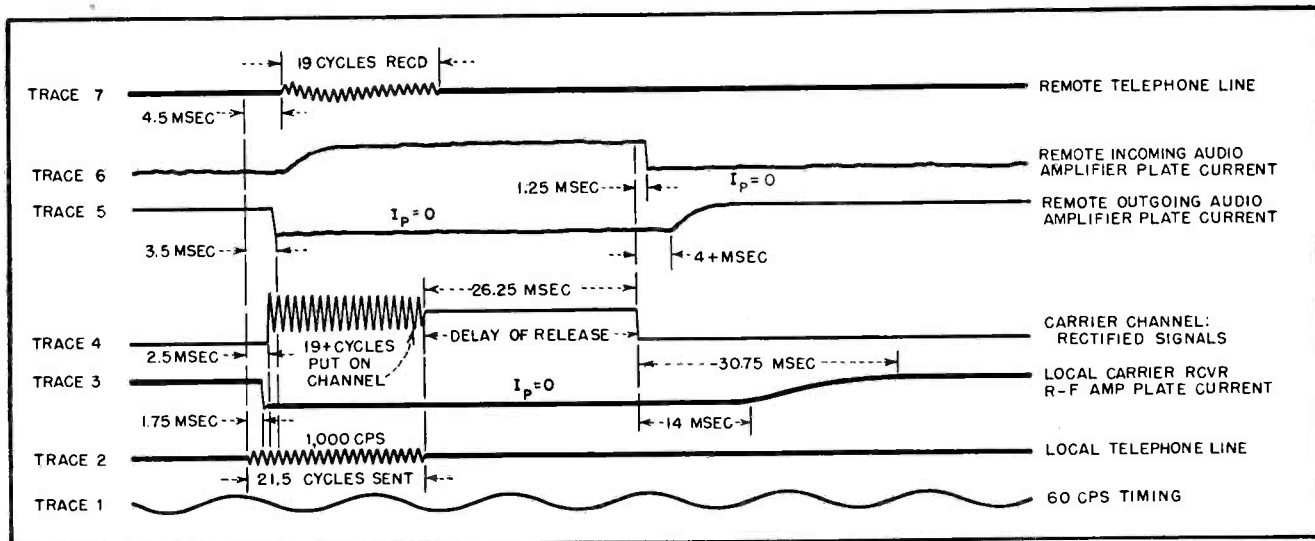

FIG. 5—Operation of electronic transfer unit under test conditions with 21.5 cycles of a 1,000-cps audio signal going out with amplitude sufficient to produce 50-percent modulation of carrier transmitter, with time constants set for faster release. Transfer unit returns system to ready condition fast enough to provide many opportunities for receiving stations to break in

4 show the response of the a-f signal channel of the electronic transfer unit.

Trace 2 shows the 1,000-cps audio signal, existing for 21.5 milliseconds in the local telephone line, that initiated the sequence of events shown in this oscillogram.

Trace 3 shows how the normal plate current of the r-f amplifier of the local carrier receiver is blocked to zero 1.75 milliseconds after arrival of the audio signal, and shows also how and when it is permitted to restore to normal.

Trace 4 indicates that the local carrier transmitter was delivering a modulated r-f signal to the power line 2.5 milliseconds after arrival of the audio signal, and actually delivered 19 of the 21.5 cycles of the originating signal to the remote listener.

Traces 5, 6 and 7 show the response of the r-f signal channel of the transfer unit at the remote station which receives the signals from the power line.

Trace 5 indicates how arrival of the modulated r-f signal blocks the outgoing audio amplifier there by driving its normal plate current to zero, and shows how this plate current is permitted to restore to normal.

Trace 6 shows (at left) the normally blocked condition of the incoming audio amplifier at the remote station, and shows the unblocking and reblocking of this amplifier in

response to the incoming r-f signal.

Trace 7 shows the final result—the portion of the original signal that is actually delivered to the remote telephone line.

For the oscillograms of Fig. 5, the delay of release was set for fast release. With this, the local carrier transmitter stays on for slightly over 26 milliseconds after the audio signal stops. A succeeding audio signal arriving within this interval is fully transmitted. Fourteen milliseconds after stopping the local carrier transmitter's r-f signal, the local carrier receiver starts to unblock, and becomes fully released in about 30 milliseconds. Thus, the total time from stoppage of the initiating audio signal in the local telephone line until the entire two-station set-up is ready to accept another such signal in the opposite direction of transmission is less than 57 milliseconds.

#### Performance Data

Recordings of conversation held over actual power-line carrier channels using this form of equipment show that on the two shortest delay-of-release settings the listener will have little or no trouble in interrupting the speaker at the transmitting station.

When using the longest delay of release, the transfer action seldom occurs except at the ends of sentences, or between words if long pauses exist. Even with this set-

ting, however, no appreciable waiting before answering is required. Even an experienced operator, anticipating the stopping of the other speaker and having an answer in readiness (but not actually trying to interrupt the other party), rarely can respond fast enough to speak before the system is cleared and ready to act upon his speech. This is due to the average human response time of 0.2 second. The delay of release to be used is usually a matter of individual preference.

High-speed operation involves use of the shortest delay of release. All other values of delay are long enough to eliminate release between syllables and even words more or less completely, depending upon the characteristics of speech of the persons using the telephone instruments. The choice of release delay has no effect upon the speed of transfer from ready to either the transmit or receive conditions.

The economics of communication facilities do not permit building lines so perfect that all of the original sounds are received by the listener, in the identical form in which they originated. Clipping of one to three milliseconds from the beginning of the speech or signals is rarely missed, since telephone lines and mental reactions sacrifice a larger percentage of the actual original signal and the listener's imagination subconsciously fills in the balance.

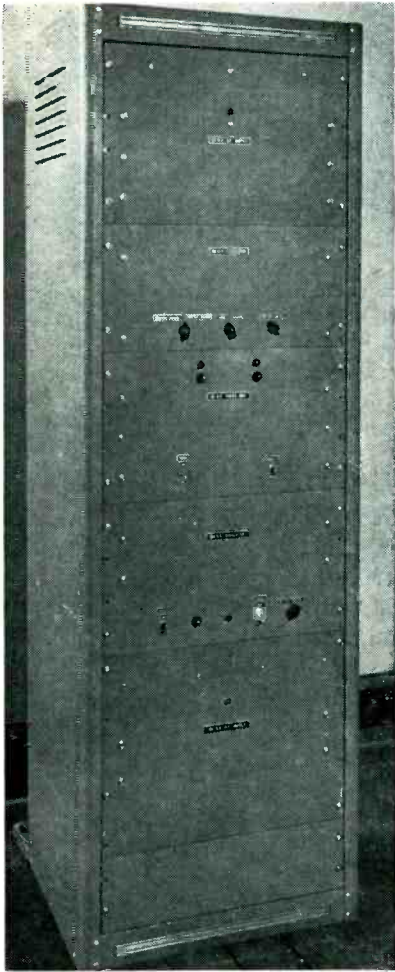

Front view of the combined supplies

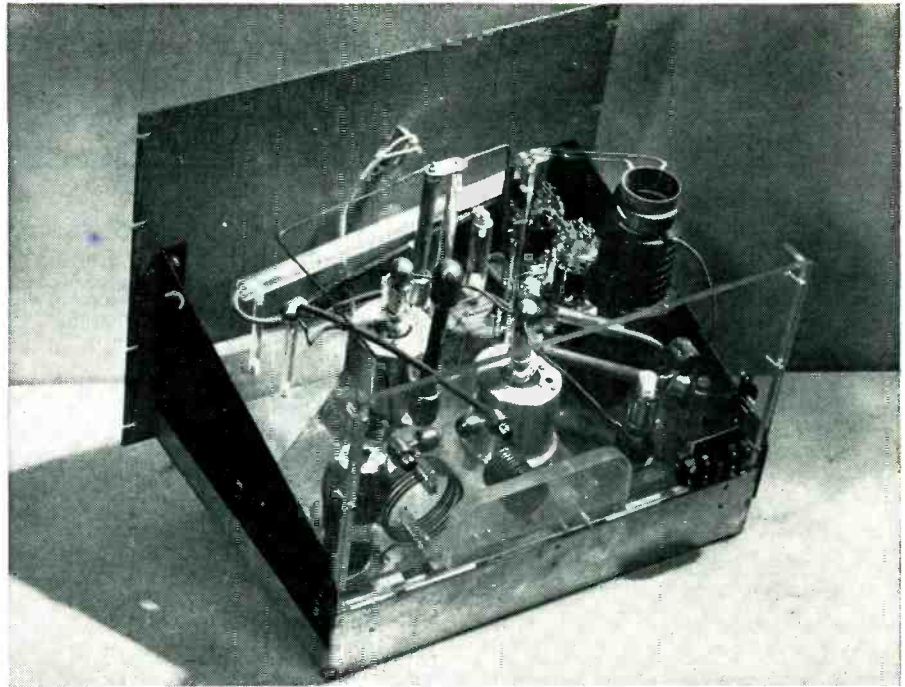

The 30-kv supply. Standard 17 x 13 x 3-inch chassis are used for both supplies. They are inverted and the chassis recesses covered with sheets of polystyrene

# Variable High-Voltage

Two separate r-f supplies furnish voltages ranging from 5 to 30 kv with better than 0.05-percent regulation. Both supplies may be operated separately, and by connecting them in series it is possible to provide 40 kv at 2 ma with a ripple content of less than 0.1 percent

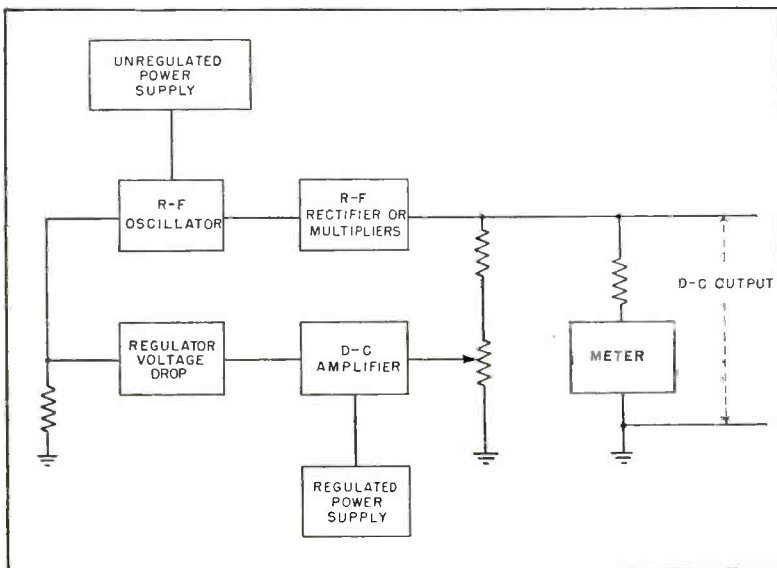
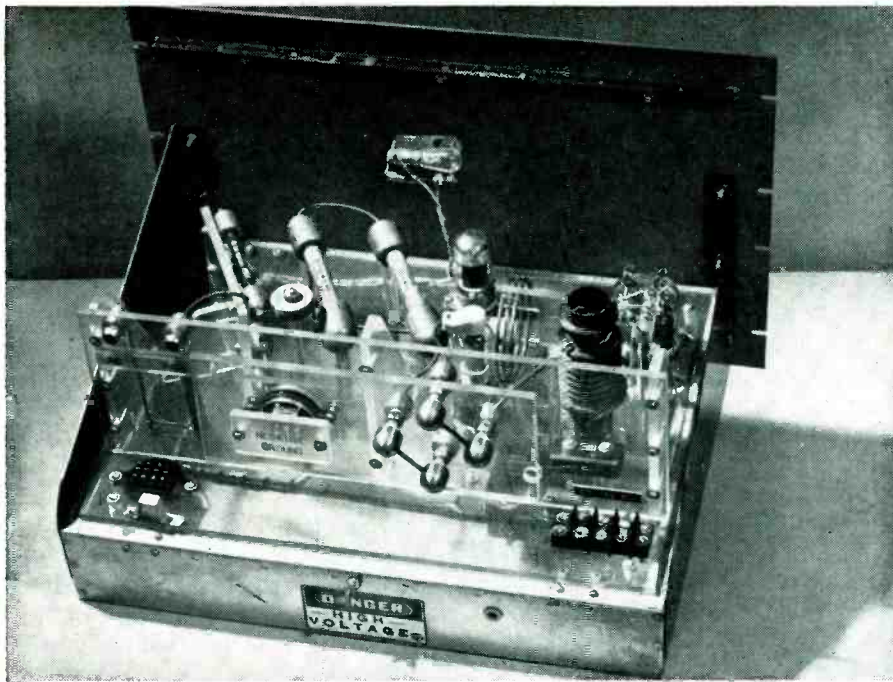

FIG. 1—Block diagram which is the basis for both high-voltage units described

**M**ANY RESEARCH LABORATORIES require well-regulated high-voltage supplies with variable output voltages. The degree of regulation required is often as high as 0.5 to 0.01 percent at voltages ranging from 5 to 30 kv. Even higher voltages are being requested by engineering staffs in development work.

This paper describes a supply system which is variable from 5 to 30 kv with at least 0.05-percent regulation. To cover this voltage range two supplies are used, one covering 5 to 10 kv and the other 10 to 30 kv. With the system described, the output can be controlled either locally or remotely and any voltage between 5 and 30



The 10-kv supply is shown above with the negative ground plug in place. The corona fittings may be seen

By **WALTER S. RAMSEY**

*Physics Laboratory  
Sylvania Electric Products Inc.  
Bayside, New York*

# Power Source

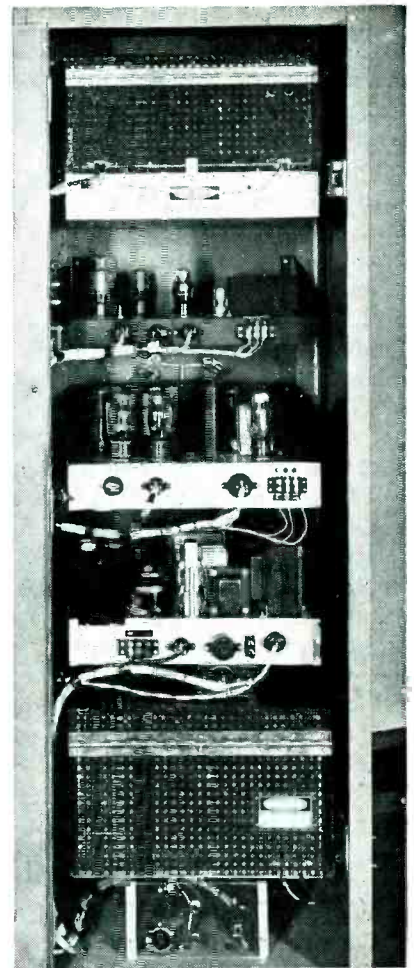

The 10-kv supply is on the top chassis

kv can be developed. The lower voltage supply can be connected with either positive or negative ground. Each supply is of the r-f oscillator type and the system involves a minimum number of different tube types. Wherever possible the components are of standard commercial types. The r-f leakage and radiation is kept at a minimum.

## Design Considerations

Both units follow the scheme shown in Fig. 1. A radio-frequency type of supply is used because of the voltage range requirements, the greater ease in filtering and the lighter and smaller components required than would be necessary at conventional power frequencies. The units described are well regulated for a 2-ma load and the 30-kv unit will deliver 90 watts at 21 kv, thus the usual safety characteristic of r-f supplies cannot be assumed.

The two supplies are housed in a

standard 6-foot rack with all controls, except the reversing ground plug on the 10-kv unit and the remote and local plugs, on the front panel. The 10-kv unit has a single output control while the 30-kv unit has, in addition, a high-low range switch. The maximum ripple content of the output varies from 0.04 to 0.08 percent depending on the voltage and load conditions. No-load to full-load regulation is better than 0.05 percent with excellent transient response. Both units use 115-volt 60-cps a-c input, the 10-kv unit at 1.5 amperes and the 30-kv unit at 4.6 amperes full load.

A pair of 829B's are used as oscillators for the high-voltage supply in order that 60 watts of d-c output can be obtained. The voltage range of this unit is from 9.6 to 30 kv. A single 829B is used in the low-voltage supply and a maximum power output of 20 watts is produced. The circuit diagrams of

the two units are shown in Fig. 2 and 3. With the plan calling for a change in voltage of greater than two to one the problem is raised of maintaining relatively constant voltages for the filaments of the high-voltage rectifiers. For this purpose a separate 6L6 oscillator at a fixed frequency of 5.5 mc is used in each unit to supply the filament power.

## Protective Features

In the smaller unit, the insulation for 10 kv is obtained by spacing a resonant secondary coil one inch away from the primary filament oscillator coil and in series with the filament of the rectifier. For the larger unit, the insulation requirements of 10, 20 and 30 kv for the tripler rectifiers are met by using the same type of construction with the spacing of the secondaries of the filament transformers set at one, two and three inches respec-

tively, or 10 kv per inch.

When a high voltage difference between a point and ground exists, dust particles nearby are charged up by the potential and collect around the source. These dust particles may cause leakage and, in time, may even lead to arcing depending on the degree of dust collection and the mechanical arrangement. All components which are mounted to a horizontal surface and which are impressed with voltages above 10 kv are separated from that surface by stand-off insulators of at least  $\frac{1}{4}$  inch to minimize the possibilities of leakage. Polystyrene is used for the base plates for mounting the components of both supplies because of its excellent moisture rejection properties and its good r-f insulator characteristics. A  $12 \times 16 \times \frac{1}{4}$ -inch sheet just covers an inverted  $13 \times 17 \times 3$ -inch cadmium plated steel chassis of standard design because of the folded over lip on what is normally the bottom of the chassis.

The socket connections of the high-voltage rectifier tubes are protected with corona shields. The shields are aluminum cups with a diameter and depth of 3 inches and rolled edges of  $\frac{1}{4}$ -inch radius. All rectifier socket connections as well as the filament transformer tuning capacitors are well within the field of these shields.

The high-voltage filter and multiplier capacitors and the rectifier tube caps both have corona guards. The corona guards are made from one-inch brass rod, one end of

which is rounded with a  $\frac{1}{4}$ -inch radius and the other drilled to fit the tube cap or the high-voltage capacitor. The edges are rounded off and the whole piece is polished and buffed. The tube guard is secured with screws, to make good contact, with the heads sunk below the side wall. The high-voltage capacitors used have threaded terminals and the corona guard is drilled and tapped so that the capacitors may be screwed into the guard thereby providing a firm base for mounting. Connections to the corona guard are made by threading a conductive mount into one side of the guard or by threading a tightly wound  $\frac{1}{8}$ -inch steel spring into the guard and using the spring as a connecting wire. Such a spring also serves to reduce corona.

In the 30-kv supply, two sphere gaps are used for the protection of components and load. One gap across the output is spaced at 0.6 inch and the other, across the second multiplier capacitor, at 0.5 inch. Should any component fail, the supply is protected against further damage by these two sphere gaps.

The r-f sections of both units are covered by perforated metal shields which are further lined with copper screen to reduce radiation. Cables are brought in through an opening at the base of the cabinet with the 60-cycle a-c source connected to a plug-in strip. The a-c source is filtered and a considerable reduction in radiation is achieved.

Jones plugs are used for interconnecting the low-voltage power source and control units, each plug having a different number of prongs to prevent any possibility of wrong connections. Giant banana plugs are used for the high voltage output of both units. In the 10-kv unit, the polarity of the ground is changed by a plug in strip which also reverses and maintains the meter at ground potential thereby eliminating the need for meter corona shields and stand-off insulators.

### Circuit Details

Regulated supplies generally have a reference or standard voltage with which they can compare and thereby correct any change in output voltage. The stability of the output voltage is of course dependent upon the stability of the reference. An excellent stable voltage source is a dry cell battery provided no current is drawn from it. The standard used in both supplies is 135 volts from two small 67 $\frac{1}{2}$ -volt batteries, series connected, in a metal shield and in series with the input grids of the d-c amplifiers. Since the batteries are in series with the control grid of vacuum tubes in class A operation, no current is drawn.

For regulation, the usual method is used of sampling the voltage variations of the output with a resistor across the output, amplifying the variations and using them to control the resistance of a series tube. The screen voltage only of the r-f oscillators is controlled with the result that the maximum current of the control voltage is below 30 ma whereas if both screen and plate voltage were controlled, the current would be about 120 ma for the 10-kv and 260 ma for the 30-kv supply.

The d-c amplifier consists of a 7F7, a 7G7, a 6AG7 series tube triode connected and a VR75. When used without some a-c feedback, it is unstable due to a time delay in the response of the r-f oscillator. In the 30-kv unit a 0.01- $\mu$ f capacitor in series with 200,000-ohm resistor from control output voltage source to the grid of the 7G7 and a 0.01- $\mu$ f capacitor from the control output voltage source to the input grid are necessary to maintain stability.

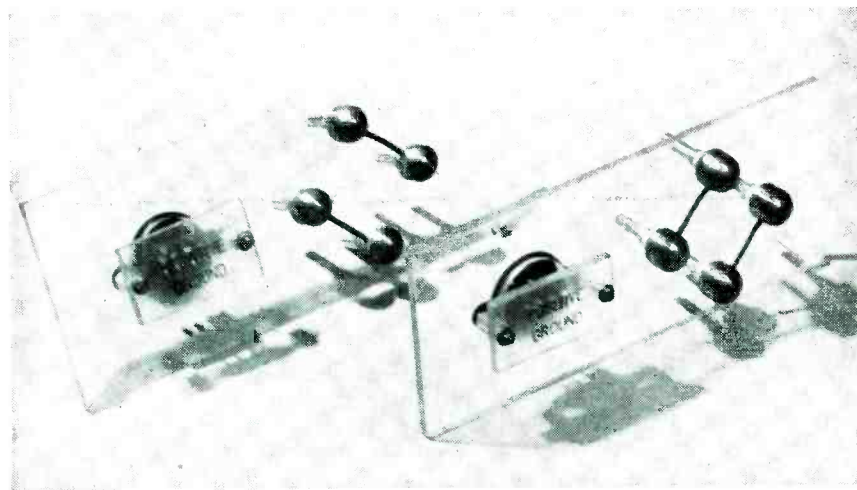

Plugs used to reverse the polarity of the 10-kv supply. Their function is shown in the circuit diagram in Fig. 2

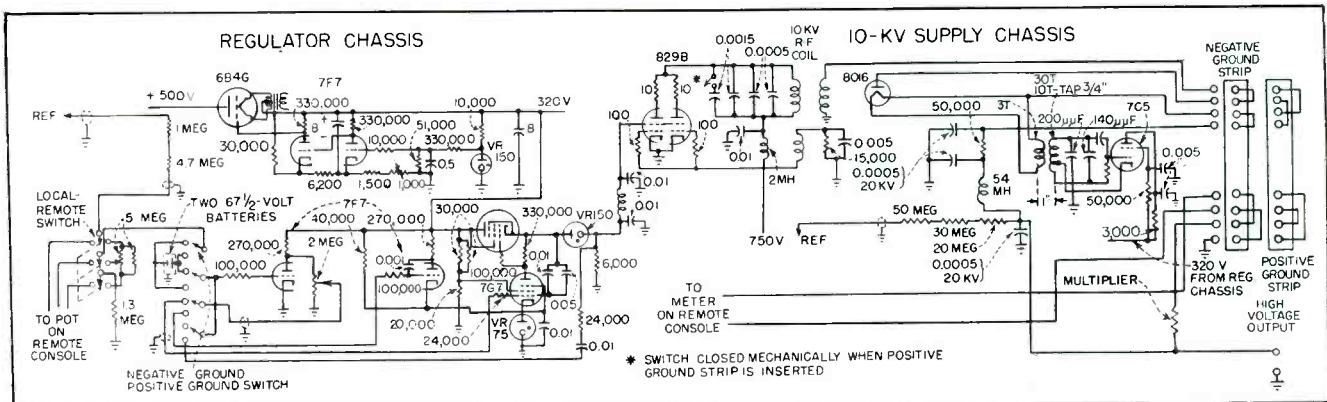

FIG. 2—Circuit diagram of 10-kv supply. The voltage-reversing plug is shown in an accompanying photograph

The transient response of the amplifier is improved by this feedback circuit, however, so that if there is a sudden change from full load to no load at maximum output voltage, there is a slight transient response in the output. The B supplies for the amplifiers are regulated supplies of 340 volts output.

The voltage variation necessary for the control of the 4 to 10-kv supply is 20 to 120 volts and 6 to 130 volts for the 10 to 30-kv unit. A VR150, in series with the series regulator tube, is used to maintain sufficient voltage across the shunt 7G7 otherwise the minimum control output voltage would be about 90 volts, allowing 15 volts across the 7G7. This would limit the minimum output voltage.

The series VR maintains the proper operating voltage for the shunt tube and also increases the range of the output voltage. In order to keep the VR fired, a bleeder resistor is placed across the control voltage output. The voltage drop across the VR varies from 150 to 145 volts but since this tube is not used for a constant voltage drop, this variation is entirely satisfactory and can be compensated for by the d-c amplifier.

For accurate measurement of the output voltage a meter of 0.5-percent accuracy with a knife-edge pointer and mirrored scale is used. The resistors used are the deposited carbon type with an average change of  $\pm 0.01$  percent after 1,000 hours use. The meter resistors are provided with corona guards. Meter range switching is accomplished by shorting out the required amount of resistance by means of a shorting bar actuated by a solenoid. Since

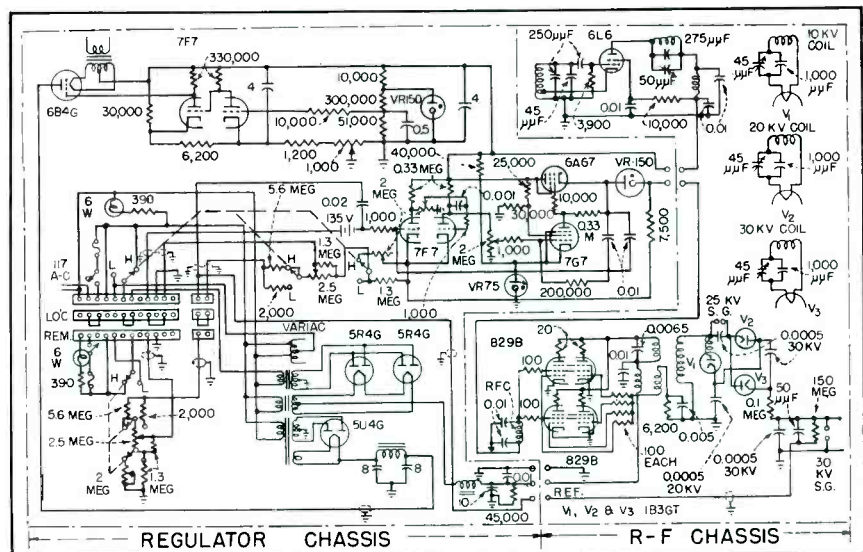

FIG. 3—The 30-kv supply uses two 829B's as the r-f oscillator. Both supplies may be controlled remotely from a special console

one side of the meter is at ground potential, a high-voltage switch is not needed. The only precaution necessary is to allow the required distance of one inch per 10 kv between the shorting bar contacts.

Changing the polarity of the ground in the 10-kv unit necessitates switching the high-voltage rectifier plate and cathode around which in turn detunes the secondary of the r-f coil. When negative ground is desired, the switch shown in Fig. 2 is open and the total capacitance across the primary r-f coil is  $0.0025 \mu\text{mf}$ .

When positive ground is wanted, the switch is mechanically closed by the positive ground strip and the primary capacitance is increased to  $0.004 \mu\text{mf}$ . The polarity-changing strips have corona guards on the four terminal connections to the 1B3GT and the r-f coil. The

base of the strip which supports the tube and coil leads and the Jones plug for changing the meter polarity is polystyrene.

The use of two separate supplies has several advantages. They both can be operated separately allowing simultaneous development of two voltages and the two supplies can be removed from the rack and used as independent units. With the positive ground connection of the 10-kv supply the two supplies can be operated in series making possible a maximum voltage of 40 kv at 2 ma.

### Acknowledgments

The author wishes to thank R. M. Klein and W. B. Whalley for their constructive criticism of this article and R. Zitta whose suggestions and cooperation contributed greatly to the success of this project.

# Stabilized Circuit

Compact instrument provides controlled and stabilized voltage to the dynodes of multiplier phototubes, a balancing circuit for dark current effects and a stable amplifier external to the multiplier tube

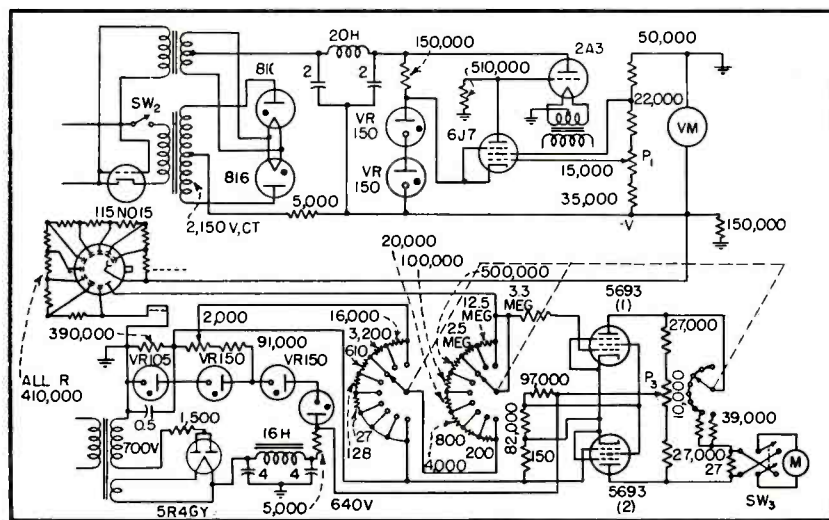

FIG. 1—Two stabilized power supplies and an additional amplifier form the circuit of the instrument. The 2,000-ohm-control at left is  $P_2$ .

**I**N MEASURING illumination of surfaces at very low intensities and determining the brightness of phosphors over wide ranges, the photomultiplier tube is a standard piece of equipment.

Because of the operating characteristics of photo-multipliers, the following manual controls are found desirable: variation of a stabilized voltage; balancing control for tube dark current; sensitivity range switch, and stabilizing controls for an additional amplifier if one is used. All of these features can be combined in one piece of apparatus that is compact and portable.

Several models of the instrument illustrated have been made up, and use over a period of time has proved them to be reliable. The stability of the circuit and the convenience of key manual controls enable the operator to concentrate most of his attention on other phases of an experiment involving low-intensity measurements. Fluctuations ordinarily experienced on a-c power lines produce negligible effects in

the output meter of the apparatus, and this stability is maintained with complete elimination of the usual dry cells.

The schematic diagram of the equipment is given in Fig. 1. There are two power supplies, one full-wave and one half-wave.

## Circuit

In the dynode voltage-supply circuit, two VR150 tubes are used instead of batteries as the reference voltage for the 6J7 control tube. The total voltage on the dynodes may be varied by potentiometer  $P_1$ , and for the circuit constants shown, a variation from 80 to slightly over 100 volts per dynode is possible. In starting, an Amperite thermal relay delays the plate voltage on the 816 tubes until the filaments heat.

The other power supply, with a fixed voltage stabilized by three VR150 tubes and one VR105 tube, supplies plate and screen voltage to the 5693 red tubes and anode voltage for the photomultiplier. A po-

tentiometer across one of the stabilizing tubes provides from the same supply a suitable potential for balancing out dark current effects. The polarity of this variable potential is such that the effect of the IR drop in the anode circuit due to dark current may be balanced out.

The anode of the multiplier tube is connected to the voltage supply through resistors arranged on a ceramic switch section to give eight sensitivity positions. A multiplying factor of five from one position to the next gives a total sensitivity range of  $5^8$  for the instrument.

Direct coupling from the multiplier tube into the first 5693 is used, but for stable operation a resistor of approximately 3 megohms is necessary in the pentode grid circuit. A conventional bridge arrangement serves for the amplifier with  $P_2$  used to balance the bridge to a null condition when the gang switch is in the first position.

The output meter (Weston model 622 microammeter) is protected by series resistors and a shunt resistor. Good damping is produced with high sensitivity. The shunting resistor is located on top of the

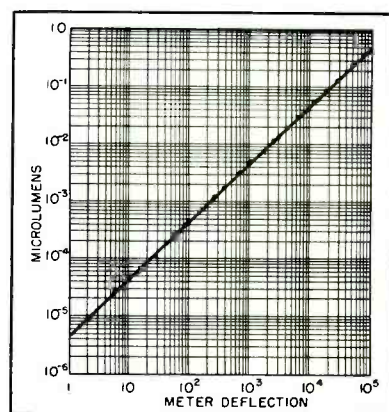

FIG. 2—Instrument sensitivity with a 1P21 phototube operated at 90 volts per stage



# for Photomultipliers

By **W. S. PLYMALE, Jr.**  
and **D. F. HANSEN**

*Navy Research Laboratory  
Washington, D. C.*

chassis and may easily be replaced by one of a higher value when the multiplier tube is refrigerated and the noise level becomes lower.

When the sensitivity switch is in position 1, the meter can be kept on zero by  $P_3$ , but as the switch is moved away from this position, dark current from the phototube produces a deflection. By setting  $P_2$  to a given position, however, the meter can be brought to zero. The proper ratio between resistors in the grid circuit of the first 5693 will insure a dark current balance for any position of the three-gang switch, the most accurate dark current balance being obtained with the switch in the most sensitive position.

A heavy-duty cable with good rubber insulation connects the main unit and the box housing the phototube. An external shield over this cable prevents stray pickups, and by grounding the shield at both ends all stray effects are eliminated.

No loss measurable with a high-scale megger test instrument may be allowed to exist between the photocathode lead, multiplier anode lead, and the ground. If humid

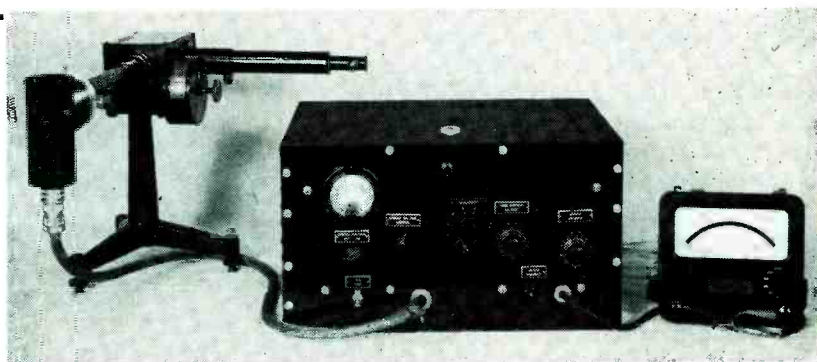

Use of connecting cables permits the pickup box and meter to be moved independently of the control cabinet

conditions are expected, it is suggested that two separate low-loss concentric cables be used for the photocathode and anode circuits.

For photometric work, it has been found convenient to use an AN connector between the phototube box and the cable.

To avoid undue thermal effects, the rectifier tubes and power resistors are placed near the back and away from the multiplying resistors and the bridge circuit. Heat baffles to isolate the heat-sensitive parts of the circuit are convenient and of value. Symmetrical mounting of the parts for the bridge circuit gives the best thermal compensation in the amplifier, and no appreciable thermal drift is encountered after the warm-up period.

## Sensitivity

The practical range and sensitivity of the instrument using a 1P21 tube are shown in Fig. 2, as determined experimentally. A lamp calibrated at a color temperature of 2,360 K was used as a source, and care was taken in reducing the intensity to low levels. Total flux incident on the photocathode (area approximately 1.6 cm<sup>2</sup>) is represented as the ordinate and the corresponding meter deflections as abscissa. The reading for the lowest point was made when the meter deflection was well above the average of the deflections caused by tube noise. This point, therefore, represents an intensity appreciably higher than that at the commonly defined point of minimum

detectivity. Operation of apparatus involving a multiplier tube near the noise level, however, introduces difficulties in obtaining meter readings by direct observation.

Figure 3 presents another calibration curve using a 1P22 tube. The curves for both tubes indicate that the overall sensitivity of the instrument is high and that the response is linear until the phototube begins to show saturation. Both curves were obtained with unrefrigerated tubes and with the output resistor values indicated in Fig. 1.

Thermal equilibrium is reached after a warm-up period of from 15 to 30 minutes, but on the higher sensitivity positions of the gang-switch a drift from zero may sometimes occur. This drift can readily be corrected by a touch-up adjustment of  $P_2$  with the shutter on the phototube box closed. If appreciable light must fall on the multiplier tube during an operation, switch  $SW_2$  enables the operator to cut off the voltage, thus preventing excessive current flow in the tube and thereby reducing fatigue effects and chances of possible damage.

When the apparatus is used for long intervals of time, there is some unavoidable loss of sensitivity due to fatigue in the multiplier tube. When a small fixed-brightness tungsten lamp, behind a suitable aperture, is used as a reference source, the instrument may be kept in calibration by occasionally readjusting  $P_1$  which controls the dynode voltage.

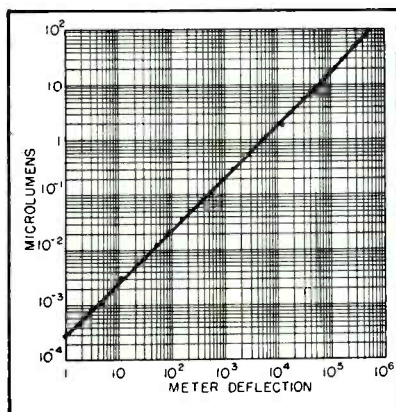

FIG. 3—Calibration curve using a 1P22 tube. Both this curve and that of Fig. 2 are for unrefrigerated tubes

**T**HE USE OF high-gain direct-coupled amplifiers for measurements of physical quantities is often avoided because of the difficulties inherent in the design and operation of such units; but when the specifications for the system call for a reproduction of frequencies from zero to 100 kilocycles the use of a direct-coupled amplifier is by far the most satisfactory and straightforward approach. The amplifier described here was designed to provide maximum flexibility of input circuits and to reduce to a minimum the problems usually associated with the operation of direct-coupled amplifiers.

The following specifications were the basis of the overall design: (1) An undistorted output of 310 volts peak to peak to feed an external cathode-ray tube, (2) frequency response from zero to at least 60 kc, (3) maximum gain of at least 40,000, (4) attenuation of 40 db in 2-db steps, (5) input impedance 100 megohms, (6) equivalent input noise voltage of less than 50 microvolts, (7) random drift as low as possible, (8) a preamplifier to give a maximum overall gain of at least 200,000, and (9) single-ended or push-pull input.

To describe how these features were incorporated into the amplifier, the circuit is broken down into simpler units. Figure 1 is a functional block diagram of the direct-coupled amplifier, which consists of a cross-coupled input stage, two stages of amplification with cathode-follower output and feedback.

The basic circuit of the cross-coupled stage is shown in Fig. 2. Considering this as a symmetrical

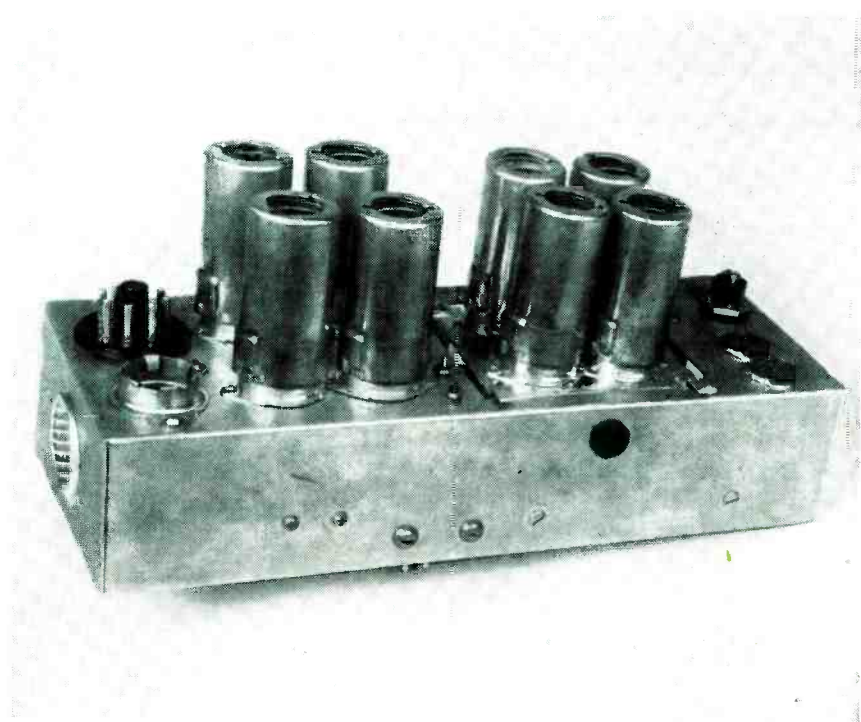

Arrangement of tubes on amplifier chassis. The three preamplifier tubes and the input tube of the d-c amplifier are mounted on a separate plate which is suspended on vibration insulators to reduce microphonics

# A D-C Amplifier

By J. N. VAN SCOYOC and G. F. WARNKE

*Armour Research Foundation  
Illinois Institute of Technology  
Chicago, Illinois*

circuit, the cathode voltages of  $V_1$  and  $V_4$  are initially equal. Single-ended input may be connected between terminals 1 and 2 or 3 and 2. The signal voltage to  $V_2$  is the dif-

ference of the cathode voltage of  $V_4$  and  $V_3$ . The signal voltage of  $V_3$  is identical but is measured in the opposite direction. Hence the signal voltage at the plate of  $V_2$  is equal in magnitude to the voltage at the plate of  $V_3$ , but is 180 degrees out of phase with it.

## Input Circuit Explained

To illustrate: if a positive voltage is applied to the grid of  $V_1$ , the voltage between the cathode of  $V_1$  and ground increases while no change occurs in  $V_4$ . This increase in cathode voltage appears as a positive grid voltage for  $V_3$  and a negative grid voltage for  $V_2$ . Thus equal and opposite grid signals and plate voltages are produced in  $V_2$  and  $V_3$ . The same conditions hold if the

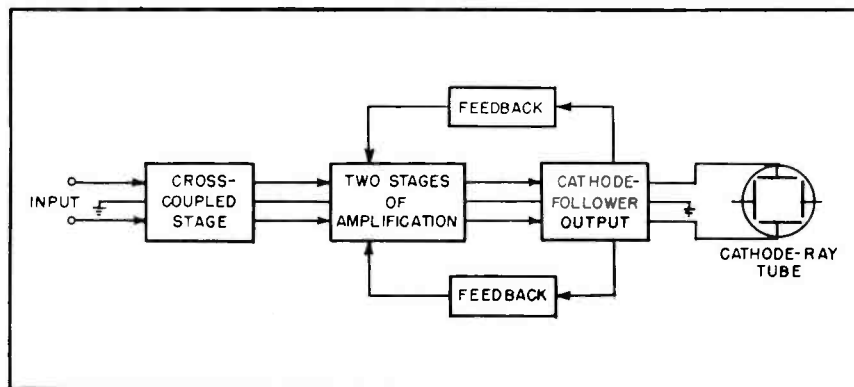
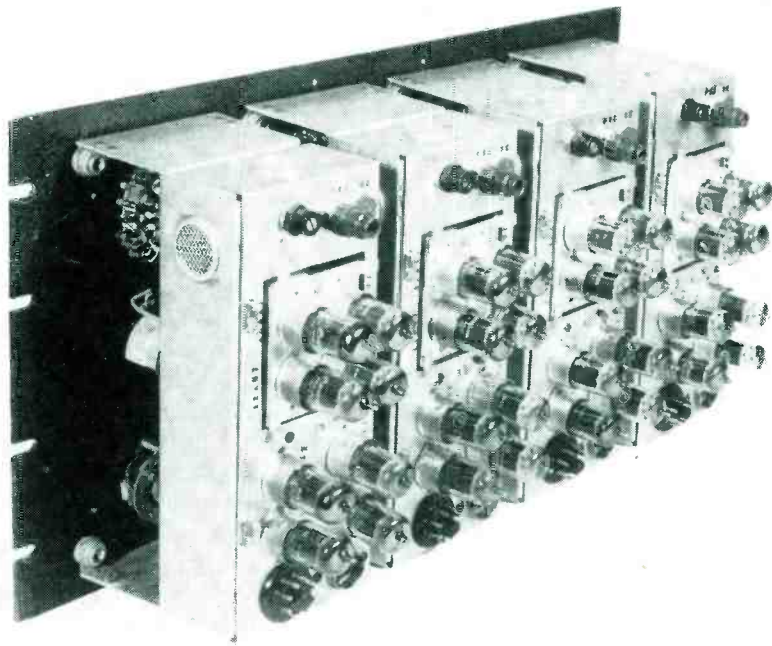

FIG. 1—Block diagram of d-c amplifier employing cross-coupled input and cathode-follower output



Arrangement of four identical amplifier units plugged into special panel-mounting brackets. Connections between panel-mounted controls are made by means of octal sockets and plugs and the chassis are held in place by small slide fasteners

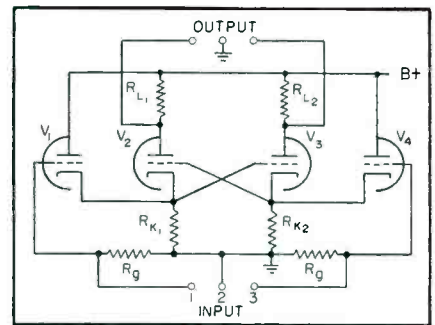

FIG. 2—Basic schematic of the cross-coupled input stage

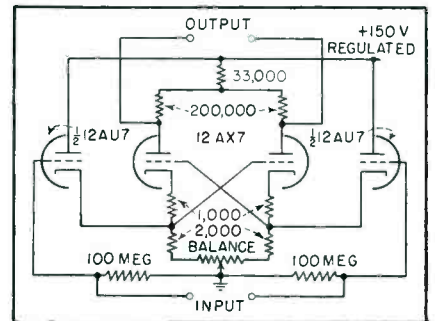

FIG. 3—Schematic diagram for cross-coupled input stage with typical values for circuit components

## with Cross-Coupled Input

Compact unit employs cross-coupled circuit to allow single-ended or push-pull input without circuit changes and low hum level with a-c heaters. Has high-input and low-output impedances with high undistorted output voltage and good frequency response

input signal is applied to the grid of  $V_4$  except that the phase of the output voltage with respect to the input is reversed. If the signal is divided between the two grids, as is the case with push-pull input, the voltage between the grids of  $V_2$  and  $V_3$  is the same as before except that, in this case, it is equally divided between cathodes of  $V_1$  and  $V_4$ . Thus it is seen that this cross-coupled input circuit may act as a push-pull input stage or a balanced phase inverter. Any hum or signal common to both inputs is effectively cancelled. In practice  $V_1$  and  $V_4$  usually are low- $\mu$  triodes while  $V_2$  and  $V_3$  are high- $\mu$  triodes. The actual circuit is shown in Fig. 3. Tubes previously described as  $V_1$  and  $V_4$  are the two halves of a

12AU7 separately connected as cathode followers. Tubes  $V_2$  and  $V_3$  are the two halves of a 12AX7. A ten-turn 2,000-ohm potentiometer is used as a single balance control for the entire amplifier. The input grid resistors labeled 100 megohms are actually 110 megohms which in parallel with the 1,000 megohms of grid-to-cathode leakage give an effective input resistance of 100 megohms. The addition of 1,000-ohm resistors in the cathode circuits of the 12AX7 produce bias for this stage.

The effectiveness of the input circuit as a phase inverter may be demonstrated as shown in Fig. 4. A sine-wave signal is applied between the two input terminals by means of a center-tapped transformer

winding and the output of the amplifier is connected to the deflection plates of an oscilloscope. The switch may be moved to any of the three positions shown, applying full voltage to either grid or a balanced voltage to both grids, without affecting the magnitude of the output voltage. It should be noted that this complete phase inversion with single-ended input is accomplished without the necessity of critical adjustments of resistors or bias voltages.

One method of connecting this input stage is shown in Fig. 5A. The grids are connected to opposite corners of a Wheatstone bridge which may consist of strain gages or other variable-resistance elements. The B— point of the bridge

should be adjusted to fix the initial balanced grid voltages at some point between ground and +10 volts, since the cross-coupled input stage will operate satisfactorily anywhere in this range. The output from the bridge will be either single-ended or push-pull, depending on whether one or two active arms are employed.

Figure 5B shows a typical connection for a crystal gage. The output of the gage is connected to one grid while the other grid is grounded through a 0.1- $\mu$ f capacitor. This arrangement takes care of possible differences in grid voltage due to grid current, which would not be true if one grid were shorted to ground.

### Feedback Amplifier

The remaining stages of the amplifier may best be considered together since they are completely enclosed in a feedback loop. This section of the direct-coupled amplifier, shown in Fig. 6, consists of two push-pull amplifier stages using 12AX7s and a 12AU7 push-pull cathode follower to give low-impedance output.

The first of these amplifier stages has a low gain because of the current feedback produced by the use

of large individual cathode resistors. The second stage is a more or less conventional push-pull amplifier providing no feedback; because of the large value of the common cathode resistor used it corrects for any inequalities in the two input signals. The final stage employs a 12AU7 as a push-pull cathode follower to improve the frequency response of the system. Low output impedance is necessary because of the capacitance of the cables connecting the amplifier to the cathode-ray tube located in a separate unit.

Additional feedback voltage is introduced across the separate cathode resistors of the first stage by means of a resistance network from the output cathode followers. Note that if the cathode terminals of the first stage were joined, no feedback voltages would appear and the amplifier would operate at maximum gain. Hence a variable resistance placed between the two input cathodes serves as a gain control by varying the amount of feedback in this section of the amplifier. The gain of the amplifier may be varied by a factor of five-hundred-to-one as this resistance is changed from zero to infinity.

In the amplifier described, the

gain is varied over a range of forty decibels in two-decibel steps by means of a single twenty-position switch which inserts appropriate resistance. The maximum gain of the d-c amplifier without feedback is 200,000. The maximum and minimum gains as determined by the attenuator resistance values are 50,000 and 500.

It should be mentioned that balanced feedback over two stages as previously described reduces inequalities in gain between the two halves of the amplifier.

The frequency response of the amplifier varies with attenuator position because of change in feedback. To compensate for this variation the attenuator is padded with three small capacitors. Representative frequency response curves for the d-c amplifier are shown in Fig. 7. When a long input cable is used with a resistive source, a decrease in bandwidth occurs due to the distributed capacitance of this cable. A small socket is provided for insertion of attenuator shunting capacitors to give the amplifier a compensatory rising frequency characteristic.

Triode tubes, particularly high- $\mu$  triodes, are seldom used as wide-band amplifiers because of the large

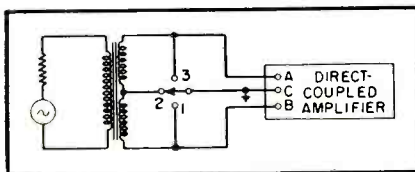

FIG. 4—Circuit for testing single-ended or push-pull input of d-c amplifier

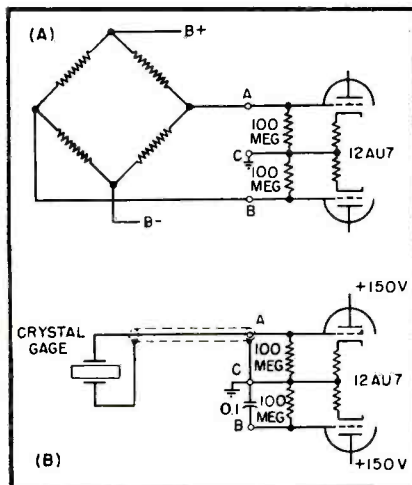

FIG. 5—Input connections for (A) Wheatstone bridge and (B) a crystal gage

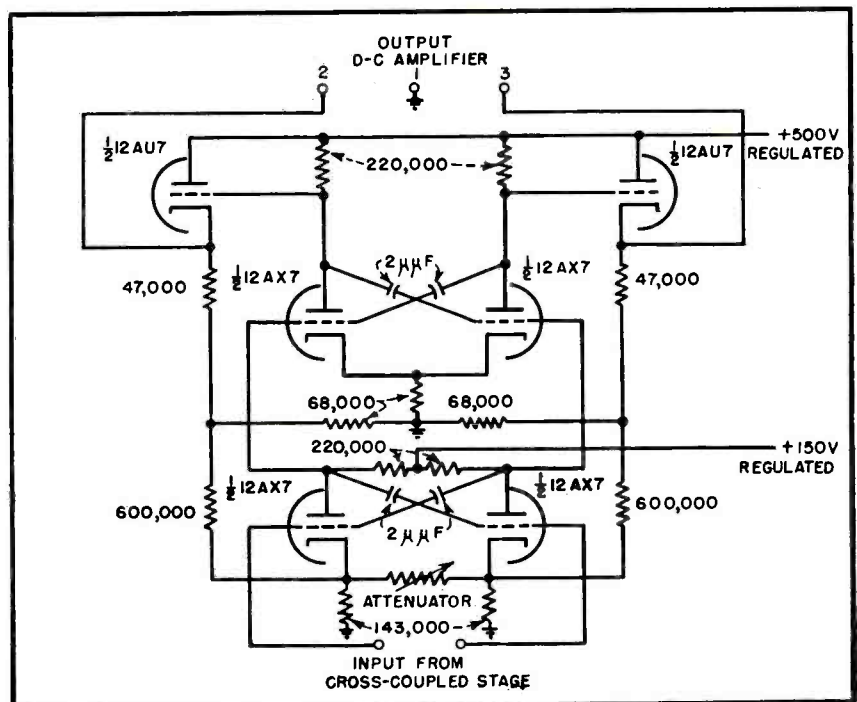

FIG. 6—Circuit diagram of two-stage amplifier with cross-coupled input and cathode-follower output

effective input capacitance. This effective capacitance may become quite large as it is approximately equal to the product of the stage gain and the grid-plate capacitance of the tube. In a push-pull amplifier this effect may be eliminated by the simple expedient of cross neutralization, the connection of a capacitor approximately equal to the grid-plate capacitance of the tube from each plate to the opposite grid. By this method the effective input capacitance of a triode may be made equal to or less than the grid-cathode capacitance of the tube. The effective output capacitance of the tube is approximately doubled. It can be shown that in push-pull amplifiers, triodes using this type of neutralization compare favorably with pentodes of the same transconductance as wideband amplifiers. Neutralization of the 12AX7 stages is accomplished by the 2- $\mu\text{mf}$  capacitors shown in the circuit of Fig. 6.

### Preamplifier

The circuit of the preamplifier, shown in Fig. 8, is essentially that of the cross-coupled stage previously described, with the addition of a cathode-follower output. The input and output stages are 12AU7's, while the cross-coupled stage is a 12AX7. The input impedance to either input grid is 100 megohms. A 50,000-ohm potentiometer is inserted between cathodes for use as a hum-balancing control. This balance is reset only when new input tubes are inserted, and the potentiometer position is determined by feeding a signal to both input grids in parallel and adjusting the potentiometer until minimum output is observed. Hum cancellations of the order of 1,000 to 1 may be achieved in this manner.

Cascaded coupling networks are used to minimize the effects of differential leakage in the coupling capacitors.

A balanced attenuator varies the gain from 5 to 50, or 20 db in 5-db steps. The maximum possible gain of the overall system is 2.5 million. The maximum usable gain because of noise is approximately 250,000 with lower and upper half-power frequencies of 0.2 and 50,000 cycles per second.

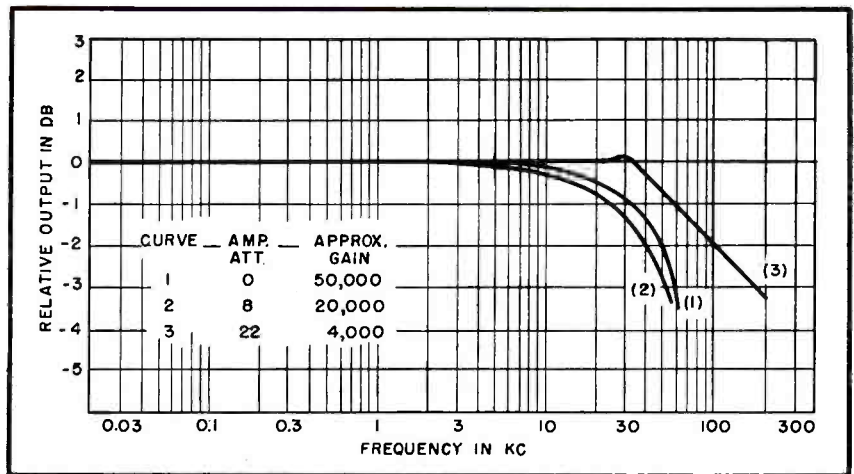

FIG. 7—Frequency response of amplifier for several typical operating conditions

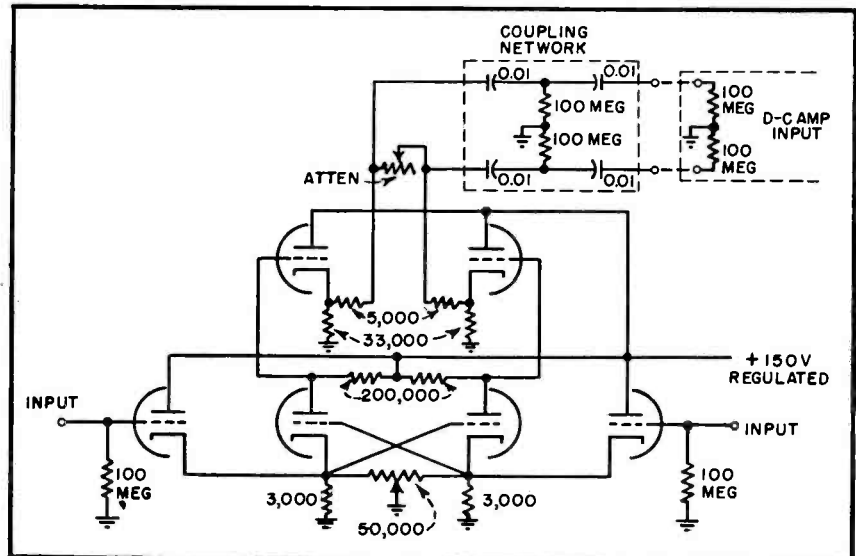

FIG. 8—Preamplifier and coupling network including cross-coupled input circuit

Because of the low power consumption of the amplifiers it was practical to use one power supply to furnish voltages to four amplifiers. This regulated supply furnishes each amplifier with 150 volts at 12 ma and 500 volts at 8 ma.

The heaters of four amplifiers are supplied by two separate 6.3-volt filament transformers. One, which supplies the heaters of the last three stages of all four amplifiers, is left floating. The other, which supplies the heaters of the preamplifiers and the cross-coupled stages of the d-c amplifiers, is center tapped to ground. Since the voltage of the latter is somewhat critical it is supplied from a regulated a-c source. This a-c operation of heaters is somewhat unusual in direct coupled amplifiers and simplifies matters greatly by elimination of a d-c regulated heater supply with

attendant worries about heater to cathode potentials.

These amplifiers were designed primarily for use in measurements of strains, pressures, temperatures, velocities and accelerations. They should find uses in other applications such as medical research, computer circuits, servomechanisms and oscilloscopes.

### Acknowledgments

The units were designed and constructed under Ordnance Contract No. W-11-022-ORD-11319 for Ballistics Research Laboratories of Aberdeen Proving Ground. The authors would like to acknowledge the aid rendered by C. W. Lampson of that agency. They wish, too, to express their appreciation to K. Dellekamp, Armour Research Foundation, for his work in construction and testing of the units.

# Measuring Color of

Recording spectroradiometer gives argument-proof check of image color on production runs of television picture tubes in 48 seconds by tracing spectral energy distribution curve of phosphor directly on paper-chart recorder. Also checks color shift with beam current

**T**HERE IS AS YET no agreement in the television industry concerning uniform methods of measuring screen color of standard black-and-white picture tubes. As in other new and expanding fields, the art is ahead of the specifications and the methods of measurement.

Cathode-ray tubes have been rejected by customers because those customers did not approve the screen colors when examined visually. Tubes have also been rejected for color shift with beam current change on the basis of visual inspection. Although the customers may have been right, the important point is that no accepted methods of measurement exist in the television industry by which to judge screen quality.<sup>1</sup>

This lack of standardization for the colorimetry of television picture-tube screens does not reflect either a lack of recognition of the problem or lack of activity directed toward its solution. The Joint Electron Tube Engineering Council (JETEC) has an active Subcommittee on Cathode-Ray Tube Screen and Phosphor Characteristics which has been working on the problem for several years. This subcommittee has conducted industry-wide correlations of color measurements among television picture-tube manufacturers. It has recently enlisted the aid of the National Bureau of Standards in devising a suitable light source for calibration of such cathode-ray tube colorimeters as are presently used in the industry. These efforts, however, have not yet reached their conclusion, nor are they of such a nature as to permit evaluation of the several types of colorimetric equipment currently in use.

It seems likely, therefore, that

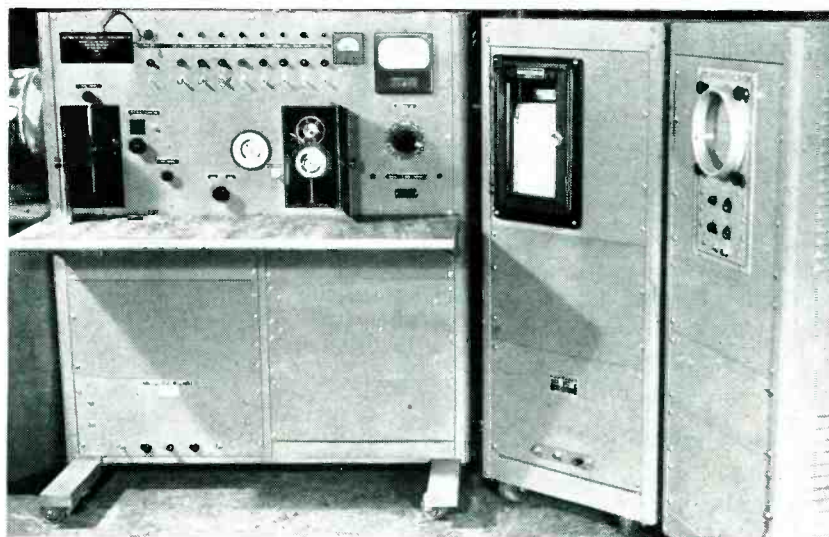

Complete cathode-ray tube spectroradiometer. Television picture tube being measured is at extreme upper left. Chief operating controls are on panel of console. Cabinet rack at center houses voltage regulator and chart recorder; cro is at right

such vigorous cooperative efforts as these must not only be continued into the future until proper standardization has been achieved, but that they must continue, as in the past, to be supplemented by fundamental research activities conducted within the laboratories of the several television tube manufacturers.

### Laboratory Techniques

For a number of years we have undertaken the careful measurement of the spectral energy distributions of luminescent sources. This work is part of a program devoted to the study of the optical properties of phosphors. Suitable optical equipment was set up at first so that precise point-by-point techniques could be employed for the determination of these curves. Gradually the needs of the groups working on the development of improved phosphors increased.

It became apparent that the

amount of spectral energy distribution data required was approaching such a magnitude that the slower laboratory techniques needed to be superseded by rapid, automatic equipment. Consequently, we developed two pieces of equipment to meet these needs. One automatic recording spectroradiometer was developed for the measurement of fluorescent lamp spectral energy distributions in 12.5 minutes. This instrument has been described elsewhere.<sup>2</sup>

Because of its special appeal to the television industry, the second automatic recording spectroradiometer is discussed here. Fundamentally, this spectroradiometer consists of a monochromator for scanning the spectrum of the light emitted by a cathode-ray tube screen, and the means for measuring and recording the intensity of the dispersed light. While there is a basic similarity between our two spectroradiometers, the present in-

# Cathode-Ray Screens

By **ALFRED E. MARTIN** and **S. N. ROBERTO**

*Physics Laboratories  
Sylvania Electric Products Inc.  
Bayside, New York*

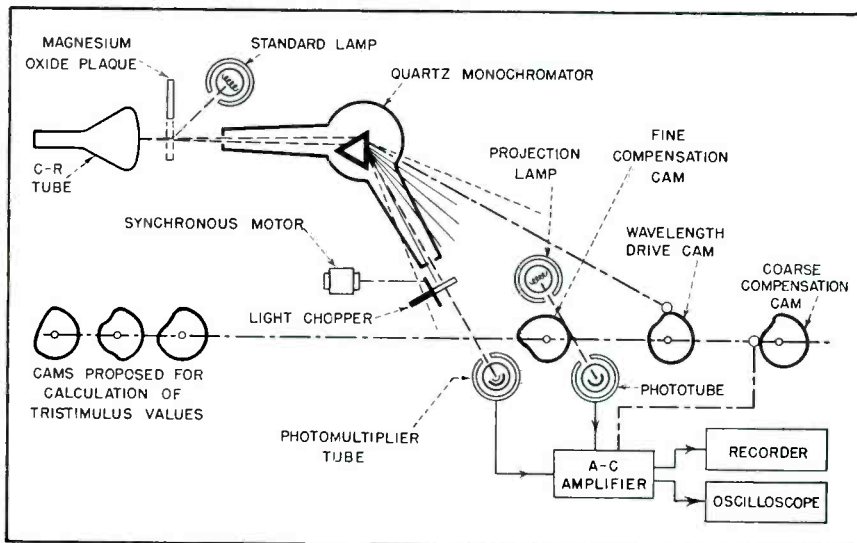

**FIG. 1**—Spectrum of c-r tube raster is swept past multiplier phototube by cam drive that is synchronized with recording paper drive, so that desired spectral response is traced on uniform wavelength scale

strument incorporates a number of new or modified features not employed in the earlier one.

The principle of operation may be explained with reference to Fig. 1. Light emitted from a standard 525-line raster on the screen of a cathode-ray tube is admitted through the entrance slit of a quartz monochromator. Portions of the spectrum produced by the prism emerge through the exit slit of the monochromator. The mechanical drive of the instrument actuates a cam which rotates the monochromator prism through the intermediary of a cam follower and lever arrangement. This wavelength drive-cam is so shaped as to move the spectrum past the exit slit in such a manner that equal wavelength intervals are scanned in equal periods of time. These successive portions of the visible spectrum cover the entire range from 7,200 angstroms (red) to 3,600 angstroms (blue) in 48 seconds.

The spectral band leaving the monochromator exit slit falls upon the cathode of a photomultiplier tube whose output is fed into an a-c amplifier. The amplifier output, suitably compensated, is rectified and presented to a 1-milliamper chart recorder whose paper drive is synchronized with the wavelength drive. This synchronization has the effect of producing a uniform wavelength scale on the recorder chart.

Optionally, the unrectified amplifier output may be presented to a 7-inch oscilloscope for persistence studies. A calibration process makes the instrument direct-reading. The standard calibrating source is a tungsten filament projection lamp operated at a color temperature of 2,848 K. Its light, diffusely reflected from a magnesium-oxide plaque, can be viewed by the entrance slit of the monochromator. Since this lamp has a known spectral energy distribution,

the instrument is considered to be in proper calibration when the recorder pen reproduces this known curve.

## Optical System

A Littrow type monochromator is used. It employs a concave mirror for collimating the incident beam and focussing the spectrum on the exit slit. The wavelength drive is operated by a reversible synchronous motor through an adjustable clutch which is geared to produce a rapid scan in 48 seconds or a slow scan in 12 minutes. One important feature of the wavelength drive is that the wavelength cam may be rotated continuously in either direction, thus eliminating the need for limit switches.

On the main drive shaft, beneath the wavelength cam, is a coarse correction cam which adjusts the output of the a-c amplifier by means of a potentiometer in one stage. Effectively, the amplifier gain is thus varied so as to make the input signal to the recorder proportional to the luminous energy at any wavelength. By this means compensation is simultaneously provided for three things: (1) the non-constant spectral sensitivity characteristic of the photomultiplier-tube detector; (2) the non-uniform absorption of the spectrum by the optical system; (3) the variable dispersion of the quartz optics.

The instrument requires fine compensation to eliminate the effect of all residual errors, such as might arise when tubes or standard lamps are replaced. This compensation is achieved by supplying a second variable d-c voltage to modify the gain of the amplifier.

The source of the fine compensation signal is a projection lamp, operated at line voltage, which illuminates a vacuum phototube. The amount of light entering this phototube is controlled by rotating a thin metal disk of varying radius

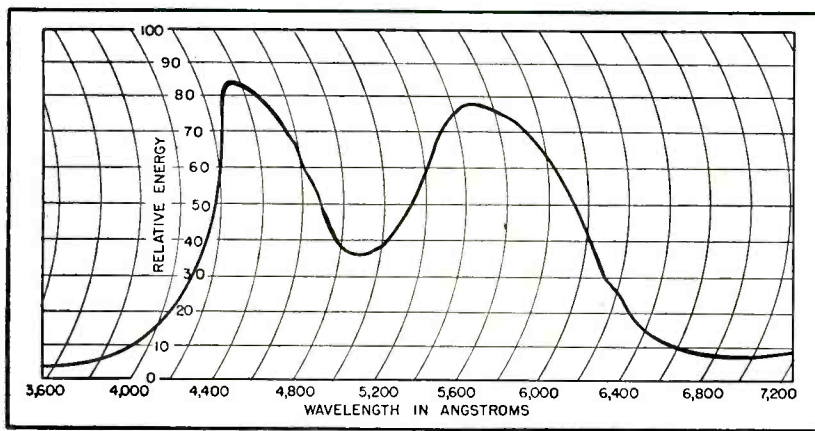

FIG. 2—Three superimposed test runs on a type 10BP4 tube using P4 phosphor produced this curve, illustrating precision of spectroradiometer in duplicating its results

in its path. This disk is rotated by means of gearing controlled from the main drive shaft.

### Calibration

A gear drive is used for determining the shape of the fine compensation disk. Briefly, this is accomplished by placing a circular piece of brass sheet on a holder. On the front panel of the console is a knurled thumb screw for the manual operation of a scribe attachment which carries a sharp needle for tracing a curve on the surface of the disk as the latter rotates. Illumination from the standard lamp is allowed to enter the monochromator, and the wavelength drive is then set into operation. The front-panel thumb screw is manually adjusted so that the recorder pen traces out on the chart the known spectral energy distribution of the standard lamp at a color temperature of 2,848 K. This calibration can be very accurately performed when the 12-minute or slow scanning speed is used. Once the brass disk has been marked, the scribe attachment is removed from the housing. The disk can readily be cut to the scribed curve and subsequently mounted on its own spindle where it performs the required compensative function.

Whenever the standard lamp is used for calibration purposes, the luminous input to the photomultiplier tube is interrupted at the rate of 60 cycles per second by means of a cylindrical light chopper. This is mounted concentrically over the photomultiplier housing and is ro-

tated by a synchronous motor. Light-chopping is necessary during calibration in order to provide an a-c signal for the amplifier. A cathode-ray tube, however, is inherently a source of pulsating light so that chopping is not needed when one of these tubes is being measured.

All power is derived from a standard 115-volt, 60-cycle, single-phase power line. This power is very carefully regulated by means of a 2-kva voltage regulator which provides 0.2-percent regulation accuracy and a maximum harmonic distortion of 5 percent. Each chassis power supply also has its own individual electronic regulation. The photomultiplier power supply is quite standard. It derives full-wave rectification from a type 5R4GY tube. The dynode voltages are fixed and are regulated by the use of a type VR105 voltage-regulator tube in each stage. The photomultiplier enclosure, which may be entered from the left side of the front panel of the console, is equipped with a safety interlock.

### Amplifier and Oscilloscope

The a-c amplifier is built in two sections, to permit bringing the gain control to the front panel without spoiling the amplifier performance on account of the capacitive loading of connecting cables. The amplifier uses current feedback in all stages. Its output into the crystal diode rectifiers is from a cathode follower. The low-frequency response has been adjusted so that a 120-cycle square wave shows only

a 10-percent drop. The high-frequency characteristics permit reproduction of a 120-cycle square wave with negligible rounding at the corners.

The oscilloscope was included for convenience in servicing the equipment and to display the build-up and decay characteristics of phosphors. The photomultiplier looks at the cathode-ray tube under test for about 8.3 milliseconds, during which time the brightness of a phosphor undergoes a number of alternations. By adjusting the horizontal sweep of the scope to 120 cps and applying the amplifier output directly to the vertical input, it is possible to observe and measure the persistence characteristics of the phosphors with the scope. With short-persistence phosphors it is merely necessary to increase the horizontal sweep frequency to its maximum value of about 30 kc.

### Performance

The wavelength calibration of the spectroradiometer was carried out by standard optical methods. No provision was made for recalibration. The wavelength calibration is sufficiently well-made so that there is no error greater than 10 angstroms in any portion of the spectral range covered.

Figure 2 illustrates the precision of the spectroradiometer. This record is a superposition of three consecutive spectral energy distribution curves taken from the same cathode-ray tube. It can be seen that errors of reproduction are quite negligible.

Once the spectral energy distribution curve of a phosphor has been obtained, the information may readily be converted into the nomenclature of the International Commission on Illumination (ICI).<sup>1,2</sup>

### REFERENCES

- (1) R. M. Bowie and A. E. Martin, Spectral Power Distribution of Cathode-Ray Phosphors, *Proc. IRE*, p 1,023, Aug. 1948.
- (2) S. L. Parsons, A. E. Martin and S. N. Roberto, Recording Spectroradiometers for Luminescent Materials, *Journal of the Electrochemical Society*, To Be Published.
- (3) E. B. Fehr, Color Measurement and Specification in Television Picture Tubes, *Proceedings of the National Electronics Conference*, 3, p 558, 1947.



# Optimum Coax Diameters

Equations and charts give optimum ratios of inner and outer conductor diameters for each of ten different transmission line properties. Comparison of curves speeds choice of best compromise ratio for a particular application. Expanded scales give  $Z_0$  for any ratio

By **PHILLIP H. SMITH**

*Technical Staff  
Bell Telephone Laboratories, Inc.  
Whippany, N. J.*

**I**F THE INNER DIAMETER  $D$  of the outer conductor of a coaxial transmission line is held constant and the diameter  $d$  of the inner conductor is varied, optimum conductor diameter ratios for different transmission line properties will range from one to infinity as indicated in Fig. 1.

It is frequently advantageous to employ a coaxial line having a conductor diameter ratio which results in a compromise between several desirable line properties. A single compromise ratio is also desirable for certain fields of use because it simplifies manufacturing and merchandising problems. These considerations have led to standardization, in effect, of a single coaxial conductor diameter ratio for high-frequency and microwave applications.<sup>1</sup> This ratio (2.3) results in a nominal characteristic impedance of about 50 ohms. For many specific coaxial line applications, however, the design engineer may find it desirable to employ a conductor diameter ratio which will give more nearly optimum results.

The derivation of the optimum ratios is briefly described and optimum values are indicated to one part in ten thousand. In all cases the medium between conductors is assumed to be a gas with a dielectric constant approaching unity, and any effect of inner conductor supports upon the optimum conductor diameter ratio for a given property is neglected.

The relationship between conductor diameter ratio and characteristic impedance, as plotted on the expanded scales of Fig. 2, is based on the familiar equation

$$Z_0 = 138 \log_{10} (D/d) \quad (1)$$

### Attenuation and Attenuators

For a given frequency and conducting material the total high-frequency resistance  $R$  of a coaxial transmission line is proportional to the inverse sum of the diameters of the individual conductors:

$$R \approx \left( \frac{1}{d} + \frac{1}{D} \right) \quad (2)$$

This equation shows that minimum resistance of a line of given outer conductor diameter  $D$  occurs when ratio  $D/d$  approaches unity. Minimum resistance does not, however, accompany minimum attenuation. As the conductor diameter ratio approaches unity the resistance approaches 0.435 times the resistance of a line having minimum attenuation, as seen from Fig. 3.

Minimum attenuation, commonly referred to as loss in a coaxial transmission line, occurs when ratio  $D/d$  is 3.592. This ratio corresponds to a characteristic impedance of 76.64 ohms.

As the conductor diameter ratio drops below the minimum-attenuation ratio of 3.592 the line resistance continues to decrease but the current required to transmit the same power through the line rises. For ratios below 3.592 the  $I^2R$  losses mount at a rate that is faster than the rate at which the re-

(continued on page 112)

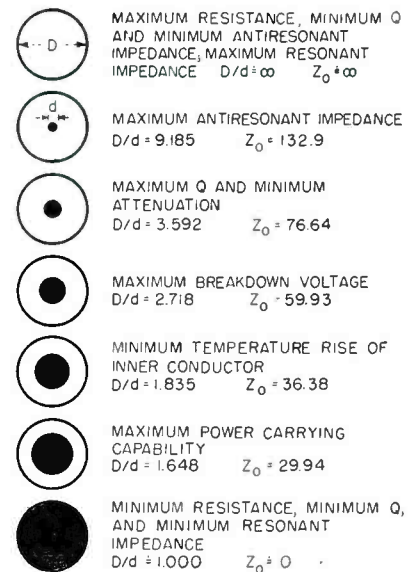

FIG. 1—Quick picture of optimum coaxial conductor diameter ratios

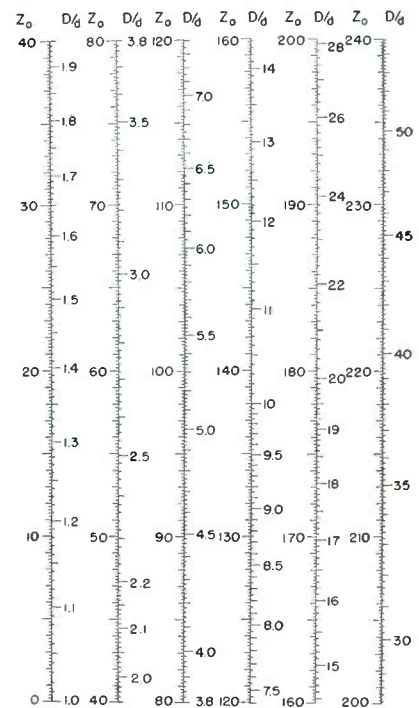

FIG. 2—Characteristic impedance in ohms of gas-filled coaxial line for various conductor diameter ratios

imum power transmission when voltage gradient is the limiting factor, is obtained by minimizing  $g$ , as given in Eq. 10, with respect to  $D/d$ . We then obtain  $(D/d) = \sqrt{e} = 1.648$ . The square root of the reciprocal of the gradient as expressed in Eq. 10 gives a quantity which is proportional to the ratio of the power-carrying capability of the line to that of a line having a maximum capability, based on minimum voltage gradient on the surface of the inner conductor. This is plotted as a function of the conductor diameter ratio in Fig. 5.

### Antiresonant Impedance

The maximum antiresonant impedance of coaxial transmission line sections is obtained when the conductor diameter ratio is 9.185, which corresponds to a characteristic impedance of 132.90 ohms.<sup>6</sup> The antiresonant impedance of a transmission line section is, in general

$$Z_{AR} = Z_0/\alpha \quad (11)$$

where  $\alpha$  is the attenuation constant of the line. Substituting the value for  $Z_0$  given by Eq. 1,

$$Z_{AR} \approx \frac{\log_{10}(D/d)}{\alpha} \quad (12)$$

Combining this with Eq. 5 then gives

$$Z_{AR} \approx \frac{\log_{10}^2(D/d)}{(D/d) + 1} \quad (13)$$

The conductor diameter ratio which provides a maximum antiresonant impedance for a line section is obtained by maximizing  $Z_{AR}$  with respect to  $D/d$ .

The absolute value of the antiresonant impedance for a transmission line of optimum conductor diameter ratio (9.185) may be computed from

$$Z_{AR} = 3,428.82/R \quad (14)$$

where  $R$  is the total resistance of the line section.

### Resonant Impedance

Minimum resonant impedance of a coaxial line section is obtained when the conductor diam-

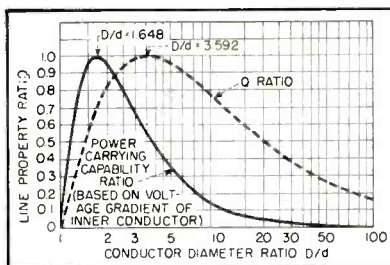

FIG. 5—Solid-line curve gives effect of  $D/d$  on ratio of power-carrying capability of line (based on voltage gradient of inner conductor) to that of line having maximum capability. Dashed-line curve gives effect of  $D/d$  on ratio of  $Q$  of line to that of line having minimum attenuation

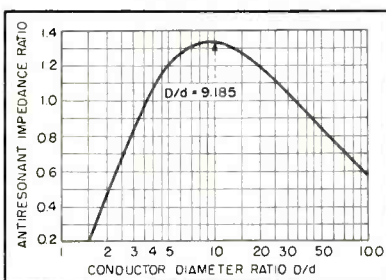

FIG. 6—Effect of  $D/d$  on ratio of antiresonant impedance of line to that of line having minimum attenuation

eter ratio approaches the limiting value of unity. As the ratio approaches this limiting value the characteristic impedance approaches zero.

The resonant impedance of a line section is, in general,

$$Z_R = \alpha Z_0 \quad (15)$$

Substituting the value for  $Z_0$  given by Eq. 1

$$Z_R \approx \alpha \log_{10}(D/d) \quad (16)$$

From Eq. 5,  $\alpha$  is proportional to  $(1/d) + (1/D)/\log_{10}(D/d)$  and the resonant impedance is therefore

$$Z_R \approx (D/d) + 1 \quad (17)$$

From inspection of Eq. 17,  $Z_R$  approaches a minimum value as  $D/d$  approaches unity.

The absolute value of the resonant impedance for a given set of conditions may be computed from

$$Z_R = R/2 \quad (18)$$

where  $R$  is the total resistance of the line section.

From inspection of Eq. 2 it may be seen that  $R$  (and therefore  $Z_R$ ) is minimum when  $d = D$  or  $D/d = 1$ .

The minimum antiresonant and the maximum resonant impedance of a coaxial transmission line section is obtained when the conductor diameter ratio becomes infinitely large, which corresponds to an infinitely large characteristic impedance. As may be seen from Eq. 13 and 17, this occurs when  $D/d$  becomes infinitely large. This is shown, with respect to a line having minimum attenuation, on Fig. 3 and Fig. 6.

### Q Ratio

If in a tuned circuit the frequency is changed from the resonant frequency by an amount  $\Delta f$  so that the power in the circuit is reduced to half the value at resonance (or antiresonance), then

$$Q = f/2\Delta f \quad (19)$$

Defining  $Q$  of resonant (or antiresonant) transmission line sections in the same way,<sup>6</sup>

$$Q = \frac{Z_0}{R} \times \frac{2\pi l}{\lambda} \quad (20)$$

where  $2\pi l/\lambda$  is the angular length of the line section in radians and  $R$  is given by Eq. 2.

The  $Q$  is maximum when  $R/Z_0$  is minimum, but  $R/Z_0$  is proportional to the attenuation of the line as shown in Fig. 3 and therefore the  $Q$  is maximum when  $D/d = 3.592$ .

The  $Q$  of a coaxial transmission line section is minimum when the attenuation of the line is maximum. As may be seen from Fig. 3, this occurs when  $D/d$  approaches the limiting value, unity, and also when  $D/d$  becomes infinitely large.

### REFERENCES

- (1) RMA Subcommittee on Antennas and R-F Lines—TR-31-2901; RMA Subcommittee on Gas-Filled Transmission Lines—TR-911.
- (2) E. J. Sterba and C. B. Feldman, Transmission Lines for Short Wave Radio Systems, *Proc. IRE*, July 1932.
- (3) C. R. Cox, Design Data for Beaded Coaxial Lines, *ELECTRONICS*, p 130, May 1946.
- (4) F. W. Peek, Jr., "Dielectric Phenomena in High-Voltage Engineering," McGraw-Hill Book Co., New York, Second Edition, p 28.
- (5) P. H. Smith, U. S. Patent No. 2,298,428, issued Oct. 13, 1942.
- (6) B. J. Witt, Concentric Tube Lines, *Marconi Review*, p 20, Jan.-Feb. 1936.

**Service  
Beyond  
The Sale!**

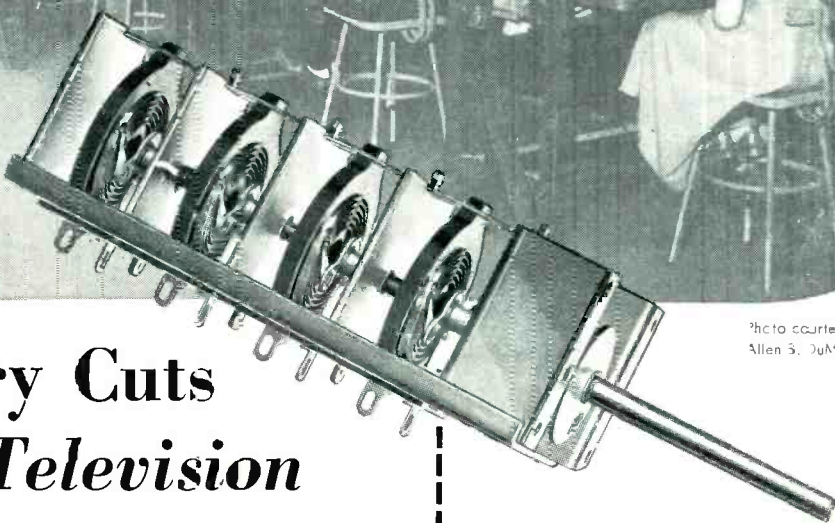

Photo courtesy  
Allen S. DuMont Labs., Inc.

## Mallory Cuts Factory Television Alignments by 6 to 1

Television receiver manufacturers who are employing the Mallory Inductuner\* are giving their customers far more enjoyment . . . split-hair tuning accuracy, greater selectivity and stability, finger tip compensation for drift, complete FM radio coverage.

In addition, they find it possible to simplify their front end design and reduce assembly operation. For example, there are just two aligning operations on each of the three or four sections of the Inductuner, compared with six times as many on other types of tuners.

Added selling features! Reduced costs! And now, in the new Spiral Inductuner these important advantages are yours at a price no higher than other tuning devices.

If you want electronic parts of complete dependability and superior performance, from a supplier qualified to work hand in hand with you in the solution of design problems, turn to Mallory!

### *Outstanding Advantages of the new Mallory Spiral Inductuner:*

1. A single control for easy selection and fine tuning of any television or FM channel.
2. Easily adapted to UHF converter use.
3. Excellent stability eliminates frequency drift.
4. Supplied in three- or four-section designs.
5. Far more quiet operation; permits high signal-to-noise ratio in front end designs.
6. Free from microphonics.
7. Greater selectivity on high frequency channels.
8. Eliminates "bunching" of high band channels. Covers entire range in only six turns.
9. Simplifies front end design and production.
10. Reduces assembly costs.

\*Reg. trade mark of P. R. Mallory & Co., Inc. for inductance tuning devices covered by Mallory-Ware patents.

Television Tuners, Special Switches, Controls and Resistors

**P. R. MALLORY & CO., Inc.**  
**MALLORY**

P. R. MALLORY & CO., Inc., INDIANAPOLIS 6, INDIANA

#### SERVING INDUSTRY WITH

Capacitors	Contacts
Controls	Resistors
Rectifiers	Vibrators
Special Switches	Power Supplies
Resistance Welding Materials	

# TUBES AT WORK

Including INDUSTRIAL CONTROL

Edited by VIN ZELUFF

Fixed-Tuned Broad-Band Television Booster.....	116
Speed Orange Sorting by X-Rays.....	134
Citizens Radio Range.....	136
Photographing Test Patterns.....	138
Remote Control by A-F Discrimination.....	142
Simple High-Speed Relay.....	150
Deluxe Television Receiver.....	152
Radio Recorded Gunnery.....	156
Timing the Ponies.....	160

## Fixed-Tuned Broad-Band Television Booster

BY ARNOLD NEWTON  
Consulting Engineer  
New York, N. Y.

THE INHERENT NOISE generated in a receiver sets the ultimate limit to its maximum useful sensitivity. The noise figure gives a measure of the noise contributed by the receiver in excess of the noise generated in the antenna radiation resistance. It is defined as the ratio of the actual available output noise power over the noise power available from a noise-free but otherwise identical receiver. Reducing the noise figure and appropriately increasing the gain is equivalent to raising the transmitted power and hence extending the transmitter service area.

The insertion of a booster is intended to improve the overall noise figure and thus raise the useful gain. If the receiver by itself has a noise figure of  $F_2$  and the booster noise figure and available gain are  $F_1$  and  $G_1$  respectively, the overall

noise figure is

$$F = F_1 + \frac{F_2 - 1}{G_1}$$

A noise figure of approximately 17 db above thermal is characteristic of a poor receiver. About 6 db is the best practical noise figure, the ideal being 3 db when the antenna is matched at the receiver input. In order that the overall noise figure shall approach  $F_1$ ,

$$G_1 \gg \frac{F_2 - 1}{F_1}. \text{ Let } G = 5 \frac{F_2 - 1}{F_1} = 50,$$

the voltage gain is then approximately 8. This gain can be obtained over a bandwidth of 40 mc, the width of one complete band. One should therefore be able to cover all the channels in two bands.

### First R-F Stage

The noise figure and gain of the first r-f stage are of primary importance. A grounded-grid triode

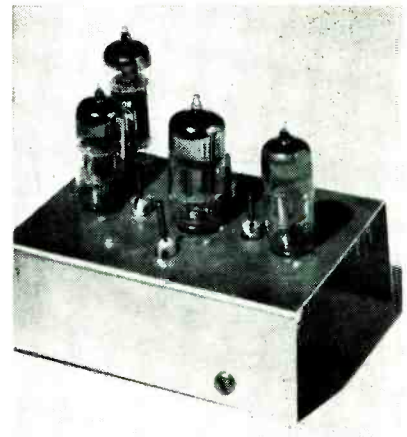

Television booster provides gain of 8 over high and low-band channels

amplifier was chosen for its low noise figure as expressed by

$$F = 1 + \frac{R_g}{R_i} + \left( \frac{\mu}{\mu + 1} \right)^2 \frac{R_{eq}}{R_g} \left( 1 + \frac{R_g}{R_i} \right)^2$$

The input resistance  $R_i$  due to input loading of a high-frequency triode is large in comparison with the antenna resistance  $R_g$  and since usually  $\mu \gg 1$ , the expression for noise figure reduces to  $F = 1 + R_{eq}/R_g$  where  $R_{eq}$  is equivalent noise resistance of the tube.

The dynamic impedance is  $(R_p + Z_L)/(\mu + 1)$ . Assuming that  $\mu \gg 1$  and  $R_p \gg Z_L$  the dynamic input resistance approaches  $1/g_m$ , where  $g_m$  is the transconductance of the tube. The  $R_{eq}$  of a triode is approximately equal to  $2.5/g_m$  and the noise figure becomes  $F = 3.5 = 5.5$  db.

The input transformer matching the antenna to the tube consists of a single tuned circuit. The dynamic input resistance of the tube shunting the circuit appears like 200 ohms and a tap at the 73-ohm resistance level is provided to terminate the transmission line. A 73-ohm input was chosen because coaxial cable is frequently used in fringe areas to minimize ignition interference.

A balun (balance to unbalance) 300-ohm to 73-ohm transformer for use with a 300-ohm line will be described later.

### Interstage Coupling

A double-tuned inductively coupled circuit is used between the plate of the first and the grid of the second r-f amplifiers. Using a 12AT7 and a 12AW6 as the first and second stages respectively the figure

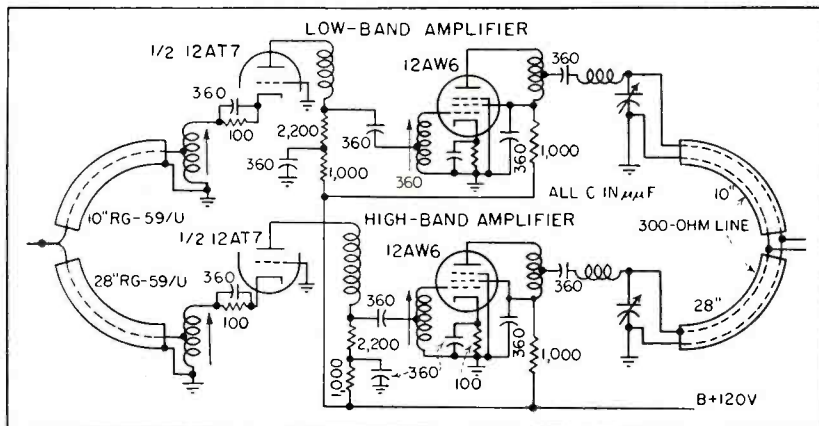

Booster circuit showing use of quarter-wave section crossover network

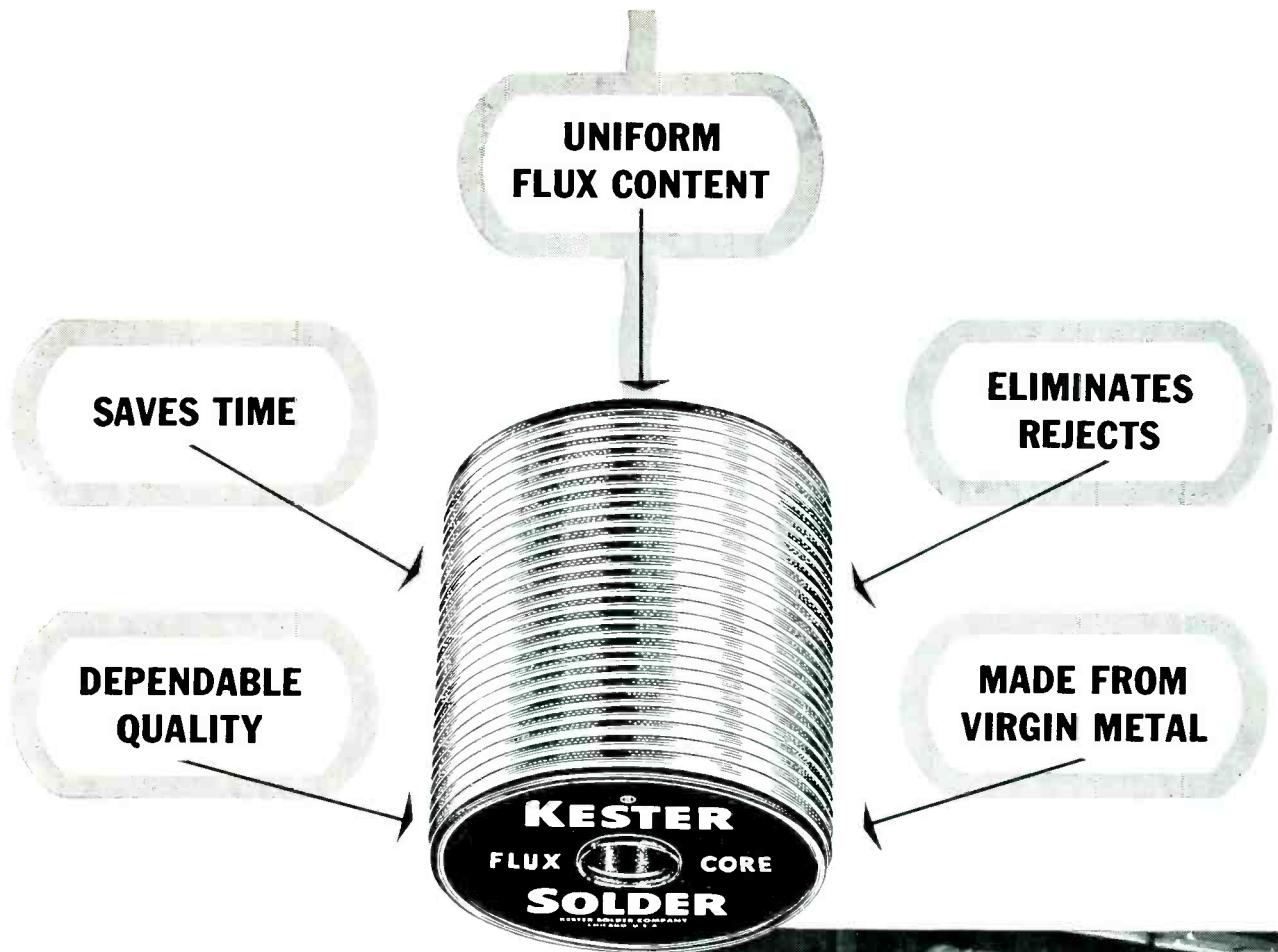

**KESTER**  
the Solder

*that gets Speed  
into  
TV Production*

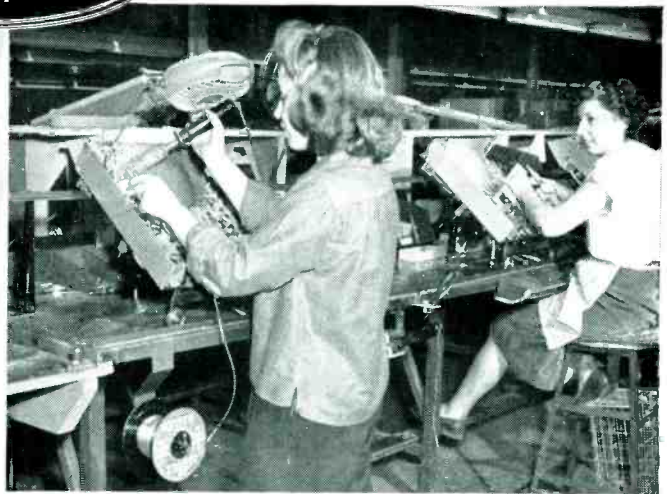

Using Kester Flux-Core Solders, Plastic-Rosin and "Resin-Five" Core Solders, will keep your solderers satisfied. Kester flows better—handles easier—faster to use. Kester Solders are made only from newly mined grade A tin and virgin lead.

**FREE TECHNICAL MANUAL**—Send for your copy of SOLDER and Soldering Technique.

**KESTER SOLDER COMPANY** • 4204 WRIGHTWOOD AVE.  
CHICAGO 39, ILL. • NEWARK, N. J. • BRANTFORD, CANADA



## THE FRONT COVER

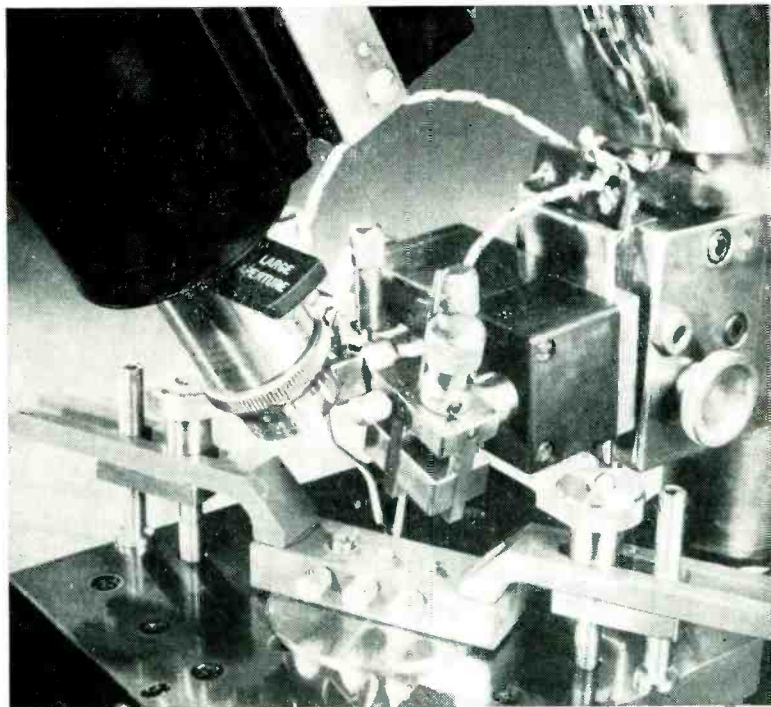

**T**HE ELECTRICAL properties of semiconductor materials, such as germanium and silicon, are altered greatly by small changes in such factors as impurity content, heat treatment, etching and pulsing. While many of these changes can be predicted, most of our knowledge at the present time is empirical and tentative explanations follow the experiment more frequently than theory predicts a new result.

The micromanipulator shown here and on the front cover was designed and constructed at the Physics Laboratories of Sylvania Electrical Products Inc. to permit quick quantitative evaluation of experimental results obtained in semiconductor research. For testing transistor action, the crystal is mounted on the bar held to the adjustable microscope stage with clamps. The two catwhiskers are separately adjustable and are connected to the power supply, signal source, matching devices, amplifier and measuring equipment. The optical system employs cross hairs for the accurate measurement of the spacing between catwhiskers.

of merit based on the estimated total input and output capacitances  $C_i$  and  $C_o$  is

$$A\Delta f = \frac{g_m}{2\pi\sqrt{C_i C_o}} = 140 \text{ mc}$$

where  $g_m = 5 \times 10^{-3}$  mhos,  $C_i = 7 \times 10^{-12}$  F, and  $C_o = 4 \times 10^{-12}$  F.

Over a bandwidth of 40 mc it should be possible to realize a gain of 3.5. Accepting a reasonable peak-to-valley ratio, higher gain will result without appreciably impairing resolution, since over any

4.5-mc interval within the transmission band the amplitude variation should be slight. Furthermore, the input circuit being single-tuned, a certain amount of stagger damping is indicated.

The second r-f stage couples into the receiver 300-ohm input resistance. Since the damping resistance is low (300 ohms), wide bandwidth is easily realized. The tuning of this circuit is broad and the overall bandwidth is little affected by its

presence. The gain of this stage is approximately 1.5. The voltage step-up in the input circuit is 1.6, so the total gain is approximately 8.

### Crossover Network

As two individual bandpass amplifiers are used, the respective inputs and outputs must be either switched or connected through a crossover network. Mechanical advantages and convenience make the latter more desirable. The crossover networks shown in the circuit diagram are of a very simple type.

Two quarter-wave sections connect the two inputs and outputs to the incoming and outgoing lines. For proper rejection, the shorter section leads to the low-band and the longer section to the high-band circuits.

Within the respective bands the loading effect of the alternate amplifier is small owing to its low input impedance and the impedance inversion property of a  $\lambda/4$  line. Although these conditions prevail at the midband frequencies only, broadband operation is secured by virtue of the transmission line's low characteristic resistance.

### Balun Transformer

The balun transformer for use with a 300-ohm line consists of a

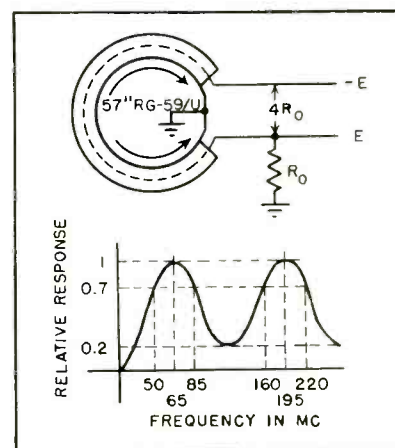

Drawing and response curve of balanced-to-unbalanced transformer made of 73-ohm coaxial cable

$\lambda/2$  section of 73-ohm coaxial line at 65 mc.

When the length of the line is  $\lambda/2$  or an odd multiple thereof and terminated in its characteristic re-

(Continued on p 134)



**The Newspaper  
that the "Savannah" delivered**

The first steamship to cross the Atlantic, it is said, brought back a newspaper containing the report of a famous European scientist "proving" that practical marine propulsion by steam was impossible.

That, of course, was in the knee-pants days of the Scientific Age. Today, it would be a rash scientist who would apply any such label to a proposed development. "Unknown" or "yet to be proved" perhaps, but not "impossible." Imagination is as much a part of modern

research and engineering background as physics or mathematics.

In electronics alone, a generation of progress was crowded into a few hectic war years. Products not known — for jobs that had never been done — became commonplace. Yet all of this represents only a fresh beginning . . . not an end. As in the past, Sprague research continues on the assumption that even the best of today's components are only test models for tomorrow's even more difficult assignments.

**SPRAGUE**

PIONEERS

**SPRAGUE ELECTRIC COMPANY**

North Adams, Massachusetts

IN ELECTRIC AND ELECTRONIC DEVELOPMENT

GLASS-TO-METAL SEALS, pioneered by Sprague, have paved the way to new and higher standards of protection and efficiency in thousands of capacitor and resistor types.



SUBMINIATURE Sprague molded Prokar\* capacitors, rated for  $-50^{\circ}\text{C}.$  to  $+125^{\circ}\text{C}.$  operation, are playing a big part in revolutionizing the engineering of ultra-small equipment.



SPRAGUE KOOLOHM\* RESISTORS, wound with ceramic insulated wire, doubly protected by outer ceramic shells, have answered one difficult resistor problem after another.



\* T. M. REG.

HPB-348

ELECTRONICS — February, 1950

119

# THE ELECTRON ART

Edited by JOHN MARKUS

Electronic Torch .....	120
High-Impedance Probe .....	120
New UHF Oscillator .....	120
Square-Wave Keying of Oscillators .....	162
Detecting Gallstones with Ultrasonic Echoes .....	172
Reduction of Pulse Rise Times for Shoran .....	178
Zirconium Arc Lamp .....	184
Survey of New Techniques .....	188

## Electronic Torch

HOT ENOUGH to cut holes in firebrick and to melt tungsten is a new cutting and melting torch developed by J. D. Cobine and other scientists of GE's Research Laboratory, utilizing the action of 1,000-mc radio waves on gases. Leading from the 1,000-mc magnetron oscillator is an antenna made of two short metal cylinders, one within the other. A high-frequency arc can be made to form on the end of the antenna. If certain gases, among them nitrogen and carbon dioxide, are fed past the

arc, a jet of flame about nine inches long is produced.

The high temperatures produced on any surface placed in the jet are caused almost entirely by heat generated as atoms join together to form molecules. The molecules of the gases are broken up into atoms by the high-frequency arc. These atoms join together again on surfaces placed in the torch. The jet itself is not necessarily hot.

The arc can break up nitrogen molecules, ordinarily composed of

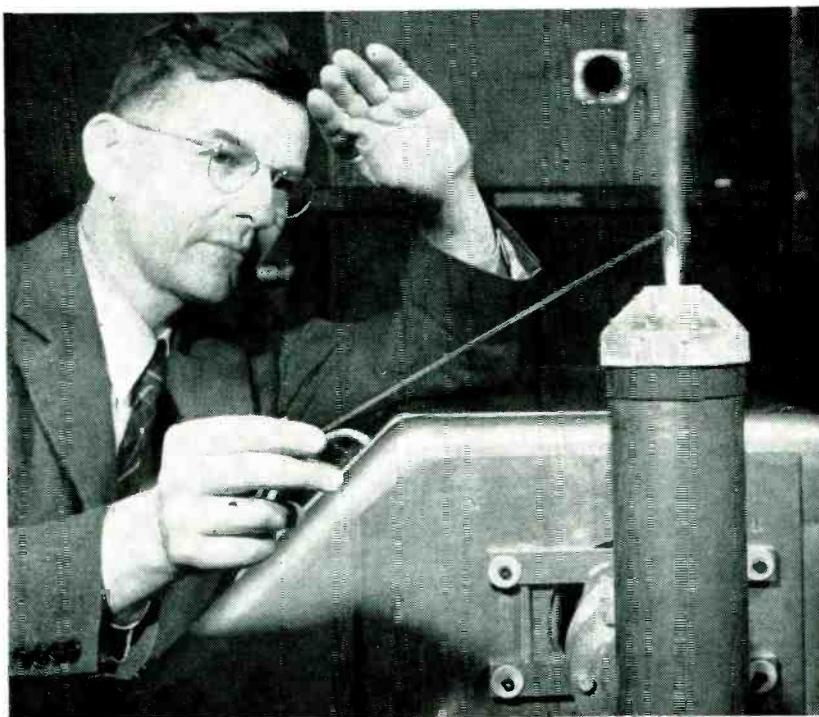

J. D. Cobine of GE melts quartz rod with new 1,000-mc electronic torch. Tungsten (3,370 C melting point) and firebrick are melted with equal ease

two nitrogen atoms, into their separate atoms. When these two atoms strike a surface, they reunite and give off heat, he said. Argon, helium, and other gases that exist normally as single atoms, give a flame essentially devoid of heat, since they cannot be broken and re-joined. An electronic torch composed of one of these gases gives off light, due to motion of the electrons caused by the radio waves, but the hand may be inserted in it without ill effects.

## High-Impedance Probe

IN CONNECTION with testing of pulse generator and high-speed flip-flop circuits at the Research Laboratory of Electronics, MIT, the

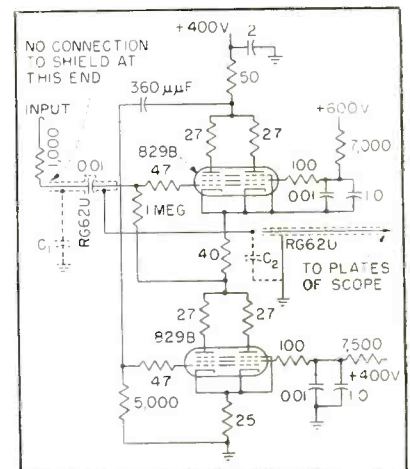

FIG. 1—High-impedance probe circuit

high-impedance probe circuit shown in Fig. 1 was developed. The probe has a rise time of  $0.25 \times 10^{-9}$  second per volt, and a somewhat faster fall time, under the condition that  $C_1 + C_2$  be equal to 100  $\mu\text{f}$ .

## New UHF Oscillator

BY D. H. PREIST  
Eitel McCullough, Inc.  
San Bruno, Calif.

THE FEEDBACK system usually presents the greatest problem in the design of uhf oscillators, except at high power level. It is very frequently found on test that although the feedback system is apparently adjusted to an optimum condition, the efficiency and power output are less than expected. This can nearly



# Laboratory Instruments for TELEVISION

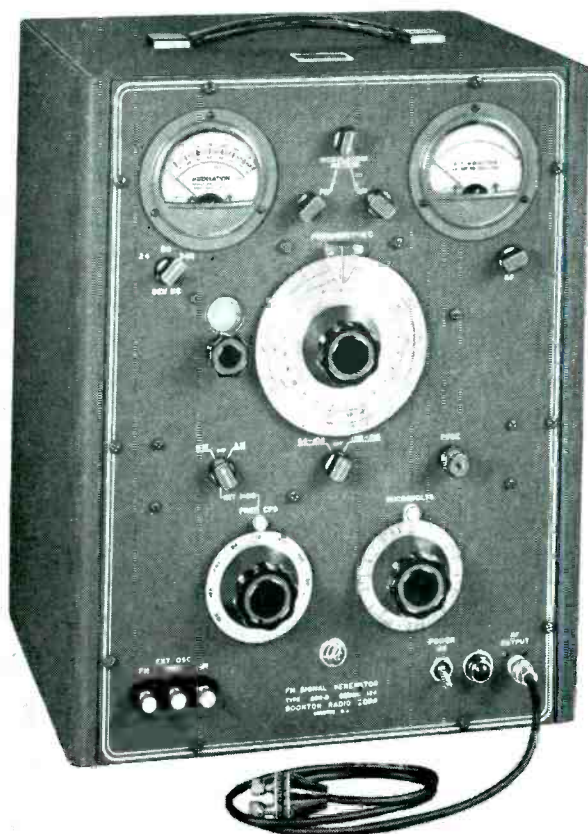

## Type 202-B FM SIGNAL GENERATOR

Frequency Range  
54-216 mc.

Additional coverage from  
0.4 to 25 mc. with accessory  
UNIVERTER Type 203-B

### FM SIGNAL GENERATOR Type 202-B

The Type 202-B FM Signal Generator is specifically designed to meet the exacting requirements of television and FM engineers working in the frequency range of 54 megacycles to 216 megacycles. Following are some of the outstanding features of this versatile instrument:

**RF RANGES:** 54-108, 108-216 mc.  $\pm$  0.5% accuracy. Also covers 0.4 mc. to 25 mc. with accessory 203-B Univerter.

**VERNIER DIAL:** 24:1 gear ratio with main frequency dial.

**FREQUENCY DEVIATION RANGES:** 0-24 kc., 0-80 kc., 0-240 kc.

**AMPLITUDE MODULATION:** Continuously variable 0-50%, calibrated at 30% and 50% points.

**MODULATING OSCILLATOR:** Eight internal modulating frequencies from 50 cycles to 15 kc. available for FM, AM.

**RF OUTPUT VOLTAGE:** 0.2 volt to 0.1 microvolt. Output impedance 26.5 ohms.

**FM DISTORTION:** Less than 2% at 75 kc. deviation.

**SPURIOUS RF OUTPUT:** All spurious RF voltages 30 db or more below fundamental.

If you have an FM or television instrument requirement, let us acquaint you with full particulars and technical data concerning the Type 202-B FM Signal Generator and Type 203-B Univerter.

DESIGNERS AND MANUFACTURERS OF THE Q METER • QX CHECKER  
FREQUENCY MODULATED SIGNAL GENERATOR • BEAT FREQUENCY  
GENERATOR AND OTHER DIRECT READING INSTRUMENTS

### UNIVERTER Type 203-B



AVAILABLE AS AN ACCESSORY is the 203-B Univerter, a unity gain frequency converter which, in combination with the 202-B instrument, provides the additional coverage of commonly used intermediate and radio frequencies.

**R. F. RANGE:** 0.4 mc. to 25 mc. (0.1 mc. to 25 mc. with no carrier deviation).

**R. F. INCREMENT DIAL:**  $\pm$  250 kc. in 10 kc. increments.

**R. F. OUTPUT:** 0.1 microvolt to 0.1 volt,  $\pm$  1 db. Also approximately 2 volts maximum (uncalibrated).

**OUTPUT IMPEDANCE:** Approximately 60 ohms at 0.1 volt jack, 470 ohms at 2 volt pin jack.

**BOONTON RADIO** Corporation  
BOONTON • N.J. • U.S.A.

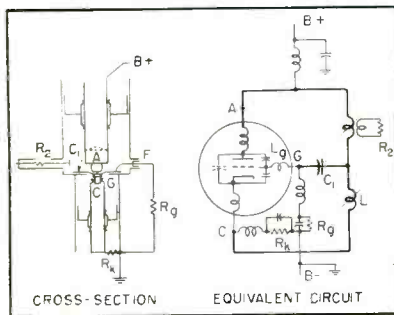

FIG. 1—New grid disc oscillator that provides simple and flexible feedback adjustment for coaxial triodes at frequencies exceeding 2,000mc

always be traced to the fact that in such oscillators the amplitude and phase of the fed-back power are so interdependent that it is impossible to adjust one without affecting the other to a major degree. It may indeed be impossible, within the limits of adjustment available, to reach the correct combination.

The advantage of the circuit to be described is that an unusually wide range of adjustment of phase

and amplitude of the feedback is available, the adjustments are simple to make, and at the same time the power-handling capacity is very high. When embodied in oscillators having the general form shown in Fig. 1, a very satisfactory result is obtained with both small and large coaxial triodes at frequencies between less than 100 and more than 2,000 mc, and at power levels less than one watt to many kilowatts.

The oscillator greatly resembles a grounded-grid amplifier. The only exception is that the tube grid connector, instead of being grounded, is fixed to a circular metal disc spaced from the transverse diaphragm or deck so as to form a simple capacitance symmetrical about the tube axis. The rectified grid currents are conducted away through filter *F*, which is a suitable r-f bypass device whose characteristics do not play any part in the operation of the circuit. The grid-anode and grid-cathode circuits are completed by the coaxial line re-

sonators of conventional design containing bypass systems which isolate the anode supply and permit the use of a cathode bias resistor if needed.

Turning to the equivalent circuit in Fig. 1, which is a close enough approximation for the purpose, the tube with its internal inductances and capacitances is shown inside the cylinder, and the larger parts of the external circuit are shown by heavy lines. The rest of the circuit, if properly designed, will have no appreciable effect on the parts with the heavy lines. It can be shown that for correct operation the output or grid-anode circuit must be tuned to the inductive side of resonance, and the total grid-cathode circuit to the capacitive side. The size of *C*, will then chiefly determine the amplitude of the feedback, so that decreasing the capacitance will increase the feedback and adjustment of *L* will control the phase over a wide angle;

(Continued on page 162)

## QUARTER-SIZE WORKING MODEL OF BEVATRON

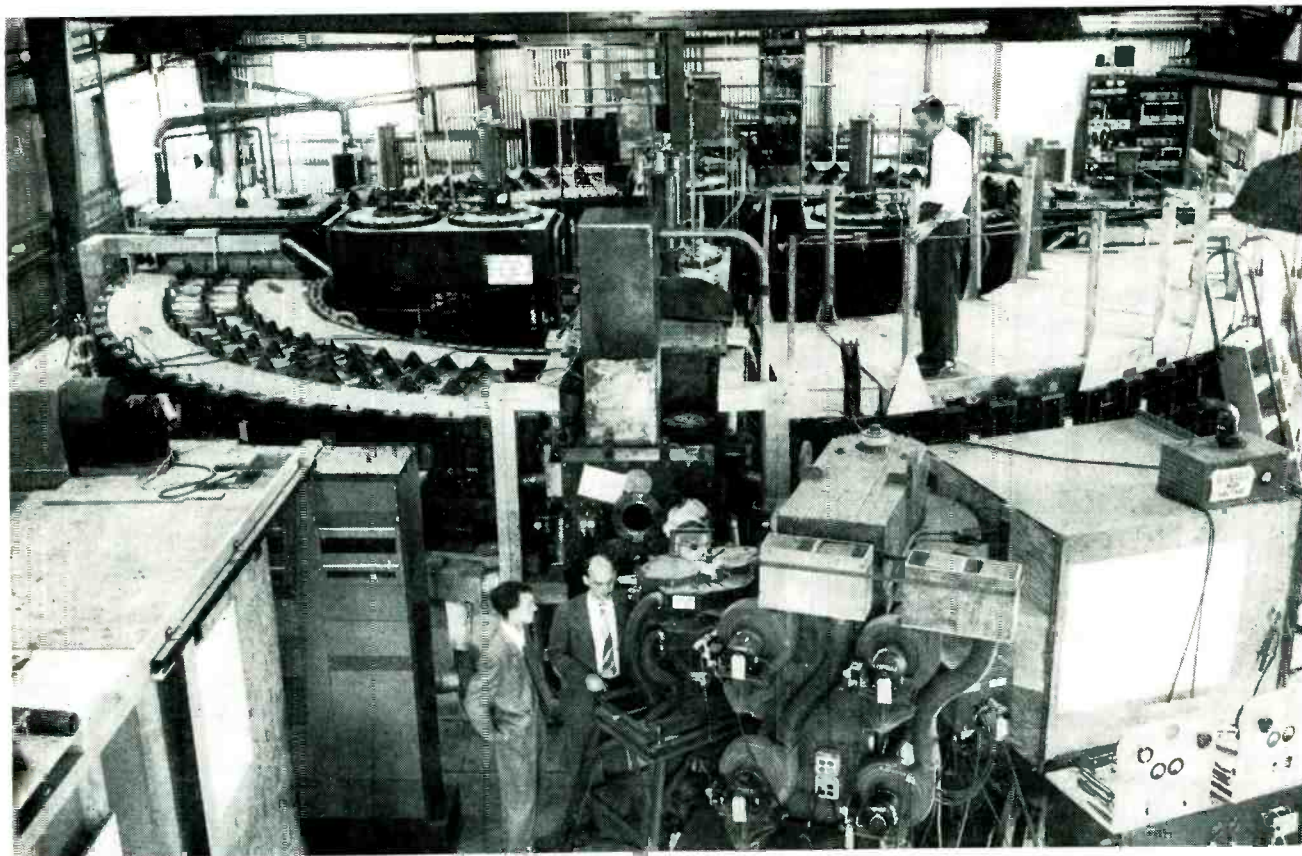

Small cyclotron in right foreground fires protons into 25-foot magnetic ring of scale-model bevatron at University of California Radiation Laboratory in Berkeley to produce striking power equal to 6,000,000 volts. Operating experience obtained here will guide final design of giant bevatron soon to be built



**LOOK AT IT  
FROM THE TILTING ANGLE...**

*As Low As 0.75°*

**AND YOU'LL PICK A**

**HONEYWELL**  
*Mercury Switch*

The angle of tilt is a mighty important thing to consider when selecting a mercury switch.

Honeywell Mercury Switches give you positive action with minimum movement. Some of them need to move only  $\frac{3}{4}$  of 1 degree . . . yet it is enough to insure certain contact and clean break.

Honeywell Mercury Switches are tiny and compact . . . are adaptable to unusual mountings. They have no open contacts . . . are sealed against dust, gas and corrosion.

Write for a copy of new Catalog 1343 for down-to-earth information, for greater latitude in product design . . . or call in your local Honeywell engineer for a detailed discussion of a particular application.



**MINNEAPOLIS-HONEYWELL REGULATOR CO.**  
BROWN INSTRUMENTS DIVISION

4428 Wayne Avenue, Philadelphia 44, Pa.

*Offices in 73 principal cities of the United States, Canada and throughout the world*

FOR  $\left\{ \begin{array}{l} \bullet \text{ POSITIVE ACTION} \\ \bullet \text{ LOW ANGULARITY} \\ \bullet \text{ LONGER LIFE} \\ \bullet \text{ WIDE SELECTION} \end{array} \right\}$  SPECIFY **HONEYWELL**  
*Mercury Switches*



*Mercury Switches*  
FOR POSITIVE ACTION



# NEW PRODUCTS

Edited by WILLIAM P. O'BRIEN

**New Tubes for Television Forecast Important Changes in Receiver Design. Tape Recorders Continue to Highlight Activity in Audio Field. Twelve Test Instruments Offered for Communications and Industrial Use**

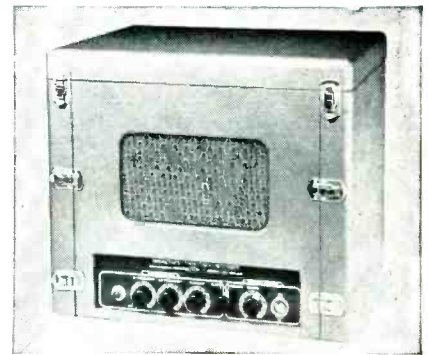

## Automatic Pager

AMPLIFIER CORP. OF AMERICA, 398 Broadway, New York 13, N. Y. An automatic recycling self-repeating tape recorder has been designed specially for paging in hotels and hospitals. Release of the microphone press-to-talk switch sets the recorder in play position for the message to be repeated continuously through an existing public-address system. The instrument operates on the Twin-Trax continuous-play principle. The 10-tube recording-playback amplifier provides a frequency response range of 50 to 9,000 cycles at  $7\frac{1}{2}$  in.-per-second tape speed.

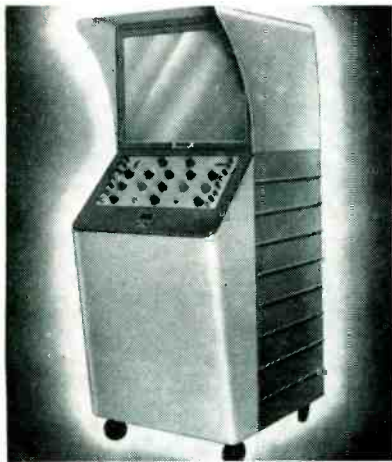

## Electronic Blackboard

TELEVISION EQUIPMENT CORP., 238 William St., New York 7, N. Y. The T-602 projection oscilloscope is particularly attractive in classroom work or in any application where large-screen display of electronic circuit phenomena is needed. It delivers pictures either 18 in.  $\times$  24 in. for small groups or 8 ft  $\times$  10 ft for larger audiences. Optical system features a 5 RPA tube, 20-kv acceleration and an  $f/2$ -5-in. coated lens. Tube brightness (100  $\times$  100-line raster) is 130 foot-candles average.

5 $\frac{3}{8}$  inches shorter than the previous 16 in. kinescope, and also shorter than present 10 and 12-in. picture tubes. It features the Filterglass face plate which gives improved picture contrast. Shortened length is made possible by use of a 70-deg deflection angle as compared to the usual angle of about 55 deg.



## Differential Computing Potentiometer

FAIRCHILD CAMERA AND INSTRUMENT CORP., 88-06 Van Wyck Boulevard, Jamaica 1, N. Y., announces the type 748D-C-P (differential computing potentiometer) designed chiefly for applications requiring addition or subtraction of two variables in a simple unit, with one voltage source. Uses include servomechanisms for computing or power amplification, and direct replacement of two single potentiometers when one is being used for compensation or correction purposes. Accuracy is  $\pm 0.1$  percent; maximum overall resistance ( $\pm 10$  percent), 150,000 ohms; power dissipation, 5 watts; service life, over 1,000,000 cycles.



## Motor-Speed Control

GENERAL RADIO Co., 275 Massachusetts Ave., Cambridge 39, Mass. Type 1701-A Variac speed control is a low-power controller similar in design to a previously announced  $\frac{1}{3}$  h-p type. The new model controls a  $\frac{1}{20}$  h-p d-c shunt motor or a  $\frac{1}{15}$  h-p universal motor directly from a-c line. Range of continuous speed variation available is from motor rated speed down to nearly zero at constant torque. A work-



## Short Picture Tube

RADIO CORP. OF AMERICA, Camden, N. J. The new short-necked 16-inch metal kinescope illustrated is

# WE CAN DO EVERYTHING BETTER THAN THEY CAN!

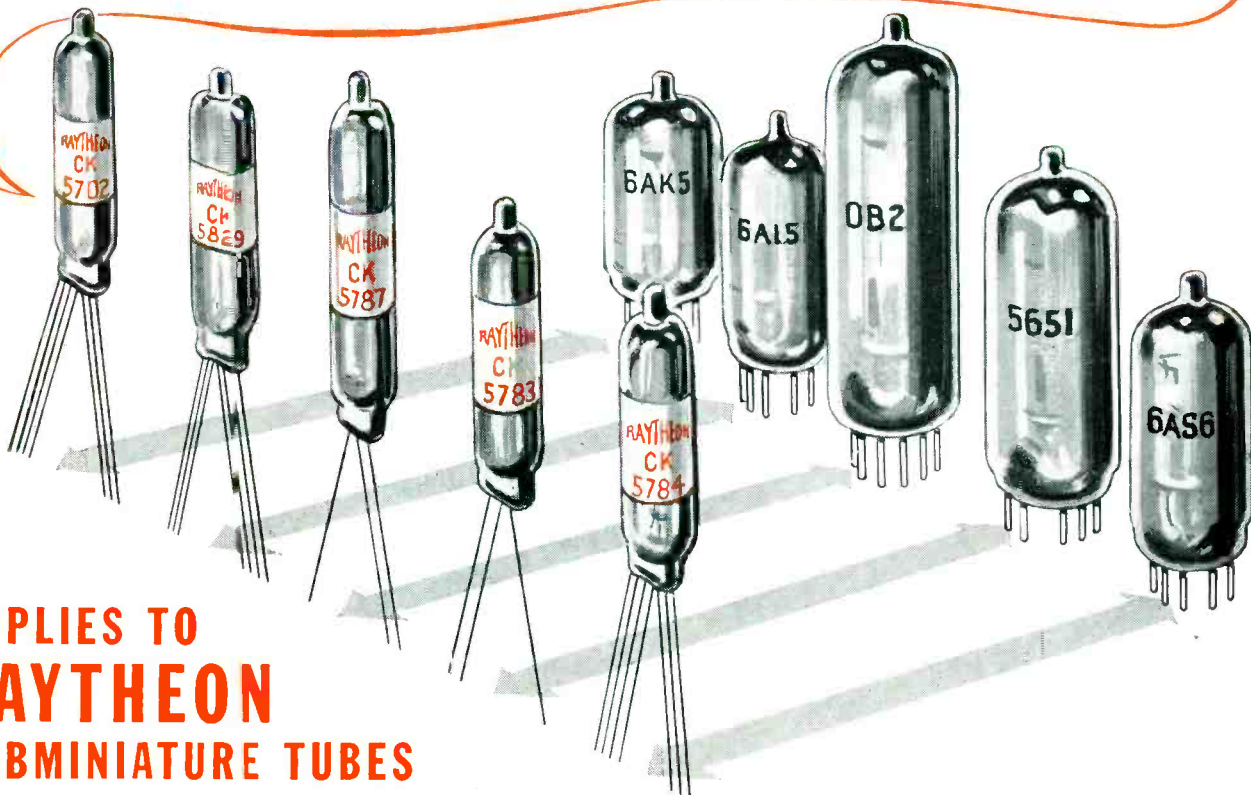

## APPLIES TO RAYTHEON SUBMINIATURE TUBES

RAYTHEON, and *only* Raytheon, SUBMINIATURES can sing that song loud and clear, as hundreds of users have already found out to their great satisfaction and profit. Compare them with their larger tube counterparts rating by rating — performance for performance.

Quality control, unequalled precision methods and experience in the making of long life tubes account for the fact that

RAYTHEON Subminiatures do the job of the bigger tubes just as well *if not better*.

RAYTHEON Subminiature Tubes simplify your design and production problems — increase product convenience and salability — are readily available from stock.

Here are a few of the many types:

This chart gives you at a glance the characteristics of representative Raytheon Subminiature Tubes

Type No.	Remarks	Maximum Diameter Inches	Maximum Length Inches	Filament Or Heater		Mutual Conductance umhos	Power Output MW	TYPICAL OPERATING CONDITIONS				
				Volts	Ma.			Plate Volts	Ma.	Screen Volts	Ma.	Grid Volts
<b>HEATER CATHODE TYPES</b>												
CR5702/CK605CX	Characteristics of 6AK5	0.400	1.5	6.3	200	5000		120	7.5	120	2.5	Rk = 200
CK5703/CK608CX	Triode, UHF Oscillator, ¼ watts at 500 Mc	0.400	1.5	6.3	200	5000		120	9.0			Rk = 220
CR5704/CK608BX	Diode, equivalent to one-half 6AL5	0.315	1.5	6.3	150			150ac	9.0			
CR5744/CK619CX	Triode, High mu.	0.400	1.5	6.3	200	4000		250	4.0			Rk = 500
CK5784	Characteristics of 6AS6	0.400	1.5	6.3	200	3200		120	5.2	120	3.5	-2.0
CK5829	Similar to 6AL5	0.300x0.400	1.5	6.3	150			117ac	5.0 per section			
<b>FILAMENT TYPES</b>												
1A4	Shielded RF Pentode — high Gm	0.300x0.400	1.5	1.25	100	2000		45.0	3.0	45.0	0.8	0
CK571AX	10 ma. Filament electrometer tube, I <sub>g</sub> = 2x10 <sup>-12</sup> amps.	0.285x0.400	1.5	1.25	10	1.6†		10.5	0.20			-3.0
CK573AX	Triode, high frequency output	0.300x0.400	1.5	1.25	200	2000		90.0	11.0			-4.0
CK474AX	Shielded Pentode RF Amplifier	0.290x0.390	1.25	0.625	20	37†		22.5	0.125	22.5	0.04	-0.625
CK5672	Output Pentode	0.285x0.385	1.5	1.25	50	625	60.0	67.5	2.75	67.5	1.1	-6.25
CK5676/CK556AX	Triode, UHF Oscillator for radio use	0.300x0.400	1.5	1.25	120	1600		135.0	4.0			-5.0
CK5677/CK568AX	Triode, UHF Oscillator for radio use	0.300x0.400	1.5	1.25	60	650		135.0	1.9			-6.0
CK5678/CK569AX	RF Pentode	0.300x0.400	1.5	1.25	50	1100		67.5	1.8	67.5	0.48	0
CK5697/CK570AX	Electrometer Triode Max. grid current 5x10 <sup>-11</sup> amps.	0.285x0.400	1.25	0.625	20	1.5†		12	0.22			-3.0
CK5785	High voltage rectifier	0.285x0.400	1.5	1.25	15							Inverse peak 3500 volts
<b>VOLTAGE REGULATORS</b>												
CK5783	Voltage reference tube — like 5651	0.400	1.63					Operating voltage 85.	Operating current range 1.5 to 3.5 ma.			
CK5787	Voltage regulator	0.400	2.06					Operating voltage 100.	Operating current range 5 to 25 ma.			
CK	⊗	RK	⊗	†Voltage Gain Ratio.								

**RAYTHEON**

Excellence in Electronics

**RAYTHEON  
MANUFACTURING  
COMPANY**

SPECIAL TUBE SECTION  
Newton 58, Massachusetts

SUBMINIATURE TUBES  
GERMANIUM DIODES  
and TRIODES  
RADIATION COUNTER TUBES  
RUGGED, LONG LIFE TUBES

ing range of 30 to 1 can be obtained with shunt motors and of at least 50 to 1 with most universal motors.

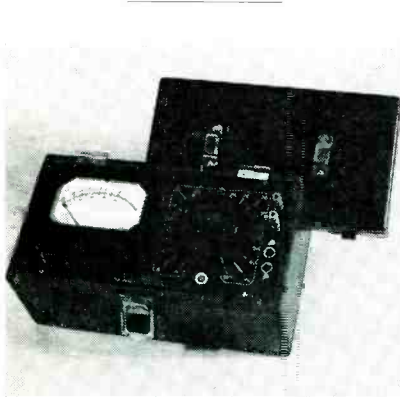

### Volume Level Indicators

THE DAVEN Co., 191 Central Ave., Newark 4, N. J., has added several units to its line of volume level indicators to meet the need for precise measurement and monitoring of sound by broadcasting stations, recording studios, medical research laboratories and allied industrial fields. The units are available having a range of 4 to 42 vu and -20 to +20 as bridging instruments, and -6 to +16, -6 to +32 and -20 to +20 in the terminating types.



### Phono Pickup

THE ASTATIC CORP., Conneaut, Ohio. Model JL-10 phonograph pickup for 78-rpm record reproduction consists of a curved drawn steel arm and a new cartridge, developed especially for the arm and available only in combination with it. Output is approximately 4.0 volts, needle pressure 1½ ounces.

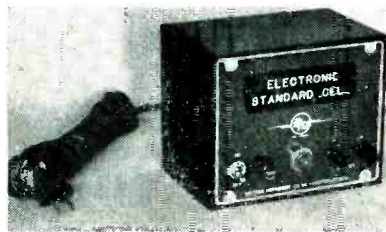

### Electronic Standard Cell

HASTINGS INSTRUMENT CO., INC., Box 1275, Hampton, Va. An elec-

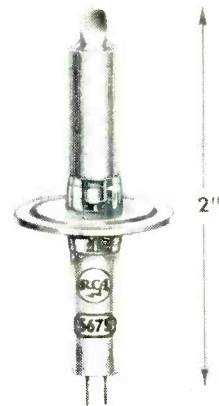

### Medium-Mu Triode

RADIO CORP. OF AMERICA, Harrison, N. J. The 5675 pencil-type medium-mu triode is designed for use in grounded-grid circuits. As a local oscillator it is capable of giving a power output of 475 mw at 1,700 mc, and about 50 mw at 3,000 mc. The triode's design employs a coaxial-electrode structure of the double-ended type in which plate and cathode cylinders extend outward on opposite sides of the grid flange.



LOTS OF VA at 400 cycles from a small inverter with six, twelve or twenty-seven volts direct-current input is available from this small package. Or, d-c to d-c combination packages can be supplied from the same manufacturers: Airpax Products Co., 1924 Greenmount Ave., Baltimore 2, Md.



ENGINEERS find that the production of television film shows is easier with this newly developed camera employing an improved video preamplifier. Maintenance men like the plug-in arrangement of components. This new broadcast equipment is manufactured by General Electric Co., Syracuse, N. Y.

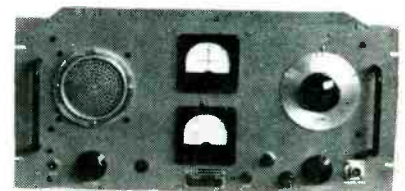

### VHF Receiver

CLARKE INSTRUMENT CORP., 910 King St., Silver Spring, Md. Model 167 vhf receiver is specially de-  
(Continued on p 192)

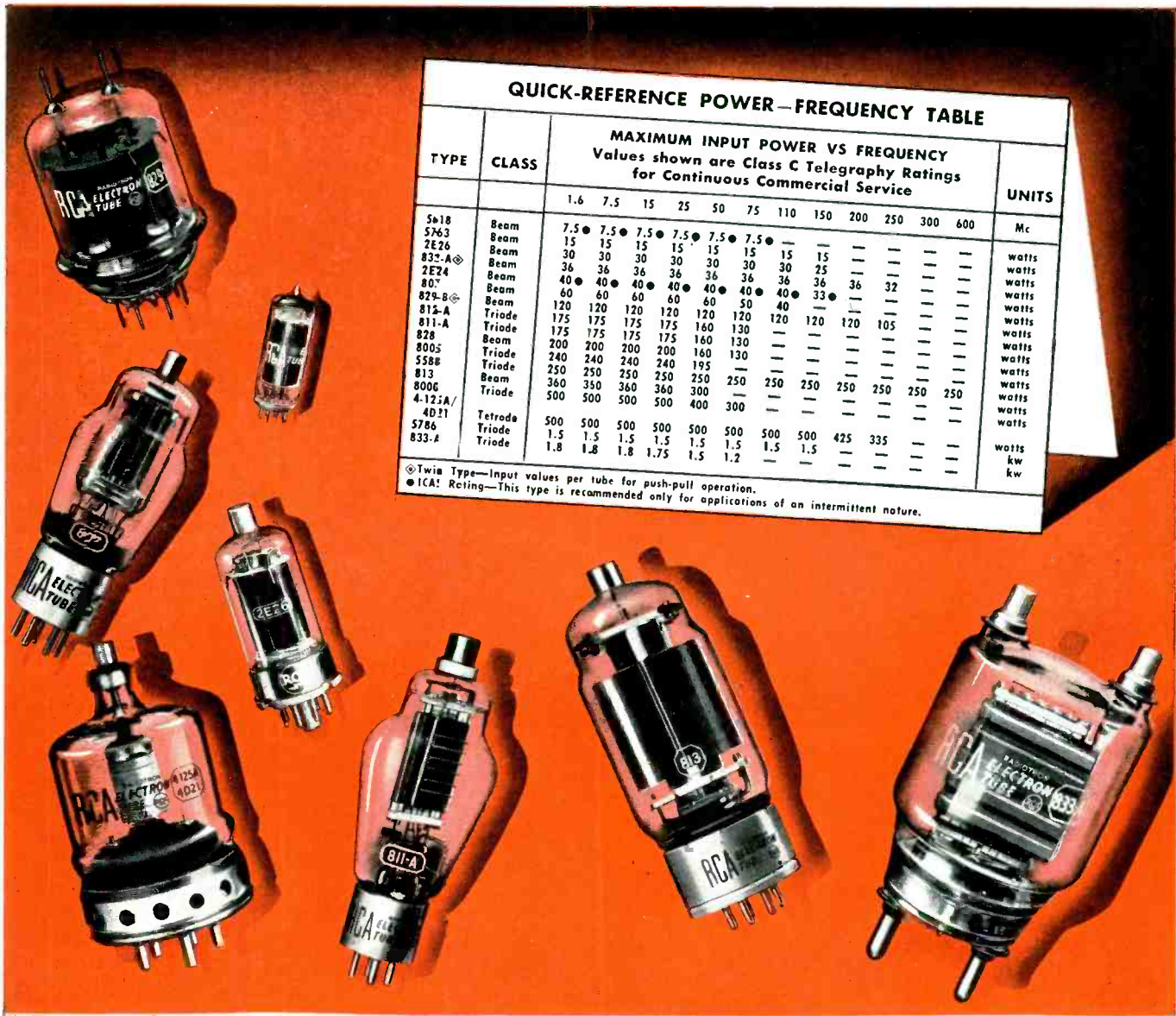

**QUICK-REFERENCE POWER-FREQUENCY TABLE**

TYPE	CLASS	MAXIMUM INPUT POWER VS FREQUENCY										UNITS		
		Values shown are Class C Telegraphy Ratings for Continuous Commercial Service												
		1.6	7.5	15	25	50	75	110	150	200	250	300	600	
5e18	Beam	7.5	7.5	7.5	7.5	7.5	7.5	—	—	—	—	—	Mc	
5763	Beam	15	15	15	15	15	15	—	—	—	—	—	watts	
2E26	Beam	30	30	30	30	30	30	15	15	—	—	—	watts	
833-A	Beam	36	36	36	36	36	36	36	25	—	—	—	watts	
2E24	Beam	40	36	36	36	36	36	36	36	36	32	—	watts	
807	Beam	60	40	40	40	40	40	40	33	—	—	—	watts	
829-B	Beam	60	60	60	60	60	50	40	—	—	—	—	watts	
812-A	Triode	120	120	120	120	120	120	120	120	120	105	—	watts	
811-A	Triode	175	175	175	175	160	130	—	—	—	—	—	watts	
828	Beam	175	175	175	175	160	130	—	—	—	—	—	watts	
8005	Beam	200	200	200	200	160	130	—	—	—	—	—	watts	
5588	Triode	240	240	240	240	195	—	—	—	—	—	—	watts	
B13	Beam	250	250	250	250	250	—	—	—	—	—	—	watts	
8006	Triode	360	350	360	360	300	250	250	250	250	250	—	watts	
4-125A/4D21	Tetrode	500	500	500	400	300	—	—	—	—	—	—	watts	
5786	Triode	500	500	500	500	500	500	500	425	335	—	—	watts	
833-A	Triode	1.8	1.5	1.5	1.5	1.5	1.5	1.5	1.5	—	—	—	kw	
			1.8	1.8	1.75	1.5	1.2	—	—	—	—	—	kw	

♦ Twin Type—Input values per tube for push-pull operation.  
 ● ICA! Rating—This type is recommended only for applications of an intermittent nature.

## Here today . . . here tomorrow

### Design with confidence around RCA Preferred Type Small Power Tubes

RCA Preferred Type small power tubes serve the major requirements of equipment manufacturers while providing wide design flexibility. The tubes listed are those you can depend upon *now* and for your *future* designs.

These RCA types are especially recommended because their widespread application permits production to be concentrated on fewer types . . . resulting in lower costs, improved quality, greater uniformity, and better availability.

RCA Application Engineers are ready to suggest the most suitable types for your design requirements. For further information write RCA, Commercial Engineering, Section B42R, Harrison, N. J.



The world's most modern tube plant . . .

**RCA, LANCASTER, PA.**

The Fountainhead of Modern Tube Development is RCA



**RADIO CORPORATION of AMERICA**  
ELECTRON TUBES

**HARRISON, N. J.**

# NEWS OF THE INDUSTRY

Edited by WILLIAM P. O'BRIEN

## New Census Machine Demonstrated

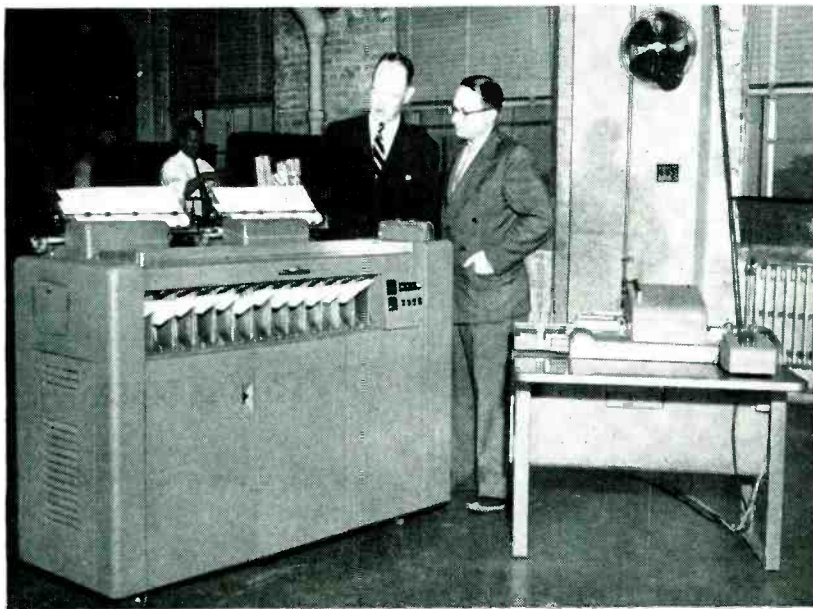

Philip M. Hauser, right, acting director of the Bureau of Census, receives the electronic statistical machine from Louis H. LaMotte, vice-president of International Business Machines Corp. The machine was developed by IBM for use in compiling the 1950 census

MILLIONS of facts concerning America's population, housing and agriculture will be compiled in 1950 by a new electronic statistical machine, recently demonstrated by International Business Machines Corp. at the Census Bureau's Washington headquarters.

The demonstration revealed that the new machine combines in one operation the simultaneous functions of classifying, counting, accumulating and editing. The machine then prints the statistical data resulting from groupings of

information and automatically balances the totals to insure their accuracy.

It has a capacity for counting up to 10,000 units in each of 60 different classifications while simultaneously sorting the cards into predetermined groups at the rate of 450 cards a minute.

Classifying, counting and tabulating the results will be completed by the spring of 1952. It is estimated that this operation will be equivalent to running 10 billion cards through one machine.

## Loran System Changes

CHANGES in power output and pulse recurrence rates for the East Coast loran chain went into effect at 1400 GCT Dec. 31, 1949. The stations operated by the Canadian Government have changed rates but still use the same transmitting equipment.

New transmitting equipment has been installed at each of the Coast Guard-operated East Coast stations. At Nantucket and Cape Hatteras

the transmitter outputs now approximate one megawatt peak. This energy is fed into new 300-foot vertical antennas and radiated into the service area more efficiently than with the previous antenna system. Pulse characteristics have been changed slightly to reduce the frequency bandwidth required by older equipments. This change in pulse characteristics will not be observable by the loran user except that

the pulses may appear somewhat steadier and more nearly alike, thus facilitating matching the leading edges with consequent increase in accuracy. The useful service area is extended about 100 miles, making the system even more useful to fishing vessels and others in remote areas. Amplitude of the signals from the new high-power stations is approximately four times that from the old transmitters.

New transmitters approximating 140-kw peak pulsed power output have been installed at Folly Island and Hobe Sound. During 1950 it is expected that construction of buildings will be completed at these stations to permit installation of megawatt equipment also. The present power increase gives approximately 50 percent more than was previously secured. Pulse characteristics are identical with those from Nantucket and Cape Hatteras.

Systemwise, the only significant change is the removal of the station from Bodie Island, N. C., and the establishment of a new station at Cape Hatteras, N. C. This change has required the recomputation of tables and the replotting of charts to indicate the navigator's position with respect to readings obtained on loran receiver-indicators. The use of new rates will effectively prevent confusion between the old and the present system.

New pulse recurrence rates are:

1H1 Port Aux Basques, Newfoundland and Deming, Nova Scotia.

1H2 Deming and Baccaro, Nova Scotia.

1H3 Baccaro and Nantucket, Mass.

1H4 Nantucket and Cape Hatteras, N. C.

1H6 Cape Hatteras and Folly Island, S. C.

1H7 Folly Island and Hobe Sound, Fla.

Rates 1H1, 1H2 and 1H3 retain previous pulse characteristics and power outputs. The old rates that are displaced are 1L7, 1L2, 1L1, 1L0, 1H1 and 1H2.

The frequency of transmission is 1,950 kc and the basic repetition rate "H" is high or  $33\frac{1}{3}$  pulses per second.

The U. S. Coast Guard is solicit-



*It's strip  
it's tape  
it's a laminate*

**...it's Kodapak Sheet for  
a multiplicity of dielectric uses**

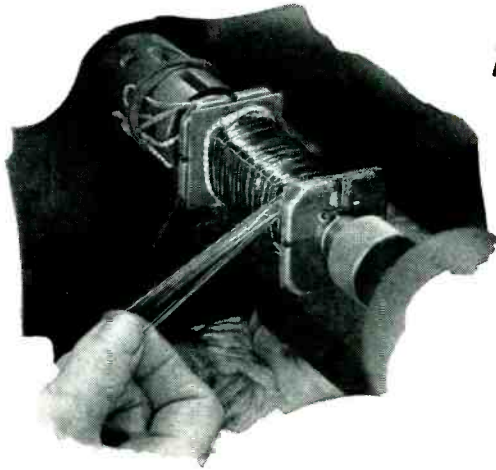

*for coils*

Kodapak Sheet is used as *strip* to provide durable interlayer insulation in low- and medium-voltage relays and transformers. Its smoothness, uniformity, and pliability produce neat, even layering in hand or machine winding—add a “finished” look. It has low moisture absorption. It's completely free of pinholes.

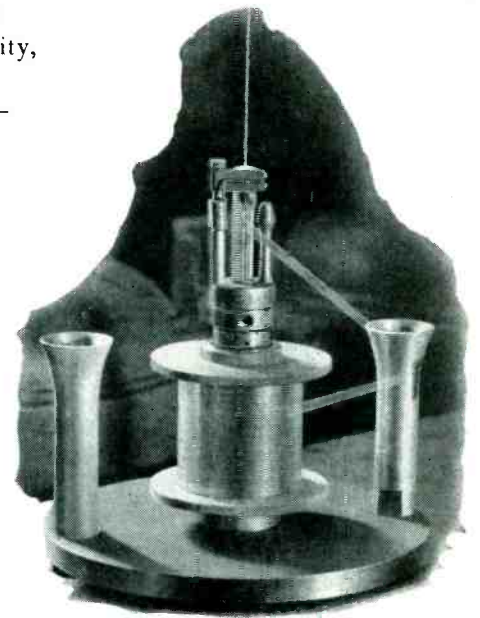

*for wires*

Kodapak Sheet is used as *tape* to provide non-corrosive primary insulation. It “serves” evenly on machines . . . produces flexible, compact coverings that meet most specifications. It takes braid smoothly; strips cleanly. It has uniform medium-voltage breakdown strength. Suitable for circuit wires, communications wires, and primary insulation in cables. Kodapak Sheet has been used more than 15 years by leading electrical manufacturers. Look into it.

*for motors*

Kodapak Sheet is used as a protecting *laminate* on paper slot insulation . . . on all types of insulation papers. It makes slot winding easier by providing smooth, pliable surfaces and edges. Protects paper against moisture absorption . . . protects windings against corrosion.

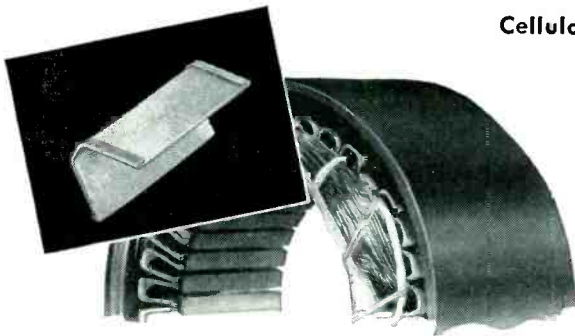

**Cellulose Products Division, Eastman Kodak Company  
Rochester 4, N. Y.**

Send for the book—

*“Properties of Kodapak Sheet”  
just mail the coupon*



**Kodapak Sheet**

**. . . for efficient insulation**

“Kodapak” is a trade-mark

**CELLULOSE PRODUCTS DIVISION  
EASTMAN KODAK COMPANY  
ROCHESTER 4, N. Y.**

Please send me your book, “Properties of Kodapak Sheet.”

Name \_\_\_\_\_  
(please print)

Company \_\_\_\_\_

Department \_\_\_\_\_

Street \_\_\_\_\_

City \_\_\_\_\_ State \_\_\_\_\_

ing reports and comments regarding the operation and coverage of the newly reorganized East Coast chain.

## Fellowships in Electronics

PREDOCTORAL fellowships in electronics for the academic year 1950-51 will be awarded at a regular meeting of the RCA fellowship board in March 1950. These fellowships, supported by the Radio Corp. of America, are designed to give special graduate training and experience in research to young men and women who have demonstrated marked ability in electronics, either as a branch of electrical or radio engineering, or in that field of physics which treats the behavior of electrons in conductance phenomena.

A fellow must be a citizen of the U. S. who has demonstrated ability and aptitude for advanced work and who has training in electronics equivalent to that represented by one year beyond the bachelor's degree, in a university of recognized merit in this field. Applications filed on or before January 10, 1950 receive consideration for tenure during the academic year 1950-51.

Further information concerning this fellowship program may be obtained from the Fellowship Office, National Research Council, 2101 Constitution Ave. N. W., Washington 25, D. C.

## National Tele System Committee Planned

THE RADIO MANUFACTURERS ASSOCIATION recently authorized its Television Committee to present to the FCC a plan for the immediate establishment of an industry-wide National Television System Committee.

The Committee would be composed of the top engineers in the field of television and electronics and would be charged with (1) presenting technical data relative to allocation of the uhf frequencies and the lifting of the freeze on vhf allocations necessary for the nationwide extension of television broad-

## MEETINGS

JAN. 30-FEB. 3: AIEE Winter General Meeting, Hotel Statler, New York, N. Y.

FEB. 27-MARCH 3: ASTM Committee Week and Spring Meeting, Hotel William Penn, Pittsburgh, Pa.

MARCH 6-9: IRE Convention and Radio Engineering Show, Hotel Commodore and Grand Central Palace, New York City.

APRIL 4-8: National Production Exposition, sponsored by the Chicago Technical Societies Council, Stevens Hotel, Chicago, Ill.

APRIL 26-28: Fourth annual meeting of the Armed Forces Communications Association, Astoria, New York City, and Fort Monmouth, N. J.

MAY 22-25: Parts Distributors

Show, Hotel Stevens, Chicago.

JUNE 26-30: Annual Meeting and 9th Exhibit of Testing Apparatus and Related Equipment, Hotel Chalfonte-Haddon Hall, Atlantic City, N. J.

AUG. 23-26: AIEE Pacific General Meeting, Fairmont Hotel, San Francisco, Calif.

AUG. 28-31: APCO National Conference, Hotel Hollenden, Cleveland, Ohio.

SEPT. 13-15: Sixth Annual Pacific Electronic Exhibit, Municipal Auditorium, Long Beach, Calif.

SEPT. 25-27: National Electronics Conference, Edgewater Beach Hotel, Chicago, Ill.

OCT. 17-21: AIEE Midwest General Meeting, Netherland Plaza Hotel, Cincinnati, Ohio.

casting generally and (2) recommending basic standards for the future development of color television.

The RMA would initiate and finance the engineering study but engineers from all branches of the industry would participate, including non-RMA companies, broadcasting interests, and qualified technical organizations. The FCC would be invited to send representatives to all committee sessions and receive regular progress reports on the committee's operations. The plan has been presented to members of the FCC by W. R. G. Baker and Edward Wheeler.

## F-M Schedule Increase

THE FCC recently instituted rule-making proceedings to increase the minimum operating schedule of f-m broadcast stations. Proposed revisions of the rules are as follows:

F-M stations not associated with a-m stations would, during their first year, operate not less than three hours between 6 a.m. and 6 p.m. and three hours between 6 p.m. and midnight, including Sundays; during the second year, not less than four hours during those

respective daily periods, and not less than eight hours daytime and four hours nighttime thereafter.

F-M stations affiliated with a-m stations would, besides meeting the above requirements, operate at least as many hours daily as the associated standard broadcast station.

## New Electrical Quantities Symbols

THE NEW edition of the American Standard Letter Symbols for Electrical Quantities was recently published by the American Standards Association. These symbols, adopted on the recommendation of a committee representing 36 important scientific, technical, educational and governmental groups in the U. S., are in excellent agreement with the symbols published by the International Electrotechnical Commission for international use, and also with American Standard symbols for physics, mathematics and the radio sciences.

Letter symbols are printed in two tables, one arranged in alphabetical order with the names of the quantities they symbolize; in the other table the letters themselves appear

(Continued on page 226)



Guided missiles...

**100 MILES UP**

and in the ground receiving system...

**29 SYLVANIA CRYSTAL DIODES**

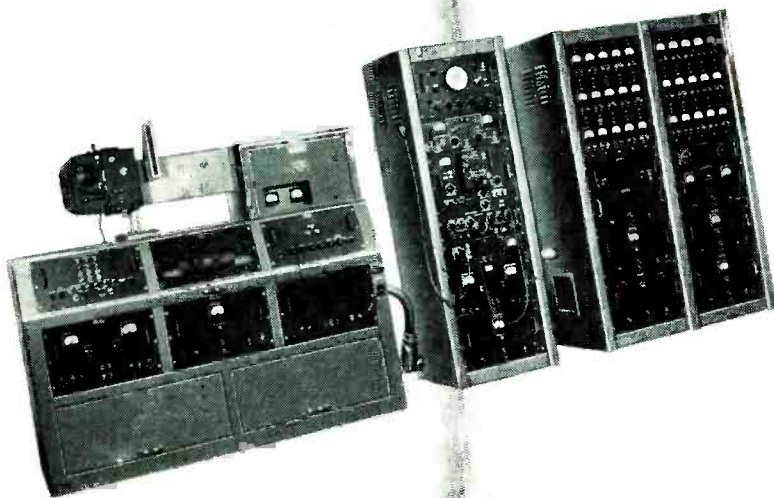

**I**N the Air Material Command's guided missile research at Alamogordo, N. M., transmitters in the airborne units, operating on a pulse system modulated with reference to time, send out pertinent data on temperature, air pressure, speed and structural strains. The signals are received by the ground telemetering system shown at the left.

This ground system uses a total of 29 Sylvania Crystal Diodes—25 1N34's and one 1N38 (Germanium); 3 1N21B's (Silicon). Major reasons for the selection of the Sylvania Diodes are their reliability and accuracy—outstanding advantages of these components *wherever* they are used, but *particularly* important in operation under desert conditions.

Sylvania Crystal Diodes may improve the performance standards of *your* equipment—or permit more compact designs. Get the facts!

*Mail coupon for literature*

Sylvania Electric Products Inc.  
Electronics Division, Dept. E-1002  
500 Fifth Avenue, New York 18, N. Y.

Gentlemen:

*Please send literature on your Germanium and Silicon Diodes.*

Name \_\_\_\_\_

Position \_\_\_\_\_

Company \_\_\_\_\_

Street Address \_\_\_\_\_

City \_\_\_\_\_ State \_\_\_\_\_

**SYLVANIA  
ELECTRIC**

*Electronics Division, 500 Fifth Ave., New York 18, N. Y.*

ELECTRONIC DEVICES; RADIO TUBES; CATHODE RAY TUBES; PHOTOLAMPS;  
FLUORESCENT LAMPS, FIXTURES, WIRING DEVICES, SIGN TUBING; LIGHT BULBS

# are businessmen

## COLD-

## BLOODED?



**OF COURSE NOT!** Literally, their normal body temperature is 98.6—same as laborers, engineers or any other group of people. And, figuratively, they're no more, or no less, cold-blooded—as a group.

We all know unreasonable generalizations can be dangerously false. Common sense and on-the-job experience show us the value of dealing specifically with ideas, problems—and *people*.

Let's not make the big—and costly—mistake, then, of generalizing on religious or racial groups. Adopt and *carry out* these common sense principles:

1. Accept—or reject—people on *their individual worth*.
2. Don't listen to or spread rumors against a race or a religion.
3. Speak up, wherever we are, *against* prejudice. Work for understanding.



*Published in the public interest by:*

# McGraw-Hill Publications

# FREED Instruments & Components

Famous for

- QUALITY
- ACCURACY
- DEPENDABILITY

**NOW AVAILABLE**  
SUB-MINIATURE HERMETICALLY SEALED J.A.N. COMPONENTS FOR SPACE SAVING APPLICATIONS.



Sub-miniature Hi-Q inductors featuring toroid coils — Diameter: 3/8" x 1" high. Hermetically sealed. Compression type terminals.



Sub-miniature hermetically sealed transformers—Diameter: 13/16" x 1" high . . . Glass type terminals.

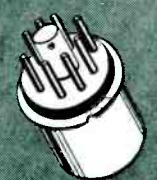

Sub-miniature transformers with octal sockets.  
**ALSO** . . . . .  
MAGNETIC AMPLIFIERS DISCRIMINATORS AND NARROW BAND PASS FILTERS FOR TELEMETERING APPLICATIONS. Send us your requirements.

"PRODUCTS of EXTENSIVE RESEARCH"



## "Q" INDICATOR

No. 1030 **FREQUENCY RANGE:** From 20 cycles to 50 kilocycles. **"Q" RANGE:** From 0.5 to 500. "Q" of inductors can be measured with up to 50 volts across the coil. Indispensable instrument for measurement of "Q" and inductance of coils, "Q" and capacitance of capacitors, dielectric losses, and power factor of insulating materials.

## INCREMENTAL INDUCTANCE BRIDGE

No. 1110 **IMPEDANCE RANGE:** One mh. to 1000 h. in five ranges. Inductance values are read directly from a four dial decade and multiplier switch. This range can be extended to 10,000 henries by the use of an external resistance.  
**INDUCTANCE ACCURACY:** Within plus or minus 1% through the frequency range from 60 to 1000 cycles.



## A NEW LINE OF HIGH FIDELITY OUTPUT TRANSFORMERS

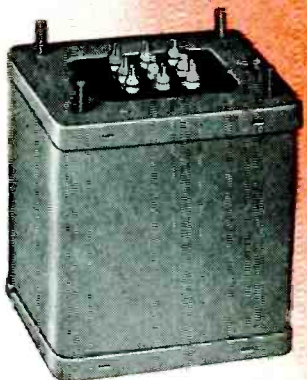

High quality output transformer combines unusually wide frequency range together with very low phase shift and harmonic distortion. Frequency range  $\pm 2$  Db 20-30,000 cycles.

Type No.	Primary matches following typical tubes	Primary Impedance	Secondary Impedance	$\pm 1/2$ db $\pm 1$ cm	Maximum level
F1950	Push pull 2A3's, 6A5G8s, 300A's, 275A's, 6A3's, 6L6's.	5000 ohms	500, 333, 250, 200, 125, 50	20-30000 cycles	15 watts
F1951	Push pull 2A3's, 6A5G8s, 300A's, 275A's, 6A3's, 6L6's.	5000 ohms	30, 20, 15, 10, 7.5, 5, 2.5, 1.2	20-30000 cycles	15 watts
F1954	Push pull 245, 250, 6V6, 42 or 2A5 A prime	8000 ohms	500, 333, 250, 200, 125, 50	20-30000 cycles	15 watts
F1955	Push pull 245, 250, 6V6, 42 or 2A5 A prime	8000 ohms	30, 20, 15, 10, 7.5, 5, 2.5, 1.2	20-30000 cycles	15 watts
F1958	Push pull 6B5, 6A6, 53, 6F6, 59, 79, 89, 6V6, Class B 46, 59	10,000 ohms	500, 333, 250, 200, 125, 50	20-30000 cycles	15 watts
F1959	Push pull 6B5, 6A6, 53, 6F6, 59, 79, 89, 6V6, Class B 46, 59	10,000 ohms	30, 20, 15, 10, 7.5, 5, 2.5, 1.2	20-30000 cycles	15 watts
F1952	Push pull parallel 2A3's, 6A5G's, 300A's, 6A3's, 6L6	2500 ohms	500, 333, 250, 200, 125, 50	20-30000 cycles	36 watts
F1953	Push pull parallel 2A3's, 6A5G's, 300A's, 6A3's, 6L6	2500 ohms	30, 20, 15, 10, 7.5, 5, 2.5, 1.2	20-30000 cycles	36 watts
F1956	Push pull 6L6 or Push pull parallel 6L6	3800 ohms	500, 333, 250, 200, 125, 50	20-30000 cycles	50 watts
F1957	Push pull 6L6 or Push pull parallel 6L6	3800 ohms	30, 20, 15, 10, 7.5, 5, 2.5, 1.2	20-30000 cycles	50 watts

**SEND FOR LATEST CATALOG!**

**FREED TRANSFORMER CO., Inc.**  
DEPT. FE 1718-36 WEIRFIELD ST., (RIDGEWOOD) BROOKLYN 27, NEW YORK

**NEW!**

WITHSTANDS  
 15 G's VIBRATION } while operating  
 25 G's SHOCK }  
 75 G's MECHANICAL SHOCK

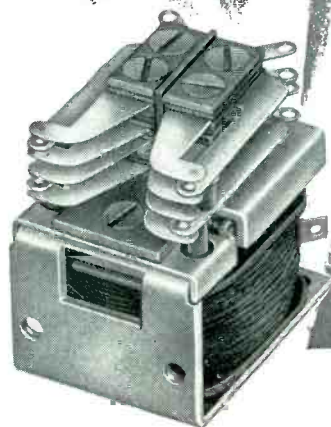
**BALANCED ARMATURE**

for vibration  
 resistance

**CUBICAL FRAME**

for shock  
 resistance

**55% MORE COIL VOLUME**

for lower  
 wattage

**TWIN AIR GAP**

for maximum  
 magnetic efficiency

# STRUTHERS

5,348  
 RELAY TYPES

# DUNN

## Military Type *MINIATURE* *MULTI-POLE D-C RELAY*

Here are miniature, low wattage d-c relays that really stand up under extreme conditions of shock and vibration. False contact operation is avoided without sacrificing desirable electrical characteristics —and at no extra relay cost. Available in any contact arrangement up to 4-pole double-throw. Open, plug-in base, metal encased or hermetically-sealed types. Write for Bulletin L2610.

**STRUTHERS-DUNN, INC.**

150 N. 13th St., Philadelphia 7, Pa.

BALTIMORE • BOSTON • BUFFALO • CHARLOTTE • CHICAGO • CINCINNATI  
 CLEVELAND • DALLAS • DETROIT • KANSAS CITY • LOS ANGELES • MINNE-  
 APOLIS • MONTREAL • NEW ORLEANS • NEW YORK • PHILADELPHIA • PITTS-  
 BURG • ST. LOUIS • SAN FRANCISCO • SEATTLE • SYRACUSE • TORONTO

recorded as an x-ray tube transmits through a predetermined standard, which is equivalent to the x-ray capacity of an average-size normal orange. These two signals are compared, and their difference is used to actuate the classification switches. The classifications are stored in a memory system which initiates a tripping mechanism that catapults the orange into the proper chute. The equipment, which was developed by H. D. Roop of the Automatic X-ray Corp. of Los Angeles, is designed to compensate for out-sized oranges.

**Citizens Radio Range**

IT HAS BEEN HINTED that the vast amount of enthusiastic but somewhat exaggerated publicity that Citizens Radio has received from the newspapers will be harmful when and if production units for operation in these frequencies become available. The Hallicrafters Company has recently conducted some extensive field tests to determine the actual performance that can be expected from what might someday be a typical production model.

The units tested have a power output of approximately 0.3 watt from a 112-volt power source, with a current drain of 15 ma, supplied from midget batteries. The filaments required 6 volts at 250 ma and were also fed from batteries. The units were grid modulated to about 30 percent on peaks, and the antennas used were half-wave folded dipoles, mounted horizontally approximately seven inches above the case. These units could be tilted for horizontal or vertical polarization.

When connected to receive, the audio power output is approximately 5 milliwatts into a single headset, using the same power source for receiving and transmitting, except that the receiver draws only 5 ma. The receiver sensitivity is about 5  $\mu$ v for 3 db quieting of the superregenerative hiss, and a one- $\mu$ v signal is audible.

Table I shows the results of testing two hand-held sets of the type described above. The great influence of height and terrain on per-



*Control panel for use with cascade rectifiers.*

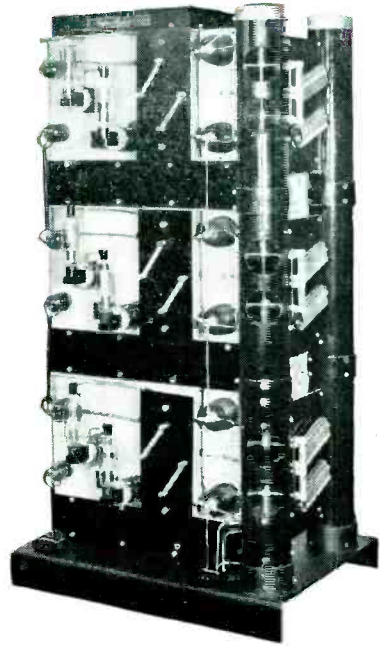

*This cascade rectifier, 60 inches high, delivers 135 kv, 10 milliamps d-c. Consists of three basic Kenotron- $\mu$ -c rectifier units.*

# Now **SMALL RECTIFIERS** **FOR DC VOLTAGES** *up to 135 KV*

New, within the last year, is this small cascade-type rectifier for generating smooth high d-c voltages. Suitable for laboratory and factory for testing and as power supply. Features: versatility, reliability, reasonable price and long tube life with much lower cost of replacement tubes. The rectifiers can be furnished for single-phase operation from 115- or 230-volt, 50- or 60-cycle power supply.

Basic unit is a 35 kv, 32 ma (continuous) rectifier, with necessary transformers mounted in an oil-filled steel tank. Each unit is 34" wide, 25" deep and 21" high. Up to four units can be

stacked, giving d-c voltages up to 135 kv. Output voltage ripple, peak to peak, will not exceed 0.1% per milliampere.

**A CONTROL PANEL** can be supplied which will provide smooth output voltage control over the complete range from zero to maximum. Accuracy of output voltage, with this panel, is  $\pm 5$  per cent of full scale; accuracy of current indication,  $\pm 2$  per cent. Overcurrent protection is included.

**SUITABLE FOR INTEGRAL MOUNTING.** Because of its small size, this rectifier can often be mounted within the en-

closure housing your own product. Such integral mounting is usually preferable from all standpoints—lowers cost, saves space, and improves appearance of the entire assembly.

**STANDARD UNITS, IN REGULAR PRODUCTION.** These cascade rectifiers are built up of standard units that are in regular production. They can be shipped on shorter schedules than are normal for this general class of equipment. *Apparatus Department, General Electric Co., Schenectady 5, N. Y.*

For prices and specific information, address inquiries to our nearest office, or to General Electric Company, Transformer Sales Division, 42-356, Pittsfield, Mass.

# GENERAL ELECTRIC

401-55



## STOPS COMPLAINTS

### because exclusive "component-matching" prevents failures

The sure way to avoid trouble due to resistor failure is to use the resistor with the *matched* components.

Ward Leonard alone *makes*—not just assembles—all the components of a resistor. (Wire is drawn to Ward Leonard specifications.) This means that all components are *balanced* in respect to thermal coefficient of expansion and other factors affecting service life. No loosening, no failure—because all parts react the same to their "environment."

Write for bulletin on Vitrohm Resistors, WARD LEONARD ELECTRIC CO., 31 South Street, Mount Vernon, N. Y. Offices in principal cities of U. S. and Canada.

**WARD LEONARD**  
**ELECTRIC COMPANY**  
*Result-Engineered Controls*

RESISTORS • RHEOSTATS • RELAYS • CONTROL DEVICES



**Table I—Maximum Distances for Two Hand-Held Citizens Band Transceivers**

Height Set A (Feet)	Height Set B (Feet)	Terrain Between Stations	Maximum Distance (Miles)
6	6	Flat, Clear	1.2
6	33	Flat, Clear	2.7
6	6	Heavily Wooded (500-ft deep)	0.5
6	33	Heavily Wooded (Ant 5 ft in clear)	1.2
33	33	Flat, Clear	7
6	6	Entirely Wooded	0.2

formance is clearly demonstrated.

By replacing one of the unit's folded dipoles with a highly directive corner reflector type of antenna the distances covered were increased three times. The distances tabulated hold for both horizontal and vertical polarization on flat terrain, but with the antennas vertically polarized, more consistent signals were produced as the units were separated. It has been calculated that the units tested could transmit and receive over distances of 30 miles between line-of-sight locations.

Using a mobile unit with a car-top-mounted ground plane antenna, and another transmitter which put 15 watts r-f into a corner reflector antenna atop a 75-foot tower, reasonable communications were possible to distances of three miles in a typical residential section, and up to nine miles over less populated areas. Signals were obstructed by large metallic objects such as water tanks, but it was often possible to establish contact by reflected waves.

These experimental data were presented before the Chicago meeting of the Armed Forces Communications Association by Harold Rensch, project engineer of the Hallcrafters Company.

### Photographing Test Patterns

BY LOUIS E. GARNER, JR.  
*Technical Consultant*  
National Radio Institute  
Washington, D. C.

IN PREPARATION of service manuals, lesson texts and similar material, it is desirable to show the effect on picture quality of different receiver



# designers!

This brand-new Armco book, just off the press, tells the technical story of the ten hot-rolled electrical steel grades produced by Armco. Every designer will find it useful in determining the correct grades of electrical steels for all kinds of appliances and equipment.

You'll find typical magnetic characteristics at various inductions, given by curves showing core loss, exciting rms volt-amperes per lb., exciting rms ampere-turns per in., d-c magnetization and permeability and hysteresis loops. Also shown for some grades are reactive volt-amperes per pound, incremental permeability and core loss at high frequencies.

The book also gives the gages and general properties of the various electrical steels. All grades are available in welded coils as well as cut lengths.

Now is a good time to become better acquainted with Armco Electrical Steels. For nearly half a century, Armco Research has pioneered in the creation of silicon steels that can be magnetized with less expenditure of energy and still possess necessary flatness, ease of punching, and adequate interlamination resistance.

Just fill out the coupon and mail for your copy of the helpful new Armco Hot-Rolled Electrical Steel book. We're sure you'll make good use of it. Armco Steel Corporation, 4199 Curtis Street, Middletown, Ohio.

*Export: The Armco International Corporation*

here's a complete new manual on  
Armco Hot-Rolled Electrical Steels

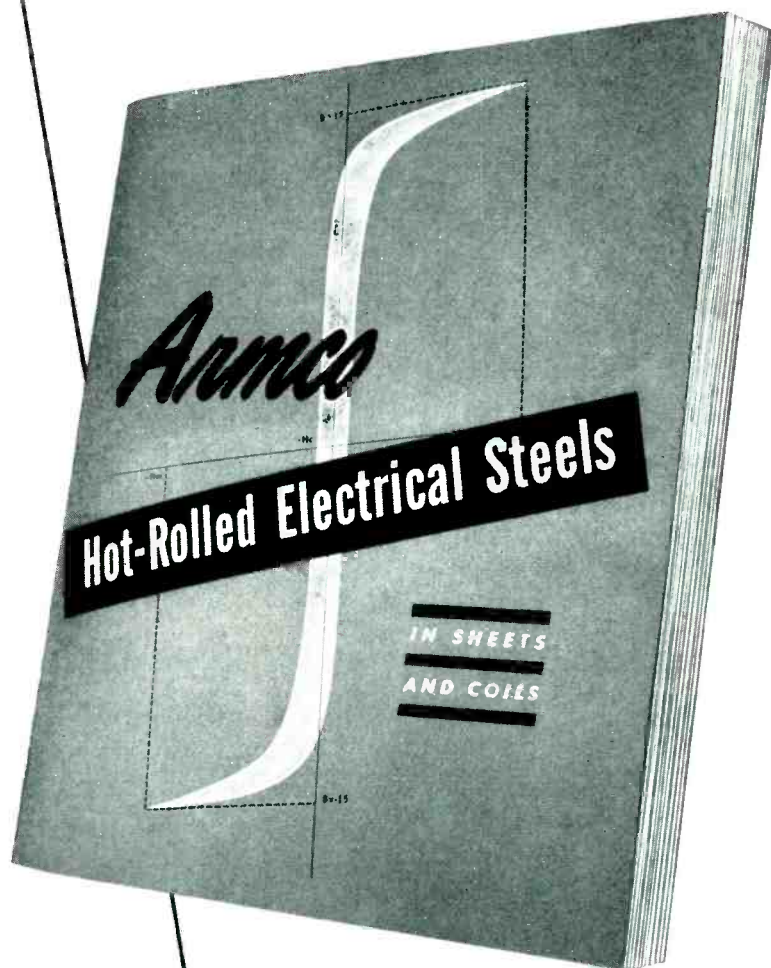

**ARMCO  
STEEL  
CORPORATION**

## MAIL THIS HANDY COUPON

Armco Steel Corporation  
4199 Curtis Street, Middletown, Ohio

Yes, I'd like a copy of Armco's new book on Hot-Rolled Electrical Steels.

Name \_\_\_\_\_

Firm Name \_\_\_\_\_ Position \_\_\_\_\_

Street Address \_\_\_\_\_

City \_\_\_\_\_ Zone \_\_\_\_\_ State \_\_\_\_\_

# NEW VISCOSUS -DAMPED TRANSCRIPTION ARM

Model 108B



Developed by  
**GRAY RESEARCH**

The patented "viscous damping" principle employed in the New GRAY Transcription Arm 108B gives you all these unprecedented features:

First basic advance in tone arm suspension in decades • Absolutely perfect tracking with lowest possible stylus force • Exhaustively PROVED by over a year's constant use • Virtual elimination of tone arm resonances • Damping exactly controlled • No groove-jumping at

fundamental resonances • Prevention of stylus damage due to dropping.

This new arm permits instantaneous change of pickups — 78 to 33.3 or 45 RPM. No counterweights or further adjustments! IT IS IDEAL FOR LP RECORDS. Accommodates all cartridges — Pickering, new GE (short), old GE (long).

Price, less cartridge, \$50.70

## NEW MODEL 603 EQUALIZER

This is the latest of the universally adopted Gray Equalizers used, with Gray Tone Arms, as standard equipment by broadcasting stations. The high-frequency characteristics obtainable comprise 5 steps — flat, high roll-off, NAB, good records, poor records. An auxiliary selector adapts the Equalizer to either Pickering or GE cartridges. Matches pickup to microphone channel.

Price, \$50.70

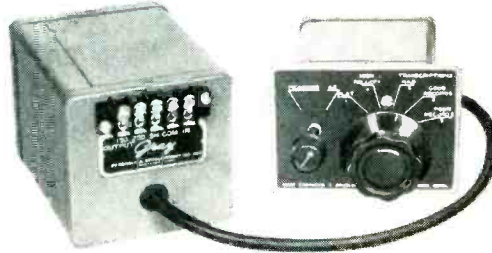

## There's Modern Magic in TV "Staging" and more PROFITABLY VERSATILE TV Broadcasting

### with the New Stage No. 1 and the **GRAY TELOP**

*This most versatile telecasting optical projector enables dual projection with any desired optical dissolve under exact control.*

*The accessory STAGE NUMBER 1 adds three functions separately or simultaneously: a) teletype news strip, b) vertical roll strip and c) revolving stage for small objects.*

*The TELOP, used with TV film cameras, permits instant fading of one object to another, change by lap dissolve or by superimposing. Widest latitude is given program directors for maximum visual interest and increased TV station income.*

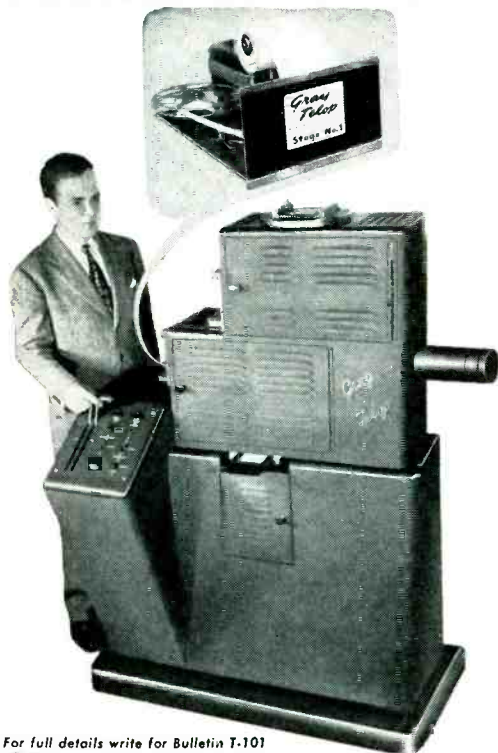

For full details write for Bulletin T-101

**GRAY RESEARCH and Development Co., Inc.**

16 Arbor St., Hartford 1, Conn.

See us at the I.R.E. Show — Booth 134



TUBES AT WORK

(continued)

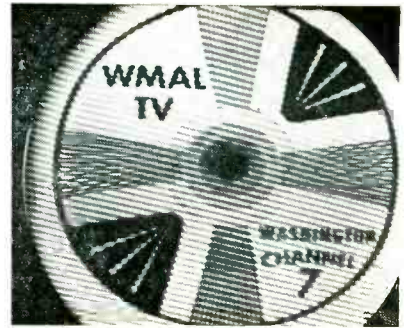

Photograph of beat-frequency interference made by the technique described

defects and interference. Although conventional photographic techniques may be employed, the photographs resulting usually tend to be gray rather than sharp black and white, due to insufficient light for proper film exposure. Since additional white is lost in the process of making half-tones, the resulting illustration may not prove satisfactory.

For this reason, it was decided to develop a special technique for making photographs of tv receiver test patterns. An RCA 630 TS television receiver chassis, using a 10BP4 cathode-ray tube, was chosen as the test receiver. A check was made on the light available, using a DeJur Critic exposure meter. With normal settings of the brilliancy and contrast controls, approximately 3 foot-candles were measured.

To increase the light available, a conventional voltage-doubling circuit, such as is often used in converting this set for operation with a 16AP4 tube, was used to bring the accelerating voltage to 11.5 kv from the normal 8 to 9 kv. Under these conditions, the available light was brought up to between 6 and 8 foot-candles, depending on the test pattern checked. Finally, a type 10FP4 Daylight tube was installed in place of the 10BP4, and the total available light was brought up to about 10 or 12 foot-candles.

To make the photographs, a Busch Pressman Model D 4x5 camera was used. The lens employed was a Wollensak f4.5, 162 mm Raptar (coated). Defender High Speed Pan 428 film was used. Although the indicated aperture was f4.5, the effective aperture was only about f6. Even under these conditions, with the high light level

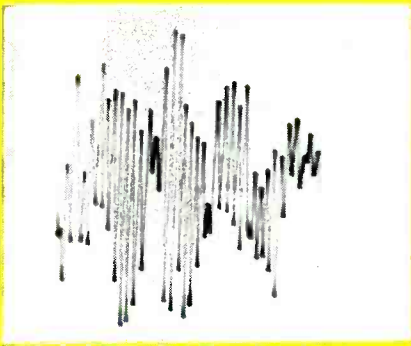

Record of vibration of an oil burner installation during 1/30 of a second, photographed on oscillograph screen.

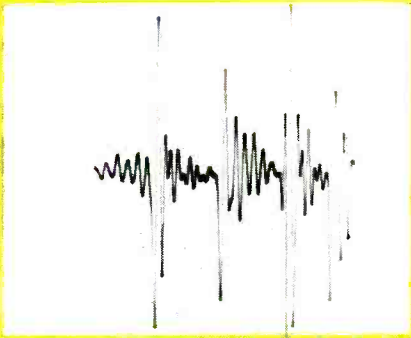

Oscillogram of vertical acceleration at the motor housing of a bench grinder, showing its vibration pattern.

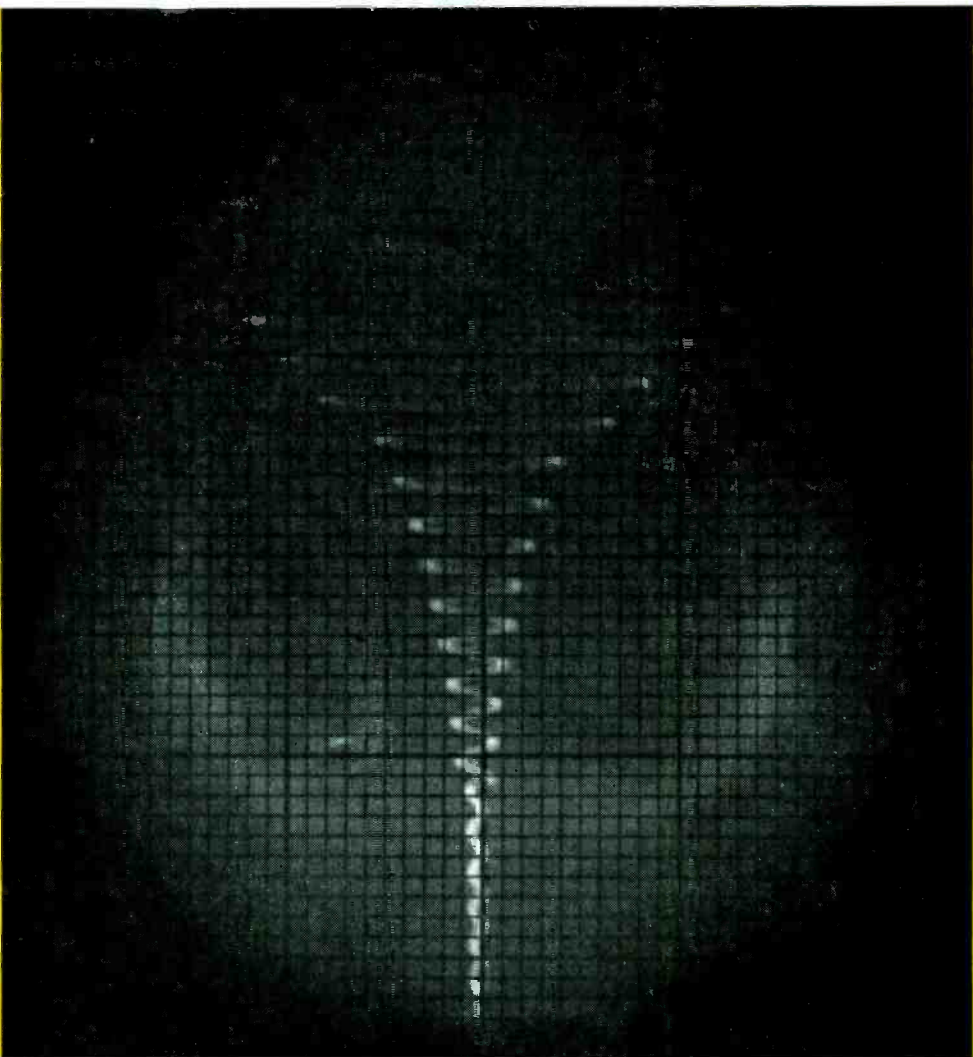

# *Pin down the fleeting*

## oscillograph trace ... by PHOTOGRAPHY

Even the fastest transients leave indisputable evidence for you to study—if you record oscillograph traces photographically.

**FOR CATHODE-RAY OSCILLOGRAPH WORK THERE ARE TWO SPECIAL KODAK FILMS:**

**KODAK LINAGRAPH PAN FILM** for the fastest cathode-ray traces on blue-emitting screens;

**KODAK LINAGRAPH ORTHO FILM** for the most often used cathode-ray tubes—those with green-emitting screens.

OR ... working with slow transients or standing patterns, you may be able to enjoy the convenience of exposing directly on paper—on *Kodak Linagraph 1127 Paper*—with a surface that takes pencil or ink markings.

**EASTMAN KODAK COMPANY**  
Industrial Photographic Division  
ROCHESTER 4, NEW YORK

Relative Speeds of these Linagraph Products				
Type of Film or Paper	Blue Speed		Green Speed	
	Very Short exposure	1/25 sec. exposure	Very Short exposure	1/25 sec. exposure
Kodak Linagraph Pan Film	640	640	125	125
Kodak Linagraph Ortho Film	400	500	125	160
Kodak Linagraph 1127 Paper		250		25

These and other Kodak Linagraph Films and Papers may be obtained from the Kodak Industrial Dealer in your area.

**Kodak**  
TRADE-MARK

# R.F. VOLTMETER

For Measurement of Very Low AC Voltages

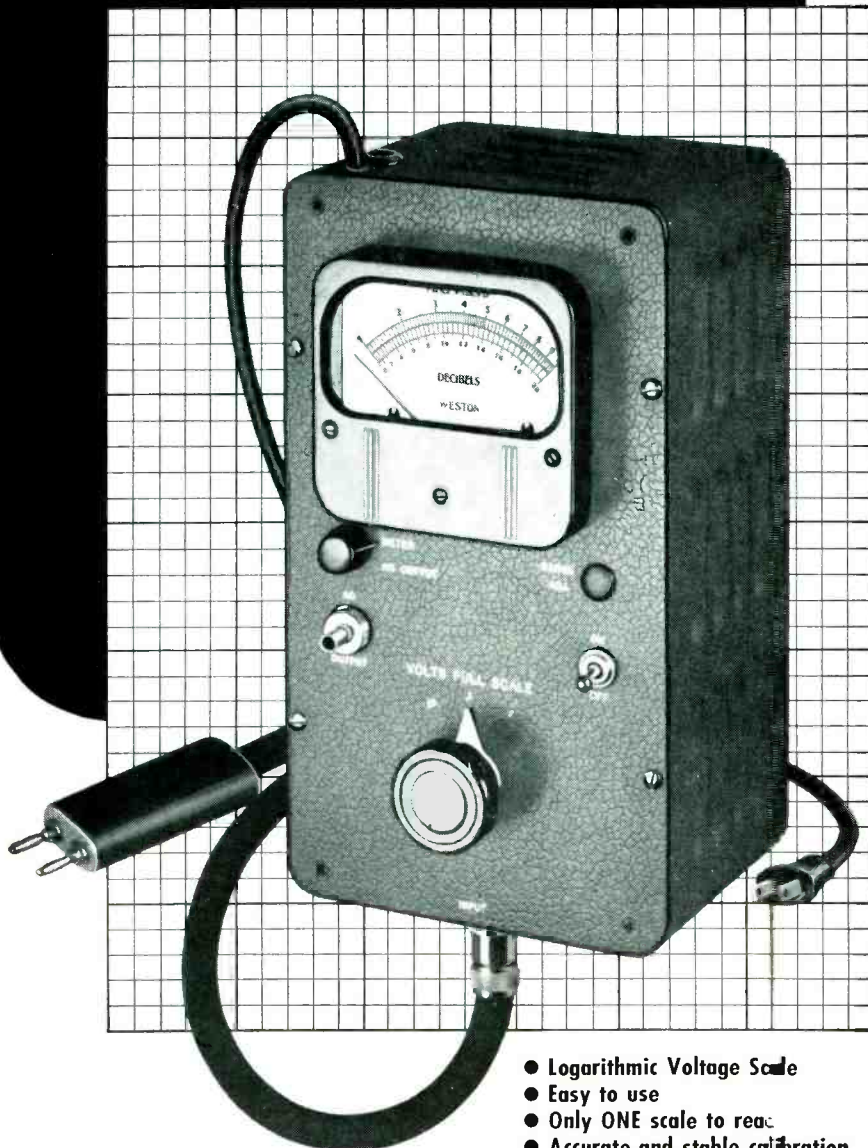

- Logarithmic Voltage Scale
- Easy to use
- Only ONE scale to read
- Accurate and stable calibration

**MODEL 304 R.F. VOLTMETER.** This instrument measures AC voltages over a range of 1 millivolt to 100 volts from 30 cycles to 5.5 megacycles. Probe type input connector attached by a flexible cable provides true indication of voltages at point of origin in circuits. Accuracy of voltmeter readings are within 5%. Input impedance is 1 megohm shunted by 9 mmfds. Can be used as wide-band amplifier. Especially useful for reading millivolts in television and FM intermediate frequency amplifier circuits, RF heating apparatus, carrier current systems and in particular for extending useful frequency range of ordinary oscilloscopes to beyond 5 megacycles.

PRICE . . . \$225.00

In addition to the Model 304 R.F. Voltmeter, Ballantine Laboratories also manufacture AC and Battery Operated Audio Frequency Electronic Voltmeters, Peak to Peak Voltmeters, Geiger-Muller Counter Tubes, and the following accessories—Decade Amplifiers, Multipliers, Precision Shunt Resistors, etc.

**BALLANTINE**   
**LABORATORIES, INC.**  
BOONTON N. J. · U. S. A.

available, it was possible to over-expose the film. The effective aperture may be determined as follows:  $f_{\text{eff}} = fd/l$  focal length, where  $d$  is the distance from the lens to the film.

To avoid blurring of the image, it is best to use a speed equal to the time of one frame (1/30 sec). Many shutters do not have a setting for this speed, however, and 1/25 sec may be used instead. The brightness control should be turned as high as possible before blooming occurs, even though the blacks become slightly gray. This insures extremely bright whites, and the contrast can be returned by making the prints on hard paper.

The illustration gives an example of the technique. It shows a condition of simulated beat-frequency interference with a received tv signal.

## Remote Control by A-F Discrimination

BY ROBERT B. MCNEIL  
*Hastings Instrument Co.  
Hampton, Virginia*

AFTER A CONSIDERATION of the methods employed in the past for the remote control of electronic apparatus, it was found possible to devise a system which would have a bandwidth no greater than that normally used for amplitude-modulated communication, together with a considerable simplification of the control equipment, without sacrificing the necessary reliability of operation. With this in mind the remote control system described below was designed. Although this particular assembly is used to control the operation of a Raydist system, its versatility is such that it may easily be adapted to numerous other similar applications for either fixed or mobile use.

In the Raydist installation for radio navigation six relay transmitters, each spaced several miles from the others, are individually remotely switched on and off from either of two master stations operating in their vicinity.

The control equipment comprises a tone-modulated transmitter at each master station, and an ampli-

# Built-in VOLTAGE REGULATION at Moderate Cost

Insure constant plate and filament voltage for your electronic products with standard SOLA "CVE" POWER TRANSFORMERS.

Specify the new SOLA "CVE" Constant Voltage Power Transformers in your circuit design to eliminate the variable of fluctuating line voltage at unusually low cost. Regulation of filament and plate supply is  $\pm 3\%$  at line voltage variations from 100 volts to 130 volts.

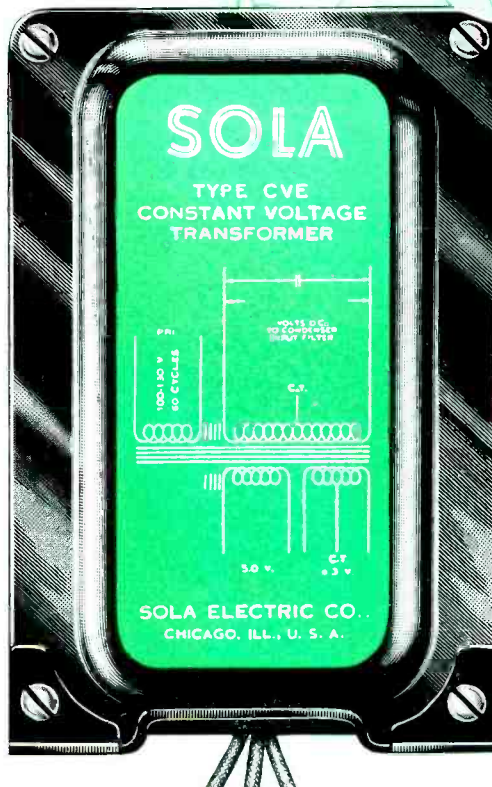

Made under one  
of the following patents:  
2,143,745;  
2,314,433;  
2,348,921  
and Patents Pend.

REGULATION COMPARISON  
SOLA "CVE" Power Transformer—  
Typical Ordinary Power Transformer—

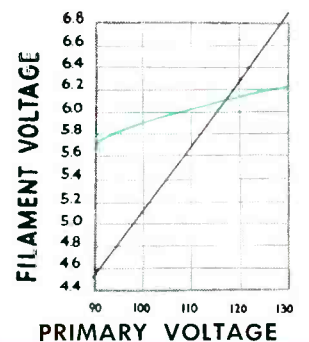
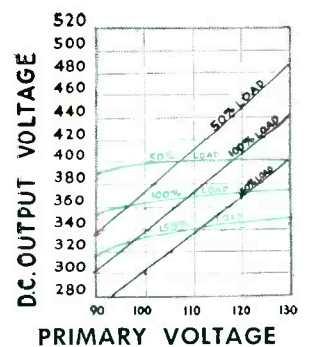

The SOLA "CVE" standard Power Transformers are completely automatic and continuous in regulation . . . have no moving parts or tubes . . . and are self-protecting against short circuit. They are stocked in 42 V.A., 75 V.A. and 210 V.A. capacities to cover most electronic power supply requirements. We invite your inquiries on the application and benefits of the moderately priced "CVE" Constant Voltage Power Transformers to your product.

## SOLA Constant Voltage TRANSFORMERS

"CV" for high precision voltage regulation. "CVE" for regulated electronic power supplies. "CVH" for constant voltage with less than 3% harmonic distortion. "CVA" for constant voltage on television receivers.

Transformers for: Constant Voltage • Cold Cathode Lighting • Airport Lighting • Series Lighting • Fluorescent Lighting • Luminous Tube Signs  
Oil Burner Ignition • X-Ray • Power • Controls • Signal Systems • etc. • SOLA ELECTRIC COMPANY, 4633 W. 16th Street, Chicago 50, Illinois

Manufactured under license by: ENDURANCE ELECTRIC CO., Concord West, N. S. W., Australia • ADVANCE COMPONENTS LTD., Walthamstow, E., England  
UCOA RADIO S.A., Buenos Aires, Argentina • M. C. B. & VERITABLE ALTER, Courbevoie (Seine), France



# Federated ROSIN CORE SOLDER

Look for the orange package . . . the universally popular solder for use in electrical applications where bonding must be secure and free from corrosion.

The flux is in the solder . . . all you need is heat! Federated Rosin Core Solder is available in 1, 5, and 20-pound sizes.



Federated makes every commercial solder . . . Asarco Body Filler Metal, acid-core, solid wire, spray-gun, and bar . . . purity and composition guaranteed by the world's leading supplier of solder.

**Federated METALS**  
 Division of AMERICAN SMELTING AND REFINING COMPANY  
 120 Broadway, New York 5, N. Y.  
 OFFICES IN PRINCIPAL CITIES ACROSS THE NATION



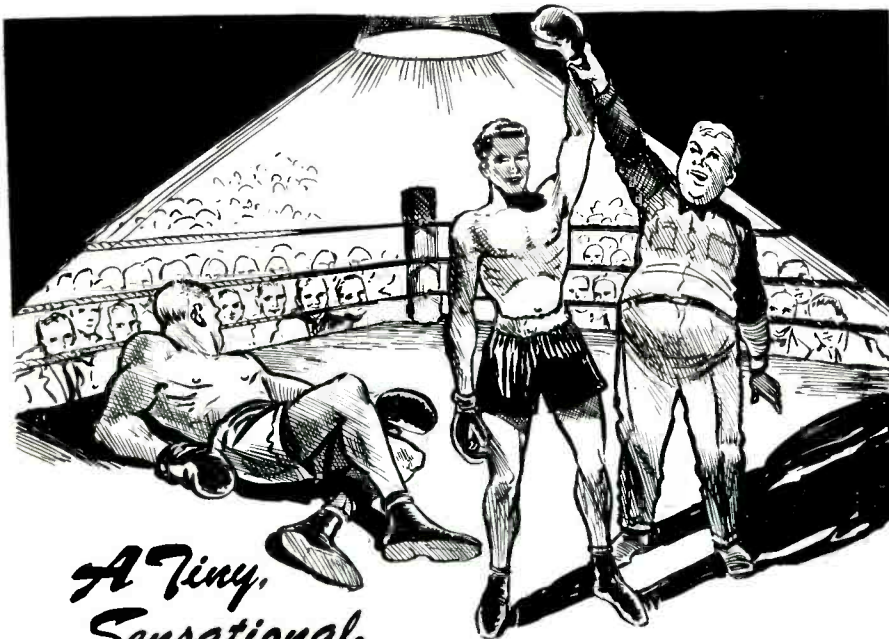

*A Tiny,  
Sensational*  
**NEW LIGHTWEIGHT**  
WITH A LONG LIST OF WINS  
OVER HEAVIES . . . THE NEW  
*Astatic "AC"*  
**CRYSTAL CARTRIDGE**

● If you want to see knockout performance from a miniature pickup cartridge, you are looking for the new Astatic "AC" Series Crystal Cartridge. This tiny unit weighs in at a total of five grams; is approximately 5/16" thick, 1/2" high and 1-1/2" long, not including pins. Yet, when it comes to performance, the "AC" will take on all-comers. Frequency response, particularly in the high frequencies, is truly championship calibre. A new low measure of inertia of the mechanical drive system is chiefly responsible for the full wide range response, excellent tracking characteristics, and assures low needle talk and long life for needle and records.

Employs Astatic's exclusive Taper-Lock Needle, easily changeable without tools. Molded Bakelite housing, with metal mounting brackets (fit standard 1/2" mounting) and needle guards. Available in four models: AC-78 with 3-mil stylus tip, precious metal or sapphire; AC, with 1-mil stylus tip, precious metal or sapphire; AC-AG with new Astatic "ALL-GROOVE" stylus; ACD turnover type, with both 1 and 3-mil point needles. Write for complete details.

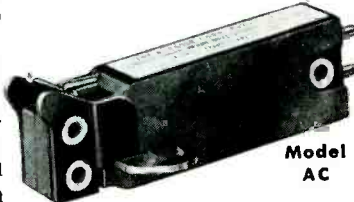
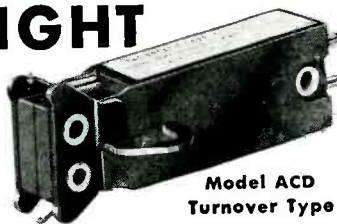

**Changing the Taper-Lock Needle**

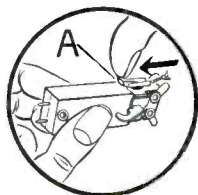

Placing thumbnail against stub at rear of needle (A), simply push in direction of arrow to remove. To insert, fold card, on which new needle comes, along scored line; place narrow end of needle shank in wide end of metal cartridge groove (B) and pull card in direction of arrow.

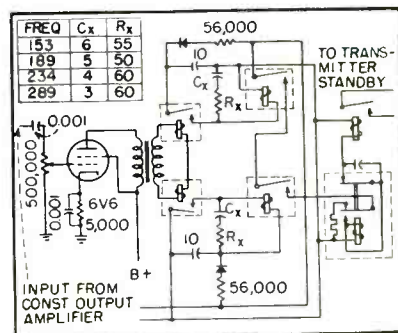
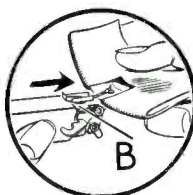

FIG. 2—Two resonant relays are connected in series, so that both of their resonant frequencies must be present in the amplifier output to trip relays

the resonant relays (Fig. 2), which have resonating frequencies corresponding to those of the two audio oscillators in use at the reference transmitter.

The resonant relays close the contacts of the two sensitive relays, which starts the time delay relay's cycle of operation. At the end of its delay period it energizes the ratchet relay which switches the relay station transmitter on or off.

The oscillator units are each composed of four Wien-bridge type oscillators. The circuit shown has been found to be exceedingly stable, having a drift of not more than two or three cycles at the frequencies used over an extended period of time, and is relatively insensitive to temperature and voltage changes. A cathode follower is inserted between each oscillator and the speech amplifier in the modulator unit to further isolate the oscillators from the Class B modulator stage.

In both oscillator units, the four audio oscillators are set to 153, 189, 234 and 289 cps, which correspond to the resonating frequencies of the resonant relays used. Six combinations of two frequencies can be obtained from the four audio oscillators without duplication.

*Auxiliary Equipment*

The modulator unit is of standard design, and may also be used for voice modulation of the reference transmitter.

The receiver at each relay station is also of a standard design, and is used as a part of the Raydist system as well as the remote control system. The constant output amplifier has an output of about two volts

**THE HOME OF  
ASTATIC PRODUCTS**

**THE Astatic CORPORATION**  
CONNEAUT, OHIO

83,196 SQ. FEET OF FLOOR SPACE

Astatic Crystal Devices manufactured under Brush Development Co. patents



# Announcing the G-R SLOTTED LINE

\$ 220<sup>00</sup>



- **Frequency Range** — 300 to 5,000 Mc
- **Detector** — silicon crystal supplied — can be used with receiver — Stub (illustrated) available for tuning crystal
- **Connectors** — G-R Type 874 Coaxial — standing-wave ratio of average connector less than 0.4 db up to 4,000 Mc. This universal connector used on all new G-R U-H-F Measuring Equipment
- **Characteristic Impedance** — 50 ohms
- **Constancy of Probe Coupling** — variations along length of line less than  $\pm 2\frac{1}{2}$  per cent
- **Intermittent Slow-Motion Drive** — disengaged by upward pressure on knob for free sliding, engaged by downward pressure for fine adjustment
- **Completely Adjustable Depth of Probe Penetration**
- **Adjustable Centimeter Scale** — simplifies calculations
- **Accessory Micrometer Vernier** — for measurement of high standing-wave ratios by the "width of minimum" method
- **Very Light Weight** — only 8 lbs.

TYPE 874-LB Slotted Line, with crystal detector	..... \$220.00
TYPE 874-D20 Adjustable Stub	..... 15.00
TYPE 874-LV Micrometer Vernier Attachment	..... 30.00

Write for complete information on the new G-R line of U-H-F Measuring Equipment.

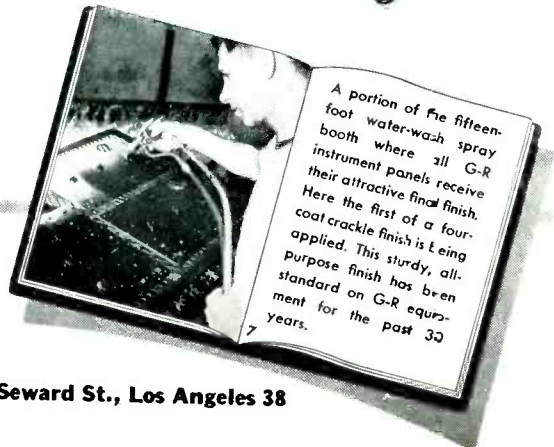

A portion of the fifteen-foot water-wash spray booth where all G-R instrument panels receive their attractive final finish. Here the first of a four-coat crackle finish is being applied. This sturdy, all-purpose finish has been standard on G-R equipment for the past 30 years.



## GENERAL RADIO COMPANY

Cambridge 39, Massachusetts

30 West St., New York 6    920 S. Michigan Ave., Chicago 5    1000 N. Seward St., Los Angeles 38

**Really Smooth—Outstandingly Quiet—Fully Dependable**

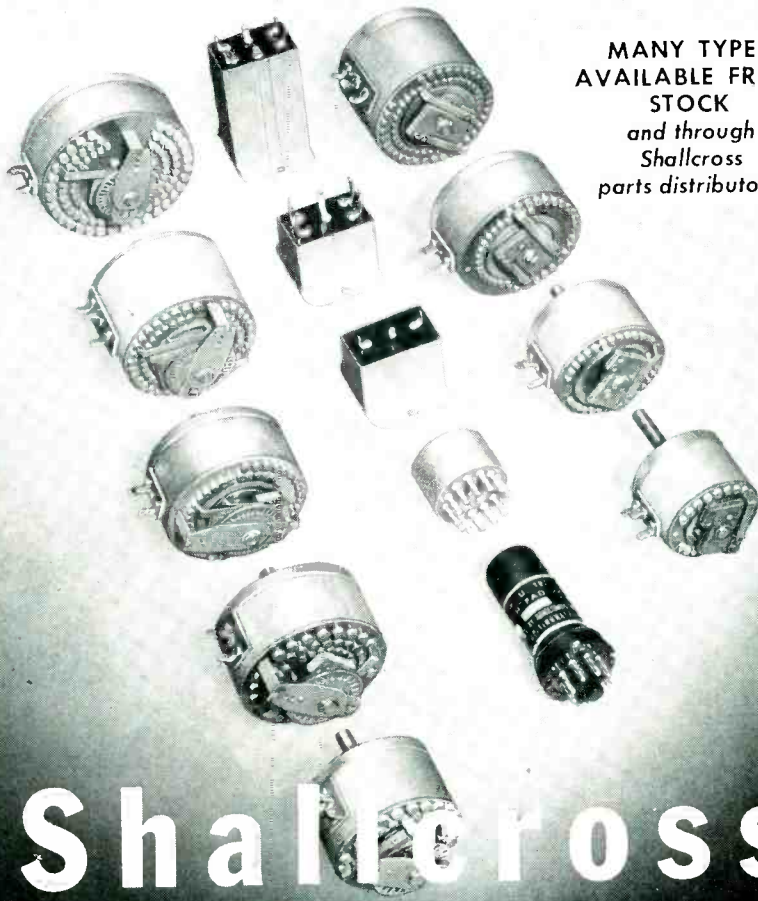

MANY TYPES  
AVAILABLE FROM  
STOCK  
and through  
Shallcross  
parts distributors

# Shallcross *Precision* ATTENUATORS

ALL STANDARD FIXED AND  
VARIABLE TYPES

- LADDER AND BALANCED  
LADDER CONTROLS

- "T" CONTROLS

- BALANCED "H" CONTROLS

- POTENTIOMETERS

- VARIABLE IMPEDANCE  
MATCHING NETWORKS

- V.U. METER RANGE  
EXTENDING ATTENUATORS

- STANDARD AND SPECIAL  
FIXED PADS

- SPECIAL NETWORKS

Perhaps you've noticed how frequently Shallcross attenuators now appear in the finest audio or communications equipment? Or how often they are chosen for replacement purposes?

There's a reason! Improved design, materials and production techniques have resulted in a line that sets new, higher standards of attenuation performance for practically every audio and communications use.

Shallcross Attenuation Engineering Bulletin 4 gladly sent on request.

**Shallcross Manufacturing Co.**  
Dept. E-20 Collingdale, Pa.

**RESISTORS — INSTRUMENTS — SWITCHES — ATTENUATORS**

TUBES AT WORK

(continued)

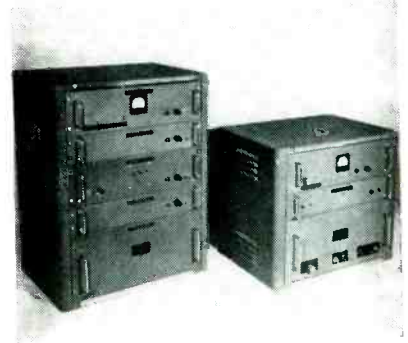

Remote control equipment used to control six relay transmitters used in the Raydist system

with an input of from 0.1 to 100 volts.

The sequence of operation in the relay box shown in Fig. 2 is as follows: The two resonant relays are energized by an incoming signal. These relays use a vibrating reed mechanism, with contacts that are closed only five percent of each cycle, so they are not suitable for direct control purposes. Therefore each is used to control the operation of a sensitive relay whose contacts remain closed as long as its specific resonant relay remains energized. The contacts of the two sensitive relays are connected in series with one another and with the supply voltage for a time delay relay, so that as long as the contacts of both sensitive relays remain closed voltage is applied to the time delay relay. At the end of its cycle its contacts close and voltage appears across the coil of the ratchet relay, which has contacts that close with one operation and open with the next.

The principal reason for using two resonant relays in each unit was to cut to a minimum the possibility that a stray heterodyne or other extraneous signal of the right frequency picked up by the receiver might cause unwanted operation of the apparatus. The time delay relay was incorporated to the same end, inasmuch as atmospheric noise and other signals will sometimes energize the resonant relays and thereby cause the sensitive relays to close momentarily.

Under actual operating conditions, this control system has been found to operate well through interfering signals and noise of such intensity as to make the control signals almost indistinguishable at the

Avedon Manufacturing Corporation, New York City, produce quality jewelry specialties. Recently they decided to try something different in the manufacture of cuff links. Their new product was a set of magnetic cuff links, where the stem was replaced by a magnet assembly. One link was the magnet itself while the second link to which it would attach was the pole plate. In the initial development of these links the various problems of the application were solved by Crucible magnet engineers in cooperation with Avedon.

aspirin size magnet cures cuff link headaches

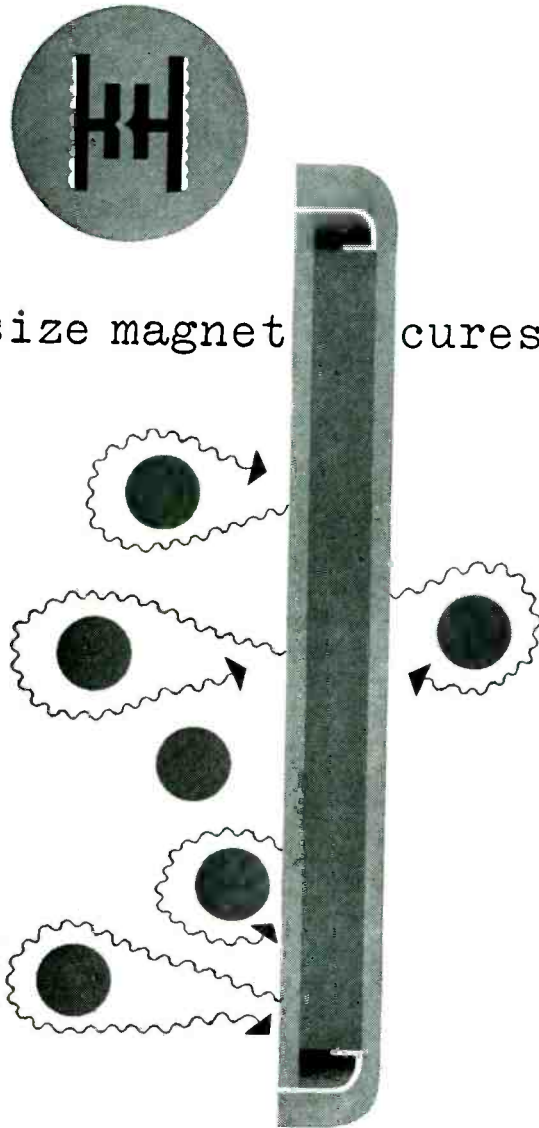

Enlarged cross section view of one link. Steel cover caps magnet.

It was recognized immediately that the best solution for a holding device of this nature was a minute magnet assembly consisting of a tiny Alnico V disc magnet set in an accurately machined stainless steel cup. Details of size and fit were worked out jointly. The disc magnet itself was aspirin size —  $\frac{3}{8}$ " x  $\frac{1}{16}$ ".

The finished assembly had a holding force on the pole plate as high as 80 ounces troy under test. Many men received these fine cuff links as welcomed gifts . . . and the overflow of orders to Avedon attests to the quality and practicability of these cuff links.

Whether your problem is cuff links or magnetrons, Crucible magnet specialists offer you a background of 50 years of magnet experience. Your magnet problem will receive the careful attention that has made Crucible the leader in the specialty steel field. **CRUCIBLE STEEL COMPANY OF AMERICA**, Chrysler Bldg., New York 17, New York.

**CRUCIBLE** first name in special purpose steels

**PERMANENT ALNICO MAGNETS**

STAINLESS • HIGH SPEED • TOOL • ALLOY • MACHINERY • SPECIAL PURPOSE • STEELS

ELECTRONICS — February, 1950

# DAVEN

## PORTABLE ATTENUATION NETWORKS

The ELECTRONIC  
INDUSTRY'S STANDARD

These secondary standards of attenuation are designed for use in general laboratory and production testing, where ease of operation and reliability are important. An outstanding feature of these units is the use of "plug-in" impedance adjusting fixed pads on both input and output. Thus, either, or both, input and output terminal impedances can be readily altered by inserting the proper fixed network.

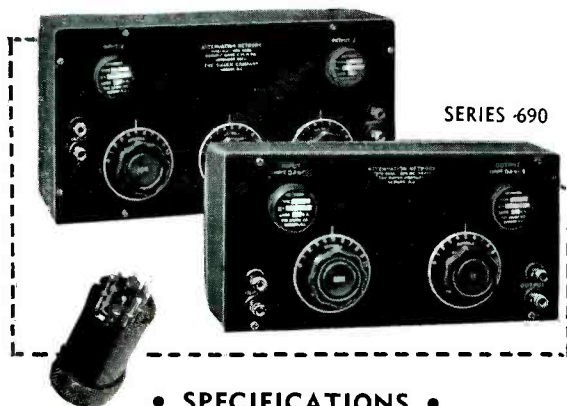

### • SPECIFICATIONS •

- **CIRCUITS:** "T" or "Balanced H".
- **IMPEDANCES:** Three base impedances of 150, 500, and 600 are available; however, input and output impedances may be changed by varying the "plug-in" pads.
- **ACCURACY:** Resistors are calibrated to  $\pm 1\%$ . Greater accuracy on request.
- **ATTENUATION RANGE:**  
2 dial models—0 to 110 DB in steps of 1 DB.  
3 dial models—0 to 111 DB in steps of 0.1 DB.
- **FREQUENCY RANGE:** 0 to 50,000 cycles. Other models available to 200 KC.
- **MOUNTING:**  
Portable models in hand rubbed walnut cabinets.  
Rack models with slip-on metal dust covers.

For further information write to Dept. E-2

THE **DAVEN** CO.  
191 CENTRAL AVENUE  
NEWARK 4, NEW JERSEY

TUBES AT WORK

(continued)

relay receivers, and its maximum range is limited only by the distance over which its modulated control signal can be reliably received.

This system was developed and used on equipment furnished under U. S. Navy Contrast NObs 47377 for the Navy Bureau of Ships by the Hastings Instrument Company.

## Simple High-Speed Relay

BY RONALD C. WALKER

Reading, England

THE USE of a flip-flop or scale-of-two counter using two tubes or one tube with a double-triode electrode system for high-speed counting is well established practice, but the use of a single stage scaler for relay switching by a high-speed transient impulse is not so well known. It can provide a useful alternative to a gas-filled triode which is the standard method of switching by microsecond impulses, without the disadvantage of cathode preheating time and the complication necessary to secure sequential switching of the cathode and anode circuits.

In the accompanying circuit the relay, which can be of the usual telephone type, is included in the anode circuit of tube *A* and one of its controlled changeover contacts in the cathode lead of tube *B*.

When switching on it is a matter of chance which anode conducts first so that the pushbutton *P* is momentarily closed to remove the cathode bias of tube *B* and ensure that this tube conducts before the first signal arrives. When a positive impulse of a few microseconds duration comes in, it switches the anode current over from anode *B* to anode *A* and

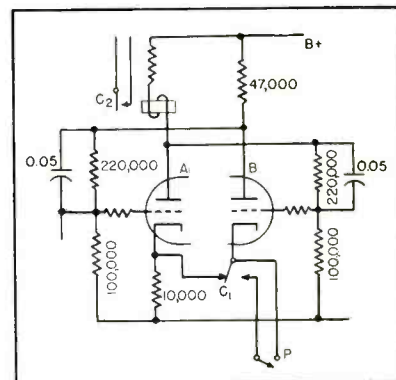

Two 6J5 tubes or a 6SN7 can be used in the relay circuit

# WOR-TV

## CO-AX SPACERS OF "TEFLON"\* HELP ELIMINATE REFLECTIONS . . . INCREASE EFFICIENCY

New spacers of Du Pont "Teflon" boost WOR-tv transmission line efficiency from 66.1% to 76.4%.

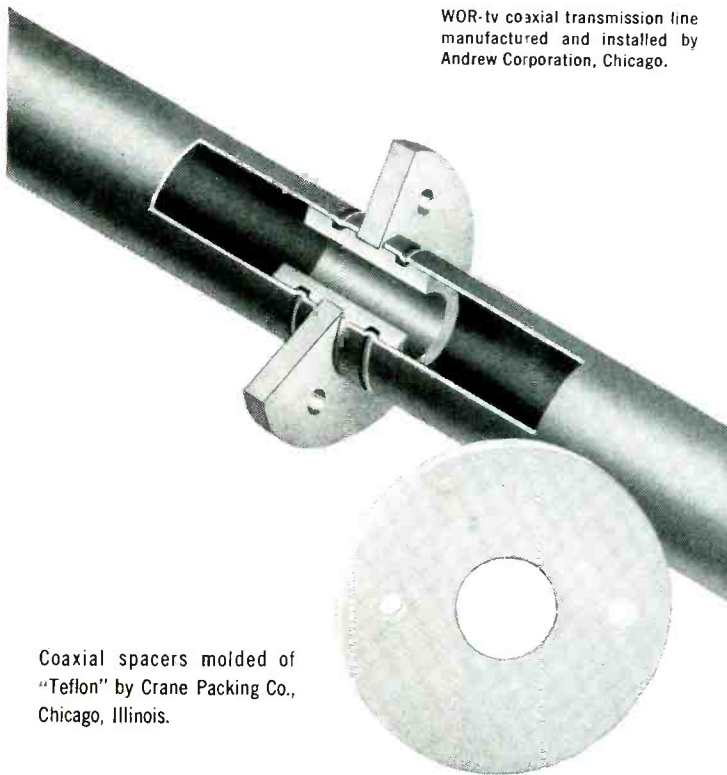

WOR-tv coaxial transmission line manufactured and installed by Andrew Corporation, Chicago.

Coaxial spacers molded of "Teflon" by Crane Packing Co., Chicago, Illinois.



These new coaxial transmission line spacers of Du Pont "Teflon" tetrafluoroethylene resin give WOR-tv the ultimate in efficient performance.

The dielectric constant of "Teflon" (2.0) is only one-third as high as that of ceramic. This simplifies elimination of reflections caused by impedance discontinuities introduced at each insulator.

Total power loss is almost as small as it would be with no insulators at all! Thus, the efficiency of the 850-foot line is boosted from 66.1% for conventional spacers to 76.4% for "Teflon," permitting

the station to operate at a lower power level.

The toughness and resilience of "Teflon," in addition, simplifies installation of the line. And it has the highest heat-resistance (serves up to 500°F.) of all commercial thermoplastics.

"Teflon" is supplied by Du Pont in standard shapes (rods, tubes, sheets and tape). Or we will recommend molders or fabricators who can supply finished parts of "Teflon." Write today for more information. Our technical staff will be glad to help you. E. I. du Pont de Nemours & Co. (Inc.), Poly-

chemicals Department, Plastics Sales Offices: 350 Fifth Ave., New York 1, N. Y.; 7 S. Dearborn St., Chicago 3, Ill.; 845 E. 60th St., Los Angeles, Calif.

\*REG. U. S. PAT. OFF.



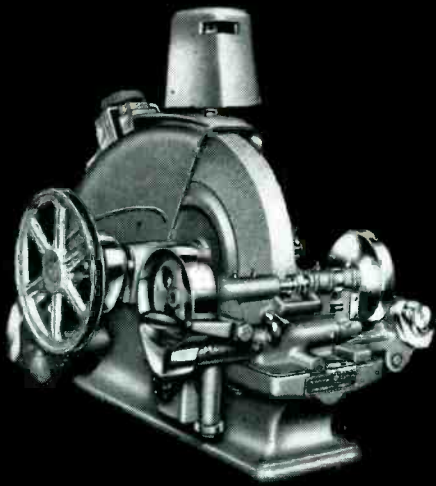

Courtesy American Optical Co.

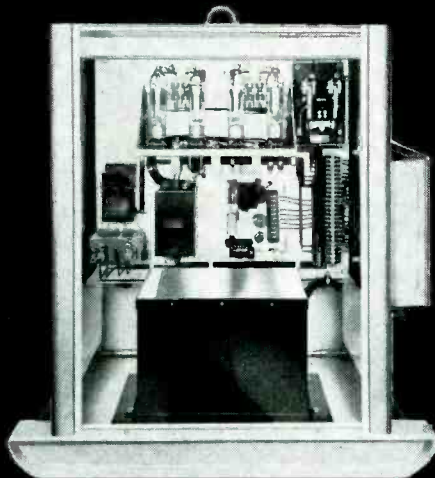

Courtesy Dynamatic Corp.

**ELECTRONS INCORPORATED**  
 127 SUSSEX AVENUE  
 NEWARK, N. J.

*Whether you're edging an eyeglass lens  
 or controlling a 5000 HP oil well brake, you  
 can rely on EL tubes to give you trustworthy  
 service.*

thus actuates the relay closing the controlled circuit through contact  $C_2$ . At the same time contact  $C_1$  changes over to cut out the cathode bias of tube  $B$  and thus switch the current back to anode  $B$ .

In the waiting condition, therefore, the current is always established in tube  $B$ .

The duration of the signal impulse must be short and the rate of repetition switching is set by the time cycle of the relay. The latter can be slugged to secure slow release if the momentary contact which otherwise results is too short to actuate the controlled circuit.

### Deluxe Television Receiver

Two of the most perfect television receivers in the world are used by British Broadcasting Corporation engineers to provide the best possible picture for monitoring purposes.

The specifications necessitated the production of a 20-inch c-r tube which gives a picture 16 by 12 inches. The equipment uses about three times as many tubes as the ordinary domestic receiver and is designed to reproduce a television picture and the associated sound program from a combined picture plus sync signal and an audio signal supplied to it by cable.

Provision is made for accepting video signals in the ranges of 1.0 volt peak to peak  $\pm 6$  db and 10 volts  $\pm 6$  db and for terminating the signal line or not at will. The signal amplifier has a flat frequency response up to 3 mc and is phase-corrected. The scan generator is designed to give deflections which are corrected for all normal errors, including those produced by the geometry of the tube. Steps are also taken to ensure perfect interlacing, even in the presence of interference.

The video amplifier receives the input at 1 or 10 volts and amplifies it to a level sufficient to modulate the c-r tube. There is a preamplifier stage, a gain control stage and an output stage. The preamplifier is separately phase-corrected and is used only for 1-volt input. Impulse interference such as caused by car ignition systems is limited in amplitude to a value just above peak white.

The black level control stage de-



- ★ Compare the style
- ★ Compare the ruggedness
- ★ Compare the performance
- ★ Compare the price

Name the job—there's a Turner Microphone that you can recommend with confidence. Turner crystal, dynamic, velocity, cardioid, and ceramic microphones set the pace for "sound performance"

One of the most popular of all Turner Microphones. The new Model 25. Available as crystal or dynamic.

Model 25X Crystal. List \$27.50.

Model 25D Dynamic. 30, 200, 500 ohms—wired for balanced line. List \$40.00. High impedance—wired single ended. List \$40.00.

**WRITE FOR LITERATURE**



**THE TURNER COMPANY**  
 905 17th Street N. E. • Cedar Rapids, Iowa

**IN CANADA:** Canadian Marconi Co., Ltd., Montreal, P. Q., and branches  
**EXPORT:** Ad. Auriema, Inc., 89 Broad Street, New York 4, N. Y.

*Crystals licensed under patents of the Brush Development Company.*

# LOOK WHAT YOU CAN DO WITH S.S. WHITE FLEXIBLE SHAFTS

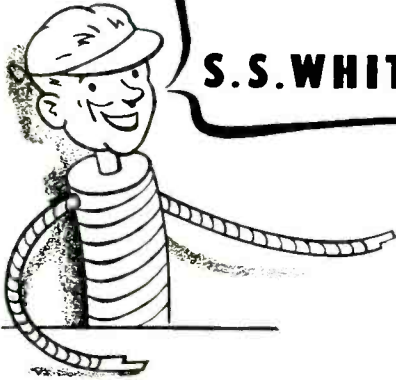

"Engineers and designers will find many valuable uses for S.S. White flexible shafts in the design of electronic and radio equipment. Some cases in point are shown at the right. These smooth turning, readily adaptable mechanical elements come in a wide range of sizes and characteristics and can be supplied to your own specific length requirements."

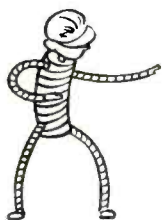

## FLEXIBLE SHAFT FACTS

Bulletin 4501 gives basic details about flexible shafts and describes the principles of their selection and application. Write for your copy today.

**S.S. WHITE INDUSTRIAL DIVISION**  
 THE S. S. WHITE DENTAL MFG. CO. DEPT. E 10 EAST 40th ST., NEW YORK 16, N. Y.



FLEXIBLE SHAFTS AND ACCESSORIES  
 MOLDED PLASTICS PRODUCTS—MOLDED RESISTORS

One of America's AAAA Industrial Enterprises

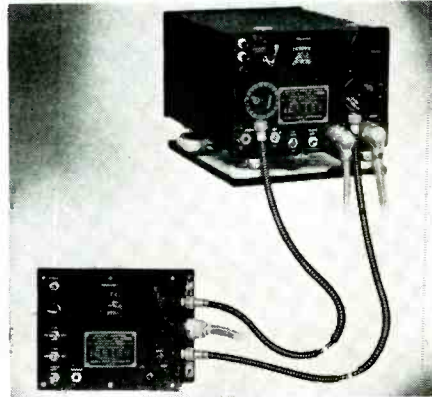

REMOTE CONTROL is easy with S.S. White flexible shafts—regardless of where a part and its control are mounted. Here's how it's done in an aircraft radio.

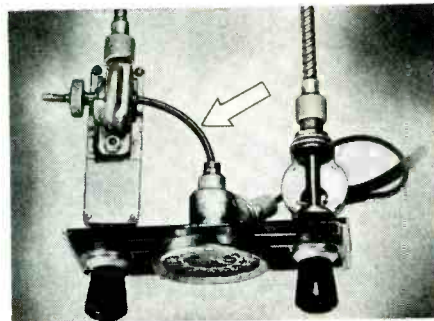

DUAL CONTROL of a variable element and an indicator dial from a single tuning knob is accomplished in this auto radio with two flexible shafts.

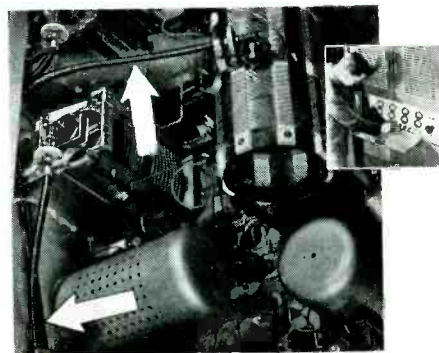

CENTRALIZING CONTROLS for more convenient operation is a simple matter when S.S. White shafts are used to link variable elements to their tuning knobs. This broadcast transmitter provides an excellent example.

rives a correcting signal from the amplified video signal, namely a bias representative of the difference between the true black level of the signal and a reference level. This bias is fed back to the input of the main video amplifier to maintain the correct d-c level. A switching pulse is generated in the sync separator to control the black level stage so that it is only operative during the black porch.

Apart from its normal function, the synchronizing signal separator stage produces a 4-microsecond control pulse for the black level control. Special circuits are used to minimize the effects of impulse interference.

### Sweep Circuits

The line scan generator is split electrically into two main parts, a synchronized pulse generator and a scan generator driven from it. Great care has been taken to ensure that all the errors introduced into the scanning waveform due to losses in the deflector and to tube geometry are corrected to a high degree.

The frame scan generator consists of a pulse generator designed to produce a pulse of constant energy despite small variations in the timing of the sync signal. This pulse is passed to an integrating amplifier which in turn produces the required waveform, again

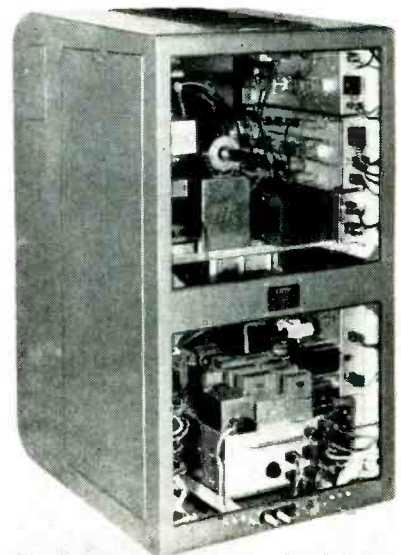

Rear view of deluxe television receiver built by Cinema-Television Ltd. for the BBC



To TV manufacturers!

# Here's Another Milestone in RECTIFIER PROGRESS by *Federal*

Who Pioneered the  
Selenium Rectifier  
for TV Design



450 MA.\*  
Type 1021  
For large consoles

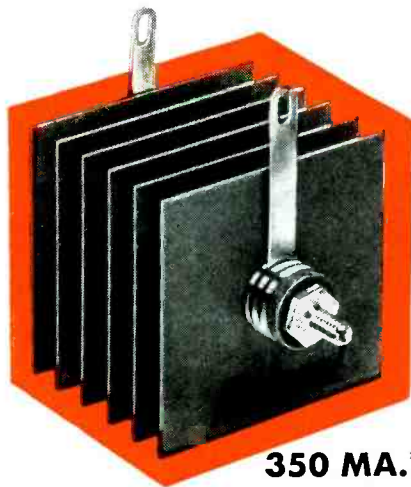

350 MA.\*  
Type 1023  
For large table models  
and small consoles

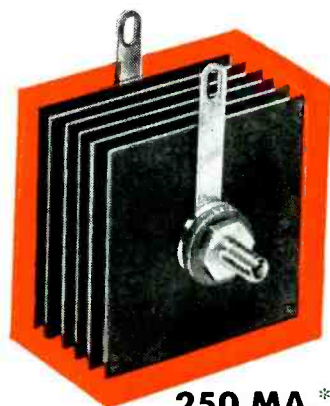

250 MA.\*  
Type 1010  
For small table models

## FEDERAL *Announces*

its "Blocks of Power" . . . Three New Selenium Rectifiers in Ratings to Cover the Full Range of TV Power Requirements with these New Features —



### ALL ALUMINUM

Plates, washers, mounting studs—all aluminum! Same coefficient of expansion under all operating conditions.



### RUGGED CONSTRUCTION

Improved mechanical design, using a one-piece mounting stud, provides a sturdy mechanical assembly that will withstand stress and shock.



### SIMPLIFIED MOUNTING

No need to stock a variety of mounting hardware. Single-end stud with simple nut and washer permits mounting anywhere in any position.



### COOLER OPERATION

Resulting from improved design and production techniques—and even greater quality control of materials.

Federal opened the way to smaller, lighter weight TV receivers. Now Federal goes further . . . provides still further weight saving for receivers of *all* sizes . . . meets all major TV power requirements . . . with new stacks to operate with the higher rated capacitors used in latest TV design. Write today for full information. Address Dept. F-713. \*Ratings shown are typical

*America's Oldest and Largest Manufacturer of Selenium Rectifiers*

## *Federal Telephone and Radio Corporation*



FEDERAL TELECOMMUNICATION LABORATORIES, Nutley, N. J. . . . a unit of I T & T's world-wide research and engineering organization.

SELENIUM and INTELIN DIVISION, 100 Kingsland Road, Clifton, New Jersey

In Canada: Federal Electric Manufacturing Company, Ltd., Montreal, P. Q.  
Export Distributors: International Standard Electric Corp., 67 Broad St., N.Y.



# THE ONLY ONE OF ITS KIND

## FOR PERFORMANCE!

## IN VALUE!

## FOR CONVENIENCE!

### Another great UNIVERSITY FIRST!

- HANDLES 30W CONTINUOUS INTEGRATED PROGRAM MATERIAL
- EASILY ACCESSIBLE, ALWAYS VISIBLE TERMINAL BLOCK
- TAPS MARKED IN BOTH IMPEDANCE AND WATTS
- SHATTERPROOF BAKE-LITE BODY, ENDURINGLY BEAUTIFUL
- SUPER-EFFICIENT "W" SHAPED ALNICO 5 MAGNET



## University

MODEL PA-30

### DRIVER UNIT

— plus BUILT-IN, MULTI-TAP LINE MATCHING TRANSFORMER



These rugged drivers represent the first high power continuous duty, completely waterproof units available with built-in line matching transformers. New type W-shaped Alnico 5 magnets result in the elimination of stray fields and a greater concentration of magnetic energy in the voice coil gap. Exclusive UNIVERSITY "rim centering" assures perfect alignment and concentricity — always. Units may be used with equal facility on constant voltage and constant impedance output systems. Transformer and voice coil terminals are brought out at the bottom of the unit to a terminal block which is an integral part of the molded housing. A translucent cover plate provides ready access to the 16, 165, 250, 500, 1000, 2000 ohm terminals and their equivalent wattages based on 70 volt line.

WRITE DEPT. E FOR ILLUSTRATED CATALOG



## University

### LOUDSPEAKERS INC

80 SO. KENSICO AVE., WHITE PLAINS, N. Y.

Famous World-Wide for LOUDSPEAKERS • DRIVER UNITS • TWEETERS • PORTABLE POWRMIKES

highly corrected as in the line scan generator. A protection unit detects the presence of line and frame scans. Should either fail, it will defocus the cathode-ray beam and remove the high voltage. The latter is rectified r-f potential stabilized at 13 kv. The unit also includes a tube which stabilizes and controls the focus current.

The sound channel has an output of 10 watts into a 12-inch twin-cone loudspeaker. Negative feedback is liberally used.

Care has been taken to shield the picture from stray fields from the main transformers. The receiver can be operated from supplies that are not synchronous with the frame sync frequency.

The deflector system for the c-tube is designed for electron beams of appreciable cross-sectional area and will operate through the normal angle, at the same time introducing minimum distortion. The focus coil has also been designed to handle the large beam.

These receivers have been built by Cinema-Television Ltd. and weigh about 336 pounds. They operate on the normal 405 lines of the BBC system. The quality of the pictures produced is reported as high as that obtained with any other system, even one employing a higher number of lines. This rather suggests that time and money would be better spent in developing the existing system to its full capacity rather than to change over to a higher number of lines with problematical improvement in quality.

—J. H. J.

### Radio Recorded Gunnery

AN AUTOMATIC METHOD for recording hits and misses in gunnery target practice, based on radio transmission of the vibrations set up when a projectile strikes the target, has been developed for use by the British Navy and RAF.

In air-to-ground and air-to-sea operation a microphone and transmitter are installed in the target. The microphone operates when the body with which it is in contact vibrates, transforming the vibration into an electric current. This current triggers a radio transmitter which sends the impulse on to the

These Case Style 40 Capacitors  
are "Sealed-for-Life"

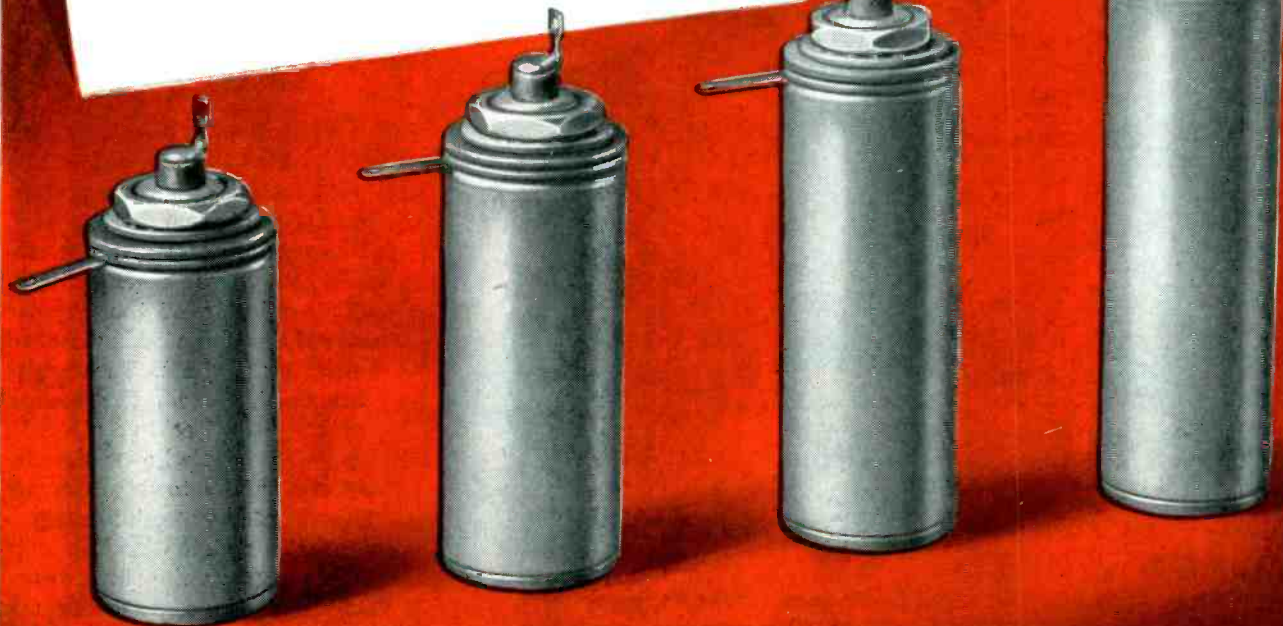

Here is a cylindrical d-c paper-dielectric capacitor that remains positively sealed, regardless of the position in which the unit is mounted. The G-E Case Style 40 utilizes a deep-drawn aluminum case with double-rolled base seams, avoiding solder-seams. The silicone bushing eliminates gaskets, maintains the hermetic seal by compression alone. And beneath the case, these units embody the excellent materials and construction, give the outstanding performance characteristic of General Electric capacitors.

The Case Style 40 capacitor for

direct panel mounting with solder-lug terminals, is built in these ratings:

600 volts—1, 2 and 4  $\mu$  f

1000 volts—1 and 2  $\mu$  f

1500 volts—.25, .5 and 1  $\mu$  f

This is but one case style of a complete line of d-c capacitors made by General Electric to JAN-C-25 Specifications and suitable for both commercial and armed services applications. G-E paper-dielectric capacitors are available in characteristics E (Mineral Oil) or F (Pyranol®) and in case styles 40, 53, 54, 55, 61, 63, 65, 67, 69 and 70. Apparatus Department, General Electric, Schenectady 5, N. Y.

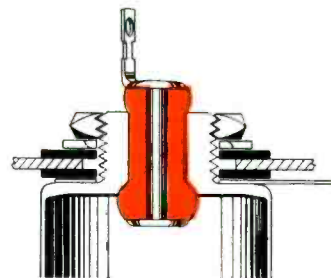

This is how the silicone bushing permanently compression-seals the new G-E Case Style 40 capacitor. Note that the conventional gasket is completely eliminated. This CP-40 can be freely handled with no worries about rupturing its seal.

Please address inquiries to Transformer & Allied Product Div., General Electric Co., Pittsfield, Mass.

GENERAL  ELECTRIC

407-165

Specialty  
Capacitors

FOR

Motors  
Luminous-tube  
transformers  
Fluorescent lamp  
ballasts

Industrial control  
Radio filters  
Radar  
Electronic equipment  
Communication  
systems  
Capacitor discharge  
welding

Flash photography  
Stroboscopic  
equipment  
Television  
Dust precipitators  
Radio interference  
suppression  
Impulse generators

AND MANY OTHER APPLICATIONS

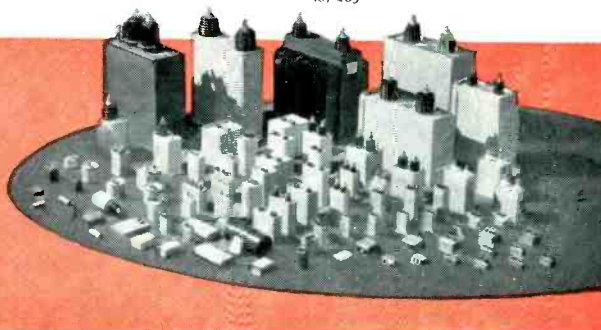

**NEW!**

# STANDARD SIGNAL GENERATOR



**MEASUREMENTS  
Model 82**

## 20 CYCLES TO 50 MC. IN ONE INSTRUMENT!

**T**HIS new Laboratory Standard is designed for the extremely wide frequency coverage of 20 cycles to 50 megacycles, employing two specially designed oscillators.

A low frequency oscillator, in the range from 20 cycles to 200 kilocycles, provides continuously variable, metered output from 0 to 50 volts across 7500 ohms. This is sufficient for most measurements at audio and supersonic frequencies. It may also be used as the modulator for the radio frequency oscillator.

A radio frequency oscillator covers the range from 80 kilocycles to 50 megacycles. It provides metered output, continuously variable with an improved mutual inductance type attenuator, from 0.1 microvolt to 1 volt. This voltage range makes possible most receiver measurements including the determination of a.v.c. characteristics and interference susceptibility.

### SPECIFICATIONS:

**Frequency Range:** 20 cycles to 50 megacycles. (20 cycles to 200 kilocycles in four ranges; 80 kilocycles to 50 megacycles in seven ranges; plus one blank range.)

**Frequency Calibration:** Direct reading dial, individually calibrated for each range.

**Frequency Accuracy:** 20 cycles to 200 kilocycles, accurate to  $\pm 5\%$ . 80 kilocycles to 50 megacycles, accurate to  $\pm 1\%$ .

**Output Voltage and Impedance:** 0 to 50 volts across 7500 ohms from 20 cycles to 200 kilocycles. 0.1 microvolt to 1 volt across 50 ohms over most of the range from 80 kilocycles to 50 megacycles. (Improved mutual inductance type attenuator.) The output voltage or impedance of either range can be changed by the use of external pads.

**Modulation:** (80 KC—50 MC range) Continuously variable from 0 to 50% from 20 cycles to 20 kilocycles by internal low frequency oscillator or external source.

**Harmonic Output:** Less than 1% from 20 cycles to 20 kilocycles; 3% or less from 20 kilocycles to 50 megacycles.

**Leakage and Stray Field:** Less than 1 microvolt from 80 kilocycles to 50 megacycles.

**Power Supply:** 117 volts, 50 to 60 cycles. 75 watts.

**Dimensions:** 15" high x 19" wide x 12" deep, overall.

**Weight:** 50 lbs.

**MEASUREMENTS CORPORATION**  
BOONTON NEW JERSEY



TUBES AT WORK

(continued)

receiving station. The sensitivity of the equipment is so adjusted that only direct hits are recorded and lesser vibration caused by ricochets, debris and acoustic vibrations are of insufficient magnitude to operate the transmitter. The transmission range of the instrument is up to 100 cps which easily covers the field of gunnery today.

### Systems

Two methods of transmission are possible in air-to-air operation. The first system is identical to that of the ground-to-air installations.

In the second system, the microphone is installed in a winged target. Transmission of the impulse is achieved through a cable attached to the towing aircraft. The results are transmitted from the towing aircraft to the attacking aircraft. The use of the cable limits the distance between the towing aircraft and the target since both the transmission cable and the towing cable must be wound on the same drum.

These methods of counting the strikes obtained during an attack are transmitted to a recorder, enabling the pilot to know the quality of his gunnery. It eliminates the former required number of personnel to maintain the targets and to count the possible number of hits.

### Equipment

The microphone is essentially similar to an electromagnetic microphone. As the contacted body vibrates, the case supporting the magnet coils vibrates in sympathy. Lead weights attached to the coils keep them stationary. This relative movement induces a small voltage in the coils which passes to the pre-amplifier stage of the transmitter.

The transmitter is crystal controlled and operates in the vhf range. It uses a crystal oscillator connected in a modified Pierce circuit, the anode circuit of which is tuned to the crystal's second harmonic. Two tripler amplifiers supply output at the 18th harmonic of the crystal. The small signal from the microphone is passed to the grid and cathode ensuring minimum damping of the microphone output. Two further stages of amplification follow. The final stage has two tetrodes in push-pull operation, with the anode circuits containing the

Dials for Zenith Radios and TV sets made of Translucent LAMICOID; instruction panel (not part of receiver shown) is Graphic LAMICOID with the message permanently laminated in the material.

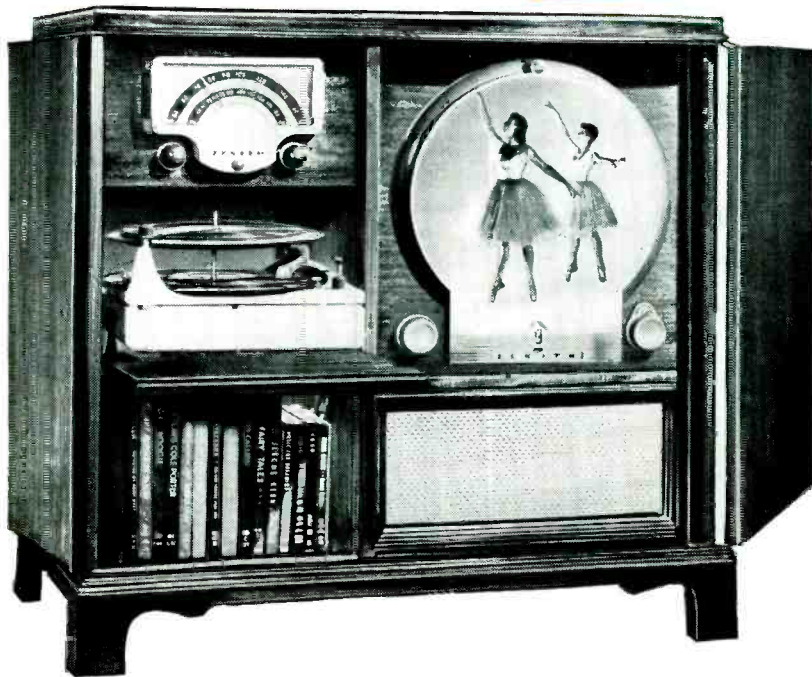

## TRANSLUCENT *Lamicoid*® DIALS

...clear seeing for clear tuning in ZENITH Radio and TV sets

Zenith Radio and TV sets are easier to tune because the Translucent LAMICOID dials are easier to see. Rear illumination suffuses Translucent LAMICOID dials with a soft glow—perfect background for dial markings.

Resistant to heat, Translucent LAMICOID dials won't "brown out" or warp out of shape. Permanent accuracy is assured. This thermosetting laminated plastic resists moisture, oils, greases and dirt. It can be wiped

clean easily with a damp cloth.

All grades of Decorative LAMICOID — Graphic, Translucent and Engraving — are easy to fabricate. Excellent electrical and mechanical properties make LAMICOID ideal for instrument dials, panels, plotting boards, wiring diagrams and other visual devices. Send us the details on your application requirements and we will be glad to make recommendations.



**MICA** *Insulator* **COMPANY**

Schenectady 1, New York



Offices in Principal Cities

LEADING SPECIALISTS IN ELECTRICAL INSULATION FOR OVER 56 YEARS

# How ALLEN HEAD precision fastenings apply to...

## RADIO • TELEVISION • INSTRUMENT AND GENERAL ELECTRICAL MANUFACTURING





For greater strength: Allen  Head Screws permit the use of smaller sizes. For instance a No. 6 Allen  Head Cap Screw is equivalent to a No. 8 conventional screw.



For space economy: Allen  Head Screws permit closer spacing of screws, eliminate projecting heads.





For greater holding power: Allen  Head Screws are insurance against avoidable costly service operations.

In hard-to-reach places: Allen  Head Screws, plus Allen Hex Keys and Drivers start screws easily and save awkward "fingering in."

For fine adjustments, close, snug fit between key and screw permits delicate adjustments that stay put.



For tamper-proof settings in gauges and instruments, Allen  Head Screws can be set below surface and wax sealed.

If vibration is a factor, the precise Class 3 fit of Allen  Head Screws will build longer trouble-free life into the product.

For a ready-made threaded hole, the new Allenut offers greater holding power and positive anchor in soft metals.

Allen  Head Screws are available as standard items in a wide range of sizes ranging upward from No. 4 x 1/8". NC and NF threads. Popular sizes also available in 18-8 non-magnetic stainless steel. Set screws stocked in cup, oval, flat cone and half dog points (full dog, special).

Sold only through leading distributors. Write the factory for technical information or regarding any special requirement.

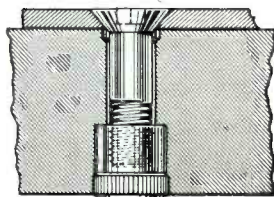

Allenut and Allen Flat Head Cap Screw used to hold thin metal plate to metal base. Allenut has been pressed into counterbored hole. Will not fall out or turn against driving action.

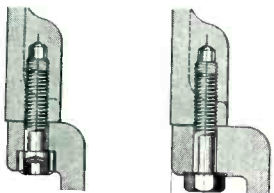

Allen  Head Cap Screws contribute to compact designing. Can be countersunk without allowing for wrench clearance.

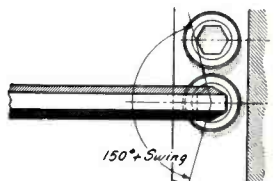

Allen  Heads permit close spacing impossible with conventional heads.

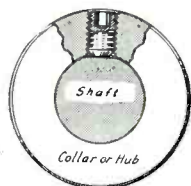

Firm grip without the use of weak slots or projecting heads.



**ALLEN**   
MANUFACTURING COMPANY  
Hartford 2, Connecticut, U. S. A.  
NEW YORK, CLEVELAND, DETROIT, CHICAGO, LOS ANGELES

FOR 40 YEARS THE BUY-WORD FOR SOCKET SCREWS

TUBES AT WORK

(continued)

energizing coils of the relay. This relay keys the crystal oscillator cathode leads.

The recorder is fed from a super-heterodyne receiver consisting of an r-f stage, a mixer, three i-f stages and a triode output tube. Adjustment is made of a variable resistance in the cathode lead of the output triode so that its relay just energizes. With the contacts of the relay open, the supply to a ratchet motor is broken and the motor is displaced one tooth from its original position. Thus pulsed transmissions produced by strikes on the target are used to rotate a pointer in the recorder unit.

### Timing the Ponies

THEY'RE OFF at Hollywood, and their progress around the race track is checked electronically by a recent installation which times the horses at each sixteenth mile. As the field breaks a light beam when they leave the starting gate, the electronic timer begins; and as they pass each 16th mile marker, the elapsed time in minutes, seconds and fifths of seconds is flashed on



Master control board of the horse-race timing equipment installed at the Hollywood Turf Club at Inglewood, California

the tote board, so that the paying customers can determine whether or not their favorites are being paced to advantage.

The photograph shows Norman Arnold, who designed and supervised the installation, beside the master control board. An outline of the track, marked with the various timing positions by check lights, can be seen on the panel.

PRODUCED BY THE MILLIONS

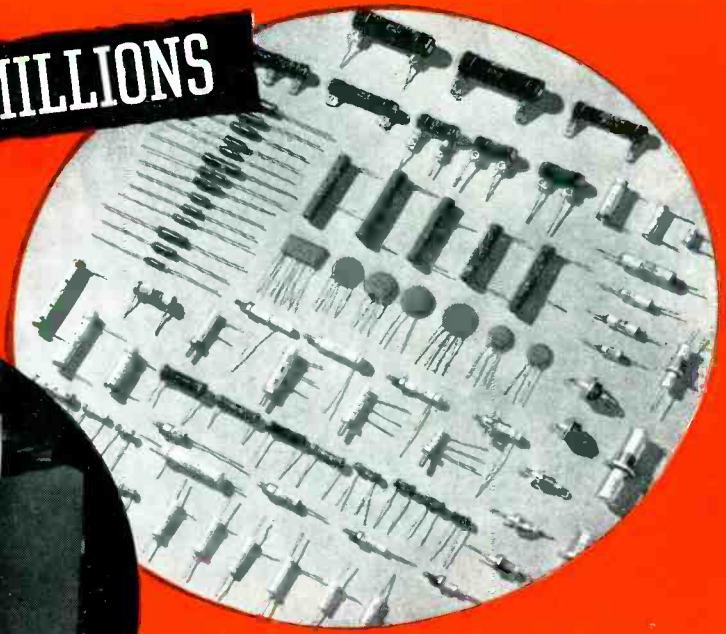

- but all to one standard

# Hi-Q COMPONENTS

Capacitors  
Trimmers • Choke Coils  
Wire Wound Resistors

## BETTER 4 WAYS

- ✓ PRECISION
- ✓ UNIFORMITY
- ✓ DEPENDABILITY
- ✓ MINIATURIZATION

● There is *no* variation in quality or high performance characteristics among the million of **Hi-Q** Components manufactured every month. Strict production control, engineering watchfulness and individual testing of every single unit guarantee that each of them maintains the uniform precision standards for which **Hi-Q** has long been noted. This never failing dependability is just one of many reasons why you will find **Hi-Q** Components the best that you can use.

*The new Hi-Q Datalog is almost ready. You are invited to write, reserving an advance copy.*

JOBBERS . . . ADDRESS: Room 1332 . . . 101 Park Avenue, New York, N. Y.

# Hi-Q

## Electrical Reactance Corp.

A DIVISION OF AEROVOX CORP.  
FRANKLINVILLE, N. Y.

SALES OFFICES: New York, Philadelphia,  
Detroit, Chicago, Los Angeles

PLANTS: Franklinville, N. Y., Jessup, Pa.,  
Myrtle Beach, S. C.

EXPORT DEPARTMENT: 15 Moore St., New York 4, N. Y., U. S. A.

# Do you have This Helpful Helipot and Duodial Catalog?

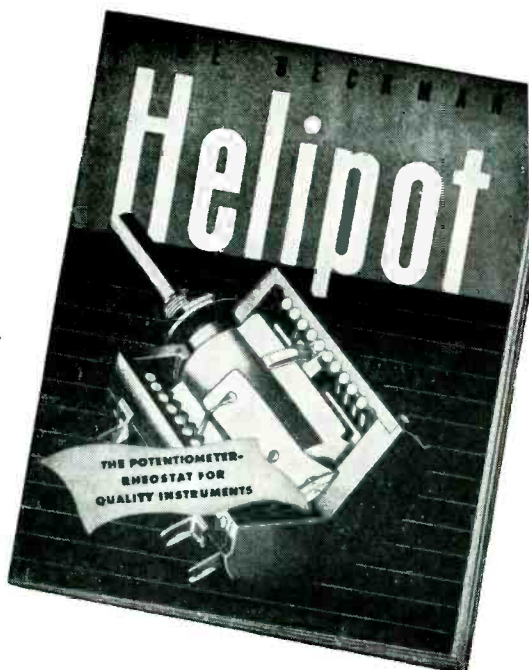

Do you have complete data on the revolutionary new HELIPOT—the helical potentiometer-rheostat that provides many times greater control accuracy at no increase in panel space? . . . or on the equally unique DUODIAL that greatly simplifies turns-indicating applications? If you are designing or manufacturing any type of precision electronic equipment, you should have this helpful catalog in your reference files . . .

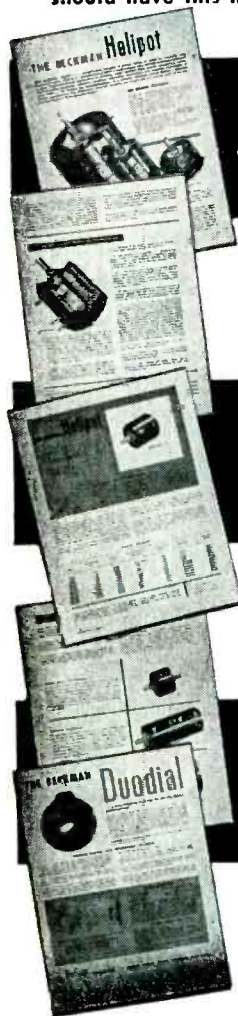

**It Explains**—the unique helical principle of the HELIPOT that compacts almost four feet of precision slide wire into a case only 1 3/4 inches in diameter—over thirty-one feet of precision slide wire into a case only 3 1/4 inches in diameter!

**It Details**—the precision construction features found in the HELIPOT . . . the centerless ground and polished stainless steel shafts—the double bearings that maintain rigid shaft alignment—the positive sliding contact assembly—and many other unique features.

**It Illustrates**—describes and gives full dimensional and electrical data on the many types of HELIPOTS that are available . . . from 3 turn, 1 1/2" diameter sizes to 40 turn, 3" diameter sizes . . . 5 ohms to 500,000 ohms . . . 3 watts to 20 watts. Also Dual and Drum Potentiometers.

**It Describes**—and illustrates the various special HELIPOT designs available—double shaft extensions, multiple assemblies, integral dual units, etc.

**It Gives**—full details on the DUODIAL—the new type turns-indicating dial that is ideal for use with the HELIPOT as well as with many other multiple-turn devices, both electrical and mechanical.

If you use precision electronic components in your equipment and do not have a copy of this helpful Helipot Bulletin in your files, write today for your free copy.

THE Helipot CORPORATION, SOUTH PASADENA 2, CALIF.

## THE ELECTRON ART (continued from p 122)

the size of  $C_1$  will depend on the series inductance of the grid connection inside the tube. This inductance which would tend to produce negative feedback must be overneutralized by  $C_1$  to produce oscillation, or  $1/\omega C_1 > \omega L_g$ .

There are, of course, an infinite number of possible combinations of  $C_1$  and  $L$  for satisfactory working. However, if  $C_1$  is varied in steps and  $L$  is adjusted to give optimum efficiency or maximum output,  $R_g$  and  $R_k$  being left fixed, it is found that within a range of at least 1.5:1  $C_1$  is not critical, provided that  $L_g$  is not appreciable.

The actual value of  $C_1$  may be surprising. For example, using a 2C39 tube as a c-w oscillator at 1,000 mc, about 1,000  $\mu\mu\text{f}$  is needed. At 2,000 mc this becomes 250  $\mu\mu\text{f}$ . Because such high values of capacitances are hard to obtain with circular plates of reasonable size, even using the thinnest polystyrene sheet, series inductances may be built into the grid disc by cutting slots in the form of arcs near the grid connector. Smaller capacitances may then be used at the expense of a reduction in the bandwidth over which a fixed value will work efficiently.

Although in the foregoing no feedback channel other than the one described is assumed to exist, the presence of considerable amounts of feedback due to the internal anode-to-cathode capacitance of the tube can be tolerated. This simply requires that the amount of feedback provided in the external circuit should be smaller in proportion.

### REFERENCE

(1) Hotine, U. S. Patent No. 2,462,866, U. S. Official Gazette, March 1, 1949.

## Square-Wave Keying of Oscillators

BY J. CARL SEDDON  
Naval Research Laboratory  
Washington, D. C.

HIGH peak power oscillators of low duty cycle present a difficult modulating problem if the pulse width is wide or extremely variable. A low-power circuit is illustrated which makes possible square-wave grid modulation of oscillators over a



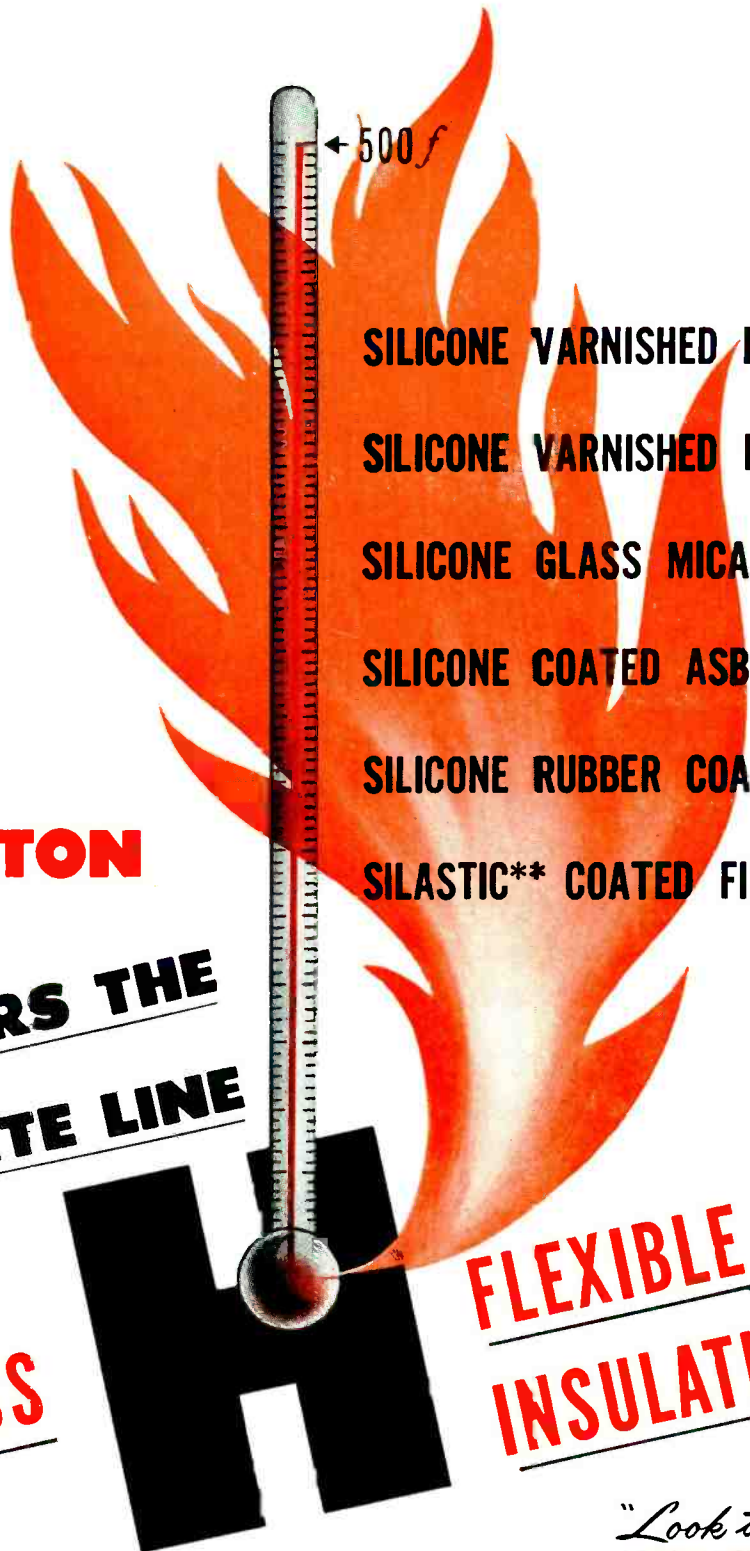

**IRVINGTON**

**OFFERS THE  
COMPLETE LINE**

**OF  
CLASS**

**H**

**FLEXIBLE  
INSULATION**

**SILICONE VARNISHED FIBERGLAS\***

**SILICONE VARNISHED FIBERGLAS\* TUBING**

**SILICONE GLASS MICA**

**SILICONE COATED ASBESTOS**

**SILICONE RUBBER COATED FIBERGLAS\***

**SILASTIC\*\* COATED FIBERGLAS\***

Again Irvington leads the way . . . with the most complete line of Class "H" insulations obtainable. Now, manufacturers faced with high temperature problems can successfully meet each specific requirement from this broad line. Designers, too, faced with the need to design more compactly, or reduce weights, can select insulations exactly suited to their needs. These Irvington Class "H" insulations are furnished in many thicknesses, and widths up to 36". Complete information, and generous samples, gladly furnished on request.

*"Look to Irvington*

*for continued leadership  
in insulation"*



**IRVINGTON**

**VARNISH & INSULATOR CO.**  
**Irvington 11, New Jersey**

\*T. M. Reg. U. S. Pat. Off. by Owens Corning Fiberglas Corp.  
\*\*T. M. Reg. U. S. Pat. Off.

# MOSINEE

*"More than Paper"*



In the field of electronics and the electrical goods industry, MOSINEE is known for its *dependable uniformity*, and its scientifically controlled physical and chemical properties, such as:

Good dielectric strength . . .  
proper softness or stiffness . . .  
high tensile or tear strength . . .  
creped with controlled stretch or flexibility . . . specified pH for maximum-minimum acidity or alkalinity . . . accurate caliper, density, liquid repellency or absorbency.

If you have a fabricating or processing problem involving paper, a discussion with MOSINEE technicians might prove helpful. Please write Dept. E.



MOSINEE PAPER MILLS COMPANY, MOSINEE, WIS.

*"Essential Paper Manufacturers"*

wide range of pulse widths and duty cycle. Only 15 watts average power will control an oscillator capable of giving 7.5 kilowatts peak power output. Pulse widths from 2 to 140,000 microseconds have been used, and this range can easily be extended. The circuit is also useful for obtaining high-voltage video pulses, either negative or positive.

The pulse transformer is useful in applications where pulse widths are not too great. However, if pulse widths are more than about 100 microseconds, the pulse transformer becomes bulky and pulse shape suffers. This is particularly serious when pulse widths are to be variable and coded in some way, such as two or three closely-spaced pulses of variable widths and spacing. The circuit described in this paper is practically independent of pulse widths and operates with a minimum of power required.

### Basic Keyer Circuit

The circuit in Fig. 1 will square-wave key a grid-controlled oscillator, but requires considerable power

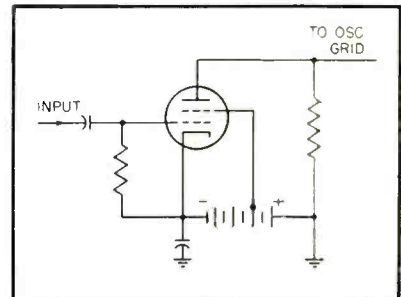
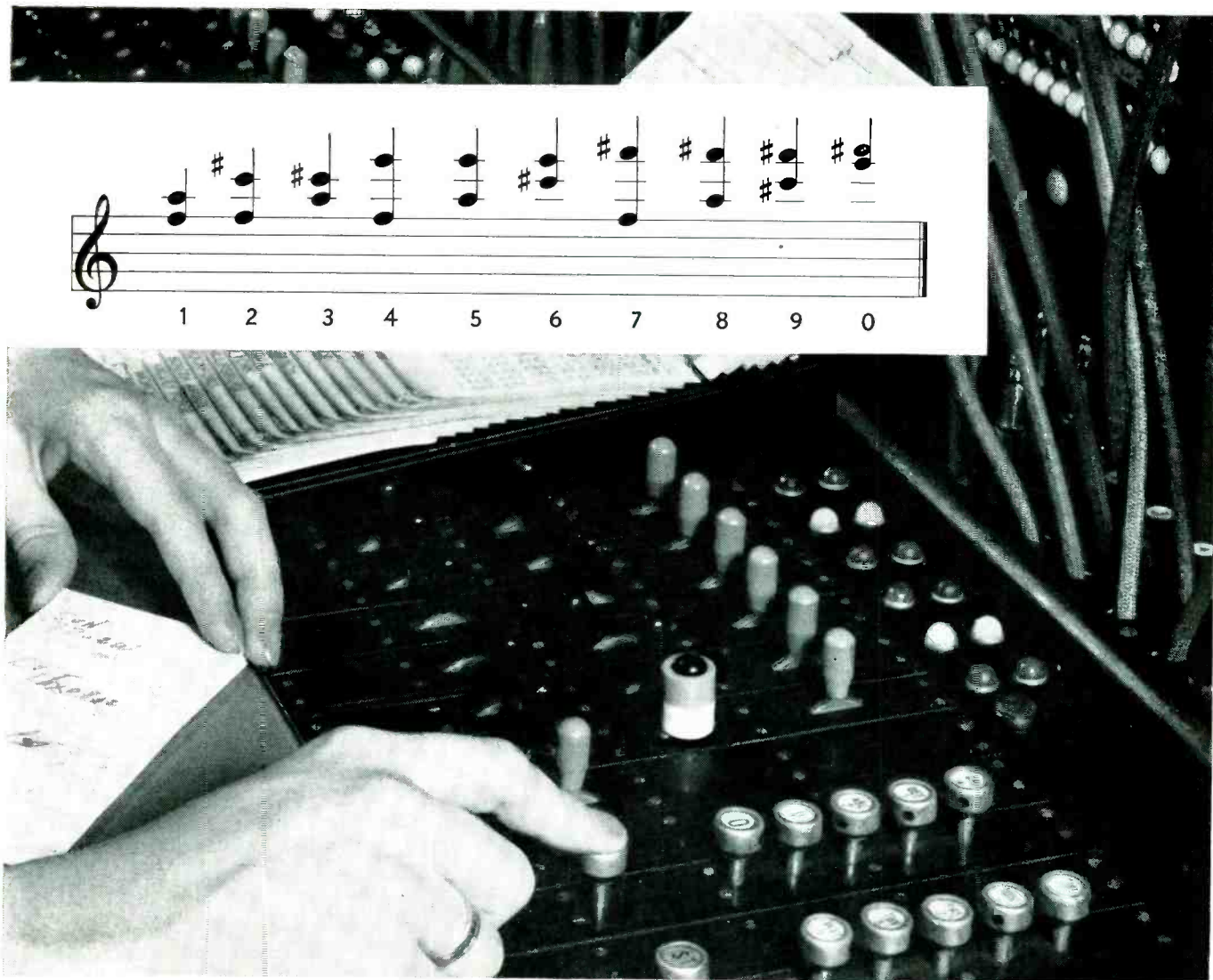

FIG. 1—Basic arrangement for square-wave keying of an oscillator

if the duty cycle is low. If there is no pulse at the grid of this tube, the plate potential will be considerably negative with respect to ground potential, and the oscillator will be kept cut off. When a negative pulse is applied to the tube, the plate will rise rapidly to ground potential. The oscillator will then oscillate. At the end of the pulse, the tube becomes conducting and the plate goes more negative, thus shutting off the oscillator.

Plate potential must be considerably more negative than that required to merely keep the oscillator cut off. As the plate resistor cannot be increased, because of the fact



Above is the Bell System's new "musical keyboard." Insert shows the digits of telephone numbers in musical notation, just as they are sent across country.

## *Playing a tune for a telephone number*

Before you talk over some of the new Bell System long distance circuits, your operator presses keys like those shown above, one for each digit in the number of the telephone you are calling. Each key sends out a pair of tones, literally setting the number to music.

In the community you are calling, these tones activate the dial telephone system, to give you the number you want. It is as though the operator reached clear across the country and dialed the number for you.

This system, one of the newest developments of Bell Telephone Laboratories, is already in use on hundreds of long distance lines radiating from Chicago, Cleveland, New York, Oakland and Philadelphia, and between a number of other communities.

It will be extended steadily in other parts of the country — a growing example of the way Bell Telephone Laboratories are ever finding new ways to give you better, faster telephone service.

**BELL TELEPHONE LABORATORIES**

Exploring and inventing, devising and perfecting, for continued improvements and economies in telephone service



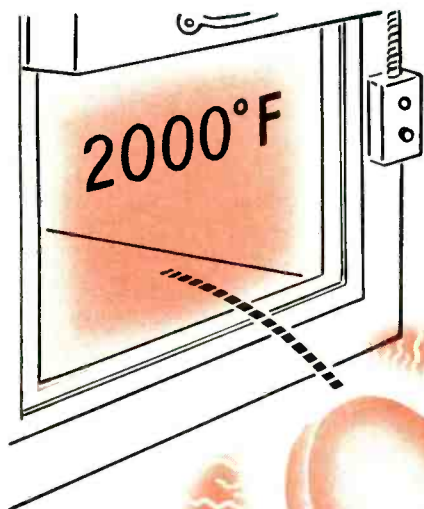

Here's the answer  
to problems of  
**EXTREME  
THERMAL  
SHOCK**

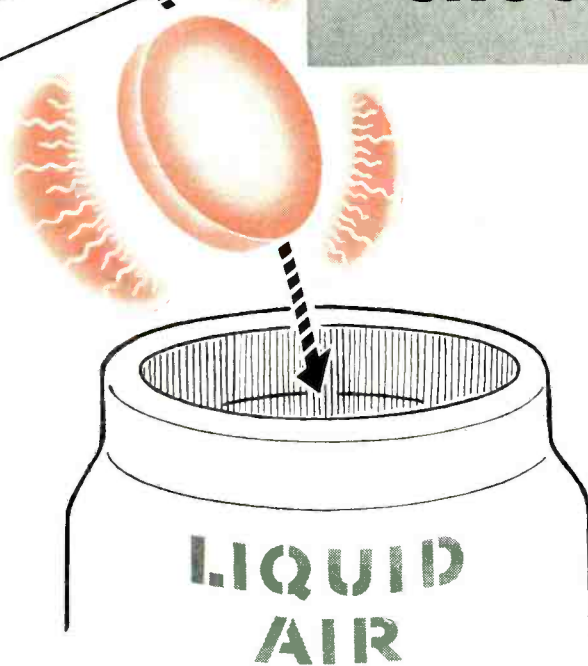

# ROUGH TREATMENT.

but it didn't harm

# STUPALITH!

This new Stupakoff Ceramic demonstrated its exceptional resistance to thermal shock, when a specimen was heated to 2000° F, and:

- plunged into ice water—100 cycles:
  - plunged into dry ice—100 cycles:
  - plunged into liquid air—100 cycles:
- with no failure and no apparent damage!

STUPALITH designates a group

of Stupakoff Ceramics which may be formulated and processed to possess Zero, Low Positive and Low Negative Expansivities. Stupalith is formed just like other ceramics, by pressing, extrusion and casting, and may be machined or ground to precision tolerances. Maximum use temperature 1200° C (2192° F).

Write for Bulletin 849, giving full details.

**STUPAKOFF CERAMIC and MANUFACTURING CO.**

Telephone LATROBE 1400 • LATROBE, PA.

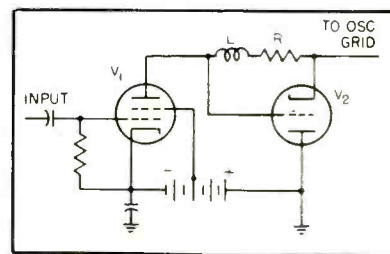

FIG. 2—Economical square-wave keyer circuit using triode as plate resistance

that it acts as the grid resistor for the oscillator, there is considerable power dissipation in the tube and resistor.

### Use of Resistance Tube

If the plate resistor is replaced by a vacuum tube, the impedance of the tube can be kept high during nonoperating time and low during operating time. In this way, the bias power required can be reduced by a factor of ten or more. Such a circuit is shown in Fig. 2.

The current flowing through the two tubes in series causes a voltage drop across  $R$  which nearly cuts off  $V_2$ . As  $V_1$  is freely conducting, nearly all of the bias supply voltage is across  $V_2$ . As the tube impedance is high, the total power required is very small.

When  $V_1$  is cut off by a negative pulse,  $L$  forces current through the grid of  $V_2$ , which becomes slightly positive with respect to the cathode. The tube impedance is thus lowered abruptly and the cathode-to-ground capacitance is discharged rapidly, bringing the oscillator grid to ground potential. The oscillator starts oscillating, with its grid current flowing through  $V_2$ . On completion of the negative pulse,  $V_1$  again becomes conducting. This causes the grid of  $V_2$  to drop to nearly the value of the bias supply voltage, thus cutting off  $V_2$ . The cathode of  $V_2$  rapidly goes more negative due to the electron currents flowing in from  $V_1$  and from the oscillator. The oscillator is thus abruptly forced to stop oscillating.

### Performance

This circuit has produced 750-volt positive pulses from 15-volt negative pulses, and has required a maximum of only 15 ma. The rise and decay times were less than one microsecond. Using an 807

# They EXPAND markets for tubes



## VMF SERIES of all-metal fractionating oil-diffusion pumps

Pump	Speed liters per sec. at 1x10 <sup>-4</sup> mm. Hg	Required Fore-pressure microns Hg	Recommended Forepump Capacity liters per sec.	Approximate Wattage
VMF-2	2	100	0.1	85
VMF-5	5	100	0.1	85
VMF-10	10	100	0.1	135
VMF-20	20	100	0.1	200
VMF-50	50	100	0.5	325
VMF-80	60	70	0.5	300
VMF-100	100	100	0.5	375

BETTER vacuum opens new markets for electronic tube manufacturers. It puts longer and longer life into electronic tubes of all kinds. That's good business because it strengthens user confidence in the equipment that employs the tubes. And that's what widens markets for you and your customers.

DPI offers an oil-diffusion vacuum pump with the most economical pumping speed for every port of every exhaust machine—a rugged, compact, inexpensive metal pump that reduces pressures down to 10<sup>-6</sup> mm. Hg and lower. We'll be glad to make specific recommendations.

Or, if you are interested in any other high vacuum application, you'll do well to put your problem up to DPI.

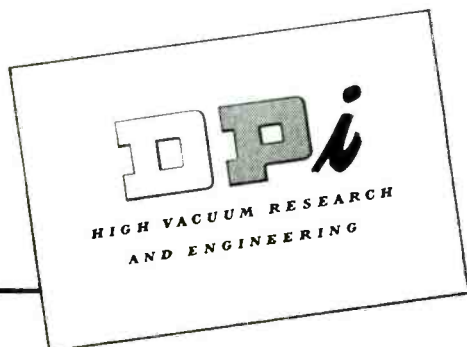

VACUUM EQUIPMENT DEPARTMENT  
**DISTILLATION PRODUCTS** *industries*

727 RIDGE ROAD WEST, ROCHESTER 3, N. Y.  
 Division of Eastman Kodak Company

*Distillers of Oil-Soluble Vitamins and Other Concentrates for Science and Industry; Manufacturers of High Vacuum Equipment.*

**OSCILLOSYNCHROSCOPE**  
Model OL-15B

Designed for maximum usefulness in laboratories doing a variety of research work, this instrument is suited to radar, television, communication, facsimile, and applications involving extremely short pulses or transients. It provides a variety of time bases, triggers, phasing and delay circuits, and extended-range amplifiers in combination with all standard oscilloscope functions.



**THESE FEATURES ARE IMPORTANT TO YOU**

- Extended-range amplifiers: vertical, flat within 3 db 5 cycles to 6 megacycles, full tube deflection; horizontal, flat within 1 db 5 cycle to 1 megacycle.
- High sensitivity: vertical, 0.05 RMS volts per inch; horizontal 0.1 RMS volts per inch.
- Single-sweep triggered time base permits observation of transients or irregular recurring phenomena.
- Variable delay circuit usable with external or internal trigger or separate from scope.
- Sawtooth sweep range covers 5 cycles to 500 kilocycles per second.
- 4,000-volt acceleration gives superior intensity and definition.

For complete data, request Bulletin MO 912

**SWEEP CALIBRATOR**



Model GL-22 A

This versatile source of timing markers provides these requisites for accurate time and frequency measurements with an oscilloscope:

- Positive and negative markers  $\sigma$  0.1, 1.0, 10, and 100 micro-seconds.
  - Marker amplitude variable to 50 volts.
  - Gate having variable width and amplitude for blanking or timing.
  - Trigger generator with positive and negative outputs.
- Further details are given in Bulletin MC-912.

**SQUARE-WAVE MODULATOR AND POWER SUPPLY**



Model TVN-7

Here is the heart of a super high frequency signal generator with square-wave, FM, or pulse modulation. Provides for grid pulse modulation to 60 volts, reflector pulse modulation to 100 volts, square-wave modulation from 600 to 2,500 cycles. Voltage-regulated power supply continuously variable 280-480 or 180-300 volts dc. For additional data and application notes, see Bulletin MM-912.

**STANDING WAVE RATIO METER AND HIGH GAIN AUDIO AMPLIFIER**

Model TAA-16



Ask for your FREE copy of our Brochure illustrating and describing all Browning Products.

- Standing wave voltage ratios are read directly on the panel meter of this sensitive, accurate measuring instrument.
- Frequency range 500 to 5,000 cycles per second.
- Two input channels with separate gain control for each.
- "Wide-band" sensitivity 151 microvolts full scale.
- "Selective" sensitivity 10 microvolts full scale.
- Bolometer/crystal switch adjusts input circuit to signal source.

Write for Bulletin MA-912 containing full details of this useful instrument.

In Canada, address Measurement Engineering Ltd., Arrnprior, Ontario.

EXPORT SALES  
9 ROCKEFELLER PLAZA  
Rm. 1422, New York 20, N. Y.



**BROWNING**  
Laboratories, Inc.  
Winchester, Mass.  
ENGINEERED FOR ENGINEERS

tube in triode connection for  $V_2$ , a one-kilowatt average power output transmitter was square-wave keyed with pulse widths varying from 140,000 to 2 microseconds. The repetition frequency of the 2-microsecond pulses was 200 kc.

A tube having the proper d-c resistance at the operating current must be selected for  $V_2$ . If the tube resistance is somewhat less than that required for the grid resistor of the oscillator, a resistor may be added between the cathode of  $V_1$  and the oscillator grid to make up the difference. This resistor, however, reduces the ability of the circuit to stop the oscillator promptly. This disadvantage can more than be overcome by placing a capacitor across it. The leading edge of the r-f pulse will, however, be considerably greater in magnitude than the trailing edge.

*Improved Control Circuit*

An additional refinement, shown at the right in Fig. 3, will give a nearly flat-topped r-f pulse and con-

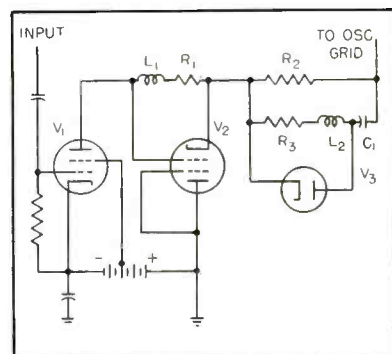

FIG. 3—Square-wave keyer using diode to get improved control

siderable improvement in control of the oscillator. Here  $V_2$  must have a low d-c resistance;  $R_2$  is the amount required to obtain the proper total resistance for the grid of the oscillator,  $C_1$  is a capacitor of at least 10 times the oscillator grid circuit to ground capacitance,  $L_2$  is an inductance whose value depends on the degree of flatness required of the r-f pulse, and  $R_3$  is a resistance of sufficient magnitude to provide more than critical damping for the  $L_2C_1$  circuit.

When the oscillator starts oscillating, the grid current will flow mainly through  $R_3$ , but some will



# METALLIC RECTIFIERS

## — the answer to lower manufacturing costs

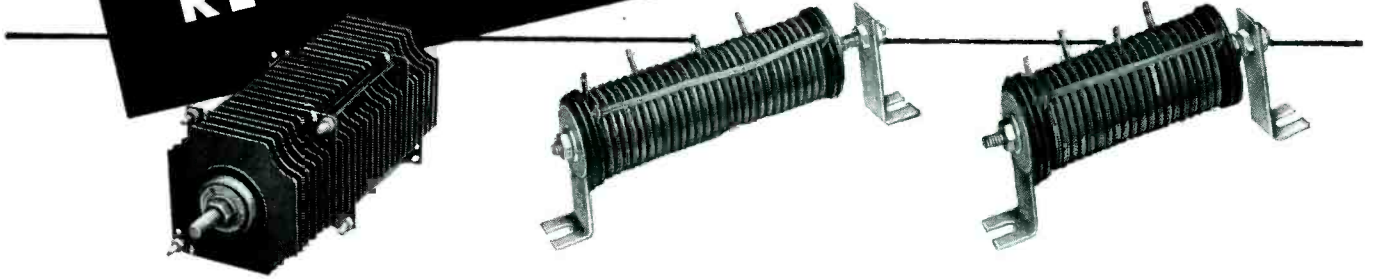

Metallic rectifiers usually offer the lowest cost method of converting ac to dc for many common applications. The list below shows a few of the cases where this has proven to be true. Look over this list; it may show you where you are missing an opportunity for similar savings.

- AC-DC radio power supply
- Acoustic shunts
- Aircraft testing and starting
- Aircraft power supply
- Alternator-rectifier chargers
- Amplidyne circuits
- Annunciators
- Arc suppressor
- Arc welding
- Automotive rectifiers
- Battery chargers
- Battery eliminators
- Beacon flashers
- Beam transmitters
- Burglar alarms
- Business machines
- Calculating machines
- Carbon arc lamps
- Carrier control
- Cathode ray tubes
- Cathodic protection
- Ceilometers
- Chemical testing
- Circuit breaker
- Coin machines
- Diesel electric locomotives
- DC power packs
- DC solenoids
- DC magnets

- Drain for static
- Dynamic speakers
- Electro cleaning
- Electro disassociation
- Electro drainage
- Electro painting
- Electro plating
- Electro precipitation
- Electric hammers
- Electric locomotives
- Electric music instruments
- Elevator brakes
- Elevator controls
- Exciter lamps
- Fence controls
- Field excitation
- Filament supply
- Fire alarms
- Fire control
- Guided missiles
- Gun control
- Hearing aids
- High voltage power supplies
- High voltage cable testing
- Iron lung motors
- Magnetic amplifiers
- Magnetic brakes
- Magnetic separators

- Milling machines
- Model trains
- Motion pictures
- Photo flash power supply
- Plate voltage power supply
- Polarized relays
- Power standby
- Power pack to operate magnetic chucks
- Power pack to operate magnetic separators
- Power pack to operate variable speed motors
- Proximity fuzes
- Radar
- Radio testing
- Radio transmitters
- Radio receivers
- Railway signalling
- Rectifier instruments
- Relays
- Telegraph
- Telephone
- Teletypewriters
- Television
- Temperature controls
- Textile machines
- Time clocks
- Tone generators
- Trackless trolley
- Traffic control
- Trickle chargers
- Truck chargers
- Voltage multipliers
- Voltage regulators
- Vibrators
- X-Ray power supply

If you manufacture any of these or similar products or require small amounts of d-c power in any process, it will pay you to investigate.

Compared to other methods of converting current, metallic rectifiers have lower initial costs, lower installation costs and lower inspection costs.

Some applications require copper-oxide, some low-voltage selenium, and others high-voltage selenium. Each type has its own characteristics, making it a natural for a specific application. To fully meet your needs General Electric makes all three types. If you have a rectifier problem, bring it to us. As we make all types, we play no favorites. You can expect an impartial recommendation. Contact your nearest G-E Apparatus Sales office or write *Apparatus Dept., General Electric Company, Schenectady 5, New York.*

# GENERAL ELECTRIC

461-1

# Press breaks down — but \$2.88 keeps editions rolling



**Press broke down** at 5 P.M., at end of evening edition's run. But this publisher got replacement parts in a hurry the same way he gets electros, mats, news photos — by Air Express. An 18-lb. carton traveled 500 miles, was delivered by 11 P.M. Shipping charge \$2.88. Morning edition published as usual.



**Air Express** is the best air shipping buy to keep any business rolling, since low rates include door-to-door service. Answers your problems because Air Express is *fastest* and *most convenient*.

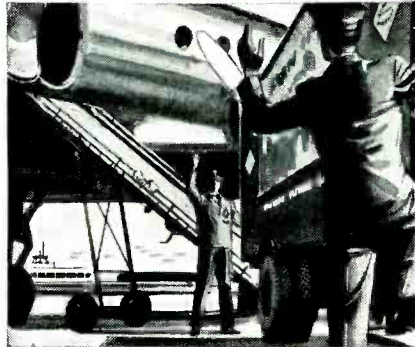

**All Scheduled Airline** flights carry Air Express. So shipments *keep moving*. All business profits from its regular use. Improves customer service; manpower or equipment never stands idle.

## Only Air Express gives you all these advantages

**World's fastest** shipping service.

**Special door-to-door service** at no extra cost.

**One-carrier responsibility** all the way.

**1150 cities** served direct by air; air-rail to 22,000 off-airline offices.

**Experienced Air Express** has handled over 25 million shipments.

Because of these advantages, regular use of Air Express pays. It's your best air shipping buy. For fastest shipping action, phone Air Express Division, Railway Express Agency. (Many low commodity rates in effect. Investigate.)



Rates include pick-up and delivery door to door in all principal towns and cities

A service of  
Railway Express Agency and the

**SCHEDULED AIRLINES of the U.S.**



flow into  $C_1$  which gradually charges up until it has the same potential across it as  $R_2$ . At the end of the pulse, the cathode of  $V_2$  will go more negative. Due to the diode,  $C_1$  will likewise go more negative, as will the oscillator grid. The oscillator can thus be shut off even though the maximum potential across  $V_2$  may be less than the d-c potential on the oscillator grid while oscillating.

### Waveforms

With 807 tubes for  $V_1$  and  $V_2$ , using pentode and triode connections respectively, about 750 volts can be developed across  $V_2$  with an 850-volt power supply. This 750 volts will easily keep two 15E transmitting triodes cut off with more than 10,000 volts on their plates. Figure 4 shows the variation in voltage of the 15E grids during the pulse. The tubes started oscillating before the grid voltage could rise to ground potential. On oscillating, the operating potential was minus 1,100 volts. At the end of the pulse,  $V_2$  drove  $C_1$  sufficiently negative that it was able to drive the oscillator grids negative enough to stop oscillation. The grid potential quickly returned to minus 750 volts.

The right-hand side of Fig. 4 shows the oscillator plate current when two 10-microsecond pulses spaced by 10 microseconds were used. Decreasing the inductance of  $L_2$  will shorten the duration of the hump on the top of the pulse, but will increase its amplitude. The peak output power of the transmitter exceeded 7.5 kw at 750 mc.

### Complete Practical Circuit

Figure 5 shows the complete circuit diagram as used on the trans-

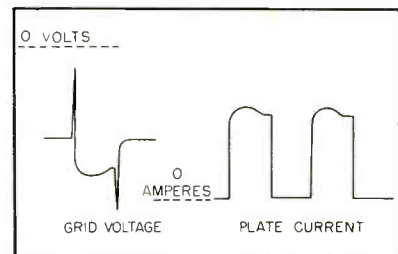
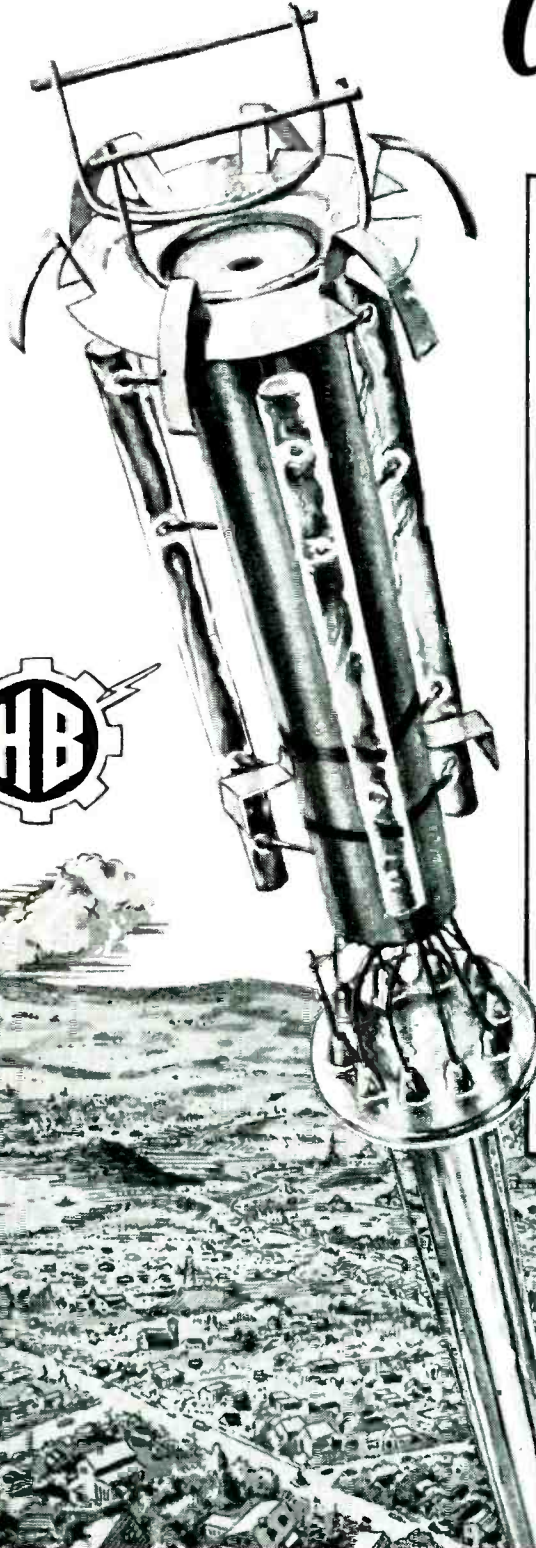

FIG. 4—Typical oscillator oscillograms obtained when circuit of Fig. 3 is used for keying



# HEART

# of the Cathode-Ray Tube!



## The HAYDU Electron Gun

Efficient mass production of today's cathode-ray picture tubes has been one of the outstanding contributors to the phenomenal growth of this new American industry. But no amount of production skill could have made this possible without the precise standardization of tube components such as the gun mount.

Haydu Brothers has made its contribution through the manufacture of more than one third million electron guns, those all-important precision components which are the key to the cathode-ray picture tube — the heart of the television industry.

Look for the rugged, 3-pillar construction, and the imprint, "HB", the identifying mark of superior electron guns.

A few of our many satisfied customers include:

Capehart-Farnsworth Corp.	— Ft. Wayne
Tel-O-Tube Corp.	— Paterson
Thomas Electronics, Inc.	— Passaic
National Video Corp.	— Chicago

**HAYDU BROTHERS**  
PLAINFIELD NEW JERSEY



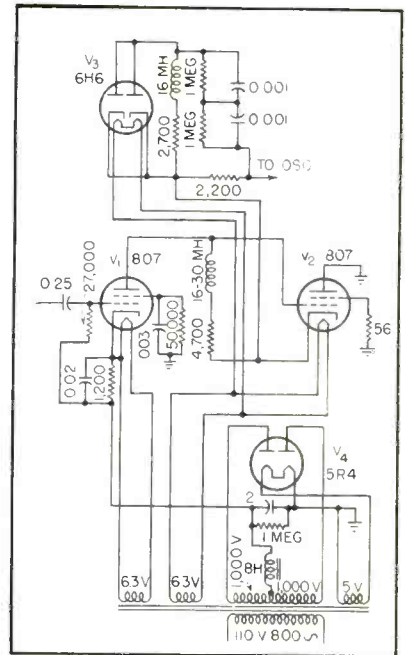

FIG. 5—Complete circuit for keying an oscillator using two 15E triodes

mitter just described. One slight change from Fig. 3 that should be mentioned is the addition of the 56-ohm resistor between the screen grid of  $V_2$  and ground. This was done to prevent arcs at the tube seal, where the control grid to screen grid spacing is small on an 807. These arcs were due to the superposition of r-f voltage on the large video pulses, probably due to the too-long lead lengths.

**Detecting Gallstones with Ultrasonic Echoes**

IN ORDER to determine whether ultrasound might be feasible for detection of gallstones and other foreign bodies lodged in tissues, the Naval Medical Research Institute and the Mechanics Division of Naval Research Laboratory collaborated in initial experiments in this field. Preliminary conclusions are abstracted here from a project report (NM 004 001, No. 4, June 16, 1949) prepared by G. D. Ludwig of USNR and F. W. Struthers of NRL.

The acoustic impedance mismatch at a tissue-gallstone interface was first determined, in order to give an estimate of the percentage of ultrasonic energy reflection that would be expected from a gallstone in tissue. The reflected

AVOID LOSSES FROM  
"BLOBBING"

Not being an extruded plastic,  
it eliminates the costly  
"blobbing" of insulations under  
heat of soldering irons

specify



"NOFLAME-COR"  
the TELEVISION hookup wire

APPROVED BY  
UNDERWRITERS  
LABORATORIES AT

90° CENTIGRADE 600 VOLTS

Proven BEST, and specified regularly, by leading manufacturers of television, F-M, quality radio and all exacting electronic equipment. For maximum output and minimum rejects. Available in all sizes, solid and stranded. Over 200 color combinations.

PRODUCTION ENGINEERS: Specify "NOFLAME-COR" for absolute uniformity of diameter, permitting clean stripping of insulation without damage to the copper conductor...

NO NICKING OF CONDUCTORS  
NO CONSTANT RESETTING OF BLADES

RUBBER	_____	75°
PLASTIC	_____	80°
"NOFLAME-COR"	_____	90°

- Flame Resistant
- Heat Resistant
- High Dielectric
- Also unaffected by the heat of impregnation — therefore, ideal for coil and transformer leads
- High Insulation Resistance
- Facilitates Positive Soldering
- Easy Stripping

COMPLETE DATA AND SAMPLES ON REQUEST

"made by engineers for engineers"

**CORNISH WIRE COMPANY, Inc.**

605 North Michigan Avenue,  
Chicago 11

15 Park Row, New York 7, N. Y.

1237 Public Ledger Bldg.,  
Philadelphia 6

MANUFACTURERS OF QUALITY WIRES AND CABLES FOR THE ELECTRICAL AND ELECTRONIC INDUSTRIES

# Every Manufacturer of...

## ELECTRONIC COMPONENTS:

The list of electronic components is long but their use is essential in all circuits designed used for either communications or industrial electronic equipment. They include hundreds that run from ammeters to X-ray tubes. Each one has its own particular characteristics – and those very characteristics are the determining factor in their use. Every one of them can be sold through the advertising pages of the GUIDE.

## COMMUNICATIONS EQUIPMENT:

This classification includes a great many components as well as complete equipment. For example, antennas to a complete "packaged" broadcast station. Their scope covers the fields of navigation, air and land transportation, police, fire patrol, automotive, aviation, etc. Whether it's a monitor, a transmitter or coaxial cable – it belongs in the advertising pages of the GUIDE.

## INDUSTRIAL ELECTRONIC CONTROLS:

Every manufacturing process – from analysis of raw material right through to counting, sorting, weighing, and packaging is a potential market for electronic controls. One of the greatest expansion possibilities exists in this market – and manufacturers will profit by telling the story of their industrial equipment in the GUIDE.

## ELECTRONIC ASSEMBLIES:

These assemblies consist of pre-designed and pre-fabricated groups of various components that are utilized as units in electronic equipment. Some examples are: – Printed Circuits, Potted Circuits, Resistor

Boards, etc. A manufacturer to insure their use in the designs of present or future equipment should beam his product story to design engineers – and there's no better place than in the GUIDE.

## TEST EQUIPMENT:

The use of instrumentation for testing has become an essential part in every industry – food, aeronautical, textile, chemical, automotive – wherever designing, development, manufacturing or processing is being done. The market potential for test equipment is large – the BUYERS' GUIDE is the place to tell your test equipment story.

## MATERIALS:

Metals, minerals, gases, plastics, insulation, rubber, silicones and literally hundreds of others play an important part in both the manufacture of components and complete equipment. And they are not selected haphazardly – their use is based entirely on their characteristics. Their story belongs in the GUIDE – directed to the engineers who are the deciding factors in their selection.

## ALLIED PRODUCTS:

The performance of electronic components or equipment depends to a considerable degree, on the mechanical elements that enter into them. Springs, flexible shafting, panels, dials, getters for tubes, varnish, insulation, etc., are important when performance is considered. Engineers don't take chances – they specify what they design-in by name, number and type. Manufacturers can reach and influence those engineers – in the GUIDE.

## can use the advertising pages of the GUIDE profitably

**FOR THE MOST COMPLETE COVERAGE** – The circulation of the ELECTRONIC BUYERS' GUIDE is the same as the regular monthly issues of ELECTRONICS (30,050 net paid June 1949 ABC statement). That wide distribution assures a manufacturer of any electronic or allied product the most complete coverage obtainable to reach his prospects or customers. Regardless of the final use or application of his product – in electronic manufacturing or in any industrial process – he can effectively cover every spot where a potential market exists.

**AT THE MOST ECONOMICAL COST** – The actual cost of attempting to duplicate the diversified coverage of the GUIDE by another method – direct mail or any other – would be much greater. In addition, lists for such a mailing are not available. Manufacturers are sure of an interested, buying audience in the GUIDE which no other media can provide. When you count up the costs, the GUIDE is the most economical and most effective medium to cover all potential markets.

**TO UNCOVER NEW MARKETS AND APPLICATIONS** – A manufacturer, by using the advertising pages of the GUIDE to tell the technical story of what his components or equipment can do, will keep on top of new markets for his products. Engineers develop new uses for components, new applications for equipment in their designs for new products. They also create a need and a market for new types of components by slightly varying characteristics to meet their new design needs. Use the GUIDE for effective market research on new applications.

**FOR A FULL YEAR'S USE** – The BUYERS' GUIDE keeps product advertising alive for a full year – ready to do a selling job throughout the year. It is an annual issue, complete and accurate, the only one used by every segment of the electronic industry – the book that has become a habit with everyone who has need of electronic or allied products information.

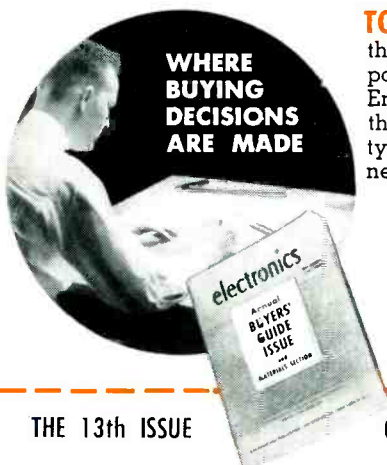

THE 13th ISSUE

*The* **ELECTRONICS BUYERS' GUIDE**  
OF ELECTRONICS • A MCGRAW-HILL PUBLICATION • 330 WEST 42nd STREET, NEW YORK 18, N. Y.

**FOR UNIFORM,  
HIGH QUALITY**

**PRESTO IS YOUR DISC**

When you've stretched your budget to the limit to buy the best equipment and still can't be sure of uniformly good recordings...

**DON'T TAKE YOUR EQUIPMENT APART...**

*Switch to  
Presto Discs*

The Presto label on a disc means uniform high quality of mechanical and chemical properties... *always.*

**PRESTO**  
**RECORDING CORPORATION**

**PARAMUS, NEW JERSEY**

*Mailing Address:*

**P. O. Box 500, Hackensack, N. J.**

**In Canada: Walter P. Downs, Ltd.,  
Dominion Sq. Bldg., Montreal**

*World's Largest Manufacturer of Instantaneous Sound Recording Equipment and Discs*

energy was found to be above the minimum required for detection by current ultrasonic techniques utilizing the echo principle. From the measurements made, it was concluded that there is a good possibility of detecting gallstones and other foreign bodies lodged in tissues by the use of ultrasound.

The characteristic acoustic impedance of both gallstones and tissues was determined. The impedance of gallstones ranged from  $1.3 \times 10^7$  to  $2.4 \times 10^7$  gm/cm<sup>2</sup>/sec, while that of tissue was approximately  $1.6 \times 10^7$  to  $1.7 \times 10^7$  gm/cm<sup>2</sup>/sec.

The individual densities of a large number of human gallstones representing the various types usually occurring were found to range from 0.82 to 1.10 gm/cm<sup>3</sup>.

The velocity of sound through slabs cut from five different types of gallstones was found to range between 1,400 and 2,200 meters per second. A mean value of 1,540 meters per second was measured for living tissue.

Optimum frequency range to insure sufficient tissue penetration and adequate resolving power, for a power output similar to that available in ultrasonic instruments now in use, was found to be between 1 and 2.5 mc. Frequencies of the order of 5 mc can be used if penetration of tissues for only a few centimeters is needed.

Human gallstones were placed in muscle tissue and in the gall bladders of living dogs. After a sufficient lapse of time to allow for wound healing, large signals were obtained from the implanted calculi when utilizing ultrasonic vibrations operating on the echo principle. However, transient smaller signals returned from this area offer considerable difficulty in interpretation.

#### *Confusing Echoes*

Bone reflects a large part of the incident energy but it is relatively easy to eliminate reflections from bone by directing the searching probe so as to avoid bony structures. In addition, the exact position of echoes from bone can be determined by calibration of the oscilloscope relative to depth in tissues;

# Single Truarc Ring Slashes Unit Cost 44% ...eliminates 3 operations and 5 parts

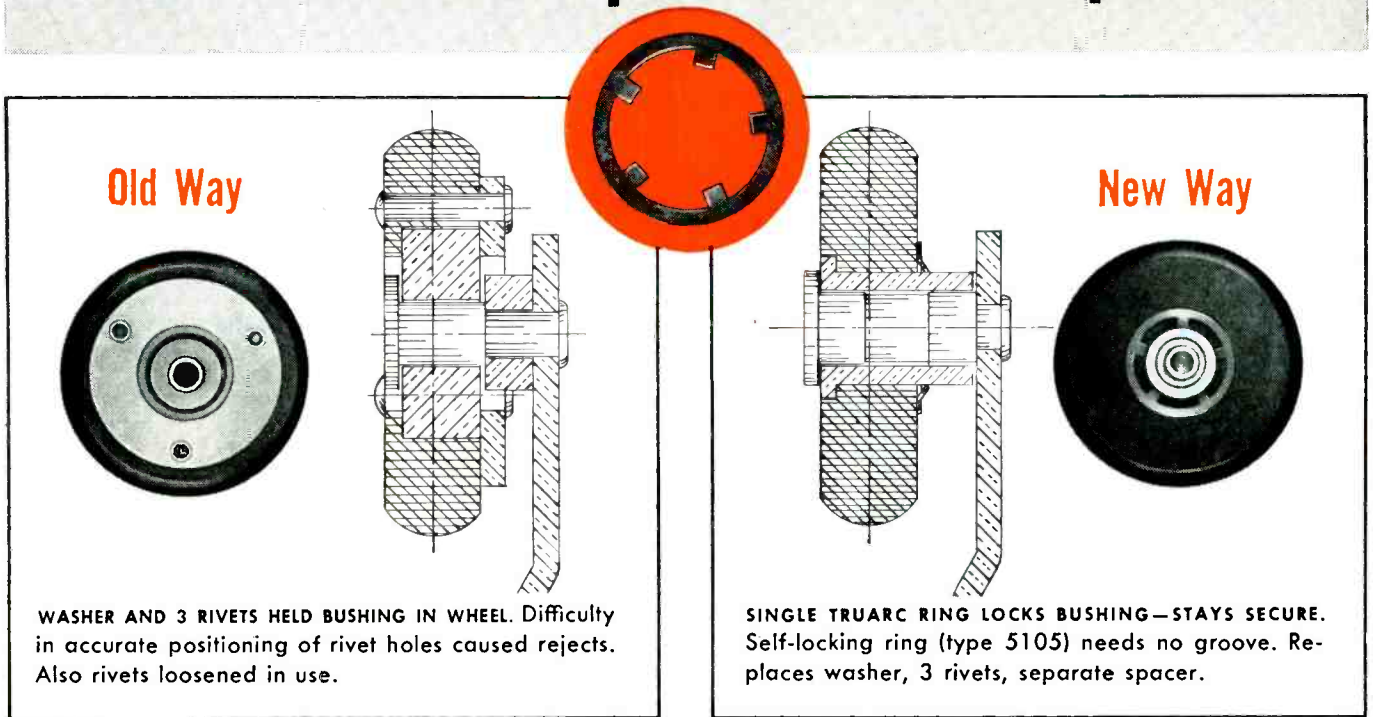

**Old Way**  
WASHER AND 3 RIVETS HELD BUSHING IN WHEEL. Difficulty in accurate positioning of rivet holes caused rejects. Also rivets loosened in use.

**New Way**  
SINGLE TRUARC RING LOCKS BUSHING—STAYS SECURE. Self-locking ring (type 5105) needs no groove. Replaces washer, 3 rivets, separate spacer.

Redesign with one Waldes Truarc Ring cuts cost of wheel used in Har-Vey Rolling Door Hardware (for residential doors) from 26.1¢ to 14.5¢—a 44% saving for Metal Products Corporation, Miami. Use of Truarc cuts manufacturing time 76%. Eliminates 5 separate parts, 3 press operations. And gives a product that stands up better in use!

Redesign with Truarc Rings and you too will cut costs. Wherever you use machined shoulders, bolts, screws, nuts, cotter pins, snap rings, there's a Truarc Ring that does a better job of holding parts together. Truarc Rings are precision engineered. They make assembly and disassembly quick and easy.

See what Truarc Rings can do toward cutting overall costs for you. Send your blueprints to Waldes Truarc engineers for individual attention, without obligation.

## Redesign with Truarc self-locking ring produces these savings:

	saving
eliminates drilling 3 rivet holes . . .	\$.0042
eliminates riveting washer . . .	.0111
eliminates punching washer . . .	.00033
eliminates washer, spacer, rivets . . .	.02236
cuts cost of inserting bushing . . .	.00037
cuts cost of inspection . . .	.0032
cuts cost of wheel, bushing, rivet . . .	.0797
	.12126
less—cost of Truarc Ring . . .	.00528
<b>TOTAL SAVING PER UNIT 44% . . .</b>	<b>\$.11598</b>

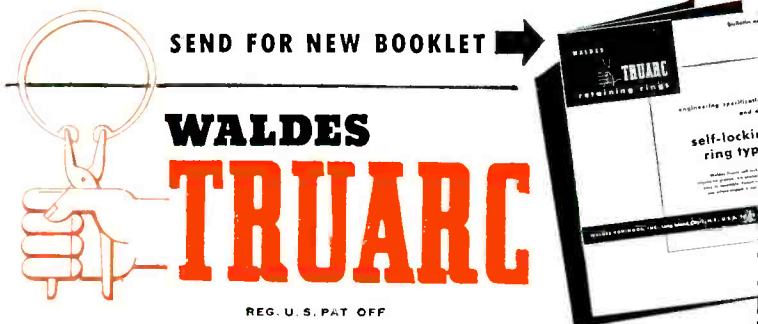

SEND FOR NEW BOOKLET →



**WALDES TRUARC**

**RETAINING RINGS**

WALDES KOHINOOR, INC., LONG ISLAND CITY 1, NEW YORK

WALDES TRUARC RETAINING RINGS ARE PROTECTED BY U. S. PATS. 2,382,948; 2,416,852; 2,420,921; 2,411,761 AND OTHER PATS. PEND.

Waldes Kohinoor, Inc., 47-16 Austel Place  
Long Island City 1, N. Y.

E-022

Please send Data Book on Waldes Truarc  
Self-Locking Ring Types.

Name \_\_\_\_\_

Title \_\_\_\_\_

Company \_\_\_\_\_

Business Address \_\_\_\_\_

City \_\_\_\_\_ Zone \_\_\_\_\_ State \_\_\_\_\_

FOR ULTRA-PRECISION  
CATHODE RAY TUBES...

# KAHLE CUSTOM-BUILT MACHINERY

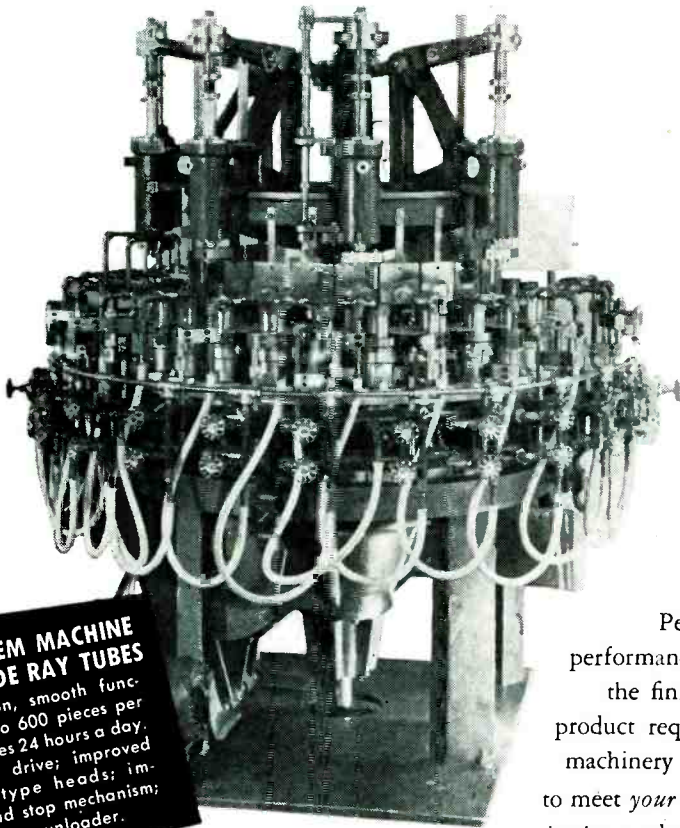
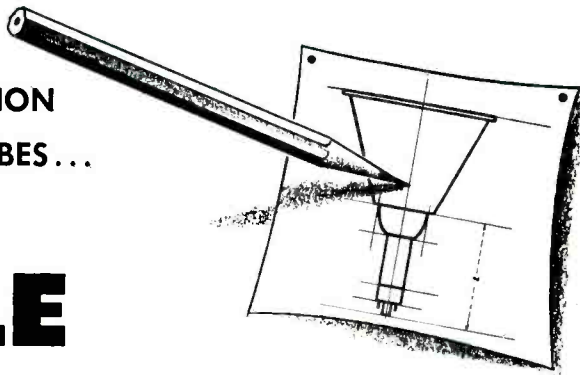

## BUTTON STEM MACHINE FOR CATHODE RAY TUBES

High precision, smooth functioning. Up to 600 pieces per hour; operates 24 hours a day. Dual motor drive; improved clean-out type heads; improved head stop mechanism; automatic stem unloader.

Perfect performance in the finished product requires machinery built to meet *your* need in the production

stage. Kahle's years of experience in meeting the *specific* requirements of ultra-precision operations with custom-engineering, has helped many outstanding manufacturers of cathode ray tubes operate efficiently and profitably. This Kahle know-how may solve your unusual problem, too. Kahle specialists are available for consultation, without obligation.

Consult Kahle On Any Requirement • Write For Complete New Catalog

Kahle Specializes in Equipment  
and Methods for the Manufacture  
of Complete Production Units For

Cathode Ray Tubes • Subminiature Tubes •  
Electronic Tubes • Fluorescent Lamps • Neon Tubes  
• Photocells • X-Ray Tubes • Glass Products

# Kahle ENGINEERING COMPANY

1309 SEVENTH STREET • NORTH BERGEN, NEW JERSEY

air, on the other hand, presents a much more difficult problem. Since the impedance mismatch at a tissue-air interface is so large, practically all of the normally incident energy will be reflected. Therefore, any viscous containing air, as for example the stomach, colon or perhaps duodenum, will act as an almost perfect reflector. In the human it would be imperative that all the gas be cleared from the gastrointestinal tract for the successful use of an ultrasonic technique to detect gallstones. For this reason detection of gallstones without opening the abdomen might be impossible of achievement. At present, various procedures are used to rid the bowel of gas before x-ray studies. This might be possible for ultrasonic techniques also.

The problem of detecting calculi in the gall bladder has been solved fairly well by use of x-ray techniques. The main problem is that of deciding whether or not the common bile duct should be explored at the time of operation. Once the abdomen is opened it should be possible to detect a stone in the common duct by exploring this region with the ultrasound probe, without having to open the duct.

### Other Applications

This technique might be extended to apply to the detection and precise localization of other foreign bodies lodged in tissues, both before and during operation for removal. Metal locators now used depend upon the conducting properties of the metal to be located and no instrument is applicable to the localization of nonconducting foreign bodies.

Table I gives the energy reflection coefficient in tissue for a number of materials that may be encountered as foreign bodies embedded in tissues. Large signals will be returned from almost any metal, wood, glass or plastic foreign body embedded in soft tissues. For example, steel shrapnel will reflect approximately 86.5 percent of the incident ultrasonic energy. Small sterilizable probes will permit insertion into the surgical wound. This should afford the surgeon guidance to the foreign body, when

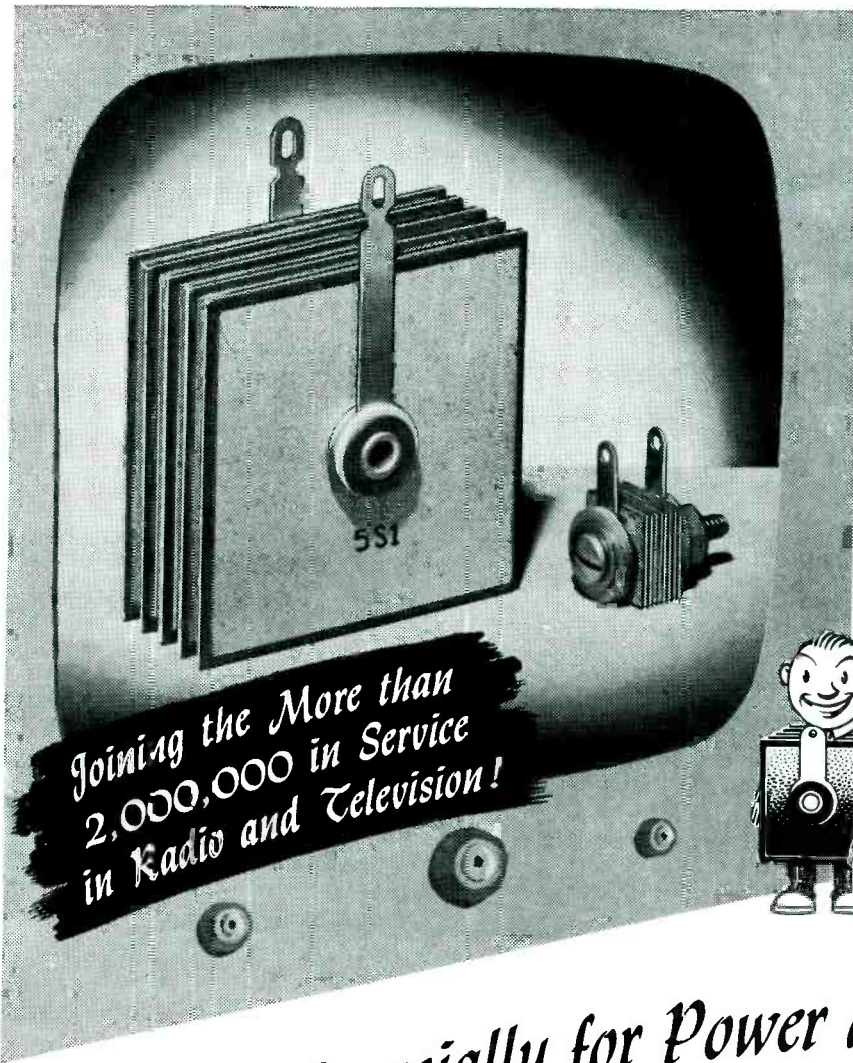

*Joining the More than  
2,000,000 in Service  
in Radio and Television!*

*Presenting...  
New Additions to the*

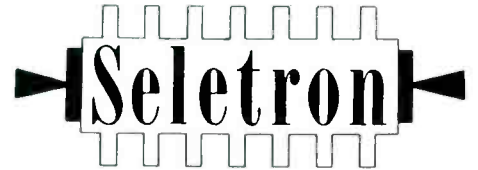

SELENIUM RECTIFIER

*Family*

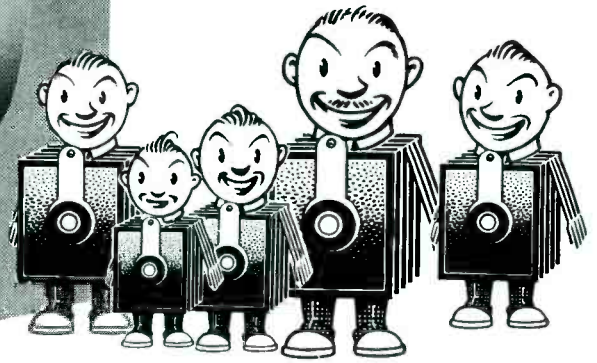

*Designed Especially for Power and Bias Supplies  
in TELEVISION*

SELETRON Selenium Rectifier miniatures have long been widely used with complete satisfaction by manufacturers in the Radio, Television and Electronics industries for receivers and other equipment.

Now SELETRON brings you these two new models ideally suitable in size and rating: No. 5S1 at 500 Mils—No. 8Y1, the "baby" of them all, measuring only 1/2" square and rated at 15 Mils, 130 volts. While these rectifiers are designed to meet television needs, engineers will find many applications for them in other electronic circuits. Other bias type rectifiers rated up to 250 volts will also be available.

MODEL NO.	PLATE SIZE	STACK THICKNESS	MAX. INPUT VOLTAGE R.M.S.	MAX. PEAK INVERSE VOLTAGE	MAX. D.C. OUTPUT CURRENT
1M1	1" sq.	3/8"	25	75	100 MA.
8Y1	1/2" sq.	1/16"	130	380	15 MA.
5M4	1" sq.	1/16"	130	380	75 MA.
5M1	1" sq.	7/8"	130	380	100 MA.
5P1	1 1/16" sq.	7/8"	130	380	150 MA.
6P2	1 3/16" sq.	1 3/16"	156	456	150 MA.
5R1	1 1/2" x 1 1/4"	7/8"	130	380	200 MA.
5Q1	1 1/2" sq.	1 1/8"	130	380	250 MA.
6Q1	1 1/2" sq.	1 1/8"	156	456	250 MA.
6Q2	1 1/2" sq.	1 3/8"	156	456	250 MA.
5QS1	1 1/2" x 2"	1 1/8"	130	380	350 MA.
5S1	2" sq.	1 1/8"	130	380	500 MA.
6S2	2" sq.	1 3/8"	156	456	500 MA.

*A new leaflet on Bias Type 8Y1, describing its circuit possibilities is available. For your copy, write Dept. ES-26.*

**SELETRON DIVISION**

**RADIO RECEPTOR COMPANY, INC.**

Since 1922 in Radio and Electronics

Sales Department: 251 West 19th St., New York 11, N. Y.

Factory: 84 North 9th St., Brooklyn 11, N. Y.

# HOT ASSIGNMENT

for this PROGRESSIVE fastener

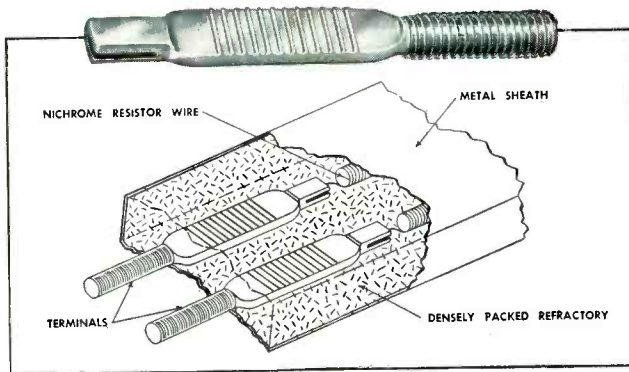

Edwin L. Wiegand Company uses this terminal pin on their versatile Chromalox seamless blade-type immersion heaters, which operate as high as 750°F. It is one of many special fasteners made by Progressive.

The design provides for electrical clearance between the pin and the metal heating blade casing — for secure fastening of the pin in the refractory — and for attaching electrical wiring connections.

Progressive is equipped to handle special fastener production with speed, precision and economy. Do what many leading manufacturers do — IF IT'S SPECIAL, see PROGRESSIVE.



WRITE FOR OUR CATALOG  
IT MAY SAVE YOU MONEY

## Other typical PROGRESSIVE "Specials"



**THE PROGRESSIVE MANUFACTURING COMPANY**

50 NORWOOD ST., TORRINGTON, CONN.

SALES OFFICES: SAN FRANCISCO, LOS ANGELES, PORTLAND, DETROIT, PHILADELPHIA, CLEVELAND, SEATTLE, BOSTON, SYRACUSE, ST. LOUIS, CHICAGO.

**Table I—Ultrasonic Reflection Data for Objects Embedded in Tissue**

Material	Density gm/cm <sup>3</sup>	Velocity of Sound meters/sec	% of Energy Reflected in Tissue
Tissue	1.06	1,540	0
Steel	7.8	5,840	86.5
Lead	11.3	2,140	75.5
Slate	2.6-3.3	4,510	53.63
Glass	2.4-2.9	5,500	56-64
Wood	0.5-0.9	3,800	0.02-18
Lucite	1.16-1.2	2,600	5.5-8.5
Polystyrene	1.05-1.07	2,680	6.8
Bakelite	1.27-1.6	2,600	10.2-18

its removal is being attempted. At present, one must rely upon pre-operative films and upon the fluoroscope during operation for removal of nonferrous objects.

The possibility of detecting tumors by use of ultrasound has been considered. In most cases, however, the density, elasticity and velocity of sound would differ but slightly from that of normal tissue. In addition, tumors rarely have sharp margins. For these reasons, and from conclusions drawn from preliminary studies, detection of tumors by the echo method is not a likely possibility.

## Reduction of Pulse Rise Times for Shoran

By S. WALD

Bendix Radio Division  
Towson, Maryland

THE IMPORTANCE of producing and utilizing short rise-time pulses whose timing is independent of the pulse amplitude is widely recognized, particularly in radar distance-measuring systems such as shoran. Timing errors may occur

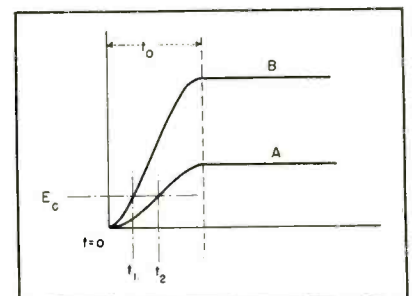
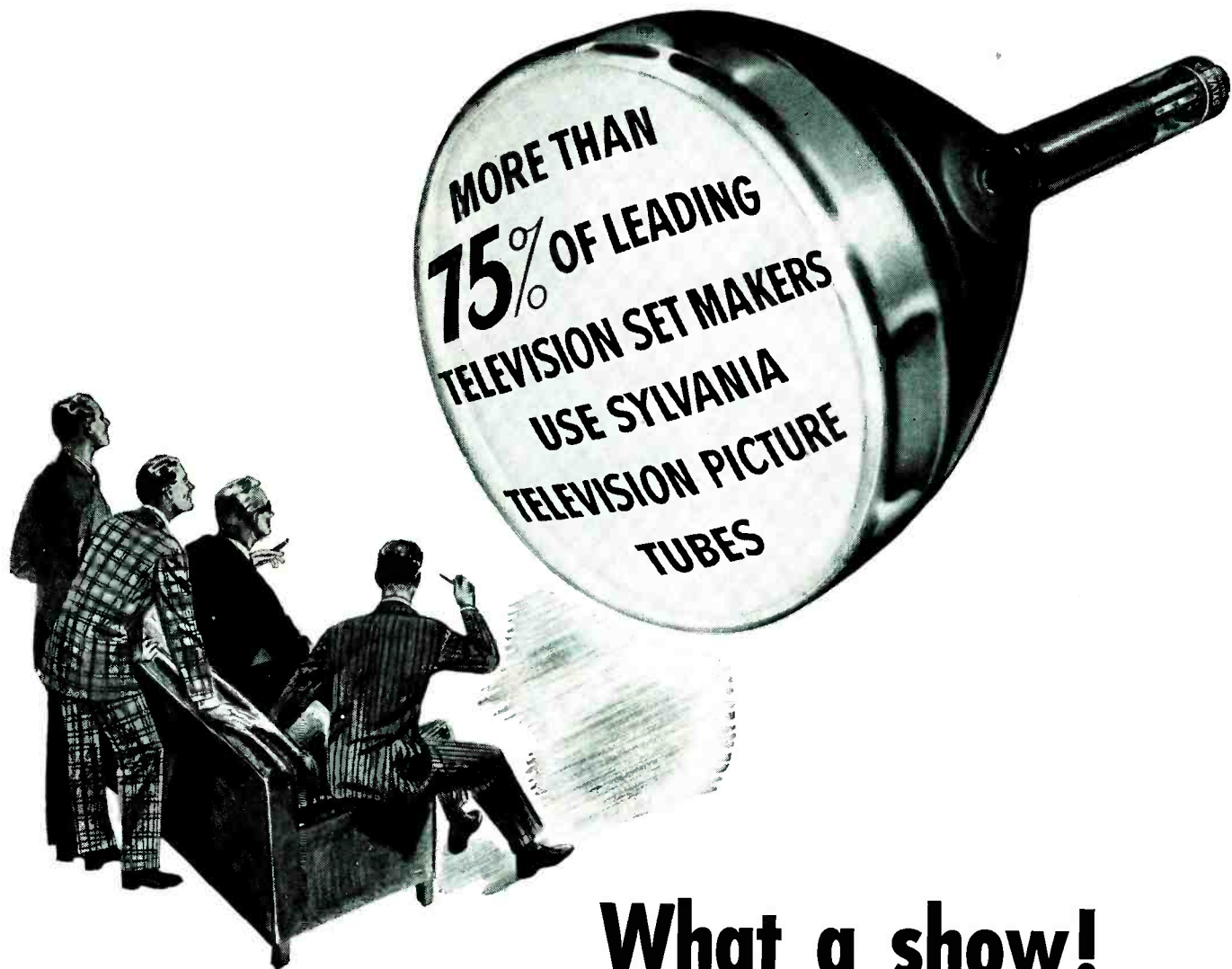

FIG. 1—Triggering-time delay of a modulator biased to cut off by  $E_c$  will vary for pulses of different amplitude by an amount depending on the length of the pulse rise times





## What a show!

A recent intensive survey discloses that among the major television set manufacturers, more than 75% use Sylvania cathode ray tubes!

This impressive showing is a tribute to the research and quality production techniques employed by Sylvania in the making of picture tubes that are unsurpassed.

If you wish full information about the entire Sylvania line of television picture tubes made by the manufacturers of highest quality radio tubes and electronic equipment, write Sylvania Electric Products Inc., Dept. R-2102, Emporium, Pa.

*These leading television set manufacturers use Sylvania Television Picture Tubes*

Admiral • Air King • Andrea • Ansley • Automatic  
 Bendix • Crosley • DeWald • Emerson • Fada  
 Farnsworth • Garod • Hallicrafters • Hoffman  
 Magnavox • Midwest • Motorola • National • Olympic  
 Packard-Bell • Philco • Pilot • Raytheon-Belmont  
 Regal • Scott • Sentinel • Silvertone • Sparton  
 Stromberg-Carlson • Tele-King • Tele-tone • Temple  
 Trav-ler • Westinghouse

# SYLVANIA ELECTRIC

Television  
deflection yoke  
insulated with  
"SCOTCH"  
Electrical Tape No. 3  
Tape also  
holds  
individual  
coils in  
place.



## Paper tape does double-duty on these TV deflection coils

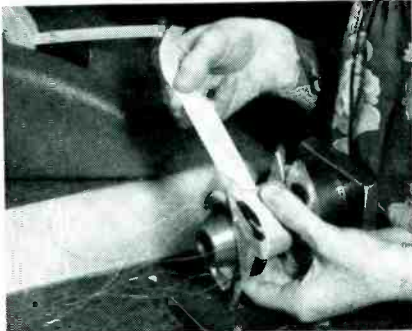

**INSULATING FILM** being secured to TV deflection yoke with "SCOTCH" Electrical Tape No. 3. Tape provides dependable hold-down, extra insulation. More than 30 different "SCOTCH" Electrical Tapes are ready to solve almost any insulating problem.

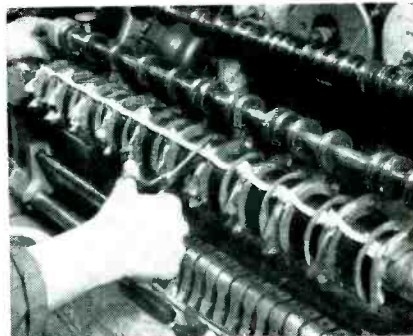

**WIRE COIL** ends are quickly fastened in place with "SCOTCH" Electrical Tape No. 3. One of our Tape Engineers will be glad to show how you can save time and money with "SCOTCH" Electrical Tapes on your next job. Just write Dept. ES today. No obligation.

REG. U.S. PAT. OFF.

# SCOTCH

BRAND

## Electrical Tape No. 3

Made in U. S. A. by **MINNESOTA MINING & MFG. CO.**, St. Paul 6, Minnesota

also makers of other "Scotch" Brand Pressure-sensitive Tapes, "Scotch" Sound Recording Tape, "Underseal" Rubberized Coating, "Scotchlite" Reflective Sheeting, "Safety-Walk" Non-Slip Surfacing, "3M" Abrasives, "3M" Adhesives.

General Export: **DUREX ABRASIVES CORP.**, New Rochelle, N. Y.  
In Canada: **CANADIAN DUREX ABRASIVES LTD.**, Brantford, Ontario

wherever nonlinear circuit elements cause the pulse to be limited or clipped. For example, Fig. 1 shows two pulses having equal rise times but unequal amplitudes. If  $A$  is applied to a modulator biased to cutoff by  $E_c$ , the plate current pulse will start at  $t_2$ , whereas curve  $B$  will trigger the modulator at  $t_1$ . Thus a time delay  $t_1 - t_2$  is caused by a change in pulse amplitude.

The test setup of Fig. 2 was devised to measure pulse rise times and study means of shortening

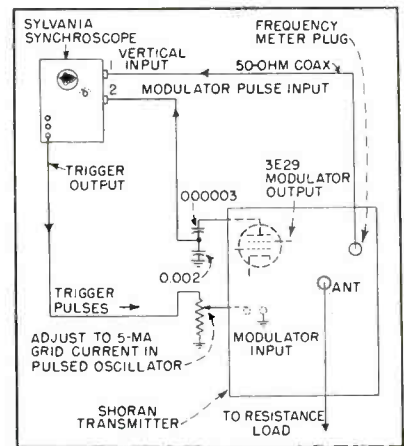

**FIG. 2**—Test setup for viewing modulator pulse produced by a shoran transmitter. Leakage back through modulator enables r-f pulse rise time to be studied simultaneously

them. A Sylvania synchroscope having a maximum sweep speed of 5 inches per microsecond was connected to a shoran transmitter and trigger pulses from the scope were fed to the input of the modulator through a resistance voltage divider. The trigger voltage was adjusted to produce about 5 ma of grid current in the pulsed oscillator. The resulting pattern on the synchroscope screen shows the envelope of the output pulse.

Pulse repetition rate was adjustable up to 4,000 per second, with highest rates giving the brightest trace on the screen. Sweep speed was checked by feeding a crystal-controlled 3-mc unmodulated carrier into the scope and counting the number of cycles that appeared. The cross-ruled transparent overlay on the screen was then calibrated as 0.02  $\mu$ sec per division. An example of the observed waveform appears in Fig. 3. The delay in r-f buildup of the modulator pulse is shown



Why does **DUMONT** spend more money on paper tubulars?

**Because**  
**DUMONT MAKES ONLY**  
**THE *Best* CAPACITORS!**  
**Yet**  
**THEY COST YOU NO MORE**



Tube impregnated in Bakelite Resin costs three (3) times more in labor and materials than Wax Coated tubes, commonly used.

**RESULT.....A MORE MOISTUREPROOF TUBE**



Plastic sealed Ends cost two (2) times more in labor and materials than the commonly used wax ends seals.

**RESULT....A MORE MOISTUREPROOF END SEAL CANNOT MELT OUT OR PULL OUT**



Mineral Oil impregnated section costs 30% more than commonly used wax.

**RESULT..A BETTER CONDENSER AT HIGHER TEMPERATURES. LONGER LIFE AT 85° C**



The pure tin foil used in Dumont Capacitors costs four (4) times more than commonly used aluminum foil.

**RESULT.....A MORE POSITIVE SOLDERED CONNECTION**



Hot tinned wire terminals cost 30% more than commonly used plain tin coated wire.

**RESULT.....EASIER SOLDERING TO THE LEADS**

DUMONT... one of the world's largest makers of small type capacitors.



Send for samples and price list.

- \*TYPE P6M... Solidly Molded Oil Capacitor.....100° C
- \*TYPE PC... Solidly Molded Ceramic Tube.....110° C
- \*TYPE PCM... Solidly Molded Ceramic Tube, miniature size...110° C
- TYPE P6... Mineral Oil Plastic End Seal..... 85° C

**DUMONT ELECTRIC CORP.**

308 DYCKMAN ST.  
 NEW YORK, N. Y.

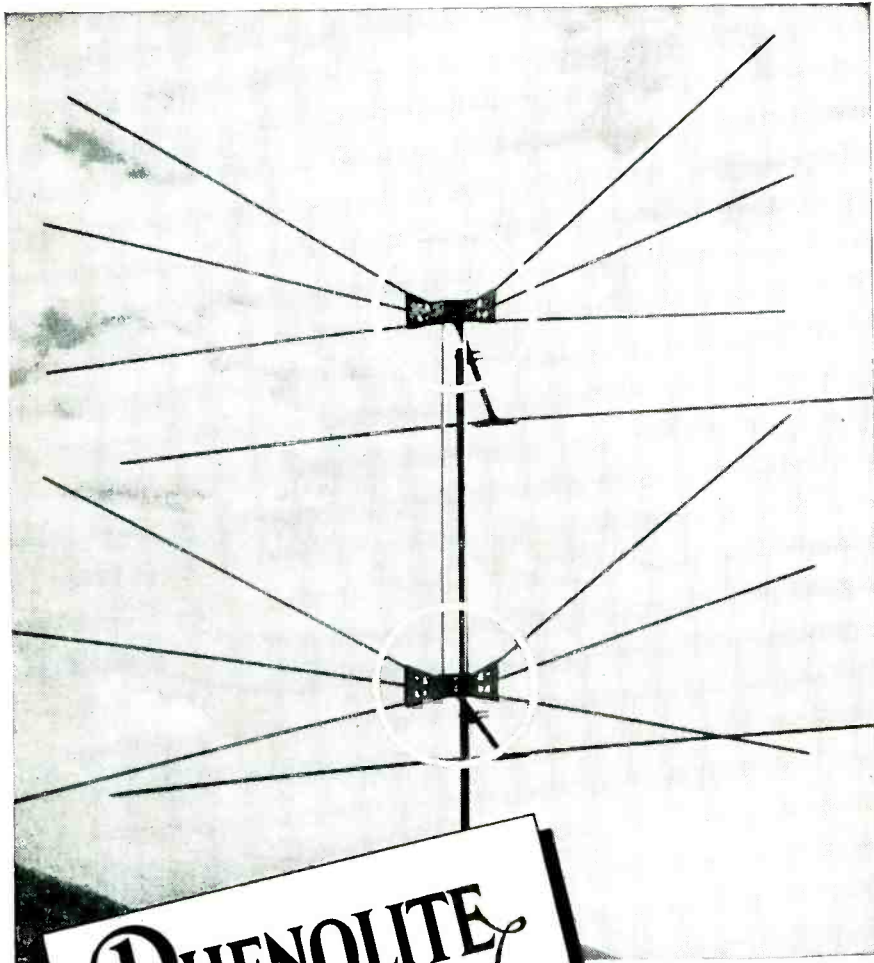

Photo—Courtesy Channel Master Corp.

## the ideal material to insulate elements of Television Antennae

In the development of television, Phenolite has played a vital role as an insulating material in antennae, TV receivers and transmitting equipment. This is due to its excellent electrical properties coupled with its ease in machining. Its low power factor at ultra-high frequencies makes it especially valuable as television and radio insulation. Because of its low moisture absorption, any variation in electrical properties is negligible, even under long exposure to high humidity—hence its value in antennae insulation. Phenolite, in addition, is light in weight with excellent machining qualities, and one of the strongest materials per unit weight known. Sheets, Rods, Tubes, Special Shapes.

*National Service Engineers will, without obligation, assist you in employing Phenolite, National Vulcanized Fibre and Peerless Insulation to your best advantage.*

NATIONAL VULCANIZED FIBRE CO.

WILMINGTON  
Offices in



DELAWARE  
Principal Cities

Since 1873

since there was some r-f leakage back into the modulator.

### Improvement Attempts

Among the expedients tried for reducing rise time were: decreasing  $Q$  of tuning lines; increasing feedback ratio of oscillator; use of a cross-coupling loop to increase the feedback between grid and cathode lines; capacitive loading of grid and cathode lines; variation of grid resistance; use of negative d-c grid bias to preclude any possibility of damping incipient shock excitation (if any); attempted reduction of time constant of wire from pulse transformer to plates of the oscillator; attempted operation of oscil-

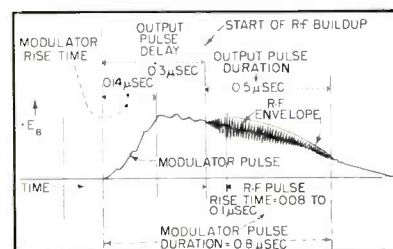

FIG. 3—Initial waveform obtained from test setup of Fig. 2

lator single-ended instead of push-pull on the supposition that the modulator pulse being applied in parallel to the two tubes tended to delay starting of push-pull oscillations. It appeared that the 0.08 to 0.1  $\mu$ sec rise time was not materially affected by slight modifications to the transmitter.

Theoretically, the time constant of a loaded oscillator having a  $Q$  of 50 will be equal to 0.064  $\mu$ sec at 250 mc, according to the formula  $t_0 = Q/\pi f$ . To reduce this experimentally verified rise time, we must decrease the  $Q$  or raise the frequency.

A significant approach to low  $Q$  would involve a comparatively low-power continuously-running master oscillator driving a pulse-modulated class-C final whose tank circuit  $Q$  might be of the order of 2 or 3. Another alternative would be to use a pulsed master oscillator-amplifier arrangement where the oscillator pulses were extremely long compared to the duration of the p-a keying. This would permit the use of lower oscillator average power.

Shock excitation of the oscillator tuned circuit would, allegedly, start

# in communications...

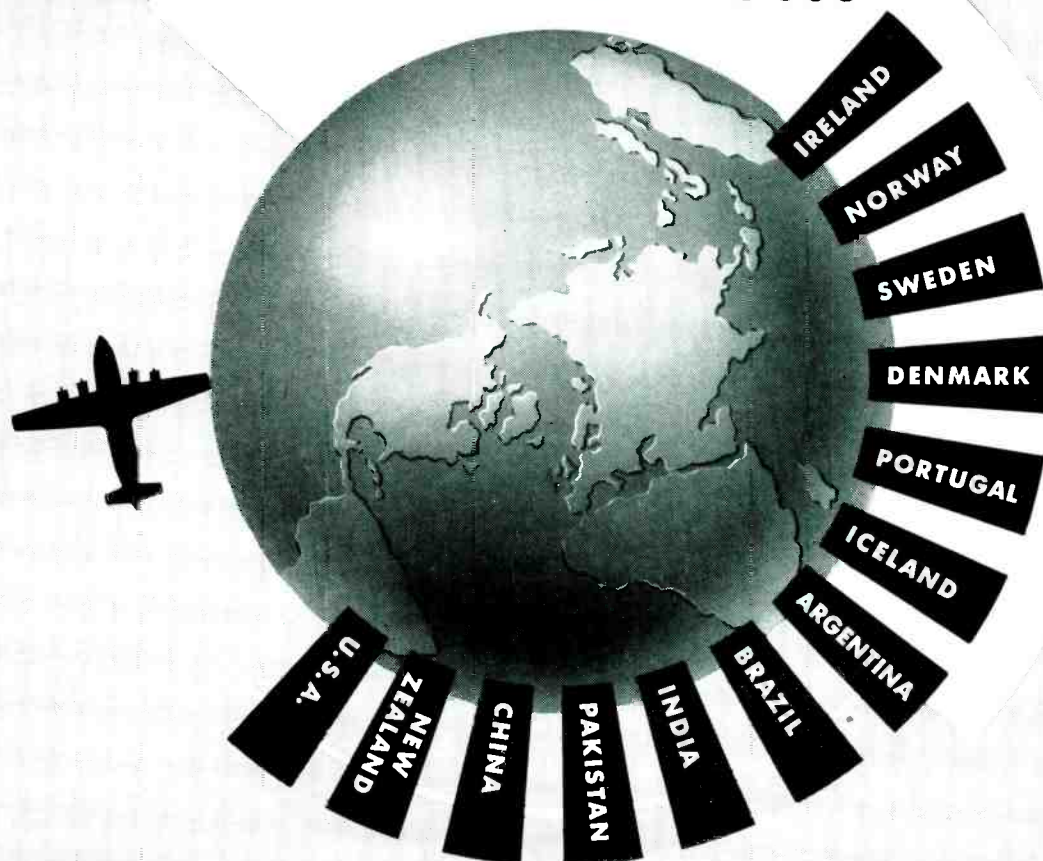

## WILCOX SERVES THE GOVERNMENTS OF THE WORLD

Wherever airplanes fly—wherever lives depend on reliable communications—you'll find WILCOX radio transmitting and receiving equipment. From the Scandinavian countries to New Zealand...from Portugal to Pakistan, the governments of the world select WILCOX because of its proven performance under all extremes of climate, temperature, and humidity.

As with many governments, WILCOX is being used by the United States government in the basic communication systems for the Air Force, Signal Corps, and the Civil Aeronautics Authority.

The governments of the world have spanned the globe with WILCOX communications. From the Berlin Airlift to the Orient...WILCOX equipments carry the messages that help keep freedom a vital force in the turbulent affairs of the world.

**WRITE TODAY...** for complete information on all types of point-to-point, air-borne, ground station, or shore-to-ship communications equipment.



**WILCOX ELECTRIC COMPANY**  
KANSAS CITY MISSOURI

oscillations before the feedback circuit became effective. However, the rise time of the modulator pulse would have to be around  $0.002 \mu\text{sec}$ . This is approximately 70 times steeper than the present modulator pulse.

#### Output Gating

If a suitable switch were inserted in series with the antenna it would be possible to delay the closing of the circuit until the oscillator level had risen to some predetermined value. Thus, at the expense of losing the first  $0.1 \mu\text{sec}$  of the oscillator pulse, an extremely steep pulse front could be obtained, perhaps in the vicinity of  $0.01 \mu\text{sec}$  rise time. If the switch were similar to a t-tube and the breakdown voltage made equal to about 0.8 of the final pulse voltage, or 560 volts (assuming 10 kw peak power into 50 ohms), then the pulse rise time would be that of the t-r gas ionization time.

This concept was verified experimentally by the very crude expedient of breaking the output connection at the cathode line and leaving an air spark gap of about  $1/32$ -in. length. The observed scope image had a rise time of  $0.01 \mu\text{sec}$  but due to the flimsy nature of the gap, there was a considerable amount of jitter. With a well-designed sealed gap, together with ultraviolet irradiation, it should be possible to obtain a means of gating the output pulse in a dependable manner. The gap should have extremely low shunt capacitance, less than  $1 \mu\mu\text{f}$ , to avoid capacitive feed-through of r-f energy. To avoid placing the gap in series with the output line, conventional t-r techniques employing gaps at the end of parallel stubs might prove more practical.

The work described in this article was performed while the author was employed by RCA-Victor.

#### Zirconium Arc Lamp

A NEW high-intensity electric arc light one-eighth as bright as the sun was announced by W. D. Buckingham of Western Union at a recent SMPE meeting in Hollywood. The light source, which operates in the open air and not in



### STRAIGHT PLUG (32-8) TYPE AF06A WITH NEW CABLE CLAMP

## FINEST DESIGN ★ BEST MATERIALS

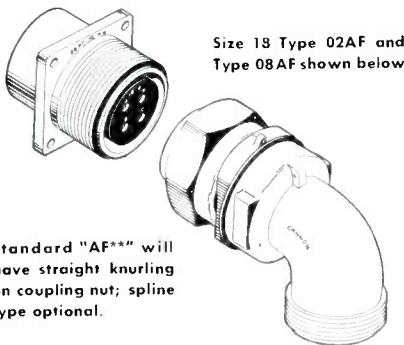

Size 18 Type 02AF and Type 08AF shown below

Standard "AF\*\*" will have straight knurling on coupling nut; spline type optional.

The new "AF\*\*" Series embodies many advantageous features: (1) Vibrationproof (2) Strong aluminum alloy shell (3) Unusual corrosion resistance (4) High dielectric qualities with the new resilient insulator material (5) Moisture-proof (6) Pressurized (7) Radio Shielded (8) Minimal voltage drop (9) Excellent insulation resistance.

Standard specification "AN" Type inserts of the "AF" are not interchangeable with standard "AN" Shells but "AF" fittings will mate with corresponding "AN" connectors to MIL-C-5015.

Write to Cannon Electric Development Company, Division of Cannon Manufacturing Corporation, 3209 Humboldt St., Los Angeles 31, Calif. Canadian offices and plant: Toronto, Ontario. World Export: Frazer & Hansen, San Francisco.

\*\*AF00, AF01, AF02, AF06, AF08.

*You Buy Quality  
When You Choose  
Cannon Electric...*

From the very first of the major development periods of the aviation industry and the electronic phase of the electrical industry, Cannon Plugs have been on the job carrying the quick disconnect circuits to the latest requirements. Because of these demands, Cannon Electric has produced the greatest variety of electric connector type series, modifications and specials within these industries; late example shown above and below.



SINCE 1915  
**CANNON**  **ELECTRIC**

REG. U. S. PAT. OFF.



# KAY

## COMPLETE RANDOM NOISE SOURCES NOW AVAILABLE: 1 to 12,500 mc

### MICROWAVE MEGA-NODE

NEW . . . HIGH  
RANGE NOISE  
SOURCE FOR  
RESEARCH  
LABORATORIES



This instrument is invaluable for supplying random noise for such work as experimentation and checking TV Relay Links and Radar Systems. It is a custom built unit. Frequency ranges for one model is from 8200 to 12,500 mc. Other models available down to 2500 mc. Noise figures available up to approximately 16 db. Other models for higher noise figures. Termination: Wave Guides RG 48/U, 49/U, 50/U, 51/U, 52/U. Standard connectors. Power supply internally regulated.

Write for specifications and prices. State your particular need.

### THE MEGA- NODE SR.

A UHF and  
MICRO-  
WAVE  
RANDOM  
NOISE  
SOURCE



- Employs a coaxial Noise diode to provide random noise over a frequency range of 100 to 3000 mc.
  - Noise figure of test circuits (db above ideal) between 0 and 20 db can be obtained.
  - Low VSWR at 50 ohm unbalanced output. Smith chart provided with each instrument indicating actual amount of mismatch.
  - Operates with diode temperature limited and has regulated filament supply.
  - Noise figure indicated on panel meter linear in db.
- PRICE: \$895.00 F.O.B. Factory.  
THE MEGA-NODE available for use as RANDOM NOISE SOURCE between 1 and 220 mc. Write for details.

### THE MEGA PIX

A 12 Channel Crystal Controlled Generator for  
TV Receiver Tests



- THE MEGA-PIX provides sound and picture carriers on each of the 12 TV channels. Channels selectable by front panel switch.
  - Accuracy of picture carriers .01%. Separation between picture and sound carriers 4.5 mc  $\pm$  500 cps.
  - Maximum carrier output amplitude approximately 30,000 microvolts on all channels.
  - Switchable attenuator provides 10db fixed and 41 db variable insertion loss 1 db steps. Continuous attenuator covering approximately 20 db also included.
  - FM deviation of sound carrier to 25 kc obtained from internal tone. Deviation excursion adjustable by panel control.
  - Picture carrier fully modulated by externally supplied standard video signal 2 volt peak to peak black negative into 72 ohms. Modulation depth adjusted by front panel control.
  - RF output impedance 72 ohms.
- PRICE: \$990.00 FOB Factory

### THE MEGA MATCH UHF MODEL

DISPLAYS AMOUNT of Reflected Energy Over Wide  
Frequency Range



- Displays reflection coefficient on standard oscilloscope over 30 mc sweep anywhere between 10 and 1000 mc.
- Useful for rapidly designing broad band antennas, transformers, TV front ends, matching distribution systems and measuring transmission line terminating impedances.
- Resolves reflection coefficients down to .01 to 500 mc and .1 to 1000 mc.
- With auxiliary signal generator and Mega-Chart (Smith Chart) can be used to determine phase of reflection coefficient and components of terminating impedances.

PRICE: \$895.00 FOB Factory

A VHF Model available at \$695.00 FOB Factory for frequency range 10-250 MC.

### DUAL MEGA-MARKER SR.

### NEW TV RECEIVER PRODUCTION INSTRUMENT

Crystal controlled TV picture and sound RF markers . . . . Output level approximately .1 volt . . . . Sound marker can be switched on or off . . . . Switchable tone modulation on sound marker . . . . Price \$350 FOB Factory  
Prices slightly higher outside U.S.A. and Canada

ELECTRIC



COMPANY

14 Maple Avenue

Pine Brook, N. J.

Phone CAldwell 6-4000

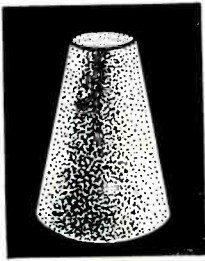

### with CONCRETE

— the small extra first cost of test samples pays off in assurance of efficiency and durability of the finished structure.

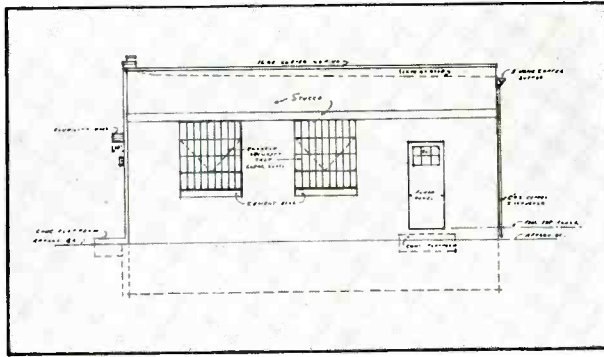

### with TRACING CLOTH . . .

The small extra first cost of Arkwright Tracing Cloth, over that of tracing paper, repays many times over in the efficiency and durability of valuable drawings.

Arkwright gives both immediate *and* future advantages. The expert work of the draftsman is made permanent. Your investment in time and money is backed by sharp, clean reproductive quality. Under repeated use—or on file for subsequent need—Arkwright assures perfect drawing performance year after year.

For every drawing worth keeping for future use—use permanent Arkwright instead of perishable tracing paper. Send now for generous samples and prove this superiority. Sold by leading drawing material dealers everywhere. Arkwright Finishing Company, Providence, R. I.

#### The Big Six Reasons Why Arkwright Tracing Cloths Excel

1. Erasures re-ink without feathering.
2. Prints are always sharp and clean.
3. Tracings never discolor or go brittle.
4. No surface oils, soaps or waxes to dry out.
5. No pinholes or thick threads.
6. Mechanical processing creates permanent transparency.



# ARKWRIGHT

## TRACING CLOTHS

AMERICA'S STANDARD FOR OVER 25 YEARS

a glass bulb, is a pool of molten zirconium metal which is maintained at a temperature near 6,500 F.

The new light source is extremely stable in operation, producing a uniformly bright, sharply defined circular spot of white light of dazzling brightness. In a 1,000-watt lamp, operating at 55 volts and 18 amperes a-c, the source spot is two-tenths of an inch in diameter and has a maximum brightness of 130,000 candles per square inch, or

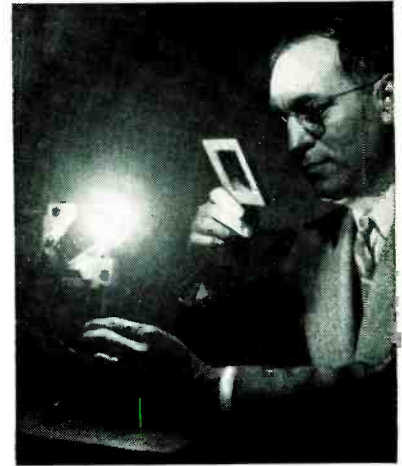

W. D. Buckingham examines new molten-zirconium arc lamp he developed, using dark filter. Intensity is one-eighth that of sun

twenty times the brightness of the ordinary tungsten filament lamp. The total light from the new lamp is 20,000 lumens.

Operation of the lamp in the open air without an enclosing glass bulb permits a high output of radiations in the infrared and ultraviolet regions of the spectrum, which are cut off by the glass bulb of most light sources. The lamp makes these radiations available for wide scientific and commercial applications. In an ultraviolet microscope working at 2,600 angstroms the new light gave twenty times as much ultraviolet energy as a quartz mercury vapor lamp.

The new lamp has a continuous spectral energy distribution and a color temperature which holds constant at 3,600 K. These last two characteristics are of particular importance in color photography. In 16-mm movie projectors it gives four times the screen brightness of equivalent-wattage tungsten lamps.

In spite of operating in the open



# Floating Rotor Prevents Motor Lag or Slippage

Specially designed light-weight rotor virtually floats in a rotating magnetic field. Rotor shaft rotates on a film of oil . . . no metal to metal contact with its bearing. These features, together with capillary oiling system, account for the fact that *All Telechron Timing Motors Are Instantly, Constantly Synchronous.*

That is why so many designers concerned with split-second timing or control of light-weight moving parts specify Telechron motors.

If you have such a problem, why not turn it over to a Telechron Application Engineer? Drawing on the experience that makes all electric timing possible (virtually all frequency-controlling master clocks in power stations are made by Telechron), he can probably show you how a standard Telechron motor can do your job, too. Consult him early in your planning for big savings in time and money. Use handy coupon below for complete data. TELECHRON INC. A General Electric Affiliate.

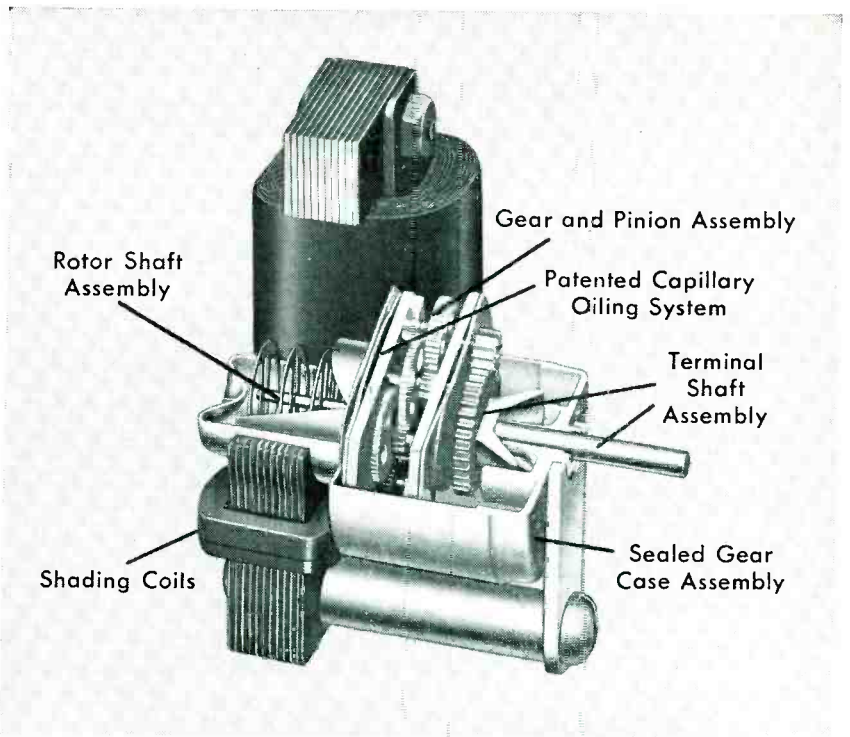

Telechron Type B Synchronous Motor. For medium duty purposes such as switches, recording-controlling mechanisms and other control equipment. Other models with lower or higher torque for light or heavy duty applications.

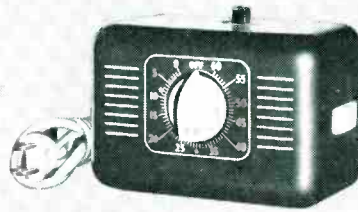

Typical of Telechron Type H3 light duty motor applications is this 60-minute timer, the purpose of which is to operate a switch or signal at the end of a pre-selected period.



Practically all time-stamps and recorders employ Telechron Type B motors to operate their timing mechanisms. Obviously a motor that is instantly, constantly synchronous is needed for such applications.

# Telechron

ALL TELECHRON TIMING MOTORS ARE

INSTANTLY...CONSTANTLY SYNCHRONOUS

**TELECHRON INC.**  
40 Union Street  
Ashland, Massachusetts

Please send me information on sizes and types of Telechron Synchronous Motors. My possible application is:

- |                                     |                          |  |                          |
|-------------------------------------|--------------------------|--|--------------------------|
| Instruments                         | <input type="checkbox"/> | Communications Equipment                         | <input type="checkbox"/> |
| Timers                              | <input type="checkbox"/> | Other (please fill in)                           | .....                    |
| Electric Appliances                 | <input type="checkbox"/> | .....  | .....                    |
| Cost Recorders                      | <input type="checkbox"/> | .....  | .....                    |
| Advertising, Display Items          | <input type="checkbox"/> | .....  | .....                    |
| Juke Boxes                          | <input type="checkbox"/> | .....  | .....                    |
| Air Conditioning & Heating Controls | <input type="checkbox"/> | <input type="checkbox"/> Please send new Catalog |                          |

NAME .....

COMPANY .....

ADDRESS .....

CITY ..... ZONE .....

STATE .....



**DOUGLAS AND MACADIE**

*Automatic*  
**COIL WINDERS**

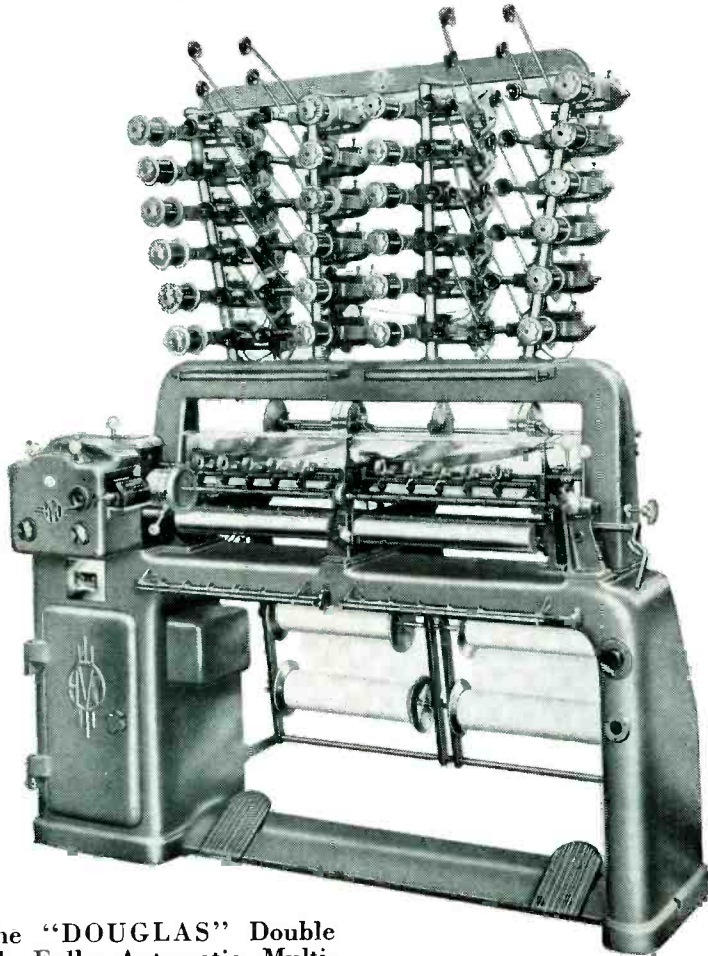

The "DOUGLAS" Double Bank Fully Automatic Multi-Winder is eminently suitable for the high-speed production of large quantities of coils with or without paper interleaving.

It will wind round, square or rectangular coils from 1-inch (25.4 mm.) to 5-inches (127 mm.) in length and up to 4-inches (102 mm.) diameter or diagonal. As many as 24 coils can be wound simultaneously (depending on the gauge of wire

being used), the total winding length of the machine being 30-inches (762 mm.).

Wires from 42 to 30 a.w.g. can be handled at variable head-stock speeds of between 600 and 2,000 r.p.m., the machine being fitted with a specially designed rapid-change gear box and a variable speed totally enclosed motor.

The machine, which incorporates the most up-to-date refinements is supplied complete with a special sliding seat which enables the operator to effect complete control without undue effort.



Our complete catalogue contains illustrations of numerous other Coil Winding and Taping Machines. A copy will be sent to interested executives on application.

**THE AUTOMATIC COIL WINDER & ELECTRICAL EQUIPMENT CO., LTD.**  
Winder House • Douglas Street • London • S.W. 1 • England. Cables: "Autowinda, Sowest, London". Code: A.B.C. 5th.

air at this extremely high temperature, the new lamp can be made to have a life of several hundred hours due to a unique operating principle whereby the zirconium metal is constantly renewed and reproduced from its own products of combustion.

**SURVEY OF NEW TECHNIQUES**

BLINK-RATE TESTER is being used by Stanford Research Institute in connection with smog elimination project sponsored by Western Oil and Gas Association. Phototube



just under goggles detects blinks of eyelid as various concentrations of contaminants are fed into mask. Output pulses of phototube are counted and recorded electronically.

COMPOSITE IRON-ALNICO structures for meter magnets are being made in England by filling with iron powder that portion of the die calling for iron. The remainder of the space is filled with the magnet powder. The spacer used to separate the powders during filling is removed before pressing. Both powders sinter at the same temperature, giving a continuous junction between the two parts of the sintered compacts. The gap and locating holes can readily be machined in the soft iron, with much greater accuracy than with castings.

COLOR OF STARS, related to distance from earth, is determined more precisely at Lick Observatory by using tungsten-filament lamp, with temperature of about 2,500 degrees absolute C, on an adjacent peak;

# GLOBAR TRADE MARK Type BNR Resistors Display Unusual NON-LINEAR Voltage-Resistance Characteristics

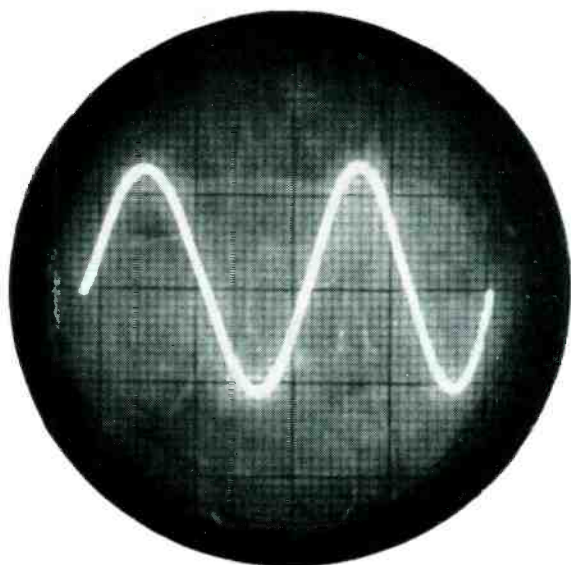

Wave Form of Applied Voltage.

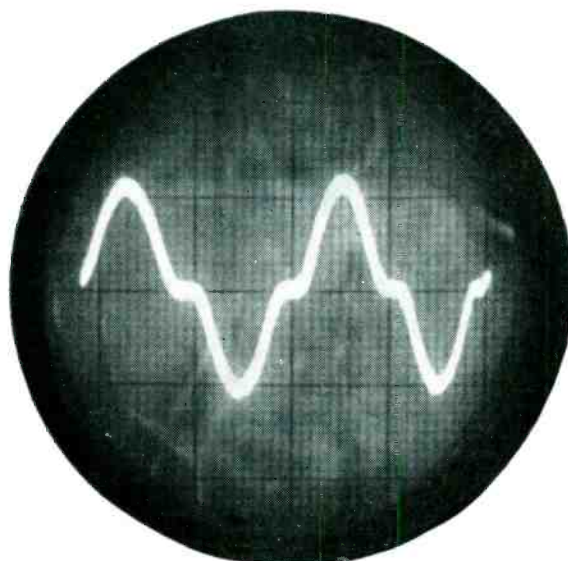

Wave Form of Current Flowing in Circuit.

Unretouched photographs of oscilloscope screen above show the effect obtained by connecting a GLOBAR type BNR resistor in series with a fixed resistor across a 115 volt 60 cycle supply.

## Typical successful applications of BNR Ceramic Resistors include:

- 1** Oil burner ignition transformers to prevent high voltage feed back into line.
- 2** Small motors to prevent arcing of governor contact points.
- 3** Stabilizing rectifier circuits by limiting peak voltages.
- 4** Voltage control circuits in electronic devices.
- 5** Protection of solenoid valves in direct current circuits.

Bulletin GR-2 contains useful engineering data on GLOBAR Type BNR Ceramic Resistors. Copies will be supplied immediately upon request. Write Dept. V-20, The Carborundum Company, GLOBAR Division, Niagara Falls, N. Y.



# GLOBAR Ceramic Resistors

## BY CARBORUNDUM

TRADE MARK

"Carborundum" and "Globar" are registered trademarks which indicate manufacture by The Carborundum Company

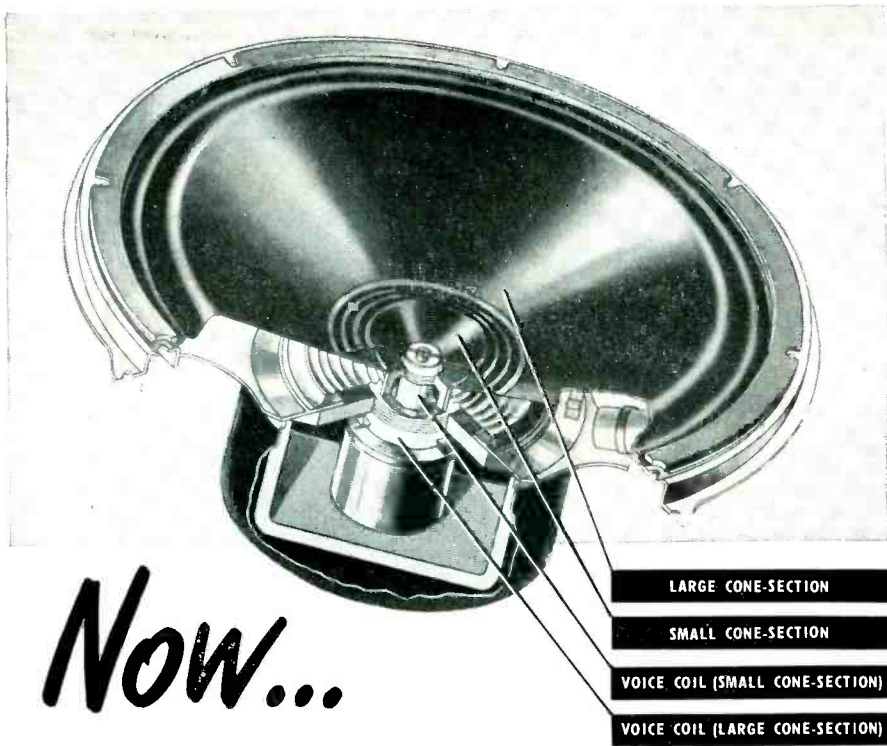

**Now...**

**the RCA 15-inch Duo-Cone High-Fidelity Speaker . . .**  
**a distinguished addition to RCA's line of quality speakers**

**Check these features—**

- ✓ Frequency response—40 cps to 12,000 cps.
- ✓ Minimum cross-over interference.
- ✓ Uniform directivity pattern.
- ✓ Wide angle of radiation.
- ✓ Low non-linear distortion.
- ✓ Designed for either rim or flange mounting.

Now . . . through the economies of mass production...RCA offers equipment manufacturers a low-priced 25-watt speaker of outstanding acoustical performance, employing the famous duo-cone principle originated by Dr. H. F. Olson, world-renowned authority on acoustics, of RCA's famed Princeton Laboratories.

The RCA-515S1 is designed for broadcast station monitors, public address systems, and high-quality radios and phonographs. It consists of coaxially mounted high- and low-frequency cone sections and voice coils so arranged that sound pressure originates from the same conical surface, thus minimizing distortion of the output waveshapes at the cross-over frequency of 2000 cycles. A unique magnetic structure contains a bridge network which supplies equal flux density to the air gap for each voice coil, with the total flux provided by a 2-pound Alnico V magnet. The directivity pattern covers an angle of 60 degrees and is approximately uniform over the entire frequency range of 40 to 12,000 cps.

The RCA-515S1 provides for RMA standard rim mounting . . . but may be mounted with the cone edge flush with the front of the baffle to obtain a uniform response characteristic.

RCA has a complete line of quality speakers for equipment manufacturers . . . designed to RMA standards. A variety of standard PM

types is available ranging from the miniature 2" x 3" to the large 12" and having power-handling capabilities from 1/8 watt to 25 watts. There's a type and size for every requirement.

For full data on the RCA-515S1 duo-cone speaker, or other types, write or phone your RCA representative or application engineer:

- |   |   |
|---|---|
| (EAST) Harrison, N. J.<br>415 S. 5th St.<br>Harrison 6-8000           | (MIDWEST) Chicago 11, Ill.<br>589 E. Illinois St.<br>Whitehall 4-2900 |
| (WEST) Los Angeles 13, Calif.<br>420 S. San Pedro St.<br>Trinity 5641 |   |

or write RCA, Commercial Engineering, Section B42S, Harrison, N. J.

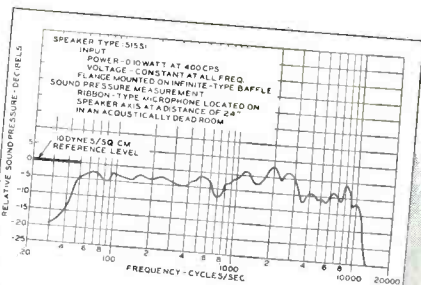

lamp is observed through telescope and its exact place in the spectrum is found, as starting point for establishing a scale for real stars of all temperatures.

RADIOACTIVE CHROMIUM 51 used as a tracer in chromium plating at the National Bureau of Standards solved a long-standing electrochemical problem by proving that the chromium metal is deposited from the hexavalent rather than the trivalent state.

CLOUD DENSITY, thickness and height are being measured with a sensing element comprising a piece of string saturated with a salt solution, carried aloft by a meteorological balloon. The airborne equipment measures the resistance of the string, which decreases with the water content of the cloud. A small transmitter sends the resulting information to a ground receiver and

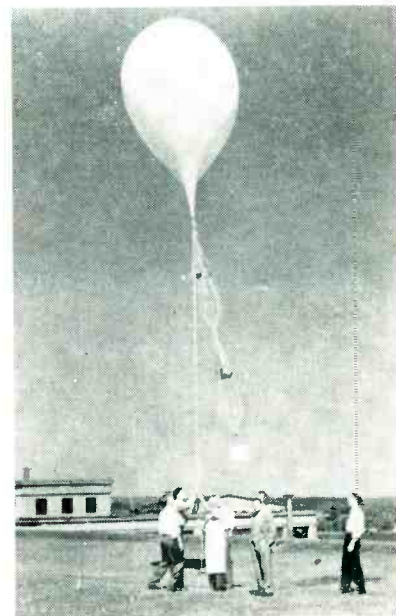

Cloud analyzer ready for trial ascension from roof of GE building in Electronics Park, Syracuse, N. Y.

recorder 120 times a minute. The receiving antenna system, also developed by GE engineers, tracks the balloon automatically even on board a rolling ship, and places direction and height data on the recorder paper. From this record the height of a cloud at its summit and base can be determined, along with the density of the cloud.



**RADIO CORPORATION of AMERICA**  
**ELECTRONIC COMPONENTS HARRISON, N. J.**

# This may be the solution to your D. C. AMPLIFICATION problems

## MICROSEN

### D. C. AMPLIFIER

The Microsen D. C. Amplifier is designed to meet the need for stable and accurate amplification that is *simple in operation, compact* to provide easy portability and convenient general use, *moderate in cost*. The amplifier has many applications in both laboratory and field work. Three different ranges are furnished in a single model. The Microsen Balance, an electro mechanical feedback amplifier, combines the advantages of high torque to current input ratio with rugged, shock-resistant construction. Available models include Voltage, Current and Potentiometer Type Amplifiers, Direct Current Converters, Direct Current Transformers, and Engineered Designs to meet special requirements.

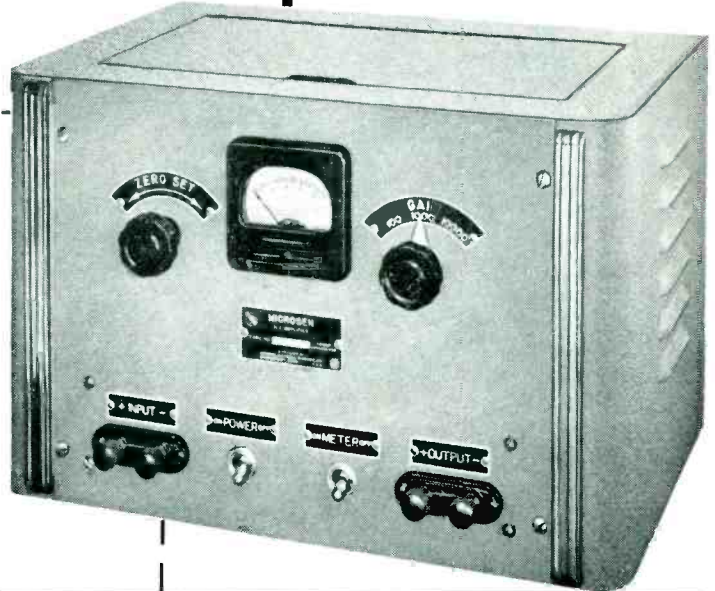

#### TYPICAL APPLICATIONS OF THE MICROSEN D. C. AMPLIFIER

Field of Measurement	Input Element	Output Instrument	Application	Design Advantages
Thermometry	Thermocouple	Recorder	Combustion Research Gas Turbine Development Thermocouple Inspection Meteorology Distillation Processes	High Speed Response Accuracy Sensitivity Stability
Photometry	Photo Cell	Recorder	Polarimetry Physiology of Blood Fluid Flow & Turbulence Density	Stability Sensitivity Responsive Accuracy
Gas Analysis	Catalytic Filament Thermocouple	Recorder	Detecting Explosive Mixture Efficiency of Filters Mixture Control	Sensitivity Stability Accuracy High Speed Response
Electrical Bridges	Resistors Resistance Elements	Recorder	Resistor Inspection Moisture Detection Conductivity Measurements	Sensitivity Stability Accuracy Fast Response
	Pirani Gauge		Vacuum Gauging	Stability
	Strain Gauge		Transient Stresses	Accuracy
Electronics	Inductance Ionization Thermionic	Recorder	Wave Guide Studies Vacuum Gauging Tube Development	Sensitivity Stability Low Resistance Input
Electrolysis	Electrolytic Cells Current Shunt	Recorder	Production Control Electrolytic Plating Electrolytic Process	Isolated Input Stability Accuracy

In each of the above applications, the Recorder could be replaced with a suitable milliammeter indicator, or the output can be used to actuate automatic control relays or signal devices. Inquiries for modification within the useful scope of the Microsen D. C. Amplifier are invited. If possible, such inquiries should contain complete application specifications.



# MICROSEN



## ELECTRICAL INSTRUMENTS

A PRODUCT OF

### MANNING, MAXWELL & MOORE, INC. STRATFORD, CONNECTICUT

Makers of 'Microsen' Electrical and 'American' Industrial Instruments, 'Hancock' Valves, 'Ashcroft' Gauges, 'Consolidated' Safety and Relief Valves. Builders of 'Show-Box' Cranes, 'Budgit' and 'Load Lifter' Hoists and other lifting specialties.

Manning, Maxwell & Moore, Inc.  
250 East Main Street  
Stratford, Conn.

We are interested in your Microsen D. C. Amplifier. Please send the bulletin describing the instrument to the following address:

Name \_\_\_\_\_  
Position \_\_\_\_\_  
Company \_\_\_\_\_  
Street Address \_\_\_\_\_  
City \_\_\_\_\_ State \_\_\_\_\_

# NEW STEVENS THERMOSTAT

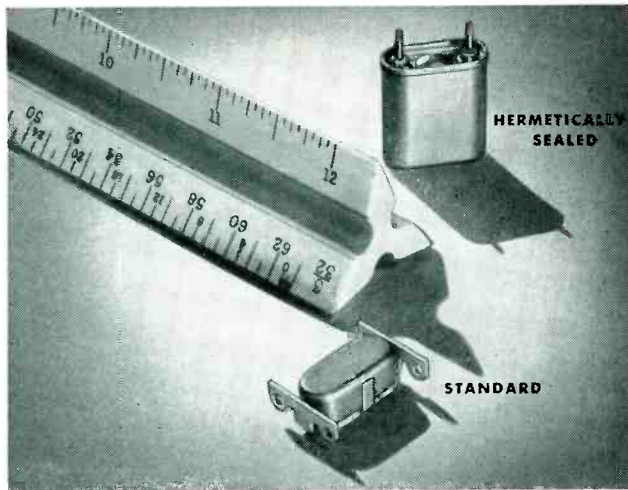

- close temperature control
- clean make and break
- fast response



Compactly designed for use in communications equipment, electronic devices and apparatus demanding a high degree of temperature stability, Stevens Type C\* thermostats feature an electrically independent bi-metal that responds *only to heat from controlled device.*

Typical temperature curve at left shows how this construction completely eliminates artificial cycling or life-shortening "jitters." Current flows readily through stainless steel or alloy contact spring . . . does not pass through high resistance bi-metal. Contacts open only when bi-metal overcomes spring pressure and friction of bi-metal strip against contact spring surface—for a *clean, positive break.*

Components are permanently riveted to dimensionally stable Alsimag base to further insure against erratic operation. Heavy-duty silver contacts assure long life.

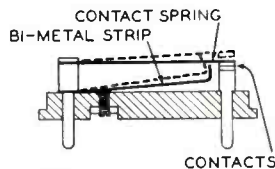

Standard and hermetically sealed Stevens Type C thermostats are carefully pre-calibrated in pots simulating actual service conditions; spot life-tests assure quality control. Specify Stevens Type C thermostats for closer temperature control—*longer life.*

A-2299

\* PATENT APPLIED FOR

**STEVENS** manufacturing company, inc.  
MANSFIELD, OHIO

## NEW PRODUCTS

(continued from p 126)

signed as terminal equipment in telemetering systems. It has a frequency range of 210 to 250 mc and features unusual sensitivity and selectivity. Provision is made for audio monitoring as well as for feeding a series of subcarrier discriminators.



### Beam Pentode

EITEL - McCULLOUGH, INC., San Bruno, Calif. Type 4E27A/5-125B pentode features design innovations such as a molded-glass header, shell-type base, low-loss leads, non-emitting grids and a Pyrovac plate. Rated at 125 watts plate dissipation and designed for vhf service, the tube is well suited for television service and air-navigational aids, as well as for general r-f and audio applications.



### Tele and F-M Tube

GENERAL ELECTRIC Co., Schenectady, N. Y. Type 6BC5 miniature tube is designed primarily for use as an r-f and i-f amplifier in television and f-m receivers. With a plate voltage of 250 volts and a

\*

FOR

**SAFETY  
ECONOMY  
CAPACITY**

See our Exhibit No. 207  
at the I.R.E.  
Radio Engineering Show

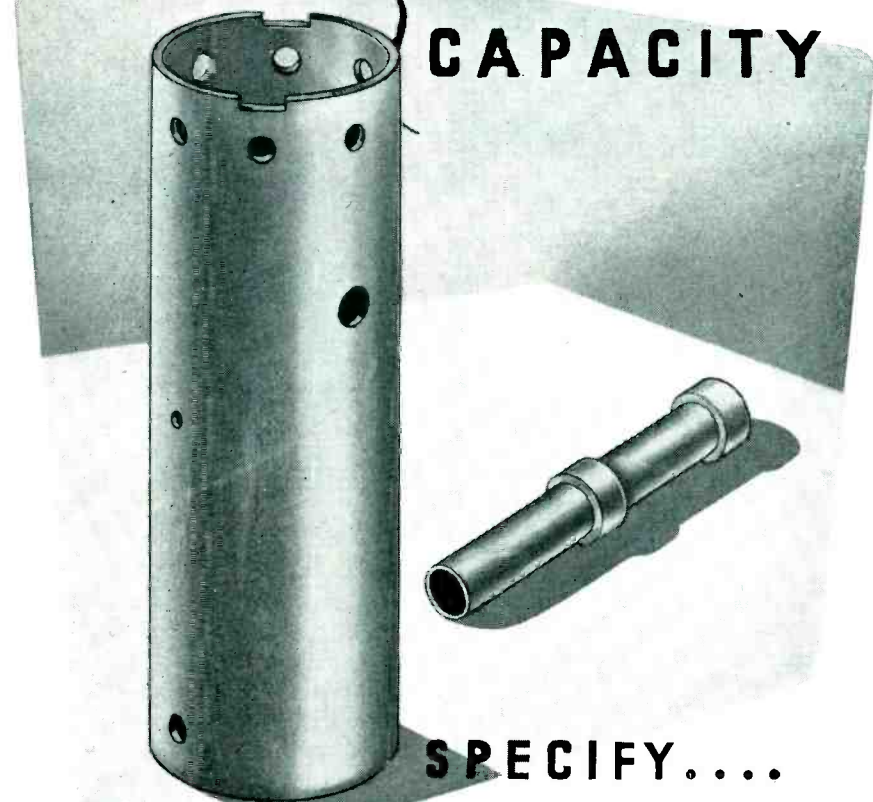

**SPECIFY....**

**"CLEVELAND"**

**COSMALITE\* SPIRALLY LAMINATED PAPER BASE  
PHENOLIC TUBES**

#102 CLEVELAND high dielectric strength coil forms for high voltage power supply circuits of television receivers.

#96 CLEVELAND coil forms with collars insure high quality at low cost. Specify that the collars be included and positioned on the core and thus secure a snug fit and an electrically stronger assembly.

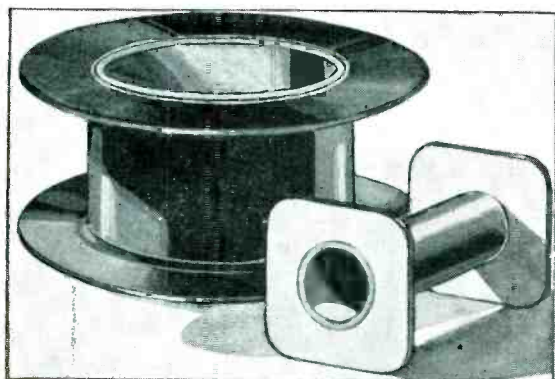

**BOBBINS . . .**

are additional applications of CLEVELAND phenolic and paper tubing. The Kirby Company, Cleveland, Ohio, whose samples are shown above, uses CLEVELAND products exclusively in their complete line of radio, television and other type bobbins.

Furnished in sizes, and with punching, notching, threading, and grooving that meet the customer's individual needs.

"Cleveland" quality, prices and deliveries are responsible for the universal satisfaction and prestige of this product.

Ask about our kindred products that are meeting both new and established needs in the electronic and electrical fields.

\* Reg. U.S. Pat. Off.

*The* **CLEVELAND CONTAINER Co.**  
6201 BARBERTON AVE. CLEVELAND 2, OHIO

PLANTS AND SALES OFFICES at Plymouth, Wisc., Chicago, Detroit, Ogdensburg, N.Y., Jamesburg, N.J.  
ABRASIVE DIVISION at Cleveland, Ohio  
CANADIAN PLANT: The Cleveland Container, Canada, Ltd., Prescott, Ontario

REPRESENTATIVES

CANADA	WM. T. BARRON, EIGHTH LINE, RR #1, OAKVILLE, ONTARIO
METROPOLITAN NEW YORK	R. T. MURRAY, 614 CENTRAL AVE., EAST ORANGE, N.J.
NEW ENGLAND	E. P. PACK AND ASSOCIATES, 968 FARMINGTON AVE. WEST HARTFORD, CONN.



*Each* OF THESE MICROPHONES  
HAS THE **SUPER-CARDIOID**  
PICKUP PATTERN THAT  
REDUCES FEEDBACK BY **73%**



LIST PRICE  
**\$67.50**



Multi-Impedance Switch  
for Low, Medium or High  
Impedance.

## THE FAMOUS "55" UNIDYNE DYNAMIC

**Unidirectional Microphone.** This superlative dynamic microphone is a Multi-Impedance Microphone—you can have either High, Medium, or Low Impedance simply by turning a switch! Because it is a Super-Cardioid, the "Unidyne" kills Feedback energy by 73%—making it possible to use under the most difficult acoustic conditions. The "Unidyne" is probably the most widely used microphone throughout the world. Recommended for all highest quality general-purpose uses.



## THE NEW "737A" MONOPLEX CRYSTAL

**Unidirectional Microphone.** The "Monoplex" is the *ONLY* Super-Cardioid Crystal Microphone made. As such, it is undoubtedly the finest of all crystal microphones. (A comparative test will prove this statement convincingly.) The "Monoplex" employs the same type of acoustic phase-shifting network used in the highest cost Shure Broadcast Microphones. Has "Metal Seal" crystal—will withstand adverse climatic conditions. Can be used in those applications where severe background noise would make conventional microphones practically useless!

LIST PRICE  
**\$39.75**

Licensed under patents of Brush Development Company. Shure patents pending.

**SHURE BROTHERS, Inc.**

Microphones and Acoustic Devices

**SHURE**

225 West Huron Street, Chicago 10, Illinois • Cable Address: SHUREMICRO

screen voltage of 150 volts, the transconductance is 5,700 micromhos. It features low input and output capacitances.



## Portable Alpha Counter

**NUCLEAR INSTRUMENT AND CHEMICAL CORP.,** 223 W. Erie St., Chicago 10, Ill. Model 2111 portable alpha proportional counter is intended to determine alpha activity on table tops, hands, clothing and other possibly contaminated locations. Several types of probes are available, and a pushbutton is provided to reset the meter immediately after exposure to a strong alpha source. The unit features a plug-in four-tube circuit.

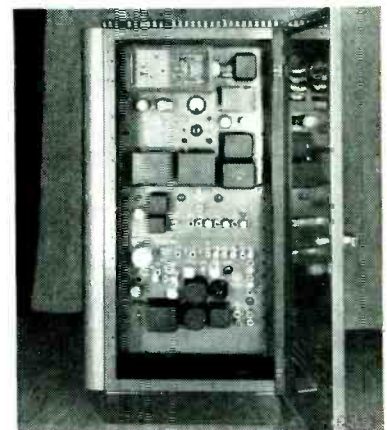

## Microwave Relay Equipment

**RADIO CORP. OF AMERICA,** Camden, N. J. The transmitter-receiver unit shown is the heart of the CWTR-5A microwave relay equipment for h-f point-to-point radio communications. It provides a modulation channel extending from



For oscillography at its *very best*, the logical choice continues to be

# DUMONT Industrial Cathode-ray Tubes

## TYPE 5XP-

Designed for high sensitivity  
at high operating potentials.

- ✓ Operates at overall accelerating potentials up to 29,000 volts with intensifier-to-second-anode voltage ratios as high as 10 for recording fast writing rates.
- ✓ Incorporates special deflection-plate assembly providing highly sensitive scan along one deflection axis.
- ✓ Deflection factor of more sensitive pair only 10-15 peak-to-peak volts per inch per kilovolt of second anode potential.
- ✓ Vertical and horizontal deflection plate assemblies are mutually isolated by metal shielding.
- ✓ Available with any standard long-, short- or medium-persistence screen. Special screen materials and metallization obtainable on special order.

◆ Years of cathode-ray tube experience and specialized research have enabled Du Mont to offer, repeatedly, such important developments as these Types 5XP- and 3RP-A:

## TYPE 3RP-A

Designed for brilliant trace and high sensitivity in a short, flat-faced 3-inch tube.

- ✓ Features extremely short overall length—9½ inches—for use in compact and portable instruments.
- ✓ Specially constructed vertical deflection plates minimize pincushion distortion usually found in flat-faced tubes of short length.
- ✓ Flat face greatly improves optical qualities of the cathode-ray tube, and increases useful screen area.
- ✓ Balanced deflection may be employed with Type 3RP-A, minimizing astigmatic distortion.

◆ Detailed literature on either or both of these Du Mont industrial tubes, on request.

© ALLEN B. DUMONT LABORATORIES, INC.

# DUMONT

## for Oscillography

ALLEN B. DUMONT LABORATORIES, INC., INSTRUMENT DIVISION, 1000 MAIN AVENUE, CLIFTON, NEW JERSEY

# MODERN ELECTRONIC DESIGN MEANS PLUG-IN UNIT CONSTRUCTION

## Alden Presents

**Components for plug-in, unit construction—electrical, electronic, and mechanical**

The trend in modern design is toward smaller, lighter, better locking equipment. Yet modern design demands easy servicing, rapid changeover, and fool-proof performance. To get these results, more and more modern design engineers are turning to *plug-in unit construction* with basic elements grouped as units that plug in, slide in, lock in, and pull out easily.

Up to now there has been no one place where components specifically designed for *plug-in, unit construction* were available. To get this type of construction — it has been necessary for engineers to design and have parts custom made or improvise with standard components in makeshift arrangements.

Here at Alden's we are designing and manufacturing components for *plug-in unit construction*. We are setting up to work with manufacturers on as many of these problems as possible. Very frankly, much of our work is still in the pilot run stage — but, in every instance — proven in use. If you don't see the answer to your problems here — let us work it out with you.

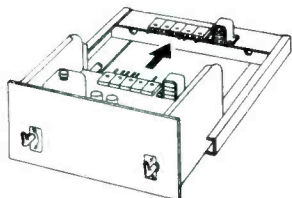
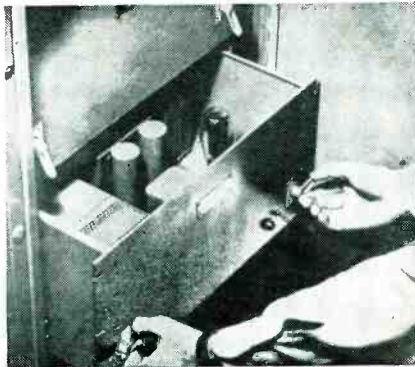

**Back connected chassis**—become instantly accessible. Half twist of handles brings chassis into place or ejects—no matter how heavy. Built for racks or as separate units — miniature and standard sizes.

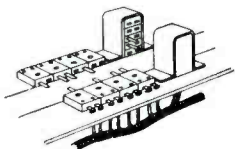

**Rugged color coded back connectors**—make and break circuits—provide rapid circuit checks. Wide mating tolerances compensate for any chassis misalignment. Miniature and heavy duty sizes.



**Top operated clamps for tubes and plug-in units**. Take minimum of space. Can be operated in cramped locations. Free floating—orients unit to socket without straining or bending pins.

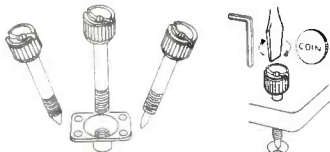

**Alden Cap Captive Convenience Screws**—Hold miniature chassis, heavy plug-in cans or detachable mechanical units securely. Assemble easily in production by power tools—yet any tool or coin services in field.

Write for new booklet on "Components for Plug-in Unit Construction"

**ALDEN PRODUCTS CO.** 117 NORTH MAIN ST. BROCKTON 64, MASS.

**At last—a base specifically designed for plug-in units.  
No more broken bosses, bent pins, "shorted" circuits.**

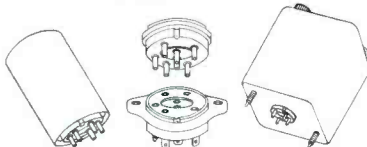

More and more engineers have been utilizing the basic elements of their circuits into compact, easily replaceable plug-in units. Since the conventional octal and tube socket bases have been the only component readily available, they have been constantly plagued by the broken bosses, bent pins, and "shorted" circuits caused by these bases.

This suggested an entirely new approach was necessary, so we went to work with some of these engineers. Out of this work the *Alden-Noninterchangeable plug-in base* was developed.

Pins have been made strong and stubby — for long, rugged use. The boss is eliminated entirely. Slight lead of center pins and locating rings with marker in the socket allow quick lining up of plug-in units. Further, this base is supplied with 2 to 11 contacts—in variable pin patterns — so that even where the same number of contacts are used, the pin layout may be varied so only the correct unit will mount in its proper socket. Pin patterns can even be selected to isolate critical voltages or signals.

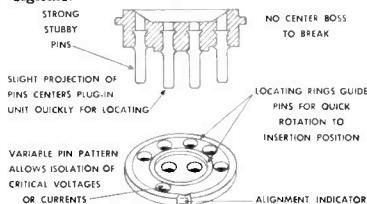

Write today for literature and samples. Let Alden work with you on your components for *plug-in, unit construction*.

300 to 30,000 cycles and is designed for unattended operation in the 940 to 960-mc band. Power output is 3 watts with a stability of  $\pm 0.005$  percent. Rated power consumption is 500 watts at 115 volts, 60 cycles. Receiver bandwidth is about 0.5 mc, and its frequency stability is  $\pm 0.01$  percent.

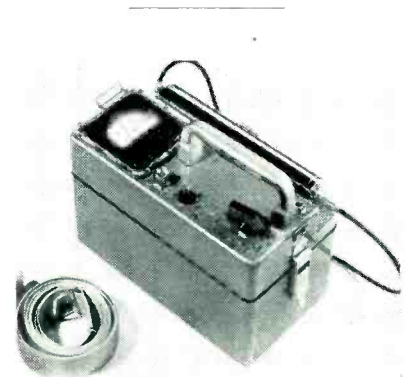

## Survey Meter

TRACERLAB INC., 130 High St., Boston 10, Mass. The SU-5 beta-gamma survey meter is portable, battery operated and weatherproof, and will serve both as a radiation dosage rate meter and a monitoring instrument. Two sets of scale ranges provide readings of 0.02, 0.2, 2.0 and 20 milliroentgens per hour; and 100, 1,000, 10,000 and 100,000 counts per minute. Meter drift during operation is not more than an average of 0.05 percent per hour. Battery life is 240 hours for continuous duty at 70 F.

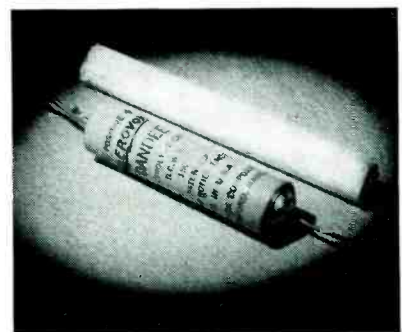

## Tiny Electrolytics

AEROVOX CORP., New Bedford, Mass., has announced a line of still smaller electrolytic capacitors, the Bantam or type SRE, especially suited for hearing aids, cathode bypass applications, screen filter cir-

for UTMOST Dependability

Hermetically  
Sealed  
Relays  
by



**AUTOMATIC**  **ELECTRIC**  
**CHICAGO**

Where reliable performance is a prime requirement, depend on Automatic Electric Hermetically Sealed Relays. "Sealed-in" controlled atmosphere protects these relays from electrical or mechanical failure from varying conditions of temperature, dust, humidity, acid, fungus or air pressure—and makes them completely tamper-proof.

**they're better relays, too!**

The Automatic Electric Relays available in hermetically sealed housings include the new, outstanding Class "B" . . . the famous Class "A" . . . the small, lightweight Class "Z" . . . the tiny, but powerful Class "S." Hermetic sealing . . . highly favored by the Armed Forces . . . maintains all the quality for which these relays are famed.



**send for circular!**

When you need hermetically sealed relays, call in the Automatic Electric field engineer. Meanwhile, for full information, address: Automatic Electric Sales Corporation, Chicago 7, Ill. In Canada: Automatic Electric (Canada) Ltd., Toronto.

**RELAYS**

**AUTOMATIC**  **ELECTRIC**

**SWITCHES**

# MYCALEX

## Miniature Tube Socket Prices Will Surprise You

We are now producing 7 pin miniature tube sockets of MYCALEX at prices formerly paid for ceramics, mica-filled phenolics and general purpose bakelite. MYCALEX is highly superior in quality yet costs no more than less effective insulating materials. MYCALEX miniature tube sockets are produced of glass-bonded mica by injection molding. It permits closer tolerances, low dielectric loss with high dielectric strength, high arc resistance and dimensional stability over wide humidity and temperature ranges.

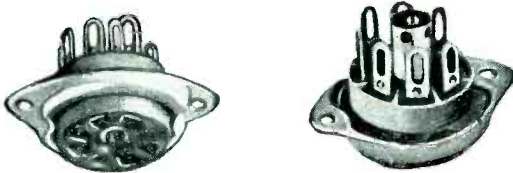

Above: Complete 7 pin miniature MYCALEX socket. Actual size, two views.

MYCALEX miniature tube sockets are produced in two qualities to satisfy different economy requirements.

MYCALEX 410 for applications requiring close dimensional tolerances not possible in ceramics and with a much lower loss factor than mica filled phenolics. This top grade insulating agent has an insulation loss factor of .015 (at 1 M.C.). It compares favorably in price with top grade mica-filled phenolics.

MYCALEX 410 X for applications where general purpose bakelite was acceptable but with a loss factor of only one fourth of that material. MYCALEX 410 X has an insulation loss factor of .083 (at 1 M.C.). Prices compare with lowest quality insulating materials.

Write us today and let us quote you prices on your particular requirements. We will send you samples and complete data sheets by return mail. Our engineers are at your disposal and would be glad to consult with you on your design problems.



Visit the Mycalex exhibit at the  
1950 IRE SHOW, Booth 82.

Our Engineers will show you the  
many problems solved with Mycalex.

### Mycalex Tube Socket Corporation

"Under Exclusive License of Mycalex Corporation of America"

30 Rockefeller Plaza, New York 20, N. Y.

## MYCALEX CORP. OF AMERICA



"Owners of 'MYCALEX' Patents"

Plant and General Offices: Clifton, N. J. Executive Offices: 30 Rockefeller Plaza, New York 20, N. Y.

cuits, personal radios and similar purposes. Bantams are hermetically sealed and comply with RMA tolerance requirements, d-c leakage-current limits, surge-voltage ratings and operating-temperature ranges.



### Multi-Combination Meter

M. C. MILLER, 1142 Emerson Ave., West Englewood, N. J. Model B lightweight multicomcombination meter was designed specifically for electrolysis and corrosion investigations and cathodic protection testing in both field and laboratory. It is available with either of two sets of instruments. In one the low-resistance voltmeter is 20,000 ohms per volt; in the other, the low-resistance is 3,000 and the high-resistance 62,500 ohms per volt. A milliammeter-ammeter is provided with nine ranges from 2 ma to 20 amperes. Voltmeters may be used separately or simultaneously by means of a circuit selector switch.

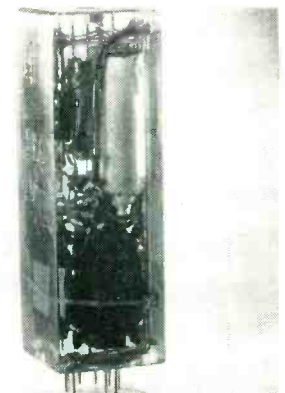

### Casting Resin

MELPAR INC., 452 Swann Ave, Alexandria, Va. Pictured is electronic circuit case in Melpak IV, a casting resin designated specifically for en-

# TWELVE HUNDRED HANDS TO FIND THE FACTS

FOUR hundred field correspondents ferret out, spade up, shoot in stories from all over the world of industry. Two hundred editors, bristling with Ph.D.'s and practical engineering and scientific knowledge, cull and correct and explain and expound. That's McGraw-Hill.

It takes a huge staff like this to keep abreast of events and developments in such a giant sphere as American industry. And the vote of thousands upon thousands of regular readers of McGraw-Hill publications seems to be: McGraw-Hill has what it takes to get the facts — fast.

To be well versed in the latest developments in *your industry*, be a cover-to-cover McGraw-Hill reader. Editors and advertisers collaborate to make your job easier. The advertising pages of all McGraw-Hill publications are packed with newsworthy information . . . the latest news on products and services that contribute to profits.

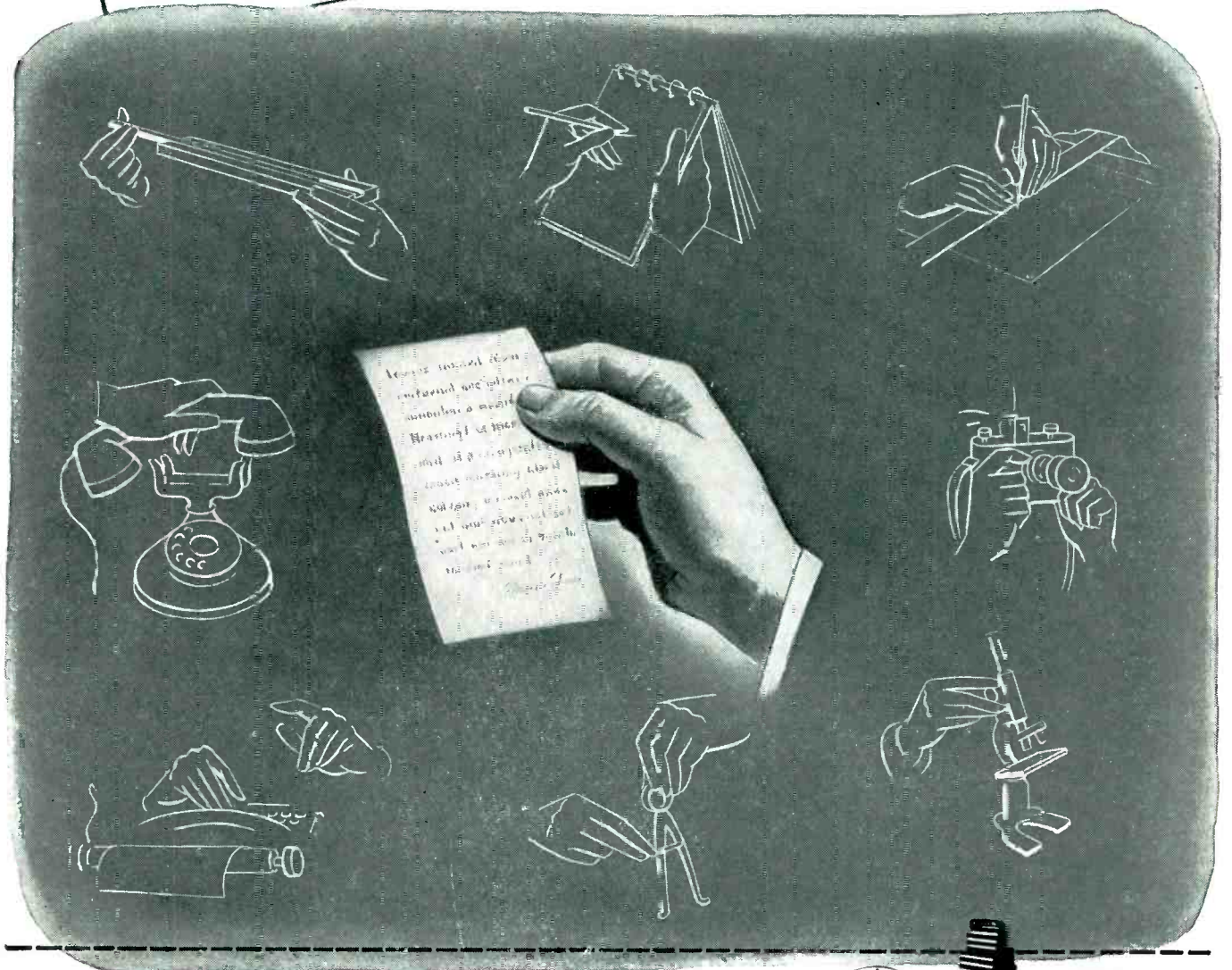

## McGRAW-HILL

Publishing Company, Inc., 330 West 42nd Street, New York 13, N. Y.



# Timing Ideas

## HERE'S A COMPACT SLOWPOKE

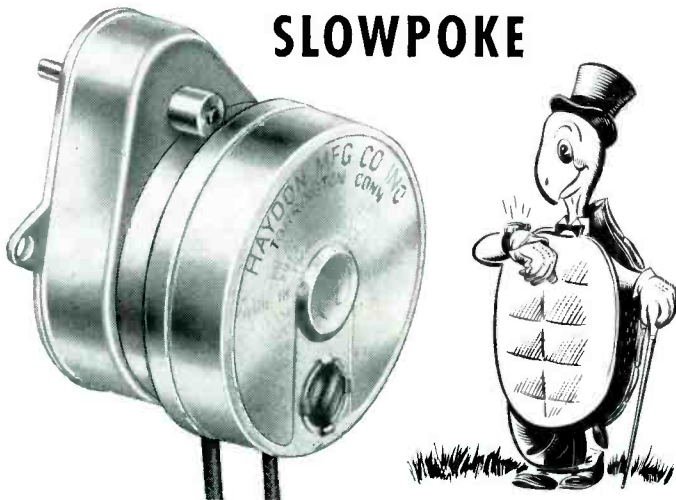

Designers and manufacturers concerned with the excessive space requirements and high cost of external reduction gearing will welcome this new slow speed timing motor. The series 4400 requires minimum space and provides, at comparatively low costs, speeds from 6 hours to 7 days per revolution. The careful design, expert engineering and precision manufacture, are advantages common to all Haydon motors.

### SUPERIORITY FEATURES

**DEPENDABILITY:** Slow 450 rpm rotor speed means less reduction gearing and fewer fast wheels, providing quieter operation and longer life.

**SMALL SIZE:** Smallest available of this type.

**TOTAL ENCLOSURE:** A basic feature of sound design.

**CONTROLLED LUBRICATION:** Separate rotor and reduction gearing lubricating systems permit selection of best methods and lubricants, control circulation, insure against leakage.

**OPERATING POSITION:** Operates continuously in any position.

**SIMPLE, SECURE ASSEMBLY:** Entire face of motor can be supported securely against mounting surface. Motor leads standard for quick, inexpensive wiring.

**STANDARD INTERCHANGEABLE DESIGNS:** Speed from 300 rpm to 1 revolution per week in only 2 interchangeable motor series.

For complete design and engineering specifications, write for catalog: Timing Motors No. 322 — Timers No. 323 — Clock Movements No. 324. Yours without obligation.

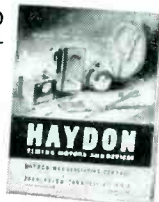

**HAYDON**  
AT TORRINGTON

HEADQUARTERS FOR  
**TIMING**

**HAYDON Manufacturing Co., Inc.**  
2426 ELM STREET

**TORRINGTON, CONNECTICUT**

SUBSIDIARY OF **GENERAL TIME CORPORATION**

capsulating subminiature circuits. The resin is recommended for audio or video applications where size, weight, temperature, moisture or rough handling pose a design problem. Temperature range is  $-85^{\circ}\text{F}$  (ambient) to  $+320^{\circ}\text{F}$  (hotspot).



### Adjustable-Speed Drive

**WESTINGHOUSE ELECTRIC CORP.**, P.O. Box 868, Pittsburgh 30, Pa. A new fractional horsepower Mot-O-Trol electronic adjustable-speed drive is now available. This control starts, stops, and controls the speeds of  $\frac{1}{8}$  to  $\frac{1}{2}$ -horsepower d-c motors, operated from single-phase, 50 or 60-cycle, 220 or 440-volt power sources.



### Magnetic Tape Recorder

**AMPLIFIER CORP. OF AMERICA**, 398 Broadway, New York 13, N. Y. Model 810-DV continuous-play Twin-Trax magnetic tape recorder

eliminates the usual continuous tape loop. Half the message is recorded on one sound track in forward tape travel, and the other half on the second sound track in reverse tape travel. Special solenoids reverse the direction in  $\frac{1}{2}$  second. Frequency response is 50 to 9,000 cycles at  $7\frac{1}{2}$  in. per second tape speed.



**Aircraft Amplifier**

MANNING, MAXWELL & MOORE, INC., Bridgeport, Conn. Type 140-AH1 Microsen amplifier for aircraft is designed to operate with 26.5 volts d-c power supply. A bipolar output of 3.0 ma d-c is obtainable in each of five fixed ranges, corresponding to input signal voltages of 75, 150, 187.5, 250 and 750 mv. A sixth variable range permits adjustment of sensitivity to any value between 75 and 750 mv.



**Wide-Angle Picture Tube**

GENERAL ELECTRIC Co., Syracuse, N. Y. Type 16GP4 wide-angle 16-inch metal television picture tube is five inches shorter than conventional tubes of this size. The new

*Timing Ideas*



**WHEN TIMING COUNTS**

You can always count on Haydon to provide the right motor for your timing job. Timing Headquarters offers a broad line of efficient, economical timing motors and timers produced by specialists who have no other interest than to provide the best in timing.

**LOW COST VERSATILITY—1600 SERIES:**

Specifically designed as a standard component for the widest possible range of timing applications with 79 speeds from 300 rpm to 1 revolution per 4 hours.

**COMPACTNESS AND SLOW SPEED—4400 SERIES:**

Designed for small size and low cost in applications requiring slower speeds from 6 hours to 7 days per revolution.

**HEAVY DUTY DEPENDABILITY—3100 SERIES:**

For control and instrument applications that require a heavy duty train and speeds from 1 hour to 14 days per revolution.

**SUPERIORITY FEATURES**

Slow (450 rpm) rotor speed makes for quiet operation and long life. Unusually small. All motors totally enclosed. Separate rotor and reduction gearing lubricating systems permit selection of best methods and lubricants, control circulation, insure against leakage. Operates continuously in any position. Simple to mount, entire face of motor can be supported securely against mounting surface. Standard, interchangeable design in only 2 motor series with speed range from 300 rpm to 1 revolution in 7 days.



For complete design and engineering specifications, write for catalog: Timing Motors No. 322 — Timers No. 323 — Clock Movements No. 324. Yours without obligation.



**HAYDON**  
AT TORRINGTON  
HEADQUARTERS FOR  
**TIMING**

**HAYDON Manufacturing Co., Inc.**  
2426 ELM STREET

**TORRINGTON, CONNECTICUT**  
SUBSIDIARY OF GENERAL TIME CORPORATION



There is a  
**SPECIALTY  
BATTERY**  
For Your  
Special  
Needs



## Custom Built Dry Batteries Built to Exacting Industrial and Electronic Requirements

If you need a battery that's completely new, one you've never heard of, or that's no longer available through normal channels, call on Specialty Battery Company. Specialty supplies hard-to-get batteries for every purpose, designs and manufactures dry batteries to your specifications.

### Send For This Free Catalog

Gives complete specifications for industrial, laboratory, instrument and ignition batteries for every possible dry battery requirement.



**SPECIALTY BATTERY COMPANY**

A SUBSIDIARY OF THE **RAY-O-VAC** RAY-O-VAC COMPANY

MADISON 3, WISCONSIN



*Big parts*



*Little parts*



..make them faster, better, at lower cost with **EASY-FLO** and **SIL-FOS**

These two low-temperature silver brazing alloys provide every property essential to both current-carrying connections and structural joints in electrical work.

High strength and ductility, high electrical conductivity, strong resistance to oxidization and corrosion — you get them all when you braze with EASY-FLO and SIL-FOS.

And the combination of low working temperature, extreme fluidity and silver content exclusive with both alloys, give you these results with substantial savings in time, labor and cost.

BULLETINS 12-A AND 15 give you full details. Write for copies today.

**Build YOUR OWN Heathkit TEST EQUIPMENT**

Heathkits are beautiful factory engineered quality service instruments supplied un assembled. The builder not only saves the assembly labor cost but learns a great deal about the construction and features of the instrument. This knowledge aids materially in the use and maintenance of the equipment. Heathkits are ideal for and used by leading universities and schools throughout the United States. Each kit is complete with cabinet, 110V 60 cycle transformer (except Handi-Tester), all tubes, coils assembled and calibrated, panel already printed, chassis all punched, formed and plated, every part supplied. Each kit is provided with detailed instruction manual for assembly and use. Heathkits provide the perfect solution to the problem of affording complete service equipment on a limited budget. Write for complete catalog.

- Heathkit AUDIO GEN KIT \$34.50
- Heathkit TELEVISION GENERATOR KIT \$39.50
- Heathkit CONDENSER CHECKER KIT \$19.50
- NEW Heathkit IMPEDANCE BRIDGE SET \$69.50
- Heathkit HANDITESTER KIT \$13.50
- Heathkit TUBE CHECKER KIT \$29.50
- Heathkit SIGNAL TRACER KIT \$19.50
- Heathkit R.F. SIGNAL GEN. KIT \$19.50
- Heathkit 5" OSCILLOSCOPE KIT \$39.50
- Heathkit BATTERY ELIM NATOR KIT \$22.50
- Heathkit ELECTRONIC SW TCH KIT \$34.50
- Heathkit VACUUM TUBE VOLTMETER KIT \$24.50

**HEATH COMPANY**  
BENTON HARBOR, 11 MICHIGAN

EXPORT DEPARTMENT  
13 EAST 40th STREET  
NEW YORK 16, N.Y.  
CABLE — ARAB — N.Y.

**HANDY & HARMAN**  
82 FULTON ST., NEW YORK 7, N. Y.

Bridgeport, Conn. • Chicago, Ill. • Los Angeles, Cal.  
Providence, R. I. • Toronto, Canada

Agents in Principal Cities



tube features a "filter-glass" face plate which improves picture contrast and clarity by reducing halation and cutting down reflections from surrounding light sources. Overall length is about 17½ inches.

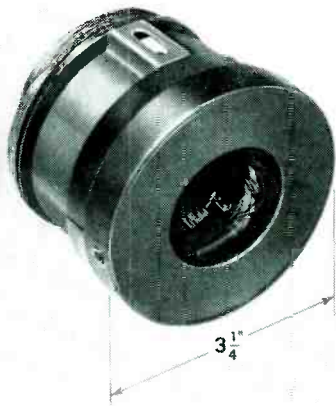

### Deflecting Yoke

RADIO CORP. OF AMERICA, Harrison, N. J. The 205D1 magnetic deflecting yoke is designed for use with kinescopes having neck diameters of 1⅞ in. and deflection angles up to about 60 deg. It has a molded spool and a molded iron core. The start and finish of each of the four coils are brought out to terminals to facilitate circuit connections. This yoke should be installed so that the capped end is toward the base of the kinescope.

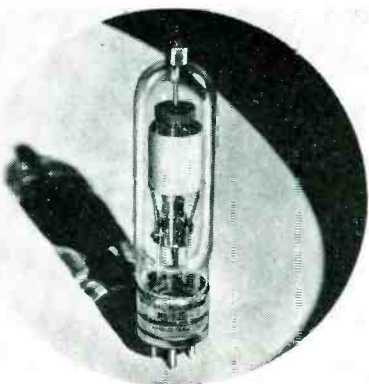

### Mercury Rectifier

NATIONAL ELECTRONICS, INC., Geneva, Ill., have introduced a new quick-heating 6.4-ampere mercury-vapor rectifier tube for industrial

**NOW... the best lines for industry and research are all under ONE roof!**

**MILO**

**ONE call  
gets  
them  
All!**

**SIMPSON ELECTRIC  
STANDARD TRANSFORMER • BURGESS  
CORNELL-DUBILIER • A. B. DUMONT • ERIE  
AMPHENOL • HAMMARLUND • NATIONAL COMPANY  
CINCH-JONES • JAMES MILLEN • SYLVANIA • BUD  
HICKOK • IRC • OHMITE • ATR • UTC • etc.**

Only Milo now answers your call for the specialized products of every outstanding manufacturer of electronic parts, tubes and equipment—for all your production, research and industrial needs.

### STREAMLINED ONE-SOURCE PURCHASING SAVES YOU MONEY, TIME AND EFFORT!

Only Milo gives you these exclusive buying advantages:

- ★ **QUICK, EASY, SIMPLIFIED PURCHASING** — One constant, dependable source for all your procurement. No wasteful hunting around. No hazardous, costly guessing.
- ★ **COMPLETE NEWEST STOCKS** — Up to specified quantities, you get the identical price the factories would give you.
- ★ **SAME-DAY SHIPMENT** — Assures you of fast, on-time delivery — prevents costly delays.
- ★ **TECHNICAL KNOW-HOW AND KNOW-WHAT** — The up-to-the-minute, right, fast answers you need, by men with decades of experience in industrial electronics requirements.
- ★ **PERSONAL ATTENTION AND ADVICE** — Whether your order is large or small, Milo's large staff of Industrial Salesmen is ready to help you with the latest information and personal consultation, at your office if you so desire.

### The Newest Products of the Best Manufacturers are always at MILO

Here are just a handful of the latest products of major interest to you now available from Milo's great warehouse of complete stocks:

**AMPEREX**—New inexpensive Geiger tubes, types 75N and 75NB, priced at \$10.00 each. New type PL-105 mercury vapor thyatron tube.\*

**ALLEN B. DUMONT LABORATORIES**—New oscilloscopes, superseding the famous 208B. Type 304, \$285.00 each. Type 304H, \$307.50 each.

**ERIE\*** — New button-style capacitors, GP ceramicons, tubular trimmers, ceramicon trimmers, etc.

**IRC\***—New type DCH and DCF precision resistors. BTS, BTA, BT2 and BW resistors, in all tolerances and values. New CLA and CL-1 insulated chokes, readily identified with RMA color coding in microhenries.

**SOLA ELECTRIC\***—Constant voltage transformers.

**SYLVANIA\***—All types of germanium crystals, new glow modulators, gas pressure tubes, TR and ATR tubes, strobotrons, thyatron tubes, flash tubes.

**TUNG-SOL**—New type 5687 miniature twin triode tube, \$7.25 each.

**ALLEN BRADLEY\***—Potentiometers, and EB, GB, HB resistors in all tolerances and values.

\*Prices and literature on these products available on written request on your letterhead.

To get it right, to get it fast, to get it at the factory price— Call Milo's INDUSTRIAL SALES DIVISION today. Ask for Mr. Lee. Or write on your letterhead for free latest Catalog E.

**MILO**

PHONE

**BEekman 3-2980**

**Radio & Electronics Corp.**

200 Greenwich Street, New York 7, N. Y.

Cable Address: MILOLECTRO

The ONE source for ALL your electronic needs

**Introducing**  
**THE NEW No. 5841**  
 Subminiature  
**CORONA REGULATOR**

★

**CHARACTERISTICS**

D.C. Starting Voltage.....(max.) 930 Volts  
 D.C. Regulating Voltage..... 900 ±15 Volts  
 Regulated Current Range..... 2-50 μa  
 Voltage Regulation (2-50 μa)...(max.) 1.5%  
 Life.....(min.) 1000 hrs.

**RATINGS**

Regulator Current.....(max.) 50 μa  
 Relative Humidity.....(max.) 100%  
 Ambient Temperatures..... -65°C to 100°C.



The 5841 sub-miniature corona regulator now in production is another Victoreen component developed to make fine instrumentation finer. This regulator supplements other specially designed electron tubes required in radiation measurement and in the broader field of laboratory instruments.

... subminiature  
**ELECTRON TUBES**

Tube Type	Typical Service	Volts Ec <sub>1</sub>	Volts Ec <sub>2</sub>	Volts Eb	μa Ib	μ	μmhos Gm	Grid current Signal grid
*5800	** Electrometer Tetrode	+3.4	***-3	+4.6	12	1	15	3×10 <sup>-15</sup>
*5803	Electrometer & D.C. Amp.	-1.7	----	+7.5	100	2.0	150	10 <sup>-14</sup>
*5828	D.C. Amp.	-1.0	----	45	250	17.5	450	10 <sup>-9</sup>

— — — and a complete line of counter tubes including the universally used 1B85, the 1B67 end window mica window tube, gamma ray counters, and sub-miniature counter tubes — — — not forgetting Victoreen hi-meg resistors vacuum sealed in glass, values 100—10,000,000 megohms.

Write for data sheets



**THE VICTOREEN INSTRUMENT CO.**  
**5806 HOUGH AVENUE CLEVELAND, OHIO**

control and rectifier applications. Designated as NL-635, it is available either with an industrial or a bracket-type base and is designed for interchangeability with inert gas-filled rectifiers. Filament voltage is 2.5 volts; filament current, 18 amperes; peak inverse voltage, 1,000 volts.



**UHF Oscillator**

MEASUREMENTS CORP., 116 Monroe St., Boonton, N. J. Model 112 uhf oscillator covers the 300 to 1,000-mc range. Frequency calibration is accurate to ±0.5 percent. It has a maximum output voltage, varying with frequency, between 0.3 volt and 2 volts. Output voltage is not calibrated in absolute value; however, an output dial calibrated in db makes possible relative voltage measurements.

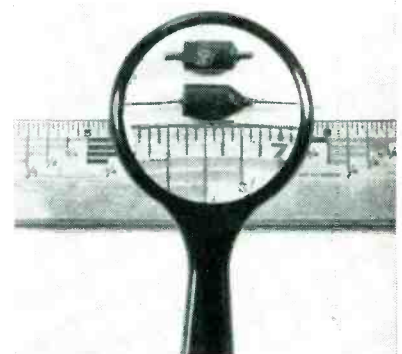

**VHF Germanium Diodes**

GENERAL ELECTRIC Co., Syracuse, N. Y. Two new germanium diodes designed for use in present vhf television receivers are the 1N64 for video detector circuits, and the 1N65 for use as a d-c restorer in tv

circuits and especially selected to provide high back resistance. Featured are small size, life rating of 10,000 hours and high humidity resistance.

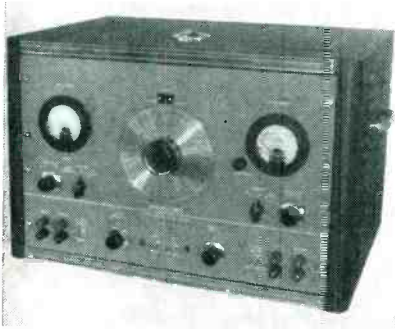

**Servo Analyzer**

SERVO CORPORATION OF AMERICA, 20-20 Jericho Turnpike, New Hyde Park, N. Y. The new Servoscope is an instrument for analyzing, testing synthesizing servomechanisms, regulators or automatic control systems by plotting the phase and amplitude responses with respect to various signal frequencies. A cathode-ray oscilloscope must be connected to the instrument shown. In measuring d-c servomechanisms, either sinusoids or square waves are available between 0.1 and 20 cps.



**Record Compensator**

PICKERING AND Co., 309 Woods Ave., Oceanside, N. Y. Model 132E record compensator provides in its six positions the flexibility required to equalize for different recording characteristics, including micro-

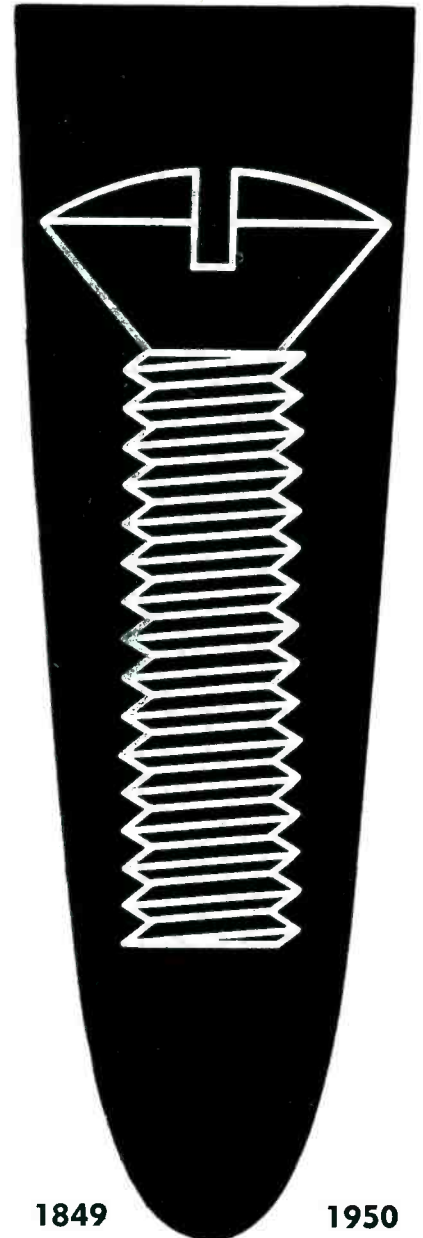

**here's your  
one-stop source  
for fastening service**

1849

1950

*Slotted or Phillips head machine screws, wood screws, stove bolts, tapping screws, special headed products; nuts, rivets, chaplets, wire forms, screw machine products . . . in steel, stainless steel, copper, brass, bronze, everdur, nickel, nickel silver, monel, aluminum . . .*



**THE BLAKE & JOHNSON COMPANY, WATERVILLE 48, CONN.**

Please send me your new catalog containing full data on the complete line of Blake & Johnson fastenings.

Name .....

Title .....

Company .....

Address ..... E-2

# VULCAN



TERMINALS AT EACH END



TERMINALS AT ONE END

## FLAT HEATING UNITS

HIGHER WATTAGE PER SQUARE INCH BECAUSE OF CERAMIC INSULATION

1. Seamless
2. Single or Three-heat
3. Standard widths— $\frac{3}{4}$ ", 1", 1 $\frac{1}{2}$ ", 1 $\frac{3}{4}$ "
4. Practically any length up to 120"
5. With or without mounting holes
6. Can be formed into Band Heaters—one piece or hinged.

If you have a problem involving electric heaters—flat, cartridge, immersion, tubular or special—write us. We like problems.

**VULCAN ELECTRIC COMPANY**  
DANVERS, 10, MASS.

Makers of Vulcan Electric Soldering Tools, Electric Solder Pots, Electric Glue Pots, Electric Branding Irons and Electric Heating Units, including the new Vulcan 900 series, for changing over any hot water heater to electric operation.



**PAPER**  
can be made to answer many electrical needs

### ARMATURE PAPER

Strong Kraft with high dielectric strength and anti-corrosion properties.

### CABLE WRAP

Flat or creped Kraft; can be water-proofed or made anti-corrosive as required.

### CORE BASE PAPER

Controlled conductivity; free from harmful chemical action.

### INSULATION PAPER

High physical strength, high dielectric strength.

### ANTI-RUST PAPER

Treated to prevent rusting of metal with which it is in contact.

### ANTI-CORROSIVE PAPER

Chemical properties carefully controlled to assure neutrality.

Centraline Engineered Electrical Papers are designed especially to solve your particular problem. They can replace more expensive materials, improve product design, increase production and reduce manufacturing costs. Uniformity and adherence to specifications is assured by laboratory control from pulp to finished Electrical Paper.

Consult a Central Paper Engineer—he will be glad to discuss your problem with you and provide samples for testing. No obligation of course.



REG. U. S. PAT. OFF.

**CENTRAL PAPER COMPANY**  
INCORPORATED

2442 LAKESHORE DRIVE, MUSKOGON, MICH.

# ZOPHAR

## Waxes, Compounds and Emulsions



Materials for potting, dipping or impregnating all types of radio components or all kinds of electrical units. • Tropicalized fungus proofing waxes. • Waterproofing finishes for wire jackets. • Rubber finishes. • Inquiries and problems invited by our engineering and development laboratories.

Zophar Mills, Inc. has been known for its dependable service and uniformity of product since 1846.

**ZOPHAR MILLS, Inc.**

ESTABLISHED 1846

117 26th STREET, BROOKLYN 32, N. Y.

groove and standard records, domestic or foreign. Because it uses linear circuit elements it has no inherent distortion. It can be connected to any amplifier having an equalizing preamplifier.

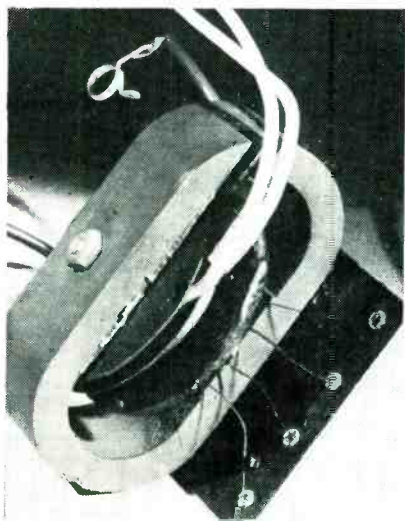

### Horizontal Output Transformer

HENRY L. CROWLEY AND Co., INC., 1 Central Ave., West Orange, N. J. The television transformer illustrated has been reduced in size and cost by employing a new powdered-iron core material known as Croloy 597. Properly designed coils using this new core material permit operation of 16-in. picture tubes with a single rectifier stage at an anode voltage of about 14 kv.

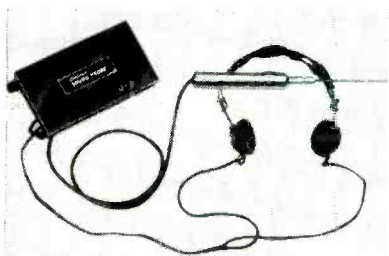

### Sound Probe

COMO-TEX Co., 128 W. Lake St., Chicago 1, Ill. A completely redesigned probe localizes sound electronically (in motors, bearings and like units) bringing it to a focal point. The new device brings out a natural reproduction of sound at the source and amplification reveals

## 2 CHANNEL DC SCOPE

with these  
**NEW**  
Features!

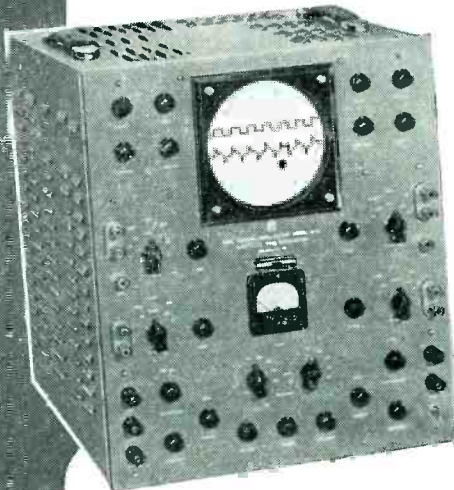

### 2 SIMULTANEOUS TRACES

on one tube face. Permits direct comparison of two phenomena—separate controls for position, intensity, and focus on each channel.

### HIGH GAIN

deflection sensitivity better than 0.036 Vrms/inch. Frequency response dc to 200 kc.

### SINGLE ENDED OR DIFFERENTIAL INPUT

Selection of either type of input can be made through terminals on the front panel.

### GREATER SWEEP RANGE

Triggered or continuous, 2 cps to 50,000 cps. Individual or common. Less than 1 micro-second delay when externally triggered.

### CONTINUOUS DIRECT CALIBRATION

0 to 100 volts. Read directly on panel voltmeter—no interpolating or measuring.

### LIGHT WEIGHT—PORTABLE

Weighs only 65 pounds, easily moved. Takes up little working space.

This more adaptable dual channel oscilloscope is making the single channel scope operated with an electronic switch obsolete in many applications, and being profitably utilized in research, testing, design and development applications where an oscilloscope had never before been utilized.

If you need a four or five channel scope, or a cathode ray tube containing up to ten or more electron guns for special applications, you'll find us able to help you. A high-gain dc amplifier and a versatile dc pre-amplifier are also available. Write for further details or any assistance you may desire.

*electronic tube corporation*

PHILADELPHIA 18, PENNSYLVANIA



**How PRECISION PAPER TUBES protect your coil windings . . .**

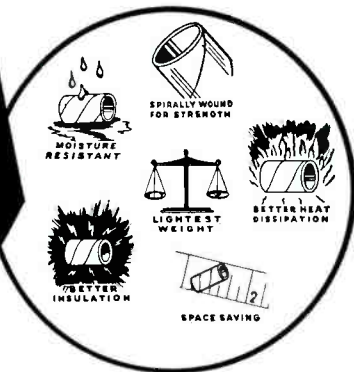

How far do these characteristics of your COIL BASES affect coil quality?

Every engineer knows the answer. Precision coil bases have long proved their reliability in these factors—with light weight and space saving. Made to your specifications of finest dielectric Kraft, Fish Paper, Cellulose Acetate or combinations. Any length, any ID or OD, round, oval, square, rectangular. Ask for new Mandrel list, over 1000 sizes.

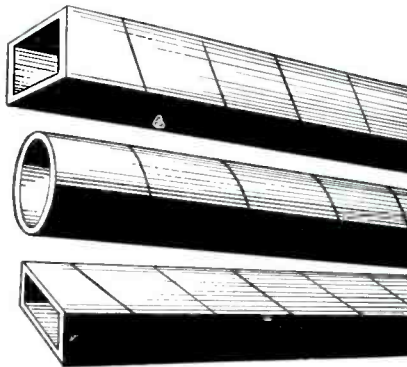

Send for sample and LOW PRICES.

# PRECISION PAPER TUBE CO.

2041 W. Charleston St. Chicago 47, Ill.  
Plant No. Two, 79 Chapel St., Hartford, Conn.

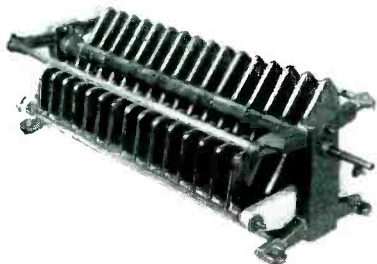

**HIGH VOLTAGE  
HIGH CURRENT**

call for **JOHNSON**  
**TYPES BC & BCD Variable Condensers**

For Commercial and Broadcast Applications where high voltage and high current conditions prevail, there is no happier choice of variable condensers than JOHNSON.

The new aluminum die cast plates have a heavy beaded round outer edge that increases the voltage breakdown and reduces corona effect.

The cast aluminum end frame, with rounded edges, further reduces corona effect, provides longer creepage paths and lighter weight.

Shielded contact spring eliminates dust accumulation, provides large contact area. L-4 Steatite insulation, nickel-plated hardware.

### SPECIFICATIONS

TYPE BC—SINGLE SECTION				TYPE BCD—DUAL SECTION			
Type No.	Min. Cap.	Max. Cap.	No. Plates	Type No.	Min. Cap.	Max. Cap.	No. Plates
50BC140	23	61	6	50BCD140	21	58	12
150BC140	46	160	16	100BCD140	34	97	22
350BC140	70	355	36	200BCD140	52	196	42
50BC160	25	56	7	50BCD160	22	53	14
100BC160	40	107	13	75BCD160	28	72	18
250BC160	63	243	31	100BCD160	36	103	26
25BC180	19	32	4	25BCD180	13	31	8
75BC180	37	75	10	50BCD180	18	51	14
150BC180	57	152	21	75BCD180	29	72	20

Last three numbers of type No. multiplied by 100 indicate peak voltage breakdown. For further specifications or information write:

**E. F. JOHNSON COMPANY**  
**WASECA, MINN.**

## COMMUNICATION CIRCUIT FUNDAMENTALS



1. Covers the physics of circuit elements, including vacuum tubes, and presents the fundamentals of a-c and d-c circuits. First discusses circuit constants, then uses them in a treatment of d-c circuits. Treats magnetism, inductance, capacitance, and the principles of a-c circuits. Presents basic theory, develops design equations, and applies them to practical problems. By C. E. Smith. 375 pages, \$5.00.

## INDUSTRIAL ELECTRONIC CONTROL

2. Explains the fundamentals of electron-tube operation and how it is applied to the basic circuits used in modern industrial electronic control. Covers the various types of electron tubes, fundamental circuit components, basic electronic circuits, and other complicated circuits. All wiring diagrams redrawn to agree with new A S A Industrial Electronic symbols. By W. D. Cockrell. Second edition, 379 pages, \$4.00.

## ELECTRONICS MANUAL FOR RADIO ENGINEERS

3. Composed of 289 outstanding articles published in Electronics, this book provides a wealth of technical information on the design, production and use of electronic equipment. Includes hundreds of circuit diagrams, formulas, patterns, analyses, equations, tables, calculations, predictions . . . with everything arranged for quick, fingertip reference. Edited by V. Zeluff and J. Markus. 879 pages, \$9.50.

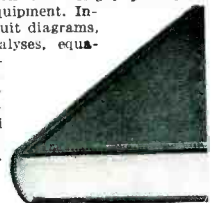

## BASIC TELEVISION

Principles and Servicing



4. An A-to-Z manual for everyone concerned with TV receiver installation and servicing. Elaborate trouble-shooting charts show symptoms, causes and cures for over 50 common TV receiver problems. Simplified diagrams, drawings and photographs clearly illustrate every topic. By B. Grob. 592 pages, \$6.50.

SEE THEM 10 DAYS FREE

McGraw-Hill Book Co., 330 W. 42nd St., N. Y. C. 18, N. Y.

Send me book(s) corresponding to numbers encircled below for 10 days' examination on approval. In 10 days I will remit for book(s) I keep, plus few cents for delivery, and return unwanted book(s) postpaid. (We pay for delivery if you remit with this coupon; same return privilege.)

1      2      3      4

Name.....

Address.....

City.....Zone.....State.....

Company.....

Position.....I-2-50

This offer applies to U. S. only

whether it be normal or foreign. Descriptive literature is available on request.



**Copper-Oxide Rectifier**

BRADLEY LABORATORIES, INC., New Haven, Conn. The CX14 series copper-oxide rectifier features a gold-to-gold internal circuit arrangement made up of vacuum-processed rectifier plates with gold contacts, specially treated gold terminals and copper alloy brackets. It is impregnated and sealed to withstand extreme humidity. Measurements are 1/2 in. x 1/8 in. x 1/4 in.

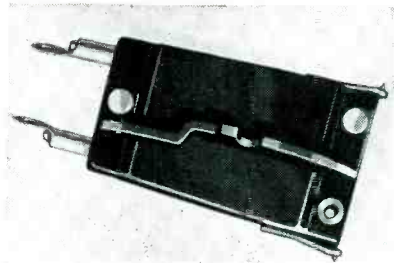

**Universal Cartridge**

WEBSTER ELECTRIC Co., Racine, Wisconsin. The Featheride type A1 universal cartridge will fit almost all record changer arms, play any combination of record speeds and perform at all speeds. Dimensions are 19/32 in. wide x 1 in. long. Tracking pressure is 7 grams. Needles are held firmly in position by specially designed friction chucks and are easily replaced by sliding into position.

**New Dielectric**

HENRY L. CROWLEY & Co., INC., 1 Central Ave., West Orange, N. J. Crothane, a new dielectric material, is suitable as a substitute for paper and bakelite-impregnated paper

**SUPERIOR SEAMLESS CATHODES**

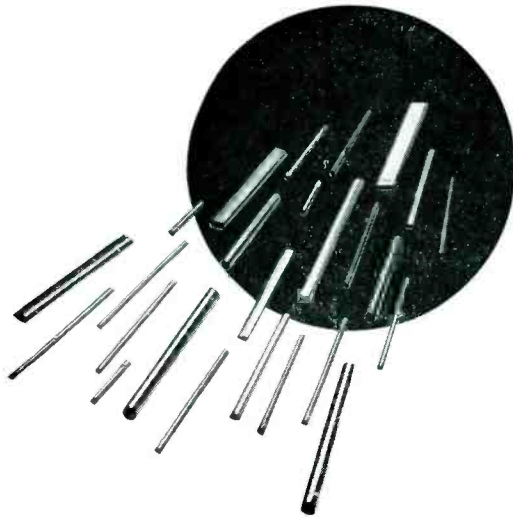

**are steps ahead**

That the major producers of television tubes use millions of Superior Seamless Cathodes is evidence of the recognized high quality of the product.

It takes *engineered* production to make, in many standard designs, Superior Seamless Cathodes.

With these steps—

**1 Selection of pure nickel (electronic grade) tubing**

**YOU GET**

*Superior*

**CATHODES WITH**

- 1** Correct operating characteristics
- 2** Freedom from seams or other obstructions—inside or outside
- 3** Less vibration in tube assembly

**2 Accurate production procedures**

**3 Clean, non-contaminating plant conditions**

**4 Rigid chemical and metallurgical controls**

The size range—.010" to .121" O.D., .0015" to .005" wall is standard production—other sizes can be produced to your specification. Complete cutting and embossing facilities are available. Write for full information.

*Superior*  
THE BIG NAME IN SMALL TUBING

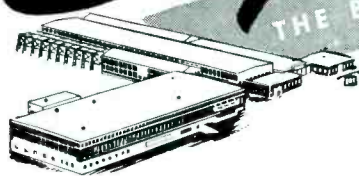

**SUPERIOR TUBE COMPANY**  
ELECTRONICS DIVISION  
2500 Germantown Ave., Norristown, Pa.

FOR ELECTRONIC PRODUCTS FOR EXPORT, CONTACT DRIVER-HARRIS COMPANY, HARRISON, NEW JERSEY. HARRISON 6-4800

HAVE YOU EVER SEEN PERFORMANCE LIKE THIS?

*Revolutionary*

D. C. TIMING MOTORS  
with **CHRONOMETRIC**  
GOVERNORS  
BY A. W. HAYDON



A PRIMARY TIME-POWER SOURCE OF EXTREME ACCURACY, PRACTICALLY UNAFFECTED BY VARYING VOLTAGE, LOAD OR TEMPERATURE.

**SPECIAL FEATURES**

- EXTREME ACCURACY
- REVERSIBLE
- COMPACT
- LIGHT WEIGHT
- WIDE RANGE OF VOLTAGE, TEMPERATURE, LOAD

Send for Catalog sheet on D. C. Timing Motor with Chronometric Governor . . . Our staff is at your service.



The **A.W. HAYDON**  
COMPANY

232 NORTH ELM STREET  
WATERBURY 20, CONN.

Design and Manufacture of Electrical Timing Devices

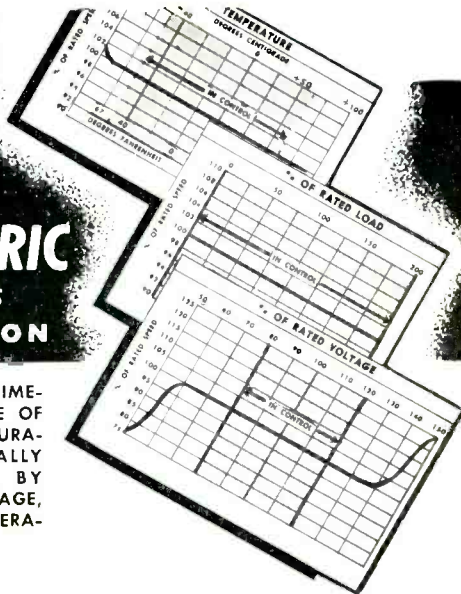

At long last an accurately controlled motor drive is available for Direct Current in a wide range of output speeds for use in computers, recorders, timers and controls. Precision timing is obtained by the use of a temperature-compensated clock escapement which pulses the motor circuit. This synchronizes the motor electrically with the speed of the escapement. Visit us at the I.R.E. Convention Booth No. 136.

**POLARAD**  
TELEVISION *Equipment*

for studio • laboratory • manufacturer

**SYNCHRONIZING GENERATOR**

Model PT 101—Television

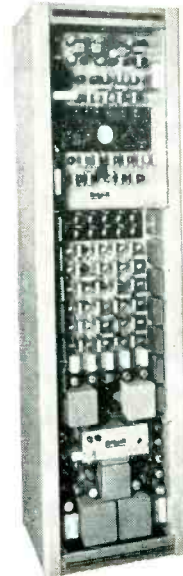

**FEATURES**

- Built-in 3" oscilloscope with synchronized sweeps for viewing Timing and Video Output pulse wave forms.
- Synchronized marker system for checking pulse width and rise time.
- Extreme stability, insured by deriving all pulses from leading edge of master oscillator pulse.
- Means for checking synchronizing pulses in odd and even fields.

**SPECIFICATIONS**

525 line, interlaced, 60 fields, 30 frames, RMA Synchronizing pulses held to tolerance specified in the NRTPB report of 1945. Output Pulses: Synchronizing, Video Blanking, Camera Blanking, Horizontal Driving, Vertical Driving Pulses. 5 volts across 100 ohm termination. Dual output jacks. 115 volts 50/60 cps. Complete with tubes.

**TELEVISION MONOSCOPE SIGNAL SOURCE**

Model PT 102

- Composite Video Signal
- Wide Band Video Amplifier, 6 DB down at 10MC
- Dual outputs for feeding two 75 or 100 lines
- Black positive or Black negative output
- Resolution greater than 600 lines

**INPUT:** Vertical and Horizontal Driving pulses, Camera and Kinescope Blanking Pulses.

**OUTPUT:** Composite Video Signal, 3 Volts, 100 ohm line 115 volts 50/60 cps. Complete with tubes and including high and low voltage power units.

9 FERRY STREET  
NEW YORK 7, N. Y.



Television engineers and consultants to the nation's great television stations.

**GLASOHM!**

- ★ Series FXG: 1 watt per winding inch. Series FYG, 2 watts.
- ★ Plain white or RMA color-coded fibre-glass braided covering.
- ★ Series FXG: 750 ohms max. per winding inch. Series FYG, 1500.

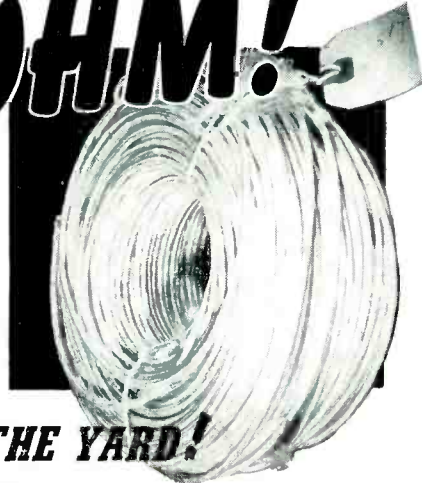

**RESISTANCE BY THE YARD!**

★ Exclusively Clarostat! Flexible fibre glass insulated wire-wound resistors with choice of terminals. Ideal for point-to-point wiring. Also as miniature heating elements in

any length desired. Used in small soldering irons, electric hair curlers, immersion heaters, crystal-control ovens, etc. Nothing to char or burn.

WRITE FOR BULLETIN 105.  
ALSO SAMPLE. LET US QUOTE.

**CLAROSTAT**



*Controls and Resistors*

CLAROSTAT MFG. CO., INC. • DOVER, NEW HAMPSHIRE • In Canada: CANADIAN MARCONI CO., LTD. Montreal, P. Q. and branches



tubes. Low electrical losses make it useful in television front-end tuners and i-f stages. It also features a low temperature coefficient. Depending on the grade used, the power factor ranges from 2.8 to 3 percent, and dielectric constant ranges from 2.6 to 3.8.

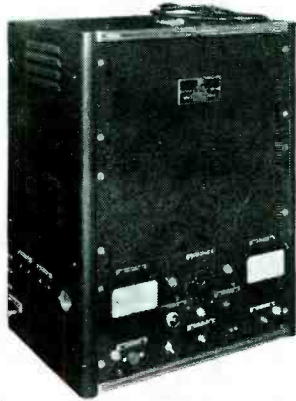

### H-V D-C Power Supply

BETA ELECTRIC CORP., 1762 Third Ave., New York 29, N. Y. Bench-type model 224 power supply is designed for breakdown testing of high-voltage components. It can provide voltages up to slightly above 40-kv d-c with currents up to 200  $\mu$ a. The short-circuit current is about 3 ma, insuring complete safety. High voltage is provided by means of rectified 60-cycle voltage and a multiplier circuit.



### Ruggedized Tubes

SYLVANIA ELECTRIC PRODUCTS INC., 500 Fifth Ave., New York, N. Y. Five new types of tubes for rough communications services are: the 6X5WGT full-wave rectifiers; 6L6-WGA beam power amplifier; 28D-7W double beam amplifier; 6SL7W high-mu duotriode; and 6SN7W

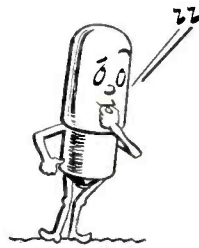

*Want to catch a customer's eye?*

## Little lamps add new appeal— make your product stand out!

Eyes turn to the product with "light appeal". Tiny jewel lights that flash a warning or an "O.K.". Lights that say "here I am" in the dark. Lights that simplify operation, add novelty and give extra safety and convenience!

Whether you're making electronic equipment for industrial use or household products, you'll find General Electric miniature lamps that fit right into your design—give it new appeal at low cost! Complete line of types and voltages—filament or neon glow. And you know you can always depend on G-E lamps for quality and long service.

For assistance in selecting the proper type, consult your nearest G-E lamp district office. Or write General Electric, Nela Park, Cleveland 12, Ohio.



*You can put your confidence in—*

**GENERAL  ELECTRIC**

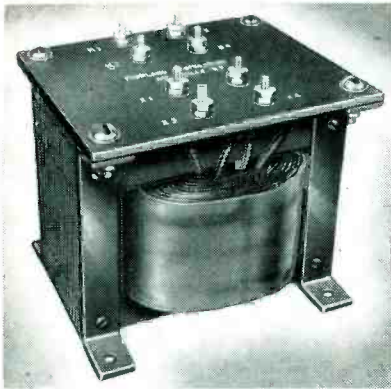

## HIGHLAND ENGINEERING

### TRANSFORMERS

for all Industrial and Electronic Applications. Open or cased. Capacities 5VA-50 KVA. Specializing in quality, service and delivery on Transformers and Inductors to suit your particular requirements. Special units built from standard parts at competitive prices and deliveries.

Send us details of your specifications or requirements which will have our prompt attention.

W. R. SPITAL

## HIGHLAND ENGINEERING CO.

HICKSVILLE, LONG ISLAND, N. Y.

Telephone: Hicksville 3-2727

# NATIONAL

- **P**roven
- **D**ependable
- **Q**uality

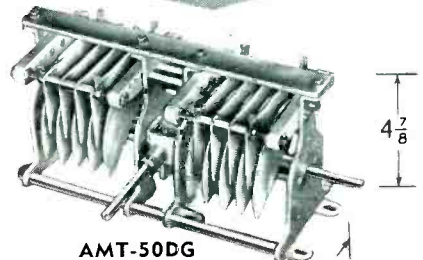

#### TYPE AMT CONDENSERS

Sturdy new condenser for exciters and transmitters. The frame is extremely rigid, with mounting feet a part of the end plates. Heavy steatite insulation.

The solid aluminum tie bar across the top of the condenser acts as a mounting for AR-18 series coils in the double stator models.

The double stator models are available in either standard end drive (D series) or center-drive (DG series) with 1/4" dia. shaft extension in standard capacities.

#### AR-18 500 WATT COILS

Air-wound coils designed to mount on the split stator models of National AMT condensers. The AR 18-C coils have fixed center links and require the XB 18-C socket. The AR 18-S coils are designed to accommodate the swinging link furnished with the XB 18-S socket. Link winding of the XB 18-S has a center tap which may be grounded for harmonic reduction. Plugs and jacks are silver plated to insure low contact resistance. Insulation, steatite. The sockets (not illustrated) are 7/4" in length.

Write for complete free catalog of popular National components.

## Shatterproof Electrical Connectors

**TOUGH** as an elephant's trunk!

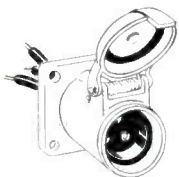

Unavoidable blows as well as careless handling quite often subject portable electrical connectors to punishment as bad as in the scene pictured above. When this happens many apparently good connectors develop cracked insulation . . . loose contacts or fail entirely.

Molded directly to cable as one-piece Neoprene units MINEs plugs are Jerk-proof, Shatter-proof and Wear-resistant. Special construction and resilient rubber mounting of pins and spring loaded sockets insure a long life of positive contact under adverse conditions . . . and MINEs famous Water-Seal automatically protects connections from moisture, dirt, oil, etc.

A wide variety of sizes, shapes and pin combinations are available to meet the portable power requirements of TV, FM, AM or PA Circuits. No. 3A156M Male Plug and No. 3A156F2X1 Female receptacle illustrated.

ME-1249 1

*Consult a  
Joy Engineer*



MINES EQUIPMENT — MINEs — Division

## JOY MANUFACTURING COMPANY

HENRY W. OLIVER BLDG., PITTSBURGH 22, PENNA.

EST. 1914

## NATIONAL COMPANY, Inc.

MALDEN, MASSACHUSETTS



*Designed for  
Application*

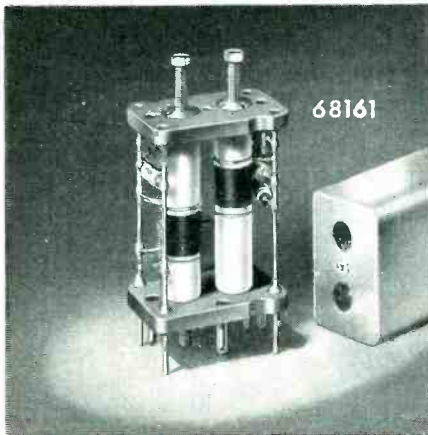

### I. F. TRANSFORMERS

The Millen "Designed for Application" line of I. F. Transformers includes both variable air dielectric condenser and permeability tuned types for 5000 KC, 1600 KC, and 455 KC, as well as permeability tuned units for 50 KC; BFO, Interstage, Diode, Discriminator; Standard as well DeLuxe Mechanical Design.

**JAMES MILLEN  
MFG. CO., INC.**

MAIN OFFICE AND FACTORY  
**MALDEN  
MASSACHUSETTS**



NEW PRODUCTS

(continued)

17 different resistance values, ranging from 1,000 ohms to 10 meg-ohms.

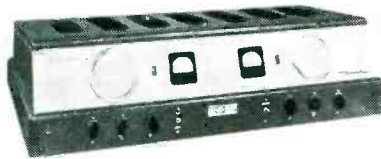

### Central Station Console

MOTOROLA INC., 4545 Augusta Blvd., Chicago, Ill., now offers a newly designed central station console to users of two-way radio equipment. The unit features two-frequency transmitter operation with complete test metering facilities, a panel-mounted cyclometer type of clock, volume and squelch controls for each receiver, line voltage meter, switching facilities to shift either receiver to a handset when it is used with the system, and a panel-mounted transmit switch for testing the transmitter.



### Linear Millivolt-Detector

SMITH INDUSTRIES, 70 Chester St., Ballston Spa, N. Y., announces a new Flying Detector for tv alignment which is linear between 10 mv and 10 v. It consists of a germanium crystal probe, a high-gain oscilloscope preamplifier and a nonlinear correction network converting the square-law output of the crystal at low signal levels into an undistorted, linear output. The unit has a 2-v output and can be

# American Beauty

## ELECTRIC SOLDERING IRONS

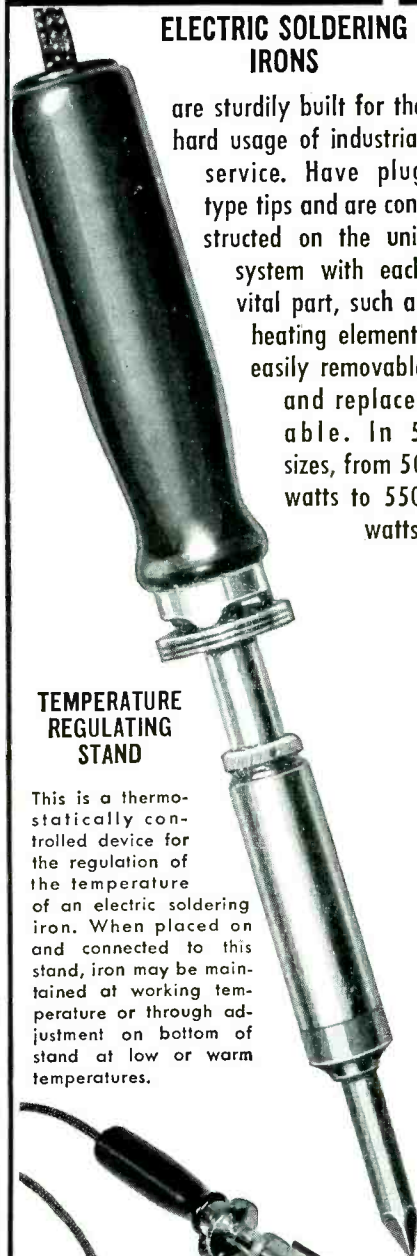

are sturdily built for the hard usage of industrial service. Have plug type tips and are constructed on the unit system with each vital part, such as heating element, easily removable and replaceable. In 5 sizes, from 50 watts to 550 watts.

### TEMPERATURE REGULATING STAND

This is a thermostatically controlled device for the regulation of the temperature of an electric soldering iron. When placed on and connected to this stand, iron may be maintained at working temperature or through adjustment on bottom of stand at low or warm temperatures.

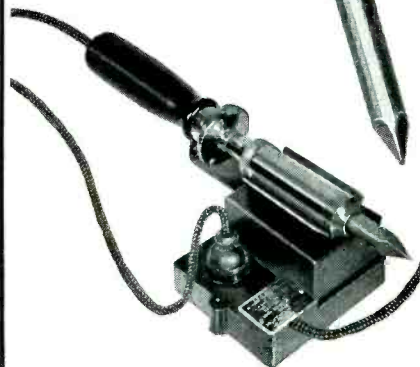

For descriptive literature write

110-1

**AMERICAN ELECTRICAL  
HEATER COMPANY**  
DETROIT 2, MICH., U. S. A.

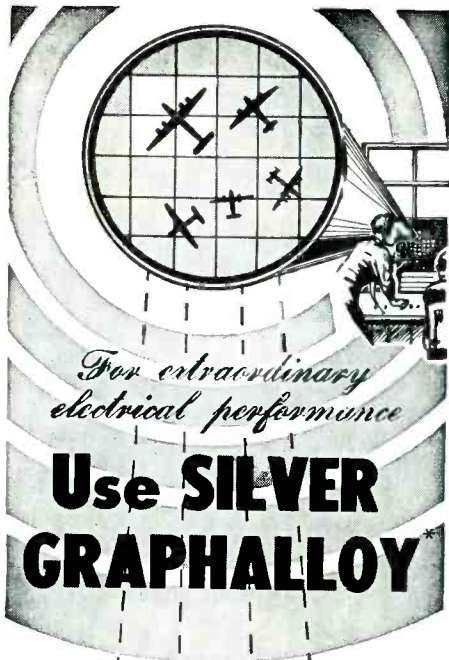

*For extraordinary  
electrical performance*

**Use SILVER  
GRAPHALLOY\***



**THE SUPREME CONTACT MATERIAL**

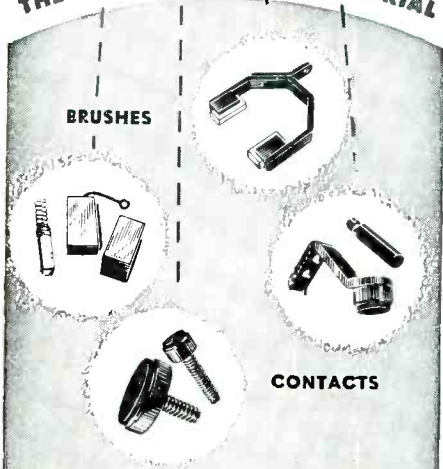

**BRUSHES**

**CONTACTS**

**in BRUSHES**

for high current density minimum wear low contact drop low electrical noise self-lubrication

**in CONTACTS**

for low resistance non-welding character

GRAPHALLOY works where others won't! Specify GRAPHALLOY with confidence.

\*A special silver-impregnated graphite

**GRAPHITE METALLIZING  
CORPORATION**

1055 NEPPERHAN AVENUE, YONKERS 3, NEW YORK

# LEKTROMESH

THE UNIQUE SOLID-METAL SCREEN

*Distinguished for its*

**STABILITY** in Use

**UNIFORMITY** of Hole Size

**WORKABILITY** in Manufacturing Processes

**DIVERSITY** of Applications to Research and Production

Electro-deposited in pure copper, pure nickel, or nickel-on-copper—in regular commercial production with counts from 25 to 400 per inch—in lengths up to 100 feet and widths up to 36 inches—with tolerances on hole size and thickness suitable for the most critical uses—LEKTROMESH is ideal for precise filtration, for fabricated products such as fuel filters and electronic shields, even for distinctive decorative screens with an integral pattern. For full details let us send our Bulletin on LEKTROMESH. Address Department 17.

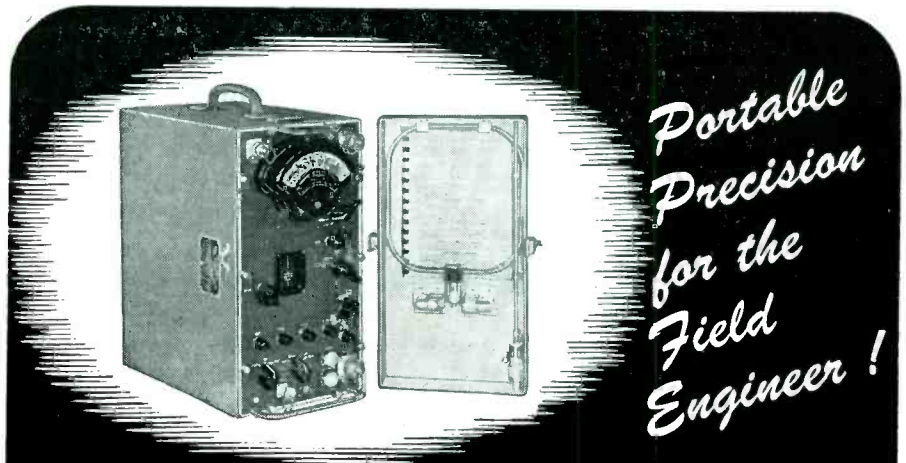

## STODDART NM-20A RADIO INTERFERENCE AND FIELD INTENSITY METER

- A portable unit that you can **DEPEND** upon! Designed especially to withstand the rigors of all-weather field operation and yet provide reliable performance.
- Measures **FIELD INTENSITIES** of radio signals and r.f. disturbances using either a rod antenna or a rotatable loop antenna.
- May be used as a two-terminal r.f.

voltmeter (balanced or unbalanced), frequency selective over the **CONTINUOUS RANGE** 150 kc to 25 mc.

- **ONE MICROVOLT SENSITIVITY** as a two-terminal voltmeter; 2 microvolts-per-meter using rod antenna.
- Operates from self-contained dry batteries or external A.C. power unit providing well-regulated filament and plate supplies.

Write for complete technical data

**STODDART AIRCRAFT RADIO CO.**

Main office and plant:

6644 Santa Monica Blvd.  
Hollywood 38, Calif.  
Phone: Hillside 9294

8-247 General Motors Bldg.  
Detroit 2, Michigan  
Phone: Trinity 1-9260

1346 Connecticut Ave.  
duPont Circle Bldg.  
Washington 6, D. C.  
Phone: Hudson 7313

# MEDCO INC.

CUSTOM Manufacturers of PRECISION  
Products for the ELECTRONIC INDUSTRY

- PRECISION WIRE WOUND RESISTORS  
JAN R-93 and Commercial
- EXTERNAL METER MULTIPLIER RESISTORS  
JAN R-29
- RESISTOR SWITCH ASSEMBLIES  
Pre-wired
- SOLENOID, RELAY and R. F. COIL WINDINGS
- R. F. CABLE and CONNECTOR ASSEMBLIES

Your Inquiry Will Receive Our Immediate Attention  
NEW RESISTOR AND MULTIPLIER BULLETIN Showing  
Both JAN and Commercial Ratings NOW AVAILABLE

**MEPCO, INC.** 37 Abbett Avenue  
Morristown, N. J.  
Telephone: Morristown 4-5777

**CABINETS • CHASSIS • PANELS • RACKS**

Planning ELECTRONIC EQUIPMENT?  
Investigate the ECONOMIES  
of PAR-METAL HOUSINGS!

We manufacture Metal Housings for every purpose — from a small receiver to a deluxe broadcast transmitter. And the cost is low!

Because we specialize in the Electronics field, Par-Metal Products excel in functional streamlined design, rugged construction, beautiful finish, and economy.

Remember, Par-Metal equipment is made by electronic specialists, not just a sheet metal shop.

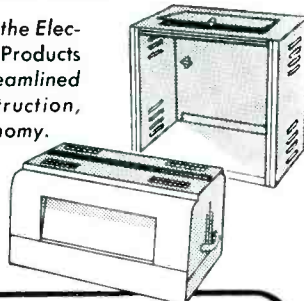

**PAR-METAL**  
PRODUCTS CORPORATION

32-62 — 49th ST., LONG ISLAND CITY 3, N. Y.  
Export Dept.: Rocke International Corp.  
13 East 40 Street, New York 16, N. Y.

**WRITE FOR CATALOG!**



used in conjunction with any standard oscilloscope.

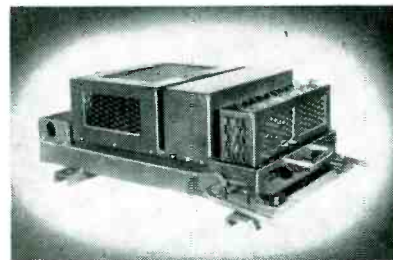

### Vibrator Inverters

CORNELL-DUBILIER ELECTRIC CORP., 2900 Columbia Ave., Indianapolis, Ind. A new line of vibrator inverters is designed specifically for railroad communications and power conversion requirements. Units are available in models for operation on 32, 64 and 120 volts d-c input. All have an output rating of 115 volts a-c, 60 cycles at 375 volt-amperes.

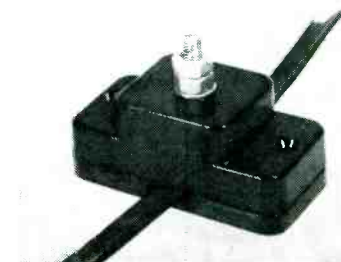

### TV and F-M Arrester

LENNOX INDUSTRIES INC., 6007 Euclid Ave., Cleveland 3, Ohio. The Rex arrester made from molded polystyrene can be used for flat or round 300-ohm line or shielded twin lead sometimes called Twin-X.

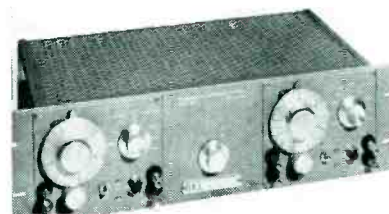

### Variable Electronic Filter

SPENCER-KENNEDY LABORATORIES, INC., 186 Massachusetts Ave., Cambridge, 39, Mass. Model 302 dual-section variable electronic filter has

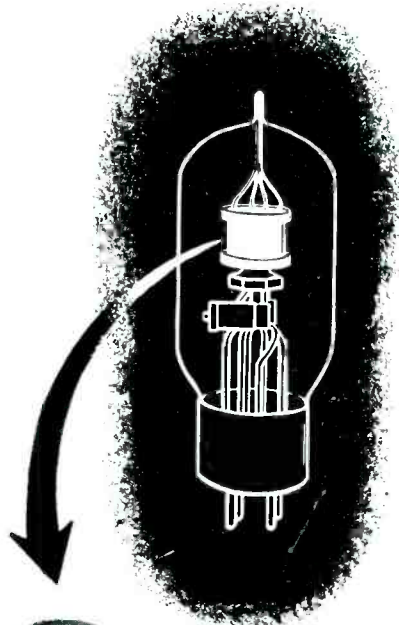

**IN  
RUGGED  
SERVICE  
SPEER**

**GRAPHITE ANODES  
WORK BEST**

You don't have to run the risk of tube failure in applications where operating conditions may be tough. Graphite — and only graphite — anodes work best when the going's roughest.

Here's why:

- Graphite anodes are capable of 200-300 % higher power rating over most metallic anodes.
- They provide stability — keep their original characteristics — won't warp even over the 200 megacycle range.
- Graphite lasts because it operates at lower temperatures, even when usage is severe and continual.

More and more, equipment manufacturers are demanding graphite anodes tubes for such applications as diathermy, vhf, short wave and FM transmitters, motor control, electrostatic precipitation, resistance welding, electronic heating, counting and sorting. Follow their lead, and you'll get better tube performance!



5464

**Speer**

**CARBON COMPANY  
ST. MARYS, PENNA.**

**PATTON-MAC GUYER**  
**P M**  
**AST RECISION** **ASTER at MANUFACTURE**

**SMALL METAL STAMPINGS**  
In Accordance With Your Prints

Extensive modern plant, complete equipment, engineering and toolmaking skill for producing your stamped metal parts accurately, economically, promptly. Moderate die charges. Facilities for large volume production. We welcome stamping problems.

**TERMINALS for ELECTRIC WIRES**

Specialists in the terminal field, we have dies to produce over 400 different kinds of separate terminals. Every modern facility to meet your standard or special requirements.

**PATTON-MacGUYER COMPANY**  
Edgewood Station Providence 5, R.I.

**CO-AX AIR-SPACED ARTICULATED R.F. CABLES**

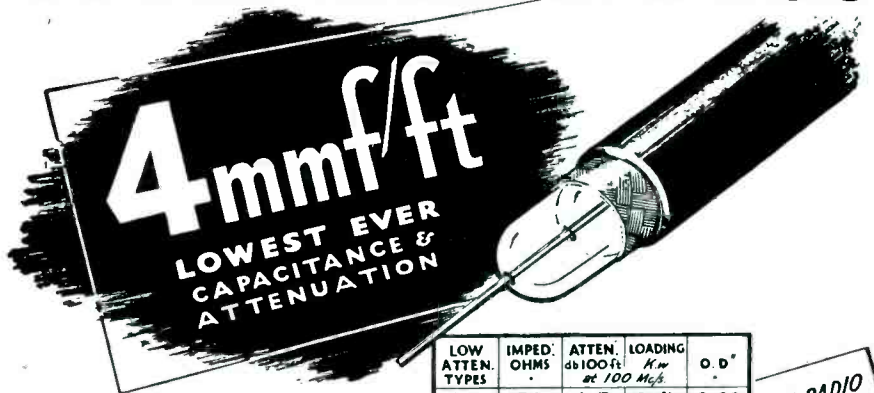

We are specially organized to handle direct enquiries from overseas and can give IMMEDIATE DELIVERIES to U.S.A.

Cable your rush order for delivery by air. Settlement in dollars by check on your own bank. Transaction as simple as any local purchase and delivery just as quick.

HIGH POWER FLEXIBLE

LOW ATTEN. TYPES	IMPED. OHMS	ATTEN. db/100ft at 100 Mc/s	LOADING $K_w$	O.D.
A.1	74	1.7	0.11	0.36
A.2	74	1.3	0.24	0.44
A.34	73	0.6	1.5	0.85

FOR RADIO FREQUENCIES

PHOTOCELL CABLE

LOW CAPAC. TYPES	CAPAC. mmf/ft	IMPED. OHMS	ATTEN. db/100ft. 100 Mc/s	O.D.
C.1	7.3	150	2.5	0.36
P.C.1	10.2	132	3.1	0.36
C.11	6.3	173	3.2	0.36
C.2	6.3	171	2.15	0.44
C.22	5.5	184	2.8	0.44
C.3	5.4	197	1.9	0.64
C.33	4.8	220	2.4	0.64
C.44	4.1	252	2.1	1.03

FOR VIDEO and SPECIAL APPLICATIONS

VERY LOW CAPACITANCE CABLES

**TRANSRADIO LTD** 138A CROMWELL ROAD  
CONTRACTORS TO H.M. GOVERNMENT. LONDON, S.W.7-ENGLAND.  
CABLES: TRANSRAD · LONDON

Functionally  
**PACKAGED**  
Electronics

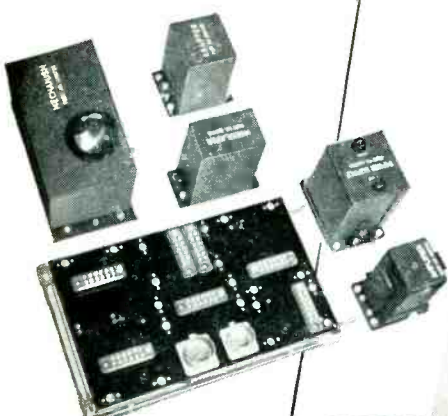

Servomechanisms, Inc.  
an organization devoted  
to the design and  
production of electronic  
components of maximum  
performance and quality.  
Engineered for . . .  
Precision Performance.  
Simplified Maintenance.  
Rapid Response  
and Stability.  
Miniaturized for  
Minimum size and Weight

INFORMATION FOR SPECIFIC  
APPLICATIONS ON REQUEST.

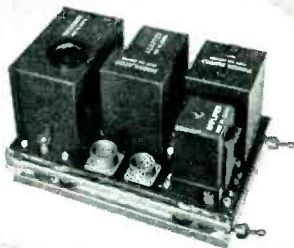

DESIGNERS AND PRODUCERS OF  
PRECISION ELECTRONIC DEVICES



Old Country & Glen Cove Roads  
MINEOLA, N. Y.  
Garden City 7-0754-5-6

NEW PRODUCTS

(continued)

a continuously variable cutoff from 20 cps to 200 kc. Each section has 18-db per octave attenuation and a maximum of about 70 db. The unit was designed as a means of sound analysis for the communications, radio broadcasting, recording and moving picture industries.

**Literature**

**Transformers.** Audio Development Co., 2833 Thirteenth Ave. South, Minneapolis 7, Minn. Catalog 49A presents a few of the hundreds of transformers in a line designed to meet the requirements of electronic audio engineers and broadcast and wired music studio engineers. Illustrations, descriptions and technical data are included.

**Vibration Mountings.** Robinson Aviation, Inc., Teterboro, N. J. A four-page folder shows the advantages to be found in Vibration shock mounting systems incorporating Met-L-Flex, a new, stainless steel resilient cushion providing dual protection against shock and vibration. Typical performance curves and illustrations are given.

**Motion Picture Films in TV.** Eastman Kodak Co., 343 State St., Rochester 4, N. Y., offers a technical booklet describing the way of most efficiently using motion picture films in television. Ten pages of the treatise are devoted to the subject of c-r tube photography.

**Mass Spectrometer.** Consolidated Engineering Corp., 620 No. Lake Ave., Pasadena 4, Calif., has published an eight-page bulletin covering the application of the model 21-201 mass spectrometer to the use and measurement of stable rare isotopes. A list of stable typical isotopes and their uses is given.

**Retractable Cords.** Coiled Kords, Inc., Box K, Hamden, Conn. A 4-page folder illustrates and describes neoprene-jacketed electric cords that are permanently coiled



These two new slug tuned coil forms by Cambridge Thermionic Corporation are designed to give you top performance while fitting easily into small or hard-to-reach places. Illustrations are actual size.

Both have silicone impregnated ceramic bodies, grade L-5, JAN-I-1C for high resistance to moisture and fungi. Ring terminals are adjustable. Both sizes are provided with a spring lock for the slug, and the mounting stud is cadmium plated to withstand severe service conditions.

The LS-5 and LS-6 are available with high, medium or low frequency slugs. Mounting hardware is supplied.

Ask for CTC's new Catalog #300 describing our complete line of *Guaranteed Components*.

See us at Booth 287 at the IRE Exposition, Grand Central Palace, March 6-9. Our representatives will be glad to discuss problems concerning electronic components with you.

**Custom or Standard  
The Guaranteed  
Components**  
**CAMBRIDGE THERMIONIC CORP.**  
437 Concord Ave., Cambridge 38, Mass.



# WIND more COILS faster

WITH YOUR  
PRESENT  
COIL-WINDING  
MACHINE!

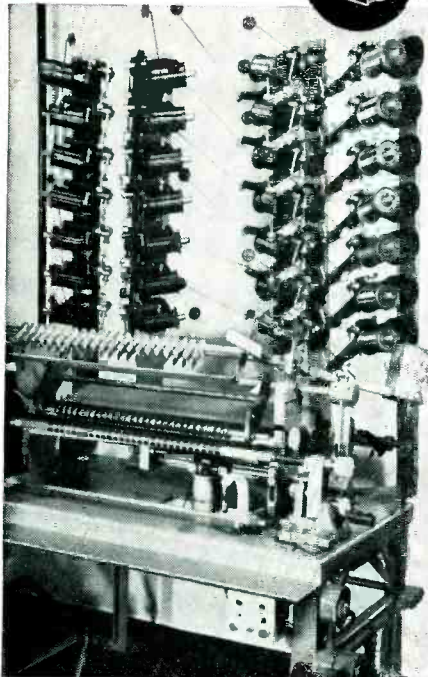

— use  
**PAMARCO**  
Wire DeReeling Tensions  
for PERFECT COILS

Installation of these inexpensive PAMARCO tensions lowers winding costs because each machine will accommodate more coils at higher winding speeds. In addition to increased production, PAMARCO tensions raise production quality. Free-running action practically eliminates wire breakage and shorted turns. Simple thumb screw setting quickly adjusts for any wire gauge. No tools or special skill are needed for operation. For complete data call or write.

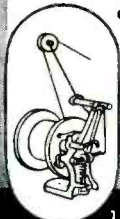

**PAPER MACHINERY  
& RESEARCH, INC.**

1014 OAK STREET  
ROSELLE, NEW JERSEY

*It's easy to fit all TV circuits with*

**GRACOIL**

"One Good Turn or a Million"

**TELEVISION**

*Transformers*

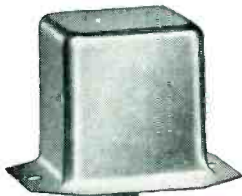

Vertical and Horizontal Blocking Oscillator. Below Chassis mounting

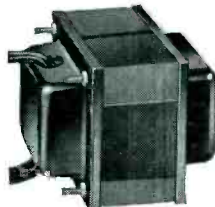
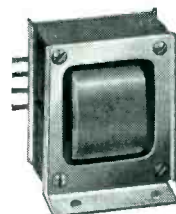

Plate and Filament Transformer with and without Magnetic Shielding

★ Order these Gracoil TV Transformers and get identical physical and electrical duplicates of original units used in all popular receivers. Used and endorsed by leading TV set manufacturers. Dependable. Trouble-free. We invite your inquiry. Write.



Vertical and Horizontal Blocking Oscillator. Above Chassis mounting



Vertical Deflection Output Transformer

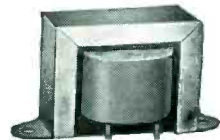

Filter Choke

## THE GRAMER COMPANY

Electrical Coils and Transformers

2734 N. PULASKI ROAD

CHICAGO 39, ILL., U.S.A.

ESTABLISHED IN 1935

# AMPERITE

THERMOSTATIC METAL TYPE

*Delay Relays*

**PROVIDE DELAYS RANGING  
FROM 1 TO 120 SECONDS**



**FEATURES:** — Compensated for ambient temperature changes from  $-40^{\circ}$  to  $110^{\circ}$  F . . . Hermetically sealed; not affected by altitude, moisture or other climate changes . . . Explosion-proof . . . Octal radio base . . . Compact, light, rugged, inexpensive . . . Circuits available: SPST Normally Open; SPST Normally Closed.

PROBLEM? Send for "Special Problem Sheet"

*Regulators*

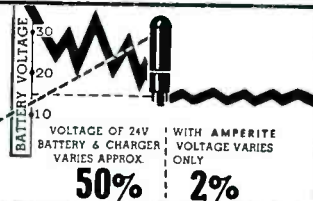

**Amperite REGULATORS** are the simplest, lightest, cheapest, and most compact method of obtaining current or voltage regulation . . . For currents of .060 to 6 Amps. . . Hermetically sealed; not affected by altitude, ambient temperature, humidity.

Write for 4-page Illustrated Bulletin.

**AMPERITE CO., Inc., 561 Broadway, New York 12, N. Y.**

In Canada: Atlas Radio Corp., Ltd., 560 King St., W. Toronto

# STABLE D. C. AMPLIFICATION

with flat frequency response to 40 K.C.

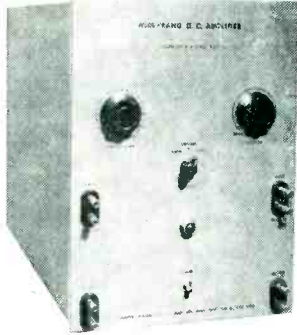

down 1% at 50 K.C.  
and 12% at 200 K.C.

INPUT — 20,000 ohms, single ended.  
OUTPUT — about 1,000 ohms, resistive,  
single ended. POWER SUPPLY — 100 V.  
to 125 V. A.C. 175 Watts. HEIGHT — 14",  
WIDTH — 10", DEPTH — 22", WEIGHT —  
45 lbs., FINISH — Navy gray crackle.

The Hanover Type 105 is designed for use as a preamplifier to provide

### D.C. SENSITIVITY OF 5.0 MV. PER INCH

with an oscillograph such as the DuMont Type 279 or Type 250 (Oscillograph synchronizing circuits and focus are not disturbed)

### STABILITY WITHIN 0.5 MV. EQUIVALENT SIGNAL

with a line voltage variation from 100 volts to 125 volts.

### NO BLOCKING WITH A 75 VOLT SIGNAL

with the amplifier at full gain. This is made possible by the avoidance of reactive compensation. This feature also accounts for the

### EXCELLENT SQUARE WAVE RESPONSE

Requirements for many special applications may be met without extensive modifications.

## HANOVER DEVELOPMENTS

401 E. 74 ST.  
NEW YORK 21, N. Y.

into a spring-like shape to provide for extension and retraction. Designed for use in industry, appliances, communication and entertainment, the cords treated measure 4 feet retracted and extend to about 25 feet. Specifications are included.

**Precision Aircraft Instruments.** Kollsman Instrument Division of Square D Co., 80-08 45th Ave., Elmhurst, N. Y., announces a reference handbook on precision aircraft instruments, specially designed for engineers and technicians. It contains information on the application, operation and performance characteristics of the instruments together with installation instructions and diagrams.

**Electrical Insulating Materials.** Insulation Manufacturers Corp., 565 W. Washington Blvd., Chicago 6, Ill. A recent mailing piece gives numerous facts on Fiberglas-base electrical insulating materials. Items described include varnished cloth and tape, sleeving and tubing, laminates and Fiberglas-mica combination products.

**Accessory Bulletins.** Philco Corp., Philadelphia, Pa. Four one-page bulletins deal with three types of biconical tv antennas for outdoor use, six handy alignment jigs for servicing tv receivers, the model M-20 3-speed record changer and 45-rpm adapter discs and non-slip driver, and the model 7001 isolation probe, respectively. Detailed description of each accessory product is given.

**Precision Audio Equipment.** Cinema Engineering Co., 1510 West Verdugo Ave., Burbank, Cal. Laboratory instruments, potentiometers, decodes, gain sets, precision resistors and other products are completely covered in a new 40-page illustrated catalog. Included are graphs and tables for computing attenuators and branching networks. Complete technical tables cover precision wire-wound resistors in four different alloys of wire.

**Servicing Data Manual.** John F. Rider, Publisher, Inc., 480 Canal St., New York 13, N. Y. Manu-

## Premium Quality — OUTSTANDING ADVANTAGES

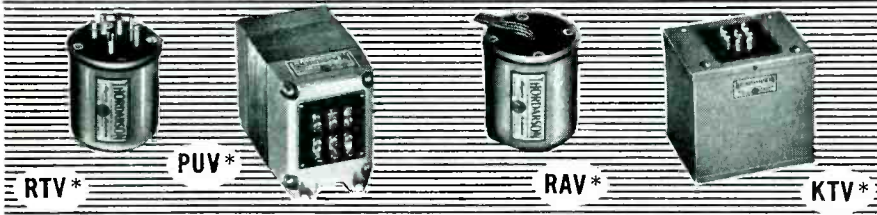

## THORDARSON CHT Transformers and Chokes

... for those who want the best!

Popular demand has brought back the famous THORDARSON CHT line of superior transformers and chokes.

Outstanding in every respect, the THORDARSON CHT line offers uniform case design, extremely conservative ratings, extended frequency range, humbucking coils in audio and driver types and compound filled cases for complete coil protection against humidity.

The CHT line can be counted upon to give utmost satisfaction. Careful design, painstaking workmanship and strict quality control are combined with the use of highest quality components. This assures you of value seldom found today under mass production methods.

For the best, always specify THORDARSON CHT transformers and chokes. They are well worth the slight additional cost!

Write For Your Complete Thorndarson Catalog Today!

### CHT LINE

- Audio Input Transformers
- Audio Interstage Transformers
- Chokes, Reactors
- Driver Transformers
- Filament Transformers
- Band Pass Speech Filter
- Modulation Transformers
- Splatter Suppressor Chokes
- Plate Transformers
- Universal Replacement Power Transformers
- Output Transformers

\*Case Styles

## THORDARSON

Electric Mfg. Div., Maguire Ind., Inc.  
500 W. Huron St., Chicago, Ill.

# Etched TUNGSTEN WIRE

FROM .0004" TO .00015"  
AND EVEN SMALLER

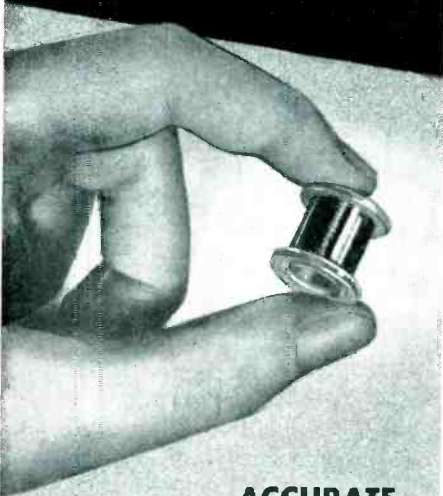

ACCURATE

UNIFORM

SMOOTH

Also  
available in  
Molybdenum  
and other  
metals

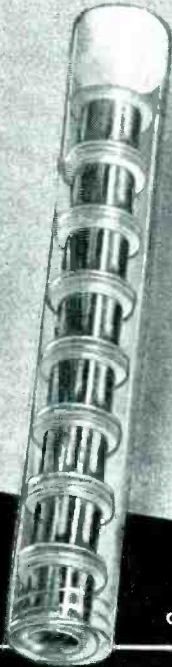

Write for Details  
and List of Products

**SIGMUND COHN CORP.**

44 GOLD ST. NEW YORK

SINCE 1901



# S.S. White MOLDED RESISTORS

ARE USED IN HIGH VOLTAGE  
"HIPOT" COUPLERS



S.S. White resistors are connected in series to permit a current flow to ground, when the "Hipot" Coupler is used to measure or to synchronize voltage of high voltage lines.

Canadian Line Materials, Ltd.—maker of "Hipot" Couplers and other transmission, distribution and lighting equipment—says—"We have always found S.S. White resistors of the highest quality". This checks with the experience of the many other producers of electrical and electronic equipment who use S.S. White resistors.

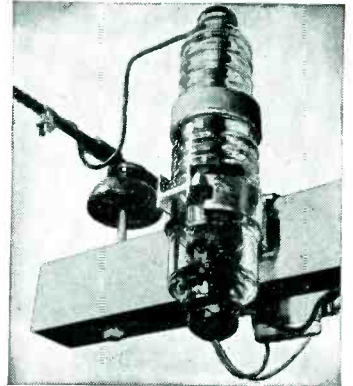

WRITE FOR BULLETIN 4906

It gives details of S.S. White Resistors including construction, characteristics, dimensions, etc. Copy with price list on request.



**S.S. WHITE RESISTORS**  
are of particular interest to all who need resistors with *low noise level* and *good stability* in all climates.

**HIGH VALUE RANGE**  
10 to 10,000,000 Megohms  
**STANDARD RANGE**  
1000 Ohms to 9 Megohms

## S.S. WHITE INDUSTRIAL DIVISION

THE S. S. WHITE DENTAL MFG. CO. DEPT R 10 EAST 40th ST., NEW YORK 16, N. Y.



FLEXIBLE SHAFTS AND ACCESSORIES  
MOLDED PLASTICS PRODUCTS—MOLDED RESISTORS

One of America's AAA Industrial Enterprises



You Can See  
Right Through Me

"There's nothing dense about me — everyone sees through me! But I'm MICRO-WEAVE Tracing Cloth and in my business transparency counts a lot. That's one reason I'm so popular with draftsmen — they can see the finest, lightest lines with crystal clearness *without* eye strain. People say that I'm the nearest thing to clear glass in tracing cloth."

MICRO-WEAVE exceeds all specifications in minute perfection of weave-in durability under repeated erasures — in minimum feathering — in better blueprints — in longer life. Test MICRO-WEAVE on your drawing board. Send for generous sample.



**THE HOLLISTON MILLS, INC.**  
NORWOOD, MASS.

NEW YORK PHILADELPHIA CHICAGO

★ MICRO-WEAVE is backed by Holliston's 50 years of leadership and experience in developing special cloths for industry.



**A rugged one-piece  
foot leveling screw  
made possible ... only**

**by COLD HEADING**



*actual size*

Here is another example that shows what Scovill can do with cold heading to give a customer a finished part that is stronger and more reliable in service than if it were made by any other process. If you need fasteners or other special parts in this general size range, check with Scovill first.

**"Guide to the Profitable Use of Cold Heading"—Bulletin No. 2 describes the advantages and limitations of this process. If you have not received your copy, write today.**

Recessed Head Screws • Sems  
Tapping Screws • Standard  
Machine Screws • Special Cold  
Headed Parts



**SCOVILL FASTENERS AND  
SPECIAL PARTS**

Industrial Fastener Sales, Waterville Division  
Scovill Manufacturing Co., Waterville 14, Conn.

New York • Detroit • Wheaton, Ill.  
Los Angeles • Cleveland • San Francisco

facturers' servicing data on a-m, f-m, auto receivers and record changers are given complete coverage in Volume 20 of the Manual. A "How it Works" book with cumulative index for volumes 16 through 20 is another prominent feature.

**High-Gain Antennas.** The Workshop Associates, Inc., 66 Needham St., Newton Highlands 61, Mass., has published a four-page brochure describing high-gain beacon antennas. Sections include: how the antennas save money, performance features, principle of operation, installation hints, complete electrical and mechanical specifications, and prices. A full page is devoted to a complete description of adaptors and connectors used with the antennas.

**High-Range Megohmmeter.** Herman H. Sticht Co., Inc., 27 Park Place, New York, N. Y. Bulletin 1029 covers the model 29 megohmmeter designed for precise measurement of electrical resistance over a 300,000-ohm to 20,000,000-megohm range in six decades. General description, principle of operation, accuracy and specifications of the unit are given.

**Quality Loudspeakers.** R. T. Bozak, 90 Montrose Ave., Buffalo, 14, N. Y. A recent four-page folder describes the following three loudspeakers: Model B-199 woofer, a specially developed, permanent magnet, low resonance, low mass unit having a felted paper cone; Model B-200 tweeter, a permanent magnet, dual-unit, wide-angle direct radiator having a paper skirt with a drawn dural apex; Model B-201 two-way direct radiator system employing the other two units in a completely enclosed hemispherical baffle. Specifications for all are given.

**Fabricated Mica.** Mica Fabricators Association, 420 Lexington Ave., New York 17, N. Y., has published a handbook dealing with fabricated natural mica. The booklet points out pertinent facts on natural sheet and block mica with particular emphasis on char-

## Cost conscious?



*try*  
**Accurate Springs**

Cost conscious purchasing agents, engineers and production men examining their sources of supply will do well to consider Accurate as a source for springs, wire forms and small stampings. We at Accurate have an enviable record of saving money for our customers. Our production "know-how" is backed by a modern plant equipped with the very latest cost-cutting springmaking machines to produce uniformly accurate components for your product.

We would welcome the opportunity to show you what we have done for others and what we can do for you. Give us a ring or write us today.



**COST CONSCIOUS QUALITY**

Since 1930

**ACCURATE SPRING MFG. CO.**

3830 W. Lake St. • Chicago 24, Ill.

*Springs, Wire Forms, Stampings*

*Engraving*

## PROFILING VERTICAL MILLING

Here is the most versatile machine...So simple to operate by unskilled labor.

**NEW HERMES**  
*Engraving*

This heavy duty bench type machine covers a larger engraving area than any other machine of its kind.

Send for illustrated booklet H



**NEW HERMES, Inc.**  
Dept. 29  
13-19 UNIVERSITY PL. • NEW YORK 3  
World's Largest Manufacturer of Portable Engraving Machines

Dies  
Displays  
Signs  
Panels  
Name Plates

# CONTINUOUSLY VARIABLE REGULATED DC

## ✓ FEATURES

- ✓ Continuously variable, 0 to 350 volts.
- ✓ Ripple voltage less than 10 millivolts.
- ✓ Regulation better than .5%.
- ✓ Maximum current 200 milliamperes.
- ✓ Stabilized variable bias supply.
- ✓ 6.3 volts AC at 5 amperes.
- ✓ Reasonably priced.



### MODEL A3 POWER SUPPLY

A PRECISION INSTRUMENT USED  
BY LEADING LABORATORIES

REQUEST BULLETIN NO. 52 FOR DETAILED SPECIFICATIONS

# Oregon ELECTRONICS

MFG. CO.  
206 S.W. WASHINGTON ST., PORTLAND 4, ORE., U.S.A.

## PHOTOVOLT VIDEO Brightness Tester MOD. 205

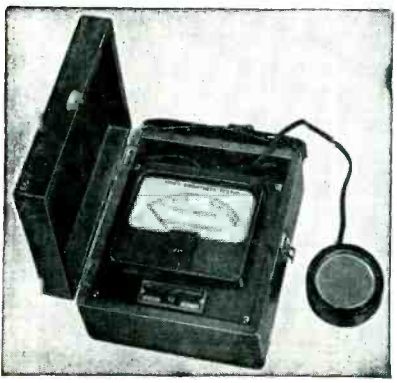

A photoelectric instrument for measuring the brightness of television tubes and screens in foot-lamberts.

**Price, \$68**

Write for literature to  
**PHOTOVOLT CORP.**  
95 Madison Ave., New York 16, N. Y.  
Photoelectric and  
Electronic Measuring Instruments

## Dynamic Strain Recording in the Field



The TYPE MRC-12 6-ELEMENT SELF-POWERED STRAIN GAGE CONTROL UNIT, and the TYPE S15-A 6-ELEMENT SELF-POWERED RECORDING OSCILLOGRAPH together make up a complete dynamic strain measuring laboratory which you can carry with you for field use ANYWHERE where electrical power is not available.

With standard SR-4 resistance strain gages, a frequency response from static to 500 cycles per second can be obtained. Magnifications are adequate for all practical needs for static-dynamic strain recording on structural members and machine parts.

- Small in Size • Light in Weight • Simple to Use
- Insensitive to Vibration • Finest Instrument Craftsmanship
- Unconditionally Guaranteed

Write for Technical Bulletin SP-177G and SP-193G

*Hathaway*

**INSTRUMENT COMPANY**

1315 SO. CLARKSON STREET • DENVER 10, COLORADO

# DO YOU KNOW?

— that a **PILOT LIGHT**  
CAN IMPROVE YOUR PRODUCT

. . . . add attraction — safety — service?

Ask

**DIALCO**

- what lamp to use
- how to use it
- what it will do
- what it will cost

**THIS MAY BE THE ONE**

Designed for low cost NE-51 Neon

- Built-in Resistor • Patented
- U/L Listed • Rugged

Catalogue Number 521308 — 997  
for 110 or 220 volts.

**SAMPLES**

for design purpose  
**NO CHARGE**

**NEW!** Write for the  
"HANDBOOK OF PILOT LIGHTS."

Write us on your design problems.



**The DIAL LIGHT COMPANY of AMERICA**

*Foremost Manufacturer of Pilot Lights.*

900 BROADWAY, NEW YORK 3, N. Y. TELEPHONE SPRING 7-1300

NEW PRODUCTS

(continued)

acteristics required for its use in electrical radio and electronic equipment.

**Industrial Control.** Niagara Electron Laboratories, Andover, N. Y. The latest bulletin describing the Thermocap relay lists other electronic industrial control equipment including an electronic timer and voltage tripping device of particular interest in the field of chemistry.

**Low-Current Rectifiers.** Standard Telephones and Cables Ltd., Connaught House, Aldwych, London WC2, England. A 24-page booklet gives a technical description of a range of small rectifier elements mounted in tubes covering currents down to a few microamperes. The assembled low-current tubular rectifiers described will, for a given current, obtain any voltage output by using a number of suitable elements in series in one tube, or by connecting several tubes in series.

**Radiation Counter Tubes.** Amperex Electronic Corp., 25 Washington St., Brooklyn 1, N. Y. Twenty-one types of self-quenching radiation counter tubes for research and industry are described and pictured in an eight-page catalog. Included therein is the new, thin metal wall type 52N, for beta and gamma detection.

**Impedance Measuring Device.** The Electrodyne Co., 32 Oliver St., Boston 10, Mass. The Model BC-1 Impedometer, for rapid, accurate, and wide-range impedance measurement, is the subject of a single-page bulletin. The unit described is used with an oscillator and vtvm to measure impedance directly on the scale of the vtvm.

**Playback Unit.** Proctor Soundex Corp., 133 North Sixth Ave., Mt. Vernon, N. Y., describes and illustrates in a recent bulletin the Floating Disc Drive, a playback unit designed for all standard and microgroove recordings. The unit treated will play at any speed with any type pickup cartridge at any precise stylus pressure.

## TEKTRONIX DIRECT COUPLED OSCILLOSCOPE

The Tektronix Type 512 is a completely new direct coupled cathode ray oscilloscope which provides the sensitivity; band pass; sweep ranges; flexibility and dependability so necessary for precision applications.

\* \* \*

Present users throughout the world—leading universities; industrial organizations; branches of armed services; physiologists; geophysicists; etc.—have come to consider the Type 512 an indispensable instrument by virtue of its full complement of outstanding characteristics.

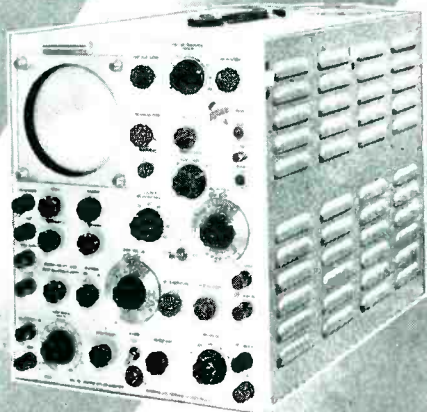

**\$950.00**  
f. o. b. Portland,  
Oregon

DC-2 mc. SWEEPS 3 sec-30 microsec. 5 Millivolt Sensitivity DC or AC

Detailed Specifications on request.



**TEKTRONIX, INC.**

712 S.E. Hawthorne Blvd. Portland 14, Oregon - EAst 6197 - Cables: Tektronix



**ONLY \$215\* FOR THE GREEN ENGRAVER**  
... yet it's fast, versatile and rugged enough for die steel

The Green Engraver offers great speed and convenience. Quickly cuts up to four lines of letters from 3/64" to 1" on curved or flat surfaces whether made of metal, plastics or wood... operates by merely tracing master copy — anyone can do an expert job. Special attachments and engineering service available for production work. Just the thing for radio, electronic apparatus and instrument manufacturers.

For quality engraving on

- Panels • Name Plates • Scales
- Dials • Lenses • Molds • Instruments

... also does routing, profiling and three dimensional modeling.

\*Price does not include master type and special work holding fixtures.

**GREEN INSTRUMENT CO.**

**GREEN** 385 Putnam Ave.  
Cambridge, Mass.

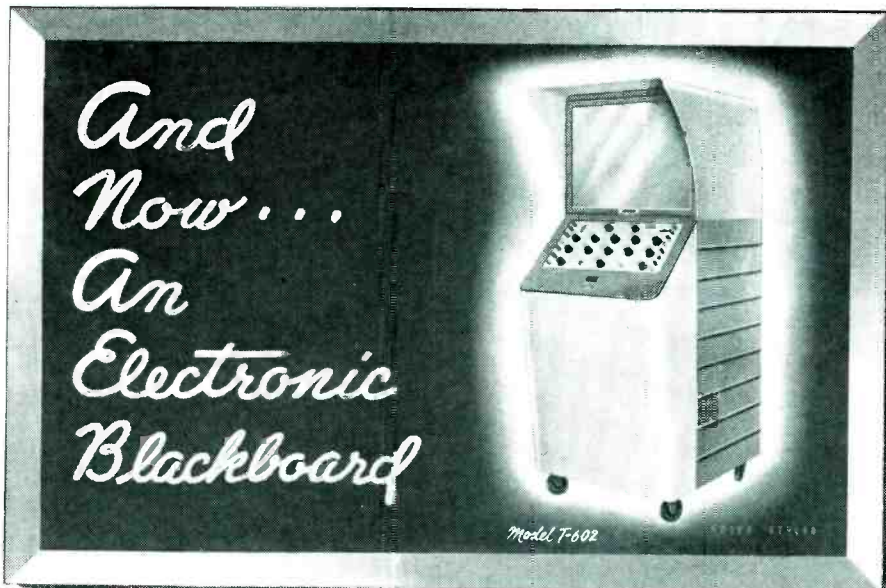

And Now...  
An Electronic Blackboard

Here's the exact duplicate of the TEC Projection Oscilloscope developed for the U. S. Navy for mass electronics training. Makes waveforms brilliantly clear to groups as large as 750 persons! No more students hunching round a tiny image! No more mistaking what you mean!

Only TEC gives you such advanced features for top performance and flexibility:

External Screen: 8" x 10" or larger. Integral Screen: 18" x 24" for smaller groups. 5RPA tube. brightness 130 fc., 20 KV acceleration B & L f/1.9 coated lens.

Y AXIS: a-c gain 1 mv rms/in., d-c gain 2.5 v/in. Response —10% 2 cps., —10% 750 kc., —3 db 825 kc. input 2 megohms, 30 µf. Attenuator 1, 10, 100X.

X-AXIS: a-c gain 60 mv rms/in. Also Z-axis input.

SWEEP CIRCUITS: Recurrent: 1 cps to 50 kc, auto. retrace blanking. Driven: 20 µs to 10<sup>6</sup> µs, auto. brightening.

INTERNAL SIGNAL CALIBRATOR • INPUT: 105-130 v, 50-60 cps, 600 watts. SIZE: 33" L x 26" W x 66" H—350 lbs.

Med. Gain Wide-Band Units available on special order.

Write TODAY for full data and prices

**TEC** TELEVISION EQUIPMENT CORP.  
238 William St. • New York 7, N. Y.

Manufacturers of Projection & Wide-Band Scopes, TV Cameras, Boosters, Antenna Telecouplers.

## Solves the Problem of Mailing List Maintenance!

Probably no other organization is as well equipped as McGraw-Hill to solve the complicated problem of list maintenance during this period of unparalleled change in industrial personnel.

McGraw-Hill Mailing Lists cover most major industries. They are compiled from exclusive sources, and are based on hundreds of thousands of mail questionnaires and the reports of a nation-wide field staff. All names are guaranteed accurate within 2%.

When planning your direct mail advertising and sales promotion, consider this unique and economical service in relation to your product. Details on request.

for Results



**McGraw-Hill**  
DIRECT MAIL LIST SERVICE

**McGraw-Hill Publishing Co., Inc.**  
DIRECT MAIL DIVISION  
330 West 42nd St., New York, 18, N. Y.

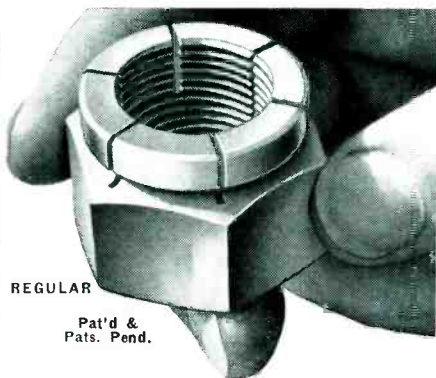

REGULAR

Pat'd & Pats. Pend.

**FLEXLOC**

**ONE-PIECE SELF-LOCKING NUTS**  
... WON'T SHAKE LOOSE!

Every day more FLEXLOC Self-Locking Nuts are being used to reduce maintenance costs. Here are lock nuts that the most chattering vibration won't budge, yet can be removed easily when desired. Furthermore, the one-piece FLEXLOC has no extra parts to lose or forget.

Why not try FLEXLOC Self-Locking Nuts? Find out how they eliminate "tinkering" and save valuable maintenance time. Both regular and thin types.

Send for samples and literature.

Over 47 Years in Business

**STANDARD PRESSED STEEL CO.**

JENKINTOWN 10 • PENNSYLVANIA  
Chicago-Detroit-St. Louis-San Francisco

**Lavite** STEATITE CERAMIC

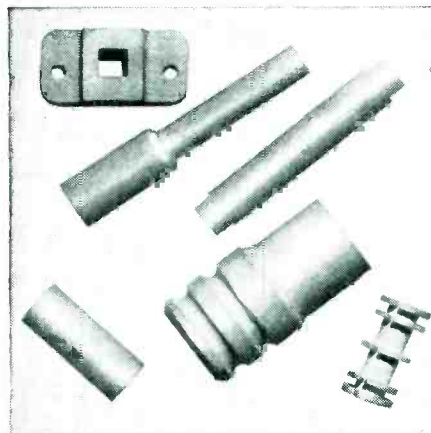

Design engineers and manufacturers in the radio, electrical and electronic fields are finding in LAVITE the precise qualities called for in their specifications... high compressive and dielectric strength, low moisture absorption and resistance to rot, fumes, acids, and high heat. The exceedingly low loss-factor of LAVITE plus its excellent workability makes it ideal for all high frequency applications.

Complete details on request

**D. M. STEWARD MFG. COMPANY**

Main Office & Works: Chattanooga, Tenn.  
Needham, Mass. • Chicago • Los Angeles  
New York • Philadelphia

# THE NEWEST SMALLEST SWITCH

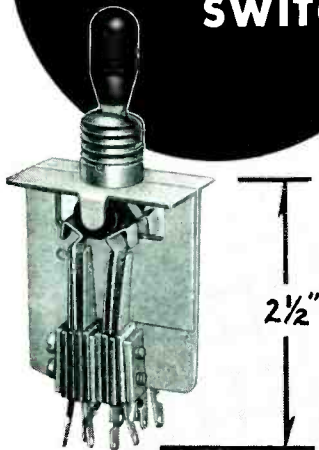

● **ONE-HOLE  
MOUNTING  
CUTS TOOLING  
AND  
INSTALLATION  
COSTS**

The new Type MCT-1 telephone-type switch — the smallest made — mounts in a single round hole — eliminates need for slotting panel and drilling and tapping four small holes — provides versatile switching action in addition to its standard features.

#### "Universal" Type MCT-4

Mounting plate has two sets of four, tapped, mounting holes to fit all standard mounting centers.

#### BOTH MODELS FEATURE

##### Electrostatic shielding

between two sets of contact sections reduces coupling between circuits.

##### Versatile lever action

provides either locking on both sides, non-lock on both sides, non-lock on one side, lock on one side, two-position with no center position.

##### Contact buildups

permit all popular as well as special circuit arrangements.

##### Cam-spring mechanism

is especially designed for quiet operation and to reduce contact bound to a new minimum.

##### MCT Ratings

Palladium contacts rated at 1 amp. at 115 volts, 60 cycles, non-inductive load.

Request Catalog Sheet and B/P #D35-100 giving details of contact arrangements, dimensions, and prices.



**GENERAL  
CONTROL  
COMPANY**

1202 Soldiers Field Rd. Boston Mass.

## NEWS OF THE INDUSTRY

(continued from p 130)

in alphabetical order. Distinctive typographical standards for distinguishing between scalars, phasors and vectors are set up.

Copies of the publication, designated as Z10.5-1949, are available from the American Institute of Electrical Engineers, 33 W. 39th St., New York, N. Y., at 60 cents per copy.

### Ship Radar Operator Waiver Extended

TEMPORARY waiver and temporary rules concerning operator requirements for ship radar stations have been extended by the FCC to May 15, 1950, or the effective date of permanent rules in the matter, whichever date occurs earlier. Hearing and oral argument looking to permanent rules were concluded on September 20, 1949. Meanwhile the Commission temporarily waives requirements that ship radar stations be operated by persons licensed by the FCC in the ship service, provided unlicensed persons do not make adjustments to affect the proper operation of ship radar stations.

## BUSINESS NEWS

THE ROBERT DOLLAR Co., manufacturers of electron tubes, recently opened their new H-K Gammatron Tube Division at 947 Broadway, Redwood City, Calif., to manufacture tubes for commercial radio transmitting, television transmitting, shortwave diathermy and industrial induction heating apparatus.

AUDIVOX, INC., 259 W. 14th St., New York, N. Y., was recently formed to take over the activities of the Western Electric hearing aid division.

MOTOROLA INC., Chicago, Ill., has announced plans for erection of a new 40,000-sq-ft research laboratory and specialized production building in Phoenix, Arizona.

HOWARD W. SAMS & Co., INC., analytical engineering laboratories, and



Manufacturers  
of—

- AC Electric Motors (1/8 HP to 1/1000 HP)
- Axial and Centrifugal Blowers (6 to 750 CFM)
- Alternators and DC Generators
- Gear Motors for Special Applications
- Other Special Rotating Devices

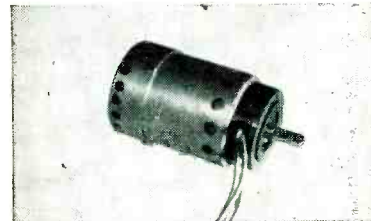

Type #J31E-5

### NOW PASS NEW AAF HUMIDITY TEST

AAF Spec. #41065-4.5  
Group 30—Method 31

The motor pictured above was built according to a new process developed and perfected by EAD Engineering and used solely by us in the production of certain Military type motors. Prototypes of the motor were submitted to the Army Air Force Equipment Laboratory at Wright-Patterson Air Force Base, Dayton, Ohio and tested as follows:

**Humidity Test—AAF Spec. 41065-4.5  
Group 30—Method 31**

This specification states that the subject unit is to be placed in a test chamber and subjected to a relative humidity of 95% ( $\pm 5\%$ ) at a temperature of 71°C ( $\pm 2^\circ$ ) with cycling of the temperature between 71°C and 38°C over a period of 360 hours (15 cycles).

We are advised that our submitted samples successfully passed the test, with no sign of corrosion which would affect performance in any way. WE ARE PREPARED TO SUPPLY ANY OF OUR MILITARY MOTORS TO MEET THIS NEW SPECIFICATION.

This is just one example of how EAD's constant search for improvement and know-how insures long-life, dependable and consistent operation for its motors in all phases of operation and in all types of applications.

ALL our MILITARY type motors are constructed of anodized aluminum parts, are fungus protected, and use approved greases in long-life, sealed bearings which assures good performance in extremely high or low ambient temperatures. This special design permits use of such units in most Military equipment.

IN GENERAL OUR STANDARD FRAME TYPES MAY BE MODIFIED WITH RESPECT TO: Voltage (25-440 Volts) — Frequency (25-1800 Cycles) — Phases—Special Shafts—External Wiring—Mounting—and other Physical Features.

#### We Invite Inquiry

For additional data  
send us your Engineering specifications

**EASTERN AIR DEVICES, INC.**  
585 DEAN ST., BROOKLYN 17, N. Y.



**BIRTCHEr**  
STAINLESS STEEL LOCKING TYPE  
**TUBE CLAMPS**

Stainless Steel      Corrosion Proof



**83 VARIATIONS**

Where vibration is a problem, Birtcher Locking TUBE CLAMPS offer a foolproof, practical solution. Recommended for all types of tubes and similar plug-in components.

**More than three million of these clamps in use.**

**FREE CATALOG**

Send for samples of Birtcher stainless steel tube clamps and our standard catalog listing tube base types, recommended clamp designs, and price list.

**THE BIRTCHEr CORPORATION**  
5087 HUNTINGTON DR.      LOS ANGELES 32

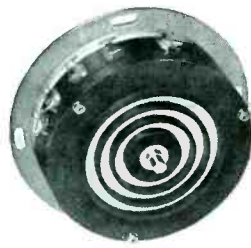

# D-C-P\*

**\* DIFFERENTIAL  
COMPUTING  
POTENTIOMETER**

NOW—add or subtract two variables in one instrument—with one voltage source! This compact unit does work of two potentiometers—saves cost by eliminating one—has high inherent accuracy of a single potentiometer.

When one variable rotates shaft and other rotates body of this Type 748 Potentiometer, net voltage sum or difference is brought out through coin-silver precision slip rings in cover plate, shown above.

Linearity of 0.10% is guaranteed—and the high resolution, long life, low noise level, and low torque found in all Fairchild Precision Linear Potentiometers can be depended upon as always.

Suggested applications for this new precision instrument include use in servomechanisms for computing or power amplification, direct replacement of 2 single potentiometers when one is being used for compensation or correction purposes, etc. For details, address: Dept. N, 88-06 Van Wyck Boulevard, Jamaica 1, N. Y.



**Stop listening to  
DISTORTED  
MUSIC**

The connoisseur of music listening wants to recognize the clear brilliance of symphonic sound and

**BROOK**  
All Triode High Quality  
**AUDIO AMPLIFIER**  
Gives It To Him



( illus. Model 10C3-30 watts )  
Also available: Model 12A3-10 watts.

with

- Distortion and intermodulation at a new low.
- Reduction of listening fatigue.
- Brilliant, clear tone.
- Separate controls—stepped-for Bass and Treble.
- Extremely low volume without any loss of quality.

Write TODAY for FREE Technical Bulletin and Detailed Distortion Analysis

**BROOK ELECTRONICS, Inc.**  
Sales Agent  
Dept. BB-0, 34 De Hart Place, Elizabeth, N.J.

Since 1887

**MILWAUKEE  
WROUGHT WASHERS**

*Better*  
**WASHERS**  
**... Competitively Priced**

Large volume production, the most advanced methods and facilities, plus more than 60 years of continuous experience in the manufacture of Washers, are factors that enable us to offer you top quality washers and stampings at competitive costs. Over 22,000 sets of dies for making Washers of every type (Standard and Special), from every type of material, for every purpose, in any finish. STAMPINGS of all descriptions; Blanking, Forming, Drawing. *Submit your blueprints and quantity requirements for estimates.*

**WROUGHT WASHER  
MANUFACTURING CO.**

*The World's Largest Producer of Washers*

2118 S. BAY ST., MILWAUKEE 7, WIS.



# NOTHELPER

## Special TRANSFORMERS



Proven by  
Past  
Performance

Over 25 years' experience in the manufacture of specials at cost that compares favorably with standard types. Built in quality proved by years of actual use.

From 10 VA to 300 KVA Dry-Type only. Both Open and Encased. 1, 2, and 3 Phase. 15 to 400 cycles.

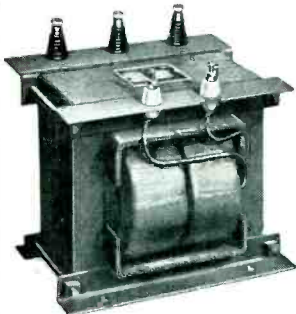
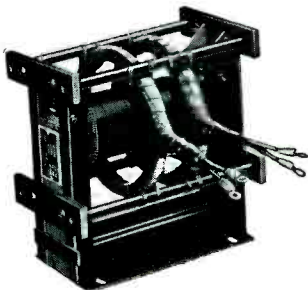

Send for NEW 8 page BULLETIN



## NOTHELPER

WINDING LABORATORIES

9 ALBEMARLE AVE., TRENTON 3, N. J.



publishers of radio, television and electronic manuals, is now located in its new 30,000-sq ft plant at 2201 E. 46th St., Indianapolis 5, Ind.

RAYTHEON MFG. Co. is constructing a two-story addition at the north end of its Waltham, Mass., plant to increase production of cathode-ray tubes.

THE RELIABLE SPRING & WIRE FORMS Co., Cleveland, Ohio, has expanded from the manufacture of close-tolerance mechanical springs and wire formations to set up a new department for the manufacture of tuner coils and other precision parts for television, radio and electronic devices.

### PERSONNEL

DANIEL H. SMITH, previously associated with Western Electric and Graybar Electric in New York, has been appointed technical director of the Maine Broadcasting System.

JOHN A. HICKEY, associated with the radio receiving tube division of Raytheon Mfg. Co. as a radio tube application engineer for the past fifteen years, has been appointed an engineering field adviser in the Raytheon replacement tube department.

CLINTON R. HANNA, associate director of the research laboratories, Westinghouse Electric Corp., Pittsburgh, Pa., has been awarded the Howard N. Potts Medal of the Franklin Institute for his initiative in the conception and development of the tank gun stabilizer.

WILLIAM C. BAREHAM, associated with engineering work at WBAL for twenty-two years, has been promoted from acting chief engineer to chief engineer of that station.

ROGER S. WARNER, former director of engineering for the Atomic Energy Commission, has joined the staff of Arthur D. Little, Inc., Cambridge, Mass., research and engineering organization.

WILLIAM SHANNON, formerly assistant chief electronics engineer at

320K SIGNAL GENERATOR KIT \$19.95  
Wired \$29.95



221K HIGH PRECISION VACUUM TUBE VOLTMETER KIT \$23.95  
Wired \$49.95



425K 'SCOPE KIT \$39.95  
Wired \$69.95



315 DELUXE SIGNAL GENERATOR \$59.95  
Wired only

## SAVE TIME, SAVE MONEY

### BUILD PRECISION INSTRUMENTS

With **TEICO** KITS!

By following the schematic and pictorial diagrams enclosed with your EICO Kit, you are certain of turning out a laboratory-type precision instrument. It's no trick at all to complete the job in one evening!

Build it yourself—save assembly labor cost—acquire invaluable electronic knowledge and experience. FOLLOW THE LEAD of numerous TV manufacturers who specify EICO instruments and kits. Ideally suited for TV: EICO VTVM goes to 30,000 volts and over 200 Mc with our accessory probes—EICO Sweep Generator has TV channels marked on panel and crystal marker—new EICO 'scope has high sensitivity and Push-pull.

Write NOW for our new catalog "E".

## TEICO

ELECTRONIC INSTRUMENT CO., INC.  
276 Newport Street, Brooklyn 12, N. Y.



145K MULTI-SIGNAL TRACER KIT \$18.95  
Wired \$28.95



EASY - TO - FOLLOW SCHEMATIC & PICTORIAL DIAGRAMS WITH EVERY EICO INSTRUMENT KIT.

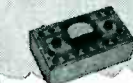

511K POCKET VOLT-OHM-MILLIAMMETER KIT \$14.95  
Wired \$17.95



360K SWEEP SIGNAL GEN'R'R KIT \$29.95  
Wired \$39.95



HI-FREQ PROBE KIT \$3.75  
Wired \$7.50  
HI-VOLTAGE PROBE  
Wired only \$6.95

the U.S. Naval Ordnance Plant, Forest Park, Ill., has been appointed an electronics engineer in the Guided Missiles Laboratory of the National Bureau of Standards.

THOMAS D. FULLER, formerly industrial engineer, has been transferred to the sales merchandising department of Sylvania Electric Products Inc.



T. D. Fuller H. DuVal, Jr.

HERBERT DU VAL, JR., formerly with General Electric Co., has joined Airborne Instruments Laboratory, Mineola, N. Y., as technical assistant to H. R. Skifter, president.

WILLIAM SLOAT, assistant chief engineer in charge of engineering at WPIX, New York News television station, recently resigned to become chief engineer of television station KEYL, San Antonio, Texas.

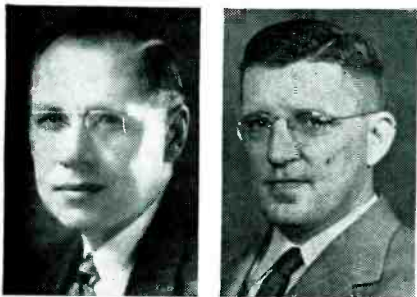

W. Sloat A. H. Lamb

ANTHONY H. LAMB, formerly assistant chief engineer, has been appointed vice-president of the Weston Electrical Instrument Corp., Newark, N. J.

LUCIEN P. TUCKERMAN, previously with the International Industrial Development Co. as chief engineer in charge of all military specification equipment, has joined the staff of the National Bureau of Standards as liaison engineer in the Guided Missiles Laboratory.

# Micro Ball Bearings

Full Race Radial

The smaller the bearing the better it runs.

1/8" to 3/8" O.D.

In the United States only MICRO bearings have ground outer rings and raceways when it comes to miniature sizes. Write for your copy of Technical Bulletin No. 50 showing RADIAL (conrad, extra light, and full race), Angular Contact, Self Aligning and Pivot Bearings 1/8" to 3/8" O.D.

New Hampshire Ball Bearings, Inc.

5 MAIN STREET • PETERBOROUGH, NEW HAMPSHIRE

The GROUND Miniature Bearing

## NEW BENDIX-PACIFIC TELEMETERING PRESSURE GAGE for 0-400 PSI range

*This Pressure Pickup*—Assembly No. 421710 (TTP-9A)—provides a new measurement range for Bendix-Pacific AN/DKT-3 Telemetering Systems. It may be used for measurement of differential pressures or for pressures relative to a reference pressure, and may be calibrated from 0 to 5 PSI or any range between 5 and 400 PSI. Differential pressures to a maximum of  $\pm 200$  PSI may be measured. ★ Natural frequency is 500 to 2000 cycles per second with the response time dependent upon the length and diameter of the connecting tubing. Acceleration error is negligible. Weight, 0.32 lbs. ★ This new gage complements the Bendix-Pacific series of high pressure gages which range from 0 to 3000 PSI. ★ Bendix-Pacific Telemetering Systems are extremely flexible in design application and maintenance due to the use of unitized, standard dimension telemetering cases and plug-in components. ★ Bendix-Pacific facilities include installation and application engineering, field operation, data reduction and engineering consultation. We are also prepared to supply complete telemetering ground station facilities on request.

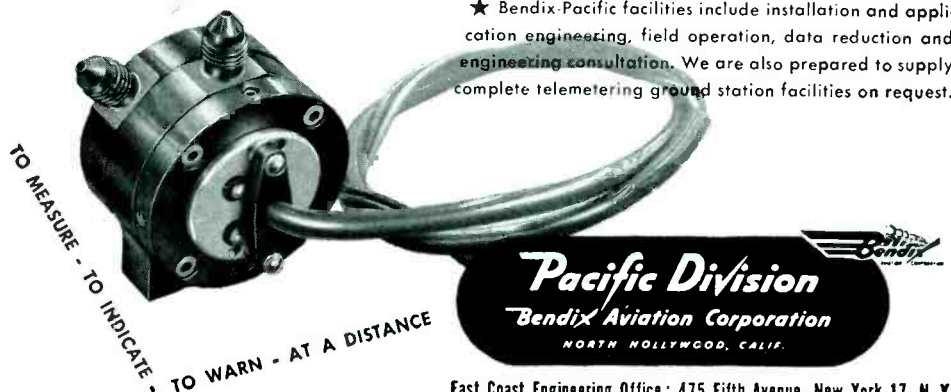

East Coast Engineering Office: 475 Fifth Avenue, New York 17, N. Y.

## MAGNETIC AMPLIFIER

DC to DC TYPE 63-1



By agreement with  
Electro Methods Ltd. of  
London, Trans-Sonics presents . . .

## MEASUREMENTS AMPLIFIER

The Type 63-1 is a precision DC to DC Amplifier having a transconductance of more than 5,000,000 micromhos. It is intended for use in measurements and control, and when used with other Trans-Sonics' instruments, makes possible the recording of pressures, acceleration, temperatures, etc., on a standard recording milliammeter.

INPUT RESISTANCE . . . . . 220 ohms  
 OUTPUT IMPEDANCE . . . . . 2 ohms  
 OUTPUT CURRENT . . . . . 300 ma. (max.)  
 ACCURACY. Gain remains constant to  $\pm 0.5\%$   
 ZERO STABILITY . . . Zero shift over a period  
 of several weeks is equivalent to less than  
 $\pm 0.08$  millivolt at the input terminals.

### LOAD RESISTANCE TRANSCONDUCTANCE

(ohms)	(micromhos)
3	$5 \times 10^4$
10	$2 \times 10^4$
30	$0.8 \times 10^4$

The excellent reliability of this amplifier makes it suitable for use in many long-life and standby applications where the reliability of vacuum tube amplifiers would not be adequate. Power supply is obtained from the AC line at commercial voltages and frequencies, the specified performance being obtained at voltage and frequency tolerances of  $\pm 10$  per cent.

## TRANS-SONICS, INC.

BEDFORD AIRPORT  
BEDFORD, MASS.

## NEW BOOKS

### Extrapolation, Interpolation and Smoothing of Stationary Time Series

By NORBERT WIENER, *Professor of Mathematics, MIT. Published jointly by The Technology Press of MIT and John Wiley & Sons, Inc., New York, 1949, 163 pages, \$4.00.*

THE CONTENTS of this book appeared during the war as a classified report to the National Defense Research Council and as such constituted the author's presentation of his important contribution to the theory of optimum filtering and prediction. Prior to this work, filter design had been commonly handled on the basis of either steady-state frequency response or on transient response to particular waveforms. Although it had been generally recognized that, in the presence of noise, the optimum bandwidth of a filter is related to the spectrum of the signal to be passed, no rigorous theory had been available for determining the optimum shape of the pass band. Professor Wiener's contribution was to consider the problem on a statistical basis, designing the filter so as to minimize the mean square deviation of the output from its desired value. By combining the theories of statistics and communications, he laid the foundation for an entirely new concept of the theory of communication and information.

The central idea of this volume is to form a quantity giving a measure of the mean square deviation of the actual output from the desired output and to determine the filter characteristic which minimizes this quantity. The desired output might be merely a delayed replica of the original signal as in the case of ordinary filter problems, or it might be some other function of the input such as its derivative or its value at some future time as in the case of a predictor. The optimum characteristic is determined on the basis of the known a priori statistics of the signal and the noise, the solution being completely determined by the correlation functions of the noise and the signal.

Although the filter characteristics obtained in this manner may be shown to be an absolute optimum

## 2 KW VACUUM TUBE BOMBARDER OR INDUCTION HEATING UNIT



For Only \$650.

Never before a value like this new 2-KW bench model "Bombardeer" or high frequency induction heater . . . for saving time and money in surface hardening, brazing, soldering, annealing and many other heat treating operations.

Simple . . . Easy to Operate . . .  
Economical Standardization of  
Unit Makes This New Low Price  
Possible

This compact induction heater saves space, yet performs with high efficiency. Operates from 220-volt line. Complete with foot switch and one heating coil made to customer's requirements. Send samples of work wanted. We will advise time cycle required for your particular job. Cost, complete, only \$650. Immediate delivery from stock.

Scientific Electric Electronic Heaters are made in the following range of Power: 1-2-3½-5-7½-10-12½-15-18-25-40-60-80-100-250KW.

*Scientific  
Electric*

Division of

"S" CORRUGATED QUENCHED GAP CO.

107 Monroe St., Garfield, N. J.

**IRE National Convention**  
 GRAND CENTRAL PALACE  
 and  
 HOTEL COMMODORE  
 New York

**RADIO ENGINEERING SHOW**  
 March 6-9 1950

**230 Exhibits**

**IRE**

**COME AGAIN  
 Electronic Men!**

"Spotlight is on the New" in 230 Electronic Exhibits for you to see. Hear the latest developments given in 175 technical papers organized into 28 sessions and symposiums covering every field of electronics. Last March 15,710 attended. The registration (4 days) is \$3.00, for electronic industry people. Not open to general public.

THE INSTITUTE OF RADIO ENGINEERS  
 1 East 79th St. New York 21, N. Y.



**ONLY MAGNECORDER PT6-JA**

**Offers Full Frequency Tape Recording at a SAVING!**

The widely acclaimed Magne-corder PT6-JA portable magnetic tape recorder is the only moderately priced instrument on the market today that gives you a flat frequency response all the way from 40 to 15,000 cps  $\pm$  2 db. — twice the range of many others! Low in distortion and wow, the Magne-corder PT6-JA meets high NAB broadcast standards.

**AMPLIFIER**  
 This amazingly low priced, high quality amplifier includes low impedance microphone and bridging inputs, gain control with VU type meter, 10 watt audio amplifier with monitor speaker and terminal for external speaker, zero level line output terminal. Three-position switch selects erase/record, playback, or public address.

**PORTABLE UNIT CONSTRUCTION**  
 The PT6-JA is built in two conveniently proportioned cases averaging about 25 lbs. each. Carry it anywhere. Either unit can be combined with other Magne-corder field or studio equipment.

See, hear, operate this outstanding tape recorder today. Call on your Magne-cord dealer, or write for his name and PT6-JA specifications.

**Magne-cord, INC., CHICAGO 1, ILL.**  
 360 NORTH MICHIGAN AVENUE  
 World's Largest and Oldest Manufacturer of Professional Magnetic Recorders

**For Advanced RELAYS specify ADVANCE**

RELAYS for general circuit control, electronic, aircraft and marine applications. Crisp action, dependable and durable. ADVANCE offers sensitive, midget, midget telephone, keying, instrument, time-delay, overload, transmission line, impulse, hermetically sealed, and ceramic insulated relays. Wide variations of these types for special applications and special relays made to specifications.

ADVANCE'S engineering ability and manufacturing facilities will assist in engineering problems and supply special relays for the most exacting requirements. Your inquiry will receive prompt and courteous attention.



ADVANCE ELECTRIC & RELAY CO.  
 1240 WEST SECOND STREET • LOS ANGELES 20, CALIFORNIA

**SMALL PARTS**

Filaments, anodes, supports, springs, etc. for electronic tubes. Small wire and flat metal formed parts to your prints for your assemblies. Double pointed pins. Wire straightened and cut diameter up to 1/8-inch. Any length up to 12 feet. LUXON fishing tackle accessories. Inquiries will receive prompt attention.

**ART WIRE AND STAMPING CO.**  
 227 High St. Newark 2, N. J.

**Little thought-of facts about capacitors**

The short time breakdown voltage of a well-made D.C. capacitor is not less than 5 to 6 times the actual working voltage at 20°—

$$E = 5 \times e \text{ min}$$

E = Breakdown voltage  
 e = Rated d.c. working voltage

INDUSTRIAL CAPACITORS are unvaryingly held to this formula.

Designed for maximum safety factor and the smallest possible volume, INDUSTRIAL CAPACITORS are the most widely used capacitor in industrial applications.

WRITE TODAY FOR DETAILED CATALOG

**INDUSTRIAL CONDENSER CORP.**

Watch this space for other capacitor facts that will help you.

Sales Offices in All Principal Cities  
 3243 N. California Ave.  
 Chicago 18, Illinois

# TWO NEW TWIN POWER SUPPLIES

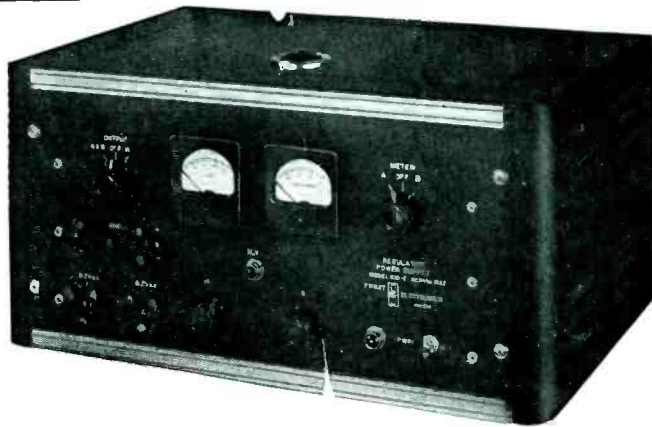

MODEL 610-F

- Precise Electronic Regulation.
- 2 Independent Sources of Power.
- 0-325 V.D.C. at 0-100 Milliamperes. Continuously Adjustable.
- 0-325 V.D.C. at 0-200 Mils if the Sources are Combined.
- Both D.C. Outputs Metered for Voltage or Current.
- 6.3 and 12.6 V.A.C. Outputs Provided.
- A.C. Ripple Less than 10 Millivolts.

MODEL 1210

- Precise Electronic Regulation.
- 2 Independent Sources of Power.
- 0-500 V.D.C. at 0-150 Milliamperes. Continuously Adjustable.
- 0-500 V.D.C. at 0-300 Mils if the 2 Sources are Combined.
- Both D.C. Outputs Metered for Voltage or Current.
- 6.3 or 12.6 V.A.C. Outputs Provided.
- A.C. Ripple Less Than 10 Millivolts.

Furst *Twin* Power Supplies double the usefulness of a single unit at considerable saving in space and cost. Write for complete specifications on these and other Furst *Twin* Power Supply Models.

Visit Booth 311 I.R.E. Convention

## FURST ELECTRONICS

10 S. Jefferson St., Chicago 6, Ill.



## FILTER VERSATILITY

Check your filter problems at Lenkurt. Lenkurt combines filter know-how—gained from years of carrier engineering—with the most modern facilities for molding precision

magnetic parts, winding toroids in a wide range of sizes and sealing assemblies for maximum life.

A few standard items illustrated... others to your most stringent specifications. Write.

**LENKURT**  
*knows how*

**LENKURT ELECTRIC CO.**  
SAN CARLOS • CALIFORNIA

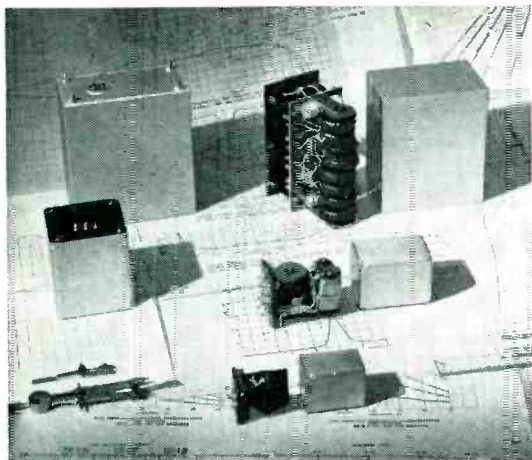

for linear or nonlinear circuits in the case where both signal and noise have the statistics of ordinary fluctuation noise, the technique is in general applicable only in the case of linear circuit elements and where the mean square error criterion gives a reasonable measure of the goodness of the result. Noise reduction by nonlinear methods such as peak limiting noise suppressors, dynamic noise suppressors, f-m systems, and pcm systems, fall outside the scope of this book. Also, although the mean square error criterion will give a reasonable measure of goodness in the majority of practical cases, there are some cases in which it does not represent a true measure of desirability and some other criterion such as the maximum peak signal-noise ratio will give better results.

Following an introduction of 21 pages, the book contains five chapters of text and three appendices. The first chapter is a resume of the fundamental mathematical motions involved. To a large extent this chapter is a review of the principles of generalized Fourier analysis previously published by the author in other volumes. The second and third chapters treat respectively the predictor and the filter for single time series. By an application of the calculus of variations, the form of the linear operator which minimizes the mean square error is determined. The solution involves a rather elaborate Fourier analysis to separate the statistics applying to the past of the input signal from those applying to the future, because a physically realizable network can operate only on the past and cannot anticipate the future except in a statistical sense. The fourth chapter considers filters and predictors for multiple time series. The fifth chapter considers several miscellaneous problems such as the problem of approximate differentiation and the problem of interpolation.

Appendix A of the book is a table of the first five Laguerre functions for values of the argument ranging from 0 to 30 with varying intervals. These functions are a set of normal and orthogonal functions whose Fourier transforms are all rational

# ASK FOR FACTS\* LISTEN FOR PROOF

Speakers by

**BOZAK**

Give unsurpassed listening pleasure

We invite the opportunity to prove our statements to critical listeners . . . with **FACTS!** You will receive promptly whatever evidence you ask, from characteristic curves, to a sample of our exclusive cone material. Meanwhile, ask your dealer for the most convincing test of all—a demonstration of the Bozak team at work. Listen for proof!

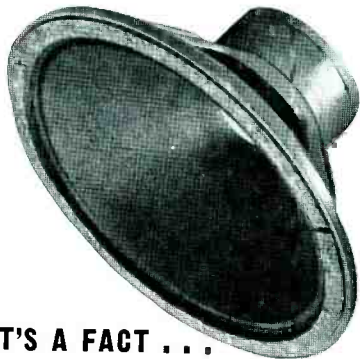

**\*IT'S A FACT . . .**

. . . that the new Bozak Woofer B-199 offers unsurpassed transient response, because of these design features:

- Low Resonance—Low Mass
- Smooth Response
- Free Moving Construction
- "Dead" Cone
- Highly Effective Damping

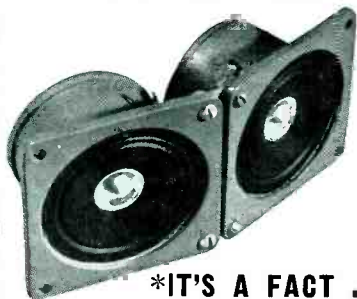

**\*IT'S A FACT . . .**

. . . that the new Bozak Dual Tweeter B-200 (Patent Pending) offers new realism of tone combined with genuine listening ease up to and beyond 13000 c.p.s., because of these design features:

- Exceptionally broad spatial coverage
- Clean, smooth response
- Highly effective damping
- Velocity of highs matched to woofer

WRITE FOR PROOF. Ask also for name of Bozak distributor in your area.

**R. T. BOZAK**

DESIGNER & MANUFACTURER

900 Montrose Ave. Buffalo 14, N. Y.

NEW BOOKS

(continued)

fractions. As such, they afford a convenient means for approximating any functions of a certain class in terms of functions having rational fourier transforms. Appendices B and C are reprints of short papers by Professor Norman Levinson giving a less complete but much simpler exposition of the main ideas of the book. In this reviewer's opinion, anyone approaching the book for the first time should start with Appendix C, follow with Appendix B and then read the main text. This sequence will serve to establish the main points of the theory before the reader becomes lost in questions of Lebesgue integrability and other subtle points of Fourier theory.

The reader who lacks an adequate background in Fourier analysis including integration in the complex plane will find the book difficult to read. Even those engineers who have had considerable experience with Laplace transforms will find the work confusing because the real axis of the complex plane is consistently used to represent real frequency. Apparently the principal reason for this is the frequent use made of complex conjugates which represent reflections about the real frequency axis. Had the conventional orientation been used, it would have been necessary to introduce a new symbol denoting a reflection about the imaginary axis. Even with this handicap, this reviewer believes that the conventional orientation in which the imaginary axis is used to represent real frequency would have made the book more understandable to the majority of readers.

The reader who is more familiar with Laplace transforms than with Fourier transforms will also have some difficulty in reconciling himself to the notion that poles in the lower half plane (right-hand half plane in the conventional orientation) do not represent time functions which grow indefinitely but instead represent time functions which do not vanish for negative time. This point is fundamental to the problem and could not have been eliminated by a change in notation. In many other places, however, it is felt that comprehension could have been facilitated by a few explanatory com-

Here's how to anchor a cordset to an electrical appliance **to Increase Product Life**

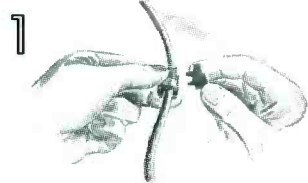

Slip a HEYCO Nylon Strain Relief Bushing on wire. (Heycos eliminate cord wear at chassis entrance.)



Snap HEYCO into chassis hole. (The Heyco imparts a positive non-slip grip; does not injure wire.)

**HERE'S WHAT A HEYCO WILL DO**

1. Save time — reduce costs
2. Absorb cord pull, push and torque
3. Insulate wire at chassis
4. Prevent fraying
5. Eliminate tying knots
6. Improve appearance of product

**HEYCOS ARE USED ON MANY PRODUCTS**

You will find HEYCOS being used on an increasing number of nationally known appliances . . . toasters, heaters, clocks, roasters, mixers, record players, radios, television sets, toys, lamps, polishing machines, etc.

**HEYCOS ARE MADE IN 11 SIZES**

for clock wire to S-10/3 cable

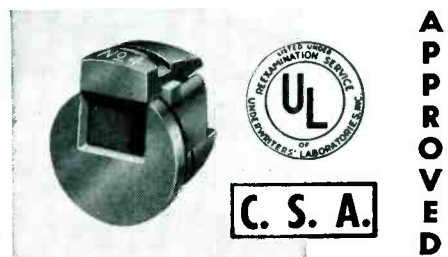

**MAKE SURE YOUR PRODUCT IS DOUBLY PROTECTED BY A HEYCO STRAIN RELIEF**



HEYMAN MANUFACTURING CO.  
KENILWORTH 7, N. J.



# COUNT TEN TIMES FASTER

## ...and accurately!

The new Photo-electronic Counter was designed for industrial applications in which mechanical counters do not count accurately or wear rapidly because of counting speed. One of the well-known Potter electronic counter decades is used to scale down the operating speed of a reliable electro-mechanical register. In the Model 310, the photo-electric "eye" is located inside the cabinet and the light enters through a small window at the rear. In the Model 312, the photo-electric "eye" is housed separately for remote counting. Small objects as well as closely spaced parts can be accurately counted since the width of the photo-electric beam is only  $\frac{1}{4}$  inch, and does not require complete interruption for actuation. Another version, the Model 311, uses an electromagnetic pick-up coil for counting shaft rotation without contact.

For complete literature or consultation on high speed counting, timing and control problems call or write Dept. 6-L.



## POTTER PHOTO-ELECTRONIC COUNTER

- ★ High speed—counts at rates up to 6000 per minute
- ★ Long life—mechanical register operates at only 1/10 normal rate
- ★ Direct reading—units digit is read from electronic counter, other digits from mechanical counter
- ★ Accurate—mechanical register not affected by detector "on-off" time
- ★ Compact—completely self-contained, no wiring required, easy to install
- ★ Flexible—self-contained "eye", separate "eye" or electromagnetic pick-up coil may be used for actuation

**POTTER INSTRUMENT COMPANY**

INCORPORATED

136-56 ROOSEVELT AVENUE · FLUSHING · NEW YORK



ments in simpler language, at no loss in rigor.

It is gratifying to note that the book is relatively free from typographical errors. In a book as intensely mathematical as this one, freedom from errors is important unless the reader is already well versed in the subject.

This book is already much quoted and is destined to become more so. An understanding of the theory contained is well worth the effort of serious engineers and for those who desire to make significant contributions to the state of the art, it is essential.—WARREN D. WHITE, *Airborne Instruments Laboratory, Mineola, N. Y.*

## Radio-Frequency Heating Equipment

BY L. L. LANGTON. *Pitman Publishing Corporation, New York, 1949, 196 pages, \$3.75.*

THE AVERAGE communication man's lack of knowledge concerning other branches of the field of electronics is frequently a source of embarrassment and indeed sometimes humiliation. In this British-authored book on r-f heating equipment, Langton has provided an extremely handy and concisely written volume which can effectively fill in the gaps on this universally used but often not completely understood subject.

The two basic types of r-f heating equipment, namely dielectric and induction, are first clearly defined. The rest of the book presents a detailed picture of the ramifications of each, including circuit details. An exceptionally complete appendix furnishes a great deal of practical information on L-C circuits, properties of dielectrics, and a survey of British tubes suitable for use in radio-frequency heating equipment. Coverage of British components and equipment does not appreciably impair the usefulness of this book to American engineers.

The book includes a special design section for college-level radio or electrical engineers which should be of interest and value to users of equipment, as well as those actually engaged in the design of such

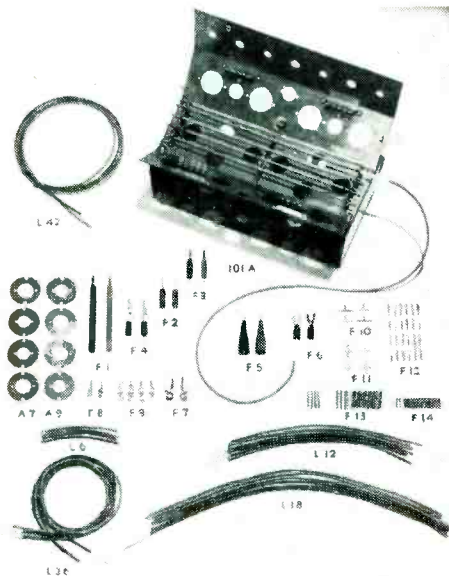

## UNICHASSIS

ELECTRONIC CONSTRUCTION SET  
Cuts "Breadboard" Time 50%

Used by leading manufacturers for the construction of experimental circuits — at a 50% saving in time and cost. Thousands of circuits have been created and tested on this device. Once completed, circuit can be stored, used as permanent equipment, or broken down for re-use.

**101A: 1 UNIVERSAL CHASSIS (UNICHASSIS)** 5 Solder filled bus bars have plug on ends. Places for 16 tube sockets have mounting holes tapped for screws. Vertical panel for mounting rheostats, potentiometers, etc.

**A7 & A9: 8 MINIATURE TUBE ADAPTORS** For converting octal socket places to 7 or 9 pin miniature socket places.

**L6 to L42: 22 PLUG ON LEADS (UNILEADS)** 6" to 42" lengths On each end of the lead is a socket into which the pins on the end of all fittings and connectors fit snugly.

**F1 to F9: 20 PLUG IN FITTINGS** Lugs, clips, plugs and prods are fitted with pins which plug into the ends of the UNILEADS.

**F10 to F14: 84 CONNECTORS** Tees, crosses and short rods used for making PLUG IN connections between UNILEADS and to binding posts & terminals.

PRICE complete **\$22.50**

f.o.b. Washington. See your local jobber or send your order direct to us. We pay postage if money order or check is advanced.

**FREE TRIAL:** We want to prove to you, at our expense, the time saving features and convenience of Unichassis. Just send us your company purchase order for one Complete Kit. If, at the end of five days, you are not satisfied, return at our expense without any obligations. If you wish to keep it, just mail us a check covering the cost.

**UNI-PRODUCTS, INC.**

1048 POTOMAC STREET, N. W.  
WASHINGTON 7, D. C.



THIS FEATHERWEIGHT WILL  
**LICK  
 SOLDERING  
 FATIGUE!**

THE NEW  
**HEXACON  
 BANTAM**  
**MODEL 30H**

Weight—5½ Ounces • Watts—  
 40 or 60 • Tip Dia.—Both 1/8" and 1/4" Tips  
 Furnished with Each Iron • Price— \$5.00

So light its weight is hardly noticeable. Out-  
 performs any iron of equal size. Hatchet de-  
 sign makes it more comfortable and practical  
 to use than a pencil iron. No transformer re-  
 quired. Write for complete catalog.

**HEXACON ELECTRIC CO.**  
 130 WEST CLAY AVE., ROSELLE PARK, N. J.

a **+** value for industry  
 Development and Production of  
**SPECIAL PURPOSE VACUUM  
 TUBES BY ECLIPSE-PIONEER**

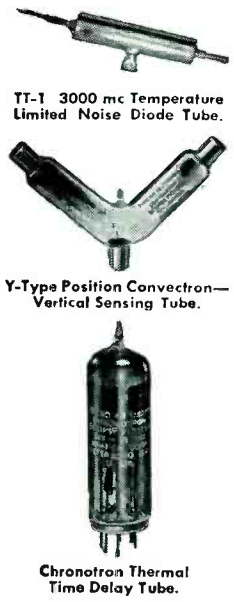

We're not in the standard vacuum tube business. But we are definitely in the business of developing and manufacturing special purpose vacuum tubes—tubes that are not generally available. During the past three years, for example, our facilities have produced, such devices as the Chronotron thermal time delay tube, the Convectron\* vertical sensing tube, the TT-1 3000 mc temperature limited noise diode tube, counter tubes, glass enclosed spark gaps, and phono pickup tubes. Quantities of all these are now serving many phases of industry in a wide variety of applications. We invite your use of our facilities to develop and produce your requirements of special purpose vacuum tubes. Your inquiries concerning the scope of our facilities or details of any of our tubes will be given immediate attention.

\*REG. U. S. PAT. OFF.

Eclipse-Pioneer Division of  
**TETERBORO, NEW JERSEY**

Export Sales—Bendix International Division, 72 Fifth Avenue, New York 11, N. Y.

Specify **GLASS  
 JEWEL  
 BEARINGS**  
 for . . . Low Cost  
 . . . Long Life

Glass Jewel Bearings by Bird are highly accurate and surprisingly inexpensive. They're ideal for use in ammeters, volt meters, timing instruments, compasses and other instruments where large volume production and low cost must be maintained.

Of special interest to instrument manufacturers is Bird's method of mounting jewels. There's a minimum of stress and strain on the bearing itself as a result of Bird's special mounting technique. It is this special mounting feature which adds so materially to the useful life of Bird Jewel Bearings.

Whenever there's a need for jewel bearings — whether in glass or in sapphire — Bird can supply the right bearing to your specifications. Write today for more information and a quotation.

Sapphire Bearings available in all jewel styles and mountings

**Richard H. Bird & Co., Inc.**  
 1 Spruce Street  
 Waltham 54, Mass.  
 "Serving Industry with Fine Jewels Since 1913"

Pioneer in Radio Engineering Instruction Since 1927  
**CAPITOL RADIO  
 ENGINEERING INSTITUTE**  
 An Accredited Technical Institute

ADVANCED HOME STUDY AND RESIDENCE COURSES IN PRACTICAL RADIO-ELECTRONICS AND TELEVISION ENGINEERING  
 Request your free home study or resident school catalog by writing to:  
 DEPT. 282B  
 16th and PARK ROAD, N.W.  
 WASHINGTON 10, D.C.  
 Approved for Veteran Training

For Precision Washers... For Precision Stampings...



**WHITEHEAD STAMPING CO.**

A preferred source of precision-made WASHERS and STAMPINGS. 46 years of experience and up-to-the-minute facilities, assure highest quality and service.



EST. 1903

**WHITEHEAD STAMPING CO.**

1691 W. Lafayette Blvd.

Detroit 16, Michigan

# a

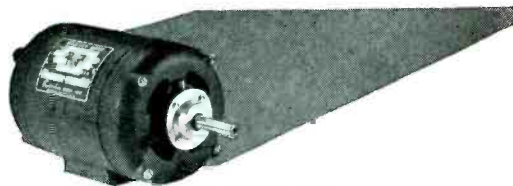

Cyclohm 2900 Motor

## adaptability...

### FRACTIONAL H. P. MOTORS

BY **EMC** AND *Cyclohm*

**The Cyclohm 2900 Motor—Long Life • Minimum Vibration • Quiet Operation • Minimum Maintenance**

There are a lot of good motors on the market...but you won't find a better motor than the Cyclohm 2900 at any price.

Cyclohm 2900 Motors can be supplied as Standard Capacitor Motors, Synchronous Hysteresis Motors, 2 Speed Capacitor Motors, Split Phase Motors or Brush Type (wound rotor) with or without gear reduction units. They are easily adaptable to your particular power problems, and as for applications, just check this list...

For laboratory equipment, vending machines, tape pulling, sound cameras, telegraph-terminal equipment, recording and facsimile equipment, take-up reels, reversing service and general service requiring a high quality motor.

These are motors worth knowing about, and so are the dozens of other motors made by EMC and Cyclohm. If your product needs fractional h.p., write today for handy reference literature and specification sheets. Two to one, you'll find the right motor at the right price.

**HOWARD**

**HOWARD INDUSTRIES, INC.**  
DEPT. E.A., RACINE, WIS.

DIVISIONS: ELECTRIC MOTOR CORP. CYCLOHM MOTOR CORP.

# V.L.F.!

Very Low Frequencies covered by the...

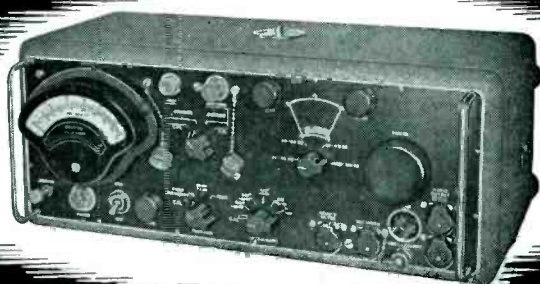

## STODDART NM-10A RADIO INTERFERENCE AND FIELD INTENSITY METER

- MEASURES radiated and conducted signals, including pulse or random interference.
- RANGE—14 kc to 250 kc.
- SENSITIVITY — Field strength using rod antennas one microvolt-per-meter to 2 volts-per-meter. Field strength using shielded loop antennas 10 microvolts-per-meter to 100 volts-per-meter. As a two-terminal voltmeter, either balanced or unbalanced, one microvolt to one volt.
- READS directly in microvolts and db.
- A.C. POWER SUPPLY REQUIREMENTS 105 to 125 volts or 210 to 250 volts A.C. Single phase source may be ANY FREQUENCY BETWEEN 50 CPS AND 1600 CPS. No shock hazard.
- GRAPHIC RECORDER included with versatile complement of accessories.

Write for complete technical data

**STODDART AIRCRAFT RADIO CO.**

Main office and plant:  
6644 Santa Monica Blvd.  
Hollywood 38, Calif.  
Phone: Hillside 9294

8-247 General Motors Bldg.  
Detroit 2, Michigan  
Phone: Trinity 1-9260

1346 Connecticut Ave.  
duPont Circle Bldg.  
Washington 6, D. C.  
Phone: Hudson 7313

equipment. The excellent organization of the material makes this book eligible for the shelves of any bookcase where a reference source on r-f heating equipment might be desired—J.F.

### Facsimile

BY LEE HILLS, *Managing Editor, The Miami Herald*, and TIMOTHY J. SULLIVAN, *Facsimile Editor, The Miami Herald*. McGraw-Hill Book Co., New York, 1949, 319 pages, \$3.50.

OUTLINE of facsimile as it stands today, written for students, newspapermen, radiomen and average readers who merely want to know what the subject is all about, without wading through theory, circuits and design data. Traces history, enumerates potential applications, explains Colorfax and Ultrafax, compares facsimile with television, covers all nonengineering aspects of operating a newspaper-affiliated facsimile station, and has one semi-technical chapter on how facsimile equipment functions. Liberally illustrated with examples of effective handling of photographs and associated copy for facsimile. An excellent book for its intended audience, and a good example of a book reproduced by offset from Varitype text, which incidentally is one of the methods used in setting up copy for facsimile.—J.M.

### Sound Reproduction

BY G. A. BRIGGS, *Wharfedale Wireless Works, Bradford, England*. Available through *British Industries Corp.*, 315 Broadway, New York 7, N. Y., 1949, 143 pages, \$2.95.

LIKE the author's previous book on loudspeakers, this is a brief review of the subject presented against the author's experiences for the benefit of the nontechnical high-fidelity addict. The book consists of two major parts: Part I: Loudspeakers; Part II: Records.

The part on loudspeakers extends the discussion of the previous book ("Loudspeakers: The Why & How of Good Reproduction", reviewed in *ELECTRONICS*, p 225, Aug. 1948), pointing out the difficulty of match-

ing a reflex cabinet to a large speaker and emphasizing the importance of a massive cabinet. (The author found a brick corner reflex cabinet quite free from irregularities in response.)

The part on records surveys recording techniques and characteristics and discusses the various ills the art is heir to, such as tracking error, surface noise and motor rumble. The most interesting feature of the book from this reviewer's viewpoint is the series of photomicrographs, taken by C. E. Watts, of needles and grooves. The 200X pictures show the effects of wear after various numbers of playing with different types of needles. They provide an excellent objective argument for using as hard a material for the tip of a pickup needle as possible.—F. ROCKETT, JR., *Airborne Instruments Laboratory, Inc., Mineola, N. Y.*

### Velocity-Modulated Thermionic Tubes

By A. H. W. BECK, *Standard Telecommunication Laboratories, Great Britain. The MacMillan Company, New York N. Y., 1948, 180 pages, \$3.75.*

AN ADVANCED analysis of velocity modulation tubes, based on British research, is presented in this volume of a series of books on Modern Radio Techniques published by the Cambridge University Press. The book will be of most value to designers of klystron tubes, but also offers a different approach to the theory of klystrons which will interest all engineers concerned with these tubes.

A short historical introduction is followed by a descriptive chapter on tube types and velocity-modulation processes. The theory is developed mathematically, but the emphasis on physical considerations simplifies the interpretation of the results. First-order theories are treated briefly and most of the chapters deal with second-order effects such as beam loading, debunching, large-signal analysis and hysteresis. Chapters on cavity resonators, high-current electron beams and manufacturing techniques, plus a brief appendix on traveling-wave tubes, are included.

Correlation between the work on

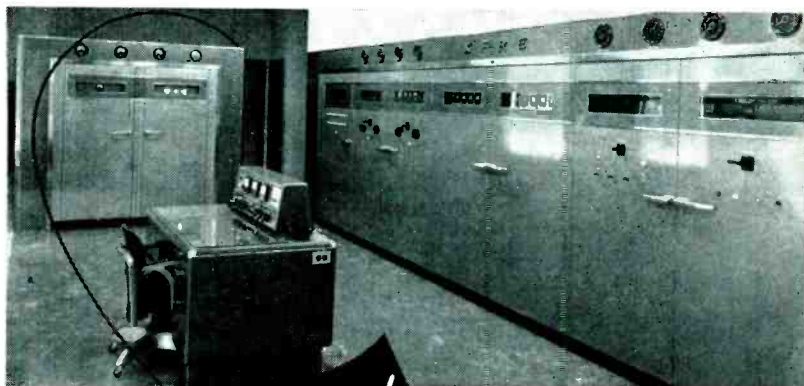

*Specially Designed*

KFRE, Fresno, California. Front view of 50 kw AM transmitter control console and Johnson cabinet containing phasing equipment.

### JOHNSON PHASING EQUIPMENT

Illustrated is a perfect example of Johnson craftsmanship — Phasing equipment exactly duplicating style and color of transmitter cabinets.

All Johnson phasing equipment is individually designed for the job. Adequate safety factor of all components, ample front panel control and adjustment of each circuit is provided.

In addition, Johnson Phasing Equipment offers optimum circuit design,

heavier components with a wider range of tuning adjustments and automatic switching from directional to non-directional operation.

Johnson, for many years a leading supplier of antenna phasing equipment, manufactures units with power ratings from 1 to 50 kw. Standard as well as custom cabinets to match your equipment are made in the Johnson plant.

Your inquiries are always welcome.

## E. F. JOHNSON CO.

WASECA, MINNESOTA



# IN-RES-CO *Wire Wound* RESISTORS

meet all instrumentation needs

TOLERANCE TO  $\pm 0.1\%$

.01 OHM TO 1.0 MEGOHM

HIGH OR LOW WATTAGE

HERMETIC SEALED TYPES

ALL TYPES OF MOUNTING



INRESCO Resistors are a product of high-speed winding techniques that introduce a new measure of economy in precision wire wound resistors.

They are available for IMMEDIATE DELIVERY, in diversified types that meet practically every circuit requirement of load, ohmic value, size, shape, and operating condition.

When planning a new circuit design, investigate the advantage of INRESCO resistors for economy, dependability and permanently fixed characteristics. For complete details, call or write today for your copy of the INRESCO catalog.

Manufacturers and designers of wire wound resistors—exclusively. Estimates on custom built resistors furnished.



## INSTRUMENT RESISTORS COMPANY

1036 COMMERCE AVENUE, UNION, NEW JERSEY

## The Design Makes the Difference

in

# LECTROHM

## "Rib-on-edge" RESISTORS

Lectrohm "Rib-on-edge" resistors are constructed of edge mounted resistance alloy ribbon of corrugated nature. Herein lies the secret of the larger than average heat dissipating area and, therefore, greatest efficiency in limited space. Vitreous enamel coating covers and anchors the ribbon to the refractory tube providing an integral and solid unit.

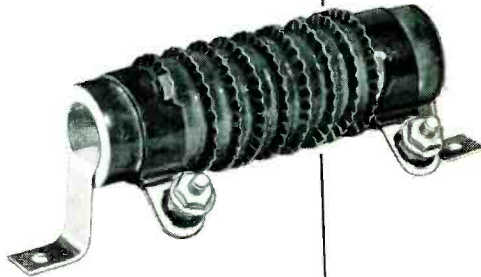

- Request sample—giving resistance, maximum current, voltage drop required and space available.
- Ask for catalog.

**LECTROHM**  
INCORPORATED

5903 Archer Avenue Chicago 38, Illinois  
Division of  
NATIONAL LOCK WASHER CO., NEWARK, N. J.

## Over 1000 Sizes

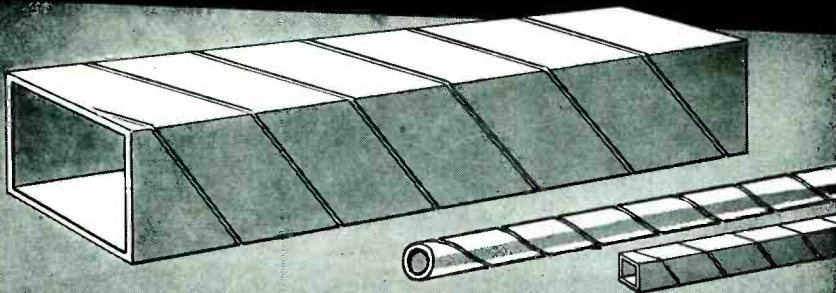

## PARAMOUNT SPIRAL WOUND PAPER TUBES

Square • Rectangular • Triangular  
Round and Half-Round

With a wide range of stock arbors . . . plus the specialized ability to engineer special tubes . . . PARAMOUNT can produce the exact shape and size you need for coil forms or other uses. *Hi-Dielectric*, *Hi-Strength*, Kraft, Fish Paper, Red Rope, or any combination, wound on automatic machines. Tolerances plus or minus .002". Made to your specifications or engineered for YOU.

Inside Perimeters from .592" to 19.0"

SEND FOR ARBOR LIST  
OF OVER 1000 SIZES

Convenient, helpful listing of over 1000 stock arbors. Includes many odd sizes of square and rectangular tubes. Write for Arbor List today. No obligation.

## PARAMOUNT PAPER TUBE CORP.

616 LAFAYETTE ST., FORT WAYNE 2, IND.

Manufacturers of Paper Tubing for the Electrical Industry

klystrons in three different countries is accomplished by frequent references to the contributions of French and American workers in this field. The result is an excellent survey of klystron theory, so well presented that an expanded version would be welcome.—A. E. HARRISON, Associate Professor of Electrical Engineering, University of Washington.

### Books Received for Review

**THE TECHNIQUE OF RADIO DESIGN.** By E. E. Zepler. John Wiley & Sons Inc., New York, 1949, second edition, 394 pages, \$5.00. Revision of first edition with additional data on receiver noise and additional diagrams, covering problems linked with daily routine work of a British receiver design engineer.

**RADIO INTERFERENCE SUPPRESSION OF HIGH FREQUENCY ARC WELDER.** Available from Office of Technical Services, U. S. Department of Commerce, Washington 25, D. C., 11 pages, 50c. Covers use of double-screened room, with adequate filtering of power lines at point of entry.

**RADIO AND TELEVISION MATHEMATICS.** By Bernhard Fischer. The Macmillan Co., New York, 1949, 484 pages, \$6.00. Guide and reference for the practical radio man and a collection of problems for instructors. The questions and their solutions are particularly useful to those preparing for FCC operator license examinations. Sections on measurements, power supplies and receivers will apply particularly to the service man.

**RADIO-TELEVISION QUESTIONS AND ANSWERS.** By Woodrow Smith. Editors and Engineers, Limited, Santa Barbara, California, 1949, \$1.00 per element (mailed individually), approximately 60 pages per element, paper cover. Three separate well-illustrated books listing representative questions and easy-to-understand answers for commercial operator license examinations. Element 2—Basic Theory and Practices; Element 3—Radiotelephony; Element 4—Advanced Radiotelephony.

**THE ELECTRON MICROSCOPE AND ITS APPLICATION TO MATERIALS PROBLEMS.** PB 97957, available from Office of Technical Services, U. S. Dept. of Commerce, Washington, D. C., 1949, 48 pages, \$1.25. Prepared to assist in training of Air Force technicians. Basic introduction to subject, with practical information on construction and operation of electron microscopes, preparation of replicas and specimens, and typical applications.

**FUNDAMENTAL TECHNIQUES IN THE FREQUENCY ADJUSTMENT OF QUARTZ CRYSTALS.** By Leland T. Sogn and Catherine Barclay. NBS Circular 480. Supt. of Documents, U. S. Government Printing Office, Washington 25, D. C., 9 pages, 10¢. Etching and hand grinding procedures for raising, and loading methods for lowering frequency.

**GIANT BRAINS.** By Edmund C. Berkeley. John Wiley & Sons, Inc., New York, 1949, 270 pages, \$4.00. This book describes several mechanical and electronic computers, predicts their effects on civilization, and explains their place in the world of science. It is carefully written to appeal to scientific-minded people of practically all educational levels.

**THE BUSINESS HELPER.** By Leslie C. Rucker. John F. Rider Publisher, Inc., New York, 1949, 138 pages, \$2.00. Practical guide to profitable operation of a small business. Covers types of business, locations, customers, buying, selling, estimating, contracts, overhead, banking, bookkeeping, collecting, advertising, insurance, credit and other factors.

# MICO ENGRAVER

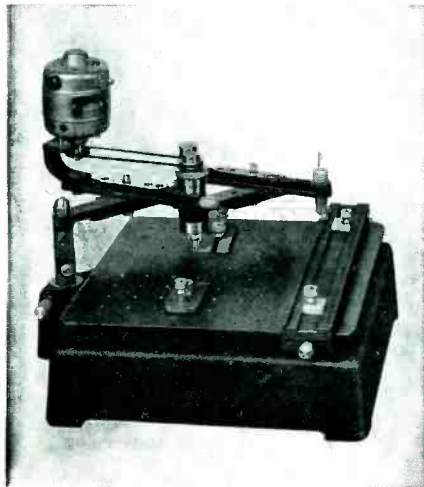

## FEATURES

1. Ball Bearing Micrometer spindle for absolute control of depth of cutter in all four ratios.
2. Accuracy of reproduction in four ratios due to excellent precision machining of pantograph arms.
3. Absolute accuracy in three-dimensional duplicating.
4. Many attachments available to increase versatility, such as extension arm, rapid self-centering vise, extension post for pantograph and copy carrier, hand engraving spindle and many more.
5. Copy and work right-side up and in view of operator.

Catalog on Request

**MICO INSTRUMENT CO.**  
76E Trowbridge St. Cambridge 38, Mass.

## Working with Inert Gases?

*Linde* HELIUM • NEON  
ARGON • KRYPTON • XENON

Now available in commercial-size cylinders in addition to glass bulbs. Write for information on sizes, prices, rigid purity tolerances, special rare gas mixtures...

### THE LINDE AIR PRODUCTS COMPANY

Unit of Union Carbide and Carbon Corporation  
30 East 42nd Street **NYC** New York 17, N. Y.  
In Canada: Dominion Oxygen Company, Limited, Toronto

The term "Linde" is a registered trade-mark of The Linde Air Products Company.

# EISLER Television Tube MACHINERY

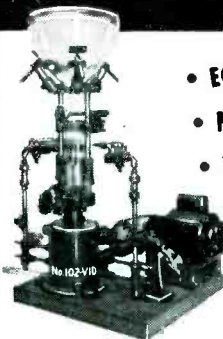

No. 102-VID



No. 57-VID

- ECONOMICAL
- MODERN DESIGN
- PRODUCTION ENHANCING

EISLER'S Electronic Equipment is especially Designed and Built to your exact requirements.  
From 5" to huge 24" Television Tube

EISLER specializes in GLASS WORKING MACHINERY for the manufacture of: Cathode Ray; Radio Tubes (Standard, Miniature, Sub Miniature); Fluorescent Lamps; Glass Ampoules; Vials; Incandescent Lamps.

- Consultation without any obligation on your part is cordially invited.

**EISLER ENGINEERING CO., INC.**  
751 SOUTH 13th ST. • NEWARK 3, NEW JERSEY

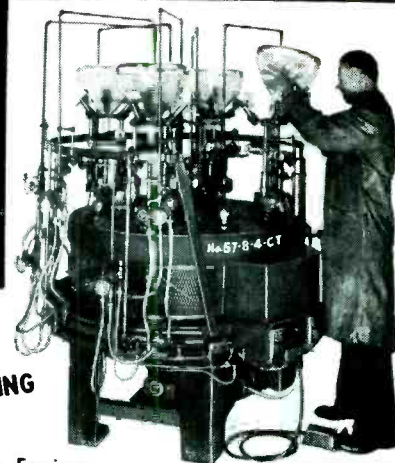

No. 57-R-4 CT



RESISTANCE WELDERS  
•  
1/4 to 300 KVA



EISLER TRANSFORMERS  
STANDARD • SPECIAL  
Air, Oil or Water Cooled

Sizes From 1/4 to 500 KVA

## Winner and Still Coil Champion DANO

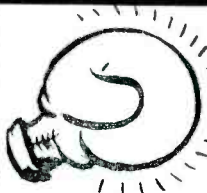

True champions because they stand up to every test, Dano coils are the wide odd favorites of experienced engineers who seek coil perfection.

Dano is completely set up to handle all your electrical coil winding problems including specially treated coils. Every coil made to your exact specifications.

ALSO TRANSFORMERS MADE TO ORDER

- Form Wound
- Paper Section
- Acetate Bobbin
- Bakelite Bobbin
- Cotton Interweave
- Coils for High Temperature Applications

**THE DANO ELECTRIC CO.**  
MAIN ST., WINSTED, CONN.

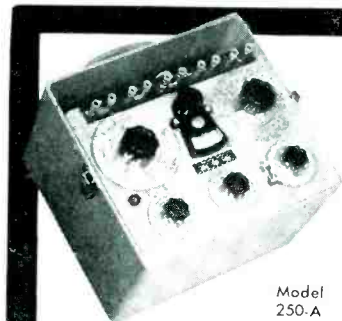

Model 250-A

\$240 F.O.B. Portland

### BECO PORTABLE

### UNIVERSAL IMPEDANCE BRIDGE

Four versatile bridges in one small instrument for rapid and accurate measurement of:

RANGE	CIRCUIT
RESISTANCE 1 milliohm to 1 megohm	• Wheatstone
CAPACITANCE 1 mmfd. to 100 mfd.	• Modified DeSauty
INDUCTANCE 1 microhenry to 100 henrys	• Hay
Size: 9 1/2" x 10 1/4" x 10 1/2"	• Maxwell

Flashlight Cell Powered—No AC Power connection required.

Laboratory Accuracy WHEN and WHERE You need it!



### BROWN ELECTRO-MEASUREMENT CORPORATION

Successor to Brown Engineering Co.

4635-37 S. E. HAWTHORNE BOULEVARD

PORTLAND 15, OREGON

FOR  
DEMONSTRATING  
& TESTING AUTO RADIOS  
from AC LINES



**ATR**

**"A" BATTERY  
ELIMINATORS**



**for DEMONSTRATING AND  
TESTING AUTO RADIOS**

New Models . . . Designed for testing D. C. Electrical Apparatus on Regular A. C. Lines. Equipped with Full-Wave Dry Disc Type Rectifier, Assuring Noiseless, Interference-Free Operation and Extreme Long Life and Reliability.



**AUTO RADIO VIBRATORS**

A Complete Line of Vibrators . . . Designed for Use in Standard Vibrator-Operated Auto Radio Receivers. Built with Precision Construction, featuring Ceramic Stack Spacers for Longer Lasting Life.

NEW MODELS ✓ NEW DESIGNS ✓  
NEW LITERATURE ✓  
ATR "A" Battery Eliminator, DC-AC Inverters, Auto Radio Vibrators  
See your jobber or write factory

**AMERICAN TELEVISION & RADIO Co.**  
Quality Products Since 1931  
SAINT PAUL 1, MINNESOTA-U. S. A.

**Backtalk**

This department is operated as an open forum where our readers may discuss problems of the electronics industry or comment upon articles which **ELECTRONICS** has published.

**Calling Doctor Kildare**

DEAR SIR:  
YOUR FEATURE ARTICLE "Inductive Prompting System", by Bruce H. Denny and Robert J. Carr, in November **ELECTRONICS**, strikes a familiar chord. In January, 1943, H. D'Almaine of Edwards & Co. asked for proposals for a doctor-calling system in hospitals, which would be heard only by the doctor being called.

I suggested a low r-f frequency loop, or single conductor, with far end grounded, as a magnetic induction type of transmitter, strung along the hospital corridors, fed by an oscillator, modulated at a single audio frequency, and with a dozen or two push-button-controlled frequency adjustments, each button carrying an identifying number.

A dozen or two very simple, fixed-crystal, fixed-tuned receivers would be provided, similarly numbered. These would consist of an appropriate cap or head band carrying an inductive pickup coil, capacitor tuned to its numbered oscillator frequency, and provided with a hearing-aid, ear-plug receiver.

Upon entering the hospital, Mr. Doctor leaves his name, and the switchboard operator gives him a receiver, recording its number opposite his name. Should this doctor be sought while in the hospital, the operator pushes his receiver number button on the a-f modulated transmitter, and he alone hears the signal. A special a-f modulation could be used for emergency calls.

The Doctor would never be more than say, 20 feet from the carrier current wire, his receiver loop would always be more or less par-

**1**

**SOURCE FOR ALL PARTS YOU NEED**

**LOCK WASHERS**  
High carbon steel, bronze, aluminum, stainless steel, monel metal, spring lock washers . . . finished or plated with cadmium, nickel, brass or copper. Also Garrett's Aluminum Spring Lock Washer—light in weight with strength of steel.

**FLAT WASHERS**  
Made to meet ASA and SAE specifications in regular steel spring steel, stainless steel, brass, bronze, monel metal, aluminum, Alclod and copper. Can be plated with zinc, cadmium, nickel, brass, chrome . . . or can be parkerized.

**STAMPINGS**  
From a small part for electronic instruments, automotive stampings and television chassis. . . Garrett can fabricate them better and cheaper than is possible in your own plant. Years of experience and modern high speed equipment assure speed deliveries . . . finished to your specifications.

**SPRINGS**  
Flat and coiled springs to meet every requirement. Every Garrett spring has controlled tension built into it to assure satisfactory performance under all conditions. All types of flat springs . . . coil springs—compression, extension . . . made of round, square or rectangular wire.

MANUFACTURED BY  
**GEORGE K. GARRETT CO., INC.**  
PHILADELPHIA 34, PA.



allel to it, and at a frequency of say, 10,000 to 20,000 cps, there would be no problem of standing-wave dead spots. The only possible objection I can foresee is from total magnetic r-f shielding by metal lath and metal doors.

It would seem, by now, high time that the blatant "Calling Doctor So and So" public address systems, now used in otherwise quiet hospitals, be relegated to some noisier locations.

B. F. MIESSNER  
*Mieessner Inventions, Inc.*  
 Morristown, N. J.

**The Logarizer**

DEAR SIRs:

WE HAVE READ with great interest W. J. Ives' article describing the logarithmic scale noise meter published in *ELECTRONICS*, August 1949, and also a further article by D. H. Bastin, describing a method of using the same circuit for microphone calibrations, published in *ELECTRONICS*, November 1948. We can support from practical experience many of the claims made by both writers. Indeed, since the grid-current logarizer was first produced by the British Broadcasting Corporation Research Department in 1934, we have had considerable experience of its practical applications, and until 1939, it was employed as a programme meter and as part of the normal circuit arrangements used for calibrating microphones. The method adopted (apart from the pulsing system) was identical with that of the Canadian Broadcasting Corporation, as described by Bastin.

The logarizer valve circuit was first used in a portable programme meter produced by E. L. Payne, B. Eng., A.M.I.E.E., and J. G. Story, members of the British Broadcasting Corporation, in 1934, when a provisional patent specification No. 11860/34 was taken out in their names.

The patent specification was never completed but a full account of it was published by the inventors in *Wireless Engineer*, November 1935, under the heading, "A Portable Programme Meter."

The logarizer valve circuit used

for

**ELECTRONIC COUNTING APPLICATIONS**

MODEL 700

*Berkeley*

**DECIMAL COUNTING UNIT**

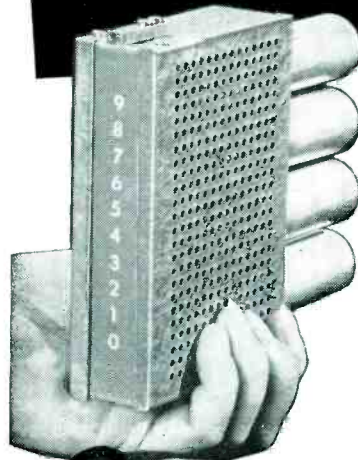

This versatile component is adaptable to a wide range of applications in counting, timing and frequency measurements. It has scale-of-ten direct reading based on a reliable binary circuit. It has easily met power and pulse input requirements and is designed for plug-in operation. It is a self-biased unit, which, although for operation at 300 v., functions consistently at 200 to 450 v. It can be easily built into your apparatus. Combined with these advantages are miniature size and sturdy construction. Price \$55.00. Discounts on quantities. Send for Bulletin DCU-114.

Now in production. Berkeley's new Time Interval Meter. Ask for Bulletin TIM-114 for full information.

*Berkeley Scientific Company*

SIXTH AND NEVIN AVENUES • RICHMOND, CALIFORNIA



**CUT COSTS**

**IN FREQUENCY CONTROL DESIGN . . .  
 ELIMINATE TEMPERATURE CONTROL OF CRYSTALS**

**WITH**

±.0025 %  
 -55°C to +90°C

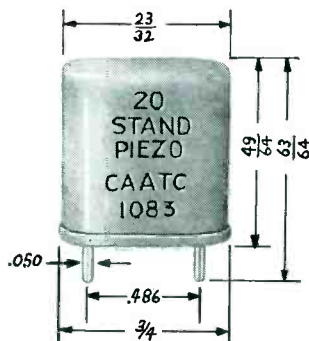

Improved processing of our hermetically sealed Type 20 unit has made it possible to eliminate the cost of temperature control.

Lower power requirements, reduced weight, compactness, ruggedness, and dependability in our improved Type 20 is your answer for reducing costs and increasing sales.

*For complete details, write for free catalog.*

Visit Booth 307 at the I.R.E. Show, March 6-9, 1950, New York



*Standard Piezo Company*  
 CARLISLE, PA.



# CONTACTS

FOR THE FIELD OF ELECTRONICS

**EISLER**—Manufactures Complete Equipment for:

SPOT WELDERS, Electric, for 1/4 to 250 KVA.  
 A.C. ARC WELDERS from 100 to 400 Amps.  
 TRANSFORMERS, Special and Standard Types.  
 INCANDESCENT LAMP Manufacturing Equipment.  
 FLUORESCENT TUBE Manufacturing Equipment.  
 NEON SIGN MAKERS EQUIPMENT.  
 ELECTRONIC EQUIPMENT, Vacuum Pumps, etc.  
 WET GLASS SLICING and Cutting machines for Laboratory use.  
 EISLER ENGINEERING CO., INC., 774 So. 13th St., Newark 3, N. J.



**FINE RIBBONS OF TUNGSTEN and MOLYBDENUM**

Quality and accuracy in our fabrication of Tungsten & Molybdenum Ribbons have characterized our service to the Electronic industry.

A development of  
**H. CROSS Co.**  
 15 Beekman St., New York 7, N. Y.



**FLUXES**  
 SODERING  
 BRAZING & WELDING  
 L. B. ALLEN CO. INC. Chicago 31, Ill.  
 6751 Bryn Mawr Ave.

**EL-TRONICS, INC.**

Research, development, and manufacture of electronic equipment—a single model to large quantities.

Specialists in Geiger-Muller equipment  
 2647-67 N. Howard St., Phila. 33, Pa.  
 Garfield 5-2026

**MICROMETER FREQUENCY METER**

will monitor any number of frequencies.

FM or AM, 100 KC to 175 MC

**LAMPKIN LABORATORIES, INC.**  
 Bradenton, Fla., U. S. A.

**SUB-MINIATURE PRINTED ELECTRONIC CIRCUITS**

produced from your schematics or existing electronic equipment. Circuits fired on ceramics or air dried on plastics and paper bases. Confidential service.

**PLASTICS & ELECTRONICS CO.**  
 272 Northland Ave., Buffalo 8, New York

**Rectangular TV Tubes?**

Our regular tube carrier designed for 10 and 12" round blanks will handle the new 16" rectangular tube without a bit of trouble, and without any changes. Capacity 28 tubes. Ball bearing swivel casters—Send for circular.

**BUCK ENGINEERING CO., INC.**  
 37-41 Marcy St., Freehold, New Jersey

**PRINTED CELLOPHANE**

Colorful - Self Adhesive - Cellophane, processed in Rolls. Easy to buy - Easy to apply - used for Packaging-Point of Sale advertising-Parts marking and Aircraft Wire terminal identification.

**TOPFLIGHT TAPE - YORK, PA.**



**SILICONE DC 4 COMPOUND**

THE NON-MELTING, WATERPROOFING AND INSULATING SILICONE COMPOUND. FOR IGNITION SYSTEMS AND ELECTRONIC EQUIPMENT. MEETS ALL THE REQUIREMENTS OF AN-C-128a.

STABLE AT TEMPERATURES FROM -40° to +40°F.

For more data on DC 4 Silicone compound write Dept. E-4

**Dow Corning**

**GRC WING NUTS**

TOP QUALITY PRICED LOWER



Rust-proof zinc alloy with GRC's recessed-wing finger-grip. All commercial finishes, all popular thread sizes. Special threads or untapped wing nuts: special designs to order.

Write today for samples and prices— and compare! Immediate Deliveries.

**GRIES REPRODUCER CORP.**  
 100 Willow Ave., New York 54, N. Y.

in this instrument was identical with that used by Ives, with the exception of a resistance in the cathode circuit inserted by Ives to increase the useful amplitude range of his noise meter.

Although the instrument was originally produced for use as a programme meter, the inventors realized the potential uses of this device and included the measurement of noise amongst its possible applications.

We realize that the development of the logarithmic scale noise meter was the subject of a Master's Thesis at McGill University and that a search was obviously made prior to its presentation. We can only conclude that the title of our equipment led to a failure to disclose the prior publication of the inventors' article in *Wireless Engineer*.

However, we consider that credit should be given to the inventors and to the British Broadcasting Corporation.

J. A. FITZGERALD  
 for Head of Engineering Secretariat  
 The British Broadcasting Corporation  
 London, England

**Chain Amplifier**

DEAR SIRS:  
 DUE TO AN UNFORTUNATE error, the response curve was omitted from our article, "200-MC Traveling-Wave Chain Amplifier", and I am submitting it herewith. This figure illustrates graphically the bandwidth from 100 kc to 200 mc of the Percival-type chain amplifier described in the article. The modifica-

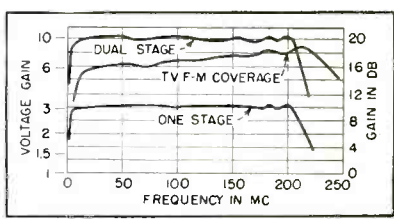

Wide-band chain amplifier response curves

tion of the amplifier for television coverage extends the bandwidth of a dual-stage chain to 240 mc at a slightly reduced gain.

H. G. RUDENBERG  
 Research Division  
 Raytheon Manufacturing Company  
 Waltham, Massachusetts

When you're in need of some product or service to speed and improve operation, or save money, you may find it here—in the Contacts Section. . . . each issue.

**DOW CORNING CORPORATION**  
 MIDLAND, MICHIGAN  
 Atlanta • Chicago • Cleveland • Dallas  
 Los Angeles • New York  
 In Canada: Fiberglas Canada, Ltd., Toronto  
 In England: Albright and Wilson, Ltd., London



# PROFESSIONAL SERVICES

Consulting—Patents—Design—Development—Measurement

in

Radio, Audio, Industrial Electronic Appliances

**AMPLIFIER CORP. of AMERICA**  
*Research, Design, Development  
and Manufacturing Engineers*  
Specializing since 1938 in All Phases of  
Magnetic Tape Recording for All Applications  
Precision Regulated Power Supplies  
Distinctive Direct-Coupled Amplifiers  
A. C. Shaney, Chief Engineer  
388 Broadway New York 13, N. Y.

**PAUL GODLEY CO.**  
*Consulting Radio Engineers*

GREAT NOTCH, N. J.  
Est. 1926 Little Falls 4-1000

**PICKARD AND BURNS, INC.**  
*Consulting Electronic Engineers*

Analysis and Evaluation  
of Radio Systems  
Research, Development & Design  
of Special Electronic Equipment  
240 Highland Ave., Needham 84, Mass.

**S. BERTRAND BARNARD, LL.B., M.E.**  
REGISTERED PATENT ATTORNEY  
Mechanical, Electronic  
Automotive and Aircraft Patents.  
PATENT ANALYSES and INVESTIGATION  
29-28 41st Avenue  
Long Island City 1, N. Y. STillwell 4-5428

**HANSON-GORRILL-BRIAN INC.**  
*Product & Mfg. Development*

ELECTRICAL - ELECTRONIC  
HYDRAULIC - MECHANICAL  
One Continental Hill Glen Cove, N. Y.  
Glen Cove 4-1922

**ALBERT PREISMAN**  
*Consulting Engineer*

Television, Pulse Techniques, Video  
Amplifiers, Phasing Networks,  
Industrial Appliances  
Affiliated with  
MANAGEMENT-TRAINING ASSOCIATES  
3308-14th St., N.W. Washington 10, D. C.

**CROSBY LABORATORIES**

*Murray G. Crosby & Staff*  
FM, Communications, TV,  
Industrial Electronics,  
High-Frequency Heating  
Offices, Laboratory & Model Shop at:  
126 Herricks Rd., Mineola, N. Y.  
Garden City 7-0284

**KENT LABORATORIES, INC.**

*Model Work in Metals & Plastics*  
Electro - Mechanical  
Design - Development - Manufacture  
Precision Mechanical Specialists  
230 Warburton Ave. Hawthorne, N. J.  
Telephone HA wthorne 7-8777

**BERNARD SACHS, B.E.E., M.S.**  
*Registered Patent Agent*

Specialist in electronic cases  
1033 E. 12th St. Brooklyn 30, N. Y.  
Cloverdale 2-6382

**EDGERTON, GERMESHAUSEN  
& GRIER, Inc.**

*Consulting Engineers*  
Research, Development and Manufacture  
of Electronic and Stroboscopic Equipment  
Specialists in High-Speed Photography  
160 Brookline Avenue, Boston 15, Mass.

**MEASUREMENTS CORP.**  
*Research & Manufacturing  
Engineers*

Specialists in the Design and  
Development of Electronic Test Instruments  
Boonton, N. J.

**SERVO  
CORPORATION OF AMERICA**

*Consultants on  
Electronic Control Problems  
for Industry*  
New Hyde Park Long Island, N. Y.

**ELECTRO-MECHANICAL RESEARCH INC.**  
*Specialized Research and Manufacture*

High and Low Frequency Circuit Development  
Electronic Measuring and Test Equipment  
Optical and Infra-Red Studies  
Special Geophysical Equipment  
Automatic Inspection Devices  
Ridgefield, Conn.

**MICROCIRCUITS COMPANY**  
*Consultation - Development - Manufacture*

PRINTED CIRCUIT  
APPLICATIONS and PAINTS  
Conducting, Resistance, and Magnetic  
Paints, Pastes, and Hot Melts  
for Experimentation and Production  
New Buffalo Michigan

**SERVO-TEK PRODUCTS CO., INC.**  
*Servo-Systems • Position Recorders  
Motor-Integrator Systems*

Specialists in Electronic Motor Speed Control  
4 Godwin Avenue Paterson, N. J.  
Tel. ARmory 4-3366 Teletype PAT 189

**ELECTRONIC ENGINEERING  
CO. of CALIFORNIA**

Radio and Electronic Consulting and  
Designing.  
2008 W. Seventh St. Los Angeles  
DUnkirk 7-8323 California

**Eugene Mittelmann, E.E., Ph.D.**  
*Consulting Engineer & Physicist*

High Frequency Heating — Industrial Electronics  
Applied Physics and Mathematics  
549 W. Washington Blvd. Chicago 6, Ill.  
State 2-8021

**A. F. SMUCKLER & CO., INC.**  
*Electronic and Communication*

Engineers and Manufacturers  
202-208 Tillary Street Brooklyn 1, N. Y.  
ULster 5-5141

**ERCO RADIO  
LABORATORIES, INC.**

*Radio Communications Equipment*  
Engineering - Design - Development - Production  
Pioneers in Frequency Shift Telegraph  
Garden City • Long Island • New York

**NIAGARA ELECTRON LABORATORIES**  
CONSULTATION - DESIGN - CONSTRUCTION  
MFG. THE THERMOCAP RELAY

Specializing in solution of problems of electronic  
and electro-physical instrumentation for the re-  
search or analytical laboratory. Industrial plant  
problems also invited.  
Andover, New York Cable Address: NIATRONLAB

**TECHNICAL  
MATERIEL CORPORATION**

*Communications Consultants*  
RADIOTELETYPE • FREQUENCY SHIFT  
INK SLIP RECORDING  
TELETYPE NETWORKS  
453 West 47th Street New York 19, N. Y.

**THE  
REAL  
VALUE**

*of placing your unusual problem in the hands of a competent con-  
sultant is that it eliminates the elements of chance and uncertainty  
from the problem and provides real facts upon which to base decisions.*

# SEARCHLIGHT SECTION

EMPLOYMENT • BUSINESS • OPPORTUNITIES • EQUIPMENT—USED or RESALE

## UNDISPLAYED RATE:

\$1.20 a line, minimum 4 lines to figure advance payment count 5 average words as a line.

INDIVIDUAL EMPLOYMENT WANTED undisplayed advertising rate is one-half of above rate, payable in advance.

PROPOSALS \$1.20 a line an insertion.

NEW ADVERTISEMENTS received by February 1st will appear in the March issue, subject to limitation of space available.

The publisher cannot accept advertising in the Searchlight Section which lists the names of the manufacturers of resistors, capacitors, rheostats, and potentiometers or other names designed to describe such products.

## INFORMATION:

BOX NUMBERS in care of any of our New York, Chicago or San Francisco offices count 1 line additional in undisplayed ads.

DISCOUNT of 10% if full payment is made in advance for four consecutive insertions of undisplayed ads (not including proposals).

## DISPLAYED—RATE PER INCH

The advertising rate is \$10.25 per inch for all advertising appearing on other than a contract basis. Contract rates quoted on request.

AN ADVERTISING INCH is measured 7/8 inch vertically on one column, 3 columns—30 inches—to a page.

ELECT.

## RCA VICTOR Camden, N. J.

### Requires Experienced Electronics Engineers

RCA's steady growth in the field of electronics results in attractive opportunities for electrical and mechanical engineers and physicists. Experienced engineers are finding the "right position" in the wide scope of RCA's activities. Equipment is being developed for the following applications: communications and navigational equipment for the aviation industry, mobile transmitters, microwave relay links, radar systems and components, and ultra high frequency test equipment.

These requirements represent permanent expansion in RCA Victor's Engineering Division at Camden, which will provide excellent opportunities for men of high caliber with appropriate training and experience.

If you meet these specifications, and if you are looking for a career which will open wide the door to the complete expression of your talents in the fields of electronics, write, giving full details to:

National Recruiting Division  
Box 200, RCA Victor Division  
Radio Corporation of America  
Camden, New Jersey

## NATIONAL UNION RESEARCH DIVISION

There are several desirable openings for experienced

### PHYSICISTS and ENGINEERS

capable of handling the design and development of electron tubes and circuits.

Our growing organization can offer excellent prospects for security and advancement to qualified personnel.

Interested applicants are invited to send their resume to:

Divisional Personnel Manager  
National Union Research Division  
350 Scotland Road, Orange, N. J.

REPLIES (Box No.): Address to office nearest you  
NEW YORK: 330 W. 42nd St. (18)  
CHICAGO: 520 N. Michigan Ave. (11)  
SAN FRANCISCO: 63 Post St. (4)

### POSITIONS VACANT

GRADUATE ELECTRONIC Engineers or Physicists with from 30 to 10 years experience in the following fields: (a) UHF and VHF circuit and antennae design, (b) design of servo-mechanisms and control circuits, (c) design of carrier-type strain gage recording systems. The position will require personnel who can supervise engineers and/or technicians, design equipment and follow construction and necessary trouble-shooting after installation. This work is required for the flight testing of piloted and pilotless aircraft. Write Chance Vought Aircraft, P. O. B. 5907, Dallas, Texas.

POSITION OPEN; Old Established Firm. Graduate Electrical Engineer from college of recognized standing. Must have majored in communications division of E.E. or be a graduate physicist with training in electronic and communication subjects. Must thoroughly understand principles underlying design and test of V.H.F. radio transmitters and receivers. Must be familiar with all modern testing instruments for V.H.F. communication. Experience in V.H.F. receiver design important. P-1761, Electronics.

ENGINEERING PHYSICIST or Specialist for research and development work on cracked carbon resistors. Man with some experience preferred. Progressive midwestern manufacturing concern. Give full data as to experience and schooling. P-1972, Electronics.

(Continued on page 245)

## RESEARCH AND DEVELOPMENT OPPORTUNITIES AT FREED-EISEMANN

Development and research projects in important new fields have created interesting opportunities for experienced men:

- Electron Tube Research Physicist
- Electron Tube Development Engineer
- Optical Engineer
- Physio-Chemist (solid state)
- Tube Technicians

Applicants should be capable of conducting experimental work in the fields of electron tubes, cathode ray tubes, photo and secondary electron tubes including techniques of high-vacuum, pumping, cathodes, screens, etc.

WRITE TO DIRECTOR OF  
RESEARCH & DEVELOPMENT

### FREED RADIO CORPORATION

200 Hudson Street, New York 13, N. Y.

## RADAR ENGINEER-PHYSICIST WANTED

Must have heavy experience in basic study and research on new radar systems and similar electronic equipment.

Excellent opportunity for Senior man. Juniors please do not apply.

State full particulars. Replies confidential.

Write: A. Hoffsommer

W. L. MAXSON  
CORPORATION  
460 W. 34th St., New York 1, N. Y.

## WHEN

Answering Advertisements

PLEASE do not send original letters, certificates or photographs. We cannot be responsible for their return. Please send photostat or carbon copies.

## Electronic Engineers

### PROJECT ENGINEERS

Five or more years experience in the design and development, for production, of major components in radio and radar equipment.

### ASSISTANT PROJECT ENGINEERS

Two or more years experience in the development, for production, of components in radio and radar equipment.

Well equipped laboratories in modern radio plant . . . Excellent opportunity . . . advancement on individual merit.

Baltimore Has Adequate Housing

Send resume to Mr. John Siena:

**BENDIX RADIO DIVISION**  
BENDIX AVIATION CORPORATION  
Baltimore 4, Maryland

**ELECTRONICS MEN**

MFG ENGR — Production exp in tubes pref \$10-\$12,000  
 PROJECT ENGRS—ME—Auto Radio Tuning de-  
 vices Design etc. \$10-\$12,000  
 PURCH ASST—electronic \$8000  
 SR. ENGR—ME—Design tubes, Component parts \$7200  
 DEVEL. ENGRS—Telev—Receivers, Oscilloscopes,  
 cathodo ray tubes, F.M. Transmitters & Re-  
 ceivers, Micro-wave or VHF antennae, Digital  
 Analog, Computers, Thermo-dynamics, VHF,  
 UHF Circuit Dev. V-HIGH  
 PROCESS ENGR—Tubes \$5500  
 CHIEF DRAFTSMAN—Radio HIGH  
 RES. PHYSICIST—Dielectric HIGH  
 RES. CHEMIST—Protective Coatings, H. F. Com-  
 ponents HIGH

Send Duplicate Resumes!

**FRANKLIN EMPLOYMENT SERVICE**  
 225 S. 15th St. Phila. 2, Pa.

**Senior ELECTRICAL ENGINEER**

New York Television Manufacturer needs experienced Television Engineer. Salary commensurate with ability. Our employees know of this ad. Submit resume, salary expected and availability.

P-1392, Electronics  
 330 W. 42nd St., New York 18, N. Y.

**POSITIONS VACANT**

(Continued from opposite page)

OPPORTUNITY FOR junior electronics engineer with college engineering degree. Send complete resume to P-1969, Electronics.

**EMPLOYMENT SERVICES**

SALARIED POSITIONS \$3,500-\$35,000. If you are considering a new connection communicate with the undersigned. We offer the original personal employment service (40 years recognized standing and reputation). The procedure, of highest ethical standards, is individualized to your personal requirements and develops overtures without initiative on your part. Your identity covered and present position protected. Send only name and address for details. R. W. Bixby Inc., 278 Dun Bldg., Buffalo, N. Y.

SALARIED PERSONNEL, \$3,000-\$25,000. This confidential service, established 1927, is geared to needs of high grade men who seek a change of connection under conditions assuring, if employed, full protection to present position. Send name and address only for details. Personal consultation invited. Jira Thayer Jennings, Dept. L, 241 Orange St., New Haven, Conn.

**POSITIONS WANTED**

TELEVISION ENGINEER, B.S. in E.E., Northwestern. Tau Beta Pi, Eta Kappa Nu. Some graduate work. Age 23, 1½ years Television Broadcast. Former Navy R.T. Interested television development or field work. Midwest. PW-1672, Electronics, 520 N. Michigan Ave., Chicago 11, Ill.

ELECTRONIC ENGINEER — Employed — Desires position as Field Engineer, Technical Representative or Sales Engineer. Experienced in Industrial Electronics, Television, Radar and telemetering design. Some teaching experience. PW-1819, Electronics.

EXPERIENCED ENGINEER wishes managing position in the field of electronics or industrial glassware. Speaks fluent Spanish. South America preferred. Best references. PW-1836, Electronics.

SALES ENGINEERING Executive, twenty years successful sales experience in electrical and electronics fields, past three years sales manager for components manufacturer, desires connection with reputable firm requiring top ability. E.E. degree. Age 46. PW-1883, Electronics.

COMMUNICATIONS OFFICER, nine years USAF, age 34, married, car, experienced airborne and ground signal supply and maintenance, needs position radio-electronics sales or apprentice design. Discharged January 1950. PW-1731, Electronics.

Wanted

**ADDITIONAL LINE**

Established New Eng. Sales Representative, Mechanical Engineer, desires ONE additional line.

RA-1900, Electronics  
 330 W. 42nd St., New York 18, N. Y.

**ADDITIONAL POSITION VACANT  
 AND  
 SCHOOL ADVERTISING**  
 on page 246

**COMMUNICATION ENGINEER**

To supervise engineers and technicians in construction of radio communications system in Middle East. Qualifications should include BE degree or equivalent and supervisory experience in installation of following types of equipment: Diversity Receivers, Frequency Shift Teletype, VHF Relaying and Carrier Telephony; knowledge of HF propagation and antenna design desired. Salary \$750.00 month plus maintenance; also substantial bonus and vacation allowance at end of 18 months. Applicants must be citizens and willing to accept single status in field.

Write full details to

P-1960, Electronics  
 330 W. 42 St., New York 18, N. Y.

**WANTED FOUR MEN**

well grounded in electronics and television, to travel in own cars and demonstrate to general industry and technical societies, excellent new product of long established prominent manufacturing company.

Territories: New England, Middle Atlantic, Midwest and West Coast.

Public speaking, sales experience, technical background, energy and imagination important. Will be expected to help select and train dealers. Salary and travelling expenses.

Write full qualifications in confidence; enclose photograph.

RW-1884, Electronics  
 520 No. Michigan Ave., Chicago 11, Ill.

**SEVERAL ENGINEERS**

needed by contractor for work at Naval Air Missile Test Center, 50 miles northwest of Los Angeles. College degree and several years experience essential. Radar, computer, or telemetering experience preferable.

**ELECTRONIC ENGINEERING CO.  
 OF CALIFORNIA**  
 2008 West Seventh Street  
 Los Angeles 5, California

**SENIOR ELECTRONIC CIRCUIT PHYSICISTS**

for  
*Advanced Research  
 and Development*

**MINIMUM REQUIREMENTS:**

1. M.S. or Ph.D. in Physics or E.E.
2. Not less than five years experience in advanced electronic circuit development with a record of accomplishment giving evidence of an unusual degree of ingenuity and ability in the field.
3. Minimum age 28 years.

**Hughes Aircraft Company**

Attention: Mr. Jack Harwood  
 CULVER CITY, CALIFORNIA

**ELECTRONIC INSTRUMENTATION ENGINEERS**

MANUFACTURER OF METEOROLOGICAL INSTRUMENTS REQUIRES

**PROJECT ENGINEERS**

Must be graduate Engineers with design and development experience in antenna design, microwave techniques, microwave components, radar and miniature or sub-miniature circuit development as applied to instrumentation problems.

Send Resume To  
 Personnel Department

**FRIEZ INSTRUMENT DIVISION**  
 Bendix Aviation Corporation  
 Taylor Avenue at Loch Raven Boulevard  
 Baltimore 4, Maryland

**SCIENTISTS AND ENGINEERS**

Wanted for interesting and professionally challenging research and advanced development in the fields of microwaves, radar, gyroscopes, servomechanisms, instrumentation, computers and general electronics. Scientific or engineering degree or extensive technical experience required. Salary commensurate with experience and ability. Direct inquiries to Mgr., Engineering Personnel, Bell Aircraft Corporation, P. O. Box 1, Buffalo 5, N. Y.

# RADAR, COMMUNICATIONS and SONAR TECHNICIANS WANTED

For Overseas Assignments

### Technical Qualifications:

1. At least 3 years' practical experience in installation and maintenance.
2. Navy veterans ETM 1/c or higher.
3. Army veterans TECH/SGT or higher.

### Personal Qualifications:

1. Age, over 22—must pass physical examination.
2. Ability to assume responsibility.
3. Must stand thorough character investigation.
4. Willing to go overseas for 1 year.

Base pay, bonus, living allowance, vacation add up to \$7,000.00 per year. Permanent connection with company possible.

Apply by Writing to

A-1, P. O. Box 3414  
Philadelphia 22, Pa.

Men qualified in RADAR, COMMUNICATIONS or SONAR give complete history. Interview will be arranged for successful applicants.

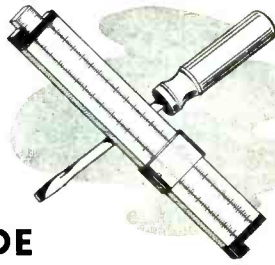

## SLIDE RULES as well as SCREWDRIVERS

... In a sense, that sums up our teaching philosophy at Industrial Tech.

We feel that the complex Industrial Electronics field must have technicians who have the "know-why" as well as the "know-how."

Our men must pass a rigorous 400-hour course in physics, mathematics, chemistry, metallurgy, blueprint reading, and circuit theory before they ever see a vacuum tube. Then they go on to study electrical and electronic circuits and devices for over 900 hours more, in the same thorough fashion.

We emphasize the ability to calculate, to record proper laboratory results, to draw and interpret graphs, to analyze circuits, just as much as the mechanical side of the work.

Of course, our graduates are also excellent mechanics, with a sound training in trouble-shooting and repair technique.

They have the INDUSTRIAL approach. They have all been trained by engineers, applying practical engineering methods to trade education.

Even if you're not hiring today, why not talk to one or two of these men? They may be just what you want next month.

A phone call or letter to our Placement Director will bring you immediate further information on our graduates and/or our school.

**SCHOOL OF  
INDUSTRIAL TECHNOLOGY, Inc.**  
149 East 26th St., New York 10, N. Y.  
Telephone OREGON 9-1878

**CONTRACT  
ENGINEERING—MANUFACTURING**  
electronic and electro-mechanical devices  
• developed to meet your specifications  
• manufactured per sample or drawings  
**TELETRONICS LABORATORY, Inc.**  
Westbury, L. I., N. Y.—Westbury 7-1028

Time is money. Save it by referring to our  
**ACCUMULATIVE INDEX FOR  
ELECTRONICS BIBLIOGRAPHY**  
Simple and Dependable  
Write for descriptive literature  
**TECHNICAL INDEX SERVICE**  
Box 632 Asbury Park, New Jersey

**ATOMIC ENERGY NEWSLETTER**  
*The business paper of the atomic energy industry*  
Current nuclear work and applications, in a specialized, up-to-the-minute, bi-weekly Newsletter. Products-processes-patents-construction-legislation; in the nuclear field. Latest industrial, medical, and biological applications of radioisotopes.  
\$18.00 a year U.S. and Canada  
Atomic Energy News, Inc., 509 5th Ave., N. Y. 16

**FOR PROMPT ANSWERS  
to your business problems  
use  
The SEARCHLIGHT SECTIONS**  
(Classified Advertising)

American Machinist	Engineering
Aviation Week	News-Record
Business Week	F. & M. J. Markets
Bus Transportation	Factory Management
Chemical Engineering	and Maintenance
Coal Age	Fleet Owner
Construction Methods	Food Industries
Electrical Construction	Nucleonics
and Maintenance	Operating Engineer
Electrical Merchandising	Power
Electrical World	Product Engineering
Electronics	Textile World
Engineering and Mining	Welding Engineer
Journal	

For advertising rates or other information address

Classified Advertising Division  
**McGRAW-HILL PUBLISHING CO., INC.**  
New York 18, N. Y.

# W A N T E D

## WILL BUY

Any quantities of new or used  
Electronic Surplus Equipment:

APN-9, RTA-1B, TS-67, TS-170  
ARC-1, ARC-3, ART-13, BC-221,  
BC-348, SCR-522, etc.

State Condition and Best Price

W-1476, Electronics  
330 W. 42nd St., New York 18, N. Y.

## WANTED TO BUY

Large and small quantities of new or  
used electronic government or manufac-  
turers' surplus tubes and equipment.  
Highest prices paid. State quantity, con-  
dition and best price in first letter.

W-1831, Electronics  
330 W. 42nd St., New York 18, N. Y.

## WANTED

Teletypewriters complete, components or  
parts. Any quantity and condition.

W-6654, Electronics  
330 West 42nd Street, New York 18, N. Y.

## WANTED WESTERN ELECTRIC VACUUM TUBES

Types 101F, 102F, 272A, 274A or B, 310A  
or B, 311A, 313C, 323A, 328A, 329A, 348A,  
349A, 352A, 373A, 374A, 393A, 394A, 121A  
Ballast Lamps.

W-6641, Electronics  
330 West 42nd St., New York 18, N. Y.

## WANTED TEST EQUIPMENT

of high quality; state asking price, age  
and condition in first letter.

W-1150, Electronics  
330 W. 42nd St., New York 18, N. Y.

## WANTED

ELECTRONIC SURPLUS, TUBES,  
PARTS, CONDENSERS, WIRE, ETC.

Write for Circular

## GOULD GREEN

252 Greenwich St. N. Y. C. 7

## WANTED TO BUY UNIVERSAL WINDING MACHINE

Model No. 96 with all accessories. State  
price and condition.

SOUTHWESTERN  
INDUSTRIAL ELECTRONIC CO.  
P. O. BOX 13058, Houston 19, Texas

# R. F. COMPONENTS - MICROWAVE - TEST EQUIPMENT

10 cm. horn and rotating joint assembly, gold plated ..... \$65.00 ea.  
**ROTARY JOINT** choke to choke ..... \$17.50  
**ROTARY JOINT** choke to choke with deck mounting ..... \$17.50

BC 987A PPI, 12" Indicator Console w/additional, A Scope BC 986B Compl/w/all Pwr Sply Osc., Control Unit, desk shelf ..... \$350.00  
 12 GPT Tubes for above ..... \$14.95

TR-ATR Section for above with 724 ATR Cavity ..... \$8.50  
 TR-ATR Section, APS 15, for 1B24, with 724 ATR Cavity with 1B24 and 724 tubes. Complete. \$21.00  
 TR CAVITY for 724 A Tube \$3.50

### RADAR BEACONS

CPN-3 10 cm. Used ..... \$1500.00  
 CPN-8 10 cm. Used ..... 1500.00  
 CXBR (3 cm) CPN-6 Prototype ..... 1500.00

APS-31 mixer section for mounting two 2K25's. Beacon reference cavity 1B24 TR tube. New and complete with attenuating slugs ..... \$42.50 ea.  
**DUPLEXER SECTION** for 1B24 ..... \$10.00

**AIRBORNE RADAR**  
 APS-4 3 cm Compl. Write  
 APS-15 All Major Components ..... \$500.00  
 APS-3 New & Complete ..... \$750.00

3 cm 180° bend with pressurizing nipple \$6.00 ea.  
 3 cm. 90 bend, 14" long 90° twist with pressurizing nipple ..... \$6.00 ea.

**THERMISTOR BRIDGE:** Power meter 1-203-A, 10 cm. mfg. W.E. Complete with meter, interpolation chart, portable carrying case. \$72.50

12" SECTION 45 deg twist 90 deg bend ..... \$6.00  
 15 DEG BEND 10" choke to cover ..... \$45.00

**PULSE EQUIPMENT**  
**MIT. MOD. 3 HARD TUBE PULSER:** Output Pulse Power: 134 KW (12 KV at 12 amp.). Duty Ratio: .001 max. Pulse duration: 5. 1.0 2.0 microseconds. Input voltage: 115 v. 400 to 2400 cps. Uses 1-715-B, 1-829-B, 6-72's, 1-73 New ..... \$110.00

3 cm 90° twist 6" ch. to cover \$8.00

**DEHYDRATOR UNIT.** CPD 10137 Automatic Cycling. Compressor to 50 lbs., Compl for Radar XSMN. Line. New ..... \$425.00

**SWR MEAS. SECTION,** with 2 type "N" output probes MTD full wave apart. Bell sizes guide. Silver plated. .... \$10.00

**200 MC COAXIAL PLUMBING**  
 Right Angle Bend ..... \$35.00  
 T Section ..... \$55.00  
 T Section with Adapter to 7/8" in rigid coax. \$65.00  
 Running Ft. .... \$5 per Ft.

"K" BAND FEEDBACK TO PARABOLA HORN, with pressurized window ..... \$30.00  
**MITRED-ELBOW** cover to cover \$4.00  
**FLEXIBLE SECTION** 1" choke to choke ..... \$5.00  
**WAVE GUIDE** 1/2 x 1/4 per ft. .... \$1.00

ASI4A/AP-10cm Pick up Dipole with "N" Cables \$4.50

TWIST 45 deg., 6" long ..... \$8.00  
 90 degree twist, 6 inches long ..... \$8.00  
 TWIST 90 deg. 5" choke to Cover w/press nipple ..... \$6.50

RL 26. Gas driven reversible engine, for laying & pick up field tel. wire. .... \$125.00  
**WIRE PIKES** ..... \$4.50

**TELEPHONE EQUIPMENT**  
 F.T. & R.  
**101-A APPLIQUE**

Provides necessary balancing facilities for four wire repeater when used on two wire lines which may be voice-frequency telephone lines or open wire, or non-loaded or loaded cable. Std. 19" channel iron rack mtg. Price, new, complete with tech manual. .... \$54.00

**MARK IV RADAR CONSOLE**  
 Compl. "L" band plg. Operating fr. 115 v 60 cy. c/o Pulser, Rec. 700A Mag. Osc., Pwr. Sply w/most tubes ..... \$750.00  
 Individ. Chassis avail. separately

3 cm. wavemeter. Ordnance type micrometer head. New: Absorption type ..... \$85.00  
 9000-9500 MCS Transmission type ..... \$92.50

**H.V. PWR. SUPPLY**  
 15000 v 30 ma. DC Bridge Rect. Pwr Sply. Oper. FM. 115v 60 cy. .... \$115.00

10 cm Wavemeter. WE type B 435490 Transmission type. Type N Fittings. Veeder Root Micrometer dial. Gold Plated W/Calib. Chart. P/o Freq. Meter X66404A. New ..... \$99.50

**SURFACE SEARCH RADAR**  
 S.E. 10 cm 115 VDC New ..... \$1200.00  
 SQ-1 10 cm. 115 VDC Used ..... \$1200.00  
 SF-1 10cm. 115 VDC New w/spares ..... \$2800.00

TR/ATR SECTION choke to cover \$4.00  
**MITRED ELBOW** and S sections choke to cover ..... \$4.50

UG 65/U 10CM flanges ..... \$6.75 each  
 UG 53/U Cover ..... 4.00 each  
 UG 54/U Choke ..... 4.50 each

ADAPTER, rd. cover to sq. cover ..... \$5.00

APS-2 10CM RF HEAD COMPLETE WITH HARD TUBE (715B) Pulser, 714 Magnetron 417A Mixer all 7/8" rigid coax. incl. revr. front end ..... \$210.00

**MAGNETRONS**  
 QK 61 2975-3200 mc ..... \$65.00  
 QK 60 2800-3025 mc ..... \$65.00  
 QK 62 3150-3375 mc ..... \$65.00  
 QK 59 2675 2900 mc ..... \$65.00

**FILAMENT TRANSFORMER**  
 for above 115V/60 cy Pri: four 6.3V/4A Sec. 5000VTR ..... \$27.50  
 Magnetron Kit of four QK's 2675-3375 inc. w/trans special ..... \$250.00

**BRAND NEW ORIG. PACKED GUARANTEED GOOD**

2J31	2J38	3J31	WRITE FOR QUANTITY & PRICE
2J21-A	2J39	5J30	
2J22	2J40	714AY, A	
2J26	2J49	7180Y	
2J27	2J61	720BY	
2J32	QK915	720CY	
2J34		725-A	
2J37		730-A	
728-AY, BY, CY, DY, EY, FY, GY			
700-A, B, C			

706-AY, BY, DY, EY, FY, GY  
 Klystrons: 723A/B 707B W/Cavity 417A 2K41

Electromagnets for magnetrons 700A \$24.50 ea.  
 GE Magnet type M765115. GI distance between pole face variable from 2 1/16" (19.0 gauge to 1 1/2" (2200 gauge). Pole dia. 1 1/8" SCR 586. New ..... \$34.50

RT32/APS 6A RF HEAD. Compl. with 725A Magnetron magnet pulse xfmr. TRA-ATR. 723 A/B local osc and beacon mount, pre amplifier. Used but exc. cond. .... \$97.50

**MAGNETRON MAGNETS**

Gauss	Pole Diam.	Spacing	Price
4850	3/4 in.	5/8 in.	\$12.50
4200	21/32 in.	3/4 in.	\$15.50
1300	1 5/8 in.	1 5/16 in.	\$12.50
1860	1 5/8 in.	1 1/2 in.	\$14.50

**WILCOX C5390 CONTROL EQUIPMENT**  
**FOR AIRPORT CONTROL GROUND STATION** - Standard relay rack housing, monitor loudspeaker, dual channel receiver amplifier. Type 109 A control panel, microphone speech amplifier, etc., spare parts, new and complete ..... \$750.00 each

AT-48 Horn Silver Plate, "N" Inpt. New \$6.50  
 AT-68 Horn, Sperry, "N" Inpt. New \$6.50  
 TS 235 UP. Dummy Load. New ..... \$87.50

**I.F.F. KW Pulsed output Pkg.** Tunable 154-186 mc. adj. modulating pulses 4-10 micro sec. comp. 115v 60cy ac pwr. supply. Video output receiver. New w/tubes ..... \$350.00  
 Wavemeter for above ..... \$75.00  
 Dipole Array for above ..... \$85.00

**RIGHT ANGLE BEND,** with flexible coax output pickup loop ..... \$8.00

**STUB-SUPPORTED RIGID COAX,** gold plated 5' lengths. Per length ..... \$5.00

**10CM ECHO BOX CABV 14A-A-1 of OBU-3, 2890 MC to 3170 MCS** direct reading micrometer head. Ring prediction scale plus 9% to minus 9%. Type "N" input. Resonance indicator meter. New and Comp. w/access. Box and 10 CM Directional Coupler ..... \$350.00

**MODEL TS-268/U**  
 Test set designed to provide a means of rapid checking of crystal diodes IN21, IN21A, IN21B, IN23, IN23A, IN23B. Operates on 1 1/2 volt dry cell battery. 3x6x7. New ..... \$35.00

**CRYSTAL DIODES**  
 No. Each  
 IN21 \$1.00  
 IN22 1.50  
 IN23 1.50  
 IN26 3.00

APS-10 Mod. Deck less tubes. New ..... \$75.00  
 L. V. Pwr. Sply less tubes. New ..... \$18.50

Rotating joint, with deck mounting ..... \$15.00  
**RIGID COAX** slotted section CU-60/AP ..... \$5.00

**LHTR. LIGHTHOUSE ASSEMBLY.** Part of RT-39/APG-5 & APG-15. Receiver and Transmitter Lighthouse Cavities with assoc. Tr. Cavity and Type N CPG. To Recv. Uses 2C40, 2C43, 1B27. Tunable APX 2400-2700 MCS. Silver plated ..... \$48.50

Magnetron Cplg. 7/8 rigid coax. 3/4 I. C. ..... \$7.50  
 7/8" rigid coaxial tuning stubs with vernier stub adjustment. Gold Plated ..... \$17.50

**SCR 584** SPARE PARTS AVAILABLE

TS 89/AP Voltage Divider. Ranges 100: 1/2 for 2000 to 20000v. 10:1 for 200 to 2000v. Input Z 2000 ohms. Output Z 4 meg ohms flat response 150 cy to 5 meg cy ..... \$42.50

AN/APS-15A "X" Band compl. RF head and mod. 725-A magnetron two 723A/B 1B24, TR, revr-amp, duplexer, HV supply, blower, Peak-Pwr Out: 45 KW apx. Input: 115, 400 cy. Mod. pulse dur. .5 to 2 micro-sec. apx. 13 KV Pk Pulse. Compl. with all tubes incl. 715-B, 829B, RKR 73, two 72's. New ..... \$210.00

TRANSITION 1 x 1/2 to 1 1/4 x 1/2, 14 in. \$8.00  
 723 A/B Klystron mixer section with crystal mount, choke flange and Iris flange output ..... \$22.50  
 3 cm. right angle bends, 1" plane 18" long cover to cover ..... \$6.50 each

**APS 4 AIRBORNE RADAR**  
 Complete sets and various components available.

**WAVEGUIDE TO 7/8" RIGID COAX "DOORKNOB" ADAPTER. CHOKE FLANGE. SILVER PLATED BROAD BAND WAVEGUIDE DIRECTIONAL COUPLER,** 2/ ab. Navy type CABV-47AAN, with 4 in. slotted section ..... \$32.50

**SO-3 RECEIVER**  
 30 mc. IF. 6 stages 6AC7, 10 mc. Band width inpt. 5.1 mc B.W. per stg., 9.6 volt gain per stage as desc. In ch. 13 vol. 23 M.I.T. Rad. Lab. Series \$99.50

All merchandise guaranteed. Mail orders promptly filled. All prices, F.O.B. New York City. Send Money Order or Check. Only shipping charges sent C.O.D. Rated Concerns send P.O.

## COMMUNICATIONS EQUIPMENT CO.

131-I Liberty St., New York, N. Y.

Phone: Digby 9-4124

ATT. Mr. Chas. Rosen

CHOKES  
INVERTERS

TRANSFORMERS

THERMISTORS  
VARISTORS

Power Transformers—115V/50-60 cps input

Volts Out	Amp	Filaments	Each
770V	.0025	2.5V/3A	\$1.98
550VCT	.050	6.3V/.5, 2.5VCT/1.75	2.49
2 x 110VCT	.01	6.3V/1.0, 2.5VCT/7	2.75
2 x 110V	.010	6.3/2.5, 2 x 2.5VCT/7	3.45
550VCT	.100	6.3V/1.8, 6.3/3.6	2.29
580VCT	.040	5VCT/3A	2.49
100VCT	.017	5VCT/3A	2.25
2300V	.004	2.5/2A	7.49
100VCT, 65V	.100	6.3VCT/10, 40V/1, 6.3/1	3.49
1500V	.160	2.5VCT/12, 30V/.01	6.95
1100V, 400V	.250	6.3V/6A	6.95
78V	.300	6.3V/2A	1.79
800VCT	.150	5V/3A, 2.5V/2	3.98
2 x 300V	.042	5.5V/1.25, 4.5/3.5	3.95
585	.086	5V/3, 6.3V/6	5.95
1080VCT	.055	6.3V/1.2, 6.3/1.2	3.95
600VCT	.155	6.3VCT/5, 5VCT/3	3.95
1120V	.600	2 x 5VCT/6, 2A, 6.3VCT/3, 6.3/300	14.95

Plate Transformers—115V/50-60 cps input

Volts Out	Amp	Each	Volts Out	Amp	Each
65V	.500	1.49	70V	1	\$1.95
500VCT	.150	3.00	100V	1	1.95
650VCT	.015	3.00	121V	1.5	2.25
2 x 150V	2 x .940	4.25	126.5V	1.5	2.25
600VCT	.0165	2.49	132V	1.5	4.95
250VCT	.077	2.49	690V	.450	24.00
			1470VCT	1.2	

Filament Transformers—115V/50-60 cps input

Rating	Each	Rating	Each
2.5V/5A HV Ins.	\$1.79	30VCT/.330	\$1.95
6.3V/2A, 78/300	1.79	34VCT/.380	
36V/1.11	1.49	1.3V/2.5, 2 x 2.5/7	3.25
5VCT/20A	5.49	2 x 2.5VCT/6.5A	3.25
4V/16A, 2.5V/1.75	4.75	2.5V/1.75, 5V/3A	3.85
5V/115A	12.95	6.5/8A, 6.5V/	
7.2V7, 6.4/10	5.95	10VCT/13A	6.95
6.4/2, 2 x 26.2	5.95	10VCT/3.25	6.95
2.5, 16V/1	5.25	5VCT/13.5	6.95
6.3VCT/20, 6.3V/	5.25	1.3V/.0091 Kva	2.95
1.8, 6.3V/6	2.75	6.3VCT/.6A	1.85
6.3 VCT/7	2.25	5V/2A	2.45
6.3/5, 6.3/1A	2.25	6.3VCT/2A	1.95
6.3VCT/3.2	2.25	6.3V/1A, 6.3V/1A	3.25
6.3VCT/1	2.25	6.3/2.5/7A	
5V/8A	1.65	2.5V/7A	
6.3VCT/1A, 5V/2A	1.10		

SPECIAL TYPES

Input	Output	Each
6, 12, 24 or 115VDC, or 230VAC	420VCT/85Ma, 6.3V/1.9, Univ. Vibrator Xfmr	\$2.39
230V 60 cy	230V/.05A	1.10
115V 60 cy	115V/78V-410A/.600MA	1.59
110/115/120	13.5V/1.1A	1.49
125		
210/220/230	2.5VCT/4A	1.49
230V 60 cy	2.5V/6.5A	1.95
230V 60 cy	200V/20A, 4 x 6.3/.900A	2.95
220/440V	286VCT/290MA	2.95
220V 60 cy	280V/.03, 100/1, 6.3/4.2	2.95
200V 60 cy	700VCT/75, 40VCT/1A	2.39
45/78/90	15/10/15V/1A	2.95
220V 60 cy	Tapped 1V to 10V	2.95
220V 60 cy	2 x 40V/.05, 2 x 5V/6A, 12.6V/1A	2.95
43/78/90/115/180/230	24V/6A, 5V/3, 2 x 6.3/1A, 2.5V/6.5A, 2.5/6.5, 6.3/4A	3.95
110/115/120/125	6/12/18/24/75/100/115V/150A	2.49
230V 60 cy	5V/9A MV INS	4.25
200V 60 cy	700VCT/.05A, 110VCT/.08A, 24V/.08, 6.3V/3, 6.3VCT/1.5V/3A, 5V/5A, 2.7V/5A	4.25
230V 60 cy	400V/.03, 190V/.03A, 5/2.5, 5V/2.5A, W/2-866 Sockets	4.25
50V 60 cy	2 x 750V/.901A	1.95
6V & 12V	84V/.009, 51V/.003, 1.4V/.500 Vibrator Transformer	1.95
230V 60 cy	250V/1A, 5V/2A, 5V/9A	4.95
220-440	3 x 2.5V/5A, 2.5V/15A	5.95
230V-115V	5VCT/7.5, 5V/7.5, 5VCT/15A	10.95
440V/60 cy 3PH	220V 30W 3 phase or 220V & 6V 1 phase 60 cy	5.95
230V 60 cy	110V/200, 33V/200, 5V/10A, 2.5-1.4/10A, 1500V/160	7.95
95-130V 60 cy	115V/3.6A, 40.9V/3/3A	10.95
220/440V	115V/6.52A	12.95
220-440V	115V/110/105/-7A	13.95

PRECISION CAPACITORS

D-163707: 0.4 mfd @ 1500 vdc. —50 to plus 85 deg C	\$4.50
D-163035: 0.1 mfd @ 600 vdc, 0 to plus 65 deg C	\$2.00
D-170908: 0.152 mfd, 300 v, 400 cy, —50 to plus 85 deg C	\$2.50
D-164960: 2.04 mfd @ 200 vdc, 0 to plus 55 deg C	\$2.50
D-168344: 2.16 mfd @ 200 vdc, 0 to plus 55 deg C	\$3.00
D-161555: .5 mfd @ 400 vdc, —50 to plus 85 deg C	\$3.00
D-161270: 1 mfd @ 200 vdc, temp comp —40 to plus 65 deg C	\$12.50

COAX CABLE

RG 9/U 52 ohms	\$24/Ft.
RG 17/U 52 ohms imp.	\$48/Ft.
RG 57/U 52 ohms imp. 95 ohms	\$55/Ft.
RG 18/U 52 ohm imp. armored.	\$51/Ft.
RG 28/U twin coax, 125 ohm imp. armored.	\$50/Ft.
RG 23/U 50 ohm imp. pulse cable. Corona min. starting voltage 17 KV.	\$50/Ft.
RG 35/U 70 ohm imp. armored.	\$50/Ft.

INVERTERS

PE 218-E: Input: 25 28 vdc, 92 amp. Output: 115 v, 350-500 cy 1500 volt-amperes. Dim: 17"x6 1/2"x10". New (as shown)	\$49.95
PE 218-H: Same as above except size: 16 1/2" x 6" x 10". New	\$49.95
PE 218H, used, good cond.	\$25.00
PE 206: Input: 28 vdc, 38 amps. Output: 80 v, 800 cy, 500 volt-amps. Dim: 13" x 5 1/2" x 10 1/2". New	\$12.50
GE 5D21N13A: Input: 28 vdc, 35 amp. Output: 115 v, 400 cy, 485 volt-amps. Dim: 9" x 4 3/4" diam. New	\$49.95



HEADSETS

Dynamic Mike and Headset Combination. A high quality, efficient unit, used in B-19 tank Nmnts. Mike and phones completed, new. \$3.75  
Inserts, M-300, for H-8-30 HEADSETS \$4.00/M  
RADIOSONDE TRANSMITTERS, T-49/AMT-1 \$3.75 ea.  
TRANSFORMERS for Collins ART13 Transmitters, GE #7472063, GE #7472065.

CARBON PILE VOLTAGE REGULATORS

Type "A": Coil current .105 to 115 amp. 80 volts. Leland Electric...\$3.00  
Type "C": Input: 22-30 v, coil, 30 amps. Output: 19 v 5.7 amps. Spec. # VR9000-2c. Leland Electric...\$3.00  
235x045B: 22v, 1.42 3 amps, for K-4B Gunlight. Webster...\$3.00



SEE YOU AT THE  
IRE SHOW  
BOOTH L, 2ND FLOOR  
MARCH 6 TO 9TH INCL.

LEAR POWER UNITS

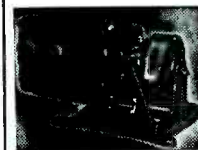

Type 133-C: 24VDC drive, 90:1 gear ratio high pow. Orig. designed for landing gear retraction. Bicycle type sprocket for multi purpose drive. Price...\$6.95

POWER EQUIPMENT

- Fil. Trans. 110v 60 cy in., 5vct/30A out. \$8.95
- In 110v 60 cy out 6.3vct/20A, 6.3v/1.8A, 6.3v/600MA \$4.95
- In 110v 60 cy out 2x5vct/6.75A, 5vct/13.5A, 3500 Test \$6.95
- In 110v 60 cy out 10vct/13A, 10vct/6.5A, 6.3vct/2A \$7.95
- In 115v 60 cy out 760vct/500MA, 800vct/40MA \$10.95
- In 110v 60 cy out 690vct/400MA \$6.95
- Tapped in. 107 to 127v out 160v to 200v/700MA \$2
- Taps: 110v 60 cy out 4v/16A, 2.5v/75A \$4.75
- In 110v 60 cy out 1700v/144MA, w/choke 26" x 29" x 13" oil immersed \$65.00
- In 115v 60 cy out 2x5v/5.5A 29kv inbl. \$24.50
- 115V 60 Cy to 10800 V or 21000 V Dirs. PRICE...\$19.95

FILTER CHOKES

5 HY 40 MA. 3 for. \$ .99	20 HY 50 MA. \$ .79
30 HY 25 MA. \$ .79	11.5 HY 90 MA. \$ 1.39
25 HY .065A. \$ 1.00	6 HY 150 MA. \$ .99
8.5 HY 125 MA. \$ 1.49	25 HY 75 MA. \$ 1.25
1.75 HY 100 MA. \$ .59	.030 HY 2A \$ 1.39
30 HY 24 MA. \$ .99	5 HY 150 MA. \$ 1.45
15 HY 100 MA. \$ .39	Dual 7 HY 75 MA. \$ 1.1
2 HY 60 MA. \$ 1.95	HY 60 MA. \$ 1.39
Swing: 1.0-3.0 HY 225-.02A. 75 HY 225 MA. \$ 2.25	HY 400 MA. \$ 1.75
Dual: 22 HY 600 MA. \$ 4	100 HY 1.4A \$ 1.95
Dual: 1.52 HY 167A 1.95	.333 HY 1.12A \$ 2.29
Dual: 120 HY 17 MA 2.49	1 HY 1 Amp \$ 3.95
Dual: 10 HY 200 MA 3.50	20 HY 300 MA. \$ 7.95
3.5 HY 500 MA. \$ 4.95	10 HY 450 MA. \$ 12.95
10 HY 500 MA. \$ 12.95	MA \$ 14.95
Swing: 9:26 HY .525/.075	2.5 HY 130 MA. \$ 1.25
6 HY 175 MA. \$ 1.50	01 HY 2.5A. \$ 1.45
.116 HY 150 MA. \$ 4.25	5 HY 200 MA. \$ 1.45
.35 HY 350 MA. \$ 7.25	

RADIO PARTS DIV. ATT. MR. ROSEN

400 CYCLE TRANSFORMERS

Input	Output	Price Each
115V	6.3V/1.8A P/O APG2	\$1.49
57/5V	2x57.5V/0001A. P/O APG2	1.95
115V	2x145V/000145A	1.49
115V	780V, 27V/1.3, 6.3V/2.9, 1.25V/20A.	3.95
115V	6.4V/11 Amp. P/O APQ7	2.25
115V	2x6.3V/1.25A, P/O APQ13	1.95
80V	6.3V/1A, 2.5V/2A. P/O PE172A	3.95
115V	15.35VCT/1A	1.95
115V	59.2V/118, 63V/8.1, 5V/2A, P/O APQ 13	3.95
118V	6.3/.9, 6.3V/6.5V/6, 640/200	4.95
115V	2x11CV/00014A, 12QV/00012A, P/O APG2	1.95
115V	3460V/400 MA. P/O APT 4	7.95
115V	23.5V Tapped 22V/47 MA.	1.95
115V	600VCT/36 Ma	1.95
115V	408VCT/11A, 120VCT/250A, 6.3V/6.15, 5V/2A, 45V Tapped 28V/8 and 3a	4.95
115-80V	6.4V/2.5, 400VCT/35Ma, 6.4/150A	3.95
115V	6.4V/7.5, 6.4/3.8, 6.4/2.5A, 780V-, 27V/4.7, 6.3/2.9, 1.25/2a	3.49
115V	6.4V/8a, 6.4V/1A, 6.3V/9.1A, 6.3VCT/6.5a	2.49
115V	2x2.5/3.5a	2.99
115V	5V/2a, 6.3V/2a, 5V/2a, 6.3/5a	3.95
115V	5V/15A, 5000V Ins.	5.95
115V	6.3/2.7, 6.3/6.6, 6.3VCT/21A	
118V	780V, 6.3V, 6.3V, 5V, 320V, 6.3V/20A	
110V	220V	\$3.75 ea.
110V	30V	
110V	20V/20V	1.49
55V	6.4/7.5, 6.4/3.8, 6.4/2.5	2.95
115V	592V/118Ma, 6.3/8.1a, 5V/2	4.95
115V	3V/E	
115V	6.3V/9.1, 6.3VCT/6.5a	2.95
115V	2x2.5/3.5A	1.98
115V	6VCT/00006 KVA	1.49
115V	6.4V/8a, 6.4V/1A	1.98
115V	1034 VCT/111a, 6.9V/10, 2x2.5/3.5A, 6.3/2, 6.3/1, 526VCT/50a, 6.3VCT/2a, 5VCT/29	6.49
115-80V	400VCT/35Ma, 6.4/2.5, 6.4/15a	3.49
80-15V	2300VCT Large Qty	3.25
115V	600VCT/36Ma	1.49
115-15V	2.5V/1.75, 5V/3A, 6.5V/6.5, 6.5/2a. For SCR729	3.95
115V	640V/500Ma, 2.5V/1.75a P/O	2.95
80-115V	APS 15B 1500V/1MA, 360VCT/20MA, 1500V/1MA, 2.5V, 6.3/2.5 6.3V/6a. P/O 29A	3.95
115V	2x2.5V/5A, 2.5V/10A. P/O APT 4	4.95
118V	2x2.5V/2.5a, 6.3V/2.25a 1200V Tap 1000V-750V P/O AN/APS-15	4.95
115V	742.5V/50 MA, 709V 47 MA, 671V/45 MA	2.95
115V	600VCT/36 MA, 2 3/4x2 1/4 x3 1/4	
115V	1150-1150, 2 3/4x2 1/4x3 1/4	
115V	640 VCT/250 MA, 6.3V/9.1, 6.3V/6.5V/6A	3.95
115V	6.3V/9.1a 2.5V/3.5a 6.3VCT/6.5a 2.5V/3.5a	3.25
115V	9800V or 8600V/32 MA, 592 VCT/120 MA, 6.3V/8a, 15V/2a	12.50
115V	4540VCT/250 MA, 5V/3a, 6.3V 2a, 70 to 111V @ 247-622VA, 5000V/290 MA, 5V/10A, 2200V/350	7.50
115V	2.5V/5, 5200V/2 MA, 13.5 KV/3.5 MA	14.95
115V	734 VCT/177a, 1710VCT/177a	11.50
115V	6.3V/9A, 7.7V/365A	6.95
100/110/120/130	2.5/20A.	2.79
115V	6.3V/12a, 6.3V/2a, 6.3V/1a P/O AN/APQ-5	4.85
115V	P/O AN/APQ-5, 6.4VCT/7.5, 6.4VCT/3.8, 6.4VCT/2.5a	5.85
115V	6.3V/2.7, 6.3V/66A, 6.3VCT/21A	4.35
115V	6.5V/12A, 250V/100 MA, 5V/2a P/O AN/APS-15	2.95
115V	400VCT/35 MA, 6.4V/15a, 6.4V/2.5a	3.50
80-115V	650VCT/50 MA, 6.3VCT/2A, 5VCT/2a P/O R58/ARQ8	2.25
115V	2400CT/5MA, 640V/5MA, 2.5V/1.75A	2.45

**OIL CONDENSERS**

1.5 MFD	6000 VDC	\$10.00
1 MFD	15000 VDC	30.00
.5 MFD	25000 VDC	35.00
1 MFD	25000 VDC	83.00
.1 MFD	10000 VDC	15.00
.06 MFD	15000 VDC	8.00
.25 MFD	20000 VDC	17.50
15 MFD	5000 VDC	23.00
15 MFD	1000 VDC	2.25
10 MFD	1000 VDC	1.95
6 MFD	1500 VDC	2.25

Many Others in Stock

**SHOCK MOUNTS**

No. 1 Square	..	..
No. 2 Square & Diamond	..	..
No. 4 Square & Diamond	..	..
No. 6 Square	..	..
No. 8 Square & Holder	TYPES	..
No. 12 Square & Holder	..	..
No. 15 Square & Holder	..	..
No. 20 Square & Holder	..	..
No. 33 Square	..	..
No. 35 Square & Holder	..	..
No. 10 Square & Holder	..	..
No. 25 Square & Holder	..	..
No. 45 Holder	..	..
No. 55 Holder	..	..

Write for More Data



**MICA CONDENSERS**

Fig.	Mfd.	Volt.	Price
B	.0012	20KV	\$27.00
B	.0015	20KV	24.00
B	.001	20KV	24.00
B	.0039	20KV	28.00
B	.0051	15KV	19.00
B	.001	6KV	4.95
B	.002	6KV	4.95
B	.006	10KV	15.00
B	.01	4KV	4.50
B	.045	2KV	4.50
B	.05	15KV	24.00
C	.0003	5KV	4.00
C	.0003	5KV	1.20
C	.0008	5KV	1.20
C	.0004	5KV	1.20
C	.00015	5KV	1.10
C	.0001	3KV	98¢
C	.006	300	98¢
C	.00005	6KV	79¢
D	.0035	5KV	89¢
D	.006	5KV	89¢
D	.006	2500	69¢
D	.0027	1200	23¢
D	.000075	2500	35¢
E	.00025	2500	35¢
E	.0043	5000	69¢
E	.005	2500	39¢
E	.0015	1000	23¢
E	.0175	1000	23¢
E	.027	1000	23¢

MANY OTHERS IN STOCK

**BC-605 Interphone Amplifier**



Easily converted to an ideal inter-communications set for office-home-or-factory. Original New, \$4.75



Private Telephone for Home or Off. Consists of Hangar, Buzzer, Pushbutton, Mount, Handset, 50 Ft. Wire, Batteries. Complete set of two phones wired ready to operate. \$14.95

**AN/GSC-TI Code Training Set**

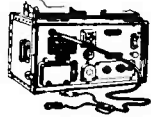

Operates on 6V-12V-24V-115 V DC 115V-230V AC with 10 keys. Contains a frequency system and frequency adjustment. A real buy for Boy Scouts and students. Enclosed in trunk. Brand New. Complete \$23.95. TG5 Telegraph Set includes Key, Buzzer, Ringer Bell in compact metal or wooden box. To learn code \$2.95

**BC-223 TRANSMITTER**

30 Watt Transmitter with crystal oscillator control on four preselected channels - also master oscillator. Frequency coverage 2000 KC. to 5250 KC. by use of three plug in coils. Five tube operation, 801 oscillator, 801 power amplifier, two 46 modulators, and one 46 speed amplifier. Price with TU-17 Tuning Unit, 2000 to 3000 KC. \$23.95

**SELSYN MOTORS**

115 V.A.C. 60 cycle #C-78248. Can be used to turn small antennas or as indicators. Size 3 1/2" x 5 1/2". Price per pair, \$6.95

**WHOLESALE ONLY**

Phone or Write for Quantity & Price

Digby 9-4124  
ATT. MR. C. ROSEN

- 1,000,000 Bathtubs
- 4,000,000 Micacs
- 300,000 Sil. Micacs
- 100,000 Oil Cond.
- 4,000,000 Resistors
- 400,000 Electrolytics
- 400,000 H.V. Micacs
- 5,000 K.V. Cond.
- 150,000 Prec. Resis.
- 500,000 Tube Clamps
- 1,000,000 An. Connectors
- 50,000 Dynamotors
- 20,000 Power Xfmrms
- 20,000 Chokes
- 100,000 Antennas
- 50,000 Audio Xfmrms
- 100,000 400 Cy Xfmrms
- 100,000 Shock Mts.
- 25,000 Magnetrons
- 5,000 Magnets
- 50,000 Pulse Xfmrms
- 50,000 Control Boxes
- 500,000 Tubes
- 300,000 Relays
- 500,000 Pots
- 35,000 Vibrators
- 200,000 UG Connectors
- 2,000 Scopes
- 1,500 Asst. Phones
- 20,000 Headsets
- 5,000 Mikes
- 100,000 Elements
- Tons of Nuts & Bolts
- Screws, Etc.
- 1,000 Gibson Girls
- 500 BC 375 New and Complete
- 500,000 Insulators
- 150,000 Binding Posts
- 200,000 Wafer Switches
- 300,000 Ceramics
- 500,000 Ferrule Resis.
- 50,000 PL 54
- 25,000 JK 26
- 40,000 C410 Xfmrms

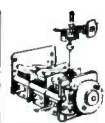

**VFO Capacitor**  
High grade unit consists of 3 gang cap. 420 MFD per sect. ceramic ins. low drift w/worm reduction gear 120:1 w/ext. shaft and 4 digit Veeder counter \$3.95

**VEEDER Counter**



Counts to 9999 and repeats. Many uses 1/2" shaft. Front meas. 1" x 1 1/4" 98c



Heineman Ckt. Kit for AC-DC Operation Amperes .010, 3, 7, 10, 50, 80, 100, 150 Pa. \$1.45 Ea. \$1.45 98c

Kilxon 25A Dual 3 & 25 Amp. \$2.49

**AMPHENOL "AN" CONNECTORS**



LARGE VARIETY AVAILABLE AT GREAT SAVINGS Send your specs and let us quote

**INSULATORS STAND OFFS**

w/alum base 1 1/4x8"	\$1.25
w/alum base 1"x6"	98¢
w/alum base 1 1/4x5"	98¢
w/alum base 1x4"	70¢
w/alum base 1 3/4x3 3/8"	1.69
w/alum base 1 5/8x3"	1.00
IN84 x31 2 1/4x3 1/2"	10¢ ea
IN81 feed support 1 1/2"	8¢
IN82 feed support 3"	16¢
Stand off 3"x1 1/4"	20¢
Stand off 6 3/4x1 1/4"	40¢
Spreader 2 1/8x5/8 Sq	8¢
Spreader 2 1/8x3/4 Sq	10¢
Thru panel 1 1/4x3/4"	15¢
Bowl thru x53, 6 3/4x3/4"	1.10
Antenna IN86	15¢



**UPRIGHT OIL CAPACITORS STANDARD BRANDS**

Fig.	Mfd.	Voltage	Terminals	Price
B	1	600VDC	2	35¢
E	.25	400VDC	2	39¢
E	.5	600VDC	2	35¢
D	1	600VDC	2	35¢
D	2 x .5	600VDC	2	49¢
B	.25	400VDC	2	39¢
B	.5	600VDC	2	35¢
B	.5	600VDC	2	35¢
B	.1	400VDC	2	35¢
B	.4	400VDC	2	39¢
D	.1	600VDC	2	45¢
B	2 x .1	600VDC	2	50¢
E	1.75	400VDC	2	35¢
A	3 x .1	600VDC	2	55¢
D	2 x .5	600VDC	2	49¢
A	.1	600VDC	2	45¢
B	.1	600VDC	2	45¢
D	.1	500VDC	2	45¢
A	.1	500VDC	2	45¢
B	.1	600VDC	2	45¢

**Birtcher Tube Clamps**

926C	
926-16	
926-B1	
926-B2	
926-B5	
926-C15	
926-C-13	
926B	
926C-19	926-B31
926B-16	926C-23
926A-14	
926A	
926C1	
926-A11	
Each 15¢	
100	\$1.40
100	12.00



**ROTARY BEAM COUPLER**  
RF Coupler 360° rotation 1 turn coupling link. Easily adapt 200 to 300 Mc. Plastic case mount on side. Price \$2.95

**MOUNTINGS**

MT-5/ARR2	
MT-7/ARR2	
MT-171A/U	
PT-265A	
PT-340	
MT-167/U	
PT-308A	
PT-222A	
MT-50/ARC5	
PT-141	
MT-85/ARC5	
MT-78/ARC5	
MT-42/ARC5	
PT-225A	
FT-229A	
FT-232A	
FT-234A	

**RF CHOKES**

1Mhy/125MA	.23
1.9-2Mhy	.10
2.5Mhy/500Ma	.89
3.2Mhy	.10
3.8Mhy	.10
5.2Mhy/200Ma	.39
5.5Mhy/500Ma	.98
6.4Mhy	.10
10Mhy/350Ma	.39
20Mhy	.18
94Mhy	.10
100Mhy	.10
115Mhy/150Ma	.39
185Mhy	.10
220Mhy	.18

Write for Flyers of Items Req.  
If You Don't See It Write For It.

**Soldering Iron 200W**

121-130V iron 5/8" removable copper tip. Heats in a minute. Complete with cord & plug. New with stand...\$3.95



**RELAYS**

Type	Conct.	Rating	Res.	Coil	Mfg.	Price
Ceramics	H DPDT	24-28V vdc	170 ohms	100F3	GECE2791B	75¢
Mmt	H SPDT	28 vdc	175 ohms		GECE2791B	75¢
	H SPDT	24-28 vdc	175 ohms		GECE2791B	75¢
	G DPDT	24 vdc	180 ohms		GECE2791G	75¢
3.1	35	SPST	44 ohms	Leach 1067-490		1.25
4	30	G DPDT	160 ohms	Leach		1.25
5	47	D SPST	250 ohms	Allied BO48		75¢
6	50	D DPST	85 ohms	Price X20-A		65¢
7	57	H SPST	280 ohms	Allied DOX-3		1.50
8.5	58	D DPDT	2400	GM 12917-1		75¢
11	60	D DPDT	280	Allied BO635		1.00
15	62	D DPDT	280	Allied KS		1.10
20	67	D DPDT	280	5910		1.00
24	70	D SPST	60	Allied BO		1.00
79	220	H (NC)		5882		85¢
115	240	H DPDT	20-30 vdc	Ounce 50XB		1.00
125	250	H DPDT	10-14 vdc	Ounce 100AB		1.00
150	350	H SPDT	24-28 vdc	PB21C057-A		1.50
180	1000	H SPDT	24-28 vdc	GECE2791		1.50
200		H SPDT	24-28 vdc	GECE2791		1.00
		A DPDT	12 vdc	Ounce		1.49
		A SPDT	10-12v	Ounce		1.49
		H DPDT	27.5 vdc	Allied		1.10
		H DPDT	9-14 vdc	Allied		1.10
		H DPDT	24V60cy	Allied		1.40

**ARC 3 MINIATURE RELAYS**

Sealed Can	SPDT 5 Prong	GECE2791C104	1.95	
C	SPDT	28 vdc	300 ohms RBM55342	35¢
C	6 PST	22-28 vdc	300 ohms RBM55528	35¢
C	SPST	22-28 vdc	300 ohms 1PM55251	35¢
C	DPDT	22-28 vdc	300 ohms RBM55531	35¢
C	DPST	22-28 vdc	300 ohms RBM55526	35¢
C	SPDT	22-28 vdc	300 ohms RBM55526	35¢

**EE65E Telephone Test Set**

To locate any kind of trouble on Tel. lines, can be used as telephone. Includes ringing circuit etc. A valuable unit \$19.95

**EE89A Telephone Repeater**

Used to extend range of field telephones. Simplex Teleg. and 20 cycle ringing possible over lines equipped with unit. Supplied w/3Q5 tube. Phone supplied (Featherweight) \$9.75

**Loading Coil C114**

Same as WC No. 632 but in waterproof case to counter balance cap. in line gives clearer signal. Army used W/W110 & W130 wire. 85¢ ea.

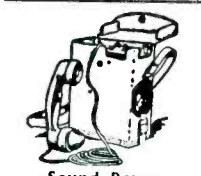

**Sound Power FIELD PHONES**  
EE-108. Talking range 9 to 12 miles without batteries or current. Has crank and generator for signaling. In fine leather case. Weighs 9 1/2 lbs. Brand New. A wonderful buy. 2 phones \$37.50

**BATHTUB CAPACITORS**

Fig.	Mfd.	Voltage	Terminal	Price
D	3 x .1	600VDC	3	33¢
D	3 x .1	400VDC	3	33¢
C	2 x .1	400VDC	2	20¢
C	2 x .1	600VDC	2	20¢
C	.025	600VDC	2	18¢
A	2	400VDC	2	25¢
A	.1	600VDC	2	25¢
A	2 x .25	600VDC	3	29¢
E	.5	100VDC	2	25¢
E	3 x .1	600VDC	3	35¢
E	.5	200VDC	2	25¢
C	.05	600VDC	2	21¢
C	.5	600VDC	2	25¢
E	.5	120VDC	2	18¢
E	.5	600VDC	2	25¢
E	.4	50VDC	2	20¢
E	.1	400VDC	1	25¢
D	3 x .1	600VDC	3	33¢
D	3 x .25	400VDC	3	37¢
D	.5	600VDC	2	25¢
D	2 x .1	600VDC	2	29¢
D	.5	600VDC	1	20¢
E	2 x .1	200VDC	2	20¢
E	.5	400VDC	1	20¢
E	.02	1500VDC	2	15¢
A	.5	600VDC	2	45¢
C	.5	200VDC	2	20¢
C	20	50VDC	2	20¢

**UNIVERSAL OUTPUT TRANSFORMER**

Amertran Silor. PRI: 20,000/16,000/5000/4000 ohms. Sect. 500. 15.7/5/3.75/1.25 ohms. 30 db. contin. Plat. to 17,000 CY. w/ Diag & Inst. for 6 watt amplifier \$4.75  
T.V. Transformer. 7" or 9" scope. 3000V/5MA. 720vct/200MA. 6.4/8.7A. 6.4/6A. 5/3A. 1.25/3A. 115 V 60 cy input. Price \$4.95

**COMMUNICATIONS EQUIPMENT COMPANY**  
CABLE ADDRESS: COMSUPO  
PHONE DIGBY 9, 4124  
131 LIBERTY ST. DEPT. E  
NEW YORK 7, N.Y.  
C.F.C. MONEY BACK GUARANTEE, 13 MIN. ORDER.  
P.O. B. N.Y.C. SEND MONEY ORDER OR CHECK, ONLY SHIPPING CHARGES SENT C.O.D.

**FULLY GUARANTEED BRAND NEW SURPLUS OFFERED BY A LEADING**

**A.C. MOTORS**

5071930, Delco, 115 V., 60 Cycle, 7000 r.p.m. Price \$4.50 each net.

36938-2, Haydon Timing Motor, 110 V., 60 cycle, 2.2 w.; 4/5 r.p.m. Price \$3.00 ea. net.



Type 1600 Haydon Timing Motor—110 V., 60 cycle, 3.2 w., 4 r.p.m., with brake Price \$4.00 each net

Type 1600 Haydon Timing Motor—110 V., 60 cycle, 2.2 w., 1/240 r.p.m. Price \$3.00 each net.

Type 1600 Haydon Timing Motor 110 V., 60 cycle, 2.3 w., 1 r.p.m. Price \$2.70 each net.

Type 1600 Haydon Timing Motor, 110 V., 60 cycle, 2.2 w., 1 1/5 r.p.m. Price \$2.70 each net.

Type 1600 Haydon Timing Motor 110 V., 60 cycle, 3.5 w., 1 r.p.m. With shift unit for automatic engaging and disengaging of gear. Price \$3.30 ea. net.

Type 1600 Haydon Timing Motor, 110 V., 60 cycle, 2.2 w., 1/60 r.p.m. Price \$3.00 each net.

Eastern Air Devices Type J33 Synchronous Motor 115 V., 400 cycle, 3 phase, 8,000 r.p.m. Price \$8.50 each net.

Telechron Synchronous Motor, Type B3, 115 V., 60 cycle, 2 r.p.m., 4 w. Price \$5.00 each net.

**SERVO MOTORS**

CK 1, Pioneer, 2 phase, 400 cycle. Price \$10.00 each net.

CK 2, Pioneer, 2 phase, 400 cycle. Price \$4.25 each net.

10047-2-A Pioneer 2 phase, 400 cycle, with 40:1 reduction gear. Price \$7.25 each net.

FPE-25-11, Diehl, Low-Inertia, 75 to 115 V., 60 cycle, 2 phase. Price \$16.00 each net.

FPE-49-7 Diehl, Low-Inertia, 115 V., 60 cycle, 2 phase, 3.0 amps., 10 w., output. Price \$34.50 each net.

FPE-25-16 Diehl Low Inertia 20 V., 60 cycle, 2 phase, 1600 r.p.m., .85 amps. Price \$10.00 ea. net.

FP 25-3 Diehl, Low Inertia, 20 V., 60 cycle, 2 phase, .50 amps., 3200 r.p.m. Price \$10.00 each net.

CK2, Pioneer, 2 phase, 400 cycle, with 40:1 reduction gear. Price \$6.50 each net.

MINNEAPOLIS-HONEYWELL TYPE B Part No. G303AY, 115 V., 400 Cycle, 2 phase, built-in gear reduction, 50 lbs. in torque. Price \$8.50 each net.

**AMPLIFIER**

Pioneer Gyro Flux Gate Amplifier, Type 12076-1-A. Price \$17.50 ea. net, with tubes.

**REMOTE INDICATING MAGNESYN COMPASS SET**

Pioneer Type AN5730-2 Indicator and AN5730-3 Transmitter 26 V., 400 cycle. Price \$40.00 per set new sealed boxes.



Kollman Remote Indicating Compass Set Transmitter part No. 679-01, indicator part No. 680k-03, 26 V., 400 cycle. Price \$12.50 each net.

**GYROS**

Schwein Free & Rate Gyro type 45600. Consists of two 28 V. D.C. constant speed gyros. Size 8" x 4.25" x 4.25".

Price \$10.00 ea. net.

Schwein Free & Rate Gyro, type 46800. Same as above except later design. Price \$15.00 each net.

Sperry A5 Directional Gyro, Part No. 656029, 115 volts, 400 cycle, 3 phase. Price \$17.50 each net.

Sperry A5 Vertical Gyro, Part No. 644841, 115 V., 400 cycle, 3 phase. Price \$20.00 each net.

Sperry A5 Amplifier Rack Part No. 644890. Contains Weston Frequency Meter. 350 to 450 cycle and 400 cycle, 0 to 130 voltmeter. Price \$10.00 each net.

Sperry A5 Control Unit Part No. 644836. Price \$7.50 each net.

Sperry A5 Azimuth Follow-Up Amplifier Part No. 656030. With tube. Price \$5.50 each net.

Pioneer Type 12800-1-D Gyro Servo Unit. 115 V., 400 cycle, 3 phase. Price \$10.00 each net.

Norden Type M7 Vertical Gyro. 26 V., D.C. Price \$19.00 each net.

Norden Type M7 Servo Motor. 26 V., D.C. Price \$20.00 each net.

Allen Calculator, Type C1 Bank and Turn Indicator, Part No. 21500, 28 V. D.C. Contains 28 V. D.C. constant speed gyro. Price \$10.00 each net.



**D.C. MOTORS**



5069625, Delco Constant Speed, 27 V., 120 r.p.m. Built-in reduction gears and governor. Price \$3.90 each net.

A-7155, Delco Constant Speed Shunt Motor, 27 V., 2.4 amps., 3600 r.p.m., 1/30 h.p. Built-in governor. Price \$6.25 each net.

C-28P-1A, John Oster Shunt Motor, 27 V., 0.7 amps., 7000 r.p.m., 1/100 h.p. Price \$3.75 each net.

Jaeger Watch Co. Type 44-K-2 Contact Motor, Operates on 3 to 4.5 volts D.C. Makes one contact per second. Price \$2.00 each net.

General Electric Type 5BA10AJ52C, 27 V. D. C., 0.65 amps., 14 oz. in. torque, 145 r.p.m. Shunt Wound, 4 lead reversible. Price \$5.00 each net.

General Electric Type 5BA10AJ37C, 27 V. D. C., .5 amps., 8 oz., in. torque, 250 r.p.m. Shunt Wound, 4 leads reversible. Price \$6.50 each net.

**D.C. ALNICO FIELD MOTORS**

5069456, Delco, 27.5 V., 10,000 r.p.m. Price \$4.70 each net.

5069600, Delco, 27 V., 250 r.p.m. Price \$5.00 each net.

5069466, Delco, 27 V., 10,000 r.p.m. Price \$3.50 each net.



5069370, Delco, 27 V., 10,000 r.p.m. Price \$4.70 each net.

5069230, Delco, 27 V., 145 r.p.m. Price \$5.00 each net.

S. S. FD6-16, Diehl, 27 V., 10,000 r.p.m. Price \$4.00 each net.

S. S. FD6-18, Diehl, 27 V., 10,000 r.p.m. Price \$4.00 each net.

S. S. FD6-21, Diehl, 27 V., 10,000 r.p.m. Price \$4.00 each net.

Sampsel Time Control Inc. Alnico Field Motor, 27 V. D.C. Overall length 3 5/16" by 1 3/8". Shaft 3/8" long by 3/16", 10,000 r.p.m. Price \$4.50 each net.

**GENERAL ELECTRIC D. C. SELSYNS**



8TJ9-PDN Transmitter, 24 V. Price \$3.75 each net.

8DJ11-PCY Indicator, 24 V. Dial marked—10° to +65°. Price \$4.50 each net.

8DJ11-PCY Indicator, 24 V. Dial Marked 0 to 360°. Price \$7.50 each net.

**COMPLETE LINE OF AIRCRAFT THERMOCOUPLES**

37 EAST BAYVIEW AVE., GREAT NECK, N. Y.

Telephone IMperial 7-1147

**INSTRUMENT ASSOCIATES**

Write for Catalog NE100

U. S. Export License-2140



**SUPPLIER OF ELECTRONIC & AIRCRAFT EQUIPMENT****IMMEDIATE  
DELIVERY****INVERTERS**

**Wincharger Corp.** Dynamotor Unit. PE-101-C. Input 13, V.D.C. or 26 V.D.C. D.C. AT, 12.6 or 6.3 amps. Output 400 V.D.C. AT. .135 amps., 800 V.D.C. AT. .02 amps., 9 V.A.C. 80 cycle at 1.12 amps.

Price \$10.00 each net.

**153F, Holtzer Cabot**, Input, 24 V.D.C. Output 115 V., 400 cycle, 3 phase, 750 V.A. and 26 V., 400 cycle, 1 phase, 250 V.A. Voltage and frequency regulated also built in radio filter.

Price \$115.00 each net.



**149H, Holtzer Cabot**. Input 28 V. at 44 amps. Output 26 V. at 250 V.A., 400 cycle and 115 V. at 500 V.A. 400 cycle.

Price \$40.00 each net.

**149F, Holtzer Cabot**. Input 28 V. at 36 amps. Output 26 V. at 250 V.A., 400 cycle and 115 V. at 500 V.A., 400 cycle.

Price \$40.00 each net.

**12117, Pioneer**. Input 12 V.D.C. Output 26 V., 400 cycle, 6 V.A.

Price \$22.50 each net.

**12117-2 Pioneer**. Input 24 V.D.C. Output 26 V. 400 cycle, 6 V.A.

Price \$20.00 each net.

**5D21NJ3A General Electric**. Input 24 V.D.C. Output 115 V., 400 cycle at 485 V.A.

Price \$12.00 each net.

**PE218, Ballentine**. Input 28 V.D.C. at 90 amps. Output 115 V., 400 cycle at 1.5 K.V.A.

Price \$50.00 each net.

**METERS**

**Weston Frequency Meter**. Model 637, 350 to 450 cycles, 115 volts.

Price \$10.00 each net.

**Weston Voltmeter**. Model 833, 0 to 130 volts, 400 cycle.

Price \$4.00 each net.

**Weston Voltmeter**. Model 606, Type 204 P, 0 to 30 volts D. C.

Price \$4.25 each net.

**Weston Ammeter**. Model 506, Type S-61209, 20-0-100 amps. D. C.

Price \$7.50 each net with ext. shunt.

**Weston Ammeter**. Type F1, Dwg. No. 116465, 0 to 150 amps. D. C.

Price \$6.00 each net.

With ext. shunt \$9.00 each net.

**Westinghouse Ammeter**. Type 1090-D120, 120-0-120 amps. D. C.

Price \$4.50 each net.

**Weston Model 545**. Type 82PE Indicator. Calibrated 0 to 3000 RPM. 2 3/4" size. Has built-in rectifier, 270° meter movement.

Price \$15.00 each net.

**VIBRATOR**

**Rauland Corp.** vibrator non-synchros type Stock No. 3H6694-11; 6, 12 or 24 V.D.C., input frequency 200 cycle.

\$3.50 each net.

**Sperry Phase Adapter**. Part No. 661102. Used for operating three-phase equipment from a single phase source. 115 volts 400 cycle. Maximum load 50 watts.

Price \$15.00 each net.

**PIONEER AUTOSYNS**

**AY1**, 26 V., 400 cycle.

Price \$5.50 each net.

**AY14D**, 26 V., 400 cycle, new with calibration curve.

Price \$15.00 each net.

**AY20**, 26 V., 400 cycle.

Price \$7.50 each net.



**AY31**, 26 V., 400 cycle. Shaft extends from both ends.

Price \$10.00 ea. net.

**AY38**, 26 V., 400 cycle. Shaft extends from both ends.

Price \$10.00 each net.

**PIONEER PRECISION AUTOSYNS**

**AY101D**, new with calibration curve.

PRICE—WRITE OR CALL FOR SPECIAL QUANTITY PRICES

**AY131D**, new with calibration curve.

Price \$35.00 each net.

**AY130D**, new.

Price \$35.00 each net.

**PIONEER AUTOSYN POSITION INDICATORS**

**Type 5907-17**. Dial graduated 0 to 360°, 26 V., 400 cycle.

Price \$15.50 each net.

**Type 6007-39**, Dual, Dial graduated 0 to 360°, 26 V., 400 cycle.

Price \$30.00 each net.

**PIONEER TORQUE UNIT**

**Type 12602-1-A**.

Price \$30.00 each net.

**Type 12604-3-A**.

Price \$30.00 each net.

**Type 12606-1-A**. Price \$40.00 each net.

**Type 12627-1-A**. Price \$80.00 each net.

**MAGNETIC AMPLIFIER ASSEMBLY**

**Pioneer Magnetic Amplifier Assembly** Saturable Reactor type output transformer. Designed to supply one phase of 400 cycle servo motor.

Price \$8.50 each net.

**PIONEER TORQUE UNIT AMPLIFIER**

**Type 12073-1-A**, 5 tube amplifier, Magnesium input, 115 V., 400 cycle.

Price \$17.50 each net with tubes.

**Type 12077-1-A**, single tube Amplifier, Autosyn input, 115 V., 400 cycle.

Price \$49.50 each net, with tube.

**BLOWER ASSEMBLY  
MX-215/APG**

**John Oster**, 28 V.D.C., 7000 r.p.m. 1/100 h.p.

Price \$4.50 each net.

**Westinghouse Type FL Blower**, 115 V., 400 cycle, 67000 r.p.m., Airflow 17 C.F.M.

Price \$3.70 each net.

**RATE GENERATORS**

**PM2, Electric Indicator Co.**, .0175 V. per r.p.m.

Price \$8.25 each net.

**F16, Electric Indicator Co.**, two-phase, 22 V. per phase at 1800 r.p.m.

Price \$12.00 each net.

**J36A, Eastern Air Devices**, .02 V. per r.p.m.

Price \$9.00 each net.

**B-68, Electric Indicator Co.**, Rotation Indicator, 110 V., 60 cycle, 1 phase.

Price \$14.00 each net.

**Weston Tachometer Generator** (aircraft type) model 752-J4 single phase. A.C. output.

Price \$17.50 each net.

**SINE-COSINE GENERATORS**

(Resolvers)

**FPE 43-1, Diehl**, 115 V., 400 cycle.

Price \$20.00 each net.

**SYNCHROS**

**1F Special Repeater**, 115 V., 400 cycle. Will operate on 60 cycle at reduced voltage.

Price \$15.00 each net.



**7G Generator**, 115 V., 60 cycle.

Price \$30.00 each net.

**2J1M1 Control Transformer** 105/63 V., 60 cycle.

Price \$20.00 each net.

**2J1G1 Control Transformer**, 57.5/57.5 V., 400 cycle.

Price \$1.90 each net.

**2J1H1 Selsyn Differential Generator**, 57.5/57.5 V., 400 cycle.

Price \$3.25 each net.

**W. E. KS-5950-L2, Size 5 Generator**, 115 V., 400 cycle.

Price \$4.50 each net.

**5G Special Generator** 115/90 V., 400 cycle.

Price \$15.50 each net.

**5SF Repeater**, 115/90 V., 400 cycle.

Price \$19.00 each net.

**2J1F1 Selsyn Generator**, 115 V., 400 cycle.

Price \$3.50 each net.

**5SDG Differential Generator** 90/90 V., 400 cycle.

Price \$15.30 each net.

**1CT Control Transformer**. 90/55 volts, 60 cycle.

Price \$35.00 each net.

**INSTRUMENT  
ASSOCIATES**

ALL PRICES, F.O.B. GREAT NECK, N. Y.

37 EAST BAYVIEW AVE., GREAT NECK, N. Y.  
Telephone IMperial 7-1147

Write for Catalog NE100

Western Union address:  
WUX Great Neck, N. Y.

# To tell the TRUTH\* you'll find the GREATEST BUYS at NIAGARA!

## Famous UTAH 15 and 25 Watt Potentiometers

Body: 2-11/16" dia., 27/32" depth behind panel. Bushing: 7/16" dia., 3/8" long. Shaft: 1/4" dia., 7/16" long from bushing. Effective rotation 300 degrees. Mounts in 7/16" hole. 15 W "PW" type wirewound on bakelite strip. 25 W "SW" type wire-wound on asbestos-covered steel strip, for greater heat dissipation. PW type has 3 terminals, no off position. SW type has 2 terminals with off position.



15W Stock No.	Resistance In Ohms	15W Stock No.	Resistance In Ohms
PW-100	100	SW-10	10
PW-150	150	SW-15	15
PW-200	200	SW-20	20
PW-250	250	SW-30	30
PW-300	300	SW-40	40
PW-400	400	SW-50	50
PW-500	500	SW-75	75
PW-600	600	SW-100	100
PW-3M	3000	SW-150	150
PW-5M	5000	SW-200	200
PW-7500	7500	SW-250	250
SW-1	1	SW-300	300
SW-2	2	SW-400	400
SW-3	3		
SW-6	6		

Stock No. PW-15 watt. ALL SIZES . . . 39c  
List \$1.50. SPECIAL.  
Stock No. SW-25 watt. ALL SIZES . . . 49c  
List \$1.75. SPECIAL.

## T-24 CARBON HAND MIKE

A rugged mike with push-to-talk switch, ideally suited for mobile or marine use. Features — 7 ft. flexible rubber cord, PL-106, anti-noise choke and JK-38 jack into which two other mikes may be plugged, making a 3-way parallel talking circuit.



Cat. No. N-278. Very special \$1.19 ea. 3 for \$3.00

## BT CUT 1000 KC. CRYSTAL

Fine precision crystal originally used in frequency standard. Low drift, moisture sealed, BT cut. Brand new in 3/4" pin spaced holders. LAST CHANCE!  
Cat. No. N-189. YOUR COST \$4.95



## HEART OF THE BC-221 FREQ. METER

This VFO Sub-Assembly, used in BC-221 Freq. Meter is ideally suited for home construction of:

- 1—Amateur V.F.O.
- 2—Freq. Mtr. Foundation
- 3—Portable Transmitter
- 4—Replacement for BC-221

Unit contains two temperature & moist compensating coils, wafer switch, 3 variable condensers, carbon resistors, & silver mica condensers. FULLY WIRED & mounted on sturdy aluminum sub-chassis, ready for installation. Brand new—in original packing.  
N-276 Very special \$6.95

\* It's no lie. Niagara's prices can't be beat! By the way, have you entered our "Tall Tales" contest? Lots of fun and cash prizes. Write for details today.

**IMPORTANT NOTICE:** Please include 20% deposit with C.O.D. orders, unless rated. Orders received without postage will be shipped railway express collect. Send us your inquiries today. We correspond in English, Spanish, French, Italian, Polish, Rumanian, Hebrew, German, Portuguese, etc. Prices subject to change without notice. All stock subject to prior sale. FOB our N.Y.C. Warehouse. MINIMUM ORDER \$2.00.

## MORE BARGAINS IN SURPLUS EQUIPMENT

1-2 or 3 of each  
Check every line!

- BC221 Freq. Mtr. w/XTAL & Calib. Book L.N. \$ 75.00
- LM Freq. Mtr. w/XTAL, Book, Mod. Exc. TVI, Navy 6 & 10 Mtr. Bat. Transceiver. 39.95
- RME69 RCVR. w/SPKR—VY.GD. 69.00
- BC-375 Tuning Units New—cased. 4.95
- BC-375 Tuning Units New—cased. 3.95
- GE 25 Watt Phone XMTR Model GF4A Pow. Sup. Exc. 29.95
- ATD 50 Watt XMTR New. 49.95
- 10 Navy 6V. Port. Audio Ampl. w/VIB. Sup. VY. GD. 9.95
- Gibson Girl Emergency XMTR. New. 2.89
- BC 614 Speech Amplifier For BC610 L.N. 55.00
- W1252 Electronic Wavemeter 22-30 Mcs. Exc. 44.95
- BC Ant. Tunner for BC610 L.N. 59.90
- Nat'l 1-10A RCVR. w/coils less Pow. Sup. L.N. 39.95
- BC 342 Navy Comm. RCVR. Exc. 69.95
- McMurdo Silver RCVR. Mod. 801 G-80 Mtrs. w/tubes L.N. 29.95
- Gon-Set 50-54 Mc. Conv. L.N. 24.95
- Beach 80 Meter VFO. New. 19.95
- Handy 28.5-29.7 Mc. Conv. New. 24.95
- BC-347C Interphone Amplif. L.N. 2.95
- Dynamotor SA 5088 Imp. 18V./Out P. 450V. 4.95
- GP7 Tuning Units—New—cased. 4.95
- GP7 Tuning Units—Used—cased. 3.95
- GP7 Tuning Units Used—no case. 2.95
- BC 376 H Model XTAL Test Osc. Exc. 14.95
- Wilcox CW-3-110V Superhet Rcvr. New. 75.00
- Antenna Rotating Motor—BL-42A Reel Exc. W.E. XMTR MOD Comp. w/controls—spares—New 225.00
- MN 26C Radio Compass—New. 32.00
- MN 26C Radio Compass—Used. 26.95
- 733D Localized Receiver Exc. 9.95
- AN-APN-1 Altimeter—L.N. 18.95
- AP8-13 Receiver—Exc. 12.95
- TG-10 Code Keyer—L.N. 14.95
- 274N Modulator BC456A w/tubes Exc. 2.65
- 274N Modulator BC456A Fair less tubes. 1.68
- SCR 522 Receiver BC624 Exc. less tubes. 7.95
- SCR522 XMTR-BC625 Exc. less tubes. 11.95
- BC 1000A Transceiver. New. 300.00
- BC 604 FM XMTR Exc. 14.95
- BC603 FM RCVR. Exc. 14.95
- BC 645 Transceiver Contr. Box, Dyn. in struction book. New. 17.95
- T-17 Handmike—200 Ohm Imp. Exc. .69
- T-24 Handmike—7 Ft. Cord—Noise Filter—Plug—New. 1.19
- PE 94 24V. DYN. for SCR522. Used. L.N. 2.95
- Surplus Radio Conv. Manual Vol. 1 or 2. 2.50
- BC 610 Tank Coils—New. 1.50
- BC 654 80 Meter XMTR & RCVR. w/tubes & XTAL. 34.95
- Collins 32 RA-7 XMTR VT GD. 125.00
- Teleplex Code Machines (Less tapes) Exc. 18.95
- ASD Radar Set Complete. New (Price on Request)
- ASD Parabolic Antenna—Rotable—L.N. (Price on Request)
- 2601A Parabolic Rot. Ant. L.N. (Price on Request)
- T784 APS 15A Electronic Camera (Price on Request)
- Sig. Gen. Ferris #16C (Price on Request)
- BC 610 Plug-in Tuning Unit. New. \$3.50

WRITE FOR NEW CATALOG "E"

## HEINEMANN CIRCUIT BREAKERS

- (A) SP5 24 Volts DC. 220 Ma. . . . \$1.25
- (A) SPST 24 Volts DC. 7 Amps. . . \$1.69
- (B) DPST 40 Volts DC. 10 Amps. \$1.75
- (B) DPST 230 Volts A.C. 8&25 Amps. \$2.25

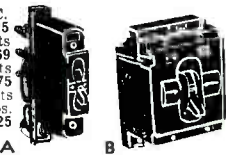

## VACUUM CONDENSERS

TYPE	CAPAC.	VOLTS	PRICE
VC-50-5	50	5,000	\$2.95
VC-12-20	12	20,000	4.50
VC-60-20	50	20,000	4.50
VC-6-32	6	32,000	5.25
VC-12-32	12	32,000	5.25

## NIAGARA'S GOLD-PLATED SPECIAL!

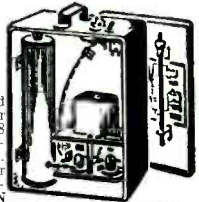

An ultra-high freq. Gold Plated Cavity Resonator with a range of 234 258 Mc/s! Fully wired, including two 955 acorn tubes. Designed by the navy for use as a portable modulated test oscillator. CAN BE USED AS A MODULATED SIGNAL GENERATOR. Battery compartment is large enough to house speech equipment and power supply, making it a desirable portable UHF Transmitter for Ham use. Complete with tuning wrench, tubes, whip antenna, and circuit diagram on inside cover. Black wrinkle finished cabinet measures 9 1/2 x 6 1/2 x 6 3/4".  
The Buy of a Lifetime!  
Cat. No. N-257. Special \$3.95

## WAVE TRAPS

Traps consist of two slug-tuned silverized coils and two ceramic condensers. All mounted on a cadmium plated bracket conveniently drilled and ready for mounting. May be used to eliminate FM sound bars in TV sets, eliminate amateur interference (shock excitation) in TV Rcvrs. Match Hi-Lo TV antennas, and dozens of other uses too numerous to mention. They're going fast, so order yours today!  
Cat. No. N-128. 3 for \$1.00 SPECIAL



## DOES YOUR TV SET DROOP FROM INTERFERENCE BLOOP?



BLEEP  
BLOOP  
BLAP

## BANISH INTERFERENCE with New NIAGARA HI-PASS FILTER!

Positive protection against interference from radar, amateur transmitters, ignition noises, diathermy and all other devices generating RF interference. Designed to fit any 300 ohm antenna feeder. Absolutely no loss in brightness or clarity. Easily assembled. Complete instructions. FCC findings under actual test included . . . . . \$1.95 per kit

anywhere in U.S.A. plus 15c postage and handling.

## ATTENTION AMATEURS!

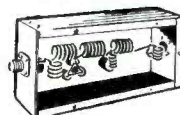

Don't be blamed for TVI. FCC tests have proven this NEW LOW PASS filter attenuates all frequencies above 40Mc. Skillfully engineered M-Derived Filter for 10, 20, 40, 80 and 160 meters prevents TVI while you're operating. Eliminates all harmonics above 40Mc at 60dB or better, passes all frequencies below 40Mc. Complete, nothing else to buy. FCC report included. Matches 52-72 ohm line.

No. N-279 plus 25c shipping charges in U.S. \$4.99



## BARGAINS IN NEW METERS

- 2" RD. Weston 0-2 RF Amps. . . . . \$3.49
- 2" RD. Westinghouse 0-5 A.C.V. . . . . 2.40
- 2" RD. Westinghouse 0-9 RF Amps. . . . . 4.95
- 2" RD. G.E. 0-10 DC. Amps. . . . . 1.88
- 3" RD. Asst'd Brands 0-4 KV DC. . . . . 1.96
- 2" RD. Asst'd Brands 0-1 R.F. Amps. . . . . 1.96
- 4" RD. W. Electric 50-0-50 Yps. Pps. Sec. (0-1 MA) . . . . . 2.95
- 8" RD. G.E. 0-30 KVD.V. . . . . 2.65
- 3" RD. —6 to +100 DB. (0-1 MA Basic-Illum) . . . . . 3.95

WRITE FOR NEW CATALOG "E"

**Niagara Radio Supply Corp.**  
Dept. E-20 160 Greenwich Street, New York 6, N. Y.  
Phone Digby 9-1132-3-4

FOR OUR  
**4<sup>th</sup>**  
ANNIVERSARY  
CELEBRATION

# NIAGARA SLASHES TUBE PRICES 50% to 90%

ALL BRAND NEW — STANDARD BRANDS

Type	Price	Type	Price	Type	Price	Type	Price	Type	Price	Type	Price	Type	Price	Type	Price
1B22	\$3.45	9CP7	15.00	721A/B	2.60	1853	1.06	WL468	6.75	6A6	.88	6SO7GT	.43	14B6	.68
1B23	8.45	9JP1	6.50	723AB	7.95	1960	.85	WL532A	1.75	6A7	.68	6SR7	.56	14B8	.88
1B24	4.49	9LP7	15.00	742A/B	2.75	2050	.95	WL562	150.00	6A8	.80	6SR7GT	.56	14C5	.88
1B25A	4.95	9NP1	7.95	755A	6.75	2051	.40	WL616	85.00	6A8GT	.78	6SS7	.58	14C7	.88
1B26	4.45	10Y	.39	726A/B C	13.50	2111	4.95	Z225	1.95	6A85 6N5	.88	6ST7	.88	14E6	.72
1B27	4.95	10SPEC.	.69	728GY	24.95	2516	5.95	ZB3200	150.00	6A85 6B7 1853	.78	6T7	.97	14E7	.88
1B29	.89	10BP4	22.45	730A	9.75	2562	10.00	ZB3200	150.00	6A85 6C7 1853	1.16	7AU5 GS	.64	14E8	.88
1B32	1.95	10CP4	29.50	750TL	49.50	7193	.18	ZP477	18	6AC7 1852	.88	6U6GT	.72	14H7	.64
1B38	34.50	12D1	12.50	800	1.75	8005	4.60	12DPP	14.95	6AD6	.88	6U7G	.54	14J7	1.06
1B40	6.95	12DP8	14.95	801A	.28	8011	2.00	0A2	1.56	6AD7G	1.28	6V6GT	.62	14N7	.88
1B59	12.95	12FP7	14.95	802	4.25	8012A	1.25	0A3 VR75	.98	6AF6G	.78	6V6GT	.62	14O7	.56
1B60	4.95	12GP7	12.95	803	3.45	8012A	2.00	0A4	.94	6AG5	.76	6W7G	.88	14R7	.68
1N21	.89	12HP7	12.95	804	8.50	8014A	24.95	0B2	1.74	6AH6	1.28	6X5GT	.48	14S7	1.06
1N23	.69	12KP4	49.50	805	3.50	8016	1.10	0B3 VR90	.64	6AJ5	.78	6Y6GT	.66	14V7	1.06
1P25	1.95	12LP4	49.50	807	1.10	3020	1.25	0C3 VR105	.78	6AK5	.84	6Y7G	.88	14X4	.88
2AP1	1.95	15E	1.25	808	2.50	8025A	1.35	0D3 VR150	.54	6AK6	.78	6Z7G	1.14	19T8	1.56
2C4	1.18	15R	.50	809	2.50	8026	2.90	0Y4	.88	6AL5	.64	6Z7G	.68	24A	.68
2C21	.25	23DA	.49	810	7.75	8026	2.50	0Z4	.56	6AL5 GT	1.06	7A4 XXL	.72	24B	.68
2C22	.28	24G	.35	811	2.00	BH	4.95	0Z4G	.98	6AO6	.58	7A5	.72	24C	.68
2C26A	.18	35T	4.95	812	2.50	CIA	4.95	0A1A	.24	6AO6 GT	.88	7A6	.66	25A6	1.06
2C34	2.95	45SPEC.	24.95	812H	6.90	CIB	6.90	0A5	.43	6AR5	.66	7A7	.56	25A6GT	1.06
2C43	9.50	75TL	3.50	813	6.75	C5B	12.95	1A4	1.08	6AO7GT	.88	7A8	.66	25A6GT	1.06
2C44	1.75	100TH	11.00	815	1.25	CA1	7.50	1A4GT	.96	6AR5	.66	7A8	.66	25A6GT	1.06
2C46	7.50	100TS	2.00	816	1.19	CE072	1.95	1A5GT	.48	6AS7G	4.95	7A8	.66	25A6GT	1.06
2C51	6.50	101F	4.95	826	.35	CK1005	.08	1A6	.66	6AU6	.46	7AD7	1.06	25B6GT	.52
2D21	1.16	114H	1.95	829A/B	7.25	CK1006	.69	1B3GT	1.49	6AV6	.46	7AG7	.71	25C5	1.16
2E22	4.95	120	5.95	830B	3.25	CK1090	2.75	1B4	1.18	6B4G	.88	7AH7	.88	25E6GT	.48
2E24	4.95	120	5.95	832A	4.95	EF50	3.35	1B5 25S	.88	6B5	1.56	7B4	.56	26	.56
2E25A	4.25	121A	2.65	833A	34.25	EL3C	4.95	1B7GT	1.06	6B6G	.78	7B5	.72	27	.46
2E26	3.95	205H	4.50	834	5.50	F123A	12.50	1C6	.88	6B7	.88	7B6	.58	28D7	.34
2E30	2.39	205F	4.50	836	1.50	F128A	70.00	1C7G	.88	6B8	1.28	7B8	.72	31	.56
2J21A	10.75	211	4.49	837	2.25	F660	110.00	1D5GP	.96	6BA6	.54	7C4 1203A	.31	36	.96
2J26	2.50	214	4.90	838	2.25	FG17	2.75	1D7G	.66	6BE6	.56	7C5	.56	32I7GT	.96
2J27	13.95	215A	.50	841	.25	FG27A	8.95	1D8GT	.94	6BG6G	1.46	7C6	.72	33	.68
2J30	19.95	218	12.50	843	4.00	FG32	5.95	1E7G	1.38	6BH6	.56	7C7	.58	34	.68
2J31	8.95	221A	1.75	845 W	69.50	FG33	3.95	1E7G	1.56	6B16	.56	7E5 1201	.66	35 51	.56
2J32	11.95	231D	1.20	849A H	25.00	FG81A	3.75	1F4	.74	6C4	.56	7E7	.68	35A5	.66
2J33	19.95	249G	7.00	851	19.50	FG95	9.95	1F5G	.74	6C5	.46	7F7	.68	35B5	.64
2J36	75.00	294A	4.50	852	35.00	FG105	9.50	1F6	1.56	6C5GT	.46	7F8	.68	35C6GT	.53
2J37	12.95	250TH	19.50	866A	1.95	FG235	59.50	1F7G	.66	6C6	.56	7G7 1232	1.06	35W4	.38
2J38	12.95	252A	4.95	866A JR	1.19	FG238R	160.00	1G6GT	.68	6C7	1.28	7G7 1232	1.06	35Y4	.48
2J48	24.50	259A	3.50	867A	1.30	GL146	9.75	1H4G	.68	6D6	.66	7H7	.63	35Z3	.56
2J49	19.50	262A/B	3.50	868A	1.19	GL473	65.00	1H5GT	.55	6D6GT	.66	7I7	.66	35Z4GT	.43
2J51	24.95	274B	1.00	869R	140.00	GL502A	1.98	1H6G	.86	6E5	.87	7K7	1.06	35Z5GT	.38
2J54B	24.95	275A	1.95	872A	110.00	GL530	49.50	1H6GT	.86	6E6	1.06	7N7	.66	36	.39
2J61	24.50	282A/B	9.95	874A	115.00	GL559	5.35	1J6GT	.88	6E6	.78	7O7	.58	37	.34
2K23	24.95	283A	10.95	876	1.75	GL673	11.50	1LA4	.88	6E7	.66	7O7	.58	38	.27
2K25	24.95	286A	10.95	876	1.49	GL697	65.00	1LA6	.78	6F6	.64	7R7	.68	39 44	.26
2K28	24.95	290A	4.95	878	1.49	GL700	3.95	1LA6	.88	6F6GT	.66	7V7	1.06	41	.51
3AP1	4.75	291A	4.95	884	11.95	GL710	17.95	1LB4	.88	6F7	.84	7W7	.88	42	.48
3B22	2.50	294A	4.50	885	115.00	GL710	17.95	1LC5	.78	6F8G	.86	7X7 XXFM	.88	43	.48
3B23	4.95	300A	3.95	889R	115.00	HF100	17.95	1LC6	.56	6G6G	.66	7Y4	.56	45 73	.56
3B24	1.98	301A	6.95	891	11.95	HF200	17.95	1LD5	.88	6H6	.46	7Z4	.56	45Z3GT	.48
3B24W	2.95	304B	5.95	892	1.50	HK254	19.95	1LE3	.88	6I6GT	.46	10A5	.56	46	.68
3B26	1.50	304TH	3.50	902P1	1.50	HY615	.20	1LG5	.88	6J5GT	.48	12A6	.56	47	.68
3B28	5.95	304TL	1.30	905	1.50	KU23	15.00	1LH4	.66	6J6	.76	12A6GT	.18	49	.88
3BP1	2.50	307A	4.95	907	1.00	KU23	9.50	1LN5	.56	6J7	.66	12A7	.97	50A5	.68
3C23	2.25	310A	7.95	917	.75	ML101	75.00	1NSGT	.66	6K7GT	.66	12A8GT	.66	50B5	.54
3C24	.35	315A	6.95	917	1.50	MX408U	.75	1O5GT	1.38	6L7	.66	12A8GT	.84	50L6GT	.51
3C30	.30	316A	.50	918	1.50	PJ23	1.35	1R4	.96	6K5GT	.44	12A6	.44	50Y6GT	.56
3C31	3.50	327A	2.50	922	1.00	R100	3.75	1R5	.68	6K6GT	.44	12AT6	.54	53	.86
3CP1	1.40	338A	3.75	923	1.40	R200	7.95	1S4	.78	6K7	.68	12AT7	1.16	54	.86
3DP1 A	2.50	350A B	8.05	930	2.60	RL130	12.95	1S5	.56	6K7GT	.78	12AU6	.66	56	.43
3EP1	2.50	350A B	8.05	930	2.60	RL300	7.50	1T4	.56	6K8	.78	12AU7	.78	57	.37
3E29	4.95	354C D	19.95	931A	1.50	RL300	7.50	1T5GT	.78	6K8GT	.78	12B6	.56	58	.48
3FP7	1.75	357B	49.50	934GT	69.50	RL300	7.50	1U4	.58	6L5G	1.06	12B6	.56	59	.88
3GP1	4.95	368AS	4.93	949A	.98	RL300	7.50	1U5	.72	6L6	1.16	12C8	.48	70L7GT	1.16
3JP7	7.95	371A B	5.93	950	.98	RL300	7.50	1V	.68	6L6G	.86	12F5GT	.67	71A	.66
4-65A	14.50	374A	2.50	954	.35	RL300	7.50	2A3	1.06	6L6GA	.86	12H6	.26	75	.38
4-125A	27.50	393A	3.50	955	.35	RL300	7.50	2A4G	.68	6L7	.78	12J5GT	.26	77	.42
4-250A	37.50	394A	3.50	956	.35	RL300	7.50	2A5	.68	6L7G	1.16	12J7GT	.80	78	.44
4A1	.98	399A	2.50	957	.19	RL300	7.50	2A6	.68	6N6G	1.56	12K7GT	.53	79	.88
4AP10	4.50	400A	3.25	958A	.18	RL300	7.50	2A7	.88	6N7	.78	12K8	.58	80	.88
4C35	19.35	401A	1.95	959	.35	RL300	7.50	2B7	.78	6N7GT	.78	12K8	.58	81	.28
4E27	12.50	403A B	1.95	960A	.99	RL300	7.50	2B7G	.88	6P5GT	.96	12K8GT	.66	82	1.28
4J26	110.00	417A	9.50	972A	2.95	RL300	7.50	2X2A	.68	6Q6G	1.06	12O7GT	.48	83	.71
5AP1	1.85	434A	2.75	975A	14.95	RL300	7.50	3A5	24.95	6Q7	.58	12S47GT	.56	83V	.88
6AP4	1.85	446A	1.00	991	.23	RL300	7.50	3A8GT	1.98	6R7	.78	12S7GT	.56	84 6Z4	.62
5BP1	1.75	446B	1.95	1613	.45	RL300	7.50	3B7	.34	6R7GT	.78	12S7GT	.56	85	.68
5BP4	2.50	450TH	24.95	1614	1.35	RL300	7.50	3D6	.34	6S7	.88	12SF5GT	.56	89	.72
5C22	49.50	450TL	35.00	1616	1.50	RL300	7.50	3E4	1.28	6S7GT	.88	12SF7GT	.56	89Y	.38
5CP1	1.50	464A	9.50	1619	.15	RL300	7.50	3F4	.58	6SA7	.43	12SH7	.34	117L7GT	1.28
5CP1A	9.95	527	6.50	1620	4.95	RL300	7.50	3G4	.66	6SA7GT	.43	12SH7	.34	117M7GT	1.56
5D21	29.95	531	4.95	1621	.98	RL300	7.50	3V4	.80	6SB7Y	.48	12SJ7	.48	117N7GT	1.36
5FP7	1.25	532A	4.95	1622	1.05	RL300	7.50	3V4	.80	6SC7	.50	12SK7	.48	117P7GT	1.26
5GP1	5.50	631P1	4.95	1624	.35	RL300	7.50	3							



# LOOKING FOR SOMETHING? LIFE IS WHERE YOU FIND IT.



## RESISTORS EB½, GB1 and HB2

LIFE OFFERS THE MOST COMPLETE INVENTORY OF ½, 1 and 2 WATT RESISTORS IN 5% and 10% TOLERANCES IN THE COUNTRY.

### PRICE SCHEDULE

Wattage	Tol.	1-49	50-199	over
EB½	½ Watt	10%	.06	.04
EB½	½ Watt	5%	.12	.08
GB1	1 Watt	10%	.09	.06
GB1	1 Watt	5%	.18	.12
HB2	2 Watt	10%	.15	.10
HB2	2 Watt	5%	.30	.20

Prices shown are per size. Resistors may not be assorted for quantity price.

THE FOLLOWING VALUES ARE AVAILABLE IN 10% TOLERANCE:

Ohms	Ohms	Ohms	Megs	Megs	Megs
10	100	1000	10000	1	1.0
12	120	1200	12000	.12	1.2
15	150	1500	15000	.15	1.5
18	180	1800	18000	.18	1.8
22	220	2200	22000	.22	2.2
27	270	2700	27000	.27	2.7
33	330	3300	33000	.33	3.3
39	390	3900	39000	.39	3.9
47	470	4700	47000	.47	4.7
56	560	5600	56000	.56	5.6
68	680	6800	68000	.68	6.8
82	820	8200	82000	.82	8.2

THE FOLLOWING VALUES ARE AVAILABLE IN 5% TOLERANCE:

Ohms	Ohms	Ohms	Ohms	Megs	Megs	Megs
10	68	470	3300	22000	0.15	1.0
11	75	510	3600	24000	0.16	1.1
12	82	560	3900	27000	0.18	1.2
13	91	620	4300	30000	0.20	1.3
15	100	680	4700	33000	0.22	1.5
16	110	750	5100	36000	0.24	1.8
18	120	820	5600	39000	0.27	2.0
20	130	910	6200	43000	0.30	2.2
22	150	1000	6800	47000	0.33	2.2
24	160	1100	7500	51000	0.36	2.4
27	180	1200	8200	56000	0.39	2.7
30	200	1300	9100	62000	0.43	3.0
33	220	1500	10000	68000	0.47	3.3
36	240	1600	11000	75000	0.51	3.6
39	270	1800	12000	82000	0.56	3.9
43	300	2000	13000	91000	0.62	4.3
47	330	2200	15000	0.1	0.68	4.7
51	360	2400	15000	0.11	0.75	5.1
56	390	2700	18000	0.12	0.82	5.6
62	430	3000	20000	0.13	0.91	6.2

## TYPE "J" POTENTIOMETERS



Available in screw-driver and regular shafts locking and non-locking type bushings.

When ordering locking type bushing potentiometers, locking nuts are available at \$.05 each. Specify whether regular or screw-driver shaft is required.

### DUAL POTENTIOMETERS TYPE "JJ"

Single Pots	Dual Pots	Triple Pots
.....\$.50	.....1.50	.....2.50

### SINGLE POTENTIOMETERS TYPE "J" AND "JL"

Ohms	Ohms	Ohms	Ohms
50	1300	2000	200,000
60	1500	25,000	250,000
150	2000	30,000	500,000
200	2500	35,000	600,000
250	3000	50,000	750,000
400	5000	60,000	1.0Meg
500	6500	75,000	2.0Meg
			2.5Meg
600	10,000	100,000	3.0Meg
1,000	15,000	150,000	4.0Meg

5 Meg/5 Meg  
1 Meg/1 Meg  
5 Meg/5 Meg

### TRIPLE POTENTIOMETERS TYPE "JJJ"

Ohms
150,000/150,000/150,000
500,000/500,000/500,000

## SILICON DIODES



Type	Design Freq. (mc)	Price each
IN21	3,000	\$5.50
IN21B	3,000	1.00
IN23	10,000	1.25
IN23A	10,000	1.50
IN23B	10,000	2.00

## GERMANIUM DIODES

Type	Price each
IN34	\$.85
IN35	2.00

## "UHF" COAXIAL CABLE CONNECTORS

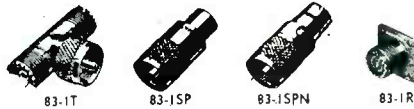

No.	AN No.	Description	1-99	100-499	500 or over
83-1SP	PL259	Plug	.35	.28	.24
83-168	UG176U	Adapter	.15	.12	.11
83-185	UG175U	Adapter	.15	.13	.12
83-1SPN	PL259A	Plug	.35	.28	.24
83-776	UG203U	Plug	.61	.55	.53
83-1R	SO239	Receptacle	.35	.28	.24
83-1R	SO239	Receptacle	.50	.45	.40
83-1R	UG106U	Hood	.12	.10	.09
83-1HP	UG106U	Hood	.27	.24	.21
83-765	UG177U	Hood	.31	.25	.22
83-1AC	---	Cap and chain	.61	.50	.45
83-1BC	---	Cap and chain	.38	.34	.31
83-1T	M358	"T" connector	1.12	.98	.90
83-1AP	M359A	Angle adapter	.35	.28	.24
83-1J	PL258	Junction	.85	.70	.65
83-1F	PL274	Feed thru	1.12	.98	.90
83-22SP	UG102U	Twin plug	.75	.68	.62
83-22R	UG103U	Twin recept	.50	.40	.36
83-22AP	UG104U	Twin ang. adapt.	.98	.80	.72
83-22J	UG105U	Twin junction	1.25	1.12	1.05
83-22T	UG196U	Twin "T"	1.65	1.50	1.35
83-22J	PL275	Twin feed thru	1.50	1.35	1.25
83-2SP	PL295	Lge twin plug	1.94	1.75	1.55
83-2R	SO265	Lge twin recept.	1.44	1.30	1.18
83-2H	M365	Lge Hood	.24	.22	.20
83-2AC	---	Lge CAP and chain	.61	.55	.50
83-2AP	PL325	Lge Twin angle adpt.	2.08	1.88	1.68
83-2J	PL305	Lge twin junction	1.45	1.30	1.18

## COAXIAL CABLES



BRAND NEW!!!  
JAN APPROVED!!!

RG No.	Impedance	Price per Thousand Ft.
RG5U	52.5 ohms	\$70.00
RG6U	76.0 ohms	150.00
RG7U	97.5 ohms	70.00
RG8U	52.0 ohms	55.00
RG9U	51.0 ohms	135.00
RG9AU	51.0 ohms	125.00
RG10U	52.0 ohms	125.00
RG11U	75.0 ohms	100.00
RG12U	75.0 ohms	190.00
RG13U	75.0 ohms	125.00
RG18U	52.0 ohms	450.00
RG19U	52.0 ohms	350.00
RG20U	52.0 ohms	450.00
RG21U	95.0 ohms	120.00
RG24U	125.0 ohms	240.00
RG25U	48.0 ohms	575.00
RG27U	48.0 ohms	290.00
RG29U	53.5 ohms	50.00
RG34U	71.0 ohms	175.00
RG38U	52.5 ohms	400.00
RG39U	72.5 ohms	180.00
RG41U	67.5 ohms	575.00
RG54U	58.0 ohms	65.00
RG54AU	58.0 ohms	75.00
RG57U	96.0 ohms	100.00
RG58U	53.5 ohms	50.00
RG59U	73.0 ohms	45.00
RG62U	93.0 ohms	80.00
RG65U	95.0 ohms	250.00
RG71U	93.0 ohms	175.00
RG74U	52.0 ohms	250.00
RG78U	48.0 ohms	80.00

Prices based on a minimum quantity of 500 ft. For cut lengths add 50% to prices shown.

## BRAND NEW!! UG TYPE CONNECTORS JAN APPROVED!!



AN No.	Price ea.	AN No.	Price ea.	AN No.	Price ea.	AN No.	Price ea.	AN No.	Price ea.
UG9/U	\$.95	UG23BU	1.29	UG88/U	1.17	UG146/U	2.25	UG235/U	28.50
UG10/U	1.56	UG27AU	2.25	UG89/U	.95	UG155/U	4.40	UG236/U	11.75
UG11/U	1.45	UG28/U	2.34	UG90/U	1.05	UG154/U	5.35	UG241/U	2.20
UG12/U	.95	UG29/U	1.22	UG91/U	1.25	UG156/U	4.25	UG242/U	2.50
UG13/U	1.56	UG29AU	1.36	UG91AU	1.05	UG157/U	4.25	UG243/U	2.75
UG14/U	1.45	UG33/U	1.75	UG92/U	1.10	UG160/U	1.90	UG244/U	2.50
UG15/U	.95	UG32/U	20.00	UG92AU	1.35	UG160AU	1.55	UG245/U	1.25
UG16/U	1.56	UG33/U	20.00	UG93/U	1.25	UG167/U	3.00	UG246/U	1.45
UG17/U	1.45	UG34/U	17.50	UG93AU	1.45	UG173/U	.30	UG252/U	4.50
UG18/U	.99	UG35AU	16.00	UG94/U	1.25	UG174/U	16.00	UG254/U	1.82
UG18AU	1.05	UG36/U	16.00	UG94AU	1.05	UG185/U	.95	UG259/U	4.10
UG19BU	1.09	UG37/U	16.00	UG95/U	1.10	UG197/U	5.00	UG260/U	.99
UG19/U	1.28	UG37AU	16.00	UG95AU	1.35	UG201/U	1.83	UG261/U	.95
UG19AU	1.38	UG57/U	.99	UG96/U	1.25	UG202/U	2.75	UG262/U	1.05
UG19BU	1.45	UG58/U	.65	UG96AU	1.45	UG204/U	2.25	UG270/U	6.50
UG20/U	1.17	UG59/U	2.75	UG97/U	3.50	UG206/U	1.02	UG273/U	1.50
UG20AU	1.26	UG59AU	1.70	UG98/U	1.55	UG208/U	2.80	UG274/U	1.98
UG20BU	1.41	UG60/U	1.90	UG100/U	2.34	UG212/U	4.50	UG279/U	2.40
UG21/U	.99	UG60AU	1.30	UG101/U	2.95	UG213/U	4.50	UG287/U	5.25
UG21AU	1.05	UG61/U	2.95	UG107/U	2.25	UG215/U	3.35	UG290/U	.85
UG21BU	1.09	UG61AU	1.80	UG108/U	1.75	UG216/U	8.70	UG291/U	1.05
UG22/U	1.08	UG62/U	28.00	UG109/U	1.75	UG217/U	3.10	UG306/U	2.03
UG22AU	1.38	UG83/U	1.50	UG114/U	1.50	UG218/U	6.50	UG333/U	4.70
UG22BU	1.34	UG85/U	1.65	UG115/U	1.33	UG222/U	35.00	UG334/U	5.75
UG23/U	.99	UG86/U	1.69	UG123/U	.45	UG231/U	2.00	UG352/U	6.00
UG23AU	1.26	UG87/U	1.40	UG131/U	6.00				

## TUBE SPECIALS

2K41	\$.65.00
2J35	125.00
5J29	14.95
5J32	35.00
417A	12.95
1Q26	35.00
9006	.39
955	.29

## ODDS 'N' ENDS SPECIALS

50 Mmfd Air Trimmers	\$.39
.1 mfd 2000 Volt Oil Condensers	.39
±TJU50020 2 mfd 5000 Volt	9.95
Dual 7-45 Mmfd Silver Trimmer	.49
JBT Model 31F 58-62 Cycle Freq. Meter	4.95
1 Pound Roll Linen Lacing Cord	1.65

# IMMEDIATE DELIVERY

# LOW PRICES

# FULLY GUARANTEED

## AC-SERVO MOTORS



Minneapolis-Honeywell

60 cycle Servo Motor  
Type M623CY1X1  
17 watts, 162 rpm.  
#SA-277.

Price \$19.50 ea.  
Pioneer Type CK-2.



26 v. 400 cycles fixed phase, var. phase 49 v. max. 1.05 in/oz. Stall torque. Rotor moment of inertia 7 gm/cm: With 40:1 gear reduction.

Stock #SA-97A. Price \$6.50 each. Also available less gear train as Stock #SA-97. Price \$4.25 each

## KOLLSMAN 400 Cycle RATE GENERATOR



Model 863-04302  
Output 4.2 volts per 1000 rpm.  
#SA-280.

Price \$16.50

## SWEEP GENERATOR CAPACITOR



Hi-speed bearings. Split stator. Silver-plated coaxial type. 5-10 mmf.

Stock #SA-167 Price \$1.75 each

## MERCURY CONTACT RELAY



W.E. D-168479  
Millisecond switching at up to 60 cycles per sec. Ideal for servo amplifiers of relay type. 4 page brochure on request. Stock #SA-259. Price \$4.75 each.

## INVERTER SPECIALS

General Electric PE-218 D—Input 28 v. d-c @ 92 amps. Output 115 v. 400 cycles @ 1500 va. Power factor 0.90. Shipping wt. 100 lbs. New—Original Cartons. Stock #SA-112. Price \$39.50 each.

Leland or Russell PE-218 E or PE-20.8H. Similar to PE-218D. Stock #SA-112A. Special Price \$29.50 each.

Leland SD-93—(10285)—Input 28 volts DC at 60 amps. Output 115 volts three phase 400 cycles at 750 va. 0.90 P.F. Second output voltage of 26 volts 400 cycles at 50 V.A. Voltage and frequency regulated. Designed for use with various autopilots. Stock #SA-209. Price \$79.50 each

Holtzer Cabot MG-149H—Similar to MG-149F but draws 44 amps DC at 28 v. Output ratings are at 0.90 P.F. Equipped with high altitude brushes. Stock #SA-4. Price \$34.50 each

General Electric 5D21NJ3A — Input 28 volts DC at 35 amps. Output 110 volts 400 cycles. 485 V.A. at 0.90 P.F. Weight 15 lbs. Stock #SA-41. Price \$9.95 each

General Electric 5AS131NJ3 — Input 26 volts DC at 100 amps. Output 115 volts 400 cycles. 1500 V.A. 0.8 P.F. Stock #SA-286. Price \$19.50 each

## BROWN TELEPLOTTER RECEIVER

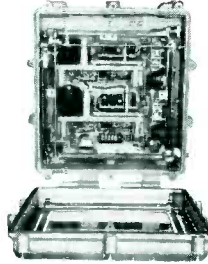

Price \$375.00

Model 791X1R  
115 volt  
60 cycles

Contains a pen driven by two balancing motors which writes on rear of a translucent chart. Pen arm position is in terms of two co-ordinates supplied balancing motors thru two amplifiers. Originally intended for recording plotted or written data from central plotting board. Writes at one half scale on 18 in. chart. Discriminator input circuit designed to operate unit as function of two varying R.F. frequencies varying about mean of approx. 430 KC. Further data on request. (Shipping weight 435 lbs.)

## LP-21-LM Compass Loops



New

Motor driven loop enclosed in graphited zepelin housing includes Autosyn transmitter.

\$9.50 each

## MAGNESYNS



Pioneer CL-3

Use as transmitter or indicator on 26 v. 400 cy. or 52 v. 800 cy. May be used as indicator with 360° potentiometer on d-c.

Stock #SA-6 Price \$1.45 each

## Remote Position Indicating System



6-12 v. 60 cycles 5 inch indicator with 0 to 360° dial. Heavy duty transmitter. Stock #SA-115. Price \$9.95 per system



AC Motor Special Eastern Air Devices J-33  
115 V. 400 cy. 3 phase synchronous. 8000 RPM. Stock #SA-59. Price \$8.00 each



Autosyn Indicator I-82F Compass Indicator. 0-360°-5 in. dial. 26 v 400 cy. 8-12 v. 60 cy. Ideal position indicator. Stock #SA-284. Price \$6.50 each

## MINIATURE DC SELSYN INDICATOR



Miniature indicator, 24 v. d-c operation with G.E. Position Transmitter or with Ohmite 360° type potentiometer. Has iron plug for zero dial adjustment. Stock #SA-268. Price \$6.75 each.

Price \$6.75 each.

## G.E. POSITION TRANSMITTER

Type 8TJ9—continuously rotatable 360 wound potentiometer. Taps every 120 degrees. Two 180° opposed sliders. 24 v. d-c operation with indicator described above. Stock #SA-13. Price \$4.75 each.

## SYNCHROS

Navy Types

1G, 1F, 1CT, 5G, 5F, 5CT, 5DG, 5HCT, 5SF, 5HSF, 5SDG, 6DG, 6G, 6DG, 7G, etc.



Prices on Request

## D.C. MOTORS

Universal Electric DC

W.E. KS-5603-1-02, 28 v. d-c 0.6 amps. 1/100 hp. 4 lead shunt. Stock #SA-233. Price \$2.95 ea. plus 15¢ p.p.



## OSTER PM MOTOR

Alineo Field

27.5 v. d-c. Can also be used as rate gen-D-101 27 v. d-c \$3.75 each



## DELCO CONSTANT SPEED MOTOR A-7155

1/30 hp. 27.5 v d-c 3600 rpm. Cont. duty. 2 1/2" diam. x 5 1/2" lg. 7/8" shaft extension, 5/32" diam. 4 hole base mounting. Stock #SA-94. Price \$4.75



Delco 5069625 Constant Speed DC Motor, 27 v. d-c 120 rpm. Governor controlled. Stock #SA-249. Price \$3.95 each.



General Electric 2 RPM Motor. Type 5BA10FJ228, 27 v. d-c @ 0.6 amps. 10 lb/in torque at 2 rpm. Shunt wound. L-C noise filter. Stock #SA-274. Price \$6.75 each.

## DC SERVO MOTORS

C-1 Autopilot Servo Unit—28 v. d-c Shunt motor. 2250 rpm. 2 magnetic clutches, reduction gear, differential and 2 magnetic brakes. Output shaft 15 rpm. Torque 225 in/lbs. Stock #SA-180 Price \$19.50 each

Elenco B-64 DC Servo Unit—armature voltage, 80 v d-c max. 27.5 v. field 1/165 hp 3100 rpm. Field current 200 ma. Armature current 200 ma. at normal torque. Stock #SA-211 Price \$12.50 each

Prices F.O.B. Paterson  
Phone ARmory 4-3366  
Teletype PAT. 199

WRITE FOR LISTING

# Servo-Tek

products co.  
4 Godwin Ave. Paterson, N. J.

## SPECIALISTS IN FRACTIONAL HORSE POWER MOTOR SPEED CONTROL

# RADIO SHACK YEAR-END CLEARANCE SALE OF DESIRABLE ELECTRONICS COMPONENTS

## NEW DELCO (G-M) DUAL AC BLOWERS



ONLY

\$14.85 Ea. lots of 1-9  
\$13.95 Ea. lots of 10-49  
\$12.75 Ea. lots of 50-99

New and in original shipping cartons! Way, way, way below regular price! Built by Delco division of General Motors. Million household, commercial and marine uses: photo dark-rooms, cooling xmtr tubes, furnace draft boosting, machinery suction unit, humidifiers, hair dryers, kitchen ventilation, etc. No brushes to cause radio interference. Quiet, continuous duty 115 V 60 cycle Delco shaded-pole motor with skewed squirrel-cage type rotor. Two multi-blade squirrel-cage type fans and pressed-steel welded 2-piece snail type housing. Die cast alloy case and housings. Operates at 2800 rpm; 2750 fpm velocity, 120 cfm free volume air delivery, 62 watts input. Black lacquer finish. Weight 11 lbs. Over-all 10 21/32" by 5 27/32" by 6 7/32", with universal mounting brackets. It's the blower-buy of all time!



## 320 POWERS TEMPERATURE RECORDER A 'STEAL' AT \$89.95

No. 100 recording duplex regulator, model 13121. Single pen recorder, 2 adj. index pointers. Range 0-250 degrees F. Has 3 pressure gauges; 115/1/60; 24 hour clock; 17x13x5. Like new! Only \$89.95. Very limited quantity.

## THERMISTORS & PULSE TRANSFORMERS

PULSE, Utah X-138T-1. Order R-0124 .95c  
PULSE, Utah X-143T-2. Order R-0123 .95c  
PULSE FORMING, W.E. D-164720. Order R-696 \$5.50  
THERMISTOR, W.E. D-164699. Order R-536 \$2.00  
PULSE INVERSION, Sub. Sig., ratio 1:1. Order R-0102 .65c

## DAVEN ATTENUATORS, ETC.

"TEE" network, dual 5000 ohms. Order T-456 \$2.50  
"POT" 5000 ohms. Order R-639 \$1.93  
"SEALD-OHM" precision resistor, 1% accuracy. 283 and 567 ohms respectively, contained in one resistor! .85c

## XFORMERS & CHOKES!

SOLA CONSTANT VOLTAGE xformer, type 30864, in 190-260 VAC, out 115 VAC at 1.7 A. Plus or minus 1% pri. var. 15x8x6". Excellent export item, easily worth over \$50! Order R-721. Only \$17.50  
HIGH VOLTAGE PLATE xformer, potted case, porcelain high voltage terms, input 115/1/60, 2600-0-2600 at 550 ma (ICAS). 8x8x8 1/2". Famous maker! Orig. packing! NOT war surplus! Ideal for broadcast, ham, etc. Order R-704A. Only \$29.95, plus 40c for crating.  
HIGH VOLTAGE PLATE xformer, same as above except 1750-0-1750 at 550 (ICAS), 7x8x7 1/2". Order R-704B. \$18.95, plus 40c for crating.  
CHOKE — 4 H at 170 ma, 95 ohms, 4x4x3" enclosed. Order R-737 \$1.25  
6L6 MODULATION xformer, Stancor 3871. 4500:8500 ohms. Boxed. Order R-728 \$1.00  
PLATE XFORMER, Stancor. In: 115/1/60; out: 545 V at .445 ma; enclosed; new. Order R-764. \$3.00

Cap. WVDC Fig. Order No. Price  
.02 600 C T-203B \$ .30  
.02 5000 B R-302 2.50  
.05 600 A T-436A .38  
.05 3000 D T-157 1.95  
.1 600 A R-313 .38  
.1 600 E R-280 .85  
.1 600 C T-439 .38  
.1 2000 D T-181 1.00  
.1 3000 B R-89 2.10  
.1 3500 D T-128 3.50  
.1 7500 D T-129 6.50  
.1-1.1 600 C T-199 .48  
.1-1.1 2500 D T-140 4.00  
.1-1.1 7000 D T-132A 6.50  
.25 400 A R-294 .39  
.25 600 C R-83 .40  
.25 1000 A R-281 .43  
.25 6000 D R-285 4.00  
.5 600 E R-346 .43  
.5 600 D T-183 .43  
.5 1500 B T-39 1.00  
.5 2000 D T-164 1.19  
.5 2500 D T-172 1.75  
.5 3000 D T-168 2.75  
.5 4000 D R-80F 4.90  
.5 6000 D T-111C 6.50  
.5-5 400 A R-348 .45  
.5-5 3000 D T-135 3.25  
1 600 E R-270 1.25  
1 600 D T-184B .48  
1 1000 D T-196 .79  
1 1500 D R-257 1.05  
1 2500 D T-160 2.10  
1 3000 D R-248 3.50  
1 3000 D T-142 3.65  
1 4000 D T-123 5.50  
1 4000 D T-111A 7.50  
1 5000 D T-170 1.11  
1.5 1500 D R-238 .63  
2 600 B R-292 1.65  
2 600 E T-156 .63  
2 1000 D R-403 1.25  
2 1000 B R-200 1.00  
2 1500 D R-141 2.50  
2 2000 D R-197 2.50  
2 2500 D R-80E 3.00  
2 3000 D R-283 4.50  
2 4000 D R-316 5.95  
2 5000 D T-112 8.95  
2X2.5/5.0 600 D R-212 1.49  
3 4000 D R-332 7.25  
3 600 B R-163 .95  
4 600 D R-306 .95  
4 400 D T-147 1.50  
4 1000 D T-119C 1.85  
4 1500 D R-262 2.85  
4 3000 D T-115 6.25  
5 600 D T-104 \$1.15  
5 600 D R-161 1.35  
5 1500 D R-253 3.50  
5 600 D R-208 1.50  
5 1000 D R-297 1.90  
5 1500 D R-89 4.00  
5 2000 D R-698 4.50  
5 1000 D R-93 2.50  
5 600 D R-699 1.65  
5 1000 D R-221 4.50  
5 1000 D R-356 6.50  
5 1000 D T-119A 7.50  
5 1500 D T-100B 7.95  
5 600 D T-34A 6.50  
5 100 D T-88 2.95

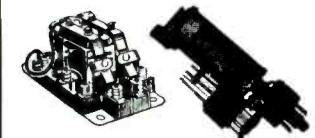

## RELAY BARGAINS!

DUNCO ADBT8, 12 VAC, DPST (NO), 30 A. Order R-503 \$1.65  
DUNCO ADBT8, 115 VAC, DPST (NO), 30 A. Order R-504 \$2.95  
DUNCO ADBT8, 115 VDC, DPST (NO), 3 A. Order R-502 \$2.25  
DUNCO 84BXC100, 115 VAC, 5PST (2NO) (3NC), 15 A. Order R-499 \$2.95  
DUNCO 5CX100, 115 VAC, 3PST, Mech. latch type, 2 coils. Order T-282 \$3.25  
SENSITIVE RELAY, 11,300 ohms, SPDT, closes .7 ma, opens .6 ma. Order R-912 \$1.25  
A-C PLUG-IN RELAY, Clare B-10155, 115 VAC, 75 ohms, 14 mils, 3P, opens two closes one; octal base; individually boxed. Order R-852 \$1.25  
RAYTHEON CPX24166 TIME DELAY relay, 115 V 60 cy. Adj 50-70 sec. 2 1/2 sec re-cycling time spring return. Microswitch cont 10 A. Holds on as long as power is applied. Order R-489 \$4.50



## FAMOUS-MAKE SWITCHES!

TRUMBULL 2250 interiors, with start-stop buttons, porcelain based. Order T-70 .69c  
TRUMBULL Flex-A-Plug PL-321, heavy duty, wall, 250 V, 30 A, 3 W, 3 phase. Order R-515, \$5.95  
H & H, toggle DPDT, bakelite, screw terms., 115 VAC, 6 A. Order T-243 .40c  
C.H. heavy duty push, 600 VAC, 10 A., red push button, 1" dia. Order R-0182 .55c  
C.H. 7910H2 heavy duty push sta. 1 1/2 hp 220-550 VAC, 10 A. Order R-0183 \$1.25  
TRUMBULL 708SW86, porcelain base knife switch, SPDT, 25 A, 3 1/2 x 1 1/4 x 1 1/4". Order R-32 .25c

## WIRE AND CABLE BUYS!

COAX PATCH CORD, W.E. CG-289/AP, 20 kv ac ins. w/heavy-duty coax connectors both ends. 25 ft. Order R-0176 .69c  
COAX PATCH CORD, W/"N" connector similar to UG22U, on 12" length of RG-8/U with shock-mounted base! Order R-0133 .69c  
COAX PATCH CORD, FOR TS-10AP, 83-1SP both ends, 12" length of RG-9/U. Order R-871 .69c  
COPPERWELD ANTENNA WIRE, #14 AWG., 5500 ft. rolls. Order R-0167. \$25.00 per roll.  
ROCKBESTOS #22, stranded, fiberglass ins., 1000 ft. reels. Order R-0193. \$4.95 per reel.  
CD-511C HEAVY DUTY LINE CORD, #14 AWG, Hubbell male plugs both ends. 25 ft. length. Order R-0173. \$1.49  
CO-136 SHIELDED 6 COND, heavy rubber ins. 100 ft. Order R-0174. \$5.75  
CD-514 SHIELDED 7 COND, heavy rubber ins., with AN connectors both ends. 20 ft. length. Order R-0175 \$1.35

## STORAGE BATTERIES!

EXIDE NAF-1062-17A, 12 volts, 17 A hr., dry charged. 8 1/2 x 8 x 8. Order R-0194 \$7.95  
EVEREADY "AIRCELL", T-1600, dry charged, 1 1/4 volts at 600 A hr. 10x5x6. Order R-734A. \$1.95  
WILLARD ERI-20-2, G.E. replacement, dry charged, 2 volts at 15 A hr. 4x3 1/2 x 5 1/2. Order R-0165. \$1.75



## LORD SHOCK MOUNTS!

No.	Fig.	Order	Per 10
1	B	R-645	25c
1	B	R-645A	35c
20	B	R-645B	75c
24	C	R-645C	75c
35	B	R-645D	75c
46	B	R-646E	85c

## BIRTCHEER TUBE CLAMPS!

Type	Order	Per 10
926B	R-0104	80c
926B-18	R-0107	80c
926C	R-0105	80c
Metal tube	R-0106	80c

## SPEED YOUR ORDER!

Send cash with order for fastest service. Send 20% cash deposit with C.O.D. orders. If you are not already on our mailing list, write today for our FREE 152-page 1950 Catalog — just off the press. Let us quote on your surplus OR new-product requirements!

## OIL-FILLED CONDENSERS!

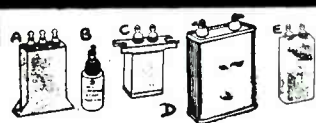

## ODDS & ENDS — CHEAP!

FREQUENCY METER, Model C2 direct-reading, 5-10 mc. Can be used up to 150 mc. .05% accuracy. \$24.45  
FREQUENCY METER, BC-906D, 150-225 mc. Order R-0195. \$22.50  
FREQUENCY METER, BC-221. Yes, it's new! Order R-0196. \$99.50  
RADAR SCOPE, RT/APS-2, 10 centimeter, 42 tubes, 60 mc i.f. strip. Order R-0146 \$33.50  
CAVITY TEST OSCILLATOR, TS-1. ARR-1, gold plated, 234-258 mc. Order R-0147 \$3.25  
SHIP-SHORE XMTR/RCVR, Hallcrafters HT-14, complete with 2 power supplies, 1680-4450 kc. New! Order R-0197 \$350.00  
SCR-522, 10 METER RIG, like new condition, with tubes. Order R-0198. \$33.95  
LAZY Q-5'er BC-1206, 200-400 kc, new! Order R-538 \$6.50  
BC-406A RADAR RCVR, converts to "hot" 10 meter unit, new, with 14 tubes! Order R-0199. \$14.50  
T-32 DESK MIKE, new, boxed. Order R-895 \$2.95  
TACHOMETER RATE GENERATOR, Elinco B-68. Order R-904 \$9.50  
PHASE SHIFT CAPACITOR, D-150734, 4 stator, 1 rotor, 360 degrees rotation \$1.95  
10 MFD @ 600 oil condenser, dual 5 mfd, easily made into popular 10 mfd unit. Guaranteed! New! 79c  
A-C MOTOR, Navy type COE, 115/1/60 at 1.25 amps, 1725 rpm, 1/30 hp. 7 1/2 x 6" dia. Flange mtd 5/16 shaft dia. Order R-710A. Regularly \$14.00. Reduced to \$5.95  
D-C MOTOR, G.E. 5BA25DJ303, 24 VDC @ 1.8 amps, 3500 rpm, 1/60 hp, shunt wound, 3x2 1/2 x 1 1/4" shaft \$2.45  
CIRCUIT BREAKER, Heineman, 10 amps. Order R-612 \$89c  
MICROSWITCH, BZE-7RNTN, metal clad, NO/NC, sealed housing. Order T-242 \$1.29  
VOLTAGE REGULATOR, Amertran #RH, 2.17 A. Order R-0166. \$4.95

The RADIO SHACK Corp.  
167E WASHINGTON ST., BOSTON, MASS., U.S.A.

# SUPERIOR VALUES FROM AMERICA'S LARGEST ELECTRICAL CONVERSION HOUSE

## GEN. ELECTRIC AMPLIDYNES



Model 5AM78AB16; 750 watts; Input: 440-3-60; Output: 250 Volts, DC; 2 amperes; 3450 RPM .....\$115.00  
Coupled directly to control motor on common base. Brand new.....\$185.00

## PINCOR ROTARY CONVERTERS

300 VA; Filtered; Brand New. Input: 115 VDC, 4.2 Amp. Output: 220 VAC, 1.36 Amp. **SPECIAL PRICE** .....\$38.00  
**GENERAL ELECTRIC DC GENERATORS;** Type BD; 1 % K.W. 125/125 Volts. 14 Amp. 1800 Speed. Rebuilt.....\$65.00  
**RAYTHEON DISTRIBUTION TRANSFORMERS;** 75 KVA; Pri: 220/240; Sec: 110 Volts, single phase, 60 cycles. Brand New .....\$12.50

## ELECTRIC SPECIALTY DC TO DC MG UNITS



Operate at 220 Volts, DC to deliver 110 Volts, 3.5 amperes. Two of these units can be used on 220 VDC to obtain 110-0-110 Volts DC. Special Price .....\$15.54



General Electric "Variac type" Controllers; 600 watts; 110/220 designed as an adjustable speed controller but can be used for any application requiring a variable transformer. Brand new and an exceptional buy at .....\$12.00

## KATO ROTARY CONVERTERS



Type 1205A Model 26KA54. Input: 24 VDC 28A. 1800 RPM. Output: 115 VAC 1 phase 60 cy. 1 KVA. Compact and ruggedly built for cont. duty oper. Filtered. Shock mounted. New \$90.00

## G. E. OIL FILLED OUTDOOR TRANSFORMERS



Brand New. 3 KVA; Type HS 3000/5200Y-115/230. **SPECIAL PRICE.** Brand New.....\$36.00

## CENTURY MOTOR GENERATOR SETS



Motor: 32 volts, D.C. 5 H.P. sh. wdg. 1800 R.P.M. directly connected to alternator delivering 120 volts, A.C. 3.75 K.V.A. cmb. wdg. Single Ph. 60 cps. Complete with spare parts, controlling field rheostat. Brand New .....\$335.00



General Electric Synchronous Motor or Alternator; excitation 2 Volts; operating at or delivering 110 volts, 3 phase, 60 cycles at 1800 speed; no name plate, but lab tests determined specs as above .....\$9.50

## HOLTZER-CABOT MG 149F

Input 28 Volts, DC at 36 amps. Output 26 Volts at 250 V. A. 400 cps. and 115 Volts at 500 V. A. 400 cycles. Rebuilt like new .....\$24.75

## G. E. ROTARY CONVERTERS



Dynamotor Model 5D4AB8 78 Volts DC input to deliver 110 Volts AC, single phase, 60 cycles, 1.5 amp. **SPECIAL PRICE (Rebuilt)** .....\$9.95

## LELAND-MURRAY HIGH FREQ. MOTOR GENERATOR SETS

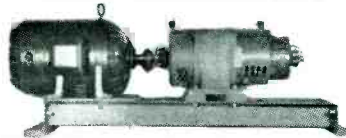

2 KVA; 115 Volts, 400 cycles; 17.2 amperes; single phase, coupled to 220/440-3-60 motor .....\$250.00  
Same specifications but operative with single phase, 110/220 Volt Motor.....\$295.00  
3 KVA; 120 Volts, 3 Phase, 400 cycles coupled to 220/440-3-60 Motor.....\$335.00  
Same unit with 5 HP-110/220 Volt Motor .....\$415.00

## CENTURY MOTOR GENERATOR SETS

7.5 KVA; 230 Volts, DC to 115 Volts, AC, single phase, 60 Cycles. Complete with automatic controller and push button station .....\$445.00

## A. T. R. INVERTERS

250 Watts, 110 VDC to 110 VAC. Brand New .....\$18.75

## GEN. ELECTRIC TRANSFORMERS



1 KVA: 460/230-230/115. Brand New .....\$19.00  
General Electric 5 KVA Auto-transformers; 110/220; Brand New .....\$26.00

## INDUCTION VOLTAGE REGULATOR



Type IRT, form M. 1.64 KVA, 3 phase, 60 cycles, cont. duty. Outdoor service. Primary: 208 V., 10.5 load amps. Oil-filled. Wgt. 365 lbs. 33 x 17" x 14".....\$83.00



## WESTINGHOUSE TRANSFORMERS

399 VA: 115/240 Volts; Brand New. **SPECIAL PRICE.** ..\$3.35



## HOLTZER-CABOT 153F

Input: 28 Volts DC at 52 Amp. Output: 115 Volts, 400 cps. 3 phase, 750 va; .9 P. F. also secondary output of 26 Volts, 400 cycles, single phase at 250 va; voltage and frequency regulated. **REBUILT LIKE NEW** .....\$59.50



## ESCO CONVERTERS

Rebuilt like new. Input: 86 VDC 2.85 amp. 3600 R.P.M. Output: 115 VAC. 2.18 amp. .50 P.F. Ball Bearings. Base for table or side mounting. Special .....\$9.80

## GENERATORS

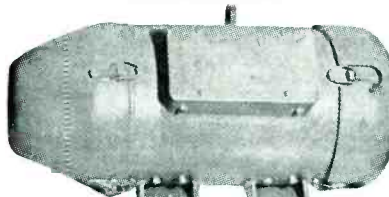

Input: 115 VDC at 14 amp. 3600 RPM. Ball Bearings. Output: 1.25 KVA; 80% PF 120 Volts, AC. 1 Ph. 10.4 amp. Centrifugal automatic controller permits line-start operation. Fully enclosed. Brand New \$99.95. Also available for 230 VDC operation at the same price

**GENERAL ELECTRIC 8 KW High Voltage Generators;** Rebuilt like new, double commutator type each rated at 4000 Volts, DC, 2.5 amperes; can be connected in series to give 8000 Volts, DC at 2.5 amperes or 4000 volts, 5 amperes in parallel. Separately excited. Units weigh about 800 pounds. Offered at a fraction of their original cost.....\$136.00

## SPEEDY POLISHING LATHES

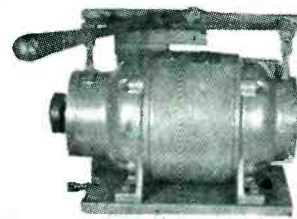

A hollow shaft motor to accommodate a 1" mandrel and tool rest operated by control handle. An ideal unit for the shop or laboratory.

Useful for a multitude of applications. 220/440 volts; 2 5/13 amperes; 3φ, 60 cycles. Brand new in original factory cases. \$30.00

## G. E. Motor CONTROLLED VOLTAGE



Cat. #837625, Type AIRS, Form M. .568 KVA, cont. duty, 60 cy., primary volts 115, Load Amps 16.2. Indoor service. Voltage controlled by mtr. 120/1/60. 1/40 HP.....\$39.50



Ideal AC to DC MG set 300 watts. Rebuilt like new. Ideal MG Set, operative at 110/220 VAC, single phase. Output: 120 VDC, 2.5 amperes. Special Price .....\$65.00

## GENERAL ELECTRIC DC/AC MG SETS

Four Bearing Marine Units: 25 HP 230 Volts, DC coupled to alternator 18.75 KVA; 80% PF; 1800 RPM Ball Bearings. 4 bearing set; marine duty. Brand New.....\$545.00

## MARATHON MOTOR GENERATORS



Input: 110 VDC. Output: 110VAC 1 phase, 60 cy. 500 VA. Marine Type with voltage regulator and frequency controller. Rebuilt .....\$65.00  
Same unit as above with 32 VDC Input and same Output, 300 V.A.....\$54.00

## ONAN HIGH FREQUENCY MG UNITS

Input: 110/220, single phase, 60 cyc. Output: 6 K.W. 115 VAC, single ph. 480 cps. Rebuilt like new.....\$138.50



Westinghouse Transformer Controller contains 300 watt, 110/220 volt transformer with multi-taps. The transformer with tap switch alone is worth more than the special price....\$6.25



## TAPE WINDERS

These tape winders consist of a motor operative at 110 volts D. C., .5 amperes; 1800 speed. A motor which is separable from the rest of the unit and which can be employed for a multitude of purposes, alone or with the gear reduction box to which it is connected. Motor is shunt wound and the speed thereof is controlled by a built-in rheostat. This makes an invaluable laboratory unit. Special Price .....\$10.99



## JANETTE ROTARY CONVERTERS

12 volts DC to deliver 110 volts, AC. Rated: 2.12 VA. With radio filter. Special Price .....\$51.00

**IF IT'S FROM ONE FREQUENCY TO ANOTHER; FROM DC TO AC OR AC TO DC;  
IF IT'S FROM ONE VOLTAGE TO ANOTHER, THEN CALL ON US.**

Established in 1922  
409 ATLANTIC AVE.

**WILLIAM I. HORLICK COMPANY**

Tel HANcock 6-2480

BOSTON, 10, MASSACHUSETTS

**SPECIAL METERS**

**SENSITROL RELAY**, 0-50 microampere sensitivity. Weston 705 type 5. Single fixed contact with 110 volt A.C. solenoid reset and adjustable index to indicate operating point. Has two scales, one for setting index, the other for reading pointer position. Contact closes on decreasing value and has a capacity of 5 Watts at 110 volts.  
List Price \$68.50 Your Cost ONLY \$27.50

**FREQUENCY METER**, 55 to 65 cycles, James Biddle Co., type MF-11. Brahm vibrating reed type, 11 reeds, 100 to 150 volt operation, 3/4" round flush bakelite case. \$7.50

**FREQUENCY METER**, WB 30-F. Dual Range covers frequency ranges from 48-52 cycles and 58-62 cycles: Dual element, vibrating reed type 115 volt, 3/4" rd flush metal case. \$5.95

**FREQUENCY METER**, 45 to 55 cycles 240 Volt Westinghouse HY switchboard type, 6" Square surface mid. \$35.00

**FREQUENCY METER**, 58 to 62 cycles 120 Volt, Westinghouse HY switchboard type, 6" Square Surface mtd. \$35.00

**"S" METER**, Simpson 25, 3" R-B, 5 MA, zero right mvt., translucent scale with rear illumination. \$4.50

**DECIBEL METER**, Weston 301 type 61, minus 10 to plus 6 DB, 3/4" rd fl bake case, 6 MW 600 ohms. High speed type, with 3 external wire wound multipliers to extend range. \$11.50

**DECIBEL METER**, Weston 506 minus 10 to plus 6 DB, 2 1/2" round flush bakelite case, Black scale luminous markings. \$5.50

**PORTABLE A.C. AMMETER** 0-3 and 0-15 Amps A.C. Weston Model 528. Complete with leather carrying case and test leads. \$12.50

**AIRCRAFT METERS**

All aircraft meters listed are 2 1/2" type with black scales unless noted otherwise.

0-30 Volt, General Electric. \$4.50

0-30 Volt, Weston 606. \$4.50

0-30 Volt, Westinghouse AX-33. \$4.50

0-30 Ampere, Westinghouse AX (USN C-30). \$5.00

30-0-30 Ampere, Weston 606. \$5.00

0-240 Ampere, Sutton-Horsley W/ext shunt. \$5.50

0-240 Ampere, Westinghouse AX-33 W/ext shunt. \$6.50

240-0-240 Ampere, General Electric W/ext shunt. \$6.50

0-300 Ampere, Westinghouse, E-1. 3/4" \$7.50

500-0-500 Microampere, General Electric, Zero center, unnumbered scale, Capston "Hot on site". \$3.95

30 Volt 60 Amp. G.E. W/ext shunt, AN Conn. type \$5.50

30 Volt 120 Amp. Westinghouse AX-33 W/ext shunt \$6.00

30 Volt 120 Amp. General Electric W/ext shunt, AN Conn. type \$5.50

30 Volt 240 Amp. Westinghouse AX-33 W/ext shunt \$7.50

**A.C. VOLTMETERS**

0-15 G.E. AW-41, 2" R-B bl sc, Signal Corps IS-122 \$2.50

0-15 G.E. AW-41, 2" R-B bl sc, 800 cycle, red mark at 10 Volt. \$3.00

0-15 G.E. AO-22, 3" R-B bl sc, MR35B015ACVV \$3.00

0-15 Weston 476, 3" R-B. \$4.50

0-15 W.H. NA-35, 2" R-B, MR25W015ACVV. \$3.95

0-40 Weston 517, 2" R-M 400 cycles. \$3.50

0-40 Weston 517, 2" R-M bl sc, Cal for 60 cycle \$3.95

0-40 W.H. NA-33, 2" R-B bl sc, Cal for 60 cycle \$3.95

0-40 W.H. NA-33, 2" R-B 400 cycles. \$3.50

0-75 Weston 517, 2" R-M ring mid. \$2.95

0-150 Weston 517, 2" R-B, MR24W150ACVV \$4.50

0-150 G.E. AO-25, 3" S-B. \$5.50

0-150 Triplett 332-JP, 3" R-M. \$4.00

0-150 Triplett 331-JP, 3" R-B. \$4.50

0-150 Triplett 331-JP, 3" R-B W/resistor for 300 volts \$5.50

0-300 Triplett 232-C, 2" R-M. \$6.00

0-300 Burlington 22A, 2" R-M. \$6.00

**A.C. AMMETERS**

0-10 G.E. AO-25, 3" S-B, expanded between 4 & 7 Amps. Scale calibrated 0-100 Amps for Direct Reading divide scale reading by 10. \$4.95

0-30 Triplett 331-JP, 3" R-M. \$4.00

0-30 Triplett 332-JP, 3" R-M. \$3.50

0-60/120 Burl 32XC, 3" R-B W/ext Transformer \$7.50

0-150 G.E. AO-22, 3" R-B, 5 Amp mvt, W/ext trans. \$7.50

**R.F. AMMETERS**

0-500 M.A. R.F. Weston 425, 3" R-B W/ext thermo-couple \$12.50

0-1 G.E. DW-44, 2" R-B bl sc. \$2.95

0-1 G.E. DW-44, 2" R-B. \$3.50

0-1 G.E. DO-44, 3" R-B. \$3.50

0-1 Weston 425, 3" R-B. \$11.00

0-1.5 G.E. DW-52, 2" R-M bl sc. \$2.95

0-1.5 Weston 425, 3" R-B. \$8.25

0-2 Simpson 135, 2" R-B. \$3.50

0-2 Weston 425, 3" R-B. \$8.50

0-2.5 McClintock MD300L, S.C. IS-111, 3" R-B \$7.50

0-2.5 Simpson 35, 3" R-B. \$4.95

0-2.5 Weston 425, 3" R-B. \$8.50

0-2.5 W.H. NT-35, 3" R-B. \$5.50

0-3 Weston 507, 2" R-B bl sc. \$3.95

0-3 Weston 425, 3" R-B W/Ext couple. \$9.50

0-3 W.H. NT-35, 3" R-B MR35W003RFAA. \$5.50

0-5 G.E. DO-44, 3" R-B. \$7.50

0-5 G.E. DO-44, 3" R-B W/Ext couple. \$8.50

0-6 G.E. DW-44, 2" R-B, bl sc. \$2.50

0-8 G.E. DW-44, 2" R-B, bl sc. \$2.95

0-8 Weston 425, 3" R-B. \$10.50

0-30 Triplett 0347-A, 3" S-B W/ext couple. \$8.00

**D.C. MICROAMMETERS**

0-100, Weston 506, 2" R-M, Bl. Sc. cal 300 Volts & 30 M.A. \$3.95

0-100, Weston 301, 3" S-B. \$14.50

0-200, Weston 301, 3" S-B. \$8.50

0-200, W.H. NX-35, 3" R-B MR35W200DCUA \$8.50

0-200, Superior 4" x 4 1/2" R-B. \$7.50

0-400, Triumph 4" x 4 1/2" R-B. \$5.50

0-400, Welch #3013, 1/2" Switchboard meter, R-M flush case with internal resistor and scale calibrated for 40 volts D.C. \$17.50

0-500 DeJaur Amisco 210, 2" R-B. \$3.00

0-500, Simpson 125, 2" R-B. \$3.50

0-500, Weston 506, 2" R-B Spec black scale calibrated 0-150% Luminous Numbers. \$4.00

**D.C. MILLIAMMETERS**

0-1 G.E. DW-41, 2" R-B se cal 140/500 Volts, M.A. \$3.00

0-1 G.E. DO-41, 3" R-B se cal 0-50 M.A. \$4.50

0-1 W.H. NX-35, 3" R-B MR35W010DCMA. \$7.50

0-2 W.H. NX-35, 3" R-B MR35W002DCMA. \$5.50

0-3 Gruen GW-550, 2" R-B, scale calibrated 30,450 & 3000. \$3.50

0-3 Simpson 126, 2" R-B MR25W003DCMA. \$3.95

0-5 Westinghouse IX-33, 2" S-B red mark for 3 Volts \$3.50

5-0-5 Western Electric 3" R-B concentric scale \$3.00

0-15 Simpson 26, 3" R-B MR35W15DCMA. \$4.95

0-20 G.E. DW-53, 2" R-B black scale. \$3.00

0-20 G.E. DO-53, 3" S-B. \$3.75

0-20 W.H. NX-35, 3" R-B MR35W020DCMA. \$4.95

0-30 G.E. DO-41, 3" R-B. \$3.50

0-50 G.E. DO-41, 3" R-B. \$4.00

0-80 G.E. DO-41, 3" R-B. \$3.75

0-150 Gruen 508, 2" R-B. \$3.00

0-200 Gruen GW-511, 2" R-B MR25W200DCMA \$3.00

0-200 G.E. DO-41, 3" R-B. \$4.50

0-200 Marion, 3" R-B. \$3.50

0-200 Simpson 26, 3" R-B MR35W200DCMA. \$4.95

0-200 Simpson 25, 3" R-B MR35W200DCMA. \$4.95

300-0-300 G.E. DO-40, 3" R-B, ring mid non-ranged case. \$3.00

0-500 W.H. NX-35, 3" R-B. \$3.95

0-500 DeJaur 312, 3" S-B. \$4.50

**D.C. AMMETERS**

0-5 Gruen 531, 2" R-B MR25W005DCAA. \$3.50

0-8 McClintock MD2001, 2" R-B, MR25W008DCAA \$3.50

0-10 G.E. DW-41, 2" R-B. \$3.95

0-10 Weston 301, 3" S-B. \$6.50

0-15 Sun AP-381, 3" R-B. \$3.50

0-15 Triplett 321-T, 3" R-B. \$4.00

0-15 Weston 301, 3" S-B. \$6.50

0-30 G.E. DW-51, 2" R-B. \$3.95

30-0-30 Beede, 2" R-M. \$2.95

30-0-30 G.E. DW-51, 2" R-M. \$3.50

30-0-30 U.S. Gauge (Automotive type) 2" R-M. \$1.25

0-40 Sun 3AP593, 3" R-B. \$4.95

0-50 Triplett 0221-T, 2" R-B, W/50 M.V. shunt. \$4.50

0-150 Simpson 125, 2" R-M with shunt. \$5.50

0-150 Triplett 221, 2" R-B 50 MV with ext shunt. \$5.50

0-200 Weston 506, 2" R-B with shunt. \$7.50

0-200 G.E. DO-41, 3" R-B, with ext shunt. \$9.50

200-0-200 Weston 506, 2" S-B W/Ext 50 M.V. shunt. \$7.50

0-300 G.E. DW-51, 2" R-B with shunt. \$7.50

0-500 G.E. DW-51, 2" R-B less shunt. \$3.50

**D.C. VOLTMETERS**

0-5 W.H. NX-35, 3" R-B 200 r/v. \$3.50

0-10 Sun 2AP458, 2" R-B 100 r/v. \$2.50

0-15 McClintock D-100-R-1, 2" R-B black scale 1000 r/v. \$3.00

0-30 DeJaur Amisco 210, 2" R-B. \$2.50

0-30 Triplett M102, 3" R-B, black sc W/pointer set A.C. type B-1. \$4.00

0-40 Sun 3AP597, 3" R-B, 100 r/v. \$4.95

0-150 G.E. DW-51, 2" R-M. \$6.00

0-150 Simpson 23, 3" R-M. \$6.00

0-150 Weston 301, 3" R-B surf mtd 200 r-v. \$4.50

**D.C. KILOVOLTMETERS**

0-1.5 G.E. DO-53, 3" S-B, 500 ua mvt, W/ext resistor. \$2.95

0-1.5 W.H. NX-35, 3" R-B W/ext resistor. \$7.50

0-2 G.E. DO-41, 3" R-B, 500 ua dc mvt, W/ext resistor. \$10.50

0-3 Weston 301, 3" S-B W/ext resistor. \$10.50

0-3.5 W.H. NX-35, 3" R-B, 1 MA W/ext resistor \$9.00

0-5 W.H. NX-35, 3" R-B, 1 MA mvt, W/ext resistor. \$11.00

0-7.5 Weston 301, 3" S-B, 1 MA mvt W/ext resistor. \$14.50

0-15 G.E. DO-53, 3" S-B, 500 uade mvt, less resistor. \$4.95

0-15 W.H. NX-35, 3" R-B 1 MA mvt, less resistor \$4.95

0-20 G.E. DO-41, 3" R-B, 500 uade mvt with ext resistor. \$34.50

0-20 G.E. DO-41, 3" R-B, 1 MA mvt W/ext resistor. \$19.50

0-20 W.H. NX-35, 3" R-B, 1 MA mvt W/ext resistor, Black scale. \$18.00

0-35 W.H. NX-35, 3" R-B, 1 MA mvt less resistor. \$4.95

**PORTABLE TACHOMETERS**

0-20,000 RPM Range Jaeger #43 A-6 Chromometric type. \$24.50

300-1200, 1000-4000, 3000-12000 RPM, Jones Motorola Co., Multiple Range, Continuous Indicating. \$24.50

300-1500, 1000-5000, 3000-15000 RPM, Jones Motorola Co., Multiple Range, Continuous Indicating. \$25.50

**CURRENT TRANSFORMER**, Weston 539, 2 1/2/10/20 Amps tapped and 50/100/200 Amps inserted primary. Secondary 1 Amp.  
List Price \$61.50 Your Cost Only \$26.50

**CURRENT TRANSFORMER**, Weston 461-4 5 Amp Secondary, Primary 50/100/200/250/500/1000 Amps, 15 V. A. Capacity.  
List Price \$98.00 Your Cost Only \$35.00

**POTENTIAL TRANSFORMER**, Weston 311 Potential ratio of 1500 & 750 to 150 volts, 15 V.A. Capacity.  
List Price \$247.50 Your Cost Only \$90.00

**SOCKET SELECTOR SET WESTON 666 TYPE 1C**

Designed for purpose of taking readings of currents, voltages and resistance and other electrical measurements in a vacuum tube circuit. It can be used with many Weston Analyzers or other make multirange volt-ohm-milliammeters. To test a tube circuit the tube is plugged into the appropriate adapter and the test plug inserted in the tube socket. This brings all currents and voltages out through a cable where they may be measured with an analyzer.  
Complete with Tube Base Data Connections and Chart, 15 Adapters, pin leads and test block.  
List Price \$30.00 Your Cost \$9.50

**GASOLINE HEATER MOTOROLA**

Model GN-3-24

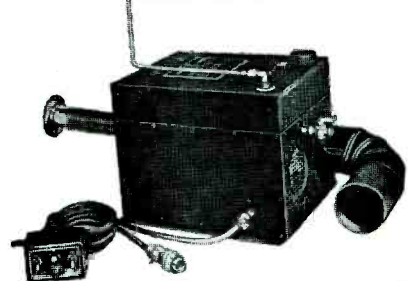

An internal combustion type heater which will give 15,000 B.T.U. of heat per hour. Ideally suited for use with equipment, farms, boats, bungalows, cabins, trailers, work sheds, darkrooms, mobile equipment, transmitter stations, etc., and any place where a quick heat is required in volume. Economical in operation—tank holds one gallon of gasoline which is sufficient for 6 hours operation. Uses any grade gasoline. This unit is designed primarily for aircraft installation, 24-28 volts d.c., but it can be readily adapted for a 115 or 230 volt 60 cycle power supply by use of a transformer and rectifier. Simple circuit diagram for adaption to 115 or 230 volt 60 cycle use supplied with each unit. Can be used on 32 volt farm or boat systems as is without the installation of additional transformers, etc. Power consumption approximately 75 to 100 watts. Takes very little space—can be readily stored when not in use—measures approximately 12" long x 9 1/2" high x 9 1/2" wide, weighs only 30 lbs complete with all accessories. These units are complete with exhaust pipe, 3" air duct elbow, control switch and cord, as illustrated, and are supplied with Technical Manual and Parts Catalog.

**SIMPLE TO INSTALL—SAFE TO USE—NO ODORS**  
**BRAND NEW—IN ORIGINAL CARTONS—READY TO USE**  
Made by Galvin (Motorola) Mfg. Company.

NET PRICE ..... **\$22.50**

**TESTED NEW PANEL METERS**

EACH METER TESTED BEFORE SHIPMENT. CALIBRATIONS ARE FOR NON-MAGNETIC PANELS. IF METERS ARE FOR USE ON MAGNETIC PANELS SPECIFY PANEL THICKNESS AND WE WILL CALIBRATE ACCORDINGLY AT NO EXTRA CHARGE. All meters have white scale and are flush mounted unless specified otherwise.

S—Square M—Metal so—scale  
R—Round r/v—Ohms per volt surf—scale  
B—Bakelite bl—Black mounted

**MARITIME SWITCHBOARD**  
**338 CANAL STREET**  
**NEW YORK, 13, N. Y.**  
Worth 4-8217



# RELIANCE SPECIALS

## POWER RHEOSTATS STANDARD BRANDS

25 WATT		25 WATT		90Ω 1/2"	
Resist. Shaft	1,500Ω	49¢	123	1/2"	59¢
10Ω	3,500	49¢	1,250	1/2"	79
15	5,000	S.D.*	2,000	1/2"	79
35			3,500	1/2"	59
145					
50 WATT		150 WATT			
with switch	2Ω	69¢	8Ω	1/2"	\$1.99
200	6	69	8	1/2"	1.99
250	8	S.D.*	12	1/2"	69
370	20	69	20	1/2"	69

RT-34/APS-13 (Tail-end radar) used. Complete with tubes & dynamotor.....\$9.95  
 RT-7/APN-1 (Altimeter) used. Complete with tubes.....\$7.95  
 TECH MANUAL BC 348, BC 610, BC 779 or SCR 522.....\$1.00 ea.

## SELSYN DIFFERENTIAL

115 V., 60 Cyc.  
#C78249  
\$2.25 ea.



Used between two #C78248's as dampener. Can be converted to a 3600 RPM Motor in 10 Minutes. Conversion sheet supplied.  
 Mounting Brackets—(Bakelite) for selsyns, and differentials shown above 25¢ pair

## PRECISION CONTROLS

6 WATT		4 WATT	
20,000Ω	Muter 314A \$1.70	500Ω	Centralab 48-501 \$9.00
20,000	GR 314A 2.50	50	De jur 292 .75
6,000	De jur 260 1.70	50	GR 301 1.10
6,000	Muter 314A 1.70	25	GR 301 1.10
5,000	Muter 314A 2.50	20	De jur 292 .75
5,000	GR 214A 1.40	12	GR 301 1.10
2,000	De jur 260 1.70		
25 WATT		12 WATT	
100K GΩ	433A \$4.95	10K	Muter 471A \$2.00
		10,000Ω	De jur 271T 2.00
		5,000	De jur 271T 2.00

O-15A  
BASIC  
MOVE  
12 Ma.  
5" x 4"  
METAL  
CASE  
MIRROR  
SCALE  
Lots of  
10—\$34



DC AMMETER  
CHOKE  
400 MA  
12 Hy.  
90 OHM  
6,000  
V. D. C.  
TEST  
\$3.85  
10 for \$34.00

## METERS

0-7.5 V.A.C. 3/4" Westinghouse.....\$3.29  
 0-15 V.A.C. 3/4" Westinghouse.....3.49  
 0-8 Amps. R.P. 3/4" Weston.....3.29  
 60-0-60 Amps. D.C. 2" Westinghouse.....1.19

## TOGGLE SWITCHES

Bat Handle, S.P.S.T. 6A, 125 V. Off-On plate.....20¢  
 Ball Handle, S.P.D.T. 6A, 125V.....24¢  
 Bat Handle D. P. S. T. 6A, 125V.....29¢  
 BRASS BINDING POST, Eby. screw down with 832 mounting screw.....Per 100 \$3.95

## ALLEN SET SCREWS

4-40 x 3/8 8-32 x 5/16 8-32 x 1/4  
 4-40 x 3/16 8-32 x 3/16 8-32 x 3/8  
 ALL SIZES (Cup Point).....\$1.50 per 100

HARDWARE ASSORTMENT (mostly brass)—screws, nuts, washers, rivets.....3 lbs., \$1.00  
 Gear Assortment.....\$6.50  
 Experimenters dream, 100 pieces, many stainless steel.  
 GYLPAT CEMENT 1 qt.....75¢. 1 gal.....\$2.50

## Wrapped—BALL BEARINGS—New

Mfg.	ID	OD	Width	Price
Fafnir 33K5	1/2"	5/32"	.25	.45
N.D. 38	5/16"	7/8"	9/32"	.45
Fafnir K8A	1/2"	1 1/8"	5/16"	.60
N.D. 5202C13M	1 1/2"	1 3/8"	1/8"	1.00
Fafnir 7308W	1 37/64"	3 9/16"	5/16"	2.00
SKF 466430	6"	4 7/8"	1"	5.00
SKF 170645	3 11/32"	4 7/8"	7/16"	1.50
Fafnir 545	2 1/16"	2 5/8"	15/32"	1.00

## NEEDLE BEARINGS

B108 1/2" wide 5/8" 13/16" 30¢  
 GB34X 1/4" wide 3/16" 11/32" 25¢

## SOUND POWERED HANDSET

Brand New! TS-10  
 Includes 6 ft. cord & spring clips \$8.92 ea. \$17.60 pr.  
 WALL HANGER—Navy type, for Sound Powered Phones.....\$1.00 each

## HAYDON TIMING MOTORS

2/3 R.P.M., 110V., 60 Cyc. Two motors connected on one shaft to make unit reversible. Only.....\$1.95  
 4 R.P.M., 115V., 60 Cycle.....\$1.79

## CAPACITORS

### POSTAGE STAMP MICAS

MMF	MMF	MMF	MMF	MMF	MFD	MFD
8.2	47	100	330	580	.0013	.0033
10	50	110	350	600	.00135	.0039
20	56	150	370	620	.00136	.0047
22	60	160	400	650	.0015	.005
24	62	220	470	680	.002	.0068
25	75	240	500	750	.0026	.0075
39	82	250	510	.001	.0027	.0082
40	90	300	560	.0012	.003	.01

### Price Schedule

8.2mmf to .001mfd 5¢ .0026mfd to .0082mfd 12¢  
 .012mfd to .002mfd 7¢ .01mfd .....18¢

## SILVER MICAS

MMF	MMF	MMF	MMF	MMF	MFD	MFD
10	66	180	330	510	.001	.0033
24	68	200	400	550	.0013	.0039
25	75	208	430	600	.0015	.004
30	100	240	468	680	.002	.0047
40	110	250	470	700	.0022	.005
47	120	300	488	800	.0024	.0051
60	125	300	500	.0027	.006	.0082
62	150	370	500	820	.003	.01

### Price Schedule

10mmf to .001mfd 10¢ .003mfd to .0082mfd 50¢  
 .0012mfd to .0027mfd 20¢ .01mfd .....65¢

Famous Makes	OIL FILLED	Brand New		
MFD V.D.C.	Price	MFD V.D.C.		
.1	25,000 \$15.95	.25	3,000 1.95	
.03	16,000 1.70	2	750 V.A.C. .39	
{.375@ 10,000 and	(2,200 V.D.C.)		.39	
1.75@ 8,000 (dual)	\$5.95	1	2,000 .95	
6	7,500	23.95	10	1,000 1.60
.1	7,500	1.55	4	1,000 .90
.1-1	7,000	1.55	3	1,000 .80
.1	7,000	\$1.50	2	1,000 .65
1	6,000	.90	1	800 .40
1	6,000	8.50	10	600 1.00
.01-03	6,000	1.45	4	600 .69
2	4,000	4.50	2	600 .39

## WW PRECISION RESISTORS, 1% OR BETTER

1/4 WATT—25c				
6.68Ω	12.32Ω	16.37Ω	123.8Ω	414.3Ω
10.48	13.02	20	147.5	705
10.84	13.62	62.54	220.4	2193
11.25	13.89	79.81	301.8	10,000
11.74	14.98	105.8	368.6	69,148

### 1/2 WATT—25c

.250Ω	13.15Ω	235Ω	4,000Ω	14,825Ω
.334	46	260	4,451	15,000
.502	55	270	5,000	15,750
.557	55.1	298.3	5,900	17,000
.627	75	400	6,500	30,000
.76	97.8	723.1	7,000	100,000
1.01	125	2,500	7,500	150,000
1.53	180	2,850	8,000	
2.04	210	3,427	8,500	
11.1				

### 1 WATT—30c

1.01Ω	5.21Ω	1,250Ω	9,000Ω	55,000Ω
2.58	10.1	3,300	18,000	55,000
3.39	10.9	7,000	50,000	70,000
5.05	270			

### 1 WATT—40c

100,000Ω	128,000Ω	180,000Ω	522,000Ω
120,000	130,000	320,000	600,000
125,000	160,000	470,000	700,000

1 Megohm—1 Watt 1%—65c; 5%—40c  
 100 pieces—10% off; 1,000 pieces—20% off.

**UNIVERSAL JOINT**  
 3/16" hole x 3/8" O.D.  
 1 1/8" long  
 Steel or Aluminum  
 50¢

**FILAMENT TRANSFORMER**  
 Amertran Type WS  
 For High Voltage Rectifiers.  
 PRI. 115V., 50/60 Cycles.  
 SEC. 5V., C/T @ 10 Amp.  
 35 KV R.M.S. Test 12 KV D.C.  
 Operating. Uses 872A Tube  
 (See our tube list).  
**NEW OVERSEAS PACKED \$10.95**

## RANGE UNIT

From AN/APS-15. Contains 11 Utah X-124-T2 (9262) Pulse Transformers, 12 Prec. Resistors, 23 V.D.C. Blower, metal cabinet and other useful parts.....SPECIAL \$10.95

## RG 8/U 52 OHM

\$50.00 per 1,000 feet

### OTHER COAXIAL CABLE

RG 7/U	97 OHM	per 1,000 ft.	\$60.00
RG 9/U	51 OHM	per 1,000 ft.	125.00
RG 22/U	95 OHM (2 cond.)	per 1,000 ft.	100.00
RG 58/U	53 OHM	per 1,000 ft.	50.00
RG 39/U	73 OHM	per 1,000 ft.	40.00
RG 62/U	93 OHM	per 1,000 ft.	50.00

## COAXIAL CABLE CONNECTORS

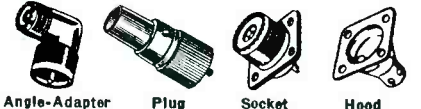

Angle-Adapter	Plug	Socket	Hood
M-359	PL-259A	SO-239	H-31
83-1AP	83-1SPN	83-1R	83-1H

Adapter for PL-259 A for use on small coax.  
 12¢ each.....\$10.00 for 100

83-1SP	\$.28	UG 13/U	.60	UG 60/U	.60
83-1J	.80	UG 21/U	.60	UG 61/U	.60
83-1T	1.12	UG 22/U	.60	UG 85/U	.60
83-1F	1.12	UG 24/U	.60	UG 87/U	.50
83-22AP	.85	UG 25/U	.60	UG 167/U	2.00
83-22J	.85	UG 27/U	.60	UG 281/U	.60
83-2J	1.50	UG 59/U	.60		

## CARBON RESISTOR ASSORTMENT

Color coded, insulated.....100 only \$1.19

## PULSE TRANSFORMERS

X 124 T2, UTAH, marked 9262 or 9280, small gray case 1 1/2" high x 1 1/2" x 5/8" with two 6-32 mtg. studs. Ratio 1:1:1, hypsiler core \$1.50  
**D161310**, 50 Kc to 4 Mc, 1/4" dia. x 1 1/2" high, 120 to 2350 ohms.....\$1.50  
**352-7178**—Spec. 10, 111 Chicago Trans., equivalent to 9262 (above).....\$1.00  
**TR 1018** Dinion Coil Co.....\$.95  
**TR 1019** Dinion Coil Co.....\$1.25  
**352-7250-2A**, cased 16/16" dia. x 1 1/2" high, DC 10 ohm, 3 1/2 ohm, 140 cy. to 175 KC.....\$1.25  
**352-7251-2A**, similar—shorter pulses.....\$1.25  
**K89800**, Ratio, 1:1:1, 2:1, Freq. range 380 to 520 C.P.S.....\$3.50  
**D106173**, W. E. Freq. response 10KC to 2 MC \$9.80  
**300 KVA GE 7557296**, 50 ohm pulse cable connection; 3,850 V. in., 17,300 V. out (250 KVA @ 1/2 microsecond).....\$13.75  
**800 KVA G.E. K2731**, 28000 Volt pk. output; Bifilar, pulse width; one-microsecond.....\$14.50

### Delay Network—All 1400Ω

T 113—Approx. 1.2 micro sec. delay.....85¢  
 T 114—Approx. 2.2 micro sec. delay.....85¢  
 T 115—Similar to T 114 with tap brought out.....85¢

## TIME DELAY RELAY

Raytheon CFX 24166 KS 10193-60 Sec.

- 115 V., 60 Cycle
  - Adj. 50-70 Seconds
  - 2 1/2 seconds recycling time.
  - Spring return
  - Micro Switch Contact, 10A
  - Holds On as long as power is applied. Fully Cased
- ONLY \$6.50

## JONES BARRIER STRIPS

Type	Price	Type	Price	Type	Price
2-140Y	\$ .05	5-141	\$ .20	10-141W	\$ .52
3-140W	.13	5-141W	.27	17-141Y	.87
4-140	.13	5-141Y	.25	2-142W	.15
8-140	.23	6-141	.23	3-142	.15
10-140W	.40	6-141W	.37	5-142	.21
13-140	.37	7-141	.27	6-142	.28
3-141W	.17	8-141W	.42	11-142W	.57
4-141W	.22	9-141W	.47	2-150	.28
4-141Y	.22	9-141Y	.42	4-150	.52

Telephone Field Wire—W110B, 1/2 mile reels.....\$7.95

## ALUMINUM TUBING—12 Foot Lengths

Size	Price	Size	Price
3/4"	\$1.00	1 1/2"	\$3.00
1 1/4"	2.10	3"	6.00
1 1/2"	2.50		

## 3AG FUSES

3AG	Price	FUSES	3AG
1/2 Amp	\$4.00 per 100	2 Amp	\$2.50 per 100
3/4	4.00	3	2.50
1	4.00	4	2.75
1 1/4	2.50	10	3.00
1 1/2	2.50	15	3.00

Fuseholder—Littlefuse—for 4AG fuse.....20¢

## TUBE SPECIAL—New—Guaranteed

# RADIO-ELECTRONIC Components by the Thousands!

## 6 OUTSTANDING VALUES FROM WELLS' FAMOUS STOCK

### B-L Auto Radio Filterpac and Battery Eliminator

Replaces storage battery for auto radio test bench or for sales demonstration. Supplies 10 amps D.C. continuous or 15 amps D.C. intermittent at 6 volts. Long life B-L Selenium Rectifier. Brand new. 115 V. A. C. Save on our low price of only \$32.50.

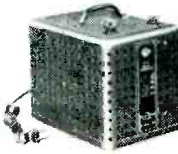

### Heavy Duty Blower

Centrifugal type blower for cooling your transmitter or dark room. Adjustable air control. Capacity 100 CFM. 115 VAC. Price only \$12.95.  
Junior Centrifugal Blower with 25 CFM capacity — \$6.95.

### S Meter

Add an S meter to your receiver at low cost. High grade 5 mil movement. 2 inch barrel. Only \$1.25.

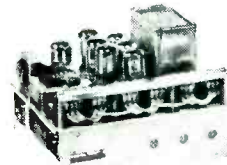

### Servo Amplifier

Beautiful 7 tube amplifier complete with 6 relays for servo system operation. Parts alone worth several times our low price. New in original packing — only \$11.95.

### Fractional H. P. Motor

Perfectly built, silent running motor originally built for ART/13 tuner. 3900 RPM. 1/20 HP. Instructions for operating on 115 VAC. Makes a fine sewing machine motor. Priced very low at \$7.95.



### Circuit Breaker

25 Ampere circuit breaker protects your equipment in case of overload. Ideal for replacing household fuse boxes. Price only \$1.95.



## WELLS

## TUBE DEPARTMENT

Brand new, standard make tubes by the thousands are ready for immediate delivery at the lowest prices in our history. Check this list for exceptional values.

TYPE	PRICE EACH	TYPE	PRICE EACH	TYPE	PRICE EACH	TYPE	PRICE EACH
0A4G	\$.095	6B4G	.95	28D7	.40	7144Y	3.90
01A	.45	6B7	.80	30	.75	7151B	9.75
1A5GT	.65	6B8	.95	30 (VT-67) Walkie	.75	717A	.85
1B22	4.35	6B6	.65	33 (VT-33) Talkie	.75	721A	3.75
1B23	7.50	6C4	.40	34	.45	753AB	14.95
1B42	5.25	6C6	.70	RK-34	.65	724A	4.25
1C5GT	.65	6C21	19.25	35Y4	.40	725A	4.25
1D8GT	.95	6D6	.60	36	.40	726A	9.95
1E7GT	1.95	6E5	.70	37	.40	730A	17.45
1E7G	1.95	6F8	.80	38	.40	801	10.95
1G0	.65	6G0G	.45	39/44	.35	801A	.50
1H4	.75	6H6	.45	45 Spec	.50	803	.70
1LC6	.75	6J5	.45	46	.75	804	5.25
1N5GT	.75	6J5GT	.45	EF50/VT250	.45	804	9.95
1N21 (Crystal Diode)	.65	6J6	.90	56	.65	805	5.95
1N21A (Crystal Diode)	.95	6J7	.70	70L7	1.05	807	1.25
1N21B (Crystal Diode)	.95	6J7GT	.72	72	1.75	808	1.65
1N22 (Crystal Diode)	.80	6J8G	.95	RKK-73	1.25	811	2.35
1N23 (Crystal Diode)	.80	6K9GT	.55	76	.55	813	7.85
1N23A (Crystal Diode)	.85	6L7	.75	77	\$0.55	814	3.75
1N27 (Crystal Diode)	.85	6N7	.75	VR-75	.65	815	2.85
1N29 (Crystal Diode)	.85	6R7G	.75	80	.65	826	.75
1Q5GT	.85	6S47	\$0.65	FG-81A	.85	826B	4.95
1R4/1294	.65	6S7GT	.70	83V	3.95	830B	3.95
1R5	.70	6S7	.65	83Y	.40	834	5.75
1F4	.75	6S7	.65	VR-90	.65	837	1.65
2A3	1.05	6SH7	.40	VR-92	.65	838	\$ 3.25
2A7	.85	6S17GT	.60	100R	2.75	841	.50
2B7	.75	6SK7GT	.60	FG-105	9.75	843	.50
2B22/GL559	3.75	6SL7GT	.60	VR-105	.85	851	39.00
2C22/7193	.35	6SN7GT	.80	VU-111-S	.55	860	2.40
2C26	.35	6SQ7GT	.60	1148	1.20	861	29.25
2C26A	.45	6SR7	.60	11723	.55	864	.45
2C34	.55	6SS7	.60	VT-127 British	.35	865	2.55
2J21A	11.45	6U7G	.85	VT-127-A (Triode)	2.95	866A	1.30
2J22	9.85	6V6GT	.75	VR-150	.50	869	19.95
2J26	8.45	6Y6G	.75	VT-158	14.95	869B	27.25
2J27	12.95	7-7-11 Ballast	.35	FG-172	19.75	872A	2.45
2J31	9.95	7A4	.60	205B	1.45	874	1.95
2J32	14.85	7A7	.60	211 (VT4C)	.60	878	1.95
2J33	18.95	7B4	.60	215A	1.75	930 Photo Tube	1.00
2J34	17.50	7C4/1203A	.40	221A	2.10	954	.45
2J37	13.85	7E6	.60	231D	1.20	955	.55
2J38	6.95	7F7	.70	268A	2.95	956	.50
2J48	12.95	7H7	.70	304TH	5.75	957	.45
2J61	27.50	7K7	.70	304LH	1.75	959	.55
2Y3G	1.20	7L7	.70	307A	4.25	991 (NE-16)	.30
2X2/879	.65	7N7	.70	316A	.75	1005	.35
3A4	.35	7Q7	.60	350B	\$ 2.55	1148	.35
3B22	2.65	10	.45	354C	14.95	1201	.75
3B24	1.75	10T1 Ballast	.50	371A	9.95	1203A/7C4	1.05
3B31	3.75	10Y	.45	371B	.85	1616	1.25
3C24/24G	.50	12A6	.25	388A	.95	1619	.45
3D6/1299	.65	12A6GT	.25	393A	4.65	1624	1.25
3E29	4.95	12AH7GT	1.10	395A	4.95	1625	.45
3F7	2.95	1208	.50	MX408U	.40	1626	.45
3FP7A	4.95	12J5GT	.65	417A	14.50	1629	.40
3GP1	4.50	12H6	.40	434A	3.40	1630	3.95
3HP7	2.95	12J5GT	.40	446A	1.55	1638	.90
3Q5	.90	12J7GT	.70	450TH	17.95	1641/RK-60	.75
3S4	.75	12K8	.65	471A	2.55	2051	.75
RPL-5	14.95	12S7	.70	527	9.95	1193	.30
5AP1	3.95	12S7GT	.65	530	9.95	8011	2.25
5B1P	2.75	12SH7	.60	531	12.95	*012	3.25
5B3P	3.95	12SK7	.60	532A/1H32	3.55	8020	3.25
5CP1	3.75	12SL7GT	.60	GL-559	3.75	8025	6.75
5D21	24.75	12SQ7GT	.60	KU-610	7.45	9001	.65
5FP7	3.25	12SR7	.60	1Y-615	1.05	7002	.45
5GP1	4.95	12X825-2-amp.	.70	700B	7.95	9003	.60
5HP4	4.75	Tungar	2.10	700C	7.95	9004	.40
5J23	13.45	13-4 Ballast	.35	700D	7.95	9006	.40
5J29	13.45	14B6	.75	702A	2.95	3811A	.45
5H4GY	.95	15B	1.20	703A	3.95		
6-4	.35	REL-21	2.75	704A	1.75		
6-7	.95	23D4 Ballast	.45	705A	2.65		
6A3	.75	RK24	1.75	707A	17.50	NEON BULBS	
6A6	.95	24A	.75	707B	19.50	NE-11	\$0.24
6A7	.90	25Z6GT	.55	708A	\$ 4.95	NE-16	.24
6AC7	.80	26	.65	710A	2.45	NE-20	.06
6AK5	.80	27	.50	713A	1.55	NE-21	.24
6AK6	.80					NE-48	.24

## JUST OUT! CATALOG H500

Manufacturers, Distributors and Amateurs write for the brand new Wells Electronic Catalog H500. Full of tremendous values in highest quality components.

Distributors: Our standard distributor arrangement applies on these items.

**WELLS**  
SALES, INC.

Order directly from this ad or through your local Parts Jobber.

320 N. LA SALLE ST., DEPT. SL, CHICAGO 10, ILL.



**Finest of Surplus PEAK ELECTRONICS CO. Fraction of Cost**



**HIGH CURRENT PLATE TRANSFORMER**

820 Volts CT at 775 MA. Pri. 110/220 Volts 60 Cycles. Wt. 36 lbs. Fully Cased.....\$5.95

**HIGH VOLTAGE VACUUM CONDENSERS**

50 MMF 32 Kilovolts.....5.50 ea.

**WESTON 0-200 MICROAMETER**

3" Square Bakelite Case, Model 301.....8.75 ea.

**MIDGET VARIABLE CONDENSERS**

Steatite Insulation

15 MMF (HF 15).....39  
Dual 15 MMF (HF 15 D).....69  
250 MMF (MC 250 S).....69  
325 MMF.....79

**U. H. F. COAX. CONNECTORS**

831AP-UG12U, UG-14U-831, R831SP.....35 ea.

Precision 15 Meg. 1% Accuracy Resistor, Non-inductive, 1 watt, hermetically sealed in glass .25 ea. 10 for.....\$1.90

Thermal Time Delay Relay. 15 to 30 seconds, plus into 4 Prong Tube Socket Glass Enclosed. 250 V.....95 ea.

Mallory Vibronack Kit. 6 Volt Input. Output 300 Volts at 100 MA. Transformer & Vibrator. \$5.95 for both

**30 WATT WIRE WOUND RESISTORS**

Ohms: 100-150-1500-2500-3k-4k-4500-5k-5300-10k-15k-18k.....15 ea. 8 for.....99

**ADJUSTABLE RESISTORS**

20 Watt: 1, 5, 50 Ohms.....25  
50 Watt: 80, 100, 500 Ohms.....35  
75 Watt: 40, 80, 100, 150, 200 Ohms.....39  
100 Watt: 20, 50, 75, 120, 180 Ohms.....49  
150 Watt: 50, 100 Ohms.....59

**WIRE WOUND RESISTORS**

5 Watt type AA, 20-25-50-200-470-2500-4000 ohms.....\$0.9 ea.  
10 watt type AB, 25-40-84-400-470-1325-1000-2000-4000 ohms.....15 ea.  
20 watt type DG, 50-70-100-150-300-750-1000-1500-2500-2700-5000-7500-10000-16000-20000-30000 ohms.....20 ea.

**SCOPE AND FIL. TRANSFORMER**

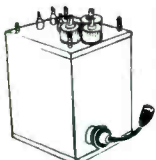

Pri. 115 volts, 60 cycles. Sec. 4400 volts RMS 4.5 MA., 5 volts CT 3 amps., Fil. Ins. 15 KV RMS test. Hermetically sealed. Has insulated plate cap for rectifier. Made by Raytheon. 4 1/2 x 5 x 5 1/2.....Only \$4.95

5 for 22.50

**SCOPE TRANSFORMERS**

Pri 110V 60CY — Hermetically Sealed  
2500 V @ 12MA.....\$2.95  
1050V @ 20MA, 20V 4.5A, 2.5V 5A.....4.75



50 megohm 35 watt Resistor with mount.....\$1.49 each; 10 for \$9.90  
10 Meg 10 Watts......49; 2 Meg 5 Watt.....35

UTC type PA 5000 ohm plate to 500 ohm line and 6 ohm voice coil. 10 watts. 60 to 10,000 cps.....DB. GREAT VALUE.....ea. \$2.75

**MISCELLANEOUS BARGAINS**

.02 400 volt dc tubulars.....15 for .99  
G.E. 2mfd 250 volts ac oil cond.....6 for .99  
10 ohm 10 watt resistor.....2 for .99  
Heineman 6 amp 110 volt ac ckt breaker.....99  
Heineman 25 amp 110 volt ac ckt breaker.....1.19  
Ceramiccon .0005 mfd.....20 for .99  
.01 600 volt dc pigtail mica.....10 for .99  
.001 600 volt dc pigtail mica.....15 for .99  
.006 600 volt pigtail mica.....12 for .99  
Butterfly cond. 2 to 11 mmf ball brngs.....3 for .99  
CD type 4 mica .001 600Vdc.....19 for .99  
25 mmf variable cond (mc250s).....6 for .99  
CRL 10,000 ohm potentiometers.....5 for .99  
Trim "Commercial" headphones.....3.75 ea.  
CD 16 mfd 450 volt electrolytic (EB9160).....3 for .99  
Hammarlund cond. 150 mmf .07 spacing.....2 for .99  
Variable ceramiccon 20 to 125mmf type 823 5 fer .99  
Western Electric silver variable .5 to 2.5 mmf 8 fer .99  
G.E. weatherproof switch DPDT 20amp 120vac .99 ea.  
CRL steatite switch 3 section—2 pole 5 positions per section, model 2524 centralab.....2 for .99



**MOSSMAN SWITCHES**

4 Pole Single Throw.....1.10  
3 PDT. plus 6 PST.....1.75



**MINIATURE HEADPHONES**

250 ohms Imp. Can be used for sound power Telephones, etc.  
Type HS 30......69 ea.  
10 For.....4.99  
HI Imp Transf. for above....45

**GENERAL PURPOSE TRANSFORMERS**

Ideal for Bias, Filament, Isolation, Steppdown, etc.  
2 isolated 110V Pri. Sec. 110V at 900 ma plus 6.3 @ 2 amps. Fully cased.....Now \$1.49 ea.

**1% PRECISION RESISTORS W. W.**

2000-2500-5000-8500-10,000 ohms.....ea.25  
50000-95000 ohms.....ea.29  
10000-750000-1 meg.....ea.69

GENERAL ELECTRIC SELENIUM RECTIFIER  
32 Volts Input. 28 Volts Output at 2 Amps. Full Wave 3.75

**WESTINGHOUSE**

**OVERCURRENT RELAY**

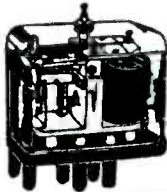

Type MN Overcurrent Relay. Adjustable from 250 ma. to 1 amp. External Push Button Reset. Enclosed in glass case. Hand calibrated adjustments, only \$5.95

GENERAL ELECTRIC Type PBC Instantaneous Overcurrent Relay. Adjustable from 100 to 200 MA. Electrical and Manual Reset, 4 PDT. Reset 110 Volts 60 Cycles.....7.95

General Electric Overload Relay. Electrical Reset 110 Volts 60 Cycle adjustable for other currents. Breaks at 640 Milliamps but easily rific value at only.....2.95



10 for 25.00



**ADVANCE D.P.D.T. ANTENNA RELAY**

110 V. 60 cycle coil Steatite Insulation. Only \$1.95 each.

DUNCO RELAY, 6 Volt 60 Cycle AC Coil DPDT Ceramic Insulation.....1.95

**ALLEN BRADLEY SOLENOID**



115 Volt 60 Cycle Coil D.P.S.T. 25 Amp Contacts. Model 702.....3.75

**FILAMENT TRANSFORMERS**

110 V 60 Cy Pri. Fully Cased.....\$2.75  
5 Volt 15 Amp.....3.49  
2.5 Volt 10 Amp.....4.75  
2.5 Volt CT 21 Amp.....1.89  
6.3 Volt 10 Amp.....4.95  
5 1/2 V CT 21A, 7.5V 6A, 7.5V 6A.....2.45  
5 Volt 4A, 6.3V, 3A.....6.95  
2.5V CT 20A, 2.5V CT 20A.....

**CHOKE BARGAINS**

6 Henry 50 ma 300 ohms.....3 for \$9.99  
6 Henry 80 ma 220 ohms.....2 for .99  
8 Henry 160 ma 140 ohms......99  
1.5 Henry 250 ma 72 ohms......59  
6 Henry 300 ma 65 ohms.....3.75  
Swing 1.6/12 Henry 1 Amp/100 ma 15 ohm.....19.95

**W. W. POWER RHEOSTATS**

150 Ohms 50 Watt......59  
250 Ohms 50 Watt......59  
300 Ohms 50 Watt......59  
Dual 200 Ohms 50 Watt......79



**STANDARD BRAND RHEOSTATS**

25 Ohms, 675 Watts Max, with Knob and Hardware.... 3.95  
10 for 29.50

**PANEL METERS—BRAND NEW**

2" WESTON 0-1 Ma DC 26 ohms res.....\$3.50  
2" G.E. 0-1 Ma DC (volt scale).....2.95  
2" G.E. 0-5 Ma DC (amp scale).....1.95  
2" G.E. 0-30 Volts DC 1000 ohm/v.....2.50  
2" G.E. 0-30 Amps DC.....2.45  
2" GE 0-1 Amp RF (Internal Thermo).....2.45  
3" WESTINGHOUSE 0-2 Ma DC.....3.95  
3" WESTERN ELECTRIC 0-80 Ma DC.....2.95  
3" DEJUR 0-100 Ma DC.....2.95  
3" GE 0-200 Ma DC.....3.95  
3" WESTON 0-50 Amps AC.....4.95  
3" TRIPLETT 75 Amps AC.....2.95  
3" WESTINGHOUSE 0-20 Ma DC.....3.95  
2" TRIPLETT 0-300 VAC.....2.95

**MEGOHM METER**

Industrial Instruments model L2AU 110/220 volts 60 cycle input. Direct reading from 0-100000 megohms on 4" meter can be extended to 500000 megohms with external supply. Sloping hardwood Cabinet 15"x8"x10". Brand new with tubes plus running spare parts including extra tubes. Great value. Only \$49.50.

**PLUG IN CAPACITOR**

8 x 8 Mfd 600 volts DC. Oil filled. Plugs into standard 4 prong socket. 3/4 h x 3 1/8 w x 1 7/8 d.....\$1.39



**Heavy Duty Tap Switch. Ohmrite Model 412**

Single Pole 6 Positions. Non-Shorting. 50 amp. contacts. Vitreous Enamel base.....Only \$2.95

WESTERN ELECTRIC TRANSTAT INPUT 115 V. 60 CY. OUTPUT, 0-130 V 10 AMP MAX. 1.3 KVA. SPECIAL EA.....\$15.75

**BAKELITE CASED MICA**

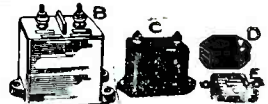

MMF	VDC	Price	MMF	VDC	Price
D .001	600	\$.18	D .005	3 KV	\$.70
E .01	600	.26	C .005	3 KV	1.24
D .02	680	.26	C .006	3 KV	1.50
E .027	680	.26	D .002	3 KV	.70
C .01	1 KV	.45	C .0001	5 KV	.70
C .056	1 KV	.50	C .0015	5 KV	.85
C .07	1 KV	.55	C .0015	5 KV	1.90
D .02	1200	.35	C .0015	5 KV	2.50
C .024	1500	.65	C .002	5 KV	2.90
C .033	1500	.75	C .005	5 KV	3.50
C .015	2 KV	.68	B .007	5 KV	2.75
C .02	2 KV	.90	B .003	6 KV	3.75
D .002	2500	.45	B .006	6 KV	4.25
E .005	2500	.55	B .005	8 KV	2.90
C .025	2600	1.25	B .0012	8 KV	3.25
C .001	3 KV	.90	B .003	8 KV	4.75
C .002	3 KV	.95	B .004	8 KV	5.59

**HIGH CURRENT MICAS**



Type G4 Ceramic Case 5 3/4" High, 5" Diameter Tolerance 5% or Better

CAP	Amps	Amps	KV	Price
MFD	1 Mc	300 Kc	DC	Each
.08	60	42	4	\$30.50
.1	70	50	4	32.50
.05	60	42	5	27.50
.037	45	35	6	32.50
.02	40	30	9	29.50
.02	55	38	10	34.50
.0117	40	27	14	27.50
.0075	39	27	15	27.50
.009	40	25	15	32.50
.00978	40	25	15	32.50
.01	43	28	15	34.50
.0025	23	15	20	32.50
.00315	26	18	20	33.50
.004	30	20	22	36.50
.0033	25	16	25	38.50
.00082	14	8	30	30.50
.001	16	10	30	31.50
.00132	20	12	30	32.50
.00153	21	13	30	33.50

**TYPE G3 4" High 5" DIAMETER**

.0013	15	9	15	19.50
.0024			6	4.95

**OIL CONDENSERS**

20	mfd	330 vac	1.85	8	mfd	2000 vdc	5.95
5	mfd	150 vac	.49	10	mfd	2000 vdc	6.95
1	mfd	600 vdc	.29	2	mfd	4000 vdc	4.95
2	mfd	600 vdc	.39	1	mfd	6000 vdc	4.50
4	mfd	600 vdc	.59	1/1	mfd	7000 vdc	2.25
4	mfd	600 vdc	.79	1	mfd	7500 vdc	1.95
3/3	mfd	600 vdc	.79	1	mfd	7500 vdc	9.25
10	mfd	600 vdc	.89	.01/.01	mfd	12 kv	
20	mfd	600 vdc	1.99				dc=5.75
4	mfd	1000 vdc	.95	.005/.01	mfd	12 kv	
4	mfd	1000 vdc	1.19				dc=5.50
2	mfd	1500 vdc	1.25	.65	mfd	12,500 vdc	
4	mfd	1500 vdc	2.25				dc=12.95
6	mfd	1500 vdc	2.95	.75/.35	mfd	18kv	7.95
1	mfd	2000 vdc	1.45	2	mfd	18 kv	dc=39.55
2	mfd	2000 vdc	2.25	1	mfd	18 kv	dc=15.95

Tremendous stocks on hand. Please send requests for quotes. Special quantity discounts. Price f.o.b. N. Y. 20% with order unless rated, balance C. O. D. Minimum order \$5.00.

**PEAK ELECTRONICS CO. Phone CO 7-6486**  
**188 Washington St., New York 7, N. Y. DEPARTMENT EA**

EQUIPMENT SALE		New	Used
BC-733D Receiver.....		\$8.95	\$3.95
R89/ARN5 Receiver.....		8.95	3.95
APN1 Transceiver.....		9.95	4.95
SCR-618 Altimeter, complete	29.50		

Sigma Sens. Relay SPDT.....	\$1.69
200W Power Supply Kit.....	16.95
Tuning Unit TU-25.....	1.95
3" Scope Shield.....	1.49

## TUBES!! BRAND NEW! STANDARD BRANDS! NO SECONDS! COMPARE! TUBES!!

A 3/VR75	\$.89	3DP1	\$.175	388A	\$.149	878	1.98	FG32	\$.495	1E7G	\$.115	6AQ6	\$.59	6V6	\$.89	11F8	\$.79
OB3/VR90	.65	3E29	8.97	393A	3.69	884	1.34	FG81A	3.69	1E7G	.55	6AR5	.52	6V6GT	.57	14H7	.57
OC3/VR05	.75	3F17	1.75	394A	3.69	885	1.34	FG95	1.75	1H5GT	.54	6AT6	.44	6W6	.63	14J7	.57
OD3/VR150	.48	3GP1	6.45	417A	6.95	902P1	3.69	FG105	9.75	1H6GT	.87	6AU6	.59	6W6GT	.77	14N7	.83
1B21	2.87	4-65A	14.49	434A	2.95	905	2.95	FG172	13.95	1J6	.75	6AV6	.47	6X4	.57	14Q7	.57
1B22	2.87	4-125A	27.45	450TH	17.95	918	1.49	FT210	13.95	1J4	.48	6B4G	.89	6X5GT	.47	14R7	.69
1B23	8.75	4-250A	37.45	450TLL	44.50	919	1.95	GL146	9.95	1LA4	.79	6BG6	.79	6Y6G	.67	19	.69
1B24	4.69	4AP10	4.75	527	5.95	923	.97	GL451	97	1LA6	.89	6B7	.87	6C7G	.98	24A	.43
1B36	3.95	4B24	2.95	559	.98	927	1.25	GL567	85.00	1L4	.89	6B8G	.69	6Z5V	.55	25L6GT	.54
1B29	3.49	4C35	19.38	575A	12.69	930	.85	GL697	69.50	1LC5	.69	6BA6	.55	7A4/XNL	.49	25Z5	.43
1B32	2.49	4E27	13.95	631P1	3.75	931A	2.49	HY115	.75	1LC6	.69	6BE6	.52	7A6	.59	25Z6GT	.49
1B36	4.49	5AP1	2.95	703A	2.49	954	.24	HY615	.25	1LD5	.79	6BF6	.57	7A7	.53	26	.42
1B38	36.50	5AP4	3.95	706CY	18.75	955	.24	HYE1148	.33	1LE3	.69	6BG6G	1.47	7AG7	.72	27	.45
1N21	.49	5BP1	7.89	706PX	47.50	956	.24	K4	49.50	1L5	.79	6BH6	.59	7B4	.53	28D7	.37
1N21A	.89	5BP4	2.39	707B	18.95	958A	.24	KU610	9.75	1L4	.79	6B6	.57	7B5	.67	30	.39
1N21B	.89	5CP1	1.69	708A	3.95	959	.37	ML101	79.50	1LN5	.59	6C4	1.19	7B6	.56	31	.55
1N23	.79	5CP7	9.95	710A/8011	.85	991	.24	ML501	69.50	1N5GT	.67	6C5	.47	7B7	.59	32	.89
1N23A	.79	5C27/227A	2.69	713A	.69	1603	2.85	ML502	89.50	1Q5GT	.67	6C6	.57	7C7	.34	32L7GT	.89
1N23B	1.95	5D21	2.47	714A Y	3.69	1611	.97	REL21	1.59	1R4	.59	6C8G	.69	7C5	.48	33	.67
1N27	.79	5E27	1.35	715B	.69	1613	.49	RE136	.59	1R5	.49	6D6	.44	7C7	.59	34	.37
1N34	.79	5GP1	1.75	717C	19.95	1614	1.39	RK23	4.85	1S4	.59	6D8G	.79	7E5	.67	35/51	.53
1P24	.79	5JP1	24.95	717A	.59	1616	.75	RK25	4.19	1S5	.49	6E5	.49	7E7	.62	35B5	.65
1AP1	3.89	5JP2	9.95	721A	2.69	1619	.19	RK33	.27	1T4	.53	6F6	.57	7F7	.59	35C5	.59
2C21	.27	5JP4	24.95	723A/B	7.75	1624	.89	RK31	.27	1T5GT	.69	6FGT	.57	7H7	.59	35L6	.52
2C22/7193	.17	5J29	12.95	724A/B	2.95	1625	.35	RK59	1.95	1U4	.59	6F7	.69	7K7	.89	35W4	.39
2C26A	.25	5J3C	39.50	725A	6.95	1626	.27	RK60	.89	2A3	.87	6G6	.87	7L7	.69	35Y4	.47
2C34	.27	5J4	13.95	726A	4.95	1630	.98	RK	24.50	2A4	.87	6G8G	.69	7M7	.54	35Z5	.49
2C40	3.49	5NP1	1.98	726B	22.95	1630	.98	Rk 2	.69	2A5G	1.07	6H6	.39	7Q7	.59	35Z1	.49
2C43	8.75	6AS6	4.95	726C	49.50	1631	1.19	RK 3	.79	2A6	.69	6H6GT	.37	7R7	.69	35Z5	.49
2C44	.59	6C21	19.69	730A	.95	1632	.69	RX21	3.19	2A6	.79	6J5	.47	7V7	.87	36	.65
2C46	6.95	6F4	5.59	750TLL	47.50	1633	.79	RX120	7.95	2A7G	.79	6J5GT	.39	7W7	.79	37	.37
2C51	5.95	6J4	4.69	800	1.49	1636	3.69	S836	.89	2X2	.37	6J6	.67	7X7	.79	38	.37
2E22	1.19	9GP7	9.95	802A	.29	1638	.65	TZ40	2.95	2X2	.37	6K5	.67	7Y4	.47	39/44	.49
2E26	3.39	9JP1	6.95	803	3.49	1960	.89	VT78	.29	2X2A	.65	6K5GT	.65	7Z4	.57	41	.79
2J21A	7.95	9LP1	19.95	804	3.95	2050	.89	VT127A	2.19	3A4	.34	6K5GT	.79	12A	.57	42	.49
2J22	7.45	9LP7	2.25	805	3.59	2051	.39	VT158	9.75	3A5	.49	6K6GT	.44	12A6	.17	43	.49
2J26	7.95	10P4	19.69	807	1.10	8005	4.75	VL468	6.95	3A5	1.59	6K7	.79	12A7	.89	45	.52
2J27	12.95	10P5	8.08	808	1.25	8011	4.75	VL468	6.95	3B4/1201	.29	6K8	.79	12ASGT	.49	45Z3	.57
2J31	8.95	12DP7	14.95	809	2.75	8012A	1.39	WL530	14.95	3FL4	.79	6L6	1.05	12AT6	.44	46	.62
2J32	12.75	12GP7	12.75	810	7.95	8013A	1.39	WL531	7.95	3Q4	.47	6L6G	.99	12AT7	.79	47	.69
2J33	18.95	12HP7	13.95	811	2.10	8014A	22.50	WL532	1.98	3Q5GT	.67	6L6GA	.85	12AU6	.57	49	.85
2J34	18.95	15E1	1.19	812	2.49	8016	1.15	WL538	2.25	3S4	.57	6L7	.79	12AU7	.67	50	1.39
2J37	12.95	15P1	6.90	812H	6.90	8020	.97	WL578	.89	3S4	.57	6L7G	.79	12AV6	.54	50A5	.69
2J38	12.95	23D7	.39	813	6.85	8025	4.95	WL616	87.50	5R4GY	1.09	6L7G	.75	12B6	.67	50B5	.53
2J39	29.50	30 Spec	.17	814	2.49	9001	.29	WL619	18.95	5T4	.87	6Q7	.64	12BE6	.49	50AGT	.49
2J40	49.50	45 Spec	.26	815	1.35	9002	.29	OA2	1.29	5U4G	.49	6R7	.79	12C8	.34	50Y6	.57
2J46	39.50	75TL	3.89	816	.97	9003	.33	OA3G	.89	5V4G	.87	6S7G	.79	12F5GT	.58	53	.87
2J48	12.95	100R	.97	826	.39	9004	.25	OB2	1.67	5V4G	.67	6S8GT	.77	12H6	.27	56	.45
2J49	22.50	100TH	10.87	828	12.59	9005	.24	.89	1.67	5V4G	.57	6S8T	.44	12J5GT	.34	57	.45
2J50	22.50	100TS	2.25	830B	7.45	9006	.39	OA1A	.39	5Y3GT	.39	6T6GT	.59	12J7GT	.67	58	.49
2J53	14.95	211	.42	830B	3.19	C5B/5C30	6.95	IA3	.44	5Z4	.49	6D7GT	.44	12K7GT	.52	59	.89
2J54	22.50	217C	9.95	832A	4.89	C6A	7.95	IA4	1.09	5Z3	.52	6SF5	.49	12K8	.59	70L7	.99
2J55	69.50	249B	2.49	833A	34.45	C6J/5C21	3.95	IA4P	.97	5Z4	.77	6S7	.59	12Q7	.49	71A	.59
2J56	34.50	249C	1.79	836A	.97	C100D	.98	IA5GT	.49	6A3	.79	6SG7	.59	12SA7	.57	75	.53
2J62	34.50	250R	7.45	837	1.69	CK507AX	.95	IA6	.79	6A4LA	1.09	6SH7	.37	12SC7	.54	76	.44
2K25	18.75	250H	18.95	838	2.45	CK1005	.99	IA7GT	.67	6A6	.67	6SH7	.47	12SP5	.59	77	.43
2K28	14.95	250TLL	18.75	841	.35	CK1006	.65	IA85	.59	6A7	.79	6SK7GT	.44	12ST7	.54	78	.49
2AP1	4.59	274A	5.50	843	.29	CK1006	.65	IB3/8016	1.15	6A8	.75	6SL7GT	.59	12S7G	.52	80	.37
2B22	2.49	274B	3.49	845	3.95	CK1090	2.95	IB4	1.19	6AB7	.79	6SN6GT	.97	12SH7	.35	81	.125
2B24	1.59	294A	2.95	851	13.95	ET150	.39	IB5/258	.89	6AC7	.74	6SN7GT	.54	12SJ7	.47	82	.84
2B25	4.87	304H	3.75	860	9.95	F123A	12.75	IC5GT	.89	6AG7	1.09	6S8GT	.45	12SK7	.57	83	.75
2B26	1.79	304TL	1.35	861	9.53	F125A	14.95	IC7G	.89	6AF6G	.59	6S8T	.52	12SL7	.59	83V	.89
2B27	1.95	305A	24.95	864	.39	F127A	16.50	IC7G	.89	6AG5	.69	6S7	.49	12SN7	.52	86/6Z4	.56
2B31	2.49	307A	3.75	865	.89	F128A	75.00	1D5GP	.97	6AG7	.79	6S7	.72	12SQ7	.49	85	.69
2C23	2.47	316A	.25	866A	1.05	F128A	75.00	1D7G	.89	6AH6	1.29	6SU7GTY	1.25	12SR7	.49	89Y	.35
2C24/24G	.37	327A	2.75	866JR	.98	F606	22.50	1D8GT	.95	6A15	.79	6SV7	.79	12Z3	.69	117L7/M7	1.19
2C30	.37	350A	1.99	869B	24.95	F660	125.00	1F4	.75	6AK5	.85	6T7G	.89	14A4	.79	117N7	1.19
2C31/C1B	1.95	350B	1.89	872A	1.19	F862A	395.00	1F5G	.75	6AK6	.79	6U5G	.69	14A7	.52	117P7	1.19
2C45	12.95	368AS	2.98	874	.39	FG17	2.85	1G4GT	.69	6AL5	.59	6UG6GT	.63	14B6	.67	117Z3	.49
2CP1	.95	371A	.69	876	.29	FG27A	8.95	1G6GT	.65	6AQ5	.59	6U7G	.49	14F7	.69	117Z6	.65
2D21A	1.29	371B	.69														

OIL CONDENSERS—DC RATINGS					
3x.1 mfd	600v	\$.49	15 mfd	2000v	\$4.95
.25 mfd	600v	.37	1 mfd	2500v	1.45
1 mfd	600v	.37	.25 mfd	2500v	1.77
2 mfd	600v	.37	.5 mfd	2500v	1.98
2x2 mfd	600v	.37	.2 mfd	2500v	2.89
4 mfd	600v	.77	.01 mfd	3000v	1.49
4 mfd	600v	.77	.05 mfd	3000v	1.75
6 mfd	600v	1.07	.1 mfd</		



**LINEAR SAWTOOTH POTENTIOMETER**  
No. KS 15138

Has continuous resistance winding to which 24 volts D.C. is fed to two fixed taps 180° apart. Two rotating brushes 180° apart take off linear sawtooth wave voltage at output. Size approximately 3 1/4" dia. x 3" deep x 4 3/4" long. Enclosed in die cast alum. frame with AN connector socket.

**\$5.75**  
Brand New



**FULL WAVE BRIDGE TYPE SELENIUM RECTIFIER**

Input up to 36V A.C.  
Output up to 28V D.C. at 1.1 amps.

8 plates 2 1/2" diameter  
Fed. Tel. & Tel. Co. Brand New **\$2.75**

**MICROWAVE RECEIVERS**

Types APR1, APR4, APR5A (38 to 6000 MCs)

Also Tuning Units in stock  
TN1, TN2, TN3, TN16, TN17, TN18  
Prices on request

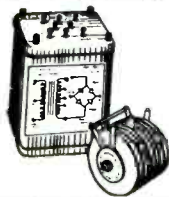

**12 and 24 Volt POWER KIT**

Consists of Power Trans. and full wave bridge selenium rectifier. Input: 115/230 A.C. Output: 12/24V D.C. at 1.1 amps. Fine for operating relays, small motors dynamotors, or for low voltage D.C. source in laboratories, etc.

Brand New **\$7.95**



**Filament Transformers**  
For type 866 tubes

Input: 115 volts. Output: 2.5 volts center tapped, at 10 amps. Glazed porcelain standoff insulated for high voltage breakdown. Mfgd. by Kenyon.

Brand New **\$3.95**

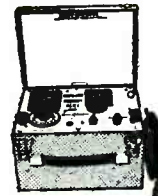

**Micro-Wave Lavoie Freq. Meter**  
375 to 725 MCS

Model TS-127/U is a compact, self-contained, battery powered, precision (± 1 MC) frequency meter which provides quick accurate readings. Requires a standard 1.5V "A" and 45V "B" battery. Has 0-5 MIN. time switch. Contains sturdily constructed HI-"Q" resonator with average "Q" of 3000 working directly into detector tube. Uses 957, LS6 and 3S4 Tubes. Complete, new with inst. book, probe and spare kit of tubes. Less batteries **\$69.50**

Full data on request.



**MP22 Mast Base Insulator**

Ideal for marine, mobile vertical whip antennas. Complete, new with mounting plate and hardware. **\$2.75**

3CM Antenna Horn For receiving or transmitting Type AT-48/UP with coax recept. Brand new **\$4.75**



**LINE FILTER**  
Elimostat 20 amp. 115 volts A.C. or 600 D.C.  
Brand new **\$1.75**

**PILOT LAMP**  
Aircraft "grain of wheat" 3V Mazda G.E. 323  
Brand New **\$1.06 ea.**

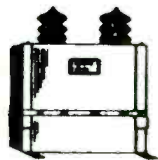

**High Voltage Capacitors**  
Oil Filled

.25 MFD., 20KV. **\$15.75**  
35 lbs. 15 MFD., 25KV. **\$23.50**  
35 lbs. 1 MFD., 15KV. **\$16.50**  
15 lbs. 1 MFD., 7.5KV. **\$5.95**  
All brand new. Made by prominent manufacturers

**BROADCAST EQUIPMENT**

Limiter Amplifiers, type BC730C. Rack Mounting with dust covers. Milliammeter and D.B. meter on front panel. Brand new with tubes. **\$89.50**  
Attenuator Panel, R.C.A. Type 89-C. Model MI-7515-E. Brand new. **\$149.50**

**MODEL AN/APA 10 PANORAMIC ADAPTER**

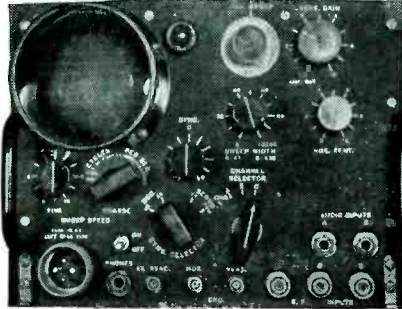

Provides 4 Types of Presentation:

- (1) Panoramic (2) Aural
- (3) Oscillographic (4) Oscilloscopic

Designed for use with receiving equipment AN/ARR-7, AN/ARR-5, AN/APR-1, SCR-587 or any receiver with I.F. of 455kc, 5.2mc, or 80mc. With 21 tubes including 3" scope tube. Converted for operation on 115 V. 60 cycle source. Includes 80 page T. M. **\$195.00**

**LINE VOLTAGE STABILIZERS**

Raytheon—Navy Type. CRP-301407 Input: 92-138V. 57/63 CPS. 1 PH. Output: 115V. 0.82 KVA., 1% Reg., 0.96 PF. Weight 250 lbs. Enclosed in Navy Grey Ventilated Cabinet for Wall Mounting. Brand New **\$97.50**  
Raytheon—Spec. No. W 5768 Input: 95-130V., 1.25A., 60 CPS., 1 PH. Output: 115V., 60 watts., Load P.F. 90%. Brand New **\$12.50**



**THERMOSTATIC TIME DELAY RELAY**

Amperite type 115 No.—45 Heater voltage 115V. Normally open SPST contacts. 45 sec. delay. Contact rating 115V-3A., A.C. (or 440V. A.C. 2A) max. voltage on contacts—1000. max. voltage bet. contacts and heater—1500. Size 3 9/32 x 1 1/4" overall. Made for U. S. Navy. **\$1.10**



**AUTO TRANSFORMER**

G.E. 400 cy. Cat. No. 80G184 K.V.A. .945S—520P Volts 460/345/230/115 New **\$4.50**



**FILAMENT TRANS.**

400/2600 cy.  
Input: 0/75/80/85/105/115/125V Output: 5V3A, 5V3A, 5V3A, 5V3A, 5V6A, 5V6A, 6.3V5A, 6.3V5A **\$3.95**

**THYRATRON POWER TRANS.**

Raytheon UX8876. 400/1600 cy. PRI: 115V. 1 PH. Sec: 50-0-50V at 0.5A. 6.3V 1.2A Test RMS1780 **\$2.75**

**Pulse, Input Trigger Inverting**

Westinghouse #145 EWP Fosterized. **\$4.95**

**PULSE**

Utah No. 9350. **\$1.25**

**BLOCKING, OSC.**

Westinghouse #132 AWP Fosterized **\$4.95**



**Synchro Differential**

90/90 volts, 400 cycles. Brand new in sealed containers. Ford Inst. type 5SDG. Brand new. **\$12.50**

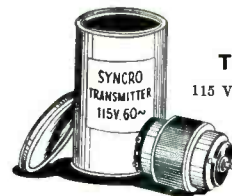

**SYNCHRO TRANSMITTERS**

115 Volt—60 cycle. Brand new in sealed metal containers. No. C78248. Size 5. Brand New. Per Pair **\$14.75**

**MERCURY CONTACT VACUUM RELAYS**  
WE Type D-168479

Glass sealed, mercury-wetted contact switches surrounded by operating coils encased in metal housings on octal tube base. S.P.D.T. contacts. 2 coils, 700 and 3300 ohms. Operating current coils seriesed 6.6 MA releasing at 5.2MA. Operating life 1000 hrs. at 60 operations per sec. Use for: High speed keying • tabulating • sorting and computing machines • Relay amplifiers • Vibrator supplies • Servo Mechanisms, etc.



Send for 4 page technical data

**\$4.75 ea.**  
Brand New

**SWEEP GENERATOR CAPACITOR**

High speed ball bearings. Split stator silver plated coaxial type, 5-10 mmfd. Brand new **\$1.00**



**CRYSTAL DIODE**

Sylvania 1N21B. Individually boxed and packed in leaded foil. Brand new **\$1.00**



**RELAY**

Clear octal base Relay No. 30PMX 115V. 60 cy. 0.140 amp. Res. 75 ohms. Makes two breaks out.



Brand new

**\$1.95**

**SHOCK MOUNTINGS**

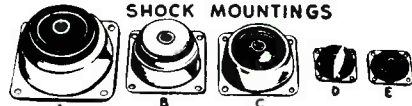

Lord -20. 3" x 3" x 1 3/4" **.30**  
U. S. Rubber #5150 C. 2 3/8" x 2 3/8" x 1 1/8" **.20**  
Lord 15. 2 3/8" x 2 3/8" x 1 1/8" **.20**  
Lord #3. 1 1/4" x 1 1/4" x 3/8" **.10**  
Lord #10. 1 1/4" x 1 1/4" x 3/8" **.10**



**High Voltage Terminal Strips**

6 Terminal with bakelite barriers **.10 ea.**  
5" x 1" x 1" high overall. Insulated for 5000 volts. May be cut shorter.

**50 AMP. FUSETRONS**

Bus type FRN 50

For 250 volts or less



**15 ea.**

**U. S. NAVY SOUND POWERED BATTLE PHONES**

Western Electric No. D173312. Type O. Combination headset and chest microphone as illustrated. Brand new including 20 ft. of rubber covered cable. **\$19.50**



Automatic Elec. Co. No. GL843-AO. Similar to above but including Throat microphone in addition to chest microphone. Brand new with 20 ft. rubber covered cable **\$19.50**

**PARABOLOIDS**

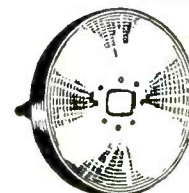

17 1/2" diameter, spun magnesium dishes, 4 inches deep. Reinforced perimeter. Two sets of mounting brackets on rear. Opening at apex for waveguide dipole assembly 1 1/2 x 1 3/8".

Brand new, per pair, **\$8.75**

**400 CYCLE INVERTERS**

Bendix Pioneer type 12121-A. Input: 24 volts D.C. at 18 amps. 12,000 RPM. Output: 115 volts. 400 cy., 3 PH., 250V.A. Weight: 10.6 lbs. Brand new. **\$129.50**  
Bendix Pioneer type 12117-2-B. Input: 24 volts D.C. at 1 amp. Output: 26 volts, 400 cy., 6VA., 1 Ph. Weight: 2.1 lbs. **\$17.50**  
General Electric type 5D21NJ3A. Input: 24 volts D.C. Output: 115V., 400 cy. at 485V.A. Brand new. **\$12.50**

All prices indicated are F O B Tuckahoe, New York. Shipments will be made via Railway Express unless other instructions issued.

**ELECTRONICRAFT**

INC.

5 WAVERLY PLACE TUCKAHOE 7, N. Y.  
PHONE: TUCKAHOE 3-0044

All merchandise guaranteed. Immediate delivery, subject to prior sale.

All Prices Subject to Change Without Notice

# SELENIUM RECTIFIERS

and

## ELECTRONIC COMPONENTS

### THREE PHASE FULL WAVE BRIDGE RECTIFIERS

Input Type	Current	Output 0-250*VDC Price
3B13-1	1 AMP.	\$22.00
3B13-2	2 AMP.	\$22.00
3B13-4	4 AMP.	\$6.00
3B13-6	6 AMP.	\$1.50
3B13-10	10 AMP.	105.00
3B13-15	15 AMP.	120.00

### CENTER TAPPED RECTIFIERS SINGLE PHASE FULL WAVE

Input Type #	Current	Output 0-8*VDC Price
C1-10	10 AMP.	\$6.95
C1-20	20 AMP.	10.95
C1-30	30 AMP.	14.95
C1-40	40 AMP.	17.95
C1-50	50 AMP.	20.95

### RECTIFIER MOUNTING BRACKETS

For Types B1 through B6, and Type C1..... \$ .35 per set  
 For Types B13..... .70 per set  
 For Types 3B..... 1.05 per set

### SINGLE PHASE FULL WAVE BRIDGE RECTIFIERS

Input Type #	Current	Output 0-12*VDC Price
B-250	250 MA.	\$ .98
B1-500	500 MA.	1.95
B1-1	1 AMP.	2.49
B1-1X5	1.5 AMP.	2.95
B1-3X5	3.5 AMP.	4.50
B1-5	5 AMP.	5.95
B1-10	10 AMP.	9.95
B1-20	20 AMP.	15.95
B1-30	30 AMP.	24.95
B1-40	40 AMP.	27.95
B1-50	50 AMP.	32.95

Input Type	Current	Output 0-26*VDC Price
B2-150	150 MA.	\$ .98
B2-250	250 MA.	1.25
B2-300	300 MA.	1.50
B2-2	2 AMP.	4.95
B2-3X5	3.5 AMP.	6.95
B2-5	5 AMP.	9.95
B2-10	10 AMP.	15.95
B2-20	20 AMP.	27.95
B2-30	30 AMP.	36.95
B2-40	40 AMP.	44.95

Input Type #	Current	Output 0-90*VDC Price
B6-250	250 MA.	\$2.95
B6-600	600 MA.	5.95
B6-750	750 MA.	6.95
B6-1X5	1.5 AMP.	10.95
B6-3X5	3.5 AMP.	18.95
B6-5	5 AMP.	24.95
B6-10	10 AMP.	36.95
B6-15	15 AMP.	54.95

### CUSTOM DC POWER SUPPLIES

Built to your specifications  
 We will be pleased to quote on your requirements. Kindly send for our specification form.

### RECTIFIER CAPACITORS

Type	Value	Voltage	Price
CF-14	3000 MFD	12VDC	\$1.69
CF-15	6000 MFD	12VDC	2.95
CF-1	1000 MFD	15VDC	.98
CF-2	2000 MFD	15VDC	1.69
CF-20	2500 MFD	15VDC	1.95
CF-3	1000 MFD	25VDC	1.25
CF-4	2X3500 MFD	25VDC	3.45
CF-5	1500 MFD	30VDC	2.49
CF-6	4000 MFD	30VDC	3.25
CF-7	3000 MFD	35VDC	3.25
CF-8	100 MFD	35VDC	.98
CF-19	500 MFD	50VDC	1.95
CF-16	2000 MFD	50VDC	3.25
CF-21	1200 MFD	90VDC	3.25
CF-9	200 MFD	150VDC	1.69
CF-10	500 MFD	200VDC	3.25
CF-12	125 MFD	350VDC	2.49

Mounting clamps for above capacitors... 15c each

### RECTIFIER TRANSFORMERS

All Primaries 115 VAC 50/60 Cycles

Type #	Volts	Amps	Shpg. Wt.	Price
XF15-12	15	12	7 lbs	\$3.95
TXF36-2	36	2	6	3.95
TXF36-5	36	5	8	4.95
TXF36-10	36	10	12	7.95
TXF36-15	36	15	20	11.95
TXF36-20	36	20	30	17.95
XFC18-14	18 VCT	14	10	5.95

All TXF Types are Tapped to Deliver 32, 34, 36 Volts. XFC type is tapped to deliver 16, 17, 18 Volts Center-Tapped.

### RECTIFIER CHOKES

Type No.	Ht.	Amps.	D.C. Res.	Price
HY5	.028	5	25	\$3.25
HY5A	.028	5	20	3.95
HY10	.02	10	30	9.95
HY10A	.014	10	04	7.95
HY15	.015	15	30	13.95
HY20A	.007	20	02	12.95

Type "A" low resistance chokes are specially suited to circuits requiring excellent voltage regulation.

ADDITIONAL SELENIUM RECTIFIER TYPES AND GENERAL INFORMATION MAY BE FOUND IN OUR CATALOG No. 719

### VACUUM CAPACITORS

Standard Brands	Value	Voltage	Price
	12 Mmfd.	2Kv	\$4.95
	50 Mmfd.	2c Kv	4.95
	50 Mmfd.	32Kv	5.95

### EDISON THERMO TIME DELAY RELAY

Heater voltage 115 V. Normal open SPST contacts, 15-30 sec. delay. Contact rating 115 V. 3A., 440 V. 2A. Size 3 3/4" x 1 1/2" diam. Standard 4 prong tube base..... **98c ea.**

### OIL CONDENSERS

.5 Mfd 400VDC telephone type.....	.20
2X.1 Mfd 600VDC Bath tub.....	.39
6 Mfd 600VDC w/mitg. Clamp.....	.79
8 Mfd 660VAC/2000VDC w/Brkts.....	3.50
15-16 Mfd 8000VDC Voltage Doubler Type 26F381 w/Brkts.....	3.95

### KLIXON 40 SECOND DELAY SWITCH

Heater operates on 115 VAC or DC. Contacts DPST—rated at 30 A., 115V. or 20 A. 220 V. plus auxiliary contacts for lighter loads. Each..... **\$2.49**

### PILOT LIGHT ASSEMBLIES

Aircraft type, pane mounting, amber jewel only. Knurled rim controls "Dim-Bright." Bakelite and aluminum construction. Bulb replaceable from front panel. For single contact bayonet bulbs. T-3 3/4 or G-3 3/4 size. Dimensions: 2 1/4" overall length, 1 1/4" diameter, 5/8" panel mtg. hole.  
**IMMEDIATE DELIVERY — 500**  
 to carton, nested, \$50.00 per carton. Prices on larger quantities on request.

### G-R VARIAC

Type 100-R 2 KVA. Input: 110 or 220 V.A.C. 60 CPS., Output: 0-250 or 0-270 Volts. Brand new—limited quantity. Shpg. Wt. 36 lbs..... **\$39.50**

### ATTENTION!!!

Bulletin #713, listing various government and commercial surplus items, is now available upon request.

### DC POWER SUPPLY

Limited quantity — Gov't Surplus Ready to operate. Full wave bridge copper-oxide rectifier, heavy duty multi-tapped transformer. Input: 85/95/105/115 VAC 50/60cps Output: 2.5/24/28/32/36 VDC at 5 amperes, unfiltered For wall or bench mounting. Overall dimen. 9" x 8 1/4" x 8 1/2" high. Shpg. wt. 30 lbs. Tested and guaranteed... **\$36.00**  
 Filter Kit, 2% ripple..... **6.65**

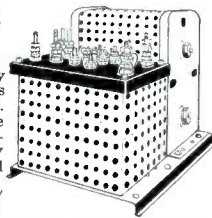

### DIEHL MOTOR

Fan duty, brushless induction type (no TV interference). For 115 VAC 60 cycles 48 watts, 1800 RPM. Shaft 3/4" diam 1 1/2" long Noiseless ball-bearings—heavy cast construction. Brand new..... **\$1.50**

### RECTIFIER KIT #612-10

6 and 12 VDC at 10 Amps This unit will deliver unfiltered direct current for operation of motors, dynamos, solenoids, electroplating, battery charging and similar equipment. The two output voltages may be used simultaneously, and varied above and below their nominal ranges. Complete with schematic diagrams and instructions. shpg. wt., 12 lbs. **\$15.95**

### Filter Kits For #612-10

1 Section choke input, 10% ripple... **\$9.64**  
 2 Section choke input, 2% ripple... **19.28**

### D-C PANEL METERS

Attractive, rugged, and reasonably priced. Moving vane solenoid type with accuracy within 5%.  
 0-5 Amperes D-C Any range  
 0-12 Amperes D-C **\$2.49 each**  
 0-15 Volts D-C

Minimum order \$3.00. No C.O.D.'s. Add 10% for Prepaid Parcel Post and Handling. Terms: Net 10 days in the presence of approved credit.  
 All prices subject to change without notice. Prices and Delivery F.O.B. our NYC Warehouse. All merchandise subject to prior sale.

### WESTERN ELECTRIC BLOWER

#K5881 — Brand New — Heavy Duty Sirocco type blower, capacitor start, 1/40 H.P. 3400 RPM 115 VAC 60 cycles. Displaces 84 C.F.M. Extremely quiet operation. Opening 2 1/2". Overall size 7 1/2" long, 6" diam. Moisture and fungus resistant. With capacitor. Shpg. Wt. 15 lbs. Quantity limited. **\$13.95**

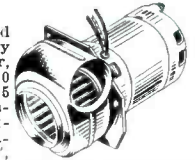

### DIEHL BLOWER

Sirocco type, displaces 115 VAC 60 cps. Moisture and fungus resistant. Flange diameter 4". Overall size 7 1/2" x 6 1/2". Removed from equipment. Tested and guaranteed **\$9.95**



Adjustable right angle aluminum extension tube to fit flange..... **\$1.98**

### WESTINGHOUSE AIRCRAFT MOTOR

Brand new—24 VDC or AC, reversible on both. 1/50 H.P. 4800 RPM continuous duty. Length of leads 18". Dimensions 3 1/4" x 2 1/4" shaft 1/4" diam. by 5/8" long. Price..... **\$2.95**  
 Reversing switch with "off" position. Each..... **70c**



# OPAD-GREEN COMPANY

71 Warren St.  
 New York 7, N. Y.

Phone: BEekman 3-7385-6

**DONT DELAY!**



**ORDER  
from  
ARROW!**

**BC-605 INTERPHONE  
AMPLIFIER**

Easily converted to an ideal inter communications set for office — home — or factory.  
Original — New..... **\$4.95**  
Like New (With schematic)..... **3.95**



All necessary parts and instructions to convert the above to AC operation with one remote station.  
\$.25 additional.

**COMMAND (SCR 274 N)  
EQUIPMENT**

	Used	New
BC-453	\$12.95	
BC-454	4.95	\$6.95
BC-455	7.95	
BC-456	1.95	2.95
BC-457	5.95	
BC-458	5.95	7.95
BC-459 (or T22)	9.95	
BC-696 (or T19)	11.95	24.95
ARC5 Transm. 2.1-3MC.	9.95	
BC-450—3 Receiver Remote Control	.89	1.95
BC-442		2.95
3 Receiver Rack	1.95	
2 Transmitter Rack	1.50	
Complete Command set as removed from aircraft—3 receivers—2 transmitters—Relay unit—control boxes—mounting racks—plugs—modulator and dynamotors—crated. Set		<b>\$34.50</b>

**MIKES—HEADSETS**

HS-23 Hi Imp.	New	\$2.95
HS-33 Lo Imp.	New	2.95
HIS-30 Hi Imp.	New	1.50
	Used	.79
T-17D Carbon Mike	New	2.75
T-24 Hi Imp. Carbon Mike	New	1.19
T-30 Throat Mike	New	.98
T-45 (or Navy) Lip Mike	New	.98
CD-307 Extension Cord for Headsets	New	.59
RS-38—Navy hand Mike Carbon		2.75

**BEAM INDICATORS**

I 82—5"	New	\$4.95
Transmitter selsyn for above	both for	2.45
	both for	7.00
I 81—3"	New	3.45
Transmitter Selsyn for above	both for	2.45
	both for	5.25
I 81	Used	2.45

**HERMETICALLY SEALED  
CHOKES**

10 H. 100 MA.	.59c
59 H. 100 MA.	.95c
3.7 H. 145 MA.	.59c
10 H. 20 MA.	.39c

**PP 12A/APS-3 RECTIFIER  
POWER SUPPLY**

110 VAC—800 to 2400 CPS input. Used to supply many voltages for APS 3 equipment. Contains four VR105; Three 5U4G; 2x2; 6AC7; 6Y6-G; VR 150; 6X5GT-G condensers, chokes, etc. Parts alone worth more than **\$6.95**

**BC 620**

Receiver-Transmitter—2 crystal channels—20 to 27.8 MC FM—13 tubes. Metered. Plate and Filament **New \$14.95**  
Used **9.95**  
PE 97 Power Supply for above 6-12 volt vibrator type  
used—complete **\$6.95**  
used less tubes, vib. & cond. **\$2.95**  
PT 250 Mount for both BC 620 and PE 97 **New \$1.50**

**BC 223**

Brand new Transmitter with all three tuning units, two tuning unit cases, spare tube carrying case, shock mount and brace; but less tubes at new low price of **\$19.95**  
Tuning units are available separately at **\$2.50 ea.**  
Cases at **\$.95 ea.**  
PE 125-12 volt vibrator Pack, new, **\$12.95**  
used **\$ 8.95**

**MISCELLANEOUS SPECIALS**

	Used	New
BC929 Scope	\$12.95	\$17.95
ID6/APN4 Scope. Excellent	29.50	
ID57/APQ7 Scope	9.95	
ID2/APS — 5PPT Assembly		6.95
R7/APS2 Receiver-Indicator		79.50
R78/APS-15 Receiver-Indicator	34.50	
BC1287A Scope	75.00	
ASB 7 Indicator Scope	12.95	
ARB Receiver 200 to 9000 KC	19.95	
SCR 522 Transceiver 100—to 150MC	34.95	75.00
BC1206 Receiver 200 to 400 KC.	3.95	5.95
NM126C or Y Receiver	17.50	24.95
RA 101A Receiver	17.50	24.95
T85/APT5 Transmitter		69.50
T39/APQ9 Transmitter	7.95	
T26/APT2 Transmitter	8.95	
BC 457 Transmitter—as is—fair condition—as they come, some with some less tubes and Xtal	1.95	
BC 458 Transmitter—as is—fair condition—as they come, some with some less tubes and Xtal	1.95	
R89 Receiver chassis less tubes and side covers.	1.95	
RT7/APN Transceiver	7.95	9.95
APN1 Complete	34.50	
BD71 6 Pos. Switchboard	9.95	12.95
EE8 Field Phones	7.95	
BC347 Interphone Amplifier	.95	
I-70 Tuning Meter	.89	9.50
AM 61 Indicator Amplifier	39.50	
SCR 625 Mine Detector	12.95	
PE 237 Power Supply	.59	
BC 461 Veeder Root Counter	1.49	
BC 442 Less Condenser	1.50	
BC 306 Antenna TU for BC 375	1.50	
A 27 Phantom Antenna	.98	
APS 13 UHF Antenna Pair	1.00	
Manual for BC 312 & 342 J.	2.50	
Manual for SCR 269 G.	3.95	
FL8 Filter	35.00	
BC 939 Loading unit for BC 610	2.95	3.95
I-97 Bias Meter	7.95	9.95
RM 20 Remote Telephone control.		.98
BC 602 Control Box		
BC 639 Receiver with RA 42 Rectifier		
ITA 1B Transceiver		
TA2124 Transmitter and MP10G Power Pack		
SCR 269 Compass installation		
R5/ARN7 Compass installation		
MN26 Compass installation		
I.L. Installation (R5-BC733)		
SCR38 Components		
AN, APR4 Receiver and tuning units		

Information and prices on request

**SURPRISE PACKAGE 20 lbs.**  
Ass't radio parts. A \$25.00 value for only **\$1.95**

**RECEIVER**

**Easily Converted for Use in  
Citizens Band**

Crystal Controlled Local Oscillator. Broad Band Pass—20.7 MC I.F.'s. Complete with 7—6AJ5, 1—12SR7, 2—12SN7, 1—28D7, relays, crystals. Schematic furnished. **\$7.95**  
Used

**NEW CATALOG**

listing many surplus values, write for your **FREE** copy TODAY.

All shipments FOB Chicago. 20% Deposit required on all orders. Minimum order accepted —\$5.00. Illinois residents, please add regular sales tax to your remittance.

**ARROW SALES, Inc.**

Dept. ES.  
1712-14 S. Michigan Ave., Chicago 16, Ill.  
PHONE: HARRISON 7-9374

**BC-604 TRANSMITTER  
FM 20-28 MC**

11 and 15 meters. Can be operated on 10 meters—10 channel push button crystal. With all tubes and meter but less dynamotor. Excellent Condition **\$12.95**  
Crystals—Set of 80..... **14.95**

**TUBES**

**Nationally Advertised Brands—  
All Brand New**

Type	Net Price	Type	Net Price	Type	Net Price
1A4P	\$0.49	6L5G	\$0.49	39/44	\$0.24
1A6	.49	6L7G	.49	49	.39
1B5 25S	.49	6L7G	.39	50	.59
1B22	2.95	6SF5GT	.39	56	.29
1B26	1.95	6S8GT	.59	57	.29
1B29	.59	6SF7	.49	76	.29
1B32-532A	2.95	6SJ7	.69	77	.29
1C6	.49	6T7G	.59	113 Vt4L	.39
1C7G	.49	6U7G	.39	250R	
1D7GP	.49	6Z7G	.59	VT166	1.29
1D7G	.49	6Z5 5G	.39	316A	.39
1F4	.49	7C4/1203A	.29	371B	.39
1F5G	.49	7E5/1201	.59	703A	1.95
1H4G	.39	10Y VT25A	19	705A	.98
1J6G	.49	12A6	.39	714AY	5.95
1J6GT	.49	12A6GT	.39	724B	4.95
1N5GT	.49	12A7	.39	801A	.69
1P5GT	.49	12A8GT	.39	836	.95
1V	.49	12C8Y	.39	837	1.95
2A3	.39	12F5GT	.39	841	.39
2A6	.39	2H6	.39	864	.39
2A7	.49	12J5GT	.29	872A	1.29
2C26A	.19	12J7GT	.39	954	.19
2V3G	.49	12K8GT	.39	955	.39
2X2 879	.39	12Q7GT	.39	957	.39
3B7 1291	.39	12S5	.39	1625	.19
406 1299	.39	12SF5GT	.39	1626	.29
3FP7	.98	12SF7	.39	1629	.29
4AP10	.98	12SH7	.29	1630	.59
5BP1	1.95	12SR7	.29	1636	2.95
5BP4	2.95	12SR7GT	.29	1638	.69
5CP1	2.95	12T3	.29	1642	.69
5D21	19.95	15R	.19	2050	.89
5GP1	.98	19	.59	2051	.59
5J23	7.95	2J22	3.95	7193	.39
5T4	.69	28D7	.39	9002	.49
5W4	.59	30SPEE	.59	9006	.29
5Z4	.59	(Vt67)	.59	904A21	.29
6A8	.59	30	.29	GL4A21	.29
6C4	.29	32L7GT	.59	Amperite	
6D8G	.59	33	.29	10T1	.29
6F5GT	.39	34	.29	Jan CRP72	1.49
6H6	.29	35 51	.29	81E 331A	.89
6J6	.39	36	.29	REL 36	.89
6L7GT	.39	37	.29	VR 150	.39
6K6G	.59	38	.29	VR 105	.89

WRITE FOR QUANTITY PRICES

**CONDENSERS**

	Each
2 mfd. 4000 VDC Oil-Filled	\$2.95
	4 for 10.00
2 mfd. 5000 VDC Oil-Filled	3.95
	3 for 10.00
1 mfd. 6000 VDC	1.98
25 mfd. 15000 VDC	4.95
.00025 mfd. 25000 VDC	2.95
.4 mfd. 1500 VDC	.29
	10 for 2.49

**DYNAMOTORS**

DM-28—For BC-348 with Mount and Filter	New \$6.95
	Used 3.95
DY-12—For ART-13 less filter and base	New 6.95
DM-36	Used .95
	New 1.95
BD-77	New 5.95
PE-206	New 6.95
	Used 2.75
PE-101	New 2.75
PE-73	New 3.95
DM-53	New 3.95
	Used .95 (3 for \$2.00)
DM-32	New 1.95
	Used .95 (3 for \$2.00)

**OUTPUT TRANSFORMER**

H1-Fil used in Scott Manufactured Navy receiver. Fully potted. Pri. 5000 ohms; output secondary 600 ohms C.T.—Inverse feedback secondary CT-60 ohms. **\$1.45**  
New





# Columbia Electronics, Ltd.



**RAYTHEON  
RECTICHARGER  
W-3155**

Supply current at a constant voltage and supplies current to a storage battery, providing an automatic AC-DC power system; No moving parts; No adjustments; Life of the battery increases as much as 40%; Eliminates voltage variations. 11/12 cells, 22-24 volts at 3 amp. output; Input 95-130 volts, 60 cy. \$45<sup>00</sup>  
cles; Weight 180 pounds.

**AN/APN-2 TRANSMITTER & RECEIVER:** designed to track down a radio signal in the 150 to 250 Mc. range. Can be used for VHF navigation. Used condition.

**TS-108/AP RADAR KIT:** necessary plumbing for testing of X-band radar xmitters or as a load for xmitter.

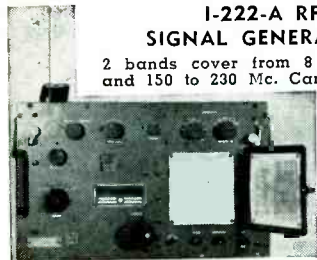

**I-222-A RF  
SIGNAL GENERATOR**

2 bands cover from 8 to 15 Mc., and 150 to 230 Mc. Can use up to the 3-harmonic; 110 V, 60 cycle built in power supply. New. \$125<sup>00</sup>

**TS-131/AP FIELD STRENGTH METER:** for AN/APN-2 radar jammer above the 200 Mc. Band. Includes pick-up assembly, control box and cord.

**TS-182/UP CEASE FIRING UNIT:** portable watt meter for testing output of radar xmitters. Includes 2" scope as indicator, for power measurement up to 1000 pulse watts.



**RA-38  
RECTIFIER**

115 V, 60 cycles, single phase input, output 0-15,000 VDC at 500 ma.

Near New \$275<sup>00</sup>

**BROADCAST EQUIPMENT:** write in for information regarding broadcast consoles, control and amplifiers.

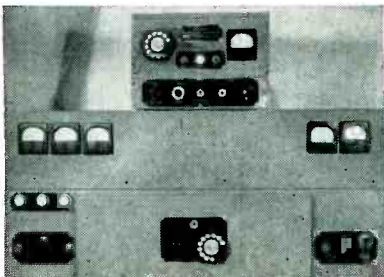

**1100-A  
FOUR TRANSMITTERS IN ONE**

Can be present on 4 bands. Has BFO or xtal on each from 1.5 to 10 mcs. Oscillators are all between 1.5 and 5 mcs. 6L6 osc. VR-150 regulator, buffer or doubler is a 6L6 into 3-807's in parallel. 125 watts on phone and 125 watts on cw. modulator has 4-6L6's in push-pull parallel. Rig has telephone dial on front for selecting any one of 4 transmitters, selecting phone, CW, turning heaters on, plate current, or turning everything off. Also has remote control unit for \$225<sup>00</sup> remote operation. Used, but in excellent condition. With Remote

**TCS AM TRANSMITTER & RECEIVER:** ready for installation on 12 VDC. Covers a range of 1.5 to 12 Mcs., continuous tuning in 4 bands. 25 watts plus on A1 emission. Both xmitter & receiver xtal controlled or MO operation. Complete with cables, control box, antenna loading coil, crystal holders, mike. Re-conditioned guaranteed operating. Ideal for Marine etc.

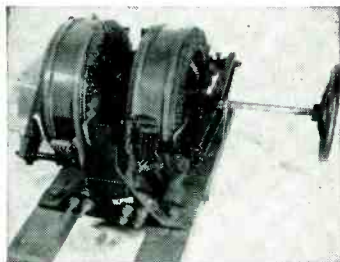

**VARIAC TRANSTAT AMERTRAN**

Input 0-115 V., 50-60 cycle; output 115 V 100 amps. 11.5 Kva. Excellent condition. \$75<sup>00</sup>

## COLUMBIA ELECTRONICS LTD.

524 S. SAN PEDRO ST.  
LOS ANGELES 13, CALIF.

Cable Address COLELECT

25% deposit with order. Balance C.O.D.  
All items subject to prior sale.

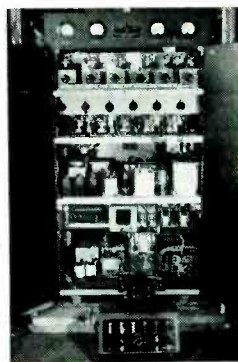

**TCR  
TRANSMITTER**

w / remote control, 6-channel, pre-set frequencies in 2 to Mc. 125-Watts output with A2 or A3 emission. Input: 105 to 125, or 210 to 250 volts at 60-cycle (50-60 cy)

\$275<sup>00</sup>

**SCR-528 FM RECEIVER & TRANSMITTER:** complete with 80 xtals for operation in the 20 to 27.9 Mc. Powered by 12 or 24 VDC—a light portable set for mobile or fixed operation.

**MARK I:** machine gun bore sighting kit complete optice for aligning various caliber of machine gun, etc.

**SCR-584 RADAR:** complete with 29 components except tubes, antenna and trailer. New, and used but good condition.

**SO-7-N RADAR:** complete search radar set with or without four wheel trailer. These units are complete with motor generator power unit and in excellent condition.

**W. E. SPEAKER:** 6-30 watt driver units with horns. Designed to be heard above the din of 16" guns. Ideal units for grandstands, etc. New .....\$69.50

**MODEL  
ET-8023-D1  
TRANSMITTER**

High frequency radio telegraph transmitter. Continuous frequency range of 2 to 24 Mcs., with A1 or A2 emission. Xmitter can be converted to A3 by slight modification of audio amplifier. 225-watts output. Input power 115-VDC. Has center section for Receiver housing. Xtal or M.O. control, with or without Receiver.

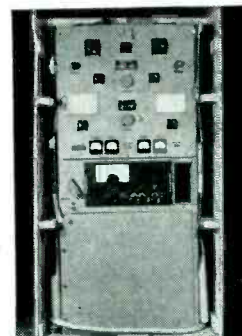

\$325<sup>00</sup> Less Receiver

# Stupendous! Gigantic! Colossal!

## BARGAINS in RADIO EQUIPMENT



### ACRO TELEVISION CHASSIS CRADLE



Eliminates broken tubes, coils, dials, etc. Cadmium plated steel fingertip control. A necessity for Television Service. Your Cost..... \$4.69

### MODEL 592 SPEED TESTER

By Supreme Instrument Corporation



Finest multimeter money can buy. Speed of operation, accuracy and meter range. 1000 ohms per volt to 100,000 ohms per volt. Double range. 1000 DC volts per volt or test microamps. No 1/4 ohm case. Rectangularly shaped. All samples priced (limited time only)..... \$49.95

### Special Buy AC-DC POCKET TESTER



Sensitive repletion meter in bakelite case. Special AC-DC Model 1111 m-Ohm. AC Voltmeter. AC Voltmeter. 0-25, 50, 125, 250, 500, 1000 Ma. 0 to 500 DC Ohms Full Scale. 100,000 Ohm Scale. 2000 Ohm Scale. 0.05 to 100 mfd. Prepaid anywhere in USA. \$7.00. DC meter lacking AC ranges \$5.50.

### A. N. ELECTRICAL CONNECTORS

A. N. electrical connectors provide a fast, easy way to connect or disconnect one or many electrical circuits. This offering is of intense interest to ALL manufacturers of electrical equipment inasmuch as we have a huge supply of these connectors and can dispose of them at very reasonable prices on a sliding scale. The more you need, the lower the price. Plugs and receptacles supplied with either male or female contacts. All built to rigid Army & Navy specs.

<b>3100</b>	<b>3100</b>	<b>3106</b>	<b>3106</b>	<b>3106</b>
28-12P	125-45	20-19P	18-20S	22-25
36-7S	85-15	105-25	24-7S	22-12S
20-15	28-16S	125-4P	18-12P	28-12S
20-1P		20-8S	22-18S	20-23S
32-8P	<b>3102</b>	18-22	24-4P	
20-22S	18-10S	20-24P	24-10P	<b>3108</b>
24-10S	18-11S	20-11P	20-15	12-5P
28-16S	18-12S	20-3P	22-14S	22-30P
24-7S	20-24S	20-7P	22-10P	22-8S
18-2P	14-3S	18-13S	24-28S	125-3S
20-15	16-7S	165-7P	24-28S	175-3S
20-9P	18-11P	165-1P	18-11S	18-11S
18-8P	24-4S	85-1S	20-22P	22-30P
18-4S	24-11P	20-27S	12-5P	22-14S
18-4S	18-8S	20-9S	125-3S	145-2S
36-15S	14-3P	165-11S	165-11S	165-15
22-18P	165-4S	12-9S	165-8S	18-12S
18-12S	165-10P	18-12S	10-15S	28-15P
12-5P	18-12P	18-4P	18-8S	145-2S
18-8P	20-8P	32-1S	22-30P	165-8S-1
18-8P	32-16P	165-3S	125-4P	165-8S-2
24-7P	32-8P	16-11S	125-4P	28-1P
20-11S		16-11P	165-15	28-15P
20-3S	<b>3106</b>	32-9P	18-12S	
20-8S	20-3P	18-15	18-15	<b>97-5107</b>
32-9S	32-101S	18-1P	18-19	28-7S
32-18P	28-9P	145-1S	165-4S	

Inquiries invited from manufacturers, foreign governments, distributors, etc. Prices quoted on basis of quantity!

### SOS EMERGENCY TRANSMITTER

Famous Gibson Girl Transmitter that saved so many lives during the war. Use only as a distress call transmitter on boats and airplanes. No external power supply required for operation. It is merely necessary to turn the crank on the top of the transmitter and power is generated and the distress signal is automatically sent out on international distress frequency. Brand New Gibson Girl Transmitter complete with tubes.

\$995

### ANTENNA KIT

For Gibson Girl Transmitter. 300 ft. antenna wire, 2 balloons, 2 hydrogen generators, box kite for windy weather searchlight. Complete kit.

\$995

### SINGLE-GANG INSULATED-VARIABLE CONDENSERS

Ideal for high-frequency applications in receivers and low-voltage transmitters. All types in stock.

10 mmf. \$1.35-10 for \$2.80-100 for \$23.00
25 mmf. \$1.35-10 for 2.80-100 for 23.00
50 mmf. \$1.35-10 for 2.80-100 for 23.00
75 mmf. \$1.35-10 for 2.80-100 for 23.00
100 mmf. \$1.35-10 for 2.80-100 for 23.00
140 mmf. \$1.35-10 for 2.80-100 for 23.00
160 mmf. \$1.35-10 for 2.80-100 for 23.00
140-140 mmf. \$1.80-10 for 12.80-100 for 100.00

### LINE FILTERS

For suppressing noise on all cars and appliances. Each contains 4 mfd oil filled condensers, 50 amp choke in full shielded case and heavy current connectors. \$17.00 value for \$1.98.

### TWIN COAXIAL CABLE

Two #12 stranded conductors shielded with vinyl-jacket polyethylene core. 70 to 95 ohms. Reg. 72¢ per ft. Your price \$15 per 100 ft. Order RG-57C. Also RG-59U 72-ohm Coax. \$4.50 per 100 ft.

### P.M. SPEAKERS

Latest type PM Speaker in a fully-enclosed metal cabinet. Speaker and case match communication receivers, in addition make perfect intercom remote stations. \$4.50. Including output transformer \$4.95.



### HEAT GUN

Red plastic, streamlined, pistol grip heat gun. Blasts 160° hot air at 20 cu. ft. per minute. Big rugged vacuum cleaner type AC-DC motor that also blows cold air. Use to clean radio chassis, heat carburetors, dry ignitions, quick-dry paint, thaw out radiators or water pipes, etc. Guaranteed or money refunded if returned, prepaid, in 5 days. \$12.95



### ISOLATION TRANSFORMERS

Eliminate shocks and firework from the adjustment jobs on radio and TV sets that require grounding of chassis, with our Isolation Transformers. As auto transformers they can also be used to change 110V to 220V or reverse. Buy now at 1/2 price. \$1.95

### 3-FOR-1 SALE

#### ALL 3 ITEMS ONLY \$7.00

**ALUMINUM GEAR BOX** 18x8x7 contains two powerful electric motors and two matched gear trains, 62 gears in all varying in size from 1/2 to 4 inches in diameter. Easily converted to rotate a beam antenna or any other similar use. \$5.00

#### SIGNAL CORP INTER-CONNECTOR RELAY BOX 730A

This valuable unit, BC816, made by Bell, is encased in a highly polished aluminum case 6 1/2 x 5 1/2 x 2 1/2, and contains 150 mfd. of condenser capacity, sensitive relays, resistors, and terminal strips. Order several at the giveaway price of only \$1.95.



**REMOTE CONTROL UNIT** Aluminum case 4 1/2 x 3 x 2 containing revolution counter, 2 potentiometers, triple pole switch, 4 knobs, phone jack, and gear mechanism. Includes 3 prong JAN connector to fit box—\$1.39.

### RT 1579 WITH TUBES, DIAGRAM AND PARTS LIST \$14.95

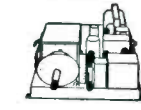

Consists of three stages (cascade 6X37A and 6F6 output stage) high gain, high fidelity amplifier with 60 cycle 110V power supply on same 1 1/2 x 1 1/2 chassis, which is protected by substantial steel cover over tubes and parts. Made by Western Electric with typical quality components such as husky power transformer and oil condensers. This unit is obviously intended to give years of trouble-free service with no more need for repairs than a telephone. Disconnecting one wire each from the special tuned input and output filters, results in an obtainable fidelity amplifier as can be obtained.



### SELENIUM RECTIFIERS

All types are rated at 130 V.A.C. Do not assort to make quantity.

Single	10 Lots	50 Lots
75 MA.....\$0.70	\$6.50	\$31.00
100 MA......75	7.00	32.50
150 MA......80	7.50	35.00
200 MA.....1.00	10.00	47.50
250 MA.....1.25	12.00	57.50

### STROMBERG CARLSON

Power Switching Relay Box. Neat 3 1/2 x 4 x 5 1/2 steel case with tight fitting cover finished in Stromberg's usual beautiful chocolate color crackle finish. Hurry! Only a few orders will be filled on first come, first served basis. \$1.00

### AUDIO AMPLIFIER

Push-Pull stage triode amplifiers having 2 of the valuable and scarce ounce type audio transformers that sell for over \$10.00 each. Neat aluminum case, fully enclosed. Perfect for intercom system, phono, mike or signal tracer amplifier for testing radio. \$25.00 bargain at only \$3.40 each.

### AC-DC Superhet Radio Kit

Extra high quality standard production line radio in kit form with complete instructions. Features 2 iron core I.F. transformers, 2 gang condensers, and polystyrene insulated edgewise wound antenna loop. Tubes include 12AT6, 12BE6, 50B5 & 35W4. Receives broadcast band from 550 to 1700 KC. Kit form \$8.75 or 2 for \$17.00. Assembled, wired and tested \$12.95 or 2 for \$25.

### Bandswitching Tuning Turret

4 bands above 100 Mc. #14 silver plated coil wire. Tuning condensers, driving motor diagram included. Only \$2.95.

### SELL OUT

24th Edition of Radio Amateur's Handbook. Tells all, shows all, over 600 pages of valuable information. \$1.00.

### SAFETY SWITCHES

Spend a dollar to save your life! G.E. Interlock Safety Switches eliminate fatal shocks. \$1.00 each.

### HURRY

2 gang midget superhet tuning condensers with 1/4" shaft and trimmers. Reg. \$1.25 each, now 5 for \$2.00.

### 1000 CYCLE AUDIO FILTERS

Navy PD52010-1 low pass audio filters that are the exact electrical and physical equivalent of commercial audio filters selling for \$35.00 wholesale. Far superior to surplus Radio Range Filters now being offered. Twice as selective as Q-tiver section of 274N, which has previously provided the amateurs highest standard of interference elimination. With diagram \$2.00.

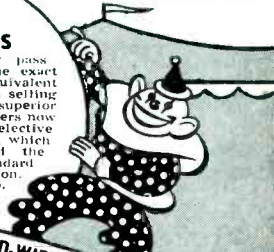

WORLD-WIDE MAIL ORDER SERVICE

BUFFALO RADIO SUPPLY, 219-221 Genesee St., Dept. E 2 BUFFALO 3, N. Y.

# TEST EQUIPMENT

APR-1 or APR-4 RADAR SEARCH RECEIVER, 30 mc I. F., 2 mc wide.

TUNING UNITS FOR APR-1 or APR-4 RECEIVERS (can be used with any 30 mc amplifier):

TN-19, range 1000 to 2000 mc. \$150.00  
TN-54, range 2000 to 4000 mc. \$150.00

30 MC I. F. STRIP AND 110 VOLT 60 cps POWER SUPPLY, bandwidth 10 mc, complete, new (part of APR-5 Receiver) \$65.00

TS-45A/APM-3 SIGNAL GENERATOR, 9200-9600 mc, 110 V, 60-800 cps

TS-155B/UP S BAND SIGNAL GENERATOR, pulsed, calibrated output, 110 V, 60 cy., NEW

TS-155A/UP S BAND SIGNAL GENERATOR, pulsed, calibrated output, 110 V, 60 cy., NEW

TS-56/AP SLOTTED LINE, slot length 16", tuned probe and meter \$100.00

TS-35/AP X BAND SIGNAL GENERATOR, pulsed, calibrated power meter, frequency meter, 8700-9500 mc

TS-13/AP X BAND SIGNAL GENERATOR, pulsed, calibrated output, 110 V, 60 cycles

TS-120/AP X BAND SIGNAL GENERATOR, pulsed, calibrated output

WAVEMETER CAVITY, 8500-9600 mc, Transmission Type \$35.00

TPS-51PB/20 S BAND 20 db PAD. \$20.00

X BAND PICK-UP HORN. \$10.00

X BAND VSWR TEST SET TS-12/AP, complete with linear amplifier, direct reading VSWR meter, slotted waveguide with rear driven traveling probe, matched termination and various adapters, with carrying case, NEW. UNITS I AND II are available separately or together as a test set.

S BAND SIGNAL GENERATOR CAVITY WITH CUT-OFF ATTENUATOR. 2300-2950 mc, 2C49 tube, with modulator chassis. \$30.00

HIGH PASS FILTER F-29/SPR-2, cuts off at 1000 mc and below; used for receivers above 1000 mc \$12.00

UPN-1 S BAND BEACON RECEIVER-TRANSMITTER \$75.00

S BAND TEST LOAD TPS-55P/BT, 50 ohms \$8.00

X BAND TEST LOAD TS-108/AP, 150 watts, accessories \$35.00

250 WATT X BAND TEST LOAD, VSWR less than 1.15 between 7 and 10 KMC. \$150.00

LAE-2 SIGNAL GENERATOR, 520-1400 mc, CW & pulse modulation, calibrated output 110 V, 60 cps, used, good condition

LAF-1 SIGNAL GENERATOR, 100-600 mc, CW & pulse modulation, calibrated output, good condition, 110 v, 60 cps operation

GENERAL RADIO SIGNAL GENERATOR MODEL 522, 250-1000 mc, good operating condition.

GENERAL RADIO POWER OUTPUT METER MODEL 583-A \$45.00

GENERAL RADIO VACUUM TUBE VOLTMETER MODEL 726, good working order. \$120.00

GENERAL RADIO PRECISION WAVEMETER TYPE 724A, range 16 kc to 50 mc, 0.25% accuracy, V.T.V.M. resonance indicator, complete with accessories & carrying case NEW. \$175.00

GENERAL RADIO SIGNAL GENERATOR 605-B, good working order. \$300.00

GENERAL RADIO VACUUM TUBE BRIDGE, Model 561D \$275.00

GENERAL RADIO FREQUENCY METER AND CALIBRATOR, Model 620.AM, 300 kc to 300 mc \$340.00

FEDERAL RADIO 605-CS, 9 kc to 50 mc SIGNAL GENERATOR (JAN version of G. R. 605) \$350.00

HEWLETT-PACKARD WAVE ANALYZER 300A \$300.00

HEWLETT-PACKARD AUDIO SIGNAL GENERATOR 205A \$230.00

HEWLETT-PACKARD DISTORTION ANALYZER MODEL 325B \$200.00

OBU-2 S BAND ECHO BOX. \$100.00

TBN-3EV THERMISTOR BRIDGE

S BAND THERMISTOR BRIDGE CU-60 ABU, Part of LZ Radar. \$60.00

RADIO RECEIVER BC-967T2, 18-160 mc, 3 bands, FM/AM, 110 V, 60 cps. \$200.00

RADIO RECEIVER BC-969B, 15-150 kc. \$150.00

MEASUREMENTS 78E, 50-75 mc, calibrated output \$100.00

FERRIS MODEL 22A SIGNAL GENERATOR, 85 kc to 25 mc. Output .2 microvolts to 1 volt, modulation variable, good working order \$175.00

FERRIS MODEL 10B SIGNAL GENERATOR, 85 kc to 25 mc, calibrated output, good working order \$100.00

FERRIS 18 C SIGNAL GENERATOR, 5-175 mc, calibrated output, good working order. \$250.00

STANDARD SIGNAL GENERATOR MEASUREMENTS 65B, 100 kc to 30 mc, 1-2,000,000 microvolts, good working order. \$400.00

LABORATORY RECTIFIER, SYLVANIA 541-A, 3500 volts at 2 amperes DC output.

LB-3 LIMIT BRIDGE, Industrial Products \$60.00

P-4 SYNCHROSCOPES, made by Sylvania or Browning Lab. \$175.00

SIGNAL GENERATOR 1-72-K, 100 kc to 32 mc, output not calibrated, 110 V, 60 cps. \$35.00

AUDIO OSCILLATOR, HICKOK 198, RC tuned, 20-20000 cps \$45.00

TEST SET TS-278/AP FOR AN/APS-13, synchronized, delayed pulse signal generator, 400-430 mc, calibrated waveguide below cutoff attenuator, synchronized marker generator, 115 V, 60 cps. NEW, COMPLETE. \$160.00

RCA SCOPE 5" MODEL 160B, NEW, export packed \$25.00

CLOUGH BRENGLER RESISTANCE CAPACITY BRIDGE, model 230A, new. \$50.00

FIXED ATTENUATOR PADS, 20 db + 0 - 2 db, DC-1200 mc, 50 ohms, VSWP 1.3 or less, 2 watts average power \$30.00

WAVEGUIDE BELOW CUT-OFF ATTENUATOR, type N connectors, rack and pinion drive, attenuation variable 120 decibels, calibrated 20-120 db, frequency range 300-2000 mc. \$32.00

WAVEGUIDE BELOW CUT-OFF ATTENUATOR, similar to above except upper frequency limit is 3300 mc \$32.00

WAVEGUIDE BELOW CUT-OFF ATTENUATOR, same as above except input is matched in range of 2200-3300 mc, VSWR less than 1.2. \$54.00

CERAMIC FEED-THRU CAPACITORS:

300 mmf. \$10 for \$2.00  
55 mmf. \$10 for \$1.00

PULSE INPUT TRANSFORMER, permalloy core, 50 to 4000 kc impedance ratio 120 to 2350 ohms \$3.00

PULSE TRANSFORMER, UTAH 9280. \$1.50

PULSE TRANSFORMER, 132-ANVP. \$6.00

PULSE TRANSFORMER, GE 68G, \$28G-1. \$5.00

TS-10/AP CALIBRATED DELAY FOR APN-1. \$25.00

TS-203/AP CALIBRATED SELSYN. \$10.00

UG-27/U TYPE N RIGHT ANGLE ADAPTERS  
10 for \$5.00; 1000 for \$250.00

U.H.F. RIGHT ANGLE ADAPTER 83-1AP  
10 for \$2.50; 1000 for \$125.00

SD-3 SHIPBOARD RADAR, New and complete with test equipment. \$1050.00

SQ RADAR, used but in good working order, complete with antenna, control unit. \$550.00

SN RADAR, used, good working order, complete \$550.00

NYERSIL CORE CHOKE, 1 Henry, Westinghouse L-422031 or L-422032. \$3.00

PULSE FORMING NETWORK, 20 kv, .92 microsecond, 50 ohms, 800 p.p.s. \$40.00

ANCHOR SCREWS from AB26CR Mast Equipment \$2.00 each

## SURPLUS EQUIPMENT AND COMPONENTS EQUIPMENT

### Navy UHF Test Receiver CPRAAJ Navy UHF Test Transmitter CPRAAK Complete

With all Tubes, Batteries, Antennas, Schematics, Carrying Sack. Each unit 16x8x8. Frequency approximately 150-30 Mc. Original packing, Brand New—50 lbs. For the Pair. \$19.95

GO-9 Aircraft Transmitter—Brand New—Complete. Tubes—P-8 \$99.95  
BC 645, IFF—New—with tubes. Original Carton \$14.95  
Bendix TA-12B, Good condition—with tubes. 80-40 Mrs. \$34.95  
W.E. Oscilloscope IC 412B—New. \$50.00

### SPERRY BOMBSIGHT IN STOCK—NEW—INQUIRE

Mark II B-19 Transceiver—New with all accessories and spares—3 cases each set—complete \$78.50  
DZ-2 Receiver—15 Kc—1750 Kc—less loop—new \$40.00  
SCR 522—like new—with plugs—dynamotor—controls—tubes \$60.00  
ARC-5—BC 454 Receiver—3-6 Mc—with tubes—used \$5.95  
BC 404D—Radar receiver—New—Complete. \$27.50  
Radar Antenna—CT 6-66 AFJ—IFF—with stub—New \$3.95  
U. S. Marine Code trainer—Model OAH—New—with spares \$39.95

### COMPONENTS

Band pass filters—cased—potted  
60 cycle—Navy type CAP-5306—hermetically sid 90 cycle—Navy type CKJ-5307—potted  
150 cycle—Navy type CKT-53071—potted  
Each \$1.95

Low pass RF line filter D170738-2 1/2x1 3/4x1" contains 3 molybdenum permalloy toroidal coils. Solid copper can. Rated 115V AC-10.0 Amps. More than 60 DB down from 150 Kc-30 Mcs. Each \$3.95

Landing indicator meter #1205649, 2 independent movements, 0-50 microamps, 0-200 microamps. Separate magnets. New—boxed. Each \$4.95

### HIGH VOLTAGE MICAS

Type D—.01 Mfd—1200W. VDC. Each \$35  
Type D—.03—1250W. VDC. Each \$40  
Type P—.00275—.003—.006 2% 2K VDC Each \$40  
Type V—.00025—.0006—.00075 2%—2.5K VDC. Each \$75  
Type F—.005-5000V DC. Each \$2.50  
Type E—.000375—.0015 2%—5K VDC. Each \$1.00  
Type 75026X-.001 Mfd—75,000 VDC. Inquire

### OIL CONDENSERS

Rectangular  
7.0 Mfd—660 VAC (2000V DC) #26F306 Each \$3.00  
6.0 Mfd—600 VDC. Each .65  
1.5 Mfd—4000 VDC—#26F386. Each \$1.00  
.5 Mfd—1500 VDC #CP 71B. Each .50  
1.75 Mfd—220 VAC (600V DC) K620175. Each \$35  
Cylindrical  
.03 Mfd—7500 VDC #25F403. Each \$1.00  
2.0 Mfd—400 VDC 66A200. Each \$40  
Bathtub  
2x1 Mfd—600 VDC-S.T. Insulated can. Each .20  
3x1 Mfd—400 VDC-S.T. Can comm. Each .20  
2.0 Mfd—400 VDC-S.T. Insulated can. Each .40

### RHEOSTATS

25 watt—25, 50, 60, 150 ohm—screw driver adjustment. Each \$30  
25 watt—40 ohm—3/8" shaft—Pr. \$25. Each \$55  
50 watt—3000 ohm—3/8" shaft—Model J. Each \$95  
75 watt—15 ohm—3/8" shaft—Model P. Each \$95  
500 watt—6 ohm. Per Sect.—9.3 amps. each section, 3 sections in tandem—New—Crated. Model R. Each \$12.50

### RESISTORS

120 watt—10,000 ohms—#120KT—with 15" brass rod, insulators, and hardware. Individually packed. Dozen \$3.00  
25 watt—25,000 ohm—Lug Mounting. Dozen \$2.40  
10 watt—25 ohm C.T. (Center Tap Transformers) Dozen \$1.00

Coax. Fitting—PL-259, SO-239—New. Each .25  
Fuse Post—little fuse 442002. \$3.00 list. Our price. Dozen \$3.00  
Magnetron Special. Original pack. 725A. \$6.50  
Many others in stock—inquiries promptly answered.  
Tube Special—RK-34—Dual Triode—Raytheon \$4 for \$1.00

Rated firms—open account  
—other 20% with order F.O.B., N. Y.

**GREENWICH SALES CO.**  
59 Cortlandt St. New York City

## ELECTRO IMPULSE LABORATORY

P. O. Box 250 Eatontown 3-0768 Red Bank, N. J.



# ACORN

## Standard Brands BATHTUB CONDENSERS

Cap.	W. V.	Type	Each
100	5	TT	\$.15
2	25	ST	.15
2 x 1	25	ST	.15
10	50	TT	.15
20	50	ST	.19
25	50	ST	.19
50	50	ST	.23
100	50	BT	.25
2 x 7	50	BT	.20
2 x 12	50	ST	.25
2 x 25	50	TT	.25
2.5	100	ST	.15
.5	120	TT	.15
.5	200	ST	.21
1	200	ST	.23
2 x 1	200	ST	.18
2 x 5	200	ST	.18
2 x 5	300	ST	.20
2 x 5	300	TT	.20
.1	400	TT	.23
.1	400	ST	.23
.1	400	BT	.23
.25	400	ST	.25
.5	400	BT	.27
.5	400	ST	.27
.5	400	TT	.27
.5	400	ST	.27
1	400	BT	.30
1	400	ST	.30
2	400	ST	.35
2 x .02	400	TT	.23
2 x 1	400	TT	.27
3 x 1	400	ST	.29
3 x 1	400	TT	.29
3 x 5	400	ST	.31
16	450	ST	.69
.1	500	BT	.20
.5	500	TT	.25
8	500	ST	.49
.05	600	BT	.20
.05	600	ST	.20
.1	600	BT	.23
.1	600	ST	.23
.1	600	TT	.23
2	600	ST	.44
.25	600	ST	.25
.25	600	BT	.25
.5	600	ST	.28
1	600	ST	.31
1	600	BT	.31
1	600	BT	.31
1.12	600	BT	.31
2 x .05	600	ST	.25
2 x .05	600	TT	.25
2 x 1	600	BT	.27
2 x 1	600	BT	.27
2 x 1	600	ST	.27
2 x 1	600	TT	.27
2 x .25	600	ST	.29
3 x 1	600	TT	.31
3 x 1	600	ST	.31
3 x 1	600	BT	.31
3 x 25	600	ST	.34
.05	1000	ST	.24
.05	1000	BT	.24
.25	1000	BT	.29
.5	1000	BT	.32
1	1000	ST	.32
2	1000	ST	.45
.01	1500	ST	.29
.06-1	1500	TT	.32
.08	1500	TT	.33
2 x .02	1500	TT	.37
.1	1750	TT	.33
.25	2500	TT	.54



20 E



2 F



14 E

## SWITCHES

Stock No.	Description	Mfr.	Each
1 B	SPDT, Airplane Type, Bat Handle	C.H.	
	Luminous tip, neutral position	AN30221B	.15
1 D	SPST, momentary, ball handle	A.H. & H.	.19
2 B	SPDT, Center position off, Bat handle, Luminous tip	C.H.	
		3021-JB	.29
2 F	DPST, normally open one side, Push Button, normally closed one side	A.H. & H.	.34
3 E	DPST, Bat handle	C.H.	
		8823K2	.39
4 A	DPDT, Push button, momentary, Soft Action	G.E.	.49
12 F	DPST, Push button, normally open, Luminous tip	A.H. & H.	.39
13 E	SPST, momentary	C.H.	
		8819K5	.29
14 E	SPST, Bat handle, airplane type, Luminous tip	C.H.	
		AN30221B	.24
15 C	DPDT, Bat handle, momentary	C.H.	
		8831K2	.59
15 F	SPDT, Bat handle, momentary, Luminous tip	C.H.	
			.34
20 E	SPDT, Bat handle, momentary, center off	C.H.	
		8905K703	.39
21 F	DPST, Bat handle, Luminous tip	A.H. & H.	.37
23 E	DPDT, Bat handle	G.E.	.49
11 B	DPST, Slide Switch	Wirt	.17
13 D	DPDT, Slide Switch	Clarostat	.22
13 F	SPST, Push button		.19

## STANDARD BRAND RESISTORS

All Sizes In Stock  
.5 ohms to 30 meg. ohms

	Each	Per C	Per M
1/2 W	.03	\$2.50	\$15.00
1 W	.04	3.00	22.50
2 W	.07	5.50	35.00

Quantity prices do not prevail in assortments

## WIRE WOUND RESISTORS



Watts	Each	Per C
5	.12	\$.10
10	.18	.15
20	.25	.20
25	.30	.24
50	.55	.50
75	.65	.60
100	.75	.70
200	.85	.75

We have on hand a tremendous stock of popular sizes in the above resistors.

## CERAMICON TRIMMER

Erie Type 554

3-12 MMF	.15 each
5-25 MMF	
8-50 MMF	\$10.00 per 100



## RHEOSTATS— Standard Brands

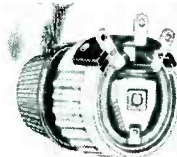

"25 Watts"  
.65 ea.  
Lots of 50  
.55 ea.

Ohmage	Price
1	60 370
1.3	75 500
3	100 500
8	160 1K
10	200 1.3K
15	225 2.5K
25	250 5K
50	300

"50 Watts"

.95 ea.  
Lots of 50  
.85 ea.

2	60	
8	100	
	150	
	225	
16	350	300
50	500	350
60	1.8K	750
	10K	

"100 Watts"  
\$1.95 ea.  
Lots of 50  
\$1.75 ea.

## MAGNET FOR MAGNETRONS

Made by Cinaudagraph. C. F. S.  
4866 Gauss. Brand New \$4.95

## RELAYS



Mfr.	Type #	Contracts	Voltage	Each
Allied	BOX-11	DPST	28 DC	\$1.49
Allied	BO-15D 35	DPDT	24 DC	1.95
Allied	BOX-66	DPDT	18-28 DC	1.49
Leach	SW-182A	DPST	12 DC	1.49
Leach	1057	DPDT	25 DC	1.69
Allied	BJ-6A110	DPDT	115 AC	1.49
Ward-Leonard	104-652	DPDT	115 AC	1.49
Leach	1154	DPST	117 AC	1.69
Allied	FX-10	SPST	7000 ohm, plate	1.19

PHONE WORTH 4-3270

## ACORN ELECTRONICS CORP.

76 Vesey St., Dept. E-2, New York 7, N. Y.

TERMS: 20% cash with order. Balance C.O.D. unless rated. All prices F.O.B. our warehouse in New York City. No orders under \$2.50.

## ELECTRONIC TUBE-MAKING MACHINERY

For manufacturing radio tubes, electronic tubes, cathode-ray tubes, lamps. New and used. Reasonably priced, satisfaction guaranteed.

AMERICAN ELECTRICAL SALES CO.  
67 E. 8th St. New York, N. Y.

Watch—  
the Searchlight Section  
for  
Equipment Opportunities

## RADAR SEARCH RECEIVER—80 to 3000 MCS

Model AN/ARD-2

This precision search receiver made by US NAVY for installation in planes has a continuous frequency range from 80 to 3000 MCS. It incorporates built-in pulse analyzer, with a pulse repetition rate of 50 to 8000 cps. Includes 115 Volt 60-2600 cycle AC power supply, test oscillator CMD-60ABG-1; Amplifier CMD-50ADC; Detector CMD-66AFH; two antennas (long/short), all tubes, cables & manuals. An excellent substitute for APR-1 & 4 series, the ARD-2 is ideal also for use as a precision frequency meter.

BRAND NEW!

COMPLETE WITH SPARE PARTS AND TUBES!

IN ORIGINAL CASES (Wt. 113 Lbs.)

Price, each . . . . . \$175.00

## COMMUNICATION DEVICES COMPANY

Cable: Communidev  
2331 Twelfth Avenue

Tel: AD-4-9277  
New York 27, N. Y.

# NEW YORK'S RADIO TUBE EXCHANGE

TYPE	PRICE	TYPE	PRICE
O44G	\$ .72	3C23	3.95
C1B	3.95	3C24	.95
IA3	.29	3C31	3.95
1B22	2.95	3DP1	1.95
1B23	8.95	3DP1A	2.75
1B24	4.95	3E29	6.75
1B26	2.95	3J31	59.95
1B38	32.50	4A1	.95
1N21	.85	4B30	1.75
1N21A	.95	4C21	1.25
1N21B	1.50	4C27	29.95
1N23	.85	4C30	1.25
1N23A	.95	4C35	19.95
1S21	3.75	4J31	95.00
2C23	.75	4J32	95.00
2C33	1.95	4J35	195.00
2C34	.59	4J38	95.00
2C40	18.00	4J40	195.00
2C40	5.75	4J44	195.00
2C43	12.50	4J52	350.00
2C44	1.25	5BP1	2.75
2C51	7.50	5BP4	3.95
2D21	1.08	5C50	9.95
2J21	9.95	5CP1	1.95
2J22	9.95	5D21	24.95
2J26	8.75	5C5B	9.95
2J27	9.75	5FP7	4.95
2J31	9.75	5J1A	45.00
2J32	12.95	5J2D	10.95
2J36	105.00	5J1A	25.00
2J38	7.95	6C6	7.95
2J40	25.00	6AC7	.90
2J42	150.00	6AC7W	1.25
2J49	24.50	6AJ5	.90
2J50	24.50	6C27	19.95
2J55	55.00	6F4	5.95
2J61	45.00	6J4	4.95
2J62	45.00	6-Q8	.95
2K25	19.95	6OSG	1.75
2K28	19.95	6SU7GT	4.95
2K29	24.95	6SU7GT	4.95
2X2A	.69	7DP4	12.50
2V3G	.99	10Y	.59
3AP1	4.95	15E	1.25
3BP1	3.95	15R	1.00
3B24	1.50	RX21	2.50
		CK72	.95

TYPE	PRICE	TYPE	PRICE	TYPE	PRICE
CK73	.95	701A	3.95	866A	1.15
OK77	249.00	703A	2.40	869B	29.95
OK47	55.00	705A	7.75	872A	2.75
OK61	49.50	707A	6.95	874A	1.95
RK39	2.25	707B	9.95	876	.75
RK49	2.40	710A	1.25	878	2.25
VK59	.45	714AY	4.95	879	.55
NR74	.45	715A	6.95	884	1.70
VR90	.79	715B	9.95	885	1.25
VR95	.45	715C	24.95	931A	3.95
100TH	10.95	717A	.95	954	.45
VR105	.79	720AY	45.00	955	.45
F123A	8.95	720BY	45.00	956	.45
VR150	.63	720DY	45.00	957	.25
VT90	1.25	721A	2.40	958A	.55
VT98	39.95	722A	3.95	959	.75
X99	.75	723A	6.95	975A	12.50
203A	3.95	723A/B	10.95	991	.25
211	.75	724A	2.95	CK1005	.35
217C	6.95	724B	3.95	CK1006	.95
CE220	.95	725A	12.95	WE1378X	2.95
RK232	.95	726A	9.95	1602	.59
RX233	1.95	726B	19.95	1611	1.05
242C	7.50	726C	36.00	1613	1.05
249C	3.75	728AY	45.00	1616	1.10
250TH	19.25	801A	.69	1619	.50
250TL	15.00	802	4.50	1624	.99
250R	5.95	803	4.50	1625	.45
HK253	6.95	804	10.95	1626	.45
274B	1.75	805	4.95	1629	.45
287A	3.95	807	1.24	1635	1.35
CE303	3.95	808	2.75	1641	1.00
304TH	95.00	809	2.75	1851	1.10
304TL	1.25	810	7.50	1852	.99
307A	4.25	811	2.11	1853	.90
310A	4.50	812	2.50	1984	2.75
316A	.69	813	7.95	2050	.99
350A	2.40	814	2.95	2051	.55
350B	1.80	815	2.50	8011	1.25
368AS	2.40	816	2.40	8012A	3.95
371B	9.95	827R	90.00	8013A	2.75
388A	1.80	829B	7.50	8014A	22.95
393A	4.95	832	3.95	8016	1.25
394A	4.95	832A	4.50	8019	1.75
417A	12.95	834	5.50	8020	2.95
368AS	2.40	835	1.10	8021	1.75
446A	17.50	837	1.95	8022	1.00
446B	.90	848A	3.75	8025	3.75
WL468	1.80	845	4.50	9001	.55
WL469	5.95	849	19.95	9002	.35
WL525	2.75	851	19.95	9003	.55
527	7.95	852	9.95	9004	.45
WL530	12.95	860	3.75	9006	.25
WL531	7.95	861	19.95		
WL532	2.95				
533	39.95				
WL535	7.75				
WL538	1.25				
GL570	1.25				
575A	12.50				
579B	5.95				
653B	.45				
700A to B...	19.50				

## LIST OF TEST EQUIPMENT

- Micro-Wave Test Equipment**
- X Band TS148/AP X Band Spect Analyzer
  - X Band Signal Generator Type TS-146/UP 115 V. 50-1200 Cycle TAA 16 Twin T Amplifier
  - X Band Sig Gen Type TS-263A TP/10 115 V. 50-1200 C.
  - TS 12/AP Unit 1 SWVR meter
  - TS 12/AP Unit 2 Plumbing for unit 1
  - TV N7 Pulse Gen for microwave sig gen (Brown-ing Labs Inc.)
  - TBN-3EV High Freq Thermistor Meter Radiation Labs MIT
  - SVWR Meter TAA-11BL Browning Labs
  - High Power Klystron Sig Gen S Band, Polarad Mod PE 102
  - BC 1287A Scope for Radar, up to 1,000,000 cycles, CW-60ABP made by Western Electric
  - BC 1277A/60ABQ-1 Signal Generator and Freq. Meter 2700-3400 MC S Band Western Electric
  - TS 62/AP X Band Echo Box
  - TS3A/AP Freq and Power meter 2400-3400 MC WE 107-1 Pulse and Sweep Gen by Hazeltine Corp.
  - I-203A Power Meter
  - X-Band Magic T
  - X-Band Precision Calibrated Load
  - X-Band Tunable Crystal Mounts
  - X-Band TS 13 Signal Generator
  - X-Band TS 145 Signal Generator
- Standard Broadcast and Short Wave Equipment**
- Model 20B Ferris Microvoltage
  - Rider Chanallist 162C
  - Rider Chanallist Short Wave Adapter
  - Hewlett Packard Model 200D
  - RCA Audio Chanallist
- Meters**
- TS 15/AP Gauss Meter
  - General Radio Tube Voltmeter Type 728A to 3000 volt
  - Airradio Millivoltmeter 0-2 Millivolt
  - Model 617-F Shallicross, Percent Limit Bridge .1 to 1,000,000 ohm
  - Model 40 Pyrometer, Elematic Equipment Co.
  - Light Spot Galvanometers, General Scientific Co.
  - Microammeter Rollere 0-10 Microamp.
- Radar Sets**
- APS3 Complete and Parts
  - APS4 Complete and Parts

350A is a long life 807  
350B is a long life 6L6G  
701A can be used for a Super 813



**LIBERTY ELECTRONICS, INC.**  
135 LIBERTY STREET NEW YORK 6, N. Y.  
PHONE WORTH 4-8262

### CONDENSER ASSEMBLIES:

**5 GANG—**  
with vernier tuning 25 MMFD to 450 MMFD each section. Size: 7 1/4" x 3 1/2" x 3 1/2". Price: \$2.95



**3 GANG—**  
25 MMFD to 450 MMFD each section. Size: 6" x 3 1/4" x 3". Price: \$1.95

### SELENIUM RECTIFIER UNITS HEAVY DUTY—30 VOLT DC OUTPUT:

115/200 V. Three Phase 400 Cycle Input:  
TYPE 143 w/Transformer & VR 100 amp. \$89.50  
TYPE 3FS-5 w/Trans., VR, & Blower 200 amp. \$99.50  
TYPE 52A-11 Rectifier only, Cased 200 amp. \$49.50  
TYPE A1 Rectifier only, Cased 300 amp. \$59.50  
TYPE RE-60 Rectifier only, Cased 400 amp. \$69.50

### 400 CYCLE GASOLINE ENGINE GENERATOR

120 Volt 1400 Watts and 28 Volts DC 14 A. Two cycle direct drive. Reconditioned. \$225.00

**ALNICO FIELD MOTOR—24 VDC, 3/4" x 1 1/2"**  
Shaft 3/16" x 3/16" w/10,000 RPM. Design No. 63662C. Price: \$3.75  
**ALNICO MIDGET DC VOLTAGE GENERATOR—**  
Type PM-2 Electric Indicator Co. 0.0175 V per RPM. 3/4" x 2 1/2". Shaft 1/2" x 5/32". Price: \$6.95  
**ALNICO FIELD MOTOR—24 VDC, 3-5/16" x 2"**  
Shaft 9/16" x 1/2" knurled. 10,000 RPM. Type P-11212. Price: \$3.75

**AUTOMATIC CODER-TIMER** complete with 110 Volt 60 cycle motor, 7.2 Watts at 4 RPM. Micro switch and adjusting discs. \$12.95

Address Dept. E. • • • • All Prices Are F.O.B., Lima, O. • 25% Deposit on C.O.D. Orders

### WHIP ANTENNA EQUIPMENT

#### MAST BASES—INSULATED:

MP-132—1" heavy coil spring, 2" insulator. Overall length: 11 1/2". Weight: 2 1/2 lbs. Price: \$3.95  
MP-22 Spring action direction of bracket, 4" x 6" mounting. Price: \$2.95  
MP-57—2" heavy coil spring, 5" insulator. \$3.95  
MP-48—2" heavy coil spring, 3" insulator. \$2.95  
MP-37—2" heavy coil spring, 8" insulator. \$3.95  
MP-47—2" heavy coil spring, 9" insulator. \$5.95

#### MAST SECTIONS FOR ABOVE BASES:

Tubular steel, copper coated, painted, 3 foot sections, screw-in type. MS-53 can be used to make any length, with MS-52-51-50-49 for taper. Price, per section: 50¢  
BAG 130-56 for carrying above 5 mast sections. 50¢ ea.

#### DYNAMOTORS:

##### PERMANENT MAGNET FIELD DYNAMOTORS:

12/24 V. input—output 275 V. 110 MA. \$3.95  
12/24 V. input—output 500 V. 50 MA. \$2.95  
BD-86 DYNAMOTOR—14 V. 22 A. input; output 600 V. 300 MA. Used with BC-375 or 191 for low output. \$7.95  
WRITE US FOR QUOTATION ON YOUR NEEDS FOR DYNAMOTORS AND INVERTERS

#### GEARED MOTOR

Ideal reversible motor for rotating antennas, displays, etc. (Similar to illustration). Weight: 4 lbs. Overall size: 7" long, less shaft. Gear Box size: 3 1/4" x 3 1/4". Motor size 4" x 2 1/2". Shaft size: 3/8" x 1 1/2" threaded. Operates from 24 volt DC, 2.9 A., 9 RPM or 36 volt AC at 75 lbs. torque per inch. Price: \$5.95  
36 Volt Transformer: \$2.95



**SYNCHRONOUS MOTOR—26 V. 60 cycle 60 RPM.**  
Size: 1 1/2" x 2 1/4". Shaft 1" x 1/16". Type 1147, with 26 V. Transformer \$2.95

# WILL SELL

Write for Prices

TS-10B/APN	1E-21A
TS-16/APN	I-122
TS-23/APN	I-126
TS-34/AP	I-145
TS-35/AP	I-152C IND.
TS-36/AP	I-196B
TS-61/AP	I-222
TS-62/AP	BC-376-H
TS-74/UPM	BC-689A
TS-110/AP	BC-754A
TS-118/AP	BC-906D
TS-126/AP	BC-929A
TS-204/AP	BC-1155A
TS-BE-67	BC-1061A
T9-APQ-2	SN7A/APQ-13
T28-APT-1	R78-APS-15A
T85-APT-5	R18-APS-3
ID57/APQ-7	RA-60A
PP72/APQ-7	CQ-164-U (24")

WRITE FOR PRICES

## Alvaradio

Dept. L-1, 341 S. Vermont  
Los Angeles 5, California  
DUnkirk 8-2217

IN DETROIT IT'S AARON

ATTENTION FOREIGN GOVERNMENTS

**LAND BASED SURFACE SEARCH RADAR EQUIPMENT—SCR-296-A**—mfg. by Western Electric Co.—Almost identical to USN MK 4 Fire Control Radar—660 to 720 MC—1650 P/RP—max. range 100,000 yds.—brand new—less antennas—some plumbing—spare parts—but with tubes—complete volume of instruction books—parts lists, etc. Write for full particulars.

**TEMPERATURE TEST OVEN**—Haller after—approx. 12"x12"x9" inside—built in rotator—orig. used for polystyrene work. \$65.00

**EXPERIMENTAL ANTENNA PEDESTAL**—FT. 336-A (FIR-5246 2A2699-336A) weighs approx. 900 lbs. \$125.00

**SPARK WHEEL RADAR MODULATOR AND BRIDGE BC-752-A** Fed. Cel. & Radio Corp. Ser. 261 (including AC motor) \$150.00

**WAVEGUIDE DEHYDRATOR UNIT CIR-1019** 8-B Signal No. 225632-12—unused—pressure meter—hose and pump—and silica gel tube—in orig. wooden boxes with 2 bags of silica. \$6.95

**OZALID SENSITOMETER No. 2** 115V 60 cy. 4.5 amp—used without bulb. \$85.00

**POWER CRAFT DOUBLE POLE DISCONNECTORS—7500 VAC 400 amps** \$20.00

**TELEGRAPH TEST SET**—Mobile Type V-576581-04 SID-100423-1-1—complete unit—write for details.

**MALLORY RECTIFIER LABORATORY POWER SUPPLY** Pri. 115 VAC 60 cy. at 30 amps—1 PH. Sec. 12 VDC at 60 amps. \$49.95

**RUBBER CABLE VULCANIZER**—Mines Equip. Co. Type VD 1B4 500 W 115 VAC. \$19.95

**GRID CONTROL RECTIFIER POWER SUPPLY—350 VDC-400 MA**—for rack mounting—less 393-A tube \$35.00

**ATB RADIO XMTR. CRV-52233**—new in cartons—with dual plug-in tuning units for 3.0-9.05 Mc. 2 channel oper.—with following tubes (1) 1625 (1) 1R-150 (2) 6N7 (2) 815. \$29.95

**INTERFERENCE REDUCER CR-736-B**—used with tubes \$18.95

**MODULATOR UNIT BC-748-A**—used, with tubes \$9.95

**TAPE CODE KEYS—McELROY**—used, less tubes and dust cover \$9.95

**NOISE MODULATED JAMMING XMTR. T-85/APT-5**—with tubes 10-40 W. CW/300-1625 MC/58 W \$69.00

**CONTROL UNIT RM-18-A**—type 5007A—used but perfect \$9.00

**CONTROL UNIT RM-27-A**—used but perfect \$18.00

**TEST UNIT 102-A**—Multi vibrators at 1-10 or 20 & 100 KC-115 V 60 cy.—used with tubes—for rack mounting \$29.95

**TS-69-AP FREQ. METER**—used, less meter. \$14.00

**HETERODYNE MONITOR BC-1255-A**—used \$11.95

**CAVITY TYPE FREQ. & FIELD STRENGTH METER BC-906-D** (14.5-23.5 MC) \$29.00

**McINTOSH SINUSTAT** \$75.00

**FENVAL THERMOSWITCH**—type #S1620 10 amp 115 VAC or 5 amp 230 VAC—cartridge type 1.50

**U. S. TORPEDO CAMERA**—new type 1—manually or elec. (24VDC) operated—5" wide—angle F 4.5 lens—uses regular 120 film—complete with attachments & manual in beautiful plywood carrying case \$39.95

**VHF RCVR. AN/CRW-2**—about 110 MC. \$5.95

**BC-733D**—localizer revr. 108-110 MC—10 tubes—6 xtals—new \$6.95

**SYNCHRONIZER BC-1045-B** \$19.00

**R-230/AYS-2C**—new in crates—37 tubes—incl. 1 5P7-1 2A1P CR tubes—with blower-motor—etc. \$39.95

**INDICATOR BC-741-A**—(12) 6AC7—(1) 6SN7 (1) 6L6 (1) 2X2 CR 1812 P7—5 neon lights—numerous amount of other misc. parts—new. \$29.95

**AN-ARQ-7 (XA-2) SEARCH RCVR & JAMMING XMTR**—in one unit—17 tubes including 884 F—2 807—brand new with instruction book—400-2600 cy.—110 VAC or 73-87 VDC & 28 VDC \$49.95

**SYNTHETIC TRAINER BOX—RC-691 TL**—with 14 tubes—generates synthetic radar echoes for training—without dust case \$39.95

TUBES

FG-172—new in boxes. \$25.00  
FG-105—orig. wrappings 12.00  
FG-235-A 40.00 pr.

POWER SUPPLY COMPONENTS

**SELSYN INDICATOR—182 F 5"** \$4.95  
**STEP-DOWN TRANSFORMER**—in metal box—with 2 fusetron thermal cutouts—115 V pri./31 V 3/4 5 A sec. or 230 V/460 pri. 115 V sec. @ 150 VA 60 cy.—ideal for 24 V supply. \$5.95  
**TRUMBULL MULTI-BREAKER**—Type M-3 double wire switches—120/240 V—70 amp—used. \$1.25  
**CONSTANT VOLTAGE TRANSFORMER**—made by SOLA—190V-250V pri. 133 VA 60 cy. phase sec. 11V 12.1 amps. \$9.95  
**SELSYN GENERATOR 7G—MK3 Ford & Arma**—90-115VAC 60 cy. \$27.50  
**RECTIFIER & TRANSFORMER RA-63D**—110V 60 cy./12V 14A. \$29.95  
**KENYON XFMR. S9527—110/220V. pri—11V CT @ 2200 VA sec.** \$39.00  
**ACME XFMR.—120V/120 shield 60 cy.—2 KVA** Cat. #T173 \$29.00  
**WESTINGHOUSE INDUCTIVE REACTOR**—50 henries—575 amp—insulated for 17,500 Volts. SO #511K742 \$90.00  
**FAST CAPACITOR**—5 MFD/10,000 VDC #A6078—approx. 12" x 5" x 4" can. \$7.95

25% with order—balance including postage C.O.D. All items used unless specified.

**AARON ELECTRONIC SALES**  
3400 CHENE, DETROIT 7, MICHIGAN • LOrain 8-9966

WORTHWHILE SAVINGS TO YOU:



**T-102 — Filament Transformer.** American Transformer Co. Spec. 39106. Type WS 050 KVA. 50/60 cyc. Single phase. 35 KVA test, 12 KV D.C. operating. Primary 115 V., secondary 5 V., 10 amps with integral standoff insulator and socket for 250 T. 371, 872 and 5563, etc. rectifier tubes \$12.50 Net Wt 15 1/2 lbs. Dim. 6 1/2" W x 6" D x 12" H.O.A.

**MOTOR GENERATORS AND PUMPS**  
G.E. type CC-21991: Input 115 v d-c @ 5.7 amps. Output 115 v a-c 60 cyc. single phase, 350 va @ 85% P.F. \$38.00  
G.E. type CC-21990: Input 32 v d-c @ 22 amps. Output 115 v a-c 60 cyc. single phase, 350 va @ 85% P.F. \$63.00  
Portable Vacuum Pump Assembly: Leland 110/220 v 60 c. 1 phase h.p. motor with 8 CFM automatic oiler; mounted on tubular steel frame \$86.00

CONSTANT VOLTAGE TRANSFORMERS

85 to 125 v. 50 c. 1 ph. input: 115 v. output:  
120 va. \$13.20  
350 va. \$27.00  
500 va. \$34.00

Raytheon

198 to 242 v. 50/60 c. 1 ph. input: 220 v. 500 w. output \$38.00

**SCR 545A SEARCH AND TRACK RADAR.** Complete trailer, power supply and spare parts. New.

NEW CAPACITORS

2 mfd 600 v. d-c tubular. \$30; 10 for \$2.50; \$20.00 per C.  
3.5/5 mfd 1,000 v. d-c wk; isolated sections 3 x 1.0 mfd 1,200 v. d-c wk; isolated sections \$1.20  
1.25/1.25 mfd 7.5 kv d-c or .625 mfd 15 kv d-c; Standard Brand. \$12.50  
.25/25 mfd 7.5 kv d-c or .125 mfd 12 kv d-c; Standard Brand. \$3.75  
1.0 mfd 25 kv d-c; Standard Brand. \$36.00  
5.0 mfd 200 wv d-c electrolytic; insulated terminals. \$95  
.001 mfd 25 kv d-c mica; 25 A @ 3,000 kc. 18 A. @ 1,000 kc. 11A. @ 300 kc. \$25.00  
50 mmfd 32 kv d-c tubular vacuum. \$4.95  
9.12 mfd 1265 v. a-c. 4000 v d-c. New; Standard Brand \$17.00

METERS

Weston or Westinghouse  
3" 0-120 a-c amps. w/current transf. \$8.50  
3" 0-20 kv d-c w/precision multiplier. 18.00  
3" 0-4 kv d-c w/precision multiplier. 9.50

SPECIALS

Westinghouse Meter Multiplier: Type R-5 1 meq., 1/2% tol., w/w noninductive \$1.25  
Immersion rect.: 10 v. 11.6 A. fl. \$32.00  
Motor: 27 v. d-c, 0.7 A., 110 R.P.M., 1 oz./ft. torque \$3.50  
Solenoids: 115 v., 60 c; continuous wt. 5 1/2 lbs. \$2.75  
Intermittent, wt. 9 lbs. \$2.75  
Indicator: 1-81-A Radio Compass. \$3.85

RESISTORS

200 watt wire wound resistors, ferrule ends 160,000 ohm, 5,000 ohm, or 1,000 ohm \$1.00

DRY DISC RECTIFIERS

Continuous Duty Ratings

3.5 v a-c. FWB, 1.8 v d-c @ 1.0 amp. \$ .90 each, 4 for \$3.00  
6.5 v a-c. FWCT, 2.2 v d-c @ 3.0 amps. \$1.20 each, 5 for \$5.00  
0-36 v a-c. HW, 200 ma d-c \$ .75 each, 2 for \$1.00  
0-54 v a-c. FWB, 1.8 amps d-c. \$4.40  
0-154 v a-c. FWB, 600 ma d-c. \$6.85  
0-180 v a-c. FWB, 400 ma d-c. \$6.90

All merchandise in "as new" condition. Add approx. 20% to net weights for estimated shipping weights. Terms are 30% with order, balance C. O. D. All prices f.o.b. Los Angeles Warehouse. Write for additional detail information on any of the above items and for special quantity discounts. Telephone MADison 6-5391.

NEW RA-38 RECTIFIERS

115 v., 60 cy. 1 phase input, output 0-15,000 v. d-c @ 500 ma. Write for detailed information.

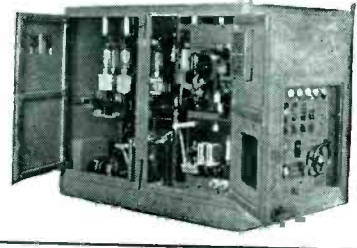

G.E. BATTERY CHARGER TRANSFORMER

Cat. #WS-99318. Pri. 105-115-125v. 60 cyc.; Secondary 105-90-75-60-45-30v. @ 8 amps. each side of center tap. Voltage reduced 10% & 20% thru tapped primary: Two X 5 v. 18 amp. C.T. (Tungar filaments) & two X 7 v. 10 amp. 7 1/2" H. x 8 1/2" W. x 5 1/2" D. Wt. 56 lbs. New—original packing. G.E. net \$52.00, our price \$47.50

GASOLINE GENERATOR

Onan type CDO-73004-A (for TBW Radio Equip.) 120 v. 800 c. 1 ph. @ 9.8 amps. 14 v. d-c @ 20 amps. New, in water-tight metal case. \$140.00

APR-4 RECEIVER: 115 or 80 v. a-c. 60 to 2600 c., includes:

TN-17 tuning unit, 74 to 320 mc. plus  
TN-18 tuning unit, 300 to 1,000 mc. plus  
TN-19 tuning unit, 950 to 2,200 mc.  
Frequency is calibrated to 1% accuracy. Service conditions are: Temperature range, 67° to 182° F. Altitude range, 0 to 50,000 ft. Humidity range, 0 to 95%. NI cond. \$475.00

TUBES

All Tubes are New. of Standard Mfg., in original boxes.

Type	Price
1B22 (10)	\$4.25
21E2 (50)	\$7.50
3B22 (175)	\$24.50
3C23 (300)	\$2.25
4B2B/S2B9414	
6 A. Rectifoon (450)	
15E (200)	2.75
127A (100)	1.25
250TL (6)	19.50
304TL (25)	.95
316A (30)	.35
388A (30)	2.75
706A (2)	9.75
701A (7)	3.50
702A (25)	2.75
703A (125)	2.75
704A (5)	1.00
706BY (6)	12.50
706EY (4)	12.50
707A (20)	12.50
707B (25)	7.00
708A (7)	2.75
713A (15)	.75
714AY (200)	3.75
715A (15)	7.50
719A (10)	9.50
721A (1)	1.75
722A (15)	7.50
725A (7)	8.50
730A (9)	10.50
730TL (22)	45.00
846 (2)	47.50
872A (300)	1.75
951A (300)	2.50
C5B (20)	7.75
C6A (40)	8.25
C6J (50)	4.75
FG81A (200)	3.75
WE-203A (4)	8.75
VT98(Br.) (30)	12.50

TRANSTATS

Variac 115 v. 50/60 c. input; 0-135 v @ 1 amp output. Type 200B. \$39.50  
115 v. 50/60 c; 0-130 v. 10 amp output \$24.50  
115 v. 60 c; 103-126 v. 2.17 amp output \$9.50  
115/230 v. 50/60 c; 0-260 v. 2.5 amp output \$21.50

TRANSFORMERS

115 v. 60c. primaries  
Amertran: 17,600 v @ 10.4 K.V.A. cont. \$65.00  
Amertran: 8,800-0-8,800 v @ 10.4 K. V. A. cont. \$75.00  
Westinghouse: 18,400-0-18,400 v @ 9 K. V. A. cont. plus 2 WL-531 rect. tubes, fl. transf. & 50 h 575 ma choke \$160.00  
24 v. @ 1 amp. uncased. \$1.60

RELAYS

Westinghouse Type SC-M Overcurrent relay, 2 to 1 A., .8 A. cont. rating 20-40% drop out ratio. \$12.95  
A-B 810 Overload Relay, 6.3-18.1 A. 600 v. max. \$7.95

CHOKES

Amertran: Swinging, 900 h @ 16 ma. 25 h @ 525 ma. 35,000 v test. \$42.00  
Kenyon: 20 h @ 300 ma. 15,000 v test. \$12.00

CONTACTORS

I.T.E.: 115 v. 60 c. coil, Single pole 115 A. 600 v. with barriers, adj. time delay & remote contact control trip \$10.95  
A-B #RC-3501: 115 v. 60 c. coil \$4.95  
D.P.S.T. 15 amp contactor. \$4.95  
Monitor: 115 v. 60 c. coil N.O.D.F. contactor, 100 A 600 v. N. C. 15-000 v. 1.0A. contact. One N.O. & one N.C. Interlock w/150 A & 30A. renewable fuses \$8.95

ASD RADAR TRANSMITTER & MODULATOR

3 centimeter: complete with 725A magnetron, cavity, two 723A/B Klystrons, one RKR73, four 72's, one 715B, one 829B, two 724B's, two 6AC7's, one IN23 crystal diode, high voltage supply, two cooling blowers, etc. Input: 115 v. 400 c. N-2 condition. \$110.00  
Pramp assembly, includes plumbing (2) 723 A/B's, (2) 6AC7's, (2) 724B's, IN23, etc. \$37.50  
725A Magnetron w/magnet. \$12.50

**SEARCHLIGHT SECTION**

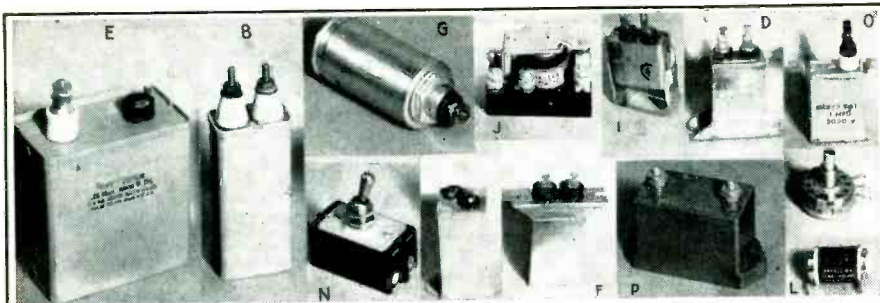

**OIL CONDENSERS**

Symbol	Capacity	Voltage	Type	Price
B	.005-.005-01	10kVdc	#25F344	\$2.50
I	.007	1000vdc	Rev. bkt	.08
B	.1	1500vdc		.28
O	.1	2000vdc		.30
G	.1	3500vdc		.35
B	.1	5000vdc		.55
G	.1	7000vdc		.90
B	.1	7000vdc	#25F453	1.10
B	.1	10000vdc	#25F434	4.25
B	.1	15000vdc	#25F572	4.75
B	.2	10000vdc	#25F433	4.50
B	.25	6000vdc	#25F659	1.25
B	.4	10000vdc	#14F267	4.75
D	.5	400vdc		.12
D	.5	500vdc		.14
B	.5	2000vdc		.75
B	.5	3000vdc		1.10
B	.5	5000vdc	#23F266	.16
F	.1	500vdc	#23F225	.18
F	.1	600vdc		.20
B	1	10000vdc	#14F267	6.00
B	1	7500vdc	#25F380	4.75
B	1.25-1.25	600vdc		.25
C	.2	600vdc		.20
G	.2	1000vdc	TLA type	.40
B	.2	1000vdc		.49
B	.2	2500vdc	With BKTS	2.15
B	.4	600vdc		.50
B	.4	600vdc		.55
B	.5	600vdc		.89
B	10	600vdc	With BKTS	2.15
B	15	1000vdc		

**TYPE "J" POTS**  
**\$ .35**

Ohms	Shank	Shaft	50000	50000	50000
50	3/8x1/8SL		50000	1/4x1/8SL	50000
200	3/8x1/8SL		50000	1/4x1/8SL	50000
500	3/8x1/8R		50000	1/4x1/8SL	50000
1000	3/8x1/8SL		100000	3/8x1/8SL	100000
2000	3/8x1/8SL		100000	3/8x1/8SL	100000
3000	3/8x1/8SL		150000	3/8x2 1/2R	150000
5000	3/8x1/8SL		200000	3/8x1/8SL	200000
10000	3/8x1/8R		250000	3/8x1/8SL (2/terms)	250000
10000	1/4x1/8S		250000	3/8x1/8SL	250000
15000	3/8x1/8S		250000	3/8x1/8SL	250000
25000	3/8x1/8SL		1Meg	1/4x1/8S	1Meg
50000	3/8x1/8S		1Meg	3/8x1/8SL	1Meg

S—Denotes Screw Driver Shaft  
 NOTES—  
 SL—Denotes Locking Type Shaft  
 R—Denotes Round Shaft

**BATHTUB CONDENSERS**  
**Priced Low**

Cap.	Volt.	Term.	Pr.
25mfd	25vdc	ST	.10
2x.01	600vdc	ST	.12
2x.025	600vdc	ST	.12
2x.05	600vdc	ST	.12
		2x.1	300vdc ST .10
		2x.1	400vdc ST .10
		2x.1	400vdc TT .10
		2x.1	400vdc BT .10

Send for Complete Bath Tub Condenser Listings

**SPECIAL—5-5mfd 400vdc Oil Cond.**

3 terms. bot. mntg flanged type. Dim. 3 3/4x3 1/4x2—Tested at 1800v. Meets commercial specifications for 600v operation. Price f.o.b. 25% with order. Balance c.o.d. plus postage. Minimum order \$2.00.

**MONMOUTH RADIO LABORATORIES**  
OAKHURST, N. J. BOX 159



**BRAND NEW RADAR SPECIALS**

- APS-4 Radomes ..... \$25.00 ea
- J-84/APS-4 Junction Box ..... \$25.00 ea
- AT-38A/APT Antenna for APR-4 ..... \$8.50 ea
- AT-49/APR-4 Antenna ..... \$8.50 ea

**AIRCRAFT RADIO EQUIPMENT and TEST SETS**

- I-96 UHF Sig. Gen. (Record) ..... \$200.00
  - AN/ARM-1 Test Set for ARC-3 ..... \$150.00 set
  - A-27 Phantom Antenna ..... 5.00 ea
  - A-58 Phantom Antenna 100 w, 200 kc—12mc. 15.00 ea
  - A-98 Phantom Antenna with special R-F Meter for testing Gibson Girls ..... 15.00 ea
  - I-100 Test Set for ARN-7 or 269 Compass ..... 850.00 set
  - I-139 Test Motor for SCR-522 ..... 12.00 ea
  - IE-19 Test Set for SCR-522 complete ..... 200.00 set
  - TS-10A/APN Altimeter Delay Line ..... 40.00 set
  - TS-16/APN Altimeter Test Set 24-v AN/APN-1 ..... 125.00 set
  - TS-16X/APN Altimeter Test 12-v AN/APN-1 ..... 150.00 set
  - TS-80/U Test Meter for AN-ARC-1 ..... 12.00 ea
  - I-86 Test Set ..... 95.00
  - RC-54 Test Set for ARC-5 or 274-N Receivers ..... 150.00 set
  - RC-55 Test Set for ARC-5 or 274-N Transmitters ..... 250.00 set
  - I-95 UHF Field Strength Ind. (100-150 MC) ..... 35.00
  - A-83 Phantom Antenna ..... 2.50
  - Model GP-7 Transmitter, complete. Brand new, all tuning units ..... \$100.00
  - W. E. Type 27B Marker Receivers 12-v (complete and reconditioned) ..... 150.00 set
  - Bendix RTA-1B Transmitter only (recond. L. N.) ..... 500.00 ea
- Some of the above Test Sets are one of a kind in stock.  
 Also in stock: AN/ARC-1, AN/ARC-3, AN/ART-13, BC-348, AN/ARN-7, MN-26, SCR-269-G.

**LARGEST DYNAMOTOR LIST AT LOWEST PRICES**

- DM-32 (24V) ..... \$ 2.00
- DY-2/ARB-1 (24V) ..... 3.00
- DM-33 (24V) ..... 12.00
- DY-8/ARC-5 (24V) ..... 5.00
- DM-28 w/filt ..... 3.50
- DM-28 less filt ..... 3.00
- DM-24 w/filt (12V) ..... 10.00
- DM-24 less filt ..... 8.00
- PE-73 (24V) ..... 10.00
- D-101 (APN-24V) ea. ..... 5.00
- D-101 (APN-1 12V) ..... 10.00
- PE-94-C (522 24V) ..... 5.00
- PE-98 (522 12V) ..... 20.00
- DA-7A (Bendix TA-2J) ..... 25.00
- DA-1A (MN-26 24V) ..... 10.00
- DA-1B (MN-26 12V) ..... 10.00
- DY-21/ARC-3 ..... 10.00
- DY-22/ARC-3 ..... 7.00
- DM-53-A (24V) ea. ..... 5.00
- DM-53-AZ (12V) ea. .... 5.00
- PE-86 w/filt (24V) ..... 12.00
- PE-86-AZ w/filt (12V) ..... 3.00
- DY-12/ART-13 w/filt ..... 35.00
- DY-12/ART-13 1/filt ..... 15.00
- BD-77 (12V) ..... 10.00
- PE-109 Inverter (12V) ..... 50.00
- MG-149-H Inverter (24V) ..... 39.00
- ZA Dyn. for 12V R-89 Rec. ..... 5.00

ABOVE MATERIAL ALL BRAND NEW IN MANUFACTURERS ORIGINAL BOXES. DELIVERY STOCK, SUBJECT TO OMISSIONS, CORRECTIONS, PRIOR SALE.

**AIRCRAFT RADIO INDUSTRIES**

780 State Street, New Haven, Conn.  
 N.Y.C. Office—274 Madison Ave.  
 Phone LExington 2-6254

**CLARE STEPPING SWITCHES**



Type SD-14, 20 steps, 6 levels. Coil 12V, DC. Lists at \$40.26; our low price \$13.00. Brand new in original boxes—not war surplus. Quantities of four or more, \$12.25 each. Satisfaction guaranteed or money refunded.

**NEOMATIC, INC.**  
879 Wellesley Ave., Los Angeles 49, Cal.  
ARIZONA 3-4897

**SOUNDTRONICS SPECIALS**

**TRANSFORMER POWER SUPPLY 115 V. 60 C.**  
 300 V. @ 55 MA., 6.3 @ 2 amps. has 5Y3, 2-8HY., 3-30 MFD Filter, Pilot, Term. Strip Completely Wired. Meas. 5" x 5" x 8" \$6.85  
 B & S # 22 1250 Volt Insul. Aeroglas wire white with tracer 100' ..... 59c  
 3 Deck 3 Pole 12 Position Ceramic Band Sw. 1 3/4" Diam. long shaft ..... \$1.98  
 20 Meg. slug tuned IF Coil in 1/16" solid copper can 1 1/2" x 3" similar to type used on BC 406 ..... 35c ea. 3/1.00  
 T. G. 10 Keyers w/Tubes ..... \$24.95

Following Equip. used but tested & practically new condition

Hj-V. D.C. Volt Meter 10/20 K. V. Ranges 6" Sq. Westinghse 0-1 MA. Meter, 20 Prec. Resistors, 6' Hj-V. Leads, Insul. Case 20" x 12" x 14" Plexi glass front ..... \$24.75  
 R.C.A. type 710A U.H.F. Signal Generator 370 to 560 Meg. ..... \$145.00  
 Transtat 3.9 K.V.A. 1 phase 50/60 cy. fixed winding 115/230 volts, output 0-260 V. Max. amps. 15 ..... \$42.00  
 Transtat 5.85 K.V.A. 1 phase 50/60 cy. fixed winding 115/230 Volts, output 0-260 V. Max. amps. 22.5, Cat. Th22 1/2 B ..... \$52.00  
 I-122 & I-126 Espy Signal Generators SL, SA3, ASB-4, ASC, Sonar, SG, SCR 296, Units Tubes & Parts in stock. Write requirements

Send name for flyer  
 Minimum order \$3.00 • 25% w/order • Balance C.O.D.

**SOUNDTRONICS LABS.**  
632 Arch St., Phila. 6, PA. MA 7-2775

**New Advertisements**

received by February 1st will appear in the March issue, subject to space limitations.  
 Classified Advertising Division  
**ELECTRONICS**  
 330 West 42nd St., New York 18, N. Y.

**GRAIN OF WHEAT LAMPS**

Used for illuminating meters, compass dials, airplane instruments, etc. Soldering iron removes lamp from base to use in models, doll houses, miniature trains, Xmas trees, etc.  
 Mazda G.E. 323 Mazda G.E. 328 3V...19A 6V...2A  
 Either type, doz. \$1.50



**MARKTIME 5 HOUR SWITCH**  
 A 10 amp. timing device. Pointer moves back to zero after time elapses. Ideal for shutting off radios and TV sets when you go to bed. Limited supply at this special PRICE... \$3.90

Also available in 15 min.-30 min.-1 hr. at \$8.50

**ISOLATION TRANSFORMER**

Nat. known Mfgs. 50 watt 2 windings, 115 V. to 115 V. 60 cy. Ideal to prevent shocks from small radios and medical and electronic devices. Shipping Weight 5 lbs. Other sizes and 220-110 in stock. \$1.95

**GONIOMETER**

Kilowatt Demand Meter Totalizer containing heavy-duty TELECHIRON B-7, 1 RPM motor and hundreds of watch size gears, clutches, springs, etc. Shipping weight 2 lbs. 5 for \$10.00 \$2.50

**RADAR MAGNETS** ..... \$5.00 to \$17.50  
 Write for Sizes and Weights.  
**RCA 930 PHOTO TUBE** ..... \$1.25  
 5 for \$5.00.

**MAGNESYN Pioneer CL-3** ..... \$1.50  
**CRYSTAL DIODE IN 34** ..... \$1.35  
**INSTANT REVERSIBLE 50 RPM HOLTZER-CABOT MOTOR 110 V.A.C.** ..... \$17.50  
**SMALL 12V. DC 40 OHM RELAY** ..... 5 for \$1.00  
 Sample 50c  
**ANT. KNIFE SWITCH S.P.D.T. 30 AMP. .95c**  
**ALLIANCE OR RUSSELL 110V AC MOTOR.**  
 \$1.85; 3 for \$5.00

We are Authorized Wholesalers for Micro Switch Corp. and carry the largest stock of Allen-Bradley Solenoids, Potter & Broomfield Relays, Guardian Electric Co. Solenoids and Relays and Haydon Clock Motors in all speeds. Electric Counters.

EST. 1923 **BLAN** EST. 1923  
**Experimenters and Inventors Supplies**  
 64 Day St., New York 7, N. Y.



**SAVE \$ SURPLUS VALUES**

**ARR-1 CONVERTER**

With 4 tubes type 954's easily converted to 10-6-2 meters. Conversion frequency 800 KC. Schematic furnished.

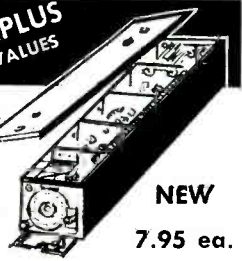

**NEW**  
7.95 ea.

**- DIRECTION FINDER -**

Type DAB-3 - Complete with spares. Frequency range 2 to 18 MC. Operates on 110 volts A.C. 60 cycle. Export packed F.O.B. Norfolk.

New ..... \$3,000.00

**SO-1 RADAR Complete less spares.**

New export packed ..... \$2,500.00

**ANTENNA MAST**— type AN 104-B. Ideal for 2 meter rig. NEW ..... \$2.00 ea.

**ARC-5 ANTENNA RF Meter & 50 MMFD Vacuum Condenser** (amp 0 to 10). Mounted ..... \$3.95 ea.

**ARC-1 TRANSCEIVERS** Complete with MT 230 Rack C-45 remote control head plugs and cables—equal to new. Guaranteed. Also spares. 10 channel, 20 channel.

**ARC-4** complete, plugs, racks, remote control box, also spares. Reconditioned. Guaranteed.

**AMPLIFIERS**

500 Watts (New) speech clipping and volume compression, tube line-up. 4-type 809, 2-type 2A3, 2-type 866, 2-type 6K7, 2-type 6H6, 4-type 6J7. Ideal for modulator (less tubes) ..... \$195.00

Same items but used ..... \$95.00

300 Watts (New) tube line-up 4-838, 2-866. Self contained power supply, 110 volt, 600 cycles. New ..... \$150.00 Used ..... \$80.00

All above amplifiers have less than 4% distortion at maximum rating. Output 500 OHMS in each case, with 500 OHM transformer back to back, perfect match for 920 watts RF input.

**VOLTAGE AMPLIFIER** 40 Watt driver for above amplifier (less tubes). Tube line-up: 4-6L6, 2-76, 2-6C6, 2-284, 2-5Z3.

New ..... \$135.00 Used ..... \$70.00

**ID-6/APN-4 INDICATOR.**

**R-9A/APN-4 POWER SUPPLY AND RECEIVER.** Complete tubes and plugs. New ..... \$145.00

**FREQUENCY METERS** LM-10 and 14 without power supply, with books ..... \$90.00 Without books, Used ..... \$30.00

**CONDENSERS** Range .01 to .008 at 5000 volts. New ..... \$1.00 ea.

**CAPACITOR** Range .02 to .09 Mica capacitor voltage range 1000 to 6000 Best Grade. New ..... \$12.00 ea.

**CONDENSER MICA** Range .00005 to .01 .20 ea.



Aircraft & Electronics Components  
639 W. 24th St.  
NORFOLK, VA

**SEND US YOUR REQUIREMENTS**

**BRAND NEW U. S. GOV'T. SURPLUS GUARANTEED**

**ALWAYS BUY TYPE "J"**

ohms shaft bush.	ohms shaft bush.
60 1/8" 1/2"	10K 1/8" 1/2"
100 1/8" 1/2"	10K 3/8" 3/8"
150 1/8" 3/8"	11K 1/4" 1/4"
300 3/8" 1/2"	12K 3/8" 3/8"
500 3/8" 1/4"	15K 1/8" 1/4"
500 1/2" 1/2"	15K 1-1/8 3/8"
600 1/2" 1/2"	16K 1/4" 1/4"
1000 1/8" 1/2"	20K 1/8" 1/2"
1000 5/8" 1/2"	20K 3/8" 3/8"
1200 1/2" 1/2"	25K 1/8" 1/2"
1400 1-1/8 1/4"	25K 1-1/8 1/2"
1500 1/8" 1/2"	30K 1/4" 3/8"
1500 1/2" 1/4"	50K 1/8" 1/2"
2000 1/8" 3/8"	50K 3/8" 3/8"
2000 1/2" 1/2"	75K 5/16" 7/16"
2100 1/8" 1/2"	80K 1/2" 1/4"
2200 1/8" 3/8"	100K 1/8" 1/2"
2200 1-1/8 3/8"	100K 9/16" 3/8"
4000 1-1/8 3/8"	200K 1/8" 1/2"
4700 3/8" 1/2"	200K 3/8" 3/8"
5000 1/8" 1/2"	250K 7/16" 1/2"
5000 1/2" 1/4"	300K 1/8" 1/2"
5000 5/8" 1/2"	1meg 1/8" 1/2"
	1meg 3/8" 1/4"

50c each

**TYPE "JJ" DUALS**

ohms shaft	ohms shaft
100/100 1/8"	100K/100K 1/8"
200/200 1/2"	100K/100K 1/2"
500/500 1/8"	130K/130K 1/8"
500/500 2-1/8	150K/150K 3/8"
600/600 1-1/2	200K/200K 3/8"
1500/1500 2-1/8	250K/250K 1/2"
2000/2000 1/8"	300K/300K 1/2"
2000/2000 1-1/8	350K/350K 3/8"
5000/5000 2-1/8	350K/25K 5/16"
10K/10K 3/8"	500K/500K 2-1/8
20K/2000 3/8"	800K/75K 1/2"
25K/10K 2-3/4	1meg/1meg 3/8"
35K/5000 3/8"	4meg/4meg 3/8"
50K/50K 1-1/4	5meg/5meg 1/2"

\$1.25 each

**TYPE "JJJ" TRIPLES**

ohms shaft	shaft
20K/200K/20K 3/8"	3/8"
45K/27K/2500 1/4"	1/4"
700K/700K/700K 3/16"	3/16"
750K/750K/750K 1-3/8	1-3/8
800K/800K/800K 1-3/8	1-3/8
1 meg/1 meg/1 meg 3/4"	3/4"

\$2.25 each

\* Screwdriver slot.  
† Locking bushing.

**"AN" CONNECTORS**



LARGE VARIETY AVAILABLE AT GREAT SAVINGS

Send your specs and let us quote

**OIL CONDENSERS**

Mfd.	Volt.	Each
1	3000	\$0.75
.25	2000	.95
.25	3000	1.10
.25	3500	1.15
1	500	.28
1	600	.35
2	400	.35
2	600	.39
4	600	.59
6	400	.75
6	600	.79
10	600	.95
14	600	1.75
15	600	1.98
15	1000	2.75
30	90V AC	3.95
3x4	3 Phase Plug-in	1.49

**BATHTUBS**

mfd	vdew	each
.033	400	.17
.05	200	.17
.05	400	.19
.05	600	.21
.1	400	.22
.1	600	.22
.1	1000	.22
.15	600	.22
.25	200	.19
.25	600	.23
.35	400	.22
.4	400	.23
.5	600	.25
.5	1000	.35
1	200	.29
1	600	.35
2	400	.44
2	600	.49
4	50	.25
8	500	.59
25	50	.28
40	25	.27
50	25	.28
200	12	.35
300	6	.39
.05-.05	600	.29
.05-.05	1500	.45
.1-.05	200	.25
.1-.1	400	.26
.1-.1	600	.28
.16-.16	600	.28
.2-.2	600	.29
.25-.25	600	.30
.5-.5	600	.35
1.0-.1	300	.29
200-200	9	.49
3x.05	600	.40
3x.1	400	.42
3x.1	600	.45
3x.25	600	.50
3x1.0	100	.40

Open Accounts to Rated Concerns  
Prices net FOB whse NYC  
Send for our Catalog

**POWER RHEOSTATS**



ohms watt ea.	ohms watt ea.
5 50 \$1.24	378 150 \$2.74
5 150 2.74	400 25 .98
6 25 .98	500 25 .98
6 50 1.24	500 75 1.97
7 25 .98	585 150 2.74
7.5 100 2.25	750 25 .98
8 50 1.24	750 150 2.74
10 25 .98	1000 25 .98
12 25 .98	1200 225 3.25
15 25 .98	1250 50 1.24
16 50 1.24	1250 150 2.74
22 50 1.24	1500 50 1.24
25 50 1.24	2000 25 .98
50 25 .98	2000 50 1.24
50 50 1.24	2500 100 2.25
60 25 .98	3000 25 .98
75 150 2.74	3000 100 2.25
80 50 1.24	3500 50 1.24
80 500 4.95	5000 25 .98
100 50 1.24	5000 50 1.24
125 25 .98	7500 50 1.24
150 50 1.24	7500 100 2.25
200 25 .98	10000 50 1.24
250 25 .98	10000 100 2.25
350 25 .98	20000 150 2.74

(Discounts to Quantity Users.)

**BIRTCHEr TUBE CLAMPS**

#926-A	#926-B22
#926-A1	#926-C
#926-B1	#926-C1
#926-B2	#926-C5
#926-B7	#926-C10
	#926-C24

18¢



**SELECTOR SWITCHES**

Pole	Pos	Deck	Type	Ea.
1	12	1	ceramic	\$5.55
1	24	3	bakelite	.55
2	11	2	bakelite	.60
4	11	4	bakelite	1.17
6	11	6	bakelite	1.68
18	5	9	ceramic	1.90

**"UHF" Coax Cable Connectors**



Cat. No.	Army No.	Type	Ea. Per/C
83-TAP	M-359	Plug	.35 .28
83-1D	PL-271	Adap	1.25 1.00
83-1F	PL-274	Feed	1.10 .90
83-1R	SO-239	Rec.	.35 .28
83-1SPN	PL-269A	Plug	.35 .28
83-22P	SO-264	Rec.	.50 .40
83-22SP	UG-102/U	Plug	.45 .40

**RADAR EQUIPMENT**

SCR-717B APS-3 APS-4 SO-9 Search Radars Complete  
APR-1 and APR-4 Receivers with Tuning Units  
DP-12 Direction Finder  
TS-51/APG-4 Test Set

**W. E. COMPUTER POTENTIOMETERS**  
D-170541 D-170542 D-170543 D-170545 D-170546  
D-170548 ..... @ \$10.00  
2438 Magnetrons ..... @ \$75.00  
Arc Connectors ..... @ .25  
6963-18 Contact Female  
55916-18 Contact Male Chassis  
9488-3 Contact Female  
55915-3 Contact Male Chassis

Write for listings of other surplus bargains

**LERU LABORATORIES, INC.**

360 Bleecker St. New York 14  
OR 5-3525

**D.C. MICROAMMETERS**

0-200 ua 3" sq. G.E. DO 50	\$ 8.00
0-100 ua 3" sq. G.E. DO 50	10.00
0-50 ua 3" sq. G.E. DO 50	12.00

**R.F. MILLIAMMETERS**

0-115 Ma 3 1/2" Weston 425	\$12.00
0-100 Ma 3 1/2" Weston 425	12.00

**PRECISION PORTABLE INSTRUMENTS**  
Single or multi-range

D.C. Microammeters, from 5 ua full scale.  
Thermo-couple Millimeters, from 1.5 Ma.  
Thermo-couple voltmeters.

Precision Electrical Instrument Co.  
146 Grand Street New York 13, N. Y.

**SPECIAL SALE**

**250,000 MICA CONDENSERS**

from 10 mfd to .5 mfd. Brand New. Large part in Silver Mica. Tolerance 1 to 5%. Only \$15.00 per thousand.

**TELETRAD**

3232 Broadway, New York 27, N. Y.  
Tel: RI verside 9-4955

# TAB for NEW TUBES TESTED and GUARANTEED

THAT'S A BUY

0A3/VR75 .98	2C40 5.50	6A7 .68	6SG7 .57	12J7GT .78	50A5 .73	WL468 6.75	930 .75	902 3.15
0A4 .94	2C43/464A 9.39	6A8 .78	6SH7 .38	12K7 .65	50B5 .54	RH507 9.98	931A 3.95	910 3AP1 4.63
0B2 1.72	2C44 1.69	6AB4 .81	6S7GT .55	12K8 .55	50C5 .59	527 7.90	935 3.12	912 89.98
0B3/VR90 .74	2C51 8.10	6AB7/1853 .77	6SK7GT .55	12L8GT 1.59	50D5 .98	531 1.80	956 .37	914 45.00
0C3/VR105 .75	2D21 1.10	6AC5 .75	6SL7GT .55	12M8GT .73	50E6 1.95	506 1.95	957 .20	Tundar Bulbs
0D3/VR150 .49	2E5 1.89	6AD6G .81	6SN7WGT .89	12S8GT .55	57 .57	57 57	958 .35	16X897 2.49
0Z4 .56	2E22 4.50	6AD7 1.17	6SO7GT .44	12SC7 .55	58 .58	58 58	959 .28	20X672 2.95
1A .45	2E25/HY65 4.00	6AF6G .77	6SR7 .56	12SF7 .56	58 RK65 22.98	54 4.98	960 .12	18904GE 3.49
1A3 .42	2E26 3.45	6AG5 .72	6SS7 .57	12SH7 .34	59 59	59 59	961 1.69	199698 2.95
1A4 1.08	2E30 2.35	6AG7 1.08	6ST7 .73	12SI7 .45	60 60	60 60	962 1.10	289881 2.50
1A5GT .48	2J21 11.45	6AH6 .98	6T7 1.17	12SK7GT .55	71 71	71 71	963 1.99	859483 3.98
1A6 .78	2J21A 11.45	6AI6 .73	6T8 .98	12SK7M .52	72 72	72 72	964 1.99	Ballast
1A7GT .66	2J22 9.75	6AK5 .78	6U5/6G5 .63	12SL7GT .54	73 73	73 73	965 1.42	IP1 49
1B3/8016 .98	2J26 8.45	6AK6 .81	6U6GT .59	12SL7GT .54	74 74	74 74	966 1.49	PM3 .98
1B21/471A 2.85	2J27 14.50	6AL5 .59	6U7G .54	12SN7GT .49	75 75	75 75	967 1.49	PM4 .98
1B22 4.50	2J31 9.95	6AL7 1.00	6V6GT .90	12SR7GT .49	76 76	76 76	968 1.49	PM5 .98
1B23 9.00	2J32 14.85	6AN5 .52	6V6M .52	12SX7GT .49	77 77	77 77	969 1.49	PM6 .98
1B24 4.65	2J33 18.92	6AO5 .54	6VAGT .72	12T3 .72	78 78	78 78	970 1.49	PM7 .98
1B26 4.50	2J34 17.50	6AR5 .54	6W7G .87	12T3 .72	79 79	79 79	971 1.49	PM8 .98
1B27 4.75	2J37 13.85	6AS5 .59	6X4 .54	14A7/12B7 .67	80 80	80 80	972 1.49	PM9 .98
1B29 3.39	2J38 12.70	6AS6 1.89	6X5GT 4.29	14A7 .67	81 81	81 81	973 1.49	PM10 .98
1B32 4.90	2J39 29.00	6AS7G 4.29	6Y6GT 1.00	14B7 .86	82 82	82 82	974 1.49	PM11 .98
1B37 45.00	2J47 49.95	6AT6 .53	6Z7G 1.08	14C7 .77	83 83	83 83	975 1.49	PM12 .98
1B38 36.00	2J48 45.00	6A7G .45	6Z7Y5G .67	14H7 .63	84 84	84 84	976 1.49	PM13 .98
1B41 49.95	2J49 22.50	6AV6 .43	7A4/XXL .57	14N7 .86	85 85	85 85	977 1.49	PM14 .98
1B42 7.50	2J50 39.00	6B4G .89	7A5 .65	14O7 .55	86 86	86 86	978 1.49	PM15 .98
1B53 49.95	2J56 81.00	6B7 .77	7A6 .77	14P7 .86	87 87	87 87	979 1.49	PM16 .98
1B54 49.95	2J61 39.00	6B8G .89	7A7 .60	14Q7 .86	88 88	88 88	980 1.49	PM17 .98
1B56 49.95	2J62 39.00	6BA4 1.00	7A8 .47	14R7 .86	89 89	89 89	981 1.49	PM18 .98
1C5 .86	2K23 23.75	6B6 1.00	7A9 .69	14S7 .86	90 90	90 90	982 1.49	PM19 .98
1C4 1.00	2K25 23.75	6B6E .52	7AG7 .69	14T7 .86	91 91	91 91	983 1.49	PM20 .98
1C7G .89	2K28 24.89	6B7 .77	7B4 1.39	14U7 .86	92 92	92 92	984 1.49	PM21 .98
1D5GP .99	2V32 6.9	6B8G .89	7B5 .52	14V7 .86	93 93	93 93	985 1.49	PM22 .98
1D8GT .99	2V36 6.9	6B9 1.00	7B6 .52	14W7 .86	94 94	94 94	986 1.49	PM23 .98
1E5 1.38	2X2 3.8	6B9G .89	7B7 .57	14X7 .86	95 95	95 95	987 1.49	PM24 .98
1E7G 1.17	3A5 9.0	6C4 2.4	7B8 .57	14Y7 .86	96 96	96 96	988 1.49	PM25 .98
1F4G 1.55	3B7/1291 .29	6C5 .47	7C4/1203A .36	15A7 .86	97 97	97 97	989 1.49	PM26 .98
1F7GT .69	3B22 2.64	6C6 .55	7C5 .49	15B7 .86	98 98	98 98	990 1.49	PM27 .98
1G6GT .67	3B24 1.75	6C6G .55	7C6 .59	15C7 .86	99 99	99 99	991 1.49	PM28 .98
1H4G .87	3B25 4.85	6C8G .62	7C7 .69	15D7 .86	100 100	100 100	992 1.49	PM29 .98
1H5G .65	3B28 5.98	6C9 23.95	7C8 .69	15E7 .86	101 101	101 101	993 1.49	PM30 .98
1H6G .99	3K25 3.98	6D1 2.75	7C23 69.00	15F7 .86	102 102	102 102	994 1.49	PM31 .98
1I6 .79	3C31/C1B 3.75	6D6 .47	7E5/1201 .65	15G7 .86	103 103	103 103	995 1.49	PM32 .98
1I4 .49	3C45 12.85	6D8 .85	7E6 .57	15H7 .86	104 104	104 104	996 1.49	PM33 .98
1I4A4GT .99	3D6/1299 .29	6E5 .69	7E7 .65	15I7 .86	105 105	105 105	997 1.49	PM34 .98
1I4B .99	3D21A 1.39	6E6 1.05	7E8 .64	15J7 .86	106 106	106 106	998 1.49	PM35 .98
1I4C .75	3D22 7.49	6E7 .47	7F7/1232 .98	15K7 .86	107 107	107 107	999 1.49	PM36 .98
1I4E3GT .85	3E29/829B 7.98	6F6 .59	7H7 .64	15L7 .86	108 108	108 108	1000 1.49	PM37 .98
1I4H .64	3F4 1.25	6F7 .47	7J7 .98	15M7 .86	109 109	109 109	1001 1.49	PM38 .98
1I4N5 .62	3Q4 .54	6F8 .84	7K7 1.05	15N7 .86	110 110	110 110	1002 1.49	PM39 .98
1I4N5GT .69	3Q5 .89	6G6 .99	7L7 .67	15O7 .86	111 111	111 111	1003 1.49	PM40 .98
1I4P5GT .54	3S4 .59	6G7 3.90	7M7 .67	15P7 .86	112 112	112 112	1004 1.49	PM41 .98
1I4Q .86	4C33 81.00	6H4 4.93	7N7 .63	15Q7 .86	113 113	113 113	1005 1.49	PM42 .98
1O26 75.00	4C35 19.45	6J5GT .48	7S7 .89	15R7 .86	114 114	114 114	1006 1.49	PM43 .98
1R4/1294 .65	4J31 95.00	6J6 .72	7T7 1.03	15S7 .86	115 115	115 115	1007 1.49	PM44 .98
1R5 .63	4J32 95.00	6J7 .65	7U7 .67	15T7 .86	116 116	116 116	1008 1.49	PM45 .98
1R5 .66	4J42/700 29.85	6J8 6.95	7V7 .85	15U7 .86	117 117	117 117	1009 1.49	PM46 .98
1S5 .97	5A 45.00	6K5GT .86	7W7 .85	15V7 .86	118 118	118 118	1010 1.49	PM47 .98
1T4 .54	4T4/2 9.95	6K6GT .42	7X7/XXFM .85	15W7 .86	119 119	119 119	1011 1.49	PM48 .98
1T5GT .105	5C22 47.00	6K7 .48	7Y4 .49	15X7 .86	120 120	120 120	1012 1.49	PM49 .98
1U4 .59	5C30/C5B 8.49	6K8 .75	10Y .60	15Y7 .86	121 121	121 121	1013 1.49	PM50 .98
1U5 .59	5D21 27.90	6L6 .84	12A6 1.18	15Z7 .86	122 122	122 122	1014 1.49	PM51 .98
1V .59	5J37 13.45	6L6 6.95	12A7 .99	16A7 .86	123 123	123 123	1015 1.49	PM52 .98
5J23 13.45	5J29 17.39	6L6G .82	12A8GT .56	16B7 .86	124 124	124 124	1016 1.49	PM53 .98
1X2 .98	5J32 99.00	6L6GA .82	12AH7GT .99	16C7 .86	125 125	125 125	1017 1.49	PM54 .98
1Z2 2.98	5R4GY 1.12	6L7 1.77	12AL5 .72	16D7 .86	126 126	126 126	1018 1.49	PM55 .98
2A3 .84	5T4 .88	6N4 1.08	12AT6 .45	16E7 .86	127 127	127 127	1019 1.49	PM56 .98
2A4G 1.06	5U4G .52	6N7GT .90	12AT7 .77	16F7 .86	128 128	128 128	1020 1.49	PM57 .98
2A5 .78	5V4 .74	6N8 6.95	12A7 .77	16G7 .86	129 129	129 129	1021 1.49	PM58 .98
2A7 .88	5X4G .71	6R7 .71	12AU6 .69	16H7 .86	130 130	130 130	1022 1.49	PM59 .98
2B4 .98	5Y3GT .37	6R7 .85	12AU7 .69	16I7 .86	131 131	131 131	1023 1.49	PM60 .98
2B7 .78	5Z3 .81	6S8GT .79	12AX7 .81	16J7 .86	132 132	132 132	1024 1.49	PM61 .98
2B22/GL559 .73	5Z4 .74	6S9GT .43	12BD6 .59	16K7 .86	133 133	133 133	1025 1.49	PM62 .98
2C21/1642 .48	6A3 6.95	6S7 .57	12BE6 .45	16L7 .86	134 134	134 134	1026 1.49	PM63 .98
2C22/7193 .15	6A3 .98	6S7GT .45	12C8 .35	16M7 .86	135 135	135 135	1027 1.49	PM64 .98
2C26 .25	6A4 1.29	6S8 .58	12H6 .34	16N7 .86	136 136	136 136	1028 1.49	PM65 .98
2C34/RK34 .55	6A6 .88	6S7 .48	12J5GT .35	16O7 .86	137 137	137 137	1029 1.49	PM66 .98
2C39 21.00				16P7 .86	138 138	138 138	1030 1.49	PM67 .98

## Write for Your FREE "TABOGRAM"—Lowest Prices on Electronic Components

**6 VOLT CARTER "MAGMOTORS"**  
 PermMagnets Extremely Hi-Eff. Compact 5/4x3x2 1/2".  
 Lifetime.  
**KMTG "MAGMOTOR" Inpt 5.5VDC: Output 400V/150Ma \$8.98**  
 5 1/2% Eff. 6500RPM 4 1/2 lbs.  
**RCVING "MAGMOTOR" Inpt 6VDC: Output 250V/100Ma 52% Eff. 4800 RPM. 4 1/2 lbs. ONLY \$4.98**  
 Both Units above, SPECIAL \$12.49

**MERCURY THERMO-REG'LATOR**  
 Dual Ckt. 105°F. ±.32°  
 1/2" Extremely Sensitive & Accurate for Most Exacting Requirements  
 Brand New. Indiv. Boxed w/data & ckt List OVER \$20. 98c; 12 for \$10

**G-E LIQUID LEVEL TRANSMITTER**  
 Amazing "TAB" Special! General Electric Tri-Selsyn for Remote Indication of liquid present in tank. Any Change in level raises or lowers float arm. Approx. Govt Cost \$100.  
**BRAND NEW! 2 for 89c**

**SNOOPERSCOPE INFRARED**  
 Image-Converter Tube Hi-Sensitivity simplified design 2" dia. Complete data & Tube... \$7.90

**Transformer Buys! 115V 60 cye Inpt.**  
 1000vct/45ma, 795vct/80ma & 380vct/55ma, 3x5v/3A, 6.3vct/1A, 6.3vct/0.3A Csd Ma  
 16 Vins. \$1.95  
 900vct/35ma, 2x2.5v/2A Csd HiVins. \$3.98  
 700vct/12ma, 115v/100ma, 2x6.3v/1A, 5V 2A Csd HiVins. \$2.98  
 420 vct/120ma, 6.3v/1.9A. Also Inpts 6-12-24 & 115vdc & 230 vac. \$1.98; 10/\$16.98  
 225vct/250ma, 6.3v/4.15A, 3v/2A, \$1.89  
 220V/50ma, 5V, 0.5A, 6.3v/2A, 6.3v/1A \$2.39  
 1080V vct or 2100V vDblr/035A Csd. \$18.95  
 7500v or 15000V Dblr/035A Csd. \$18.95  
 3000V/10ma \$4.50  
 2x330vct/10ma (or 660vct/10ma) \$9.80  
 6.3vct/2.5A, 6.3vct/1A, Csd. HiVins. \$2.29  
 2.5v/7.5A, 2A, Wndg (for 872A's) 7.95  
 4v/16A, 2.5v/1.75A Csd HiVins. \$4.95  
 12.0vct/1.25A Csd HiVins. \$4.99  
 7.5vct/12A Csd Raytheon. \$3.29  
 6.3vct/4A (end 6.5A) Csd HiVins. \$6.69  
 6.3vct/0.6A Csd HiVins. \$4.99

**CRYSTAL DIODES**

Type	Each	10 for	Type	Each	10 for
1N21	\$5.40	\$4.00	1N27	\$1.75	\$14.98
1N21A	1.00	8.30	1N34	.84	7.98
1N21B	1.75	14.98	1N35	2.75	25.98
1N22	1.50	14.00	1N37	1.25	10.00
1N23	1.50	14.00	1N44	.85	7.50
1N23A	1.50	14.00	1N45	1.00	8.39
1N23B	3.00	27.50	1N48	1.15	10.49
1N26	3.00	27.50	1N51	1.08	9.49

**Rectifiers—Brand New!**  
 Sensational BRADLEY Double Bridge, Balanced Current & Temp. 1% from -40° to +85°C. Input to 4.5 VAC. Output to 3VDC/5 Ma.  
**Brand New, Amazing Buy 98c**  
 Selenium. 36Vin/30Vout/150Ma w/Mfg. Flange. 2 Units Can Connect in C.T. for Full Wave. 4 Units Usable as Full Wave Bridge. Ea. Unit .36c; 2 for 60c; 4 for \$1.00  
 Selenium. FEDERAL 100Ma. \$72c  
 200Ma .98c  
 Full-Wave Bridge Set Rect for Relays or Pwr. Inpt 115 to 130VAC: Output 115VDC/40Ma. Ea. \$1.49; 2 for \$2.49; 4 for \$4.49

**BRIDGE RECTIFIERS**

Inpt	Output	Amps	Each
18			

# INDEX TO ADVERTISERS

1949 BUYERS' GUIDE ADVERTISING INDEX ..... 135

Accurate Spring Mfg. Co. ....	222	Eitel-McCullough, Inc. ....	51
Acheson Colloids Corp. ....	48	Electrical Reactance Corp. ....	161
Advance Electric & Relay Co. ....	231	Electronic Instrument Co., Inc. ....	228
Aeronautical Communications		Electronic Tube Corp. ....	207
Equipment, Inc. ....	52	Electrons, Inc. ....	152
Aerovox Corp. ....	30	El-Tronics, Inc. ....	242
Alden Products Co. ....	196	Eric Resistor Corp. ....	7
Allen Co., Inc., L. B. ....	242	Essex Wire Corp. ....	20
Allen Manufacturing Co. ....	160		
Allied Control Co., Inc. ....	54	Fairechild Camera & Instrument Corp. ....	227
American Electrical Heater Co. ....	214	Federal Telephone & Radio Corp. ....	155
American Phenolic Corp. ....	134	Freed Transformer Co., Inc. ....	133
American Screw Co. ....	24	Furst Electronics ....	232
American Smelting & Refining Co. ....	145	Fusite Corporation ....	61
American Television & Radio Co. ....	210		
American Time Products, Inc. ....	22	Garrett Co., Inc., Geo. K. ....	240
Amperex Electronic Corp. ....	Third Cover	General Aniline & Film Corp. ....	16, 17
Amperite Company ....	219	General Control Co. ....	226
Arkwright Finishing Co. ....	186	General Electric Co. ....	
Arma Corporation ....	59	Apparatus Dept. .... 41, 44, 45, 137, 157, 169	
Armedo Steel Corp. ....	139	Electronics Dept. ....	35
Arnold Engineering Co. ....	38	Lamp Dept. ....	211
Art Wire & Stamping Co. ....	231	General Radio Co. ....	147
Astafic Corp. ....	146	Gramer Company ....	219
Audak Company ....	280	Graphite Metallizing Corp. ....	215
Automatic Coil Winder & Electrical		Gray Research & Development Co., Inc. ....	140
Equipment Co., Ltd. ....	188	Green Instrument Co. ....	225
Automatic Electric Sales Corp. ....	197	Gries Reproducer Corp. ....	242
Ballantine Laboratories, Inc. ....	142	Handy & Harman ....	202
Barker & Williamson, Inc. ....	144	Hanover Developments ....	220
Barry Corporation ....	62	Hathaway Instrument Co. ....	223
Bell Telephone Laboratories. ....	165	Haydon Co., A. W. ....	210
Bendix Aviation Corp. ....		Haydon Mfg. Co., Inc. ....	200, 201
Eclipse-Pioneer Div. ....	235	Haydu Brothers ....	171
Pacific Div. ....	229	Heath Company ....	202
Bentley, Harris Mfg. Co. ....	28	Heinemann Electric Co. ....	14
Berkeley Scientific Co. ....	241	Helipot Corporation ....	162
Bird & Co., Inc., Richard H. ....	235	Hewlett-Packard Co. ....	8
Bircher Corporation ....	227	Hexacon Electric Co. ....	235
Blake & Johnson Co. ....	205	Heyman Mfg. Co. ....	233
Blaw-Knox Company ....	45	Highland Engineering Co. ....	212
Boonfak Radio Corp. ....	121	Hollist Mills, Inc. ....	221
Bozak, R. T. ....	233	Howard Industries, Inc. ....	236
Bridgeport Brass Co. ....	34		
Brook Electronics, Inc. ....	227	Industrial Condenser Corp. ....	231
Brown Electro-Measurement Corp. ....	239	Institute of Radio Engineers ....	231
Brown Instruments Div. ....		Instrument Resistors Co. ....	237
Minneapolis-Honeywell Regulator Co. ....	123	International Resistance Co. ....	5
Browning Laboratories, Inc. ....	168	Irvington Varnish & Insulator Co. ....	163
Brush Development Co. ....	55		
Buck Engineering Co., Inc. ....	242	Jelliff Mfg. Corp., C. O. ....	215
Burnell & Company ....	39	Johnson Company, E. F. ....	208, 237
		Jones Div., Howard B., Cinch Mfg. Corp. ....	280
		Joy Manufacturing Co. ....	212
Cambridge Thermionic Corp. ....	218	Kable Engineering Co. ....	176
Cannon Electric Development Co. ....	184	Karp Metal Products Co., Inc. ....	36
Capitol Radio Engineering Institute. ....	235	Kay Electric Co. ....	185
Carborundum Co. ....	189	Kenyon Transformer Co., Inc. ....	49
Central Paper Co., Inc. ....	206	Kester Solder Co. ....	117
Centralab, Div. Globe-Union, Inc. ....	9, 10, 11, 12	Kinney Manufacturing Co. ....	13
Cinch Manufacturing Corp. ....	113	Kollsman Instrument Div., Square D Co. ....	56
Clare & Co., C. P. ....	23		
Claroastat Mfg. Co., Inc. ....	210	Kable Engineering Co. ....	176
Cleveland Container Co. ....	193	Karp Metal Products Co., Inc. ....	36
Coburn Corporation, Sigmund ....	221	Kay Electric Co. ....	185
Collins Radio Co. ....	43	Kenyon Transformer Co., Inc. ....	49
Condenser Products Co. ....	15	Kester Solder Co. ....	117
Consolidated Molded Products Corp. ....	33	Kinney Manufacturing Co. ....	13
Cornell-Dubilier Electric Corp. ....	53	Kollsman Instrument Div., Square D Co. ....	56
Cornish Wire Co., Inc. ....	172		
Cross Co., H. ....	212	Lampkin Laboratories, Inc. ....	242
Crucible Steel Co. of America. ....	149	Lectrohm, Inc. ....	238
		Lenkurt Electric Co. ....	232
		Linde Air Products Co. ....	239
Dano Electric Co. ....	239	Magnecord, Inc. ....	231
Davon Company ....	150	Mallory & Co., Inc., F. R. ....	64, 115
Dial Light Co. of America ....	224	Manning, Maxwell & Moore, Inc. ....	191
Distillation Products Industries. ....	167	Marion Electrical Instrument Co. ....	2
Dow Corning Corp. ....	212		
Driver Col. Wilbur B. ....	19		
Driver-Harris Co. ....	47		
Dumont Electric Corp. ....	181		
Du Mont Laboratories, Inc., Allen B. ....	26, 195		
du Pont de Nemours & Co., E. I. ....	151		
Eastern Air Devices, Inc. ....	226		
Eastman Kodak Co. ....			
Cellulose Products Div. ....	129		
Industrial Photographic Div. ....	141		
Eisler Engineering Co., Inc. ....	239, 242		

## APPLICATION ENGINEERED "PRECISION"

Circuit Tester  
20,000 Ohms per Volt



## THE SERIES "85"

Compact, laboratory style, high sensitivity test set. "Application Engineered" for production, test, laboratory, school and service-maintenance phases of modern radio-electronics-communications.

20,000 Ohms per Volt D.C.  
1000 Ohms per Volt A.C.

VOLTAGE RANGES: 0-3-12-60-300-1200-6000  
A.C. & D.C.

CURRENT RANGES: 0-120 microamps  
0-1-2-12-120-1200 MA.  
0-12 Amps D.C.

RESISTANCE RANGES: 0-6000-600K Ohms  
0-6-60 Megohms.

DECIBEL RANGES: From -26 to +70 DB.

Complete with batteries  
and test leads **\$3875**

### PLUS superior physical features:

- ★ 4 3/8" wide angle meter
- ★ Heavy duty molded bakelite instrument case, size 5 1/2 x 7 1/8 x 3"
- ★ Heavy gauge, anodized aluminum panel
- ★ Rotary Range and Function Selection
- ★ Recessed 6000 volt safety jacks
- ★ Only two pin jacks for all standard ranges

### LC-1 Leather Carrying Case

Custom designed top-grain cowhide case **\$875**  
with tool and test lead compartment.

See this and other "Precision" Application Engineered instruments on display at leading radio parts distributors. Write for latest catalog.

**Precision Apparatus Co., Inc.**  
92-27 HORACE HARDING BLVD.  
ELMHURST 10, N. Y.

\*Reg. U.S. Patent Office  
Export: 458 B'way, N.Y.C., U.S.A. Cables: MORHANEX  
In Canada: Atlas Radio Corp. Ltd., Toronto, Ontario

when you use  
the **Audax**  
**POLYPHASE...**  
**ONE** single unit  
plays **ALL**  
your records  
**SUPERBLY...**  
and at less  
than the cost  
of ordinary  
magnetic pick-ups

*"The Standard  
by which  
Others  
Are Judged  
and Valued"*



Microgroove,  
78 r.p.m., etc.

Only \$11.70  
net cost to you—  
believe it or not!

See it at your  
local distributor  
or write us

**AUDAK COMPANY**  
500 5th Ave., Dept. 22 New York 18  
*Fine Music Reproducers Since 1915*

*Ideal for*  
**ANTENNA CONNECTIONS**  
**PHOTO-CELL WORK**  
**MICROPHONE CONNECTIONS**

**JONES**  
**SHIELDED TYPE**  
**PLUGS & SOCKETS**

**LOW LOSS PLUGS AND  
SOCKETS FOR HIGH  
FREQUENCY CONNECTIONS.**  
SUPPLIED IN 1 AND 2  
CONTACT TYPES:

101 Series can be furnished with 1/4", .290", 5/16", 3/8" or 1/2" ferrule for cable entrance. Knurled nut securely fastens unit together. Plugs have ceramic insulation and sockets have bakelite. Quality construction. Fine finish. Assembly meets Navy specifications.

For full details and engineering data ask for Jones Catalog No. 17.

**JONES MEANS  
Proven QUALITY**



**HOWARD B. JONES DIVISION**  
CINCH MANUFACTURING CORPORATION  
CHICAGO 24, ILLINOIS  
SUBSIDIARY OF UNITED-CARR FASTENER CORP.

McGraw-Hill Book Co	208	Waldes Kobinoor, Inc	175
Measurements Corp.	158	Ward Leonard Electric Co.	138
Mepco, Inc.	216	Ward Products Corp.	18
Mica Insulator Co.	159	Webster Electric Co.	42
Mico Instrument Co.	239	White Dental Mfg. Co., S. S.	154, 221
Millen Mfg. Co., Inc., James	214	Whitehead Stamping Co.	235
Milo Radio & Electronics Corp.	203	Wilcox Electric Co.	183
Minnesota Mining & Mfg. Co.	180	Wrought Washer Mfg. Co.	227
Mitchell-Rand Insulation Co., Inc.	50		
Mosinee Paper Mills Co.	164		
Muirhead & Co., Ltd.	3		
Myalex Corp. of America	198		

National Company, Inc.	212
National Vulcanized Fibre Co.	182
New Hampshire Ball Bearings, Inc.	229
New Hermes, Inc.	223
Nothelfer Winding Laboratories	228

Ohmite Manufacturing Co.	32A, 32B
Oregon Electronics Mfg. Co.	223

Paper Machinery & Research, Inc.	219
Paramount Paper Tube Corp.	238
Par-Metal Products Corp.	216
Patton-MacGyver Co.	217
Photovolt Corp.	223
Plastics & Electronics Co.	242
Polarad Electronics Co.	210
Potter Instrument Co., Inc.	234
Precision Apparatus Co., Inc.	279
Precision Paper Tube Co.	208
Presto Recording Corp.	174
Progressive Mfg. Co.	178
Pyramid Electric Co.	60

Radio Corp. of America	37, 127
	190, Fourth Cover
Radio Receptor Co., Inc.	177
Railway Express Co., Air Express Div.	170
Rauland Corporation	21
Raytheon Manufacturing Co.	125

Sangamo Electric Co.	27
Scientific Electric, Div. of "S" Corrugated Quenched Gap Co.	230
Scovill Mfg. Co.	222
Servomechanisms, Inc.	218
Shallcross Manufacturing Co.	148
Shure Brothers, Inc.	194
Sigma Instruments, Inc.	63
Sola Electric Co.	143
Soparel	25
Sorensen & Co., Inc.	29
Specialty Battery Co.	202
Speer Carbon Co.	217
Sprague Electric Co.	119
Stackpole Carbon Co.	10
Standard Piezo Co.	241
Standard Pressed Steel Co.	225
Stevens Mfg. Co., Inc.	192
Steward Mfg. Co., D. M.	225
Stoddard Aircraft Radio Co.	215, 236
Struthers-Dunn, Inc.	136
Stupakoff Ceramic & Mfg. Co.	166
Superior Electric Co.	6
Superior Tube Co.	209
Sylvania Electric Products, Inc.	131, 179

Tektronix, Inc.	224
Teledron, Incorporated	187
Television Equipment Corp.	225
Thordarson Electric Mfg. Div., Maguire Ind., Inc.	220
Titanium Alloy Mfg. Div., National Lead Co.	32
Topflight Tape Co.	242
Transradio, Ltd.	217
Trans-Sonics, Inc.	230
Triplet Electrical Instrument Co.	199
Tung-Sol Lamp Works, Inc.	57
Turner Company	153

Union Carbide & Carbon Corp.	239
Uni-Products, Inc.	234
United Transformer Co.	Second Cover
Universal Winding Co.	58
University Loudspeakers, Inc.	156

Varian Associates	213
Vickers Electric Div., Vickers Inc., A Unit of The Sperry Corp.	31
Vivtoren Instrument Co.	204
Vulecan Electric Co.	206

Zophar Mills, Inc.	206
--------------------	-----

**PROFESSIONAL SERVICES** ..... 243

**SEARCHLIGHT SECTION**  
(Classified Advertising)

**EMPLOYMENT**

Positions Vacant	244, 245	246
Selling Opportunities Offered		245
Positions Wanted		245
Selling Opportunities Wanted		245
Employment Services		245

**SPECIAL SERVICES**

Contract Work	246
---------------	-----

**EDUCATIONAL**

Schools	246
---------	-----

**EQUIPMENT**  
(Used or Surplus New)

For Sale	247-278
----------	---------

**WANTED**

Equipment	246
-----------	-----

**ADVERTISERS INDEX**

Aaron Electronic Sales	273
Acorn Electronics Corp.	271
Aircraft Radio Industries Co.	276
Alvaradio Supply Co.	272
American Electrical Sales Co., Inc.	271
Arrow Sales, Inc.	266
Atomic Energy News, Inc.	246
Bell Aircraft Corp.	245
Bendix Aviation Corp. Bendix Radio Div.	244
Bendix Aviation Corp., Friez Instrument Div.	245
Blan	276
Buffalo Radio Supply	269
Clarendon Glass Blowing Co.	274
Columbia Electronics, Ltd.	268
Communications Devices Co.	271, 274
Communications Equipment Co.	247, 248, 249
Dubin Electronics Co., Inc.	275
Electro Impulse Laboratory	270
Electro Sales Co.	267
Electronic Engineering Co. of Calif.	245
Electronicraft, Inc.	264
EPCO	273
Fair Radio Sales	272
Franklin Employment Service	245
Freed Radio Corp.	244
Green, Gould	246
Greenwich Sales Co.	270
Horlick Co., William I.	257
Hughes Aircraft Co.	245
Instrument Associates	250, 251
Electronic Research Laboratories	261
Leru Laboratories, Inc.	277
Liberty Electronics, Inc.	272
Life Electronic Sales	254
Maritime Switchboard	258
Maxson Corp., W. L.	244
McConnell's	274
Mogull Co., Inc., Alexander	277
Monmouth Radio Laboratories	276
National Union Radio Corp.	244
Neomatic Inc.	276
Niagara Radio Supply Corp.	252, 253
Opad-Green Co.	265
Peak Electronics Co.	262
Precision Electrical Instrument Co.	277
Radio Corp. of America	244
Radio Ham Shack, Inc.	263
Radio Shack Corp.	256
Reliance Merchandizing Co.	259
School of Industrial Technology, Inc.	246
Schultz, Inc., George J.	277
Servo-Tek Products Co., Inc.	255
Soundtronics Laboratories	276
Southwestern Industrial Electronic Co.	246
TAB	278
Telectrad	277
Technical Index Service	246
Teletronics Laboratory Inc.	246
Universal General Corp.	275
Wells Sales Inc.	260
Weston Laboratories	274

This index is published as a convenience to the readers. Every care is taken to make it accurate, but ELECTRONICS assumes no responsibility for errors or omissions.

# *NEW* AMPEREX tubes

Specifically designed for grid-control operation at peak anode voltages as high as **21,000 v.** for heavy duty INDUSTRIAL uses and high power TRANSMITTERS with outputs to **150 KW.** (3 phase full wave)

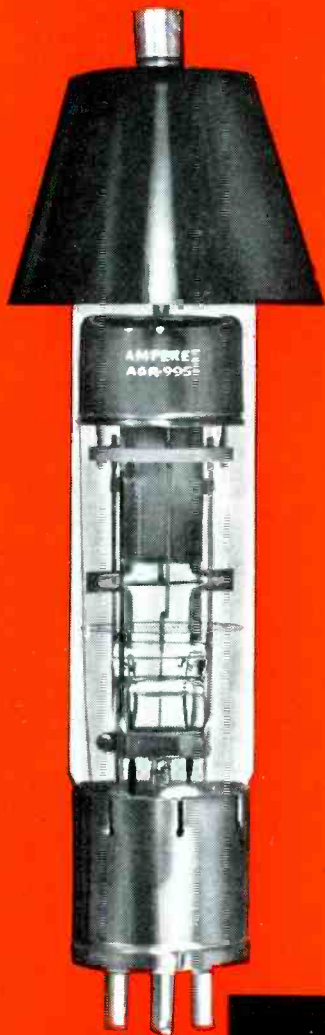

	AGR-9951/5870		AGR-9950/5869	
<b>CATHODE</b> Directly Heated, Oxide Coated				
<b>MAXIMUM PEAK ANODE VOLTAGE</b>				
Inverse .....	21,000	10,000	13,000	10,000
Forward .....	21,000	10,000	13,000	10,000
<b>CONDENSED MERCURY TEMPERATURE LIMITS</b> (centigrade)	+30° to +45° +25° to +60°		+25° to +55° +25° to +60°	
<b>MAXIMUM PLATE CURRENT</b> (Amperes)				
Peak .....	10		4	
Average .....	2.5		1	
<b>FREQUENCY RANGE</b> (cps).....	25 to 150		25 to 150	
<b>FILAMENT VOLTAGE</b> .....	5.0		5.0	
<b>FILAMENT CURRENT</b> (amperes).....	15		6.5	
<b>TUBE VOLTAGE DROP</b> (volts, approx.).....	14		15	
	(1b = 10 amperes)		(1b = 4 amperes)	

**PROVEN LIFE**

AGR-9951/5870  
\$90.

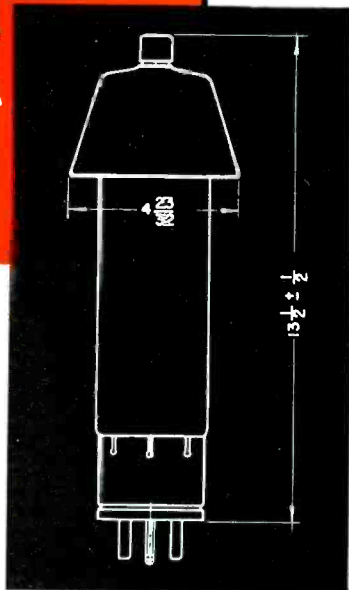

*Re-tube  
with  
AMPEREX*

**THREE-ELECTRODE, MERCURY VAPOR  
RECTIFYING TUBES**  
with NEGATIVE CONTROL characteristics

## GENERAL CONTROL CHARACTERISTICS

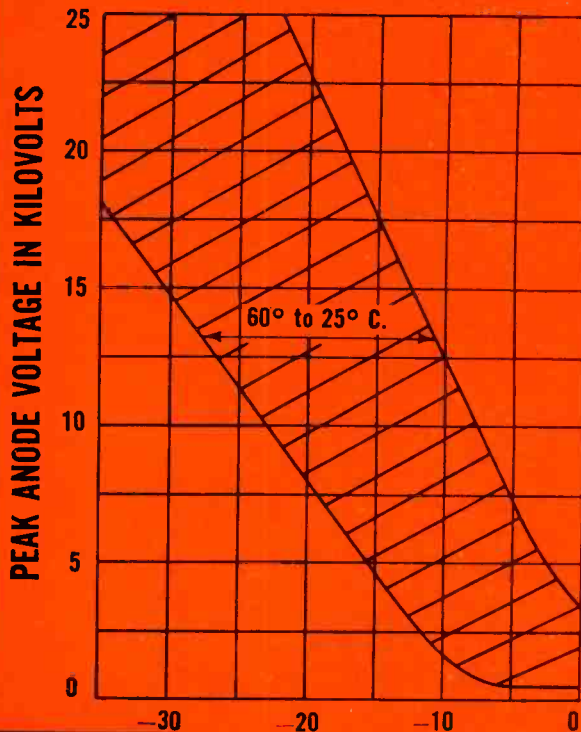

AGR-9951/5870

**D-C CONTROL-GRID  
VOLTAGE IN VOLTS**

Data sheets and charts  
available on request



**AMPEREX ELECTRONIC CORP.**

25 WASHINGTON STREET, BROOKLYN 1, N. Y.

In Canada and Newfoundland: Rogers Majestic Limited  
11-19 Brentcliffe Road, Leaside, Toronto, Ontario, Canada

*Another RCA First*

...the 16GP4

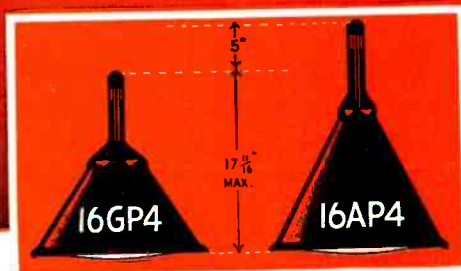

... the new, short metal-cone kinescope with "Filterglass" face plate

The new RCA-16GP4 offers special advantages to designers of large-screen television receivers:

**Shorter**—Nearly 5" shorter than the 16AP4, the new, wide-angle RCA-16GP4 permits reduction in depth of chassis and cabinet, and thus makes possible greater compactness in receiver styling. In addition, the 16GP4 permits economies in tube stocking, packaging, and shipping.

**"Filterglass" Face Plate**—Of high-quality glass and almost flat, the "Filterglass" face incorporates a neutral light-absorbing material to give improved contrast by minimizing ambient-light reflections and reflections within the face plate itself. The circular face plate provides a large picture with full scan.

**Tilted Ion-Trap Gun**—New tilted gun requires only a single-field, external magnet.

**Duodecal 5-Pin Base**—Permits use of lower-cost segment socket.

**Less Weight**—The RCA-16GP4 weighs substantially less than a comparable all-glass tube so that, with ordinary precautions, it can be safely shipped in the receiver.

**RCA Application Engineers** are ready to co-operate with you in applying the 16GP4 and associated components to your specific designs. For further information write RCA, Commercial Engineering, Section B42R, Harrison, N. J.

**ANOTHER new RCA tube . . .**

... the RCA-6CD6-G Horizontal-Deflection Amplifier for 16GP4 Systems. The RCA-6CD6-G makes possible the design of horizontal-deflection circuits in which the plate voltage for the tube is supplied in part by the circuit and in part by the low-voltage power supply. Ordinarily only one 6CD6-G is required for kinescopes with deflection angles up to 70° and operating at 14 kv.



THE FOUNTAINHEAD OF MODERN TUBE DEVELOPMENT IS RCA



**RADIO CORPORATION of AMERICA**  
ELECTRON TUBES  
HARRISON, N. J.