

MARCH - 1949

# electronics

A MCGRAW-HILL PUBLICATION

A black and white photograph of a man in a plaid shirt and safety glasses working on a large metal picture tube. He is wearing a protective sleeve on his left arm. The tube is mounted on a complex mechanical apparatus with various pipes and components. The background shows a laboratory or industrial setting with a large cabinet and other equipment.

SEALING METAL PICTURE TUBE



# FOR HIPERM ALLOY TRANSFORMERS

The UTC Hiperm alloy audio transformers are specifically designed for portable and compact service. While light in weight and small in dimensions, neither dependability nor fidelity has been sacrificed. The frequency characteristic of the Hiperm alloy audio units is uniform from 30 to 20,000 cycles. These units are similar in general design and characteristics to the famous Linear Standard audio Series.

## UTC Hiperm Alloy Transformers Feature

- True Hum Balancing Coil Structure** . . . maximum neutralization of stray fields.
- Balanced Variable Impedance Line** . . . permits highest fidelity on every tap of a universal unit . . . no line reflections or transverse couplings.
- Reversible Mounting** . . . permits above chassis or sub-chassis wiring.
- Alloy Shields** . . . maximum shielding from induction pick-up.
- Multiple Coil, Semi-Toroidal Coil Structure** . . . minimum distributed capacity and leakage reactance.
- High Fidelity** . . . UTC Hiperm Alloy Transformers have a guaranteed uniform response of  $\pm 1.5\text{DB}$  from 20-20,000 cycles.



## FOR IMMEDIATE DELIVER

From Your Distributor

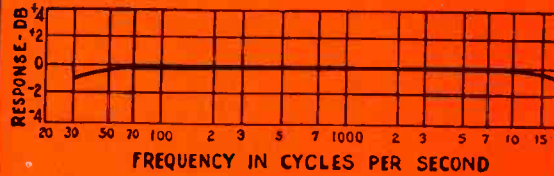

Typical Curve for HA Series

Type No.	Application	Primary Impedance	Secondary Impedance	$\pm 1$ db from	Max. Level	Max Unbal. DC in primary	List Price
HA-100	Low impedance mike, pickup, or multiple line to grid.	50, 125, 200, 250, 333, 500 ohms	60,000 ohms in two sections	30-20,000	+22 DB	5 MA	\$19.00
HA-100X	Same as above but with tri-alloy internal shield to effect very low hum pickup.	50, 125, 200, 250, 333, 500 ohms	120,000 ohms over-all, in two sections	30-20,000	+22 DB	5 MA	24.00
HA-101	Low impedance mike, pickup, or multiple line to push-pull grids.	50, 125, 200, 250, 333, 500 ohms	50, 125, 200, 250, 333, 500 ohms	30-20,000	+22 DB	5 MA	22.00
HA-101X	Same as above but with tri-alloy internal shield to effect very low hum pickup.	50, 125, 200, 250, 333, 500 ohms	50, 125, 200, 250, 333, 500 ohms	30-20,000	+22 DB	5 MA	27.00
HA-108	Mixing, low impedance mike, pickup or multiple line.	8,000 to 15,000 ohms	135,000 ohms 1.5:1 ratio, each side	30-20,000	+22 DB	0	16.00
HA-106	Single plate to push-pull grids	8,000 to 15,000 ohms	50, 125, 200, 250, 333, 500 ohms	30-20,000	+22 DB	1 MA	18.00
HA-113	Single plate to multiple line.	5,000 to 10,000 ohms	50, 125, 200, 250, 300, 500 ohms	30-20,000	+32 DB	5 MA	20.00
HA-134	Push-pull 89's or 2A3's to line.	3,000 to 5,000 ohms	30, 20, 15, 10, 7.5, 5, 2.5, 1.2	30-20,000	+32 DB	5 MA	19.00
HA-135	Push-pull 2A3's to voice coil.						

The above listing includes only a few of the many Hiperm Alloy Transformers available . . . write for catalog.

**United Transformer Co.**  
 NEW YORK 13, N. Y.  
 150 VARICK STREET  
 DEPT DIVISION: 13 EAST 40th STREET, NEW YORK 16, N. Y.,  
 CABLES: "ARLAB"

# electronics

A McGRAW - HILL  
PUBLICATION



MARCH • 1949

SEALING METAL PICTURE TUBE.....		Cover
Metal-to-glass seals of a 16-inch metal picture tube are made with 40-kw electronic induction heater of Scientific Electric Division of "S" Corrugated Quenched Gap Co. See p 126. Photo by Syd Karson		
FINDING NEW PRODUCTS, by Paul G. Weiller.....		72
The best ideas are often to be found right in your own organization		
PORTABLE REPEATING FLASH UNIT, by W. H. Fritz.....		74
Voltage regulator offsets battery aging to provide uniform photographic flashes		
TELEVISION FIELD INTENSITY MEASUREMENTS, by J. B. Epperson.....		78
Procedure required by FCC of all television station operators, as applied at station WEFW		
HETERODYNE ELIMINATOR, by J. L. A. McLaughlin.....		83
Interference-frequency inverter permits attenuation of undesired signals on either side of carrier		
VIBRATION TESTING OF AIRPLANES, by Abner R. Willson.....		86
Electronic equipment simulates vibrations encountered in flight and records results for subsequent analysis		
LOCATING GALLSTONES, by Eric A. Walker, E. G. Thurston and C. K. Kirby.....		92
Distinctive sound is produced as piezoelectric probe strikes foreign bodies		
MULTI-V ANTENNA FOR F-M BROADCASTING, by M. W. Scheldorf.....		94
Simple, lightweight construction permits array to be mounted on existing a-m towers		
CERAMIC TRANSMITTER CAPACITORS, by A. J. Bauer.....		97
New types of dielectric in high-power units make improved performance possible		
TRAIN TELEVISION, by Frank R. Norton, Charles G. McMullen and Glenn L. Haugen.....		100
Special circuits and antennas provide satisfactory reception		
A-M AND NARROW-BAND F-M—Part 2, by Emerick Toth.....		102
Conclusion of modulation and equipment comparison for naval mobile service		
RADIO-FREQUENCY SWEEP GENERATOR, by Millett G. Morgan.....		109
Overdriven amplifier switches sweep circuit to generate 250-kc time base		
INDUSTRIAL HIGH-SPEED INFRARED PYROMETER, by W. S. Gorrill.....		112
Measures temperature of tin-can seams during soldering process		
FLUSH-MOUNTED ANTENNA FOR MOBILE APPLICATION, by Donald R. Rhodes.....		115
Built-in annular slot for mobile and citizens band operation		
HIGH-FIDELITY RESPONSE FROM PHONOGRAPH PICKUPS, by Elwin J. O'Brien.....		118
Feedback equalizer circuits make high-fidelity response possible with practically any type of phono pickup		
TELEVISION I-F COIL DESIGN, by J. H. Felker.....		122
Nomograph gives in one operation the number of close-wound turns needed to give desired inductance		
BUSINESS BRIEFS.....	66	
CROSSTALK.....	71	
TUBES AT WORK.....	124	
ELECTRON ART.....	128	
NEW PRODUCTS.....	132	
NEWS OF THE INDUSTRY.....	136	
		NEW BOOKS BACKTALK INDEX TO ADVERTISERS

**DONALD G. FINK**, Editor; **W. W. MacDONALD**, Managing Editor; John Markus, Vin Zeluff, Frank H. Rockett, A. A. McKenzie, Associate Editors; William P. O'Brien, James D. Fahnestock, Assistant Editors; Hal Adams Burleson, Ann Mastropolo, Editorial Assistants; Gladys T. Montgomery, Washington Editor; Harry Phillips, Art Director; Eleanor Luke, Art Assistant; R. S. Quint, Directory Manager; Russell F. Anderson, Editor, World News; Dexter Keezer, Director Economics Department

**KEITH HENNEY**, Consulting Editor

**H. W. MATEER**, Publisher; **WALLACE B. BLOOD**, Manager; D. H. Miller, H. R. Denmead, Jr., New York; Wm. S. Hodgkinson, New England; Warren W. Shew, Philadelphia; C. D. Wardner, Chicago; J. L. Phillips, Cleveland; J. W. Ottersan, San Francisco; Carl W. Dysinger, Los Angeles; Ralph C. Maultsby, Atlanta; Bernard H. Butler, London, England; J. E. Blackburn, Jr., Director of Circulation.

Contents Copyright 1949, by McGraw-Hill Publishing Company, Inc. All Rights Reserved. McGRAW-HILL PUBLISHING COMPANY, INCORPORATED, JAMES H. McGRAW (1860-1948), Founder • PUBLICATION OFFICE 99-129 North Broadway, Albany 1, N. Y., U. S. A. EDITORIAL AND EXECUTIVE OFFICES, 330 West 42nd St., New York 18, N. Y., U. S. A.—Member A. B. P. Member A. B. C.

James H. McGraw, Jr., President; Curtis W. McGraw, Vice-President and Treasurer; Eugene Duffield, Executive Assistant for Publications; Nelson Bond, Director of Advertising; James A. Gerardi, Secretary; and J. E. Blackburn, Jr., Director of Circulation.  
ELECTRONICS, March, 1949, Vol. 22, No. 3. Published monthly, with an additional issue in June, price 75c a copy for U. S. and possessions, and Canada; \$1.50 for Latin America; \$2.00 for all other foreign countries. Directory issue \$2.00. Allow at least ten days for change of address. All communications about subscriptions should be addressed to the Director of Circulation. Subscription rates—United States and possessions, \$6.00 a year, \$9.00 two years, \$12.00 for three years, Canada (Canadian funds accepted), \$7.00 a year, \$11.00 for two years, \$14.00 for three years. Latin American countries \$15.00 for one year, \$25.00 for two years, \$30.00 for three years. All other countries \$20.00 for one year, \$30.00 for two years, \$40.00 for three years. Please indicate position and company connections on all subscription orders. Entered as Second Class matter August 29, 1936, at Post Office, Albany, New York, under the Act of March 3, 1879. BRANCH OFFICES: 520 North Michigan Avenue, Chicago 11, Ill.; 66 Post Street, San Francisco 4; Aldwych House, Aldwych, London, W.C. 2; Washington, D. C. 4; Philadelphia 3; Cleveland 15; Detroit 26; St. Louis 8; Boston 16; Atlanta 3, Ga.; 621 So. Hope St., Los Angeles 14; 738-9 Oliver Building, Pittsburgh 22. ELECTRONICS is indexed regularly in The Engineering Index.

EXPU...

*Smaller than your  
fingernail*

**BUT SKY HIGH IN PERFORMANCE...**

### EL-MENCO CAPACITORS

One sure way to protect the performance of your radio, electrical and electronic equipment is to specify El-Menco fixed mica dielectric capacitors. These small-size, high capacity condensers not only meet Army and Navy JAN-C-5 specifications, but they are tested at *double* the working voltage.

All impregnated and molded in low loss bakelite, El-Menco Capacitors do a better job in any climate under the most severe operating conditions. Look to El-Menco to help you build and keep your reputation for using the superior components that make your electrical equipment superior.

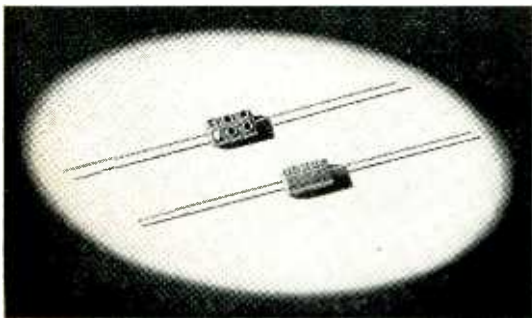
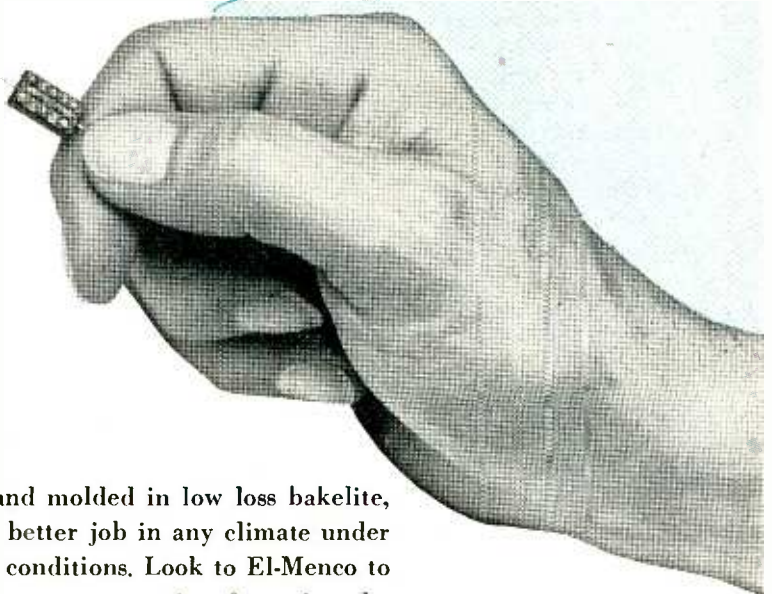

NEW CM 15 MINIATURE CAPACITOR

**THE ELECTRO MOTIVE MFG. CO., Inc.  
WILLIMANTIC CONNECTICUT**

Actual Size 1/32" x 1/2" x 3/16".  
For Television, Radio and other Electronic Applications.  
2 - 420 mmf. cap. at 500v DCA.  
2 - 535 mmf. cap. at 300v DCA.  
Temp. Co-efficient  $\pm 50$  parts per million per degree C for most capacity values.  
6-dot color coded.

*Write on your  
firm letterhead  
for Catalog and Samples.*



# MOLDED MICA **El-Menco** MICA TRIMMER CAPACITORS

Foreign Radio and Electronic Manufacturers communicate direct with our Export Dept. at Willimantic, Conn. for information.

**ARCO ELECTRONICS, INC.**, 135 Liberty St., New York, N. Y. Sole agent for jobbers and distributors in U. S. and Canada.



**For work that  
no other metals can do!**

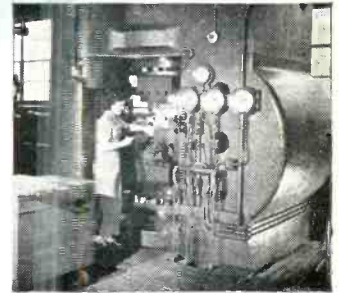

*Fansteel controls every step in metallurgical processing beginning with the ore.*

# Fansteel Tungsten and Molybdenum

Tungsten and Molybdenum are two of the most important refractory metals in electrical, electronic and mechanical industries. Their high melting points, low vapor pressure, resistance to arc erosion and great mechanical strength when combined with other metals intensify their values.

Both metals are used for electrical contacts, particularly in automotive ignition, vibrators, telegraph relays. They are components in the Fansteel Fastell® metals wherein their high resistance is combined with the electrical conductivity of silver or copper.

Heating elements in vacuum equipment—electric furnaces of temperatures 1600° C to 2000° C—on electrodes for inert gas welding and many other uses require Tungsten or Molybdenum.

Why not investigate Fansteel Metallurgy for better service and possibilities of economy in *your* problems? Fansteel Metallurgical Corporation, North Chicago, Illinois, U.S.A.

*Tungsten and molybdenum ores are refined to pure metal powder by chemical operations. Powders are compacted to ingots in a powerful hydraulic press. (above). Ingots are sintered in hydrogen atmosphere furnaces by heavy electrical current. (lower picture). Intense heat causes the powder particles to fuse into a strong solid mass without melting.*

#### PURE METALS

Tantalum, Tungsten, Molybdenum, and Columbium in sheet, rod, wire, special shapes and parts.

#### POWDER METALLURGY PRODUCTS

Finished or semi-finished shapes and parts of special analysis to achieve high strength, density, electrical conductivity, resistance to wear, impact, heat erosion, or combinations of these and other properties.

#### COPPER BASE ALLOYS

Copper alloyed with other elements, to combine high conductivity with strength, elasticity, resistance to heat, impact, or wear. Available in bars, rod, sheet, strip, castings, forgings, finished or semi-finished parts, for current-carrying springs and other parts, soldering tips, resistance welding electrodes, dies and fixtures.

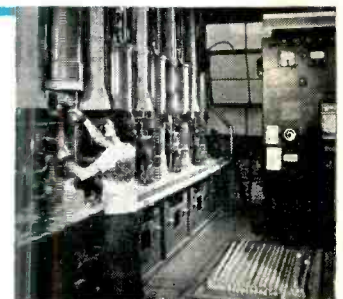

11601

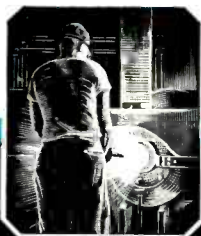

# Fansteel

**SPECIAL PRODUCTS**  
*In Controlled Metallurgy*

# UP TO WIRING PEAK!

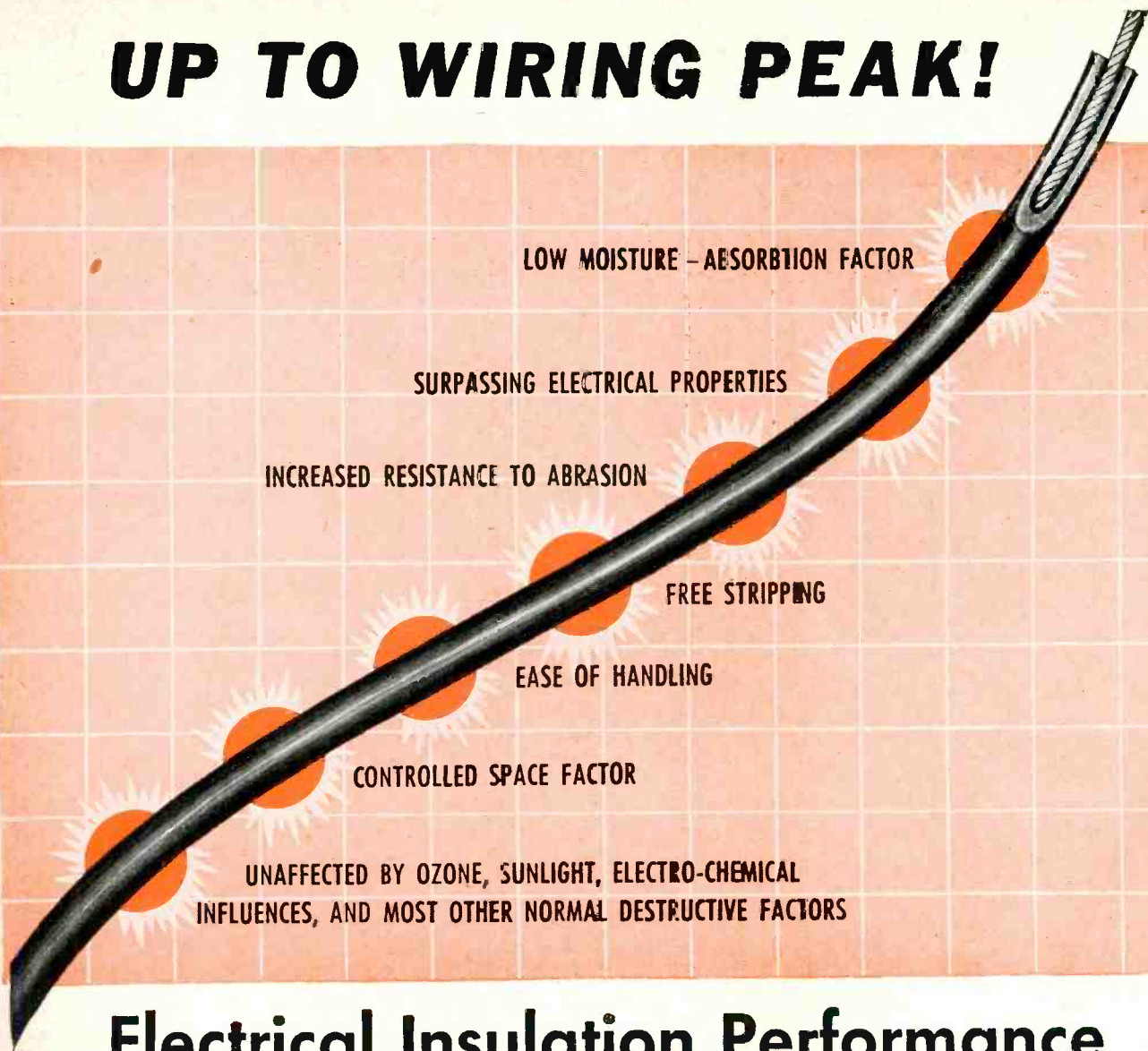

LOW MOISTURE - ABSORPTION FACTOR

SURPASSING ELECTRICAL PROPERTIES

INCREASED RESISTANCE TO ABRASION

FREE STRIPPING

EASE OF HANDLING

CONTROLLED SPACE FACTOR

UNAFFECTED BY OZONE, SUNLIGHT, ELECTRO-CHEMICAL INFLUENCES, AND MOST OTHER NORMAL DESTRUCTIVE FACTORS

## Electrical Insulation Performance takes a **JUMP!** with new **TURBOTHERM PLASTIC INSULATED WIRE**

Beyond which TURBOTHERM Insulated Wire, available with solid or stranded copper conductor, offers a flexible, assembly-facilitating process. This means production-time economy right at your own line and bench-manufacturing points. Your requirements of insulated wire within the gauge range of No. 14 down to No. 30 can be most advantageously served by TURBOTHERM. Ask for samples and become convinced.

Underwriters Laboratories Approved for 80 degree C. Appliance, Radio Hook-up and Instrument Wire; T. F. and T. F. F. for decorative wall brackets and candelabra lighting fixtures, and small electrical tools and controls, where operation in oil at 60 deg. C. is a requisite.

### WILLIAM BRAND & COMPANY

276 FOURTH AVENUE, NEW YORK 10, N. Y.— 325 W. HURON STREET, CHICAGO 10, ILL.

OIL TUBING • SATURATED SLEEVING • VARNISHED CAMBRIC • PAPER AND TAPE • MICA AND



MICA PRODUCTS

March, 1949 — ELECTRONICS



## Top quality power tubes for more than 25 years

**B**ROADCAST engineers from coast to coast have learned through the years to depend on Western Electric tubes for long life and top quality performance.

Included in Western Electric's line are power tubes and rectifiers for stations of every power, AM and FM. Designed by Bell Telephone Laboratories, these tubes are now manufactured for Western Electric by Machlett Laboratories, Inc., another pioneer in the development of electron tubes.

For full information on Western Electric tubes to meet your station's needs, call your local Graybar Representative—or write Graybar Electric Co., 420 Lexington Ave., New York 17, N. Y.

*Western Electric transmitting tubes will be on display at the I. R. E. Convention.*

— QUALITY COUNTS —

# Western Electric



DISTRIBUTORS: IN THE U. S. A.—  
Graybar Electric Company. IN  
CANADA AND NEW FOUNDLAND—  
Northern Electric Company, Ltd.



**E**arly this year the one-billionth Sprague Capacitor rolled off the fast-moving production lines in North Adams.

Fittingly enough, this billionth unit was one of the revolutionary new molded paper tubulars. Throughout the years, it has been engineering progress as typified by this development that has enabled Sprague to attain its present position as one of the largest, most diversified and most dependable sources of capacitor supply.

Other important developments which have helped materially in swelling the total of Sprague production include \*Vitamin Q capacitors for higher voltages, higher temperatures and higher insulation resistance; \*Hypass 3-terminal networks; glass-to-metal sealed capacitors; molded \*Prokar capacitors for sub-miniature assemblies; high-voltage coupling capacitors; electrolytics for dependable operation up to 450 volts at 85°C., and many other types of capacitors.

\*T. M. Reg. U. S. Pat. Off.

# SPRAGUE

Pioneers of Electric and Electronic Progress

SPRAGUE ELECTRIC COMPANY • North Adams, Mass.

March, 1949 — ELECTRONICS



Get into Production in a few hours  
with **WHISTLER**  
**ADJUSTABLE DIES**

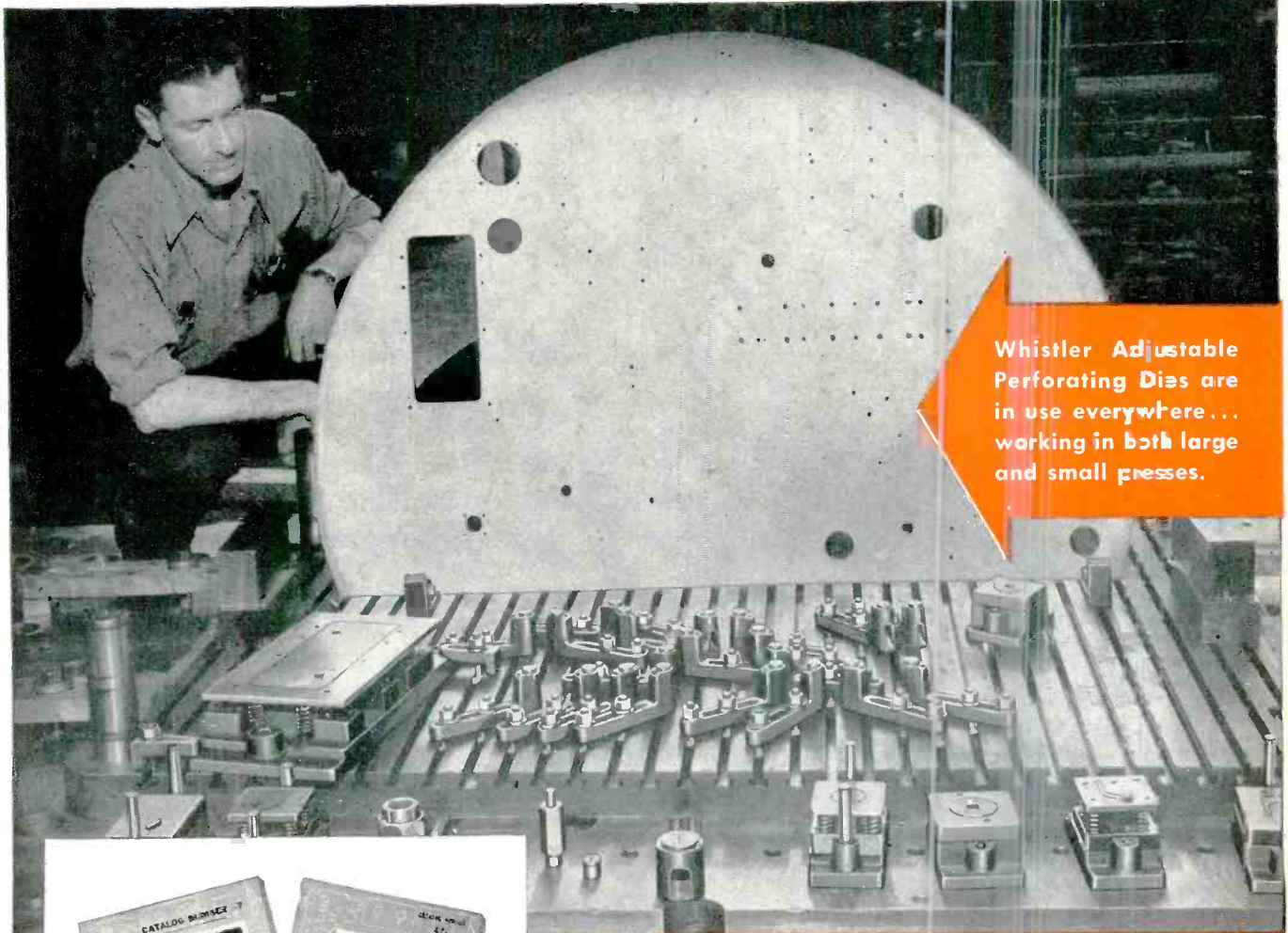
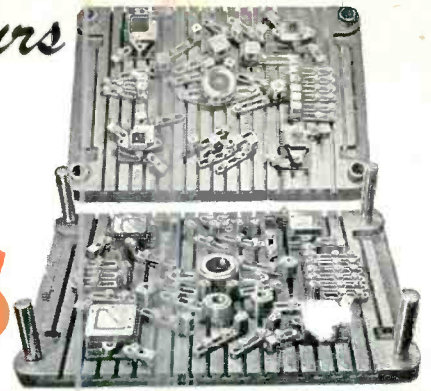

Whistler Adjustable Perforating Dies are in use everywhere... working in both large and small presses.

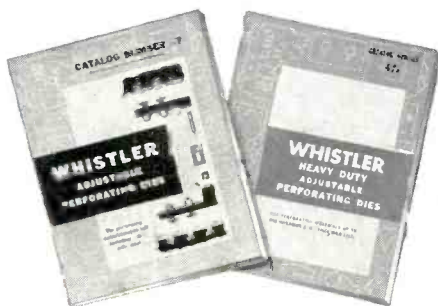

There are plenty of other advantages in using Whistler Adjustable Dies. It makes sense to get the complete story. And it's easy to do. Write for your Whistler Catalogs today.

Whistler perforating dies now offer a double-barreled advantage in getting into production faster. Standard sizes of round hole punches and dies...  $\frac{1}{32}$  to 3"... can be shipped promptly. Special shapes... squares, ovals, rectangles, group and notching dies, are quickly made to order.

Equally important, set-ups are simple... take only a short time. Some units can be rearranged or units added in setting up different jobs. Production is thus speeded while die costs are amortized through continued re-use.

No special tools are needed. All parts are interchangeable. The heavy duty series of punches and dies easily pierce materials up to  $\frac{1}{4}$ " mild steel.

**S. B. WHISTLER & SONS, Inc.**

742 MILITARY ROAD, BUFFALO 17, NEW YORK

# Heat dissipation can be

# for resistors



**H**eat dissipation can be mighty tough . . . but not for IRC resistors. They are universally engineered for the lowest possible operating temperatures and maximum power dissipation within the smallest size units consistent with good engineering practice.

Long experience with the widest line of resistor types in the industry has provided IRC with a wealth of "know-how" on resistor heat dissipation. In Power Wire Wound Resistors for example, the complete range of tubular and flat types manufactured by IRC utilizes a special cement coating to attain rapid heat dissipation. This dark rough surface does double duty by effectively guarding the windings against harmful atmospheric moisture and corrosion. Use the handy coupon to get complete data on proven advantages of IRC Power Wire Wounds.

There are 52 specific types of IRC Power Wire Wound Resistors.

IRC Flat Wire Wound Resistors offer a higher space-power ratio.

Adjustable types feature the exclusive IRC non-corrosive contact band.

Power ratings from 2 to 225 watts. Variety of 8 terminal types.

Windings are of highest grade alloy wire on tough ceramic forms.

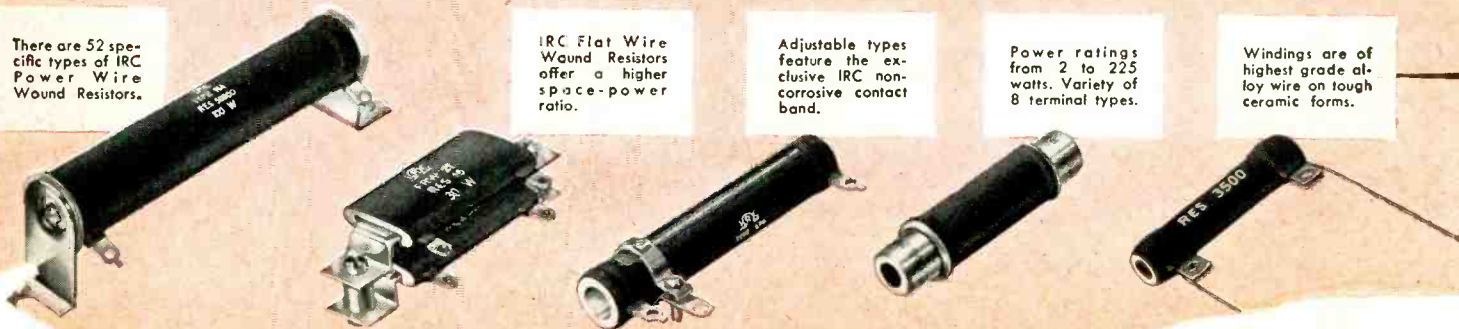

# tough

# too!

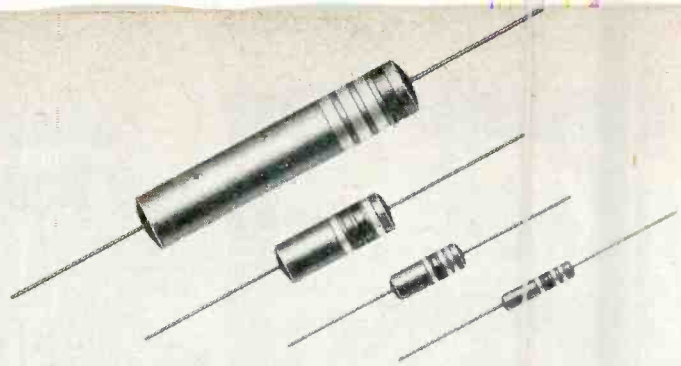

**New, ADVANCED BT Resistors** obsolete present performance standards for fixed composition resistors. Extremely low operating temperature and excellent power dissipation in compact, light weight fully insulated units at 1/3, 1/2, 1 and 2 watts. These ADVANCED resistors meet JAN-R-11 specifications. All the facts are included in 12-page technical data Bulletin B-1.

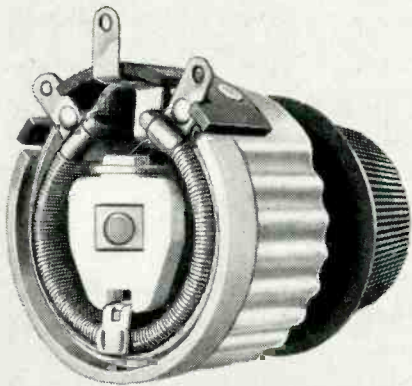

**Heat dissipation properties of aluminum** are used to full advantage in housing and winding core of IRC Power Rheostats, 25 and 50 watts. Type PR Rheostats operate at full rating at about half temperature rise of equivalent units. Can be operated at full power in as low as 25% of rotation without appreciable difference in temperature rise. Direct contact between rheostat and mounting panel allows rapid conduction to panel of a portion of heat dissipated. Send for Bulletin E-2.

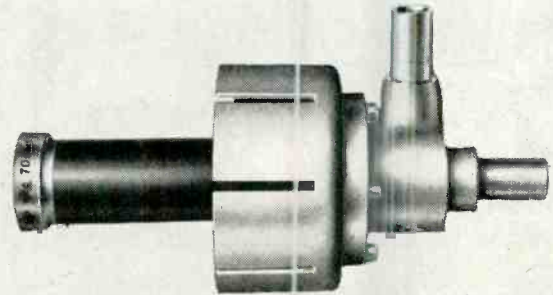

**Water-cooled LP Resistors** utilize high velocity water stream flowing in spiral path against thin resistance film. High power dissipation is made possible by centrifugal force holding water in thermal contact with resistance surface. Resistance film less than 0.001" thick with active length much less than 1/4 wave length at FM and television frequencies, gives excellent frequency characteristics. Resistance values 35 to 1500 ohms; 15% tolerance standard; power dissipation up to 5 K.W. ac. Bulletin I-2 gives all the facts.



If you have the heat put to you for speedy service on small order resistor requirements for experimental work, pilot runs, etc., you'll appreciate the advantages of IRC's Industrial Service Plan. This enables you to get 'round-the-corner service from the local stocks of your IRC Distributor. He's a good man to know . . . we'll gladly send you his name and address.



Wherever the Circuit Says

Power Resistors • Voltage Dividers  
Insulated Composition Resistors • Low  
Wattage Wire Wounds • Controls  
Deposited Carbon Precistors • Precisions  
HF and High Voltage Resistors  
Voltmeter Multipliers • Rheostats

**INTERNATIONAL  
RESISTANCE COMPANY**

403 N. Broad Street, Philadelphia 8, Pa.

Canadian Division: International Resistance Co., Ltd., Toronto, Licensee

J.F. ARNDT & CO., ADV. AGENCY

**INTERNATIONAL RESISTANCE COMPANY**  
403 N. BROAD ST., PHILA. 8, PA.

Send me additional data on items checked below:

- Power Wire Wounds (tubular)     Flat Power Wire Wounds  
 Advanced BT Resistors     Power Rheostats     Water-Cooled Resistors  
 Name and address of our local IRC Distributor

NAME .....

TITLE .....

COMPANY .....

ADDRESS .....

# CHICAGO... The Engineer's Transformer

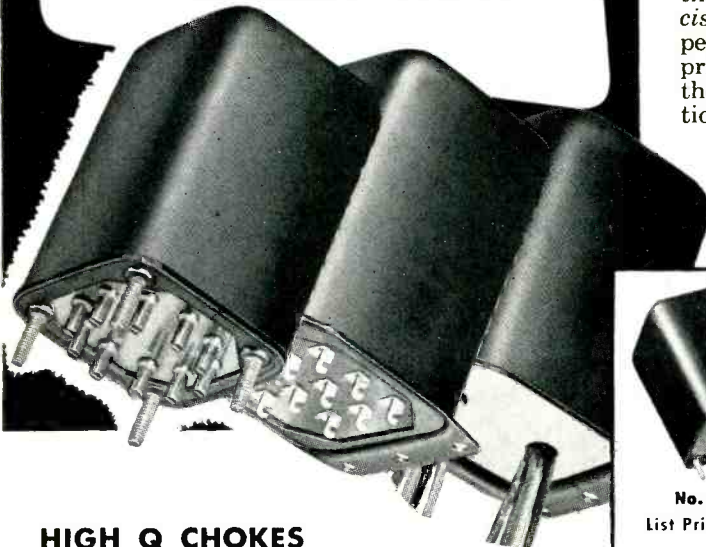

## HIGH Q CHOKES for Dynamic Noise Suppression Circuits



Write for  
literature

Two precision-built chokes with inductance values of .8 and 2.4 henrys respectively—accurate to within  $\pm 5\%$  with up to 15 ma d-c. Units have a minimum Q of 20. Exceptionally compact,  $1\frac{1}{16}'' \times 2\frac{3}{8}'' \times 1\frac{1}{16}''$ .

No.	Inductance	List
NSI-1	.8 h	\$10.00
NSI-2	2.4 h	10.00

## Famous "Sealed in Steel" New Equipment Line

Chicago Transformer's New Equipment Line offers transformer engineering *ahead* of the trends in circuit design. It's the Transformer Line preferred by experts in the P.A., ham, communication and experimental fields, and by broadcast stations and manufacturers.

Check these features—*drawn steel cases* to provide compact, streamlined mounting; *conservative ratings* that meet all RMA and FCC recommendations; *precision characteristics* for stable, uniformly excellent performance—these, and many others. Check the prices—and you'll learn how little more these advanced units cost over conventional transformers.

Typical of the New Equipment Line are the outstanding audio transformers listed below. Get full details on the complete line—write for descriptive catalog today.



No. BO-6  
List Price \$23.00

### Response within .2db, 30 to 20,000 cycles New Full Frequency Range Output Transformer

No. BO-6. For use in high fidelity amplifiers. Couples push-pull 6L6's (7500 ohms, C-T) to 6/8 or 16/20-ohm voice coil. Center-tapped tertiary winding provides 15% inverse feedback to reduce harmonic distortion to a minimum. In drawn steel case,  $4\frac{3}{16}'' \times 3\frac{7}{8}'' \times 3\frac{1}{16}''$ , with mounting studs and pin-type terminals.

There's a CHICAGO OUTPUT TRANSFORMER For Every Full Frequency Use

Cat. No.	Application	Impedance	Max. Power	List
BO-1	Single Plate to Line	Pri.—15,000 ohms at 0 to 10 ma d-c *Sec.—600/150 ohms CT	+20 dbm	\$13.00
BO-2	P.P. Plates to Line	*Pri.—20,000 ohms CT *Sec.—600/150 ohms CT	+30 dbm	19.00
BO-3	P.P. Plates to Line	Pri.—5,000 ohms CT *Sec.—600/150 ohms CT	+40 dbm	17.00
†BO-4	P.P. Plates to Line	Pri.—7,500 ohms CT *Sec.—600/150 ohms CT	+43 dbm	18.00
BO-5	P.P. Plates to Line	Pri.—10,000 ohms CT *Sec.—600/150 ohms CT; 16/8/4 ohms	+37 dbm	24.00

†Tertiary winding provides 15% inverse feedback. \*Split and balanced windings.

## Television Transformers to fit today's leading TV circuits

Because Chicago Transformer is the largest single supplier of transformers to the Television industry, you gain the advantages of "Original Equipment" components when you buy Chicago TV Transformers. Available now, the three units described here are part of a complete new line, soon to be announced.

**Vertical Blocking Oscillator Transformer No. TBO-1.** 60-cycle unit for creating the vertical sweep "saw-tooth" voltages required in conventional circuits.

Pri. Inductance: 1.15 hy  $\pm 20\%$  at 3 v., 1000 cycles  
Pri. Leakage Inductance: 8 mh  $\pm 25\%$ ,  $-15\%$   
Ratio, Primary to Secondary: 1 to 4.2

Exact equivalent to R. C. A. Part No. 20872. List Price, \$3.10

Write for Descriptive Literature

**TV Power Transformer No. TP-365.** Designed to supply 405 volts d-c with two 5U4G's to an 80 mfd condenser input. Copper shorting band around core reduces external magnetic field; cuts image distortion to a minimum.

Pri.: 115 v., 60 cycles      Fil. No. 1: 12.6 v., 5 amps, C-T  
H.V. Sec.: 362-0-362 v., a-c,      Fil. No. 2: 5 v., 2 amps  
.295 amps d-c      Fil. No. 3: 5 v., 6 amps

Exact equivalent to R. C. A. Part No. 201T6. List Price, \$26.00

**Vertical Scanning Output Transformer No. TSO-1.** Couples vertical output tubes to picture tube deflection yoke.  
Pri. Impedance: 19,000 ohms at 30 v., 60 cycles, 13 ma d-c  
Ratio, Primary to Secondary: 10 to 1

Exact equivalent to R. C. A. Part No. 204T2. List Price, \$5.90

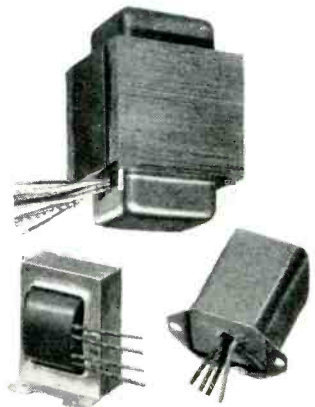

TRADE MARK REG.

# CHICAGO TRANSFORMER

DIVISION OF ESSEX WIRE CORPORATION

3501 ADDISON STREET • CHICAGO 18, ILLINOIS

Millions of nationally-known receivers produced annually are equipped with Chicago Transformers

# 800 ohms / cmf

Temp. Coeff. of Resistance:  
 $\pm 0.00002$  max. from  $-50^{\circ}\text{C}$  to  $+100^{\circ}\text{C}$

## Karma

### the improved electrical resistance alloy!

#### Higher Ohmage makes possible Smaller Resistors—Increased Savings

Compared with Manganin and Constantan (Advance\*), the copper-base alloys widely used for high accuracy wire-wound resistors, the electrical resistivity of Karma\* is exceptional — 800 ohms per circular mil foot, at  $20^{\circ}\text{C}$ , it is more than 2.7 times greater. Now you can wind even smaller precision resistors at still lower cost per ohm.

#### More Stable Resistance permits Wider Applications—at Wider Temperature Ranges

The comparably Low Temperature Coefficient of Resistance of Karma remains constant over a very much wider temperature range than that of Manganin or Constantan (Advance\*). The "useful range" of Karma is more than 8 times that of Manganin and 4 times that of Constantan (Advance\*). Karma, therefore, is especially adapted for service in precision resistors that are subjected to severe changes in temperature.

#### Low Thermal EMF Value against Copper assures Extreme Accuracy

In cases where error due to voltage generated by thermal EMF against copper must be confined to negligible proportions, Manganin has long been accepted as ideal for resistor windings. The thermal EMF value for Karma against copper is equal to that of Manganin itself!

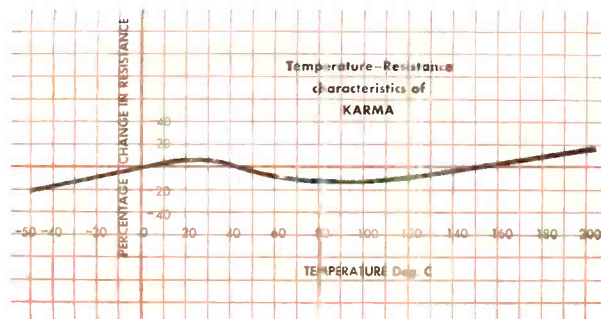

#### High Resistance to Oxidation prolongs Electrical Properties

The superior surface oxidation resistance of Karma, essentially a nickel chromium alloy, enables it to retain its fine electrical properties longer than the copper-base alloys Manganin and Constantan (Advance\*).

#### Higher Tensile Strength permits Faster Winding Speeds — saves Production Time

In addition to its outstanding electrical qualities, Karma affords physical advantages over the commonly accepted alloys. Its higher tensile strength permits faster winding speeds; its lower thermal expansion minimizes distortion and movement in windings.

In a word, this urgently needed Driver-Harris alloy offers plus values all along the line. Ask us about it. We shall be glad to supply you with complete data.



KARMA<sup>®</sup> is manufactured only by

## Driver-Harris Company

HARRISON, NEW JERSEY

BRANCHES: Chicago, Detroit, Cleveland, Los Angeles, San Francisco, Seattle

Manufactured and sold in Canada by

The B. GREENING WIRE COMPANY, LTD., Hamilton, Ontario, Canada

\*T.M. Reg.U.S.Pat.Off. \*Formerly D-H experimental alloy #224



*You've got to be ready for Microgroove!*

**M**ICROGROOVE long-playing recordings are here to stay. This means that every broadcast station and recording studio must have quality equipment, especially for microgroove reproduction.

The new PRESTO type 153 reproducers include two separate Pickering diamond stylus heads for microgroove or regular recording, an exceptionally fine arm, and a 4-position compensating network.

Durability of equipment, fine performance, and economical first cost make these PRESTO reproducers ideal for microgroove and also for lateral standard recordings.

Write today for full specifications on the PRESTO 153M for microgroove recordings and 153R for regular recordings. Your nearest PRESTO distributor can show you the equipment.

**FOR HIGHEST FIDELITY . . . IT'S PRESTO DISCS**

Microgroove, even more than regular recording, demands a perfect disc. The answer is Presto. For, sixteen years ago, Presto made the first lacquer-coated discs . . . and today Presto discs are first in quality.



**RECORDING CORPORATION**

Paramus, New Jersey

*Be ready for Microgroove!*

Mailing Address: P. O. Box 500, Hackensack, N. J.

In Canada: WALTER P. DOWNS, LTD., Dominion Sq. Bldg., Montreal

WORLD'S LARGEST MANUFACTURER OF INSTANTANEOUS SOUND RECORDING EQUIPMENT AND DISCS

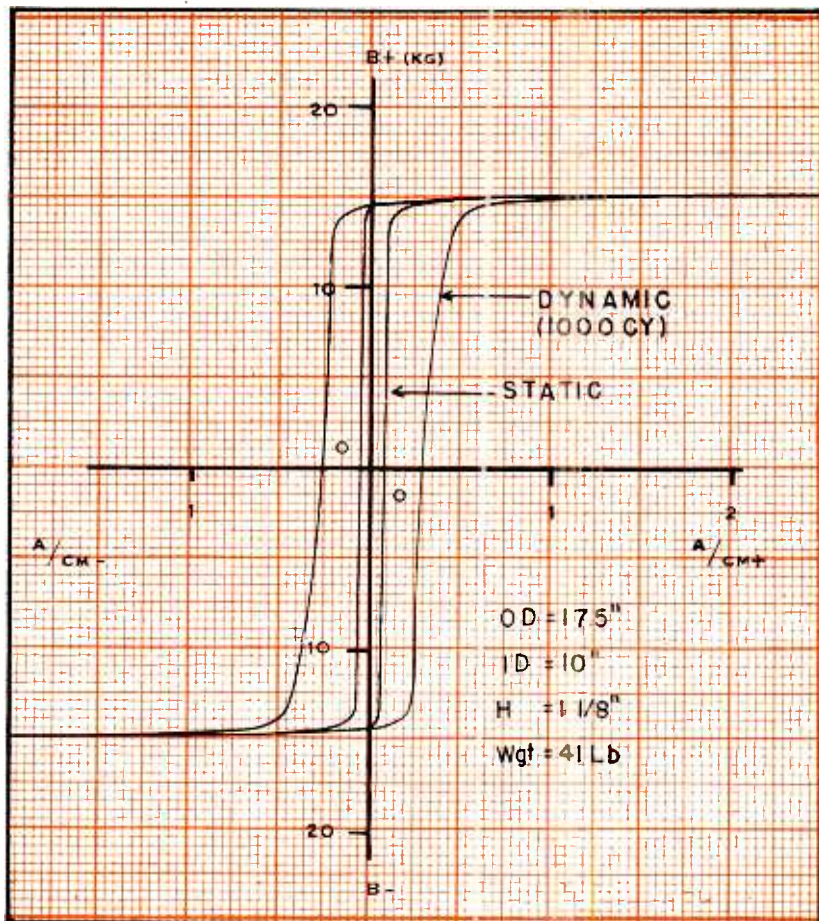

## One Look TELLS THE STORY

... of new and better products made possible. These curves show the static and dynamic (1000 cycle) magnetization characteristics of "Permanite". This new magnetic alloy has the extremely useful property of reaching magnetic saturation with a very slight change in magnetizing current.

Utilization of this property in a core and coil assembly results in a magnetic amplifier of extreme reliability for many applications.

Permanite cores are available now. I-T-E can deliver spiral wound permanite cores of any size, all having identical magnetization characteristics. This will enable designers to predict equipment performance accurately and positively.

One look at the curve tells the story of "Permanite". But Permanite is only part of the continuing story of I-T-E research and development to bring you better equipment and better designs — first.

*For additional information write — Rectifier division I-T-E or consult your local I-T-E representative*



### THE LEADER IN TECHNICAL EXCELLENCE

I-T-E CIRCUIT BREAKER CO., 19TH & HAMILTON STREETS, PHILADELPHIA 30, PA.  
 31 OFFICES IN THE UNITED STATES. In Canada, Eastern Power Devices, Ltd., Toronto  
 SWITCHGEAR • UNIT SUBSTATIONS • ISOLATED PHASE BUS STRUCTURES • RESISTORS • SPECIAL PRODUCTS

# Centralab reports to

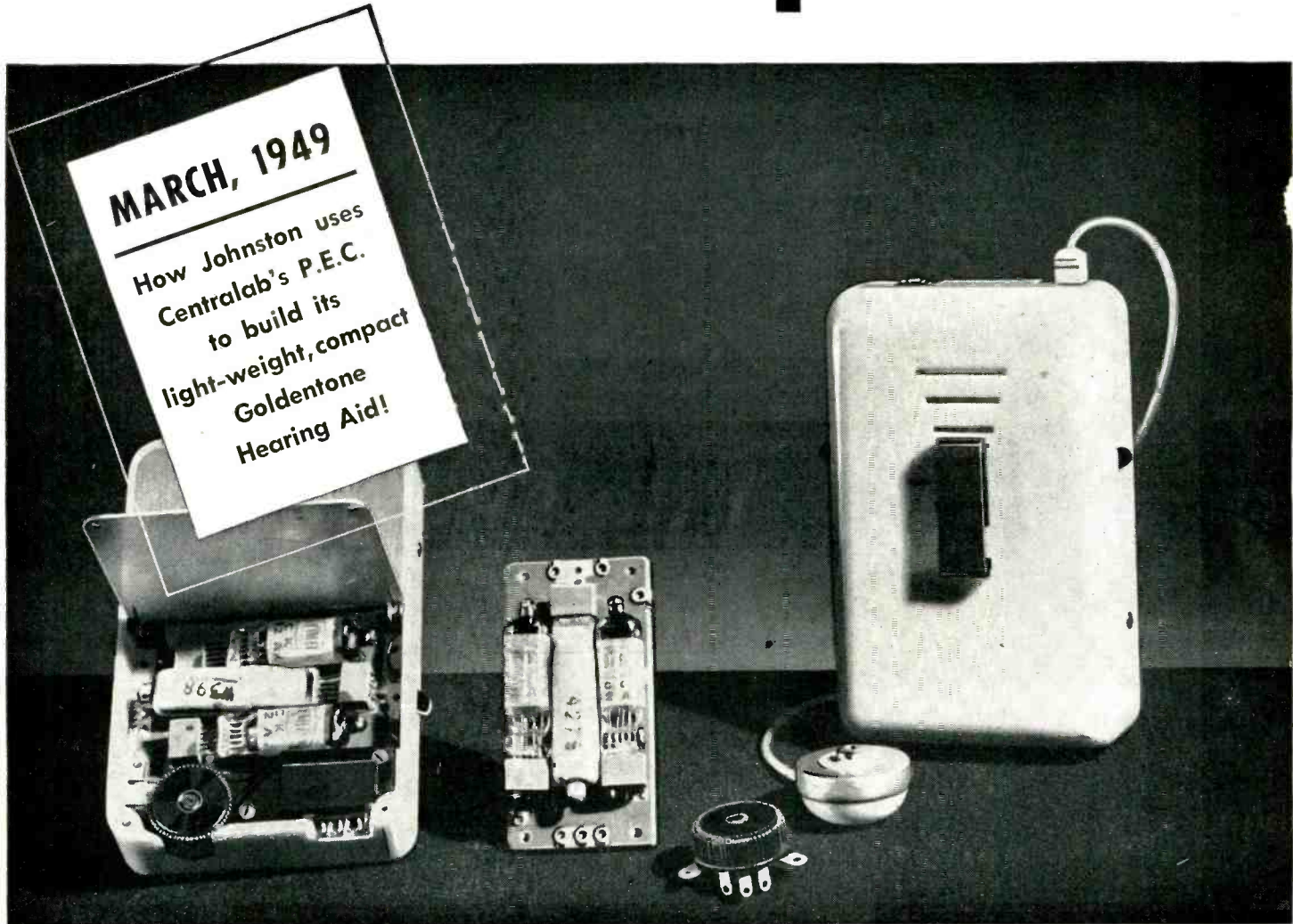

**MARCH, 1949**

How Johnston uses  
Centralab's P.E.C.  
to build its  
light-weight, compact  
Goldentone  
Hearing Aid!

Models courtesy of Johnston Hearing Aid Mfg. Co.

**I** Customer comfort . . . greater output . . . dependable performance. That's what Johnston wanted for its new Goldentone Hearing Aid. And that's what it got — with the help of Centralab's amazing P.E.C. Yes, *Ampec* — a complete three-stage audio

amplifier — made it possible to save space and material by reducing the number of components needed. It cut production time by eliminating many assembling operations. It improved performance. For *Ampec* facts, see Bulletin 973.

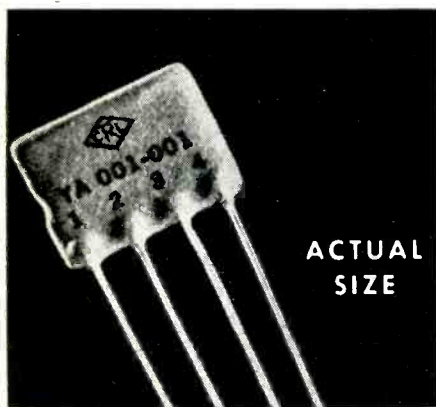

**ACTUAL  
SIZE**

**2** CRI's *Couplate* consists of a plate lead resistor, grid resistor, plate by pass capacitor and coupling capacitor. Write for Bulletin 42-6.

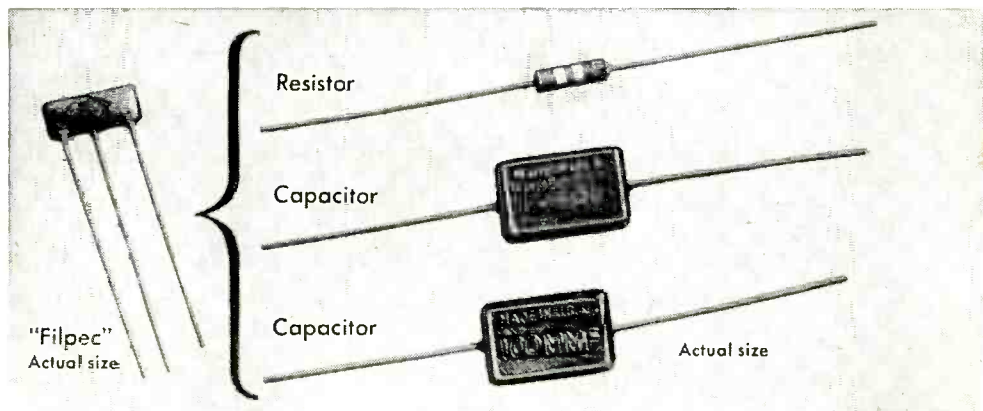

**3** Centralab's *Filpec* is designed for use as a balanced diode load filter, combines up to three major components into one tiny unit, lighter and smaller than one ordinary capacitor. Capacitor values available from 50 to 200 mf. Resistor values from 5 ohms to 5 megohms. For complete information, write for Bulletin 42-9.



# Electronic Industry

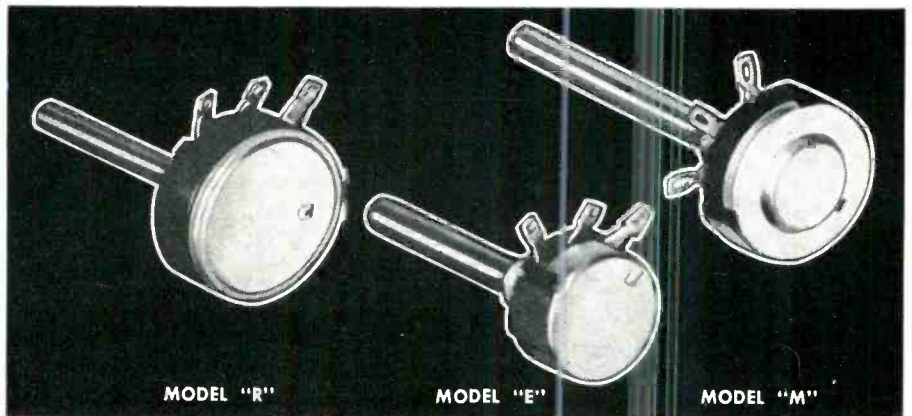
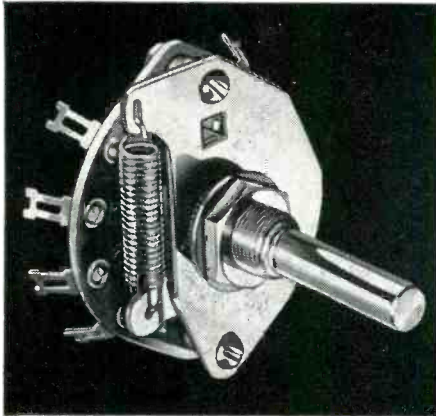

**4** Great step forward in switching is CRL's New *Rotary Coil and Cam Index Switch*. Its coil spring gives you smoother action, longer life.

**5** Let Centralab's complete *Radiohm* line take care of your special needs. Wide range of variations: *Model "R"*—wire wound, 3 watts; or composition type, 1 watt. *Model "E"*—composition type, 1/4 watt. Direct contact, 6 resistance tapers. *Model "M"*—composition type, 1/2 watt. For complete information, write for Bulletin 697.

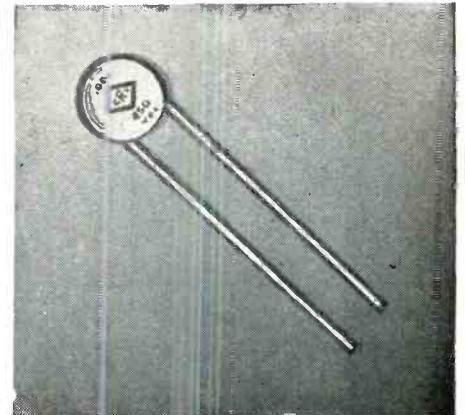
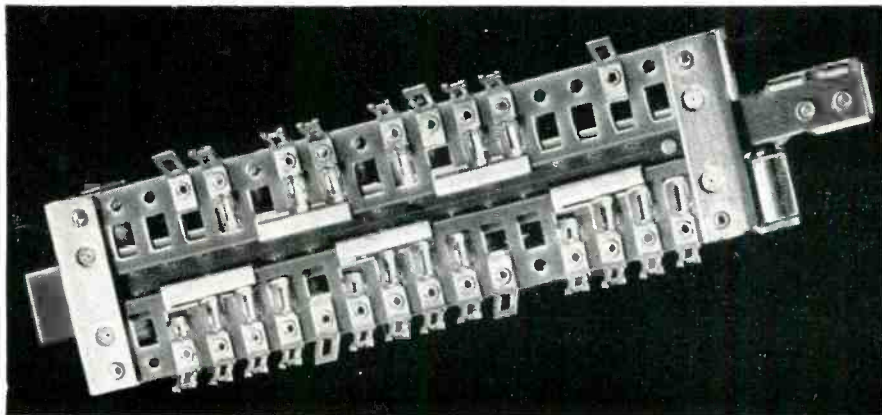

**6** Centralab's development of a revolutionary, new *Slide Switch* promises improved AM and FM performance! Flat, horizontal design saves valuable space, allows short leads, convenient location to coils, reduced lead inductances for increased efficiency in low and high frequencies. Rugged, efficient. Write for Bulletin 953.

**7** For by-pass or coupling applications, check CRL's original line of ceramic disc and tubular *Hi-Kaps*. For full facts, order Bulletins 42-3 and 42-4.

**LOOK TO CENTRALAB IN 1949!** *First in component research that means lower costs for the electronic industry. If you're planning new equipment, let Centralab's sales and engineering service work with you. Get in touch with Centralab!*

# Centralab

**DIVISION OF GLOBE-UNION INC., MILWAUKEE, WIS.**

*Be sure to visit Booths 234-235 at the I.R.E. National Convention March 7-10 New York City*

**NEW**

**WESTON**

**MODEL 901 SERIES  
A-C AND D-C PORTABLES**



*the modern concept*

**in READABILITY...  
in SHIELDING!**

**D**esigned...and styled...to bring you Weston's concept of the finest general purpose portables ever produced! These instruments are offered with full assurance that their dependability will reflect credit upon the name they bear. Write for Circular A-22-A. Weston Electrical Instrument Corp., 618 Frelinghuysen Ave., Newark 5, N. J.

**WESTON  
INSTRUMENTS**

Albany • Atlanta • Boston • Buffalo • Charlotte • Chicago • Cincinnati • Cleveland • Dallas • Denver • Detroit • Houston • Jacksonville • Knoxville • Little Rock • Los Angeles • Meriden • Minneapolis • Newark  
New Orleans • New York • Orlando • Philadelphia • Phoenix • Pittsburgh • Rochester • San Francisco • Seattle • St. Louis • Syracuse • Tulsa • In Canada, Northern Electric Co., Ltd., Powerlite Devices, Ltd.

Plastics where plastics belong

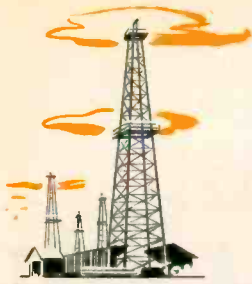

for strength,  
wear resistance,  
and ease  
of machining . . .

Structural strength, wear resistance, and ease of machining are three of Synthane's many properties which, in combination with its other mechanical, chemical and electrical characteristics make it one of industry's valuable materials.

A good electrical insulator, Synthane, the set plastic, is stable over a wide range of temperatures. Hard, dense and durable, it also possesses desirable moisture and corrosion-resistant qualities.

The ability of Synthane to stand up under adverse conditions is interestingly demonstrated by its use in the Turbo-Jet Float Shoe.

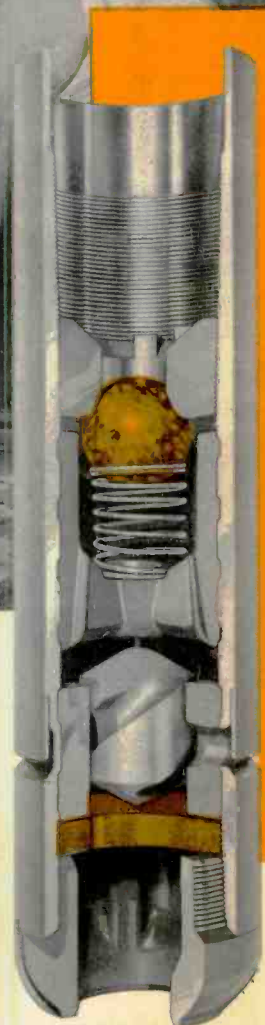
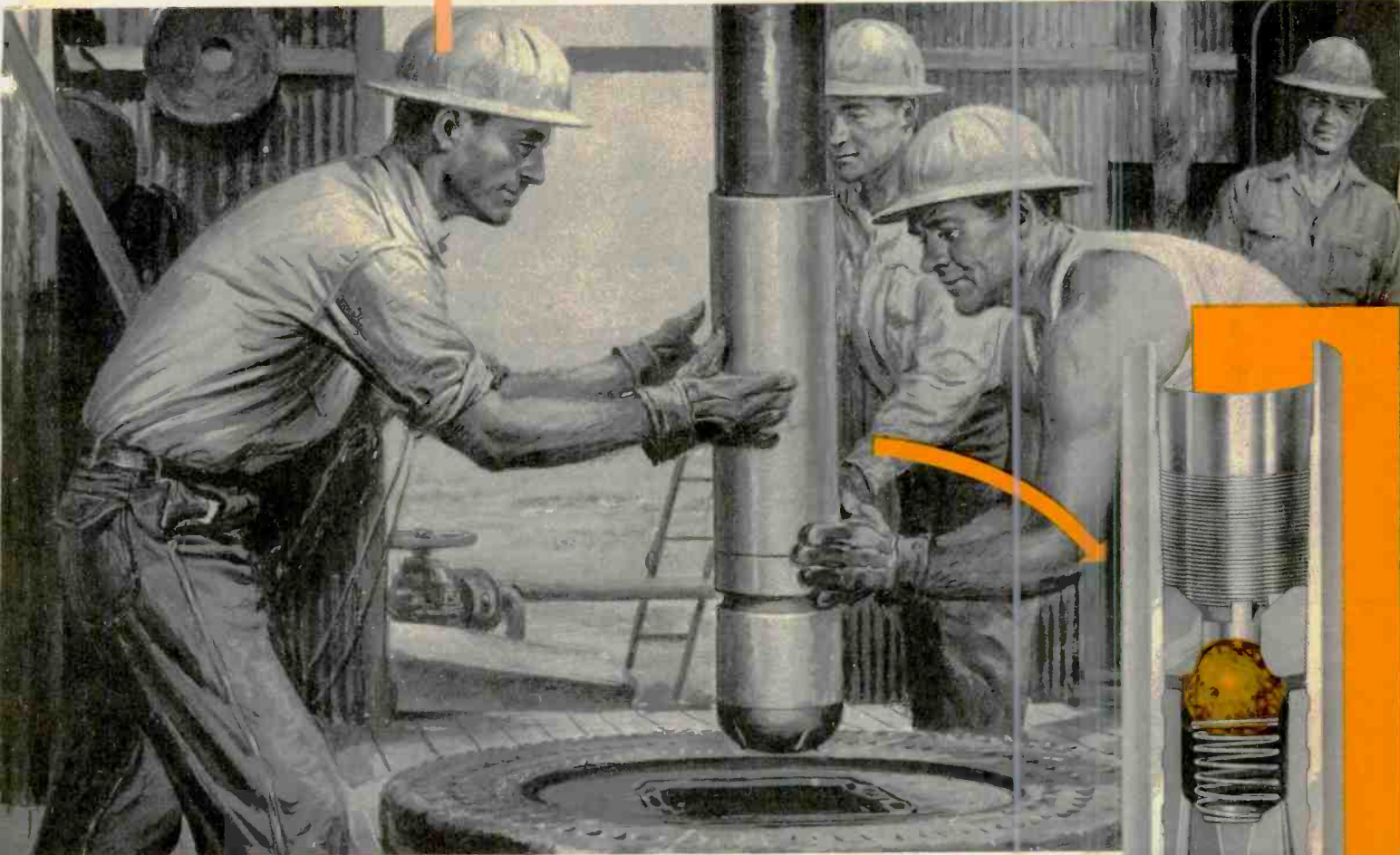

Various parts of Float Shoes, used in cementing oil wells, are fabricated from Synthane, for example, the valve ball and thrust plate in the shoe illustrated at the right.

Synthane resists the abrasive action of the liquid cement pumped through the shoe. It is thermosetting, so that it retains its original size and shape, yet is easily drilled out after the cement has set. Thus, Synthane's combination of strength, wear resistance, stability and ease of machining make it a perfect material for this difficult job.

If this brief review of Synthane's unique combination of desirable properties suggests its use in your product, let us help you with design, materials or fabricated parts. Write today for the new Synthane Plastics Catalog, 6 River Road, Oaks, Pennsylvania.

**SYNTHANE**  
S

where Synthane belongs

SHEETS • RODS • TUBES • FABRICATED PARTS • MOLDED-LAMINATED • MOLDED-MACERATED



# PORTRAIT OF A HUNTER

If you are always hunting for a better material, one which combines many valuable physical, chemical and electrical characteristics—consider Synthane laminated plastics.

Synthane has a place in almost every industry because its unusual combination of desirable properties can often make a good product or process better.



*On a weight-for-strength basis Synthane compares favorably with many metals. It is durable, lightweight, high in tensile, compressive and flexural strengths.*



*Synthane resists corrosive atmospheres, moisture, oils and solvents. Synthane is also the set plastic, stable over a wide range of temperatures.*



*Synthane is an excellent insulator—with high dielectric strength, low power factor and low dielectric constant. The ease with which it may be machined adds to its value for practical applications.*



*Hard and dense, Synthane resists fatigue under repeated impact. Withstands abrasion, does not splinter.*

If these properties of Synthane suggest its possible use in your product, let us work with you on materials or fabricated parts. Send Coupon for your copy of the Synthane Plastics Catalog . . . no obligation of course.

◆ ..FOR MORE ANSWERS ON PLASTICS.. ◆



SYNTHANE CORPORATION, 6 RIVER ROAD, OAKS, PA.

Gentlemen:

Please send me without obligation a complete catalog of Synthane technical plastics.

Name \_\_\_\_\_

Company \_\_\_\_\_

Address \_\_\_\_\_

City \_\_\_\_\_ Zone \_\_\_\_\_ State \_\_\_\_\_

# SYNTHANE

S

DESIGN • MATERIALS • FABRICATION • SHEETS  
RODS • TUBES • FABRICATED PARTS • MOLDED,  
MACERATED • MOLDED

# LOW CURRENT PAYS OFF...

## with the **GENERAL ELECTRIC PM-EM\* FOCUS COIL!**

**P**ERFORMANCE-ENGINEERED at Electronics Park, the General Electric Focus Coil is now being used by many leading television manufacturers. The reason for this widespread adoption of the G-E Focus Coil by design engineers is best explained by the following equation:

$$\begin{aligned} \text{PEM} &= I^2R = .109^2 \times 247 = \underline{2.93 \text{ watts}} \\ \text{PEM-PM} &= I^2R = .029^2 \times 960 = \underline{0.81 \text{ watts}} \\ \text{Power Saving} &= \underline{2.12 \text{ watts}} \end{aligned}$$

In addition to its low current requirements (which permit the use of lower-priced power supplies) the G-E focus coil is small, compact and light in weight. These features provide additional space which TV set designers can use to advantage.

For complete information on the G-E Focus Coil and other television components, write: *General Electric Company, Electronics Park, Syracuse, New York.*

\*Permanent Magnet—Electro-Magnet.

*You can put your confidence in—*

**GENERAL  ELECTRIC**



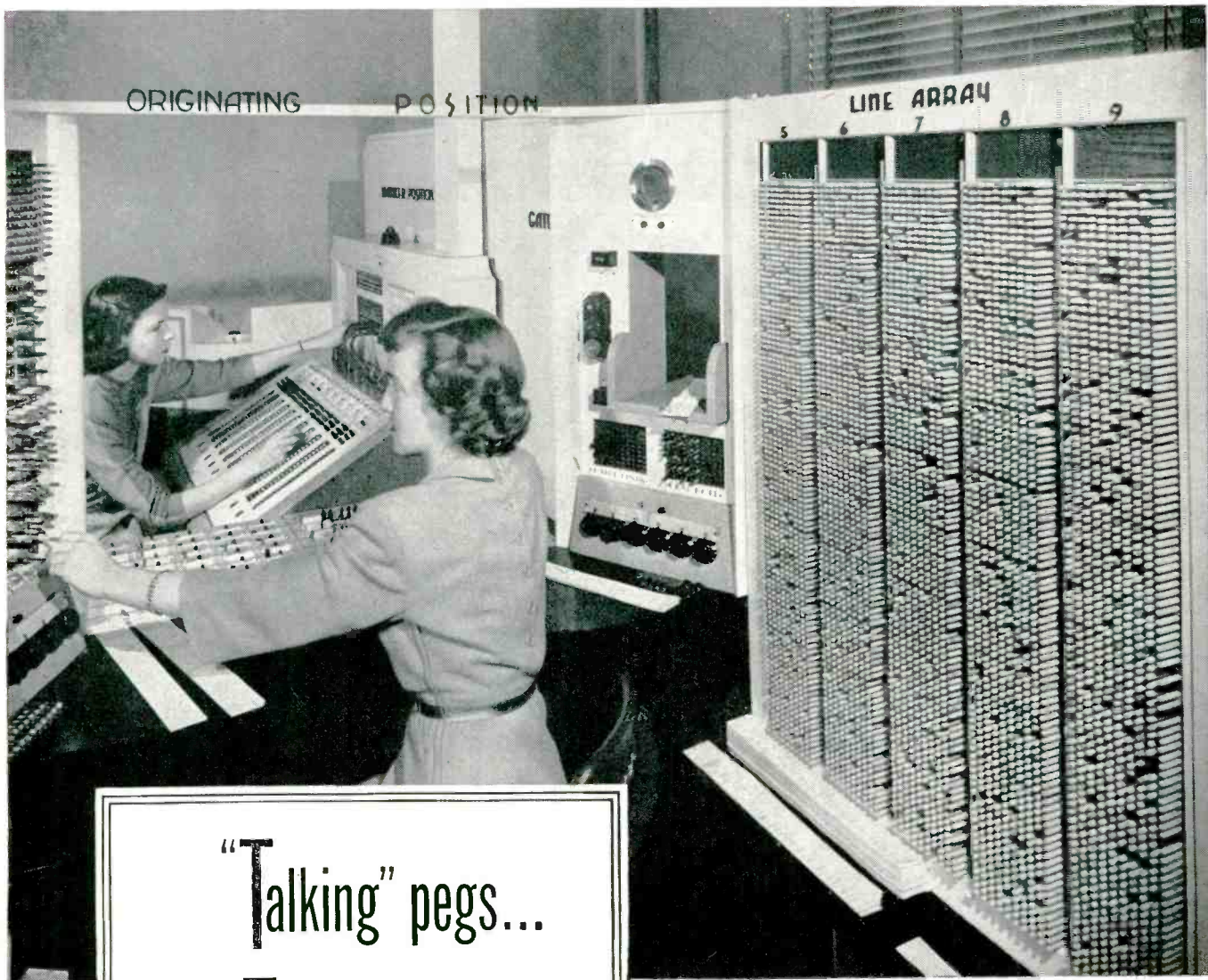

“Talking” pegs...  
and Talking people

THERE ARE 10,000 pegs in this machine, representing 10,000 subscribers in a crossbar telephone exchange—the latest switching system which handles dial calls with split-second swiftness.

The pegs represent many types of telephone users—two-minute talkers and ten-minute talkers . . . people who dial accurately . . . those who make a false start or two. They are starting a journey through a unique machine which analyzes the performance of dial equipment in a typical central office.

But while an actual crossbar exchange connects your call in a matter of seconds, this counterpart moves far more slowly. It gives the Bell Laboratories engineers who built it time to observe what happens

to each call—where bottlenecks develop, which parts are overworked or underworked, which of the circuits are most used.

In a manual exchange, the number of operators may be changed to meet different traffic conditions. In crossbar, all switching is done by complex electro-mechanical devices, permanently built in. This machine shows how many devices of each kind there must be in a new exchange to give you the best of service with a minimum of expensive equipment.

This traffic-study machine is one of the many ingenious research tools devised by the Laboratories as part of its continuing job—finding new ways to give you better and better telephone service.



**BELL TELEPHONE LABORATORIES**

EXPLORING AND INVENTING, DEVISING AND PERFECTING, FOR CONTINUED IMPROVEMENTS AND ECONOMIES IN TELEPHONE SERVICE

# GENERAL INDUSTRIES leads the L.P. Parade...

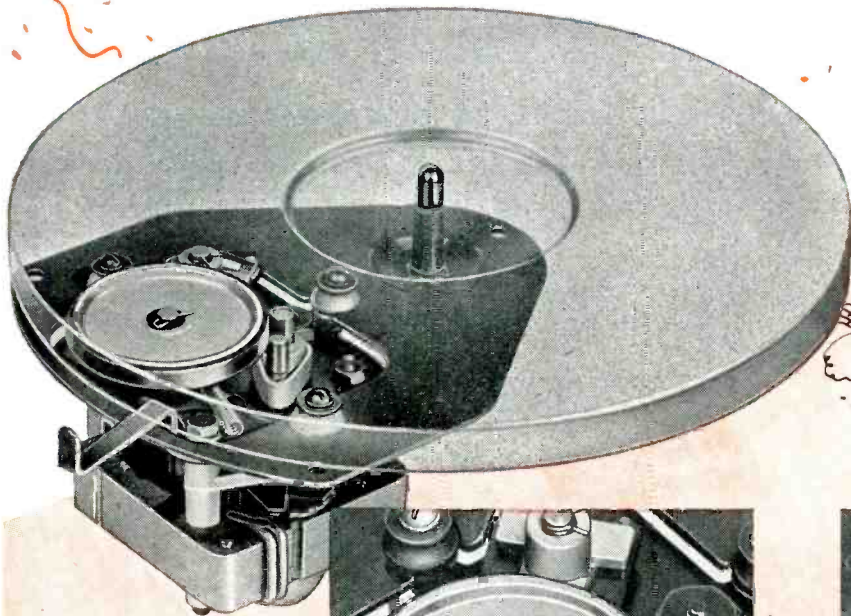

MODEL DM—Compact 2 pole, shaded pole motor, already being widely used by many of America's leading radio and record-changer manufacturers. Simple speed change mechanism incorporates a special long-lasting molded neoprene belt. Speed change lever extends beyond turntable rim

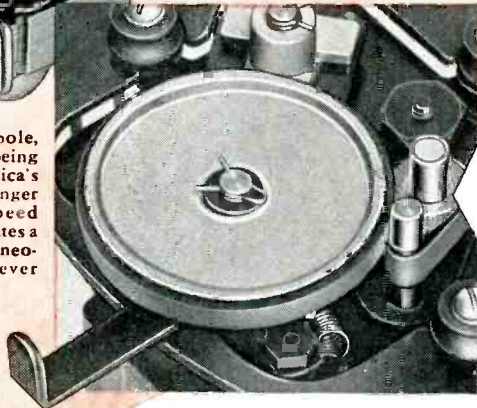

78  
RPM

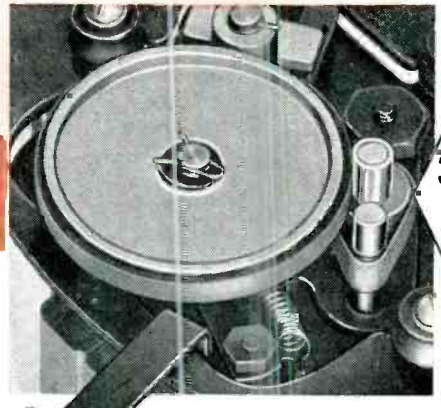

33 1/3  
RPM

## with a low cost, rim drive **DUAL SPEED PHONOMOTOR** FOR BOTH 33 1/3 AND 78 R.P.M. RECORDS

It's L.P. for *Larger Profits* when your record-changers and record-players will handle both the new long-playing microgroove and conventional 78 R.P.M. records. And it's General Industries—oldest name in the phonomotor field—which offers you an economical turntable unit to capture this popular, profitable market.

Like all GI Smooth Power products, this

motor has undergone tests far more rigid than service conditions encountered in normal use. It is the result of years of research and development . . . built to exacting performance standards, but surprisingly low in cost.

General Industries offers prompt delivery of this motor in quantity lot shipments. For additional information, specifications and quotations, write *today*.

In addition to the Model DM, General Industries also manufactures a Model DR rim drive dual speed phonomotor. It is a heavy-duty 4-pole shaded pole motor for use where the ultimate in performance is desired. Novel speed change mechanism is both simple and positive in operation.



The **GENERAL INDUSTRIES Co.**

DEPARTMENT B • ELYRIA, OHIO

# For Negative Resistance-Voltage Characteristics

# GLOBAR

TRADE MARK

## TYPE BNR RESISTORS

Responding instantly to voltage changes, GLOBAR type BNR Silicon Carbide Resistors provide increased resistance as a potential is decreased. Conversely, as a potential is applied, resistance decreases. These resistors have what is commonly referred to as "negative resistance-voltage". They are used to dampen the effect of transient voltages and provide instant protection for electrical circuits.

### TYPICAL APPLICATIONS WHERE THESE RESISTORS OPERATE SUCCESSFULLY INCLUDE:

- 1** Oil burner ignition transformers to prevent high voltage feed back into line.
- 2** Small motors to prevent arcing of governor contact points.
- 3** Stabilizing rectifier circuits by limiting peak voltages.
- 4** Voltage control circuits in electronic devices.
- 5** Protection of solenoids in direct current circuits.

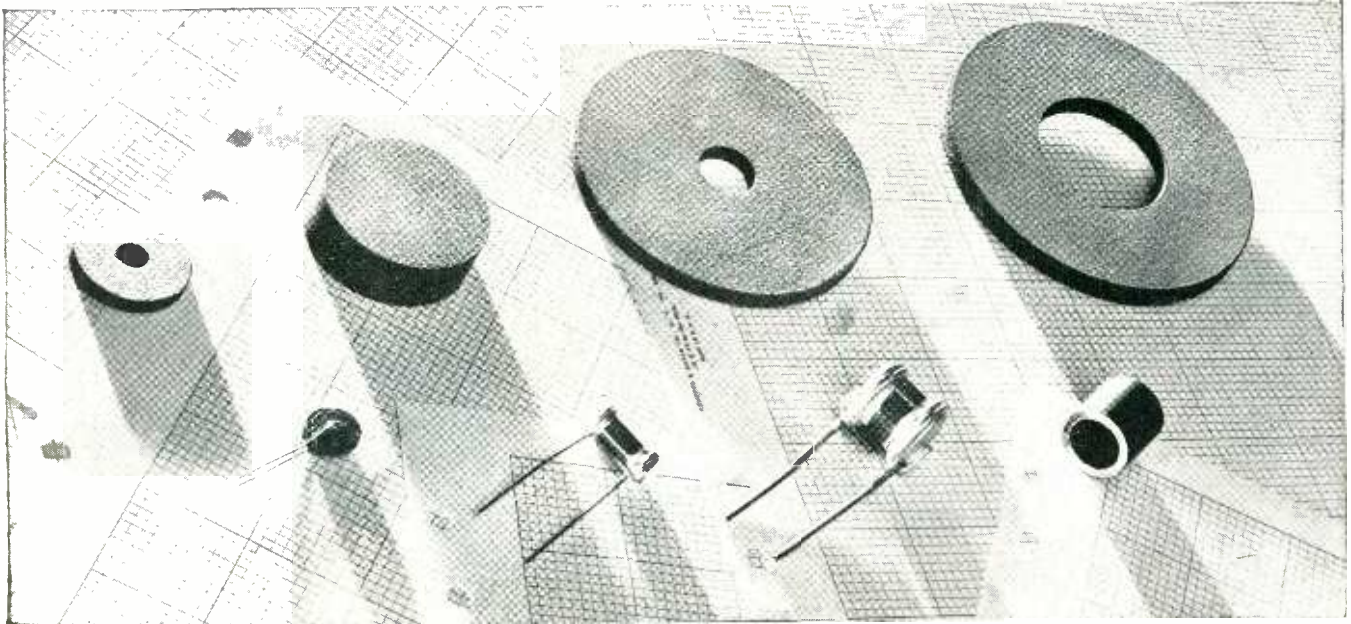

▶ Resistors of this type are readily made to meet exact specifications. Working samples are available on short notice. To be sure of receiving resistors made to correct specifications, the following information should be furnished:

- Type of apparatus in which resistors are to be used.
  - Method of mounting and space limitations.
  - Normal operating voltage and peak voltage if available.
  - Resistance and inductance of the circuit if available.
  - Ohmic resistance of the resistor and allowable plus or minus tolerance.
  - Maximum voltage applied continuously or intermittently.
  - Duration of load and elapse of time between applications.
- Furnishing this data will also avoid unnecessary delay and confusion.



Bulletin GE-R1-B contains useful engineering data on GLOBAR BNR Ceramic Resistors. Copies will be supplied immediately upon request. No obligation of course. Write Dept. V-39, The Carborundum Company, GLOBAR Division, Niagara Falls, N. Y.



# GLOBAR Ceramic Resistors

## BY CARBORUNDUM

TRADE MARK

"Carborundum" and "Globar" are registered trademarks which indicate manufacture by The Carborundum Company



# If you manufacture Electronic Equipment...

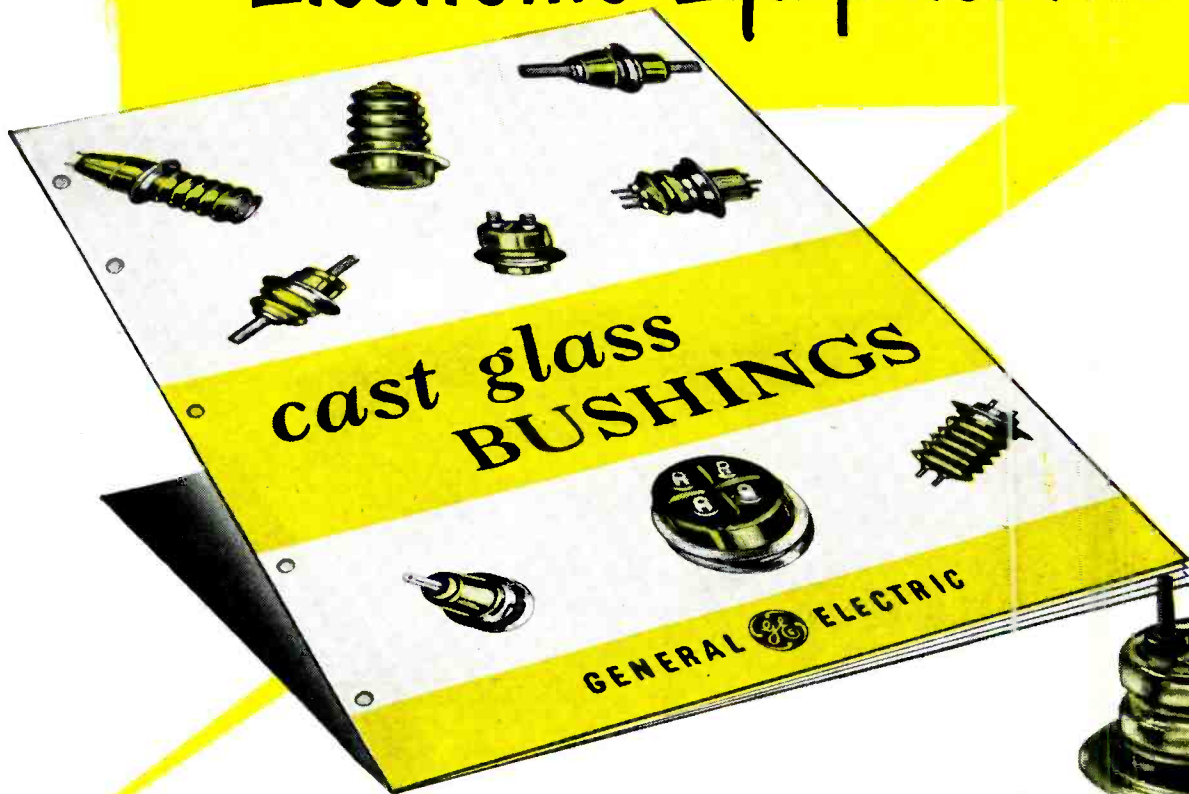

## you'll want this NEW bulletin on glass bushings

General Electric is now offering to other manufacturers the cast glass bushings it has used so successfully on many types of electrical equipment.

These bushings are cast of a stable, low-expansion glass. Metal hardware is a special nickel-alloy steel, fused to the glass in casting. Bushings can be attached directly to the apparatus without gaskets—by soldering, welding or brazing.

The resulting joint between bushing and equipment is permanent, vacuum-tight, and of high mechanical strength. It is especially desirable for equipment subject to vibration, shock, attack by fungus growth or severe changes in temperature. It eliminates moisture problems and often permits more compact, light-weight design of equipment.

Our new bulletin, GEA-5093, contains a complete listing of standard designs now available—giving withstand voltages, current ratings and physical dimensions. A copy of this bulletin is yours for the asking. Just write *Apparatus Department, General Electric Company, Schenectady 5, New York.*

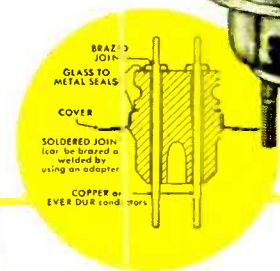

Glass bushings are currently available to meet dry, 60-cycle, flashover values of from 10 to 50 kv, and in current ratings of 25 and 50 amperes (large sizes up to 800 amperes). They may be single or multi-conductor and can be provided with a top flange to permit mounting tube sockets directly on the bushings. Diameters range from 1½ to 3¾ inches and weight from 2½ oz. to 4 lb.

GENERAL  ELECTRIC

431-67

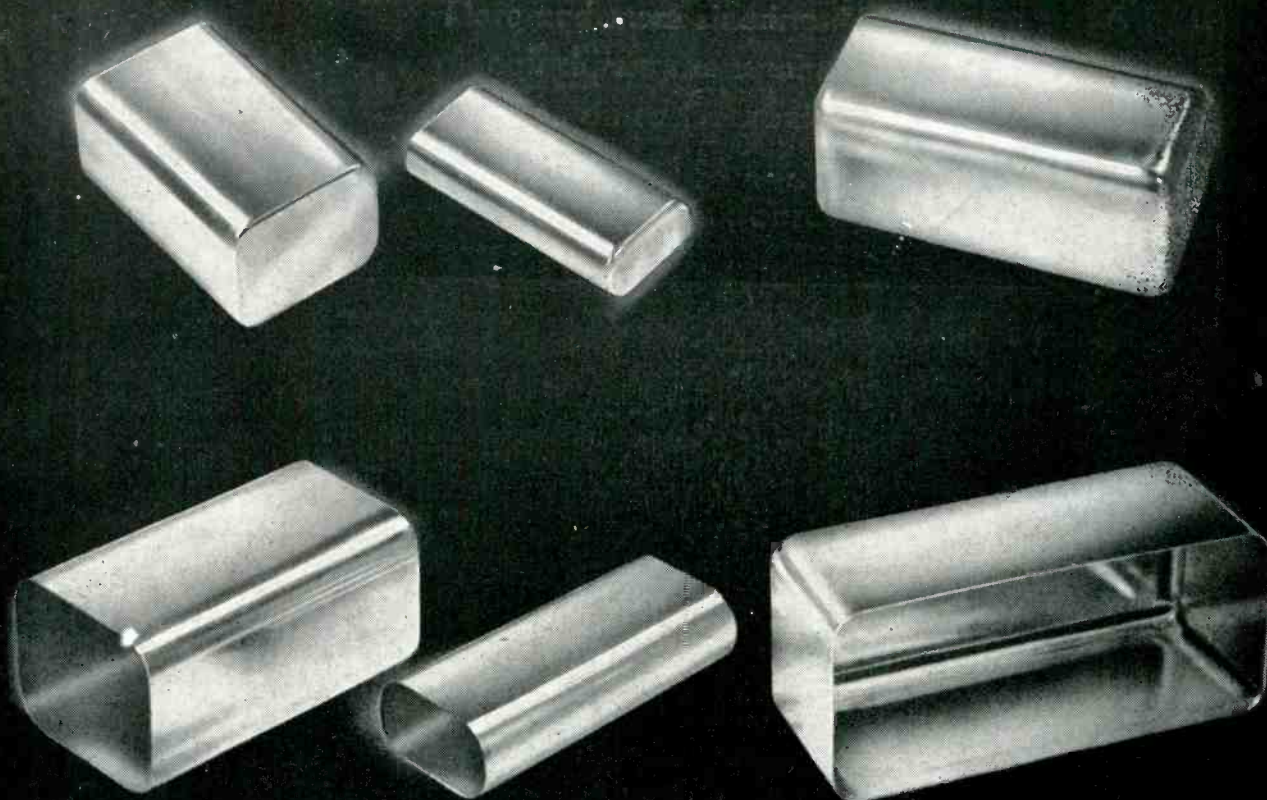

## REVERE SHEET AND STRIP FOR DRAWN PARTS

FOR all products to be made by drawing, stamping and similar sheet metal operations, Revere sheet and strip of copper or brass offer maximum ease of fabrication. Not only are these metals naturally ductile, but they benefit further from the metallurgical skill which Revere has gained in 147 years of experience.

In composition, mechanical properties, grain size, dimensions and finish, you will find Revere metals highly uniform. They enable you to set up economical production methods and adhere to them. They can help you produce better products at faster production rates, with less scrap and fewer rejects.

Revere copper, brass and bronze lend themselves readily to the widest variety of finishing operations—polishing, lacquering, electro-plating. With these superior materials it is easy to

make radio shields and similar products beautiful as well as serviceable.

That is why wise buyers place their orders with Revere for such mill products as—*Copper and Copper Alloys*: Sheet and Plate, Roll and Strip, Rod and Bar, Tube and Pipe, Extruded Shapes, Forgings—*Aluminum Alloys*: Tubing, Extruded Shapes, Forgings—*Steel*: Electric Welded Steel Tube. We solicit your orders for these materials.

# REVERE

**COPPER AND BRASS INCORPORATED**

*Founded by Paul Revere in 1801*

230 Park Avenue, New York 17, N. Y.

*Mills: Baltimore, Md.; Chicago, Ill.; Detroit, Mich.*

*New Bedford, Mass.; Rome, N. Y.*

*Sales Offices in Principal Cities, Distributors Everywhere.*



**ALSiMAG**

TRADE MARK REG. TERT. U.S. PATENT OFFICE

**CUSTOM MADE  
TECHNICAL CERAMICS**

**AMERICAN LAVA CORPORATION**

*Main Plant and Office*

Production experience and  
continuous research for  
almost half a century have made  
this building the headquarters  
for problems on  
Technical Ceramics

47TH YEAR OF CERAMIC LEADERSHIP

**AMERICAN LAVA CORPORATION**

CHATTANOOGA 5, TENNESSEE

SALES OFFICES: ST. LOUIS, MO., 1123 Washington Ave., Tel: Garfield 4959 • NEWARK, N. J., 671 Broad St., Tel: Mitchell 2-8159 • CAMBRIDGE, Mass., 38-B Brattle St., Tel: 878-1108 • CHICAGO, 9 S. Clinton St., Tel: Central 1721 • LOS ANGELES, 324 N. San Pedro St., Tel: Mutual 9071 • PHILADELPHIA, 1649 N. Broad St.

**AUTOMATIC MANUFACTURING CORPORATION**  
MANUFACTURERS OF

*Coils and Capacitors*

65 GOUVERNEUR STREET

NEWARK 4, N. J.

January 19, 1949

PHONE  
HUMBOLDT 5-2100

Mr. T. R. Moore, Jr.  
Sales Manager, Antara Products  
Div. of General Aniline & Film Corp.  
444 Madison Avenue  
New York 22, N. Y.

Gentlemen:

You may be interested to learn that G.A.F. Carbonyl Iron Powders have been a major factor in the success of our K-TRAN. Never before has any radio component of unusual design been so universally accepted by the entire radio industry.

The excellent uniformity and high volume production of your product has enabled us to develop a special process for the production, in extremely large quantity, of a complex tuning core which is the "heart" of the K-TRAN.

Your product has enabled us to design into our K-TRAN both very high electrical performance and unparalleled mechanical and climatic stability, otherwise only obtainable in much larger and more expensive units, and eagerly sought after by K-TRAN imitators. We feel that it is only reasonable that you should realize the part you are contributing to the success of our product.

Very truly yours,

AUTOMATIC MANUFACTURING CORPORATION

*John P. Tucker*  
J. P. Tucker  
Application Engineer

JPT/hm

## Here's a distinguished user

As the manufacturer of the famous "K-Tran" points out, when it comes to performance *with* economy, there's nothing to equal G. A. & F. Carbonyl Iron Powders.

No other iron powder gives the *superior* performance of Carbonyl Iron Powder. It is easier to control from the standpoint of manufacture. It is uniform, therefore requires very little control work on the part of the manufacturer.

G. A. & F. Carbonyl Iron Powders are easier to mold and machine. They save money because of assured longer tool life, and save time because tools need changing less often. Savings of 5 to 1 have been reported.

# G. A. & F. Carb



K TRAN made by Automatic Manufacturing Co. Available in RF and IF transformers covering frequency ranges from 20 KC to 30 Megacycles and higher.

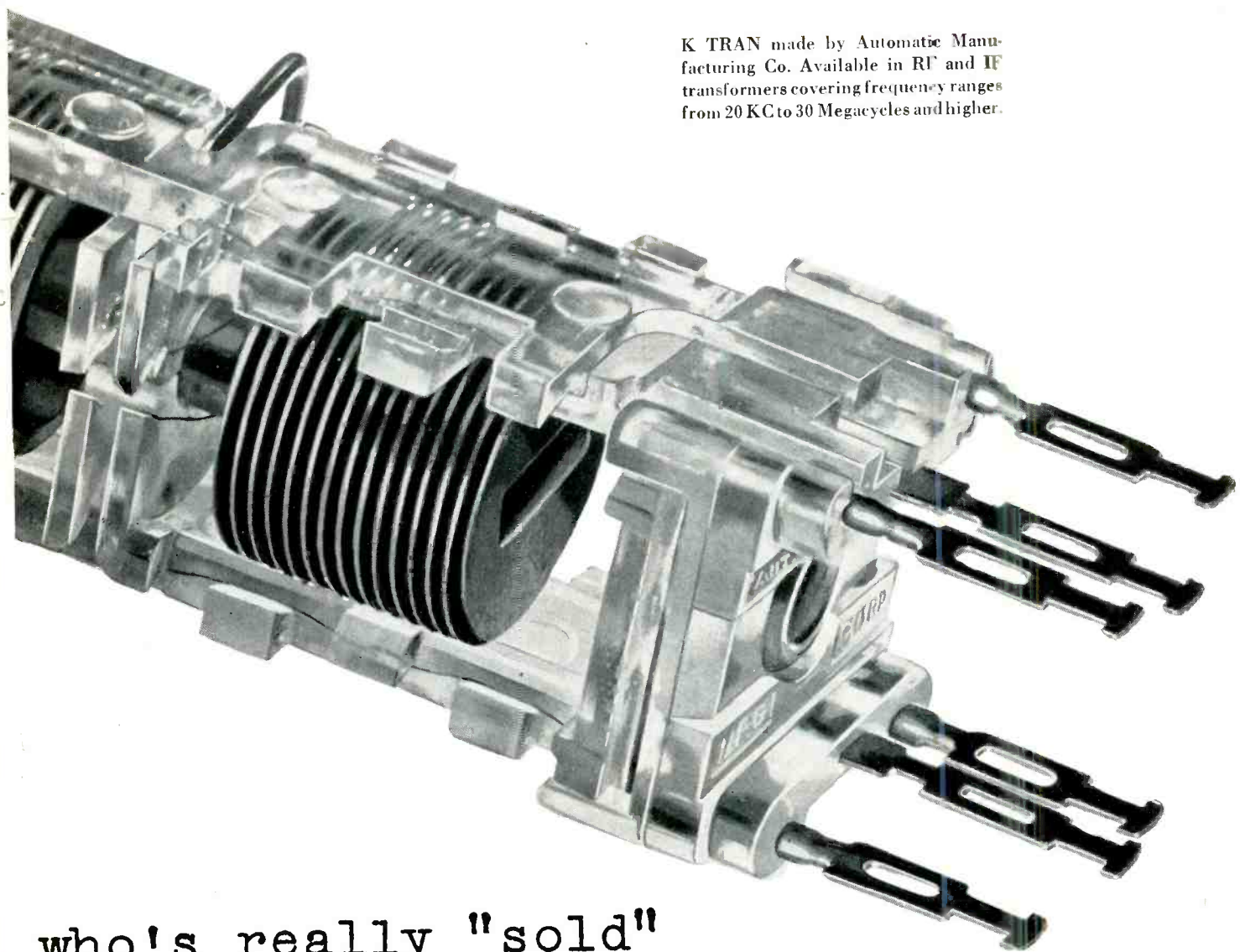

who's really "sold"

For the highest permeability for the Q developed, follow the advice of Automatic Manufacturing. Ask your core maker. Ask your coil winder. It's a well-known fact among electronics experts that Carbonyl Iron Powders are better!

See Antara Products' "Parade of Cores & Coils"—Booth 27 and 28, Radio Engineering Show of 1949 I.R.E. National Convention, Grand Central Palace, New York City, March 7-10. Carbonyl Iron Powders also on exhibition at the Spring Meeting of the Metal Powder Association, Drake Hotel, Chicago, April 5 and 6.

**ANTARA PRODUCTS**

A DIVISION OF  
GENERAL ANILINE & FILM CORPORATION  
444 Madison Avenue  
New York 22, N. Y.

# Carbonyl Iron Powders

# Where cables can't go



## TIME SHARING MULTIPLEX *can*

Natural hazards are no longer obstacles to the telephone engineer. Standard Time-sharing Multiplex can provide a thoroughly reliable trunk system which is easy to install and maintain in the most difficult terrain.

Each equipment deals with up to 24 channels, handling any kind of A.F. traffic in the 300-3400 c/s range, including teleprinter and automatic telephone signals. Time-sharing Multiplex ensures low crosstalk and noise levels, and fading does not affect speech levels.

A UHF carrier is used, and the normal line-of-sight range can be extended by automatic repeaters.

Complete terminal equipment occupies a double cabinet 7' wide x 2'4" deep x 6'6" high, and aerials may be up to 100' from the main equipment.

Write for Bulletin No. 511 which gives further facts and figures.

*Standard Telephones and Cables Limited* Radio Division

Associates of the International Telephone and Telegraph Corporation

OAKLEIGH ROAD, NEW SOUTHGATE, LONDON, N.11, ENGLAND  
R.D.6.

# PROGRESS REPORT ON P.E.C.

More and more Hearing Aid  
Manufacturers are turning to  
Centralab's *Printed Electronic Circuits*  
to Simplify Production . . . to Build  
Smaller, Finer Units!

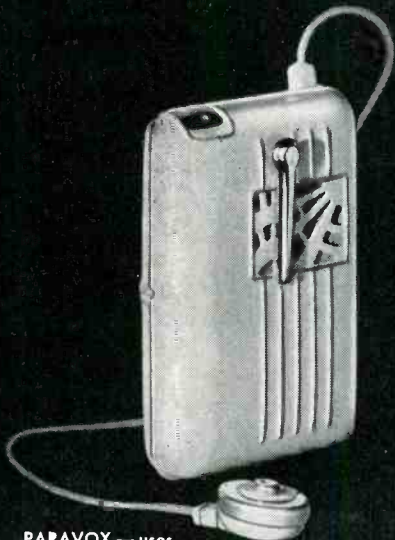

**PARAVOX** — uses  
custom CRL Ampec for  
quick assembly.

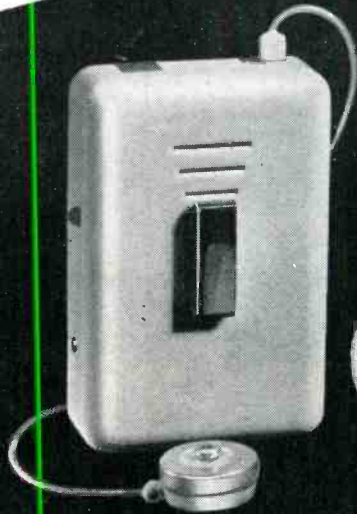

**JOHNSTON** — finds  
special Ampec audio-  
amplifier cuts weight.

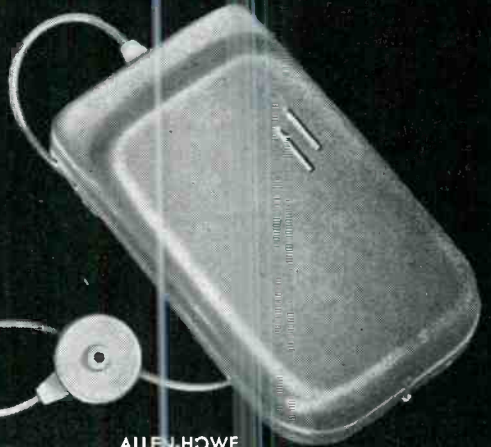

**ALLEN-HOWE**  
— was first to use P. E. C.  
in hearing aids.

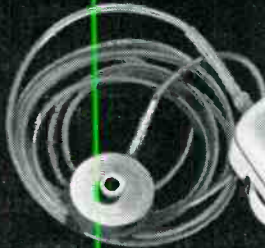

**MICROTONE** —  
uses 12 P. E. C.  
units to save space.

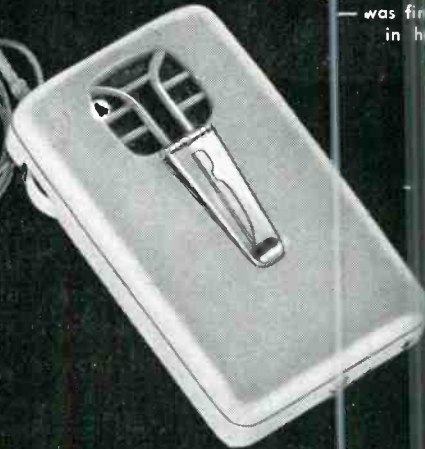

**BELTONE** — replaces  
45 parts with one  
P. E. C. unit.

The illustrated units are now on the  
market — Watch for at least 5 more  
by June First!

LOOK TO **Centralab** IN 1949!

Division of GLOBE-UNION INC., Milwaukee

Watch  Master

# Frequency Standards

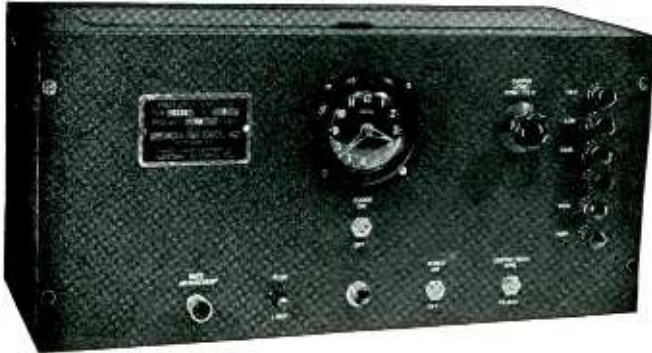

**GUARANTEED  
ACCURACY**  
1 part in 100,000  
(.001%)

## Uses

Time bases, rate indicators, clock systems, chronographs, geo-physical prospecting, control devices and for running small synchronous motors.

## Features

1. Bimetallic, temperature-compensated fork, no heating or heat-up time is required.
2. Fork is hermetically sealed, no barometric effects on frequency.
3. Precision type, non-ageing, low coefficient resistors used where advantageous.
4. Non-linear negative feedback for constant amplitude control.
5. No multi-vibrators used.
6. Synchronous clock simplifies checking with time signal.

## Specifications

Accuracy—1 part in 100,000 (.001%).

Temperature coefficient—1 part in 1,000,000 per degree centigrade (or better).

Outputs—

1. 60 cycles, sine wave, 0-110 volts at 0 to 10 watts (adjustable).
2. 120 cycle pulses, 30 volts negative.
3. 240 cycle pulses, 30 volts positive and negative. Pulse duration, 100 micro-seconds.

product of

**AMERICAN TIME PRODUCTS  
INC.** New York 19, N. Y.  
Operating under patents of the Western Electric Company

Type 2121 A.

TERMINATION

Front and Rear

CONSTRUCTION

Standard 8 $\frac{3}{4}$ " x 19" Panel

HOUSING

8 $\frac{3}{4}$ " x 19" x 8" Metal Cabinet

WEIGHT

25 pounds

American Time Products, Inc.,  
580 Fifth Ave., New York 19, N. Y.

Gentlemen:

Please send descriptive folder, No. 2121A.

Name.....

Company.....

Address.....

City..... State.....



— nothing short of being best . . .

**ABBOTT LABORATORIES**

North Chicago, Illinois.

uses this **PLASTIC CAP** as a functioning part of highly specialized hospital equipment, and it must be right!



"Many things difficult to design prove easy to performance." ★

Thanks to Samuel Johnson for a good, if unintentional description of the ingeniously designed *Abbott Venoclysis Equipment* — which, together with *Abbott Intravenous Solutions* is the choice of many hospitals.

★ The above is an excerpt from a professionally directed Abbott advertisement.

**A Versatile Bit of Equipment, states ABBOTT**

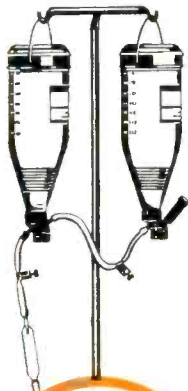

This dispensing cap, in conjunction with rubber tubing, is used for venoclysis. It is designed to fit all Abbott bottles containing intravenous solutions. A versatile bit of equipment, it makes possible several different variations in venoclysis technique.

This compact cap permits introduction of supplementary parenteral medication directly into the flow without disturbing the patient. It can be used with one bottle, or hooked up with additional bottles, in series. The sketches to the left, reproduced through the courtesy of Abbott Laboratories, show these caps as installed and arranged for a two-bottle series hook-up.



**This Piece is our Salesman for more Plunger Molding**

When you plan molding, consider the plunger method—and call Consolidated. By plunger-processing this intricately designed and threaded part of black Babelite, we maintained precision quality, used fewer cavities, lowered tool costs and, through shortened cycles—increased production.

Of prime importance is the fact that the customer is well pleased . . . and the equipment well served. As a result of this and other Consolidated-solved problems, we invite the opportunity to apply our know-how to any and all custom molding assignments—plunger, compression, injection. Our experienced sales engineers are at your service. Inquiries invited!

**CALL IN**

**Consolidated**  
MOLDED PRODUCTS Corporation  
309 CHERRY STREET,  
SCRANTON 2, PA.

YOUR BLUEPRINT



IN PLASTIC

Branches: NEW YORK, 1790 Broadway • CHICAGO, 549 W. Randolph St. • DETROIT, 550 Maccohee Bldg. • CLEVELAND, 46-4 Prospect Av. • BRIDGEPORT, 211 State Street.  
PRODUCT DEVELOPMENT • MOLD DESIGN • MOLD CONSTRUCTION • PLUNGER MOLDING • TRANSFER MOLDING • INJECTION MOLDING • COMPRESSION MOLDING

# When the Underwriters Say:

"Where heater cord is used and the temperatures on the braid within the appliance exceed 90°C., supplementary insulation is required over the braid."

## Would you choose--

### This

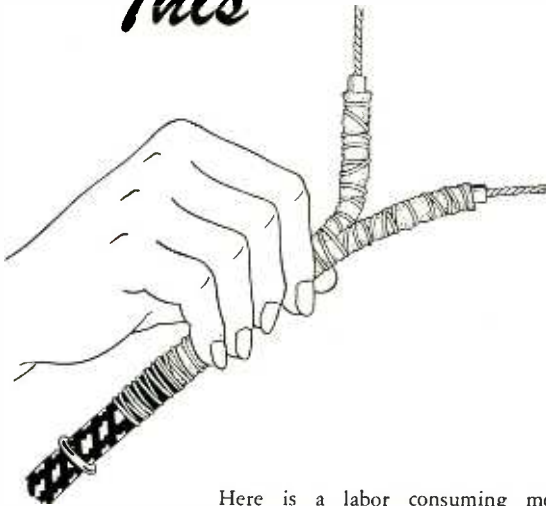

Here is a labor consuming method of hand-wrapping an electric cord with thread to provide the supplementary insulation required by Underwriters' Laboratories, Inc.

Now BH Non-Fraying Fiberglas Sleevings gives you a better, faster way of providing supplementary insulation required by the Underwriters' for built-in heater cord. Recent assembly tests have shown savings of three minutes in the insulation of a single heater cord. Slow hand-wrapping methods take time, cost more and are not uniform. With BH Non-Fraying Fiberglas Sleevings, there are no threads to break or unravel. No possibility of partially-uncovered braid. No time spent in job-training employees.

By simply slipping a section of BH Fiberglas Sleevings over each asbestos covered lead, and then fitting a larger BH Fiberglas Sleevings over the braid, the job is completed quickly and efficiently. Stays snug

### or This?



Here is an electric heater cord with "pants" of BH Non-Fraying Fiberglas Sleevings, easily slipped over the leads and covered by a larger BH Fiberglas Sleevings. Saves minutes in assembly time. Approved by Underwriters' Laboratories, Inc.

yet remains flexible as string because no hardening varnish or lacquer is used in BH Fiberglas Sleevings. Will not fray, crack or split when bent. Heat resistant to 1200°F. if necessary. Can be spread to cover knobs and terminals smoothly.

Leading appliance manufacturers in every section of the country specify BH Fiberglas Sleevings for supplementary insulation in their products. BH Non-Fraying Fiberglas Sleevings is made in all standard sizes and colors, in standard 36" lengths and 500' coils, or it may be supplied in short lengths to meet specific requirements. Use it in your plant, in your product. Write today for details.

BENTLEY, HARRIS MFG. CO., CONSHOHOCKEN, PA.

# BH Fiberglas\* SLEEVINGS

\*BH Non-Fraying Fiberglas Sleevings are made by an exclusive Bentley-Harris process (U. S. Pat. No. 2393530). "Fiberglas" is Reg. TM of Owens-Corning Fiberglas Corp.

-----USE COUPON NOW-----

Bentley, Harris Mfg. Co., Dept. E-32, Conshohocken, Pa.

I am interested in BH Non-Fraying Fiberglas Sleevings \_\_\_\_\_ for \_\_\_\_\_ (size or I.D.)

\_\_\_\_\_ (product) operating at temperatures of \_\_\_\_\_°F. at \_\_\_\_\_ volts. Send samples

so I can see how BH Fiberglas Sleevings stays flexible as string, will not crack when bent.

NAME \_\_\_\_\_ COMPANY \_\_\_\_\_

ADDRESS \_\_\_\_\_

Send samples, pamphlet and prices on other BH Products as follows:

- Cotton or Rayon-base Sleevings and Tubing
- Ben-Har Special Treated Fiberglas Tubing

# **sorensen** voltage regulators eliminate color changes due to changes in lamp voltage



The Hunter Color and Color Difference Meter, shown here in phantom is a photo-electric tristimulus colorimeter equipped with photocell windows and measuring circuits so chosen as to permit the reading of three values of color direct from 10-turn potentiometer rheostats. Precise measurements of color and small color differences may be quickly obtained.

This is another precision instrument from which accurate measurements can be obtained only through accurate voltage regulation. The Sorensen Model 150A Electronic Voltage Regulator is employed with the Hunter Color Meter to eliminate color changes when the voltage of the lamp changes.

Where precise voltage control is essential to accurate reading, Voltage Regulators and Nobatrons by Sorensen offer you these essential advantages:

- precise regulation accuracy
- excellent wave form
- fast recovery time
- constant output voltage
- insensitivity to line frequency fluctuations

Write for catalog or tell us your voltage regulation problems. Our engineers will be happy to make specific recommendations.

THE FIRST LINE OF STANDARD ELECTRONIC VOLTAGE REGULATORS

Representatives in principal cities.

 **Sorensen** and company, inc.

375 Fairfield Ave., Stamford, Connecticut

# INSUROK *By* RICHARDSON

dependable  
names in  
plastics

**EXPERIENCE** is just one of the factors that make the names of INSUROK and Richardson more significant to manufacturers whose products require laminated or molded plastics. Richardson customers benefit from this experience in many ways.

(1) Richardson experience with a wide variety of plastic materials helps you select the one that accomplishes your purpose most effectively, efficiently and economically.

(2) Richardson experience in the design and production of Laminated INSUROK and Molded INSUROK products has re-

sulted in savings to scores of manufacturers.

(3) Richardson's many proven grades of Laminated INSUROK are available in sheet, rod or tube stock or in fabricated, punched or post-formed component parts for an endless variety of applications.

(4) INSUROK plastic products and Richardson services have played an important part in the development and refinement of many products.

It might be to our mutual advantage to know how these materials and services can work for you.

INSUROK is a registered trade-mark of The Richardson Company

## *The* RICHARDSON COMPANY

GENERAL OFFICES: LOCKLAND, OHIO

FOUNDED IN 1858

Sales Headquarters: MELROSE PARK, ILLINOIS

CLEVELAND - DETROIT - INDIANAPOLIS - MILWAUKEE - NEW BRUNSWICK, (N. J.) - NEW YORK - PHILADELPHIA - ROCHESTER - ST. LOUIS

# NOW AMERTRAN HIGH IMPEDANCE TRANSFORMERS

## for every tube requirement!

To meet the need for filament excitation of large vacuum tubes, we are for the first time offering a complete line of high impedance transformers for this application. AmerTran High Impedance Transformers, designed for use with specific tubes, limit the inrush and operating currents to the values recommended by tube manufacturers.

You will find listed below a rating to be used with your particular tube requirements. Several ratings are furnished for certain tubes so that the designer may choose single or polyphase operation.

Attractive, economical, and light in weight, AmerTran High Impedance Transformers will meet your exacting requirements.

Consult our Sales Representatives listed below for further information.

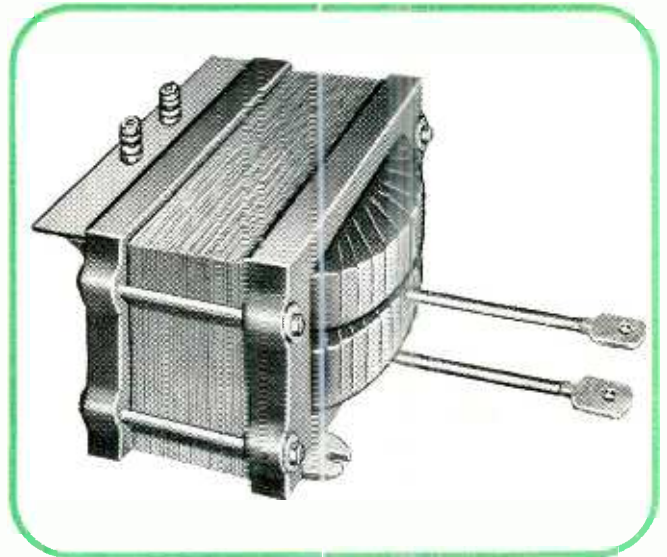

	Tube Types	Input VA	Primary Volts	Frequency CPS	Secondary		Max. Amps. Limited to	Sec. Test KV	Catalog Number	
					Volts	Amps.				
R. C. A.	8014	265	230	50/60	15.0	14.5	30A	5	162-001	
	8D21	530	230	50/60	3.2	125.0	220A	5	162-002	
	7C24	480	230	50/60	12.6	29.0	50A	5	162-003	
	891-892	800	230	50/60	11.0	60.0	120A	5	162-004*	
	891R-892R									
	891-891R									
	892-892R	1600	230	50/60	22.0	60.0	120A	5	162-005	
	889A-RA									
	A.	5671	4390	230	50/60	11.0	125.0	187A	5	162-006*
		880	5630	230	50/60	12.6	320.0	425A	5	162-007
5592		5700	230	50/60	11.0	412.0	480A	5	162-008	
898A		9700	230	50/60	33.0	210.0	750A	5	162-009	
9C21-9C22		10200	230	50/60	19.5	415.0	315A	5	162-010	
							750A	5	162-011	
W E S T E R N  E L E C.	5530	385	230	50/60	5.0	55.0	82.5A	5	162-021	
	5541	580	230	50/60	7.5	55.0	82.5A	5	162-022*	
	228A-236A-240B 220C-220CA	1180	230	50/60	21.0	40.0	60A	5	162-023	
	341AA, 343A, 343AA	1740	230	50/60	21.5	57.5	86.25A	5	162-024*	
	342A	1880	230	50/60	20.0	67.0	100A	5	162-025	
F E D E R A L  T. & R.	7C23, 7C25	380	220	50/60	11.0	28.5	57.0	5	162-031	
	5680	565	220	50/60	13.0	36.0	72	5	162-032	
	8C25	980	220	50/60	7.0	100	150	5	162-033	
	F125A, F125R	1360	220	50/60	13.6	65.5	92.5	5	162-034	
	F129B, F129R	1720	220	50/60	20.0	71.0	142	5	162-035	
	F124A	2600	220	50/60	27.2	68.5	103	5	162-036	
	9C28, 9C29, 9C30, 9C31	2850	220	50/60	15.0	135	202.5	5	162-037	
	F134	21800	220	50/60	25.0	625	937.5	5	162-038	
E I M A C	1500T	255	220	50/60	7.5	25	40	5	162-041	
	3X2500T	505	220	50/60	7.5	48	72	5	162-042	

\*Scott Taps (115/199/230)

THE AMERICAN TRANSFORMER CO., 178 Emmet St., Newark 5, N. J.

### Sales Representatives

Holliday-Hathaway Co., 238 Main Street, Cambridge 42, Mass.  
 Joralemon, Craig & Co., 112 South 16th Street, Philadelphia, Pa.  
 Holliday-Hathaway Co., 276 South Drive, Rochester 12, New York  
 Royal J. Higgins Co., 600 So. Michigan Ave., Chicago 5, Illinois  
 Don L. Davis, 3021 No. 3rd St., Harrisburg, Pa.  
 Emmett N. Hughes, 1709 W. 8th St., Los Angeles, California

**AMERTRAN**  
 MANUFACTURING SINCE 1901 - NEWARK, N. J.  
 Pioneer Manufacturers of Transformers, Reactors and Rectifiers for Electronics and Power Transmission

# BURNELL & CO., A LEADER IN THE DEVELOPMENT OF MINIATURE AND SUB-MINIATURE COILS AND FILTERS.. INTRODUCES.. THE 'WEDDING RINGS', WORLD'S SMALLEST HIGH 'Q'TOROIDAL

## COILS



ACTUAL SIZE

Since discovering that toroidal coils are the solution to problems in compactness of communication and control equipment, design engineers have been confronted with the ever pressing problem of miniaturization.

A major step towards a solution has now been found and we take pleasure in presenting to the electronics field, the penultimate in the design of miniature high Q coils, the types TC-4 and TC-5 and the ultimate, sub-miniature TC-0 which is not much larger than a thumb nail.

For many applications, design engineers will benefit from our specialized experience in the manufacture of miniature components and filters by utilizing the performance capabilities, degressively, of their larger associates (Types TC-1, TC-2, TC-3) but compressed into midget proportions, permitting an elegant solution to the importunate problem of miniaturization.

All of the TC series are toroidally wound on molybdenum permalloy cores providing high Q with a stability unattainable by any other material.

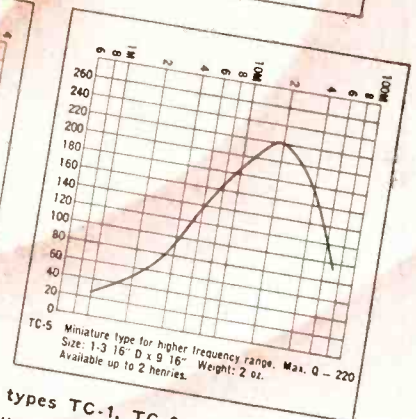
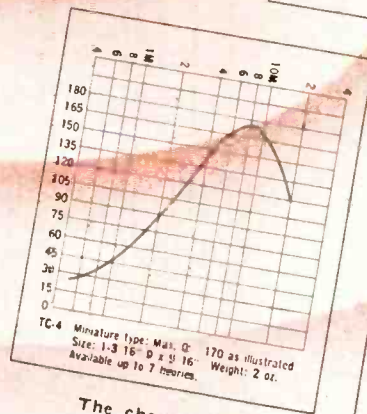
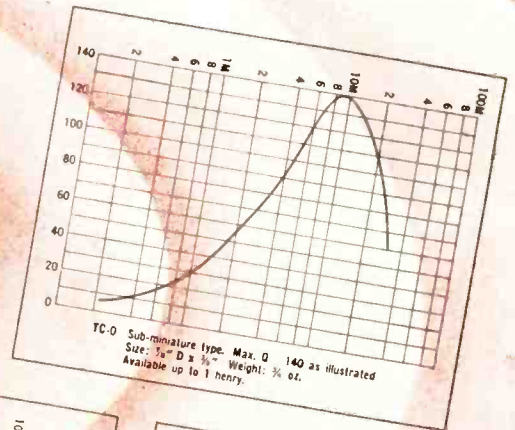

The characteristics of the types TC-1, TC-2 and TC-3 are available upon request.

EXCLUSIVE MANUFACTURERS OF



COMMUNICATIONS NETWORK COMPONENTS

ALL INQUIRIES WILL BE PROMPTLY HANDLED

**Burnell & Company**  
YONKERS 2, NEW YORK

CABLE ADDRESS "BURNE.L"

WRITE FOR TECHNICAL INFORMATION



# TIME OUT FOR TEST AVOIDS TIME OUT FOR EQUIPMENT—

**GENERAL ELECTRIC INDUSTRIAL TUBE ANALYZER—TYPE YTW-3**—The widespread use of thyatron and phanatron tubes in modern industrial operations demands a test device that can quickly and accurately determine the performance characteristics of these types.

The General Electric analyzer, type YTW-3, has been designed as a compact, portable unit—simple in operative procedure so that non-technical personnel can learn to use it in a short time. This permits frequent tube tests that will maintain equipment at a high level of efficiency and avoid costly shut-downs due to tube failure in critical operations.

The analyzer measures the peak arc drop voltage of these rectifier tubes under maximum rated load or under specific application load. Readings are taken directly from a large dial which controls an accurate slide-back type voltmeter.



General Electric Industrial Tube Analyzer Type YTW-3

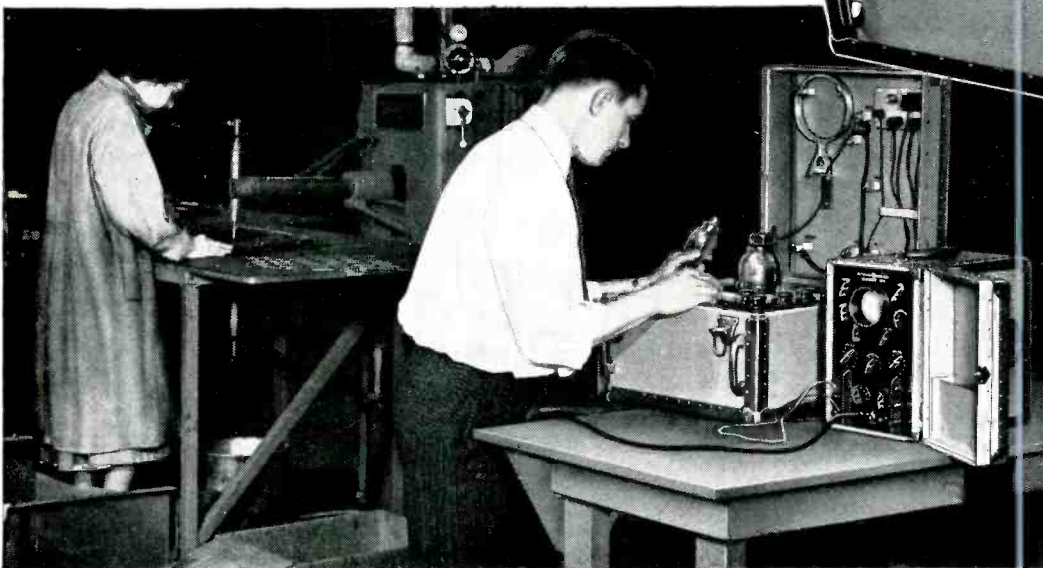

General Electric Industrial Oscilloscope Type YNA-4

**GENERAL ELECTRIC INDUSTRIAL OSCILLOSCOPE—TYPE YNA-4**—This industrial oscilloscope was built for one specific job—industrial testing. Designed to meet strict plant safety requirements, it is enclosed in an insulated case. The cathode ray tube is rubber mounted with a protective window in front of the tube.

A special power transformer provides isolation from the power line circuits for safer and more dependable operation.

Covers a wide range of trouble shooting and preventive maintenance applications in connection with welding, control, and

power rectifier equipment. Also invaluable in the production testing of switches, relays and other electrical components. In welding operations particularly, its fundamental value can be recognized quickly. When the quality of welds begins to deteriorate, checks with the industrial scope locate the trouble and aid in maintaining quality.

For complete information on these industrial test equipments and other performance-engineered instruments write: *General Electric Company, Electronics Park, Syracuse, New York.*

*You can put your confidence in—*

**GENERAL  ELECTRIC**

**two great names**

**Faradon** CAPACITORS



**Important Announcement To Our Many Friends**

**In The Broadcasting And Specialty Electronics Fields**

**CORNELL-DUBILIER ELECTRIC CORPORATION**  
333 HAMILTON BOULEVARD

*Faradon*

So. PLAINFIELD, N.J.



To Our Customers:

We take pleasure in announcing the purchase of the Faradon Capacitor Division of the Radio Corporation of America.

Cornell-Dubilier acquired by the purchase the good will and trademark of "Faradon", the inventory, tools, dies, molds, equipment, instruments, designs, processes, and patent licenses. We have moved the Faradon equipment to our plants and are presently manufacturing the complete line of Faradon capacitors previously manufactured by the Radio Corporation of America.

Cornell-Dubilier transmitting capacitors and Faradon capacitors will be sold as separate lines, as Faradon capacitors are not always interchangeable with those of Cornell-Dubilier. Orders for Faradon capacitors, using the Faradon part numbers, may be mailed to our Sales Office at South Plainfield, New Jersey.

The high quality for which both Faradon and Cornell-Dubilier have been known for the last four decades will be meticulously maintained. The addition of the Faradon line will greatly improve our services, particularly to the broadcast stations and for those engaged in the specialty electronic fields.

The continued confidence of our customers in our product has made possible the acquisition of this additional outstanding line.

Sincerely yours,

CORNELL-DUBILIER ELECTRIC CORPORATION

President

OB:K

PLANTS LOCATED IN U. S. A.

AT SOUTH PLAINFIELD, N. J., PROVIDENCE R. I., INDIANAPOLIS, IND., NEW BEDFORD, MASS., WORCESTER, MASS. AND BROOKLINE, MASS.

**CORNELL DUBILIER ELECTRIC CORPORATION**

**CAPACITORS . AUTO VIBRATORS . TV AND FM ANTENNAS . POWER CONVERTERS**



**ANNOUNCING...**  
**"Three-Sixty" Hypex**  
**PROJECTORS**

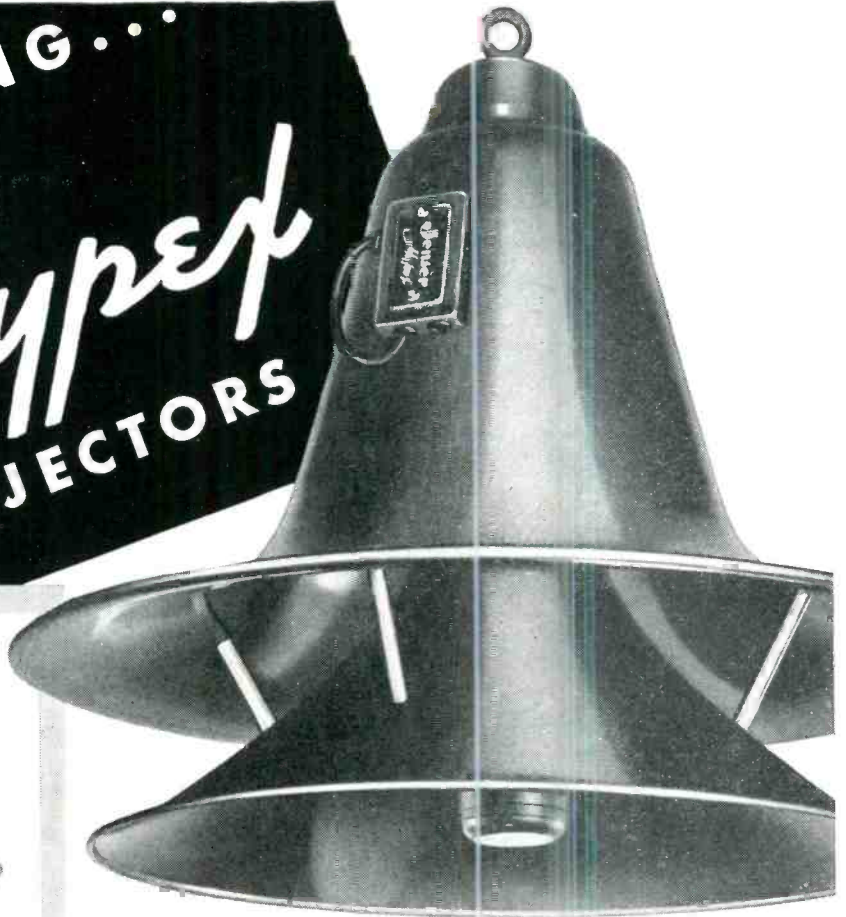

**MODEL VR-11 "THREE-SIXTY" HYPEX**  
 (above) 15 WATTS, 280 CPS CUT-OFF.  
**MODEL VR-241 "THREE-SIXTY" HYPEX**  
 (at right) 25 WATTS, 140 CPS CUT-OFF.

**T**WO new Hypex\* Projectors—designed for 360-degree sound dispersal—are now available. With sound distributed horizontally in all directions, these new models are intended for installations where coverage of relatively large areas and suspension from the ceiling are desired. Like all Hypex Projectors, these radial units incorporate the famous Hypex formula† which results in improved acoustic performance.

By the addition of the two radials to the four previously announced Hypex units illustrated below, the Hypex line now includes a model for every "sound" need, indoors or outdoors.

**Jensen**  
**Hypex**

**JENSEN MANUFACTURING COMPANY**

Division of the Muter Company

6607 SOUTH LARAMIE AVENUE, CHICAGO 38, ILLINOIS

\*Trade Mark Registered Patent 2,338,262

Write for Data Sheet 143

In Canada: COPPER WIRE PRODUCTS, LTD., 351 CARLAW AVENUE, TORONTO



**MODEL VH-24 HYPEX**  
 25 WATTS, 110 CPS CUT-OFF



**MODEL VH-20 HYPEX**  
 25 WATTS, 140 CPS CUT-OFF



**MODEL VH-15 HYPEX**  
 15 WATTS, 180 CPS CUT-OFF



**MODEL VH-91 HYPEX**  
 15 WATTS, 300 CPS CUT-OFF

**PICK UP  
AND GO**

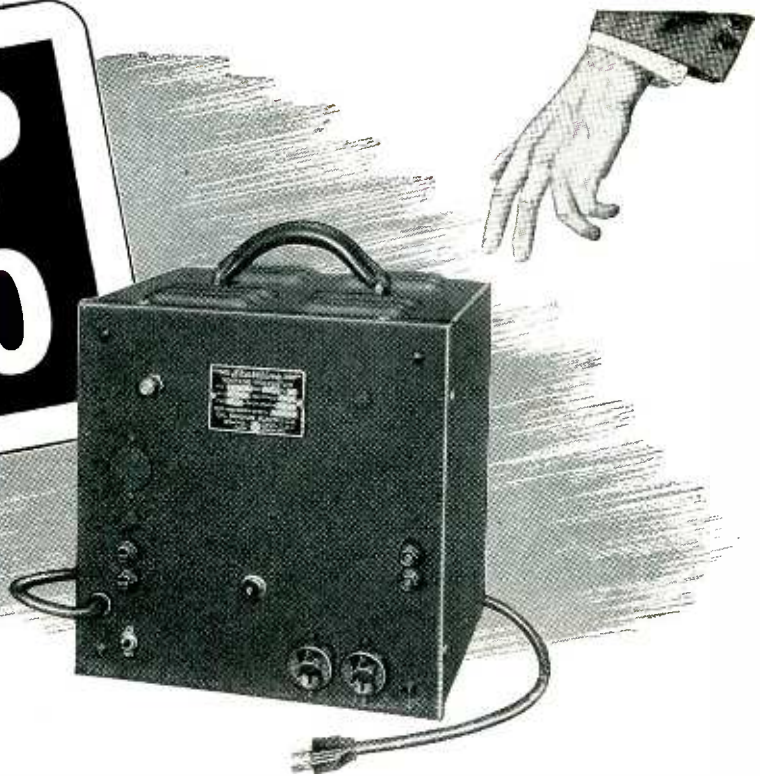

*New*  
**250 VA  
STABILINE IE VOLTAGE REGULATOR**

The new 250 VA STABILINE Type IE51002 is the latest addition to the Superior Electric line of dependable instantaneous electronic automatic voltage regulators. It's easy to carry this compact, portable unit to any location in shop or laboratory — from one test station or operation to another. And packed into its black wrinkle-finished case are the same superior characteristics of workmanship and performance found in STABILINES of larger capacity. Here are the ratings for the new 250 VA STABILINE Type IE51002 — **Input Voltage Range:** 95 to 135 volts. **Output Voltage Range:** adjustable between 110 and 120 volts. **Rated Output:** 0 to 250 volt-amperes. **Frequency in Cycles:**  $60 \pm 10\%$ . **Load Power Factor:** 0.5 lagging to 0.9 leading. **Waveform Distortion:** never exceeds 3%. **Stabilization:**  $\pm 0.1$  volts of preset value. **Regulation:**  $\pm 0.15$  volts of preset value. **Recovery Time:** 3 to 6 cycles.

Among the many advantages of this new voltage regulator is the fact that all tubes but one are standard — and the non-standard tube is made by a well-known manufacturer. Tube replacement is thereby made easy — at no extra trouble to you. The 250 VA STABILINE Type IE51002 is easy to order, too. There are no annoying suffixes to watch on your order — no "extras" to buy. The standard cataloged model provides equal or improved characteristics over so-called "special designs".

Each unit is complete, offering all the superior features. Operation is simple. No extra parts or accessories are needed — no special adjustments to achieve maximum performance and service.

The new 250 VA STABILINE Type IE51002 is a self-contained unit measuring  $11\frac{1}{2}'' \times 11\frac{1}{2}'' \times 10\frac{1}{4}''$ . It's complete with carrying handle, 6' cord and plug, 2 outlet receptacles and a pair of Superior 5-Way Binding Posts. Fuses are located in the input for complete protection. There's a handy "on-off" switch, pilot light and a screw-driver adjustment for output voltage.

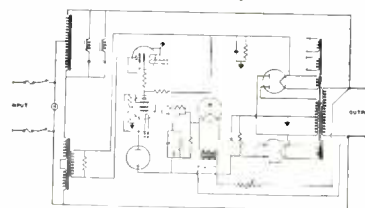

Connection diagram showing operating circuit of the new 250 VA STABILINE Type IE51002.



Rear view showing compactness and superior workmanship in the IE51002.

Write today for complete information.

4039 MEADOW STREET  
BRISTOL, CONNECTICUT

**THE SUPERIOR ELECTRIC CO.**  
BRISTOL, CONNECTICUT



Powerstat Variable Transformers • Voltbox A C Power Supply • Stabiline Voltage Regulators.

a NEW and SENSATIONAL *Motorola* "FIRST" that makes  
2-WAY RADIO more valuable than ever before!

**NOW...Your cars  
hear only your  
calls!**



*Motorola*  
**"QUIK-CALL"**  
SELECTIVE  
SIGNALING  
EQUIPMENT

**Just press a button to call your  
cars—individually, or by groups**

Now you can control and direct calls to your fleet, or to any one car in your fleet with the new Motorola "QUIK-CALL" selective signaling equipment! Your cars can be called only by *your* base station. Another "FIRST"—Motorola "Quik-Call" prevents your cars from receiving calls sent by other transmitters on the same or adjacent channels...they need not hear any calls except those coded from your station alone. Interference from diathermy is completely locked out during standby and, most important, skip interference false calling and squelch opening is eliminated.

Motorola "QUIK-CALL" prevents nuisance interference from stations in nearby communities, reducing driver fatigue and increasing the utility of any radio system.

Developed after two and one half years of exacting research, Motorola "QUIK-CALL" is based upon the use of a pure tone generator of instrument precision, called the Vibrasender, and a responding resonant responder—called the Vibrasponder. These "electro-mechanisms" in various combinations, are capable of calling your fleet (with the single-key system) or of selectivity calling up to 1,350 individual units (with the 24-key system) with the precision and speed of adding machine operation.

**A product of Motorola Research Laboratories**

ELECTRONICS — March, 1949

*Motorola* "QUIK-CALL" can be added  
to your present *Motorola* equipment

It doesn't matter whether you're installing a whole new communications system, or if you already have 2-way radio... the Motorola "QUIK-CALL" can be adapted to your system in bringing it up to date. Enjoy the advantages of this new kind of 2-way radio.

**FREE!**

**GET THE COMPLETE DETAILS  
DESCRIPTIVE BOOKLET  
MAIL THIS COUPON TODAY**



COMMUNICATIONS DIVISION  
4545 West Augusta Boulevard  
Chicago 51, Illinois Dept. E

Please mail me a FREE copy of the descriptive booklet on Motorola "QUIK-CALL" selective signaling equipment.

Name ..... Position .....

Address .....

City ..... Zone ..... State .....

★ You can  
**Reduce Costs**

★ You can **Improve**  
Performance with

# ARNOLD

## PERMANENT

## MAGNETS



Where's the manufacturer these days who doesn't need all the competitive and cost advantages he can get? Maybe you have new electrical or mechanical equipment in mind—designs or re-designs that should employ permanent magnets for best results. Maybe you have existing applications that permanent magnets will do *better*—save you time and money in production, and step up the efficiency of your product.

In either case, let Arnold's engineering service help you to find the answers to your magnet problems. Arnold offers you a fully complete line of permanent magnet materials, produced under 100% quality-control in any size or shape you require, and supplied in any stage from rough shapes to finish-ground and tested units, ready for final assembly. Write direct, or to any Allegheny Ludlum branch office.

W&D 1295



### **THE ARNOLD ENGINEERING CO.**

Subsidiary of **ALLEGHENY LUDLUM STEEL CORPORATION**

147 East Ontario Street, Chicago 11, Illinois

*Specialists and Leaders in the Design, Engineering and Manufacture of PERMANENT MAGNETS*

HERE'S on-the-job Proof of

Westinghouse  
Instrument Performance!

Universal Tube Test Station—model 733AS—designed and manufactured by the Radio Corporation of America.

YOU CAN BE SURE..  
IF IT'S  
Westinghouse

Where Accuracy,  
Simplicity, Readability  
mean so much  
they choose . . .

Westinghouse  
Instruments

Westinghouse Instrument Specialists are available in the field for consultation on your instrument problems. Call your nearest Westinghouse office, or write Westinghouse Electric Corporation, P. O. Box 868, Pittsburgh 30, Pa.

Send for Booklet B-2209-A, Communication Instrument Booklet B-3283, or Switchboard Instrument Booklet B-3363.

. . . *unfailing performance* and *co-ordinated space-saving design* . . . these, too, were instrument "musts" for the receiving tube test station manufactured by RCA.

Westinghouse Instruments easily met these requirements. The result . . . an exact, diverse and rapid control over the quality of all modern types of receiving tubes.

**What Are YOUR Electrical Measuring Problems?**

Would they include . . . reliable performance? . . . styling? . . . size? . . . readability? . . . or different types of service? . . . portable? . . . switchboard? . . . panel? . . . recording?

The completeness of the Westinghouse line of electrical measuring instruments will answer your special or ordinary problems. Every Westinghouse Instrument is backed by more than 60 years of skill and experience in every field of industry.

J-40366

**Westinghouse Instruments Also Provide You With . . .**

- Dials that stay white under all conditions
- Magnets that stay permanent
- Pivots with high shock capacity and low friction
- Springs that remain constant for life
- Quick delivery of more different ratings and types
- Complete nationwide service



Westinghouse  
PLANTS IN 25 CITIES . . . OFFICES EVERYWHERE

*Electrical Measuring Instruments for ANY Job.*

**RADIO • TELEVISION • INDUSTRIAL**

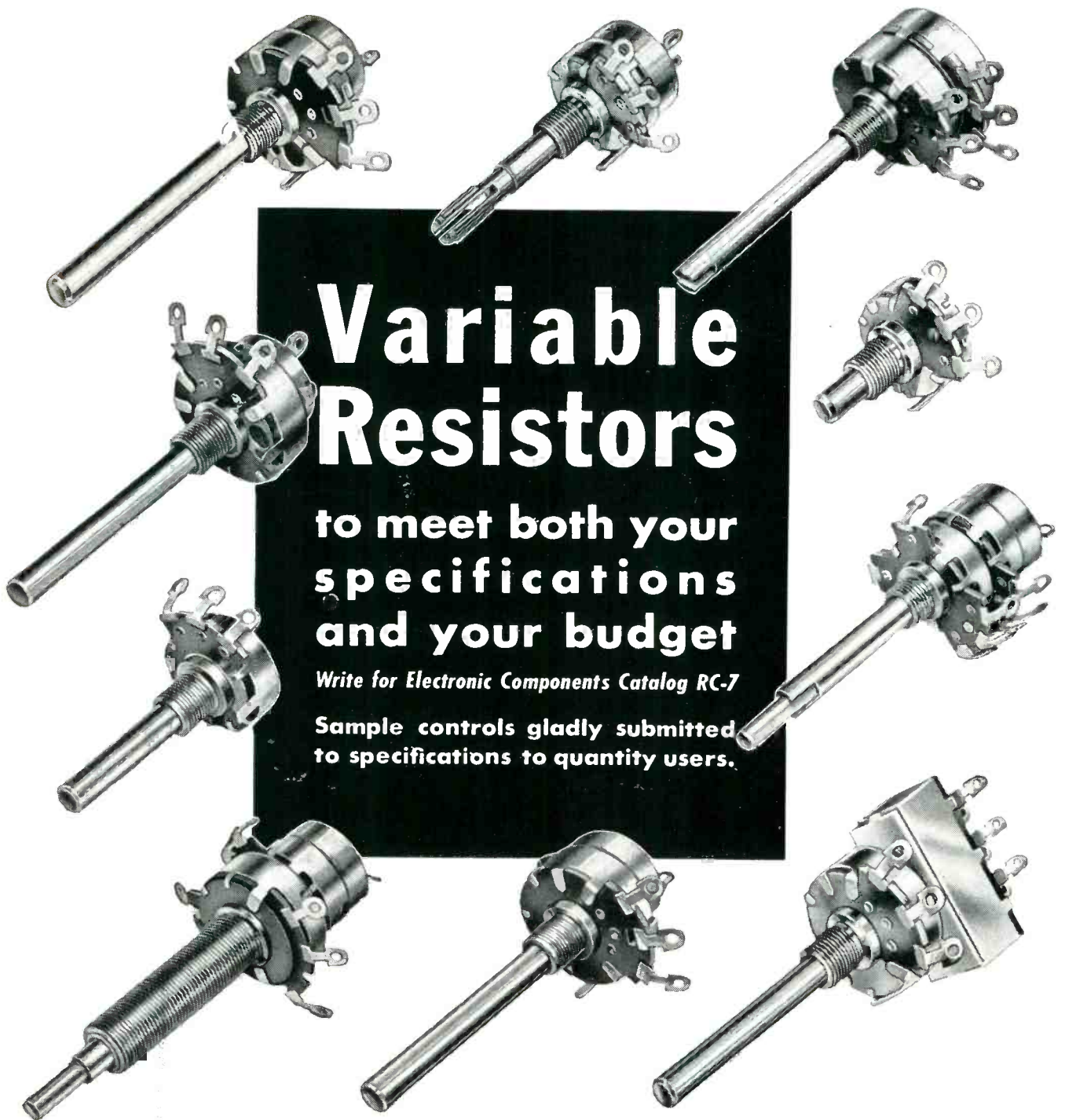

# Variable Resistors

**to meet both your specifications and your budget**

*Write for Electronic Components Catalog RC-7*

**Sample controls gladly submitted to specifications to quantity users.**

# STACKPOLE

Fixed and Variable Resistors • Iron Cores (All standard and special types) • Switches (inexpensive line, slide and rotary-action types) • Sintered Alnico II Permanent Magnets . . . and hundreds of molded iron powder, metal, carbon and graphite products.

*Electronic Components Division*

**STACKPOLE CARBON COMPANY • ST. MARYS, PA.**



# GIVES YOU PERSON-TO-PERSON HELP WITH YOUR MEASURING PROBLEMS

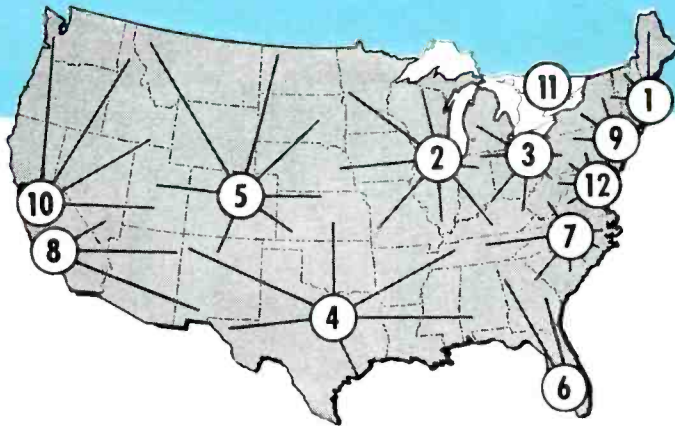

**-hp-** has selected the best independent organizations in America to provide you with personal attention to your measuring problems. Their technical men have complete information about **-hp-** instruments and can help you select the correct measuring equipment for your needs. The **-hp-** direct-to-consumer sales policy saves you money, and the **-hp-** field service program saves your time. Whenever or *wherever* you need personal help on measuring problems, call the nearest **-hp-** field representative.

- |  |  |
|--|--|
| <p><b>1 BOSTON, MASS.</b><br/>Burlingame Associates<br/>270 Commonwealth Avenue<br/>Kenmore 6-8100</p> <p><b>2 CHICAGO 6, ILL.</b><br/>Alfred Crossley &amp; Associates<br/>549 W. Randolph St.<br/>State 7444</p> <p><b>3 CLEVELAND 12, OHIO</b><br/>M. P. Odell<br/>1748 Northfield Avenue<br/>Potomac 6960</p> <p><b>4 DALLAS 5, TEXAS</b><br/>Earl W. Lipscomb<br/>4433 Stanford Street<br/>Logan 6-5097</p> <p><b>5 DENVER 10, COLORADO</b><br/>Ronald G. Bowen<br/>1896 So. Humboldt Street<br/>Spruce 9368</p> <p><b>6 FORT MYERS, FLORIDA</b><br/>Arthur Lynch and Associates<br/>P. O. Box 466<br/>Fort Myers 1269M</p> | <p><b>7 HIGH POINT, N. C.</b><br/>Bivins &amp; Caldwell<br/>Room 807, Security Bank Building<br/>Phone 3672</p> <p><b>8 LOS ANGELES 46, CALIF.</b><br/>Norman B. Neely Enterprises<br/>7422 Melrose Avenue<br/>Whitney 1147</p> <p><b>9 NEW YORK 7, NEW YORK</b><br/>Burlingame Associates<br/>11 Park Place<br/>Digby 9-1240</p> <p><b>10 SAN FRANCISCO 3, CALIF.</b><br/>Norman B. Neely Enterprises<br/>954 Howard Street<br/>Douglas 2-2609</p> <p><b>11 TORONTO 1, CANADA</b><br/>Atlas Radio Corporation, Ltd.<br/>560 King Street West<br/>Waverley 4761</p> <p><b>12 WASHINGTON 9, D. C.</b><br/>Burlingame Associates<br/>2017 S Street N.W.<br/>Decatur 8111</p> |
|--|--|

This **-hp-** staff of trained specialists is the largest organization of its kind in the world.



## NEW, HIGH SENSITIVITY, WIDE RANGE VOLTMETER

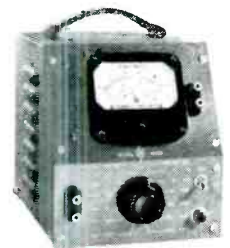

### **-hp-** 400C Voltmeter

This new **-hp-** voltmeter makes fast, accurate readings from .1 mv to 300 v., 20 cps to 2 mc. Voltage range 3,000,000 to 1. Panel switch selects 12 ranges. Input impedance 10 megohms.



### **-hp-** 200C Oscillator

One of 5 basic **-hp-** audio oscillators. **-hp-** 200C covers frequency range of 20 cps to 200 kc. Constant output, low distortion, great stability. No zero setting necessary during operation.

**For complete details, write direct or see your -hp- representative.**

**HEWLETT-PACKARD CO.**  
1851 - A Page Mill Road, Palo Alto, California

See the new **-hp-** models!  
I. R. E. Show - Booths 40-41  
Grand Central Palace - Mar. 7-10



# Designers

take your choice...  
**FIXED  
PAPER-DIELECTRIC  
CAPACITORS**

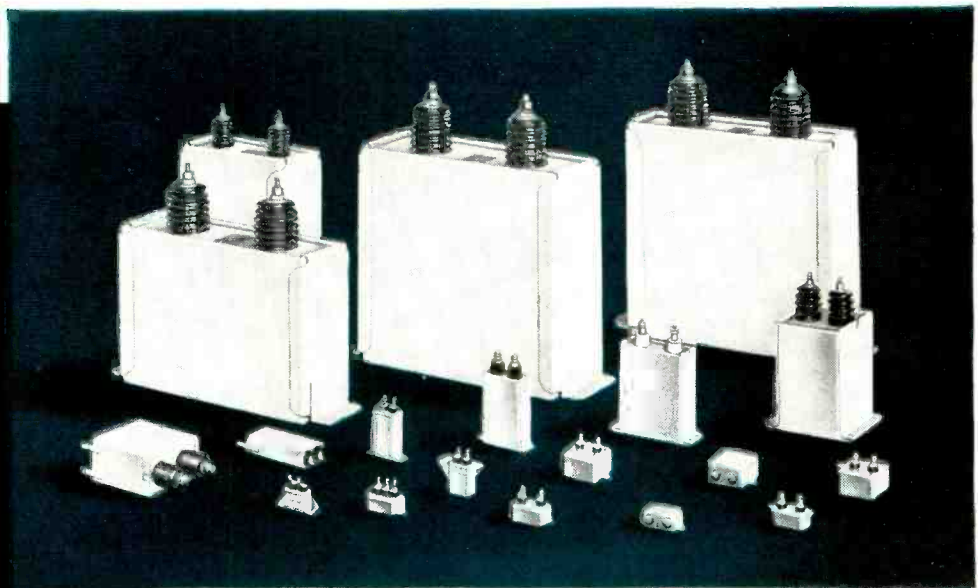

Readily available for DC electronic applications, these capacitors are manufactured in accordance with joint Army-Navy specifications JAN-C-25. Case styles include types CP 53, CP 54, CP 55, CP 61, CP 63, CP 65, CP 67, CP 69 and CP 70. Capacitance ratings are from .01 Muf to 15 Muf, and voltage ratings are listed from 100 to 12,500 volts.

These capacitors are constructed with thin Kraft paper, oil or Pyranol\* impregnated, which provides stable characteristics and high dielectric strength. Plates are aluminum foil, manufactured according to detailed specifications. Special bushing construction provides for short internal leads, preventing possible grounds and short circuits. The cases have a permanent hermetic seal to provide longer life. A variety of mounting arrangements are available for various installation requirements. Write for detailed description and operating data: Bulletin GEA-4357A.

\*Pyranol is General Electric's non-inflammable liquid dielectric for capacitors.

**SAVE SPACE  
CUT COSTS**

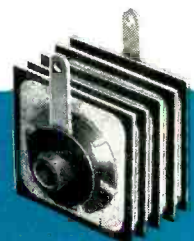

Less than one inch long, and only one inch square, this postage-stamp-size selenium rectifier offers radio builders substantial savings in production costs. Only two soldering operations and a minimum of hardware are necessary for installation in places where a rectifier tube and socket won't fit. They're built to safely withstand the inverse peak voltages obtained when rectifying (half-wave) 110-125 volts, rms, and feeding a capacitor as required in various radio circuits. Tests prove that selenium rectifiers will outlast the conventional type of rectifier tubes, at the same time costing less. Send for bulletin GEA-5238.

**GENERAL**  **ELECTRIC**



# Digest

## TIMELY HIGHLIGHTS ON G-E COMPONENTS



**HOLDS  
OUTPUT VOLTAGE  
CONSTANT**

This 500-va voltage stabilizer is suitable for a wide variety of electronic applications where constant voltage is demanded. Voltage variations from 95 to 130 volts are absorbed almost instantaneously and output voltage maintained at 115 volts (plus or minus 1 percent). There are no moving parts, no adjustments to make. This unit will operate continuously at no load or short circuit without damage to itself. It will limit the short circuit current to approximately twice stabilizer's normal full load current rating. Other sizes available range from 15 to 5000 va. For details, check bulletin GEA-3634B.



**WANT TO TIME  
TUBE LIFE?**

Suitable for installation in radio transmitters, these G-E time meters provide accurate record of tube operating time.

They record in hours, tenths of hours, or minutes. Ratings range from 11 to 460 volts. Installation on a panel or switchboard is simplified by quick-wiring leads. Timer harmonizes with other panel instruments in appearance and size. Dependability is assured by Telechron\* motor drive. Also available for portable use or conduit and junction box mounting. Check bulletin GEC-472.



**FOR YOUR TELEVISION SETS**

General Electric's television cord set comes in 6-foot lengths, made of 2/18 Pot-64 brown Flamenol\* rip-cord. Set has brown plastic plug and new brown Flamenol connector molded on opposite end. Rip-cord has smooth finish, resists oil, water, acids, alkalis, or sunlight deterioration. Rating is 7 amps., no. 18 wire. Set is designed for assembly on

\*Trademark Reg. U. S. Pat. Off.

television receiver rear panel, automatically disconnects when panel is removed. Write for further information.

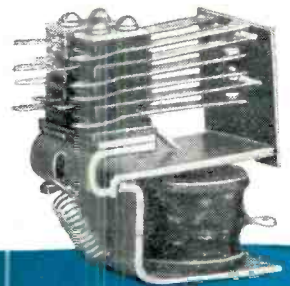

**DEPENDABLE CONTROL  
FOR AUTOMATIC DEVICES**

G.E.'s multi-contact relays are inexpensive units built specifically for appliances and vending machines. Construction features assure quiet, reliable operation, and compactness makes them adaptable to a variety of devices such as coin changers, phonographs, and television receivers. Single-circuit contacts or combinations of contacts for multi-circuit application are attached to the same sturdy frame and coil assembly, affording a multiplicity of relay forms. Ratings are 5 amperes at 115 volts or 24 volts, a-c or d-c. Get details from Bulletin GEC-306.

General Electric Company, Section A667-1  
Apparatus Department, Schenectady, N. Y.

Please send me the following bulletins:

- GEA-3634B Voltage Stabilizers
- GEA-4357A D-C Capacitors
- GEA-5238 Selenium Rectifiers
- GEC-306 Multi-contact Relays
- GEC-472 Tube Timers

NAME .....

COMPANY .....

ADDRESS .....

CITY .....

STATE .....



**-35°C to +45°C**

Aerocom's new V.H. frequency AM radiotelephone transmitter is designed and built to operate amid ice and snow or steaming jungles, and what's more, this fine transmitter will give long trouble free efficient service with low maintenance and operating costs. Built in two models VH-200 and VH-50 to meet your communications needs.

## Model VH-200

The model illustrated (VH-200) operates on one Crystal Controlled frequency (plus one closely spaced frequency) anywhere in the range 118-132 Mcs. or 132-165 Mcs., A-2 (with accessory unit) or A-3 AM. Nominal carrier power 200 watts up to 132 Mcs., reduced power up to 165 Mcs. Low temperature operation using gas filled rectifiers. Normal temperature operation using mercury vapor rectifiers. Relative humidity up to 95%. Model VH-50 has similar characteristics except nominal carrier power is 50 watts. Complete technical data on both models on request. Aerocom builds other radiotelegraph and telephone transmitters with accessories, and invites your inquiry if you have a communications problem.

CONSULTANTS, DESIGNERS AND MANUFACTURERS OF STANDARD OR SPECIAL ELECTRONIC, METEOROLOGICAL AND COMMUNICATIONS EQUIPMENT



**AER - O - COM**  
(Reg. U. S. Pat. Off.)

**AERONAUTICAL COMMUNICATIONS EQUIPMENT, INC.**  
3090 Douglas Road, Miami 33, Florida

DEALERS: Equipetro Ltda., Caixa Postal 1925, Rio de Janeiro, Brasil ★ Henry Newman Jr., Apartado Aereo 138, Barranquilla, Columbia ★ Radelec, Reconquista 46, Buenos Aires, Argentina

**"PRODUCTS of EXTENSIVE RESEARCH"**

**USE**

**FREED INSTRUMENTS & COMPONENTS!**

No. 1160  
 10 x 1 HY steps  
 10 x .1 HY steps  
 10 x .01 HY steps  
 500-15,000 cycles

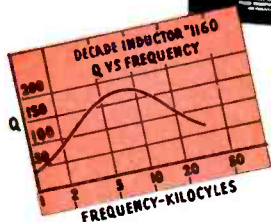

No. 1161  
 10 x .1 HY steps  
 10 x .01 HY steps  
 10 x .001 HY steps  
 2000-50,000 cycles

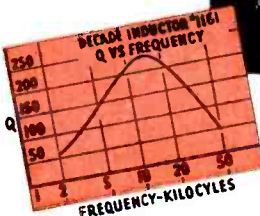

No. 1162  
 10 x .01 HY steps  
 10 x .001 HY steps  
 10 x .0001 HY steps  
 10,000-300,000 cycles

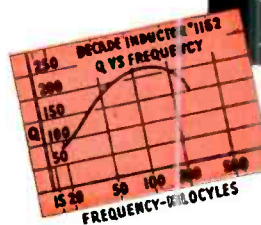
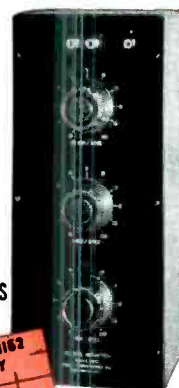

## FREED *Decade Inductors*

Primarily designed for use in wave filters, tuned circuits and equalizers for audio and supersonic frequencies. The stability, accuracy and high value of  $Q$  make these Decade Inductors invaluable laboratory instruments.

No. 1164  
 10 x 10 HY steps  
 10 x 1 HY steps  
 10 x .1 HY steps  
 50-1000 cycles

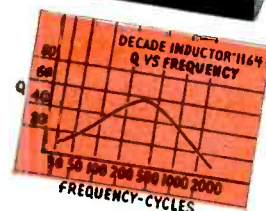

**FREED HERMETICALLY SEALED  
 CLASS A GRADE 1 COMPONENTS**



**MANUFACTURERS OF**

- POWER TRANSFORMERS
- FILTER REACTORS
- AUDIO TRANSFORMERS
- SUPERSONIC TRANSFORMERS
- WAVE FILTERS
- HI-Q COILS
- DISCRIMINATORS
- SATURABLE REACTORS
- PULSE TRANSFORMERS
- CHARGING CHOKES



SEND FOR THE *new* FREED CATALOG



# FREED TRANSFORMER CO., INC.

DEPT. ME 1718-36 WEIRFIELD ST., BROOKLYN 27, NEW YORK

# CAUTION

••••• BEFORE YOU SPECIFY  
EXTRUDED PLASTIC TUBINGS  
THAT MUST WITHSTAND EXTREME  
HIGH TEMPERATURES BE SURE  
YOU HAVE NOTED THE PHYSICAL  
& ELECTRICAL PROPERTIES OF •••••

**Flexite**  
THE FLEXIBLE, EXTRUDED  
PLASTIC TUBING THAT  
RESISTS HIGH  
TEMPERATURES  
ABOVE... 105° C

## FLEXITE PHYSICAL & ELECTRICAL PROPERTIES

- a—tensile strength, minimum average.....2500 PSI
- b—ultimate elongation, minimum average.....300%
- c—dielectric strength, minimum.....800 v/mil
- d—flammability.....non-inflammable
- e—heat resistance—after 100 hours at 300° F. the tubing is not brittle and when flexed does not crack.
- f—heat endurance—recommended for continuous operating temperatures up to 105° C., and when baked at 125° C. for 2,000 hours does not become brittle.
- g—low temperature flexibility.....—30° C.
- h—heat shrinkage.....ASTM Standards
  - # 20 — # 17 incl. — less than 8%
  - # 16 — # 6 incl. — less than 5%
  - # 5 and larger — less than 3%

i—oil resistance—highly resistant to effects of transformer and lubricating oils, does not stiffen when continuously exposed to them.

Colors—black, white, red, green, yellow and blue are standard colors.

Dimensions and Tolerances—standard sizes to fit B & S wires #20 to #0 inclusive, as specified by ASTM Spec. D922-47T.

Wall Thickness—in accordance with ASTM Spec. D922-47T, as follows:  
# 20 — # 10 incl. — .016" ± .003"  
# 9 — # 0 incl. — .020" ± .003"

Standard Lengths—Standard 36" lengths or continuous lengths in coils. Sizes #20 — #10 incl., will be supplied on paperboard spools when so ordered.

Quality—uniform in quality and condition, smooth on both inside and outside, free of defects such as pin-holes, blisters, foreign inclusions and other imperfections.

Test Methods—properties enumerated in above specifications shall be determined according to Tentative Methods of Testing Nonrigid Polyvinyl Tubing, American Society for Testing Materials, Designation D876-46T.

YES, FLEXITE is the electrical insulation tubing that sets new standards for resistance to extreme high temperatures. Compounded of a plasticized copolymer of vinyl chloride and vinyl acetate and manufactured with a true wall thickness, smooth inside and outside, FLEXITE PLASTIC TUBINGS offer the greatest resistance to high and low temperatures, are extremely flexible and have great tensile strength

Other significant properties of FLEXITE compare more than favorably with tubings of similar nature. Check the specifications of FLEXITE, compare them with the requirements for your products and if you wish against other insulations for identical use . . .

YES, FLEXITE sets a new high standard for protection against high temperatures, high dielectric, stretching, tearing, abrasion, exposure to acids, oils and alkalis, flammability, etc., etc., etc. — . . . samples and additional information will be sent upon request.

And for a Plastic Tubing to Withstand Normal High Temperatures  
Mitchell-Rand Offers . . . Flexite-Norm . . . write for specifications.

## MITCHELL-RAND INSULATION CO. Inc.

51 MURRAY STREET · COrtlandt 7-9264 · NEW YORK 7, N. Y.

A PARTIAL LIST OF M-R PRODUCTS: FIBERGLAS VARNISHED TUBING, TAPE AND CLOTH · INSULATING PAPERS AND TWINES · CABLE FILLING AND POTHEAD COMPOUNDS · FRICTION TAPE AND SPLICE · TRANSFORMER COMPOUNDS · FIBERGLAS SATURATED SLEEVING · ASBESTOS SLEEVING AND TAPE · VARNISHED CAMBRIC CLOTH AND TAPE · MICA PLATE, TAPE, PAPER, CLOTH, TUBING · FIBERGLAS BRAIDED SLEEVING · COTTON TAPES, WEBBINGS AND SLEEVINGS · IMPREGNATED VARNISH TUBING · INSULATED VARNISHES OF ALL TYPES · EXTRUDED PLASTIC TUBING

M-R THE  
ELECTRICAL  
INSULATION  
HEADQUARTERS  
FOR 59 YEARS



Follow the Leaders to

**Eimac**  
TUBES  
The Power for R-F

**Accepted**

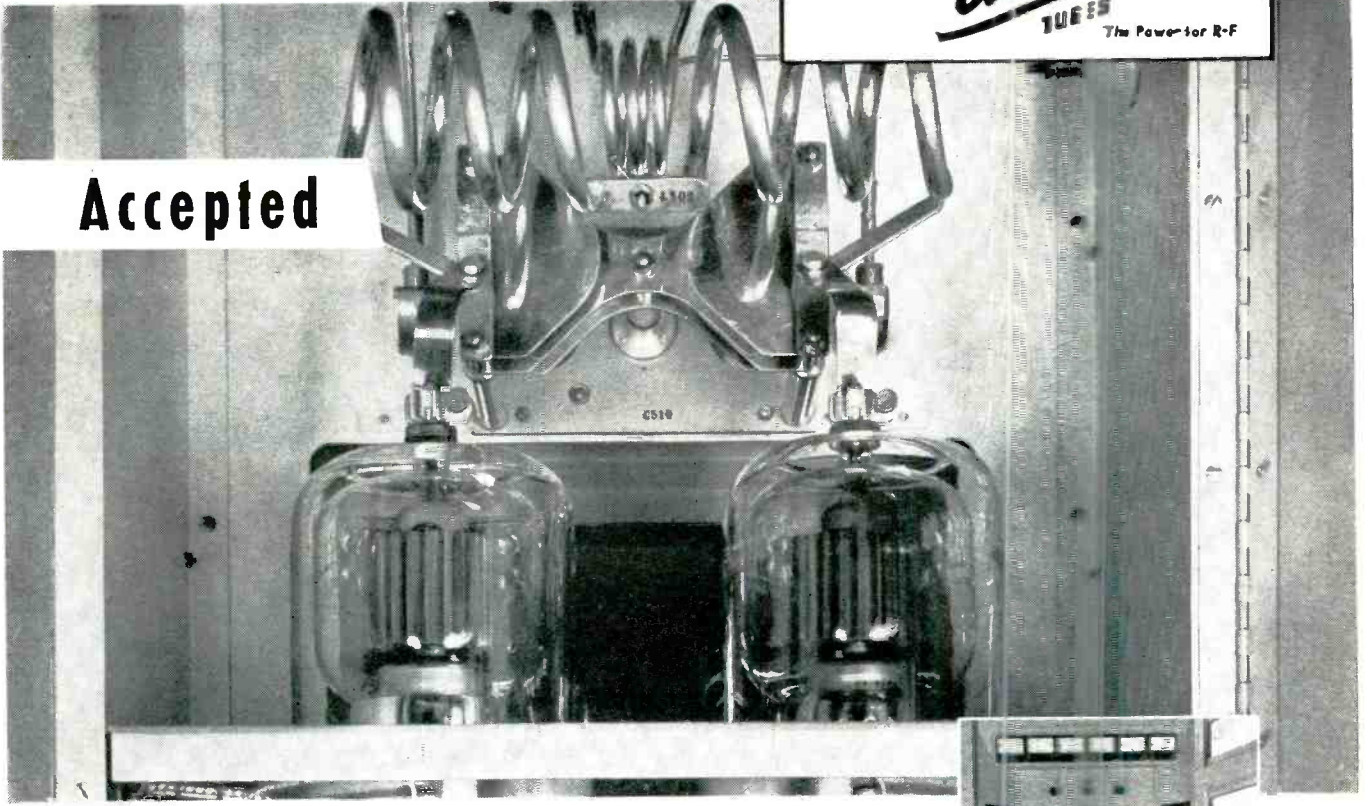

**For Emergency Services . . . . .  
The Link 3000 UFS Transmitter  
and Eimac 4-1000A Tetrodes**

Here's a team that fills the bill by providing the dependability of performance required by police and other emergency communication services.

Link Radio, well known manufacturers of radio communication equipment, in designing their 3 kw 30-50 Mc. FM transmitter choose Eimac 4-1000A tetrodes to power the final amplifier. The high power-gain of these tubes enabled Link to use their standard 50 watt transmitter as a driver. The resulting compact simplified transmitter is ideally suited for control through telephone circuits from remote locations. A single pair of telephone lines carries transmitter modulation, power control, overload relay reset, and frequency selection plus receiver output and selection.

Because of their power-gain abilities, stability and other exceptional characteristics, the 4-1000A tetrode offers the design engineer interesting potentialities . . . write direct for further information, data is available.

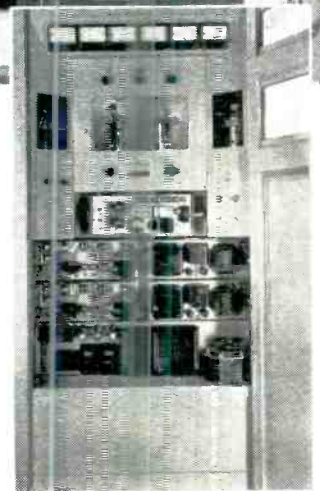

LINK 3000 UFS

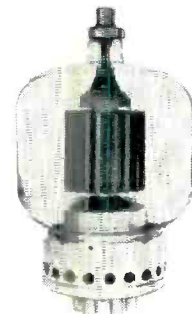

EIMAC 4-1000A TETRODE

**E I T E L - M c C U L L O U G H , I N C .**

212 San Mateo Ave., San Bruno, California

Export Agents: Frazar & Hansen, 301 Clay St., San Francisco, California

# INDIANA PERMANENT MAGNETS MAY BE YOUR ANSWER, TOO

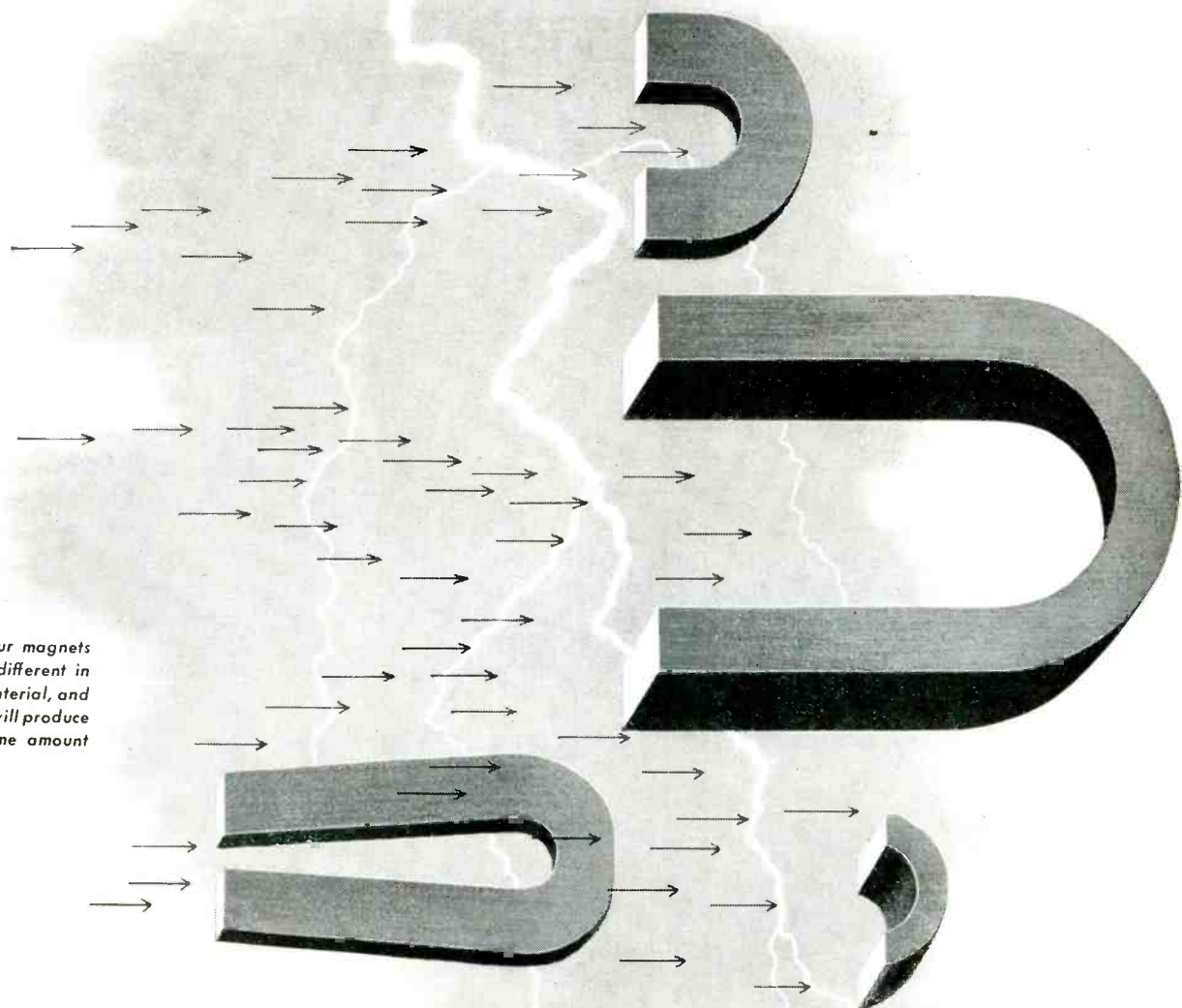

Each of the four magnets shown here is different in size, weight, material, and price; yet each will produce exactly the same amount of energy.

## "PACKAGED ENERGY" SAVES SPACE, CUTS COSTS

INDIANA permanent magnets fit your need like a doctor's prescription—the right material, the right design, the *right magnets to do your job best.*

When you buy *Indiana* permanent magnets, you buy *product improvement* . . . new and higher efficiency . . . new versatility . . . new economy. Today, *Indiana* magnets are performing operations that were impractical only a few years ago—actually replacing many mechanical and electrical devices—and with less weight, less bulk, *lower cost.*

For example, certain radar magnets of Alnico originally weighed 14 pounds. Through *redesign* by *Indiana*, their size was reduced materially and their weight cut to 3½ pounds. Both were of identical material; both produced the same energy. The substantial savings in weight and cost were accomplished wholly by a change in design. Consultation with our engineers may result in similar savings for you.

NEW! BOOKLET NO. 4-E3— TELLS ALL ABOUT PERMANENT MAGNETS. A NOTE ON YOUR COMPANY LETTER-HEAD WILL BRING YOU A FREE COPY.



*Indiana* is the *only* manufacturer of all types of commercially used permanent magnet alloys. Continuous research and production control assure top quality and uniformity of *all* your *Indiana* permanent magnets, regardless of size or quantity. Call on our Special Design Service in solving *your* problems.



### THE INDIANA STEEL PRODUCTS COMPANY

PRODUCERS OF "PACKAGED ENERGY"

6 NORTH MICHIGAN AVENUE • CHICAGO 2, ILL.

SPECIALISTS IN PERMANENT MAGNETS SINCE 1908

PLANTS: VALPARAISO, INDIANA; CHAUNCEY, N. Y.



# FOR ELECTRONIC HEATING

**A great h-f tube now more dependable to install—because its new G-E water-jacket seals more tightly, the higher the water pressure!**

**W**ITH this step forward in tube installation technique, G.E.'s service-proved GL-880 triode becomes a "must" component of your next high-frequency-heater circuit. The new water-jacket is completely new in concept and design. Cooling water itself forces the seal—a neoprene "O" ring—always tighter. Even bursting pressures involve no leakage.

A simple, easily applied metal split-ring (see sketch) with large threads, exerts the start-off sealing effect, locking tube and "O" ring in place. After that the pressure of the circulating water takes over, producing an ever-more-effective seal.

The new jacket is clean in contour, designed to reduce the chance of corona. Chrome-plating accents smart appearance and helps ward off corrosion. Bosses inside the jacket center the anode of the tube, so that water flows equally over the surface to be cooled. This protects against "hot spots" which would cause gassing and shorten tube life. In every way General Electric's superior new water-jacket contributes to satisfactory GL-880 performance!

Get further facts, including the favorable price, without delay. Phone your nearby G-E electronics office, or wire or write *Electronics Department, General Electric Company, Schenectady 5, N. Y.*



**GL-880  
POWER  
TRIODE**

## CHARACTERISTICS, TYPE GL-880

Filament voltage	12.6 v	
current	320 amp	
Max plate ratings, Class C telegraphy:	(for #1electric h'g) (for induction h'g)	
voltage	10,500 v	15,000 v
current	6 amp	4.5 amp
input	60 kw	67.5 kw
dissipation	20 kw	20 kw
Frequency at max ratings	25 mc	1.5 mc
at 50-percent ratings	100 mc	

Hands alone apply the split-ring that locks tube and neoprene seal in place. This method suffices for the water pressures commonly used to cool electronic tubes.

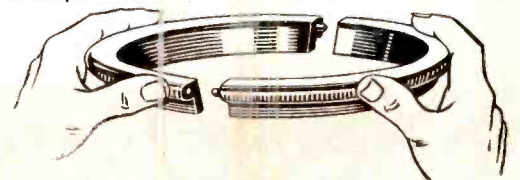

Other features of the new GL-880 water-jacket: its sealing properties are unaffected by production-tolerance differences in tube dimensions . . . All cast parts are centrifugally cast, to avoid porosity. In the three places where brazing is used, special electronic brazing assures a tight, uniform connection. Non-ferrous metals are employed throughout to minimize corrosion . . . A firmer tube installation results from the jacket's being designed to fit flush against the mounting flange . . . Either tapped or soldered water connections are available, depending on the customer's needs.

**GENERAL  ELECTRIC**  
100-M26-8850

FIRST AND GREATEST NAME IN ELECTRONICS

ELECTRONICS — March, 1949

Now!

Specify

# KENYON

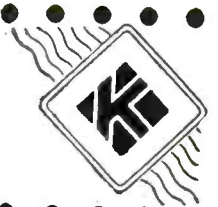

**KENYON** one of the oldest names in transformers, offers high quality specification transformers custom-built to your requirements. For over 20 years the KENYON "K" has been a sign of skillful engineering, progressive design and sound construction.

**KENYON** now serves many leading companies including: Times Facsimile Corporation, Western Electric Co., General Electric Co., Schulmerich Electronics, Sperry Gyroscope Co., Inc.

Yes, *electronification* of modern industrial machinery and methods has been achieved by KENYON'S engineered, efficient and conservatively rated transformers.

For all high quality sound applications, for small transmitters, broadcast units, radar equipment, amplifiers and power supplies — Specify KENYON! Inquire today for information about our JAN approved transformers.

### Check Your Requirements

#### "T" LINE TRANSFORMERS HERMETICALLY SEALED TRANSFORMERS "A" LINE TRANSFORMERS

- ✓ PLATE TRANSFORMERS
- ✓ FILAMENT TRANSFORMERS
- ✓ REACTORS
- ✓ CHOKES
- ✓ MODULATION TRANSFORMERS
- ✓ INTERSTAGE TRANSFORMERS
- ✓ INPUT & OUTPUT TRANSFORMERS
- ✓ SPECIAL FREQUENCY TRANSFORMERS
- ✓ ISOLATION TRANSFORMERS
- ✓ AUDIO TRANSFORMERS
- ✓ HUMBUCKING TRANSFORMERS
- ✓ AUTO TRANSFORMERS

Now — for the first time in any transformer catalog, KENYON'S new modified edition tells the full complete story about specific ratings on all transformers. Our standard line saves you time and expense. Send for the latest edition of our catalog now!

#### SEND FOR OUR CATALOG NOW!

KENYON Transformer Co., Inc.  
840 Barry Street, New York 59, N. Y.

Send me the latest edition of your new catalog without obligation

Name..... Address.....

Position..... City.....

Company..... State.....

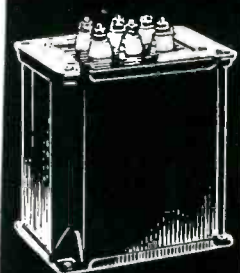
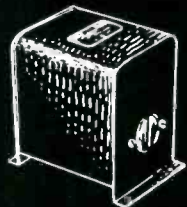
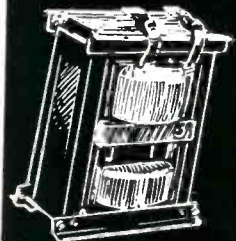
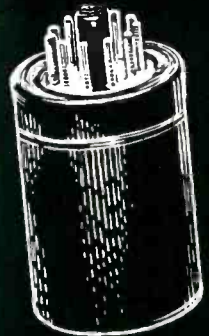
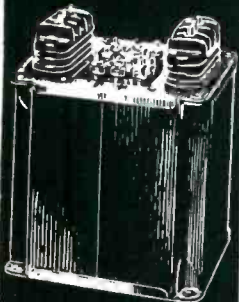
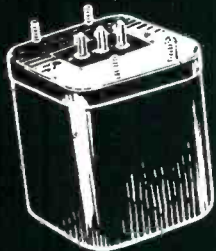
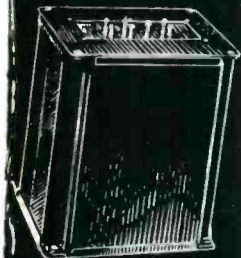

# KENYON TRANSFORMER CO., Inc.

840 BARRY STREET  
NEW YORK 59, N. Y.



# MARION ...helps HEWLETT-PACKARD

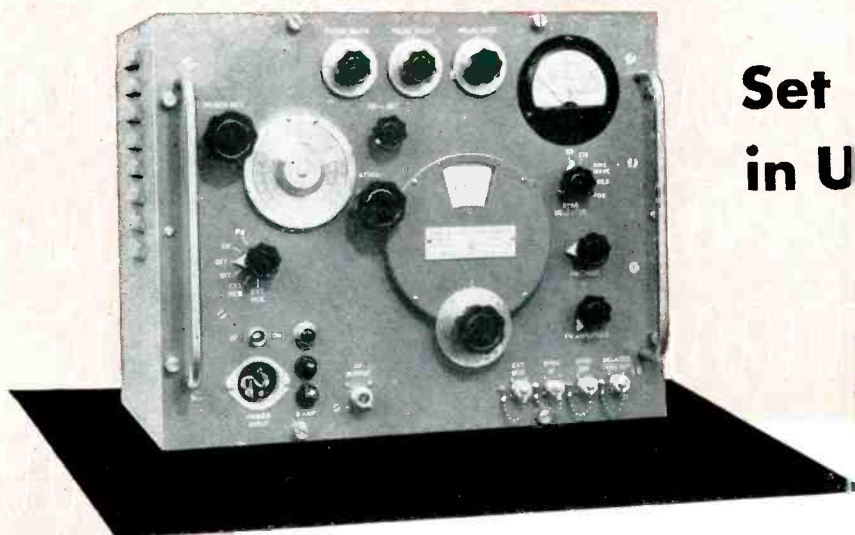

## Set Standards in UHF Signals

The Hewlett-Packard Model 616A is the only UHF Signal Generator which covers the 1800—4000 mcs frequency range and is directly calibrated in frequency and voltage output. Designed to withstand U. S. Aircraft Service conditions, it is used by the U. S. Air Corps, Army, Navy, research laboratories, schools and colleges throughout the world.

At -hp's- request, Marion developed a small, specially designed panel-mounting type of meter for the Model 616A UHF Signal Generator. This indicates power level and gives fast direct readings in decibels. Thus does it play a vital part in helping -hp- generate UHF signals with accuracy so precise that it sets standards used to measure *receiver sensitivity, signal-noise ratio, conversion gain, standing wave ratios, antenna gain* and *transmission line characteristics*.

When you need general or special-purpose meters for electrical indicating or measuring functions, you are invited to call on Marion. We at Marion have had long and *practical* experience in helping others with these problems. We would like to help you too.

THE NAME "MARION" MEANS THE "MOST" IN METERS



MARION ELECTRICAL INSTRUMENT COMPANY

MANCHESTER, NEW HAMPSHIRE

Export Division, 458 Broadway, New York 13, U. S. A., Cables MORHANEX

IN CANADA: THE ASTRAL ELECTRIC COMPANY, SCARBORO BLUFFS, ONTARIO

# “Which of these is on your mind?”

television  
camera  
cable

special  
video  
transmission  
cable

special  
antenna  
cable

radio  
chassis  
hook-up  
wire

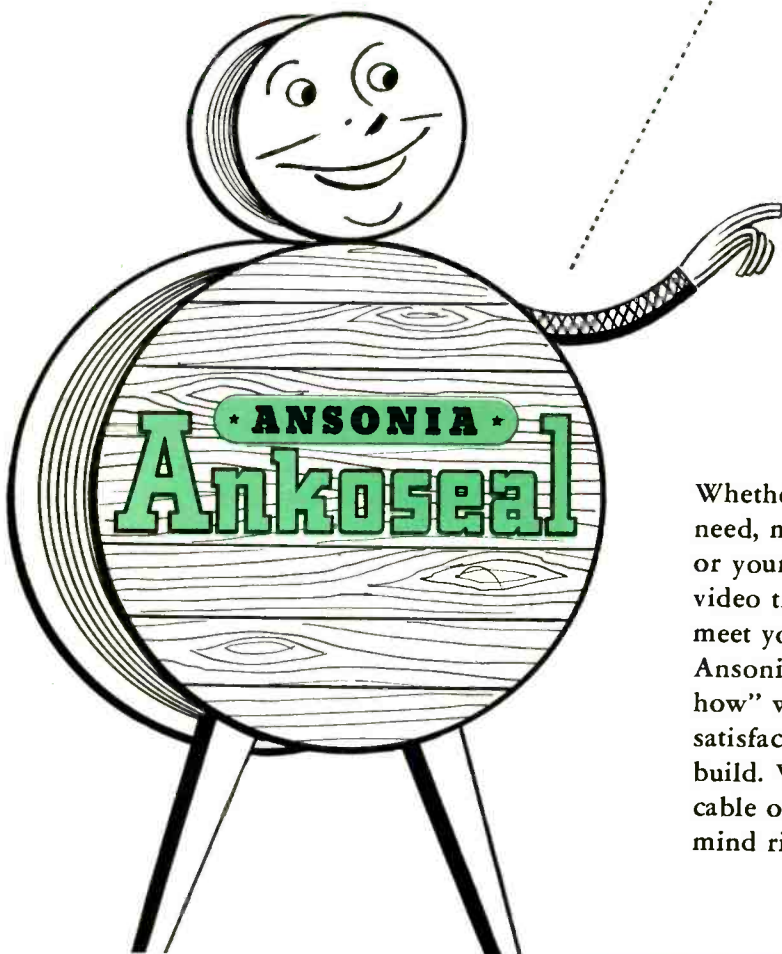

Whether it's just good hook-up wire you need, made to government, Underwriters', or your own specifications...or...a special video transmission cable engineered to meet your precise requirements—Ansonia Engineers have plenty of “know-how” which will help to assure long-term satisfaction from the equipment you build. Why don't you write us about the cable or wire problem that's on your mind right now!

## THE ANSONIA ELECTRICAL COMPANY

SUBSIDIARY OF NOMA ELECTRIC CORPORATION

ANSONIA, CONNECTICUT

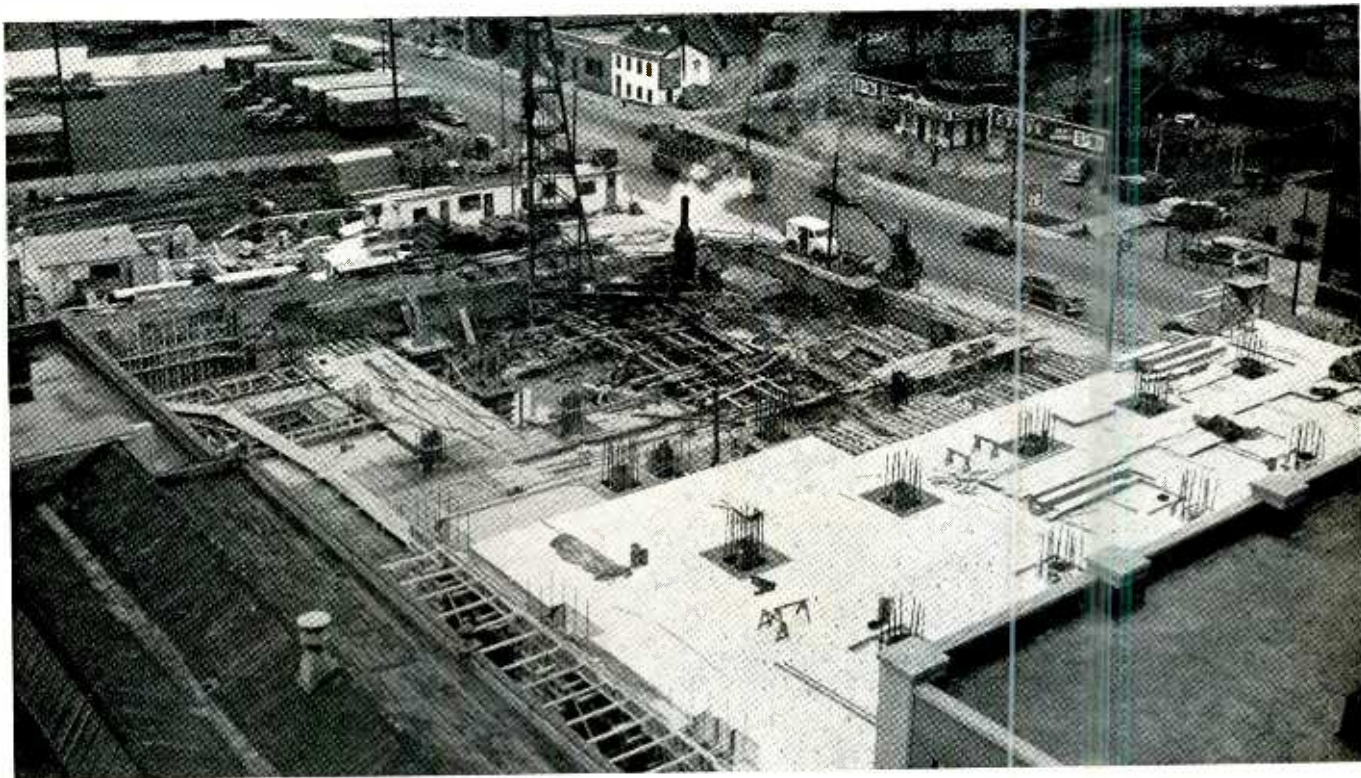

A NEW ADDITION TO THE ALLEN-BRADLEY PLANT FOR PRODUCING A-B FIXED AND ADJUSTABLE RESISTORS

## A REPORT to the Radio Industry about Allen-Bradley Radio Resistors

Radio manufacturers have discovered that fixed resistors of run-of-mine quality will not meet the requirements of television circuits.

This situation has, overnight, created an unprecedented demand for the top quality and stability found in Allen-Bradley fixed resistors. In spite of weekly shipments of many millions of Bradleyunits in  $\frac{1}{2}$ -watt, 1-watt, and 2-watt ratings, the current demand still far exceeds the capacity of the Allen-Bradley radio resistor department . . . and our customers are unhappy with our resistor deliveries.

But a large addition to the Allen-

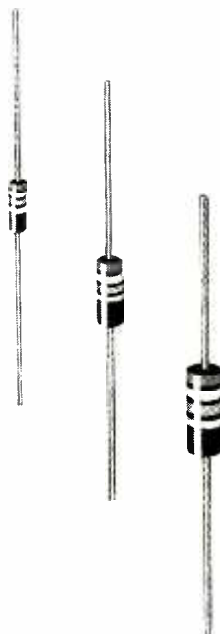

Bradley factory is under way. Much additional resistor production machinery is under construction. However, it will take time before these facilities will be ready for the increased production of Bradleyunits.

Meantime, Allen-Bradley is working twenty-four hours per day—seven days per week—to produce the maximum output of Bradleyunits. It is physically impossible to do more at this time.

During this stringency, we appeal to the radio industry to restrict its use of our products to applications in which Bradleyunit quality performance is absolutely essential.



ALLEN-BRADLEY COMPANY, 110 W. GREENFIELD AVE., MILWAUKEE 4, WISCONSIN

*New...*  
**for positive identification...**

**ERIE Radial Lead  
 Insulated CERAMICONS<sup>®</sup>  
 now have distinctive  
*red bodies***

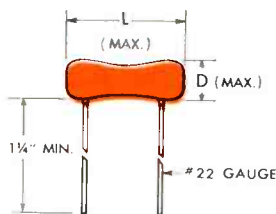
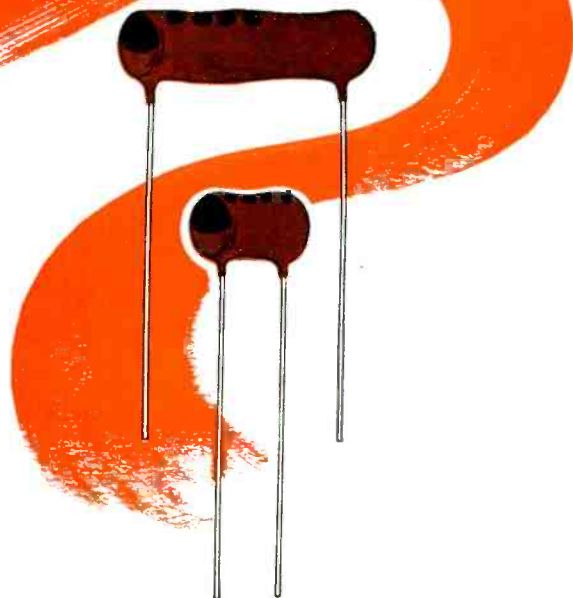

DIPPED PHENOLIC INSULATED

Style	Dia. "D"	Length "L"	Max. Cap.
331	.240	.460	715 MMF
332	.240	.710	1500 MMF
338	.312	.550	2000 MMF
337	.312	.937	4100 MMF
333	.315	1.250	5100 MMF
344	.415	1.213	8000 MMF
335	.415	1.650	.012 MFD
336	.415	2.025	.016 MFD

**E**RIE brings order out of confusion . . . by the simple expedient of giving ERIE radial lead, dipped phenolic coated Ceramicons distinctive red bodies.

In the past manufacturers have found it almost impossible to differentiate between the various makes of such condensers. The common brown body color has sometimes caused confusion in incoming inspection departments and in the final assembly lines. In addition, it has been difficult to fix responsibility for any service reports.

Now, ERIE Radial Lead Insulated Ceramicons are positively and unmistakably identified . . . and the red body also makes it easier to read all RMA color code dots. ERIE axial lead ceramicons will continue to have molded low-loss phenolic insulation.

When you see ceramic condensers with the red body color, you can be sure you have high-quality, dependable ERIE radial lead insulated Ceramicons which will "stay put" in your chassis for the life of the set.



*Electronics Division*  
**ERIE RESISTOR CORP., ERIE, PA.**  
 LONDON, ENGLAND      TORONTO, CANADA.

# HURRICANE!

*How violent? Where heading? How fast?*

Hurricane warnings that save so many lives on land and sea—where do they come from? From seismograph recorders, perhaps better known for their earthquake-locating power. These sensitive instruments, stationed all over the country and on Atlantic and Pacific island outposts, locate and plot the minute-by-minute movement of violent atmospheric disturbances... and pen the vital data on tape.

The heart of each of these life-savers is a Telechron Timing Motor... *instantly, constantly synchronous*. No other motor could be trusted with the tremendous responsibility of feeding facts to the scientists who dedicate their time and talent to this most important work.

### Have you a timing problem?

What variable factors do you want to control or record with split-second accuracy? The chances are that the correct application of a standard Telechron Motor is the answer to your problem. A Telechron Application Engineer can quickly tell you. Consult him early in your planning and save time and trouble. In the meanwhile, fill in and mail the coupon below today for up-to-the-minute facts about Telechron Synchronous Motors.

*Telechron*  
®

ALL TELECHRON TIMING MOTORS ARE

INSTANTLY...CONSTANTLY SYNCHRONOUS

Telechron Inc. A General Electric Affiliate  
40 Union Street  
Ashland, Massachusetts

Please send me information on Telechron Synchronous Motors (maximum torque: 2 pound inches at 1 rpm). My possible application is:

- |   |  |
|---|--|
| <input type="checkbox"/> Instruments                | <input type="checkbox"/> Air Cond. & Heat'g Controls |
| <input type="checkbox"/> Timers                     | <input type="checkbox"/> Communications Equipment    |
| <input type="checkbox"/> Electric Appliances        | Other (please fill in)                               |
| <input type="checkbox"/> Cost Recorders             | <input type="checkbox"/> _____                       |
| <input type="checkbox"/> Advertising, display items | <input type="checkbox"/> _____                       |
| <input type="checkbox"/> Juke Boxes                 | <input type="checkbox"/> _____                       |

NAME \_\_\_\_\_

COMPANY \_\_\_\_\_

ADDRESS \_\_\_\_\_

CITY \_\_\_\_\_ ZONE \_\_\_\_\_ STATE \_\_\_\_\_

# NEW Miniature Telephone Type Relay

## NEW LK RELAY

**MOUNTING:** End mounting for back of panel or under-chassis wiring. Interchangeable with standard "Strowger" type mounting.

**COIL POWER:** From 40 milliwatts to 7 watts D.C.

**CONTACTS:** Standard 2 amperes, special up to 5 amperes. 2 amperes up to 6 P.D.T. 5 ampere contacts (low voltage) up to 4 P.D.T. Special 20 ampere power contacts S.P.S.T., normally open, paralleled.

### DIMENSIONS:

1<sup>5</sup>/<sub>8</sub>" HIGH, 2<sup>7</sup>/<sub>32</sub>" LONG,  
1<sup>3</sup>/<sub>32</sub>" WIDE

*These are the dimensions  
for the 6 pole relay.*

*Will meet Army and Navy  
aircraft specifications  
as a component unit.*

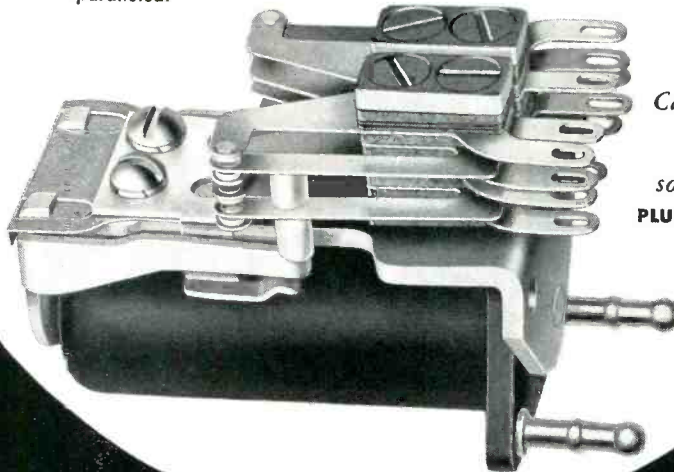

*Can be furnished  
hermetically  
sealed with  
solder terminals.*

**PLUG-IN MOUNTING-SPECIAL.**

## SK RELAY

**MOUNTING:** Front of panel mounting and wiring.

**COIL POWER:** From 100 milliwatts to 4.5 watts D.C.

**CONTACTS:** Same as "LK".

**DIMENSIONS:** 1<sup>1</sup>/<sub>2</sub>" HIGH, 1<sup>1</sup>/<sub>16</sub>" LONG, 3<sup>1</sup>/<sub>32</sub>" WIDE.

*These are the dimensions  
for the 4 pole relay.*

*Will meet Army and Navy  
aircraft specifications  
as a component unit.*

**CAN ALSO BE FURNISHED  
HERMETICALLY SEALED  
WITH SOLDER TERMINALS.  
PLUG-IN—SPECIAL.**

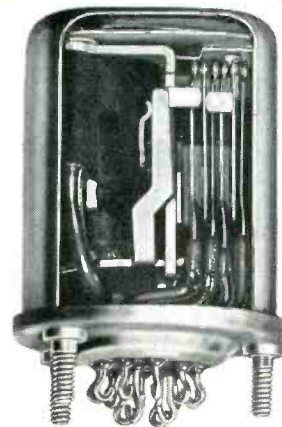

SK, HERMETICALLY SEALED

AL-132



**ALLIED CONTROL CO. INC.** 2 EAST END AVE., NEW YORK 21, N. Y.

BE SURE TO SEE ALLIED AT THE I.R.E. SHOW. BOOTH 280 GRAND CENTRAL PALACE, NEW YORK CITY.

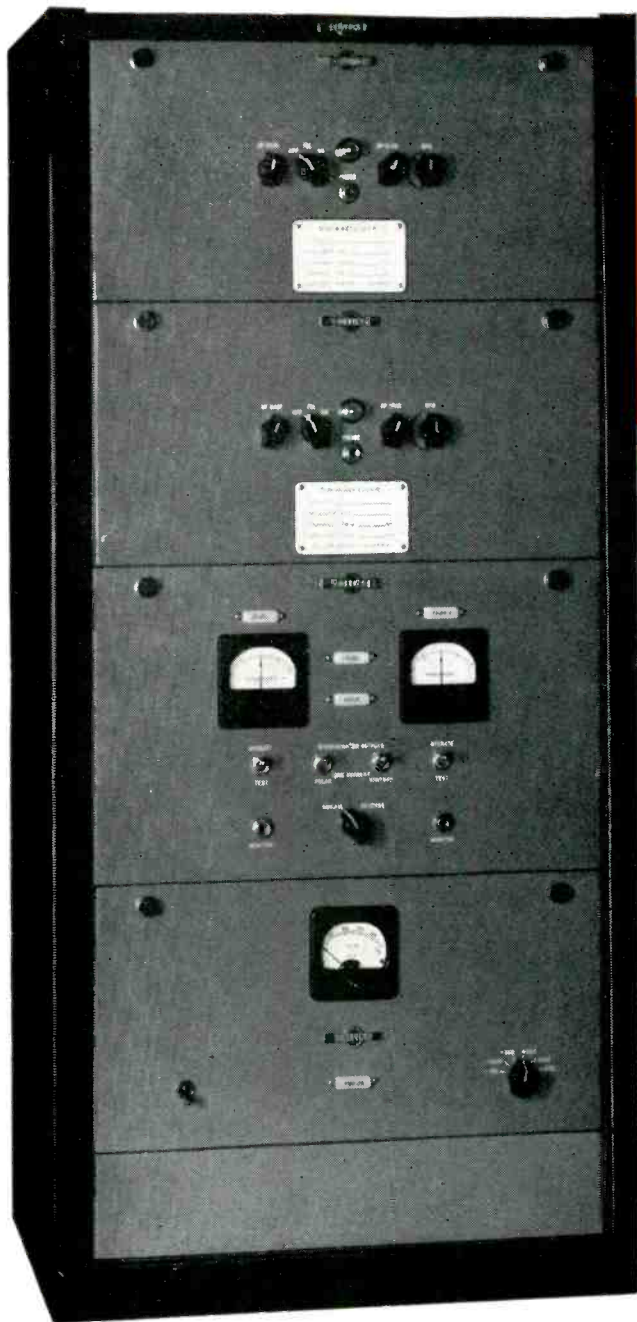

Top to bottom: two Collins 51N-4 communication receivers, Collins 706A-1 radioteletype converter, and Collins 707A-1 power supply.

# Announcing

... the New Collins

## Radioteletype Receiving Package

● The new Collins radioteletype receiving package is engineered for applications where extreme reliability is required in the reception and conversion of single channel or multiplex printer transmissions.

The Collins 706A-1 converter, heart of the package, is designed to operate from the output of two Collins 51N-4 communication receivers arranged for diversity reception of frequency shift signals.

The electrical circuits of the 706A-1 consist of two input filters, two limiters, two discriminators, a channel selector, a mark-hold circuit, and output amplifier circuits which provide proper direct current voltages to operate printer equipment located either locally or remotely. All d-c and a-c voltages for the converter are provided by the 707A-1 power supply.

The 51N-4 receivers employed are highly efficient single-channel superheterodynes, thoroughly engineered for reliable continuous duty. The use of six tuned circuits ahead of the mixer gives more than 60 db rejection of image response.

New Collins radioteletype transmitting equipment is also in production. We will be glad to give you further information on request.

Be sure to visit our booths 75 through 80 at the I. R. E. Convention

IN RADIO COMMUNICATIONS, IT'S . . .



**COLLINS RADIO COMPANY, Cedar Rapids, Iowa**

11 West 42nd Street, New York 18, N. Y.

458 South Spring Street, Los Angeles 13, California

# Introducing A NEW TEAM TO

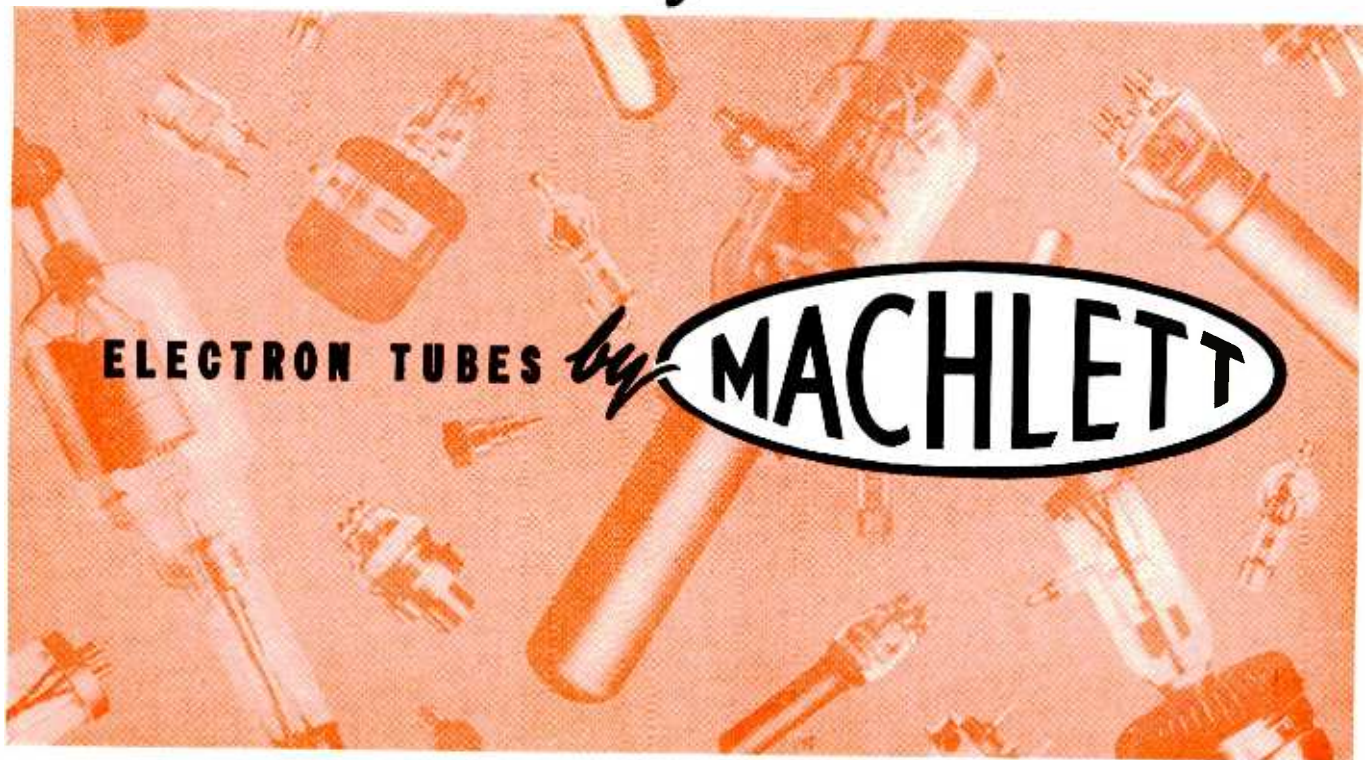

## Combining Research—Development—Manufacturing Skill

Here's great news for broadcasters and industrial tube users. Machlett Laboratories and Graybar Electric Company have joined forces in a new distribution line-up to bring you more efficient and complete service on electron tubes.

For over a half century, Machlett has pioneered and made notable contributions to the development of the electron tube art. Today, through its modern plant, development laboratories and skilled personnel, Machlett tubes will set the highest standard of performance in broadcast and industrial service.

This combination of Machlett and Graybar is your best assurance of getting superior tubes. For better value—better service—try Machlett tubes now distributed via Graybar.

**TO SEE THE FULL LINE OF MACHLETT TUBES, VISIT THE GRAYBAR BOOTH,  
NO. 96-97, AT THE IRE SHOW, MARCH 7-10.**



**OVER 50 YEARS OF ELECTRON TUBE EXPERIENCE**

Famous as the outstanding manufacturer of X-ray tubes, the name, Machlett, on electron tubes has been the mark of quality, top performance and long life for more than 50 years. Experience, skill and a "singleness of purpose" to produce the best in electron tubes have made Machlett first choice around the world.

**MACHLETT LABORATORIES, INC., Springdale, Connecticut**



# SERVE BROADCASTERS AND INDUSTRY

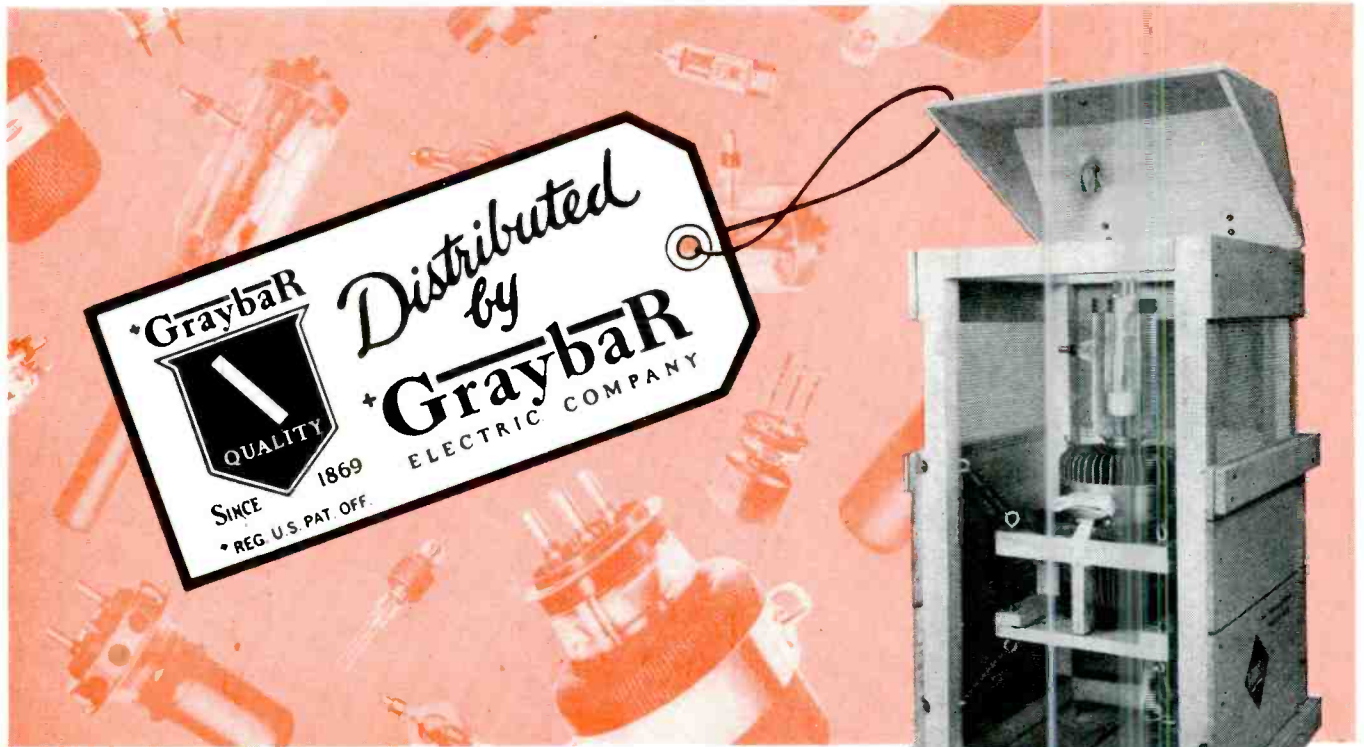

## with National Distribution Service

In keeping with its policy of "Bringing You Broadcasting's Best Equipment," Graybar is proud to assign its Tag—the Symbol of Distribution—to the Machlett line of electron tubes for both broadcasters and industry.

This new connection will bring you dual benefits: (1) products from an outstanding manufacturer of electron tubes, (2) distribution service from an organization offering specialized assistance in choosing the best type of product for your requirements.

Machlett tubes can now be quickly and conveniently ordered through near-by Graybar "Supply Stations" located in over 100 principal cities from coast-to-coast. When you order Machlett tubes "via Graybar," you'll have the right combination for extra service and performance.

Call your local Graybar Representative. Graybar Electric Company, Inc., Executive Offices: Graybar Building, New York 17, N. Y.

EVERYTHING ELECTRICAL TO KEEP YOU ON THE AIR



These are the Graybar Broadcast Equipment and Electron Tube Specialists in key cities:

**ATLANTA**  
E. W. Stone, Cypress 1751  
**BOSTON**  
J. P. Lynch, Kenmore 6-4567  
**CHICAGO**  
E. H. Taylor, Canal 4104  
**CINCINNATI**  
J. R. Thompson, Main 0600

**CLEVELAND**  
W. E. Rockwell, Cherry 1360  
**DALLAS**  
C. C. Ross, Central 6454  
**DETROIT**  
P. L. Gundy, Temple 1-5500  
**JACKSONVILLE**  
W. C. Winfree, Jacksonville 5-7180

**KANSAS CITY, MO.**  
R. B. Uhrig, Grand 0324  
**LOS ANGELES**  
R. B. Thompson, Trinity 3321  
**MINNEAPOLIS**  
W. G. Free, Geneva 1621  
**NEW YORK**  
F. C. Sweeney, Watkins 4-3000

**PHILADELPHIA**  
G. I. Jones, Walnut 2-5405  
**PITTSBURGH**  
R. F. Grossett, Court 4000  
**RICHMOND**  
E. C. Toms, Richmond 2-2833

**SAN FRANCISCO**  
K. G. Morrison, Marker 5131  
**SEATTLE**  
D. I. Craig, Main 4635  
**ST. LOUIS**  
J. P. Lenkerd, Newstead 4700



Transformer built by Moser-Glaser for Ciba Ltd., internationally famous manufacturers of chemical products. It is a "DLS-100", 94 kva, 220 volt, three phase, 50 cycle Adjustable Voltage Type with a five-step switch mounted on top. Switching is done under oil. All leads are insulated and protected by Natvar 400, the Extruded Vinyl Tubing with superior resistance to both heat and oil.

# NATVAR 400 in SWITZERLAND!



- Varnished cambric—straight cut and bias
- Varnished cable tape
- Varnished canvas
- Varnished duck
- Varnished silk
- Varnished special rayon
- Varnished Fiberglass cloth
- Silicone coated Fiberglass
- Varnished papers
- Slot insulation
- Varnished tubings and sleeveings
- Varnished identification markers
- Lacquered tubings and sleeveings
- Extruded vinyl tubing and tape
- Extruded vinyl identification markers

Ask for Catalog No. 21

Moser-Glaser & Co., A.G., well-known electrical manufacturing firm, Muttensz bei Basel, Switzerland, use Natvar 400 Extruded Vinyl Tubing to insulate and protect leads of their transformers. They know that it will meet operating temperature requirements (approved for 105° C), and at the same time provide uniformly superior resistance to oil.

This tubing is supplied through Micalfil A.G., Zurich-Alstetten, Switzerland, Natvar agents for Switzerland, Austria, Bulgaria, Czechoslovakia, England, France, Germany, Greece, Holland, Hungary, Italy, Luxemburg, Rumania, Spain, Turkey and Yugoslavia.

Prompt deliveries can be made either from a conveniently located wholesaler's stock or direct from our own. Full Underwriters' report on request.

## THE NATIONAL VARNISHED PRODUCTS

*Corporation*

TELEPHONE  
RAHWAY 7-2171

CABLE ADDRESS  
NATVAR: RAHWAY, N. J.

201 RANDOLPH AVENUE ★ WOODBRIDGE NEW JERSEY

*"Give us the tools . . ."*

# *McGraw-Hill Surveys*

## BUSINESS NEEDS

**If it can get the money American industry in 1949 will go full steam ahead with a vitally-needed program of improving its facilities. This program since V-J Day has kept business expanding and has made belated headway in modernizing industry.**

**Furthermore, if it can get the money American industry will carry on for the next five years with its unprecedented program of expenditure for new plant and equipment. Plans already made call for spending about \$55 billion.**

These are findings of the McGraw-Hill national survey of "Business' Needs for New Plants and Equipment." Major results of the survey, which have been rechecked since election day, are summarized on the following page. They report what American industry is now planning to spend for new plant and equipment. *They do not and cannot show what will be done if the plans are hamstrung by political action.*

*In 1949, the survey shows, American industry plans to spend \$14.1 billion for new plants and equipment. That is only about 5% less than was actually spent in 1948.*

If these plans are carried out, actual capital expenditures this year may be somewhat larger than they were in 1948. That is because expenditures usually prove to be larger than planned.

Fulfillment of American industry's plans for investment in new plant and equipment this year would no doubt mean a continuation of general prosperity. The record shows that when capital expenditures are high general business thrives.

Even more remarkable than the 1949 prospect is the fact that:

**Industry already plans to spend \$41 billion in the years 1950-53 to improve its plants and equipment.**

Plans tend to taper off, of course, as they are pushed further into the uncertain future, five years from now. But the striking fact is that plans for expenditures so far ahead are as great as they are. They show American in-

dustry's need for tremendous improvements in its plants and equipment.

Again, let there be no mistake. These survey findings are not a five-year forecast. They report what leading corporations now are planning to do — *if they can get the money.*

*But — won't industry be top-heavy with plants and equipment if it carries through any such program?*

The answer is clearly — "No".

Here are some of the reasons why not that were disclosed by the McGraw-Hill survey:

First, manufacturing industries are shifting emphasis from expansion to improving efficiency.

They have increased their total capacity 56% since 1939. Their expenditures in 1948 went almost 50-50 for expansion and improvement. But in the next five years they plan to spend three-quarters of their funds to replace and modernize facilities, only one-quarter for expansion.

Second, the prospective rate of expenditure for new plant and equipment is relatively low.

Planned expenditures for new plant and equipment in 1949 represent about 7.5% of the present value of all plant and equipment. That rate of capital expenditure is no higher than the rate during previous periods of prosperity. And industry must overcome years of starvation for new equipment, caused first by the depression of the 30's, then by diversion to war production.

Third, industry is following an extremely cautious policy in buying new equipment.

Three out of four companies report that they will not buy equipment unless it will pay for itself within five years. And a third of the companies report that they expect new equipment to pay for itself within three years. The reason most frequently given for such expectations was that all the money available can be spent on equipment which does pay for itself quickly.

**The program of capital expenditure planned by American industry is one of the greatest bargains ever offered to the American people.**

To pay for itself in a few years, as equipment must if most companies are to consider buying it, that equipment

*continued on next page*

## WHAT THE SURVEY SHOWS

● **HERE ARE THE MAJOR FINDINGS** of McGraw-Hill's survey of "Business' Needs for New Plants and Equipment". Rechecked since Election Day, results show what industry is now *planning* to spend for new plants and equipment. They do not forecast what will actually be spent. The survey shows:

1. Industry now plans to spend \$14.1 billion in 1949 – and almost \$41 billion in the four years beyond, 1950-53.
2. Manufacturing industries alone plan to spend \$7.2 billion in 1949. This is 7.5% of the estimated value – \$96 billion – of all manufacturing facilities.
3. Manufacturers estimate conservatively that it would cost \$136 billion to completely replace their facilities with the most modern plants and equipment available.
4. Postwar expansion is virtually complete in most manufacturing lines. Major exceptions: steel and petroleum refining.
5. Expansion programs of railroads, utilities, and oil companies still have two to five years to run.
6. Manufacturing industries have increased their capacity 56% since 1939. But expansion is slowing down. Increase planned in the next five years is only 13%.
7. Efficiency is emphasized more and more in planning new facilities. Manufacturers plan to devote almost three-quarters of their funds to replace and modernize. In 1948, 58% went to increase efficiency this way.
8. Equipment should pay for itself in five years or less, say three out of four manufacturing companies. New buildings, say 77% of them, should pay out in 15 years or less.
9. Profits and reserves are counted on to pay for new buildings and equipment by three out of four manufacturing companies. Some 15% expect to borrow, only 9% plan to sell stock. However, 20% would like to sell stock, only 4% want to borrow.
10. More liberal depreciation allowances for income tax purposes would prompt almost two-thirds of the companies to speed their purchase of new plants and equipment.

● A copy of a complete report on "Business' Needs for New Plants and Equipment" may be obtained by writing me at McGraw-Hill Publishing Co., 330 West 42nd St., New York 18, N. Y.

must promise to produce much better products or make great savings in labor and material. The savings go first to the companies buying the equipment but, as they always have, they soon spread to everyone in the form of better products at lower costs.

*Where does industry expect to get the money to buy this bargain for the American people?*

Most of the companies covered by the McGraw-Hill survey (76% of the total) count on their own resources – largely profits – to pay for new plant and equipment. About 15% of them expect to borrow money, although only 4% like the idea of getting saddled with fixed debt. Only 9% of the companies expect to sell stock to investors, although twice that many report they wish they could.

*What are the chances that business can get the money?*

The survey provides no answer to that question. No survey can.

The answer will come from Washington – in what Congress does about taxes on profits and taxes on the millions of Americans who might invest a part of their income in industry's new plants and equipment.

The answer will be found also in the energy and skill shown by investment bankers, particularly in mobilizing the resources of the millions of Americans whose incomes have increased enough since 1940 to make them potential direct investors in industry.

Still another important part of the answer will be given by labor leaders. About half the companies surveyed by McGraw-Hill are holding back on new construction – primarily because of high costs. What organized labor does about wages and productivity can swell or shrink that percentage.

**The McGraw-Hill survey leaves no doubt that Ameri-**

**can industry is fulfilling its responsibility. It is planning the capital improvements needed to make the nation secure, prosperous, and progressive.**

But business today lacks confidence and badly needs added incentives. Proper taxation and increased depreciation allowances are vital if we are to open the capital markets to finance industry.

What will happen now depends in large part on what is done in Washington. In his State of the Union message, the President said that "business should plan for steady, vigorous expansion." But in his budget message he proposed new taxes which would divert a substantial share of the money industry is using for expansion and improvement. Moreover, he said nothing about the vital issues now freezing the capital markets.

It is not possible to have it both ways. Fulfillment of the President's tax program means cutting industry's program for new and better equipment. It means slowing down industrial progress. It means delaying the advance toward much higher standards of living tomorrow in order to have a little more government spending today.

**I urge you to see that your Representative and your Senator have all the facts on industry's needs for new plant and equipment. What they do to this program will have a decisive bearing on the nation's security and welfare.**

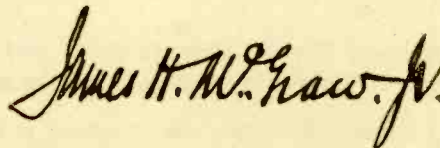

*President, McGraw-Hill Publishing Company, Inc.*

*This is the fourth editorial of a special series on industry's needs for new plants and equipment – and what these needs mean to all Americans.*

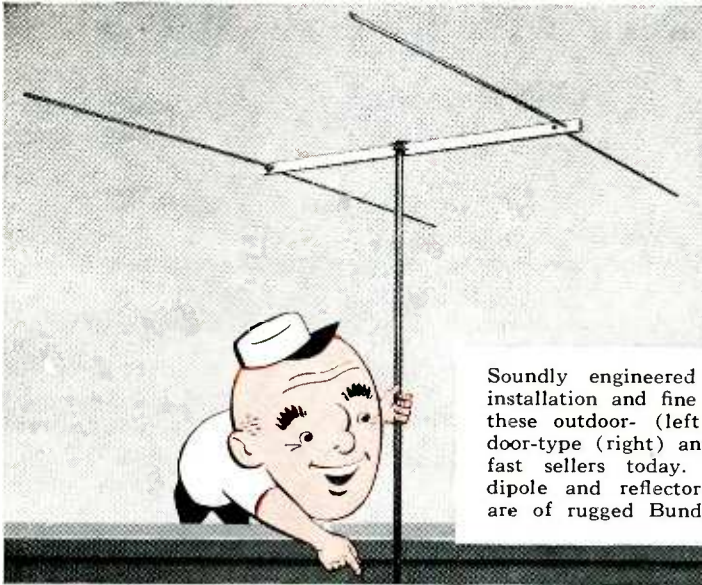

Soundly engineered for easy installation and fine reception, these outdoor- (left) and indoor-type (right) antennas are fast sellers today. Both the dipole and reflector elements are of rugged Bundy Tubing.

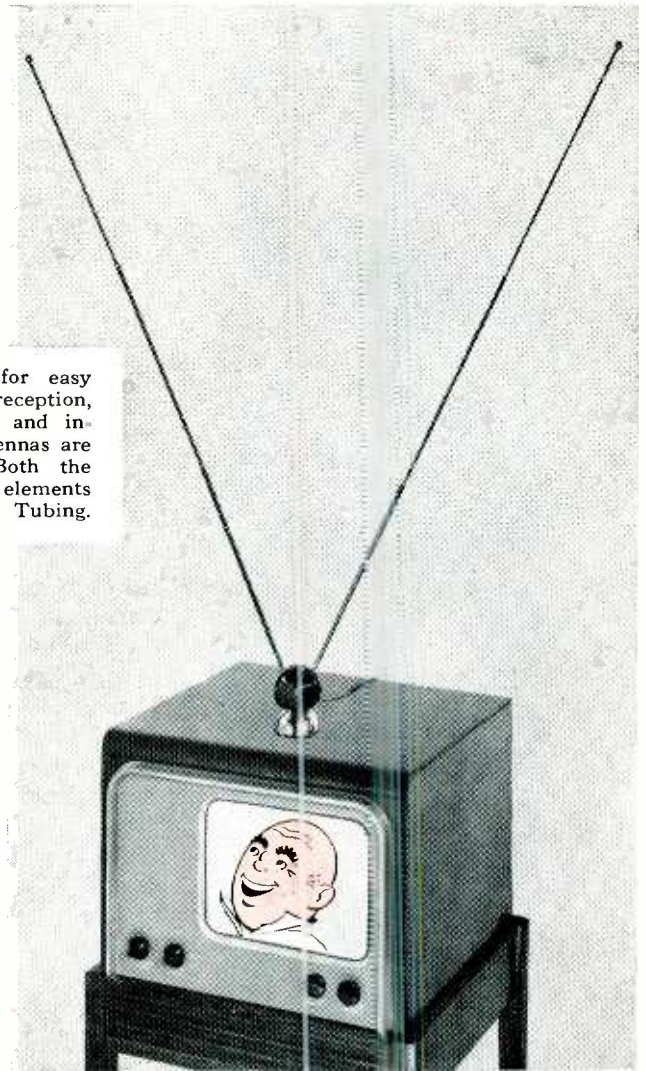

# Look at Bundyweld\* for better TV antennas

Do you make television antennas, either the indoor or outdoor type?

If so, you most certainly should consider Bundyweld\* Tubing. Many other manufacturers have and they are turning out better antennas at lower costs because of Bundyweld's special advantages.

Double-walled Bundyweld is strong yet ductile. Simply stated, this means greater ease of fabrication for you.

It can also be supplied in the hard-drawn condition. This makes it doubly well suited for dipole and reflector elements, which must take all kinds of wind and weather without swaying or sagging.

Bundyweld is inexpensive. It lowers production costs, saves production time, gives better television antennas at bigger profits to you.

## WHY BUNDYWELD IS BETTER TUBING

**1** Bundyweld Tubing, made by a patented process, is entirely different from any other tubing. It starts as a single strip of basic metal, coated with a bonding metal.

**2** This strip is continuously rolled twice laterally into tubular form. Walls of uniform thickness and concentricity are assured by close-tolerance, cold-rolled strip.

**3** Next, a heating process fuses bonding metal to basic metal. Cooled, the double walls have become a strong ductile tube, free from scale, held to close dimensions.

**4** Bundyweld comes in standard sizes, up to 5/8" O.D., in steel (copper or tin coated), Monel or nickel. For tubing of other sizes or metals, call or write Bundy.

## BUNDY TUBING DISTRIBUTORS AND REPRESENTATIVES

Cambridge 42, Mass.: Austin-Hastings Co., Inc., 226 Binney St. • Chattanooga 2, Tenn.: Peirson-Deakins Co., 823-824 Chattanooga Bank Bldg.  
 Chicago 32, Ill.: Lapham-Hickey Co., 3333 W. 47th Place • Elizabeth, New Jersey: A. B. Murray Co., Inc., Post Office Box 476 • Philadelphia 3, Penn.: Rutan & Co., 404 Architects Bldg. • San Francisco 10, Calif.: Pacific Metals Co., Ltd., 3100 19th St. • Seattle 4, Wash.: Eagle Metals Co., 3628 E. Marginal Way • Toronto 5, Ontario, Canada: Alloy Metal Sales, Ltd., 881 Bay St.

BUNDYWELD NICKEL AND MONEL TUBING IS SOLD BY INTERNATIONAL NICKEL COMPANY DISTRIBUTORS IN PRINCIPAL CITIES.

## See us at the Show

Stop in and say hello to us at Grand Central Palace, New York, March 7-10, if you're attending the I.R.E. National Convention. If you don't get an opportunity to visit our exhibit there, contact your near-by Bundy representative, among those listed below, for the full story on Bundyweld or write directly to *Bundy Tubing Company, Detroit 14, Michigan.*

## BUNDY TUBING

★ ★



★ ★

\*REG. U. S. PAT. OFF.

®

ENGINEERED TO

YOUR EXPECTATIONS

# BUSINESS BRIEFS

By W. W. MacDONALD

Sylvania's Frank Mansfield says television sets are standing up much better than many manufacturers expected. According to a recent survey 58 percent of several hundred dealers contacted said that sets were performing virtually without service, 27 percent said the necessity for service was about the same as in connection with radios, 7 percent reported continual trouble, and the remaining 8 percent said they had not yet had enough experience to comment.

Regarding screen size, 84 percent of the dealers said sets with 10-inch tubes sold best in 1948, 9 said 7-inch, 6 said 12-inch, and 1 said larger direct-view and projection types. Concerning 1949, 44 percent said they expected 12-inch types to sell best, 42 said 10-inch, 2 said 7-inch and 12 expected to do best with very-large-screen models.

**Tele Set And Tube Makers** are understandably cagey about predicting the life of c-r tubes but it does seem to be narrowing down to something between two and four years under average conditions of use. This forecasts a very healthy replacement market.

**Television Receiving Antennas** will use about 53,000,000 feet of tubing in 1949. This estimate is based upon the assumption that the average array will consist of a high-band folded dipole and reflector and a similar arrangement for the low band, that 90 percent of the receivers installed will be equipped with outside antennas, and that 2,000,000 sets will be sold.

**A Custom Home Builder** on Long Island reports that his last three customers have specified television-antenna mounting brackets and conduits for transmission lines as part of their contracts.

**Speaking Of Long Island**, our Manager, Wally Blood, says he almost spent a lost weekend out

there when he wandered off a main road to duck traffic. Then he remembered that television antennas point toward the big city, noted their position and drove home on the beam.

**We Are Indebted** to A. P. Bock of Westinghouse for suggesting a method by which the cost of operating industrial radio-frequency heating apparatus may be roughly determined.

Required generator power is estimated by applying to the job under consideration the equation

$$KW = \frac{\text{lbs/hr} \times \text{specific heat} \times \text{degrees rise F}}{3,413}$$

adding, if water is to be evaporated during the heating cycle,

$$KW = \frac{\text{lbs/hr of water evaporated} \times 970}{3,413}$$

then adding 10 percent of the overall figure for safety and, finally, looking up the cost of operating a generator of the required power in the accompanying graph.

Labor required to operate the

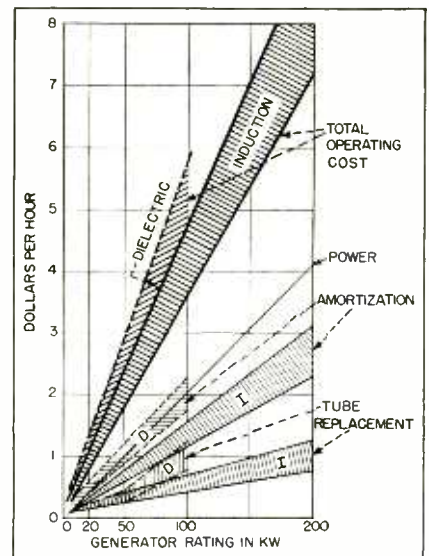

heating apparatus, generally unskilled and relatively inexpensive, is not included in the graph. Nor is the cost of any machinery needed to bring work to the heater. It should also be noted that figures resulting from the use of the graph apply to applications in which the heating apparatus is in

Choose  
**PYRAMID**  
ELECTROLYTICS  
for  
Top performance  
at 85c



Pyramid Type 85TM Capacitors are now in volume production for leading TV-receiver manufacturers throughout the U.S.A. and Canada.



**PYRAMID**  
CAPACITORS

**PYRAMID ELECTRIC COMPANY**

155 Oxford Street  
Paterson, N. J., U.S.A.

TELEGRAMS: WUX Paterson, N. J.  
CABLE ADDRESS: Pyramidusa

Visit Our Booth #208, I.R.E. Show March 7-10, 1949

# HERE'S THE FIRST BIG FM NEWS

## FROM REL FOR 1949!

### THE REL MODEL 707 FM RELAY LINK

A complete 890 to 960  
mc system for \$3950  
F.O.B. FACTORY—LONG ISLAND CITY, N. Y.

#### EQUIPMENT INCLUDES:

- 1 CRYSTAL CONTROLLED 5 WATT TRANSMITTER MOUNTED IN RELAY RACK CABINET
- 2 15 db PARABOLIC TRANSMITTING ANTENNA
- 3 CRYSTAL CONTROLLED RECEIVER MOUNTED IN RELAY RACK CABINET
- 4 15 db PARABOLIC RECEIVING ANTENNA
- 5 ONE COMPLETE SET OF TUBES AND CRYSTALS

.. offering wide application for FM STL, all other aural broadcast STL requirements, point-to-point communication, multi-channel voice relay systems.

The Model 707 FM Relay Link is a high quality equipment that meets or betters FCC and RMA requirements for FM studio-to-transmitter link in the 940 to 952 mc band or a one-way voice communication relay system within the 890 to 960 mc band. It is also recommended for inexpensive but highly reliable relay service where multiple voice frequency channels are desired. With suitable terminal equipment five such channels can be handled.

Salient features of this equipment include low first cost, low maintenance (all tubes are standard low cost types) and exceptional performance characteristics resulting from the application of the REL SERRASOID MODULATOR to the system. Complete details including field performance of the basic design covering many months will be supplied promptly on request on company letterhead. Visit us at Booths 324-326 at the IRE Show, Grand Central Palace, New York.

#### ELECTRICAL PERFORMANCE

- FREQUENCY: 890 to 960 megacycles.
- FM SIGNAL TO NOISE RATIO: 70 db. below 100% modulation.
- AUDIO RESPONSE: 0.5 db., 50 to 15,000 cycles.
- DISTORTION: Harmonic distortion is .50% at 100% modulation.
- CENTER FREQUENCY TOLERANCE: .003%.
- PRIMARY POWER: 115 volts, 60 cycles, single phase.
- TRANSMITTER AUDIO INPUT: Impedance—600/150 ohms Level—+10 dbm, balanced or unbalanced.
- RECEIVER AUDIO INPUT: Impedance—600/150 ohms Level—+18 dbm maximum, balanced or unbalanced.
- TRANSMITTER POWER OUTPUT: 5 watts.
- MODULATION BAND WIDTH: 50-20,000 cycles.
- SPACE ATTENUATION: For signal to noise ratio of 70 db. with 75 microseconds de-emphasis, 105 db. max.

**REL**

**RADIO ENGINEERING LABS • INC**

35-56 — 36th STREET, LONG ISLAND CITY 1, N. Y.



# LEDEX ROTARY SOLENOID



... solves remote control problems

The many production uses of Ledex Rotary Solenoids vary from actuating bomb releases in military aircraft to controlling hydraulic valves in heavy duty industrial material handling equipment.

Five Ledex Rotary Solenoid models are manufactured. Diameters range from 1 1/8 to 3 3/8 inches. Predetermined rotation up to 95°, either right or left, can be engineered to suit your production requirements. Starting torques for 45° of rotation range from 1/4 to 50 pound-inches.

Precision manufacture to exacting specifications and individual operating tests are your assurance of dependable, long-life service under severe operating conditions.

*Magnetic action moves the armature along the solenoid axis. This action is converted into a rotary motion by means of ball bearings on inclined races.*



**G. H. Leland** INC.  
DAYTON 2, OHIO

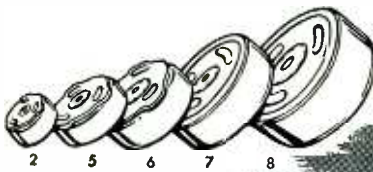

MODEL No.	2	5	6	7	8
Diameter	1 1/8"	1 7/8"	2 1/4"	2 3/4"	3 3/8"
Torque Lb.-Inches	1/4	5	10	25	50
Weight Lbs.	1/8	1/2	1	2 1/4	4 1/4

G. H. LELAND, INC.  
118 Webster Street, Dayton 2, Ohio

Send descriptive literature on the Ledex Rotary Solenoid. The Ledex Rotary Solenoid may be applicable to our ...

Product \_\_\_\_\_  
 Name \_\_\_\_\_  
 (Please Print)  
 Company \_\_\_\_\_  
 Street Address \_\_\_\_\_  
 City \_\_\_\_\_ State \_\_\_\_\_

FILL IN  
AND MAIL  
COUPON FOR  
ILLUSTRATED  
FOLDER GIVING  
COMPLETE  
INFORMATION

more or less continuous use during the work day. Costs increase sharply where the duty cycle is short.

Power cost is figured at 1 cent per kilowatt-hour. Five years is allowed for amortization of initial costs, with the apparatus operating 16 hours per day. Tube life is estimated at 3,000 to 5,000 hours.

Licensed Radio Stations totalled 140,838 as of October 31, 1948, broken down as follows:

Broadcast	
Standard (a-m)	2,103
Frequency-modulation	996
Remote pickup	578
Television (experimental)	168
Television	124
Noncommercial educational	46
International	37
Studio-transmitter	22
Developmental	15
Facsimile	2
Non-Broadcast	
Amateur	81,170
Aeronautical	24,596
Marine	17,172
Police	4,308
Taxicab	3,188
Utility	2,025
General industrial	822
Experimental	555
Forestry	516
Petroleum	515
Railroad	235
Highway maintenance	141
Fire	97
Special emergency	92
Transit utility	83
Lumber	69
Citizens	66
Intercity busses and trucks	32
Common Carrier	
General mobile	855
Experimental	127
Fixed public telegraph	56
Fixed public telephone	27

Licensed operators totalled 534,917, broken down as follows:

Commercial	363,000
Aircraft radiotelephone	91,368
Amateur	80,549

Mort Kahn of Temco claims the average age of radio amateurs is rising. Anyone else, outside of ourselves, share that view?

Industrial Instrumentation is one of the most important influences on improved living standards, better working conditions and, ultimately, lower prices, according to Henry Dever of Brown Instruments.

Dever says that the ratio of instrumentation to overall plant expansion has increased fourfold since 1939, that measuring and controlling devices experienced a sales increase of 11 percent in 1948 over 1947, and that this same rate of expansion should carry through 1949 and possibly 1950.

Instrument sales totalled \$30,000,000 in 1920 and \$150,000,000



in 1940. In 1948, according to Dever, some 1,200 companies turned out about 20,000 types of instruments and instrument-equipped industrial apparatus having a sales value in excess of \$2 billions.

Development of three electronic devices designed to facilitate the landing, departure and taxiing of aircraft in instrument weather has been suggested to the Air Navigation Development Board by the Air Coordinating Committee's Air Navigation Panel, as an initial step in the government's 15-year, billion-dollar, all-weather airways program.

The three devices for which priority is recommended are: Airport Surface-Movement Detection Equipment, the Airport Approach-Control Timer, and the Interim Private-Line Visual Communications System.

F-M Industry is now a billion-dollar industry, according to the F-M Association. The estimate covers total investment in stations and sets.

**Taken To Task** about a statement we made in January (p 71) to the effect that the cost of operating hearing aids might soon drop below one cent an hour, we hasten to add what we should have included in the original item. We meant the cost of operating *single-unit* aids with internal batteries. And we meant devices turning out high rather than so-called low or medium audio power.

A number of aids using external batteries operate well below the cent-an-hour figure, some closer to a half cent. There are even a few operating for less than a cent an hour on internal batteries, turning out sufficient power to be useful to perhaps 50 percent of the potential users.

Hope this makes everybody happy.

**Discussing Phonograph Records**, an engineer of our acquaintance made what we consider an apt though somewhat cryptic remark. He says that so far as he can see the only immediate effect of the latest innovation will be to put a bigger hole in the business.

Precise <sup>at</sup> PERFORMANCE  
Telegraphic SPEEDS

## The Series 7JOZ Sigma Relays

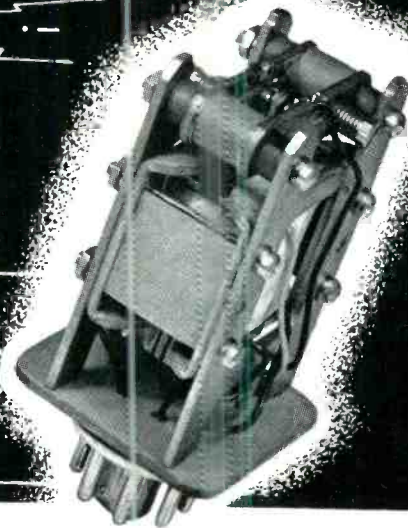

### Polarized RELAY for High-Speed Telegraphy

**SPECIAL FEATURES:** Contacting is essentially bounce-free. Characteristic distortion is entirely absent except at extreme speeds.

**PHYSICAL DESCRIPTION:** Size  $1\frac{1}{8}$ " x  $1\frac{1}{8}$ " x  $2\frac{5}{8}$ " seated height. Hermetically sealed. Mounts on standard octal socket — can be clamp-mounted with stirrup. Balanced armature construction with unusually high ratio of force to mass (high vibration resistance).

**CHARACTERISTICS:** High speed, sensitive S.P.D.T. polarized relay. Although designed for speeds of 50 to 150 words per minute it is serviceable up to 250 w.p.m. Developed under Signal Corps Contract calling for smaller size and improvement over existing types.

**WINDING:** Matched pair with resistance around 150 ohms each for differential, polarized or "polarential" service. Various other combinations available — up to 14,000 ohms in a single winding. Standard twin 150 ohm model operates satisfactorily on 5 ma reversals in one winding, and "just trips" at approximately 1 ma. For high speed economical operation, exceptionally long life and compactness, specify the new Sigma Series 7 Polarized Relay.

ALSO AVAILABLE FROM SIGMA, a variety of other types of sensitive relays AC — DC — Polarized — Single or Multiple Contact. We shall be glad to assist in the engineering of your relay problems.



Sigma Instruments, INC.  
Sensitive RELAYS  
62 Ceylon St., Boston 21, Mass.

FOR DETAILED  
INFORMATION ON  
THE NEW  
SERIES 7JOZ  
ASK FOR  
BULLETIN

P. R. MALLORY & CO. Inc.  
**MALLORY**

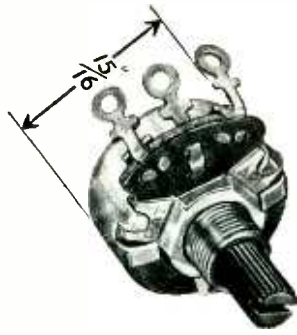

# Midgetrol

## Has Designing Ways

### MALLORY

sets the pace in carbon controls with the revolutionary Mallory Midgetrol.

#### NEW TELEVISION TYPES

Resistance stability specially provides for critical applications in television circuits. Insulated shafts are knurled for ease in adjustment. Shaft and current-carrying parts provide 2000-volt insulation.

#### NEW SMALL SIZE

The small size of  $\frac{13}{64}$ " diameter saves precious space, can be specified where a  $\frac{1}{8}$ " diameter control ordinarily would be required.

#### NEW FLAT SHAFT

It makes possible a standardization of products which means faster production schedules and faster deliveries.

#### NEW TWO-POINT SHAFT SUSPENSION

Double bearing suspension of the new flat shaft eliminates shaft wobble. Assures smooth, even contact pressure on the resistance element. Improves the quality of the control mechanically and electrically.

#### NEW RESISTANCE ELEMENT

Resistance element is automatically machine-coated and electronically selected to eliminate any chance of human error.

#### NEW CONSTRUCTION

Use of phenolic material eliminates metal-to-metal contact, thus there's no chance for mechanical noise.

#### NEW CONTACT ASSEMBLY

The contact assembly is made of a special Mallory contact alloy. New contact design makes the Mallory Midgetrol the quietest, smoothest control by laboratory tests.

#### NEW TYPE END TERMINALS

End terminals are hot tinned—can be formed, bent, or twisted many times without breaking. Terminal holes are large enough to easily and quickly secure all leads.

#### NEW SWITCH

Designed and manufactured by Mallory under the highest quality standards. This new switch is built for a long, trouble-free life and eliminates many switch problems.

...It's the little Volume Control with BIG Advantages

Are you planning for smallness, and yet want to deliver big results? Well, here's an all-new revolutionary volume control that lives up to Mallory's name.

It's rugged. It can take it. It gives longer life and it is the quietest by actual tests. Yes, the Mallory Midgetrol has designing ways...and more and more designers have fallen in love with its nine big features.

Mallory Midgetrol is the crowning result of years of work to pack all the dependability, all the toughness and all the precision work that has made Mallory famous into SMALLER space.

We earnestly suggest you study the many extra features offered by the Mallory Midgetrol which are listed in the box here. They, in total, prove again that the Midgetrol is worthy of joining the big Mallory line of volume controls of every type for every use.

*You Expect More And Get More From Mallory*

Precision Electronic Parts—Switches, Controls, Resistors

P. R. MALLORY & CO. Inc.  
**MALLORY**

P. R. MALLORY & CO., Inc., INDIANAPOLIS 6, INDIANA

#### SERVING INDUSTRY WITH

Capacitors      Rectifiers  
Contacts        Switches  
Controls        Vibrators  
Power Supplies  
Resistance Welding Materials



# CROSS TALK

► **DUEL . . .** Along with many another publication, including the metropolitan dailies throughout the country, we feel impelled to comment on the present confused situation in the phonograph record field.

One fact is manifest: lack of interchangeability between the 78, 45 and 33 $\frac{1}{2}$ -rpm records is viewed with alarm by nearly all commentators, reflecting the general public and trade reaction. The feeling is shared by many broadcasters who desire to use all three types of disks, and by some manufacturers who supply record-reproducing equipment for broadcasting.

These attitudes will no doubt find expression in the marketplace, and are not the primary concern of engineers as such. But the situation has implications of grave importance to engineering. It brings up anew the troublesome question of whether intricate technical devices should be standardized in advance of public offering. Advance standardization is evidently necessary when, as in television broadcasting, there is a lock-and-key relationship between two parts of the system (transmitter and receiver), only one of which is operated by the public.

It may be argued that disks are different, in that the system (turntable and record) is operated as a whole by the ultimate consumer, who can select the system he likes best, or all three if he can afford it. To us, the difference is one merely of degree; three television systems using different scanning rates could exist together, and the public could take its choice, or all three. Only the shortage of spectrum space makes such a plan unthinkable.

No doubt there are valid differences in the technical quality and convenience of the three record systems now extant. Presumably one of them will demonstrate its superiority in the course of time and will be adopted to the exclusion of the others. To the extent that these differences in quality depend on differences in turntable speed, size of the spindle hole, and radius of the stylus tip, they should be exploited and their acceptance determined by the public. But to the extent that such differences make no substantial difference in the final result, the values should be standardized in advance of public offer-

ing. Nothing is gained by any other course; much may be lost.

Despite the fact that the present hue and cry about "trade war" is, in our opinion, overdone and likely to do harm to all facets of the record business, we cannot refrain from quoting an advertisement which recently appeared in the *Toronto Daily Star*. It offered a "duel-speed automatic record changer." Touché!

► **BRIGHT . . .** We are indebted to W. C. White for calling our attention to a recent paper reporting, among other items, the brightness of the luminous spot formed on an experimental mercury cathode. The author of the paper, J. R. Haynes, reports quarter-microsecond sparks having a brightness of a million candles per square centimeter, or some six times brighter than the surface of the sun. Bill White guesses that few engineers know that such bright sources are available and that they might be put to good use. All those interested are urged to read Mr. Haynes's paper (p 891, April 15, 1948 issue of the *Physical Review*).

► **OBIT . . .** Hendrick Johannes van der Bijl died on December 2nd in Johannesburg, after a long and distinguished career that encompassed many fields of professional interest, notably mining and electronics. Perhaps the majority of those active in the field of electronics, including all but the most recent additions to the staff of this journal, went through school at a time when the only electronics textbook was van der Bijl's "Thermionic Vacuum Tubes", first published in September 1920. After an early career with AT&T and Western Electric, Dr. van der Bijl turned to South Africa, where he entered the industrial life of that community with such vigor that he is credited as the father of that country's industrial revolution. When he died he was chairman of the Electricity Supply Commission and the South African Iron and Steel Industrial Corporation. His career is testimony to the fact that a vigorous, creative and penetrating engineer may also assume the burdens of industrial leadership.

# Finding

# NEW PRODUCTS

The best ideas are generally to be found either in your own organization or by personal contact with distributors and customers. Evaluation of new-product market potential is best left to one competent man, who may be either a company executive or a consultant

**I**T IS GENERALLY AGREED that the war-induced sellers' market is fading fast. Aggressive selling is again the order of the day.

But selling alone is not enough. New products are also in order. So the hunt for new products is on—a hunt that seems to be a first-class headache to most companies.

For one thing, the belief that somewhere outside the organization there can be found an item mysteriously easy to make and even easier to sell at a prodigious profit is widespread. As a result, the finished and partially-finished brain-children of engineers already on the payroll are often left to gather dust. All kinds of proposals by outsiders are expensively investigated. Promoters and inventors by the score are gravely listened to. "Product-wanted" ads are run in newspapers to bring still more inventors and promoters to the conference table.

These activities consume much money and time, but they rarely bring the expected results.

### **Beware "Self-Selling" Products**

A text book on the selection of new products is hard to imagine, because individual cases differ so widely. A simple set of precautions can, however, be formulated.

Do not look for miracles. The odds against finding a self-selling humdinger are a million to one at best. And if you do find such an item competition will probably reduce its attractiveness to the vanishing point before you can cash in.

### **By PAUL G. WEILLER**

*New York, N. Y.*

Do not blindly assume that your proposed new product is unbeatable. An example will best illustrate this point. In 1928 an elaborate survey of the radio business was made for a banking house. A determination of the characteristics, appearance, dimensions and general design features of the best-selling receivers was part of it. As a by-product of the survey, the conclusions on receiver design were offered to three set manufacturers.

The first manufacturer said he needed no assistance because his new set was so superlative that it would drive all others off the market, and quickly too. The second manufacturer similarly refused to consider the results of the survey, being equally positive that his own set would drive all others from the market. Essentially the same conversation was repeated in the third case. Of the three receivers in question, only one ever saw the light of day. That one was a success, but it drove no one else out of business. All three firms had good new products, but so also did hundreds of others. Competition was too great, changes too rapid, and blind conceit changed dreams to nightmares for two out of three.

### **Stay in Your Own Field**

If a suggested new product is even remotely related to your old

line, the talent within your own organization should be able to produce it. Or, if your departments are overloaded or understaffed, an outside engineer can produce a design in cooperation with your organization.

If a new product is quite unconnected with your own line, and there may in some cases be good reason for going afield, your problem is more difficult to solve. You are then among new and unfamiliar surroundings. The hazards are much greater and harder to recognize, especially if your organization lacks an expert on whom you can rely for evaluation of the product idea during its various stages of development. Markets are still more difficult to estimate. Finally, if you have to buy a design or a patent outright from outside sources, worthwhile advice becomes so hard to get that the venture approaches a real gamble.

### **Selling Starts With Design**

Whether you do your own development or buy a finished item or a new idea, sales appeal must be designed into its appearance at an early stage. Strive for individuality. Be sure that the new item has the imprint of your organization in its design. For here is an important point. If the new product is recognized by regular customers as yours and yours alone, this product-recognition will add to its sales appeal—for you. If you exaggerate in this respect, however,

## WAYS AND MEANS

Waiting for a self-selling humdinger is usually a waste of time. Such items are few and far between, and competition quickly reduces their attractiveness.

Design new sales appeal into any product with which you are familiar, or one closely allied, and it will probably do better than something foreign to both company and customer.

Sales appeal does not necessarily mean super-duper performance. It may be better business to design for lower cost, greater convenience of operation or better appearance.

Ideas from engineering and sales departments can be equally valuable in the initial stages of a new-product search. But overall management should make the final decision.

you produce a freak. Freaks sometimes sell for a while, but they seldom have staying power.

### The Performance Problem

Advertising copywriters so often scream that the particular wares they sell are the best. One wonders whether that old cliché has any punch left.

When your product belongs to a well-explored art, and that is true even of some electronic devices in spite of the youth of the art, it may be difficult to give it outstanding performance characteristics without increasing costs too much. Less costly designs might be best.

On the other hand, careful attention to production methods can result in economies that can be passed on to the customer in price reductions, or in the form of more or better materials in the product. Where, for example, an increase in apparent weight is desirable and is no functional detriment, a combination of the right material and skillful design can make equipment look sturdier. Convenience of operation, smoothness of controls and good visibility of dials, scales, and markings are other excellent selling points.

### Pre-Design Surveys

One good way to determine possible sales appeal is the pre-design survey. Send out an experienced sales engineer to call on distributors or users of your future product. Have him try to determine what

they like or dislike about similar products now on the market. This is not a job to be done with a questionnaire and subsequent tabulation. The investigator must weigh each piece of information in accordance with his own estimate of the informant's knowledge.

In the 1928 survey of the radio business already referred to it became evident that the cabinets of best-selling radio receivers were of the same width and height within about 2 inches. Sets with different dimensions did not sell as well. In this case the motivation was hard to discover but the facts were nevertheless clear.

If the survey is dealing with a tool you may find preference for some particular shape or weight. If it is an electronic control, a dial with large, heavily-blocked lettering which can be seen at 100 feet might be a major sales point. In any event, the objective of a properly conducted survey is not a mess of figures, comments or quotations; rather, it is a clear and definite idea of what the new product should be, based on careful interpretation and analysis of the collected opinions of potential customers. The following example illustrates how a market survey can reveal needs for new products.

During the middle thirties one large company was selling an electronic timer giving excellent performance for \$1,200. Another manufacturer offered a timer for \$160, which also sold in quantities in

spite of rather poor performance. It appeared logical to assume that still another timer which could do about 70 percent of the jobs the expensive timer did and was easy to install and to maintain could be marketed at \$300. The assumption was later borne out in practice.

### Testing The Market

Some time ago a young sales manager read a paper on market analysis before one of the engineering societies. He described the conventional type of market survey and then said "You wind up with a nicely bound tome with gold letters on the cover and a lot of figures in the text. Most people are inclined to take such data as facts. But they are not facts at all. They are only the surveyors' opinions".

The story emphasizes one point. A market survey is only as good as the men who make and analyze it. It is a job for the top men in your organization, not for the newest junior salesmen, because the value of the survey to you can never exceed the knowledge and judgment of the surveyors. It is impossible to get dependable data on such an important subject by routine methods, no matter how elaborate they may be.

The final, all-important deciding rule in choosing new products is this: Choose the man who will do the choosing wisely and then do not interfere with him. This is one task which is seldom carried out successfully by a committee.

Examples of action-stopping photographs taken with unit, using microphone and amplifier to trigger flashtube. Microphone was placed three feet from balloon, giving about three milliseconds delay to allow progression of action after balloon was pierced with pin



# Portable Repeating Flash Unit

Unique combination of vibrator, transformer and cold-cathode rectifier tubes produces over 800 flashes of Sylvania type R4330 flashtube from one set of four 67½-volt batteries, at one-tenth the cost of expendable lamps. Voltage-regulator circuit maintains storage-capacitor at 2,000 volts  $\pm 1.25$  percent to insure uniform photographic exposures

**R**EPEATING FLASH UNITS employing a high-voltage power supply, an energy-storage capacitor and a gas-filled discharge tube to convert electrical energy into light are receiving wide attention in the fields of industrial and studio photography. These units make it possible to use even an ordinary box camera to take short-exposure photographs that would otherwise re-

quire elaborate camera equipment.

Repeating flash units are generally relatively bulky high-capacitance studio units that operate from the a-c line and provide high light output. There is also a need, however, for portable units operating independently of line power and providing lower light output. This article deals with the design and construction of the latter type, operating from standard radio dry batteries.

**By W. H. FRITZ**

*Manager, Battery Engineering Dept.  
National Carbon Co., Inc.  
New York, N. Y.*

operation are necessary to its success. The effective light output should approximate that available from a midget expendable photo-flash lamp, and the light output in each of a succession of flashes should be consistent, to insure uniform exposures. The last consideration is particularly important in taking color pictures. These performance specifications should be met with low operating cost per flash, which calls for high circuit efficiency.

Another requisite of repeating flash units is short energy-storage-capacitor charging time between flashes. However, the charging time need be no less than the time normally required to advance the film in the camera (or change the film holder), cock the shutter and refocus. These operations usually require from 10 to 15 seconds, although in some cases photographers may reduce this time interval.

## Design Requirements

Portability places severe restrictions on the equipment designer. To be truly portable, a repeating flash unit must be small and light. Little or no maintenance and simple

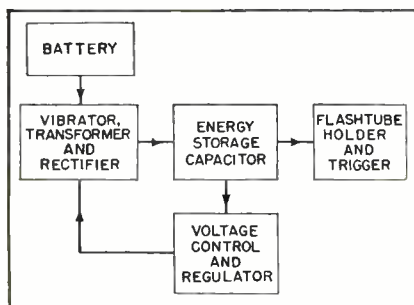

FIG. 1—Block diagram showing essential units of dry-battery-operated repeating flash unit



Dry-battery-powered flash unit connected to camera. Model-airplane ignition-coil and trigger-circuit components are mounted in flashtube holder

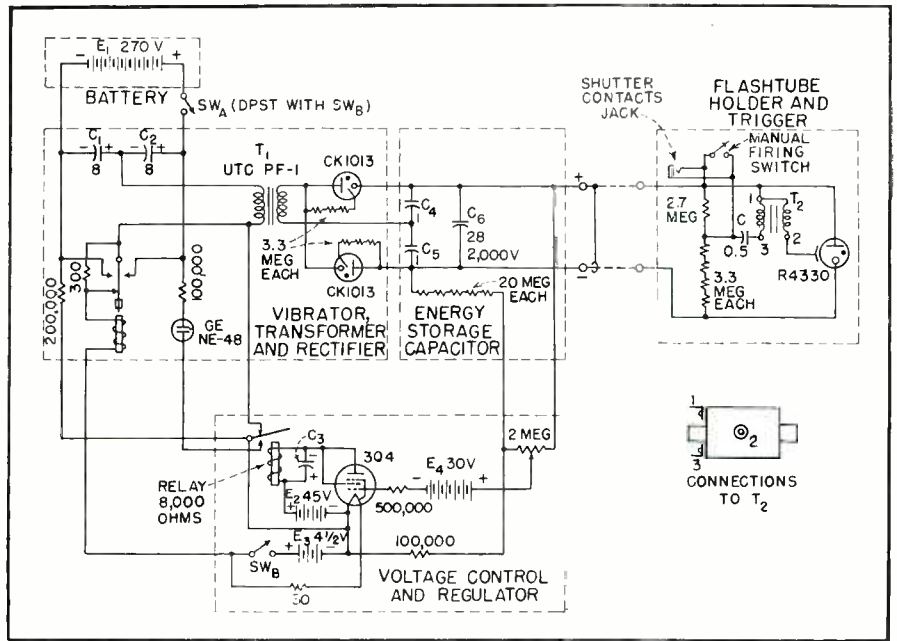

FIG. 2—Complete circuit diagram. Four 67½-volt radio batteries making up primary battery at upper left last for over 800 flashes before voltage drops below point at which regulator can maintain constant light intensity. Neon plot lamp glows to indicate that storage capacitor is fully charged

Capacitor charging time depends upon the capacitance value and the equivalent series resistance of the power supply. Experiments indicate that for charging time under 10 seconds, the primary source of energy must be capable of delivering an instantaneous peak power of approximately 50 watts at the start of the charging cycle. The rate of energy delivery drops off exponentially as the energy-storage capacitor gathers charge.

It is desirable to keep the primary current low, particularly when dry batteries are used. The use of a battery providing approximately 270 volts and an appropriate voltage-multiplying system requires only moderate battery current for reasonably rapid capacitor charging. The dry-battery-powered repeating flash unit described here incorporates such a system arranged as in Fig. 1 and connected as in Fig. 2.

The energy in the light flash is obtained from the battery shown as  $E_1$ , which consists of four Eveready No. 467 miniature 67½-volt units of the type widely used in personal-portable radios. The four batteries are connected in series to yield a nominal open-circuit poten-

tial of 270 volts. Energy from  $E_1$  is converted into light via a vibrator, transformer, rectifier, storage capacitor and flashtube.

If more economical operation is desired, five heavy-duty 45-volt units can be used. Their use will place a severe weight restriction on the device, however, and will reduce portability.

#### Vibrator Power Supply

The voltage-multiplying system employed in the flash unit is an unusual combination of vibrator, transformer and rectifier tubes. The method of establishing a flow of alternating current in the transformer primary is of particular interest. It can best be explained by reference to Fig. 3, which shows an elementary vibrator circuit of the new type and voltage waveforms at different circuit points.

It will be assumed that both similar capacitors  $C_1$  and  $C_2$  are charged to voltages  $e_1$  and  $e_2$ , the sum of which is  $E_1$ , the battery voltage. When the vibrator reed contacts the upper pole,  $C_1$  is discharged through the load resistance  $R$  while the charge in  $C_2$  is increased by current also flowing through  $R$ . Note that both charge and discharge currents

flow the same way through load  $R$ .

When the vibrator reed reverses direction and touches the lower pole, the process is reversed. Now  $C_2$  discharges through  $R$ , and  $C_1$  charges through  $R$ . In this condition the two currents are also additive, but in the opposite direction.

It can be shown that regardless of the initial voltage distribution across  $C_1$  and  $C_2$ , an equilibrium condition is reached, after a few cycles, in which voltages  $e_1$  and  $e_2$  are symmetrical. The wave shape shown in Fig. 3 is a function of the load resistance, the output voltage  $e_R$  approaching more nearly a square wave as the load resistance is increased.

Mathematical development shows that the system will have a power-transfer characteristic that may be readily computed. It is a function of  $E_1$ ,  $C$ ,  $T$ , and  $R$ , where  $T$  is the time interval in which the vibrator reed contacts either of the two poles. Assuming zero vibrator-reed transfer time, the power output  $P$  in watts is

$$P = \frac{E_1^2 C}{T} \tanh \frac{T}{4RC_1} \quad (1)$$

The vibrator frequency may be expressed as  $f = 1/2T$ , hence Eq. 1

can be rewritten as

$$P = 2fE_1^2 C_1 \tanh \frac{1}{8fRC_1} \quad (2)$$

It can also be shown that the power output approaches a maximum when the load resistance approaches zero. Then the power output is independent of  $R$  so Eq. 2 becomes

$$P_{max} = 2fE_1^2 C_1 \quad (\text{when } R \rightarrow 0) \quad (3)$$

A practical example will illustrate what to expect of a particular combination of elements. When  $f = 80$  cps,  $E_1 = 200$  volts, and  $C_1 = C_2 = 8 \mu\text{f}$ ,  $P_{max} = 51.2$  watts. This condition is closely approximated in the repeating flash unit described. The vibrator circuit is essentially a voltage halver when  $R$  is large.

In the circuit of Fig. 2, the primary winding of transformer  $T_1$  is substituted for the load resistance  $R$ . Transformer  $T_1$  is a standard readily available type normally used to step up 117 volts at 60 cycles to high voltage for photoflash work. Its turns ratio is approximately 15:1. The filament winding tap on the secondary is disregarded.

A conventional voltage-doubling system is used in the secondary circuit, employing two Raytheon type CK1013 cold-cathode rectifier tubes. This combination provides a peak voltage considerably in excess of the nominal 2,000 volts which is the normal energy-storage-ca-

pacitor voltage. The reason for this will be evident when the voltage control circuit is explained.

Main energy-storage capacitor  $C_0$  is a 18- $\mu\text{f}$ , 2,000-volt unit. This capacitance is slightly augmented by two 1- $\mu\text{f}$  capacitors in series,  $C_1$  and  $C_2$ , which are essential to the voltage doubler. The measured capacitance of the combination is 30.5  $\mu\text{f}$  in the model built by the author. At 2,000 volts the available stored energy is 61 watt-seconds.

Use of the approximate conversion relation of 40 lumens per watt for flashtubes indicates an approximate light output of 2,500 lumen-seconds. This is somewhat lower than the design objective, but it has proved adequate for black-and-white negatives of good density without resorting to special development procedure.

#### Voltage Regulator

With age and use, the closed-circuit voltage at  $E_1$  will be reduced. Unless a voltage-regulating circuit is provided, the capacitor voltage and the light output will become a function of the battery condition. One method of overcoming this disadvantage is to provide a considerably higher open-circuit rectifier output voltage than the voltage to which the capacitor is charged. The voltage-regulator circuit serves to stop the vibrator when the storage capacitor voltage  $e_c$  reaches a predetermined value. This action is shown in Fig. 4. When the capacitor voltage drops slightly, the vibrator starts and runs until the upper limit is again reached. This action maintains essentially constant voltage across the storage capacitor and also reduces the charging time by using only the steep portion of the capacitor voltage curve.

The voltage control and regulator circuit shown in Fig. 2 employs a triode-connected 3Q4 tube whose grid is overbiased by the 30-volt battery at  $E_4$  when the storage-capacitor voltage is zero. As the capacitor voltage increases, a positive potential tends to cancel the negative 30-volt grid potential. At some point, depending upon the setting of the 2-megohm potentiometer, the 3Q4 tube becomes conduc-

tive and the sensitive relay in its plate circuit operates. This stops the vibrator and makes the neon indicator lamp glow to indicate full capacitor charge. As current leaks from the storage capacitor, its voltage drops to a point where the regulator starts the vibrator again. This action is repeated until the main power switch is turned off.

Battery  $E_3$  delivers driving power to the vibrator and also lights the 3Q4 control-tube filament. A separate 45-volt battery  $E_2$  supplies plate current to the 3Q4 tube. This was done, rather than tapping  $E_1$ , to provide uniform plate voltage in the control circuit.

Careful tension adjustment in the sensitive control relay results in maintenance of voltage across the storage capacitor at 2,000 volts  $\pm$  1.25 percent. Since light is proportional to the voltage squared, it will be within  $\pm$  2.5 percent of nominal. The nominal working voltage can be controlled over a range from 1,400 to 2,500 volts by rotation of the potentiometer.

#### Flashtube and Trigger

A Sylvania type R4330 flashtube was used in the model. This was connected in a conventional trigger circuit. The bleeder resistors used in the trigger circuit are higher in value than those normally recommended, to conserve energy in the standby condition. The trigger coil, shown in Fig. 2 as  $T_2$ , is a model airplane ignition coil.

When the manual firing switch is closed or when shutter contacts close, capacitor  $C_1$  is suddenly discharged through the ignition coil primary. The secondary voltage is then high enough to start ionization in the flashtube and the energy-storage capacitor is immediately discharged through the flashtube helix. The resulting sharply peaked light flash has an effective duration of approximately 0.0002 second, which is sufficient to stop most normal action. All of the trigger-circuit components are contained in the handle of the flashtube holder.

An interesting mode of operating high-voltage flashtube devices of the type described is to trigger them by sound. Using open-flash technique in subdued light will then result in very striking pictures.

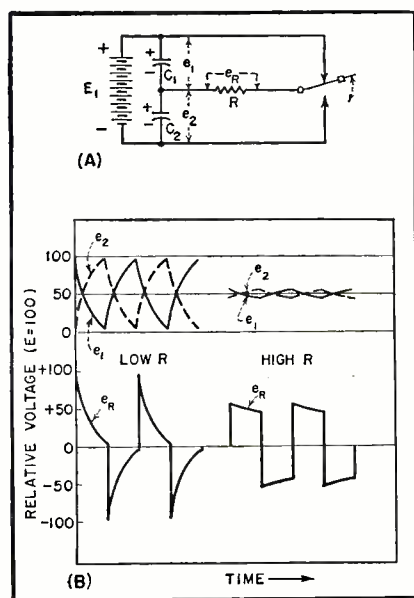

FIG. 3—Basic inverter circuit, and corresponding output-voltage waveforms. For simplicity, vibrator-reed transfer time is assumed to be zero here



For example, a bursting balloon was photographed by substituting a microphone, a small amplifier and a thyatron for the firing switch. By locating the microphone at a known distance from the source of sound, the delay between the initial sound of bursting and the flashtube triggering could be controlled.

### Circuit Performance

Because of limited time and measuring equipment, empirical methods were used to arrive at approximate integrated efficiency values for various battery conditions. It was assumed that the battery  $E_1$  and associated multiplying circuit were replaced by a hypothetical battery having  $E_m$  as its open-circuit voltage and an internal resistance of  $R_m$  ohms. It was also assumed that these values remain constant over one charging cycle; while not strictly correct, this assumption introduces only moderate error.

The input power over the charging cycle and the storage-capacitor voltage were measured. These values are plotted in Fig. 4. Then, assuming that the capacitor-voltage curve was a true exponential relation, the hypothetical voltage  $E_m$  and resistance  $R_m$  may be determined from the terminology of Fig. 4 and the relations

$$R_m = \frac{T}{C \log_e \left( \frac{e_1}{E_2 - e_1} \right)} = \frac{0.434T}{C \log_{10} \left( \frac{e_1}{E_2 - e_1} \right)} \quad (6)$$

This expression can be solved for  $R_m$  since all other values are known.

$$E_m = \frac{e_1^2}{2e_1 - E_2} \quad (7)$$

Here again, both values on the righthand side are known.

As shown in Fig. 4, an imaginary battery having an open-circuit emf of  $E_m$  volts and  $R_m$  ohms internal resistance can be substituted for the vibrator supply, to compute instantaneous and integrated efficiencies for various conditions of the battery  $E_1$ . The rate of energy transfer into the storage capacitor may be expressed as

$$p_2 = \frac{E_m^2}{R_m} \left( e^{-\frac{t}{R_m C}} - e^{-\frac{2t}{R_m C}} \right) \quad (8)$$

The integral of this curve between 0 and  $2T$  is total energy stored in

the capacitor. This area divided by the entire area under the curve for  $p_1$  yields the integrated efficiency for one flash. The curve of  $p_1$ , the power taken from  $E_1$ , is determined by measuring the closed-circuit voltage across, and the current out of, the battery  $E_1$ . Values obtained for integrated efficiency range from 30 percent for a new battery to 35 percent after 675 flashes.

A practical test of the experimental model yielded 840 flashes spaced at random over 88 days from one set of primary batteries. The maximum number of flashes in one day was 60; the minimum was 5. With fresh batteries, the charging time was 6.1 seconds. At the end of the test, the charging time had increased to 15 seconds. An unused set of batteries 11 months old will charge the capacitor to 2,000 volts in approximately 7.5 seconds. The indicated cost-per-flash ratio of this repeating flash system compared with the use of expendable lamps is approximately 1 to 10.

### Photographic Effectiveness

In taking flash pictures, it is common practice to use guide numbers. The guide number for a particular lamp, film type and shutter speed is constant, and is expressed as  $f \times d$ , where  $f$  is the effective relative aperture number and  $d$  is the lamp-to-subject distance. A published chart (General Electric Flashtubes—Technical Information, January, 1948) relates stored energy, film speed and approximate guide number. The approximate guide numbers for four Kodak films as obtained with the use of the chart are:

Film	ASA Exposure Index (Daylight)	Guide No.
Super Panchro Press (Sports)	250	120
Super XX	100	90
Plus X or Verichrome	50	60

These guide numbers have yielded good results. As a check on the validity of the numbers, the author has on several occasions taken an outdoor picture with exposure meter, an outdoor picture with a GE No. 5 expendable lamp and another outdoor picture using the experimental repeating flash unit, all on the same roll of film.

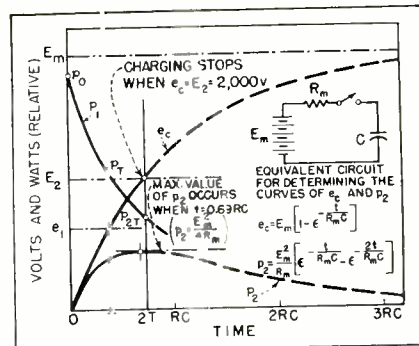

FIG. 4—Generalized performance curves for flash unit, where  $T$  is time interval during which vibrator reed is against one of its contacts

The roll was then taken to a commercial photofinisher with no special instruction as to development. Negatives of good density in each case produced very satisfactory prints. Higher guide numbers than those shown may be used by resorting to special negative development.

### Conclusions

The experimental model fulfilled most of the design objectives. It would be relatively simple to adapt the device to line as well as battery operation by tapping the secondary winding and switching out the voltage-regulator circuit, for the transformer primary is designed for 117-volt 60-cycle line operation.

As built, the unit has commercial limitations, chief of which is its marginal light output. More stored energy would be desirable, but this poses another problem, for the charging time is close to the maximum tolerable limit with the present energy-storage capacitor. As built, the unit is usable with shutters having built-in X-type synchronizer contacts. It cannot be used, unless modified, with solenoid-type shutter trippers.

Not enough work has yet been done with the experimental model to justify any conclusions regarding its effectiveness with color film. The light available is marginal, unless the lamp-to-subject distance is kept small.

The writer wishes to acknowledge the assistance rendered by Raytheon Mfg. Co., Sylvania Electric Products Co. and General Electric Co. in supplying some of the components and design information used in this article.

# Television Field

Procedure used at television broadcast station WEWS to meet FCC proof-of-performance requirements for all holders of construction permits. Methods of running radials, plotting median values of signal intensity, and determining elevation profile

**E**ACH holder of a construction permit for television broadcasting is required to make proof-of-performance field intensity measurements before a station license is granted by the Federal Communications Commission.

Continuous recordings of measured field intensity must be made along at least eight radials. Routes taken by the measuring car must follow, as closely as possible, the radials which were submitted with the application for a construction permit. The chart recordings must be analyzed and the distance to the 5,000 and 500-microvolt-per-meter contours determined from the measurements. The FCC must be furnished with a complete description of the measuring procedure which includes: method of making measurements, sample recordings, plot of the median values versus distance for the several radials, routes over which the field intensity measurements were made and the intervals for which median field intensity values were determined. A summary of the tests and the results thereof must be submitted in order that it may be determined if the effective radiated power, visual

**By J. B. EPPERSON**

*Chief Engineer  
Scripps-Howard Radio, Inc.  
Cleveland, Ohio*

and aural, is in accordance with the values specified in the construction permit.

## Making the Field Survey

Continuous recordings of field strength for radio station WEWS were made along eight radials as specified in the FCC *Standards of Good Engineering Practice*. These radials followed, or paralleled, the theoretical radials as closely as possible. Recognized measuring equipment was used with a recording device that was driven directly from the speedometer of the station wagon in which the equipment was mounted.

Measurements were made with a chart speed of approximately five inches per mile. Where possible the car was driven at a uniform speed of 30 miles per hour. Locations and speedometer readings were marked on the chart at frequent intervals to fix the relation between the measured field intensity and the location. A sensitive aneroid altimeter was also mounted

in the measuring car and altitudes were marked on the chart as desired. Since the altimeter operation depends upon barometric pressure it can not be expected to give continuously accurate altitude readings. Recording the altitudes did, however, prove to be helpful in analyzing the tapes. If certain recorded signal levels appeared too high or low it was usually found that the altitude variations accounted for the change. Measurements were made to a point on each radial which was well beyond the 500 microvolt-per-meter contour except where Lake Erie intervened.

Station WEWS operates on channel 5 (76 to 82 mc) with a radiated power of 16.3 kw video and 8.15 kw aural. The transmitter is rated at 5-kw peak power and operates into a three-section Super-Turnstile antenna which is triplexed with WEWS-FM. The f-m carrier operates on 102.1 megacycles with a radiated power of 10.3 kw. Rated power gain for the antenna is 3.8 for channel 5 television and 4 for 102.1 f-m. The transmission-line efficiency is 88 percent. The effective height of the antenna above average terrain from two to ten miles is 642 feet. Effective height above mean sea level is 1,526 feet.

All measurements were made while the transmitter was operating at authorized 5-kw peak power with either picture or sine-wave modulation. The output power was determined by measurement into a water-cooled load. A suitable peak-to-average power-correction factor, obtained by measurement, was used to determine the true peak field intensity for the television signal.

The field car is a wooden station wagon modified for the installation of a recording field set and receiving antenna. The field set and the

## PROOF OF PERFORMANCE

**REQUIRED:** Find the distance from the television station to the 5,000 and 500 microvolt per-meter contours. Photostats of all basic data must be submitted to the FCC in affidavit form.

**FIELD MEASUREMENTS:** Continuous recordings of field strength from a carefully adjusted transmitter along a minimum of eight radials, with careful checking of location by map and land marks

**COMPUTATION:** Plotting corrected median values of signal strength against airline distance by sectors (not less than 15 sectors for each radial). Plotting calculated field intensity for each radial. Plotting elevation profile (shown for sector midpoints) against same airline distance scale. Finding average elevation of terrain between two and ten miles from transmitter

**EQUIPMENT:** Car or truck with standardized antenna; calibrated receiver and field-strength meter (the two may be combined); continuous-chart recorder driven from the speedometer shaft; altimeter (optional); FCC *Standards of Good Engineering Practice Concerning Television Broadcast Stations*; USGS Topographical Quadrangle sheets; Sectional Aeronautical Charts

# Intensity Measurements

recorder are mounted on a heavy table. Vibrations while driving serve to advantage in keeping the recording pen free from drag against the paper tape. The Measurements Corp. uhf noise and field strength meter, model 58, used is a laboratory-type, five-band superheterodyne receiver with gain

standardized at a fixed value. To insure accuracy the instrument possesses a self-contained calibration circuit, a preselector stage having high image rejection, a balanced-to-ground attenuator network and provisions for obtaining either peak or average measurements. The average measuring position

was used at all times due to the high susceptibility of the peak measuring position to ignition noise and other electrical disturbances.

A horizontal dipole antenna was used for all measurements. Special authority was obtained from the FCC for use of a dipole antenna since nondirectional antennas gave insufficient signal-to-noise ratios in low signal areas.

The recorder, an Esterline-Angus type AW with suitably damped movement, was driven through reduction-gear boxes from the speedometer drive shaft.

Calibration of the field intensity meter was made frequently in accordance with the operating instructions furnished by the manufacturer of the instrument. Such calibration is accomplished by applying a voltage of known magnitude to the input terminals of the r-f amplifier and adjusting the receiver gain until the output meter reads a particular value. The stand-

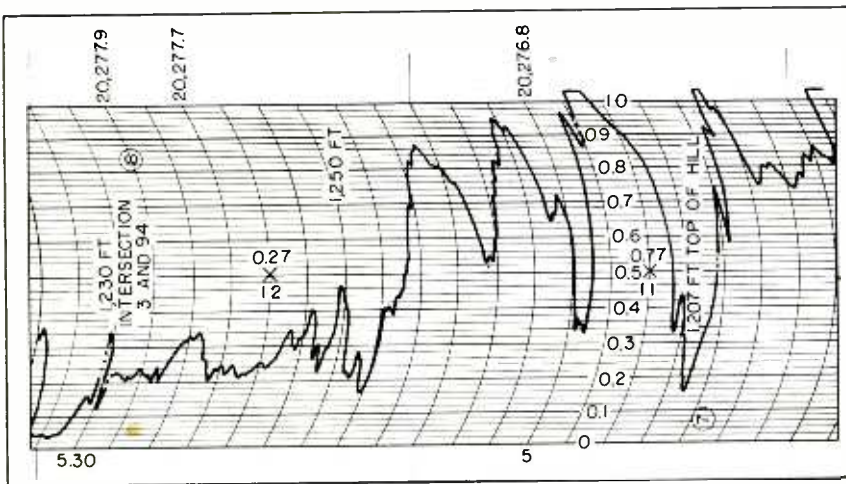

FIG. 1—Portion of recorded chart with field information, marked off into two sectors for analysis

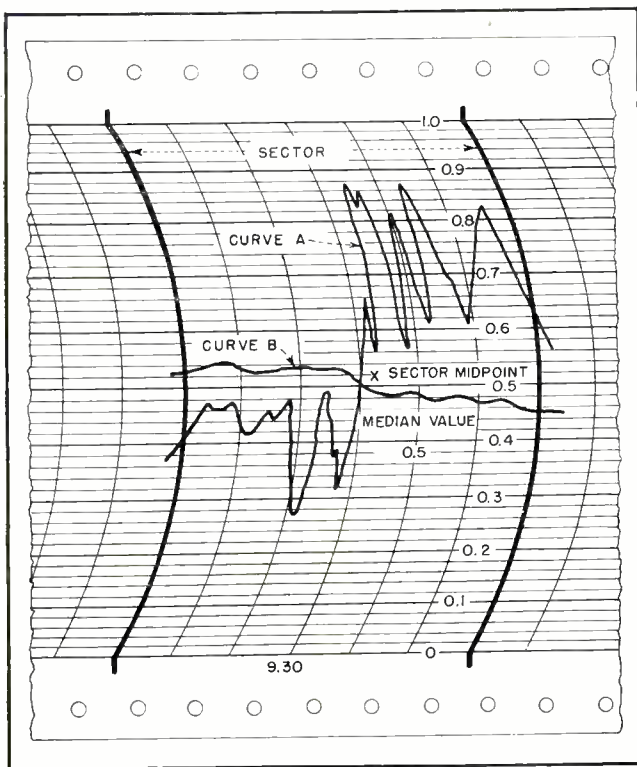

FIG. 2—Sample chart with two curves drawn to exhibit median values of 0.5 within one sector

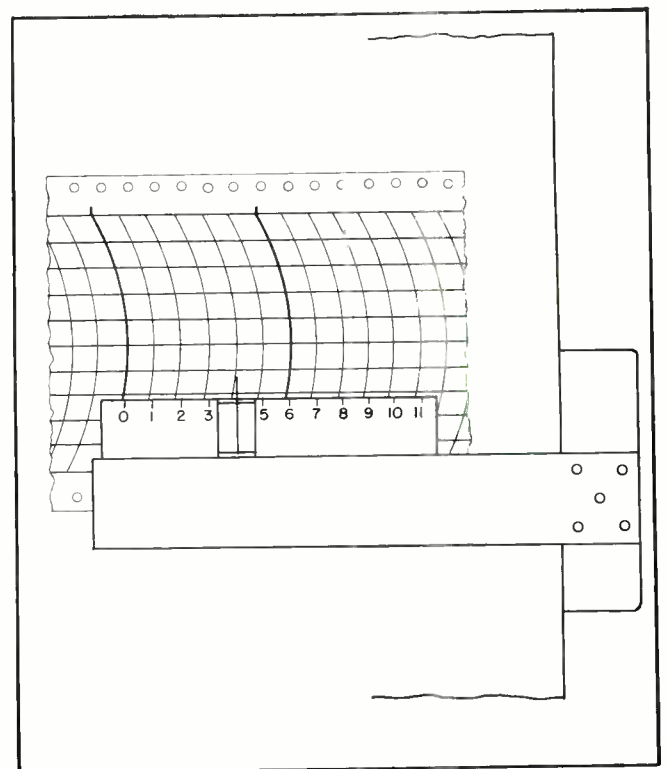

FIG. 3—Modified slide rule used for quickly determining median values by summation

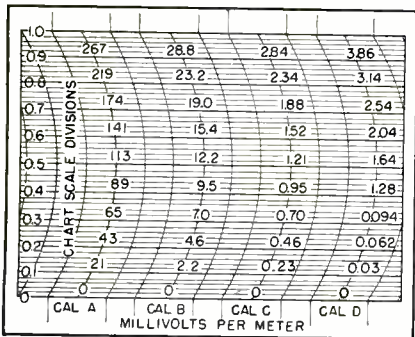

FIG. 4—Chart calibration for different attenuator settings

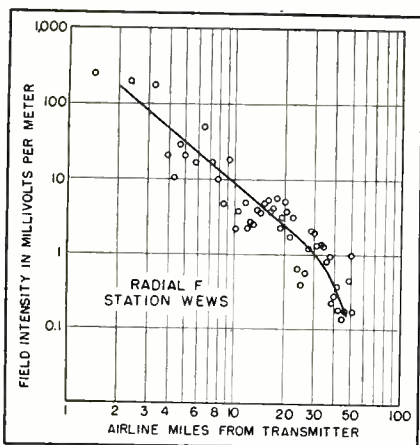

FIG. 5—Field intensity plotted against airline distance

ard signal level source in the field meter is provided by a shot-noise diode.

In order further to insure accuracy of calibration, the field meter was sent to the National Bureau of Standards for certification. All correction factors submitted by that agency are reflected in the final field strength values chartered for field intensity versus distance.

Calibration measurements made in the field revealed that the dipole antenna mounted on the station wagon had the same gain as the standard dipole antenna adjusted to 77.25 megacycles. Therefore, the conversion factor between the recording antenna and the standard dipole furnished with the instrument is a factor of unity.

The height of the receiving dipole, as installed in the station wagon, was 10.5 feet. Field intensity readings were multiplied by 2.86 to convert to an equivalent 30-foot antenna height. Use of this factor assumes that the field strength increases in a linear manner with height in accordance with theory. This assumption is not strictly valid but the FCC approved the use of

2.86 in the absence of any more definite or proven conversion factor.

All recordings were made while driving away from the transmitter. The dipole antenna was positioned at all times for maximum response. The station-wagon position, as determined by field checks, had no measurable effect on antenna gain while making the radial recordings. This condition held even when the station wagon was driven at right angles to the radial measured.

The field intensity meter was set up at a fixed location and used to measure the relative field intensities for various conditions of transmitter operation. A factor of 1.26 was found necessary to convert from the field intensity reading obtained when receiving a 1,000-cycle sine wave plus synchronizing pulses, (or normal picture modulation) to the field intensity reading corresponding to the peak radiated power output of 16.3 kw. The conversion factor is the average of five separate measurements.

Using the National Bureau of Standards calibration, and considering the peak-to-average factor plus the antenna height conversion factor, the following equation is applicable to the measurements taken on WEWS at 77.25 megacycles.

$$V = KM (1.26) (2.86) / F \quad (1)$$

When  $V$  = field intensity in microvolts per meter

$K$  = corrected value of attenuator (NBS)

$M$  = corrected value of meter reading (NBS)

$F$  = 0.96 field intensity factor (NBS)

1.26 = peak-to-average conversion factor.

2.86 = 10.5 - to - 30 - foot antenna conversion factor.

Upon completion of the measurements, each recorder chart was divided into sectors. Sector lengths for the first 20 miles were 1 mile and from 20 miles to the end of the radials the sectors were two miles long.

Figure 1 shows a sample recording with two sector divisions. The X points 11 and 12 represent the midpoints of the two sectors which are approximately one mile each in length. The figures 0.77 for 11 and 0.27 for 12 represent the 50-percent median field intensity values for these two sectors.

#### Determining Median Values

The distinction between median and average should be clearly understood. Median refers to a point midway in position. As used in the chart analysis, median represents the horizontal line along the chart which has as many points below as there are above it. In determining median values, therefore, it is necessary to determine not equal areas above and below a given line but an equal number of points above and below a given line.

In Fig. 2 the curves A and B each have a 50-percent median value of 0.5 in terms of the recorded chart scale because each

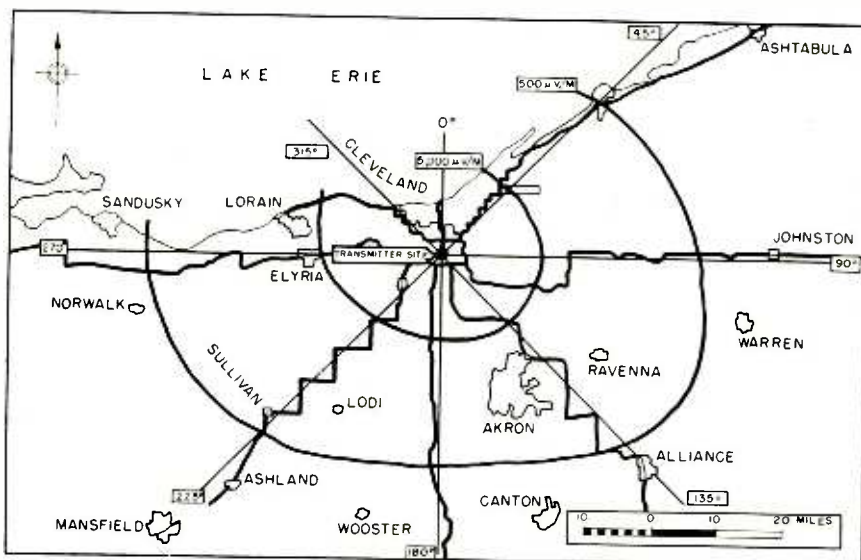

FIG. 6—Skeleton map of area served by WEWS, showing radial routes of measurement car and important signal contours

curve crosses the 0.5 chart line only once and this at the sector midpoint. In other words, for 50 percent of the time the two curves are above the 0.5 line and 50 percent of the time they are below it. In analyzing the recordings to determine the 50-percent median field it becomes necessary to locate that horizontal line which has the curve below it for half the time and above it half the time. By inspection, a line is taken that appears to be approximately correct. Then a test is made to determine whether or not this line represents the correct value.

If, throughout the entire sector, the recording curve is above the line in question for just half the time, the correct value has been estimated. If not, another try must be made and the process repeated. This summation process can be done by sliding a sheet of paper along the proper chart line, making successive marks on the paper to add the various short line lengths. Dividers might be used in like manner. Both of these methods are tedious and subject to inaccuracies. The writer devised a satisfactory median calculator from a 25-cent slide rule as shown in Fig. 3. A hairline indicator about  $\frac{3}{4}$ -inch long is fastened to the cursor of the slide rule at right angles to the rule length. When used in conjunction with a T-square the slide rule can easily be moved along any chart line. As the hairline indicator guides the cursor along the small line-lengths to be added, the top side of the rule provides a reference for the summation process. The rule should be calibrated in chart scale divisions.

The field intensity in each chart sector for all recording tapes was analyzed to determine the median field and this field intensity was associated with the corresponding sector of the radial. The chart scales were converted to millivolts (rather than microvolts) per meter by reference to separate calibration curves for each attenuator step. The calibration curves took into account all of the correction factors shown in Eq. 1. During the field recordings a note was made on the chart whenever the attenuator step was changed. When the tapes were

Table I—Radial F., Southwest 225 Degrees

Sector	Elevation in Feet at Sector Midpoint	Airline Miles from Transmitter	Median Field Intensity in mv per m Corrected for 30-foot Antenna	Location
1	1,000	1.45	248	Rt 3 at Pleasant Valley
2	1,140	2.35	200	On Rt 3
3	1,260	3.25	175	Rt 3 & Wallings Rd
4	1,140	3.92	21.0	On Rt 3
5	1,010	4.35	10.6	On Rt 82, North Royalton
6	890	4.70	29.3	Rt 82 at York Rd
7	880	5.00	21.0	On Rt 82
8	820	5.90	15.4	Rt 82 & W 130th St
9	900	6.55	50.0	On Rt 82
10	930	7.40	16.7	Jct Rt 82 & 42
11	970	7.96	10.0	On Rt 42
12	1,020	8.65	4.80	On Rt 42
13	1,220	9.3	18.6	On Rt 42, Cuyahoga-Medina County Line
14	1,150	10.15	2.30	On Rt 42
15	1,190	10.65	3.65	On Rt 42
16	1,120	11.46	4.80	Jct Rt 42 & 303
17	1,048	11.95	2.30	On Rt 303
18	993	12.6	2.79	On Rt 303
19	880	13.22	2.64	On Rt 303 CL & W RR
20	840	13.86	3.85	Jct Rt 303 & 252
21	840	14.48	3.70	On Rt 252
22	880	15.25	4.38	On Rt 252
23	900	16.10	5.30	On Rt 252
24	940	16.55	3.85	CL & W RR on Rt 252
25	970	17.19	4.10	On Rt 252
26	983	18.29	5.55	Jct 252 & 18. Mallet Creek
27	990	18.89	2.30	On Rt 18
28	1,018	19.55	3.20	On Rt 18
29	1,043	20.25	5.10	On Rt 18
30	1,035	20.75	3.85	On Rt 18
31	1,020	21.65	1.80	Jct 18 & 76, Litchfield
32	1,060	22.7	3.16	On Rt 76
33	1,100	21.0	0.68	On Rt 76
34	980	25.4	0.42	Jct Rt 76 & Rt 162, Chatham
35	860	26.75	0.58	On Rt 162
36	900	28.05	1.21	Jct Rt 162 & 301, Spencer
37	940	29.36	2.11	On Rt 301
38	1,011	30.46	2.06	On Rt 301
39	1,060	31.83	1.38	Jct Rt 301 & 224, Homeville
40	1,100	33.21	1.42	On Rt 224, Medina-Ashland County Line
41	1,120	34.5	1.33	On Rt 224
42	1,150	35.48	0.85	Jct Rt 224 & 58, Sullivan
43	1,214	37.3	0.96	Jct Rt 58 & 89
44	1,170	38.82	0.23	On Rt 58

Table II—Summary of Measurements

Radial degrees	Bearing in degrees	Average Terrain Elevation in Feet	Antenna Elevation Above Average in Feet	Distance To 5 mv per m Contour in Miles		Distance To 0.5 mv per m Contour in Miles	
				Computed	Measured	Computed	Measured
A	0	695	831	20.4	Lake E.	44.5	Lake E.
B	45	805	721	18.5	14	42.4	33
C	90	835	691	18.4	15.2	40.9	39.2
D	135	1,025	501	16.0	15.0	39.5	41
E	180	1,150	376	14.5	12.6	34.0	32
F	225	965	561	16.8	13.6	33.5	38.5
G	270	825	701	18.7	18.0	41.5	45
H	315	770	756	19.5	Lake E.	42.5	Lake E.

divided into the one and two-mile sectors care was exercised to see that sector divisions did not overlap between attenuator settings. This condition, of necessity, caused some sector lengths to vary from the normal one or two-mile divisions.

A summary of the recording chart calibrations is shown in Fig.

4. For making the actual conversions, separate graphs of chart scale readings versus field strength in millivolts per meter were used for each attenuator setting. These charts were plotted on linear graph paper.

After median values were determined for all sectors for each of the

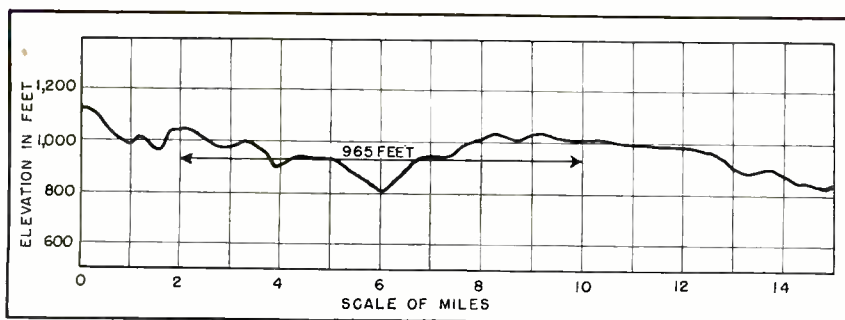

FIG. 7—Actual profile along radial F plotted from map elevations

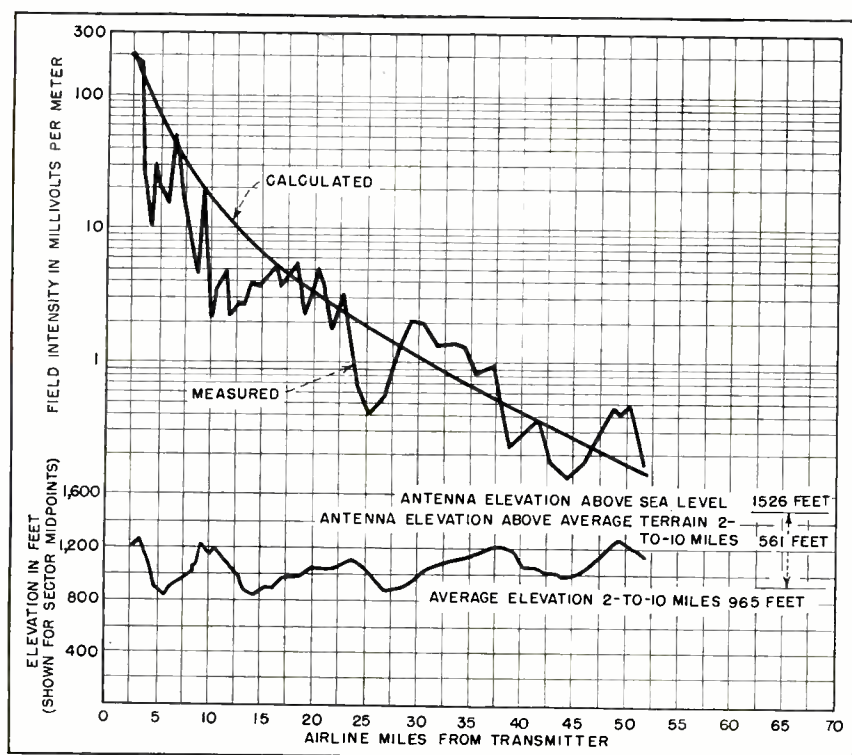

FIG. 8—Final summation of field strength information as presented to FCC. Elevation based on sector midpoints is plotted against distance

eight radials, the routes followed by the measuring car were plotted on USGS Topographical Quadrangle sheets and each sector midpoint was marked and identified by number. Airline distances were determined from this map. The elevation taken at sector midpoints gave a better correlation with field strength values than did those plotted along the car route, or along the theoretical radial.

Airline distance from transmitter to sector midpoint, elevation at the sector midpoint, median field intensity in millivolts per meter and location along the routes were tabulated as shown in Table I for radial F. Similar tabulations were made for the other seven radials. Median points (sector midpoints) were plotted for each radial on logarithmic  $7 \times 2.2$ -cycle K&E 369-

127G paper and a smooth curve drawn between the points. Figure 5 shows the curve for radial F. Field intensity is plotted in millivolts per meter versus airline miles from transmitter. The distance to the 5 and 0.5 millivolt-per-meter contours for each radial was read from these curves and used to draw the contour lines shown in Fig. 6. This map also shows the routes used with respect to the theoretical radials. Table II shows a summary of measurements that gives an interesting comparison of the distance to the 5 and 0.5 millivolt per meter contours for each radial, both measured and computed, the latter values being based on the FCC ground-wave signal chart. The profile along the F radial as plotted from map values, and shown in Fig. 7, was used in determining the

2 to 10-mile average elevation.

Figure 8 shows the median points plotted for field intensity in millivolts per meter versus airline miles from the transmitter. These curves show a comparison of the theoretical signal strength, (based on the two to ten-mile average) with the measured signal strength. Elevation is shown for sector midpoints. The field intensity portion of these curves is plotted on K&E 359-81LG semilogarithmic paper, 4 cycles  $\times 10$  to the inch, 5th lines accented. The elevation portion is plotted on K&E 359-11L linear paper,  $10 \times 10$  to the half inch, 5th lines accented. The two sections were joined together with rubber cement. In the preparation of the final photostats for submission to the Commission a film negative was made of each chart, which could be used for making either photostats or blueprints. The photostatic process allowed a reduction of the charts to notebook size and permitted easy correction of any inking errors. Where an inking error occurred a new piece of graph paper was pasted over the old and the lettering redone. However, if desired, the graph paper used and referred to here by number can be used as a direct negative for making blueprints.

A period of three months was required for analysis of the tapes and preparation of the necessary FCC engineering exhibits. Approximately 1,000 miles of driving over northern Ohio roads was made by the field measuring car. For the f-m survey another 1,000 miles of driving was required since independent measurements were made on the f-m transmitter fields. Good correlation was obtained between the f-m and television recording tapes.

The field survey and analysis described in this paper was made under the general supervision of the writer. R. K. Olsen, chief transmitter engineer for WEWS and WEWS-FM, assisted with the field work and the tape analysis. Carl E. Smith and Thomas B. Friedman, consulting radio engineers of Cleveland, were engaged to make the continuous-tape field measurements, assisted by either Mr. Olsen or the writer.

# Heterodyne Eliminator

Beat-note interference is attenuated by means of a frequency converter which inverts the numerical order of all frequencies either side of a desired carrier and places the off-frequency interference on the cut-off side of an asymmetrical filter

By **J. L. A. McLAUGHLIN**

*La Jolla, California*

**O**VER-CROWDING of the radio-frequency spectrum has led to the development of a number of signal-separating devices for use in conjunction with standard communications receivers.

The unit described in this article is capable of high attenuation of interference close in frequency to that of a c-w or modulated carrier, with no loss in transmitted intelligence. The system has been employed extensively in radio intelligence work where standard communication receiver selectivity proved to be inadequate.

## Principle of Operation

This particular type of heterodyne eliminator is known as an asymmetrical off-frequency inverter, and is suitable for both phone and c-w reception. The circuit diagram, excluding power supply and audio amplifier, which are conventional, is shown in Fig. 1.

The unit is suitable for use with a communications receiver having an i-f of approximately 455 kc. No receiver realignment or circuit changes are required. The inverter is connected to the receiver by a small coaxial cable, the end of which has an insulated loop. This loop is placed over the plate pin of the first i-f amplifier tube and the tube replaced in its socket.

The block diagram, Fig. 2, illustrates the functions of the elements employed. The front end of the system is the off-frequency inverter (mixer), which consists of two crystal-controlled oscillators either of which will convert the desired carrier to a frequency of 50 kc.

When the oscillator lower in frequency than the desired carrier is

employed the numerical order of all off-frequencies will remain unchanged. However, when the oscillator higher in frequency is substituted the numerical order of the converted off-frequencies will be inverted. Should the desired carrier be off the center frequency a positive amount in the first case, this error will appear negative in frequency by the same amount in the second case. This holds true for all frequencies off the symmetrical center frequency of the system.

## Filter Design

An asymmetrical high-pass filter is connected to the output of the

off-frequency inverter. When an undesired carrier is present in the high-pass side of the filter, it can be frequency shifted to the cut-off side by switching oscillators, whether or not it originally was above or below the desired carrier frequency. In the case of a phone signal, one side of this asymmetrical filter's selectivity is suitable for attenuation of off-frequencies close enough to produce beat-notes and yet broad enough on the other side to permit the passing of speech frequencies without attenuation. This passband can of course be extended to permit high-fidelity reception.

Toroidal coils make possible the design of a compact high-pass filter



Two views of complete unit, including power supply and two-stage audio amplifier

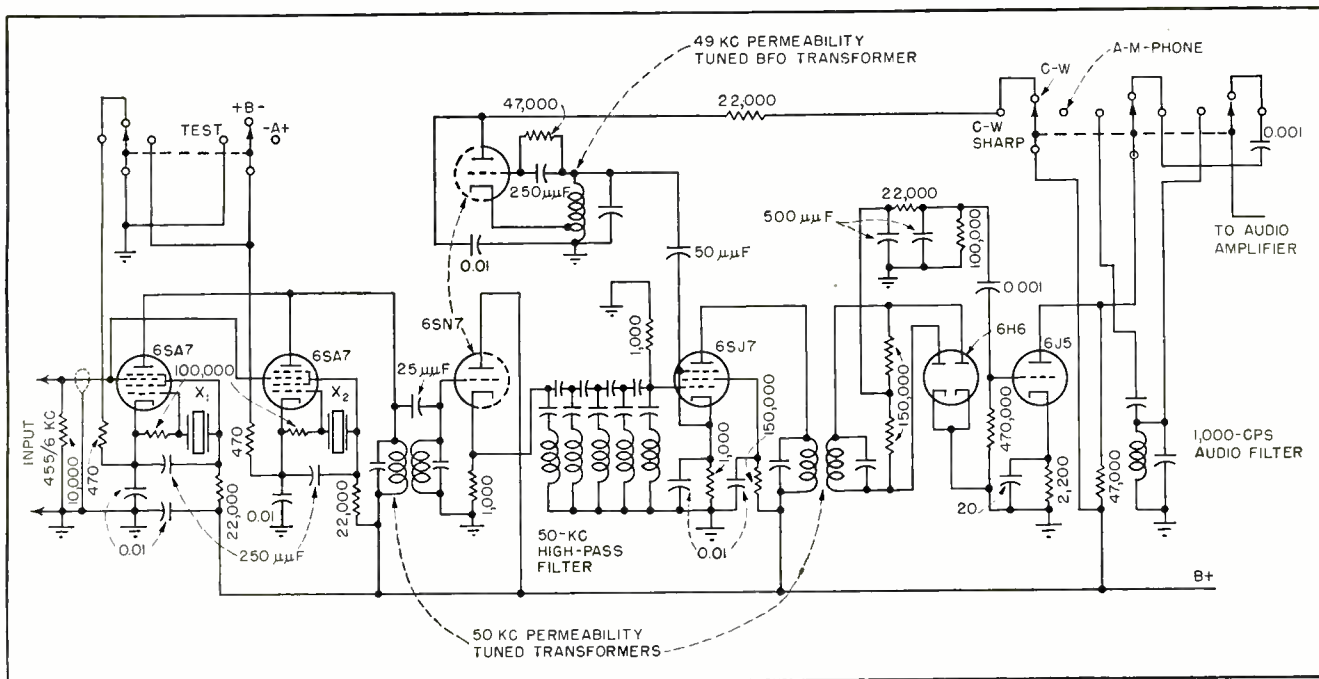

FIG. 1—Schematic diagram of off-frequency inverter. Crystals  $X_1$  and  $X_2$  operate 50 kc above and below the  $i-f$  frequency

with attenuation characteristics suitable for this service. The unit used is sealed in a  $2\frac{1}{2} \times 2\frac{1}{2} \times 4$ -inch case. The desired high-pass attenuation characteristic is supplied by two medium-Q 50-kc transformers. They also supply sufficient attenuation to reduce the return peaks on the cutoff side of the fixed high-pass filter.

The high attenuation in the cutoff side of the asymmetrical filter also supplies the selectivity needed for elimination of the audio-frequency image inherent in heterodyne c-w reception. The overall frequency response curve of this filter is shown in Fig. 3. The beat-frequency oscillator is preset at 49 kc to produce with the desired signal an audible beat-note of 1,000 cycles. The audio-frequency image will therefore result from a signal of 48 kc. It will not be heard, since this frequency is down more than 100 db.

The actual value of attenuation of the heterodyne beat-note will depend on the rectifying action of the detector. This action will be influenced by the relative strength of the two signals appearing at the detector's input. Under normal receiving conditions, rectifying action of the detector with regard to the desired signal will be linear. However, in the case of the audio-frequency image the high attenua-

tion of the filter will weaken this signal's energy to a point where the detector's action becomes square law. These factors must be considered in evaluating the attenuation of beat-note interference both in c-w and phone reception.

To achieve the selectivity required for c-w reception, a sharply peaked audio filter after detection is more practical and economical than attempting to obtain this selectivity in the 50-kc filter. If this filter is made asymmetrical, signal frequencies can be inverted here as in the first filter by switching the off-frequency inverter oscillators in the front end of the system. Figure

4 shows the response curve of a commercial 1,000-cycle filter suitable for this use. It has an attenuation of approximately 40 db per octave, which makes its asymmetrical frequency characteristics 2-to-1 in db. In other words, an interfering signal 200 cycles above the frequency of the desired one will produce a beat-note of 1,200 cycles in one off-frequency switch position with an attenuation of 10 db. In the opposite switch position the beat-note is changed to 800 cycles and an attenuation of approximately 20 db is achieved. This 2-to-1 asymmetrical filter gives high selectivity with good economy.

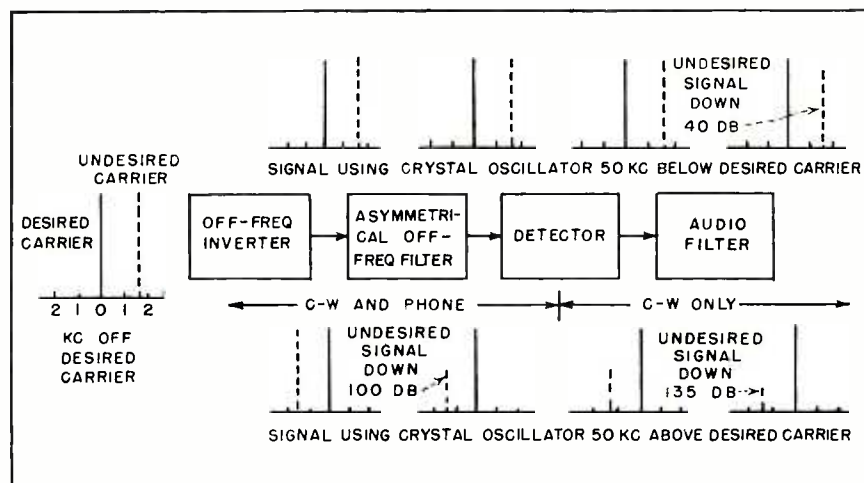

FIG. 2—Simplified block diagram of heterodyne eliminator showing effects of circuit components on undesired carrier with and without off-frequency inversion



It is well known that extremely selective circuits have a tendency to ring on c-w signals, which destroys their usefulness. An asymmetrical filter, however, will provide considerably more useful selectivity before this ringing state is reached.

#### Tuning Technique

The tuning of a c-w signal on an asymmetrical off-frequency inverter receiver is simpler and faster than on a conventional type.

The asymmetrical off-frequency inverter eliminates the need for two variable c-w controls found essential in communications receivers for elimination of the audio-frequency image and off-frequency interference. (The variable BFO and the crystal filter phasing control). The phasing control provides a form of asymmetrical response. Because the standard communications receiver lacks the ability to invert off-frequencies, it is necessary in the presence of interference in the broader side of the crystal filter, to move the phasing control

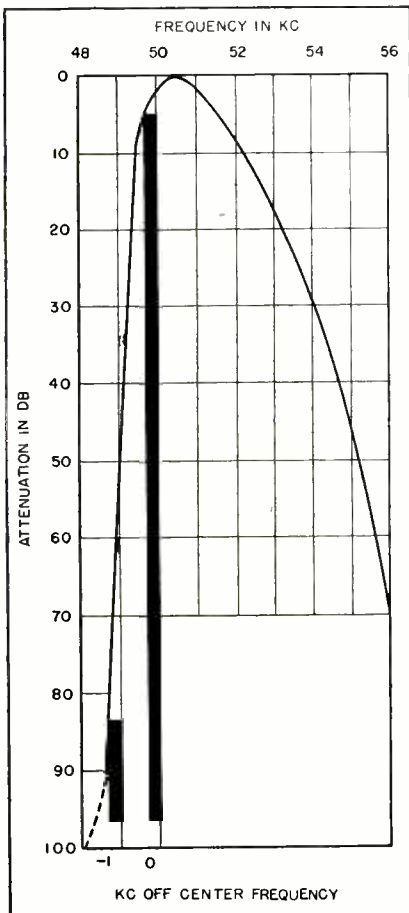

FIG. 3—Frequency response curve, showing attenuation of off-frequencies

to this side for attenuation. These variable adjustments are superfluous in the asymmetrical off-frequency inverter system.

The usefulness of the system for phone reception in the presence of interference is obvious. However, to be practical a sound tuning technique for location of the desired phone signal's carrier in the correct position of the asymmetrical filter has to be employed. In some earlier models, suitable for high-fidelity reception, a tuning indicator connected to a sharply peaked 50-kc carrier amplifier was employed. Another scheme which suggested itself was the use of a locked-in oscillator to supply an exalted carrier. Such devices are commonly employed in single-sideband communication, where channel separation is sufficient to preclude heterodyne interference. However, in the type of work we are more interested in, where communication is always imperiled by off-frequency interference, the exalted-carrier system proved impractical. Too often the close-in off-frequency interference takes control of the locked-in oscillator, destroying its usefulness.

The tuning of a desired phone signal in present models is by aural means. When no interference is present the desired signal is tuned to maximum response and intelligibility as in normal receiver practice. This is made possible by peaking the nose of the response curve. By rocking the tuning control slightly the operator can sense the cut-off side of the filter by the rapid attenuation feel of this side, compared to the other. The correct location of the carrier (50 kc) will of course be toward this cut-off side, slightly below peak response. A good operator will, with practice, be able to hit this point with high accuracy. However, a tuning error of plus or minus 500 cycles is permissible.

#### High-Precision Tuning

A test position is provided on the off-frequency inverter switch for high-precision tuning of the desired carrier when necessary. In this position both oscillators are employed, which will produce two signals moving in opposite directions

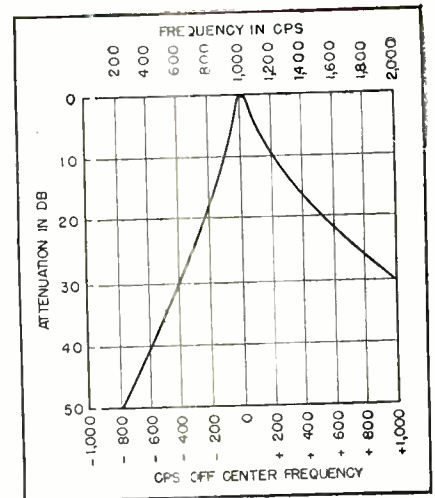

FIG. 4—Frequency response curve for 1,000-cps audio filter

as the receiver is tuned. The difference between the two signals will be heard as a beat-note, and the correct carrier position will be indicated at zero-beat.

The tuning technique in the presence of a heterodyning beat-note is quite simple. With the off-frequency inverter switch in one position and the receiver tuned to maximum beat-note interference, the opposite switch position will remove the heterodyne. Since the side the interference was originally on, with respect to the carrier, may be in doubt, this procedure should be followed in both switch positions. When the correct switch position for greatest attenuation is found, a slight detuning will give further attenuation, particularly if the beat-note interference is low in frequency.

Figure 3 shows the increase in attenuation to low frequencies a slight detuning of the desired carrier towards the cut-off side achieves. The left hand edge of the solid line at 50 kc indicates a frequency shift of the carrier of approximately 300 cycles. At this point the carrier will be down 5 db. The bottom of the curve illustrates the increase in attenuation this small frequency shift gives a signal 1 kc removed from the desired carrier. Thirty-db greater attenuation has been realized. Frequencies closer to the carrier than 1 kc will receive proportionate improvement in attenuation. Frequencies below the voice range can be satisfactorily attenuated in the a-f amplifier.

# Vibration Testing

Electronic techniques that can be applied to complete airplanes, accessory equipment and structural parts on the ground to simulate vibrations encountered in flight, and methods of measuring, recording and analyzing intensity and frequency of resulting motions

By **ABNER R. WILLSON**

*Group Engineer, Vibration Laboratory  
Boeing Airplane Co., Seattle, Wash.*

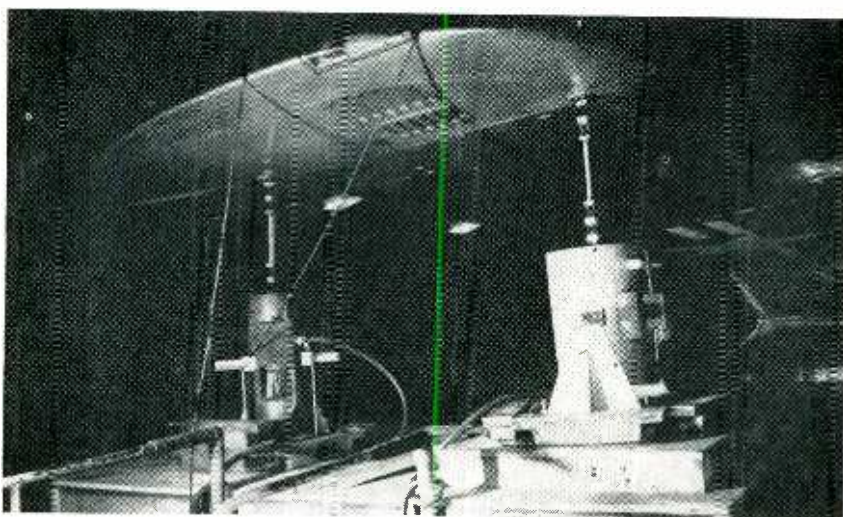

Setup for vibrating wing of airplane. Large vibrator is attached near wing tip, at front spar, and small vibrator is attached at rear spar

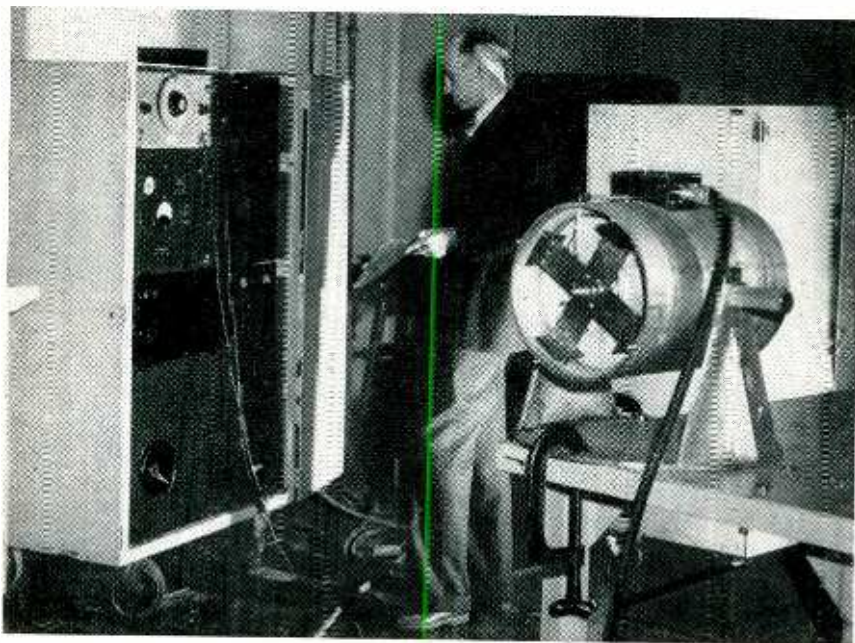

Electronic power source and one of vibrator units (clamped to table) used to simulate vibration stresses and strains an airplane would encounter in flight

**I**T IS THE GOAL of an airplane manufacturer to have his accidents in the laboratory rather than in the air. Vibration is recognized as the cause of many failures and malfunctions, and is attaining more importance with each increment of airplane weight and speed.

The low-frequency vibrations of the main structural members and the possibility of dangerous flutter caused by mechanical coupling of their several frequencies are prime factors in an airplane's safety. Low frequency is defined as frequencies ranging from 0.5 to 50 cps.

The elimination of higher-frequency vibrations at high g's is also imperative for reliable operation of controls and other functional equipment such as relays, valves, ducts, coupling hoses, racks and radio equipment.

It is recognized that fatigue resulting from vibratory forces requires structural members to be several times as strong as is necessary for static loads alone. While the safe static working load of an aluminum alloy member may be upwards of 30,000 lb per sq in., the same member will fail in a few hours if working under half this load while vibrating at large amplitudes. The magnitude of vibration is often expressed as  $g = 2 \times \frac{f^2}{19.56}$ , where  $g$  is the acceleration expressed as multiples of the acceleration of gravity,  $2 \times$  is inches of double vibration amplitude (peak to peak), and  $f$  is the frequency in cps. Amplitudes needed at various frequencies to produce g's from 0.01 to 192 are plotted in Fig. 1 to

# of Airplanes

emphasize the exponential nature of this relationship. Note that at 500 cycles the vibration of less than 0.001 inch is sufficient to give 10 g's, whereas at 10 cycles the vibration must be about 2 inches to produce the same acceleration.

Values of  $g$  for fatigue testing of equipment to be installed at various locations in a large airplane are also shown in Fig. 1. The entire frequency range specified for each area should be explored for resonance, and endurance testing should be conducted at the resonant frequencies. Note that resonant frequencies for torsion are generally higher than those for bending.

Resonant frequencies of the principal structural parts of a typical modern large airplane are given in Table 1, as obtained from recorded results of vibration tests. The resonant frequencies of control and auxiliary equipment may be much higher, ranging from 50 to 500 cps.

## Types of Vibration Testing

There are three general types of vibration testing. Fatigue vibration testing is used to establish the comparative lives of various materials and structural components under various frequency and load conditions. Vibration testing of structural components, control surfaces and controls is used to determine resonant frequencies and vibration amplitudes and to investigate the probability of a dangerous flutter condition caused by dynamic mechanical coupling. Vibration testing of auxiliary equipment is used to determine operating characteristics under simulated airplane vibration conditions. These tests also determine whether or not shock mounting is necessary.

In fatigue testing, the load and frequency are held constant and the test specimen is kept vibrating until failure occurs. This procedure is repeated for enough different loads to permit plotting a curve of load vs the total number of cycles

before failure of the test specimen.

One end of the test specimen is fastened to a vibrating beam and the other end is fixed, as shown in Fig. 2. The load on the specimen is adjusted by changing the tension on a spring or changing the weight on the beam. The beam may be

actuated by an electromagnetic transducer that is self-synchronous, with a pickup attached to the beam. The electromagnetic drive is required to furnish only the losses in the vibrating system, consequently five or six thousand pounds of vibrating load may be

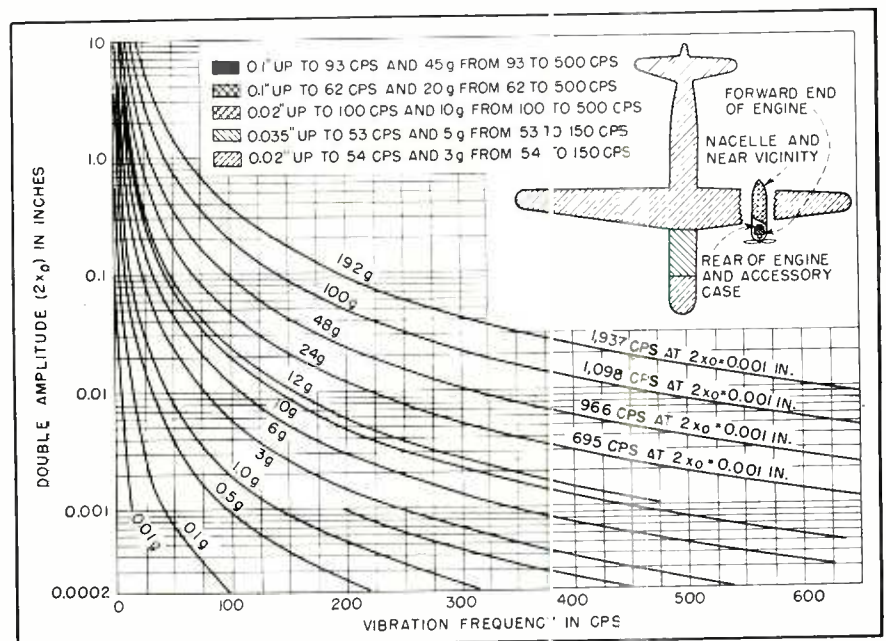

FIG. 1—Vibration amplitudes required to produce accelerations up to 192 g's at various frequencies up to 600 cps. Maximum double amplitudes and peak accelerations that equipment must withstand in various areas of a representative large airplane are indicated at upper right; values include c factor of safety and hence are larger than normal. Boundaries between areas are not sharply defined

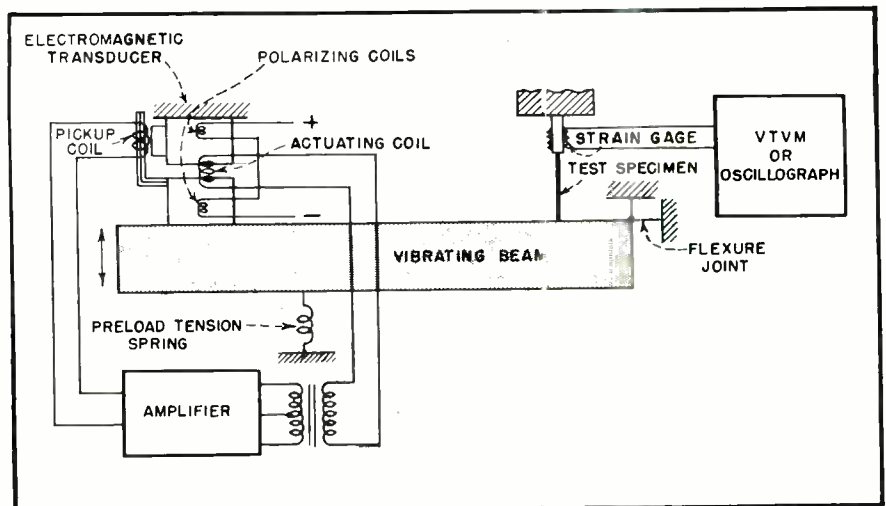

FIG. 2—Vibrating-beam setup for conducting fatigue tests of individual test specimens used in airplane construction. Voltage output of pickup coil is amplified and fed back to actuating coil to produce vibration at natural frequency of system

obtained from a comparatively small driving force, of the order of a hundred watts.

In structural vibration testing a structural member of an airplane, such as a wing, stabilizer or aileron, is shaken by a sinusoidal force throughout a wide frequency range, at sufficient amplitudes to excite the several resonant frequencies or modes.

In a typical large airplane vibration test some 28 characteristic modes have been identified and analyzed. These modes are indicated in Table 1, with the resulting resonant frequencies. The vibrating force during the several phases of this test was applied at 29 different attachment points, and 352 oscillograph records were taken of the frequency, amplitude and damping of the vibrations which occurred at some 113 test locations.

Airplane vibrations are transmitted from the engine to delicate instruments and pieces of control equipment. Some of these vibrations and their harmonics excite vibrations of sufficient magnitude in some types of equipment to cause faulty operation or even failure.

Vibration tests of individual pieces of equipment reveal these weaknesses. For example, one type of relay chattered so severely at 70 to 150 cps that a redesign was necessary. In some radio tubes the elements resonate around 350 cps and cause faulty operation of the equipment of which they are a component. One type of electromagnetic valve functioned erratically in the range of 100 to 150 cps. A small rectifier malfunctioned in one piece of equipment when vibrated at 200 to 250 cps. Some switch contacts failed between 300 and 500 cps.

#### Typical Airplane Test

Figure 3 shows a typical layout of vibrators and accelerometer-type signal pickups on a four-engine airplane. Two vibrators are used together, located at each wing tip and at each stabilizer tip, to excite the various symmetrical and anti-symmetrical bending and torsional modes. For symmetry the actuating coils of the two vibrators are connected in phase. One actuator is reversed to provide 180-degree out-of-phase vibration when it is

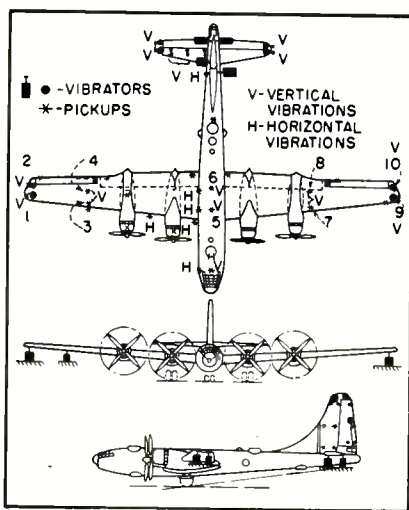

FIG. 3—Typical layout of vibrators and pickups for vibration testing of large airplane. Typical test run employs either two or four vibrators and ten pickups, such as those numbered 1 to 10

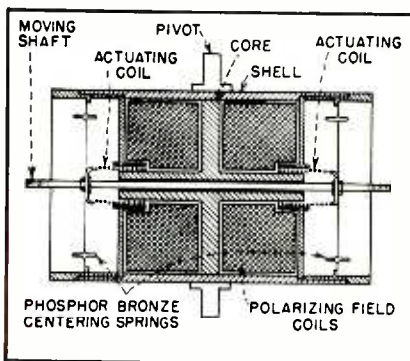

FIG. 4—Cross-section of vibrator unit

desired to excite the antisymmetrical modes.

Four vibrators are operated together for exciting torsion. They are attached at the leading and trailing edges of each wing tip or each stabilizer tip. All four are driven from a single oscillator but separate power amplifiers drive each pair of vibrators. Four combinations of in-phase and out-of-phase operation are conveniently switched on the control panels.

For locations near the ground the vibrators merely rest on platforms or aerostands whose height and angle may be quickly adjusted with a self-contained hydraulic hand pump. When the vibrator attachment point is high in the air, as for vibrating a fin, the vibrators are slung from roof supports with flexible aircraft control cables. The 300-lb weight of a vibrator is sufficient to react the vibrating force.

Connecting a wing tip or other flexible member to the oscillating

shaft of the vibrator frequently presents a mechanical problem because there is always some movement which causes misalignment. Several types of connecting links have been used, including universal joints and 90-degree X-type flat spring links. The X-type links operate quietly, permit about 7 degrees of misalignment and do not loosen the fitting even during long runs under full vibrator load.

#### Vibrating Equipment Details

The Boeing electromagnetic vibrating equipment used for exciting the types of vibration discussed above is housed in two identical cabinets, each of which contains an oscillator, a driver amplifier and its rectified power supply, a coupling transformer used between driver and power stage, a power amplifier and its rectified power supply, an output transformer for impedance-matching power tubes to vibrator actuator coils, and a rectified power supply for vibrator polarizing fields. The vibrators are separate, two for each power unit. The electronic equipment provides sinusoidal output down to 3 cps. For lower frequencies down to 0.3 cps a separate motor-triggered thyratron power supply is used.

The vibrators are in effect over-size loudspeakers, with voice coils on both ends and a push rod instead of cones. They are of two sizes; the 300-lb unit is 12 inches in diameter and 17 inches long, while the 150-lb unit is 8 inches in diameter and 20 inches long. As shown in Fig. 4, the moving shaft extends entirely through the core and projects beyond the shell for connection to a flexible coupling or a flat mounting disc. A polarizing field is induced with two coils, usually operated at 5,000 to 8,000 ampere-turns. The actuating coils are mounted on each end of the shaft.

Two pairs of phosphor-bronze loop springs mounted at 90 degrees keep the actuating coils centered in the magnetic air gap. These springs are stiff in transverse shear but very flexible in longitudinal bending. The shell is pivoted to rotate about the midpoint, so that the vibrator may be attached at any angle from vertical to horizontal.

The power input to the actuating

coils during a normal test run may vary from 50 to 600 watts. These coils are wound with glass-enamel magnet wire on glass-cloth plastic bobbins, and weigh much less than equivalent coils made from regular enameled magnet wire on aluminum bobbins.

The actuator coils in the vibrators are driven by one of the two power supply arrangements shown in Fig. 5. The vibrators must deliver a force which is truly sinusoidal, for otherwise some of the harmonic components would excite mechanical vibrations of amplitudes magnified beyond that which pure sinusoidal excitation gives. Oversize capacitors and transformers are therefore essential for amplification of the required low-frequency sine waves without distortion, and all amplifier tubes are operated class A.

The coupling transformer used between the TZ40 driver stage and the 250TH power stage has an impedance ratio of three to one and weighs about 60 lb. The coils are pie wound, with primary and secondary coils alternately spaced within a shell-type iron core.

The final output of the all-electronic unit is sinusoidal down to about 3 cps. At lower frequencies

than this the oscilloscope shows considerable distortion and the output power drops off rapidly because the transformer current is fast approaching direct current.

The plate voltage for the power tubes is obtained from a conventional full-wave rectifier using type 872 tubes. The voltage is controlled on the primary side with a 50-ampere Powerstat. The tube load seldom exceeds 500 ma at 3,000 volts.

The plate voltage for the driver amplifier tubes is obtained from a conventional full-wave power supply using type 866 tubes. A similar supply, not shown, serves the polarizing field coils of the vibrators.

Because the frequencies at which the amplifier operates approach direct current (2 to 3 cps), it is necessary to provide many turns of magnet wire and a large iron cross-section for the output transformer. The resulting unit weighs 195 lb, and can deliver more than a kilowatt of low-frequency energy into the vibrator actuating coils. The impedance ratio is 100 to 1. The secondary a-c voltage is from 250 to 400 volts and the power output is from 300 to 600 voltamperes into one vibrator.

Throughout the operating fre-

Table 1—Resonant Frequencies in Typical Large Airplane

Mode	Frequency in cps
<b>WING</b>	
1st symmetrical bending	3.33
2nd symmetrical bending	9.67
3rd symmetrical bending	25.51
1st anti-sym. bending	6.62
2nd anti-sym. bending	13.17
Symmetrical torsion	....
1st anti-sym. torsion	4.10
2nd anti-sym. torsion	21.47
<b>AILERON</b>	
1st symmetrical rotation	7.67
2d symmetrical rotation	45.51
1st anti-sym. rotation	....
2nd anti-sym. rotation	47.00
Anti-sym. torsion	26.51
Tab rotation	18.50
Tab torsion	51.68
<b>FUSELAGE</b>	
1st side bending	3.80
2nd side bending	16.67
Torsion	5.23
Vertical bending	14.74
<b>STABILIZER</b>	
Symmetrical bending	11.47
Anti-symmetrical bending	25.00
Torsion	33.84
<b>ELEVATOR</b>	
Symmetrical rotation	5.27
Anti-sym. rotation (torque tube torsion)	14.29
Symmetrical torsion	34.50
Anti-symmetrical torsion	38.51
Tab rotation	25.00
<b>RUDDER</b>	
Torsion	28.34-29.17

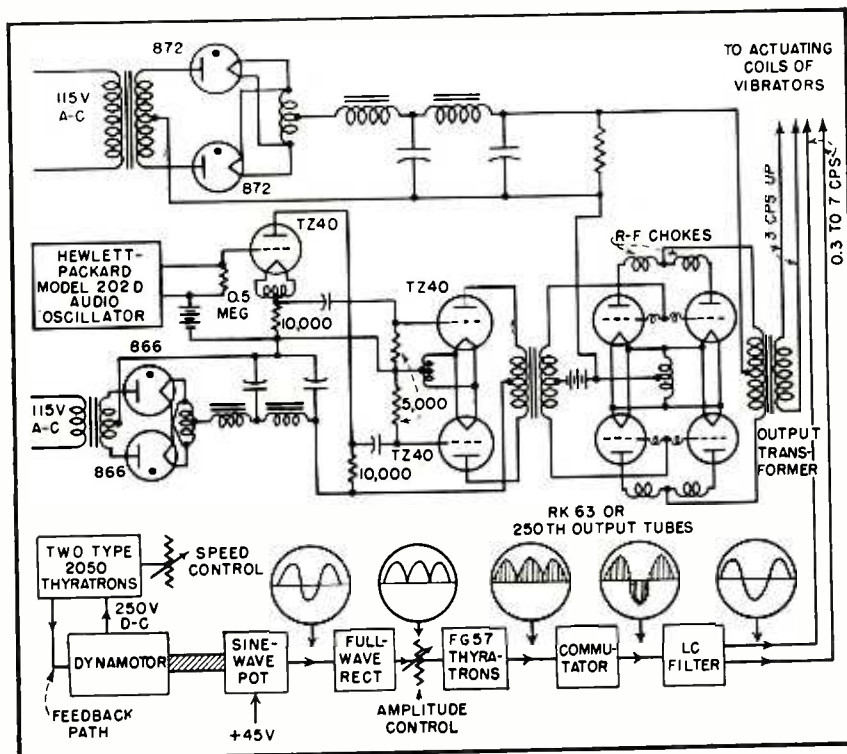

FIG. 5—Circuit used for driving actuating coils of vibrators above 3 cps, and block diagram of motor-triggered thyatron system used at lower frequencies

quency range the actuator coil impedance varies from about 25 to 75 ohms. Taps are provided to change the transformer impedance ratio, but experience has indicated that sufficient power is available without changing taps. A typical test seldom requires full power, normal operation being about one-fourth of full output.

#### 0.3 to 7-cps Generator

The low end of the required frequency spectrum is obtained from a separate power unit that is essentially a pair of thyatrons fired by a motor-driven sine-wave potentiometer, as shown in the lower part of Fig. 5.

The 250-volt winding of the dynamotor that drives the sine pot is energized by a pair of 2050 thyatrons. Motor speed is controlled by a voltage divider in the rectifier control circuit. A feedback loop from the dynamotor stabilizes the

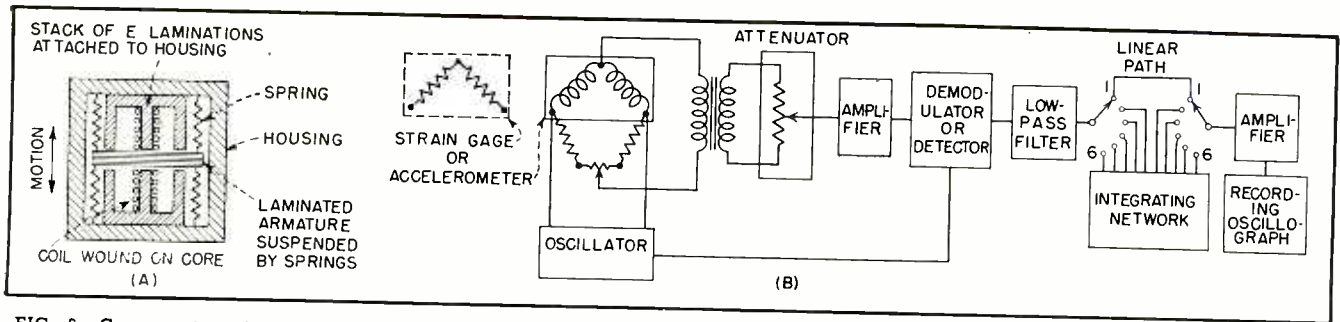

FIG. 6—Cross-section of variable-inductance accelerometer-type pick up and block diagram of carrier amplifier system used with this pickup and with strain gages for recording vibration and strain

speed. The sine-wave potentiometer is a square card of resistance wire with 45 volts d-c across its terminals. It rotates against brushes from which is obtained a sine-wave voltage whose frequency is determined by the drive motor speed as stepped down by a worm gear ratio of 25 to 1.

The sinusoidal output of the potentiometer is rectified, and the resulting half-waves fire the main FG57 thyratrons. A voltage divider varies the grid input and thereby regulates the output. The envelope of the thyatron output is commutated and filtered to obtain a final sine-wave output.

#### Measuring Methods

The final objective of a vibration test is to obtain an accurate and checkable record of the frequencies, amplitudes and damping of the vibrations which occur at the various test locations.

If a force is applied to the free end of an elastic member such as a wing (cantilever beam) and the force removed, the member will vibrate at its resonant frequency. The rate at which the vibrations die out is a measure of its damping.

In airplane structural testing a continuous vibrating force is applied and the frequency of the force is varied until the peak amplitude of the vibrating member indicates resonance. At this point an ammeter in the actuating coil of the vibrators takes a dip because less force is required at resonance. At this resonant point an oscillograph record is taken. While the oscillograph is still recording, the power to the vibrators is cut and the oscillograph then records the decaying vibrations as the member comes to rest. From this part of the record is obtained the damping of the

member. Damping may also be obtained from the rate at which the record amplitude increases as the forcing frequency approaches resonance.

#### Accelerometer Details

The three types of signal pickups used for measuring vibration are accelerometers, velocity pickups and strain gages. The signal amplitude of an accelerometer is proportional to acceleration, but the signal voltage may be integrated to obtain either velocity or displacement. The signal amplitude of the velocity type is proportional to velocity, but may be integrated for displacement. The signal amplitude of the strain gage type is proportional to displacement.

The cross-section diagram in Fig. 6A shows the construction of a typical variable-inductance accelerometer-type pickup. Motion of the frame changes the air gaps between the armature and the stacks of E laminations, thereby changing the inductances of the two coils. As shown in Fig. 6B, these coils serve as adjacent arms of a standard Wheatstone bridge whose output is proportional to the acceleration of the exciting motion.

Accelerometer output  $k(x_0)f^2$  may be integrated in the amplifier to  $k(2x_0)$ . This equation is true from zero frequency to some frequency near the natural frequency of the accelerometer seismic mass, which is in the order of 80 to 100 cps. The seismic mass must be properly damped or it will vibrate at its own natural frequency. Damped or not, it will not function as an accelerometer at frequencies greater than its resonant frequency. The higher frequencies are therefore obtained from the velocity-type pickup which has a reso-

nant frequency in the order of 5 cps and is usable above this value.

An accelerometer is used with a carrier-type amplifier and integrating network like that in Fig. 6B, to drive the galvanometer elements in a recording oscillograph. The accelerometer output signal, in the order of microvolts, must be amplified from 15 to 60 db to swing the oscillograph galvanometers sufficiently to obtain a usable record. The same circuit arrangement is also employed for modulated carrier-type strain gages.

A switch in the integrating network provides a choice of the following six characteristics: (1) linear path for acceleration; (2) velocity path linear down to 2 cps, wherein filtered detector output is integrated once through a series resistor and shunt capacitor; (3) velocity path as before but the integrating constants chosen to discriminate against frequencies below 8 cps; (4) displacement linear down to 2 cps, wherein filtered detector output is integrated twice with a reactance-resistance network; (5) displacement as before but with constants chosen for cut-off below 8 cps, (6) strain gage, with no integration and with some of previously introduced feedback eliminated to obtain increased gain.

#### Velocity-Type Pickups

The construction of a typical self-generating velocity-type pickup is shown in Fig. 7A. Motion of the housing produces relative motion between the permanent magnet and the fixed voice coil, thereby generating an a-c voltage that is proportional to the velocity of the relative motion. The pickup output, equal to  $k'(2x_0)f$ , is fed directly into an integrating network using a reactance-resistance circuit to produce

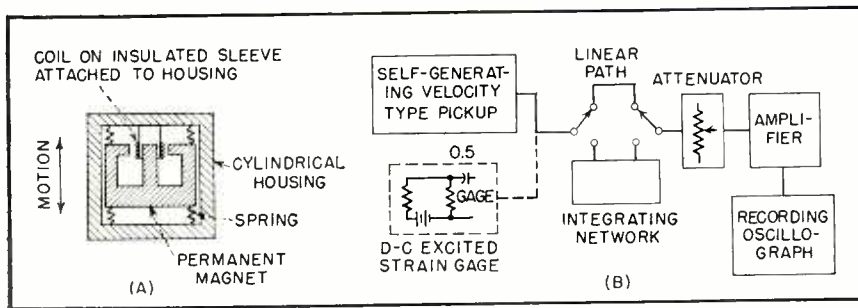

FIG. 7—Cross-section of self-generating velocity-type pickup and block diagram of typical linear and integrating amplifier used with it and with strain gages

for the following amplifier a signal that is proportional to pickup displacement, as indicated in Fig. 7B. This arrangement is also used for d-c excited strain gages, where the output is directly proportional to the amplitude of motion.

#### Recording Oscillograph

The recording oscillograph has 14 isolated galvanometer systems, and a timing line system, all acting simultaneously on 6-inch-wide photographic paper. The light beams reflected from the galvanometer mirrors may also be scanned on a viewing ground glass. A record number is automatically photographed on each record. A device momentarily blanks out each of the elements consecutively to permit identification of each trace.

The oscillograph records taken during a vibration test provide data which defines the frequency, amplitude, and relative phase relation-

ships of the vibratory motions which occur at each pickup location. These data may all be obtained from a single sweep record for which the frequency of the vibrators is changed at a constant slow rate by a motor driving the frequency-control dial. The sweep is usually from 2 to 40 cps. The vibratory force is held constant during the sweep.

As the frequency passes through resonant points the amplitudes of the traces on the scanning screen of the oscillograph build up to peaks, then decay as frequency is further increased. A sweep requires about a minute and may require a hundred feet of record paper. A short check record is also taken of each major resonant frequency while the oscillator frequency is held constant.

Figure 8 is the oscillograph record of data taken during the vibration of an airplane empennage to obtain body torsion. Two vibra-

tors were attached to each stabilizer tip, at the front and rear spars, with the two pairs 180 degrees out of phase so as to produce a twisting moment about the longitudinal axis of the fuselage. This is shown by the comparatively large displacement of pickup 49 on top of the fin and by the 180-degree phase difference of the two stabilizer tips (30-38 and 29-37).

The db values at the pickup locations in Fig. 8 represent the attenuation needed to make all traces have approximately equal amplitudes, and hence are an indication of pickup outputs. The full amplifier gain is about 60 db. The amplification for pickup 49 was only 6 db, but 42 db of gain was necessary for the signal from pickup 35.

#### Acknowledgements

The author expresses appreciation to several engineers of the Boeing Vibration Laboratory Group for assistance in the preparation of this article. John J. Sheppard prepared the material for the sections explaining pickups and record analysis. Donald W. Nelson developed the low-frequency vibrator power unit. The X-type spring link couplings were developed under the direction of Harold L. Adams, chief of Boeing's Structural Test Unit. Floyd A. Swenson and Paul T. Sauber contributed information and assistance.

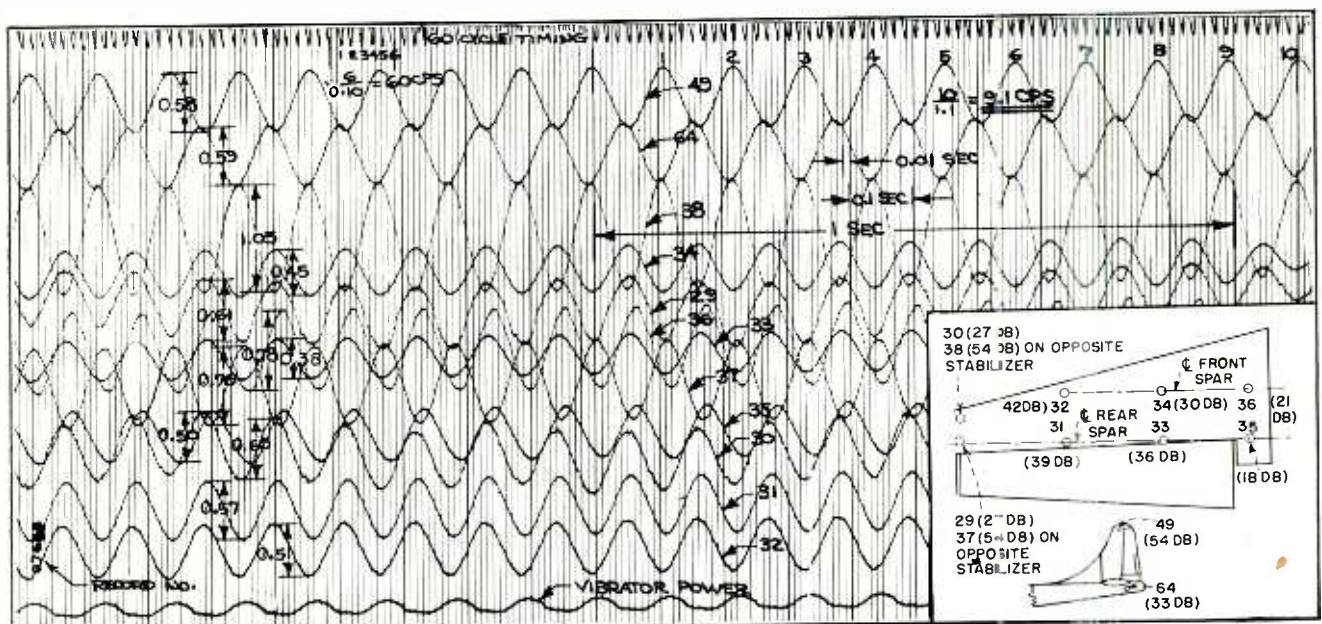
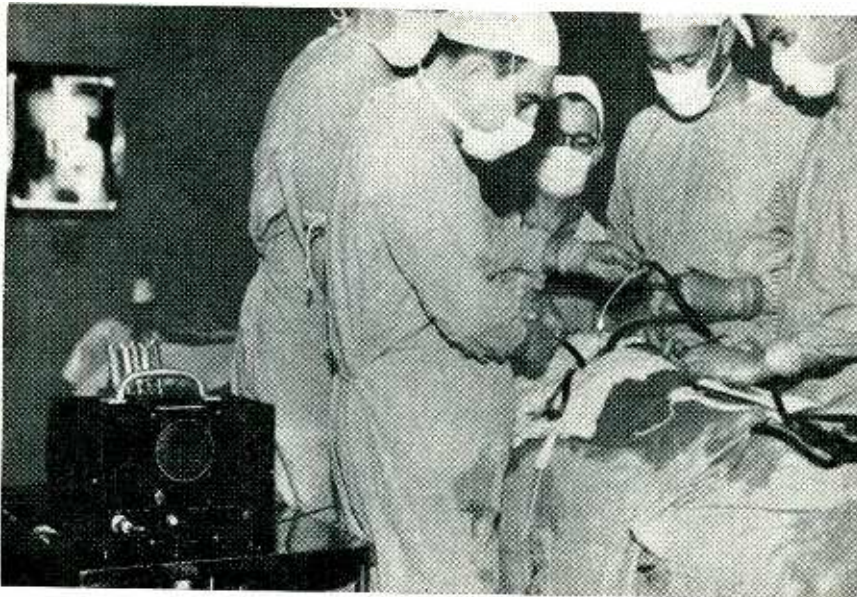

FIG. 8—Example of oscillograph record obtained for airplane-body torsion test. The ten traces are produced by correspondingly numbered pickups at location shown in lower right. Vertical timing lines are 0.01 sec apart, with heavy lines every 0.1 sec



During an operation for gall bladder removal or for gallstones, surgeons use electro-acoustic detector to locate stones that are otherwise difficult to find

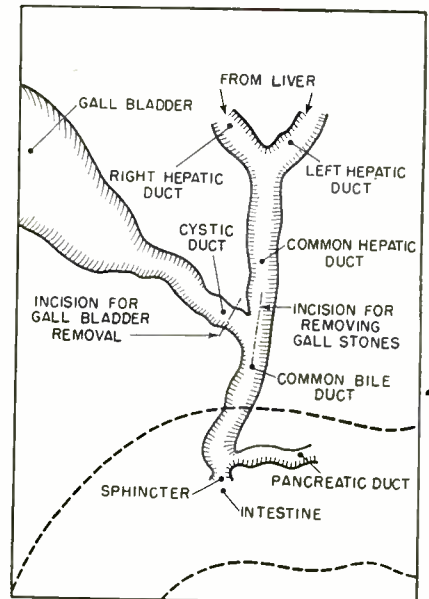

FIG. 1—Diagram of biliary tract shows bile ducts in which gall stones may lodge

# Locating Gallstones

**A** SERIOUS PROBLEM which confronts surgeons during gallstone operations is to determine whether all the stones have been removed from the bile ducts. In some operations which are otherwise successful one or more stones are left in the bile ducts, principally because of inability to detect their presence. Convalescence may be prolonged and difficult, and a second operation may be required.

## Need for Locating Gallstones

Referring to the diagram of the biliary tract shown in Fig. 1, the bile ducts are small tubular structures which convey bile from the liver to the intestine. The right and left hepatic ducts which drain the right and left lobes of the liver join to form the common hepatic duct which, in turn, is joined by the cystic duct from the gall bladder to form the common bile duct. After joining with the pancreatic duct, the common bile duct terminates in a small sphincter, or circular muscle, in the wall of the intestine. The sphincter allows bile to flow into the intestine but effectively seals the duct against reverse flow.

Gallstones form in the gall bladder (rarely in the bile ducts) and may pass through the bile ducts into the intestine if they are small enough to go through the sphincter. If not, they are arrested at the sphincter and block the flow of bile into the intestine.

Usually the obstructing stones cannot be seen or felt, and present methods of detecting them are often inadequate. The most effective method consists of repeatedly passing a grasping forceps up and down the ducts, removing the stones as they are encountered. Passage of instruments and catheters through the sphincter into the intestine is regarded as strong evidence that the obstruction has been relieved but does not demonstrate

that all stones adjacent to the sphincter or in the proximal ducts have been removed. The use of x-rays, taken during operation with a radio-opaque dye injected into the ducts, has been suggested but not widely used.

An equally important problem is whether to open the common bile duct to explore for stones during operations for removal of the gall bladder. In many instances the presence or absence of stones in the bile ducts cannot be determined in any other way. Opening of the common bile duct is undesirable if unnecessary. An instrument which could be passed through the cystic duct upon removal of the gall bladder to detect the presence of stones in the bile ducts might there-

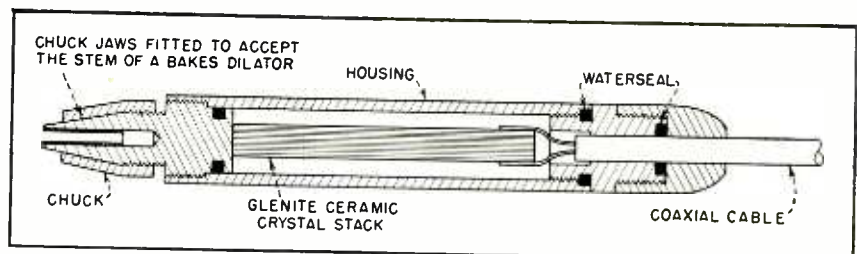

FIG. 2—Cross section of probe shows its simple construction





# MULTI-V ANTENNA for F-M Broadcasting

Folded dipoles are bent into V's to form a lightweight array that can be mounted atop existing a-m antennas. The array is tuned by extensions on each arm, without seriously changing the impedance match and radiation pattern

By **M. W. SCHELDORF**

Engineer in Charge of Research  
Andrew Corporation  
Chicago, Ill.

**T**HE MULTI-V ANTENNA is a simple lightweight transmitting array designed for operation in the f-m broadcast band from 88 to 108 megacycles. A basic two-bay design can be attached readily to the sides, corners or top of existing a-m radiators. Additional bays may be added for higher gain.

The radiating portion of the

antenna elements takes the shape of a V, or strictly speaking, of a truncated V. This configuration gives a horizontal radiation pattern that is close to circular.

To increase the antenna impedance the folded dipole principle commonly used in receiving antennas is employed. This permits the use of a 51.5-ohm main feeder line. There being no need to feed both halves of the system when the folded antenna principle is used with antennas of low radiation resistance, this technique also reduces the number of transmission lines to half that otherwise required.

Although it is possible to build antennas that will cover the entire f-m band without adjustment, it is necessary to provide adjustments if the array is to be relatively small and light. The complication of these adjustments varies considerably with existing f-m antennas, and in most cases adjustments change both horizontal pattern and impedance. Usually pattern variations

are tolerable, but impedance changes need to be counteracted by matching elements or tunable stubs.

With the multi-V one adjustment tunes the antenna to resonance for each frequency in the f-m band without materially affecting impedance values. Tuning is accomplished by extending secondary arms, primary arms remaining a fixed length determined by the highest frequency of operation. This tuning scheme also has a distinct advantage in connection with the power-handling capacity of the system. In antennas of this general type, where the effective operating length is about a quarter wavelength, the highest voltage occurs at the open end. It is important, therefore, to keep open ends far apart. The diverging arms of the V antenna meet this requirement and provide a safety factor in addition.

In the development of the antenna element, it was found that the condition of horizontal pattern uni-

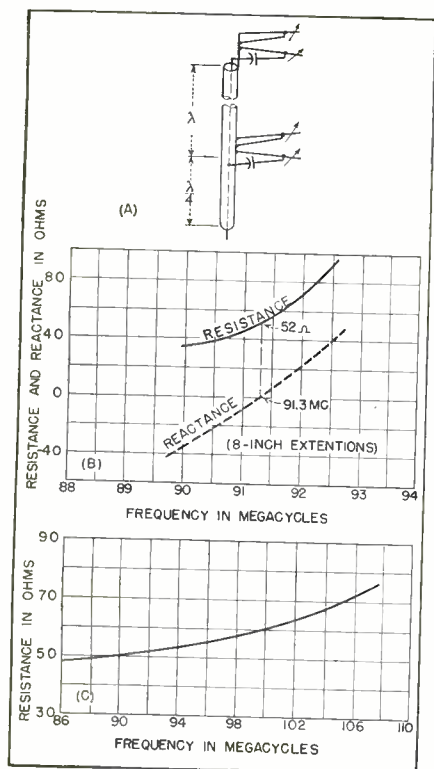

FIG. 1—(A) Circuit of two-element array, (B) driving impedance of one bay with extensions fixed for resonance at 91.3 mc, and (C) resistance of one bay at resonance as it is tuned over the f-m band

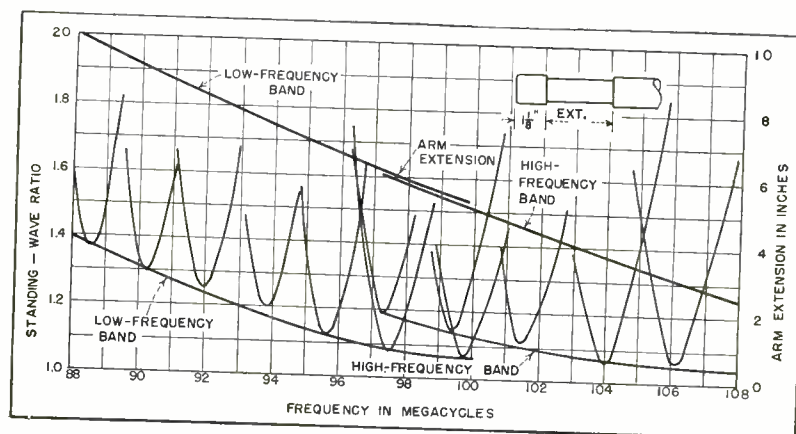
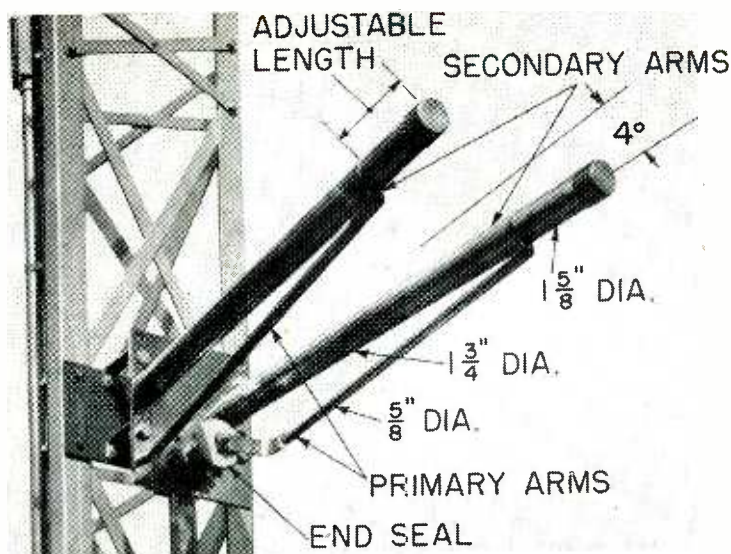

FIG. 2—Standing-wave ratio curves about resonance of antennas when tuned to various frequencies in the band, showing uniform performance



One element of the V antenna, mounted on an existing a-m antenna tower, showing the details of its construction. For usual installations, two elements on a supporting I-beam would be mounted on the top of the a-m tower

formity was possible only by operating at a frequency several megacycles above resonance; in other words, with a positive reactance present in the direct driving impedance. A series capacitor placed in the transmission line just below the end seal unit supplies the proper necessary reactance correction over the band.

#### Feeding the Array

In connecting two bays of the V antenna, it was necessary to make some arbitrary choices for the sake of simplicity. The widest frequency coverage results when equal-length lines to each bay are provided, and this is commonly done by placing the junction point halfway between them. If the impedances at the junction are higher than the characteristic impedance of the main

line it is best for bandwidth to parallel them. If they are less than this value, it is best to connect them in series. However, this requires a balun and means for reversing the phase of one of the elements. A simpler method is to run one line to the top bay and tap it at the second bay. This scheme effectively places the antenna elements in parallel at the junction point, so such a system is best adapted to driving impedances of values higher than 51.5 ohms (ideally 103 ohms).

The driving impedance inherently varies over the frequency range, and because it is impractical to step up to precisely 103 ohms by means of the folded-dipole principle, a compromise is acceptable and a matcher is utilized to transform the impedance at the junction point to one that averages 51.5 ohms over

the frequency range. The resultant schematic diagram is shown in Fig. 1A. Each antenna element has its series capacitor, and the common impedance at the junction point is matched to 51.5 ohms. Note that the feed line is completely isolated for direct currents, permitting an insulation resistance check without disconnection of the elements.

The single - interconnection scheme makes it necessary to feed the antenna with a line one wavelength long between the two bays. In addition, the use of rigid line for this purpose fixes the vertical spacing also at a wavelength. Specifically due to the reduced velocity of propagation in the lines used (it is necessary to support the inner conductor at regular intervals with a dielectric material), the spacing becomes  $K\lambda$  where  $K$  is the relative velocity of propagation and  $\lambda$  is the wavelength in free space.

The radiators proper consist essentially of straight pieces of hard-temper copper tubing. Each pair of arms has a  $\frac{5}{8}$ -inch-diameter fixed length and a  $1\frac{3}{4}$ -inch-diameter length with a telescoping  $1\frac{5}{8}$ -inch extension for frequency adjustment. The single excited input conductor is connected to a standard end seal to support its free end.

The two elements are identical but they are attached to the tower differently. The lower bay is fastened rigidly to the tower. The upper bay is held by a set of four straps, which permit vertical movement but prevent horizontal movement. This mounting affords a simple means of allowing for ex-

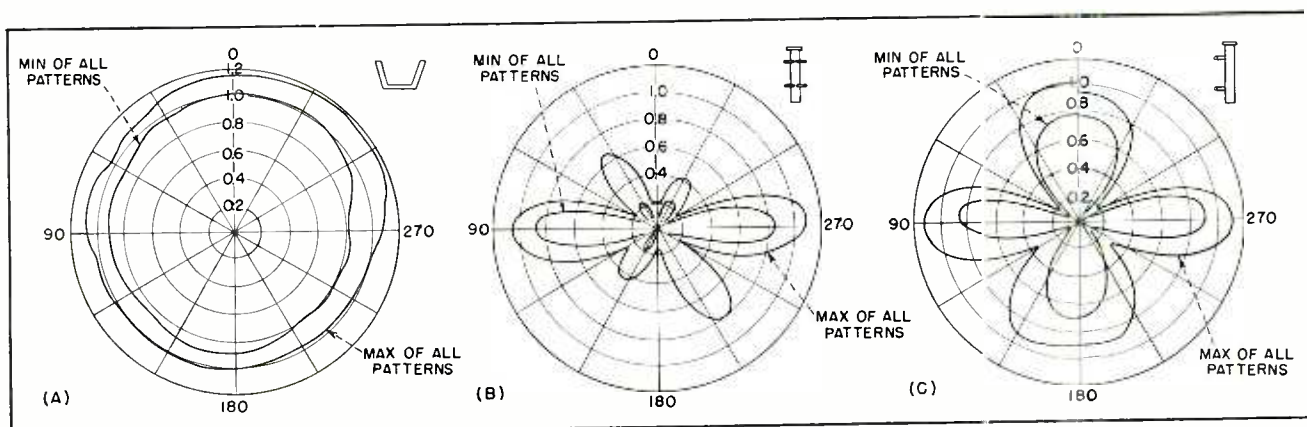

FIG. 3—Horizontal radiation pattern limits (A) show relative independence of tuning adjustment. Vertical pattern limits (B) across V (see insert showing orientation of array) and (C) along V, show somewhat greater variation

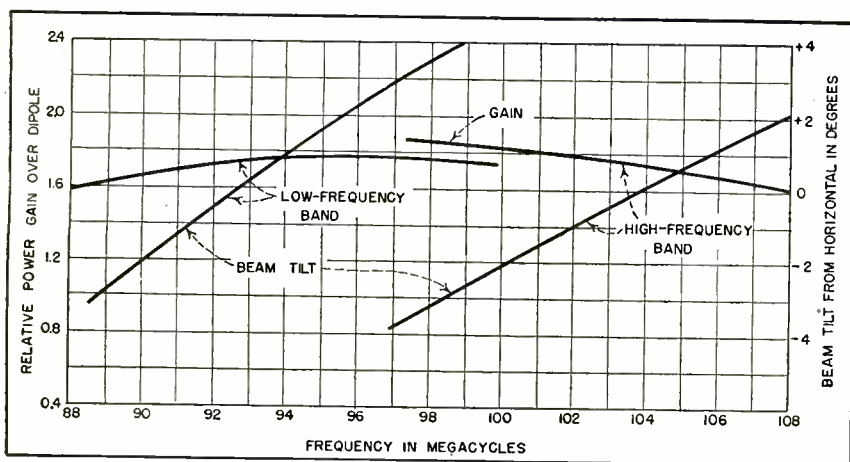

FIG. 4—Changes in radiation patterns shown in Fig. 3 produce slight changes in effective antenna gain, which is mostly due to changes in tilt angle of major lobe of beam. The decreased gain at the edges of the band are chiefly due to this tilt

pansion differences in the copper of the interconnection line and the steel of the tower. It also allows the tower to bend without stressing the copper line unduly.

The support for one type V antenna is a steel H-beam so oriented that the well on one side forms a protective enclosure for the transmission line and matcher. The climbing steps are attached to the edges of the flanges on the opposite side, so that unusual freedom for climbing is achieved. Each of the elements has a series capacitor built into the inner conductor of the transmission line just below the end seal. The capacitor consists of a coaxial element with appropriate support insulators. The matcher element consists of an oversized inner conductor and a multiplicity of standard insulators, electrically a quarter-wavelength long and having the proper effective characteristic impedance. The junction line is made in two lengths to suit two frequency bands.

When the extensions of the large radiator arms are set for a given frequency of operation (91.3 mc, for example), the driving impedance of each element is indicated by the curves of Fig. 1B. These curves demonstrate the ability of the antenna to operate over the modulation band with an associated f-m transmitter and transmission line. A family of these curves serves to determine the matcher characteristics, using the values of resonant resistance, of which 52 ohms is representative for 91.3 mc. A collection of the resonant resist-

ance values may be plotted as shown in Fig. 1C. This particular curve indicates that the uniformity is sufficient to permit the construction of just one matcher to cover the entire f-m range. The matcher for the system is therefore designed for a characteristic impedance of 39.8 ohms and is made effectively a  $\lambda/4$  long at the center of the range.

Measurement of standing-wave ratio on the main feed line is made with the entire antenna mounted well away from reflecting and absorbing surfaces. A series of measurements made over a frequency band, corresponding to fixed positions of the radiator extensions, is of vital importance. Curves of these measurements are shown in Fig. 2. Two corresponding curves showing the necessary arm-extension settings are also given in this figure. The uniformity of the results demonstrates the reliability with which the arms may be set in the factory.

#### Horizontal and Vertical Radiation

Horizontal field patterns were measured and plotted over the f-m range. The magnitude of the plots was adjusted to give the same radiation in the horizontal plane as an antenna with equal radiation in all directions with a power gain of 1.0. The variations from a circle over the f-m range are so small that the limits can be shown by two curves as in Fig. 3A.

The corresponding vertical patterns are shown in Fig. 3B and 3C. The first is taken perpendicular to the neutral plane and the second is

taken in this plane. The difference is due to symmetry for the first case and lack of it in the second.

It might appear that the vertical radiation represented by Fig. 3C would lead to low gain in the horizontal plane, but it should be pointed out that this field is effective in a small solid angle whereas the field in the horizontal direction is effective in a large solid angle. The limit curves also seem to indicate greater variations than those of Fig. 3A, but this is not harmful as it is due to the variation in tilt of the horizontal beam and side lobes as the phase relations between the currents of the two bays vary across the bands.

From the horizontal patterns and two major vertical patterns it is possible to calculate with sufficient practical accuracy the gain of the antenna system, in the horizontal plane, over a dipole antenna. The calculated curves are in Fig. 4.

When the antenna is operated at 93 mc or 103 mc, for which frequencies the junction lines produce exactly in-phase currents at the two bays, the horizontal beam is precisely horizontal. Below these frequencies the beams tilt downward, and above these frequencies the beams tilt upward. By splitting the f-m range into two bands, as previously mentioned, the tilt has been kept to a low enough value so that the gain is not impaired. Figure 4 also shows curves of beam tilt obtained from the experimental curves.

Because of the wide separation of the high-voltage portions of the radiators, the individual elements are well suited for high-power operation. A conservative rating of 5 kw per bay has been placed on the antenna, although field experience probably will justify a greater power rating.

The writer wishes to acknowledge the able assistance of H. M. Anderson and C. W. Meyer in the development of this antenna.

#### BIBLIOGRAPHY

- (1) Bruce E. Montgomery, A Very-High Frequency Aircraft Antenna for the Reception of 109 Megacycle Localizer Signals, *Proc. IRE*, 33, p 767-772, Nov. 1945.
- (2) Lewis Winner, A Report on the Sixth Annual Conference of Broadcast Engineers, *Communications*, 26, p 30-74, April 1946.
- (3) M. W. Scheldorf, FM Circular Antenna, *General Electric Review*, 46, p 163-170, March 1943.

# Ceramic Transmitting CAPACITORS

Improved dielectrics and new design features increase ratio of power-handling capacity to physical size for units used in transmitting applications. Experiments reveal possibility of even higher ratings by use of cooling fins and forced air ventilation

By **A. J. BAUER**

*Chief Research Engineer  
United Insulator Co., Ltd.  
Surbiton, England*

**N**EW TYPES of dielectrics and new design features permit the manufacture of ceramic transmitting capacitors combining high load ratings with small physical dimensions.

Low-loss ceramics with Q values of 1,000 and more and permittivities up to 90 are now well established as dielectrics for small capacitors used in broadcast and television receivers. Their low losses, small size, and the ease with which they may be used to compensate for the temperature coefficient of associated circuit elements are advantages which make them superior to other dielectrics in many circuits.

#### Early Uses

It seems, therefore, an obvious step to make use of the low losses of ceramic dielectrics for the design of transmitting capacitors with a good ratio of power handling capacity to volume. The first types of this kind originated in Germany and took the form of plates or pots in rutile ( $\text{TiO}_2$ ) or steatite material, shown in Fig. 1. The edges of the silvered electrode layer were extended on to sheds familiar from high voltage insulator design, which served to taper off the electric field on the edges of the electrode layer, and to provide a flash-

over path consistent with the rated working voltage.

An added advantage of this type of capacitor is that ceramic dielectrics, which are formed from fully vitrified material, do not suffer from the progressive deterioration which is generally associated with many other dielectric materials normally impregnated with or immersed in hydrocarbon materials.

Subsequent wartime development in Great Britain was mainly concentrated on the improvement of the ceramics used, while adher-

ing to the original pot shape. Thus materials based on magnesium titanate were produced which gave Q values of 10,000 to 20,000.

#### Metallizing Technique

Ceramics intended for transmitting capacitors have to comply not only with the usual requirements for receiver applications, but they must also show low losses under the stress conditions obtaining at high r-f loads. In addition, such capacitors are usually rated for a maximum body temperature of approxi-

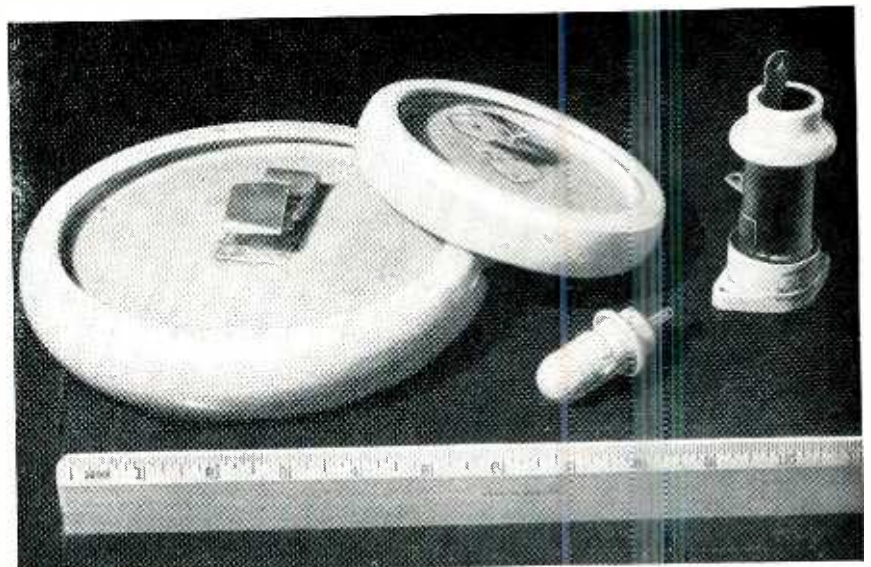

FIG. 1—Ceramic pot and plate transmitting capacitors of German origin

mately 100 C, and the dielectric strength as well as all other properties have to be satisfactory at this temperature.

Measurements show that a material with a low static power factor—as measured on a Q-meter—will not necessarily show a good dynamic power factor when subjected to an appreciable r-f voltage. This voltage coefficient of power factor is, therefore, an important parameter, and most of the development work on transmitter ceramics has been directed toward the production of low-loss ceramics where this factor and the static power factor have been kept to a minimum.

Apart from the losses attributable to the properties of the dielectric, which are mainly a function of voltage, losses due to the r-f current will occur in the metal film forming the conductive layer on the body of the capacitor. This layer is usually produced by applying one or more coats of a silver solution consisting of finely divided metallic silver or silver oxide suspended in a suitable vehicle, which also contains such additions of

fluxes as are required to produce good adhesion to the ceramic after firing to 700 or 800 C. Considerable research has recently been carried out to devise a coating with minimum losses and with satisfactory mechanical properties.

Owing to the flux content and the incomplete sintering of the silver layer, its conductivity may be appreciably less than that of pure silver. Any skin effect will tend to concentrate the current along the junction of the ceramic and the silver layer. Any reinforcement by plating will therefore be of relatively small assistance, and it is generally more convenient to provide fittings designed to cut down the maximum current density on any portion of the silver layer.

Both the firing conditions and the composition of the silver solution will have a considerable influence on the losses produced by the r-f current.

#### Loss Measurement

The measurement of losses under r-f load can be carried out by a variety of methods. One simple and reliable arrangement suitable for small test pieces is that shown in Fig. 2. Containers A and B are of identical volume. The test object is suspended in A and a replica of the test object fitted with a suitable heater winding is placed in B. A drop of colored liquid in the capillary C serves as a sensitive pressure-differential indicator. When r-f power is applied to the test object the heat generated by the r-f losses will expand the air in A and drive the drop in the capillary towards B. By regulating the heat

input to the heater in B pressure equilibrium can be restored and the input into the heater will correspond to the r-f losses in the test piece. By fitting both containers with a suitable heater jacket measurements can be carried out at elevated temperatures.

If a series of measurements are carried out on a test piece, and the losses are plotted against frequency with the r-f load in kva as parameter, the curve in Fig. 3A results.

It can be seen that increased losses occur both at the low-frequency end where the r-f voltage for a given load is highest, and at the high-frequency end where a heavy r-f current occurs.

Since the losses under any working conditions are a combination of dielectric losses occurring in the ceramic and electrode losses occurring in the silver layer, it is of importance to consider separately the two kinds of losses, so as to assess their relative importance under given working conditions.

Dealing first with the high-frequency end, we may assume that the electrode losses will be:  $W = I^2R + W_d$ , where  $W$  represents the total losses,  $I$  is the r-f current,  $R$  the resistance of the silver layer, and  $W_d$  the dielectric losses.

Plotting the losses as a function of  $I^2$  results in Fig. 3B, and it can be seen that to the right of point A the curve continues as a straight line. In this part of the working range the losses are proportional to  $I^2R$  and the dielectric losses are a constant. By extending the straight portion of the curve to the left, dielectric losses  $W_d$  for frequencies corresponding to currents

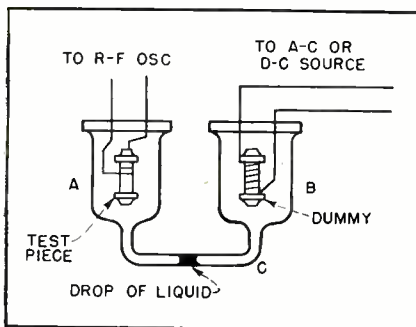

FIG. 2—Thermal method for determination of losses of ceramics under r-f load

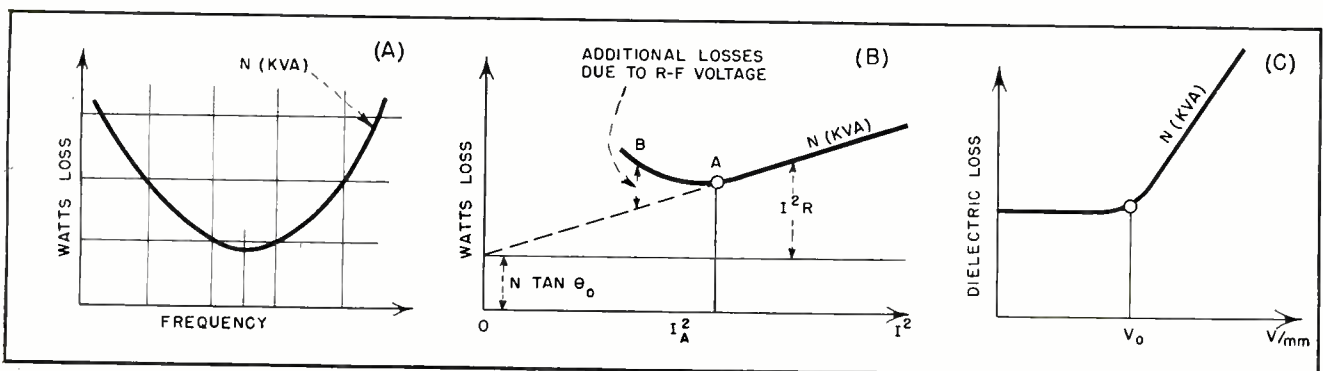

FIG. 3—Typical curves showing losses in ceramics as functions of frequency, the square of the r-f current, and the r-f voltage

greater than  $I_A$  can be evaluated, and we can say  $W_d = N \tan \theta_0$ , where  $\tan \theta_0$  is the power factor of dielectric at low r-f voltages (static power factor), and  $N$  is the r-f load.

If we examine now the portion AB of the load curve, it can be seen that the total losses increase in spite of the fact that the  $I^2R$  losses become smaller. It must, therefore, be assumed that the increase of losses is due to additional dielectric losses, and that these additional losses are related to the increased r-f voltage which occurs at the low end of the frequency range, for a given load. Plotting the loss curve minus the  $I^2R$  losses as a function of the specific voltage in  $V/mm$  across the dielectric results in the curve of Fig. 3C. It can be seen that the dielectric losses are constant below the voltage  $V_0$  corresponding to conditions at point A in Fig. 3B. At voltages exceeding  $V_0$ , a rise in power factor takes place which is roughly proportional to the voltage, and we can call this a voltage coefficient of power factor.

Care must be taken to check whether the simplified assumptions outlined above actually hold good for a particular ceramic as all the parameters involved may be to a greater or lesser degree functions of frequency and temperature.

#### Body Shapes

The choice of the shape for the ceramic body is partly governed by the application, capacitance, and operating voltage desired. The main objectives are, however, good heat dissipation, possibility of forced air cooling, and ease of manufacture. The original pot and plate shapes have now been superseded by a tubular "Hi-load" design as illustrated in Fig. 4. The tubular shape has resulted in a considerable increase in permissible power rating due to its better heat dissipation. The middle size body in Fig. 4, which is about the same value as the larger pot capacitor in Fig. 1, will give about three times the r-f rating of the former. About 30 percent of this increased rating is due to improved dielectrics. The large body in Fig. 4 is the largest ceramic

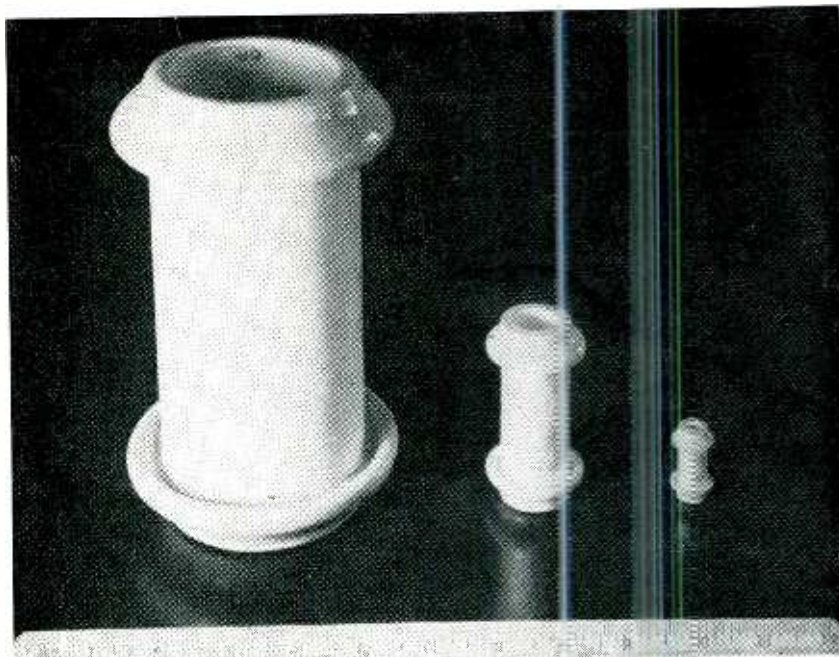

FIG. 4—Various sizes of high-voltage capacitor bodies. Large size is largest ceramic capacitor in rutile manufacturing on a commercial scale

capacitor in rutile manufactured on a commercial scale. Its rating is 150 kva with a maximum r-f voltage of 10 kv peak, and a maximum current of 70 amp. Capacitance is 4,000  $\mu\text{f}$ .

Various types of mounting electrodes have been developed. They are designed to produce an even current distribution over the silver layer, and to offer little resistance to the air current if forced cooling is employed. The small types, which fit most applications, have two spiders soldered to the ends of the inner silver layer. These are connected by a rod with suitable terminals, thus giving facilities for lead-through applications or series connection when the r-f voltage exceeds that of the single capacitor.

A capacitor with three radial mounting lugs is available for use where several capacitors are to be connected in parallel. In that case, the capacitors are mounted in a plate with suitable holes. A lead-through flange fitting is intended for bypassing r-f on a high-voltage supply, and would be mounted in the panel between the power supply and the r-f unit. Body dimensions of these capacitors are  $3\frac{1}{2}'' \times 1\frac{1}{4}''$  and capacitance is 1,000  $\mu\text{f}$ .

Experimental work has been done

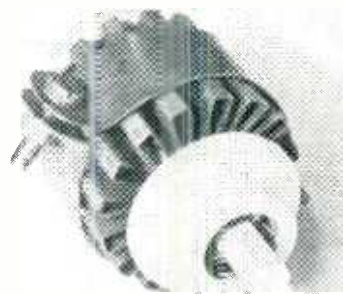

FIG. 5—Experimental capacitor with cooling fins

on radiators similar to those used on vacuum tubes (Fig. 5). Even mild blasts as produced by an ordinary desk fan will produce a considerable increase in the permissible ratings.

Rating for a temperature rise of 75 C in still air is 30 kva with 20 amp maximum and maximum r-f voltage of 7.5 kv peak. With 15 ft per sec air cooling the maximum kva figure is increased to 110 kva with 30 amp max. The same body fitted with a radiator will give 200 kva with 50 amp max. The increased current rating is due to the better current distribution produced by the radiator.

# Train Television

Special circuit techniques, incorporated in an experimental receiver, and ram's horn antennas provide generally satisfactory pictures on a railroad train where conditions are usually considered too extreme for normal reception

By **FRANK R. NORTON, CHARLES G. McMULLEN** and **GLENN L. HAUGEN**

*Research and Development Dept.  
Bendix Radio Division  
Baltimore, Maryland*

**R**ECEPTION of television programs in a moving train is a severe test of a receiver and its antenna due to many sources of electrical noise along the right of way and obstacles in the path of the signal. Such problems were encountered in the first public demonstration of train television, held last October on the Baltimore and Ohio "Marylander", as previously reported in these pages<sup>1</sup>.

As a train travels past buildings, through cuts, under bridges and trestles and suddenly passes other steel trains, there are extreme variations in the received field strength of the television broadcast signals. Moreover, there is often a rapid change in picture quality as the propagation path may be direct at one spot, then a few feet farther on multiple-signal paths of different lengths may be simultaneously effective, producing ghosts in the picture.

Practical experience with the vagaries of television reception aboard a moving train has been obtained with an experimental receiver. The pictures generally look best when the train is either standing still or traveling fast. At high speed, the automatic gain control circuits of the receiver take care of variations in the amplitude of the signals and any ghost patterns which are obtained do not last long enough to seriously degrade the observed pictures. If a train is moving slowly, ghosts last long enough to be quite annoying at times.

## Antennas

The maximum available clearance for an antenna above the steel roof of the standard railway car is approximately 15 inches for a width

of only about 5 feet. At greater distances from the center line of the track, the clearance line is still lower and at the full width of the car the clearance line is below the roof of the car at its center. Since a train often changes its direction with the curvature of track, the antenna should be omnidirectional. Between Baltimore and Washington, for example, the direction of the train changes plus and minus 90 degrees from the general south-westerly direction.

A horizontal ring-type antenna was first tried. If the ring diameter was reduced sufficiently to give an omnidirectional pattern the pickup was then considerably less than the maximum for a folded dipole. A ram's horn antenna, a folded dipole with the ends bent back as shown in Fig. 1, was found to be satisfactory, with a ratio of maximum to minimum pickup in the horizontal plane of about 3 db.

Two antennas were used, since either one alone was found to have a greater standing-wave ratio than was considered desirable over the range from 54 to 216 megacycles. The larger antenna was usually

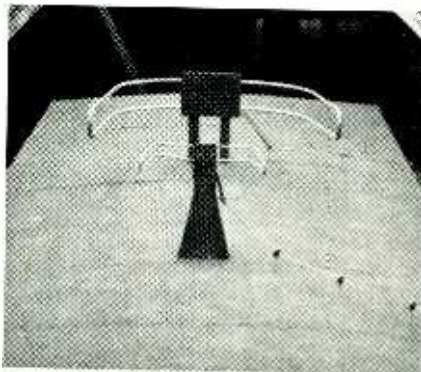

FIG. 1—High and low-band ram's horn antennas installed on the roof of a railway car

quite satisfactory on the low channels and the smaller antenna usually gave the sharper picture on the high channels. However, when the train was standing still, this situation was sometimes reversed due to the standing-wave pattern in space existing at that particular spot.

A separate transmission line (300-ohm twin lead) was brought into the car from each antenna with about one-foot insulator spacing on the car roof to withstand vibration and constant high wind velocities due to train speed. A switch on the receiver was used to select the desired antenna line.

## Receiver Circuits

The experimental television receiver used in the train tests has a 12-channel turret input tuner<sup>2</sup>. It has a 300-ohm balanced input using three twin triodes, one for a push-pull grounded grid r-f amplifier, a push-pull mixer and a push-pull oscillator. The four-stage i-f amplifier is stagger-tuned and has an overall bandwidth of approximately 3.8 megacycles with the picture carrier at 36.1 mc and sound carrier at 31.6 mc. A germanium crystal is used for video detector with sync peaks negative, followed by a single stage of video amplification direct coupled to the cathode of the 10FP4 aluminized picture tube. The picture agc circuit holds the i-f amplifier black level output very constant. The picture contrast is adjusted by varying the screen potential of the video amplifier.

The agc circuit may be best considered with reference to Fig. 2, a simplified receiver circuit. The twin-triode pulse clamper operates only during the back porch interval when its grids are driven positive



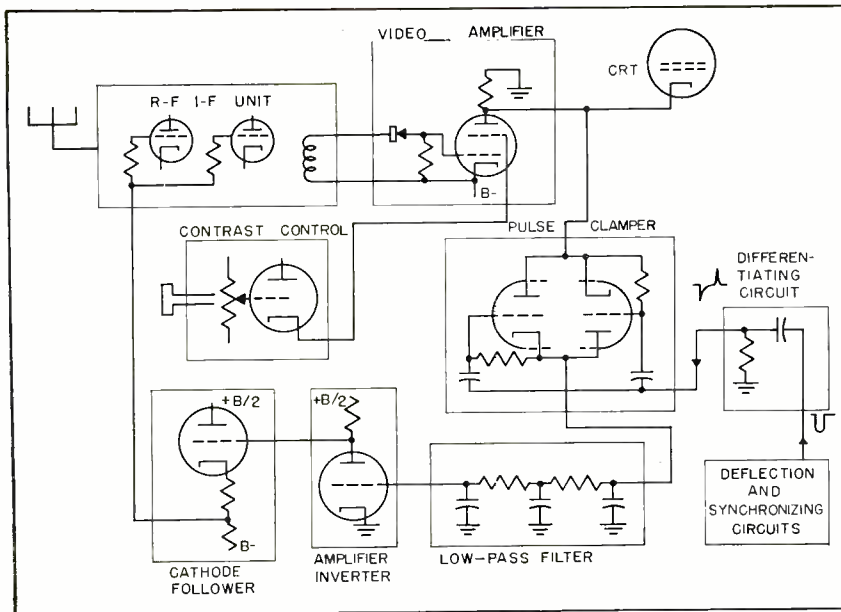

FIG. 2—Simplified block diagram of the receiver and circuit of the pulse clamper

by the trailing edge of the differentiated negative pulse derived from the horizontal sweep flyback. This type of age circuit was first discussed by members of the Bendix staff in October 1946 and a receiver incorporating it was built in July 1947.

Ideally this type of circuit would set the gain during the conduction interval, hold that level for one picture line, then reset for the succeeding line. This line-by-line age would be ideal, but a wide-band feedback loop would be necessary to adjust gain completely in such a short interval. The low-pass filter prevents true line-by-line action. The cutoff was designed to give a high attenuation at half line frequency where age oscillations are most likely to occur when a line-by-line clamp is used.

The amplifier stage is necessary to invert the age signal and provides extra gain so that the i-f output is held extremely flat. The cathode follower maintains a low impedance and provides a convenient way of adjusting the d-c level to the proper bias region for i-f control without excessive loss of gain.

The action of the age is to hold the blanking level constant at the picture-tube cathode. The contrast control in this circuit avoids the undesirable effect of changing black level with contrast variation. The screen-grid voltage of the video am-

plifier is controlled. This has only a minor effect on overall age gain and does not appreciably change the instantaneous voltage on the plate when clipping occurs. Of course, the input grid voltage required to reach cutoff (clipping level) does vary with the screen voltage.

Since the video stage is a d-c amplifier, a cathode follower is used to control the screen grid voltage thus achieving the necessary low d-c impedance with minimum bleeder current. Excellent immunity to impulse noise is achieved by making the sync peak level close to cutoff in the video.

#### Sync Operation

The synchronization of this receiver is greatly improved over that in other receiver models using the same synchronizing circuits but not having the double-clamp age circuit. This improvement is due to the clipping level in the video amplifier being substantially equal to the peak synchronizing signal output, which would not be possible without a very stable age circuit.

At no time during the train tests was horizontal synchronization ever lost due to any condition in the receiver unless the received signal strength was so low as to make the picture completely unrecognizable. The vertical synchronization was not quite as good but was nevertheless exceptional in comparison with many commercial receivers.

The receiver uses the intercarrier sound method with two twin-triode clippers (limiters) in cascade, the first grid being coupled to the video amplifier plate. There is a 4.5-megacycle sound trap between the video plate and the cathode of the picture tube. The twin-triode clipper is superior in this application to the more commonly used cascaded pentode limiters.

A conventional type discriminator and audio amplifier with push-pull output is used to drive twin p-m loud speakers, one on each side of the picture tube. The maximum sound output (at low distortion) is sufficient to give a high sound level for a viewer located close to the receiver. However, the noise level due to track noise and train rumble is so high as to indicate the desirability of multiple loudspeakers with reasonably low sound output level distributed along the car.

The lights and other electrical equipment on a train are supplied from a 32-volt train battery, or from a separate battery in each car. A d-c generator, driven from an axle of the car, is used to keep the battery charged. The voltage on the car lines may drop to 28 volts (or less) when the train is stopped and rise to nearly 40 volts when the generator is running. The television receiver was designed for 117 volts at 60 cycles. This voltage was obtained from a Bendix type MP-54A inverter, designed for train radio communication systems. The regulator of the inverter was adjusted to operate at 60 cycles. It maintained the output frequency within a small fraction of a cycle, with an output voltage variation of about  $\pm 1$  volt, with the input varying from 28 to 40 volts.

We wish to acknowledge the assistance and cooperation of many of our associates, including David Fales III, antenna engineer, and B. H. Chterbeck mechanical engineer. Cooperation of the Baltimore and Ohio Railroad made it possible to test and demonstrate the practicability of train television.

#### REFERENCES

- (1) Train Television, *ELECTRONICS*, p 219, December 1948.
- (2) H. Goldberg, G. W. Clevenger and E. L. Crosby, Jr., Unitary Television Tuner, IRE Convention, March 1948.

# A-M and Narrow-Band F-M

Conclusion of a report that evaluates two types of voice modulation used in mobile naval communications. Theoretical effects are checked against field trials. General equipment specifications are outlined

By **EMERICK TOTH**

Naval Research Laboratory  
Washington, D. C.

**T**HE THEORETICAL SOLUTIONS for output  $s/n$  ratio of an f-m system with no limiting and with ideal (mathematically perfect) limiting were derived in forms capable of providing figures in the weak-signal region where the available solutions did not satisfactorily extend. The following equation was obtained for the no-limiter case

$$\left(\frac{s}{n}\right)_0 = \left[ \frac{2x^4 d^2}{3 - \frac{(2-\gamma_c)^4}{24} + 2x^2 \gamma_c \left[ 4\rho^2 + 2d^2 + \frac{\gamma_c^2}{3} \right]} \right]^{1/2} \quad (1)$$

where  $\left(\frac{s}{n}\right)_0$  = rms output signal-to-noise ratio (no limiter)  
 $x$  = rms unmodulated carrier-to-noise ratio at the input to the f-m detector  
 $d$  = ratio of maximum carrier-frequency deviation to the

half-bandwidth at the input to the detector (for example, half-bandwidth of the r-f plus i-f amplifiers)  
 $\gamma_c$  = ratio of output bandwidth (for example, audio-amplifier bandwidth) to the half-bandwidth at the input to the detector  
 $\rho$  = detuning ratio, that is, ratio of amount by which the carrier frequency is detuned from the discriminator center-frequency to the half-bandwidth at the detector input

This equation has been derived for the case of square-law rectifiers, but it also provides a very good approximation for an f-m detector with linear rectifiers, particularly when the value of  $d$  is considerably less than 1. The approximation holds well for all values of  $x$  but is best for  $x > 2$ . It is limited to the overall condition that the sum of the deviation from center-frequency plus the amount of detuning plus the output bandwidth does not appreciably exceed

the half bandwidth at the input to the detector  $[(d + \rho + \gamma_c) \leq 1]$ .

## F-M Signal-To-Noise Ratio with Limiting

The equation for the ideal limiter case was derived for square-law rectifiers in the f-m limiter-detector system but is also a very good approximation for a detector with linear rectifiers. It becomes inaccurate, however, at values of  $x$  less than 2, but can be extended by a graphical method to the lower values of  $x$ . Like Eq. 1, it is limited to the condition that  $(d + \rho + \gamma_c) \leq 1$ .

$$\left(\frac{s}{n}\right)_0 = \frac{\sqrt{3} dx (x^2 + 1) \sqrt{\frac{1}{\gamma_c}}}{[12\rho^2 + 6d^2 + (x^2 + 1)^2 \gamma_c^2]^{1/2}} \quad (2)$$

where  $\left(\frac{s}{n}\right)_0$  = rms output signal-to-noise ratio with perfect input limiting. When the input carrier-to-noise ratio is large ( $x \geq 10$ ), and the input carrier is exactly centered on a perfectly symmetrical and balanced discriminator characteristic ( $\rho = 0$ ), Eq. 2 assumes the simpler form

$$\left(\frac{s}{n}\right)_0 = \sqrt{3} x R \sqrt{\frac{1}{\gamma_c}} = x R \left(\frac{3f_i}{2f_a}\right)^{1/2} \quad (3)$$

where  $R = \frac{d}{\gamma_c} = \frac{f\Delta}{f_a}$  = deviation ratio (or the modulation index,  $m_f$ , when the modulating frequency equals the audio cutoff frequency)  
 $f\Delta$  = frequency deviation from the center frequency  
 $f_i$  = input bandwidth at the detector  
 $f_a$  = output bandwidth (or audio-cutoff frequency at the high end)

Equations 1, 2, and 3 are based on such ideal assumptions as a perfect rectangular input selectivity curve, a perfect limiter with no threshold level, and ideal slope filters for the frequency discriminator,

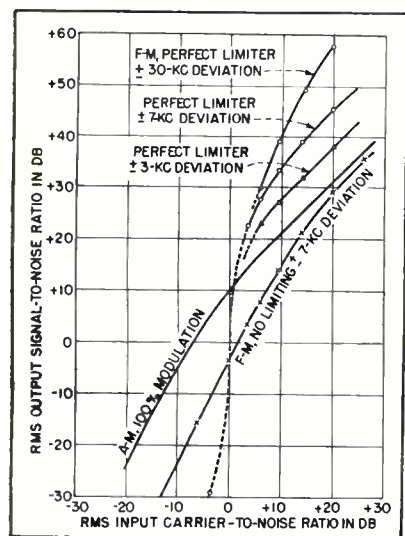

FIG. 15—Theoretical range performance of f-m and a-m

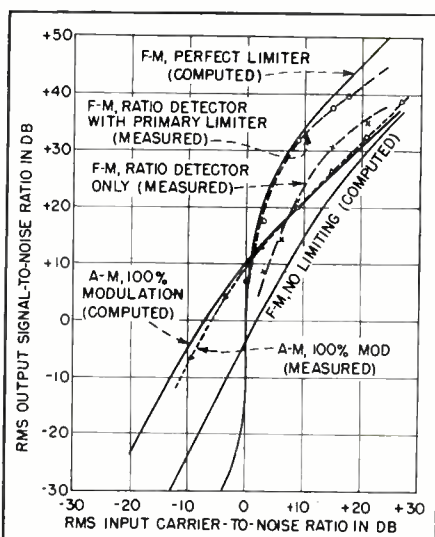

FIG. 16—Theoretical limits of experimental range

# in UHF Communications

## Part II

with perfect symmetry and balance throughout.

### Theoretical A-M Signal-To-Noise Ratio

The output  $s/n$  equation for the a-m case is based on square-law detection but is also a very good approximation for linear detection. Its accuracy is greater for the lower values of modulation percentage.

$$\left(\frac{s}{n}\right)_0 = mx^2 \left\{ \frac{2\beta}{f_a [1 + x^2 (2 + m^2)]} \right\}^{1/2} \quad (4)$$

where  $\left(\frac{s}{n}\right)_0$  = rms output signal-to-noise ratio  
 $m$  = modulation depth in percent  
 $\beta$  = half-bandwidth at the input to the detector  
 $x$  = rms unmodulated carrier-to-noise ratio at the input to the detector  
 $f_a$  = output (a-f) bandwidth (or audio cutoff frequency at the high end)

The input selectivity curve is assumed to be a perfect rectangle.

### Theoretical Range Curves

Figure 15 shows the computed a-m and f-m output rms signal-to-noise ratios corresponding to increasing values of input rms carrier-to-noise ratio ( $c/n$ ) for the conditions of the subject a-m/f-m investigations. The output values with perfect limiter for input  $c/n$  ratios below +6 db were derived as follows:

The  $\pm 7$ -kc deviation f-m no-limiter curve was constructed, using Eq. 1, for  $c/n$  ratios from -10 to +40 db. As stated previously, Eq. 1 holds quite closely for all values of  $x$ . It was then assumed that the noise energy for  $c/n$  ratios of -6 db and less could be considered as an equivalent carrier exhibiting the same capture or depression effect on the desired signal

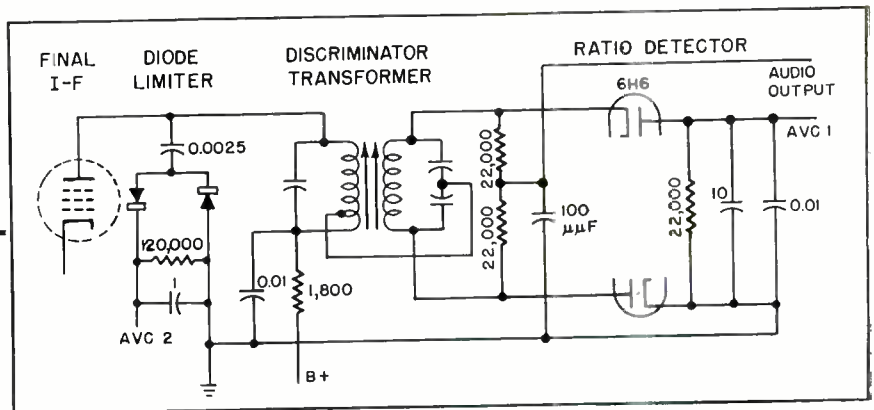

FIG. 17—Circuit of f-m detector with added primary-side limiter

as the desired signal exhibited with regard to noise for  $c/n$  ratios of +6 db and above. The f-m curve for the perfect limiter case was then drawn as much below the no-limiting curve for  $c/n = -6$  db, -10 db, and so on, as it was above the no-limiting curve for  $c/n = +6$  db, +10 db, etc. The two curve sections resulting were then joined by extension, passing through the no-limiting curve at  $c/n = 0$  db, which was considered the capture transition point. The computed values for  $c/n = \pm 3.5$  db have been plotted as a guide to construction.

The f-m perfect limiter curve for  $\pm 7$ -kc deviation crosses the a-m theoretical curve for 100 percent modulation at about +11-db output signal-to-noise ratio. These two curves were used for computing the theoretical range comparison in Fig. 6. Increasing the maximum deviation from  $\pm 7$  to  $\pm 30$  kc ( $m_r = 10$ ) changes the ideal limiter a-m/f-m crossover point very little, as shown by the 30-kc deviation curve. On the other hand, the increased deviation results in improvement of output signal-to-noise ratio for input  $c/n$  above about +5 db. Decreasing the deviation to  $\pm 3$  kc ( $m_r = 1$ ) affects mainly the output levels corresponding to  $c/n$  ratios of over about +2 db, with the a-m/f-m crossover estimated as occurring at about +12 db  $s/n$ . The  $\pm 3$ -kc and  $\pm 30$ -kc no-limiting

curves which were used in construction of the corresponding perfect-limiter curves are not shown in Fig. 15 for the sake of simplicity.

### Experimental Range Curves

A series of signal-generator measurements was made on an f-m receiver of the same type as used in the comparison trials discussed above, to verify the theoretical curves of Fig. 15 and to determine the relative position of the ratio detector within the no-limiting-to-perfect-limiting area. Companion a-m measurements were made on the same receiver, after rewiring the final detector for a-m operation. The experimental curves, which were plotted against microvolts input from the signal generator, were matched to the theoretical curves, which were in terms of input  $c/n$  ratio, by assuming that the experimental a-m curve was substantially identical with the perfect theoretical case at about +20-db output  $s/n$ . This assumption was supported by previous measurements of i-f amplifier output versus receiver input in microvolts. The resultant overlay is shown in Fig. 16. The curve for  $\pm 7$ -kc deviation with the ratio detector without added limiting (the condition for the laboratory and field trials) shows the experimental a-m/f-m crossover at +18.5-db output  $s/n$ , a close check with the average crossover of the laboratory trials

(as indicated in Fig. 5A).

To determine the effect of more nearly ideal limiting, the half-wave secondary shunt-limiting inherent with the ratio detector was supplemented by shunt-limiting on the discriminator primary side. This added limiting was made full-wave, since it demanded very few additional components over a half-wave limiter and would serve to hold the operating level of the ratio detector more nearly constant. Germanium diodes were used, because of their economy of space, low forward-resistance, and low self-generated contact potential with consequent low inherent limiting threshold. The circuit diagram for this modification is shown in Fig. 17. Connection of the primary-side limiter resulted in an insertion-loss, in reserve gain only, of 2 to 4 db.

The resulting performance is shown by the curve marked ratio-detector with primary limiter in Fig. 16. It comes within 1 to 2 db of the theoretical perfect-limiter performance in terms of output  $s/n$  from about +1 to +15-db input  $c/n$  ratio. The lower portion of all the measured curves for output  $s/n$  ratios below about +10 db was determined from wave-analyzer measurements which segregated the desired signal by filtering out much of the noise. Magnetic-tape recordings made of the f-m performance shown in Fig. 16 provided aural confirmation of the experimental measurements and also revealed some difference in character of the noise background, the added primary limiter case producing a smoother noise output with a somewhat higher apparent pitch.

#### Theoretical Effect of Detuning

Equations 1 and 2 were also solved at various  $c/n$  levels for values of  $\rho$  (the detuning factor) up to about 90 percent of the half-bandwidth of the i-f system. Two sets of the resulting curves, for  $c/n$  of +9.5 and +20 db, are plotted in Fig. 18. These show the deterioration of output  $s/n$  with increase in detuning and indicate that with no limiting, the deterioration is substantially independent of the  $c/n$  ratio. With perfect limiting, how-

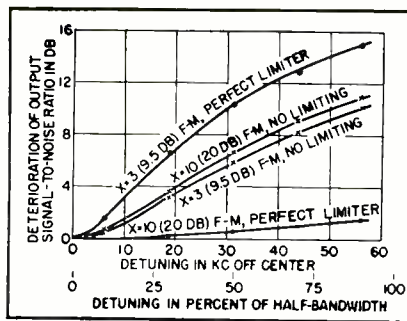

FIG. 18—Theoretical deterioration of output  $s/n$  with detuning

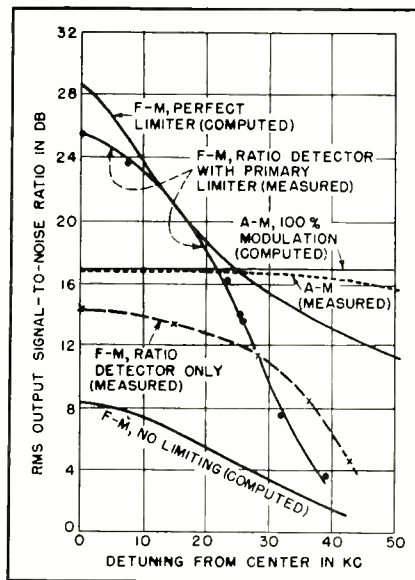

FIG. 19—Experimental detuning measurements to theoretical limits

ever, detuning is much more damaging at the lower  $c/n$  values; at the higher  $c/n$  values, detuning causes little  $s/n$  deterioration.

Figure 19 shows the measured effects of detuning both the a-m and the f-m versions of the receiver used in the experimental confirmation of the theoretical range data. The measurements were taken at a signal input level corresponding to a  $c/n$  ratio very close to +6 db. The theoretical limits for detuning with this  $c/n$  value are also shown in the graph. The departure of the experimental curves from these limits above about 25 kc or 40-percent detuning can be ascribed in part to the difference between the rectangular selectivity curve postulated in the mathematical treatment and the more nearly trapezoidal form of the actual selectivity characteristic.

The ratio detector with its im-

perfect half-wave limiting is less affected by detuning than the more nearly ideal limiter case obtained with the added primary limiter. The crossover between the two experimental curves occurs at 28-kc detuning. Magnetic-tape records confirmed that up to about 30 kc off center, the ratio detector with primary limiter sounded better than the ratio detector alone, with considerable difference in character of noise output. Deterioration of  $s/n$  with detuning of the a-m receiver departed from the theoretical a-m performance shown in Fig. 18 by an amount determined largely by the difference between the actual and mathematical selectivity curves.

#### Limiting of Impulse-Noise

Measurements were made of f-m output  $s/n$  ratio with and without the added primary limiter in the presence of impulse-noise interference. These showed that the improvement in output  $s/n$  with additional limiting that was obtained with only fluctuation noise present was also obtained in the presence of impulse-noise interference. The improvement in performance was equivalent to 2 to 5 db less required f-m transmitter power to produce given output  $s/n$  from +5 to +25 db. This decrease of required transmitter power will make the f-m performance under conditions as shown in Fig. 7 more nearly equal to a-m performance with the noise limiter on. The f-m impulse-noise reduction was, however, much more dependent on perfect symmetry and centering on the discriminator characteristic, and the detuning curves with impulse noise closely resemble those for fluctuation noise as shown in Fig. 18.

Figure 20 shows the desired-signal depression and noise-exaltation effects encountered in cochannel operation, as measured at a desired-carrier input level which provided +20-db output  $s/n$  ratio from the a-m receiver. The noise curve obtained for the f-m case with added primary limiter shows the peak which is characteristic of an f-m system with limiting approach-

ing theoretical optimum. This peak occurs in the vicinity of an undesired-to-desired carrier amplitude ratio of 1. The noise increase is caused by abrupt phase shifts in the resultant of the two carriers, which produce sharp bursts of energy, resembling noise, in the output of the f-m detector. These phase shifts are maximum for equal amplitude of the two carriers and are less on either side of equality. The halfwave limiting typical of the ratio detector masks this peak, as shown by the curves.

The low contact-potential of the germanium crystal diodes used to obtain improved limiting results in a decreased capture threshold. Thus the f-m curve for 30-db output  $s/n$  depression for the ratio detector alone case (Fig. 8) shows that +7.5-db undesired-to-desired carrier-level ratio is required to produce such a value of depression for a desired input signal level corresponding to +30-db output  $s/n$  without interference. With the added primary limiter, however, only +4 db undesired-to-desired carrier-level ratio is required to produce the same depression (Fig. 20A). As previously mentioned, the intelligibility comparison curve (Fig. 9), with better limiting and the same initial interference-free output  $s/n$ , can be expected to show a greater downward tilt between -10 and 0-db undesired-to-desired carrier ratio.

The slope of the desired-signal output curve in the region where capture is well under way is an index to the degree of capture. In Fig. 20, the slope for the f-m case with ratio detector alone is 76 deg, while with added limiting, it is 78 deg; the a-m curve with avc off has a slope of about 50 deg, which becomes about 60 deg with avc on. Perfect capture would be indicated by a slope of 90 deg. It should be noted that the a-m capture slope with avc off will increase with increasing input signal level as the amplifier stages preceding the final detector begin to exhibit saturation effects. With linear detection, no saturation effects, and no avc, the a-m capture curve should have a slope of 45 deg, or one db of de-

sired-signal depression for db of increase in interfering signal. With square-law detection, however, substantially no a-m capture should occur.

As Fig. 20B shows, the a-m system exhibits very little change in output noise with increase of interfering carrier level, while large noise changes occur in the f-m system. The output signal-to-noise ratio depression effects observed in the adjacent-channel trials are caused by phenomena essentially identical with those occurring in the common-channel case. With limiting approaching the ideal, the depression effects in the f-m system will be intensified for any given initial interference-free value of output  $s/n$ , as the interfering carrier approaches the desired-carrier frequency; the curves of Fig. 12 can therefore be expected to take a steeper downward tilt toward 0-mc frequency separation.

#### Range Results

It is generally considered desirable to restrict the distance or range rating of a communication system to a safe-communication range which provides not less than about +15 to +20-db output signal-to-noise ratio for peak or 100-percent modulation, but the usefulness of lower  $s/n$  ratios must not be overlooked. It has been established by the series of tests mentioned previously that +5-db output

$s/n$  for peak or 100-percent modulation represents a low-limit below which 300 to 3,000-cps voice message systems must, in general, never be allowed to fall. Figure 21 shows the horizontal or azimuthal radiation pattern for a good uhf vertical dipole antenna installation on shipboard. The outstanding characteristic of such patterns, despite all precautions, is rapid and large variation in radiation intensity with bearing. Vertical patterns for the same antenna would also reveal variations with elevation. The maneuvering of ships and planes with transmitting and receiving-antenna patterns such as that shown would result in large fluctuations of signal input to the receivers, even though the range or distance were maintained constant. Thus, at the safe-communication range limit, radical variations of output  $s/n$  could be expected to occur in the f-m system, with the signal abruptly disappearing and reappearing as the relative bearings and inclinations from the vertical varied with pitching, rolling, banking, and turning of the communicating craft. The less abrupt range cutoff characteristic of the a-m system would be particularly advantageous under such conditions; its relative freedom from downward a-m limitations would also be desirable.

Figure 22 is a plot of the output  $s/n$  variation for both types of

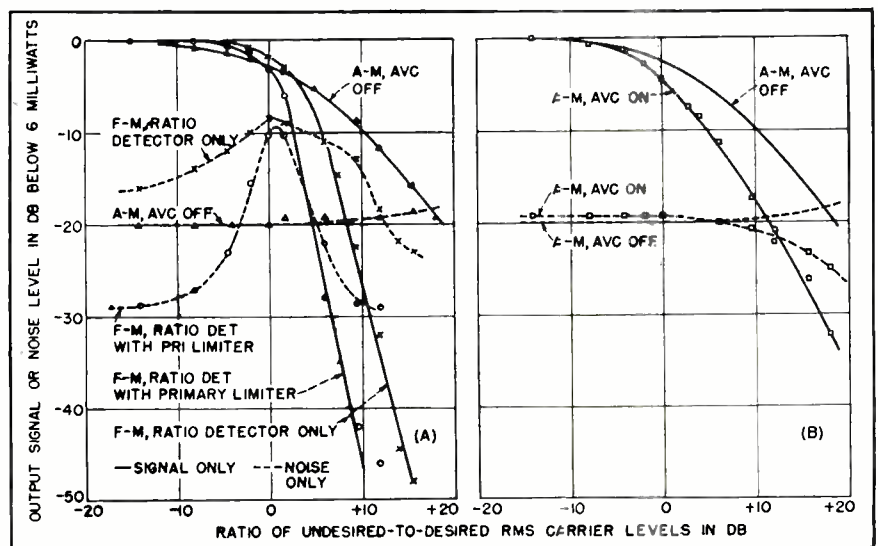

FIG. 20—Cochannel effects for a-m and f-m, using two signals

modulation as the receivers with perfect receiving-antenna patterns assumed move through a sector of 170 deg to 240 deg bearing relative to the radiation pattern shown in Figure 21. The 0-db circle on the pattern represents approximately the average radiation level that would be applicable for safe-communication range estimation. The curves of Fig. 22 have been plotted for that constant distance or range at which the a-m system provides +20-db output  $s/n$  for a radiation level corresponding to the 0-db circle on the antenna pattern. The unmodulated carrier-power output of the f-m transmitter is the same as that of the a-m transmitter in this comparison. The graphs show that the a-m output  $s/n$  generally holds up better than the f-m  $s/n$  in the antenna pattern hole from about 185 to 225 deg relative bearing. At no time does the a-m output signal drop below the +5-db low-limit of intelligence.

Curve C of Fig. 22 approaches the theoretical limit of performance. It, however, represents operation under carefully maintained and controlled conditions which, unfortunately, cannot be expected when normal service conditions prevail. Slight misalignments and drifts of the discriminator circuits; receiver and transmitter oscillator initial frequency displacements and subsequent drifts, with resultant detuning; changes in reserve r-f gain with tube aging that have consequent influence on limiter levels will all combine to reduce the f-m advantage at received signal levels above the a-m/f-m output  $s/n$  crossover where it would otherwise be much better than a-m.

#### Noise Interference Results

The single-signal range investigations revealed the relative performance of the two types of modulation in the presence of fluctuation noise. Amplitude-limiters of the noise-peak class which are applicable to voice-modulated a-m systems have little or no reduction effect on such noise. These limiters can, however, perform very effectively on impulse noise, particularly when fairly broad r-f or i-f bandwidths precede the a-m detector. Best results are normally obtained in re-

ceivers operating at the higher radio-frequencies, although excellent performance has been obtained even in the vlf range with some of the simplest types of limiters.

The impulse-noise interference studies showed that the a-m system with a simple series-diode type noise limiter was at least as good as the f-m system in the weak-signal range, even when the f-m equipment approached the theoretical ideal limit. The f-m system was, however, inherently capable of better performance above about +20-db output  $s/n$ . On the other hand, the f-m system was also liable to serious deterioration with regard to impulse-noise suppression with detuning, or when discriminator symmetry and balance were disturbed by misalignment or drift, whereas the a-m system was essentially unaffected by detuning or by dissymmetry of the selectivity characteristic preceding the a-m detector.

Effective a-m receiver limiters produce distortion of the detected modulation resembling the speech-clipping or amplitude-compression that can be deliberately introduced in transmitters. Such clipping or compression is, in the presence of impulse noise, generally more advantageous when applied at the receiving end of an a-m circuit. Because good f-m limiting does not under normal single-signal conditions, result in any considerable distortion in the detector output, f-m has an inherent advantage for truly high-fidelity reproduction when the discriminator character-

istic is linear and symmetrical, and the signal carrier is properly centered thereon.

#### Common-Channel Operation

Capture effect is not, in general, desirable in communication systems in which both transmitting and receiving terminals are highly mobile. For a number of reasons, knowledge of the presence of another, weaker transmission on the same channel as the desired signal is of military importance. A minimum vulnerability to deliberate or accidental jamming is also essential in any system in which many communication circuits must be maintained under rapidly changing conditions of position and signal strength. The same characteristics which make f-m output signal-to-noise ratio superior to a-m above the weak-signal region of operation also tend to make f-m systems more vulnerable to jamming and capture. Deliberate reduction of the f-m capture and masking effects to approach a-m performance in this regard will usually result in loss of much of the f-m  $s/n$  output advantage above the weak-signal region.

On the other hand, capture can be put to good use in f-m communication or broadcast systems in which the transmitting and receiving terminals are relatively fixed in geographical location and the receivers are well-designed, carefully maintained, and properly operated. Although anomalous propagation may at times work havoc with reception when geographical allocations are based on capture as a consideration, the average performance, except in the fringe area of nearly equal field intensities, should be good. Police f-m radio systems are an example of such an application; by proper choice of frequency and geographical allocations, the fringe area can be at a distance between two systems such that undesired capture very seldom occurs.

Audible-tone heterodyne interference will occur in both a-m and f-m systems when the frequency separation between two carriers is less than the upper audio-frequency cutoff of the receivers. In addition to heterodyne beats, the f-m

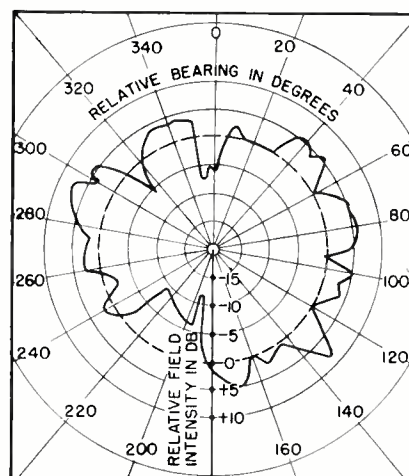

FIG. 21—Horizontal pattern of ship's uhf vertical dipole

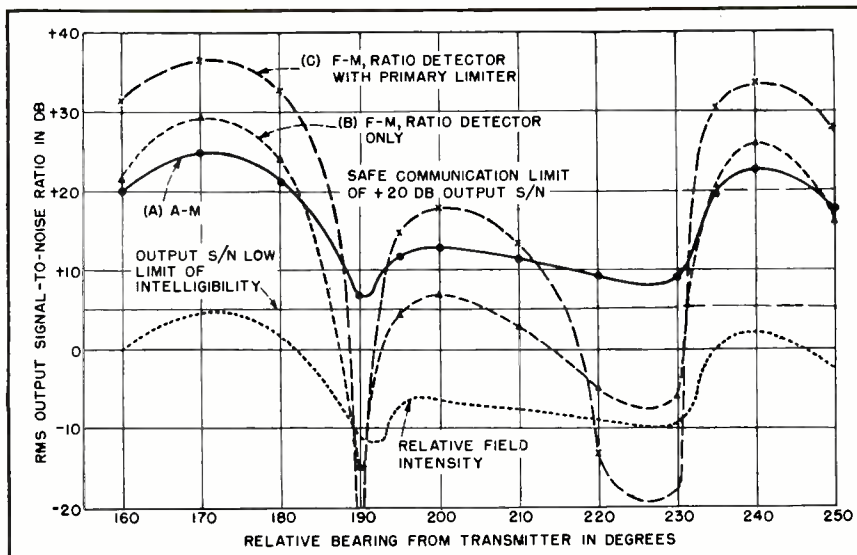

FIG. 22—Output s/n variation for 160 to 250-degree sector of antenna pattern

system output will exhibit fluctuation-noise increase and swish effects due to modulation as the undesired-signal carrier increases toward equality with the desired-signal carrier at the input to the limiter-detector system.

#### Adjacent-Channel Operation

Cross-modulation effects in a-m systems usually determine the minimum channel-separation frequency which can be tolerated when transmitting and receiving antennas working in different channels are located close to each other, as on a ship. Output  $s/n$  depression in an a-m system is usually negligible compared to cross-modulation. The cross-modulation interference takes the form of crosstalk in the receiver output; it can be reduced by additional selectivity preceding the first tube of the receiver, use of better remote-cutoff tubes, and various other means. The f-m systems are generally free of cross-modulation but are subject to output signal-to-noise ratio depression effects produced by essentially the same mechanism as cochannel capture. Increased selectivity preceding the f-m detector is about the only practical means of reducing this effect without sacrificing f-m performance in other regards.

The a-m crosstalk due to cross-modulation in speech communication will usually consist of another conversation; it will always be at a lower average level than the de-

sired conversation under normal conditions, with the usual breaks and pauses, and can be segregated from the desired message to some extent by concentration on the part of the listener. The  $s/n$  depression effect with f-m is, however, a function of the relative interfering carrier level and is essentially unaffected by the modulation of the undesired signal. It has no breaks or pauses so long as the undesired carrier is on, and the listener's ability to concentrate on the desired message through continuous fluctuation noise will determine how much intelligence he can obtain from the desired signal. The absolute low limit without repeats will be the same as for single-signal operation; about +5-db peak output  $s/n$  for the conditions of this problem.

#### Multipath Propagation

In general, multipath reception of an f-m signal with its resultant phase-interference effects can produce more output distortion than similar multipath reception experienced with an a-m signal. As the frequency deviation is increased for a given modulation frequency, the number of significant interference points in the spectrum of the signal also increase, making wide-deviation f-m even more vulnerable to multipath propagation effects.

While no specific tests for multipath reception were made in this problem, a considerable body of contract research reports and other

technical literature concerning this aspect of radio communication was studied, leading to the above generalization. Inspection of the field test data has also indicated that more marked and severe fluctuations or fades in signal output from the receivers were experienced with f-m than with a-m. This comparison was made for signal-input levels which eliminated, in so far as possible, the weak-signal region where f-m begins to exhibit its abrupt cutoff effects with decreasing input level; the f-m output fluctuations observed could, however, have been partly due to the downward a-m capability limitations of the ratio detector. This limitation appears to be characteristic to some degree of all practical f-m detector systems and is most apparent with low signal-input levels, where the limiter circuits are usually operating near their threshold region. It is obviously undesirable under the conditions of signal fading characteristic of multipath propagation.

#### Pre-Emphasis and De-Emphasis

Standard f-m broadcast pre-emphasis would have contributed very little to the performance of either system used in the subject comparison, due to the 6-db cutoff at 3,000 cps already provided in both systems. Some tests were, however, made with 400-cps tone modulation and de-emphasis in the experimental receiver starting at 500 cps; the results obtained are shown in comparative form in Fig. 23.

Considering the effect of de-emphasis in terms of the reduction it allows in input  $c/n$  ratio for a given value of output  $s/n$  ratio, the improvement with f-m with limiting approaching the theoretical ideal is not more than 1-db reduction in  $c/n$  ratio until the detector input  $c/n$  ratio exceeds about +3 db. With the ratio detector, however, the improvement is considerably greater. The a-m system benefits most, particularly in the linear region above  $c/n = 0$  db. One result of de-emphasis, which is due to the relative slopes of the a-m and f-m curves, is an increase of about +5 db in output  $s/n$  ratio at the a-m/f-m crossover, which becomes about +15 db instead of about +11

db for the nearly ideal case of the ratio detector with primary limiter, and about +23 db instead of about +18 db for the ratio detector only. The de-emphasis characteristic used was one which leads to a practicable transmitter pre-emphasis characteristic, since, with male voices, the peak speech energy region in frequency occurs below 500 cps.

The reduction in the input  $c/n$  ratio required for a given value of output  $s/n$ , as made possible by de-emphasis, is the direct equivalent of a decrease in transmitter radiated power required in the communication system. Taking +20-db output  $s/n$  as the reference value, de-emphasis as incorporated in the tests would permit 1-db (about 20 percent) reduction in transmitter power rating for the f-m system with nearly ideal limiting, 3-db reduction (50 percent) for f-m with the imperfect limiting of the ratio detector only, and about 4 db (about 60 percent reduction) for a-m.

#### Transmitter Design

In addition to performance considerations, a comparison of a-m and f-m systems must take into account circuit and other physical differences in the transmitters and receivers. For transmitters, the following statements can be made.

The audio modulating power required for an a-m transmitter is greater than that required for an f-m transmitter. High-level plate modulation of an a-m transmitter requires audio power approximately equal to 50 percent of the d-c power input to the final carrier amplifier. The use of f-m can result in a reduction of transmitter primary input power and elimination of many of the circuit components necessary to produce the a-m high-level modulating power output. The saving for an f-m transmitter over an a-m transmitter generally becomes a greater absolute value in terms of the total primary power, weight, and space as the output power rating of the transmitter is increased. For the 30-watt transmitters used in the a-m/f-m comparison trials, it is estimated that this saving would amount to between 10 and 20 per-

cent in primary power input, and total weight and space.

This saving is partially offset by the necessity for providing phase-modulator and integrating circuits or other frequency-modulating means in the f-m transmitter.

#### F-M Modulators

Distortion-free modulation of f-m transmitters is not simple or easy of achievement, particularly in crystal-controlled designs. It may require use of much higher orders of multiplication than would be necessary in an equivalent a-m transmitter, particularly with large deviations, and thereby tend to negate transmitter simplification and spurious response improvements such as are possible with harmonic-mode crystals. In fact, f-m, because it represents a controlled frequency instability, tends to oppose the frequency sta-

present in the received signal before final detection, and a means of converting low-percentage frequency variations into closely equivalent amplitude variations for detection must also be incorporated.

The means for minimizing amplitude variations usually takes the form of one or more types of amplitude limiters. Many of these devices possess serious shortcomings in that they exhibit threshold effects, and peculiarities with respect to transient response. Even the best of them forces compromise in receiver design not normally necessary in an a-m receiver. Conversion of low-percentage frequency variations into directly proportionate amplitude variations requires linear phase discriminators which are highly sensitive to small changes in carrier frequency. For instance, in the uhf system under consideration, the average carrier-frequency deviation due to speech modulation was less than  $\pm 0.001$  percent. With good limiting, the frequency discriminator in this case requires a frequency stability which approaches quartz-crystal tolerances. Since maintenance of this high degree of precision and frequency accuracy by manual means is a practical impossibility under operational conditions, some form of automatic centering means, such as afc, must be considered. Such devices, if used, result in added complications which tend further to compromise the f-m system.

A-m receivers require some form of amplitude limiter to provide impulse-noise reduction comparable to f-m receiver performance. Several simple and effective circuits which are not affected by detuning are available for this application, but their use generally involves added output-harmonic distortion at high modulation levels not usually present in limited-carrier f-m receiver output.

#### Acknowledgement

The author acknowledges his indebtedness to the many persons who cooperated in the prosecution of this problem, with particular thanks to Robert M. Maiden and James D. Wallace, Jr.

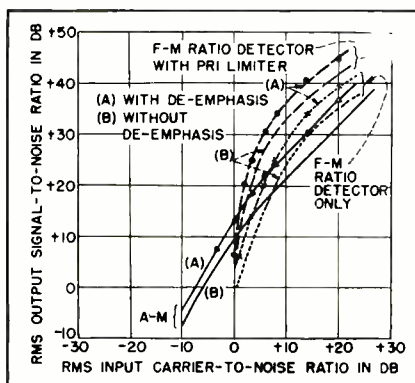

FIG. 23—Comparison with and without de-emphasis, both systems

bilization incorporated in a transmitter.

The advent of effective and simple low-level a-m modulation techniques may reduce the f-m advantage. At 100-percent modulation, the transmitter requires 1.8 db additional radiation power for its sidebands as compared to the zero-modulation condition. Since, however, peak modulation occurs only part of the time with speech transmission, various devices may be used to reduce the average modulating power required by the a-m transmitter.

In general, f-m receivers require two elements not normally necessary in a-m receivers. Some means must be provided to minimize or eliminate the amplitude variations



# Radio-Frequency SWEEP GENERATOR

An overdriven amplifier is used as the switching tube in a resistance-capacitance sweep generator. To synchronize the sweep with the phenomena to be observed, the base frequency of the sweep circuit is multiplied to drive the equipment that is being tested

**V**IEWING phenomena of very short duration has been made quite convenient for low-recurrence rates by the synchroscope and high writing-speed cathode-ray tubes having isolated deflection circuits. However, methods for observing high-recurrence-rate phenomena have been less thoroughly treated.

The method described here is suitable for viewing the radio-frequency output of high-frequency transmitters and the pulse output of high-recurrence-rate pulsers, especially when the output frequency is derived by harmonic amplification from a lower-frequency base oscillator.

An overdriven amplifier is used to produce a sawtooth sweep from a sinewave. This sweep, being rich in harmonics, is followed by harmonic amplifiers that produce a synchronous output to drive the transmitter or pulser. The method is simple and is easily incorporated within the equipment with which it is to be used.

## Design Problems

Laboratory oscilloscopes commonly generate their sweeps by resistance-capacitance charging or discharging circuits, using gas-tube switches and series-pentode linearizing devices. When sweep recurrence rates appreciably beyond 50 kc are desired, two difficulties arise: (1) The gas tube will not deionize sufficiently between operations; (2) The output capacitance of the sweep generator becomes too large as a result of the fact that the

By **MILLETT G. MORGAN**

*Assistant Dean  
Thayer School of Engineering  
Dartmouth College  
Hanover, N. H.*

series pentode must be connected with its cathode, rather than its plate, following the generated sweep voltage. Whether it is arranged to charge or to discharge the sweep-generating capacitance as the sweep is generated, the pentode must be connected in the unfavorable polarity. (Whether the capacitance charges or discharges is merely a matter of whether it is connected from plate to the positive terminal of the high-voltage supply or from plate to the negative

terminal of the high-voltage supply.)

The excessive capacitance imposed by the series tube results from two sources. First, there is the cathode-heater capacitance in series with the interwinding capacitance of the filament transformer. If the voltage developed across the cathode-heater capacitance is excessive, a filament-type tube must be used and the full interwinding capacitance may be imposed across the sweep output. This may be several hundred  $\mu\text{f}$ , but can be materially reduced by spacing the secondary winding of the filament transformer away from the core and primary winding and accepting the leakage reactance which results. Secondly, the requirement that the



Sweep generator includes electron-coupled oscillator in box on top and sweep circuit in chassis below; blowers are for resistors in sweep circuit

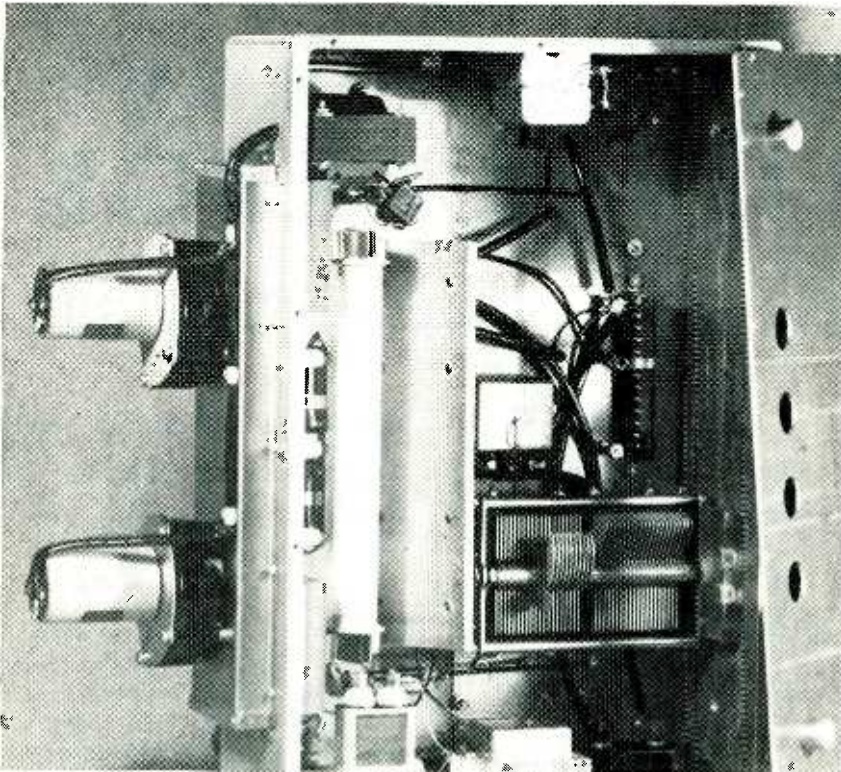

Underside of oscillator and sweep circuit chassis shows special constant-impedance-capacitor voltage divider that controls the sweep amplitude

control grid and screen grid potentials of the series tube be maintained constant with respect to the cathode, in order to obtain constant-current characteristics, also presents difficulties. The control grid is no special problem, but in order to maintain the proper screen grid voltage, the potential of the entire screen voltage supply must follow the generated sweep voltage.

These factors lead one to seek a hard-tube sweep generator and some other means of linearizing. A sweep can be generated by an overdriven amplifier. Such an amplifier, when driven by a large sinusoidal input, can be caused to produce in the plate circuit a sharp negative pulse having a duration of one-quarter the period of the input wave. Using such a tube as a switch, one can cause a capacitor to charge for three-quarters of the input wave period and discharge through the conducting tube for one-quarter of the period. Thus an exponential sawtooth, with the rise time three times the fall time, is generated. A common method for obtaining approximate linearization is to use a charging voltage greatly in excess of the desired sweep

amplitude so that only a small portion of the exponential curve is used. A blocking capacitor, between the switch tube and the sweep generating capacitor, moves the axis of the output wave up so that it swings alternately positive and negative by the same amount. Centering voltage for the horizontal-deflection plates is thus eliminated, even with a plate grounded.

#### Capacitance Divider

The sawtooth voltage is a suitable source of harmonic voltage for generating a higher frequency, synchronous sinewave output for use

with any type of modulation. In this event the input to the succeeding harmonic amplifiers must be of constant amplitude, but at the same time it may be desirable to vary the sweep amplitude. This necessitates the use of a constant-impedance divider to satisfy both conditions simultaneously.

The divider is formed by placing a variable capacitor in series with the indicator capacitance which consists mainly of the coaxial cable capacitance. This is a satisfactory method of control except that the net shunting capacitance is still varied somewhat. The effect can be eliminated by ganging a compensating capacitor, with specially shaped rotor plates, to the sweep amplitude control capacitor. A resistor in series with the coaxial cable carrying the sweep to the indicator may be required in order to prevent the initiation, with each sweep cycle, of oscillations on the line due to improper impedance termination at the receiving end.

The rotor plates of the divider capacitor must be specially shaped to provide the required constant impedance. This capacitor is at the output of the circuit shown in Fig. 1. Let  $C_1$  be the capacitance of the cable to the indicator,  $C_2$  the amplitude control capacitance (1,000  $\mu\mu\text{f}$ ),  $C_3$  the minimum capacitance of  $C_2$ , and  $C_4$  the compensating capacitance produced by the special rotor. The two sections are ganged so that  $C_4$  increases as  $C_2$  decreases.

The shape of the rotor can be determined by analysis. It is required to maintain a constant total capacitance  $C_T$  across the circuit, therefore  $C_4 + C_2 = C_T$ , where  $C_4$

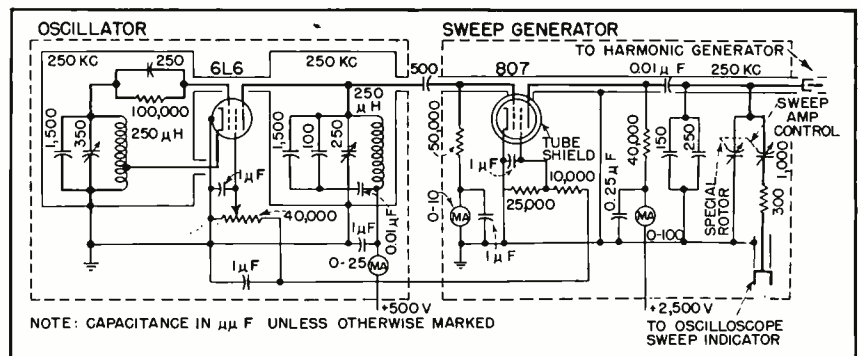

FIG. 1—Circuit of 250-kc oscillator and sweep circuit; sweep takes  $\frac{3}{4}$ th of a cycle and retrace takes  $\frac{1}{4}$ th cycle of the oscillator's frequency

is the resultant of  $C_1$ ,  $C_2$  and  $C_3$  neglecting the 300-ohm damping resistor. Both  $C_4$  and  $C_N$  are functions of the angular position, but  $C_T$  is not. By writing the differential equations for the capacitances as functions of angular position and solving, we find that

$$r^2 = r_{MAX}^2 \left( \frac{C_1 + C_3}{C_1 + C_2 + C_3} \right)^2 + r_1^2 \left[ 1 - \left( \frac{C_1 + C_3}{C_1 + C_2 + C_3} \right)^2 \right]$$

where  $r$  is the radius of the rotor,  $r_{MAX}$  is the maximum radius of the plates (determined by the original capacitor dimensions), and  $r_1$  is the radius of the arc cut in the stator plates to accept the rotor shaft.

If  $C_2$  is known as a function of  $\phi$  (it may be assumed to be  $K\phi$  if constant radius plates are used for  $C_2$ ), then  $r$  is computed for various angles from 0 to 180 degrees. Enough plates so shaped are used on  $C_4$  to maintain  $C_T$  constant. In general an integer number of plates will not produce perfect compensation. Enough plates are used to produce overcompensation and  $r_{MAX}$  is reduced on one or more plates. Inasmuch as the foregoing equation for  $r$  neglects edge effects near the limits of  $\phi$ , which will have to be compensated by cut-and-try methods, it is also reasonable to simplify the calculations by assuming that  $r_1$  and  $C_3$  are zero. The minimum capacitance of  $C_4$  serves only to increase  $C_T$ .

#### Using the Equipment

Figure 1 shows a 250-kc electron-coupled oscillator and sweep generator, of the type described above, with outputs to an indicator and harmonic amplifier. Figure 2 shows waves obtained with the equipment. By this method, one can supply a synchronous sweep for indication of any output which is obtained by harmonic amplification. In the case of a transmitter whose output frequency is much greater than four times the base frequency, it is desirable to take the sweep generator input from an intermediate point so that a reasonable ratio of output frequency to sweep frequency will be maintained. The method is less suitable for transmitters operating straight through on one frequency, for the sweep generator input then must be de-

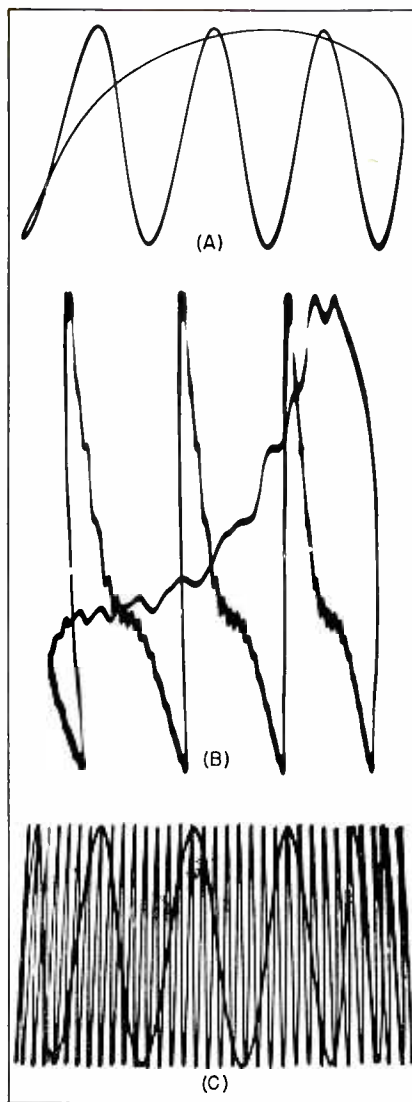

FIG. 2—(A) Trace of a 1-mc wave on the 250-kc sweep, (B) parasitic oscillation in a 1-mc wave, and (C) a 10-mc wave on the 250-kc sweep

veloped by use of a synchronized multivibrator, as is done in a synchroscope when used for synchronous sampling, or preferably by regenerative modulation.

It is revealing to be able to view the performance of circuits at higher frequencies. For example, in the 250-kc oscillator shown, a small transient, reinitiated with each cycle and having a frequency of about 100 mc, was a source of perplexity for some time. The transient was found to be initiated by dynatron action at that point in the cycle where the instantaneous plate voltage fell below the screen voltage. Without the high speed sweep, the transient would not have been easily detected and the source of trouble would therefore have been

very difficult to diagnose.

In the case of large duty-ratio pulses, the sweep is equally suitable. As the duty ratio becomes smaller, it is desirable to increase the sweep frequency. This may be carried, by harmonic amplification, to the point where the sweep frequency is greater than the pulse recurrence frequency. The only objection to this situation is a bright, solid base line produced on the screen. In general, a blanking pulse for the return trace is not required. By proper phasing of the voltage to be viewed, the return trace (though not linear) can be used for expansion as shown in Fig. 2. Blanking and intensification do become desirable when the sweep frequency greatly exceeds the pulse recurrence frequency. Writing speed becomes a limitation only when pulses of extremely short duration and small duty ratio are displayed.

The final consideration in the design of such an indicator, is the choice of a cathode-ray tube with suitable characteristics. In order to prevent feeding of the unknown voltage into the sweep through the interelectrode capacitances of the cathode-ray tube, it is desirable to use a tube having the deflection plate connections on the neck, such as the Du Mont 5JP1. Coaxial lines can then be used to carry the sweep and unknown voltages to the tube. The capacitance of one deflection plate to either plate of the other pair, is ordinarily about the same due to mechanical symmetry and can be balanced more perfectly with external capacitance. Hence, if each plate of the other pair has equal impedance to ground, each receives equal voltage from the first plate and no perturbation results. This impedance balance can be obtained by using push-pull deflection voltage. Inasmuch as feeding can occur in either direction, it is desirable to use push-pull voltages for both deflection circuits if the frequencies are high enough to cause cross-feeding within the tube. Using balanced deflection circuits has the further advantage of reducing defocusing effects by greatly reducing the potential excursion of points between a pair of plates so fed.

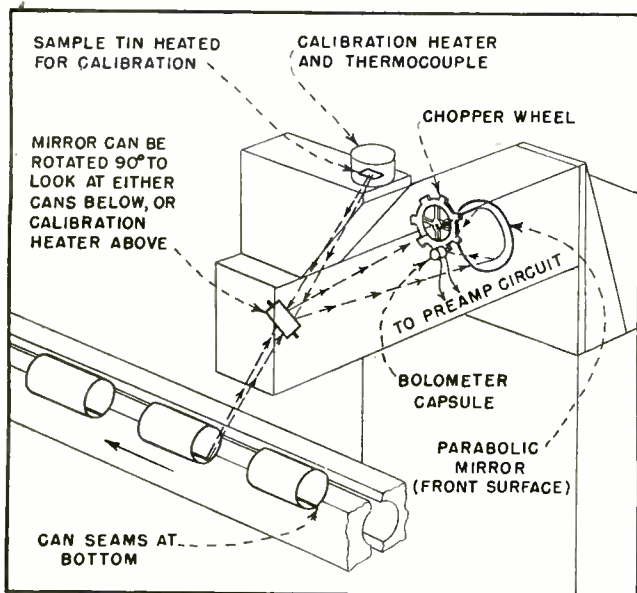

FIG. 1—Infrared radiation from heated tin cans or from calibration heater is beamed through chopper wheel to bolometer capsule

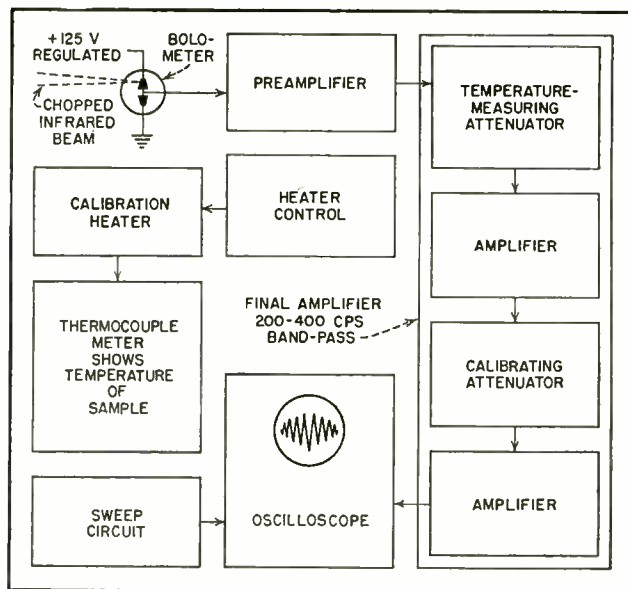

FIG. 2—Signal from bolometer is 300-cps voltage varying in accordance with intensity of infrared radiation

# Industrial HIGH-SPEED

Accurate measurement of the temperatures of tin cans moving at high speeds is made possible by the use of infrared pyrometry. Special amplifier and sweep circuits provide maximum flexibility of equipment for operation under a variety of conditions

By **W. S. GORRILL**

*Hanson-Gorrill-Brian Inc.  
Glen Cove, New York*

**T**HE INSTRUMENT described in this article was designed to meet the need for a device that would accurately and continuously measure the temperature of a soldered seam on the sides of tin cans as they move past the measuring point at rates as high as 6 cans a second.

On the machine which forms the cylindrical portion of the tin can, the seam to be soldered is subjected to a series of heating and cooling operations. The proper adjustment of the heating flames and the flow of cooling air which will give the best soldering job can only be found by measuring the temperature of the soldered seams as the cans pass from one operation to the next at

normal operating speeds.

Inaccessibility and the rapid motion of the cans prohibited the use of physical-contact measuring devices, and the relatively low temperatures involved (400 to 700 F) made infrared pyrometry the only possible method of temperature measurement. Although the cans pass the pyrometer at a maximum rate of only six cans a second, the time available for measurement on each can may be as short as 1/100-second because the pyrometer must look at an angle into the end of the can in order to receive the infrared radiation from the hot seam being soldered.

### Operating Principle

The infrared energy being emitted by the heated seam is picked up by the optical system as shown in Fig. 1. The infrared beam thus formed is then passed

through a 15-slot 1,200-rpm chopper wheel which creates a pulsating beam that is in turn focused on a thermistor flake in the bolometer capsule. The thermistor is thus alternately heated and cooled at the rate of 300-cps.

The thermistor which receives the infrared beam is connected in series with an identical compensating thermistor across a well-filtered d-c voltage, as shown in Fig. 2. The signal appearing between the two thermistors is a 300-cps voltage resulting from the changes in resistance of the one receiving the infrared signal from the optical system.

In the bolometer used, the thermistors were mounted in an evacuated capsule in order to minimize microphonic effects, and the thin thermistor flakes were backed by quartz to obtain the shortest possible thermal time constant.

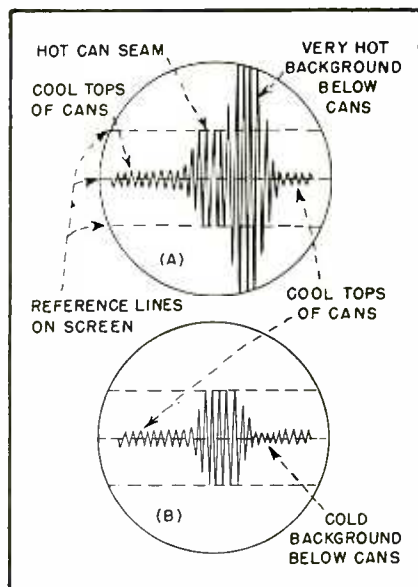
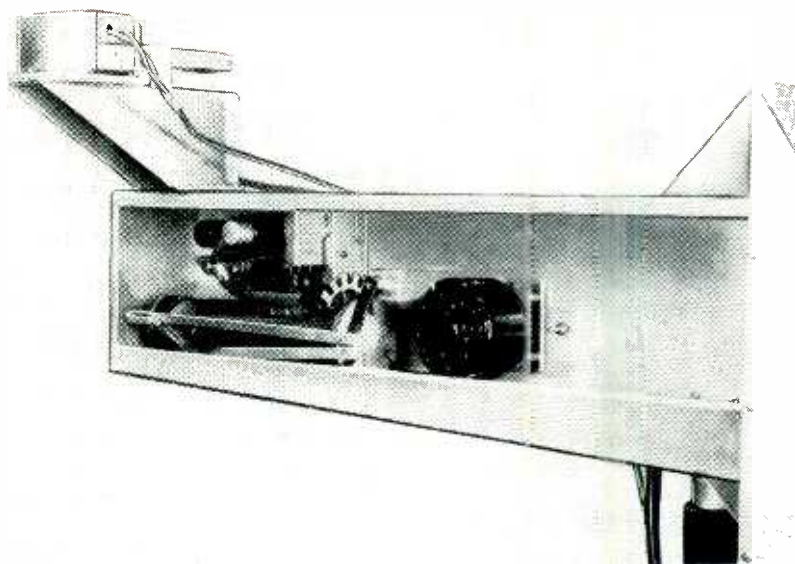

FIG. 3—Typical oscilloscope patterns. Envelope indicates relative temperatures



View of optical system, chopper wheel and motor, and calibration heater of infrared pyrometer

# INFRARED PYROMETER

The 300-cps signal from the bolometer circuit varies in amplitude in accordance with the intensity of the infrared radiation, and thus with the temperature of the area being viewed. It is then amplified and fed into a cathode-ray oscilloscope which is used essentially as a null indicator, the temperature being read on a calibrated attenuator in the amplifier system which is adjusted to give a predetermined signal height on the oscilloscope screen.

Since there is a wide variation in the infrared emissivity of different surface coatings used on cans, provision is made for calibration of the pyrometer from a sample of the material being used. The sample is heated by a small electric heater, and its temperature measured by a thermocouple in conjunction with a meter which is calibrated in degrees Fahrenheit. The calibration heater is so positioned (Fig. 1) that by simply flipping a mirror, the operator can check calibration by focusing on the sample instead of the moving cans.

An oscilloscope is used instead of a meter for the null indicator

because it is necessary to pick out the desired signal from other temperature signals which are of no interest. Two typical oscilloscope patterns are illustrated in Fig. 3.

### Scope Pattern Interpretation

The horizontal sweep circuit frequency is adjusted to give one sweep as each can passes the optical system. In Fig. 3A the optical system is at a position on the assembly line where it sees an extremely hot area between cans (such as the heating flame which raises the seam

temperature well above the solder's melting point and allows removal of excess solder). Figure 3B shows the pattern when the optical system views a cold area between cans, such as the factory floor, or relatively cool parts of the machinery.

Looking at Fig. 3A, and picturing the cans passing the optical system (as shown in Fig. 1) the relatively cool can tops may be seen to give a low signal. As the hot seam just enters the viewing area, the signal begins to rise until the whole viewing area is focused on the seam, at which time the signal levels

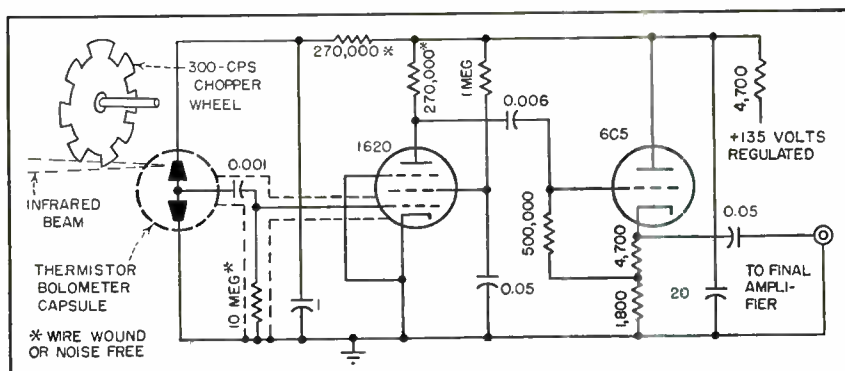

FIG. 4—Circuit diagram of preamplifier. Extremely rigid wiring in the input circuit is necessary to prevent microphonic



# Flush-Mounted Antenna for Mobile Application

Small annular slot antenna with the same radiation pattern as a dipole can be built into the metal roof of a car. Theoretical development and experimental results are given for operation at mobile-service and citizens-band frequencies

By DONALD R. RHODES

*The Antenna Laboratory  
Ohio State University Research Foundation  
Columbus, Ohio*

THE FREQUENCIES initially used for two-way mobile radio were relatively low, so the problem of radiating and receiving signals was usually solved by placing as long an antenna as possible in a convenient physical location. This position was not critical because of the ease with which low-frequency radiation could be diffracted around the conducting surface of an automobile body, and the length was not critical because of the physical impracticability of erecting a vertical rod more than a small fraction of a wavelength in height.

The problem of providing an antenna at the high frequencies in use today is not as easily solved and requires careful consideration of all the influencing factors. As the frequency is increased the effects of diffraction around an automobile diminish, creating electrical shadows,—barriers to the propagation of radio-frequency energy. The antenna dimensions can no longer be chosen arbitrarily but must be part of a systematic engineering design.

Considering that the antenna should have a nearly omnidirectional pattern and that its energy should be directed along the horizon for ground communication purposes, the most natural antenna choice is the vertical stub above ground now being used by police, taxicabs, telephone companies, and others in the 150-mc region. Although a vertical stub on an automobile roof is electrically excellent, its size and appearance leaves much to be desired. Release of the citizens communications band by the Federal Communications Commission will create an additional widespread popular demand for two-way mobile radio systems and the problem of designing a less conspicuous antenna will no doubt present itself.

#### Fundamental Principles

A short stub antenna mounted above a ground plane can be considered an electric dipole in free space. A small circular-loop antenna may be considered a magnetic dipole on the axis of the loop

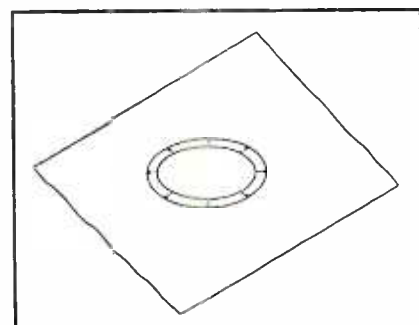

FIG. 1— $\pi n$  annular slot cut in a conducting surface, excited by a uniform radial electric field

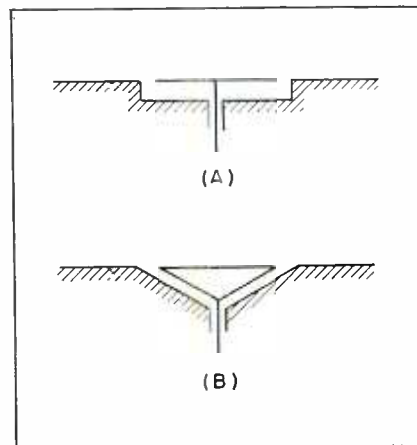

FIG. 2—Cross-sectional view of two possible feed systems for the annular-slot antenna

and has the same radiation pattern as an electric dipole with the radiated electric and magnetic fields interchanged. Furthermore, a circular loop carrying magnetic current rather than the conventional electric current will produce the same pattern as the electric dipole if the radiated fields are interchanged. A small magnetic-current loop can not be distinguished from a short electric dipole lying in the axis of the loop. Thus a small magnetic-current loop can be substituted for the vertical stub above ground with no change in the radiated field pattern.

Physically a magnetic-current loop can be realized by an annular slot in a conducting plane if the slot is excited by a uniform radial electric field as shown in Fig. 1. It has been shown from diffraction theory by Pistolkors<sup>1</sup> that the relative radiation pattern of a narrow annular slot in a perfectly conducting ground plane can be expressed as follows

$$|E_{\theta}| \approx kr J_1(kr \sin \theta)$$

where  $\theta$  is the angle between the direction of measurement and a line perpendicular to the ground plane,  $r$  is the radius of the annular slot,  $k$  is  $2\pi/\lambda$ , and  $J_1$  is the first order Bessel function. This same expression was obtained by Foster<sup>2</sup> for the radiated magnetic field of a circular loop with uniform electric current. The relative radiation pattern of a thin wire stub above a perfectly conducting ground is given by the following<sup>3</sup>

$$|E_{\theta}| \approx \frac{\cos(kl \cos \theta) - \cos kl}{\sin \theta}$$

where  $l$  is the length of the stub. If the slot radius is small the expression for radiated electric field may be simplified by neglecting all but the first term of the expanded Bessel function. Likewise the expression for the electric field radiated from a short stub may be simplified by neglecting all but the lowest-order terms in the expanded sine and cosine functions. For a small slot

$$|E_{\theta}| \approx \frac{(kr)^2}{2} \sin \theta$$

and for a short stub

$$|E_{\theta}| \approx \frac{(kl)^2}{2} \sin \theta$$

thus we have an exact analogy between the radiated field of a short

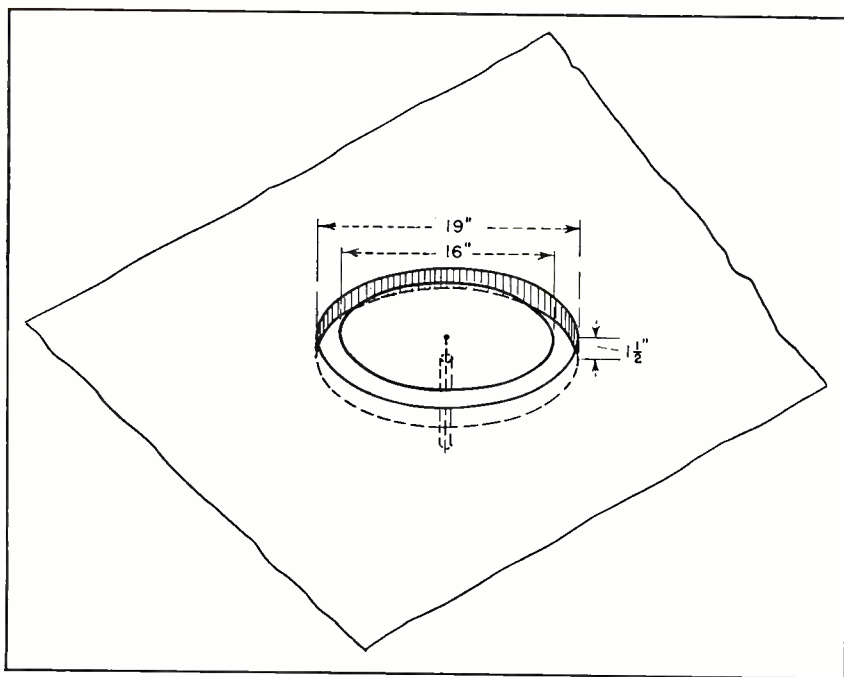

FIG. 3—Sketch showing dimensions of full-scale experimental annular slot. The radiation pattern of this slot was measured at 150 mc and 450 mc

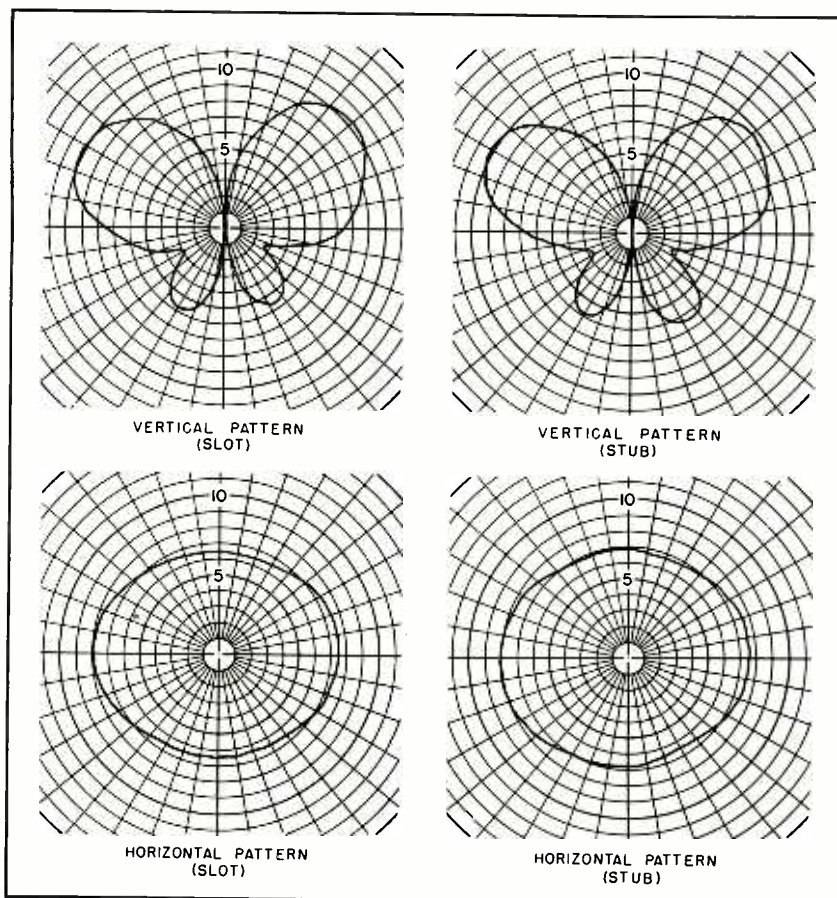

FIG. 4—Radiation patterns in the vertical and horizontal planes of an annular slot and a vertical stub, measured at 150 mc



vertical stub and a small annular slot.

The requirement of a uniform field at the surface of the slot necessitates a symmetrical feed system, the particular feed system used to be determined largely by space limitations and the input impedance desired. Two possible feed systems which can be used to produce a uniform radial electric field at the slot are shown in cross-section in Fig. 2. Both feed systems consist essentially of a radial two-conductor transmission line coaxially fed. Type A has a cylindrical cavity which occupies less space than the conical cavity of type B. However type B provides a more gradual transition of energy from the source to free space and will therefore have a different input impedance. The impedance will depend entirely upon the manner in which the cavity matches the trans-

mission line to the impedance of free space.

#### Radiation Patterns

To illustrate the analogy between a small annular slot and a short stub above ground for a practical case, a one-seventh scale model of an automobile roof was constructed and the annular slot of the form shown in Fig. 3 was installed. The vertical and horizontal radiation patterns were measured in free space at model frequencies corresponding to the full-scale frequencies 150 mc and 450 mc and are shown in Fig. 4 and 5, respectively. Then the annular slot was removed and replaced by a short vertical stub. Radiation patterns for the vertical stub were measured under the same conditions as the slot patterns and are shown for comparison in Fig. 4 and 5. It can be seen that there is, indeed, a

striking similarity between the corresponding slot and stub patterns. The correspondence is better at 150 mc than at 450 mc because there the slot is small in terms of wavelength. This suggests that a smaller slot than the one illustrated could be used at 450 mc with an increase in signal level in the horizontal plane for a given power input to the antenna.

Since the radiation patterns shown were measured on a model in free space the true pattern of an antenna on an automobile will be modified by reflection from the ground and from other reflecting surfaces. Radiation below the horizon as indicated in the vertical plane patterns will be reflected from the ground and will add vectorially to the energy radiated along and above the horizon. Because of the difficulties inherent in determining the magnitude and phase of energy reradiated from innumerable objects the vertical plane patterns can serve only as an approximate indication of the space distribution of energy radiated from the actual automobile antenna system.

An antenna of the flush-mounted type should preferably be fabricated by the automobile manufacturer and considered part of the overall vehicle design. If one of the types of feed suggested in Fig. 2 is used, the lower portion of the cavity may be included in the car-top die or constructed separately and welded into place. The width of the slot gap is not critical, so the upper portion of the cavity may assume any convenient proportions.

#### Fabrication

Several types of dielectric material are available to fill the cavity and exclude rain, snow and dirt. It is important that a nonconducting paint be used over the slot area to prevent excessive loss of power. The final result should yield an efficient, self-contained radiating system for two-way mobile radio.

#### REFERENCES

- (1) A. A. Pistorikors, Theory of the Circular Diffraction Antenna, *Proc IRE*, p 58, Jan. 1948.
- (2) Donald Foster, Loop Antennas with Uniform Current, *Proc IRE*, p 604, Oct. 1944.
- (3) Ramo and Whinnery, "Fields and Waves in Modern Radio," John Wiley and Sons, p 433, 1944.

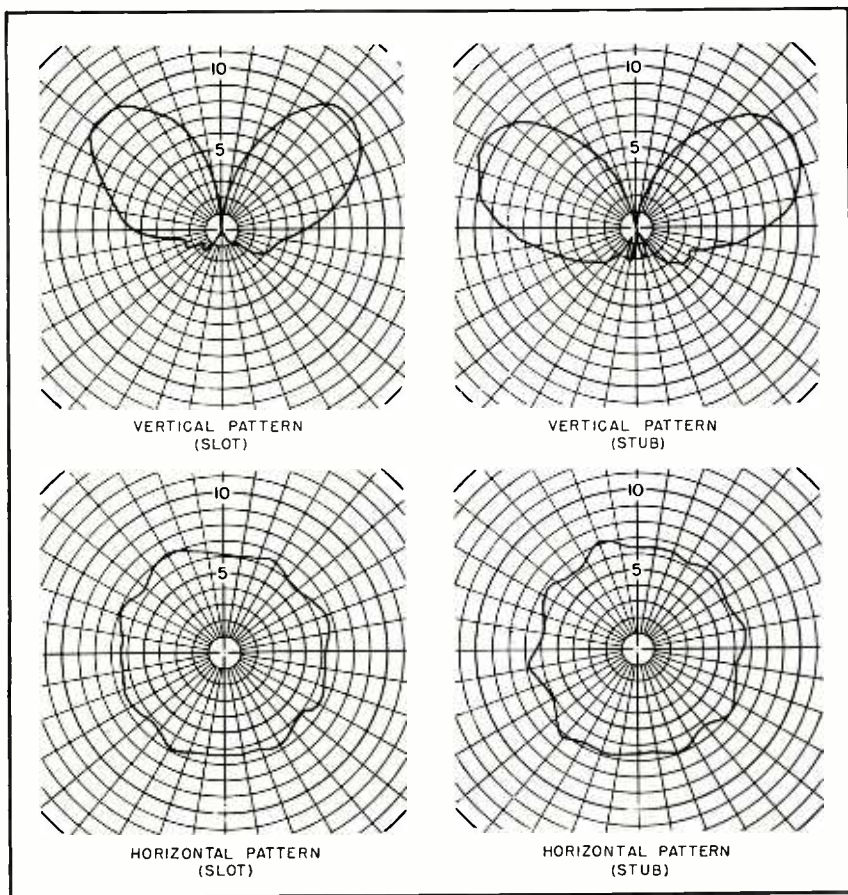

FIG. 5—Radiation patterns in the vertical and horizontal planes of an annular slot and a vertical stub, measured at 450 mc

# High-Fidelity Response From Phonograph Pickups

Basic requirements for high-fidelity phonograph reproduction are discussed briefly. Ways of introducing feedback to compensate for nonlinearity in inexpensive crystal pickups are shown. Includes typical curves for various feedback networks

By **ELWIN J. O'BRIEN**

Associate Professor of Electrical  
Engineering  
Southern Methodist University,  
Dallas, Texas

ONE CLASSIFICATION of sound divides its components into two groups, pure tones and complex sounds. To be classified as a true high-fidelity sound-reproducing system, an amplifier and its associated components must be capable of reproducing both the pure and the complex sound components exactly as to pitch and intensity, and its output must be free from new frequencies introduced by intermodulation or harmonic distortion in any part of the system.

Intermodulation is defined as the production of frequencies equal to the sum and difference of integral multiples of two or more of the frequencies transmitted to a system. Any resonance in a system will produce nonlinear or intermodulation

distortion, unless suitable compensation is provided.

Resonance can occur in any mechanical system containing inertia and elasticity. The effect of a constant driving force applied to an electroacoustic device where resonance is present, such as a crystal pickup, is to produce transient complex vibrations. These vibrations, in the presence of inherent nonlinearity, beat with the periodic vibrations of the music to produce discordant sounds.

Additional transient vibrations, those which produce annoying surface noise, are caused by granular irregularities in records. These random irregularities will produce transient oscillations if there is any resonance in the pickup arm or the pickup itself, and again, in the presence of nonlinearity, intermodulation products will be generated and the surface noise voltages will be increased.

Typical unequalized response curves for two popular crystal pickups as obtained from an ideal lateral test record are shown in Fig. 1 along with the equivalent circuit of the ideal unit. The ideal crystal pickup would be equivalent at audio frequencies to a zero impedance generator in series with a capacitor and would have a frequency response for a constant needle amplitude that decreases at the rate of 6 db per octave. Actually, however, inherent resonance causes high voltages to be generated in the pickup itself and its arm at certain frequencies.

Negative feedback applied to the pickup circuit will reduce this resonance. Each of the two general types of feedback, voltage and current, tend to make the voltage output a replica of the signal voltage, but their effects on the impedance of the circuit are different. Voltage feedback lowers the internal impedance of an amplifier, while current feedback raises the impedance.

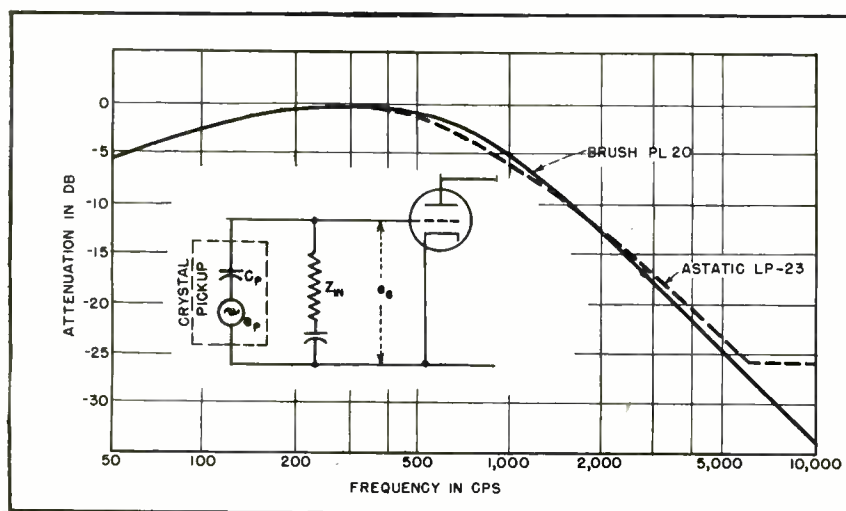

FIG. 1—Relative voltage output curves for typical crystal pickups without feedback, and equivalent circuit for input section of a typical amplifier

## Feedback

The voltage amplification with voltage feedback is  $A_f = A/(1 - A\beta)$  where  $A$  is amplification without feedback and  $\beta$  is the fraction of the output voltage introduced in the input of the amplifier. If the amplitude of the feedback factor  $\beta$  is made a function of frequency, the amplification  $A_f$  with feedback will also be variable with frequency.

It is therefore possible to use negative feedback as an equalizer for a phonograph pickup. If all the low frequencies below the turn-over are attenuated equally by

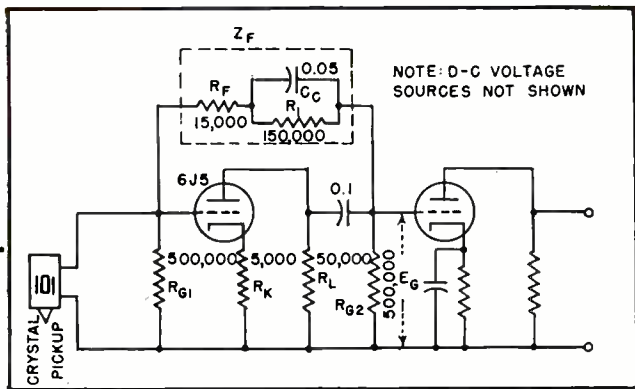

FIG. 2—Typical schematic diagram for phono input circuit employing feedback

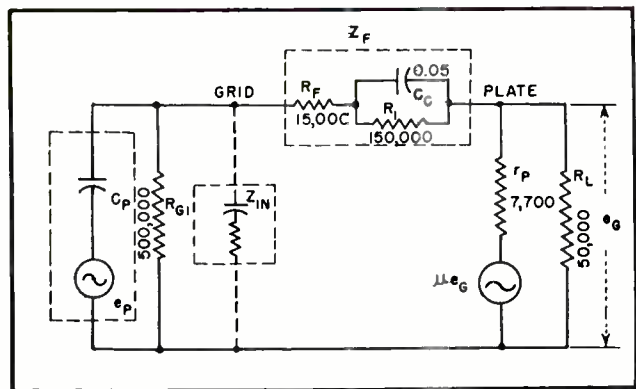

FIG. 3—Equivalent circuit for first stage of amplifier shown in Fig. 2

about 25 db and the frequencies above the turnover are allowed to increase at the rate of 6 db per octave we should have a perfect crystal phonograph pickup equalizer.

Considering the above principle, the phonograph amplifier circuit shown in Fig. 2 was developed experimentally for an Astatic LP-23 or a Brush PL-20 cartridge.

This amplifier, using both voltage and current feedback, includes the pickup impedance in the feedback loop. Calculations for gain and input admittance, using the equivalent circuit shown in Fig. 3, are shown in Table I along with tabulated results for several frequencies. It can be seen that the gain above 500 cycles increases at the rate of about 6 db per octave and, since the amplitude on typical test records drops off at this rate, a flat voltage output would be expected when making frequency response tests.

#### Input Impedance

Table I shows that the input impedance  $Z_{IN}$ , shown dotted in Fig. 3, can be represented by a resistor of approximately 1,500 ohms and a capacitor of approximately 0.5  $\mu$ f across the pickup, forming a capacitance voltage divider with the capacitance of the crystal pickup (Fig. 3). This nullifies the effect of the crystal capacitance on the grid voltage when used in the normal manner. The output voltage of the feedback amplifier, then, is proportional to the velocity of the modulated groove, making the resultant pickup response equivalent to a magnetic pickup above the turnover point. The increasing

Table I—Calculations for gain, voltage input to second stage, and input impedance, and tabulated results for feedback circuits

Frequency	Gain With Feedback	Voltage and Input Admittance at Amplifier Grid	
		$E_g$	$Z_{IN}$
100	0.818	0.00143	$33.8^\circ$ 1,265-j1,890
500	0.827	0.00437	$70.4^\circ$ 1,310-j166
1,000	0.832	0.00788	$78.6^\circ$ 1,230-j247
5,000	0.888	0.0592	$78.6^\circ$ 1,880-j79
10,000	1.000	0.118	$89^\circ$ 1,880-j32

variable capacitance with decreasing frequency below the turnover point also produces a constant voltage over this portion of the frequency range. These two effects produce a flat frequency response over the whole range.

The low impedance placed across the pickup also has the effect of damping out any natural resonance in the pickup, causing the needle to follow the groove without extra oscillation. The high damping has the effect of reducing surface noise by preventing the forced natural oscillation of the needle when an irregularity in the record groove has been struck.

In order to appreciate fully the

high-fidelity results, a listening demonstration of the circuit is desirable. However, the frequency response must be adjusted by playing a calibrated test record, since an adjustment by ear alone, because of listening habits, will seldom give a flat frequency response.

It is possible to equalize almost any of the commercial permanent-sapphire-needle crystal pickups to a flat response over the frequency range of 50 to 10,000 cycles and have only a relatively small amount of noise present. The old model removable-needle types are more difficult to equalize and damp critically because of the increased inertia.

For a typical measure of the

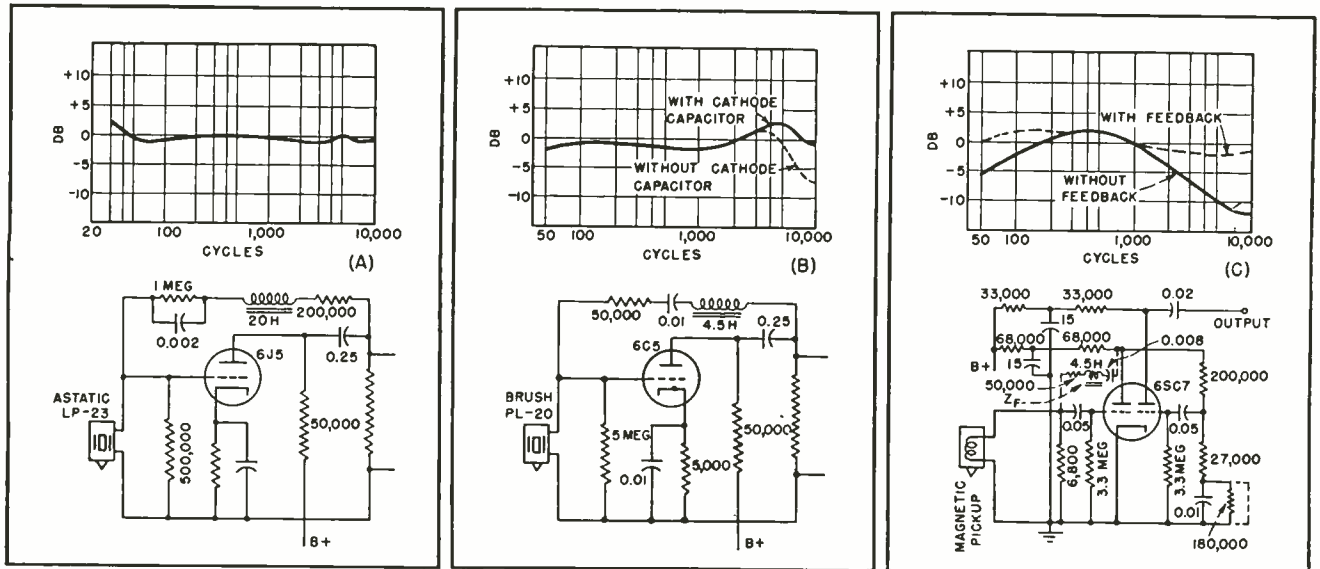

FIG. 4—Input circuits for several popular pickup types using feedback, with associated response curves

flexibility of feedback as an equalizer, the following experimental data are presented:

The original circuit as used with an Astatic HP-36 crystal phonograph pickup using the LP-23 cartridge is shown in Fig. 4A. The low-frequency boost can be removed by decreasing the value of the 1-megohm capacitor shunt in the feedback network. Fig. 4B shows a similar circuit used with a Brush PL-20 pickup. Both of these circuits, because of the relatively small amount of feedback, can be classed as selective feedback equalizers.

The effect of feedback on a magnetic pickup may be seen in Fig. 4C together with the GE phonograph preamplifier schematic diagram. The solid curve is the normal amplifier response with the GE pickup, while the dotted curve was obtained with the dotted feedback network connected and the 180,000-ohm resistor shorted.

The curves of Fig. 5 show that practically any shape of response curve may be obtained by a variation of the feedback network. The results shown in 5B were obtained with increased amounts of feedback and can be classed as equalization by control of input admittance.

If the new Astatic QT-j cartridge with removable sapphire needle is used the feedback resistance should be reduced as shown in Fig. 5C. The increased amount of feedback is necessary to remove the 3,000 to 5,000-cycle resonance peak intro-

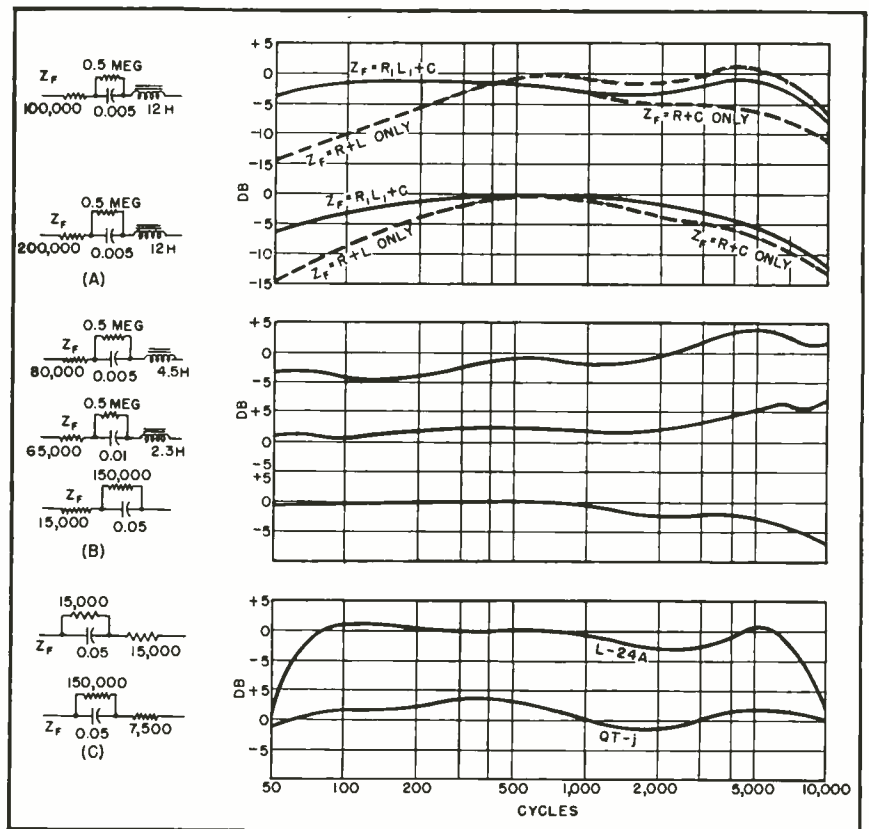

FIG. 5—Typical curves for different types of feedback networks, including one suitable for a magnetic pickup

duced in the pickup to improve the normal frequency response of the cartridge. This boost is not desirable when feedback equalization is used. From these curves it can be seen that the frequency response of the circuit is essentially independent of pickup type or manufacturer, provided the internal

capacitance of the pickups is low compared to the input capacitance of the tube circuit.

#### REFERENCES

- (1) J. Millman and S. Seely, "Electronics," p 614, McGraw-Hill Book Co., New York, 1941.
- (2) R. I. Sarbacher and W. A. Edson, "Hyper and Ultra High Frequency Engineering," p 430, John Wiley & Sons, New York, 1943.

**CINCH ENGINEERS** have designed  
and produced a complete line of  
**Molded and Laminated Miniature Sockets**  
for the **NOVAL 9 prong tube**

# NOVAL MOLDED MINIATURE SOCKETS



Miniature Molded  
Noval Chassis Clinch  
No. 53 G 13301



Saddle type, molded with .093  
mtg. hole, 1-1/8" mtg. center  
53F 12617 — Mica  
53F 12641 — Black  
53F 13505 — Ceramic

are now available in the various types as pictured here; the new chassis clinch, the saddle type and attached base type with molded button top casting.

Also available is a complete line of laminated Noval sockets with the locking type contact, "grip pin", that provides high extraction pull out . . . supplying maximum tube retentivity.

*Write for samples and further details.*



**At the IRE  
NATIONAL  
CONVENTION  
— NEW YORK —  
Booth No. 257**



Attached base with .093 mtg.  
hole, 1-1/8" mtg. center, mold-  
ed button top casting  
53F 12625 — Mica  
53F 12826 — Black  
53F 13503 — Ceramic



6G 12626 — Shield, 1-1/2"  
6G 12627 — Shield, 1-15/16"  
6G 12628 — Shield, 2-3/8"

AVAILABLE AT LEADING ELECTRONIC JOBBERS . . . *everywhere*

**CINCH MANUFACTURING CORPORATION**

Subsidiary of United-Carr Fastener Corporation, Cambridge 42, Mass.

2335 W. VAN BUREN ST.  
CHICAGO 12, ILLINOIS

# Television I-F Coil Design

VARIOUS nomographs, charts, and calculators are available for the calculation of the inductance of coils, but most of these graphical aids do not cover the range of values of interest to the designer of coils for television, f-m, and radar i-f frequencies. The accompanying nomograph has been designed to fulfill this need. Unlike other coil nomographs, it gives in one operation the number of close-wound turns required to get a desired inductance.

The nomograph is based on a modification of H. A. Wheeler's inductance formula<sup>1</sup>

$$L = \frac{r^2 n^2}{9r + 10l} \text{ microhenrys} \quad (1)$$

where  $r$  is the radius of the coil in inches,  $l$  its length in inches, and  $n$  the number of turns. In close-wound coils,  $l$  is a function of  $n$ . Substitution of  $nd$ , where  $d$  is the diameter of the wire in inches, for  $l$  in Eq. 1 gives an

equation which can be solved for  $n$  to give

$$n = \frac{10dL + \sqrt{100d^2 L^2 + 36r^3 L}}{2r^2} \quad (2)$$

The complexity of Eq. 2 accounts for the unusual structure of the nomograph and indicates the computational labor avoided by its use.

D. Pollack<sup>2</sup> has shown verification for the formula  $L = N^2 D / (102 S + 45)$  microhenrys, where  $D$  is the diameter of the coil in centimeters,  $N$  is the number of turns, and  $S$  is the ratio of the length of the coil to its diameter. Changing the centimeter dimensions of  $D$  in Eq. 3 to inches and employing Wheeler's symbols gives  $L = r^2 n^2 / (8.85 r + 10l)$ , verifying Eq. 1.

## REFERENCES

- (1) H. A. Wheeler, Simple Inductance Formulas for Radio Coils, *Proc IRE*, p 1,398, Oct. 1928.
- (2) D. Pollack, The Design of Inductances for Frequencies Between 4 and 25 Megacycles, *Electrical Engineering*, Sept. 1937.

By  
**JEAN HOWARD FELKER**

*Bell Telephone Laboratories, Inc.  
Whippany, New Jersey*

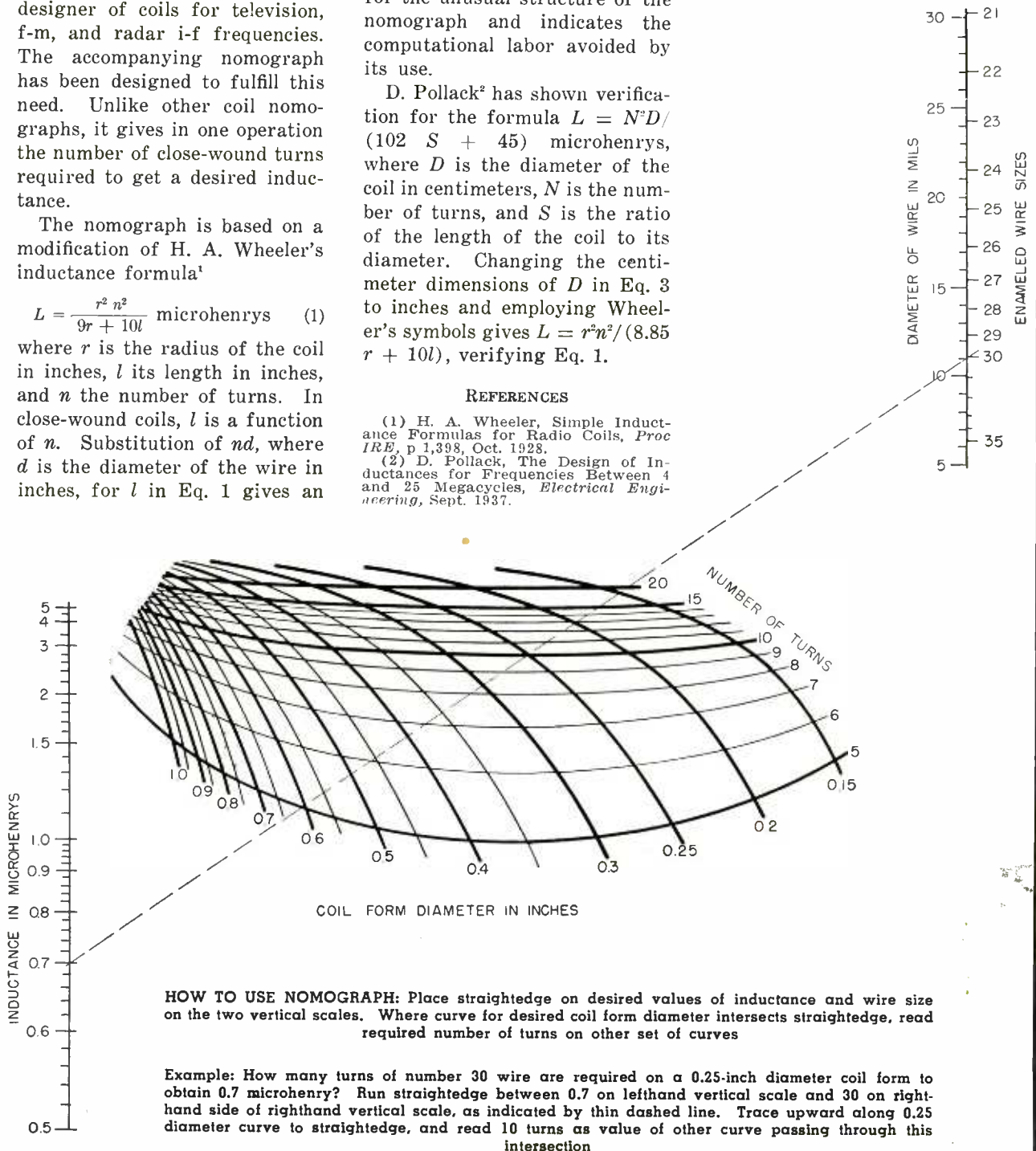

**Response has been terrific!**  
*There is still time to get your  
 Mallory Vibrator Data Book*

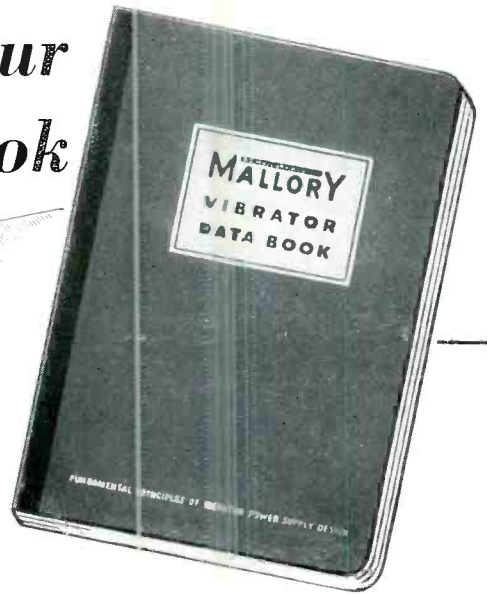

TABLE OF CONTENTS		Page
Chapter I	General	9
Chapter II	Basic Vibrator Structures	13
	General	13
	Basic Types	13
	Driving Systems	15
	Contacts	16
	Load Limitations	17
Chapter III	Mallory Standard Vibrators	17
	Mechanisms	20
	Frequency	21
	Mallory Standard Types	23
Chapter IV	Preliminary Design Considerations	23
	Information Required Before the Design Can Be Started	29
Chapter V	The Choice of a Vibrator	33
Chapter VI	Basic Power Transformer Characteristics	36
	Transformer Starting Characteristics	40
	Transformer Core Characteristics	43
	Core Steel Grades	44
	Leakage Inductance	46
	Coil Construction	49
Chapter VII	Tables, Charts, Graphs and Formulas	50
	Design Formulas	65
Chapter VIII	Development of Basic Transformer Formula with Design Examples	65
	Auto Radio Power Units	68
	Primary Turns	68
	Core Area	68
	Flux Density	69
	Wire Size	71
	Coil Design	74
	Impregnation	76
	Lamination Size	76
	Coil Resistance	77
	Transformer Design Procedure	78
	No. 1—Sample Design Vibrator Transformer	83
	No. 2—Sample Design Vibrator Transformer	88
	Low Output 6-Volt and 4-Volt Power Units	89
	No. 3—Sample Design Vibrator Transformer	91
	Twelve-Volt, 24-Volt and 32-Volt Power Units	95
	High-Frequency Vibrator Transformer	99
	No. 4—Sample Design Vibrator Transformer	101
Chapter IX	Timing Capacitor Considerations	107
	Application of the Timing Capacitor Equation to the Sample Designs	117
	Determination of Values for the Sample Designs	119
Chapter X	Vibrator Power Supply Construction and Interference Elimination	125
Chapter XI	Vibrator Power Supply Circuits	131
Chapter XII	Inspection of Vibrators	

From schools, factories, and engineers all over the country have come enthusiastic letters praising the Mallory Vibrator Data Book—the first and only one in the field. Some typical remarks were:

*"It is one of the finest collections of theoretical and practical data—amply illustrated, but still in one small volume."*

*"... your company is to be congratulated again for coming out with pertinent design data of this type."*

*"... this is a history making publication and very much needed by engineers in this work."*

The Mallory Vibrator Data Book brings you the results of eighteen years of specialized experience and research. It answers important questions on vibrator applications... information is complete... original... cannot be duplicated! This book is a "must" for the library of anyone who designs or uses vibrator power supplies.

You can get your copy by ordering now. The price is only \$1.00. Free to recognized engineers and teachers when requested on your letterhead.

*More Mallory Vibrators are used in original equipment than all other makes combined*

**Vibrators and Vibrapack\* Power Supplies**

**P. R. MALLORY & CO., Inc.**

# MALLORY

**P. R. MALLORY & CO., Inc., INDIANAPOLIS 6, INDIANA**

**SERVING INDUSTRY WITH**

- Capacitors      Rectifiers
- Contacts        Switches
- Controls        Vibrators
- Power Supplies

Resistance Welding Materials

\*Reg. U. S. Pat. Off.

# TUBES AT WORK

Including INDUSTRIAL CONTROL

Edited by VIN ZELUFF

Two-Way Radio for Tractor Maintenance.....	124
New Record Design .....	126
Surge-Testing Motor Windings.....	140
Conversion of Aircraft Equipment.....	144
Transmission-Line Fault Finders.....	148
Multi-Purpose British Radio Tube.....	156
Well-Drilling Control .....	162

## Two-Way Radio for Tractor Maintenance

By F. R. BREWSTER  
*McGraw-Hill World News  
London Bureau*

FARMERS in remote hill villages in Lanarkshire, Scotland, can have help sent to them by radio if they have trouble with their farm machinery or if they suddenly need new spare parts for their tractors.

Livewire Lanark engineer Daniel Ross has established his own radio station and a system of two-way radiotelephony between his headquarters and a fleet of five vans with which he services several hundred Ferguson tractors he has

sold to farmers in the county.

To the road-licensing authorities one 14-hp van is DVD600, but to Ross and driver Bill Boyd, it is Ross Able (its sister vans are Ross Baker, Ross Charlie, Ross Dog and Ross Easy).

Inside the vans a panel below the dashboard holds the two-switch controls. Behind the driver's seat a case some eighteen inches square houses receiver and transmitter. Range of the equipment varies



Parking the repair car on the farmer's field alongside the tractor allows the mechanic to tinker and hear calls from headquarters

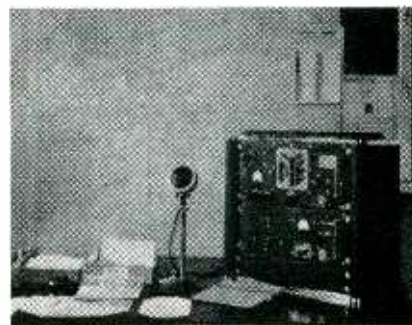

Headquarters station of the tractor-repair service

from 25 to 40 miles, according to local conditions. On routine monthly service checks of tractors on farms, the receiver is switched on, a green light showing under the dashboard, and the van is parked close to the tractor being serviced. This permits the driver-operator to hear calls that come through from headquarters.

### Control Station

Back at headquarters, ex-Wren Jessie Young moves counters about a map of Lanarkshire as the vans report their whereabouts, and decides which van is nearest to the farmer who needs help. It is much the same job Jessie did for Fleet Air Arm planes at Donnybristle during the war.

Without the two-way radio equipment, a farmer might lose a whole afternoon of precious time before a van could be contacted and sent to his rescue. With the chancy weather of southern Scotland that wasted afternoon might be serious.

"I reckon", said Mr. Ross, "that I save a gallon of petrol a day on every van. But that's not the important thing. What matters is that help gets to the farmers quickly. We are selling a system of completely mechanized farming; it's up to us to keep pace."

The radio telephones use amplitude modulation and are designed by the Telecommunications Division of Pye Ltd., Cambridge. The system incorporates at headquarters a 12-watt transmitter, crystal-controlled to operate on a single frequency around 80 megacycles, allotted to private users by the G.P.O. under international agreement, a vhf receiver and a vertical coaxial dipole aerial giving omnidirectional coverage.

In each service van there is a 12-



# CHATHAM

## ELECTRONIC TUBES and EQUIPMENT

Chatham also designs, develops and manufactures Electronic Equipment to exact customer specifications. Inquiries regarding this service are invited.

LOOK FOR US AT THE IRE SHOW  
BOOTHS 120 and 121

### CHATHAM 2D21 THYRATRON



A Xenon filled shield grid thyatron for grid controlled rectifier service. Permits use of high resistance in the grid circuit. Heater 6.3 volts, .6 amp. . . Inverse peak plate voltage 1300 volts, 100 ma. average plate current.

### CHATHAM 5594 THYRATRON



Xenon filled thyatron. Operates through ambient temperatures from  $-55^{\circ}\text{C}$  to  $+90^{\circ}\text{C}$  without auxiliary equipment to maintain bulb temperature. Fil. 2.5 volts, 5.0 amperes . . . Peak inverse 5000 volts; anode current 0.5 amps. average, 2.0 amps. peak.

### CHATHAM 884 THYRATRON



An Argon filled thyatron for use as a sweep circuit oscillator in cathode ray tube circuits. Stable oscillator. Heater 6.3 volts, 0.6 amp. . . Peak forward plate voltage 300 volts, 75 ma. average plate current.

### CHATHAM 1B46 REGULATOR



A cold cathode glow discharge tube designed for voltage stability. D.C. operating voltage 82 volts —operating current range 1 to 2 mA dc.

### CHATHAM 4032 RECTIFIER



A rugged half wave Xenon filled rectifier. Operates in any position throughout an ambient temperature range of  $-75^{\circ}\text{C}$  to  $+90^{\circ}\text{C}$  Fil. 5 volts, 7.5 amp. . . Inverse peak anode voltage 10,000 volts, 1.25 amp. average anode current.

### CHATHAM B66-A RECTIFIER



A rugged half wave Mercury Vapor rectifier to withstand high peak inverse voltages. Heavy duty filament. Fil. 2.5 volts, 5.0 amp. . . Peak inverse anode voltage 10,000 volts, .25 amp. average anode current.

### CHATHAM 1B3GT RECTIFIER



High voltage vacuum rectifier for Television and similar applications. Low filament power permits efficient operation from R.F. supply. Filament 1.25 volts, 200 ma. . . Inverse peak plate voltage 30,000 volts, 2 ma. average plate current, 17 ma. maximum plate current.

### CHATHAM 3B2B RECTIFIER



This rugged half wave Xenon filled rectifier will operate in any position and throughout an ambient temperature range of  $-75^{\circ}\text{C}$  to  $+90^{\circ}\text{C}$  Fil. 2.5 volts, 5.0 amp. . . Inverse peak anode voltage 10,000 volts, .25 amp. average anode current.

### CHATHAM 1Z2 RECTIFIER



A small bulb high voltage vacuum rectifier. Low cathode heating power and low dielectric losses make tube suitable for radio frequency supply circuits. Fil. 1.5 volts, .290 amp. . . Inverse peak plate voltage 20,000 volts, 2 ma. average plate current, 10 ma. peak plate current.

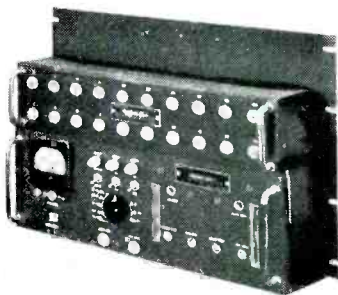

• Pulse life test equipment built by CHATHAM checks receiver type tubes under pulse operating conditions.

### CUSTOM BUILT

## ELECTRONIC EQUIPMENT

CHATHAM specializes in the development, design, and construction of custom-built electronic equipment to exactly meet customers' requirements. Our capable staff of engineers will furnish prompt estimates or, if desired, will call to discuss your problem personally. Call or write today for complete information.

Write today for the informative CHATHAM catalog. For free copy address requests on company letterhead — no obligation.

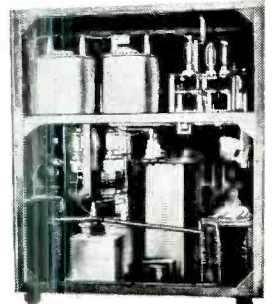

• 5 Megawatts radar modulator built by CHATHAM to rigid government standards.



## CHATHAM ELECTRONICS • INC

475 WASHINGTON STREET, NEWARK 2, NEW JERSEY

## THE FRONT COVER

**B**OTH ends of the conical metal shell of 16 and 19-inch cathode-ray tubes for television receivers can be sealed by high-frequency induction-heating equipment. The accompanying photograph shows the setup employed in sealing the glass face to the metal shell. A single-turn coil is mounted around the joint to be made and fed with energy from the 40-kilowatt Scientific Electric electronic generator in the background. This heats the outer edge of the metal cone sufficiently to melt the glass in contact with it and form the seal. The tube assembly is rotated throughout the heating and sealing time to provide a uniform seal. To prevent the glass disk from dropping into the cone when the glass melts, air at low pressure is supplied to the inside of the tube assembly. After removal from the heating jig, the tube is cooled slowly at room temperature.

In sealing the glass neck of the tube to the metal wall, as illustrated on the front cover, rotation is also used but the molten joint is alternately stretched and compressed a few times just as in conventional glassblowing, without use of air pressure.



watt crystal-controlled transmitter, matching receiver, audio amplifier, and power-supply unit, mounted together in a shock-absorbing cradle behind the driver's seat, and a control unit mounted under the dashboard comprising a five-position switch controlling the radio and a three-position volume control switch, a moving-coil microphone with a press-to-talk switch, and a

quarter-wavelength tuned aerial of flexible steel rod.

### Cost

The bill for the fixed station was 180 pounds; equipment for each of the vans 140 pounds. License fee charged by the G.P.O. is 5 pounds a year for each station, whether fixed or mobile, plus an additional 5 pounds for the overall operation.

Total license fees for the headquarters station and five vans, 35 pounds (\$140).

Mr. Ross believes he is the first to use two-way radiotelephone equipment for directing tractor-servicing operations. Licenses for private commercial operation have been issued only during the past 18 months or two years; some 150 licenses have been granted. About half of these users are public utility firms; the other half are largely made up of car-hire operators and other commercial users.

## New Record Design

**SIMPLIFICATION** of record-changer design is achieved by RCA Victor with the introduction of a new type of record having a  $1\frac{1}{2}$ -inch spindle hole. This permits the extremely fast changing mechanism to be built right into the center post.

Construction of the new  $6\frac{3}{8}$ -inch record is illustrated in the accompanying cross-section drawing. The overall diameter is  $6\frac{3}{8}$  inches but the thickness is not uniform; a

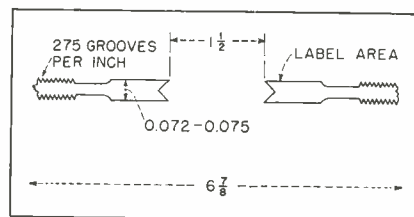

Construction details of 45-rpm record

collar is created around the label area, which is thicker than the playing area. Thus an air space between adjacent records in a stack is provided so that the playing surfaces do not touch.

An indentation is provided on the record where it touches the center post to fit the knives of the center-post changer mechanism. The records are formed of vinyl plastic and rotate at 45 rpm. At this speed, the maximum playing time is five minutes and five seconds. The recommended needle tip radius is 0.001 inch, groove width is 0.0025 to 0.003 inch and recommended tracking weight is 5 grams.

The associated record player contains a  $1\frac{1}{2}$ -inch-wide red plastic-topped center post which houses the

(continued on p 140)

● Cavity Frequency Meter



● Tunable Barrotter Mount



● Cross-Guide Directional Coupler

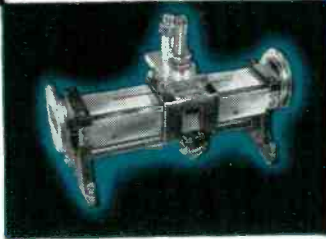

● Impedance Motor

# PRECISION-MADE

for precision measurements...

Sperry

*Microline* \*

■ Accurate, repeatable electrical measurements over a broad band of frequencies . . . modern radio engineers demand these characteristics in microwave test instruments. *Precise* electrical results call for *precise* mechanical tolerances. These fine mechanical tolerances are an integral part of Sperry Microline, industry's most complete line of microwave test and measuring instruments.

■ Microwave measuring instruments require almost perfect geometrical forms maintained in metal. Sperry has developed processes to obtain these stress-free forms which assure instruments of the required accuracy and durability. With Microline, research and development engineers can obtain reliable measurements which assure correct design results.

■ Sperry with its long experience and knowledge in microwave techniques has developed virtually every instrument essential to this phase of electronics. The Microline instruments shown here are only a few of the several hundred which are available. Our nearest district office will be glad to give you additional information on Microline instruments and how they apply to your individual requirements.

● Triple-Stub Transformer



● Detector Wave Motor

**SPERRY GYROSCOPE COMPANY**



DIVISION OF THE SPERRY CORPORATION • GREAT NECK, NEW YORK  
NEW YORK • CLEVELAND • NEW ORLEANS • LOS ANGELES • SAN FRANCISCO • SEATTLE

®Trademark

# THE ELECTRON ART

Edited by FRANK H. ROCKETT

Coaxial Transistor .....	128
High-Frequency Impedance Plotter .....	128
Standard Broadcast Radios as Nuclear Indicators .....	166
Electronic Analog Computer .....	168
Pulse-Sinewave Converter .....	174
CBS Listener-Counter .....	180
Rotating Probe Machine .....	182
Survey of New Techniques .....	189

## Coaxial Transistor

DEVELOPMENT of a semiconductor amplifier using two point contacts pressing against opposite sides of a germanium disk was announced by W. E. Kock and R. L. Wallace, Jr. of Bell Telephone Laboratories, Inc. at the AIEE Winter Convention in New York City. The germanium disk has a spherical depression ground and lapped into either or both faces to give a spacing of only a few thousandths of an inch between coaxially mounted contacts.

Amplification of the coaxial transistor compares favorably with that of the conventional semiconductor triode having both points on the same germanium face. Advantages of the new construction are improved mechanical stability of the points since they rest in depressions, complete electrostatic shielding between the input and output circuits, and elimination of construction problems involved in placing two spring contacts side by side within a few thousandths of an inch.

Principle of operation is identical with that of the wedge-shaped transistor devised by J. N. Shive of

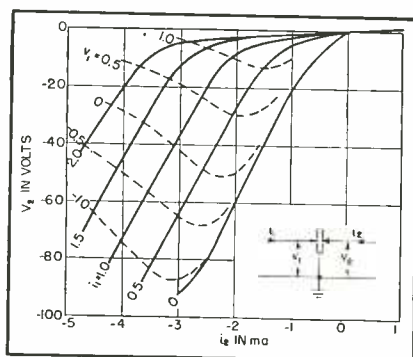

Direct-current amplifying characteristics of typical sample of new coaxial transistor. These curves compare moderately well with those of a unit having both points on the same side of the germanium

Bell Laboratories, wherein amplification is obtained with contact points on opposite sides of a germanium wedge that is a few thousandths of an inch thick at the location of the contacts. The geometry of the wedge transistor is reproduced in circularly symmetrical form in the coaxial transistor. The current amplification process in both cases is apparently occurring within the semiconductor and not at the surfaces.

Since high polish of the active surfaces of germanium permits

passage of higher currents before burnout occurs, the spherical depressions in the 20-mil-thick,  $\frac{1}{8}$ -inch diameter germanium blank are lapped with diamond lapping compound and electropolished after initial grinding. Where maximum current capacity is not required, the conventional procedure of etching and electrically forming the collector point by passing large currents in the reverse direction yields quite satisfactory results. Amplifier action occurs also with the depression in only one face.

## High-Frequency Impedance Plotter

By RICHARD C. RAYMOND and CARL E. DRUMHELLER

Department of Physics  
The Pennsylvania State College  
State College, Pa.

A HIGH-FREQUENCY impedance-measuring system consisting of a circular slotted line that is scanned rapidly by a probe, an oscilloscope and a mechanical computer has been developed. It is fairly accurate for standing wave ratios less than 4 to 1 and covers a range from 140 to 1,200 mc. For rapid surveys in which accuracy is not important at large standing wave ratios but in which it is necessary to make many measurements, this equipment reduces the labor.

### Basis of Operation

To reduce the measurements to the magnitude and phase angle of the impedance being studied, the standing wave is presented on an oscilloscope and then transferred to

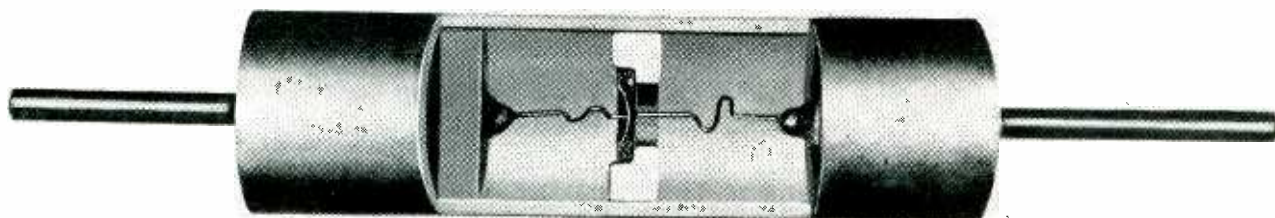

Cutaway view of coaxial transistor as designed for moderate quantity production. The germanium disk positioned between the contact points has a depression on only one face here; grinding of both faces gives added mechanical stability

# For the MEASUREMENT of Q, INDUCTANCE and CAPACITANCE

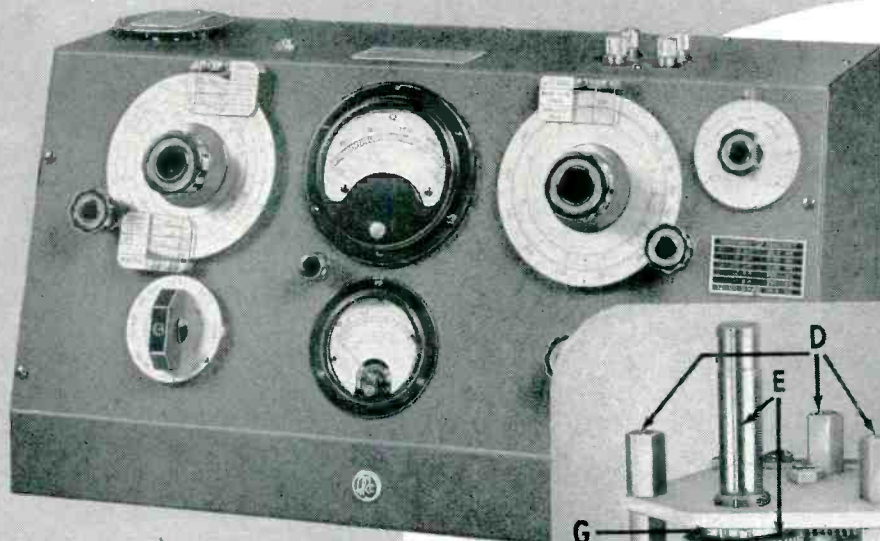

The  
**160-A Q-METER**  
50 KC. to 75 MC.

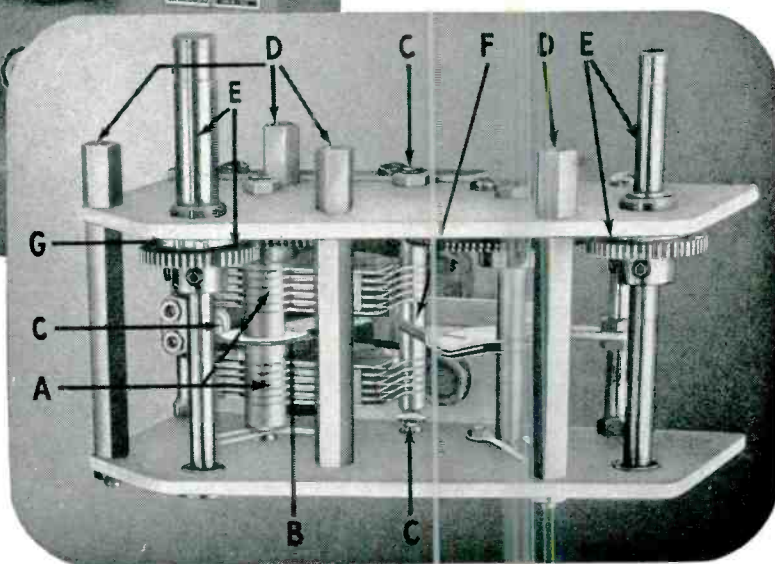

Radio frequency circuit design often requires the accurate measurement of Q, inductance, and capacitance values. For this application, the 160-A Q-Meter has become the universal choice of radio and electronic engineers throughout the country.

Each component part and assembly used in the manufacture of this instrument is designed with the utmost care and exactness. Circuit tolerances are held to values attainable only in custom built instruments.

Consider, for example, the Q tuning capacitor assembly of the 160-A Q-Meter, specially manufactured for maximum range, low loss, and minimum residual inductance. The ultimate design of this unit was reached only after months of intensive engineering research to produce the finest in performance, quality, and workmanship.

This is but one of the many desirable features of the 160-A Q-Meter which contribute to its outstanding accuracy and dependability.

Be sure to include the 160-A Q-Meter in your new equipment plans for 1948.

Write for Catalog "F"

**BOONTON RADIO**

BOONTON · N · J · U · S · A ·

*Corporation*



Shown above is the Q tuning capacitor assembly of the 160-A Q-Meter. Note the following design features of this unit—features which insure reliable, trouble-free operation.

- A. Parallel connection of dual rotor and stator assemblies minimizes internal inductance and resistance.
- B. Spring silver fingers contact both sides of silver disc to provide low series resistance.
- C. Three point pyrex ball stator suspension reduces losses and permits accurate stator alignment.
- D. Four point panel mounting designed to produce maximum structural rigidity and capacitance stability.
- E. Precision-cut brass spur gears and stainless steel shafts, mounted in oversize bearings, assure long, trouble-free service.
- F. Common stator mounting for main and vernier stator plates reduces loss and internal series resistance of vernier capacitor section.
- G. Positive shaft stop protects main rotor assembly and gears against mechanical overload.

#### SPECIFICATIONS

Oscillator Frequency Range: 50 kc. to 75 mc. in 8 ranges.

Oscillator Frequency Accuracy:  $\pm 1\%$ , 50 kc.—50 mc.  
 $\pm 3\%$ , 50 mc.—75 mc.

Q Measurement Range: Directly calibrated in Q, 20-250. "Multiply—Q—By" Meter calibrated at intervals from x1 to x2, and also at x2.5, extending Q range to 625.

Q Measurement Accuracy: Approximately 5% for direct reading measurement, for frequencies up to 30 mc. Accuracy less at higher frequencies.

Capacitance Calibration Range: Main capacitor section 30-450 mmf, accuracy 1% or 1 mmf whichever is greater. Vernier capacitor section —3 mmf, zero,—3 mmf, calibrated in 0.1 mmf steps. Accuracy  $\pm 0.1$  mmf.

DESIGNERS AND MANUFACTURERS OF THE Q METER · QX CHECKER  
FREQUENCY MODULATED SIGNAL GENERATOR · BEAT FREQUENCY  
GENERATOR AND OTHER DIRECT READING INSTRUMENTS

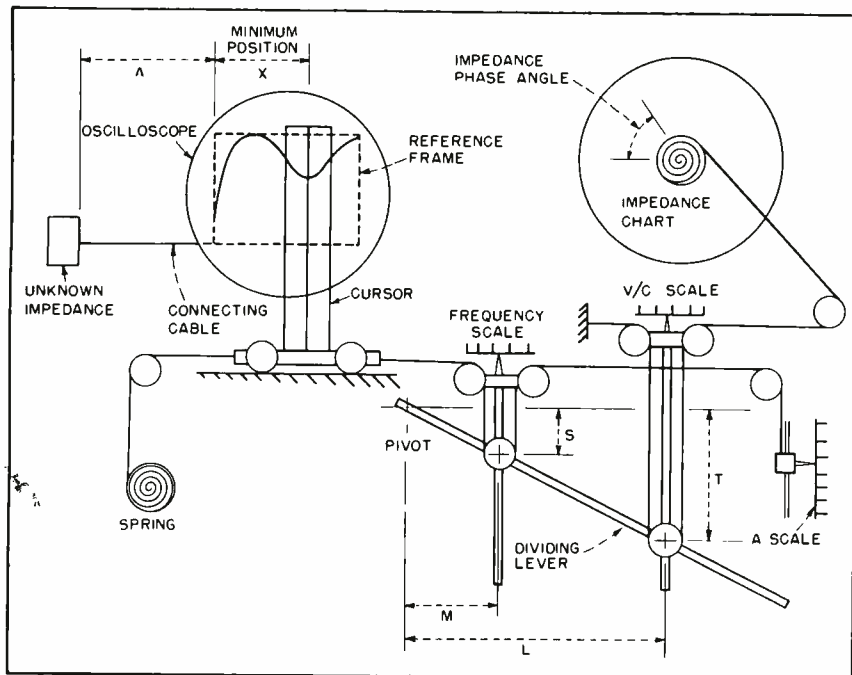

FIG. 1—Mechanical computer transfers position of minimum of standing wave ratio pattern traced on c-r tube to phase angle of unknown impedance on Smith chart

a circular impedance chart by the cord-and-linkage computer of Fig. 1. The trace on the oscilloscope is obtained as shown in Fig. 2, showing second portion of the computer.

An oscillator feeds a circular slotted line through an impedance matcher. The slotted line is a section of a coaxial line formed in a circle of 11-inch mean diameter, made by turning grooves in two brass discs. The center conductor of copper wire is supported in a polystyrene ring milled to accept it and with a slot for the probe. At one end the line smoothly joins a straight section terminating in a coaxial fitting. The other end of

the line is brought through the back cover. Because the line is proportioned to have the same characteristic impedance and diameter as the cable with which it is used, tapers are unnecessary.

This circular construction of the slotted line enables the probe to be moved continuously around it. The varying r-f current thus picked up is fed through a detector to a balanced amplifier that is flat from 30 cps (the frequency with which the probe travels around the line) to about 100 cps to a 12-inch cathode-ray tube, which gives a useful swr plot 6 by 8 inches. The vertical amplifier must have sufficient sensitivity to produce full-scale deflection with inputs of the order of 100 microvolts. The linear sweep circuit is synchronized with the rotating probe. The trace on the crt is then the squared swr as a function of position along the line. This is the same information that would be obtained on a manually-operated slotted line, and the load impedance could be obtained from it by the same computations. However, it is simpler to use a mechanical computer.

#### Phase Angle and Magnitude

There are two computations necessary. These are performed by two motions for plotting a point on the impedance chart: (1) a rotation

of the chart corresponding to a measured line distance in half wavelengths and (2) a radial motion corresponding to a standing wave ratio. The first computation is accomplished by the mechanism of Fig. 1, the second by that of Fig. 2.

The standing-wave pattern on the oscilloscope is adjusted to a reference frame using the centering and gain controls. When the detector probe passes through the short space in the circular line between the input and output connectors, there is no signal, thus a zero reference is established as shown in the lower left-hand corner of the oscilloscope (Fig. 1) to which the reference frame is positioned. To determine the angle of rotation of the impedance chart, the distance from the unknown impedance to the cur-

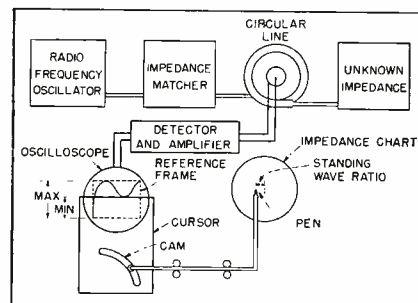

FIG. 2—Standing wave ratio, obtained from circular slotted line, is displayed on oscilloscope, then transferred to impedance chart to give value of unknown impedance

rent-minimum shown on the oscilloscope must be found. If a connecting cable is used between the unknown impedance and the slotted line, its electrical length must be considered. This is done by the A scale, which is calibrated at the oscilloscope in terms of equivalent length of the cable. The elements of the dividing lever are then set to the proper positions on their scales, one for operating frequency, the other for the relative velocity on the wave in the slotted line. The lever is then moved so that the vertical cursor intersects the swr pattern at its minimum. With the computer built to the proper dimensions for the particular parameters used in the setup (velocity of propagation in the slotted line, circumference of chart driving drum and so forth), the chart is rotated to show the proper phase angle.

The magnitude of the unknown

(continued on p 166)



Measurement and computation of impedance at very high frequencies are simplified with this mechanical plotter used with an oscilloscope.



This New  
**VARGLAS Tubing**  
 is better 5 ways!

Varglas Permafil Tubing excels oleoresinous and other synthetic coated tubing in several important performance characteristics. Outstanding among these are:

Impregnated with  
**PERMAFIL**  
 for superior  
 insulation...

**1 TOUGHNESS**

Remains pliable even after severe flexing. This new tubing can be twisted, bent or tied in knots with no loss in its dielectric value (7,000 volts).

**3 HEAT AGING**

Withstands more than 2,000 hours at 105° to 110° C., 1,000 hours at 125° C. and extensive periods at 150° C.

**2 SOLVENT RESISTANCE**

Is relatively immune to alcohol. Petroleum and aromatic hydrocarbons have only slight effect after long exposure.

**4 BAKING**

Can be after-treated in baking and varnishing operations—reacts better than most oleoresinous materials.

**5 AVAILABLE IN COILS**

—in standard colors and wide range of sizes. Meets or exceeds all requirements of A.S.T.M. specifications.

Send for **FREE SAMPLE** and complete data.



**VARFLEX Corporation, 308 Jay St., Rome, N. Y.**

Please send me full information as well as a free sample of your new Varglas Tubing impregnated with G.E. Permafil. I am particularly interested in samples suitable for.....

Name.....

Company.....

Street.....

City..... Zone ..... State.....

# NEW PRODUCTS

Edited by A. A. MCKENZIE

## New Record Player

RADIO CORP. OF AMERICA, Camden, N. J. A new record player operating at 45 rpm uses records 6 3/4 inches in diameter that play for approximately 5 minutes. A record has 275 grooves per inch with



width varying between 0.0025 and 0.003 inch. The playing needle with a 1-mil tip tracks at 5 milligrams pressure. Owing to the geometry of the discs, a simple but effective changer is possible.

## Slotted Line

HEWLETT-PACKARD Co., 395 Page Mill Road, Palo Alto, Calif. Type 805A slotted line substitutes two parallel planes and a rigid central circular conductor for the conventional coaxial arrangement. Slot



opening is less than 0.001 inch, keeping leakage low. Residual vswr can be held to less than 1.04. Frequency range for the new slotted line is 500 to 4,000 mc and characteristic impedance is 50 ohms.

## Hermetic Bushings

LUNDEY ASSOCIATES, 694 Main St., Waltham, Mass., has available a

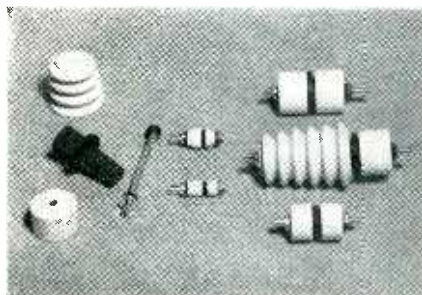

new line of steatite-neoprene compression type terminals designed for use in hermetically sealed transformers and capacitors and other electronic equipment where relatively high voltages are involved.

## Micromicroammeter

MILLIVAC INSTRUMENTS, Box 3027, New Haven, Conn. Type MV-171 d-c micromicroammeter comprises the type model MV 17A meter and MV-171 shunt box. Current meas-



urements in the range from 10 micromicroamperes and 10 amperes are possible. Time constant is 0.3 second, resulting in practically instantaneous readings. Details are given in bulletin II-121.

## Pantograph Engraver

MICO INSTRUMENT Co., 80 Trowbridge St., Cambridge 38, Mass. Type 252 pantograph engraving machine can be used to make small



dies and molds for plastics, rubber, glass, die castings, and templates. Three-dimensional milling is accomplished by tracing the shape of an enlarged master with the stylus. A micrometer depth control graduated in thousandths of an inch of feed, has a range of 0.25 in.

## Ultrasonic Generators

CENTRAL SCIENTIFIC Co., 1700 Irving Park Road, Chicago, Ill. Two new ultrasonic generators are now

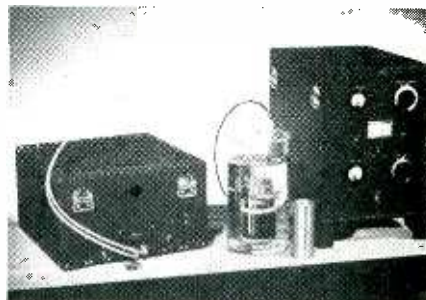

available for research and laboratory work. Type U-300 Ultrason delivers 300 watts of sound energy to an oil bath. Model 100 delivers 6 watts. Both operate at 450 kc.

## Polystethoscope

C. CURIE, 2 rue Idrac, Toulouse (Hte-Gne), France. The electronic stethoscope illustrated permits a group of students to listen simultaneously to the auscultation of a

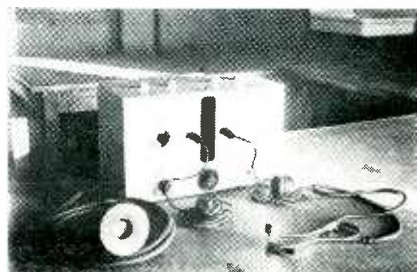



Developed for the Thermionics Branch  
of Evans Signal Laboratory

This Subminiature Mixer using separate oscillator Type 1A65 has higher conversion transconductance than any other Filamentary Subminiature Mixer.

This Filamentary Subminiature Shielded RF Pentode, Type 1AD4, has comparable Gm (2000 umhos) to the Type 6X7GT at only one-fifth of the A power, one-tenth of the B power and less than half of the B voltage.



# ADD THESE TO THE LIST OF SMALL SIZE, BIG PERFORMANCE RAYTHEON SUBMINIATURE TUBES

Standard Throughout the World for 10 Years

Raytheon Filamentary Subminiatures *improve product salability . . . reduce size . . . are flat shaped . . . permit small batteries because filament drain is extremely low . . . fit standard sockets or can be soldered or welded into the circuit . . . are quickly available from stock, over half a million on hand at all times . . . are standard throughout the world, more in use than all other makes combined.* Application recommendations are backed by unsurpassed production and engineering experience and resources.

→ NEW TYPES

This chart gives you at a glance the characteristics of representative Raytheon Subminiature Tubes

Type No.	Remarks	Maximum Diameter Inches	Maximum Length Inches	Filament Or Heater		Mutual Conductance umhos	Power Output MW	TYPICAL OPERATING CONDITIONS				Grid Volts	
				Volts	Ma.			Plate Volts	Ma.	Screen Volts	Ma.		
<b>HEATER CATHODE TYPES</b>													
CK5702/CK605CX	Characteristics of 6AK5	0.400	1.5	6.3	200	5000		120	7.5	120	2.5	-2.0	
CK5703/CK608CX	Triode, UHF Oscillator, 3/4 watts at 300 Mc	0.400	1.5	6.3	200	5000		120	9.0			-2.0	
CK5704/CK608BX	Diode, equivalent to one-half 6AL5	0.315	1.5	6.3	150			150ac	2.0				
CK5744/CK619CX	Triode, High mu.	0.400	1.5	6.3	200	4000		250	4.0			-2.0	
CK5784	Characteristics of 6AS6	0.400	1.5	6.3	200	3200		120	5.2	120	3.5	-2.0	
<b>FILAMENT TYPES</b>													
→ 1AD4	Shielded RF Pentode — high Gm	0.300x0.400	1.5	1.25	120	2000		45.0	8.0	48.0	0.8	0	
→ 1A65	Heptode Mixer	0.300x0.400	1.5	1.25	60	200		45.0	0.9	48.0	2.0	0	
						60V, 60RD.							
2E31-32	RF Pentode for pocket radio	0.300x0.400	1.56	1.25	50	500		22.5	0.4	22.5	0.3	0	
2E35-36	Output Pentode for pocket radio	0.290x0.390	1.56	1.25	30	385	1.2	22.5	0.27	22.5	0.07	0	
2E41-42	Diode Pentode for pocket radio	0.290x0.390	1.56	1.25	30	375		22.5	0.35	22.5	0.12	0	
2G21-22	Triode Heptode for pocket radio	0.300x0.400	1.56	1.25	50	75		22.5	0.20	22.5	0.30		
						conv. cond.							
RK61	Gas Triode, Exp. Radio Control	0.550	1.81	1.4	50			45.0	1.5	Special Circuit			
CK502AX	Output Pentode	0.285x0.385	1.5	1.25	30	550	6.0	45.0	0.6	45.0	0.15	-1.25	
CK503AX	Output Pentode	0.285x0.385	1.5	1.25	30	550	9.5	45.0	0.8	45.0	0.25	-2.0	
CK505AX	Voltage Amp. Pent.	0.285x0.385	1.5	0.625	30	381		22.5	0.125	22.5	0.04	-0.625	
CK506AX	Output Pentode	0.285x0.385	1.5	1.25	50		25.0	45.0	1.25	45.0	0.40	-4.5	
CK510AX	Double Space Charge Tetrode Amplifier	0.285x0.400	1.25	0.625	50		1501	45.0	0.06			0	
						both units							
CK512AX	Low microphonic voltage amplifier	0.285x0.385	1.25	0.625	20	371		22.5	0.125	22.5	0.04	-0.625	
CK522AX	Output Pentode 20 ma. filament	0.285x0.385	1.5	1.25	20	450	1.2	22.5	0.30	22.5	0.08	0	
CK523AX	Output Pentode	0.285x0.385	1.5	1.25	30	360	2.5	22.5	0.30	22.5	0.075	-1.2	
CK524AX	Output Pentode	0.285x0.385	1.5	1.25	30	300	2.2	15.0	0.45	15.0	0.125	-1.75	
CK525AX	Output Pentode	0.285x0.385	1.5	1.25	20	325	2.2	22.5	0.25	22.5	0.06	-1.2	
CK526AX	Output Pentode	0.285x0.385	1.5	1.25	20	400	3.75	22.5	0.45	22.5	0.12	-1.5	
CK527AX	Output Pentode 1.5 ma. filament	0.285x0.385	1.5	1.25	15	225	0.75	22.5	0.10	22.5	0.025	0	
CK529AX	Shielded Output Pentode	0.290x0.390	1.5	1.25	20	275	1.2	15.0	0.20	15.0	0.05	-1.5	
CK533AX	Output Pentode	0.285x0.385	1.5	1.25	15	425	2.0	22.5	0.4	22.5	0.1	0	
CK535AX	Output Pentode	0.285x0.385	1.5	1.25	20	275	1.2	15.0	0.20	15.0	0.05	-1.5	
CK535AX	Output Pentode	0.285x0.385	1.5	1.25	30	235		22.5	0.17	22.5	0.043	0	
CK551AX	Diode Pentode	0.300x0.400	1.56	1.25	50	550		22.5	0.42	22.5	0.13	0	
CK553AX	RF Pentode	0.300x0.400	1.56	1.25	50	550		10.5	0.20			-3.0	
CK571AX	10 ma. filament electrometer tube, I <sub>g</sub> = 2x10 <sup>-12</sup> amps.	0.285x0.400	1.5	1.25	10	1.61							
CK573AX	Triode, high frequency output	0.300x0.400	1.5	1.25	200	2000		135	14.0			-7.5	
CK574AX	Shielded Pentode RF Amplifier	0.290x0.390	1.25	0.625	20	371		22.5	0.125	22.5	0.04	-0.625	
CK5672	Output Pentode	0.285x0.385	1.5	1.25	50	625	60.0	67.5	2.75	67.5	1.1	-6.25	
CK5676/CK56AX	Triode, UHF Oscillator for radio use	0.300x0.400	1.5	1.25	120	1600		135.0	4.0			-5.0	
CK5677/CK568AX	Triode, UHF Oscillator for radio use	0.300x0.400	1.5	1.25	60	650		135.0	1.9			-6.0	
CK5678/CK569AX	RF Pentode	0.300x0.400	1.5	1.25	50	1100		67.5	1.8	67.5	0.48	0	
CK5697/CK570AX	Electrometer Triode Max. grid current 5x10 <sup>-13</sup> amps.	0.285x0.400	1.25	0.625	20	1.51		12	0.22			-3.0	
CK5785	High voltage rectifier	0.285x0.400	1.5	1.25	15				0.1	Inverse peak 3500 volts			
<b>VOLTAGE REGULATORS</b>													
CK5783	Voltage reference tube — like 5551	0.400		1.63				Operating voltage 85. Operating current range 5 to 3.5 ma.					
CK5787	Voltage regulator	0.400		2.06				Operating voltage 100. Operating current range 5 to 25 ma.					

CK ⊗ RK ⊗

[Voltage Gain (times)]

NEW — Write for Socket and Mounting Notes for Flat Press Subminiature Tubes.

**RAYTHEON MANUFACTURING COMPANY**  
SPECIAL TUBE SECTION  
Newton 58, Massachusetts

**RAYTHEON**

RADIO RECEIVING TUBES • SUBMINIATURE TUBES • SPECIAL PURPOSE TUBES • MICROWAVE TUBES *Excellence in Electronics*

sickness without additional discomfort to the patient. The device has been in use by groups of about ten students, but many more could be served by the same amplifier.

### Special I-F

HAMMARLUND MANUFACTURING Co., 460 West 34th St., New York 1, N. Y. Type SS-50 is a double per-

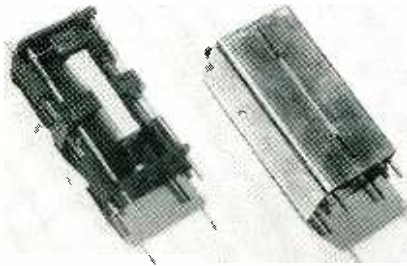

meability tuned i-f transformer for use in the region of 50 kc. A single i-f stage using two of the transformers gives attenuations ranging from 6 db at 0.8-kc bandwidth down to 60 db at 5.0-kc bandwidth.

### New Television Tube

GENERAL ELECTRIC Co., Syracuse, N. Y. A new television picture tube with a diameter of 8½ inches will give a fifty-percent increase in picture size to small set owners at no

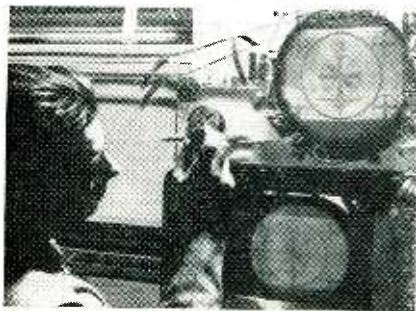

appreciable extra cost. A metal type using magnetic focusing and deflection, the new tube will get into production during 1949. Samples will be available soon.

### Dual-Channel Oscilloscope

ELECTRONIC TUBE CORP., 1200 East Mermaid Lane, Philadelphia 18, Pa. Model H-2GTC oscilloscope is a laboratory instrument for registering two separate phenomena ranging from d-c to 1 megacycle. To provide greatest flexibility, the deflection amplifiers are designed as



removable units. Tube furnished is the dual-gun 5SP1, although type 5SP11 for photographic applications can be substituted.

### Signal Generator

AIRCRAFT RADIO CORP., Boonton, N. J. Type H-12 signal generator covers the frequency range from 900 to 2100 megacycles. It can be



operated as a calibrated source of continuous-wave r-f energy or as an amplitude pulsed r-f source. It is the commercial equivalent of the military TS-419/U illustrated.

### Educational Broadcasting

RADIO ENGINEERING LABORATORIES, 35-54 36th St., Long Island City, N. Y. Model 706 10-watt transmitter using the Serrasoid modulator



can be used on any single frequency in the f-m broadcast band, or employed as a driver for high-power stages. It has been particularly designed for broadcasting by schools and colleges within a limited service area. Total weight is 90 pounds and cost is \$1,595.

### Matching Transformer

THE WORKSHOP ASSOCIATES, INC., 66 Needham St., Newton Highlands, Mass. The T-72 broad-band impedance-matching transformer is designed for use at frequencies of



50 to 225 mc. It consists of an r-f transformer with a specially designed polyiron core, mounted in a small aluminum container. At one end is mounted a standard miniature connector for attachment to 72-ohm unbalanced coaxial line. Out of the side a 6-inch piece of 300-ohm balanced line is provided.

### Microwave Signal Generator

POLYTECHNIC RESEARCH AND DEVELOPMENT Co., INC., 202 Tillary St., Brooklyn 1, N. Y. A broadband microwave signal generator covering the frequency range from 4,200 to 10,300 mc includes a direct reading frequency meter and a variable attenuator calibrated directly in db below 1 milliwatt. Provision is



(Continued on p 191)

# In a nutshell

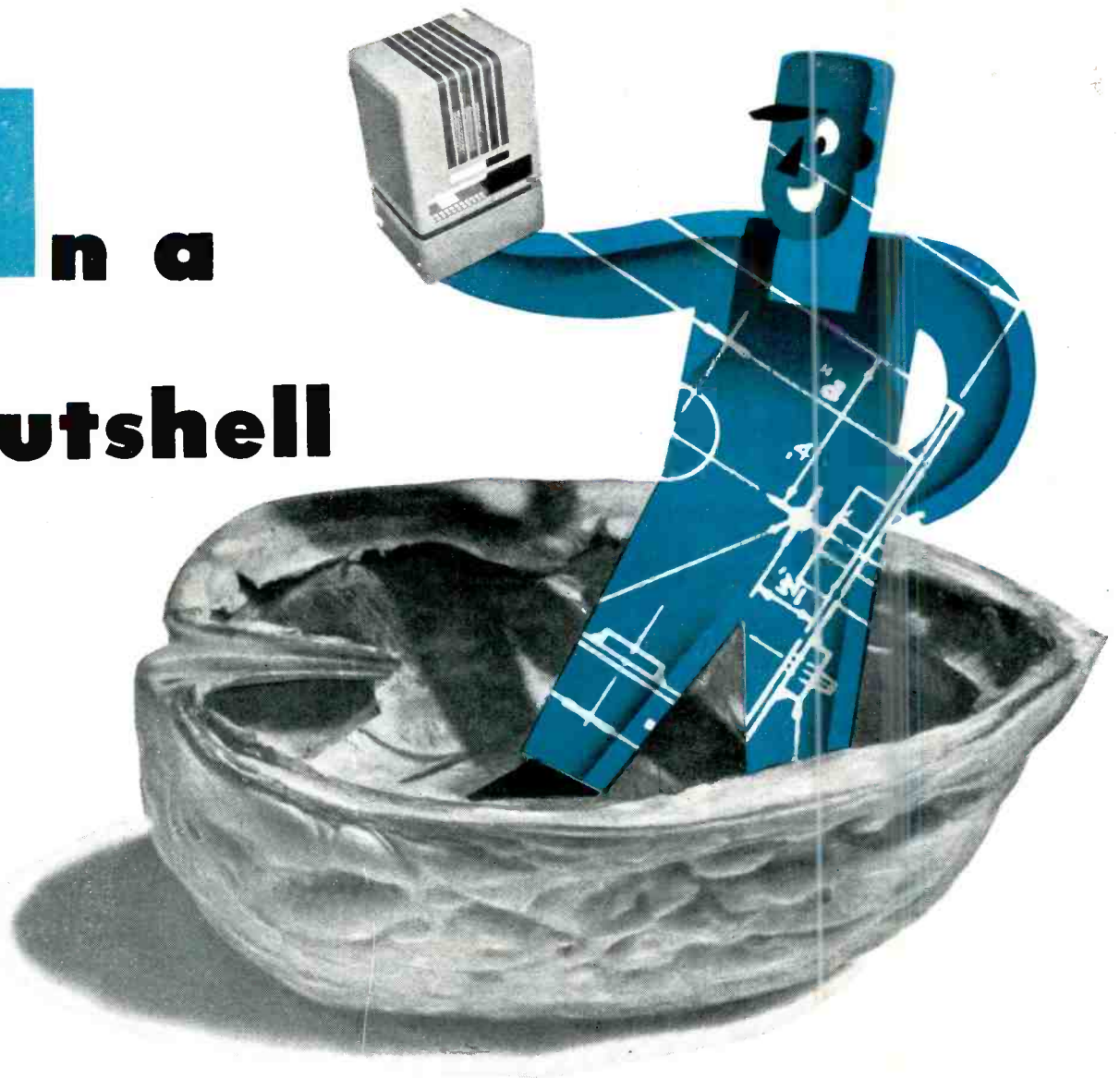

## •••• the Karp story is this:

We're a group of sheet metal fabrication specialists with almost 25 years' experience in our craft.

We believe we have some of the most ingenious men in the industry—especially in our engineering department and among our skilled craftsmen.

We have 70,000 square feet of ultra-modern plant, with every up-to-date aid in the way of tools and machinery.

We have the very latest in air filtered painting and finishing facilities.

We are geared to produce—at the right cost for its specifications—anything from a simple box or chassis to the largest studio broadcasting apparatus housings—and in any quantity.

In short, we're at your service for sheet metal fabrication at its best. And we mean service!

**Visit Our Exhibit, Booths 49-50 at the I. R. E. Show**

## **KARP METAL PRODUCTS CO., INC.**

215-63rd STREET, BROOKLYN 20, NEW YORK

*Custom Craftsmen in Sheet Metal*

# NEWS OF THE INDUSTRY

Edited by WILLIAM P. O'BRIEN

## East-Midwest Television Network Opened

A COAXIAL cable link between Philadelphia and Cleveland via Pittsburgh was placed in operation Jan. 12, 1949 to unite the Bell System eastern and midwestern television networks. The combined network now covers an area where one-fourth of the nation's population lives. It extends over 2,100 miles, of which 1,740 route miles are coaxial cable and 370 route miles are radio relay. Cities now served by cable are New York, Philadelphia, Baltimore, Washington, Richmond, Pittsburgh, Cleveland, Buffalo, Toledo, Chicago and St. Louis. Radio relay is used between New York and Boston, Toledo and Detroit, and Chicago and Milwaukee.

The Bell System network now uses 540 booster amplifiers along the cable to maintain the energy of the television signal as it travels from city to city. Some 250 additional amplifying devices in the television terminals in telephone buildings in each city on the network are used to put the broadcasters' programs on the channels.

In addition to intercity television

facilities the Bell System, through its associated companies, also provides broadcasters with television channels between local pickup points and their studios, between the studios and the broadcasting transmitters and between the studios and their networks.



Worker makes a splice on a section of the coax cable between Pittsburgh and Cleveland, part of the link joining the Bell System's eastern and midwestern television networks. Splices are made in a temporary pit dug into the ground to the level at which the cable is placed by the plow

Plans for the expansion of these networks depend on the development of the television industry. More television channels, both radio relay and coaxial cable, are planned along the existing main routes of the Bell System television networks and extension will also be provided from the present networks to additional cities.

## New Advances in Printed Circuits

THE PROCEEDINGS of the Printed Circuit Symposium held last October by the Aeronautical Board's Aircraft Radio and Electronics Committee, under the supervision of the National Bureau of Standards, have been published in a 73-page booklet designated as "New Advances in Printed Circuits." This NBS Miscellaneous Publication M 192 is available from the Superintendent of Documents, U. S. Government Printing Office, Washington 25, D.C., at 40 cents (cash only) per copy.

Topics covered, as presented by representatives of industry and government laboratories, include the status of printed circuits; conductive silver preparations; printed resistors; trends in military communication; vitreous-enamel dielectric products; printed electronic

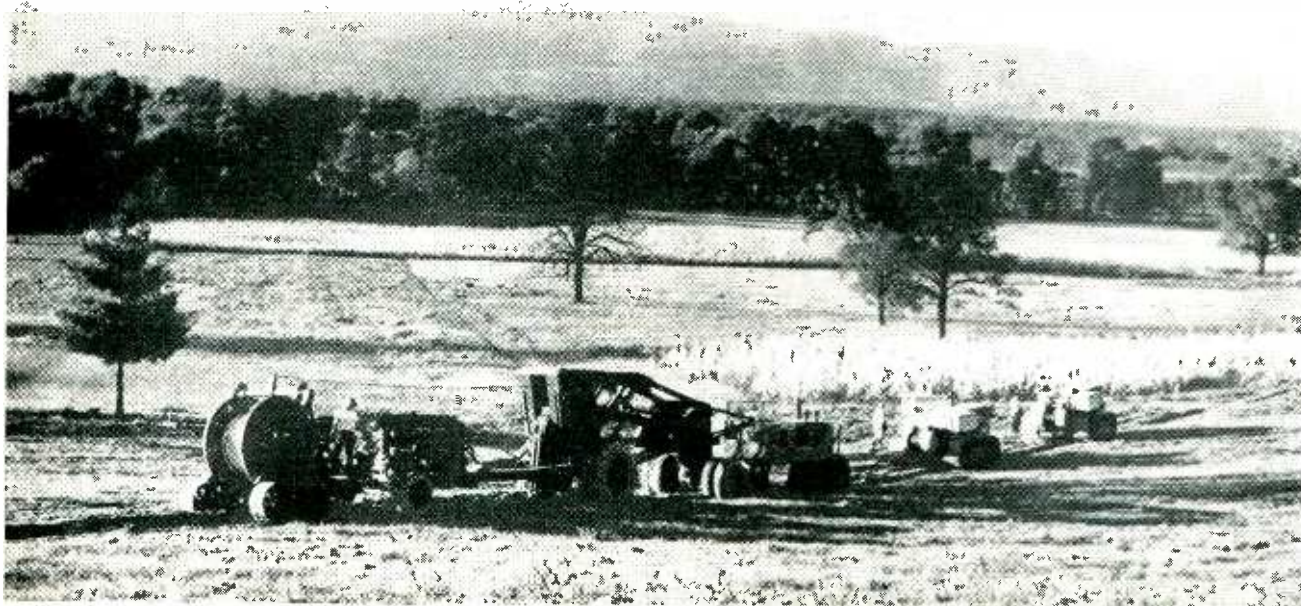

A 27-ton giant cable plow rolls along the route of the expanding network. Just behind the plow, the cable may be seen entering the slotted plowshare

# A UNIQUE UHF SERVICE

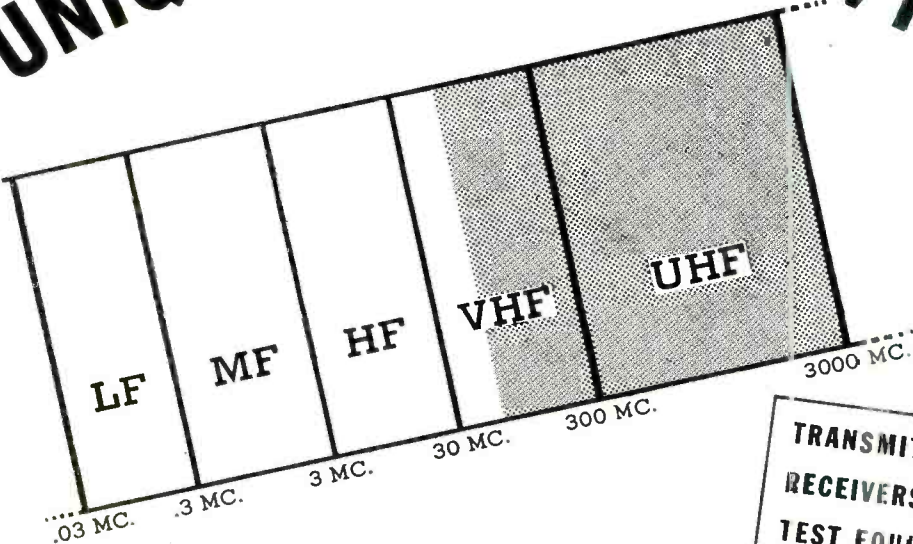

**LAVOIE LABORATORIES** offer you a unique service in that we *specialize* in the development, design and production of U.H.F. equipment.

Our Engineering Department as well as our shops and shop methods, are geared to U.H.F. production, assuring **CORRECT** design, **PRECISION** work and **LOW UNIT** cost.

We are prepared to collaborate on every phase of U.H.F. work—in the confidential development of new ideas or the re-design of old products. A few, typical, completely-developed LAVOIE products are listed at the right.

If you will address us on your letterhead, we shall be glad to send you a resume of LAVOIE U.H.F. facilities.

VISIT US AT  
BOOTHS

**87 AND 88**

RADIO ENGINEERING SHOW



- TRANSMITTERS
- RECEIVERS
- TEST EQUIPMENT
- OSCILLOSCOPES
- ELECTROMYOGRAPHS
- PULSE GENERATORS
- RADAR RECEIVERS
- UHF RADIO SETS
- SIGNAL GENERATORS
- WAVEMETERS
- HARMONIC GENERATORS
- FREQUENCY STANDARDS
- PRECISION EQUIPMENT
- ANTENNAS and MOUNTS
- UHF EQUIPMENT
- ELECTRONIC PRODUCTS
- SQUARE WAVE GENERATORS
- FREQUENCY METERS
- VIDEO AMPLIFIERS
- FIXED FREQUENCY RECEIVERS

## Lavoie Laboratories

RADIO ENGINEERS AND MANUFACTURERS  
MORGANVILLE, N. J.

**Specialists in the Development and Manufacture of UHF Equipment**

components on glass, plastic and other nonconductors; imprinted circuit inlays; spraying techniques; mechanization of electrical wiring; die-stamped wiring; typical commercial applications. The booklet also summarizes the present status of this art and includes discussions of technical questions raised at the symposium.

### IRE Convention Program

TWENTY-SEVEN technical sessions and six symposia will be featured at the 1949 convention of the IRE at the Hotel Commodore and Grand Central Palace, New York City, March 7 to 10. A total of 143 papers will be delivered at the sessions, on subjects embracing virtually the entire radio-electronic art; symposia will cover nuclear science, network theory, electronic computers, radio aids to navigation, semiconductors and marketing. No more than five sessions will run concurrently.

On March 8, B. E. Shackelford, past-president of the IRE, will be toastmaster at the president's luncheon to introduce incoming presi-

### MEETINGS

**MARCH 7-10:** IRE Annual Convention, Hotel Commodore and Grand Central Palace, New York City.

**MARCH 28-29:** Third Annual Meeting, Armed Forces Communications Association, Shoreham Hotel and Naval installations, Washington, D. C.

**APRIL 4-8:** SMPE 65th Semi-annual Convention, Hotel Statler, New York.

**APRIL 6-12:** 27th Annual Convention of the National Association of Broadcasters, Stevens Hotel, Chicago, Ill.

**APRIL 11-12:** AIEE Conference on the Industrial Application of Electron Tubes, Statler Hotel, Buffalo, N. Y.

**APRIL 25-27:** Fourth Annual Spring Meeting of the RMA and IRE, Benjamin Franklin Hotel, Philadelphia, Pa.

**MAY 2-4:** URSI-IRE Joint Meeting, National Bureau of Standards, Washington, D. C.

**MAY 12-13:** Fourth Annual Spring Meeting of the Instrument Society of America, Royal York Hotel, Toronto, Canada.

**MAY 16-20:** Radio Parts Industry Trade Show and RMA Silver Anniversary Convention, Hotel Stevens, Chicago, Ill.

**JUNE 20-24:** AIEE Summer General Meeting, New Ocean House, Swampscott, Mass.

dent Stuart L. Bailey. Toastmaster at the annual banquet on March 9 will be Raymond F. Guy of NBC.

Technical program is as follows:

- Monday P. M., March 7**
- Systems I--Modulation Systems
  - Development of a High Speed Communication System, by Donald S. Bond.
  - Distortion in a Pulse-Count-Modulation System with Nonuniform Spacing of

- Levels, by P. F. Panter and W. Dite.
- Cross-Talk Considerations in Time-Division Multiplex, by S. Moskowitz, L. Diven, and L. Feit.
- Experimental Verification of Various Systems of Multiplex Transmission, by D. R. Crosby.
- Interference Characteristics of Pulse-Train Modulation, by E. R. Kretzmer.
- Factors Involved in the Design of an Improved Frequency-Shift Receiving System, by Colin C. Rae.

#### Antennas I

- Some Properties of Radiation from Rectangular Waveguides, by J. Bolljahn.
- Elliptically Polarized Radiation from Inclined Slots on Cylinders, by G. Sinclair.
- A Broadband Transition from Coax to Helix, by C. O. Lund.
- Theory of End-Pire Helical Antennas, by A. E. Marston and M. D. Adcock.
- Equivalent Circuits for Coupling of Waveguides by Apertures, by N. Marcuvitz.

#### Symposium: Network Theory

- Modern Developments in the Topology of Networks, by R. M. Foster.
- A Summary on the Status of Linear Network Theory, by E. A. Guillemin.
- Recent Developments in Broadband Active Networks, by J. C. Linvill.
- A General Review of Linear Varying Parameters and Nonlinear Circuit Analysis, by W. R. Bennett.

#### Instruments and Measurements I-- Microwave

- Measuring the Efficiency of a Superheterodyne Converter by the Input Impedance Circle Diagram, by H. Wheeler and D. Dettinger.
- Electrolytic-Tank Measurements for Microwave Delay Lens Media, by S. B. Cohn.
- Impedance Instrumentation for Microwave Transmission Lines, by P. A. Portmann.
- A Michelson Type Interferometer for Microwave Measurements, by B. A. Lengyel.
- A Broadband High-Power Microwave Attenuator, by H. J. Carlin.
- An Absolute Method for Measuring Microwave Power of Low Intensity, by H. Herman.

#### Audio

- The Reproduction of Sound, by H. E. Olson.
- New Developments in Studio Design in Europe, by L. L. Beranek.
- The Technique of Television Sound, by R. H. Tanner.
- The Measurement of Nonlinear Distortion, by A. Peterson.

#### Tuesday A.M., March 8

#### Antennas II

- Antenna Systems for Multichannel Mo-
- (continued on p 226)

## COILS PRESENT TRANSPORT PROBLEM



Two giant coils, one weighing 92 and the other 97 tons, are made secure aboard the Seatrain New Jersey for shipment to New Orleans, La. Built at the Brooklyn (N. Y.) Navy Yard for the cyclotron at the Carnegie Institute of Technology, Saxonburg, Pa. (about 375 mi. from N.Y.C.), the coils were too large to go by rail or highway and had to be shipped coastwise to New Orleans, and thence by river to Pittsburgh, Pa., a short highway haul to Saxonburg. The coastal route is about 3,000 miles



1D21/SN4



R4350



OA5  
(Triggertube)



SA-309

# If it's a **STROBOTRON** it's made by **SYLVANIA**

THERE'S just *one* source of supply for the Strobotrons you need for "freezing" the motion of reciprocating or rotating machinery —Sylvania Electric!

Sylvania Strobotrons SA-309 and R4350 produce high-intensity, bluish-white light pulses . . . are ideal for applications where true-color viewing is essential. The R4350 flashes at rates

up to 15 per second; the SA-309, up to 100 per second.

Type 1D21/SN4 provides a source of neon-red light, at frequencies up to 240 flashes per second.

Typical applications of Sylvania Strobotrons include: automotive timing; wheel balancing; adjustment of packaging machinery; regulation of high-speed multi-color printing presses.

TRIGGER TUBE TYPE OA5 provides a convenient means of triggering the SA-309, R4350 or 1D21/SN4 from current sources of very low value. The OA5 may also be used for electronic relay and switching applications as well as for other regular Strobotron purposes.

### MAIL THE COUPON FOR BULLETINS

Sylvania Electric Products Inc.  
Electronics Division, Dept. E-2903  
500 Fifth Avenue, New York 18, N. Y.

Gentlemen:

Please send me descriptive bulletins on Sylvania Strobotrons and Triggertubes.

I am also interested in receiving literature covering applications of your other products in the fields of:

- Communications and Industrial Electronics
- Radioactivity  Radar and Microwaves

Name.....

Position.....

Company.....

Street Address.....

City..... Zone #..... State.....

# SYLVANIA ELECTRIC

Electronics Division, 500 Fifth Avenue,  
New York 18, N. Y.

ELECTRONIC DEVICES; RADIO TUBES; CATHODE RAY TUBES; PHOTOLAMPS; FLUORESCENT LAMPS; FIXTURES; WIRING DEVICES; ELECTRIC LIGHT BULBS.

# PRECISION RESISTORS!



**Shallcross  
makes  
them  
all!**

- ... Wire wound with any alloy to meet JAN-R-93 styles
- ... Hermetically sealed
- ... With low temperature coefficient
- ... With predetermined time constants
- ... For high resistance in small space
- ... With definite positive or negative temperature coefficient
- ... With special low-tolerance
- ... With highest stability of resistance values
- ... For high voltage applications
- ... Potted (for RC, bridge and fixed pad networks)
- ... Mounting styles for any need

**Latest Data on  
SHALLCROSS  
AKRA-OHM RESISTORS**

**to meet JAN Specifications**

The new Shallcross Engineering Bulletin R-3 brings you complete mechanical and electrical data on close tolerance resistors that meet joint Army, Navy and Air Force Specifications—also suitable for practically any industrial application. A copy will gladly be sent on request.

**SHALLCROSS MANUFACTURING COMPANY Dept. E-39 Collingdale, Penna.**

**Shallcross—the only complete  
precision resistor line!**

*Write for  
your copy  
today!*

## TUBES AT WORK

(continued from p 126)



Simplified record changer for the new records

fast-drop mechanism. Its eight-record capacity allows about 42 minutes of total playing time.

### Surge-Testing Motor Windings

IT IS COMMON KNOWLEDGE that voltage distribution in motor windings may change with frequency, and that the voltage distribution produced by a complex surge (as might occur in service) will be non-linear. Therefore, it is necessary that the voltages used in testing motor windings for voltage breakdown should be of the same complex nature.

It is further known that the breakdown time depends on the waveshape of the voltage being applied. A sine wave, for instance, will cause more rapid breakdown than a voltage of the same peak amplitude and frequency in the form of recurring pulses, because the time during which the voltage exceeds a certain value will be greater in the case of the broader sinusoidal waveshape.

The schematic diagram in Fig. 1 shows a means for subjecting motor windings to tests with these facts considered. The power-frequency trigger circuit initiates the horizontal sweep of the scope and starts the thyatron conducting. Capacitor *C*, which has been charged through *V*, on the previous half cycle, discharges through the thyatron into the reversing switch



outstanding advantage offered  
in Highest Quality Potentiometer

# GIBBS MICROPOT GUARANTEES

**±0.1% ACCURACY**

● "Integral Molding" . . . Exclusive  
Gibbs Engineering Development . . .  
Forever Locks Coiled Resistance Element  
and Terminals into One Integral Unit  
with Housing . . . Assures Unequalled and  
Permanent Operational Accuracy.

*. . . and only the*  
**MICROPOT**  
*has it!*



**VISIT  
US  
at booth 236**



Result of  
"INTEGRAL  
MOLDING"  
process . . .

Resistance element and terminals  
are one integral part of housing

## OTHER IMPORTANT FEATURES OF GIBBS TEN-TURN MICROPOT

### Write Today!

For engineering specifications and complete detail folder. Submit any problems to our engineering staff for recommendations. Units for immediate shipment. — 1,000 to 30,000 ohm range. Special resistance values made to order.

- Resistance output is directly proportional to shaft rotation through a full 3,600 degrees within  $\pm 0.1\%$ ; this linearity is carried right to the counter clockwise stop. In the Gibbs MICROPOT such results are obtained by precision manufacturing and methods.
- Precision ground, stainless steel, double thread, lead screw guides the rotating contact, *guarantees* smooth action, low uniform torque

and accurate settings — *permanently*.

- Rotor assembly, supported on two bearings, assures long life and low torque.
- Ends of resistance element *soldered* to terminals *before molding*.
- Anti backlash spring in contact guide—assures you positive setting and resetting.
- The  $43\frac{1}{2}$ " length of resistance element gives you a finer resolution.



DEPT. 31 **GIBBS Division**

**THE GEORGE W. BORG CORPORATION**  
**Delavan • Wisconsin**

# They Discover Oil with Aid of ADC Transformers

## THE STORY OF

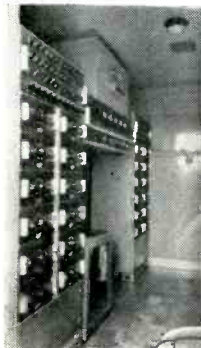

SEISMIC  
EQUIPMENT  
and OIL  
PROSPECTING



The Century Geophysical Corporation of Tulsa, Okla., is a prominent manufacturer of seismic equipment for oil prospecting.

With Century equipment Geophysicists and Geologists determine the general location of new oil fields by charting fault patterns, salt domes, and deep seated limestone beds, all of which is done on a principle of echo.

These techniques require extreme accuracy so that comparison of soundings will reveal slight contour changes at depths of up to three miles.

That ADC was selected by Century to manufacture transformers and inductors for their special electronic components is another evidence that "Audio Develops the Finest."

## HOW ADC TRANSFORMERS HELP DISCOVER OIL...

Heart of the geophysical unit for detecting oil deposits is the seismic equipment in the recording truck. Century called on ADC to work out the complicated specifications on transformers and inductors for seismograph amplifier, etc., to obtain the extreme accuracy, durability and dependability they require.

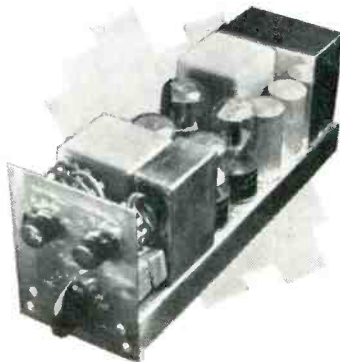

TUBES AT WORK

(continued)

which directs the current surge first through the unit being tested and then through a standard. So, two traces will appear on the screen of the cathode-ray tube, and if they both coincide, the unit being tested is similar in every respect to the standard used for comparison.

Experience in using this set-up reveals that different patterns on the scope indicate different faults in the winding, but that similar faults give similar patterns.

Many different types of motor windings are in use. Each of these has its own characteristic impedance and therefore voltage distribution. So in order to use this testing equipment intelligently, a preliminary analysis of the surge

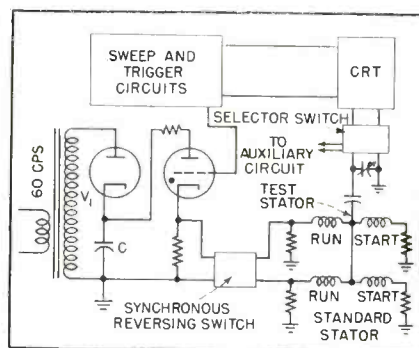

FIG. 1—Schematic diagram for motor winding fault finder

must be made to see if it is of the type desired.

This test idea is not limited to motor windings. Such a device has been used to find weak spots in the insulation of small transformers and reactors and led to their correction.

For use in locating winding faults, a few pieces of auxiliary equipment must be used with the winding tester. Pickup coils are placed near the sections of the winding in which the short appears. By amplifying the induced voltage and observing the wave-shape on the insulation tester scope, the section containing the short will immediately become obvious.

With an experienced operator, faults and their locations may quickly and easily be found with this device. Marion C. Halleck of General Electric's Fort Wayne Works Laboratory is responsible for the development of this equip-



**Audio DEVELOPMENT CO**  
*Audio Develops the Finest*  
2847 13th AVE. SOUTH • MINNEAPOLIS 7, MINN.

YOU GET QUALITY PLUS ENGINEERING SERVICE

with



# PERMANENT MAGNETS

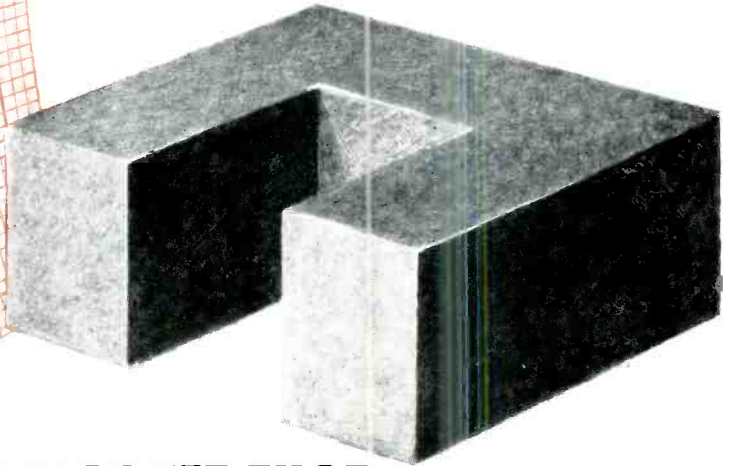
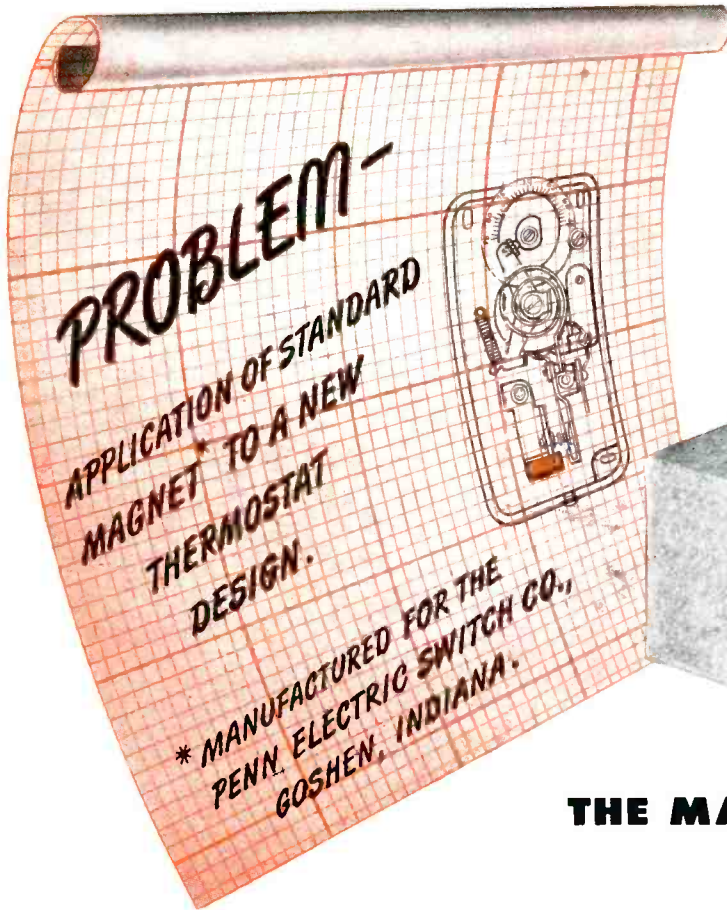

## THE MAGNET THAT

# Heats Your Home

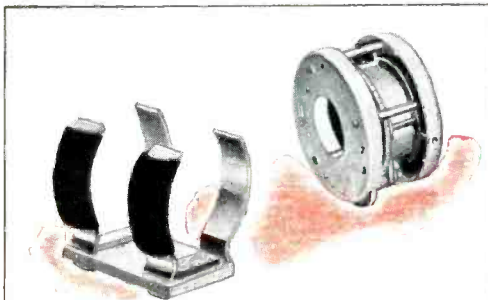

### G-E Permanent Magnet SUB-ASSEMBLIES

Here's a new product which may lower your permanent magnet costs. Permanent magnet component assemblies are specially designed to your specifications—ready for immediate installation in your final product. All permanent magnets are mounted for maximum efficiency. And, assembly and calibration operations are completely eliminated at your plant. For your free copy of General Electric's new bulletin on G-E Permanent Magnet Sub-assemblies mail the coupon shown below.

Here's a magnet that's simple in design yet is the heart of Penn room thermostats. . . thermostats which *anticipate* heat requirements before temperature *changes*. The Sintered Alnico 2 permanent magnet snap-acting contact mechanism responds almost instantly to temperature variations.

This application is an excellent example of cost-saving by using stocked G-E permanent magnets. Since the magnet is stocked there are no special tool charges. And orders for stocked magnets are filled quickly, eliminating costly production slow-downs to you.

Perhaps a standard listed magnet can be used in your applications. And if a standard G-E permanent magnet will not meet your requirements, our engineers will be glad to design one specially for you. Remember, too, that General Electric manufactures all grades of cast and sintered Alnico as well as special magnet alloys.

CHEMICAL DEPARTMENT, SECTION 14-3  
GENERAL ELECTRIC COMPANY  
PITTSFIELD, MASS.

Please send me: ( ) Bulletin, CDM-2A, "G-E PERMANENT MAGNET CATALOG" ( ) Bulletin, CDM-16, "G-E PERMANENT MAGNET SUB-ASSEMBLIES"

Name .....  
Company .....  
Products Mfrd. ....  
Address .....  
City ..... State .....

# GENERAL ELECTRIC

CD49-61

**WARD LEONARD  
RESISTORS**

**688**  
**QUICK SOLUTIONS**

to  
as  
many  
resistor  
problems

## because Ward Leonard has that many types of resistors in stock

You can get immediate delivery on Ward Leonard Vitrohm wire-wound resistors—both adjustable and fixed—in watt ratings from 5 to 200 and resistance values from 1 to 150,000 ohms.

Resistive element embedded in Ward Leonard's exclusive crazeless vitreous enamel, gives these resistors consistent accuracy and stability even under the most prolonged adverse operating conditions.

Write for Resistor Catalog D130. Ward Leonard Electric Co., 31 South Street, Mount Vernon, N. Y. Offices in principal cities of U. S. and Canada.

**WARD LEONARD  
ELECTRIC COMPANY**

**R**esult-**E**ngineered Controls

RESISTORS • RHEOSTATS • RELAYS • CONTROL DEVICES



ment which has been used extensively for surge testing many types of windings.

## Conversion of Aircraft Equipment.

By JOSEPH ALBIN  
New York, N. Y.

WEIGHT-SAVING is an important factor to an airline when it decides to rework surplus or other equipment. Another factor to be considered is fitting the reworked equipment mechanically and circuit-wise to operate along with existing instruments and wiring. Thus the possible economy achieved by con-



FIG. 1—More frequencies and an easier reading front panel are provided by conversion changes

version needs to be considered in conjunction with these other factors.

Solving such problems leads to certain interesting reworking operations. Some of these that have been done in the radio overhaul shop of American Airlines at La Guardia Field will be described.

In Fig. 1, a mechanic is shown making modifications to a crystal selector panel used in ARC/1 vhf aircraft equipment. This relay unit is the frequency control unit of a glide path receiver, part of the instrument landing (blind landing) system used in all American Airlines aircraft. The purpose of the rework is to increase the number of frequencies available in the receiver by adding four relays to have a total of ten. The mechanic is

# PHILCO

## MAKES HISTORY IN TELEVISION TEST EQUIPMENT

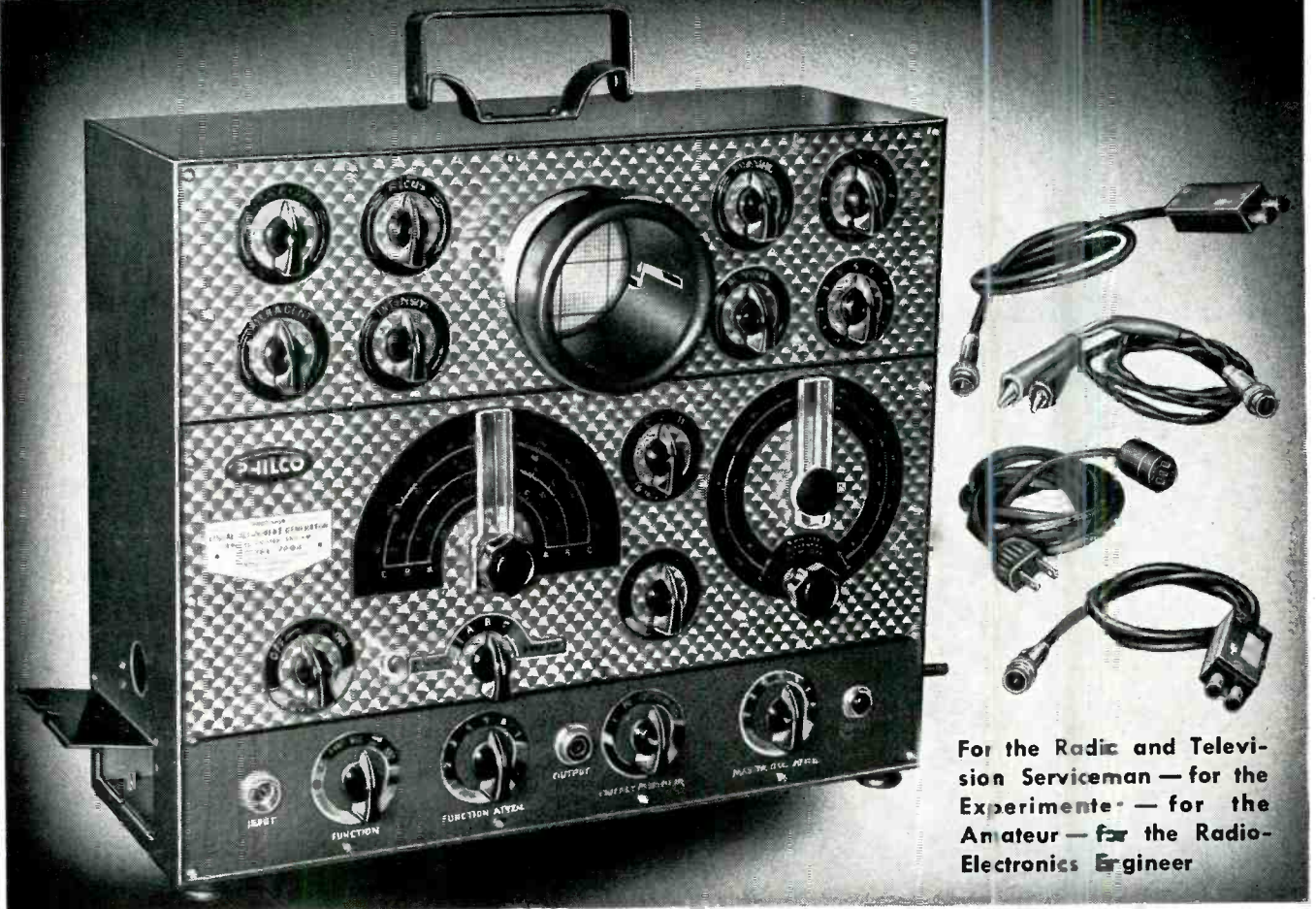

For the Radio and Television Serviceman — for the Experimenters — for the Amateur — for the Radio-Electronics Engineer

### PHILCO 7008 VISUAL ALIGNMENT GENERATOR

The only completely self-contained and moderately priced instrument for aligning television and FM receivers. Includes 5 different signal generators with their associated controls; a complete oscilloscope with centering, gain, focus, intensity, phasing and blanking controls, and power supplies; separate RF probe for measurements of sensitive high frequency circuits. Removable crosshatch screen for ultra-short 3" cathode-ray tube. Compartment for cables and RF probe.

WRITE FOR TECHNICAL LITERATURE  
Philco Corporation, Philadelphia 34, Pa.

- No. 7008 Philco Visual Alignment Generator
- No. 7001 Philco Electronic Circuit Master
- No. 7070 Philco RF Signal Generator
- No. 5072 Philco Crosshatch Generator
- No. 7030 Philco Dynamic Tester
- No. 7019 Philco Junior Scope

### PHILCO TEST EQUIPMENT SERVES MANY INDUSTRIAL & COMMUNICATIONS NEEDS

Today's wide use of electronic devices in industrial plants, laboratories and communications services requires new precision instruments for radio measurements, in compact, portable, inexpensive form. Here, Philco has long been a leader—providing equipment for radio's best informed group of service technicians, the 25,000 members of Philco Service. For fast, accurate work experience-wise servicemen choose Philco Test Equipment. Know the reasons why Philco is preferred, by writing for technical literature.

PHILCO CORPORATION • Philadelphia 34, Pa.



# MOSINEE

*"More than Paper"*

In the field of electronics and the electrical goods industry, MOSINEE stands for paper-base processing materials with scientifically controlled chemical and physical properties, high quality standards and dependable uniformity... with good dielectric strength, high tensile or tear strength; proper softness or stiffness; creped with controlled stretch or flexibility; specified pH for maximum-minimum acidity or alkalinity; accurate caliper, density, liquid repellency or absorbency... or other technical characteristics vital to your quality standards and production requirements.

**MOSINEE PAPER MILLS COMPANY • MOSINEE, WIS.**

*"Essential Paper Manufacturers"*

TUBES AT WORK

(continued)



FIG. 2—Popular on the two-meter amateur band, the SCR 522 has been adapted by American Airlines as a ground station receiver

shown handling the original panel containing the relays and associated components.

On the left of the illustration is another example of rework on a control panel, comprising a change in type of switches and type of indicator. In place of engraved numbers to show all channels at once a knob having a window is used. This change permits the number of a single channel to stand out plainly with less ambiguity than formerly.

Figure 2 shows an SCR 522 vhf receiver which has been converted into a ground station receiver for use on a 115-volt a-c line. A new power supply is substituted in place of the 28-volt aircraft power supply. The former automatic solenoid-operated method of controlling frequency is superseded by a mechanical method for local control by the operator. The frequency selection is now accomplished by a cam-operated switch. A few circuit changes were made, and the crystal panel was relocated for purpose of accessibility.

The adaptation of another aircraft receiver to ground station use is done in Fig. 3 on a former AVR 7A beacon receiver in aircraft. It is now used for monitoring local beacon transmitters. Added parts are a power supply, output transformer, a small loud speaker to avoid use of headphones and a panel and chassis for mounting in a standard relay rack.

Final rework procedures are established after planning on a drafting board and a model has been

Try these resistors

for **SIZE!**

- they're a  
**SURE FIT**  
for price  
and quality



TYPE	MAX. RES.*	MAX. WATTS	BODY DIA.	BODY LENGTH	LEADS
IR-107	1200	1/8	7/64"	3/8"	.025" x 1-1/2"
IR-125	2500	1/4	1/8"	1/2"	.025" x 1-1/2"
IR-156	3500	1/2	5/32"	1/2"	.028" x 1-1/2"
IR-187	6000	1	3/16"	3/4"	.028" x 1-1/2"
IR-250	12000	2	1/4"	1"	.035" x 1-1/2"
IR-375	28000	5	3/8"	1-1/2"	.040" x 1-1/2"

\*Maximum resistance using .00135" dia. wire. Higher ohmic values can be furnished using smaller wire.



MIDGET  
IN SIZE

MIDGET  
IN PRICE



GIANT FOR  
QUALITY

## IN-RES-CO TYPE IR WIRE WOUND RESISTORS

IN-RES-CO TYPE IR resistors meet all requirements where precision resistance values and exceptionally small size must be satisfied at lowest possible cost. Although no larger than molded resistors,

Type IR units are wire-wound to a standard tolerance of  $\pm 1\%$  and maintain this accuracy throughout their life. Ability to withstand rough usage and intermittent over-load have always been an important feature of IN-RES-CO resistors and these new IR types are built to the same high standards. Ratings are conservative in every instance allowing ample margin of safety in all classes of service. Prompt delivery assured—write today for complete details.



Write for your copy of the completely illustrated IN-RES-CO Catalog today. No obligation—merely address request on company letterhead for prompt mailing.

### INSTRUMENT RESISTORS COMPANY

Makers of Quality Wire-wound Resistors for Every Electrical Need

1036 COMMERCE AVENUE • UNION • NEW JERSEY



Moisture and fungus proof coating protects every IR type resistor against deterioration in any and all climates.

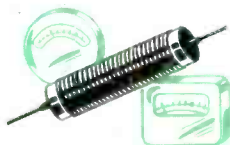

Enameled resistance wire minimizes waste space, permits use of larger wire size for extra load capacity.



Bakelite form eliminates shrinking, swelling and effects of temperature—insures permanency of characteristics.

**AIRCRAFT  
RADIO  
CORPORATION**

*Announces*

THE TYPE H-12

# SIGNAL GENERATOR



**900-2100 Megacycles**

*... for research and for  
production testing*

- 900-2100 megacycles, single band
- Continuous coverage with single-dial control directly calibrated
- Directly calibrated attenuator, 0 to -120 dbm
- CW or AM pulse modulation
- Extensive pulse circuitry

*Write for details*

**Aircraft Radio Corporation**

BOONTON, New Jersey



**Dependable Electronic Equipment Since 1928**

TUBES AT WORK

(continued)



FIG. 3—The AVR 7A beacon receiver is fitted to a standard rack panel and chassis which also contains the accessory units to make it a complete receiver

tried out. Necessary metal parts are fabricated in the manufacturing section of the radio shop, where necessary hand and power tools are available for turning out work in required quantities.

### Transmission-Line Fault Finders

IN A RECENT Association of American Railroads report, several different types of transmission-line fault finders were described. They all employ the pulse-echo technique, taking advantage of the fact that electrical echoes occur within transmission lines wherever any impedance irregularities exist.

The Lookator was developed by J. T. Schott of Bell Labs for locating faults on telephone lines. When connected to a telephone circuit, the Lookator shows the condition of the circuit along its length by means of a trace on a cathode-ray tube. If steady or swinging faults are present, their general nature can be detected, and their distance from the Lookator can be measured by a simple procedure. The device is thus a fault locator that permits the operator, in effect, to look out over the circuit. The visual method of examining a telephone circuit, without making any of the usual location measurements, makes the device useful for examining a circuit while it is being installed, thus



# First all-new watt-hour meter in 50 years

**GENERAL ELECTRIC CO.** says: "The I-50 is the first all-new watt-hour meter in 50 years—new in conception, design, operation, and use of modern materials and techniques. It has greater sustained accuracy, longer life."

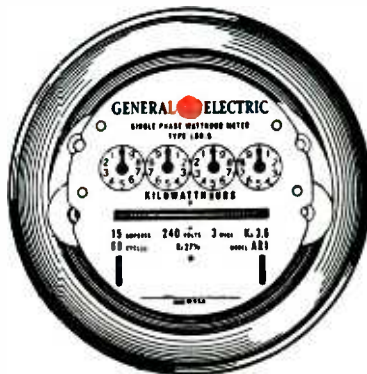

For greater insulation strength, reliability and secure positioning, the potential coil is molded to the electromagnet core with Du Pont polythene. This plastic combines high dielectric strength with low moisture-absorption.

## employs Du Pont POLYTHENE

G. E.'s new potential coil stands about 15 kv under impulse, and 10 kv under 60-cycle breakdown. The polythene insulation stands up under humidity, sunlight and increased temperatures. It's non-corrosive, resists tracking (90 seconds minimum by ASTM test), permits better-insulated leads and neater mechanical design.

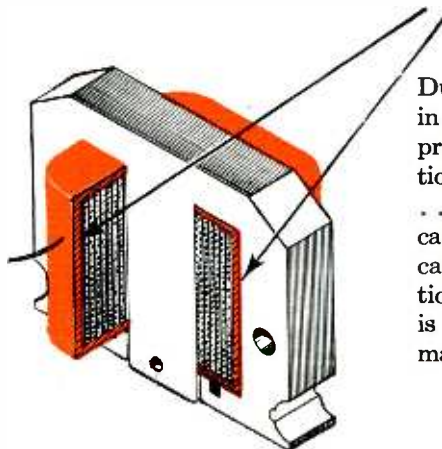

Du Pont polythene serves today in a myriad of better electrical products. Wire and cable insulation . . . insulating films and tapes . . . insulating discs for coaxial cables—those are just a few. Because of its remarkable combination of good properties, polythene is steadily replacing many other materials for electrical work.

## for extra-long life of potential coil

Look to polythene for improving *your* products! It's light, tough, strong; resists chemicals and moisture. It has high dielectric strength, a low power factor and is stable over years of service. Polythene molding powders are available in colors . . . may be injection- or compression-molded or extruded as sheeting, tubing or wire-covering.



**Write today** for the facts on versatile Du Pont polythene! We'll send properties data plus data on how others have used it in making a host of improved products of many different types. Just write: E. I. du Pont de Nemours & Co. (Inc.), Plastics Department, Room 143, Arlington, N. J.

*Tune in to Du Pont "Cavalcade of America" Monday nights—NBC coast to coast*



## Handful of Miles

Copper stock comes to our plant in rods a quarter inch in diameter. One machine draws these rods down — by carbolloy diamond dies — to strands one-sixteenth of an inch in diameter. After properly annealing to counteract hardness, further drawing reduces the wire to required sizes for winding into coils and for other applications. As an example, Wheeler craftsmen, through years of experience and with modern equipment, make wire drawn to No. 44 American Wire Gauge. This size runs 84,000 feet, or over 15 miles, to the pound. Even smaller diameters are available to special order.

Wheeler specializes in wires of extremely fine dimensions; can supply wire with yarn insulation in many of those "hard-to-find" sizes. These yarns, of silk, nylon, celanese, cotton or glass, are made up in multiple strands to meet the most rigid specifications. Enameled wire and Litzendraht are also made in our plant.

Send us your requirements for Wheeler magnet wire — rapidly becoming standard for the industry. Let us put some of these miles of wire to work for you.

WRITE TODAY FOR COMPLETE WIRE INFORMATION

**THE WHEELER INSULATED WIRE CO., INC.**



DIVISION OF THE SPERRY CORPORATION  
**1003 EAST AURORA ST.**  
**WATERBURY 91, CONNECTICUT**  
 BALLASTS • COILS • COMMUNICATIONS EQUIPMENT

TUBES AT WORK

(continued)

finding errors and faults immediately.

The principle employed for locating faults with the instrument and its associated equipment is to measure the time for an electrical pulse to travel from some reference point of measurement out to a fault and return in the form of a reflected pulse to the reference point. Knowing the speed of transmission of the pulse over the particular facility, the distance to the fault can be found. In practice the time is determined automatically by the equipment. This is accomplished by properly setting a measuring dial, noting its reading and using a previously prepared calibration curve for the location of the trouble.

The Lookator consists of an oscillator, an initial-zero adjusting circuit, a pulse generator, a hybrid coil with its associated adjustable balancing network, a receiving circuit, a measuring circuit, a sweep circuit, and a cathode-ray tube with associated control circuits. Keys are provided for testing and talking on either a two or four-wire basis. The bridge-stabilized 220-cycle oscillator controls the rate at which the pulses are generated. The pulses, having individually the approximate shape of a positive lobe of a 3-kc sine wave, are delivered to the line through a hybrid coil and a set of keys. The balancing network forms part of the hybrid-coil circuit, and may be adjusted to balance any line impedances likely to be encountered.

### *Deflection Voltages*

The outgoing pulses travel along the line to the impedance irregularity caused by a fault. They are here reflected, and return along the line to the Lookator, where they enter the receiving amplifier, and appear as a vertical deflection on the screen of the cathode-ray tube. A second output of the oscillator feeds through the measuring circuit into the sweep circuit, where it controls the frequency of the horizontal sweep.

The zero-adjusting circuit and the measuring circuit permit the phase of the voltage supplied to the pulse generator and sweep circuits to be controlled individually. Consequently, the time at which func-

# Here's Real News!

## AC-DC TELEVISION MADE POSSIBLE FOR THE FIRST TIME

### Trend Is to New Low Prices for Lighter, Smaller 7" and 10" TV Sets

### SMALL, COMPACT POWER SUPPLY HANDLES AM-FM-TV COMBINATION

#### All Resulting from Federal's New Miniature 500 MA Selenium Rectifier

YES, this mighty miniature makes big television headlines! Its hitherto unapproached power-handling capacity promises a virtual revolution in television design. Think of the possibilities... a single Selenium Rectifier power supply able to handle an AM-FM-TV combination... AC-DC television... drastic reductions in size, weight and price of 7" and 10" sets.

These important savings result not only from the small size of this new Federal Miniature Selenium Rectifier, but its elimination of large, heavy, expensive transformers and expendable rectifier tubes in the power supply. What's more, it can be used with smaller condensers with lower voltage ratings.

Here's the diagram of a suggested circuit for an AC-DC power supply for 7" and 10" electrostatic deflection tubes.



438D3428A

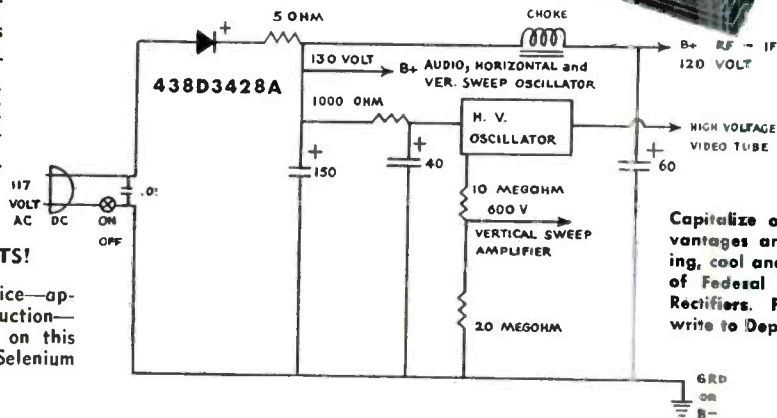

Capitalize on these design advantages and the instant starting, cool and efficient operation of Federal Miniature Selenium Rectifiers. For technical data, write to Department F219.

#### TO HELP REDUCE TELEVISION COSTS!

A new low price—approx. 30% reduction—now in effect on this Federal Selenium Rectifier.



## Federal Telephone and Radio Corporation

SELENIUM and INTELIN DIVISION, 900 Passaic Ave., East Newark, New Jersey

In Canada: Federal Electric Manufacturing Company, Ltd., Montreal, P. Q.  
Export Distributors: International Standard Electric Corp. 67 Broad St., N. Y.

KEEPING FEDERAL YEARS AHEAD... is IT&T's world-wide research and engineering organization, of which the Federal Telecommunication Laboratories, Nutley, N. J., is a unit.



"At 15 Inches!"

**NEW!**

Fairchild

## **PROFESSIONAL TAPE RECORDER**

YES—THE NEW FAIRCHILD PROFESSIONAL TAPE RECORDER is the only top quality equipment designed from the start to deliver the ultimate in performance at approximately half the tape speed of the German Magnetophone. It is not just another copy of the German machine. New and advanced theory and design have resulted in performance which exceeds the requirements set by the latest proposed NAB specifications and formerly thought possible only at 30 inches per second. No compromise has been made with the maximum requirements for signal-to-noise, frequency response or minimum distortion limits. This means double the continuous recording time, half the cost of tape and nicer controls of starting, stopping, spotting, editing, etc. 7½ or 30 inches per second operation may, of course, be included for special applications.



## **STUDIO QUALITY**

IN KEEPING with standards of the Fairchild line of sound equipment nothing has been left undone to make this the finest professional tape recorder. Qualified listeners fail to detect a difference in instantaneous switching between the monitoring of a live program and the same from the Fairchild Tape Recorder. However, despite its performance which we believe exceeds that of any other equipment regardless of price, it is being sold at the lowest figure our anticipated production will permit. Currently, orders are being scheduled for delivery in approximately 30 days at its present low price of \$2,750. Details are available for prospective users.

## **MICRO-GROOVE RECORDING . . .**

Are you aware that Fairchild Synchronous Disk Recorders and Transcription Arms are handling the rigid requirements of recording and reproducing Micro-Grooves for the most critical users? Write for detailed information.



154th STREET AND 7th AVENUE, WHITESTONE, NEW YORK  
152

TUBES AT WORK

(continued)

tions in the sending and sweep circuits take place can be adjusted as desired with respect to each other.

Since the oscillator frequency is fixed, a measure of the difference in phase between the a-c voltages controlling the electrical events in the two circuits will be a measure of the time required for the pulse to travel from the Lookator to the fault and back again. It is then possible to prepare a curve showing the relationship between time in arbitrary scale divisions and the distance out to known points on a particular facility.

The Lookator can be used for many other purposes such as general laboratory testing, for adjusting networks properly to balance lines, for adjusting line terminations, for observing short time changes in the height of the Ionosphere, and in its present form for indicating the presence of large crosstalk coupling and showing about where the irregularity responsible for the crosstalk is located.

### *Telemetroscope*

The Tobe Deutschmann Telemetroscope is a portable, self-contained, instrument that makes it possible for the operator to see, on the screen of a cathode-ray tube, the condition of an electric circuit, whether in cable or in open wire line, and to determine almost instantly the location of a fault existing at the time of test. It locates open circuits, grounds and short circuits. Field tests on both underground and overhead lines have demonstrated that these faults can be located with an accuracy of about 100 feet in ten miles, within one or two minutes after the faulted circuit is isolated from the system and the instrument is connected.

Direct mileage calibration of the time base allows the distance to the fault to be determined almost instantly by station operating personnel who need have no familiarity with the theory of operation of the instrument.

The Telemetroscope comprises a pulse-generating circuit, means for impressing the pulses on the circuit to be tested, a high-gain receiver, a cathode-ray oscilloscope tube, a calibrating circuit, the usual oscil-

March, 1949 — ELECTRONICS



# COMPONENTS

Specified by FRANKLIN *Airloop* CORPORATION

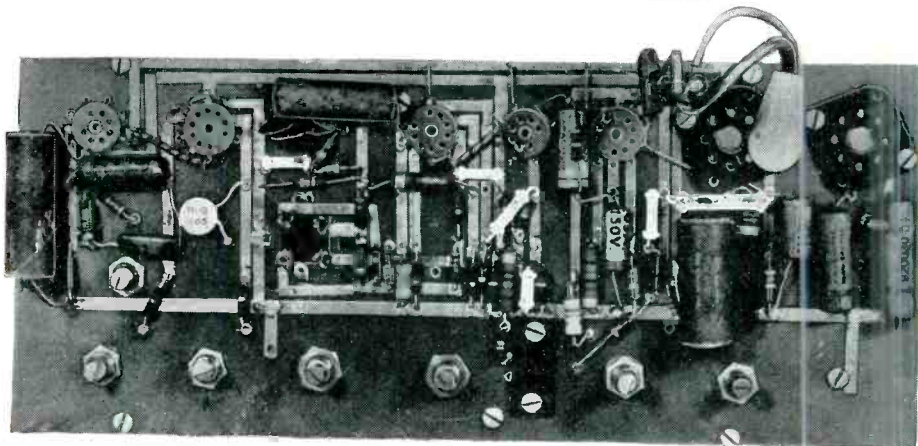

FRANKLIN AIRLOOP'S COMPLETE DEFLECTION CIRCUIT

● The great demand for lower cost television receivers is one of the big problems confronting engineers today.

Die stamped inductances as developed by the Franklin Airloop Corporation are a partial answer to reduced manufacturing costs. Truly a precision operation, its successful performance is dependent upon precision components.

**Hi-Q** components — noted for their *precision* — *dependability* — *uniformity* and *miniaturization* contribute their part, not alone to Franklin, but to all manufacturers whose standards demand these 4 **Hi-Q** features.

Our engineering department is available for consultation with your engineering staff in the design of new circuits and the application of **Hi-Q** components to them. Why not write us today?



The **Hi-Q** Disc Capacitor used in the above deflection circuit is a high dielectric capacitor designed for application where physical shape is more adaptable than tubular units. Close connections are easily made, reducing inductance to a minimum.



**Hi-Q** COMPONENTS  
BETTER 4 WAYS

**PRECISION** Tested step by step from raw material to finished product. Accuracy guaranteed to your specified tolerance.

**UNIFORMITY** Constancy of quality is maintained over entire production through continuous manufacturing controls.

**DEPENDABILITY** Interpret this factor in terms of your customers' satisfaction . . . Year after year of trouble-free performance. Our **Hi-Q** makes your product better.

**MINIATURIZATION** The smallest **BIG VALUE** components in the business make possible space saving factors which reduce your production costs . . . Increase your profits.



*Electrical Reactance Corp.*

FRANKLINVILLE, N. Y.

Plants: FRANKLINVILLE, N. Y. — JESSUP, PA. — MYRTLE BEACH, S. C.  
Sales Offices: NEW YORK, PHILADELPHIA, DETROIT, CHICAGO, LOS ANGELES

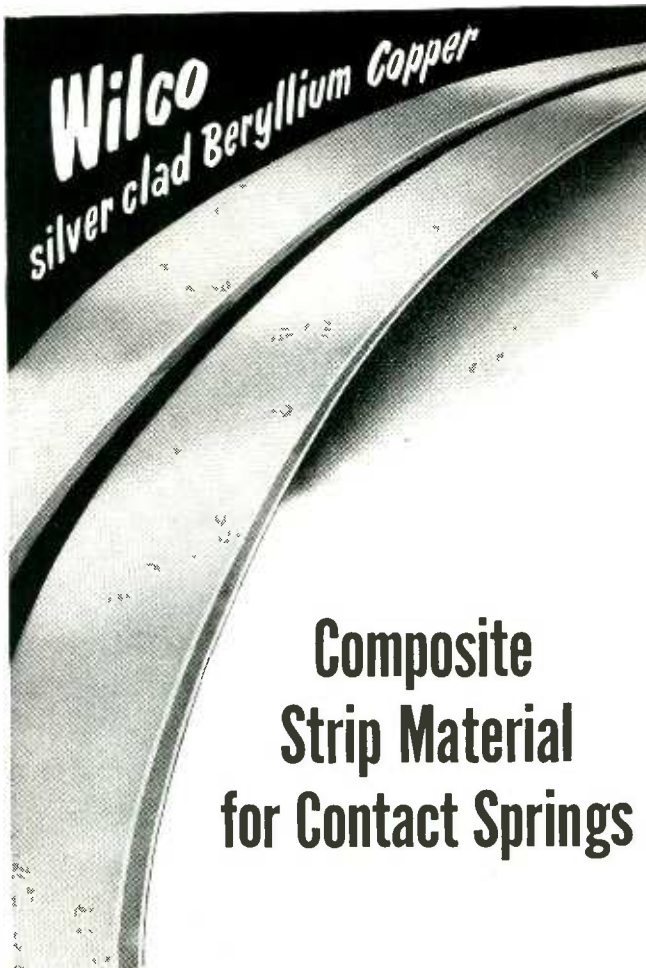

## Composite Strip Material for Contact Springs

**WILCO SILVER OVERLAY** on BERYLLIUM COPPER is one of the newer WILCO materials designed and produced to reduce fabrication problems on contact spring assemblies.

- PREFERRED . . .** because
1. It is comprised of a silver contact surface permanently bonded to Beryllium Copper, which can be heat-treated in the normal manner to bring about its excellent spring properties.
  2. It increases the permissible thermal and electrical limits.
  3. Available with one or both faces silver clad, in standard thicknesses and widths, soft or cold-rolled tempers, or finish heat-treated to maximum spring properties. Also available as fabricated parts made to your most exacting requirements and specifications.

The **WILCO** Sales and Engineering Departments are prepared to recommend the proper application of this and other WILCO products to manufacturing customers' individual needs. WRITE FOR A WILCO ENGINEERING DATA BULLETIN which gives more complete technical information.

**WILCO PRODUCTS INCLUDE:** THERMOSTATIC BIMETALS: All temperature ranges, deflection rates and electrical resistivities. ELECTRICAL CONTACTS: Silver, Platinum, Tungsten, Alloys, Sintered Powder Metal. SILVER CLAD STEEL: For industrial use. NI-SPAN C\* Constant Modulus alloy: JACKETED WIRE: Silver on Steel, Copper, Invar and many other combinations. SPECIAL ALLOYS: Including high conductivity, high strength Copper Alloys. ROLLED GOLD PLATE AND GOLD FILLED WIRE.

\*Reg. Trade Mark, The International Nickel Co., Inc.

**THE H. A. WILSON COMPANY**  
105 CHESTNUT STREET, NEWARK 5, NEW JERSEY  
Branch Offices: Chicago, Detroit, Los Angeles, Providence



SPECIALISTS FOR 34 YEARS IN THE MANUFACTURE OF THERMOMETALS - ELECTRICAL CONTACTS - PRECIOUS METAL BIMETALLIC PRODUCTS AND SPECIAL ALLOYS

TUBES AT WORK

(continued)

lescope control circuits; and all necessary power supplies.

Controls on the front panel of the instrument include the usual focusing and positioning controls for a cathode-ray tube, the time-base expansion control (horizontal amplifier), the vertical amplifier control, a control for matching the impedance of the instrument to the impedance of the circuit under test, and a control for adjusting the calibrating circuit to the correct speed of propagation for the individual cable or line.

The distance graduation appears on the scope screen as a series of vertical lines spaced along the time base at intervals corresponding to known, equal distances over the full measuring range of the instrument. The interval between range markers is established, in manufacture, at the value best suited to the service in which the Telemetroscope is to be used. It is normally about one-tenth the total range of the instrument. Thus a five-mile instrument has range markers every half-mile, while a hundred-mile instrument has range markers ten miles apart.

The time-base expansion control provides ten-to-one expansion of any part of the scale to permit accurate checking of any portion of the circuit. A scale having fifty graduations is provided on the face of the scope; this allows a circuit discontinuity or impedance change, within the line length corresponding to any two range markers, to be located with an accuracy of one part in fifty.

The Telemetroscope employs 23 tubes, all of which are standard types, including the 5-inch cathode-ray tube.

### *The Fault-Finder*

The Fault-Finder is a similar device, but in addition to determining the position of the discontinuity, it reveals the nature of the fault. If the reflection is caused by an open circuit or increase in line spacing, the reflected pulse will show positive (above the base line) on the cathode-ray tube screen, and if caused by a partial or complete short circuit or decrease in line spacing, the reflected pulse will show negative (below the base line). The

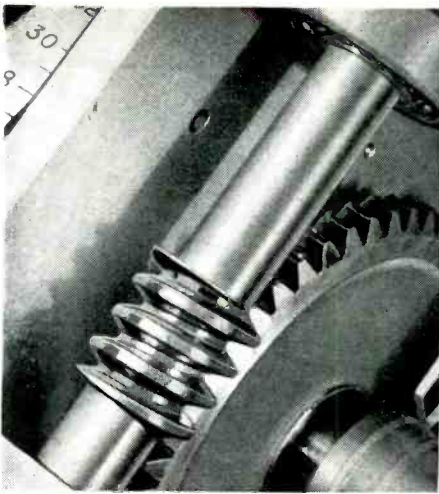

This 50-to-1 worm drive, equipped with a 3 1/2 inch dial, is used for the fine setting adjustment. Backlash is kept very low by spring pressure on the worm shaft. Eccentricity from set screws and misfit is eliminated by cutting the worm and its shaft from an integral steel shafting.

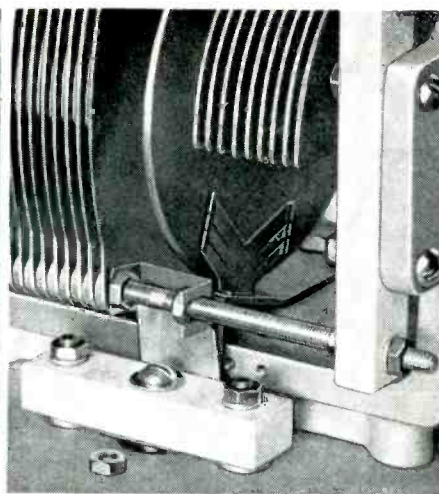

Two small, waxed steatite bars insulate the stator plates. A Figure of Merit (Dissipation Factor x Capacitance) of 0.04  $\mu\mu\text{f}$  is secured (0.003  $\mu\mu\text{f}$  with quartz insulators). Connection to the rotor is through spring-tempered silver alloy brushes bearing on a silver-overlay brass disc.

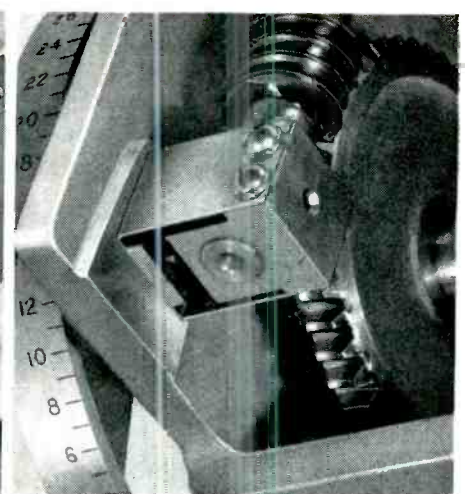

The worm shaft is held to a tolerance of 0.0004 inch radial eccentricity of the worm gear is less than 0.002 inch. The main rotor shaft is held to a tolerance of 0.0005 inch and its bearing surfaces to 0.0002 inch. Ball bearings are used on worm and main rotor shafts.

## The STANDARD of Variable Capacitance

Recently the accuracy of the well-known G-R Type 722 Precision Condensers has been increased, making these standards of variable capacitance of even greater use in the laboratory and as the variable element in many instruments such as oscillators and frequency meters.

Typical of the three different models of this condenser is the Type 722-N, with extra low metallic resistance and inductance. This condenser (illustrated) is direct reading to  $\pm 1 \mu\mu\text{f}$ . When the corrections (charted on the front panel) are applied to the direct-reading settings the accuracy is increased to  $\pm 0.1\%$  or  $\pm 0.4 \mu\mu\text{f}$ , whichever is greater, and the corresponding accuracy for capacitance differences is  $\pm 0.1\%$  or  $\pm 0.5 \mu\mu\text{f}$ .

### SPECIFICATIONS

- **CAPACITANCE RANGE:** 100 to 1100  $\mu\mu\text{f}$ , direct reading
- **STANDARD CALIBRATION:** Direct reading in  $\mu\mu\text{f}$  at 1 kc to  $\pm 1 \mu\mu\text{f}$ . Mounted correction chart gives corrections to 0.1  $\mu\mu\text{f}$  at multiples of 100  $\mu\mu\text{f}$ .
- **WORM CORRECTION:** For very precise measurements a worm correction calibration can be supplied. When these are applied capacitance can be determined within  $\pm 0.1 \mu\mu\text{f}$  or  $\pm 0.1\%$ , whichever is greater, and capacitance differences to  $\pm 0.2 \mu\mu\text{f}$  or  $\pm 0.1\%$
- **METALLIC RESISTANCE:** Series resistance about 0.008 ohm at 1 Mc
- **SERIES INDUCTANCE:** Approximately 0.024  $\mu\text{h}$
- **TEMPERATURE COEFFICIENT:** Approximately 0.002% per deg. C.

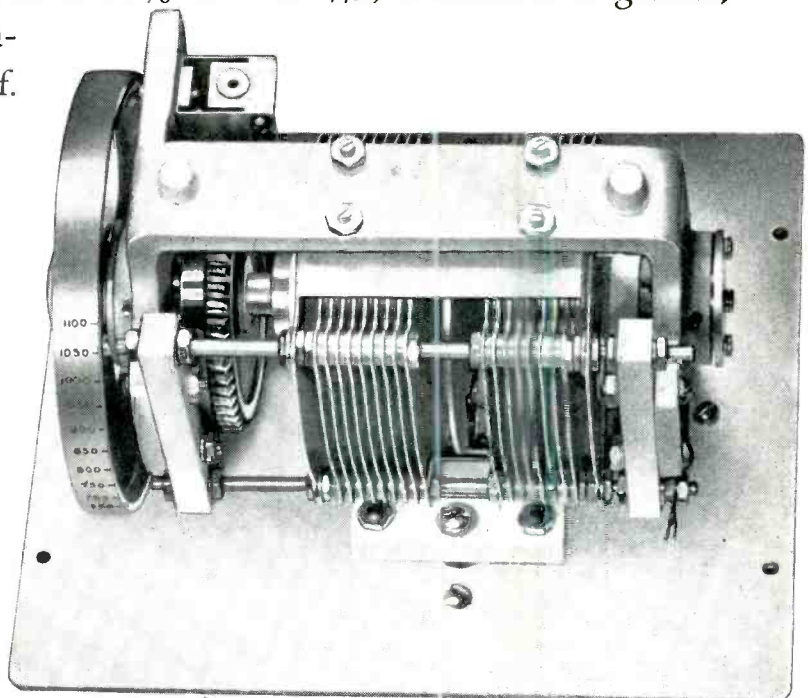

- TYPE 722-N PRECISION CONDENSER ..... \$160
- Worm Correction Calibration ..... 50
- Quartz Insulation ..... 85



# GENERAL RADIO COMPANY

Cambridge 39,  
Massachusetts

90 West St., New York 6 920 S. Michigan Ave., Chicago 5 1000 N. Seward St., Los Angeles 38

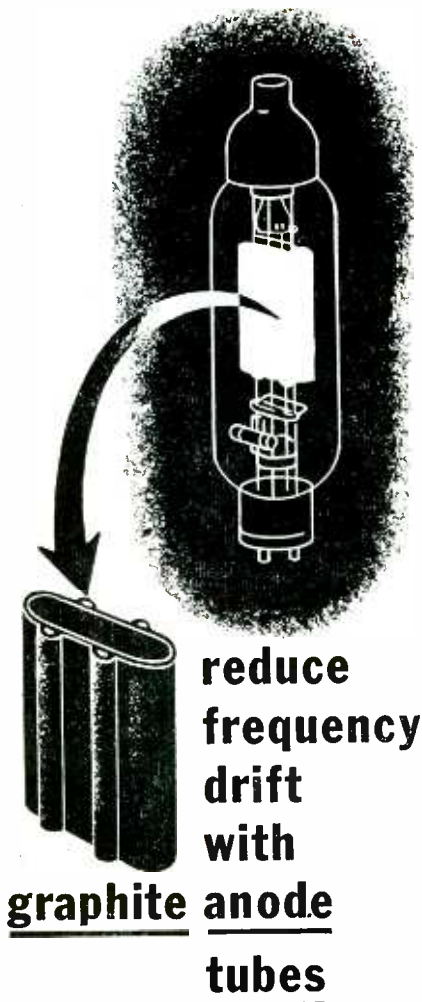

Frequency drift from short wave and FM transmitters, diathermy and electronic heating machines can be reduced with graphite anode oscillators.

And when tubes are equipped with non-warping Speer graphite anodes, frequency drift reaches a new low — stability of inter-electrode capacitances is assured — warping in other tube elements is inhibited.

In other vacuum tubes — power, rectifier and modulator, Speer graphite anodes impart these characteristics which cannot be obtained through the use of any other type anode. Try graphite anode tubes in your equipment and you'll see why the current trend is to graphite.

Look for graphite anodes when you're looking for better tubes.

**SPEER** 4722  
**Speer**  
CARBON COMPANY  
ST. MARYS, PENNA.

magnitude of the reflected pulse permits the observer to estimate the resistance of the fault.

With proper coupling networks, the Fault-Finder can be used on any transmission line, whether high-voltage power line, cable, or telephone circuit. Ordinary twisted pair will show a very irregular pattern on the screen of the tube because of the large number of impedance variations along its entire length caused by changes in wire spacing. The type of line will determine the maximum length over which faults can be detected.

The Type F-1 transmits a sharp d-c pulse of about 5 microseconds duration, and 900 volts amplitude. Normal range of the instrument on a high-voltage power transmission line is 100 miles, but provision is made for receiving reflections from as far as 200 miles. The Fault-Finder is a product of Radar Engineers of Seattle, Washington.

**Multi-Purpose British  
Radio Tube**

By JOHN H. JUPE  
Enfield, England

TO AID IN THE PRODUCTION of radio receivers which could be sold at low prices all over the world, John A. Sargrove, the British inventor, has developed a multipurpose tube known as the Sargrove-Tungstram UA-55.

It is capable of meeting the largest possible number of applications, sometimes a little better and sometimes nearly approaching the efficiency of specialized tubes but always with the object of being the least expensive tube obtainable in

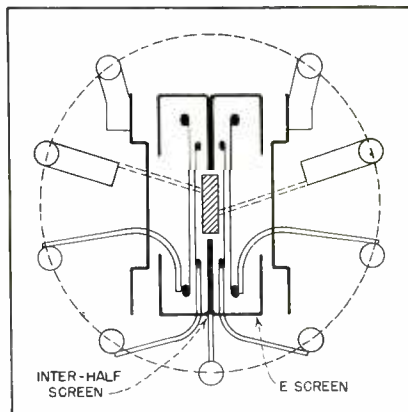

Cross-sectional diagram of UA-55 electrodes, showing internal leads to pins



F-13A

Manufacturers use the advertising pages in this magazine to get news about their products or services to you... quickly and effectively. Their advertisements contain information designed to help you do your job better, quicker, and cheaper, which is just as newsworthy as the editorial columns. To be well-informed about the latest developments in your business, your industry... and to stay well-informed... read all the ads too.

**McGRAW-HILL  
PUBLICATIONS**





# SYLVANIA TUBES ARE RIGHT AT HOME IN THE FINEST HOME RECEIVERS

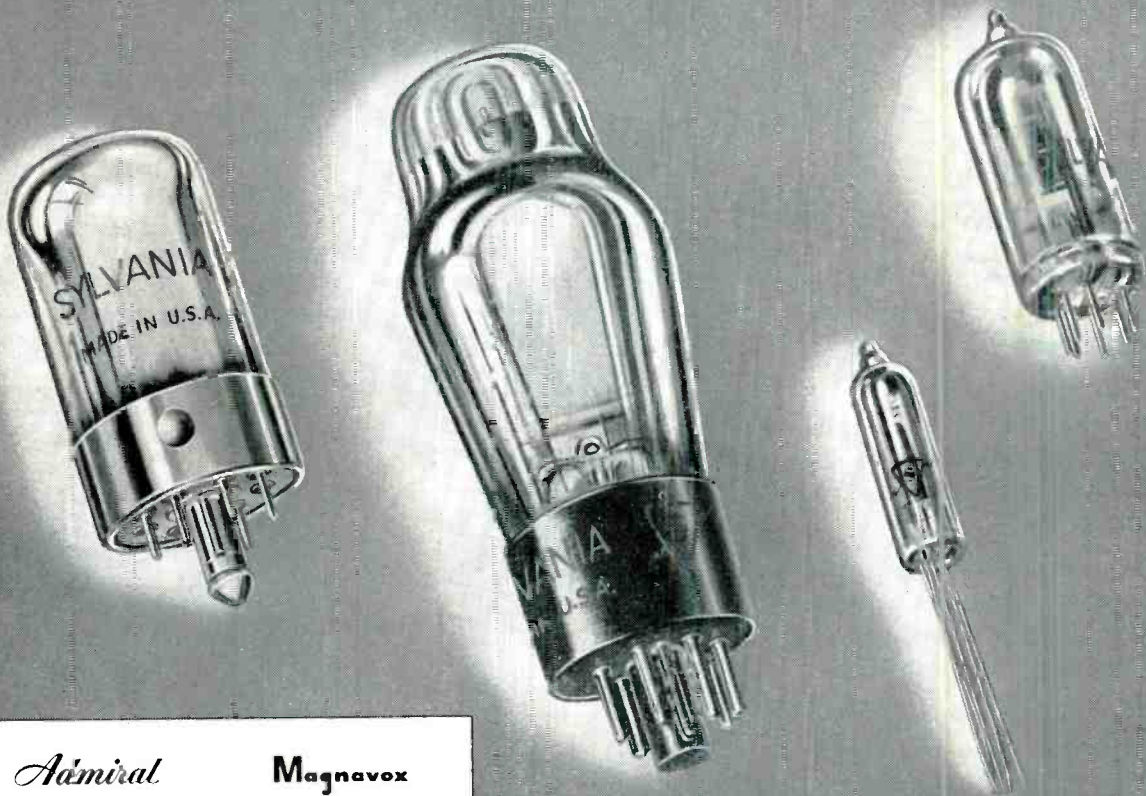

*Admiral*  
*Andrea*

**PRVIN**

*Automatic*  
*Radio*

*Belmont*

*Bendix*  
*Radio*

**CROSLEY**

*Emerson*  
*Radio*

**ESPEY**

*FADA*  
*Radio*

*Farnsworth*

**GARDNER RADIO**

**GLOBE**

*hallicrafters*

*Hoffman*

**Magnavox**

*Motorola*

**NATIONAL**

**Olympic**  
Radio and Television

**PHILCO**

*Regal*

*Sentinel Radio*

*Silvertone*

*Spartan*

**STROMBERG-CARLSON**

*Tele-tone*

**Temple**

*TRAV-LER*

*Westinghouse*

**ZENITH**  
RADIO



Sub-miniatures, seven- and nine-pin miniatures, standard types, and the great Lock-In radio tubes are all included in the famous Sylvania line . . . all represented in the leading makes of home receivers—from portable models to console combinations and television receivers.

It is the high quality of these Sylvania tubes that has made them preferred . . . has made them famous throughout the world.

For full information about Sylvania tubes, see a Sylvania Distributor, or write Sylvania Electric Products Inc., Radio Tube Division, Emporium, Pa.

# SYLVANIA ELECTRIC

RADIO TUBES; CATHODE RAY TUBES; ELECTRONIC DEVICES; FLUORESCENT LAMPS, FIXTURES, WIRING DEVICES; PHOTOLAMPS; ELECTRIC LIGHT BULBS

# A Ballantine ELECTRONIC VOLTMETER

For every requirement

ALL MODELS HAVE THE  
SIMPLIFIED  
LOGARITHMIC  
SCALE

STANDARD  
Model 300



Ideal for the *Accurate* measurement of AC voltages in the Audio, Supersonic, Carrier Current and Television ranges.

Use of Logarithmic voltage scale assures uniform accuracy of reading over whole scale while permitting range switching in decade steps.

Each Voltmeter equipped with an output jack so that the instruments can be used as a high-gain stable amplifier.

## SPECIFICATIONS

### MODEL 300

RANGE—.001 to 100 volts.  
FREQUENCY—10 to 150,000 cycles.  
ACCURACY—2% at any point on scale.  
AC OPERATION—110-120 volts.

### MODEL 304

RANGE—.001 to 100 volts.  
FREQUENCY—30 c.p.s. to 5.5 megacycles  
ACCURACY—0.5 DB.  
AC OPERATION—110-120 volts.

### MODEL 302

RANGE—.001 to 100 volts  
FREQUENCY—5 to 150,000 cycles.  
ACCURACY—2% at any point on scale.  
DC OPERATION—self-contained batteries.

Send for Bulletin for further description

Model 302  
BATTERY  
OPERATED



Model 304  
R-F  
VOLTMETER



TUBES AT WORK

(continued)

order to meet the requirements of overseas markets of low spending power.

The structure of the new tube is shown in the accompanying drawing. It will be noticed that there is a superficial resemblance to a beam tetrode, except that the whole structure is split along the cathode axis, into two halves. The two beam-forming plates are of an unusual shape, having an "E" shaped cross-section. The center limbs come very close to the narrow edges of the flat cathode and with the latter, form the separating screen between the two halves of the tube. The outer limbs of the E act as beam-forming electrodes and also as screens from anodes to control grids.

The main novelty is in the grids, where much development work has

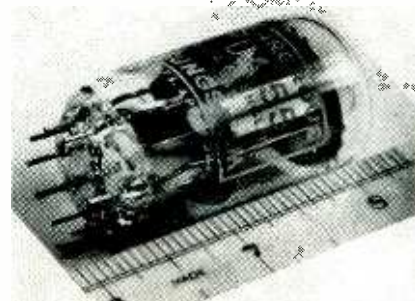

Sargrove-Tungsrham multi-purpose tube UA-55

yielded a construction having many new and valuable features.

The half control grids and half accelerator grids are ladder-like structures all having the same number of grid wires per inch. To permit a high anode current at comparatively low voltage the grids are rather open meshed and close to the cathode. The accelerator grid wires are aligned behind the control grid wires, without any special optical aids, by the novel method of grid making, which results in grids having wires and side rods substantially at right angles to each other. On being dropped into the holes in the bottom mica, they register and align themselves to the bottom grid wires of both control and accelerator electrodes. This provides further economies in production and ensures a reliable tube, inasmuch as it will hold throughout its life the initial high ratio of anode current to screen current, which is

## BALLANTINE LABORATORIES, INC.

BOONTON, NEW JERSEY, U. S. A.

*Now Available*

## **FLEXIBLE CABLE**

*Shielded with*

## **"326" MONEL TAPE**

**Recommended for use under wet,  
corrosive, abusive conditions.  
Good for voltages up to 35,000.**

More corrosion-resisting than tinned copper—"326"\* Monel shielding offers a new way to extend cable life.

No other metallic sheathing will give you the equal of Monel's resistance to corrosion and mechanical abuse. In addition, "326" Monel is essentially non-magnetic at the service temperature—a property of primary importance in the efficient transmission of power. These magnetic properties are not appreciably influenced by hot or cold work.

Ease of brazing and welding are other advantages of "326" Monel shielding.

More information on flexible "326" Monel shielded cable for power transmission and "tough-service" cords is available from individual cable manufacturers. For names and addresses, please fill in the coupon.

\*Trade-Mark

### **THE INTERNATIONAL NICKEL COMPANY, INC.**

*67 Wall Street, New York 5, N. Y.*

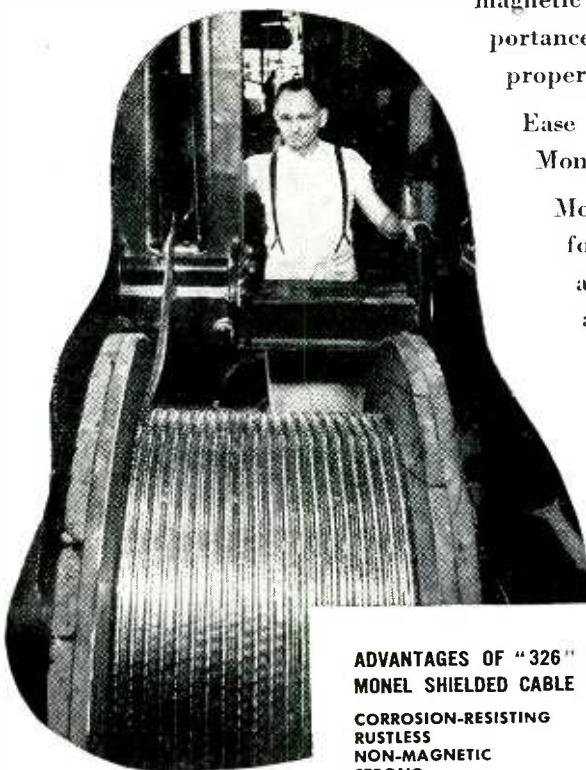

#### **ADVANTAGES OF "326" MONEL SHIELDED CABLE**

**CORROSION-RESISTING  
RUSTLESS  
NON-MAGNETIC  
STRONG  
TOUGH  
FLEXIBLE  
EASY TO SOLDER  
LIGHTWEIGHT**



**THE INTERNATIONAL NICKEL COMPANY, INC.**  
67 Wall Street, New York 5, N. Y.

GENTLEMEN: Please send me the names and addresses of manufacturers of "326" Monel Shielded Cable.

NAME .....

COMPANY .....

ADDRESS .....

CITY .....

E3-49

STATE .....

# **MONEL ...FOR MINIMUM MAINTENANCE**



## THE TURNER MODEL 22

**PREFERRED FOR PERFORMANCE**

### Time-tested general-purpose crystal or dynamic microphone

The most popular general purpose microphone on the market. The Turner Model 22 has an exceptionally smooth response that appeals to discriminating users yet the price is moderately low. A great favorite with amateurs and widely used in paging and call systems, recording, and general sound work indoors or out. Fully shielded to prevent r-f pickup. Distinctive modern styling and rich satin chrome finish. Equipped with full ninety-degree tilting head and quick-change removable cable set.

#### MODEL 22X CRYSTAL

high quality humidity protected crystal in mechanical shock proof mounting. Response: 50-9000 c. p. s. Level: 52 db below 1 volt/dyne/sq. cm. List . . . . . \$20.00

#### MODEL 22D DYNAMIC

featuring high quality Alnico magnets in well balanced acoustic circuit. Response: 50-9000 c. p. s. Level: 24 db below 1 volt/dyne/sq. cm. at high impedance.

200, 500 ohms, or high impedance . . . . . \$25.50  
50 ohms. List . . . . . 23.50

**ASK YOUR DEALER**

TURN TO TURNER FOR SOUND PERFORMANCE

**THE TURNER COMPANY**  
905 17th STREET N. E. • CEDAR RAPIDS, IOWA  
**MICROPHONES BY TURNER**



Licensed under U. S. patents of the American Telephone and Telegraph Company and Western Electric Company, Incorporated. Crystals licensed under patents of the Brush Development Company.

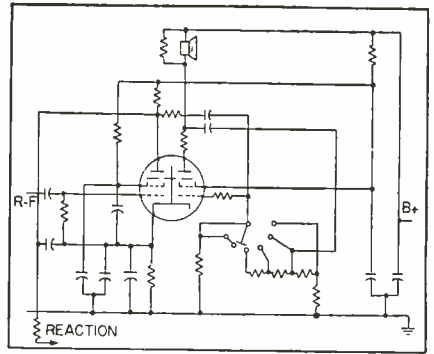

Typical circuit using UA-55 as tetrode-detector and tetrode output in a receiver

about ten to one.

The screening of the input and output electrodes, as well as the inter-half system screening is completed between the main structures and the bottom base by further interposed wing-type screens, shielding the two anode leads from each other, as well as from all the other electrodes.

To enable the characteristics of the tube, used as a whole or in separate halves, to be varied at will, both halves of the accelerator grid have been brought out separately. To do this, as well as to accommodate the two control grids and two anode connections, one cathode and two heater leads a nine-pin base became necessary. By using an arrangement similar to that used on miniature tubes no trouble has been experienced.

#### Characteristics

*Power Amplifier*—With anode and accelerator potentials of only 90 volts, the output is greater than 1 watt (load 2,500 ohms). It has a very useful transconductance of 7,000  $\mu$ mhos at these voltages and at a grid bias point of -5 volts.

*Voltage Amplifier*—By dropping the accelerator potential to +15 volts a high impedance tube is obtained for voltage amplifier stages, with a transconductance of 4,500  $\mu$ mhos.

*Variable Mu*—By applying +10 volts to the accelerator on one side of the cathode and +25 volts on the other, a variable-mu tube is obtained, in fact by varying the two voltages many types of variable-mu tubes can be made, or even variable-variable mu tubes.

*Triodes*—Each half of the tube can be separately made into a triode in three different ways, producing

*achieving a new 'high' of efficiency!*

**U.I.C.**

**CERAMIC *Hi-Load* CAPACITORS**

Designs registered U.S.A., U.K. and other territories.

**for R.F. Heaters and Transmitters**

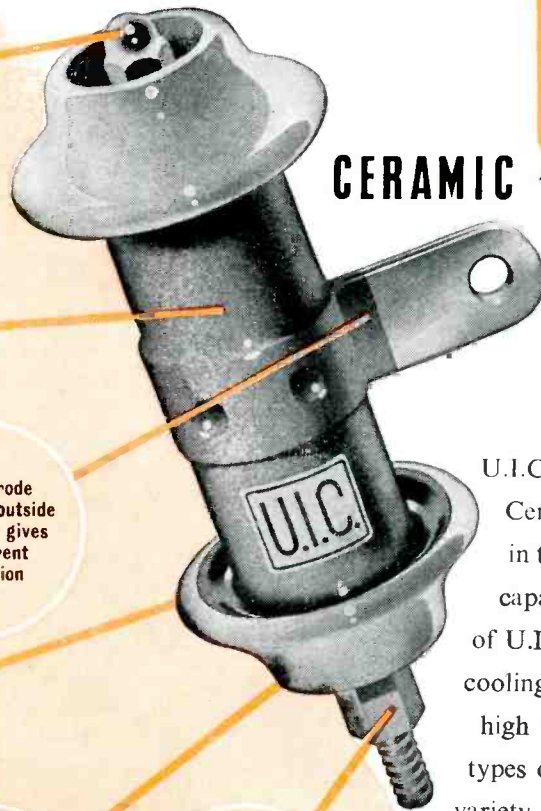

Special silver layer gives low-loss high conductivity electrode surfaces

Special ceramic body gives low losses under R.F. load

Tag electrode soldered to outside silver layer gives even current distribution

Glazed sheds give ample flash-over path in all conditions of humidity

Aero-dynamic shape gives improved cooling, particularly with forced draught

Heavy rod with double spider mounting gives reliable heavy current connection to inside silver layer

TAG MOUNTING TYPE

U.I.C. of England, pioneers in the manufacture of Ceramic Transmitter Capacitors, are foremost in the application of aerodynamic principles to capacitor design. The new aerodynamic shape of U.I.C. "Hi-Load" Capacitors gives optimum cooling in still air. With forced draught their high R.F. ratings can be multiplied. All three types of mounting assist cooling and cater for a variety of applications, such as single stand-off tag fitting, parallel and series banking for very large powers, and lead-through types for anode by-pass.

*Examples from a wide range of Types*

Type	HLS2031	HLT2021	HLT2021	HLC2011	HLC2014★
Capacitance	200mmF	330mmF	500mmF	1250mmF	1000mmF
Max. R.F. Load	70KVA	50KVA	50KVA	25KVA	40KVA
Peak Voltage	7.5KV	7.5KV	7.5KV	7.5KV	7.5KV
Max. R. F. Current	30 Amps	30 Amps	30 Amps	30 Amps	30 Amps
Body Dimensions	1 1/8" x 3 1/2"	1 1/8" x 3 1/2"	1 1/8" x 3 1/2"	1 1/8" x 3 1/2"	1 1/8" x 3 1/2"

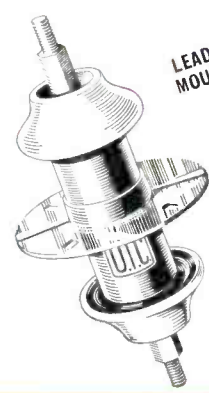

LEAD-THROUGH MOUNTING TYPE



TRIPLE MOUNTING TYPE

★ Lead-through type, all other examples tag type.

**UNITED INSULATOR CO. LTD**

TOLWORTH · SURBITON · SURREY · ENGLAND

CABLES: CALANEL · SURBITON · SURREY

ELECTRONICS — March, 1949

**U.I.C.**  
Unsurpassed In Ceramics

*Components which are contributing an essential service in the progress of radiation instrumentation.*

### 10 mil-filament subminiature tubes

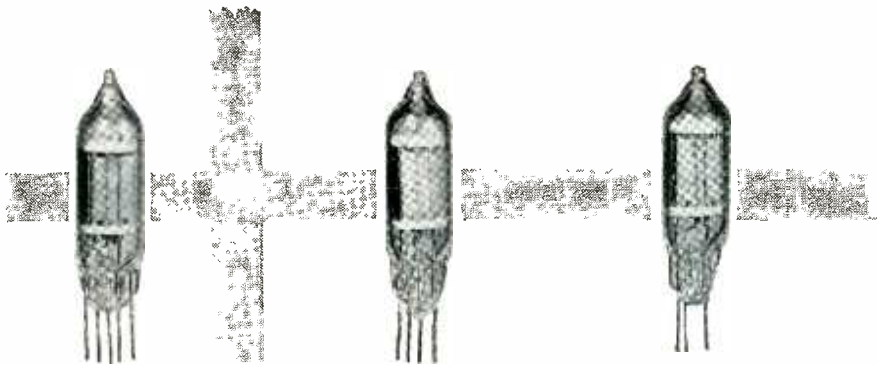

VX-41A  
Electrometer

VX-32B  
Triode

VX-21  
Diode

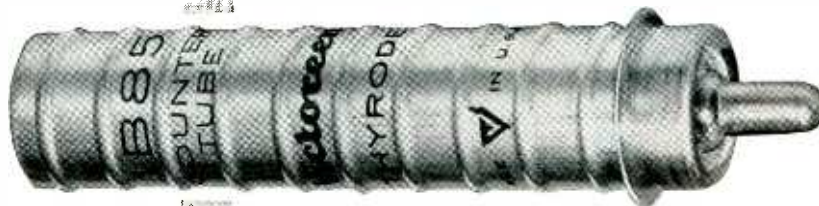

1B85

The new 1B85 Thyrode is a thin rib re-enforced aluminum self-quenched, beta-gamma counter tube operating at 900 volts. Wall thickness 30 mg/sq. cm.

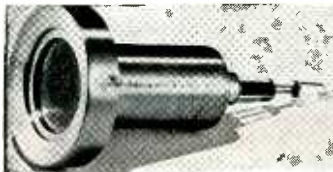

1B67/VG-10A

RMA TYPE 1B67 has been assigned to the standard laboratory mica window self-quenched, beta thyrode which operates at 1200 volts. Window thickness 2.0 to 2.6 mg/sq. cm. Other thicknesses on request.



1B87

The new 1B87 sub-miniature Thyrode is designed to operate at 900 volts with a plateau greater than 100 volts and a nominal background counting rate of 12 counts per minute.



Hi-Meg

### Hi-Meg resistors

Hi-meg resistors vacuum sealed, from  $10^8$  ohms to  $10^{13}$  ohms measured to within 1% accuracy are a symbol of reliability in all ion chamber radiation measuring instrument and electrometer circuits.

# Victoreen

5806 HOUGH AVENUE

CLEVELAND 3, OHIO

entirely different characteristics.

By connecting the screen grid to the anode, a high-slope, low-impedance tube results. It is suitable for use as an oscillator with the other half of the tube as a tetrode mixer.

Connecting the two grids together gives a triode suitable for positive-drive power amplifiers or a high-impedance, low anode-current amplifier. The third triode arises when the second grid is used for input and the normal control grid is connected to a slightly positive cathode. It gives a choice of impedance between the other two methods of connection.

*Rectifiers*—Although the UA-55 may be considered complex for a rectifier, it is possible to make its use as such economically feasible by using for this purpose those tubes which are outside normal tolerances as double tetrodes.

*Mixer Oscillator*—At an anode voltage of only 90, and a total cathode current of 9 ma, the conversion conductance is 700  $\mu$ mhos.

*Detector and A-F Amplifier*—In these positions the new tube can be made to act quite satisfactorily, especially as a bi-phase demodulator and a-f amplifier. A tetrode-detector/tetrode output circuit is also excellent for an inexpensive export receiver.

*R-F Amplifier*—Owing to its relatively high input capacitance (0.07  $\mu$ mf for one-half) the UA-55 is not suitable for really high-gain r-f or i-f stages. It can, however, be used in short wave or television broad-band amplifiers, where gain is low.

Using simple but unorthodox circuits, stable i-f stages operating up to about 460 kc can be built, with a gain between 300 and 500.

*Superheterodyne* — The heaters of four tubes can be connected in series to run directly off 220-volt mains, with 22 watts consumption. A four-tube six-stage superheterodyne receiver is thus an easy arrangement to design.

### Well-Drilling Control

EXACT WEIGHT for a drill bit as it penetrates oil-bearing formations thousands of feet below the earth's surface is provided by a new auto-

SOME OF OUR BEST FRIENDS ARE

# VU METERS\*

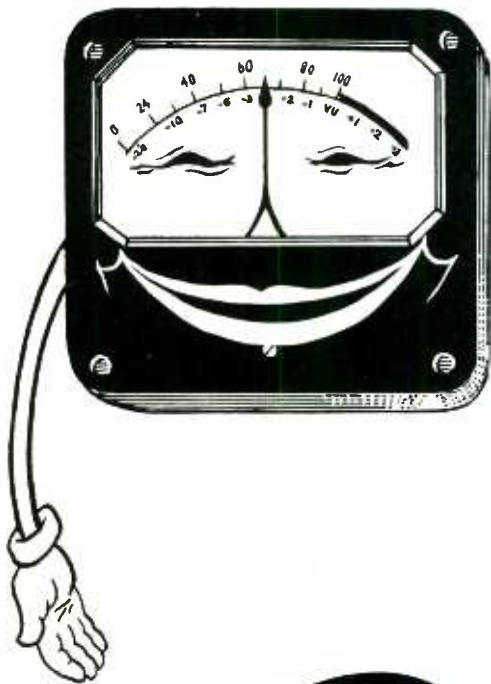

Some discs hiss, some swish, and some whistle. With Soundcraft the recording engineer whistles while he works.

VU meters in hundreds of AM, FM, and television stations have been telling engineers that Soundcraft discs make the *most consistently* quiet recordings known to radio programming.

To their unvarying ease of cutting, Soundcraft discs owe their rapid growth to America's best seller. Realizing the potential pricelessness of every instantaneous and master recording, Soundcraft has never broken faith with its users by experimenting with the formula.

The Soundcraft trick is in the coating: micro-grain "acetate", micro-filtered in application, cured in micro-filtered air, produced in a plant that makes its own seasons. Because Soundcraft produces a grade for every purpose, these discs are the economy product for competition-conscious stations.

If, perchance, you are not already a Soundcraft disciple, mail the coupon and learn why you should be following the other experts to *consistently* good sound reproduction.

*\*Volume unit meter commonly used for measuring sound level in audio systems*



**REEVES Soundcraft CORP.**  
 10 EAST 52nd STREET • NEW YORK 22, N. Y.  
*Export Address*  
 REEVINTER, N. Y.

To: REEVES SOUNDCRAFT CORP.  
 10 E. 52nd St., N. Y. 22, N. Y.

Please send story, distributor list, and free sample Soundcraft disc to

Name.....  
 Company.....  
 Address.....

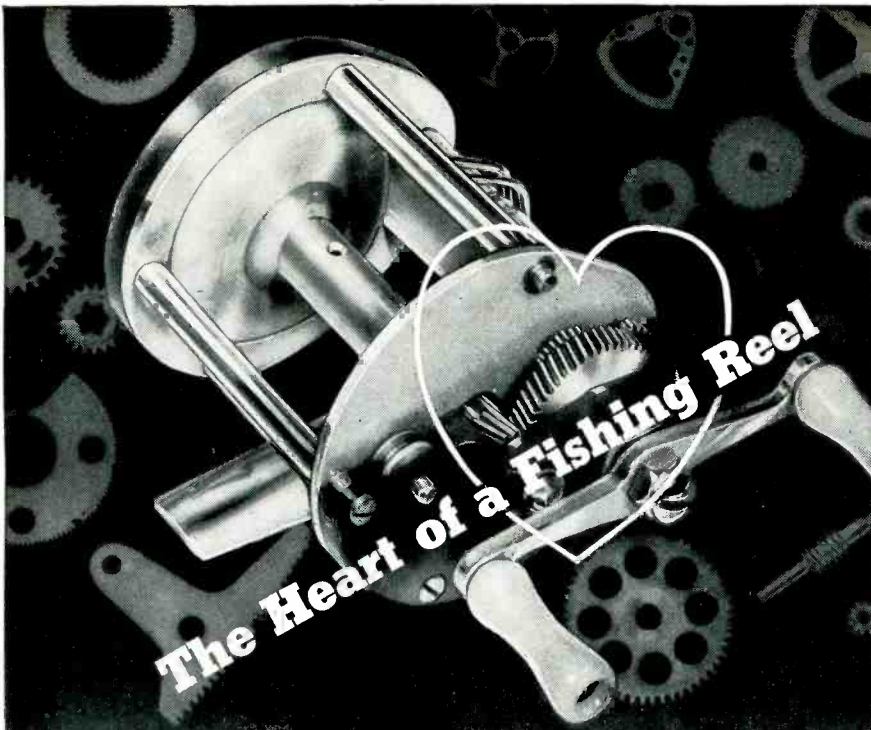

Fishing reel gears must operate smoothly at a speed of 3000 revolutions per minute or more, when a cast is executed. These gears must also withstand the strain of hauling in a fighting fish of unpredictable size and strength, thus rendering a dual purpose: speed and velvety smoothness in one direction—strength and durability in the other.

Instruments and machines have individual gear problems. For over a quarter of a century, Quaker City Gear Works has solved thousands of them and produced millions of gears of every description up to 60" in diameter for manufacturers in many diversified industries.

Aircraft controls, dental drills, electric clocks, gauges, indicators, heat controls, machine tools, radar, radios, washing machines and motion picture projectors are but a few of the many conveniences of modern progress which depend upon the heartbeat of Quaker City Gears. Your gear problem is our business, our large productive capacity is at your service.

YOUR INQUIRIES WILL RECEIVE PROMPT ATTENTION

*The heart of the Outdoorsman Castomatic reel illustrated above is but one of many gear trains developed by our engineers and produced in our fully equipped plant.*



**Quaker City Gear Works**

INCORPORATED

1910 N. Front Street, Philadelphia 22, Pa.

matic electronic control.

Developed cooperatively by companies in the oil and refining industries, drilling equipment makers and industrial instrument engineers, the system makes use of a strain-gage assembly, a Brown Instruments Division electronic potentiometer which operates as a weight indicator on the drilling bit, and a pneumatic brake which maintains the desired weight. The brakes feed the drilling line at a rate which assures a constant and predetermined weight on the bit through all types of sub-surface formations.

Automatic feed and uniform weight is becoming important because of increasingly deeper drilling, which entails greater drill-pipe torque, and to a decreasing sensitivity of heavier equipment to the feel of the driller. Use of electronic control is reported to have resulted in faster and more efficient drilling while eliminating manually controlled equipment losses and too little or too much weight on the drill bit.

## COACHING VIA RADIO



Radio apparatus enables an instructor to coach during an actual practice game in London, England, without stopping play. Players are equipped with a light harness carrying a miniature-tube device on a head-piece, and communication is made between the touchline microphone and the player by means of a copper-braid antenna strung across the field and pinned firmly close to the ground





# TELEVISION SPRINGS

*Lewis*

has the  
**FACILITIES, EXPERIENCE**  
to meet your requirements

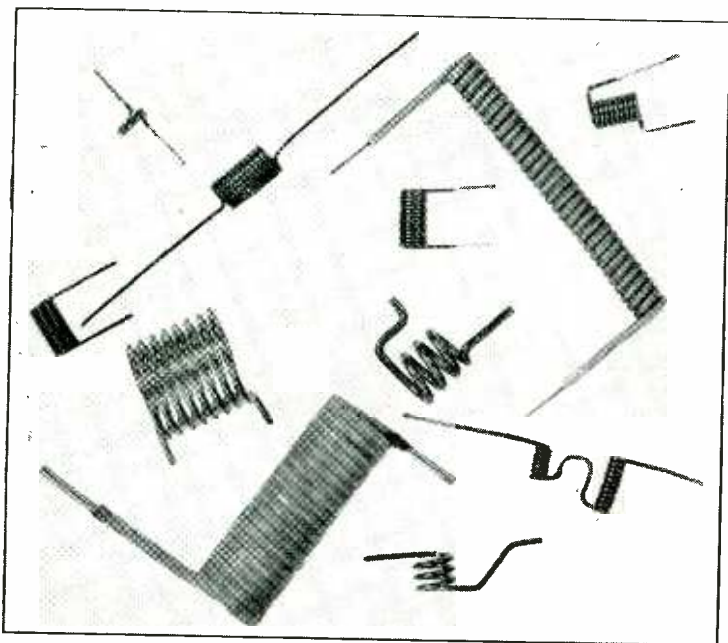

DEPEND ON LEWIS for your spring needs — choke springs, band tuning springs, channel springs, contact springs and others. You're assured of precision work, economical prices and prompt delivery.

We are well equipped to handle volume production on any type television springs desired. Experience in designing and manufacturing such a variety as shown above gives us a valuable "know-how" of efficient television spring production. Our modern facilities and skillful techniques permit moderate costs.

Have a Lewis Engineer check your spring requirements today. There's no obligation.

**LEWIS SPRING & MANUFACTURING CO.**  
2650 W. North Ave., Chicago 47, Illinois

*Lewis*  **PRECISION SPRINGS**  
THE FINEST LIGHT SPRINGS AND WIREFORMS OF EVERY TYPE AND MATERIAL

## THE ELECTRON ART

(continued from p 130)

impedance is determined by the standing wave ratio. The trace on the oscilloscope is adjusted, using the gain control, so that it touches the top and bottom of the reference frame, as shown in Fig. 2. The horizontal cursor is then aligned with the minimum. This position is transferred, through a cam that is made by plotting the square law characteristic of the detector, to the impedance chart.

With this equipment the characteristics of wideband systems can be determined quickly and the effects of adjustments on them readily observed. Both the phase angle and impedance magnitude determined with the equipment are determined with reliability for swr less than 4 to 1. Because of the square law response of the detector, the magnitude of the impedance is in error at higher ratios, but the phase angle is still in good agreement with other measurements.

## Standard Broadcast Radios as Nuclear Indicators

SELF-QUENCHING Geiger-Muller tubes can be connected to standard broadcast receivers to form indicators of nuclear radiations. The diagram shows the manner in which

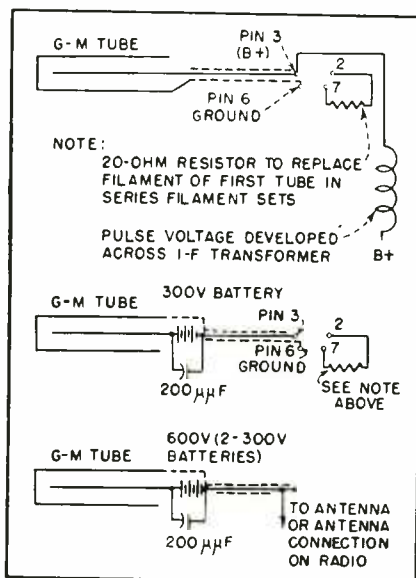

Impulse delivered to r-f section of radio by self-quenching G-M tube shock excites the resonant circuits in the front end, producing a damped wave that makes a click in the loudspeaker. The rapidity of clicks increases as one approaches a radioactive area. That the equipment is operating can be determined by holding a radium treated watch dial near the G-M tube

BUILT ON ALUMINUM

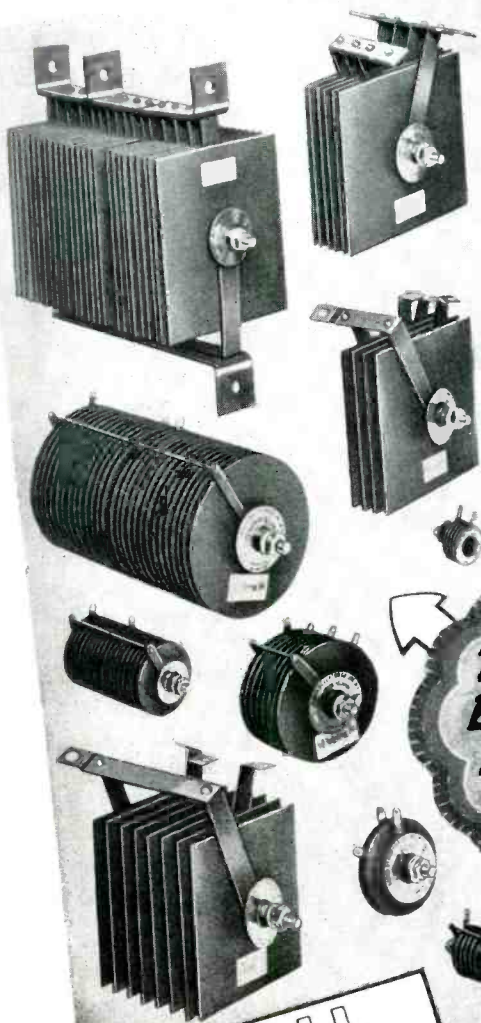

**Seletron**  
SELENIUM RECTIFIERS

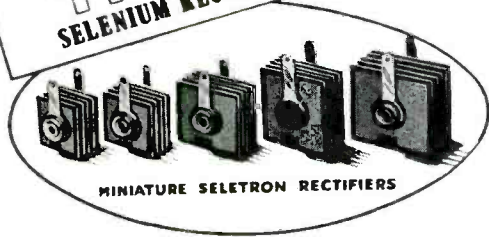

For assured dependable service in all Electronic and Radio applications specify Seletron Miniatures.

CODE NUMBER	5L1	5M1	5P1	5R1	5Q1
Current Rating	75 ma.	100 ma.	150 ma.	200 ma.	250 ma.
Plate Height	1"	1"	1 $\frac{1}{8}$ "	1 $\frac{1}{2}$ "	1"
Plate Width	$\frac{7}{8}$ "	1"	1 $\frac{1}{8}$ "	1 $\frac{1}{4}$ "	1"

The "EXTRA SOMETHING"  
that spells  
**TOP PERFORMANCE**



THEY BOTH HAVE IT!

NO "primrose path" guides the fancy skater to the championship spotlight. The amazing feats that thrill her audiences were made possible only through tireless practice and tenacity of purpose—the "Extra Something" that spells Top Performance.

In the manufacture of Seletron Selenium Rectifiers we have labored with similar tenacity of purpose to impart to our product the "Extra Something" that spells Top Performance—extra quality in materials, extra care in maintaining the highest precision standards, extra testing and inspection from start to finish of the production line.

Where such an exacting formula is followed the result must be a product of dependable performance and long life.

Write today for catalog. Address Dept. ES-15



SELETRON DIVISION  
**RADIO RECEPTOR COMPANY, Inc.**

Since 1922 in Radio and Electronics  
251 WEST 19TH STREET. NEW YORK 11, N. Y.

# MEASURE NOISE FIGURE DIRECTLY WITH THE MEGA-NODE

[NOise dioDE]

A CALIBRATED RANDOM NOISE SOURCE



## HELPS OVERCOME RF FRONT END PROBLEMS

- Extend the range of your high frequency receiver (TV, FM, Radar) by reducing noise. The MEGA-NODE provides a simple method of determining the noise figure. Read the noise figure in db directly from a meter.
- Indicating meter reads db on a linear scale. Choice of several output impedances. Output contains negligible hum.
- Uses: Laboratory, production line testing, development of TV, FM, Radar and other high frequency receivers.

### SPECIFICATIONS

Frequency Range: 1 to 220 mc  
 Output Impedances: 50, 70, 100, 150, 300 ohms and infinity; controlled by panel switch  
 Noise Figure Range: 0 to 17 db at 50 ohms  
 0 to 23 db at 300 ohms  
 Filament Voltage: Regulated d.c. used on filament of noise generating tube.  
 Power Supply: 117±3 volts 60 cps  
 Dimensions: 8" x 16" x 8"

Price \$295.00 F.O.B. FACTORY

## KAY ELECTRIC COMPANY

25 Maple Avenue

Pine Brook, New Jersey

Caldwell 6-4000

### MANUFACTURERS OF

Mega-Sweep — Megaligner — Mega-Marker SR. — Key Sound Spectrograph — Mega-Marker — Mega-Match — Mega-Pulser — Megalyzer — Mega-Pipper — Microwave Mega-Match

See these instruments at Booth 22 IRE Convention.

THE ELECTRON ART

(continued)

the counter tube can be connected to a typical receiver. The G-M tube responds to beta or gamma rays from radioactive elements or fission products, producing clicks or thumps from the loudspeaker in proportion to the density of the radioactivity.

In the first connection the G-M tube must be the type that operates at about 300 volts, which is difficult to manufacture and is short lived. However, further developments of halogen-filled tubes may overcome these difficulties. The second connection shows a means (battery) for operating a 600-volt tube. The third connection, by not requiring an adapter on the tube socket, would be easier to make to the receiver. The first connection has the advantage of being compact, but in any case batteries for this application are small and have a life substantially equal to their shelf life. The G-M tube in each case is the self-quenching vapor-filled type having a life in the order of 10<sup>8</sup> counts.

The purpose of thus using a radio receiver with a G-M tube is to provide a readily procurable detector of radioactivity. As most homes have at least one receiver, all they would need to detect radioactivity would be the G-M tube and possibly the battery. Car radios could be used in prospecting and to warn of contaminated areas, especially in the event of a national emergency, without the need for constructing precision detectors in large quantities. Of course, as W. D. Schafer of the Los Alamos Lab who developed this adaptation points out, the indications are only qualitative. The merits of the method are its simplicity and availability.

## Electronic Analog Computer

By H. R. HEGBAR

Manager Electronics Section  
 Electronics and Control Aerophysics Dept.  
 Goodyear Aircraft Corporation  
 Akron, Ohio

CREATIVE ENGINEERS have long been burned with the necessity of performing laborious complicated mathematical operations in transforming their ideas to numerical design values. Digital computers, from desk calculators to complex

You've got to sell it . . .

**BEFORE** the design is off the board

To sell to the electronic industry you've got to put your product story across — to the engineer as he is planning — **BEFORE** his design is off the board. That's the time when buying decisions are started and purchases are made for experimental models.

Because electronic components or equipment are the results of a precise science, the electronic manufacturing industry's purchasing is engineer-dominated. Every product used is specified only on its electrical, mechanical or physical characteristics which are determined by the engineer **BEFORE** the design is off the board.

When the experimental model is completed and approved, and before production starts, purchases are made, this time in quantity, based on products used in the experimental model. It's obvious then, that buying decisions are made **BEFORE** the design is off the board.

How do you reach design engineers at this important buying stage? Salesmen can't be there all the time — but **ELECTRONICS** is — and it's the one publication that engineers consistently use for technical data and product information. Make sure that, each month, you keep your product story before them.

*ELECTRONICS Annual Mid-June BUYERS GUIDE, because of its complete information and year 'round use, has become the industry's basic buying book and therefore the ideal medium in which to present, in condensed form, complete information on all your products for ready reference by engineers when designs are on the board.*

THE 12 MONTHLY, AND THE ANNUAL BUYERS' GUIDE ISSUES OF

**electronics**

A MCGRAW-HILL PUBLICATION



330 WEST 42nd STREET  
NEW YORK 18, N. Y.



*Standard in the*  
**RADIO AND TV FIELD**



Kester is constantly developing new and better flux-core solders. At present there are over 100,000 types and sizes, each designed to do a certain job in the most efficient manner.

Take advantage of Kester's highly specialized Technical Service. Call in a Kester technical engineer today and let him specify the solder that will enable you to do your soldering faster and better.

**Free—Technical Manual**

Send for Kester's new 28-page manual, "SOLDER and Soldering Technique" . . . a complete analysis of the application and properties of soft solder alloys and soldering fluxes.

**KESTER SOLDER  
 COMPANY**

4201 Wrightwood Avenue, Chicago 39, Illinois

Factories Also At

Newark, New Jersey • Brantford, Canada



**KESTER  
 SOLDER**

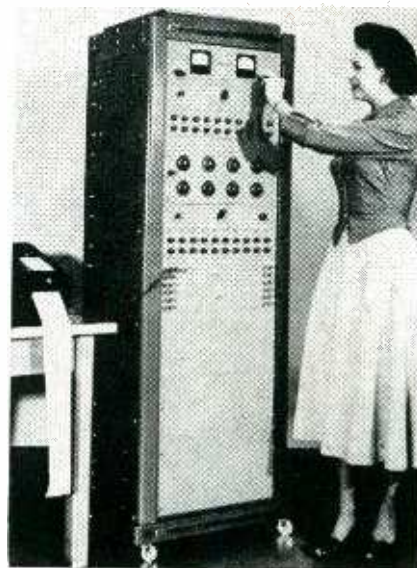

Linear differential equations are solved by math technician Marion Crawford on this compact computer in one-tenth the time required by hand computation; the answer is recorded as a curve on the paper tape

electronic machines, make possible the solution of complicated research problems involving much data. The analog computer, on the other hand, in which continuous rather than incremental information is used, provides engineers with workable design constants at a minimum expenditure of time and effort. For these reasons the computer developed for the United States Air Forces by the Goodyear Aircraft Corporation's Electronics and Control Aerophysics Dept. is of the compact electronic analog type.

This computer employs stable, high-gain plug-in d-c amplifiers, which, with associated input and feedback networks, become functional units performing the linear operations of summing, multiplying, integrating, and so forth. Each of these operations may be performed with an error of less than 0.1 percent. When properly connected, the computer obtains the general solutions to sets of simultaneous differential equations having constant coefficients. It is particularly useful in the field of aircraft stability analysis, simulating the dynamic characteristics of the airframe and autopilot.

Each computer contains 20 universal d-c amplifiers that can be used for any of the linear operations. It also contains 10 one-microfarad polystyrene capacitors for

# Introducing— Another Plasticon Development



## LABORATORY-GRADE CAPACITORS

for the following applications:

- Electronic Computers
- Differential Analysers
- Frequency Determining Circuits
- Bridge Standards, etc.

### Characteristics

- **LOW DIELECTRIC ABSORPTION** —.01-.02% residual
- **LOW DISSIPATION FACTOR** —.0002-.0003 at 1 Mc
- **CONSTANT Q and CAPACITANCE** —from DC to 100 Kc
- **HIGH INSULATION RESISTANCE** — $10^{12}$  ohms/mfd. average
- **NEGATIVE TEMPERATURE COEFFICIENT** —minus 400-500 ppm/°C.

Cat. No.	Cap. Mfd.	Dimensions
LAG101 .....	.0001	19/32x1 3/16"
LAG201 .....	.0002	19/32x1 3/15"
LAG501 .....	.0005	19/32x1 3/16"
LAG102 .....	.001	19/32x1 3/16"
LAG202 .....	.002	19/32x1 3/16"
LAG502 .....	.005	3/4x1 3/4"
LAG103 .....	.01	3/4x1 3/4"
LAG203 .....	.02	3/4x2 1/4"
LAG503 .....	.05	29/32x2 1/4"
LAC 104 .....	.1	2 1/4x1 3/4x1"
LAC 204 .....	.2	2 1/4x2 1/2x1 3/16"
LAC 504 .....	.5	4x2 1/2x1 3/16"
LAC 105 .....	1.	4x3 3/4x1 1/4"
LAC 205 .....	2.	4x3 3/4x2 1/4"
LAC 505 .....	5.	6x3 3/4x4 9/16"

TYPE LAG—Glassmike style. TYPE LAC—Rectangular metal can.  
Specify Tolerance—Std.—2%, 5%; 1% to order.  
RATED VOLTAGE—500VDC. Resistance and absorption readings taken at 200 VDC.

Come in and see us at Booth No. 334 at the  
I.R.E. National Convention in New York  
March 7th - 10th



## Condenser Products Company

1375 NORTH BRANCH STREET • CHICAGO 22, ILLINOIS



**ENGINEERING GIVES YOU**

*Greater Reliability*

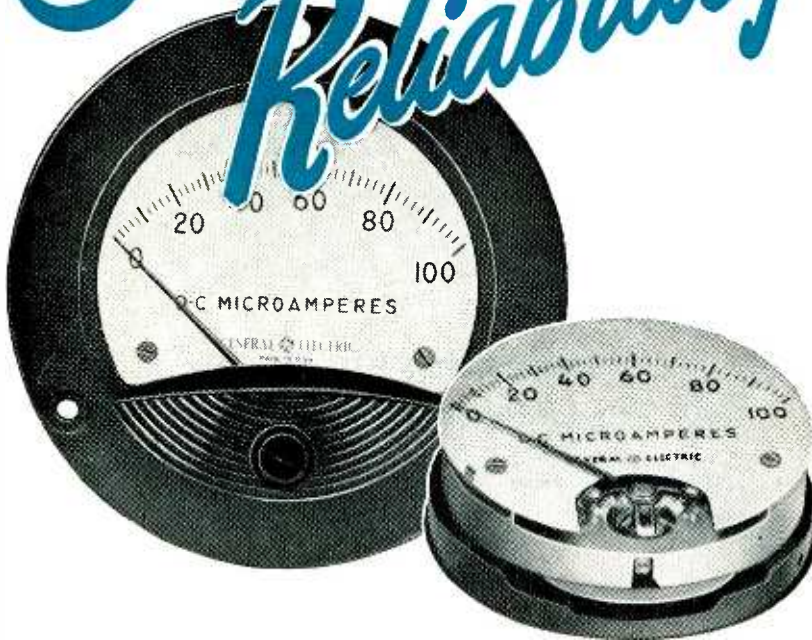

**IMPROVED MECHANISM IN NEW  
3 1/2-INCH PANEL INSTRUMENTS. TYPE DO-71\***

These instruments have been designed for greater reliability, more accuracy, and longer life. The use of high-strength Alnico magnets results in high torque, good damping, and quick response. This allows the use of larger pivots which give greater sturdiness. It also permits a large clearance between the stationary and moving parts to help assure years of trouble-free performance. And all main components are rugged integral units (greater strength and fewer parts to get out of order).

**EASIER READING AND IMPROVED APPEARANCE** result from other new features . . . New type of tapered pointer, absence of arc lines, simplified scale layout, and legibility-tested numerals all contribute to ease and accuracy of reading.

**THE HIGH ACCURACY** and performance of the DO-71 instruments will add to the quality of your products. Plan to incorporate them in your design. Your nearest G-E representative will be glad to discuss applications with you. See him today, or write for Bulletin GEA-5102. Apparatus Dept., General Electric Company, Schenectady 5, N. Y.

\* Available (in round or square case) as d-c ammeters, milliammeters, microammeters, voltmeters, thermocouple ammeters, and rectifier microammeters, milliammeters, and voltmeters. A-c instruments of same appearance and frontal dimensions also available as milliammeters, ammeters, and voltmeters.

**GENERAL ELECTRIC**



602-144

THE ELECTRON ART

(continued)

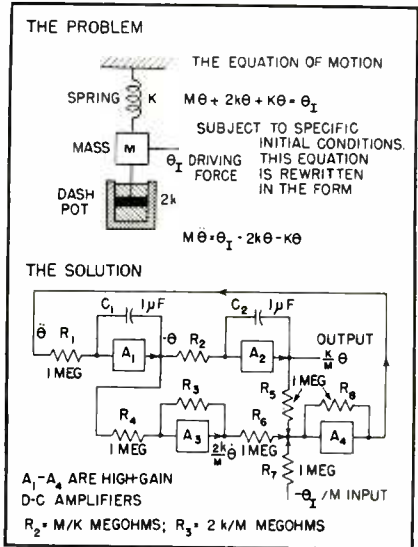

Computer arranged to solve illustrative mechanical problem: First two amplifiers are integrators, third multiplies by a constant, fourth is a summer and each amplifier changes the sign of its input and can be adjusted to multiply by a constant. Unused portions of computer are not shown

use in integrating circuits and 10 precision potentiometers for varying the design parameters that are being studied. Other constants of the problem are fixed by plug-mounted resistors furnished with the computer. The complete unit includes a variable, accurate step-function generator and circuits for applying initial conditions in the form of voltages across the integrating capacitors. Dual voltage limiters simulate mechanical or other limits that may be inherent in some problems.

Problems are wired at the rear of the computer by interconnecting amplifiers, resistors, capacitors, potentiometers, limiters and source voltages on a patch-board. Design changes may be studied by varying the controls on the front of the computer where initial conditions and step-function voltages are set and applied and constants are varied. When the complexity of the problem exceeds the scope of one computer, two or more units may be connected to provide the required computing capacity.

The complete electronic sliderule weighs 650 pounds and is contained in a standard 19-inch relay rack cabinet 6 feet high. The computer houses all required regulated power supplies in addition to the functional circuits; it requires about 1,000 watts at 105-125 volts. Solutions to problems are available as



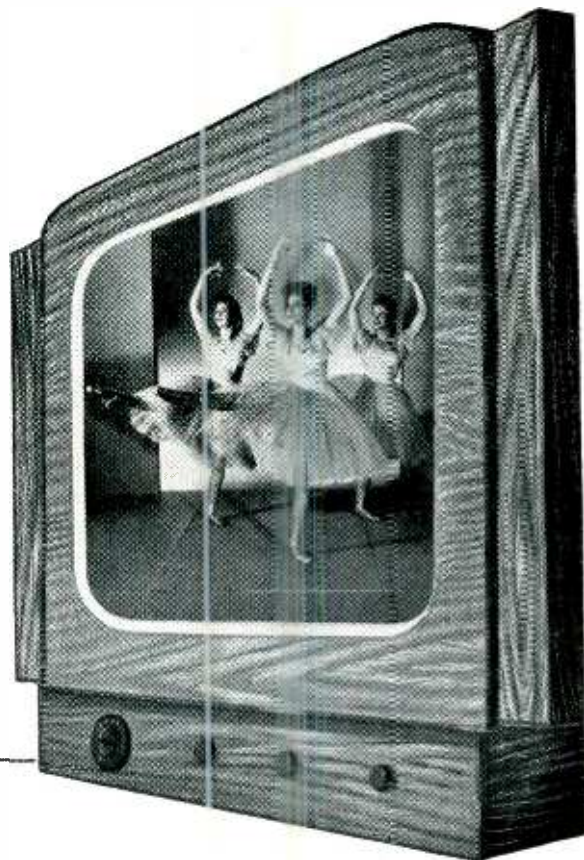

## ATV LEAD-IN LINES

# Get Good Receptions!

YOU WILL BE MORE CERTAIN to get the best receptions from your television or FM set when you specify ATV<sup>®</sup> lead-in lines.

The effects of attenuation and impedance mismatch on FM and Television reception are minimized by Anaconda Type ATV lead-in lines.

The satin-smooth polyethylene insulation of Type ATV line sheds water readily, thus avoiding subsequent impedance discontinuities. This material also has exceptionally high resistance to corrosion. Count on Anaconda to solve your high-frequency transmission problems—with anything from a new-type lead-in line to the latest development in coaxial cables.

48446

*\*An Anaconda Trade-Mark*

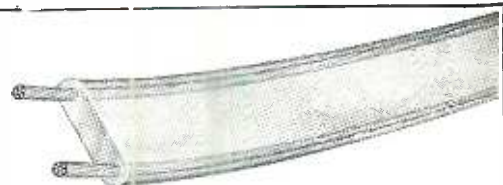

### A TYPE ATV LEAD-IN FOR EVERY NEED

Anaconda offers a complete selection of Type ATV lead-in lines for 75, 150 and 300 ohms impedance unshielded and shielded lines of high impedance. For an electrical and physical characteristics bulletin, write to Anaconda Wire and Cable Company, 25 Broadway, New York 4, New York.



# Anaconda Wire and Cable Co.



# New Astatic LONG-PLAYING PICKUPS are your...

## ...Neatest Answer TO A KNOTTY PROBLEM

THE FUTURE of long-playing records and the equipment to play them depends upon public satisfaction and convenience. For the present, to give both to the public requires a means of playing any type of record on one phonograph. That single unit must have an absolute minimum of extra trappings, and must operate with complete ease and simplicity. Phonograph owners whose sets operate with an Astatic FL Series Pickup are enthusiastically satisfied, encounter no inconvenience. Their set includes only one pickup. They have no limitations on the type of record they can buy. For, Astatic FL Pickups play all three types of records—33-1/3, 45 and 78 RPM. They switch from one to the other WITHOUT CHANGING NEEDLE PRESSURE or making similar adjustments. All that need be done is to insert one tiny slip-in cartridge for any long-playing records, slip it out and insert another for 78 RPM recordings. It's so easy a child can make the change in seconds, for these specially designed cartridges seat themselves into playing position on the same slip-in principle which joins cap and barrel of many modern fountain pens. Entirely new pickup engineering provides the ultimate in clarity and depth of tone, absence of surface noise . . . assures perfect tracking at only five grams needle pressure. Write for illustrated literature, complete details.



Visit Astatic Booth No. 219 at  
I. R. E. Convention, New York  
March 7 to 10, inclusive

Astatic Crystal Devices manufactured  
under Brush Development Co. patents



variable voltages and currents and may be recorded with any instrument having an input resistance greater than 25,000 ohms and a frequency response commensurate with the frequency components in the solution.

### Pulse-Sinewave Converter

By W. M. CAMERON

Technical Officer  
Division of Radio & Electrical Eng.  
National Research Council  
Ottawa, Canada

ALTHOUGH in most apparatus using pulse techniques the desired end result is in pulse form, there are exceptions such as in pulse frequency-modulation systems and radar radio links where sinewave output is desired. A simple and useful method of converting the output pulses to sinewaves is to produce a positive and a negative exponential, which are then folded to produce a wave having approximately sinusoidal characteristics. The circuit for doing this requires few components.

#### Wave Synthesis

Several practical considerations suggest the sort of converter most suited to this problem. The pulse energy, when averaged over a recurrence cycle, is quite low. Thus, although low-pass filters are conventionally used to obtain sinewaves from pulses, it would be preferable that the converter con-

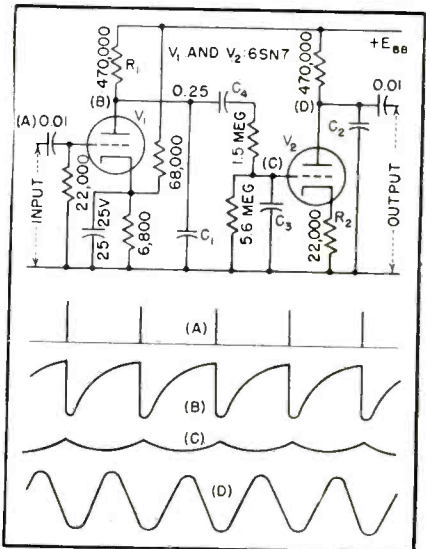

FIG. 1—Circuit for converting pulses to sinewaves is simple and more compact than a passive filter. Component values are for a representative application

# How to deal effectively with VIBRATION:

## Locate it-

### ...with an MB PICKUP

Any trace of vibration comes to light when you attach this sensitive electrical pickup to your product. A rugged, precision-built product, it will withstand rough treatment.

When bolted to equipment under test, this velocity-type pickup faithfully converts vibratory motion to an electrical output. Signal can be visualized with an oscilloscope. Major industries today find it indispensable for accurate analyses. Write for bulletin 124.



## Reproduce it-

### ...with an MB EXCITER

You can't beat this electro-dynamic exciter for shaking "bugs" out of products. With its frequency and force adjustments, you can "scan" a product for vibratory response—or fatigue-test it.

Take one case where a manufacturer of turbines was beset by blade failures. With an MB Exciter, he was able to resonate blades to destruction quickly—while studying their motions with stroboscopic light. In this way, he got to the cause of the trouble *visually!* More data in our bulletin 210B.



## Isolate it-

### ...with ISOMODE\* MOUNTS

Because Isomode mounts have equal spring rates in all directions, they're efficient at all angles — and they isolate all modes of motion!

That's why, by adopting Isomode units, one company was able to simplify suspension brackets and save on manufacturing costs in *addition to* improving vibration control! Another has been better able to cushion heavy duty engines—*without* re-designing the mounting system! Ask for bulletin 202 and Design Chart.

\*Trade Mark Reg. U.S. Pat. Off.



You can see why more and more engineers contact MB when they run into trouble with vibration. We'll be happy to cooperate with you on *your* problems. For more information and for bulletins on the above MB products, write to Dept. E5.

Will you be at the I. R. E. show in N. Y.?  
See our demonstration in Booth 250, March 7-10.

ELECTRONICS — March, 1949

THE  
**MB** MANUFACTURING COMPANY, INC.  
1060 State Street  
New Haven 11, Conn.

VIBRATION ISOLATOR UNITS • VIBRATION TEST EQUIPMENT



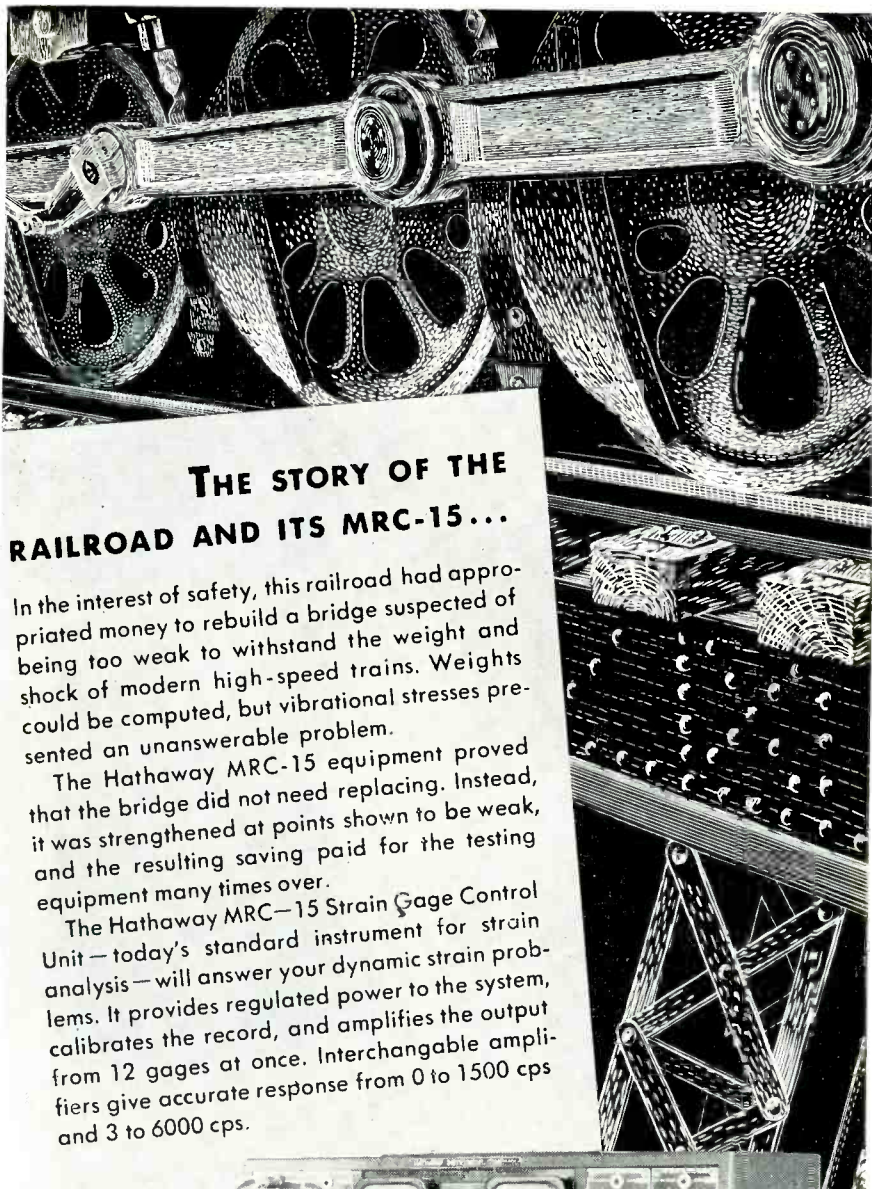

## THE STORY OF THE RAILROAD AND ITS MRC-15...

In the interest of safety, this railroad had appropriated money to rebuild a bridge suspected of being too weak to withstand the weight and shock of modern high-speed trains. Weights could be computed, but vibrational stresses presented an unanswerable problem.

The Hathaway MRC-15 equipment proved that the bridge did not need replacing. Instead, it was strengthened at points shown to be weak, and the resulting saving paid for the testing equipment many times over.

The Hathaway MRC-15 Strain Gage Control Unit—today's standard instrument for strain analysis—will answer your dynamic strain problems. It provides regulated power to the system, calibrates the record, and amplifies the output from 12 gages at once. Interchangeable amplifiers give accurate response from 0 to 1500 cps and 3 to 6000 cps.

The Hathaway Type MRC-15 Strain Gage Control Unit



WRITE FOR TECHNICAL BULLETIN SP-195R

*Hathaway*  
**INSTRUMENT COMPANY**  
 1315 SO. CLARKSON STREET • DENVER 10, COLORADO

tain an internal power source to furnish an output of reasonable amplitude. This requirement implies the use of vacuum tubes, but the number of tubes should be held to a minimum. The converter output should have reasonably low harmonic content, so that additional filtering can be a minimum, but cannot use resonant circuits for this purpose because the output frequency should be a function of the pulse rate.

Figure 1 shows a circuit that meets these requirements. The first tube is biased to cutoff. A positive pulse on its grid causes  $C_1$  to discharge through the tube for the duration of the pulse, after which it charges slowly through  $R_1$ . The exponential wave thus obtained is applied through an R-C network to the grid of  $V_2$ . The plate circuit of this tube also has a long time constant that prevents any sharp discontinuities from appearing in the output wave. The curves on the diagram show the waveforms at various points when the circuit is operating at the frequency for which the second harmonic is the least. With an input pulse of 30 volts peak, the output has an amplitude of about 17 volts peak to peak.

### Design and Performance

For tube and component values as shown in Fig. 1, the values of  $C_1$  and  $C_2$  for least second harmonic distortion at frequency  $f_n$  are given approximately by the empirical formula

$$C_1 = C_2 = 3.70 \times 10^6 (f_n^{-1.08}) \mu\text{F}$$

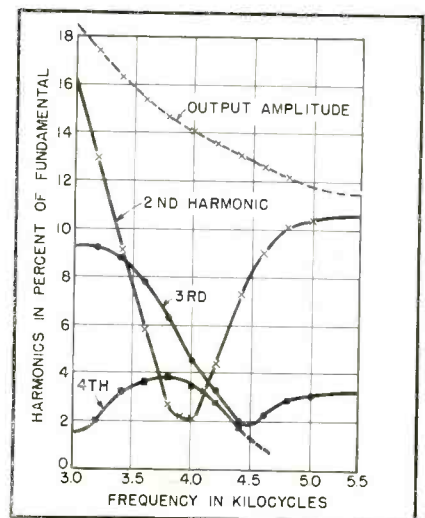

FIG. 2—Measured variations of voltage output and percent harmonics show performance of pulse-to-sinewave converter

# PRD

## PRECISION MICROWAVE MEASUREMENT COMPONENTS

### TYPE 211—PRECISION WAVEGUIDE SLOTTED SECTION ( $\frac{1}{2}$ " x $\frac{1}{4}$ " Waveguide)

Broadband Operation; Crystal and Bolometer Detection; Ball Bearing Carriage Support

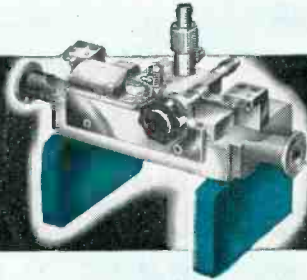

- Similar slotted sections and probes in standard rectangular waveguide and coaxial line sizes make possible precise impedance measurements over the microwave spectrum from 1000 to 40,000 megacycles per second.

### TYPE 612—TUNABLE CRYSTAL AND BOLOMETER MOUNT (Type N— $\frac{3}{8}$ " Coaxial Line)

Broadband Operation; Accurate Square-Law Detection



- The instrument illustrated serves both as a general purpose crystal or bolometer detector and as an harmonic generator for the multiplication of crystal-controlled u-h-f signals into the microwave region.

### TYPE 575—REACTION TYPE FREQUENCY METER ( $1\frac{1}{2}$ " x $\frac{3}{4}$ " Waveguide)

Micrometer Precision; Full Waveguide Frequency Coverage; Ease of Operation

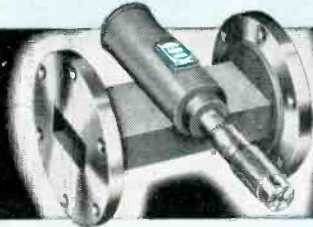

- Currently available in three waveguide sizes to provide coverage from 3950 to 16,000 megacycles per second, these frequency meters combine simplicity of operation, precision, and reliability.

### TYPE 559-A—PRECISION FREQUENCY METER ( $1$ " x $\frac{1}{2}$ " Waveguide)

Direct Reading Dial; Linear Drive; Hermetic Sealing; Temperature Compensation



- This unit is representative of a complete new line of precision frequency meters available with reaction or transmission coupling, and providing maximum accuracy even when exposed to extremes of temperature and humidity.

### TYPE 170—PRECISION CALIBRATED VARIABLE ATTENUATOR ( $2$ " x $1$ " Waveguide)

Metallized-glass Attenuating Element; Precise and Permanent Calibration; Negligible Insertion Loss



- A full complement of fixed and variable attenuators and broadband terminations in standard waveguide sizes provides coverage from 2600 to 40,000 megacycles per second.

The instruments illustrated above are the result of the continuing efforts of PRD's skilled staff to provide the microwave research engineer with test equipment of ultimate accuracy and reliability over broader and broader frequency bands. Techniques

of novel character are used to give the many outstanding features available in the complete PRD line of precision microwave measurement and test equipment. An illustrated catalog may be obtained by writing on company letterhead to Dept. E-1.

*Polytechnic* RESEARCH  
and DEVELOPMENT COMPANY • Inc  
202 TILLARY ST., BROOKLYN 1, NEW YORK



# Speaking of Percentages

## THE

# MYCALEX

## CORPORATION OF AMERICA

sincerely believes that every user of insulation will be interested in the following progress report on Mycalex 410, molded — exclusive formulation of the Mycalex Corp. of America — for the four year period, 1945-1948:

- Average selling price of Mycalex 410 reduced by more than 50% over the past four year period.
- Raw material costs increased approximately 150%.
- Labor costs to make Mycalex 410 increased approximately 50%.
- Demand and production of Mycalex 410 increased approximately 500%.

The constantly increasing number of users of Mycalex 410 have benefited — with a better product — better service and deliveries — at a lower cost.

Research, plant expansion, improved engineering, additional new efficient manufacturing equipment — have permitted us to make available in increased quantities — Mycalex 410 — molded — at prices comparable to other less efficient molded insulations.

## MYCALEX 410 is now priced to meet rigid economy requirements

Send us your blue prints. We can handle the tough jobs as well as the less complicated ones. Any interest evidenced on your part in Mycalex products and services — will receive the prompt, courteous and intelligent attention of a competent Mycalex factory sales engineer. He will receive the fullest backing and cooperation from other factory executives — to serve you promptly — with a quality product and at an economical and fair price.



and  $C_3$  is ten percent of this value. The coupling capacitor  $C_1$  should be kept large so that it does not introduce appreciable phase shift. Part of the justification for this approximate formula is that the impedances in the circuit are adjusted to produce only slight loading on previous loops in the networks. The approximation is within ten percent of the rigorous result, which is commensurate with the tolerance of commercial components.

Other factors than component values influence the waveform. With plate supply voltages of 200, 150 and 100 volts the corresponding second harmonics were 15, 17.3 and 20 percent at 2,200 cps. Values ranging from 14.5 to 21 percent were found at the same frequency when other tubes of the same type were substituted. Figure 2 shows the harmonic content from a typical converter (measured on a General Radio type 636-A Wave Analyzer) expressed as a percentage of the fundamental. Four converters operating within the band from 500 to 4,000 cps but having different  $f_H$  were tested. The second harmonic present at  $f_H$  was 2.7, 3.2, 4.0 and 2.1 percent respectively.

In planning an adaptation of this converter for other ranges or tube complements, the two functions of the circuit should be kept in mind. The part of the circuit to the left of  $C_1$  produces an exponential wave from the pulse input. A large exponential voltage change across  $C_1$  is desired and will be obtained when the impedance of  $R_1-C_1$  is high and  $V_1$  has low plate resistance and high emission capability; a sharp cutoff tube requires lower input pulses than a remote cutoff type. The part of the circuit to the right of  $C_1$  is a dynamic filter in which  $R_2$  is in series with the plate resistance of  $V_2$  during both charging and discharging of  $C_2$ , the voltage change across  $C_2$  being effected by varying the plate resistance. With other tubes,  $R_2$  should be chosen for best filter action. While one might obtain the required filtering with a passive L-C network, the size of the inductances necessary at these frequencies that will match a driving impedance in the order of 0.5

# MYCALEX 410 MAKES HISTORY

Sets astonishing high operational record for telemetering commutator used on aeronautical research projects . . . MYCALEX 410 only insulation to fill exacting requirements.

To February 7, 1949, more than 200 hours of maintenance free, high speed, clean signal telemetering commutator performance has been logged on MYCALEX 410 Units. . . . Experience indicated four hours was optimistic . . . specifications hoped for ten hours . . . and the challenging problem was solved by MYCALEX 410 molded insulation.

#### SPECIFICATIONS TO BE MET IN PRODUCING MYCALEX 410 MOLDED INSULATION COMMUTATORS FOR TELEMETERING

0.0. 2.996" + .000 - .002 • Location of 3 slip rings and the 3 contact arrays from the center has a total tolerance of  $\pm .001$ . • Contact spacing 6° apart  $\pm 1$  minute. • Parting line thicknesses on insulation body are + .002 - .000. • Concentricity between ball bearing bushing and 0.0. .0015. • Assembly height from face of slip rings and contacts to Mycalex 410 has tolerance of + .002 - .000. • Every contact must be tested from its neighbor contact for infinity on a 500 volt megger meter • Plate ambient -20° C. to + 100° C. • Plate to operate at 95% humidity must not warp, crack, change in dielectric constant or resistivity • Contacts to resist high temperatures and must not loosen when repeatedly heated by soldering.

SPECIFY MYCALEX 410 for Low Dielectric loss. . . . High Dielectric strength. . . . High Arc Resistance. . . . Stability over wide Humidity and Temperature Changes. . . . Resistance to High Temperatures. . . . Mechanical Precision. . . . Mechanical Strength. . . . Metal Inserts Molded in Place. . . . Minimum Service Expense. . . . Cooperation of MYCALEX Engineering Staff.

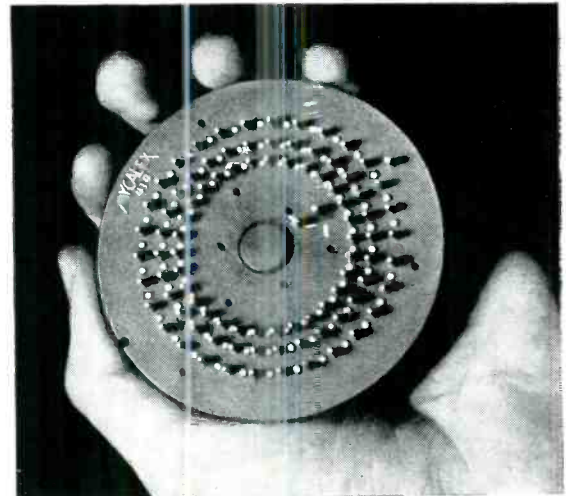

Illustrated are top and bottom views of the MYCALEX 410 molded insulation commutators manufactured to the specifications of Raymond Rosen Engineering Products, Inc., for Air Material Command and Navy telemetering projects. This commutator, with 180 contacts and 3 slip rings of coin silver, samples sixty channels of information such as air speed, altitude, angle-of-attack, temperature, pressure, voltage and other variables; and provides thirty synchronizing pulses.

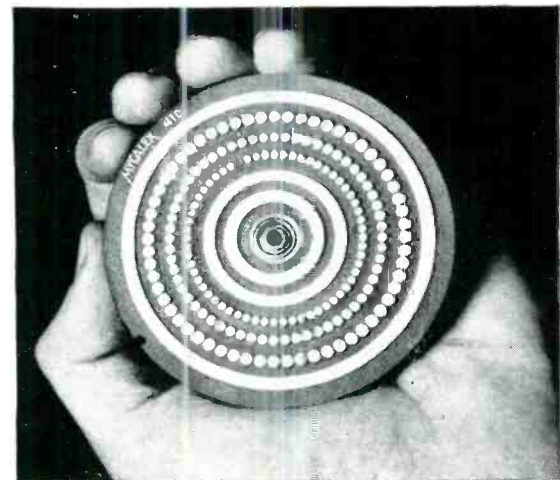

MYCALEX 410 molded insulation is designed to meet the most exacting requirements of all types of high frequency circuits. Difficult, involved and less complicated insulation problems are being solved by MYCALEX 410 molded insulation . . . the exclusive formulation of MYCALEX CORP. OF AMERICA . . . our engineering staff is at your service.



## MYCALEX CORP. OF AMERICA

"Owners of 'MYCALEX' Patents"

Plant and General Offices, CLIFTON, N. J.

Executive Offices, 30 ROCKEFELLER PLAZA, NEW YORK 20, N. Y.

\* You are cordially invited to visit our display at the Radio Engineering Show, Booth 82 on the main floor, where you will see in test the MYCALEX 410 COMMUTATOR, above described . . . also on display will be a great many high frequency electronic components molded of MYCALEX 410 insulation.

# Stupakoff HERMETIC SEALS

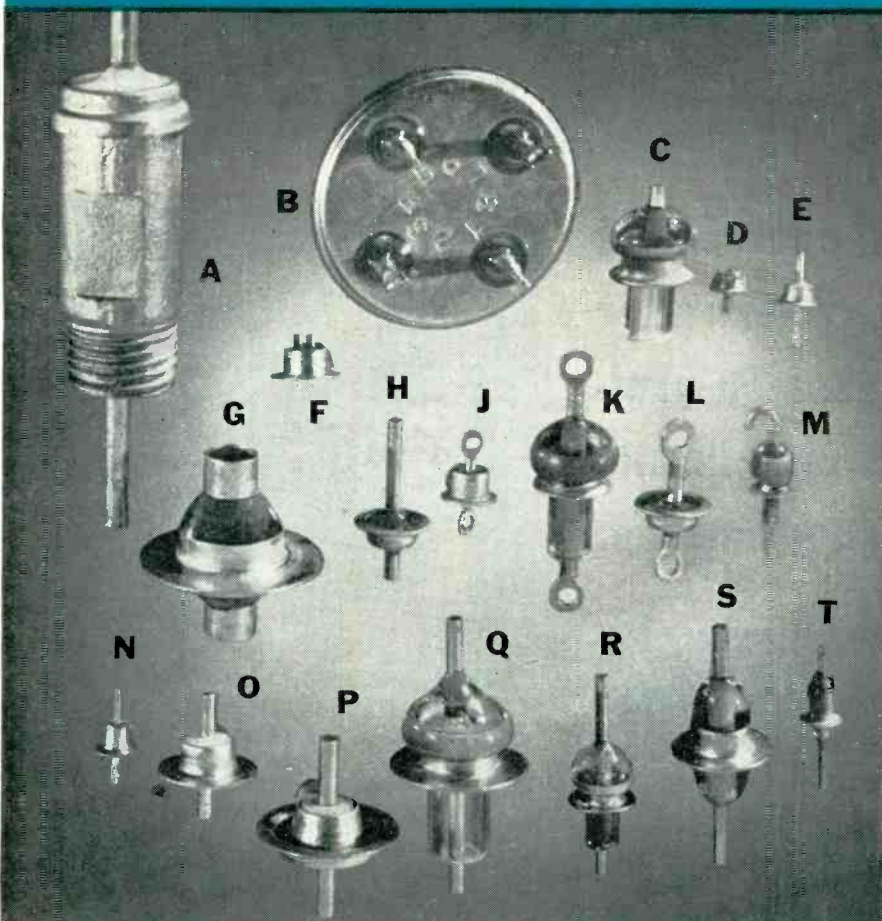

megohm is the main drawback.

When the electronic converter circuit is used in frequency-modulation equipment, the deviation should be limited to five percent of the recurrence frequency. A circuit of this type was used successfully in a pulse frequency-modulation system that carried audio frequencies to 2 kc on a mean recurrence frequency of 5 kc.

## CBS Listener-Counter

OPERATION of a newly developed Instantaneous Audience Measurement system known briefly as IAMS was described by Peter C. Goldmark, director of engineering research for Columbia Broadcasting System, at a recent IRE New York section meeting. The system involves having 1,000 transceivers located in preselected homes and actuated by pulses sent out by a master broadcasting station along with its regular program. When interrogated, the transceivers broadcast uhf pulses in turn that are picked up and collated at the measuring location. Results appear in the form of a graph on paper tape, showing the percentage of sets in use and tuned to a particular station at the time of interrogation.

Each transceiver is about the size of a cigar humidior. Installation merely involves plugging into a wall outlet and connecting to the a-m, f-m and tv sets in the home. Additional features that can be incorporated include a yes-no push-button that allows the listener to vote on various questions asked over the air, and means for identifying in which of three income groups and three geographic groups the responding transceivers are located.

Motor-driven clocks in the transceivers are synchronized with a master clock at the transmitter that has its face divided into 60 information segments, 20 each for a-m, f-m and tv sets. As the hand of the clock in each transceiver reaches a segment, the transceiver sends out a pulse if the set and station assigned to that segment are on in that home. The clock hand makes one revolution in 2½ minutes, and the 1,000 transceivers polled at

## • TYPES AND SIZES TO MEET YOUR NEEDS

Listed below are typical standard sizes of Stupakoff KOVAR-GLASS Terminals. We are equipped to handle orders of any size.

FIGURE	TERMINAL NO.	FLANGE DIAMETER (Inches)	OVERALL LENGTH (Inches)	MAXIMUM AMPERES	MAXIMUM LEAKAGE PATH (Inches)
A	960044	.625	2.500	30.0	.188
B	954004	1.250	.750	15.5	.125
C	952065	.380	.875	12.0	.400
D	952056	.200	.220	4.0	.060
E	950053	.200	.484	5.5	.025
F	955007	.340	.250	4.0	.025
G	952013	.875	.937	75.0	.200
H	952006	.375	.843	12.0	.080
J	951049	.280	.531	10.0	.020
K	951027	.380	1.250	15.5	.400
L	951015	.375	.800	15.5	.090
M	951007	.212	.781	5.5	.312
N	952053	.220	.531	4.0	.060
O	950049	.500	.687	15.5	.080
P	950048	.718	1.000	21.5	.150
Q	950044	.672	1.500	15.5	.550
R	950041	.340	1.125	10.0	.425
S	950022	.500	1.375	15.5	.255
T	950001	.212	.875	5.5	.070

Write for detailed specifications and prices.

**STUPAKOFF**  
CERAMIC & MANUFACTURING CO.  
LATROBE, PENNA.





# ONLY THE POTTER DECADE COUNTER OFFERS:

## -the simplest and most reliable decade circuit

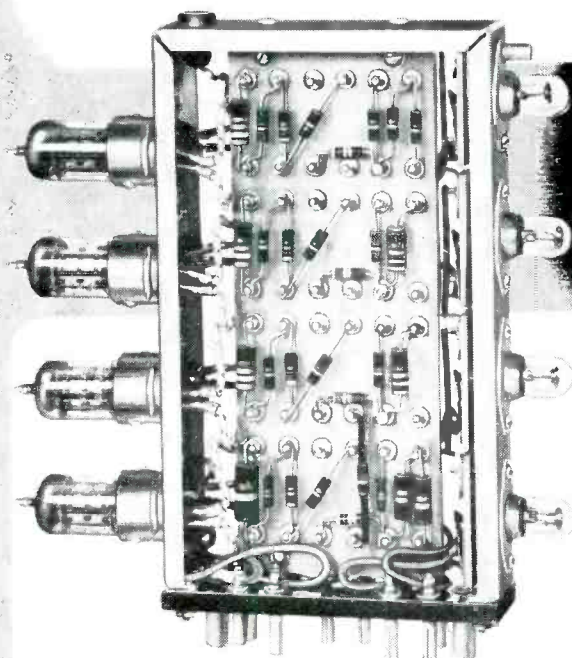

Plug-in type decade using 12AU7 tubes. Note the simple, accessible construction.



The POTTER 4-tube Decade Counter Circuit has been proven by over five years of actual operation in Government proving grounds as well as in numerous industrial applications in which a precise count is required for packaging or automatic machine control. The Decades are available either as components to be used in your equipment, or in a packaged POTTER Scaler, Predetermined Counter, or Precision Counter Chronograph. Modified or specially-designed counting, timing and calculating equipment can be supplied for special applications.

For an accurate appraisal of your problem, call or write Department 6-A.

**WHEN YOU ATTEND THE IRE SHOW**

We extend a cordial invitation to visit our plant in Flushing — only 30 minutes from Grand Central.

- **DIRECT DECIMAL READ-OUT** — four neon glow lamps designated 1—2—4—8, provide a direct indication (0 to 9) of the four trigger stages without a complex resistor matrix.
- **WIDEST BIAS RANGE** — (best test for a counter circuit) insures stable operation.
- **PREDETERMINED COUNTS** — exclusive complementary predetermining makes possible a simple count selector switch and single pulse output at the predetermined count.
- **SMALLEST NUMBER OF COMPONENTS**—uses only four tubes, four glow lamps and the minimum number of parts.
- **DEPENDABLE**—all components are the finest. Examine any of our counters to see the best in electronic construction.

### APPLICATIONS:

PULSE AND SINE WAVE COUNTING	MEMORY AND TRANSLATION
PRECISION TIMING	PACKAGING BY PREDETERMINED COUNT
FREQUENCY MEASUREMENTS	FLUID AND GAS FLOW MEASUREMENT
RADIATION MEASUREMENTS	BUSINESS MACHINE CALCULATORS
AUTOMATIC MACHINE CONTROL	
FREQUENCY DIVIDING	

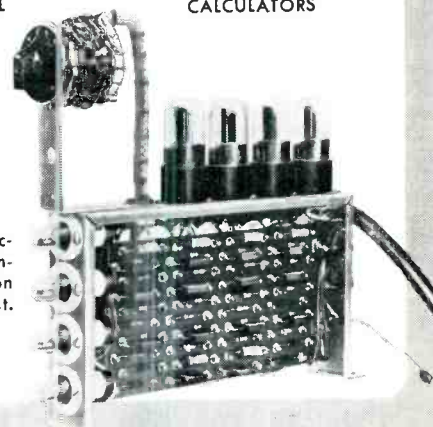

Single Predetermined type decade using 6SN7 tubes. A simple switch provides selection of any predetermined count.

## POTTER INSTRUMENT CO • INC

136-56 ROOSEVELT AVENUE, FLUSHING, N. Y.

**YOU CAN COUNT ON POTTER!**

SEE OUR EXHIBIT BOOTH 210 AT THE I.R.E. SHOW IN NEW YORK MARCH 7th TO 10TH

**TYPE "AN"**

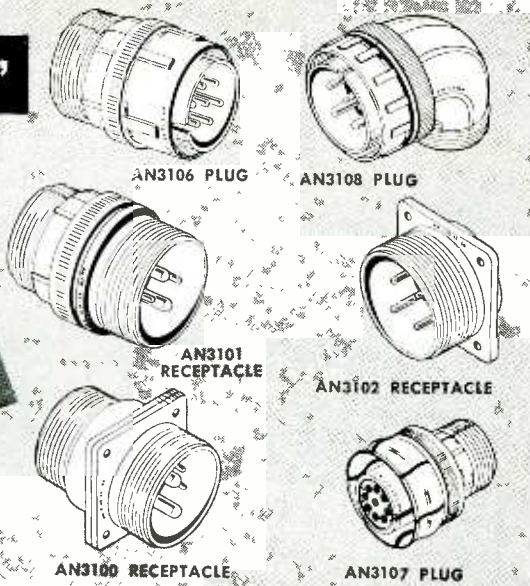

**2 BASIC TYPE SERIES OF THIRTEEN**

*Cannon Plug*

**THOUSANDS OF VARIATIONS AND ACCESSORIES**



**TYPES "K" - "RK"**

Shown here are the basic shell designs of the two leading type series of connectors for aircraft, radio, instruments, television, camera and general electrical and electronic applications, combining more than 400 different insert (contact) arrangements. Listed in the above bulletins which will be sent free upon request. Address Department C-120.

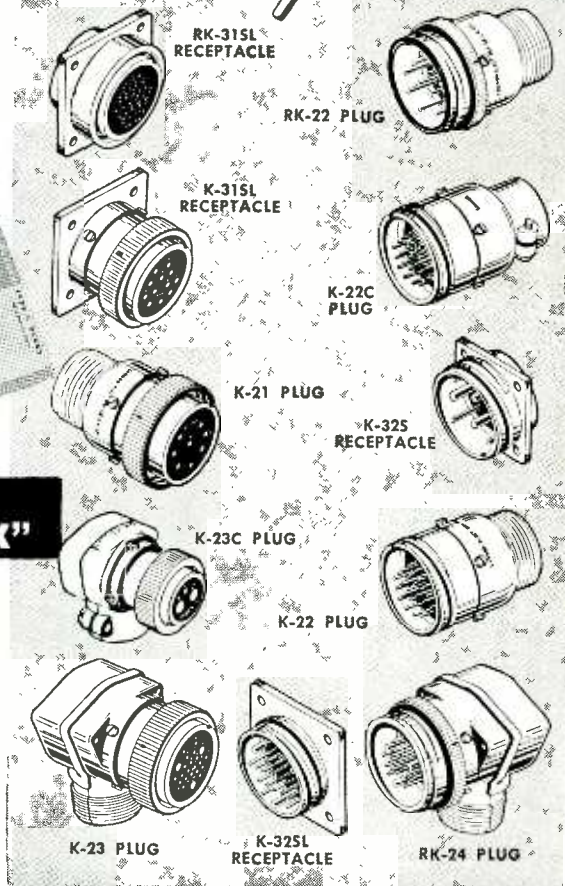

each of the 60 segments can thus send up to 60,000 separate responses to the system receiving antenna. During the nine months of operational tests this antenna has been atop the Chrysler building along with a special uhf receiver and binary counter capable of counting up to 250,000 units per second. The output of the counter is coded and sent over phone line to CBS headquarters, where the information is uncoded and recorded on a Leeds and Northrup instrument that gives the desired information at a glance.

**Rotating Probe Machine**

By GEORGE L. STAMBACH  
Naval Research Laboratory  
Navy Department  
Washington, D. C.

To INVESTIGATE the nature of field patterns in multicavity magnetrons, rotating probes have been used. The machine developed at this laboratory possesses novel features that make it simple and reliable in use.

*Construction of Machine*

The rotating probe machine is a device for exploring fields in regions of cylindrical symmetry and, as developed for use with magnetrons, displaying the field intensity distribution on a synchroscope. Its use permits the identification of oscillation modes in magnetrons without laborious measurements. The accompanying photograph of

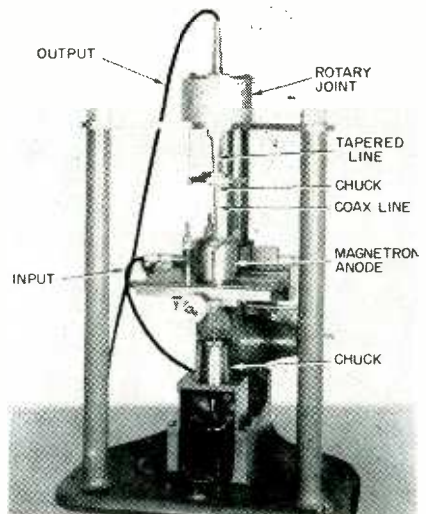

Field patterns inside magnetrons can be measured easily with this probe machine.

SINCE 1915

**CANNON ELECTRIC**

*Development Company* 3209 HUMBOLDT ST., LOS ANGELES 31, CALIF.

IN CANADA: Cannon Electric Ltd., Toronto • World Export: Frazar & Hansen, San Francisco, California

# Announcing

## THREE IMPORTANT NEW PANORAMIC INSTRUMENTS FOR AF to UHF SPECTRUM ANALYSIS

MODEL  
**SB-7\***

Panoramic Ultrasonic Analyzer, Model SB-7 for easy, fast Ultrasonic Analysis

### FEATURES

- Direct Reading
- Linear Frequency Scale
- Continuously Variable Scanning Width
- Linear and 40db linear log amplitude scale
- Stabilized Frequency Calibrations
- Continuously Adjustable Selectivity
- Wide Input Voltage Range

### USES

- High Frequency Vibration Analysis
- Transmission Line Investigations
- Carrier System Monitoring
- Harmonic Analysis
- Feedback System Studies
- Material Testing
- Telemetry
- Medical Studies

An entirely new instrument, the SB-7 is engineered to meet the urgent demands for panoramic reception of ultrasonics—demands ranging from high speed panoramic analysis of jet engine vibrations to panoramic-simplified monitoring of telemetering sub-carriers.

The SB-7 an automatic scanning receiver graphically presents frequency and level of signals in the ultrasonic spectrum. Special control features enable selection and spreading out of any narrow band for highly detailed examination.

PANALYZOR MODEL **SB-8\*** PANADAPTOR MODEL **SA-8\***

### Versatility PLUS in RF Spectrum Analysis

Incorporating completely new design features to provide long and short persistence Panoramic displays with extremely fine signal resolution, the SB-8 and SA-8 offer increased possibilities in RF spectrum analysis.

Typical new applications include . . . Energy distribution investigations of pulsed RF signals with low p.r.f.'s • Side band analysis of AM and FM signals modulated by low audio frequencies • Monitoring of signals very closely adjacent in frequency.

Both Analyzer and Panadaptor Models are available in the following three types: T-200, T-1000 and T-10,000 having scanning widths of 200 kc, 1 mc and 10 mc respectively.

### FEATURES

- Variable Resolution 10:1 Range
- Long persistence Cathode-ray Tube . . . 5" Screen
- Synchronous or non-synchronous scanning
- Variable Scanning Rates
- Signal Amplitude Compression
- Continuously Variable Scanning Width

### USES

- Analyzing AM and FM Transmitters
- Testing Industrial RF Equipment
- Spotting Spurious Oscillation and Modulation
- Monitoring Communications Frequencies
- Telemetry
- Checking Diathermy Units
- Investigating Pulsed RF Signals

## PANORAMIC SONIC ANALYZER, MODEL AP-1\*

Complex Audio Wave Analysis with Speed PLUS

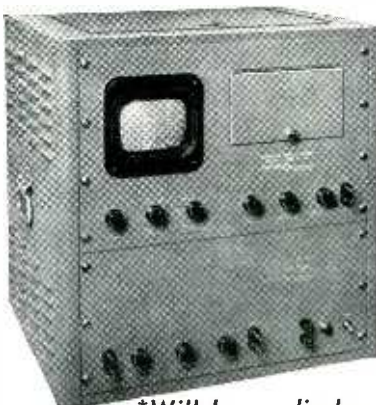

Model AP-1 assures faster and far simpler audio analysis by automatically separating and simultaneously measuring the frequency and amplitude of complex wave components.

Whether your problem is investigation of harmonics, transmission characteristics of lines or filters, vibration, intermodulation, noise or acoustics, the startling advantages offered by the Panoramic Sonic Analyzer will provide solutions faster.

**ADVANTAGES:** Quick graphic views of the 40-20,000 cps spectrum are provided once per second • Chances of missing weak or high frequency components are removed • Random changes in wave content can be observed • Operation is comparatively simple • Measures amplitude ratios as high as 1000:1

**FEATURES:** • Logarithmic frequency scale • Linear and linear log voltage scale • Wide input voltage range • High sensitivity • Direct reading • Calibrated for absolute or relative amplitude measurements.

\*Will be on display at the March IRE Convention, Booth 241-2  
Write for Complete Specifications on the above four instruments

**PANORAMIC**  
RADIO CORP.  
10 So. Second Ave.  
Mount Kisco, N. Y.  
Exclusive Canadian Representative: Canadian Marconi, Ltd.  
Cable Address  
PANORAMIC, NEW YORK



● If your requirements are for extra fine-pitch gears and pinions with precision tolerances, send us your prints for quotation. Beaver Gear engineers are trained to assist you in the design and application of this type gear. Our workmen are specialists in manufacturing small and medium size, fine and extra fine-pitch gears to your most exacting specifications.

MEMBER OF



SEND FOR BULLETIN

*Beaver Gear Works Inc.*

1021 PARMELE STREET, ROCKFORD, ILLINOIS

## PARAMOUNT PAPER TUBES

*... used in*  
*Sparton*  
RADIO



Another Prominent Manufacturer  
Relies on Paramount Quality

SEND FOR  
ARBOR LIST OF  
OVER 1000 SIZES

Lists great variety of  
stock arbors. Includes  
many odd sizes. Write  
for Arbor List today.

Inside Perimeters  
from .592" to 19.0"

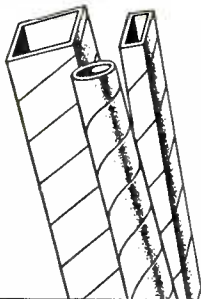

● This is typical of the wide use of PARAMOUNT paper tubes by leading manufacturers of electrical, radio and electronic products. With over 15 years of specialized experience, PARAMOUNT can produce exactly the shape and size tubes you need for coil forms or other uses. Square, rectangular, or round. *Hi-Dielectric*, *Hi-Strength*. Kraft, Fish Paper, Red Rope, or any combination, wound on automatic machines. Tolerances plus or minus .002". Made to your specifications or engineered for you.

**PARAMOUNT PAPER TUBE CORP.**

616 LAFAYETTE ST., FORT WAYNE 2, IND.

Manufacturers of Paper Tubing for the Electrical Industry

THE ELECTRON ART

(continued)

the machine shows its essential parts.

The magnetron anode assembly is clamped on a table that can be moved horizontally and vertically to permit centering and exploring the field axially or radially. The anode is excited by a loop or waveguide coupling into one of its cavities. The magnetron's cathode is replaced by the coaxial line of the rotating probe. The probe proper consists of a short wire projecting radially from the center conductor of the line through a hole in the outer conductor. The voltage induced on this probe is the integrated effect of the radial electric field between the tip of the probe proper and the outer surface of the cylinder (face of the replaced cathode).

The lower end of the coaxial line of the probe is held and driven by a chuck, the details of which are shown in Fig. 1. The upper end of the line is coupled through a rotat-

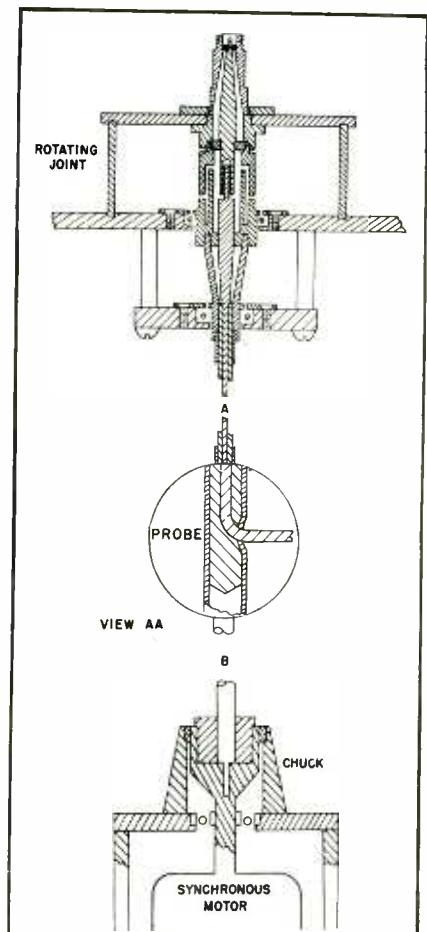

FIG. 1—At the top is the cross-section of the rotating r-f joint, in the middle is the probe, and below is the centering chuck. The rotating joint eliminates sliding electrical contacts

We'll gladly **SPLIT A HAIR** for you . . .  
*and gold-plate it, too!*



**F**INE Wire Headquarters often gets the darndest problems . . . solves 'em, too! Here's a typical example:

A manufacturer of special-purpose electronic tubes required a quantity of .00028" fine Tungsten wire, which is 1/10th the diameter of a human hair. And this had to be plated with a coating of gold to a uniform thickness of

.000006". Uniformity of the goldplating was as important to performance characteristics of the wire as the exact diameter of the wire itself.

Fine Wire Headquarters accepted this challenge, went to work with speed and accuracy and delivered this gold-plated hair-splitting assignment to the customer's complete satisfaction.

\* \* \*

North American Philips specializes in drawing, enameling and plating extremely fine wires in practically all metals and alloys.

So, when you have a problem on Fine Wire, Tungsten, or Molybdenum, why not call on Fine Wire Headquarters? Phone, wire or write to North American Philips, makers of NORELCO Fine Wires and ELMET Tungsten and Molybdenum products.

## NORTH AMERICAN PHILIPS COMPANY, INC.

Dept. XT-3, 100 East 42nd Street, New York 17, N. Y.

Export Representative • Philips Export Corporation • 100 East 42nd Street, New York 17, N. Y.

# Seven new planes completed ...at a cost of \$4.30!

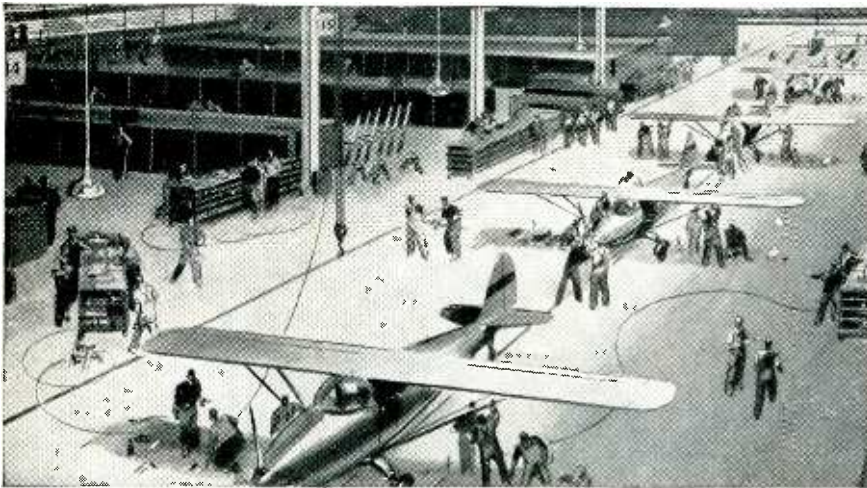

New planes can't fly without control cable, and this manufacturer needed some—fast. He got it the same way he regularly gets many supplies and parts—by Air Express. Ordered in A.M., delivered to plant same day. 500 miles, 28 lbs., Air Express charge only \$4.30. So production continued without a break.



**\$4.30** included pick-up and delivery at no extra charge—and receipt for shipment. All this, plus the world's fastest shipping service. That's Air Express—used with profit by every business.

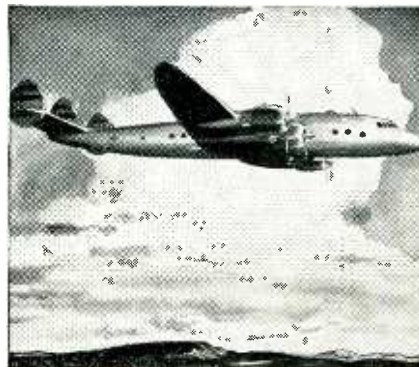

Shipments go on all flights of Scheduled Airlines. Speeds up to 5 miles a minute—no waiting around. Direct service to over 1,000 airport cities, air-rail for 22,000 off-airline offices.

## Facts on low Air Express rates:

22 lbs. of new fashions goes 700 miles for \$4.73.  
6-lb. carton of new jewelry line goes 1,000 miles for \$2.24.  
Same day delivery in both cases if you ship early.

Only Air Express gives you all these advantages: Special pick-up and delivery at no extra cost. You get a receipt for every shipment and delivery is proved by signature of consignee. One-carrier responsibility. Assured protection, too—valuation coverage up to \$50 without extra charge. Practically no limitation on size or weight. For fast shipping action, phone Air Express Division, Railway Express Agency. And specify "Air Express delivery" on orders.

**SPECIFY AIR EXPRESS**  
GETS THERE FIRST



AIR EXPRESS, A SERVICE OF RAILWAY EXPRESS AGENCY AND THE  
**SCHEDULED AIRLINES OF THE U.S.**

ing radio-frequency joint to the detector, which can be simply an untuned crystal rectifier if the signal is strong enough, or a tuner and receiver as shown in Fig. 2. The output of the detector feeds the synchroscope which is synchronized with the rotation of the probe. The rotating joint was designed for 10 centimeters, and, although it is frequency sensitive, its impedance remains constant with angle of rotation, and good patterns have been obtained over the range from 7 to 35 centimeters; Fig. 1 shows the details of its construction.

In mounting an anode on the table for measurement, the probe is removed through the lower chuck, the anode assembly mounted

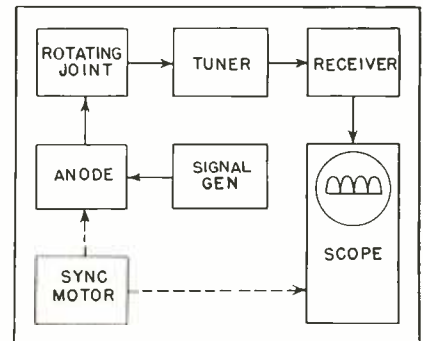

FIG. 2—Block diagram shows association of other measuring equipment with the rotating probe machine

firmly on the table, the table above the chuck, the probe returned to position, and the anode finally centered on it. The chuck and rotating joint are precision machined because a small eccentricity of the probe produces considerable shifting of the resonant frequency of the anode thus distorting the patterns obtained. This chuck holds the shaft to less than one-thousandth of an inch deviation.

### Measuring Magnetron Modes

Under the usual condition that the only modes of a magnetron that are of interest are those in which the cavities act as quarter-wave resonators, there are as many independent modes as there are cavities. Each of these modes has its particular field configuration. In turn, the field pattern of any mode can be analyzed into a series of configurations varying sinusoidally with angular position around the cavity. The probe samples the radial component of voltage of the

# Massive VOLUME



**15" dia.**  
(25 WATTS)

**18" dia.**  
(50 WATTS)

Particularly  
suitable for  
Electric  
Organ work

Reliability is the keynote of these high-power reproducers. Rugged in construction, yet built with the precision of scientific instruments, they have been designed especially for heavy duty P.A. application. Both Loudspeakers combine the three essential requisites — efficiency, clarity and utmost dependability.



# GOODMANS

**15" & 18" HEAVY DUTY P.M.**  
*Loudspeakers*

**GOODMANS INDUSTRIES LTD.**  
**Lancelot Road, WEMBLEY, Middlesex, ENGLAND**

**15" P.M. LOUDSPEAKER**  
Type T10/1501/15

Maximum Power Capacity ..... 25 watts peak A.C.  
Response ..... 40/6,000 c.p.s.  
Fundamental Resonance ..... 60 c.p.s.  
Voice Coil Impedance ..... 15 ohms.  
Total Flux ..... 215,000 lines  
Overall Depth ..... 8 3/8"  
Net Weight ..... 28 lbs. 6 ozs.

**18" P.M. LOUDSPEAKER**  
Type T11/1801/6

Maximum Power Capacity ..... 50 watts peak A.C.  
Response ..... 35/4,000 c.p.s.  
Fundamental Resonance ..... 55 c.p.s.  
Voice Coil Impedance ..... 6 ohms.  
Total Flux ..... 267,000 lines  
Overall Depth ..... 9.9/16"  
Net Weight ..... 35 lbs.

**WARD  
LEONARD  
calls on  
HAYDON  
for  
DEPENDABILITY**

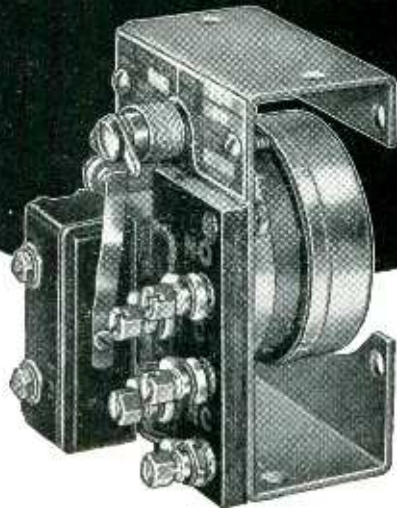

**in TIME DELAY RELAYS**

Ward Leonard is one of many reputable manufacturers of fine quality timers, time delay relays and electrical control apparatus, who depend upon the versatility and adaptability of the Haydon synchronous motors in the design of superior products.

The time delay relay illustrated is designed primarily for such industrial applications as delayed timing for preheating electronic tube filaments before applying voltage and sequence timing in motor controllers. The Haydon 1600 motor provides almost instantaneous self-recycling on breaking the pilot circuit through means of a magnetic shift; choice of standard motor speeds make possible a wide range of adjustable time delay periods and the built-in one-way friction prevents damage to motor on return travel of the cam.

Take time to talk time with Haydon engineers on this and other applications. A fully illustrated Engineering Data Catalog is yours for the asking. WRITE 2415 ELM ST., TORRINGTON, CONNECTICUT

**HAYDON**

MANUFACTURING COMPANY, INC.

TORRINGTON



CONNECTICUT

HARNESS TIME TO

YOUR PRODUCTS

SUBSIDIARY OF GENERAL TIME INSTRUMENTS CORPORATION

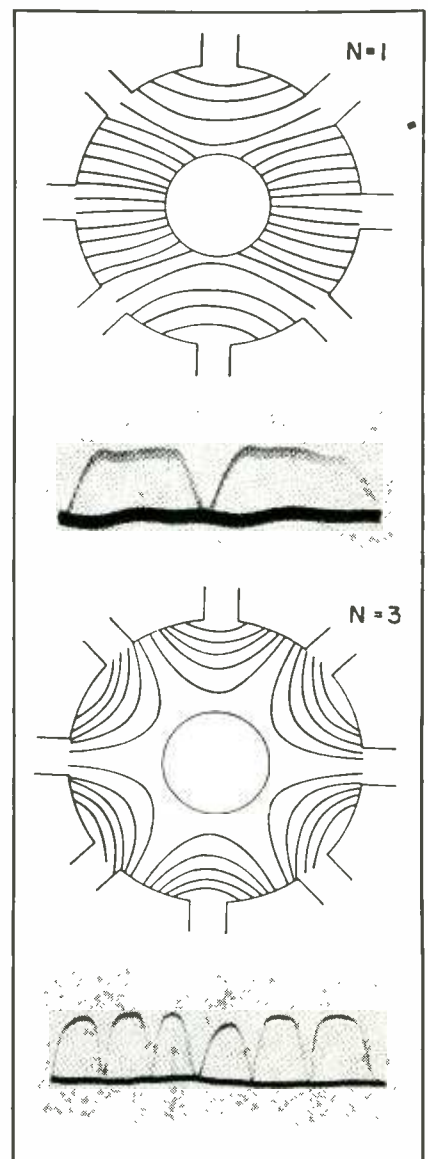

FIG. 3—Comparison of theoretical field patterns for first and third modes with measured component at cathode show nature of distortions inside magnetron

urations. Because the higher harmonics of the field pattern fall off rapidly with radius, the short probe is more sensitive to the lower components.

The presence of the metallic probe disturbs the field configuration. The probe should, therefore, be as short as possible.

Figure 3 compares the field configurations for the first and third modes of an eight cavity magnetron with the measured field strength as displayed on the synchroscope. The magnetron anode was fed with pulsed power so that the field strength periodically fell to zero, thus producing the base line shown in the oscillograms. If the pattern is distorted due to extraneous in-



terference, ripple in the receiver, or other noise, the base line is distorted the same as the pattern so that accurate measurements can still be made.

### SURVEY OF NEW TECHNIQUES

X-RAY MOVIES (cinefluorographs) are being used in studying movements of joints and swallowing. The technique, developed at the Department of Radiology of the University of Rochester School of Medicine and Dentistry and described at the annual meeting of the Radiological Society of North America, permits such studies as the detailed movement of x-ray opaque contrast medium through the arteries and veins. As an adjunct to medical education, it will permit teaching students or assistants in considerably less time than that now required. The apparatus, shown in the accompanying picture, limits the x-ray dosage received by the patient to those levels commonly used in routine diagnostic x-ray procedures by diaphragming the x-ray beam to cover only the part of the body under study and by synchronizing the x-ray output with the camera movement so that there is radiation only while the film is being exposed. The equipment at Rochester had its origin in an Eastman Kodak Co. 16-mm unit and subsequently changed to 35 mm. A General Electric transformer, control and CRT 1-2 tube provide the source of x-rays that produce an image on a Patterson E2 fluorescent screen. This image is focused on the motion picture film by a specially designed Bausch & Lomb f0.85 lens.

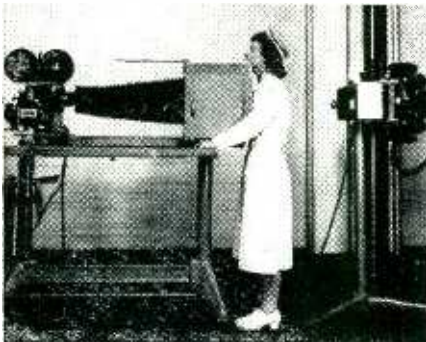

A nurse demonstrates the use of cinefluorographic equipment. The motion picture camera and fluoroscope screen are mounted on a lathe bed for rigidity.

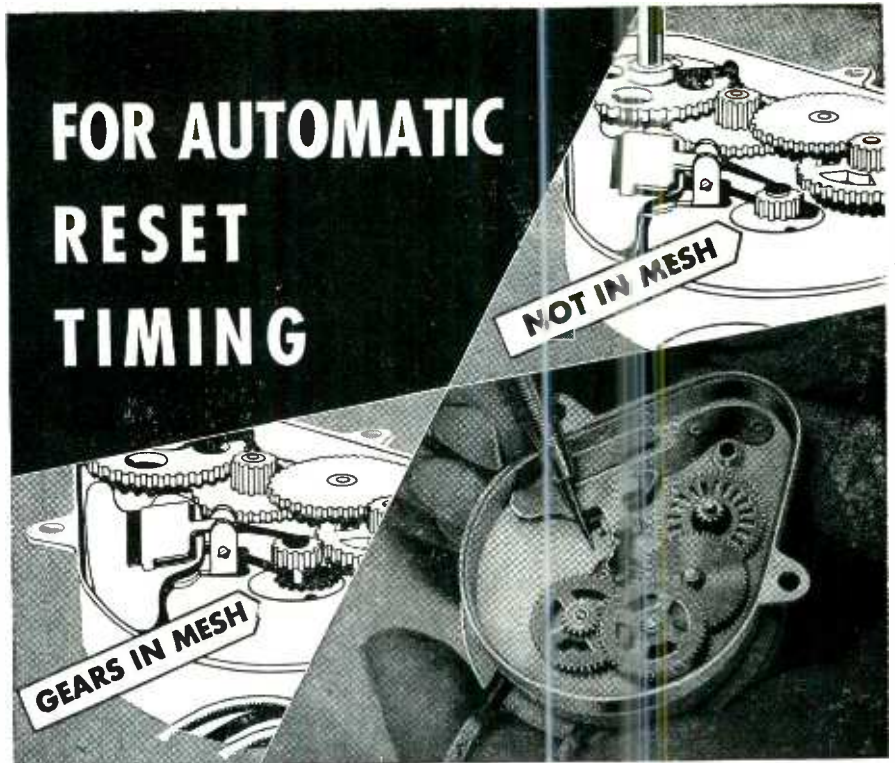

## an EXCLUSIVE HAYDON feature THE INTERNAL SHIFT MECHANISM

An automatic shift mechanism has been built into the Haydon 1600 series synchronous motor and gear unit by Haydon engineers, making possible immediate automatic resetting for devices such as time delay relays, process timers, interval timers, etc. The magnetic pull of the energized motor field is utilized to engage the gear train while the timing operation is in progress. A counterbalance in the shift disengages the gear train from the motor when the motor field is de-energized. The drive shaft is then free to be reset to its starting position by means of an external spring. Engaging and disengaging action is uniform in any position.

- ☆ Available in speeds from 15 to 1/10 rpm.
- ☆ Information on this exclusive shift feature, and complete data on all Haydon synchronous motors and timers, is available in the new Engineering Catalog.
- ☆ If it's about time, request a demonstration of Haydon products at your desk.

WRITE 2415 ELM STREET, TORRINGTON, CONNECTICUT

# HAYDON

MANUFACTURING COMPANY, INC.

TORRINGTON

CONNECTICUT

HARNESS TIME TO

YOUR PRODUCTS

SUBSIDIARY OF GENERAL TIME INSTRUMENTS CORPORATION

# NOW...SOUND PATTERNS VISIBLY, PERMANENTLY RECORDED

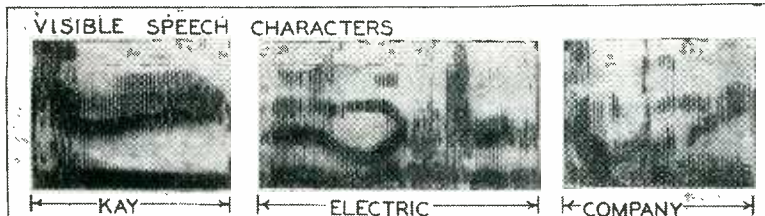

Two records of speech or other complex waves available. One record plots energy level vs. frequency and time. Other record plots energy vs. frequency at any selected time.

The KAY SOUND SPECTROGRAPH may be used for general laboratory analysis of sounds and other complex waves. It is also useful for speech education of the deaf, phonetic research, instruction in foreign languages and other forms of training where VISI-BLE SPEECH is required. Write for full details.

SEE KAY  
SPECTROGRAPH &  
OTHER NEW  
INSTRUMENTS  
AT BOOTH NO. 22,  
I. R. E. SHOW



## KAY ELECTRIC COMPANY

25 S. Maple Avenue

CAldwell 6-4000

Pine Brook, N. J.

# Standard TIMERS

WORLD'S MOST ACCURATE AND RUGGED  
TIME MEASURING INSTRUMENT.  
CAN BE MANUALLY OR ELECTRICALLY  
OPERATED. FURNISHED IN PORTABLE  
CASES OR FOR PANEL MOUNTING

T-1E



Model	Reads	Totalizes	Accuracy
S-100	1/5 sec.	6000 sec.	±.02 sec.
S-60	1/5 sec.	60 min.	±.02 sec.
SM-60	1/100 min.	60 min.	±.02 sec.
S-10	1/10 sec.	1000 sec.	±.02 sec.
S-6	1/1000 min.	10 min.	±.02 sec.
S-1	1/100 sec.	60 sec.	±.01 sec.
MST	1/1000 sec.	.360 sec.	±.001 sec.
MST-500	1/1000 sec.	30 sec.	±.001 sec.

WRITE FOR BULLETIN 153

also Standard Chrono-Tachometers •

Standard Custom-built Laboratory Test and Distribution panels

THE *Standard Electric Time Co.*

97 Logan Street



Springfield, Mass.

A *NEW*,  
improved Fastener  
for mounting

Miniature  
Shield  
Cans



NO. 702 **PALNUT**  
TRADE MARK  
SHIELD CAN FASTENER\*

- Strong, positive grip
- No tolerance problem
- Low assembly cost

Installs in  
popular shaped  
holes shown below



Live Spring arch  
holds can tightly  
against chassis

Will not pull out  
until deliberately  
released

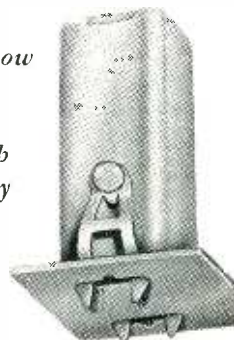

A quick snap of the PALNUT Shield Can Fastener into the chassis provides a secure job, speedily assembled at low cost. Good ground contact is maintained. May be used on any chassis thickness.

SAMPLES and data on PALNUT Shield Can Fasteners sent upon request on your Company letterhead.

\*Pat. Pending

The **PALNUT** Co.

77 CORDIER ST., IRVINGTON 11, N. J.

**NEW PRODUCTS**  
(continued from p 134)

made for both c-w and pulse operation with rise time of 0.1 microsecond. The r-f attenuator is of the waveguide-below-cutoff type with matched resistive loops. Army-Navy designation of the equipment is TS-602/U.

**C-R Sweep**

JAMES MILLEN MFG. CO., INC., Malden, Mass. A new oscilloscope amplifier and sweep unit has been developed for use with any of the line of 2-, 3-, and 5-in. rack panel oscilloscopes. Type 90920 comprises



horizontal and vertical amplifiers, a hard-tube sawtooth sweep generator and power supply mounted on a standard 5 1/2-in. panel.

**Servo Analyzer**

FLIGHT RESEARCH ENGINEERING CORP., P. O. Box 1-F, Richmond 1, Va. The type 5 servo analyzer is a general purpose servo test instrument for measuring dynamic response of d-c or 400 cycle a-c servo-



mechanisms, servo amplifiers and networks. It is suitable for testing servos whose resonant frequencies are in a range between 0.1 and 60 cps. A 17-page booklet of operating instructions is available.

**Artificial Antenna**

AERONAUTICAL COMMUNICATIONS EQUIPMENT, INC., Miami, Florida. The artificial antenna illustrated permits tuning aircraft transmit-

**CHIEF DESIGNER FLEXY SAYS:—**

**WHEN YOU SEE AN ARROW  
THINK OF S.S. WHITE  
FLEXIBLE SHAFTS**

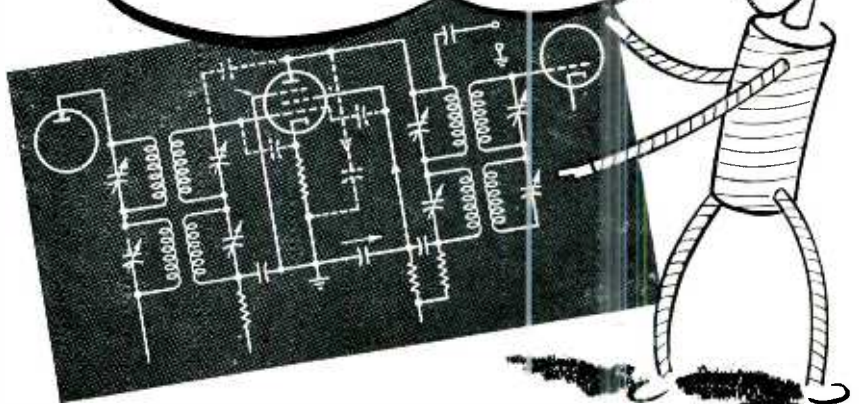

"As you know, an arrow through a symbol means a variable element. In a circuit diagram variable elements are no problem. You just draw them where you want them. But it's quite different when you come to design the actual equipment. Then, you have to consider electrical efficiency, operating convenience, ease of wiring, space economy, appearance and servicing.

"You can satisfy every one of these requirements by coupling variable elements to their controls with S.S.White flexible shafts, because this simple arrangement gives you complete freedom to put both the elements and their controls where it's best for them to be.

"So, whenever you see an arrow, think of S.S. White flexible shafts. And here's how you can get complete information about them . . . ."



The designer of this broadcast transmitter circuit thought of S.S.White flexible shafts—and used them effectively to get optimum circuit efficiency and conveniently centralized control.

**WRITE FOR THIS FLEXIBLE SHAFT HANDBOOK**



It contains 260 pages of facts and engineering data on the subject of flexible shafts, their selection and application. Copy sent free if you write for it on your business letterhead and mention your position.



**S.S. WHITE INDUSTRIAL**  
THE S. S. WHITE DENTAL MFG. CO., DEPT. E 10 EAST 40th ST., NEW YORK 16, N. Y.



FLEXIBLE SHAFTS AND ACCESSORIES  
MOLDED PLASTICS PRODUCTS—MOLDED RESISTORS

One of America's AAAA Industrial Enterprises



*Now!*

*Stable*



## D. C. AMPLIFICATION at moderate cost

The Microsen Balance principle, developed in our electrical instrument laboratory, makes possible for the first time at moderate cost, a D. C. Amplifier incorporating High Stability, Fast Response, Isolated Input, and Versatility.

Models available include Voltage, Current and Potentiometer Type Amplifiers, Direct Current Converters, Direct Current Transformers, and Engineered Designs to meet special requirements.

Line voltage variations of 15% cause output changes of less than .5%. No mechanical rectifiers or choppers. Standard tubes. Time constant from .001 to .2 seconds. Drift less than 5 Microvolts per day. Not affected by temperature variations.

May we send you our bulletin 143-E.



# MICROSEN D. C. AMPLIFIER

*A Product of*

**MANNING, MAXWELL & MOORE, INC.**  
BRIDGEPORT 2, CONNECTICUT

Makers of 'American' Industrial Instruments, Hancock Valves, Ashcroft Gauges, Consolidated Safety and Relief Valves. Builders of 'Shaw-Box' Cranes, 'Budgit' and 'Load-Lifter' Hoists and other lifting specialties.

NEW PRODUCTS

(continued)

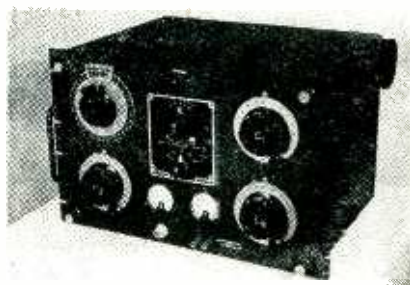

ters at the test bench. Various settings simulate characteristics of any airborne antenna.

### Tele Monitor

ALLEN B. DUMONT LABORATORIES, INC., 1000 Main Ave., Clifton, N. J. Type 2116 picture monitor for television broadcast station use has a



20-in. picture tube and operates from a composite picture signal on a 75-ohm line with a level between 0.5 and 2.5 peak-to-peak volts.

### Ribbon-Line Plug

JAMES MILLEN MANUFACTURING CO., INC., Malden, Mass. The new type 37412 plug designed for use with 300-ohm polyethylene r-f transmission line fits the type 33102 socket previously available for

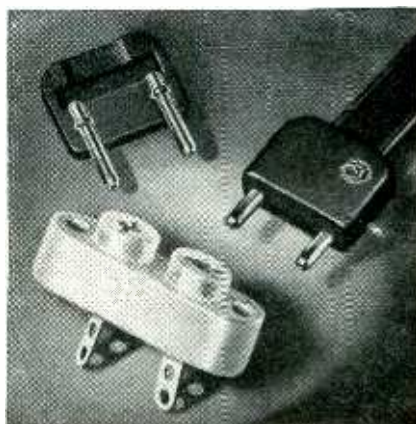

# **NEW** Subscription Order

Please enter my new subscription for **THREE YEARS** of **ELECTRONICS** for **\$12**.

(If you prefer 1 year of **ELECTRONICS** for \$6 check here )

Name:..... Position.....

Home Address:.....

City:..... Zone..... State.....

Company Name:.....

Foreign Rates (1 year) Canada \$7, Latin America \$15, Other \$20

3-40

---

# **NEW** Subscription Order

Please enter my new subscription for **THREE YEARS** of **ELECTRONICS** for **\$12**.

(If you prefer 1 year of **ELECTRONICS** for \$6 check here )

Name:..... Position.....

Home Address:.....

City:..... Zone..... State.....

Company Name:.....

Foreign Rates (1 year) Canada \$7, Latin America \$15, Other \$20

3-40

Postage  
Will be Paid  
by  
McGraw-Hill  
Pub. Co.

No  
Postage Stamp  
Necessary  
if Mailed in the  
United States

**BUSINESS REPLY CARD**

First Class Permit No. 64 (Sec. 510, P. L. & R.) New York, N. Y.

**4¢ POSTAGE WILL BE PAID BY —**

McGRAW-HILL PUBLISHING CO., Inc.

**ELECTRONICS**

330 WEST 42nd STREET

NEW YORK 18, N. Y.



Postage  
Will be Paid  
by  
McGraw-Hill  
Pub. Co.

No  
Postage Stamp  
Necessary  
if Mailed in the  
United States

**BUSINESS REPLY CARD**

First Class Permit No. 64 (Sec. 510, P. L. & R.) New York, N. Y.

**4¢ POSTAGE WILL BE PAID BY —**

McGRAW-HILL PUBLISHING CO., Inc.

**ELECTRONICS**

330 WEST 42nd STREET

NEW YORK 18, N. Y.



mounting control crystals. Pin spacing is half-inch, with pin diameter 0.095 inch.

**Radio Noise Locator**

ELTRON, INC., Jackson, Mich., has announced a lightweight device designed to quickly locate radio noise sources on all types of electrical power circuits. The unit weighs 11 pounds, is equipped with an illuminated output indicating meter, accurate sensitivity switch, loop antenna and earphones. In operation the sensitivity control is set to maximum and the antenna held parallel to the electric circuit while one moves parallel to the circuit.



curate sensitivity switch, loop antenna and earphones. In operation the sensitivity control is set to maximum and the antenna held parallel to the electric circuit while one moves parallel to the circuit.

**Twenty-Six Point Switch**

C. P. CLARE & Co., 4719 Sunnyside Ave., Chicago 30, Ill. A new high-speed spring-driven stepping switch with from one to ten bank levels, each comprising 26 contacts is now

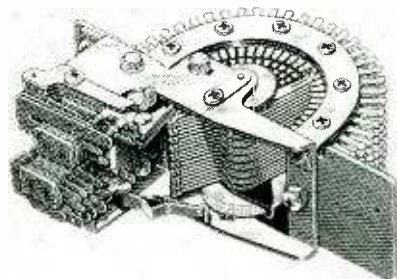

available. Remote operation at a maximum of 30 steps per second and self-controlled operation at about 60 steps a second is possible with a 48-volt power supply. Only direct current can be used for operation.

**Standing-Wave Indicator**

HEWLETT-PACKARD Co., 395 Page Mill Road, Palo Alto, Calif. Type 415A standing wave indicator, designed for use with type 805A



☆  
**2 new stars in the field**

☆  
**For TELEVISION RECEIVERS**  
☆

**Specify COSMALITE\***

Cosmalite Coil Forms give exceptional performance at a definite saving in cost to you.

Punched, threaded, notched and grooved to meet your individual specifications.

See our Exhibit #220 at the I.R.E. Radio Engineering Show

Ask us about the many various punching dies we have available. Inquiries given quick action and specialized attention.

\*Reg. U. S. Pat. Off.

**The CLEVELAND CONTAINER Co.**  
 6201 BARBERTON AVE. CLEVELAND 2, OHIO  
 • All-Fibre Cans • Combination Metal and Paper Cans  
 • Spirally Wound Tubes and Cores for all Purposes  
 • Plastic and Combination Paper and Plastic Items

PRODUCTION PLANTS also at Plymouth, Wisc., Ogdensburg, N.Y., Chicago, Ill., Detroit, Mich., Jamesburg, N.J.  
 PLASTICS DIVISION at Plymouth, Wisc. • ABRASIVE DIVISION at Cleveland, Ohio  
 SALES OFFICES: Room 5632, Grand Central Term. Bldg., New York 17, N.Y., also 647 Main St., Hartford, Conn.  
 CANADIAN PLANT: The Cleveland Container Canada, Ltd., Prescott, Ontario

# FABRICATED SHEET METAL PRODUCTS

to your specifications . . .

COMPLETE facilities under one roof for quantity mass production—including welding, baking and finishing. Whistler and Wiedermann equipment for short runs. Tool and die engineering and designing.

Substantial sheet steel inventories permit speed, service and cooperation. Large assortment of stock and special dies for the radio and electronic field. Production and engineering under the personal direction of Mr. E. B. Gunzburg, president—who has had 35 years' experience in sheet metal fabrication.

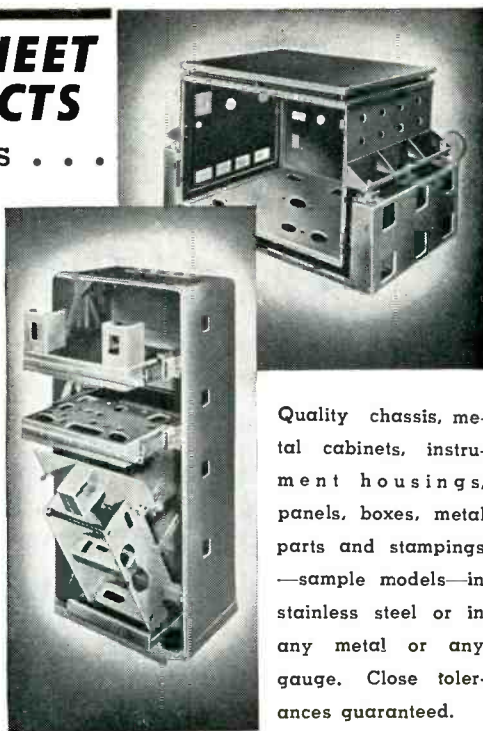

Quality chassis, metal cabinets, instrument housings, panels, boxes, metal parts and stampings—sample models—in stainless steel or in any metal or any gauge. Close tolerances guaranteed.

Send your blueprints and requests for prompt attention and quotations.

## ART-LLOYD METAL PRODUCTS CORP.

2973 Cropsy Ave.

Brooklyn 14, N. Y.

Telephone: ESplanade 3-2400

**NEW...IMPROVED**

**PRECISION ATTENUATORS**

**by TECH LABS**

TYPE

850-A 850-B



The units illustrated represent a complete redesign of our older precision attenuators for laboratory standards. Flat for all frequencies in the audio range. Reasonably flat to 200 k.c. up to 70 db.

VISIT BOOTH 206, I.R.E. Show



Manufacturers of Precision Electrical Resistance Instruments  
BERGEN BLVD., PALISADES PARK, N. J.  
Tel: LEonia 4-3106

3½ KW

VACUUM TUBE  
BOMBARDER

OR

INDUCTION  
HEATING UNIT



Only \$975

Never before a value like this 3½ KW bombarder or high frequency induction heater . . . for saving time and money in surface hardening, brazing, soldering, annealing and many other heat treating operations. Is

Portable . . . mounted on four rubber coasters. Width 14½"; depth 27"; height 42½"; weight 300#.

Operates from 220 volt line. Complete with foot switch and one heating coil made to customer's requirements. Send samples of work wanted. We will advise time cycle required for your particular job. Cost, complete, only \$975. Immediate delivery.

Scientific Electric Electronic Heaters are made in the following ranges of power: 1-2-3-5-7½-10-12½-15-18-25-40-60-80-100-250. KW.

*Scientific  
Electric*

Division of

"S" CORRUGATED QUENCHED GAP CO.

105 - 119 Monroe St., Garfield, N. J.



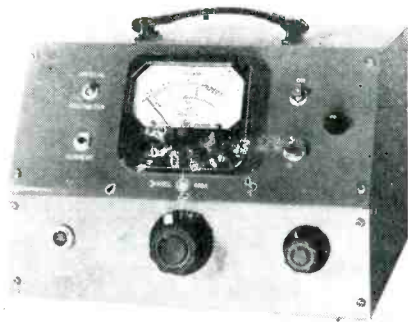

parallel-plane slotted line measures relative audio voltages detected by a crystal rectifier or bolometer. Used with other slotted-line systems, it will determine flatness of a coaxial or waveguide system, measure impedance, locate sources of reflection and determine percentage of reflected power. The instrument comprises a high-gain amplifier with low noise level operating at a fixed audio frequency. Amplifier output is measured with a square-law vtvm. Calibration is in db and vswr. As furnished, the indicator operates on 1,000 cycles. Other frequencies from 300 to 2,000 can be obtained on special order. Overall amplifier Q is about 20.

### Magnetic Amplifiers

VICKERS ELECTRIC DIVISION, VICKERS INC., 1815 Locust St., St. Louis 3, Mo., has a wide line of magnetic amplifiers for lamp and furnace

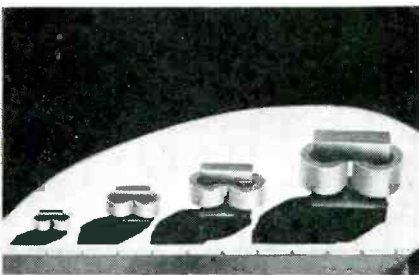

controls, line-to-line voltage regulators, instrument amplifiers and control relays. General use of tubeless amplifier circuits is involved. Power supply requires merely the single-phase or polyphase a-c line voltage. They feature high ratio output power to control power.

### Short Leads

ELECTRO WIRE SERVICE, 5 Beekman St., New York 7, N. Y. Very short hookup leads or shunts are avail-

Here are some of the tubular parts made to the exacting requirements of the Electronics Industry.

The Electronics Division of the Superior Tube Company has grown along with this expanding and vital Industry, producing, to precise standards, a great variety of tubular parts. The needs of the Industry have been met by Superior only because long ago it was realized that ordinary methods of manufacture were not sufficient. Chemical and metallurgical engineering controls, together with a new, and penetrating production system, form the "watch-dog" team that makes Superior's electronic parts outstanding.

Used as anodes and grid cylinders for television and cathode ray tube gun structures, these parts can be rolled at either or both ends, straight cut or angle cut, expanded and rolled, or specially shaped to meet all requirements.

Turn to Superior for electronic tubular parts—they give satisfaction. We will be glad to send you full information.

**Superior**  
THE BIG NAME IN SMALL TUBING (.050" TO 1/2" O.D. MAX.)

**SUPERIOR TUBE COMPANY  
ELECTRONICS DIVISION**

2500 Germantown Avenue • Norristown, Pa.

For Electronic products for export, contact Driver-Harris Company, Harrison, New Jersey, Harrison 6-4800



# Here

are the superlative new Series of Shure "Vertical Drive" Crystal Cartridges. They reproduce *all* the recorded music on the *new* wide-range high-fidelity pressings. Unusually highly compliant, these "Vertical Drive" Cartridges will faithfully track standard records with a force of only 8 grams—micro-groove records with a force of only 5 grams (an added protection for treasured recordings). Will fit standard or special mountings. Have more than adequate output for the average audio stage. They are requisites for the critical listener . . . the lover of fine music. They are especially recommended for those applications where *true fidelity* is essential. Available in single needle and dual needle turnover models—as illustrated above.

For full details, write on company letterhead to Dept. "E."

Licensed under patents of Brush Development Company. Shure patents pending.



## SHURE BROTHERS, INC.

*Microphones and Acoustic Devices*

225 WEST HURON STREET, CHICAGO 10, III. • CABLE ADDRESS: SHUREMICRO

able in lengths from  $\frac{7}{8}$  to  $1\frac{1}{2}$  inch in No. 22 tinned wire in a choice of seven different colors. Other lengths, gages, insulations, or colors can be furnished on special order.

### Five-Channel Oscilloscope

ELECTRONIC TUBE CORP., 1200 E. Mermaid Ave., Philadelphia 18, Pa. Model E5GVM five-channel oscil-

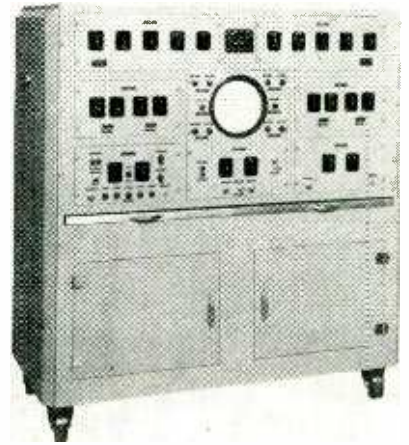

loscope illustrated has been designed for medical research. A five-gun c-r tube is employed. Amplifiers used are suitable for certain responses such as respiration and changes in blood pressure.

### Carrier System

LENKURT ELECTRIC CO., 1113 County Road, San Carlos, Calif. Designed for simple convertibility, the new wire-line or radio-link type 33 carrier system permits installation of a single channel by itself and the later addition of one or two

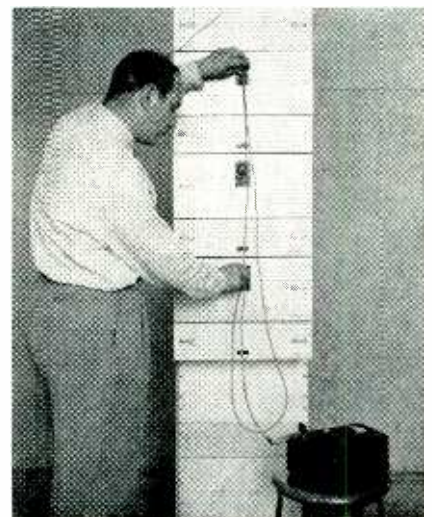

more channels as required. The loop gain of 30 db allows satisfactory service up to 250 line-miles without repeaters. Nominal transmitting level is +14 dbm. Minimum received level for a zero-db equivalent is -16 dbm. Either 2 or 4-wire operation can be used. Modulation of a single-sideband fully-suppressed carrier is employed.

### Spectroradiometer

SYLVANIA ELECTRIC PRODUCTS, INC., Emporium, Pa. An automatic recording spectroradiometer for



production control of commercial television tubes plots energy output of tube screens throughout the entire visible light spectrum in 48 seconds.

### New Resistors

INTERNATIONAL RESISTANCE Co., 401 N. Broad St., Philadelphia, Pa. A new insulated fixed composition resistor designated type BT is now being produced in  $\frac{1}{8}$ ,  $\frac{1}{4}$ , 1, and 2-watt ratings. The new resistor



meets JAN-R-11 specifications. Temperature coefficient varies from 0.02 percent per degree C for low ranges to 0.14 percent per degree C for high ranges. Other significant details are included in technical data bulletin B-1.

### Noise Generator

KAY ELECTRIC Co., Pine Brook, N. J. The Meganode is a calibrated source of random noise covering the frequency range from 0 to 220 mc. Output impedances of 50, 70, 100,

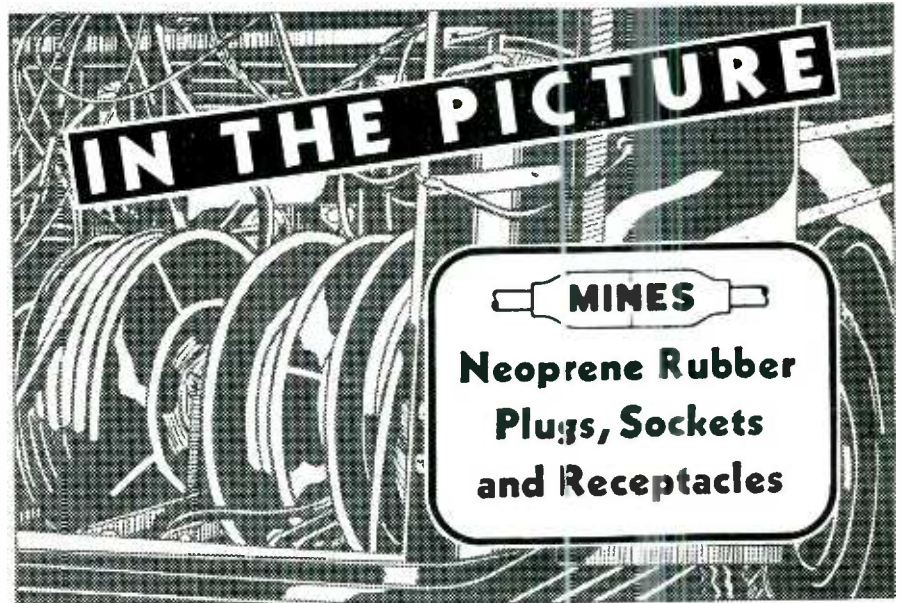

## FOR VIDEO, F.M., A.M., & P.A. PWR. CABLE



No. BH6-182UA  
Universal plug



No. H16-187KF  
Female plug



No. H16-187KM 2X1  
Male Receptacle

Because perfect electronic transmission starts at the power supply, electrical connectors for this stage should be carefully selected to meet all mechanical as well as electrical requirements of their installation. Temperature, humidity, chemical conditions, and allowance for rough handling are all important factors in a power connector's performance. 23 years of specialization in the design and manufacture of integrally molded rubber plugs, receptacles and jumpers particularly qualifies MINES EQUIPMENT for first consideration as a source for the portable power connector needs of Video, FM, AM or PA Systems.

#### CONSIDER THESE UNIQUE FEATURES:

- 1st—MINES Connectors are molded as integral units of flame, acid, oil and moisture-resistant "Neoprene" rubber.
- 2nd—MINES Connectors are molded directly to cable: eliminating assembly costs and providing extra strength at the vital Cable-Connector Junction.
- 3rd—MINES Connectors won't crack when dropped or shatter when run over.
- 4th—MINES Connectors are (ampere for ampere) lighter, less bulky, and safer to handle.
- 5th—Special spring loaded construction and the resilient rubber mounting of pins and socket contacts in MINES Connectors insure a longer life of low contact resistance.
- 6th—MINES Connectors automatically seal against dirt, oil or water infiltration to vital contacts when connected.

For a quotation, submit your requirements to our Industrial Division.

*Write for Complete Details Now!*

MANUFACTURED BY  
**MINES EQUIPMENT COMPANY**

4265 CLAYTON AVE.



ST. LOUIS 10, MO.

**IF IT'S  
SPECIAL  
SEE  
PROGRESSIVE**



**BLUE  
PRINT**

**QUALITY  
PROMCO  
BRAND**



**ENLARGED VIEW**

**KEEP YOUR COSTS DOWN**

Progressive specializes in manufacturing special heads, threads and finishes on any metal or alloy adapted to cold upset. Please write for catalog showing many Progressive specials. Catalog includes purchasing and engineering helps.

*The* **PROGRESSIVE  
MANUFACTURING CO.**

50 NORWOOD ST.  
TORRINGTON, CONNECTICUT

# THE "How to"

## ON BRAZING PIPE AND TUBING

**INSTRUCTIONS FOR BRAZING FITTINGS  
TO PIPE AND TUBING  
WITH EASY-FLO AND SIL-FOS**

**LOW-TEMPERATURE SILVER ALLOY BRAZING** with EASY-FLO or SIL-FOS is extremely used for joining pipe and tubing in metal assemblies that are strongly permanently leak tight and non-ferrous-free and is an extremely simple four-step process. Anyone who knows how to use an oxyacetylene torch can quickly become proficient in an hourly matter of following the correct procedure as covered by the INSTRUCTIONS in this bulletin. These instructions apply to the brazing of fittings to both pipe and tubing. For simplification only the word pipe and tubing is used throughout the same when brazing with EASY-FLO or with SIL-FOS.

**1. CUTTING AND FITTING**



**2. CLEANING**



# FILTER VERSATILITY

Check your filter problems at Lenkurt. Lenkurt combines filter know-how—gained from years of carrier engineering—with the most modern facilities for molding precision

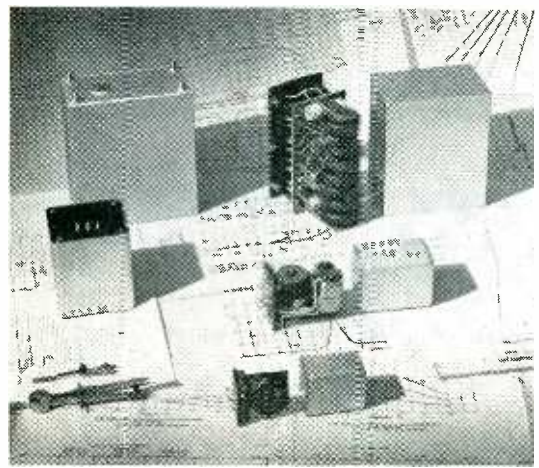

magnetic parts, winding toroids in a wide range of sizes and sealing assemblies for maximum life.

A few standard items illustrated... others to your most stringent specifications. Write.

**LENKURT**  
*knows how*



**LENKURT ELECTRIC CO.**  
SAN CARLOS • CALIFORNIA

## .. in this new BULLETIN 17

If you do any brazing of pipe and tubing with EASY-FLO or SIL-FOS—or want to know just what the process is like, you will find this new bulletin helpful. It gives the procedure, step by step, for—cutting and fitting — cleaning — fluxing — supporting assemblies—heating and flowing the alloys — cleaning after brazing. It tells how to make vertical up, vertical down and horizontal joints. Write today for a copy of BULLETIN 17.

**HANDY & HARMAN**  
82 FULTON ST., NEW YORK 7, N. Y.

Bridgeport, Conn. • Chicago, Ill. • Los Angeles, Cal.  
— Foxboro, Mass. • Toronto, Canada  
Agents in Principal Cities

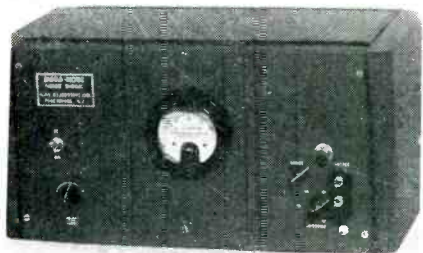

150, 300 ohms and infinity are selected by a front-panel control. Noise figure ranges from 0 to 17 db up to 0 to 23 db are available. The direct-reading instrument can be used to determine noise figure of television, f-m, or radar receivers. The fob price is \$295.

**Gamma Survey Meter**

EL-TRONICS, INC., 2647 North Howard St., Philadelphia 33, Pa. A new beta-gamma survey meter

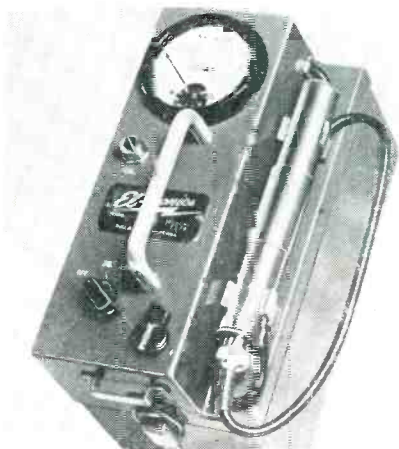

model SM-3 provides direct readings in three full-scale ranges of 0.2, 2.0, and 20 milliroentgens per hour. Ninety percent of final reading is reached in 3 seconds.

**Aircraft Relay**

COOK ELECTRIC CO., 2700 Southport Ave., Chicago 14, Ill. This miniature aircraft Diaphlex relay has

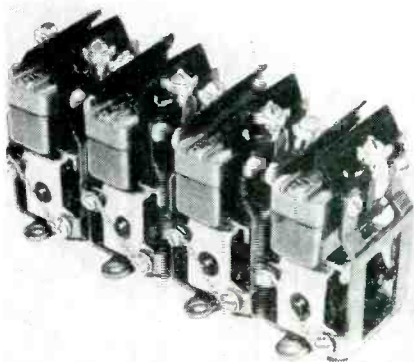

**TRANSFORMERS**

New York Transformer Company builds hermetically sealed transformers to meet your most exacting requirements. Specifications are translated by NYT experience and skill into the components you require.

Enlarged facilities for the development and manufacture of fine equipment assure the production of hermetically sealed units in accordance with your schedules. Ten or ten thousand—every transformer is built with the same specialized care. Shop procedures for testing insure the perfection of the seal on every unit. Hermetically sealed transformers from NYT meet all civilian and government specifications — including current JAN T-27, U. S. Navy 16-T-30, and Signal Corps 71-4942. Other sealed type transformers include specially treated, uncased, lightweight units for airborne use, built to government specification.

Engineering and design facilities, as well as production know-how, are always at your service. Write or phone your requirements.

*Radio and television power transformers and reactors . . . audio transformers, filters and chokes . . . control and operating transformers . . . calibrators and special equipment for electronics.*

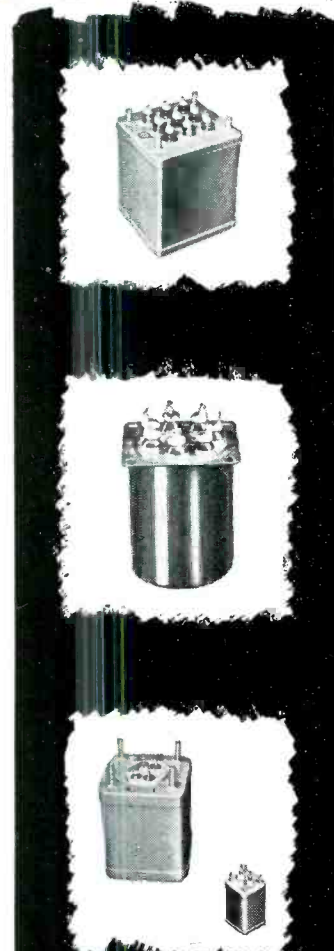

**NEW YORK  
TRANSFORMER CO. INC.**  
Alpha, New Jersey



*Specify...*

**AMPHENOL**

**"AN" CONNECTORS**

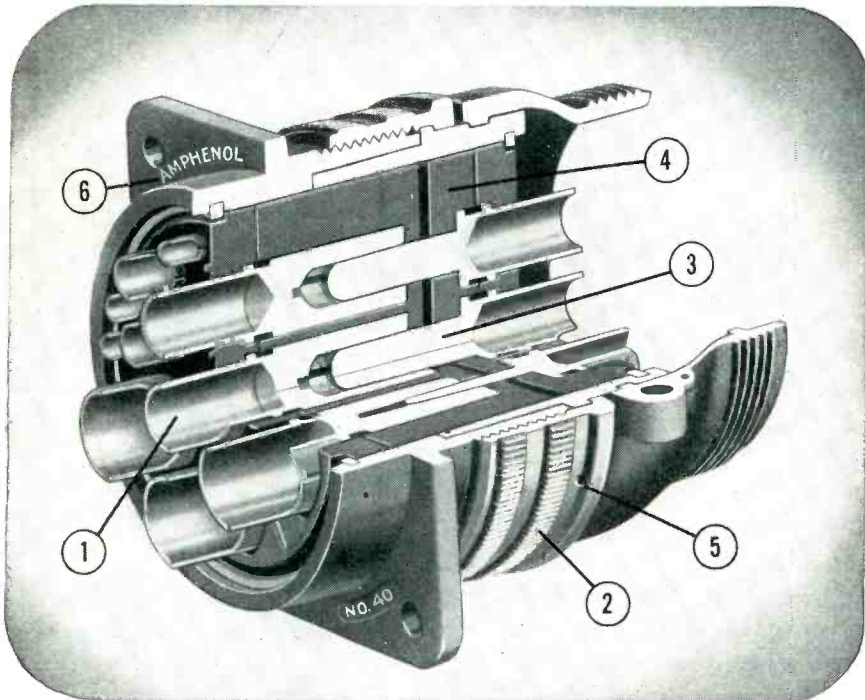

**FOR POWER, SIGNAL and CONTROL CIRCUITS  
in AIRCRAFT and ELECTRONIC EQUIPMENT**

• Amphenol provides features which compare to and carry beyond the specifications for "AN" Connectors.

1. Non-rotating contacts with solder cups aligned for fast efficient soldering.
2. Coupling rings are a screw machine part made from solid aluminum bar stock providing 80% greater tensile strength.
3. Contacts are of selected high conductivity alloys, silver plated and with pockets pretinned for soldering.
4. On sizes 20 and up, Amphenol provides 70% thicker inserts—stronger to withstand rugged operating conditions.
5. Coupling rings and assembly screws are drilled for safety wiring in accordance with Army-Navy specifications.
6. For satisfaction and security be sure with "AMPHENOL."

• Let Amphenol engineers and technicians assist you in specifying connectors for application and adaptability in instrument, power and control problems—these men are available for consultation without obligation.

**72 PAGES OF "AN" CONNECTORS**

*This is a new catalog, just off the presses a few months; long enough, however, to receive the acclaims of top engineers as the most complete and informative on the subject of "AN" Connectors. We are glad to provide a copy for your reference, kindly make request on company letterhead to our Department 13E.*



**AMERICAN PHENOLIC CORPORATION**  
1830 SO. 54TH AVENUE • CHICAGO 50, ILLINOIS

NEW PRODUCTS

(continued)

main supports made entirely of anodized aluminum for corrosion resistance. Coil resistance is 150 ohms, 28 volts d-c; switch is snap action spst with magnetic blowout, normally open, rated at 10 amperes, 110 volts, d-c inductive. The unit is suitable for operation from - 65 to + 160 F.

**D-C Scope**

AMERICAN BRITISH TECHNOLOGY, INC., 57 Park Ave., New York 16, N. Y. The latest in a series of d-c oscilloscopes manufactured by



Furzehill Laboratories is type 1684N. Its range extends from zero to 50 kc with negligible phase distortion up to 30 kc. Vertical amplifier has a maximum sensitivity of 2.5 millivolts per inch.

**Subminiature Triode**

RAYTHEON MFG. Co., Newton, Mass. Type CK5744/CK619CX is a sub-miniature high-mu triode suitable



for general purpose use as a high-frequency mixer in superheterodyne circuits when a separate oscillator is provided.

**Torque Indicator**

MORILL AND MORILL, 30 Church St., New York 7, N. Y. Torac torque indicator is a light, high-precision instrument for calibrating screw-drivers and wrenches. It is fur-



nished in four standard ranges from 0-to-2 up to 0-to-20 pound-inches. Further details are given in circular 461.

**Power Tetrode**

RADIO CORP. OF AMERICA, Harrison, N. J. Type 4-250A/5D22 is a forced air-cooled power tetrode with



maximum plate dissipation of 250 watts. Full ratings obtain up to 75 mc and reduced ratings to 120 mc.

**Photocontrol**

FISHER-PIERCE Co., INC., 70 Ceylon St., Boston 21, Mass. Series 62405 outdoor photoelectric lighting control is a single unit photorelay and

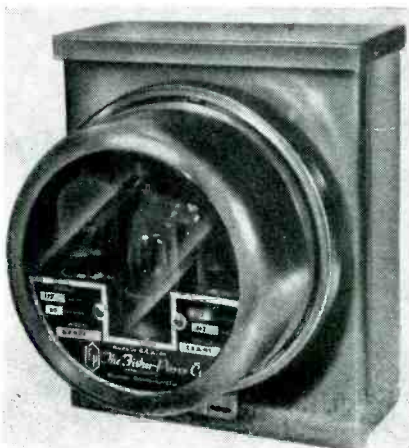

**Broadcast Engineers Helped Design it!**

**Network Shows Use it!**

**Now Compare it with any in your Studios!**

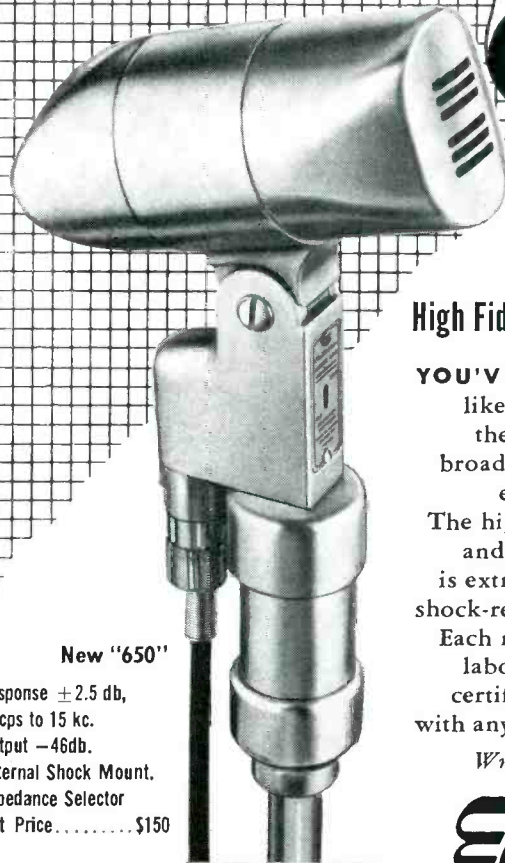

**New "650"**

Response  $\pm 2.5$  db,  
40 cps to 15 kc.  
Output -46db.  
External Shock Mount.  
Impedance Selector  
List Price.....\$150

Nothing like  High Fidelity Broadcast Dynamics

**YOU'VE WANTED** microphones like these! Performance meets the highest FM and AM broadcast standards. The bass end is smooth and flat. The highs are particularly clean and peak-free. Construction is extremely rugged and shock-resistant. Omni-directional. Each microphone individually laboratory calibrated and certified. Try one. Compare it with any mike in your own studios.

*Write for full facts today!*

**Electro-Voice**

ELECTRO-VOICE, INC., BUCHANAN, MICH.  
Export: 13 East 40th St., New York 16, U.S.A.  
Cables: Arlab

**New "645"**

Response  $\pm 2.5$  db,  
40 cps to 15 kc.  
Output -50 db.  
External Shock Mount.  
Impedance Selector.  
List Price.....\$100

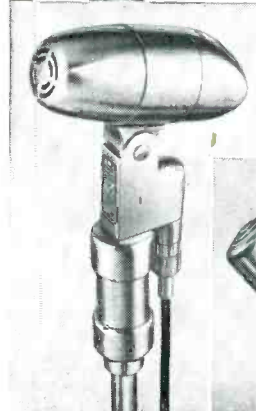

**The "635"**

Response  $\pm 2.5$  db,  
60 cps to 13 kc.  
Output -53 db.  
Impedance Selector.  
For Hand or Stand.  
List Price.....\$60

# LONG LIFE



Fairchild  
Precision Linear Potentiometer

**POTENTIOMETER  
PERFORMANCE  
THAT EXCEEDS  
SPECIFICATIONS**

Specifications covering Fairchild Type 748 Linear Potentiometers guarantee a service life of more than 1,000,000 cycles at 30 rpm and linearity of .1%—yet laboratory tests have revealed a service life of several million cycles at 100 rpm with the original linearity tolerance increasing to only .15%!

This amazing performance stems from Fairchild's exclusive design and precisionized skills that provide just the right contact materials, the right resistance wire—and the exact adjustment of wiper arm pressure.

For further information on the only precision potentiometers that offer a service life of over 1,000,000 cycles with sustained accuracy address: Dept. J, 88-06 Van Wyck Boulevard, Jamaica 1, New York.



ADVANCE — AMPHENOL — AEROVOX — ASTATIC  
ALTEC-LANSING  
B & W-BUD  
BIRN BACH  
BURGESS  
CENTRALAB — CIN AUDAGRAPH — CORNELL — DUBLIER  
EIMAC — ELECTROVOICE — GE — JFD — IRC — JENSEN  
MALLORY — LITTLEFUSE — MEISSNER — MILLEN  
MILLER — NATIONAL — OHMITE — RCA — SANGAMO  
SHURE — UTAH — STEVENS — STANCOR — WELLER  
UNIVERSITY — SYLVANIA — THORDARSON — WEBSTER  
PICKERING — ICA — PRECISION — UNITED ELECT.  
CALL JACK KIRSCHBAUM RI DIGBY 9-4714

**MEET US  
AT THE IRE SHOW  
BOOTH #314**

**ARROW ELECTRONICS**  
INCORPORATED  
82 CORTLANDT STREET, NEW YORK 7, N.Y.

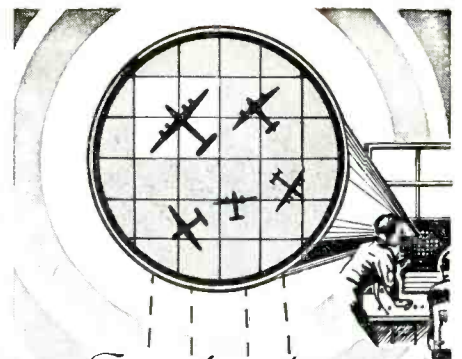

*For extraordinary  
electrical performance*

**Use SILVER  
GRAPHALLOY\***



THE SUPREME CONTACT MATERIAL



BRUSHES

CONTACTS

**in BRUSHES**

for high current density • minimum wear • low contact drop • low electrical noise • self-lubrication

**in CONTACTS**

for low resistance • non-welding character

GRAPHALLOY works where others won't! Specify GRAPHALLOY with confidence.

\*A special silver-impregnated graphite

**GRAPHITE METALLIZING  
CORPORATION**

1055 NEPPERHAN AVENUE, YONKERS 3, NEW YORK



synchronous time switch for billboards, parking lots, rural street lights. The contactor in the unit will switch up to 30 amperes of incandescent light load.

### All-Triode Amplifier

BROWNING LABORATORIES, INC., 742-750 Main St., Winchester, Mass. Model AA-20 high-fidelity amplifier features all-triode voltage-gain and power stages for response within 1 db from 10 to 17,000 cycles with



less than 1.5-percent harmonic distortion at 14 of the rated 15 watts output. Hum level is 65 db below maximum rated output. The unit is designed for use with the RJ-20 tuner.

### Tandem Vibrator

KURMAN ELECTRIC Co., INC., 35-18 37th St., Long Island City 1, N. Y. The tandem vibrator unit illus-



trated has been designed for heavy duty applications. It measures 5  $\frac{1}{8}$  x 2  $\frac{1}{2}$  x 3  $\frac{1}{8}$  inches.

### Radial Projector

JENSEN MFG. Co., 6601 S. Laramie Ave., Chicago 38, Ill. Model VR-241 ST-789 Hypex projector has a developed acoustic path length of 54 inches and a useful frequency response range from 140 to 6,000 cps. Voice coil impedance is 16 ohms;

# A "NEW" SMALL REVERSING CONTACTOR

... a result of three years experience in actual service



**for Continuous Duty Control**  
OF EITHER AC OR DC EQUIPMENT

## Ideal for "Built-in" applications . . . Completely serviceable from the front

**T**HE FIRST small reversing contactor, introduced by Struthers-Dunn over 3 years ago, represented a big improvement over existing methods of controlling hoists, door operators and similar equipment. The design of this new contactor, Type 175KXX is based on broad experience in applying the original unit and incorporates still further advantages including greater ruggedness and the ability to withstand continuous service. Ratings are as follows:

*AC single phase:* 1 hp. 115 or 230 volts  
*AC polyphase:* 2 hp. 110 or 220 volts  
1 hp. 440 or 550 volts  
*Direct current:* 1 hp. 115 or 230 volts

Two 3-pole solenoids, for forward and reverse operation, are mounted on a common frame and mechanically interlocked to prevent simultaneous closure. Contacts are completely insulated with melamine. Open arc chutes allow rapid cooling and escape of ionized gases.

Auxiliary contacts can be added for electric lock-up or interlock. All fixed contacts are interchangeable as are the moving contacts and corresponding parts on each solenoid. All parts are easily replaceable from the front.

Write for Data Bulletin 7100.

# STRUTHERS-DUNN

Struthers-Dunn, Inc., 150 N. 13th St., Philadelphia 7, Pa.

ATLANTA • BALTIMORE • BOSTON • BUFFALO • ROCHESTER • CHARLOTTE  
CHICAGO • CINCINNATI • CLEVELAND • DALLAS • DENVER • DETROIT  
HARTFORD • INDIANAPOLIS • LOS ANGELES • MINNEAPOLIS • MONTREAL  
NEW ORLEANS • NEW YORK • PITTSBURGH • ST. LOUIS • SAN FRANCISCO  
SEATTLE • SYRACUSE • TORONTO

# Brush Oscillographs Offer



## instantaneous recordings from DC to 100 CPS

Either A. C. or D. C. signals can be measured.

Whenever desired, recordings may be  
stopped for notations on chart-paper.

## permanent ink on paper recordings

by Brush Oscillographs  
make their use almost unlimited.

## accurate recordings of voltages,

pressures, strains, vibrations and  
countless other phenomena.

*investigate* Brush measuring devices before you buy...  
they offer more for your money. Why not have a Brush field  
engineer call? At no obligation, of course. Just call or write—  
today—you'll find it worth a few seconds' time!

THE  
*Brush*  
DEVELOPMENT COMPANY

3405 Perkins Avenue • Cleveland 14, Ohio, U.S.A.  
MAGNETIC RECORDING DIV. • ACOUSTIC PROD. DIV.  
INDUSTRIAL INSTRUMENTS DIV. • CRYSTAL DIVISION

Canadian Representatives:

A. C. Wickman (Canada) Ltd. P. O. Box 9, Station N, Toronto 14

NEW PRODUCTS

(continued)



power rating is 25 watts maximum  
signal input. The driver unit has a  
phenolic diaphragm and Alnico-5  
magnetic.

### Portable Audiometer

MICROTONE Co., Minneapolis, Minn.  
The audiometer illustrated graphically  
demonstrates hearing losses,



and is designed to aid the proper  
selection of hearing aids for the  
particular deficiency encountered.

### P-M Speakers

RADIO CORP. OF AMERICA, Harrison,  
N. J. Two new permanent magnet



speakers type 308S2 and 408S2 have  $\frac{3}{4}$ -inch diameter voice coils and 8-inch cones. Each speaker has a power handling capability of 6 watts. Holes are provided for mounting output transformers.

### Industrial Miniature Tube

GENERAL ELECTRIC Co., Schenectady, N. Y. Type GL-5610 7-pin miniature electronic tube has a



plate dissipation of 3 watts and its characteristics include heater voltage, 6.3 v; plate current 17 ma; plate resistance 3,500 ohms.

### Projection Tele Lens

SPELLMAN TELEVISION CO., INC., 130 W. 24th St., New York 11, N. Y. The f 1.9 projection television lens can be used to project picture sizes



from several inches to  $7 \times 9$  feet. It incorporates in the barrel a removable corrective lens for use with a 5TP4 projection tube. Dimensions: 7 inches long, 4 $\frac{1}{2}$  inches in diameter; f 1.9; ef, 0.5 inch.

### Test Probes

PRECISION APPARATUS CO., INC., 92 27 Horace Harding Blvd., Elmhurst, L. I., N. Y. The series TV high-voltage safety test probes afford direct measurement facilities up to 30,000 volts d-c. Featured



THE transmission of photographs by wire and radio is accomplished by a series of meticulously accurate and miraculously synchronized vibrations. Fidelity of reproduction demands that there shall be no competition with outside vibrations.

Acme Telephoto has solved the problem through the use of a LORD Vibration Control System. Its stationary Transceiver models are mounted on Lord Tube Form Mountings. Light staticary and portable units are mounted on Plate Form Mountings. Machines used on board warships of the U. S. Navy are supported by Lord Plate Form Mountings on bars which are again supported on Lord Plate Form Mountings.

Whether your product needs protection and isolation from outside vibratory forces or control of vibration created by its own movements Lord engineers can help you.

See our bulletin in Sweet's 1949 File for Product Designers or write for Bulletin 900 today. It describes the complete line of Lord products and services.

**LORD MANUFACTURING CO., ERIE, PA.**

Canadian Representative: Railway & Power Engineering Corp., Ltd.

**LORD Vibration Control Systems**

# IRN

## magnetic iron powders

**MEPHAM**  
hydrogen  
reduced

**IRN** magnetic iron powders (Mephram hydrogen reduced) are available in 10 different types for high-frequency cores, core material, tele-communication and magnetic applications. . . . All are described in a revised technical bulletin, containing 28 pages of comprehensive data, including performance graphs and engineering reference material of value to designers, manufacturers and users. Your copy of this bulletin will be mailed on request.

*Metallurgical and Electronic Division*

**C. K. WILLIAMS & CO.**

2001 Lynch . . . . East St. Louis, Ills.

# IRN

## KOBZY QUALITY . . . .

### Your safe answer for those standard and special needs—

### MOUNTINGS AND BRACKETS

FOR TELEVISION AND OTHER PURPOSES IN  
THE ELECTRONIC INDUSTRY

• Let us cooperate with you in the production of laminations—housings—contacts—lugs, and miscellaneous metal stamping parts. Get the benefit of our experience, quality, and service. We work very closely with our customers and design to their specifications.



Send for the **KOBZY** catalog—keep it handy as your guide to quality.

**K O B Z Y**  
TOOL COMPANY  
1539 DAYTON ST. CHICAGO 22, ILL.

### AFTER YEARS OF RESEARCH . . .



## STANDARD

*offers a*

### COMPACT - STURDY LOW FREQUENCY CRYSTAL UNIT

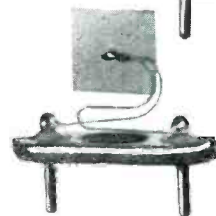

*We are in  
a position  
to make  
prompt  
delivery.*

A special process has been developed to overcome fragility and give sturdiness to this STANDARD unit. Range —200 to 1200 kc. CT and DT cut. Hermetically sealed and filled with dry nitrogen. Good stability over wide temperature range. Meets government specifications. Write or wire for additional information.

**STANDARD PIEZO COMPANY**  
Office & Development Laboratories  
CARLISLE, PENNSYLVANIA

are the extended high dielectric anti-leakage paths, multi-channeled guard barrier, multi-channeled guard barrier, and directly-grounded arc-back barrier and shield. Standard models cost \$15.45 each.

### Speaker Replacements

RADIO CORP. OF AMERICA, Harrison, N. J. A new line of replacement speakers comprises 14 permanent-magnet and three field-coil types. Several elliptical speakers are included. In some of the models a universal transformer mounting bracket and adapter plate are included.

### Audio Amplifier

SCHUTTIG AND Co., Ninth and Kearny Sts., N. E., Washington 17, D. C. Type S190A regulated output amplifier is a three-stage push-pull device to provide constant output level which can be adjusted for

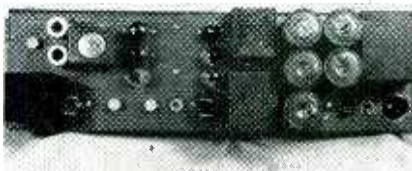

any value between minus 10 and plus 5 db. An independent noise-suppressing circuit eliminates noise between transmissions. Input impedance is low, ranging from 25 to 600 ohms. Maximum gain is 75 db.

### Titanium Metal

E. I. DUPONT DE NEMOURS AND Co., INC., Wilmington 98, Delaware. Ductile titanium metal, sometimes used for electron tube anodes, is now becoming available in small quantities through operation of a pilot plant. The metal is comparable to stainless steel in strength and corrosion resistance, but weighs little more than half as much per unit volume.

### Laminate Insulator

ST. REGIS PAPER Co., 230 Park Ave., New York 17, N. Y. A new pheno-

"Tiny—but these Phenolite parts sure solved that tough insulation problem\*."

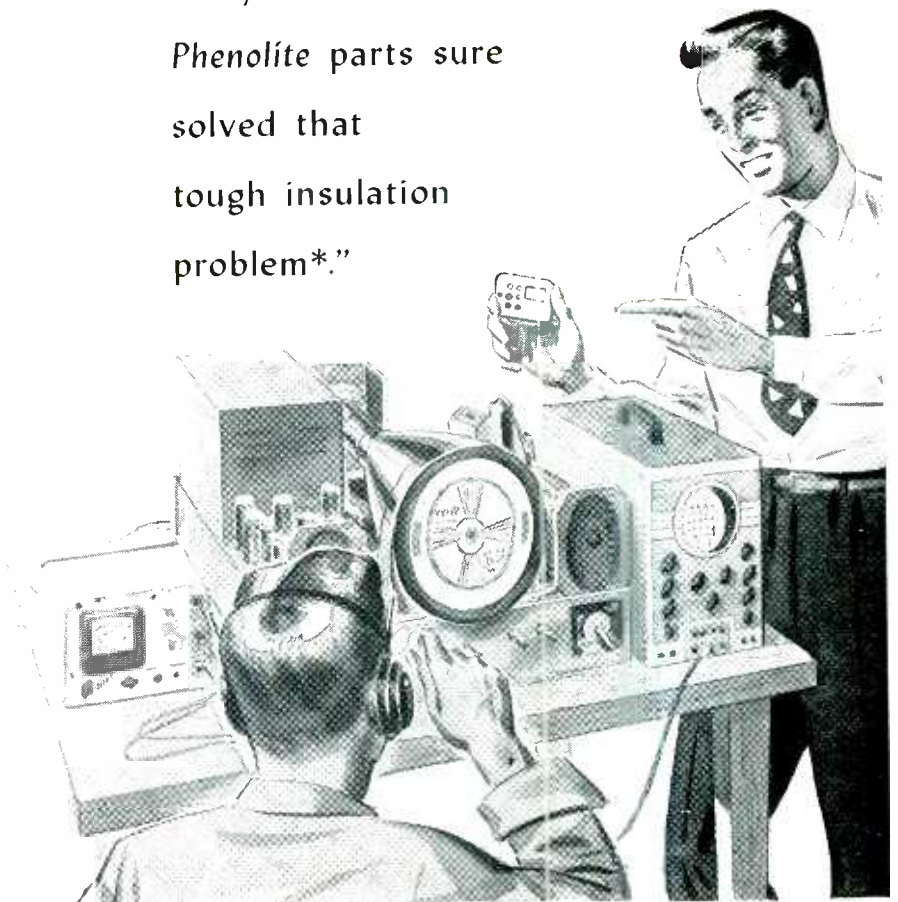

\*Required:

*A material with very high insulation resistance under all atmospheric conditions—with good mechanical strength and ready machinability. Phenolite, laminated plastic, with all these qualities, plus—was the perfect answer.*

In your development of efficient, economical products, it pays to investigate

**PHENOLITE**  
Laminated PLASTIC

About one-half the weight of aluminum, possesses an unusual combination of properties—a good electrical insulator, great mechanical strength, high resistance to moisture; ready machinability. Sheets, Rods, Tubes, Special Shapes.

**NATIONAL  
VULCANIZED  
FIBRE**

A tough, horn-like material with high dielectric and mechanical strength. Excellent machinability and forming qualities, great resistance to wear and abrasion, long life, light weight. Sheets, Rods, Tubes, Special Shapes.

**PEERLESS  
INSULATION**

The first fish paper developed for electrical insulation. Strong, smooth, flexible, with excellent forming qualities. High dielectric strength. Sheets, Rolls, Coils.

*To help you solve your specific development problem—available without obligation—National Research and Engineering Service.*

**NATIONAL VULCANIZED FIBRE CO.**

WILMINGTON

Offices in



DELAWARE

Principal Cities

Since 1873

# NOTICE OF IMPORTANCE TO THE ELECTRICAL INDUSTRY

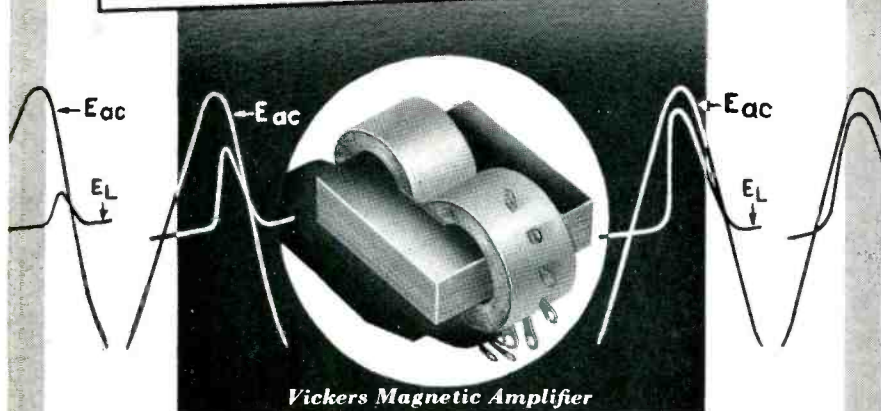

Vickers Magnetic Amplifier

**VICKERS ELECTRIC DIVISION, Vickers Inc.,**  
Announces a complete Research and Development Section  
available for your technical problems in relation to the  
following —

**MAGNETIC AMPLIFIERS  
MAGNETIC AUDIO AMPLIFIERS  
STATIC VOLTAGE REGULATORS  
STATIC MOTOR SPEED CONTROLS  
POWER SATURABLE REACTORS  
RECTIFIERS  
PHOTOELECTRIC CELLS  
SERVOMECHANISMS  
MAGNETIC FLUID CLUTCHES  
SPECIAL MOTORS AND GENERATORS  
TRANSFORMERS • ARC-WELDERS  
CONTROLLED POWER RECTIFIERS FOR  
ELECTRO-CHEMICAL PROCESSES**

*The fundamental schemes employed in many of the above involve  
general use of tubeless amplifier circuits—Magnetic Amplifiers.*

*For information regarding application of the above relative to your  
requirements, you are cordially invited to consult our Engineering  
Department.*

**VICKERS**  **ELECTRIC**  
**DIVISION**

1815 LOCUST ST.

ST. LOUIS 3, MISSOURI

A UNIT OF THE SPERRY CORPORATION

NEW PRODUCTS

(continued)

lic laminate recently announced shows resistance of 2,500 megohms when tested under JAN-P-13 specifications, and 10,000 megohms when tested according to the ASTM method. The new material is suitable for hot punching or stamping.

## Floating Battery Chargers

POWER EQUIPMENT Co., 55 Antoinette St., Detroit 2, Michigan, has announced a new line of electronically controlled and regulated floating battery chargers for power

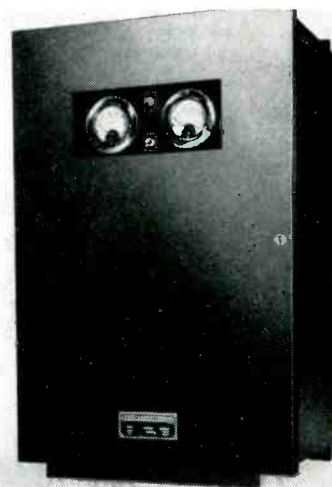

stations, communications and other applications. Electronic overload protection limits current to the preset maximum value and reduces terminal voltage below battery voltage until peak requirement is passed.

## Impedance-Phase Meter

TECHNOLOGY INSTRUMENT CORP., 1058 Main St., Waltham 54, Mass. Type 311-A r-f Z-angle meter was designed primarily to fulfill the requirements of broadcasting for measurements at radio frequencies of antennas, transmission lines, coupling networks, as well as general laboratory measurements. Frequency range is 100 kc to 2 mc with phase angle range from zero to 90. Upper impedance range varies between 500 and 5,000 ohms depending upon frequency.

## Television Converter

CARTER MOTOR Co., 2644 N. Maplewood Ave., Chicago 47, Ill. Model D1010CT television converter is designed to operate 7-in. television

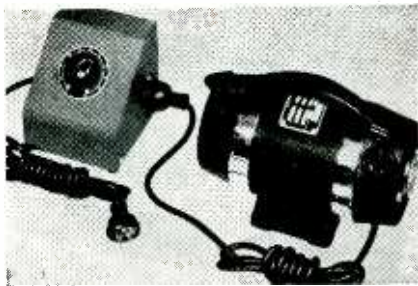

receivers of 125 watts power or less, from 115 volts d-c. The picture control illustrated regulates the converter frequency and eliminates frequency waves and picture flutter. See bulletin 948 for further information.

### High-Voltage Capacitors

AMERICAN CONDENSER Co., 4410 N. Ravenswood Ave., Chicago 40, Ill. New Amoil capacitors rated at 6,000 volts d-c are now available in capacitance values ranging from 0.0005 to 0.05 microfarad. The units are impregnated with a newly developed petroleum oil similar in characteristics to mineral oil.

### Vibrator

P. R. MALLORY & Co., INC., 3050 E. Washington St., Indianapolis 6, Ind., has developed the type 1501 vibrator for use on 6-volt batteries.

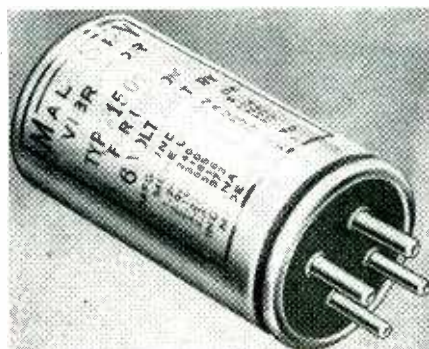

It is applicable to f-m receivers, push-to-talk transmitters, test equipment and special commercial uses.

### Static Eliminator

CANADIAN RADIUM AND URANIUM CORP., 630 Fifth Ave., New York 20, N. Y. The Alphasatron static eliminator utilizes polonium to produce ionization about 1,000 times greater in effect than an equivalent weight of radium. The units act to

# For the MEASUREMENT OF TIME

*We are proud to present a new  
tool to Science and Industry—the*

## AMERICAN HIGH SPEED CHRONOSCOPE

*An Electronic Stop-watch  
combining simplicity with accuracy  
in the region from*

### 10 Microseconds to 1 Second

The American High Speed Chronoscope—Model 100—indicates directly on a five-inch clock dial the length of any time interval which is presented to it in the form of a voltage pulse or a mechanical short or open circuit.

Four ranges—1, 10, 100 and 1000 milliseconds full scale—are provided, and average accuracy is better than one scale division (1%) on any range.

• *Designed for extreme simplicity of operation, the American High Speed Chronoscope is the solution to problems in many fields, including the design, development and production of*

RELAYS, CONTACTORS AND CIRCUIT BREAKERS  
PHOTOGRAPHIC SHUTTERS AND FLASHLAMPS  
HIGH SPEED COMMUNICATION EQUIPMENT  
AUTOMATIC PROCESS MACHINERY  
BUSINESS MACHINES AND CALCULATORS  
RADARS AND ALLIED SYSTEMS

*For further information write, wire or phone for  
Bulletin 100 A*

## AMERICAN CHRONOSCOPE CORPORATION

150 SOUTH MIDDLE NECK ROAD, GREAT NECK, N. Y.

TEL: GREAT NECK 2-7474

# PRECISION POTENTIOMETERS

Toroidal and Sinusoidal

For use in computing and analyzing devices; generation of low frequency saw tooth and sine waves; controls for radio and radar equipment; position indicators; servo-mechanisms; electro medical instruments, measuring devices—telemetering; gun fire control where 360° rotation, high precision and low noise levels are essential.

The type RL14MS sinusoidal potentiometer is illustrated. It is wound to a total resistance of 35,400 ohms and provides two voltages proportional to the sine and cosine of the shaft angle. It will generate a sine wave true within  $\pm 0.6\%$ . Overall dimensions are  $4\frac{3}{8}$ " diameter x  $4\frac{11}{32}$ " long plus shaft extension  $\frac{1}{4}$ " diameter x  $1\frac{1}{4}$ " long.



Write for Bulletin F-68

**THE GAMEWELL COMPANY**

Newton Upper Falls 64, Massachusetts



# A quick reference on 433 PRACTICAL ELECTRONIC CIRCUITS

• with full diagrams and data for each one

WHETHER you want to brush up on the wiring system of a five-hundred-watt ultrasonic generator circuit or need complete information on a circuit for detecting either metallic or non-metallic objects—you'll find all the answers in the pages of this handy manual. It contains all types of circuits—from counting to welding control, both simple and advanced. It brings you hundreds of industrial circuits developed during the war when research and practical improvements hit an all-time high.

Just Published

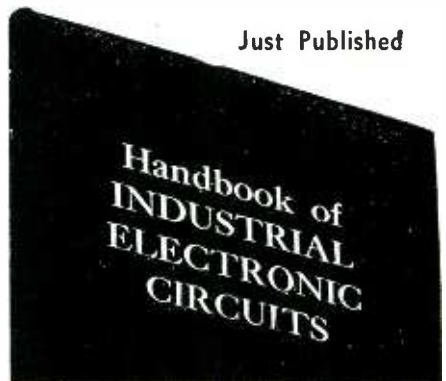

By John Markus and Vin Zeluff

Associate Editors of 'Electronics'

272 pages, 433 diagrams, \$6.50

Here's a ready source of information about the circuits you need for any industrial electronic application. For every circuit, you find a clearly-drawn diagram along with a brief yet comprehensive discussion of . . . how it works . . . performance characteristics . . . everyday practical applications, etc. With this data as a starting point you can easily convert the theoretical circuit to actual practice.

Covers all types of circuits—

- audio frequency
- capacitance control
- cathode-ray
- control
- counting
- direct-current amplifier
- electronic switching
- limiter
- multivibrator
- oscillator
- photoelectric
- power supply
- troboscopic
- telemeter
- temperature control
- timing
- measuring
- metal-locating
- motor control
- ultrasonic
- voltage regulator
- welding control

----- MAIL COUPON TODAY -----

McGraw-Hill Book Co., Inc.  
330 West 42nd St., N. Y. C. 18, N. Y.  
Please send me Markus and Zeluff's **HANDBOOK OF INDUSTRIAL ELECTRONIC CIRCUITS** for 10 days' examination on approval. In 10 days I will remit \$6.50, plus a few cents postage, or return the book postpaid.\*

Name .....

Address .....

City ..... Zone ..... State .....

Company .....

Position ..... 1-3-49

\*We pay mailing costs if you send cash with this coupon. Same return privilege.

# SOLDER PRE-FORMS

**SPEED ASSEMBLY**

**STANDARDIZE**

**SAVE MONEY**

Step up production—bring costs in your shop down—with solder pre-forms. Pre-formed rings, washers, pellets, discs, etc., made to your order, insure better bonds, lower costs, and faster assembly. We can supply you with custom-made pre-forms of any shape required, in a wide variety of solders, copper and brazing alloys.

Write for complete information.

**Soldering Specialties**

Dept. C, Summit, N. J.



eliminate fire and explosion hazards by dissipating static charges caused by friction of belts against pulleys and from similar sources.

**Radio Timer**

INTERNATIONAL REGISTER CO., 2614 W. Washington Blvd., Chicago 12, Ill. The RC-1021 radio clock timer

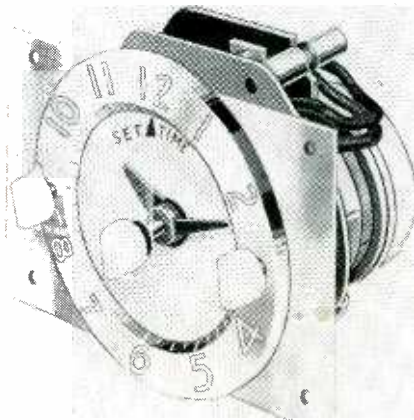

can be set to turn a radio on or off at any time.

**Triple Amplifier**

SCHUTTIG AND Co., Ninth and Kearny Sts., N. E., Washington 17, D. C. Type S183 triple power amplifier comprises three identical amplifier units operating from a

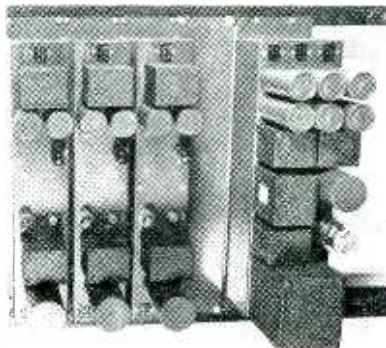

common power supply. Each unit provides a maximum output of 2 watts and a gain of 60 db. The response is essentially flat over the range 100 to 4,000 cycles.

**Tube Guard**

STAVER MFG. Co., 254 Atlantic Ave., Brooklyn 2, N. Y. The Mini-Spring tube guard consists of a hard steel, cadmium-plated post and an alloy coated, hard drawn steel wire

**New Headset from TELEX . . .**

**NO PRESSURE ON THE EARS**

Here's a really new headset: TELEX TWINSET! Sweaty, tiresome "ear-cups" are gone forever! Signal may be piped directly into the ear so that *nothing touches the ear* at all! Matched in-phase magnetic receivers banish listening fatigue—listen for hours in complete comfort with this high-fidelity, 1.6 ounce headset.

An all purpose headset, the unique TELEX TWINSET, is designed for your hearing comfort and exacting headset demands. Obtainable from your favorite parts jobber, or, write Dept. 10, Telex Inc., Telex Park, Minneapolis, Minnesota.

**SPECIFICATIONS:**

**Sensitivity**—101 decibels above .000204 dynes per sq. cm. for 10 microwatts input  
**Impedances**—1000 ohms and 64 ohms  
**Construction**—Weight: 1.6 oz.

Tenite plastic and bright nickel construction, with headband of 17-Nickel steel wire encased in plastic. Single 5-foot cord plugs into either receiver. Sealed, rust-proof diaphragms.

*Special Cord with built in miniature Volume Control also available*

**NEW TELEX TWINSET**

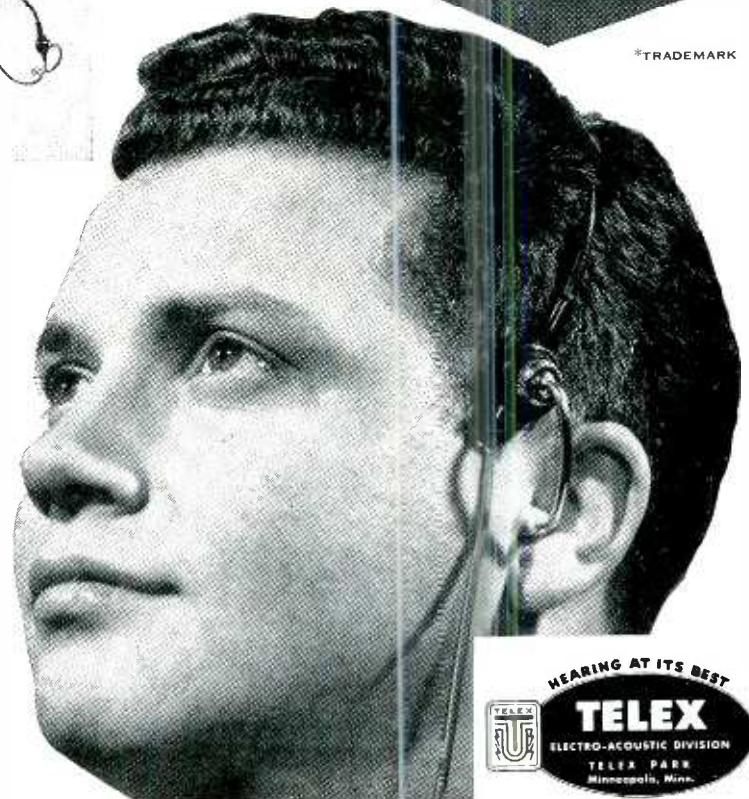

\*TRADEMARK



**TELEX, Telex Park, Minneapolis, Minnesota**

Manufacturers of Telex Monoset\* • Telex Pillow Speaker • Telex Precision Hearing Aids

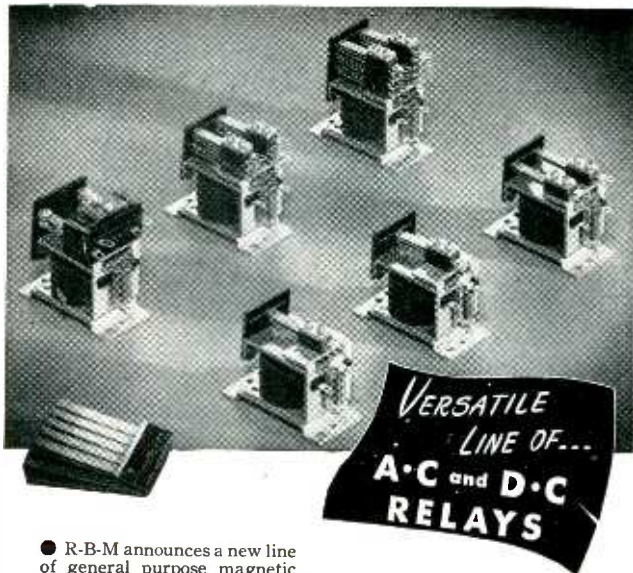

● R-B-M announces a new line of general purpose magnetic relays with either A.C. or D.C. shunt coils or series coils for electronic applications.

Relays are available in standard contact arrangement of single and two pole normally open, normally closed; or double throw with light and heavy contacts. Four and six pole double throw relays are available with 3 ampere contacts at 32 volts or less.

For further information write for Bulletin 570, R-B-M DIVISION, Essex Wire Corporation, Logansport, Ind. Address Dept. D-3.



MANUAL AND MAGNETIC ELECTRIC CONTROLS  
— FOR AUTOMOTIVE, INDUSTRIAL, COMMUNICATION AND ELECTRONIC USE

# a + value for industry

Development and Production of

## SPECIAL PURPOSE VACUUM TUBES BY ECLIPSE-PIONEER



TT-1 3000 mc Temperature Limited Noise Diode Tube.

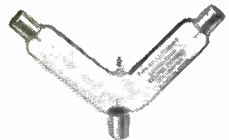

Y-Type Position Convectron—Vertical Sensing Tube.



Chronotron Thermal Time Delay Tube.

We're not in the standard vacuum tube business. But we are definitely in the business of developing and manufacturing special purpose vacuum tubes—tubes that are not generally available. During the past three years, for example, our facilities have produced, such devices as the Chronotron thermal time delay tube, the Convectron\* vertical sensing tube, the TT-1 3000 mc temperature limited noise diode tube, counter tubes, glass enclosed spark gaps, and phono pickup tubes. Quantities of all these are now serving many phases of industry in a wide variety of applications. We invite your use of our facilities to develop and produce your requirements of special purpose vacuum tubes. Your inquiries concerning the scope of our facilities or details of any of our tubes will be given immediate attention.

\*REG. U. S. PAT. OFF.

Eclipse-Pioneer Division of  
TETERBORO, NEW JERSEY



Export Sales—Bendix International Division, 32 Fifth Avenue, New York 11, N. Y.

# If you need Radio Parts...

in quantities

suitable to Volume

Production...it may

pay you to call upon

the Design

Engineers of

United-Carr and its

subsidiaries. They

have helped many

manufacturers

★ CUT COSTS

★ SPEED PRODUCTION

★ TURN OUT FINER  
FINISHED PRODUCTS

**UNITED-CARR  
FASTENER Corp.**

CAMBRIDGE 42, MASSACHUSETTS

MAKERS OF DOT FASTENERS



spring. It is designed for easy mounting and quick installation or removal of a tube in electronic equipment.

### High-Voltage Tester

INDUSTRIAL DEVICES, INC., Edgewater, N. J. Hi-Volt model 500 covers a range from 1,600 to 15,000 volts a-c. The device is intended for testing high-voltage trans-



formers such as used for oil-burner ignition and television. Featured in the unit are a 15-megohm multiplier incorporated in the 7-inch prod and a neon indicator.

### VOM

THE TRIPLETT ELECTRICAL INSTRUMENT Co., Bluffton, Ohio. Model 630 volt-ohm-mil-ammeter features six



## Laboratory and Research Instruments

ENGINEERED FOR ENGINEERS

### OSCILLOSYNCHROSCOPE Model OL-15B

Designed for maximum usefulness in laboratories doing a variety of research work, this instrument is suited to radar, television, communication, facsimile, and applications involving extremely shortly pulses or transients. It provides a variety of time bases, triggers, phasing and delay circuits, and extended-range amplifiers in combination with all standard oscilloscope functions.



#### THESE FEATURES ARE IMPORTANT TO YOU

- Extended-range amplifiers: vertical, flat within 3 db 5 cycles to 6 megacycles; horizontal, flat within 1 db 5 cycles to 1 megacycle.
- High sensitivity: vertical, 0.05 RMS volts per inch; horizontal 0.1 RMS volts per inch.
- Single-sweep triggered time base permits observation of transients or irregularly recurring phenomena.
- Variable delay circuit usable with external or internal trigger or separate from scope.
- Sawtooth sweep range covers 5 cycles to 500 kilocycles per second.
- 4,000-g acceleration gives superior intensity and definition.

For complete data, request Bulletin MO-93

### SWEEP CALIBRATOR



Model GL-22

This versatile source of timing markers provides these requisites for accurate time and frequency measurements with an oscilloscope:

- Positive and negative markers at 0.1, 0.5, 1.0, 10, and 100 microseconds.
  - Marker amplitude variable to 50 volts.
  - Gate having variable width and amplitude for blanking or timing.
  - Trigger generator with positive and negative outputs.
- Further details are given in Bulletin MC-93.

### SQUARE-WAVE MODULATOR AND POWER SUPPLY



Model TVN-7

Here is the heart of a super high frequency signal generator with square-wave, FM, or pulse modulation. Provides or grid pulse modulation to 60 volts, reflector pulse modulation to 100 volts, square-wave modulation from 600 to 2,500 cycles. Voltage-regulated power supply continuously variable 280-480 or 180-300 volts dc. For additional data and application notes, see Bulletin MM-93.

### STANDING WAVE RATIO METER AND HIGH GAIN AUDIO AMPLIFIER

Model TAA-16



Write for Bulletin MA-93 containing full details of this useful instrument.

- Standing wave voltage ratios are read directly on the panel meter of this sensitive, accurate measuring instrument.
- Frequency range 500 to 5,000 cycles per second.
- Two input channels with separate gain control for each.
- "Wide-band" sensitivity 15 microvolts full scale.
- "Selective" sensitivity 10 microvolts full scale.
- Bolometer/crystal switch adjusts input circuit to signal source.

In Canada, address Measurement Engineering Ltd., Arnprior, Ontario.



# PRECISION Transformers

**FOR TODAY'S  
MORE EXACTING  
REQUIREMENTS**

**POWER -- AUDIO  
CHOKES -- FILTERS**



ENCLOSED CASE, compound filled, for high moisture resistance. Standard cases up to 500 VA. Wide range of standard audio transformer units.

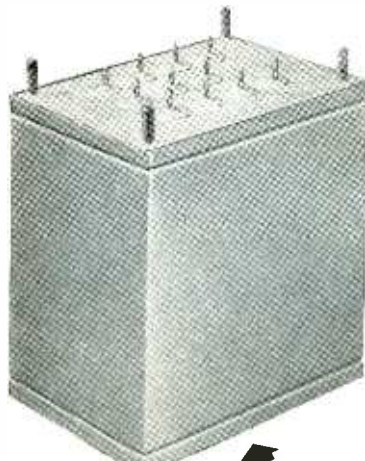

HERMETICALLY SEALED and compound filled cases. Glass or ceramic sealed terminals. Designed to meet JAN salt water immersion tests.

For Television and all other applications where specifications are precise and the emphasis is on quality and performance, famous FERRANTI transformers offer superior value.

Into each unit goes long years of specialized experience, plus up-to-the-minute knowledge of today's improved practices and latest materials. Our large and varied stock of patterns, tools, and dies often permits us to supply "custom" requirements from standard parts, effecting worthwhile savings. We invite your inquiries.

# FERRANTI

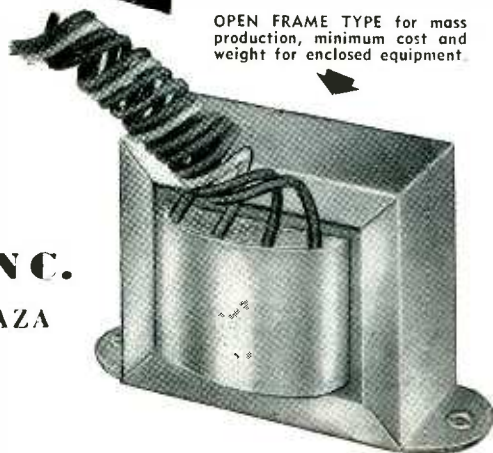

OPEN FRAME TYPE for mass production, minimum cost and weight for enclosed equipment.

**FERRANTI  
ELECTRIC, INC.**  
30 ROCKEFELLER PLAZA  
New York 20, N.Y.

NEW PRODUCTS

(continued)

d-c voltage ranges for testing television and other high-resistance d-c and a-c circuits; six a-c ranges for audio and other high-impedance a-c circuits; precision resistors, and complete insulation.

## Anti-Feedback Amplifier

DAVID BOGEN Co., INC., 663 Broadway, New York, N. Y. The HX50, a new 50-watt amplifier, incorporates anti-feedback control. A tone



corrector gives bass control from -20 to +20 db at 60 cycles, and treble control of +20 to -20 db at 10,000 cycles. The unit uses a push-pull 807 output stage.

## Crystal Selector

E. F. JOHNSON Co., Waseca, Minn. The instant crystal selector provides 10 crystal sockets and an 11-position switch so that the unit

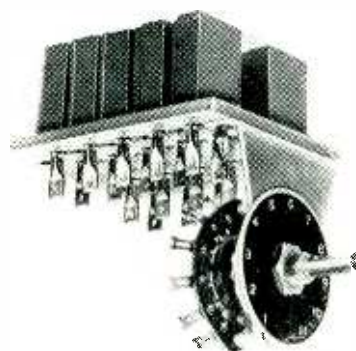

provides selection of the crystal group and some other channel such as a variable frequency oscillator. The holder accommodates crystals with half-inch spacing.

## Wire Markers

WESTERN LITHOGRAPH Co., 600 E. Second St., Los Angeles, Calif. E-Z code wire markers are short narrow strips mounted on a card. When pulled off and wrapped around a wire, adhesive causes the



# GERMANIUM DIODES

**Welded Contact  
Self-Healing  
Molded Plastic Case**



**G**ENERAL ELECTRIC Germanium Diodes have 3 distinct advantages that are immediately apparent.

- 1. WELDED CONTACT.** Electrical stability is improved through the welding of the platinum whisker point to the germanium pellet. This rigid construction also enables G-E diodes to withstand reasonably severe shock or vibration and makes them practically immune to microphonic effects.
- 2. SELF-HEALING.** G-E diodes return to normal quickly after sudden applications of excessive voltage when not accompanied by excessive current.
- 3. MOLDED PLASTIC CASE.** The non-conducting case simplifies mounting problems and permits greater flexibility of application.

General Electric is prepared to supply high back resistance and high peak inverse voltage units in production quantities.

For complete information on G-E Germanium Diodes write today to: *General Electric Company, Electronics Park, Syracuse, New York.*

*You can put your confidence in—*

**GENERAL  ELECTRIC**

# Linde Announces

## Synthetic Calcium Tungstate Crystals for Radioactivity Counters

We are pleased to announce the availability in research quantities, of clear, single crystals of synthetic calcium tungstate which fluoresce when exposed to radioactive radiations, cathode rays, and X-rays.

This fluorescence can be detected and amplified sufficiently by a photo-multiplier tube to count individual pulses. Good optical transmission, and rapid decay time qualify this material for use in this application. In addition, these crystals are unaffected by atmospheric exposure.

Synthetic calcium tungstate crystals are currently available in rods  $\frac{1}{8}$  inch in square section, up to 2 inches in length; other forms are under development. Windows and small parts can readily be fabricated from the rod.

For further information, please write to the New Products Division.

### THE LINDE AIR PRODUCTS COMPANY

*Unit of Union Carbide and Carbon Corporation*  
30 East 42nd Street  New York 17, N. Y.



### Low loss insulators for all frequencies in standard stock shapes or special designs

General Ceramics low loss insulators function efficiently in all frequency ranges and are capable of withstanding most all conditions of shock or vibration. Specification of standard shapes offers an opportunity to effect production economies. For unusual designs or mechanical specifications consult General Ceramics engineers. Estimates without obligation.

## General CERAMICS and STEATITE CORP.

GENERAL OFFICES and PLANT: 21 CROW'S MILL ROAD, KEASBEY, N. J.

MAKERS OF STEATITE, TITANATES, ZIRCON PORCELAIN, ALUMINA, LIGHT DUTY REFRACTORIES, CHEMICAL STONWARE, IMPERVIOUS GRAPHITE, FERRITES, COAXIAL CABLE

thousands to one

IN *Your* FAVOR

If your needs call for special, high-precision instrument-type motors and generators, designed to your own requirements, the odds are thousands to one in your favor when you call on Elinco. You can have our engineers design a unit to your exact requirements . . . or there are

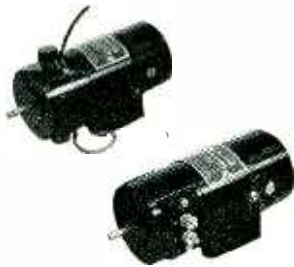

over 400 basic Elinco models, each one a precision instrument. With the ability to adapt any of these to meet an almost limitless variety of specifications, electrically and physically, there are literally thousands upon thousands of possibilities to fill your needs, regardless of how exacting they may be.

OVER  
**400**  
BASIC  
MODELS

Elinco does not manufacture, or carry in stock, low-cost mass-production motors. Every order is special, engineered and produced to the customer's own exact specifications. We produce only special, high-precision instruments demanding the highest engineering ability, and manufactured with the skill and care that the name Elinco has meant for years.

**ELECTRIC INDICATOR CO.**  
PARKER AVE. STAMFORD, CONN.

NEW PRODUCTS

(continued)



marker to stick. The designations are waterproof and will not fade. Preprinted in numbers, letters, and standard codes, they can also be furnished to specifications.

### Test and Display Rack

RADIO CORP. OF AMERICA, Harrison, N. J. Rack WS-16A was designed to serve as a cabinet for six matched units of test and measuring equipment and as a service rack

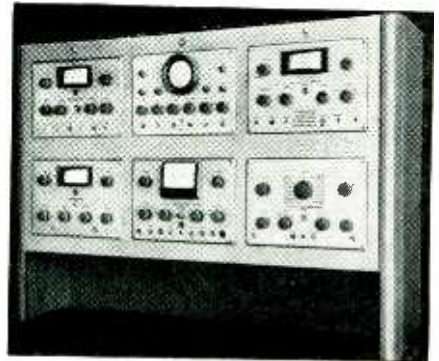

for quick servicing of a-m, f-m and television receivers in shops, laboratories and schools. Intended for mounting on top of a workbench, the rack's lower shelf is eight inches above the bench top. Measurements are 4 x 3 x 1 ft.

### Precision Switch

UNIMAX SWITCH DIVISION OF THE W. L. MAXSON CORP., 460 W. 34th St., New York 1, N. Y. Model KMX metal-cased precision switch has a die-cast gasketed aluminum housing protecting it against

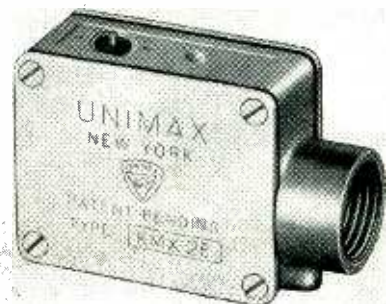

# ELECTRICAL INSTRUMENTS

for Laboratory & Plant



## WHEATSTONE & KELVIN BRIDGES

Eighteen models covering laboratory, plant and field applications. Ranges from 0.00001 ohm to 100 megohms. High accuracy. Exceptionally sturdy construction. Bulletin 100.

## GALVANOMETERS

Fifty-one models in a wide range of sensitivities for nearly every application. Spotlight Galvanometers with sensitivities up to 0.0006  $\mu$ A per mm. Widely used in laboratory and production line testing, for deflection as well as null measurements. Bulletin 320.

## PRECISION POTENTIOMETERS

Twenty-seven laboratory and portable models for precise voltage measurement. Widely used as laboratory standards in meter calibration and for thermocouple measurements. Bulletin 270.

## COIL TESTERS

For rapid low-cost production testing of shorts and opens in coil windings of nearly every shape and size. Bulletin 109.

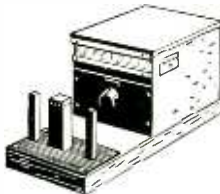

## LIMIT BRIDGES

For rapid low-cost production testing of resistors from 1 ohm up to 10 megohms. Bulletin 100.

## DECADE RESISTANCE BOXES

Thirty-five models covering the range from 0 to 100,000 ohms. Decade Resistors with increments down to 0.01 ohm available. Exceptionally sturdy construction assures long-term accuracy. Bulletin 100.



## STANDARD RESISTORS

Reichsanstalt and National Bureau of Standards types from 0.001 ohm up to 10,000 ohms, limit of error 0.02% and 0.01%. Standard shunts from 0.00002 ohm to one ohm, limit of error 0.04%. Bulletin 100.

## SPECIAL INSTRUMENTS

In addition to the partial listing of instruments above, the Rubicon Company produces a wide variety of special equipment involving in one way or another the precise measurement or control of some electrical quantity. Inquiries for equipment to meet special needs are invited.

# RUBICON COMPANY

Electrical Instrument Makers  
3757 Ridge Avenue • Philadelphia 32, Pa.

# S.S. White MOLDED RESISTORS

The All-Weather Resistors

Of particular interest to all who need resistors with inherent low noise level and good stability in all climates



Actual Size

## HIGH VALUE RANGE

10 to 10,000,000 MEGOHMS

This unusual range of high value resistors was developed to meet the needs of scientific and industrial control, measuring and laboratory equipment—and of high voltage applications.

SEND FOR BULLETIN 4505



It gives details of both the Standard and High Value resistors including construction, characteristics, dimensions, etc. Copy with Price List mailed on request.

## STANDARD RANGE

1000 OHMS TO 9 MEGOHMS

Used extensively in commercial equipment including radio, telephone, telegraph, sound pictures, television, etc. Also in a variety of U. S. Navy equipment.

# S.S. WHITE INDUSTRIAL DIVISION

THE S. S. WHITE DENTAL MFG. CO. DEPT. R. 10 EAST 40th ST., NEW YORK 16, N. Y.



FLEXIBLE SHAFTS AND ACCESSORIES  
MOLDED PLASTICS PRODUCTS—MOLDED RESISTORS

One of America's AAA Industrial Enterprises

## HEAT RESISTANT WIRES FOR EVERY APPLICATION . . .

### COAST TO COAST

Our Representatives are eager to help you solve your heat resisting wire problems. Be sure to call them if you need any of these products →

- |                            |  |
|----------------------------|--|
| California—                | Mr. John B. Tubergen<br>1406 South Grand Avenue<br>Los Angeles           |
| Illinois—                  | Mr. Gerald G. Ryan<br>549 West Washington Blvd.<br>Chicago               |
| Ohio—                      | Mr. H. Q. Gamble<br>1836 Euclid Avenue<br>Cleveland                      |
| Pennsylvania—              | Mr. John F. Orsi<br>1123 Real Estate Trust Bldg.<br>Philadelphia         |
| New York City & New Jersey | Mr. James L. Fitzsimmons<br>34 Bellevue Avenue<br>Belleville, New Jersey |

- HEATING UNITS
- HEATING ELEMENTS
- RESISTANCE LINE CORD
- THERMOCOUPLE WIRE
- ASBESTOS LEAD & FIXTURE WIRE
- INSULATED RESISTANCE WIRE
- FIBERGLAS INSULATED WIRE
- WIRE TO ANY SPECIFICATIONS



## THE LEWIS ENGINEERING CO.

Wire Division  
NAUGATUCK CONNECTICUT



## Present 3 clean-cut Advantages

1. EXTREME UNIFORMITY
2. SUPERIOR STAKING QUALITIES  
... ends will roll without splitting.
3. BETTER FOR MOLDED PARTS  
.. closed end keeps compound out.

If you use pins for vacuum tubes, adapters, fluorescent lamps, plugs, or electrical equipment of any kind, the chances are you'll save time, money and rejections by using these super-smooth, *seamless*, patented Radio Pins. They are available in a wide variety of styles and sizes, with staking end either closed or open. For a quotation, simply send a sketch, sample or description and state the quantity you need.

## Radio or Radar Equipment?

In addition to Radio Pins, we produce large quantities of top caps, base shells and adapter shells for vacuum tubes; also a wide variety of other metal products including deep drawn shells and cups, blanks and stampings, ferrules, grommets, washers, vents, fasteners—and, for almost every manufacturing requirement, the world's largest assortment of eyelets. 47426



## THE AMERICAN BRASS COMPANY

### Waterbury Brass Goods Branch

General Offices: Waterbury 88, Connecticut

Subsidiary of Anaconda Copper Mining Company

In Canada: ANACONDA AMERICAN BRASS LTD., New Toronto, Ont.

## NEW PRODUCTS

(continued)

splashing oil, moisture and abrasive. Bulletin KMX-26 containing full details is available.

## Marine Radiophone

APPLIED ELECTRONICS Co., 1246 Folsom St., San Francisco 3, Calif. Model 23 marine radiotelephone in-



corporates a 4-channel crystal-controlled transmitter and broadcast receiver, together with a 2 to 3-mc receiver.

## Multimeter

ROLLER-SMITH, Bethlehem, Pa. Model 500 volt-ohm-milliammeter measures to 7,500 volts a-c or d-c at 20,000 ohms per volt. Measure-

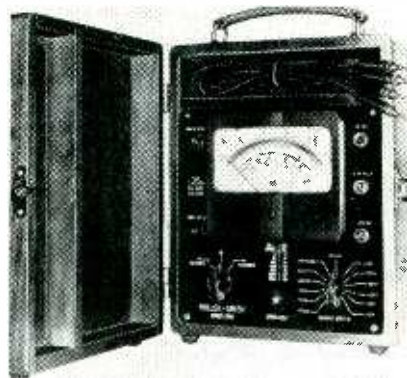

ments as low as 10  $\mu$ amp, 0.2 volt, and 1 ohm are easily read. Catalog 4423 describes the meter in detail.

## Television Connectors

MINES EQUIPMENT Co., 4215 Clayton Ave., St. Louis 10, Mo. The new push-latch connector illustrated was originally developed for

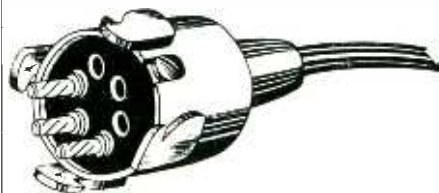



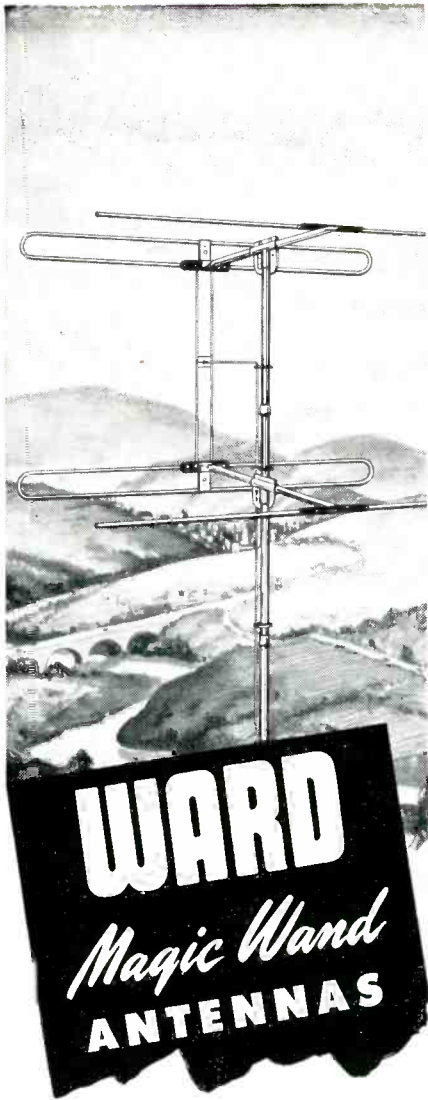

**THE ONLY BROAD BANDED,  
HIGH GAIN, STACKED ARRAY  
ON THE MARKET**

Many times more sensitive for TV reception in fringe areas and poor signal locations, the WARD TVS-6 STACKED ARRAY achieves maximum forward gain by stacking two high gain folded dipoles and reflectors with effective  $\frac{1}{2}$  wave spacing rather than the ordinary  $\frac{1}{8}$  or  $\frac{1}{4}$  wave which materially reduces sensitivity. THE ONLY STACKED ARRAY ON THE MARKET THAT IS BROAD BANDED, it will give excellent results with MANY CHANNELS where others are too selective. The advanced engineering and PRE-ASSEMBLED design of the WARD TVS-6 is only one of the reasons why WARD is the largest exclusive manufacturer of antennas in the world. See any leading parts distributor or write for catalog.

**THE WARD PRODUCTS CORPORATION**  
1523 E. 45TH STREET, CLEVELAND 3, OHIO.

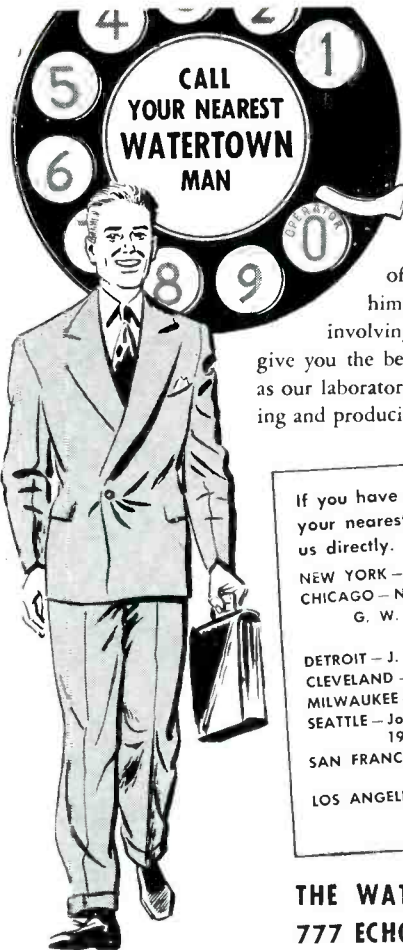

**... to quote or counsel  
on molded plastics**

Your Watertown man is an expert in plastics, backed by 34 years of experience with every type of plastic, every type of molding method. Calling him in to quote or consult on any part, product or idea involving molded plastic won't cost you a cent . . . will give you the benefit of our design and engineering skill, as well as our laboratory — second to none in the industry — in developing and producing the job to your satisfaction and your customers'.

If you have a custom molded plastics job on the fire, phone your nearest Watertown man today . . . or phone or write us directly. Here are the Watertown men . . .

NEW YORK — H. A. Rankow, 175 Fifth Ave.  
CHICAGO — National Insulations Company, 2808 W. Lake St.  
G. W. Glaescher      P. Greener      R. C. Farquhar  
J. P. Bonamy      J. R. Kallaheer  
DETROIT — J. P. Greener from Chicago  
CLEVELAND — Carl F. Linn, 866 Hanna Bldg.  
MILWAUKEE — Roger L. Miller, 729 N. Broadway  
SEATTLE — John W. Witherow, National Vulcanized Fibre Co.  
1927 First Ave., South  
SAN FRANCISCO — G. W. Harmssen, National Vulcanized Fibre Co.  
273 Seventh Ave.  
LOS ANGELES — Fred M. Foley, National Vulcanized Fibre Co.  
2325 East Eighth St.

**THE WATERTOWN MANUFACTURING CO.**  
777 ECHO LAKE RD., WATERTOWN, CONN.



**Cetron**



**THYRATRONS** are the  
**IMPULSE** of American Industry

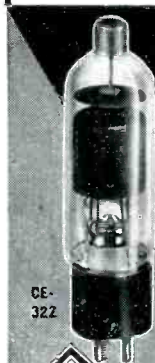

CE-322

QUICKER STARTING

GREATER RUGGEDNESS

DESIGN ENGINEERS will want precision-made Cetron Mercury Vapor and Gas-filled Grid Control Rectifiers for

MOTOR CONTROLS      WELDING CONTROLS  
CONTROLLED D.C. SUPPLIES

Continental's longer experience in developing and perfecting steady-duty, inexpensive Rectifiers means greater dependability and higher efficiency.

ASK FOR CE-320 (2.5 Amp.) or CE-322 (6.5 Amp.) Rectifiers

(We also make a fine series of engineer-perfected, high quality Phototubes)

FOR LONGER LIFE

LABORATORY TESTED

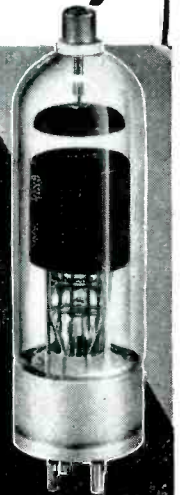

CE-320



**CONTINENTAL ELECTRIC CO.**  
GENEVA, ILLINOIS

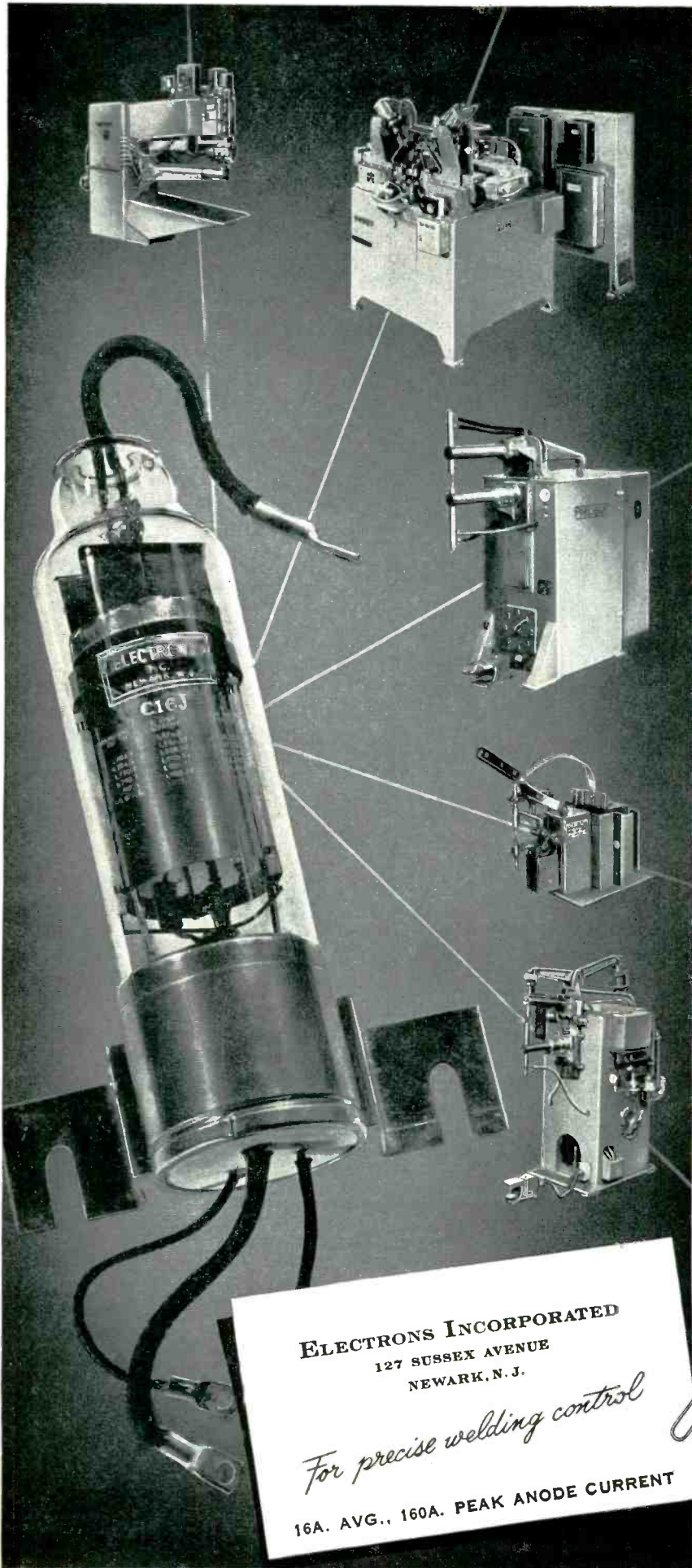

**ELECTRONS INCORPORATED**  
 127 SUSSEX AVENUE  
 NEWARK, N. J.

*For precise welding control*

16A. AVG., 160A. PEAK ANODE CURRENT

signal and communications circuits but is also adaptable to a-m, f-m, and television applications as well as for service in public address connections.

**F-S Exciter**

ERCO RADIO LABORATORIES, INC., Garden City, N. Y. Type 250-T frequency shift exciter has been designed to replace the existing crystal or master oscillator in any transmitter in order to key the transmitter by the f-s method. A front-panel switch permits selection of three crystal-controlled operating frequencies each preset to individual carrier frequency and mark-space shift requirements.

**Cowling Fastener**

DZUS FASTENER CO., INC., Babylon, N. Y. The new cowling fastener illustrated has been designed to

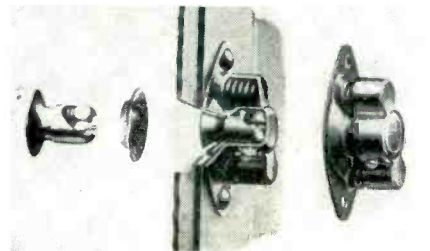

meet demands of modern high-speed aviation as embodied in specification AN-F-8b.

**Literature**

**Insulation Resistance Testers.** James G. Biddle Co., 1316 Arch St., Philadelphia 7, Pa. Bulletin 21-20-14 deals with the "Megger" heavy-duty type insulation resistance testers. Hand-driven, motor-driven and multivoltage instruments, their features, ranges and applications are described in detail.

**Densitometer.** Western Electric Co., Inc., 120 Broadway, New York 5, N. Y. The RA-1100B integrating sphere densitometer useful in all photographic fields, particularly in measurements of sound track density is described and illustrated in a new 6-page brochure. Specifications given include power

# KNOW THE TRUE FACTS OF OPERATION AT HIGH FREQUENCY with CW-AM-FM-TV TRANSMITTERS

Use

## TERMALINE COAXIAL LOAD RESISTORS

Frequency Range... Zero (d-c) to 4000 mc  
Power Range..... To 2000 Watts  
Impedance..... 51.5 OHMS



### MODEL 81

Power Rating..... 50 W  
V.S.W.R..... Less than 1.15 to 4000mc

### MODEL 81B

Power Rating..... 80 W  
V.S.W.R..... Less than 1.15 to 4000mc

### MODEL 82

Power Rating..... 500 W  
V.S.W.R..... Less than 1.2 to 2700mc

### MODEL 82C (water-cooled)

Power Rating..... 2000 W  
V.S.W.R..... Less than 1.2 to 2700mc

**BIRD  
ELECTRONIC  
CORPORATION**  
1800 E. 38<sup>th</sup> ST., CLEVELAND 14, OHIO  
Represented on the West Coast by:  
**NEELY ENTERPRISES**  
7422 Melrose Blvd., Hollywood 46, Calif.  
Instrumentation for Coaxial Transmission

Booth **X**... I. R. E. Show

Transcription

Sound Effects

Lp

Broadcasting Equipment

**THE GRAY RESEARCH & DEVELOPMENT COMPANY, Inc.**  
16 ARBOR STREET • HARTFORD, CONN.

*How*

**PARKWOOD  
LAMINATED TUBING**  
*improves*  
**TRANSFORMER-CORE**  
*quality*



1. Higher Dielectric Strength
2. Greater Structural Strength
3. Lower Overall Production Costs
4. Fewer Rejects (Core won't collapse after winding)
5. Shape and Size Tolerances the Same After Winding.
6. Better Quality because Parkwood Tubing is made of a combination of phenolic impregnated paper and mahogany veneer.

Write — TODAY — for complete details and prices

**PARKWOOD CORPORATION**  
WAKEFIELD, MASSACHUSETTS

AVAILABLE IN  
THESE DIMENSIONS

**SQUARE**  
1/4" x 1/4" minimum inside dimension.  
2" x 2" maximum inside dimension.

**RECTANGULAR**  
3/16" x 3/16" minimum inside dimension.  
1 1/2" x 1 1/2" maximum inside dimension.

**WALL THICKNESS**  
.020" through .060" ± .005" tolerance.

supply, dimensions, weight and finish.

**Miniature Tube Characteristics.** Raytheon Mfg. Co., 55 Chapel St., Newton 58, Mass., announces publication of a tube characteristic chart listing over 70 miniature receiving types. The 4-page folder gives all pertinent characteristics, applications, terminal connection diagrams and outline drawings.

**Antennas and Accessories.** L. S. Brach Mfg. Corp., 200 Central Ave., Newark, N. J., has issued loose-leaf catalog No. 1304 giving details of its tele and f-m antennas, antenna accessories, police, fire alarm and telephone accessories, and other items such as the Test-O-Lite for checking electrical circuits.

**Precision Potentiometer.** Technology Instrument Corp., 1058 Main St., Waltham 54, Mass., recently released a bulletin describing the type RV2 precision potentiometer. Illustrations, specifications and prices are included.

**Electronic Instruments.** Furzehill Laboratories Ltd., Boreham Wood, Herts, England. A new brochure devotes 28 pages to a description and illustration of various types of c-r oscilloscopes, voltmeters, power supply units and other electronic instruments.

**Socket and Mounting Notes.** Raytheon Mfg. Co., Inc., 60 E. 42 St., New York 17, N. Y. An 8-page booklet gives information about subminiature tube sockets and explains other methods of connecting to the tube, shielding it and potting it in plastic.

**Tape Recorders.** Amplifier Corp. of America, 396 Broadway, New York 13, N. Y. Compiled from an analysis of over 5,000 letters, this booklet lists everyday questions and answers on the performance, construction, specifications and availability of Twin-Trax dual-channel magnetic tape recorders.

**Broadcast Equipment.** RCA Victor Division, Camden, N. J. Those requesting on broadcast station letterhead may obtain three new brochures. Form 2J-4367 on the a-m broadcast transmitter; Form 2J-4604 on the broadcast two-

## RCA WO-27A D.C. OSCILLOSCOPE

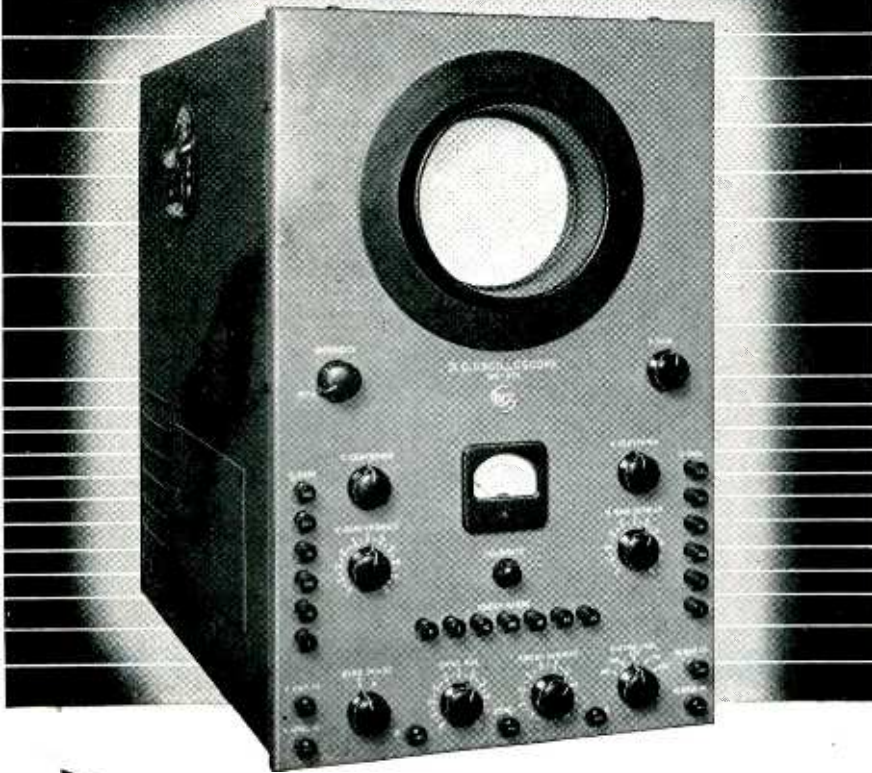

# Unusual Versatility...

## Frequency range—zero cycles to 100 kc.

Specifically designed for the accurate analysis of extremely low-frequency phenomena in mechanical, hydraulic, pneumatic, electrical, and electronic systems, the RCA WO-27A D.C. Oscilloscope has a wide range of applications in the laboratory and industrial plant.

It features triggered sweep and blanking circuits that permit the observation and photographic recording of one-time, high-speed transients. This oscilloscope also shows a.c. and d.c. simultaneously, providing more information than can be obtained from a simple stroboscope. The 5-inch C-R tube can be readily interchanged from the front with a tube of other persistence characteristics.

Ask your local RCA Test and Measur-

ing Equipment Distributor for further details, or write RCA, Commercial Engineering, Section 42CY, Harrison, N. J.

### SPECIFICATIONS

Frequency Range:		
Vert. and Horiz. Amplifiers..	0 cycles to 100 kc.	
Timing Axis Oscillator.....	1 cycle to 30 kc.	
Blanking Amplifier.....	30 cycles to 100 kc.	
Deflection Sensitivity (Volts per inch)		
	D.C. or	RMS
	Peak-to-Peak	Sine Wave
Vertical Amplifier.....	0.084	0.030
Horiz. Amplifier.....	0.105	0.037
(Direct to Deflection Plates)		
Vertical.....	54	19
Horizontal.....	67.5	24
Power Supply.....	105/125 volts, 50/60 cycles	
Power Consumption.....	130 watts	
Dimensions.....	w. 13"; h. 20"; d. 25"	
Weight.....	80 lbs.	

Available from your RCA Test and Measuring Equipment Distributor.



**RADIO CORPORATION of AMERICA**  
TEST AND MEASURING EQUIPMENT

HARRISON, N. J.



Have you tried

**SANGAMO**

*Electrolytic*  
**CAPACITORS?**

**Better for Every Application**

Sangamo electrolytics reflect a great advance in capacitor manufacturing technique. They are fabricated under controlled conditions of almost surgical cleanliness, utilizing the very finest materials and production procedures available in the industry, and are backed by years of practical experience in manufacturing the finest capacitors for the radio and electronic industries.

These new electrolytics will give you the maximum in dependability and long-life performance. As original equipment—or for all replacement needs—they are better for every radio and electronic application.

*Chieftain*  
TYPE MT



*Warrior*  
TYPE PL



*Mohican*  
TYPE SL



*Tomahawk*  
TYPE CS



*Apache*  
TYPE CF



Get the full story by writing  
for Catalog No. 825.

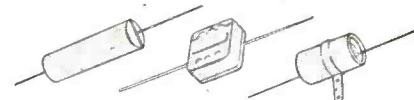

PAPER • MICA • SILVER  
and ELECTROLYTIC CAPACITORS

**SANGAMO**  
**ELECTRIC COMPANY**  
Springfield, Illinois

SC491A

IN CANADA: SANGAMO COMPANY LIMITED, LEASIDE, ONTARIO

**POLARAD**  
**LABORATORY Equipment**

for studio • laboratory • manufacturer

**20 MC**  
**VIDEO AMPLIFIER**  
Model V



- Flat frequency response from 100 cps to 20 mc.  $\pm 1.5$ db.
- Uniform time delay of .02 micro-seconds.
- Gain of 50 db.
- Frequency compensated high impedance attenuator calibrated in 10 db steps from 0-50.
- Fine attenuator covers a 10 db range.
- Phase Linear with frequency over entire band.

This unit is designed for use as an oscilloscope deflection amplifier for the measurement and viewing of pulses of extremely short duration and rise time, and contains the Video Amplifier Unit, Power Unit and a Low Capacity Probe.

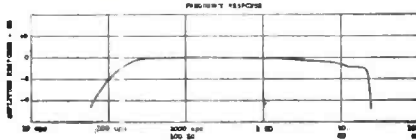

**Specifications:**

Input Impedance: Probe—12mmf + 470,000 ohms; Jack—30mmf + 470,000 ohms; Output Impedance 18mmf + 470,000 ohms each side push pull;  
Max. Input Volts 500 peak to peak with probe; Max. Output Volts 120 volts peak to peak (push pull);  
Power: 115 volts 50/60 cps AC Line; Size 19 1/4" x 22" x 14 3/4".



9 FERRY STREET NEW YORK 7, N. Y.

TELEVISION ENGINEERS and CONSULTANTS to the Nation's Leading Television Stations

**NATIONAL MOLDITE**  
**MOLDED IRON CORES**

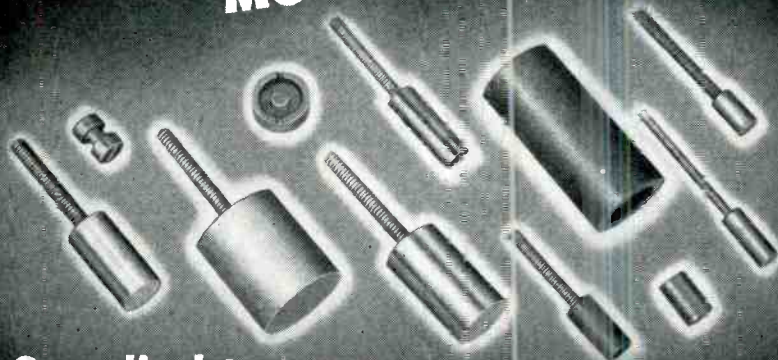

**Supplied to your**  
**EXACT SPECIFICATION**



Moldite iron cores for television FM, AM and audio frequencies are manufactured with the most advanced techniques to your exact mechanical and electrical specifications. New formulae and carefully supervised production result in higher Q Values, permanent stability and quantity delivered to meet your needs. When Moldite iron cores are designed into your circuit, you are assured of maximum performance, smaller physical size, reduced costs, proven reliability. Write for Catalog #02.

**ENGINEERING SERVICE**

Moldite engineers will gladly cooperate in determining the exact solution to your iron core problems for your design and production requirements.

**SAMPLES**

Sample iron cores will be submitted for design, test and pre-production purposes.

**NATIONAL MOLDITE COMPANY**  
HILLSIDE • NEW JERSEY

MID-WESTERN REP.  
IRV ROSE  
314 NO. MICHIGAN AVE.  
CHICAGO, ILL.

WESTERN REP.  
PERLMUTH-COLMAN & ASSOC.  
1335 SO. FLOWER ST.  
LOS ANGELES, CALIF.

S. AMERICAN REP.  
JOSE BU PONTET  
CORDOBA 1472  
BUENOS AIRES, ARGENTINA



Designed for



Application



90921

**The No. 90921  
'SCOPE AMPLIFIER-SWEEP  
UNIT**

The No. 90921 comprises horizontal and vertical amplifiers, a hard tube saw tooth sweep generator and power supply mounted on a standard 5 1/4" rack panel for use with the 2, 3, or 5 inch Millen basic 'scopes.

**JAMES MILLEN  
MFG. CO., INC.**

MAIN OFFICE AND FACTORY  
**MALDEN  
MASSACHUSETTS**



NEW PRODUCTS

(continued)

studio consolette, and Form 2J-4622 on consolette switching systems.

**Transformer Catalog.** Eisler Engineering Co., Inc., 750 S. 13th St., Newark 3, N. J. A 26-page transformer catalog No. TR-49 describes and illustrates a line of transformers from 0.25 to 400 kva and potentials up to 15,000 volts for every class of service.

**Relay Catalog.** Comar Electric Co., 2701 Belmont Ave., Chicago 18, Ill. Recently released is the new loose-leaf catalog illustrating relays, transformers, coils and terminals. It is available to those requesting on company letterhead.

**Speech Clipper.** Electro-Voice, Inc., Buchanan, Mich., has issued bulletin 145 on the model 1000 Speech Clipper. It explains how the unit clips tops and bottoms from speech frequencies which rise above a preset amplitude. List price and specifications are given.

**General Catalog.** Meissner Mfg. Division, Maguire Industries, Inc., Mt. Carmel, Ill. Catalog 48B lists and illustrates a group of products including a television receiver, components, tuner, amplifier and a line of kits and coils.

**Dial Light Catalog.** Dial Light Co. of America, 900 Broadway, New York 3, N. Y., has recently published a very complete 192-page catalog, Form L-149, that lists its line of dial and pilot lamp assemblies, dimming devices, lens holders, light shields, and other accessories. Factors in the choice of lamp and housing are clearly explained to the designer.

**Phototelegraph.** Muirhead & Co., Ltd., Beckenham, Kent, England. Bulletins B-621-B, B-574-C, B-618-B, and B-575-E all describe various units of the Muirhead-Jarvis and Muirhead-Belin phototelegraphic equipment for use on wire lines or radio, including fixed station and portable transmitters.

**Loudspeakers.** Goodmans Industries, Ltd., Lancelot Road, Wembley, Middx., England. Brochures are available on a line of loudspeakers and high-fidelity transformers. A twin-diaphragm, or coaxial speaker, is included.

Here Are...  
**IMPORTANT MEMBERS of the PHALO FAMILY**

PHALO TWIN TRANSMISSION LINE 75-150-300 OHM

PHALO RAINBOW CABLE

PHALO COAXIAL CABLE

PHALO MICROPHONE CABLE

PHALO RIGHT ANGLE PLUG AND CORD SET

PHALO MULTICONDUCTOR INTERCOMMUNICATION CABLE (ALL-OVER BRAID)

PHALO RADIO HOOK-UP AND FIXTURE WIRE

PHALO HEAVY DUTY CORD SET AND MOLDED PLUG

PHALO MULTICONDUCTOR PLASTIC JACKET INTERCOMMUNICATION OR CONTROL CABLE

PHALO 2/C PARALLEL SHIELDED INTERCOMMUNICATION CABLE

For complete "PHALO FAMILY STORY" Ask for the NEW 22 page Illustrated PHALO CATALOG

**PHALO**  
*Plastics Corporation*

CORNER OF COMMERCIAL ST.  
WORCESTER, MASS.  
Manufacturers of Insulated Wire, Cables, Cord Sets and Thermoplastic Tubing

Visit our booth (No. 39) at the  
I. R. E. Show

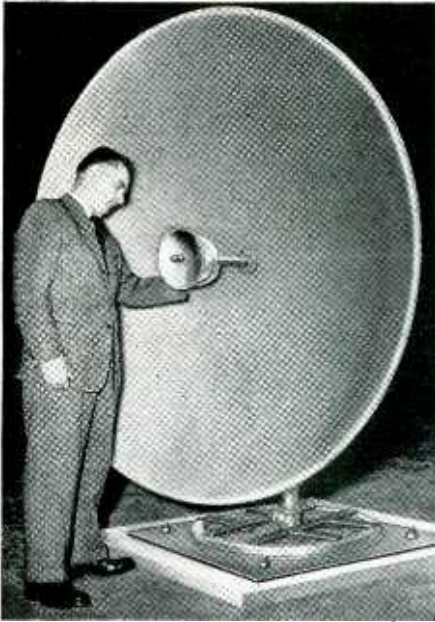

Immediate Delivery...

## PARABOLIC ANTENNAS FOR

- FM and AM Studio-to-Transmitter Link
- Television and Facsimile Relay Work
- Multi-channel Point-to-Point Relay
- Research and Development Laboratories

The Workshop can supply parabolic antennas in a wide range of types, sizes and focal lengths, plus a complete production and engineering service on this type of antenna.

Workshop test equipment and measurements for the determination of antenna characteristics is outstanding in the industry. These facilities, coupled with the wartime experience of its engineers on high frequency antennas, assure exceptional performance.

**PARABOLAS** — Precision-formed aluminum reflectors. Can be supplied separately, if desired.

**MOUNTINGS** — Various types of aluminum reinforced mountings can be supplied with all antennas.

**R. F. COMPONENTS** — Precisions machined and heavily silver plated. Critical elements protected by low-loss plastic radome.

**PATTERN AND IMPEDANCE DATA** — A series of elaborate measurements of both pattern and impedance are made to adjust the settings for optimum performance. Pattern and impedance data are supplied with each antenna.

**POLARIZATION** — Either vertical or horizontal polarization can be obtained easily by a simple adjustment at the rear of the reflector.

**SPECIAL ANTENNAS** — Parabolas can be perforated to eliminate wind resistance or sectioned to produce a specified antenna pattern.

**OTHER ANTENNAS** — FM and television receiving antennas. A complete line of amateur antenna equipment.

Prices on Request

The WORKSHOP ASSOCIATES, Inc.  
64 NEEDHAM STREET  
Newton Highlands, Massachusetts



## New Tools You Should Have for PRESSURE RESEARCH



### The Syncro-Marker PRESSUREGRAPH

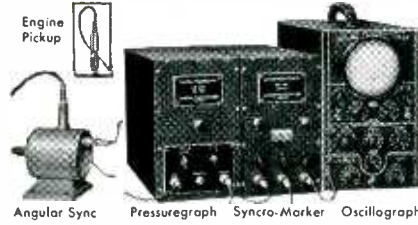

Here is your complete answer in instrumentation for checking pressure variations, both regular and instantaneous. Provides oscillograph pictures showing relation of pressures to engine shaft rotation (top dead center or indications in degrees of rotation and also relates pressures to time (milliseconds).

Accurately measures pressure rise with time. Can be applied to hydraulic, gas, steam or pressure line measurement of static, dynamic or instantaneous pressures. New detachable diaphragm permits measurement in any pressure range from vacuum to 14,000 p.s.i.

Now used in oil fields by many leading producers.

### ITS LITERATURE



Write for your copy of "Pressure Indications in Engine Fuel Research" illustrating typical Pressuregraph applications and giving data on dynamic studies of pressure waves.

## ELECTRO PRODUCTS LABORATORIES

549 W. Randolph St.

Chicago 6, Ill.

Phone STate 2-7443

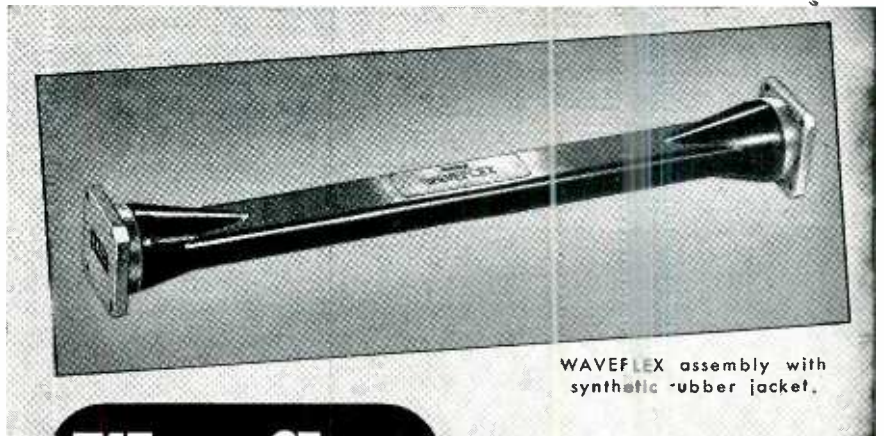

WAVEFLEX assembly with synthetic rubber jacket.

# Waveflex

## Flexible Waveguides

Offer these *Outstanding Advantages* in microwave transmission:

- Lower attenuation loss
- Excellent impedance match
- Extreme flexibility without loss of efficiency

energy and at the same time take advantage of flexible tubing construction by specifying WAVEFLEX flexible waveguides. Write for literature today.

TITEFLEX, INC. 410 Frelinghuysen Ave., Newark 5, N. J.

WAVEFLEX, the flexible waveguide made by Titeflex, Inc., affords designers all of the advantages of standard rigid waveguides plus the added feature of flexibility.

You can preserve costly transmission



# AN AMAZING IMPROVEMENT!



## Glaser LECTRON ROSIN CORE SOLDER

### Speeds Soldering Operations on the Production Line

Glaser Lectron Rosin Core Solder is superior to any other rosin core solder on the market. An outstanding achievement in the radio and electronic industries. Made with a specially "energized" rosin flux, an exclusive development of the Glaser Research Laboratories. More efficient and faster than ordinary rosin core solders. Speeds production and lowers your costs — so important in today's competitive market.

Glaser Lectron Rosin Core Solder bonds perfectly copper, brass, nickel, chrome and other metals — yet is non-corrosive and non-conductive.

Lower tin-content solder used with Glaser Lectron Rosin Flux does as good a job as higher tin solder with ordinary rosin flux. Requires minimum flux and gives you more solder for your money!

Available in any tin-lead composition and wire gauge.

**For greater economy in all soldering operations  
use Glaser Lectron Rosin Core Solder**

Our Engineering Department is at your service in solving any soldering problem, without obligation. Contact us promptly.

**SEE US AT THE I.R.E. SHOW**  
Grand Central Palace, Booth No. 260

**GLASER LEAD CO., INC.**  
21-31 Wyckoff Avenue, Brooklyn 27, N.Y.

Manufacturers of the famous Glaser Quality Line of Solders,  
Fluxes and Tinning Compounds.



**OUR 27TH YEAR OF DEPENDABLE SERVICE TO AMERICAN INDUSTRIES**

## NEWS OF THE INDUSTRY

(continued from p 138)

bile Telephone, by W. Babcock and A. W. Nyland.

Wide-Angle Metal-Plate Optics, by J. Ruze.

The Measurement of Current and Charge Distributions on Transmitting and Receiving Antennas, by T. Morita.

The Diffraction Pattern from an Elliptical Aperture, by R. Adams and K. S. Kelleher.

A Low-Drag Aircraft Antenna for Reception of Omnidirectional Range Signals in the 108- to 122-Mc Band, by J. Shanklin.

### Passive Networks I—Synthesis

Amplifier Synthesis through Conformal Transformation, by J. Pettit and D. L. Trautman, Jr.

Exact Design of Bandpass Networks Using  $n$  Coupled Finite-Q Resonant Circuits ( $n = 3$  and  $4$ ), by M. Dishal.

Network Approximation in the Time Domain, by W. H. Huggins.

A Method of Synthesizing the Resistor-Capacitor Lattice Structure, by J. L. Bower, J. T. Fleck and P. F. Ordnung.

The Design of Frequency-Compensating Matching Sections, by V. Rumsey.

### Instruments and Measurements II—Oscillography

An Impulse Generator — Electronic Switch for Visual Testing of Wide Band Networks, by T. R. Finch.

A 50-Mc Wide-Band Oscilloscope, by A. Levine and H. Hoberman.

A Timing-Marker Generator of High Precision, by R. C. Palmer.

The Evaluation of Specifications for Cathode-Ray Oscillographs, by P. S. Christaldi.

Photographic Techniques in Cathode-Ray Oscillography, by C. Berkley and H. Mansberg.

### Electronic Computers

The Binac, by J. P. Eckert, Jr., J. W. Mauchly and J. R. Weiner.

An Electronic Differential Analyzer, by A. B. Macnee.

An Analog Computer for the Solution of Linear Simultaneous Equations, by R. M. Walker.

The Electronic Isograph for a Rapid Analogue Solution of Algebraic Equations, by B. O. Marshall, Jr.

A Parametric Electronic Computer, by C. J. Hirsch.

### Tuesday P.M., March 8

#### Symposium: Electronic Computers

The Binac, by J. W. Mauchly.

Mark III Computer, by H. H. Aiken.

IBM Type 604 Electronic Calculator, by Ralph Palmer.

Electrostatic Memory for a Binary Computer, by F. C. Williams.

Counting Computers, by G. R. Stibitz.

Programming of a Chess Game on a Computer, by Claude Shannon.

### Wave Propagation I—Television

VHF Television—Propagation Aspects, by E. W. Allen, Jr.

Propagation Variations at VHF and UHF, by K. Bullington.

Propagation Tests at UHF, by J. Fisher.

A Test of 450-Mc Urban-Area Transmission to a Mobile Receiver, by A. Aikens and L. Y. Lacy.

Echoes in Transmission at 450 Mc from Land to Car Radio Units, by W. R. Young and L. Y. Lacy.

### Passive Networks II—Analysis

Impedance Curves for Two-Terminal Networks, by E. Michaels.

An Analysis of Triple-Tuned Coupled Circuits, by N. Mather.

The Bridged Parallel-Tee Network for Suppressed-Carrier Servo Systems, by C. F. White.

Transient Response of Linear Networks with Amplitude Distortion, by M. Di Toro.

Spectrum Analysis of Transient-Response Curves, by H. Samulon.

### Components and Materials

Subminiaturization of IF Amplifiers, by G. Shapiro and R. L. Henry.

New Applications of a Four-Terminal Capacitor, by A. A. Pascucci.

Frequency Control Units, by A. E. Miller.

Type 5811 and Type 5807 Tubes. The Smallest Commercial Pentode Amplifiers, by L. G. Hector and H. R. Jacobus.

Conductive Plastic Materials, by M. A. Color, A. Lightbody, F. Barnet and H. Perry.

### Nucleonic Instrumentation

Industrial Thickness Gauges Employing



# NULLI SECUNDUS!

Yes, you'll find upon careful appraisal, thorough investigation and direct comparison that TEKTRONIX instruments are truly **SECOND TO NONE**.

The Tektronix Field Engineering Representative in your area will be pleased to demonstrate either instrument upon request.

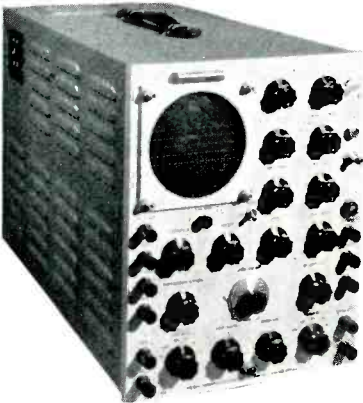

**Tektronix Type 511-AD Oscilloscope**  
\$845 f.o.b. Portland

## Wide Band, Fast Sweeps

The Type 511-AD, with its 10 mc. amplifier, 0.25 microsecond video delay line and sweeps as fast as .1 microsec./cm. is excellent for the observation of pulses and high speed transient phenomena. Sweeps as slow as .01 sec./cm. enable the 511-AD to perform superlatively as a conventional oscilloscope.

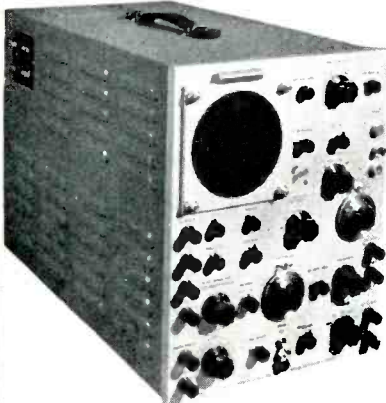

**Tektronix Type 512 Oscilloscope**  
\$950 f.o.b. Portland

## Direct Coupled, Slow Sweeps

The Type 512 with a sensitivity of 5 mv./cm. DC and sweeps as slow as .3 sec./cm. solves many problems confronting workers in the fields where comparatively slow phenomena must be observed. Vertical amplifier bandwidth of 1 mc. and sweeps as fast as 3 microsec./cm. make it an excellent general purpose oscilloscope as well.

## Both Instruments Feature:

- Direct reading sweep speed dials.
- Single, triggered or recurrent sweeps.
- Amplitude calibration facilities.
- All DC voltages electronically regulated.
- Any 20% of normal sweep may be expanded 5 times.

Phone  
EA 6197



Cables  
Tektronix

**712 S. E. Hawthorne Blvd.**  
**Portland 14, Oregon**

# PROCTOR SOUNDIX PICKUP ARM

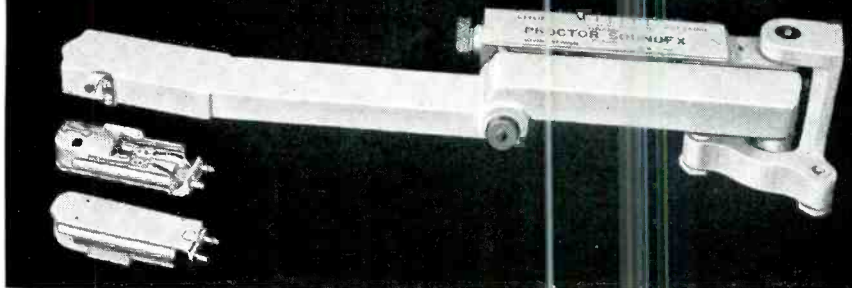

Proctor—a pioneer in the design, engineering and manufacture of a long line of recording and transcription equipment—announces the above illustrated pickup arm—embodying important new functional features—and designed for use with the latest lightweight high compliance cartridges.

- A universal cartridge carrier which slides the cartridge in and out of the arm and offers instant substitution of all standard and LP microgroove cartridges.
- A self-contained stylus pressure scale which is inscribed in grams and includes a zero setting pointer.
- A stylus pressure selector knob which permits precise stylus pressure adjustment over a wide range accordant to scale reading.

All of the other features previously found to be of advantage in a pickup arm, such as the three point self-leveling base and a finger lift to aid in cueing have been incorporated in the new Arm. The finest type of angular contact ball pivot bearings are used for both vertical and lateral pivots, making the pivots virtually frictionless. The channel cross section and the lightweight magnesium combine to affect the greatest degree of stiffness without excessive mass. A large amount of vertical inertia is undesirable, but some degree of horizontal inertia is essential for performance of high compliance pickup cartridges. The Proctor Soundix Arm has, so far as is practicable, divorced one from another. For this reason the Stylus Pressure Scale and Knob of the Arm are separated from the arm itself and do not contribute to the vertical inertia.

**PROCTOR SOUNDIX CORP. 133 No. 6th Ave., Mt. Vernon, N. Y.**

Telephone: Mount Vernon 7-1126

# TECHNICRAFT 3 BASIC FLEXIBLE WAVEGUIDE TYPES

## COMBINATION ASSEMBLIES

Decrease Cost

Reduce Weight

Save Space

By the use of Technicraft Combination rigid-flexible assemblies, many advantages can be realized. Many times design changes are made unnecessary by use of one or more Technicraft flexible waveguide assemblies or a Technicraft-built rigid-flexible unit.

Skilled craftsmen in Technicraft's own plant attach Type L or Type S flexible waveguide to rigid plumbing WITHOUT THE USE OF FLANGES.

Technicraft is prepared to fabricate the entire assembly or attach the right type of flexible waveguide to rigid plumbing supplied by the user. Before saying it can't be done, consult Technicraft. You will be surprised what has been done.

### It's New!

Technicraft Laboratories Bulletin F-2 entitled "How to Select Flexible Waveguide Assemblies" now available upon request.

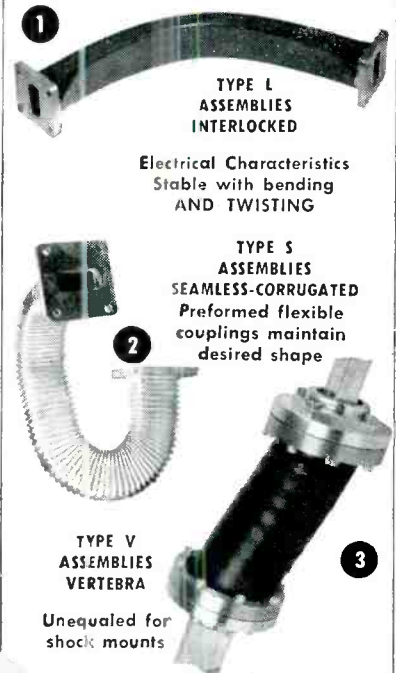

Electrical Characteristics  
Stable with bending  
AND TWISTING

Preformed flexible  
couplings maintain  
desired shape

Unequaled for  
shock mounts

# TECHNICRAFT LABORATORIES

INCORPORATED

THOMASTON-WATERBURY RD.

THOMASTON, CONNECTICUT

# Crystals for the Critical

## EVERYTHING YOU WANT IN "STABILIZED" CRYSTALS

High quality—quick delivery—modest cost! All three are yours when you use James Knights Co. "Stabilized" crystals.

Whether you wish standard crystals, or crystals built to your exact specifications, The James Knights Co. is equipped to supply you promptly.

A special production system is maintained to effect greater savings for you on short run jobs.

The James Knights Co. fabricates a complete line of "Stabilized" crystals to meet every need—precision made by the most modern methods and equipment.

Whenever you think of crystals, think of JK "Stabilized" crystals. They're your best bet—your best buy!

New James Knights Co. Catalog On Request



A COMMUNICATIONS COMPANY needed precision low frequency crystals to synchronize their facsimile system. The James Knights Co. made the crystals, installed them in ovens, and delivered them promptly.

BOOTH NO. 33  
IRE CONVENTION

The JAMES KNIGHTS Co.

SANDWICH, ILLINOIS



### NEWS OF THE INDUSTRY

(continued)

Radioisotopes, by J. Carlin.

The Design of a G-M Counter Tube for High Counting Rates, by W. Managan.

Electrometer Tubes and Circuits, by F. H. Starke.

Proportional Counter Equipment for Beta Detection, by W. Bernstein.

A High-Voltage Supplier for Radiation-Measuring Equipment, by R. Weissman and Stewart Fox.

Symposium: Nuclear Science

The Fundamental Particles, by D. J. Hughes.

The Detection and Measurement of Nuclear Radiation, by H. L. Andrews.

The Effects of Ionizing Radiation on Tissue, by J. P. Cooney.

The Application of Nuclear Radiation to Industry, by J. R. Menke.

Wednesday A.M., March 9

Television I

A Unidirectional Reversible-Beam Antenna for Twelve-Channel Reception of Television Signals, by O. M. Woodward, Jr.

A Method of Multiple Operation of Transmitter Tubes Particularly Adapted for Television Transmission in the Ultra-High-Frequency Band, by G. H. Brown, W. C. Morrison, W. L. Behrend and J. G. Reddeck.

Transient-Response Tests in the WPTZ Television Transmitter, by R. C. Moore.

The Synchronization of Television Stations, by R. D. Kell.

Television by Pulse-Code Modulation, by W. M. Goodall.

Symposium: Radio Aids to Navigation

The Radio Technical Commission for Aeronautics—Its Program and Influence, by J. H. Dellinger.

Frequency Allocations to the Aeronautical Services above 400 Mc, by V. I. Weihe.

Experimental Multiplexing of Functions in the 960 to 1660-Mc Frequency Spectrum—Its Influence on Weight and Complexity of Equipment, by P. C. Sandretto and R. I. Colin.

The Philosophy and Equivalence Aspects of Long Range Radio Navigation Systems, by M. K. Goldstein.

The Future in Approach and Landing Systems, by H. Davis.

Active Circuits I

G Curves as an Aid in Circuit Design, by K. A. Pullen.

A Direct-Coupled Amplifier Employing a Cross-Coupled Input Circuit, by J. N. Van Scoyoc and G. Warnke.

Annular Circuits for High-Power Multiple-Tube Generators at VHF, by D. H. Preist.

Considerations on Electronic Multi-couplers, by W. R. Aylward and E. G. Fubini.

Improved Degenerative Regulators, by Y. T. Yu.

Instruments and Measurements III

Radar Circuit Powered X-Ray Movie Equipment for Operation at 150 Frames per Second, by D. C. Dickson, Jr., C. T. Zavales and L. F. Ehrke.

An AM Broadcast Station Monitor, by H. Summerhayes.

The Speed of Electronic Switching Circuits, by E. Williams and D. F. Aldrich.

A Magnetostrictive Delay Line, by E. Bradburd.

An Electromechanical Strain-Gage Multiplier, by C. Woods, E. St. George, L. Isenberg and A. C. Hall.

Electronics I—Tube Design and Engineering

Microphonism Investigation, by Lester Feinstein.

A Critical Survey of Methods of Making Ceramic-to-Metal Seals and Their Use for Vacuum Tube Construction, by R. P. Welling.

Rugged Tubes, by G. W. Baker.

An Improved Method of Testing for Residual Gas in Electron Tubes and Vacuum Systems, by E. W. Herold.

Design Factors, Processes, and Materials for the Envelope of a Metal Kinescope, by R. D. Faulkner and J. C. Turnbull.

Wednesday P.M., March 9

Television II

The Measurement of the Modulation Depth of Television Signals, by R. P. Burr.

Development and Performance of Television Camera Tubes, by R. B. Janes, R. E. Johnson and R. S. Moore.

An Anastigmatic Television Deflection

# DUMONT GLASSITE

THE WORLD'S  
FINEST TUBULAR

# CAPACITORS

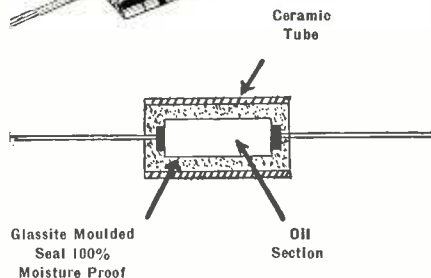
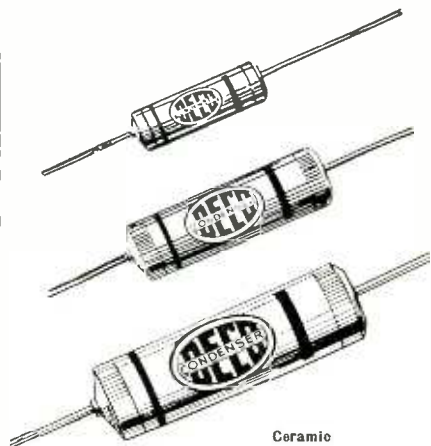

At last! . . . after years of painstaking research the Dumont Engineers now offer the finest tubular condenser ever designed. Moulded right into a Ceramic Tube . . . oil sections . . . 100% moistureproof and heatproof. Sizes from .0001 to .5 and from 100 Volts to 20000 Volts. From 1/4" x 5/8" long to 1-1/2" x 4" long.

Also available in  
Silicone Oil for 125°C operation.

Send for Literature and Samples

# DUMONT

ELECTRIC CORP.

MFR'S OF  
CAPACITORS FOR EVERY REQUIREMENT

308 DYCKMAN ST., NEW YORK, N. Y.

# DIRECT WRITING RECORDERS



Galvanometer available separately if desired

## PERMANENT

Records



NO INK



RECTILINEAR

Writing



RUGGED

Construction

with

EXTREMELY HIGH torque movement (200,000 dyne cms for 1 cm deflection)

While designed primarily for use in the Sanborn direct-writing electrocardiograph (the Viso-Cardiette) this assembly (or the galvanometer alone, if desired) has sufficient potential value for varied industrial applications to warrant this announcement of availability for non-medical uses.

The complete unit illustrated comprises the galvanometer and writing arm, with associated paper drive (No. 572M-500). The galvanometer and

writing arm are available as a separate unit (No. 572M-300). Recording styli available in two types; fine line writing approximately 1/3 mm; wide line writing approximately 1 mm. Recording paper can be furnished in 200 ft rolls, 6 cm wide (No. 572-737-P3).

### TABLE OF CONSTANTS

Sensitivity	10 ma/1 cm.
Coil resistance	3,000 ohms, center tapped for push-pull operation.
Critical damping resistance	500 ohms.
Undamped fundamental frequency	45 cycles/sec.
Stylus heater requires from external source	1.25 volts, 3.5 amps, AC or DC
Maximum undistorted deflection	2.5 cm. each way from center
Marker requires from external source	1.25 volts, at 1.5 amps, AC or DC
Paper speed	25 mm/sec.
Chart ruling	1 mm intervals

In the development stage are other Sanborn "medical recording" instruments which have apparent industrial applications. These include an Electromanometer for direct measurement of "pressures", and several models of multi-channel (2 to 6) recorders, both direct recording and photographic.

Visit Booth "S" at I.R.E. Convention for demonstration, or write for descriptive bulletin.

INDUSTRIAL DIVISION

**SANBORN COMPANY**

39 Osborn St.

Cambridge 39, Massachusetts

# Simplify Your Wiring Problems

with

**KULKA**

TERMINAL STRIPS

for all types of

**Electronic Equipment**

Eliminates Splicing

and Messy Connections;

Stops leaks and shorts

Made of high tensile strength Bakelite—with nicked-brass screws and solder lugs. Come in 3 sizes with 1 to 13 terminals, and in several styles: with binder screws (top cut); with either one-sided, or two-sided solder lugs — held by binder screws (center cut), or eyeletted to block; with bottom solder lugs (bottom cut).



FULL SIZE



FULL SIZE



Write Today For Detailed Circular

**KULKA**

**ELECTRIC MFG. CO., INC.**  
Beach St., Mt. Vernon, N. Y.

ONE OF A SERIES

# MICROSCOPIC INSPECTION

**WHY BURLINGTON PANEL INSTRUMENTS PROVIDE UTMOST RELIABILITY . . .**



100% microscopic inspection is given pivots, jeweled bearings, hairsprings and other materials, of minute size, which cannot be inspected by ordinary methods. All ranges AC and DC available in rectangular or round case styles and are guaranteed for one year against defects in workmanship or materials. Refer inquiries to Dept. F-39.



**INSTRUMENT COMPANY**  
BURLINGTON, IOWA

# Laboratory Standards



## STANDARD SIGNAL GENERATOR

Frequency range: 75 kc. to 30 mc. Output 0.1 microvolt to 2.2 volts. **MODEL 65B**

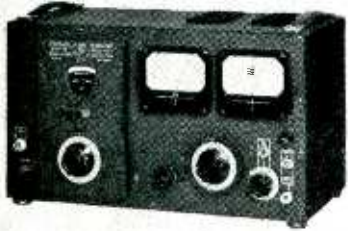

## STANDARD SIGNAL GENERATOR

Frequency range: 2 mc. to 400 mc. Output 0.1 microvolt to 0.1 volt. **MODEL 80**



## SQUARE WAVE GENERATOR

5 to 100,000 cycles. Recommended for AM, FM and television testing. **MODEL 71**



**MODEL 59**

## MEGACYCLE METER

A versatile grid-dip oscillator covering the frequency range of 2.2 mc. to 400 mc.

CIRCULARS ON REQUEST

MANUFACTURERS OF  
Standard Signal Generators  
Pulse Generators  
FM Signal Generators  
Square Wave Generators  
Vacuum Tube Voltmeters  
UHF Radio Noise & Field Strength Meters  
Capacity Bridges  
Megohm Meters  
Phase Sequence Indicators  
Television and FM Test Equipment

**MEASUREMENTS CORPORATION**  
BOOKTON NEW JERSEY

### NEWS OF THE INDUSTRY

(continued)

Yoke and Associated Circuits, by K. Schlesinger.

A High-Efficiency Sweep Circuit, by B. M. Oliver.

Progress Report on UHF Television, by T. T. Goldsmith.

#### Wave Propagation II

An Analysis of Distortion Resulting from Two-Path Propagation, by I. H. Gerks.

On the Origin of Solar Radio Noise, by A. V. Haefl.

(Geometrical Representation of the Polarization of a Plane Electromagnetic Wave, by G. A. Deschamps.

Propagation Conditions and Transmission Reliability in the Transitional Microwave Range, by T. F. Rogers.

A Forward-Transmission Echo-Ranging System, by D. B. Harris.

#### Active Circuits II

A Laboratory and Analytical Analysis Comparing the L-C Toroidal Filter with the Parallel-Tee Feedback Amplifier Filter, with the Parallel-Tee Feedback Amplifier Filter, by A. J. Stecca.

A Peak-Picker Circuit, by M. J. Parker. Low-Frequency Synchronized Sawtooth Generator Providing Constant Amplitude Sweep with Aperiodic Synchronization Input, by P. Yaffee.

High-Power Sawtooth Current Synthesis from Square Waves, by H. E. Kallmann.

Regenerative Amplifiers, by Y. P. Yu. A Rectifier Filter Chart, by R. Lee.

#### Instruments and Measurements IV

High-Impedance Millivolt Measurements above 5 Mc, by W. K. Volkens.

Some Aspects of the Performance of Mixer Crystals, by P. D. Strum.

A Wide-Band Audio Phasemeter, by J. R. Ragazzini and L. A. Zadeh.

A Device for Admittance Measurements in the 50- to 500-Mc Range, by W. R. Thurston.

An Improved RF Capacitometer, by E. F. Travis and T. M. Wilson.

A Radio Frequency Discharge Phenomena and its Application to Mechanical Measurements, by K. S. Lion and J. W. Sheetz.

#### Electronics II—Electron-Tube Cathodes

The Effects of Various Barium Compounds with Respect to Cold-Cathode Behavior as a Function of Life in a Glow Discharge, by H. Jacobs and A. P. LaRoque.

Oxide-Cathode Properties and their Effects on Diode Operation at Small Signals, by G. C. Dalman.

Microanalysis of Gas in Cathode-Coating Assemblies, by H. Jacobs and B. Wolk.

Exposure of Secondary-Electron-Emitting Surfaces to the Evaporation from Oxide Cathodes, by C. W. Mueller.

The Use of Thoriated-Tungsten Filaments in High-Power Transmitting Tubes, by R. B. Ayer.

#### Thursday A.M., March 10

##### Systems II—Relay Systems

A Microwave System for Television Relaying, by J. Z. Millar and W. B. Sullinger.

Synchrodyne Phase Modulation of Klystrons, by V. Learned.

Intercity Television Radio Relays, by W. H. Forster.

Video Design Considerations in a Television Link, by M. Silver, H. French and L. Staschover.

A Six-Channel Urban Mobile System with 60-Kc Spacing, by R. C. Shaw, P. V. Dimock, W. Strack and W. C. Hunter.

##### Navigation Aids I

The Determination of Ground Speed of Aircraft Using Pulse Radar, by I. Wolff, S. W. Seeley, Earl Anderson and W. D. Hershberger.

The Dimeal Aircraft Approach and Landing System, by L. B. Hallman, Jr.

Theoretical Aspects of Nonsynchronous Multiplex Systems, by W. D. White.

Band-Pass Circuit Design for Very-Narrow-Band, Very-Long-Range Direction Finder Receivers to Minimize Bearing Error Due to Receiver Mistuning, by M. Dishal and H. Morrow.

Crystal Control at 100 Mc for Aerial Navigation, by S. H. Dodington.

##### Symposium: Marketing

Market Research, by E. H. Vogel. The Application of Market and Field Research in Product Planning and De-

end

Fluctuations

in

Capacity



with new ceramic soldered

Subject them to the toughest service, and JOHNSON'S new Type L Variables "come up" smiling—continue to maintain capacities and deliver peak performance!

Thanks go to JOHNSON'S use of perfected ceramic soldering which by eliminating the need for eyelets, nuts and screws, also eliminates possibility of stator wobble and fluctuations in capacities.

There is nothing to work loose!

Available for all types of communications equipment having tuned circuits operating as high as several hundred mc., JOHNSON'S new Type L Variables come in .030" and .080" spacing.

**SINGLE TYPE**—Available in six models: 2.8 to 11 mmf, 3.5 to 27 mmf, 4.6 to 51 mmf, 5.7 to 75 mmf, 6.8 to 99 mmf, 11.6 to 202 mmf.

**DUAL TYPE**—Available in three models: 3.5 to 27 mmf, 4.6 to 51 mmf, 6.8 to 99 mmf.

**DIFFERENTIAL TYPE**—Available in three models: 2.8 to 11 mmf, 3.5 to 27 mmf, 4.6 to 51 mmf.

**BUTTERFLY TYPE**—Available in three models: 2.8 to 10.5 mmf, 4.3 to 26 mmf, 6.5 to 51 mmf.

Other capacities and spacings available on special order. Write today for your copy of the new JOHNSON Type L Variable Catalog.

**JOHNSON**

E. F. JOHNSON CO. WASECA, MINN.

**EAD NEW!**

*Variable Frequency Induction Motors and Blowers*

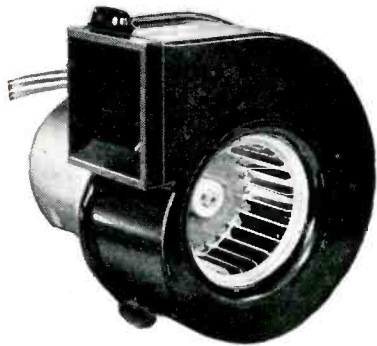

115 volts:  
400-800 Cycles—140 C.F.M.  
400-1600 Cycles—15-20 C.F.M.  
**NOW IN PRODUCTION**

Other frequency ranges available  
**GEAR MOTORS, AXIAL FLOW FANS  
AND MOTORS ALSO FURNISHED**

These Induction Motors and Blowers are designed for use with engine driven alternators supplying variable frequency power throughout a wide range. They are very suitable for use in cooling tubes and amplifier boxes, band switching or driving mechanisms on military and electronic equipment.

**ALSO NEW  
PERMANENT MAGNET**



**ALTERNATORS**  
For critical Instrument and Equipment Applications.

**PURE WAVEFORM**  
1, 2, or 3 Phase  
2, 4, 6, 8, or 12 poles

**All Frequencies**

*Special Types for customer needs  
Standard Types Available.  
Continuous Duty*

- N2A 115V; 3 Phase, 45VA, 400 cycle at 6000RPM
- N2B 115V; 2 Phase, 15VA, 60 cycle at 3600RPM
- N3C 15V; 1 Phase, 1.1VA 180 cycle at 3600RPM
- N4A 70V; 1 Phase, 10 VA, 60 cycle at 3600RPM
- N6A 45V; 1 Phase, 25 VA, 1000 cycle at 5000RPM

**EASTERN AIR DEVICES, INC.**  
585 DEAN ST., BROOKLYN 17, N. Y.

**DESIGNERS AND BUILDERS OF STANDARD  
AND SPECIAL ROTATING EQUIPMENT**

# HI-QUALITY CORES

• **RAD-A-COR** •

*For Audio and AM Frequency*

• **TEL-A-COR** •

*For FM and TV Frequency*

## TOPS IN QUALITY

Over 12 years manufacturing experience

Finest of Materials

Immediate delivery

Facilities increased 100%

We invite your inquiries

## MAGNETIC CORE CORPORATION

142 So. Highland Ave.,

Ossining, N. Y.

Telephone: Ossining 222

Manufacturers of

Electronic Powder Metallurgy

## AN Anchor PRODUCTS INNOVATION

**Completely new. . . . .**

**sleeve and mounting ring adds  
super-safety to metal TV tubes**

Anchor T.V. Sleeve and Mounting Ring. Pat. Pend.

Anchor Products' shock proof sleeve ring assembly of Aeroflex, a polyethylene compound, sheaths the tube completely, leaving a single metal terminal contact point.

A genuine rubber gasket guards entire assembly against shock and locks parts into simple, integral unit. Easy mounting on panel board.

Protects serviceman from high tube voltage. Available in colors to match cabinet trim.

Can be extruded to your exact specification. Plastic extrusions of all types and descriptions.

Your inquiry will receive prompt attention.

**ANCHOR PLASTICS CO., Inc.**  
533-541 Canal St., New York 13, N. Y.

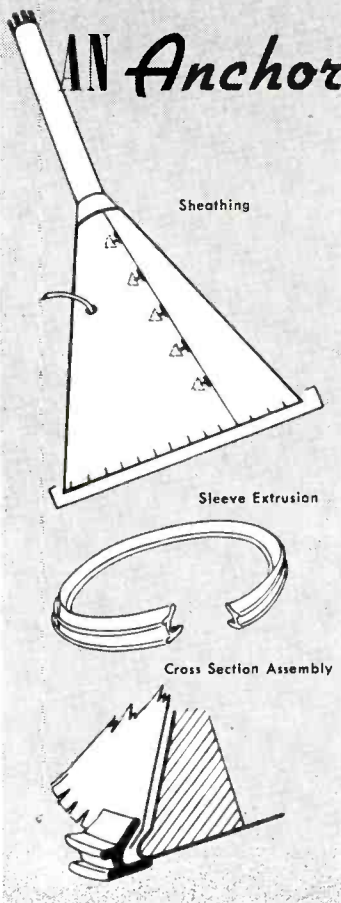

# The Original Carter Genemotor



for TAXICAB, MARINE  
and Police  
Mobile Radios

Unequalled performance and dependability are assured when you specify Carter Genemotor Power Supplies. The favorite for over 15 years.

- \*\*\*\*\* SPECIFICATIONS \*\*\*\*\*
- Frame capacity 80 watts cont. 150 watts int. (up to 400 watts, on Marine models only.)
  - Input volts DC—5.5 to 115
  - Input current DC—up to 50 amps.
  - Output volts DC—up to 800 volts
  - Output current DC—up to 500 MA.
  - AC ripple content—1% or less
  - Overall efficiency—50-75% average
  - Output regulation—20% no load to full load
  - Starting time—300 milliseconds average



2646 N. MAPLEWOOD AVE., CABLE: GENEMOTOR

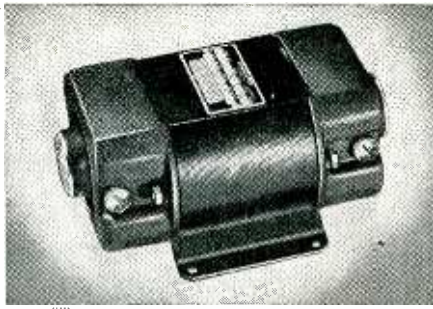

Carter Genemotor 7-1/16" long, 4-1/8" wide, 3-1/2" high. Weight only 10 lbs.

## Check These features

- Small size—Can be mounted on its side.
- Reliable—100,000 transmissions without servicing.
- Armature triple insulated. Transformer grade laminations. Static and dynamically balanced. Precision ball bearings require NO lubrication.
- Super Precision—Frames line reamed to .0001 accuracy.

## WRITE

Bulletin No. 447-J illustrates the Genemotor and many other Carter Rotary Products. Write today.

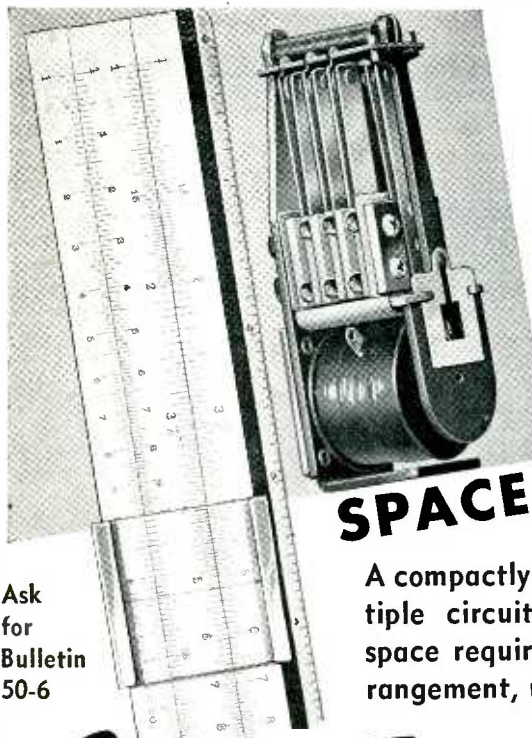

# MULTIPLE ARM RELAY SOLVES YOUR SPACE PROBLEM

A compactly designed relay for multiple circuit switching. No more space required for any contact arrangement, utilizing up to 18 arms.

Ask for Bulletin 50-6

# SIGNAL ENGINEERING

and MANUFACTURING COMPANY  
154 WEST 14th ST. NEW YORK 11, N. Y.

sign, by O. H. L. Jensen.  
Sales Planning and Distribution, by Lee McCanne.  
National Advertising, by M. F. Mahony.  
Sales Training and Sales Promotion, by W. E. Macke.

Electronics III—Electron-Tube Theory  
General Solution of the Two-Beam Electron-Wave-Tube Equation, by A. V. Haeff, H. D. Arnett and W. Stein.  
Aspects of Double-Stream Amplifiers, by J. R. Pierce, W. B. Hebenstreit and A. V. Hollenberg.  
On the Theory of Axial Symmetric Electron Beams in an Axial Magnetic Field, by A. L. Samuel.  
Electron Beams in Axial Symmetric Magnetic and Electric Fields, by C. C. Wang.  
Space-Charge Effects and Frequency Characteristics of CW Magnetrons Relative to the Problem of Frequency Modulation, by H. W. Welch, Jr.

### Thursday P.M., March 10

Symposium: Germanium and Silicon Semiconductors  
Electrical Properties of Germanium and Silicon, by K. Lark-Horovitz.  
The Metallurgy of Germanium and Silicon Semiconductors, by J. H. Scaff.  
Theory of Rectification, by F. Seitz.  
Transistors, by W. H. Brattain.  
Information Transmission and Noise  
Design in Nature as Exploited, by the Communication Engineer, by L. A. de Rosa.  
Experimental Determination of Correlation Functions and the Application of these Functions in the Statistical Theory of Communications, by T. P. Cheatham, Jr.  
The Transmission of Modulation Through Band-Limited Transmission Systems, by W. P. Boothroyd and E. M. Creamer, Jr.  
Signal-to-Noise Improvement Through Integration in a Storage Tube, by J. V. Harrington and T. F. Rogers.  
The Theory of Receiver Noise Figure, by L. J. Cutrona.

### Navigation Aids II

Very-High-Frequency Airborne Navigational Receiver and Antenna System, by A. G. Kandoian, R. T. Adams and R. C. Davis.  
Certain New Performance Criteria for Localizer and Glide-Slope Ground Installations, by P. R. Adams.  
Phase and Other Characteristics of 330-Mc Glide-Path Systems, by S. Pickles.  
Principles of Volume Scan, by D. Levine.  
The Control of Structural Resonance Effects on the Radio Bearings of an Aircraft High-Frequency Direction Finder, by M. Goldstein.

### Oscillators

An Analysis of Oscillator Performance under Varying Load Conditions and an Electronic System for Automatic Load Compensation, by E. Mittelmann.  
Low-Power Wide-Tuning-Range UHF Oscillators, by J. N. Pettit and F. J. Kamphoefner.  
Reactance-Tube Modulation of Phase-Shift Oscillators, by F. R. Dennis and E. P. Felch.  
A Low-Distortion AF Oscillator, by C. W. Clapp and C. L. Hackley.  
An Automatic-Frequency-Control System for Mechanically Tuned Oscillators, by J. G. Stephenson.  
Electronics IV—New Forms of Tubes  
The Graphophon—A Picture Storage Tube, by L. Pensak.  
The Pencil-Type UHF Triode, by G. M. Rose and D. W. Power.  
Practical Applications of the Resatron in the High-Power Transmitter Field, by W. W. Salisbury.  
The Electron Coupler—A New Tube for the Modulation and Control of Power at the Ultra-High Frequencies, by C. L. Cuccia and J. S. Donal, Jr.  
A Low Power Wide-Band CW Magnetron, by L. R. Bloom and W. W. Cannon.

### Industrial Tube Conference

To PROVIDE means for electronic tube users to discuss mutual problems with control equipment de-

# 205

## Exhibiting Manufacturers

are showing this label on their letters, literature and advertising. The spotlight is on the new at the Radio Engineering Show, come and see —

### Electronic Equipment

Registration \$3 non-members  
\$1 to IRE members



**IRE NATIONAL CONVENTION**

**RADIO ENGINEERING SHOW EXHIBITOR**

**GRAND CENTRAL PALACE AND HOTEL COMMODORE**

**MARCH 7 to 10**

**1949**



## AMERICAN AIRLINES CHOOSES ALTEC LANSING 8" SPEAKERS FOR FAMOUS FLEET OF DC-6s

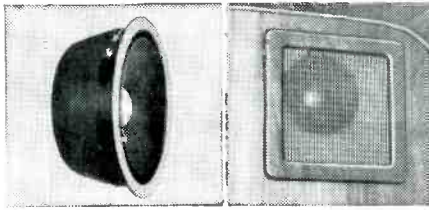

400B DIA-CONE SPECIFICATIONS:

Power Rating . . . . .	12 watts
Voice Coil Impedance . . . . .	8 ohms
Required Amplifier Output Impedance . . . . .	4-8 ohms
Voice Coil Diameter . . . . .	1 3/4"
Speaker Diameter . . . . .	8 1/4"
Speaker Depth . . . . .	3 3/8"
Weight . . . . .	4 lbs.

After exhaustive competitive in-flight operating tests of Altec Lansing and other speakers, American Airlines' communications division engineers reported: "Observers all voted for the Altec system on the basis of quality and clearness." Entire passenger fleet of DC-6's will be Altec Lansing 8" 400B Dia-cone equipped.

*Send for brochure describing entire Altec Lansing line of speakers, containing frequency response curves.*



161 Sixth Avenue  
New York 13, N.Y.  
1161 North Vine St.  
Hollywood 38, Cal.

## Lavite STEATITE CERAMIC

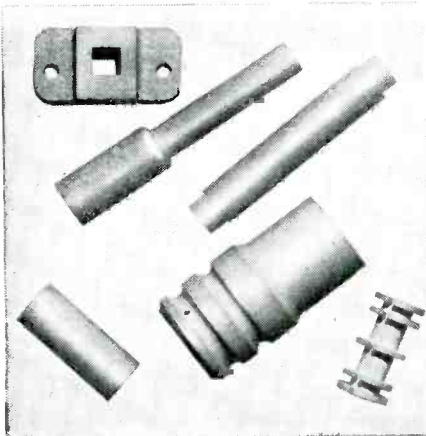

Design engineers and manufacturers in the radio, electrical and electronic fields are finding in LAVITE the precise qualities called for in their specifications . . . high compressive and dielectric strength, low moisture absorption and resistance to rot, fumes, acids, and high heat. The exceedingly low loss-factor of LAVITE plus its excellent workability makes it ideal for all high frequency applications.

Complete details on request

### D. M. STEWARD MFG. COMPANY

Main Office & Works: Chattanooga, Tenn.  
Needham, Mass. • Chicago • Los Angeles  
New York • Philadelphia

Developed by  
**TEL INSTRUMENT**  
FOR THE  
**TELEVISION INDUSTRY**

## New Type 12 CHANNEL R.F. SWEEP GENERATOR

- Instant Channel Selection by Push Button
- Rated for Continuous Service
- Pulse Type Markers at picture and sound carrier frequencies. Either or Both May be Turned On or Off.

No spurious markers produced.  
Accuracy 0.02% Xtal controlled.

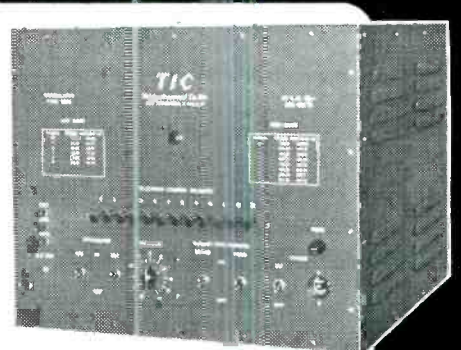

Precision Wobbulator for television production line. 15 M.C. band width on all channels. Output is oscillator fundamental frequency. Zero signal output reference baseline always present. Output 1v. across 75 ohms. Attenuator range 60 Db. Monitor signal provided.

PRICE \$1330 F.O.B. E. RUTHERFORD, N. J.

BOOTH "T" I.R.E. CONVENTION

Write for Full Data

## Tel-Instrument Co. Inc.

50 PATERSON AVENUE • EAST RUTHERFORD, N. J.

# NEW!

**WINCHESTER ELECTRONICS CO.**  
Develops a New Miniature

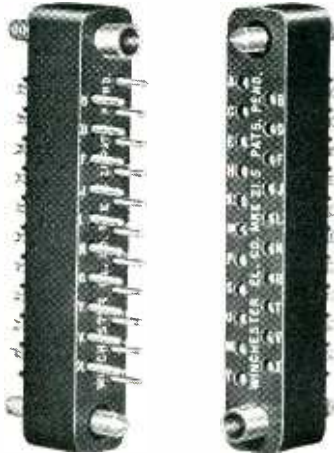

ACTUAL SIZE

## 21-CONTACT CONNECTOR

**COMPACT  
LIGHTWEIGHT  
SELF-ALIGNING  
RACK and PANEL TYPE**

These  
Are  
Proved  
Features:

**MONOBLOC\* CONSTRUCTION** assures a minimum number of creepage paths.

**MOLDED MELAMINE** assures high arc resistance and mechanical strength.

**MINIATURE 21 CONTACTS:** Each contact, precision machined and silver plated, assures low contact resistance and ease of soldering.

\*trade mark

Guide Pins provide self-alignment which makes Winchester Miniature Connectors ideal for rack and panel type equipment. Compactness and light weight make them particularly suitable for aircraft application.

### SPECIFICATIONS:

Number of Contacts ..... 21  
Creepage path between contacts 1/8" min.  
Air space between contacts ... 5/64" min.  
Contacts and guide pins:  
Pins ..... Brass, silver plated  
Sockets—Phosphor Bronze, silver plated  
Maximum wire size ..... #20 AWG

Write for more information in Bulletin MRE-21

**WINCHESTER  
ELECTRONICS COMPANY**  
6 East 46th St., New York 17, N.Y. (U.S.A.)

NEWS OF THE INDUSTRY (continued)

signers and tube manufacturers, an AIEE conference on the industrial application of electron tubes will be held in the Statler Hotel, Buffalo, N. Y., on April 11 and 12, 1949.

Program for the first day will include a technical session on the application of electron tubes in control and other industrial equipment, an inspection trip to the Westinghouse plant in Buffalo and a presentation of papers by several users of electron tubes describing their operating experience and their maintenance schedules.

The second day will feature a discussion of the items considered by manufacturers in designing equipment using tubes. A technical session will follow, dealing with methods used in building and rating tubes for industrial applications.

Sponsors of the conference are the AIEE subcommittee on electron tubes of the Electronic Committee, the subcommittee on electronic control of the Industrial Control Committee and the Niagara Frontier Section of the AIEE.

### Communication Instructors Wanted

VACANCIES have been announced for the position of general communication instructor at Scott Air Force Base, Illinois. Duties are to instruct or supervise instruction of officers and enlisted men of the Air Corps, Reserves or friendly foreign nationals in communications subjects in accordance with a definite instructional program of prescribed course of study, to prepare or assist in preparing text material for class instruction, and to perform related duties.

Minimum qualifications are five years of experience as electronics instructor, or five years experience in repair, installation and maintenance of electronic equipment, or a combination of both aggregating five years. Study in colleges and recognized radio training schools may be substituted year for year for experience under certain conditions.

Salary is \$3,727.20 per year. Age limits are from 18 to 62. Applications should be submitted on Stand-

## 90% TELL US WHAT TO DO—

Since practically every coil requirement is different, 90% of Precision Bobbins are made to customer specifications.

Cores can be made any length, any shape. Flanges die cut to any size of shape—with combinations of slots or holes for terminal wiring—embossed or recessed to fit any type mounting.

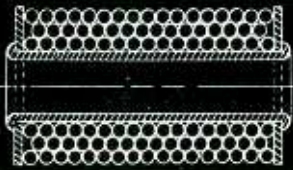

## PRECISION BOBBINS

### THE MASTER COIL BASE

Lighter, stronger coils are made with Precision Bobbins—cores are spirally wound and heat treated under compression for greater strength—less weight. Insulation strips are unnecessary—giving closer windings—stronger magnetic fields.



WRITE TODAY  
FOR SAMPLES—DETAILED  
ILLUSTRATED BULLETIN

### PRECISION PAPER TUBE CO.

2041 W. Charleston St. Chicago 47, Ill.  
Plant No. 2  
79 Chapel St. Hartford, Conn.



Use the Vacuum Pump  
that Gives You

- ✓ Faster Pump Down
- ✓ Lower Pressure
- ✓ Higher Efficiency
- ✓ Longer Service

For vacuum exhausting at low pressures in electronic and electrical work: Beach-Russ Type RP Pumps offer the advantages of positive, rotary, automatically lubricated, noiseless and vibrationless performance that puts them at the top either for final vacuum or for backing diffusion pumps. Fitted for pressure down to 2 to 4 microns. Thousands in use in your industry.



Capacity — 17 to 845 c.f.m.

**BEACH-RUSS**  
high vacuum  
PUMPS

Write for  
Catalog  
No. 84

**BEACH-RUSS COMPANY**  
52 CHURCH ST. NEW YORK 7, N. Y.

## MIGHTY MITES OF RECORDING!

For cutting —

*Brilliantone*  
RECORDING NEEDLES

For cutting direct on all coated aluminum, paper, or glass base discs. Machine-lapped to insure a mirrorlike finish... a clean, quiet-cut groove.

For playback —

*Actone*  
TRANSCRIPTION NEEDLE  
100% SHADOWGRAPHED

Made to fit the groove cut by the Brilliantone Recording Needle. Used by top radio stations and transcription companies.

Products of *Bagnshaw*

Famous for Fine Needles Since 1892

For New Catalog and Current Price Lists, write to: Advertising Division

**H. W. ACTON CO., INC.**

Sole Distributor

370 Seventh Ave., New York 1, N. Y.

# "Wow-Meter"



Newly developed direct-reading instrument simplifies measurements of variations in speed of phonograph turntables, wire recorders, motion picture projectors and similar recording or reproducing mechanisms.

The Furst Model 115-R "Wow-Meter" is

suitable for both laboratory and production application and eliminates complex test set-ups.

A switch on the front of the panel permits selection of low frequency cut-off and corresponding meter damping for use on slow speed turntables.

Frequency Response: 1/2 to 120 cycles or 10 to 120 cycles

Visit our Booth R at the National IRE Convention

Designers and Manufacturers of Specialized Electronic Equipment



## FURST ELECTRONICS

10 S. Jefferson St., Chicago 6, Ill.

## DIFFERENTIALS

$\frac{3''}{16}$      $\frac{1''}{4}$      $\frac{5''}{16}$

Precision Plus!

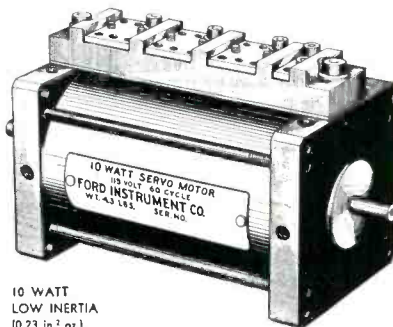
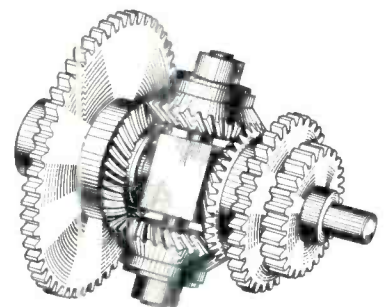

10 WATT  
LOW INERTIA  
(0.23 in.<sup>2</sup> oz.)

## LOW INERTIA SERVO MOTORS

Descriptive Literature on Request

**FORD INSTRUMENT CO.**

DIVISION OF

**THE SPERRY CORPORATION**

31-10 THOMSON AVENUE

LONG ISLAND CITY 1, N. Y.

INTEGRATORS

ESTABLISHED  
1915

ESYNS

# Building Airborne Electronic Equipment?

THEN YOU'LL WANT THE *best* IN AIRCRAFT VIBRATION ISOLATION

## BARRY AIR-DAMPED VIBRATION-ISOLATORS

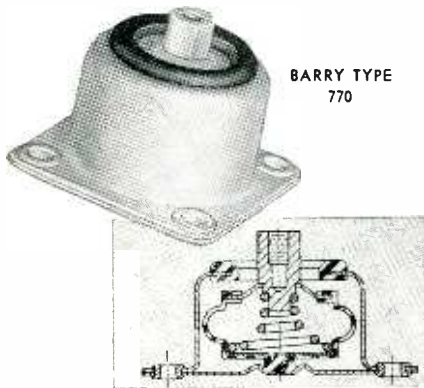

BARRY TYPE 770

### FEATURES

- Exclusive *air-damping* to limit excursion at resonance.
- Meets government requirements.
- Operative over wide temperature limits.
- Equally effective at high altitudes—proven by test.
- Good performance over wide load range.
- Air cushioned shock protection during warmup, taxiing, and landing.
- Available now for loads up to 35 pounds.
- Available also on standard or special size mounting bases.

SEND FOR TECHNICAL CATALOG

VISIT OUR EXHIBIT  
BOOTH #293 (second floor)  
I.R.E. SHOW MARCH 7-10

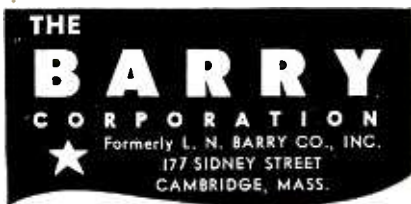

ard Form 57, obtainable at any first or second class post office, or from Scott Air Force Base, Illinois.

### National Telemetry Forum

SEVERAL companies and organizations interested in telemetry systems and components recently organized a group known as the National Telemetry Forum. Purpose of the organization is to provide a freer exchange of telemetry information and more widespread discussion of technical problems. Only personnel who are invited and cleared to receive classified information may attend the Forum's meetings.

Meetings are held approximately bimonthly at the place of business of any of the participating organizations who volunteer to serve as hosts. The host acts as chairman of each technical meeting, and is also responsible for issuing invitations and for preparing and distributing a report of the activities.

The last meeting was held February 14 and 15 at the Warwick Hotel, Philadelphia, with the Raymond Rosen Engineering Products, Inc., acting as hosts. Topics discussed were the design of commutators for telemetry applications and pre-flight preparation and calibration of telemetered missiles.

All inquiries concerning the Forum should be directed to one of the following officers of the organization: chairman, W. J. Mayo-Wells of the Applied Physics Laboratory, Johns Hopkins University, Silver Spring, Md.; vice-chairman, George Adams of Boeing Airplane Co., Seattle 14, Washington; secretary, H. B. Schultheis of the Pacific Division, Bendix Aviation Corp., North Hollywood, Calif.

### URSI-IRE Meeting

A JOINT meeting of the International Scientific Radio Union (URSI) and the IRE will be held in the East Building Lecture Room, National Bureau of Standards, Connecticut Ave. and Van Ness Street, N. W., Washington, D.C., on May 2, 3 and 4, 1949. During the first two days papers of a fundamental scientific and research character will be presented on the following



## METALLIZED CONDENSER PAPER

by SMITH

When you use Metallized Condenser Paper, it is possible to:

1. Manufacture a one-layer condenser.
2. Save 75% space.
3. Use more economical neutral oils.
4. Use less impregnating materials.
5. Eliminate the use of foil electrodes.
6. Use simpler capacitor winding machines.
7. Eliminate breakdown effects through self-healing.
8. Obtain higher insulation resistance, higher dielectric strength.

Get all the facts on Smith Metallized Condenser Paper as it applies to *your* industry. A card, letter or phone call to Smith Paper, Inc., Lee, Massachusetts (telephone Lee 7) will bring you the information you seek, without obligation on your part.

VISIT US AT BOOTH "M"  
I.R.E. SHOW

Manufacturers of Condenser Papers

SMITH PAPER, INC.  
LEE, MASSACHUSETTS





Available In All Types  
of Bulbs and Jewels

Underwriters approved, the JOHNSON 147-1000 Series features porcelain insulation, has soldered terminals and candelabra screw base. Fits 1" hole. One inch jewel is in friction type holder with polished chrome bezel. Colors available include red, green, amber, blue, opal and clear.

For S6 bulb, candelabra screw base.  
Cat. No.  
147-1000 ..... faceted jewel  
147-1001 ..... smooth jewel  
147-1002 ..... colored disc

For NE-45 Neon (T4½) bulb  
No resistor required for 110 volts.  
Cat. No.  
147-1003 ..... faceted jewel  
147-1004 ..... smooth jewel  
147-1005 ..... colored disc

JOHNSON carries in stock a complete line of standard pilot light assemblies to meet every ordinary need. Special assemblies, to meet your most exacting requirements, can also be furnished in production quantities on special order. Your inquiries are invited.



## Flexible Shafts

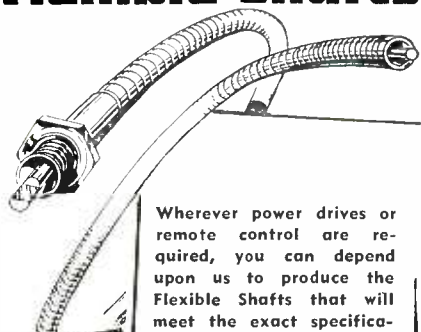

Wherever power drives or remote control are required, you can depend upon us to produce the Flexible Shafts that will meet the exact specifications. We have years of experience in manufacturing flexible shafting for all types of industry. If we do not have what you require in stock, we can make shafts to your specifications. Our engineers will be glad to work out your problems without obligation.

WRITE FOR MANUAL D



**F. W. STEWART MFG. CORP.**  
4311-13 RAVENSWOOD AVE.  
CHICAGO 13, ILL.  
WEST COAST BRANCH:  
431 VENICE BLVD. LOS ANGELES 15, CAL.



Multi-Channel Equipment for Standard Communication Frequencies. Adapts existing transmitting and receiving facilities for radio multiplex.

The System illustrated is a four-channel unit under test. The two bays at the left are the complete receiving units; next, the transmitter terminal and exciter facilities; the two bays at the right are the test equipment.

For full details on Radio Multiplex Systems, plus a complete line of communications terminal and frequency shift equipment, see our exhibit at the

I. R. E. CONVENTION • BOOTHS 275-276

**NORTHERN RADIO COMPANY**  
Incorporated  
143-145 WEST 22nd ST. NEW YORK 11, N. Y.

# RADIO MULTIPLEX SYSTEMS



## rpc HIGH VOLTAGE RESISTORS

FOR TELEVISION • TEST  
EQUIPMENT • NUCLEAR RESEARCH

These stable resistors are made in many sizes from one inch to 18½ inches long, with voltage ratings from 3.5 to 125 KV. Resistance values up to one million megohms can be furnished. These resistors are designed for easy mounting on a panel or stand-off insulator. RPC resistors can be assembled to make various tapped combinations. For high voltage instrumentation matched pair units are available with 2% accuracy. RPC High Voltage Resistors are used in quantity by leading manufacturers, instrument makers, universities and laboratories.

**RESISTANCE PRODUCTS CO.**  
714 RACE STREET HARRISBURG, PA.

Also Manufacturers of High Quality Precision Resistors and High Frequency Resistors



## A VERSATILE FINE-WIRE WINDING MACHINE BY GEO. STEVENS

The No. 25 shown is a combination of the Universal Winding Machine and the 6" Space Winding Machine. Handles wire from 24 to 40 gauge. Progressive Universal Coils may be up to 3½ inches in length.

- Other models for winding Coils, Transformers, Resistors, and Solenoids
- Dial Counters also available separately
- We welcome the opportunity to consult with you on your needs and would like you to have our latest catalog ... write!

**GEO. STEVENS MFG. CO.**  
6022 N. ROGERS AVE.  
PULASKI & PETERSON  
CHICAGO 30, ILLINOIS

Now Ready

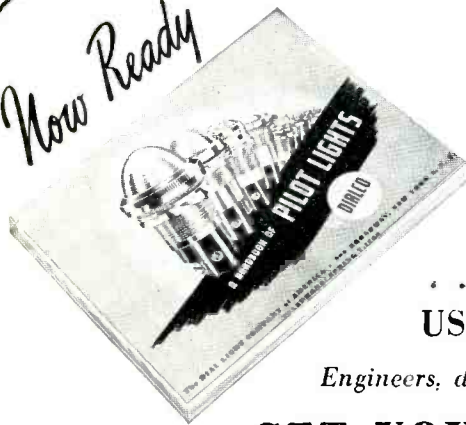

# The NEW DIALCO HANDBOOK

... 192 PAGES of USEFUL INFORMATION

Engineers, designers, purchasing agents —

## GET YOUR COPY

You will find complete data on the lamps used in pilot lights.

And illustrations - all full size - of hundreds of items you will use.

There is a table of resistors for operation of lamps on all voltages.

Complete dimensional data on each unit.

More than 2,000 Underwriters' Listed Assemblies.

### The DIAL LIGHT COMPANY of AMERICA

Foremost Manufacturer of Pilot Lights.

900 BROADWAY, NEW YORK 3, N. Y. TELEPHONE SPRING 7-1300

Write for Handbook D-149

VISIT US at Booth 46 at the I.R.E. NATIONAL CONVENTION

## TRANSICOIL CONTROL MOTORS, GEAR TRAINS and COMBINATIONS

for 400 cycle or 60 cycle operation

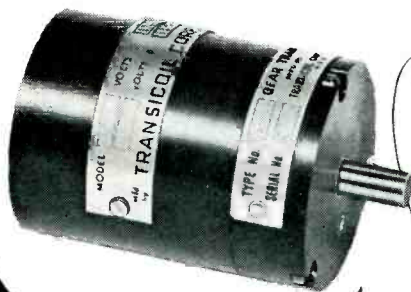

Newly developed design features PLATE - TO - PLATE operation, eliminating use of output transformer in the servo-amplifier.

Stall torque .25 in. oz. up to 4.25 in. oz.

Gear Train backlash can be held to .5° where required.

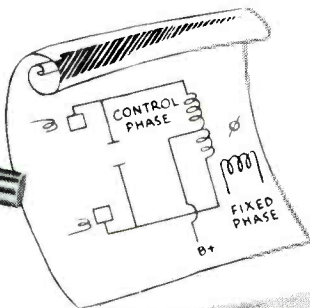

## TRANSICOIL CORPORATION

114 WORTH ST., NEW YORK 13, N. Y.

Complete Technical Data Available. Request on Company Letterhead

topics: radio standards, methods of measurement, terrestrial radio noise (natural and man-made), communication theory, antennas, circuits, electron tubes, semiconductors and properties of matter. The last day will be reserved for meetings of various national commissions.

Booklets listing the program titles and abstracts will be available for distribution before the meeting. Correspondence should be addressed to Dr. Newbern Smith, Secretary, U.S.A. National Committee, URSI, National Bureau of Standards, Washington 25, D.C.

### Eta Kappa Nu Awards

THE OUTSTANDING young electrical engineer of 1948, chosen by Eta Kappa Nu, national honor society for electrical engineers, was Abe Mordecai Zarem, manager and chairman of physics research for the Stanford Research Institute, Los Angeles, Calif. He has conducted research on transient electrical discharges and has developed a method for photographing them. Another achievement is his invention of the Zarem camera. The recognition award, bestowed annually upon a young engineer (35 years of age or less and out of college under 10 years) "for meritorious service in the interest of his fellow men", was presented on January 31, 1949 at the Winter General Meeting of the AIEE.

One of the two honorable mentions for the recognition award was given to Milton E. Mohr, member of the technical staff of Bell Telephone Laboratories, Inc. Holder of 13 U.S. patents, he was responsible for the r-f sections of the broadcast receivers recently exhibited by Bell Labs to demonstrate circuits in which transistors might be used instead of vacuum tubes.

The second recipient of an honorable mention certificate was Jay Wright Forrester, associate director of the Servomechanisms Laboratory, MIT. His major technical contributions have come in the past three years. The group of 200 persons that he heads is working on a new electronic digital computer technique to solve aircraft analyzer

# RAHM

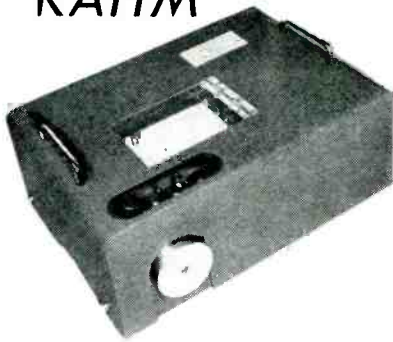

## MULTI-CHANNEL OSCILLOGRAPH

### FEATURES

- Stable AC-DC Combination Amplifiers
- 1-2-4-6 Channels
- Unit Design
- Unequalled Sensitivity MM/MW
- Direct Writing
- Inkless Recording
- Rugged—Durable
- Adjustable Response
- Multi-Speed Chart Drive

Write for Information

**RAHM INSTRUMENTS INC.**

12 West Broadway New York 7, N. Y.

**NOW!**

# Micro Match

**FOR 50 TO  
500 MCS**

**RF Power and SWR Monitor**

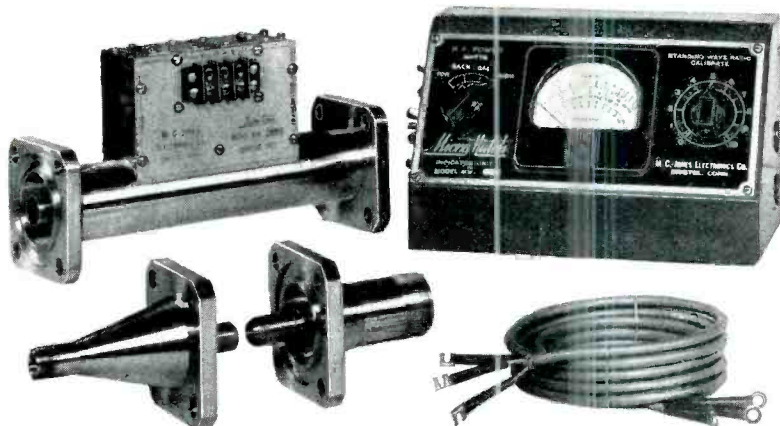

### • SPECIFICATIONS

Frequency Range	50 to 500 MCS
Impedance	51.5 ohms
Connectors	Standard 1 5/8" flanged 51.5 ohm line Adapters available for RG-17/U and RG-8/U
Accuracy	± 4% of full scale for RF power ± 10% for standing wave ratio
Power Ranges:	
Model MM 401	0 to 400 watts
MM 402	0 to 1200 watts
MM 403	0 to 4 KW
Reflection Coefficient	Negligible (less than 0.01)

### MODEL MM 401 and Adapters

Power and SWR readings are independent of frequency with this newest Micro-Match. This instrument monitors both transmitter and load characteristics in the frequency range from 50 to 500 MCS.

### PRICE

Micro-Match (all models) \$225.00  
Adapters (each) 28.00

Write for complete descriptive literature.

**M. C. JONES ELECTRONICS COMPANY BRISTOL, CONN.**

Distributed outside continental U. S. A. by RCA International Division Radio Corporation of America

## Working with Inert Gases?

*Linde* HELIUM · NEON

ARGON · KRYPTON · XENON

are spectroscopically pure

Consult LINDE for your rare gas requirements . . . We can meet your individual needs of purity . . . volume . . . mixtures . . . containers . . .

**THE LINDE AIR PRODUCTS COMPANY**

Unit of Union Carbide and Carbon Corporation  
30 East 42nd Street  New York 17, N. Y.  
In Canada: Dominion Oxygen Company, Limited, Toronto

The term "Linde" is a registered trade-mark of The Linde Air Products Company.

## COMPOUNDS

Scientifically compounded for specific applications from waxes, resins, asphalts, pitches, oils, and minerals. Available in wide range of melting points and hardnesses. Special potting compounds are heat conducting and crack resistant at extremely low temperatures. Recommendations, specific data, and samples will be furnished on request.

for

### IMPREGNATING

radio coils  
transformer coils  
ignition coils  
wire coverings  
paper tubes and forms  
porous ceramics

### DIPPING

Coils  
Transformers  
Condensers

### SEALING

condensers  
batteries  
switch base terminals  
socket terminals  
light fixtures

### POTTING

Radio Transformers  
Light Units  
Loading Coils  
Condensers



**BIWAX CORPORATION**

3 4 4 5 HOWARD STREET  
SKOKIE, ILLINOIS

## DANO plus KNOW - HOW bring you COIL PERFECTION

Our Engineering Department is at your service.  
Samples cheerfully analyzed without obligation.  
**TRANSFORMERS Made To Order**

Not just any coil but the exact coil winding you need, skillfully made to your exact requirements. The dependability and service behind our name are your assurance of perfect coil performance.

**THE DANO**

**ELECTRIC CO. 93 MAIN ST. WINSTED, CONN.**

## Investigate COPPER ARMORED SISALKRAFT



Reinforced  
with tough Sisal Fibres

### SUCCESSFULLY USED FOR *electrostatic shielding*

OF TELEVISION AND RADIO  
STUDIOS, TESTING ROOMS,  
INDUSTRIAL LABORATORIES,  
AND DIATHERMY, RADAR,  
AND ELECTRONIC EQUIPMENT

The success of COPPER ARMORED SISALKRAFT for shielding during the past decade suggests that you might find this reinforced "electro sheet copper" product practical for rooms and large enclosures or equipment requiring electro-static shielding. On the basis of experience gained in such installations as:

Steinmetz Hall, New York • Hollywood Television Studio of Don Lee • WBKB Radio Station, Chicago • Sentinel Television Testing Rooms • Corn Products Company's Argo Laboratory • Delco Radio Sets • CBS Radio Testing Laboratories  
SISALKRAFT engineers will be glad to furnish data on the merits of COPPER ARMORED SISALKRAFT in these and allied fields.

Available in 1-oz., 2-oz., and 3-oz. weights, in rolls 4" to 60" wide. Reasonable cost . . . as low as \$9.75 per 100 square feet. Send for samples.

## COPPER ARMORED SISALKRAFT

. . . A Product of

The SISALKRAFT Co., Chicago 6  
New York 17 • San Francisco 5

The SISALKRAFT Co., Dept. EL,  
205 W. Wacker Drive, Chicago 6, Ill.

Please send samples of  One-Ounce;  
 Two-Ounce;  Three-Ounce COPPER  
ARMORED SISALKRAFT. The use I con-  
template involves (describe briefly)

Name.....

Address.....

City, Zone and State.....

simulator problems. Using the electrostatic storage principle he has carried his research to the development and construction of a versatile line of test equipment for the computer field, as well as new construction and measurement techniques.

### BUSINESS NEWS

SYLVANIA ELECTRIC PRODUCTS, INC., recently purchased a plant at Seneca Falls, N. Y., to expand television picture tube production.

POLYTECHNIC RESEARCH AND DEVELOPMENT Co., INC., has opened new and expanded research laboratories at 202 Tillary St., Brooklyn, N. Y.

CORNELL-DUBILIER ELECTRIC CORP. has purchased from Maguire Industries, Inc. all the stock of the Radiart Corp. of Cleveland, Ohio, manufacturers of auto radio vibrators and auto and television antennas.

FURST ELECTRONICS, manufacturers of specialized electronic laboratory instruments, has moved to enlarged quarters at 12 S. Jefferson St., Chicago, Ill.

VIDEO CORP. OF AMERICA, television receiver manufacturer, has moved to new and larger quarters at 229 W. 28th St., New York City.

RAULAND-BORG CORP., a newly formed organization, has purchased the sound division of the Rauland Corp. from Zenith Radio Corp. to continue manufacture and sale of sound products.

THE ACRO ELECTRIC Co., Cleveland, Ohio, manufacturers of rolling-spring snap-action switches, has been purchased by a group including Willard F. Rockwell, Jr., president of the Rockwell Mfg. Co., Pittsburgh, Pa.

KIMBLE GLASS DIVISION OF THE OWENS-ILLINOIS GLASS Co. has taken over the parent company's Columbus, Ohio, plant to expand television bulb manufacturing operations.

MULTI-TRON LABORATORY, Chicago, Ill., was recently established to con-

## Save Time... Speed Assembly with CTC ALL-SET Boards!

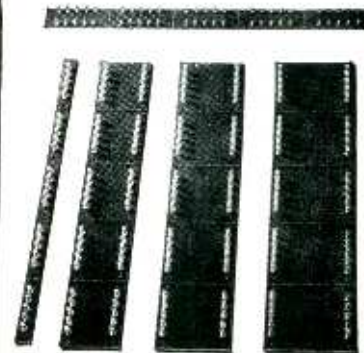

On the assembly line and in the laboratory, CTC ALL-SET Boards are valuable time-savers.

With Type 1558 Turret Lugs, a new board now offers mounting for miniature components. 1 1/16" wide, 3/32" thick, only. (Type X1401E.)

With Type 1724 Turret Lugs, boards come in four widths: 1/2", 2", 2 1/2", 3" — in 3/32", 1/8", 3/16" thicknesses.

With the addition of the new miniature board, CTC ALL-SET Boards now cover the entire range of components.

All boards are of laminated phenolic, in five-section units, scribed for easy separation. Each section drilled for 14 lugs. Lugs solidly swaged into precise position . . . whole board ready for your assembly line.

### SPECIAL PROBLEMS

Custom-built boards are a specialty with CTC. We're equipped to handle many types of materials including the latest types of glass laminates . . . many types of jobs requiring special tools . . . and all types of work to government specifications. Why not drop us a line about *your* problem? No obligation, of course.



Custom or Standard  
The Guaranteed  
Components

CAMBRIDGE THERMIONIC CORPORATION

437 Concord Avenue, Cambridge 38, Mass.

# MICO

## 2 & 3-DIMENSIONAL ENGRAVER

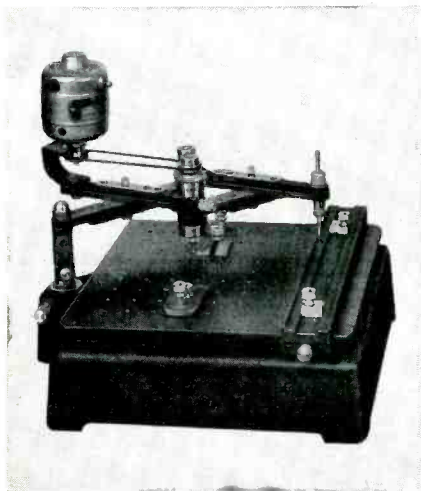

Used in making small molds and dies or engraving panels and nameplates of metal or plastic.

Permits accurate reproduction of three-dimensional master on any of four reduction ratios.

Catalog on Request

**MICO INSTRUMENT CO.**

76 TROWBRIDGE STREET  
CAMBRIDGE 38, MASS.

# NEY PRECIOUS METALS IN INDUSTRY

NEY-ORO #28B BRUSH CONTACT ON  
ADVANCE\* WIRE WOUND POTENTI-  
OMETER RUNS 4,300,000 SWEEPS  
WITH NO CHANGE IN RESISTANCE

Examine these unretouched photographs of mandrel (wound with Advance\* #36 B&S) and brush adjusted for 50 gms pressure. There is no appreciable wear on the winding after 4,300,000 sweeps of the brush and the wear on the brush is less than .008". Throughout the test there was no perceptible change in resistance. Truly a remarkable performance when you consider the additional fact that the test was conducted at a speed of 37.5 cycles (75 sweeps) per minute, considerably faster than normal operation. The test was conducted by a leading manufacturer of precision equipment and the complete test data is available on request. It is, we believe, further convincing evidence of the interesting possibilities offered by the use of Ney Precious Metal Alloys in industrial and scientific applications.

Write or phone (Hartford 2-4271) our Research Department.

\*Reg. T. M. of D-H Co.

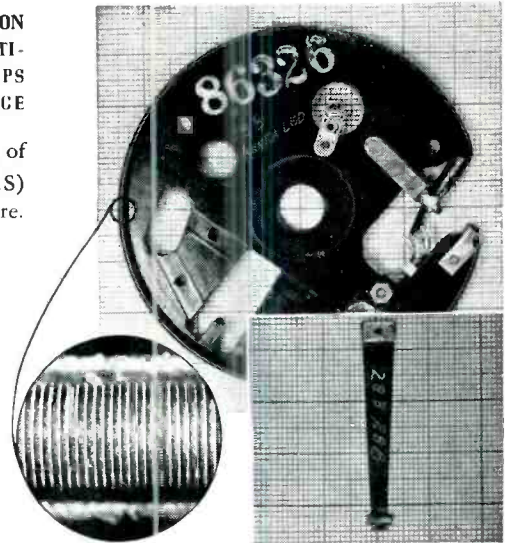

Mandrel and brush shown 40% full size.  
Section of mandrel 6x magnification.



**THE J. M. NEY COMPANY**  
179 ELM STREET • HARTFORD 1, CONNECTICUT

# BIRTCHEr

STAINLESS STEEL - LOCKING TYPE

## TUBE CLAMPS

Stainless Steel

Corrosion Proof



**83 VARIATIONS**

Where vibration is a problem, Birtcher Locking TUBE CLAMPS offer a foolproof, practical solution. Recommended for all types of tubes and similar plug-in components.

More than three million of these clamps in use.

### FREE CATALOG

Send for samples of Birtcher stainless steel tube clamps and our standard catalog listing tube base types, recommended clamp designs, and price list.

**THE BIRTCHEr CORPORATION**  
5087 HUNTINGTON DR. LOS ANGELES 32

# CAPITOL RADIO ENGINEERING INSTITUTE

Pioneer in Radio Engineering Instruction Since 1927

An Accredited Technical Institute

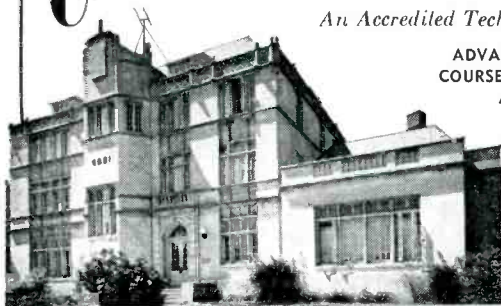

ADVANCED HOME STUDY AND RESIDENCE  
COURSES IN PRACTICAL RADIO-ELECTRONICS  
AND TELEVISION ENGINEERING

Request your free home study or residence  
school catalog by writing to:

REGISTRAR  
16TH AND PARK ROAD, N.W.  
WASHINGTON 10, D. C.

Approved for Veteran Training

# TELEVISION CAPACITORS

Approved by Industry

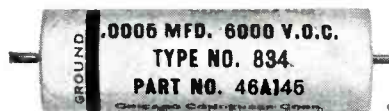

Your specifications for quotation  
will be given prompt attention.

Built to last, oil impregnated 6000  
volts and up. Small and compact.  
Ample safety factor. All capacities.



**CHICAGO CONDENSER CORPORATION**  
3255 WEST ARMITAGE AVENUE CHICAGO 47, ILLINOIS

## NO OBSOLESCENCE

ONE AMPLIFIER for ALL RECORDS  
... plus \*Dynamic Noise Suppression

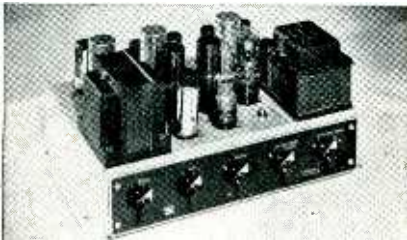

New developments in recording, regardless of turntable speed or pick-up point, will not obsolete the H. H. Scott type 210A amplifier because it already includes every feature necessary for faithful reproduction of recorded or broadcast music.

And in addition, the built-in \*Dynamic Noise Suppressor assures freedom from rumble, hiss, and the scratch that inevitably increases with each playing of any record.

Brilliant, realistic reproduction of every record, 33, 45, or 78 RPM . . . and of FM and AM broadcasts as well . . . is certain now and for many years to come with the H. H. Scott 210A amplifier.

Hear it TODAY and you'll agree that it satisfies tomorrow's requirements. For complete technical data, write Dept. 903-E2.

**GUARANTEED FOR A FULL YEAR**

## Now \*DYNAMIC NOISE SUPPRESSION

with your present Radio-Phonograph or Amplifier on both Standard and Long-Playing Records.



Reduces scratch and rumble without fixed loss of "highs" or "lows".

Add realism to your music reproduction by these 2 simple steps.

1. Plug in the "Little Wonder" \*Dynamic Noise Suppressor between your pick-up and amplifier.
2. Plug in the socket adapter to the power-tube socket.

The "Little Wonder" (Type 110-A) realizes the full capabilities of your present equipment; remote control mounts anywhere; high-and-low-frequency noise suppression; two inductor type high-frequency gate circuit; two separate control rectifiers; compact — 7 x 3 $\frac{1}{4}$  x 4 $\frac{3}{4}$  inches. For full specifications write for bulletin 903-E1.

\*Licensed under U. S. and foreign patents pending and issued.

**HERMON HOSMER SCOTT**  
**INCORPORATED**  
"PACKAGED ENGINEERING"  
385 PUTNAM AVE. • CAMBRIDGE 39, MASS.

## NEWS OF THE INDUSTRY

(continued)

duct research and development in the fields of electronics, radiation, optics and nuclear physics. Nicholas D. Glyptis is the director.

VICKERS INC., magnetic amplifier manufacturers, recently announced expansion of their line of electrical



Vickers Electric Division new plant

products and a move to larger quarters in St. Louis, Missouri.

ELK ELECTRONIC LABORATORIES, New York City, was recently formed to specialize in the design and development of test equipment for the communications, radar and allied fields.

THE WHEELER INSULATED WIRE Co., INC. has moved from Bridgeport to Waterbury, Conn., to provide more adequate space for expansion in electronic and television fields.

GAROD ELECTRONICS, LTD., Long Beach, Ontario, Canada, is a new company formed by Garod Electronics Corp., to manufacture radio and television receivers.

GENERAL ELECTRIC RESEARCH LABORATORY, Schenectady, N. Y., recently established a crystallography division to work on problems of interatomic arrangement, particularly with respect to the structure of crystals.

## PERSONNEL

ROBERT E. MOE, with GE since 1934, has been appointed division engineer for electronic receiving tube product lines of the company's tube divisions, with headquarters at the Owensboro, Ky., plant.

ARTHUR V. NICHOL, after 18 years with Philco Corp., has been named chief engineer responsible for the development of auto radio.

WILLIAM A. GRAY, formerly with Raytheon Mfg. Co., has established

FOR  
DEMONSTRATING  
& TESTING AUTO RADIOS  
from AC LINES

**ATR**



## "A" BATTERY ELIMINATORS



### for DEMONSTRATING AND TESTING AUTO RADIOS

New Models . . . Designed for testing D. C. Electrical Apparatus on Regular A. C. Lines. Equipped with Full-Wave Dry Disc Type Rectifier, Assuring Noiseless, Interference-Free Operation and Extreme Long Life and Reliability.



## AUTO RADIO VIBRATORS

A Complete Line of Vibrators . . .

Designed for Use in Standard Vibrator-Operated Auto Radio Receivers. Built with Precision Construction, featuring Ceramic Stack Spacers for Longer Lasting Life.

NEW MODELS ✓ NEW DESIGNS ✓  
NEW LITERATURE ✓  
ATR "A" Battery Eliminator, DC-AC Inverters, Auto Radio Vibrators  
See your jobber or write factory

AMERICAN TELEVISION & RADIO Co.  
Quality Products Since 1931  
SAINT PAUL 1, MINNESOTA-U. S. A.



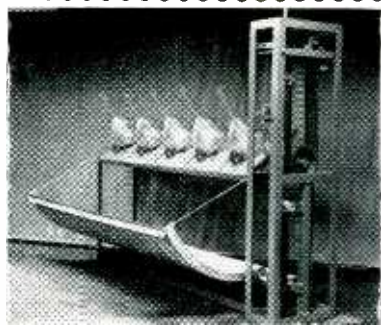

We Build Special Equipment for  
**TUBE MANUFACTURERS**  
PRODUCTION — TESTING

TILTING TABLE, shown above, for 10" and 12" C. R. Tubes. Standard or special designs for any tube, type or size.

CARRIER for 10" and 12" Tubes; greater capacity; less floor area; no dirt on screens

**BUCK ENGINEERING CO., INC.**  
37-41 Marcy St. Freehold, N. J.

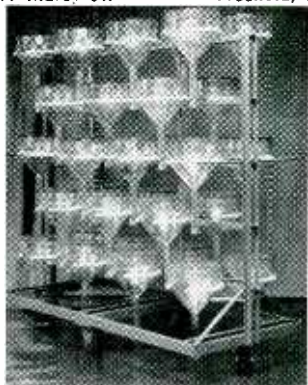

# WIDELY USED . . .

## UNBRAKO SOCKET SCREW PRODUCTS

Reg. U.S. Pat. Off.

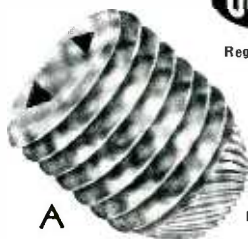

A

Pat'd & Pats. Pend.



B

Patd.



C

### THEY'RE KNURLED!

(A) The KNURLED cup point of this popular "UNBRAKO" Socket Set Screw makes it a Self-Locker . . . because the keen edges of the counter-clock-wise KNURLS prevent creep, regardless of the most chattering vibration. A real fastener, if ever there was one . . . positively won't shake loose! (B) The KNURLING, as shown, swages the threads of this patented "UNBRAKO" Socket Set Screw—so that it becomes a most excellent Self-Locker—for use where a hardened steel shaft prevents the use of a knurled point. A Set Screw that positively "won't shake loose"! (C) The head of this ubiquitous "UNBRAKO" Socket Head Cap Screw is KNURLED to speed assembly. The KNURLS "gear" right to the fingers—the handiest of wrenches—no matter how oily, and a positive slip-proof grip is the result—no futile motion. Sizes available from No. 4 to 1½" diameter, in a full range of lengths.

Knurling of Socket  
Screws originated with  
"Unbrako" in 1934.

Write us for the name and address of your  
nearest "UNBRAKO" Industrial Distributor,  
and for your copy of the "UNBRAKO" Catalog.

Over 46 Years in Business

## STANDARD PRESSED STEEL CO.

JENKINTOWN, PENNSYLVANIA, BOX 596

Chicago • Detroit • St. Louis • San Francisco

## FREE

send today for this  
big book of values in

**TELEVISION**  
RADIO, ELECTRONIC,  
INDUSTRIAL, SOUND &  
AMATEUR EQUIPMENT



### NEW 1949 NEWARK CATALOG

20,000 items including everything in STANDARD BRAND equipment! 148 pages packed with pictures, charts, and vital information!

**KITS! SETS! PARTS! ACCESSORIES!**

No matter how tiny the part, how tremendous the system . . . it's listed in this mammoth catalog . . . the one easy, satisfactory way to always get top-performing, top-value equipment! The most complete essential reference book for pros, hams, hobbyists, novices, oldtimers . . . anyone, everyone interested in TV, radio and sound equipment!

24-HR. MAIL SERVICE • ONE YEAR TO PAY

**3 GREAT STORES!** Uptown at 115 West 45th Street and Downtown at 212 Fulton Street in NEW YORK  
323 West Madison Street in the heart of CHICAGO



MAIL COUPON TODAY

Newark Electric Co.  
242 W. 55th St., NYC

Dept. C-8 Please send FREE Newark Catalog to:

NAME \_\_\_\_\_

ADDRESS \_\_\_\_\_

CITY \_\_\_\_\_ STATE \_\_\_\_\_

## RADIO FREQUENCY COILS

— TV - FM - AM —

Standard coils and coils to specifications.

Engineering department enlarged to permit additional cooperation with design engineers.

ALL inquiries will receive prompt attention!

May we quote on your coil requirements?

### HARNETT ELECTRIC CORPORATION

138 Haven Ave., Port Washington, Long Island, N. Y.

Telephone: Port Washington 7-0751

*Fifty Thousand Volts!*  
*at fifty thousand ohms/volt*

KILO VOLTER Model 4000

- Input impedance 1250 megohms
- Shielded Polysterene Probe
- Ranges 0-25/50 kilovolts

Complete with Probe \$67.50 net

See this and other "Bradshaw" test instruments at your radio parts distributor. Write for Catalog.

**BRADSHAW INSTRUMENTS CO.**

348 Livingston St.,

Brooklyn 17, N. Y.



a management consulting service at Watertown, Mass., for the electronic equipment and tube industry.

RICHARD M. SOMERS has been promoted from assistant chief engineer to chief engineer of the Edison Division of Thomas A. Edison, Inc., West Orange, N. J.

PALMER M. CRAIG, chief engineer of Philco's radio division since 1943, was recently appointed director of engineering of electronics division of engineering department.



P. M. Craig



H. G. Booker

HENRY G. BOOKER, formerly lecturer in mathematics at Cambridge, England, and researcher on radio propagation in the stratosphere, was recently appointed a professor of electrical engineering at Cornell University, Ithaca, N. Y.

GEORGE E. ZIEGLER, acting chief administrator of the Midwest Research Institute in Kansas City, Mo. for six months, was recently appointed director of the Institute.

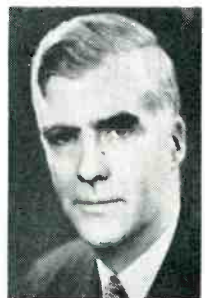

G. E. Ziegler



R. M. Hanson

ROBERT M. HANSON, formerly with the Thordarson Electric Co., Chicago, Ill., is now chief engineer at Audio Development Co., Minneapolis, Minn.

JENNINGS B. DOW, wartime chief of the electronics section of the Bureau of Ships in Washington, D.C., has been elected executive vice-president of Hazeltine Electronics Corp.

REMOTE INSTRUMENTATION  
BY BENDIX-PACIFIC

*Introducing  
the New*

TTP-8A  
TELEMETERING  
PRESSURE  
GAGE

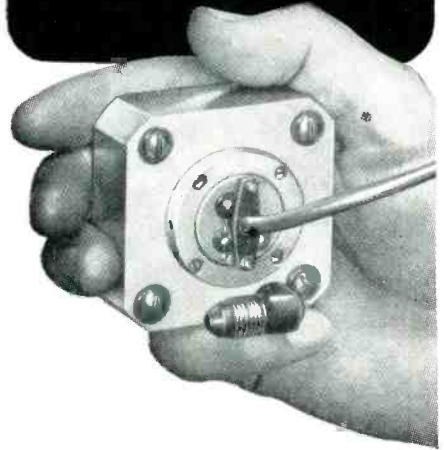

BENDIX-PACIFIC now has available a Telemetering Pressure Gage with accuracy equal to or exceeding that of aircraft altimeters. The TTP-8A aneroid type pressure gage is a variable reluctance instrument designed to measure barometric pressures.

As an altimeter this device provides a maximum range of 0 to 25,000 ft. with a temperature error of less than 0.015% of band width per degree Fahrenheit over a wide range of temperatures.

The TTP-8A has extremely small vibration and acceleration errors and the pressure determinations are reproducible within 1/2%. It operates with a plug-in type inductance oscillator, and the intelligence can be transmitted via the 80-84 mc and 210-220 mc telemetering channels, or by use of a land line.

This gage is for use in guided missiles, rockets or experiment aircraft when accurate altitude measurements are desired.

The TTP-8A complements a complete line of precision components for the remote instrumentation field. Bendix-Pacific facilities include installation and application engineering, field operation, data reduction and engineering consultation.



TO MEASURE - TO INDICATE - TO WARN - AT A DISTANCE  
Eastern Engineering Office: 475 Fifth Ave., N. Y. 17

WINCHARGER  
REG. U. S. PAT. OFF.

ANTENNA  
TOWERS

1<sup>st</sup>

CHOICE\*

- \* 1st CHOICE of new station applicants.
- \*\* 1st CHOICE of station operators.
- \*\*\* 1st CHOICE of Police, Airlines, Government, and private communications systems.

There is a reason. VHF, FM, and standard AM broadcasters acclaim the structural excellence and all around low cost of Wincharger's performance proven towers. The precision of Wincharger vertical radiator's patterns is testified by the fact that over one hundred and twenty stations are now using Wincharger towers in directional arrays even six element arrays! Higher quality, wider versatility, lower cost have made Wincharger antenna towers America's first choice.

WINCHARGER Corporation

Sioux City 6, Iowa, U.S.A.

## TEST YOUR MAGNETIC CIRCUITS



**RAWSON FLUXMETER  
TYPE 504**

The only portable fluxmeter available which returns rapidly to zero when a single button is depressed. Simple and fast in operation. Convenient and light in weight.

Not limited to a single type of measurement. Has universal application for laboratories or production. Measures strength of magnets and electromagnets, permeability and hysteresis loops for iron and steel, total flux lines in circuit, flux lines developed in air gap, etc.

Has a mechanical clamp to protect the pivots and jewels when in transit.

### RAWSON ELECTRICAL INSTRUMENT COMPANY

111 POTTER STREET, CAMBRIDGE 42, MASS.

Representatives

CHICAGO

LOS ANGELES



A mere  
6 ounces! Folds  
compactly.

**LOOK! NO HANDS!**

GET MAXIMUM EFFICIENCY  
IN TESTING WITH ROANWELL'S  
STYLE 197 FOLDING HANDSET

Wearer's hands are free at all times with the Roanwell Folding Handset! Combination mouth-to-ear unit makes it possible to talk and move head simultaneously without loss of contact or time. Lightweight receiver and single wire head band eliminate headache complaints. Folded, it can be stowed away in pocket. Interchangeable with conventional telephone apparatus.

Now being used extensively for maximum efficiency in testing by such outstanding organizations as:

*N. Y. Central Railroad . . . .*  
*Westinghouse Electric . . . .*  
*Bendix Aviation . . . . .*  
*Otis Elevator Co. . . . .*  
*American District Telegraph.*

Roanwell specializes in fitting assemblies to your exact needs. Write for details of typical assemblies . . . and a copy of our new catalog.

THE AVIOMETER DIV  
*Roanwell* CORPORATION • 662 PACIFIC ST. • BROOKLYN 17, N. Y.

*For  
HIGHEST ELECTRICAL  
& MECHANICAL EFFICIENCY!*

## New JONES SERIES 2400 PLUGS & SOCKETS

- Improved Socket Contacts—4 individual flexing surfaces. Positive contact over practically their entire length.

- Cadmium plated Plug and Socket, Contacts mounted in recessed pockets, greatly increasing leakage distance, INCREASING VOLTAGE RATING.

- Interchangeable with 400 Series.



P-2406-CCT



S-2406-SB

Send for complete Catalog No. 17. Plugs, Sockets, Terminal Strips.

### HOWARD B. JONES DIVISION

Cinch Mfg. Corp.  
2460 W. GEORGE ST. CHICAGO 18, ILL.

## For Originality LOOK TO XCELITE

### QUICK-CHANGE REAMERS For Your XCELITE Handles

Detachable to fit your XCELITE No. 14 Nut Driver or "Combination-Detachable" Screwdriver! Short enough to get in where ordinary reamers can't! Enlarge holes in plastic, sheet metal, wood! See your dealer or supply jobber NOW!

"ANOTHER XCELITE FIRST"

PARK METALWARE CO., INC.

Dept. C Orchard Park, N. Y.

**Quality Tools PREFERRED BY EXPERTS**

*First to use plastic for screwdriver handles*

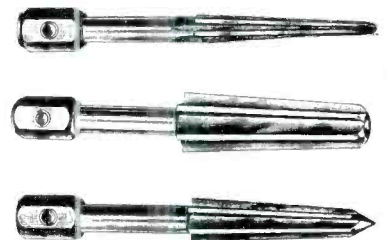

Available in 3 sizes!  $\frac{1}{8}$  to  $\frac{5}{16}$ ,  $\frac{1}{4}$  to  $\frac{1}{2}$ ,  $\frac{1}{2}$  to  $1\frac{1}{16}$ . Shown above  $\frac{1}{2}$  actual size.

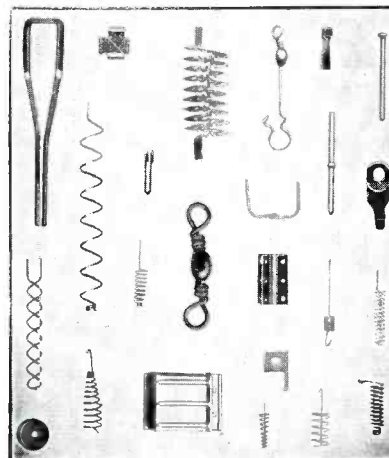

## SMALL PARTS

Filaments, anodes, supports, springs, etc. for electronic tubes. Small wire and flat metal formed parts to your prints for your assemblies. Double pointed pins. Wire straightened and cut diameter up to  $\frac{1}{8}$ -inch. Any length up to 12 feet.

LUXON fishing tackle accessories. Inquiries will receive prompt attention.

### ART WIRE AND STAMPING CO.

227 High St.

Newark 2, N. J.

**NOW IN BOOK FORM—**

in answer to the pressing demand of the entire industry

**TELEVISION COURSE**

by A. C. W. Saunders and B. V. K. French

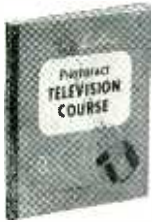

A popular, easy-to-understand exposition of current Television receiver principles, operation and practice. Main sections cover Cathode Ray Beam Formation and Control; Beam Deflection Systems; Beam Modulation and Synchronization. Includes analysis of CR tube construction, camera tubes, voltage supplies, saw-tooth generators and their use, sync circuits, control functions, receiving antenna circuits, RF input tuning systems, IF systems,

AGC, DC restoration, video amplification, contrast—an authoritative treatment of the listed subjects. Includes full bibliography. 208 pages; profusely illustrated; sturdily bound, 8 1/2 x 11". Order TV-1.....Only \$3.00

**... FOR THE ENGINEER'S LIBRARY ...**

**1948 AUTOMATIC RECORD CHANGER MANUAL**

Complete standardized data on 45 different models made in 1948, including new LP and dual-speed changers, plus leading wire and tape recorders. Entirely original data, based on analysis of the actual instruments. Gives full change cycle data, adjustment notes, needle landing data; "exploded" views; uniform treatment throughout. Over 400 pages; fully illustrated; deluxe binding; 8 1/2 x 11". Order CM-2.....Only \$6.75

**1947 AUTOMATIC RECORD CHANGER MANUAL**

Covers 41 different postwar changers and recorders produced up to 1948. Includes excellent description of general types of changers and motor drive systems. Over 400 pages; deluxe binding; 8 1/2 x 11". Order CM-1.....Only \$4.95

**POST-WAR COMMUNICATIONS RECEIVER MANUAL**

Provides a complete detailed analysis of more than 50 of the most popular post-war communications receivers. Includes Hallcrafters, National, Hammarlund, RME, Collins, Harvey Wells, Jefferson Travis, Airadio, Learadio, Gonset, Heath, Motorola and Ranger units. Each receiver is uniformly treated; includes diagrams, chassis photos, alignment data, replacement parts information. All data is based on actual analysis of each instrument. 264 pages; profusely illustrated; durable binding, 8 1/2 x 11". Order CR1.....Only \$3.00

**POST-WAR AUDIO AMPLIFIERS**

Covers 102 post-war audio amplifiers, FM tuners, and intercom systems, as well as popular wire and tape recorders—the products of 29 well-known manufacturers. Detailed uniform analysis of each unit; entirely original data based on actual laboratory examination. 352 pages; fully illustrated; sturdy binding, 8 1/2 x 11". Order AA-1.....Only \$3.95

**THE RADIO INDUSTRY "RED BOOK"**

This single volume offers complete information on all replacement parts for approximately 17,000 home receivers made from 1938 to 1948. Includes complete accurate listings of all 9 major replacement components as well as correct replacement parts made by 17 leading parts manufacturers. Full data on capacitors, transformers, controls, IFs, speakers, vibrators, phono cartridges, tubes, dial lights and batteries. 448 pages; sewed binding, 8 1/2 x 11". Only \$3.95

Write for descriptive literature covering famous PHOTOFACT Data Volumes—complete original analysis of all post-war radio receivers and associated equipment.

**10 DAYS FREE EXAMINATION**

HOWARD W. SAMS & CO., INC.  
2926 E. Washington St., Indianapolis 7, Ind.  
Send volumes checked below for 10 days' examination on approval. In 10 days, I will remit price of books I wish to keep, plus a few cents postage, and will return unwanted books postpaid.

- TV-1     CM-2     CM-1  
 CR-1     AA-1     "Red Book"

Name .....

Address .....

City.....Zone.... State.....

Company .....

(If you send cash or check with order, we pay postage and packing charges. Same return privilege.)

**NEW BOOKS**

**Cybernetics**

By NORBERT WIENER, *Professor of Mathematics, Massachusetts Institute of Technology. The Technology Press, John Wiley and Sons, Inc., New York, 1948, 194 pages, \$3.00.*

THIS BOOK, a study of "control and communication in the animal and the machine", transcends the field of electronics. Written by one of the great intellects of our time, it brings together a vast range of related sciences and philosophies in a coherent theory of man and the machine as mechanisms, a theory couched in the terms of physiology and electrical communications. It is required, if difficult, reading for every physiologist and electronist who has the slightest interest in the future of these arts.

It is an interesting fact that the young intellects who have pioneered in the new theory of communications, Shannon, Tuller and Sullivan, all were students of Professor Wiener at MIT during the past decade. This book, which reports work carried out during the same ten years, covers the essentials of this new theory, and states the new law, regarding transmission of intelligence in the presence of noise, on page 104, in more general form than has appeared elsewhere. But it is typical of the book that this important result and its derivation are included in almost parenthetical fashion, a footnote as it were to the larger issue of the book. This issue is the question of how the muscles, sinews, nerves and brains of living bodies can be described, and their actions explained, in terms of the recent theory of communications.

The book is simple to read in parts, often deceptively so, but a large part of the book, particularly Chapters II and III, is couched in mathematical terms. While these do not interrupt the thread of the argument, it should be noted that there are only a few hundred men alive today who can read every word and symbol in the book, and lay valid claim to understanding it all. Fortunately Professor Wiener has a very great command of the language and he is evidently attempting to make the subject as simple as his standards of rigor will allow.

If this review has no other effect

**BRADLEY RECTIFIERS**

**SMALL-SIZE, HIGH VOLTAGE SELENIUM RECTIFIER**



Bradley's new high voltage selenium rectifier—model SE8L—is low-priced for production requirements. Rated at 1.5 ma D. C. and up to 3,000 volts peak inverse. For higher voltage requirements, model SE8L can be used in series or multiplier circuits. Measures only 1/4-inch in diameter—up to 3 inches in length. Completely sealed.

**PHOTO CELLS**

**SIMPLIFY PHOTO CELL CONTROL**



Luxtron\* photo cells convert light into electrical energy. No external voltage is required to operate meters and meter relays directly from Bradley photo cells, improving control over your processes, reducing your costs. Housed model shown. Many different sizes and shapes, mounted and unmounted.

\*T. M. REG. U. S. PAT. OFF.

Our engineers will select or develop rectifiers or photo cells to meet your needs exactly. Write for BRADLEY LINE showing basic models.

**BRADLEY LABORATORIES, INC.**  
82 Meadow St. New Haven 10, Conn.

**MICRODIMENSIONAL  
WIRE & RIBBON**

Wires drawn to .0004" diameter.

Ribbon rolled to .0001" thickness.

Wollaston Process Wire .0005" to .000010"

Made in almost all ductile metals and alloys; or we will draw wire from your own metals.

Your inquiry, with engineering specifications is invited.

**SIGMUND COHN CORP.**  
44 GOLD ST. NEW YORK  
SINCE 1901

NEW BOOKS

(continued)

than to convince readers of this journal that "Cybernetics" is worth twenty hours of the best effort one can give it, at any level of understanding, it will have served its purpose. This is a book to own, to read and re-read. More, it is a book worth going back to school to understand.

There is no slight doubt in this reviewer's mind that the avenues of thought and the demonstrations in this book will affect profoundly the future course of a dozen sciences, including communications in all its branches, mathematical computation, physiology, even psychiatry. The analogy between the anxiety complex of psychiatric states and the overcrowded telephone exchange is not merely an interesting idea, fully and carefully developed in this book. It is very possibly a grand idea, in the classic tradition of Newton and Maxwell, one which may permit an engineering approach to the anxieties and troubles which so beset us as individuals and nations. Professor Wiener is fully aware of this possibility and makes the point that such an approach may be the only hope of our civilization. One cannot find a better avenue of effort in engineering, to balance such studies against those that produced the proximity fuze. The communications engineer has the vocabulary, at least, with which to start on the fascinating new road along which this book beckons.—D.G.F.

### Industrial Electronics Reference Book

By ELECTRONICS ENGINEERS OF THE WESTINGHOUSE ELECTRIC CORPORATION. *John Wiley & Sons, Inc., New York, 1948, 680 pages, \$7.50.*

THIRTY-SIX chapters, written singly or jointly by various Westinghouse engineers, start the readers with atomic theory (E. V. Condon and E. G. F. Arnott), take him through the entire field of industrial electronics, and end up with a nine-page maintenance and troubleshooting section by C. J. Madsen.

Although basic information predominates in the various chapters, this is in every instance brought up to date or even ahead of other



## LINEAR AMPLIFIER

A-10-A-A

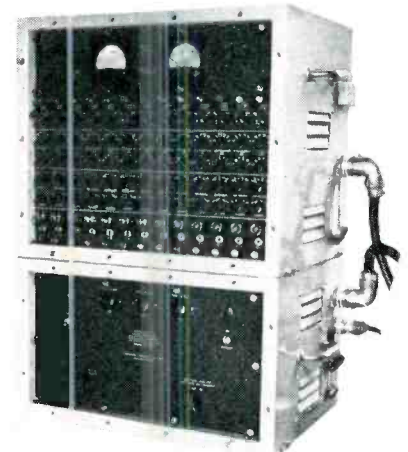

A-10-P-A

13 Channel Linear Amplifier has been specifically designed to operate low impedance type of galvanometer oscillographs. The output of the amplifier is 1.3 ohms, and full output voltage is 230 millivolts. The low output impedance and high output voltage permit loading down galvanometers of higher impedance, thus improving their frequency response. For example, if 40 ohm galvanometer with response up to 2KC be loaded down, the performance will be flat up to 5KC. The unit consists of A-10-A-A 13 channel amplifier, A-10-P-A power supply and A-10-C-A accessories (including cables, test jigs, etc.).

Each channel is a plug in unit containing all controls including metering. Spare units are available.

### ALSO MANUFACTURERS OF

#### POCKETSCOPES

Model S-10-A  
Model S-10-B  
Model S-11-A

#### RACK MOUNTED OSCILLOSCOPES

Model S-12-A

#### 3" RAYONIC CATHODE RAY TUBE

Model 3MPI

#### RAYONIC CATHODE RAY TUBE

ACCESSORIES

Model 3MP

For additional technical data on any of the above, please write:

**WATERMAN PRODUCTS CO., INC.**  
PHILADELPHIA 25, PA.

For **LONG**

**TROUBLE-FREE-OPERATION**

*Specify*

**N·W·L**

**CUSTOM-BUILT TRANSFORMERS**



From 10VA to 300 KVA  
Dry-Type Only. Both  
Open and Encased, 1,  
2, & 3 Phase 15 to 400  
Cycles.

Over 25 years' experi-  
ence in the manufacture  
of specials at cost that  
compares favorably  
with standard types.  
Built-in quality proved  
by years of actual use.

**NOTHELFER**

**WINDING LABORATORIES**

9 ALBERMARLE AVE.

TRENTON 3, N. J.



*Precision*  
**Rod Cutting**  
at High Speed

with the New

**DI-ACRO ROD PARTER**

The DI-ACRO Rod Parter further increases the appli-  
cations of "DIE-LESS DUPLICATING" as a cost-cut-  
ting, time-saving production technique so well established  
by DI-ACRO Precision Benders, Brakes and Shears.

**Do you require precision?**—The DI-ACRO Rod Parter holds  
tolerance to .001" on duplicated cuts. The ends are square,  
and roundness is maintained.

**Do you want speed?**—The Rod Parter exceeds output of  
other methods with equal accuracy, on rods and bars up  
to 5/8". Torrington Roller Bearings incorporated in an  
exclusive multiple leverage arrangement provide remark-  
able ease of operation in both heavy and light materials.

**GET "DIE-LESS DUPLICATING" CATALOG**

Shows parts produced without die expense by DI-ACRO  
Benders, Brakes, Shears, Rod Parters, Notchers,  
Punches. Send for your free copy.

Pronounced "DIE-ACK-RO"



**O'NEIL-IRWIN MFG. CO.**

321 EIGHTH AVENUE • LAKE CITY, MINNESOTA

"PARTS OFF"  
MANY  
MATERIALS

- All hot and cold  
rolled rods
- Stainless steel
- Chrome Molyb-  
denum
- Aluminum Brass
- Copper Bi-metals
- Many types of  
plastics
- Fibre Rubber  
Wood

NEW BOOKS

(continued)

printed literature to such an extent  
that the book in its entirety consti-  
tutes a survey of the present status  
of the art and science of industrial  
electronics.

Design engineers will find here  
the equations, graphs, theoretical  
analyses and voluminous references  
needed for intensive development of  
new tubes and new devices contain-  
ing tubes. Practical engineers, with  
their own inherent ability to skip  
over pages containing math, will  
find a wealth of data and ideas for  
applying existing successful elec-  
tronic solutions to new problems in  
industry.

Particularly deserving of men-  
tion is the chapter by Venable and  
Kinn on radio-frequency heating,  
which covers the entire field from  
theory of induction heating through  
examples of applications, with em-  
phasis on practical aspects of load  
coil design and requirements for  
successful induction soldering and  
brazing. Dielectric heating theory  
and practice are covered with equal  
thoroughness.

For getting so many different  
authors to produce such commend-  
able material on such a variety of  
topics with a minimum of overlap-  
ping, the Westinghouse Book Com-  
mittee deserves every credit. Any-  
one who has edited an engineering  
handbook or a library of books by a  
group of authors knows the prob-  
lems involved in getting engineers  
to write to an outline for a dead-  
line.—J.M.

**Cathode-Ray Tube Displays**

By T. SOLLER, M. A. STARR, and G. E.  
VALLEY, JR. *Volume 22 of MIT Radia-  
tion Laboratory Series. McGraw-Hill  
Book Company, New York, 1948, 746  
pages, \$10.00.*

THE SUBJECT matter of this book  
is considerably broader in scope  
than might be indicated by the  
title. Means of providing cathode-  
ray tube displays are treated in  
detail, and design data on special  
circuit components such as focus  
coils and deflection yokes are in-  
cluded. Like most books of this  
group the text is in part a reworked  
and editorialized version of project  
reports prepared by the Radiation  
Laboratory staff members. Recog-  
nized authorities on the several

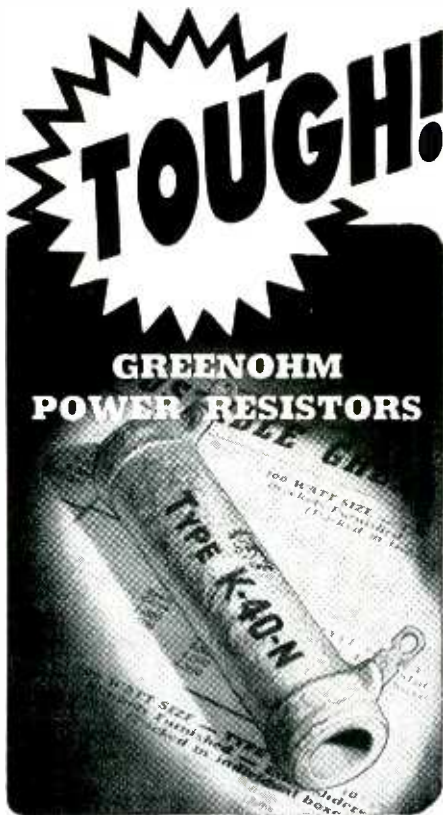

**GREENOHM  
POWER RESISTORS**

★ Yes, TOUGH! Greenohms (made by Clarostat exclusively) are found in radio-electronic and electrical assemblies that simply MUST stand the gaff.

These green-colored power resistors handle heavy overloads without flinching. The exclusive cold-setting inorganic cement coatings means that the wire winding remains unimpaired in manufacture. Coating withstands the heat shock of frequent on-off operation without cracking, flaking, peeling. Yes, TOUGH!

Fixed and adjustable. 5 to 200 watt ratings. Widest choice of terminals and mountings.



Bulletin 113 sent on request. Let us quote on your requirements

*Controls and Resistors*

**CLAROSTAT MFG. CO., Inc., Dover, N. H.**

In Canada: **CANADIAN MARCONI CO., Ltd.**  
Montreal, P.Q., and branches

**NEW BOOKS**

(continued)

subjects are included in the list of contributing authors.

The book contains a detailed treatment of all types of cathode-ray tubes, both electrostatic and magnetic, used to present radar displays. A less detailed analysis of the associated circuits is provided since circuitry is the subject of several other books in the series.

Much of the material contained was of a classified nature during the war and is available here for the first time to all electronic engineers. Particularly good treatment of cathode-ray screen characteristics including specialized types is included. A practical disadvantage to the text is the lack of adequate descriptive subheadings for sections dealing with a number of specialized circuits. Considerable tabular data on video amplifiers and cathode-ray tubes is included which is of real practical value to the design engineer. Actual circuit values are given for most circuits described.

While television as such is not covered, the basic material on both tubes and circuits is of importance to the television design engineer. It is felt that this volume will be a valuable addition to the reference library of the electronic engineer who employs cathode-ray techniques.—HORACE ATWOOD, JR., *Industrial Television, Inc., Clifton, New Jersey.*

• • •

**Books Received for Review**

**PHYSICS FOR ARTS & SCIENCES.** By L. Grant Hector, Herbert S. Lein and Clifford E. Scouter. The Blakiston Co., Philadelphia, 1948, 731 pages, \$5.50. For beginners in physics at colleges. Part I deals with mechanics, heat and sound; Part II, on electricity, optics and nuclear physics, was previously published as "Electronic Physics" and has been brought up to date.

**POST WAR COMMUNICATIONS MANUAL,** including aircraft and marine radio. Compiled and published by Howard W. Sams & Co., Inc., Indianapolis, Ind., 1948, 264 pages, paper cover, \$3.00. Service data on about 50 communications receivers produced from the end of the war to mid-summer of 1948. The information is arranged in the same style as the Photofact folders put out by the same company.

**RADIO OPERATING QUESTIONS AND ANSWERS.** By Arthur R. Nilson and J. L. Hornung. McGraw-Hill Book Co., New York, 1948, 9th edition, 524 pages, \$3.60. Review questions and answers for commercial radio operator examinations, arranged according to the six elements used in the tests. Includes questions and answers recently added to elements 2, 3 and 4 covering f-m and television techniques.

**A complete survey of industrial electronics and its practical applications**

**Industrial Electronics and Control**

By **ROYCE G. KLOEFFLER**

*Professor and Head of the Department of Electrical Engineering, Kansas State College*

THIS comprehensive treatment of industrial electronics covers the basic principles of electronics and their present-day applications in field and laboratory work. The volume starts with a discussion of Bohr's early theory of the atom and proceeds to the fundamental theory of electron tubes, associated circuits, and control component devices. In the latter part of the book, the author discusses the major applications of electronics to practical industrial problems. The electronics engineer will find this book a valuable reference book and guide.

**Partial Contents**

Electron Emission; Grid-controlled Vacuum Tubes; Gaseous and Vapor Electron Tubes; Photoelectricity; Components and Circuits for Control; Principles of Control and Servomechanisms; Resistance Welding; Electronic Operation of D.C. Motors; Photoelectric Control Devices; X-Ray Applications; Special Photo Applications.

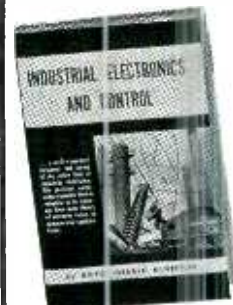

478 pages  
480 illus.  
\$5.50

**ON APPROVAL COUPON**

**JOHN WILEY & SONS, INC.**  
440 Fourth Ave., New York 16, N. Y.

Please send me, on 10 days' approval, a copy of Kloeffler's **INDUSTRIAL ELECTRONICS AND CONTROL**. If I decide to keep the book, I will remit \$5.50 plus postage; otherwise, I will return the book postpaid.

Name.....  
Address.....  
City..... Zone..... State.....  
Employed by.....  
*(Offer not valid outside U. S.)* E-3-49

# TITONE

**FIRST  
BASIC  
PICKUP  
ADVANCE  
in 10 years!**

LIST PRICE \$7.50

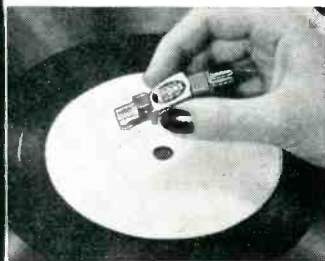

**NEW  
TITONE  
PICKUP  
helps every  
record player!**

This original piezoelectric pickup does wonders for tone and stability in every kind of climate. Wider frequency range gives unequalled reproduction. Designed to fit all tone arms. Made by SONOTONE, famous makers of hearing aids and miniature tubes.

- **TRANSCRIPTION TONE QUALITY!** Full frequency to 10,000 cycles! Bell-like super-tone makes even old players thrilling!
- **SURE-FIRE IN HUMID CLIMATES!** Unaffected by climate, moisture, fungus! Booms sales, wins back customers.
- **DOUBLES RECORD LIFE AND PLEASURE!** Gives "ordinary" records sparkling quality—revives worn favorites. Will play down to 1/2 normal pressure. NO "needle talk"!
- **RUGGED! PERMANENT!** No crystals, magnets, filaments to fail! No pre-amplifiers. Ceramic TITONE performs perfectly for years!

**NO TONE LIKE  
TITONE**

**INQUIRIES INVITED!**

write now to  
SONOTONE, Box T-4, Elmsford, N.Y.

## Backtalk

This department is operated as an open forum in which our readers may discuss problems of the electronics industry or comment upon articles that **ELECTRONICS** has published.

### High Voltage

DEAR SIRs:

THIS is in reference to a recent article (p 100, Dec. 1948) on portable high-voltage G-M power supplies by Alexander Thomas. I should like to answer some of Mr. Thomas' comments on the r-f power supply, in which his principal objection is the inefficiency of this type of design due to losses in the r-f transformer.

In designing portable G-M radiation detectors, I experimented with all of the types of power supplies described in the article, and finally settled on the circuit shown. It was discovered that using a powdered-iron core transformer with a high-impedance secondary resulted in a very satisfactory oscillator whose tank circuit was the reflected impedance of the secondary at resonance. (The operating frequency was approximately 11 kc.)

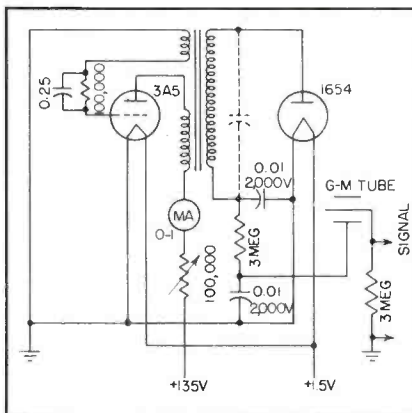

This system produced an oscillator which was always tuned to the frequency required to generate the highest possible voltage in the secondary. The objection to this circuit at first was as Mr. Thomas claimed, the excessive losses in the transformer, so that it required 10 ma at 135 volts to produce 1,500 d-c volts with a G-M load of 3  $\mu$ a. This figure of 10 ma was of course

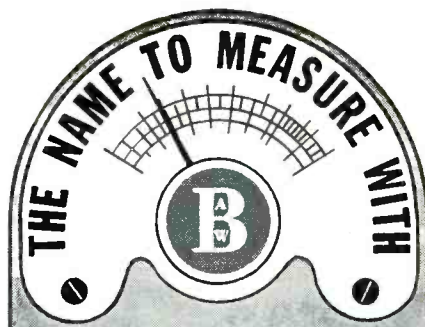

### THE NAME "BARBER"

is a guarantee of proved superiorities on Production Lines; in Laboratories; at Test Benches. Let our advanced technologies, experience, skills, facilities, help you with any type of special Electronic units.

*Alfred W Barber*

#### WIDE RANGE VACUUM TUBE VOLTMETER

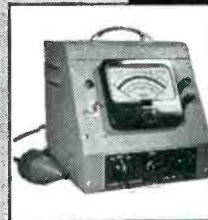

0.1 to 100 Volts in 5 ranges, A-C & D-C; Easy reading 4 1/2" meter; Permanent accuracy; Probe will not "short" in crowded circuits.

Many other vital features. Ask for Bulletin 28.

#### HIGH VOLTAGE R. F. ELECTRONIC VOLTMETER

5 to 10,000 Volts in 5 ranges; Frequency 100 K. C. to 100 M. C. within 0.5 D.B. High voltage Coupler attenuates and rectifies radio frequency voltages from 100 K. C. to 100 M. C. and up to 10,000 r.m.s. Many other features. Get Bulletin R.F.



#### JUNIOR R. F. VOLTMETER

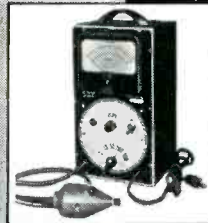

0.25 to 300 r.m.s., in 5 ranges. 20 cycles to over 300 M. C. This simple, well-built Voltmeter is of laboratory quality, with all unnecessary complications eliminated. Write for Bulletin LKV.

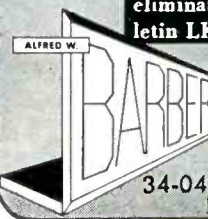

LABORATORIES

34-04 Francis Lewis Blvd  
Flushing, N. Y.



# PROFESSIONAL SERVICES

Consulting — Patents — Design — Development — Measurements

in

Radio, Audio, Industrial Electronic Appliances

## THE BARRY CORPORATION

Specialists in the Control of  
VIBRATION      IMPACT      NOISE  
*Engineering Development  
Manufacturing*  
179 Sidney Street      Cambridge, Mass.  
Telephone: ELIot 0861-0140

## FRANKEL & NELSON

*Consultants in Mathematical Physics*  
7716 Firenze Ave.      Los Angeles 46, Calif.  
Granite 6970

## ALBERT PREISMAN

*Consulting Engineer*  
Television, Pulse Techniques, Video  
Amplifiers, Phasing Networks,  
Industrial Appliances  
Affiliated with  
MANAGEMENT-TRAINING ASSOCIATES  
3308-14th St., N.W.      Washington 10, D.C.

## CROSBY LABORATORIES

MURRAY G. CROSBY & STAFF  
*Specializing in FM,  
Communications & TV*  
Offices, Laboratory & Model Shop at:  
126 Old Country Rd.      Mineola, N. Y.  
Garden City 7-0284

## GENERAL INSTRUMENT & ENGINEERING

CONSULTATION RESEARCH DEVELOPMENT  
IN  
ELECTRONICS, E. E., PHYSICS  
100 Barr Building      Washington 6, D. C.

## PAUL ROSENBERG ASSOCIATES

*Consulting Physicists*  
Main office: Woolworth Building, New York 7, N. Y.  
Cable Address      Telephone  
PHYSICIST      Worth 2-1939  
Laboratory: 21 Park Place, New York 7, N. Y.

## EDGERTON, GERMESHAUSEN & GRIER, Inc.

*Consulting Engineers*  
Research, Development and Manufacture  
of Electronic and Stroboscopic Equipment  
Specialists in High-Speed Photography  
155 Massachusetts Avenue, Cambridge 39, Mass.

## PAUL GODLEY CO.

*Consulting Radio Engineers*  
GREAT NOTCH, N. J.  
Est. 1926      Little Falls 4-1000

## A. F. SMUCKLER & CO.

*Electronic Engineers*  
Electronic Product Manufacturing  
Contractors to United States Government  
338-346 East 23rd St.      New York 10, N. Y.  
GRamercy 5-8151

## ELECTRO IMPULSE LABORATORY

*Consulting Physicists*  
Radio Interference and Noise Meters; Interference  
Suppression Methods for Ignition Systems and  
Electrical Devices.  
P. O. Box 250      Red Bank, New Jersey  
Red Bank 6-4247

## HANSON-GORRILL-BRIAN INC.

*Product & Mfg. Development*  
ELECTRICAL - ELECTRONIC  
HYDRAULIC - MECHANICAL  
One Continental Hill      Glen Cove, N. Y.  
Glen Cove 1922

## SPECTRUM ENGINEERS

Electronic & Mechanical Designers  
540 North 63rd St., Philadelphia 31, Pennsylvania  
Granite 2-2333; 2-3135

## ELECTRONIC ENGINEERING CO. of CALIFORNIA

Radio and Electronic Consulting and  
Designing.  
2008 W. Seventh St.      Los Angeles  
DRexel 8323      California

## MEASUREMENT ENGINEERING LIMITED

Consultants on Special Equipment for measurements  
and production tests, communications and audio  
systems.  
Head Office and Plant  
Arnprior      Canada  
60 Front Street West      Montreal  
Toronto, Canada      Canada

## TECHNICAL MATERIEL CORPORATION

*Communications Consultants*  
RADIO TELETYPE • FREQUENCY SHIFT  
INK SLIP RECORDING  
TELETYPE NETWORKS  
453 West 47th Street      New York 19, N. Y.

## ERCO RADIO LABORATORIES, INC.

*Radio Communications Equipment*  
Engineering - Design - Development - Production  
Pioneers in Frequency Shift Telegraph  
Garden City • Long Island • New York

## Eugene Mittelman, E.E., Ph.D.

*Consulting Engineer & Physicist*  
High Frequency Heating — Industrial Electronics  
Applied Physics and Mathematics  
519 W. Washington Blvd.      Chicago 6, Ill.  
State 2-8021

## YARDENY LABORATORIES, INC.

*Research and Development*  
Remote Controls and Electro Chemical  
Generators of Energy  
105 Chambers Street      WO 2-3534, 35  
New York, N. Y.

THE  
CONSULTING  
ENGINEER

*"By reason of special training, wide experience and tested ability, coupled with professional integrity, the consulting engineer brings to his client detached engineering and economic advice that rises above local limitations and encompasses the availability of all modern developments in the fields where he practices as an expert. His services, which do not replace but supplement and broaden those of regularly employed personnel, are justified on the ground that he saves his client more than he costs him."*

**Memo** to purchasing agent —  
 for everything in electronics, sound,  
 & T. V. equipment, call Terminal's  
 Industrial Dept. Complete stock!  
 P.S. ask for their big catalog.

**TERMINAL**  
 RADIO CORPORATION

85 CORTLANDY ST.—NEW YORK 7 • Phone—WOrth 4-3311 • Cable—TERMRADIO

## ALFAX ELECTROSENSITIVE PAPER

Now available to laboratories, instrument manufacturers, and experimenters.

**ALFAX ELECTROSENSITIVE PAPER**—marks directly by electric impulse. Density varies directly with intensity of signal so recordings can be made self-calibrating by introducing standard signals of different intensities.

**ALFAX ELECTROSENSITIVE PAPER**—in helix type recorder will record signal the instant it occurs—without overshooting,—no need for compensation or damping. **IT IS INERTIA FREE.**

**ALFAX ELECTROSENSITIVE PAPER** is extremely sensitive, so that the paper can be fed slowly, yet extremely rapid variations will be recorded in the helix stroke with no difficulty at writing speeds 300" or more per second.

**ALFAX ELECTROSENSITIVE PAPER** is ideal for recording a group of related signals without the problems of multiple pens and their maintenance. Recordings differentiate the transient or stray signals from the true signals. Sudden signals of unusual amplitude cannot damage the recorder nor result in false readings as in D'Arsonval movements and pen type movements.

**ALFAX ENGINEERING** includes making special papers or developing electronic circuits and electrode materials to emphasize any portion of wave form or signal. Recordings are easily interpreted even where noise to signal ratio is greater than one.

### MAIL THIS COUPON

Alfax Paper & Engineering Co.  
 45 Riverside Avenue  
 Brockton, Mass.

Enclosed is one dollar for a roll of Alfax Electro-sensitive paper for experimental purposes to be mailed postpaid with booklet, "Questions and Answers on Electro Sensitive Paper."

Name .....  
 Position .....  
 Address .....

Recording Four  
 Simultaneous  
 Signals



BACKTALK

(continued)

excessive and made the circuit impractical. By adjusting the grid-leak to change the oscillator into a blocking oscillator with an oscillation time of about 10 percent, the plate current was reduced to well under 1 ma.

This type of oscillator is possible only because of the extremely high impedance of a G-M circuit which draws only a maximum current under any conditions of about 3  $\mu$ a. The output voltage remained 1,500 volts with very satisfactory regulation in the region of 0 to 5- $\mu$ a load.

An additional advantage to this type of circuit is that the output voltage may be continuously metered without the use of a bleeder as in Mr. Thomas' circuit, with the resulting increase in efficiency. Metering is accomplished in the plate circuit of the oscillator tube, since it was found that the rectified high voltage is exactly proportional to the plate current of the oscillator.

It is my opinion that the r-f type of power supply will prove very useful for many portable G-M radiation detectors.

PAUL ABRAMSON  
 Chief Engineer  
 Electronics Associates  
 New York, N. Y.

## Grenz Rays

DEAR SIRS:

IT MAY BE of interest to some of your readers who have considered the possibility of Grenz-ray radiation from television picture tubes to know that no appreciable amount can be detected in the proximity of the tube.

No, fogging of dental x-ray films was found, using a lead aperture pattern, after approximately twenty hours of exposure. The films were distributed around the cabinets and tubes of receivers, including a 27-kilovolt projection type, but no radiation was detected at any position. This procedure would not detect a minimal amount of radiation which might possibly be detected by a thin-window Geiger counter, but it shows that the radiation produced is at most of very small order of magnitude. Information of this type is relevant at this time in view of the emphasis on the study of environmental causes of cancer.

LEO MACKTA  
 Brooklyn, New York

# Vital Aids TO

## MANUFACTURERS OF MINIATURE TUBE RADIOS AND EQUIPMENT



★ Star Miniature Socket Wiring Plugs for accurate alignment of miniature socket contacts during wiring. Precision cast of zinc base alloy—pins of stainless steel. #JE-9 (9 pin); #JE-10 (7 pin).

★ Star Miniature Tube Pin Straighteners (with stainless steel insert) to obtain a perfect fit when the tube is placed in the equipment. #JE-15 (9 pin); #JE-13 (7 pin).



Scientifically designed — Precision made  
 Immediate Delivery in Any Quantities

★ **STAR** EXPANSION  
 PRODUCTS CO., INC.  
 147 CEDAR STREET, NEW YORK 6, N. Y.

Visit Our Display Booth, I. R. E. Show, March 7-10, 1949

(Continued from page 288)

Berkeley Scientific Co.....	255
Blan .....	280
Brooks Inc., R. D.....	281
Brush Development Co.....	255
Buffalo Radio Supply.....	276
Communications Devices Co.....	278
Communications Equipment Co.....	262, 263
Compass Communications Co.....	278
Edlie Electronics Inc.....	283
EPCO .....	279
Electronic Corp. of America.....	278
Electro Impulse Laboratory.....	277
Electro Sales Co.....	272
Electronic Sales Co.....	278
Electronicraft, Inc.....	273
Electronic Surplus Brokers.....	256
Electronics Research Publ. Co.....	256
Ereco, Rick Rose.....	279
Fair Radio Sales.....	281
Gaylin Products Co.....	283
Hi-Mu Electronics.....	285
Instrument Associates.....	260, 261
Klein, Manuel .....	283
Lectronic Research Laboratories.....	282
Leru Laboratories, Inc.....	282
Liberty Electronics, Inc.....	280
Life Electronic Sales.....	285
Maritime Switchboard.....	269
Mel-Guage Co.....	256
Melpar, Inc.....	255
Microcircuits Co.....	256
Modulation Products Co.....	256
Mogull Company Inc., Alexander.....	280
National Geophysical Co., Inc.....	257
National Instrument Co.....	282
National Union Radio Corp.....	257
Neomatic Inc.....	280
Niagara Radio Supply Corp.....	258, 259
Opad-Green Co.....	281
Peak Electronics Co.....	270
Pi Electronics.....	284
Pocle, J. H.....	285
Powertron Electrical Equip. Co.....	268
Precision Electrical Instrument Co.....	280
Radio Ham Shack Inc.....	271
Radio Corp. of America.....	254
Reliance Merchandising Co.....	266
Servo-Tek Products Co., Inc.....	275
Sperry Gyroscope Co., Inc.....	256
Srepro Inc.....	282
T.A.B.....	267, 286
Telemarine Communications Co.....	274
Universal General Corp.....	283
Weightman, H. G.....	256
Wells Sales Inc.....	264, 265
Winters Radio Lah.....	256

## EISLER SPOT WELDERS

SIZES 1/4 TO 300 KVA

FOR ALL TYPES OF WELDING  
BUTT-GUN-ARC WELDERS



### EISLER

Specializes also in the manufacture of accessories and complete laboratory equipment for electronic and radio tubes, burners, cross fires, torches, vacuum pumps, etc.

Ask For Special Catalog

**EISLER ENGINEERING CO., Inc.**

CHAS. EISLER, Pres.

751 So. 13 St. (near Avon Ave.) Newark 3, N.J.

# CONTACTS

FOR THE FIELD OF ELECTRONICS

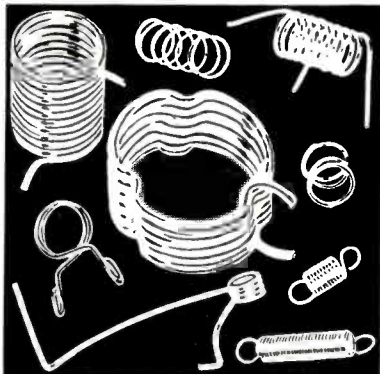

Antenna Coils, Grid Clips, Dial Cord Springs and Precision Springs of all types pertaining to Radio and Television.

Your Inquiries Invited

**WEBSTER SPRING CORPORATION**

97 South 5th Street EV. 7-3224 Brooklyn 11, N. Y.

## MICROMETER FREQUENCY METER

for Checking Transmitters  
from 100 Kc to 175 Mc.  
within 0.01 per cent

**LAMPKIN LABORATORIES, INC.**  
Bradenton, Fla., U. S. A.

## FLUXES

SODERING  
BRAZING & WELDING

L. B. ALLEN CO. INC. Chicago 31, Ill.  
6571 BRYN MAWR AVE.

## LOCKING TYPE Stainless Steel TUBE CLAMPS

Send for illustrated catalog and engineering data  
**THE GEORGE S. THOMPSON CORPORATION**  
South Pasadena, California

## EL-TRONICS, INC.

Research, development, and manufacture of electronic equipment—a single model to large quantities.

Specialists in Geiger-Muller equipment  
2647-67 N. Howard St., Phila. 33, Pa.  
Garfield 5-2026

When you're in need of some product or service to speed and improve operation, or save money, you may find it here—in the Contacts Section. . . . each issue.

# Kahle

## ELECTRON TUBE MACHINERY OF ALL TYPES

### STANDARD AND SPECIAL DESIGN

We specialize in  
Equipment and Methods  
for the manufacture of

RADIO TUBES  
CATHODE RAY TUBES  
FLUORESCENT LAMPS  
INCANDESCENT LAMPS  
NEON TUBES  
PHOTO CELLS  
X-RAY TUBES  
GLASS PRODUCTS

Production or Laboratory Basis

**Kahle ENGINEERING CO.**  
1309 SEVENTH STREET  
NORTH BERGEN, N. J., U. S. A.

## EISLER

SPECIALIZES IN EQUIPMENT FOR THE  
COMPLETE MANUFACTURE OF

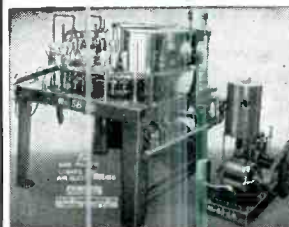

36-Head Radio Tube Exhausting Machine.

Incandescent  
and  
Fluorescent  
Lamps,  
Luminous  
Neon Signs,  
Radio, Cathode  
Ray, Television  
and Electronic  
Tubes of All  
Sizes

## Transformers of All Types IN SIZES FROM 1/4 TO 300 KVA

For  
Lighting  
Power  
Welding  
Phase  
Changing  
Auto  
Testing

Special  
Transformers  
For Electronic  
Devices

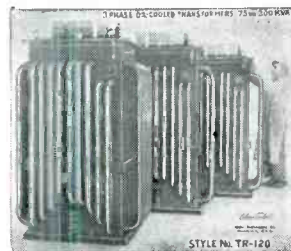

**EISLER ENGINEERING CO. Inc.**  
751 So. 13th St. Newark 3, N. J.

## MARSH STENCIL MARKING

**SPEED** shipments to your customers. Save \$50 a month with Marsh Stencil Machines, Brushes, Inks! Electric and Hand Operated machines cut 1/2", 3/4", 1" letters. For sample stencil, Shippers' Handbook, prices, pin this to business letterhead with name.

**MARSH  
STENCIL MACHINE CO.**  
46 Marsh Building • Belleville Ill., U. S. A.

## FINE RIBBONS OF TUNGSTEN and MOLYBDENUM

Quality and accuracy in our fabrication of Tungsten & Molybdenum Ribbons have characterized our service to the Electronic Industry.

A development of  
**H. CROSS Co.**  
15 Bookman St., New York 7, N.Y.

## ALPHA and NEUTRON MONITORS

Write for Complete Information to  
**TELEMARK, INC.**  
79 Prospect St. Stamford, Conn.

## BALL BEARINGS

MPB makes **40** different types and sizes . . . more than

For precision instruments, laboratory equipment, electronic devices to minimize friction, space, weight, and to overcome starting torque specify MPB bearings.  
Radial • Pivot • Angular Contact • Thrust  
Promptly Available • Ask for catalog EL-10

**MPB MINIATURE Precision BEARINGS**  
INCORPORATED  
KEENE, NEW HAMPSHIRE, U.S.A.



# How linear amplifier circuits are designed and constructed

- Here is a sound analysis of the principles, special problems and employable constructional techniques of many important types of vacuum tube amplifiers.
- While discussion of design principles chiefly from the standpoint of relatively high frequencies, it is general in its application, and may be applied to filter amplifiers operating at frequencies as low as 50 cps.

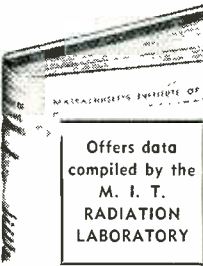

Offers data compiled by the  
M. I. T.  
RADIATION  
LABORATORY

## VACUUM TUBE AMPLIFIERS

By GEORGE E. VALLEY, Jr.,  
Asst. Prof. of Physics, M.I.T.  
and HENRY WALLMAN,  
Assoc. Prof. of Mathematics, M.I.T.

733 pages • Illustrated • \$10.00

This authoritative book discusses those amplifiers which, in general, are characterized by very high gain—by large bandwidth—by great dynamic range—or by precise response. Explained are the theoretical and practical aspects of the several methods of amplifying, with varying degrees of fidelity, pulse-modulated carrier frequencies as high as 200 Mc/sec. Amplifier measurement and testing are explained and the following characteristics discussed: Gain • Bandwidth and shape of pass band • Pulse response • Overload characteristics • Freedom from regeneration

Mail coupon below for 10 day FREE TRIAL

McGRAW-HILL BOOK CO.,  
330 W 42d St., NYC 18

Send me Vol. 18, MIT series, Valley and Wallman's VACUUM TUBE AMPLIFIERS for 10 days' examination on approval. In 10 days I will remit \$10.00, plus a few cents delivery charge, or return the book postpaid.

Name .....

Address .....

City.....Zone.....State.....

Company .....

Position .....

Just Published

# ELECTRONIC INSTRUMENTS

Edited by IVAN A. GREENWOOD, Jr., Research Group Leader, General Precision Lab.; J. VANCE HOLLAM, Jr., Director of Research, Laboratory for Electronics, Inc., and DUNCAN MACRAE, Jr., Teaching Fellow, Harvard Univ.

721 pages • Illustrated • \$9.00

This new book discusses the design theory and some practical aspects of electronic instruments—from overall design procedures of automatic, electronic, and electro-mechanical computers to data on lightweight, low-power electronic servomechanisms. It covers test equipment development and design, the design of accurately stabilized power supplies and the construction of prototype equipment. The book is divided into five major parts, each section complete in itself.

1. Explains procedures used in design of electronic computers.
2. Illustrates potentials for new applications of servo systems . . . techniques used in their design.
3. Analyzes pulse test equipment and its design.
4. Takes up design of voltage and current regulators.
5. Solves the pre-design and design problems of electronic instruments.

Volume 21 in the M.I.T. Radiation Laboratory Series

See the book 10 Days On Approval

McGRAW-HILL BOOK CO.,  
330 W. 42d St., N. Y. C. 18

Send me Vol. 21, MIT series, ELECTRONIC INSTRUMENTS by Greenwood, Hollam, and Macrae for 10 days' examination on approval. In 10 days I will remit \$9.00, plus a few cents delivery charge, or return the book postpaid.

Name .....

Address .....

City.....Zone.....State.....

Company .....

Position .....

# WANTED: career men in electronics

"... so wide is the scope of radio science today, and so great its possibilities for the future, that it is beyond human power to foresee all the new advances that will appear; it is safe to prophesy that some developments will overshadow in significance many of the achievements of the past. This much is certain: our scientists and engineers will continue to devote their energies and skill toward extending the usefulness of the electronic and communication arts so that the Radio Corporation of America will remain World Leader in Radio—First in Television."

**If You Are an Engineer or Physicist** whose closest interests are wrapped up in the electronics of *tomorrow*, the above quotation from David Sarnoff's report on RCA operations during 1948 will be of special interest to you, for this quotation embodies in a few words the spirit which has always travelled in advance of RCA progress and achievement.

**Today, as Never Before**, RCA Victor Division of the Radio Corporation of America is engaged in far-reaching electronic developments whose horizons in the fields of radiation and sound extend four to five years, or more, into the future. These expanding horizons have created a large need for career men of talent—graduate electrical and mechanical engineers, physicists, with a thorough background in electronics and development-design experience in high-frequency and micro-wave techniques.

**Working in Close Collaboration** with distinguished scientists of RCA Laboratories, these men will work for RCA Victor in carrying basic research discoveries through the stages of advanced design and development. Unlimited laboratory resources and facilities are waiting for top-flight men ready to assume responsibilities in handling and administering advanced projects in virtually every phase of electronics—infrared, ultrasonic, audio and acoustic equipment; television receivers, antennas, transmitters, field and studio equipment; radar; mobile communications; aviation communications and navigational aids; coils, transformers and components.

**These Openings Represent** a permanent expansion in RCA Victor design and development activities, providing careers for men of high calibre with appropriate training and experience.

**If You Meet These Specifications**, and if you are looking for a career which will open wide the door to the complete expression of your talents in the fields of electronics, write, giving full details, to:

Arnold K. Weber, Personnel Manager  
Box 133, RCA Victor Division  
Radio Corporation of America  
Camden, New Jersey

# SEARCHLIGHT SECTION

EMPLOYMENT • BUSINESS •

OPPORTUNITIES

• EQUIPMENT—USED or RESALE

**UNDISPLAYED RATE:**

\$1.20 a line, minimum 4 lines to figure advance payment count 5 average words as a line.

**INDIVIDUAL EMPLOYMENT WANTED** undisplayed advertising rate is one-half of above rate, payable in advance.

PROPOSALS \$1.20 a line an insertion.

**INFORMATION:**

BOX NUMBERS in care of any of our New York, Chicago or San Francisco offices count 1 line additional in undisplayed ads.

DISCOUNT of 10% if full payment is made in advance for four consecutive insertions of undisplayed ads (not including proposals).

**DISPLAYED—RATE PER INCH**

The advertising rate is \$10.25 per inch for all advertising appearing on other than a contract basis. Contract rates quoted on request.

AN ADVERTISING INCH is measured  $\frac{7}{8}$  inch vertically on one column, 3 columns—30 inches—to a page.

NEW ADVERTISEMENTS received by February 28th will appear in the April issue, subject to limitation of space available

## ENGINEERS

### PROGRESSIVE ELECTRONIC RESEARCH AND DEVELOPMENT COMPANY

has several openings for Senior Electronic Engineers of superior ability, with experience in design and development. Excellent opportunities for top flight men. Send complete resumes and salary requirements to:

Personnel Department

## MELPAR, INC.

452 SWANN AVENUE, ALEXANDRIA, VIRGINIA

### PRODUCTION-METHODS ENGINEER WEST COAST

OPPORTUNITY WITH RAPIDLY EXPANDING MANUFACTURER OF ELECTRONICS, ELECTRO-MECHANICAL, AND RADIATION INSTRUMENTS.

**REQUIREMENTS:**

5-10 years experience as electronic and mechanical instrument production-methods engineer in small lot production. Thorough electronic theory grounding.

INTERESTING WORK ON IMPORTANT PROJECTS WITH SMALL PROGRESSIVE ORGANIZATION.

### BERKELEY SCIENTIFIC CO.

Sixth & Nevins Richmond, California

EASTERN MANUFACTURER OF PAPER CONDENSERS AND SPECIALTY CONDENSERS SEEKS SALES REPRESENTATIVES FOR ALL TERRITORIES EXCEPT N. Y. STATE.

RW 7804 Electronics

330 West 42nd St., New York 18, N. Y.

WHEN

*Answering  
Advertisements*

PLEASE do not send original letters, certificates or photographs. We cannot be responsible for their return. Please send photostat or carbon copies.

## WANTED

## ACOUSTICAL ENGINEER

with experience in the design of electromechanical transducers. Please state your background and your salary requirement.

Address replies  
to Attention:

Chief Engineer

THE BRUSH  
DEVELOPMENT COMPANY  
3405 PERKINS AVENUE  
CLEVELAND, 14, OHIO

REPLIES (Box No.): Address to office nearest you  
NEW YORK: 330 W. 42nd St. (18)  
CHICAGO: 520 N. Michigan Ave. (11)  
SAN FRANCISCO: 68 Post St. (4)

### POSITIONS VACANT

ELECTRONICS ENGINEER with experience in the development of measuring and controlling apparatus for aircraft. Age—under 30. Location—Southern New England. P-7577, Electronics.

RESEARCH ENGINEER or Physicist: Recent graduate with E.E. (Communications major) or Physics degree who is interested in joining a growing research laboratory in a well-established textile firm and working with experimental stress analysis, electronic instrumentation, and test development. We would prefer previous experience but will consider applicants who are to graduate in February or June, 1949. Please write for application blank and to arrange interview. P 7775, Electronics.

WANTED—PATENT Examiner. Degree in mechanical or electrical engineering. Must have experience in electronics, technical writing, and patent disclosures and applications. Give full details of experience and education to SLX-1, P. O. Box 5800, Albuquerque, New Mexico.

VACUUM TUBE Engineer (starting salary \$6235.20) to head well equipped and well staffed vacuum tube development shop in Government laboratory. Requires engineer or physicist with several years broad experience in vacuum tube development and construction and a genuine interest in developing new tube making techniques. P 7684, Electronics.

SENIOR AND Junior Engineers needed with experience on SCR-584 radar or similar equipment. Location about 50 miles from Los Angeles. Electronic Engineering Company of California 2008 W. 7th St., Los Angeles 5.

ELECTRONICS ENGINEER—Radio and industrial electronics instructor for a two year technical college—Extension Division of Georgia Institute of Technology. College degree required. Write The Technical Institute, Chamblee, Georgia.

### EMPLOYMENT SERVICES

SALARIED POSITIONS \$3,500-\$35,000. If you are considering a new connection communicate with the undersigned. We offer the original personal employment service (39 years recognized standing and reputation). The procedure, of highest ethical standards, is individualized to your personal requirements and develops overtures without initiative on your part. Your identity covered and present position protected. Send only name and address for details. R. W. Bixby Inc., 278 Dun Bldg., Buffalo 2, N. Y.

EXECUTIVES \$3,000-\$25,000. This reliable service, established 1927, is geared to needs of high grade men who seek a change of connection under conditions assuring, if employed, full protection to present position. Send name and address only for details. Personal consultation invited. Jira Thayer Jennings, Dept. E, 241 Orang St., New Haven, Conn.

ENGINEERING OPENINGS! Broadcast-TV (1st phone license); Sales, Design-Development Engineers-Technicians needed for all phases radio-electronics. RRR-Radio-TV Employment Bureau, Box 413, Philadelphia, Pa.

### SELLING OPPORTUNITY OFFERED

MANUFACTURER HIGH GRADE varnished fabric tubings wants representatives for electronic, radio, television line. RW-7341, Electronics.

(Continued on page 256)

Additional Position Vacant Ads on Pages 256 & 257

# PROJECT ENGINEERS

Real opportunities exist for Graduate Engineers with design and development experience in any of the following: Airplane Stability and control, Servomechanisms, radar, microwave techniques, microwave antenna design, communications equipment, electron optics, pulse transformers, fractional h.p. motors.

Send complete resume to employment office.

**SPERRY  
GYROSCOPE CO.**  
Division of the Sperry Corp.  
GREAT NECK, LONG ISLAND

(Continued from page 255)

### POSITIONS WANTED

**GRADUATE ENGINEER**, seven years experience in aircraft and naval electronics, desires position under competent supervisor who can add to my know-how. Prefer Sales and Service or Field Research on specialized equipment. PW 7779, Electronics.

**CATHODE RAY Tube Technician** 20 years experience in the manufacture of vacuum tubes. Would like to make contact with manufacturer of Cathode Ray Tubes. PW-8017, Electronics.

**ENGINEER, BACHELOR** of Science degree, 3 years experience as radio instructor, 2½ years as instruction book writer-editor, 3 years as librarian. Age 42. Available. PW 8003, Electronics.

**ELECTRONICS ENG.**, age 22, Cornell grad., 2 yrs. electronic design and equipment, some sales, ham and commercial radio exper., desires permanent connection with small concern in the metropolitan N.Y.C. area. PW 8001, Electronics.

### SELLING OPPORTUNITY WANTED

**SALES REPRESENTATIVE** many years experience calling on jobbers and manufacturers, New York and vicinity, is open to represent reliable concern. References. RA 7854, Electronics.

### FOR SALE

Oscilloscope: DuMont 224, 3 in. h-f scope. Range 2-c-2mc. Used. Excellent condition. Complete with probe and instr. book. Reasonable. T. Conte, 2117 Ginter St., Richmond, Virginia.

### CONTRACT WORK

Small electronics manufacturer now has facilities for handling additional contracts specializing in wire and cable assembly, small receivers and PA systems. CW 7995, Electronics.

### Competent Engineering & Sales Representation

Entire Eastern Seaboard, through four offices in key cities, is offered to manufacturers of high-grade Electronic, Electrical and Electro-mechanical items. Fourteen years experience with most desirable accounts. References furnished on request.

RA 7161 Electronics  
330 West 42nd St., New York 18, N. Y.

### CALIFORNIA Manufacturers Representative

Has capacity for two more products in the electro-mechanical field. An established sales and engineering service of unusual quality.

**H. G. WEIGHTMAN**  
1820 Vine Street, Berkeley 9, Calif.

**ELECTRICAL ENGINEERS and PHYSICISTS** are invited to discuss employment with our Personnel Manager, who will be available at the Hotel Commodore throughout the 1949 IRE Convention, March 7 - 10. His room number will be posted on the registration bulletin board.

**POSITIONS ARE AVAILABLE FOR** Bachelors, Masters, and Ph.D.'s with actual experience in research and development of microwave transmitters, receivers, antennas; radar; servos, motor-control systems; instrumentation; or general electronics.

*If you are not attending the convention, write to the Personnel Manager of*

*Airborne Instruments Laboratory*  
INCORPORATED  
160 OLD COUNTRY ROAD · MINEOLA, N.Y.

## • EXPERT DIAGNOSIS and TREATMENT •

for Ailing Communication and Television Receivers and Transmitters  
by **TRAINED SKILLED TECHNICIANS**

When trouble comes and your receiver acts up, don't blame sun spots . . . let factory trained experts check your set's health.

**HALLICRAFTERS HAMMARLUND COLLINS  
NATIONAL PIERSON RME**

Complete realignment—Bandspread Calibration—Sensitivity Measurements—Image Rejection Ratios—S Meter Calibration. Rebuilding to rigid factory standards.

*Authorized Collins, Hallicrafter, National and RME  
Service Center*

### WINTERS RADIO LABORATORY

11 WARREN STREET Cortland 7-1361 New York 7, N. Y.

### WE CAN ASSURE LOW PRICES!

Stamping Up To 100 Tons, Finishing, Assembling, Packing, Labelling and Shipping Facilities

**ALL TYPES AND SIZE**

### PRODUCTION WORK WANTED

Complete facilities available for production of items from thimbles to parts of electric ranges. Can take work requiring presses up to 100 tons and produce anything out of steel, brass or any alloy. Have facilities for enameling, polishing, buffing and chrome plating. Will pack and ship with your label. We produce parts and completely finished products for nationally known companies. Write today sending us full description of your requirements with blueprints or sketches. We will reply promptly.

**MEL-GAUGE CO.**

EAST HAVEN, CONN.

### Manufacturers Wholesaler's Dealers

A service to save you time and money by locating your "hard to find" items and selling your "non-movable" surplus.

Please write on company stationery. TELLING us your needs—SELL us your surplus.  
**ELECTRONIC SURPLUS BROKERS**  
3232 Broadway, N. Y. C. 27

### ARE YOU STUCK?

Do you have equipment which cannot be sold in its present condition?

Do you require equipment in a hurry?  
**WE CAN** 1. Recondition used equipment.  
2. Modify power output, frequency, type of emission or operating voltage.  
3. Supply complete equipments to your requirements.

**LOW COST • FAST DELIVERY  
MODULATION PRODUCTS COMPANY**  
202 East 44 St. New York 17, N. Y.

### PRINTED CIRCUIT KITS NO MORE WIRES

Learn Printed-Circuit Methods. An important new aid in designing, testing, and repairing modern electronic circuits. Paint working circuits over your rough sketches or any nonconductor. High instruction value for colleges. Kits \$3 and \$5, contain air-drying conducting and resistance (30 ohms to 2.5 megohms) paints plus free manual. Manual separately 25¢. Free literature.

### Microcircuits Company

Dept. 7D, New Buffalo, Michigan

**SAVE RESEARCH TIME BY CONSULTING**  
The Indispensable Bibliographical Reference

### ELECTRONIC ENGINEERING MASTER INDEX

*Descriptive Literature on Request*  
**ELECTRONICS RESEARCH PUBL. CO.,**  
2 W. 46th St., N. Y. 19

**IF there is anything you want**  
that other readers can supply—  
**OR . . . something you don't want—**  
that other readers can use—  
**Advertise it in the SEARCHLIGHT SECTION**



## Radar, Communications AND Sonar Technicians WANTED For Overseas Assignments

### Technical Qualifications:

1. At least 3 years practical experience in installation and maintenance.
2. Navy veterans ETM 1/c or higher.
3. Army veterans TECH/SGT or higher.

### Personal Qualifications:

1. Age, over 22—must pass physical examination.
2. Ability to assume responsibility.
3. Must stand thorough character investigation.
4. Willing to go overseas for 1 year.

Base pay, Bonus, Living Allowance, Vacation add-up to \$7,000.00 per year. Permanent connection with company possible.

Apply by writing to  
W-72, P.O. BOX 3552,  
PHILA. 22, PA.

Men qualified in RADAR, COMMUNICATIONS or SONAR give complete history. Interview will be arranged for successful applicants.

### WANTED

## Mathematicians, Engineers, Physicists

Men to train in oil exploration for operation of seismograph instruments, computing seismic data, and seismic surveying. Beginning salary \$250.00 to \$300.00 per month dependent on background. Excellent opportunity for advancement determined on ingenuity and ability. Nature of work requires several changes of address each year; work indoors and out; general location in oil producing locations.

To apply write giving scholastic and employment background, age, nationality, marital status, and include recent snapshot to

NATIONAL GEOPHYSICAL CO., INC.  
8800 Lemmon Ave. Dallas 9, Texas

## ELECTRONIC ENGINEER

To work on challenging control projects of an electrical, electro-mechanical and electronic nature. Good pay with excellent future with an established New England company of top rating for young man with necessary background who has initiative and imagination. Apply

P-8038, Electronics  
330 W. 42nd St., New York 18, N. Y.



## ELECTRONIC ENGINEERS

BENDIX RADIO DIVISION  
Baltimore, Maryland

manufacturer of

RADIO AND RADAR EQUIPMENT

requires:

### PROJECT ENGINEERS

Five or more years experience in the design and development, for production, of major components in radio and radar equipment.

### ASSISTANT PROJECT ENGINEERS

Two or more years experience in the development, for production, of components in radio and radar equipment. Capable of designing components under supervision of project engineer.

Well equipped laboratories in modern radio plant . . . Excellent opportunity . . . advancement on individual merit.

### Baltimore Has Adequate Housing

Arrangements will be made to contact personally all applicants who submit satisfactory resumes. Send resume to Mr. John Siena, Department 69:

**BENDIX RADIO DIVISION**  
**BENDIX AVIATION CORPORATION**  
Baltimore 4, Maryland

### ELECTRONIC ENGINEERS PHYSICISTS

"A leading Electronics Company in Los Angeles, California offers permanent employment to persons experienced in advanced research and development. State qualifications fully."

P 6606 Electronics  
68 Post St., San Francisco 4, Calif.

### SCIENTISTS AND ENGINEERS

Wanted for interesting and professionally challenging research and advanced development in the fields of microwaves, radar, gyroscopes, servomechanisms, instrumentation, computers and general electronics. Scientific or engineering degrees required. Salary commensurate with experience and ability. Direct inquiries to Mgr. Eng. Personnel.

**BELL AIRCRAFT CORPORATION**  
P. O. Box 1 Buffalo 5, New York

## INVESTIGATE THIS OPPORTUNITY

To join the staff of one of the largest research organizations in the country devoted exclusively to

## VACUUM TUBE RESEARCH

Working conditions are ideal in these laboratories which are located in the New York Suburb of Orange, New Jersey. Your associates will include men of many years experience in vacuum tube research and development.

This rapidly expanding organization is devoted to both commercial and military research. It is a division of one of the oldest vacuum tube manufacturers in America. Security and stability for the years to come are assured. You will have an opportunity to gain experience with the different kinds of vacuum tubes, receiving, power, cathode ray, sub-miniature, micro-wave, radial beam and various special types.

If you can qualify as a

PHYSICIST • ELECTRICAL ENGINEER • CIRCUIT  
TECHNICIAN • VACUUM TUBE TECHNICIAN

write at once to

RESEARCH DIVISION

**NATIONAL UNION RADIO CORPORATION**  
350 SCOTLAND RD. ORANGE, NEW JERSEY



# TUBE PRICES SLASHED!

ALL BRAND NEW  
STANDARD BRAND

MINIMUM ORDER \$5.00  
QUANTITY PRICES ON REQUEST

Type	Price	Type	Price	Type	Price	Type	Price	Type	Price	Type	Price	Type	Price
1B23	\$ 9.50	211	0.98	891	110.00	UH50	5.95	5X4G	.72	6SK7	.66	12X3	.98
1B24	4.95	215A	3.00	902P1	7.95	70D	6.95	5Y3GT	.42	6SL7GT	.66	12Z3	.88
1B26	4.95	217C	7.50	904	9.95	VR75	.98	5Y4G	.60	6SL7GT	.96	14A7/12B7	.88
1B29	.89	218	49.50	905	11.95	VR78	.75	5Z3	.72	6SN7GT	.88	14A7/XXD	.88
1P24	.89	221A	2.95	913	7.95	VR90	.75	5Z4	1.06	6S07	.60	14B6	.88
1C21	1.29	231D	3.49	920	2.98	VR91	1.49	6A3	1.28	6S07GT	.60	14B8	.88
1S21	1.99	234D	3.49	923	2.98	VR105	.75	6A6	1.06	6SR7	.72	14C5	.88
2A21	3.95	250R	7.95	925	1.40	VR150	.98	6A7	.80	6SR7GT	.72	14C7	.88
2C21	.98	250TH	19.50	929	1.25	VT127A	3.00	6A8	.80	6ST7	.88	14E6	.72
2C22	.39	250TL	19.50	930	1.10	VU111	1.10	6A8	.80	6ST7	.88	14E7	.88
2C26A	.28	252A	4.95	931A	4.95	WL460	14.19	6ABGT	.80	6SV7	1.24	14F7	1.06
2C34	.59	254	19.95	954	.75	WL468	14.95	6AB5/6N5	1.06	6T7G	.88	14F8	.88
2C40	1.98	259A	4.95	956	.75	WL532A	4.95	6AC5GT	1.16	6U5/6G5	.72	14F9	1.06
2C43	7.50	274A/B	1.25	956	.75	WL562	150.00	6AC7/1852	1.16	6U6GT	.72	14F9	1.06
2C43	7.50	282A/B	9.95	957	.75	WL616	105.00	6AD6	.88	6U7G	.72	14N7	1.06
2C46	3.69	304TH	6.95	958A	.75	Z25	1.95	6AD7G	1.28	6V6GT	1.28	14O7	.88
2D21	1.18	304TL	1.49	1608	4.95	ZH120	6.95	6AG5	1.06	6W7G	.88	14S7	1.06
2E22	1.50	307A	4.95	1611	.98	ZP477/12DA8	14.95	6AG7	1.28	6X4	.60	14W7	1.06
2E24	4.95	316A	.69	1613	1.75	0A3 VR75	.98	6AH6	1.56	6X5GT	.60	14X7	.88
2E25	4.25	322A	4.95	1616	1.39	0A4G	1.06	6AJ5	.99	6Y6G	.96	14X8	.88
2E26	3.95	327A/B	4.95	1619	.75	0B2	2.05	6AK5	1.56	6Y7G	.88	1978	1.06
2E30	2.49	331A	5.95	1621	1.98	0B3 VR90	.75	6AK6	.96	6Z5G	1.28	22	1.28
2J21A	12.39	338A	4.95	1622	1.75	0C3 VR105	.75	6AL7G	1.06	7A4/XXL	.72	24A	.88
2J26	8.95	350A/B	19.95	1624	1.75	0D3 VR150	.75	6AO5	.80	7A5	.72	25A6G	1.06
2J31	10.95	354C/D	4.95	1625	1.75	OYA	.88	6AO6	.88	7A6	.72	25A6GT	1.16
2J32	13.95	368AS	4.95	1626	.49	OZ4	.88	6AO7GT	.88	7A7	.72	25A6GT	.66
2J33	13.95	371A/B	4.95	1628	4.95	OZ4G	.69	6AR5	4.95	7A8	1.06	25Y5	1.16
2J34	24.95	393A	4.50	1629	1.50	01A	.72	6AS7G	.60	7D7	.72	25Z5	.60
2J37	22.95	394A	24.95	1631	1.65	IA3	1.56	6A56	.80	7AF7	.88	25Z6GT	.60
2J38	17.95	417A	3.95	1633	1.49	IA4	1.56	6AV6	.80	7AG7	.88	27	.60
2J38	13.95	434A	1.95	1634	1.10	IA5P	.72	6B4G	1.28	7B4	.72	28D7	.39
2J49	24.95	446A/B	24.95	1635	5.95	IA6	1.28	6B5	1.56	7B5	.72	30	.39
2JB51	4.95	450TH	7.50	1636	.79	IB4	1.49	6B6G	1.28	7B6	.72	31	.39
2J54B	17.95	464A	12.95	1638	.98	IB4GT	.79	6B7	1.28	7B7	.72	32	1.28
2K25	6.50	531	24.50	1641	.79	IB4GT	.79	6B8	1.28	7B8	.72	32L7GT	1.28
2K28	34.95	575A	14.95	1642	.98	IB4GT	.79	6B8	1.28	7C4/1203A	.39	32L7GT	1.28
3AP1	4.95	701A	4.95	1644	1.49	IB5/25S	1.49	6B8	1.28	7C5	.72	33	.39
3B22	4.95	703A	4.95	1644	1.98	IB7GT	1.06	6BA6	.80	7C6	.72	35/51	.80
3B23	4.95	703A	4.95	1851	1.25	IC5GT	.88	6BE6	.72	7C7	.72	35A5	.72
3B24	.65	706CY	18.95	1852	1.06	IC6	1.28	6BG6G	1.28	7E6	.72	35B5	.80
3B24	.89	707A/B	24.95	1853	1.06	IC7G	1.28	6BG6G	1.28	7E7	.72	35L6GT	.66
3BP1	3.95	708A	7.95	1960	.95	ID5GP	1.19	6C1G	1.28	7E7	.72	35W4	.46
3C21	5.95	710A	2.95	2050	1.19	ID7C	1.28	6C4	.39	7F7	.66	35Z3	.72
3C22	18.95	713A	1.65	2051	.98	ID8GT	1.56	6C5	.66	7G7/1232	1.06	35Z4GT	.60
3C23	4.95	714A	6.95	5514	4.95	IE7G	1.38	6C5GT	.66	7H7	1.06	35Z5GT	.60
3C24	4.95	715A/B	24.95	5516	10.00	IF4	1.06	6C6	1.28	7J7	1.06	36	.39
3C30	1.50	715C	.99	7193	.39	IF5G	1.06	6C6	1.28	7K7	1.06	37	.39
3CP1	3.00	717A	34.95	8003	5.95	IF6	1.56	6C8G	1.28	7L7	1.06	38	.39
3D2A	1.50	720DY	4.35	8005	4.95	IF7G	1.56	6D6	.66	7M7	1.06	39	.39
3DP1	3.95	721A/B	7.95	8011	2.95	IG4GT	1.06	6D8G	1.28	7N7	1.06	39/44	.39
3EP1	3.95	723A/B	4.95	8012	4.95	IG6GT	1.06	6E5	1.85	7O7	.72	41	.66
3E29	4.95	724A/B	4.95	8013A	2.95	IH4G	.88	6E5	.66	7P7	.88	42	.66
3F21	3.95	725A	24.95	8014A	24.95	IH5GT	.66	6F5GT	.66	7S7	1.06	43	.66
3J31	49.50	726A	23.50	8016	1.49	IH6GT	1.28	6F6	.80	7V7	1.06	45	.66
4-65A	14.50	750TL	49.50	8016	3.95	IH6GT	1.28	6F6GT	.66	7W7	1.06	45Z3	.60
4-125A	27.50	800	2.25	8025	7.95	IL4GT	1.28	6P7	1.06	7X7/XXFM	1.06	45Z3	.60
4-250A	37.50	801A	2.95	8025	12.95	IL4	.80	6P7	1.06	7Y4	.72	46	1.06
4A1	1.98	803	8.95	C6J	12.95	IL4A	1.06	6F8G	1.28	7Y4	.72	47	.96
4B10	6.95	804	12.95	CEQ72	1.95	IL4A	1.06	6G6G	1.06	7Z4	.60	49	.96
4B24	4.95	805	5.95	CK1005	.39	ILB4	1.06	6G6G	1.06	12A	.60	50	.96
4C35	19.95	807	1.25	CK1006	.69	ILC5	1.06	6H6GT	.60	12A6	.60	50A5	1.56
4E27	12.95	808	1.89	CK1090	4.95	ILC6	1.06	6J5	.54	12A6GT	.39	50B5	.88
4J26	110.00	809	2.95	EF50	.79	ILD5	1.06	6J5GT	.54	12A6GT	1.28	50L6GT	.66
5AP1	5.95	810	7.95	ELIC	4.95	ILE3	1.06	6J7	1.06	12AH7GT	.88	50L6GT	.72
5B1	2.95	811	2.45	EL225	4.95	ILH4	1.06	6J8	1.28	12AL5	.80	53	1.06
5BP4	4.95	812	6.90	FI23A	12.95	ILN5	1.06	6J8G	1.06	12AT6	.96	56	.66
5CP1	3.95	813	8.95	FG60	150.00	IN5GT	.80	6K5GT	.96	12AT7	1.06	57	.80
5CP7	13.95	815	3.95	FG17	3.25	IP5GT	1.06	6K6GT	.66	12AU6	.80	58	1.06
5D21	29.95	814	2.95	FG27A	9.95	IO5GT	1.06	6K7	.66	12AU7	.80	59	1.06
5FP7	3.95	816	1.19	FG33	8.95	IR4	1.06	6K7GT	.96	12B6	.72	70L7GT	1.56
5GP1	9.95	826	.69	FG67	12.95	IR5	.80	6K8	.96	12BE6	.72	71A	.80
5HP4	9.95	828	6.95	FG81A	12.95	IR5	.80	6L8GT	.96	12C8	.69	75	.66
5J29	17.50	829A/B	7.95	FG105	19.95	IS5	.72	6L8	1.42	12F5GT	.72	76	.66
5JP2	11.95	829B/3E29	4.95	FG172A	32.50	IT4	.80	6L6	1.16	12H6	.39	77	.66
6A6G	8.88	830	2.95	FG235	59.50	IT5GT	1.06	6L6G	1.16	12J5GT	.39	78	.66
6C21	24.95	830B	5.25	FG238B	160.00	IU4	.80	6L6GA	1.16	12J7G	.80	79	.88
6D4	1.29	832A	4.95	GL146	11.00	IU5	.72	6L7G	1.16	12K7GT	.80	80	.46
7B7	4.95	833A	34.50	GL530	49.50	IV	1.28	6N6G	1.56	12K8	.66	81	1.56
7EP4	17.95	834	1.15	GL559	49.50	2A3	1.28	6N7	.96	12K8	.88	82	1.06
9AP4	24.95	836	1.15	GL697	150.00	2A4G	1.28	6N7GT	.96	12K8GT	.96	83	1.06
9GP7	15.00	837	2.50	HF100	3.95	2A5	.88	6N7GT	.96	12K8GT	.96	84/62A	1.28
9JP1	7.95	838	3.95	HF210	17.95	2A6	1.06	6P5GT	.96	12O7GT	.72	85	.72
10Y	.69	841	.69	HY65	2.49	2A7	1.06	6O6G/6T7G	1.06	12SA7	.66	85	.88
10SPEC.	.69	843	.69	HY69	2.49	2B7	.88	6O7	.88	12S7GT	.72	89	.72
12DP7	14.95	845	5.95	HY77	1.25	2P5	.88	6O7GT	.72	12S7GT	1.06	89Y	1.56
12DP8	14.95	845W	5.95	HY7615	1.25	2V3G	1.98	6R7	1.06	12SF5	.80	117L7GT	1.56
12FP7	14.95	849A	60.00	HYE1148	.48	2X2A	1.25	6R7GT	1.06	12SF5GT	.80	117M7GT	1.56
12CF7	14.95	849H	60.00	KU610	9.95	3A4	.39	6S7	1.28	12SP7	.80	117N7GT	1.56
12HP7	14.95	851	75.00	ML101	150.00	3A8GT	1.98	6S7GT	1.06	12SP7GT	.80	117P7GT	1.56
15E	1.50	860	3.00	RRK21	3.95	3B7	.36	6SA7	.66	12SG7	.72	117Z3	.60
15R	1.50	861	49.95	RRK22	4.95	3C4	.88	6SA7GT	.66	12SH7	.72	117Z4GT	1.16
23D4	.49	864	.69	RRK25	2.95	304	.36	6SB7GT	.66	12SK7	.66	117Z6GT	.96
24C	.98	866A	2.98	RRK33	.98	305GT	.96	6SB7Y	.88	12SL7GT	.66	FM-1000	1.28
455PEC	.49	866A	.99	RRK34	.59	354	.80	6SC7	.72	12SN7GT	.88	UX120	1.38
75TL	3.95	868	1.95	RRK59	3.95	3V4	.80	6SD7GT	.49	12SO7GT	.80	UX200	1.28
100TH	12.95	869B	75.00	RRK60	24.95	5A74	.56	6SE7	.72	12S07GT	.80	9001	.89
100TS	3.00	872A	2.95	RRK65	2.49	5R4GY	1.15	6SF7GT	.80				





# Save Money!

**BUILD YOUR OWN HIGH QUALITY  
LABORATORY TEST EQUIPMENT**

## HIGH FREQUENCY F. F. Probe Fits MOST V.T.V.M.'S

A handy addition to your laboratory. Will measure R.F. voltage to over 200 mc, with a minimum of circuit loading. An excellent method of signal tracing for Television, F.M., and amateur radio. Contains the 1N34 crystal. This highly accurate and dependable crystal makes a small compact unit that is easy to use. Fits the Model 221 and Model 113A as well as most other.

V.T.V.M.'s KIT FORM ..... **\$3.75**  
COMPLETELY BUILT AND TESTED ..... **\$7.50**

## DUMONT 164 E SCOPE

A popular 3 inch scope for the discriminating user:

- Freq. response Horiz. and Vert. amplif. from 5 to 100,000 CPS Uniform within 7½%.
- Deflection factor, Vertical. .7 RMS Volts per inch Max.
- Deflection factor, Horiz. .55 RMS Volts per inch Max.
- Sweep freq. continuous from 15 to 30,000 cycles.
- Primary input 110 Volts 40 to 60 cy.

ONLY A FEW LEFT AT THIS AMAZING PRICE ..... **\$75.00**



## The NEW 900A VTVMVOMAX

Accurate AC-DC and RF Voltage measurements of Laboratory caliber:

- 5" giant meter providing 45 ranges fused.
- 24 Volt DC Voltages thru 3000 Volts.
- AC, AF, IF, RF Ranges 20 cys. thru 100 megacycles.
- DB ranges from plus 10 minus 10, plus 30 plus 50, 0-DB equal 1MW in 600 ohms impedance.
- Current ranges—6 ranges from 1.2 ma. to 12 amps. Plus or minus 2% absolutely stable.

Complete with test leads, tubes and all accessories. .... **\$68.50**

## GOING MOBILE?



Here is a Rig for 80 or 10 meters. Will deliver 8 watts output modulated. Fits in Glove Compartment or under dash. Only 4x5x5½ in. Designed for T17 B Mike or equivalent. Less tubes, mike, Xtal and power supply. Requires 3-6AG7 and 350V. DC at 110Ma.

MODEL 129-27 to 29.7 MC.  
MODEL 175-3750 to 4000 KC.  
YOUR COST ..... **\$23.95**  
SET OF TUBES ..... **\$3.84**

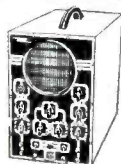

## MODEL 400-S 5" OSCILLOSCOPE KIT

Easy to read assembly instructions and diagrams.

- Horizontal Sweep Freq. 15 to 30000 cycles.
- Graph screen for measuring peak to peak voltages.
- Internal and External Synchronization.
- Deflection sensitivity .65 volts per inch full gain.

- Amplifier freq. response from 50 cycles to 50 KC.
  - Input impedance 1 meg. and 50 MMF.
  - X axis intensity modulation provided.
  - Size 8½ x 13" x 17" WHT. 38 lbs.
- YOUR COST ..... **\$39.95**  
COMPLETE ABOVE UNIT COMPLETELY ASSEMBLED AND TESTED ..... **\$69.95**

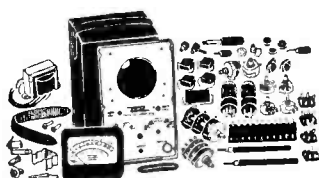

## MODEL 221K VACUUM TUBE VOLTMETER KIT

Comes complete, nothing else to buy.

- DC and AC ranges 0-5, 10, 100, 1000 Volts.
- Ohmmeter ranges, ranges .2 to 100 megohms. 5 ranges R x 1 - R x 100, R x 1000, R x 10,000, R x 1 megohm.
- DB scale from minus 20 to plus 16 DB.

- DC input resistance 25 megohms constant on all ranges.
  - AC input impedance over 1½ megohms constant on all ranges.
  - Large 4½" linear movement 2% accurate with minimum friction.
  - Size 97/16 x 6" x 5" WHT. 10 lbs.
- YOUR COST, KIT ..... **\$23.95**  
ABOVE UNIT COMPLETELY BUILT ..... **\$49.95**



## VOLT-OHM MILLIMETER KIT

Easy to assemble—Easy to use.

- 3" meter.
  - DC 0/5/50/250/500/2500 volts.
  - AC 0/10/100/500/1000 volts.
  - Ohmmeter 0/500/10,000 and 0/1 meq.
  - DB 8 to 55.
  - Size 5½ x 8 5/8 x 3½.
  - Output 0/10/100/500/1000 volts.
  - DC mills 0/1/10/100 ma.
  - DC amps 0/1/10.
- COMPLETE KIT, NOTHING ELSE TO BUY ..... **\$14.95**  
WIRED AND FACTORY TESTED ..... **\$17.95**

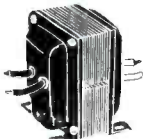

## TRANSFORMER

24 volts at 10 amps will deliver 18 Volts DC from full wave selenium rectifier at 10 amps—good quality 110V 60 cy input... **\$4.95**

## SELENIUM RECTIFIER

2 amps—18 to 24 Volts input—18 to 12 Volts output. Your cost ..... **\$2.49**



## 1000-1000 Mfd FILTER

Cond.-upright can at 15 Volts—Perfect filter for low voltage DC Supplies. Each ..... **\$1.95**

## BUTTERFLY CONDENSER

This cond. has the tank circuit built in—just plug in a tube. (Designed for W.E. 368AS) Operates from 200 to 1000 mcs. Can be used with any high frequency triode. **\$1.98**

## RG 22U-TWIN COAX

Nominal impedance 95 ohms—Perfect for television or where Shielded Balanced Transmission Line is Needed ..... **15 per ft.**

## DO YOU OWN AN SCR-522?

We have a complete power supply, including a separate voltage regulated bias supply chassis and schematic—all in kit form. This kit will supply all voltage necessary for operation of the set. All parts guaranteed.

COMPLETE AT THE AMAZINGLY LOW PRICE OF ..... **\$14.95**

## IT'S SENSATIONAL

Hottest Item Out! Make your SCR-522 Receiver operate on 144 to 148 MC with ONE DIAL control, in less than 1 hour.

PARTS AND INSTRUCTION ..... **\$3.00**

## Model 200-EA 5-ELEMENT 2-METER BEAM KIT

Folded 5-pole driven element. All-aluminum construction. Feed with low impedance coaxial cable.

AMATEUR NET PRICE ..... **\$8.40**



## HI FREQUENCY BUZZER

This buzzer and a key will get your code-speed up for that ticket. **.88**

## K 200-TWINEX

Mfg. by Federal. Will handle 3 KW of R.F.; very heavy Poly base—Unaffected by moisture—Get all of that RF up to the Ant. Sample on request. PER FT. .... **.08**

20% DEPOSIT WITH ORDERS UNLESS RATED

**NIAGARA RADIO SUPPLY CORP.**  
160 E GREENWICH STREET NEW YORK 6, N. Y.

Phone Dlgby 9-11-32-3-4

All Prices F. O. B. N. Y. C.

# SAVE

## BRAND NEW GUARANTEED

### PIONEER AUTOSYNS

AY1, 26 volts, 400 cycle.  
Price \$4.00 each net.

AY20, 26 volts, 400 cycle.  
Price \$5.50 each net.

AY30, 26 volts, 400 cycle.  
Price \$10.00 each net.



AY31, 26 volts, 400 cycle. Shaft extends from both ends.  
Price \$10.00 each net.

AY38, 26 volts, 400 cycle. Shaft extends from both ends.  
Price \$10.00 each net.

### PIONEER PRECISION AUTOSYNS

AY101D, new with calibration curve.



PRICE—WRITE OR CALL FOR SPECIAL QUANTITY PRICES

AY131D, new with calibration curve.  
Price \$35.00 each net.

### PIONEER TORQUE UNITS

Type 12602-1-A.  
Price \$30.00 each net.



Type 12606-1-A.  
Price \$34.00 each net.

Type 12627-1-A.  
Price \$70.00 each net.

### PIONEER TORQUE UNIT AMPLIFIER

Type 12073-1-A.  
Price \$17.50 each net.

### GYROS

Schwein Free & Rate Gyro type 45600. Consists of two 28 volt D. C. constant speed gyros. Size 8" x 4.25" x 4.25".  
Price \$10.00 each net.

Schwein Free & Rate Gyro, type 46800. Same as above except later design.  
Price \$11.00 each net.

Sperry A5 Directional Gyro Part No. 656029, 115 volts 400 cycle, 3 phase.  
Price \$17.50 each net.

Sperry A5 Vertical Gyro. Part No. 644841, 115 volts 400 cycle 3 phase.  
Price \$20.00 each net.

Sperry A5 Amplifier Rack Part No. 644890. Contains Weston Frequency Meter. 350 to 450 cycle and 400 cycle, 0 to 130 voltmeter.  
Price \$8.00 each net.

Sperry A5 Control Unit Part No. 644836.  
Price \$7.50 each net.

Sperry A5 Azimuth Follow-Up Amplifier Part No. 656030. With tube.  
Price \$5.50 each net.

Pioneer Type 12800-1-D Gyro Servo Unit. 115 volts 400 cycle, 3 phase.  
Price \$9.00 each net.

Norden Type M7 Vertical Gyro. 26 volts D.C.  
Price \$19.00 each net.

Norden Type M7 Servo Motor. 26 volts D.C.  
Price \$20.00 each net.

General Electric Type 8672162 Azimuth Gyro Assembly Contains Delco Type 5067125 Constant speed motor and Signal assembly.  
Price \$12.75 each net.

### WESTON FREQUENCY METER

Model 637, 350-450 cycle, 115 volts.  
Price \$10.00 each net.

### D. C. MOTORS



5069625, Delco Constant Speed, 27 volts, 120 R. P. M. Built-in reduction gears and governor. Price \$4.25 each net.

A-7155, Delco Constant Speed Shunt Motor, 27 volts, 2.4 amps., 3600 R. P. M., 1/30 H. P. Built-in governor. Price \$6.25 each net.

5BA10J18D, General Electric, 27 volts, 0.7 amps., 110 R. P. M.  
Price \$2.90 each net.

5066665, Delco Shunt Motor 27 volts, 4000 R. P. M. Reversible, flange, mounted. Price \$4.50 each net.

C-28P-1A, John Oster Shunt Motor, 27 volts, 0.7 amps., 7000 R. P. M., 1/100 H. P. Price \$3.75 each net.

### D.C. ALNICO FIELD MOTORS

5071895, Delco, 27 V., 250 R. P. M.  
Price \$3.00 each net.

5069600, Delco, 27 V., 250 R. P. M.  
Price \$4.00 each net.

5069466, Delco, 27 V., 10,000 R. P. M.  
Price \$3.00 each net.



5069611, Delco, 12 V., 10,000 R. P. M.  
Price \$3.50 each net.

5067043 Delco, 12V., 10,000 R. P. M.  
Price \$3.50 each net.

5067125, Delco, 27 V., 10,000 R. P. M. With Governor.  
Price \$6.50 each net.

S. S. FD6-16 Diehl 27 V., 10,000 R. P. M.  
Price \$3.75 each net.

S. S. FD6-18 Diehl 27 V., 10,000 R. P. M.  
Price \$3.75 each net.

### GENERAL ELECTRIC D.C. SELSYNS



8TJ9-PDN Transmitter, 24 volts.  
Price \$3.00 each net.

8DJ11-PCY Indicator, 24 volts. Dial marked -10° to +65°. Price \$4.00 each net.

8DJ11-PCY Indicator, 24 volts. Dial marked 0 to 360°. Price \$6.50 each net.

# INSTRUMENT ASSOCIATES

Write for complete listings

147-57 41st AVENUE FLUSHING, N. Y.  
Telephone INdependence 3-1919

# SAVE

**BRAND NEW  
GUARANTEED**

### A.C. MOTORS

5071930, Delco, 115 volts, 60 cycle, 7000 R. P. M.

**Price \$4.50 each net.**

36228, Hayden Timing Motor, 115 volts, 60 cycle, 1 R. P. M.

**Price \$3.15 each net.**



Hayden Timing Motor—110 V. 60 cycle 3.2 Watts, 4 R. P. M., with brake.

**Price \$4.00 each net.**

45629R Hayden Timing Motor, 110 volts, 60 cycle, 2.2 watts, 1/240 RPM.

**Price \$3.15 each net.**

Eastern Air Devices Type J33 Synchronous Motor 115 V., 400 cycle, 3 phase, 8,000 R. P. M.

**Price \$8.50 each net.**

### SERVO MOTORS

CK1, Pioneer, 2 phase, 400 cycle.

**Price \$10.00 each net.**

CK2, Pioneer, 2 phase, 400 cycle.

**Price \$4.50 each net.**

FPE-25-11, Diehl, Low-Inertia, 75 to 115 V., 60 cycle, 2 phase.

**Price \$16.00 each net.**

FP-25-2, Diehl, Low-Inertia, 20 volts, 60 volts, 2 phase.

**Price \$9.00 each net.**

FP-25-3, Diehl, Low-Inertia, 20 volts, 60 cycle, 2 phase.

**Price \$9.00 each net.**

### MAGNETIC AMPLIFIER ASSEMBLY

Pioneer Magnetic Amplifier Assembly Saturable Reactor type output transformer. Designed to supply one phase of 400 cycle servo motor.

**Price \$8.50 each net.**

### INVERTERS

12117-2, Pioneer. Input 24 volts D. C. Output 26 volts, 400 cycle.

**Price \$15.00 each net.**

12117, Pioneer. Input 12 volts D. C. Output 26 volts, 400 cycle.

**Price \$17.00 each net.**



12123-1-A, Pioneer. Input 24 volts D. C. Output 115 volts, 400 cycle, 3 phase. Voltage and frequency regulated. 100 V.A.

**Price \$75.00 each net.**

WG750, Wincharger, PU16. Input 24 volts D. C. Output 115 volts, 400 cycle, 1 phase, 6.5 amps. Voltage and frequency regulated.

**Price \$35.00 each net.**

149H, Holtzer Cabot. Input 28 volts at 44 amps. Output 26 volts at 250 V. A. 400 cycle and 115 volts at 500 V. A. 400 cycle.

**Price \$39.00 each net.**

149F, Holtzer Cabot. Input 28 volts at 36 amps. Output 26 volts at 250 V. A. 400 cycle and 115 volts at 500 V. A. 400 cycle.

**Price \$35.00 each net.**

153F, Holtzer Cabot. Input 24 volts D. C. Output 115 volts, 400 cycle 3 phase, 750 V. A. and 26 volts 400 cycle, 1 phase, 250 V. A., Voltage and frequency regulated also built in radio filter.

**Price \$125.00 each net.**

5D21NJ3A General Electric, Input 24 volts D. C. Output 115 volts 400 cycle at 485 V. A.

**Price \$14.00 each net.**

### RATE GENERATORS

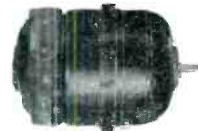

PM2, Electric Indicator Company, .0175 V. per R. P. M.

**Price \$7.25 each net.**

F16, Electric Indicator Company, two-phase, 22 V. per phase at 1800 R. P. M.

**Price \$12.00 each net.**

J36A, Eastern Air Devices, .02 V. per R. P. M.

**Price \$9.00 each net.**

B-68 Electric Indicator Co., Rotation Indicator, 110 volts, 60 cycle, 1 phase.

**Price \$14.00 each net.**

### SINE-COSINE GENERATORS

(Resolvers)

FJE 43-9, Diehl, 115 volts, 400 cycle.

**Price \$20.00 each net.**

### SYNCHROS

If Special Repeater, 115 volts, 400 cycle. Will operate on 60 cycle at reduced voltage.



**Price \$15.00 each net.**

2J1M1 Control Transformer 105/63 Volts, 60 cycle.

**Price \$20.00 each net.**

2J1G1 Control Transformer, 57.5/57.5 volts 400 cycle.

**Price \$2.00 each net.**

2J1H1 Selsyn Differential Generator, 57.5/57.5 volts, 400 cycle.

**Price \$3.25 each net.**

5G Generator, 115 volts, 60 cycle.

**Price \$25.00 each net.**

W. E. KS-5950-L2, Size 5 Generator, 115 volts, 400 cycle.

**Price \$3.50 each net.**

5G Special, Generator 115/90 volts, 400 cycle.

**Price \$15.50 each net.**

2J5S1 Selsyn Differential Generator, 105-105 volts, 60 cycle.

**Price \$15.50 ea. net.**

2J1F1 Selsyn Generator, 115 volts, 400 cycle.

**Price \$3.50 ea. net.**

# INSTRUMENT ASSOCIATES

*Write for complete listings*

WUX Flushing, N. Y.

147-57 41st AVENUE FLUSHING, N. Y.  
Telephone INdependence 3-1919

## RADIO RADAR SONAR Sets

- SE (new)
- SF (new)
- SG (new)
- SN (new)
- SO-1 (used)
- SO-13 (used)
- SQ (used)
- CPN-6 (unused)
- APS-3 (used)
- APS-4 (used & new)
- APS-15 (near comp.)
- QBG-1 (new)
- TBM (used)
- TDE (used)
- RAK-7 (new)
- TBK-19 (new)
- RC 148 (new)
- RC 145 (new)

Send for add'l info.



### MICROWAVE TEST EQUIPMENT

- THERMISTOR BRIDGE:** Power meter 1 203-A. 10 cm. mfg. W.E. Complete with meter, interpolation chart, portable carrying case as shown ..... \$72.50
- TS12/AP VSWR Test Set.** 3cm. New, complete in 2 units, with all accessories ..... \$425
- Bell Labs. Dual Mount mixer-beacon assemblies.** 2 complete mixer-beacon mounts on gold-plated waveguide section ..... \$50.00
- Slotted Line, Bell Labs. 1 1/2" x 5/16" guide, goldplated** ..... \$150.00
- TS-238 GP.** 10 cm. Echo box with resonator, indicator and micrometer adjust cavity, 2700 to 2900 Mcs calibrated as shown ..... \$85.00
- TS 108-AP dummy load** ..... \$65.00
- W. E. I 138.** Signal generator, 2700 to 2900 Mc range. Lighthouse tube oscillator with attenuator & output meter. 115 VAC input, reg. Pwr. supply. With circuit diagram ..... \$50.00
- 3 cm. Wavemeter:** 9200 to 11,000 mc transmission type with square flanges ..... \$15.00
- 3 cm. stabilizer cavity, transmission type** ..... \$20.00
- 3 cm. Wavemeter, Micrometer head mounted on X-band guide. Freq. range approx. 7900 to 10,000 Mc.** ..... \$75.00

### VARISTORS

- D-171631 ..... \$95
- D-167176 ..... \$95
- D-168687 ..... \$95
- D-171812 ..... \$95
- D-171528 ..... \$95
- D-163298 ..... \$95
- D-168549 ..... \$95
- D-162482 ..... \$3.00
- D-166271 ..... \$2.50
- D-162356 ..... \$1.50
- D-161871A ..... \$2.85

### THERMISTORS

- D-167332 (tube) ..... \$95
- D-170396 (head) ..... \$95
- D-167613 (button) ..... \$95
- D-166228 (button) ..... \$95
- D-164699 for MTG, in "X" hand Guide ..... \$2.50
- D-167018 (tube) ..... \$95

### COAX PLUGS

- 831SP ..... \$35
- 831AP ..... \$35
- 831HP ..... \$15
- UG 21/U ..... \$85
- UG 86/U ..... \$95
- UG 254/U ..... \$75
- UG 255/U ..... \$125
- UG 146/U ..... \$100
- UG 85/U ..... \$125

### MAGNETRONS

Tube	Frg. Range	Pk. Pwr. Out.	Price
2J31	2820-2860 mc.	265 KW.	\$25.00
2J21-A	9345-9405 mc.	50 KW.	\$25.00
2J22	3267-3333 mc.	265 KW.	\$25.00
2J26	2982-3019 mc.	275 KW.	\$25.00
2J32	2965-2992 mc.	275 KW.	\$25.00
2J32	2780-2820 mc.	285 KW.	\$25.00
2J37			\$45.00
2J38 Pkg.	3249-3263 mc.	5 KW.	\$35.00
2J39 Pkg.	3267-3333 mc.	10 KW.	\$65.00
2J49	9305-9325 mc.	58 KW.	\$85.00
2J49	3000-3100 mc.	50 KW.	\$35.00
2J55 Pkg.	9345-9405 mc.	35 KW.	\$65.00
2J61	3000-3100 mc.	35 KW.	\$65.00
2J62	2914-3010 mc.	35 KW.	\$65.00
3J31	24,000 mc.	50 KW.	\$39.50
5J30			\$25.00
714A			\$25.00
718DY			\$25.00
720BY	2800 mc.	1000 KW.	\$50.00
720CY			\$50.00
725-A	9345-9405 mc.	50 KW.	\$25.00
730-A	9345-9405 mc.	50 KW.	\$25.00

**Klystrons:** 723A/B \$12.50; 707B W/Cavity \$20.00  
417A \$25.00; 2 K41 \$65.00

### MAGNETRON MAGNETS

Gauss	Pole Diam.	Spacing	Price
4850	3/4 in.	5/8 in.	\$12.50
2500	1 5/8 in.	1 1/16 in.	\$12.50
1500	1 5/8 in.	1 1/2 in.	\$12.50
D161392*	1 5/8 in.	1 5/16 in.	\$12.50

\*Mfr's Number.

### TUNABLE PKGD. "CW" MAGNETRONS

- QK 61 2975-3200 mc. QK 62 3150-3375 mc.
  - QK 60 2900-3025 mc. QK 59 2675-2900 mc.
- New. Guaranteed. Each \$65.00

### PULSE EQUIPMENT

#### MODULATOR UNIT BC 1203-B

Provides 200-4,000 PPS. Sweeptime: 100 to 2,500 microsec. in 4 steps, fixed mod. pulse, suppression pulse, sliding modulation pulse, blanking voltage, marker pulse, sweep voltages, calibration voltages, fil. voltages. Operates 115 vac. 50-60 cy. Provides various types of voltage pulse outputs for the modulation of a signal generator such as General Radio #804B or #804C used in depot bench testing of SCR #95, SCR #95, and SCR #35. New as shown. .... \$125.00

**MIT. MOD. 3 HARD TUBE PULSER:** Output Pulse Power: 114 KV (12 KV at 12 amp). Duty Ratio: .001 max. Pulse duration: 5, 1.0 2.0 microsec. Input voltage: 115 v. 400 to 2,000 cps. Uses 1-715-B, 1-829-B, 3-722, 1-775. New. .... \$110.00

**APQ-13 PULSE MODULATOR.** Pulse Width .5 to 1.1 Micro Sec. Rep. rate 624 to 1348 lps. Pk. pwr. out. 35 KW. Energy 0.018 joules. .... \$49.00

**TPS-3 PULSE MODULATOR.** Pk. power 5 amp. 24 KV (1200 KV pk); pulse rate 200 PPS; 1.5 microsec; pulse line impedance 50 ohms. Circuit—series charging version of DC Resonance type. Uses two 705-A's as rectifiers. 115 v. 400 cycle input. New with all tubes ..... \$49.50

**APS-10 MODULATOR DECK, Complete, less tubes** ..... \$75.00

APS-10 Low voltage power supply, less tubes ..... \$18.50

#### PULSE NETWORKS

- G.E. #25P5-1-350-50P2T. 25 KV, 3 sections, "E" circuit, 1 microsecond pulse length, 500 PPS, 50 ohms impedance ..... \$45.00
- G.E. #6E3-5-2000-50P2T. 6KV, "E" circuit, 3 sections, .5 microsecond, 2000 PPS, 50 ohms impedance ..... \$6.50
- G.E. #3E (3-84-810; 8-24-405) 50P2T. 3KV, 24 CKT Dual Unit; Unit 1, 3 Sections, .84 Microsec, 810 PPS, 50 ohms imp.; Unit 2, 8 Sections, 2.24 Microsec, 405 PPS, 50 ohms imp. .... \$6.50
- 7.5E3-1-200-67P. 7.5 KV, "E" Circuit, 1 microsec, 200 PPS, 67 ohms impedance, 3 sections. .... \$7.50
- 7.5E4-16-60-67P. 7.5 KV, "E" circuit, 4 sections, 16 microsec, 60 PPS, 67 ohms impedance, 3 microsec. .... \$15.00
- 7.5E3-3-200-67P. 7.5 KV, "E" Circuit, 3 microsec, 200 PPS, 67 ohms imp., 3 sections. .... \$12.50

#### DELAY LINES

- D-168184: .5 microsec. up to 2000 PPS, 1500 ohm term ..... \$4.00
- D-170499: .25/.50/.75/. microsec. 8 KV, 50 ohms imp ..... \$16.50
- D-165997: 1 1/4 microsec. .... \$7.50

#### PULSE TRANSFORMERS

- G.E.K.-2745 ..... \$39.50
- G.E.K.-2744-A ..... \$39.50
- W.E. #D166173 HI-Volt input transformer, W.E. Impedance ratio 50 ohms to 900 ohms. Freq. range: 10 kc to 2 mc. 2 sections parallel connected, potted in oil ..... \$36.00
- W.E. KS 9800 Input transformer. Winding ratio between terminals 3-5 and 1-2 is 1:1:1, and between terminals 6-7 and 1-2 is 2:1. Frequency range: 380-520 c.p.s. Permalloy core. .... \$6.00
- G.E. #K2731 Repetition Rate: 635 PPS, Pri. Imp: 50 Ohms. Sec. Imp: 450 Ohms. Pulse Width: 1 Microsec. Pri. Input: 9.5 KV PK. Sec. Output: 28 KV PK. Input: 800 KV. Bifilar 2.75 Amp \$64.50
- W.E. #D169271 Hi Volt input pulse transformer \$27.50
- G.E. K2450A Will receive 18KV, 4 micro-second pulse on pri., secondary delivers 14KV. Peak power out 100KW G.E. .... \$4.50
- G.E. #K2748A Pulse Input, line to magnetron, \$36.00 #9280 High Pulse or Blocking Oscillator XFMR Freq. limits 79-810 cy-3 windings turns ratio 1:1:1 Dimensions 1 13/16 x 1 1/4" 19/32. .... \$1.50

### MICROWAVE PLUMBING

#### 3 CENTIMETER PLUMBING

(STD. 1" x 1/2" GUIDE, UNLESS OTHERWISE SPECIFIED)

- "X" BAND PREAMPLIFIER, consisting of 2-723A/B local oscillator-beacon feeding waveguide and TR/ATR Duplexer section, including 60 mc. 1P amp. .... \$47.50
- RANDOM LENGTHS of waveguide, 6 in. to 18 in. long ..... \$1.10/ft.
- WAVEGUIDE RUN, 1 1/2" x 1/2" guide, consisting of 4 ft. section with rt. angle bend on one end and 9" 45 deg. bend other end ..... \$8.00
- WAVEGUIDE SECTION, 1 1/2" x 1/2" choke to choke, 4 ft. long ..... \$6.75
- DUMMY LOAD, TS 332/UP ..... \$22.50
- "X" Band pressurizing gauge section, with 15-lbs. range and pressurizing nipple ..... \$18.50
- 45 DEG. TWIST, 6" Long ..... \$10.00
- 12" SECTION, 45 deg. twist, 90 deg. bend. .... \$6.00
- 11" STRAIGHT WAVEGUIDE section choke to cover. Special heavy construction, silver plated. .... \$4.50
- 15 DEG. BEND 10" choke to cover ..... \$4.50
- 5 FT. SECTIONS, choke to cover ..... \$14.50
- 18" FLEXIBLE SECTION, 90 deg. bend ..... \$7.50
- "E" and "H" PLANE BENDS ..... \$12.50
- BULKHEAD FEED THRU ..... \$15.00
- "X" BAND WAVEGUIDE, 1 1/2" x 5/8" OD. 1/16" wall, aluminum ..... per ft. \$ 7.75
- WAVEGUIDE, 1" x 3/4" I.D. per ft. .... \$1.50
- TR CAVITY for 724-A TR tube ..... \$10.00
- 3" FLEX SECTION, square flange to circular flange adapter ..... \$7.50
- 724 TR tube (41-TR-1) ..... \$2.50
- SWR MEAS. SECTION, 4" L, with 2 type "N" output probes MTD full wave apart. Bell size guide. Silver plated ..... \$10.00
- ROTARY JOINT with slotted section and type "X" output pickup ..... \$17.50
- WAVEGUIDE SECTION, 12" long choke to cover, 45 deg. twist & 2 1/2" radius, 90 deg. bend. .... \$4.50
- SLUG, TUNER/ATTENUATOR, W.E. guide, gold plated ..... \$6.50
- TR/ATR DUPLEXER section with iris flange ..... \$8.00
- TWIST 90 deg. 5" choke to cover, w/press nipple ..... \$6.50
- WAVEGUIDE SECTIONS 2 1/2 ft. long, silver plated, with choke flange. .... \$5.75
- WAVEGUIDE, 90 deg. bend E plane, 18" long ..... \$4.00
- ROTARY JOINT, choke to choke ..... \$17.50
- ROTARY JOINT, choke to choke, with deck mount. .... \$17.50
- S. CURVE WAVEGUIDE, 8" long cover to choke. .... \$3.50
- DUPLEXER SECTION for 1B24 ..... \$10.00
- CIRCULAR CHOKE FLANGES, solid brass. .... \$5
- SQ. FLANGES, FLAT BRASS. .... \$5
- APS-10 TR/ATR DUPLEXER section with additional iris flange ..... \$10.00
- CU 105/APS 31 Directional coupler, 25 db. .... \$15.00
- CU 106/APS 33 Directional coupler, 25 db. .... \$15.00
- FLEX. WAVEGUIDE ..... \$4.50/ft.
- "X" BAND calibrated attenuator ..... \$85.00
- SHIELDED KLYSTRON tube mounts with rough attenuator outputs ..... \$90.00
- 2 1/2" FLEXIBLE SECTION, cover to cover. .... \$5.00

SEE YOU AT THE  
**IRE SHOW**  
BOOTH 311

### 10 CENTIMETER

**WAVEGUIDE** directional coupler, 27 db. Navy type CABV-47AAN, with 4 in. slotted section, as shown ..... \$42.50

**SQ. FLANGE** to rd choke adapter, 18 in. long OA 1 1/2 in. x 3 in. guide, type "N" output and sampling probe ..... \$32.00

"S" BAND CRYSTAL MOUNT, gold plated, with 2 type "N" connectors ..... \$12.50

**POWER SPLITTER, 726 Klystron input, dual output** ..... \$5.00

**WAVEGUIDE TO WAVEGUIDE** coupler with 721-A duplexer cavity, gold plated ..... \$27.50

**10 CM WAVEGUIDE SWITCHING UNIT,** switches 1 input to any of 3 outputs. Standard 1 1/2" x 3" guide with square flanges. Complete with 115 vac or d.c. arranged switching motor. Mfg. Raytheon. CRP 241-A. New and complete. .... \$150.00

**10 CM. END-FIRE ARRAY POLYRODS.** \$1.75 ea.

"S" BAND Mixer Assembly, with crystal mount, pick-up loop, tunable output. .... \$3.00

**721-A TR CAVITY WITH TUBE,** Complete with tuning plungers ..... \$12.50

**10 CM. MONOLAY CAVITY TYPE SQ.** \$3.50

**WAVEGUIDE SECTION, MC-445A, rt. angle bend, 5 1/2 ft. OA 8" slotted section.** ..... \$21.00

**10 CM. O.C. PICKUP LOOP,** with male Homedell output ..... \$2.00

**10 CM. DIPOLE WITH REFLECTOR** in lucite ball, with type "N" or Sperry fittings ..... \$4.50

**10 CM. FEEDBACK DIPOLE antenna,** in lucite ball, for use with parabola. .... \$8.00

**3/8" RIGID COAX—3/8" I.C.**

**RIGHT ANGLE BEND,** with flexible coax output pickup loop ..... \$8.00

**SHORT RIGHT ANGLE bend,** with pressurizing nipple ..... \$3.00

**RIGID COAX** to flex coax connector. .... \$3.50

**STUB-SUPPORTED RIGID COAX,** gold plated ..... \$5.00

**RT. ANGLES FOR ABOVE.** \$2.50

**RT. ANGLE BEND 15" L. OA.** ..... \$3.50

**FLEXIBLE SECTION, 15" L. Male to female.** ..... \$4.25

**MAGNETRON COUPLING** to 3/8" rigid coax with TR pickup loop, gold plated. .... \$7.50

**3/8" RIGID COAX, 1/4" I.C.**

**3/8" RIGID COAX, BEAD SUPPORTED** per ft ..... \$1.20

**SHORT RIGHT ANGLE BEND.** ..... \$2.50

**ROTATING JOINT,** with deck mounting ..... \$15.00

**RIGID COAX** slotted section CU-60/AP. .... \$5.00

**1.25 CENTIMETER**

"K" BAND FEEDBACK TO-PARABOLA HORN with pressurized window. .... \$30.00

MITRED ELBOW cover to cover. .... \$4.00

TR/ATR SECTION choke to cover. .... \$4.00

FLEXIBLE SECTION 1" choke to choke. .... \$5.00

ADAPTER, rd. cover to sq. cover. .... \$5.00

MITRED ELBOW and S sections choke to cover. .... \$4.50

### MICROWAVE GENERATORS

AN/APS-15A "X" Band compl. RF head and modulator, incl. 725-A magnetron and magnet, two 723A/B klystrons (local osc. & beacon), 1B24 TR, revr-amp, duplexer, HV supply, blower, pulse xtnr. Peak Pwr Out: 45 KW. apx. Input: 115, 400 cy. Modulator pulse duration: 5 to 2 micro-sec. apx. 13 KV PK Pulse. Compl with all tubes incl. 715-B, 829B, RKR 73, two 72's. Compl. pkg. new. .... \$210.00

APS-15B. Complete pkg. as above, less modulator ..... \$150.00

"S" BAND AN/APS-2. Complete RF head and modulator, including magnetron and magnet, 417-A mixer, TR, receiver, duplexer, blower, etc., and complete pulser. With tubes, used, fair condition ..... \$75.00

**10 CM. RF Package.** Consists of: SO Xmttr-receiver using 2127 magnetron oscillator, 250 KW peak input, 707-B receiver-mixer ..... \$150.00

**Modulator-motor-alternator unit** for above ..... \$ 25.00

**Receiver-rectifier power unit** for above ..... \$ 25.00

**Rotating antenna** with parabolic reflector for above. New ..... \$75.00

ALL MERCHANDISE GUARANTEED. MAIL ORDERS PROMPTLY FILLED. ALL PRICES F.O.B. NEW YORK CITY. SEND MONEY ORDER OR CHECK ONLY. SHIPPING CHARGES SENT C.O.D. RATED CONCERNS SEND P. O.

MERCHANDISE SUBJECT TO PRIOR SALE

## COMMUNICATIONS EQUIPMENT CO.

131 "E" Liberty St., New York, N. Y. Cable "Comsupo" Ph. Digby 9-4124

# SEARCHLIGHT SECTION



## DYNAMOTORS

Type	Input Volts	Input Amps	Output Volts	Output Amps	Radio Set	Prices*
DM 416	14	6.2	330	.170	RU 19	\$15.95N
DY-2/ARR-2	28	1.1	250	.060	ARC-5	
DM 36	28	1.4	220	.080	SCR 508	8.75N
DM 53AZ	14	2.8	200	.080	BC 733	7.00N
PE 73CM	28	19	1000	.350	BC 375	24.50N
DM 21	14	3.3	235	.090	BC 312	3.45N
DM 21CX	28	1.6	235	.090	BC 312	3.45N
DM 25	12	2.3	250	.050	BC 367	2.49LN
DM 28R	28	1.25	275	.070	BC 348	8.95N
DM 33A	28	7	540	.250	BC 456	5.50N
DM 42	14	46	515	.110	SCR 506	6.50LN
			1030	.050		
			2/8			
PE 86	28	1.25	250	.060	RC 36	3.95
PE 101C	13/26	12.6/7	400	.135	SCR 515	5.25N
		6.3	800	.020		
BD AR 93	28	3.25	375	.150		4.95N
23350	27	1.75	285	.075	APN-1	3.50N
35X045B	28	1.2	250	.060		3.50N
ZA .0515	12/24	4/2	500	.050		3.95N
ZA .0516	12/24	8/4	12/275	3/.110		5.50N
B-19 pack	12	9.4	275	.075	Mark II	9.95N
			500	.050		
D-104	12		225	.100		14.95N
			440	.200		
DA-3A*	28	10	300	.260	SCR 522	3.95
			150	.010		
			5	.5		
#5053	28	1.4	250	.060	APN-1	3.95N
DA-7A	26.5		1100	.400	TA-2J	25.00N
CW 21AAX	13	12.6	400	.135		17.50N
	26	6.3	800	.020		
			1	1.12		
BD 77KM	14	40	1000	.350	BC 191	20.00N
						14.00LN
PE 94	28	10	300	.260	SCR	15.00N
			150	.010	522	
			14.5	.5		

N—New. LN—Like New. \* Less Filter Box & Relay  
Replacement dynamotors for PE 73, less filter box.....\$12.00

### HAND GENERATORS

GN 35: 350 v, 60 ma; 8v, 2.5 A. New, with hand cranks.....\$12.50  
GN 45: 500 v, 100 ma; 6v, 3 amps. Slight use, ex. cond., with cranks.....\$12.50

### GREAT TUBE VALUES

01-A	\$4.55	12A6	\$3.55	8B0	\$15.00
1B24	4.85	12K8Y	.65	801	40.00
2C21	.69	12SE7	.49	874	1.95
2C22	.69	12SR7	.72	876	4.95
2J21-A	25.00	15R	1.40	1005	.35
2J22	25.00	28D7	.75	1619	.21
2J26	25.00	30 (Spec.)	.70	1624	.85
2J27	25.00	45 (Spec.)	.59	1629	.35
2J31	25.00	39/44	.49	1961	5.90
2J32	25.00	35/51	.72	9029	.65
2J38	35.00	227A	3.85	9004	.47
2J39	35.00	225	8.80	CEC 72	1.95
2J55	35.00	268-A	20.00	EF 50	.79
2J40	65.00	355-A	19.50	F-127	20.00
2J49	85.00	417A	25.00	FC 258A	165.00
3J31	55.00	530	90.00	GL 562	7.50
2X2/870	.69	531	45.00	FC 271	40.00
3BP1	2.25	532	3.95	GL 562	75.00
3C24	.60	559	4.00	GL 623	75.00
3C30	.70	562	90.00	GL 697	75.00
3D6	.79	615	89	ML 100	60.00
3CP1	3.50	703-A	7.00	QK 59	65.90
3D21-A	1.50	704-A	.75	QK 60	65.00
3DP1	2.25	705-A	2.85	QK 61	65.00
3EP1	2.95	707-B	20.00	QK 62	65.00
3FP7	1.20	714A Y	25.00	*RCA 932	.65
3Q5	.79	720BY	50.00	VR 91	1.00
5BP1	1.95	720CY	50.00	VR 135	1.25
5BP4	4.95	721-A	13.60	VR 137	1.25
5CP1	3.75	723A/B	12.50	VR 120	1.00
5FP7	3.50	724B	11.75	VL 134	1.00
5J30	39.50	726-A	25.00	WL 532	4.75
6C	2.00	800	15.00	WN 150	3.00
6GS7	.70	801-A	2.25	WT 260	5.00
7C4	1.00	804	1.10	twix cavity:	
7E5	1.00	815	9.95	Cavity only 5.00	
7E6	.72	837	2.50		
10Y	.60	843	1.15	*Photocell	

### MASTER OSCIL-LATOR UNITS

M.O. units designed for open-2-18 mc TBK. Flexible plug in units using type 860 tube in ECO circuit. Tunes 2000 to 4565 kc in 6 bands. Freq. Determining elements are enclosed in shock mounted oven assembly, and has frq monitor PU link coupled to output. Net Wt: 138 Lbs, Dim: 21 in, d x 14 1/2 in. W x 2 1/2 in. H. New (with tube).....\$150.00

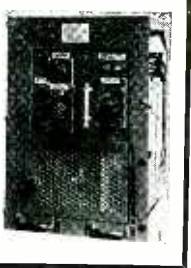

### PRECISION CAPACITORS

D-163707: 0.4 mfd @ 1500 vdc, —50 to plus 85 deg	
D-163038: 0.1 mfd @ 600 vdc, 0 to plus 65 deg C	\$4.50
D-170908: 0.152 mfd, 300 v, 400 cy, —50 to plus 85 deg C	\$2.00
D-164960: 2.04 mfd @ 200 vdc, 0 to plus 55 deg C	\$2.50
D-168344: 2.16 mfd @ 200 vdc, 0 to plus 55 deg C	\$3.00
D-161555: .5 mfd @ 400 vdc, —50 to plus 85 deg C	\$3.00
D-166602: 16 mfd @ 400 vdc, temp comp 50 to 85 deg C	\$12.50
D-161270: 1 mfd @ 200 vdc, temp comp —40 to plus 65 deg C	\$12.50

## TELEPHONE EQUIPMENT

**F.T. & R. 101-A APPLIQUE**  
Provides necessary balancing facilities for four wire repeater when used on two wire lines which may be voice-frequency telephone lines of open wire, or non-loaded or loaded cable. Std. 19" channel iron rack mtg. Price, new, complete with tech manual.....\$54.00

### SB-19/GT CONSOLE

Provides facilities for patching and monitoring network of lines for telephone intercom, radio reception, telegraph reception, recording, etc. Complete central office supervising position.....\$350.00

### EE-89A REPEATER

Extends range of field telephone apparatus, such as EE-8 up to 25 miles, when inserted in a line. New, with spare tube and instruction manual, less standard type batteries.....\$21.50

### BC 686 LINE AMPLIFIER

With magnetor ringer; 3-tube 25L6 amplifier. For local point-to-point telephone operation, remote operation of Phone Xmt, remove reception of receiver output, monitoring facility. Requires only 24 vdc for tube. "B" plus supply for full operation. New, less tubes, in wooden chest.....\$18.50  
Per pair for 2-way pt-to-pt operation.....\$35.00

### F.T. & R. 102-B REPEATER EE-99

May be used as Terminal or Intermediate Repeater. 20 cycles ring- ing & DC Telegraph. Applicable on simplex operations. Provides facilities, equalizing facilities, Dry or storage battery operation. New.....\$55.00  
Telephone switchboard lamp holders: 10 lamp holders per strip.....\$4.25  
LAN/TRANS FOR TELEPHONE SWITCHBOARDS, GREEN, RED, WHITE.....\$0.65 ea.  
Large quantities available.

## COAX CABLE

R3 9/U 52 ohms	\$24/Ft.
R3 17/U 52 ohms	\$45/Ft.
R3 57/U Twin Cond. 85 ohms	\$55/Ft.
R3 18/U 52 ohm imp. armored	\$51/Ft.
R3 23/U twin coax. 125 ohm imp. armored	\$.50/Ft.
R3 28/U 50 ohm imp. pulse cable. Corona min. starting voltage 17 KV.	\$.50/Ft.
R3 35/U 70 ohm imp. armored	\$.50/Ft.

## CERAMIC CONDENSERS

\$7.50 per 100			
3 mmf	±5%	60 mmf	±3%
5 mmf	±5%	67 mmf	±20%
4 mmf	±5 mmf	115 mmf	±2%
8 mmf	±5 mmf	120 mmf	±3%
11 mmf	±5 mmf	240 mmf	±3%
15 mmf	±2.5 mmf	250 mmf	±3%
50 mmf	±20%	1000 mmf	±5%

### \*Silver-Mica Button Capacitors (Erie, Conralab) \$9.50 per 100

18 mmf	±2.5 mmf
17 mmf	±2.5 mmf
50 mmf	±10%

## CARBON PILE VOLTAGE REGULATORS

Type "A" Coil current 105 to 115 amp, 80 volts. Leland Electric.....\$3.00  
Type "C" Input: 25-30 v. coil, 30 amps. Output: 19 v, 5.7 amps Spec #V19000-2c. Leland Electric.....\$3.00  
#35X045B: 22v, .1 to 3 amps. for K-14B Gunsight. Webster.....\$3.00

### TEST SET 159 TPX

Measures frequency between 150 & 200 mc. by heterodyne method. Power of Xmttr can be directly measured. Measures DC voltages up to 500 Volts. Original operation on 110 V, 400 cy, but simple conversion makes it operable on 110 V, 60 cy. new, and complete with tubes, crystal, cal. chart, antenna, meter.....\$29.95

## INVERTERS



PE 218-E: Input: 25-28 vdc, 92 amp Output: 115 v, 350-500 cy 1500 volt-amperes. Dim: 17" x 6 1/2" x 10". New (as shown).....\$49.95  
PE 218-H: Same as above except size: 16 1/2" x 6" x 10". New.....\$49.95  
PE 218H, used, good cond.....\$25.00  
P: 206: Input: 28 vdc, 38 amps. Output: 80 v, 400 cy, 500 volt-amperes. Dim: 13" x 5 1/2" x 10 1/2". New.....\$12.50  
GE 5021NJA: Input: 28 vdc, 35 amp. Output: 15 v, 400 cy, 485 volt-amperes. Dim: 9" x 4 1/2" diam. New.....\$49.95

## AUTOMATIC CODE EQUIPMENT

TAPE PULLERS: (McElroy) TP 890, 110-120 v. AC.....\$12.50 ea.  
TAPE BRIDGES: (McElroy) TG 815, complete.....\$3.50  
TAPE LOOPS: For TG-8 and TG-9.....\$1.00  
BLANK CODE TAPE: 4" rolls. 3/8" wide. Per roll \$1.15

## MINE DETECTOR

Model AN/PRS 1 Detector will detect buried Metallic an- Non Metallic objects, such as: rocks, pipes, war pockets, etc. Ideal for home owners, campers, prospectors. Uses meter and phones for visual and aural indications. Price: New, including detector, amplifier, phones, resonator, and all cables.....\$12.75  
With Batteries.....\$21.65

## ARC-3 AUDIO TRANSFORMERS

T-102, #55544 T-104, #55547  
T-103, #55546 T-105, #55554  
T-206, #55320  
Price, each.....\$9.95  
MOD XFMR: PE 807a to PE 807c CL.....\$1.65  
DRIVER XFMR: 6115 Driver to FP 811 Grids.....\$1.45  
UNIVERSAL OUTPUT: Amertran Silcor, PRI: 20,000/16,000/5000/4000 ohms. Sec: 500/15/7.5/3.85 ohms. 30db. continuance Plat to 17,000 CY.....\$2.75

## A Complete Line of Subsigs and Raytheon XFMRs in Stock. Send for List

### OIL CONDENSERS

1 mfd @ 25,000V, Type A6734	\$99.50
2x1 mfd, 7000V, 25F774	\$4.95
1.5 mfd, 6000 vdc	\$12.50
.25 mfd, 20,000 vdc	\$17.50
10 mfd, 1000 vdc	\$1.79
3x10 mfd, delta connected synchro-capacitor, 90 v, 6 cycles	\$4.95
.1 mfd 6000 vdc, 25F509G2	\$6.50

Typewriter Desk Wells Mount-d on Steel Panel for Standard Rack Mtg. 1 1/2" H x 30" W x 1/2" Thick. Well is 22" Wide, 20" Working. Affordable Full Working Space. Grey Crackle Finish. New.....\$9.90 ea.



Inserts, M-300, for HS-30 HEADSETS.....\$4.00/M  
RADIOSONE TRANSMITTERS, T-49/AMT-1.....\$3.75 ea.

TRANSFORMERS for Collins ART13 Transmitters, GE #7472063, GE #7472065.

### HEADSETS

Dynamic Mike and Headset Combination. A high quality, efficient unit used in B-19 tank Xmters. Mike and phones completed, new.....\$3.75  
HEADSET, WE #716A, with dual plug patch cord.....\$9.95

# COMMUNICATIONS EQUIPMENT CO.

131-"E" LIBERTY ST., NEW YORK, N. Y. DIGBY 9-4124

# RELAYS

## FOR EVERY PURPOSE

### Over a Million in Stock!

Whether you require large quantities of relays for production runs or single units for laboratory or amateur work, Wells can make immediate delivery and save you a substantial part of the cost.

Our capable engineering staff is prepared to offer assistance in the selection of correct types to suit your exact requirements.

Each relay is brand new, standard make, inspected, individually boxed and fully guaranteed.

The following list represents only a tiny portion of our relay stock. Write or wire us for information on types not shown.

**STANDARD DC TELEPHONE RELAYS**

Stock No.	Operating Voltage	Coil Resistance	Contacts	Manufacturer	Net Each
R-101	24V	1500.	DPST (NO)	Auto. Elec.	\$1.35
R-102	24V	400.	SPDT (NO)	Auto. Elec.	1.10
R-103	24V	DUAL-1000	3PST (NO)	Auto. Elec.	1.35
R-105	24V	600.	3PST (NO)	Clare	1.20
R-106	24V	1300.	3PST (NC)	Clare	1.25
R-152	12V	50.	DPDT-SPST (NO)	Guardian	1.10
R-153	12V	200.	SPDT-SPST (NO)	Stromberg	1.20
R-154	12V	200.	SPDT (NO)	Clare	1.25
R-155	12V	150.	SPST (ANDANC)	Auto. Elec.	1.15
R-158	6V	50	4PST (NO)	Stromberg	1.10
R-159	6V	50	DPST (NO)	Stromberg	1.10
R-160	6V	12	3PDT-3PST (NO)	Auto. Elec.	1.05
R-161	6V	10	3PST (ZNC-INO)	Auto. Elec.	.90
R-121	150V	5000.	2PST (NO) SPDT	Clare	1.65
R-123	150V	6300.	SPST (NO)	Clare	1.75
R-602	150V	6500.	3PST (NO)	Clare	1.75
R-515	24V	750	SPST (NO)	Clare	1.25
R-517	12V	250	DPST (NO)	Clare	1.20
R-519	250V	14000.	SPDT	Auto. Elec.	1.95
R-520	250V	14000	DPDT	R. B. M.	1.20
R-521	32V	1000.	DPDT	Kellagor	1.20
R-156	24V	DUAL-200.	DPDT-SPST (NO)	Stromberg	1.59
R-158	24V	DUAL-200.	4PST (NO)	Auto. Elec.	1.20
H-240	250-350V	40000	DPST (NO)	Auto. Elec.	2.95
H-241	48V	650	SPDT-SPST (NO)	Clare	1.25

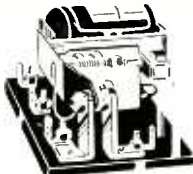

**SENSITIVE DC RELAYS**

Stock No.	Operating Voltage	Coil Resistance	Contacts	Manufacturer	Net Each
R-218	4-6V	1800.	SPDT	Allied Cont.	1.20
R-220	75V	5000	SPDT (NO)	Allied Cont.	1.15
R-221	18 24V	5000	DPST (NO)	G. M.	1.85
R-174	250V	11000	DPDT-SPST (NO)	G. M.	2.95
R-176	24V	250	DPST (NO)	G. M.	1.50
R-177	24V	300	4PDT	S-Dunn-KS	2.10
R-600	8-12V	5000	SPDT	Guardian	1.15
R-507	24-48V	1000	SPDT-SPST (NC)	Guardian	1.15

**CUTLER HAMMER HEAVY DUTY CONTACTORS**

Stock No.	Operating Voltage	Coil Resistance	Contacts	Manufacturer	Net Each
R-178	24V DC	100	SPST (NO) 100A.	6141H34A	\$3.85
R-179	6V DC	6.5	SPST (NO) 50A.	6041H83A	3.00
R-180	12V DC	25.	SPST (NO) 50A.	604H308	3.25
R-181	24V DC	65.	SPST (NO) 100A.	6041H8B	3.85
H-232	24V	55.	SPST (NO) 50A.	Metal Cased	3.25
H-233	6V	15	SPST (NO) 50A.	Metal Cased	3.15
H-235	24V	70.	SPST (NO) 100A.	Type B6	3.85



**TYPE 18 DC TELEPHONE RELAYS**

Stock No.	Operating Voltage	Coil Resistance	Contacts	Manufacturer	Net Each
R-109	24-48V	4000.	SPDT	Auto. Elec.	1.50
R-110	24-32V	3500	DPDT	Auto. Elec.	1.50
R-112	90-120V	6500	SPST (NC)	Auto. Elec.	1.75
R-114	24V	500	4PST (NO)	Auto. Elec.	1.30
R-603	24V	400	DPST (NO)	Auto. Elec.	1.25
H-238	24V	150	DPDT-SPST (NC)	R. B. M.	1.25
H-239	24V	180	DPST (NO)	Auto. Elec.	1.25

**TYPE B0 DC RELAYS**

Stock No.	Operating Voltage	Coil Resistance	Contacts	Manufacturer	Net Each
R-169	24V	250	SPST (NO)	Allied Cont.	\$1.95
R-171	24V	230	DPDT	Allied Cont.	2.15
R-172	5-8V	30	DPDT-SPST (NO)	Allied Cont.	1.70
R-173	2-6V	5	SPST (NO)	Allied Cont.	1.65
R-529	24-48V	1000	DPDT	Allied Cont.	2.50

**DIRECT CURRENT AIRCRAFT CONTACTORS**

Stock No.	Operating Voltage	Coil Resistance	Contacts	Manufacturer	Net Each
R-182	28V	80	SPST (NO) 25 A.	Guardian	\$1.85
R-183	24V	60	SPST (NO) 50 A.	Allen Bradley	2.75
R-184	28V	50	SPST (NO) 100A.	General Elec.	2.95
R-185	24V	100	SPST (NO) 50 A.	Leach 5055ECR	2.75
R-186	24V	132	SPST (NO) 50 A.	Leach 7220-3-24350	2.95
R-187	24V	100	SPST (NO) 50 A.	Allen Bradley	2.95
R-188	24V	200	SPST (NO) 75 A.	Allied Cont.	2.95
H-234	14V	45	SPST (NO) 38 A.	—	1.65



**SEALED DC TELEPHONE RELAYS**

Stock No.	Operating Voltage	Coil Resistance	Contacts	Manufacturer	Net Each
R-125	24V	300.	DPDT	Clare	\$2.75
R-126	90-120V	2000	DPDT	Clare	3.00
R-504	24-70V	2800	SPDT	GE-C103C25	3.00

**V TYPE DC TELEPHONE RELAYS**

Stock No.	Operating Voltage	Coil Resistance	Contacts	Manufacturer	Net Each
R-164	24-32V	1000.	SPST (NO)	W. E.	\$1.20
R-512	24-48V	3500	DPDT	W. E.	1.30
R-513	12-24V	300	DPDT-SPST (NC)	W. E.	1.20
R-514	4-6V	60	SPDT	W. E.	1.05
R-526	6V	35	DPDT-SPST (INC-INO)	W. E.	1.05

**TYPE BJ DC RELAYS**

Stock No.	Operating Voltage	Coil Resistance	Contacts	Manufacturer	Net Each
R-204	12V	65	SPST (NO)	Allied Cont.	\$1.15
R-205	24V	260	DPDT	Allied Cont.	1.25
R-224	12V	75	SPST (NO)	Allied Cont.	1.15
H-237	27V	230	DPDT	Allied Cont.	1.25

**ANTENNA CHANGEOVER RELAYS**

Stock No.	Operating Voltage	Coil Resistance	Contacts	Manufacturer	Net Each
R-192	6-12V DC	44	2PDT 10 AMP	Allied-NB5	\$1.35
R-231	12VDC	100.	DPDT 6 AMP	G. E.	1.95
R-256	24-32V DC	—	DPDT-SPST (NC) 1kW	Guardian	1.45
R-501	110 AC	4	DPDT (1KW)	G. E.	2.45
R-503	12-32V DC	100	SPDT-SPST	G. E.-500 W.	1.95

**AC-STANDARD TELEPHONE RELAYS**

Stock No.	Operating Voltage	Coil Resistance	Contacts	Manufacturer	Net Each
R-212	90-125V	—	NONE	Clare	\$0.95
R-213	5-8V	—	DPST (NO)	Clare	1.50
R-605	24V	—	3PST (NO)	Auto. Elec.	.95
R-606	24V	—	DPST (1NO-1NC)	Auto. Elec.	.95
R-607	24V	—	SPST (NO)	Auto. Elec.	.95

**HEAVY DUTY KEYING RELAYS**

Stock No.	Operating Voltage	Coil Resistance	Contacts	Manufacturer	Net Each
R-248	28V DC	150	SPST (NO) 10A.	Guard 36471	\$1.05
R-244	75V AC	765	SPST (NO) 20A.	Leach 1327	1.75
R-206	24V DC	150	SPDT-3 AMP.	P&B-KL	1.20
R-207	24V DC	210	4PDT-3 AMP.	P&B-KL	1.10
R-219	50V DC	1500	DPST (NO) 15A.	P&B-SP	1.25
R-217	115 AC	600	SPDT-10 AMP.	St. Dunn IXAX22.25	1.25
R-525	24V DC	200	DPDT-10 AMP.	Guard. 34464	1.25
R-508	110 AC	600	SPDT-6 AMP.	Guad. 37189	1.95
R-506	24 V DC	300	DPST (NO) 6A.	—	.95
R-510	24 V DC	200	3PDT-10 AMP.	Guard 516983	1.05
R-604	24 V DC	200	SPST (NO) 30A.	St. Dunn-BZA	1.25
H-608	115 AC	35	SPST (NO) 20A.	St. Dunn-LHX22.25	1.25
R-620	12V DC	150	SPST (NO) 40A	Price Bros.	1.05
R-223	28V DC	80.	DPST (NO) 10A.	Price Bros.	1.35
H-230	12-24V DC	230.	DPST (NO) 10A.	—	1.20
H-231	24V DC	230.	DPST (NO) 5A.	R. B. M.	1.15

**COMBINATION PUSH BUTTON AND REMOTE RELAY**

Stock No.	Operating Voltage	Coil Resistance	Contacts	Manufacturer	Net Each
H-244	12-24 V DC	Dual-60	SPDT	CR2791-R106C8	\$1.65



**DIRECT CURRENT MIDJET RELAYS**

Stock No.	Operating Voltage	Coil Resistance	Contacts	Manufacturer	Net Each
R-132	24V	300	DPD	Clare	\$1.20
R-133	24V	300	NONE	Clare	.60
R-134	24V	250	4PDT	Clare	1.20
R-135	24V	300	SPST (NC)	Clare	1.15
R-137	24V	300	SPDT	Clare	1.15
R-138	24V	300	4PST (NO)	Clare	1.15
R-139	24V	200	4PDT	Clare	1.15
R-140	24V	280	SPDT	R. B. M.	1.15
R-141	24V	280	3PST (NO)	R. B. M.	1.15
R-142	24V	400	DPDT	Allied Cont.	1.20
R-143	24V	280	SPST (NO)	R. B. M.	1.15
R-144	24V	250	SPST (NO)	Allied Cont.	1.15
R-145	24V	300	DPST (NO)	Allied Cont.	1.10
R-146	12V	125	DPST (1NO) (1NC)	Clare	1.10
R-147	9-14V	75	SPDT	Guardian	1.05
R-148	12V	100	DPDT-SPST (NC)	Price Bros.	1.10
R-149	6-8V	45	SPST (NC)	Clare	1.00
R-150	6V	30	SPST (NO)	E-2 Elec.	.95
R-522	2-6V	2.	SPST (NO)	R. B. M.	.65
R-523	90-125V	6500	DPDT	Clare	1.90
H-222	12V	100	DPST (NO)	P & B	.95
H-242	24-32V	300	DPDT	R. B. M.	1.20
H-243	24-32V	300	4PDT	R. B. M.	1.20

**DC-TYPE 76 ROTARY RELAYS**

Stock No.	Operating Voltage	Coil Resistance	Contacts	Manufacturer	Net Each
R-197	9-16V	70	DPDT	Price Bros.	\$1.65
R-198	9-16V	125	6PST (3NO) (3NC) SPDT	Price Bros.	1.65
R-199	24-32V	250	SPDT-SPST (NC)	Price Bros.	1.65
R-200	24-32V	275	3PDT-SPST (NC)	Price Bros.	1.65
R-201	24-32V	250	DPST (NO) SPDT (NC) DPDT	Price Bros.	1.65
R-601	9-14V	60.	3PST (NO)	Price Bros.	1.65

**ADJUSTABLE TIME DELAY RELAY**

Stock No.	Operating Voltage	Coil Resistance	Contacts	Manufacturer	Net Each
R-246	115 AC	—	SPST (NO) or (NC) 10 AMPS	R. W. Cramer	\$6.95

**DC MECHANICAL ACTION RELAYS**

Stock No.	Operating Voltage	Coil Resistance	Contacts	Manufacturer	Net Each
R-245	12V	25.	4' Lever	G. M.	\$0.95
R-527	6-12V	200.	2' Lever	—	.95



**DIRECT CURRENT KEYING RELAYS**

Stock No.	Operating Voltage	Coil Resistance	Contacts	Manufacturer	Net Each
R-190	12V	65	DPDT 10 AMP	Advance Elec.	\$1.15
R-191	28V	125	DPDT 10 AMP	Guardian	1.20
R-192	12V	44	3PDT 10 AMP	Allied Cont.	1.35
R-193	5-8V	11	OPDT 10 AMP	Type NB5	1.05
R-194	24V	265	SPST (NO) 10A.	Type 1027	1.35
R-195	6V	32	DPST 10 AMP	Type 1054SNW1.25	1.15
R-196	12V	50	DPDT 10 AMP	G. E. Co.	1.15
R-242	24V	170	SPST (NC)	Guardian	1.15
H-236	5-8V	18.5	SPDT 10 AMP	Type 1253DEW1.25	1.25
				Leach-RFM	1.05

**TYPE C.M.S. RELAY**

Stock No.	Operating Voltage	Coil Resistance	Contacts	Manufacturer	Net Each
R-511	24V DC	200	MICRO-SW SPST (NO)	Clare	\$2.45

**DC CURRENT REGULATOR**

Stock No.	Operating Voltage	Coil Resistance	Contacts	Manufacturer	Net Each
R-509	6-12V DC	40	SPST (NC)	G. E.	\$0.85

**LATCH AND RESET RELAY**

Stock No.	Operating Voltage	Coil Resistance	Contacts	Manufacturer	Net Each
R-500	12V DC	10.	DPDT-10 AMP	St. Dunn-CX-3190B	\$2.85

**DC-ROTARY STEP RELAY**

Stock No.	Operating Voltage	Coil Resistance	Contacts	Manufacturer	Net Each
R-621	6-12V	30.	3 POLE 23 POSITION	W. E.	\$10.95

**DC-RACHET RELAY**

Stock No.	Operating Voltage	Coil Resistance	Contacts	Manufacturer	Net Each
R-230	5-8V	2.	SPDT-DPST (NO)	Guardian	\$2.15

**Special Sample Engineering Offer**

Any ten relays listed (one of each type) with the exception of Stock Nos. R-621 and R-246—only \$10.00.

**ORDER DIRECTLY FROM THIS AD OR THROUGH YOUR LOCAL PARTS JOBBER**

Manufacturers: Write For Quantity Prices.  
Distributors: Write For The New Wells Jobber Manual.



**320 N. LA SALLE ST., DEPT.-SL, CHICAGO 10, ILL.**



# COAX CABLE

TREMENDOUS VALUES IN GUARANTEED COAXIAL CABLE • ANTENNA WIRE MICROPHONE AND HIGH VOLTAGE CABLE

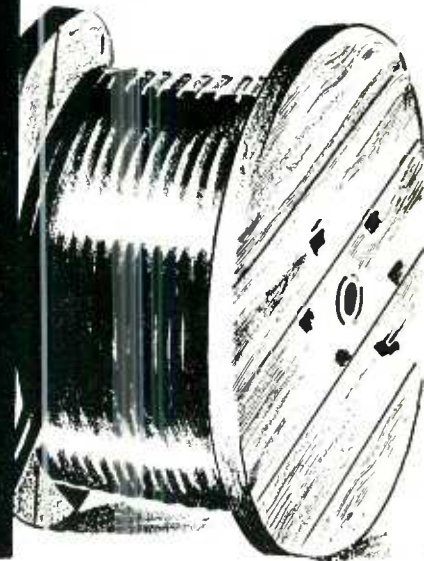

### COAX CABLE

RG-7/U	97.5 ohms impedance; outside diameter .370"; black vinyl jacket; polyethylene insulation. On original manufacturer's reels of 2040 feet.....	\$37.50/M
	100 ft. coils.....	.04/ft.
RG-29/U	53.5 ohms impedance; outside diameter .184"; black vinyl jacket. Packaged on 4000 ft. reels.....	27.50/M
	1000 ft. reels.....	32.00/M
	100 ft. coils.....	.035/ft.
RG-29/U-W	Same characteristics as RG-29/U except cotton braided covering. Per 1000 feet.....	25.00/M
	100 ft. coils.....	.03/ft.
	RG-29/U is ideal for television to eliminate lead-in pick up of local interference. RG-29/U is similar to RG-58/U.	
RG-57/U	2 conductor Coax. 95 ohms; Kilowatt Rating. Any length.....	.18/ft.
RG-8/U	Limited quantity.....	40.00/M

### LOW LOSS BEADED COAX CABLE, 72 ohms impedance.

Type 72-12 — for ultra high frequency, with black vinyl covering supplied in any length desired.....	.11/ft.
Type 72-12-W — Same as above, except varnish cambric covering supplied on 60 ft. coils, only.....	.07/ft.

### OTHER WIRE AVAILABLE FROM WELLS

PWD-20-2	Plastic coated assault wire two-conductor twisted Type W-130. Available on 1000 to 2500 ft. steel reels, individually boxed.....	7.00/M
PWD-20-3	3000 ft. payout reels (packed two reels per box).....	6.50/M
PWD-20-10	10,000 ft. steel reels.....	6.25/M
AWT-18-1	Army Field Wire, Type W-110B. Two conductor, stranded, rubber covered, weather proof. 1000 ft. reels.....	10.00/M
AWT-18-10	Army Field Wire, Type W-110B. Two conductor, stranded, rubber covered, weather proof. 1/2 mile steel reels.....	9.50/M
AWT-18-20	Army Field Wire, Type W-110B. Two conductor, stranded, rubber covered, weather proof. 1 mile steel reels.....	9.00/M
KW-3	Flexible Phosphor Bronze No. 18 bare aerial wire 300 ft. spool.....	1.00/Sp
KW-10	Flexible Phosphor Bronze No. 18 bare aerial wire 1000 ft. coil.....	3.00/M
AJ-18	Aerial Wire, No. 18, Copperweld, solid — on 3000 ft. reels, only.....	4.00/M
SWB-20	Single conductor No. 20, shielded, over-all braid, 1000 ft. reels.....	15.00/M
SC-20-1	Single conductor, ANJC-48, No. 20, stranded, glass braid, lacquered 1000 volt insulation, 2000 ft. reels.....	10.00/M
SC-20-3	Single conductor No. 20 glass braid, lacquered, 3000 volt insulation for Transmitters, 1000 ft. coils.....	12.00/M
MW-1	Shielded, single conductor microphone cable, rubber covered, extra flexible, inter-conductor stranded silver wire, 500 ft. coils.....	12.50/coil

MANUFACTURERS: WRITE FOR QUANTITY PRICES.

JOBBERS: REGULAR DISTRIBUTOR'S ARRANGEMENT APPLIES • ORDER FROM THIS AD.

WE CARRY A COMPLETE STOCK OF COAX CONNECTORS . . . WRITE FOR LISTING NO. 100M.



320 N. LA SALLE ST., DEPT. SL, CHICAGO 10, ILL.

# RELIANCE SPECIALS

## PRECISION RESISTORS

**WIRE WOUND 1% Tol. or Better**  
Any Order For 10% Off  
100 pieces..... 20% Off  
1000 pieces.....

**1/4 WATT—25c**

6.68Ω	12.32Ω	16.37Ω	123.8Ω	414.3Ω
10.45	13.02	20	147.5	705
10.84	13.52	62.54	220.4	2,193
11.25	13.89	79.81	301.8	10,000
11.74	14.98	105.8	366.6	59,148

**1/2 WATT—25c**

.250Ω	11.1Ω	1235Ω	4,451Ω	15,000Ω
.324	13.15	260	5,000	15,750
.502	46	270	5,900	17,000
.557	52	298.3	6,500	20,000
.627	55.1	400	7,000	25,000
.76	75	723.1	7,500	30,000
1.01	97.8	2,500	8,000	100,000
1.53	125	2,850	8,500	150,000
2.04	180	3,427	10,000	
2.25	210	4,000	14,825	

**1 WATT—30c**

1.01Ω	5.21Ω	1,250Ω	18,000Ω	70,000Ω
2.58	10.1	3,300	50,000	75,000
3.39	10.9	7,000	55,000	
5.05	270	9,000	65,000	

**1 WATT—40c**

100,000Ω	128,000Ω	180,000Ω	470,000Ω	525,000Ω
120,000	130,000	250,000	600,000	
125,000	160,000	320,000	522,000	700,000

1 Megohm, 1 Watt, 1%—65c 5%—40c

## CAPACITORS

**OIL FILLED**

MFD	V.D.C.	Price	MFD	V.D.C.	Price
.012	25,000	\$19.95	2	750 V.A.C.	\$.39
.20	25,000	6.20	(2,200 V.D.C.)		
.03	16,000	5.75	1	2,000	.95
.375@	16,000 and	14.95	4	1,100	.30
.75@	8,000(dual)	1.95	1	1,000	1.00
.1	7,500	1.95	3	1,000	.80
.1-1	7,000	1.45	2	1,000	.65
.1	7,000	1.85	1	800	.40
.02-.02	7,000	1.65	10	600	1.35
.1	6,000	1.75	4	600	.69
.03-.03	6,000	1.65	2	600	.39
1	6,000	3.50	1	600	.29
.01	6,000	1.35	8	500	.90
2	4,000	5.50	1	500	.19
.25	3,000	1.75	.5	500	.24

## PULSE TRANSFORMERS

X 121 T2, UTAH, marked 9262 or 9280, small gray case 1 1/2" high x 1 1/2" x 5/8" with two 6-32 mtg. studs. Ratio 1:1:1, hypersil core \$1.50

Spec.—10, 111, Chicago Transformer equivalent of 9262 ..... \$1.50

7172407, GE, core 5/8" x 1 1/2" x 3/16", 2 windings (0.6 ohm and 0.08 ohm DC) ..... \$1.25

80G16, GE ..... \$1.25

D161310, Western Electric, cased 1 1/2" dia. x 1 1/2" high, impedance ratio 120 to 2350 ohms, molybdenum Permalloy tape core, Frequency response 50 Kc to 4 Mc. .... \$2.00

D166638, W. E., cased 1 1/2" x 1 1/2" x 2 1/4", 2 semitoroidal windings 150 turns ea. of two windings, used in portable oscilloscope. \$1.25

352-7250-2A, cased 15/16" dia. x 1 1/2" high, DC 10 ohm, 3 1/2 ohm sine wave response 140 cy. to 175 Kc. .... \$1.25

352-7251-2A, similar to above but for shorter pulses ..... \$1.25

300 KVA GE 7557296, 50 ohm pulse cable connection; 3,850 V. in 17,300 V. out. (250 KVA @ 1/2 micro second) ..... \$15.00

800 KVA K2731, 28,000 Volt pk. output, Bifilar, pulse width: one microsecond ..... \$19.50

## POSTAGE STAMP MICAS

8.2mmf	50mmf	200mmf	560mmf	
10	56	220	600	.00
15	60	250	650	.0026
18	70	270	680	.003
20	90	300	800	.0039
22	100	370	.001mfd	.0051
25	140	400	.0012	.007
40	150	470	.0013	.008
47	180	500	.00135	.01

Price Schedule  
8.2mmf to .001mfd 5¢  
.0012mfd to .002mfd 7¢  
.003mfd to .008mfd 12¢  
.01mfd 18¢

## SILVER MICAS

10mmf	125mmf	400mmf	665mmf	.0024mfd
22	150	430	700	.0025
29	180	466	750	.0027
39	200	470	800	.003
62	240	488	820	.0033
66	250	500	.001mfd	.0039
68	300	510	.0012	.005
100	360	525	.0013	.0051
110	370	540	.0015	.0068
120	390	560	.002	.01

Price Schedule  
10mmf to .001mfd 10¢  
.0012mfd to .0027mfd 20¢  
.003mfd to .0068mfd 50¢  
.01mfd 65¢

## TOGGLE SWITCHES

H & H D.P.D.T.; 3A., 250 v., Molded Body, Bat Handle ..... Only 60¢ ea.  
..... \$50 per hundred

H & H S.P.D.T.; 6A., 125 v., Molded, Ball Handle ..... 30¢ ea.  
C-H D.P.S.T.; 10A., 125 v., Molded, Bat Handle Luminous tip ..... 40¢ ea.

G.E. D.P.D.T.; 3A., 125 v., Molded, Ball Handle ..... \$1.50 ea.

H & H Power switch. D.P.D.T., 10A., 125 v., Ball Handle ..... \$1.50 ea.

C-H D.P.D.T.; Center Off, 20A., 125 v., Bat Handle ..... \$1.75 ea.

## TIME DELAY RELAY



115 V. 60 Cyc.

Raytheon # CPX 24166, KS 10193-60 Sec.  
Made by Paragon. Used to delay time of applying high voltage to rectifier tube. Adjustable 50-70 seconds. 3.6 watt, 1/2 R.P.M. clutch motor. Holds ON as long as power is applied. 2 1/2 second recycle time. .... ONLY \$6.50

Glyptal Cement { 1 qt. cans, GE #1286 75¢  
1 gallon cans. .... \$2.50  
5 gallon cans. .... \$11.00

HARDWARE ASSORTMENT—(mostly brass) screws, nuts, washers, solder lugs. 3 lbs. \$1.00

All Orders f.o.b. PHILA., Pa.

## MULTIMETER

Superior 770: 6 AC, 6 DC, 4 current, 2 resistance ranges. Guaranteed for 1 year. .... \$13.90

## JONES BARRIER STRIPS

Type	Price	Type	Price
2-140Y.....	\$ .05 ea.	20-141.....	\$ .65 ea.
3-140 3/4W.....	.12	2-142.....	.10
3-140.....	.10	3-142Y MSX.....	.23
5-140Y.....	.19	4-142.....	.18
2-141.....	.09	5-142.....	.21
2-141Y.....	.11	6-142.....	.25
3-141.....	.11	7-142.....	.29
5-141Y.....	.25	8-142.....	.38
8-141.....	.27	9-142Y.....	.52
8-141 3/4W.....	.38	9-142.....	.37
8-141MSX.....	.38	10-142 3/4W.....	.58
9-141Y.....	.42	10-142.....	.40
10-141 3/4W.....	.47	10-142Y.....	.58
10-141Y.....	.47	11-142Y MSX.....	.76
11-141.....	.36	12-142.....	.48
11-141Y.....	.51	12-142Y.....	.68
15-141Y.....	.69	17-142.....	.67
17-141Y.....	.78	17-142Y.....	.97
20-141Y.....	.93	4-150.....	.46
		18-240.....	.35

Any order for 100 pieces—10% off; for 1,000 pieces—20% off

Vernier dials, 2 1/2" dia. 0-100 in 360° black with silver marks, thumblock. For BC221..... \$85

## UNIVERSAL JOINT ALUMINUM



1 1/2" long x 1/2" O.D. 1/4" ID  
35c

## ALLEN SET SCREWS

1-40x1/8	6-32x1/8	8-32x3/16
4-40x3/16	8-32x1/8	3-32x5/16
All sizes.....		\$1.50 per C

## Wrapped—BALL BEARINGS—New

Mfg.	ID	OD	Width	Price
Fafnir 33K5E	3/16"	1/2"	5/32"	25¢
Fafnir 38K	5/16"	7/8"	9/32"	45¢
Timken	1/2"	1 3/8"	7/16"	85¢
ND5202C13M	1/2"	1 3/8"	1 3/8" (dual)	1.25
ND 88503	43/64"	1 37/64"	21/32"	1.00
MRC 206SF	1 5/32"	2 7/16"	5/8"	1.25
Fafnir 545	2 1/8"	2 5/8"	15/32"	1.00

## NEEDLE BEARINGS

B88 1/2" wide	1/2"	11/16"	25¢
B108 1/2" wide	5/8"	13/16"	30¢
GB34X 1/4" wide	3/16"	11/32"	25¢

## CERAMIC CONDENSERS

\$7.00 per 100

3mmf	10mmf	22mmf	68mmf	115mmf
3.44	15	27	75	200
4.7	16	47	82	1000
6.8	18	50	91	1090
8	20	56	100	

## — GEARS —

### Sample Assortment

See our ad in the  
OCTOBER, 1948, ELECTRONICS

— Page 294 —

Write for our complete catalog

# RELIANCE MERCHANDIZING CO.

Arch St. Cor. Croskey, Philadelphia 3, Pa. Telephone Rittenhouse 6-4927



# SEARCHLIGHT SECTION



**SNOOPERSCOPE INFRARED**  
Image-Converter Tube HiSensitivity simplified design 2" dia., Willemite screen-Resolution up to 350 lines/inch. Complete data & Tube "TAB"  
**SPECIAL \$8.98**  
I2DP7 GE MagnDefTelcr CR & Data SPECIAL \$12.95, 2 for \$25, 10 for \$115.00  
5FP7-5" CR Tube SPECIAL \$1.49, 2 for \$2.75  
9LP7-9" CR Tube SPECIAL \$2.69, 2 for \$4.98  
6L6 Metal RCA Kenrad 896; 10/58; 100/870  
G.E. GL434A sim7C29 IKW HP RP ..... \$7.95  
866A Combination Tubes Sockets Xfmr ..... \$5.95  
872A Combination Tubes Socket Xfmr ..... \$2.95



Write For Your FREE "TABGRAM"

## Storage & Dry Batteries

- A. BR16, BB52/5oz/36Vmin S Battery 12 for \$10
- B. BURESS 3V/F2BP/dated 47, 8 for \$1.00
- D. BB54/2V/27amp WILLARD S-Baty ..... \$1.89
- E. WILLARD 4V/40AH/TBY S-Baty ..... \$4.95
- F. BB206U/2V/11AH WILLARD S-Baty ..... \$1.89
- WILLARD 6V/25AH/7 1/2" W6 1/2" H 3.39 2 for \$9.98
- 5V/2EA 3V/100mV Duty Minimax B413/OSCR284 90 45/1 1/2" w/octal sckt&handle 2 5/8x4x6 1/4" 3xS100 Lote 47 ..... \$1.39; 2 for \$2.49; 10 for \$10.00
- Battery Acid (R'Exp Only) 1 pt 59c; 2 pts 98c.
- USN Hydrometer Kit & Box ..... \$1.98

## TELEVISION

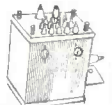

**TRANSFORMER TV POWER SUPPLY KITS**  
No RF bursts! Hi. Lo & Filament Voltages. FEATURING Herma's Xfmr. USN oil filled Xfmr Inputs 105/115/125VAC 50-425 cps Outputs HV&500VCT or 300VCT/235MA & 8.3V/10A, 5V/8A, 2.5V/3A, 5V/7A, exc for 630TS to 16" CR 1000V. & 300VDC & ALL Filaments Supply Kit & ALL Filaments 2-3B24 Doubler-Rect & 5U4G rect. & ALL cndrs, sockets, choke & data.  
**\$29.95**

**SPECIAL 5000V 300VDC & ALL Filaments KIT** Same Xfmr plus 5U4G & 3B24 rect., cndrs, sockets, choke, sckts, data.  
**\$21.95**  
Xfmr Only; Fl. LoelH. Vols \$16.95  
Basic TV & CRT PWR KIT 2.5 KV Xfmr out of RC412 Scope with 2.5V/1.75A for 2X2 fil & 4.3V/1.6A winding KEYS ON. Sockets, S13336 or Equiv Only.  
**\$8.95**

Above Xfmr plus 2X2 Tube & Safety Socket ..... \$9.95  
**POWER PACKS—Basic Kits!**  
Complete CRT & Scope. Pwr Supplies—110V/60cyc Input.  
KIT A Hi&Lo Plate & Fil Vols for TV or CRT scope 1320 VOLTS H.V. & 375VCT/10ma; Filaments 5V/3A, 2.5V/3.25A, 8.3V/2.5A USN Herm Std 5/4x4 1/2x3 1/2" 5Y 3GT & 2X2 rect & sckts 2-10mfd electrolytics & oil cndrs & 8 Hy Csd HiVins CHOKE "TAB" SPECIAL \$21.95  
KIT B—2400 VOLTS HV; 2X1mrs PLUS 2x866A rect & sckts & 2X2mfd 2000VDC cndsr & 12 Hy 300ma Csd HiVins CHOKE "TAB" Special ..... \$21.95  
Single Xfmr 1200VCT, Only 5.50  
Medium Power Kits for Your Rig—110V/60cyc.  
KIT C—700 VOLTS CT/125MA Filaments 2x6.3V/2A, 5V/2A and 115V/100MA. Isolation Winding FEDERAL Tel for USN HV ins Herm Std 5x5x3 1/2" PLUS 5Y3GT rect. & sckts 2-10 mfd electrolytics & 10 Hy Csd CHOKE "TAB" Special. 4.49  
KIT D—500 VOLTS CT/60Ma & 6.3V/4A. Cylind USN HV ins Herm Std 3 1/2xHx3" dia PLUS ins rect. 2-10mfd electrolytics & 30 Hy Csd H.V. Ins CHOKE "TAB" SPECIAL ..... \$2.98

**TELEVISION SIGNAL BOOSTER**  
Sonar TELEBOOSTER Ultra-sens 13 CHANNEL Booster w/2-6 1/2" in Sharp Tuned Ckts. SELF-POWERED! Fine Walnut Case, COMPLETE ..... \$19.98

## TUBES . . . JAN & STANDARD TYPES

0A4G ..... \$1.04	3D6/1299 ..... 8.85	6SF5 ..... \$6.00	35W4 ..... \$4.44	865 ..... \$1.00
OZ4 ..... .85	3E29 829B ..... 3.85	6SG7 ..... .71	35Z5 GT ..... .45	866 ..... 1.59
1A4 ..... 1.26	3GP1 ..... 4.05	6SH7 ..... .69	37 ..... .37	866A ..... 1.25
1A5GT ..... .70	3H12 ..... 2.95	6SJ7 ..... .59	38 ..... .38	868 PJ.31 ..... 1.49
1A7GT ..... 1.26	30S6 ..... 1.94	6SK7 ..... .58	44 ..... .39	872A ..... 2.45
1A7GT G. 69	4AP10 ..... 6.95	6BK7 ..... .65	41 ..... .58	874 ..... .96
1B3GT/8016	4C35 ..... 19.90	6SL7 ..... .75	50 ..... 1.56	878 ..... 2.47
	5AP1 ..... 2.75	6SL7GT ..... .94	50B5 ..... .66	884 ..... .89
1B21/471 ..... 2.95	5B1P1 5GP1 1.95	6SN7 ..... .86	50L6 ..... .58	885 ..... .96
1B23 ..... 49.00	5B1P4 ..... 3.95	6SN7GT ..... .69	81 ..... 1.56	902 ..... 5.49
1B24 ..... 4.89	5CP1 ..... 2.98	6S7 ..... .59	81A ..... 1.05	918 CE1G ..... 1.49
1B27 ..... 4.89	5CP7 ..... 13.49	6SR7 ..... .70	83V ..... 1.95	922 ..... 1.49
1B62 ..... 4.95	5D21 ..... 19.00	6S87 ..... .71	84 6Z4 ..... .72	923 ..... .95
1C6 ..... 1.26	5FP7 ..... 1.49	6T7G ..... 1.53	114B ..... 1.23	930 ..... 1.00
1C7G ..... 1.26	5HP1 ..... 1.95	6U5 6G5 ..... .81	117N7 ..... 1.54	931A ..... 3.95
1D5GP ..... 1.25	5LP7 ..... 1.95	6U6 ..... 1.49	205B VT2 ..... 1.98	954 ..... .33
1E4G ..... .89	5R4 ..... 1.25	6U7 ..... .70	211 ..... .89	955 ..... .33
1F4 ..... 1.04	5T4 ..... 1.15	6U7G ..... .58	215A ..... .25	956 ..... .33
1F7GV ..... 1.54	5U4G ..... .59	6V6 ..... .69	227 ..... 3.90	957 ..... .33
1G4GT G. 1.04	5V4G ..... .53	6X5 ..... .81	231 ..... .98	958A ..... .63
1H4G ..... .88	5W4 ..... .87	6X5GT ..... .58	250TH ..... 19.49	991 ..... .67
1H6G ..... 1.28	5X4 ..... .70	6X6GT ..... .87	250TH ..... 18.98	1294/1R4 ..... 1.04
1JG ..... .96	5Y3G ..... .38	6Z7G ..... 1.23	304TH ..... 5.95	1603 ..... 6.75
1J6G ..... 1.35	5Z3 ..... .81	7A4 ..... 1.98	304TL ..... 1.98	1609 ..... .98
1L4 ..... 1.04	5Z4 ..... .88	7A6 ..... .69	307A RK75 ..... 4.25	1613/6F6X ..... .69
1LA4 ..... 1.04	6-11 Ballast ..... 5.9	7A8 ..... .69	327A ..... 4.90	1614/6LX ..... 1.50
1LB4 ..... 1.04	6A3 ..... 1.26	7B5 ..... .70	376 GL276 ..... 5.98	1616 ..... 1.39
1LC6 ..... 1.05	6A4 ..... 1.53	7C4 1203A ..... 4.9	388A ..... .40	1619 ..... .39
1LE3 ..... 1.04	6AB7 1853 ..... 8.9	7E5 ..... 1.00	393A ..... 5.95	1625 ..... .40
1LH4 ..... 1.05	6AC7 ..... .69	7E6 ..... .70	446B ..... 1.98	1626 ..... .45
1LN5 ..... .69	6AF6 ..... 8.6	7E7 ..... .85	559 ..... 1.73	1629 ..... .98
1NSGT ..... .69	6AG5 ..... .97	7G7 ..... 1.04	575V/975 ..... 14.25	1641 RK60 ..... .75
1P5GT ..... .69	6AG7 ..... 1.05	7L7 ..... .86	701A ..... 3.95	1851 ..... 1.23
1P24 ..... 2.95	6AJ5 ..... .98	7N7 ..... .69	702A/702B ..... 3.49	2050 ..... .69
1Q5GT ..... 1.04	6AK5 ..... .89	7Q7 ..... .86	703A ..... 4.90	2051 ..... .88
1R4 ..... .69	6AL5 ..... .70	7R7 ..... 1.04	704A ..... 1.75	2052 ..... .88
1T5GT ..... 1.04	6AS5 ..... .98	9-3 Ballast ..... 3.95	705A 8021 ..... 2.25	3013A ..... 3.95
1V ..... .86	6BA6 ..... 5.9	91P1 ..... 3.95	707B ..... 2.25	8020 ..... 13.49
2A3 ..... 1.04	6B4G ..... 1.15	9LP7 ..... 2.69	2K28 ..... 10.98	9001 ..... .59
2A5 ..... .86	6B5 ..... 1.26	10 ..... .67	2K28 8011 ..... 2.75	9002 ..... .59
2A7 ..... 1.04	6B8 ..... 1.54	10-4B ..... .67	713A ..... 1.63	9003 ..... .49
2B7 ..... 1.26	6B8G ..... 1.05	10-4B Ballast ..... 5.9	715B ..... 8.90	9004 ..... .49
2C21 1642 ..... 81	6C7 ..... .59	10V ..... .60	722A/287A ..... 9.95	9006 ..... .49
2C26 ..... .59	6C5 ..... .54	12A6 ..... .23	722A/287A ..... 9.95	9007 ..... .49
2C34 RK34 ..... 55	6C8G ..... 1.05	12AH7GT ..... .87	723 ..... 4.95	9008 ..... .49
2C40 446A ..... 75	6C21 ..... 1.05	12C8 ..... .87	723A ..... 4.95	9009 ..... .49
2C43 464A ..... 49	6C7H ..... 24.90	12C8GT ..... .87	723AB ..... 5.90	9010 ..... .49
2C44 ..... 1.69	6D4 ..... 1.25	12H6GT ..... .39	723A ..... 5.90	9011 ..... .49
2D21 ..... 1.20	6E5 ..... 1.15	12K8 ..... .85	723A ..... 5.90	9012 ..... .49
2E22 ..... 1.45	6F6 1613 ..... .69	12Q7GT ..... .70	723A ..... 5.90	9013 ..... .49
2E25 HY65 3.49	6F8 ..... 1.04	12S7GT ..... .64	723A ..... 5.90	9014 ..... .49
2J21 725 ..... 12.95	6G6G ..... 1.04	12S7 ..... .70	723A ..... 5.90	9015 ..... .49
2J26 ..... 12.95	6H4G ..... .59	12S7GT ..... .70	723A ..... 5.90	9016 ..... .49
2J31 ..... 16.95	6J4 ..... 5.95	12S17 ..... .64	723A ..... 5.90	9017 ..... .49
2J33 ..... 14.50	6J5 ..... .96	12S17GT ..... .59	723A ..... 5.90	9018 ..... .49
2J34 ..... 18.95	6J6 ..... .96	12SK7 ..... .85	723A ..... 5.90	9019 ..... .49
2J42 700A 29.95	6J7 ..... .70	12SL7GT ..... .86	723A ..... 5.90	9020 ..... .49
2K25 ..... 24.49	6K5G ..... .86	12S7 ..... .58	723A ..... 5.90	9021 ..... .49
2K26 ..... 10.98	6K6GT ..... .69	12SR7 ..... .39	723A ..... 5.90	9022 ..... .49
2K29 ..... 6.98	6K7 ..... .70	14B6 ..... .69	723A ..... 5.90	9023 ..... .49
2K3 ..... 1.96	6K7G ..... .64	14R7 ..... .86	723A ..... 5.90	9024 ..... .49
2V3G ..... 1.05	6K8 ..... .86	15E ..... 1.39	723A ..... 5.90	9025 ..... .49
2X2 ..... .49	6L5 ..... 1.04	24G 3C24 ..... .69	723A ..... 5.90	9026 ..... .49
3A4 ..... .70	6L6 ..... 1.04	2516 ..... 1.98	723A ..... 5.90	9027 ..... .49
3B1 1291 ..... .95	6L6M 1622 ..... .75	25Z5 ..... 5.87	723A ..... 5.90	9028 ..... .49
3B24 ..... 1.29	6L7 ..... 1.05	25Z6GT ..... .59	723A ..... 5.90	9029 ..... .49
3BP1 ..... 1.49	6N7 1635 ..... .85	28D7 ..... .39	723A ..... 5.90	9030 ..... .49
3BP1A ..... 2.95	6P5G ..... .94	30 ..... .39	723A ..... 5.90	9031 ..... .49
3C23 ..... 4.95	6S7 ..... .87	31 ..... .39	723A ..... 5.90	9032 ..... .49
3C39 ..... 6.95	6S7GT ..... .54	32L7GT ..... 1.18	723A ..... 5.90	9033 ..... .49
3L8SP1 ..... 1.49	6S8GT ..... .49	35 ..... .70	723A ..... 5.90	9034 ..... .49
3D22 ..... 7.49	6SCT ..... .71	35L6GT ..... .58	723A ..... 5.90	9035 ..... .49

## KITS



### AMPLIFIERS

**HIGH FIDELITY—A Hi-Fi circuit with perfect linear response, phase inverter & full tube complement featuring 2-2A3 PP output, 6S7 and 6SN7. All parts, tubes, control knobs & re-usable RCA Audio Amplifier Chassis described below. Less Output Xfmr. THIS IS A BUY!**  
**TRULY GREAT BUY \$14.95**

**17.5 WATT AMPLIFIER KIT—** Similar above with all major components except 2-16I5/6L6 delivering 17.5 Watts. 14 WATT AMP. LIFER KIT—Similar above except 2-6V6GT delivering 14 watts. 17.5 or 14 Watt Kit less output Xfmr. Only **\$12.95**

**RCA AUDIO AMPLIFIER CHASSIS FOR AMPLIFIER KITS** above. Heavy duty porcelainized chassis. Gray rustproofed 7 1/2 x 12 1/2 x 2 1/2". 9 Amphenol sockets incl 6 octal, 3 inputs, output for pwr transf & choke. Chassis marked for 2 Mic. Vol. Tono, Fuse, Tubes (7) Complete with 3-FP triple section Electrolytics. **BASIC ALL-ELECTRONIC VIVM Kit.** An ultra-sensitive tester; similar to RCA Volt-Ohmyst Jr. Includes PRECISION resistors. 4" Sq GE 200 microamp meter (read 3-10-30-100-1000V DC; 100-1000/1000000/1 meg/10 meg/ohms), 11 megohms. **\$19.95**  
Inpt res. Less case.

**BASIC 3" SCOPE KIT.** Sensational visual tester foundation. 3BP1 CRT plus 5Y3GT & 2X2 tubes. 115V60cycXfmr—1320V, 375 VCT/10ma, 5V/3A, 2.5V/3.25A. All cndrs & choke for Lo & Hi Vols supply & sockets. Less chassis, amplifier & sweep circuits. **\$16.95**

**LAMPS, PILOT LIGHTS**  
Tungar\* Bulbs ..... \$2.95  
20x672\* ..... 2.95  
199898\* ..... 2.95  
289881\* ..... 2.50  
Aviation Lgts C1249/12VGR ..... 25 for 1.00  
Sealed Beam 4522/250W ..... 1.49  
4522/600W ..... 3.50  
**MAZDA PL\*\***  
44\*\*Box 10 ..... 50  
47\*\*Box 10 ..... 50  
49\*\*Box 10 ..... 50  
W1468 ..... 1.95  
W1531 ..... 1.95  
W1619 ..... 2.00  
CRT Tubes Gtd against price cage only when Ship- ped R'Exp.  
313/28V\*\* ..... 1.29  
323/3V\*\* ..... 1.10  
4522/250W ..... 1.49  
4522/600W ..... 3.50  
**NEON BULBS**  
NE2-Qty100 4.50  
NE16/991 ..... .25  
NE51/NE20 ..... .08  
Qty100-NE20 ..... 6.00  
TEL. Slide Lamps 6,24,30amp. ea. 18c  
100 for ..... \$15

## TELEVISION COMPONENTS

- A. V'Output Xfmr sim RCA204-T2 ..... \$2.98
- B. Utah9318 H'BlkgOsc Xfmr H'sld ..... .98
- C. UTC88662 V'BlkgOsc Xfmr H'sld ..... .98
- D. Erie HV Cndr 500mmf/10KV ..... .40
- E. Jeffers HV Cndrs 500mmf/20KV ..... .75
- F. Yoke MagnDeflec sim RCA201D1 ..... \$4.59
- F. FocusCoil for Magn Kinescops ..... 3.95
- G. HV Flybak H'OutXfmr sim RCA211T1 ..... 5.49
- Ion-Trap Magnet RCA203D1 ..... 2.98
- 300 ohm TWINEX Cable 100 ft \$2.25; 1000 ft. \$17.50
- Heller Speed Tracker for fast TV TwineX Cable taking w/5000Hvy Dty Staples ..... 13.95
- Staples Hvy Dty 5000 Boxed ..... 2.98
- DECALS Television Set of 8 for ..... .49
- BASIC FOTOFASH KIT**—Complete Pwr Supply Incl cndrs, tubes, xfms, circ diag, all instructions & FOTOFASH Lamp & reflector. For 115 VAC Only ..... **\$29.95**
- STUDIO KIT**—Famed Air Corps 1503 Set for 115V AC or battery w/2 lamps ..... \$53.95
- FLASH-CONDENSERS—FILM**  
7mf/2500VDC/21.9Watt-Sec's ..... \$2.75  
5 (109.5 Watt-Sec's) ..... 12.50  
15mf/330VAC/2000VDC intermitnt ..... \$4.50  
25mf/330VAC/2000VDC intermitnt ..... 7.95  
16mf/660VAC/3000VDC intermitnt ..... 7.95

## HI-POWER VARIABLE ANT. MATCHING NETWORK 1001A

1KW H.F. RF NEW 1.5 to 7mc. converted HF. PiNet adj IN&OUT CSD 15x15x23" RackMtg RibbonCoil & 240mmf/7000V cndsr RfMtr, Instrs & Manual. Matches most ANTS. 4" polished etched dials BRND NEW (Coil turns loose.) Worth 10 times the price for parts alone. **\$8.95**

## DYNAMIC MIKE & XMR SPECIAL!

Teardrop Baragnet Combination high gain dynamic mike transformer (UTC/Supper Elec 3 wdg, 600CT & 4000 ohms tapped 250 & 150 ohms. Fully shielded H'sld plus excellent fidelity dynamic microphone. While they last. .... \$1.49  
**COBALT BAR MAGNET** Wide Hysteresis (hi-fidelity) charged COBALT bars (3 3/4"x2 3/4") Pair for ..... **79c**

**2 1/2 Mtr. Butterfly Cndsr.** 30 mmf w/RF tank & choke  
**SPECIAL 2 for \$1.25**  
**PHASING CNDSR 90°** quadrants 4 taps 360° SINE WAVE GENERATOR ..... 2.39

## BLOWERS—Cool that Tube!

- 40 CFM/28VACDC/LR Type ..... \$3.49
- 100 CFM/12VACDC ..... 5.95
- 100 CFM/28VACDC ..... 9.95
- Xfmr 12 or 28V to 115VAC ..... 1.69
- 250 CFM/28VACDC ..... 8.95
- 250 CFM plus 28/115VAC Xfmr ..... 10.95
- 150 CFM/110VACDC, Hvy Duty ..... 7.95
- FOXBORO GRAPHIC TAPE RECORDER** Brand New—Write for specs ..... \$39.95
- DUPLEXER USN CT50ACW** for TELEVISION. Radar. FM—Write for specs ..... \$6.98
- FILTER FL-5 New!** 1020 cps audio w/Switch ..... 98c
- ANTENNA AN-30 Telescopic Whip**  
Collapses 12" to 9 ft New  
O'Seas pko ea. .... \$1.49; 2 for \$2.49  
**ANTENNA AT5/ARR1, AT1/APN2 30cm/12"** lg w/coax conn w/prt gask&mtgFlange. Each ..... 98c; 3 for \$2.00  
**ANTENNA AN130B Spring Swiveled Whip** END L'd 33" lg ..... \$1.98  
**ANTENNA P108/LU5 12em lg w/coax fitting** Each ..... \$1.98  
**ANTENNA AS23/APw/coax fitting** ..... 2.98  
**ANTENNA MS19-54, 8 ft Whip** ..... 3.98
- FILTER CHOKES**  
13.5Hy/1Amp/420hm/17KV ins ..... \$54.00  
15-29Hy/150ma Swinging Cased ..... 2.95  
12Hy/300ma ..... \$3.95; 3Hy/40ma 3 for ..... 1.00  
15Hy/400ma or 20Hy/300ma/12KV ins ..... 7.95  
8Hy/150ma NewUTCerckedBkltT'hd 2 for ..... 2.25  
50Hy/125ma Csd ..... \$1.95; 8Hy/100ma ..... 1.10  
12Hy/275ma \$3.29; 15Hy/80ma GEc79@ 10 for 6.98  
30Hy/50Ma ..... .49c; 5 for ..... 2.00

**TAB MONEY BACK GUARANTEE 30 MIN. ORDER F.O.B. N.Y.C. ADD SHIPPING CHARGES AND 25% DEPOSIT. PHONE WO. 2-7230**

**THAT'S A BUY**      **THAT'S A BUY**

**DEPT. 2E. SIX CHURCH ST. NEW YORK 6, N.Y., U.S.A. - CORNER CHURCH & LIBERTY STS. ROOM 200**



## SURPLUS BARGAINS — NOW !!

### WESTON MODEL 271 Microammeter



Another of the famous Weston fan shaped line. Very large scale 5.8" long. These meters were made by Weston to General Radio specifications, with special mirrored scale and knife edge pointer. Accuracy 1%.  
0-600 Microamps  
170 M.V.  
Coil Res: 250 Ohms

Your Price ..... **\$22.50**

### GE TYPE DO 50 DC AMMETER

50 MV FULL SCALE RECTANGULAR 3 1/4" x 3", Barrel 2 3/4" DIAM, x 1 1/2" DEEP, MOUNTING HOLES 2 5/8" x 2 5/8" c. to c. Special Scale, can be used with Ext. Shunt for any range, bakelite case

A BUY! Price ..... **10 for \$27.50**

### GE TYPE DO 50 DC VOLTMETER

3 volts full scale, 100 ohms 1V, special scale, same dimensions as above, bakelite case.

A BUY! Price ..... **10 for \$27.50**

### A SCOOP on a 'SCOPE DUMONT Used! Guaranteed

#### Model 164-E



3" CRT operates at accelerating potential of 1100 V—brilliant well-defined trace, Vert amp voltage gain approx 43, horiz amp voltage gain approx 55, Freq. range vert. & hor. amp both uniform ±3 DB from 5-100,000 CPS Input impedance 1 megohm vert., 8 megohm hor. Operates 115 V, 40-60 cycle.

Price New **\$115.00**  
Your Cost **\$77.50**

### MICROVOLTER—FERRIS Model 20B

.2 to 100,000 microvolts output, continuously variable... operates on 115 V. 60 cycle AC... push button selector for 18 frequencies from 455 K.C. to 22 M.C.... with or without 400 cycle 30% modulation... frequency may be varied ±2% by screwdriver adjustment.

Your Price ..... **\$100.00**

### BC 403E OSCILLOSCOPE

Made for Signal Corps by RCA for use in SCR-270D Radar—Can be converted to other uses — A Gold Mine for Parts — Shipping Weight: 400 lbs—Without Cathode Ray Tube 5BP4

NEW! **\$57.50**

### HIGH VOLTAGE CAPACITORS

1 MFD 20 KV DC 18"x13 1/2"x5" ..... **\$25.00**  
1 MFD 25 KV DC-13"x7"x4" ..... **9.85**  
100 MFD 50 KV DC-5 1/2"x7 1/2"x4" Insulators  
4" dia. x 7" high. .... **12.50**

Cap Mfd.	Volts D.C.	Height	Width	Length	Price
10	1000	5-7/8"	1-3/4"	3-7/8"	\$1.85
1	1000	3-5/7"	2-3/4"	1-1/4"	.85
1	1000	3-5/7"	2"	1-1/16"	.50
1	500	2"	1-1/4"	1-1/16"	.25
.25	1000	1-1/2"	1"	3/4"	.25

### WHSE PORTABLE GALVANOMETER



Type PX-12, Movement 7 MA, special scale, solid connecting terminals, contains a 1 Volt internal cell which can be easily removed for conversion to DC AMMETERS & VOLTMETERS, with leather case and canvas carrying strap.

A buy at **\$4.95**

### STRUTHERS-DUNN RELAYS

D.P.S.T., Normally open, 115 V, 60 Cycle, AC coil, 30 Amp. contacts, fibre base with 4 holes for mounting. Dimensions, 4 1/2" L x 3" W x 8 3/4" H.

A Real Buy At ..... **\$2.50**

### PANEL METERS

Code—R-Round, S-Square, B-Bakelite, M-Metal, F-Flush, SF-Surface, FS-Full Scale

#### A. C. VOLTS

Weston	517	0-10 2"	R-M	2.95
Weston	517	0-15 2"	R-B	2.95
Weston	517	0-150 2"	R-B	3.50
Simpson	125	0-150 2"	R-B	2.95
Weston	476	0-1.5 3"	R-B	4.50
Whse	RA35	0-7.5 3"	R-B	3.95
Weston	476	0-8 3"	R-B	3.95
Weston	476	0-10 3"	R-M	4.75
Trpltt	331JP	0-150 3"	R-B	4.50
GE	AO22	0-150 3"	R-B	5.50
Brington	32XA	0-150 3"	R-B	4.50
Whse	NA35	0-15/150 3"	R-B 3 Studs	5.95
Whse	DY-2	0-15 4"	R-M Ext. Mult	9.75
Weston	642	0-75 4"	R-M SF or F	7.50
Whse	RA37	0-300/600 4"	S-B	9.75

#### AC AMPS

Whse	NA35	0-3A FS, 0-120 Scale	3" R-B	9.95
Trpltt	431AC	0-5A FS, 0-150/300 Scale	3" S-B	4.95
Trpltt	332JP	0-30 3"	R-M	4.95
Weston	642	0-75 4"	R-M SF or F	7.50
Whse	RA37	0-75/150 4"	S-B	9.75

#### DC MICROAMPS

Weston	301	0-100 3"	R-B	12.50
--------	-----	----------	-----	-------

#### DC MILLIAMPS

McClntk	2001	0-1 2"	R-B	3.95
Weston	506	0-1 2"	R-B Spec. Scale	4.50
Sun	525	0-2 2"	R-B	2.50
Weston	506	0-3 2"	R-B	3.95
Weston	506	0-15 2"	R-B	3.50
GE	DW41	0-25 2"	R-B Wide Flange	3.50
GF	DW41	0-30 2"	R-B	3.50
Weston	506	0-50 2"	R-M	3.95
McClntk	2001	0-100 2"	R-B	3.50
Simpson	25	0-1 3"	R-B Spec Scale	4.50
GE	DO41	0-1 3"	R-B	4.95
GE	DO41	0-1 3"	R-B Black Spec Scale	4.50
Weston	301	0-1 3"	R-B Spec Scale	7.50
Weston	301	0-2 3"	R-B	7.50
Simpson	25	0-5 3"	R-B	4.75
GE	DO41	0-10 3"	R-B	4.75
Whse	NY35	0-15 3"	R-B	4.50
Simpson	25	0-15 3"	R-B	3.95
GE	DO53	0-20 3"	R-B	3.95
Weston	301	0-25 3"	R-M	5.95
Weston	301	0-30 3"	R-M	5.95
Weston	301	0-100 3"	R-B	6.50
Whse	NX35	0-200 3"	R-B	4.50
Weston	301	0-200 3"	R-B	6.50
Weston	301	0-300 3"	R-B	6.50
Weston	301	0-500 3"	R-B	6.50
Weston	301	5-0-5 3"	R-B Spec Scale	5.50
GE	O58	0-R 4"	S-B Blk Scale	7.50
GE	DO58	0-30 4"	S-B	7.50

#### DC AMPS

Weston	506	50-0-50MV	2" S-B Spec Scale	3.95
GF	DO50	50MV	3" S-B Spec Scale	2.95
Weston	301	0-1 3"	R-M	6.50
GE	DO41	0-1.5 3"	R-B	4.75
Simpson	25	0-10 3"	R-B SF	4.50
Weston	301	0-10 3"	R-B	7.50
Trpltt	421	0-1.5 4"	S-B	3.50

Whse	KX24	Concentric 50-0-50MV	4" S-B BlkSpecScale	14.95
Whse	KX24	Concentric 50MV	4" S-B Spec Scale	14.95

#### DC VOLTS

Sun	378	0-3 2"	R-B	2.50
GE	DW40	0-15 2"	R-B Short Flange	3.50
Weston	506	0-20 2"	R-B	3.50
Simpson	125	0-35 2"	R-M	2.50
Weston	506	0-40 2"	S-B	3.95
Weston	506	0-250 2"	R-M	5.50
Weston	301	0-30 3"	R-M	5.95
Weston	301	0-150 3"	R-M Blk Scale	5.95

All Scales White, All Cases Flush Unless otherwise specified.

3PST, #1CX100, Coil 115V. AC Contacts 115V. AC, 6 Amps, Bakelite Base, Dimensions, 3 1/2" x 2 1/2" x 2H" ..... **\$2.95**

### HIGH VOLTAGE TRANSFORMER

GE Cat No. 7470609 can-enclosed with insulators

PRI—115/230 V. 50/60 Cycles  
SEC—14000 V., Rating 1.4 Kva  
Dimensions: 16"H x 12"W x 10"D.  
Shipping Weight: 178 lbs.

A buy at **\$45.00**

### R. C. A. POWER TRANSFORMER

PRI—440/220 V. 60 CYCLES  
SEC—125/115/105 V. at .8KVA  
Bracket mounted, pri & sec terminal board.  
Dimensions: 5 3/4" H x 7 1/2" W x 8" D, Shipping weight: approx 40 lbs.

Your price **\$12.50**

### STEP DOWN TRANSFORMERS SPECIAL

Made by GE, heavy duty, considerable overdesign, open frame, ideal for rectifier application, size: 3 1/2" x 3 1/2" x 4".  
PRI—115 Volts 60 Cycles  
SEC—15 V at 12 Amps

**\$3.75**

### POWER TRANSFORMER

PRI—440/220 V. 60 Cycles  
SEC—125/115/105 V., RATING .8KVA  
RCA Open construction. Bracket mounted, pri & sec terminal board. Overall dimensions: 5 3/4" H x 7 1/2" W x 8" D. Mounting dimensions: 6 3/4" x 5 3/4".

Price **\$12.50**

### GE Step Down Power Transformer

GE Type M Cat #61021, Enclosed, Size: 4-9/16" H x 4 3/4" W x 12 1/4" L.  
PRI—460 V 60 Cycles; SEC—115 V  
RATING—750 Watts

**\$9.00**

### GE STEPDOWN TRANSFORMER

Cat No. 61G5, Fully Enclosed, Wall or Bench Mounting, Isolation Type  
PRI—230 Volts, SEC—115 Volts  
RATING—250 Watts, 60 Cycles  
Dimensions—8Hx4Wx4 1/2D, Shipping Weight approx. 21 lbs.

### GE #K2731 PULSE TRANSFORMER



Pri. Imp. 50 Ohms  
Sec. Imp. 450 Ohms

1 Micro-second, 635 PPS, Pri. Input 9.5 KV PK, Sec. Input 28 KV PK, BWR Out 800 KW, Bifilar 2.75A.

A buy at ..... **\$17.50**

### TRANSTATS



Type RH Input: 115 V. ±10%. Output: 115 V. Made as a line voltage corrector ±10% of input voltage, or can be connected to give ±20% of input. Rating .25 KVA.

Your price ..... **\$6.50**

### RATING 3KVA, MAX AMPS 26

same as above, can also be reconnected to be used as an isolation type step down with variable secondary, Input: 115V, Output: 0-30V, at 30 Amps.

Your price **\$18.00**

### RATING 1.85 KVA, MAX AMPS 16

same as above, can also be reconnected as isolation type transformer above Input 115 V, Output: 0-30 V, at 16 Amps.

Your price **\$17.00**

### DYNAMOTOR MADE BY G. E.



INPUT 28 V D.C. OUTPUT 1000 V D.C. CAPACITY 350 MA. With voltage regulator box on top. Approx. dimensions: 12" L x 6" Diam. Weight: 30 lbs.

A buy at **\$5.75**

3PDT #1XCX114, Coil 115V. AC Contacts, 115 V. AC, 6 Amps, Micalex Base, Dimensions 3 1/2" x 2 1/2" x 2" H. .... **\$3.95**

4 Pole St, Coil 115V. AC, Contacts 115V. AC, 30 Amps, Fibre Base, Dimensions, 5" x 5" x 3" H. .... **\$4.95**

ALL PRICES INDICATED ARE FOB OUR WAREHOUSE NYC. SHIPMENTS WILL BE MADE VIA RAILWAY EXPRESS UNLESS SUFFICIENT POSTAGE IS INCLUDED OR OTHER INSTRUCTIONS ISSUED. WE WILL REFUND EXCESS POSTAGE IN STAMPS.

# POWERTRON Electrical Equipment Co.

117 LAFAYETTE STREET

Phone: WOrth 4-8610

NEW YORK 13, N. Y.



# SAVE MONEY!

## DO YOU WANT TO MAKE YOUR DOLLAR GO FURTHER?

Take advantage of this opportunity—Buy BRAND-NEW-GUARANTEED SURPLUS MATERIAL at PRICES FAR BELOW DEALERS COSTS



### PORTABLE CHRONOMETRIC TACHOMETER

Measures shaft speeds from 10 R.P.M. to 20,000 R.P.M.  
Measures lineal speeds 5 F.P.M. to 10,000 F.P.M.  
Meets Navy specs, 1/2 of 1% accuracy.  
With accessories, in case 5" x 3 1/2" x 1 1/2". List Price \$75.00. Net Price.....\$24.50

### PORTABLE TACHOMETER MULTIPLE RANGE

Continuous Indicating Shaft or lineal speeds from 300-1200, 1000-4000, & 3,000 to 12,000 RPM.  
Meets Navy specs 18-T-22 Type B, Class A. With accessories in case 7 1/4" x 4" x 5". List Price \$75.00. NET PRICE.....\$24.50

TACHOMETER same as above, except ranges are 300 to 1500, 1,000 to 5,000 and 3,000 to 15,000  
Your Net Price \$25.50

### ROTARY CONVERTER

.750 K.V.A.,  
115 Volt 9.4 Amp D.C.-Input  
110 Volt 6.8 Amperes, 60 cycles, 1 phase-Output  
3600 R.P.M., with Filter unit, Pinco type IK75  
Your Net Price \$65.00

### ROTARY CONVERTER

.225 K.V.A.,  
230 Volt 1.5 Amp D.C.-Input  
110 Volt 2.5 Amperes, 60 cycles, 1 Phase-Output  
3600 R.P.M., with filter unit,  
Janette type CA-16-F Your Net Price \$55.00

### MOTOR GENERATOR SET

1.25 K.V.A.,  
230 Volt 6.8 Amp D.C.-Input  
120 Volt 10.4 Amperes, 60 cycles, 1 Phase-Output  
3600 R.P.M., Centrifugal starting,  
Allis-Chalmers Mfg. Your Net Price \$100.00

All meters are in round flush bakelite case with white scale and are standard in every respect unless otherwise specified.

All items are Surplus—New Guaranteed. C.O.D.'s not sent unless accompanied by 25% Deposit. Orders accepted from rated concerns, public institutions, etc., on open account.

The above is only a partial listing of the many items we have in stock. Send for free circular.

MANUFACTURERS, EXPORTERS, DEALERS—we invite your inquiries.

NOTICE—We Repeat—all items are Surplus—New—Guaranteed. All prices FOB, N. Y.

## MARITIME SWITCHBOARD

335 Canal Street      Worth 4-8217      New York 13, N. Y.

### MODEL TS-268/U CRYSTAL RECTIFIER TEST SET

The equipment is designed to provide a means of rapidly checking crystal rectifiers to determine if they are good or bad. The unit is completely self-contained in a waterproof, portable aluminum case 3" x 6" x 7". An automatic shut-off feature is provided in the form of a switch which is actuated when the case cover is closed. The operation of this switch opens the battery circuit, thereby precluding the possibility of leaving the equipment turned on when not in use.

The equipment operates from a 1 1/2 volt dry cell power source, the battery supplying this power being mounted in the unit on the back side of the panel. All controls necessary for operation are readily accessible on the panel of the equipment. The panel also incorporates a Weston 301 0-1 D.C. Milliammeter, 100 ohms resistance, in a 3" square flush bakelite case which is calibrated in kilohms for resistance measurements and in milliamperes for current readings. The current scale is provided with colored sections which facilitate acceptance or rejection of crystals according to the type being tested. Complete as illustrated.

Your Net Price \$17.50

### MOTOROLA MODEL GN-3-24 Gasoline Heater

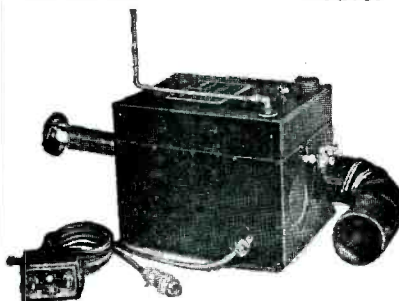

An internal combustion type heater which will give 15,000 B.T.U. of heat per hour. Ideally suited for use with equipment, farms, boats, bungalows, cabins, trailers, work sheds, darkrooms, mobile equipment, transmitter stations etc., and any place where a quick heat is required in volume.

Very economical in operation—tank holds one gallon of gasoline which is sufficient for 6 hours operation. Uses any grade gasoline.

This unit is designed primarily for aircraft installation, 24-28 volts d.c., but it can be readily adapted for a 115 or 230 volt 60 cycle power supply by use of a transformer and rectifier. Simple circuit diagram for adaption to 115 or 230 volts 60 cycle use supplied with each unit. Can be used on 32 volt farm or boat systems as is without the installation of additional transformers, etc. Power consumption approximately 75 to 100 watts. Approximately 12" long x 9 1/2" high x 9 1/2" wide. Complete with technical manual and parts list.

@ \$22.50 F.O.B. N. Y.

### COMBINATION OFFER

#### 150 VOLT A.C. METER

Triplet 331-JP, 3 1/2" Rd flush case

#### 30 AMP A.C. METER

Triplet 331-JP, 3 1/2" Rd flush case

Both meters for \$7.95



### "VIBROTEST" INSULATION RESISTANCE and A.C. - D.C. VOLTAGE TESTER

RESISTANCE RANGE: 0-200 Megohms (at 500 volt test potential) 0-2000 ohms  
VOLTAGE RANGE: 150-300-600 Volts D.C.  
150-300-800 Volts A.C.

Push button action for resistance readings. Operates from internal power supply off two # 6 dry cells. Large 4" meter and Knife edge pointer insures accurate readings. Complete with test leads & instructions in metal carrying case as illustrated. Associated Research Model # 201 (Brand new but slightly shelfworn from Gov't stock room).....Your Net Price \$38.00

### PYROMETER PANEL

0-1200°F Bristol Co. Model 482F. Complete with 8 Iron-constant in right-angle-head thermocouples 1/2" pipe thread, 25 Position selector switch.  
Your Net Price \$80.00

A.C. AMMETER, Switchboard type, 0-60 Amp. Westinghouse DY-2, 4 1/2" rd surf mtd case. \$8.00

A.C. AMMETER, Port, 0-1, 0-5, 0-10 Amp. Mult. range, Weston 435 use with 461-4 C.T. \$55.00

DUAL RANGE AMMETER, 0-3, 0-15 Amp. A.C., Weston 528 w. case & leads. \$12.50

D.C. VOLTMETER, Port, 0-10 Volts, 125 ohms per volt, Weston 489, (D.C. matching model of above 528 A.C. Meter. \$9.50

D.C. VOLTMETER, Port, 3-0-3 Volt, 200 ohms per volt, Westinghouse PX-4. \$9.50

D.C. VOLTMETER, Port, 0-3, 0-150 V., Dual range, W.H. PX-4. \$17.50

D.C. VOLTMETER, Port, 50 M.V. mvt., WH PX-4 range, R.S. Steel 6. \$21.00

D.C. AMMETER, Port, 50 M.V. mvt., WH PX-4 sc. cal 1000, 2000, 4000 Amp, less shunts. \$17.50

VOLT OHM MILLIAMMETER, Port, Weston 665 \$45.00

ZERO CENTER MILLIAMMETER, Weston 592, 6" sq ft mtd Switchboard meter, 1-0-1 M.A., Black Sc, calibrated 900-0-600 R.P.M. \$18.00

R.F. MILLIAMMETER, 0-120 M.A. R.F. panel meter, 3 1/2" rd fl bake case, Simpson Model 35, AWS # MR35W120 R.F. M.A. \$8.50

DECIBEL METER, Weston 506 minus 10 to plus 6, 0 MV in 600 ohms 2 1/2" rd fl bake case. \$5.50

DECIBEL METER, Weston 301, type 61, minus 10 to plus 6, 3 1/2" rd fl bake case, 6 MW 600 ohms, Zero 1 B-1.9 volts. High speed type 29-35

Second to final reading. Only 2-6% overthrow, 5000 ohms at Zero DB, 16-50 Damping factor. Complete with external wire wound precision resistors to extend the range to any or all of the following ranges

— 20 to + 16 DB

— 30 to + 26 DB

— 40 to + 36 DB

Ideal for sound and broadcasting applications (Quantity Available). Total List Price...\$37.50

Your Cost Only.....\$11.50

BOWL INSULATOR, clear glass, Corning #67076 Type C overall dia 8 3/4" Pin 3/8" x 1 1/2". All brass fittings S.C. stock #3G-1830-67076.1. \$6.00

We carry a complete line of surplus new meters suitable for every requirement, such as portable, panel, switchboard, laboratory standards, etc.

### OVER 50,000 METERS IN STOCK

We also have in stock various surplus components, tubes, code keying and recording units, code-training sets, tachometers, analyzers, tube testers, converters, precision resistors, current transformers, transmitters, receivers, condensers, and other electronic units, parts and accessories.

Finest of surplus  
at a fraction of cost

# PEAK ELECTRONICS CO.

Industrials  
Schools - Labs

### CHOKE BARGAINS

6 Henry 30 ma 300 ohms	3 for \$ .99
6 Henry 70 ma 200 ohms	2 for .99
8 Henry 100 ma 140 ohms	.99
1.5 Henry 250 ma 72 ohms	.59
6 Henry 300 ma 65 ohms	3.75
4.3 Henry 620 ma 42 ohms	6.95
10 Henry 750 ma 95 ohms	11.50
Swing, Choke 1.6/12 Henry 1 amp/100 ma	24.50
15 ohms	
.07 Henry 7 amps .5 ohm	4.50

### H.V.-H. CURRENT PLATE TRANS.

1500-0-1500 volts at 1.5 amps. Tapped at 1350 and 1250. Pri. 110/220 volts 50/60 cycles in 2 Separate windings. Built to rigid Navy specs by Amertran. Suitable for broadcast transmitters, induction heating, etc. Continuous duty. 10 x 10 x 7. Swt 125 lbs.



Now only \$39.95

### MEDIUM CURRENT PLATE

As illustrated above. 1500-0-1500 volts at 600 ma. Pri. 110/220 v. 50/60 cycles. 8 x 8 1/2 x 7 s.w.t. 78 lbs



### ADVANCE D.P.D.T. ANTENNA RELAY

110 V. 60 cycle coil Steatite insulation. Only \$1.95 each. As above but 3 P D T \$2.75. As above but 4500 ohm DC Coil \$1.75

### RECTIFIER TRANSFORMER

2 separate 110 v primaries. Sec. 70-75 v at 3 amps. 35-37 v (pri in series). Fully cased. Now only \$1.89 ea.

### GENERAL PURPOSE TRANSFORMER

Ideal for Bias, Filament, Isolation, Stepdown, etc.. 2 isolated 110v pr. sec. 110v at 900 ma plus 6.3 @ 2 amp. Fully cased. Now \$1.49 ea.

### HIGH CURRENT PLATE TRANSFORMER

820 volts ct at 775 ma. Primary 110/220 v 25 to 60 cycles. Fully cased 6 1/2 x 6 1/2 x 7. \$6.95 ea. Thordarson Plate Transf. 2370 volts ct at 250 ma. Tapped at 300-0-300 volts. Separate 215 volt 55 ma. bias winding. Pri 110v 60 cy. Fully shielded. \$11.95 ea.

UTC type PA 5000 ohm plate to 500 ohm line and 6 ohm voice coil. 60 to 10,000 cps ± 1 DB. 10 watts



### RADAR JAMMER

425-750 MCS AN-APT 2. Con-tains 10 tubes:  
(1)-307 (2)-703A (2)-6AG7 (1)-6AG7 (2)-5R4GY (1)-2x2 (1)-931A. Unit has blower motor and 400 cycle own supply complete with all tubes, etc.  
BRAND NEW. Now \$12.95 ea.

### STEPDOWN TRANSFORMER

220/110 volts, 100 watts. Fully encased, 5 1/4 x 4 1/4 x 5 1/4. 110V. 60 cycle. \$2.49 each

### U. H. F. COAX. CONNECTORS

831AP-UG12U-UG21U-UG-14U-UG146U-UG-206U, 831R-831SP \$35¢ ea.

### FILAMENT TRANSFORMERS

110 Volt 60 cy. Pri.—H.V. Ins.—Fully Cased  
6.3 V 10 Amps \$1.89  
5 Volts 15 Amps 2.95  
2.5 Volts 10 Amps 3.75  
5 Volts Ct 3 Amps 1.50  
10 Volts Ct 3.25 Amps 1.75  
2.5 Volts Ct 21 Amps 4.95

### MULTI-SECONDARIES

5v CT 13.5A, 5v CT 7A, 5v CT 7A 5.95  
5 1/4v CT 21 Amp, 7.5v 6 Amp, 7.5v 6A 5.95  
10 volts CT 13 Amps, 7.5v 2.5 Amp. 5.50  
6.3v 21 Amp, 6.3v 2A, 2.5v 2A 4.75  
5 volts 4A, 6.3 volts 3 Amp 2.50  
2.5v CT Amps, 2.5v CT 20A 7.95  
2.5v CT 10A, 6.3v 1A, 5v 3A, 5v 3A 4.50

### PHASE SHIFT CAPACITOR



4 Stator Single Rotor, 0-360 Degrees Rotation. Only \$2.95 each

WE BC 1091A-Radar RF unit—With magnetron, etc., in pressurized tank 59.50

CW1 60 AAG range calibrator and power supply, hook, cables, etc. 29.50

### VARIABLE CONDENSERS—CERAMIC INSULATION

MIDGET	XMITTING
35 mmf .39	75 mmf .3 spacing \$5.95
250 mmf .48	150 mmf .07 spacing .95
325 mmf .59	Dual 250 mmf .051 Spc. 2.75
APC 140 .35	125 mmf .07 Spc. .89

### ODDS 'N' ENDS BARGAINS

Federal OPDPT Anti-Cap Switch	.75
Heineman 5 Amp Circuit Brkr 110 VAC	.95
Butterfly Cond. 2-11 MMF Bld Bearings	.59
CD .002 3500 w V DC Type 9 Mica	.49
GD 16 Mfd 450 WV Elect. in Can w/leads	.39
JAN 6C4 Tubes New, Boxed	4 for .99
.1 x .1 2 KVDC Oil Cond.	.29
Midget Closed CKT Jacks	2 for .75
1000 and 25 WVDC Elect in Can	.75
Trimmm Commercial Phones HI Imp.	3.99
BZRS Microswitch S.P.D.T. 10 Amp	.29
.0015 5% Silver Micas	9 for .99
10 ohm 20 watt Resistors	12 for .99
2 Mfd 250 VAC Oil Cond.	5 for .98
25 Mfd 25 VDC Elect. Tubular	6 for .99
500 ohm 50 watt Adjustable Slider	5 for .99
50 ohm 25 watt Adjustable Slider	5 for .99
Silver Var. Cond., 5 to 2.5 Mmf.	.79
1/2 Meg. Pots with Switch	.99
1/40 Amp (25 Ma) Littlefuses	15 for .99
100 ohm 100 watt Adjustable Slider	.49
C-H Battogale DPST 20 Amps 250 VAC	.39
100K, 1.5K Pots	.39
.5 Meg. Pots S.D.S.	.29
H-H SPST Push Button Switch N.O.	.39
MV Switch with Roller SPST 15A/110	.39
705A Ceramic Sockets	5 for .99
3 Section Ceramic Wafer Switch, 2 Pole 5 Position Per Section, Non Shorting	.69¢ ea.
100 ohm 100 watt Resistors	4 for .99
20K ohm 50 watt FGR Resistors	2 for .99
H-S 30 Earphones	2 for .99
IRC 220 ohm 100 watt	5 for .99
1000 ohm 200 watt	2 for .99
Corning Glass Slug Form and Var. Cap.	5 for .99
Shielded Littlefuse Holders 3 AC	10 for .99
CTC 3:1 PP Input, Hermetic Seal	2 for .99

### WIRE WOUND RESISTORS

5 Watt type AA, 20-25-50-200-470-2500-4000 ohms	.09 ea.
10 watt type AB, 25-40-84-400-470-1325-1900-2000-4000 ohms	.15 ea.
20 watt type DG, 50-70-100-150-300-750-1000-1500-2500-2700-5000-7500-10000-16000-20000-30000 ohms	.20 ea.
30 watt type D1, 100-150-2500-3000-4500-5300-7500-18000-40000 ohms	.24 ea.

Precision 15 Meg. 1 watt Accuracy Resistor. Non-inductive, 1 watt, hermetically sealed in glass. 29 ea. 10 for \$2.50.

50 Megohm, 50 watt, IRC Type NVC Resistor with mount. \$1.49

### 1% PRECISION RESISTORS

Wire Wound—Standard Make	
2300-2500-5000-8500-10,000 ohms	.39 ea.
50000-95000 ohms	.49 ea.
100000-750000-1 meg	.89 ea.

### W. W. POWER RHEOSTATS

25 Ohms 25 Watt	.49
300 Ohms 50 Watt	.89
150 Ohms 50 Watt	.89
Dual 200 Ohms 50 Watt	.89

### VARIABLE CERAMICONS

1.5 to 7 MMF	.24	4 to 30 MMF	.24
3 to 13 MMF	.24	7 to 45 MMF	.24

### FIXED CERAMICONS

Capacity in MMF: 1-2-3-4-5-8-10-12-15-17-18-20-25-30-35-40-50-60-85-120-200-500. Your cost any capacity .09 each

Voltage Regulated Power Supply—input 110 v. 60 cy. Delivers 150 v. DC—Well filtered (3 chokes) uses VR 150 and 6x5. Has extra 6.3 v winding. Swell for eco's, freq. meters, etc., 16x3 1/2 x 5 with tubes. Only \$6.85

### MEGOHM METER

Industrial Instruments Model L2AU 110/220 volts 60 cycle input. Direct reading from 0-100000 megohms on 4" meter can be extended to 500000 megohms with external supply. Sloping hardwood Cabinet 15"x8"x10". Brand new with tubes plus running spare parts including extra tubes. Great value Only \$69.50.



### OIL CONDENSERS

11 mfd 250 vac	.85	1/1 mfd 7000 vdc	2.25
5 mfd 150 vac	.49	1 mfd 7500 vdc	1.95
1 mfd 600 vdc	.29	1 mfd 7500 vdc	9.25
2 mfd 600 vdc	.39	4 mfd 8 kv dc	10.95
4 mfd 600 vdc	.59	.01/.01 mfd 12 kv dc	5.75
6 mfd 600 vdc	.79		
3/3 mfd 600 vdc	.79	.005/.01 mfd 12 kv dc	5.50
10 mfd 600 vdc	.95		
2 mfd 1000 vdc	.79	.03 mfd 16 kv dc	5.75
4 mfd 1000 vdc	.95	.65 mfd 12,500 vdc	12.95
15 mfd 1000 vdc	2.25		
2 mfd 1500 vdc	1.25	.75/.35 mfd 8/16 kv	7.95
6 mfd 1500 vdc	2.95	.02 mfd 20 kv dc	7.95
1 mfd 2000 vdc	1.45	2 mfd 18 kv dc	59.50
2 mfd 2000 vdc	2.25	2 mfd 4000 vdc	5.50
4 mfd 2000 vdc	3.65	1 mfd 5000 vdc	4.50

### WESTINGHOUSE



Type MN Overcurrent Relay, Adjustable Form 250 ma. to 1 amp. External Push Button Reset. Enclosed in glass case. Hand calibrated adjustments, only \$7.95

### METER SPECIALS—BRAND NEW

2" Weston 0-250 volt DC	\$ 2.95
2" GE 0-30 amps DC	2.95
2" GE 0-1 amp RF (internal thermo)	2.95
2" GE 0-5 Ma DC (amp scale)	1.95
2" GE 0-1 Ma DC (volt scale)	2.95
2" GE 0-500 Ma DC	2.95
2" McCintock 0-100 Ma DC	2.95
2" GE 0-30 volts DC 1000 ohms/v	2.45
2" Gruen 0-3 volts DC 1000 ohms/v	2.45
2" GE 0-10v ac	2.95
2" Weston 150-0-150 micro amps	3.49
3" Westinghouse 0-50 amps AC	3.95
3" Weston 0-50 amps AC	4.95
3" Triplett 0-75 amps AC	3.95
3" Western Electric 0-80 Ma DC	3.95
3" McCintock 0-1 Ma DC	3.95
3" Westinghouse 0-2 Ma DC	3.95
3" Westinghouse 0-20 Ma DC	3.95
3" GE 0-15 Ma DC (square case)	3.95
3" Westinghouse 0-150 volts AC	3.95
3" GE 0-200 Ma DC	3.95
3" Westinghouse Running Time 110v/60	7.95
3" Industrial Running Time 110v/60	7.95

### HIGH VOLTAGE—CURRENT MICAS

FIL .01 1000 VDC	\$ .50
FIL .056 1000 VDC	.50
FIL .07 1000 VDC	.50
FIL .024 1500 VDC	.75
FIL .033 1500 VDC	.75
F2L .015 2 KV DC	.85
F2L .02 2 KV DC	.90
F2L .025 2500 VDC	1.25
F2L .001 3 KV DC	.90
F2L .002 3 KV DC	.90
F2L .003 3 KV DC	.90
F2L .005 3 KV DC	1.20
XR .0001 MMF 5 KV DC	.75
F2L .0005 MMF 5 KV DC	.85
F2L .001 MMF 5 KV DC	1.30
F2L .0015 MMF 5 KV DC	1.60
F2L .003 MMF 5 KV DC	1.90
XS .005 MMF 5 KV DC	7.50
F3L .007 MMF 5 KV DC	2.75
*G1 .00024 MMF 6 KV DC	4.50
*G1 .001 MMF 6 KV DC	4.75
F3L .002 MMF 6 KV DC	3.50
F3L .0025 MMF 6 KV DC	3.60
F3L .003 MMF 6 KV DC	3.75
*MX .004 MMF 6 KV DC	7.95
F3L .005 MMF 6 KV DC	2.90
F3L .006 MMF 6 KV DC	3.00
*PL .001 MMF 8 KV DC	4.95
F3L .0015 MMF 8 KV DC	3.50
F3L .002 MMF 8 KV DC	4.00
F3L .0025 MMF 8 KV DC	4.50
F3L .003 MMF 8 KV DC	4.00
F3L .01 MMF 8 KV DC	6.50
F3L .004 MMF 8 KV DC	5.50
F3L .005 MMF 8 KV DC	6.00
*G2 .005 MMF 10 KV DC	5.95
*G2 .002 MMF 10 KV DC	6.95
*G2 .001 10 KV DC	5.95
XA .0005 MMF 12 KV DC	4.90
*G4 .008 MMF 12 KV DC	26.50
*G4 .001 MMF 25 KV DC	32.50
*PL .0005 30 KV DC	32.50

\* Ceramic Case. Tol ± .5%.

### G.E SCOPE TRANSFORMER

Hermetically Sealed  
Pri 110v 60 cy. sec.  
0-625-1050 v 20 MA, 20.3V 4.50A, 6.3V 3A, 2 x 2.5 V 2.5A \$4.95

### Hermetically Sealed SCOPE TRANSFORMER

Pri 110v 60 cy. sec. 2500 v 12 ma. \$4.95

Tremendous stocks on hand. Please send requests for quotas. Special quantity discounts. Price f.o.b. N. Y. 20% with order unless rated, balance C. O. D. Minimum order \$5.00.

**PEAK ELECTRONICS CO.**  
188 Washington St., New York 7, N. Y.

PHONE CO-7-6443  
DEPARTMENT EA  
SEND FOR BULLETIN



## ANNOUNCING!

Greater Values Than Ever Before in Our New Larger Store At 189 Greenwich St., N. Y. 7. (Come in and Browse Around)



## ANNOUNCING!

The Opening of Our New Larger Quarters at 189 Greenwich St., N. Y. 7 (formerly at 63 Dey St.)

### 1 K.W. POWER SUPPLY KIT

2500-0-2500 Volts @ 500 MA

2000-0-2000 Volts @ 500 MA  
(oil-filled Xformer from BC610) **\$39.95**

- 1—Swinging choke . . . . . 14.95
- 1—Smoothing choke . . . . . 7.95
- 1—Filament Xformer . . . . . 9.95
- 2—2 Mfd., 3000 v. Condensers, ea. 3.45
- 2—872A Tubes . . . . . each 1.95
- 2—Plate Caps for 872A . . . . . each .20
- 2—Sockets for 872A . . . . . each 1.19
- 2—Hash Filter Chokes . . . . . pr. .79

# \$79.50

All parts New! Reduced to

### SELENIUM RECTIFIERS

#### Full Wave Bridge Type

INPUT		OUTPUT		
up to 18v AC	up to 12v DC	1/2 Amp.	\$0.98	
up to 18v AC	up to 12v DC	1 Amp.	1.95	
up to 18v AC	up to 12v DC	5 Amp.	4.45	
up to 18v AC	up to 12v DC	10 Amp.	7.45	
up to 18v AC	up to 12v DC	15 Amp.	9.95	
up to 18v AC	up to 12v DC	30 Amp.	14.95	
up to 36v AC	up to 28v DC	1 Amp.	3.45	
up to 36v AC	up to 28v DC	5 Amp.	7.45	
up to 36v AC	up to 28v DC	10 Amp.	12.45	
up to 36v AC	up to 28v DC	15 Amp.	18.95	
up to 115v AC	up to 100v DC	.25 Amp.	2.95	
up to 115v AC	up to 100v DC	.6 Amp.	6.95	
up to 115v AC	up to 100v DC	5 Amp.	19.95	
up to 115v AC	up to 100v DC	3 Amp.	12.95	

### OIL CONDENSERS NATIONALLY ADVERTISED BRANDS

All Ratings D. C.

2x.1mfd. 600v	\$0.35	1mfd. 2000v	\$0.95
.25mfd. 600v	.35	2mfd. 2000v	1.75
.5mfd. 600v	.35	4mfd. 2000v	3.75
1mfd. 600v	.35	10mfd. 2000v	4.95
2mfd. 600v	.35	1mfd. 2500v	3.98
4mfd. 600v	.40	2mfd. 2500v	2.49
8mfd. 600v	1.10	1mfd. 2500v	1.25
10mfd. 600v	1.15	25mfd. 2500v	1.45
3x.1mfd. 1000v	.45	5mfd. 2500v	1.75
.25mfd. 1000v	.45	.05mfd. 3000v	1.95
1mfd. 1000v	.60	1mfd. 3000v	2.25
2mfd. 1000v	.70	25mfd. 3000v	2.65
4mfd. 1000v	.90	1mfd. 3000v	3.50
8mfd. 1000v	1.95	12mfd. 3000v	6.95
10mfd. 1000v	2.10	1mfd. 4000v	5.95
15mfd. 1000v	2.25	1mfd. 5000v	4.95
20mfd. 1000v	2.95	1mfd. 7000v	2.95
24mfd. 1500v	6.95	1mfd. 4000v	6.95
1mfd. 1750v	.89	2mfd. 3000v	3.45
1mfd. 2000v	.95	2x.1mfd. 7000v	3.25
.25mfd. 2000v	1.05	.02mfd. 12000v	9.95
.5mfd. 2000v	1.15	.02mfd. 20000v	11.95

### HIGH CAPACITY CONDENSERS

10,000 mfd.—25 WVDC	\$6.95
2x3500 mfd.—25 WVDC	3.45
2500 mfd.—3 VDC	.39
3000 mfd.—25 WVDC	2.49
2x1250 mfd.—10 VDC	1.25
1000 mfd.—15 WVDC	.99
200 mfd.—35 VDC	.59
100 mfd.—50 WVDC	.49
4x10 mfd.—40 VDC	.89
4000 mfd.—18 WVDC	1.95
4000 mfd.—25 WVDC	2.95
4000 mfd.—30 WVDC	3.25

### FILTER CHOKES

#### HI-VOLTAGE INSULATION

8 hy @ 550 ma.	\$7.95	325 hy @ 3 ma.	\$3.45
8 hy @ 300 ma.	3.95	1 hy @ 800 ma.	14.99
25 hy @ 160 ma.	3.49	10 hy @ 250 ma.	2.45
12 hy @ 150 ma.	2.25	10 hy @ 200 ma.	1.98
30 hy @ 70 ma.	1.39	10/20 @ 85 ma.	1.59
.05 hy @ 15 amps.	7.95	15 hy @ 125 ma.	1.49
1 hy @ 5 amps.	6.95	15 hy @ 100 ma.	1.39
4 hy @ 600 ma.	5.95	3 hy @ 50 ma.	.29
200 hy @ 10 ma.	3.49	30 hy Dual @ 20 ma.	1.49
600 hy @ 3 ma.	3.49	8/30 hy @ 250 ma.	3.50
.065 hy @ 2.5A.	2.49	10 hy @ 100 ma.	1.29

## RADIO TUBES

NEW! STANDARD BRANDS!

1B24	\$4.75	726A	\$4.50	1LH4	\$7.79
1B26	4.95	800	1.69	1LN5	.79
1B29	.89	801A	.49	1Q5GT	.95
1N21	.59	802	2.95	1R5	.79
1N23	.59	803	3.75	1S4	.69
1N34	1.59	805	3.95	1S5	.59
1P24	.89	807	1.19	1T4	.59
2AP1	2.39	808	1.95	3Q4	.89
2C22	.19	809	1.98	3Q5	.69
2C26	.29	810	4.89	3R5	.59
2C40	.74	811	1.49	5Y4GT	.49
2C44	.69	812	1.39	6A7	.59
2C46	3.75	813	5.25	6A8GT	.59
2D21	1.19	814	2.75	6AG5	.89
2J21	12.45	815	1.45	6AG7	.98
2J22	12.95	816	1.10	6HG	.95
2J26	9.95	826	.49	6B6G8	1.49
2J31	11.49	829B	2.89	6C6	.49
2J32	14.75	832A	2.49	6D6	.49
2J36	24.95	833A	29.50	6F5GT	.49
2J37	18.95	836	.79	6F6GT	.49
2J38	14.75	837	1.19	6F6	.59
2J39	18.95	838	2.95	6H6GT	.39
2J40	18.95	841	.50	6J5GT	.42
2J46	18.95	843	.39	6J5	.55
2J49	26.95	845	3.29	6J7GT	.55
2J51	69.50	851	17.95	6K6GT	.49
2J54B	18.95	860	1.98	6K7GT	.55
2J55	15.95	861	11.95	6L6G	.95
2K25	24.95	865	.79	6L6	1.23
2K28	6.95	866A	.98	6L7	.79
2V3G	.79	866JR	1.10	6Q7GT	.55
2X2	.27	869B	18.75	6SA7GT	.49
3A1	2.39	874	.69	6SC7	.55
3BP1	1.39	876	.69	6SF5GT	.59
3B22	.59	878	1.29	6SH7	.49
3B24	1.29	884	.99	6SJ7GT	.49
3B26	.89	885	.78	6SK7GT	.49
3CP1	2.95	902P1	5.95	6SL7GT	.59
3C32	19.95	905	4.95	6SN7GT	.59
3C33	2.49	923	.69	6SQ7GT	.49
3C24	.29	984	.24	6V6GT	.59
3C30	.59	955	.35	6X5GT	.69
3C31	1.49	956	.45	7A8	.69
3DP1	2.25	957	.24	7B7	.69
3DD1A	1.50	958	.35	7C5	.59
3E29	3.39	1011	.98	7C8	.69
4B24	2.25	1013	.58	7H7	.49
4E27	12.95	1016	.75	7Y4	.49
5A24	4.75	1019	.21	12A8GT	.63
5BP1	1.49	1022	1.59	12A7E	.49
5BP4	2.45	1024	.85	12A6	.75
5CP1	1.99	1028	.49	12B36	.59
5D21	18.95	1025	.29	12B36	.59
5FP7	.85	1029	.29	12J5GT	.49
5JP1	11.95	1030	1.98	12J7GT	.49
5J29	18.95	1038	.49	12Q7GT	.59
5J30	18.95	1054	1.98	12SA7GT	.49
5L21	11.95	1060	.68	12SF5GT	.49
5R4GY	.89	1060	.45	12SK7GT	.49
5T4	.69	2051	.65	12SQ7GT	.49
5U4G	.45	8005	1.98	12SR7GT	.49
5V4	.72	8011	.65	12S7GT	.49
5X4	.59	8012	1.39	12T8GT	.49
5Y3	.35	8013	.89	14A7	.69
5Z3	.55	8014	3.98	14B6	.69
5Z4	.79	8014	1.39	14Q7	.69
6AB7	.85	8020	.89	24A	.49
6AC7	.59	8025	3.45	25L6GT	.59
6AK5	.89	9001	.39	25Z5	.47
6AL5	.59	9002	.35	25Z6GT	.45
6C4	.25	9003	.35	25Z7	.45
6D4	1.29	9004	.29	27	.49
6J4	5.49	9005	.39	30 Spec	.39
6J6	.89	9006	.29	32L7GT	1.19
6Q5G	1.25	CK1005	.29	35/51	.59
7B7	17.95	CK1006	.69	35A5	.59
10Y	.19	CK1690	1.49	35L6GT	.49
12A6	.25	FF50	.50	35V4	.39
12DP7	13.95	F123A	8.95	35Y4	.69
12GP7	12.95	F127A	17.50	35Z3	.57
15E	.89	F128A	39.50	35Z5	.49
15R	.39	F660	39.50	36	.79
75TL	2.49	FG8A	3.95	41	.52
100TH	9.95	FG105	8.75	42	.49
211	.49	FG238B	29.50	43	.52
227A	3.75	GL146	7.95	45	.52
231D	1.49	GL605	39.50	47	.74
249C	.75	GL697	29.50	50A5	.89
250TH	19.49	HY75	1.25	50B5	.59
304TL	.89	HY615	.39	50L8GT	.59
304TH	3.39	ML100	19.95	50Y6GT	.59
316A	.35	ML101	39.50	56	.54
327A	1.95	ML502	39.50	59	.95
350B	1.95	UR75	.89	70L7GT	1.29
368AS	1.79	UR90	.65	71A	.59
371B	.99	VR105	.65	75	.65
450TH	29.95	VR150	.65	76	.49
527A	4.89	VT127A	2.49	77	.49
531	2.50	VO111	.49	78	.49
559	.75	OZ1	.59	80	1.55
703A	2.95	IA7GT	.59	82	.89
705A	1.49	IH5GT	.54	83	.89
706GY	18.95	IN5GT	.59	83V	.89
714AY	6.95	ILA4	.95	84	.59
715B	9.95	ILA6	.95	89	.69
715C	18.95	ILB4	.95	117L7GT	1.15
717A	.59	ILC6	.95	117P7GT	1.15
721A	1.59	ILD5	.95	117Z3	.49
723A/B	12.95	ILE3	.95	117Z6GT	.69
724A/B	17.95				
725A	7.45				

### 500 WATT POWER SUPPLY KIT

(Ideal for BC-191 & BC-375E)

- 1—Transformer—Pri: 105/250v.
- 60 cyc. in 5v Steps
- Sec: 1120-0-1120v @ 500 MA
- 2 1/2 v CT @ 10 AMPS.
- 12v @ 14 AMPS.
- 17v @ 2 1/2 AMPS.
- 32v @ .025 AMPS. **\$32.50**
- 2—Filter Chokes @ \$7.95 ea.
- 2—Condensers 3 Mfd @ 2000v DC @ \$4.45 ea. **8.90**
- 2—866 Tubes @ \$8.99 ea. **1.78**
- 2—Plate Caps Ceramic @ \$.20 ea. **.40**
- 2—Sockets @ \$.20 ea. **.40**
- 1—Pair Hash Filter Chokes **.79**

# Extra Special Buy \$49.50

### TRANSFORMER—115 V. 60 Cy. HI-VOLTAGE INSULATION

371v @ 10 ma.; 2x2 1/2v @ 3A	\$9.95
2500v @ 15 ma.	4.95
2500v @ 4 ma.; 2 1/2v @ 2A; 6.3v @ 1 amp.	5.95
2150v @ 15 ma.	3.95
1	

# SPECIAL SURPLUS BROADCAST OF OUR SUPER SPECIALS!!!



## Amertran "TRANSTATS" Voltage Regulator



11.5 KVA 50/60 cy. Commutator range 0-115 V. Max. Amps. 100. Reconnection diagram available for 230 V. 50 A operation. BRAND NEW. Factory Cases \$100.00  
 2 1/2 KVA fixed winding 115/170V. Commutator range 0-115 V Max Amps. 5.5 \$2.50  
 2 1/2 KVA fixed winding 115/170V Max Amps. 5.5 \$2.50  
 2 1/2 KVA fixed winding 115/170V Max Amps. 5.5 \$2.50

103-126 V. Max AMPS. 2.17  
 KCS 10 W Output w/spare parts PHONE, AND CW opt. \$45.00  
 RA-50A WESTERN ELECTRIC RADAR HIGH VOLTAGE POWER SUPPLY FOR SCR 296A—Consists of trans. 20,000 VCT 750 VA Filtering by .05 MFD @ 12,500 V with two 705A Tubes. Fil trans. supplies 5 V 10 A @ 15,000 VT 2 1/2 x 17 x 11 1/2 \$49.95  
 LAB METERS—1 1/2" scale desk type: 150-0-150 MADC LN \$2.50  
 TRANSMITTER AND RELAY RACK CABINETS—Chrome decorated hinged door on top and back with catch. Amateur or W.E. notched. Black cracked 2 3/4" H. 18" D Panel space 2 1/2" LN \$15 ea. 2 for \$27.00  
 PE204 VIBRATOR POWER SUPPLY—Input 12 VDC Output Two 4.3 VDC @ 50 MA; Two 45 VDC @ 0.5 MA; Two 85 VDC @ 5 MA. Loaded with parts. \$1.00  
 BATTERY CHARGERS—Input 115 V 60 cy. Output 7.5 V 6 A. Portable Insulated leads. \$2.25  
 WILLARD STORAGE BATTERIES—Used in GE Portable Model LB350—2 V 20 AH. 1/4" x 3 1/4" x 5 1/2" @ \$2.50 each. 10 \$20.00, case lots of 36... ea. \$1.50  
 INTERCOM SETS—Two way system for YR shack and home. Battery oper. Complete w/wire, per \$9.95

"FLASHLITES" by KWIKLITE—2 cell metal—60c PLASTIC 75c; 3 CELL METAL—80c; PENLITES 35c  
 25' EXTENSION LIGHT heavy duty cord. Switch on handle. Metal bulb protector. \$2.10  
 BATTERY CLIP ASSEMBLY—8 two cond. cord w/2 prong Hubbell male and female connector, heavy duty Alligator battery clips on ends. \$6.94  
 B & W 300 WATT TANK COILS—4.5-5.7 MC @ 75c; 20 METER W/LINK @ 95c; 40 METER W/LINK @ 95c; Bud 160 METERS 50 W Socket type \$9.95

WESTERN ELECTRIC PRECISION CRYSTALS—40 Meter Band 7270 KC 95c ea. 2 for \$1.75  
 DAVEN SOUND ATTENUATORS. Compact constant impeded attenuators that will dissipate 10 W in any position. Ladder network. Type 350A 30/30 ohms impeded. Attenuation 2 DB. Linear. \$2.50  
 GUYWIRE—1/16" Dia. Galv Tuff Steel. Excellent elasticity. Rust proof. Ideal for TV antenna installations. 1000 ft rolls. \$3.00/M  
 HEAVY DUTY PLATE TRANSFORMER—Amertran Pri 115/230 VAC 60 cy Soc. 4720/2385. KVA 1.66 RMS 12 KV. Wgt. 150# 11"x11"x3" \$27.50  
 RL-42B ANTENNA REEL—W/MOTOR AND GEAR BOX—Perfect beam rotators. Wt. 4 lbs. magnetic clutch. Reversible with SPDT switch. \$3.95  
 "BEAM INDICATOR" SELSYNS—GE model 2JIG1. Operates from 57.5/57.5 V. 400 cy w/wiring diagram for 110 V 60 CY oper. \$2.50 pair. Also available GE Model 2J1F1 115/57.5 V 400 CY. \$3.00 pair  
 SELSYNS—Diehl/BEID SYNCHRO TRANS. MITTERS. 115 V 60 cy 3" Dia. ea. \$4.35 Pr. \$7.95  
 ANTENNA CHANGE OVER SWITCH—SPDT, knife operated. Heavy duty. Isolantite insulation. 25c  
 HEINEMAN CIRCUIT BREAKERS—24 VDC @ 220 A. SPST 95c ea.; 0811 M-10. 24 VDC @ 10 A. SPST \$1.45. 0322M-10 24 VDC @ 15 A. DPDT. \$2.25  
 SYNCHRON MOTORS. Model 600 110V 60 cy. 1 RPM 1/4" sh. \$2.95  
 HEAVY DUTY AIR COOLED RESTORERS. 52 ohms or 10 ohms 1000W. Your choice. \$1.00  
 REMOTE CONTROLS. RM29A Telephone Units, no ext. power nec. Good up to 50 miles. pair \$12.95  
 Magneto  
 CALORID HEATERS GE. #5A760 115V 200W \$1.50  
 GE. 5A699 65W 87.5V. .75  
 G.E. FUSE HOLDERS TYPE EL-1. Neon lamp indicating Midget size #6328725G1. 15A. \$3.95  
 G. E. 6227889G1. 60A. .49

PHONES—HS-300 600 OHM IMPD. rubber ear inserts LN 35c ea. 65¢ new. HS-23. 8,000 OHM IMPD. LN. \$1.00. New \$1.25  
 "MIKES"—T-17 1/2" hand mike, carbon. .95c  
 T-32 Carbon. Desk mount. \$3.25

GONIOMETERS. Western Electric Two Fixed Coils 90° apart with center rotary coil. .79

YJ RADIO EQUIPMENT. Two Channel, automatic responding Radar Beacon or Racon. Designed for shore installation. Automatically transmits coded signals in reply to interrogating signals from craft equipped with radar or IFF equipment. Replies to interrogating signals in the (A) Band 176 MC. (B) Band, 515 MC. Rectifier power unit; A and B Band transponders, transmitter and receiver complete with 30 tubes, 115/170 36" L. 18" H. 17" W. Wgt. 290 lbs. LN. Price \$80.00  
 SOLDERING IRONS JACKSON "STANDARD" No. 223. Removable tip 150 Watt 115 VAC/DC \$2.95. General Electric Model 1-79 115 VAC/DC 250 Watt. Removable tip. Heavy duty. \$7.50  
 FRACTIONAL HORSE POWER MOTORS—OSTER 27.5 VDC 1/20 HP 3600 RPM SHUNT wound. \$7.55  
 UNIVERSAL ELECTRIC 115 VDC. .12 AMPS. 003 HP 5000 RPM. \$4.50  
 OSTER 6 VDC 1.8 AMP'S 5000 RPM. 6 oz./in. torque W/BLOWER Size 1 1/2 AND IMPELLER \$4.50  
 EMC 110 VAC 60 cy. 1/40 HP 1725 RPM. LN. \$4.50  
 OSTER 27.5 VDC 100 HP. Series 7000 RPM. \$2.50  
 UNIVERSAL ELECTRIC 28 VDC. 0.6 AMP'S 6000 RPM. \$2.50  
 EMERSON 24 VDC 24 AMP'S. Series wound. 100 RPM 160 OZ/FT torque. \$7.95  
 GE. 27VDC 5 AMP'S 250 RPM 8 OZ/IN LN. \$2.50

DYNAMOTORS—PE103. HALLENTINE 6V-21A/12V-11A; 500 VDC @ 160 MA W/O Filter. \$8.95  
 GE. 28 VDC 1.25 AMP'S 575 VDC @ 160 MA. \$3.95  
 DM21C 14V @ 3.3A. 235V @ 0.90A. \$3.50  
 PE94C SCR252 24VDC W/Filter. \$3.25  
 BD-AR83. PIONEER 14 VDC @ 6.5 AMP'S. 375 VDC @ 150 MA. \$2.95  
 DM410. 14V 2.6A; 240V 80 MA W/Filter. \$2.95  
 PE-36D. 28 VDC @ 1.25 A 250 VDC @ 60 MA. \$2.00  
 EUCOL. 13 VDC @ 3.3 A 220 VDC @ 100 MA. \$2.50  
 WINCO. 18 V. 450 VDC @ 150 MA. \$1.95  
 DM36-D. 28 VDC @ 1.4A; 220V @ 80 MA. \$1.05  
 CHOKES—2.5 H @ 700 MILS. 14 OHMS. \$5.95  
 20 HENRIES @ 45 MILS. 500 OHMS. .60c  
 40 HENRIES @ 20 MILS. .80c  
 150 HENRIES @ 1 MIL. 7,000 OHMS. .45c

TRANSFORMERS—THORDARSON (70R2C) 350-0-350 @ 115 V 60 cy. 145 MILS; 5 V @ 3 A; 6.3 VCT @ 4.5 A. \$4.25  
 JEFFERSON PTL-20 Volts @ 10 A. \$3.95  
 POWER Thordarson (92R21) Sec. 389-0-389 Volts @ 200 MA; 5 V @ 3 A; 6.3 VCT @ 5 A. \$4.95  
 POWER. 650 VCT @ 150 MA; 5 V @ 3 A; 6.3 V @ 5 A. \$4.00  
 POWER. 430 VCT 145 MA; 6.3 V @ 5 A; 5 V @ 3 A. \$3.50  
 OPEN CORE POWER. 18 V @ 6 A. \$2.50  
 POWER. 600 VCT 10 MA; 5 V 2 A; 6.3 V 2 A \$2.50  
 Audio-Output. Pri 5000 OHMS Sec 16 OHMS BERM. \$9.50  
 SPALD. \$9.50  
 MIKE TRANS—PRI 150 OHMS Sec. S. Grid. Ratio 20:1. "UTC". .85c  
 MIKE TRANS—PRI 35 OHMS Sec. 800/200 OHMS \$1.00  
 INPUT—Ratio 1:2. Freq. Resp. 500-15,000 within 3 DB. \$6.00  
 AUDIO—FEDERAL "OUNCER" PH 8000 OHMS SEC 600 OHMS. .60c  
 MIKE TRANS—"OUNCER" PRI 300 OHMS. Sec. 25 MEG. \$5.00  
 OUTPUT TRAN. BC 221. 125 OHMS. .35c  
 Raytheon PH Type U 836A. Sec. 2.9 V @ 19A. \$1.95  
 Raytheon PH Type U-8370 Pri—220/440 60 CY. SEC. #1, #2, #3—2.5 Volts @ 5 Amps. Sec. #4 2.5 Volts @ 15 Amps 8KV Test. Price. \$6.50  
 Raytheon Dist Type CRP-30382. Pri: 220/440 V 1-71 A Sec: 115 V @ 6.5 A. 4000. \$14.00  
 Raytheon Fil T-5083 Pri: 220/440 V 60 Cy Sec. 5 Volt @ 30 Amps. 1780 test Volts. \$10.95  
 Raytheon Plate and Fil U3508A. 640V @ 80 Ma 6.3 V @ 3.2A; 5 V. \$3.00  
 Raytheon Plate and Fil Type U8824 770 V @ 107 A; 5 V @ 3 A. 5 V @ 6 A. 2.5 V @ 10 A. \$3.95  
 FUSE HOLDERS—3 AG HUSS TYPE HCM. \$1.50  
 NEON TESTER—Indicates 60-500 VAC/DC. Useful for determining open or short CKTS. .39c  
 CORDS Rubber 7' W/PL-68 .22c  
 PANEL LAMPS—#44 and #47 5 1/2" ea. #51 @ 4 1/2" ea. 6 S @ 110 V D.C. BAY. 12 1/2" ea. neons. NEON LAMPS—NE 45 @ 20c ea.; NE 48 @ 15c ea.; NE 32 @ 25c ea.; NE 2 @ 8c ea. cartons of 10 only.

B.C.-604 F.M. TRANSMITTER. Wide or narrow-band FM. 30 watt power output. Excellent possibility for ten or eleven meter exciter. Range 20-27.9 MC. Working space permits modification. Complete with tubes but less power supply and xtls. LN. \$11.50



All prices f.o.b. Boston. Orders accepted for rated concerns on open accounts. Net 30 days. Minimum order \$3.00.

CATHODE RAY TUBES—5BP1 @ \$3.00; 5 BP4 @ \$4.95; 5 CP1 @ \$3.50; 3 EP1 @ \$2.95.  
 HOT SPECIALS—CONDENSERS—Standard Brands 2x50 MFD @ 150 WVDC TUBULAR. .50c  
 10 MPD. @ 200 WVDC TUBULAR. .20c  
 16 MPD. @ 600 WVDC TUBULAR. @ ea. 15c  
 25 MFD. @ 600 WVDC OIL IMPREG TUBULAR CAW 481074 17c ea.; 10 for \$1.50  
 Same as above but 400 volt 15c ea. 10 for \$1.35  
 .01 MFD @ WVDC PAPER TUBULAR HERM. SEALED. 10c ea.; 10 for \$1.00  
 RAYTHEON DEFLECTION COILS. #U8820 \$1.85  
 51977. CRT Metal Case. \$40.00  
 UNDERWATERSOUND EQUIPMENT MODEL QBC. INDICATORS CBM 55081 Ranges 0-1000 and 0-5000 yds. 115 V 60 cy. \$35.00  
 DRIVER RECTIFIERS CBM 52265. Freq. 18-25KC. Emission A1. 30W Output 115V 60 cy. \$40.00  
 RECEIVER AMPLIFIER CBM 46169. Freq. 17-25KC 115V 60 cy. \$35.00

BECKMAN HELIPOTS Model A. 10 turns, 3600° rotation, 20,000 ohms resistance, 5 watt 0.5% guaranteed linearity, 5% resistance tolerance. With aluminum stop as pictured \$5.00 Without stop \$4.50  
 ALL METAL BINDING POSTS—40 for \$1.00  
 POLYSTYRENE RODS—5" L 3/8" dia. \$1.75  
 TV SCREEN (Frosted Glass) 2 1/2 x 2 1/2 x 1/8. \$3.00  
 SHEET ALUMINUM 1/4" x 24" x 27" @ \$2.00  
 ARC-5 ACCESSORIES KC COIL/BC459A 30c; 4 for \$1.00  
 #7278 SLUG TUNED IF FREQ. 7-9 MC 30c; 4 for \$1.00

ROYAL PLUG FUSES—15 or 25 AMP. \$2.12  
 FRICTION TAPE—1/2 lb. 3/4" wide. 15¢ 10/1.00.  
 CARBON PILE VOLTAGE REGULATORS—BENDIX/ECLIPSE TYPE 956 1 Style A. 13 V. \$1.25  
 ECLIPSE TYPE 1339-4-6. 115 AC W/Rectifier/Transformer Unit. \$2.95  
 ECLIPSE TYPE 1339-1-A. 115 AC. \$2.95  
 LI-LAND Set at 13 Volts. \$1.25  
 PHONO MOTORS—GENERAL IND 115 V 60 cy. .5 A. 80 RPM Minus turntable. \$2.50  
 Same as above but 115/230 Volt AC. \$4.00  
 SOCKETS—OCTAL TUBE—Either in red or blue bakelite. MTD in metal plate. .10c  
 MINIATURE—"POLY" with metal flange. 10 for \$1.25

MAGIC EYE—with 8" of wire attached. Each. 25c  
 AMPHENOL—4 and 5 prong steatite sockets W/out MTG rings 6c ea.; 10 for .50c  
 TRANSMITTING—Heavy Duty 8 prong isolantite. 15c ea.; 10/\$1.25; 4 or 5 prong. Each. .12c  
 "CINCH" OCTAL ISOLANTITE WITH MTG PLATE 15c; 10 for \$1.25  
 WAVE TRAP PERMEABILITY SLUG TUNED IF W/AIR TRIMMERS 1500 KC. .55¢; 4/2.00  
 MICRO SWITCH—NO or NC. .75c  
 MICRO SWITCH—W/Leaf only NO. .69c  
 MICRO SWITCH ASSORTMENT. 5 for \$1.10  
 POINTER KNOBS 1 1/4" L. 1" H. 3/4" DIA. Black; 10/70c.  
 PLAIN BLACK ROUND FLUTED 1" Dia. 1/4" SH 8¢ 10/70c.  
 Mounting Rock for ARC—5. \$2.12  
 WEST. WATT HOUR METERS Type CS 240V/60cy/1 ph 15 Amp. 3 Wire. \$12.50  
 Type CS. 120V/60cy/1 ph 15 Amp. 2 Wire. \$9.50  
 Type CA. 120V/60cy/1ph 15 Amp. 2 Wire. \$9.50  
 BELL RINGING TRANSFORMERS—Input 115V 60 cy Sec. 6 V 25 VA \$1.69; 6V 200 VA. \$2.00  
 25V 25 VA @ \$1.00; 10. \$7.50

METAL BOXES—2 3/4" x 2 1/2" x 1 1/8" (Clean) @ \$8.45  
 1 1/2" x 3 1/2" (With compartments) \$2.50  
 1 1/2" x 1 1/2" x 3 1/2" (With partitions) \$2.50  
 1 1/2" x 1 1/2" x 9" (Clean) \$2.50  
 SHAFT COUPLING—bakelite 1/4" 16¢ 10/1.25  
 HARDWARE BY THE POUND—Our assortment of screws, nuts, washers, cable clamps, lugs, spacers, springs, etc. 1 lb. assortment. \$5.00  
 25 lbs. assortment. \$10.00  
 BRONZE #10 LOCKWASHERS. Per M. \$1.00  
 THROAT MIKE—T-30 39c; LIP MIKE—T-45. 39c  
 INSUL BATTERY CLAMPS. Heavy duty. .pr. 30c



NEW SWITCH INTERLOCKS. Cory Type B557. Single Key Oper. Used for interlocking of doors, vaults, reactor or resistor enclosures, oil circuit breaker tank compartment and disconnecting switches \$1.98  
 Cory Type B986. Single Key Oper. SPST SW. w/Vale Cyl Lock. 60A tumbler lock. \$2.49  
 Cory Type H1536. Supervisory Oper. 2 Key Type. \$2.95  
 STANDARD BRAND FIELD RHEOSTATS. 32 Ohms 2.5a 600 v plate. 6¢ Plate. \$2.98  
 Dual 6" plate. 062 ohms. 32.4A 600 V max. \$7.50  
 Four 13" plate in series 100 Ohms 8-2A 345 V Max. \$19.95

# ELECTRO Sales Co.

DEPT. E3, 110 PEARL ST., BOSTON 10, MASS. . . . LIBERTY 2-5589 . . . HANCOCK 6-5069



**VOLTAGE REGULATOR UNIT**  
 Any unfiltered source of 350-400 volts DC may be connected to this unit to provide filtered and regulated output at 150 and 300 volts. Contains 12 Hy-choke; 3-4 mfd. capacitors; bleeder, divider and current limiting resistors, etc. Ideal in the Lab for experimental set-ups. Complete, brand new with 2-VR 150 tubes.

**Brand New \$7.95**

**OSCILLOSCOPE 400-2600 CY. POWER SUPPLY**

**Input:**  
 80 or 115 volts, 400 to 2600 cycles

**Output:**  
 1200 volts D.C. at 1.5 MA., 400 volts D.C. at 130 MA., 6.4 A.C. volts at 0.8 A (ins. for 1500v. D.C.)

Includes tubes: 1-5R4GY, 1-2x2, 1-6AK5, cathode ray tube socket, resistance capacitance filter, two focus controls, an intensity control and 6AK5 reinsertor circuit.

**Brand New \$13.75**

**LINEAR SAWTOOTH POTENTIOMETER**  
 W.E. No. KS 15138

The d-c potentiometer consists of a closed type die-cast aluminum alloy frame consisting of a continuous resistance winding to which electric power is supplied through two fixed taps 180 degrees apart. Two rotating brushes (180 degrees apart and bearing on the resistance winding) and two take-off brushes are provided for the output voltage. Varying the position of the brushes varies the output voltage in accordance with a linear sawtooth wave. The potentiometer is excited with 24-volt direct current, is arranged for panel or bracket mounting, is approximately 3-11/16 inches in diameter, 3 inches deep, 4 3/4 inches long, and has an approximate weight of one pound. External connections are made through a standard AN type connector.



**Brand New \$5.75**

**SHOCK MOUNTS**

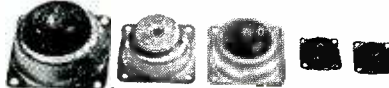

A. Lord #20, 3" x 3" x 1 1/4" . . . . . \$ .40  
 B. U. S. Rubber #5150 C, 2 3/4" x 2 3/4" x 1 1/4" . . . . . \$ .30  
 C. Lord 15, 2 3/4" x 2 3/4" x 1 1/4" . . . . . \$ .25  
 D. Lord #10, 1 3/4" x 1 3/4" x 3/4" . . . . . \$ .10  
 E. Lord #3, 1 1/4" x 1 1/4" x 3/4" . . . . . \$ .10

**BRAND NEW**

**G. E. 400 CYCLE SERVO AMPLIFIERS**  
 Type 2CV1C1



**Brand New . . . . . \$29.50**  
 Metal Dust Cover Included

**STEPDOWN TRANSFORMERS**



**Input:** 115 V. 60 cycles.  
**Output:** 20 V., at 10 amps. Also tapped at 6V., for pilot light. Ideal for Selenium Rectifier Applications, etc.

**Brand New \$2.45**

**10 CM WAVEGUIDE**



Solid bronze, 90° elbow flatwise bend.

**Brand New \$20**

**SELSYN GENERATOR**  
 Briqge Type



Type 2JIF3-115 volts—400 cycles. Brand New.

**Price \$3.95**

**SELENIUM RECTIFIER**  
 Briqge Type



**Input:** 30 V. AC.  
**Output:** 28 V. DC., 1.1 Amps.

**Brand New \$2.75**

**MICROWAVE PARABOLOIDS**



Ideal for Microwave experimental work. Spun Magnesium dishes Reinforced Perimeter 17 1/2" Diameter x 4" Deep Two sets mounting brackets on rear Open center hole 1 1/2" x 1 5/8"

**Per Pair, Brand New . . . . \$8.75**

**MERCURY CONTACT RELAY**  
 Western Electric D-163479



For applications in all types of high speed switching devices. Long service life, high operating speeds. Large current and voltage handling capacity, uniform and contact operating characteristics under adverse atmospheric conditions. Hermetically-sealed mercury-wetted contacts in gas-filled glass envelope. Free from moisture, dirt, corrosion and atmospheric pressure. Single pole double throw contacts. 7000 hours life at 60 operations per second. Two coils of 700 ohms, and 3300 ohms. Operating current, c.s. series aiding—6.6 mls. Release current, coils series aiding—5.2 mls. Four page Technical Data on request.

**Brand New in Original Cartons, \$4.75**

**SOUND POWERED CHEST SETS**  
 No Batteries Required  
 Ideal for television installers, or any antenna measurement work. Leaves hands free to make adjustments. Set consists of microphone and headset as illustrated.



**Brand New Per Set \$19.50**

**MOTOR GENERATORS**



Brand new. Built by Allis Chalmers to rigid specifications of the U. S. Navy

K.V.A. output 1,250 R.P.M. 3600  
 K.W. output 1. Cont. Duty Ph. Single  
 P.F. 80 Cycles 60  
 Volts input 115 D.C. Volts output 120 A.C.  
 Amps input 14 Amps output 10.4  
 Length 26"; width 12 7/8" height 13"  
 Compound accumulative A.C. and D.C. fields. Centrifugal starter. Splashproof covered. Frequency adjustable to load, plus or minus five cycles.

**PRICE \$97.50**  
 Identical Machine, but 230 volts D.C. input, \$125.00

**SCUND POWERED TELEPHONE HANDSETS**  
 W. E. Type TS-10M.  
 Complete with 7 ft. cord.



**Brand New \$16.95**

**POTENTIOMETER**



20,000 ohms, complete with engraved dial assembly.

**Brand New . . . \$1.95**

**SOUND POWERED TELEPHONES**  
 Type TP-3



For two-way signalling for voice communication. No batteries needed. May be used on metallic or grounded circuits, on wire lines, cables or circuits using local-battery telephones, switchboards; two-way ring-down trunk circuits of common battery switchboards, etc. Contained in treated waterproof fabric cases with adjustable carrying straps.

**Brand New \$39.50**

**COAXIAL PHONE JACK ADAPTER P-106**



Phone jack, one end. Coax. Receptacle other end.

**Brand New Price \$1.35**

All prices indicated are F O B Tuckahoe, New York. Shipments will be made via Railway Express unless other instructions issued.

**ELECTRONICRAFT**  
 INC.  
 5 WAVERLY PLACE TUCKAHOE 7, N. Y.  
 PHONE: TUCKAHOE 3-0044

All Merchandise Guaranteed. Immediate delivery, subject to prior sale.  
 All Prices Subject to Change Without Notice

**— THE BEST IN ELECTRONIC SURPLUS —**



**AMAZING "SNOOPERSCOPE" TUBE**

An infra-Red Image Converter Tube made in Britain that enabled combat men to see in the dark and through camouflage. Type CIK-143. No scanning or amplifiers necessary! Uses only infra-red light source and simple high-voltage supply which can be easily built from toy ignition transformer and rectifier tube. An optical system for long-range work or where magnification of image is desired, can be made from toy telescope. Shows image in greenish-white color on 1 3/4" screen. Has wonderful possibilities for darkroom work, fog penetration devices, night photography, etc. With technical data and diagrams. All NEW.

individually boxed tubes.

PRICE, EACH  
TWO, FOR

**\$10.00**  
\$15.00

**AMPLIDYNE MG SET**  
Motor 110/220, 60 C. A. C.

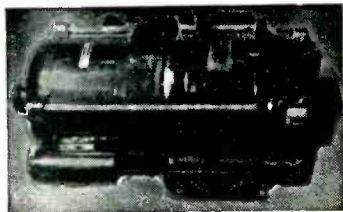

For Automatic or Remote Control of heavy equipment. Mfd. by General Electric. Generator is Type V-5875677, motor 73AB53; Navy type CG-21ABU. Generator delivers 250 volts, DC, 375 watts. Motor, 115 or 230 volts 1-phase, 60 cycles AC, rated at 3/4 HP RPM-1725. Includes capacitor for starting, and instructions for 115 or 230 volt connections. Generator section can be removed, and entire assembly shortened to make valuable 3/4 H.P. AC motor. Quantity sufficient to warrant this conversion. New Units.

PRICE, EACH ..... **\$60.00**

**32 VDC 110V AC CONVERTER**



Mfd. by Kato Engineering, for marine or farm installation. Rotary type, compact and ruggedly built for continuous duty. Rubber shock mounting on filter case, with complete input and output filtering. Output 110 volts, 60 cycles AC. 225 KVA, but will operate efficiently on loads up to 300 watts. New units only.

PRICE, EACH ..... **\$39.95**  
Quantities, 10 or more, Each **\$32.00**

**FOR OSCILLOSCOPE USERS**

**VOLTAGE DIVIDER PROBE.** Permits viewing and measuring voltage waves of larger magnitudes than normally possible. Consists of 3-piece molded body containing resistors and capacity which make up divider circuit, plus coax cable and alligator clips for connections. Permits measuring and analyzing voltage peak values of 1400 volts, with less loading on source and less wave shape distortion. NEW, with technical bulletin.

PRICE, EACH ..... **\$4.95**

**RADAR**  
**TREMENDOUS ASSORTMENT**

Hundreds of major radar components, mostly for navy types, includes power transformers, wave-guides, plumbing of all sorts, magnetrons, cavity chambers, echo boxes, connectors, antennas. Inspection invited, or write us your requirements.

SF RADAR, NEW and Complete, in original cases with operating spares. PRICE, Complete...\$2500.00

**SPECIAL BARGAINS!**

Simplex-Bludworth Motor-Generators, 110V, DC input, 110/1/60 AC output at .5KVA. New. EACH **\$85.00**  
Holtzer-Cabot M.G., 115V, DC input, 115/1/60 output at .460 KVA. EACH ..... **85.00**  
ESCO M.G. 115V, DC input, 115V/1/60c. output, .460KVA. EACH ..... **85.00**  
Mark II Hand Generators, delivers 162 volts at .03 amps, and 3.1 volts at 3 amps. Complete with seat pedestals, cranks, carrying bags, cords. Packed 4 to a case. NEW. Price per case of FOUR..... **30.00**  
General Electric Model 5AM78AB17 (Amplidyne) Motor Generator set. Motor 3HP, 440V, 3 phase. Output 250V, DC at 3 amps, and 60V, DC at 12.5 amps. Excellent Condition. EACH ..... **80.00**  
SB-23/GTA-2. Console panel; fixed station; non-multiple; cordless board with patchboard, 28 line capacity, no trunks, no connecting positions; fully equipped 28 lines, manual operation; common battery type. 52-5/32"H x 28-5/32"W x 18-5/16"D. Steel cabinet, floor mounting. Used with Army-Navy radar set AN/CPS-4 and Signal Corp SCR-615; part of Army-Navy monitoring equipment AN/GTA-2. New. EACH ..... **\$150.00**  
SB-14/GT. Telephone Power Panel. Welded steel cabinet containing facilities to provide 24 volts D.C. power and 20 cycle ringing power for telephone circuits from a source of 110 volts 60 cycles AC; provides AC power outlet. Included in panel are battery charger (uses Sig. Corp. battery BB-55, not supplied); ringing generator, 6 circuit breakers and 6 power outlets; dimensions approx. 24" long x 15" W; x 45" H., weight approx. 395 lbs. New. EACH **\$175.00**

**RADIO TRANSMITTERS**  
**MODULATORS, AND**  
**POWER SUPPLIES**

*Immediate Delivery from Stock*

2.5 KW Press Wireless, Model 2.5 consisting of 2-sections, one—the 2.5 KW P.A. with power supply, second section containing exciter-driver stages with crystal-controlled oscillator (with oven for constant temperature control). Emission A1. Freq. range 2 to 23 mc. Operates from 220 V.A.C. Excellent condition. **WRITE FOR PRICE.**

2 KW Power Amplifier, Press Wireless, as described above power amplifier section and power supply only. When used with above complete installation provides additional instant-changeover frequency of operation. Also, ideal as a spare PA and power supply for above. **WRITE FOR PRICE.**

TCR—Radlomarine Transmitter, 125 watts (conservative) A1, A2, & A3. For ship or shore stations radio telephony, 6 channels in 2 to 3 mc band controlled by remote control box supplied. Complete RF, modulator and power supply (for 110 or 220 V. 50/60 cycles AC) in one cabinet. Excellent condition, with tubes and remote control box. EACH ..... **\$500.00**

BC—319-A Transmitter, CW only 300 watts output. Freq. range 4.0 to 13.4 mc. Operates from 110/220 volts, 60 cycles AC. Excellent condition. Less tubes. PRICE, EACH ..... **\$300.00**

Wilcox, 96-200A 2-KW RF section, 125 to 525 KC. Large cabinet with complete RF end containing the VFO, intermediate sections and PA stage. Almost new, but lacks PA inductance only. Power supply separate unit not available, but can be built. Less tubes. PRICE ..... **\$800.00**

**MACKAY SHIP TRANSMITTERS.** The following Mackay ship-radio types are available: 150-A.Y, 151-A1, 149-A, 136-A, 104-M, 147-M. Some new, most in excellent condition. Write for prices.

**LINK FM Transmitter Receiver, 70-100 MC.** Model 1498 DC, 50 watts output, wall style cabinet containing transmitter, receiver and 4 V.D.C. power supply, handset. Dim: 34"x21"x11". NEW CONDITION. Complete with tubes, crystals, special telescopic antenna, instruction book. PRICE, EACH ..... **\$600.00**

**RADIO TRANSMITTER BC-339, CW only.** 1-KW output. Freq. range 4.0 to 26.5 mcs. Six crystal positions also M.O., four intermediate stages and two 833s final. Operates on 220 volts 50/60 cycles. Reconditioned. Complete with power supply and one set operating tubes. PRICE ..... **\$2400.00**

**MODEL AT-14A TRANSMITTER.** Mfd. by Phillips. Output A1 275 watts; A2, A3 225W. Freq. range 2 to 20 mcs. Four xtal positions & separate M.O. Operates on 110/200/220/240/260 volts 50/60 cycles. PRICE, complete with power supply & set of operating tubes ..... **\$900.00**

**MODEL SVC100L/110 TRANSMITTER.** Output A1 150-watts, A2-A3 50 W. Mfd. by Phillips. Freq. 2 to 20 mcs, with 6 pre-tuned channels. Operates from 90-260 volts 50/60c. A.C. COMPLETE, with tubes ..... **\$450.00**

**RCA 2-CHANNEL A.F. AMPLIFIER.** 250W, per channel, total 500W. Complete with power supply, voltage gain stages for low level input, metering circuits, in one cabinet approx. 6 ft. high. Operates from 110 volts 50-60c A.C. Almost new cond. with tubes. PRICE ..... **\$750.00**

**BC-1100 (HP 263), 75W, A1, 50W, A2, 4 channel, dial selection of channel. 1.5-10 mcs, 110-260V 25-60c. A.C., with remote control. New. EACH ..... **\$575.00****

**Supreme ship-to-shore transmitter receiver,** 110W output, 9 channel, 2-3 mcs., crystal controlled, for 110V, 60c. A.C. Condition N-2. Complete with tubes and microphone. EACH ..... **\$600.00**

110V, DC to 110V, AC M.G. for above, when used on DC source ..... **\$85.00**

**Northern Radio ship to shore transmitter-receivers,** 5 channels crystal controlled, 65W, output, 110V, DC. 1.5 to 5.6 mcs. With tubes. EACH ..... **\$250.00**

**Halstead model 10LFA transmitters,** A3, 25W, output, 200-400Kc. 110V 60c. operation. Condition N2. EACH ..... **\$100.00**

NOTICE: Prices quoted above do not include crating or packing. Price for packing will be quoted upon specification as to whether export or domestic packing is desired.

**20-40 MC RADIO BEACON EQUIPMENT**

For SCR-508, 528, 608, 628, and Similar Sets

**MODEL RC-163** is designed for ready connection to RADIO SET SCR-508, 528, etc., and 608, 628, etc.—or similar transmitting and receiving equipment. It permits directive transmission and reception, and can also be used for navigation by using two beacons on a base line. The beacon eqpt. consists essentially of a rotating directional antenna (Adcock type) synchronized to an automatic code keyer (which can be removed). Four sets of plug-in inductors are supplied to cover the 20 to 40 mc range. Designed to operate from a 12-volt storage battery, power consumed approximately 54 watts (4.5 amps.). Supplied with antenna array, antenna mount with rotating motor, code discs, audio oscillator, phase-load box, mast sight, tuning indicator-receiver which checks field strength as well as frequency, valuable compass and tripod, control panel, all necessary cables and complete technical manuals for installation, theory and service. Equipment is NEW and export packed, two cases per complete set.

PRICE, EACH ..... **\$169.50**

All Prices F.O.B. N. Y. C.

All Material Offered Subject to Prior Sale

Phone—  
LOnacre 4-4490-1

**TELEMARINE COMMUNICATIONS COMPANY**

280 Ninth Ave.,  
N. Y. 1, N. Y.



**LOW  
PRICES**

**IMMEDIATE  
DELIVERY**

**FULLY  
GUARANTEED**

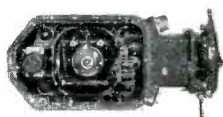

**GYRO  
SERVO  
UNIT**

Pioneer 12800-1-D. 115v. 400 cy. Low inertia motor and follow-up Autosyn. Stock #SA-160. Price \$8.50 each



**Blower Assembly  
MX-215/APG**

John Oster C-2P-1L 28 v. DC. 7000 RPM 1/100 hp. #2 L-R Blower.

Stock #SA-202. Price \$2.95 each

**MICROWAVE  
ANTENNA**

AS-217A/APG 15B. 12 Cm dipole and 13 inch Parabola housed in weatherproof Radome 16" dia. 24 v. DC spinner motor for conic scan. Stock #SA-95. Shipping wt. 70 lbs.

Price \$9.50 ea.



**MAGNESIYS**

Pioneer CL-3

Use as transmitter or indicator on 26 v. 400 cy. or 52 v. 800 cy. May be used as indicator with 360° potentiometer on DC. Stock #SA-6. Price \$1.95 each



**Compass System**

Kollsman remote transmitter and indicator for operation on 26 v. 400 cycles power source.

Stock #SA-22. Price \$6.95 each

**SYNCHROS**

Navy Types

1G, 1F, 1CT, 5G, 5F, 5CT, 5DG, 5HCT, 5SF, 5HSF, 6DG, 7G, etc.

Prices on Request



Elenco B-64 DC Servo Unit—80 v. DC max. armature voltage, 27.5 v. field. 1/165 hp. 3100 rpm. Field current 200 ma. Armature current 200 ma. at normal torque. Stock #SA-211. Price \$12.50 each

Bendix A-14795 DC Motor—28 v. 1 amp. 1/100 hp. Series wound. Use on AC or DC. Stock #SA-234. Price \$1.45 each

G.E. Servo Amplifier—2CV1C1 Aircraft amplidyne control amplifier, 115 volt 400 cycles. Two channel. Uses 2 6SN7GT and 4 6V6GT tubes. Supplied less tubes. Stock #SA-168. Price \$9.50 each

Edison Time Delay Relay—Vacuum sealed in glass, s.p.s.t. contacts normally closed. 30 v. 7 second delay to open. Many experimental applications. Special Price Three for \$1.95

**MOTOR SPECIALS**



Universal Electric DC V.E. KS-5603-L02. 28 v. DC. 0.6 amps. 1/100 hp. 4 lead shunt. Stock #SA-233. Price \$1.95 ea. plus 15c p.p.



**Bodine NYC-13  
AC Motor**

115 v. 60 cycles. 1/40 hp. 1800 rpm. Cont. duty. .55 amps. Stock #SA-245. Price \$9.50 ea.



**EMC DC Gearhead  
Motor**

115 v. DC. Type SPN-33562. Shunt wound. Reversible with s.p.d.t. switch. Output shaft speed approx. 8 rpm. Motor diam. 2 1/2" x 2 1/2" with 2" gear housing extension. Stock #SA-246. Price \$8.50 each.



**Delco 5069466 Motor**

Alnico PM field. 27.5 v. DC. 1" x 1" x 2" lg. Pinion gear on shaft. Stock #SA-65. Price \$2.95 each plus 15c p.p.

Fractional Motors M-100. 3/16 HP. Compound wound. Cont. duty. 115 v. DC. 5" diam. 8" lg. 1 3/4" shaft ext. x 1/2" diam. Stock #SA-171. Price \$6.75 each. (230 volt models also available.)

**Bodine NSH-53P. 1/12 HP DC Motor**

80 volts armature; 115 volt field. Cont. duty. 0.81 amps. 2 1/2 ratio gear reduction. Output shaft speed 880 rpm. Torque 4.1 in. lbs. Limited quantity. Special Price \$12.50 each.

Robbins and Meyers 1800 RPM AC Motor 115 v. 60 cycles. Single phase. 1/50 hp. 0.91 amps. Cont. duty. Complete with capacitor. Frame SK-105. Limited quantity. Special Price \$9.50 each.

**3 HP DC Motor—230 V. DC.**

2200 rpm. Double shaft extension. Base mounting for either horizontal or vertical operation. Limited quantity. Price \$17.50 each.

**AUTOSYNS**

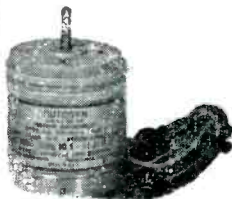

**Pioneer Types**

AY-1, AY-14, AY-20, AY-30, AY-54D, 2320, and AY-101D.

Prices on request



**DYNAMOTOR**

D-101. 27 v. DC in @ 1.5 amps. DC output 285 v. @ 0.60 amps. Stock #SA-187. Price \$1.50 ea.

**SWEEP GENERATOR CAPACITOR**



Hi-speed bearings. Split stator. Silver plated coaxial type. 6-10 mmf.

Stock #SA-167. Price \$2.75 each.



**Remote Position  
Indicating System**



6-12 v. 60 cycles 5 inch indicator with 0 to 360° dial. Heavy duty transmitter. Stock #SA-115. Price \$9.95 per system

**LP-21-I.M Compass Loops**



New

Original  
Cartons

Stock #SA-99.  
Price \$9.50 each

**AC-SERVO MOTORS**

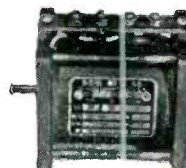

Pioneer—CK-3 and 10047-2A for 400 cy. Kollsman—774-01 for 400 cycles. Diehl—FP-25-3, FPE-25-11 (CDA-211052) and ZP-105-14 for 60 cycles.

Prices on Request

C-1 Autopilot Servo Unit—28 v. DC shunt motor. 2250 rpm. 2 magnetic clutches, reduction gear, differential and 2 magnetic brakes. Output shaft 15 rpm. Torque 225 in/lbs. Stock #SA-80. Price \$19.50 each

1/2 HP DC Motor—G.E. 5BA25MJ409. 24 v. 7.5 amps. 7100 rpm. Cont. duty. 5" lg. x 2 1/2" diam. 3/4" shaft ext. Stock #SA-35. Price \$4.75 each.

Sperry A-5 Amplifier Rack—614890 Contains Wes on 350-450 cy. freq. meter and 0-130 vol. voltmeter. Mounting for associated amplifiers. Stock #SA-183. Price \$8.95 each

Phase Shift Capacitor—4 stators single rotor 0-360° phase shift. (Use in complex wave synthesis.) Stock #SA-114. Price \$4.75 ea.

TWX Pat-199.

Write for complete listing,  
or call ARmory 4-3366

4 Godwin Ave.

**SERVO-TEK**  
**PRODUCTS Co.**  
Incorporated  
Surplus Division

Open account shipments  
to rated concerns.

All prices F.O.B. Paterson, N. J.

Paterson, N. J.



## RADIOMEN'S HEADQUARTERS WORLD-WIDE MAIL ORDER SERVICE !!

BUFFALO RADIO SUPPLY, ONE OF AMERICA'S LARGEST ELECTRONIC DISTRIBUTORS, IS IN A POSITION TO SUPPLY MOST OF THE REQUIREMENTS OF FOREIGN PURCHASERS, DIRECTLY FROM ITS GIANTIC STOCKS OR THOSE OF ITS AFFILIATES. EXPORT INQUIRIES ARE SOLICITED BOTH FROM EXPORT HOUSES AND FROM FOREIGN GOVT. PURCHASING COMMISSIONS HERE AND ABROAD. EXPENSE CAN BE REDUCED AND REQUIREMENTS FILLED WITH A MINIMUM OF DELAY BY CONTACTING BUFFALO RADIO SUPPLY INITIALLY.

### \$8.95 Takes All 3 BIG BARGAINS

**1. ALUMINUM GEAR BOX 18x8x7** that contains two powerful electric motors and two matched gear trains, 62 gears in all varying in size from 1/2 to 4 inches in diameter. This unit is readily converted to rotate a beam antenna or any other similar use. **\$3.00**

**2. SENSATIONAL FASCINATING, AMAZING SELSYNS.** Brand new selsyns made by G. E. Co. Two or more connected together work perfectly on 110 VAC. Any rotation of the shaft of one selsyn and all others connected to it will rotate exactly as many degrees in the same direction, following unerringly as if the units were connected together by shafting instead of wires. This is true whether you twist the shaft of the master unit a fraction of a revolution or many revolutions. Useful for indicating the direction of weather vanes, rotating directional antennas, or controlling innumerable operations from a distance. Complete with diagram and instructions. Per matched pair. **\$4.95**

**3. DUAL METER**—one 50 uA and one 200 uA movement in the same case. This meter is ideally suited for use as a combination modulation percentage and carrier shift indicator. If desired the movements may be removed from the case and used separately. All meters are in perfect operating condition, but a few have cracked glasses. This super value costs only **\$1.95**

### OUR PE 109 DIRECT CURRENT POWER PLANT

This power plant consists of a gasoline engine that is coupled to a 2000 watt 32 volt DC generator. This unit is ideal for use in locations that are not serviced by commercial power or to run many of the surplus items that require 24-32 DC for operation. The price of this power plant tested and in good condition is only **\$79.95**. F. O. B. Buffalo, or we can supply strictly "as is" condition for **\$59.95**. F. O. B. New York City. These latter are exactly as received in heavy steel strapped cases and we are unable to determine if the individual units are new or used or what the condition is if used. The \$79.95 units are some of the same that we have brought to Buffalo for testing and repair if necessary. We do not recommend gambling on the "as is" condition, except for quantity purchasers. We can also supply a converter that will supply 110V AC from the above unit or from any 32V DC source for **\$12.95**

commercial power or to run many of the surplus items that require 24-32 DC for operation. The price of this power plant tested and in good condition is only **\$79.95**. F. O. B. Buffalo, or we can supply strictly "as is" condition for **\$59.95**. F. O. B. New York City. These latter are exactly as received in heavy steel strapped cases and we are unable to determine if the individual units are new or used or what the condition is if used. The \$79.95 units are some of the same that we have brought to Buffalo for testing and repair if necessary. We do not recommend gambling on the "as is" condition, except for quantity purchasers. We can also supply a converter that will supply 110V AC from the above unit or from any 32V DC source for **\$12.95**

**Battery type BA38.** 103.5v battery used in handy talkies and mine detectors. 1x11 1/2" Outdated but tests OK. **\$1.98**  
Standard type normally open **MICROSWITCHES** ... **.39¢**  
Leaf actuator **SPDT MICROSWITCHES** ... **.49¢**  
Brand new fully shielded GE single button mike transformer in beautiful silver finish case ... **.99**  
Television 300 ohm twinline, per 500 ft. spool ... **\$9.95**  
Miniature bayonet pilot light sockets—per hundred ... **\$2.50**  
Universal 4 lead broadcast band oscillator coil (can be converted to 3 lead type by addition of jumper). Six for ... **\$1.00**

### GENERAL ELECTRIC 150 WATT TRANSMITTER

Cost to You—**BRAND NEW EXPORT PACKED, \$100.00**  
Cost the Government **\$1,800.00**

This is the famous transmitter used in U. S. Army bombers and ground stations, during the war. Its design and construction have been proved in service, under all kinds of conditions, all over the world. The entire frequency range is covered by means of plug-in tuning units which are included. Each tuning unit has its own oscillator and power amplifier coils and condensers, and antenna tuning circuits—all designed to operate at top efficiency within its particular frequency range. Transmitter and accessories are finished in black crackle, and the milliammeter, voltmeter, and RF ammeter are mounted on the front panel. Here are the specifications: **FREQUENCY RANGE:** 200 to 500 KC and 1500 to 12,500 KC. (Will operate on 10 and 20 meter band with slight modification for 15 and 30 meter bands.) **OSCILLATOR:** Self-excited, tuned, compensated, and self-aligned. **POWER AMPLIFIER:** Neutralized class "C" stage, using 211 tube and equipped with antenna coupling circuit which matches practically any length antenna. **MODULATOR:** Class "A" uses two 211 tubes. **POWER SUPPLY:** Supplied from plate with dynamotor which furnished 1000V at 350 MA. from either 12 or 24 volts. Complete instructions are furnished to operate set from 110V AC. **SIZE** 2 1/2 x 23 x 9 1/4". Total shipping wt. 200 lbs., complete with all tubes including a full set of spares besides three tubes necessary for operation. Dynamotor power supply, seven tuning units, antenna tuning unit and the essential plugs.

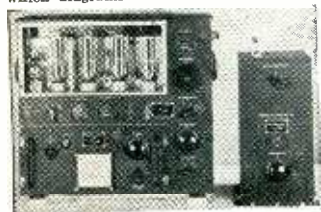

### AUTO RADIO DEALERS! ATTENTION!

Nationally advertised brand of 1949 car radio which will fit practically any car and every pocket-size Six tube superheterodyne with three gang condenser and 6 1/2" speaker. \$32.20 for sample, or Dealer price \$29.97 each, in lots of two or more. Here is an item that no serviceman who repairs auto radios should be without. Nationally advertised ATB heavy duty toroid that supplies perfectly filtered 12 VDC or 6 VDC at 14 amp from 110 VAC \$36.00



### RT 1579 with tubes diagram & parts list only \$14.95

A three stage cascade 6SJ7's and 6F6 output stage high gain, high fidelity amplifier with 80 cycle, 110V power supply on the same 13 1/2 x 14 1/2 chassis, which is protected by a substantial steel cover over tubes and parts. Made by Western Electric with typical quality components such as a husky power transformer and oil condensers, this unit is obviously supplied with no more need for repairs than a telephone. Disconnecting one wire each, from the special input and output filters, will result in as high a fidelity amplifier as can be obtained.

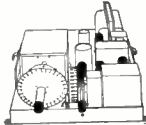

### PORTABLE ELECTRIC DRILL

**TERRIFIC VALUE ONLY \$20.95**

Equipped with 1/4" Jacobs reamed Chuck and Key  
Not an intermittent duty drill, but a full size rugged tool. Most convenient type switch, natural grip handle, and balance like a six-shooter. Precision cut gears—turbine type cooling blower—extra long brushes. Not stalling under heaviest pressure because of powerful 110 Volt AC or DC motor and multiple ball thrust bearing. Other bearings self-aligning lifetime-lubricated Oilite type. Made for toughest year-in-year-out service in plant or on construction jobs. Amazing perpetual factory guarantee assures you of a lifetime of trouble-free use. Full refund (you pay transportation) if not pleased with drill after trial.

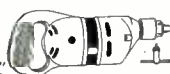

### Stupendous Value in 3 sections PERMEABILITY TUNER

The entire variable tuning section of a deluxe General Motors radio. Amazingly tiny 4x3x2" though truly half of a radio. Shielded R.F. sections litz wire wound. All 3 tuned circuits adjustable at both low and high ends of dial. Amazingly tiny (4x3x2 1/2"). Compact enough to be used to pep up any 2 or 3 gang superhet or 2 gang RF. Will substitute for entire original tuning system including variable condenser or if desired the original tuning condenser can be connected to these coils, and the coils set to proper inductance just as before, although much greater sensitivity and selectivity will result. Can be used as a multiple section wavetrapp that will cut out undesirable interference as with a knife, or if only a little bit better than average results with a slug-tuned wavetrapp are necessary, the unit can be split up into a couple of minutes into 3 coils that can be used on 3 different jobs. These coils, supercompact and really hot, can also individually replace any broadcast band RF oscillator, or let detector coil do a dozen just for general repair or replacement work. Cost the manufacturer several dollars. Your cost **\$1.49**.

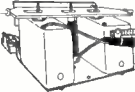

### VACUUM TUBE VOLT-OHM-CAPACITY METER

There are more features engineered into this all purpose instrument than in any other instrument on the market regardless of price. It was designed not only to meet present conditions but to be readily adaptable to future needs. At the sensational low price of this precision instrument no school, plant, lab or service shop need deprive itself of the "new look" in measuring equipment. Here are a few of the many features of this outstanding meter:

- 5 inch easy to read meter.
- 6 DC voltage ranges from 0 to 1000 V (input resistance as high as 1 megohm per volt).
- 5 AC voltage ranges from 0 to 1000 V (No dry disc rectifier to age and destroy the accuracy of this VACUUM TUBE VOLTMETER).
- 6 Resistance ranges from 2/10 ohm to 1000 megohms.
- 4 Capacity ranges from .000025 to 20 MFD.
- A zero center range for balancing FM discriminators.
- Isolating resistor built into probe.
- Sturdy natural finish hard wood case. The outstanding development of one of the best manufacturers of test equipment costs only \$39.50 complete with all leads, as illustrated.



**STROMBERG CARLSON Power Switching Relay Box.** Neat 3 1/2 x 4 x 5 1/2" steel case with tight fitting cover finished in Stromberg's usual beautiful chocolate color crackle finish. **\$98.**



**REMOTE CONTROL UNIT**—Aluminum case 4x3x2 containing 2 potentiometers, triple pole switch, 4 knobs, phone jack, gear mechanism and revolution counter. 99¢. With a strong JAN connector to fit box **\$1.39.**

### RT 1655 only \$14.95

11 tube crystal controlled SUPERHET RECEIVER that covers the FM band. The ultra modern circuit uses the latest types of tubes. Beautiful chassis and aluminum cabinet. Tubes & schematic supplied.



### COMPRESSED AIR INSTANTLY, Anywhere!!

Portable Air Compressor and storage tank. Ruggedly built of best materials using lifetime lubricated ball-bearing oil impregnated main bearing on shaft. Unusual design forever eliminates valve trouble, the most common fault in air compressors. **PATENTED** unique air intake system increases efficiency tremendously over other compressors so that air output is much greater than that from lesser compressors powered by heater motors. Will deliver approx. 3500 cu. in. air per min. at maintained pressure of 30 lbs., or will inflate a 90 lb. truck tire in less than 1 min. Complete with 100 lb. gauge, fingertip adjustment allows setting of output pressure at any value, which will automatically be maintained. Works from any 1/2 H.P. motor. Useful for spraying paints or lacquers, disinfectants, insecticides, annealing or brazing with natural gas, inflating tires, etc. Price \$14.50 postage prepaid anywhere in U. S. Efficient, adjustable siphon type spray gun, complete with 12 ft. of 1/2 lb. test hose for only \$7.75 with pint container, also prepaid.

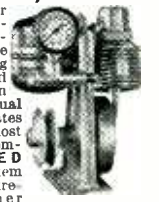

Latest type PM Speaker in a fully-enclosed black crackle finished metal cabinet. This speaker and case match communication receivers, and in addition make perfect intercom remote stations. Price, \$4.50. Including output transformer **\$4.95**



### HEAT GUN

Strips all 110ed pistol heat gun in vivid red housing, that delivers a powerful 20 Cubic Ft. per minute blast of hot air at 160° Fahrenheit. Ordinary blowers have small fan motors, but this unit is brand new, includes 3 electric motors or generators, 6 of which are of the permanent magnet field type; relays: 20 precision resistors plus numerous others of the ordinary kind; and 9 tubes which alone have a total value of \$15.00. All for **\$14.95**. Satisfaction guaranteed or money refunded if returned prepaid within 5 days.



### SUPER SPECIAL

**POWER UNITS** for Fairchild bombsights. A limited quantity of these arrived too late for a photo, but each unit is brand new, includes 3 electric motors or generators, 6 of which are of the permanent magnet field type; relays: 20 precision resistors plus numerous others of the ordinary kind; and 9 tubes which alone have a total value of \$15.00. All for **\$14.95**.

### 1949 MODEL MUTUAL CONDUCTANCE TUBE TESTER

with new 9 pin socket to handle **\$49.95** all future tube developments. No possibility of good tubes reading "Bad" or bad tubes reading "Good" as on dynamic conductance testers or other ordinary emission testers. Attractive panel and case equal to any on the market in appearance. Large 4 1/2" meter as a Bad-rated micrometer scale as well as individual sockets for all tube base types—voltages from .75 volts to 117 volts and complete switching flexibility allow all present and future tubes to be tested regardless of location of elements in the tube base of the indicator gas content and detects shorts or opens on each individual section of all local, octal and miniature tubes including cold cathode, magic eye and voltage regulator tubes as well as all ballast resistors. Name of the nationally known manufacturer withheld because of special price offer.

Model "C"—Slipping front counter case ... **\$52.95**  
Model "P"—Handsome hand-rubbed portable case ... **\$57.95**  
Built-in-roll chart with either of above \$5.00 extra.

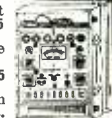



# COMMUNICATION DEVICES CO.

2331 TWELFTH AVENUE, NEW YORK 27, N. Y.

**TO WHOM IT MAY CONCERN:**

One thousand circulars were random mailed to clinics, labs and the radio industry, describing the remarkable INFRA RED IMAGE CONVERTER TUBE as advertised by us in the February "ELECTRONICS". The response was overwhelming. If we inadvertently missed you, please forgive us. Write for details, or ORDER now and "see" for yourself what the fluorescent image on the face of the tube will do in the dark with infra red filters. All are brand new surplus, guaranteed, packed in individual boxes, each including schematics for portable or fixed power supplies (2500 to 6500 V. at 1 Ma.), plus additional data on its history and applications. These I.R.I.C. tubes are priced low at . . . . . \$9.00 each. Mounted Filters, infra red . . . \$35 each.

While on the subject of complete, clean and guaranteed surplus items for communications, we list here a cross section of our inventory:

BC-339 Fed. Tel. & Tel., 1 KW Transmitters, 4-26.5 Mc; 220V.50/60 cycles. All are complete, UNUSED, export packed.

BC-640 Bendix, VHF Airport ground control transmitters, 110V AC. Complete, UNUSED, export packed.

CW-3 Wilcox, fixed frequency receivers, 110V AC, with manuals, tubes, 1 set of coils, UNUSED, export packed. Each . . . \$29.50.

Point-to-Point radiotelephone relay. SCR-528, 20-27.9 Mc with transmitter, receiver, interphone amplifier, all tubes, dynamotors (12 or 24 V.), extals, microphone, headset, antenna mtg and whip, control

box, shock mounts and other accessories. For broadcast, teletype or communication link. Export packed. (Two full pages describing it in catalog). TDE Westinghouse, 300-18,100, CW/phone for ship-board, with all tubes and motor generator; absolutely clean & tested.

Collins 32-RA; Meissner 150-B; AVT-112A, AVR-20A; AVA-126A and others for portable, mobile or aircraft.

TOWERS NEW manufacturers stock, self supported or guyed towers made of durable aluminum alloy able to withstand a 90 M.P.H. wind top loading. In 10 ft to 100 ft heights, for AM, FM, Television, Airports, etc. Shipped knocked down.

Why not write for our bulletins pictorially describing the above and other items of interest to yourselves or to your accounts.

Very truly yours,

**COMMUNICATION DEVICES CO.**

FOB: WHSE

## FOR SALE! SURPLUS INVENTORY

### CONDENSERS

- .001 mfd 600 Volt Paper Tubular Condensers
- .002 mfd 600 Volt Paper Tubular Condensers
- .004 mfd 600 Volt Paper Tubular Condensers
- .02 mfd 200 Volt Paper Tubular Condensers
- .1 mfd 400 Volt Paper Tubular Condensers
- 100 mmf 500 Volt Mica Condensers
- 1 mmf 500 Volt Ceramicons
- 150 mmf Ceramicons
- 10 mmf Ceramicons
- Standard Brand Oil filled Condenser .05 mfd
- 7500 Volt Bath tub Condenser .05 mfd 600 Volt

### MISCELLANEOUS

- 50L6 Output Transformers
- On-Off Rotary Switch Clarostat S P S T
- Mallory Phono-Radio AC Switch 2 Pole 3 Position
- Bath tub Condensers .1 mfd plus .05 mfd 600 Volt
- Pilot light Sockets
- Alden Motor Plugs Male and Female With Leads
- 3Q4 and 50B5 Output Transformers

SPOT CASH AVAILABLE FOR YOUR SURPLUS STOCKS

**ELECTRONIC CORP. OF AMERICA**

Surplus Division • Circle 6-1985  
353 West 48th St., New York 19, N. Y.

BRAND NEW!

## 5" TELEVISION

or C. R. TUBES

5BP4 BLACK & WHITE  
PICTURE TUBE

or 5BP1 GREEN—MED. PERS.

**\$2.95** Add 60¢ for each tube to cover postage and handling

**ELECTRONIC SALES CO.**

Dept. E-1, 3923 Van Buren  
Culver City, Calif.

## SHIP TRANSMITTERS, RECEIVERS AND RADAR

ET-8023D1—200 watt ship transmitter. Mfr: RMCA. New, \$550 ea. • TBL—350 watts cw, 50 watts phone. 175-600 and 2.0-18.1 mcs. • TAJ—500 watts cw, 150-550kcs. • TBK—500 watts cw, 2.2-20.0 mcs. • TCE-2 transmitter. • 136A-Mackay ship transmitter with 115 V dc m/gy & spares. \$115 per set. • RAK-7—low frequency receivers, excell. cond., less power supply. \$65 ea. • RCA-250 watt radiotelephone 2.0-20.0 mcs; 110 ac. excellent. \$825. • Underwater Sound Beacons—Model NAA. Beacon emits 5 watts audio at 10 to 20 kcs at chosen code for 48 hours. NEW, original packing. \$300.00. • Also various parts of SK, SF, SL, SA and SO radar.

### MOTOR GENERATORS & CONVERTERS — DYNAMOTORS — INVERTERS

We carry a large variety in stock for ship, aircraft and general use. 12, 24, 32, 110 and 230 Vdc input, various outputs.

### AIRCRAFT EQUIPMENT

ASB-5—515 Mes. Airborne Radar. Brand new, \$150. • GP-7 transmitter complete. New. \$100 ea. • MN-26—Bendix Radio Compass. New. Complete. \$125. • ZA—Blind Landing Eqpt. 90-100 mcs. New. • APS—4 Junction boxes—J-84. New. • APG—amplifier cans. • TDY Radar jammer—Power oscillator only. Operates from 110 ac. New, less tubes, at \$95.00 ea. • SCR-269 and SCR-27 N sets and components. • Oxygen and De-icer Kits. • Propeller Protectors in mahogany instrument case. \$25 ea.

**METER MULTIPLIERS — PRECISION RESISTORS**, 20,000 volts, 20 megohms. Accuracy ± 0.5%. New, in original packing. Standard Brands. Manufacturer's current list is more than \$240.00! Our price: \$22.00.

We carry an extensive stock of marine and aircraft accessories, as well as end equipment. Request for quotations from governments, manufacturers, laboratories and institutions are especially invited.

### 50,000 STANDOFF INSULATORS

3" to 12" brass or bronze bases and caps—12 in. @ \$1 ea. Thousands of strains and feed thru's too

Terms: Cash or net 10 if rated.

Prices fob our warehouse.

All material offered subject to prior sale.

## COMPASS COMMUNICATIONS CO.

37 MONTGOMERY ST.,

DElaware 2-4656

JERSEY CITY 2, N. J.



*Dear Dick, send me what you feel right.*

**Yes Sir! the HOTTEST LIST**  
in the LAND. brim full of electronics, hydraulics, aircraft parts, gadgets  
**Rush me your name TODAY**

## LEAR ROTARY ACTUATOR Type 111



1 to 5 RPM. 10 to 27 Volts AC/DC. Split field series reversible motor. Laminated field. Double spline output shaft. Adjustable limit switches. OD 8 x 5 x 4". Wt. 4 1/4 lbs.

**New ea. \$7.95**

The answer to your remote control problems.

## RAY AUTOSYNS

These pioneer autosyns will operate on 6-12 Volts 60 cycle (26 V 400 cy 52V 800cy). The receivers can be used as transmitters. Perfect condition.

### DUAL INDICATOR

OD 6 3/4 x 3 1/4". Wt. 1 1/4 lbs.  
**ea. \$2.95**

### POSITION TRANSMITTER

OD 5 1/2 x 2 1/2 x 1/2". Wt. 3/4 lb.  
**ea. \$1.49**

### SINGLE INDICATOR

OD 4 1/4 x 3 1/4 x 3 1/4". Wt. 3/4 lb.  
**ea. \$1.69**

### AUTOSYN UNIT

OD 2 1/4 x 2 1/4 x 2". Wt. 4 oz.  
**ea. \$1.49**

## 500 CYCLE GENERATOR



4KVA, 110 Volt single phase, 1/2" dia. 3400RPM. Just the thing to hook up to a 60 cycle motor as a power source to operate surplus 400-500 cycle equipment. Has 1-1/2" keyed drive shaft, built-in exciter & separator DC output of 14V @ 40 Amps. OD 12 1/2 x 12" dia. Wt. Approx. 200 lbs. Brand New. FOB EVERETT or MIDWEST.....

**ea. \$79.95**

## AMPLIDYNE



GE#5AM31NJ9A 28VDC input 60-0-60 VDC output at 8.8 Amps. 1 watt field power controls 330 Watts output power. The ideal DC motor speed control & AC generator

voltage control. Brand New.....

**ea. \$2.95**

## 10,000 VOLT 23 MA TRANSFORMER



Pri. 115 Volt 60 cycle GE#56G9. UL approved. OD 7 1/2 x 5 1/2". Wt. 14 lbs. Brand New.....

**ea. \$6.95**

Satisfaction Guaranteed or your money back. Hundreds of bargains in our free illustrated list.

**DICK ROSE ERECO**  
2912 Hewitt Ave. Everett 20, Wash.

# INDUSTRIAL POWER SUPPLY EQUIPMENT

for worthwhile savings to you

## CAPACITORS

Standard Brands

### ELECTROLYTIC:



500 mfd @ 200 d-cwv; 2 insulated terminals; 2" dia. x 4 1/8" can; mounting bracket; new, factory packed. (A-1) ... **\$ .95**

A-1



.25/.25 mfd @ 6,000 v d-c or .125 mfd @ 12,000 v d-c; oil filled w/ mounting bracket; new, factory packed; 5" x 3 1/2" x 9 1/2" o.a. height. (JF-1) ... **\$3.75**

JF-1



### MICA:

.001 mfd @ 25,000 v d-c; .25 amp @ 3,000 kc; .18 amp @ 1,000 kc; .11 amp @ 300 kc; 10 1/2" x 4" x 9" o.a. height; new, factory packed (CD-1) ... **\$25.00**

CD-1

2 mfd. @ 600 v d-c; tubular oil ..... **\$ .39**

3.5/.5 mfd 1,000 v d-c, oil Net wt. 1 lb. .... **\$ .90**

1.0/1.0/1.0 mfd 3,000 v d-c test 1,200 v d-c working, isolated sections ..... **\$1.20**

9.12 mfd @ 1265 v a-c, 60 c single phase, 5 kvar. .... **\$17.50**

1.25/1.25 mfd @ 7,500 v d-c Net wt. 21 lbs. .... **\$12.50**

1.0 mfd 25,000 v d-c; net wt. 65 lbs. (C-107) ..... **\$36.00**

VACUUM CAPACITOR: 50 mmfd @ 32,000 v d-c; tubular; 2 1/4" dia. x 6 1/2", clip mounting; new, factory packed **\$4.95**

## POWER SUPPLY KITS

- #1 YOU GET: Full wave high voltage transformer, rectifier, capacitor combination.  
2 KENYON TRANSFORMERS type S-13483: 115 v 60 c pri.: 3,200 v 1/2 wave sec. @ 250 ma. Coupled together they give 3,200 v full wave @ 500 ma.  
1 KENYON FILAMENT TRANSFORMER type T-389: 115 v 60 c pri.; 2.5v of sec. @ 10 amps 9,000 v test.  
2 866A tubes. 2 JOHNSON SOCKETS.  
4 CAPACITORS, Cat. #23F47: 2 mfd 4,000 v d-c.

### COMPLETE

**\$35.00**

- #2 Do you need a low voltage supply? Then don't pass this up! There's  
1 THORDARSON TRANSFORMER type T-92F21: 115 v 60 c pri.; sec. #1: 400-0-400 v @ 210 ma; sec. #2: 5v @ 3 amps; sec #3: 6.3 vct @ 5 amps;  
1 THORDARSON CHOKE type T-74029: 15 h @ 150 ma.  
2 CAPACITORS type PT-SC-2: 8'8 mid @ 600 v d-c; oil filled; 4 prong plug-in type;  
1 5T4 RECTIFIER TUBE: 1 SOCKET;

### FOR

**\$9.50**

## DRY DISC RECTIFIERS

Continuous Duty Ratings

- 3.5 v a-c, FWB, 1.8 v d-c @ 1.0 amp. .... **\$ .90**  
6.5 v a-c, FWCT, 2.2 v d-c @ 3.0 amps. .... **1.20**  
0-36 v a-c, HW, 200 ma d-c. .... **.75**  
0-54 v a-c, FWB, 1.6 amps d-c. .... **4.40**  
0-154 v a-c, FWB, 600 ma d-c. .... **6.85**  
0-180 v a-c, FWB, 400 ma d-c. .... **6.90**

T-102—Filament Transformer, American Transformer Co. Spec. 29106, Type WS .150 KVA, 50/60 cyc. Single phase, 35 KVA test, 12 KV D.C. operating. Primary 115 V., secondary 5 V., 10 amps with integral standoff insulator and socket for 250T, 371, 872 and 5563, etc. rectifier tubes. .... **\$12.50**  
Net Wt. 15 1/2 lbs. Dim 6 1/2" W x 6" D x 12" H.O.A.



## KILOVOLT METER

WESTON MODEL 301: 20 kv @ 1,000 ohms per v; 3" face calibrated to read 0 to 20 kv; 1 ma full scale deflection; flush type, calibrated for steel panel mounting; used with Weston precision 20 meg resistor (orig. cost over \$125.00), which is included, plus standoff insulators and mounting clips. .... **\$18.00**

## Voltage Regulators

TRANSTAT: 115 v 50/60 c input; 103 to 126 v output @ 2.17 amps. .... **\$9.50**  
TRANSTAT: 115/230 v 50/60 c input; 0 to 260 v output @ 2.5 amps. .... **\$21.50**  
TRANSTAT: 115 v 50/60 c input; 0 to 130 v output @ 10 amps. .... **\$24.50**  
VARIAC: 115 v 50/60 c input; 0 to 135 v output @ 5 amps; cased. .... **\$14.50**

## SPECIALS

CHROMOLOX STRIP HEATER: 115 v 300 w; 1/4 x 1 1/2" x 12" ..... **\$1.00**  
FENWALL THERMOSTAT SWITCH: adjustable from -50° to +40° F.; 110/220 v; 2500 w contacts ..... **\$1.60**  
WESTINGHOUSE METER MULTIPLIER: 1 meg; 1/100% accuracy; wire wound; non-inductive ..... **\$1.25**  
WESTERN ELECTRIC TIME DELAY RELAY: #250A; 110/220 v, 60 c; adjustable from 0 to 15 minutes ..... **\$6.50**  
TUBE WL 386/ML-3W: 125 kv X-ray rectifier; oil immersion type; filament: 10 v @ 11.6 amps ..... **\$32.00**

## A-C AMMETER

WESTON MODEL 476: 3" face, calibrated to read 0 to 120 amps, has 3 amps full scale deflection; used with 40 to 1 current transformer, which is included ..... **\$8.50**

## SOLA CONSTANT VOLTAGE TRANSFORMERS:

95 to 125 v 50 c input; 115 v output: 30 va. .... **\$ 6.00** 250 va. .... **\$18.00**  
60 va. .... **8.40** 500 va. .... **34.00**  
120 va. .... **13.20**

## TUBES

TRANSMITTING  
RK75/307A ..... **4.50**  
750TL ..... **47.50**  
WL533 750W U.H.F. ....  
Triode ..... **17.50**  
714AY Magnetron. .... **9.50**  
730A Magnetron. .... **10.75**

THYRATRONS  
2D21 Min. .... **1.25**  
3C23 ..... **4.75**  
FG81A ..... **4.75**  
C6A ..... **8.50**  
C6J ..... **9.50**  
931A Photo-Mult. .... **2.75**  
All Tubes New, Boxed

RECTIFIERS  
371B ..... **5.95**  
531 ..... **18.00**  
872A ..... **1.75**  
3B22 ..... **2.95**  
4B28/289414 6 Amp. Rectigon ..... **3.95**

All merchandise in "as new" condition. Add approx. 20% to net weights for estimated shipping weights. Terms are 30% with order, balance C. O. D. All prices f.o.b. Los Angeles Warehouse. Write for additional detail information on any of the above items and for special quantity discounts. Telephone MADison 8-5391

1527 E. SEVENTH ST.

# EPCO

LOS ANGELES 21, CALIF.

# SEARCHLIGHT SECTION

## BRAND NEW U.S. GOV'T. SURPLUS GUARANTEED

### POWER RHEOSTATS

**25 Watt — 98¢ ea.**

6 ohms	60 ohms	500 ohms
10 ohms	125 ohms	750 ohms
12 ohms	200 ohms	1000 ohms
15 ohms	250 ohms	2000 ohms
25 ohms	350 ohms	3000 ohms
50 ohms	400 ohms	5000 ohms

**50 Watt — \$1.24 ea.**

5 ohms	50 ohms	2000 ohms
6 ohms	100 ohms	5000 ohms
8 ohms	150 ohms	7500 ohms
22 ohms	1250 ohms	10000 ohms

**100 Watt — \$2.25 ea.**

5 ohms	2500 ohms	3000 ohms
7500 ohms		10000 ohms

**Others**

5 ohms	150 w	2.74
25 ohms	150 w	2.57
1250 ohms	150 w	2.74
500 ohms	75 w	1.97
1200 ohms	225 w	3.25
80 ohms	500 w	4.95

Discounts to quantity users

### VOLUME CONTROLS

#### CARBON

**15c**

100 of a Type  
Smaller Lots 20¢ ea.  
1.0 meg.\*

ohms	ohms
200	10000*
700	10000
1000	14700
2200*	15000*
4000	20000
5000	25000*
1000*	25000
10000	30000
20000	50000*
30000	50000
50000*	70000
75000	

#### WIREWOUND

**20c**

100 of a Type  
Smaller Lots 25¢ ea.  
20000

ohms	ohms
15	1000*
20	1000
25*	2000
25	2500
30*	3000
30*	5000*
50*	5000
100	5150
200*	10000*
200	10000
400	20000
1000	70000
700	200000

### OIL CONDENSERS

Famous makes  
ALL BRANDS GUARANTEED  
NEW—most with ceramic pillar insul.

1 Mfd—3000 vdw	\$0.75
.25 Mfd—3500 vdw	1.15
1.0 Mfd—500 vdw	.28
1.0 Mfd—600 vdw	.35
2.0 Mfd—400 vdw	.38
2.0 Mfd—500 vdw	.39
4.0 Mfd—500 vdw	.59
4.0 Mfd—600 vdw	.69
6.0 Mfd—400 vdw	.75
6.0 Mfd—600 vdw	.79
10.0 Mfd—600 vdw	.98
14.0 Mfd—600 vdw	1.44
15.0 Mfd—1000 vdw	2.25
4-4-4 Mfd 400 vdw 3 sec. 4 prong plugs in can 4 1/2" high x 3" Diam.	\$1.49

### AB CONTROLS

Type J

ohms	ohms	ohms
60	2100	25000
100	2200	30000
150	4000	50000
200	4700	75000
400	5000	80000
500	10000	100000
600	11000	110000
1000	12000	250000
1200	15000	300000
1500	16000	500000
2000	20000	1.0 meg.
2 x 10 K	5.0 meg.	

Type "JJJ"

ohms	ohms	ohms
2 x 400	x 150 K	
2 x 400	x 200 K	
2 x 2 K	x 250 K	
2 x 10 K	x 1.0 meg.	

Type "JJJ"

ohms	ohms	ohms
3 x 750 K	3 x 800 K	3 x 1.0 meg.

Special Prices Quoted Upon Request

**WRITE WIRE PHONE**

### DUAL CONTROLS

#### CARBON

**39c**

2x10K\*  
2x250K\*  
2x2.0 meg.\*  
2x1.0 meg.\*

#### WIREWOUND

**48c**

2x200  
2x3K  
2x7.5K\*  
2x10K  
2x20K\*  
2x25K

\* Indicates Screw Driver Slotted Shaft. All others have Shafts on 1/8" Dia.

**TERMS**

20% cash with order—balance COD—FOB our warehouse NYC.  
No Orders Under \$5.00 Please. All Merchandise Subject to Prior Sale.

Open Accounts to Rated Concerns  
Write for Free Bulletin

### ELECTROLYTIC CONDENSERS

Famous makes—FP type in cans

40/40 mfd 300 vdw & 80 Mfd/50 vdw 3 sec 3" high x 1 3/4" Dia.	\$0.58
8/16 mfd 475 vdw 2 section	.69
1000 mfd 15 vdw 1 section	.79
1000 mfd 25 vdw 1 section	.88
1250/1250 mfd 10 vdw 2 section	1.29
500 mfd 200 vdw 1 section	2.49

### BATH TUB CAPACITORS

Famous makes—All Brands Guaranteed New Oil filled bathtubs

.033/400 V—17¢	1/600 V—22¢
05/200 V—23¢	1/600 V—23¢
05/400 V—19¢	1/600 V—23¢
05/600 V—14¢	2x5/600 V—21¢
1/200 V—17¢	2/600 V—23¢
1/400 V—20¢	5/200 V—20¢
5/400 V—23¢	2x16/600V—24¢
5/600 V—25¢	2x25/600V—29¢
1.0/200 V—12¢	2x5/600 V—24¢
1.0/600 V—34¢	3x.05/600V—30¢
2.0/600 V—40¢	3x.1/600 V—33¢
2x.05/1500 V—33¢	3x.25/600V—38¢
2x.1/600 V—29¢	3x1.0/100V—25¢
2x.1/1000V—31¢	

### ELECTROLYTIC BATH TUBS

4.0/50V—30¢	200/12V—20¢
25/25V—26¢	300/8V—20¢
25/40V—26¢	2x10/25V—20¢
25/75V—25¢	2x200/9V—35¢
50/25V—23¢	

### GRAIN OF WHEAT LAMPS



Used for illuminating meters, compass dials, airplane instruments, etc. Soldering iron removes lamp from base to use in models, doll houses, miniature trains, Xmas trees, etc.

Mazda G.E. 323 3V..19 A \$0.75  
Mazda G.E. 328 6V..2 A \$0.75

Photo, 3 times actual size. Glass Bulb 1/8" x 3/8"  
Either type \$1.50 doz. \$75.00 per M.

### ALNICO FIELD MOTOR

3 1/2" x 1 3/4"



Operates on Flashlight batteries, speed depending on the voltage. Fairly strong on 6 volts, full power and speed on 27 volts. Designed to be used in bombsights, automatic pilots, etc., 250 RPM. FEW MORE AT \$5.00

A newly Written (1948) Book on Photoelectric tubes (Electric Eye) Circuits and Relays... \$1.00  
10 for \$7.50

HAYDON or TELECHRON SYNCHRONOUS MOTOR to operate switches, etc., 1 Rev. per minute at this SPECIAL PRICE \$3.85  
Many other speeds available at \$5.25 up

EST. 1923 **BLAN** EST. 1923  
Experimenters and Inventors Supplies  
64 Dey St., New York 7, N. Y.

## ALEXANDER MOGULL CO., INC.

161 Washington St., N. Y. 6, N. Y.      Worth 4-0865

### UNUSUAL PRICES FOR PERFECT STANDARD MAKE TUBES



minimum order \$10.00 add postage or tubes will be sent by Express Collect

Rectifiers	Modulators	802	4.25	958A	45	
2X2A	4C35	803	5.95	959	45	
2X2A	527	807	1.25	9001	55	
371B	701A	808	1.95	9002	35	
5R4GY	715A	814	2.75	9003	45	
RK72	715B	824	3.75	9004	55	
RK73	715C	845	3.25	9006	35	
872A	5D21	849	29.95	C. R. Tubes		
3.95	5D21	850	1.98	3BP1	2.50	
250R	6C21	860	19.95	3CP1	1.50	
705A		1624	.45	3BP1	1.50	
719A	12.00	2C34	.35	25 5BP1	1.95	
866A	1.35	2E24	4.50	1.50 5BP4	3.50	
872A	2.50	2E26	3.95	1.65 5CP1	1.95	
878	3.95	3C24	.50	8012A	1.50	
1616	2.75	350B	1.95	8025	3.00	
8020	2.70	368AS	1.80	10BP4	37.00	
T. R. Tubes	9.95	388A	1.20	Acorn		
1B24	9.95	446A	1.80	29 12JP4	62.50	
1B32	5.95	450TH	19.95	35 12L14	62.50	
1B34	4.95	WL468	8.95	45 15AP4	135.00	
1B38	19.95	703A	1.80	957	29 20BP4	270.00
721A	2.75					

135 Liberty St., New York 6, N. Y.  
Phone: WOrth 4-8262

In Electronics since 1925

### D. C. MICROAMMETERS

0-100 ua 4" sq. G.E. DO 58	\$12.00
0-100 ua 4 1/4" round Weston 643	14.00
0-50 ua 4 1/4" round Weston 643	15.00
0-200 ua 3" sq. G.E. DO 50	8.00
0-50 ua 3" sq. G.E. DO 50	12.00

### R. F. MILLIAMMETERS

0-100 Ma 3 1/2" r. Weston 425	\$11.00
0-120 Ma 2 1/2" r. Weston 507	7.00
0-10 Ma 4 1/4" r. Weston (vacuum)	22.00
0-2 Ma 4 1/4" r. Weston (vacuum)	26.00

### A. C. VOLTMETERS

0-300 v 3 1/2" r. Weston 476	\$8.00
------------------------------	--------

Precision Electrical Instrument Co.  
146 Grand Street New York 13, N. Y.

### ROTARY STEPPING SWITCHES

ALL NEW—ORIGINAL CARTONS

AUTOMATIC ELECTRIC—25 steps, 4 levels, 12V. DC. coil—Special price—\$12.50

Clare Relay—Type SD-14—20 steps, 6 levels, Coil 12V. DC. Lists at \$40.26; our price—\$13.07

Also have Jones Plugs & Terminal Strips, 1 RPM Motor, Littelfuses & holders, etc. Write for list. New equipment; not surplus, but at less than surplus prices.

**NEOMATIC, INC.**  
938 W. Washington Boulevard  
Los Angeles 15, California

### ELECTRONIC TUBE-MAKING MACHINERY

For manufacturing radio tubes, electronic tubes, cathode-ray tubes, lamps. New and used. Reasonably priced, satisfaction guaranteed.

**AMERICAN ELECTRICAL SALES CO.**  
67 E. 8th St. New York, N. Y.

### SURPLUS

AN/ART-13 Xmtrs, new & complete with dyn. Domestic Dkg.	\$385.00
2000T tubes, Elmec.	97.50
1500T tubes Elmec.	72.50
VHF var. condenser, butterfly constr, ceramic shaft.	4.90
3-gang 15-100uf.	5.90
4-gang 8-35uf.	
ES-7907, Electronics	

330 West 42nd St., New York 18, N. Y.

### FOR SALE AN/APR4 RECEIVER UNITS

Two receiver units, 3 TN-17 Heads, One TN-16, 18, 19, and 54; All Like New. Complete Lot \$425 Pre-Paid Freight to Anywhere in U. S.

FS 7971 Electronics  
68 Post St., San Francisco 4, Calif.



## NEW TRANSFORMERS And CHOKES BY POWER CONVERSION CO.

### TRANSFORMERS

INPUT: 115/230 V.A.C. 50 or 60 cycles. OUTPUT: 2500-0-2500 V.A.C. (2000 V.D.C. after choke input filter at 500 M.A.) NH-102.....\$39.75

### ALL FOLLOWING TRANSFORMERS 115 V. A.C. 60 CYCLE INPUT:

OUTPUT: 750-0-750 V.A.C. (600 V.D.C. after choke input filter at 250 M.A.) Includes 6.3 V.A.C. winding at 5 amps and 5.0 V.A.C. winding at 4 amps. NH-106.....\$7.95

OUTPUT: 625-0-625 V.A.C. (500 V.D.C. after choke input filter at 250 M.A.) Includes 6.3 V.A.C. winding at 5 amps and 5.0 V.A.C. winding at 4 amps. NH-107.....\$7.35

OUTPUT: 600-0-600 V.A.C. at 250 M.A. 12 V.A.C. at 3 amps; 12 V.A.C. at 3 amps and 5 V.A.C. at 3 amps. Designed for Army surplus transmitters. NH-108.....\$6.90

OUTPUT: 250-0-250 V.A.C. at 60 M.A. 24 V.A.C. at 6 amps; 6.3 V.A.C. at 6 amps. Designed for Army surplus Receivers. NH-109.....\$3.00

OUTPUT: 6.3 V.A.C. at 6 amps. NH-110.....\$2.25

OUTPUT: 24 V.A.C. at 2 amps. NH-111.....\$2.25

OUTPUT: 2.5 V.A.C. at 10 amps. center tapped and shielded. Open frame mounting insulated for continuous operation at 5,000 volts. NH-113.....\$4.20

### CHOKES:

NH-115-8 Henries at 500 M.A. filter choke, 5,000 volt insulation.....\$8.67

NH-116-5-20 Henry 500 M.A. swinging choke, 5,000 volt insulation.....\$8.37

NH-117-8 Henries at 700 M.A. filter choke, 7,500 volt insulation.....\$12.90

NH-118-5-20 Henries at 700 M.A. swinging choke, 7,500 volt insulation.....\$12.45

### ALL ABOVE ITEMS BRAND NEW— NOT SURPLUS!

### METER SWITCH



Battery Balancing Switch used to read battery voltage and to switch load from one battery to another. Contains 2" Weston Meter 0 to 15 DC Volts, switch DPDT-20 amp, 125 V. pilot light indicator, and pull sw. Case size: 4" x 6 1/2" x 2 3/4". Price: NEW.....\$2.95

### GASOLINE GENERATORS:

**HOMELITE ENGINES**—Consist of a 30 Volt DC, 50 ampere (1500 watt) generator driven by a single cylinder, 2 cycle air-cooled gasoline engine, approx. 3 HP. Rope or electric starting. No. MG-105. Prices: As is.....\$39.50 Tested.....\$49.50

**DELCO ENGINES**—Consist of a 12 Volt DC 750 watt generator driven by a one cylinder, four cycle air-cooled gas engine approx. 2 HP, with self-starter and voltage regulator. Used to charge batt. in Gov't. vehicles. No. MG-106. Price: Tested.....\$79.50

**RECTIFIER UNIT**—110 V. 60 cycle input; output 12 V. DC 10 amps. Electronic Lab. Mfg. Price—NEW.....\$29.95

**SOLA CONSTANT VOLTAGE TRANSFORMER**—#2060 Pri. 95 to 125 1000VA 60 cycle 1 phase; Sec. 115 V. 8.7 amps. Price: Used.....\$69.50

**TRANSTAT VOLTAGE REGULATOR**—#29144 Voltage Range 103-126 V. 2.17 amps. Price—NEW.....\$9.95

**MOTOR CONTROL RHEOSTAT STANDARD BRAND**—Heavy duty, wire wound control. D-150, 150 Watt, 8.28 ohms, 5 amps. Price.....\$1.75

### GENERATORS

Input	Output	Stock No.	Price
9 V. DC	405 V. 95 MA	DM 635 X	\$3.95
9 V. DC	450 V. 60 MA/with Blower	D 9450	3.95
12 V. DC	220 V. 100 MA	D 402	3.95
12 V. DC	440 V. 200 MA	D 401	7.95
12/24 V. DC	F/No. 19 MARK II P/S No. 3		9.50
12/24 V. DC	440 V. 200 MA & 220 V. 100 MA	D 104	9.95
12/24 V. DC	500 V. 50 MA	USA/O151	1.95
13/26 V. DC	F/BC-645	PE 101	2.95
14 V. DC	230 V. 100 MA	DM 20	3.95
28 V. DC	F/Comin. Receivers	DM 32	1.95
28 V. DC	400 Cycle Inverter (Reconditioned)	MC 149 F	12.95

Address Dept. E All Prices Are F.O.B., Lima, O. • 25% Deposit on C.O.D. Orders

## FAIR RADIO SALES

132 So. Main St. Lima, Ohio

## SHEET METAL MACHINERY

NEW and Used — Brakes — Shears  
Forming Rolls — Folders — Punches —  
Di-Acro, Pexto, Niagara & Whitney Equip-  
ment.

R. D. BROOKS CO., INC.

Han. 5226  
361 Atlantic Ave., Boston, Mass.

# SELENIUM RECTIFIERS AND SPECIALIZED ELECTRONIC COMPONENTS

## THIS MONTH'S SPECIALS !!

### SILVER CERAMIC TRIMMERS

Type 820-Z 5-20 Mmfd Zero Temp.....24c each.  
Type N-300 5-20 Mmfd Neg. Temp.....24c each.

Nat'l Velvet Vernier Planetary Drive From "AM" Dials 5 to 1.....80c each.

COLLINS FILAMENT TRANSFORMER

PRI: 210/220/230/240/250 VAC. 50/60 CPS.  
SEC: 7.5 VAC C.T. @ 24 Amps. Herm. Sealed.  
Insulation 2500 Volts.....Price \$11.95

**OIL CAPACITOR \$1750**  
.125 MFD. 27 KV.DC.  
With mounting brackets

**FENWAL THERMOSWITCH \$1.25**  
Normally open or closed. Adjustable from -40 to +400° F. each

### TRANSFORMER

HIGH CURRENT  
AMERTRAN

5.1 Volts at 190 Amps.  
Primary 105/125 Volts

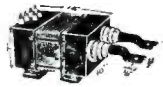

Can easily deliver 250 Amps. Insulation 35 Kv. Test. Approx. Shipping weight 96 lbs.

Plus \$2 crating charge **\$1750**

### Full Wave Bridge Types

Input 0-18VAC	Output 0-13VDC	Type#	Current	Price
B1-250	250 MA.			\$98
B1-500	500 MA.			1.95
B1-1	1 AMP.			2.49
B1-1X5	1.5 AMP.			2.95
B1-3	3 AMP.			3.49
B1-5	5 AMP.			5.95
B1-10	10 AMP.			9.95
B1-15	15 AMP.			13.95
B1-20	20 AMP.			15.95
B1-30	30 AMP.			24.95
B1-40	40 AMP.			27.95
B1-50	50 AMP.			32.95
B1-60	60 AMP.			36.95

### Full Wave Bridge Types

Input 0-54VAC	Output 0-40VDC	Type#	Current	Price
B3-150	150 MA.			\$1.25
B3-250	250 MA.			1.95
B3-600	600 MA.			3.25
B3-5	5 AMP.			13.95
B3-10	10 AMP.			24.95

Input 0-72VAC	Output 0-54VDC	Type#	Current	Price
B4-1X2	1.2 AMP.			\$7.95
B4-3X5	3.5 AMP.			15.95
B4-5	5 AMP.			17.95
B4-10	10 AMP.			32.95

### Full Wave Bridge Types

Input 0-36VAC	Output 0-26VDC	Type#	Current	Price
B2-150	150 MA.			\$98
B2-220	220 MA.			1.25
B2-300	300 MA.			1.50
B2-450	450 MA.			1.95
B2-600	600 MA.			2.95
B2-1	1 AMP.			3.95
B2-2	2 AMP.			4.95
B2-3	3 AMP.			6.95
B2-5	5 AMP.			9.95
B2-10	10 AMP.			15.95
B2-20	20 AMP.			27.95
B2-30	30 AMP.			36.95

### Three Phase Bridge Types

Input 0-120VAC	Output 0-130VDC	Type#	Current	Price
3B7-4	4 AMP.			\$32.95
3B7-6	6 AMP.			48.90
3B7-15	15 AMP.			70.00

Input 0-234VAC	Output 0-250VDC	Type#	Current	Price
3B13-4	4 AMP.			\$56.00
3B13-6	6 AMP.			81.50
3B13-15	15 AMP.			120.00

### Input 0-115VAC

Output 0-110VDC	Type#	Current	Price
B6-150	150 MA.		\$1.95
B6-250	250 MA.		2.95
B6-600	600 MA.		5.95
B6-3X5	3.5 AMP.		21.95
B6-5	5 AMP.		24.95
B6-10	10 AMP.		36.95

Input 0-234VAC	Output 0-180VDC	Type#	Current	Price
B13-5	5 AMP.			\$54.95
B13-10	10 AMP.			69.95

### CENTER TAPPED TYPES

Input 12-0-12VAC	Output 0-8VDC	Type#	Current	Price
C1-10	10 AMP.			\$7.95
C1-20	20 AMP.			12.95
C1-30	30 AMP.			17.95
C1-40	40 AMP.			21.95
C1-80	80 AMP.			34.95
C1-120	120 AMP.			46.95

\* Select Proper Capacitor From List Shown Below, to Obtain Higher D.C. Voltages Than Indicated

### RECTIFIER MOUNTING BRACKETS

For Types B1 through B6, and Type C1.....\$ .35 per set  
For Types B13......80 per set  
For Types B5.....1.20 per set

### RECTIFIER CAPACITORS

CF-13	6000 MFD	10VDC	\$2.49
CF-14	3000 MFD	12VDC	1.69
CF-15	6000 MFD	12VDC	2.95
CF-1	1000 MFD	15VDC	.98
CF-2	2000 MFD	15VDC	1.69
CF-3	1000 MFD	25VDC	1.69
CF-4	2X3500 MFD	25VDC	3.45
CF-5	1500 MFD	30VDC	2.49
CF-6	1500 MFD	30VDC	3.25
CF-7	3000 MFD	35VDC	3.25
CF-8	1000 MFD	50VDC	.98
CF-9	500 MFD	60VDC	1.95
CF-10	2000 MFD	60VDC	3.25
CF-11	200 MFD	150VDC	1.69
CF-12	500 MFD	150VDC	3.25
CF-11	100 MFD	350VDC	2.25
CF-12	125 MFD	350VDC	2.49

### Rectifier Transformers

All Primaries 115VAC 50/60 Cycles

Type#	Volts	Amps.	Price
TXF15-12	15	12	\$3.95
TXF36-2	36	2	3.95
TXF36-5	36	5	4.95
TXF36-10	36	10	7.95
TXF36-15	36	15	11.95
TXF36-20	36	20	17.95

All TXF Types are Tapped to Deliver 32, 34, 36 Volts.

### RECTIFIER CHOKES

Type	Amps.	Price
HY2 .03 Hy	2	\$2.25
HY3 .03 Hy	3	2.95
HY5 .02 Hy	5	3.25
HY8X5 .02 Hy	8.5	7.95
HY10 .02 Hy	10	9.95
HY12 .02 Hy	12	12.95
HY15 .016Hy	15	13.95

### VARIABLE AIR TRIMMERS

Standard Brands—Screw Driver Adjustment

	Lots of 10	Lots of 100
7.5 MMF	\$2.90	\$27.00
25 MMF	3.10	20.00
50 MMF	3.30	31.00
100 MMF	4.10	39.00
140 MMF	4.90	47.00

### METERS

O-15 M.A.D.C. Weston #506 2" Rd	\$2.95
O-50 A.D.C. Weston #301 3 1/2" Rd., Enclosed shunt	5.50
O-60 A.D.C. West., w. shunt, 2 1/2" Rd., aircraft type	3.25
O-120 A.D.C. West. w. shunt, 2 1/2" Rd., aircraft type	4.95
O-8 V.A.C. G.E. 3 1/2" Round	2.95
O-30 V.D.C. West. 1 1/2" Rd., aircraft type	2.95
O-300 V.D.C. 2 1/2" R.I., Bake Case	2.95

To avoid shipping errors, kindly order by type #. All prices subject to change without notice.

### ATTENTION !!!

INDUSTRIALS, EXPORTERS, SCHOOLS  
GOV'T AGENCIES, LABORATORIES  
Our engineering staff is at your service to facilitate the application of rectifiers to your specific requirements.  
Write for quantity discount on company letterhead.

Minimum order \$3.00. No C.O.D.'s under \$25.00. 25% deposit on C.O.D. Add 10% for Prepaid Parcel Post and handling. Terms: Net 10 days to rated concerns only.

Orders Promptly Filled From Our Stocks  
All Prices F.O.B. Our N.Y.C. Warehouse

# OPAD-GREEN COMPANY

71 Warren St. Phone: BEekman 3-7385 New York 7, N. Y.

# SURPLUS LABORATORY EQUIPMENT

**GENERAL RADIO**  
**620-A HETERODYNE FREQUENCY ME-TER** .....\$375.00  
 (For frequency measurement between 300 Kc and 300 Mc  $\pm$  0.1%)  
**107-M VARIABLE INDUCTORS** ..\$ 35.00  
 (1.5 to 50 Millihenrys—NEW)  
**775-A FREQUENCY LIMIT MONITOR**  
 (1.6 to 45 Mc).....\$125.00

**FERRIS**  
**16-C STD. SIGNAL GENERATOR**  
 50 Kc to 28 Mc. 0.1 to 2 Volts Output  
**34-A U.H.F. CRYSTAL CALIBRATOR**  
 \$175.00  
 (1, 5, 10 Mc. Crystals—useful up to 500 Mc.)

**WESTERN ELECTRIC**  
**TS5/AP RANGE CALIBRATOR**..\$ 65.00  
 (SWEEP MARKER GENERATOR) .25, 1, 5, 10 Nautical & Statute Miles—NEW  
**RA-90-A H.V. HIGH ALTITUDE POWER SUPPLIES** .....\$ 7.50  
 (+4900V, —1000V, Input 110V-400 Cps—NEW)  
**D-151754 MODULATOR OIL UNIT** \$ 40.00  
 (Contains 3B24, 1B3, 6ACT, 6SN7, 3E29—NEW)

**G. E.**  
**LU RADAR TEST EQUIPMENT**..\$ 50.00

**INDUSTRIAL INSTRUMENTS**  
**MB-8 MEGOHM BRIDGE**.....\$ 60.00  
 (1-100,000 Megohms  $\pm$  5%)

**WESTON**  
**MODEL 45 (0-75 V.D.C.  $\pm$  0.5% \$ 35.00**  
**796 MEGOHMETER (0-200 Megohms)** \$ 50.00

**BOSTON GEAR WORKS**  
**LBT-150 TWINTABLES** .....\$ 20.00  
 (Gear Reduction 150—NEW)

**BOONTON**  
**140-A BEAT FREQUENCY GENERATOR**  
 \$550.00  
 (20 Cps to 5 Mc  $\pm$  2% Output 1 MV to 32 volts)  
**155-A F.M. SIGNAL GENERATOR** \$350.00  
 (1 To 11 Mc and 38 To 50 Mc.—0.1 To 1 Volt output—0-225 Kc deviation)  
**120-A V.H.F. CIRCUIT CHECKER** \$ 95.00  
 (3 Ranges—24-210 Mc.) For TV & FM Testing



**BOONTON 120A**

ALL PRICES F. O. B. N. Y. C. WAREHOUSE SUBJECT TO PRIOR SALE

## THE NATIONAL INSTRUMENT CO.

FAR ROCKAWAY, N. Y.

CABLE ADDRESS NATINSTRU, NEW YORK

TELEPHONE FAR Rockaway 7-1123

# TUBES

All Brand New in Original Factory Package

<b>MAGNETRONS</b>	<b>TRANSMITTING</b>
2122 .....\$15.00	15E .....\$ 2.95
2132 .....15.95	24G .....49
2138 .....15.95	VT-25A (10Y).....39
2148 .....15.95	VT-158A .....4.90
5123 .....15.95	211 .....98
5129 .....15.95	388A .....4.95
714AY .....9.80	GL434A .....7.95
725A .....12.50	446A (2C40).....1.74
	WL530 .....19.95
	708A .....2.00
<b>KLYSTRONS</b>	715B .....9.95
417A .....9.80	801 .....95
417B .....9.80	804 .....6.95
723A .....4.00	807 .....1.19
726A .....4.75	829B .....4.50
	841 .....49
	1022 .....1.49
	1626 .....39
	1629 .....29
<b>SPECIAL PURPOSE</b>	7193 (2C22).....2.99
IB24 .....2.95	
VR-150 .....69	<b>RECTIFIER</b>
724B .....1.95	2X2A .....1.80
2051 .....49	3B2A .....1.95
	RK60 .....69
<b>RECEIVING</b>	CRP-72 .....2.95
3A5 .....98	250R .....4.95
3D6/1299 .....39	WL-531 .....19.95
6AK5 .....1.56	705A .....1.85
7C4/1203A .....39	WLB69B .....29.95
12A6 .....39	
12A6GT .....39	<b>CATHODE RAY</b>
VT-32 (SPEC 45).....39	3BP1 .....2.95
446A (2C40).....74	5AP1 .....2.49
717A .....98	5BP1 .....1.95
954 .....49	
957 .....49	

**SPECIAL: 3CP1/S1 Cathode Ray Tube with Altimeter Markings** ..... 98¢  
 We invite inquiries on large quantities.  
 MINIMUM ORDER \$2.00  
 TERMS—Cash with order or 20% Deposit, Balance C.O.D.

ALL PRICES ARE NET, F.O.B., DAYTON, OHIO

**SREPCO, INC.**  
 STANDARD RADIO & ELECTRONIC PRODUCTS  
 135 E. Second St. - DAYTON 2, OHIO - Tel. Fullon 2174

### RADAR ANTENNAS

**YAGI ANTENNA**—ASB Radar 5 element wide spaced array (450 to 560 MC) ..\$ 2.00  
**SAME** with Sperry type F hydraulic servo controls for remote rotation.....\$20.65  
**DOUBLE STACKED ASB YAGI**—same freq. consists of two 6 element beams.....\$12.70  
**SAME** with hydraulic servo controls for remote rotation.....\$31.65  
**DOUBLE STACKED ASA YAGI**—two 6 element beams (370 to 430 MC).....\$20.40  
**SAME** with hydraulic servo controls for remote rotation.....\$18.75  
**AT-49A/APR-4**—(300 to 3300 MC) .....\$13.70

### GENERAL ELECTRIC FG-172 THYRATRONS

Brand new in original cartons. This tube is used in many industrial controls. **FULLY GUARANTEED.**  
**SPECIALLY PRICED AT \$14.80 EACH**  
**\$10.00** each in lots of 10

### WESTINGHOUSE HYPERFIL Transformers

Pri. 115V 60 cy ¼ KVA—Sec. #1 240V at 1.56A, Sec. #2 240V at 1.56A, Wt. 30 lbs .....ea. \$11.50  
**\$10.00** each in lots of 10

### HYDRAULIC SERVO CONTROLS

**Type 1**—Sperry type F (or equivalent) for transmitting rotary motion.  
**Type 2**—SAME except receiver produces linear motion. Either type \$20.00 per set (transmitter and receiver). **\$17.85** each in lots of 10.

**PHASE SHIFT CAPACITOR**—4 Stators, single rotor.....\$1.92 each; 10 for \$16.75  
**HOYT Model 515 portable DC ammeter**, range 0-15 amps.—\$3.95 each; 10 for \$35.00

### 200 WATT WIRE-WOUND Ferrule Type RESISTORS

Fixed taps at each 10% of full resistance value. Dimensions 1½" dia. x 9½" long.  
 25 ohms 198 ohms 500 ohms 2000 ohms  
 50 ohms 300 ohms 1500 ohms 5000 ohms  
**77¢** each, 10 for \$6.10

### GENERAL ELECTRIC AMPLIDYNE Motor-Generator

Consists of G.E. model 5KC67BB475 1HP 116V 1 ph 60 cy 11.5A 3450 RPM continuous duty motor coupled to G.E. model 5AM65FB31 250V DC 2A 0.5KW 3450 RPM Amplidyne generator.  
**BRAND NEW \$97.50**

WRITE FOR LATEST BARGAIN BULLETIN

## ELECTRONIC RESEARCH LABORATORIES

1021-23 Callowhill St. New Location Phila. 23, Pa.

Telephones: MArket 7-6590 and 6591

### RADAR EQUIPMENT

**APS-3 & APS-4 3cm search sets complete**  
**SO-12 complete w/trailer & gas driven supply**  
**SO-9 10cm shipborne search set compl. w/spares**  
**APR-1 Receivers** ..... 750.00  
**QBF Sonar Sets** ..... 750.00  
**SO-9 Pulse Networks 1 microsec.**  
 15 Kwatt ..... 15.00  
**SO Pulse transformers** ..... 15.00  
**AY-101D Autosyn w/calibration** ..... 30.00  
**Weston mod. 45 0-25 amp. DC** ..... 40.00  
**2J1G1 Selsyn motor** ..... 2.00  
**PR-112 Power unit** ..... 25.00  
**APQ-2 Transmitter & Power unit** ..... 75.00  
**Westinghouse Freq. Met. 58-62 CY.** ..... 22.50  
**G.R. Type 471A 50,000 ohms** ..... 5.00  
**Selenium rectifier, full-wave 115VAC 250ma, DC** ..... 1.20  
**BD-77 Dynamotor** ..... 9.50  
**Vacuum tube pump station complete w/pumps, manifold, ionization gauges, oven, etc.**  
**Tubes:** 350 ..... 1.50 803 ..... 5.00  
 715B ..... 15.00 RK72 ..... 1.30  
 723A/B ..... 10.00 726A ..... 12.50  
 725A ..... 12.50 3BP1 ..... 2.50

Write for listings of other surplus bargains.  
**LERU LABORATORIES, INC.**  
 360 Bleeker St. New York 14, New York

### SAVE AT AMSCO!

**PARABOLIC REFLECTORS**—15" spun alum. Alzak fin. for 1200 Mo. up.....pr.\$3.00  
**PHASE SHIFT CONDENSERS**—2 sections, split stator 4-15 mmfd. silver plated.....\$ .65  
**CAPACITORS ELECTRO.** 40-40 250 volts 6 for .....\$1.79  
**VIBRATORS**—7 prong 2 volt for GE portables Replaces LB-530 2 for.....\$2.49  
**MICRO AMMETER**—Beede 0-200 DC.....\$3.49  
**MILLIAMMETER**—Beede 0-1000 DC.....\$2.79  
**METER RECTIFIERS Full Wave**.....\$ .95  
 Half Wave.....\$ .65  
**WIRE-WOUND RESISTORS** vitreous enameled 10 watt 1, 40, 100, 200, 2000, 10000 and 25000 ohms 25 Watt 12, 1000 and 5000 ohms .....\$6.50

Available 1949 Catalog Write Today  
**AMERICAN SALES CO.**  
 1811 W. 47th St. Chicago 9, Ill.



## NEW SHIPMENT

### AC RELAYS!

Struthers Dunn #CS2368A Coil 110 Volts, 60 Cycle DPST Contacts 110 V.A.C., 30 Amps. Price only \$1.95  
**Cased AC Relay Allied #BJH 6A115** Coil 115 Volts 50/60 Cycles DPDT Contacts Housed in hermetically sealed can with feed-through glass-wire terminals. Price \$1.95  
 Struthers Dunn #2367 Coil 110 Volts 60 cycles 3PDT Contacts 110 Volts 30 amps. Price \$2.95  
 Struthers Dunn #2366 Coil 110 Volts 60 cycles 3PST Contacts 110 Volts 30 amps. Price \$1.95

**110 Volt DC Relay—Leach type 2058-SMX** coil 4200 ohms. Heavy contacts DPDT plus Holding Contact. Mounted on micalex base with mica and micalex insulation. Price \$1.45

### Glass-Ferrule POWER RESISTORS

Resistance	Wattage	Price
5 ohms	8	\$ .35
10 ohms	8	\$ .35
4000 ohms	11	\$ .40
16 K "	12	\$ .40
100 "	15	\$ .45
400 "	15	\$ .45
4000 "	15	\$ .45
5MEG		\$ .45
6MEG		\$ .45
160	20	\$ .50
4000	20	\$ .50
13 K	20	\$ .50
12 1/2 K	20	\$ .50
25 K	20	\$ .50
100K	24	\$ .55
100	40	\$ .60
20	100	\$ .75

### TRANSTAT VOLTAGE REGULATOR

Type RH  
 Fixed Winding 115 Volts—400 cycles  
 Commutator ranges 75-120 Volts  
 Load—72 KVA  
 Housed in Shielded case 5 1/2" x 6" x 6 1/2"  
 Price \$1.65

### 115-220/440 TRANSFORMER

Type CRP-30451 Pri. 220/440 Volts 60 Cycle Sec. 115 Volts 5.22 amps Test Volts 1780 RMS  
 Price only \$8.95

## MARCH SPECIALS

Co-axial Cable RG54/U . . . . . Price \$35/1000 Ft.  
 (no order accepted for less than 500 ft.)  
 Litz Wire 15 Strands #44 S. S. Enameled . . . . . Price \$2.25/lb.  
**Multiple Cased Electrolytic Condenser** 4 x 20 mfd. —450 Volts #D8556 Dimension 3 1/2" x 1 3/4" x 3 1/4" . . . . . Price \$3.85  
**Dual Air Trimmer.** Mounted on Ceramic base. 6.60 mmf Sickles Type. Condensers separated by metal shield . . . . . Price \$1.15  
**Air-Trimmer.** Sickles type—capacity range 6-60 mmf. Ceramic Insulation . . . . . Price \$1.10  
**High Frequency Assembly—**Consists of a Sickles ceramic trimmer 6-60 mmfd attached to polystyrene coil which can be resonated 40-70 megacycles. . . . . Price \$3.25  
**Coaxial Angle Connector #M-359** Similar to Amphenol type 83-1AP . . . . . Price \$1.19 each  
**U.H.F. Tank Antenna Quarter-Wave** 11 1/2 Inches long, mounted to bakelite base with female coaxial connector underneath. Suitable for use on 1 1/4 meter band. . . . . Price only \$3.35

### RADIO NOISE FILTERS

Mallory NF7-3A—Housed in silver-plated rectangular case 3 3/4" x 1 7/8" x 2 1/2" with male and female amphenol AN3108 plugs. . . . . Price \$3.45  
 Mallory NF7-4—Housed in rectangular case 3" x 1 1/2" x 7 1/2". Internal screw terminals. Rated at 12 amperes—35 V.D.C. . . . . Price \$6.65  
 Mallory NF2-2—Housed in square case 3 3/4" x 2 1/2" high—Rated at 50 amperes 35 volts. . . . . Price \$3.55  
**General Electric Noise Filter—**Housed in square case 4 1/4" by 3" high. Rated at 200 amperes at 50 volts . . . . . Price \$3.75  
**Bendix—model 3937—Generator Filter—**50 amps. 120 Volts D.C.—Housed in shielded containers 4" x 3 3/4" x 3" . . . . . Price \$1.25  
**Line Noise Filter—**Unshielded and mounted on a bracket. Suitable for use on regular power lines—Consists of two .01 molded condensers and 140 turn solenoid choke coil. . . . . Price only \$1.10

### UTILITY MODEL NFRD NOISE FILTER

Designed for radios, appliances, and electrical equipment consuming up to 1300 watts (12 amperes) at 120 volts AC or DC  
 Housed in a metal case 1 3/4" x 3" x 7 1/2" complete with male and female line connectors. . . . . Price only \$1.95

Write for New Complete Catalog

## NEW SURPLUS

### 4000-6000 VOLT LOW CURRENT DC SUPPLY

Brand new completely wired and tested. Ready to operate from 115 volt power line. D.C. output is filterless. . . . . Price Complete \$12.50

### PRECISION RESISTORS

Types WW3, WW4, and WW5

Following sizes are

in 1% and 2% tolerance	Price \$35
1 me	46,000
.8 "	33,000
.75 "	26,500
.7 "	20,000
.6 "	17,000
.268 "	17,300
.22 "	15,000
125,000	13,300
120,000	12,000
109,000	10,000
95,000	8,000
92,000	7,500
84,000	4,500
82,000	4,300
80,000	4,000
54,500	2,500

Following sizes are 5% or better tolerance, Price \$15

	70	50	30
12,000	70	50	30
40	35	30	

The following sizes are 1% or better. Price \$10

	23.29	4.3
4.285	23.29	4.3
220.4	13.52	3.94
147.5	13.333	3.5
105.8	10.2	1.563
53.96	5.1	.29
53.32	4.4	.25
33.22	4.35	

# EDLIE ELECTRONICS, INC.

154 GREENWICH STREET

TELEPHONE DIgby 9-3143

NEW YORK 6, N. Y.

## 2nd Annual Penny Sale!

The biggest money saving sale you ever saw. For 1¢ more you get 2. \$500,000 worth of Electronic and Radio merchandise thrown into this sale.



For Example: HI FIDELITY 20,000 ohms to 600 ohms. 2" d x 3 1/2" h RAYTHEON No. CRP 303/5A Suitable from preamp. plate to line or phones. Flat from 15 to 20,000 CFS. No. Tx240. Ship. Wt. 2 1/2 lb.

\$2.29, 2 for \$2.30



PRICE ROTARY 14V coil 30° Rotation 8 1/2 oz.-in. torque. Single wafer

\$1.49, 2 for \$1.50

Antenna Switching Relay. 115V A.C. DPDT 10 Amp. contacts, manual release latch. 200 ohms. Allied

\$1.49, 2 for \$1.50

Prices net FOB our plant. Include enough for postage and insurance. WRITE FOR COMPLETE PENNY SALE LISTINGS. YOU'LL BE AMAZED AT THE BARGAINS!

# Universal/general corp.

365 Canal St., N. Y. 13 (Dept. E) Walker 5-9642

## MACHINERY FOR MANUFACTURING ELECTRONIC TUBES

Large inventory, used approximately 2 years. Will Sacrifice.

GAYLIN PRODUCTS CO.  
 40 E. 21st St. New York 10, N. Y.

## GENUINE WESTERN ELECTRIC HI-FI TWEETER

Also Supplied Complete with Projector

You'll Need 10

HI-FI TWEETER or Driver Unit

\$5<sup>95</sup> F.O.B. N.Y.C.

10 For \$49.50



GOV'T COST \$40.00

The Highest Standards of Electronics and Mechanical Tolerance Are "Built-in" This Sensational TWEETER or DRIVER UNIT.

FULL FREQUENCY RESPONSE 35 WATTS

8 Ohm Voice Coil Will Handle up to 55 Watts Peak Efficiency—Perfect Alignment. Supplied with a breakdown-proof diaphragm of modern plastic, replacing the old metal type.

Completely impervious to climatic changes and corrosion.

Better Buy 4



WESTERN ELECTRIC DRIVER UNIT with REFLEX PROJECTOR

HERE IT IS!!!

\$19<sup>95</sup> F.O.B. N.Y.C.

4 For \$75.00

A Blast-Proof, Blare-Proof Reflex Speaker with a Projector especially designed for use with the famous WESTERN ELECTRIC DRIVER UNIT.

Heavy Gauge metal construction throughout, including the main trumpet section, gives you peak performance without blaring or blasting.

Excellent for Concessions—Ball Parks—Schools—and P. A. Work.

Western Electric Driver Unit and Projector complete with an additional Western Electric Driver Unit for the seasonally low price of . . . . . \$24.95 F.O.B.N.Y.

SPECIAL!

25% DEPOSIT WITH ORDER, BALANCE C.O.D.

MANUEL KLEIN 74 CORTLANDT ST. NEW YORK 7, NEW YORK



# SEARCHLIGHT SECTION



MEASUREMENT CORP.

U.H.F. Model 75

## STANDARD SIGNAL GENERATOR

Frequency Range 50 to 400 meg. in one range. Output voltage: Continuously variable from .2 microvolt to .2 v, balanced to ground. Output impedant constant, 35 ohms to ground. Modulation: variable continuously to 50% from 400 and 1000 cycles—internal osc. or from external source—built in modulating amplifier

List Price \$1,700.00 **\$695.00**

OUR PRICE

(Used) In Perfect Condition

Subject to Prior Sale

## SUBMARINE INTERCOMMUNICATING SYSTEM INTERIOR UNIT

Model No. SI-43A

115 Volts, 60 Cycles - Mfg. by Kegron - 5 channels

BRAND NEW

**\$49.95**



**SPRAGUE  
PULSE  
NETWORK**  
15-A5-1-400-50M  
H504

**\$14.95**

Terms: Net Cash

**WESTERN  
ELECTRIC  
TEST HEADSET**  
716A

Low Impedance—Brand New

**\$14.95**



F.O.B. New York City



## GE 100 WATT TRANSMITTER

Government Cost over \$1,000.00.  
Cost to you ..... \$14.95

Developed by Army Signal Corps for use in planes and mobile ground equipment. Designed and constructed to operate under all adverse weather and mechanical conditions. These transmitters can be tuned through wide frequency range with plug-in tuning units which are available. Each plug-in unit has its own oscillator and PA tuning components which operate within its frequency band. Three meters, 1 for oscillator and modulator plate currents, 1 for filament volts and 1 for RF amperes all front panel mounted. These transmitters will operate on the 10 & 20 meter bands with slight modification. All frequency sensitive components are thermally compensated. Uses 4 type 211 tubes and one type VT 25 speech amplifier. These transmitters may have one cracked antenna board when you receive yours otherwise in very good condition. Shipped with 1 tuning unit and all tubes.

## 1000 VOLT DYNAMOTOR

1000 VDC @ 350 output. 12 VDC input. Can be used as plate supply with above transmitter. BD-77 mfd. by General Electric. Remote control starting relay. Filtered output. Like new ..... \$8.95

## GASOLINE DRIVEN ELECTRIC GENERATORS

FULLY TESTED TO DELIVER MAXIMUM  
OUTPUT BEFORE SHIPMENT

ONAN W3M 3 KW, 115 VAC, 60 cycle 26.1 amps, 1 phase, 2 cylinder gas engine. Size 40" L x 33" H x 20" W ..... \$295.00

V-45 ONAN 5 KW, 115 V, 43.4 amps, 60 cycle, single phase, 12 V charging, 4 cylinders, 1800 RPM. Fully enclosed. Self-starting. Battery included. Trailer mounted. 4 pneumatic tires. Power Unit 65" L x 25" W x 36" H ..... \$489.00

PE-95 5 KW, 115 VAC, 60 cycles single phase. Battery charger. Remote or local starting. Gasoline engine, 4 cylinder, 4 cycles water-cooled, 1200 RPM, 12 volt starting. 72 1/2" L x 27 1/2" W x 38 1/2" H. Wt. 1600 lbs. .... \$589.00

WISCONSIN TYPE AEH 2.0 KW, 115 VDC, 17.4 amps, air-cooled, single 3/4" cylinder, 1800 RPM. Equipped with carrying handles, outlet box and voltmeter. Weight 150 lbs. Size 30" L x 23" H x 21" W ..... \$189.00

## HIGH VOLTAGE FUSES

5,000 V @ 1 Amp. and 5,000 V @ 1 1/2 Amp. Buss #HVJ or Littlefuse #702001  
Either size ..... .25 ea.  
Box of 100 ..... \$19.00

Satisfaction Guaranteed—Order by Mail

Prices subject to change, without notice. Subject to prior sale. Drop us a line, we probably have it.

## 0 to 115 V AC at 20 AMP.

Amertran Transtat, provides continuously variable voltage from 0 to 115 V AC up to 20 Amp, 2.3 KVA. Input required 115V, 60 cycles. Amertran #88978.  
11 1/2" D x 10" L ..... \$34.50

## JAN TUBES

RK-63 ..... \$13.50 450TL Triode... \$19.95  
VT-127A Triode. 2.95 6L-8020 Rectifier 3.95  
304TL Triode.... 6.95 12DP7 Cathode Ray 12.95

Case lot of six 12DP7, export packed \$8.95 each.

## BC-325—TRANSMITTER

400 Watts CW and 100 Watt phone, very conservatively rated. Frequency range 1.5 to 18 megacycles. Temperature controlled master oscillator and choice of 5 crystal frequencies from front panel. Thermostatically controlled blower, parallel 800's power amplifier. All circuits metered and tuned from front panel. Eleven 3/4" meters all front panel mounted. One inch cathode ray modulation monitor. All tubes and CRT furnished. Power supply 110/220 single phase 60 cycle. Completely enclosed in oversize rack. A real commercial transmitter. In top-notch operating condition. Mfg. Federal ..... \$495.00

## DIRECTION FINDER EQUIPMENT

Part of SCR-551-T2 consists of the following: Input Amplifier and Electronic Switch, National NC-100 A Receiver, Oscilloscope and D.C. Amplifier and Control Panel. Completely assembled and in cabinet. In excellent condition..... \$349.50

## GE AUTO TRANSFORMERS 300 Watts 60 Cycle

Type "A" Pri. 115 volts tapped at 140/150/160 V or Type "B" Pri. 115 volts tapped at 160/170/180 V Fully Enclosed. State type wanted..... \$2.95

## PANEL LIGHT ASSEMBLY

Fits up to 1/2" panel. Candelabra socket. Red slip fit bezel. Drake type 75. .... \$ .29

## FRANKEL TEST CLIPS

Insulation piercing. Shank Threaded for 6/32 screw, also 6/32 thumb screw.  
20 for ..... \$ .89  
1000 for ..... \$32.00

## BULLETINS FURNISHED ON:

Transformers, Power Units, Cable, Pole Line Equipment, Photographic Equipment, Test Equipment, Tools & Hardware and Clothing.

## ABELL DISTRIBUTING CO.

Dept. E3

5 E. Biddle Street Baltimore 2, Maryland

# At Your Service

—for bringing business needs or "opportunities" to the attention of men associated in executive, management, sales and responsible technical, engineering and operating capacities with the industries served by the following McGraw-Hill publications:

## The SEARCHLIGHT SECTIONS of

(Classified Advertising)

- American Machinist
- Aviation Week
- Business Week
- Bus Transportation
- Chemical Engineering
- Coal Age
- Construction Methods
- Electrical Construction & Maintenance
- Electrical Merchandising
- Electrical World
- Electronics
- Engineering and Mining Journal
- Engineering News-Record
- E. & M. J. Metal & Mineral Markets
- Factory Management and Maintenance
- Food Industries
- Operating Engineer
- Power
- Product Engineering
- Textile World
- Welding Engineer

For advertising rates or other information address the

Classified Advertising Division

**McGRAW-HILL  
PUBLISHING CO., Inc.**

330 West 42nd Street  
New York 18, N. Y.

## WANTED

### WANTED

**300-1000 Mc. sig. gens.,  
test equipment transmitters,  
recvrs., etc.**

**J. H. POOLE**  
1009 SECURITY BLDG.  
LONG BEACH, CALIF.

## WANTED

**W. E. Carrier Telephone and Carrier  
Telegraph Equipment and  
components. Filters, repeating  
Coils, Transformers, Equalizers.  
Type CF1, CF2, H, C, and other  
carrier equipment, telephone and  
telegraph repeaters.**

W-6660, Electronics  
330 West 42nd St., New York 18, N. Y.

### WANTED

#### WESTERN ELECTRIC VACUUM TUBES

Types 101F, 102F, 272A, 274A or B, 310A  
or B, 311A, 313C, 323A, 328A, 329A, 348A,  
349A, 352A, 373A, 374A, 393A, 394A, 121A  
Ballast Lamps.

W-6641, Electronics  
330 West 42nd St., New York 18, N. Y.

## WANTED

**TS-13 AP  
TS-14 AP  
TS-33 AP  
TS-34 AP  
TS-35 AP**

And other test sets  
Also APR-1 and APR-4 Receivers

W-7335, Electronics  
330 West 42nd Street, New York 18, N. Y.

## WANTED

Teletypewriters complete, components or  
parts. Any quantity and condition.

W-6654, Electronics  
330 West 42nd Street, New York 18, N. Y.

### WANTED ELECTRONICS SURPLUS

Complete equipment, components, trans-  
formers, resistors, gov't surplus, speakers,  
sets, etc. Unlimited quantities. Plenty of  
ready cash. Write:

W 7985, Electronics  
330 West 42nd St., New York 18, N. Y.

# Coaxial Cables and Connectors Brand New!! JAN Approved!!

### "UHF" COAXIAL CABLE CONNECTORS



No.	An. No.	Description	Each	Price per 100
83-1SP	(PL259)	Plug	28¢	22¢
83-1SPN	(PL259A)	Plug	28¢	22¢
83-168	(UG176U)	Reducing adapter.	15¢	12¢
Use with 83-1SP or 83-1SPN				
83-1H	(UG106U)	Hood	12¢	10¢
83-1R	(SO239)	Receptacle	35¢	28¢
83-1AP	(M359)	Angle Adapter	28¢	22¢
83-1T	(M358)	Connector	\$1.25	\$1.12
83-1J	(PL-258)	Junction	85¢	70¢
83-22R	(UG103U)	Receptacle	50¢	40¢
83-22SP	(UG102U)	Plug	50¢	40¢

### COAXIAL CABLES

RG5U	per 1000 ft.	\$70.00
RG6U	per 1000 ft.	120.00
RG7U	per 1000 ft.	70.00
RG8U	per 1000 ft.	40.00
RG9U	per 1000 ft.	135.00
RG10U	per 1000 ft.	90.00
RG11U	per 1000 ft.	100.00
RG12U	per 1000 ft.	175.00
RG13U	per 1000 ft.	125.00
RG18U	per 1000 ft.	320.00
RG22U	per 1000 ft.	120.00
RG29U	per 1000 ft.	37.50
RG34U	per 1000 ft.	175.00
RG39U	per 1000 ft.	55.00
RG54A/U	per 1000 ft.	60.00
RG57U	per 1000 ft.	65.00
RG58U	per 1000 ft.	75.00
RG59U	per 1000 ft.	59.00
RG62U	per 1000 ft.	45.00
RG62U	per 1000 ft.	50.00
RG71U	per 1000 ft.	120.00

Prices based on a minimum quantity of 500 ft.  
For cut lengths add 50%

### UG TYPE CONNECTORS

Deduct 10% from prices shown  
on orders of 100 or more per type

AN #	Price ea.	AN #	Price ea.
UG-4/U	1.14	UG-97/U	3.50
UG-11/U	1.56	UG-98/U	1.55
UG-11/U	1.45	UG-100/U	2.34
UG-12/U	1.14	UG-101/U	2.95
UG-12/U	1.56	UG-107/U	2.25
UG-14/U	1.45	UG-108/U	1.75
UG-14/U	1.14	UG-109/U	1.75
UG-16/U	1.56	UG-114/U	1.50
UG-17/U	1.45	UG-115/U	1.35
UG-18/U	1.25	CW-123/U	.45
UG-18A/U	1.05	UG-155/U	.40
UG-18B/U	.99	UG-154/U	3.75
UG-19/U	1.28	UG-155/U	3.75
UG-19A/U	1.38	UG-156/U	4.25
UG-19B/U	1.45	UG-160/U	1.90
UG-20/U	1.17	UG-160A/U	1.55
UG-20A/U	1.26	UG-167/U	2.25
UG-20B/U	1.41	UG-173/U	.30
UG-21/U	.99	UG-175/U	.15
UG-21A/U	1.05	UG-176/U	.15
UG-21BU	.99	UG-188/U	1.30
UG-22/U	1.03	UG-201/U	1.22
UG-22A/U	1.38	UG-202/U	2.75
UG-223/U	1.34	UG-206/U	1.02
UG-23/U	.99	UG-208/U	28.50
UG-23A/U	1.26	UG-212/U	4.50
UG-233/U	1.29	UG-213/U	4.50
UG-27A/U	2.25	UG-215/U	3.35
UG-28/U	2.34	UG-216/U	8.70
UG-29/U	1.22	UG-213/U	3.10
UG-30/U	1.75	UG-218/U	6.50
UG-33/U	30.00	UG-222/U	35.00
UG-34/U	35.00	UG-231/U	2.00
UG-35A/U	28.00	UG-236/U	11.75
UG-36/U	35.00	UG-241/U	2.20
UG-37/U	28.00	UG-242/U	2.50
UG-37A/U	30.00	UG-243/U	2.75
UG-57/U	.99	UG-244/U	2.50
UG-58/U	.63	UG-245/U	1.25
UG-59/U	2.75	UG-246/U	1.45
UG-59A/U	1.70	UG-252/U	4.50
UG-60/U	1.90	UG-254/U	1.82
UG-60A/U	1.30	UG-255/U	1.85
UG-61/U	2.05	UG-260/U	1.12
UG-61A/U	1.80	UG-261/U	.95
UG-62/U	28.00	UG-262/U	1.05
UG-83/U	1.50	UG-269/U	2.60
UG-85/U	1.65	UG-273/U	1.50
UG-86/U	1.69	UG-274/U	1.98
UG-87/U	1.40	PL-274	1.12
UG-88/U	1.17	UG-290/U	.85
UG-89/U	.95	UG-291/U	1.05
UG-90/U	1.05	UG-306/U	2.03
UG-91/U	1.25	UG-333/U	4.70
UG-91A/U	1.05	UG-334/U	5.75
UG-92/U	1.10	UG-352/U	6.00
UG-92A/U	1.35	UG-287/U	5.25
UG-93/U	1.25	UG-270/U	6.50
UG-93A/U	1.45	UG-259/U	4.10
UG-94/J	1.25	UG-279/U	2.40
UG-94A/U	1.05	UG-167/U	4.25
UG-95/J	1.10	MX-195/U	.55
UG-95A/U	1.35	UG-197/U	5.25
UG-96/J	1.25	UG-235/U	28.50
UG-96A/U	1.45		

## Life Electronic Sales

91 Gold St.

Tel: DI gby 9-4154

N. Y. 7, N. Y.

## WANTED

### WANTED, AIRCRAFT RADIOS

AN/ART-13, BC-348, RTA-1B, AN/APN-9, R5A/ARN-7, AN/ARC-1, AN/ARC-3, SCR-718, BC-788-C, I-152, MN-26-C, Test Sets with TS- or I- prefix. State quantity, condition and best price first letter.

**HI-MU ELECTRONICS**  
BOX 105, NEW HAVEN, CONN.

### WANTED TO BUY

Western Electric CF-1, CF-2, CF-3, CF-4, CF-5, CF-6, H, H-1 Carrier, EE100, EE101A ringing equipments. All models teletype. All models RCA Marine transmitters. All W.E. C.E. switchboards.

W-7162, Electronics  
620 North Michigan Ave., Chicago 11, Ill.

# SEARCHLIGHT SECTION



## TOP TRANSFORMER BUYS!

**POWER TRANSFORMERS**—115V/50-60 cps input  
 500VCT/60ma; 6.3V/4A Herm Csd. \$1.49  
 700VCT/150ma; 10V/3.25A, 6.3VCT/2A, 5V/3A and 2.5V/10A HV insul. Csd. \$3.95  
 700VCT/120ma; 20V/1.2A and 5V/2A; 115V/80VCT/125 to 250ma; 6.3V/3A, 6.3V/2A, 5V/3A \$4.45  
 1100VCT/150ma; 6.3V/3A and 5V/3A HVins. \$4.50  
**PLATE TRANSFORMERS**—115V/50-60 cps input  
 put 7500V or 15000V 100/250ma. \$19.95  
 10800V or 21000V Dblr/95ma. \$19.95  
 1200VCT/300ma \$5.95

**FILAMENT TRANSFORMERS**—115V/50-60 cps input  
 2.5V/40A GE 6.4V/12A, 6.4V/10A \$4.95  
 25KVins 3x5V/9A, 2.5V/17.7A \$4.95  
 2.5V/10A/10KV \$3.95 7.5VCT/6.5A, 6.3VCT/3A \$3.75  
 2.5V/10A/20KV \$6.95 5V/12A/HV insul. \$4.95  
 5V/60A KENYON HV 10V/8A/12KV \$6.95  
 1.03 22VCT/7A, 10VCT/10A, 1.3 220V/2A, 3x6V/1A \$7.95  
 5V/115A \$12.95 2x6V/2A, 3x6V/1A \$7.95  
 4x6.3V/4A, 6.3V/2A \$8.95  
 3x5V/4A \$4.50 6.3V/2A \$1.59

**SPECIAL TYPES**  
 Input Output Each  
 110 or 220V 10VCT or 5VCT/10A \$4.95  
 110 or 220V 5VCT or 2.5VCT/20A \$5.95  
 6, 12, 24, 115VCT 420VCT/85ma, 6.3V/3A 2.49  
 115 or 230VAC Univ. Vibra. Xfmr. \$4.95  
 220V 220 to 200V/250Watt \$4.95  
 110V 220 to 410V/250Watt \$4.95  
 115 or 230V AutoXfmr 1.8KW \$16.95  
 115 or 230V AutoXfmr 2KW \$19.95  
 208 to 251V 6800V or VCT/1A/17KVins \$59.50  
 105 to 126V 3400V or VCT/1A/17KVins \$59.50  
 107 to 250V 2240VCT/500ma; 10V/2.5A \$19.95  
 1W/4.5A, 2.5V/10A  
 Tube Checker Xfmr UTC-20 filaments from 3/4 V \$3.39  
 to 117V & HV 430, 250 & 115  
 Step Up Step Down 120 to 220 or 440 or 440-220 \$5.98  
 or 110V/350Watts

## VIBRAPACKS

6VDC in 425V/110ma out \$10.95  
 Vibrapack 1E157Spkr Bat & Chgr. 8/5 SCR 593 & Spkr. 8.95  
 1P/18AR inpt 12-13V out 3.49  
 24VDC \$6.95

## VOLTAGE REGULATORS—VARIACS—POWERSTAT

CONSTANT V'REG NEW RAYTHEON IN 95-130V/60 cy; Out 115V/60cy Cased 60 watts/1% Regltn \$10.95  
 RAYTHEON 190 to 242 inpt/50-60cps; Out-put 220V/500Watts/0.5% Regltn Rackmtg. \$36.00  
 SOLA CONSTANT V'REG USN Csd in 95or 190V/50-60cps; Output 115or220 2KW/17.4 Amps Constnt Duty, 1% Regltn LN\* \$130  
 Same NEW USN Cost \$369, Only \$162  
 Variac, 200B/175Watt/0-135V GR \$15.98  
 Variac, 200C/850Watt/0-135V GR \$18.00  
**POWERSTAT in 115V/50-130V/1KW**

## SELSYNS MOTORS GENERATORS

**NEW SERVO AUTOSYN BENDIX BUILT TO RIGID ORDNANCE & NAVY SPECIF.** Removed from New Unuse. Mi Gun Directors. TYPE SYN-CHROTRANSmitters 115V/60 cy. operation continuous heavy duty. PRECISION accuracy made for gun-fire control. Cost gov't \$90 each. Wgt 5 lbs.—Dimensions 4 1/2x3 1/4" Dia. Shaft 5/16 dia. 7/8" mfgd by Bendix, Diehl, Electroflux, Hobart. Complete diagrams included. SPECIAL per PAIR \$12.95  
**SYNCHRO-DIFFERENTIALS TYPE 5 11V 60** \$7.95  
**SYNCHRONOUS REPEATER TYPE II** 115V/60cy BRONZE UNITS per PAIR \$20.00  
**AUTOSYNS TYPE 5/50V/60cy per PAIR** 9.95  
**SYNCHRO DIFFERENTIAL TYPE 5/50V** 4.95  
**AUTOSYNS AY115/28V** 40W can be used 4.50  
**24V/60cy & Instructions** 70W for \$4.50  
**GE SELSYN 115V/110V/60 cy** 4.50  
**GE SYNCHRONOUS INDUCTOR MOTOR** 55MM50H36 115V/60cy TORQUE 40oz\* RPM 75 14.95  
**GE SELSYN TANK GAGE & SELSYN LEVEL** XMTR indicates qty liquid in one to 3 tanks operates 24VDC/AC or 110VAC \$9.95  
**DIEHL 3 phase MOTOR** operates 1 phase 110V/60cy reversible cont duty 1/40 HP/5/8 shaft/1 1/2"/3450RPM & capacitor used LN\* 4.95  
**HOLTZER CABOT 1e3 phase/1HP/115V/60cy/3450 RPM reversible MOTOR** BALL bearing/cont. duty/removed from gun control Moisture P1 GDVT COST \$180 LN\* 18.95  
**KOLLSMAN SERVO 403-2875** 9.95  
**Telephone INVERTER & CONVERTER inpt 43-47VDC, Outpt 90V/20cy W.E. NEW** 18.00

**CRYSTALS—Mtd FT243 exacting S.C. Specs.**  
 3525Kc 4190Kc 5235Kc  
 3735Kc 4780Kc 5485Kc  
 3980Kc 5030Kc ea. 98c; 3 for \$2  
 Write for other frequencies.  
**Hi Accy Xtal Frequency Standards**  
 101.95Kc \$1.98 BC221 \$4.49  
 800Kc 5.98 4700Kc 98  
 200Kc 3.98 4700Kc 98  
 500Kc 12.98 5000Kc 3.98  
**CRYSTALS—Mtd htr Owens HiAccy Stability**  
 5010, 5025, 5056Kc, ea. \$14.98

## Variable Condensers

A. 150mmf/3000Vgap/HF \$1.00  
 B. DUAL 15mmf/sect/3000V gap .79  
 C. DUAL 75mmf/sect/3000V gapHF .49  
 D. Neut RT 12mmf/5000V gap/locknut 1.29  
 VERNIER DRIVE 10-369mmf, ea. 79c; 3 for 2.00  
 MIDGET 3to15mmf midline, ea. 49c; 3 for 2.00  
 VACUUM Condenser 50mmf/7500V 1.98

## PRECISION RESISTORS

NO MFRS CHOICE. We ship types in stock\*

.116	182	689	2850	14460
.42	199	697	3800	14500
.425	200	700	2900	15000
.407	209	733	3000	15500
1.03	216	750	3100	16500
1.3	220	800	3290	17000
1.75	225	806	3295	17500
2.5	230	854	3384	18000
3.75	235	910	3509	18500
5.383	240	917	3700	18500
7.978	245	946	3730	19000
11.000	250	978	3780	19500
15.362	271	1000	4000	20000
20.5	275	1030	4200	20500
28.025	282	1056	4280	21008
38.0	286	1060	4300	21500
51.0	289	1100	4314	22000
68.0	299	1110	4444	22500
91.0	300	1150	4440	22900
122.0	310	1155	4500	23000
163.0	311	1162	4720	23150
217.0	320	1175	4750	23325
288.0	325	1200	4850	23400
384.0	330	1225	4885	24000
510.0	350	1250	4900	24600
675.0	366	1260	5000	25000
900.0	370	1322	5100	25200
1200.0	375	1350	5210	25400
1575.0	380	1355	5235	26600
2100.0	389	1400	5200	27500
2800.0	390	1495	5500	29000
3700.0	400	1500	5600	29500
4900.0	410	1510	5730	29900
6500.0	414	1518	5910	30000
8700.0	418	1600	6000	31000
11500.0	425	1640	6140	33000
15300.0	426	1646	6200	35000
20300.0	427	1650	6300	37000
27000.0	437	1670	6495	38140
35800.0	450	1680	6600	39000
47500.0	452	1710	6840	39500
63000.0	470	1740	6990	40000
84000.0	475	1770	7000	43000
111000.0	478	1800	7500	47000
146000.0	480	1818	7700	47500
198000.0	487	1830	7930	49000
264000.0	500	1865	8250	48600
350000.0	510	1900	8500	49000
465000.0	525	1910	8700	50000
615000.0	540	1960	8800	52000
815000.0	550	1980	8920	54000
1080000.0	575	2000	9030	56000
1425000.0	580	2045	9445	60000
1875000.0	588	2080	9500	61430
2475000.0	600	2095	9710	62000
3270000.0	607	2145	10000	64000
4320000.0	612	2160	10450	65000
5670000.0	625	2195	10900	68000
7470000.0	633	2200	10600	70000
9870000.0	640	2250	11000	72000
13000000.0	641	2300	11400	75000
17000000.0	649	2400	11500	77000
22200000.0	650	2450	11600	80000
29000000.0	657	2463	12000	84000
38000000.0	665	2485	12600	90000
50000000.0	669	2490	13220	91000
66000000.0	670	2500	13500	95000
87000000.0	675	2600	14000	
114000000.0	680	2635	14400	
149000000.0	684	2700	14410	

**ABOVE SIZES EACH 30¢ @ TEN FOR \$2.50**  
 100000 166750 240000 380000 620000  
 110000 169360 245000 400000 621000  
 115000 180600 250000 402000 654000  
 120000 185000 255000 422000 750000  
 125000 190000 260000 448000 813000  
 130000 200000 275000 478000 800000  
 135000 201000 294000 500000 900000  
 140000 220000 307500 520000 930000  
 145000 225000 314000 521000  
 147000 229000 330000 570000  
 150000 235000 333500 575000  
 155000 239000 353500 600000

**ABOVE SIZES EACH 40¢ @ TEN FOR \$3.50**  
 1 Meg 2.5 Meg 3.9 Meg 9.05 Meg 20 Meg  
 1.2 2.855 4 10  
 1.5 3.5 4.23 11.5 12.83  
 2 3.5 5.5 19.5  
 3 3.673 5 19.5

**ABOVE SIZES EACH 75¢ @ TEN FOR \$6.50**  
 .12, .25, .6, .75, .83, .99 megohms  
 1, 1.5, 2, 3, 3.75 megohms 0.5% accuracy  
**SPECIAL \$1.00 @ TEN FOR \$7.50**  
**SEALED 2Meg/10KV/9W \$1.35@10for 10.00**  
**MVZ8/20 Watt/30 Megohms/25KV \$1.95@6for 10.00**  
**MFC105 1Mh/5% accy/1AnR/20 \$1.95@6for 10.00**  
**Type 2/20mef/AnR/29/20KV/0.5%accy \$29.95**  
**SPRAGUE 20 meg/20KV/W/W% accy. 10.98**  
**IRC MVE-8/25Watt/40KV mtg brackets \$1.98; 6/\$10**  
**IRC 100000 ohms 20 position Attenuator 2.98**  
**IRC 250000 ohms 20 position Attenuator 4.98**

**XTAL DIODES & THERMISTORS**  
 IN34 \$1.20; 2/\$2.30; 10/\$11  
 IN21, 21A, 22, 23, 23A ea. \$1; 12/\$10  
 IN21B, IN27, \$2.00; 10 for \$17.50; 100 for \$150  
 IN23B, IN26, NEW \$2.75; 10 for \$25.00  
 IN35 Dual Diode \$2.69  
 D168391, Therm Compensator \$2; 3/\$5  
 D170396 HF pwr meas. \$0.30; 3 for \$2.50  
 IC Bulb Time Delay \$0.30; 3 for \$2.50  
 Varistor 38C USN CW20259 \$2.98

## RADIO, RADAR Equipment

BC457 Xmir as is less tubes 3.49  
 BC456 Modulator as is less tubes 1.49  
 BC456 Modulator w/Tubes & Dyn Good Used 4.98  
 Collins ART13 Sp Amp, less tubes 4.50  
 Same w/Clipper Kit, tubes, data, New 8.25  
 TA12 Xmir Bendix 40WusedLN\* 29.95  
 AP4 CR INd & RVR 150-210Hic w/tubes, New 25.95  
 BC1206 Sockel Cartson BattyRevr 200-400Kc 29.95  
 Good Used w/tubes(5) Special 3.95  
 Gibson Girl Xmitter 4.95  
 USN ABF/SCR95 Rvrr and Equip LN\* 9.95  
 BC1066 UHF Batty Revr New 9.95  
 BC1-196 SigGen UHF Bat New 5.95  
 MC906 p/o IE46 Fq Mtr & Monitor 140 to 230 Mc, New 29.95  
 BC1073 WaveMtr, 150-210McUsed 10.95  
 APS13 RvrXmtr, less tubes LN\* 8.95  
 BC433/MN26 Compnd Rvrr Less Tubes Used 21.95  
 APN4 C'RAY INd less tubes 19.95  
 APN4 RVR less tubes 14.95  
 APN4 CR INd & RVR less tubes 16.95  
 X BandWavemeter30CM Maguire 19.95  
 Same Mtg & X band Wavemeter 29.95  
 723AB OSC Mtg & Transition to two type N coaxial fittings (RG9U etc.) 4.95  
 Parallel Tunable Coax Cavity w/adj hat 300-400 Mc, New 4.95  
 W E 250 Watt Beachmaster SOUND SYSTEM Complete, Write for Specs. BRAND NEW 450.00  
 Pulse Xformer H & V BTO, GE, Raytheon UTAH specify Type, Write Qty prices. 1.49  
 Remote Control Units SCR573 & 574 CRB23367 Selector Cont up to 110V60cy & CRB23368 op24 VDC Controls 2Xmtrs & Rvrrs Automatic SEND RECEIVE switching on either of 2 channels. Write for Specs BOTH UNITS 29.95

## Switches—MICRO, MU, TOGGLE, ETC.

A) MU/Leaf Sw 3 1/2" DPNO&NC/15A 1/2" @ .98  
 B) MICROSWITCH Pin Plunger SPDT 10A @ .54  
 C) MICROSWITCH Plunger SPDT/10A @ .59  
 D) MICROSWITCH Plunger SPNO/10A @ .69  
 E) ARROW H & H PLUNGER SPNO/6A @ .39  
 F) MICROSWITCH ROLLER SPNC 10A @ .89  
 G) AH & H Toggle 6A/DPST 30c @ 4 for 1.00  
 H) MICROSWITCH PLUNGER SPNOC @ .59  
 H) MU & MICROSWITCH SPDT w/reset .65  
 I) MICROSWITCH PLUNGER Button SPDT @ .69  
 J) MICROSWITCH SPNO/30 Amp/Cased @ .98  
 K) SWITCHETTE DPNO&NC 30c; SPNO @ .25  
 S/Q'D START&STOP push button control. .98

METER 200 MicroampDC GE 4" Sq 5 scales AC&DCV&ohms Red & Black K.K.E. pointer NEW, Made for RCA Volt \$7.95  
 METER 0-120 Ma RF Weston JAN 3 1/2" round B'cstd \$12.95  
 Accurate to 65 Mc  
 METER 0-300 Ma RF Weston JAN 3 1/2" round B'cstd Accurate to 65Mc \$12.95  
 Write for Complete Meter List.

## FIRE EXTINGUISHER

CarbonTet PYRENE Igal 200lb Self Charging w/MTR LN\* Shipped dry \$10.98  
 GMT TIME MONTH DATE Clock Stamp LN\* 6.98  
 USN Siren FOGHORN \$1.98; 6 for 10.00  
 CLARE DS-H Automatic Stepping Relay 24/32 VDC 3-lever 10 steps 7.95  
 Sound-Pwrld Headset e Mic e Cable, ea. \$10.98; Pair \$19.49

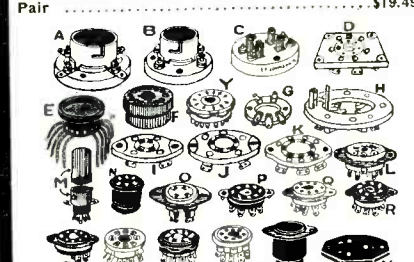

## SOCKETS—All Types!

A. RCA 5-pin GIANT for 803, RK25 USN 90c  
 B. Johnson 4-pin bayonet for 806, etc. 49c  
 C. Johnson Type124-213 for30ATL, 152TL 90c  
 D. Johnson 7-pin Steatite 8291/3129, 826, ea.25¢/15/\$1  
 E. Small Shell DUODECAL for 2P4I, 5TPI, 5UP1 59c  
 F. Med Shell DIEPTAL Cinch mica Bkltc 69c  
 G. 5-pin ACORN 1 9/16"diaHaml'nd, ea.25¢/5for\$1.00  
 H. Johnson 12-234, 5D21, 721w/tube lock. 69c  
 I. 4-prong STEATITE Johnson for 806 etc. 24¢/5/\$1  
 J. 5-prong STEATITE Johnson for 807 etc. 27¢/4/\$1  
 K. 7-prong STEATITE Johnson 1625 etc. ea.29¢/2/49c  
 L. 7-pin NATIONAL CIR7L Steatite, ea.24¢/5 for \$1  
 M. MIN 7-pin Mical47-913 & shield. 28c  
 N. MIN 7-pin Amph 78-71T, ea. 11¢; 10 for 98c  
 N. Amphenol 783FP in 4.5, 6, 7, 8 ea. 16¢; 6 for 89c  
 O. 4-pin Amphenol 49RS&4K Ceramic 24¢/5for\$1  
 P. OCTAL 8pin/plateSteatite Cinch ea. 18¢/12for\$1  
 Q. OCTAL 8pin/plateSteatite Cinch ea. 18¢/7for\$1  
 R. LOKTAL Spin&lock mtg plateCINCH 11¢; 10for\$1  
 S. KLYSTRON socket Cinch, ea. 35¢; 10 for \$3  
 T. LOKTAL Amphenol 49SSU steatite 24¢; 5 for \$1  
 U. OCTAL Amphenol 7858'micalBkltc\* 8¢; 25for\$1.49  
 U. 11-pin 7851/831Amph \$15¢; 7 for \$1  
 V. OCTAL Amphenol 49SSU steatite. 15¢; 12 for \$1.49  
 W. HiVolts Safety 4pinAmph77A4mical3, 30¢/for1.15  
 Y. Magnal J9-S811L Ceramic. 54¢; 2 for 98c  
 BANTAM Jr. 78-5H Amphenol 5-pin. 49c  
 SOCKET FOR 827/211 49c  
 MAGIC EYE Assembly Amphenol 59c

**TAB MONEY BACK GUARANTEE**  
 \$3 MIN. ORDER F.O.B. N.Y.C.  
 ADD SHIPPING CHARGES AND  
 25% DEPOSIT. PHONE WO. 2-7230

**THAT'S "TAB" THAT'S A BUY**

**DEPT. 3E SIX CHURCH ST. NEW YORK 6, N.Y., U.S.A. - CORNER CHURCH & LIBERTY STS. ROOM 200**

**TAB MONEY BACK GUARANTEE**  
 \$3 MIN. ORDER F.O.B. N.Y.C.  
 ADD SHIPPING CHARGES AND  
 25% DEPOSIT. PHONE WO. 2-7230

# INDEX TO ADVERTISERS

Acton Co., Inc., H. W.	235	Erie Resistor Corp.	58
Aeronautical Communications Equip- ment, Inc.	46	Essex Wire Corp.	212
Aircraft Radio Corp.	148	Fairchild Camera & Instrument Corp.	202
Alfax Paper & Engineering Co.	252	Fairchild Recording Equipment Corp.	152
Allen-Bradley Co.	57	Fansteel Metallurgical Corp.	3
Allen Co., Inc., L. B.	251	Federal Telephone & Radio Corp.	151
Allied Control Company, Inc.	60	Ferranti Electric, Inc.	214
Altec Lansing Corporation	233	Ford Instrument Co.	235
American Brass Co.	218	Freud Transformer Co., Inc.	47
American Chromscope Corp.	209	Furst Electronics	235
American Lava Corp.	23	Gamewell Company	210
American Phenolic Corporation	200	General Ceramics & Steatite Corp.	215
American Television & Radio Co.	242	General Electric Company	
American Time Products, Inc.	28	Apparatus Dept.	21, 44, 45, 172
American Transformer Company	33	Chemical Dept.	143
Anaconda Wire & Cable Co.	173	Electronics Dept.	17, 35, 53, 215
Anchor Plastics Co., Inc.	231	General Industries Co.	19
Ansonia Electrical Company	56	General Radio Company	165
Antara Products Div. of General Aniline & Film Corp.	24, 25	Glaser Lead Co., Inc.	226
Arnold Engineering Company	40	Goodmans Industries Ltd.	187
Arrow Electronics, Inc.	202	Graphite Metallizing Corp.	202
Art-Lloyd Metal Products Corp.	194	Gray Research & Development Co., Inc.	221
Art Wire & Stamping Company	245	Handy & Harman	198
Astatic Corporation	174	Harnett Electric Corporation	243
Audak Company	288	Hathaway Instrument Co.	176
Audio Development Company	142	Haydon Mfg. Company, Inc.	188, 189
Ballantine Laboratories, Inc.	158	Hewlett-Packard Company	43
Barber Labs., Alfred W.	250	Indiana Steel Products Co.	52
Barry Corporation	226	Institute of Radio Engineers	233
Beach-Russ Co.	235	Instrument Resistors Company	147
Beaver Gear Works Inc.	184	International Nickel Co., Inc.	159
Bell Telephone Laboratories	18	International Resistance Co.	8, 9
Bendix Aviation Corporation		I-T-E Circuit Breaker Company	13
Eclipse-Pioneer Div.	212	Jensen Manufacturing Co.	37
Pacific Division	244	Johnson Company, F. F.	237
Bentley, Harris Mfg. Co.	30	Jones Div., Howard B., Cinch Mfg. Corp.	230
Bird Electronic Corp.	221	Jones Electronics Co., M. C.	239
Bitcher Corporation	241	Kahle Engineering Co.	251
Bitzer Corporation	239	Karp Metal Products Co., Inc.	135
Boonton Radio Corporation	129	Kay Electric Co.	168, 190
Borg Corp., George W.	141	Kenyon Transformer Co., Inc.	54
Bradley Laboratories, Inc.	246	Kester Solder Company	170
Bradshaw Instruments Co.	243	Knights Co., James	228
Brand and Co., Wm.	4	Kobzy Tool Company	206
Browning Laboratories, Inc.	213	Kulka Electric Mfg. Co., Inc.	229
Brush Development Company	204	Lampkin Laboratories, Inc.	251
Buck Engineering Co., Inc.	243	Lavoie Laboratories	137
Bundy Tubing Co.	65	Leland, Inc., G. H.	68
Burlington Instrument Co.	229	Lenkurt Electric Company	198
Burnell & Company	31	Lewis Engineering Company	217
Cambridge Thermionic Corp.	240	Lewis Spring & Mfg. Co.	166
Cannon Electric Development Co.	182	Linde Air Products Co.	215, 239
Capitol Radio Engineering Institute	241	Lord Mfg. Co.	205
Carborundum Company	20	Machlett Laboratories, Inc.	62, 63
Carter Motor Company	232	Magnetic Core Corp.	231
Centralab, Div. Globe-Union, Inc. 14, 15,	27	Mallory & Co., Inc., P. R.	70, 123
Chatham Electronics, Inc.	125	Manning, Maxwell & Moore, Inc.	192
Chicago Condenser Corporation	241	Marion Electrical Instrument Co.	55
Chicago Transformer, Div. of Essex Wire Corp.	10	Marsh Stencil Machine Co.	251
Cinch Manufacturing Corp.	121	MB Manufacturing Co.	175
Clare & Co., C. P.	165	McGraw-Hill Book Co., Inc.	210, 254
Clarostat Mfg. Company, Inc.	249	Measurements Corporation	230
Cleveland Container Company	193	Mico Instrument Co.	241
Cohn Corporation, Sigmund	247	Millen Mfg. Co., Inc. James	197
Collins Radio Company	61	Mines Equipment Co.	251
Condenser Products Company	171	Miniature Precision Bearings, Inc.	251
Consolidated Molded Products Corp.	29	Mitchell-Rand Insulation Co., Inc.	50
Continental Electric Company	219	Mosinee Paper Mills Co.	146
Cornell-Dubilier Electric Corp.	36	Motorola Research Laboratories	39
Cross Co., H.	251	Mycalex Corp. of America	178, 179
Dano Electric Company	239	National Moldite Co.	223
Daven Co. Inside Back Cover		National Varnished Products Corp.	64
Dial Light Company of America	238	National Vulcanized Fibre Co.	207
Driver-Harris Company	11	Newark Electric Co.	243
Dumont Electric Corp.	228	New York Transformer Co.	199
Du Mont Laboratories, Inc., Allen B.	18, 49	New York Transformer, J. M.	241
du Pont de Nemours & Co., E. I.	149	North American Philips Co., Inc.	185
Eastern Air Devices, Inc.	231	Northern Radio Co., Inc.	237
Eisler Engineering Company, Inc.	251	Nothelfer Winding Laboratories	248
Etel-McCullough, Inc.	51	O'Neil-Irwin Mfg. Company	248
Electric Indicator Co.	216	Palnut Company, The	190
Electrical Resistance Corp.	153	Panoramic Radio Corp.	183
Electro-Motive Mfg. Co.	2	Paramount Paper Tube Corp.	184
Electro Products Laboratories	225	Park Metalware Co., Inc.	245
Electro-Voice, Inc.	220	Parkwood Corporation	221
Electronics, Inc.	220	Phalo Plastics Corporation	224
El-Tronics, Inc.	251	Philco Corporation	145
		Polarad Electronics Company	223
		Polytechnic Research & Development Co., Inc.	177

20 Millivolts  
Vertical Sensitivity  
**PRECISION**  
SERIES ES-500  
5" OSCILLOSCOPE



NET PRICE \$149.50

Complete with light shield, calibrating screen and operating manual. Size 8 1/4 x 14 1/2 x 18".

## IMPORTANT FEATURES

- \* Wide Range High Sensitivity Vert. Amplified Response to 1 Megacycle
- \* 2 Megohm input resistance
- \* Vertical Input Step Attenuator. x1, x10, x100. Additional continuous vernier control
- \* Cathode follower input circuit
- \* Extended Range Horizontal Amplifier Response to 5MC. 1/2 meg. input resistance
- \* Linear Multi-Vibrator Sweep Circuit 10 cycles to 30 KC. Improved circuits assure unusual linearity throughout range
- \* Amplitude Controlled Synch. Selection
- \* "Z" Axis Modulation terminals
- \* Phasing Control
- \* Audio Monitoring phone jacks plus direct access to Ho. and Vert. plates.
- \* Light Shield and Calibrating Screen Removable and rotatable
- \* Tube Complement 1 each type 6J5, 6AK5, 7N7, 6X5, 2X2. 2 each type 7W7, 5CP1/A CR tube.
- \* Fully Licensed under patents of A.T.&T. and W.E.
- \* PLUS many 'Precision' refinements that must be seen to be appreciated.

The complete Precision line of AM, FM and TV instruments will be on display at the I.R.E. Radio Engineering Show—Booth #222.

See the new Precision 5" Oscilloscope and Series E-400 Sweep Signal Generator on display at leading radio equipment distributors. Write for catalog fully describing the complete line of selected test instruments for all phases of AM, FM, and TV.

**PRECISION**  
APPARATUS CO., Inc.  
92-27 Horace Harding Blvd.  
Elmhurst 10, N. Y.

Export Division: 58 Broadway, N. Y. City, U. S. A.  
Cables: MORHANEX

For Precision Washers... For Precision Stampings...



## WHITEHEAD STAMPING CO.

A preferred source of precision-made WASHERS and STAMPINGS. 46 years of experience and up-to-the-minute facilities, assure highest quality and service.



EST. 1903

**WHITEHEAD STAMPING CO.**

1691 W. Lafayette Blvd.

Detroit 16, Mich.

# Audax

Trade Mark

## TUNED-RIBBON

reproducers

LM-79



for

**MICROGROOVE DISCS**  
**STANDARD DISCS**  
**VERTICAL DISCS**

(Special arms not shown)

other models for every purpose

ST-81  
ST-99



**"The Standard by Which Others Are Judged and Valued"**

We have said this often, and we shall repeat it many times because of its importance to YOU the listener:—It is futile to buy the most modern records, if you do not give them the very BEST pick-up to bring out their built-in excellence!

There is so much in present-day discs, that even a mediocre pick-up is bound to bring something out of them. However, to obtain the fullest results of which these discs are capable, they must be reproduced with the finest reproducer for that purpose—the AUDAX TUNED-RIBBON reproducer—operating with the extremely low point-pressure and stylus-point required.

Remember, two singers may both be able to hit "high C" . . . yet, one will please the ear—the other not at all. There is much more than mere WIDE-RANGE to quality reproduction. AUDAX reproducers deliver not merely WIDE-RANGE, but also all vital factors essential to highest quality of musical performance and unequalled EAR-ACCEPTABILITY.

"Permanent" points\*, whether sapphire, diamond or metal, keep their original shape for only a limited number of plays . . . then they progressively destroy record grooves. TUNED-RIBBON models permit easy stylus changing—by the owner himself . . . very important!

\*Write for complimentary pamphlet on the life of permanent needles

# AUDAX COMPANY

500 Fifth Avenue

New York 18

**"Creators of Fine Electro-acoustical Apparatus since 1915"**

VISIT US AT BOOTH NO. 43, RADIO ENGINEERING SHOW

Potter Instrument Co., Inc.	20
Precision Apparatus Co., Inc.	234
Precision Paper Tube Co.	12
Presto Recording Corporation	227
Proctor Soundex Corporation	198
Progressive Mfg. Company	66
Pyramid Electric Company	164
Quaker City Gear Works, Inc.	222, Back Cover
Radio Corp. of America	67
Radio Engineering Labs., Inc.	167
Radio Receptor Company, Inc.	239
Rahm Instruments Inc.	186
Railway Express Company, Air Express Div.	245
Rawson Electrical Instrument Co.	135
Raytheon Manufacturing Co.	212
R-B-M Div. of Essex Wire Corp.	163
Reeves Soundcraft Corp.	237
Resistance Products Co.	22
Revere Copper & Brass, Inc.	32
Richardson Company	245
Roanwell Corporation	217
Rubicon Company	246
Sams & Company, Inc., Howard W.	229
Sanborn Company	223
Sangamo Electric Co.	194
Scientific Electric, Div. of "S" Corrugated Quenched Gap Co.	242
Scott Incorporated, Hermon Hosmer	140
Shallcross Manufacturing Co.	196
Shure Brothers, Inc.	69
Sigma Instruments, Inc.	232
Signal Engineering & Mfg. Co.	240
Siskraft Company	236
Smith Paper, Inc.	210
Soldering Specialties	250
Sonotone	31
Sorensen & Company, Inc.	156
Sperry Carbon Company	127
Sperry Gyroscope Company	6
Sprague Electric Company	42
Stackpole Carbon Company	190
Standard Electric Time Co.	206
Standard Piezo Company	243
Standard Pressed Steel Co.	26
Standard Telephones and Cables, Ltd.	252
Star Expansion Products Co., Inc.	237
Stevens Mfg. Co., Geo.	203
Stewart Manufacturing Co., D. M.	180
Stewart Mfg. Corp., F. W.	38
Struthers-Dunn, Inc.	195
Stupakoff Ceramic & Mfg. Co.	139, 157
Superior Electric Company	16A, 16B
Superior Tube Company	194
Sylvania Electric Products, Inc.	227
Synthane Corporation	233
Tech Laboratories, Inc.	59
Technicraft Laboratories	251
Tektronix, Inc.	211
TEL Instrument Company, Inc.	232
Teledyn, Incorporated	251
Telex, Inc.	211
Terminal Radio Corp.	232
Thompson Corp., George S.	251
Titelux, Inc.	225
Transcoil Corporation	238
Turner Company	160
Union Carbide & Carbon Corp.	215, 239
United-Carr Fastener Corp.	212
United Insulator Co., Ltd.	161
United Transformer Co., Inside Front Cover	131
Varfex Corporation	131
Vickers Electric Div., Vickers Inc., A Unit of The Sperry Corp.	208
Victoreen Instrument Co.	162
Ward Leonard Electric Co.	144
Ward Products Corp.	219
Waterman Products Co., Inc.	247
Watertown Mfg. Company	219
Webster Spring Corp.	251
Western Electric Co.	5
Westinghouse Electric Corp.	41
Weston Electrical Instrument Corp.	16
Wheeler Insulated Wire Co., Inc.	150
Whistler & Sons, Inc., S. B.	7
White Dental Mfg. Co., S. S.	191, 217
Whitehead Stamping Company	287
Wiley & Sons, Inc., John	249
Williams & Co., C. K.	206
Wilson Company, H. A.	154
Wincharger Corporation	244
Winchester Electronics Co.	234
Workshop Associates, Inc.	225

**PROFESSIONAL SERVICES . . . . . 251**

SEARCHLIGHT SECTION  
(Classified Advertising)

<b>EMPLOYMENT</b>	
Positions Vacant . . . . .	254, 255, 256, 257
Selling Opportunities Offered . . . . .	255, 256
Positions Wanted . . . . .	256
Selling Opportunities Wanted . . . . .	256
Employment Services . . . . .	255
<b>SPECIAL SERVICES</b>	
Contract Work . . . . .	256
Rebuilding . . . . .	256
<b>BUSINESS OPPORTUNITIES</b>	
Offered . . . . .	256
<b>EQUIPMENT</b>	
(Used or Surplus New)	
For Sale . . . . .	256, 258-286
<b>WANTED</b>	
Equipment . . . . .	285

ADVERTISERS INDEX

Abell Distributing Co.	284
Airborne Instruments Laboratory	256
American Electrical Sales Co., Inc.	280
American Sales Co.	282
Bell Aircraft Corp.	257
Bendix Aviation Corp.	257

(Continued on page 252)

**Audax**  
Trade Mark

# reproducers



for  
**Microgroove DISCS**  
**Standard DISCS**  
**Vertical DISCS**

*The Standard by Which  
Others Are Judged  
and Valued*

It is futile to buy the most modern records, if you do not give them the very BEST pick-up to bring out their built-in excellence! There is so much in present-day discs, that even a mediocre pick-up is bound to bring something out of them. However, to obtain the fullest results of which these discs are capable, they must be reproduced with the finest reproducer for that purpose—the AUDAX.

Remember, two singers may both be able to hit "high C" . . . yet one will please the ear—the other not at all. There is much more than mere WIDE-RANGE to quality reproduction. AUDAX reproducers deliver not merely WIDE-RANGE, but also all vital factors essential to highest quality of musical performance and unequalled

**EAR-ACCEPTABILITY**

*Complimentary pamphlet on  
important points*

Union Carbide & Carbon Corp. . . . . 134  
United-Carr Fastener Corp. . . . . 198  
United Transformer Co. . . Inside Front Cover

Vanfex Corporation . . . . . 123  
Vickers Electric Div., Vickers, Inc., A Unit of The Sperry Corp. . . . . 187, 213  
Victoreen Instrument Co. . . . . 188  
Vulcan Electric Co. . . . . 206

Waldes Kohinoor, Inc. . . . . 19  
Ward Leonard Electric Co. . . . . 150  
Webster Spring Corp. . . . . 219  
Weller Manufacturing Co. . . . . 205  
Western Electric Co. . . . . 4  
Westinghouse Electric Corp. . . . . 29  
White Dental Mfg. Co., S. S. . . . . 170, 204  
Whitehead Stamping Co. . . . . 213  
Wilcox Electric Co. . . . . 26  
Worcester Pressed Steel Co. . . . . 47  
Wrought Washer Mfg. Co. . . . . 180

Zetka Television Tubes, Inc. . . . . 217  
Zophar Mills, Inc. . . . . 196

## PROFESSIONAL SERVICES . . . . . 221

### SEARCHLIGHT SECTION

(Classified Advertising)

#### EMPLOYMENT

Positions Vacant . . . . . 221, 222  
Selling Opportunities Offered . . . . . 222  
Positions Wanted . . . . . 222  
Selling Opportunities Wanted . . . . . 221  
Employment Services . . . . . 221

SPECIAL SERVICES . . . . . 244  
Contract Work . . . . . 244

#### EQUIPMENT

(Used or Surplus New)  
For Sale . . . . . 223-246

#### WANTED

Equipment . . . . . 244  
Misc. . . . . 244

### ADVERTISERS INDEX

Acorn Electronics Corp. . . . . 245  
American Electrical Sales Co., Inc. . . . . 243  
Atlantic Industrial Co. . . . . 243  
Avion Instrument Corp. . . . . 222  
Bell Aircraft Corp. . . . . 222  
Bendix Aviation Corp. Radio Div. . . . . 222  
Blan . . . . . 243  
Brooks Inc., R. D. . . . . 245  
Coleman Cable & Wire Corp. . . . . 245  
Communications Devices Co. . . . . 242  
Communications Equipment Co. . . . . 226, 227, 228  
Construction & Power Machinery, Inc. . . . . 245  
Duban Electronics Co., Inc. . . . . 239  
Electro Impulse Laboratory . . . . . 242  
Electronicraft Inc. . . . . 234  
Electronic Surplus Brokers . . . . . 244  
EPCO . . . . . 241, 244  
Ereco, Dick Rose . . . . . 244  
Finnegan, H. . . . . 244  
French-Van Breems Inc. . . . . 241  
Green Gould . . . . . 245  
Harvey-Wells Electronics, Inc. . . . . 245  
Haydu Brothers . . . . . 236  
Hi-Mu Electronics . . . . . 244  
Instrument Associates . . . . . 224, 225  
Klein, Manuel . . . . . 240  
Kronenberg, M. . . . . 244  
Lectronic Research Laboratories . . . . . 242  
Leru Laboratories, Inc. . . . . 244  
Life Electronics . . . . . 243  
Maritime Switchboard . . . . . 231  
Mogill Co., Inc., Alexander . . . . . 240  
National Union Radio Supply Co. . . . . 222  
Niagara Radio Supply Corp. . . . . 232  
Opad-Green Co. . . . . 229  
Peak Electronics Co. . . . . 230  
Powell, Harold H. . . . . 241  
Precision Electrical Instrument Co. . . . .  
Radio Ham Shack Inc. . . . .  
Radio Shack Corp. . . . .  
Raytheon Mfg. Co. . . . .  
Radio Merchandise . . . . .  
Radio Merchandise . . . . .

[www.americanradiohistory.com](http://www.americanradiohistory.com)



Engineers and Designers who insist on dependable components have adapted ADVANCE RELAYS into their control circuits. They are specifying ADVANCE products, and are submitting their relay problems to us. Our expanded engineering and plant facilities, plus the recognized dependability of ADVANCE RELAYS, make it possible for us to offer the most complete line of relays for light, intermediate and heavy duty applications. Proved and Improved relay performance through ENGINEERED adaptability.

Follow the Engineers  
to ADVANCE



ADVANCE ELECTRIC & RELAY CO.  
1240 WEST SECOND STREET • LOS ANGELES 26, CALIFORNIA

**THIS FEATHERWEIGHT WILL  
LICK  
SOLDERING  
FATIGUE!**

